

# POPULAR MECHANICS

## MAGAZINE

WRITTEN SO YOU CAN UNDERSTAND IT

REG'D. TRADE MARK, GREAT BRITAIN, No. 40420

REG. U. S. PAT. OFF.



SEE PAGE 938

# Fast drivers: Oil which lasts longest at high speed, lubricates best!

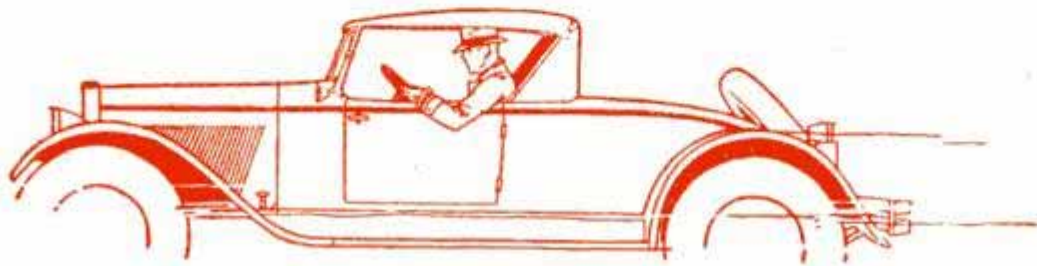

Thousands of miles of speedway tests have shown that the New Mobiloil stands up better and lasts longer at high speeds than other oils. So we can confidently say: The New Mobiloil can keep the first-year feel in *your* engine for at least 30,000 miles.

the New



# Mobiloil

### Make this chart your guide

It shows the correct grade of Gargoyle Mobiloil for certain prominent cars. If your car is not listed below, see complete Mobiloil Chart at your Mobiloil dealer's.

NAMES OF PASSENGER CARS	1929		1928		1927		1926	
	Engine		Engine		Engine		Engine	
	Summer	Winter	Summer	Winter	Summer	Winter	Summer	Winter
Auburn, 6-66	BB	Arc	BB	Arc	BB	Arc	A	A
" 8-cyl.	A	Arc	A	Arc	A	Arc	A	A
" other models	BB	Arc	BB	Arc	BB	Arc	BB	Arc
Buick	BB	Arc	BB	Arc	BB	Arc	BB	Arc
Cadillac	BB	Arc	BB	Arc	BB	Arc	BB	Arc
Chandler Special Six	A	Arc	A	Arc	A	Arc	A	Arc
" other models	A	Arc	A	Arc	A	Arc	A	Arc
Chrysler	A	Arc	A	Arc	A	Arc	A	Arc
Chrysler, 4-cyl.	BB	Arc	BB	Arc	A	A	A	A
" Imperial	A	Arc	A	Arc	A	A	A	A
" other models	A	Arc	A	Arc	A	A	A	A
De Soto	A	Arc	A	Arc	A	Arc	A	Arc
Dodge Brothers	A	Arc	A	Arc	A	Arc	A	Arc
DuPont	A	Arc	A	Arc	A	Arc	A	Arc
Eskone	A	Arc	A	Arc	A	Arc	A	Arc
Evers	A	Arc	A	Arc	A	Arc	A	Arc
Ford, Model A	A	Arc	A	Arc	E	E	E	E
" Model T	BB	Arc	BB	Arc	BB	Arc	BB	Arc
Franklin	BB	Arc	BB	Arc	BB	Arc	BB	Arc
Gardner, 8-cyl.	BB	Arc	BB	Arc	BB	Arc	BB	Arc
" other models	BB	Arc	BB	Arc	BB	Arc	BB	Arc
Graham-Page	BB	Arc	BB	Arc	A	A	A	A
Hudson	A	Arc	A	Arc	A	Arc	A	Arc
Hupmobile	BB	Arc	BB	Arc	BB	Arc	BB	Arc
La Salle	BB	Arc	BB	Arc	BB	Arc	BB	Arc
Mamm	A	Arc	A	Arc	A	Arc	A	Arc
" 8-cyl.	A	Arc	A	Arc	A	Arc	A	Arc
" other models	A	Arc	A	Arc	A	Arc	A	Arc
Moon	A	Arc	A	Arc	A	Arc	A	Arc
Nash, Adv. & Sp. 6	BB	Arc	BB	Arc	BB	Arc	BB	Arc
" other models	A	Arc	A	Arc	A	Arc	A	Arc
Oakland	A	Arc	A	Arc	A	Arc	A	Arc
Packard	A	Arc	A	Arc	A	Arc	A	Arc
Peerless, 72, 90, 91	BB	A	BB	A	BB	A	BB	A
" other models	A	Arc	A	Arc	A	Arc	A	Arc
Plymouth	A	Arc	A	Arc	A	Arc	A	Arc
Pontiac	A	Arc	A	Arc	A	Arc	A	Arc
Reo	A	Arc	A	Arc	A	Arc	A	Arc
Stearns Knight, 6-80	BB	Arc	BB	Arc	BB	Arc	BB	Arc
" other models	BB	Arc	BB	Arc	BB	Arc	BB	Arc
Studebaker	A	Arc	A	Arc	A	Arc	A	Arc
Veie, 8-cyl.	BB	Arc	BB	Arc	A	A	A	A
" 6-cyl.	A	Arc	A	Arc	A	Arc	A	Arc

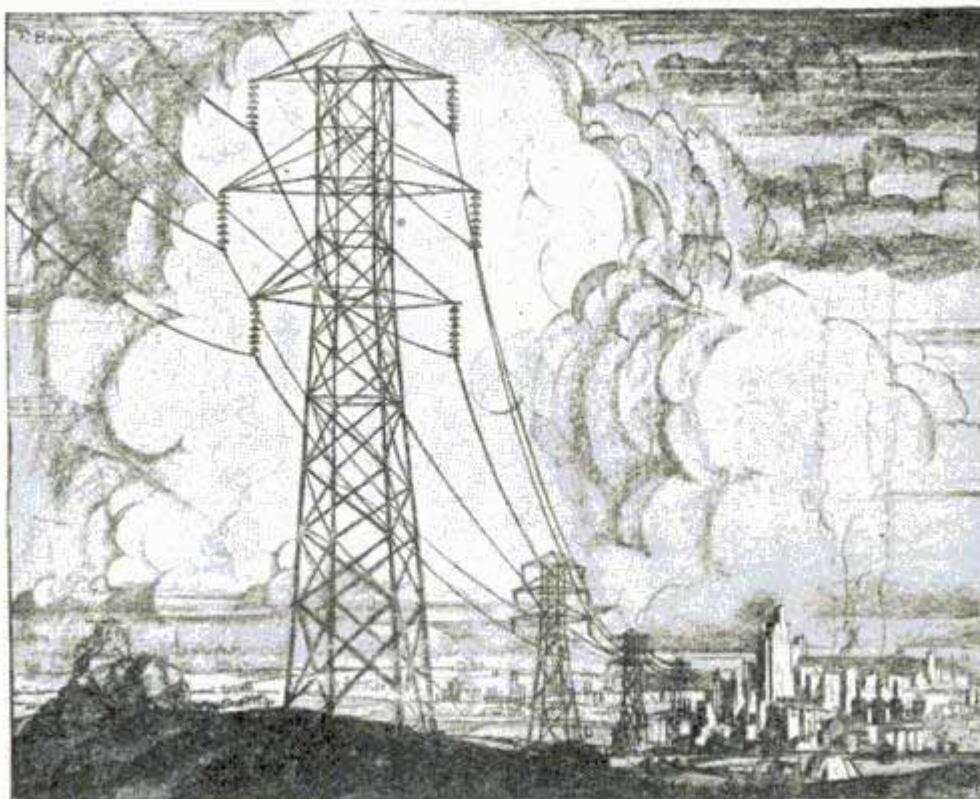

## ELECTRICITY—*the lifeblood* of America's industrial expansion

**E**LECTRICITY is steadily remaking American industry in terms of faster, better, more accurate, and more economical production.

New and more effective uses for this great force are being developed continually, and the greatest benefits have come to industrialists who follow these developments closely.

It is also significant that the electrification of industry, already 70 per cent complete, has made its greatest progress in the plants whose policies are guided by accurate cost-accounting methods—and that these plants have grown and prospered.



This monogram is on many of the latest electrical installations that are setting new production records in industry. It also appears on conveniences for the home. General Electric engineers will be glad to keep you informed as to electrical developments and to help you solve any problem in the application of electricity.

JOIN US IN THE GENERAL ELECTRIC HOUR, BROADCAST EVERY SATURDAY AT 8 P.M., E.S.T. ON A NATION-WIDE N.B.C. CHAIN

# GENERAL ELECTRIC

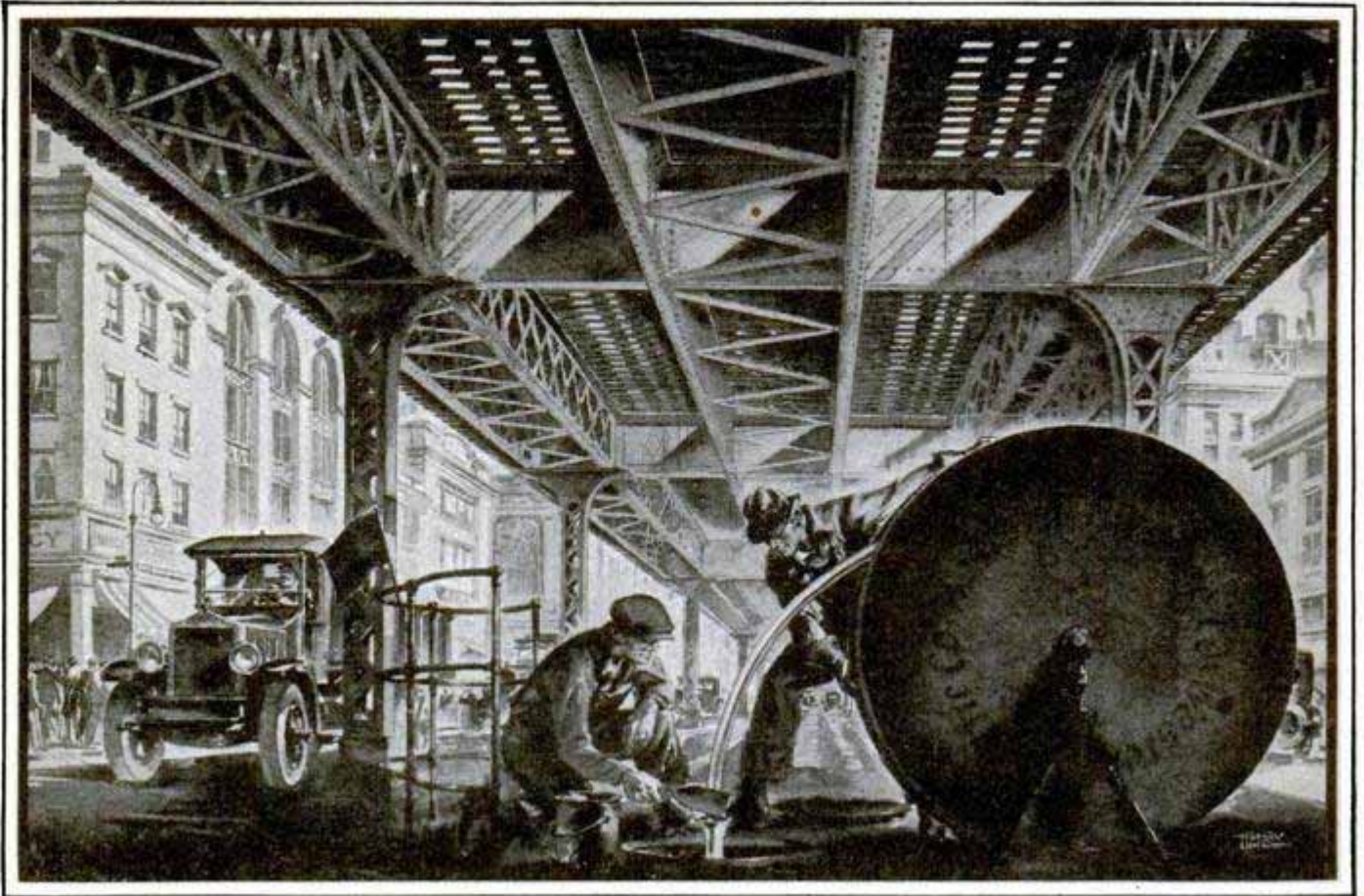

## 1800 conversations at once through a cable less than 3 inches thick

*An Advertisement of the  
American Telephone and Telegraph Company*

THE earth beneath our great cities is crowded. Steam, gas, sewer and water-mains, compressed air pipes, pneumatic tube systems, telephone and telegraph cables, light, power and rapid transit conduits lie so close together that any further additions create serious engineering problems. Yet the number of telephone calls that must flash through the underground arteries of great cities is steadily increasing.

The challenge to the scientific minds of the Bell System was to find a way for more conversations in existing conduits. Fifteen years ago, the pride of the System was a cable containing nine hundred pairs of wires. Then by many improvements a cable of twelve hundred pairs was perfected.



It was rightly considered a scientific triumph.

Today, cables containing eighteen hundred pairs of wires are in service, and these cables, with every wire insulated are only two and five-eighths inches in diameter, one-half as large as the first nine hundred-pair cable. Eighteen hundred conversations at once—six hundred more than before—can now pulse through this two and five-eighths inches of cable.

There is no standing still in the Bell System. Better and better telephone service at the lowest cost is the goal. Present improvements constantly going into effect are but the foundation for the greater service of the future.

# Popular Mechanics Magazine

200 E. Ontario Street, Chicago, U. S. A.

H. H. WINDSOR, Founder

H. H. WINDSOR, Jr., Editor and Publisher

London: Hachette & Cie.,  
16-17 King William Street, Charing Cross, W. C. 2

Paris: Hachette & Cie.,  
111 Rue Reaumur

Melbourne: Gordon & Gotch  
509-513 Little Collins St.

ISSUED MONTHLY

SUBSCRIPTION:

SINGLE COPY, 25 CENTS

In United States and its possessions, also Canada, Cuba, and Mexico, per year, postpaid . . . \$2.50

To all other countries in the Postal Union . . . . . 3.00

All subscriptions are discontinued at expiration. Please examine the date printed on your wrapper.

Entered as Second Class Matter Sept. 15, 1905, at the Post Office at Chicago, Illinois, under Act of March 3rd, 1879.

Entered as Second Class Matter at the Post Office Department, Canada.

Published monthly by POPULAR MECHANICS CO.

Copyright, 1929, by Popular Mechanics Co.

Copyright in Australia. Copyright in France

Vol. 51

Contents for June, 1929

No. 6

## Special Features

Putting the Run into a Running Horse	898
Wild Life is Preserved in Glass Cages	908
The Truth about the Tongs	914
When the City's "Pie-Crust" Breaks	930
Edison to Remake First Light	940
On the Trail of the Mountain Lion	946
Drivers' Tests Save Lives	954
Soup from the Sea	962
Capturing Trained Seals	978
The Storm King's Challenge	994
Radio in the Arctic	1001

Advertising—robots to pass circulars	925	Boats and Boating	924
Airplanes		steel outboard motorboat built like seaplane	961
flying hotel to carry eighty	907	tests with model rudders aid safety	985
odd flying boat aids travel on Long Island	929	Bolt—that locks itself resists vibration	967
pigeons carried in to aid flyers	975	Book Rest—fitted on chair leaves hands free	937
problem of noise baffles engineers	929	Bridge—odd two-level auto, spans Los Angeles river	907
refueling to aid flyers in second ocean hop	989	Buildings	
seventy-five million spent in America for	958	glass house keeps out dust and disease germs	960
ski feet for, land on ground or snow	969	modern art for apartments	951
tailspin warning given airmen by buzzer	950	Butterfly Wings—artists in, do work backward	913
turbine propellers to develop high speed	949	Cabs—commanded by radio to speed service	924
Archæology—evidence of Noah's flood	944	Chicago World's Fair—first plans for include novel	
Archery—the trail of the arrow	970	features	897
Automobiles		Church—pulpit like vessel's bow	999
automatic coupling stops gear-shift troubles	988	Clock—that won't run one of Edison's successes	960
mile cost of running six and a half cents	984	Coil—rapid spring winder	907
traction band for wheel helps car out of ruts	949	Compass—magnet, finds gas mains	937
Automobiles—Accessories		Concrete—meter for mixing	983
anti-glare shield on hat for driver	912	Corn—ice box freezes in field to improve crops	983
sweep wiper for windshield	911	Crane	
Automobiles—Driving		on top of high tower eliminates scaffolds	945
lights turn with wheels	999	on tractor feet speeds swamp work	984
sings while driving to relieve ears	967	Culvert	
Automobiles—Tires		steel, as piers aid bridge builders	968
clicks tell motorist when he needs air	969	with flat bottoms	967
press for inner-tube tests	977	Deafness—electric set to teach deaf	906
Automobiles—Truck		Dye—concrete, resists acid and fading	951
three-wheeled reduce congestion	904	Electric Light	
Aviation		powder inside removes black deposit	961
aviator rescued from tree	905	"thresher" salvages brass in old	925
beat marks for airways	906	Electric Set—for kitchen is six tools in one	929
fans of light guide flyers in making landings	945	Eraser, Ink—made of glass shaped like pencil	989
floating airport to serve line to Bermuda	938	Eyes—tears contain a chemical that kill germs	993
students taught blind flying in a barrel	937	Filling Station—price gauge for gasoline aids	912
water tower to guide flyers by revolving lights	960	Fires—coated matches and cigarets to reduce hazard	976
Batteries—clamp for terminal requires no solder	992	Food—electric warmer for	905

[Continued on Page 41

*Delivering news from all*

*Direct. Vender 993*

horse racing 939

Speed scale 957

in Journal 924

Lead cover 1985

[4] [Contents—Continued]

Journal Radio 924  
Spring W 90

Fruit—coin-in-slot vendor	993
Games—coin-in-slot horse-races	939
Gardening	
rotary hoe for	936
sower for small gardens	985
Grain—cleaner on thresher	953
Grinder—run at high speed sharpens dies	912
Gun—drives pin through metal	975
Hair—index to left-handedness found in	975
Hammer—tool kit in handle	974
Hospital—liquor skills in help cure disease	939
Household Devices	990
House Plan	1055
Hydroelectric Power—from the water wheel to super-hydro power	952
Iron, Electric	
easier to push when chromium plated	977
safety stand for	938
Lamps—dust-tight reflector cover	959
Language—for all nations	977
Lifeboats	
davits to throw farther from vessel	989
that won't sink holds many persons	911
Light—living, a possibility scientist declares	912
Maps—mapping Canadian wilds from air	927
Measuring—tape under sea measures distance to Azores	974
Measuring Instruments—rate of travel given by scale	951
Meat—electric unit for making tender	950
Mines—rich of Montezuma still yield treasure	969
Moving Pictures	
by wire or radio from single set	928
camera aids talking pictures	926
make-up key for actresses	986
Musical Instruments—music is played by alphabet	958
Navigation—dry-land sailing teaches cadets	904
Navy, German—new styles in battleships set by	959
Paints and Painting—best for radiators found by tests	986
Pipe Wrench—has grip like hand and doesn't mar work	928
Pliers—safety catch for prevent slipping	944
Printing—press for paper boxes	937
Punching Bag—toy balloon held by vacuum cup	959
Radio	
past, present and future	1009
tips from the laboratory	1010
Radio—Aerials—loop-wire tightener	1007
Radio—Apparatus—double resistor saves space	1014
Radio—Application—process enables radio pictures in colors	904
Radio—Batteries—charging panel for Edison-type "B"	1013
Radio—Condenser	
high voltage by-pass	1009
testing filter	1007
Radio—Construction	
adjustable subpanel brackets	1008
selectivity with one dial	1014
Radio—Loud Speaker	
automatic dynamic speaker control	1014
kink for cloth-speaker builders	1005
placing the	1008
Radio—Receivers	
list of blueprints for Popular Mechanics tested circuits	1013
set disconnected by alarm clock	1006
Radio—Reception	
reducing interference from farm lighting plants	1008
shielded lead-in wire reduces interference	1006
Radio—Television—reflector for the neon lamp	1008
Radio—Tube	
adapter for two power	1006
new power tube for a.c. sets	1005
Radium	
"clock" to run for centuries	945
is fireman in rubber plant	983
Railroads	
game board traces trains	950
tractor is motored by auto engine	906
Roads—auto, over railways to relieve congestion	974
Safety Devices and Measures	
death's head in redlights warns drivers	977
face mask guards eyes and mouth of worker	968
signals worn by pedestrians	939
Sander—and polisher also runs drill	953
Screws—simple gauge to test	950
Shaving Accessories—roller guard for safety razor	989
Shears—bar cutter for rescue squad	961
Shoelace—lock tips for	967
Shoes—have special system of ventilation	975
Silverware—metal plate polishes	993
Sink—how to tell proper height of	967
Snowplow—loads trucks saving handwork	988

three part 1048

Sorting Machine—for nuts and bolts	925
Sports, Water—golf played on pond	976
Stamp Collection—decorate room with stamps	985
Stationery—hotel dispenser reduces waste	959
Submarine—lung saves two from ocean's depth	987
Swimming—forty-acre pool reduces hazards	913
Toys—galloping pony for children gives good exercise	926
Water Supply—model of Chicago's system	992
Welding—pipe line to prevent gas leaks	993
Windows—tighteners on sash keep out cold	989
Wood Bit—threads on side of help bore holes	982
Woodworking—three-surface sanding block fits hand and work	913
Work—mixing nationalities speeds production	925
Vending machines	939
AMATEUR MECHANICS	
Automobiles—Accessories—light to illuminate motorometer	1035
Automobiles—Repairing	
preventing wear on touring car tops	1022
replacing auto rear end	1035
safety-first while working on car	1026
Boats and Boating	
how to handle hot outboard motor	1036
oar used as rudder for rowboat	1026
serviceable canoe jig for boat house	1017
Book—how to make an envelope	1024
Camera—eyeshade for reflecting	1018
Camping	
an outdoor stove	1025
iceless refrigerator for campers	1034
rainproof inclosure made from saplings	1021
Check Protector—simple homemade	1022
Cistern—safety cover for	1036
Fish and Fishing—keeping casting rod guides in line	1018
Flowers—novel flower garden	1024
Glass—drilling	1026
Golf—in your own backyard	1015
Grease Cup—holding covers in place	1023
Joints, Wood—for the amateur	1027
Lawn Mower—manipulating on steep terraces	1035
Mud Shoes—wooden	1023
Paper Cup—holder for conical	1017
Photography	
cabinet for drying films and prints	1022
holding films for drying	1021
Slide—homemade for the children	1036
Stamp—homemade rotary	1021
Swimming Pool—a backyard	1030
Tools—rack holds tools of many shapes	1025
Waste Paper—a burner for	1024
Window Box—better window gardens	1019
Wood Bit—extension easily made	1020
Workbench—vibration stopped	1023

SHOP NOTES

Airplanes—better wings for model planes	1043
Automobiles—Repairing	
aligning auto wheels	1048
remedy for engine leakage and clutch troubles	1054
tool for removing bearings from axle spindles	1045
Ball—steel, gauging size of without tools	1049
Blasting—short-circuiting leading wires of apparatus	1040
Boats and Boating—supercharger for outboard motor	1037
Bottle—protection for the acid	1054
Brake Lining—surfacing new	1049
Building Construction—spacer for frame building	1041
Calipers—emergency internal	1042
Cams—jig for layout of	1047
Clamp—made of wire cable	1050
Cotter Pin—quickly removable	1041
Irrigation—pails help irrigate orchard	1046
Ladder—carrying on an auto	1050
Matrices—making stereotype	1042
Nut—substitute for small	1045
Protractor—aids draftsmen's work	1046
Pump—increasing the lift of a hand suction	1054
Reaming—brass and bronze bushings	1047
Rubber Bands—small containers improvised from	1048
Saws and Sawing—power hacksaw for small shops	1051
Shafts—fixture for removing pinions from	1047
Thread—depth-indicating gauge	1050
Welding	
care of oxyacetylene tips	1046
ground clamp for electric	1041
Workbench—on front of truck	1042

# DRAKE'S PRACTICAL MECHANICAL BOOKS

## THEY WILL RAISE YOUR PAY— ORDER ON 5-DAY TRIAL

The books listed below will perfect you in your chosen trade—pave the way to the big positions. Written in non-technical language—easy to read and understand. Every book covers its subject completely. An entire course of instruction condensed into one volume. Your choice sent postpaid—you benefit 5 days—money refunded in full if not entirely satisfactory. Order direct from this page.



### Automobile Books

- Automobile Starting, Lighting and Ignition, by Manly... 700 pp. \$3.00
- Brookes' Automobile Handbook... \$2.00
- Ford Motor Car, Truck and Tractor, by Manly... Cloth \$1.50
- Auto and Radio Battery, Care and Repair, by Manly... Leatherette \$2.00
- Motorecycle Handbook, by Manly... \$1.50



### Shop Practice Books

- Practical Heating Systems, Trouble Jobs and Ventilation... \$4.00
- Sheet Metal Workers' Manual... \$2.00
- Oxy-Acetylene Welding and Cutting... Cloth \$1.25
- Slide Rule and Logarithmic Tables... \$2.00
- Handbook for Millwrights... Cloth \$2.00
- Machine Shop Practice... Cloth \$2.00
- Mechanical Drawing and Machine Design... Cloth \$2.00

### ORDER DIRECT FROM THIS PAGE—ON OUR MONEY-BACK PLAN

The books listed above are only a few of the many in our catalogue, which you will receive promptly after filling out and mailing us the attached coupon. For quick action order direct from this page—cross name of each book wanted and send in with price quoted. We prepay postage and send the books on our money-back plan.

**FREDERICK J. DRAKE & CO.**  
Publishers

R508—179 No. Michigan Ave. CHICAGO  
Drake Books Are For Sale at All Book Stores

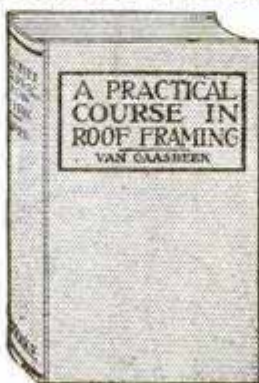

### Carpentry Books

- Cloth Binding
- Modern Carpentry, 2 vols... \$3.00
  - The Steel Square, 2 vols... \$3.00
  - Modern Estimator... \$1.50
  - Timber Framing... \$2.00
  - Builders' Architectural Drawing... \$2.00
  - Concretes... \$1.50
  - Practical Bungalows... \$1.00
  - Roof Framing, by Van Gaasbeek... \$1.50

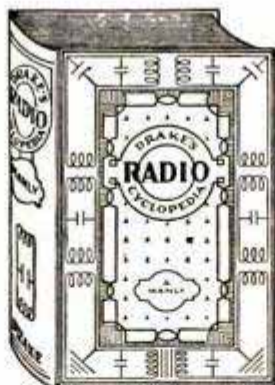

### Drake's Radio Cyclopedia

June, 1928 Edition  
By H. P. Manly  
920 Pages, 1025 Illustrations, 1700 Subjects, arranged alphabetically. For Service and Repair Men, Dealers, Salesmen, Experimenters and Designers. Bound in Art Buckram. Price... \$6.00



### Painting and Decorating

- The Lacquer System of Sign Painting... Cloth \$3.00
- Practical Estimating for Painters and Decorators... Cloth \$2.00
- How to Draw Funny Pictures—a Complete Course in Cartooning... Cloth \$3.00
- Layouts for Advertising... Lea. \$3.00
- Furniture, Furniture Finishing, Decoration and Patching... \$5.00
- Ross Crane Book of Home Furnishing and Decoration... Cloth \$3.00
- House Painting Methods... Cloth \$2.00
- Interior Wall Decoration, by Vanderwalker... Leatherette \$4.00
- The Mixing of Colors and Paints, by Vanderwalker... Cloth \$2.00
- Studio Handbook—Letter and Design... \$3.00
- A Show at Sho' Cards... Cloth \$4.00
- Sign Painting, by Atkinson... Cloth \$4.00
- Strong's Book of Designs, Leatherette \$4.00
- Modern Painters' Cyclopedia, Cloth \$2.00
- Automobile Painting... Cloth \$1.50
- Wood Finishing, Plain and Decorative... Cloth \$2.00

### Steam Engineering

- Swingle's Handbook for Steam Engineers and Electricians... Leatherette \$4.00
- Examination Questions and Answers for Marine and Stationary Engineers... Leatherette \$2.00
- Steam Boilers... Leatherette \$2.00
- Swingle's Catechism of Steam, Gas and Electrical Engineering... Leatherette \$1.50

### Modern Languages

- By Prof. P. S. Allen, U. of Chicago
- French without a Teacher... Cloth \$1.25
- Spanish without a Teacher... Cloth \$1.25
- German without a Teacher... Cloth \$1.25
- Everyday French... \$1.25
- Everyday Spanish... \$1.25

**Mail Coupon For Free Catalogue**  
**Your Guide to Home Study**

**FREDERICK J. DRAKE & CO.**  
R508—179 No. Michigan Avenue  
Chicago, Ill.

GENTLEMEN:—Please send me free, postage paid, your illustrated catalogue which lists and describes 200 Practical Mechanical Books for Home Study.

My name is \_\_\_\_\_  
and my ad \_\_\_\_\_  
.....

This One



GKYZ-OQQ-ONHZ

1929 1930 1931 1932 1933 1934 1935 1936 1937 1938



## Will You Be Clerk or Manager Ten Years from Now?

**S**URELY, this could never happen to *me*," you say—"that I should be sitting at the same desk—be doing the same work, *for ten straight years!*"

But wait a minute—

Exactly the same thing is happening to thousands upon thousands of men thruout the country. It has probably happened to men right in the company you now are working for. *And—unless you deliberately fit yourself for a better job—there is a very good chance that it will happen to you!*

Unthinkable? That's what R. M. Whitney, of Rochester, N. Y., said to himself. Yet lack of training kept him slaving away at low wages for more than twenty years . . .

### Trebled His Salary in Three Years

—For more than twenty years, till finally, at the age of 47, and still receiving only thirty dollars a week, R. M. Whitney resolved to be a bookkeeper no longer. He enrolled with LaSalle for training in Higher Accountancy, and completed the course. Almost immediately came the offer of a bigger job.

Less than three years later, the Davenport Machine Tool Company—the very company he had worked for as a clerk—invited him to come back. He returned as Auditor, at a salary-increase of better than 300 per cent.

Today, he is Treasurer of this great company; and in a letter to LaSalle, after commenting on the opportunities LaSalle affords to men in their forties or early fifties, he adds, "And for the young man, who is just getting a foothold in the business world, LaSalle Extension University training is the most profitable investment he could make."

### Says Good-bye to Clerkship— Now Heads Successful Firm

We have told you about a man who *waited*—at a cost to himself of probably not less than \$100,000. Now consider the experience of a younger man—G. Roy Eshelman, of Decatur, Illinois—

Eshelman was occupying a subordinate position in the purchasing department of a manufacturing concern—salary \$16 a week. Visualizing the opportunities for skilled accountants, he enrolled with LaSalle for training in Higher Accountancy.

"Thru this training," writes Mr. Eshelman, "I became interested in the Auditing Department and often remained after working hours watching the Auditor at his work. Observing my interest, he soon placed me in his department at a 50% increase in pay, and as I progressed with my LaSalle work, I was shortly rewarded with an additional 40% increase.

"My studies rapidly equipped me to strike out for myself, and at present I have an extensive practice as a Public Accountant, employing four accountants. It is sufficient to say that my present income is many, many times greater than when I enrolled."

### Send For These Two Books and Start Toward Real Success

Need you hear more before you investigate the opportunities in Accountancy? Shall we tell you about Pentland—or Gray—or McDuffie—all of them commanding incomes better than \$10,000 a year and all of them still in their thirties?

Or will you face the problem of your future NOW—and send to LaSalle and get further facts and particulars?

Without cost or obligation, the coupon will bring you two books—one a 64-page book entitled, "Accountancy, the Profession that Pays," the other, "Ten Years' Promotion in One."

How about those next ten years—will you wait, or will you START TODAY to realize the opportunities that lie ahead of you thru sound and practical home-study business training?

Measure your grit and ambition by what you do with this coupon—NOW.

— — — — Find Yourself Through LaSalle — — — —

## LaSalle Extension University

The World's Largest Business Training Institution

Dept. 664-HR Chicago

Opportunities in Accountancy—Check below and we will send you copy of "Accountancy, the Profession that Pays," also copy of "Ten Years' Promotion in One," all without obligation.

### Higher Accountancy:

Leading to position as Auditor, Comptroller, Certified Public Accountant, Cost Accountant, etc.

Other LaSalle Opportunities: If more interested in one of the other fields of business indicated below, check here:

- Business Management
- Modern Salesmanship
- Traffic Management
- Railway Station Management
- Law: Degree of LL.B.
- Commercial Law
- Industrial Management
- Business Correspondence
- Credit and Collection Correspondence

- Banking and Finance
- Modern Foremanship
- Personnel Management
- Expert Bookkeeping
- C. P. A. Coaching
- Business English
- Commercial Spanish
- Effective Speaking
- Telegraphy
- Stenotypy—Stenography



Name.....

Present Position.....

Address.....



# POCKET EDUCATORS

For all BUILDERS AND MECHANICS



Read Audels Pocket Educators for advancement and profit in your work. Every mechanic in the building trades should have this inside trade information at his fingers' ends. Learn the scope and possibilities of your profession. Any job can be done better if you are well informed. To earn more, learn more.



4 Vols. \$6

## AUDELS CARPENTERS AND BUILDERS GUIDES—4 VOLS. \$5



Inside Information for Carpenters, Builders, Joiners, Building Mechanics—all Woodworkers. **1600 pages; 3700 diagrams; flexible; pocket size.** Short-cut instructions, new methods, ideas, solutions, plans, systems—money saving suggestions. An easy progressive course for the apprentice. A practical daily helper and Quick Reference for the master worker. A Helping Hand to Easier and Better Work and Better Pay. To get this aid for yourself, simply fill in and mail the FREE COUPON below.

### INSIDE TRADE INFORMATION ON:

How to use steel square; How to file and set saws; How to build furniture; How to use mitre box; How to use chalk line; How to use rules; How to make joints; Carpenters' arithmetic; Mensuration problems; Estimat-

ing strength of timbers; How to set girders and sills; How to frame houses and roofs; How to estimate costs; How to build houses, barns, garages, bungalows, etc.; How to read and draw plans; Drawing up specifications; How

to excavate; How to use settings 12, 13 and 17 on the steel square; How to build holts and scaffolds—skylights; How to build stairs; How to put on interior trim; How to hang doors; How to lay floors; How to paint.

"Audels Guides worth four times their price—hurry and get them in pocket for reference." W. J. Bates, Knoxville, Pa.



4 Vols. \$6

## AUDELS PLUMBERS AND STEAMFITTERS GUIDES—4 VOLS. \$6



A new set—just out! A practical, illustrated, Reference Library and Study-Course for Master Plumbers, Journeymen and Apprentice Steamfitters, Gas Fitters and Helpers, Sheet Metal Workers, Draughtsmen, Master Builders, Engineers and all Building Trade Students. **1670 pages; 3642 diagrams; flexible; pocket size.** Guides explain all the principles, advances and short cuts of the Plumbing and Heating trade. Contains instructions on how to figure and estimate jobs. Use FREE COUPON below to examine, without obligation, this valuable work.

### INSIDE TRADE INFORMATION ON:

Soldering, tinning, joint wiping, bending, heating. Pipe—iron, steel, threading. Mathematics, tables, physics. Materials—iron, steel, copper, brass, lead, tin, antimony. Sheet metal—galvanized—plate. Sanita-

tion, syphonage, tanks. Drainage, sewage, purification. Fixtures—bath—kitchen. Pipe fittings, soil pipe, tools. Laying out work. Roughing. Screwed fittings, flanges, joints. Pipe bending, examples. Elbows. Heating, ven-

tilation, refrigeration. Water supply, mains, wells, tanks. Gas-fittings. Underwriters. Sheet metal work, problems, methods, brazing, heating, lead burning. Welding, various welds, methods. Blacksmithing, forges, tools.

"Audels Guides are practical, easy to understand, reliable. Cover the field in plain language." W. F. Arming, Annapolis, Md.



4 Vols. \$6

## AUDELS MASONS AND BUILDERS GUIDES—4 VOLS. \$6



A new, complete, illustrated trade reference library, for Bricklayers, Cement Workers, Plasterers, Tile Setters and Stone Masons, including a practical outline of Steel Construction. **1100 pages; 2067 diagrams; flexible; pocket size.** A practical Trade Assistant explaining modern methods of masonry construction. Easy to understand and apply. A reliable and authentic reference work and study-course for Master Journeyman and Young Mechanic. Use FREE COUPON below and find out for yourself, without obligation, whether this set will benefit you.

### INSIDE TRADE INFORMATION ON:

Bricklaying, tools, materials; Brick designs, patterns, bonds; Setting frames and foundations; Mortars, scaffolds, estimating; Mortars and mortar mixing; Tile setting, mosaic, hollow tile; Straight edge test, trow-

eling; How to figure brick work; Safe loads, piers, chimneys; Boiler settings, anchors, fire stops; Labor tables; Concrete, forms; How to figure concrete work; Stucco—on old and new buildings; Plastering—wood lath—metal;

Plasterers agreement; Plastering on various surfaces; Stonemasonry; Cutting, finishing, estimating stone; Derricks, rigging; Steel construction; Fire proof; How to read blue prints.

"Audels Masons Guides are the best books on the subject I have read in 12 years and am able to judge." H. A. Sonnett, Corlies, Pa.



## PRACTICAL ELECTRICITY — 1 VOL. \$4

Audels Handy Book of Practical Electricity is a simplified Ready Reference and Study Course in one pocket size, leather bound volume—for Engineers, Professional Electricians and Students. **1040 pages; 2600 diagrams; flexible red leather bound.** A reliable authority and handy helper for every electrical worker. Contains important and valuable wiring diagrams, calculations, machine sketches, helps on maintenance and repair. Use this FREE COUPON today and find out, without obligation, how this handy book will help you in your daily work.

Complete in one handy, red leather bound volume

### INSIDE TRADE INFORMATION ON:

Electro-Therapeutics, X-Rays, Shocks, Welding, Brazing, Radio Hook-ups, Motion Pictures, Telephone, Telegraph, Cranes, Bells, Elevators, Pumps, Tools, Ship Drive, Railways, Vehicles, Automobile Electric Systems, Ignition, Generation, Lighting, Plant Management, Power Plans, Armature Winding, Repairing, A. C. Motors and Apparatus, D. C. Motors and Apparatus, Alternator Construction, Dynamos, Wiring Diagrams, Sign Flashers, Cable Splicing, Power Wiring, Outside Wiring, Switches, Lighting, Rectifiers, Converters, Transformers, Fuses, Circuit Breakers, Rheostats, Electro Plating, Electrolysis, Storage Batteries, Magnetism, Electrical Energy, Conductors, Insulators, Static, Dynamic, Radio Electricity, Applications, Ready Reference and Index Covering the entire field of Modern Electricity.



1040 Pages 2600 Diagrams

## Learn More and You Will Earn More!

Know your job and you'll never be without one. The skilled man is always in demand. Knowledge is power. Learn your trade thoroughly by easy reading. This coupon is your opportunity for advancement and better pay. You risk nothing in sending for Audels Guides for free examination. Send it NOW!

**FREE EXAMINATION COUPON**

**THEO. AUDEL & CO.,**  
65 W. 23 ST., NEW YORK CITY

Please mail me for free examination the books marked (x) below. If I find them satisfactory, I agree to mail \$1 in 7 days, on each set ordered, and to further mail \$1 monthly on each set until I have paid the purchase price.

4 CARPENTERS GUIDES \$6     4 PLUMBERS GUIDES \$6

4 MASONS GUIDES \$6     1 ELECTRICIANS HANDY BOOK \$4

NAME .....

ADDRESS .....

OCCUPATION .....

EMPLOYED BY .....

**See Here!** ANSWER THIS AD

You want a Steady Job—<sup>UP TO</sup> \$75<sup>00</sup> a Week—  
Be Your Own Boss \$5000 to \$10,000 a Year



**Morrision Did!**

When Morrision of Parkersburg, W. Va., wrote for my Auto Book he was working in a steel mill for low pay.

**Becomes Own Boss in 6 Months**

In six months he doubled his earnings and got into business for himself. You can have the same book that started Morrision to success. Mail the coupon today!

**BE AN Auto Expert**

Say goodbye to low pay, out-of-work and no opportunity. Get into the Auto Business where big pay—steady jobs—extra money—promotions come quick.

**The World's Biggest Business**

A brilliant future is yours in the Auto Business—5 Billion Dollars spent annually for upkeep alone—23 Million Cars on the road—thousands of trained men needed. If you're earning less than \$40.00 a week, send for my free Book. Learn how \$40, \$50, \$75 a week or a big paying business of your own is possible for you now.

**Yancy Now Makes \$90 a Week**

Before he took my training he never made over \$30 a week.

**Deal Earns Over \$400 a Month**

From \$10 a week as a farm hand to over \$400 a month in his own business.

**Zimmerman's Profit \$20 a Day**

His shop always full of cars—making as high as \$20 a day where he used to earn \$4— independent—successful. That's what's ahead of YOU in the Auto Business. What these and hundreds of other men have done you can do, too. Clip the coupon now!

AVIATION Ground Course  
3 WORKING OUTFITS  
Included  
**FREE**  
OF EXTRA CHARGE!



*At Last!*

**A NEW EASY WAY TO**

**LEARN AUTOS**

**At Home in Spare Time!**

Keep your job—stay at home—loan me part of your spare time and I'll make you a trained Auto man! Job-Way training is the new, easy way to learn Autos—to put you on the road to success—quick!

**I Train You the New "Job-Way" Right at Home—No Books—No Classes**

Job-Way teaches you everything about autos by a most amazingly practical and simple method—no dry as dust, out of date books—no slow, tiresome classes. Loose leaf job-lessons—Modern job-tickets—working outfits—practical experience while training—consultation service—employment service—and other features make it the best of all known methods of training. And you get it at home—in your spare time. My free Book tells you how!

**Experience Education Not Needed**

**Make Money Quick!**

**Money Back Agreement**

If you can read, write and understand everyday English, that's all that's necessary.

You don't wait until you finish. You earn while you learn. More Money comes Quick.

Your success, your satisfaction is backed by my Money Back Agreement—You take no risk.

**MAIL THIS FOR FREE BOOK**

B. W. Cooke, Directing Engineer, Chicago Motor Training Corporation, Dept. A-116, 1916 Sunnyside Ave., Chicago, Ill.

Send me your free Auto Book with details of opportunity for me in Auto Business and of Job-Way Training, including your Aviation Outfits, Employment Service and Money Back Offers. No obligation to me.

Name.....  
Address.....  
Town..... State.....  
Age..... Occupation.....

**GET THE FACTS! Send for Free Auto Book Now!**

Address me **Personally B. W. COOKE** Directing Engineer

**Chicago Motor Training Corporation**

**Dept. A-116, 1916 Sunnyside Ave., CHICAGO**

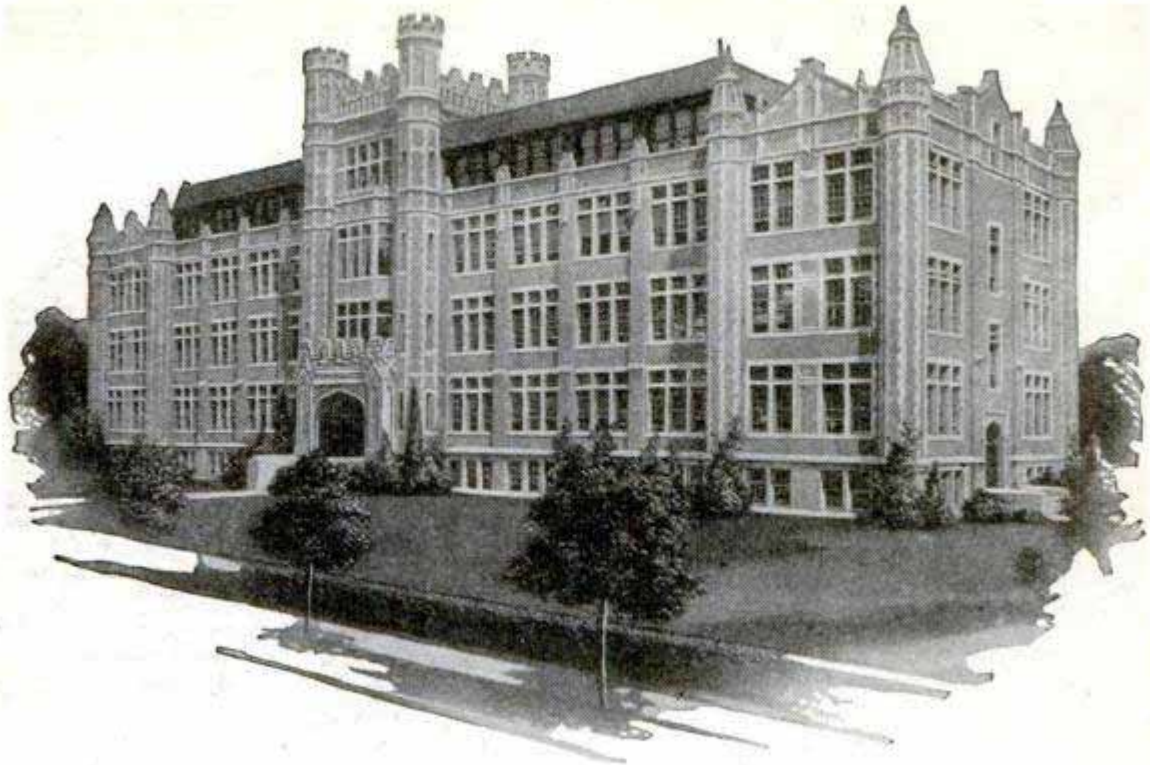

# Go to High School at Home

You can secure a high school education right at home by studying the splendid new courses recently prepared by the International Correspondence Schools.

These courses are equivalent to the courses given in resident high schools. They have been specially arranged for men and women who wish to meet college entrance examinations, to qualify for a business position, or to make up the education they missed when forced to leave school too soon.

The College Preparatory Course, the High School Commercial Course and the High School English Course include English, algebra, ancient, medieval, modern and U. S. History, physiology, literature, geography, Latin, book-keeping, drawing, geometry, shorthand, physics, chemistry, salesmanship, advertising, civics, trigonometry, economics, American business law, corporation finance, money and banking, business and trade economics, etc. A diploma is given at graduation.

The lessons are easy to understand and you will make rapid progress because you will be *in a class by yourself* and you will study under the guidance of instructors who are sincerely interested in helping you to get ahead and achieve the bigger things in life.

Just mark and mail the coupon and we will gladly send you interesting free booklets

describing the High School Courses of the International Correspondence Schools or any other subject in which you are interested.

---

## INTERNATIONAL CORRESPONDENCE SCHOOLS

*"The Universal University"*

Box 5618-F, Scranton, Penna.

Without cost or obligation, please send me a copy of your booklet, "Who Wins and Why," and full particulars about the subject before which I have marked X in the list below:

- College Preparatory Course
- High School Commercial Course
- High School English Course
- High School Vocational Course
- High School Agricultural Course

### BUSINESS TRAINING COURSES

- |  |   |
|--|---|
| <input type="checkbox"/> Industrial Management                   | <input type="checkbox"/> Advertising                                      |
| <input type="checkbox"/> Personnel Management                    | <input type="checkbox"/> Business Correspondence                          |
| <input type="checkbox"/> Traffic Management                      | <input type="checkbox"/> Show Card and Sign Lettering                     |
| <input type="checkbox"/> Accounting and C. P. A. Coaching        | <input type="checkbox"/> Stenography and Typing                           |
| <input type="checkbox"/> Cost Accounting                         | <input type="checkbox"/> English  |
| <input type="checkbox"/> Bookkeeping                             | <input type="checkbox"/> Civil Service                                    |
| <input type="checkbox"/> Secretarial Work                        | <input type="checkbox"/> Railway Mail Clerk                               |
| <input type="checkbox"/> Spanish <input type="checkbox"/> French | <input type="checkbox"/> Common School Subjects                           |
| <input type="checkbox"/> Salesmanship                            | <input type="checkbox"/> High School Subjects                             |
|  | <input type="checkbox"/> Illustrating <input type="checkbox"/> Cartooning |

### TECHNICAL AND INDUSTRIAL COURSES

- |   |  |
|---|--|
| <input type="checkbox"/> Electrical Engineering | <input type="checkbox"/> Architect                                       |
| <input type="checkbox"/> Electric Lighting      | <input type="checkbox"/> Architects' Blueprints                          |
| <input type="checkbox"/> Mechanical Engineer    | <input type="checkbox"/> Contractor and Builder                          |
| <input type="checkbox"/> Mechanical Draftsman   | <input type="checkbox"/> Architectural Draftsman                         |
| <input type="checkbox"/> Machine Shop Practice  | <input type="checkbox"/> Concrete Builder                                |
| <input type="checkbox"/> Railroad Positions     | <input type="checkbox"/> Structural Engineer                             |
| <input type="checkbox"/> Gas Engine Operating   | <input type="checkbox"/> Chemistry <input type="checkbox"/> Pharmacy     |
| <input type="checkbox"/> Civil Engineer         | <input type="checkbox"/> Automobile Work                                 |
| <input type="checkbox"/> Surveying and Mapping  | <input type="checkbox"/> Airplane Engines                                |
| <input type="checkbox"/> Metallurgy and Mining  | <input type="checkbox"/> Agriculture <input type="checkbox"/> Navigation |
| <input type="checkbox"/> Steam Engineering      | <input type="checkbox"/> Mathematics <input type="checkbox"/> Radio      |

Name.....

Street Address.....

City..... State.....

Occupation.....

*Persons residing in Canada should send this coupon to The International Correspondence Schools Canadian, Limited, Montreal, Canada*

# SAY FELLOWS

I've taken thousands of fellows just like you out of small pay, man killing jobs and made it easy for them to make more money in an interesting, big future field

Read my message on the opposite page. Then if you want to get ahead quick fill in the coupon and mail it in to me and I'll send you my big Free book.

Sincerely  
A. C. Lewis

READ THIS MESSAGE ON  
PAGE 11.



## 500,000 VOLTS

"Artificial lightning" being developed in Coyne School. Spark of 500,000 volts is shown jumping 30 inches. This gigantic Tesla Coil is the same as that used by Steinmetz, absolutely harmless, because of high frequency.

# Learn Electricity By Doing - Not Books *in 12 Weeks!*

By **ACTUAL WORK**—in the Great Shops of Coyne



ANYONE with common schooling who can see and understand the English language can learn electricity in 90 days. I teach you with as complete an outlay of electrical apparatus as was ever assembled in any institution—30-foot control board—transmitting stations—skeleton houses, huge motors—dynamos—sub-stations—automobiles—switchboards. In one department we generate enough electricity to supply a small city!

### No Books—No Classes

Enter anytime. Experts teach you on electrical machinery and *not books*. They guide you every step of the way with individual attention. You do the actual work on real full-size machinery in full operation. Take motors for instance. Instead of learning from books and charts—you actually build motors. You can't help but know all about them. Anyone can learn this fascinating way.

### No Experience Necessary

That's how my methods make men learn electricity in 12 wonderful weeks. You don't need experience—Coyne training starts from the very beginning. You don't need advanced education—you learn by doing.\* Age is no handicap—Coyne students range from 16 to 45.

Not a Correspondence School

# COYNE Electrical SCHOOL

H. C. Lewis, President Dept. A9-72  
500 So. Paulina St., Chicago

### Triple Your Earning Power

I don't need to tell you about the opportunities in electricity. They are too many and too amazing to mention. Ordinary jobs run \$50—\$60 and up a week. And Coyne training leads to the biggest positions. Many Coyne men are making up to \$500 a month. Demand for Coyne men often exceeds the supply. Our employment bureau gives you lifetime service after graduation.

### Earn While You Learn

We help many students who haven't much money to secure part-time jobs to earn a good part or all of living expenses while training.

### All Details Sent Free

This school is 29 years old—Coyne training is tested—proven beyond all doubt—endorsed by electrical industry. You can find out everything absolutely free. Simply mail the coupon and let me send you the big, free Coyne book of 150 photographs—facts—jobs—salaries—opportunities. See what Coyne training can do for you in just 90 days! This does not obligate you. So act at once. Just mail the coupon.

### Get This FREE Book

**Fill In And Mail To Day**

Mr. H. C. Lewis, Pres. Dept. A9-72  
COYNE ELECTRICAL SCHOOL,  
500 S. Paulina St., Chicago, Ill.

Dear Mr. Lewis: Without obligation send me your big free catalog and all details of Free Employment Service, Radio, Aeroplane and Automotive Electrical Courses, and how many "earn while learning." Also tell me about your offer of railroad fare to Chicago.

Name.....

Address.....

Town..... State.....

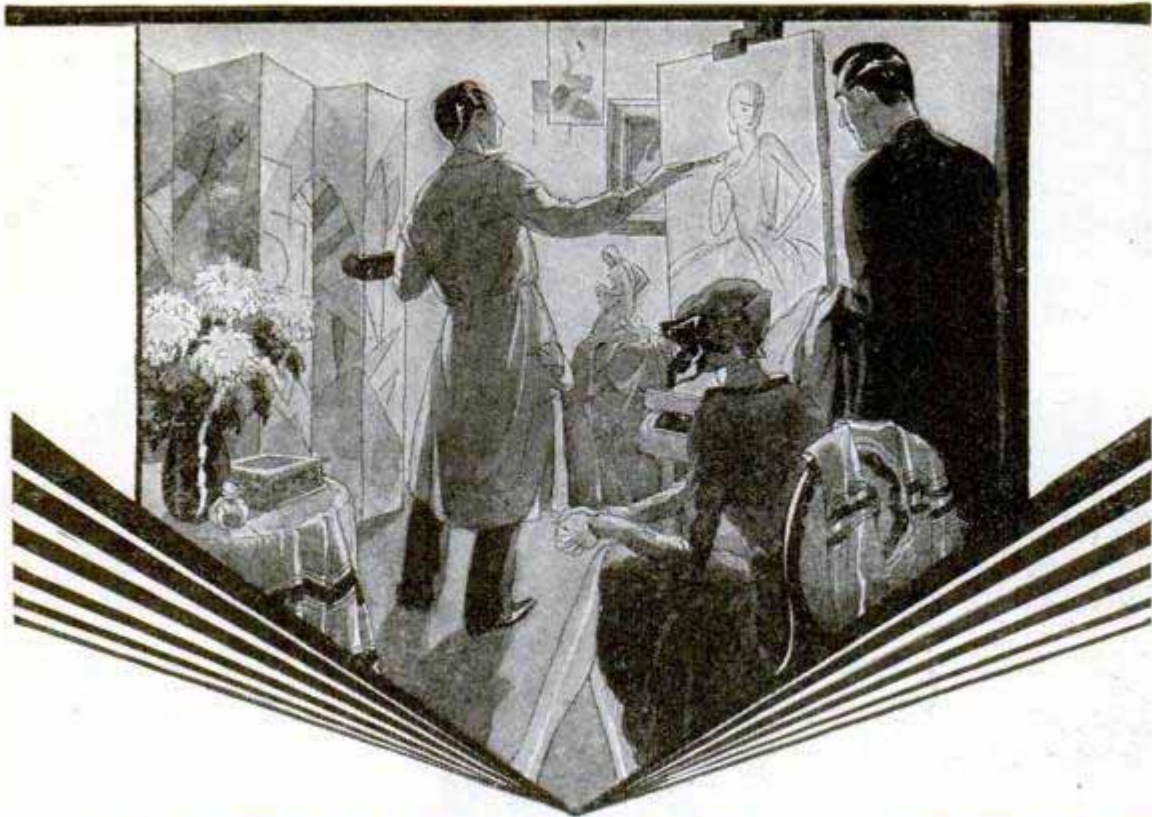

## ENJOY YOUR WORK be an artist!

**"IF** I could only be in some line of work that gripped me, I know I would succeed." How often you have said this to yourself! And you are right. When you love your work, you can throw your whole soul into it — success comes faster.

Many successful artists worked in commonplace jobs before they found themselves. One internationally famous cartoonist and art editor was clerk and bookkeeper in a general store. Another great illustrator was a taxidermist. You may have hidden artistic talent—wasted in your present work—which will help you succeed with training.

Through the Federal Course in Illustrating more than fifty famous artists give you the benefit of their experience in Illustrating, Cartooning, Lettering, Poster Designing, Window Card Illustrating, etc. The methods of these highly paid artists as explained through the

Federal Course help you to become a professional.

If you have artistic talent, you will be happier and will learn quickly and easily when you commence the Federal Course. You can learn at home during your spare time — continue your present work while fitting yourself for art. Art is a vital part of today's business. Publishers spend millions of dollars each year for illustrations.

### FIND YOURSELF—READ THIS FREE BOOK

"A Road to Bigger Things" gives fascinating details about how famous artists of today started their careers — tells how you can learn to earn in art and shows examples of our students' drawings. Many successful Federal Students are earning from \$2500 to \$6000 a year—some even more. Write your name, age and address on the coupon and we will send a copy of this encouraging book together with Vocational Art Test — both without charge.

## FEDERAL SCHOOL of ILLUSTRATING

6139 Federal Schools Building

Minneapolis, Minnesota

Federal School of Illustrating,  
6139 Federal Schools Building,  
Minneapolis, Minnesota.

Please send me free book, "A Road to Bigger Things," and Standard Art Test.

Name \_\_\_\_\_ Age \_\_\_\_\_

Occupation \_\_\_\_\_ Address \_\_\_\_\_



We have placed machinists, carpenters, masons, plumbers, railroad men, office clerks, farmers and even laborers in fine Drafting Jobs under this plan. Mail coupon for details of our remarkable offer.



# Men Who Work With Their Hands Make the Best DRAFTSMEN



## and We'll Back Them With Tested Plan to Get Into DRAFTING



"Only one other man and I, of six taking California State Board examination for Architect passed. Then I realized the thorough and practical training given by American School. In 18 months I have gone from tracer to Chief Draftsman, in charge of all architectural and engineering work in one of the oldest offices here." R. L. WARREN, Los Angeles, Calif.



"When I started American School training in the Spring of 1915 I was working 14 hours a night, seven nights a week for \$1.83 a night. That Fall I got a job in the Engineering Dept. of a large firm near here. Today I work 5 1/2 days a week and my salary is larger than I ever dreamed of when I began that course in Mechanical Drafting." B. H. SEAVERN, South Bend, Ind.

We are looking for more ambitious young fellows with factory, building-trade or any other kind of mechanical experience to prepare for and help place in well-paid Drafting positions. Such men, we find, are unusually successful as Draftsmen, because they know how things are done, and that's a priceless asset to the man who makes the blueprint plans. For there's a great deal more to Drafting than "mechanical drawing" and reading blueprints. The real jobs, those paying \$50 to \$100 a week, give you a chance to cash in on your entire past mechanical experience. Get in touch with me and I'll tell you how.

### DRAFTING is Logically YOUR NEXT MOVE!

Of course you realize the biggest handicap to mechanical work is that you're limited in earning capacity to the output of your two hands, as long as you live. Even the skilled mechanic earning \$50 to \$60 a week has reached his limit. He can never earn more and when he gets old he will earn less. So I don't blame any man for wanting to get away from his futureless outlook. For wanting to get into something where he can use his head as well as his hands—where he will be paid for what he **knows**, instead of only for what he **does** . . . You know enough about blueprints to understand that PLANS govern every move in factory and construction job. The Draftsman who makes them is several jumps ahead of the workman who follows them. And so I want you to know that DRAFTING is a logical, natural PROMOTION from mechanical and building work—better-paid, more interesting—just the kind of work you'd enjoy doing.

### Get My NO-RISK Plan

The way to a fine Drafting job for you—is easier than you think. It takes no "artistic talent" or advanced education. Thousands of men no smarter than you, with no more education or ability have learned it quickly and you can, too. With the cooperation of some of the biggest employers and engineers in the U. S. we have worked out a plan to prepare you for Drafting work in your spare time at home—to help you get a fine position and to raise your pay. Backed by the contract shown above to refund the small cost, if we fail. Mail the coupon and I'll be glad to tell you all about this life-time chance to get into Drafting.

### The American School

Dept. DA-74, Drexel Ave. and 58th St., Chicago, Ill.



**We will make this Contract with you**

1. We will prepare you for a fine simplified Drafting job with rapid, practice, at home, in spare time.
2. As soon as you are ready, we will help you get a good position, without cost to you or to employer—
3. At a substantial increase in salary, —OR MONEY REFUNDED.

**Mail Coupon for Complete Information.**

### 3 Drafting Lessons Actually FREE To Show You How Interesting and Simple Drafting Is . . .

I wish I had the room here to tell you all about DRAFTING—how it has become the most important branch of every kind of manufacturing and construction work—how fascinating the work is—what a fine bunch of fellows Draftsmen are, the big salaries paid—how while Drafting is white-collar office work, it is closely hooked-up with big projects and big men. All that takes a 36-page book to tell and I'll be glad to send it to you free, and in addition I want to send you the first three lessons of our home-training so you can see how you'll like the work and how simple it is to learn. Coupon brings everything—mail it right away.

American School, Dept. DA-74, Drexel Ave. & 58th St., Chicago, Ill.

Please send free and without the slightest obligation 3 Drafting lessons, 36-page book about the opportunities in Drafting and your plan to help get me a Drafting Job and a Raise.

Name.....

St. No.....

City..... State.....

Age..... Occupation.....

# How Fred Fisher made \$30 a week Extra in Spare Time with the TENOR BANJO

Found Course Easy Right from Start; Now Enjoys More Friends, More Parties

"Had no idea it was so easy, until I received my first two Lessons. Ever since then, things have gone right along easily. Nobody could go wrong with your clear, sure method. I now have more friends, and never miss any house parties. Recently I have been earning thirty dollars a week, in my spare time, playing in a cafe. There is always a job for a Tenor Banjoist."—Fred Fisher, 123 Ridge St., Steelton, Pa.



**YOU Can Learn Quick Right at Home to Make Big Spare-Time Money**

Why "wish" for plenty of friends, fun and ready cash when you can have them—QUICK! Our tested, easy system—"The Play-Way"—in 1 to 3 months at home will teach you how to make \$5 to \$15 an evening for spare-time playing; \$65 to \$100 a week or even more playing in orchestras, etc. Be popular, be invited everywhere; have the money you want. Don't let lack of cash keep the good times and good things of life away from you any longer! Learn quick and earn quick! Find out now about the Tenor Banjo Play-Way to Popularity and Big Pay.

C. E. Samwell  
20 Devonshire Ave., Brantford, Ont., (shown above) writes: "Was only quarter way through Course when playing in one of the best orchestras here. Have found Tenor Banjo a real easy, sure way to Big Money. My playing now paying for me \$550 Banjo. Owe success to you."

## FREE BOOK tells how

This inspiring book—that has shown countless others the short-cut to SUCCESS—is yours FREE immediately upon receipt of the coupon below. No obligation—we'll rush it to you gladly. It will show you how to get the friends you want, the popularity you deserve and the money you need—quick! Get all the facts about this fascinating method. The same amazing course that taught Fisher Samwell and thousands of other prosperous Tenor Banjoists can teach you, too. No knowledge of music or notes necessary. No extras to buy. We teach everything; furnish everything you need. Clip the coupon, fill it in and mail at once.

**Big Tenor Banjo Records and Outfit FREE When You Enroll**

### with First Lesson

The same day we receive your enrollment for this tested, time-saving Course, you are shipped a handsome, full-tone, professional size Tenor Banjo worth \$20—lessons and Complete Outfit—and correct, fool-proof Demonstration Phonograph Records of every selection in the Course!



## Mail Coupon Now

A. F. Bloch, President,  
New York Academy of Music,  
Studio 1069,  
100 Fifth Avenue, New York City.

Dear Mr. Bloch: Please rush me your FREE Book telling how I too can make a Quick Success and Big Money with the Tenor Banjo.

Name .....

Address .....

# 8 weeks then BIG WAGES

In eight short weeks I train you for one of the 70,000 jobs open everywhere. Why work for boy's wages? No schooling required; no book study. No unions to join; no apprenticeship. Get this amazing offer. Become an expert.

## AUTO Tractor and AVIATION

## Real Wages

Large firms want McSweeney trained men. Our graduates are earning up to \$6,000 a year and more. Learn with real tools on real equipment.

## BIG FREE BOOK

Save One-Third NOW on our Special Reduced Tuition Offer. Write today for particulars and big FREE book.

(No facilities for colored men.)

**McSWEENEY**  
AUTO, TRACTOR and AVIATION SCHOOLS  
Dept. 11-B Cleveland, Ohio

## "CHOOSING A VOCATION"

Interesting 48 Page Book Free

Helpful discussion of this important problem, also presenting opportunities up to \$5000 a year in Mechanical Dentistry—making crowns, plates, bridges, etc., for dentists. Write for Bulletin 2.

### BODEE INSTITUTE

**New York** 1755 Broadway  
**Philadelphia** 1305 North Broad Street  
**Brooklyn** 85 Court Street

## Learn to PAINT SIGNS and SHOW CARDS

We quickly teach you by mail, or at school, in spare time. Enormous demand. Big future. Interesting work. Oldest and foremost school. **EARN \$50 TO \$200 WEEKLY**

Otto Wiegand, Md., home-study graduate, made \$12,000 from his business in one year. John Vassoe, N.Y., gets \$25 for a show card. Crawford, B. C., writes: "Earned \$200 while taking course." Write for complete information.

DETROIT SCHOOL OF LETTERING  
154 Stinson Ave. Est. 1899 Detroit, Mich.



## STAMMER

Write for my free book "Millard's Advanced Natural Corrective Course" and a free copy of my speech magazine. 10,000 cases successfully treated. Est. 24 years. Largest school for stammerers in world. Millard Inst. of Normal Speech, 2317 Millard Bldg., Milwaukee, Wis.

## LEARN WATCH REPAIRING



You can learn by our modern and original system of instruction every part of the Watch Repairing Trade at home as good or better than at a shop. You can earn money while learning and secure a well paying position or start in business after completing our course of instruction. Good watch repairers are always in demand and earn from \$50 to \$75 per week. For particulars apply to the Wisconsin School of Watch Repairing 166 Mason St., MILWAUKEE, WIS.



# If You Were Dying TONIGHT

and I offered something that would give you ten years more to live, would you take it? You'd grab it. Well, fellows, I've got it, but don't wait till you're dying or it won't do you a bit of good. It will then be too late. Right now is the time. Tomorrow or any day, some disease will get you and if you have not equipped yourself to fight it off, you're gone. I don't claim to cure disease. I am not a medical doctor, but I'll put you in such condition that the doctor will starve to death waiting for you to take sick. Can you imagine a mosquito trying to bite a brick wall? A fine chance.

## A RE-BUILT MAN

I like to get the weak ones. I delight in getting hold of a man who has been turned down as hopeless by others. It's easy enough to finish a task that's more than half done. But give me the weak, sickly chap and watch him grow stronger. That's what I like. It's fun to me because I know I can do it and I like to give the other fellow the laugh. I don't just give you a veneer of muscle that looks good to others. I work on you both inside and out. I not only put big, massive arms and legs on you, but I build up those inner muscles that surround your vital organs. The kind that give you real pep and energy, the kind that fire you with ambition and the courage to tackle anything set before you.

## ALL I ASK IS NINETY DAYS

Who says it takes years to get in shape? Show me the man who makes any such claims and I'll make him eat his words. I'll put one full inch on your arm in just 30 days. Yes, and two full inches on your chest in the same length of time. Meanwhile I'm putting life and pep into your old back-bone. And from then on, just watch 'em grow. At the end of thirty days you won't know yourself. Your whole body will take on an entirely different appearance. But you've only started. Now comes the real works. I've only built my foundation. I want just 60 days more (90 in all) and you'll make those friends of yours who think they're strong look like something the cat dragged in.

## A REAL MAN

When I'm through with you you're a real man. The kind that can prove it. You will be able to do things you had thought impossible. And the beauty of it is you keep on going. Your deep, full chest breathes in rich, pure air, stimulating your blood and making you just bubble over with vim and vitality. Your huge square shoulders and your massive muscular arms have that craving for the exercise of a regular he-man. You have the flash to your eye and the pep to your step that will make you admired and sought after in both the business and social world.

This is no idle prattle, fellows. If you doubt me, make me prove it. Go ahead, I like it. I have already done this for thousands of others and my records are unchallenged. What I have done for them, I will do for you. Come then, for time flies and every day counts. Let this very day be the beginning of new life for you.

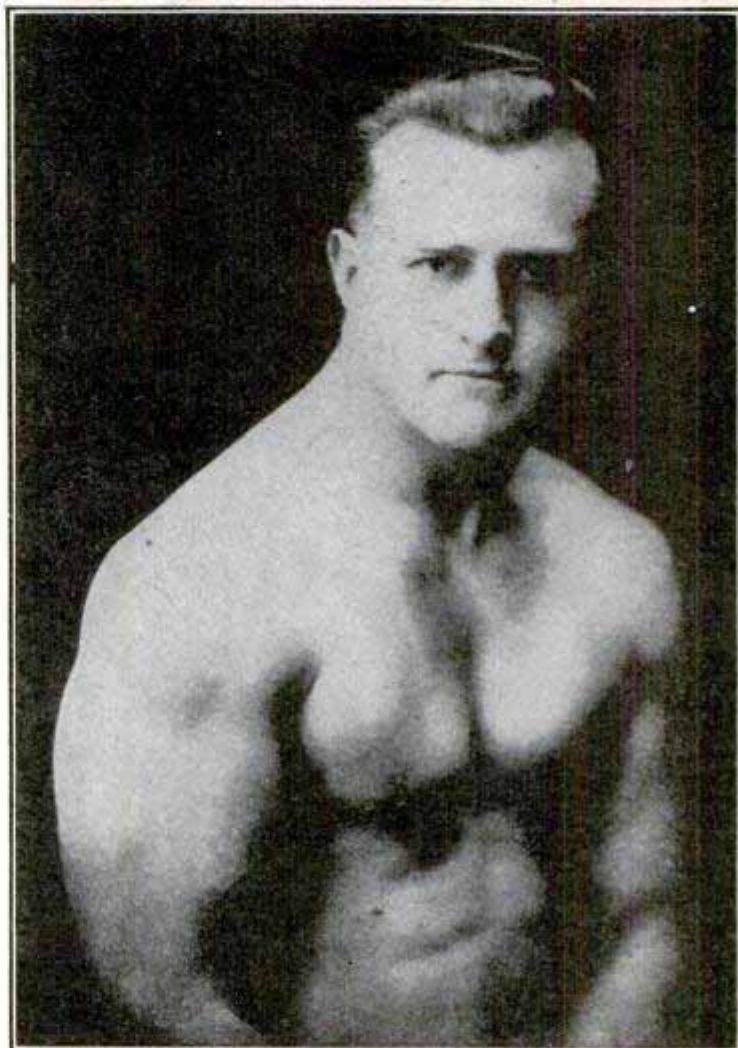

**EARLE LIEDERMAN, The Muscle Builder**  
Author of "Science of Wrestling," "Muscle Building,"  
"Secrets of Strength," "Here's Health," "Endurance," etc.

Send For My New  
64 Page Book

# "Muscular Development"

IT IS FREE

It contains over four dozen full-page photographs of myself and some of the many prize-winning pupils I have trained. Some of these came to me as pitiful weaklings, imploring me to help them. Look them over now and you will marvel at their present physiques. This book will prove to be an impetus and a real inspiration to you. It will thrill you through and through. And it's all yours. I don't ask a cent. This will not obligate you at all, but for the sake of your future health and happiness do not put it off. Send today—right now before you turn this page.

## Earle Liederman

Dept. 2006 305 Broadway, New York City

DON'T  
SEND ONE  
PENNY

YOUR  
NAME  
AND  
ADDRESS  
ON A  
POSTAL  
WILL DO

**EARLE LIEDERMAN**

Dept. 2006, 305 Broadway, New York City

Dear Sir: Please send me, without any obligation on my part whatever, a copy of your latest book, "Muscular Development." (Please write or print plainly.)

Name .....

Street .....

City ..... State .....

# Learn Electricity IN LOS ANGELES

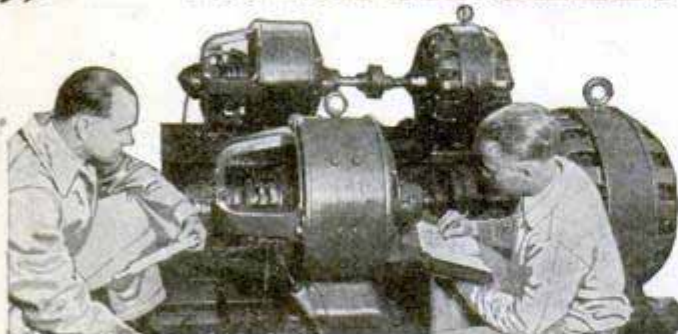

—and learn IT RIGHT!

### 1. What Kind of School is National?

A practical-technical school, established in 1905—24 years ago—recognized throughout the electrical industry as one of America's foremost trade schools. National offers intensive courses in all electrical branches. Thorough training of the highest quality in fundamentals of electricity, mathematics, physics, and other essentials. Extremely practical electrical experience in completely equipped, modern work departments assures you success in the profitable electrical trades.

### 2. How Long to Learn Electricity?

A LIFETIME—and then you'll never know it all! BUT—to become properly qualified in the shortest practical time, without sacrifice of quality in instruction or endangering your chances for securing satisfactory employment in electricity, National's condensed course of nine months fully trains you as a Practical Electrician.

### 3. What Employment Service does National Guarantee?

National GUARANTEES to qualify you as a Practical, Competent Electrician and to render an unlimited Employment Service to students wishing to earn living expenses while learning and graduates ready to enter the electrical field, which is the most any school can be expected to do.

### 4. What Inducements Does National Offer?

National offers YOU the very best technical - practical training that money can buy at a cost within every man's reach. It does not offer to pay your railroad fare, room and board or other personal expenses, preferring to limit its activities to the PROPER TRAINING OF MEN FOR SUCCESS. Los Angeles is in the heart of rapid electrical development—an ideal city in which to study and prepare for success in Electricity.

Write at Once for FREE Illustrated Catalog "ELECTRICITY—Your Life Vocation"



## National Electrical School

Dept. 532, 4006 Figueroa St.,  
Los Angeles, California.

Send me your big free illustrated catalog of Electrical Opportunities.

Name.....

Address.....

Age..... City..... State.....

## THE CHICAGO DAILY NEWS School and College Bureau

### Offers You Its Specialized Services in Choosing a School

Last year the School and College Bureau of The Chicago Daily News saved many busy parents and questioning boys and girls both time and worry by sending them prompt, reliable information about just the kind of school they wanted—personal requirements as to location and tuition charges being considered in each individual case.

Again this year many young people will be perplexed by the problem of finding the right school. Why not let us help you?

The Chicago Daily News maintains this service absolutely free of charge to you. No need to hurriedly select a school on mere hearsay when expert advice can be obtained by telephoning Dearborn 1111, writing or calling for a personal interview at

**THE CHICAGO DAILY NEWS**  
*School and College Bureau*  
Dept. K, 15 N. Wells St., Chicago, Illinois

## Learn Advertising at HOME

Send your name and address for free booklet giving interesting information and vital facts about Advertising. Find out how we prepare you at home, in your spare time, for the opportunities open in this fascinating business. Practical work. No text books. Old established school. Successful graduates everywhere. Just the plan you have always wanted. Write today. No obligation.

**PAGE-DAVIS SCHOOL OF ADVERTISING**  
Dept. 135-A 3601 Michigan Ave. Chicago, U. S. A.

## "STAMMERING Its Cause and Cure"

You can be quickly cured if you stammer. Send 10 cents coin, or stamps, for 288 page cloth bound book on Stammering and Stuttering. It tells how I cured myself after Stammering and Stuttering for 20 years. **BENJAMIN N. BOGUE**  
11118 Bogue Building, 1147 N. Ill. St. Indianapolis

## GOV'T POSITIONS

\$35 TO \$75 WEEKLY

MEN - WOMEN	Ry. Mail Clerk	Steno-Typist
	Prohibition Inv.	Immigrant Inspector
	R. F. D. Carrier	Seamstress
	Special Agent (Investigator)	Auditor
	City Mail Carrier	Steno-Secretary
	Meat Inspector	U. S. Border Patrol
	P. O. Clerk	Chauffeur-Carrier
	File Clerk	Watchman
	General Clerk	Skilled Laborer
	Matron	Postmaster
	Typist	

OZMENT INSTRUCTION BUREAU, 111 Arcade Bldg., St. Louis, Mo. Send me FREE particulars How To Qualify for positions marked "X". Salaries, locations, opportunities, etc. ALL SENT FREE.

NAME.....

ADDRESS.....

# ...Raised His Pay \$4800\* After Reading This Amazing Book Which Is Now *FREE!*

\* Based on the combined experiences of F. B. Englehardt, Chattanooga, Tenn., A. F. Thompson, Sioux City, Iowa, B. F. Boilon, Columbus, Ohio, and many others.



## Caught in a Rut

I wonder I put up with it as long as I did! Every day was filled with nothing but deadly routine and monotonous detail. No freedom or independence. No chance to get out and meet people, travel, nor have interesting experiences. I was just like a cog in a big machine with poor prospects of ever being anything more.



## Long, Tiresome Hours

Every hour of the day I was under somebody's supervision. The TIME-CLOCK constantly laid in wait for me—a monument to unfulfilled hopes and dying ambition. Four times a day, promptly on the dot, it hurled its silent challenge at my self-respect, reminding me how unimportant I was and how little I really **COUNTED** in the business and social world!



## Low Pay

Paid just enough to keep going—but never enough to enjoy any of the **GOOD** things of life every man **DESERVES** for his family and himself. Always economizing and pinching pennies. Always wondering what I would do if I were laid off or lost my job. Always uncertain and apprehensive of the future.



## Desperate

Happened to get a look at the payroll one day and was astonished to see what big salaries went to the sales force. Found that salesman Brown made \$200 a week—and Jenkins \$275! Would have given my right arm to make money that fast, but never dreamed I had any "gift" for salesmanship.



## A Ray of Light

Stumbled across an article on salesmanship in a magazine that evening. Was surprised to discover that salesmen were made and not "born" as I had foolishly believed. Read about a former cowpuncher, Wm. Shore of California, making \$525 in one week after learning the ins-and-outs of scientific salesmanship. Decided that if **HE** could do it, so could I!

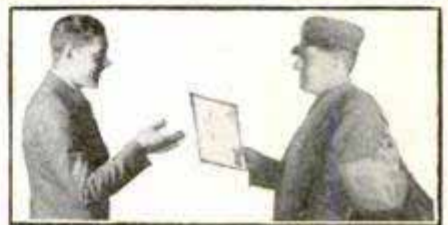

## The Turning Point

My first step was to write for a certain little book which a famous business genius has called "The **MOST AMAZING BOOK EVER PRINTED**". It wasn't a very big book, but it certainly opened my eyes to things I had never dreamed of—and proved the turning point of my entire career!

## What I Discovered



Between the pages of this remarkable volume, I discovered hundreds of little known facts and secrets that revealed the **REAL TRUTH** about the science of selling! It wasn't a bit as I had imagined. I found out that it was governed by simple rules and laws that almost **ANY** man can master

as easily as he learned the alphabet. I even learned how to go about getting into this "highest paid of all professions". I found out exactly how Mark Barichievich of San Francisco was enabled to quit his \$8 a week job as a restaurant-worker and start making \$125 a week as a salesman; and how C. W. Birmingham of Dayton, Ohio, jumped from \$15 a week to \$7500 a year—these and *hundreds* of others! It certainly was a revelation!



## Employment Service

Furthermore, I discovered that the National Salesmen's Training Association, which published the book, also operates a most effective employment service! Last year they received requests from all over the U. S. and Canada for more than 50,000 salesmen trained by their method. This service is **FREE** to both members and employers and thousands have secured positions this way!



## Making Good At Last!

It didn't take me long to decide to cast my lot with N. S. T. A.—and after a few weeks I had mastered the secrets of Modern Salesmanship during spare time, without losing a day or a dollar from my old job. When I was ready, Mr. Greenslade (the president) found me over a dozen good openings to choose from—and I selected one which paid me over \$70 a week to start!



## Was It Worth It?

Today my salary is \$4800 greater than ever before! No more punching time-clocks or worrying over dimes and quarters! **NOW** my services are in **REAL DEMAND** with bigger prospects for the future than I ever dared **HOPE** for back in those days when I was just another "name" on a pay-roll!



## Get Your Copy FREE

Right now the book—"The Secrets of Modern Dynamic Salesmanship"—which banished all my fears and troubles and showed me how to get started on the road to success and independence—will be mailed as a gift to any ambitious man absolutely **FREE**. And since there is no obligation, why not see for yourself what amazing facts it contains! Just mail the coupon now—for there is no better way in the world to invest a 2-cent stamp! **I KNOW!**

National Salesmen's Training Assn., Dept. G-101, N. S. T. A. Bldg., Chicago, Ill.

Without obligation, please send me a free copy of "The Secrets of Modern Dynamic Salesmanship."

Name..... Address.....

Town..... State.....

Age..... Occupation.....

# 5 Easy Ways to Make \$3.00 an hour in Your Spare Time in RADIO

Each of these plans, developed by the Radio Training Association of America, is a big money-maker. Set owners everywhere want to get rid of static, to have their sets operate from the electric light socket, the tone improved, and the volume increased, and transformed into single-dial controls. Phonograph owners want their machines electrified and radiofied. If you learn to render these services, you can easily make \$3.00 an hour for your spare time, to say nothing of the money you can make installing, servicing, repairing, building radio sets, and selling supplies.

Over \$600,000,000 is being spent yearly for sets, supplies, service. You can get your share of this business and, at the same time, fit yourself for the big-pay opportunities in Radio by joining the Association.

## Join the Radio Training Association of America

A membership in the Association offers you the easiest way into Radio. It will enable you to earn \$3.00 an hour upwards in your spare time—train you to install, repair and build all kinds of sets—start you in business without capital or finance an invention—train you for the \$3,000 to \$10,000 big-pay radio positions—help secure a better position at bigger pay for you. A

membership need not cost you a cent

The Association will give you a comprehensive, practical, and theoretical training and the benefit of its Employment Service. You earn while you learn. Our cooperative plan will make it possible for you to establish a radio store. You have the privilege of buying radio supplies at wholesale from the very first.

**Earned \$2,000 in Spare Time**  
Frank J. Deutsch, Penn.: "I have made over \$2,000 out of Radio in my spare time."

**Radio Engineer in One Year**  
Claude DeGrave, Canada: "I knew nothing about Radio when I joined a year ago. I am now a member of a very exclusive organization of Radio Engineers, and my income is 225% greater than it was."

**Doubles Income in 6 Months**  
W. E. Thon, Chicago: "Six months after I enrolled I secured the management of large Radio store and doubled my income."

Radio Training Association of America  
Dept. PM-6, 4513 Ravenswood Ave., Chicago

Gentlemen: Please send me by return mail full details of your Special Membership Plan, and also copy of your Radio Handbook.

Name.....

Address.....

City..... State.....

## ACT NOW—If You Wish the No-Cost Membership Plan

To a limited number of ambitious men, we will give Special Memberships that may not—need not—cost you a cent. To secure one, write today. We will send you details and also our handbook filled with dollars-and-cents radio ideas. It will open your eyes to the money-making possibilities of Radio.

Radio Training Association of America  
4513 Ravenswood Ave., Dept. PM-6, Chicago, Ill.

Now, Take Your Place in  
**AVIATION**  
Easily and Quickly

Fly  
Yourself

"Easy to  
Start"

Let This famous  
**WORLD-WAR  
FLYER**  
Teach You

Major Rockwell is a famous world-war flyer, decorated at the front with the Legion of Honor and the War Cross. As a member of the dare-devil French Lafayette Escadrille, he spent hundreds of thrilling hours in the air. Since the war he has devoted himself to teaching men eager to get the right start in Aviation. Let him train you for this great new industry as only a veteran world war flyer can train you—and your future in aviation is assured.

**Major R. L. Rockwell** AIR CORPS **U.S.R.**

Member of the Daring Lafayette Escadrille  
Chevalier of the French Legion of Honor

Invites You to Join Him  
in **AVIATION**

Thousands of Big Pay,  
Fascinating Jobs, on  
the Ground and in the  
Air, are Begging for  
Trained Men • NOW.

**MAN**—now you can get into AVIATION easily and quickly! Now you can take your place in the most thrilling, fastest growing industry in the world! Break away from low pay and humdrum work. Aviation is begging for trained men now—mechanics, builders, flyers—at \$50 to \$250 a week. In this new, uncrowded field of adventure and big pay a place is waiting for you. Let me

prepare you at home—in your spare hours, to be a successful air man. Let me give you in a few short months the store of practical aviation experience it took me many years to get. Let me prepare you for one of the thousands of big pay jobs. With my training, many men are now earning three and four times their former incomes. You can do the same. I'll not only train you at home—I'll also help you find the job you want after you graduate. Aviation is the game red-blooded fellows are flocking into. It is growing faster than the automobile or radio industry. Now—on the threshold of aviation's greatest development—is the time for YOU to act. Rush the coupon to me for FREE copy of my famous book. Every page will thrill you.

**ACTUAL FLYING to GRADUATES**  
in Dayton, where Aviation was Born

My practical home study course prepares you to fill any aviation ground job in America. You need no further training. It also prepares you to FLY. Then I'll bring you to Dayton—the cradle of aviation and the home of the Wright Brothers and Wright Field. Come here and get your actual flying at one of the world's finest and best equipped air ports. The mail service and the passenger lines are waiting for you. You can get into aviation quickly. You need no previous education or experience. Get the facts—and my remarkable tuition offer.

**Major Rob't L. Rockwell**  
**THE DAYTON SCHOOL OF AVIATION**  
Desk G-1 DAYTON, OHIO

Rush this coupon for my big FREE BOOK. No obligation to you.

Major Rob't L. Rockwell,  
The Dayton School of Aviation,  
Desk G-1, Dayton, Ohio.

Dear Major: Please send me ABSOLUTELY FREE a copy of your book on AVIATION and your remarkable tuition offer. I am not obligated.

Name.....

Address.....

Town..... State..... Age.....



**\$ 1 9 0 0 T O \$ 2 7 0 0 A Y E A R**



**FRANKLIN INSTITUTE, Dept. 5173, Rochester, N. Y.**

Rush to me entirely free of charge: 32 page book, with list of U. S. Gov't Jobs obtainable and particulars telling how to get the job here checked.

- ... Railway Postal Clerk . . . . . (\$1900-\$2700)
- ... Post Office Clerk . . . . . (\$1700-\$2300)
- ... City Mail Carrier . . . . . (\$1700-\$2100)
- ... Rural Mail Carrier . . . . . (\$2100-\$3300)
- ... Prohibition Agent . . . . . (\$2300-\$2800)

**MANY OTHER U. S. GOVERNMENT POSITIONS**

- Customs Clerks
- Rural Carriers
- City Mail Carrier
- City Postal Clerks

**MEN—BOYS 18 OR OVER**

- Short Hours
- Rapid Advancement
- Pleasant Work
- Permanent Employment
- Long Vacation with Pay

**Mail Coupon Now. Act at Once.**

**DO IT TODAY. TOMORROW YOU MAY FORGET.**

Name .....

Address .....

**Does Your English Help or Hurt You?**

Wonderful new way to improve your English. No rules to learn. No hard study. Grammar, spelling, punctuation, and expression, taught in 15 minutes a day—at home. Self-correcting feature makes it fascinating as a game. Write today for free book "How to Speak and Write Masterly English." Address



**SHERWIN CODY SCHOOL OF ENGLISH**  
56 Searle Building Rochester, N. Y.

**LAW**

**STUDY AT HOME**

Become a lawyer. Legally trained men win high positions and big success in business and public life. Be independent. Greater opportunities now than ever before. Big corporations are headed by men with legal training. Earn

**\$5,000 to \$10,000 Annually**

We guide you step by step. You can train at home during spare time. Degree of LL.B. conferred. LaSalle students found among practicing attorneys of every state. We furnish all text material, including fourteen-volume Law Library; Low cost, easy terms. Get our valuable 64-page "Law Guide" and "Evidence" books FREE. Send for them NOW. LaSalle Extension University, Dept. 664-L, Chicago, The World's Largest Business Training Institution

**LEARN CARTOONING**

**AT HOME DURING SPARE TIME**

with the course that has trained HUNDREDS of beginners successfully. The Landon Picture Chart Method of teaching ORIGINAL drawing by mail makes cartooning easy to learn. This school is a Member of The National Home Study Council. Write today for sample picture chart to TEST YOUR ABILITY and examples of the work of successful students now earning from \$50 to \$200 and more per week. Enclose 6c in stamps and STATE YOUR AGE.

**THE LANDON SCHOOL, 2838 National Bldg., Cleveland, Ohio**



**PATENTS**

**Booklet Free Highest References Promptness Assured Best Results**

Send drawing or model for preliminary examination and advice.

**ALL BUSINESS GIVEN PROMPT AND PROPER ATTENTION**

Listed Patent Lawyer in the latest editions of the Rand-McNally Directory of Bankers and Bonded Attorneys, published by Rand-McNally & Co., Chicago, Ill.; The Baggott & Ryall Directory of Guaranteed Attorneys, published by the Ryall Legal Directory Company, New York City; Flugel's List, published by the Legal Directory Publishing Co. of St. Louis, Mo.; the American Lawyers Annual, published in Cleveland, Ohio; Eyre's Law List, Bush Terminal Building, New York City.

**WATSON E. COLEMAN,**  
REGISTERED PATENT LAWYER

Victor Building, 724 Ninth Street, N. W.  
**WASHINGTON, D. C.**

# A FRANTIC CALL FOR MEN WHO CAN READ BLUE PRINTS OF BUILDINGS

## Leads Quickly to Jobs Paying \$4,000 to \$12,000 a Year

See how easy it is to get into the building game. Nowhere else does such simple training count for so much. Nowhere else can a man make \$4,000 to \$12,000 a year so quickly and so easily. Nowhere else are there so many countless thousands of openings as there are with contractors, builders, and real estate firms, who are constantly calling for men who can read blue prints. Six billion dollars a year is spent for building. Trained men are at a premium in this gigantic industry. Untold thousands are needed at steady salaries far above the scale wage.

# 90

## DAYS' EASY TRAINING PUTS YOU IN THE 6 BILLION DOLLAR BUILDING FIELD

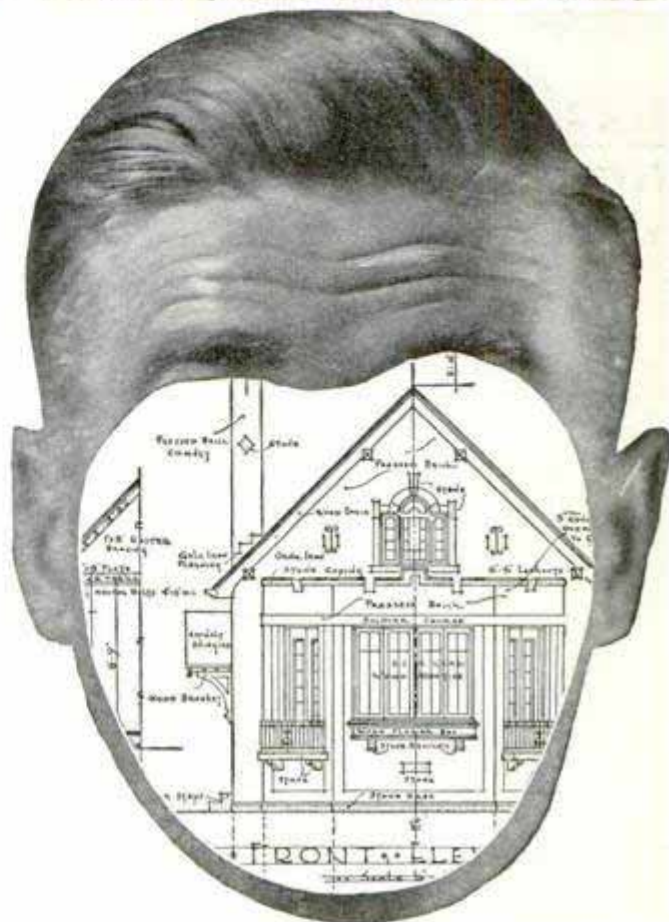

NO longer is it necessary to start at the bottom of the building trades and spend years to work up. Now you can get three years' training in three months. There are no barriers to your success in the great outdoor building field. You do not need more than a common school education. We train you at home, in spare time, by the fascinating blue print method with lessons that are as easy to read as your newspaper.

These tested plans come to you from one of the oldest and largest schools of building construction and superintendence in the country. This course is endorsed by leading contractors and master builders. These tested, practical plans and lessons are the kind of training that puts men in \$5,000 to \$15,000 jobs and in profitable building and contracting businesses of their own. You learn from actual blue print plans—from practical building experts—you learn how to read all the plans, estimate the costs and supervise the entire construction of a building—you learn everything a contractor has to know when he undertakes the construction of a building.

Amazing opportunities are open to you when you know blue prints, plans, estimating and construction. There is building superintending—the best outdoor profession on earth—that pays handsome salaries and often a bonus for efficient work. Clifford Scholl went from clerk to Asst. Superintendent at 49% increase in salary in 8 months. Thousands of builders and contractors need men like Clifford Scholl.

**IF YOU LIVE IN OR NEAR CHICAGO**

Visit our School for Builders, open day or evening. Thousand men attend each year. Enter any time. You can get the same training at home, by mail. Same plans; same lessons; same instructors. The Coupon brings all facts FREE.

**Every Job Must Have a Contractor**

The building field is wide open for men who want to go into business for themselves. Henry Mehl, Pa., a policeman, now owns his own contracting business. Burgert, Ill., stepped into a foremanship at 200% increase in salary. Busch, Kan., writes, "I have been offered \$300 a month several times." Boyes, Can., writes, "Your school has increased my wages 40% already." Patrick, Mich., says: "My salary has been increased 92%." Marchand, La., writes, "I am getting along fine. My salary is now increased 196%."

**Chicago Technical SCHOOL for BUILDERS**

Dept. G-142, 118 E. 26th Street, Chicago, Ill.

If you really want more money—if you hope to own a business of your own—get into the building business . . . no matter what your job is now. No overcrowding in this tremendous field—room for thousands every day. Why buck competition in crowded industries where only a few men can succeed?

Clerk or carpenter—office man or bricklayer—salesman or superintendent—it makes no difference. You can get into the building business quickly . . . easily. Or if you are in it at present, get this training now that you must have for success.

## FREE Trial Lesson

Simply mail the coupon below for an intensely interesting free book, "How to Read Blue Prints," and full information. See what fascinating fun this first trial lesson is. Get these facts before you. See what amazing opportunities open up for you in the Six Billion Dollar Building Field. Don't wait or delay. Act now. Simply mail the coupon below.



Chicago Technical School for Builders, Dept. G-142, 118 E. 26th Street, Chicago, Ill.

Send me, without obligation, your free book, "How to Read Blue Prints," and full details of the course and the opportunities in the Building Field. It is understood that no salesman will call on me.

Name.....

Address.....

City..... State.....

Age..... Occupation.....



# “The Boss Was Stumped”

“HE WAS trying to figure out a way to speed up the machines. I could see he was stumped and I asked him if he would let me try my hand at it.

“Go ahead,” he said, “but I don’t believe you can help much. Looks like an outside job to me.”

“So I started right in and pretty soon I had the whole thing worked out. The boss was watching me and I could see he was surprised.

“How did you learn all that?” he asked in that quiet way of his. And then I told him I’d been studying at home nights through the International Correspondence Schools.

“He didn’t say anything more and I thought he had forgotten all about it until he called me in his office a few weeks later and said he was going to make me foreman and increase my salary \$75 a month.

“Keep on studying,” he told me, “and you’ll get another promotion soon. You can’t beat those International Correspondence Schools text-books for good, sound, practical knowledge.”

That’s a true story of what spare-time study has done for just one man. There are thousands of others. Why don’t you take up a home-study course with the International Correspondence Schools and prepare yourself to earn more money? At least get the facts.

Mail the Coupon for Free Booklet

INTERNATIONAL CORRESPONDENCE SCHOOLS  
Box 5621-F, Scranton, Penna.

Without cost or obligation, please send me a copy of your booklet, “Who Wins and Why,” and full particulars about the course before which I have marked X in the list below:

**TECHNICAL AND INDUSTRIAL COURSES**

- |  |   |
|--|---|
| <input type="checkbox"/> Architect               | <input type="checkbox"/> Automobile Mechanic                                |
| <input type="checkbox"/> Architectural Draftsman | <input type="checkbox"/> Aviation Engines                                   |
| <input type="checkbox"/> Building Foreman        | <input type="checkbox"/> Plumber and Steam Fitter                           |
| <input type="checkbox"/> Concrete Builder        | <input type="checkbox"/> Plumbing Inspector                                 |
| <input type="checkbox"/> Contractor and Builder  | <input type="checkbox"/> Foreman Plumber                                    |
| <input type="checkbox"/> Structural Draftsman    | <input type="checkbox"/> Heating and Ventilation                            |
| <input type="checkbox"/> Structural Engineer     | <input type="checkbox"/> Sheet-Metal Worker                                 |
| <input type="checkbox"/> Electrical Engineer     | <input type="checkbox"/> Steam Engineer                                     |
| <input type="checkbox"/> Electrical Contractor   | <input type="checkbox"/> Marine Engineer                                    |
| <input type="checkbox"/> Electric Wiring         | <input type="checkbox"/> Refrigeration Engineer                             |
| <input type="checkbox"/> Electric Lighting       | <input type="checkbox"/> R. R. Positions                                    |
| <input type="checkbox"/> Reading Shop Blueprints | <input type="checkbox"/> Highway Engineer                                   |
| <input type="checkbox"/> Telegraph Engineer      | <input type="checkbox"/> Chemistry  |
| <input type="checkbox"/> Telephone Work          | <input type="checkbox"/> Pharmacy   |
| <input type="checkbox"/> Mechanical Engineer     | <input type="checkbox"/> Coal Mining Engineer                               |
| <input type="checkbox"/> Mechanical Draftsman    | <input type="checkbox"/> Navigation <input type="checkbox"/> Assayer        |
| <input type="checkbox"/> Machine Shop Practice   | <input type="checkbox"/> Iron and Steel Worker                              |
| <input type="checkbox"/> Toolmaker               | <input type="checkbox"/> Textile Overseer or Supt.                          |
| <input type="checkbox"/> Patternmaker            | <input type="checkbox"/> Cotton Manufacturing                               |
| <input type="checkbox"/> Civil Engineer          | <input type="checkbox"/> Woolen Manufacturing                               |
| <input type="checkbox"/> Surveying and Mapping   | <input type="checkbox"/> Agriculture <input type="checkbox"/> Fruit Growing |
| <input type="checkbox"/> Bridge Engineer         | <input type="checkbox"/> Poultry Farming                                    |
| <input type="checkbox"/> Gas Engine Operating    | <input type="checkbox"/> Mathematics <input type="checkbox"/> Radio         |

**BUSINESS TRAINING COURSES**

- |  |   |
|--|---|
| <input type="checkbox"/> Business Management                     | <input type="checkbox"/> Business Correspondence      |
| <input type="checkbox"/> Industrial Management                   | <input type="checkbox"/> Show Card and Sign Lettering |
| <input type="checkbox"/> Personnel Management                    | <input type="checkbox"/> Stenography and Typing       |
| <input type="checkbox"/> Traffic Management                      | <input type="checkbox"/> English                      |
| <input type="checkbox"/> Accounting and C. P. A. Coaching        | <input type="checkbox"/> Civil Service                |
| <input type="checkbox"/> Cost Accounting                         | <input type="checkbox"/> Railway Mail Clerk           |
| <input type="checkbox"/> Bookkeeping                             | <input type="checkbox"/> Mail Carrier                 |
| <input type="checkbox"/> Secretarial Work                        | <input type="checkbox"/> Grade School Subjects        |
| <input type="checkbox"/> Spanish <input type="checkbox"/> French | <input type="checkbox"/> High School Subjects         |
| <input type="checkbox"/> Salesmanship                            | <input type="checkbox"/> Cartooning                   |
| <input type="checkbox"/> Advertising                             | <input type="checkbox"/> Illustrating                 |
|  | <input type="checkbox"/> Lumber Dealer                |

Name.....

Address.....

City..... State.....

Occupation.....

If you reside in Canada, send this coupon to the International Correspondence Schools Canadian, Limited, Montreal, Canada

## Books on 65 Practical Subjects

Popular Mechanics Press specializes in supplying the outstanding best books on many subjects. As new books of merit appear, we will revise the list accordingly.

- |   |  |
|---|--|
| <b>AIR NAVIGATION AND METEOROLOGY</b><br>Simplified, non-technical \$3.00           | <b>INVESTMENT</b><br>Policies that pay<br>By Ray Vance..... \$4.00                             |
| <b>AIRCRAFT ENGINES</b><br>Dyke's New Instructor<br>Latest Types..... \$5.00        | <b>JOINT WIPING</b><br>(New Edition)..... \$1.00   |
| <b>ARCHITECTURAL</b><br>Drawing and Lettering \$2.00                                | <b>LACQUERING</b><br>(Practical). Valuable<br>New Book for Metal<br>Working Industry... \$3.50 |
| <b>ARMATURE WINDING</b><br>and Motor Repairs... \$3.00                              | <b>LANDSCAPING</b><br>Practical..... \$2.50  |
| <b>AUTO ENCYCLOPEDIA</b><br>Dyke's. (Covers New<br>Model A Ford)..... \$6.00        | <b>LATHE WORK (METAL)</b><br>and Drilling and Thread<br>Cutting..... \$1.00                    |
| <b>AVIATION</b><br>Everybody's Guide... \$2.00                                      | <b>LETTER WRITING</b><br>Social and Business<br>Only..... \$1.00                               |
| <b>BIRD HOUSES</b><br>How to Make..... \$1.00                                       | <b>MACHINIST</b><br>419 Kinks for..... \$1.50  |
| <b>BLUE PRINTS</b><br>How to Read..... \$2.00                                       | <b>MAGIC</b><br>200 New Tricks for Amateurs..... \$1.00  |
| <b>BOAT BUILDING</b><br>Outboard Motor Type<br>30 Designs..... \$3.00               | <b>MAKING THINGS YOURSELF</b><br>900 Different Articles... \$3.00                              |
| <b>BOY MECHANIC</b><br>4 Vol. Library. Covers<br>4000 Things to Make. \$7.00        | <b>MATHEMATICS</b><br>Made Easy for the Practical Man..... \$1.50                              |
| <b>BUILT-IN FURNITURE</b><br>How to Make..... \$2.50                                | <b>MECHANICAL DRAWING</b><br>Practical Course in... \$1.00                                     |
| <b>CARPENTRY</b><br>Handbook of Kinks... \$1.50                                     | <b>MODEL AIRCRAFT</b><br>Building and Flying for<br>Boys..... \$2.25                           |
| <b>CHEMISTRY</b><br>For Old and Young Beginners..... \$2.50                         | <b>MOVIE MAKING</b><br>for Amateurs..... \$3.00  |
| <b>CIVIL SERVICE</b><br>How to Prepare for... \$3.00                                | <b>OUTDOOR OPPORTUNITIES</b><br>for Making a Living... \$2.00                                  |
| <b>COLOR SIMPLIFIED</b><br>Practical (for Color Users)..... \$3.50                  | <b>OUTDOOR SPORTS</b><br>for All Year 'Round... \$1.50   |
| <b>CONCRETE</b><br>173 Ways of Using<br>New Edition (Cloth) \$1.00                  | <b>PAINTING</b><br>House (Best Methods) \$2.00   |
| <b>CONTRACTOR</b><br>Building Cost Estimator \$2.00                                 | <b>PETS</b><br>For Pleasure and Profit. \$2.00   |
| <b>DICTIONARY (ENGLISH)</b><br>New, Simplified, 1500<br>Pages, 3000 Illus... \$5.00 | <b>PLUMBING</b><br>Repair Your Own..... \$1.50   |
| <b>DIESEL ENGINES</b><br>(New Work). Best Authority..... \$5.00                     | <b>POLTRY RAISING</b><br>for Profit..... \$2.00  |
| <b>DOGS</b><br>Care and Raising..... \$2.00   | <b>POWER WIRING (D. C.)</b><br>Electrical (Just Out) \$3.50                                    |
| <b>ELECTRICIAN</b><br>214 Practical Kinks... \$1.50                                 | <b>PUZZLES</b><br>Amusing Mathematical \$1.50  |
| <b>ELECTROPLATING</b><br>Practical Results Easily<br>Obtained..... \$1.00           | <b>RADIO</b><br>Trouble Shooting..... \$3.00   |
| <b>ENAMELING</b><br>and Japanning (Baked<br>Finishing)..... \$3.50                  | <b>ROPE SPINNING</b><br>Only Book on Subject... \$1.50   |
| <b>ENGLISH</b><br>Self-Improvement in... \$2.50                                     | <b>SHIP MODEL</b><br>Making..... \$2.50  |
| <b>ETIQUETTE</b><br>New 560-Page Book.<br>Only..... \$1.00                          | <b>SHOP NOTES</b><br>16 Vols. of 6000 Valuable<br>Kinks..... \$5.00                            |
| <b>FARMERS' BOOK</b><br>of 861 Kinks and Book<br>for Farmers' Wives... \$1.00       | <b>SKYSCRAPERS</b><br>and the Men Who Build<br>Them. For the Layman... \$3.50                  |
| <b>FLY (HOW TO)</b><br>Written So a Boy Can<br>Understand It..... \$2.50            | <b>STEEL SQUARE</b><br>Pocket Book, Practical \$1.00   |
| <b>FORMULAS</b><br>10,000 Money Making \$4.00                                       | <b>TAXIDERMY</b><br>Best Book of Methods... \$3.50   |
| <b>FURNITURE</b><br>Homemade (3 vols.)... \$3.00                                    | <b>TENNIS</b><br>By Helen Wills..... \$2.00  |
| <b>HEATING</b><br>Systems (Practical) and<br>Ventilation..... \$4.00                | <b>WELDING</b><br>ENCYCLOPEDIA<br>All Methods..... \$5.00                                      |
| <b>HOME REPAIRS</b><br>Practical Book of... \$2.50                                  | <b>WIRING</b><br>House (New Book)... \$2.50  |
| <b>INVENTIONS (AMERICAN)</b><br>Popular History of<br>2 vols. Reduced to... \$5.00  | <b>WOOD TURNING (LATHE)</b><br>Practical Course in... \$1.50                                   |
|   | <b>WOODCRAFT</b><br>Famous 590 Page Book<br>by Ernest Thompson<br>Seton; Only..... \$1.00      |

## Books sent C. O. D. anywhere in U.S.

Just check the books you want, write your name and address below, and mail the advertisement. It is your order blank. When postman hands you books, pay him the price and the postal charges. If outside the U. S. remit when ordering and include 10 cents per book extra for postage. We have many other books on these and 2,000 other subjects. Catalog free.

Name.....

City..... State.....

Address.....

Mail to Popular Mechanics Press,  
Room P6—200 East Ontario St., Chicago, Ill.



# Learn AVIATION at GREER COLLEGE

## Come into Aviation

### Man's Dream Is Answered—Aviation Is Here

#### Transport Flyers will train you

Greer Air Transport supervises all flying instruction. Greer pilots have had long experience in instruction and transport flying. You are safe and will learn quickly with their expert help.

and Civilian Aviation Experience—supervises all ground schooling. He has been in Aviation and actual Flying for over twelve years.

#### Earn Big Money in a 4 Hour Day

What are a Flyer's hours? Four Hours—not work—but fun—nevertheless those are usually the hours for him.

And the pay! Many make \$300 on a single Sunday. My Free Book gives astonishing details. Send for it now!

**Adventure—Prestige—Thrills—BIG PAY—Easy, Fascinating work that IS Aviation.**

#### Capt. Bryan superintends ground training

Captain Bryan—with years of Army

#### I'll pay your fare to Chicago

Come to Chicago. I'll pay your fare when you enroll. Here is the **real** hub of the Aviation Industry. The World's finest and biggest Airport is here. Get my Free Book — tells all remarkable facts.

#### LEARN DAYS OR EVES A Job while Learning

You can attend the Great Shops of Greer College and learn Aviation either days or eves. We even help get you a job so you earn as you learn—in short—what does this wonderful training cost? Nothing!



Erwin Greer



### HOW!

I offer you a \$100 a week opportunity, perhaps more. But you must prepare. \$100 a week jobs mean nothing unless you can hold those jobs—so Prepare. I make it easy—26 years doing it—proves it, so when those jobs arrive—be ready—I'll help you get them—but be able to hold them.

**TODAY** Tomorrow is just a day—but think—is it to be a day **wasted** or a day **rushing** to success? Think of it. Tomorrow, may be just the second day to your real triumph—but tomorrow can't possibly come before today. I ask you to do nothing but find out for yourself. My Book is Free. Look at it at least, it costs you nothing and it **will** help you if you enroll or don't.

Sincerely, **ERWIN GREER, Pres.**

## GREER COLLEGE

**Dept. 601**  
**2024 So. Wabash Ave.**  
**CHICAGO**



**ERWIN GREER,**  
President  
Dept. 601  
2024 So. Wabash Avenue,  
Chicago, Illinois

Send Free Book and details of Special offer, without obligation to me.

Name.....  
Address.....  
Age.....

# You can play the HAWAIIAN GUITAR just like the Hawaiians!

Play all the latest hits just as the Hawaiians do. Be the most popular member of your set, a happy crowd always around you, everybody enjoying and admiring your playing. Get in on all the good times. Entertain your friends—or play professionally. We will help you.



### Native Hawaiian expert directs you

You get expert instruction, directed by a world-famous player and teacher, Prof. Walter Kolomo-ku. He quickly reveals to you the secrets of this fascinating instrument.

### Complete Conservatory Course

You get 52 complete printed lessons. Nothing is omitted. Pictures explain every move. And no matter how little you know about music when you begin, no matter if you have never touched a musical instrument, you can positively learn to play by our plain, easy picture method. You are sure to learn! What we can do for others we can do for you. 51,000 successful students. This record assures your success.

### Learn at home in spare time

Study in spare time—in absolute privacy—when you like—as long as you like. Even if you don't know one note from another, our method is so simple you begin a piece your first lesson. In half an hour you can play it!

### Only 4 motions to learn

Then you can play any music—popular songs, classical, old-time melodies, native Hawaiian airs—or real jazz—separately or with accompaniment. You'll never be lonesome after you learn to play on this beautiful Hawaiian Guitar.

# GIVEN when you enroll— \$18 to \$20 Hawaiian Guitar

With Genuine Seal Grain Fabrikoid Cover and Complete Playing Outfit

Reliable retailers ask \$18 to \$20 for a similar instrument and outfit without the fine Fabrikoid Case, which alone is valued at \$3.50. Yet you receive this sweet-toned splendidly built Hawaiian Guitar, case and entire playing outfit, including picks, steel playing bar, tuning pipe, etc., without one penny of expense, as soon as you enroll.

### Pay as you play

We make it easy for you. Start any time with a small first payment—then pay while learning. It comes to only a few cents per lesson. And bear in mind: Your only investment is the cost of the course—we furnish everything else.

### No waiting—begin now

No waiting for a class to form—begin at once. The sooner you do, the sooner you will realize your ambition to become a real Hawaiian Guitarist. ACT!

OTHER COURSES: Tenor Banjo, Violin, Tiple, Tenor Guitar, Ukulele, Banjo Ukulele—well-known instructors.

### FIRST HAWAIIAN CONSERVATORY OF MUSIC, Inc.

9th Floor Woolworth Bldg. Dept. 648 New York, N. Y. Approved as a Correspondence School Under the Laws of the State of New York. Member of National Home Study Council.



### Send This Coupon for Liberal Offer!

FIRST HAWAIIAN CONSERVATORY OF MUSIC, Inc. 9th Fl., Woolworth Bldg., Dept. 648, New York, N. Y.

Please send full information about your 52-lesson Hawaiian Guitar Course. I am not obligated to enroll unless I want to.

Name \_\_\_\_\_  
 Address \_\_\_\_\_  
 City \_\_\_\_\_ State \_\_\_\_\_



## LEARN BY DOING

Every phase of all branches of

# ELECTRICITY

taught by

## Actual Practice

In one of America's foremost institutions for trade training

ESTABLISHED 1902

## No Books Used

Individual Instruction Start Any Day

Write for FREE 64-page catalog

## THE NEW YORK ELECTRICAL SCHOOL

44 West 17th St., New York City



# LAW Free Book

Write today for FREE 64-page book, "THE LAW-TRAINED MAN", which shows how to learn law in spare time through the Blackstone home-study course prepared by 80 prominent legal authorities, including law school deans, and U. S. Supreme Court justices. Combination text and case method of instruction used. All material necessary furnished with the course, including elaborate 25-volume law library, delivered immediately upon enrollment. Many successful attorneys among our graduates. LL. B. degree conferred. Moderate tuition, low monthly terms. Money-Back Agreement. Write for free book today.

BLACKSTONE INSTITUTE, 807 N. Michigan Ave. Dept. 50-A Chicago



# BE AN ARTIST

WE CAN TEACH YOU DRAWING in your own home during your spare time. Twenty-five years of successful teaching proves our ability. Artists receive large salaries.

Write Today for Art Year Book  
**SCHOOL OF APPLIED ART**  
 ROOM NO. 2 BATTLE CREEK MICH.



## Learn Watchwork, Jewelrywork and Engraving

A fine trade commanding a good salary, and your services always in demand. Address **HOROLOGICAL**, Dept. P, Bradley Institute, PEORIA, ILLINOIS, for our latest catalog.



WHY NOT spend Spring, Summer and Fall gathering butterflies, insects? I buy hundreds of kinds for collections. Some worth \$1 to \$7 each. Simple outdoor work with my instructions, pictures, price-list. Send 10 cents (not stamps) for my illustrated Prospectus before sending butterflies. MR. SINCLAIR, DEALER IN INSECTS, Dept. 6, Box 1424, San Diego, Calif.



Wonderful, new device, guides your hand; correct your writing in few days. Big improvement in three hours. No failures. Complete outline FREE. Perfect Penmanship Inst. D-34, St. Louis, Mo.

# Just Learn These 5 Simple Steps

—And you can dance  
with anyone

**N**O matter how poorly you dance now—even if you've never been on a dance floor in your life—my new method of teaching dancing is so simple and easy to understand that you can master any of the latest steps in one evening — without music, partner, or teacher!

For I have discovered that all modern dancing is based upon *five fundamental movements*. The step pictured here is one of these basic movements. *The other four are just as simple*. Once you have mastered these key steps you can learn to do any dance—no matter how complicated it may appear—in almost no time.

## How to Be Popular

Think what that means! Good dancers are always popular—always sure of a good time wherever they go! And dancing is great fun—wonderful exercise. It takes your mind off your worries and cares. Keeps you happy and healthy—always on your toes and full of pep. Develops self-confidence—gives you poise—helps you overcome timidity and awkwardness. It enables you to make friends easily—to be well-liked—and often opens the doors to important business and social contacts.

And it's so easy now to be a good dancer and get your full share of fun and popularity! As soon as you receive the lessons you can learn the fundamental steps—in just a few hours. Then the very next time dancing starts, you can surprise your friends by stepping right on the floor with the best dancers in your set—and with as much ease and assurance as if you had been dancing for years!

For my new method makes learning to dance just as simple as taking one step after another. Nothing is omitted—nothing taken for granted. You start right at the beginning, and go through the entire field of social dancing. You learn to master every step from the simple waltz to the newest, smartest dances and all their variations.

## Five Lessons FREE

I have already taught over 400,000 men and women how to dance at home without music, partner, or teacher. And I'm so sure that you, too, can become a good dancer and get your full share of fun and

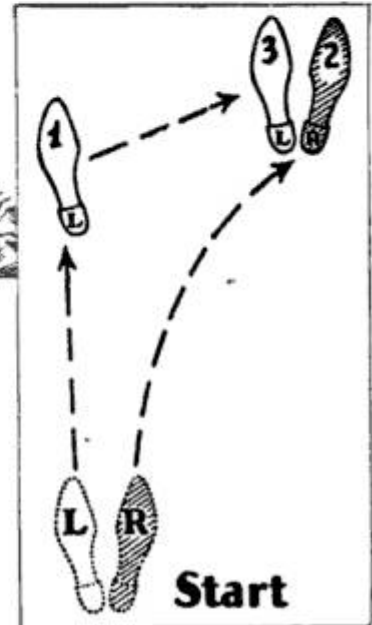

popularity through my amazingly easy method that I'm willing to send you five lessons from my remarkable course, *without charge*.

Simply send the coupon, with 10c to cover cost of printing and mailing, and these valuable lessons will be forwarded at once. Also a free copy of my new booklet "The Short Cut to Popularity." Don't wait — you owe it to yourself to clip and mail the coupon

NOW. ARTHUR MURRAY, Studio 928, 7 East 43rd St., New York City.

ARTHUR MURRAY,  
Studio 928, 7 East 43rd Street, New York City.

To prove that I can learn to dance at home you may send the FIVE FREE LESSONS. I enclose 10c (stamps or coin) to pay for postage, printing, etc. You are to include free "The Short Cut to Popularity."

Name.....

Address.....

City.....State.....



Here is Edwin McTeer (address on request) and some of his work. The crude pen drawing was made before he had any training and the striking story illustration (worth \$100) was made after he took the Federal Home Study Course.

# He did it— Why don't you?

Edwin McTeer is only one of the hundreds of young men (and young women, too) who are succeeding in commercial art with the help of the practical training offered by the Federal Home Study Course. Well trained artists earn \$50, \$75, \$100, \$150 a week and more.

## SUCCESS IN COMMERCIAL ART

begins with a liking for drawing and the ambition to follow through with the right training. Mr. McTeer was thirty years old when he clipped a coupon like the one at the bottom of this ad, and took up the Federal Course. He progressed rapidly, increasing his earnings each year until, at the end of five years, he was making around \$10,000 a year. Read what he wrote us:

"I was not very talented when I entered this training with you people as you certainly know, and I had not even had high school training and I know any one with a love for the work can accomplish even more than I if they will just let you people, the Federal Schools, help them.  
"I suppose you remember I opened my own independent commercial art studio and, to make a long story short, my earnings are now at the rate of over \$10,000 a year."

## SEND FOR "YOUR FUTURE"

If you like to draw—send for book "Your Future" and find out what amazing progress you can make with the right art training. Use the coupon now, giving age and occupation.



# Federal School

of Commercial Designing

643 Federal Schools Bldg., Minneapolis, Minn.  
Please send me "Your Future."

Age ..... Present Occupation .....

Name .....

Address .....

**ACCOUNTING LESSON FREE**

Don't wonder about Accounting Courses

Find out about this one by trying it free

Send for our 84-page book "How to Learn Accounting" and the first lesson free of charge.

INTERNATIONAL ACCOUNTANTS SOCIETY, INC.  
A Division of the  
ALEXANDER HAMILTON INSTITUTE  
Dept. 48, 3411 So. Michigan Ave., Chicago

## MUSIC LESSONS IN YOUR HOME



You can read Music like this quickly

Write today for our FREE booklet. It tells how to learn to play Piano, Organ, Violin, Mandolin, Guitar, Banjo, etc. Beginners or advanced players. Your only expense about 3c per day for music and postage used. American School of Music, 51 Manhattan Bldg., Chicago.

**STAMMERING**

easily, permanently corrected. Win happiness and success. Ask for full information and special phonograph record. Send dime for postage

12972 Woodward Ave., LEWIS INSTITUTE, Detroit

**LEARN WATCHMAKING AND ENGRAVING**

BY OUR PROFIT-SHARING PLAN  
**OUR GRADUATES SUCCEED**

One of our Iowa students started in a very small way—now doing over \$30,000 a year. Another in Wisconsin, over \$10,000 the first year. Day or night classes. Call or write for FREE BOOK.

Chicago School of Watchmaking, Dept. 5301, 549 W. Randolph St., CHICAGO

# BIG Demand for Skilled Mechanics!

The entire country is calling for skilled mechanics! Good pay—steady work—good opportunities for advancement! Master this fascinating trade with the aid of the

**AMERICAN MACHINISTS' LIBRARY**

6 volumes—2,000 pages—2,500 illustrations

(A combined home-study course and reference library)

This library of machine shop practice was written for practical men. It gives you the best methods for every kind of machine shop work. It explains machine tools and their operation, tool work, gears and grinding, jigs and fixtures, automatic screw machines, their tools, punches, dies, etc. Plainly written—completely illustrated—the best kind of help to the machine-shop man who wants to advance himself.

Free TRIAL No money down—only 7c a day

**FREE EXAMINATION COUPON**

McGraw-Hill Book Co., Inc., 370 Seventh Ave., New York

Send me for 10 days' free examination the AMERICAN MACHINISTS' LIBRARY. If satisfactory, I will send \$1.50 in 10 days and \$2 monthly until the special price of \$17.50 is paid. If not wanted, I will return the books at your expense.

Signed .....

Address .....

City and State .....

Position .....

Company .....

P. M. 6-29

**H**ERE is an airplane view of the famous PORTERFIELD School. This institution is one of the largest and best-equipped in the world and trains men for all phases of aviation work.

It is located in the heart of FAIRFAX Airport at Kansas City, recognized as a center of U. S. aviation. In this area are some of the largest manufacturers of planes and parts in the country.

The PORTERFIELD system of direct, intensive training is said to be the best of its kind, graduating men quickly and effectively.

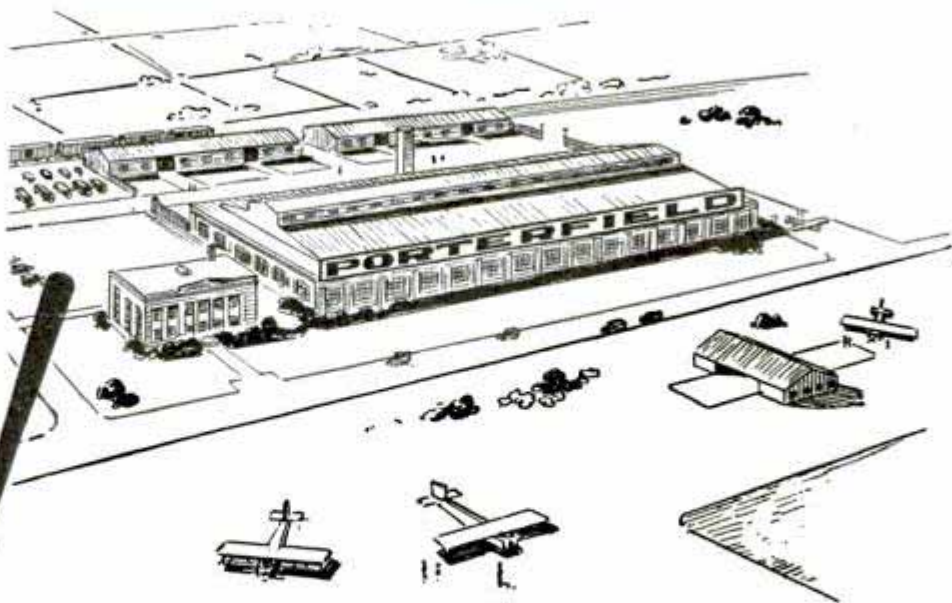

*Now!*

## Aviation Demands Porterfield Men

### You Learn Best By Actual Experience

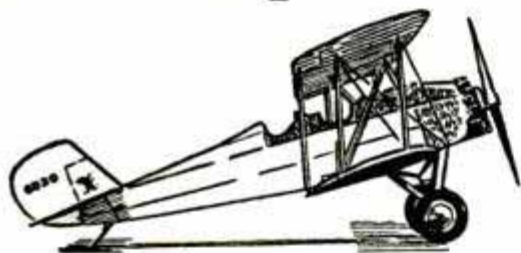

There's only one way to enter aviation right and immediately start to earning big money. That's by actually doing the work on motors, wings, fuselages, etc. That is the secret of PORTERFIELD Success. Under the careful teaching of nationally-known instructors only a few short weeks of training in this fine, modern factory fits you for a big job, at a big salary.

Here you tear down a motor entirely and rebuild it—actually tune and rig planes, dope wings, assemble units. PORTERFIELD training is recognized as best by factories and distributors all over the United States and the demand for PORTERFIELD graduates far exceeds the supply. Whether you decide to be a pilot or ground-worker, PORTERFIELD training insures you immediate success. Make up your mind to enter aviation today—do it the sure, quick way through PORTERFIELD.

E. E. PORTERFIELD, President,

# PORTERFIELD University of Aviation

1451 Grand Ave., KANSAS CITY, MO.

**M**ORE PORTERFIELD-Trained men is the constant cry of the aviation industry. So efficient and successful have PORTERFIELD graduates been in aviation work that the demand for graduates exceeds the supply. Factories, distributors and private owners insist on men trained under this direct, practical system. Aviation jobs pay all the way from \$300.00 to \$900.00 a month. Only a grammar school education and a normal body is required to enter PORTERFIELD.

## Choose Any of These Big Pay Jobs

For every pilot in the air there are many jobs paying big money on the ground. Trained men are in demand for  
**PILOTS** (transport, commercial and private) **LICENSED MECHANICS**  
**FACTORY WORK** **PLANE SALESMEN** **ASSEMBLERS**  
**INSPECTORS** **WOOD AND METAL WORKERS** **RIGGERS**

*PORTERFIELD Men are Qualified for Department of Commerce Licenses as Licensed Pilots and Licensed Mechanics.*

## Get Your Copy of This

**BIG FREE ILLUSTRATED BOOK**—If you want to enter the greatest industry of the century, write today for this big, free, illustrated book, "A Flying Message". Tells all about Aviation Opportunities, with details of airplane construction, how to fly, map-making, new instruments—a complete treatise on Aviation. Very valuable in assisting you to choose the proper aviation field to enter. Sent **ABSOLUTELY FREE AND YOU ARE UNDER NO OBLIGATION**. Simply send name and address or fill in this handy coupon.

PORTERFIELD UNIVERSITY OF AVIATION  
 1451 Grand Avenue, Kansas City, Mo.  
 Send me a free copy of "A Flying Message."

Name .....

Address .....

City..... State.....

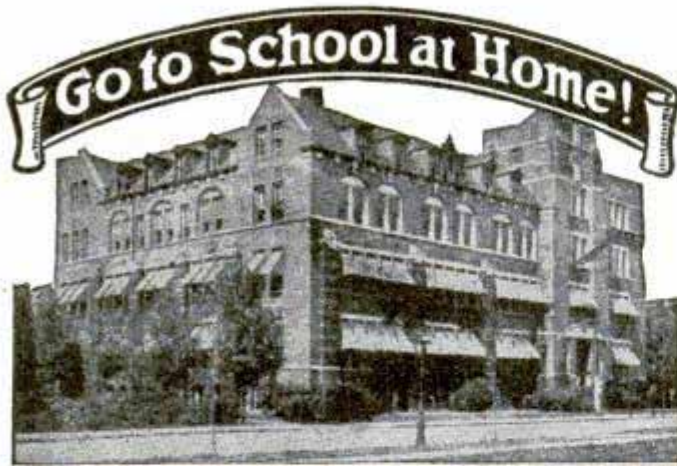

# High School Course in Two Years!

## You Want to Earn Big Money!

And you will not be satisfied unless you earn steady promotion. But are you prepared for the job ahead of you? Do you measure up to the standard that insures success? For a more responsible position a fairly good education is necessary. To write a sensible business letter, to prepare estimates, to figure cost and to compute interest, you must have a certain amount of preparation. All this you must be able to do before you will earn promotion. Many business houses hire no men whose general knowledge is not equal to a high school course. Why? Because big business refuses to burden itself with men who are barred from promotion by the lack of elementary education.

### Can You Qualify for a Better Position

We have a plan whereby you can. We can give you a complete but simplified high school course in two years, giving you all the essentials that form the foundation of practical business. It will prepare you to hold your own where competition is keen and exacting. Do not doubt your ability, but make up your mind to it and you will soon have the requirements that will bring you success and big money. YOU CAN DO IT.

Let us show you how to get on the road to success. It will not cost you a single working hour. Write today. It costs you nothing but a stamp.

### American School

Dept. HA-74 Drexel Ave. and 58th St., Chicago

### American School

Dept. HA-74 Drexel Ave. and 58th St., Chicago

Send me full information on the subject checked and how you will help me win success.

- |                              |                            |
|------------------------------|----------------------------|
| .... Architect               | .... Business Law          |
| .... Building Contractor     | .... Lawyer                |
| .... Automobile Engineer     | .... Machine Shop Practice |
| .... Automobile Repairman    | .... Mechanical Engineer   |
| .... Civil Engineer          | .... Shop Superintendent   |
| .... Structural Engineer     | .... Employment Manager    |
| .... Business Manager        | .... Steam Engineer        |
| .... Cert. Public Accountant | .... Foremanship           |
| .... Accountant and Auditor  | .... Sanitary Engineer     |
| .... Bookkeeper              | .... Surveyor (& Mapping)  |
| .... Draftsman and Designer  | .... Telephone Engineer    |
| .... Electrical Engineer     | .... Telegraph Engineer    |
| .... Electric Light & Power  | .... High School Graduate  |
| .... General Education       | .... Wireless Radio        |
| .... Vocational Guidance     | .... Undecided             |

Name.....

Address.....

# attractive professions ART and ADVERTISING

Meyer Both Company, a dominant factor for 28 years in art and advertising service, with over 5,000 clients thruout the English speaking world, offers practical instruction in these two fascinating fields open to both men and women. This instruction—based upon so wide an experience—translates the maze of vague theory into demonstrated fact. Individualized home study instruction. If interested in a career in either of these well paid professions send for free book on (1) Art (...) or (2) Advertising (...).

**MEYER BOTH COMPANY**  
MICHIGAN BLVD. AT 20TH ST. Dept. 16, CHICAGO

## WORLD NEEDS PLUMBERS

Old style plumbers are fading like the horse and buggy. The world demands modern Plumbing and Skilled Trained Mechanics to do it. Unlimited, swift growing field. Make \$50 to \$100 a week or start own shop. We train you quick. Learn in 8 to 12 WEEKS to do any job with skill and science. Need no previous experience. Strictly tool using system. Opportunity knocks. Investigate today—amazing offer—low tuition. World's greatest school.



Write—

**UNIVERSAL PLUMBING SCHOOL**  
2130 Troost Ave. Kansas City, Mo.



## There's Quicker, Bigger MONEY for YOU—in POULTRY

No Matter Where You Live—You Can Make \$1000 to \$5000 a Year—EXTRA!



A Big money-making opportunity is waiting for YOU right NOW—in your own back yard! Thousands of my students are cashing in BIG, the way you can—in part or full time. Start with a small flock—small investment, and make a good profit. Eggs and poultry meat are in big demand at high prices. I'll PROVE that I can put YOU among the big money-makers QUICK!

Spare Time or Full Time YOU Can Cash-in BIG

No matter where you live—city, town or country—or what you do now, my proved methods will assure your success right from the start. I give you all the "secrets"—all the "short cuts." You'll be your own boss and I'll show you how to make from \$1000 to \$5000 a year—and UP!—and how to make your tiny investment multiply itself automatically. What I've done for thousands of others—I can do for you.

FREE Book Shows Way to Success and BIG Profits

Mail coupon below TODAY—for my Big NEW FREE Book, "How to Raise Poultry for Profit." My forty years of experience are yours. The Poultry Industry needs YOU. You need my book. Get it—and get in line for the BIG Money that's waiting for you in POULTRY.

## Mail NOW for FREE Book

NATIONAL POULTRY INSTITUTE, Dept. 411-K  
Washington, D. C., Attn: Harry M. Lamson, Pres.

Dear Mr. Lamson: Send me your FREE Book, "How to Raise Poultry for Profit." I want to know more about my opportunity to make \$1000 to \$5000 a year, spare or full time.

Name.....

Address.....

# "Don't make a monkey of yourself"

cried Bob as

I sat down at the piano

I was spending my vacation with Bob when I met his cousin, Helen. It was love at first sight with me. But unfortunately she didn't seem to feel the same way about it.

"You've got nothing to worry about," Bob insisted when I told him my tale of woe. "Just leave it to me. All you need is a little publicity. . . ."

The very next day he announced that he'd just had a long talk with Helen.

"Boy! What I didn't tell her about you!" he exulted. "Believe me, I boosted your stock sky high!"

"What did you tell her?"

"Well, she's crazy about music. So I conveniently forgot that you can't play a note, and told her you are an *accomplished pianist!*"

"But Bob . . ."

"Not another word! I've got you sitting pretty, now. If you're asked to play—just say that you've sprained your wrist."

That very night we were all invited to the Carews' party. On the way over, I sensed a big difference in Helen—a difference that made my heart beat fast with a new hope.

## I Am Asked to Play the Piano

A little later in the evening we were all gathered around the piano, listening to the rather indifferent performance of one of the guests.

"I've heard so much about your talent!" said Helen. "Won't you play something for us?"

"Yes!" "Yes!" "Please!" came from all sides.

With a smile I bowed low . . . and replied that it *would be a pleasure!*

Bob's grin changed to amazement. Calmly ignoring his frantic signals I walked over to the piano. Quick as a flash he followed me.



"For the love of Pete get away from that piano," he whispered excitedly.

"Don't make a monkey of yourself. If Helen ever hears you play she'll think everything else I told her is bunk—too!"

Turning to the guests, Bob announced, "Perhaps we should wait until some other time. His wrist was slightly sprained in tennis this afternoon, and . . ."

"Oh, that's nothing!" I broke in, and without any further hesitation, I began the first notes of Irving Berlin's famous "Russian Lullaby"! The tantalizing, irresistible strains seemed to throw a spell over the guests. I forgot Bob's astonishment—forgot the glow of admiration in Helen's eyes. On and on I played—losing myself in my music—until thunderous applause shook the room.

That brought me to myself with a start. For the rest of the evening I was the lion of the party.

Bob could hardly restrain his curiosity until we were safely home.

"Why didn't you tell me you knew how to play? When did you learn?"

"You never asked whether I knew how to play," I countered.

"Of course not! Last summer you didn't know one note from another—how was I to guess you'd blossomed into an accomplished pianist overnight?"

"Not overnight, exactly!" I smiled.

"Although it almost seemed that way! Remember that Free Demonstration Lesson in music I sent for last summer? Well, when it came and I saw how easy it was to learn without a teacher, I sent for the complete course. It's great! Why, almost before I knew it, I was playing simple tunes! I can play *anything* now . . ."

"So you really *are* an 'accomplished' pianist! The joke's on me, all right!"

"Oh, I wouldn't say 'accomplished'." I laughed. "But enough of a pianist to get a lot more fun out of life than I used to!"

\* \* \* \* \*

The above story is typical. You, too, can learn to play your favorite instrument by this remarkable "at home" method. You don't have to know the slightest thing about music. First you are *told* what to do—then a picture *shows* you how to do it—then you do it yourself and *hear* it. No private teacher could make it any clearer.

You learn at home in your spare time. You study when you please—and as much or as little as you please. There are no tiresome scales—no laborious exercises. You play simple, familiar melodies *by note* right from the start.

## Free Book and Demonstration Lesson

Our wonderful Illustrated Free Book and our Free Demonstration Lesson explain all about this remarkable method. The booklet will also tell you all about the amazing new *Automatic Finger Control*.

If you really want to learn to play take this opportunity to make your dreams come true. Now! Sign the coupon and send it before it's too late. Instruments supplied when needed, cash or credit. U. S. School of Music, 76 Brunswick Bldg., New York City.

U. S. SCHOOL OF MUSIC

76 Brunswick Bldg., New York City

Please send me your free book, "Music Lessons in Your Own Home," with Introduction by Dr. Frank Crane, Free Demonstration Lesson and particulars of your easy payment plan. I am interested in the following course:

Have you above instrument?.....

Name.....

Address.....

City..... State.....

### PICK YOUR INSTRUMENT

Piano	Violin
Organ	Clarinet
Ukulele	Flute
Cornet	Saxophone
Trombone	Harp
Piccolo	Mandolin
Guitar	Cello
Hawaiian Steel Guitar	
Sight Singing	
Piano Accordion	
Voice and Speech Culture	
Drums and Traps	
Automatic Finger Control	
Banjo (Plectrum, 5-String or Tenor)	



# Mechanical Engineering

*Learn at Home*

MECHANICAL Engineering embraces the design, construction and operation of machines and machine tools. It is a profession which offers almost unlimited opportunities to men who combine natural mechanical ability with technical training.

For this is The Age of Machinery. Almost every convenience, luxury or necessity which we enjoy depends on machinery for its production or adaptability to our needs. Every new invention multiplies the opportunities for competent designers, builders, erecting engineers, etc.

One of the best ways to train yourself to secure a position as a Mechanical Engineer is through the home-study courses of the International Correspondence Schools.

These courses are complete and up-to-date, and especially arranged to meet the needs of the student who studies at home.

They are particularly helpful because they are written by well-known mechanical engineers with years of practical experience, who know the quickest, best way to solve every problem.

Just mark and mail the coupon and we'll gladly send you Free Booklets describing the I. C. S. courses in Mechanical Engineering or any other course in which you are interested.

**INTERNATIONAL CORRESPONDENCE SCHOOLS**  
Box 5619-F, Scranton, Penna.

Without cost or obligation, please send me a copy of your booklet, "Who Wins and Why," and full particulars about the course before which I have marked X in the list below:

- |  |   |
|--|---|
| <input type="checkbox"/> Mechanical Engineering  | <input type="checkbox"/> Toolmaking   |
| <input type="checkbox"/> Mechanical Course       | <input type="checkbox"/> Blacksmithing and Forging                          |
| <input type="checkbox"/> Drafting                | <input type="checkbox"/> Patternmaking                                      |
| <input type="checkbox"/> Mechanical Drawing      | <input type="checkbox"/> Foundrywork  |
| <input type="checkbox"/> Complete Shop Practice  | <input type="checkbox"/> Machine Shop Practice                              |
| <input type="checkbox"/> Architect               | <input type="checkbox"/> Plumber and Steam Fitter                           |
| <input type="checkbox"/> Architectural Draftsman | <input type="checkbox"/> Plumbing Inspector                                 |
| <input type="checkbox"/> Building Foreman        | <input type="checkbox"/> Foreman Plumber                                    |
| <input type="checkbox"/> Concrete Builder        | <input type="checkbox"/> Heating and Ventilation                            |
| <input type="checkbox"/> Contractor and Builder  | <input type="checkbox"/> Sheet-Metal Worker                                 |
| <input type="checkbox"/> Structural Draftsman    | <input type="checkbox"/> Steam Engineer                                     |
| <input type="checkbox"/> Structural Engineer     | <input type="checkbox"/> Marine Engineer                                    |
| <input type="checkbox"/> Electrical Engineer     | <input type="checkbox"/> Refrigeration Engineer                             |
| <input type="checkbox"/> Electrical Contractor   | <input type="checkbox"/> R. R. Positions                                    |
| <input type="checkbox"/> Electric Wiring         | <input type="checkbox"/> Highway Engineer                                   |
| <input type="checkbox"/> Electric Lighting       | <input type="checkbox"/> Chemistry <input type="checkbox"/> Pharmacy        |
| <input type="checkbox"/> Electric Car Running    | <input type="checkbox"/> Mining Engineer                                    |
| <input type="checkbox"/> Telegraph Engineer      | <input type="checkbox"/> Navigation <input type="checkbox"/> Assayer        |
| <input type="checkbox"/> Telephone Work          | <input type="checkbox"/> Iron and Steel Worker                              |
| <input type="checkbox"/> Civil Engineer          | <input type="checkbox"/> Textile Overseer or Supt.                          |
| <input type="checkbox"/> Surveying and Mapping   | <input type="checkbox"/> Cotton Manufacturing                               |
| <input type="checkbox"/> Bridge Engineer         | <input type="checkbox"/> Woolen Manufacturing                               |
| <input type="checkbox"/> Gas Engine Operating    | <input type="checkbox"/> Agriculture <input type="checkbox"/> Fruit Growing |
| <input type="checkbox"/> Automobile Work         | <input type="checkbox"/> Poultry Farming                                    |
| <input type="checkbox"/> Airplane Engines        | <input type="checkbox"/> Mathematics <input type="checkbox"/> Radio         |

**BUSINESS TRAINING COURSES**

- |  |   |
|--|---|
| <input type="checkbox"/> Business Management                     | <input type="checkbox"/> Business Correspondence      |
| <input type="checkbox"/> Industrial Management                   | <input type="checkbox"/> Show Card and Sign Lettering |
| <input type="checkbox"/> Personnel Management                    | <input type="checkbox"/> Stenography and Typing       |
| <input type="checkbox"/> Traffic Management                      | <input type="checkbox"/> English                      |
| <input type="checkbox"/> Accounting and C. P. A. Coaching        | <input type="checkbox"/> Civil Service                |
| <input type="checkbox"/> Cost Accounting                         | <input type="checkbox"/> Railway Mail Clerk           |
| <input type="checkbox"/> Bookkeeping                             | <input type="checkbox"/> Mail Carrier                 |
| <input type="checkbox"/> Spanish <input type="checkbox"/> French | <input type="checkbox"/> Common School Subjects       |
| <input type="checkbox"/> Salesmanship                            | <input type="checkbox"/> High School Subjects         |
| <input type="checkbox"/> Advertising                             | <input type="checkbox"/> Cartooning                   |
|  | <input type="checkbox"/> Illustrating                 |

Name.....  
Address.....  
City..... State.....  
Occupation.....

If you reside in Canada, send this coupon to the International Correspondence Schools Canadian, Limited, Montreal, Canada

# Increase Your Earning Power

Apply time and labor-saving kinks to your work. Your efficiency will soon be recognized and you will be in line for advancement.

If you do machine shop work of any kind, sheet-metal work, painting, carpentry, auto repairing, farming, concrete work, plumbing, electrical work, welding, building, glass work, general repairing, tool-making, poultry raising, masonry or home repair work, get this

## LIBRARY OF 6000 TIME AND LABOR SAVING IDEAS FOR SHOPMEN AND HANDYMEN

**JUST PUBLISHED**

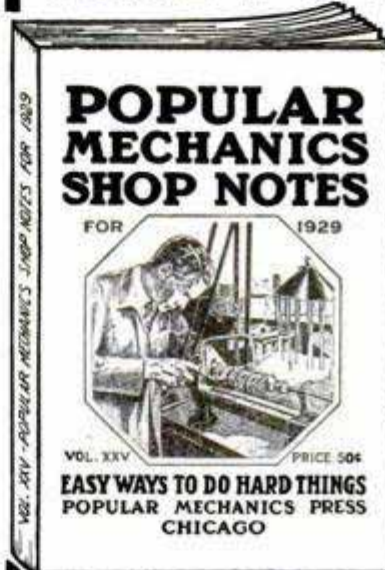

## SHOP NOTES

for

**1929**

347 Articles  
400 Illustrations

**PRICE 50 CENTS**

See list of partial contents below

Including the new 1929 issue illustrated above, there are now 16 volumes in the Shop Notes Library of 6,000 easily understood short cuts to every-day jobs. Here are just a few of the subjects taken from the 347 articles in the latest issue.

- |                         |                           |                           |
|-------------------------|---------------------------|---------------------------|
| Aluminum Mending        | Drilling Kinks            | Plant                     |
| Artistic Doorplates     | Dumb Waiter               | Practical Mimeograph      |
| Artistic Plaques        | Electric Crucible         | Reamer Holder             |
| Attractive Lampshades   | Furniture Designing       | Removing Roller Bearings  |
| Bird Bath in Concrete   | Handy Workshop            | Renewing Old Pumps        |
| Blowtorch Making        | Homemade Jack             | Renovating Gaskets        |
| Brass Pipe Handling     | Homemade Silo             | Repairing Laundry Tubs    |
| Build Your Own Garage   | Insulating Hot Water Tank | Rush or Fibre Seats       |
| Burning Coke            | Lathe Kinks               | Safe Folding Ladder       |
| Burning Out Carbon      | Long Narrow Photographs   | Six-Inch Bench Shaper     |
| Camera Exposure Meter   | Machine for Making Rope   | Softening Leather Belting |
| Candlestick Making      | Paint Removing            | Tables in Art Moderne     |
| Chute for Parcels       | Piston Ring Compressor    | Tin Can Mechanics         |
| Colonial Spinning Wheel | Pneumatic Soldering       | Tractor for Light Work    |
| Crane for Small Garage  |                           |                           |
| Double Vise Press       |                           |                           |
| Draft Regulator         |                           |                           |

Each volume contains approximately 500 articles and 400 illustrations and has 224 Pages. At the regular price of 50 cents per single volume this library costs \$8.00, but for a limited period we will supply the 16 vols. when ordered at one time at the special reduced price of only \$5.00.

**SPECIAL OFFER COUPON**

**POPULAR MECHANICS PRESS,**  
200 E. Ontario St., Room P6, Chicago, Ill.

Send me, as per your special offer the following books. I will pay for books C. O. D. when they arrive. My money will be refunded if I am not satisfied. (Check what you want.)

1929 Shop Notes and Drilling and Thread Cutting Handbook, 98c.  
 Complete Shop Notes Library (16 vols.) \$5.00.

Name.....  
Street and No.....  
City..... State.....



# Be A RADIO Expert



## Seldom Under \$100 a Week

"My earnings in Radio are many times greater than I ever anticipated they would be when I enrolled. They seldom fall under \$100 a week. My profits for the past three months were \$577, \$645, \$465. If your course cost 4 or 5 times more I would still consider it a good investment. You give a man more for his money than anybody else."

E. E. WINBORNE,  
1414 W. 48th St., Norfolk, Va.



## Making \$400 a Month

"I really believe that every man should take your course in Radio. If he has anything in him at all there is every chance for him to get some place. The field hasn't been scratched and it is getting bigger and better every day. A man just can't go wrong. I was making good money but could see the opportunities in Radio. Believe me, I am not sorry, as I have made more money than ever before. I have made more than \$400 each month."

J. G. DAHLSTEAD,  
1484 So. 15th St., Salt Lake City, Utah.

# Many make \$50 to \$200 a week

I GIVE YOU THE RADIO PARTS FOR A HOME EXPERIMENTAL LABORATORY

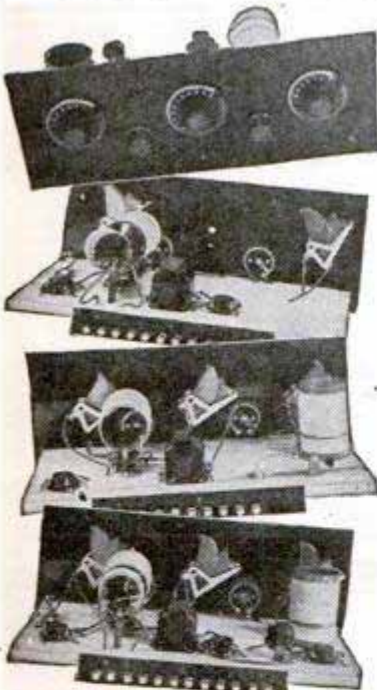

WITH THEM YOU CAN BUILD 100 CIRCUITS. 4 YOU BUILD ARE SHOWN HERE MY BOOK EXPLAINS THIS PRACTICAL, FASCINATING WAY OF LEARNING RADIO AT HOME

Don't slave your life away for \$25, \$35 and \$40 a week in a no-future job. You're foolish to be satisfied with less than \$50, \$60 or \$75 a week for more than the short time it takes to get ready for Radio. That is what the good Radio jobs pay. And \$50 to \$75 a week is only the beginning. Many lead to as high as \$200 to \$250 a week.

## Big Growth Making Hundreds of Fine Jobs Yearly

Over 300,000 jobs have already been made by Radio's amazing growth. It continues to grow and expand fast. This big growth can put you ahead fast. I have doubled and tripled salaries. I have shown hundreds how to make much more money in Radio than they were making in other fields. Let me show you what I can do for you.

## Many Make \$5 to \$25 Extra A Week Almost at Once

The day you start I will show you how to do 10 Radio jobs most common in every neighborhood so you can begin making extra money. Frank Golden, 329 Walnut St., Newark, N. J., says, "I made over \$900 in my spare time in about 10 months." This is the world-famous course that pays for itself.

## I Will Train You at Home In Your Spare Time

Hold your job. My 50-50 method of training—one-half from lesson books and one-half from practical experiments using Six Big Outfits of Parts given without extra charge, makes learning at home easy, fascinating. It is unequalled. It gives you practical Radio

## Jumps From \$35 to \$100 a Week



"It is certainly great sport to do Radio work and a profitable one too. I had the pleasure of earning \$110 last week servicing and selling sets. I have made as high as \$241 in two weeks. Before I entered Radio I was making \$35 a week. You started me off on the right foot by giving me the knowledge every man should have to succeed in Radio."

J. A. VAUGHN,  
4202 Arsenal St., St. Louis, Mo.

experience while learning. You don't have to be a high school or college graduate. Many of my most successful graduates didn't finish the grades.

## Your Money Back if Not Satisfied

My training is right up-to-the-minute with Radio's latest developments. Television, Talking Movies, Radio in Aviation, Screen Grid Tubes, A.C. Sets are included. It fits you for Radio factories, broadcasting stations, a spare-time or full-time business of your own, operating on board ship which gives you world-wide travel without expense, commercial land stations, research laboratories and many more branches. Every penny will be returned if after completion you are not satisfied with the lessons and instruction service.

## FREE Book Tells What Radio Offers You

"Rich Rewards in Radio" gives you the facts about Radio, what your prospects are for the future, how you can get in without delay, what you can make. It explains our lifetime Employment Service after graduation and many other fine features. Get a copy AT ONCE.

J. E. SMITH, Pres.,  
Dept. 9SP

National Radio Institute  
Washington, D.C.



J. E. SMITH

## Mail this Coupon at Once

J. E. Smith, President,  
National Radio Institute,  
Dept. 9SP  
Washington, D. C.

Dear Mr. Smith: Without obligating me, send "Rich Rewards in Radio," your book on Radio's opportunities for big success.

Name \_\_\_\_\_  
Address \_\_\_\_\_ Age \_\_\_\_\_  
City \_\_\_\_\_ State \_\_\_\_\_



This is Radio's Biggest Year

# LEARN AUTOS IN LOS ANGELES

**Jobs Open Now—\$40 to \$100 a Week**

You are urgently needed to help repair the one and a half million autos in California. Trained auto repair men are also needed badly in every other state. The rapidly increasing number of cars means prosperity and big pay for auto men—more garages, tire shops, battery stations are needed. You can be one of the highly paid men in this fastest growing industry—if you get the right training.

**YOU CAN BE An Auto Expert!**

National Automotive special, practical Shop Training makes it easy for you to become an Auto Expert. In a quarter century this great institution has trained

20,000 men for bigger pay. It will help YOU make more money by giving you individual instruction on repairing Packards, Buicks, Cadillacs, Fords, etc., all types of electrical equipment, machine shop equipment, etc. You learn everything RIGHT at National.



**Paul Briggs Earns \$4000 a Year**

"I want to thank you for the big part National has played in helping me to success in auto work. I am now assistant sales manager and made \$4,000 this year—which is more than I would have made in three years at my former work."—Paul Briggs, Portland, Ore.

**Money-Making Book—FREE**



**Earn While You Learn**

Free employment service. Spare time jobs help pay expenses while training. All tools included. No extras. Send for big free illustrated catalog explaining how National trains you for bigger pay. Learn the opportunities for you in California. Mail coupon now.

**Million Dollar Training Headquarters for Auto Experts**



**NATIONAL AUTOMOTIVE, Dept. 723, 4006 Figueroa St., Los Angeles, Calif.**

Send me, absolutely free, your big illustrated catalog of Automotive Opportunities showing how I can train for a Big-Pay Auto Job.

Name.....  
 Address.....  
 Age..... City..... State.....

**BEDFORD YMCA TRADE SCHOOL**

Auto Mechanic  
 Aviation Mechanic  
 Starting, Lighting, Ignition  
 Electric Welding  
 Oxy-Acetylene Welding  
 Machine Shop. Battery Repair  
 Electrical Course. Radio Mechanic  
 Plumbing, Brick-laying  
 Plastering, Tile Setting  
 Mechanical, Architectural Drawing  
 Blue Print Reading  
 Building Estimating  
 Show Card Writing  
 Window Dressing. Sign Painting  
 Commercial Art. Fine Art  
 Write for Catalog 50

Brooklyn Engineering Institute  
 (Operated by Bedford Y. M. C. A.)  
 1125 Bedford Avenue, Brooklyn  
 New York City

## FOREMEN!

Every foreman, factory worker, manager and ambitious mechanic will find a gold mine of inside information in "The Modern Foreman," by Robt. Grimshaw. The 28 chapters of this great work, are a complete \$25 lecture course pointing the way to success, efficiency, better pay and the job higher up. A complete study course in leadership; a handy, daily reference and guide.

"The Modern Foreman" has 297 pages, quick reference index, many tables, diagrams, illustrations and forms; big type, easy to read and understand; rich binding, gold stamped. Size 6 x 9 x 1 1/4. Reg. price \$2.50. Our special sale price \$1.98. Send no money. Mail name and address only. Pay postman \$1.98 plus postage on arrival. Satisfaction guaranteed.

GREGG PUB. CO., Dept. A, 20 W. 47 St., New York, N. Y.

**Learn Watchwork, Jewelrywork and Engraving**

A fine trade commanding a good salary, and your services always in demand. Address **Horological**, Dept. P, Bradley Institute, PEORIA, ILLINOIS, for our latest catalog.

## TRAVEL - for 'UNCLE SAM'

**RAILWAY POSTAL CLERKS**

**MAIL CARRIERS—POSTOFFICE CLERKS  
 PROHIBITION AGENT—INVESTIGATOR**

**\$1700 to \$3400 a Year for Life**

No "lay-offs" because of strikes, poor business, etc.—sure pay—rapid advancement. Many other U. S. Government Jobs. City and country residents stand same chance. Common sense education usually sufficient.

**STEADY WORK**

Cut coupon and mail it before turning the page.

**MEN—BOYS  
 18 to 45**

Use Coupon Before You Lose It

**COUPON**

**FRANKLIN INSTITUTE, Dept. S 176, Rochester, N. Y.**  
 Rush to me, free of charge, (1) A full description of the position checked below; (2) 32-page book, with list of positions obtainable; (3) Tell me how to get the position checked.

- Railway Postal Clerk (\$1900 to \$2700)
- General Clerk (\$1260 to \$2100)
- Postoffice Clerk (\$1700 to \$2300)
- Prohibition Agent (\$2300 to \$2800)
- City Mail Carrier (\$1700 to \$2100)
- Rural Mail Carrier (\$2100 to \$3300)

Name .....

Address.....



"Take it easy for a while!" said a fresh young voice. "That was a narrow escape."

# "14 WORDS of Magic Power"

—that is what the multi-millionaire gave to the young man who saved his life. He wouldn't give MONEY because given money usually breeds neglected opportunities. He couldn't give him a JOB because the young man didn't know enough. So he gave him instead that which had enabled himself to create his millions: FOURTEEN WORDS OF MAGIC POWER, and when

that young man understood and used those fourteen words, they made him worth a quarter of a million dollars in five years.

## What Are the Fourteen Magic Words?

You'll never know until you have read this fascinating little copyrighted story book by Charles Henry Mackintosh. It won't cost you a cent to do so and it may be worth a quarter of a million to you as it was to Arthur Holmes. You can understand the Magic Words and you can use them; if you do use them as Holmes did they should also make you rich, famous, useful and happy and bring you whatever you want.

## This Fascinating Story Book Free—IF

I will send you this story FREE,—(1) if you are an ambitious forward-looking young man between the ages of 16 and 32. (2) If you live in the United States or Canada (others enclose \$1.00), and (3) if you are willing to consider (without obligation) using a part of your spare time in preparing to fill a worth-while position in the big-pay fields of Drafting, Engineering, Electricity or Architecture. Such positions are open to men who take training under any one of these three plans:

**FIRST:** A regular three year (B. S. Degree) Course or a two year (Diploma) Course in Engineering or Architecture at Chicago Technical College. This well-known school has had 25 years experience in training young men for the higher salaried positions. Opportunities to earn while learning. Day and Evening Classes,—or

**SECOND:** A short 4 Months' Special Course in Mechanical, Electrical, Structural or Architectural Drafting. We help you to secure position when through training,—or

**THIRD:** Train at Home in Drafting. Keep your present job and prepare for a better one in spare time right in your own home. All tools furnished without extra cost.

## Mail the Coupon—Read With Profit

Send for this little book and read the fascinating story—the FOURTEEN WORDS and what they did—and may do for YOU! I'll send it Free! I only ask that you carefully fill out the coupon below.

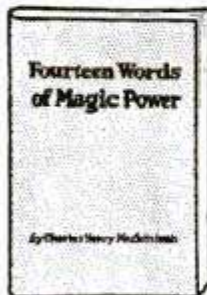

Actual Size 3 1/2" x 5 1/4"

**FREE to YOU**  
in return for  
**THIS COUPON**  
Chicago Tech. College  
Dept. G-77  
Chicago Tech. Bldg.  
118 E. 26th St.  
CHICAGO, ILL.

## "14 Words of Magic Power" FREE Coupon

Charles W. Morey, President, Chicago Technical College,  
Dept. G-77, Chicago Tech. Bldg. (22nd St. Station), Chicago, Ill.

Send me "FOURTEEN WORDS OF MAGIC POWER." It's agreed that I pay you nothing and owe you nothing in return, but I am interested in knowing more about the plan I have checked below:

Your Name..... Age.....

Home Address.....

Town or City..... State.....

Present Occupation.....

### Check Here the Plan You Like Best

Regular Training  
2 yr. or 3 yr. (B. S.)  
at Chicago Tech.

Short 4 Months'  
Drafting at  
Chicago Tech.

Training at  
My Home for  
Drafting Job

*I'll Refund Your R.R. Fare to Chicago*

# Learn Electricity

## Men Wanted

I can help place 20 TO 40 men a day, in JOBS, while learning and after. Never before such unusual opportunities. Get my free book now. Learn about the big pay in ELECTRICITY—the Big Pay BUSINESS of today. That's why GREER College selected this Great Field. Coupon brings you amazing facts.

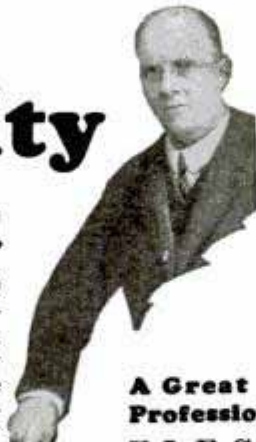

**A Great Profession**  
E L E C -  
T R I C I T Y  
now pays  
hundreds of  
Greer trained  
men up  
to \$200 A  
WEEK. Here

**Earn up to \$150.00 a week**

is a most wonderful business. One hundred million is spent annually to keep it going. Get your share—clip the coupon.

Greer trained men are NEEDED. I HAVE MADE hundreds of \$10,000 A YEAR MEN. 90,000 in the last 26 years have come to Greer.

## Only 3 Months

Learn in ONLY 3 MONTHS in GREAT GREER SHOPS on large *See equipment*. I'LL PAY YOUR FARE HERE Free of extra cost, then help you to a job while learning. Then I not only FIT YOU to GET the big pay job, but I'll help YOU HOLD IT. Young and Old, Educated and Uneducated, Inexperienced and Unexperienced have found GREER SHOPS training easy, fascinating and valuable.

### COUPON BELOW BRINGS YOU BIG FREE BOOK

Don't let money hold you back. Get my Free Book Find out NOW how I PAY YOUR FARE HERE, let you ATTEND either days or evenings and help you find DAY OR EVENING WORK to PAY YOUR EXPENSES while learning. Then when trained we help you find the real big pay job. Learn about amazing opportunities in Electricity, and GREER COLLEGE. Right now, if you act quick, I can make you a most unusual short time offer. Address me personally

Erwin Greer, President, GREER COLLEGE  
Dept. 601E, 2024 So. Wabash Av., Chicago.

**FREE BOOK**

Erwin Greer, President  
Dept. 601E, 2024 So. Wabash Avenue, Chicago, Illinois  
Send Free Electrical Book and details of Special offer without obligation to me.

Name.....

Address.....Age.....

# \$25.00 DRAWING COURSE for \$2.98



Haven't you often wished that you could draw cartoons, illustrate some idea, sketch some pretty face, etc.? You can do all of these things. One of America's most famous Cartoonists and Illustrators has developed a great, simple system for success in all branches of Commercial Art. This system has revolutionized the entire theory of drawing. It means that drawing can be as easy for you as writing—much simpler than learning shorthand, bookkeeping or typewriting. We are now placing this original system for learning Drawing, Art and Cartooning, consisting of 34 lessons with over 500 illustrations, within reach of every one. If you will devote a few hours each week to the Course WE ABSOLUTELY GUARANTEE that you will learn to draw and draw well before you have half finished the Course. If we fail to make this claim good, we will refund every cent paid us. By eliminating a large office force for answering correspondence, expensive catalogs, etc., we are enabled to make a price of \$2.98, the cheapest price ever known for a high-grade, home study course. Many have sent us letters similar to that of Rob't P. Davis of Detroit, who wrote: "I can't see how you ask so little. It is more than I expected." Learn to draw. It is a big asset, no matter what field you are in.

## Send No Money

Just order the course and \$2.98 on arrival pay postman plus a few cents postage, payment in full for the entire Course and Drawing Outfit. If not entirely satisfied, return within five days and we will Refund Money. Address:

If you order the course at once, we will include a drawing outfit, consisting of artist's pencils, pens, paper, erasers, thumb tacks, etc., enabling you to go to work without any additional cost.

LEDERER SCHOOL of DRAWING, Dept. 748-X, Chattanooga, Tenn. Orders from outside the U. S. A. are payable \$3.28 cash with order

# Make Much Money

Making and Selling Your Own Goods. Formulas by experts. Manufacturing Processes. Trade-Secrets. All Kinds. All Lines. Send for interesting catalog, special circulars, free.

W. THAXLY CO., Washington, D. C.

# HOT PIANO



Ultra-modern Piano  
Jazz taught by mail. Note or ear. Easy rapid lessons for adult beginners. Also Self-instruction system for advanced pianists. Learn 358 Bass Styles, 976 Jazz Breaks, hundreds of Trick Endings, Hot Rhythms, Sock, Stomp and Dirt Effects; Symphonic and Wicked Harmony in latest Radio and Record Style. Write for Free Booklet.

WATERMAN PIANO SCHOOL, 1826 W. Adams St., Los Angeles, Calif.

## Rider Agents Wanted

Select from 44 Styles, colors and sizes of Mead Bicycles. Ride and exhibit sample RANGER and make money.

**Factory to Rider:** We ship on approval for 30 Days' Free Trial, direct from FACTORY. Get our marvelous offers before buying.

**Tires** Lamps, horns, wheels, parts, equipment, and repairs at half usual price.

**Mead Cycle Company** Write us today for free catalog  
Dept. K-109 Chicago



# Learn Watchwork, Jewelrywork and Engraving

A fine trade commanding a good salary, and your services always in demand. Address **Horological**, Dept. P, Bradley Institute, PEORIA, ILLINOIS, for our latest catalog.

# Study LAW

Lincoln did it! Also thousands of other great lawyers, politicians and business men. YOU, too, can become a lawyer or law trained businessman through home study guided by the successful practicing lawyers of our faculty. Write today for free book.

AT AMERICAN CORR. SCHOOL OF LAW HOME 3601 Michigan Ave., Dept. 135-A, Chicago



**Why  
Don't YOU  
MAKE  
MONEY  
Taking Pictures**

**\$50 to \$250 a Week Salary  
or a Business of  
Your Own**

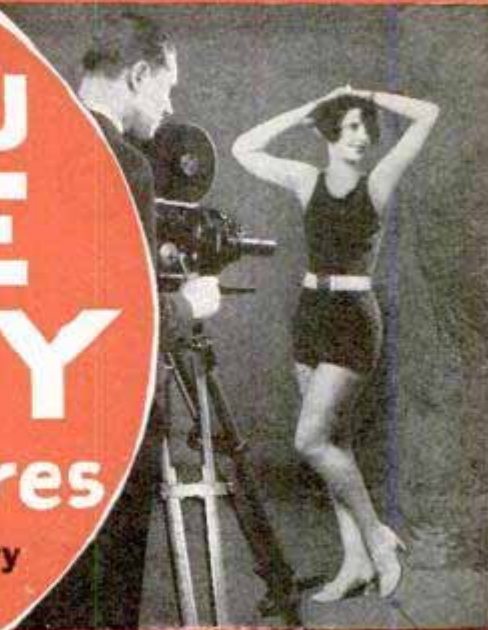

**Hundreds of Opportunities  
Await You in PHOTOGRAPHY**

Find out what the "world's most interesting industry" offers you. A most fascinating career. Thousands of positions with big pay. You can have your own business; practically no capital is needed or you can make money in your spare time; there is no easier or more practical way to do it.

**Choose Your Place in Portrait,  
Commercial or Motion Picture Photography**

All branches offer splendid rewards. Do the work you like best. Portrait Photography is a field as wide as the world itself; Commercial Photography yields amazingly high prices for business pictures of all kinds; News Photography invites you to an adventurous career on a newspaper, the chance to travel; Motion Picture Photography is romance itself, with salaries running into hundreds of dollars a week in the great studios, and openings all over the world for newsreel work.

**No Previous Experience Needed**

You can easily get into this great industry. Even if you have never taken a picture before, you can quickly train to do the kind of work that brings big prices. You can learn at home, or in the New York studios of the world's foremost school of Photography. The training that has helped hundreds of others to success will open the door to your future.

**We Furnish Camera With Course**

Well-known experts give you practical training that enables you to start making money almost at once. You learn by doing, with an Outfit equipped to do professional work.

**Earn While Learning — Free Employment Service**

You can turn your spare hours into dollars even before completing your training. And when you are ready for a position, our Free Employment Service is at your disposal. Because of the standing of the Institute, it is called upon by many of the leading concerns in the industry to supply trained men and women for attractive positions.

**FREE BOOK and Job Chart**

It will pay you to investigate the great opportunities open today. An interesting illustrated book gives full details. It will be mailed to you without cost or obligation, together with Job Chart. Mail the coupon or write, now.

**NEW YORK INSTITUTE OF PHOTOGRAPHY,  
Dept. 49, 10 West 33rd Street, New York City**



**Earn  
up to  
\$125  
a  
Week  
as a**

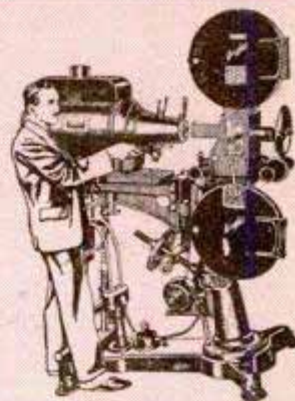

**Motion Picture Operator**

This may be the vocation you will like best of all. The pay is big in Motion Picture Operating and Projection—the hours are short and the work is light, clean and interesting. In moving picture theatres, vaudeville houses and wherever movies are shown, trained operators are required. Up to \$125 a week is paid for only a few hours' work a day!

Let us tell you all about this profitable field and how you can learn Motion Picture Operating and Projection at home. Foremost experts teach you everything, from beginning to end.

**Projector Given**

To make your training thoroughly practical, a Projector is given to you with your training, without extra charge. Get the full details of this remarkable offer at once. Mail the coupon or write NOW.

**New York  
Institute of  
Photography  
Dept. 49,  
10 West 33rd St.,  
New York City.**

Gentlemen: Please send me FREE your handsome Book and Job Chart, describing the money-making opportunities in Photography and Motion Picture Operating. Also details of Free Employment Service and Outfit offers.

Name.....

Address.....

Town..... State.....



# 400,000 miles of flight are behind the training Hinton gives You



WHAT'S more, Hinton's hundreds of thousands of miles in the air is only one side of his remarkable experience. The thing that so many other star performers lack—the thing that makes Hinton what he is today, a real Maker of Men—is his ability to share his knowledge with others in a clear, simple, interesting manner. As proof of that, consider Hinton's record during the war. He was one of the crack pilots singled out by the U. S. Navy to instruct recruits. Under his capable, seasoned eye, hundreds of newcomers learned their P's and Q's of Aviation; made their first excursions into the clouds.

## Now's the Ideal Time to Get Into Aviation

**WALTER HINTON**  
First—to pilot a plane across the Atlantic (the famous NC-4)—to fly from North to South America—to explore the wild regions of the Upper Amazon by air.

**There's Your First Step—That BOOK**  
Many, when they first wrote to Hinton, were skeptical. They didn't realize that Aviation is MORE than a pilot's pastime. But they changed their minds in a hurry—and have been glad ever since—the moment they met up with Hinton in the interesting pages of his big, FREE book. Are you, too, willing to listen? Can you stand a great surprise? Will you pause for fifteen minutes to look into Aviation's future—YOUR FUTURE—through Walter Hinton's eyes? If your answer is YES!—use the coupon.

The business world has taken to the air in earnest. Letters fly from coast to coast. During the past eighteen months, Ford-Stout planes, operating between half a dozen cities, have already carried more than 20,000 people. There's a daily passenger schedule from Chicago to San Francisco and between scores of other important centers. Yet our growth in the air has just begun. The things you see today will be nothing within five years. See Aviation's future ahead of the crowd. Get your training; get BUSY—while the industry is young. Get ahead in Aviation before Aviation gets ahead of you.

## Get Your Ground Work Where You Are—AT HOME

Right at home, in spare time, Hinton will fit you for a job while your chance to grow fast is greatest. Hinton's course takes you over a plane inch by inch; shows you all about construction, rigging, motors, instruments, theory of flight, air navigation—EVERYTHING. It's the foundation for any one of Aviation's fifty highly paid branches. Beyond that, Hinton will help you get a job. If it's actual flying you seek, he'll even see that your rates are specially reduced. Don't pass this page until you've called for the book below.

## Aviation Institute of U. S. A.

Walter Hinton, President  
1115 Connecticut Avenue  
Washington, D. C.

### Send to Washington Quick

AVIATION INSTITUTE OF U. S. A. 1-V  
Walter Hinton, President  
1115 Connecticut Avenue  
Washington, D. C.

Send at once your big FREE book telling about the opportunities in Aviation and about your method of giving me my "ground work" right at home.

Name.....Age.....  
Street.....  
City.....State.....

# NEW INDUSTRY NEEDS MEN

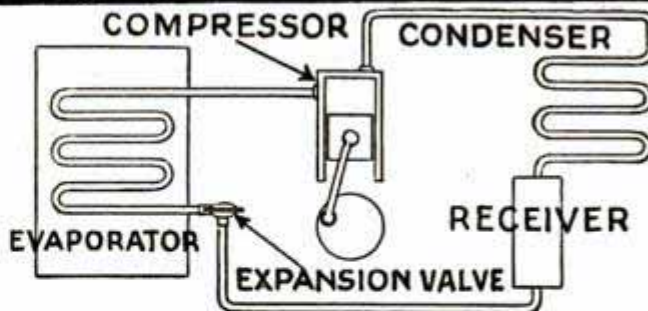

## ELECTRIC REFRIGERATION Calls You!

Newest American Industry needs men for \$200 to \$1,000 a month jobs in production service, installation and sales. Fastest growing, money-making field—backed by General Motors, General Electric, etc. New easy home training qualifies you for big pay job. This training endorsed by Servel, Kolvinator, Copeland and other large manufacturers.

## Get Valuable New Book—FREE

Our new illustrated book—*Rick Rewards in Electric Refrigeration*—just off the press, reveals amazing plan to ambitious men. Sent absolutely free, without obligation. Be the first in your locality to get into this new magic industry. Write today!

UTILITIES ENGINEERING INSTITUTE  
Dept. 16, 3120 N. Clark St., Chicago, Ill.



## FREE BOOK ON MIND TRAINING

An instructive book which explains an amazing system of mind training already used by more than 650,000 people. Let us send you a free copy of "Scientific Mind Training." It will show you how and why Pelmanism is the *only* system of teaching for developing *all* the mental powers at the same time. Endorsed by such distinguished men as Judge Ben B. Lindsey, Sir Harry Lauder, Jerome K. Jerome, Prince Charles of Sweder, and hundreds of others. Write TODAY to

THE PELMAN INSTITUTE OF AMERICA  
71 WEST 45th STREET DEPT. 66 N. Y. C.

## LEARN TO Mount Birds

We teach you At Home by Mail to mount Birds, Animals, Heads, Tax Furs and Make Eggs. Be a taxidermy artist. Easily, quickly learned by men, women and boys. Tremendously interesting and fascinating. Decorate home and den with beautiful art. Make Big Profits from Spare Time Selling Specimens and Mounting for Others. **Free Book**—Yes absolutely Free—beautiful book telling all about how to learn taxidermy. Send Today. You will be delighted. Don't Delay! Northwestern School of Taxidermy OMAHA, NEB.



## DRAW CARTOONS

### Turn Your Talent Into Money

Cartoonists earn from \$50 to \$250.00 per week—some even more. Remarkable new Circle System of Drawing teaches you in half the usual time. Send for **booklet** and sample **lesson plate** explaining full details of the Course.

THE NATIONAL SCHOOL OF CARTOONING  
623 Penton Building Cleveland, Ohio



## LEARN WATCHMAKING

and become independent. We help you secure a position. Easy to learn. Send for FREE CATALOG.

ST. LOUIS WATCHMAKING SCHOOL Dept. 5, ST. LOUIS, MO.

## DEVELOP POWER

### AT HOME

to *initiate, persevere, achieve*; carry on through life your education; earn credit toward a Bachelor degree, by using the 450 courses

## The University of Chicago Gives by Correspondence

Inquire, or check the advertisement to show desire and mail to 327 Ellis Hall, University of Chicago, Chicago, Illinois.

*The "PICTURE WAY" Replaces Old-Fashioned Methods*

**DRAFTSMEN  
PAID  
\$60 to \$100 a week**

**Get Into This  
WORK**

**BIG PAY** *with my new  
amazingly simple*  
**PICTURE-METHOD**



At last—a quick, complete, fascinating way to learn Drafting, and learn it **right!** Experts acknowledge my new, simple, easy "Picture Method," to be the first new idea in teaching Drafting in 30 years. It's the most easily-grasped, sound and sensible plan ever devised for Home Study instruction—so clear, so interesting, so practical that almost before you know it, you're through—have finished—and are ready to go to work on a Big Pay Job.

**Learn to Earn—\$60 to \$100 a Week**

That's what the expert draftsman gets. And he's never out of work the year 'round—for he's the King-Pin of Industry—the man they've got to have. Not a wheel can turn, not a brick can be laid, not a wire can be strung, until the job has first been planned and drawn on paper by a draftsman. Why don't you get into work like that? Why don't you be a man they can't get along without—a Big Pay Man with a year 'round Big Pay Job? You can—it's easy—I'll show you how!

**I'll Quickly Prepare You for Drafting**

With my new copyrighted "Picture Method," I'll help you get ready for a Big Pay Draftsman's job so quickly you will be astonished. Spare time only needed. With my method—you just watch my hands in the pictures—you see how it's done, and you do it yourself almost **automatically.** It's amazingly simple—yet so thorough and complete you learn Drafting from A to Z—learn it so you can sit in with the best of them on the Jobs that pay Big Money.

**Investigate First**

Don't sign up for any Drafting Course until you've investigated my amazing new "Picture Method." Mail coupon for Big FREE Book. See my great Earn-while-Learning Plan—see the big Professional Drafting Outfit you get at no extra cost—learn about my Nation-wide Job Service—my positive Money Back Agreement. Mail coupon NOW!

**MAIL COUPON FOR FREE BOOK**

K. M. Boyd, Chief Drafting Engineer  
L. L. COOKE SCHOOL OF DRAFTING  
Dept. 1-A, 2132 Lawrence Ave., Chicago, Illinois.

Send me your book "Draw Big Pay in Drafting" and tell me more about your "Picture Method." This does not obligate me in any way.

Name.....

Address.....

City..... State.....



*This  
Professional  
Outfit  
given without  
extra charge*

Associated with the **L.L. COOKE SCHOOL of ELECTRICITY** *in helping the Working Man earn More Money-*

# BARBERING

Now One of the Highest Paid Professions! \$ **90** to \$ **150** Every Week!



**Easy to Learn—Quick to Earn!**

That's BARBERING for YOU! And the best part of it all is this—scientific barbering, as taught the modern MOLER way, makes YOU a Master Barber in a short course of intensive training, at small expense! You soon step out as your own Boss, if you wish, in your own Shop, which we will gladly help you equip.

## MOLER Graduates are Always Busy!

MOLER trained Men are always given the preference, for they alone possess the valuable, thorough MOLER training in the application of all the latest scientific Barbering methods, including the Electric hair cutter, the mechanical massage, and the latest vogues in ladies' hair bobbing. MOLER also gives special training in ladies' marcelling and an easy practical course in the treatment of skin diseases.

## EARN WHILE LEARNING!

"Where there's a Will there's a Way" to earn BIG pay! Write to the nearest MOLER College, there is one near you, and learn how you can earn while you learn the barber trade. Ask for the new FREE MOLER Barbering Booklet B. Find out HOW MOLER helps you help yourself AFTER you graduate, as well as BEFORE! Find out why MOLER Men are making DOUBLE the money others made last year, before Ladies' Shingle Bobbing became so popular. You're NEXT in line for big pay—the MOLER way. Send Coupon TODAY!

### Standardized Branches

## Moler System of Colleges

- |                                   |                                    |
|-----------------------------------|------------------------------------|
| 139 E. 23rd St., New York City.   | 109 S. 15th St., Omaha, Nebr.      |
| 512 N. State St., Chicago, Ill.   | 501 E. Water St., Milwaukee, Wis.  |
| 810 N. 6th St., St. Louis, Mo.    | 81 Forsyth St., N.W., Atlanta, Ga. |
| 801 Main St., Kansas City, Mo.    | 81 S. Second St., Memphis, Tenn.   |
| 206 E. 4th St., Cincinnati, Ohio. | 912 Main St., Dallas, Texas.       |
| 215 Huron Road, Cleveland, Ohio.  |                                    |
| 559 Michigan Ave., Detroit, Mich. |                                    |

### Address Nearest Branch

Please send me without obligation on my part your Booklet B.

Name.....

Address.....

City..... State.....

*Learn to Write*

### I Teach by Mail

Begin Today—Write for My FREE Book, I can make a good penman of you at home during spare time. Write for my FREE BOOK, "How to Become a good Penman." It contains specimens and tells how others mastered penmanship by the Tamblin System. Your name will be elegantly written on a card if you enclose stamp to pay postage. Write today for book.

F.W. Tamblin, 418 Ridge Bldg., Kansas City, U.S.A.

## FREE BOOK CATALOG

Send today, without obligation, for our new 72 page catalog, describing books on more than one hundred and fifty practical and scientific subjects, including books on Aviation, Automobiles, Air Brakes, Alloys, Electricity, Horology, Heating, Hydraulics, Model Making, Metallurgy, Radio, Ship Models, Soaps, Perfumes, Recipes, Plumbing, Inventions, Tanning, Television, etc.

Norman V. Henley Publishing Co., 2 West 45th St., New York, N. Y.

**Engineering Degree in 2 Years**

Be a Civil—Electrical—Mechanical or Chemical Engineer in 96 weeks. No entrance examinations or high school diploma required. Low tuition and expenses. Degrees conferred by State authority. Also 2 year Business Courses. Write for free catalog. State course you are interested in.

**TRI-STATE COLLEGE, Box E-B113, Angola, Ind.**

Learn to **PAINT SIGNS and SHOW CARDS**

We quickly teach you by mail, or at school, in spare time. Big demand. Big future. Interesting work. Oldest, foremost school.

**EARN \$50 TO \$200 WEEKLY**

Otto Wiegand, Md., home-study graduate, made \$12,000 from his business in one year. John Vassos, N. Y., gets \$25 for a show card. Crawford, B. C., writes: "Earned \$300 while taking course." Write for complete information.

**DETROIT SCHOOL OF LETTERING**  
150 Stimson Ave. Est. 1899 DETROIT, MICH.

## AVIATION Information FREE

Send us your name and address for full information regarding the Aviation and Airplane business. Find out about the many great opportunities now open and how we prepare you at home, during spare time, to qualify. Our new book *Opportunities in the Airplane Industry* also sent free if you answer at once.

**AMERICAN SCHOOL OF AVIATION, Dept. 135-A, 3601 Michigan Ave., CHICAGO**

**"BECOME A LIGHTNING TRICK CARTOONIST"**

Send \$1.00 for Laugh Producing Program of 23 Trick Drawings with Instructions. Catalog of Chalk Talk Supplies Free.

**BALDA ART SERVICE, Dept. 1, Oshkosh, Wis.**

*See the Craters in the MOON!*

## Astronomical and Terrestrial TELESCOPE

Magnifies 30 Times

Own a genuine Astronomer's Telescope. See thousands of miles away. Make sun, moon, planets, stars your next door neighbors. Moon Craters, Sun Spots, Eclipses, Comets enlarged 30 times. Strange thrills!

Price Only **\$2.95**

Hours of fun looking at scenery, games, bathing beauties. Great for trips and voyages. Made like telescopes used in observatories. Gerding wrote, "Moon seemed 10 yards away."

**EARN \$10 A DAY**  
Charge 25c to look at the moon.

See Landscapes, Games, Ocean Scenes, Enlarged 30 Times!

Inside diameter 2 inches. Special friction adjustment for focusing. Adjustable bracket and clamp can be fastened to chair, fence, branch, etc. Finest materials. Will last lifetime.

**5 Days' Free Trial**

Rush only \$1.00 now. Pay balance (\$1.95 plus postage) when postman delivers. Keep 5 days. If not delighted, return telescope and money will be refunded.

**R. B. SPECIALTY CO.**  
Dept. M-305  
318 Sycamore St., Cincinnati, O.



# Get YOUR Training at *one of*

## America's Leading Aviation Schools

# VON HOFFMANN

### The only way to BIG PAY

There is money for you in Aviation, if—you get thorough training NOW! Our courses will give you this training—they cover everything about planes, motors, their operation, maintenance and construction. Everything a pilot or mechanic must know to secure a good-paying position. We guarantee that upon completion of a course at our school you will have all the knowledge necessary to qualify you for an immediate position in the particular branch of Aviation for which you have trained, whether on the ground or in the air.

### Ground Course



Our School Registered, All Instructors and Airplanes Licensed by U. S. Government, Aeronautics Branch, Dept. of Commerce

## aviation needs you

The training which the Von Hoffmann student receives is the exact training which he must have to qualify for immediate positions on the ground or in the air. The cost is low considering daily flying, the thoroughness of theoretical and ground instruction on latest modern type planes, Wright Whirlwind and other standard motors.

### Practical Training with Modern Equipment

All Airplanes used by us for both instruction and passenger service are planes licensed by the U.S. Government and our instructors are U. S. Licensed Transport Pilots and U. S. Licensed Mechanics. Our equipment is new and of modern design, subject to daily U. S. Government Inspection. (We have a resident U. S. Government Inspector on the field—think what this means to you.)

### Easy Monthly Payments

It is easy to pay the Von Hoffmann way because small monthly payments are extended. Let us show you how you can start now and pay later, even after you have finished the course of training.

### Von Hoffmann Aircraft School

118 Lambert-St. Louis  
Flying Field  
(Lindbergh's Own Field)  
St. Louis,  
Mo.

OUR INSTRUCTORS ARE EX-ARMY PILOTS EACH WITH OVER 3000 HOURS OF FLYING



### Flying Course

We teach you by actual flying and practical instruction; no long course needed. No student bond required. Our ground course gives thorough instruction in ground work and qualifies you for a position as motor and plane mechanic, rigger, electrician, or any other ground position, or you can take the course combining ground instruction and flying which will qualify you for an industrial, limited commercial or transport pilot.

# Start NOW!

**Free Information Coupon**

Von Hoffmann Aircraft School,  
118 Lambert-St. Louis Flying Field (Lindbergh's Own Field) St. Louis, Mo.  
Please mail FREE information at once.

Name.....  
Address.....  
Town.....  
State.....  
Age.....

# We Will Train You in a Few Months



Day and Night Schools in Chicago, Detroit, Cleveland, Boston, Phila.

No Books—  
No Classes—

Wonderful Future in this Uncrowded Field

Experts Earn Up To

**\$125 A WEEK**

as **MECHANICAL DENTISTS**

We teach you to make rubber plates, crowns, bridge work, metal base dentures, etc., for dentists. After graduating you are ready for a job or can open your own laboratory. We assist you.



## Big Demand for Men!

Mechanical Dentistry is the laboratory bench work which the dentist turns over to the laboratory worker. Master this profession and help meet the demand of 64,000 dentists for laboratory work. Every city and every town where dentists are located offers work to the mechanical dentist. We train you in a few months in day or night school for this uncrowded field—no classes—no books—no mechanical experience necessary. **No Educational Requirements.**

## Work Your Way Thru School

We will help you find a job to meet your expenses while taking our training. And we will help you find satisfactory living quarters when you arrive.

Schools located in Chicago, Detroit, Cleveland, Boston, Philadelphia. Day and night schools.

## INTERESTING FREE BOOK

Our illustrated free book on Mechanical Dentistry will acquaint you with some surprisingly interesting facts. It tells about the thriving profession of Mechanical Dentistry—the way to swift and certain success. And it tells about the progress of many of our graduates—men who have succeeded beyond their expectations, also full details of our liberal offers. Mail the coupon and find out more about this fascinating opportunity.

**McCarrie School of Mechanical Dentistry**  
1338 S. Michigan Ave., Dept. 282, Chicago, Ill.

McCARRIE SCHOOL OF MECHANICAL DENTISTRY  
1338 S. Michigan Ave., Dept. 282, Chicago.

Without cost or obligation, send me your illustrated book on Mechanical Dentistry, and complete information as to my opportunities in dental laboratory work.

Name .....

Address .....



## BLISS ELECTRICAL SCHOOL

Condensed Course in Theoretical and Practical Electricity

A special technical school, with comprehensive course.

## ELECTRICAL

men with training are in demand. Since 1893 this school has been training men of ambition and limited time for the electrical industries. Condensed course in Electrical

## ENGINEERING

enables graduates to secure good positions and promotions. Mathematics and Mechanical Drawing. Students construct motors, install wiring and test electrical machinery. Regular course designed to be completed in one college year. Over 5000 men trained. Thoroughly equipped fireproof dormitories, dining-hall, laboratories, shops. Prepare for your profession in the most interesting city in the world. Catalog on request.



**BLISS ELECTRICAL SCHOOL**  
116 Takoma Ave., Washington, D. C.

## COME TO THE YELLOW AIRWAY SCHOOL OF AVIATION

Large enough to train you thoroughly under expert instructors on new production, licensed planes. Small enough to give you personal instruction. Send now for **FREE** book, "Sky Riders."



## ZIP-ZIP SHOOTER

THOUSANDS of boys are made happy with this wonderful Zip-Zip shooter, scientifically and practically made. If you like hunting and outdoor sports, get a Zip-Zip shooter with plenty of pep and force. If your dealer happens not to have them, order from us. Zip-Zip shooter 35c or three for \$1.00; send stamps, coin or money order.



Automatic Rubber Co., Columbia, S. C.



## GIVEN!

Boys! Here's the great Navy model Airship. Large 6-foot air bag with inflators, parachute with automatic release and complete instructions for flying. Will fly for miles at height of 1000 feet. Great chance to study aerial navigation. Send name and we'll send 6 of our new art pictures to dispose of on special 25c offer. Send the \$1.50 you collect and as a reward for this service we will send this wonderful Airship with full instructions free.

C. M. THOMAS, 337 W. Madison St. 6K91 Chicago

# Money Making Tools

ALL are Regular Draftsman's Tools SENT AT ONCE

Sent to **YOU**  
Become a **BIG PAY MAN**  
with My Help

COMPLETE OUTFIT

ALSO DRAFTING TABLE

### Earn as You Learn

I tell you how to start earning extra money a few weeks after beginning my training.



Copy this Jack and Get this Draftsman's Rule

# FREE

Automobiles—Electricity—Motor Busses—Aviation—Building Construction. There are jobs for Draftsmen in all of these industries and in hundreds of others. Aviation is expanding to enormous proportions. Electricity is getting bigger every day. Motor Bus Building is becoming a leading world industry. Building of stores, homes, factories and office buildings is going on all the time. No structure can be erected without plans drawn by a draftsman. No machinery can be built without plans drawn by a draftsman. I train you at home, in Drafting. Keep the job you have now while learning drafting. I will train you in drafting right where you are in your spare time. I have trained men who are making from \$3,500 to \$9,000 a year. There is a big future for draftsmen because you plan and supervise the work of others, or you go into business for yourself. Get started now toward a better position, paying a good, straight salary, the year around. Comfortable surroundings. Inside work.

**Employment Service** After training you I help you to get a job without charging you a cent for this service. Employers of Draftsmen come to me for men because they know that Dobe Trained Men make good as they have learned drafting by actually doing the work themselves, in a practical way. Employers know they are not taking chances on men trained by me.

### Money-Back Agreement

I train you at home under a positive Money-Back Agreement. If my training does not satisfy you after you have finished, you get every penny back.

### Age or Lack of Education No Drawback

Previous experience is not necessary. You do not need to be a college man or high school graduate.

## Get My Pay-Raising Plan —also FREE

If you will mail sketch at once I'll send you also FREE "My Pay-Raising Plan"



I'll train you at home. —Engineer Dobe

If You Earn Less Than \$70 a Week—Write Me Today!

Mail this coupon, at once with copy of Jack. Get "My Pay Raising Plan" and "Successful Draftsmanship". Both of them point the way to Success. You owe it to yourself to find out what a big opportunity there is in practically all industries, for Draftsmen. These two books are Free. They come to you post-paid. Mail the Coupon for them TODAY.

**Engineer Dobe, 1951 Lawrence Ave., Div. A-135 Chicago**



### MONEY-MAKING TOOLS COUPON

**ENGINEER DOBE, 1951 Lawrence Ave., Div. A-135, Chicago**

Here's my copy of Jack. Send me free of all cost your book, "Successful Draftsmanship", also plan to earn money while learning and proof of big money paying positions. Also your new book "My Pay-Raising Plan." Also tell me about your Money-Making Tools which you furnish. Send the free Pocket Rule.

Name..... Age.....  
Address.....  
Post Office..... State.....

# The Truth about Voice

**New Voice Book Discloses Startling Voice Facts**

**Sent Post-Paid for 30 Days FREE Reading No Money Down**



**KNOW The TRUTH about YOUR VOICE**



Eugene Feuchtinger  
A. M.  
Master of Voice  
European Maestro

Send today—for 30 days free reading—for the most remarkable voice book ever written. This book has startled the whole voice world. Written by a man recognized the world over as a voice authority—a man with the courage to tell the TRUTH about voice, about the vocal organ and the real basic, fundamental truths about voice training. Advances astounding new method. Discloses startling facts that may save hundreds of dollars to every

man and woman seeking a strong, rich, compelling singing or speaking voice. Send for this most remarkable voice book today.

**FREE 30 Days Reading**

Certainly I could not afford to make you this liberal 30 days free reading offer if I did not KNOW what "The Truth About Voice" will do for YOU. Send for this book today. KNOW the truth about YOUR voice—a truth just as SIMPLE as it is astounding! Know WHY I actually guarantee to improve every man or woman's voice at least 100%. 30 days free reading to prove this! Then, if convinced, send only \$1.00—although you'll gladly admit that the book may be worth thousands to you. If not—return it—that's all! Mail coupon NOW—before the demand exceeds the supply!

Prof. Eugene Feuchtinger, Studio A-135  
Suite 29, 1810 Wilson Ave., Chicago, Ill.

Send me at once—for 30 days free reading—with no obligation to buy, your "The Truth About Voice" Book. If after the free reading period I desire to keep the book I am to send you \$1.00. Otherwise, I have the liberty to return it with no further obligation.

Name .....

Address .....

Sensational  
NEW

## AUTOMOBILE CIGAR LIGHTER "PULL-A-LITE"

with ONE HAND WHILE DRIVING

**NO WIRES  
NO TOOLS  
NO BATTERIES  
JUST PULL  
for a Sure Light**



**Make \$72 PROFIT A DAY! ON ONLY TWELVE EASY SALES TO DEALERS**



Men, here is a brand new money maker that is taking the country by storm. The new sensational Pull-a-Lite is just what every motorist needs. Lights instantly by a single pull with one hand while driving. Works without clumsy wires or batteries. Attached in a second to dashboard without tools. The new patented suction grip holds like iron to any surface. Can be removed in a jiffy and carried in pocket. Also useful in homes and offices. Pull-a-Lite is made of Bakelite in beautiful assorted colors and mottled designs, all richly Duco finished. Burns ordinary pocket lighter fluid—the most practical lighter ever invented. Retail for only \$1.50, the lowest price of any automobile lighter now on the market.

**Our Five Tested Selling Plans Start You Making Big Money at Once**

Our Dealer Plan will show you how to start a business of your own and make \$72.00 a day profit on twelve easy sales. The Consignment Plan, Mail Order Plan, Initial and Emblem Plan and Demonstrating Plan will show you how to make big money right from the start.

**SEND FOR SAMPLE OR DOZEN NOW!**

Exclusive territory is now available to men who qualify. Your margin of profit is 100% selling wholesale to dealers or 200% selling direct to consumers. The lighters are packed in assorted colors, twelve to a smart self-selling display carton. You can use this carton to start right out taking orders from dealers in your territory or sell out the twelve lighters in less than an hour, almost on a single demonstration, at \$1.50 each and pocket \$19.50 clear profit. Send your order now for a trial carton at our sample dozen price \$7.50, or \$1.00 for a single sample. Send full amount or \$1.00 deposit—will ship down C. O. D. for balance. Our five tested selling plans with quantity price list will be sent to you with either sample or dozen. You take no risk. We guarantee sales or refund your money. Order today and reserve your territory now.

Gordon Manufacturing Co. (Dept. LF-19), 110 E. 23rd St., New York City



**FREE!** The rare, valuable secret book which has astounded the world. Reveals the secrets of hypnotism, telepathy, personal magnetism, mesmerism, clairvoyance, mind reading, etc. This book—called the wonder of the 20th Century—worth \$3 but sent Free to you if you order our remarkable course in Practical Hypnotism—teaches you how to control others—make everybody obey your every wish and desire—conquer bad habits, enemies, win success in life and Love, obtain power, wealth, social position. Explains the greatest force in the history of man. The most perfect, complete and easily learned system. Pay only \$2.45 on arrival, including the "Hypnotic Eye," greatest aid to beginners.

EDUCATOR PRESS, 19 Park Row, NEW YORK Dept. H-24

# DEAF

## Hear After Using Radio

Many people heretofore deaf are hearing after using radio. Sympathetic sound vibration can cause locked parts to move again. The principle used has been embodied in a self-contained device, the SYNCRO-VIBRATOR, which has given wonderful results. Some helped immediately. No radio needed, nothing to wear, but just a simple home treatment. Full details on request. Address Yorke Burgess, Consulting Electrical Engineer, Crystal River, Florida. Dept. 6-B.

# LEARN AVIATION

**AT THE  
AIR CAPITAL**

Wichita, the Air Capital of America, produced one-fourth of all commercial airplanes flying in America today. Nine airplane factories are now in the game at Wichita and several more are being organized. Aviation steel, accessories, propellers, etc., are made or supplied right in Wichita, and one of the nation's leading aviation schools is located here—The BRALEY SCHOOL OF FLYING, Inc.

With a group of large brick and steel buildings totaling 63,500 square feet of floor space and unexcelled ground and flying equipment, this is the ideal aviation college of APPLIED instruction.

**AT THE HOME OF ONE OF  
AMERICA'S  
FASTEST CLIMBING  
AIRPLANES**



When the "Beezle Bug," sensational new training plane designed and produced in the shops of The Braley School of Flying, hopped off in 20 feet and climbed 2,000 feet in one minute it was simply meeting advance calculations of experts in the Braley staff. LEARN AVIATION from such experts

**At One of the Finest Airports  
Devoted Exclusively to Training!**

The Braley School field, 313 acres, a half mile from Wichita's new municipal airport, is one of the most excellent in the nation. It is in the midst of aerial activity, with five of Wichita's leading aircraft factories in proximity. At Braley School you are in CONTACT with aviation OPPORTUNITIES.

ENROLL TODAY for training in the greatest and most fascinating industry the world has ever known. TRAINED MEN are urgently needed and prospects are wonderful even for young men without college education. Many Braley students EARN AS THEY LEARN, in Braley's own factory. Employers everywhere recognize the value of the BRALEY O.K. Courses adapted to varied objectives; prices \$75 and up. Write for details.



Board and Lodging in the New Braley School Dormitory at Very Low Rates.

## The BRALEY SCHOOL OF FLYING Inc.



BRALEY SCHOOL OF FLYING, Incorporated, 502 York Rite Temple, Wichita, Kan. Please send me "The Dope" about learning aviation in Wichita, the Air Capital.

Name..... Age.....

Rt. or St..... City..... State.....

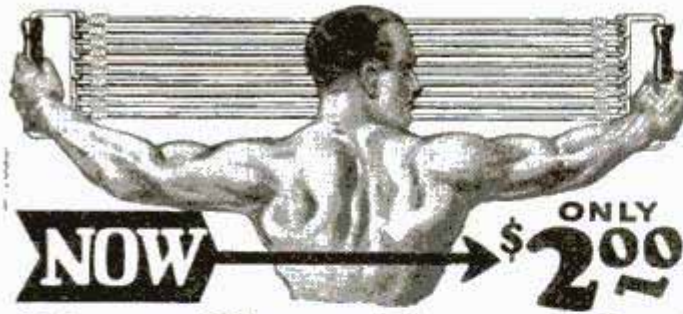

**NOW** → **ONLY \$2.00**  
**Giant Chest Expander**

**and Progressive Exerciser**

Be a muscular marvel. Have the muscles of a superman. Become strong for your health's sake or to astound your friends with extraordinary feats which only men of giant strength can do. In a few short weeks you will easily do stunts which now seem difficult—then real muscles and strength will be yours—and yours to keep. If you want exercise to just keep in good shape you can reduce the strength of the Progressive Exerciser by eliminating as many cables as you wish. If you want great resistance so as to build up big solid muscles then use the full strength.

**Send No Money Use This Money Saving Coupon**

**How the Giant Chest Expander and Progressive Exerciser is Made**

The Giant Chest Expander and Progressive Exerciser is made with new live, springy rubber so as to give it long wearing and great resisting qualities. Do not pay more for an exerciser that has forty or less rubber strands to each cable. Get the best and most durable. The Giant Progressive Exerciser has 50 strands of the finest rubber procurable to each cable.

**Free Instructions**

We do not think it enough to send you an exerciser worth double what we ask, so for a limited time, we will also include instructions absolutely free. These instructions are interesting and simple to follow—they show you the short cut to health and strength. Order today before this wonderful offer is withdrawn.

**Your Guarantee**

The Giant Chest Expander is sold with a guarantee that you will say it is the finest you ever saw or your money back.

**5 Cables or double 10 Cables for strength for**

**\$2** The double strength exerciser has resistance of over 200 lbs. **\$4**

**How to Order—Send No Money**

Sign your name and address to coupon below and get your Giant Exerciser at the present low introductory price by return mail. The price is made low because we want everyone to enjoy muscles and strength at the lowest possible cost. Don't pay more—order from us—get the most for your money. Use coupon now.

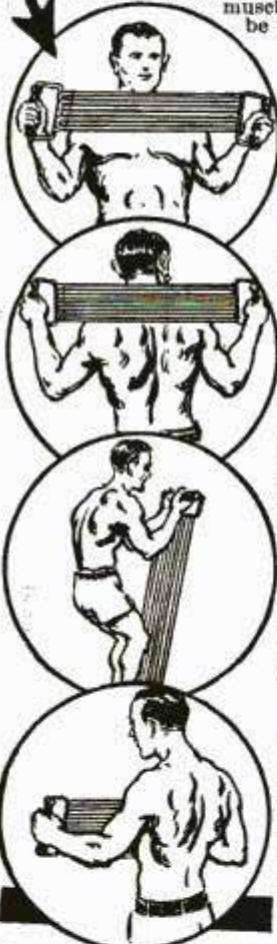

**PROGRESSIVE EXERCISER CO.,**  
 4006 Langdon Bldg.,  
 Broadway and Duane Street, New York

Please send  Your 10 cable Progressive,  
 Your 5 cable Exerciser.

Check the Exerciser you want, and it will be sent you by return mail. Pay postage introductory price, plus few cents postage on arrival. It is understood that if you are not entirely satisfied with your exerciser you may return it within 5 days and get your money back.

Name.....  
 Street.....  
 City..... State.....

If you live outside the United States, send cash with order.

**Will you accept this position?**

**IN RAILWAY TRAFFIC INSPECTION ?**

It pays from \$120 to \$250 per month salary plus expenses, to start. And the future offers unlimited opportunities. You travel or remain near home—are practically your own boss, reporting only to high railway officials. Hours are regular—work pleasant.

**“Will You Accept This Position?”**

Those are the words you will hear after a few weeks of spare time home instruction in Railway Traffic Inspection, for we will train you and upon completion, assist you to a position at a salary of \$120 per month or more, or refund your tuition. There's no hunting a job—no hard selling—no starvation period. And with experience, your salary rapidly increases to \$175, \$200, \$250 per month.

**Send for Free Booklet**

For ten years this school has trained men for Railway Traffic Inspection, and assisted them to positions upon completion of training. Railways look to us for men. Our free booklet explains the opportunities in Railway Traffic Inspection, and how we assist you to a position or refund your tuition. Send for it today.



**STANDARD BUSINESS TRAINING INSTITUTE**  
 Div. 2 Buffalo, N. Y.



**DRAFTING**  
**BOOKS SENT FREE!**

**For Beginners**

Written so you can understand every word, by 18 famous Engineers and Architects. Deluxe, flexible binding. 1750 pages, 1050 blue prints, charts and diagrams. Prepares you for a good Drafting job in mechanical or architectural lines. Sent for 15 days' free use, if you mail coupon immediately.

Only fifteen minutes a day with these WONDER BOOKS will prepare you for a good Drafting job in less than a year! Mechanical and Architectural Drafting from simple straight lines to important, complex plans, a step at a time! Built especially for beginners, for men with only grammar schooling. Drafting room practice plus engineering made easy and clear!

**Big Field—Big Demand—Big Pay!**

Competent Draftsmen are urgently needed right now in all building and manufacturing lines at \$50 to \$100 a week. That's just the beginning—for draftsmen have the best chances for advancement! Pleasant, fascinating work, easy to learn and do. Learn quick with these books—send coupon for a set FREE, and see for yourself!

*A year's Consulting Membership in the American Technical Society now given free to all readers of this famous Cyclopaedia of Drafting. Many say that's worth more than cost of books.*

American Technical Society  
 Dept. DA-19, 58th & Drexel Ave., Chicago



**Modern American Homes FREE!**

American Technical Society  
 Dept. DA-19, 58th & Drexel Ave., Chicago

Send for 15 days' free use 4-volume set of **DRAFTING**. In return for mailing this coupon promptly send absolutely FREE "Modern American Homes," 112 plates, exteriors, interiors and plans. I will pay the few cents delivery charges. If I wish I may return books in 15 days and owe you nothing. But if I prefer to keep them I will send \$1.50 after 15 days, then \$2.00 a month until \$14.50 (special reduced price) is paid.

Name.....  
 Address.....  
 Employed by.....  
 Address.....



# Bald Men! Free



One Full Ampoule of my amazing Hairerbs fluid which I discovered myself and which grew hair on my head. This Ampoule is absolutely free. Don't send any money. There is no C.O.D. No charge whatsoever. All I want is an opportunity to show you how easily I grew hair on my own and hundreds of other men's heads. Merely mail coupon below for Free Ampoule.

**Here is How I Used to Look**

I was just as bald as this picture. It is a true photograph without any tampering or retouching. It is exactly like I used to look. Then look at the full head of hair I have in the picture on the left! As I have stated so often, I don't know whether I am the first man who discovered this great secret, but I do know I have it, that I grew my own hair and that I am growing hair on the heads of other men all the time.



## Bald Men Grow Hair Quick!

What I accomplished on my own head and on other heads I can do for you, provided you are under 45 years of age and loss of hair was not caused by burns or scars. Anyhow, I must succeed or you pay nothing. No apparatus. My home treatment is simple, quick, inexpensive.



Here is Brennan while he was bald. And Brennan after Vreeland grew his hair. Write and I will tell you Brennan's story and give you his address.



Here is Wiseman. Wiseman was bald like this. But Wiseman grew this head of hair with my wonderful Hairerbs fluid. All about Wiseman and how he did it, if you write. You will get his address, too.



### Mail This Free Coupon

Mail the coupon today—Right Now—I will send you, immediately, one full Ampoule of my marvelous Hairerbs fluid which I discovered, of which I hold the secret and which grew my own hair on my own bald head. Besides the Free Ampoule of Fluid, I will send photographs, names and addresses of men and women who successfully used my Hairerbs Fluid for Dandruff, Falling Hair and Baldness.

**VREELAND**  
A-135 Euclid-Windsor Building  
Cleveland, Ohio

### FREE COUPON

**VREELAND** A-135 Euclid-Windsor Bldg. CLEVELAND, O.

Please send me, entirely free, one full Ampoule of the same Wonderful Hairerbs Fluid which grew your hair.

My Name.....

My Address.....

State.....

# Oil Heating Revolutionized!

## New Amazing Oil-Gas Burner



**Only Wick Type Oil Burner on Market**

Ignition unnecessary. Flame never goes out. You are sure of dependable operation all the time. No other burner offers this advantage. We own all wick type patents.

**JUMPS FROM 68th TO 9th PLACE IN U. S. SALES OVERNIGHT**

**New Principle—Installs Right in Present Heating System**

Now—oil heating within reach of all. The LACO OIL-GAS BURNER can be installed right in your present range, steam-heating, warm-air or vapor-heating plant, your parlor furnace, heating stove, etc. A new heating system unnecessary. The oil is turned into hydro-carbon gas, which is burned fast as it is made, eliminating waste, incombusted or unburned gas.

**Cost of Oil System Cut to Fraction of Present Price**  
7 Sizes—Low as \$18

First cost and operating cost equally low. Users' records show positive proof of lower oil cost. Operates quietly. No grease, soot or smoke. Nothing to adjust. It's installed and you forget about it. Automatic temperature control—just as you like it—no variations. Designed to last a lifetime. Guaranteed. Complies with all ordinances. Actually safer than the ordinary gas range used in a kitchen.

**Easy Terms—Payments Start Sept. 1st**

Special proposition if you get in touch with us now. Write for more particulars, and give name of your nearest dealer if possible. Tell us present type of heating system you have.

**SALESMEN—DEALERS WANTED**

Here is a rare opportunity, also, for the man who wants to go into business for himself. No home can afford to be without oil heat now the Laco has been invented. A size every home can afford. Service worries eliminated. Get your franchise now before it's too late—going fast.

**LACO OIL BURNER CO.**

**1120 LACO BLDG.**

**GRISWOLD, IOWA**

### Learn TO FLY EASY WAY!

**EARN \$50 TO \$100 A WEEK!!**

Expensive courses unnecessary. Learn fundamentals of flying like Wright Brothers did, with a Glider of your own—plus easy Home Study Course.

Let us show you how you can quickly prepare to earn \$50.00 to \$100.00 per week in aviation. Write ACE SCHOOL OF AVIATION, 304 Cherokee Bldg., Hollywood, Calif., for BIG FREE BOOK and all about how to get—

**\$5.00 SET GLIDER PLANS FREE**

### Learn Photography at HOME

Make money taking pictures. Prepare quickly during spare time. Also save while you learn. No experience necessary. New easy method. Nothing else like it. Send at once for free book, OPPORTUNITIES IN MODERN PHOTOGRAPHY and full particulars

**AMERICAN SCHOOL OF PHOTOGRAPHY**  
Dept. 135-A 3601 Michigan Ave. Chicago, U. S. A.

### ELECTRICITY

Graduates in Constant Demand at Big Salaries. Intensive, practical training. Low Tuition Rates. Diploma in 1 year. Engineering degree in 2 years. Special 12 weeks' courses. Also Aviation Electricity. No time wasted. Expert instructors. Extensive modern equipment. Free employment service for graduates. Part-time work secured during training. 28th year. Write Today for Free Illustrated Catalog. FINLAY ENGINEERING COLLEGE, 1001-B Indiana Ave., Kansas City, Mo.

### TELEGRAPHY

(Morse and Wireless) and RAILWAY ACCOUNTING, taught thoroughly. Big salaries; great opportunities. Oldest, largest school. Endorsed by Telegraph, Railway, Radio, and Government officials. Expenses low—opportunities to earn large portions. Catalog free. DODGE INSTITUTE, Jones St., Valparaiso, Ind.

### MAKE MONEY AT HOME!

Painting photos and miniatures. No talent required. Fascinating work. Make \$35-\$100 a week. Earn while learning. We teach you at home. Professional artist's outfit, employment service, given. Write for FREE book TODAY. NATIONAL ART STUDIOS, 1008 N. Dearborn, Dept. 24-6 Chicago.

### WANT THIS JOB?

**RAILWAY POSTAL CLERKS**  
CITY CARRIERS—POST OFFICE CLERKS

**\$1700 to \$2700 Year**  
MEN—BOYS, 18 UP

Steady work. No layoffs. Paid vacations  
Travel—See Your Country

Common education sufficient. Mail coupon today—SURE!



**FRANKLIN INSTITUTE, Dept. S-199, ROCHESTER, N. Y.**  
Sirs: Rush to me without charge copy of 32-page book, "How to Get U. S. Government Jobs," list of positions obtainable and full particulars telling how to get them.

Name .....

Address .....



# SHAME ON YOUR WEAKNESS!

## Why Be Despised When You Can Be Admired?



**LIONEL STRONGFORT**

Dr. Sargent, of Harvard, declared that Strongfort is unquestionably the finest specimen of physical development ever seen.

strong can afford to be without the experience and research of a health building into my startlingly interesting book, "Life's Energy Through Strongfortism." It is priceless! In it are plain facts that will astonish you and help you out of your sorry plight. It will tell you frankly how you can make yourself over into a vigorous specimen of vital manhood with 100% pep, power and personality. It doesn't mince words. It will show you how to be true to the best that is within you—teach you how to be a real fellow. It is a man-builder—a success-maker and a life-saver. Just check the subjects on the free consultation coupon on which you want special confidential information. Send for your copy of this book right now—TODAY!

Here's something that ought to make you sit up and take notice if you are lacking in energy, pep and staying powers. "Physical weakness is a crime"—many states say so when they require certain physical qualities in applicants for marriage licenses. "Physical weakness is a crime"—the United States Army and Navy say so when they put you through a rigid physical examination before enlistment. Big corporations say so, too, by insisting on higher physical standards in their employees. There is no place for you if you are a weakling!

If you are a nervous, timid, fidgeting, shambling fellow, you are not wanted anywhere—you don't attract men or women—you repel them. You can't indulge in the ordinary pleasures of life. You can't enter sporting contests—you lack the energy and stamina of the athlete. You don't get on in school or college—the fellows won't stand for your ailing and complaining, and your mental gloom. You can't hold down a good job—you are too languid and pepless. Your outlook on life is marred by fits of the blues.

Nature exacts a terrible penalty when you've gone too far with her. She whips you into such a state of debility and despair that you become a miserable specimen of a man—an object to be pitied or shunned.

### DON'T FOOL WITH DOPE AND DRUGS

Man, you won't get anywhere experimenting with drugs, dope and booze to stimulate the system. Gymnastic apparatus, stretching, pulling and lifting machines often aggravate your condition. Starvation diets may merely weaken you more. Electrical and many other trumped-up treatments, muscle manipulation, baths, ordinary physical culture, forced deep breathing, mystics—all fail to get to the cause of your weaknesses and diseases. Nature only can help you. Nature is supreme in the regulation, restoration and revitalizing of the human body. But you must give Nature a chance—you must help her—and this you can do most certainly, most effectively through

## STRONGFORTISM

—Science of Health and Strength. It Will Do Wonders for You

Strongfortism isn't an experiment. There's no guesswork about it. It was through the methods I used in developing my own body until I won the world's record as the finest specimen of muscular development and championships in feats of great strength, in Europe and in the United States, that I constructed the science of STRONGFORTISM. It is through it that I reclaim wrecked and weak men, make them into new beings and give them a body and arms of which they can boast. I require you to use no apparatus. No drugs or medicines are prescribed. No inconvenient hours are required. Only a little of your time in the privacy of your own home is necessary to follow my easily understood instructions—and, oh man, how glad you'll be that you listened to me, once you start on my course. It means a new day for you, that's sure as you're alive.

You can banish your weakness. You can be a man to be feared in physical combat. There is no doubt about it. I can prove it if you'll just sit down and tell me frankly that you are willing to be guided by what I tell you.

Send for My Free Book  
It Will Prove a Revelation

No man seeking to be healthy, vigorous and this book. I've packed lifetime of physical and interesting book, "Life's Energy Through Strongfortism." It is priceless! In it are plain facts that will astonish you and help you out of your sorry plight. It will tell you frankly how you can make yourself over into a vigorous specimen of vital manhood with 100% pep, power and personality. It doesn't mince words. It will show you how to be true to the best that is within you—teach you how to be a real fellow. It is a man-builder—a success-maker and a life-saver. Just check the subjects on the free consultation coupon on which you want special confidential information. Send for your copy of this book right now—TODAY!

## STRONGFORT INSTITUTE

LIONEL STRONGFORT, DIRECTOR.

Physical and Health Specialist for Over 30 Years.

Dept. 919

NEWARK, N. J., U. S. A.

Send this coupon

### Free Confidential Consultation

Mr. Lionel Strongfort, Strongfort Institute, Dept. 919, Newark, N. J.—Please send me absolutely free my copy of your book, "LIFE'S ENERGY THROUGH STRONGFORTISM," printed in . . . . . English . . . . . German . . . . . Spanish. This does not place me under any obligation and no salesman is to call on me. I have marked (x) before the subjects in which I am most interested.

- |             |                 |                         |
|-------------|-----------------|-------------------------|
| .. Catarrh  | .. Constipation | .. Weak Heart           |
| .. Colds    | .. Rheumatism   | .. Lung Troubles        |
| .. Asthma   | .. Nervousness  | .. Round Shoulders      |
| .. Headache | .. Overweight   | .. Stomach Disorders    |
| .. Rupture  | .. Weak Back    | .. Increased Height     |
| .. Thinness | .. Weak Eyes    | .. Muscular Development |
| .. Pimples  | .. Short Breath | .. Great Strength       |
| .. Insomnia |                 |                         |

Other Ailments . . . . .

Name . . . . .

Age . . . . . Occupation . . . . .

Street . . . . .

City . . . . . State . . . . .

# You Fellows Who Want BIG PAY

Get into

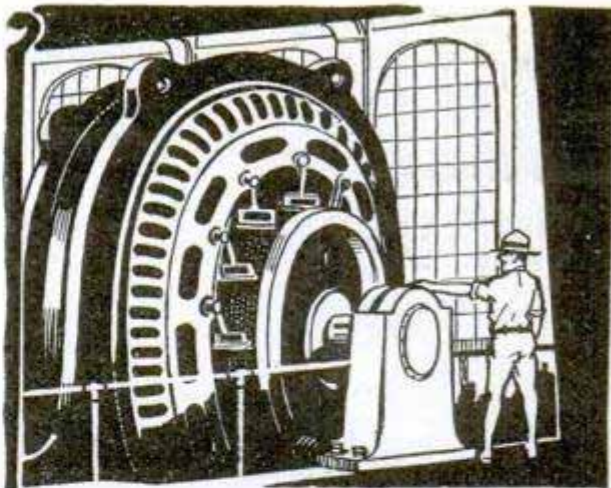

**WHY** earn \$15 or \$20 or \$30 a week, when in the same six days as an Electrical Expert, you can make \$70 to \$200 — and do it easier — not work half so hard. Why, then, remain in a small-pay, no-future job that offers no chance for big promotion — no chance for big income? Fit yourself for a real job. **Get into Electricity.** That's where the big money is being made, and always will be made.

# ELECTRICITY

*Hundreds of Men I have trained are now earning*

**\$70 to \$200 A WEEK!**

So Can You

**If you earn less than \$70 a week INVESTIGATE ACT NOW**



I'll train you at home in a few short months. L. L. COOKE

**FREE BOOK COUPON**

L. L. COOKE, Chief Instruction Engineer, Dept. 1-A, 2150 Lawrence Ave., Chicago, Ill.

Send me FREE and prepaid, your Big Book "Secrets of Success in Electricity," with all details about your Home Study Course in Electricity.

Name \_\_\_\_\_  
Address \_\_\_\_\_  
City \_\_\_\_\_ State \_\_\_\_\_

Residents of Canada send coupon to: L. A. Farrow, Special Representative, 7 Medbury Lane, East, Windsor, Ontario, Canada.

**Electricity — The Big Pay Field**

Today even the ordinary Electrician — the "screw driver" kind — is making money — big money. But it's the trained man — the Electrical Expert, — who makes the really big money. — \$12 to \$30 a day — \$70 to \$200 a week. Be a Big-Pay man, yourself. Get in line, now, for one of these "Big-Pay" Jobs.

**I'll Train You At Home**

I'll train you at home, — in your spare time. You work just as you are working now — at your same job. My now famous "Work-Sheet and Job-Ticket" method, guarantees you simplified, practical training along work-shop lines. In a few short months you can step out of your old job into a new job — into electrical work where you can be a Big-Pay man in this Big-Pay field.

**You Earn As You Learn**

To learn Electricity my way you don't have to be a College man, or even a High School graduate. You can read. You can write. That's enough. With me, you get experience as you go along and make good money while learning. I'll show you how, — and I'll give you, without extra cost tools and apparatus to work with — 6 Big Outfits in all.

**Money Back If Not Satisfied**

That's what I agree to do. And back of me in this agreement stands the Chicago Engineering Works, a \$2,000,000 Illinois Corporation. There's nothing like "Cooke" Training, anywhere. It's the Training that big Electrical men are praising; it's the Training that employers recommend; it's the Training that one of our greatest Engineering societies, has endorsed 100 percent. **It's the Training for you.**

**If You're Earning Less Than \$70 A Week — Investigate**

Don't wait a minute! Find out today why "The Cooke Trained man is the Big-Pay Man", everywhere! Find out how "Cooke" Training will help you boost your pay! Mail coupon right now for my Big FREE Book of Facts. See the Six Big Working-Outfits I give you without extra charge. See the hundreds of pictures, the proofs, the Big-Pay letters of other "Cooke" Trained Men. Get this great free Book. Send for it today. Clip, sign, and mail coupon RIGHT NOW!

L. L. COOKE, Chief Instruction Engineer

**L. L. COOKE SCHOOL OF ELECTRICITY**

Dept. 1-A,  
2150 Lawrence Ave.  
Chicago, Illinois

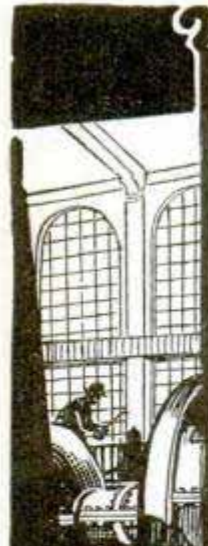
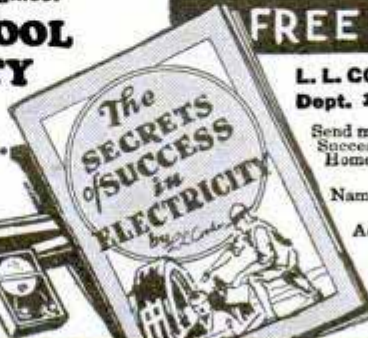

**\$30 A DAY**

Dear Mr. Cooke: I was making \$25 a week when I enrolled. Now with my own Electrical Shop I make as high as \$30 a day. A. J. Daigrenault, 225 Worcester, Southbridge, Mass.



**\$1.50 AN HOUR**

Dear Mr. Cooke: I had to work like a slave for 40c an hour before I enrolled. Now, thanks to you, Mr. Cooke, I make \$1.50 an hour. G. W. Oprea, 4229 N. Meade Av., Chicago, Ill.

**6 BIG OUTFITS NO EXTRA COST**



**The "Cooke" Trained Man is the "Big Pay" Man**

# Classified Advertisements

## WORLD'S BEST WANT AD MEDIUM

Advertisements in this section, 30 cents per word, each insertion, minimum 10 words, payable in advance. To be inserted under proper classification in July issue, copy should be in our office May 18th

### ADVERTISING AGENCIES

**ADVERTISERS**—Send immediately for our new 1929 68-page improved rate book with United States map in colors, just off the press. Gives complete information best paying daily, weekly and monthly newspapers and magazines. Our copy department has seasoned advice to give on advertising and selling. No obligation. Frank W. Lenhoff Advertising Agency, 66 East Lake St., Chicago. (Established 1897.)

**ADVERTISE** in 24 Big Sunday Newspapers, 24 words \$15.00. Excellent for securing agents, salesmen and business opportunities. Catalog listing 1,000 leading dailies, weeklies, mail order magazines. Everything. Free. Wade Advertising, Baltimore Bldg., Chicago.

**BEFORE** Advertising get our catalog. No charge. 25 years in business. The largest classified agency in the world. Ankrum Advertising Agency, 100 No. LaSalle St., Chicago, Ill.

**GET** into advertising. Learn quickly at home. Experience unnecessary. New easy plan. No text books used. Practical work. Old-established school. Send name and address for interesting free booklet. Page-Davis School of Advertising, Dept. 3431, 3601 Michigan, Chicago.

**FREE**—New 1929 Advertisers Rate Guide. 44 pages. Includes everything. Lowest rates. E. H. Brown Advertising Agency, 140 S. Dearborn, Chicago.

**ADVERTISING**—Display or classified, placed anywhere; no additional charge. Copy prepared, lists free. LeGrand Agency, 34 West 33rd., New York.

**ADVERTISE** 50 Magazines 5c word; \$4.00 inch. 5000 Country Weeklies 1c line, per page; lists free. Evans King Co., 672P, Wilmington, Delaware.

**TIME** Counts in applying for patents. See pages 140 and 141. Clarence A. O'Brien, Registered Patent Attorney, Washington, D. C.

**INCH** Display 50 Monthlies Thrice \$8.00. Meyer Agency, 4112M Hartford, St. Louis, Mo.

### FOR ADVERTISERS

**ADVERTISE** 52 Monthly magazines, 4c word; \$2.00 inch. Patterson Publishers, 4111 University, Des Moines, Iowa.

**ADVERTISE** 300 Country newspapers, 28 words, \$10. Business getter. Lists free. Keator, Hartford Bldg., Chicago.

### SALES PROMOTION

\$50 to \$50,000 Daily sales secured for our clients. This eastern client in fall 1927 had one product, but no distribution. Our counsel, plans, copy has now given him distribution in 26 states through 1200 outlets for 25 other products besides his original product. 35 years salesmanship-in-print experience back of our campaigns. Submit sales problems for free diagnosis. 10 years Sales Promotion, Manager Larkin Co. James C. Johnson, 118A Woodbridge Ave., Buffalo.

**CASH**—Coaxing, dollar-digging letters! Literature! Complete mail order campaigns! Individual pieces! Ineffective advertising! Reconstructed. Charges moderate! Correspondence invited. Finkel-Advertising, 131-p Glenwood, Jersey City, N. J.

**"THE Master Letter Writer,"** including 500 successful letters, by Ad-Man Davison, world-famous letter expert; 704 pages, \$3. Circular sent. Opportunity Press, Westport, Conn.

**LETTERS** That talk—If you need sales letters that really sell. Mailing lists; form letters; any direct-mail advertising service. Write Omaha List & Letter Co., Box 1172, South Omaha, Nebr.

### LETTER SPECIALISTS

**BUSINESS** Building letters, circulars, booklets, speeches, etc., prepared. Rates moderate. Suggestions submitted free. Maynard Clemens, 2044 Kennedy Ave., Baltimore, Md.

### BRANCH OFFICE SERVICE

**CHICAGO**—6 No. Michigan Ave. A real address. Write Russell Albin.

### TYPING SERVICE

**EXPERT** Typing all kinds duplicate manuscripts 50c. 1,000 words, Box 183, Hackettstown, N. J.

### AUTOMOBILE SUPPLIES

**TWINSHOT** Detonators, the sensational new ignition instrument. Replaces antiquated spark plugs. Increases ignition 230%. Adds 5 to 10 horsepower to engine. Absolute reliability makes it positively necessary to every automobile, airplane, bus, truck, etc. Will not foul or miss and everlasting. New Fords and Chevrolets about 40 miles per gallon. Uses lower grade gas. Faster, smoother running engine, quicker pickup. Instant starting. Doubles gas and oil mileage. Opportunity open for aggressive distributors. No competition. Fast seller. Money back guarantee. Price \$1.50 each. E. R. Holmes, Littleton, Colorado, (Denver Suburb).

**PRIVATE** Garage! Drive in or out safely. Let "Ajax" doorholders hold the doors open. Easily installed. Complete set \$2.00. Money refunded if not satisfied. Fast seller. Agents write, Metro Auto Supply Co., 1142 Intervale Ave., New York City.

**CARBURETORS**—Repair work guaranteed—allowances made on new carburetors. The carburetor man, 4437 W. Madison St., Chicago, Ill.

**INNER-TUBE** Tester, test tubes under high pressure, locate minute leaks readily, save time and trouble. Satisfy your patrons, write Geo. E. Maceos, Manufacturer and Distributor, Libbie and Monumental Aves., Richmond, Va.

**STEERING** Wheel tires. If your dealer does not sell them, write to Rid-Ged Grip Company, Akron, Ohio. Price \$1.50.

**BLUEPRINTS**, Dimensions, material list for building Ford express body \$3.00. Enclosed delivery body \$5.00. Cab only, \$1.50. State year. Southern Body Service, Box 488, Heights, Houston, Texas.

**SAVE** Money on auto and truck repairs. Gears, axles, bearings, motor and transmission parts at 50 to 75% off factory list prices. Satisfactory parts guaranteed. Prompt service. Price lists free. Century Parts Co., 1712 Lafayette Ave., St. Louis, Mo.

**YOU** Are wanted to resilver mirrors at home. Immense profits plating autoparts, tableware, etc. Write for information. Sprinkle, Plater, 77, Marion, Ind.

**MECHANICS** Get out of the grease, travel, and make real money selling our electrical tools to garages and mechanics, easy sales, very liberal commission. Barker Specialty Co., Girard, Pa.

**USED** Air compressor, fully automatic, upright space saving type, beltless, fully automatic. Reconditioned and guaranteed like new. Shipped on trial and easy terms. Also a few test stands, car washers, battery chargers and paint sprays. E. M. Connor, Box M693, Troy, Ohio.

**GIVE** 'Em the Razzberry with Jazzbird the newest horn for your car. \$2.00. John Samon, Yorkville, N. Y.

**BRAKE** Lining at lowest prices. Satisfaction or money back. Price 80% off list. 2x3-16" at 20c per foot. F. C. Bentley, Box 1392, Charlotte, N. C.

**AUTO** Parts new and used. Lowest prices. Bankrupt supplies, motors, wheels, radiators, transmissions, generators, gears, carburetors, touring tops complete \$15. Brakelining 50% off. Brightman, 2065 Main St., Hartford, Conn.

**RADIATORS** At wholesale prices. All standard makes. Satisfaction guaranteed. Send for prices, stating make and model. Independent Radiator Co., 1119 S. Wabash Ave., Chicago.

### AUTOMOBILES

**DON'T** Buy a new radiator—Use plumbers' secret. Also saves hot-water systems. Dime and your address brings everything. Mechanics' Service Bureau, Marina Station, Mayaguez, Porto Rico.

**TIME** Counts in applying for patents. See pages 140 and 141. Clarence A. O'Brien, Registered Patent Attorney, Washington, D. C.

**AUTOMOBILE**—Make your own motor car, toy size, operated with motorcycle engine. Any boy can make it. Costs little aside from engine. Full directions with drawings and dimensions in The Boy Mechanic, Book 3. Send No Money. Pay postman postage and \$2. Popular Mechanics Press, Room 806, 200 E. Ontario St., Chicago, Ill.

### AUTO SERVICE EQUIPMENT

**SAVE** Money—Garage equipment reconditioned and guaranteed like new. Unusual bargains in test stands, car washers, battery chargers, air compressors, etc. Shipped on trial, easy terms. What do you need to complete your equipment? E. C. Galbreath, Box M694, Troy, Ohio.

**REMOVE** Rear wheels instantly without harm. New method. No pullers, strength or tools required. Instructions with data, \$1.00. Reis Company, 1542 Atlantic Ave., Brooklyn, N. Y.

**MECHANICS**: Set eight semi-spiral expansion reamers, \$11.95; catalog. W. Barnitz, 203 Briggs, Harrisburg, Pa.

**HYDRAULIC** Jacks, 10 ton, brand new, \$9.00; regular price \$45.00. S. Breakstone, 2110 Wabash Ave., Chicago, Ill.

**GENERAL** Electric panel type mercury arc charger. Ken Trost, Tippecanoe City, O.

**RUBBER** Top dressing made from old inner tubes, makes old tops new. Send \$1.00 for formula and instructions. Glover Rubber Co., Rome, Ga.

**BIG** Opportunity in 8-hour battery charging. Let me tell you how you can install equipment with practically no investment. Earn \$150 to \$300 monthly from it. Bargains in used outfits. Write today. Also have a few reconditioned car washers, paint sprays, automatic air compressors. I. C. Helmick, Box M695, Troy, Ohio.

### FOR FORD OWNERS

**FORD** A Dual down draft manifold with dual Zenith carburetor increases speed and acceleration. Big demand, dealers wanted. Racing cars, racing boats, racing motors, speed specialties. Catalog 10c. Green Motor Co., Dayton, Ohio.

**AURORA** Underlugging parts and 3.1 racing gears. Speedster bodies, headlights, hi compression head. See Sport Factories ad, page 154.

**FAMOUS** Bailey Handbook—The book that prepares you to pass the examination for any grade of license for Stationary, Marine and Diesel Engineers, Firemen and Boiler Inspector in any state of the Union or any province of Canada. Flexible cover. Handy Pocket Size. Pay Postman \$2.00 plus postage when he hands you the package. Popular Mechanics Press, Room 806, 200 E. Ontario St., Chicago, Ill.

### MOTORCYCLES, BICYCLES AND SUPPLIES

**MOTORCYCLES** \$25 To \$50. Easy terms. Tires \$2.50, frames \$3, forks \$3, tanks \$5, wheels \$4, chains \$2, saddles \$5, handle bars \$5, engines \$15, side cars \$25, transmissions \$12, belts \$6, airplane engines \$15, airplane wheels \$5, bicycle tires \$1.25, velocipedes \$7.50, bicycles \$9.50, new auto tires \$3, used auto tires \$2.50. Send 50c for catalogs. Price Cutter Deninger, Rochester, N. Y.

**BARGAINS** In used motorcycle parts for all makes. Goodyear balloon tires \$8.25 each. Also bike supplies and tires. J. B. Dahl, 3661-63 Archer Ave., Chicago, Ill.

**MOTORCYCLE** Parts, new and used. Lists free. Tower Cycle Co., Pine Lawn, Mo.

**PRICES Slashed!** Send for catalog showing bargains in rebuilt genuine Harley-Davidson motorcycles. Some as low as \$50.00. Fully guaranteed to look, act and last like new. Special easy-payment plan. These bargains won't last long. Write today. Heinz Motor Company, 607 West North Ave., Baltimore, Md. (Authorized Harley-Davidson Distributors).

**SPECIALIZED Harley-Davidson service depot.** Harley-Davidson parts, accessories, oil. Send us your motors and parts and we will rebuild them like new. Let us overhaul your motorcycle. All work guaranteed. Send 25c in stamps for our flat rate repair costs and parts and accessories book. Knuth's Harley-Davidson Agency, 2525 Fond Du Lac Ave., Milwaukee, Wis.

**FINE Harley-Davidson bargains.** \$50.00 and up. Order your motorcycle now for spring delivery. Send for our new catalog, "Money-Saving Motorcycle Bargains." Knuth's Harley-Davidson Agency, 2525 Fond Du Lac Ave., Milwaukee, Wis.

**USED Motorcycles,** all makes, lowest prices; price list free; used parts half price and less. Rochester Harley Davidson Corp., 129 West Main St., Rochester, N. Y.

### AVIATION

**SUPPLIES**—"Everything for the man who flies," parts for all motors, vellumoid gaskets, dope, fabric for wing covering, aircraft finishes in all colors. Pioneer and Consolidated Instruments. Safety belts. Whatever you want we have it. Eastern Aircraft Supply Co., Bradford, Pa.

**GET** The new 1929 sportplane Constructor-book containing 8 full page blueprints, drawings, photographs, etc. Answers hundreds of questions, sizes, weights, material, dimensions, methods, motors, flight instruction. All for \$1.00. Circular five stamps. Russell Aero, Box 455, Toledo, Ohio.

**BUILD** Your own glider. Complete plans \$7.50. Special price list 25c. J. P. Schroeter, 346 Prospect Ave., Milwaukee, Wis.

**BUILD** a "Flying Filver." Blue prints \$5. Latest plane, motor and propeller circulars 10c. Storms Aviation Co., Spartanburg, S. C.

**IT'S** New. A real flyer—no winding, no shooting, flies by its own power, guaranteed. \$1 postpaid. Vano Co., 316 Washington St., Brooklyn.

**AIRPLANE** Motors. 80 H. P. LeRhone, 9 cylinder rotary, hub and propeller, new, especially suited for light training planes. Reliable, durable. Cost U. S. Government \$4,250 each. Every motor tested by U. S. inspectors. Only \$425. Other motors and propellers 28 to 200 h.p. Write for list. Smith Machinery, P. O. Box 1343, Houston, Texas.

**KITS**—Byrd's Antarctic, Lockheed Transcontinental, Army Pursuit, or Navy Seaplane scale models, quarter each. Indoor tractor, 50c. Three foot twin pusher, \$2.00. All postpaid, all guaranteed. Casson-Craft, Canton, Mass.

**FLYING** And ground school pay as you go. Tonnele Aircraft, 159 Tonnele Ave., Jersey City, 5 minutes from New York.

**MODEL** Airplane Builders. Send for free catalog. Shifter-Smith construction set, \$2.50. Tudor-Morris construction set, \$2.75. Lindbergh Plane construction set, \$3.25. Lockheed-Vega construction set, \$5.25. New Model R.O.G. kit 60c. Fine blueprint for any above model 25c. Model Airplane Supply, August Schaefer, 29 North Ave., New Rochelle, N. Y.

**THE** American School of Aviation announces a new correspondence course in Mechanics of Aviation. A thorough training in Practical Aeronautics. American School of Aviation, Dept. 1872, 3601 Michigan Ave., Chicago, Ill.

**MODEL** Aeroplanes. Build and fly, the finest scale 3 foot Curtiss Sea Hawk. Also 4½ foot 6 cylinder air motor driven. Send 10c coin for illustrated catalogue. Miniature Aircraft Corp., 83 Low Terrace, New Brighton, N. Y.

**AMERICA'S** Most popular sport plane. Heath super parasol, 10c for large booklet. See our ad on page 159 this issue.

**GET READY!** One fine pair adjustable bridge, curved lens ventilated aviation goggles. Price \$7.00. One fine soft glove leather form fitting helmet. Price \$5.00, both for \$8.00. Send \$2.00 with order. Detroit Aero Motors Co., 5055 Townsend Ave., Detroit, Mich.

**VARIOUS** Sizes wood, reeds, bamboo, rubber band, wheels, propeller, onion skin covering and other supplies. Big bundle for 25c, five for \$1.00. No stamps. Will also send circular on free three foot model. Aero Shop, 3050 Hurlbut Ave., Detroit, Mich.

**"SKYWARD HO!"** Wonder book on aviation—32 pages, 150 illustrations. Shows you complete training for flying career, fame, fortune! Sent free. Write today! Parks Air College, 213 Mo. Theatre Bldg., St. Louis, Mo.

**FINEST** Model airplanes, supplies. Prices lowered! List 10c. dealers wanted! Wholesale list 35c (no stamps). Cleveland Models, 1866 P West 57th St., Cleveland, Ohio.

**WORLD-RECORD** Model airplane kits, 12½ minute hydro \$3.00; 9¼ tractor \$2.50; bargain list, best supplies obtainable 10c. Advanced Peru Model, Peru, Ind.

**AIR** Navigation and meteorology—New, simple, nontechnical book needed by every flyer. Nothing else on the subject like it. Written by Captain Duncan who has over 3,000 hours of flying to his credit. 225 pages. Flexibly bound. 80 pictures, maps, etc. Pay postman \$3.00 when he delivers book. Popular Mechanics Press, Room 804, 200 E. Ontario St., Chicago.

**BIGGEST.** Best catalog model airplanes; parts, supplies; 5c postpaid. Ideal Company, 19 West 18th St., New York.

**SIMPLEX** Air Model Co., Auburn, Mass. Send five cents for supply booklet.

**PROPELLERS.** For snow and ice sleds. Small airplanes and boats. Blueprints for ice sleds, one dollar. Crawford Airport, Seal Beach, Calif.

**ACTUAL** Photographs of Famous Flying Fleet, 20 sparkling photos of 20 famous planes, only \$1 for 20 photos. Illinois Aerial Photo Co., 226 E. Superior St., Chicago, Ill.

**PROPELLERS** For model aeroplanes. Semi-carved 6" 35c; 8" 40c; 10" 45c; 12" 50c. Postpaid. Aero Shop, 3050 Hurlbut Ave., Detroit, Mich.

**TIME** Counts in applying for patents. See pages 140 and 141. Clarence A. O'Brien, Registered Patent Attorney, Washington, D. C.

**PROPELLERS**—4", \$8.75; 5", \$13.25; 6", \$16.50; Special Henderson propeller, \$15.00; Aerodrive boat or sled blueprints, 50c each. Helmets, \$3.00; goggles, \$3.00, both only \$5.00. Engines, fuselages, Ostergaard Aircraft, 4303 North Narragansett, Chicago.

**THE** Age of the Air Is Here. For reliable information on both airplane building and flying we recommend "Aeroplane Construction and Operation," by Rathbun, a book used in government schools. All features of construction treated. Send no money. Pay postman \$2.50 and postage. Popular Mechanics Press, Room 806, 200 E. Ontario St., Chicago, Ill.

### BOOKS AND PERIODICALS

**4TH** EDITION, revised "Radio Theory and Operating," by Mary Texanna Loomis. The standard radio text and reference book of America. 992 pages, 800 illustrations, flexible binding. Price \$3.50 postage paid. For sale by hundreds of book dealers throughout America and many foreign countries. Or may be purchased direct from the publishers. Send check or money order to Loomis Publishing Company, Dept. 18, Washington, D. C.

**SOMETHING** New. Midget Bible, size of stamp. Masterpiece, \$1.00 postpaid. Creative Art Studios, 93 Putman St., Tunkhannock, Pa.

**BOOKS**—Aviation, automobiles, electrical, mechanical, radio, model making, etc. Discount prices. Catalog, Manhattan Co., 333d W. Manhattan Blvd., Toledo, Ohio.

**REFRIGERATING** Machine, homemade. Operates successfully. Gives better service than ice. This and 328 other practical articles in our book "Home Mechanics." Just ask for this and "Handbook for Women," containing 394 valuable household helps and pay postman 98 cents and postage for the two books. Popular Mechanics Press, Room 806, 200 E. Ontario St., Chicago, Ill.

**INDUSTRIAL** Alcohol. Wright's book. Full directions for making, fully illustrated. \$2.50. Spon & Chamberlain, 120 P.M. Liberty Street, New York, N. Y.

**BOOKS,** 6th and 7th Book of Moses, 75c; Albertus Magnus, 75c; Pow-Wow, 60c; Silent Friend, \$1.00; Book of Luck, 25c; The F. & R. Co., 87 Fourth Ave., Dept. "L," New York.

**HYPNOTISM** Easily learned. Lessons guaranteed. Postpaid, \$1.10. Smith Pub. Co., Dept. 3, Springfield, Mass.

**DO** you like to make things? If so, you should have a copy of Popular Mechanics new book entitled "Make It Yourself." A large book of 480-pages describing how to make 900 different articles, 823 illustrations. Price \$3 postpaid. A full description will be sent upon request. Popular Mechanics Press, Room 806, 200 E. Ontario St., Chicago, Ill.

### PICTURES AND POSTCARDS

**ANY** Sized photo or snap-shot copied, 25—\$1.00, 50—\$1.50, satisfaction guaranteed. (Sample 2c stamp). Eli-Ess Photo Service, 1819 Humboldt Blvd., Chicago.

**HAND** Colored photographs of South's most gorgeous flower, the azalea. Quarter each. Southern Scenic Studio, Box 680, Mobile, Ala.

**ART** Pictures—220 all different. 160 samples \$1.00. Particulars 10c. Howard Sales Co., Dept. 15, Box 529, San Francisco, Calif.

**SOUVENIR** Folders—California resorts, cities—two, 25c. Lists. Studio, Box 1410, Hollywood.

### NOVELTIES, CURIOS, ETC.

**NOVELTIES** Illustrated catalogue free. Paris-Photo Publishers at Neuilly-Plaisance, (S-&O), France.

**CONCERTINA** Plays by rolls, talking cards. Pittle, New Bedford, Mass.

### GAMES, ENTERTAINMENTS AND PLAYS

**PLAYS,** Musical comedies and revues, minstrels, comedy and talking songs, black-face skits, vaudeville acts monologs, dialogs, recitations, entertainments, juvenile plays and songs, musical readings, make-up goods. Catalog free. T. S. Denison & Co., 623 So. Wabash, Dept. 11, Chicago.

**LIKE** Puzzles? Join the puzzle club. A new puzzle every month. Fascinating, instructive. Cash prizes every month for best solutions. A straight amusement, nothing for you to buy or sell. Send one dollar for 12 puzzles. The Puzzle Club, Box 1236, Richmond, Calif.

**LEARN** Ventriloquism by mail—small cost, 2c stamp brings particulars. Geo. W. Smith, Room 8-345, 125 N. Jefferson St., Peoria, Ill.

**CHALK-TALK** your way to popularity. Audiences at your feet if you learn how to entertain with a few simple pictures. Little artistic ability needed. "How to Chalk Talk" tells what to say and what to draw. Profusely illustrated. Make \$1 and more a night. Send no money. Just order on a postal. Pay postman \$1.00 and postage. Popular Mechanics Press, Room 810, 200 E. Ontario St., Chicago, Ill.

### MAGIC TRICKS, BOOKS AND JOKER NOVELTIES

**"THE** Book of 1,000 Wonders" will be sent postpaid for 10c. Explains many mystifying tricks with coins, cards, handkerchiefs, etc., you can do. Also, contains complete catalog of magic tricks, jokes, puzzles, books, escapes, mindreading acts, spiritualistic effects, illusion plans, curios and imported novelties, lowest prices. You will amaze and elicit from many foreign lands. Large assortment of your friends! Send 10c today. Lyle Douglas, Station A-5, Dallas, Tex.

**LEARN** Ventriloquism the easy way. Illustrated catalog and talking picture 25c. The hottest thing out, real whoopee maker! Monkey evolution 25c. Frank Marshall, 5518 S. Loomis, Chicago.

**TWELVE** Novelty tricks. Dollar post paid. Warren Novelty, Warren, O.

**TWELVE** Card tricks. Instructions with each. Dollar, no stamps. Warren Novelty, Warren, O.

**ENTERTAIN** Your friends with interesting card tricks. Eight tricks thirty cents. D. G. Meredith, Route No. 2, Richmond, Va.

**MAGIC** Catalog 20c. Lynn's, 105 Beach, Dept. 3, Jersey City, N. J.

**SIX** Wonderful magic tricks, with apparatus, directions, professional magicians' catalog. Complete 25c. Weber, 647-K4, East 62nd, Chicago.

**ELECTRIC** Fun! Seventy stunts, 110 volts, \$1. Kutting Sons, Campbell, Calif.

**MAGIC** Tricks, card tricks, coin tricks, Hypnotism, ventriloquism, popular books, 10c each. All five 40c. Geo. Fenner, 2401 Jefferson, Louisville, Ky.

**MAGIC—Tricks, Books and Supplies.** For amateurs as well as the great professionals. Anyone can learn through our instructions. Feature Acts in Mind-Reading, Spiritualism, Rope Ties, etc. Large illustrated professional catalog, 20c. Chicago Magic Co., 149 So. Dearborn St., Dept. B, Chicago, Ill.

**NEW!** Send 2c for list of imported novelties. Schreiber's, South Bend, Wash.

**ESCAPE from Sacks, Rope Ties and Chains.** Easy with these complete instructions. Give an evening's entertainment and mystify the "wise ones." Let them tie you hand and foot, place you in a bag and seal the bag. In a minute you are out. Complete instructions in "33 Rope Ties" and "Sack Escapes." Send no money. Pay postman \$1.50 and postal charges for these two books. Popular Mechanics Press, Room 810, 200 E. Ontario St., Chicago, Ill.

**TRICKS, Puzzles, novelties, catalog free.** B. Z. Puzzles, Fairview, Mass.

**MAGIC Tricks and novelties.** Send 15c for illustrated catalog. E. Kay Magic Shop, 8832 Commercial Ave., Chicago, Ill.

**SEVEN Magical Delusions and catalogs—25c.** Gilmagico, Morgan Park, Ill.

**FREE With \$25 order die box.** Send 20c for our large catalog of tricks, wigs, sensational escapes. Oaks Magical Co., Dept. 548, Oshkosh, Wis.

**READ Sealed Messages in Dark; messages retained by audience; burned message appears on blank slate; spirit message appears on slate in sitter's presence; spirit rappings; spirits appear in the dark; answer questions written on folded papers while blindfolded.** All this you can do with directions in "Behind the Scenes with The Mediums." 69 best secrets of mediums fully exposed. The best because most baffling, yet all easy to do. Send no money. Just write a postal. Pay postman \$1.50 and postal charges. Popular Mechanics Press, Room 806, 200 E. Ontario St., Chicago, Ill.

#### CHALK TALKS

**LAUGH Producing program, \$1.00.** Catalog free. Balda, The Cartoonist, Oshkosh, Wis.

**BECOME Chalk talk wizard in one evening.** Make crayon, clay, sand and smoke pictures. New method. No talent needed. G. E. Hendrickson, Argyle, Wis.

#### STAMP COLLECTING

**SAMPLE Copy free.** In order to introduce the readers of this magazine to Scott's Monthly Journal, philately's finest magazine, we will send a copy free to all who write us and ask for it. Scott's Monthly Journal is not only a very interesting and up-to-date philatelic journal, but it is also a monthly supplement to the Standard and the specialized U. S. catalogs, listing new issues, price changes, etc. Approvals. The world-wide connections of this company have made it possible for us to build up, and keep on hand, one of the finest assortments of fine approvals in the world. Write us for approval circular. Scott Stamp and Coin Co., 1 West 47th St., New York, N. Y.

**MYSTIC "Queer Country" Packet!** Contains scarce stamps from the following strange lands: San Marino, Antioquia, Congo, Cyprus, Fiji Islands, Gwalior Hyderabad, Iceland, Jhind, Kenya, Uganda, Lebanon, Monaco, North Borneo, Nyassa, St. Thomas Prince, Eastern Roumelia, Siam, Sierra Leone, Tanganyika, Trinidad Tobago, Ubungu, Upper Volta, Wallis Futuna, Alaouttes. Get this wonderful packet of "freak countries" and make your friends envious! Price only 10c to approval applicants! Write today. Mystic Stamp Company (Dept. 8), Camden, N. Y.

**500 DIFFERENT Stamps for 25c.** Big collection from Bosnia, Crete, Epirus, Honduras, Iceland, Kenya, Liberia, Malta, Nyassa, Quillmanne, Siam, Zambesia and other "hard" countries. Catalog value \$10. Price 25c to approval applicants! Bargains, 1,000 different 79c; 15 triangles 49c; 100 Africa 45c; 100 Asia 50c; 100 Balkans 35c; 100 British Colonies 30c; 100 French Colonies 35c; 100 Portuguese Colonies 50c. Eight packets for \$3.00! Illustrated lists free. Loma Stamp Co., 3926 32nd St., San Diego, Calif.

**82 FAR OFF countries only 10c—Quillmanne, Inhambane, Travancore, Kouang Tcheou, Syria, Martinique, Liban, Pierre, Peru, South Africa and 72 other countries—82 different stamps from 82 different countries for only 10 cents.** Big lists and approvals with each order. Reimers, 7 Flatiron Bldg., Fort Worth, Tex.

**\$1.00 FREE.** Black U. S. postage, given away with each order. Pioneer Stamp Album with 500 illustrations, 150 different stamps from 40 countries, Syria, Lebanon, Hejaz, Liberia, New French Colonies, British, Portuguese Colonies, South Africa, Australia, 500 hinges, 36 page illustrated catalog. All for 15c. Big commission to agents for the best approval sheets of stamps ever offered. Write for sample outfit. Hussman Stamp Co., Dept. M, 620 Olive St., St. Louis, Mo.

(1) FANTASTIC Liberia set! (2) Airmail set. (3) Triangle stamp. (4) Strikingly beautiful Azores 1928 Independence commemorative set of 5 stamps. (5) 50 different stamps from 50 different far off countries. All 5 groups of stamps above, containing birds, beasts, boats, buildings, battles, circus, savages, scenery, airplanes, maps, portraits, and many other showy picture stamps for only 10c to approval applicants. Western Philatelists, 6021 Harper Ave., M5, Chicago.

**ANCHERS \$\$\$ Outfit—only 12c!** Fine triangle stamp; set German stamps with (pre-war) value forty million dollars (interesting!); perforation gauge, mm scale; airmail set; scarce stamp from smallest republic on earth; newspaper set; packet good stamps and Travancore, Malay, Dutch Indies, etc. Entire outfit for 12c to approval applicants! (Nice pocket stock book, value 25c, with every order!) Ancher Stamp Co., Box 126, Rutherford, N. J.

**A SNAP—300 different foreign and 60 different U. S. stamps, including \$1 and \$2 revenues, all for only 25c.** Free, with each order, our pamphlet which tells "How to Make a Stamp Collection Properly," together with our price lists of albums, supplies and hundreds of bargains in sets, packets, etc. Queen City Stamp & Coin Co., Room 36, 604 Race St., Cincinnati, Ohio.

**ANNIVERSARY Offer!** (15c) seven beautiful sets: "Airmail," "Commemorative," "Red Cross," "Occupation," "Charity," "Prisoners," "Pictorial," also three packets: (International) (Colonies) (Bulgaria). Approvals, bargains, discounts! Deering, Fairmount Street, Marlborough, Mass.

**HEADHUNTER.** Sphinx, Tiger, Elephants, packet 105 varieties, nickel plus postage to approval applicants. Universal Shop, 91 Gelston Ave., Brooklyn, N. Y.

**SIAM Airmail 10c, set of 4 weird and mysterious stamps, only 10c to applicants of my low-priced approvals.** E. P. Johnson, Box 692, San Jose, Calif.

**"PENNY Approvals sent on request."** Larson, 1655 W. 18th Place, Chicago, Ill.

**200 DIFF. Stamps free with three months subscription 10c.** Philatelist, 161 Brook, Dunmore, Pa.

**ILLUSTRATED.** Descriptive U. S. list, 1929, price 50 cents; also second edition U. S. and B. N. A. list, Stanley Gibbons, Inc., 38 Park Row, New York City.

**50 DIFFERENT Genuine foreign, dime stamps.** Holt, 3 Ave., des Seasons Ixelles, Belgium.

**BEST One cent approvals in America.** F. P. Hand, 1117 So. 60th St., Philadelphia, Pa.

**DANZIG Stamps free—interesting packet from Danzig with big catalog free for 2c.** Midland Stamp Company, Toronto, Can.

**STAMPS Sent on approval. Discount 70%.** Send 60c minimum deposit. E. G. Peters, Peters-Woolworth Bldg., Rome, Ga.

**1,100 UNUSED Stamps, cataloging nearly \$25.00.** Only 95c. Seventy page illustrated price list free. West Coast Stamp Company, Alhambra, Calif.

**PERU: 20 Varieties 15c postpaid.** Lists free. Allison, Angola, Ind.

**LIBERIA Snake Triangle and two other triangles in our packet of 53 genuine foreign stamps for five cents.** Crowder Company, Waverly, Baltimore, Md.

**BOYS! Dealer's Outfit—200 stamps, blank approvals, hinges, 15c.** Alvin Johnson, Storm Lake, Iowa.

**250 DIFFERENT Stamps for dime.** Aladdin, 1550 Carroll, St. Paul, Minn.

**SUMVALUE! 25 Airmails, 10c.** Famous dime packets—free hinges—50c approvals, references please. Webster Stamp, Box 11, Tremont Sta., New York.

**SURPRISE 25c Packets Stamps, coins, shells, curios, antiques.** Burton, Madison, New York.

**FREE Packet to approval applicants with references.** John F. Miller, 156 West 44th St., New York.

**300-300-300.** All different stamps (\$6.00 catalog); 300 hinges; 5 approval sheets; duplicate stamp album; perforation gauge; millimeter scale and ruler to approval applicants for only 20c. Edgewood Stamp Company, Milford, Conn.

**STAMP Collectors, magazine.** Finest monthly stamp paper. Write for free sample copy. Philatelic Publishing Co., Inc., 13 John St., New York, N. Y.

**FREE Iceland Airmail to penny approval applicants.** Stoll, 4425 Broadway, Louisville, Ky.

**9 FIJI—25c, 75% Discount approvals.** Hill, 3325 Beechwood, Cleveland, Ohio.

**SPECIAL Bargains in sets and packets.** International Stamp Co., 1140 S. Albany Ave., Chicago, Ill.

**FIRST Flight airmail covers; Cleveland and Toledo, 30c.** Chapin, 3684 Concord, Detroit.

**FREE! 15 French Colonies. Postage 2c.** R. F. Roberts, 801 Fourth, Bay City, Mich.

**TRIANGLE Packet 6c. Approvals.** Applebaum, 1258 Brook Ave., New York.

**FREE Stamps with approvals, postage 2c.** Dundonald Stamp Company, Box 452, Station F, Toronto.

**JUGO SLAVIA Set, cat. \$1.81 for 10c.** send one thin dime and your application for our new low priced approvals to Beyer, 269 Jewett Ave., Jersey City, N. J.

**BEAUTIFUL Packet with approvals, 2c.** Reid, 608 Yonge St., Toronto.

**BEST One cent approvals in America.** F. P. Hand, 1117 So. 60th St., Philadelphia, Pa.

**183 VARIETIES—Including 75 British, French, Portuguese Colonials. Over 45 Oriental, American, West Indian, etc. Countries.** Only 19c with approvals. Stamp Mart, St. Paul, Minn.

**STAMPS On approval 1/4c up. Premium 2c.** Kelgwin, Middletown, N. Y.

**1/2c APPROVALS—5,000 Borneo, Liberia, etc.** References. Philatelic Exchange, Huntington, W. Va.

**1,000 MIXED 50c. Free 25 select.** G. E. Pigeon, Meriden, Conn.

**FREE, 6 Different Luxemburg to approval applicants.** E. D. Stamp Co., 3905 Forest Park Ave., Baltimore, Md.

**ALBUM, 1,000 Hinges, 200 foreign, 25 Cuba, 25 Japan, 35c.** Burtiss Company, Saratoga, N. Y.

**100 DANDY Different Stamps free with 1,000 Hinges, 5 Malay Tigers, 25 Greece and 2 Triangles all for 25c.** Webers Stamp Shoppe, 1377 Park Ave., Plainfield, N. J.

**COVERTCO Packet, 10 different Piume, 10 cents, with 60% discount approvals.** Covert Stamp, 39 State, Rochester, N. Y.

**SPOT Cash paid for stamp collections.** Kelgwin, B192, Middletown, N. Y.

**105 CHINA, Etc., 2c.** Album (500 Illustrations) 3c. Bullard, Sta. BB, Boston.

**CANADIAN Confederation special packet 25c diff. Canada, 5c diff. Nfld., and our new large illustrated lists for only 10c to approval applicants.** We list 282 countries in our dime packets. Specials: 500 diff. 25c, 1,000 diff. 75c, 2,000 diff. \$2.50. Victoria Stamp Co., Dept. 4, London, Ont., Can.

**101 STAMPS Free with approvals.** Postage 2c. Johnson Stamp Co., (PM) Jamestown, N. Y.

**PHILLIPS' Monthly Bulletin (illustrated) offers over 2,000 special bargains, sets, new issues, packets, etc., each issue.** Free. Phillips, Box 1012, Hartford, Conn.

**DANDY Mint stamps 2c to those requesting approvals.** Harvey Teeple, Decatur, Ind.

**75 DIFFERENT Foreign stamps, from 20 countries (every continent), stamp hinges, perforation gauge and illustrated album with places for hundreds of stamps for 10c (coin) and 2c stamp, 1,000 all different 90c, 1,000 mixed 30c.** Dept. 38, Argonaut Stamp Co., New Canaan, Conn.

**MAGNIFICAROUS Packet free—Beauties from distant lands, many richly colored, unusual designs.** 2c postage. Empire Stamp Co., Toronto, Can.

**FREE, 12 Diff. British colonies for a request for my popular approvals of large showy picture stamps, at 50% discet.** Postage 2c. Chas. Bushnell, 4728 Princeton Ave., Tacony, Phila., Pa.

**BARREL Of foreign stamps while they last.** 25c-1,000 or pound \$1.00 (over 4,000). Approvals sent. Hinges 3,000-25c. Elmer, 61 Court St., Boston.

UNITED States, 24 varieties 1/2 to \$2 current, catalog \$1.25 for 25c. Ledue, Red-lion, Penna.

1,000 MIXED U. S., old and new, 25c. Weatherby, Box 1087-A, Cleveland, Ohio.

DIME Packets, 25 Africa, 12 Cape Verde, 25 Asia, 12 Mozambique, 7 Nyassa, 10 Togo, only 10c each, three for 25c. Skillman, Titusville, N. J.

FREE—20 Different Argentine. Approvals. List. Send 4c today for postage, etc. Reuter, Santa Ana, Calif.

STAMPS, 100 Varieties, Africa, Brazil, Peru, Cuba, Mexico, etc., 10c; 25 different U. S. 25c; 1,000 mixed, 40c; 1,000 hinges, 15c. List free. C. Stegman, 5941 Cote Brillante, St. Louis, Mo.

FREE Souvenir and packet to approval applicants 4c postage. Huffman, 405 Pennsylvania Ave., Brooklyn, N. Y.

ONLY 5c! 10 Airmail stamps, including scarce Estonian triangular stamp; Portuguese Red Cross set and 10 different Central Lithuanian stamps. Approvals and free lists with each order. Curhan Stamp Company, Gloucester, Mass.

APPROVAL Stamp packet sent on request. Paul Cornish, Schenectady, N. Y.

STAMPS, 100 all different. Postage 2c. Lists free. P. M. Quaker Stamp Co., Toledo, Ohio.

REVENUES—Telegraphs—Every country. Pretty—Intriguing—Cheap. Mint \$5.00 revenue free to applicants with references. Vanderhoof, 1114 Logan, Denver, Colo.

FREE 50 British Colonials. If approvals requested. Postage 4c. Berkeley Stamp Co., South Berkeley, Calif.

110 NEW Europe All Different, a wonderful collection cataloging several dollars, free to collectors requesting our Net Approvals. Postage 2 cents. Badger Stamp Co., Milwaukee, Wis.

24 VARIETIES Cuban stamps, 10 cents. List of 6,000 low-priced stamps free. Address Chambers Stamp Co., 111P, Nassau St., New York City, N. Y.

200 DIFFERENT stamps 10c; 1,000 Hinges 10c. R. H. Carlton, 380 W. So. Temple, Salt Lake, Utah.

300 DIFFERENT, 20c; 600, 50c; 1,100, \$1 2,000, \$3.50. Fred Onken, 630 79th St., Brooklyn.

STAMPS sent on approval at 76% discount. Reference required. Emory Renoll, Hanover, Pa.

FREE Germany air mail (5 var.) for new applicant of my 1, 2c and 3c approvals and also my 50% discount. Chas. W. Schmidt, P. O. Box 4832, Frankford Sta., Philadelphia, Pa.

FREE! 115 Different stamps to approval applicants, 2c postage. Paige Stamp Co., Oak Park, Ill.

FREE! Triangles, airmail, Iceland and 50 others to approval applicants inclosing 3c postage. Hawkeye Stamp Co., Cedar Rapids, 39, Iowa.

FREE—31 Different stamps to applicants for Royal approvals. 2c return postage. Royal Stamp Company, 1728 S. 58th St., Philadelphia, Pa.

111 DIFFERENT, Arabia, Azerbaijan, Zanzibar, etc., 10c to approval applicants. Floyd Marsh, 524 Hamilton Ave., Indianapolis, Ind.

FREE, 12 Diff. large, showy picture stamps for a request for my popular approvals. Postage 2c. Premiums with every purchase. A. Bauer, Palmyra, N. J.

110 DIFFERENT Stamps, many unused, high values, free to collectors requesting our net approvals. Postage 2 cents. Christensen, Milwaukee, Wis.

101 DIFFERENT Free with 50% Approvals, 2c postage. Noemus Stamp Co., 312 East 23rd St., New York.

PENNY Approvals that Satisfy. Neil Gronberg, Box 5441, Philadelphia, Pa.

150 GOOD Mixed foreign stamps 3 cents. Stanton, Niantic, Conn.

40 DIFFERENT United States 10c. 60% approvals. Seldenberg, Baroda, Mich.

250 DIFFERENT Foreign postage stamps only 10c. Skillman, Titusville, N. J.

FREE, 20 Different United States and 100 foreign with approvals. L. W. Hudson, 1429 East 7th St., Plainfield, N. J.

UNITED States—Send on approval. Send me your want list. Ref. please. M. Hanna, New Kensington, Pa.

BEAUTIFUL New set 2c with approvals. Send reference. Edgewater Stamp Co., Box 2731, Cleveland, Ohio.

100 FOREIGN Stamps 3 cents. Lufbery Stamp Co., Branford, Conn.

#### RARE COINS

WHILE They last. 25 large cents, \$1.00, 100 foreign coins, \$1.00. Romano's Old Coin Shop, 929 Main St., Springfield, Mass.

40 OLD Coins all different, \$1.00, 100 different coins, \$3.00. Stone Mountain half-dollar unc, 75c. 300 different Germany warbills, \$1.00. 300 different Austria warbills, \$1.00. 60 different Germany banknotes, \$1.00. Claud Denney, Box 315, Dallas, Texas.

3 DIFFERENT Fine bronze or nickel coin, 2 large crisp bank notes and catalog 10c. George Best, Cedar Rapids, Iowa.

OLD Money wanted. Do you know that coin collectors pay up to \$100.00 for certain U. S. cents? And high premiums for all rare coins? We buy all kinds. Send 4c for large coin folder. May mean much profit to you. Numismatic Co., Dept. H, Ft. Worth, Tex.

LARGE Priced U. S. Coin Encyclopaedia, valuable, useful, 25c postpaid. Maitland Milliken, Fostoria Bldg., Denver, Colo.

15 DIFFERENT Coins 25c. 30 different, 50c. Oddehon, Box 681, Kansas City, Mo.

CATALOGUE, 10 Coins, 25c. 45 Emergency Bills, 15c. Wacker, Minster, Ohio.

CALIFORNIA Gold quarter 27; half 52; Confederate \$1.00, 20c; \$3 1856, 15c. A. Wylie, 365, Wheaton, Ill.

6 DIFFERENT Foreign coins 10c. Greenclay, Box 2551, Denver, Colo.

CALIFORNIA Gold—Quarter size, 27c; 1/2 size, 53c; 3c piece and catalog, 10c. Norman Shultz, Box 746, Salt Lake, Utah.

RARE United States and foreign coins, war medals and decorations. Chinese coin and catalog 10c. Alexis Mengelle, Colorado Springs, Colo.

\$2 TO \$500 Each paid for hundreds of old coins. Keep all old money, it may be very valuable. Send 10 cents for illustrated coin value book, 4x6. Prices guaranteed. Get posted. We buy and sell. Clarke's Coin Office, Box 5, Le Roy, N. Y.

OLD Coins, large spring selling catalog of coins for sale free to collectors only. Catalog quoting prices paid for coins, ten cents. William Hesselein, 101A Tremont St., Boston, Mass.

GET Profit and pleasure in collecting old coins. Send 10c for large illustrated coin catalog. You'll be delighted with it. Send for it right now. B. Max Mehl, Numismatist, Mehl Bldg., Dept. P, Fort Worth, Tex. Largest Rare Coin Firm in the U. S.

UNITED States. Large cent, two-cent bronze, three-cent nickel and bargain list, 25c. Thirteen dates large cents, \$1.00. George Coffin, Greenwood Mountain, Me.

AMERICAN Coins. Relics bought. Coin value booklet, 12c. Frank Saco, 735 45th St., Brooklyn, N. Y.

#### CAMERAS AND PHOTO SUPPLIES

FREE. Our bargain book listing hundreds of slightly used Cameras, Kodaks, Lenses and supplies at great savings. Some sample bargains: Vest pocket size Kodak 1 1/2 x 2 1/4 with f:7.7 Anastigmat Lens \$8.50, 3 1/4 x 4 1/4 revolving back series B Graflex Camera with Kodak f:4.5 Lens \$72.50, 2 1/2 x 4 1/4 Box Brownie Camera \$24.50, 3 1/4 x 5 1/2 Eastman Kodak with f:7.7 Lens and Ball Bearing Shutter \$17.50, 5x7 Bausch and Lomb 1c Tessar f:4.5 Lens in Barrel \$42.75. Every item guaranteed and sold on ten days trial. Send for your copy right now. Central Camera Co., PM6C—112 S. Wabash Ave., Chicago, Ill.

NEGATIVES Made of your prize prints. 4x5 \$1.25; 5x7 \$2.00 each. Greatest care. Safe return. Shaw Studio, 376 Boylston St., Boston.

COLORING Photos: Anyone who can take a picture can color it—by the Marshall method. No brushes necessary—colors self-blending. John G. Marshall, 1752 Atlantic Ave., Brooklyn, N. Y.

GERMAN Cameras, lenses. Baritto, 6436 La Riba Way, Los Angeles, Calif.

MAKE Money in photography. Learn quickly at home. Spare or full time. New plan. Nothing like it. Experience unnecessary. American School of Photography, Dept. 3432, 3601 Michigan Ave., Chicago.

TIME Counts in applying for patents. See pages 140 and 141. Clarence A. O'Brien, Registered Patent Attorney, Washington, D. C.

BIG Money in photography, motion picture projection. Catalog 49A free. New York Institute of Photography, 10 W. 33d St., New York.

\$50.00 FOR Photographs—This price paid for photographs meeting our requirements. Perhaps one of yours will bring this amount. Full particulars free. Redkrafts, Denver, Colo.

ENLARGEMENTS. Best ever, 8x10 50c. Send film or negative. Price list other sizes. Jengar Photographic Laboratory, 478-79 Simon Long Bldg., Wilkes-Barre, Penna.

HAVE You a Camera? Write for Free sample of our big magazine, showing how to make better pictures and earn money. American Photography, 116 Camera House, Boston, 17, Mass.

FILMS Developed. Special Trial Offer. Any Size Kodak film developed 5c, prints 3c each. Trial 6x10 Enlargement in handsome folder 40c. Overnight Service. Roanoke Photo Finishing Co., 209 Bell Ave., Roanoke, Va.

EARN Big money with your camera in your spare time, using Halldorson Home Portrait Lamp. Write for booklet "Home Portrait Photography" and catalog—both free. The Halldorson Company, 4746 N. Western Ave., Chicago.

#### MOTION PICTURES

JUST Published and sent to you for \$5.00 postpaid, Motion Pictures with Sound by Cameron, 373 pages, complete information and complete operation from A to Z. Telephone, Movietone, Vitaphone, Phonofilm and Bristolphone and all other systems. Invaluable for projectionist or amateur. Send for your copy. Bass Camera Company, 179 West Madison Street, Chicago, Ill.

16 MM Films for sale or rent. Historical—Educational—Religious—Drama—Comedy. Send for catalog. Protecto Films, Inc., 105 West 40th Street, New York.

PRACTICALLY New Sept. Motion and still picture Camera with f:3.5 Anastigmat Lens, 8 Magazines and Case \$29.50, (this Camera is brand new), 100 ft. roll Cine Kodak 16mm., Film, \$5.00, Universal Motion Picture 35mm., Turret front Camera with f:3.5 B&L Tessar 50mm., and a 75mm. B&L Tessar f:3.5 Lens, also a 4-7-18 in. focus Tessar f:4.5 Lens (3 lenses). Has focus in and out device, 200 ft. capacity, 2 magazines \$425.00. Every item guaranteed fully and ten days trial allowed. Send for a copy of our bargain book issued free. Central Camera Co., PM6C—112 S. Wabash Ave., Chicago, Ill.

NEW 16mm Pathex Cameras, anastigmat lens f:3.5, leather case, tripod and bag, with Pathex Projector and accessories, \$33 complete. Silver screen, 36x42 inches, \$5.00. Our 1929 program catalogue of new film productions, featuring Hollywood's biggest stars, in Comedy, Drama, Westerns, Sport, Travel, Cartoon, Educational, etc., leads the 16mm field. Rodney Milfeurs De Sarro, 27 Chauncey St., Astoria, L. I.

MOVIE Film. Complete program rolls, consisting of news, comedy, scenic, western. 250 ft. for \$1.00 postpaid. Home Movies, Box 744, Minneapolis, Minn.

FILM Standard size 250 ft., \$1.00; lots of action. J. Brink, 42 Church St., Boston, Mass.

MOVIES Made to order. Developing, printing. Lorenz Pictures, Madison, Ind.

SUPER Quality films—reels \$3.00 each. Two for \$5.00. 250 feet \$1.00. Westerns—Action Dramas Only. Perfect Condition. Eastin Feature Films, Galesburg, Ill.

NEW Life for Motion Picture Films. Save them before they deteriorate. Use Teitel's "New Life" method. Full particulars will be sent upon request. Albert Teitel, Film Expert, 105 W. 40th St., N. Y.

FILMS \$2.00 Reel. 6 reel features complete \$12.50 up; 250 feet \$1.00. Stamp for list. Werner-Leslie, 4442 South Broadway, St. Louis, Mo.

NEW Weeklies, comedies, westerns \$2.50 per thousand feet. Projectors cheap. List. Colonial Films, 630 Ninth Ave., New York.

FILMS! Bargains in new features and comedies. List. R. Bothe, 6534 Laffin, Chicago, Ill.

MOVIE Camera and projector for sale. 32 volt motor and 2 bulbs, also hand crank. Demonstrator. First Class. Also about 40 reels. Total cost \$150.00. First M.O. for \$60.00 takes all. Fred C. Peterson, Oak Island, Minn.

FILM Bargains—quitting the road. Complete features, \$7.50. Felix cartoons, \$5.00. Thousands others cheap. Big list free. Leonard Lowe, Apt. No. 6, Norfolk Bldg., Cincinnati, Ohio.

THEATRES Need trained managers. Learn at home. Catalog N. Moving Picture Theatre Managers Institute, Elmira, New York.

**STARTLING Bargains** in motion-picture cameras, projectors, apparatus. Send stamp for the 192nd issue of the Bass Bargaingram. Never in history has such startling bargains been offered in guaranteed apparatus. Write for your copy now. Remarkable motion-picture exposure meter, \$2.00. Sixty-six page catalog. Send stamp. Bass Camera Company, 179 W. Madison St., Chicago, Ill.

**EXCELLENT** Westerns, features, \$2.50 per reel. Stewart Marshall, Rome, Ga.

**BE A movie exhibitor—Big opportunity—Only moderate capital required—Complete equipment at remarkably low prices. Write. Atlas Moving Picture Co., 624 South Michigan Ave., Chicago, Ill.**

**MOVIE Films**, 1,000 ft. reels, \$2.50 each; shipped anywhere on receipt of remittance. Particulars on request. Independent Films, 177 Golden Gate Ave., San Francisco, Calif.

**NEW** And rebuilt projectors for theaters, schools, churches, traveling shows. Supplies and complete theater equipments. Bargain prices. Free catalog. Monarch Theatre Supply Co., Memphis, Tenn.

**FILMS**; 200 Feet \$1.00. Reels \$2.50. List. Edgewood Sales, Box 155, Blue Island, Ill.

**BIG Money** in photography, motion picture projection. Catalog 49A free. New York Institute of Photography, 10 W. 33d St., New York.

**FILMS**—250 Feet 80c., westerns, etc. A. Savarese, 149 Palisade Ave., Union City, N. J.

**\$1,250 FOR** Original photoplay story. Our sales department sold unknown author's first story for above amount. We revise, copy-right and market stories for both silent and talking pictures. Located in the heart of motion-picture industry. We know the demand. Established 1917. Free booklet. Universal Scenario Company, 206 Western and Santa Monica Bldg., Hollywood, Calif.

**OUT** And ready for you! The great spring number. Bass Bargaingram No. 196. A mighty array of bargains in motion picture cameras, projectors for amateur and professional, text books and accessories. You can make big money by becoming a camera man. This great bargaingram will be sent to you on receipt of 4c in stamps. Send for it today. Bass Camera Company, 179 West Madison St., Chicago, Ill.

**TIME** Counts in applying for patents. See pages 140 and 141. Clarence A. O'Brien, Registered Patent Attorney, Washington, D. C.

### SCENERY TO RENT

**WORLD'S** Most Beautiful Settings for operas, plays, minstrels. Amelia Grain, Philadelphia.

### RADIO SETS AND SUPPLIES

**NEW** 300-Mile pocket radio \$3.50, complete with special loud receiver. No tubes or batteries required. Order direct. Spencer Laboratories, 116 Atlas, Akron, Ohio.

**BOSCH** Cruiser—Model No. 66 brand new, 6 tube, completely shielded, bargain \$35.00. J. Gerow, 89 Maple St., Yonkers, New York.

**BRAND** New Atwater Kent Model 35, 6 tubes radios in original cartons, \$16.00. French Sales Company, Melrose, Mass.

**RADIO** Trouble Shooting—Here is the book all radio men have been waiting for. Greatest book ever published from the point of view of assisting the repairman as well as showing how the radio owner can do his own repairing. 328 Pages. Over 300 Illustrations. Flexible. Pay postman price \$3 and postage when he delivers it. Popular Mechanics Co., Room 806, 200 East Ontario St., Chicago, Ill.

**ELIMINATORS**, 180 volt \$12.00. Miller, 628 North Eighth, Allentown, Pa.

**BROADCAST** From your own radio. Fun galore. Complete plans and program ideas 50c. McChesney, 2712 Elliott, Minneapolis, Minn.

**SAVE** One-half on Radio Supplies. Speakers, Extension Cords, Lightning Arresters, Speaker plugs, Tubes. Leaflet free. H. A. Zettler, Luxemburg, Wisconsin.

**BEST** Radio Book—New Revised Edition. Radio Theory and Operating by M. T. Loomis of the Loomis Radio College is America's Standard Radio Text-Book. Used by the various gov't departments, and schools and leading radio schools. 900 pages, 700 illus., flexible krafty leather binding. Sent C. O. D. Pay postman \$3.50 and the postage when package is delivered. Popular Mechanics Press, Room 806, 200 E. Ontario St., Chicago.

**TIME** Counts in applying for patents. See pages 140 and 141. Clarence A. O'Brien, Registered Patent Attorney, Washington, D. C.

**WANTED:** Men to work with National Radio Service organization. No selling scheme. Radio Doctors, Inc., Dept. M, Essex St., Salem, Mass.

### TRADE AND TECHNICAL SCHOOLS

**BE A** blue print reader. Write for facts. See how men in your trade got to the top. 'What's your trade?' Carroll Ramsey, Drexel Bldg., Philadelphia.

**TELEGRAPHY**—Both Morse and wireless—taught thoroughly. Big salaries. Wonderful opportunities. Expenses low; chance to earn part. School established fifty-four years. Catalog free. Dodge's Institute, Fern St., Valparaiso, Ind.

**OUR** Commercial radio operating and junior engineering course pays our graduates \$150 to \$300 monthly from start. Rapid advancement. Winter term begins in January. Write for catalog of course including Extension Course. Loomis Radio College, Dept. 5-E, Washington, D. C.

**BECOME** Watchmaker, diamond setter, own your business. Paying job. Standard Watchmaker's Institute, 111 W. 111th, N. Y.

**DRAFTSMEN!** Be an expert. By our method we train you quickly. Books and tools furnished. Write for illustrated catalog. Columbia School, 204P Drexel Bldg., Philadelphia.

### BUSINESS OPPORTUNITIES

**HAVE** You a patented hardware specialty, new household necessity, new automotive accessory or a new and useful patented novelty? Advertiser, investing quarter-million dollars annually, with thousands of trained agents and house-to-house salesmen, now ready to take on new products. If you have any special articles that look like winners, yet lack capital or sales organization to properly promote same, write us. We are looking for anything good that can be advertised and sold through specialty salesmen, and are in position to develop big sales in a short time. Will buy outright or develop on royalty basis. Our annual sales now running over million dollars. If you have something good, or a good idea for a quick selling article, it will pay you to get in connection with us. Room 225, c/o Popular Mechanics.

**\$125 PER** Week—in your own business. Inexpensive equipment—easy terms. Lewis Vandenberg writes, "My electric H-B Rug-Washer now earning over \$125 weekly. Earned \$60 my worst week." Finishes rugs like new on customer's floor. No shop necessary. Hundreds of customers in your vicinity—residences, hotels, offices, schools, clubs, theaters. Backed by \$33,000,000 Company. Method successful 10 years. Large profits at prices below other methods. Build permanent year around business. Start now before spring housecleaning. Write today for Booklet 609-A. No obligation. H-B Co., Racine, Wis.

**WILL** Buy products or inventions. We will make liberal all cash or cash and royalty offer for complete rights on products or patented inventions. Household, automotive or other specialties with eye-catching demonstration preferred. Prefer type of article not sold in stores, easy and economical to manufacture, sold at low price. Product must be completely protected with patents or be patentable, have real novelty and merit, and meet an existing or potential demand in big market. Give complete facts in letter, including product's selling history (if any.) If interested, will close deal at once. Rhodes Kriss-Kross Corp., Dep. G-3683, 1418 Pendleton Avenue, St. Louis, Mo.

**READ** The Mail Order News—America's pioneer mail trade journal. Quarter century old. Approximately 600 pages yearly of valuable information for beginners and established mail-order houses. Analyzes mail-order business, its opportunities. Practicable mail-order ideas, legitimate money-making schemes, instructive articles. Tells how to start, what to sell. Published monthly. Subscription \$3.00 yearly. Send 25c for sample copy. None free. Mail Order News, 500 Fifth Ave., New York.

**COMPOSITION** Floor making earns industrious men \$12 and more daily if used as trade. Or make business of it with profits up to \$10,000 yearly. Openings everywhere. Semi-Tile, Box 43, Hollis, N. Y.

**YOU** Can make more money now, and steadily increase your earnings. We teach you—at no cost to you—and start you in business in your own locality. You join a 12 million dollar organization. We back you with advertising. We need more men to handle our business—and this is your chance. Write for full information and free book—no obligation. Address Sales Manager, Dept. B, Drawer 2053, Hartford, Conn.

**MAN** In each town to plate auto parts, reflectors, bathroom fixtures, refinish beds, mirrors, chandeliers; by new method. No capital or experience required. Simple plan of manufacturing at home starts you in big money-making business. Outfit furnished. Free particulars and proofs. Gun Metal Co., Ave. H, Decatur, Ill.

**START** A plating plant in your basement. Make money evenings. Nickel-plate auto parts, lighting fixtures, tableware. Metal cost 50c, will plate work worth \$9.00. Send stamp for samples, data. Lincoln Engineering Company, 855 South 37th, Lincoln, Neb.

**MIRRORS** Resilvered at home. Costs near 5 cents per square foot; you charge 75 cents. Immense profits plating like new, brassy worn-off autoparts, reflectors, tableware, stoves, etc. Outfits furnished. Details free. Sprinkle, Plater, 127, Marlon, Ind.

**AN** Honest circular mailer looking for business. Make up a package, key them, inclose what you think a fair price and I guarantee to mail every piece to live prospects. No nude pictures or etc. Edward Armour, 136 East 28th St., New York.

**SEAT** Covers, \$10.00 a day and more, we teach you, make money from the start, the quickest trade to learn. National, 462 W. 37th St., Los Angeles, Calif.

**\$100 STARTS** Route automatic vending machines. Large steady profits. Write Chewit Corp., Dodworth St., Brooklyn, N. Y.

**PENN** Realty School trains men and women at home, by mail, prepares them for starting business or assuming well paid executive positions. Booklet free. 1131 S. 19th St., Philadelphia, Pa.

**CAPITAL** Wanted to manufacture modern combined harvester machine. Particulars, write W. C. Leonard, Room 17, S223 Browne Street, Spokane, Wash.

**250,000** ARTICLES At low wholesale prices—Directory 10c. W-Wecco, 4111 University, Des Moines, Iowa.

**SELL** And install Electric Light Plants. \$150 each. Liberal agent's commission. Easy to carry in car. Write. Onan & Sons, 11 Royalston Ave., Minneapolis, Minn.

**BUSINESS** Profession of your own and earn income in service fees. See Stephenson Laboratories, display ad page 130.

**PICTURED** Sign Cards. 400% Profit. Samples 10c. Breneman, J-4, Lima, Ohio.

**"WHY** Not a business of your own?" Cleaning hats, clothes, dyeing and pressing. Particulars free. Scientific American Cleaner, 432 Tenth St., New Kensington, Pa.

**MANUFACTURING** Concrete building blocks is your home town opportunity. Particulars free. Concrete Machine Co., 5 Main St. Louis, Mo.

**SELL** Business books by mail. Sample circulars. Wholesale prices 10c. Green 15788 Parkside, Detroit, Mich.

**LEARN** Marbleizing and stone enameling concrete products. New method. Resembles polished marble, all colors. Learn mold making for all uses, very cheap. These make a real business with small capital. Write John Cowell, Grayling, Mich.

**KING** System mail order business, co-operative idea. It's new! Honest! Different! Big profits! Details free. Evans P. King Co., Wilmington, Delaware.

**SELL** Your own goods. Fast sellers. Labels, Formulas, Service Guide, Shows how 10c. Box 184P, McCleary, Wash.

**PROFITABLE** Business of your own, \$150.00 to \$300.00 capital required. Lawrence P. Raleigh, 3216 N. Francisco Ave., Chicago, Ill.

**OUTDOOR** Opportunities. Instructions for raising and selling rabbits, guinea pigs, mitch goats, silver foxes, ferrets, white rats, white mice, dogs, cats, pigeons, pheasants, bantams, canaries, bees, frogs, mushrooms, ginseng and golden seal all profitably on town lot. Just write for "Outdoor Opportunities." Pay Postman \$2 and postage. Popular Mechanics Press, Room 806, 200 E. Ontario St., Chicago, Ill.

**ARTIFICIAL Marble** sanitary flooring instructions, covering wood or cement flooring ½ inch thick, fireproof, waterproof, all colors, low cost. Ornamental casting, concrete, plaster, papier-mache decorations, garden furniture, statuary, flexible molds. 18 years instructing the public; particulars and illustrations free. Chris. Mahler, Huntington, N. Y.

**MAIL Order** business your opportunity. Brenner's famous hand books by expert 28 years' experience show how to start selling articles you make or buy—all or part time—small capital. Fascinating, profitable. Set eleven books, \$3.25. Brenner Company, 1607 P. Sanson, Philadelphia. Sample book, 25c, pay \$3 for other ten if satisfied.

**BUILD Refrigerating machines.** Plans 25c. Parts, Box 251, Ames, Iowa.

**EARN \$15 Daily.** No canvassing, no selling. Real profit maker in an unlimited field. Complete dope in book form, 25c postpaid. No stamps. Tranole, 715 East 4th St., Brooklyn, N. Y.

**FREE Booklet** describes 67 plans for making \$20.—\$100 weekly in home or office business of your own. Elite Co., 84 Elizabeth St., N. Y.

**UNPATENTED Ideas** can be sold. I tell you how and help you make the sale. Free particulars (Copyrighted). Write W. T. Greene, 910 Barrister Bldg., Washington, D. C.

**CAPITAL**—For copy of the "Promoter's Hand Book," a leaflet on financing, an eye opener for capital seekers, send \$1.00 to Amster Leonard, East Orange, N. J.

**SUPPLIES** For making chipped glass house numbers and signs. Tinfoils, glass and frames. Osborne Sims, 13580 Tuller, Detroit, Mich.

**SIXTY Successful mailorder products.** sales plans. K. Home, 3949 Metropolitan, Chicago.

**501 WAYS To make money.** Particulars free. Arthur A. Terry, 1964 West 7th St., Brooklyn, N. Y.

**LEARN Telephone advertising.** New profession. Good income quick. Man or woman. Capital and experience unnecessary. Booklet free. Teleplan, Brown Bldg., Wichita, Kans.

**GO Into Crispette business**—Everybody likes Crispettes; make a lot of money. Geo. Alexander, Pennsylvania, reports "profits \$3,000 in four months." We start you. Write for facts. Long-Eakins, 1960 High, Springfield, Ohio.

**MAKE Your own products.** Employ agents yourself. Toilet articles, soap, extracts. We furnish everything. Valuable book free. National Scientific Laboratories, 1984W Broad, Richmond, Va.

**MECHANICS.** Painters, carpenters, start furniture refinishing, painting, handyman shop on nearly nothing; winning plan brings customers quickly. John Braceland, 1439 So. Ninth, Philadelphia, Pa.

**FREE Book.** Start your own little business anywhere, selling novelties by mail. My beginner's outfit contains everything required, novelties, circulars, instructions, etc. Descriptive book free. Hadwil, 3A-74 Cortland St., New York.

**LOIDLAC Wonderful, new, amazing discovery** ends polishing and repainting. Restores colors—makes the old car look like new in 30 minutes! Not a polish, paint, cleaner or wax. Make it yourself, have hundreds selling it. \$14.00 gallon profit. Write for exclusive manufacturing rights. Miller, Chemist, 706 Jetton, Tampa, Fla.

**CHEMICAL Expert** furnishes manufacturing directions. Reliable individual service only. No lists. Charges reasonable. Correspondence invited. Dr. Arthur Vaning formulas and processes with complete Heeden, 2410 Congress, Chicago.

**TIME Counts** in applying for patents. See pages 140 and 141. Clarence A. O'Brien, Registered Patent Attorney, Washington, D. C.

**LEARN the collection business.** Good income, quick results. Interesting booklet, "Skillful Collecting" free. National Collectors Assn., Long St., Newark, Ohio.

**GIGANTIC Mail:** Over 100 pieces guaranteed if you list your name in my directory; one month 10c, 3 months 25c. Edward Armour, 136 East 28th St., New York.

**A BUSINESS** of your own making—Sparkling Glass Name and Number plates. Checkerboards, signs. Big book and sample free. E. Palmer, 540, Wooster, Ohio.

**I MADE \$30 a Week Home.** French Breadmaking. 15 years' experience; Free Booklet tells. Ashbrook 67, Marengo, Ohio.

**AMATEUR Cartoonists:** Sell your cartoons. New plan. Smith's Service, PA-1194, Wenatchee, Wash.

**SUCCEED** With your own products. Make them yourself. Formulas, processes, trade-secrets. All lines. Catalog, circulars free. B. Thaxly Co., Washington, D. C.

**\$200 WILL** Start your own business; chance to enlarge; unlimited money-making possibilities; you manage, distribute and collect; experience unnecessary. For particulars, address Manager, 603 N. Eutaw St., Baltimore, Md.

**WE Start** you in business, furnishing everything Men and women, earn \$40 to \$100 weekly operating our original "New System Specialty Candy Factories." Begin home spare time. Unlimited opportunity. Valuable booklet free. W. Hillyer Ragsdale, Drawer 4, East Orange, N. J.

**"SCHEMER"** Subscribers surely succeed. One reports \$50,000 from one tip; another \$25,000 from three Schemes; another \$10,000 from one formula. Try your luck! Year, \$1.00; three months, 30c. Patterson, Publisher, Alliance, Ohio.

**CHEMICAL Expert** will furnish formulas and trade secrets. All lines. Lists free. W. L. Cummings, Ph. D., 228 Gordon Ave., Syracuse, N. Y.

**CHARTERS:** Delaware; best, cheapest; free forms. Colonial Charter Co., Wilmington, Del.

**SELL by Mail!** Books, novelties, bargains! Large profits! Particulars Free! B-Elco, 525 South Dearborn, Chicago.

**MAKE Big profits** with a fur farm in your backyard Chinchilla rabbits, muskrat, mink. Write for facts. 252 Conrad's Ranch, Denver, Colo.

#### TELEGRAPHY

**TELEGRAPHY**—Both Morse and wireless—taught thoroughly. Big salaries. Wonderful opportunities. Expenses low; chance to earn part. School established fifty-four years. Catalog free. Dodge's Institute, H St., Valparaiso, Ind.

#### CHEMISTRY

**CHEMICAL Analysis, consultation, formulae, processes developed.** F. J. Andress, 625 Crown, Cincinnati, Ohio.

**1929 BOOKLET** of chemical experiments. Illustrated. 15c. General Chemical Company, Box 397, Reading, Penna.

**CHEMICAL Analysis, Processes, technical information.** Robert Henderson, Laboratory, Madison, Me.

**YOUR Chemical problems** solved and formula or process furnished for \$5.00. Write me. W. Stedman Richard, Industrial Chemist, Box 2402, Boston, Mass.

#### FORMULAS AND TRADE SECRETS

**NOT Wax, Polish or Paint**—marvelous effortless automobile instantaneous refinisher formula. 50c. Any formula, 50c. Bernard Wells, Room 301, 852 George, Chicago.

**SEND \$10 Today** for formula and instructions for manufacturing Tubette (United States patent office protection). Stops punctures in pneumatic tires. Every car owner prospect; tremendous opportunity. Costs 50c per car to manufacture; sells at \$10. Postoffice Box 64, Seattle, Washington.

**ANYONE** of our 50,000 guaranteed master formulas 50 cents. All industrial lines. Federal Laboratories, 542 North Ave., Chicago, Ill.

**REPAIR Golf Balls.** Big profits. No competition. Simple, new, guaranteed process \$1.00. Parco, 507 Brown Bldg., Wichita, Kans.

**TESTED Formulas.** Catalog and actual samples free. Grinstead Company, Oswego, Kans.

**FORMULAS, Processes;** chemical problems solved. Moderate charges. Individual service by experienced industrial chemist. Inquiries invited. L. Clore, Industrial Chemist, Crawfordsville, Ind.

**GUARANTEED Formulas and trade secrets.** Big money making your own products. A. Hanlon, Strafford, Pa.

**FORMULA, Expert supplies, up-to-date formulas.** Lists free. Donahoo, 2621 Jackson, Wilmar, Calif.

**MOST Sensational formula** bargain ever offered. Latest, best sellers. List free. Specialty Mfg. Service, 801 So. Farragut, Bay City, Mich.

**400% PROFIT.** Two guaranteed formulas \$1.00. Metal polishing cloths, windshield cleaning cloths. Bussier Company, 103 Ruth, New Bedford, Mass.

**3,000 FORMULAS \$1.00.** 500, 50c. National Service, 2937 Marburg, Cincinnati, O.

**MY Silver plating fluid, formula \$1.00.** Reliable Products Distributors, 925 S. 22d, South Bend, Ind.

**TABLECLOTH**—Looks like linen, washes like oilcloth! Mystic polishing floss. Lac-Nu auto refinish. These tested formulas, \$1.00 each; samples free. Catalog. Grinstead Company, Oswego, Kans.

**FREE Formula catalog, illustrated, agent-pitchmen-household and automobile specialties.** Western Chemical, Salem, Oreg.

**FORMULAS:** Guaranteed, latest and reliable, catalog free. Golden West Specialty Labs., 5132 N. 17 St., Omaha, Nebr.

**MAKE Your own products.** Employ agents yourself. Toilet articles, soap, extracts. We furnish everything. Valuable book free. National Scientific Laboratories, 1984W Broad, Richmond, Va.

**ASSOCIATED Chemists, Indianapolis, Ind.** Analysis and chemical consultation. Manufacturing ideas developed. Money-making formulas. Charges moderate. Write.

**INDUSTRIAL Chemist** furnishes formulas, plans, trade secrets. All lines. Work guaranteed. Lists free. J. F. Mazur, 941 20th, Lorain, Ohio.

**GUARANTEED Formulas, best science** can produce for making popular, biggest-selling specialties all lines. Don't buy formulas till you've received valuable eye-opening literature. Miller, Chemist, 706-F Jetton, Tampa, Fla.

**15,000 FORMULAS** in "Scientific American Cyclopedic of Formulas." Includes following and many others: Accidents and emergencies, agriculture, alloys and amalgams, artist's materials, beverages, cements, glues, pastes, muellages, bleaching, renovating, coloring metals, dyeing, glass, heat treatment of metals, household formulas, ice cream, confectionery, chewing gum, lapidary work, exterminating vermin, lubricants, paints, varnishes, photography, condiments, canning formulas, rubber soap, candles, soldering, toilet preparations, perfumes, waterproofing, fireproofing, writing materials. Send no money. Just write a postal. When postman hands you book pay \$5.50 and postal charges. Popular Mechanics Press, Room 806, 200 E. Ontario St., Chicago, Ill.

**SUCCEED** With your own products. Make them yourself. Formulas, processes, trade-secrets. All lines. Catalog, circulars free. B. Thaxly Co., Washington, D. C.

**FORMULAS:** Guaranteed, catalog free. Bestoval Laboratories, 6720 Oconto, Ave., Chicago.

#### AGENTS WANTED

**WANTED** At once: More good men to introduce and retail Rawleigh's Good Health Products. Town and Country. Wonderful opportunity. Get into business with backing of largest manufacturer of its kind. Capital over 15 million dollars. Quick freight, express, parcels post service from 10 great factories and branches—one near you. Nothing new—no experimenting. No experience required. You simply follow the same old time-tested Rawleigh Methods which secure the most business everywhere and have given consumers best values and satisfaction for 40 years. 170 necessities frequently needed every home. Enormous demand. Annual sales now over 35 million products. Big free trial inducements. Quick easy sales. Repeat every 30-60 days. Enormous profits—\$200-\$400 month and more clear profits. Steady year around; no lay-off. No boss—you become sole owner and manager. Practically no capital required. We supply everything—stocks, outfit, sales and service methods. Big pay every day. Profits increase every month. "First come first served." For full particulars write W. T. Rawleigh Co., Dept. A-6PPM, Freeport, Ill.

**\$241.10 CASH** One day. That's what A. E. Martin made without experience just showing most amazing auto light—38,000 candle power without glare. Fits any headlamp, easily installed. No dimming, no tilting. Makes astounding demonstration anywhere night or day. Distributors cleaning up to 250% profits. Sells on sight. Hamilton does \$2,000 first month. You bank \$127 weekly on only three sales a day. Exclusive territory open. Write today. Aerial Electric Co., 337 W. Ohio St., Chicago, Ill.



**JUST Out**—New patented apron. No strings or straps—\$20.00 a day every day; over 100% profit; commissions daily. Write for free outfit. Sta-Put Co., Dept. 206, St. Louis, Mo.

**AGENTS**—Make a dollar an hour. Sell new kind of sharpeners. Sharpens all knives and tools quickly. Demonstrating sample 10c. Premier Mfg. Co., Dept. 92, Detroit, Mich.

**OVER 125** Reliable manufacturers need representatives in every locality in the United States. For complete list of firms and full particulars write Opportunity News, Dept. M, 750 No. Michigan, Chicago, Ill.

**\$50 WEEKLY.** Men wanted to demonstrate and take 10 orders daily direct from motorists. Amazing magnetic trouble light. Sticks anywhere! More orders, bigger pay. Write for demonstrator and particulars. Magno, Beacon Bldg., Dept. 166, Boston, Mass.

**AGENTS:** Free catalog 200 household specialties, toilet preparations, food products, portraits, frames, pillow tops, medallions, religious goods, pictures. Credit. James C. Bailey Co., Station C-6, Chicago.

**AGENTS** Make big money—selling new invention adjustable steel closet and pantry shelf 24 to 48 in. long. One minute to put up. Sell every home, hardware, drygoods store. Send \$1.50 or 3 for \$4.00 postpaid. Exclusive territory given. Ball Mfg. Co., 715 E. 62nd St., Chicago.

**VICTORY** Tire Rim Tool. Changed tire 24 seconds. No experience necessary. Splendid opportunity for active men, select your territory today. Write immediately for information. Victory Tire Rim Tool Co., 1516 Pico Blvd., Santa Monica, Calif.

**200% PROFIT.** Amazing, new polishing cloth. Distributors wanted, appoint sub agents, and sell dealers. Sample free. P. M. Sterling, 1913 West Ninth St., Los Angeles, Calif.

**LEATHER** Compound, new. Fills holes in shoes, cracks, rubbers, wears like leather, waterproof. Agents repeat business. Sample can \$1.00. Henry Steffen, 620 Belmont, Chicago.

**HEY-Y-Y!** Tablecloth—Looks like Linen; washes like oilcloth. Make them yourself; formula, process, \$1.00. Sample free. Mystic Polishing Floss; formula \$1.00. Sample free. Lac-Nu Auto Refinish; formula, \$1.00. Formula catalog free. Grinstead Company, Oswego, Kans.

**\$75-\$150 WEEKLY;** Glo-Bac! Amazing new necessity for every car owner, fleet owner, garage. \$2.00 saves \$75.00. Big profit. Marvel-Glo Company, Dept. B-3, Columbus, Ohio.

**POLMET** Polishing Cloth removes tarnish from metals without the use of liquid, paste or powder. Our agents say it sells like "hot cakes." Retails 25c; sample free. Gale & Co., Inc., 15 Edinboro St., Boston, Mass.

**32 SECONDS** Complete tire change by Detmer, Ohio, with Morey Quick Action Rim Tool. Sold, singly, 49 three days cleared \$100. Anderson, Mont., sold 1,400 in 14 weeks. Get details for good territory. Harvest time now. M. Morey Rim Tool, Buffalo, N. Y.

**REMNANT** Store, Bethel, Ohio. Greatest Dry Goods Bargains on Earth. Agents and Dealers.

**WHOOPEE** Hats going over big. Everybody's wearing 'em. You can't afford to overlook this. Write immediately for particulars. (Sample postpaid \$1.25). J. P. Braun Company, 912 Trinity Avenue, New York.

**\$10-\$25 DAILY** Simply showing new Polly wrench. 10 wrenches in one. Guaranteed seller. Sample free. Gellman Mfg. Co., Dept. 6F, Rock Island, Ill.

**AGENTS**—Magic counter cards of Gits—sniffers; pays agents \$20 day; our amazing plan guarantees sales. Write Gits Co., N5419 Chicago Ave., Chicago, Ill.

**5,000 MEN** Wanted to collect and refine used crank-case oil by great new discovery. No machinery—enormous profits, permanent business. Tested and approved by leading chemists. Send \$1 for complete money back guaranteed process. R. W. Barker, Chemist, 1706 S. Michigan, Chicago.

**\$75 WEEKLY.** Man or woman wanted with ambition and industry, to distribute Rawleigh's Household Products to steady users. Fine openings near you. We train and help you so you can make up to \$100 a week or more. No experience necessary. Pleasant, profitable, dignified work. Write to-day. W. T. Rawleigh Co. Dept. F-53 PPM, Freeport, Ill.

**NO Dull** times selling food! People must eat. Federal distributors make big money; \$3,000 yearly and up. No capital or experience needed; guaranteed sales; unsold goods may be returned. We furnish you with sample case, license and free samples for customers—sure repeat orders. Exclusive territory. Ask now! Federal Pure Food Co., A2307 Archer, Chicago.

**MAKE \$500.** Show Tablecloths. Save laundry bills. Women scramble for them. Free sample. Mohler, Box 453-CK, Chicago.

**PATEST \$1.00** Seller ever produced. Housewives buy on sight. Approved by Good Housekeeping. Patented Duplex Sifter sifts and re-sifts without removing flour. Saves time and labor. Magnus sold 120 first 24 hours. Profit \$54.40. Protected territory. Sample sales outfit 60c stamps. Oneek, 4501 Lexington, Chicago.

**MAKE \$20 To \$35 a day** selling Imprint Book Matches, spare or full time. Big repeat business—no investment—every merchant a prospect. Write Imprint Book Match, Dept. A-11, 877 Meigs St., Rochester, N. Y.

**MEN** With cars to demonstrate and sell the best auto polish on the market. Big money. Write Vocco Chemical Co., 3342 N. Whipple, Chicago.

**ARE You** old at forty? See our advertisement on page 73 of this issue. The Electro Thermal Company, 2118 Morris Ave., Steubenville, Ohio.

**FREE Sample**—Ha-Pe-Da Washing Tablets. Carl-Abbott Company, Oswego, Kans.

**SELL** Goodyear raincoats; \$2.95 up. Goodyear Rainwear, 346 Sixth Ave., New York.

**STOP!** 400 Fast selling specialties from many parts of world. Write for free wholesale catalog. Importing Co., Lesueur Center, Minn.

**AGENTS;** Big profits installing new German patent. Auto-Way-Indicator operated by button from wheel. Write for territory and free offer. Karl A. Neise, Technical Dept., 123 W. Madison St., Chicago.

**EXCELLENT** Sales and business opportunities in new chemical specialties in Peoples Review, 2519 So. Crawford Ave., Chicago, Ill. Copy free.

**MECHANICS** Improved scale holders. Roman Arndt, Box 1401, Detroit, Mich.

**AGENTS \$60 Week**—Sell finest line guaranteed hosiery. All new styles and big sellers. Big commission. Earn silk hose for your own use. Write quick for sample outfit. Silknet Hosiery Co., Dept. 431, Dayton, Ohio.

**AGENTS.** Send for free sample. "Fretnot" washes clothes snow white without rubbing. \$7.00 daily and more easily made. Credit given. Empire, 2646 Lincoln Ave., Dept. 101, Chicago.

**MAKE** Your own products. Employ agents yourself. Toilet articles, soap, extracts. We furnish everything. Valuable book free. National Scientific Laboratories, 1984W Broad, Richmond, Va.

**GENUINE** Gold Leaf Letters anyone can put on store windows. Guaranteed to never tarnish. Large profits. Enormous demand. Free samples. Write today. Metalite Letter Co., 438-D North Clark, Chicago.

**\$2.95 AUTOSEAT** Covers—Cash daily—Amazing all America-Postcard brings Leatherette Sales Outfit. "Quality," 5513 So. Dearborn, Chicago.

**\$350.00 MONTHLY** Selling newest, longest wearing Everkleen Tablecloths. Beautifully embroidered. Looks like linen. No laundering necessary. Get sample. Linenette Mfg. 361 W. Ontario, Chicago.

**GENERAL** Agents. Sell well known Cedar crystals—kills moths, disinfects. Retails 35c, also 25c paddle that hangs on hook. Women buy one to six. Free particulars. Cee-Dar, H77 W. Washington, Chicago.

**\$2.98 GENUINE** Trench Coats all colors. Also full line raincoats, DuPont launderless Fabrikoid tablecloths, dresses, rubber aprons, famous protecto bag, etc. 100 live sellers. Free outfit. American C726, Roosevelt, Chicago.

**AGENTS**—That something new and different you have been looking for. Just out. No competition. A quality product that makes steady sales and repeats certain. 100% profit to you. \$10.00 to \$20.00 daily. Seeing is believing. Send \$1.00 for sample and information. J. R. Council, Sales Manager, Box 372, Hollywood, Calif.

**DUST REMOVERS.** Saves nine tenths of car washing. Sample sent dealers on application. Dust Remover Co., Fayette, Ohio.

**SELL** Patented Nitralgram Automobile Crests with interchangeable initials and fraternal emblems. Every car owner a prospect. Sells for \$1.50 a set. Costs you 75c. Send for literature and sales proposition. Morton Jewelry Co., 74 West 46th St., New York City.

**SELL** Ties—Make big profits. Get big sample selling outfit absolutely free. Wonderful patterns. Splendid value. Liberal commissions. Write today to Pubite Mills, 4933-CP Hudson Boulevard, North Bergen, N. J.

**EXCLUSIVE** Condolence card. The Orphans Mothers Day. Hand painted onyx stock. Sample 12c. Big 25c seller. James Chambless, Bessemer, Ala.

**SELL** By mail! Books, novelties, bargains! Domestic and imported, large profits. Particulars free. Institute, Desk 14, GPO Box 223, New York.

**12,000,000 SOLD** Annually. "The World's keenest business." Sell razor blades, all makes under your own name, retail, wholesale, through agents and by mail. 40 page book 10c, or free particulars. H. Bruns & Sons, 2501P, Sherman Avenue, Madison, Wis.

**\$50.00—\$75.00 WEEKLY.** Newest window letters out. Easiest to put on. No experience needed. Free samples. "Ralco," 1045 Washington, Boston, Mass.

**WANTED.** Agents to sell our wonderful invention \$20.00 per day easy made. C. A. Myers Company, 6324 Woodlawn Ave., Chicago, Ill.

**NOVELTIES;** 165 Designs, 10c. Black Studio, 1249 S. Grand, Los Angeles.

**"KLEVER KLAU."** The wonder tool of a thousand uses. Greatest demonstrator. Free sample. Full particulars. Kyser Bros., Lowell, Mich.

**HOSIERY** Agents: New manufacturing process enables us to offer our famous pure silk hosiery at lowest prices ever known! Agents making \$5-\$15 daily! Big outfit free! Write, Racine Feet Knitting Co., Dept. 10, Beloit, Wis.

**DISTRICT** Managers! Crew managers! General agents! Wanted: Men and women to appoint saleswomen to sell "New Idea" imported sanitary necessity. New feature never before used. Every woman buys and repeats. New sales plan nets you big profit on sub-agents. Exclusive territory to producers. Write quick, Box J-708, Meriden, Conn.

**\$15 DAILY** Selling custom quality shirts and ties. Largest cash commissions, extra bonuses. Outfit free. District managers wanted. Farmode, 21 Lesser Bldg., St. Louis.

**AGENTS**—Make money and friends selling Old-Gold Quality Toilet Goods. Write Old-Gold Chemical Co., 49-51 South Third Street, Memphis, Tenn.

**MIRROBS** Resilvered at home. Costs near 5 cents per square foot; you charge 75 cents. Immense profits plating autoparts, reflectors, tableware, stoves, refinishing metalware, etc. Outfits furnished. Details Free. Write Sprinkle, Plater, 128, Marion, Ind.

**GREATEST** Soap discovery of the age! Made from South Sea Island plants. Produces 2 and 3 times more lather. Sensational seller. \$1.25 an hour easy. Write for samples. Albert Mills, 3775 Monmouth, Cincinnati, O.

**SELL** "Prevents Runs." Guaranteed to prevent runs in silk hosiery. Large profits. Particulars, Specialty Mfg. 307 West First, Los Angeles, Calif.

**VACATION** Money! Sell attractive greeting cards, gifts. Hurry! Arthur Studios, 363 Montague, Montclair, New Jersey.

**AGENTS.** Lustre-Bac, new auto refinish restores color lustre instantly. Donahoo, 2621 Jackson, Wilmet, Calif.

**SELL** Supreme No-Cement tire and tube patches. 300% profit. Particulars. Supreme 135 Winder, Detroit, Mich.

**CARTER** Wigd-w washer. No investment. Big profits. Exclusive distributors. Cleans, dries, polishes. Carter Products, 955 Front Cleveland, Ohio.

**EASIEST** Thing ever sold. Rubber nozzle washer won't scratch car. Retails, \$2.00. Sponge Nozzle Co., 3780 Clairmount Ave., Detroit, Mich.

**AMAZING** Invention, combs and waves hair. Sells every woman, pocket carries dozens. Rex Sales, 1235 Lexington Ave., New York City.

**AGENTS** Become a regular established McConnon dealer! Buy on credit; sell for cash or credit. 228 absolute household necessities; all repeaters. Enjoy a sure income 52 weeks per year, year after year. City or country trade. Capital, experience unnecessary. McConnon & Co., Dept. M906, Winona, Minn.

**ZIPLITERS**—Gasliter samples 25c. Cigarliters 50c. Enormous profits. Ziplite Mfrs. 3216 Kossuth Ave., Bronx, New York.

**FREE** Booklet describes 67 plans for making \$20—\$100 weekly in home or office business of your own. Elite Co., 84 Elizabeth St., N. Y.

**ENERGETIC** Men earn \$60 weekly installing dust shields; women dislike cleaning corners. Write: Ideal Stairway Equipment Co., Dept. PM, Canton, Ohio.

**\$15 A Day** sure. Guaranteed solid leather shoes. Unequaled low prices. 85 styles: men's, women's, children's. Free outfit offers complete line shoes, raincoats, leather coats, puttees. Consolidated Shoe System, Dept. 615, Eau Claire, Wis.

**MANUFACTURE** Auto Specialties; Radiator Seal, Hand Soap, Puncture Plugger, Silk Life, Glass Cleaner. Get my free list. John Mickman, Chemist, St. Paul, Minn.

**AGENTS** Wanted—On a fast selling 25c item for the kitchen, costs you 8½c. Sample sent parcel post prepaid for 10 cents. P. Seed Filter Mfg. Co., Inc., 353 Broadway, New York.

**BIG** Money manufacturing vanilla flavor in your own home. Sell to housewives, stores, bakeries, hotels. Guaranteed formula. Instruction \$5.00. Stark, 1216E College, Bowling Green, Ky.

**SELL** Cigar Lighter like fountain pen. 50c. Stevenson, 162 Champlain, Rochester, N. Y.

**AGENTS**—\$75.00 Weekly! "Dependo" garage door holders—something new. Sells on sight. Garage owners and builders live prospects. Melbye, 3204 N. Oakley, Chicago.

**AGENTS**, \$15 Daily made easily with Mistle Ice Blankets; costs 40c, sells for \$1, selling outfit free. United Laboratory, Dept. 21, Batavia, Ill.

**IT** Rings the bell for salesmen who must have big money. Krystal Kleen actually sells 100% on calls. Its demonstration is irresistible, its field is three-fold. Fifty-fifty deal. Write today. Fenton Chemical Company, Jackson Heights, New York.

**WE** Offer the selling agency for the world's largest, most complete direct to wearer men's wear line; consists of 135 large cloth samples, shirts, neckties, underwear, pajamas, waterproof trench coats and lumberjacks; spare or full time; experience unnecessary; outfit free. Howard, 1213 Van Buren, Factory 242, Chicago.

**WONDERLITE** Mfg. Co. Wants men to sell new Magnetic Trouble Light—most useful automobile accessory—sells at sight—commissions, special bonuses—big money getter. Send for demonstrator and particulars. Dept. P, 1201 Industrial Trust Bldg., Providence, R. I.

**A GOLD MINE**—New liquid discovery mends fabrics—hosiery. Stops runs. 400% profit! Every woman buys. 100 other fast sellers. Johnson Co., Dept. 478, 6129 Wentworth, Chicago.

**BECOME** Your home town leading business man. Sell full line of groceries, motor oils, paints. Everybody a customer. No capital or experience necessary. Selling outfit free. Write Loverin & Browne, 1602F, So. State, Chicago.

**INSTANT** Weld welds rubber instantly. Steek's profit one day \$72.25. Enormous demand. Exclusive territory. Free sample. Tourists Pride Mfg. Co., Desk E, Minneapolis, Minn.

**WELLS** Cleared \$620.00 in one month with amazing book "Business Guide" and free legal service. Outfit free! Prof. Nichols, Dept. 117, Naperville, Ill.

**STRANGE** New electric iron cord! Prevents scorching. Saves electricity. Cannot kink or snarl. Used on telephones also. \$25 daily. Samples free. Neverknot, Dept. 6-A, 4503 Ravenswood, Chicago.

**SELL** Men's neckwear—wonderful proposition. Astor-M, 39 East 28th, New York.

**\$5 SALE**—\$5 Commission. New combination life-accident policy. Write immediately. United Underwriters, PM-3, Willow Hill, Ill.

**AGENTS**—\$250 Month. Raincoats. All colors. Your choice \$2.65. Part time \$2 hour. Complete line 60 patterns, silks, suedes, tweeds, Leather-Lyke. Outfit sent free, postage prepaid. Write Comer Mfg. Co., Dept. W-5143, Dayton, Ohio.

**AGENTS**—Absolutely new! Our hand-colored popular-priced Photo Statuettes going big! Everyone wants them! Agents making \$10-\$25 daily! Samples furnished! Cruver Mfg. Co., L2456, Jackson, Chicago.

**WHERE** To buy 500,000 articles at lowest wholesale prices. 1929 directory. Distributors wanted. Pruitt System, Brookfield, Ill.

**MAKE** \$20 Daily selling merchant's Changeable Letter Show Window Signs. Experience unnecessary. Send for free sample offer. Maze Company, 542 W. Washington, Chicago.

**\$15 DAILY** Selling custom quality shirts and ties. Largest cash commissions, extra bonuses. Outfits free. District managers wanted. Parmode, 21 Lesser Bldg., St. Louis.

**AGENTS**—No selling—Place Mystery Floss in stores. Easy winner. Counter Display. Mohler, Box 453-CU, Chicago.

**MAKE** Your own products. Employ agents yourself. Toilet articles, soap, extracts. We furnish everything. Valuable book free. National Scientific Laboratories, 1984W Broad, Richmond, Va.

**WE** Have the finest needle case, self threading needles, needle threaders. \$5.00 to \$200.00 weekly. Samples 25c; particulars free. Empire, 2646 Lincoln Ave., Dept. 201, Chicago.

**AGENTS** \$300 Month. Bonus besides. Sell guaranteed silk hosiery. Must wear 7 months or replaced. Producers earn auto. Write for samples. Free silk hosiery for your own use. Betterknt Hosiery Co., Silk, 4431, Greenfield, Ohio.

**AGENTS** "Strike a gold mine" when selling Nulustro Cloths at 25c; cleans, polishes all metals; the duller the metal, brighter it shines. Everybody delighted. Agents sells 102 boxes out of 116 calls. Write for free samples and proof. Shef Mfg. Co., 1 Shef Bldg., Weehawken, N. J.

**BIG** Pay every day taking orders for Dress Shirts, Work Shirts, Pants, Overalls, Sweaters, Underwear, Hosiery, Pajamas, Playsuits! Experience unnecessary. Outfit free! Nimrod Co., Dept. S, 4922-28 Lincoln Ave., Chicago.

**AGENTS**. Our cigar lighters, musical novelties and salesboards sell quick. Large wholesale catalog free. Joseph Sales Company, 223 Madison St., Chicago.

**EARN**. From 2-4 dollars an hour in your spare time taking orders for (Superior Home-made Rugs). Inquire, W. A. Baum, Marietta, Pa.

**IT'S** New—It's great. Sells everywhere. Metal polish in tubes. A real money maker. Trial tube free. P. M. Reid Manufacturing Co., 1619 Clark, St. Louis, Mo.

**100% PROFIT**. Amazing Paste quickly removes rain spots, polishes nickel on automobiles, etc. Complete line home necessities. Williams Corp., 305 Williams Bldg., Montclair, N. J.

**FREE** Shirts, Hosiery, Underwear and \$35. Weekly for spare time—\$90 Full time. Sure Sales Plans Guarantee Success. Selling outfit free. Write today. Shaughnessy Knitting Co., 784-C, Shaughnessy St., Watertown, N. Y.

**BIG** Cash commissions daily taking orders for new patented mothproof clothes hanger. Eliminates bags, chests, sprays. Every housewife buys 6. Big season now. Sample free. Austin Accessories, F-2630 Shields, Chicago.

**SELLING** Like blazes! Beautiful toilet goods assortment at \$1.50 with 24 inch Pearl Necklace free to your customers. 100% profit. E. M. Davis, 234 W. North Ave., Dept. 530, Chicago.

**\$25 DAILY**. Raincoats, all colors, \$2.45. Trenchcoats, alligators, leatherettes. Free coat and outfit. Bradley, Dept. AB-6, 230 So. Wells, Chicago.

**AGENTS** \$240 Month. Dri-Kleanit removes dirt, grease, tar, all one operation. Cleans car for 10c. No soap or water used. Car looks like new. Wonderful seller. Free sample. American Accessories Co., Desk 4831, Cincinnati, Ohio.

**AGENTS** Buy direct, hosiery, lingerie at lowest mill prices. Unusual opportunity. Act quick. Superior Knitting Company, Dept. 17, New Haven, Conn.

**MAKE \$15.00 Daily!** Simply show Rhinestone Initial Buckles, Fountain Pens, etc. We deliver. No competition. No investment. Write quick for special free sample outfit. Chaton Novelty Co., Dept. C, 608 Blue Island Ave., Chicago.

**SELL** Ceiling fly swatters, sample 30 cts. Ceiling Swatter Co., Glenoiden, Pa.

**AGENTS**, \$15 Daily in advance selling the only guaranteed electric waffle iron at \$2.50. Everybody buys. Sample furnished. Supreme Products, D8 So. Dearborn, Chicago.

**BURG-LA-PROOF!** Men and women to sell our automatic window lock. Allows windows to be opened for ventilation, yet locked in any position for protection. Instantly demonstrated without tools. Sell at least six to each home. 100% profit. B-L-P Window Catch Company, Box 57, Everett, Mass.

**\$75.00 WEEKLY** Demonstrating and distributing Rich's Soft Drink Powders to homes, stores, stands. Powell sells 30,000 monthly. Start with or without capital. Sol F. Rich Co., 622 So. Sangamon, Chicago.

**NEW** Summer line ready sweaters, hosiery, shirts, underwear, silk lingerie, raincoats. Undersell stores—make \$110 weekly. Outfit free. May Co., 103 So. Wells, Chicago.

**MAIL** Order information—an unusual money making proposition; particulars free. Flemco, Box 5, Station F., N. Y.

**AGENTS** Coin money showing our line Sturgis Novelty Shop, Sturgis, Mich.

**AGENTS**, Look! Mens imperfect fancy hosiery \$14.00 gross pairs, rayon imperfect neckwear, \$6.00 gross. Send today \$10.00 for one gross assorted. Lewis Hosiery, 12 N. 3rd, Philadelphia, Pa.

**\$61.50 WEEKLY** Introducing and selling a new gas light burner for kerosene lamps. No chimney. No mantle. Samples free. Luther Mfg. Co., Dept. 650, Cincinnati, O.

**SHARPENER** For scissors and knives. Has flat, movable, re-versible, and re-newable sharpening surface. Live seller at 300% profit. Sample 25c. Lake Mfg. Co., Clarendon, Va.

**TREMENDOUS** Weekly earnings. Sell greatest labor-saving device ever invented. Patented article sells on one-minute demonstration every home, factory, store, office. Write today. Dept. PM6, Wonder Window Washer, 31 East 10th St., New York.

**\$150—\$200 WEEKLY**. Amazing new invention brings new riding comfort to coach owners! Grab this quick. Over 16 million prospects. Go-It, Flint, Mich.

**EVERY** Gillette user wants a Jones Strop-Per. A gold mine for workers. Sample \$1.00, refunded with first dozen order. Jones-Rutherford Co., 3856 Bryant St., Denver, Colo.

**LACEY'S** Patent Sense. Valuable book free. See ad page 145.

**FREE** Booklet describes 67 plans for making \$20—\$100 weekly in home or office business of your own. Elite Co., 84 Elizabeth St., N. Y.

**SELL** Hanslick, powdered soap. On market 8 years. Easy seller, everybody customer. Fine repeater. Big profits. Sample free. Solar Products, J2144 S. Troy, Chicago.

**AGENTS**: Our gold-eyed needle cases are wonderful sellers; immense profits: \$50 to \$300 weekly; proof free; sample outfits 10c; factory prices. Paty Needle Co., West Somerville, Mass.

**SPLENDID** Income for crew managers. Extra heavy demand in spring and summer for Duo Wonder Cleanser, Gloss Oil, other specialties. Large all-year line household necessities. Prices right. Big discounts on large orders. Beautiful premiums for customers. A-1 service. Write today. Duoform Co., M-1, Attica, N. Y.

**HINGE** Clevis every farmer must have. Sells on sight. Send 50c for sample and proposition. Hinge Clevis Co., Canistota, S. Dak.

**MONOGRAM** Automobiles, \$1.35 Profit ten minutes' work; every owner wants them; millions without; particulars free. Motorists Accessories Co., Mansfield, Ohio.

**PORTRAIT** Men: Why not Pasco portraits? We refund your money for all you cannot deliver. Frame catalog free. Portrait Agent's Supply Co., Dept. F, LaPorte, Ind.

**GOLD-LEAF** Window letters and script signs; no experience; 500% profit; samples free. Consolidated, 69-T West Van Buren, Chicago.

"MAGNAKLOTH" Taking people by storm, one rub, absorbs dust from car or furniture, quick sales, big profits. National Service Co., B. Pierre, S. Dak.

ARVEO Polishing Cloths offer big profits to salesmen. Sample and particulars free. Arveo Industries, Box F 147, Gross Ile, Mich.

AGENTS For "aladdin" polishing cloths; big demand wherever shown. 200 per cent profit; sample free. L. Dougherty, 518 West 39th St., New York.

\$60-\$200 A WEEK. Genuine gold letters for store windows. Easily applied. Free samples. Liberal offer to general agents. Metallic Letter Co., 438-B North Clark Chicago.

GET Our free sample case—Toilet articles, flavorings and specialties. Wonderfully profitable. LaDerma Co., Dept. A, St. Louis, Mo.

MAGIC Polishing cloth. Great seller. Big profit. Try this cloth. It's a money maker. Samples free. Get this proposition. Newton Co., 25 Main St., Newark, N. Y.

START A business of your own selling fifty different kinds of household brushes. Send for catalog and free sample case offer. National Brushes, St. Louis, Mo.

WRITE Atlas Sign Works for free working equipment. Beautiful gold window sign letters. Penny each! Any size. Wonderful offer to general agents. K1032 E. 55th St., Chicago, Ill.

START The new year right! Manufacturing these popular specialties yourself. Have salesmen everywhere. Investment small. Profits great! Get my eye-opening literature explaining all. Mystery Polishing Floss, Loidax, guaranteed automobile refinishing, Thermax Eveready Anti-Freeze; twenty-six new unusual carded specialties, many other wonderful necessities. Here's an exceptional opportunity. Miller, Chemist, 706-B Chemical Building, Tampa, Fla.

ENGRAVED Nameplates, signs, numbers, initial, desk, city nameplates. Big profits. Hilton Specialty, 90 Stewart, Providence, R. I.

AGENTS—Fastest selling household necessities for men and women. Big profit. Ideal Utensil Company, Otis Bldg., Chicago.

AGENTS: Stamping names on pocket-key protectors. Sample check with your name and address, 25c. Stamping outfits. Emblem checks, check-fobs, name plates. Hart Mfg. Co., Desk 2, 303 Degraw St., Brooklyn, N. Y.

AGENTS—\$50 Weekly selling shirts. No capital or experience needed. Commissions in advance. Samples free. Madison Company, 566 Broadway, New York.

BIG Money and Fast Sales. Every owner buys Gold Initials for his auto. You charge \$1.50; make \$1.35. Ten orders a day easy. Write for particulars and free samples. American Monogram Co., Dept. 40, East Orange, N. J.

PHOTO Medallion Men and Women, the largest line of Photo Novelties in the world. Lowest prices, quickest service. Send for catalogue showing over 200 money makers. Photo medallions, photo medallion clocks, photo mirrors, photo fountain pens, photo powder compacts, photo jewelry and photo buttons. Gibson Photo Jewelry Co., 608-614 Gravesend Ave., Brooklyn, N. Y.

THE Christensen Mop Wringer. It rubs the mop and scrubs it clean. H. K. Christensen, Fort Atkinson, Wis.

AGENTS—Mosco Corn and Callous Remover will build you a steady repeat business. Send today for pocket-size trial outfit. The Moss Company, 429 Searle Bldg., Rochester, N. Y.

MAN In each town to plate auto parts, reflectors, bathroom fixtures, refinish beds, mirrors, chandeliers; by new method. No capital or experience required. Simple plan of manufacturing at home starts you in big money-making business. Outfit furnished. Free particulars and proofs. Gun Metal Co., Ave. H, Decatur, Ill.

FLAVORING Extracts—Bottle yourself! Concentrated, add water. Free labels. 600% profits! Whirlwind moneymaking opportunity! Hurry! Thomas Manufacturing Company, Indianapolis, Ind.

OUR Luminous Crucifix Shines in the Dark. Every one amazed at the wonderful effect. Easily demonstrated—easily sold. W. G. Hannan Co., 2543 So. State St., Chicago.

40 CENTS Profit on every \$1.00 sale. Our article is a repeater. Excello Sales Co., Shreveport, La.

ELECTRIC Cigar lighters. Make \$100 week. Brilliant flashing advertisements. Three beautiful models. Used by dealers everywhere. Write Drake Mfg. Company, Dept. M, Milwaukee, Wis.

AGENTS—Clever Invention! Inkspoon makes every pen a fountain pen. Fast office seller; big profit, demand increasing everywhere. Exclusive territory offered. Sample free. H. Marul Company, Tribune Bldg., New York, N. Y.

TWO Money makers for agents. "Francia" Pocket Adding Machine retails \$4.85. To you \$1.00. "Excelligraph" Rotary Stencil Duplicator \$37.50 retail. Write Typewriter Supply, 102 Hersch Bldg., Pittsburgh, Pa.

SUCCEED With your own products. Make them yourself. Formulas, processes, trade-secrets. All lines. Catalog, circulars free. B. Thaxly Co., Washington, D. C.

\$50.00 WEEKLY Easy, applying gold initials on automobiles. No experience needed, \$1.45 profit every \$1.50 job. Free samples. "Ralco Monograms," X1043 Washington, Boston, Mass.

REPLATE Brass worn-off automobile parts, reflectors, bath room fixtures, worn spoons, forks, etc., with pure silver. Looks like new. Use U-Kan-Plate Polish. Positively no mercury. \$1.00 half pints. Post paid. Satisfaction guaranteed. Agents wanted. Dept. A, U-Kan-Plate Co., Philadelphia.

MAKE Big money. Be the sign man in your town. New process. Beats them all. Particulars free. Swanson's, Inc., Mankato, Minn.

WE Start you without a dollar. Soaps, extracts, perfumes, toilet goods. Experience unnecessary. Carnation Co., 641, St. Louis, Mo.

BIG Profits! Fast sales! \$9.75 automatic washing machine. Guaranteed. Write Storm Royalty Co., 3601 Enright, St. Louis, Mo.

MAKE Your own products. Employ agents yourself. Toilet articles, soap, extracts. We furnish everything. Valuable book free. National Scientific Laboratories, 1984W Broad, Richmond, Va.

AGENTS \$240 Month. Bonus besides. Producers earn auto. Introduce new guaranteed hosiery. 126 styles, colors. Finest silks. Credit given. Silk Hose for your own use. Samples furnished. Wilknit Hosiery Co., Dept. 7031, Greenfield, Ohio.

A BUSINESS of your own—making sparkling glass name and number plates, check-boards signs. Big book and sample free. E. Palmer, 512, Wooster, Ohio.

AGENTS—Engraved name plates, signs, numbers, etc., easily sold, profits large. Brett Bros., Roxbury Crossing, Boston, Mass.

CALIFORNIA Perfumed beads selling like hot cakes. Agents coinng money. Big profits. Catalog free. Mission Factory P, 2328 W. Pico, Los Angeles, Calif.

"HOW to Secure Agents," a specially prepared booklet, tells of one of the most inexpensive methods in which to secure good live producing agents. It is free; write for your copy today! M. L. Rund, Mgr. Classified Advertising, Popular Mechanics Magazine, 200 E. Ontario St., Chicago, Ill.

MAKE Your own products. Employ agents yourself. Toilet articles, soap, extracts. We furnish everything. Valuable book free. National Scientific Laboratories, 1984W Broad, Richmond, Va.

\$12.00 DAILY Showing new table cloth. Looks like linen. Wash like oilcloth. No laundering. You just take orders. We deliver. Pay daily. Sample free. Bestever, 152 Irving Park Station, Chicago.

PORTRAIT Agents make more money than any other class of agents. Write for our new catalog—Portrait enlargements, medallions, etc. Adam J. Kroll & Co., 2543 South State St., Chicago, Ill.

FROM The Argentine. Imported from Buenos Aires, latest novelty, never before on American market, tremendous possibilities. Write: don Francis X. Cassera, Dept. PM, 23 Washington St., New York.

SELL Stores carded 5c Breathlets. Cost you 1c per package, 150% profit. S. H. Carroll Co., Albany, N. Y.

TIME Counts in applying for patents. See pages 140 and 141. Clarence A. O'Brien, Registered Patent Attorney, Washington, D. C.

\$50,000 PICTURE Man Friedman made canvassing. Beginners can make \$100.00 weekly with my sales talk. Experienced men make more. Free book "Profits in Portraits" explains. Sample free. Picture Man Friedman, Dept. 8, 109 West Austin, Chicago.

GOLD-LEAF Sign letters; copyrighted manufacturing instructions; profits 1,000%. Johnston Co., Quincy, Ill.

### HIGH-GRADE SALESMEN WANTED

FEW \$1,000 Monthly earnings ads are truthful. Our men actually earn \$300 to \$500 regularly selling our lines. Adelite, the newcomer in electric window salesmen, is making a big hit. More for the money than anybody gives. Business posters for every line. Changeable letter system too. Permanent business for you working with us. Territory protected and repeats credited. Fat commissions. Full details will prove very interesting. Display Products, Ltd., 409-A East 31st St., Kansas City, Mo.

TO Market 3A garage door holders, simple automatic action, quickly installed, instantly attracts garage owners, builders, dealers. Write for exclusive territory proposition. Knowlson-Stevenson Co., 1118 Packard, Ann Arbor, Mich.

SALESMEN—Earn \$100 weekly taking orders for Dazzler and Rainbow glow electric signs. Big commission. Exclusive territory. High grade proposition. Write Chicago Sign Sales Co., Dept. 77, Charlotte, N. C.

STATE Manager wanted—Eastern manufacturer of marvelous auto safety signal, wishes to correspond with man or firm financially responsible to develop your state. Worth \$7,500 per year and up. Write Safety Sales Co., Distributors, 501 Colorado Bldg., Denver, Colo.

AGENTS, Salesmen, amazing \$-getter good for \$75-\$100 weekly; an everyday necessity in big demand at drug, department, novelty, cigar and general stores; sells 365 days of the year; cash sales; repeat orders come fast; lifetime opportunity for energetic men; get free folder, tells how. President, Tyrrell Products, 455A First, Martins Ferry, Ohio.

SALESMEN—Sell Suredge, the proven money maker. Only guaranteed low priced razor blade sharpener, honing and stropping all blades in ten seconds. 100% profit. Suredge, 15 E. 40th, Dept. E-1, New York.

BIG Pay every day taking orders for Dress Shirts, Work Shirts, Pants, Overalls, Sweaters, Underwear, Hosiery, Pajamas, Playsuits! Experience unnecessary. Outfit free! Nimrod Co., Dept. 65, 4922-28 Lincoln Ave., Chicago.

COVERALL Salesmen—Make \$20 daily selling new \$3.50 improved Coveralls, also service coats with customers name embroidered on back. Unusual construction. Commission 75%! Wonderful advertising value. Lowest priced; highest commission. Free outfit. Am. B. Co., P-329 W. Monroe, Chicago.

SALESMEN—Don't look further. Here is what you want for 1929. Best staple necessity to sell garages, oil stations, accessory stores. Always in demand. Liberal commission. Best co-operation. Our proposition will surprise you. Write today for particulars to Box 197, Spencer, Iowa.

BUSINESS Stationery—largest line—highest quality—quickest delivery—biggest commissions—liberal bonuses—free copyrighted cuts every business. Experience unnecessary. Instructions and outfit free. David Lionel Press, 312 S. Hamilton, Dept. 54, Chicago.

SALESMEN—\$4 In your pocket every half hour. Write orders for Hollywood Picture News. New idea advertising service for store windows. No competition; every store prospect. Permanent repeat business. Free sales outfit. Retail Stores Service Corp., 1165 Broadway, Dept. J4, New York.

AGENTS—I want a good, honest man or woman, all or part time, to look after my established business in your locality; take a few orders; distribute teas, coffees, extracts, spices, things people eat and use every day. I furnish everything, make you my partner; you keep half of what we take in; pay starts as soon as case arrives. Get my amazing offer. Curtis W. Van De Mark, 103-F Health-O Bldg., Cincinnati, Ohio.

CASH Paid for Butterflies, Insects. See Sinclair Display Advertisement on page 24.

**BIG Money** selling new preparation that will prevent runs in silk hose. Agents everywhere report tremendous sales. Every woman a prospect. We furnish amazing new sales guide and charts. Don't delay, write today. Save-O-Silk Laboratories, Box M, 262 Troy, Ohio.

**AMAZING Screw-holding screwdriver!** New patented invention! Removes, inserts screws instantly inaccessible places. Sells \$1.50, 100% profit. Factories, mechanics, garages, electricians, radio, buy on sight! Exclusive territory, Jiffy, 1068 Winthrop Bldg., Boston.

**\$18 TO \$25 Daily;** biggest selling line of 2-piece suits, \$9.95 and \$12.50; 3-piece wool suit, \$17.95 (regular \$28.00 value). All-wool overcoats \$18.50. Splendid rain-coats, slickers and boys' suits. Biggest commission. Free outfits. "Jim" Foster, Inc., Dept. 26, 2250 S. Spaulding Ave., Chicago, Ill.

**ADVERTISING Specialty men** traveling in specified territory are earning from \$75.00 to \$200.00 per week selling our line of original and patented advertising novelties. Commissions paid same day order is received. No one but experienced men will be considered. Write today fully and frankly. Spotswood Specialty Co., Lexington, Ky.

**ARE You old at forty?** See our advertisement on page 73 of this issue. The Electro Thermal Company, 2118 Morris Ave., Steubenville, Ohio.

**SALESMEN!** New imported, popular price tickets. Merchants instant buyers. Every store needs them. Full (part time). Big proposition. Tiara, 160 Fifth Ave., New York.

**SELL Printing;** experience unnecessary; main or sideline. 40% commission advanced; copyright cuts and elaborate outfit free; beats all competition. Meyerson, R1132 So. Racine, Chicago.

**EARN \$20 A day.** Establish income for life selling for \$1 a year, \$1,500 accident policy. Write W. C. Stone, 11 So. La Salle, Chicago.

**POOL Shooter.** New fascinating vending machine. Merchants everywhere buy! Sideline men make \$200 weekly! Free pocket outfit! Specialty Mfg. Co., Dept. 1, 617 W. Division, Chicago.

**HURRY!** A sensational new vending machine just out! Can be used everywhere. Merchants waiting. \$200.00 weekly easy. Experience unnecessary. Chicago Mint, 4344 Ravenswood, Chicago.

**ELECTRICAL Appliances** and fixtures, needed every home, sell direct or to trade. Liberal commission. Kapneck, 1438 Columbia Road, Washington, D. C.

**SALESMEN.** Wonderful sideline. 40% commission paid daily. Sells all merchants. Pocket outfit free. Willens Co., Dept. 221, 2130 Gladys Ave., Chicago.

**SELL "Union Label" business stationery.** Lowest prices. Prompt delivery. Big commissions advanced. Amazing bonus. Cuts furnished, every business. Experience unnecessary. Outfit free. Northwestern, 2002 Division, Chicago.

**NEW Invention—Sells every business.** Used by Bell Telephone, Armour, etc. Four \$15 sales daily pay \$268 weekly. Write quick for exclusive territory. Adjustment Service, Dept. PM, Mobile, Ala.

**SELL Printing.** Commission in advance with or without deposit; 48-hour service. Write for outfit. E. Willis Printing Co., 5939 Wentworth, Chicago.

**37% COMMISSION.** Liberal repeats. New sales producing service increases business 20% to 50%. Every retailer live prospect. Sales Builders, 507 W. Madison, Chicago.

**A PAYING Position** open to representative of character. Take orders shoes-hosiery direct to wearer. Good income. Permanent. Write now for free book "Getting Ahead." Tanners Shoe Mfg. Co., 2006 C St., Boston, Mass.

**EVERY Home** a prospect. Make big money. Take orders tree, shrubbery. Experience unnecessary. No dull season. Commissions paid weekly. We deliver, collect. Write Perry Nurseries, Dept. R-6, Rochester, N. Y.

**WONDERFUL Invention.** Seals fifty envelopes minute. Sells on sight at \$3.50. Attractive proposition. Square deal. Bank references. Kendall Sealer Co., C-12 East Jaffrey, N. H.

**NEWEST, Finest** and most complete line of novelties and pencils for 1929. State experience. Advertising Novelty Company, Newton, Iowa.

**SALESMEN—Become independent.** Own your business; experience unnecessary, selling our \$10,000 Accidental Death; \$50 Accident; \$25 Sick Weekly Benefits—\$18.00 yearly. Other amounts proportionate. Guaranteed steady income from renewals. \$250,000 deposited Insurance Department, Universal Policy, Dept. A, 10 Clinton St., Newark, N. J.

**ALL Year round profitable business.** Earn extra money spare time selling wonderful new water softener and cleanser. Cleans like magic, grease, ink and dirt from every thing. Every home and business place a live prospect. 100% profit. Big repeat orders. Agents protected. Trial case \$4.00 delivered U. S. A. Seacoast Laboratories, Inc., Sea Bight, N. J.

**\$78.00 MADE** By Iowa salesman first day selling new hot dog machine at \$18.50, commission \$8.50; direct factory connections. Leonard E. Dickerson, Dept. E-13, Springfield, Mo.

**BIG Opportunity** sell vending machines. Resort towns, \$12.50 on \$32.50 sale. Pay daily. Postal Confection Co., (Manufacturers), 2033 Charleston, Chicago.

**SELL Printing—40% commission daily;** lowest prices; with or without deposit. Copyright cuts free. Inquiry brings pocket outfit. Merchants Assn., Insurance Center Bldg., Chicago.

**CANVASSERS: Stop! Look! Listen!** Mexican curios, den fixtures, Indian rugs, feather work. Fastest selling goods. Full particulars, samples fifty cents. G. Medina, 78-P LaRosa St., Mexico City, Mexico. Highest references.

**MAKE Your own products.** Employ agents yourself. Toilet articles, soap, extracts. We furnish everything. Valuable book free. National Scientific Laboratories, 1984W Broad, Richmond, Va.

**ADVERTISING Pencils.** Quick-action sideline money-maker. Free samples for real salesmen. Northern Pencil Works, 126 So. Clinton, Chicago.

**PRINTING Salesman** wanted; salesbooks, manifold printing, stationery, restaurant checks, register printing fanfold, tags; full or part time; splendid opportunity. Shelby Salesbook Co., Shelby, Ohio.

**JUST Out!** Amazing new vending machine! Pays merchant 1,600% profit! Sensation wherever introduced. \$50.00 daily! Dept. 9, Acme, 4554 Broadway, Chicago.

**GOLD-LEAF Window letters** and script signs; no experience; 500% profit; samples free. Consolidated, 69-V West Van Buren, Chicago.

**STATE Mgr.** Marvelous invention seals 3,000 envelopes hourly! Sells \$4.50 only; equals work expensive electric machines. Offices buy 1-100. Exclusive territory. Opportunity earn \$7,000 yearly. Free trial offer. Write quick! Rede, 32 Winthrop Bldg., Boston.

**SALESMAN:** Sparkling chipped glass, name plates, house numbers, signs. Request particulars. Roscoe Lynch, Bausman, Penna.

**REPRESENT Auto seat cover manufacturer.** Direct to automobile owners. High quality, low prices. Make \$125 weekly. Elaborate samples free. Marcelo, 2302 Wabansia, Chicago.

**PUNCHBOARD Men!** Sideline salesmen! Sensational merchandise catalog just added to famous "Lincoln Line"! No more closed territory! \$200 weekly. Easy repeat commissions paid daily. Smashing color catalog free. Samples unnecessary. Best season now. Get busy! Lincoln Sales, 116 So. Wells, Chicago, Dept. D.

**SUCCESS Is no accident!** You will fully understand this slogan when you examine our automatic credit and collection plan. Copyrighted, brand new, unusual. You make 250% on original sale. Half cash on repeats without call-backs. Commonwealth J. Publishing Company, 508 So. Dearborn St., Chicago, Ill.

**SALESMEN—Four \$15.00 sales** to merchants net you \$40.00 daily. Sayers Systems, 2812 Sheffield, Chicago, Ill.

**SALESMEN: Manufacturer** and distributor one of country's leading lines automotive shop equipment and hand tools offers exclusive territory. Proposition assures good income; advance against commission basis. Applicants must be financially responsible, have some knowledge of tools and must own car. Write for proposition to Mr. Merrell, Woods Organization, Inc., 37 W. 20th St., New York, N. Y.

**SIDELINE—New!** Quick seller to merchants, banks, manufacturers. Full commissions daily. Pocket sample free. Carroll Co., 319 N. Albany, Dept. 346, Chicago.

**PUNCHBOARD Salesmen.** \$10,000 yearly. New line. All fast sellers. Lowest prices. Full commission on repeat business. Catalog free. Hurry! Puritan Novelty Co., 1409 Jackson, Chicago.

**\$100-\$200 A WEEK.** Genuine gold letters for store windows. Easily applied. Free samples. Liberal offer to general agents. Metallic Letter Co., 438-A North Clark, Chicago.

## HELP WANTED

**THE Boulder dam.** Eight year's work. Latest information regarding conditions, employment, concessions, etc., sent by return mail for \$1.00. Money back if dissatisfied. M. Roberts Service Bureau, Box 1051, Denver, Colo.

**WANTED:—Women** who need quick money. "New Idea" imported ladies' necessity sells on sight; everyone buys; representatives everywhere are cashing in big. Miss Ely has made \$1900; Mrs. Hart \$2200, without experience. New salesplan put you in business for yourself. Sample free. Write Mary P. Coleman, Meriden, Conn.

**CASH Paid** for Butterflies, Insects. See Sinclair Display Advertisement on page 24.

**BIG Wages** paid in Canada for construction work, etc. Write for list of positions. Stamp appreciated. A. Allard, 4724 Des Erables, Montreal, Can.

**SILVERING Mirrors.** French plate, patented process, easily learned. Immense profits. Plans free. Wear, Excelsior Springs, Mo.

**OBTAIN Employment!** Get best positions quickly anywhere. Learn how. Request free offer. Write Box 39-101, Station K, New York.

## EDUCATIONAL AND INSTRUCTION

**WANT A government job?** \$105.00 to \$280.00 month. Steady work. Short hours. Paid summer vacation. Common education usually sufficient. Experience unnecessary. 25 men—women, 18 to 50 coached free. We coach you without leaving home. 32 page book with full particulars free. Write immediately. Franklin Institute, Dept. 83, Rochester, N. Y.

**FIREMEN, Brakemen, baggagemen** (white or colored). Sleeping Car, Train Porters (colored). \$150—\$350 monthly. Experience unnecessary. 810 Railway Bureau, East St. Louis, Ill.

**TRACE Missing people.** Excellent paying work. Open to all. Write National Headquarters, 169 East 83rd, New York.

**BECOME Automobile mechanics.** Hundreds positions. \$24.00 week up. Sample training free. Franklin Institute, Dept. 400, Rochester, N. Y.

**INVESTIGATING** And tracing. Work home or travel. Experience unnecessary. Write American System, 2188 Broadway, N. Y.

**LEARN Linotype—Pays good salary;** home or college course; small cost; free catalog. Linotype School, Maumee, Ohio.

**WANT A government job?** \$105.00—\$280.00 month. Steady work. Short hours. Paid vacations. Experience usually unnecessary. 25 men—boys, 18 to 50, coached free. 32-page book with particulars free. Write today sure. Franklin Institute, Dept. 814, Rochester, N. Y.

**STUDY A scientific profession.** Microbiology. Bacteriology. Sanitation. Extension-residential course. Diplomas, degrees granted. Urinalysis outfit—prospectus free. College of Microbiology, 23 State, Hammond, Ind.

**BECOME A cosmetic chemist** at home in few weeks. Earn \$50 to \$200 a week. New profession. Diploma issued. Positions everywhere. National School of Cosmetic Chemistry, 2985 West 15th St., Los Angeles, Calif.

**DON'T Prepare** for any civil service examination without seeing our catalog. Free. Columbian Correspondence College, Washington, D. C.

**BIG Money** in Real Estate business. Our complete guaranteed twenty lesson course shows you how. Only \$2. Real Estate Sales Co., Box 1, Everett, Wash.

**LEARN Retail shoe selling.** Stores everywhere need men. Fine positions! Excellent pay! Write, Shoecraft, 36 Lefferts Place, Brooklyn, New York.

**ART.** Earn \$100.00 weekly in commercial art. Satisfaction guaranteed or money back. Complete art course, cartooning, illustration posters, advertising, 120-page reference book, supplies. Send no money, pay postman \$2.98 plus postage. No more to pay. Studio, 156 Somerset, New Brunswick, N. J.

**HIG** Demand for photoplay talking picture and magazine stories. We revise, develop and copyright. Sell on commission. Established 1917. Booklet free. Universal Scenario Company, 406 Western and Santa Monica Bldg., Hollywood, Calif.

**AMATEUR** Cartoonists: Sell your cartoons. New market. Smith's Service, PR-1194, Wenatchee, Wash.

**BECOME** A landscape architect. Uncrowded profession; wonderful opportunity for money-making. Easily mastered by mail. Earn while you learn. Est. 1916. Write for details. American Landscape School, 29 Plymouth Bldg., Des Moines, Iowa.

**WANTED** Immediately, men-women, 18-55 qualify for government position, \$125-\$250 month. No experience required. Steady work. Vacations with full pay. Write, Ozment Inst., 101, St. Louis, Mo.

**U. S. GOVERNMENT** wants men, \$1,700-\$1,900 and up at start. Railway mail clerk examination coming. Let our expert (former government examiner) prepare you for this and also rural carrier, post office, customs, internal revenue, and other branches. Write today for free booklet. Dept. 8, Patterson School, Rochester, N. Y.

**BIG** Money in photography, motion picture protection. Catalog 49A free. New York Institute of Photography, 10 W. 33d St., New York.

**DOUBLE** Entry bookkeeping 60 hours with 8 keys; guaranteed. (Diplomas.) International Bookkeeping Inst., 8 Springfield, Mo.

**10,000 FORMULAS.** A real Gold Mine of money-making ideas. Tells how to make almost everything under the sun. You can make and sell cosmetics, nuilage, anti-freeze solutions, battery solutions, beverages, cheese, chewing gum, cleaning preparations, extracts, hair preparations, inks, bluing, leather polish, mirrors, perfumes, polishes, typewriter ribbons, carbon paper, washing powders, liquid soap, and hundreds of other profitable articles. Send No Money. Just write a postal for "Henley's 20th Century Book of Formulas." Pay postman postage and \$4. Popular Mechanics Press, 200 E. Ontario St., Room 806, Chicago, Ill.

#### INFORMATION, SERVICE, COUNSEL

**W. SCOTT WILKERSON**, 602 Westory Bldg., Washington, D. C.

**DETAILED** Information, advice, any subject, 25c. Money back if we cannot answer. Julius Goldin, 926 Southern Blvd., New York.

**TRACING.** Make secret investigations. Work home or travel. Experience unnecessary. Write, American System, 2188 Broadway, N. Y.

**ELECTROPLATING.** New printing of popular book by H. C. Reetz. Complete instructions for plating with all kinds of metals. Send no money. Just write a postal asking for "Electroplating." Pay postman the postage and \$1.00. Popular Mechanics Press, Room 806, 200 E. Ontario St., Chicago, Ill.

#### TYPEWRITERS AND SUPPLIES

**TWO** Typewriter ribbons 9c. Miller, 628 North Eighth, Allentown, Pa.

**TYPEWRITERS.** Motorcycles, Radios, \$9.99-\$39.99, terms, Knights, 1516 Locust, St. Louis, Mo.

**TYPEWRITERS**—Factory rebuilt Royals, Remingtons, Underwoods, New Royal, Remington and Corona portables. New "Excelsior" Rotary Stencil Duplicator \$37.50. Catalog free. Pittsburgh Typewriter Supply, Dept. 945, Pittsburgh, Penna.

**TYPEWRITERS**, all standard makes, \$10 up. Fully guaranteed. Free trial. Write for complete illustrated lists. Northwestern Typewriter Exchange, 121 N. Francisco Ave., Chicago.

#### ADDING MACHINES

**NEW** \$3.50 Automatic adding machine. Adds, subtracts, multiplies, absolutely accurate. Capacity \$999,999.99. Fully guaranteed. 75,000 pleased users. Makes adding easy, positive, quick. Eliminates mistakes. Saves time. Postpaid \$3.50. Bassett Co., 1458-A, Hollywood Ave., Chicago.

#### PRINTING, ENGRAVING AND MULTIGRAPHING

**500 MIMEOGRAPHED** Typewritten letters, excellent bond paper, three dollars prepaid. Chicago Lettergraph, 542 North Ave., Chicago.

**MAKE** Your own printing device. It's practical—it's different! Particulars, printed specimens free. Grinstead Company, Oswego, Kans.

**1,000 BUSINESS** Cards \$1.65. Cash with order. Tick, 3338 Arkansas St., Oakland, Calif.

**SPECIAL Offer**—150 8½x11 letterheads and envelopes printed, \$1.50. J. Ferreira, 249 Eugenia St., New Bedford, Mass.

**FINE** Printing—Low prices. Large modern plant (thirty employees) in small town, low operation cost. Special prices on stationery, circulars, pamphlets, ruled forms, catalogs, large or small orders. Write for samples and prices. Shenandoah Publishing House, Inc., Box 1080, Strasburg, Va.

**PRINTING**, Property produced, promptly, reasonably. Price list, samples on request. Moulton Press, 1410-P, E. 8th, Kansas City, Mo.

**1000 BUSINESS** Cards \$2.75 postpaid. Samples free. John Miller, Montgomery Avenue, Narberth, Pa.

**QUALITY** Stationery, 500 8½x11 Bond Letterheads, 250 6¼ envelopes, \$3.25. Satisfaction. Samples. H. Curtis, 811 Harrigan, Kalamazoo, Mich.

**500 HAMMERMILL** Bond letterheads or envelopes \$2. Patton Company, 534 Paxton Block, Omaha, Neb.

**SPECIAL**, 400 Attractive 5½x8½ Bond Letterheads, four line copy \$1.00. Artcraft, Chillicothe, Mo.

**5,000 ELEGANT** Enamel folders \$3.75; 5,000, 5½x8½ circulars, \$10.00; envelope slips, \$5.00. Samples. Goodprint, Harrisonburg, Va.

**100 LETTERHEADS**, 100 Envelopes neatly printed, postpaid, \$1.00. James Pierce, 6138 Iroquois, Detroit, Mich.

**"NEARGRAVURE"**—"Neargravurembo" processes. Special—Neargravure, 250 envelopes, 500 8½x11 letterheads \$3.33—8½x11" \$4.44, postpaid. Solidays, Knox, Ind.

**FINEST** Bond letterheads 8½x11, \$3.95m. Envelopes, \$2.95. Oberman Company, Box 1042, Chicago.

**MULTIGRAPHING**—Expert work. Get prices, samples. Box 1071, Knoxville, Tenn.

**FREE**—Samples of our printing and price list. Letter Service, 4019 East 15th, Kansas City, Mo.

**SAMPLES** Raised letter printing with special prices free. LaClyde Service, Westfield, Mass.

**200 LETTERHEADS** And 100 envelopes \$1.00. 200 letterheads, 8½x11, 150 envelopes \$2.00. 250 cards \$1.00. Hoosier Print Shop, Portland, Ind.

**QUALITY** Printing! Reasonable Prices! Send for Free Standardized samples and prices. Folders, Circulars, Catalogs our specialty. Earnest Fantus, 525 South Dearborn, Chicago.

**MULTIGRAPHING** Business correspondence two dollars thousand. Hammermill letterheads, four dollars; inexpensive quality, three dollars. Miscellaneous printing. Mayera Corporation, Monmouth, Ill.

**250 BOND** Letterheads, Envelopes, Billheads, Cards, \$1.35 each. Economic Press, Leonia, N. J.

**WE** Print stationery, booklets, catalogs, circulars. Samples. Commercial Press, Batavia, Ohio.

#### PRINTING OUTFITS

**PRINT** Your own stationery, cards, bookplates, Christmas cards, circulars, book, pamphlets, etc. Junior Press \$5.90, large, \$11; rotary, \$149. Print for others. Easy and interesting; rules sent. Write for catalogue presses, type, paper, etc. Kelsey Company, L-11, Meriden, Conn.

**PRINTING OUTFITS**—Presses, type supplies, type novelties. Send stamp for catalog. Model Press, York, Penna.

#### GUMMED LABELS

**1,000 PRINTED:** Name, business address 50c. JBS Company, Box 93, Holyoke, Mass.

#### DUPLICATORS AND DEVICES

**STENCIL** Duplicator—Anyone can make. Particulars, specimens free. Grinstead Company, Oswego, Kans.

**YOU** can make 50 to 100 copies of a letter, notice, etc., at a cost of three cents on a Hoyer Quality Duplicator. Write for free trial offer. The Hoyer Duplicator Co., 909 Jackson Blvd., Chicago, Ill.

**"EXCELLOGRAPH"** Portable rotary stencil printing duplicators \$39. Terms. Description, testimonials, printed samples, free. Pittsburgh Typewriter Supply Co., Dept. 331, Pittsburgh, Pa.

#### RUBBER STAMPS

**MUSIC** Stamps, metal badges, trade checks, catalogue 40c. Walt. Karstaedt, Dayton, Ohio.

#### MAILING LISTS

**1000—1929** Iowa Farmers' names, \$1.00. J. Mitchell, 3853 Marmora Ave., Chicago, Ill.

**JUST** Compiled: 1000—1929 (men) mail order list, \$1.00. National Sales, Box 691, Chicago.

**1,000 FRESH** Rural women names, \$1.00. Sheasgreen, PM1427 North Penn, Minneapolis, Minn.

#### FOR THE HOME

**GRANDFATHER'S** Clock Works, \$5.00. Build your own case; instructions free; make good profits selling your friends. Clock works with chimes for old or new cases. Write for full particulars. Clock Co., Ruffner St., Philadelphia.

**DON'T** Discard old straw hats: Write for free bulletin M telling how to make and keep them like new. Agents wanted. The Kyolac Corporation, 100 Fifth Ave., New York City.

**NEW** Invention—Sharpens lawn mower in five minutes. Koch's Kleen Kut Sharpener does the trick; positively accurate. State size mower. Prepaid, 75c. Agents wanted. Kleen Kut, Box 573, St. Paul, Minn.

**AUTOMATIC** Hot Water Control System, with remote button control, complete \$16.00. Nothing like it. Lapointe Products Co., Ann Arbor, Mich.

**CEDAR** chests only \$11.65—"Red-I-Kut" complete with rich copper trim—you assemble and save half—send for pictures. Kuempel Furniture Company, Guttenberg, Iowa.

**BUY** Direct from manufacturer. Mexican curios, den fixtures, Indian sarapes, rugs, novelties, cushion covers. Bed-rock prices. Samples fifty cents. G. Medina, 78-P La-Rosa St., Mexico City, Mexico. References furnished.

#### FOR MECHANICS

**ATTENTION**—Home mechanics: We sell unusual cabinet hardware, chest trimmings, tea wagon wheels and casters, big line small hinges, locks, etc. Upholstering supplies electrical hardware, knocked down cedar chests, etc. Send ten cents stamps for catalog. Thurston Manual Training Supply Company, Jobbers and Manufacturers, Anoka, Minn.

**SHOP** Notes for 1929. Get your copy now. Only a limited edition. Contains all the articles published in the Shop Notes department of Popular Mechanics Magazine during 1928. Send 50 cents. If you want the entire set of Shop Notes books consisting of 16 volumes including the 1929 number and 15 others issued previously we will send them C. O. D. at a special reduced price of \$5. Popular Mechanics Press, Room 806, 200 E. Ontario St., Chicago, Ill.

#### RAZORS AND BLADES

**SELL** New patent safety razor blade sharpener, makes old blades better than new. Improves new blades 100%. All types including Gillette, Durham Duplex, Eveready, etc. Sample post paid anywhere \$1.00. Viking Blade Company, 1706 Sunset Blvd., Los Angeles, Calif.

**"NO** Profit" Sale to introduce our merchandise, a nationally advertised razor, five blades, brush, cream, 75c lotion and styptic pencil. Deposit \$1.00 plus postage with postman. Money back if dissatisfied. Holzinger, 341 So. Campbell, Chicago.

**1c** EACH Gillette razor blades sharpened better than new. Peter Weiterquist, Rockford, Ill.

**10** NEW Gillette type blades, 35c. Steffen, 620 Belmont, Chicago.

#### GUNS AND FISHING TACKLE AND SPORTING GOODS

**SPORTING** Goods, baseball, boxing, tennis, golf, rifles, shotguns, poker racks, binoculars, etc. Send stamps for big catalog. Hudson, W-52 Warren St., New York.

**SPORTSMEN**—Send for free 1929 catalog of fishing tackle, guns. We guarantee to save you money. Outdoor Equipment Company, Wilmington, Ohio.

**MAKE** Your own fish bait. Catch all formula 35 cts. coin. Chas. Morris, Box 1484, Santa Fe, New Mex.

#### ARCHERY

**"MOHAWK"** Bow and 3 Arrows. \$1.25 postpaid. Targets \$1.00. Courtney Co., Box 27, Wallbrook P. O., Baltimore, Md.

#### FIELD GLASSES, TELESCOPES AND MICROSCOPES

**USED** Fieldglasses; \$2 to \$75. J. Alden Loring, Dept. J, O-we-go, N. Y. California St., Ventura, Calif.

**25 POWER** German microscope \$1 prepaid. Lead pencil size,  $\frac{3}{8}$  in. x  $4\frac{1}{2}$  in., wt.  $\frac{1}{2}$  oz. Enlarges 625 times; 60 power \$4. Used by General Electric, Colleges, Schools, Engineers, Scientists. College and other representatives wanted, DuMaurier Importers, Dept. 206-A, Elmira, N. Y.

#### BOATS AND LAUNCHES

**BUILD** Your own boat using our ready cut semi assembled materials, 55 designs, Outboard Speedsters, Cruisers, Runabouts, Launches, Sail, Row. Send 10c for catalog. Hurry if for this season's use. Brooks Boat Co., Inc., Saginaw, Mich., Box NN.

**HUBBELL** Marine Coolers convert Ford engine into marine motors. Booklet free. Ford speedboat easily built, large blueprint and directions one dollar. C. C. Hubbell, Perry Ave., Norwalk, Conn.

**COMPLETE** Building plans "Kingfisher" 18 foot outboard runabout, 35c. The Rudder, 15 Murray St., New York City.

**PROPELLERS**, Pumps, stuffing boxes, bearings, rebuilt reverse gears. Wm. H. Baker, Pond St., Quincy, Mass.

**NEW Boat Book** telling how to make 21 kinds of boats. Also many other helpful ideas on boating. Profusely illustrated. With this we include the big book, "Outdoor Sports the Year Round." Directions for making all sorts of devices for outdoor recreation. Send no money. Simply pay the postman \$1.98, plus postage when books are delivered. Popular Mechanics Press, Room 806, 200 E. Ontario St., Chicago, Ill.

#### ANTIQUES, WAR RELICS AND INDIAN GOODS

**INDIAN** Arrowheads—6 Selected, perfect Ancient Indian Stone Arrowheads for \$1.00—or 15 for \$2.00—postpaid. Guaranteed genuine. Money back if not pleased. H. E. Moore—"The Relic Scout," 615 N. Pearl St., Janesville, Wis.

**ANTIQUÉ** Firearms: Lists to buyers. Dexter, 910 Jefferson, Topeka, Kans.

**SEND** 5c For fine new list Indian relics, antique firearms. F. E. Ellis, Webster Groves, Mo.

#### PHONOGRAPHS AND RECORDS

**BUILD** Your own Phonograph. Parts catalog and instructions to build new horn, mailed for 10c. American Phonograph Co., 4116 West 24th Place, Chicago.

#### MUSIC AND MUSICAL INSTRUMENTS

**AMAZING** Opportunity. Learn to play Hawaiian Guitar, tenor banjo, banjo guitar, mandolin, or banjo mandolin in the simplest and shortest way ever conceived. No knowledge of music necessary. Free instrument and entire equipment of playing when you enroll in our academy. Pick your favorite instrument and write for free particulars. International Academy of Music, 201 Olympia Bldg., New Bedford, Mass.

**COMPOSERS**—Verse or music. Brilliant opportunity. Write, Van Buren, 1850, McClurg Bldg., Chicago.

**VIOLINS**, Deep, mellow, soulful—on credit. Easy terms for wonderful instrument. Get details today. Gustav F. Henning, 302 University Building, Seattle, Wash.

**POEMS** Wanted, 50-50 plan. Great Eastern Song Bureau, Dept. 27, Thomaston, Me.

**SONG** Poems solicited. A different proposition. Richard Broughton, Sioux Falls, S. Dak.

**SONG-POEM** Writers: Address Monarch, 236 W. 55th, Dept. 304, New York.

**CORNETISTS**—Trombonists—Saxophonists—Clarinetists. Get "Free Pointers." Name instrument. Virtuosi School, Buffalo, N. Y.

**PLAY** Piano by Ear. A Sound System. Booklet free. Boucher's Harmony Studio, Ottawa, Can.

**I WROTE** the song hits "Dreamy Carolina Moon," "Twilight," "Somebody Lied," "Little Gray Mother O' Mine," 100 others. I will personally write melody to your song poems. Investigate before investing. Evans Lloyd, 8 So. Dearborn, Chicago.

**SONG** Poem Writers, Write Sequoia Songwriters' Service, Sherman Branch, Los Angeles, Calif.

**SONGWRITERS**: Submit your song-poem or complete song. Will return it immediately if not accepted. Chester Escher, Music Publisher, 125 W. 45th St., New York City.

**FREE**—"Song Writers Guide." Beaver, 1257 Elm, Green Bay, Wis.

**VIOLINS**—Handmade masterpieces. Expert repairing. Lahto, 935 14th, San Pedro, Calif.

**SONG** Writers. Send for our "Publishing Agreement." McKinley Music Printers, 1501 E. 55th St., Chicago.

**SONGWRITERS**: Substantial advance royalties are paid on publisher's acceptance. Write for free booklet on developing ideas for song words or music required by talking pictures. Newcomer Associates, 1674 Broadway, New York.

**SONG** Poems arranged for publication. Submit poems. Brennen, Song Specialist, 11652 Broadway, New York.

**SONG** Poem writers—"Real" proposition. Hibbeler, D1, 2194 N. Keystone, Chicago.

**"MUSIC** Composed" to words. Bauer Bros. (formerly of Sousa's Band), Oshkosh, Wis.

**WRITE** Songs. Big money and reputation. Write for information. J. Gordon Pub. Co., 201 N. Hoyne Ave., Chicago.

#### PATENT ATTORNEYS

**PATENTS** Procured; trade marks registered—preliminary advice furnished without charge. Booklet and form for disclosing idea free. Irving L. McCathran, 704 International Building, Washington, D. C.

**PATENTS** Procured at reasonable rates with time to pay. Sales negotiated. Staff of registered attorneys and engineers. A complete service for inventors. Write for particulars. Inventors Service Bureau, Dept. B, Union Trust Bldg., Washington, D. C.

**PATENTS** Procured under my easy payment plan. See ad page 145. M. S. Cayne.

**LACEY'S** Patent Sense. Valuable book free. See ad page 145.

**UNPATENTED** Ideas can be sold. I tell you how and help you make the sale. Free particulars (Copyrighted). Write W. T. Greene, 906 Barrister Bldg., Washington, D. C.

**SELL** Your invention before patenting. Write for free particulars. W. T. Green, 901 Barrister Bldg., Washington, D. C.

**PATENTS**, Trade-Marks, Designs. This firm has 27 years' experience and gives expert personal service at reasonable rates. We properly protect your invention. Write for free information and exact cost of procuring patent before proceeding. John B. Thomas & Co., 902 F St., N. W., Washington, D. C.

**PATENTS** Procured, prompt service, personal, careful and efficient service. Highest references. Moderate fees. Send sketch or model for actual search and advice. George P. Kimmel, Master of Patent Law, 54-F Legal Bldg., Washington, D. C.

**MONROE E. MILLER**, Ouray Bldg., Washington, D. C., Patent Lawyer; Mechanical, Electrical Expert. Booklet and Priority Record blank gratis.

**ESTABLISHED** 1864. Milo D. Stevens Company. Free Booklet. Patents, Trade-Marks, Copyrights. Offices, Monadnock Block, Chicago; Barrister Building, Washington, D. C.

**INVENTORS**—Write for our Guide Book, "How to Get Your Patent," and Evidence of Invention Blank. Send model or sketch of your invention for our prompt examination and instructions free. Randolph & Co., Dept. 430, Washington, D. C.

**PATENTS**. Prompt personal service. Write for information. Albert E. Dieterich, Registered Patent Lawyer, 621½ Ouray Bldg., Washington, D. C.

**LANCASTER** and Allwine, 221 Ouray Bldg., Washington, D. C. "Originators of the Form Evidence of Conception." Before disclosing your invention to anyone send for blank form to be signed and witnessed. Form and patent information bulletin free.

**PATENTS**—Write for our free book, "How to Obtain a Patent" and Record of Invention Blank. Send model or sketch of invention for inspection and instructions free. Terms reasonable. See advertisements on pages 142 and 143. Victor J. Evans & Co., 934 Ninth, Washington, D. C.

**TIME** Counts in applying for patents. See pages 140 and 141. Clarence A. O'Brien, Registered Patent Attorney, Washington, D. C.

**PATENTS**. Send sketch or model for advice. Free book: "How to Obtain a Patent." Established thirty years. Highest references. Prompt service. Reasonable charges. Chandlee & Chandlee, 910 F St., Washington, D. C.

**PATENTS**. Booklet free. Highest references. Best results. Promptness assured. Send model or drawing for preliminary examination. Watson E. Coleman, Patent Lawyer, 724 Ninth St., Washington, D. C.

**PERCY S. WEBSTER**, 203 Saving and Loan Building, Stockton, Calif. Patent booklet free.

**PATENTS**, Trade-marks, Copyrights. Reliable services by an experienced practitioner devoting personal attention to each case. Inquiries invited. References furnished. B. P. Fishburne, Patent Lawyer, 525-A McGill Bldg., Washington, D. C.

**INVENTOR'S** Advisor with mechanical movements sent free. Labiner, Three Park-row, New York.

**"INVENTOR'S** Guide," valuable information, free. Frank Ledermann, Registered Attorney-Engineer, 1712 Woolworth Bldg., New York.

**PATENTS**—Write for free instructions. Send drawing or model for examination. Carl Miller, Registered Patent Attorney (former Patent Office examiner), 259 McGill Bldg., Washington, D. C.

**PATENTS**—Free instructions. Former patent office examiner. Moderate terms. Booklet. Albert Jacobs, 727 Barrister Bldg., Washington, D. C.

**INVENTORS**: Send for booklet telling how to patent and sell your inventions at lowest cost. Ralph Burch, Patent Lawyer, 900 F St., Washington, D. C.

#### FOR INVENTORS

**PATENTS**. If you have an invention which you wish to patent you can write fully and freely to Munn & Co., for advice in regard to the best way of obtaining protection. Please send sketches, or a model of your invention and a description of the device, explaining its operation. All communications are strictly confidential. Our Hand-Book on Patents is sent free on request. This explains our methods, terms, etc., in regard to patents, trade marks, foreign patents, etc. "Scientific American" contains patent office notes, decisions of interest to inventors and particulars of recently patented inventions. Munn & Company, Solicitors of Patents, 1523 Scientific American Building, 24 W. 40th St., New York City; 524 Scientific American Bldg., Washington, D. C.; 1313 Tower Bldg., Chicago, Ill.; 666 Hobart Bldg., San Francisco, Calif.; 521 Van Nuys Bldg., Los Angeles, Calif.

**INVENTORS** Universal - Educator—contains 900 mechanical movements; 50 perpetual motions. Tells how to obtain and sell patents. Suggests new ideas. Explains how to select your attorney and avoid patent sharks. Price (revised edition) \$1.00 postpaid. Albert E. Dieterich, 621 Ouray Bldg., Washington, D. C.

**NEW** Electrical Dictionary. Complete up-to-date electrical dictionary to which has been added a special dictionary of radio words and terms together with illustrations of electrical symbols, radio diagrams and other wiring diagrams. 191 Pages—Vest pocket size. Price only 35c postpaid. Popular Mechanics Co., Room 810, 200 East Ontario St., Chicago, Ill.

**GET** your own patents. Legal blanks, complete instructions \$1. Cutting Sons, Cambell, Calif.

**INVENTORS**—Manufacturers: Have you a specialty of real merit that you would like to have marketed nationally? We will develop your idea and sell the product for you. Wm. M. Rankin Co., 3117 No. Market St. Louis, Mo.

**UNPATENTED** Ideas can be sold. I tell you how and help you make the sale. Free particulars (Copyrighted). Write W. T. Greene, 907 Barrister Bldg., Washington, D. C.

**SELL** Your invention before patenting. Write for free particulars. W. T. Greene, 902 Barrister Bldg., Washington, D. C.

**INVENTORS**—Ideas developed and working models built. Electrical problems solved. Lowest charges and confidential service. Industro Electric Tools Co., Petersburg, Va.

**BUILD** Your own lathe, drill press, band saw, etc. Can be made at a small cost. Detailed blue prints price \$2.00. Clarence Gustelius, 1827 West 75th Street, Los Angeles, Calif.

**INVENTIONS** Sold on commission basis. G. W. Pierce, Ferris, Texas.

**SHIP** Models—Worth while. Easy to make. Decorative Ships Picturesque Barbary Pirate Felucca and Beautiful Spanish Treasure Galleon (both 17th century). Instructions so simplified that any handy person can make these models with a few household tools almost without expense. No personal knowledge of ships or naval architecture required. New book only one of its kind. Pay postman \$2.50 plus postage when book is delivered. Popular Mechanics Press, Room 810, 200 E. Ontario St., Chicago, Ill.

**TECHNICAL** Service for inventors and manufacturers: A technical service which includes a \$100,000 laboratory, equipped to conduct mechanical, electrical, radio tests and development work. Advice as to commercial practicability of inventions. Brown Walker, 2404 Salmon Towers, New York City, N. Y.

**TIME** Counts in applying for patents. See pages 140 and 141. Clarence A. O'Brien, Registered Patent Attorney, Washington, D. C.

**INVENTIONS**—Write for our free book "How to Obtain a Patent" and Record of Invention Blank. Send model or sketch of invention for inspection and instructions free. Terms reasonable. See advertisements on pages 142 and 143. Victor J. Evans & Co., 157 Ninth, Washington, D. C.

**PATENTS**—Write to B. P. Fishburne (a South Carolinian), Registered Patent Lawyer, 525-E McGill Bldg., Washington, D. C.

**INVENTIONS** Wanted—Patented, unpatented. If you have an idea for sale, write Hartley, Box 928, Bangor, Me.

**INVENTORS**—Cash in on your invention now! Don't delay the sale any longer! Send for a free copy of our specially prepared booklet, "Turn Your Patent Into Money," today! It contains helpful information for all inventors. M. L. Rund, Mgr. Classified Advertising, Popular Mechanics Magazine, 200 E. Ontario St., Chicago, Ill.

#### PATENTS FOR SALE

**AUTOMOBILE** Non-Glare Headlight, Combination lamp and visor. New outstanding advantages and trouble lighting conveniences. Super light. Demonstrated with success. Very neat. Adds appearance. Two patents. Numbers 1,672,779 and 1,707,874. Outright or royalty. Highest offer accepted. Byron F. Raidt, Shenandoah, Iowa.

**OUTRIGHT** Automatic street car ticket holder. Big profit. Frank Rabbe, 35 Ivy Ave., Ottawa, Canada.

**OUTRIGHT** or Royalty. Game of skill similar to checkers and chess; intensely interesting. John Mayer, 1331 Watt St., Schenectady, N. Y.

**FOR** Disposition, water power sprayer, Joe S. Johnson, El Centro, Calif.

**OUTRIGHT** Or royalty metal polish can't be beat, will clean anything. Patent pending. L. Gerzele, 2622 Mildred St., Chicago, Ill.

**AUTOMATIC** Parachute; opens and closes mechanically. Pending. John Regula, 229 Howard St., Larksville, Pa.

**OUTRIGHT** Or royalty basis. New tool chest. No. 1655148. Fred U. Larson, 554 Division St., Benton Harbor, Mich.

**OUTRIGHT** Or royalty. New quick generating ever ready blowtorch. Henry Birnbaum, Box 3, Shelton, Wash.

**OUTRIGHT** Or royalty. Water-proof cigarette case, weight two ounces, worn on bathing suits. Harry Weinberg, 319 Broadway, Little Rock, Ark.

**OUTRIGHT** Simple practical and adjustable electric lamp holder. W. Smith, Box 111, Clearwater, Calif.

**PATENT** For sale: Window Shield to protect cashiers booth in banks. Bullet proof and operated with electric motor. Have perfect working model. Cash or royalty. J. D. Lawrence, 1348 Brooklyn Ave., Detroit, Mich.

**OUTRIGHT** Oaring device for row boats, canoes and other hand-propelled boats. Charles A. Bilestine, Drawer M, Toledo, O.

**UNITED STATES** And Canada patent sanitary attachment used in administering oaths, prevents diseases. James Johnson, 436 N. Wrenn St., High Point, N. C.

**UNPATENTED** Ideas for Sale. A new sardine can opener, cheap, made good profits. R. Pellerin, General Delivery, City Hall Station, New York City.

**U. S. And Canadian** house and outbuildings. Simple. Cash and royalty. David Smith & Son, Box 6, Howe, Nebr.

**MY** Canadian patent for sale and up-to-date band saw guide, tried, tested, found perfect in every way. G. W. Gillespy, Asbury, Mo.

**DRAFTSMAN** And inventor with several new patented and unpatented inventions. Wants position with manufacturer wishing new articles to make and sell. On royalty basis. Write, Box 383, Eagle Grove, Ia.

**OUTRIGHT** Or royalty. Canadian patent Hair Barrette. M. Miller, 26 West Erie, Chicago.

**COMBINATION** Motor truck, concrete and mortar mixer; establishing a new mixing principle and will prove a big money maker to manufacturer. Chas. Payne, 27 Fulton Ave., Waukegan, Ill., U. S. A.

**TIME** Counts in applying for patents. See pages 140 and 141. Clarence A. O'Brien, Registered Patent Attorney, Washington, D. C.

**YOUR** Idle patent can be turned into ready cash, quickly! One inventor sold his patent at a cost of only \$3.50. Send today for a free copy of our booklet, "Turn Your Patent Into Money." M. L. Rund, Mgr. Classified Advertising, Popular Mechanics Magazine, 200 E. Ontario St., Chicago, Ill.

#### WATCH REPAIRING

**WATCH** Repairing and making shows how to clean and repair all kinds of watches. 214 page book with over 200 illustrations. Pay postman \$3 and postage when he delivers book. Popular Mechanics Co., Room 806, 200 E. Ontario St., Chicago, Ill.

#### MODELS AND MODEL SUPPLIES

\$100.00 **SHIP** Model for \$4.98. Build the historic Santa Maria, LaPinta or the Mayflower. We send you C. O. D. the parts cut to fit, ready to assemble for \$4.98, plus a few cents postage. No tools needed except a small hammer. Parts for model of Constitution sent C. O. D. for \$8.98, plus postage. Write for illustrated catalog. Miniature Ship Models, Inc., Dept. P, 3216 Baring St., Philadelphia, Pa.

**THREE** Ship model plans for \$1. Catalog 6 cents. Richter's, 3217 Walnut St., Milwaukee, Wis.

**WORK** With master machinist; 15 years experimental experience, well equipped shop. Albert Weiss, 161 W. 21st St., New York City.

**MODEL** Steam engines and boilers for miniature power boats. Boat and boiler fittings. New catalog 15c. Model Machine Shop, 212 Price St., Rahway, N. J.

**MODELS.** Experimental work. Equipped for complete machine construction any description. Hullt & Company, Machinists, 115 South Clinton, Chicago.

**THE** Modelmaker, a magazine for all interested in making working models, boats, etc. Sample 10c. Modelmaker, 122 Liberty St., New York.

**MODEL** And experimental work at lowest cost. Wagar Model & Machine Works, 115 So. Clinton St., Chicago.

**SPECIAL** Machine builders, tool and die makers, inventors' models production work of all kinds. Dept. L, Quality Hardware & Machine Corporation, Ravenswood and Thorndale Aves., Chicago, Ill.

**SHIP** Model Fittings: Send Dime for booklet. A. J. Fisher, 1002 Etowah Ave., Royal Oak, Mich.

**WE** Make working models for inventors and do experimental work and carry a complete stock of brass gears and model supplies. Send for catalog. The Pierce Model Works, Tinley Park, Ill.

**TIME** Counts in applying for patents. See pages 140 and 141. Clarence A. O'Brien, Registered Patent Attorney, Washington, D. C.

#### MANUFACTURING

**SPECIALTY** Manufacturing. Models, dies, stampings, casting, screw machine, wire products, plating, enameling and assembling very reasonable. Quantity production. Estimates promptly furnished. Satisfaction guaranteed. Majestic Products Mfg. Company, Box 877, Chicago.

**MACHINE** Work, special machines, models, electric welding. T. A. Oberhellmann, 1025 N. 6th St., St. Louis, Mo.

**MANUFACTURING** Models, dies, stampings, brass work, one or thousands. Circular free. Baum's Metal Specialties, Kansas City, Mo.

**ECONOMICAL** Manufacturing from sheet, bar, wire or tubing. Models, dies, special machinery. Swanberg, 5124 N. Kildare Ave., Chicago.

**SPECIAL** Machinery or parts, dies, tools, metal specialties, models, special gears, stock gears and model supplies. Send for Catalogue. The Pierce Model Works, Tinley Park, Ill.

**WIRE** goods made to order. Cooley Mfg. Co., 530 N. Western Ave., Chicago.

**METAL** Specialties, turnings, stampings, models, tools and dies. Write us for prices. Presco, 888 Helmsdale Road, Cleveland, O.

#### FOR MANUFACTURERS

**SPECIALIST** In tubular parts, replacing screw machine products. Any length— $\frac{3}{4}$  in. or less diameter. Send us samples. J. T. Healy & Son, 196 No. Main St., Attleboro, Mass.

#### MACHINERY, TOOLS AND SUPPLIES

**NO. 3 CINCINNATI** Universal Milling Machine, with dividing heads, \$550.00; 14 in. x 6 ft. Von Wyck lathe, \$140.00; No. 60 Head Grinder, \$275.00; 20 in. Hendy Shaper, \$225.00; 24 in. Steptoe Back Geared Crank Shaper, \$550.00; 36 in. x 18 ft. Niles Lathe, \$775.00; 20 in. Barnes Drill Press, complete, \$65.00; Quincy Air Compressor with tank and hose, \$65.00; 10 in. Bench Drill Press, \$19.00. Terms to suit. Write for catalog. Cincinnati Machinery & Supply Co., 27 West Second St., Cincinnati, Ohio.

**CONCRETE** Building block machines and molds. Easy payments. Catalog free. Concrete Machine Co., 5 North Main St., St. Louis, Mo.

**START** business of your own, small investment required, doing nickel, copper and silver plating. This work in big demand. Information free. Electro Platers Supply Co., 547 Considine Ave., Cincinnati, Ohio.

#### ENGINES, MOTORS AND DYNAMOS

**NEW** With pulleys.  $\frac{1}{4}$  horse, 110-volt, alternating motors, cord and plug, \$7.00. 32 and 110-volt General Electric, 500-watt, 1,750 speed generators, \$18.50. 1-3 horse, 110-220 volt, 1,750 speed, repulsion-induction, alternating, heavy-duty motors, \$12.00. Write for quantity discounts or quotations on others. Electrical Surplus Company, Dept. 12, 1911 Chicago Ave., Chicago.

**BARGAINS**—Elec. drills \$11.95; bench saw outfit \$7.35; elec. bench grinders, \$13.20; combination lathe, \$8.15; scroll saw, \$5.60; motors, generators, farm plant equipment; flexible shafts; 100 other bargains. Send for special bargain bulletin. Acme Tool Co., 627 W. Washington, Chicago.

**EDISON** Phonograph motors with speed governor, Westinghouse dictaphone motors, both universal motors, \$5.00 plus express 10 lb. Geo. Schulz, Calumet, Mich.

**100—PRACTICALLY** New Westinghouse  $\frac{1}{4}$  h.p., 110 volt, a.c. motors. Price \$8.00 each, f.o.b. New Haven, while they last. Botwink Bros., Inc., 67 Water St., New Haven, Conn.

**GOVERNORS**, For auto engines when used for power plants. Circulars. Candee-Smith Governor Co., 215 W. Manchester Ave., Los Angeles; or Springville, N. Y.

**SMALL** Motors geared to run about four revolutions per minute with contactor arrangements for flashers. \$9.00 each. Special priced air compressors, transformers, magnet wire. Pioneer Air Compressor Co., 176 Grand St., New York, N. Y.

**ELECTRIC** Motors, reconditioned equal to new. a.c. or d.c.  $\frac{1}{2}$  h.p. \$16.50,  $\frac{3}{4}$  h.p. \$18.50, 1 h.p. \$24.00. Others to 10 h.p. Tell us your motor problems. Temps Bros. Motor Company, 4-10 Leo Place, Brooklyn, New York.

**TIME** Counts in applying for patents. See pages 140 and 141. Clarence A. O'Brien, Registered Patent Attorney, Washington, D. C.

**BRAND New** ¼ h.p. 110V. a.c. motors \$7.50; 32V. motors. ½ h.p. \$12.50; ¾ h.p. \$8.50; 1 h.p. \$8.50. 32V. motors with emery, buffer and drill chuck \$6.50. Large stock 32 volt generators, also 110V. All machines guaranteed. Queen City Electric, 1736 Grand Ave., Chicago.

**FOR Sale:** 1-6 ¼ h.p. motors, 60 cycle, alternating current, slightly used, first class condition; all motors tested before shipping \$4.50 and \$5.00 while they last. Cash with order. The Maytag-Chicago Co., 337 W. Madison St., Chicago, Ill.

**NEW Gasoline Engines**, one horsepower, air-cooled, magneto. Complete for pumping or farm work. \$35. Onan & Sons, 9 Roy-alston Ave., Minneapolis, Minn.

**FOR Sale:** 1 Roth Bros. & Co. Generator Name Plate, amps. 71; volts 60-65 R.P.M. 2150; Winding compound. Mack's Electric Shop, Marion, Kansas.

**ELECTRIC Motors**—Yours for rewinding or make your own quarter, half and one horse-power electric motors. A.c. induction motor winding models show winding connections plain sight. Learn quick, easy way. Gaines Bros., Box 481, Gainesville, Tex.

**NAVY Surplus** 800 new radio generators, d.c. and 500 cycle. Unusual prices. Literature. Henry Kiengle, 501 East 84th St., New York.

**STEAM Engines**—One H. P. \$18.00; ¼, \$12.00. James Chambliss, Bessemer, Ala.

### SURVEYING INSTRUMENTS

**OPPORTUNITY** To save on transits and levels. Rebuilt and guaranteed. All makes. Easy terms. Write for descriptive list M-36, Warren - Knight Co. Manufacturers of "Sterling" Transits and Levels, 136 N. 12th St., Philadelphia, Pa.

### LUMBER

**CABINET Woods**, 20 samples; walnut, mahogany, chestnut, rosewood, etc., labeled. Inlay woods, 20 samples; zebra, ebony, satinwood, vermillion, etc. labeled. Either set one dollar, postpaid. Both \$1.75. Kiln-dried wood, cut to size. Send for list. Craftsman Wood Service, 715B East 62nd Chicago.

### FARMS AND FARM LANDS

**ARKANSAS Ozarks**—Improved farm lands from \$4.00 per acre up. Write for free illustrated bulletin. King Realty Co., Fayetteville, Ark.

**CASH** For your property, farm, business or residence. No matter where located. Free information. International Realty Co., Ford Bldg., Detroit.

**SMALL Dairy and poultry farms** in Southeastern Wisconsin. Good buildings, soil and location. Write for list. O. R. Moyle, Union Grove, Wis.

**CALIFORNIA** Small fruit and poultry farms near Los Angeles; 5 advisers; U. S. rabbit exp. station; co-operative marketing. Illus. booklets. Write owner, Fontana Farms Co., 631 (R) S. Spring, Los Angeles, Calif.

**PECAN-Orange-Fig groves** "On the Gulf." Monthly payments. Guaranteed care. Big, quick returns. Suburban Orchards, Dept. M., Biloxi, Miss.

**OZARKS**—10 acres near White river and proposed power dam, \$100, \$5 monthly. Alvin Zimmerman, 1802 N. 5th, Kansas City, Kans.

**GET Quick cash sale** for your property anywhere. Details free. Write Fisher Agency, Hannibal, Mo.

**SELL** your property quickly for cash, no matter where located. Don't pay big commission. Particulars free. Real Estate Salesmen Co., Desk B, Lincoln, Nebr.

**FREE Books**, descriptive of the opportunities offered homeseekers and investors in Minnesota, North Dakota, Montana, Washington and Oregon. Low round-trip homeseekers' tickets every Tuesday. E. C. Leedy, Dept. 157, Great Northern Railway, St. Paul, Minn.

**MONEY** made in Mich. potatoes. \$10 down now and easy terms buys land near markets, lakes, streams. Write today. Swigart & Co., P-1276, 1st Nat'l Bank Bldg., Chicago.

**CALIFORNIA** Fruit and poultry farms on hard surfaced streets with gas, electricity, water and all city conveniences at Muscoy adjoining city limits of San Bernardino, population 43,000, east of Los Angeles. Send for 36 page book free. J. B. Roof, Inc., Owners, 708 Quinby Bldg., Los Angeles, Calif.

**861 PRACTICAL Ways to Reduce Farm Labor and Expense and Increase Income.** One farmer writes he would not part with this information for \$100, if he could not duplicate it. Nothing experimental. These ideas have all been put to test and proven practical. Send today for a copy of our Handbook for Farmers and get ready to put these ideas into operation for your own benefit. Pay postman only 98 cents and the postage when he hands you the package. Popular Mechanics Press, Room 806, 200 E. Ontario St., Chicago.

### ROOTS AND HERBS

**HERB Doctor book**—10 cents. 250 recipes for making herb medicines. Hazzard Company, Box 1, Vanderveer Park, Brooklyn, N. Y.

### RABBITS

**RAISE Rabbits.** Very profitable. Youngsters cheap. Harrison Rabbitries, Fitzgerald, Ga.

**MAKE Big profits** with Chinchilla rabbits. Real money-makers. Write for facts. Fox Farms, Inglewood, Calif.

### MUSKRATS

**MAKE Money** From Muskrat Fur—Raise Muskrats in dry land pens or hutches. Get the facts. 652, Conrad's Ranch, Denver, Colo.

### DOGS AND PETS

**MAKE Your own dog cakes.** Recipes 25c. Smith Basset Hound Kennels, Spring Valley, Ohio.

**BEAUTIFUL German Shepherd Police pups.** Registrable cheap. Otto Henkel, Sublette, Ill.

**POLICE Dogs** for sale. Pictures sent. Wencel Husnik, Luxemburg, Wis.

**CHOW Puppies.** A real one man dog. Arnold Ross, Iron, Minn.

**FOR Sale.** Minks, squirrels, raccoons, foxes, ferrets, muskrats, ginseng, rabbits, skunks, wolf pups, opossums. B. Tippman, Caledonia, Minn.

**WHITE Collies** and other colors. Beautiful and useful. Dept. P, Shomont Kennels, Monticello, Iowa.

### WANTED—MISCELLANEOUS

**MAIL Us** your discarded jewelry, gold, crowns and bridges, watches, diamonds, silver, platinum. Money promptly mailed. Goods returned if offer refused. United States Smelting Works (The Old Reliable), Dept. 71, Chicago.

**HUNDREDS** of people have sent their old gold, silver, platinum jewelry, dental work to me. Why not mail yours today? Highest prices paid. Satisfaction guaranteed, or goods returned. F. Polcer, 2408 South Cicero Ave., Cicero, Ill.

**WANTED**—Back numbers of Popular Mechanics Magazine. We will pay 25c each for the following copies delivered to us in good condition: August 1917; February, March, May, June, July, 1918; May, July, 1919; April, September, October, November 1920; December 1922; November 1923; August 1924; July 1925; January 1926. Send to Popular Mechanics Magazine, Room 408, 200 East Ontario St., Chicago.

### FOR SALE—MISCELLANEOUS

**ADDRESSOGRAPHS.** Letter folders, multigraphs, envelope sealers, duplicators, less than half price. Guaranteed. Pruitt Co., 117 No. Wacker Drive, Chicago.

**SHARPEN YOUR** own lawnmower. The pocket lawnmower sharpener does the work. \$1.50 prepaid. Anderson Manufacturing Company, 207 York St., Newport, Ky.

**KINKS** On Metal Work. 419 discoveries for anyone who works with metal. For mechanic, machinist or the man who tinkers at home. 287 illustrations. Send no money. Just write a postal asking for "Machinist's Kinks." When postman hands you book pay postage and price of book, \$1.50. Popular Mechanics Press, Room 810, 200 E. Ontario St., Chicago, Ill.

### PERSONAL

**MEDICINAL Herbs** and Roots for many ills. Over 1000 varieties. Write for free list recipes. Botanicals, 145 West 112th St., Chicago.

**TOBACCO** Or snuff habit cured or no pay. \$1.50 if cured. Remedy sent on trial. Superba Co., N3, Baltimore, Md.

**ADVICE.** Information, any subject, 25c coin. References. Fred Klotz, Reading, Pa.

**THE "Sanatory Physician,"** an 80-page book teaching natural laws of health, also suggests reliable self-treatment of disease. Appreciated by every reader. Mrs. S., Denver, Colo., says: "I owe my regained health to that dear little book." Postpaid 20c. Address Author, 320 James St., Seattle, Wash.

**FUN Making Things.** Four large profusely illustrated books telling how to make almost everything from a sail boat to a toy automobile propelled by a motorcycle engine. Now \$2 per book or \$7 for the four if ordered at once. Send no money. Just write a postal saying, "Send the Boy Mechanic Library." Pay postman \$7 and postage. For single books, specify either Book 1, Book 2, Book 3, or Book 4. Popular Mechanics Press, Room 810, 200 E. Ontario St., Chicago, Ill.

**HOW to Work with Tools and Wood** for the home workshop is an unusually interesting new book just published by the Stanley Rule and Level Plant. 180 pages, illustrated. Cloth bound. Price \$1. Pay postman price and postage when he delivers package. C. O. D. Order from Popular Mechanics Press, Room 810, 200 E. Ontario St., Chicago.

**PEN Picture** of yourself by cartoonist 8x10. Send photo and 50c coin. E. Hildreth, 2136 Clinton Ave., New York City.

### MISCELLANEOUS

**ELECTRIC Light plants**, 110 volt, complete and ready to run, \$130. Fine for summer homes, camps and farms. Onan & Sons, 10 Royalston, Ave., Minneapolis, Minn.

**MIRRORS.** Resilvered at home. Costs near 5 cents per square foot; you charge 75 cents. Immense profits plating autoparts, reflectors, tableware, stoves, refinishing metalware, etc. Outfits furnished. Details free. Write, Sprinkle Plater, 288, Marion, Ind.

**QUIT Tobacco** easy. Harmless home remedy. NI-Ko System, Wichita, Kans.

**TATTOOING** Outfits, electric and hand, inks designs colors, free circular. Sergt. Bonzey, 367 So. Main, Providence, R. I.

**MEXICAN Made** holsters, lariats, horse-hair articles; rattlesnake belts. Send four cents for illustrated list. Tex-Mex Leather Co., 309 Esperson Bldg., Houston, Tex.

**SELF Propelling** floor surfacing machines cheap. G. C. Walter, 935 Broadway, Denver, Colo.

**CASH Paid** for Butterflies, Insects. See Sinclair Display Advertisement on page 24.

**OIL Painting** anyone can learn—start studio, free instruction. Write, Hughesm, Box 1264, Los Angeles, Calif.

**WEEDS**—Cut them with cutter bar on Shaw Garden Tractor. Also plows, cultivates and runs belt machinery. Low prices. Immediate delivery. Shaw Manufacturing Company, Dept. C, Galesburg, Kans.

**HOMEOPATHIC** And Biochemic preparations sent postpaid to all parts of the world. Manual and booklet free. Halsey Bros. Co., 5547 Ravenswood Ave., Chicago, Ill. Established 1855.

**TATTOOING** Outfits, supplies. Illustrated list free. "Waters," 965 Putnam, Detroit.

**TIME Counts** in applying for patents. See pages 140 and 141. Clarence A. O'Brien, Registered Patent Attorney, Washington, D. C.

**ARTISTS** And art students are printing 250 signs or pictures an hour without machinery. Sample and particulars 10c. Straco, 1013 Mulberry, Springfield, Ohio.

**AMATEUR Cartoonists:** Sell your cartoons. New market. Smith's Service, PN-1194, Wenatchee, Wash.

**GOLD Finishing.** Composition, molds; \$1.00. Hardacker, Box 717, East San Diego, Calif.

**CUTS** Anybody can make. Simple, cheap process. \$1. Specimens, particulars. 2c stamp. M. Day, Windfall, Ind.

**TELL** An army of 3,000,000 live readers all about your offer! If you have anything to sell, buy or exchange, or if you have any reasonable proposition, tell our readers all about it—they'll respond quickly. Our booklet "How to Create More Business" contains some very interesting, helpful facts. Write today for your copy—it's free. M. L. Bund, Manager Classified Advertising, Popular Mechanics Magazine, 200 E. Ontario St., Chicago, Ill.



# How \$5 Grew to \$100,000 In This Amazing Business

Let me send you my free book. It tells how, starting with a \$5 bill, I made \$100,000 in less than 5 years as a real estate specialist. I had no experience, little education, was in poor health, and had no influence. But I did have a system of my own which worked! And it is working today for many others who are making more money than they ever dreamed they would! My book tells their stories, too. Mail the coupon for your free copy

I STARTED with \$5—and an idea. My friends laughed and said, "It's a fool idea."

But I was doing work I was not fitted for and which I thoroughly disliked, so I decided to "take a chance," especially since I had nothing to lose.

I was living in a gloomy boarding house, wearing cheap clothes, striving to keep out of debt, and getting mighty few of the good things of life.

In less than two years after I started to specialize in real estate, I was making nearly *one thousand dollars a month*. And in less than five years I cleaned up a net profit of *over one hundred thousand dollars*.

You, too, can make big money MY WAY. You can start in your own home, in your spare time. I don't care how old or how young you are or how discouraged you may be. I don't care how little education or influence you may have. I don't care how little business experience you may have had. You can make big money if you follow my methods — and when I say big money I MEAN it.

## Amazing Earnings

The first step is for you to write for my free book.

Read my own story. Then read how W. E. Shoop, a former weaver, made \$6,000 on his first sale; how



Mrs. Evalynn Balster, a widowed schoolteacher, made \$5,500 commission on her first sale; how Eugene Walrath, formerly in the clothing business, cleared \$17,000 on one deal; how Thomas E. Mone, Jr., a former insurance man, made \$40,000 in 2 years, using my method. How Chas. F. Worthen, formerly a salesman, made \$8,500 in 17 weeks by following my method. How H. G. Stewart earned \$14,400 in commissions in 6 months. How Earl Beam earned \$910 in spare time after supper in a few months with my system. How Anthony C. Maurell made \$4,000 in 3 months. How Al West made \$3,200 in 15 days. How A. D. Perkins, formerly in the furniture business, made

\$2,556 in 2½ months. How F. B. Bennett made \$435 on his first day. They all did it in this amazing business, using my methods.

My free book tells all about these wonderful successes. It tells how when I started in real estate I thrust overboard all the hit-or-miss, haphazard, rule-of-thumb methods of the past and put into operation my system which is as superior to the old way as the modern ocean liner is superior to the old sailing vessel.

## A Wonderful Business

Real estate—conducted my way—is a great business. It is as permanent as the earth itself. It is getting bigger and bigger as the country grows. It doesn't require years of study to learn like most other businesses and professions. It offers enormous earnings to ambitious men and women. Users of my system report earnings of \$1,000—\$5,000—\$10,000—on single deals—as much as the average man gets for months and years of hard work. And the business is practically unlimited. Ten million properties are now on the market for rent, sale or exchange. And you can start without capital or experience—right at home—in your spare time. I did. So did others. So can you. My free book tells you how.

## Get Free Book Now

My big, new illustrated book is full of fascinating facts about my kind of a real estate business—what I did—what others are doing—what you can do.

Mail coupon right now and get this valuable, money-making information free. It doesn't cost you a nickel to find out what this book can do for you. So, act at once. You will never forgive yourself if you turn your back on this unusual chance to win big business success. Address PRESIDENT, American Business Builders, Inc., Dept. F-44, 18 East 18 Street, New York.

## \$1,000 Reward

Here's the proof that this is the biggest money-making opportunity of all: *one thousand dollars in gold* will be paid to anyone who shows us any other business course of any kind that has helped as many men and women make as much money in as short a time as our remarkably successful Real Estate Course.

American Business Builders, Inc.

President, American Business Builders, Inc.

Authorized Capital, \$500,000.00

Dept. F-44, 18 East 18 St., New York, N. Y.

Mail me your free book telling how you made \$100,000 in a new kind of real estate business—how others are making big money and how I can do the same.

Name.....  
Please print or write plainly

Address.....

City..... State.....



**T**HIS is the electrical age, with unlimited opportunities for the man who has educated himself in the finer points of electrical practice.

Fit yourself for a big-pay job by knowing electrical practice complete, including inside and outside work, central stations, and the whole subject. With the aid of the Croft books you can know electricity as experts know it and put yourself in line for an expert's pay.

## The Croft Library of Practical Electricity

A reference library and self-training course in eight volumes. 3000 pages—2100 illustrations

In these volumes Croft teaches you electrical practice complete. He takes you in quick, easy steps from the simplest principles to the complete and economical operation of a great central station. He tells you all that he has learned in twenty years of shirt-sleeve practice. With these books at his elbow a man can learn as much about electricity in six months—good practical "bread and butter" stuff—as he would ordinarily learn in a lifetime of practice.

Flexible binding for easy handling



59,000 Croft Sets NOW IN USE

### The Standard in Practical Electrical Training

The Croft Library is a complete electrical educator. It is founded on practice—on work as it is actually done. It is jammed from cover to cover with the kind of hard-headed facts you want. Written so that the beginner can easily understand it, yet so sound, so thorough, that it is the daily guide of 59,000 highly paid electrical workers and engineers.

Croft tells you the things you need to know about motors, generators, armatures, commutators, transformers, circuits, switchboards, distribution systems—electrical machinery of every type—wiring for light and power—wiring of finished buildings—underwriters and municipal requirements—illumination in its every phase—the latest and most improved methods of lighting—lamps and lighting effects, etc.—how to do a complete job, from estimating it, to completion.

Make no mistake about it—there are big jobs in electricity ready for you when you're ready for them. Thousands of men who have the Croft Library know that to be a fact. The Library itself, on a FREE TRIAL BASIS, will prove it to your own absolute satisfaction.

### NO MONEY DOWN SMALL MONTHLY PAYMENTS

Fill in and mail the coupon attached and we will send you the entire set of eight volumes for ten days' Free Examination. We take all the risk—pay all charges. You assume no obligation—you pay nothing unless you decide to keep the books. Then \$1.50 in ten days and the balance at the rate of \$2.00 a month. Send the coupon NOW and see the books for yourself.

10 Days FREE TRIAL Just Mail the Coupon

#### FREE EXAMINATION COUPON

McGraw-Hill Book Co., Inc., 370 Seventh Ave., New York

Send me for 10 days' free examination the Croft Library of Practical Electricity. If satisfactory I will send you \$1.50 in 10 days and \$2.00 monthly until the special price of \$19.50 is paid. If not wanted, I will return the books at your expense. (To insure prompt shipment write plainly and fill in all lines.)

Name.....

Address.....

City and State.....

Position.....

Company..... P. M. 6-29

## The MOCAR

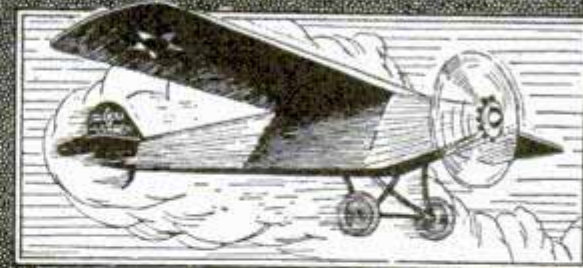

### Model Airplanes That FLY

**BOYS** Here is the Greatest Value You've Ever Seen—A Genuine Aluminum Model Airplane That Really Flies at a Small Price.

The "Mocar" monoplane—Set No. 1—is a copy of Lindbergh's famous Spirit of St. Louis. Wing spread 18 inches, fuselage 13 inches, powerful motor, special propeller, rubber tired disc wheels. Weight complete only about 2 1/2 oz. This is a practical, simple, real model plane that gives you a whole lot of fun at a very moderate cost. The all metal construction makes a sturdy plane that will stand a lot of abuse. The outfit is mounted on cardboard with all parts plainly marked and full instruction for assembly. Pliers only tool necessary. Construction set No. 1. Complete with rivets, bolts, wheels, wing and fuselage covering material, only \$1.50 postpaid (3 for \$4.00). Model L made up ready to fly \$2.25 (3 for \$6.00) postpaid.

Great fun, learn how to make and fly airplane Order now—Immediate Delivery

THE MOUNT CARMEL MFG. CO.

Dept. M

NEW HAVEN, CONN.

Set No. 1

Only

\$1.50

Complete Postpaid



## Be a drummer!



Trap Drumming made easy in a short time. Our free instruction course furnished with genuine Ludwig Trap-Drum Outfit. Develop your natural sense of rhythm. Go to your nearest dealer or write for full details.

LUDWIG & LUDWIG, 1611 North Lincoln Street, Chicago

## SHOWCARD CARTOONIST

A New Book just chucked full of ideas, better methods, short cuts,—shows you how to make cartoons and comics that give show cards and posters a real selling punch. You'll use it.—write now for Show Card Cartoonist, \$1.25 postpaid. Another good one—"Their Best Stunts," by 25 successful chalk talkers, \$1.25 postpaid. Two new catalogs: A—Art Supplies, 8—Show Card Supplies.



BART SUPPLIES, 519 EUSTIS BLDG., MINNEAPOLIS, MINN.

## How To Secure A Government Position

Why worry about strikes, layoffs, hard times? Get a Government job! Increased salaries, steady work, travel, good pay. I'll help you become a Custom House Clerk, Railway Postal Clerk, Post Office Clerk, City Mail Carrier, Rural Carrier—or any other Government job you want. I was a Secretary-Examiner of Civil Service Commission for 8 years. Have helped thousands.

### Now FREE

My 32-page book tells about the jobs open—and how I can help you get one. Write TODAY. ARTHUR R. PATTERSON, Civil Service Expert, PATTERSON SCHOOL, 86 Winner Building, Rochester, N. Y.



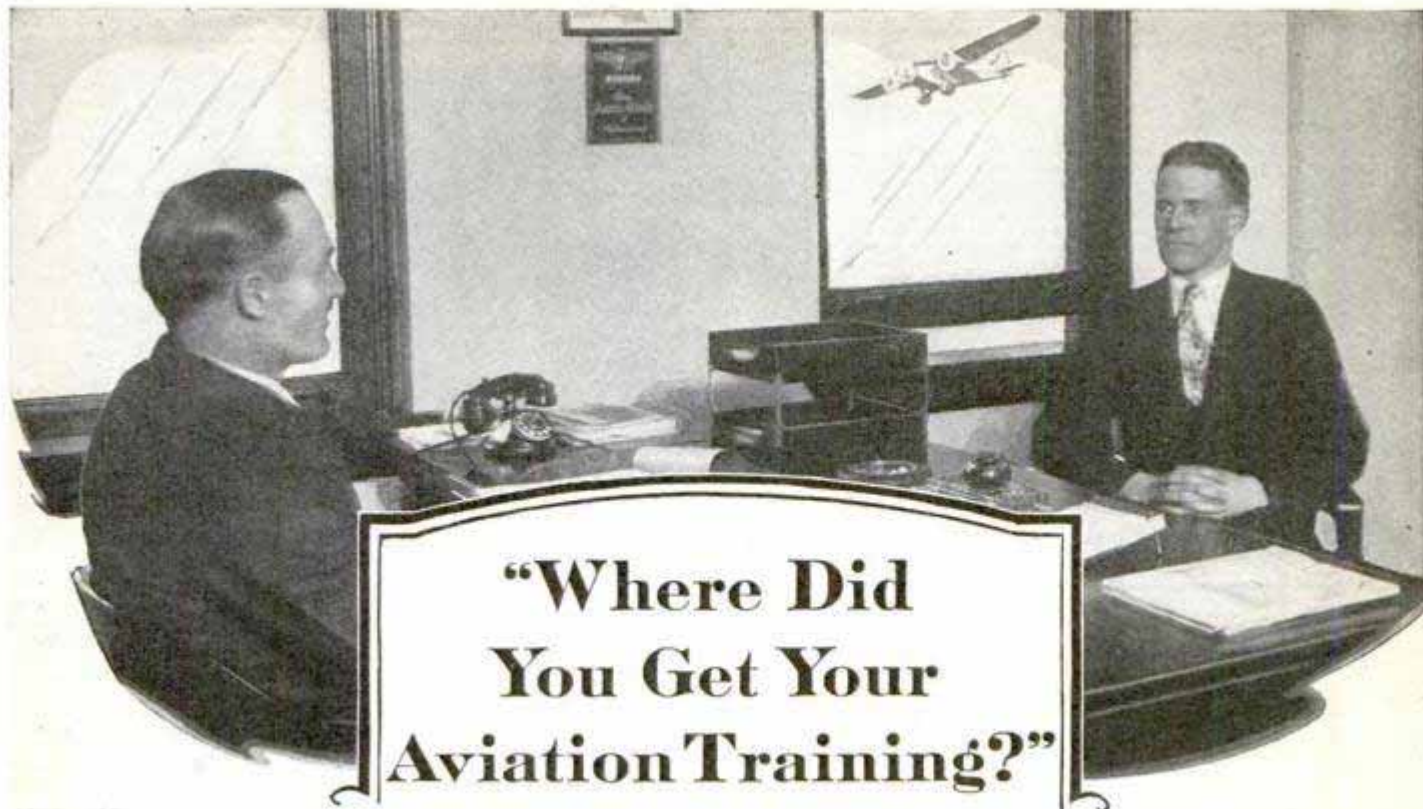

**"Where Did You Get Your Aviation Training?"**

*the employer's first question in hiring pilots and mechanics*

**T**HE man who can reply that he secured his training in one of the Universal Aviation Schools is going to receive the preference. For business men know the thoroughness with which Universal Aviation School training is given. They have read, in such magazines as the Saturday Evening Post and Liberty, of the facilities offered by Universal Aviation Schools. When in need of pilots or mechanics they naturally inquire of Universal and show preference for the Universal trained men.

cial resources running into many millions of dollars. The schools, in most cases, are established at airports out of which Universal planes are constantly operating. Universal students at all times are in the midst of aviation's biggest developments.

**Thorough Training**

Equipment of Universal Aviation Schools is strictly modern — new type planes, air cooled motors and up-to-date shop tools. Instructors have been chosen from among the best men available in the country. Flying instructors

are all licensed transport pilots having thousands of hours of flying experience. Training in all courses includes every subject required to secure government license. The Universal trained man, whether he takes a Flying Course, Aviation Mechanic's Course, or a Business Course, knows his subject thoroughly.

**Have You Read This Book?**

A new book, "Aviation—What It Means To You," is just off the press. It tells you, without exaggeration, what aviation can offer you. Every man interested in aviation should read it. The book also lists various aeronautical terms with which you should be familiar and other educational data. It is sent on receipt of 25c. Fill in the coupon and mail with stamps or coin.



**Universal Aviation Schools**

- Robertson Flying School, St. Louis, Mo.
- Mid-Plane Flying School, Minneapolis, Minn.
- Egyptian Flying School, Marion, Ill.
- Porterfield Flying School, Kansas City, Kan.
- Braniff Flying School, Oklahoma City, Okla.

- Universal Flying School, Rochester, Minn.
- Universal Flying School, St. Paul, Minn.
- Universal Flying School, Memphis, Tenn.
- Universal Flying School, Cleveland, Ohio
- Universal Flying School, Columbus, Ohio

**A Division of the Universal Aviation Corporation**

Operating air lines between Chicago, St. Louis, Kansas City, Tulsa, Oklahoma City, Omaha, Cleveland, Cincinnati and Louisville, carrying air mail and passengers.

Studying the structure and operation of a Wright Whirlwind Motor in the school's shop at one of the Universal Aviation Schools.



  
Member Aeronautical Chamber of Commerce



**UNIVERSAL AVIATION SCHOOLS**  
1047-56 Boatmen's Bk. Bldg., St. Louis, Mo.

Enclosed find 25c for your explanatory book, "Aviation—What It Means to You." I am interested in:  Flying  Mechanics  Business Course.

Name..... Age.....  
Address.....  
City..... State..... NR322



## "AVIATION" GUIDE FREE With Auto Books!

For a limited time only we will give absolutely free Major PAGE'S sensational "best seller" among aviation books, 256 pages crammed full of the latest dope on modern aircraft, airplane motors, control systems, lessons on flying, etc. Written in simple, non-technical language, especially for beginners planning to go into aviation. Mail coupon, send no money.

# AUTO BOOKS SENT FREE!



## Can You FIX IT?

Can you take the "play" out of differentials? Can you kill the SHIMMY in steering? Can you reset TIMING? Can you put your finger on engine-trouble without guessing or tinkering? Can you pull the STARTER off and fix it? Can you adjust and repair transmission, rear-axles, engines and electrical systems?

## These Books Tell HOW!



Whether you are a mechanic or helper, expert or student, auto owner or driver, by all means take advantage of this opportunity to see and use the latest and most complete library on AUTOS every published! Built by eighteen of America's greatest automotive engineers. Simple enough for men with little schooling to understand, yet in daily use by thousands of engineers, service station superintendents and foremen. Tells you how to do any auto job RIGHT the first time.

### 5 BIG VOLUMES

2400 pages, over 2000 illustrations, wiring diagrams, equipment charts, etc. DeLuxe edition with gold-stamped flexible binding. Sent FREE for 15 days' use. If not wanted return express collect. If kept, send only \$2. after 15 days, then \$3. a month until special advertising price, \$24.80 is paid.

### Don't "Study"—LOOK IT UP!

The ten-billion dollar auto industry offers rich prizes to men with gumption enough to really learn all branches of automotive mechanics. A better job—bigger pay—the chance to go into business for yourself and get a share of the huge profits are waiting for any man who even half tries to improve his ability to deliver service. And here's the quickest, easiest way—no tedious memorizing or lessons. JUST LOOK UP the facts you seek. You'll find the answer to any auto problem literally at your finger-tips in the famous JIFFY INDEX.

American Technical Society  
Dept. AA-19 Drexel Ave. & 58th St., Chicago, Ill.

## DON'T SEND A PENNY!

American Technical Society  
Dept. AA-19 Drexel Ave. & 58th St., Chicago, Ill.

I would like to see the new 5-volume edition of your AUTO BOOKS, but without obligating me to buy them. I will pay the few cents delivery charges only, and if I choose to, I will return them express collect. If after 15 days' use I prefer to keep them I will send you \$2 and pay the balance at the rate of only \$3 a month, until \$24.80 is paid. Please include a year's consulting membership free, and send "AVIATION GUIDE" without cost after I notify you I will keep the books.

Name.....

Address.....

Employer's Name.....

Employer's Address.....

### AVIATION BOOK FREE

A guaranteed 10-Cable CHEST PULL (the most powerful one ever manufactured), adjustable up to 200 lbs., that will quickly develop muscles of shoulders, arms, abdomen and back—

both only \$3.95

and a pair of patented HAND GRIPS for developing powerful grip and forearms . . . all for only \$3.95. Free illustrated Course of Instruction also included.

5-Cable Chest Pull and pair of Hand Grips for only \$1.95. ORDER TODAY!

Fred A. F. Korth, 1139 Tiffany St., New York City

STATEMENT OF THE OWNERSHIP, MANAGEMENT, CIRCULATION, ETC., REQUIRED BY THE ACT OF CONGRESS OF AUGUST 24, 1912, of Popular Mechanics Magazine, published monthly at Chicago, Ill., for April, 1929.

State of Illinois, County of Cook, ss.  
Before me, a notary public in and for the state and county aforesaid, personally appeared H. H. Windsor, Jr., who, having been duly sworn according to law, deposes and says that he is the editor and business manager of the Popular Mechanics Magazine and that the following is, to the best of his knowledge and belief, a true statement of the ownership, management, etc., of the aforesaid publication for the date shown in the above caption, required by the Act of August 24, 1912, embodied in section 411, Postal Laws and Regulations, printed on the reverse of this form, to wit: First. That the names and addresses of the publisher, editor, managing editor, and business manager are: Publisher, Popular Mechanics Co., 200 East Ontario St., Chicago, Ill. Editor, H. H. Windsor, Jr., 200 East Ontario St., Chicago, Ill. Managing Editor, L. K. Weber, 200 East Ontario St., Chicago, Ill. Business Manager, H. H. Windsor, Jr., 200 East Ontario St., Chicago, Ill. Second. That the owner is: (If owned by a corporation, its name and address must be stated and also immediately thereunder the names and addresses of stockholders owning or holding one per cent or more of total amount of stock. If not owned by a corporation, the names and addresses of the individual owners must be given. If owned by a firm, company, or other unincorporated concern, its name and address, as well as those of each individual member, must be given.) L. B. Windsor, 200 East Ontario St., Chicago, Ill.; H. H. Windsor, Jr., 200 East Ontario St., Chicago, Ill. Third. That the known bondholders, mortgagees, and other security holders owning or holding 1 per cent or more of total amount of bonds, mortgages, or other securities are: (If there are none, so state.) None. Fourth. That the two paragraphs next above, giving the names of the owners, stockholders, and security holders, if any, contain not only the list of stockholders and security holders as they appear upon the books of the company but also, in cases where the stockholder or security holder appears upon the books of the company as trustee or in any other fiduciary relation, the name of the person or corporation for whom such trustee is acting, is given; also that the said two paragraphs contain statements embracing affiant's full knowledge and belief as to the circumstances and conditions under which stockholders and security holders in a capacity other than that of bona fide owner; and this affiant has no reason to believe that any other person, association, or corporation has any interest direct or indirect in the said stock, bonds, or other securities than as so stated by him. H. H. WINDSOR, Jr., Editor and Publisher. Sworn to and subscribed before me this 28th day of March, 1929. J. GRAHAM, Notary Public. (My commission expires June 16, 1932.)

### PAINT SHOW CARDS

and SIGNS. LEARN AT HOME IN SPARE TIME. WE TEACH YOU QUICKLY FASCINATING WORK. \$75 WEEKLY. SEND 6c IN STAMPS FOR INTERESTING BOOK. NEW HAVEN, CONN.

Universal School of Lettering

### NEW AUTO-MATIC RADIO GAS LIGHTER

LIGHTS GAS LIKE MAGIC  
No Flint—No Friction

No spark or flame. Lights instantly mantles, gas stoves, jets, and heaters. Held directly over gas flow. Flame appears instantly. Absolutely safe.

Light Gas by RADIO Gas Lighter

Make \$36 A Day

A big 25c seller, paying 400% clear profit. A gross easily sold in a day brings \$36.00 and costs you \$10.00. You make \$26.00 clear profit. Rush \$10.00 for gross, or \$1.00 for sample dozen, with amazing new sure-fire self-selling plan.

MASTERLITE MFG. CO.  
Dept. RF-19, 110 E. 23d St., New York City

# 24 STRENGTH TESTS

## Complete Course on STRENGTH FEATS

### ONLY 25c

Realize your ambition to accomplish feats of strength. Amaze your friends! Enjoy popularity and be admired by both sexes. I will pave the way for you. I will give you the secret of the following twenty-four strength tests that will make you the marvel of everyone. I will show you how to: Bend iron poker around neck; How to do iron scroll work with the hands; Bending spikes with one hand; How to wrap iron around arms; Breaking heavy spikes in two with the hands; Breaking heavy spikes with the jaws; How to drive spikes through planks and plate steel with a blow of the hand; How to snap chains apart in the hands; Leverage principles on iron bending; How to lift more with one finger than with two hands; How to develop the iron jaw; How to tear two decks of cards in half; How to tear telephone books; How to resist the pull of twelve men; The secret of supporting horses and automobiles on the body; Wrist lifting; How to resist the pull of four horses; Harness lifting; Breaking a chain with a blow of the fist; How to lift a horse with the hands; How to burst a rock with a blow of the fist; The secret of breaking horse shoes; How to crush bottle tops with your fingers.

The way to do these Strength Feats has never before been revealed but I will send, in typewritten form, complete information for the small sum of only 25c. With it I will include a free copy of my book, "The Thrill of Being Strong."

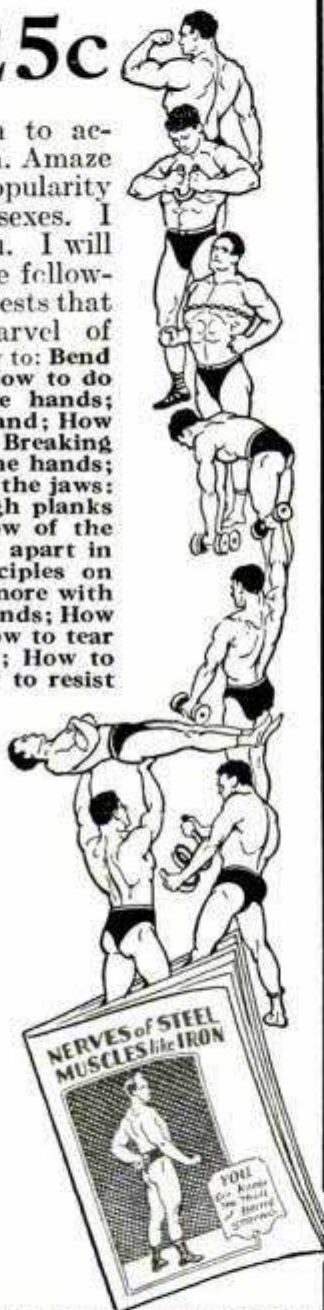

**Rush Coupon Today!**

**JOWETT INSTITUTE OF PHYSICAL CULTURE, Inc.**

422 Poplar St., Dept. 4T. Scranton, Pa.

Dear Mr. Jowett:

Enclosed find 25c, for which send me postpaid your course on "Secrets of Strength" and a free copy of "The Thrill of Being Strong."

Name.....

Address.....

*I'll Refund Your R.R. Fare to Chicago*

# Auto Experts

Get

## BIG PAY!

### Men Wanted

I can help place 20 TO 40 men a day, in JOBS, while learning and after. Never before such unusual opportunities. **Get my free book now.** Learn about the big pay. AUTOS lead WORLD'S BUSINESS. That's why GREER College selected this Field. Coupon brings you amazing facts.

**Be Your Own BOSS**

**Earn up to \$150.00 a week**

AUTOS now pay hundreds of Greer trained men up to \$200

A WEEK. Here

is a most wonderful business. BILLIONS—not millions, but BILLIONS of dollars are spent in it every year.

Greer trained men are NEEDED. I HAVE MADE hundreds of \$10,000 A YEAR MEN. 90,000 in the last 26 years have come to Greer.



Learn to Boss the Job

### Only 3 Months

Learn in ONLY 3 MONTHS! in GREAT GREER SHOPS on large *line equipment*. I'LL PAY YOUR FARE HERE Free of extra cost, then help you to a job while learning. Then I not only FIT YOU to GET the big pay job, but I'll help YOU HOLD IT. Young and Old, Educated and Uneducated, Inexperienced and Experienced have found GREER SHOPS training easy, fascinating and valuable.

### COUPON BELOW BRINGS YOU BIG FREE BOOK

Don't let money hold you back. Get my Free Book. Find out NOW, how I PAY YOUR FARE HERE, let YOU ATTEND either days or evenings and help you find DAY OR EVENING WORK to PAY YOUR EXPENSES while learning. Then when trained we help you find the real big pay job. Learn about amazing Auto opportunities and GREER COLLEGE. Right now, if you act quick, I can make you a most unusual short time offer. Address me personally

Erwin Greer, President, GREER COLLEGE  
Dept. 601 AT, 2024 So. Wabash Ave., Chicago

## FREE BOOK

Erwin Greer, President  
Dept. 601 AT, 2024 So. Wabash Avenue, Chicago, Illinois.

Send Free Auto Book and details of Special offer without obligation to me.

Name.....

Address..... Age.....



# Just Out!

*the very latest and never before disclosed Secrets of*

# Magic



**Astonish Your Friends**

## Be a Magician!

Write for Details

NOW!—if you act quick!—you can learn magic, real professional magic, right direct from the world famous magic wizard, Dr. Harlan Tarbell. All made

simple and easy by his great new method. Send today for details, low prices, easy terms and big free literature.

**Tarbell System, Inc., Studio A-135  
1926 Sunnyside Avenue, Chicago, Ill.**

**Tarbell System, Inc., Studio A-135  
1926 Sunnyside Avenue, Chicago, Ill.**

Gentlemen: Without any obligation send me your free literature and information all about your wonderful "Tarbell Course in Magic." Also tell me about your Low Price Offer and Easy Payment Plan.

Name.....  
Address.....  
Age.....

# New! BAKELITE

## Suction Grip Attachment

# Ash Receiver

For AUTOS, HOMES and OFFICES



Men, here is the handiest specialty created in recent years. The patented Master Suction Grip Ash Receiver sticks to any surface by its suction grip. Handy on the auto dashboard, windshield or wall. Convenient on the desk, on the bridge table or radio. Made of Bakelite in six distinctive colors, all richly Duco finished. Retail for only 50c; you make 100% profit selling wholesale to dealers and 200% profit selling direct to consumers.

### Agents Clean Up \$60 a Day!

#### With This Sensational Seller

Our five amazing selling plans outline sure ways of making big money selling to consumers, to dealers in quantities and getting orders by mail from empty autos by distributing our patented, self-selling envelope. The dealer plan shows you how to make \$60.00 a day by placing our self-selling display carton on store counters and building a steady growing repeat business. With our initial and emblem plan you simply cannot miss a sale. A dozen sold in a half hour nets you \$3.00 clear profit.

### Send for Sample or Dozen NOW!

Get started today. Send 50c for sample Ash Receiver or, better still, order a dozen in assorted colors, packed in display carton at our dozen price of \$3.00. Send full amount or enclose a dollar deposit, balance C. O. D. Use this sample box to take orders from dealers or sell them out at 50c each and make \$3.00 clear profit. Full details of all our selling plans will be sent you at once with your order for sample or dozen. Order today and reserve your territory.

**GORDON MFG. CO., (Dept. NF-19) 110 E. 23rd St., New York, N. Y.**

## YOU CAN OIL PAINT

Amazing new method teaches men or women to earn after first lesson. OIL PAINT photos—portraits, landscapes or art subjects. Earn \$18 to \$50 and more a week. OIL PAINT OUT-FIT GIVEN. Send now for free illustrated book. PICTORIAL ART STUDIOS Inc. Dept. MP, 2926 Broadway, Chicago, Ill.

## The Big Pay Trade ELECTRIC WELDING

Send now for booklet describing COLEMAN SYSTEM of practical training on new A. C. and D. C. welders.

**LEARN QUICKLY AT LOW COST**

Also shop training in all other electrical subjects. Coleman Electrical School, 1628 Main St., Kansas City, Mo.

## LAW HIGH-GRADE INSTRUCTION BY CORRESPONDENCE

College, Post Grad. and Bar Ex. Rev. Courses. Law has attracted more keen, brainy men than any other calling. Send today for catalog. Low cost, easy terms. Standard texts, Degrees.

**Chicago School of Law Dept. 801, Resper Block Chicago, Ill.**

## BUCHSTEIN'S FIBRE LIMB



is soothing to your stump—strong, cool, neat, light. Easy payments. Braces for all deformities. **D. BUCHSTEIN CO., 610 3rd Ave., So. MINNEAPOLIS, MINN.**

Send for Catalog Today

# How I Lost 97 Pounds



I weighed 279 lbs.! After trying many ways to reduce, a leading insurance medical advisor told me of a new way... a natural, pleasant, healthful way.

I lost 97 pounds. I feel better, look better, have more energy and vitality, no flabby or wrinkled skin.

Send name and address for full particulars FREE, without obligation.



**M. E. HART**

85 Hart Building

Dept. 33  
New Orleans

# Quick SUCCESS in RADIO

**Satisfaction Guaranteed  
or Money Refunded**

At last! A guaranteed method of radio training . . . sponsored by RCA . . . based on the research and discoveries made in the great RCA laboratories . . . a method that insures quick success in all branches of radio; manufacturing, servicing, selling, ship and shore broadcasting, television, photoradiograms! Radio needs you . . . big pay . . . amazing opportunities . . . thrilling work . . . adventure galore. Prepare at home . . . through this marvelous new laboratory method! Act now . . . mail the coupon for thrilling free

book about this guaranteed shortcut to success in America's fastest growing profession! Radio Institute of America, Dept. PM-6, 326 Broadway, New York, N. Y.

**FREE!**

This valuable book on Radio's great opportunities . . . written by one of America's well-known authorities.



RADIO INSTITUTE OF AMERICA, Dept. PM-6  
326 Broadway, New York, N. Y.

Gentlemen: Please send me your big FREE 50-page book which describes the brilliant opportunities in Radio and your laboratory-method of guaranteed instructions at home.

Name.....  
Address.....

# Win A Well-Paid HOTEL POSITION

**PROOF!**

**B. R. Casaday:**—"I have been in charge of one of the finest resorts in the country, since last March. I owe a great deal to Lewis Training."

**Allan Gustavson:**—"Now Assistant Manager of this golf club. I am putting Lewis principles into everything I do."

**Henry A. Leisenring:**—"I am employed as Steward and yesterday was given a substantial increase, which I attribute directly to your valuable instructions."

**A. L. Cummins:**—"After completing one third of the Course, your Employment Department assisted me in securing a clerk's position. After less than four months I was offered a position as Manager."



**Thousands Earn \$2,500 to \$10,000 a Year—YOU CAN DO AS WELL!**

**WITHOUT** cost let us show you how big pay, fascinating work, quick advancement can be yours in the great hotel and institutional field. Today, more than ever before, there are opportunities in this uncrowded industry that YOU cannot afford to miss.

**We Train You in Your Spare Time**

Thousands of positions open all the time in America's 3rd Largest Industry. Hotels, clubs, restaurants, schools, colleges, hospitals and institutions everywhere are daily calling for Lewis Trained Men and Women. \$1,750,000,000 building program this year means almost 200,000 positions open—positions paying \$2,500 to \$10,000 a year, with meals and apartment frequently included, FREE!

**Previous Experience Unnecessary**

We train you right at home and put you in touch with well-paid positions. Thousands of Lewis Students winning quick success. Totally unacquainted with hotel work before taking the Lewis Course, W. P. Plymale is now Manager of a beautiful hotel—B. G. Trumbower is Assistant Manager of a Country Club. Free Book, "YOUR BIG OPPORTUNITY," tells how YOU can do as well. Send for it today—NOW!



**LEWIS HOTEL TRAINING SCHOOLS**  
Room BM-304 WASHINGTON, D. C.

Charter Member  
National Home Study  
Council.  
The Original and  
Only School of  
its Kind in the  
World.

**Be a Hotel Manager**

Hotels, clubs, restaurants everywhere looking for Trained Managers. YOU can qualify!

Lewis Hotel Training Schools,  
 Room BM-304, Washington, D. C.  
 Send me, without obligation, the Free Book,  
 "YOUR BIG OPPORTUNITY."  
 Name.....  
 Address.....  
 City..... State.....

**OPPORTUNITY COUPON**



# BOYS

## Make Big Spare Time Money

### Surprise your chums

# Learn

# ELECTRICITY

## This Quick Easy Way

Electricity is great fun! And it pays. Lots of my boys still in school are making \$10 to \$15 a week in spare-time—and getting a real training besides for a regular he-man's Big-Pay job in Electricity when school days are over. You can, too! I'll show you how. Begin right now to prepare for a big future in this fascinating field of great opportunity. Your chances of success are simply wonderful!

### Learn Right at Home

With my easily-learned, spare-time Electrical Course I will train you at home like I trained hundreds of other boys who are now big successful men. It won't interfere with your school work. And you'll find it so enjoyable it will be more like play than study. It's just the thing for you fellows who are ambitious to get somewhere and be somebody after you have finished school.

### I Train You RIGHT!

My training is practical—you learn along work-shop lines by doing. I furnish you with all necessary equipment to work with. And it doesn't cost you a penny extra! Six Big Outfits of tools, material and apparatus, including a real electric motor—not toys, but the real thing. And they're yours to keep—to learn right with, and to help you do the spare-time work I tell you how to get and how to do.

### Mail Coupon for Book

If you want lots of spending money—if you want to be ready to jump into a Big-Pay Electrical Job when you're through school—my Big Book will show you how. Get it—you'll like it—it's full of "dope," data and pictures that will thrill you. And it's FREE—won't cost you a penny—mail coupon for it right now

**L. L. COOKE**

Chief Instruction Engineer  
Dept. 01-A, CHICAGO, ILL.

### RADIO COURSE NO EXTRA CHARGE

Every fellow wants to earn radio. And this Course is a dandy. It's simple—it's thorough. You'll be surprised what it will teach you about Radio. And it's yours without a penny of extra cost!

### 6 BIG OUTFITS given, including a REAL MOTOR

What a thrill you'll get from these Six Big Outfits of tools and apparatus! There's enough equipment in this fine layout for you to tackle any kind of spare-time work. Imagine having all this for "keeps."



### Use this SPECIAL OFFER Coupon

L. L. COOKE, Chief Instruction Engineer,  
L. L. Cooke School of Electricity,  
Dept. 01-A, 2150 Lawrence Ave., Chicago, Ill.

Send me free and fully prepaid your Big Book about Electricity, and full particulars about your Electrical Course and extra Radio Course. This does not obligate me.

Name.....  
Address.....  
City..... State.....  
(This coupon only for use of boys 15 years old or more)

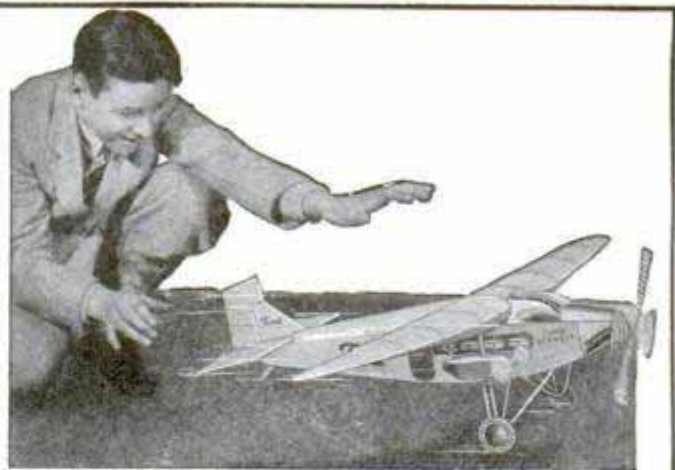

## Build This IDEAL Flying Model of the FORD MONOPLANE

A perfect 3-foot miniature of the "Floyd Bennett," the Tri-motor plane now in use by Commander Byrd at the South Pole. Anybody can build and fly it. The IDEAL Complete Construction Outfit contains everything needed; all parts, fittings and materials, full plans, diagrams and instructions. The Model is guaranteed to fly when correctly built. Complete Construction **\$8.50** Outfit.....  
(West of Denver, Colo., and in Canada \$9.00)  
Ask Your Dealer or Order Direct.

### Plans for Model Airplanes

Complete, accurate, 1/2-size Plans with Building-Flying Instructions, for any one of the following: Ford, New York-Paris; FOKKER; Curtiss; DeHAVILLAND; NC-4 Seaplane, Beriot; Taube or Nieuport Cecil Peeli—**Model Book Free with each plan. Each 25c**



### 64-pg. Book for Model Builders

Contains plans for building Gliders and Racers, full information about Scale Models; and most complete catalog of Parts, Supplies, Materials and Fittings for all kinds of Models. **5c** Postpaid for.....

**Ideal Aeroplane & Supply Co., Inc.**

26 West 19th Street New York City

**40 Miles per Hour**

# Oh, Boy!

## Win \$50

### Building This Car from our PLANS!

Any boy can build this car from our easy plans. Tread 36" wheel base 75". Send 50c today for detailed building plans, simplified so you can easily build this car. Also full information of prize contest. Five grand prizes. First prize \$50. Hurry. Write today.

**SYCO SALES CO., 1524 Fernwood, Toledo, Ohio**

## Turn Water into Money With 20 Minute Car Washing

The new HB Double Action Car Washer throws more water per minute with lower water and current cost per car than any other on the market. Easily washes a complete car in 20 minutes—earns exceptionally large profits.

### Only \$20 Monthly Cost

Comes to you on Trial and easy monthly payments of only \$20. Will pay for itself. Write today for complete details without obligation.

**Hobart Bros., Box M692 Troy, Ohio**







# FREE!

## Body Chart

If you will mail the coupon below, this Anatomical and Physiological Chart will be mailed to you without one cent of expense. It shows the location of the Organs, Bones of the Body, Muscles of the Body, Head and Vertebra Column and tells you how the nerves radiate from your spinal cord to all organs of the body. This chart should be in every home.

### Where Is That PAIN?

It may be in the neck, back, hips, stomach, liver, legs or arms. Wherever it is, the chart will help to show you the location and cause of your ailment. For instance, this chart will help you locate vermiform appendix pains. Hundreds of lives might have been saved if people had known the location and character of the pain and had received proper attention.

# Stop that Pain

By Relieving the Cause with  
**Violet Ray - Vibration  
Ozone - Medical Electricity**  
The Four Greatest Curative Powers Generated by This  
**Great New Invention!**



Elco Health Generators at last are ready for you! If you want more health—greater power to enjoy the pleasures and delights about you, or if more beauty is your desire—write! Ask for the book on these inventions which has just been prepared. It will be sent to you without cost. It tells you how Elco Health Generators aid you in leaving the lethargy and hopelessness of bad health and weakness behind forever. Re-vitalize yourself. Bring back energy. Be wholly alive. Write today!

Here's What Elco Users Say—

"Wouldn't take \$1000 for my Elco."  
"Has done me more good in 2 weeks than doctors did in three years."  
"Cured my Rheumatism."  
"My Eczema gone."  
"Cured my stomach trouble."  
"Cured my weakness."  
"Now I sleep soundly all night."  
"Thanks to Elco my strength and vigor are back."  
"No more pain."  
"Colds never bother me now."  
"Chronic Constipation banished."



These great new inventions generate Violet Ray, Vibration, Electricity and Ozone—combined or separate. They operate on the electric light in your home or on their own motive power at less than 50 cents per year. Elco Health Generators are positively the only instruments which can give you in one outfit Electricity, Violet Ray, Vibration and Ozone—the four greatest curative agents. Send the coupon below. Get the Free Book NOW!

## MAIL COUPON for FREE BOOK

Do not put this paper down without sending the coupon. Don't go on as you are with pains and with almost no life and energy. You owe it to yourself to be a better man or woman. You were put here to enjoy life—not just to drag through it. So do not rest another day until you have put your name on the coupon here. That will bring the whole story of these great new inventions. Do it today—now.



**Lindstrom & Co.** [Makers of Therapeutic Apparatus since 1892.]

2322 Indiana Avenue Dept. A-135 Chicago

Please send me your free book, "Health—Power—Beauty" and full information of your 10-day Free Trial Offer.

Name.....

Address.....



## New Fluid Restores Finish of Old Autos

Unquestionably this is one of the greatest discoveries in the automobile field. Think of it! A marvelous liquid called NUREX, almost magical in its effect, does away entirely with all polishes and waxes.

**WITH A SWEEP OF THE HAND**

NUREX requires no rubbing, painting, cleaning nor waxing. Just a sweep of the hand and the drab, dull surface vanishes before your eyes and the hidden color gleams forth with wonderful lustre. Your car then looks like it just came from a paint shop and the beautiful new finish will last indefinitely.

**PAYS YOU EASILY \$100 PER WEEK**

By merely showing NUREX you will make big money. Every car owner to whom you demonstrate will buy. Sales rapidly multiply. Every sale brings you enormous repeat business. In your spare time you can easily make from \$5 to \$10 an hour with little effort.

**REFINISH YOUR OWN CAR FREE**

We are now appointing men in various localities to take care of the big demand. A sample supply of NUREX is furnished FREE to workers. Just write and say, "Send me your FREE sample and big money making offer."

**NUREX PRODUCTS CO., Sta. C, Dept. 170, MILWAUKEE, WIS.**

## PROFITS BUY \$9,000. HOME

"Your plant hasn't cost me a cent for repairs. Today I have a \$9,000 home, my own business property, well stocked and nothing to worry about." Arthur O. Wallace.



### Be Your Own Boss

Over 100,000,000 tires now in use. Big opportunity for ambitious men. Small capital. Big earnings. We furnish everything—\$100 and up.

**Easy Payments** Free training. Write immediately for big free book, "Steps to Success."  
**J. A. SCHREIBER, Pres.**  
**Haywood Tire Equipment Co.**  
2330-H Ogden Ave., Chicago, Ill.

## WANTED

AMBITIOUS MEN to finish their education at home in a new, simple and inexpensive way. No dry lessons to learn. Prepares you for big pay at amazingly low cost. This is your golden opportunity! Write at once for "Circular No. 514." It's free.

**LEWIS COPELAND CO. 119 W. 57th St. New York, N. Y.**

## Photos ENLARGED

Size 16x20 inches

Same price for full length or bust form groups, landscapes, or pet animals, etc., enlargements of any sort of group picture. Safe return of your own original photo guaranteed.

# 98c

**SEND NO MONEY** Just mail photo or snapshot (any size) and within a week you will receive your beautiful life-like enlargement size 16x20 in. guaranteed fadeless. Pay postman 98c plus postage or send \$1.00 with order and we pay postage.

With each enlargement we will send FREE a hand-tinted miniature reproduction of photo sent. Take advantage now of this amazing offer—send your photo today.

**UNITED PORTRAIT COMPANY**  
1652 Ogden Ave., Dept. G-369, CHICAGO, ILL.



## Mechanical Toys

Ship Models, Colonial Bric-a-Brac, Leather and Celluloid articles and hundreds of other useful things are described in our new book, Make It Yourself. 460 Pages. Illustrated. Price \$3 Postpaid.

**POPULAR MECHANICS PRESS, 200 E. Ontario St., Chicago**

## EVERY FLYER NEEDS

Practical Air Navigation and Meteorology: the new, simplified, non-technical treatise by Capt. Richard Duncan, who has over 3000 hours of flying to his credit. No subject is of greater importance to the flyer. 243 Pages. 70 Illustrations, Maps, Charts, etc. \$3 postpaid.

**Popular Mechanics Press, 200 E. Ontario St., Chicago**



# FREE To Men Past 40

**A** WELL-KNOWN scientist's new book about old age reveals facts which, to many men, will be amazing. Did you know that two-thirds of all men past middle age are said to have a certain seldom mentioned disorder? Do you know the frequent cause of this decline in vitality?

### Common Old-Age Symptoms

Medical men know this condition as hypertrophy of the prostate gland. Science now reveals that this swollen gland—painless in itself—not only often cheats men of vitality, but also bears on the bladder and is often directly responsible for sciatica, back-ache, pains in the legs and feet, frequent nightly risings, and dizziness denoting high blood pressure. When allowed to run on it is frequently the cause of the dreaded disease cystitis, a very severe bladder inflammation.

### 65% Have This Gland Disorder

Prostate trouble is now reached immediately by a new kind of home treatment—a new, safe hygiene that goes directly to the gland itself, without drugs, medicine, massage, lessons, diet or the application of electricity. It is absolutely safe. 50,000 men have used it to restore the prostate gland to normal functioning. The principle involved in this treatment is recommended by practically all the

physicians in America. Amazing recoveries are often made in six days. Another grateful effect is usually the immediate disappearance of chronic constipation. Usually the entire body is toned up, as much of your youthful vigor is restored. These results are guaranteed: Either you feel ten years younger in six days or the treatment costs nothing.

### Send for FREE Book

If you have this gland trouble or if you have any of the symptoms mentioned above, you should not lose a day in writing for the scientist's free Book, "Why Men Are Old at 40." It will enable you to ask yourself certain frank questions that reveal your true condition. Every man past 40 should make this test, as insidious prostate disorder often leads to surgery. This book is absolutely free, but mail coupon immediately, as the edition is limited. Address

### ELECTRO THERMAL CO.

2118 Morris Avenue, Steubenville, Ohio

If you live west of the Rockies, mail your inquiry to  
The Electro Thermal Co.  
303 Van Nuys Building, Dept. 21-U  
Los Angeles, California  
Desk 21-U, 53 Yonge St., Toronto, Ont., Canada

THE ELECTRO THERMAL COMPANY.  
2118 Morris Avenue, Steubenville, O.

Please send me Free, and without obligation, a copy of your booklet, "Why Men Are Old at 40." Mail in plain wrapper.

Name.....

Address.....

City..... State.....

### FOY'S BIG PIGEON BOOK

in NATURAL COLORS, a complete guide to successful Squab and Poultry Raising. Tells how to feed, breed, grow and make money raising squabs. Quotes low prices.  
Write today. FREE.

F. FOY Box 18 CLINTON, IOWA



### SQUAB BOOK FREE

Breed squabs and make money. Sold by millions for more than chickens. Write at once for free 48-page book beautifully printed in colors telling how to do it. You will be surprised.  
PLYMOUTH ROCK SQUAB CO.  
634 H Street Melrose Highlands, Mass.



### "CHOOSING A VOCATION"

Interesting 48 Page Book Free

Helpful discussion of this important problem, also presenting opportunities up to \$5000 a year in Mechanical Dentistry—making crowns, plates, bridges, etc., for dentists. Write for Bulletin 2.

### BODEE INSTITUTE

New York  
1755 Broadway

Philadelphia  
1305 North Broad Street

Brooklyn  
85 Court Street



# TRAVEL for "UNCLE SAM"

\$158 to \$225 Month

Mail Coupon Before You Lose It

FRANKLIN INSTITUTE, Dept. S171, ROCHESTER, N.Y.

Sirs: Rush to me without charge copy of 32-page book, "How to get U. S. Government Jobs," list of positions obtainable and full particulars telling how to get them.

Name.....

Steady Work—No Layoffs—Paid Vacations

## LUMINOUS PAINT

**Make Your Watches, Clocks, Etc., Visible by Night**

The very latest discovery in the scientific world. Hitherto, practically unobtainable except at an exorbitant price, we have at last succeeded in producing this remarkable LUMINOUS PAINT, which, applied to the surface of any article, emits rays of white light, rendering it perfectly visible in the dark. THE DARKER THE NIGHT, THE MORE BRILLIANT IT SHINES. Quite simple to use. Anyone—you can do it. A little applied to the dial of your watch or clock will enable you to tell the time by night. You can coat the push buttons or switch plates of your electric lights, match boxes, and innumerable other articles; make your own Luminous Crucifixes, Luminous Rosaries, etc. Small bottle, price 25c. Larger sizes, 50c and \$1 postpaid. **JOHNSON SMITH & CO.** Dept. 839 RACINE, WIS.



### CIGARETTE MAKER

Roll your own and save money. Better and quicker; saves more than half. Use your favorite brand of tobacco. Neat, useful, handy. Pocket size, weighs 1/2 oz. Made entirely of metal, nickel plated. 25c, 3 for 65c postpaid anywhere.



### Exploding Cigarettes

JUST LIKE ORDINARY CIGARETTES, BUT SUCH REAL STARTLERS! The box contains ten genuine cigarettes of excellent quality. They appear so real, but when each cigarette is about one-third smoked, the victim gets a very great surprise as it goes off with a loud BANG! A great mirth provoker yet entirely harmless. Price 25c box.

### GOOD LUCK RING

Very striking, quaint and uncommon. Silver finish; skull and crossbones design, two brilliant, flashing gems sparkle out of the eyes. Said to bring good luck. Only 25c ppd.

### NOVELTY BADGES



Kissing Permit 10c. Garter Inspector 10c. Two very novel metal badges, nickel plated, that you can wear, giving you fun out of all proportion to their trifling cost. 10c, each badge, 3 for 25c, or 75c per doz. postpaid anywhere.

### MIDGET BIBLE



GREAT CURIOSITY Smallest Bible in the World. Size of a postage stamp. 200 Pages. Said to bring good luck to the owner. A genuine work of art. Must be seen to be appreciated. Make good money selling them to friends, church acquaintances, etc. PRICE 15c each, 3 for 40c, 12 for \$1.35, 100 for \$7.50. Also obtainable in Leather Binding, with gold edges. Price 50c each, 3 for \$1.25, \$4.50 per doz. Magnifying Glass for use with Midget Bible 15c.

### STAGE MONEY



With a bunch of these bills, it is easy for each person of limited means to appear prosperous by flashing a roll of these bills at the proper time and peeling off a genuine bill or two from the outside of the roll, the effect created will be found to be all that can be desired. Prices, postpaid: 40 Bills 20c, 120 for 50c, or \$3.50 thousand postpaid.

### MAGIC NOSE FLUTE



The Magic Nose Flute, or Hummatone, is a unique and novel musical instrument that is played with nose and mouth combined. There is just a little knack in playing it which, when once acquired after a little practice, will enable you to produce very sweet music that somewhat resembles a flute. There is no fingering, and once you have mastered it you can play all kinds of music with facility and ease. When played as an accompaniment to a piano or any other musical instrument, the effect is as charming as it is surprising.

### SURPRISE MATCHES

More fun than fighting with your wife. Look just like ordinary matches. Put up in boxes just like regular Safety Matches. As the victim tries to light one he gets quite a surprise. Price 10c per box, 3 boxes for 25c, 12 for 75 cents.

### STAR TOY MAKER

Greatest boys' book written. Tells how to make a Pinhole Camera, a Canoe, model Railroad, a Telephone, Boomerang, Telegraph Instrument, Box Kite, Talking Machine, Microscope, Electric Motor, Electric Door Bell, Water Wheel, Paddle Raft, a pair of Skis, a Dog Sled, Bird House, Rabbit Yard, etc. 64 pages. 150 illustrations. PRICE 10c postpaid.

### Wonderful X-Ray Tube

A wonderful little instrument producing optical illusions both surprising and startling. With it you can see what is apparently the bones of your fingers, the lead in a lead pencil, the interior opening in a pipe stem, and many other similar illusions. A mystery that no one has been able to satisfactorily explain. Price 10c, 3 for 25c, 1 dozen 75c. Johnson Smith & Co.

### NOSE BLOWER

When some men blow their noses it sounds like a trombone. Now the NOSE BLOWER has come to torment us. It is a starter! It is ingeniously concealed in the handkerchief. Proceed to blow your nose and your friends will think they heard a steam engine or something. You can blame the hideous noise to your having a very bad cold and keep up the fun as long as you like. PRICE 10c, 3 for 85c, or 75c doz. postpaid.

### Serpent's Eggs

Box contains 12 eggs. When lit with a match, each one gradually hatches itself into a snake several feet long, which curls and twists about in a most life-like manner. Price per box, 10c postpaid, 3 for 25c.

## BLANK CARTRIDGE PISTOL



Protection against Burglars, Tramps, & Dogs. Special Offer 1 Blank Cartridge Pistol 100 Blank Cartridges 1 650-page Novelty Catalog ONLY \$1.50 The Lot Shipped by Express Only Cash With Order Only Well made and effective, modified on latest type of Revolver; appearance alone is enough to scare a burglar. When loaded it may be as effective as a real revolver without danger to life. It takes standard .22 Cal. Blank Cartridge - obtainable everywhere. Special cash with order offer: 1 Superior quality Blank Cartridge Pistol, 100 Blank Cartridges, and our new 650 page De Luxe Catalog of latest novelties; all for ONLY \$1.50. Shipped by Express only. Cannot go by parcel post. Extra Blank Cartridges 50c per 100. Special Offer (Cowboy Type) for pistol 50c. No C. O. D. shipments.

## LOOK 35¢ LOOK Wonderful Instrument.

Greatest thing yet. Nine separate articles in one. Everybody delighted with it. Odd, Curious and Interesting. Lots of pleasure as well as very useful. It is a double Microscope for examining the wonders of nature. It is also an Opera Glass, a Stereoscope, a Burning Lens, a Reading Glass, a Telescope, a Compass, a pocket Mirror, and a Laryngoscope—for examining eye, ear, nose and throat. It is worth all the cost to locate even one painful cinder in the eye. Folds flat and fits the pocket. Something great—you need one. Don't miss it. Sent by mail. Only 35c or 3 for \$1.00. **JOHNSON SMITH & CO., DEPT. 839, RACINE, WIS.**

## INVISIBLE INK | Rubber Chewing Gum

The most confidential messages can be written with this ink for the writing makes no mark. Cannot be seen unless you know the secret. Invaluable for many reasons. Keep your postals and other private memorandums away from prying eyes. Great fun for playing practical jokes. Only 15c a Bottle; 3 for 40c. It is just like a regular package of chewing gum and looks so real that it fools everybody. Of course no one suspects it is not genuine until they start to chew it. There's a world of fun in this rubber chewing gum - 5 sticks to the package. Price, 10c Pkg.; 3 for 25c; 12 for 75c postpaid. **Johnson Smith & Co., Dept. 839, Racine, Wis.**

## Watch Charm Pistol \$1.75



Exact reproduction of a real pistol; actually fires REAL BLANK CARTRIDGES of miniature size. Illustration is actual size. 1 1/4 inches long, with ring at end for attaching to watch chain. Loads like a regular pistol. Pull the trigger and it goes off with a loud bang. Pistol is break open type; illustration shows position for loading. Made entirely of high grade steel, nickel plated, octagon barrel, handomely engraved handles, complete in box with cleaning rod. PRICE \$1.75. Also furnished with pearl handles, \$2.50. BLANK CARTRIDGES, 50c per box of 25. **JOHNSON SMITH & CO., DEPT. 839, RACINE, WIS.**

## MICROPHONE TRANSMITTER BUTTON



You can easily make a highly sensitive detector-phones by using this Transmitter Button to collect the sound waves. You can build your own outfit without buying expensive equipment. It is simple and inexpensive. You can install an outfit in your home and hear conversations being held all over the house. You can connect up different rooms of a hotel. This outfit was used by secret service operatives during the war. It is being used on the stage. It is ultra-sensitive and is the greatest invention in microphones. You can mount the button almost anywhere—card board boxes, stove pipes, stiff calendars, on the wall behind a picture frame, etc. Button is so light and small it cannot be detected. Persons can be overheard without suspecting it. You can listen in on conversations in another room. A deaf person in the audience can hear the speaker. Connected to phonograph, piano or other musical instrument, music can be heard hundreds of feet away. Button may be used to renew telephone transmitters; often makes an old line "talk up" when nothing else will. The ideal microphone for radio use; carries heavy current and is extremely sensitive. Amplifies radio signals. Countless other similar uses will suggest themselves. Experimenters find the button useful for hundreds of experiments along the lines of telephones, amplifiers, loud speakers, etc. Many fascinating stunts may be devised, such as holding the button against the throat or chest to reproduce speech without sound waves. PRICE \$1.00. **JOHNSON SMITH & CO., DEPT. 839, RACINE, WIS.**

# JOHNSON SMITH & CO.

Dept. 839 RACINE, WIS. A De Luxe Edition of our new 1929 CATALOG mailed on receipt of 25c. Handsome binding. Bigger and better than ever. Only book of its kind in existence. Nearly 600 pages of all the latest tricks in magic, the newest novelties, puzzles, games, sporting goods, rubber stamps, unusual and interesting books, curiosities in seeds and plants, etc., unobtainable elsewhere. Remit by Coin, Money Order, Check or unused U. S., Canadian and Foreign Stamps for all articles listed above.

# BOYS! BOYS! BOYS! Throw Your Voice

Into a trunk, under the bed, under a table, back of the door, into a desk at school, or anywhere. You get lots of fun fooling the teacher, policemen, peddlers, and surprise and fool all your friends besides.

## THE VENTRILO

is a little instrument that fits in the mouth out of sight. Cannot be detected. It is used in connection with the above, and with the aid of this wonderful **DOUBLE**



**THROAT, or VENTRILO**, you can imitate many kinds of birds, animals, etc. Remember you get everything for **ONLY TEN CENTS**—a booklet giving you full instructions how to become a ventriloquist and throw your voice, the **Double Throat**, or **Ventrilo**, and our big 600 page catalog of novelties, tricks, puzzles, masks, books, etc., **10 cents**  
ALL SENT POSTPAID TO ANY ADDRESS FOR ONLY **10 cents**

### LEARN TO PITCH

By the world's greatest pitchers. Prepares you mentally, morally and physically to become a great baseball player and a great athlete. Special course of lessons by **CHRISTY MATHEWSON**, who explains the secret of how to throw the great "FADEAWAY" ball, so much feared by the great batters; **ED WALSH**, the pitcher who discovered the secret of throwing that famous, mystifying, and unhittable "SPIT BALL"; **JOE WOOD**, the "Smoke Ball" marvel, next to the speediest pitcher in the world; **WALTER JOHNSON**, the man who has struck out more league batters in a single season than any other pitcher known; **NAP RUCKER**, inventor of the "Knuckle Ball"; and **DOC WHITE**, who teaches you the art of **Shadow Pitching** by which you can develop control and speed necessary to become a star pitcher. Clearly described and illustrated by 56 pictures. Everything complete for **ONLY 25 cents** postpaid anywhere. Nothing more to buy.



you mentally, morally and physically to become a great baseball player and a great athlete. Special course of lessons by **CHRISTY MATHEWSON**, who explains the secret of how to throw the great "FADEAWAY" ball, so much feared by the great batters; **ED WALSH**, the pitcher who discovered the secret of throwing that famous, mystifying, and unhittable "SPIT BALL"; **JOE WOOD**, the "Smoke Ball" marvel, next to the speediest pitcher in the world; **WALTER JOHNSON**, the man who has struck out more league batters in a single season than any other pitcher known; **NAP RUCKER**, inventor of the "Knuckle Ball"; and **DOC WHITE**, who teaches you the art of **Shadow Pitching** by which you can develop control and speed necessary to become a star pitcher. Clearly described and illustrated by 56 pictures. Everything complete for **ONLY 25 cents** postpaid anywhere. Nothing more to buy.

### MAGICIAN'S BOX OF TRICKS

Apparatus and Directions for a Number of Mysterious Tricks, Enough for an Entire Evening's Entertainment..... **\$1.00**

**ANYONE CAN DO THEM**

It is great fun mystifying your friends. Get this Conjuror's Cabinet, and you will be the cleverest fellow in your district. It contains the apparatus for ten first-class tricks, including the **MAGIC BALL AND VASE TRICK** (a wooden ball is placed inside, and upon replacing the lid has disappeared and is found in someone else's pocket); the **HINDOO TRICK CARDS** (can be made to change completely no less than five times); **DISAPPEARING COIN BOX** (a coin, placed in the wooden box, vanishes entirely or changes into a coin of another denomination); the **GLASS GLOBE TRICK** (a coin is dropped into a glass of water and when the water is poured out the coin has vanished and is found somewhere else); the **RIBBON FACTORY FROM THE MOUTH TRICK** (a seemingly endless supply of colored paper ribbons comes out of your mouth); the **DISAPPEARING HANDKERCHIEF** (a handkerchief held in the hand mysteriously vanishes); the **WIZARD'S RING COIN TRICK**; the **ENCHANTED RING COIN TRICK** (a ring is placed on the finger and disappears, and is found underneath yet no one has touched the ring); and last, but not least, the **GREAT PHANTOM CARD TRICK**, or two from five leaves nothing. Full instructions are sent for performing each trick. In addition to the above, a number of other feats and illusions are fully explained for which you can easily make or procure the necessary apparatus. Price complete **\$1.00** postpaid. **JOHNSON SMITH & CO.**



### U. S. BABY TANK

It goes with real Yankee Pep—by its own power



Most remarkable toy ever invented. By drawing the tank backward, either with the hand or over the floor or table and then placing it down, it will crawl along, overcoming all obstacles, in the same life-like manner as the larger tank that proved so deadly in the great war. What makes it go is somewhat of a mystery, for there is no mechanism to wind up as is usually understood with mechanical toys, yet this tank will keep plodding along ten times longer than the ordinary run of toys. It will perform dozens of the most wonderful stunts; 2 1/2 inches long. Price only **25c** prepaid. Stamps accepted. **JOHNSON SMITH & CO.**

### KEYLESS COMBINATION LOCK



These clever Locks cannot be opened unless you know the combination. Each Lock has a different combination, the secret of which we send with the Lock. No key is necessary, simply arrange the tumblers in the proper order and the Lock opens. For your locker, bicycle, tool chest, mail box, thousands of uses. A good, strong lock, weighing about 4 ounces, that will baffle the attempts of all unacquainted with the secret combination to open it. Price, with secret and full instructions **Only 50c** postpd. **JOHNSON SMITH & CO., Dept. 839, RACINE, WIS.**

### RESURRECTION PLANT

Great curiosity. Place in water, plant opens up and starts to grow in few minutes. Taken out it dries up and goes to sleep until put in water again. Price **10c**, 3 for **25c**, 75c dozen, postpaid.



### DISSOLVING VIEWS

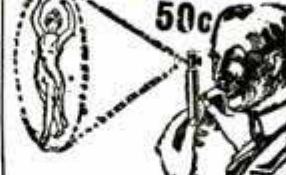

You may have a lot of fun with this little peep show. A regular starter. Made entirely of metal, having a microscopic lens fitted into one end. While the victim is absorbed in admiration of the pretty picture, and turns the button in the confident expectation of seeing something interesting, a spring syringe is brought into action, and the observer experiences a very great surprise. **50c** p. d. **JOHNSON SMITH & CO., Dept. 839, Racine, Wis.**



Comical Motto Rings. Lots of harmless fun and amusement wearing these rings. Made in platinum finish (to resemble platinum), with wording on enameloid, as illustrated. Price only **25c** Postpaid.

### Great Fire Eater



A great trick by which you can apparently breathe fire from mouth, to the horror and consternation of all. Quite harmless. All apparatus necessary sent complete in box for **ONLY 30c**, p. d. **JOHNSON SMITH**

### SQUIRT ROSE



**25c**  
A REAL STARTLER. This is the most popular of all squirt tricks. The flower in your coat looks so fresh and sweet that everyone is tempted to inhale the delightful perfume. Then is the moment to press the bulb. Geewhikkens. Don't they jump? There is a very long rubber tube that easily reaches to the pocket of your coat or trousers, and the bulb is large enough to make a dozen shots with one loading. Price **25c** each, or 3 for **65c** postpaid.

### SEEBACKROSCOPE

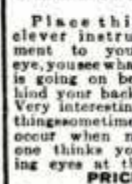

Place this clever instrument to your eyes, you see what is going on behind your back. Very interesting things sometimes occur when no one thinks you are looking. Just like having eyes at the back of your head. Price **25c** POSTPAID

### The "Little Giant" Typewriter



A First Class Writing Machine For **\$1.50**

A perfect little typewriter for \$1.50. There are thousands of persons who would like to use a typewriter but whose needs and business do not warrant the expense attached to the purchase and use of a fifty or seventy-five dollar machine. To such persons we cordially recommend our Little Giant. It is strongly made, but simple in construction, so that anyone can quickly learn to operate it, and write so rapidly as they would with pen and ink. The letters of the alphabet most frequently used are so grouped as to enable one to write rapidly, the numerals 1 to 10, and the punctuation marks being together. With this machine you can send your next girl typewritten love letters, address envelopes, make out bills, and do almost any kind of work not requiring a large, expensive machine. With each typewriter we send a tube of ink and full printed instructions for using the machine. Price complete **\$1.50** by mail postpaid to any address in the world.

Send remittance (Postage Stamps accepted) for all articles listed above also in our other ad on previous page **JOHNSON SMITH & CO. Dept. 839 Racine, Wis.**

# SAVE YOUR BODY

Conserve Your Health and Efficiency First

**"I Would Not Part with it for \$10,000"**

So writes an enthusiastic, grateful customer. "Worth more than a farm," says another. In like manner testify over 100,000 people who have worn it.

## The Natural Body Brace

Overcomes **WEAKNESS** and **ORGANIC AILMENTS** of **WOMEN AND MEN**. Develops **erect, graceful figure**.

Brings restful relief, comfort, ability to do things, health and strength.

**Wear It 30 Days Free at Our Expense**

Does away with the strain and pain of standing and walking; replaces and supports misplaced internal organs; reduces enlarged abdomen; straightens and strengthens the back; corrects stooping shoulders; develops lungs, chest and bust; relieves backache, curvatures, nervousness, ruptures, constipation, after effects of flu. Comfortable and easy to wear.

**Keep Yourself Fit** Write today for illustrated booklet, measurement blank, etc., and read our very liberal proposition.

**HOWARD C. RASH, Pres. Natural Body Brace Co.**  
123 Rash Building SALINA, KANSAS



**For Boys and Girls Also**



## AIRCRAFT HANDBOOK

HERE is the outstanding book on airplane mechanics—complete, practical and up-to-date. For students, airplane mechanics and builders. Gives complete information on the operation and maintenance of the standard aircraft engines of the day. The newest developments in aircraft instruments, including the earth inductor compass, are given prominence. Official Air Regulations of the Department of Commerce have been included.

**Covers such Topics as:**

Adjustment of ailerons; construction of airports; shooting trouble on the Whitney-Wasp engine; various license requirements; earth inductor compass; aluminum propellers; engine inspection; longitudinal stability; valve timing on the Wright-Hispano; etc., etc., etc.

Send for a copy of this book to examine for 10 days free. No obligation to purchase—no agents—no red tape. You can keep the book or return it, as you wish. But be sure to see it. Clip and mail the coupon below.

464 pages, 151 illustrations, flexible keratol binding.

### FREE EXAMINATION COUPON

McGraw-Hill Book Co., Inc., 370 Seventh Ave., NEW YORK

Send me Colvin and Colvin's AIRCRAFT HANDBOOK. 3rd Edition, \$4.00, for 10 days' free examination. I agree to return the book, postpaid, in ten days or to remit for it then.

Signed.....

Address.....

Official Position.....

Name of Company.....

P.M. 6-29

## "SUCCESS OVERNIGHT"

A. L. Pelton is in the millionaire class; J. A. Stransky, former candidate for Gov. of South Dakota is making \$150,000 a year; I picked C. J. Doherty up from the street, penniless and in less than 2 months he was earning \$400.00 a week.



### \$25,000 A DAY

At the age of 23, I was on easy street, doing a \$25,000.00 a day business. My office was like a bank—sending out as many as 900 checks a day. My mailing department looked like a shoe store—with boxes of envelopes stocked to the ceiling. I maintained seven cars, had a chauffeur, owned a magnificent home and wore the most beautiful and costly diamonds in the state. Yes sir. All at the age of 23. If I and others can succeed, you can, and legitimately too. You are just as good a man as I am. In one volume I have explained thoroughly the foundations of my success together with ideas. (It is of the same form that the largest store in the world is built.) "Success Overnight" contains several chapters. One chapter, alone, contains nearly 100 pages, explains everything in detail and is fully illustrated. This book sells for \$2.00 and if after giving it a fair trial you don't succeed, return it and we will return your money.

I. R. HOUGH, Publisher, 168 W. 96th St., N. Y. C. Enclosed find \$2.00 for which send me "Success Overnight."

Name.....

Address.....



## AGENTS TRIPLE INCOMES!

Three times as much profit! Sales three times as fast! Repeat business multiplied by three! Such is the amazing opportunity outlined here. Read it all. Then get the Free Test Outfit at once.



# Queer New Way to Open Cans Pays \$7 to \$10 First Hour

Men! Here is the story that has been amazing everyone! So dramatic that inventors as well as business men, experts as well as housewives, all alike are fascinated by it. So sensational and new that 9 out of 10 people anywhere will look, stop and buy almost before you realize it. Now, men, l-i-s-t-e-n . . .

NO more awkward stabbing and hacking with old-style can openers! No more danger of blood poisoning from gashed and lacerated fingers. For now a remarkable new invention banishes every old-style can opener to the scrap heap. Now a simple twist of the wrist opens any can in a couple of seconds. No wonder they all simply go wild over it! No wonder salesmen often sell to every house in the block and make from \$5 to \$11 in an hour!

### Works Like a Charm

This queer little device doesn't just chop a ragged hole in the top of the can. It cuts the entire top completely out, clean as a whistle! The machine takes hold of the can—opens it—flips up the lid so you can grab it—and gives it back without any sharp edges to snag your fingers. You just put the can in the machine—turn the handle—and almost instantly the job is done!

### Sells Itself in 10 Seconds!

Everyone knows how women detest the dangerous old-style can opener. Imagine, then, how

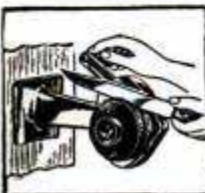

### Revolutionary New Sharpener

Works like magic. Puts a razor edge on any knife or tool in a few seconds. Anyone can use it. Sharpens scissors, too. The coupon brings full details.

### Opens Any Can in a Jiffy



or oval, in a few seconds. And, men, IT'S PATENTED, so there is no competition.

they welcome this startling new method—this automatic way of doing their most distasteful kitchen task. Men, honestly, I'm not exaggerating one bit when I tell you that not ten words are necessary to sell any of them! All you do is hand your demonstrator to your prospect and let her try it! She sells herself in ten seconds by the clock—and you pocket a nice, fat profit! Yes, really, it's just that simple and easy! That's why \$75 to \$150 a week is easy anywhere.

### Act Quick for Free Trial Offer

I don't care whether you're an old timer or just breaking in—the quickest, easiest money of your life is waiting for you now, right here! That's a mighty

strong statement. But all I ask is a chance to prove it at my risk. I know this proposition will coin money for you so fast that it will make your head swim! Territories are closing fast. The Free Test costs you nothing. Just mail me the coupon and I'll shoot you the most sensational dollar making plan you ever heard of. Mail it today! Right now!

## Central States Manufacturing Company

Dept. G-702, 4500 Mary Avenue  
St. Louis, Mo.

### Oh Boy! How the Dollars Roll In! FULL TIME \$265 in a Week



"Here is my record for first 30 days with Speedo: June 13, 60 Speedos; June 20, 84 Speedos; June 30, 192 Speedos; July 6, 288 Speedos. Speedo sells to 9 out of 10 prospects."

M. Orloff, Va.

### SPARE TIME— \$9 First Half Day

"The first afternoon I received my Speedo outfit I made \$9."

Mrs. R. Spain, Kans.

### PART TIME— \$20 in 3 Hours

"I worked about three hours and took 25 orders. This is certainly a money-maker."

O. C. Gregg, Wyo.

Central States Mfg. Company,  
Dept. G-702, 4500 Mary Ave.,  
St. Louis, Mo.

Tell me how I can make \$75 to \$150 a week through your Free Test Offer.

Name.....

Address.....

Town..... State.....

( ) Check here if interested only in one for your home.



## Tobacco Is Hurting You

Look at the facts square in the face, Mr. Tobacco User. You may think tobacco is not hurting you.

That is because you haven't as yet, perhaps, felt the effects of the nicotine poison in YOUR system. For you know that nicotine, as absorbed into the system through smoking and chewing tobacco, is a slow working poison. Slow, yes—but sure.

Tobacco is lowering your efficiency. It slows a man down. Makes it harder for you to concentrate your mind on your work. You haven't near the amount of "pep" and energy you would have if you stopped using it. There's many a man twice as old as you in years who's twice as young in energy, simply because he lets tobacco alone.

Some day you will realize to what an alarming extent tobacco has undermined your system.

When your hands begin to tremble—  
and your appetite begins to fail—  
and your heart seems to "skip a beat" now and then—  
and slight exertion makes you short of breath—  
then you have a right to suspect that  
**TOBACCO** is getting the upper hand.

Any well-informed doctor will tell you that these are only a few of many symptoms of tobacco poisoning.

And YOU know that the use of tobacco in any form is an expensive, utterly useless habit. You know you ought to quit.

## Tobacco Habit Banished Let Us Help You

It doesn't make a particle of difference whether you've been a user of tobacco for a single month or 50 years, or how much you use, or in what form you use it—whether you smoke cigars, cigarettes, pipe, chew plug or fine cut or use snuff—**Tobacco Redeemer** will positively remove all craving for tobacco in any form in a very few days. Not the slightest shock to the nervous system. Your tobacco craving will usually begin to decrease after the very first dose—there's no long waiting for results.

**Tobacco Redeemer** contains no habit-forming drugs of any kind and is marvelously quick, scientific and thoroughly reliable.

It is in no sense a substitute for tobacco. After finishing the treatment you have absolutely no desire to use tobacco again or to continue the use of the remedy. It helps to quiet the nerves and make you feel better in every way.

**Results Guaranteed** A single trial will convince you. Our legal-binding, money-back guarantee goes with each full treatment. We will refund every cent you pay for the treatment if after taking it according to the easy-to-follow directions, it should fail to banish the tobacco habit completely.

**SEND Coupon for Free Proof** Let us send you our free booklet on the deadly effects of tobacco, together with testimonial letters from men all over the country telling how they have been absolutely freed from the tobacco habit by this simple home treatment. You could not ask for stronger proof that **Tobacco Redeemer** will free you from the habit than the evidence we will gladly send on request. Just mail the coupon—or a postal will do.

**NEWELL PHARMACAL CO.**

Dept. 300 Clayton Station St. Louis, Mo.



## Free Book Coupon

**NEWELL PHARMACAL CO.**

Dept. 300 Clayton Station St. Louis, Mo.

Please send, without obligating me in any way, your free booklet regarding the tobacco habit and proof that **Tobacco Redeemer** will positively free me from the tobacco habit or my money will be refunded.

Name .....

Street and No. ....

Town..... State.....

# BOYS! *What do you need?*

**B**OYS, do you need baseball or camping equipment, wrist watch, radio, bicycle or roller skates?

You can get these, and many, many other prizes as shown in our Big Book of Prizes.

Hundreds of boys are getting the things they need without cash. You can do the same.

## Now Is the Time

You can earn these and many other splendid prizes by delivering The American Magazine, Woman's Home Companion and Collier's, The National Weekly. This will only take a part of your spare time and you need no experience to start. We teach you how to find prospective readers and will furnish all material.

## It's So Easy to Start

Your name and address sent on the coupon will start you as a salesman. We will send you our Big Book of Prizes showing over three hundred prizes you would be proud to own. Send the coupon now.



Here's  
how to  
get it

Mr. Jim Thayer, Dept. 99,  
The Crowell Publishing Co.,  
Springfield, Ohio.

Dear Jim: I want to earn money and some of your dandy prizes. Please start me off as a salesman.

Name.....

Address.....

Town.....State.....





# You Can Learn HYPNOTISM ... or No Cost Try FREE 5 Days!

**DON'T** be unpopular, lonesome, or unhappy a minute longer. Now you can make your life what you want it to be—now you can win admiration, success and big money—through the strange power of hypnotism. I'll show you how to use this great force to help you master every situation or *The Five Day Trial is FREE!*

In just a few hours I'll teach you the hidden secrets of Hypnotism—the methods used by the great operators—the amazing things you can accomplish once you understand this mighty power. You can use it to overcome obstacles, achieve your fondest ambitions and become MASTER of yourself, friends and acquaintances—either sex. See for yourself how Hypnotism can banish fear, worry and opposition—improve your memory—increase your earnings—and force others to give you the good things in life you deserve!

In his startling NEW book, *The Science of Hypnotism*, the world famous hypnotist—Prof. L. E. Young—reveals the most carefully guarded secrets of this fascinating subject. He not only explains the methods of noted hypnotists, step by step—but tells clearly all about the nine stages of hypnotism, the Hypnotic Mirror, Mental Telepathy, how to select your subjects, magnetic healing, methods of hypnotizing, how to waken the subject, how to make money out of hypnotism!

**Try 5 Days FREE—  
Send No Money**

So confident are we that Prof. Young and his great book will quickly teach you the science of hypnotism, that we will send you a copy without one cent in advance! Simply clip and mail the coupon below. When the book arrives pay the postman the special low price of \$2.50 plus few cents postage. Then test the powers of Hypnotism 5 days! If not amazed and delighted return the book and money will be refunded at once! Mail the coupon now.

**FRANKLIN PUBLISHING CO.  
Dept. G-70, 800 N. Clark St., Chicago**

### Mysteries of Hypnotism Revealed

- How to Hypnotize at a Glance
- Susceptible Subjects
- How to Hypnotize by Telephone
- How to Give an Entertainment
- How to Make Others Obey You
- Overcoming Bad Habits
- How to do Dozens of Hypnotic Feats
- Use of Hypnotism in Operations



Franklin Publishing Co., Dept. G-70,  
800 N. Clark St., Chicago

Please send me your amazing new book—*The Science of Hypnotism*—by Prof. Young. When the book arrives I'll pay the postman only \$2.50 plus postage. If I am not satisfied after 5 days' trial, I may return the book and you are to refund my money.

Name.....

Street and No.....

Town.....State.....

If you are likely to be out when postman calls, send \$2.50 with coupon and we'll pay delivery charges. Customers outside U. S. must send cash with order.

# QUIT TOBACCO

No man or woman can escape the harmful effects of tobacco. Don't try to banish unaided the hold tobacco has upon you. Join the thousands of inveterate tobacco users that have found it easy to quit with the aid of the Keeley Treatment.

## KEELEY TREATMENT STOPS Tobacco Habit

Quickly banishes all craving for tobacco. Write today for Free Book telling how to quickly Free yourself from the tobacco habit and our Money Back Guarantee.

**THE KEELEY INSTITUTE**  
Dept. A-922 Dwight, Illinois



### BOW LEGS and KNOCK-KNEES UNSIGHTLY

Those afflicted with BOW LEGS should wear the "PERFECT LEG FORMS" and overcome this deformity. Trousers hang perfectly straight. Made of the highest grade Aluminum. Sanitary, Light and Durable. Easy to put on or off. Send for booklet showing photos of men with and without the "PERFECT LEG FORMS."

**PERFECT SALES CO.**  
140 N. Mayfield Ave. Dept. S Chicago, Ill.

### NO JOKE TO BE DEAF —EVERY DEAF PERSON KNOWS THAT



I make myself hear, after being deaf for 25 years, with these Artificial Ear Drums. I wear them day and night. They stop head noises and ringing ears. They are perfectly comfortable. No one sees them. Write me and I will tell you a true story, how I got deaf and how I make you hear. Address



**GEO. P. WAY, Artificial Ear Drum Co. (Inc.)**  
80 Hoffman Bldg., Detroit, Mich.

### 10c NEW SCIENTIFIC WONDER "X-RAY" CURIO

3 for 25c



SILVER ONLY

BOYS

You apparently see thru Clothes, Wood, Stone, any object. See Bones in Flesh. FREE—PKG. RADIO BIG FUN

PICTURE FILMS. Takes pictures without camera. "You'll like 'em." 1 pkg. with each 25c order.

**MARVEL MFG. CO. Dept. 31 NEW HAVEN, CONN.**

# Stop Using a Truss

**STUART'S ADHESIF PLAPAO-PADS** are entirely different from trusses—being automatically continuous mechanico-chemico applicators of the herbal muscle-tonic "PLAPAO" to the affected parts. Made self-adhesive purposely to minimize painful chafing and dangerous slipping and to eliminate harmful pressure.

Comfortable when—  
no straps,  
buckles  
or springs  
attached.



Fabric soft as velvet—easy to apply.

For almost a quarter of a century satisfied thousands report success without delay from work. Stacks of sworn statements on file. Process of recovery natural, so no subsequent use for a truss. Awarded Gold Medal, Rome, Grand Prix, Paris, etc. Test of factor "PLAPAO" sent you **FREE**

Mail Coupon below **TODAY.**  
**Plapao Co., 1307 Stuart Bldg., St. Louis, Mo.**

Name.....

Address.....

Return mail will bring Free Trial "PLAPAO"

# A NEW CAR *in 30 minutes*

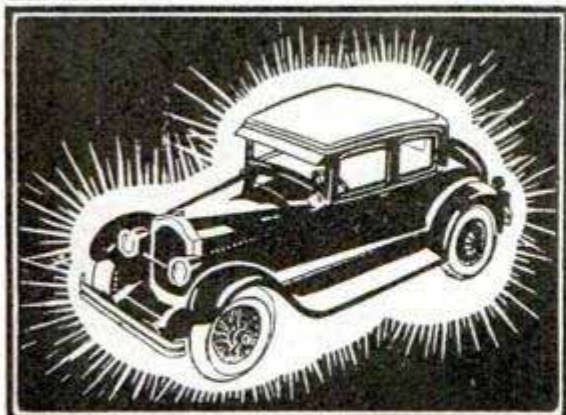

Get the **BEAUTY** and **LUSTRE** of a **NEW PAINT JOB** at a Small Fraction of the Cost

**DO IT YOURSELF - - WITH NUKAR**

Not a Wax—Not a Paint—Not a Polish—Not a Cleaner—No Waiting—No Delay—Drive Your Car the Same Day—Flows on—Like Water from a Sponge

This startling new invention is revolutionizing the auto-refinishing industry. Developed in the same research laboratories and by the same expert chemists who produced the latest flexible aircraft dopes and lacquers. This astonishing new liquid is simply flowed on with cheesecloth, as quick and easy as wiping with a wet sponge. Results are astonishing. With one Pass of your hand you bring back the original color and add a High, Brilliant, Mirror-like Lustre. NUKAR produces a hard protective coat that does not catch or imbed dirt and dust. The Brilliant Lustre lasts for many months. The magic touch of NUKAR makes Old, Dull, Faded, Shabby cars look like the day they were purchased NEW. Manufactured by an old, long-established, financially responsible concern with years of experience in the production of the finest coach finishes, and sold under one of the strongest guarantees ever placed on any product.



## MEN! Amazing Cash Profits

Earn Up to \$50 a Day—Full or Part Time

**WE START YOU IN A BUSINESS OF YOUR OWN AND BACK YOU TO THE LIMIT**

Money could not buy the **START** we furnish **FREE**. Millions of Car Owners want and need NUKAR, and are eagerly waiting to pay you Big Profits for furnishing it to them.

We want live, aggressive men to distribute NUKAR and to establish and supervise Service Stations. The Auto Business leads the world in profits today, and here is the biggest thing in the industry. The results produced by NUKAR are so startling that motorists buy on sight. Join with us NOW. Get started in this new, highly profitable business. You will make Big, Quick Cash profits that will astonish and amaze you. Get the facts. Mail Coupon NOW and we will send prepaid, without charge or obligation, our Big Illustrated Book in colors describing every detail of this wonderful business, and a **FREE SAMPLE** of NUKAR.

**ATLAS SOLVENT CO., 5647 Harper Ave., Dept. 116, CHICAGO**

**ACT NOW**

Millions of Car Owners want to pay you Big Profits for furnishing it to them.

Atlas Solvent Co., Dept. 116  
5647 Harper Ave., Chicago, Ill.

©1929 A. S. Co.

I am interested. Send me **FREE** and without Obligation your **BIG BOOK** and a **FREE SAMPLE** of NUKAR. (Write plainly.)

Name .....

Address .....

P. O. .... State .....

## New Food Idea Pays Big Profits!

Men! Women! Investigate the wonderful **NEW Brown Bobby GREASELESS Doughnut**. Sells like wildfire! You can easily make \$50 week spare time; \$5000 year full time. Investment *small!* No experience needed. Write today for big special offer.

**Food Display Machine Corp., Dept. A 135, 500-510 N. Dearborn St., Chicago**



## X-RAY-BAG-I-SCOPE

Wonderful astounding instrument, thru which unobserved you see what is going on behind you. Watch your SWEETHEART. Your ENEMIES—SEE ALL. Ready to use. Lasts lifetime. SEND \$1.00 bill. Mailed postpaid.

**LA MAE CO. 481 WABASHA ST. ST. PAUL, MINN.**

# Learn to Fly



Fly to Fame and Fortune! Find Romance. Adventure, Thrills in the air — and **BIG PAY** besides! Flyers are needed for war, commerce, air mail, exploration, fire fighting, exterminating, etc. **LEARN NOW!** No special education needed!

You will receive also three 25c issues of the **AMERICAN AVIATOR** magazine and a paid-up membership in "**WINGS OF AMERICA**" with money-saving discount card and emblem — all for **\$2.95**. Nothing more to pay. Guaranteed satisfactory or money back. Send stamps or M.O. or pay on delivery plus postage.

Our complete course for beginners teaches everything needed in simple language. Easily mastered. Profusely illustrated with charts, photos, diagrams. Endorsed by famous aces and flying authorities.

**EDUCATOR PRESS**  
19 Park Row New York Dept. FC-24

## PIN MONEY \$5 to \$35 a week for You

Our beautifully illustrated book tells how. It tells all about our new methods of art decoration, art treatment and how anybody can learn without previous training or experience. It contains page after page of handsome color illustrations of what you can make and sell. You can make good money and this book is **FREE**

Our system is amazingly easy to learn and the profits are larger than in almost any other business. You can produce beautiful finished art objects almost from the beginning. You don't have to know how to draw or have any experience. Begin making money now. All supplies are sent by us with the instructions and many have made \$25 the first week. Some society women have taken up this work for their amusement. Either way, pleasure or profit, it's the most delightful home work you can imagine. Write Now for your copy of this valuable book; it's **FREE**.



**FIRESIDE INDUSTRIES, Dept. 66-G, Adrian, Mich.**

# AMUSE THE PUBLIC AND EARN 60<sup>00</sup> WEEKLY

No experience required. Wonderful opportunities for men and women from 18 to 70. Stay at home or travel. Nothing to sell. No canvassing or soliciting.

## FREE BOOK EXPLAINING 50 WAYS

Entirely new plans. Hundreds earning from \$60 to \$100 a week and more. Write quick for full particulars and free book. Trifling investment required.

**Storekeepers** retailing cigars, drugs, groceries, candies, etc. You can add \$30 to \$50 a week to your profits without interference with your business.

H. C. EVANS & CO., 1528 W. Adams St., Chicago, Ill.



VIOLIN, TENOR BANJO, HAWAIIAN GUITAR, BANJO, CORNET, UKULELE, BANJO UKULELE, GUITAR, BANJO MANDOLIN, BANJO GUITAR, MANDOLIN, SNARE DRUM, FIELD DRUM, PIANO OR ORGAN

by our Copyrighted easy to learn home study courses. Thousands of men, women, boys and girls have learned to play by our method. Our system of teaching is so simplified you can learn to play by note after the first 10 lessons in less time than it usually takes by private instruction and at one-half the cost. A few cents a day pays for your lessons. You pay while you learn. Instruments except Piano and Organ furnished at cost if desired. Instrument and first lesson sent for examination and 3 days' trial. Write today for full particulars.

CHICAGO CORRESPONDENCE SCHOOL OF MUSIC, INC. 1632 No. Halsted St., Dept. 784, Chicago, Ill.

## Electrical Engineering

Foremost, best equipped electrical school in America, 24 years old, offers a complete practical course in Commercial Electrical Engineering in one year. B. S. Degree in 3 years. Lacking credits can be made up. Shorter courses available in: Residence Courses in Armature Winding, Radio, Broadcast, Automotive Elec. Elec. Refrigeration. Recognized expert faculty. Splendid laboratory facilities.



**Learn While You Earn** We will aid you earn your board and room at cost. Write today for illus. catalog. Mention age, education and course interested in.

FREE SCHOOL OF ENGINEERING Dept. P. M. 629 CATALOG 163 E. Wells St. Milwaukee, Wis.

## LEARN MECHANICAL DENTISTRY

**EARN UP TO \$5000 A YEAR** THIS money-making profession easily learned in a few months in day or evening sessions. Practical training. Individual instruction. Easy terms. Rail-road fare allowed—no extra cost. Write NOW for free catalog P and special tool offer. Address—

NEW YORK SCHOOL OF MECHANICAL DENTISTRY, 147 W. 33rd St., NEW YORK

## MEN WANTED for RAILROADS

Nearest their homes, everywhere, to train for Firemen, Brakemen, beginners \$150 to \$250 monthly. Promoted to Conductor or Engineer —\$300 to \$400 monthly. Highest wages on railroads. Also cl. rks.

RAILWAY EDUCATIONAL ASSOCIATION DEPT. D 1 BROOKLYN, N. Y.

**LEARN CODE** Morse or Radio with **Omnigraph**

LEARN with the OMNIGRAPH Automatic Transmitter AT HOME. Used by U. S. Gov't. scientific institutions, colleges, etc. Best, quickest way for 20 years. Telegraph and Short wave CODE sent at all times. Interesting. Catalog. Omnigraph Mfg. Co., 810 E. 39th St., P. N., Brooklyn, N. Y.

**INVENTORS** — Read the marvelous history of American Inventions, the most impressive record in the annals of human achievement. A very limited edition of Waldemar Kaempffert's Popular History of American Invention in 2 vols. 1034 Pages. Over 500 Illustrations. Cloth. \$5 per set postpaid (just half price of original edition). Popular Mechanics Press, 200 E. Ontario St., Chicago

# These Men Say it's easy to make more money in Radio than in other fields . . .

### \$400 A Month

"I was making good money but could see the opportunities in Radio. I have made more than ever before. More than \$400 a month. The opportunities in Radio are unlimited."

J. G. DAHLSTEAD, 1484 So. 15th St., Salt Lake City, Utah.



### Seldom Under \$100 A Week

"My earnings in Radio are many times greater than I ever expected they would be. They seldom fall under \$100 a week. They hit close to \$600 last month and \$525 this month."

E. E. WINBORNE, 1414 W. 48th St., Norfolk, Va.



### \$100 A Week

"I was making \$35 a week before entering Radio. Last week I earned \$110. I have made as high as \$241 in two weeks. You started me right by giving me the knowledge every man should have to succeed."

J. A. VAUGHN, 4202 Arsenal St., St. Louis, Mo.



## Radio's Big Growth Can Put YOU Ahead Fast Too

I am doubling and tripling the salaries of men by fitting them for Radio's good jobs. I have trained hundreds to make much more money in Radio than they were making in other fields. I will train you too, at home in your spare time, to be recognized in Radio. Radio's amazing, astounding growth has made a lifetime opportunity for you. Don't pass it up. "Rich Rewards in Radio," a 64-page book, tells you all about Radio's many openings and the training which made these successes and hundreds of others. Get a copy.

## FIND OUT QUICK WHAT RADIO OFFERS YOU

MAIL THIS

J. E. Smith, President, National Radio Institute, Dept. 98PP Washington, D. C.

Dear Mr. Smith: Without obligating me in the least, send at once "Rich Rewards in Radio," your 64-page book on Radio's opportunities for big success.

Name \_\_\_\_\_ Age \_\_\_\_\_  
Address \_\_\_\_\_ State \_\_\_\_\_  
City \_\_\_\_\_

# Who Else Wants Muscle?



**See the Change!**

Try and find a muscle on that puny, sickly fellow above. That's how Daniel Gully used to look. But now take a slant at a real **ATHLETE**. Danny has become a marvel of physical development. Massive layers of powerful muscle cover his body. He has the perfect proportions of a sculptor's model. Titus Training has wrought this amazing change in thousands—it can do the same for YOU.

## Easily—Quickly—Safely!

**H**ELLO There! You young fellow—you mechanic—you business man—you chap past forty! Send me your name. I want to give you the greatest dope on Body-Building you ever heard of. It's **FUN** getting strong my way. All the snap and go of your favorite sport—just a few minutes a day of honest-to-goodness, clean cut pleasure—right in your own home. But Man, how it builds **MUSCLE!** Look at Daniel Gully. Danny was a frail, puny weakling before he came into the **TITUS** fold. But look at him **NOW!** He's **there** when it comes to any physical contest. He enjoys grabbing hold of an oar, a tennis racquet, a canoe paddle—or squating off for a round or so. He's got the speed, agility and power of a **PANTHER!** Titus-trained men aren't afraid of competition. **THEY** never take the dirty end of the stick!

## I'll Make You a Real Athlete



**TITUS, Dept. M-139**  
105 East 13th St., New York, N. Y.

Dear Titus: Send me your big, illustrated book, "MIRACLES IN MUSCLE"—**FREE**—explaining your snappy, scientific system of Body-Building in a few minutes a day.

Name.....  
Address.....  
Town..... State.....

### Mail This Coupon

What's your favorite sport? Boxing, wrestling, football, baseball, track? Whatever it is, I'll increase your ability 100%. I'll give you the stamina and vitality that stands the gaff. I'll give you the virility of dominant **MANHOOD!** I'll give you the body of a young Greek God. I **GUARANTEE** that every girl you meet will remark on your splendid physique. You know what that means, friend—**POPULARITY** plenty!



**SAXTON**  
**World-Famous Strong Man Says:**  
"My feats of strength on the stage have brought me hundreds of inquiries asking how I developed such extraordinary strength. I tell them all to write to Titus; he'll show them how to develop physical power that will amaze them. Every red-blooded man should send for that marvelous book, "MIRACLES IN MUSCLE".

## FREE MIRACLES IN MUSCLE

I can't begin to tell you here about Titus Training—how it scientifically re-builds every organ, every fibre in your body—how it makes your muscles **GROW**—how it charges you with new life, pep and energy. My big **FREE** Book tells the whole wonderful story. Man, you **MUST** read this book. Just send me your name and address—that's all. Mail the coupon, a postcard or a letter. But do it **NOW** if it's the last thing you do today.

The One **TITUS** 105 East 13th St., and Only **TITUS** New York, N. Y.

**GIANT TELESCOPE ONLY \$1.95**

Over 3 ft. long; in 5 sections; brass bound; powerful lenses. See distant objects. Loads of fun! Carrying Case **FREE**.  
**Send No Money** Postpaid only \$1.95 or C. O. D. plus postage. Satisfaction guaranteed or money back. **Ferry & Co., Dept. 1778, Chicago**

**MEN TO LEARN MOTION PICTURE PROJECTION**  
A BIG-MONEY PROFESSION—\$2,000 to \$4,000.  
We Assist Students to Earn While Learning  
**MOVIE OPERATORS SCHOOL**  
61 Sproat Street Dept't 23 DETROIT, MICHIGAN

The man who studies gets ahead. Popular Mechanics Press will advise you what books to read to advance in your trade. 200 East Ontario Street, Chicago, Illinois.

**WIN A BUICK or \$1900.00**

**GIVEN WITHOUT EXPENSE**

**WIN A BUICK or \$1900.00**

### Who Will Win? Why Not You?

Don't delay. Make this your chance to get behind the wheel of a beautiful new 1929 Buick Sedan—**ALL YOURS!** Or have your choice of the cash value of this splendid prize, if you prefer. \$1320.00 in cash! to the prompt winner, \$1900.00 in all. Imagine it! No puzzles to solve! No list of words to make or write. We offer these prizes free to advertise. No tricks or chance involved—it costs you absolutely nothing, yet you can absolutely be rewarded! **Hurry!** Be the **CHIEF BOOSTER** in your community. Win the beautiful Buick or a fortune in cash! Mail the coupon right this minute.

### HERE GOES AGAIN! Another Buick Given—and 3 Other Big Cars—\$5200.00 in Prizes!

New! Startling! A barrel of fun for everybody! Four marvelous new automobiles and dozens of breath-taking prizes for the lucky ones! We must advertise our business in your locality and we are willing to spend all this money to gain publicity and expand our business—\$5200.00 worth of prizes in all! J. C. Long, Charles Vogtmann, Mrs. J. E. Fields, Viola Javins, and many others, all gave us their help in our last big publicity offers—**THEY WON BIG BEAUTIFUL SEDANS FOR HELPING US!** We gladly gave away over 800 prizes in one year, over \$11,000 in a single month! Here are more, dozens of them, bigger and better than ever! It will be marvelous fun!

### It's Your Turn This Time

#### Send No Money—You Buy Nothing

Imagine it—everything's free! You have nothing to buy, now, later, or ever. We want this offer to be the greatest of all. Why not make this **YOUR** turn for wealth? First of all, cut out the coupon below. Rush it back to me at once, and I will promptly send you a splendid sample of our well known product—**ABSOLUTELY FREE**. You can make all the folks in your community know about our product. This is the very best way for us to advertise, and soon every one will be talking about it. Boosters are going to win all of these marvelous prizes. Become a booster right this minute—

**ACT AT ONCE! BE PROMPT!**  
**\$500.00 Extra for Promptness**

So rush the free coupon to me at once. Don't waste a minute. Here is why: I am going to give you **\$500.00 CASH EXTRA FOR PROMPTNESS** if you are prompt and win first prize, so hurry now!

### Send No Money

#### MAIL THE COUPON RIGHT AWAY

M. W. Myers, Dept. 346,  
500 N. Dearborn St., Chicago, Ill.  
Here's my coupon. Count me in on the fun. I am after that biggest prize—absolutely free—no obligation or expense to me.

Name.....  
Address.....  
City..... State.....

# Motion Pictures Train You **QUICKER**



**THE NEW WAY**



## For a **BIG-PAY JOB** in **ELECTRICITY**



NOW—it's easy to get a better job with bigger pay—to get ahead—to save money—to become independent.

Everybody agrees that the field of **ELECTRICITY** is where the real opportunities are today and will be for years to come. And here is an amazing new way to sure success in **ELECTRICITY**. It will startle you with its improvement over old methods.

Now you learn from **MOTION PICTURES** right in your own home. You get a \$75 DeVry motion picture machine without extra cost. You are furnished thousands of feet of film. You watch the motion pictures. You see giant dynamos in operation, moving diagrams, trained men at actual electrical work. It's so plain and easy anyone can understand. What your eye sees your mind remembers. It's just as easy as it sounds. Students everywhere are enthusiastic. You will be too. So lose no time in finding out all about this newest, quickest, easiest way to train for a big-money job.

*The  
NEW WAY  
Is the Best Way*

Just as the giant electric locomotives of today are superior to the first wheezy old steam engines. As the 150 mile an hour monoplane is swifter than the Pony Express. So is our new **MOTION PICTURE** electric training quicker, better and easier than the old hard to learn book methods. E. A. B., Brooklyn, N. Y., says "I finished Reel Lesson No. 8 today and certainly can understand now why you claim your course is so easy to learn. The films make it easy to grasp any point."

### Make \$60 to \$150 a Week

Thousands of trained men are needed in the electrical field. Demand exceeds supply. \$60.00 to \$150.00 or more per week is common. You can get in on this big money. You take no risk. We guarantee in writing to give you the training and employment service necessary to get a better job at bigger pay or you need not pay a cent.

**Write Now for  
Big FREE Book**

It costs you nothing to get all the facts on this remarkable new **MOTION PICTURE** method. Our big **FREE Book**, *The Film Way to Bigger Pay*, tells you just how we train you for a bigger job. Send for it today. Find out how easy it now is to qualify for the big money. Mail coupon and get the facts.

**The NATIONAL SCHOOL of  
VISUAL EDUCATION**  
"The Film Way to Bigger Pay"  
537 S. Dearborn Street, Chicago, U. S. A. Dept. 6H  
Send book, "The Film Way to Bigger Pay," with facts about this new, easier way to master electricity.

Name \_\_\_\_\_ Age \_\_\_\_\_  
St. or R.F.D. \_\_\_\_\_  
City \_\_\_\_\_ State \_\_\_\_\_

**Mail this  
Coupon**

**TAKE THE FILM WAY  
TO BIGGER PAY**

**Read this Clipping Carefully**

**PLANE MAKERS HARD HIT FOR SKILLED AID**

BY J. C. ROYLE

Commercial 1937 by The Star Telegram  
SPRINGFIELD, Mo., 14—There are  
only approximately 30 in the United  
States who are not enough skilled  
to fill the planes and  
There are not enough skilled  
men in the industry to fill the  
plans, manufacturing and  
repair, manufacturing and  
aircraft.

**T-A-T GRADUATES**

*are filling these Big Pay Jobs!*

Do you want the same kind of training that is enabling T-A-T Graduates to hold these important jobs? You can get it here in the Private School of one of the nation's largest air line operators. At T-A-T you will train in the heart of important aviation activities. You will be given the personal attention of well-known aviation executives, veteran air mail pilots and licensed mechanics. You will learn to fly in *NEW, SAFE* planes.

T-A-T and related companies fly Air Mail and Passenger routes over four states; maintain shops in the larger cities and are distributors for airplanes and airplane motor parts. *You, as a T-A-T student, will be a part of this rapidly growing organization, and in touch with the opportunities it holds for hard work and ability. NOW is the time to get in.*

Ground School and Mechanical Courses give you practical shop work in the same completely equipped shops where T-A-T planes are maintained. Here you will get first hand, actual experience. All subjects necessary for a Transport Pilot License are thoroughly taught.

**Enroll NOW for Special Summer Course**

Six Regular Courses and a special summer course are offered, ranging in cost from \$75 to \$1,650 and requiring from 30 days to 6 months to complete. These courses prepare you to become a Pilot, Mechanic, Salesman of airplanes, parts and accessories, or an Aviation Executive, depending upon your ability, previous experience and the course you choose.

Write today for "Flying the Golden Trail," the illustrated booklet giving full information.

**FLYING T-A-T SCHOOL**

Fort Worth Dallas San Antonio Houston

612 Fort Worth Nat'l Bank Bldg., Fort Worth, Tex.

Send me your fully illustrated FREE Booklet.

Name.....

Address.....

City..... State.....

Age..... Occupation.....

**Don't Be Afraid To Tackle That Concrete Job!**

With the instructions found in the new, revised edition of Popular Mechanics Concrete Handbook you can make any of the following useful articles:

Garden Seats—Fountain and Basin—Flower Boxes and Vases—Pedestals and Bird Baths—Ornamental Pools—Sanitary Drinking Fountain—Gateposts—Auto Driveway—Sidewalks—Boat Landings and Docks—Entrance and Garden Walks—Sidewalk Flagging—Narrow Curb Walks—Curbs and Gutters—Wall Coping—Steps—Garage Floor—Basement Floor—Fence Posts—Lawn Roller—Cistern—Chimney Cap—Refuse Burner—Culvert—Benches for Greenhouses—Tile—Retaining Walls—Foundation Supports—Engine Foundations—Septic Tank—Toy Blocks—Forge—Fireproof Safe—Ice House—Watering Troughs—Milk House—Smokehouse—Silo—Horse Stalls—Hitching Post—Rural Mail Box Post—Cyclone Cellar.



**Build With Ease for Permanence and Beauty**

This is a book of practical plans for using concrete about the home, farm or shop. For amateurs as well as contractors. In addition to making all the articles mentioned above the making of good concrete mixtures for various classes of construction is given; mechanical mixers and homemade tools are dealt with. All necessary form and mold making are covered as well as many other valuable pointers too numerous to mention here.

Simply write and ask us to send you this book. When postman hands you the package pay him \$1.00 plus the postage. If outside U. S. remit when ordering and include 15 cents extra for mailing.

**POPULAR MECHANICS PRESS**  
Room P6 200 E. Ontario Street CHICAGO

**\$244.00 PROFIT One day!**

That's Helmer's news from Minnesota on **Trippe Reflectors**. 100% more light—no glare, no dimming, no tilting. This amazing auto light just awarded Grand Prix, two gold medals at Paris World's Fair. Makes astounding demonstration, fits any car, sells on sight. Low priced, big profits, big repeater. You bank \$127.00 weekly on only three sales daily. **WRITE FOR FREE SAMPLE OFFER TODAY!**

**38,000 CANDLEPOWER NO GLARE!**

**AERIAL ELECTRIC CO.**  
336 W. Ohio St. CHICAGO

**ELECTRIFY YOUR RADIO FOR ONLY \$6.85 COMPLETE**

Why discard your present good set when you can electrify it for only \$6.85, and banish the annoyance and expense of buying new "B" batteries?

**Over 100,000 Townsend "B" Power Units in Use**

Hooked up in a few minutes. Use same tubes—no c. arges. You'll be amazed at the improvement in reception and distance getting. Send name and address today for full details, proof and Free Trial Offer.



**TOWNSEND LABORATORIES**  
715 Townsend St., Chicago, Ill.

Please send me full information on the Townsend "B" Power and Free Trial Offer.

Name.....

Address.....

City..... State.....



## Announcing-PILOT'S NEW Radio Thrill!

### Check These Features

- ✓ Both a splendid broadcast receiver and a most efficient short wave set—covers 15 to 500 meters!
- ✓ On very first test received loud and clear broadcast programs from Chelmsford, England; Costa Rica, Central America; PCJ Eindhoven, Holland; Manitoba, Canada, etc.
- ✓ Two sets of plug-in coils cover all wave bands—15 to 500 meters.
- ✓ The only Short Wave Receiver having a stage of tuned R. F. with screen grid tube giving greater sensitivity and selectivity.
- ✓ Condenser-Controlled Regenerative Detector. All-drilled metal chassis. Illuminated Vernier Dial for both condensers.
- ✓ Smooth operation, consistent results, easy to tune. Splendid loud-speaker results.
- ✓ Low losses—ingenious design reduces all R. F. connections to one and a half inches or less!
- ✓ No A. C. Hum pick-up. Completely shielded R. F. and Detector Stages eliminate hand de-tuning effects.
- ✓ Simplicity of assembly due to "sectional cans" and minimum wiring. Assemble and operate it same evening!

Assemble it and hear it the same evening!

Note: Illustration shows half of shields removed.

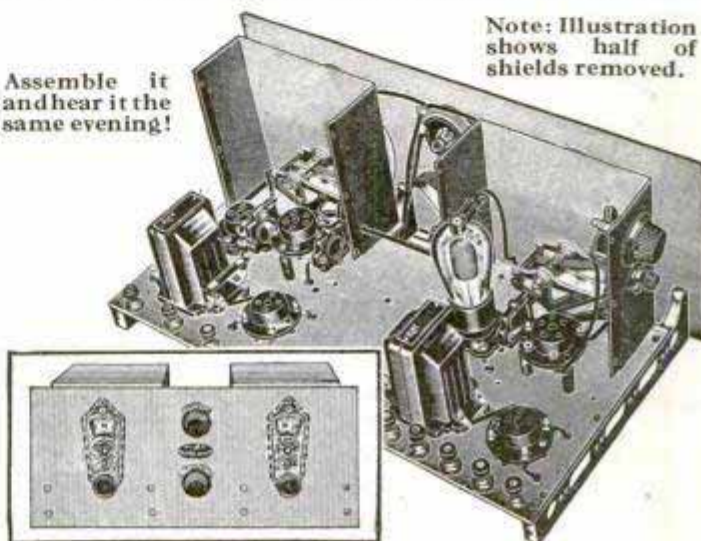

**W**ITH the *Super-Wasp Kit* you assemble in one evening a double duty receiver that shifts from Short Wave to Broadcast Band as quickly as you shift from one speed to another in your car.

Distance dissolves on the Short Wave Bands—you bring in 10,000 miles as easily as locals! When America goes to sleep, plug in the Short Wave coils for *international* Short Wave broadcasts! With your *Super-Wasp* you hop from continent to continent for entertainment from *all the world!*

If there is no Pilot dealer in your locality, write us.

RETAIL PRICE  
Catalog No. K-110

Including 2 sets of 5 plug-in coils each, full-sized blue-print and complete assembly data.

**\$29<sup>50</sup>**

SEND FOR RADIO DESIGN

50c brings you one year's subscription to "Radio Design" Quarterly Magazine, chock-ful of latest Radio, Short-Wave and Television Developments. "Radio Design," 103-C Broadway, Brooklyn, N. Y.

*The Pilot Super-Wasp Kit is Made in World's Largest Radio Parts Plant!*

**PILOT ELECTRIC M'FG. CO.**  
323 BERRY ST.  **BROOKLYN, N.Y. INC.**  
ESTABLISHED 1908 TRADE MARK REG.

2639 Ralph Starbuck, National Lamp  
Works, Nela Park, Cleveland,  
Ohio

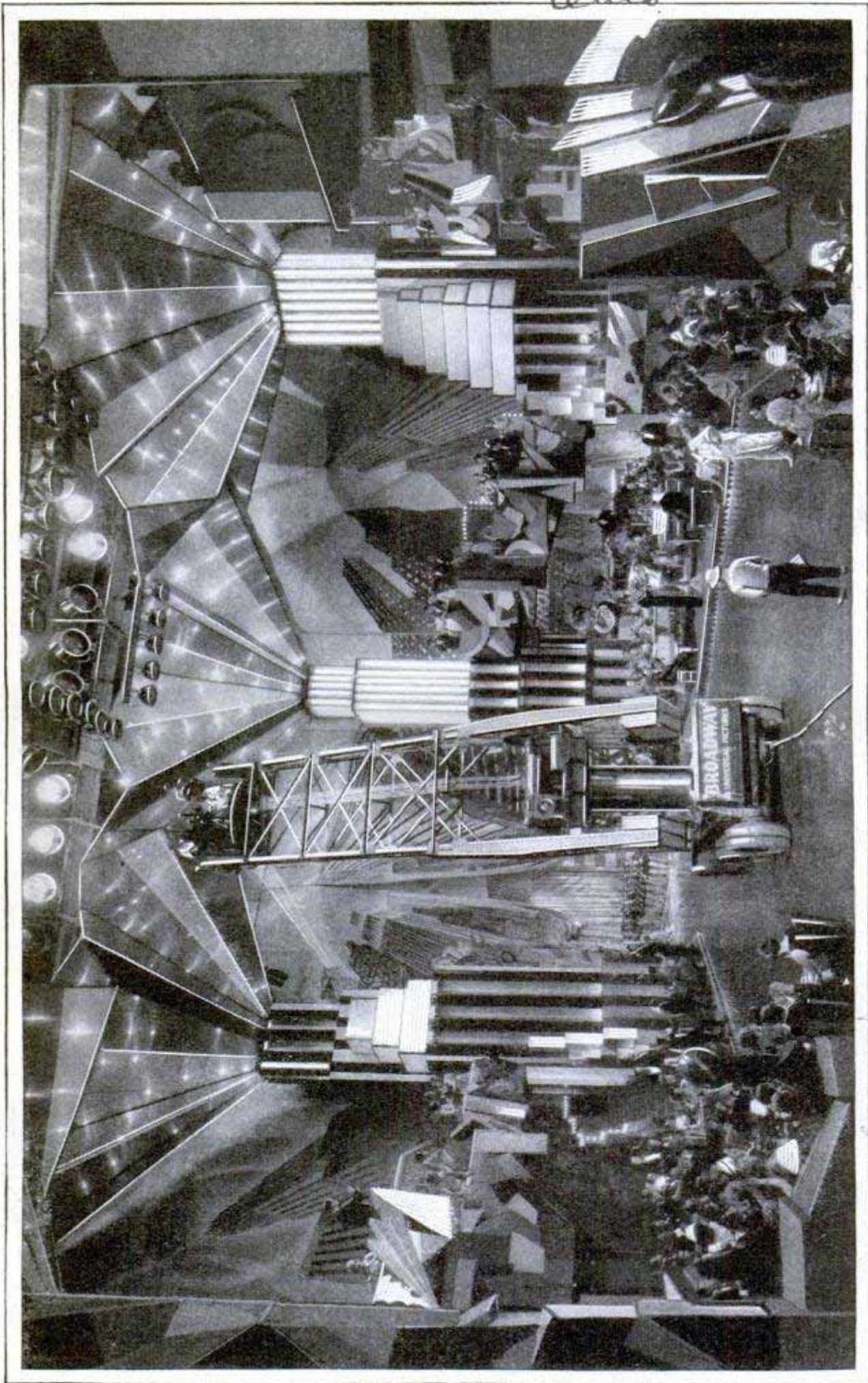

It Took 5,228 Horsepower to Light a Talkie Movie Scene Filmed Recently When 4,800 Incandescent Lamps, Totalling 3,900,000 Watts, Were Used; the Lamps Have Replaced the Old Carbon Arcs for Talking Movie Scenes Because the Sputtering of the Latter Interfered with Recording



# Popular Mechanics Magazine

REGISTERED IN U. S. PATENT OFFICE

WRITTEN SO YOU CAN UNDERSTAND IT

Vol. 51

JUNE, 1929

2614

No. 6

## What Price Speed?

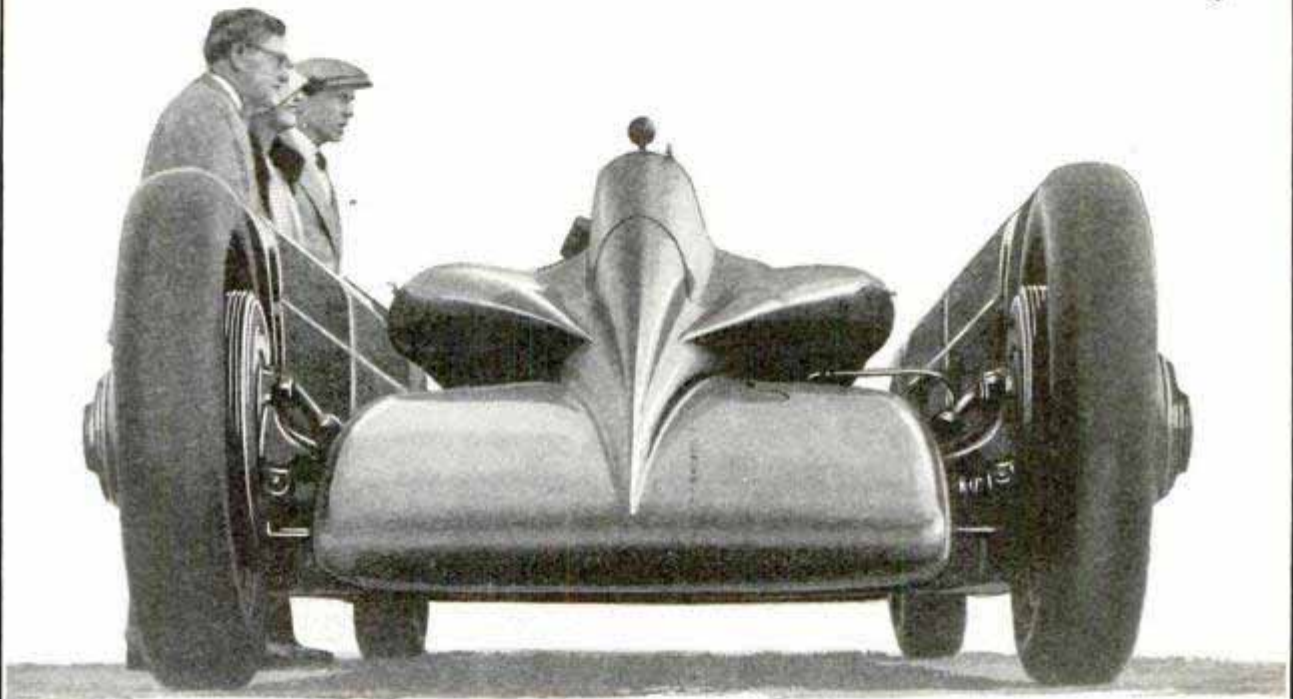

Pared Down to a Shadow. Yet Holding a Motor of Terrific Power, the Super-Streamlined "Golden Arrow" Shot along at Record Speed Partly Because Its Design Reduced Restraining Vacuums to a Minimum

**T**HE SPECTACULAR record of 231.-3624 miles per hour, established at Daytona Beach by Maj. H. O. D. Segrave, the British auto racer, is the result of developments in high-speed cars. It is now believed by those who have watched the effort to develop great power in cars of low wind resistance that this record can be broken by a high margin, although the tests are so extremely perilous that it may be years before anyone attempts to do so.

Records of 250, or even 300, miles an hour are considered likely, and one of the foremost designers has stated he believes 500 miles an hour is not beyond possibility. The present record, however, is somewhere near the top of that which can be attained on an eleven-mile course such as

that staked off on Daytona Beach, which gives five miles to attain maximum velocity, one mile at top speed, and five miles to slow down to a stop. It is thought that more of the Daytona Beach course can be used for racing, allowing cars to reach 250 to 300 miles an hour.

Both of the two cars that have ended their wild race in wreckage and death and all the three which have added a new high record for fast time on land, have contributed something of value to the science of high-speed racing. Major Segrave's "Golden Arrow" represents the highest present development of that science. It is a branch of automobile engineering that is quite distinct from the manufacture of ordinary tourist or racing cars. Terrific

26/14  
882

strains must be withstood by every part of the car, the engine, and the tires. But it leads the way for improvement.

The development of tires to stand the terrific heat and stress is a case in point. When Major Segrave, in 1927, for the first time exceeded a speed of 200 miles an hour, setting the world's record at 203.79 in his giant "Mystery S," the problem of tires was one of grave concern. For months, experts had worked to perfect tires that would stand the enormous centrifugal force, the intense heat, and strain. But the "Mystery S's" tires showed almost no wear. Starting with the "Mystery S," the first car to exceed the 200-mile-an-hour mark, consider the development of the modern high-velocity racing automobile as exemplified in the "Golden Arrow."

The "Mystery S," first of the superspeed creations, was designed by Louis Coatalen and built by a British motor-car company at a cost of \$100,000. The car weighed over three tons. Two twelve-cylinder aviation engines, in front and rear, between which was the driver's seat, delivered more than 1,000 horsepower.

The "Mystery S" was not well streamlined. But despite this drawback, as it was the most powerful automobile in the world up to that time, it came out with a world's record. It was evident, however, that the poor streamlining held the car below the ground speed which its engines were expected to deliver. As a result, three cars, two American and one British, were built, the four-ton thirty-six cylindered "Triplex," which strove entirely for power and ignored streamline design, the late Frank Lockhart's 2,900-pound "Stutz Special," a tiny car, which was the refinement

of streamlining, and Capt. Malcolm Campbell's "Bluebird," a British car, developing about 900 horsepower.

The "Triplex," which was calculated to develop from 1,500 to 2,000 horsepower, was the most powerfully engined car ever built. Under ideal weather and beach conditions, it might have been the fastest car, as it was calculated to do 253 miles an hour, allowing ten miles an hour loss for slippage. But although very heavy and powerful, the "Triplex" was not designed to compete with the furious hurricanes, cross currents of air and back-vacuum pulls which a superspeed car encounters.

The little Lockhart car, on the other hand, was very small and shaped like a cigar. But even with its relatively small engine, it developed almost 450 horsepower and a speed of over 202 miles an hour, since it had to overcome only a relatively slight wind resistance. Its cylinder capacity was ninety-one cubic inches, and the power was derived from the high speed of the engine, which wound up to 7,500 revolutions per minute. It was, however, too light, in the opinion of many, for such terrific speed as it was capable of attaining.

Midway between these two cars was Capt. Malcolm Campbell's "Bluebird," winner of the speed trials in February, 1928, with a record of 206.89 miles per hour. The "Bluebird," which bested Major Segrave's first record, was a finely streamlined car of moderate proportions with probably as powerful an engine as could be placed in a car of its size, developing 950 horsepower. It was bested two months after winning by the gigantic "Triplex," which made 207.55 miles per hour. The "Bluebird"

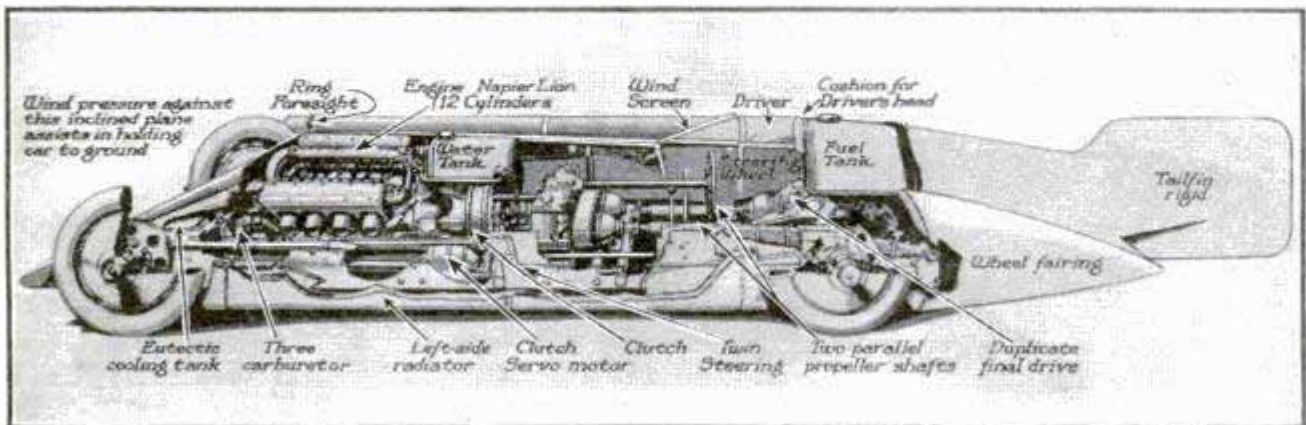
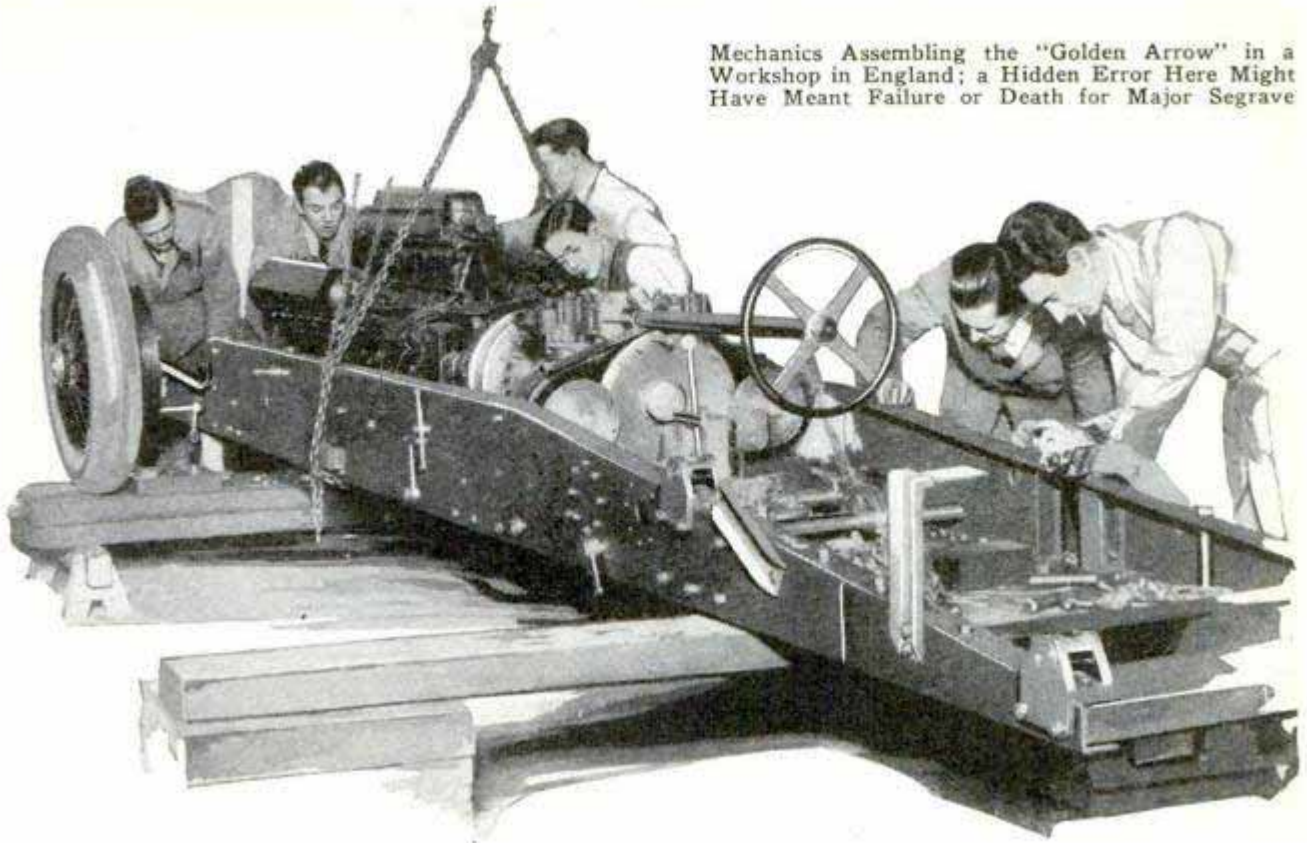

Diagram of the "Arrow's" Most Interesting Secrets; Note Especially the Incline at the Front That Provided Wind Pressure for Holding the Car to the Ground

Mechanics Assembling the "Golden Arrow" in a Workshop in England; a Hidden Error Here Might Have Meant Failure or Death for Major Segrave



was so designed that the wind would tend to hold it on the ground, a vital point. From these three cars, four facts of prime importance became evident:

First, that great power was required, since a powerful car even without streamlining had won the record; the air resistance, by the way, increases as the cube of the speed, which calls for tremendous reserve power when bucking a stone wall of wind.

Second, that streamline design could not be ignored, since the well-designed "Bluebird" came very close to the record of the much more powerful "Triplex" and, in fact, had won the world's one-way speed record.

Third, that the effort to minimize wind resistance could not be carried to the extent of greatly reducing the weight and hence the stability of the car.

Fourth, that engines of a high turnover, which would keep winding up and increasing speed, were desirable, as the "Triplex" with its large cylinders would decrease in speed after 2,300 revolutions per minute.

The results of this demonstration were apparent in the "Golden Arrow." Future racers, with engines in tandem, that develop still greater power than the "Golden Arrow," but offer less wind resistance, yet

possess weight and design to hold them to the ground, will probably some day be built to shatter the "Golden Arrow's" record by a great margin.

Coupled with this great reserve of power, which provided continued acceleration until the maximum was reached, was the design of the "Golden Arrow" to encounter a relatively very low wind resistance, and the fact that the big car weighed two and one-half tons and was less than four feet high, sitting close to the ground. These qualities make for high speed and stability.

In low gear, Major Segrave's highest speed was eighty-one miles an hour; in second, 166 miles an hour, and in high, 246 miles. The "Golden Arrow" was especially designed to meet the problems of aerodynamics which face drivers of the latest high-speed racers.

The engine of the "Golden Arrow" weighed almost 1,000 pounds. The steel frame was enormously strong. Its springs were very stiff so that they would not give, should the car leap on striking some slight irregularity in the sand. As a whole, the car is cigar-shaped and, with its long projecting tail, has an over-all length of twenty-six feet. The engine is of the same type as that in the "Bluebird," Capt. Malcolm Campbell's famous racer.

*Wm. A. ...*  
**Archer's Company**  
POPULAR MECHANICS  
Asheville, N.C.

*Letter  
ret'd.*

*2569*

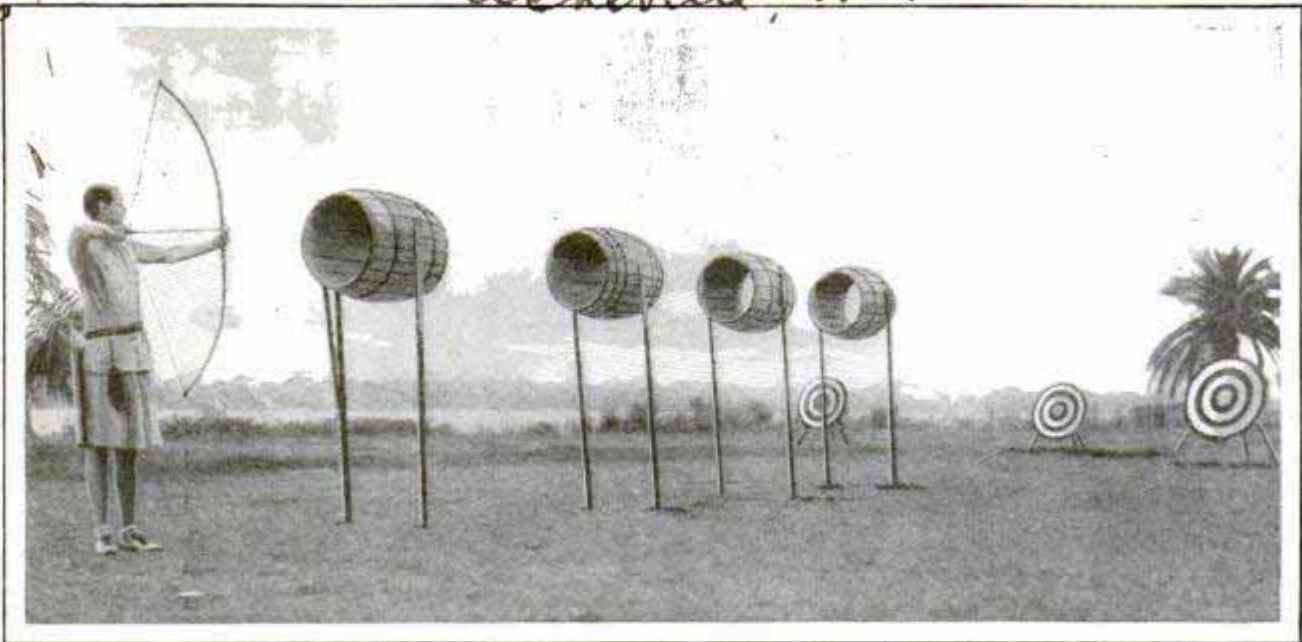

*Wide World*  
Making Archery More Difficult; Sending Her Arrows through the Four Barrels, This Woman Scored Five Bull's-Eyes in Six Shots

### SHOTS THROUGH FOUR BARRELS SHOW ARCHER'S SKILL

Arrows sped from the bow of a woman archer, shot through four open barrels and struck five bull's-eyes in six attempts, during a recent test at a Florida resort. The facts that the barrels were not of great diameter and that the arrows described an arc during their course, emphasized the woman's accuracy and skill.

### AUTOMATIC BRAKES ON TRAILER STOP BOTH WHEELS

An auto trailer with automatic brake drums on both wheels is being marketed in England. The trailer has a box body to carry camping equipment, and can be fitted with blocks on top for the support of a canoe, rowboat or a small motorboat. The coupling bar is equipped with a spiral spring, and connected to it is a lever, the lower end of which is joined to the cables actuating the brakes. When the brakes of the automobile are applied, the momentum of the trailer carries it forward against the tension

of the coil spring. When it has moved a couple of inches, the lever brings the brakes of the trailer into play. As the towing auto starts again and picks up the load, the action is reversed and the trailer brakes released.

### BOTTLES HELP SOLVE MYSTERY 2606 OF OCEAN CURRENTS

Released in the Pacific ocean some 1,200 miles north of the Fiji islands, a bottle was picked up recently by a steamer crew off the coast of Queensland, 2,500 miles from the place where it had been set adrift. The bottle was sent to London, where the papers inside were examined by the meteorological office and entries made in the records that are being kept of the currents from the data furnished by the bottles. Arrangements have been made with nearly 500 British sailing and steamships to throw over daily at sea, sealed bottles containing drift papers which the finder is asked to mail to the air ministry at London. Last March, one of these bottles was picked up on the beach off the coast of France which had

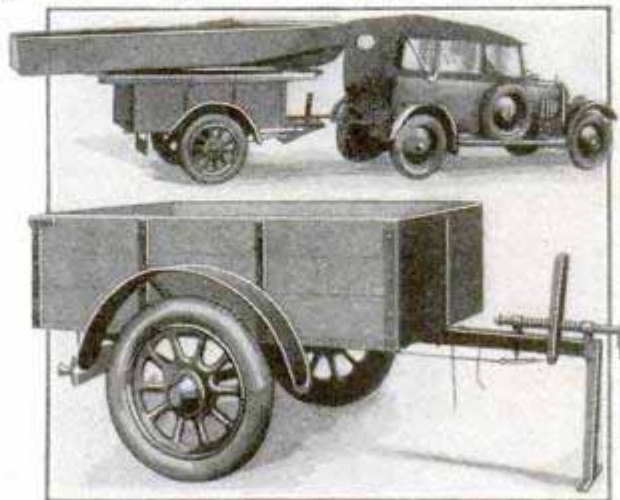

Trailer Equipped with Brakes That Operate in Unison with the Automobile Brakes

*Wilbur*

*Thornton Engineering Co. Ltd. Bradford  
50 Mainingham Lane  
524 England*

2556  
1314 Seneca Ave  
Brooklyn, N.Y.

been thrown into the sea July 20, 1927, by the captain of the White Star liner "Celtic," later wrecked on the Irish coast.

**"WEATHER MAKER" FOR HOME  
KEEPS OUT DUST**

2518

Better health and more comfort in the home are objectives of an air-conditioning plant for domestic use, modeled closely after the larger outfits that have been employed for some time in theaters, etc. It filters, heats, humidifies and circulates the air. The filtering system is designed to remove ninety-eight per cent of the dust which ordinarily floats through the house, lodging on furniture and menacing health. The heating is done entirely by gas and is controlled automatically. The humidifier, which supplies the air with the proper amount of moisture, is capable of evaporating several gallons of water a day, an important function when extreme cold outside demands more heat with the consequent likelihood of drying the air inside the house until it becomes unhealthful. Doctors and engineers have agreed that the air in the average American home, especially during the winter, is deficient in moisture much of the time. A survey showed that in the eastern part of the United States, the average humidity in a home on a winter day was ten to eighteen per cent. This is less than the average maintained in the usual kiln for drying lumber.

Chicago 56 & W Washington

Carrier Engineering Corp

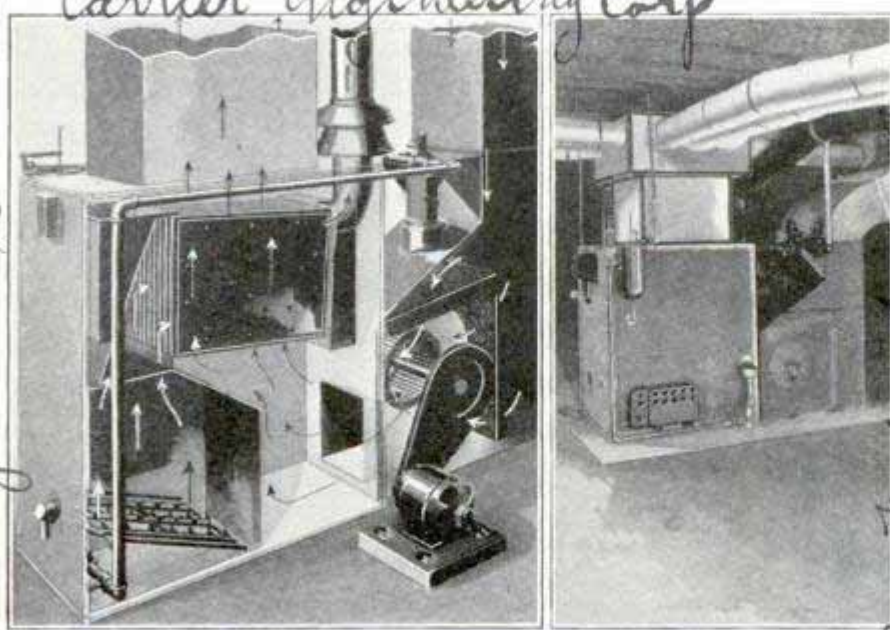

Air Conditioner for Domestic Use; It Filters, Heats and Humidifies the Air and Circulates It throughout the House

Willis H. Carrier  
Carrier Engineering Corp  
New York



Attachment to Tennis Racket Allows Strings to Be Tightened or Loosened

**TIGHTENER ON TENNIS RACKET  
LENGTHENS LIFE OF STRINGS**

Strings on a tennis racket recently devised, can be loosened or tightened simply by turning a small handle at the base. This enables the player to reduce the strain on the strings after a game, and so prevent breakage.

**CATAPULTS TO LAUNCH PLANES  
ON SMALL FIELDS**

Adaptation of the catapult method of launching airplanes, the system used by the Wright brothers in their early try-outs with flying craft, may solve some of the landing-field problems of today, in the opinion of Maj. Alfred Hildebrandt, famous German flyer, who visualizes a return to the frequently ridiculed arrangements of the Wrights. A catapult, in improved form, would be useful in helping to launch heavily loaded ships, he declares, and would also be of service at the smaller airdromes, where lack of space renders impossible the construction of long runways.

250 5th Avenue New York

Herald Examiner  
3/31/29

Liner. Patrucau-  
Aircraft Corp. Bristol, Pa

# Flying News from

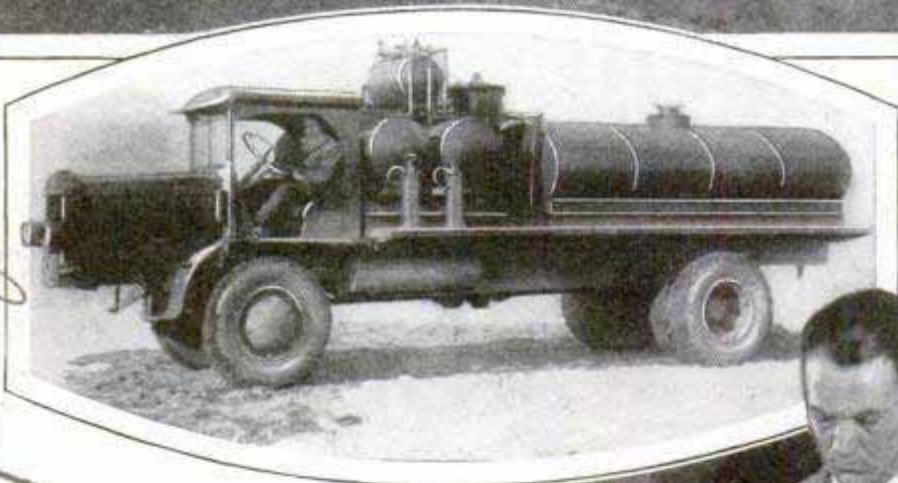

Inclosed Motors, a Larger Cabin and Improved Streamline Design Feature This Recent Passenger Air Liner; at Left, a Big Fuel and Service Truck to Supply the Planes and Landing-Field Tanks

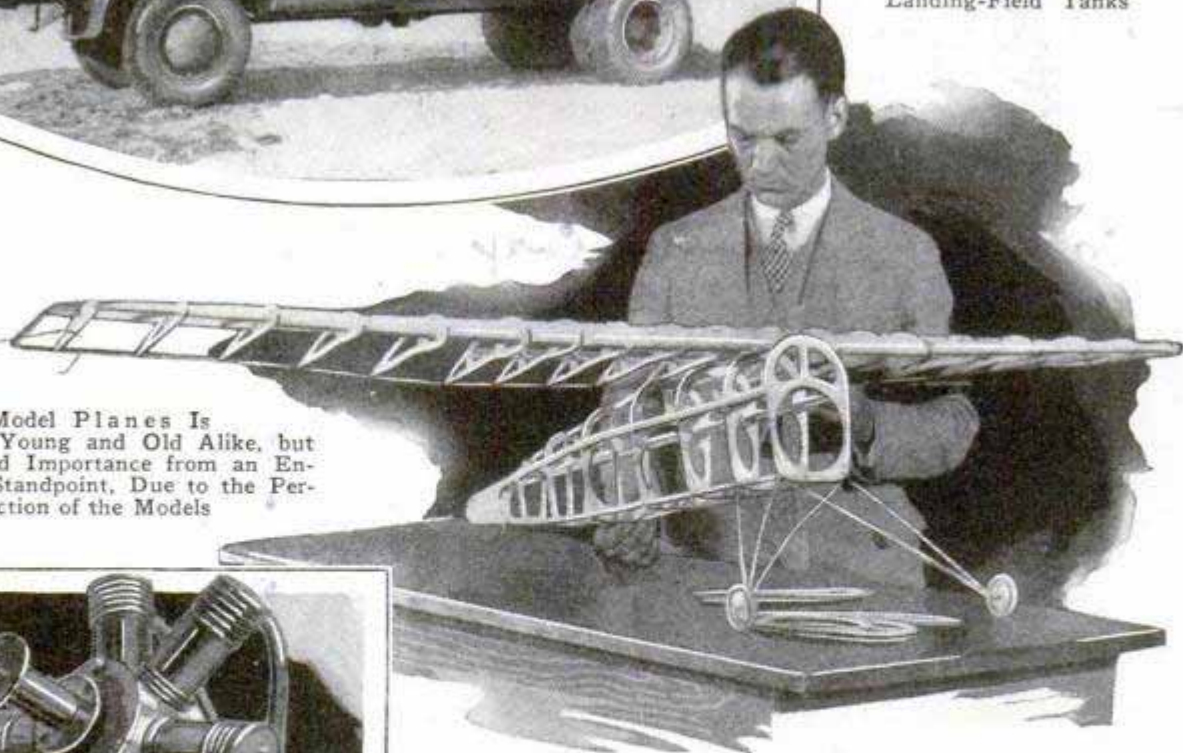

Building Model Planes Is Sport for Young and Old Alike, but Has Gained Importance from an Engineering Standpoint, Due to the Perfection of the Models

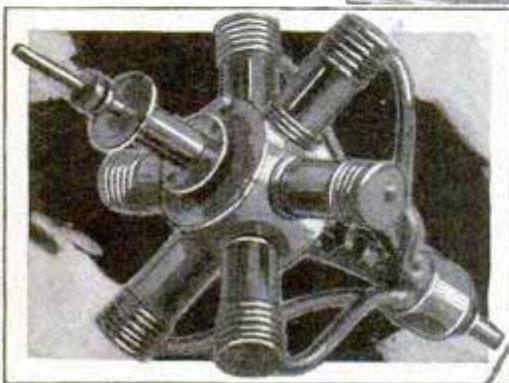

Tiny Compressed-Air Motor for Driving a Model Plane; It Will Turn at 1,500 Revolutions per Minute, Makes a Realistic Sound and Will Run for a Minute and a Half Wide-Open; It Is Supplied with Air from Special Tank Pumped Up by Electric or Hand Compressor

2549  
Det, Amalgamated Sales & Service Corp  
542 W. Jackson Blvd. Chicago

nm on motor.  
permanence data

Miniature Aircraft Corp  
P. O. Box 1 - Terrace, New Brighton

# All the World

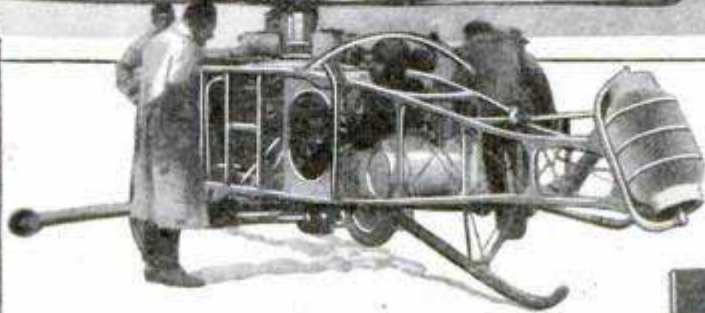
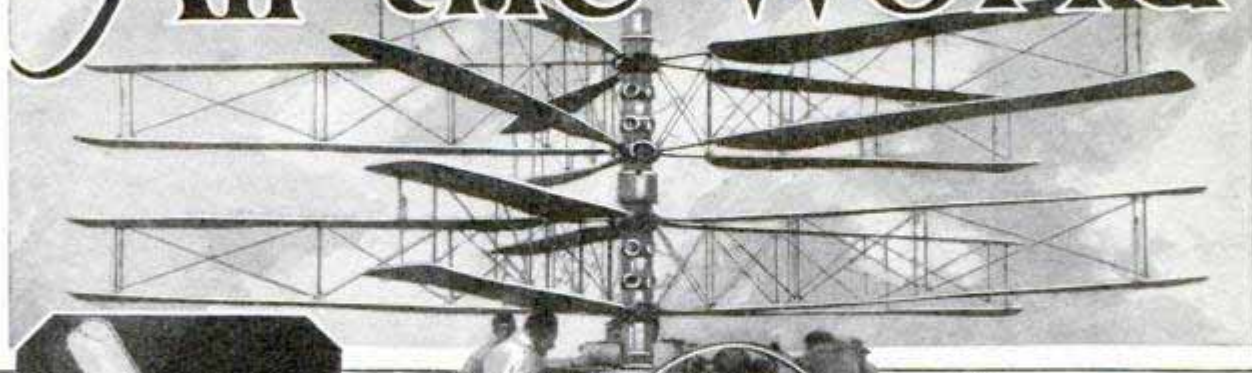

Pescara Helicopter That Made Records in Vertical Flight. One of the Chief Aims of the Modern Aviation Engineer, and, Left, Bloxham Control Stick

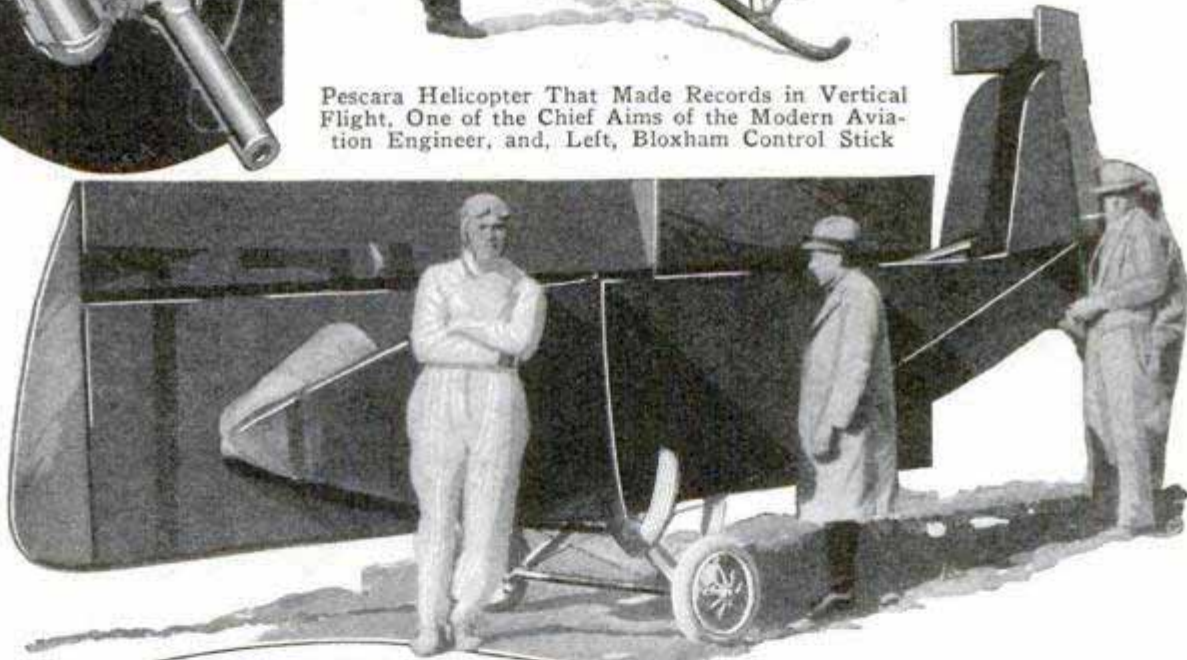

Gliding Is Being Recommended as a Means of Learning the "Feel" of the Air and Becoming Familiar with the Controls; Here Is a Glider That Folds Up in Small Space; Its Designer, Maurice W. Collins, in Flying Suit, Has Made Successful Flights with the Craft, Which Has a Wing Spread of Thirty-Four Feet; at Left, Motor of a Flying "Flivver" with the Engine Cowl Removed, to Show Simplicity of Design and Compact Form; Air Flivvers Are Proving Successful When Conditions Are Favorable for Comparatively Little Power

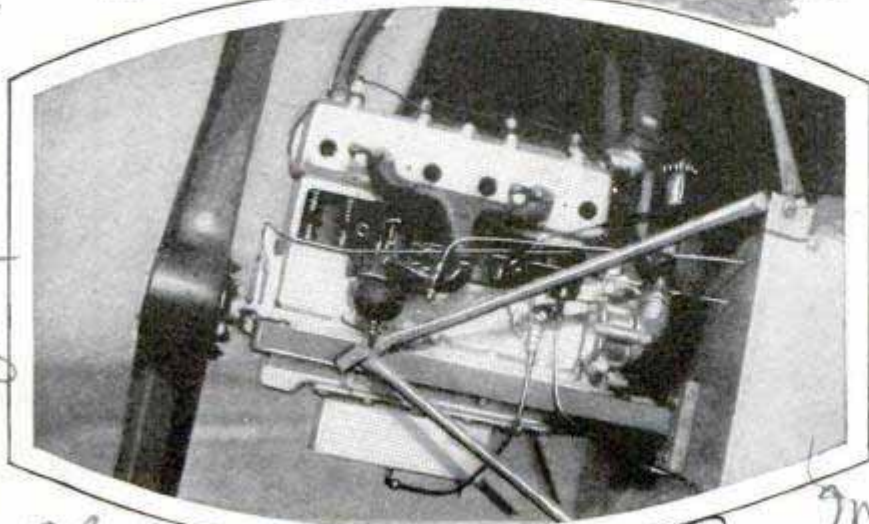

*Mying Flivver plans -*

*Plans and parts of B. International Engineering Corp. 1125 1/2 Bldg Washington St E*

*manager by Dept. Los Angeles store*

*Philadelphia College of Pharmacy and Science*

**PREDICT GOWNS OF ASBESTOS FOR DURABLE WEAR**

2586

Dresses of asbestos that will be as lustrous as silk and will give long wear, with ease in cleaning, are predicted by an eastern scientist. In view of the fact that fabrics are already being made from trees and vegetables and that the Romans made a sort of cloth from asbestos fibers centuries ago, this prophecy is considered entirely reasonable by experts. The use of asbestos in the early Roman days was confined largely to the weaving of shrouds. According to tradition, Charlemagne had a tablecloth of asbestos which was cleaned by throwing it into the fire. In the seventeenth century, Chinese merchants displayed asbestos handkerchiefs and the Eskimos in Labrador have used lampwicks made of an asbestos fabric for many years.

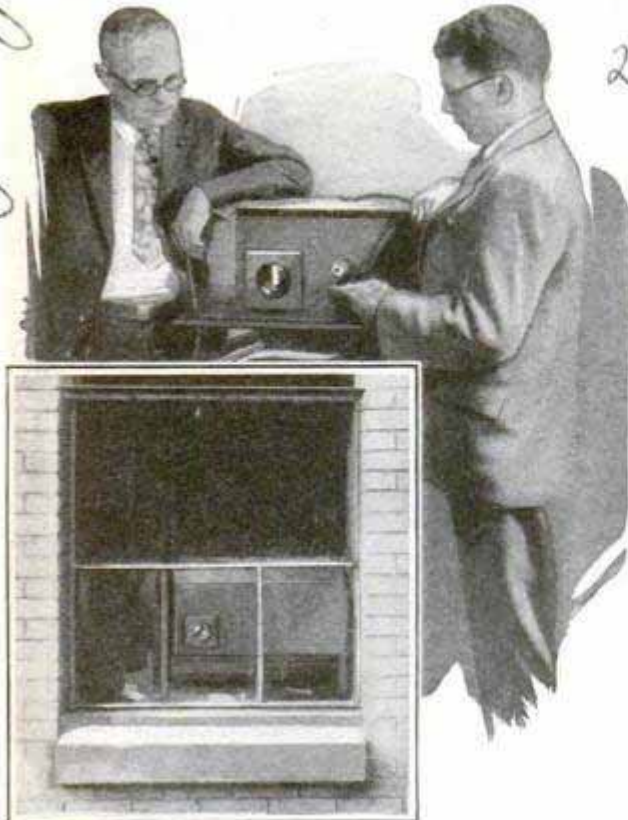

Inspecting the "Eye" Cabinet, and View of the Window with the Set Installed

**ELECTRIC "EYE" TELLS WHEN TO LIGHT SCHOOL**

When natural light becomes too dim for reading without straining the eyes, a photoelectric cell, installed at an eastern school, snaps the inside lights on. The cell is contained in a small box, resembling a radio set, near a window, and connections are made to the electric switch. The light coming through the window is deflected, through a lens, upon the cell. As long as there is sufficient intensity, the unit remains inoperative, but as a certain carefully determined point is reached, when the light is too dim for the good of the pupils, the "eye" reacts upon an electric relay and the room lights flash on. Engineers point out that the plan is good in more than one respect. If the lights are left entirely to the teacher's discretion, pupils in a less brightly illuminated portion of the room may suffer eyestrain without her knowledge, and turning the lights on too soon wastes current. According to investigators, twenty-five per cent of high-school graduates are afflicted with impaired vision, and seventy-five per cent of this number owe their troubles to improper illumination in the schools.

**WRECKED PLANE ON A GARAGE ADVERTISES SERVICE**

2565

Motorists journeying between Los Angeles and Hermosa Beach see what appears to be an airplane crash as they reach the peak of a hill. A ship evidently has dived, nose first, into the roof of a building. But the seeming wreck is only the clever device of an automobile-garage owner to attract attention to his service. He has mounted the wings and fuselage of an old JN-4 plane vertically on the top of his shop and just above his sign.



Old Plane Mounted at Front of Service Station, to Advertise Garage

*Carl Math Weinstock  
845 W. 102nd Place*

*General Electric Co, Schenectady, Ny*



## LATEST "V"-MOTOR BLOCK IS CAST IN ONE PIECE

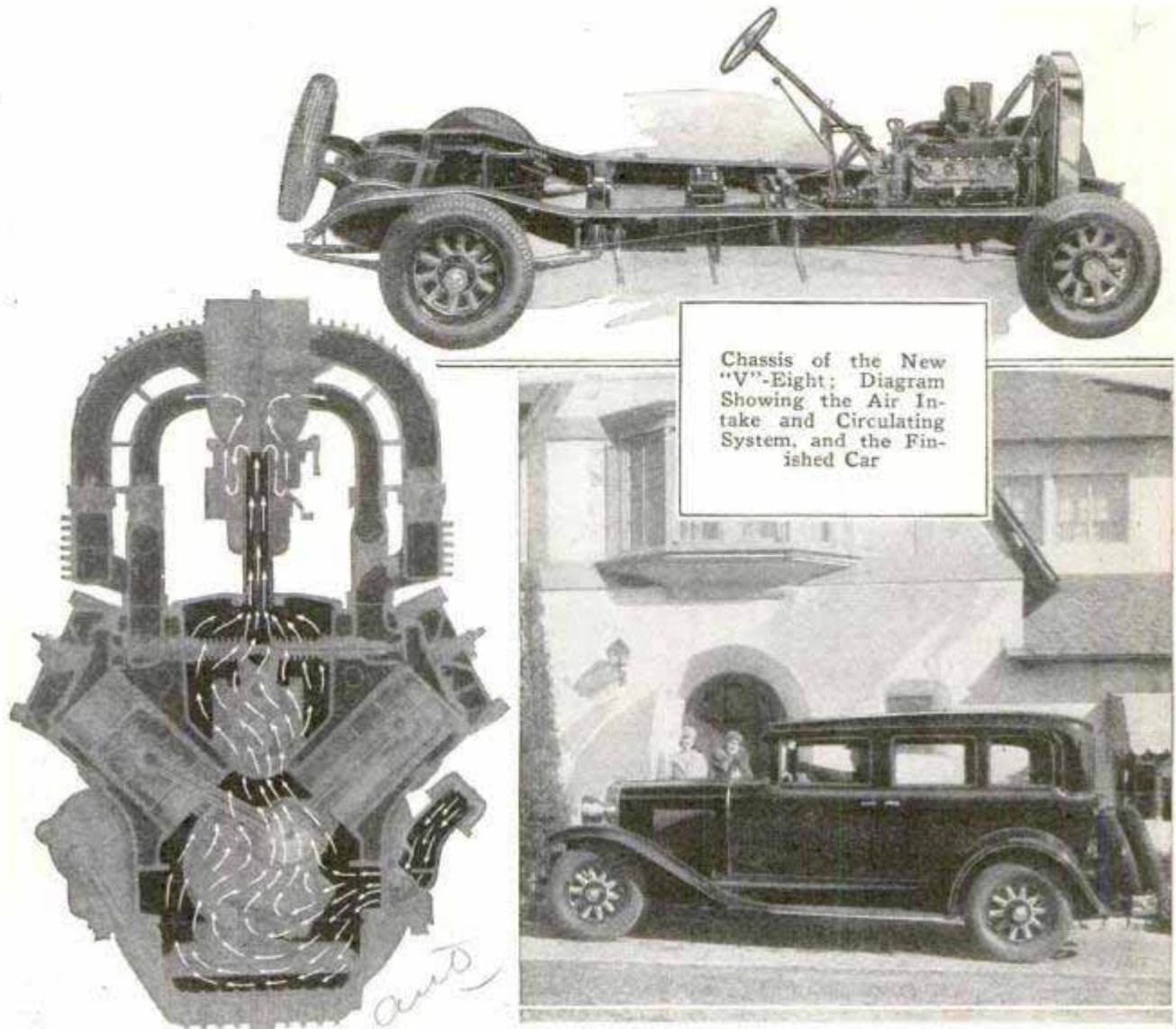

Chassis of the New "V"-Eight; Diagram Showing the Air Intake and Circulating System, and the Finished Car

A "V"-type eight-cylinder engine, with the engine block cast in one piece, has just made its appearance in the automobile market. Another feature of the engine is that the valves are placed in a horizontal position, operated by a rocker direct from the camshaft, giving a semi-overhead-valve arrangement. Oil cleaning is accomplished by a "fish-ladder" arrangement, a series of cross strips in the bottom of the pan which trap foreign particles as the oil flows past. A further innovation is an air intake through a breather cap fitted with an air cleaner, on the side of the crankcase. Air, laden with moisture and oil spray, passes up a pipe running to the base of the carburetor air cleaner, and thence to the carburetor, an arrangement that is claimed to improve carburation. The mounting of the carburetor above the engine gives

a down draft to the cylinders. The intake valves are equally spaced from the carburetor to insure even distribution of fuel to all cylinders. The exhaust gas from the left side of the block is carried up over the intake manifold and carburetor vent, and a hot spot is provided to preheat the gases.

### FIFTEEN MILLION TALK AT ONCE TO EQUAL HORSEPOWER

2588 It would require 15,000,000 persons, all speaking at once, to generate mechanical energy equal to one horsepower, according to the findings of Prof. Vern O. Knudsen, of the University of California, during research in acoustics. He measured the voice energy of speakers in rooms of varying sizes and used the results in preparing a formula for determining the acoustic rating of an interior.

2557



Trimming Trees with the Aid of the Ladder Truck; the Steps Swing on a Turntable

**TRUCK FOR TRIMMING TREES HAS AERIAL PLATFORM**

Equipped with an adjustable ladder that can be elevated to various heights and swung at different angles, a truck for the use of tree trimmers, wire repair men, and other workers, is on the market. A particular advantage is that in repairing street lights, for instance, the ladder may be adjusted in such a way that other vehicles can pass under it, thus preventing any interference with street traffic. At the top of the ladder is a wide platform with rails to protect the worker. Instead of rungs, there are eight-inch steps, and the ladder works on a turntable which can be locked simply by pressing a lever.

**FISH ARE FOUND BY ECHOES USED TO SOUND SEA**

Echo-sounding instruments, such as were used during the World War to locate submarines and are now being employed in taking depth measurements and for other purposes in navigation, have been harnessed by fishermen on some of the English steam trawlers to locate places where the fishing is likely to be good. By means of the echo-sounding system,

shoals are easily located, and the skippers know that, generally, the fishing will be better at such places than farther out in the deeper waters. The echoes are also used to help guide the vessels when fogs obscure the vision.

**SHOWER-BATH CABINET FITS ANY ROOM**

Consisting of a leak-proof base and walls of porcelain-enameled iron, a shower-bath compartment now on the market is simple to install, saves space and reduces construction costs. The unit is not built in, but is separate and complete in itself, so that settling of the building walls and floors will not crack or damage the base of the compartment. The cabinet is furnished with either glass door or curtain.

**SPECIAL CLOCK FOR TELEPHONE SAVES EXTRA TOLLS**

To keep accurate check on the time consumed in talking over the long-distance telephone, a special clock has been introduced. It is set going simply by pressing a lever at the side, runs for six minutes and rings a bell at the expiration of three minutes and at the end of the total period. A large dial allows the talker to keep constant watch, so that he will be less likely to exceed the charge limit and will also obtain the full benefit of the period on which his charge is based. The clock is accurate, inclosed in a handsome nickel case and serves as a paper weight on the desk when not in use with the telephone.



Close View of the Dial, and Clock in Use with Telephone

*Chicago Seagrave Corp. 111 W. Washington*

2607

*hydrophone*

*Wilkins*

*Slogau Co., 1893 Bond. Meally*

*sent up*

*107 Park Ave N.Y.C.*

## IMPROVED RADIO FOR PLANES ADDS TO SAFETY



Plane Equipped with the Radio Aerial; Close View of the Receiving Set, and Interior of Transmitting Station

Bad weather and other perils of aviation will prove less bothersome over lines of the National Air Transport, it is expected, as a result of the installation of an extensive system of communication by radio with the pilots while in flight. Following months of experimenting, radio-beacon stations have been constructed, planes have been equipped with improved receivers, and plans are under way for the installation of apparatus whereby two-way intercourse between the ground and the moving plane will be made possible. The beacon stations transmit what is known as equisignal calls in dots and dashes by which the pilot can tell if he is on his proper course. A dot-and-dash signal will indicate that the plane is to the left of the course. Swinging over and receiving a dash and a dot, shows that the ship is to the right. The pilot turns a little to the left and when the dots and dashes blend into one dash, he knows that he is follow-

ing the correct path of the airway. Weather reports are transmitted to the pilot by the voice from the ground stations, on sets tuned to a greater wavelength than that used for the directional beacons. An interruption in the radio beacon will serve as a signal to the pilot to tune in on the weather-receiving set and hear the latest word as to a storm or some other change that may necessitate a change of course. The beacon helps guide the pilot to the airport in fogs. This is accomplished by the varying intensity of the beam signals, according to the position of the plane with respect to the proper route. Marker beacons, sending strong signals, are to be installed at the fields.



2245

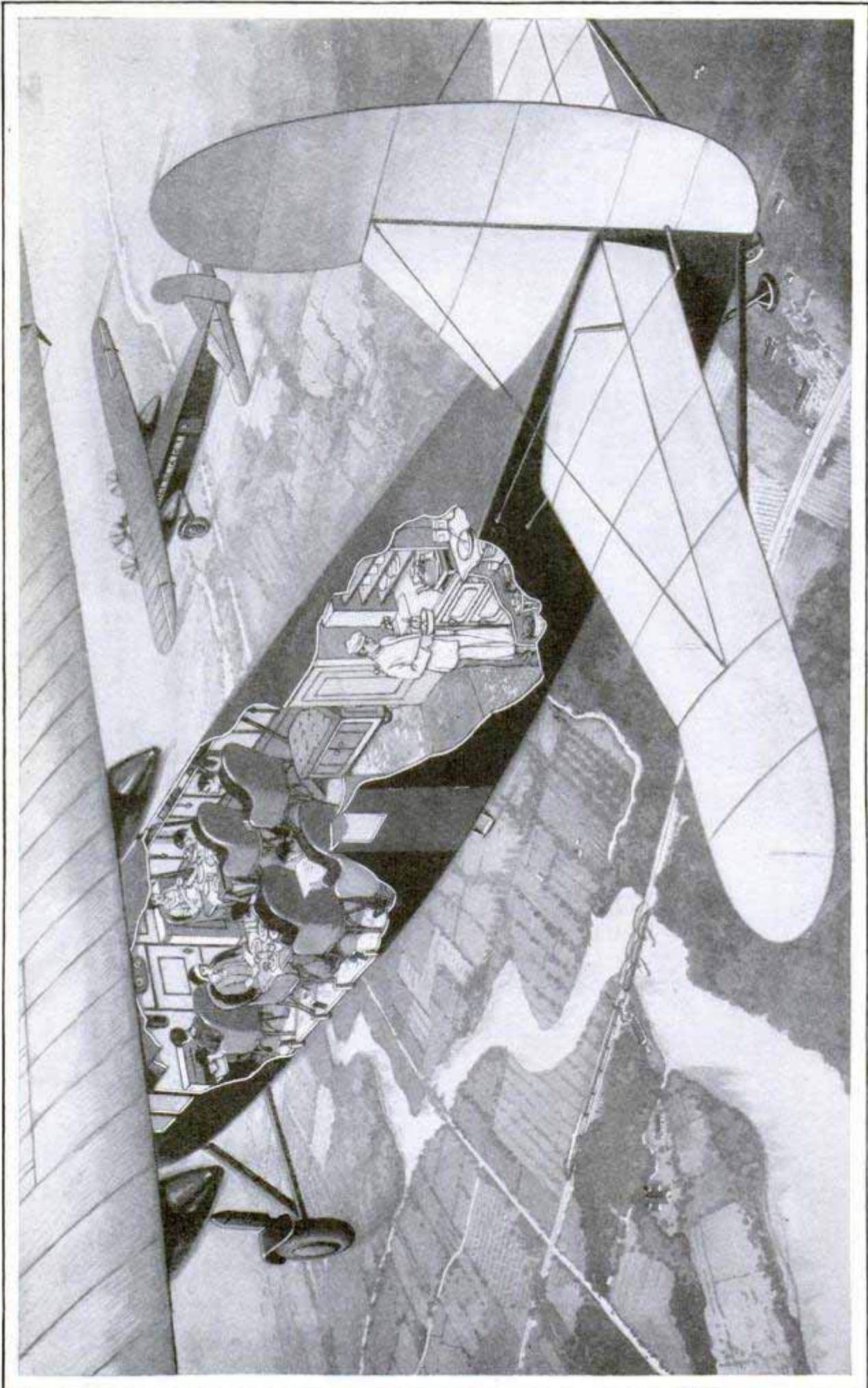

Artist's Drawing of the Sky Diner in Flight, Showing the Cook's Galley, the Electric Refrigerator, and the Interior Arrangement of the Cabin

227 Universal Aviation Corp  
105 W. Monroe, Chicago  
Mason Peters, publicity director

# Aboard the Sky Diner

"A BUSINESS man is not investing \$82,000 in an airplane, expecting it to crack up," declared William P. McFail, veteran pilot, who has spent more than 2,000 hours in the sky. He was talking of his latest position as chief pilot for the Universal Air lines on the Twin-City-Chicago route, as he sat at the controls of the new tri-motor Fokker in which hot meals are served to pas-

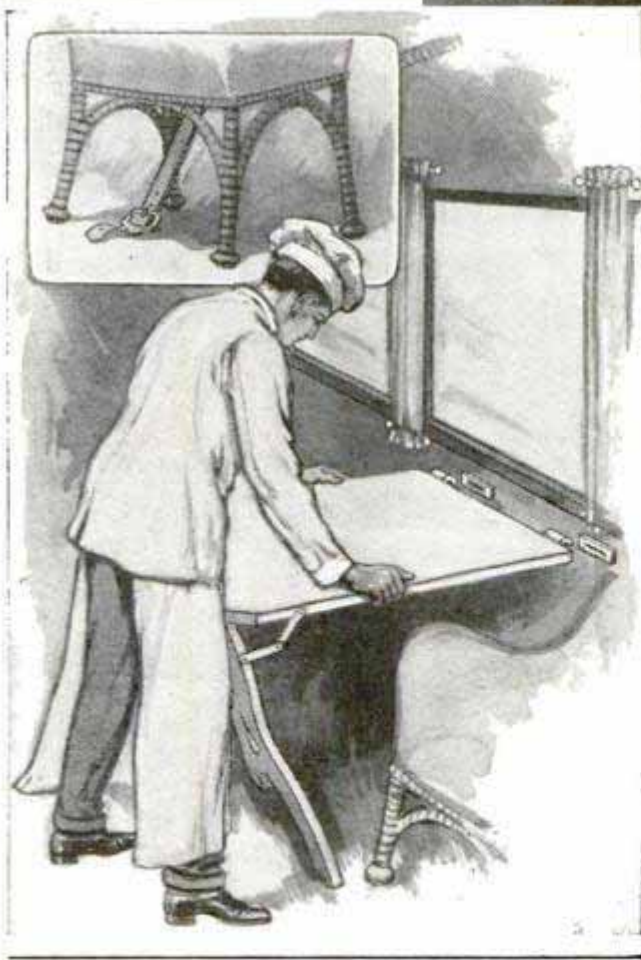
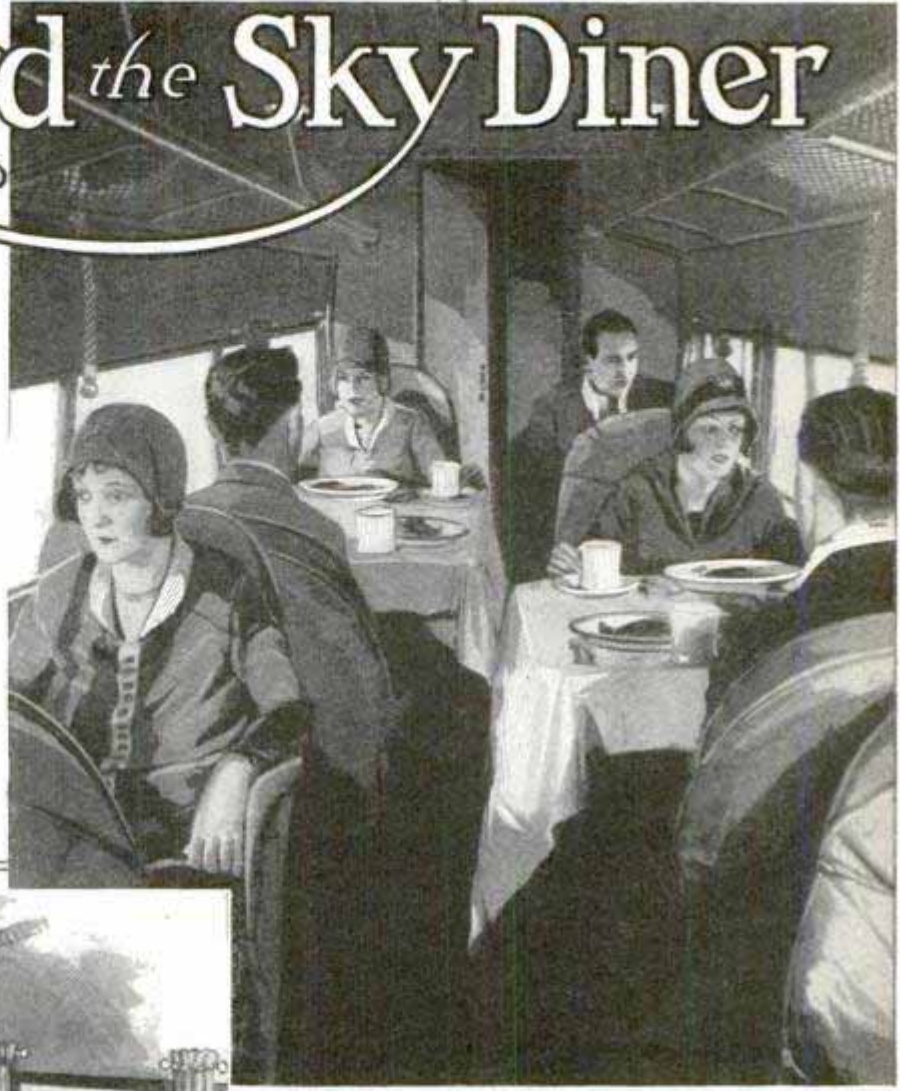

Dining in the Skies, and Sketch, Showing Method of Adjusting the Tables and the Chair Straps; the Plane Has a Permanent Desk for Writing

sengers—the big "sky diner" that has practically all the conveniences of a Pullman. "This really isn't flying," he continued, recalling some of his earlier planes. He learned to solo after an hour and forty-five minutes in the air, but he doesn't recommend such speed to the youngster who wants a job as pilot today. "Flying means thrills and more action," he said. "I like to get into a smaller ship, something like that slick Lockheed-Vega over there. It will do 170 miles an hour and a few stunts on the side, but, of course, aviation wasn't planned just for the fun of the pilot. This is the day of sky travel. Why, they're already planning a bigger ship than this. The next step is a four-motored, thirty-two passenger, sixteen-berth sleeping-car plane. The motors will have 2,100 horsepower. You see, the flying idea of the day is for bigger size as well as greater speed. These big planes are just air busses, and the pilot—well, may be you can call him

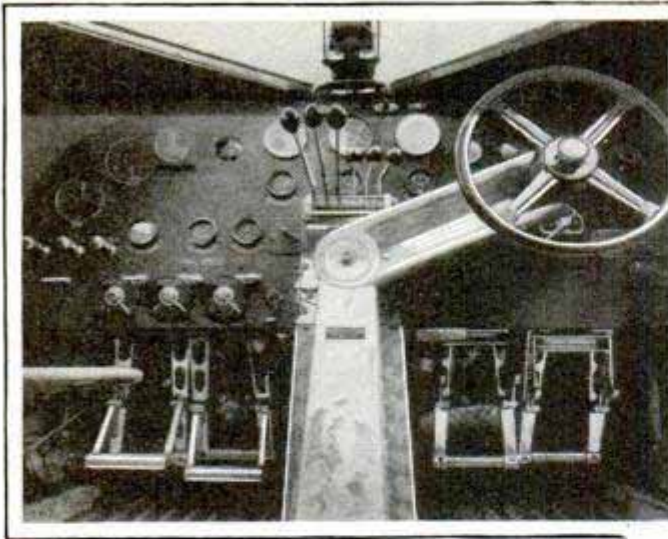

Instrument Board of the Fokker Tri-Motor Dining Plane



a cross between a motorman and a bus driver, and, when the flying sleeper comes along, he'll have a dash of Pullman porter."

The armchairs of the latest sky diner are deeply upholstered and there also is a sort of lounge inviting to a nap. At one side of the little door that leads to the pilots' compartment is a handy writing desk, similar to that in a Pullman club car, and on the other side a cabinet for supplies. An ample rack above the seats holds coats and smaller bundles, magazines, ash trays—yes, smoking is permitted in this roomy cabin plane—and other conveniences are generously distributed. Over the pilots' door is an altimeter so that passengers can always see how high they are flying, and a clock in true aviation style, its face showing only the quarter divisions of a twelve-hour day in numerals. Wide, sliding windows afford a clear view of the ground.

Step to the cook's galley which is just to your right as you enter the plane and back of the well-appointed lavatory. Like

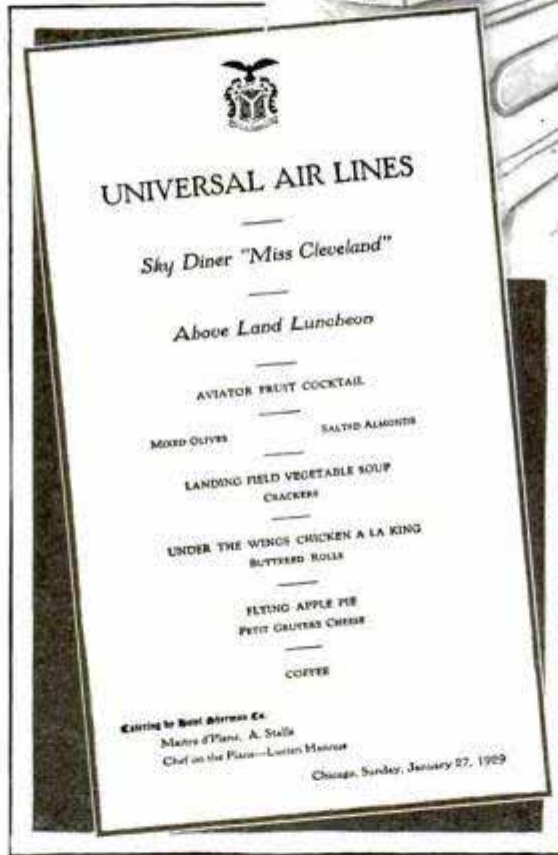

Sketch of the Chef Preparing a Meal, and Menu Served on "Miss Cleveland's" Initial Trip

all dining-car pantries and kitchens, this is small and compact but completely equipped, ready for serving anything from a five-course dinner to a light luncheon. The chef is blazing a new trail in the culinary arts and already is discovering new problems. For instance, a three-minute egg may not be as hard as a patron may like, but the chef is not to blame and neither is

the water, nor the egg. The sky traveler must remember that the boiling point of water varies every 300 feet of extra altitude or about sixteen degrees to the mile and the sky diner sometimes cruises at an altitude of 5,000 to 10,000 feet. Cooking is done on a small electric stove supplied with current generated by the plane. The dining tables swing out from the side of the cabin and, to the person unfamiliar with the luxury of travel in a cabin air-

EAST BOUND	:15	:30	:45	1:00	1:15	1:30	1:45	2:00	2:15	2:30	2:45	SCHEDULE
ACTUAL												
WEST BOUND	2:45	2:30	2:15	2:00	1:45	1:30	1:15	1:00	:45	:30	:15	SCHEDULE
ACTUAL												

plane, are surprisingly steady. The movements, if any, are slow and deliberate, not jerky as in a railroad diner, and there is no need of devices to clamp the dishes to the table as is sometimes necessary in ocean liners. The diner's schedule permits you to leave Minneapolis at noon, arriving in Chicago at half-past three o'clock—plenty of time for luncheon on the wing—or you may leave Cleveland at about seven o'clock in the morning and breakfast among the clouds while your plane soars along in time to land you at Chicago shortly after half-past eight. The three big motors of 400 horsepower each roar smoothly along, but the noise is scarcely greater than that experienced in a train.

The commercial success of flying lies largely in the tri-motor ship, according to Pilot McFail's estimate of the passenger situation.

"The hazards of the single-motor plane have been reduced to a minimum," he



Time Card Issued Passengers, So That They May Check the Route as They Fly, and Steward Serving

said, "but there is no question about the value of those two extra motors. Instances of a failure of all three are exceedingly rare. If one quits, you can still proceed with the other two. Even if two should stop, you would be in a much better situation than with a dead motor in a single-engined ship, for, with just one going, the tri-motor ship can glide a sufficient distance to enable the pilot to pick a suitable landing field. Of course, you can glide a long way in any good ship without a motor running, but your gliding radius in such a case depends almost entirely on the altitude. With one engine going, the

ship's gliding area is greatly extended. No pilot worries any more about the so-called 'air pockets.' They aren't pockets at all, simply ascending or descending currents of air and their effect on the plane is simply that of a small bump, not so violent as to frighten anyone, and rarely even jars the dishes on the tables.

2245

"Some people worry about lightning. But airplanes do not attract lightning. They haven't any ground. And you can run around a thunderstorm or turn back, or even sit down if you have to and fly away again, but forced landings are rare these days. I've flown more than 200,000 miles, I should say, and I've never hurt a passenger or even 'scratched' a ship." He smiled and tapped his knuckles on a convenient piece of wood.

"Flying," he continued, "is a matter of using your noodle. We know that the laws governing the flight of a ship are complex and all that, but, in a way, they are very simple. A ship must fly if it is properly designed and handled. The big passenger planes of the tri-motor type carry relief pilots and there are dual controls. In place of the old-type joystick, there is a control wheel like that of an automobile. This operates the eighty-foot ailerons on the diner and the elevators with practically no effort on the part of the pilot. As I said, instances of forced landings are extremely rare and often examination shows, they are caused by overlooking some simple thing. For instance, a plane was forced down in Cleveland the

other day—a tri-motor ship. The pilot landed safely with all the passengers and no one was hurt. The ship wasn't even damaged much; but what was the reason for the descent? The motors ran out of gasoline! That is likely to happen to your automobile. There are really just a few hazards left in the whole flying business. Bad weather is the worst of these. Fog is a problem, and when ice starts forming on your wings; well, that is bad, too. But the pilot can turn back when such an emergency arises and that is just what a wise flyer does when possible. The other alternative is a landing. I have had just two forced landings since I started carrying passengers. One was caused by a storm and the other was due to a frozen oil vent."

McFail is typical of the pilot who is being placed in command of the big passenger ships of our air lines. Resourceful, experienced and cool, he nevertheless thoroughly enjoys flying and says that his passengers enjoy their rides all the more when they see that he, too, is getting a "kick"

out of it. "I have had a thrill from every air trip I ever took," he declared. "Nevertheless," he repeated, "the operation of a big tri-motor ship is a tame proceeding compared with that of piloting a swifter and smaller craft."

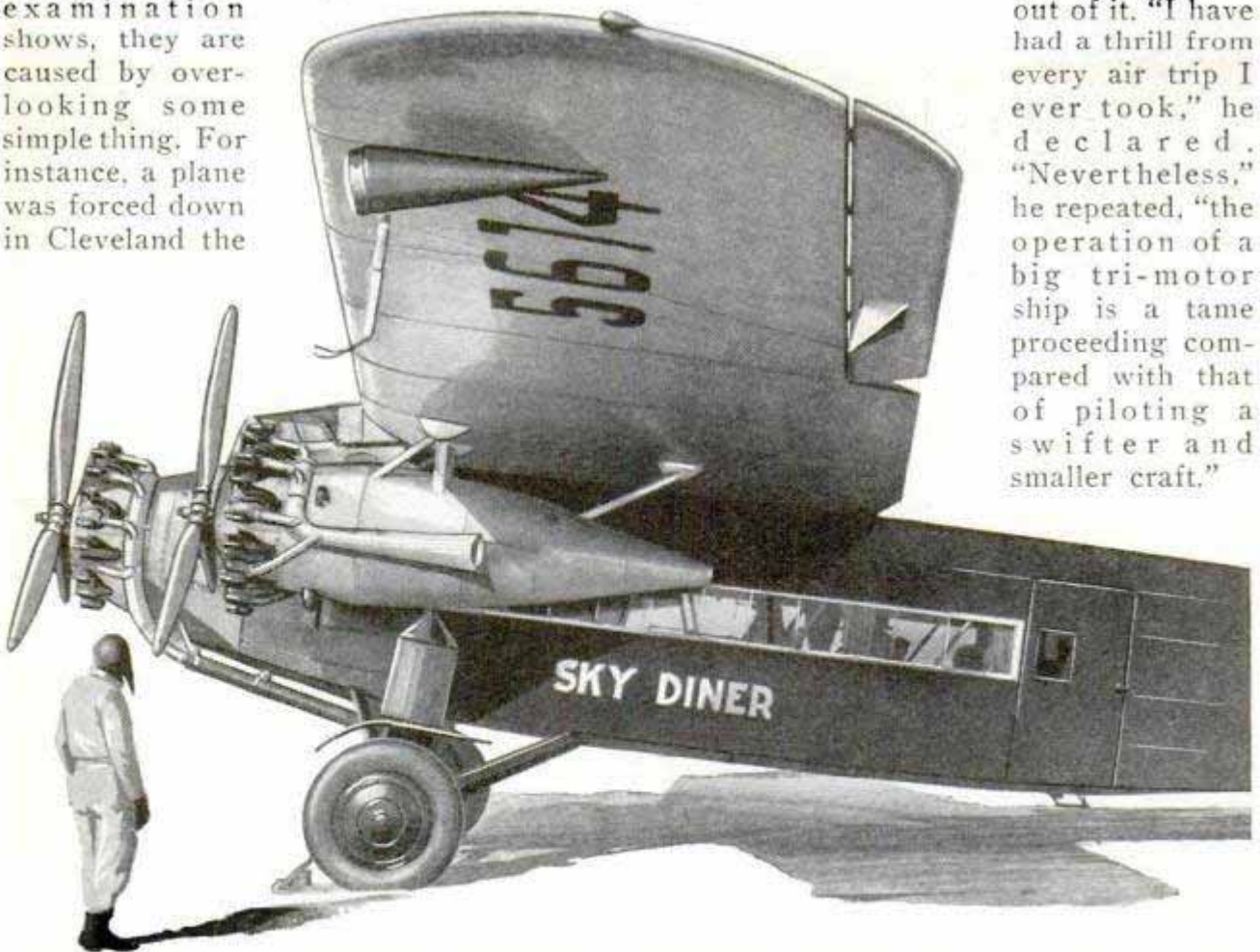

Three-Bladed Propellers Bore through the Air in Front of the Sky Diner's Powerful Motors; Side View of the Ship with Its Wide Entrance Door and Roomy Cabin



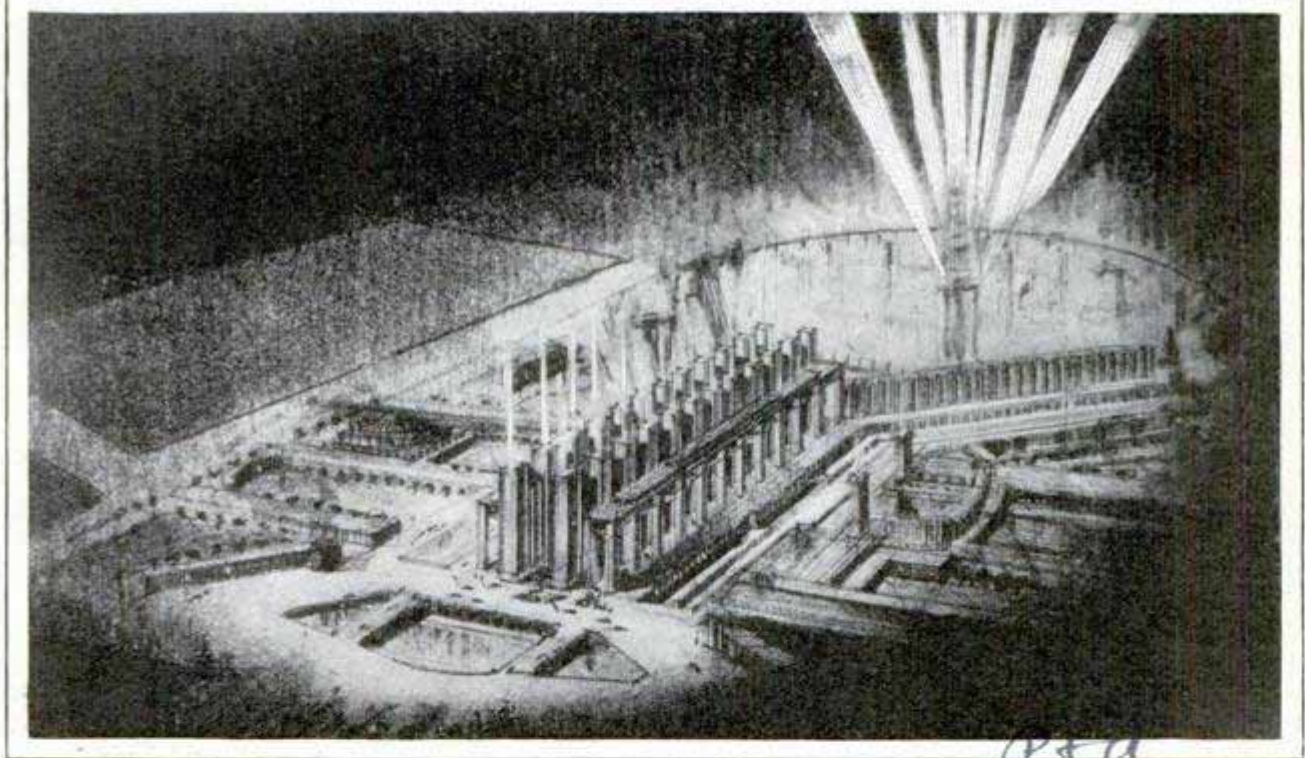
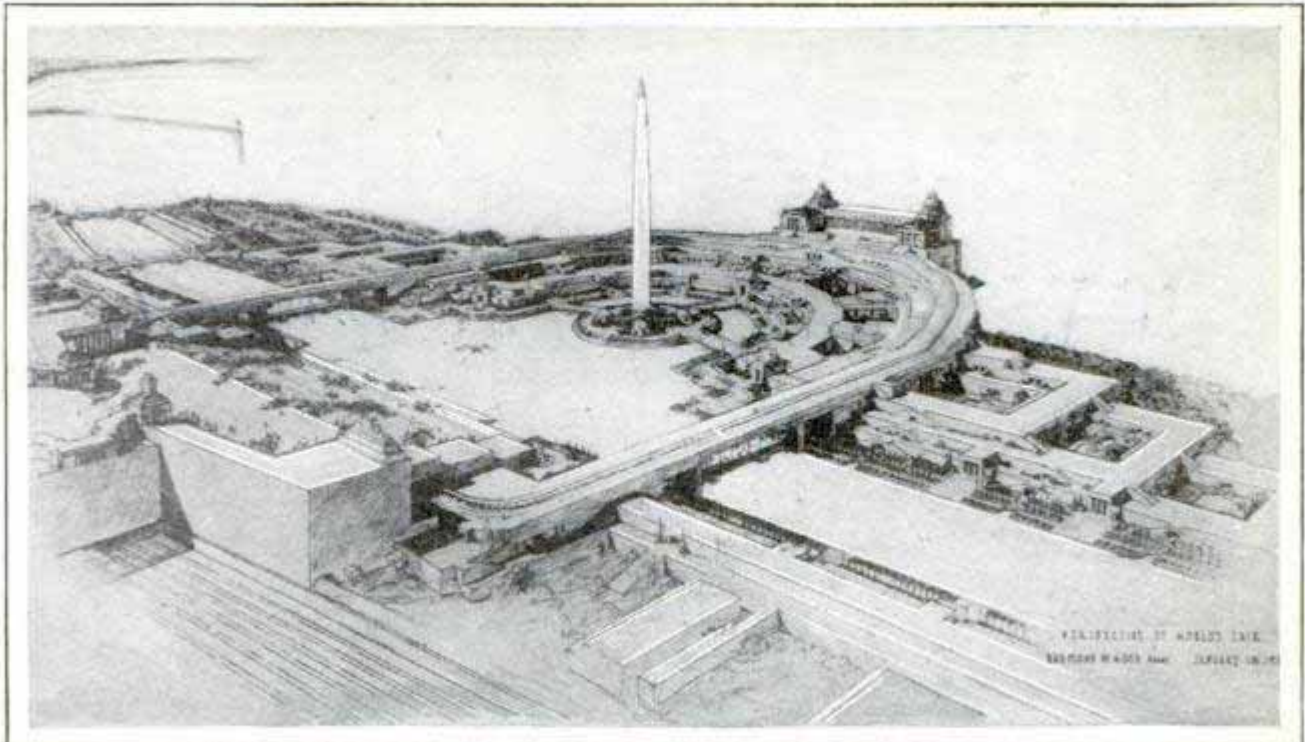

Sketches of Plans Proposed for the Chicago World's Fair in 1933; Some of the Buildings Will Be Constructed on Islands near the Lake Michigan Shore

### FIRST PLANS FOR WORLD'S FAIR INCLUDE NOVEL FEATURES

That the Chicago World's Fair, scheduled for 1933, will be vastly different architecturally from the famous exposition of 1893 is apparent from the preliminary sketches which architects have submitted to a commission of the coming fair. Moving sidewalks and a towering column as a dominant feature, are among the ideas

suggested, while a science building of modern design, to be built of steel and hollow tile, is another interesting proposal. Those planning the fair say that unusual effects will be produced with the aid of modern methods of lighting, and extensive use is to be made of glass as a material for building construction.

☐ The area of Greenland is about four times that of France.

24 28

# Putting the Run into

By EARL CHAPIN MAY *St. James Hotel, 109 W. 45th St. New York*

ABOUT seventy thousand light harness horses are listed in the American trotting register because they have officially trotted a mile in 2.30 or better or have paced a mile in 2.25 or better. Blood lines are not ignored in these "standard-breds." But running horses are thoroughbreds whose ancestry traces back to three Arabian runners brought into England during the seventeenth century.

The breeding and racing of running horses has been the sport of gentlemen since George Washington patronized it long before he became a general and a president. Light harness "trots" and "pacers" are favored by our ruralties be-

repeatedly before going two to five miles to win a race. Runners, "gallopers" or "bang-tails" walk to the barrier and are "away." One short dash decides a running race.



A Flock of Runners Out of a Huge Field of Twenty-Five, Passing the Stands in the Royal Ascot, One of England's Most Famous Races

cause they developed from impromptu races on country roads. Trotters and pacers must be "warmed up" for their track contests. Ten miles of such warming is commonplace. Then they must "score"

The trainer of a light harness horse generally drives his pupil, win or lose. The trainer of a running horse must mount a light jockey on his pupil and depend on the boy for victory. Hence, training a

# a Running Horse

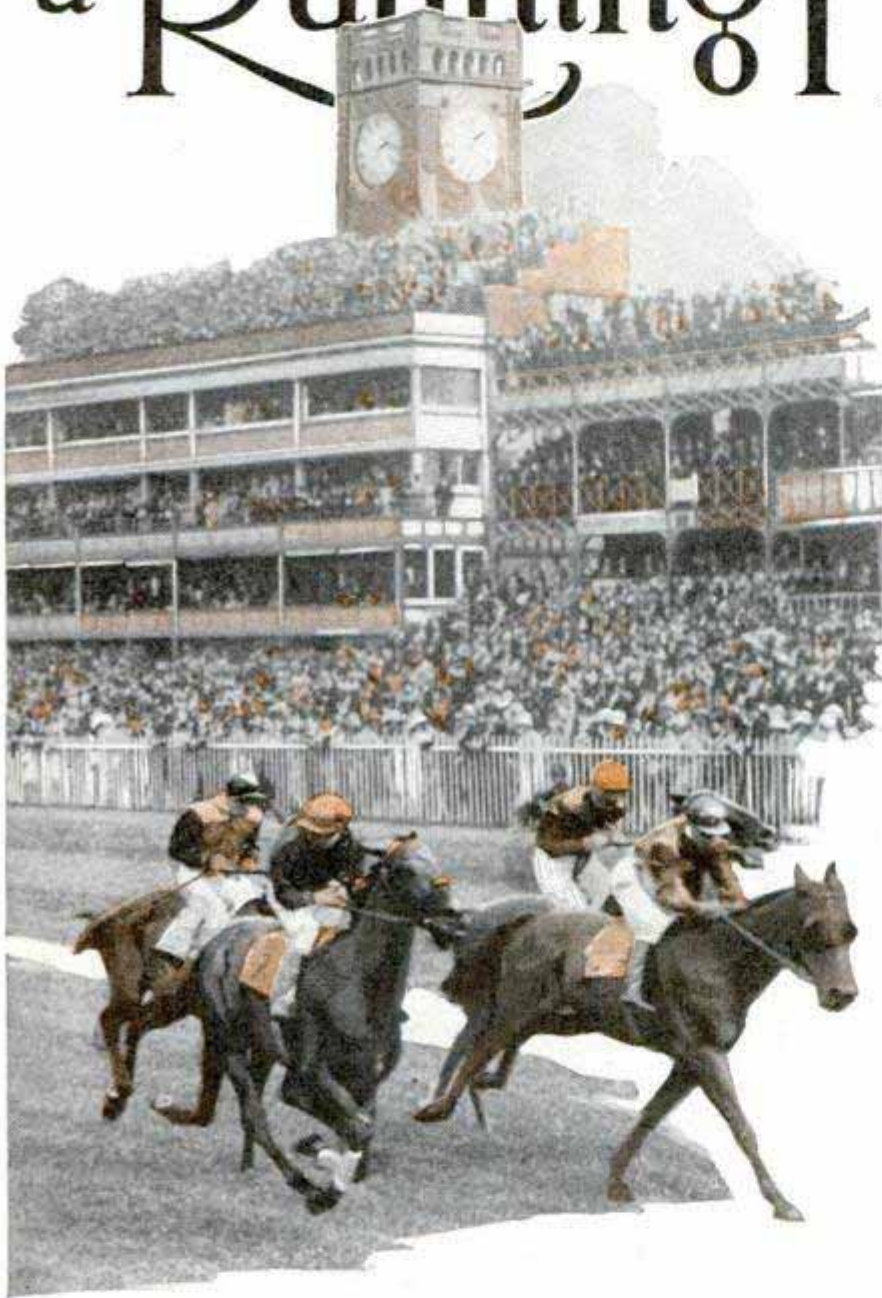

runner calls for a technique different from that in training a trotter or pacer. The trainer of a thoroughbred must study his horse and jockey, too. This is essentially a study of character.

While no rules hold in racing horses, a trotter is generally more dependable than a thoroughbred. Given the same track and race conditions, a light harness horse, which goes a mile in 2.02 on Monday afternoon, will go the same mile in the same time the following day. But no man can depend on a thoroughbred. It is too warm-blooded, too temperamental. It can

buck as suddenly and as viciously as a bronco.

The first evidence of the strong "personality" possessed by every thoroughbred is given when the gangling colt is introduced to the halter. Thoroughbreds are hardy animals, born with great strength of body and spirit. Most of those seen on our running tracks are bred in the famous blue-grass region of Kentucky. The lime and phosphorus of that succulent pasturage make small, tough bones and supple muscles, in spite of which young racing weanlings are fragile creatures.

When "Man-o'-War," greatest race horse of this decade, was in the weanling stage, he cut one of his legs on a fence, went lame and was apparently ruined as a "flat" racer. But he was nursed through the difficulty and became a champion. One of the colts of "the golden

stallion" was so much like "Red," as the stable boys always called "Man-o'-War," that it was valued at \$250,000. It gave its owner a mighty scare by shying and kicking itself into lameness. But it, too, got over it.

Because modern racing methods demand speed contests by two-year-olds and a horse does not naturally acquire full development until it is four years old, the thoroughbred speed nurseries in Kentucky have to "force" the youngsters from babyhood. That is one reason the blue-grass region is so popular. With blue

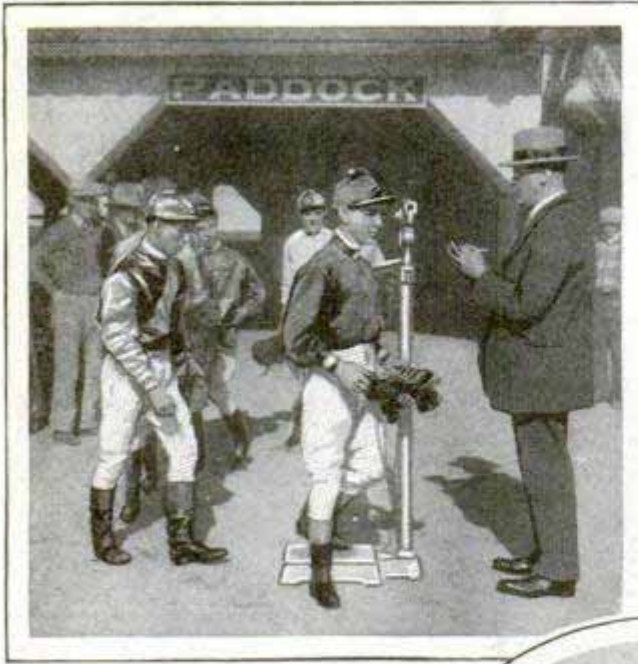

grass as a foundation feed, a two-year-old may stand fifteen hands high in "its stocking feet." But, according to Miss Elizabeth Daingerfield, it costs about \$1,000 to raise a thoroughbred foal to the yearling stage.

Miss Daingerfield, most skillful of all women in rearing thoroughbreds, gains a youngster's confidence by gentleness. She had charge of "Man-o'-War" from infancy and had small difficulty in making "Red" halter-wise. But when, as a yearling, "Man-o'-War" was sold by Maj. August Belmont to Samuel Riddle, and the latter's trainer, Louis Fuestel, slowly and peacefully made him bridle-wise by getting the future record breaker used to a soft leather bit and then to a large-ringed metal snaffle, there was trouble when it came to saddling "Red."

Compared to getting a colt trotter used to bit and reins and to a noisy, clumsy breaking cart, it should be simple to make a colt runner saddle-wise. Without the leaden impost weights, so often called for by the race handicapper, a runner's saddle weighs about three pounds. It is so light and so innocent in appearance that many prospective runners do not resent the

feeling of it on their back. Yet young "Man-o'-War" bucked, reared, screamed and fought the saddle several weeks. By patience and persistence, Louis Fuestel finally had his way. Then "Man-o'-War," like various other thoroughbred champions, became well-mannered on the track. Sometimes he cut capers at the barrier, but he generally saved his energy for racing. His willingness to behave was partly due to the influence of his boon equine companion, "Major Treat."

In the vernacular of the running tracks, "Major Treat" is a "lead pony." Nearly every runner has such a companion from its babyhood. As soon as the colt is halter-broke, it goes round and round the paddock or pasture lot following the lead of its equine pal. The pal is cold-blooded, that is, not entirely thoroughbred. Being of a less nervous temperament, it cools the ardor of the thoroughbred.

When bridle lessons have been



Jockeys Weighing in at Tia Juana; Derby Horses Working Out at Churchill Downs, and an Early Morning "Clocker"



An Upset That Thrilled England; Pat Donoghue, Fifteen-Year-Old Son of the Famous Steve Donoghue, Won the Lincolnshire Handicap Riding a Hundred-to-One Shot

completed, and the colt has ceased to buck and kick at the saddle girth, it is led by the pony to the training track where a light exercise boy of some hundred pounds is given a "leg up" on the candidate for honors at Belmont, Saratoga or Churchill Downs. Racer and pony then temporarily part company.

If the trainer is doubtful about his pupil's nature, he may cling to the "shank" or tie-rope on the halter, which he leaves on the colt's head beneath the bridle. If the pupil bolts, the trainer pulls, so the boy in the saddle need not injure the young racer's mouth. Thoroughbred stock is too valuable to risk rough treatment. At best, this first track try-out is critical.

No one knows whether the youngster will shy at the track rails or at its veteran companions of the track, whether it will run away or behave. The trainer does not have one problem which faces the trainer of a trotting horse, for running is a natural gait, and hence there is no danger of the novice breaking from a trot or pace. But there is always the question of temperament. Many an exercise boy, unseated by unexpected bucking, hits the ground.

A quarter mile is long enough for the

first running lesson. Each day the colt is galloped more and more. Gradually its speed increases until special "clockers" with stop watches begin to take the time of "dashes."

As the yearling enters its second year, the trainer is able to anticipate some of his pupil's possibilities. An apprentice jockey mounts the saddle. An apprentice is a light boy who has won less than forty races, hence his fee is not expensive. If the two-year-old shows promise, a star like Earl Sande or Laverne Fator tries him out some early morning.

Like horses and trainers, the jockeys must be at the track by broad daylight. They diet more carefully than the horses. Laverne Fator's daily program gets him out of bed by 5:00 a. m. and allows him a breakfast of fruit and toast with sugarless black coffee. From six to ten o'clock he is on the track, exercising, schooling or galloping horses of all ages and characters. While the track is harrowed for the afternoon's races, Fator is in bed resting, but, at 1:00 p. m. he reports to the jockey room. On a lunch of orange juice and raw egg, he rides his mounts, perhaps to victory. At 6:00 p. m. he dines, without starchy foods, sugars, milk, cream or pas-

try. At ten o'clock he is back in bed again. One of his jobs, as of any jockey's, is to accustom the colts to the race-track barrier. This is a rubber webbing stretched across the track at the starting line. The horses stand quietly or "act up" back of it, until it is snapped and they are away.

A quick getaway is mighty important to a "bang-tail" dasher. Many races are won or lost at the barrier. It is the jockey's job, with assistance from the trainer and others, to keep his mount's nose pointed in the right direction while he keeps an eye out for competitors. Some racers are "post actors," that is, they cut up abominably at the barrier. But many runners stand quiet though "on their toes." Such a one was "Billy Kelly."

When Sande rode "Billy Kelly" for Comm. J. L. K. Ross, the fast horse was so barrier-wise the grandstand often commented on "the sleepy one." But from the time the jockeys were called out and the saddles put on, and "Billy" left his lead pony and the paddock for the track, he knew what it was all about. While other horses pranced and reared, he kept his head so close to the webbing that he "got the jump" on the rest of them. Such a horse, said Sande modestly, hardly needs

a mount at all. But others are not so tractable. Even after months of training no one knows just what to expect.

In the meanwhile the trainer must solve the shoeing problem. Runners seldom need to be "balanced" as do trotting horses, yet such breeders and trainers as John E. Madden, whose horses have won thousands of track events, either shoe their own with light plates or have their own farriers on the job. A month is a long time for a shoe to last, even if it is of aluminum, yet sometimes they last longer than the runner's legs.

Tendons are watched particularly. A bowed tendon, resulting from pounding of hoofs on hard tracks, may permanently retire a running horse. That is what retired "Man-o'-War" when "the golden stallion" was beating everything. Hot cloths and water, and much rubbing, may reduce a bowed tendon effectively, but in stubborn cases a stable veterinary may "pin-fire" the swelling with hot irons after deadening its nerves with cocaine. A trainer must watch his horses' feet and legs as carefully as he watches their digestion and appetite.

A jockey is responsible for about a half of running-race results. That is why one so intelligent and reliable as Sande won \$2,500,000 for his employ-

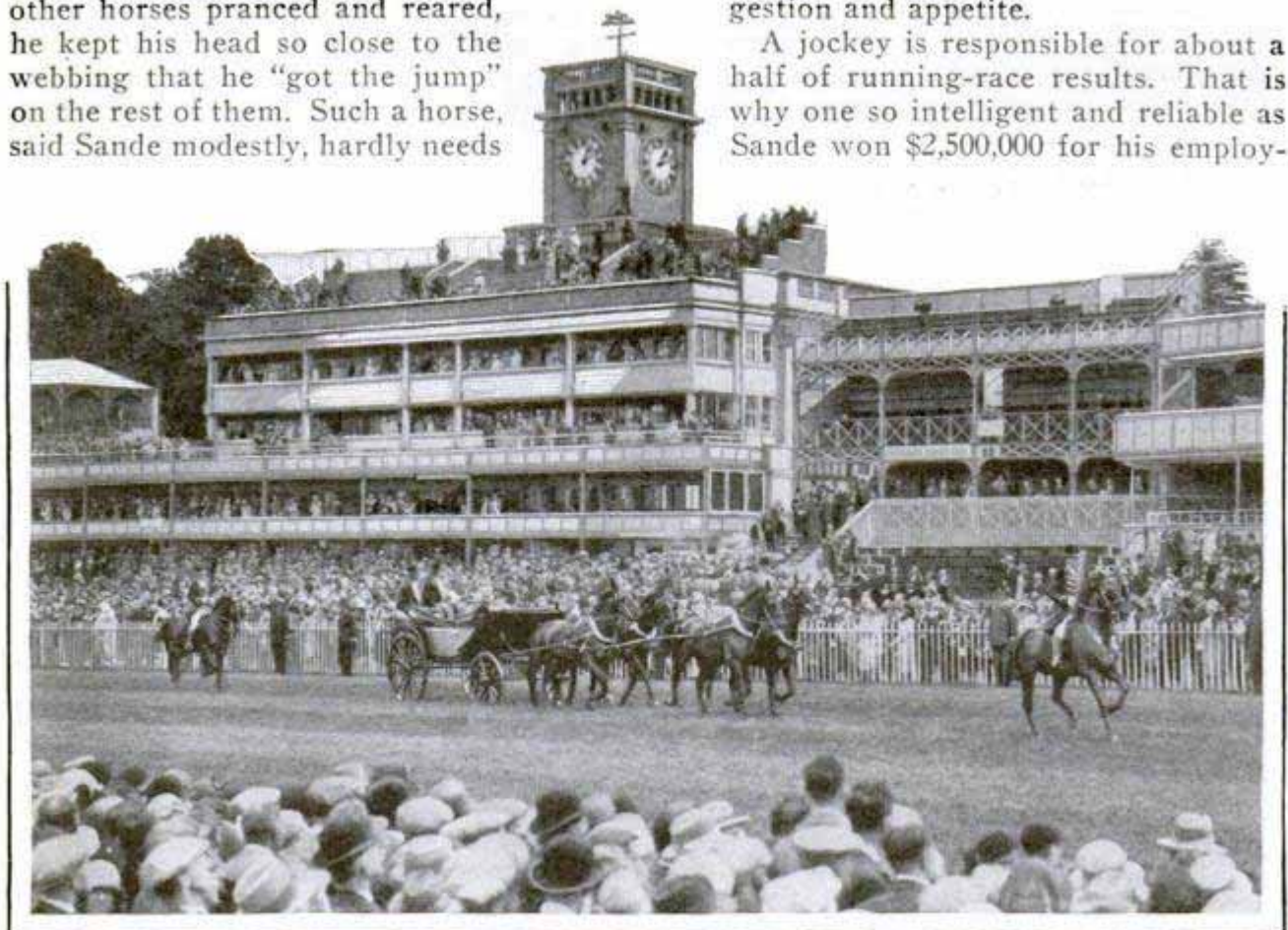

The Sport of Kings Is More Colorful in England, For There Are Kings There to Enjoy It; Here Are the King and Queen Riding down the Course Before the Royal Ascot Is Run



"Whiskery," after Winning the Kentucky Derby, Took the Twin City Handicap at Belmont Park; Here Harry Payne Whitney's Famous Horse Is Shown Leading the Field in the Stretch

ers in eleven years and, when retired by increasing weight, was able to start a training stable of his own. A trainer makes and picks his runners, but the jockey has to boot them home.

Producing winners is the trainer's job. Max Hirsh, who trained such sensations as "Sarazen," "Gray Lag" and "Flying Cloud," admits that it is a mystery why a horse that wins easily one day in 1.39 will be beaten on the same track and under the same conditions the next day in 1.39½. Yet under his management, "Sarazen," for whom Mrs. W. K. Vanderbilt paid \$35,000 on Hirsh's advice, won more than \$215,000. Mr. Hirsh, who is one of the leaders among the younger generation of "bang-tail" trainers, says: "In picking a yearling, I must see something in his walk and appearance that appeals to me. But he should have a good eye in an intelligent head, well set on, with a wide jowl to a good neck; a deep, rather than a broad, chest to give him plenty of heart room; deep girth, well-sprung ribs, short forelegs from knees to fetlocks; wide hips; straight hindlegs, not too fleshy; full lower quarters and good flat bone, and he must not be so closely coupled that free action is difficult." To which he might have added a hundred other things. Among things to avoid are eccentricities.

Good horses turn out to be "rogues" that raise Ned at the barrier and bolt

when they should hold steady or be smoothly galloping. Among the banes of the trainer's life is the "morning glory." One such made history on a western track. This horse went like the wind in morning try-outs. A "rail-bird" spotted and "clocked" the wonder. A moneyed owner was tipped off to it and bought the "world beater" at a fancy price. But when the afternoon race came off the wonder didn't win. That horse was a whiz during rehearsal hours but a dud in racing. He was incurably a "morning glory."

2579  
**GROW CLAMS BY NEW PLAN  
 TO AID BUTTON INDUSTRY**

Constant and better supplies of fresh-water clams, whose shells are used in the manufacture of buttons and various novelties, are visioned as the result of an improved propagating and restocking program to be undertaken by the government in streams of the Mississippi valley. Dr. M. M. Ellis, of the University of Missouri, has developed a nutritive fluid which can be deposited in the river beds and is said to remove much of the uncertainty of the early life of the young clams. The first two weeks of their lives are the most difficult, for they are left to shift for themselves, and only a few can find the right kind of food to insure their growth during the first twelve or twenty days.

*Chicago Daily News*

Comr. James Suddeth  
Box 54, Sea Rich.

Warehouse Radio  
Corp. of America

POPULAR MECHANICS

Atlanta, Ga

203 Broad St.

904

24 9.5

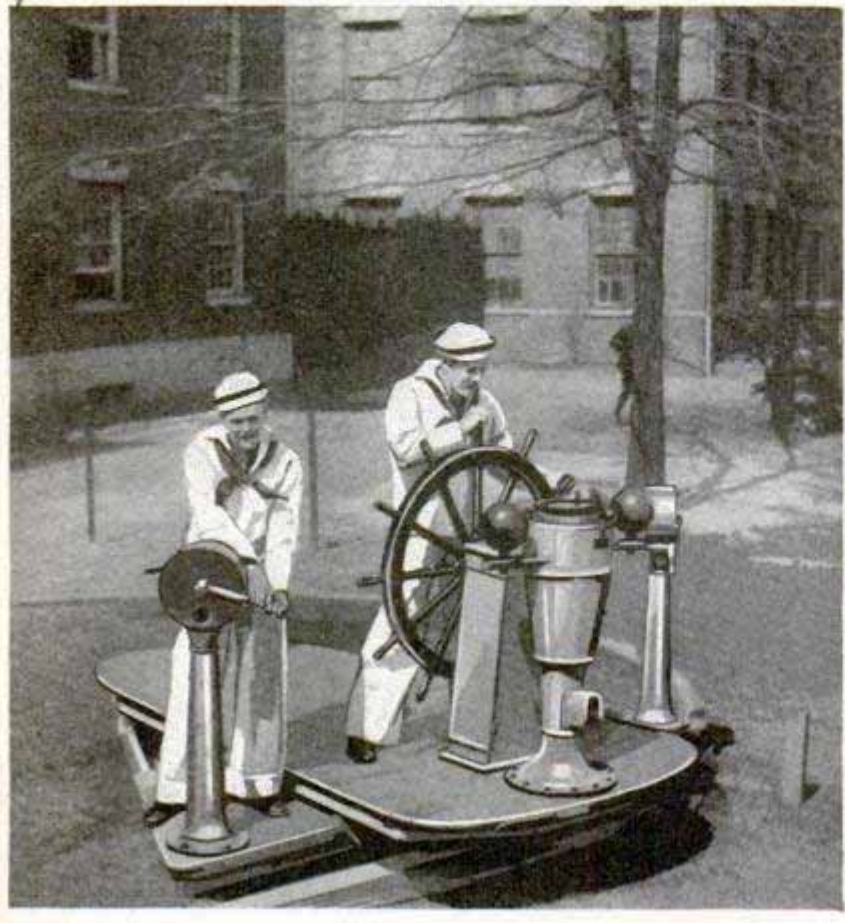

Learning the Tricks of Navigation on Dry Land; Naval R. O. T. C. Men at Georgia School of Technology Taking a Lesson

### DRY-LAND SAILING TEACHES CADETS NAVIGATION

Members of the naval R. O. T. C. unit at the Georgia School of Technology are taught some of the principles of navigation on a moving ship's bridge, set up on the grounds. It is equipped with a wheel and instruments, and when the wheel is turned, the bridge is guided on a circular track, moving in much the same manner as a real vessel would. With this apparatus, the cadet can learn to steer a prescribed course almost as accurately as he could on board ship.

### LONGER-BURNING FLARES AID AIR PILOTS IN LANDING

Flares that will burn for twenty minutes and produce a bright glow have been introduced to fill the need of better emergency illumination on intermediate landing fields and to warn and flag aviators. One of the red flares was seen from a distance of ten miles and an altitude of 1,000

to 5,000 feet, although there was a slight ground mist. The distinguishing distance of this type of red flare was about five miles. It has been recommended that these longer-burning flares be substituted for those now in use which burn only about ten minutes.

### PROCESS ENABLES RADIO PICTURES IN COLORS

Rapid color printing of pictures transmitted by radio has been accomplished by an eastern inventor. He employs a heat-sensitive, wax-coated paper, over which a hot-air brush is passed, the jets being actuated by radio impulses. The hot air melts away the wax making a pattern that corresponds to that on the original photograph

being sent. An ink roller is run over the wax surface, bringing out the picture almost instantly and in permanent form. By means of a code, the receiving operator is able to ink the picture in colors.

### THREE-WHEELED AUTO TRUCKS REDUCE CONGESTION

Three-wheel automobile trucks have appeared in London and are used with success in the crowded parts of the city, according to reports. They can be turned around in their own length, are easily steered, and have large carrying capacity.

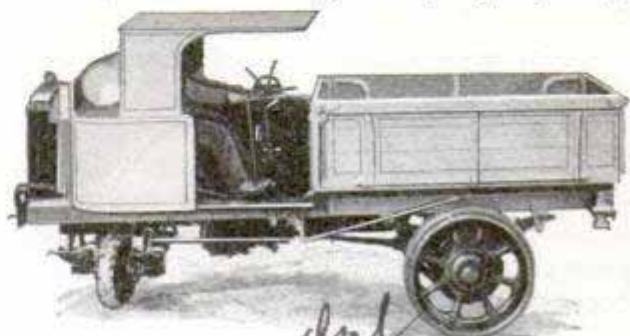

Easily Steered among Congested Traffic, This Three-Wheel Auto Truck Is Proving Useful in London

Atlanta, Ga

Warehouse Radio Corp.

2542  
Frank Es  
Warehouse Radio Corp.

Dept. of Commerce



Hall, Lawrence &  
Ratcliffe 1123 W

Made in Chicago

**"TELEGRAPH-POLE" PLAN  
JAIL TO REDUCE CRIME**

Interesting features <sup>255</sup> found in Cook county's new criminal courthouse and jail at Chicago, recently completed at a cost of approximately \$7,500,000. Having, in round numbers, 1,400 cells, the jail occupies part of the rear portion of an eleven and one-half acre plot and has been constructed on the so-called "telegraph-pole" plan, that is, with various units extending on either side of a central two-story corridor, representing the pole. Each cell is five by eight feet in size, and all have drinking fountains. Included in the typical cell block, or group of cells, is a large day room, for the prisoners. At the entrance to each block from the main corridor, is the guard's room, from which all the cell doors are locked or unlocked, separately or together, by mechanical controls operated by systems of levers. Visitors are allowed to speak to inmates but may not come directly in contact with them, thus preventing any attempt to pass in weapons or drugs. This is accomplished by means of booths with windows of shatter-proof glass. The prisoner stands on one side, the visitor on the other, and conversation is easily carried on, as the sound of the voice is carried through openings in the corrugated metal partition between the glass window and the frame, but these openings are so arranged that no article of any kind can be passed through.



Lowering Aviator Safely to the Ground After His Plane Had Been Wrecked in a Tree Top

**ELECTRIC WARMER FOR FOOD  
REQUIRES NO WATER**

Food is kept warm by electric radiation and hot air in a "steam" table recently introduced. No water is required.

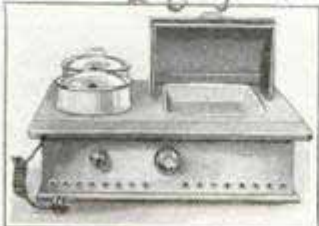

Current is supplied from a house-lighting socket and no special wiring is necessary.

Allrite Co  
1111 N. Dearborn St.

**AVIATOR RESCUED FROM TREE  
AFTER PLANE IS WRECKED**

<sup>2184</sup> Thomas Halton,  
A tree saved the life but wrecked the plane piloted by a Pennsylvania aviator recently. At an altitude of 2,500 feet, the ship went into a tailspin and could not be brought into full control before it crashed into the tree. The pilot, who suffered only slight injuries, was rescued with ladders and ropes.

Scranton Pa.

☐ We want all our readers to write us freely and often whenever they wish additional information on articles published in this magazine. Address Bureau of Information, Popular Mechanics, Chicago.

2575

*School for the deaf  
 6045 - Stanton and Electro  
 branch*

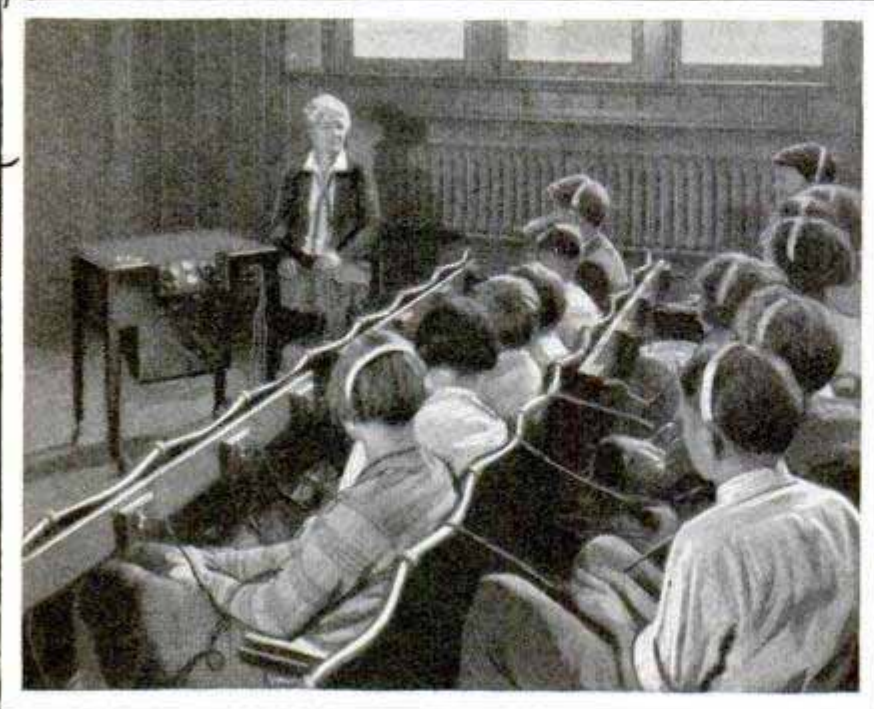

Classroom Installation of the Radio Apparatus for Instructing Pupils Who Are Hard of Hearing

**ELECTRIC SET TO TEACH DEAF RUNS FROM LIGHT SOCKET**

Use of sound amplification to teach deaf children and other persons of deficient hearing was highly stimulated by the birth of radio, since amplifying equipment of much greater effectiveness than any known before became available and sound could be controlled. Radio apparatus for instruction of the deaf has been improved along with other wireless units. One of the latest installations, adapted especially for teaching children in a classroom, is so connected that several pupils can listen at one time from their seats. Music or voice is picked up electrically from a record in the main cabinet, which uses no batteries but operates from a lighting socket. This permits even service at all times, which is an important feature.

*and or*  
**BEST MARKS FOR AIRWAYS SHOWN BY COMMITTEE**

*2539*  
 Adequate markings for the guidance of aviators in every city, town and hamlet are urged by the department of commerce. A report declares that legends should be as simple as possible, that chrome-yellow characters on a dead black background are preferable, and that the height of the letters should be from ten

to thirty feet. In no case should the letters be less than six feet. The spacing between the characters should be not less than one-fourth the height of the letters. Careful specifications for the illumination of airway signs and guides also were worked out.

**RAILROAD TRACTOR IS MOTORED BY AUTO ENGINE**

2488

A five-ton railroad tractor, for use in moving cars in factory yards and similar industrial switching, is being marketed in France with a Ford engine for motive power.

Power is transmitted to both axles by a single chain drive, so all four wheels are drivers, and the necessary weight to give traction is obtained by casting the entire chassis, thirteen feet long, in one piece. The machine has three speeds in either direction, each controlled by a separate clutch, so that all gears remain constantly in mesh, including those of the reversing mechanism. The normal hauling speeds are two, four and one-eighth and six and one-fourth miles an hour, and from a standing start, the machine can move 120 tons on level tracks. Some idea of the difference in American and European machinery prices is gained from the fact that the machine complete sells at \$1,400.



Railroad Tractor, Powered with Converted Ford Engine, for Use in Moving Cars in French Yards

*Aeronautics Branch*

*Caston Meyer*

2570  
1512 1/2  
CMT. City  
Rosalia Road  
Los Angeles Calif

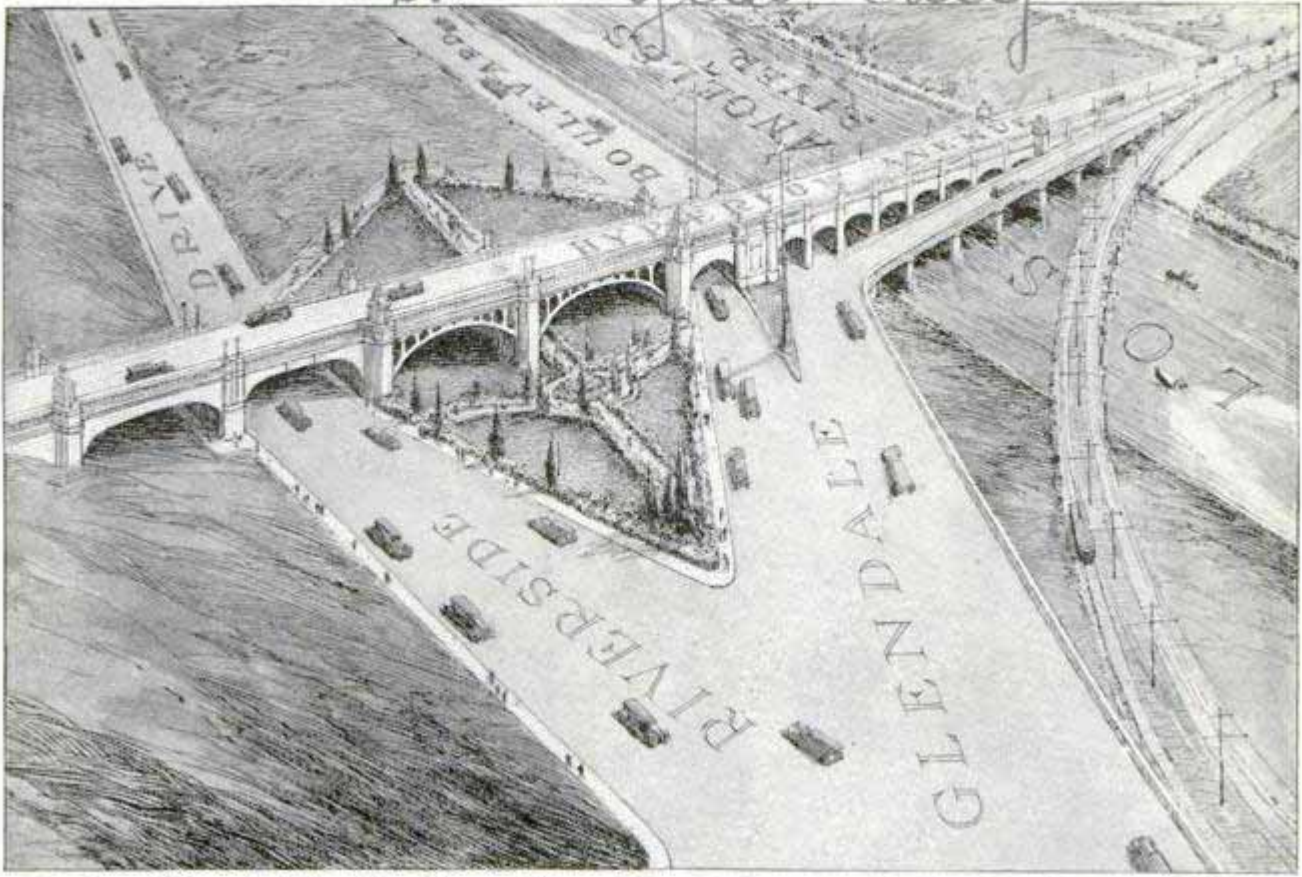

Drawing of Unusual Viaduct That Spans a River and Two Boulevards and Enables Easy Passage to Different Levels; It Solved a Difficult Traffic Problem near Los Angeles

**ODD TWO-LEVEL AUTO BRIDGE RELIEVES CONGESTION**

Several unusual features are combined in a highway bridge near Los Angeles. It spans the Los Angeles river and, at this point, is really three bridges in one, in order to accommodate traffic to and from

the city and on one of the main boulevards it serves. There are thirteen spans in all, of varying height and length; the bridge proper is 1,600 feet long, and the project cost more than \$1,000,000. By skillful engineering, automobile and electric-railway traffic was going on uninterrupted during the construction.

**FLYING HOTEL TO CARRY EIGHTY AND HAVE TWELVE MOTORS**

Twelve-motor flying boats, capable of carrying eighty passengers at 200 miles an hour, are being planned by Dr. Claude Dornier, the German designer. The huge ships will virtually be hotels of the air, offering restaurants, reading rooms, promenades and other features associated with land structures. The boats, of which three are being planned, will have a wing spread of 150 feet; the twelve motors will develop 6,000 horsepower; each ship will weigh fifty tons loaded and can cruise 2,700 miles. They will be able to land or take off in a heavy sea and are to be of the monoplane type. The craft will be used to carry mail from Europe to South America and for passenger traffic about Europe. Doctor

Dornier believes that planes carrying as many as 250 persons are a probability of the next few years.

**RAPID COIL-SPRING WINDER MAKES MANY SIZES**

Coil springs of many lengths and diameters are quickly and easily prepared on a simple winding machine which has been placed on the market recently. Duplicate springs can be made with great accuracy, it is asserted, and care rather than skill is required to operate the winder so as to produce uniform coils.

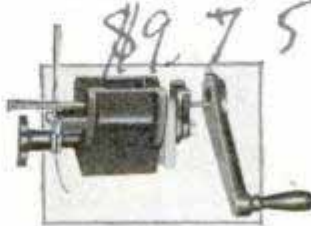

Herald Examiner  
2/22/24

The Shaler Co  
West Park Place

2165

Paradise

# Wild Life is Preserved in Glass Cages



A. G. Rueckert, Staff Taxidermist of the Field Museum of Natural History, Preparing a Model Bear Group

THE wildest-looking wild animals to be seen in civilization today are not in the zoos or circuses, but in the big glass cases of the modern museum. Of course, they are dead—and hollow too—but they seem alive in all their natural beauty because skilled sculptors and other craftsmen have literally taken the stuffing out of taxidermy. The days of stuffed animals are practically gone. The craft, by the way, is one of the most recent of all the arts, probably not much more than 300 years old, and in late years, improved tools, better methods and higher standards have given the profession a wholly new tone. Today, a true taxidermist is a sculptor-painter-naturalist, and his work is full of

thrills and adventure as well as hardship and difficulty.

When the late Carl Akeley prepared the ponderous body of "Jumbo," beloved circus elephant killed in a railroad wreck, and the first large African elephant to be mounted in this country, and when Dr. William T. Hornaday, a few years before, finished his orang-utan group, one of the first of its kind in America, they laid the foundation for present-day methods in taxidermy. They, and a few others who followed in their footsteps, are largely responsible for the effectiveness and educational value of

the modern museum groups which literally bring the animal life of jungles, deserts and the frozen seas to the doors of the cities.

Many steps are involved in the creation of a big-animal tableau and a complete description of them all would require a book. In the studios of the Field Museum of Natural History, some of the most important steps in this highly interesting work may be observed.

Over there in one corner, A. G. Rueckert, one of the staff taxidermists, and a member of the recent Rawson-Macmillan-Field museum expedition to Labrador, is preparing the working plans for a large bear group. From photographs, silhou-

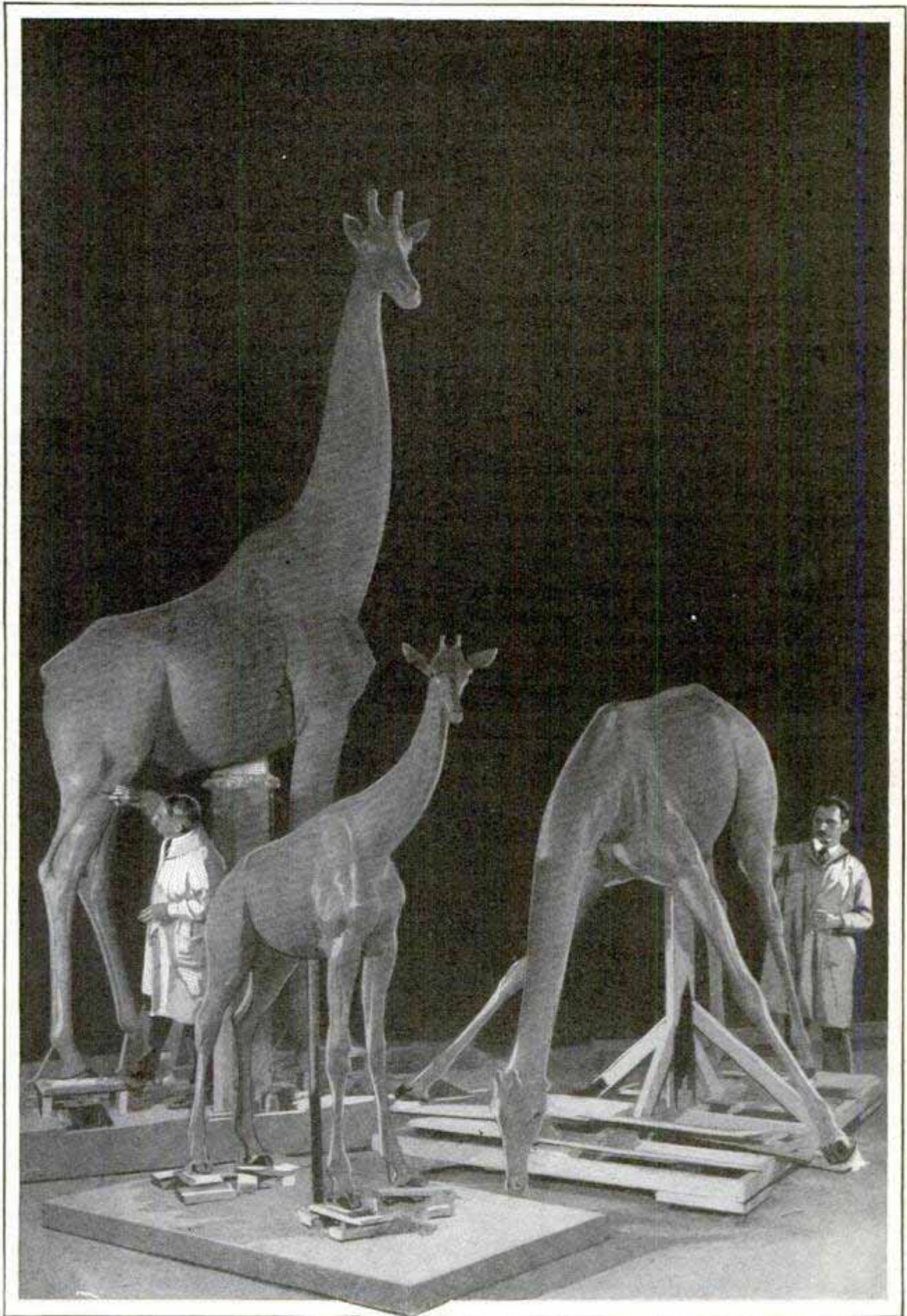

Courtesy American Museum of Natural History

**At Work on Giraffe Specimens for the Water-Hole Group in the American Museum of Natural History; These Three Fine Specimens Were Obtained in Africa by an Expedition Headed by the Late Carl Akeley**

2165

ettes cut in paper and from other data, he is preparing a small model on the scale of an inch and a half to the foot. The tiny animal figures are carefully molded and arranged as they are to appear in the finished display and a painted background is added so that this first model is literally a miniature of the final booth.

J. Friesser and his assistants are at work on the big figures. They are using some of the actual bones from the animal specimens to form a foundation, and a clay model is built up after the pattern of the small wax figures. From the clay, a plaster-of-paris mold is made and from this cast the final body of the animal is obtained. This—the "manikin"—is built up from plaster and reinforcing materials and is the structure over which the animal's original skin, which has been carefully tanned and treated, is stretched. The base is anatomically correct in every detail, a fact that largely explains the lifelike appearance of the finished animals. Charles A. Corwin, museum artist, who accompanies some of the expeditions that he may obtain his material directly from nature, has painted the large scenic background for

installation inside the case. Building the cabinet itself is a special task, as it must be as nearly airtight as possible to keep out dust, and the lighting arrangements are adjusted with great care in order that the group may be displayed to the best advantage. After the entire assembly has been approved by Dr. Wilfred H. Osgood, curator of zoology, and by other naturalists of the museum staff, it is ready for public exhibition.

The more exciting episodes in the work, of course, occur on the hunts, and some of the taxidermists' most important work is done out in the wilderness, far from the museum's studios. For instance, careful measurements and death masks are made of some of the animals' heads and other parts a few moments after the specimens have been killed, and the larger bones are removed for the model foundations. All this requires skill and expert knowledge of the animals and their anatomy. Only the most perfect individuals are selected for the museum displays. The choice requires familiarity with the best kinds of hides and skins, knowledge of the species being selected, and care must be taken not

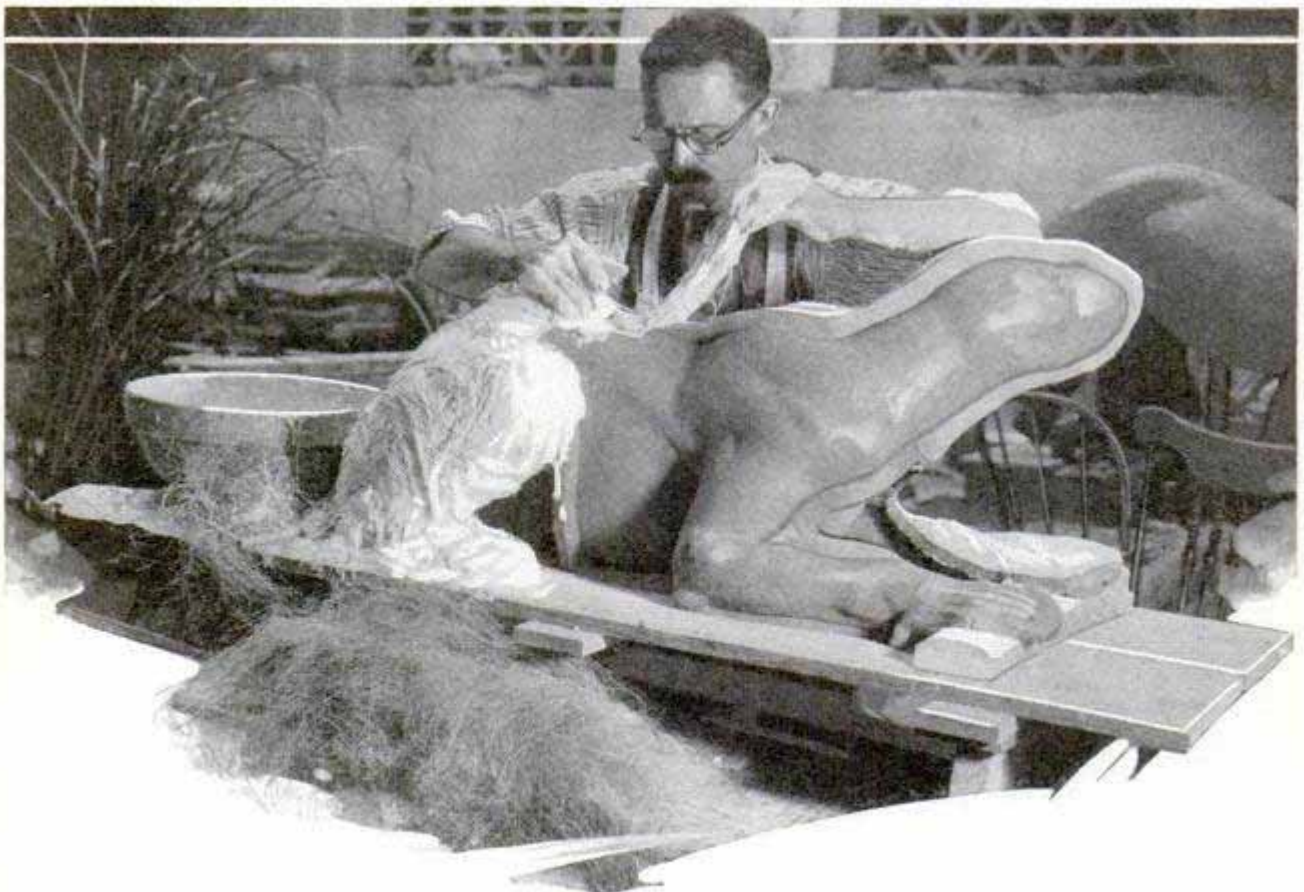

J. Friesser Building Up the Plaster Cast of a Bear from a Clay Model; the Finished "Manikin" Is the Base over Which the Skin Is Stretched; No Stuffing Is Employed in the Figure

to mutilate the animal in the killing or in the skinning.

The successful taxidermist-naturalist must be a man of resource, endurance and bravery. Up in Labrador and Baffin island, for instance, members of the Rawson-Macmillan-Field museum expedition met severe hardships and perils along with the joys of the trip. They found treacherous ice fields that gave way under the dog teams and human travelers, severe winds hampered their progress and they were forced to wage constant warfare against the two most desperate foes of

the northern traveler, the mosquito and the black fly. These pests bite with great ferocity at all times of the day and far into the night. After a day of travel, it is not uncommon to find one's underclothing stained with blood from their savage thrusts. Hands and wrists must be bandaged and the face protected as thoroughly as possible. Were it not for these enemies, Labrador would be an ideal summer resort in many ways, the travelers declare, for it abounds with beautiful scenery, the waters teem with fish, and there are countless wild flowers of gorgeous colors even far above the timber line. Most of the trees, where trees grow at all, are dwarflike, some not exceeding a few inches in height.

Some of the members of the expedition helped build a ten-room house as a base of operations at Anatalok bay. At another time, a member of the party had an opportunity to show his resourcefulness. He had collected a number of valuable birds' eggs, some of them worth more than \$10 apiece, but discovered that the blowing outfit had been left at camp sixty-five miles away. With part of a condensed milk can and some bits of adhesive tape, he devised a successful blowpipe and brought the precious eggs safely back along with some 6,000 other specimens the expedition had collected.



Big Lifeboat Being Tested off English Coast; It Holds 150 Persons and Has Eight Water-Tight Compartments

### LIFEBOAT THAT WON'T SINK HOLDS MANY PERSONS

Fitted with eight water-tight compartments, a non-sinkable lifeboat introduced in England, will hold 150 persons. The craft has performed satisfactorily in tests.

### SWEEP WIPER FOR WINDSHIELD CLEARS ENTIRE TOP

Clearing a wider area, an improved type of windshield wiper operates with a sweeping action and cleans nearly the entire top of the glass. This is said to cause less interference with the vision.



Wide Windshield Wiper Which Sweeps across the Top of the Glass, Clearing a Larger Space

*Special American Institute of Cooper Union*

2519



Gasoline-Price Gauge at Filling Station, with Adjustable Arrow for Quoting the Latest Figure

### PRICE GAUGE FOR GASOLINE AIDS FILLING STATION

Motorists are clearly informed as to the current prices of gasoline at a California filling station by means of a huge arrow gauge which can easily be adjusted to point to the proper figure. The device was especially helpful in attracting customers during a recent price war when the cost of gasoline changed almost daily.

### GRINDER RUN AT HIGH SPEED SHARPENS DIES

For sharpening threading dies, a grinding wheel, run by a high-speed motor, has been introduced. It turns at more than 400 revolutions per second, the fast rate being attained by the special motor and frequency changer, which converts 60-cycle current into 420 cycles. The oiling system for the motor is automatic so that it requires little attention.

### "LIVING LIGHT" A POSSIBILITY SCIENTIST DECLARES

Will man be able to duplicate the fire-fly's light? In the opinion of Dr. E. Newton Harvey, of Princeton, some form of "living light" may be produced in the scientist's laboratory through the application of known principles. He asserts that it is possible to devise a lamp in which "luciferin" is burned continuously over and over again. The resulting light is weak but the principle is there and may be applied in the future development of a new means of illumination, he says. The fire-fly is highly economical in that it burns an oil and then re-forms the substance so that it can be burned again. Doctor Harvey found that this light, and that from other organisms which produce luminescence, is an oxidation and requires oxygen and water. Some animal matter, he discovered, became luminous again after moistening. If oxygen is removed from a luminous animal, its light disappears completely, but returns when the oxygen is readmitted.

### ANTI-GLARE SHIELD ON HAT FOR AUTO DRIVER

Easily attached to the brim of the hat, an adjustable shade is intended to shield the wearer's eyes from the glare of automobile headlights. It does not interfere with the vision, and may quickly be raised out of the way when not needed.



Shield Adjusted to Hat Rim, to Protect the Eyes from the Glare of the Sun and of Auto Headlights

2554  
*new York Times 2/20/29*

2553

*Garbes + Myers, 172  
Main St. Worcester, Mass*



2438 Mr. W. J. & Rager,  
 151 2/3 Rosalia Road  
 Los Angeles, Calif.  
 POPULAR MECHANICS 913



Tide Rips and Undertow, Which Often Prove Dangerous, Are Eliminated at a New California Beach, Which Has a Long Semicircular Sea Wall to Insure Still Water in the Pool

**FORTY-ACRE SWIMMING POOL  
 REDUCES HAZARDS**

Swimming in still sea water will be enjoyed in a forty-acre pool now being constructed close to shore at Long Beach, Calif. Breakwaters will shield the swimmers from surf and tides that sometimes prove dangerous. The pier is in the form of a horseshoe and, at the open end, is to be an eight-acre plot which will provide space for a large auditorium, theater, and convention and athletic halls. There will be a roadway for vehicles on top of the breakwater, which is 3,800 feet long. On the inner rim will be a gallery with large seating capacity for those who wish to watch the bathers. The project is to cost \$5,000,000 and is scheduled for completion some time in 1930.

Answers 8/16/29

**ARTISTS IN BUTTERFLY WINGS  
 DO THEIR WORK BACKWARD**

Artists who develop designs from butterfly wings at a London studio, work with great care not to destroy the fragile material and spoil the coloring, and build up the patterns backward in order that they may appear in the proper arrangement on the vases and other articles they decorate. As many as fifty wings are used for a sin-

in Clerkenwell  
 London, Eng

gle picture, the outline of which is first traced and a small portion sketched in with paints. The greater area of the design is developed with the wings, which cannot be surpassed for their natural coloring and blending. Small shears and tweezers are used in preparing the wing fragments. The pieces are never touched with the hands as that would disturb the colored dust. Many of the wings are shipped from the swamps of central South America, where natives collect them after the insects have died.

Hardware  
 Lubin  
 Gray

**THREE-SURFACE SANDING BLOCK  
 FITS HAND AND WORK**

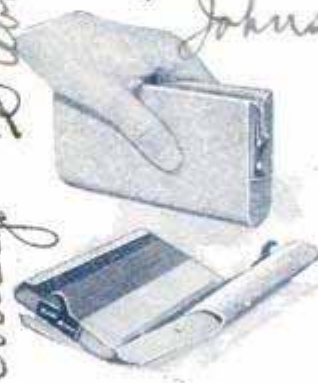

Ease of operation and efficiency are features claimed for a sandpaper block that comfortably fits the hand, takes a half sheet of standard-size paper and has three sanding surfaces. One is for grooves, the

other for curves and the third for flat surfaces. The paper is held in place by adjustable clips.

Johnson  
 Paul E. Wylie  
 629 S Spring St  
 Los Angeles, Calif

# The TRUTH about the

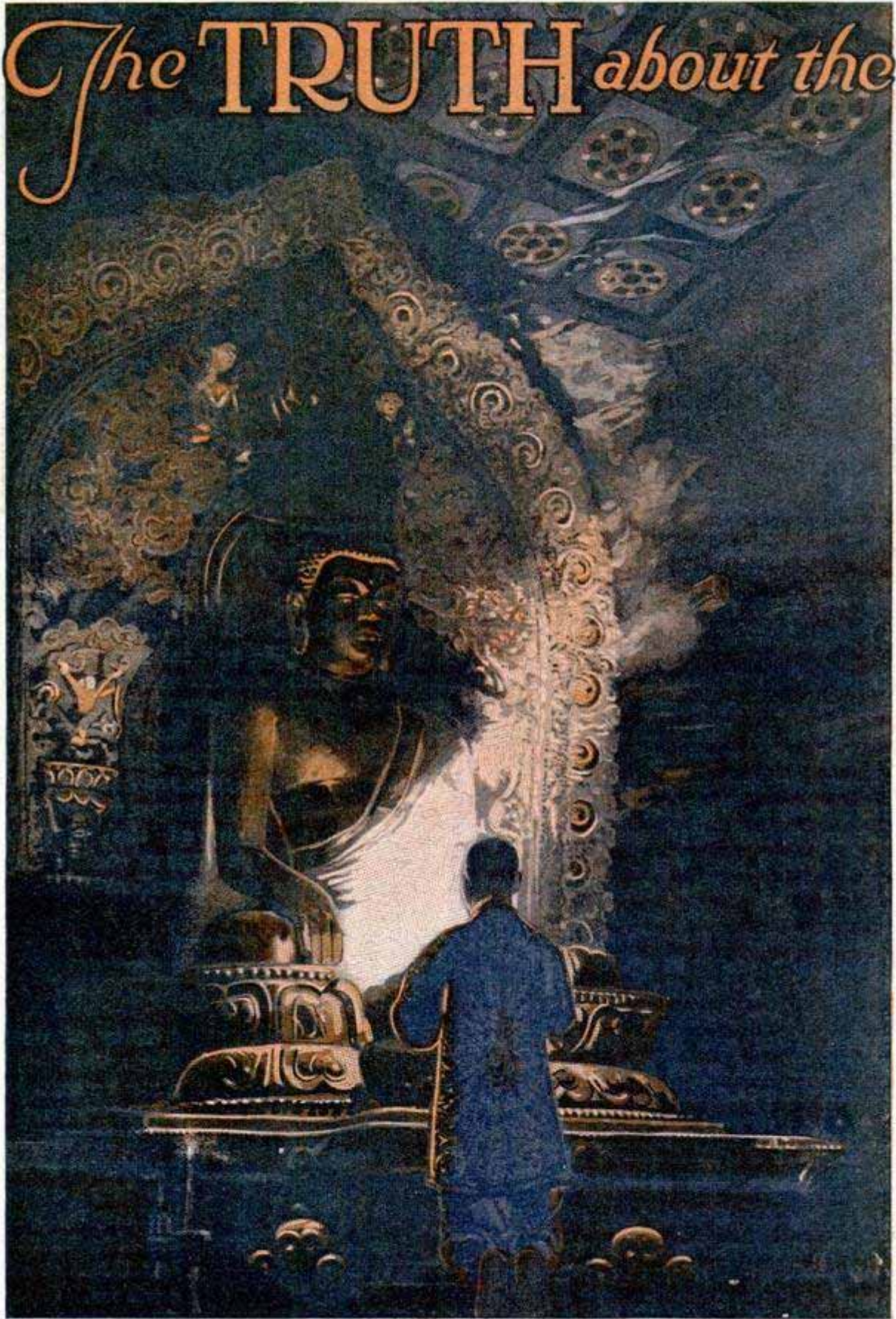

Courtesy The Sphere

The Color of Old China; a Buddhist Monk Praying before the Principal Altar in the Temple of Ten Thousand Generations, near Peking; in a Wing of This Temple Tsi-Hsi, the Last Empress of China, Established a Library Where She Spent Many Hours in Study

# TONGS

Young China in America: Boys in San Francisco's Chinatown Getting New-Year's Good Fortunes from the Mouth of the Great Dragon That Means Peace and Joy for All Who Behold It; Some Processional Dragons Are Hundreds of Feet in Length



"TONG War Breaks Out Again," headline the newspapers about once every year or two, with details of the killing of one or more Chinese in some American city or cities, and the added information that police in San Francisco, Chicago, New York and other centers of Chinese colonies are on the watch to avert further violence.

Coupled with these news stories, the reader usually finds the names of two organizations—the On Leong tong and Hip Sing tong—and the average reader concludes a Chinese tong is some sort of gangsters' organization. Nothing could be farther from the fact.

For example, there is Ming Gai Hong, otherwise known as the Four Brothers' tong. If Ming Gai Hong is a gang, then the D. A. R. and the Pilgrim's society are

gangs, for virtually the only difference between the Four Brothers' society—which is what the word "tong" means—and the Sons or Daughters of the American Revolution is that the Ming society is quite ancient, being a few years older than Christianity itself.

Why does a tong war almost invariably involve On Leong and Hip Sing? If the newspapers announced that, as a result of labor difficulties between the Chinese merchants' and employers' association and the union of Chinese restaurant and laundry workers, one or more Chinese on one or both sides had been killed during strike riots, the story of a tong war would cease to be a mystery.

Hip Sing is the Chinese version of a labor union, and On Leong, the Chinese merchants' association, is a chamber of

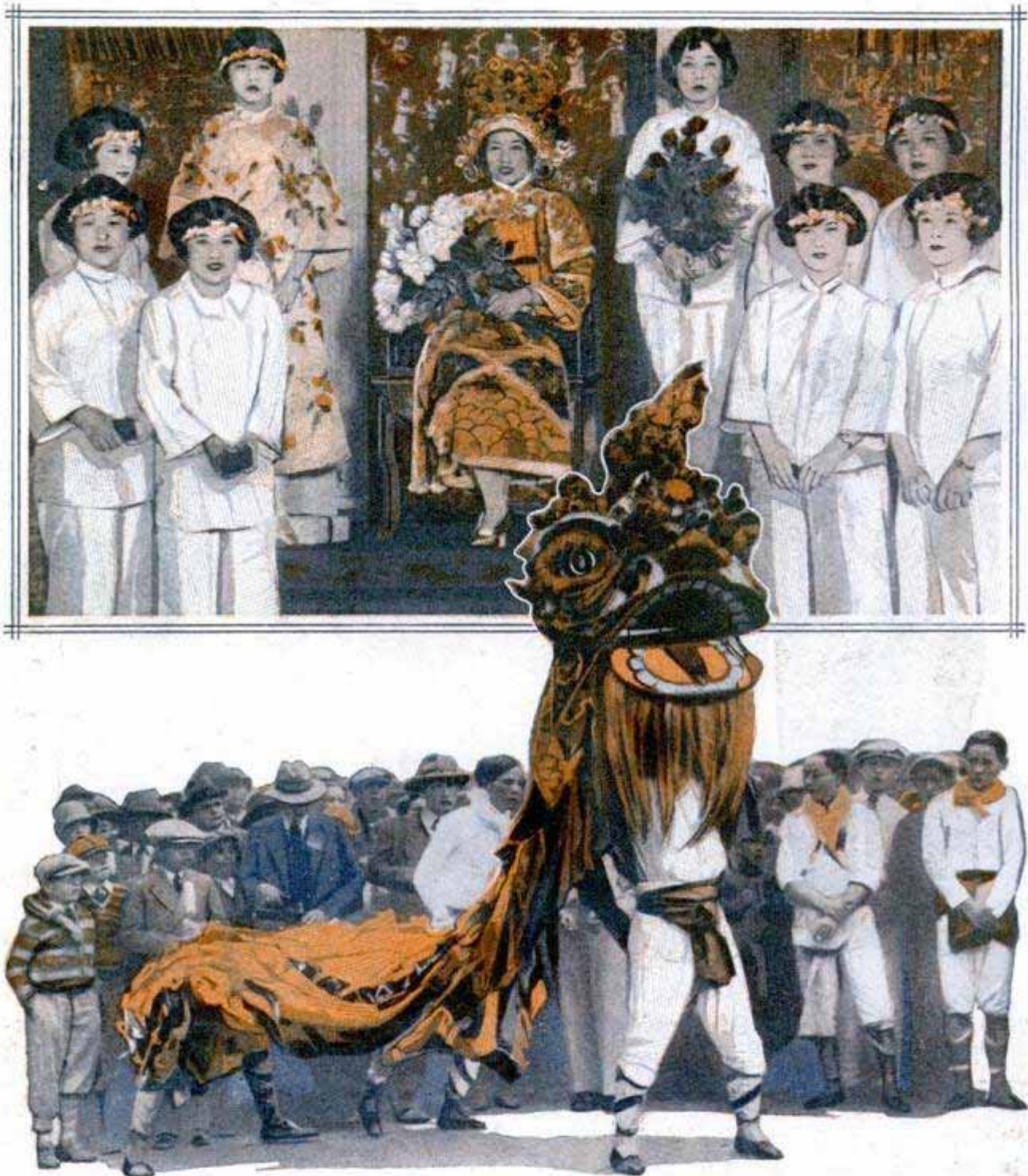

Lina Leong, Queen at the Opening of a Chinese Hospital in San Francisco, and, Below, Tsewje, the Lion, Chasing Evil Spirits Away during the New-Year's Festivities in February

commerce, church, fraternal society, city council, judge and jury and public school, all rolled in one.

Both of them are comparatively young, as Chinese societies go, and both were organized in America. On Leong is slightly over forty years old, and Hip Sing less than that. Compared with Hoy On and the Ming Gai Hong tongs with their history of more than 2,000 years, both are newcomers.

On Leong, however, has become the

most important tong in the United States because its local chapters include practically all of the more well-to-do merchants. In San Francisco, Chicago and New York elaborate tong houses have been built, blending Chinese and American architecture in a striking new composite.

From the time of the first white invasion of the Chinese seaports down to within the last two years, every foreign nation, in its treaties with the Chinese, insisted on the right of extra-territoriality for the

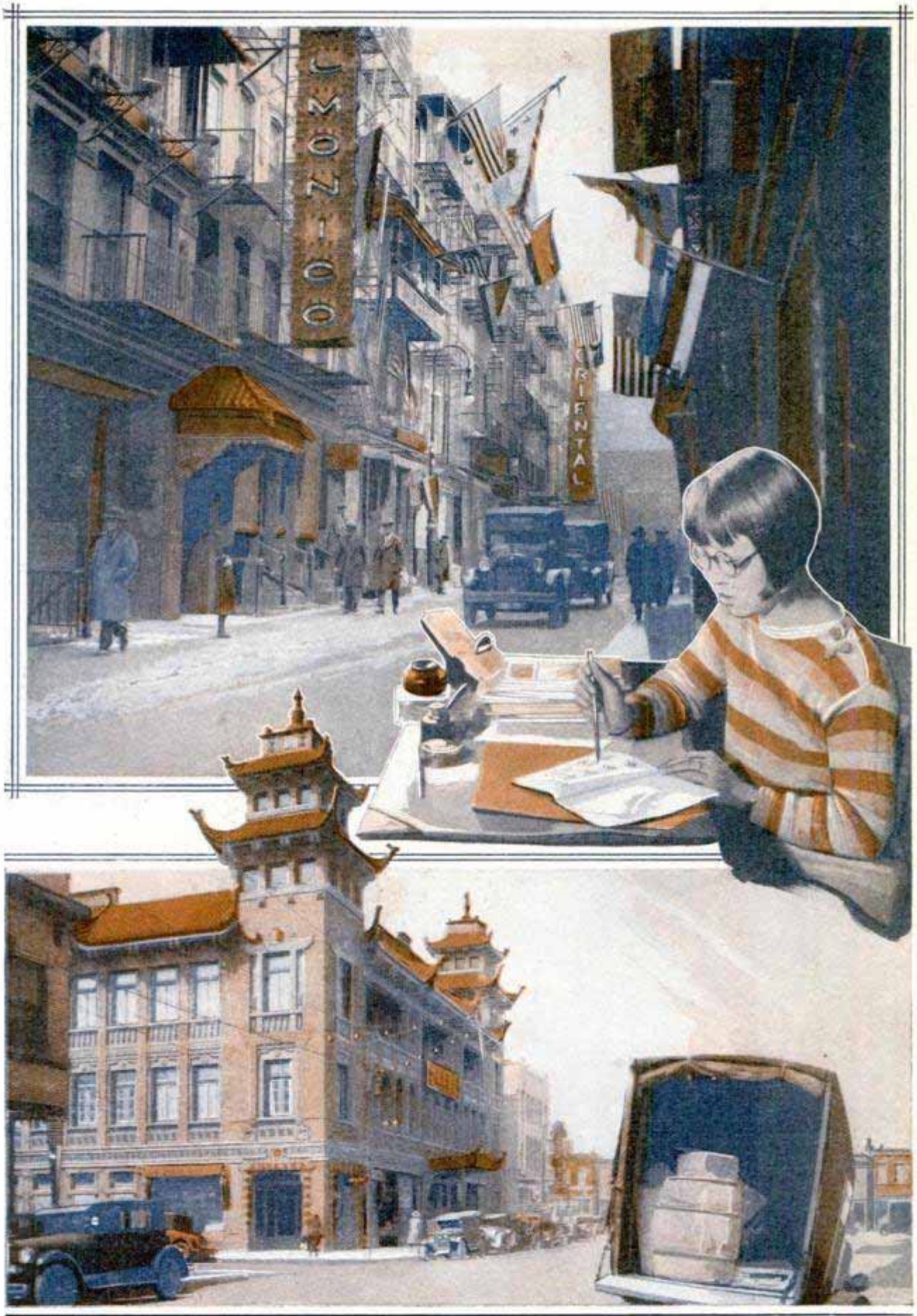

Pell and Mott Streets, the Heart of New York Chinatown, and, Below, the On-Leong Headquarters in Chicago; the Inset Shows One of the Teachers in the On-Leong Chinese School

2831  
918

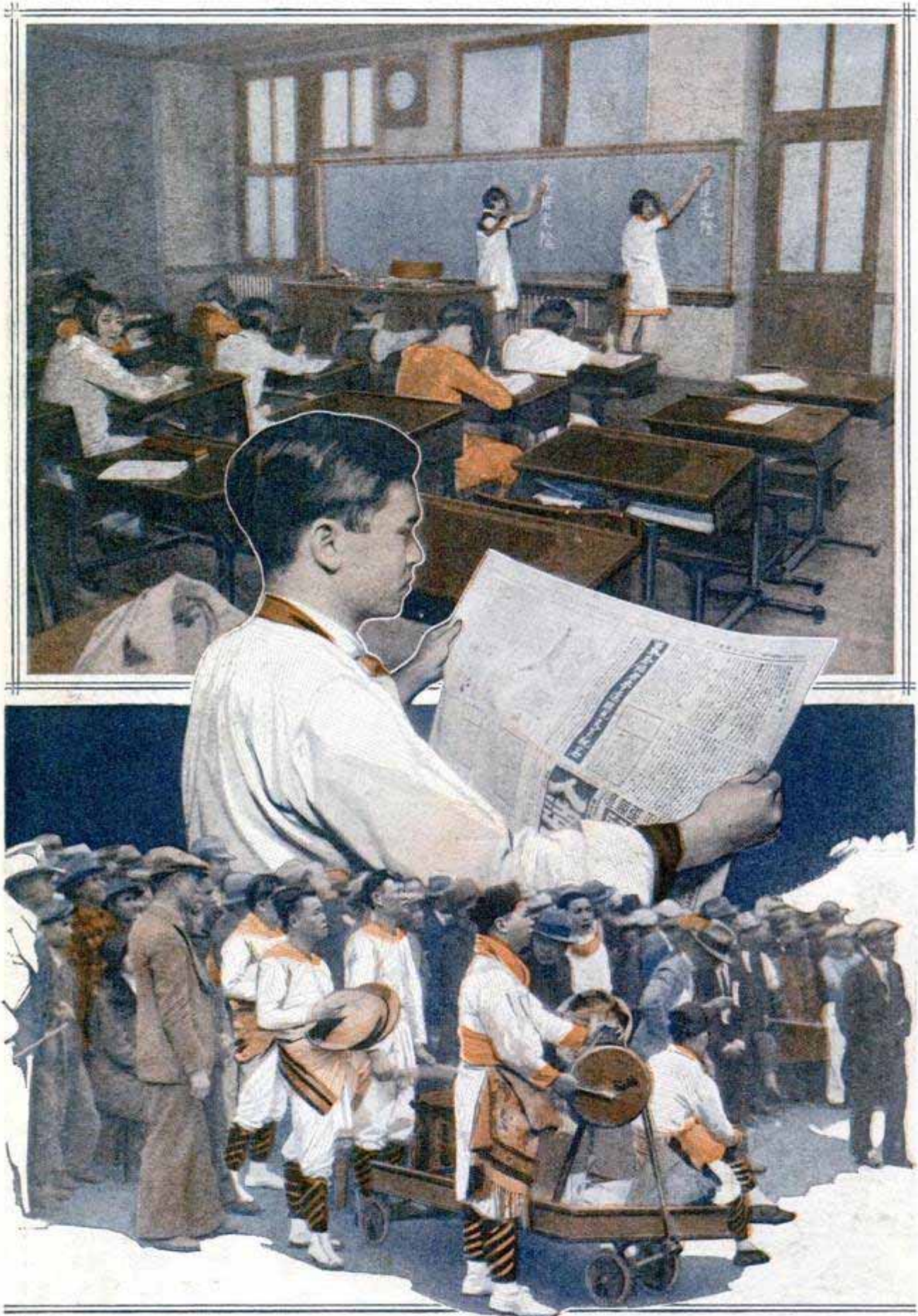

Learning Chinese Character Reading and Writing amid American School Surroundings; a Proofreader on a Chinese Newspaper, and the Band That Helps Tsewje Chase Evil Spirits Away

foreigners, including trial only in white courts. Without any treaty protection, the Chinese in America have gone much farther than that and set up their own government through the tongs. Every big Chinese center has its Chinese mayor, courts, judges, juries and schools. There they settle all disputes between themselves, the society as a whole being banded together to enforce its decisions.

Chinese are practically unknown in the American law courts—one civil case only, and that one a divorce suit, has been filed in Chicago, with its 10,000 Chinese population, in recent years. Aside from arrests during the tong wars, and an occasional arrest for violation of the narcotic laws, criminal cases involving Chinese are almost nonexistent.

The organization of the new On-Leong tong house in Chicago, opened last summer with firecrackers, dragons and a typical Chinese celebration, is representative of the bigger societies. In a very modern American-style council chamber and

courtroom, the directors of the society regulate the activities of its 2,000 Chicago members, hear their disputes, and in a near-by room, under a Chinese inscription reading "Comfort for all Law-Abiding Citizens," the juries reach their verdicts.

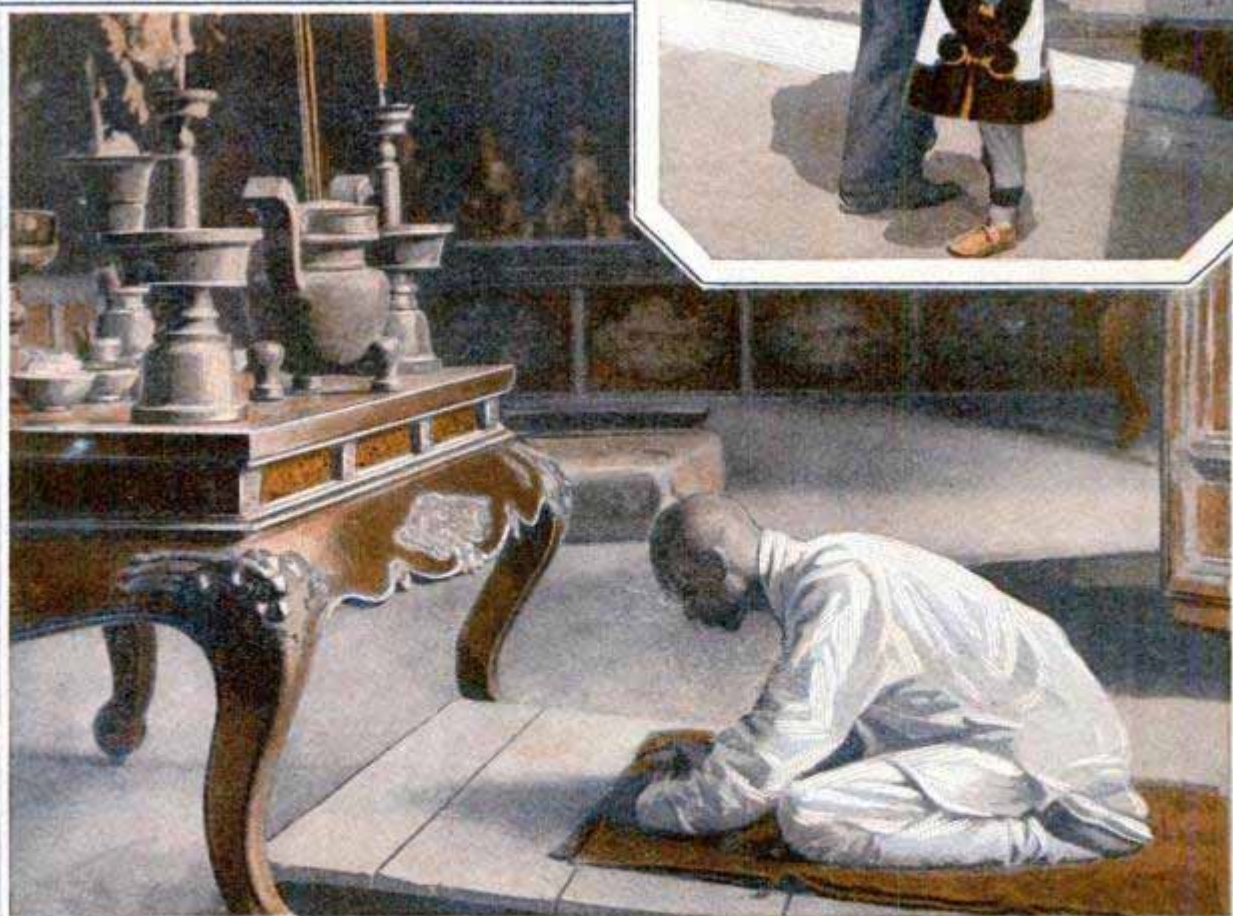

Bottom, Courtesy The Sphere

The Contrast of Old and New; a Chinese-American Reading Bulletins on a San Francisco Wall, and a Priest Praying in the Temple of Ten Thousand Generations near Peking

2331



The Chinese High School in San Francisco, Where Night Classes in the Classics Are Held to Keep the Public Day School from Completely Americanizing the Children



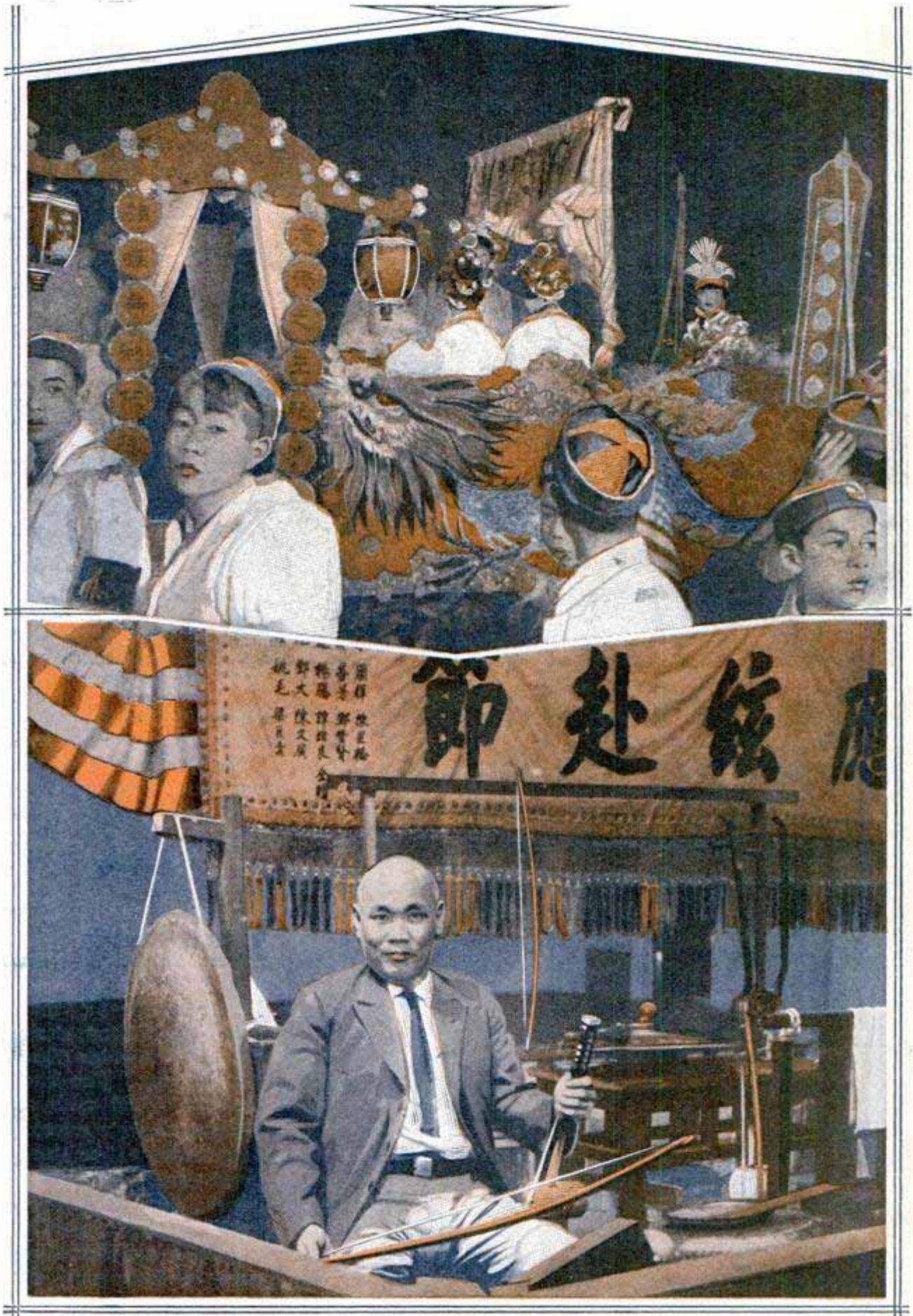

Mary Chu, Queen of the Feast of Lanterns, One of the Festivities of the Chinese New Year in San Francisco, and, Below, a Two-String-Fiddle Player in the Chinese Theater Orchestra

2331



The main chamber, however, is the temple of Kwan Tai (pronounced "Toy"), warlord of the Hun (pronounced "Hahn") dynasty, who flourished 2,000 years ago. There, before a great gilded altar, incense burns day and night, and offerings of fruits, rice and other foods stand amid bright-red prayer papers, printed in Chinese characters on long, narrow strips.

Around the room rows of marvelously carved teakwood chairs provide seats for the elder dignitaries of the society. The back of each chair is inlaid with an oval of marble, each piece selected because the graining of the stone, in black, brown and gray, resembles a Chinese landscape. On special occasions, such as the Chinese New Year's celebration, which comes in February, the backs are hidden under beautifully embroidered covers, in bright reds, greens, pinks and gold thread.

Lee Toi, President of On Leong in Chicago, and Frank Moy, "Mayor" of Chinatown, at the Altar of Kwan Tai, and, Below, Moy Placing a Food Offering on the Altar



Downstairs, three classrooms house 150 Chinese children each weekday afternoon for two hours. They attend the American school until 3:00 p. m., and at 3:30 are due in the Chinese classrooms to study Chinese character writing and reading and the history of China.

The same Kwan Tai, who is patron saint of On Leong, also is one of the deities of the Four Brothers. The other three were Low (pronounced more like "Lew"), Joung and Chew, and the descendants of their four families are the members of the tong today. The four became famous when, although they were only commoners, they rallied an army to keep one of the last of the Hun emperors on his throne, 2,000 years ago. Kwan Tai was in his thirties when he became the warlord of the dynasty. Both Kwan and Joung were famous fighters, but when Chew, who was only seventeen at the time, joined

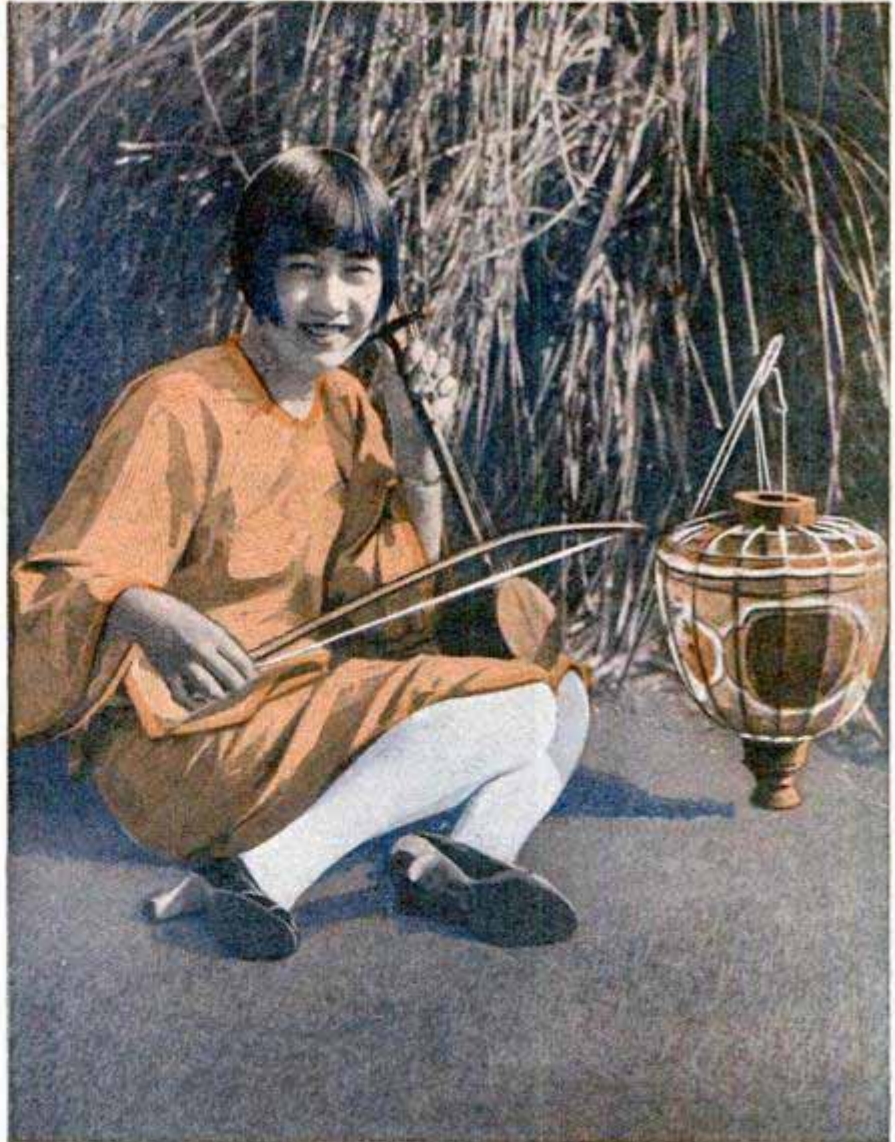

Rose Lee, Candidate for New Year's Queen, Demonstrates Her Skill on a Two-Stringed Instrument; Top, Children in San Francisco Chinatown Firing Holiday Firecrackers

them, he soon acquired an even greater reputation, according to the Chinese histories.

In recent years the Ming Gai Hongs have split, in this country, into an original Four Brothers' society and a Younger Four Brothers, the latter including the younger American-born and trained Chinese who became impatient with the conservatism of their elders.

The Americanization of the younger Chinese is rapid. In the schoolrooms of On Leong, while waiting for classes to begin, the youngsters romp around, shouting the latest American slang and singing the latest song made popular by radio. The Chinese school endeavors to keep them versed in Chinese literature and ideals, but as they grow up, they turn to baseball, the movies, and other American innovations, and few of the younger generation are seen in the Chinese theaters.

The Chinese theaters, presenting both the older classics and modern plays, are in a class by themselves. The plays are really operas, for a good part of the show is sung, in a flat, screechy monotone, accompanied by a Chinese orchestra that can produce more weird sounds than all the jazz writers of America ever dreamed of. One, two, three and four-string fiddles, a set of drums and a fair-sized boulder on which the drummer can beat a tattoo—supplement these with a pair of extra-size cymbals, and you have a Chinese orchestra. Wind instruments are not used in the one selection that is played for all songs in the regular opera, but for such special scenes as a wedding or occasional procession, a set of trumpets and Chinese flutes and oboes join in with an ear-splitting din.

On the stage, there is neither scenery nor backdrop, and all the props are piled up in plain view. A stage hand, usually in a blue coat with brass buttons, wanders back and forth, placing the props as they will be needed, and jerking them away as soon as they are used. A good part of the acting is pantomime, and a good Chinese actor needs few props to convey his idea, even to an American audience. Some of it is very funny to American eyes. To see a stage hand place a table in the center of the stage, put a chair at either end, and two more on the table top, and then watch a procession of actors solemnly climb over chairs and tables, to represent a journey over the mountains, while the stage hand stands by to remove the first chair used as the last actor steps off it, is, to say the least, something different.

But that is Chinatown.

*for*  
**CABS COMMANDED BY RADIO  
TO SPEED SERVICE**

*2517*  
"Cab No. 7; the passenger you just took to 2857 Market street left an umbrella in your cab. Return with it at once." "No. 11; call at 158 West Main street for three passengers." Messages such as these are

passing through the air at Akron, Ohio, where a fleet of radio-directed taxicabs is in operation. Broadcasting is done on a short-wave set from the central office, and the orders are received on special sets installed near the driver. Headphones were used at first, but these have been abandoned for loud speakers. Tests have shown that the system is practical and saves drivers and customers time, as orders can be transmitted to cabs while en route with or without a fare.



One of the First Radio-Equipped Taxicabs; Headphones Later Were Discarded for Loud Speakers

*Akron Taxicab Co  
Akron Ohio*

Iron Age 3/1/19 R 810

### MIXING NATIONALITIES SPEEDS PRODUCTION, EXPERT FINDS

Mixing men of two nationalities in a working team will result in a greater work output than if one nationality alone is employed, according to Dr. Edwin Hulme McIlvain, director of the employment service of a large Philadelphia industry. The mixed crews worked better also in teams where the numerical strength was unequally divided, as in a five-man gang in which three were of one race and two of another. A study of national characteristics and personal temperament also is necessary, according to Doctor McIlvain, to fit men to the proper jobs.

### SORTER FOR NUTS AND BOLTS SAVES FACTORY TIME

Patents have been applied for on a sorting machine to separate bolts and nuts of different sizes. It is operated by an electric motor and consists chiefly of revolving master screws that take the contents of a hopper and spread it along over a mesh which has openings in graduated sizes. The smaller units fall through first into the proper bins and the larger ones are carried along until they also slip through the mesh into the compartments arranged for their size. Screws, nuts and bolts are not placed in the hopper at the same time, as special adjustment of the master screw is necessary in handling them.



Sorter That Separates Nuts or Bolts of Different Sizes from Hopper

Inv. H. E. Fielder  
of Tool Dept. Parke Electric Shops



Views of the Mechanically Operated Attendants Used to Pass Out Advertising Circulars

### ROBOTS TO PASS CIRCULARS AID ADVERTISERS

Mechanically operated manikins appeared in Paris recently to aid an advertising campaign. One handed out circulars from a tray, performing the motions smoothly and accurately.

### BRASS IN USED-UP LIGHT BULBS SALVAGED WITH "THRESHER"

Burned-out electric-light bulbs, usually discarded by the householder, are considered so valuable by an eastern company that it has constructed a special apparatus for breaking up the bulbs to obtain the brass shells, the only part worth saving. The machine is driven by an electric motor and is simply a revolving steel cylinder perforated with many holes, to allow the broken fragments to fall through, and having two long steel bars inside covered with projecting prongs. From 300 to 500 bulbs are dumped into the barrel at one time, the cylinder is revolved at high speed and the glass, filament, wires and even cement are knocked from the brass shells.

Jouets et Automates  
Francais, 36 me  
Montmorency, Paris, III France  
New York Edison Co  
Long Place + 15 et St  
New York

2512

2530

2555

2520  
926

*Ocean Service  
News Bulletin  
477 6 3/22/29*

*Paramount Studios 5457  
Marathon St. Hollywood  
Calif*



Soundproof Camera Cover Stops the Grinding of the Machine from Being Recorded on "Talkie" Film

**SOUNDPROOF MOVIE CAMERA AIDS TALKING PICTURES**

To keep out foreign noises, engineers have had to muzzle the movie camera in filming scenes for the talkies. A special insulated covering prevents clicking and grinding sounds from reaching the sensitive microphones.

**FLYERS MAKE THE DESERT BLOSSOM**

Large areas of cut-over timber land in the Pacific northwest are being sown to grass by means of airplanes which fly over barren tracts and distribute the seed from a special hopper. It falls over a wide path, blown by the propeller blast. From 150 to 200 acres a day was the performance of one pilot. The best

2574

*Merri & Bealson*



Combination of Hobby-Horse and Scooter That Runs Forward as the Rider Moves Up and Down

**STOVE SMALL AS A WATCH BAKES OIL ROCK**

Rock samples that may contain oil are being baked in a small stove no larger than a watch at an eastern laboratory. Its oven is about the size of a quarter. A slice of rock, so thin that 1,500 slices side by side would measure only an inch, is placed in the tiny oven and, as the heat is applied, any minute changes that occur are noticed through a special microscope. As the stove gets hotter, some of the ingredients are seen to give off liquids varying from light oils to tarlike residues. From these tests, better methods of distilling oils from rocks are expected.

*American Petroleum Institute*

**GALLOPING PONY FOR CHILDREN GIVES GOOD EXERCISE**

Sport and healthful exercise are afforded children by a mechanical horse that performs a galloping action as soon as the rider jumps into the saddle. The wheels turn and the seat goes up and down through the operation of springs. The movement exercises the muscles of the back and abdomen; the horse is easy to steer and stop and is of sturdy construction. The handlebars serve as reins for the horse, which can be used in the house as well as outdoors.

2501

*Merri & Bealson  
707  
Merri & Bealson Corp.  
Malibu, Cal*

2419  
22.304465 Bay St  
Toronto 2 Ont Canada

# MAPPING THE CANADIAN WILDS FROM THE AIR

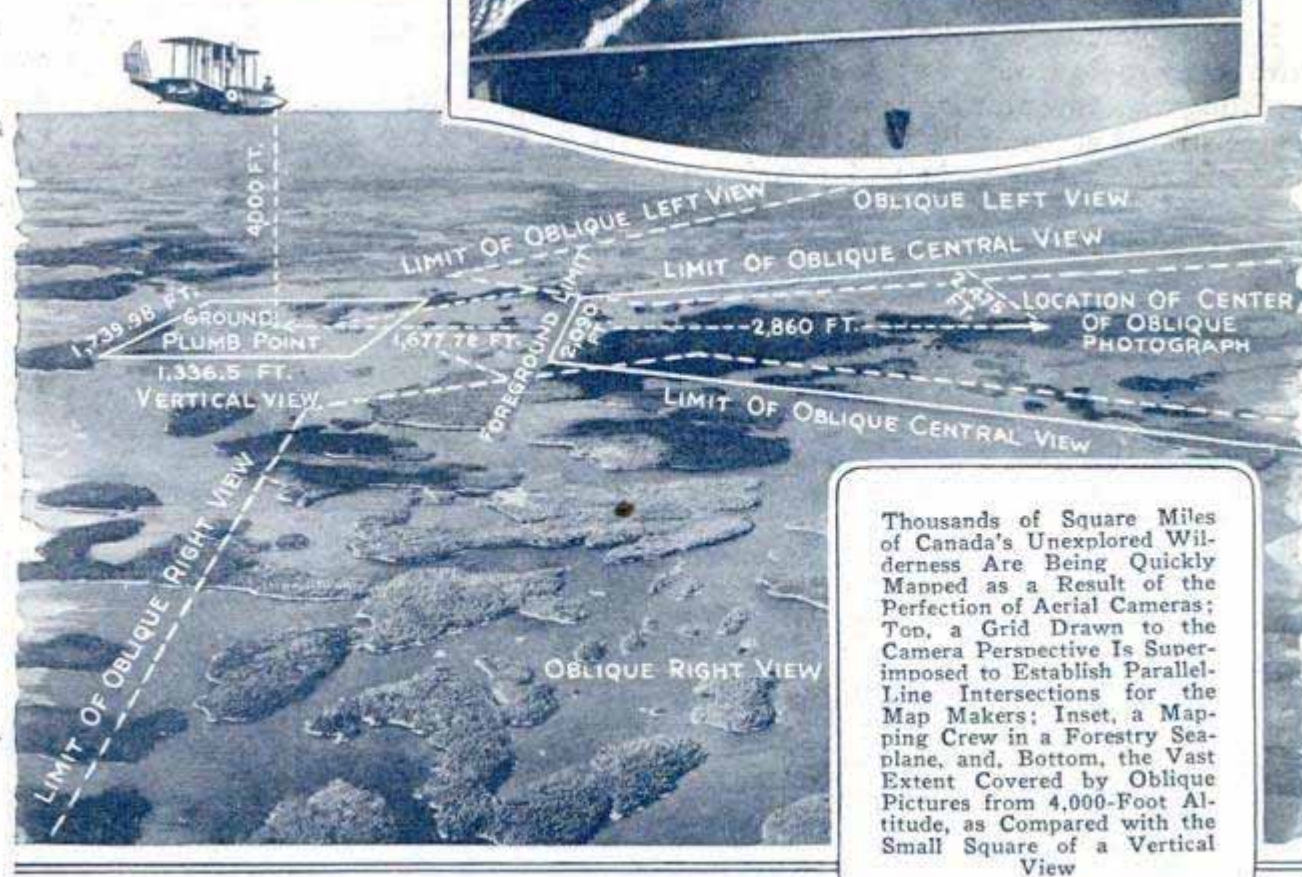
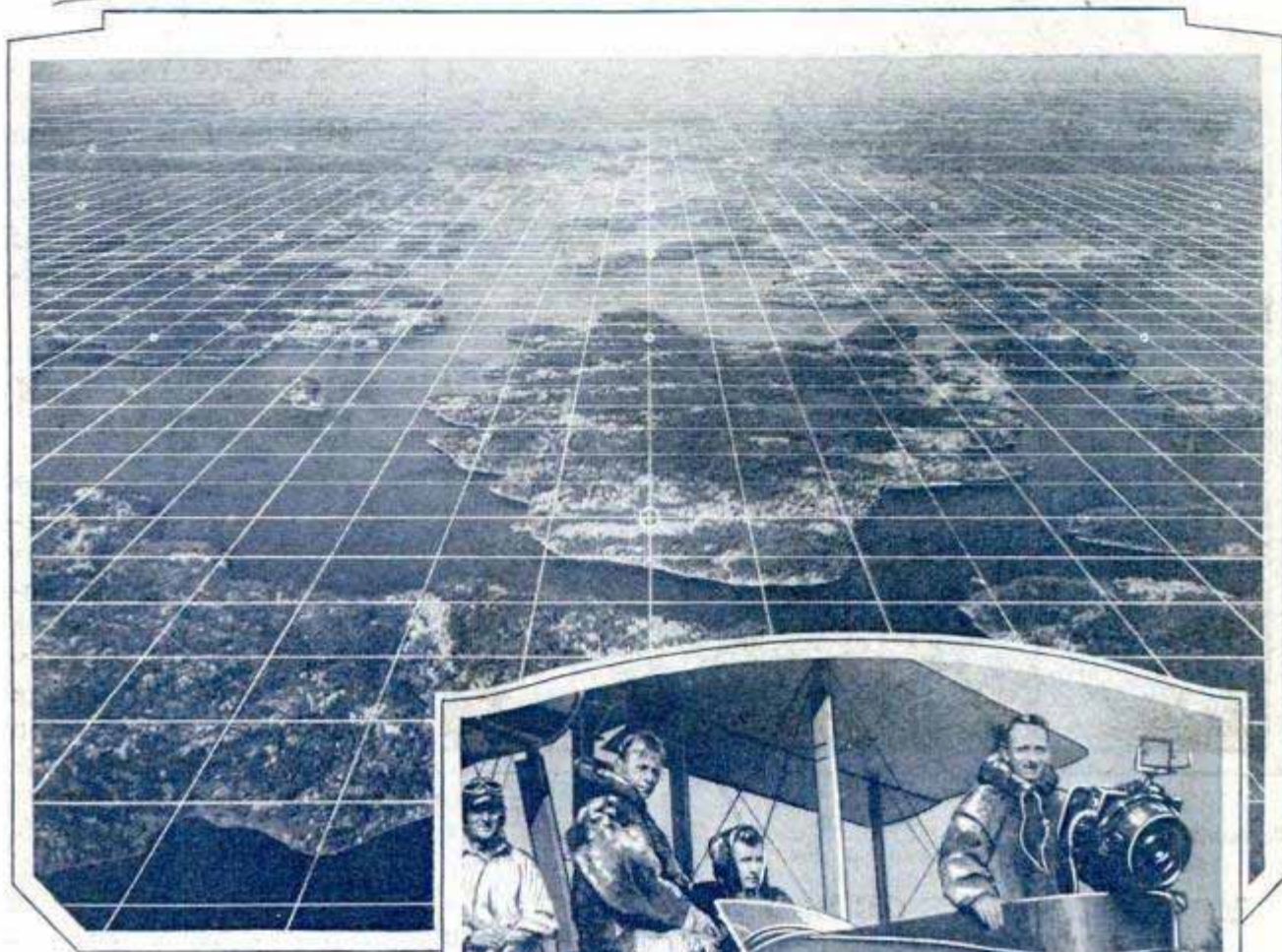

Thousands of Square Miles of Canada's Unexplored Wilderness Are Being Quickly Mapped as a Result of the Perfection of Aerial Cameras; Top, a Grid Drawn to the Camera Perspective Is Superimposed to Establish Parallel-Line Intersections for the Map Makers; Inset, a Mapping Crew in a Forestry Seaplane, and, Bottom, the Vast Extent Covered by Oblique Pictures from 4,000-Foot Altitude, as Compared with the Small Square of a Vertical View

2454

von Michaly Berlin  
Germany

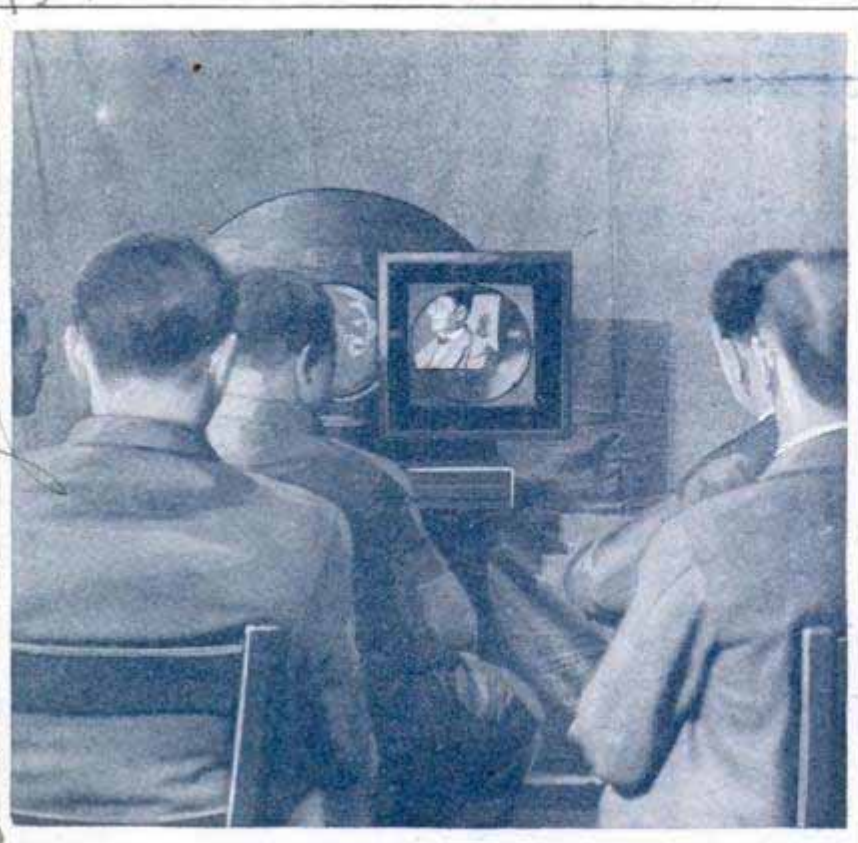

© P. & A.

Transmitter That Sends Moving Pictures Either by Wire or Radio; It Is the Invention of an Hungarian

### MOVIES BY WIRE OR RADIO FROM SINGLE SET

Motion pictures may be transmitted by wire or by radio from an apparatus which an Hungarian inventor is reported to have demonstrated successfully in Berlin. The outfit is relatively simple and permits a quick and easy change from wire transmission to radio.

Germany

### TOOTHACHE UNKNOWN TO CATS AND DOGS OF EARLY TIME

Study of the teeth of the saber-tooth cats, and of the giant wolves that lived and died in prehistoric times, has shown why these animals and their descendants knew no such thing as toothache. Examination of teeth found in asphalt pits in California revealed that, in every case, the teeth of an adult of the species had only a scanty supply of nerves. As the animal grew up, the root canal, which is the main route for the nerves into the pulp chamber of the tooth, became comparatively shut off. The pulp chamber, with its filling of sensitive nerve tissue, grew very small. The nerves that reached the chamber were only the

257

2476 U.S. A.

small fibers that penetrated the tooth by minute channels. Since there were no nerves, there could, of course, be no toothache. This condition has been passed on to the descendants of the early species, examination of the teeth of modern animals shows.

2494

### PIPE WRENCH HAS GRIP LIKE HAND

Fitted with a toothless girth that grips in somewhat the same manner as a human hand, an improved pipe wrench has been placed on the market. It does not damage the pipe, saves lost motion and can be used in difficult places. The slightest motion of the handle affords a new hold, and

the wrench is said to make or break the tightest joints. Being without teeth, it will not chew brass or other pipe. Its ratchet action permits its use in difficult places. The girth of the wrench is easily attached to the handle.



Even Soft Brass Pipe Is Not Injured by This Wrench, Which Grips like a Human Hand

Wahworth

Parnellee

Paris

Science Service Bulletin  
4178 3/22/19

The Wahworth Co  
taller 12/19





© Curtis Flying Service

One of the Most Spectacular of the Modern Craft of the Skies; a Giant Sikorsky Amphibian Plane of the Type Now in Use over Long Island

### ODD FLYING BOAT AIDS TRAVEL ON LONG ISLAND

With wide areas of comparatively quiet water on which to land, flying boats are expected to be increasingly popular for travel along the coasts. A giant Sikorsky amphibian plane has already proved efficient for transport service across and around Long Island, N. Y. It has great carrying capacity and is not limited to the somewhat restricted areas of the regular landing fields.

what like the snapping of a whip. One solution of the matter has been offered in wrapping the metal propeller with something like soft rubber. The scheme appears to have merit but, Mr. Carroll points out, no one has suggested exactly how to apply the rubber and make it stay on. Even when the engines are throttled down and the windows of a cabin plane are closed, there is considerable noise made by the passage of the ship through the air. As yet, proper methods of insulation have not been adapted to planes, and the problem of noise is one that engineers will discuss with keener interest in the near future.

### PROBLEM OF AIRPLANE'S NOISE Baffles Engineers

Can the airplane be made absolutely silent as it rushes through the air? Thomas Carroll, chief test pilot of the national advisory committee for aeronautics at Langley field, suggests that the problem is far from solved even with the introduction of mufflers for the motors and other devices which reduce, but do not stop all the noise. After the engines are silenced, the propeller is still a noisy member and one of the loudest of all. Those of wood or of metal vibrate and, at certain speeds, the tips produce a cracking noise some-

### ELECTRIC SET FOR KITCHEN IS SIX TOOLS IN ONE



Operated by current from a lighting socket, a set of electrical appliances saves the kitchen worker time and trouble. It consists of a squeezer for fruits, a beater, whipper, mixer, polisher and a grinder for sharpening knives and other tools.

Hampton Va

249  
Sweeney 177  
2377

New York  
at 4th  
225 W. 34th

Science Service  
News Bulletin 916 a

220. All appliances  
Curtis 77 1st Mahawk

1/5/29 P. 11

2156

# When *the* City's "Pie-

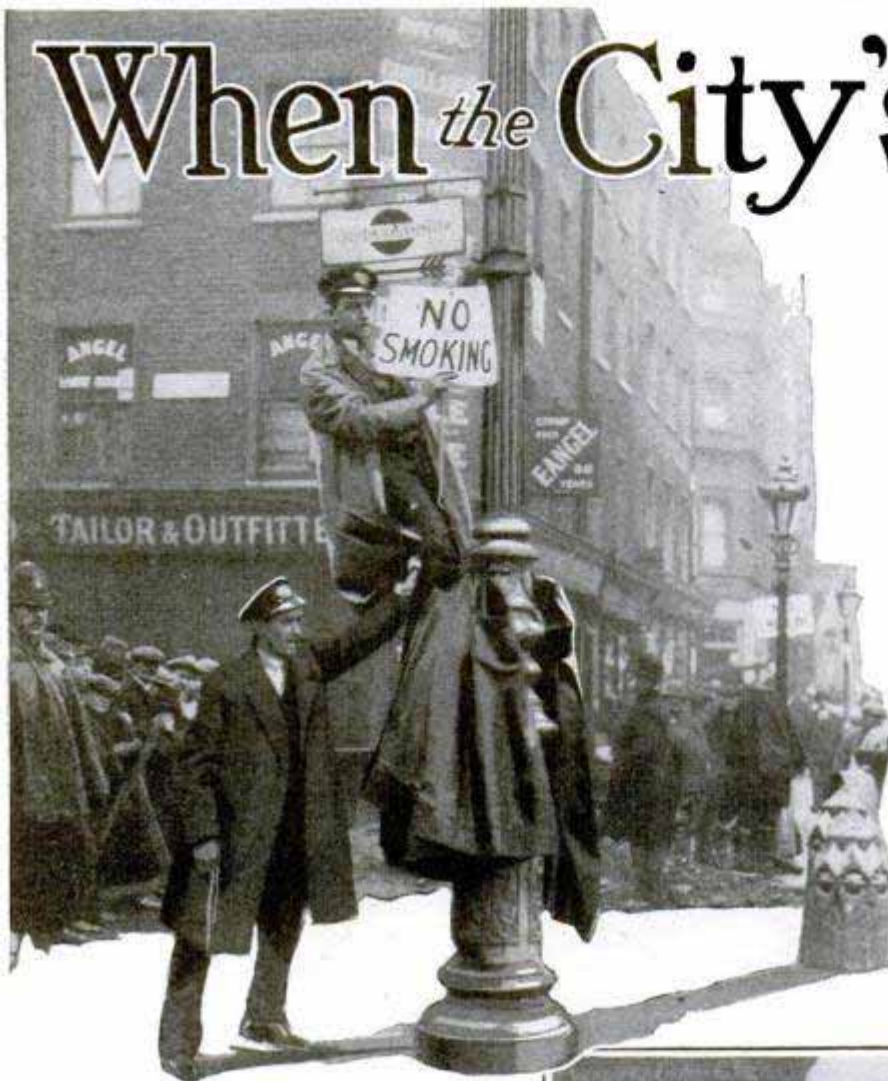

sixty years ago and originally used as a pneumatic-tube package-delivery system. Years ago, it had been taken over by the post office department, which also operates the telephone and telegraph systems, and used as a conduit for wires. Two workmen removed a manhole cover and one descended to close a switch and start the motor-driven fans to clear the tunnel of sewer gas. There was a roaring blast and his body, enveloped in flames, shot out of the manhole. Apparently the explosion spread down the tunnel, feeding on the accumu-

**A**RE modern cities pie crusts forming an insecure covering over a labyrinth of subterranean tunnels, pipes, wires and sewers which are potential agencies of destruction?

That question has been agitating London for months, following a series of explosions which began shortly before Christmas and continued almost daily, sometimes at the rate of a dozen or more a week.

The first and worst was a triple blast that ripped open more than a mile of street, killed one man, upset and destroyed a taxicab, and then set fire to the offices of the British film company and, feeding on the stock of movie film, gutted the building.

The blast occurred in an old iron-plate tunnel, built more than



© Quick Picture, Ltd.  
Posting "No Smoking" Signs in the Danger Zone after London Explosions, and Firemen in Gas Masks Tackling the Fires

# Crust" Breaks



© Quick Picture, Ltd.

**An Overturned Taxicab Burning in a London Street Following the Holborn Gas Explosions, and, in the Background, a Film-Company Office Building, Which Also Was Destroyed**

lated gas, until, nearly a half mile away, a second manhole erupted into the air, upsetting a passing taxicab, and, some distance farther on, a third blew up and set fire to the film headquarters.

The cause of the blasts, after an investigation, was decided to have been the presence in the tunnel of fermentation gases from decomposing material in the surrounding ground. Much of London is built over an old marsh area into which the Thames backwaters fed in Roman times, which accounts for the difficulty encountered in getting stable foundations for large buildings.

The gas, akin to methane or marsh gas, which is seen sometimes flickering over marshy ground, filtered into the tunnel through the rusting iron plates (it was built before the day of concrete), and when the workmen were called after neighbors had complained of the odor,

the entire tunnel system was charged with explosive, waiting only for a spark to touch it off.

At first it was thought the closing of the electric-blower switch caused the spark. The switch was so located that it was necessary to climb down an iron ladder to reach it. After the fire, however, investigators discovered the switch was open, and apparently had not been closed. It finally was decided the ladder, the fastenings of which were loose, had swayed as the workman descended and brushed against the tunnel wall, striking a spark.

The blast ripped open the street in places, and at others bulged the paving into the air without breaking it. Gas mains alongside the tunnel were broken and added their supply to the flames, which raged up and down the street. The inflammable mixture of air and gas was so thick that "No Smoking" signs were

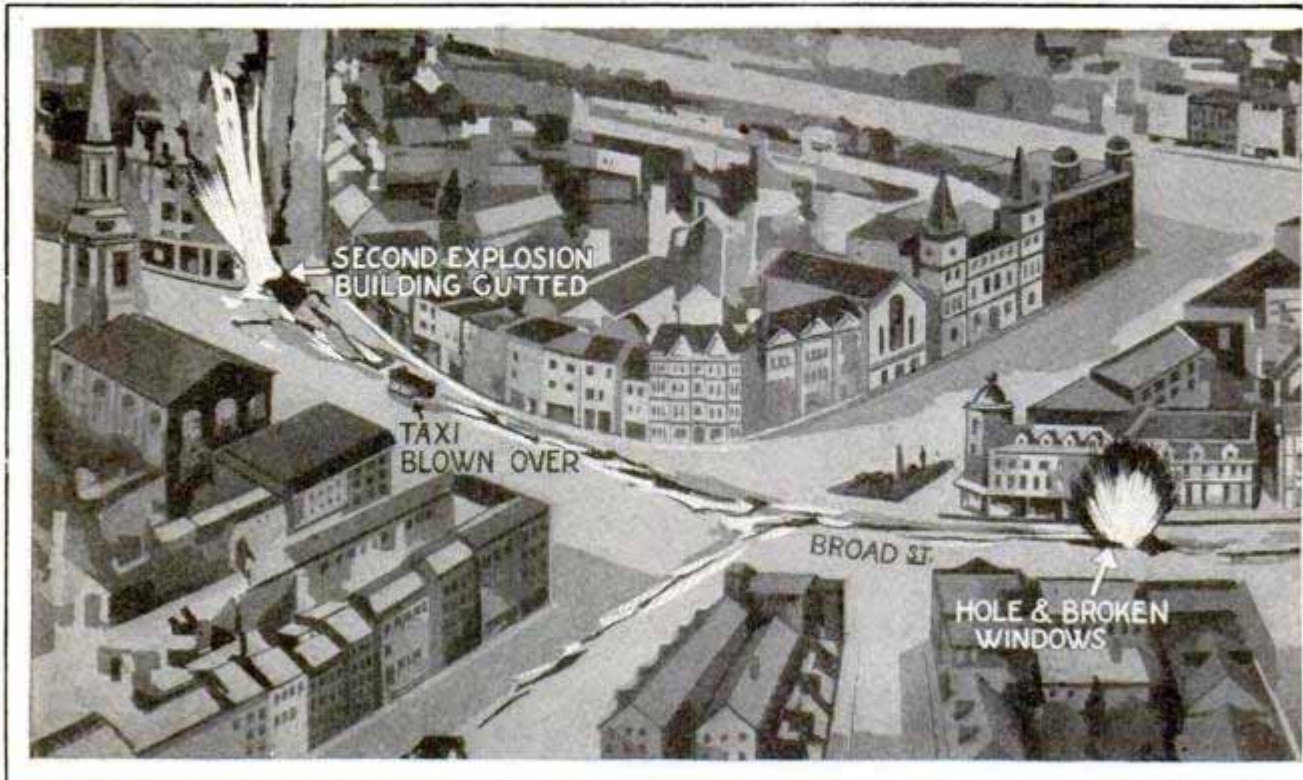

How a Street Explosion Spread Both Ways; the First Blast Is Shown on the Opposite Page; the Second and Third Explosions, the Last of Which Burned a Building, on This

posted for blocks around, and workmen passing into the danger zone were equipped with gas masks.

In the following weeks street blasts were of almost daily occurrence. Sometimes it was gas mains, sometimes water mains and at other times sewers. That they came with such startling regularity added to the mystery. The best explanation offered was that the majority of the old metal pipes had been laid at approximately the same time and, through rust and electrolysis, wore out at the same time. Electrolysis, or the chemical decomposition of metal by stray electrical currents, has been a baffling problem ever since the introduction of street cars and underground electric wires became common. Current flowing through the grounded street-car rails has a tendency to stray off to parallel metal pipes, and the result is a chemical action which eats holes in the pipes. Gas and water mains have been the chief sufferers in this country. In London, the electric-railway companies in the past have paid considerable damages to the gas and water companies for such damage.

One result of electrolysis, in addition to the eating of holes in metal pipes, is the production of explosive gases through the decomposition and chemical change

of the metal. If confined in underground cavities, these gases can become highly dangerous.

One of the engineers who has helped dig most of the underground tunnels in London declared after the first explosions that, "London is standing on a pie-crust foundation. The honeycomb of tunnels underneath the city is the most intricate in the world, and unless a halt is called, thousands of lives might be imperiled.

"During the last three years, hundreds of miles have been tunneled by electricity concerns, the post office and railways. The explosions this week may prove to be in the nature of a blessing. Had they occurred in certain parts of London, whole streets might have fallen down. And the important factor at the moment is that such explosions are possible in areas where the foundations are tunneled like a rabbit warren."

The foundations of London, particularly in the central business district known as "the City"—the part over which the Lord Mayor presides—has been a problem of concern for some time, as a result of the discovery that St. Paul's cathedral was in imminent danger of collapsing. Work to save Sir Christopher Wren's famous masterpiece has been under way, largely through forcing concrete into the founda-

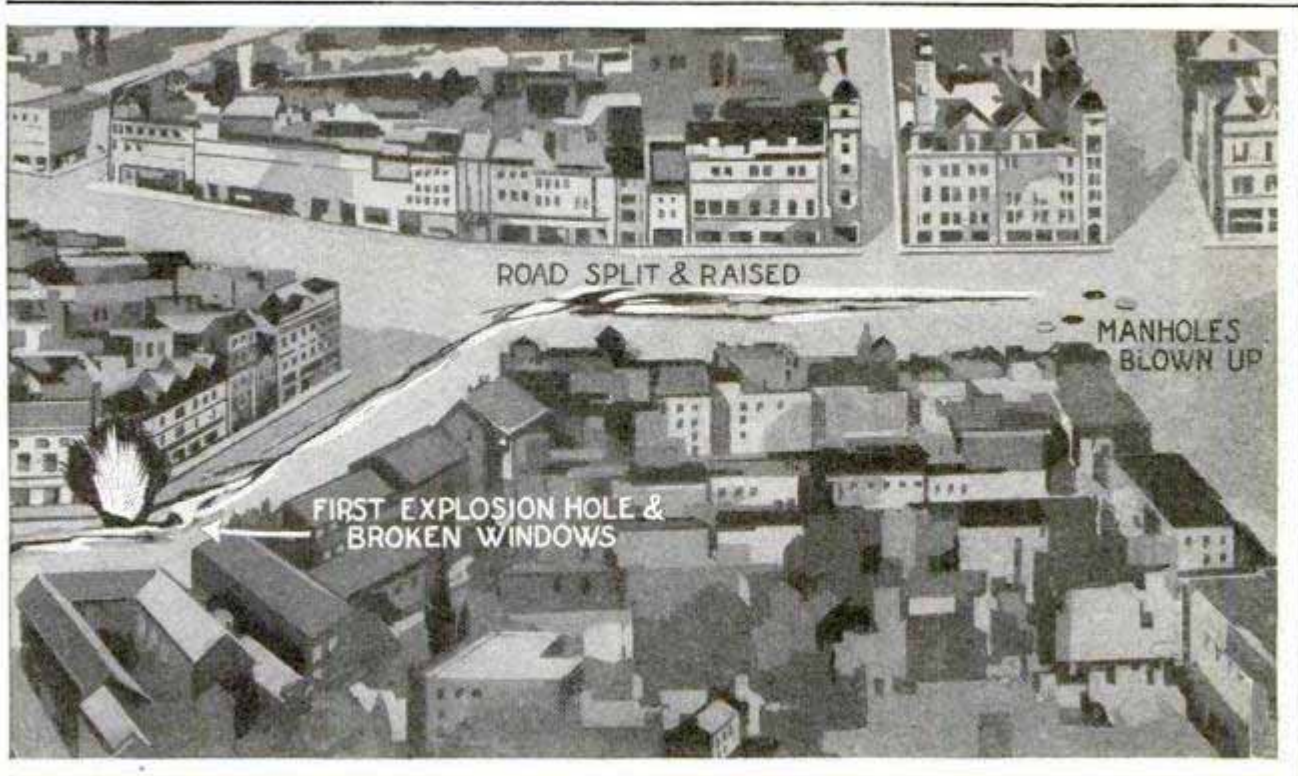

The Series of Blasts Finally Died Out When Sufficient Manhole Covers Had Been Blown Off to Release the Gas from the Tunnel; Roads Were Ruined by the Underground Disturbance

tions and tying the pillars and dome together with massive chains, as illustrated recently in *Popular Mechanics* magazine.

The secretary of the institute of civil engineers said, in commenting on the series of explosions:

"The perils of London's underground system have been the subject of intense investigation since the St. Paul scare. This research is still proceeding, and, even at this stage, no engineer can express an opinion—because he might be wrong."

Other engineers said the tunneling system, for everything from subways to electric conduits, was started at a time when no one could have anticipated the immense increase in street traffic which has followed the invention of the automobile, and has continued apparently without regard to the changing traffic conditions. One cause of danger is claimed to be the older post office cables of telegraph and telephone wires. Those laid years ago were put in wooden troughs, filled with melted tar. As a result, the production of explosive bitumen gas from the tar is a constant menace. A short circuit from other electrical conduits or apparatus may be sufficient to produce the spark necessary to touch off this gas.

A month after the first explosions, two big gas mains blew up within a few days

of each other. Commenting on the occurrence, one of the London papers presented figures showing more than one thousand miles of underground tunnels under the city. A new danger was cited by some of the engineers interviewed, who declared the pneumatic drill used to break up paving could do more damage to the underground structure, through vibration, in a single day than an entire year of traffic could cause.

"London is roofed in far more than it was a few years ago," another engineer pointed out. "What were once back gardens in central London are now covered in by the vast-span roofs of garages, workshops, factories, and innumerable structures on which rain falls, and is carried direct to the sewers, instead of sinking into the earth.

"So completely has London altered in recent years that the sewers are quite inadequate to carry any heavy fall of rain, with the result that, below the road surface, the water is exercising a terrific strain on the sewers, and in many instances heavy leakages have occurred at weak points.

"The escaping water finds an outlet into soil which has steadily been getting drier as more roads are ceasing to be of the old macadam type. Each year, more

roads are paved with wood, asphalt, or concrete, through which no rain water can get to the soil immediately below, and while this soil becomes dry, the soil some feet lower down is being washed away by leakages from overfilled rain sewers.

"This causes the dry soil to shift, and in many places, under pavements and roadways, cavities have appeared near gas mains and other heavy pipes which sag or shift when the ground around them becomes disturbed."

This problem is not confined to England. Every big American city, and many smaller ones, has

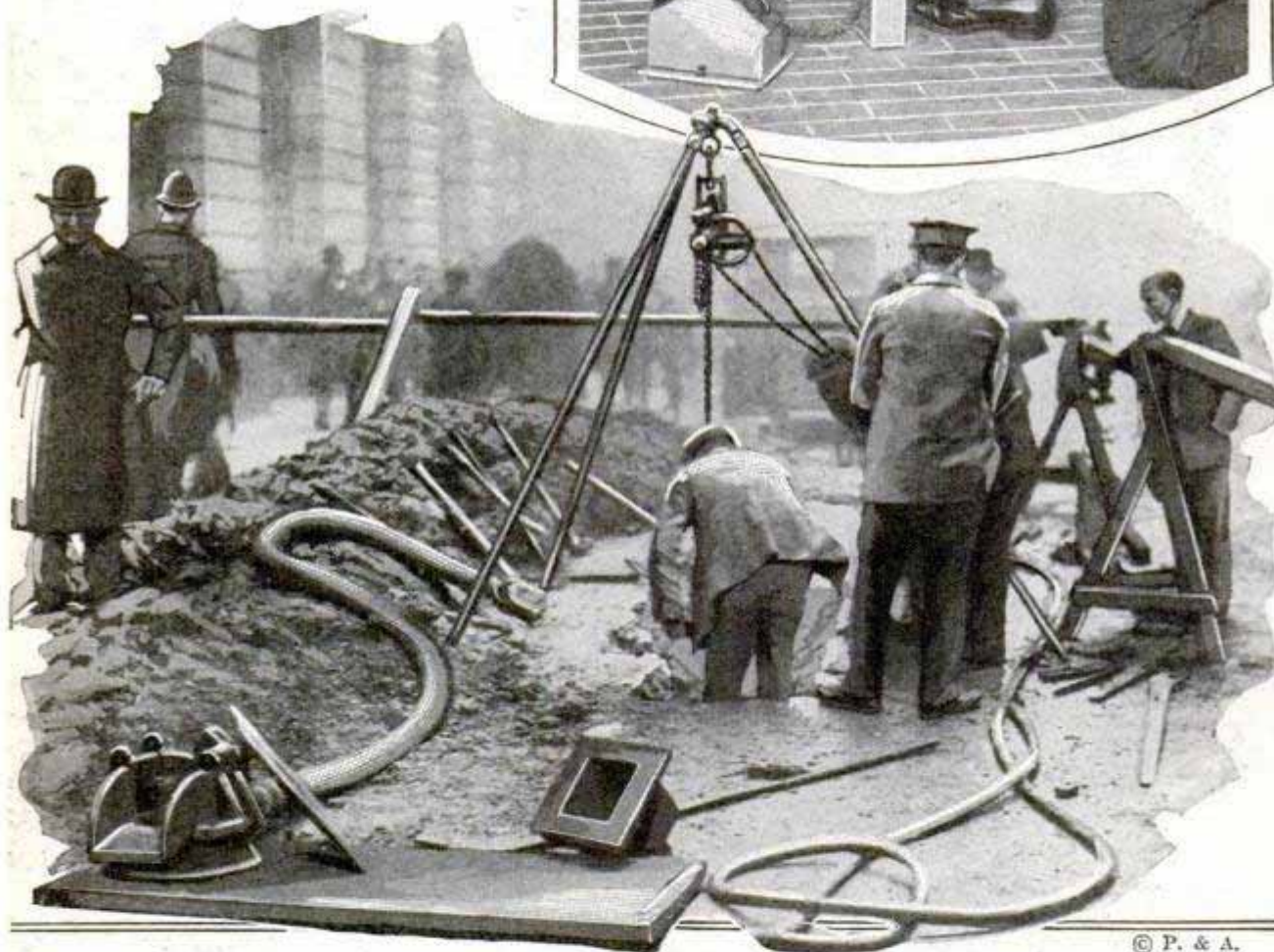

© P. & A.

Testing a Sample of Rubber Paving. One of the Suggested Means of Localizing Traffic Vibrations, and, Below, the Scene Following the Bursting of a Big Water Main

had experience with such accidents. After drying out beneath the pavement for some years, the soil apparently becomes so pulverized that, when water does reach it, it is easily washed away, some probably filtering through cracks in sewers and other

pipes. That leaves an underground hole, and sooner or later, the constant hammering of heavy traffic, supplemented by the presence of more water, will wear away the street's foundations until the paving falls in.

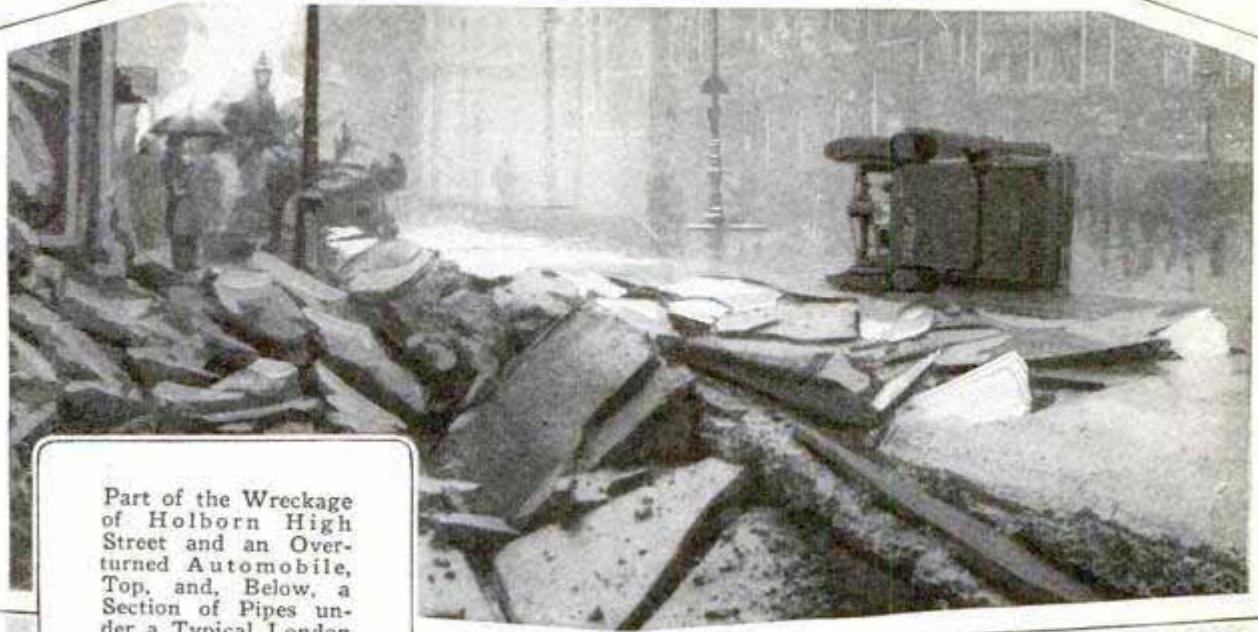

Part of the Wreckage of Holborn High Street and an Overturned Automobile, Top, and, Below, a Section of Pipes under a Typical London Street

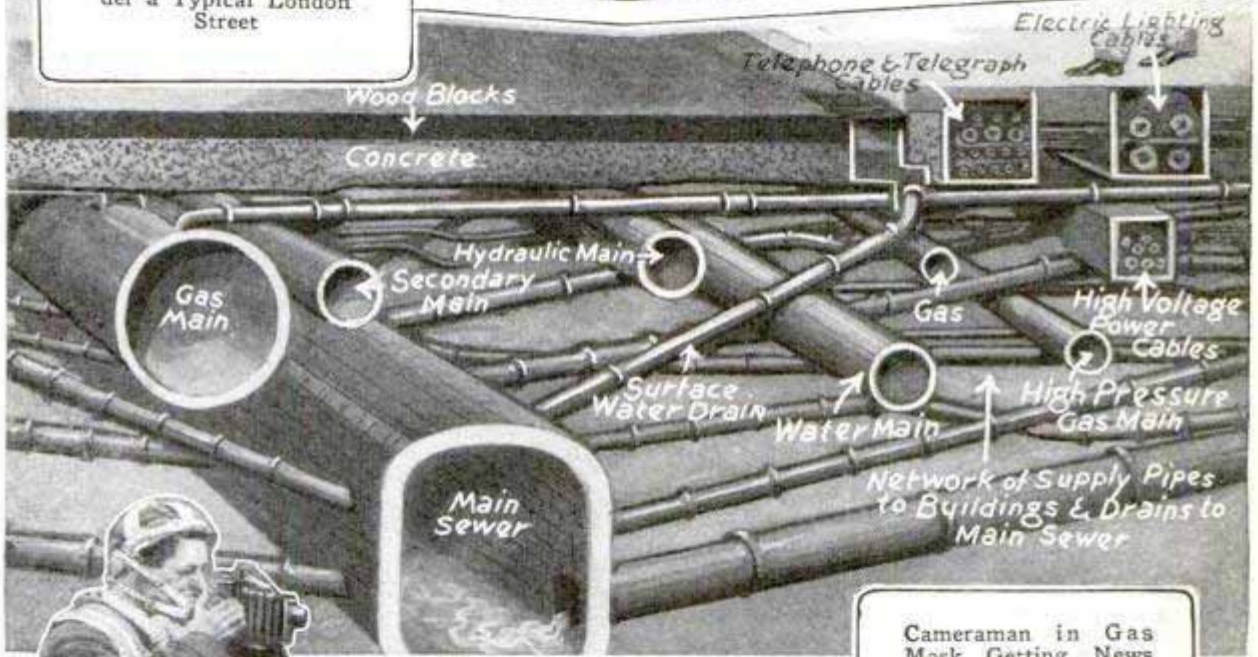

Cameraman in Gas Mask Getting News Pictures in Wrecked Street Following the Explosion of an Underground Tunnel; Heavy Concrete Was Broken into Small Bits as the Terrific Blast Below Ripped Up a Mile of Street, Overturned Cars and Set Fire to the Gas Mains



Hunting for a Gas Leak: London Became So Alarmed, Every Smell of Gas Resulted in an Immediate Digging Expedition to Locate the Source

"Absolutely nothing can be done to insure that further gas and water mains will not blow up or burst," Mr. John Todd, the district surveyor of the City of London, declared during the recent series of explosions. "There is no remedy—no precautions to take. We must just wait, hoping there will not be a 'next'." It was Todd who discovered the condition of St. Paul's and served notice on Dean Inge that it was a "dangerous structure" and would have to be repaired or closed to the public.

"The authorities are unable to take any precautions or suggest any measures to obviate further accidents," Mr. Todd continued. "We believe the mains are in good condition, and, therefore, there is nothing but the heavy overload traffic to lead us to expect further accidents. The ever-increasing traffic puts a mighty strain on the mains, and this is considered to be the only reason for the accidents which have already occurred.

"But what can be done? The roads cannot be cleared of traffic, and it would be an almost impossible task to open up London to inspect the hundreds of mains which run in all directions. Such a scheme would take years to complete, the whole life of the city would be stopped, and the

cost would amount to a staggering number of millions of pounds."

One result of the London accidents, however, has been the centering of engineering interest on the problem. While mains and sewers and subways, already down, may not be opened for inspection or change, it is probable that something new in the way of underground tunnels and conduits may be developed to cope with the increasing traffic load.

American cities, because of their more modern buildings, and because skyscraper foundations usually are built down to bedrock, have had less trouble from street vibrations. In the

more congested sections of New York, Chicago, and other large cities, buildings more than twenty-five years old are quite rare, while the constant rebuilding that goes on, even in outlying sections, lessens the danger of weakened foundations. Another difference between American and European cities is the prevalence here of concrete foundations for large buildings.

2356  
**ROTARY HOE FOR GARDENER SAVES TIME AND WORK**

Four tools are combined in one in a rotary-hoe unit for cultivating and weeding gardens. It includes a weed killer, cultivator and soil mulcher as well as a hoe. Operated somewhat like a lawn mower, it has reversible blades and guards for protecting the leaves of plants, and one of the cultivator shovels may be used as a marker for planting. The unit is adaptable to many tasks, is easy to operate and strongly built.



*Rowe Mfg Co  
Essex, Mass*



*New England Bureau  
of Service & Information*

*Wiley News 7/4/29*

*24 miles Boston Mass*

*2433 POPULAR MECHANICS*

*Industrial Flour 937*

### MAGNET COMPASS FINDS PIPES IN "LOST" GAS MAINS *2454*

Successful application of the magnetic compass, the type that has been used by mariners for hundreds of years, has been made by a gas company in finding gas mains, the exact location of which was not known. By holding the compass at the surface, the deflection of the needle aided the engineers in finding the mains. The method is practical when the pipe is buried not more than two feet below the top, and in finding piping hidden in house walls.

### AVIATORS TAUGHT IN A BARREL MASTER BLIND FLYING *2470*

Students at a Paris flying school take their lessons in one of the oddest classrooms in the world. It is like a half barrel and is equipped with flying instruments by which the pupil is expected to correct the motion of his compartment as it lurches and swings about. The plan is part of the method for training pilots to rely on their instruments rather than on their senses when flying through fogs or at night. It is predicted that the larger planes of the future will be operated by two pilots, one who will take the ship off and land it while seated where he has a full view of the outside, and another who is inclosed in a hooded part of the cockpit, where he will keep his eyes riveted on his instrument board and govern the plane accordingly. Experiments have shown that even a green pilot, flying blind, obtains better results than when he trusts to his reactions in the open. Changing lights, the temptation to look at the wing tips, the rattling of ice on wings and fuselage in storms; these and other factors tend to disturb the beginner.

*Sug Lav*



Shelf and Book Rest, as Set on Arms of a Chair; the Hands Are Left Free

### BOOK REST FITTED ON CHAIR LEAVES HANDS FREE

Easily attached across the arms of a chair, or in any other convenient position, a book rest permits the reader to work at other tasks while reading, as the hands are left free. The shelf part of the rest serves as a table for dishes or working implements such as a sewing basket.

### PRESS FOR PAPER BOXES PRINTS FIFTY THOUSAND AN HOUR *2496*

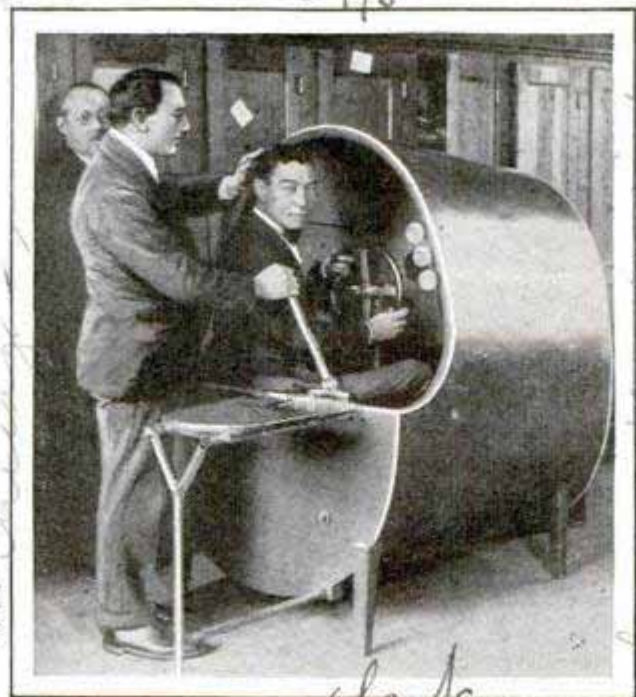

Receiving a Lesson in the Barrel Classroom; Unit Employed at French School in Teaching Blind Flying

For printing and cutting paper-box cartons, a timesaving machine, introduced in a western city, has a capacity of 50,000 an hour. It prints one on both sides in four colors, cuts the paper and scores it ready for folding. It will also print colored designs on transparent wrapping material in more than one tint, something that heretofore has been impractical with certain kinds of wrappers.

*Rotary Carton Machine Co 244 S. 4th St. Minneapolis, Minn*

*Rotary Carton Machine Co 244 S. 4th St. Minn*

*no. Edward Armstrong  
July 1929*

*Oct. 1935 572.*

FLOATING AIRPORT TO SERVE LINE TO BERMUDA

*see July 1929. 56 April 1934-566*

*2405*

*23 W 43rd St New York  
see  
Central Wilmington*



Sketch of the Armstrong Floating Airport, to Be Built at a Cost of \$1,500,000 as the World's First Ocean Landing Field; It Is to Be Tried on the Bermuda Run

Construction of an experimental floating-island landing field for airplanes is to be started immediately, according to Henry J. Gielow, famous yacht designer, who has been retained by the Armstrong Seadrome Development company as consulting engineer. The island, which was patented two or three years ago by Mr. Armstrong, has already been tested in model form in a floating basin. As planned, it will be a steel platform, 1,200 feet long and 400 feet wide, riding normally at least 100 feet above the waves. Six chains, each 21,150 feet long, attached to specially designed sea anchors, will hold the island in place. Forty-three men will constitute the island crew, and the equipment will include hangars, a machine shop, hotel, restaurant and a radio beacon to guide the planes to the landing stage. Six thousand tons of steel and 2,000 tons of iron will be used in the construction. The first island is to be anchored halfway between New York and Bermuda and used in experiments over that route. If it proves a success, a series of eight islands are planned to be placed between New

York and the European coast. Tests made with large Sikorsky amphibian planes show they can land on a field only sixty per cent the size of that which the island will afford.

**SAFETY STAND FOR FLATIRON**  
**2434 REDUCES FIRE HAZARD**

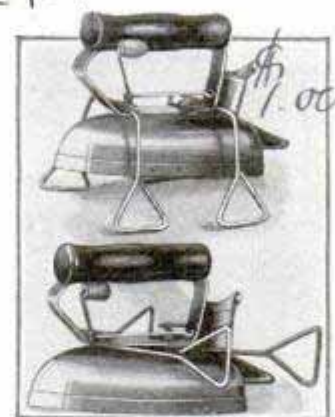

Quickly attached to the flatiron, a stand prevents fires and keeps the ironing-board cover and garments from being scorched. It also helps to protect the current cord to the socket and, as it is permanently connected to the handle of the iron

by means of hinges, it saves hunting for a loose stand. By keeping the iron from coming in contact with other metals when the current is on, the life of the iron is prolonged.

*see July 1929. 56*

*Hallingsway Sales Co,  
Box 128, Oakland*

2334

**SIGNALS WORN BY PEDESTRIANS TO AVOID AUTO ACCIDENTS**

Engineers of the General Electric company have been experimenting with various kinds of signals to be worn by pedestrians and make them more easily visible to motorists at night so that accidents will be prevented. One of the best devices tried was a white handkerchief, held with the arm full length at the side. In this position, it caught the beams from the headlights and reflected them so that the handkerchief could be easily seen, especially when it flared open. Light-colored clothing was more plainly visible than dark, and one of the chief reasons for the effectiveness of street lighting, so far as making the pedestrian visible, was that the best systems revealed a walker in silhouette. Bright headlights alone were found not to be sufficient, for, unless the clothing of the pedestrian reflected their illumination, the driver was likely to approach too close to the person before plainly seeing him.

2525

June 7's & Wacker line

**LIQUOR STILLS IN HOSPITALS HELP CURB DISEASE**

Confiscated stills have been put to a useful purpose in the county hospital and jail in Los Angeles. They are adapted as inhalators for spreading helpful fumes in sick-rooms, and are also converted into washtubs and pans.

247



Part of an Old Still in Use in Hospital as a Vaporizer to Curb Disease



4 Imitation of Derby Played by Inserting Coin in Slot and Manipulating Levers

**COIN-IN-SLOT HORSE-RACE GAME TESTS PLAYERS' SKILL**

Some of the thrills of a genuine race track are enjoyed in a cabinet game operated by a coin in the slot. The model horses are controlled by two wheels which are turned by the players. The speed of the ponies depends upon the skill of the operators, for the wheels are fitted with governors. If turned too fast, the horses balk and stop, so that practice is needed to develop the highest possible speed.

**GOPHERS ON LANDING FIELD LATEST FLYING MENACE**

Pocket gophers that throw up mounds of earth in digging their homes, are proving a problem to aviation in some of the western states. At the Douglas, Ariz., municipal airport, they piled up more than 2,000 mounds on the landing field. The bumps and the holes made smooth and easy descents difficult.

St. Joseph News Press 3/5/19

Chester - Pollard Amusement Co. Inc. 188 W. 4th St. New York

2436

# Edison to Remake

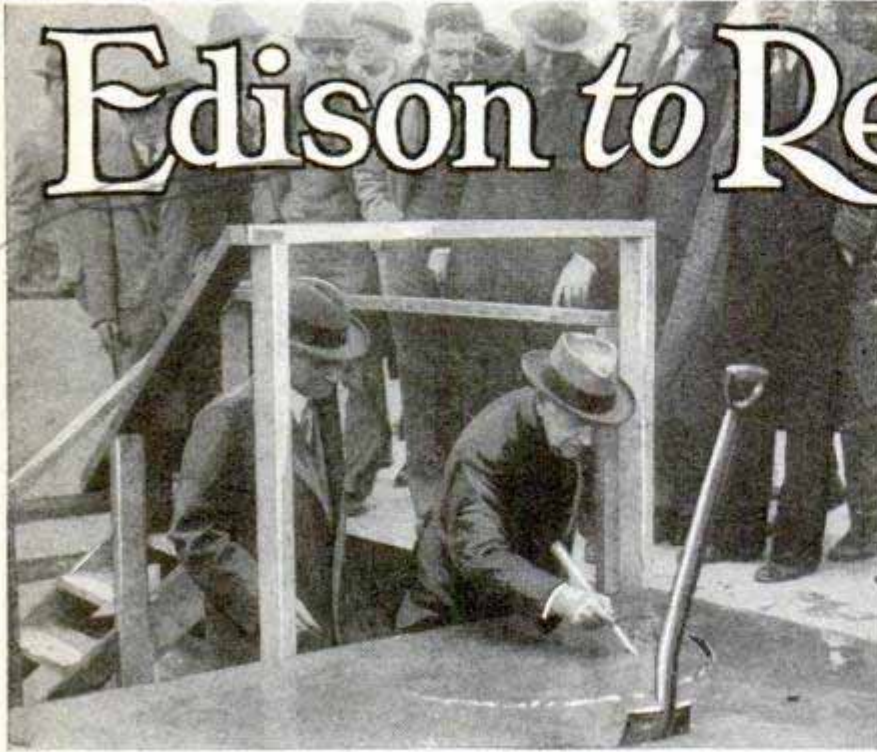

ings on the museum proper and its grounds, indicate the vast scale and the unique character of the enterprise. The little buildings seem crude and out of place beside the modern structures near them, but this contrast only emphasizes their significance, for in some of those very build-

By PAUL D. PADDOCK

THE PAGES of history will be turned back this October, when Thomas A. Edison remakes the first electric light he invented fifty years before. Veteran assistants will help him, and the little shop in which they meet will be the same laboratory restored where the original experiment was performed, for this historic workshop and others made famous by the great inventor, have been moved to Dearborn, Mich., as a special group in honor of Edison for the vast historical collection Henry Ford is assembling to tell the romantic story of the progress of America. The keynote of the museum is suggested by the inscription above the entrance to the present Ford experimental laboratory: "Mankind Passes from the Old to the New on a Human Bridge Formed by Those Who Labor in the Three Principal Arts: Agriculture—Manufacturing—Transportation."

Only the beginnings of the undertaking are visible today, but the little clusters of frame structures, a short distance from the Ford administration building and research laboratories, and the preliminary work-



Edison Penning His Autograph in Cement, While Henry Ford Looks On, and Close-Up of Block with Luther Burbank's Spade

ings occurred events that have changed the world.

For instance, there is the original laboratory in which Edison worked for many years at Ft. Myers, Fla. It has been shipped from the south and reconstructed here with all its original equipment. Menlo Park, N. J., scene of scores of the inventor's triumphs, is being represented completely either in the original buildings, sent from the east and rebuilt here, in parts of the originals or in reproductions. Among the structures is Mrs. Jordan's

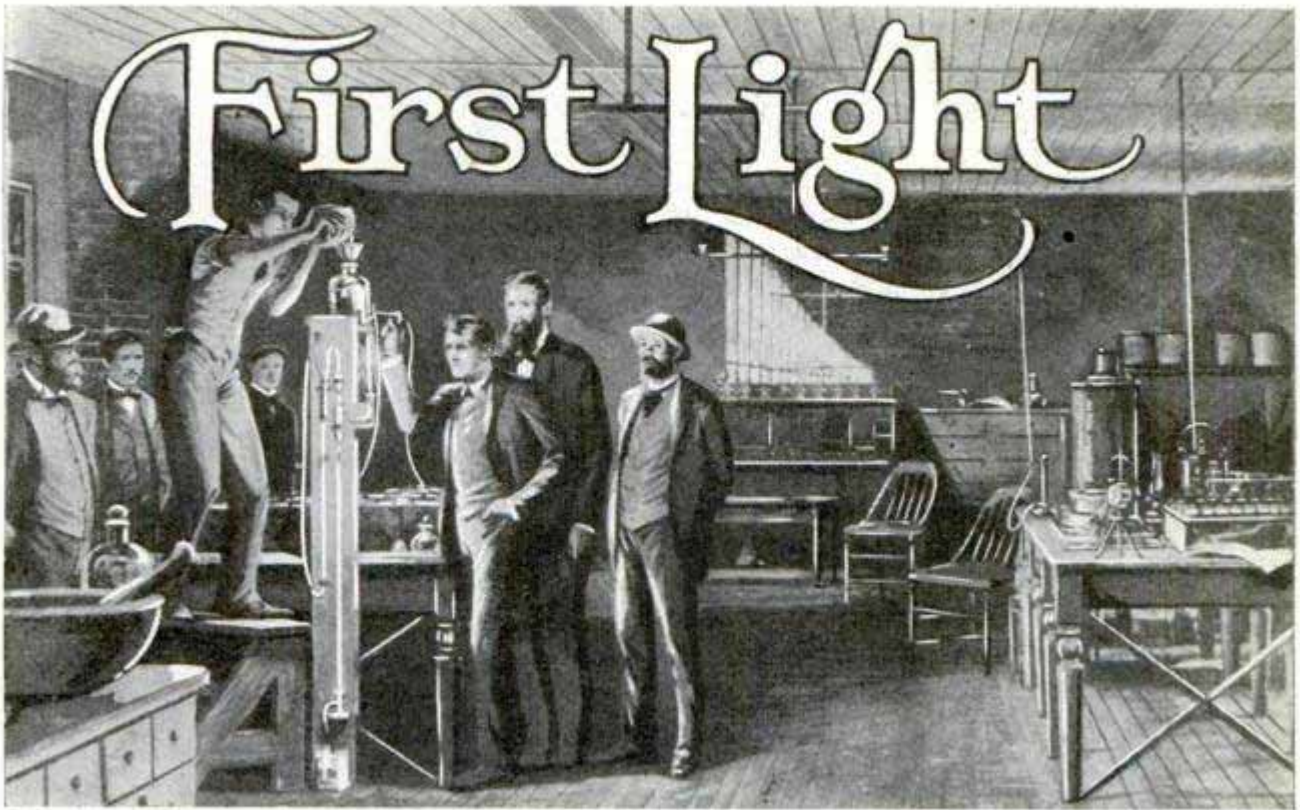

Scene at the Birth of the Incandescent Light, Nearly Fifty Years Ago; Edison Is Third from the Right; This Interesting Event Is to Be Restaged at Dearborn, Mich., This Fall

boarding house, the first building in the world to be lighted with incandescent lamps. Many of the tools Edison used in developing his inventions will be exhibited. The entire group will make clear the inventor's position as the real projector of modern American production methods and his historic contributions to our national progress, for Mr. Ford said recently, "we are ahead of all other countries today, simply and solely because we have Mr. Edison."

The celebration of the fiftieth anniversary of the incandescent light at Dearborn, amidst scenes as nearly like the original as possible, will therefore constitute a unique tribute to Mr. Edison and will stimulate further interest in the vast museum project which is scheduled for completion in approximately three years. The finished museum will mark the realization of one of Mr. Ford's fondest dreams, an idea he and Mrs. Ford developed after they had begun to restore the old Ford home near Dearborn. The thought has been extended to the nation so that, in years to come, visitors may see into the domestic and industrial life of their forefathers as closely as an individual may do

when he visits his old homestead. The chief purpose of the museum is educational, but the element of human interest is highly developed.

This human side was well illustrated when Mr. Ford obtained a memento which is to be one of the principal exhibits in the museum. Last September, Mr. Edison was his guest at Dearborn. The inventor stepped upon a block of soft concrete, inserted Luther Burbank's spade, left impressions of his own footsteps, and then wrote his name and the date in the concrete which will preserve them forever. This block will occupy a prominent place near the entrance to the museum. Burbank's original office building, by the way, has been shipped from California and rebuilt near the museum site, where, with many of his tools and examples of his experiments, it will form part of a Burbank memorial.

Passing from the reproduction of Menlo Park, the main tribute to Mr. Edison, the visitor will find himself in another group of frame buildings, "The Village," a center built around a commons such as characterized the early New England towns. There is the original Clinton Inn, pur-

2936

chased some time ago by Mr. Ford for his collection. In houses and shops, workers, dressed in the costumes of the times, are to be engaged in the various crafts of the period. Some of the cobblestones in the streets have been brought from New England. All the buildings are furnished as they were in the early days, and each is lighted with lamp or candle, according to the period to which it belongs. There is a well with its old oaken bucket, a quaint mill with its overshot water wheel, hitching posts, vehicles of other days, including a stagecoach that will creak down the streets at visitors' hours. As nearly as possible, everything in the village is to be shown in action. One of Mr. Ford's chief aims is to avoid dead exhibitions, even though the purpose of the entire display is essentially that of a museum.

Menlo Park and "The Village" form an attractive setting for the main structure, the big museum building, which is to be a faithful replica of Independence Hall at Philadelphia on a gigantic scale. Under its generous roof will be housed the bulk

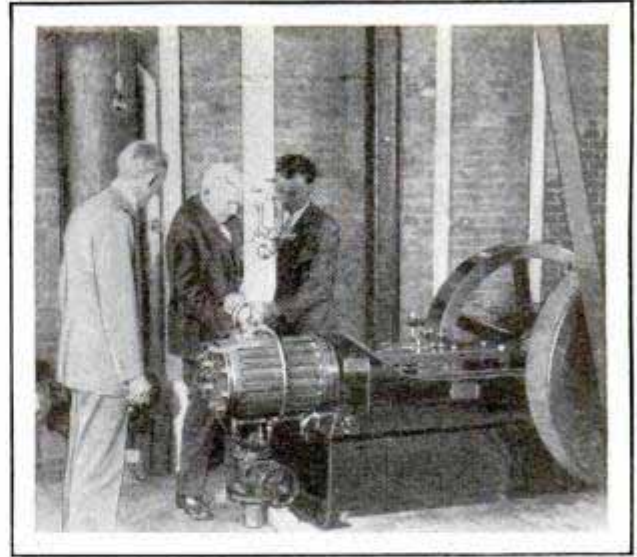

Edison and Mr. Ford Examining the Old Engine Now Running Again in the Moved Laboratory

of the great collection that Mr. Ford and his representatives have been gathering for years. One wing of the structure will be a roundhouse in which will be kept some of the locomotives to be exhibited. These trophies, representing the development of our railroads from earliest times, as well as other machines, are to be restored, repaired and otherwise put in running order before they are displayed. Staffs of expert mechanics have been long engaged in this interesting work, grooming the ancient relics for their appearance before the public.

Corridor after corridor, filled with relics of the past, stretch out into the dim shadows in the big building where part of the collection now is temporarily stored. It

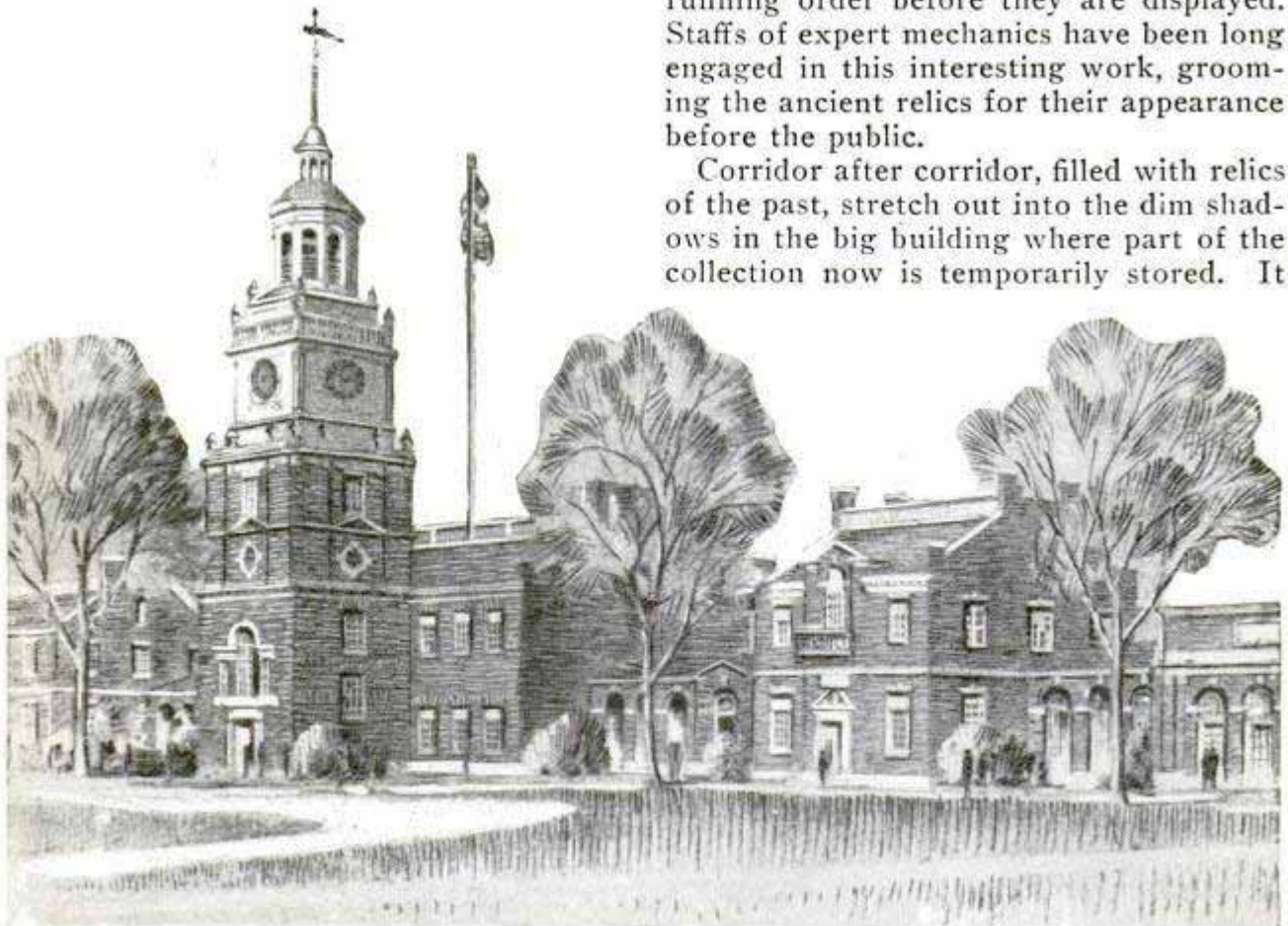

Architect's Drawing of Part of the Front of the Huge Ford American Museum Now under Construction at Dearborn, Mich.; It Will Be a Faithful Reproduction of Independence Hall on a Gigantic Scale

is as though thousands of attics and store-rooms had pooled their treasures in one huge display, to tempt the caller on an endless afternoon of pleasant exploration and rummaging. Rows upon rows of fine old chairs, secretaries, beds and other furniture, glassware, cutlery, pewter, spinning wheels and clocks. An old-fashioned music box tinkles a mellow tune while a collection of wooden Indians, such as once guarded the cigar-store entrance, gaze stolidly ahead. Sleighbells, horsewhips and harnesses, buggies, wagons and sleighs, lamps, candlesticks, and quilting frames, lathes of every age, including one of the primitive type that was worked by a rope fastened to a sapling, cooking utensils dark from a hundred fireplaces, dolls, cribs, cradles and trundle beds—these, and thousands upon thousands of other articles, all waiting for the day when the doors of the big museum will swing open upon the romantic tableau of human progress.

Many of the objects have personal associations. One of these is a sap bucket, fashioned by former President Coolidge's grandfather, and given to Mr. Ford by the former chief executive. This bears Mr. Coolidge's autograph and also that of the Prince of Wales. Another is a baby jumper in which Henry Wadsworth Longfellow learned to walk. The collection also includes the old lunch cart in which



Model of Edison's First Incandescent Light in Holder, Being Compared with a Recent Bulb

Mr. Ford took many meals when he was learning the machinist's trade in Detroit and the ancient Dearborn band wagon in which the Dearborn band toured the country giving patriotic concerts during Civil War times. Mr. Ford's uncle, also named Henry, played fife in that band. There is Mr. Ford's first desk, his first lathe and, of course, a complete collection of all the Ford motors from the first to the latest.

Of special interest will be the display of steam engines and electrical apparatus

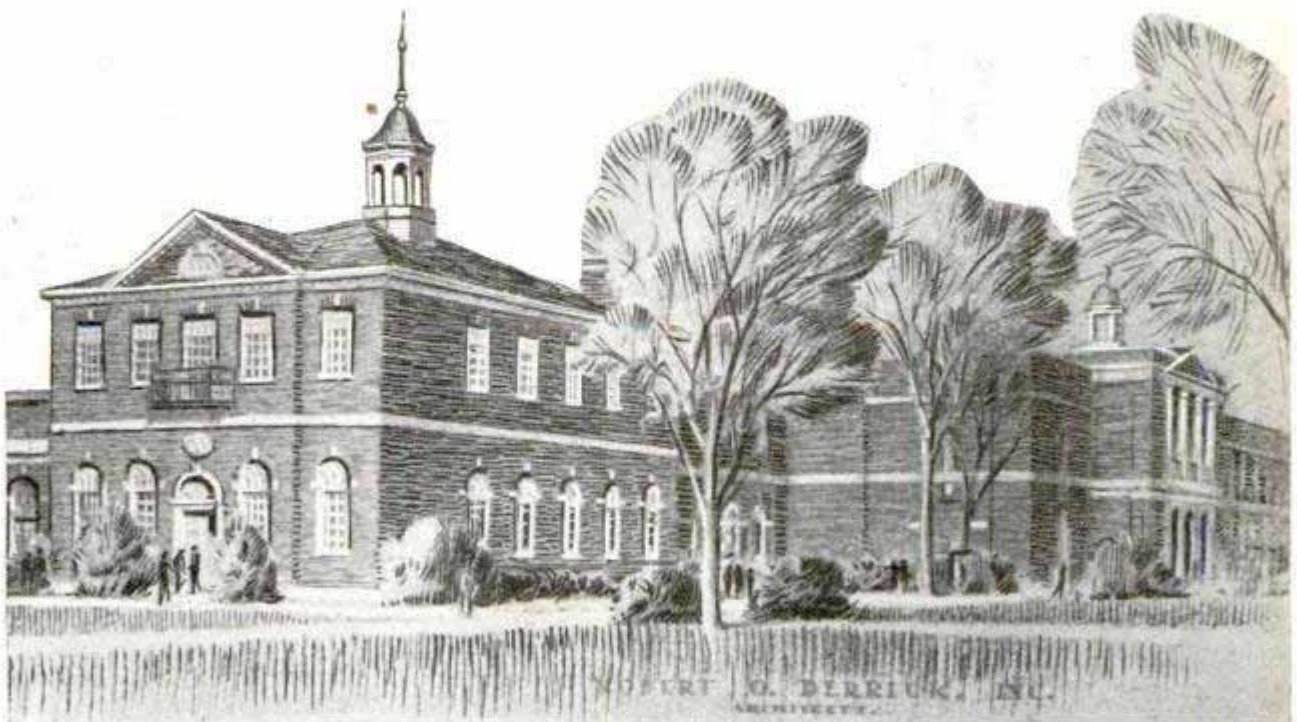

Another View of Elevation of the Museum; the Edison Autograph in the Cement Block Is to Be Displayed in a Prominent Place at the Entrance to the Main Building

24 944

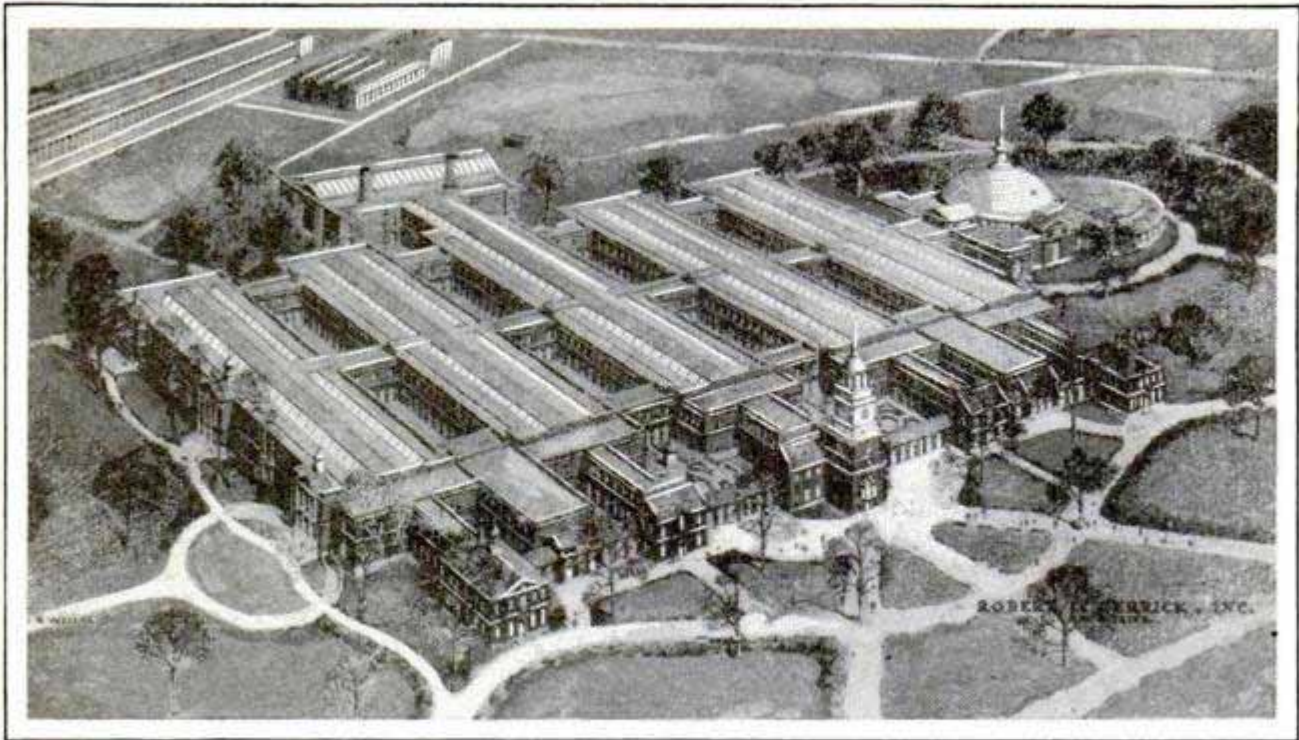

View of the Entire Building; Since This Sketch Was Made, It Has Been Decided to Inclose the Area under One Roof, Instead of Several as Shown; Note the Roundhouse for Locomotives at Right

of all kinds. The various pieces will all have been restored to running order and will be arranged in an ascending scale, that is, in the order of their development, so that the visitor can visualize, at a glance, the progress that has been made throughout the years. This collection of engines and other machines already has been put to practical use from time to time at the Ford works. When a supposedly new principle in mechanics is introduced, or there is some doubt as to an old one, the old engines themselves are consulted and, more than once, highly trained mechanics and engineers have been surprised to discover that an idea they had supposed to be original with them, had already been adapted years before.

**EVIDENCE OF NOAH'S FLOOD FOUND BY SCIENTISTS**

Evidence supporting the story of the great flood of Noah's time, as related in the Bible, has been uncovered on the site of the ancient Sumerian city of Kish, in Mesopotamia, by members of the Field Museum-Oxford University expedition. Indications are that the city was destroyed not once, but twice, by inundations similar to that described in the book of Genesis. Scientists estimate that the first flood oc-

curred about 4000 B. C. and the later, the one in which, according to the Bible story, Noah saved the human race, happened about 600 years later. Kish was rebuilt after each flood, and relics of the successive habitations are found in the different strata through which the explorers have dug. The remains of the original city were uncovered at a depth of fifty-five feet, ten feet below the second. Scholars are at work deciphering inscriptions on some of the tablets found among the ruins, in the belief that further light may be shed upon the civilization of those times.

**SAFETY LATCH FOR PLIERS PREVENTS SLIPPING**

2510



To keep the jaws of the pliers from slipping off the work, a western inventor has introduced a safety latch or dog that keeps them in place. The attachment does not interfere with the regular operation of the tool and is easily and quickly set for service.

2532

Chicago Tribune 3/19/29

Inv. & maker of  
E. N. Lotus 438 Laurel



2451

FANS OF LIGHT GUIDE FLYERS  
IN MAKING LANDINGS

24 79

Rotating fans of colored lights, which can be adjusted at different angles, are now in operation at the Cleveland municipal airport, to help direct pilots to a safe landing. Half of the beam is white and half red, producing alternating flashes that distinguish the lights from those of the parks and other places.

"CLOCK" TO RUN FOR CENTURIES  
SHOWS RADIUM'S POWER

24 8

It doesn't tell time, yet scientists call it a clock and it is expected to run for centuries without any attention. It is a radium unit, a vacuum tube, inside of which is a small cylinder of the mysterious substance. As the radium disintegrates, it charges two gold leaves with electricity. They gradually diverge until they touch the sides of the vacuum tube where they discharge their electricity and drop down. This action is repeated every thirty-four seconds and will continue as long as the radium is active. This is probably one of the nearest approaches to so-called perpetual motion yet developed. Scientists estimate that at the end of 2,000 years, the "clock" will still be running, although the cycle of the gold leaves will be performed but once every sixty-eight seconds.

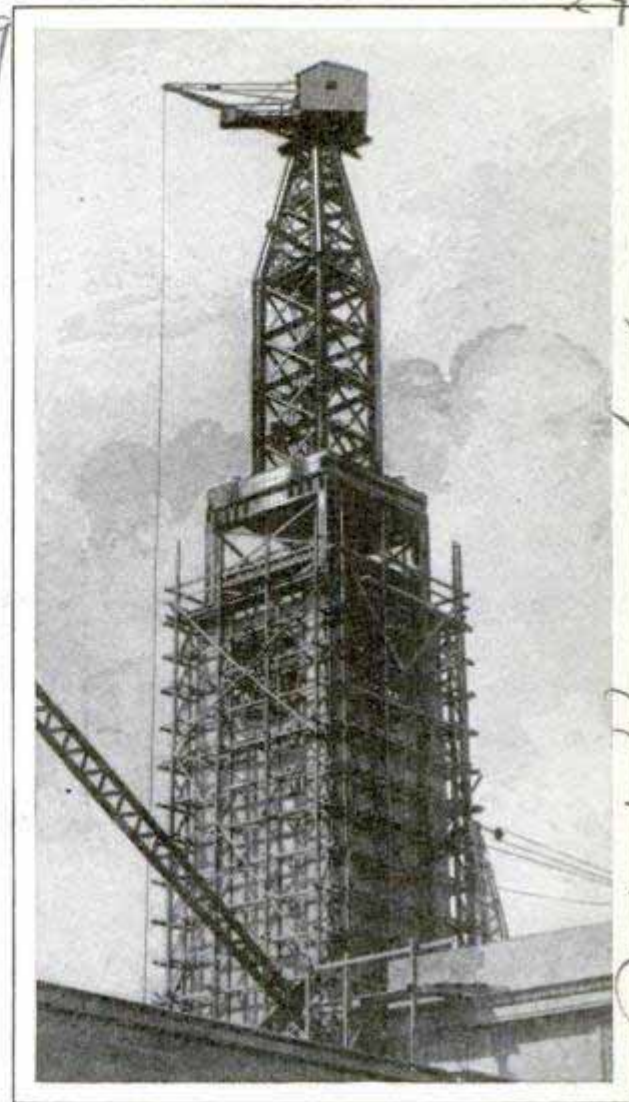

Steel Tower under Construction in Australia; the Crane on Top Saved Builders Time and Labor

CRANE ON TOP OF HIGH TOWER  
ELIMINATES SCAFFOLDS

That modern methods of steel construction are followed in Australia as well as in other parts of the world is illustrated by the accompanying photograph of the town-hall tower under process of erection at Brisbane. A crane was installed at the peak of the tower, 300 feet above the ground, saving the task of building a system of scaffolding. The corner stone of this interesting structure was laid by the Prince of Wales in 1920, and the work is expected to be finished this year.



Radium "Clock" That Needs No Winding and Is Expected to Run for Centuries

2451  
Cmt Robert Ravnagh Farm  
Road, Newmarket Brisbane  
Queensland Australia

¶The Popular Mechanics' Bureau of Information offers its free service to all readers of this magazine. Names and addresses of manufacturers and dealers in articles described, and any other details in our possession, will be promptly furnished.

Mr Frank Edward Simpson  
69 Madison Avenue

2251



# On the Trail of the

By H. R. HILL / 1653  
*Lep Roy an. Berkeley, Calif*

AS THOUGH shot from a catapult, a tawny body goes hurtling through the air. It is a California mountain lion bent upon a kill, the intended victim a motion-picture cameraman.

"Click-click-click." True to the tradition of his calling, the cameraman continues steadily to grind, although death is but a split-second away. Then, in a flash, the heavy camera is shoved to one side, the man falls prone to the ground, and 150 pounds of steellike muscle, fangs and claws pass safely overhead.

As the lion strikes the ground, rebounds and leaps swiftly away into the forest, dogs baying madly at its heels, the cameraman rises to his feet and hastily inspects his costly camera. And another thrilling incident is closed in the career of Sidney A. Snow. The vicious leap of the lion has been filmed, the camera escaped injury, and last, if not least, the cameraman himself emerged with a whole skin.

For this is no movie scene with a hairbreadth escape accomplished by means of double exposure. It's the real thing, too real at times for comfort. Snow, son of the late H. A. Snow, the big-game hunter, has been engaged for four years in the filming of the California mountain lion in its native haunts. It is a task to try the courage of the hardest hunter.

With J. C. Bruce, official lion hunter of the California state fish and game commission, Snow has engaged in some sixty expeditions into the mountainous region east and south of San Francisco bay. With camera equipment varying in weight from twenty-five to one hundred pounds, which he is often obliged to carry through dense thickets and up steep mountainsides, he has followed the veteran Bruce and his trained dogs over hundreds of miles of trailless forest. Hard work, excitement and adventure—that describes Snow's amazing project.

The California mountain lion is at once

*Oakland Calif*

A Strip of Sidney Snow's Movie Film of a Young Mountain-Lion Cub Treed by the Dogs and Getting Ready to Put Up a Fight

# Mountain Lion

the most difficult and dangerous animal subject in the world for motion-picture purposes, says Snow. And he speaks with no slight authority, most of his thirty years having been spent on the trail of big game, first in Africa with his father, next in the arctic. African lions and polar bears alike have fallen before his rifle and been filmed by his movie camera. He "shot" the roping of a full-grown polar bear, and the beast now is in the municipal zoo of Snow's home city, Oakland, Calif.

But neither the king of the jungles nor the monarch of the ice floes are comparable to the California mountain lion in pure viciousness, wariness and general cussedness. Bruce holds what is believed to be the world's record for mountain lions killed—348 in all—and the killings of many of them have been recorded on the celluloid by Snow. But the ambition of this young camera hunter goes beyond the mere killing of the predatory beasts. He wants to "shoot" the spectacular scene



Sidney Snow "Shooting" a Tread Lion, and, at Right, a Member of the Party Who Picked Up More Than an Armful When He Gathered in an Angry Young Lion Cub



With a Young Lion off the Ground and Trying to Fight Off the Dogs, Bruce Has a Busy Time

of a full-grown male lion being roped from a tree!

Incredible as the feat may sound, Snow and Bruce believe it to be possible. In fact, they once succeeded in getting the loop over a lion's head, but the beast, maddened with rage, leaped to the ground with such force that its neck was broken.

The roping of a mountain lion has a technique all its own, the foundation of which is earthquake-proof nerves. In the first place, a lion always takes to a tree when pressed by the dogs. Generally it crouches on a limb well above the ground, there to survey its enemies below with baleful yellow eyes that seem fairly to shoot fire. Bruce then prepares a loop which he hangs on the forked end of a long pole. Snow meanwhile has found an advantageous position for his camera.

The trick is to place the loop over the lion's head, draw it tight and drag the snarling beast to the ground. Should Bruce be unable to reach the lion, he endeavors to climb the tree, and often the dogs try this same stunt. The lion, growling and spitting after the manner of cats large or small, bats the loop away with one mighty blow of its forepaw.

Vision this scene: Bruce has climbed part way up the tree and essayed unsuccessfully to loop the lion. The rope, slapped repeatedly by the lion, has become snarled in the fork of the stick. So Bruce starts to climb back down the tree.

Snow is grinding away at his camera. Suddenly, the lion has turned and now is stalking Bruce, slipping down the tree behind him, preparing to spring as he gets clear of intervening limbs.

A shout—a flash of tawny hide! Bruce from the corner of his eye glimpses the leaping lion. He lets go and drops, leaps to safety. The dogs close in and he is safe.

Meanwhile, Snow has been filming the near tragedy. Not once does he stop turning the crank, for he knows that here is a picture which may never be filmed again—a man in a tree being stalked by a mountain lion!

Dangerous? You bet. But Snow and Bruce have discounted that phase of their strange profession. Snow's African and Alaskan experiences are standing him in good stead in the filming of this story of

*Karl Schapel*  
 5035 Fair Ave. h,  
 2450 Hollywood  
 Calif 949

wild life. In fact, without that background, he says, he would not be able to withstand the strain of it. As for Bruce, that famous hunter was born and bred in the mountains; he is reputed to know more about the habits of the mountain lion than anyone living.

Action! There was plenty of it the time the big male lion, measuring seven feet, leaped full at Bruce and Snow. Snow managed to evade the death-dealing slash of the powerful paws. Bruce and the lion struck the ground in a whirlwind of dust and leaves. Snow's younger brother, Homer, who often goes on these expeditions, stood, with pistol in hand, prepared to come to the rescue of anyone in trouble. There was plenty of trouble now, but nothing could be done about it. To shoot the lion might mean to kill Bruce.

But Bruce, a powerful six-footer, was equal to the occasion. Knowing that in the next instant he might be soaring into eternity with a crushed head or backbone, he managed with one superhuman effort to draw his revolver. Blindly he fired upward. The lion, with a last agonized cry, rolled over dead. Not always are the scenes so fraught with possible tragedy. Bruce delights in capturing alive the half-grown lions he encounters, and for this purpose he has mastered a method. While the young lion stands at bay, Bruce ropes it by the hind feet which he lifts from the ground with one hand. With the other he grasps the beast by the neck. Thus caught, the lion is comparatively helpless.

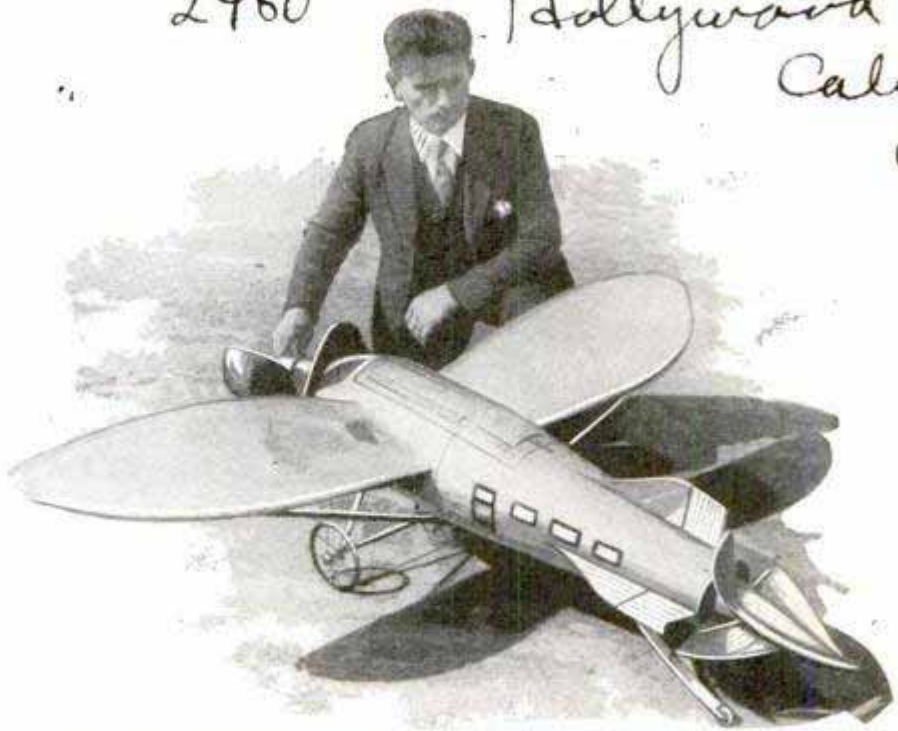

Model of Plane with Turbinelike Propellers at the Front and Rear; the One Behind Can Be Reversed and Used as a Brake

**TURBINE PROPELLERS ON PLANE TO DEVELOP HIGH SPEED**

Speed of 500 miles an hour is predicted with an airplane a California inventor is designing. It has turbinelike propellers at the front and rear, is to be fifty feet long and have a wing spread of sixty feet. The rear propeller, somewhat like that of a ship, is intended to serve as a stabilizer and, when reversed, as a brake.

**TRACTION BAND FOR WHEEL HELPS CAR OUT OF RUTS**

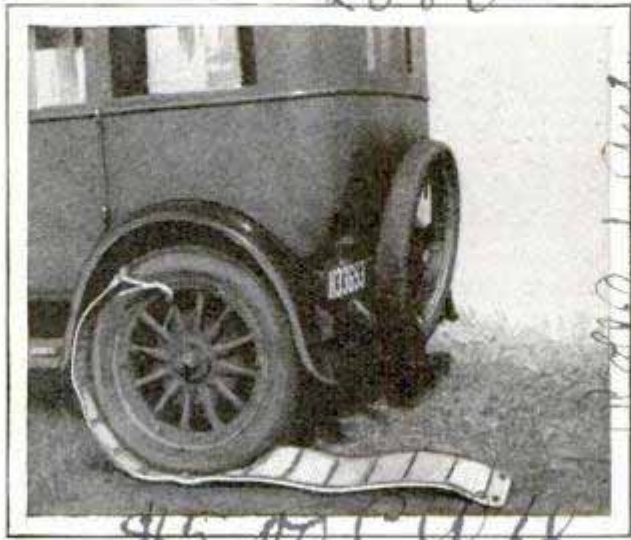

Tractor Band Partly in Place to Show How It Is Adjusted; Note the Cross-Pieces

Quickly attached to the rear wheel of the automobile, a canvas-and-rope band affords traction in getting out of a rut. The rope is threaded across the band at intervals of five inches to form effective grips and the whole is tied around the wheel. When not in use, the band can be rolled up and may be carried under a car seat.

*Karl Schapel*  
 5035 Fair Ave. h,  
 2450 Hollywood  
 Calif 949

*H.A. Cuyward, 98 Howard St, Hoboken, N.J.*

2380

4500000

W. C. ... Clagg Telegraph Office ... A. U. Macdonald Ottawa Flying Club, Ottawa, Ont. Can.



"Cribbage Board" Train Indicator, Used in Tower at Louisville, Ky., to Keep Track of Train and Engine Movements in Yards

**GAME BOARD TRACES TRAINS AT SIGNAL TOWER**

Keeping track of trains is a sort of game at a signal tower in Louisville, Ky. A unit somewhat resembling a cribbage board is used to indicate, by means of pegs, what blocks are occupied as the trains advance. The outfit is operated in connection with the manual block system.

**ELECTRIC FINGERS TREAT MEAT TO MAKE IT TENDER**

Somewhat like a large flatiron in appearance, an electric unit for making meat tender has been introduced for restaurant and household use. It has a number of sharp fingers that pierce the meat so that the cooking will be done more

thoroughly and the piece made easier to cut and chew. The tenderer operates with



helpful when the pilot's attention is likely to be occupied in picking out a landing spot, or in some other activity that may cause him to neglect the speed of the ship.

**SIMPLE GAUGE TO TEST SCREWS DETECTS FAULTY THREADS**

For rapid and accurate inspection of screws as they come from the machine, a simple gauge now on the market easily indicates those that are defective, warns the operator before the tolerance limit is reached and provides a dependable tolerance zone by which the fit of the screw may be determined. The screw is simply inserted and turned into the gauge.

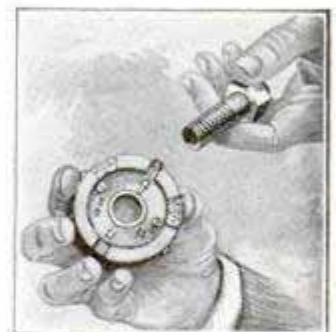

The world's richest emerald mines are in the Ural mountains.

current from a lighting socket and is constructed to last a long time.

**TAILSPIN WARNING GIVEN AIRMAN BY BUZZER**

To signal the pilot when his plane is losing speed and is liable to go into a tailspin, an electric warning unit has been developed by a Canadian aviator. The apparatus is adjusted in such a way that, when the air speed decreases to the danger point, an electrical contact is made, and a buzzing sound is produced in the earphones worn by the pilot. The signal is given with a margin of safety so that the operator will have time to increase his speed before the spin. The attachment is considered especially

American Meat Tender Corp. W. 23rd New York  
W. C. Clagg  
A. B. G. 29  
77

246  
69  
J. Macdonald  
James Cameron Machine Co. Montreal, W.

*The Modern*  
 10/26/40  
 2409 Com. Frank  
 Williams, P/5  
 951  
 POPULAR MECHANICS  
 Van Ness Ave  
 Santa Ana Calif

**RATE OF TRAVEL QUICKLY GIVEN BY SCALE**

A simple chart to calculate speed from the time taken to travel a known distance has been developed by Ramon Zubiga, of England. Three parallel scales are used, one calibrated for distance, with one to ten units on one side, and ten to 100 on the other; a second for time, laid out for one to ninety minutes above and from ten minutes to fifteen hours below; and the third for speed, calibrated from six to sixty miles. The chart can be used to calculate in any system of measuring, either miles or kilometers. To use it, a straightedge is placed on the figures corresponding to the distance traveled and the time it took to cover it. The ruler then shows, on the third scale, the rate in miles or kilometers per hour. For example, if a vehicle or boat covers seven miles in ten minutes, the ruler is placed on the seven in the distance column, ten in the time column, and rests on forty-two in the speed column. If distance is ten miles or less, use scales AA; if over ten, use BB.

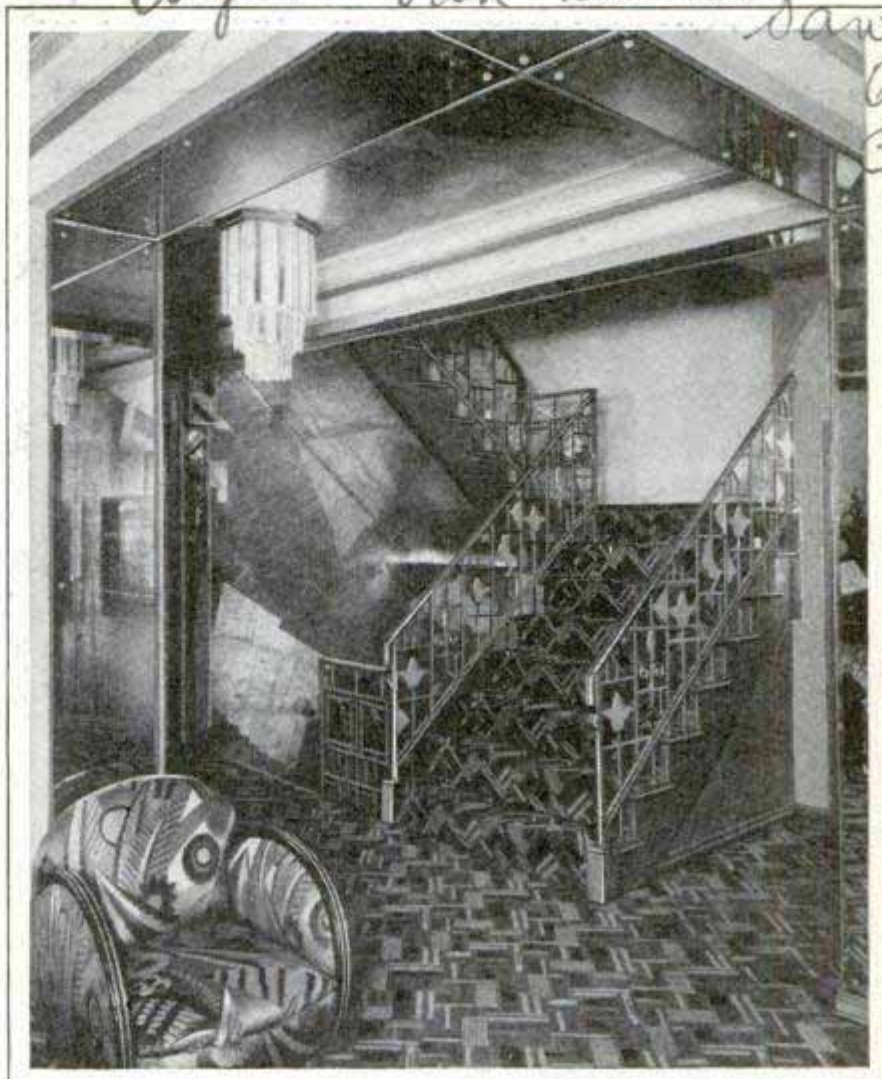

Colors, Angles and Novel Use of Materials Are Evident in This Modern-Art Treatment of an Apartment-House Entrance

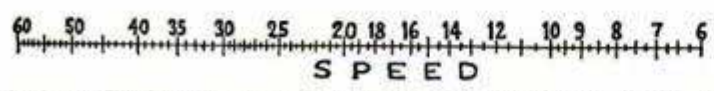
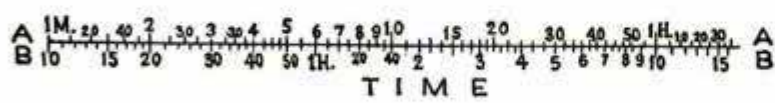

Calculator Which Translates Distance and Time into Speed, by Placing a Straightedge across the Known Factors

**MODERN ART FOR APARTMENTS ADDS NOVELTY TO HALL**

To create an impressive entrance to an apartment building in Los Angeles, an architect has resorted to elaborate use of the so-called "art moderne." Odd arrangements of angular designs and of different colors produce distinctive results.

**CONCRETE DYE RESISTS ACID AND FADING 2516**

For staining concrete, marble and various composition materials, an improved dye substance is said to penetrate to a considerable depth, does not deteriorate in the sun, and is not affected by various acids. It is intended as a substitute for paint.

*Chas. L. M. Kremer,  
 2460 N. Clark*

*no further information*

2143  
952

*built by Dr. C. C. Bates  
an Englishman and holder  
of a Mexican land grant*

POPULAR MECHANICS

FROM THE WATER WHEEL TO SUPER HYDRO POWER

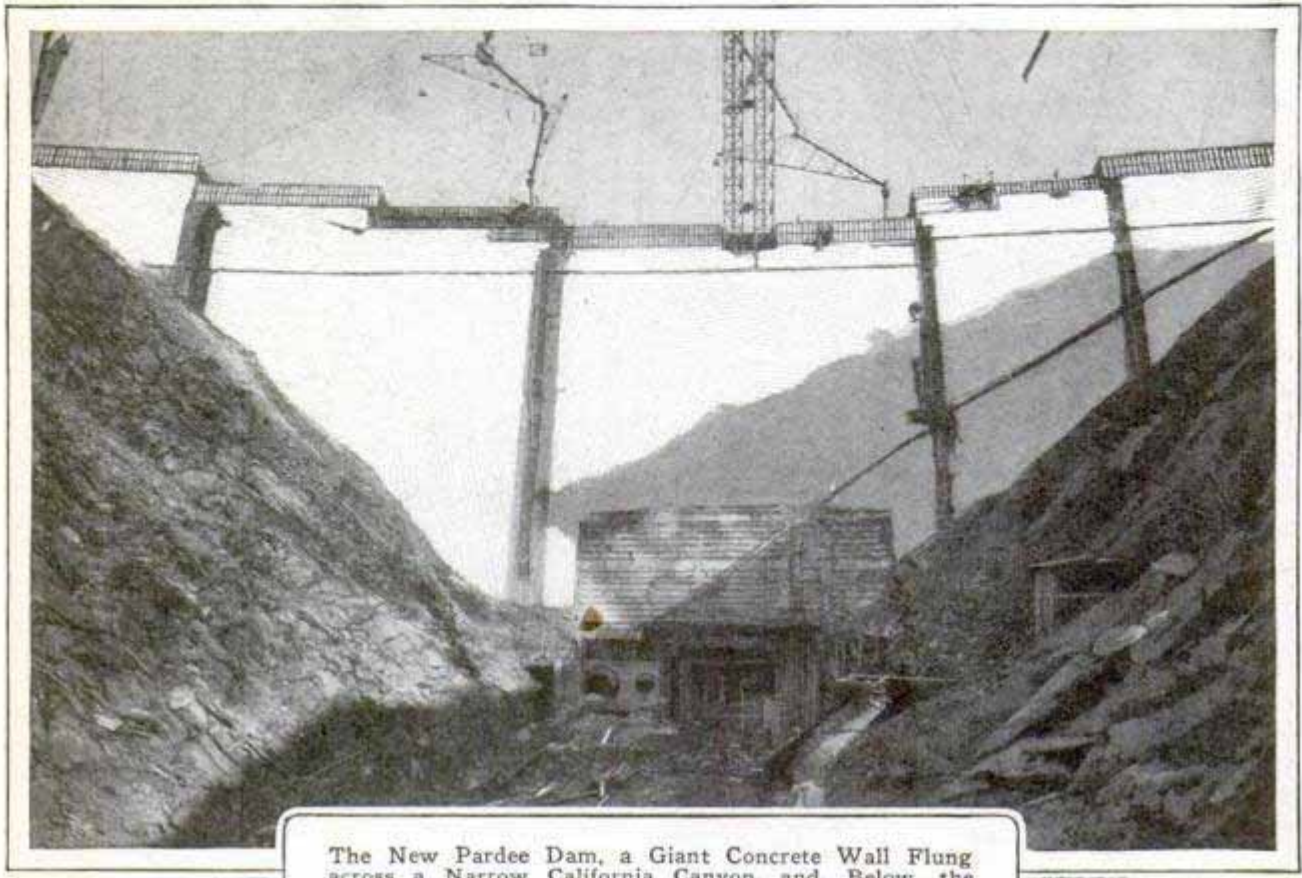

The New Pardee Dam, a Giant Concrete Wall Flung across a Narrow California Canyon, and, Below, the State's First Power Plant, Built before the Gold Rush and Still Standing in Napa County

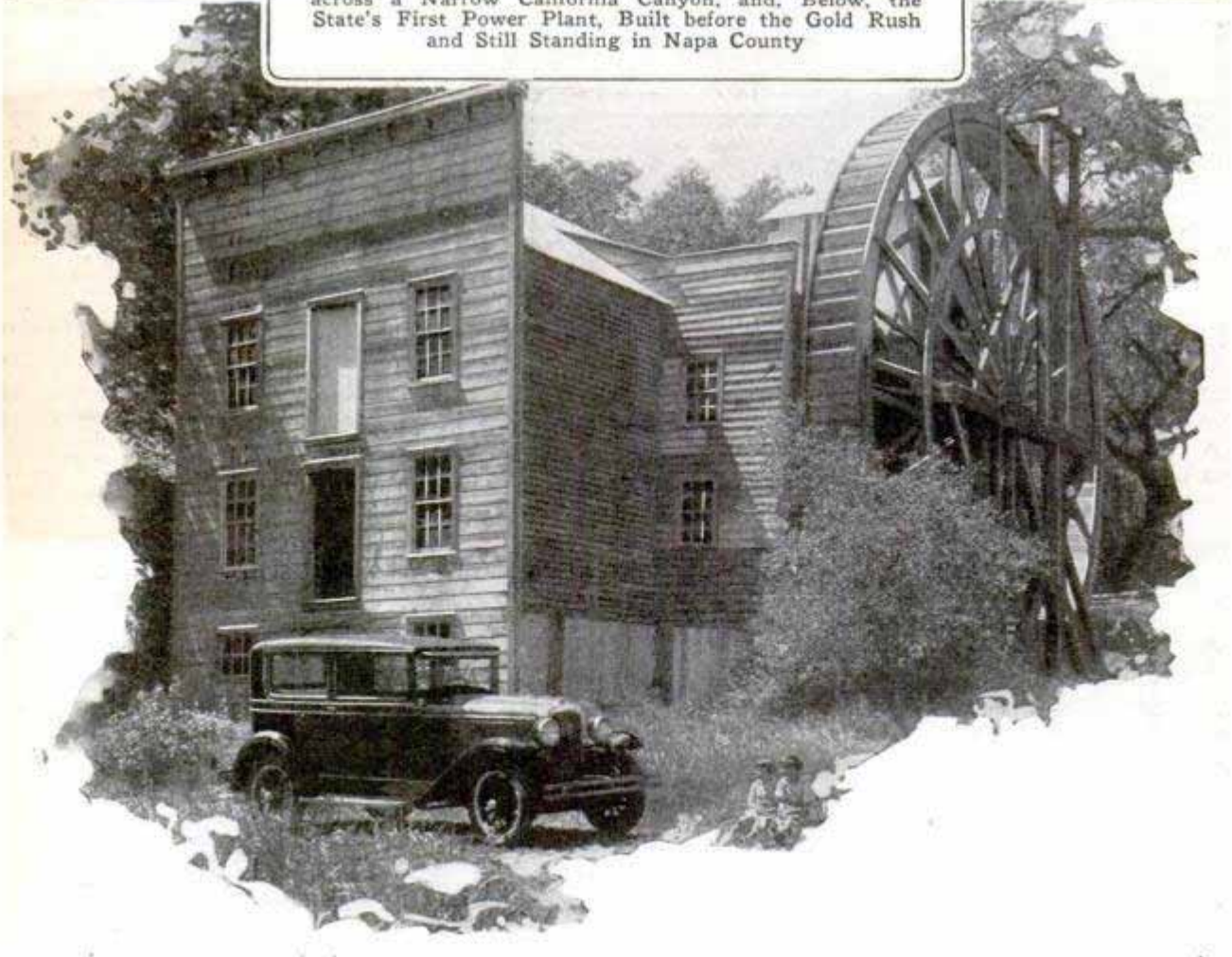



*Science News Letter Carter - Mayhew*

*3/16/29*

POPULAR MECHANICS

953

*2439*

*655-19 H. N. E.*

*Manufactured in U.S.A.*

*Euphorbia*

*intensity*  
**PLANT YIELDING MORE RUBBER FOUND IN MADAGASCAR**

Scientists, and all who are concerned with the possible production of rubber in this country, are interested in a new species of rubber tree brought here by Dr. Charles F. Swingle, of the department of agriculture, from Madagascar. It is of a variety that has all but been exterminated and differs essentially from other kinds in that the rubber separates itself from the sap or latex on exposure to air. No coagulation or smoking processes are necessary as with the usual forms of rubber. The roots consist of chains of bulbous swellings, somewhat like sweet potatoes, and due to these tubers, which serve as water reservoirs during drouths, the plant is able to withstand desert weather. Experiments are to be made to determine if the species can be cultivated in the southern parts of the United States and in Mexico. It survives drouths, but whether it will stand light frosts remains to be seen. It is a slow-growing variety, so that years will be required before commercial production of rubber can be realized from it, even if the plant is found suited to climatic conditions here.

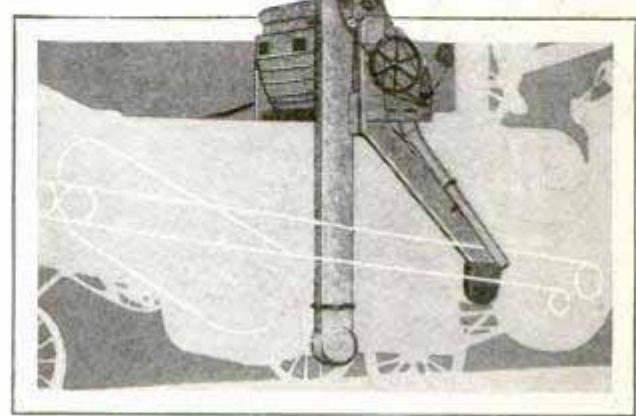
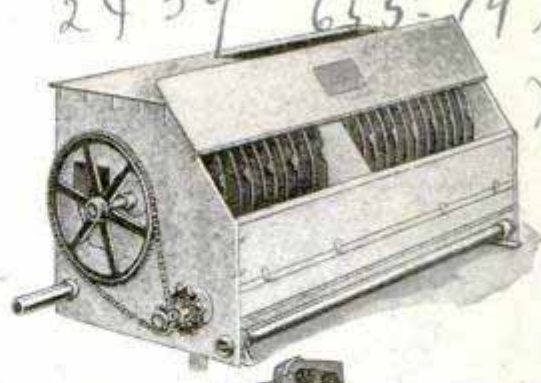

Cleaner Unit Detached, and Drawing to Show Its Relation to the Rest of the Threshing Machine

**GRAIN CLEANER ON THRESHER INCREASES FARM PROFIT**

To give the grain a thorough cleaning as it comes from the thresher, a disk attachment is now on the market. It separates the dockage, which often constitutes a considerable percentage of the total crop. Unless this is saved at the farm and used for feed, it represents a loss, as the grower

must pay freight on it with the grain, but it adds nothing to the price he will obtain for the crop. The unit has no screens or sieves, saves rehandling the grain and is easy to install and operate. It adds comparatively little to the total weight of the thresher and has proved popular with farmers who hire their threshing done by outsiders.

☐ In 1819, the first steamship crossed the Atlantic ocean.

**MOTOR SANDER AND POLISHER ALSO RUNS DRILL**

Operated by current from a lighting socket, a portable sander and polisher that weighs but a few pounds, can also be used for running a drill. Attachments are provided for this as well as for buffers and brushes of different kinds. The unit is especially adapted to use on automobiles, boats, floors and the like. Grips give the operator an unusually convenient hold on the unit and control is in easy reach.

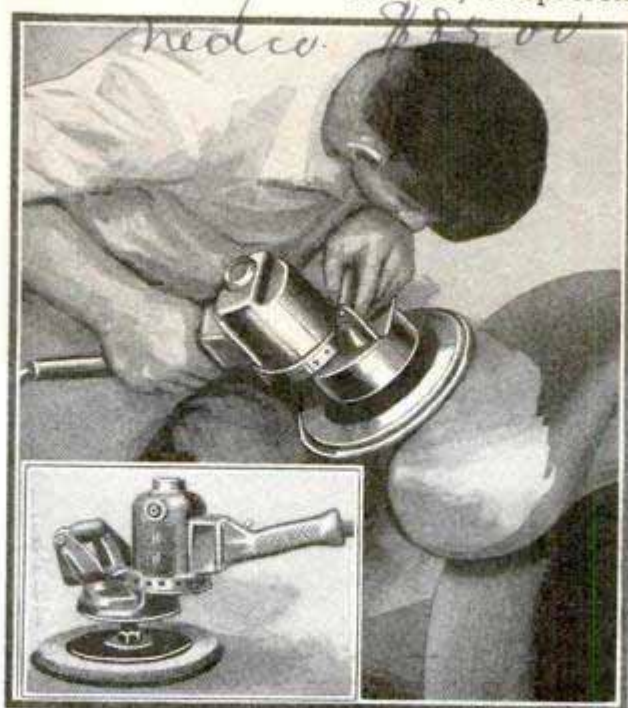

Buffer in Operation and Close View, Showing Grips and Method of Attaching the Polisher

*C. Warren Mfg Co, Natich, Mass.*

the and e

# Drivers' Tests

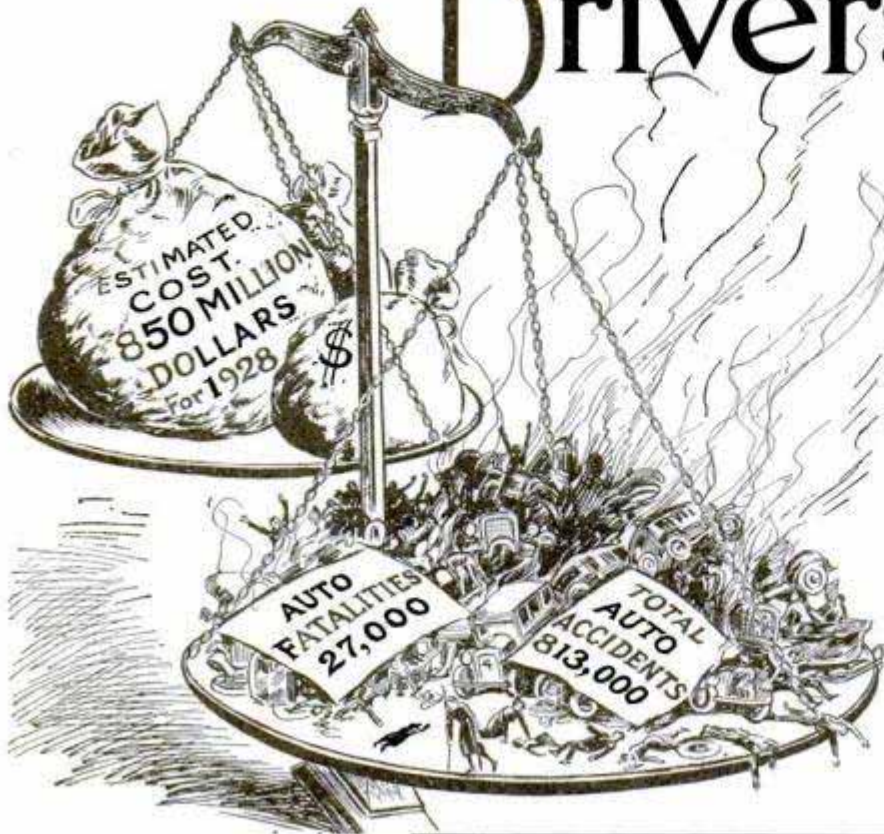

tem of traffic signs, signals and markings. One reason for such a step is that, last year alone, 2,000 persons were killed because they became confused by signs with which they were unfamiliar. The increase in interstate travel by auto demands a uniform set of guides, the experts declare.

In the second place, there is, according to J. S. Baker, of the National Safety council, the human element. "It is not the breakdown of the automobile that is caus-

## Wide World

THERE were 800,000 automobile accidents in the United States last year; 27,000 persons were killed and the loss involved was \$850,000,000, according to figures of the National Safety council. Fatalities were five per cent greater than in 1927.

Congestion caused by traffic in the motor-choked streets of our towns and cities, most of which were planned for buildings not over six stories high and for horses and buggies, is estimated to cost New York city \$540,000,000 a year, St. Louis \$16,000,000 and Detroit more than \$30,000,000.

What can be done about it? In the first place, a nation-wide movement is on to establish a uniform sys-



Cartoon by the National Safety Council, Showing the Automobile-Accident Situation, and, Below, Inspector W. Black, of Detroit, Cautioning a Driver Just Licensed; above the Blackboard Are Signs Applicants Must Identify at Sixty Feet during Tests

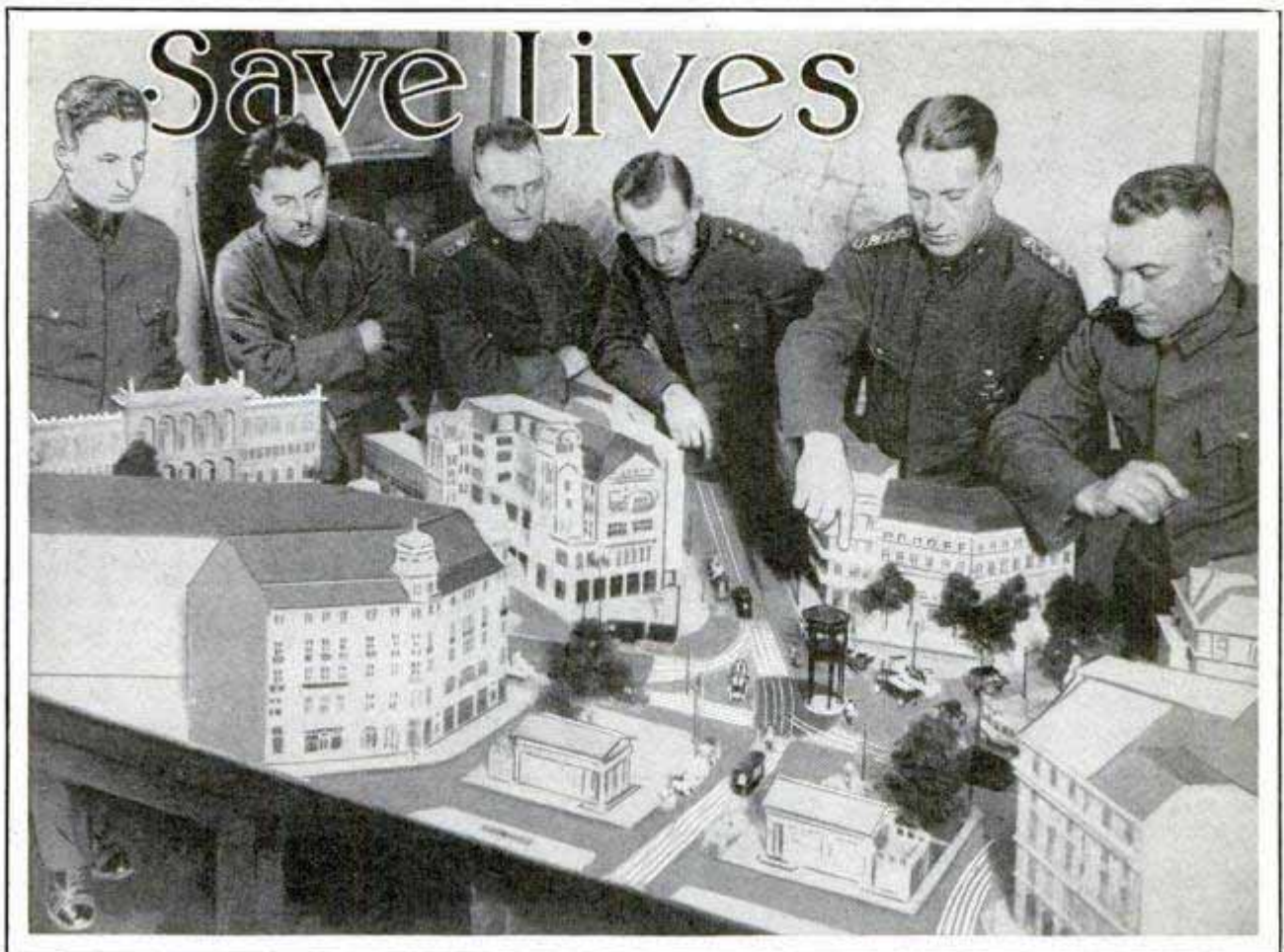

Efficient Handling of Automobile Traffic Is Essential to Safety; These Candidates for Special Positions in the Berlin Police Department Are Studying Routing Problems with Aid of Scale Models

ing accidents," he says, "it is the breakdown of the driver." The breakdown has also been traced to the pedestrian, for in thousands of cases, he and not the motorist is to blame for the mishap. Consequently, some cities are passing strict regulations against "jay walking," pedestrians are being routed in definite traffic lanes while on the sidewalks, in order that there may be less confusion there and less danger in crossing the streets, and a nation-wide drive is being conducted among school children to teach them care and thoughtfulness in order that accident may be avoided.

Already, results of these movements are on record. Washington, D. C., with a population of nearly 600,000, went through last December without a single motor fatality. Detroit suffered seventy-four fewer automobile deaths in 1928 than in 1927, although the population increased by 45,000 and the number of automobiles by 90,000. The year was marked by a twenty-per-cent decrease in automobile fatalities.

The effects of the Detroit educational campaign were particularly noticeable

among the school children. In the first nine months of last year, fatalities among children between the ages of five and fourteen were nearly thirty-four per cent less than in the same period in 1927. Old persons showed a similar good record. Fatal accidents by automobiles to those over fifty-five years old were reduced more than twenty-seven per cent. The smallest improvement was noticed in the group from sixteen to fifty-four years of age, the span of greatest activity and, often, of greatest carelessness. The reduction was less than eight per cent in this last division. More than half of the accidents in the entire city involved persons between the ages of twenty-five and fifty-four, although that group comprises considerably less than half of the population.

Michigan and several other states require that every driver of an automobile obtain a license before he can operate a car. Every state having such a law, has had encouraging results from it. On the basis of the records of these states, properly administered drivers' license laws would result in a twenty-per-cent reduc-

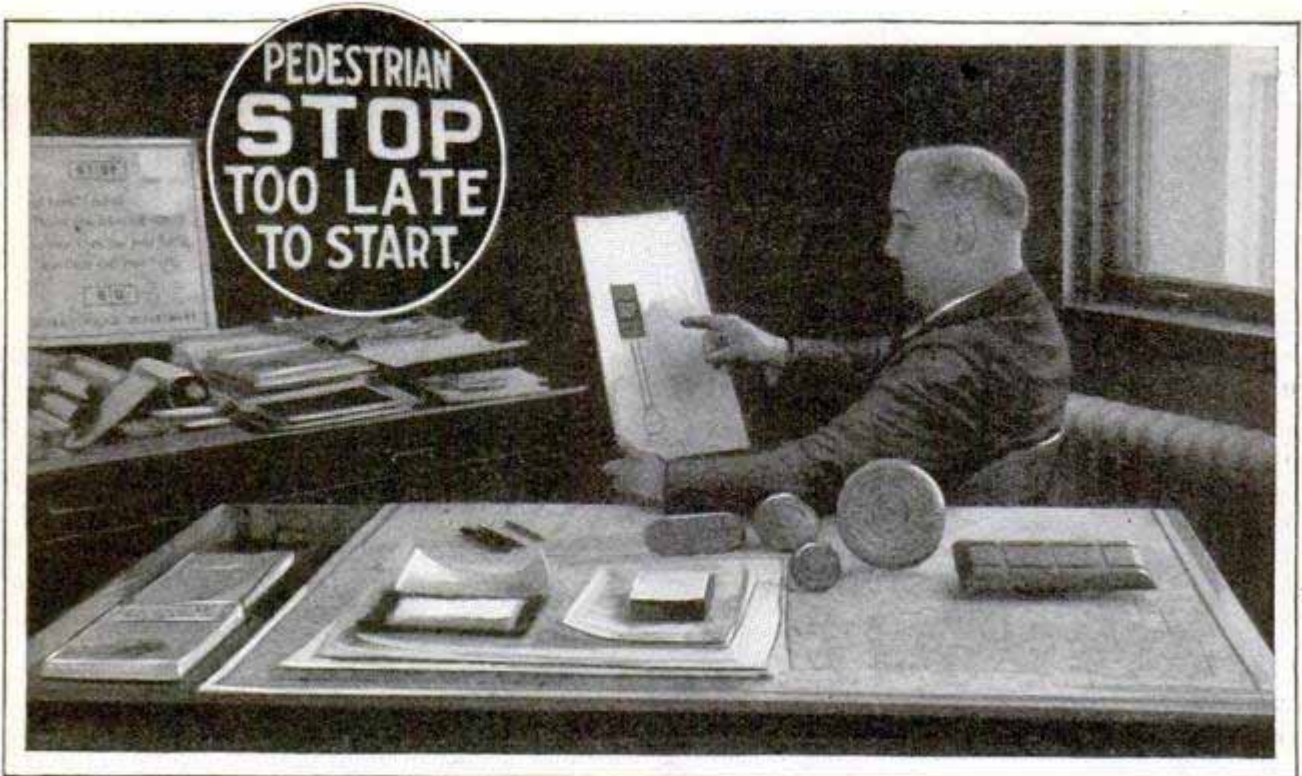

William L. Potts, of Detroit's Traffic-Survey Department, Examining Drawing of Proposed Neon-Gas Sign to Warn Pedestrians Not to Cross; Sign in Use and Sidewalk Line Guides Shown on Desk and Upper Left

tion in motor-vehicle fatalities throughout the country, according to Sidney J. Williams, of the National Safety Council. As applied in Detroit, the law is typical of the state of Michigan and of other states. Step into the police headquarters building where the licenses are applied for and watch it in operation.

Applicants of all classes, both men and women, must fill out the necessary papers and then answer a number of questions concerning traffic regulations. They are required to pass hearing and sight tests, including the identification of colors and various street-traffic signals and signs. After filling out the blanks and obtaining a notary's seal, the prospective driver passes to an examiner. Questions, picked at random from the police book of regulations, are put to him by an examiner. He must read the traffic signs and distinguish the colors on cards hung on the wall about sixty feet away. These posters are exact duplicates of the street signs. The examination often reveals serious eye defects, inability to tell colors and other difficulties that need correction before his application is approved.

Step upstairs, and you see what happens to those who fail in the verbal examination of the traffic rules. They are sent to school, which is held at noon daily except

Sunday and three nights each week. By means of a blackboard diagram, Sergt. J. Wesley Brown is explaining why it is unwise and unsafe to attempt to pass another car at an intersection, and is demonstrating other features of the regulations. Since the school was started about five years ago, he has taught more than 200,000 pupils who failed at the application tests. Usually, one or two sessions at the school enable the candidates to pass the verbal examination at the next trial. Applicants under eighteen years of age, and those having some physical defect, are required to take an actual road test under the eyes of a competent examiner.

The training school has revealed a number of interesting facts. During the first ten months of its operation, careful records were kept of the performance of "graduates." Chauffeurs of light and heavy trucks, for instance, who had attended the sessions, were involved in fewer accidents. In fact, there was a marked decrease in the number of fatalities and other accidents by automobile trucks as a result of the school, while there was an increase in the accident totals among operators of passenger vehicles who did not take the special schooling. The work of instruction is extended by the bureau of

public safety, of which the drivers' school is but one department, to the organization of safety patrols in both public and parochial schools, reaching the parents through evening meetings at the schools, distributing safety literature and giving motion-picture and other educational displays. School janitors have been enlisted in the street-patrol work. Police caps were ordered for them, and they took pride in the task. Pupils picked for patrol duties must maintain a certain scholarship level, and, in many cases, the opportunity to be a patrol guard proves an incentive to a youth who has been backward in his school work.

While these educational programs are going forward among drivers and school pupils, a traffic-survey bureau is laboring to find the causes of automobile congestion and danger in the streets and at

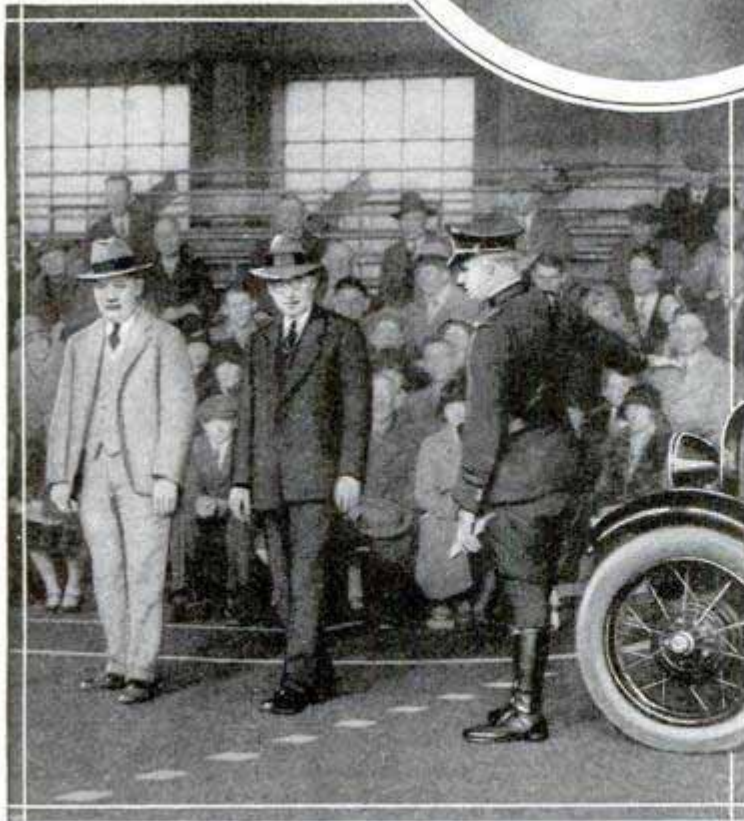
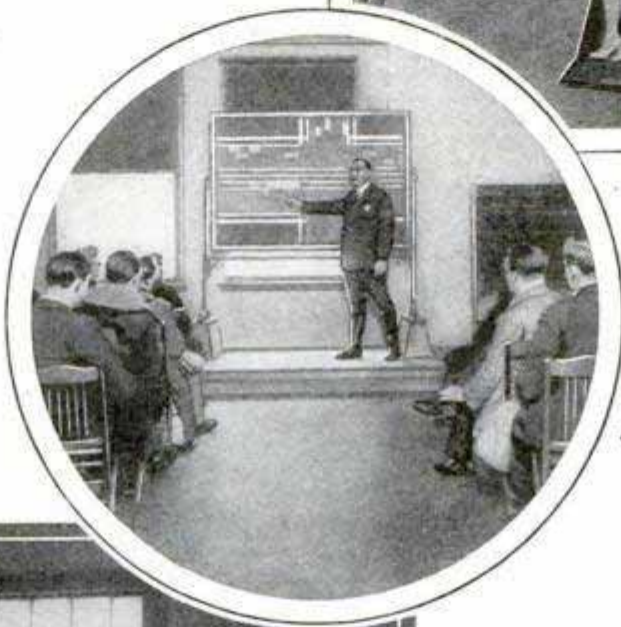

"Lady Godiva," Detroit's Safety-Zone Guardian; Sergeant J. Wesley Brown Giving a Traffic Lesson, and a Safety School in Session at Indianapolis

intersections. To warn the motorists of safety zones, officials introduced them to "Lady Godiva," a rubber model clothed in black and white and decorated with glass ornaments to reflect the headlights of automobiles. The "lady" was placed at the entrance to the safety zone and kept in an upright position by flexible bracings. Most drivers steered out, warned by the figure that they had reached a safety zone. Those who did strike Lady Godiva were relieved to discover that they had not maimed or killed anyone, for the rubber model promptly bobbed up when the car had passed. A glaring skull and crossbones in neon-gas lights is another effective warning that is being tested at safety zones, and a rubber stop sign, also decorated with glass jewels and set upright in the pavement, where it will be plainly visible and will fly back again should it be run over, is also being used. Last year, in Detroit, 160 vehicles hit protected safety zones,



Candidates for Automobile Driver's License Lined Up at the Bureau in Detroit's Police Headquarters Building; on the Wall at the Rear Are Traffic Signs That Must Be Identified during Examination

killing six persons and injuring 208. At the unprotected zones, ten persons were killed and 268 injured. The unprotected, occupied safety zones were entered by 229 vehicles.

Recognizing that control of pedestrian traffic in crowded areas would greatly aid the general situation, officials of the survey bureau established sidewalk lanes at a busy down-town block. These helped in keeping persons to the right and were of great benefit, not only in decreasing con-

fusion on the sidewalk, but in keeping order at the street intersections, where people commonly jostle and crowd each other, losing precious seconds. A helpful device for the pedestrian is now under preparation in the form of a neon-gas stop sign that will warn him that it is too late for him to cross the street. This is expected to be of great aid, for pedestrians, unaware that the danger light is about to flash against them, commonly find themselves stranded in the center of the street.

**MUSIC IS PLAYED BY ALPHABET AS SUBSTITUTE FOR NOTES**

Little skill is required in playing a new musical instrument introduced in a west-

ern city. It has a disk plate, lettered with characters of the alphabet. By turning the disk to the letter desired and blowing, the player produces the right note.

2423

1.00 per piece



Playing the New Musical Instrument by Alphabet

**SEVENTY-FIVE MILLION SPENT IN AMERICA FOR PLANES**

Last year, the United States spent \$75,000,000 for airplanes, according to a report of the aeronautical chamber of commerce. Production of commercial aircraft in 1928 was 140 per cent greater than the year before, 5,000 airplanes being built and sold and 3,500 aircraft motors marketed. Wichita, Kans., is the center of the airplane-manufacturing industry with 927 planes built in 1928, seventy more than were constructed in New York city, which ranked second. Rapid extension of air passenger routes and the opening of joint air-rail lines indicate the advance of commercial aviation in this country.

243

Mr. Playstone Co  
113 South Ave  
New York City

Retail - Weigelt Bros

Herald Examiner  
5/1/29

NEW STYLES IN BATTLESHIPS  
SET BY GERMANS

Smaller, faster battleships and cruisers, armed with twelve-inch guns, the favorite caliber of pre-war days, may replace some of the huge floating fortresses, such as the "Nelson" and the "Maryland" with their batteries of sixteen-inch guns, if the style represented by the new German "surprise" ships is followed. These vessels have a speed of twenty-six knots, sufficient to run away from any battleship now built, big enough to sink them, except for four big cruisers in the British navy and four in the Japanese. Other nations have plenty of cruisers fast enough to overtake the new German ships, but they are armed with eleven-inch guns. Naval authorities are wondering if a medium-sized battle cruiser, of about 17,500 tons and armed with twelve-inch guns, would not be advisable. There were boats of this general description in the British navy before and during the war, but they were scrapped in accordance with the Washington treaty. One chief advantage of the smaller guns is that they can be fired much more rapidly than the big ones and, although a single projectile from the twelve-inch guns is less effective than one from a sixteen-inch, the greater number, fired in a given time, would cause as much, if not more, damage in the opinion of experts.

HOTEL STATIONERY DISPENSER  
REDUCES WASTE

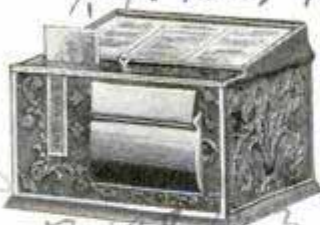

At the turn of a small wheel, writing paper and envelopes are dispensed from an attractive metal holder for the hotel desk. This saves time and keeps the paper from becoming lost, mussed and soiled. The holder has space for advertising legends.

The Popular Mechanics' Bureau of Information offers its free service to all readers of this magazine. Names and addresses of manufacturers and dealers in article described, and any other details in our possession, will be promptly furnished.

no change

Sander, Puff Co.  
122 7 1/2 South Ave. N.



Balloon Punching Bag in Use, and Close View Showing Vacuum Cup

TOY-BALLOON PUNCHING BAG  
HELD BY VACUUM CUP

Anchored by a rubber vacuum cup which may be attached firmly to almost any smooth surface, a small rubber balloon, when inflated, becomes an effective punching bag. It affords healthful exercise as well as amusement, requires no rigging of any kind, and can be put up or taken down in a few seconds.

DUST-TIGHT REFLECTOR COVER  
SIMPLIFIES CLEANING LAMP

Easily attached, a clear-glass disk cover fits over the electric-light reflector to keep out dust. To clean the fixture, all that is necessary is to wipe off the outside of the glass, thus renewing the maximum light output. The disk is firmly held in position and also keeps particles from flying upon the hot bulb, a dangerous factor in some plants.

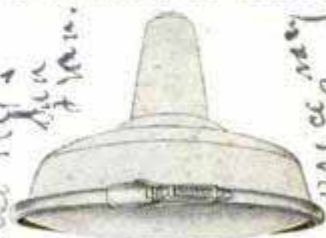

Beston  
max

Langarinn

2354  
Benjamin  
120  
Benjamin  
120

24 73 0 1/2

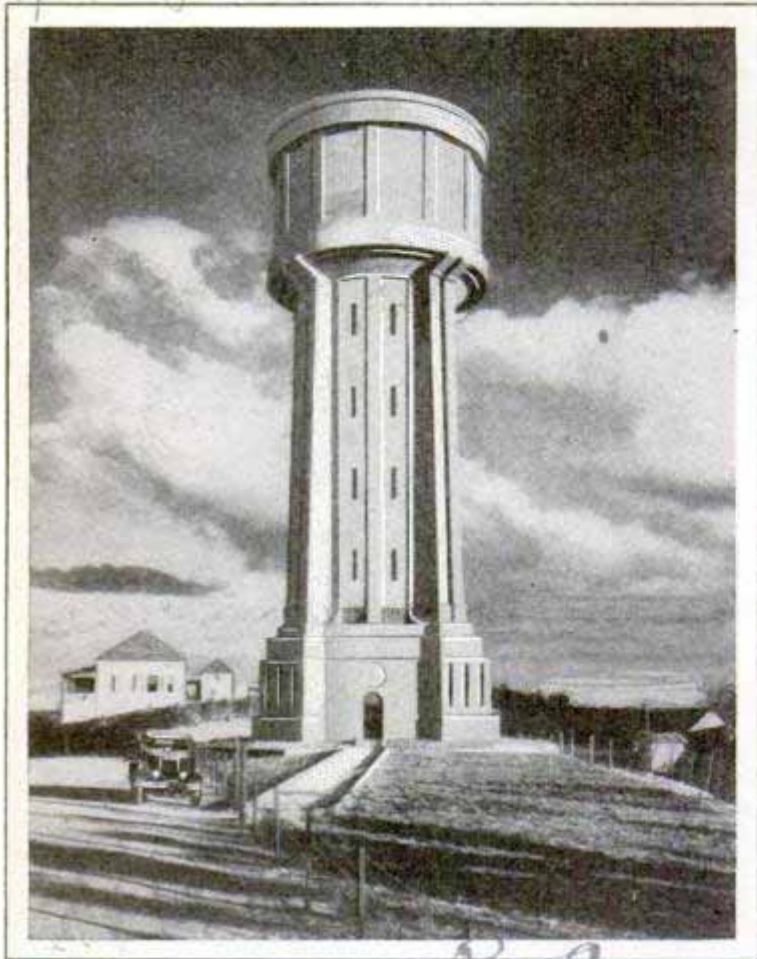

Water Tower, at Nassau, in the Bahamas; on the Top Will Be Installed Powerful Lights to Guide Aviators

**WATER TOWER TO GUIDE FLYERS BY REVOLVING LIGHTS**

Air liners in the Pan-American service will be guided by brilliant revolving lights on top of a water tower, 210 feet above sea level, at Nassau, in the Bahamas. The crest of the tower is reached by an elevator and affords a wide view.

**GLASS HOUSE KEEPS OUT DUST AND DISEASE GERMS**

A Japanese scientist has constructed an all-glass house which is said to be air, dust and bacteria-proof. It is built of glass blocks, cellular in form and consisting of a number of thin plate-glass rectangles held together by iron frames. There are no windows. The air passes out through a number of small ventilators along the ceiling of the second story but cannot flow into the building through them. Fresh air is pumped into the house through a pipe line from a far-distant point and is filtered to exclude all impuri-

ties. Sunlight and heat penetrate the walls freely from all sides. Some of the blocks are filled with a heat-absorbing salt solution so that the rooms are cooler than they would be if protected by awnings and shades. In the evening, when the temperature falls, the heat absorbed during the daytime is given off and keeps the house comfortable in the night. A few hours of sunshine in a day suffices to keep the interior comfortable for twenty-four hours.

**CLOCK THAT WON'T RUN ONE OF EDISON'S SUCCESSES**

24 87

One of the most interesting of Thomas A. Edison's inventions is a clock that never ticked a second or turned a wheel, and yet it is one of his many successes. It now stands on the mantelpiece of his laboratory building, which has been moved to Dearborn, Mich. from Ft. Myers, Fla., for Henry Ford's American Museum. It stood there when Edison was

performing some of his most important experiments and was using the clock, too, although it had never registered an hour. The clock face is simply the cross-section cut from a small log and is without numerals or hands. The pendulum that hangs but never moves, ends in a bob similar to the face, but smaller. Rings on the face and the pendulum are prominent and suggest the true function of the clock, which was to remind the workers that they were not to be regulated by hours or minutes but by results. Time, in the usual sense, meant little to Edison and his co-experimenters. The measure of a day's work was its results. The clock's case is of American walnut, and it has an etched glass front.



2/21/29  
i. instrument  
250

American Walnut  
No. 22. 616  
Chicago



*2151 Ave. B. - ... England*

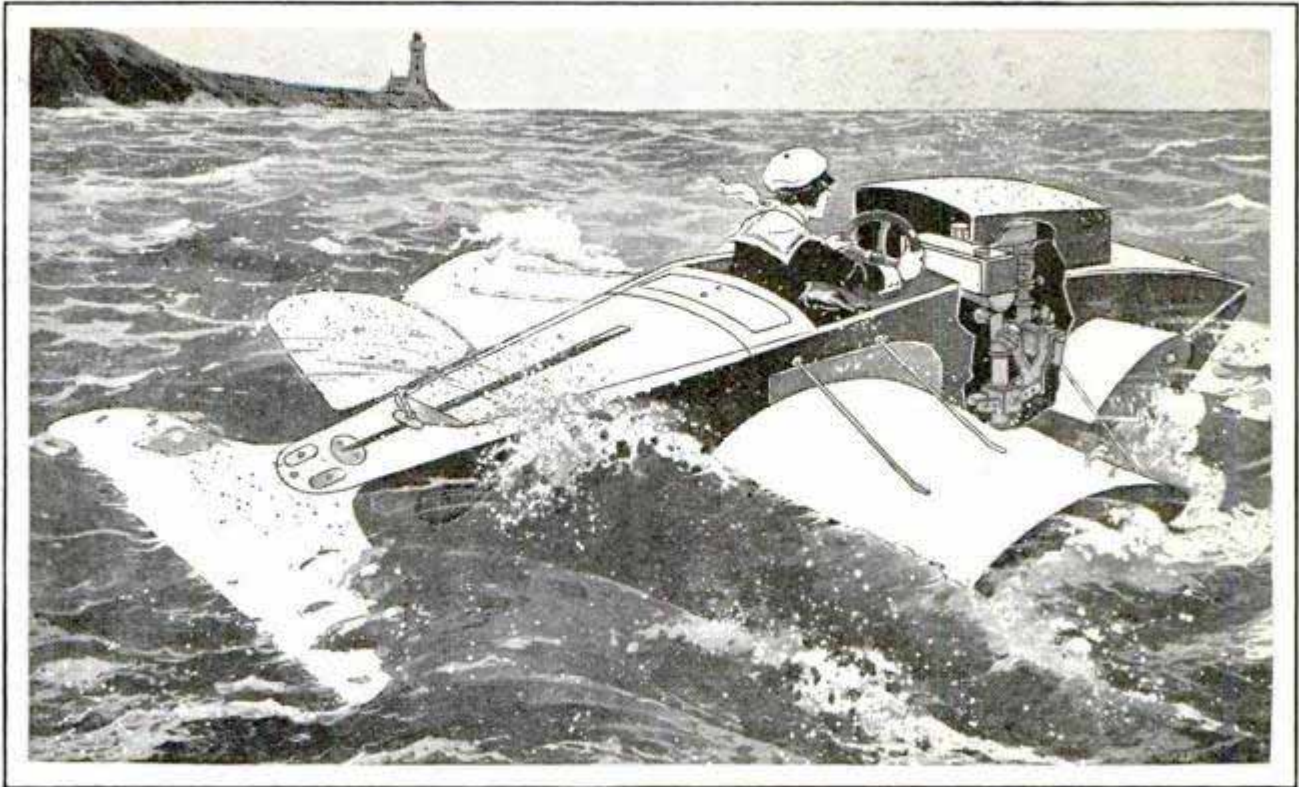

Drawing of the Plane-Shaped Motorboat. Showing the Arrangement of the Wing Floats and the Engine; Note the Air Rudder Just Forward of the Tail

**STEEL OUTBOARD MOTORBOAT BUILT LIKE SEAPLANE**

Several novel features have been introduced in a steel outboard motorboat recently constructed by an English inventor. It is designed after a seaplane with streamlined hull, an air rudder and floats that resemble the wings of a plane. The exhaust is carried to a silencer under the boat, from which, through the propeller-shaft boss, the gases are shot into the spray. The special use of the air rudder is in the nature of an experiment when the motorboat is running through a heavy spray from which the engine is protected by a cowl. The engine is installed in the bow. When the boat is operated at high speed, the air rudder goes out of action and steering is done with the water rudder.

**POWDER INSIDE ELECTRIC LIGHT REMOVES BLACK DEPOSIT**

By placing a tablespoonful of coarse tungsten powder inside the electric-light bulb before it is sealed, engineers have found a way to remove the black "soot" that is deposited on the interior of an incandescent bulb. When the lamp so treated becomes blackened, it is simply

*Lamp developed in Laboratory  
of General Electric Co. at Lamp Dept.  
General Electric Co. Schenectady, N.Y.*

removed, inverted and the deposit is swept from the glass by the powder. The method prolongs the life of the bulb.

**BAR CUTTER FOR RESCUE SQUAD HELPS SAVE LIVES**

For rescuing persons who may be trapped in burning structures, the Washington fire department has been equipped with a huge cutter to sever bolts and bars. It is essentially a pair of shears with handles for applying powerful leverage.



© U. & U. For Speedy Rescue Work; These Powerful Cutters Sever Steel Bars in a Few Seconds

*Rescue Squad*

7-48

# Soup

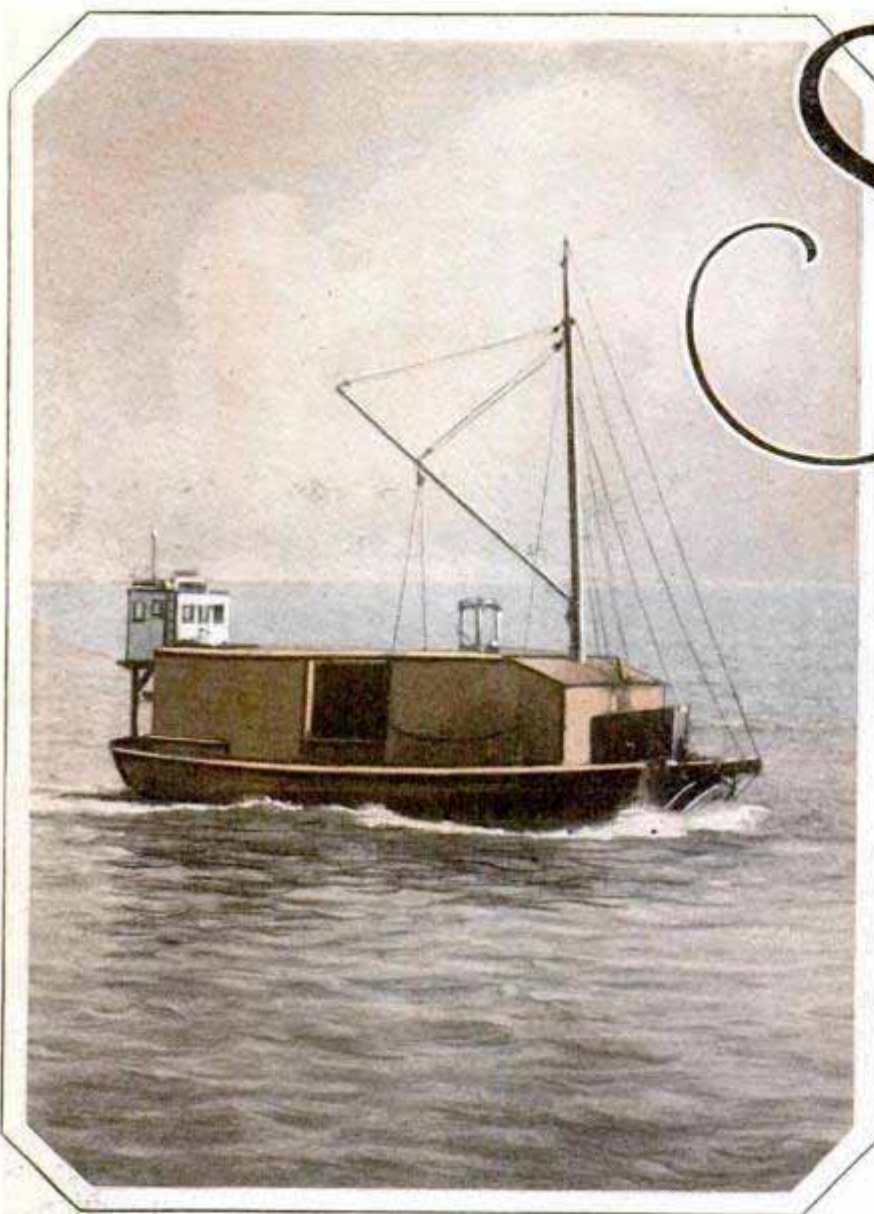

than half a million dollars' worth of turtle meat which came into the United States last year was taken in flimsy seines, by daring men who risked their lives every time a "tortuga" hit the net. Even whaling holds few greater risks than the taking of green sea turtles, though modern mechanical equipment has reduced the danger, just as it has in whaling.

The remote ancestor of the sea turtle, eight to twelve feet long and standing four feet high, armored from head to tail and from backbone to belly, took a nip at the dinosaur, defied the sa-

A "Mother Ship" for Turtles, with Derrick to Lift the Huge Creatures Aboard, and a Sliding Door to Discharge Them into the Ponds

By H. H. DUNN  
*park Blvd. idy lagoon*

WHEN nature built the turtle, she provided man with meat, kettle in which to cook it, bowl in which to serve it, fat for the cooking, plates for the serving, and spoons and forks for the eating. She even furnished the package for the shipping of the meat; all that remained for man to do was catch the turtle. He is pictured, usually, making this capture by dexterously flipping a 400-pound, land-wandering sea turtle to its back on a moonlit sand bar in some tropical lagoon.

Even, however, if the turtle would hold its flipper outside its shell long enough to be flipped on its back, there are few men since Goliath who could do the flipping, and by far the greater part of the more

ber-toothed tiger, and chortled in his carapace at whatever monsters roamed the prehistoric seas in which he wandered. The descendant of this antediluvian turtle retains armor and defiance of every living thing except man, with the result that sea turtles are increasing in numbers in all parts of the world, and maintaining themselves as the basis of an unusual industry.

When man goes after the turtle, he starts from San Diego, Galveston, New Orleans, Mobile, Tampa, Key West, or even up as far as Baltimore, on the Atlantic coast. Turtles are caught in all tropical and semitropical seas, but American methods of taking them are most productive. Each turtle hunter has his own fleet of half a dozen boats, and his crew of eight or ten men. First of all, there

# from the Sea

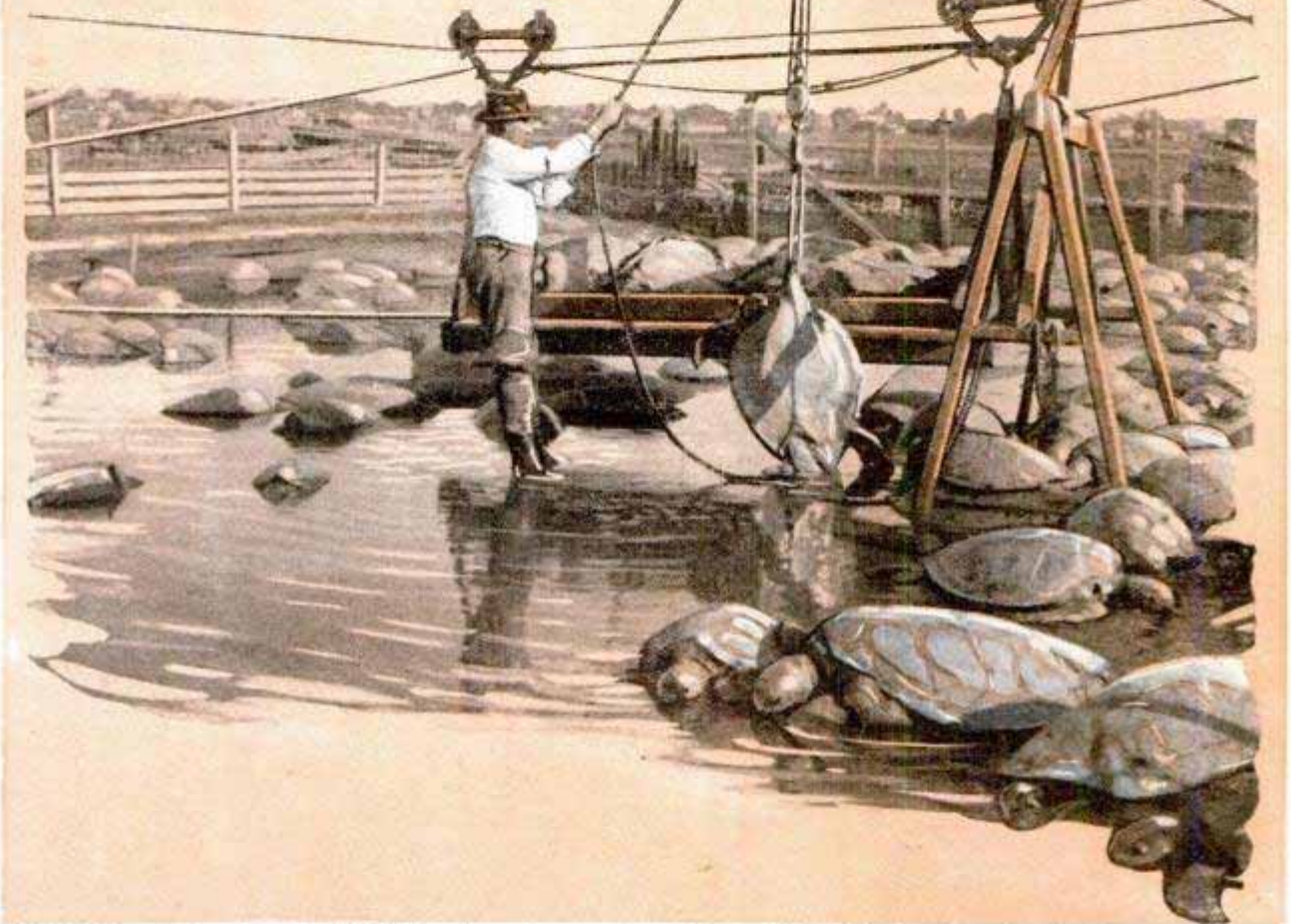

Hundreds of Huge Turtles, Weighing from One to Four Hundred Pounds, Are Kept in the Cannery Ponds Waiting to Be Turned into Steaks and Soups When Needed

is the "mother ship," fifty to one hundred feet long, driven by gasoline or oil engines, and equipped with tanks occupying most of her hold or her deck space. Pumps, driven from the propelling engine, keep salt water from overside constantly circulating in these tanks, and a cargo mast, boom and winch are provided to handle the turtles into and out of the great boxes of sea water.

On deck of such a "turtler" are carried six to eight skiffs, provided with oars, water tanks and food supplies for two men each for a week or more. Running with or towed behind the main vessel, are two motorboats, twenty to thirty feet long, equipped with one seine to each boat.

These nets, 1,000 to 1,200 feet long, 100 feet wide, rimmed at frequent intervals along the top with large cork floats, and weighted at the bottom with sheet-lead rolled around the rope binder, are known as "lamparas," "parmentas," or "retiaras," the latter almost a complete retention of the name given the net used by gladiators in the ancient Roman arenas. Each one of the motorboats has a towing post for attachment of lines from the skiffs.

So equipped, and with provisions for the crew and fuel for the engines for a month's run, sometimes more, the turtler starts south, into the Mexican waters of the Pacific, the Gulf, or to the Caribbean sea on the Atlantic side. Two or three

hundred miles south of his American port, a lookout is posted to watch for turtles asleep on the ocean. Usually, these "floaters" are solitary, but if more than two are seen together, the fishing starts. The mother ship drops over a sea anchor, made of canvas, in shape like a huge umbrella or an exaggerated mushroom, to hold her steady in one place. One of the motorboats takes two or three of the skiffs in tow and proceeds to the rear of the turtles. There one of the skiffs, carrying a free end of the long net, is loosed, and, with the seine running from her stern, the motorist swings in a wide circle, around the sleeping turtles, and back to the skiff, whose end of the lampara is taken inboard on the larger boat, and the "drove" of turtles inclosed, with the skiffs also inside the circle of the seine.

If the turtles waken, they charge the seine. Weighing from one hundred to four hundred pounds, and with great power in their flat flippers, these tortugas will cut through any ordinary net, but this net is woven of half-inch oiled rope, with large meshes, so that the turtle, even though it become entangled, may not

choke itself to death, for the dead turtle is useless. Like the sea lion, to have any value in the market, it must be taken, and kept, alive.

The skiffs move backward, slowly and silently down on the sleeping turtles, a man with a heavy noose of rope in one hand leaning out of the stern, and the other rowing from the forward half of the boat. Reaching the turtle, the noose is passed quickly and dexterously around the shell just forward of the hind flippers. This is the craftiest part of turtle catching, for if the noose slips the turtle may escape; if the creature feels the touch of the rope before it tightens, it may turn in the water and take with it the hand of the fisherman, or it may seek the deep water from which it cannot be lifted.

If the turtle escapes the noose, but remains on the surface, the fisherman plunges after it, seizes the shell just forward of the front flippers, so close to the head that the turtle cannot bite, and hangs on with a bulldog grip. The weight of its body prevents the turtle from diving and slows the latter's speed so that instead of crashing through the seine, it



Huge Green Sea Turtles, Being Lifted from a Net into the Fishermen's Dory in a Pacific-Coast Lagoon on the Lower California Coast, 500 Miles below San Diego

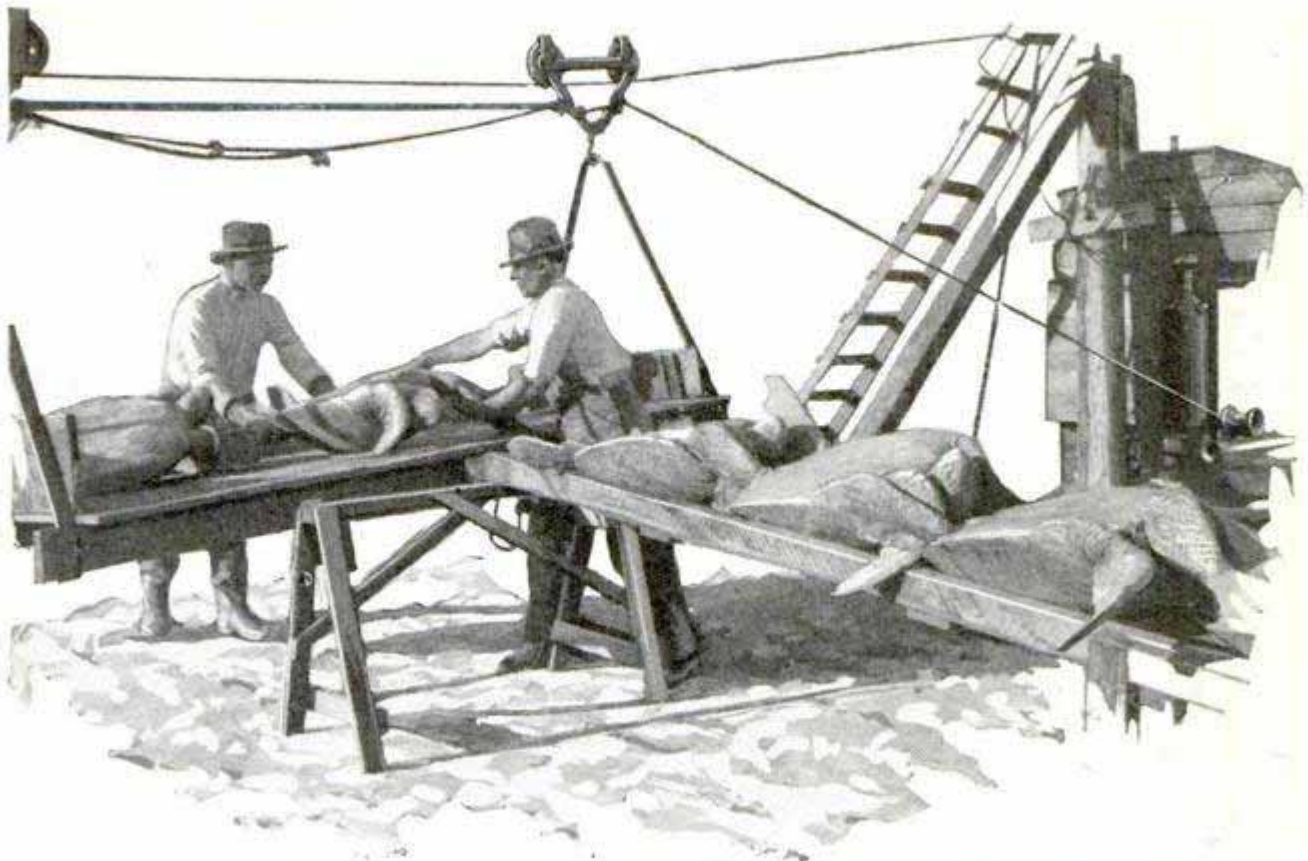

The Turtle's Last Ride; Once on Its Back, the Most Powerful of These Deep-Sea Dwellers Cannot Move; Each Turtle Is Worth About Fifty Dollars "on the Shell"

merely becomes entangled in it. About two out of five turtles are caught in this manner, at great danger to the fisherman, because if the turtle does dive, the fisherman must let go immediately, to avoid drowning in the downward rush, and at the same time get his hands so quickly away from the shell that the powerful "beak" cannot reach out and seize him.

Turtles entangled in the seine are hauled inboard with it, if not too heavy; otherwise, a rope is passed around them. Once brought to the skiff, the turtle is skidded inboard, on its back, and left lying in that position, so that it cannot turn over. There is constant danger from the sharp, beaklike jaws of these chelonians, and many a turtler walks with a limp as a remembrance of a cut on ankle or leg clear to the bone. Once at grips with the enemy, the turtle holds on until the jaws are pried open with an iron bar or the head is cut off. If a hand is seized, the head is withdrawn within the shell, and the member slowly chewed off, a process of considerable unpleasantness to the fisherman.

During the actual taking of the great green turtles, the men in the skiffs lead active lives; indeed, the fabled mice on a

hot griddle could have been little less active. When the drove of turtles is captured, the skiffs are picked up, with their seine, by the motorboat, and towed back to the mother ship, where the turtles are hoisted in, turned right side up and dropped into the tanks. One might think that the skiffs could be eliminated and the fishing done directly from the motorboat, but long experience has taught that, when a 300 to 400-pound turtle is taken, the small boat can be tipped up by the weight of both men in the stern, or dipped on either beam by their weight, so that the lift becomes a matter of only a few inches, instead of two or three feet, as it would be with the larger craft.

Though a few turtles are taken on the deep sea, often fifty miles or more from land, the center of the industry on the Pacific is in the comparatively shallow lagoons where the sea turtles congregate at certain seasons of the year. These are numerous on the western coast of Lower California, and all the way down both sides of Mexico, Central America and South America to points hundreds of miles below the equator. In these lagoons the nets are spread on stakes at nightfall, and the turtles picked up in the morning.



No Ordinary Net Will Hold a Turtle, So the Boats Follow the Rim of the Seine Closely to Lift the "Tortugas" Inboard Before They Decide to Make a Dash for Freedom

A few are taken on the sandy shores, after they have laid their eggs, but this is slow work, with few turtles for a night's labor.

When the mother ship is filled with live turtles, she turns back to the American port from which she came. There the catch is placed in large, shallow tidal ponds, so fenced in that the waters of the sea may flow in and out. Thousands of turtles are so stored for months at a time, one set of ponds at San Diego alone containing more than 5,000 of them at once. From the ponds, the turtles are lifted on cranes to wooden trays, traveling on cable "railways" to the cannery platforms, whence they are slipped, on their durable backs, down long troughs to the cleaning tables and cooking vats, to appear at the other door of the packing plant in the form of steaks and soup.

The tropical coastal dweller, however, goes to no such trouble to get his green-turtle soup. He merely catches his turtle at the shoreside, cuts off its head and flippers, dresses the meat, and cooks it in its own broth by the simple expedient of raising the shell on four stones, and building a fire underneath. Once cooked, he eats it from a plate made of a piece of the shell of another turtle, with a fork and a spoon carved from the same shell. No fat or water is added in the cooking, and the result is a dish never equaled in flavor by

the prepared product of the American turtles' long voyages.

#### MYSTERY OF WEATHER CHANGES REVIVED BY COLD WINTER

Scientists are discussing anew several theories in regard to the weather, as a result of the recent cold winter in various parts of the world. One supposition is that these periods of arctic intensity are likely to recur in a definite cycle at intervals of slightly more than thirty-three or thirty-five years. In England, for instance, there was a cold spell in 1826, 1860, 1895 and again this year. Another theory is that the cold and hot periods are the result of the solar cycles and sunstorms at definite times. The various ice ages that have occurred in the past history of the earth are thought to have resulted from the wandering position of the poles or the eccentricity of the earth's path around the sun. The shifting of the poles, somewhat like the wobbling of a top as it spins, is the result of a gyroscopic force and is believed to account for the presence in temperate parts of the earth, of red soil usually found in hot desert places. The red earth and the coal beds, made of tropical vegetation, suggest that areas in North America and Europe may once have occupied the latitude of the

Conk U. Aldin

Wardell Threadlok Corp 120 Broadway N.Y.

present Sahara desert. Opposing this view is the theory that in the course of ages, there has been a slow sliding of the outer skin of the earth and a consequent shifting of the continents.

### SINGS WHILE DRIVING AUTO TO RELIEVE EARS

After taking long drives in an automobile, an eastern physician was bothered by an uncomfortable feeling in his ears. He attributed this to the constant noise of the motor and found a way to avoid the trouble by singing while driving. He points out that the exercise is beneficial to the lungs, helps posture and promotes circulation, thereby relieving congestion that may form in the ears, a condition that induces the discomfort after a long drive.

### BOLT THAT LOCKS ITSELF RESISTS VIBRATION

For use in many fields of industry, a patented self-locking bolt, now on the market, eliminates the need of lock washers, cotter pins and other devices, as it is so constructed that the nut cannot be loosened by vibration, according to reports. This is accomplished by the special design of the threads. The nut is screwed on in the usual way and can be removed with less difficulty than the usual type, it is said. The bolt is intended for special service on airplanes and other vehicles where shock and vibration are important factors

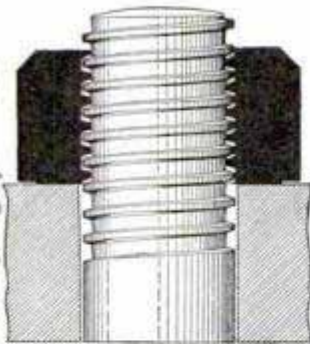

### HEIGHT OF KITCHEN SINK

To tell if the kitchen sink is at the proper height, the housewife stands before it and places her palms on the bottom. If she can do so without stooping, the sink is properly adjusted. The one-piece enameled sink, with a high back and two drainboards, has proved satisfactory in the majority of kitchens, according to a survey by the University of Nebraska.

### CULVERTS WITH FLAT BOTTOMS REDUCE RAIL HAZARDS

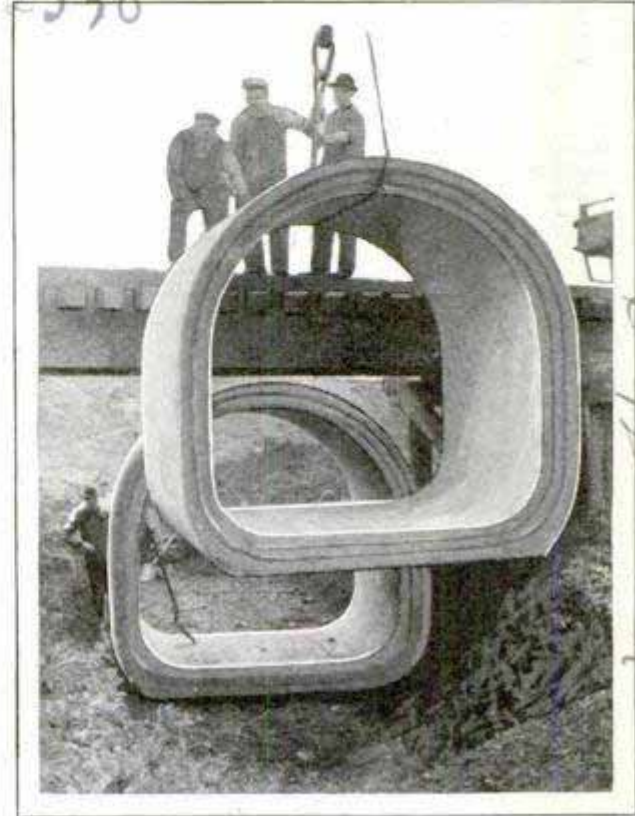

Installing Flat-Bottomed Culverts That May Be Used for Cattle Walks under Railroad

Flat-bottomed concrete culverts that serve both as water carriers and as cattle passes are being installed by the Chicago, Milwaukee, St. Paul and Pacific railroad. They eliminate the hazardous method of driving cattle across the tracks, are not difficult to place and are substantially built for long life.

### LOCK TIPS FOR SHOELACES PROLONG THEIR LIFE

Adjustable screw tips for shoelaces that are not likely to be pulled off when once properly attached, have been introduced to lengthen the life of the laces and to prevent the bother of ragged, frayed ends. The lace is simply inserted through the base of the tip and then the top part is screwed on. It penetrates the lace and binds it against the base so that it is not easily pulled out.

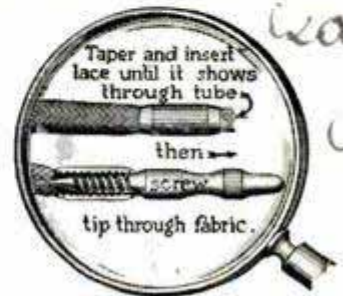

End Earle Shuff The Cambridge  
14 06 Chicago Ear Stanton, Ill  
way  
Universal Lock Tip G Boston  
168 Marlborough Mass

Agricultural College  
Lincoln Notes Lincoln

**WORKERS' SAFETY FACE MASK  
GUARDS EYES AND MOUTH**



Face Mask Raised over the Goggles; It Can Be Lowered Quickly to Protect the Wearer

Goggles and face protector are combined in a safety mask which shields the worker from strong lights and from flying fragments as well. The goggles may be removed, if desired, and the gauze mask, which is usually worn out of the way at the top, may be pulled down over the face.

**MOON HAS NO EFFECT ON CROPS  
WEATHER BUREAU SHOWS**

One of the most persistent superstitions about the weather, government scientists have found, is the false belief that the moon has some effect on crops, and that better or less favorable results will be obtained if planting and other operations are performed at certain times when the moon is in a particular phase. According to legends, if the horns of the new crescent moon tip downward, it is a "wet" moon, indicating rain. The weather bureau points out that, on any given date, the position of the crescent moon is always the same in places having the same latitude. If the sign were a reliable one, the same kind of weather would prevail throughout

a belt of latitude extending around the world. This is not the fact, as any investigation will quickly show. Again, the proverbs say that when the young moon is in a horizontal position, dry weather is coming. The absurdity of this is easily seen near the equator, a part of the world notorious for its rainfall and where the new moon is generally in a nearly horizontal position. If the moon could be seen from the north or south pole, its position, to the superstitious, would indicate wet weather, but these regions have so little rain or snow that they are classed among the most arid in the entire world. The chief things affecting the growth of crops are temperature of the soil and air, composition of the adjacent atmosphere, kind and intensity of light, presence or absence of disease, and soil conditions. The moon has nothing to do with any of these factors, the weather bureau declares.

**STEEL CULVERTS AS PIERS  
SAID BRIDGE BUILDERS**

Steel culverts filled with concrete were successfully employed as bridge piers for an electric-railway viaduct over lowlands in Kansas. The finished work cost no more than concrete piers made with wooden forms, considering the expense of building and removing the forms, and the culverts made a neat trestle besides saving time in construction.

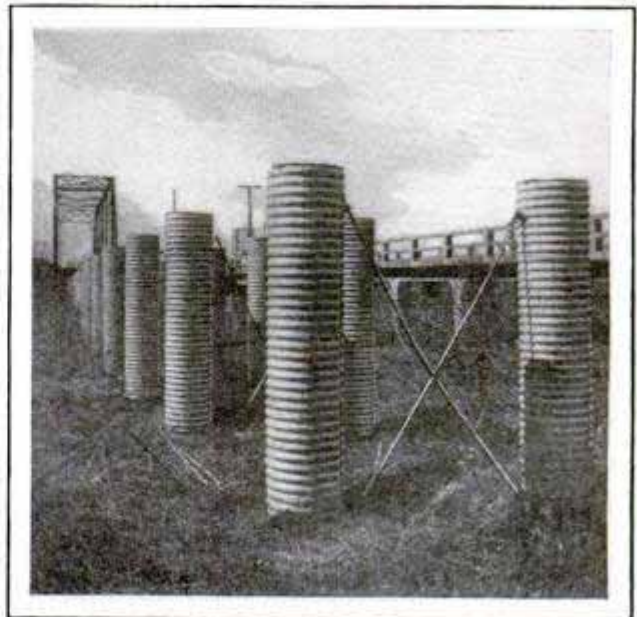

Culverts Filled with Concrete and in Place for the Bridge Piers; Their Use Proved Economical

*Cont. Stanley Russell  
Winfield, Kans*

*2469  
Exhibition in Berlin.*

*dent*

*250*

*2544*



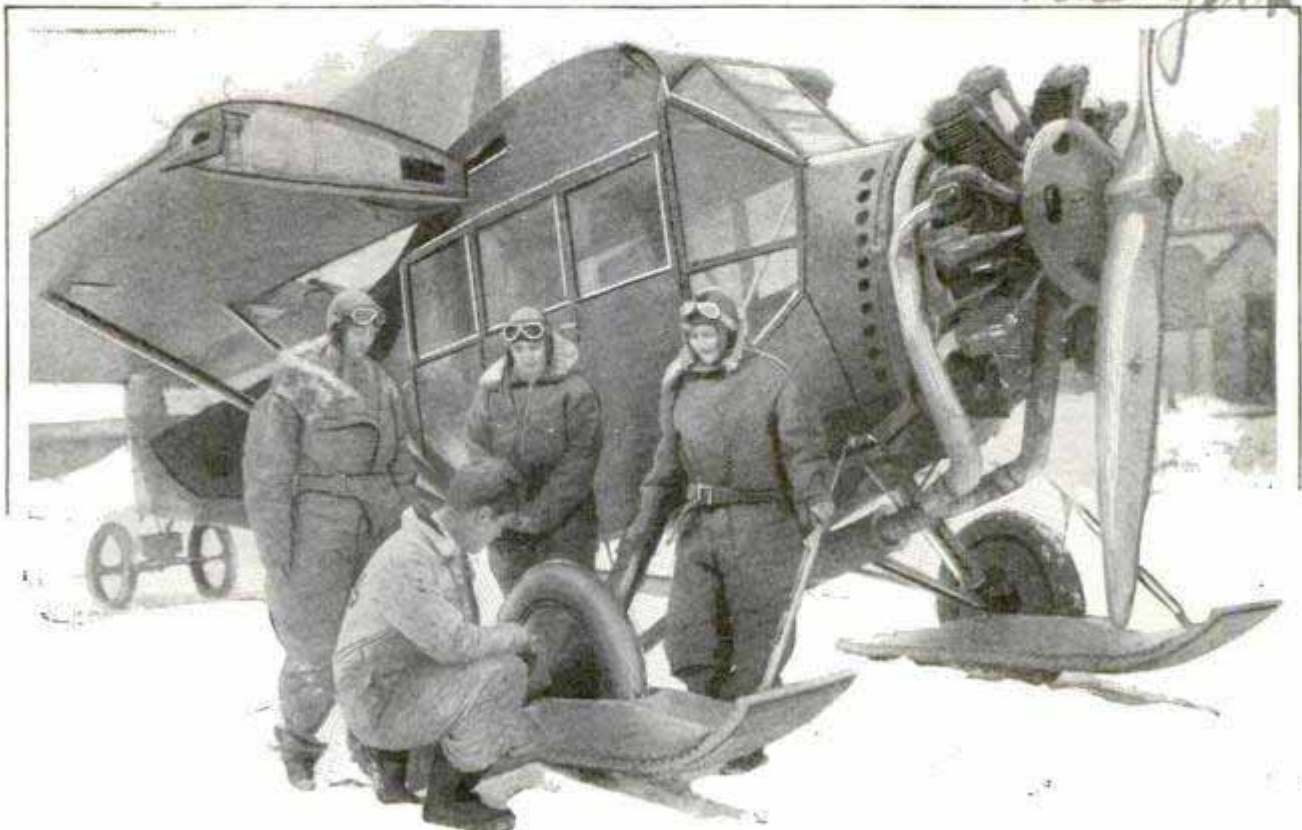

Plane Fitted with Ice and Snow Skis That Do Not Have to Be Removed for Landing on Dry Ground; the Wheels Extend through the Skis, Leaving Ample Space for Rolling

*cut*  
**SKI FEET FOR AIRPLANES LAND ON GROUND OR SNOW**

Fitted over the landing wheels, special skis have been introduced for airplanes so that the craft can descend on bare ground or on ice or snow. The landing-gear wheels project through the ski frames, permitting them to turn and support the plane just as though the skis were not attached.

*2483*  
**RICH MINES OF MONTEZUMA STILL YIELD TREASURE**

Mines that were worked by slaves in Mexico, to fill the tribute lists of Montezuma before the discovery of America, are still yielding wealth and are more important than any recent discoveries of metal deposits, according to a report of the Mexican chamber of mines. The early miners tapped the richest veins. Ventilation of the shafts was an unsolved problem, illumination was accomplished by oil lights or tallow candles, and the ore was carried out on the human back. When the richest mines were exhausted, they were deserted. Modern mining science has enabled the worker of today to gather

fortunes from the old sites, not by finding new ore deposits but by working the comparatively low-grade ores at a profit.

*2471*  
**CLICKS TELL MOTORIST WHEN TIRES NEED AIR**

To warn the driver when his tires need inflating, a metal ticker has been introduced. It operates on the same principle as the toy noise makers that produce a loud sound when they are bent and straightened. The metal piece is inserted under the rim and extends down over the outside of the casing. When the tire becomes deflated and sags to the danger point, the bulge causes the signal to give a loud clicking sound with each revolution of the wheel.

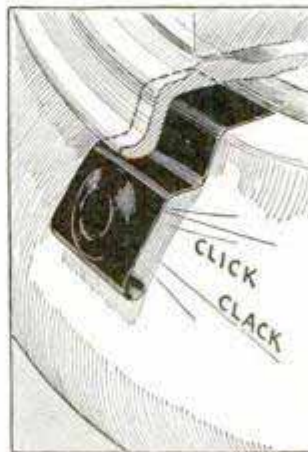

Whenever you find that you wish to know more about any article in this magazine, write our Bureau of Information.

*Wichita, Kans*  
*Co 313 st*  
*Market*  
*Wichita, Kans*

*Kansas City Star*

*Bk 2429*

Published by The U.S. Archer's Co., 106 N. 4th St.,  
Washington, D.C.

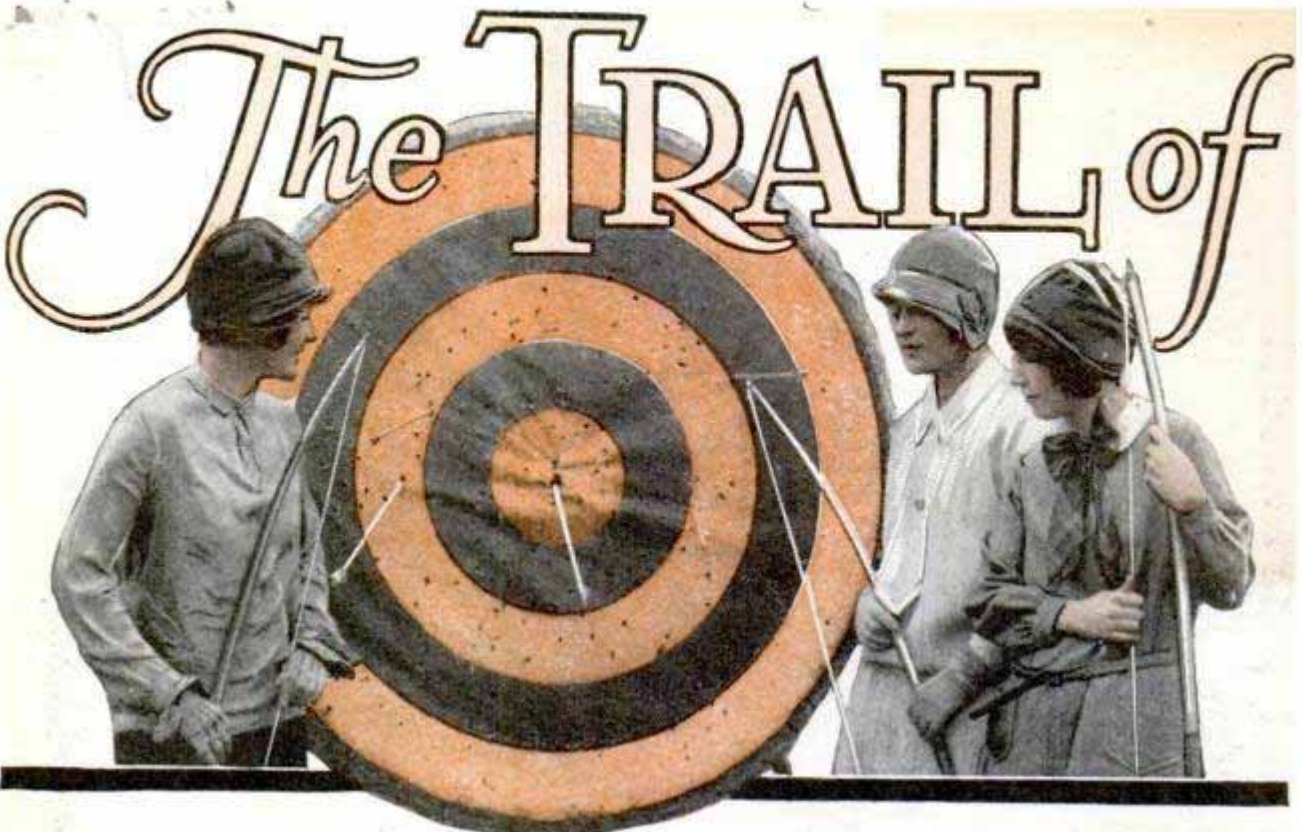

Washington School Girls Studying Their Target after Discharging a Flight of Arrows; Archery Is Becoming More and More Popular among Both Sexes in the Larger Cities

Philip Reinzele & Co. U.S. Archer's Co., Pe...  
Lelan ret'd.

"WHY, the feat's impossible! There's some trick to it."

Such were typical comments of scores of Boston archery enthusiasts not so long ago as they watched Dr. Saxton Pope, nationally known archer of California, shooting seven arrows, one after the other, into the air before the first could hit the ground. He had accomplished something that had been deemed beyond the power of man, had indeed rivaled the legendary skill of Hiawatha, who was said to have delivered his tenth arrow before the first descended.

But there was nothing magical about Doctor Pope's unique feat. It just happened that he was scientist enough to study carefully the problem and, after so doing, had built a dozen light arrows having wide "nocks" (tips of the arrow where the wood is grooved for the bowstring) and with rear ends flattened so they might be fingered readily. Next he devised a way to grasp a supply of ready shafts in the bow hand and invented an arrow release in which all the fingers and thumbs could hold the arrow on the string while remaining entirely on the right side of it.

Equally novel and revolutionary have been certain other of Doctor Pope's arch-

ery tests. Indeed, he is one of a trio of prominent Americans who have been spending their spare moments hoping to develop a "mechanical archer" that, by entirely eliminating the errors involved by the personal equation, may ultimately go far toward helping solve many of the perplexing problems that always have confronted the wielder of the bow and arrow. The other men in this trio are Dr. Robert P. Elmer of Wayne, Pa., one-time champion archer of the United States, and Dr. C. N. Hickman, research physicist.

Recently Doctor Pope explained that he wanted to know the answer to the question: "How would an arrow fly if the bow were held in a mechanical rest and the string released mechanically?" After months of experiment, he succeeded in building a mechanical archer. Using the same arrow each time, with the target set at sixty yards, he found that the arrow tended usually to fly to the left. And when he tested nine different arrows he found that five consistently flew exceedingly near the same mark, whereas four went far afield. Doctor Pope's conclusions were that, while it might be possible to select arrows that would act in a fairly uniform way, yet it was obvious enough

Research Dept  
American Piano Co

ROUN  
NOTE  
EXP  
Funeral  
elle, 40 y  
ionally kn  
ied Frida  
utomobil  
. Y., of  
m. to  
oadwa  
k W  
d be

# the ARROW

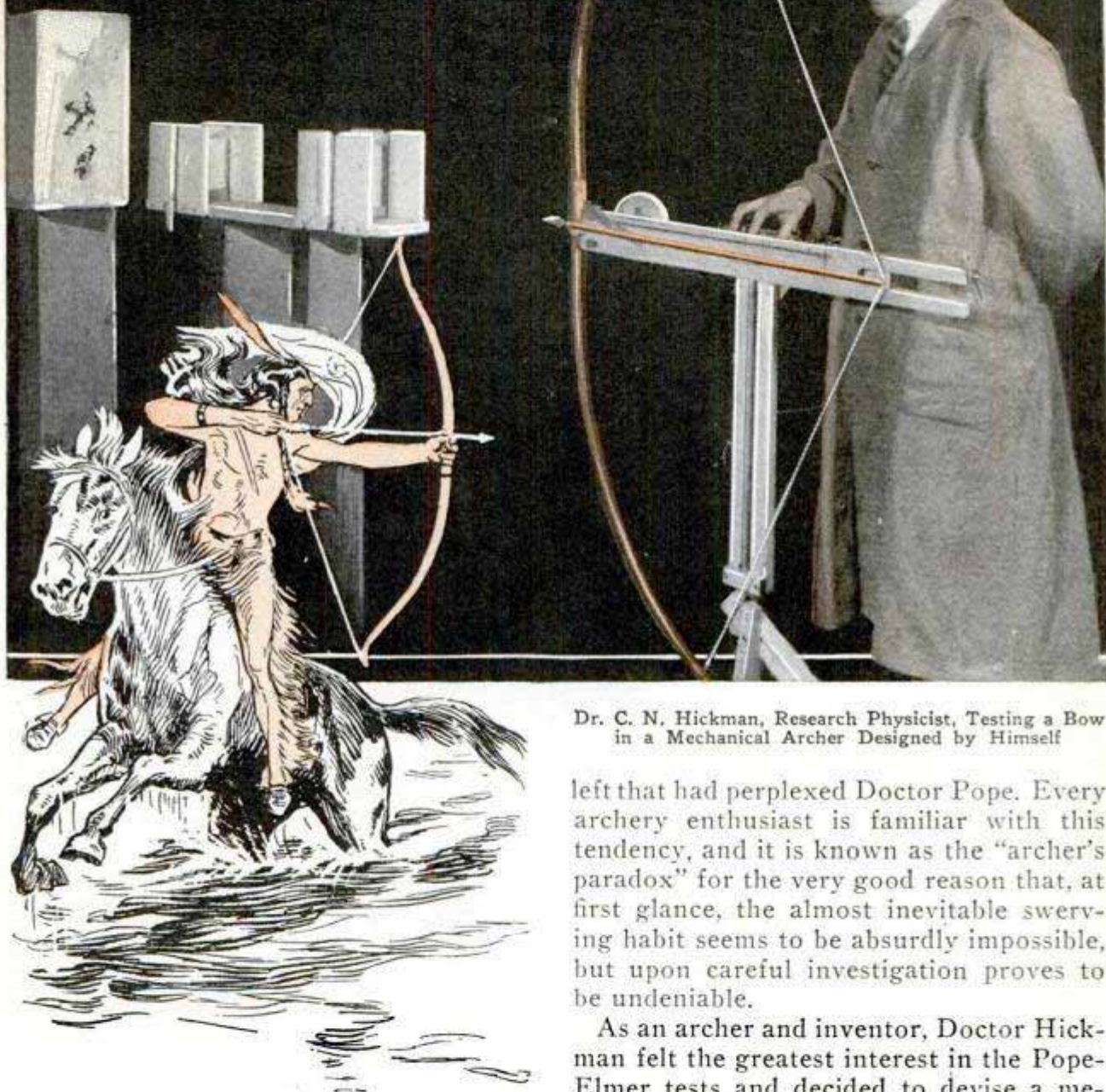

Dr. C. N. Hickman, Research Physicist, Testing a Bow in a Mechanical Archer Designed by Himself

that any good archer could manage to group the hits considerably closer than the machine could deliver them. Doctor Elmer likewise turned inventor and constructed a stand of four large timbers to which he bolted a bow and arranged for the string a mechanical catch with a trigger. He also experienced that strange tendency of the arrow to swerve to the

left that had perplexed Doctor Pope. Every archery enthusiast is familiar with this tendency, and it is known as the "archer's paradox" for the very good reason that, at first glance, the almost inevitable swerving habit seems to be absurdly impossible, but upon careful investigation proves to be undeniable.

As an archer and inventor, Doctor Hickman felt the greatest interest in the Pope-Elmer tests and decided to devise a mechanical archer of his own. But before so doing, he endeavored to apply some reasoning like this: As the human archer holds the bow in his hand, pulls the string back and releases it, the string moves in a path straight toward the center of the bow, and its second position, when it comes to rest, is still directly back of that central point.



What has happened? As every archer knows, all arrows have little nicks on the tips, or nocks, as the correct term has it, which prevent the arrow from jumping off the string before the proper shot is achieved. Now, as the string moves from position two, this nock is carried along with it. The result is that the arrow has been pulled around so that it now is pointing farther to the left than it was originally.

Bearing these theories in mind, Doctor Hickman began designing his mechanical archer, taking care to try to remedy what he regarded as defects in the Pope-Elmer devices. Summed up, these might be defined as existing because the two men had been unable to approximate closely enough the archery maneuvers of the human arm. When the Hickman device was finally developed, the bow was mounted in the end of a light wooden member made the same length as the average man's arm and pivoted in a fashion that was almost uncannily human.

In his very first test Doctor Hickman demonstrated that as many as twenty-two shots could land in the bull's-eye of the

regulation target, which is four feet in diameter. These results also explained the behavior of the arrows as employed in the Pope apparatus. For instance, why did certain of them swerve to the left to about the same degree, whereas others went far afield? The answer is, Doctor Hickman concludes, that, as the arrow passes over the bow, it receives initially a high velocity in a direction straight toward the target. But as the string comes nearer the bow, the feathered end of the arrow is pointed to the right, with the almost inevitable result that the arrow either has to bend or else its front end kicks quickly around to the left. Since naturally a very stiff arrow won't bend readily, it will tend to go much farther to the left than will the very limber kind.

But even with its revolutionary advantages as an arrow-testing machine, the Hickman archer was unable to stay away from the archer's paradox, though, to be sure, the tendency of the arrow to shoot to the left was far less pronounced. So Doctor Hickman concluded that he had not yet been able to simulate hand shooting to the degree he had hoped

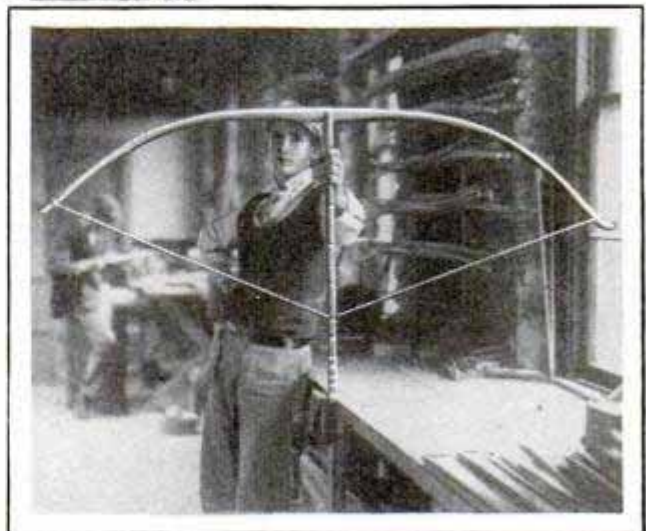

Courtesy The Archer's Company  
Archery Golf, at Top; A Hunter's Bow-and-Arrow Bag, Center; Workman Setting a Bow at Pinehurst



Group of Washington Girls Ready to Let Loose the First Flight at the Target; Ninety Arrows Are Usually Fired by Each Contestant, with a Possible Score of 810 Points

for. He once more concentrated his attention on just how the bowstring is released and noticed that, during the process, the string invariably hits the arm, a fact so well-known that, to offset it, the archer commonly wears an arm guard.

Next he figured out that if the string were able to travel straight toward the center of the bow it would never touch the arm. Indeed, the only way the string can move to the left is by the rotation of the bow in the hand or at the wrist, or by actually somehow deforming the string so that its ends are not in the same shooting plane with the nock of the arrow. In the latter case, a great deal of force necessarily would have to be expended.

This entire situation is really very simple and may be verified readily by all archers, Doctor Hickman says. They need merely grip the bow tightly and give it a clockwise tension once the string has been pulled back, and they will discover that the arrow will tend to go farther to the right than if they held the bow loosely. On the other hand, if they give it a counterclockwise motion, the arrow will tend to travel somewhat to the left.

Now, many archers, without knowing just why, hold the bow loosely in the hand. This is highly commendable, Doctor Hickman says, for his tests have convinced him

that this procedure permits the bow to rotate freely and thereby reduces the tendency of the arrow to fly to the left. The fact is, he points out, that those who grip the bow tightly must exert greater control of the arm muscles than those who grip it loosely.

Arguing this way, it became evident to Doctor Hickman that if some means could be devised whereby the bow could be gripped in an absolutely uniform and efficient manner, then an archery difficulty that has existed for centuries might be almost altogether eliminated—our familiar friend, the archer's paradox.

Right now, it would seem that Doctor Hickman has been successful in this respect. He has invented a new and simple kind of handle that can be attached to a bow in a few seconds. Made of brass tube, a couple of inches wide, the handle permits the archer to grip the bow as tightly as he wants to, while offering the uniformity of hold described above. That it has proved its worth, may be found in the fact that, when used only a few times, it thus far has increased the inventor's score twenty-five per cent, according to his own statement.

☞ Giant bullfrogs in South Africa weigh about ten pounds.

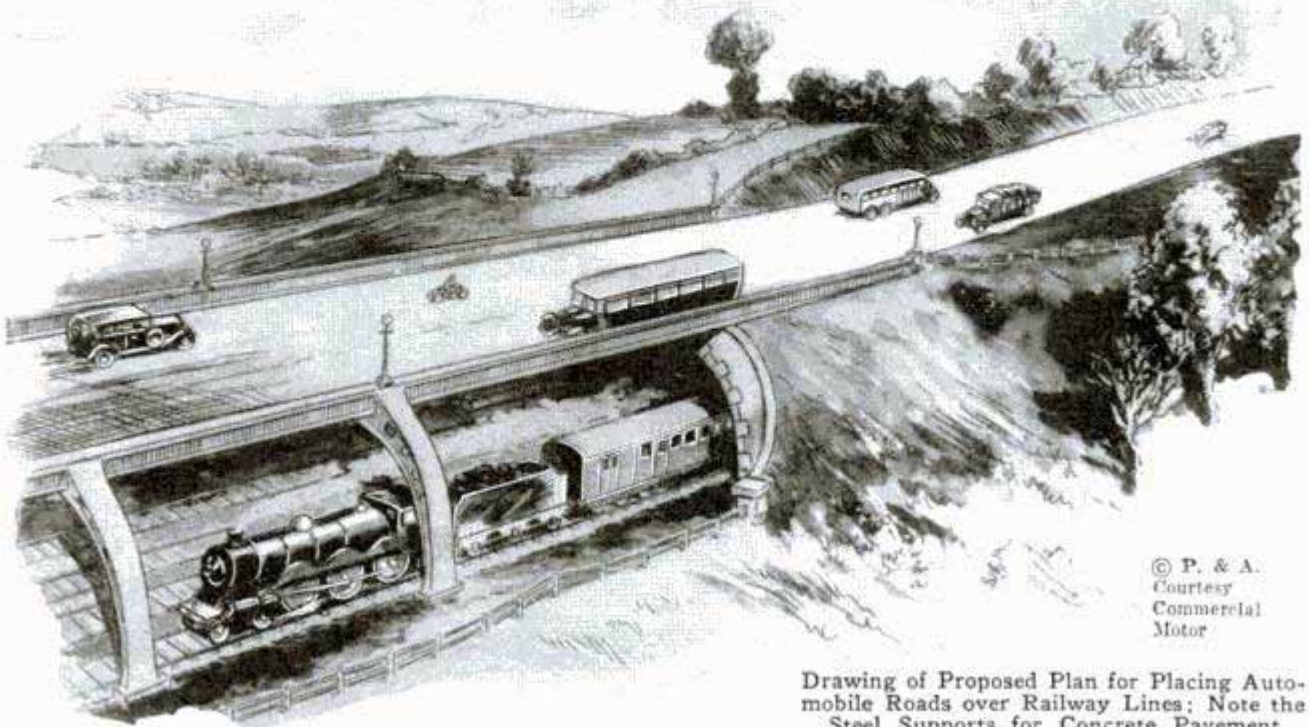

© P. & A. Courtesy Commercial Motor

Drawing of Proposed Plan for Placing Automobile Roads over Railway Lines; Note the Steel Supports for Concrete Pavement

### AUTO ROADS OVER RAILWAYS TO RELIEVE CONGESTION

Engineers have suggested a series of automobile roads to be constructed over railway lines entering London. They would be laid on cross girders and a foundation of concrete over the tracks, and would lead from the crowded city centers to points where they could be joined to existing highways.

The method was expensive, but was the best that could be devised and was employed for the reason that any greater length would have seriously upset the estimates made by the engineers in designing the cable for the transmission of messages at a certain speed. The steel wire gave the distance traveled by the ship and the irregularities on the floor of the sea were indicated by accurate charts for every mile of the way; hence, the cable men were able to judge the amount of slack required for the entire line.

### TAPE UNDER SEA MEASURES DISTANCE TO AZORES

To measure the distance sailed by the cable steamer "Dominia" between Bay Roberts, Newfoundland, and Horta, in the Azores, a tape-line in the form of a slender piano wire, was payed out as the ship proceeded. The distance was 1,264 miles, just seventy-seven miles less than the previous calculations of the cable engineers.

### TOOL KIT IN HAMMER HANDLE AIDS HOUSE WORKERS

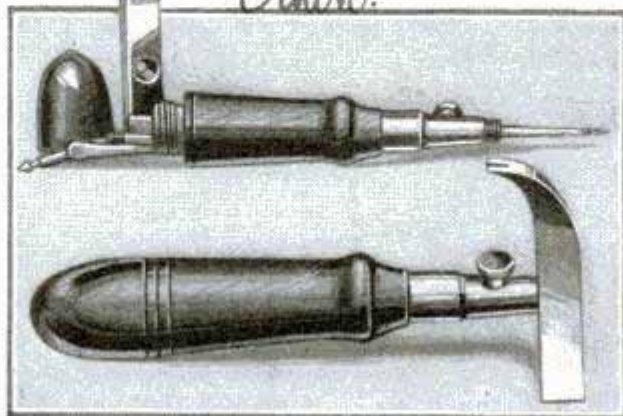

Hammer and a Few of the Tools in Its Handle

The head of a hammer now on the market unscrews, revealing a chuck and a number of tools carried in the handle. They are held in the chuck by a setscrew, and the entire outfit is useful in performing a number of household and shop tasks.

*and Mrs. S. S. Coleman / Kansas City  
3.7.15 from Loggell Ave. 5477*

*Dist. George Borgfeldt & Co  
1118 16th St. New York  
Crown Cutlery Co. Germany*

*Marshall Field & Co.  
Household Appliances Dept. Chicago*

*Chicago 9 January 1917*

**INDEX TO LEFT-HANDEDNESS FOUND IN HAIR**

*254*

After a close study of several sets of identical twins, two eastern scientists have observed that there is an apparent relation between the tendency to left-handedness and the direction in which whorls in the hair curve. In every case where it was possible to determine whether the hair on the crown of the head grows in a right-handed, or clockwise, spiral, it was discovered that the person had a more or less strongly developed tendency to right-handedness. If the whorl was curved to the left, the person was left-handed. Examination of the twins showed that they were more likely to be both right-handed or both left-handed rather than one left-handed and the other right-handed. In an identical set, the right side of one was more closely matched by the right side of its twin than by its own left side.

*An American Magazine*

**SHOES THAT "BREATHE" TO STOP FOOT TROUBLES**

Greater health and comfort are expected from shoes that have a special system of ventilation. As the wearer walks, air is drawn in and forced out through holes at the toe. Various foot ailments are expected to be prevented by these shoes.



Blowing Smoke through the Openings in the Shoe to Show How Well the Article Is Ventilated

*J. K. Hamilton  
439 Russell Blvd } Los Angeles*



Pilot with Carrier Pigeon Taken on Flights as a Possible Rescuer in Case of Forced Landing

**PIGEONS CARRIED IN AIRPLANE TO AID FLYERS**

To help him in case he should be forced down on a flight, a western aviator takes a pigeon with him on his journeys. The bird would be released, should necessity demand, and fly home with information as to the pilot's location, written on a paper slip in the small tube the pigeon carries.

**GUN AS SUBSTITUTE FOR DRILL DRIVES PIN THROUGH METAL**

*2545*

Explosives are being used in various ways for peace-time purposes, and one of the most interesting is the adaptation of a special gun to fire steel pins and other parts through metal plates as a substitute for drilling. In a recent test, a spiral-fluted pin was fired through a plate about three-fourths of an inch thick. When the pin was backed out, the hole was found perfectly grooved, and the engineers declared that a straight or tapered pin could have been shot through with equal success. The surface of the metal in the hole was smooth, as if burnished, and should withstand long wear.

*... at ... 24 56*

*Laura ...  
Henry ...  
Bill ...  
Portland Ore*



Water Golf on the Swimming Pool Provides Amusement for Players and Spectators; the Hole Is a Floating Ring and the Caddy Has an Extra Job as Boatman

*Paradise*

*Chute note note*

**GOLF GAME PLAYED ON POND  
— LATEST WATER SPORT**

Water golf has appeared at a California resort and is reported to be popular among those seeking novelty and a thrill. The holes are represented by rings that float on the surface. The caddy holds the bag as usual, but is also the oarsman to ferry the player around the course in a small boat. Considerable skill is required in making shots and in keeping balance.

**COATED MATCHES AND CIGARETS  
TO REDUCE FIRE HAZARD**

Discarded matches, cigaret and cigar stubs cause a fire loss of some \$90,000,000 a year, according to the national board of fire underwriters, and interesting tests have been conducted at the bureau of standards in an effort to reduce this destruction by making matches and cigarets that will go out more quickly when they are thrown away. Use of a cork tip an

inch long, either plain or coated on the inside with water glass, proved effective, as the butt naturally ceased to burn much more quickly than that of the ordinary cigaret. Asbestos paper, a double thickness of cigaret paper and boric-acid solution also were effective in decreasing the hazard of the stub. It is estimated that approximately 170,000 cigaret stubs are discarded every minute. In 1927, more than 30,000 fires are believed to have been caused by smokers in public and private forests of the country. More than 7,000,000 acres were burned with a loss of over \$6,000,000. Attacking the match problem in the same way, the investigators found that the water-glass coating, applied to all but one-half inch next to the head, greatly reduced the possibilities of ignition from the discarded stick. Statistics show that nearly 550,000 matches are used in the United States every minute. The fire hazard from them is greater than from the cigaret, as the match usually falls with a live flame instead of a glow.

2535

*Science Service Bulletin*

*4/7 a 3/18/29*



2402

*Washing Machine*  
*Carl Peterson*

### FLATIRON IS EASIER TO PUSH WHEN CHROMIUM-PLATED

Here is good news for the housewife. Engineers have discovered that by plating the bottom of the electric flatiron with chromium, thirty per cent less energy is required to push it across the ironing surface. Figuring this in terms of the number of these special irons to be manufactured in 1929, there will be a saving of 20,800,000,000 foot-pounds of energy by the American housewives during the year. This is six times the amount required to drive the steamship "Leviathan."

*304*

### DEATH'S HEAD IN RED LIGHTS WARNS CARELESS DRIVERS

To urge motorists to drive carefully, a skull-and-crossbones sign glows in red on some of the safety zones in Detroit streets. The sign is intended to be of special service in preventing drivers from crashing into the posts that guard the zones where passengers board street cars. They are of glass tubes filled with neon gas and can be seen at a great distance. The device is understood by everyone whether he can read the word "danger" or not.



Neon-Gas Sign at Entrance to Safety Zone in Detroit to Warn Autoists to Turn Out

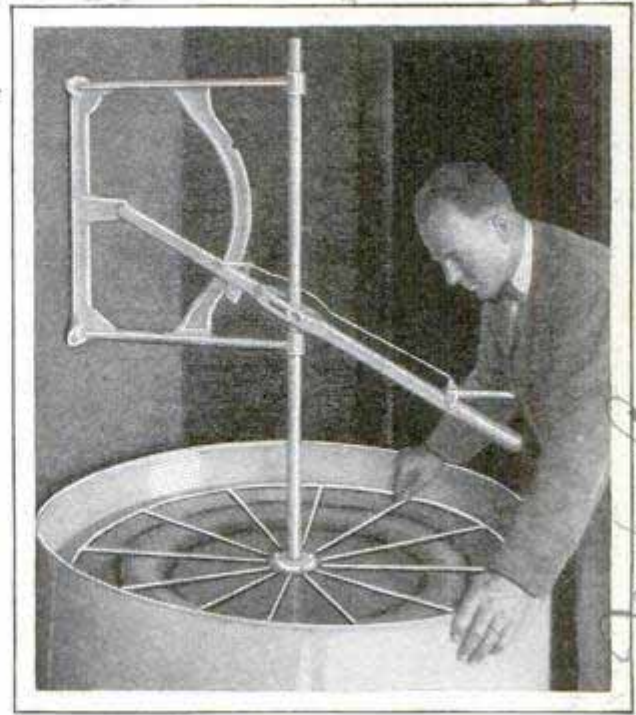

Entire Inner Tube Depressed under Rack in Water for Puncture Testing

### PRESS FOR INNER-TUBE TESTS HELPS LOCATE PUNCTURES

Testing an inner tube for leaks by immersing it in water, is a reliable method but limited in efficiency because the whole tube cannot be submerged at one time and by the fact that bubbles which are not caused by leaks also are formed. To simplify and improve the process, a simple testing outfit, recently introduced, eliminates these troubles. The entire tube can be submerged and held under water by means of a press rack that fits over the tube. A lever arrangement enables the operator to force it down with little effort, and hold it in this position by a locking device. The operation is done smoothly and without disturbing the water, so that bubbles other than those from a leak are not likely to appear.

### LANGUAGE FOR ALL NATIONS HAS FIVE HUNDRED WORDS

Scientists and scholars at Cambridge university have developed a new international language. It contains just 500 words and can be printed on a single sheet of note paper. English is the basic tongue chosen, and it is said that persons of any nation may learn the reduced vocabulary in a few weeks or months. It is called "panoptic English."

*My Co.,*  
*U.S. Pedrante*  
*U.S. America, Calif.*

2450

23  
Lion  
18728's Park Road  
San Diego, Calif

---

# Capturing



A Sea-Lion Pup, Fresh from the Ocean, but So Tame When Captured That It Enjoys Being Petted; It Takes Less Than a Month to Train Such a Tame One for the Stage

**T**HE SEAL on the end caught the ball, set it spinning by a rotating motion of his doglike head and passed it to the one in the middle. But the sleek, black 500-pound fellow merely rooted it further up into the air, caught two more balls from his master and kept all three dancing on his snout as the curtain fell to applause equal to that of the star at the head of the night's program. For the trained seal today is the greatest and most popular performer in the world.

This popularity is attested by the fact that there is a market all the year round for about 600 untrained but tractable seals, and that the supply is never equal to the demand. Be it known, too, that the trained seal is not a seal at all, but a sea lion, once more accurately known as sea dog, whose fur is worthless as furs go, but whose capacity for domestication and receptivity to teaching is even greater than that of the

dog. Inability to move freely and gracefully on land alone prevents the sea lion from becoming a common pet.

A thoroughly trained seal is worth from \$2,000 to \$5,000, depending, as an old showman said to the writer, "on the degree of its intelligence." An untrained sea lion, especially one which has accepted captivity with good grace, is worth from \$500 to \$750. Not more than six weeks is required to train the slowest-witted of sea lions; usually a month is enough to put the animal on the stage, well equipped to do his, or her, share in the program.

But where does the trained seal come from? He is not "born on the stage," as some of our human stars claim to have been. He is not even reared from puppyhood behind the footlights, because pup sea lions rarely live to maturity in captivity. There are no sea lion "ranches," as there are lion "farms," prepared to sup-

# Trained Seals



After Being Caught in a Net, the Sea Lion Is Worked into a Wire Cage, to Be Carried to the Hunters' Boat; There Is a Strictly Enforced Law against Killing the Animals

ply trained seals on order, and, so far, no one has established a school for these affectionate, docile, intelligent mammals of the sea. Indeed, every sea lion now on the stage, anywhere in the world, was once wild and free; most of them, as a matter of fact, swimming around three barren islands off the coast of Mexico, known as the Coronados, some fifteen or twenty miles south of the California boundary.

These islets, inhabited only by introduced goats, domestic goats which have gone wild, and sea birds, are the source of by far the greater number of all the sea lions in the zoological gardens and circuses, or on the stages of the world today. The rocky slopes and ledges of the Coronados are filled at the proper season with pup sea lions, friendly little fellows, no larger than a foxterrier, easily caught, but valueless because, if taken from their mothers, they would not live. Oddly enough, these puppies cannot swim and apparently never would learn except that their mothers teach them, with much effort and great patience. Until they have learned to swim, these puppies may be picked up, patted and played with by anyone who visits their rookery, and who is wise

enough in sea-lion ways to keep a sharp watch for the mother of the particular pup being handled.

But after the young sea lion learns to swim, when he has reached a weight of 100 pounds or more, then he, or his sister, is "ready for the market." But neither of them can be picked up then, or petted, except in those unexplained instances in which a wild sea lion, either half or full-grown, accepts man willingly as his friend. Among sea-lion hunters, such instances are many. There have been cases in which the animal, after allowing the hunter to stroke and feed it, followed him to the beach, was lifted into a boat, and so carried away to captivity without protest. Other sea lions, of the same age, size and herd, prove entirely untractable and must be returned to the sea or placed in the pools of a zoo. The old bulls, each the head of a harem, are in this class, and attempting to capture one of them is like trying to handle 1,000 pounds of dynamite at the instant it explodes.

The older cows, too, are untamable, fight furiously to protect their puppies, and form the snarling rear guard when the herd leaves the rookery at the approach



After the Hunters Get the Sea Lion into the Wire Crate, Carrying Poles Are Inserted through the Meshes

of men. The young cows, however, are more intelligent than their brothers, and command higher prices for the stage, though the bulls are the more beautiful for zoological gardens and traveling shows. Victor Goularte, skipper of a tuna-fishing boat out of San Diego, lifted an eighty-pound sea lion, which had been eating sardines thrown overboard in "chumming" for tuna, to the deck of his craft, by the simple method of leaning over the rail, seizing the young bull by the tail and heaving him inboard. This seal, placed in one of the bait tanks for a few hours, became so friendly that it was released and given the freedom of the after deck, where it stayed until the vessel returned to San Diego, where the animal was turned over to the zoo.

But the catching of sea lions for stage and exhibition purposes is one of the world's unusual industries, which has reached its greatest development on the Coronados, from which, and from the mainland coast of the Mexican state of Lower California, are taken annually some 450 of these animals. So prosperous has the industry become that modern mechan-

ical aid has been called in, and the catch this year will be proportionately increased, without even approaching what is known in other industries as the "saturation point."

The older and simpler method, by which virtually all the trained seals you have seen on the stage were captured, required six to eight men, and a sea lion a day was a large catch. The hunters, traveling in a large schooner or motorboat provided with individual cages for the animals and with ample space on the stern to place the cages so that their occupants could not reach each other, voyaged from San Diego to the inland, or eastern, side of the larger of the Coronados. Here they anchored the larger

vessel and transferred themselves into a skiff, approaching the rookery with the utmost quietness, usually at midday, so as not to arouse the herds. This movement had to be made at full high tide.

Landed at one side of a rookery, the hunters lay heavy seines, made of half-inch rope, with lead weights at bottom and cork floats at the top, across the mouth of any one of a number of small but deep inlets, running back into caverns in the rocks. These inlets and caves fill with water at high tide, and the younger sea lions swim back into them, apparently in search of certain shellfish which open when covered with sea water. As the tide recedes, the lions follow it back to the Pacific. To aid them in getting out of the caverns, the water is beaten with long poles in the hands of two of the hunters. The sea lions, thinking the splashing is caused by a school of fish trapped in the inlet, rush out.

Meanwhile, two or three men, on each end of the seine, which is fifty to sixty feet long, hold it across the inlet. If eight or ten sea lions come out together, the net usually is torn from the hands of the

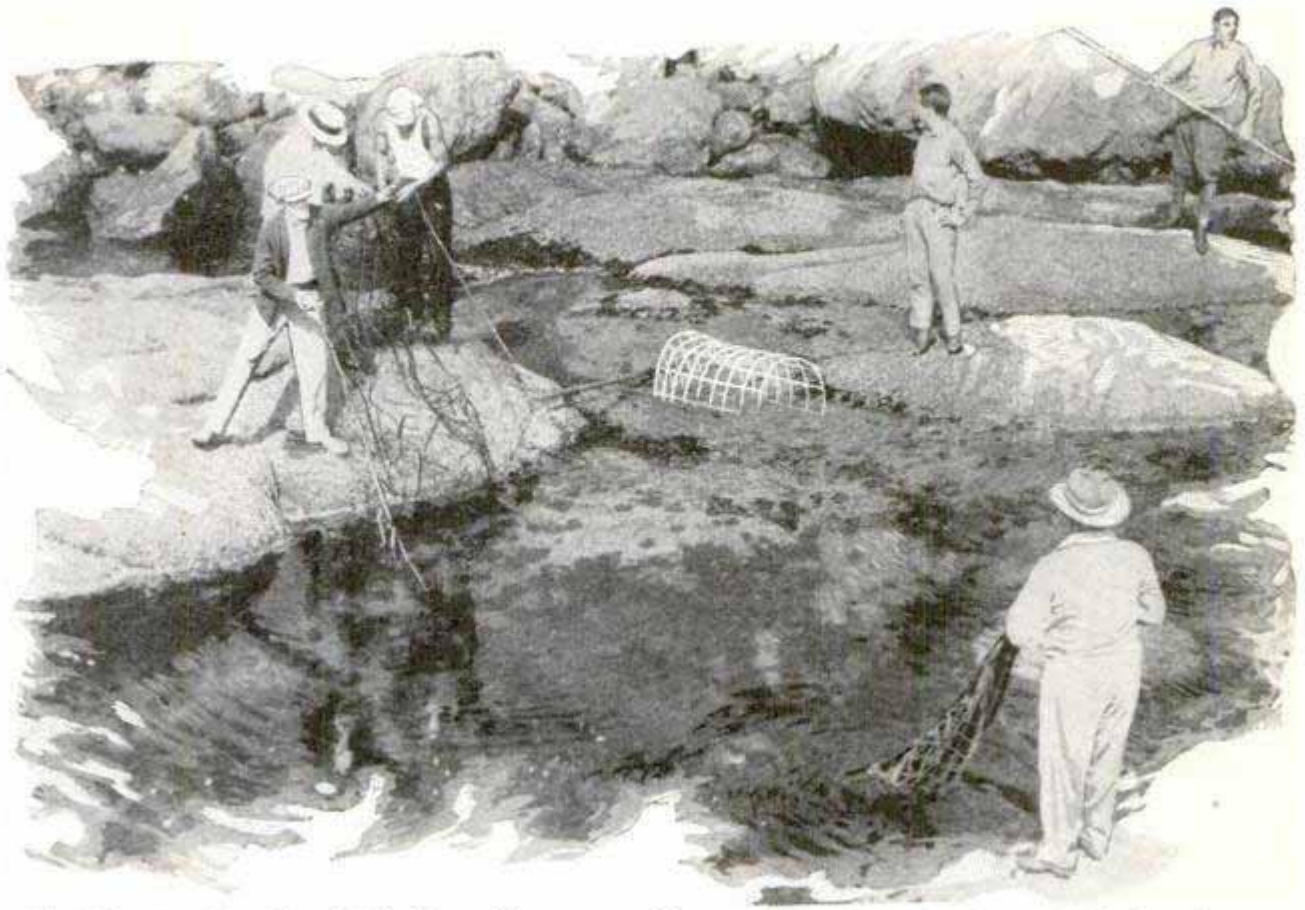

The First Step Is to Stretch the Heavy Net across a Narrow Estuary in the Rocks at the Rookery Just as the Tide Begins to Drop, Then the Lions Are Scared into It

hunters, who are fortunate if they escape being pulled over the rocks and out into the 200 to 400 feet of water which surrounds the island on all sides. If two or three of the animals come out first, they pull down the upper side of the seine, and raise the lower edge, so that the sea lions following them pass over and under the struggling mass of captives, and so escape to the sea. The hunters prefer one sea lion at a time.

Great care has to be exercised that the animals do not drown themselves while in the seine, or fall to fighting each other, in which case the long and sharp teeth, like those of a dog, inflict wounds that usually are death to the animal receiving them. The state governments of California and of Lower California maintain strict laws against the killing of sea lions, and the penalty for violation is severe. Some sea lions submit almost immediately to the net and are transferred easily to the oval carrying cages, made of heavy wire, but the greater number fight until they lose hope of freedom.

Once transferred from the seine to the cage, long and stout poles are passed lengthwise through the meshes, and the

animal is carried to the skiff, which takes it at once to the larger vessel where fish and plentiful dousings with salt water await the captive. Six sea lions, safely on board the schooner or motorboat, is a good week's catch by this method, and as a rule all so caught are delivered safely to the zoological society's ponds in San Diego, whence they are distributed, through exchange and sales, to other zoos, circuses and to owners of troupes of trained seals.

By the more modern method, which is having its first trial this year, boats carrying tanks large enough to contain ten or twelve sea lions, with a separate compartment for each animal, are being used. Electrically driven pumps bring salt water in quantity from overside, circulate it gently through these tanks and return it to the sea, giving the sea lions as near natural conditions as possible for their stay on board ship. Other tanks will contain quantities of live sardines and squids, also kept in circulating salt water, so that the fresh food to which the valuable bulls and cows are accustomed may be given them.

Each of these boats is equipped with a heavy mast and electrically operated boom



A Few of the Many Thousands of Lions That Play about the Coronado Islands; the Young Pups Cannot Swim, but Have to Be Taught That Art by Their Mothers

with a lifting capacity of five tons. A specially designed seine, to be handled by this boom, will be spread over the stern, and trailed through the swimming herd of sea lions, frightened from the rookery at the proper moment by men firing blank cartridges from the hills above. While such a ship could pick up ten or more sea lions of large size at one hauling of the seine, no attempt will be made to do so, because of the danger to the captured animals. Two or three, at most, will be the limit, if the operators of the seine boom are able to pick their sea lions out of the water as they believe they can. The advantage will come in the ability to cruise around the islands until ten or more sea lions have been taken, resulting in a cargo worth \$5,000 or more delivered in San Diego. Further advantage lies in surety of delivering all animals caught in good condition.

These boats are completely equipped with electric auxiliaries for refrigeration, lighting, radio, pumps, anchor winches, cargo hoist and even cooking. Propelling power is a heavy oil engine of 300 or more

horsepower, giving them speeds of eleven to twelve miles an hour, and enabling them to come into San Diego from the Coronados in less than two hours.

2224  
**THREADS ON SIDE OF WOOD BIT  
HELP BORE HOLES**

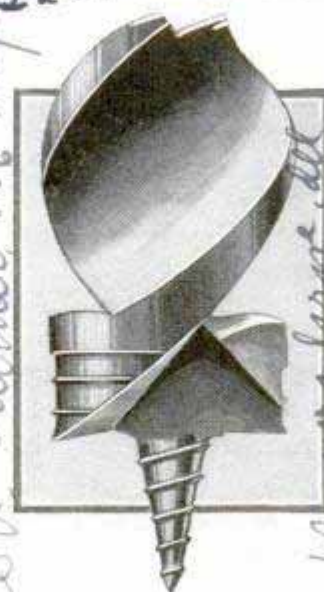

Less pressure need be applied, smoother holes are made and greater ease is experienced in cutting through knots and tough wood with a bit that has threads on the sides of the cutting blades, according to reports. The arrangement also helps prevent breaking the bits, enables the operator

to bore on straighter lines and works without splintering the wood.

*E. O. Palmer  
806 Maple Ave. ...*

1929  
 March  
 Country Gentleman  
 Sidney Leates

**RADIUM IS FIREMAN  
 IN RUBBER PLANT**

Radium has been adapted to snuff out dangerous sparks of static electricity and so prevent fires in a Russian rubber factory. Only a small quantity of radium is required, and the method costs but a few dollars per year. When the rubber solution is flowed upon a fabric base, and dries, enormous charges of static electricity are produced from the friction of the rubber-covered material against parts of the drying machinery. In time, the pressure of the accumulated charges becomes so great that a hot spark is caused. This has been counteracted by leading the electricity away with a fine wire brush, but a small quantity of radium has proved more effective. Placed near the point where the electricity is generated, it ionizes the air in such a way that the dangerous charges of electricity flow harmlessly through it to the nearest metallic part and thence to the earth.

Corn-Freezing Unit in Operation in Field, Testing What Cold Varieties Will Stand

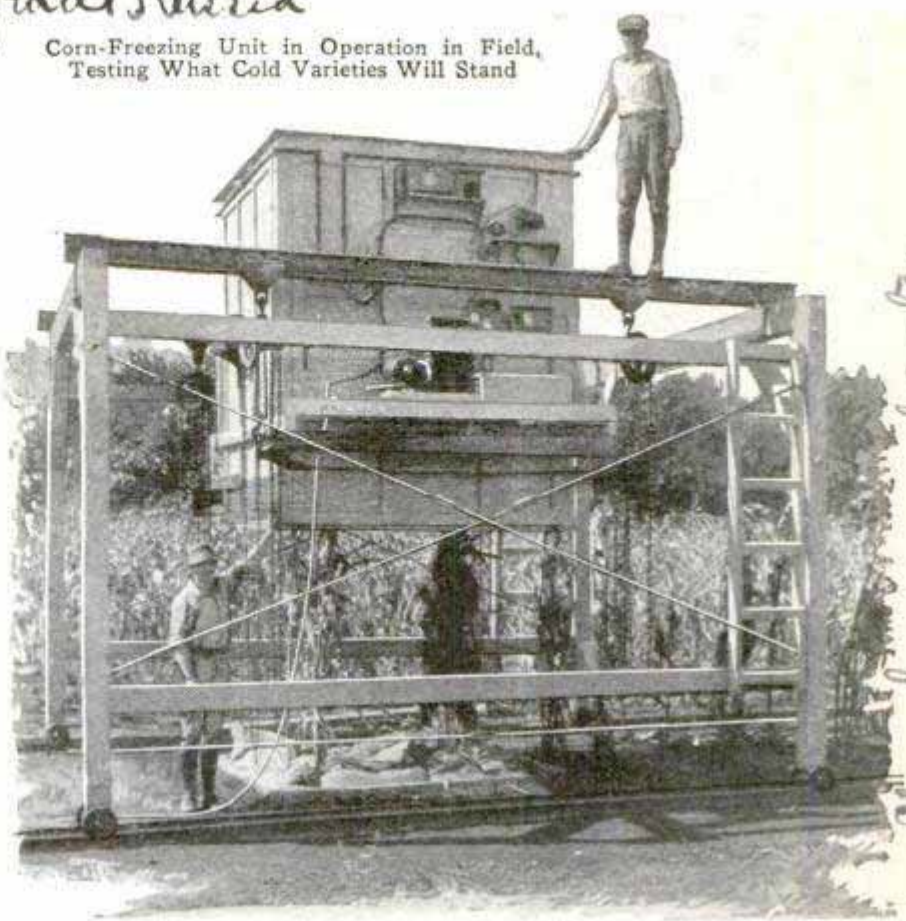

Reprinted by Permission of The Country Gentleman

**ICE BOX FREEZES CORN IN FIELD  
 TO IMPROVE CROPS**

How much cold will corn stand and what varieties of corn are best to plant where there is a likelihood of frosts? These and other interesting questions relating to better and bigger crops are answered with the aid of a portable electric refrigerator that is wheeled directly over the growing corn plants in the field and freezes them or exposes them to low temperatures while careful records are made. Temperatures are accurately controlled throughout the entire test, and the experiment can be done at different periods during the development of the corn so

that the effect of a frost would be indicated at any stage. The tests have shown that some varieties of corn successfully withstand twenty-eight degrees Fahrenheit while others are killed at forty.

**METER FOR MIXING CONCRETE  
 HELPS REDUCE WASTE**

How much aggregate and cement are required for making a cubic yard of rammed concrete is indicated on a simple meter, devised by an employe of a western company. It consists of a rotating disk with numbers that show through slots, to tell the quantities of the different materials that are needed. It shows what amounts of cement, sand and stone to use, even with stone of various sizes.

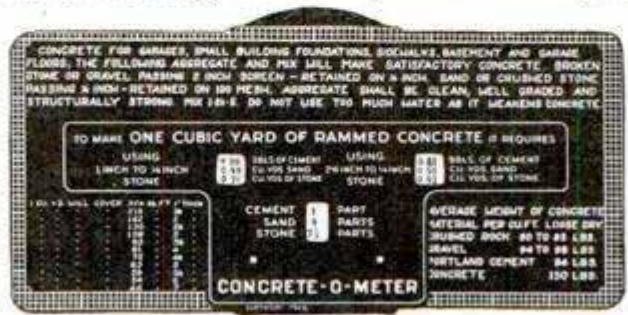

Concrete-Mixing Meter, Showing the Indicators, on Sides and in Middle, That Tell Proportions to Use

San Francisco, Calif.  
 1044 Southern Pacific Bldg  
 2358  
 2nd Boys' & Tambrich, R. 1044 Southern Pacific Bldg  
 Engineering Dept. 537  
 Sold by Braun-Knecht  
 76 Mission St. San Francisco, Calif.

## BIG CRANE ON TRACTOR FEET SPEEDS SWAMP WORK

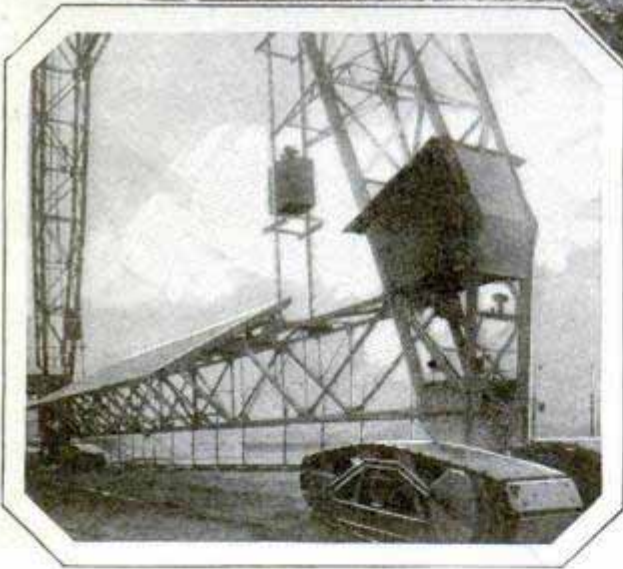
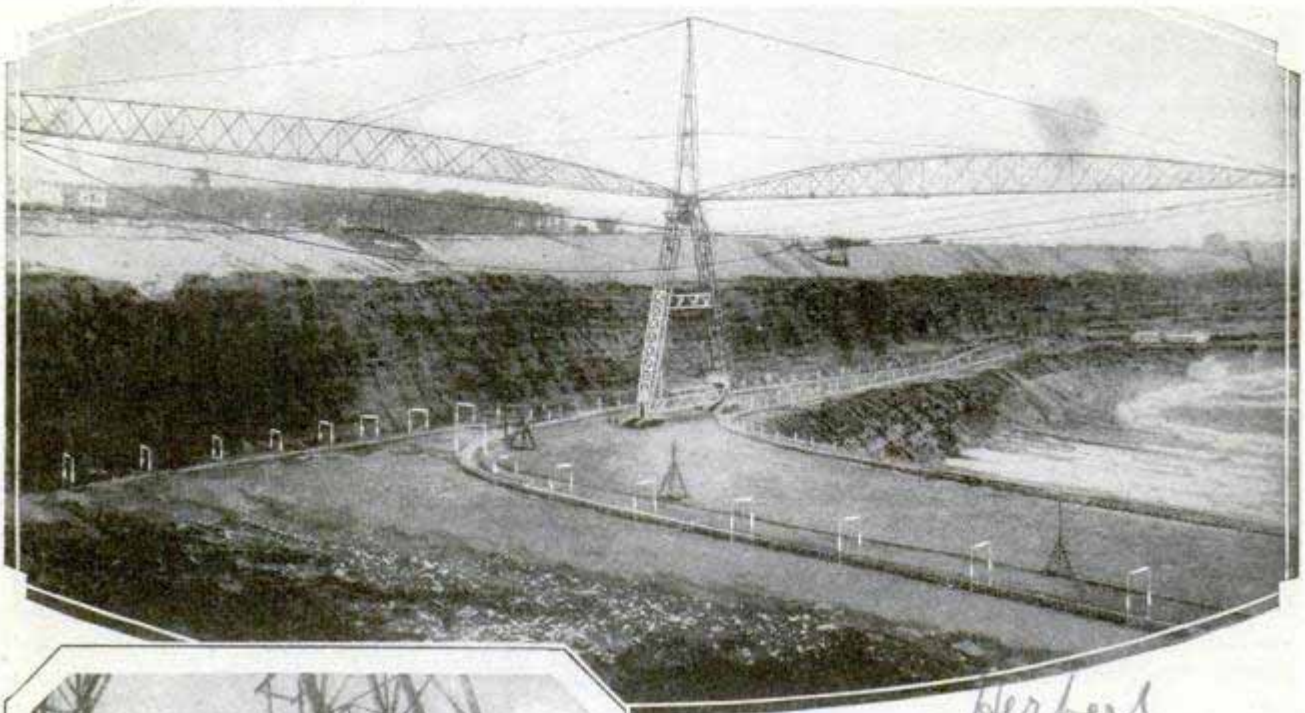

*Herbert*  
Big Crane in Operation, and a Close View to Show How the Derrick Rests on Tractors.

Moving a hill into a swamp was a big but comparatively simple task in Germany, as engineers made use of a huge traveling crane to convey the dirt. It had two swinging arms that lifted the soil from the slope and then deposited it in the swamp. Further speed was made possible by the fact that the crane was carried on endless-tread tractors so that the entire outfit could be moved about quickly, while at work. For longer transportation the crane is disassembled.

### MILE COST OF RUNNING AUTOS SIX AND A HALF CENTS

*2455*  
Data collected from the operation of more than 800 automobiles in different parts of the United States and on various kinds of roads, show that the average cost of running a car is six and one-half cents a mile. These figures have been gathered by the Iowa State Engineering Experiment station under the direction of T. R. Agg, highway engineer. Based on an annual travel of 11,000 miles, the average for all the cars on which reports were received, the operating costs range from four to nine cents a mile. Medium-

weight six-cylinder automobiles cost 8.4 cents per mile. The medium-weight four-cylinder was approximately two cents less. Interesting facts were revealed as to the effect of good or poor roads on operating costs. Estimated savings in the average car-running costs due to road improvements were nearly one cent per mile, by changing from an intermediate road to one of high-type construction; 1.07 cents a mile on a low type changed to intermediate type, and 2.06 cents a mile when the low type was changed to a high. The data were compiled from a study of cost records on approximately 800 automobiles and 900 trucks.



**TESTS WITH MODEL RUDDERS  
AID BOAT SAFETY**

Interesting experiments with model ships and rudders have been conducted by Prof. Charles F. Gross, of the University of California, in order to check accidents which not uncommonly occur in steering ferryboats into the slipways. In spite of the best efforts of the pilots, the boats often fail to enter the slips centrally. Professor Gross discovered that, in most cases, the rudder with its area low in the water, showed a more decided tendency to alter the course of the ferry than did the usual type of rudder with its area nearer the surface. There was also a marked effect on the steering when the rudder was long on the surface of the water, long at the bottom of the ship or had a small portion of its area forward of the center line of the rudder stock. The tests did not take into consideration such factors as tide conditions, misjudgment or failure on the part of the steering gear.

Associate Prof. Marine Eng. & Naval Architecture



Interior of the "Jubilee Stamp House" at North Bersted, Eng., Showing Some of the Stamp Decorations

**SOWER FOR SMALL GARDENS  
— SAVES STOOPING**

One seed is dropped at a time from a simplified sower, introduced for the small garden. It permits keeping straight rows, saves time and labor and allows the operator to stand in an upright position.

Hand-Operated Seeder for the Small Garden

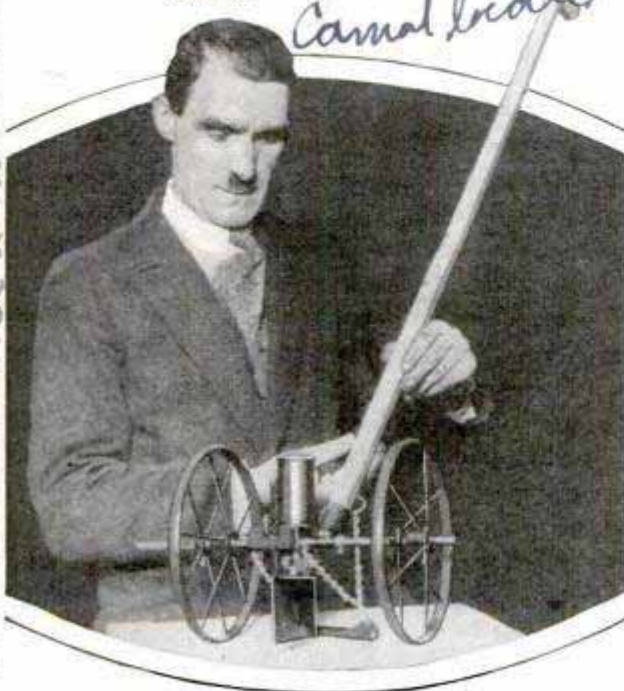

Shown at British Industries Fair

*Carnal locate*

**DECORATE ROOM WITH STAMPS  
VALUED AT THOUSANDS**

More than 8,000,000 stamps are included in a collection housed in a cottage at North Bersted, Eng., known as the "Jubilee Stamp House." They are used on the walls as substitute for ordinary wall paper, decorations have been fashioned from them, and they ornament busts and other articles in the house. The entire collection has an estimated value of about 400,000 dollars.

**ENORMOUS QUANTITY OF GOLD  
CARRIED BY GULF STREAM**

According to estimates by M. Georges Claude, famous French inventor and scientist, the Gulf Stream, in passing a given point off the Florida coast, carries about two cents worth of gold in each cubic meter. This would amount to about \$800,000,000 worth of gold an hour over the whole extent of the stream at the same point, he declares. At present, there is no practical method for separating this "rainbow" gold from the sea water.

2407

Culver City  
Calif

BEST RADIATOR  
PAINTS FOUND  
BY TESTS

Interesting experiments performed at the University of Michigan have furnished the data as to the best kind of paint to apply to the radiator so that heat losses will be reduced to a minimum. The tests showed that some kinds of paint increase the heating efficiency of the unit. One radiator was left unpainted and the other coated with five different types of paint, including aluminum, flat brown, cream, liquid gold and white-gloss enamel. Both were operated under exactly the same conditions. Taking the bare cast-iron foundry finish as 100, liquid gold showed a relative performance of 93.5 or six and one-half per cent less. The radiator was then coated with cream paint and the readings showed 104.9 or four and nine-tenths per cent better than the bare iron. Adding a coat of aluminum reduced the performance to 94.6, and a layer of brown brought

2257

	-ANITA PAGE-	
	BLONDE - NO-1	
	LIPS-	NO-2
	KEY	NO-1
	EYELASHES - BROWN NO-2	
	-JOAN CRAWFORD	
RED-HEAD - NO-4		
	LIPS	NO-5
	KEY	NO-4
	EYELASHES - BROWN NO-5	
-DOROTHY SEBASTIAN		
BRUNETTE - NO-3		
	LIPS	NO-3
	KEY	NO-3
	EYELASHES - BROWN - 3	
ALL NUMBERS STANDARD PANCHRO-		

Mar Zactor Studios  
Hollywood, Calif

Make-Up Chart as Prepared for Three Movie Stars; the Shades Refer to Standard Hues That Already Have Been Tested under the Lights

MAKE-UP KEY FOR ACTRESSES  
IMPROVES MOVIES

So that actresses' make-up may appear uniform when photographed, a color chart, which serves as a guide to performers and photographers, has been devised at a Hollywood studio. Hair, lips and eyes are codified according to scale which already has been tested.

☐ We want all our readers to write us freely and often whenever they wish additional information on articles published in this magazine. Address Bureau of Information, Popular Mechanics, Chicago.

the figure back to 104.7, while the white enamel, applied on top of the brown, resulted in a relative performance of 103.6. The summary of all the tests indicated that the performance of radiators coated with the flake-metal paints was 93.8 average and for the lead paints 103.7 average. In a room at a temperature of eighty degrees Fahrenheit, the metallic-painted radiators would have a heat-emitting ability of ten per cent less than if covered with colored lead paints. At seventy degrees Fahrenheit, the reduction would be about thirteen per cent. The tests are especially timely, as greater use of gas has emphasized the need of efficient equipment.

2330 *Chr. Clatworthy*

SUBMARINE LUNG SAVES TWO FROM OCEAN'S DEPTH

Mr. M  
Dear  
of Socie  
chart.  
of posta  
Name -

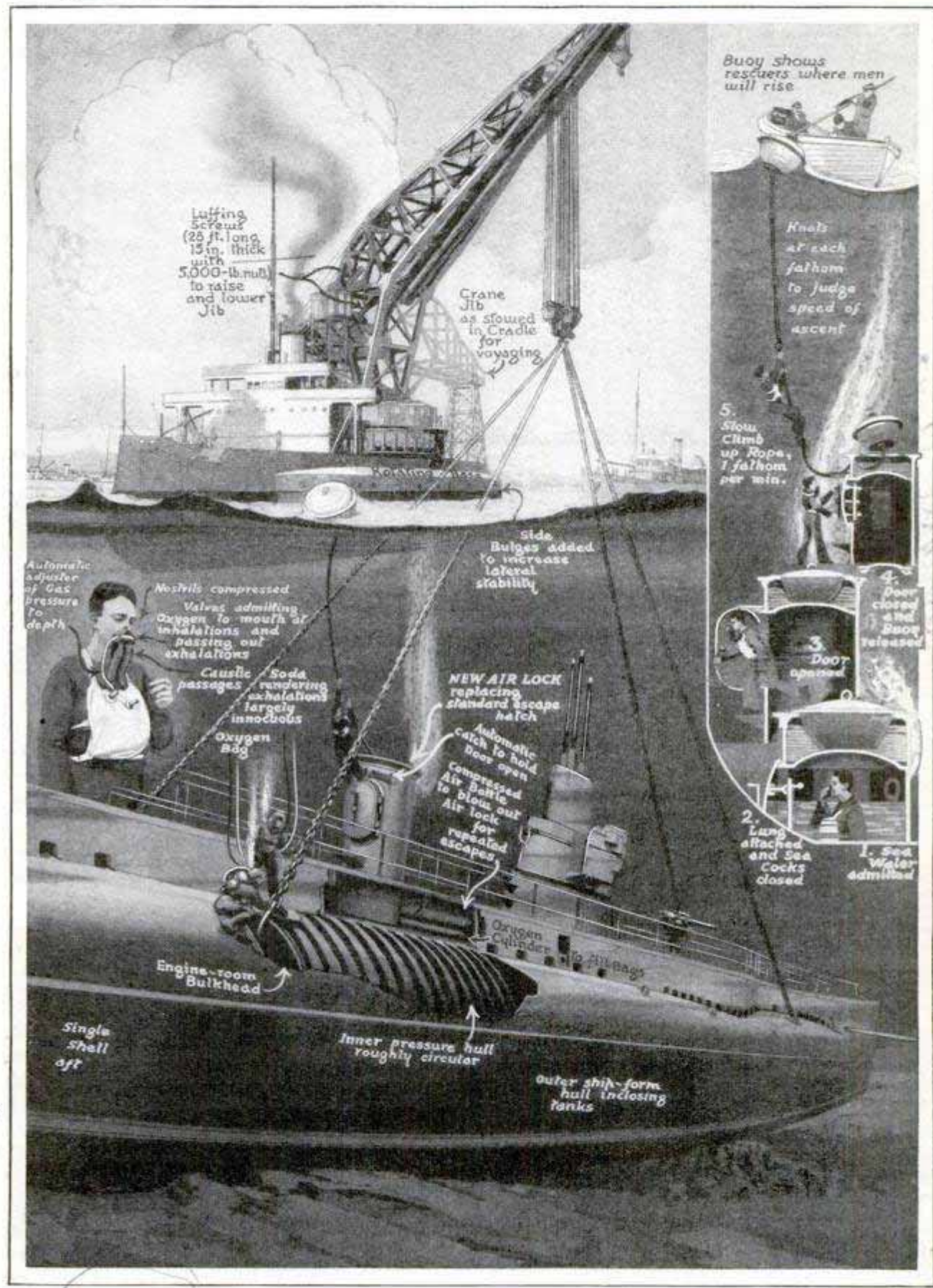

*Washington Bureau of Construction and Repair Naval*

© S. W. Clatworthy

For the first time in history, two men escaped from a submarine, sunk 200 feet beneath the surface, recently in tests off Florida; the escapes were made possible by an oxygen mask, or "lung," permitting breathing under water; sketch shows the great navy lifting crane, which so far has not proved a success

*see March 300.  
demanded by Capt Charles Tomson,*

2 345

*Klauer Mfg Co  
Dubuque Iowa*



From the Road to the Truck; Removing Snow with the Special Scoop and Conveyor; If the Trucks Are Not Loaded, the Snow Is Thrown to One Side, Out of the Way

### SNOWPLOW LOADS TRUCKS SAVING HANDWORK

Besides clearing the road, a snowplow, tested in Chicago, loaded the trucks at the same time, saving extra handling of the material. If the wagons are not to be used at the plow, it throws the snow far to one side of the road. With deep snow, a truck was filled in less than half a minute.

### AUTOMATIC COUPLING STOPS GEAR-SHIFT TROUBLES

An automatic coupling, which makes it possible to change automobile gears up or down without clashing, has been invented by P. M. Salerni, an Italian engineer living in London, and tested with success by the chairman of the technical committee of the Royal Automobile club. The device can be fitted to any car with an ordinary gear box,

and will cost, it is estimated, about \$10. It consists of an ordinary dog clutch, between two members of which there is a ring. The coupling is mounted in the gear box behind the gears and in front of the universal joint connecting the gear shaft to the propeller shaft. The purpose of the ring is to prevent the dog-clutch members from engaging each other when both are turning at exactly the same speed. In use, the coupling acts as a free-wheel device, giving the same effect as when the clutch is depressed in coasting, but it has the advantage that the normal drive can be regained at any time by simply depressing the clutch again, and the engine can be used as a brake, without shifting in or out of gear. In tests by motoring writers of the London papers, gears were shifted from bottom to top and from top down, with the engine turning up to maximum speed, and in each case the coupling took up the load with ease.

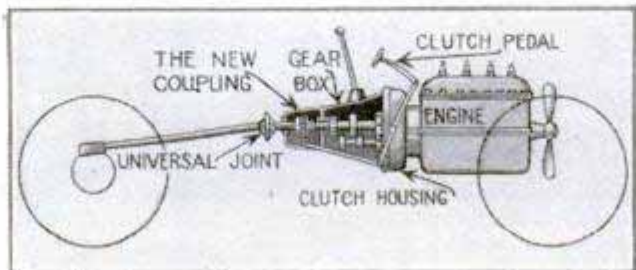

Diagram of the Clutch System, Showing the Location of the Special Coupling That Prevents Clashing

*2511 11/11/20*

*2/14/20  
H. M. Salerni*

*new road coupling*



2234

# Making Home



Steel Holder for the Laundry Bag Simplifies the Task of Making Up the Laundry and Serves Both as a Table and as a Container; It Is Thoroughly Ventilated

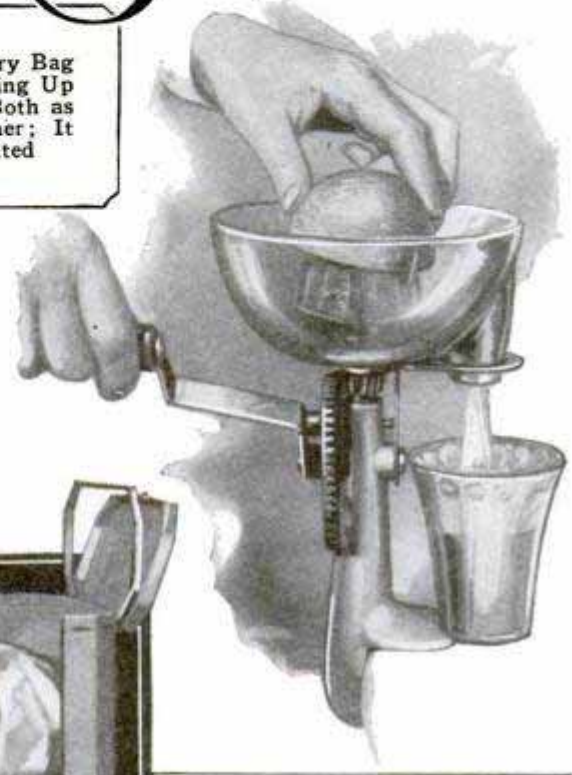

Rapid Fruit-Juice Extractor Is Quickly Attached to the Table and Comes Apart for Easy Cleaning; High Bowl Prevents Spattering and the Mechanism Is Fitted with Ball Bearings

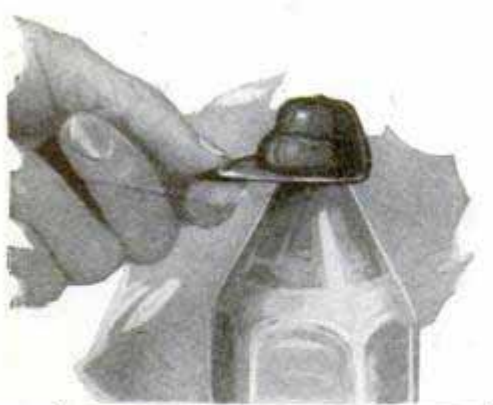

This Baby's Milk-Bottle Cap Has a Handy Tab for Easy Removal, the Invention of a Nurse; It Is Made of Pure Para Rubber and May Be Boiled for Sterilization



Splash Preventer for High Heels; It Is Easily Slipped over the Regular Heel and Has a Base of Sponge Rubber That Soaks Up Muddy Water and Squeezes It Out in Walking, Eliminating the Splash

# Tacks a Pleasure



Wood and Metal Handle for the Recolorator  
 Not Burn; It Is  
 and Lower  
 ust-  
 Fin-  
 sist-  
 sely  
 ng . er



Infant's Improved High Chair Has an Adjustable Back Rest; a Safety Bar, to Keep Child from Standing Up and Falling Out; Safety Strap to Prevent Sliding under Table, and a Footrest, Adjustable to Different Heights



Easily Slipped onto the Broom Handle and Thrust Out of the Way When Not in Use, This Brush Is Designed for Reaching into Corners

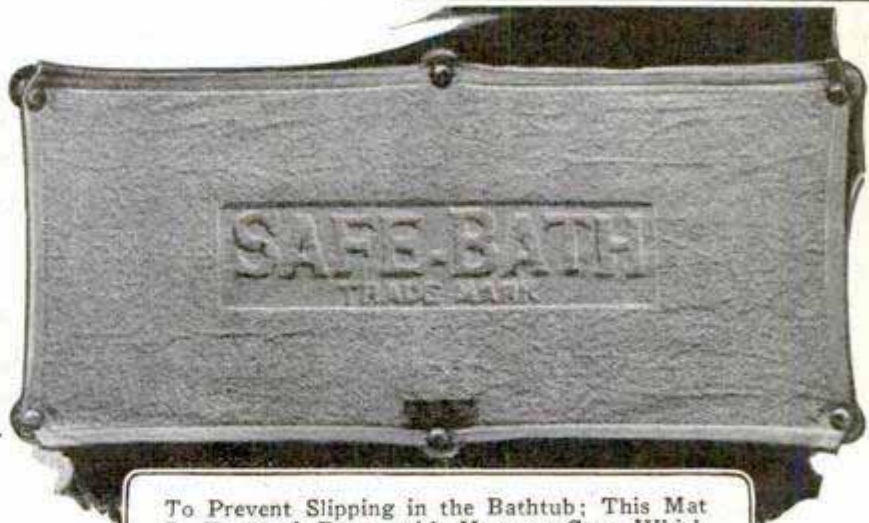

To Prevent Slipping in the Bathtub; This Mat Is Fastened Down with Vacuum Cups Which Are Easily Removed and Hold Securely When Pressed Firmly upon the Bottom of the Tub; the Mat Is Also Useful on a Manicure Table, to Protect Instruments, and in a Sink, to Keep Dishes from Breaking

24 42  
992

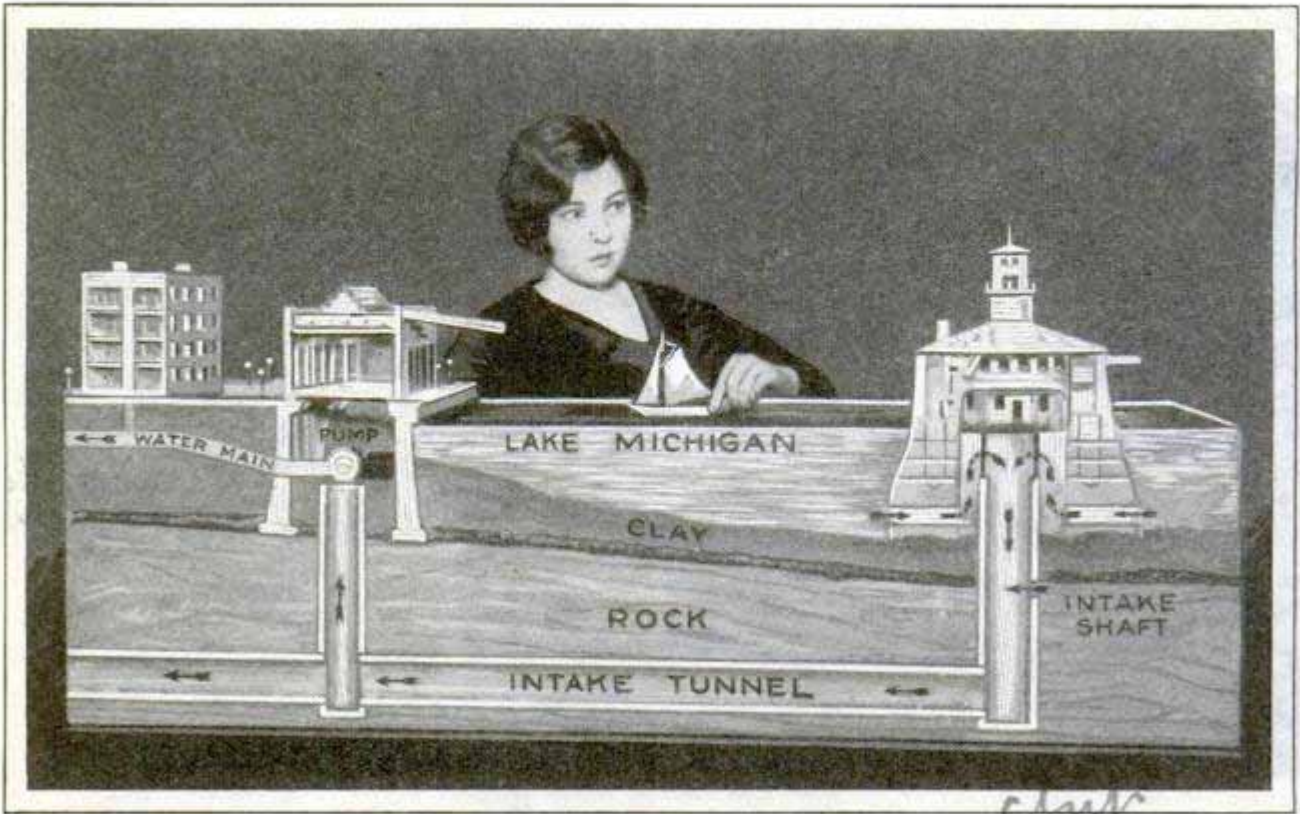

Model of a Unit in Chicago's Water-Supply System; It Shows How the Water Is Taken In from the Lake through Crib and Intake Tunnel and Pumped into the Mains

### HOW CITY RECEIVES ITS WATER SHOWN BY MODELS

One of the most interesting displays at the recent twenty-fifth anniversary of Chicago's City club was a model of one of the water-supply units that serve millions of gallons daily from Lake Michigan. The replica clearly explained the relative positions of the crib, the inclosed reservoir far out in the lake where the water is purified and directed into the intake shaft, the pumping station on shore where the water is forced into the mains, and the method of distributing the supply to apartment buildings and other structures.

### ODD MIRAGE HAMPERS AUTOIST IN SPEED-RECORD TRIALS

Capt. Malcolm Campbell, who is trying to lower the world's speed record on a novel motor track in the desert near Verneuk Pan, South Africa, has had trouble with the moving mirage, a phenomenon which has baffled expert riflemen and native hunters although they are well accustomed to mirages. The marksman finds that he has to allow for drift or "windage" on a target which seems to be constantly moving to the left or right. This is due

to the extreme heat and radiation on the dry veldt, where rocks, trees and other natural objects sometimes seem to be slipping silently across the sights. When a racing motorist has to look 300 or 400 yards ahead on the track, he may be deceived as to the course of the car and meet a serious accident. The strange mirage has given rise to the name of the Verneuk Pan, which means "Deception Desert."

### CLAMP FOR BATTERY TERMINAL REQUIRES NO SOLDER



Boltless storage-battery terminals, that are said to end corrosion troubles and require no solder, are now available for use on motor cars and elsewhere. Only three simple operations are necessary to

install them. The lead clamp is loosened, the terminal is placed over the battery post and tapped in place with a hammer, and the clamp is then tightened with wrench or pliers.

24 42  
992

24 42  
992  
1394  
1394  
1394



**WELD PIPE LINE ELECTRICALLY TO PREVENT GAS LEAKS**

Linking New Mexico and Texas, a 205-mile gas pipe line is being electrically welded. Twenty-seven welding outfits, some mounted on tractors and driven by the tractor engine, and others on trucks and trailers, are being employed. The pipe is sixteen inches in diameter, is in thirty-foot sections, and seven of these lengths are handled at one time. One crew fixes the sections temporarily in position by tack welding and another completes the work. Every seventh joint is an expansion joint, to give added flexibility and to allow for expansion and contraction when the main is in service. Each operator is able to make approximately thirteen welds in ten hours by using a welding electrode, three-sixteenths of an inch in diameter, and current ranging from 175 to 190 amperes.

**METAL PLATE POLISHES SILVER WITHOUT RUBBING**

Silver or gold objects are restored to luster in a few minutes without the use of powders or other cleaning agents by means of a small metal plate. This is placed in hot soft water with the article to be cleaned touching it. In a short time, the tarnish will have disappeared and the article may be removed and dried. The plate itself is kept clean with scouring powder and will last for a number of years, it is claimed.



Method of Using the Silver-Cleaning Metal, and, at Right, Close View of a Sample, to Show Its Form



Fresh-Fruit Dispenser for the Convenience of Railway Travelers; It Holds Several Different Kinds

**COIN-IN-SLOT FRUIT VENDOR SERVES RAIL TRAVELERS**

By dropping a coin in a slot, passengers at London railway stations procure a variety of fresh fruits from a cabinet that keeps the contents clean. The vendor accepts coins of two denominations.

**TEARS REGARDED AS BLESSING FOR THEY KILL GERMS**

Tears contain a chemical that kills germs and are therefore of benefit to the eyes even though weeping usually is associated with sorrow. One teaspoonful of the pure chemical substance found in tears has antiseptic powers equal to more than 100 gallons of salty water against bacteria that may hurt the eyes, tests have shown. The same material is discovered in the white corpuscles of the blood which wage war on harmful germs.

*Handwritten notes:*  
An article  
The road line  
Pass to the...  
We d  
or B  
frut  
st:  
ir  
w

*Handwritten notes:*  
Refer to Consolidated Automatic  
Merchandising Corp. 245-5th Ave  
New York

*Handwritten number:* 2473

*Handwritten notes:*  
The...  
197...

*Handwritten notes:*  
if 20...

2363

# The Storm King's



In Some of the Prairie States, Tornado Drill Is as Important as Fire Drill in the Schools; Here the Teacher Is Shepherding the Pupils Out of the Tornado Cellar

By CALVIN FRAZER

EVERY severe blow that occurs in a settled portion of the United States administers an equally severe blow to the pride of American engineers and builders. Despite the great skill attained in the building arts, the excellence of modern materials, including steel and concrete, despite all that has been learned about the laws of the winds and the mechanism of storms, not a year passes in which many buildings and engineering works of all kinds do not topple like the proverbial house of cards before the tempest's fury.

Less than two years ago a tornado plowed through the city of St. Louis. Scores of buildings were reduced to mere rubbish heaps and many hundreds more were badly shattered. Twice within the last few years, cities and villages on the coast of Florida have been wrecked by tropical hurricanes. The average annual windstorm damage to buildings in this country amounts to millions of dollars, to say nothing of the killing and maiming of human beings caught in the collapse of these buildings or hit by flying fragments.

With all this devastation, the maximum

possible damage by a single storm has never been experienced or even approached. Tornadoes, the most furious storms on earth, occur at an average rate of about a hundred a year in the United States, but the skyscraper district of a great American city has never yet been hit by one of them. Sooner or later this may happen, and, if it does, the results are likely to be appalling.

What can be done about these tremendous losses? Even by methods now known, it is probably quite feasible to construct buildings that would be proof against any wind that blows, including the most violent tornado, but the cost of doing so on a general scale would be prohibitive. It seems, however, a practical proposition to make buildings of all kinds so strong, that they will pass unscathed through the worst storms that ordinarily occur in their localities, and will suffer only moderate damage in storms of extraordinary violence.

In designing a sewer system, an engineer studies rainfall records, if they are available, and plans the system to take

# Challenge

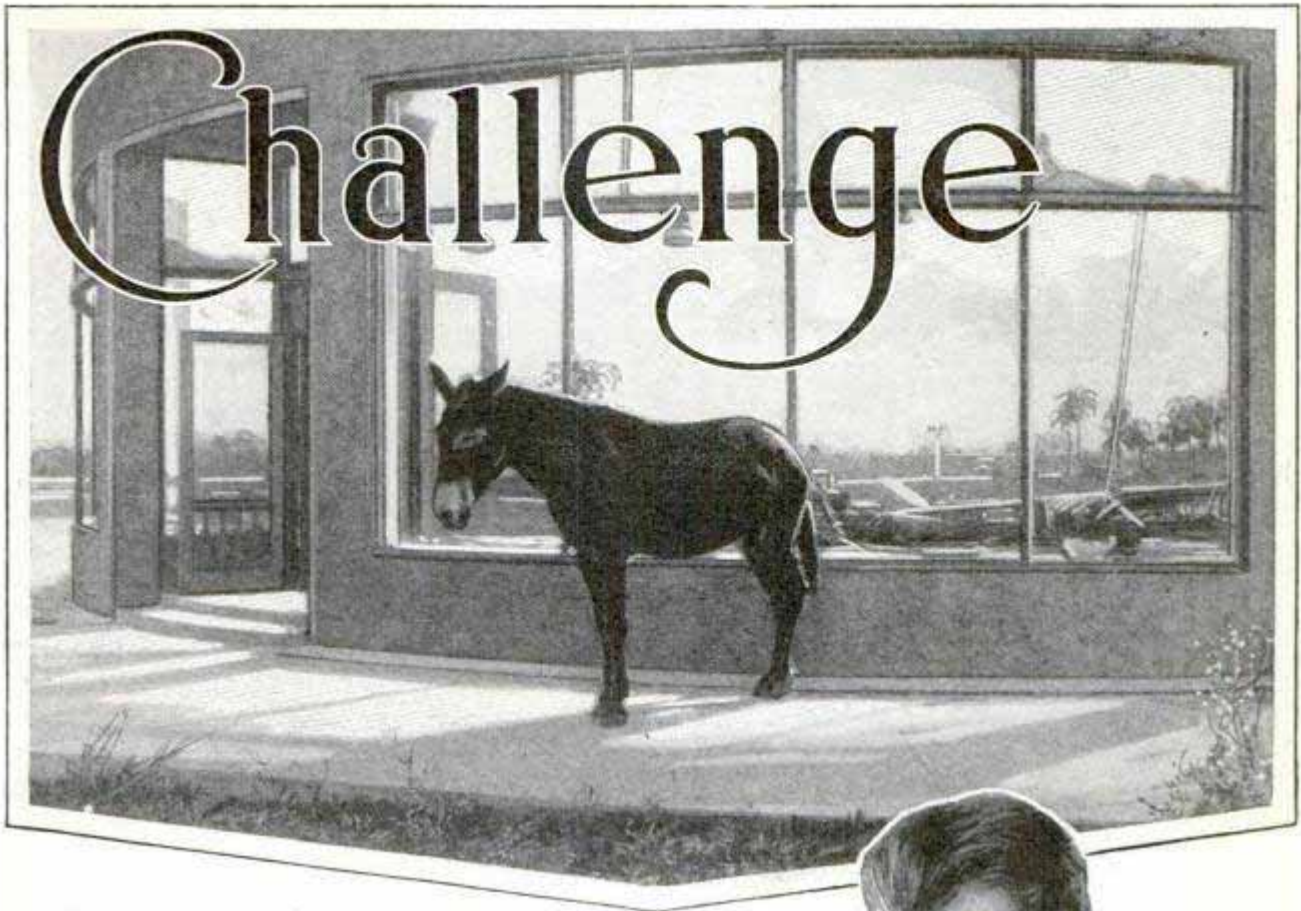

care of the most intense downfall that occurs, say, once in twenty years, on an average. He does not plan for the cloudburst that may or may not occur in the course of a century. The tornado and, in this country, the full-fledged tropical hurricane bear much the same relation to ordinary windstorms that the cloudburst bears to average rainstorms. They are everywhere exceptional events and their destructive effects are always confined to small areas.

The fact that the village of Codell, Kans., has not only been visited by three tornadoes, but experienced these storms in three consecutive years and in each case on May 20, is certainly one of the most amazing coincidences on record. Contrary to popular belief, Kansas is not more afflicted with tornadoes than some of the other states of the middle west. The average number per annum during a

Top, What a Tropical Hurricane Left of a Drug Store at Pompano, Florida; Just the Front Wall and Doors; Below Is an Electrical Recorder Which Charts Wind Velocity and Direction, Rainfall and the Amount of Sunshine Each Day



period of thirty years was 8.8. As the area of the state is 82,000 square miles and as the destructive area of the average tornado is about ten square miles, it follows that any given locality in Kansas is likely to suffer damage from a tornado only once in about 930 years.

The tornado frequency is lower in some

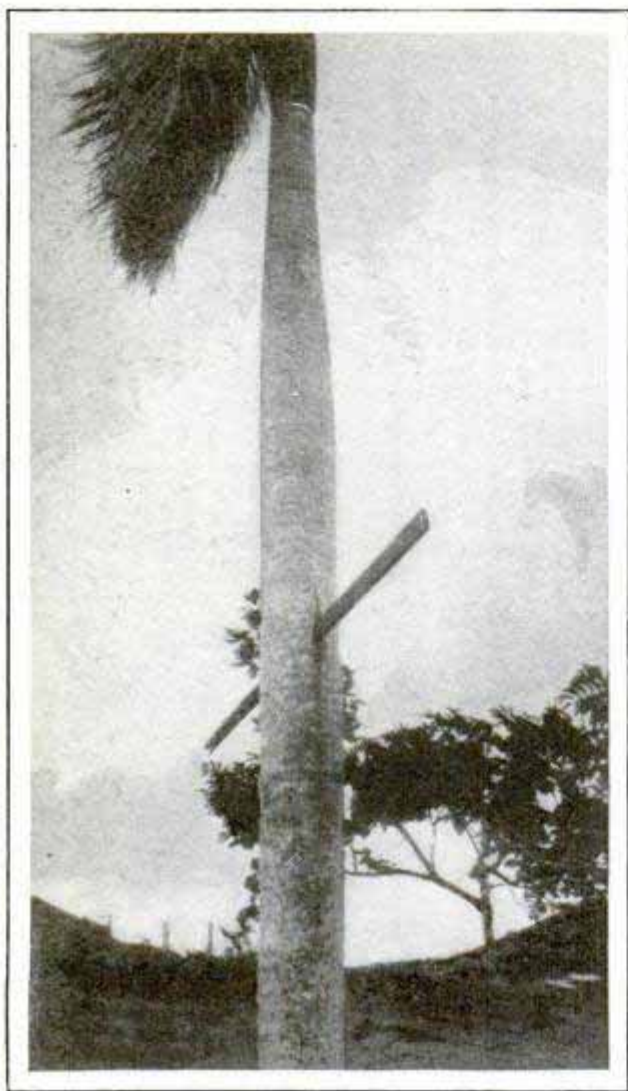

Royal Palm at Naranjito, Porto Rico, Pierced by a Board Torn from a Building; the Tree Is Fourteen Inches in Diameter

other parts of the country, but only an insignificant area of the United States is absolutely exempt from these storms. During twenty-three years, ending 1923, Pennsylvania had forty-two tornadoes, New York thirty-five and Massachusetts ten. During the same period, 177 occurred in Kansas, 124 in Iowa, and seventy-two in Nebraska. Per unit area, Massachusetts actually had more tornadoes than Nebraska and more than half as many as Kansas and Iowa. The District of Columbia was visited by two tornadoes during the year 1927, and one of these wrecked buildings within a mile of the capitol.

Next in violence to tornadoes among the storms come the tropical hurricanes that occasionally visit our southeastern coasts during the months from June to October, inclusive. The occurrence of one of these storms in any particular lo-

cality is a much rarer event than most people suppose. Not all the tropical cyclones that reach our coast are severe enough to rank as hurricanes, and, in those that are, the winds of destructive force are limited to a comparatively small area near the storm center, so that the track within which damage is done is, in some cases, only a few miles in width. Of the eighty-four tropical hurricanes that have occurred on the Gulf and Atlantic coasts during the past fifty years, only sixteen were classed by the weather bureau as great hurricanes, and even in these the path of destruction was only forty or fifty miles wide and a few hundred miles long.

The barometric lows of non-tropical origin that travel across the country from west to east, usually leaving the continent by way of New England and the Gulf of St. Lawrence, are sometimes attended by winds of hurricane force, especially on the coasts and in the mountains. The greatest wind velocity ever registered instrumentally in the United States was 186 miles an hour at the summit of Mt. Washington, N. H., Jan. 11, 1879, but with the type of anemometer employed, this reading requires reduction to a true velocity of about 140 miles an hour. One of the most violent storms, other than tornadoes, that ever occurred in the northern part of the country was the so-called "Olympic Blowdown" of Jan. 29, 1921, which felled thousands of big trees, aggregating about 8,000,000,000 board feet of timber, in the Olympic peninsula of western Washington.

As may be inferred from the preceding paragraphs, a good deal is known about the relative frequency of storms in different parts of the United States, but unfortunately not nearly so much is known about the velocity, or force, attained by the winds in these storms. Probably no other kind of climatic statistics is so unsatisfactory as the figures relating to wind force. There are several reasons for this.

In the Old World the majority of such figures are based on estimates, which are considered to be, on the whole, more trustworthy than instrumental records. In this country, the wind is measured at the 200 regular stations of the weather bureau and at a few other places by means of a whirling arrangement known as a cup



The Hurricalike Blast, Known as the "Avalanche Wind," Which Rushes Out in Front of a Snowslide, May Demolish Houses and Uproot Trees Hundreds of Yards Away

anemometer, the hemispherical metal cups of which turn in the wind. In the standard instrument now used, there are three cups, instead of four, which was formerly the rule. The new type of instrument gives more accurate and consistent results, especially at high wind velocities, but it is still subject to certain well-recognized defects.

One defect common to all anemometer records is that they are greatly affected by the exposure of the instrument and especially by its height above the ground. The force of a wind generally increases with altitude. Hence an anemometer placed on top of a skyscraper indicates stronger winds than those prevailing at the level of ordinary buildings. In a city, on the other hand, the instrument must generally be placed at a great height in order not to be screened from the winds by surrounding buildings.

The cup anemometer has another serious fault from the point of view of the engineer, who wishes to know the maximum force attained by the wind in storms. A wind, especially near the earth's surface, is not a steady flow of air, but is

made of innumerable brief gusts and lulls. In the course of a few seconds, its force may increase, say, from forty to sixty miles an hour, and then drop as quickly to twenty miles. Instruments known as pressure-tube anemometers have been devised for registering these brief fluctuations, but they are complicated and costly, and very few of them are in use. The cup anemometer does not register gusts, but merely shows the average strength of the wind over a period of a minute or more; hence this instrument probably never indicates the greatest wind force to which neighboring buildings are exposed in a storm. In weather-bureau practice, the maximum velocity is the average for a five-minute period, while the extreme velocity is obtained from the fastest single mile of wind recorded.

In the Florida hurricane of 1926, a three-cup anemometer at Miami Beach gave a corrected maximum reading of 123 miles an hour and an extreme of about 150 miles an hour before it was blown away—the usual fate of anemometers in violent storms. Meanwhile the force of the wind during gusts may well have reached 180

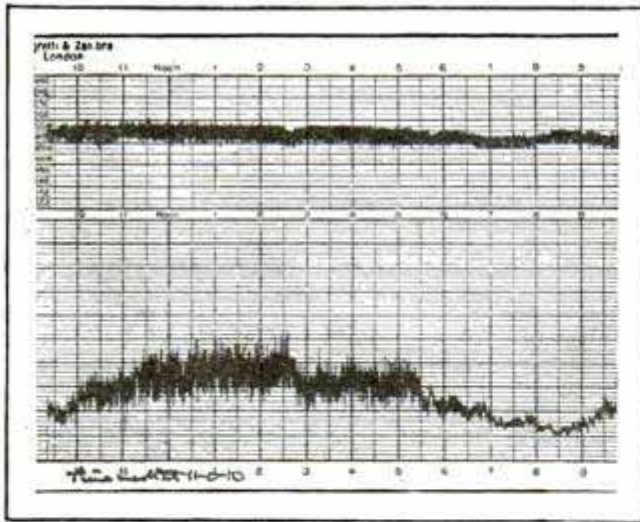

or 200 miles an hour. At San Juan, Porto Rico, during the hurricane of Sept. 13, 1928, the three-cup anemometer at the weather-bureau station registered a maximum of 150 miles an hour and an extreme of 160 miles an hour just before one of its cups was carried away by the wind. An hour later, another cup disappeared, and finally what was left of the instrument was blown away and deposited a third of a mile from the station.

Another difficulty in connection with wind data, from the engineering standpoint, is that there is great uncertainty about the relation between wind velocity and wind pressure. Not only have different formulas been employed for reducing velocity in miles per hour to pressure in pounds per square foot for winds blowing at right angles to a surface, but the pressure is known to vary with the area exposed to the wind, being less per unit area for large surfaces than for small. When the wind does not blow at right angles to the surface, the relations between velocity and pressure are complex in the extreme. This fact has been well brought out in a long series of experiments made at the bureau of standards, in which small models of buildings, chimneys, etc., were exposed at various angles in a tunnel to winds of known velocities and the resulting pressures on all parts of their surfaces measured.

In view of all these facts, it is not strange that much diversity of opinion

prevails among engineers as to what provision should be made for wind stresses in the design of buildings and other structures, and should be required by building codes. Controversies on this subject have raged for years, both in this country and abroad. It was, in fact, an event of half a century ago—the famous Tay Bridge disaster of 1879, in which a section of the world's longest railway bridge, at Dundee, Scotland, was blown down, with heavy loss of life—that first aroused British en-

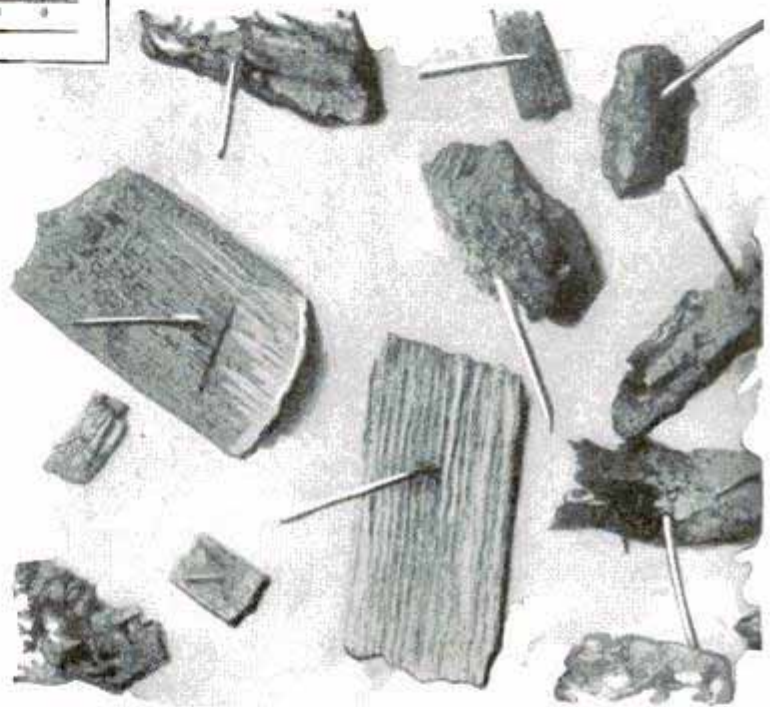

The Lower Record on the Chart Shows the Lulls during a Wind-storm; Bottom Picture, Straws Driven through Bits of Wood

ineers to the necessity of investigating the subject of wind pressure, and some of the questions raised at that time have never been satisfactorily answered.

Nowadays the usual sequel of a destructive storm in the United States is a careful survey of its effects on buildings, conducted by some of the engineering societies or by government agencies.

Though windstorm damage to buildings cannot be entirely prevented, it certainly might be much reduced, and this would contribute to the safety of human beings in a storm area. As an example of what can be done in this line, mention may be made of the fact that, when a tornado passes over a building, there is a tendency for the walls to be thrust outward, owing to the difference between the normal pressure of the atmosphere indoors

and the reduced pressure in the storm vortex outside. This difference amounts, in extreme cases, to about one-tenth of an atmosphere, giving a sudden thrust of about 200 pounds per square foot. The forest products laboratory has been studying the phenomenon, and finds that a simple and inexpensive system of automatic vents, which would open when the pressure occurs, would relieve pressure on the walls and prevent their collapse.

Absolute safety for humanity in a tornado can be found only underground. There has been a marked revival of interest recently in tornado or cyclone cellars; they have been constructed in large numbers in open country districts, where an approaching tornado can usually be seen several minutes before its arrival, so that people have ample time to seek shelter. The best refuge from a tropical hurricane is, in most cases, to be found well above the ground instead of below it, since these storms are usually accompanied by tidal waves on the coast and by torrential rains and floods inland. Mr. H. C. Hunter, of the weather bureau, says:

"The proper refuge would be low towers. Very firm anchorage and powerful framework are essential in these proposed refuges, and flimsy construction of the inclosed rooms must be avoided. Port-holes would be better than the strongest windows. Furthermore, it would be important to see that no trees grew near enough or high enough to fall against the refuge. Each of these refuges could serve an area of four or five miles square, if persons in peril could be persuaded to start before wind and rain became intense. There would need to be an able leader or committee for each refuge to watch constantly for need of repairs and to marshal the threatened residents." The feasibility of this plan depends upon the fact that, in most regions subject to tropical hurricanes, the coming of these storms is always heralded many hours in advance.

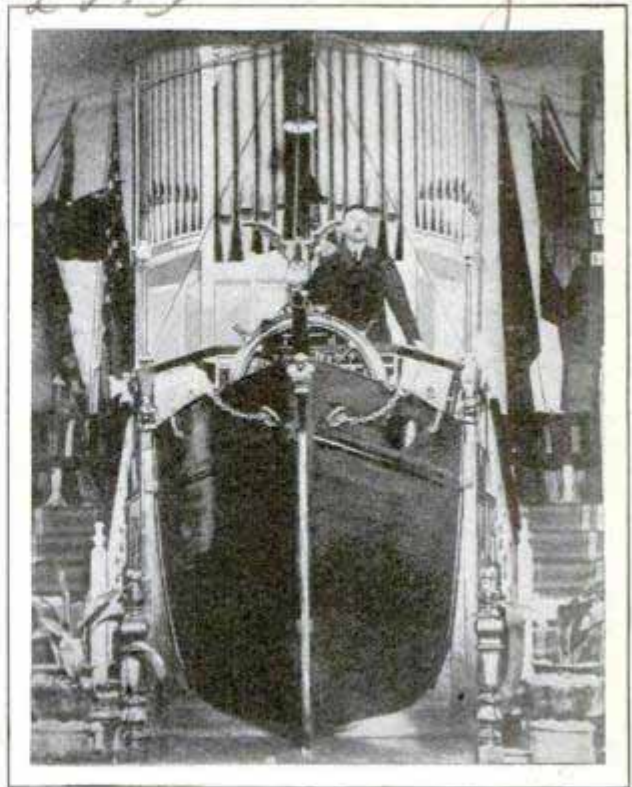

Unique Pulpit in Mission at Falmouth, Eng.; It Is Modeled after a Vessel's Prow

### PULPIT LIKE VESSEL'S BOW SERVES PORT MINISTER

At a mission in Falmouth port, England, the minister preaches from a pulpit that closely resembles the prow of a ship. Regulation starboard and port lights, which are illuminated during the services, increase the effectiveness of the illusion. The pulpit was dedicated to the late King Edward VII and has been in service for seventy-five years.

### LIGHTS TURN WITH WHEELS FOR SAFER DRIVING

By means of an attachment developed by a New Zealand man, the headlights of the automobile turn with the front wheels so that adequate illumination is provided in going around curves. Better visibility at the side of the road is also claimed, and the device is said to reduce the glare in the eyes of motorists driving in the opposite direction.



When the Front Wheels Turn, the Headlights Turn with Them, Directing Their Rays around Corners

273 Bank St. Ottawa, Ont. Canada

Peter Mackenzie  
 of Capital Appraisal Co

2286

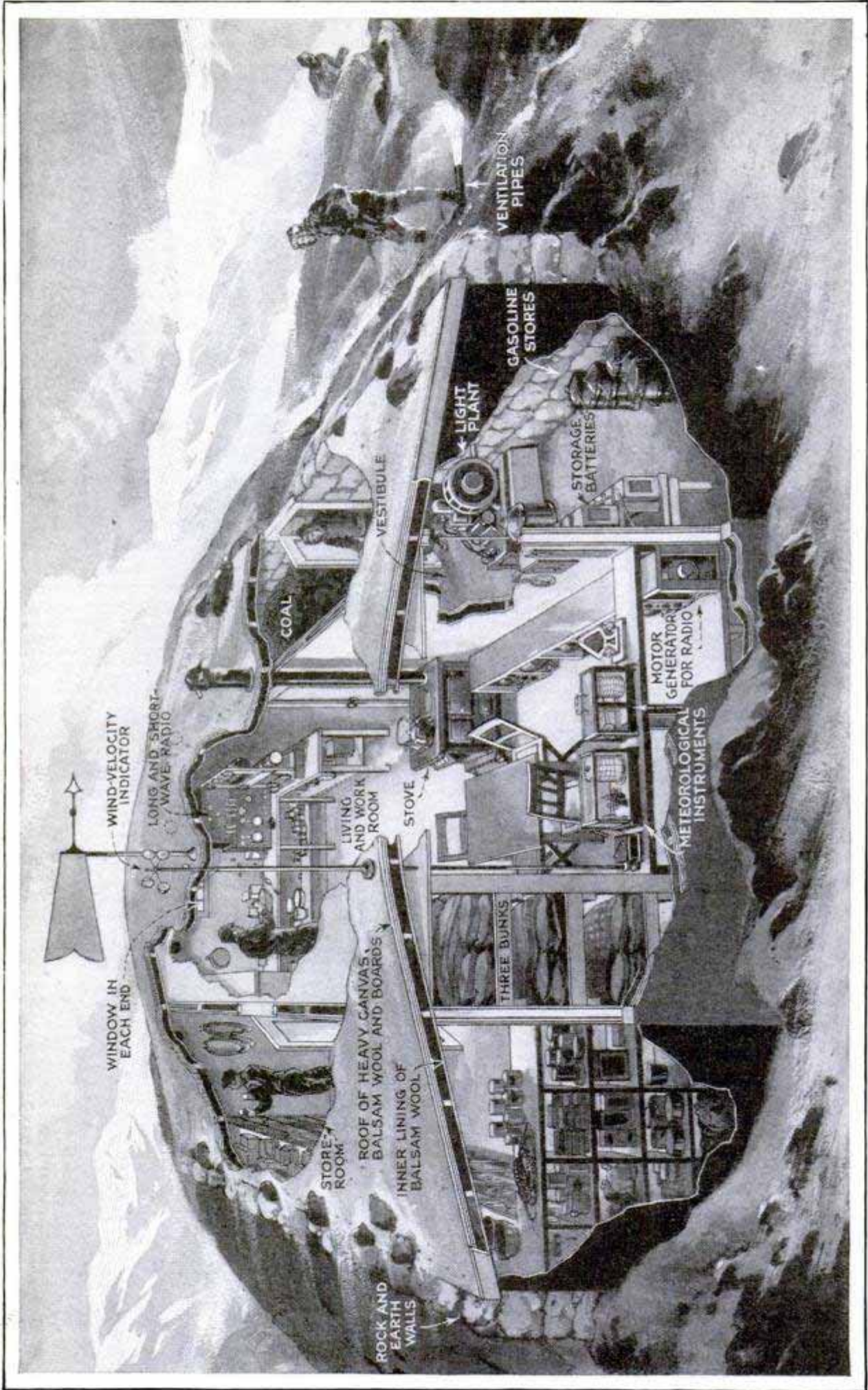

Where Three Men Spend the Winter on the Greenland Ice Cap, a Diagrammatic Sketch of the University of Michigan Observatory at Mt. Evans, Which Keeps in Touch with the World by Short-Wave Wireless during the Long Months of the Winter Night



# RADIO *in the* ARCTIC

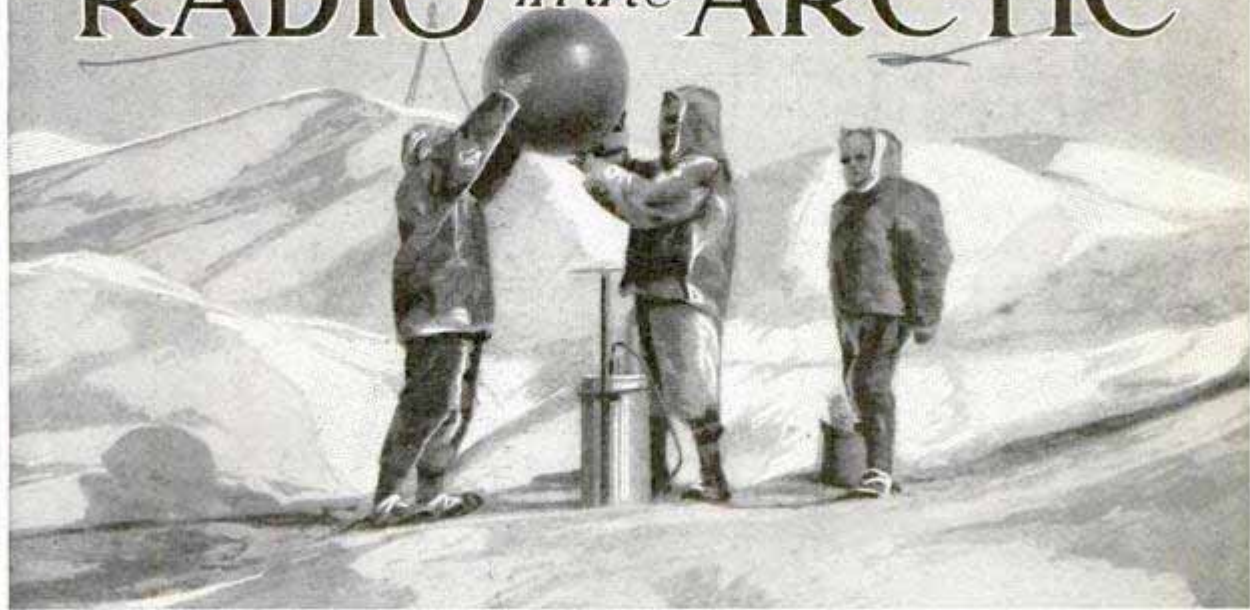

Sending Up a Sounding Balloon from the Arctic Ice, to Chart the Wind Velocity and Direction at the Higher Altitudes; One of the Daily Tasks at Mt. Evans

**M**T. EVANS, Greenland, via radio, station NX-1-XL to station W-8-AXZ, Ann Arbor, Mich.—In this farthest outpost of the University of Michigan, so far north that we see the northern lights in the southern sky, three men, two aerologists and a radio operator, are spending a six months' night in a little room that measures nine by fourteen feet.

The three are the winter's guard of Dr. William H. Hobbs' Greenland expeditions, which, since 1926, have been studying this home of the north wind, the great polar ice cap, 1,500 miles long and averaging 700 in width, covering all of the vast interior plateau of Greenland.

Save for an occasional Eskimo hunter, passing with a dog sled to visit his fox traps, not a single visitor has appeared since early fall, and none will come until early summer, but there isn't a spot in the world that we can't talk to almost every night.

Dick Byrd's operators come on the air, via short-wave wireless, from the Bay of Whales, in Antarctica, to exchange gossip about the relative merits of an antarctic summer compared with an arctic winter. As dusk falls and darkness stretches over the sea from Greenland to Europe, London, Paris, Berlin, and amateur and commercial stations in Denmark, Germany,

France, Italy, Norway, Holland and England, as well as ships at sea, tune in to exchange weather information, the day's news, or just gossip.

Later in the evening, when distant Europe is going to bed, two-way talk on the short-wave code set is just getting good with Canada, the United States and the rest of the western hemisphere, and the long-wave receiver is bringing in the strains of a jazz band beside the palm-lined shores of Florida, a speaker in New York, or music and voice from distant California. As the night progresses and darkness moves on to the west, reception from ships in the Pacific picks up. We have worked a ship rounding the Cape of Good Hope, South Africa, and an amateur in New Zealand on our short-wave set.

That's the change that radio has made in polar life in a few short years. Instead of hibernating for the winter, growing tired of each other's conversation and bored with life, we get the life of the world, from the day's news to the latest song, served up nightly.

Last summer, when we packed a little portable transmitter and receiver seven miles out to an emergency landing field, to establish a watch for Bert Hassell and Parker Cramer in the "City of Rockford," when they attempted to fly to Europe via

Mt. Evans observatory, we whiled away the time by tuning in on the round-by-round report of the Tunney-Heeney fight. And though the nearest church is 100 miles away, and a Danish one at that, and we have to send a message 7,700 miles by radio and cable to talk to anyone there, we get our church service in English every Sunday morning, thanks to the short-wave rebroadcasts from the United States.

There isn't anything within a hundred miles of us to cause radio interference, which may look like an ideal location, but we have our own radio troubles. For one, the January gale a couple of weeks ago, blew down a steel mast that took eleven strong men to erect last summer, and broke that fine mast into three pieces, which called for a lot of emergency repair work. And for another, though the short wave works perfectly in winter and fairly well at night in summer, the long-wave receiver, on which most of our music and voice comes in, is particularly troubled by fading from about ten o'clock at night until after midnight. As this is the period during which the display of northern lights is the strongest, there may possibly be a connection between the two.

Contrary to general belief outside, it isn't so cold here, even in the dead of winter. For seventy-two hours during January, when the hurricane blew at a hundred miles an hour or better (once it reached 120 miles an hour), the temperature at Mt. Evans remained consistently above freezing, averaging around forty above zero. Back on the vast ice plateau where the hurricane originated, it probably was fifty below zero, at the very least, but when the cold wind dropped down over the edge of the ice cap and slid to a level a mile and three-quarters lower than the plateau, the condensation was so great that the air was warmed ninety or a hundred degrees.

Station NX-1-XL is a short-wave radio transmitter using 250 watts of power, and working on approximately the same wave bands used by American amateurs. A gasoline engine, a storage battery and a motor generator supply the current needed. The short-wave receiver is of standard make, but equipped with only two tubes, while a long-wave receiver of three tubes gets the commercial stations

and the broadcast programs. A power tube has been added to increase amplification from either set.

The observatory on Mt. Evans is 1,294 feet above the waters of the great Soendre Stroemfjord, which stretches away seventy-five miles to the open sea in Davis strait. Because of that location, wind and weight both had to be considered in designing the aerial and the radio outfit itself, as everything was packed up the hill on human backs. A bamboo mast, used in the winter of 1927-28, swayed so badly in hurricane winds as to be almost useless, so this year's forty-foot steel mast was substituted, and it too failed.

We have experimented with all kinds of aerials, with wires stretched three feet, twenty feet and thirty-five feet above the ground; and with aerials ranging from a six-foot indoor aerial to an outdoor one of three hundred feet, yet, with all of these, the signal strength on the short waves remained virtually unchanged, and the only noticeable effect was better long-wave reception on the long outside aerial. The difficulty of keeping a long wire taut and eliminating swaying so far overbalanced the gain in reception that we soon abandoned it. Swaying of the aerial is the chief difficulty we have found with short-wave reception, and, because the indoor aerial eliminates it entirely, it proved the best. With waves only a few meters in length, even a slight swinging in the wind suffices to interfere with reception. As for directional effect, we found, with all of the aerials we tried, direction had no bearing on the signal strength.

While the weather in winter is fairly mild, there are some cold spells, enough of them to make it necessary to wrap the storage batteries in heavy insulation to prevent their freezing.

The observatory itself is really a three-room structure, built of timber and insulating wool, and banked with rocks and earth. The center room, nine by fourteen feet with a small window high in each end, serves as living room, dining room, bedroom, kitchen, radio office, meteorological laboratory, and anything else. The outer room is used for storage of coal and gasoline, and for the light plant and storage batteries, while an inner room, reached only through the main room, contains our



The Observatory as It Appears during the Short Summer, When Winter Supplies Are Being Carried up the Mountain on the Backs of the Scientists and Their Eskimo Helpers

food supplies. To save floor space in such cramped quarters, we sleep three deep on a triple bunk, which brings the topmost sleeper right up under the canvas, board and balsam-wool roof.

Mt. Evans' location at the edge of the great inland ice mass, and about seventy-five miles inland from Davis strait and the open sea, makes it one of the most isolated observatories in the north. During the summer months, Eskimo visitors, in kayaks—little skin-covered boats—can make the trip from the nearest settlement in about three days. Larger motorboats, coming by way of Davis strait and the Soendre Stroemfjord can, if the weather is fair, make the journey from Holstensborg in about the same time, but in stormy weather, it may take a week. Aside from these, the only summer visitors are an occasional hunting party in a umiak—otherwise a "woman boat"—which has places for ten or a dozen women to row while the men rest at ease. It was a hunting party coming up the fjord last summer that saw the signal smoke of the lost flyers Hassell and Cramer, on the hills of the south shore and notified us, so we could go over and rescue them. Their plane, the "City of Rockford," had been landed on the glacial ice two weeks before, and they had been walking for fourteen days, averaging an advance of not more than six miles a day, due to long detours around

open crevasses, and hummocks that could not be scaled.

There are no near neighbors to the observatory for the reason that, in the entire continent of Greenland, there are no inhabitants save in the little settlements along the coast. These coastal villages are situated just within the mouths of the great fjords, which carry the melting glacial streams down to the sea. In the villages are generally to be found the families of the Danish local governor, the doctor and the preacher, and a few Eskimos.

The news of the outside world, since wireless arrived, reaches Greenland daily, via a long-wave station situated near the southern tip of the continent. From there, it is relayed to the little settlement of Godhavn, halfway up the west coast. Every afternoon at five o'clock, Mr. Holton Moller, at Godhavn, goes on the air and, in the Danish language, repeats the news, which he has received in code. In each little fishing village up and down the coast, Eskimos can be seen moving toward the governor's house at the hour of the broadcast, to crowd around the door and listen to Greenland's only daily newspaper arriving by air.

If a message is to be forwarded from Europe to anyone at a station in Greenland, the usual course is to send it to Godhavn and Mr. Moller will sandwich it in with the day's news broadcast. No reply

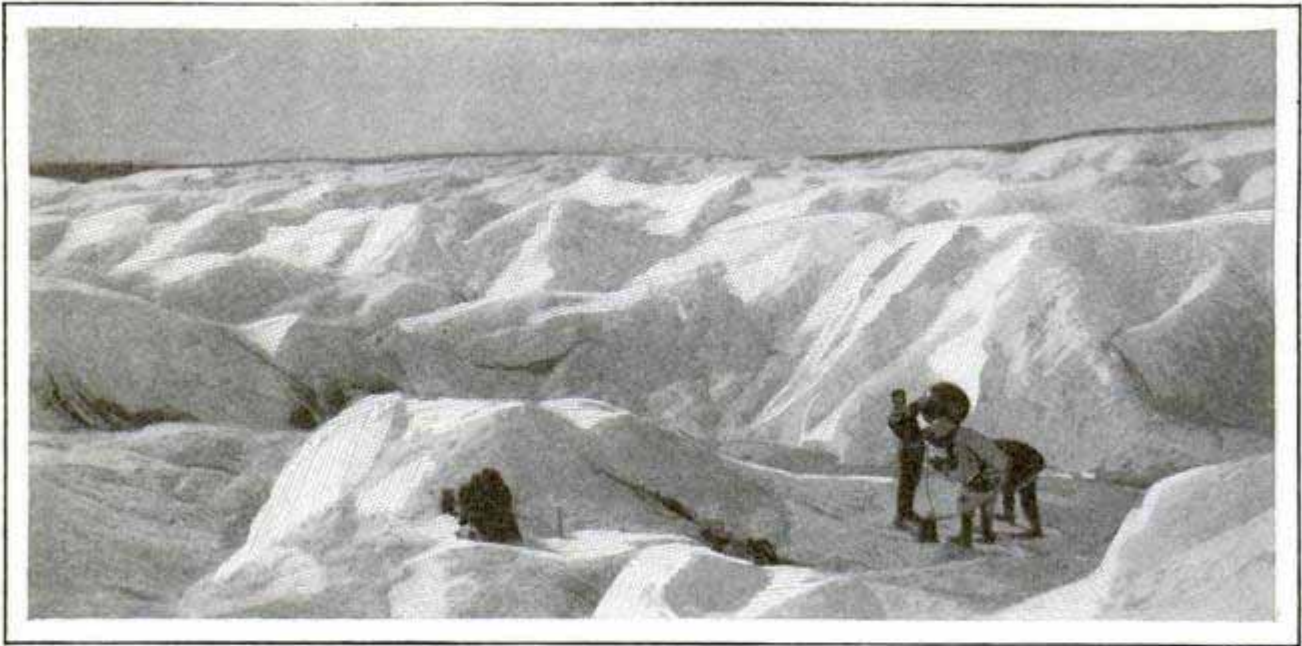

During the Summer Months Several Exploration Trips Have Been Made into the Interior; This Picture Was Taken on the Glacial Ice Leading to the Inner Ice Plateau

can be sent by radio, except on those rare occasions when a vessel equipped with wireless comes into the fishing port, so, if an answer is urgent, it has to be sent down the coast on a small sloop manned by an Eskimo crew.

During the early winter of 1927-28, it was necessary to send some additional supplies into the observatory. The supplies came down the coast fifty miles by motorboat, and were then started overland on dog sleds. When the sleds were ready to return, it was necessary to notify the Danish governor at Holstensborg, which is about 100 miles from the observatory, to have the motorboat meet the dog teams. To get that message to Holstensborg by direct radio was impossible, as we have only a short-wave transmitter, and the village has only long-wave receivers.

Therefore the message was sent by short wave direct to Doctor Hobbs, at Ann Arbor, Mich., through the wireless station of the military department at the university. From Ann Arbor, Doctor Hobbs cabled the message to London, and from there it was relayed by telegraph and cable to Reykjavik, the capital of Iceland. There, the official Danish long-wave radio put the message on the air, to be picked up at Julianehaab, in southern Greenland. In long wave, it was relayed to Godhavn, and there the announcer included it in his next news broadcast, and Governor Bistrup,

at Holstensborg, got it, while we, listening in here for the daily news, heard it delivered. To get the word to the governor 100 miles away, the message had traveled 7,700 miles by long and short-wave wireless, telegraph and cable.

Getting to Greenland from the states is an equally round-about process, unless, like Comm. Donald MacMillan and other explorers, one has his own ship. The trip looks easy, as it is just up the coast past Canada and part of Labrador, and then across the Davis strait. There is no trade following that path, however, so the only boat connections are the Danish government steamers, which make the trip at intervals in summer. As a result, to reach the observatory from New York, you first go to Copenhagen, and then come back. The visit to Denmark is necessary in any case, to arrange your financing, as there is no money in circulation in all Greenland, except for some very small coins with which stamps can be purchased.

Doctor Hobbs arranges a credit in Denmark by depositing a sum of money each year with the government. The Danish governors are then notified that he has that credit, and we are ready for business. If we buy a caribou from a wandering Eskimo hunter, we give him a written order for the price agreed on. At the nearest village, seventy-five miles down the fjord, he can buy anything he wants in the store and cash the order, which will eventually

E. J. Cunningham, Chgo. 376. 9. 46. 6. e. h. e. e. f. o. r. k.

find its way up the coast to the governor at Holstensborg, and be entered in the books. All purchases, from the charter of a boat down to day labor, are paid for in the same way. As our orders for payment are all written in English, which the governor understands, but no Eskimo could either read or write, we are as well protected against alterations and forgery as though we used a check protector in writing them.

**New Power Tube for A.C. Sets**

A new power amplifier tube for supplying large undistorted output to the loud speaker is now available. The tube is known as the UX-245 and CX-345. It is designed for use in the last audio-amplifying stage of power-line-operated sets which supply not more than 2.5 volts to the last audio socket and also proper grid and plate voltages. The tube is capable of delivering a power output equal to that of the 210-type, but at a plate voltage not exceeding 250 volts. The filament is of the coated-ribbon type, assuring great strength and high efficiency. The tube is not interchangeable with the 171-A or any other power-amplifier tube. It can only be used with apparatus especially designed for it, and the high plate current must be kept out of the loud-speaker windings by some form of coupling, such as an output transformer or a choke coil and condenser. The characteristics of the tube are as follows: plate voltage, 180 to 250 volts; negative grid bias, 33 to 50 volts; plate current, 26 to 32 milliamp.; filament, 2.5 volts at 1.5 amperes.

**Kink for Cloth-Speaker Builders**

Airplane-cloth speakers of the tension-diaphragm type are easy to build and, when properly constructed, give excellent results. One point in their design, however, is frequently overlooked, which, if neglected, will quickly cause loss of tone and volume. This is due to tension changes in the cloth by atmospheric conditions and mechanical stresses. The

Left, Completed Speaker, Showing the Adjustable Frame in Position; Right, Construction Details

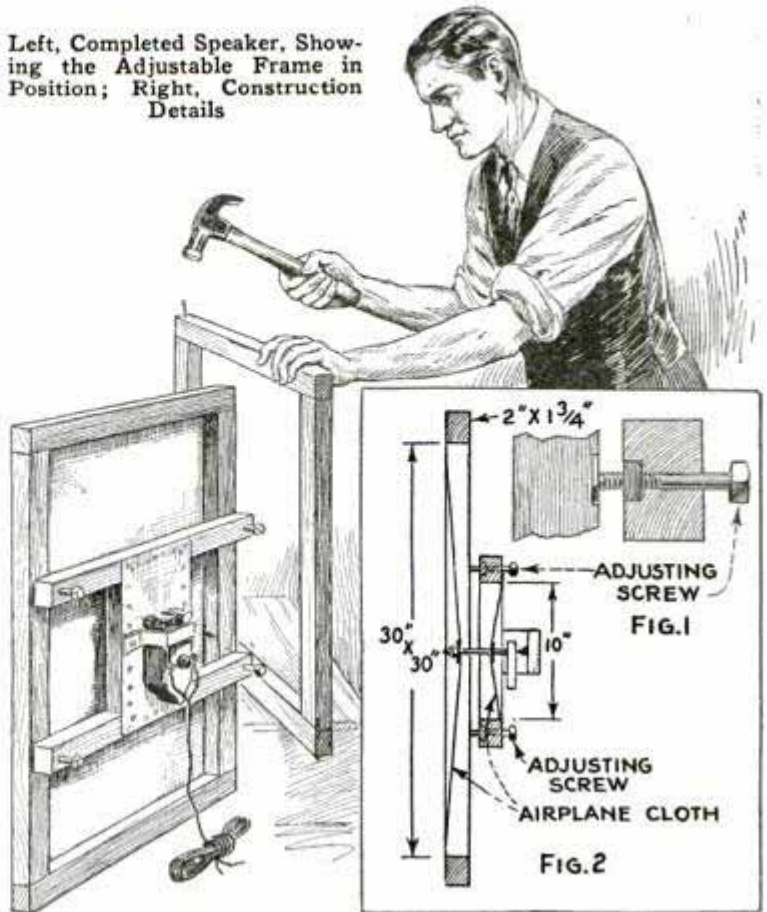

remedy lies in providing a means of adjusting the tension to meet these conditions. Speakers of this kind consist of two frames, clamped back to back, over which the airplane cloth is stretched as shown, the speaker unit with its threaded driving pin being mounted on the small frame at the rear (Fig. 2). The cloth diaphragms are perforated at the center and the driving pin is clamped to the cloth at front and rear with small metal disks and nuts. In constructing a speaker of this type in which the tension on the diaphragms can be varied, the frames must not be fastened together. The smaller one is held in position by means of four adjusting screws—common square-head bolts that rest on metal disks and are passed through nuts set into frame (see Fig. 1) so that the tension of the two diaphragms can be changed whenever they get slack or become overstrained from atmospheric changes.

Popular Mechanics' radio department offers its information service free to all readers of our magazine. We will be glad to help you with your problems, and will promptly answer all inquiries.

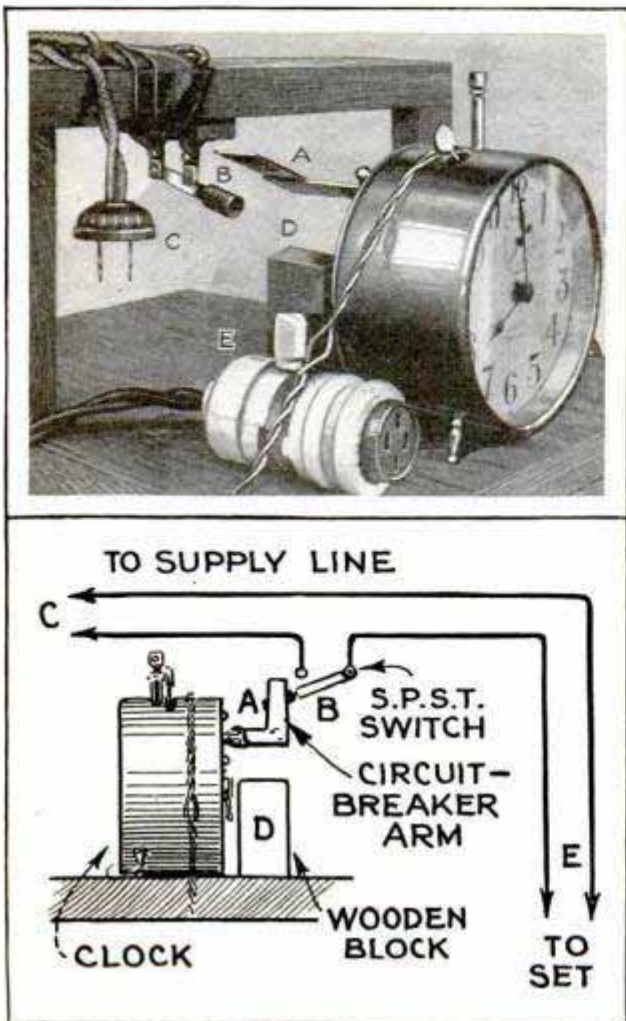

Above, Photo Showing the Arrangement of the Clock and Line Switch; Below, Diagram of Connections

**Radio Set Disconnected by Alarm Clock**

An old alarm clock may be set to throw a small switch disconnecting an a.c. radio set at any predetermined hour, if arranged as shown in the photo and diagram. The owner may retire and leave the set in operation with the assurance that it will be disconnected from the power line at the time the clock is set to throw the switch. The diagram is self-explanatory and little comment is necessary. The bell is removed from the clock and an L-shaped piece of metal is soldered to the alarm key. A small block of wood, nailed to the table in the position shown, stops the alarm lever after it has opened the switch. —H. E. Reynolds, Berkeley, Calif.

**Shielded Lead-In Reduces Interference**

Interference from elevator motors, vacuum cleaners, medical apparatus and sign flashers in some congested districts may be reduced by shielding the lead-in wire

to the set. Use lead-covered wire or ordinary insulated No. 14 in conduit, ground the metal sheath and extend the shielding from the set to the roof. The shielding will in some cases affect the reception slightly, and it may be necessary to increase the length of the horizontal antenna wire several feet to obtain the same signal strength. If interference of this type occurs only in the daytime, a single-pole double-throw switch may be installed so that the shielding can be disconnected from the ground and used as an extra pick-up for the antenna at night. To do this connect the shield to the center pole, the antenna to one terminal and the ground to the other.

**Adapter for Two Power Tubes**

Two power tubes may be used in parallel by means of the simple adapter shown in the illustration, greatly improving reception and tone. Employed in this manner, they prevent overloading of the power stage and eliminate undesirable loudspeaker noises. The unit may be quickly installed as follows: Remove the power tube from the socket of the last audio stage, as shown in Fig. 1, and insert it in one of the sockets in the adapter. Another power tube of exactly the same type is then placed in the other socket, as shown in Fig. 2. The adapter, with the power tubes, is then plugged into the last audio socket of the receiver, as in Fig. 3. The unit can be inserted but one way, so there is no danger of making wrong connections. Either 112, 171, 210 or 250-tubes may be used in parallel.

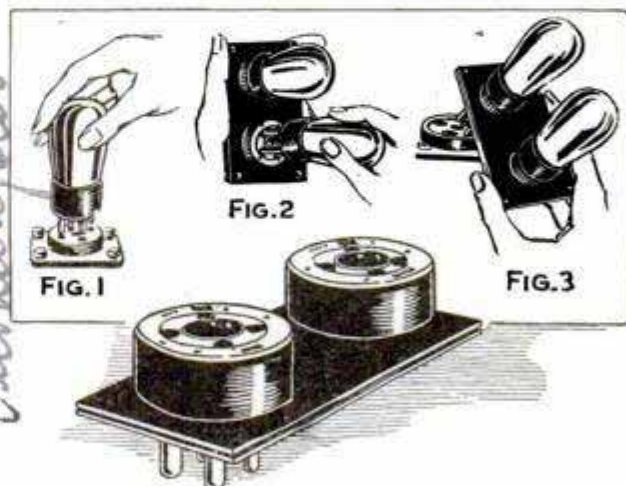

Twin-Tube Adapter, and Sketches Showing the Three Steps in Its Installation

*Subdaster*  
 (1) remove the power tube  
 1775 B at away

### A Loop-Wire Tightener

The wire on a loop soon becomes loose, lowering the efficiency of the coil. Details are shown in the drawing for con-

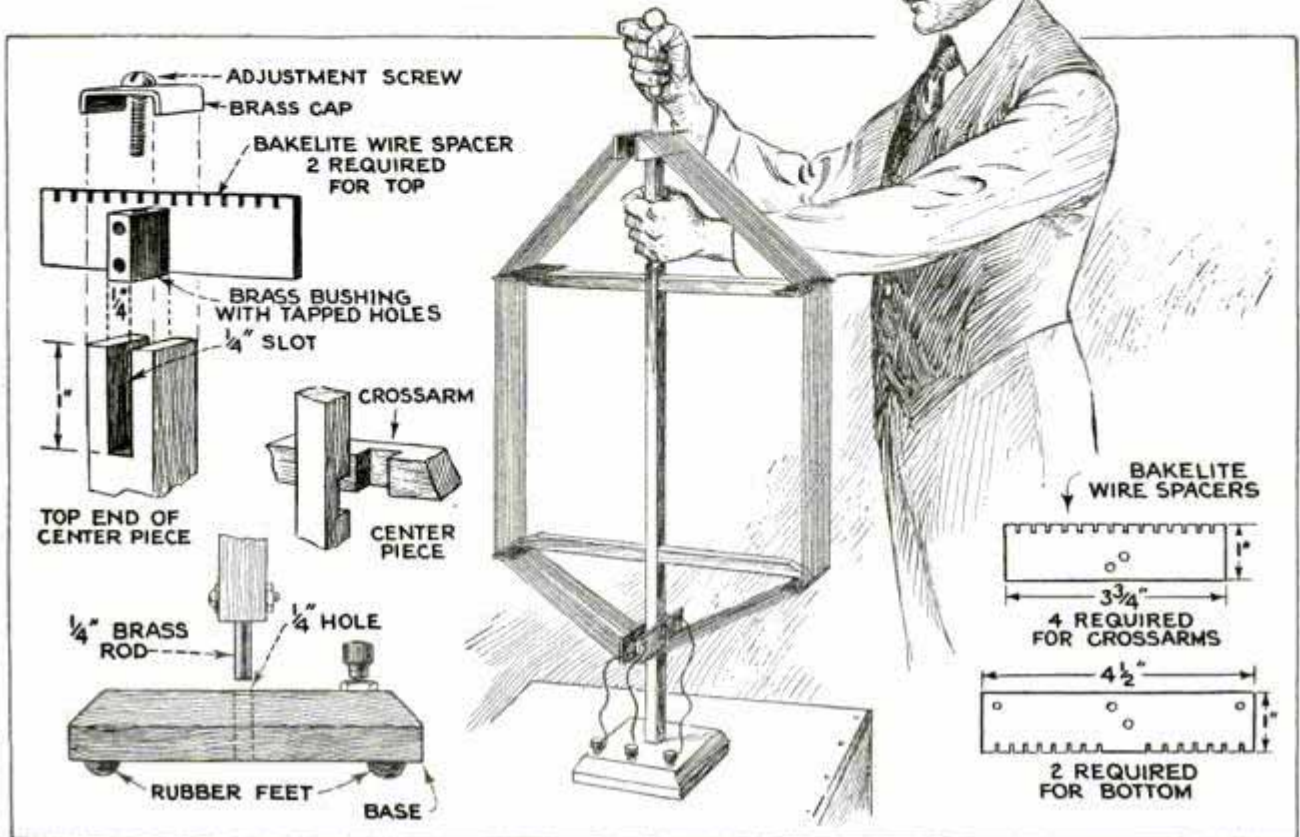

structing a loop on which the wire can always be kept tight and uniformly spaced. The centerpiece, crossarms and base are made from hardwood. In the top of the centerpiece a slot is cut and in the bottom end a hole is drilled and fitted with a brass rod. Then the crossarms and centerpiece are half-lapped, as shown in the drawing, and glued together, forming a flush joint. Drill a hole in the base for the brass rod, and three holes for the binding posts. The frame is now varnished, and as soon as the varnish is dry, the wire spacers, except the topmost two, are fastened with wood screws. These spacers are made from bakelite, and notches, to hold the loop wire, are cut in them with a hacksaw. Use two blades together in the hacksaw. The brass bushing or carrier shown is placed in the slot at the top and the two top wire spacers are fastened to it with short machine screws. This bushing should slide up and down in the slot freely. Next put the brass cap on the end and insert a machine screw through the cap hole into the tapped hole in the brass bushing, as detailed in the drawing.

Allow the bushing to rest on the bottom of the slot, then wind the loop wire in the notches on the spacers. These notches are made for 14 turns, this being the correct number for a .0005 condenser. For a .00035 condenser make the spacers long enough for 16 turns. A wire is soldered to the seventh turn and then connected to the center binding post. If the loop gets slack, tighten it by turning the screw so that the bushing carrying the top spacers will slide upward. All stock for the frame is  $\frac{3}{4}$ -in. square; the upright is  $27\frac{1}{2}$  in. long over all, and the crossarms  $14\frac{1}{4}$  in. Space the upper arm 6 in. from the top, and the lower one 3 in. from the bottom.

### Testing Filter Condensers

When testing filter condensers in a power device, use a pair of headphones in series with a dry cell. One click should be heard when the circuit is completed to the condenser, and successive clicks on the same condenser should be barely audible; on the other hand, if the condenser is broken down, each click will be loud.

### Adjustable Subpanel Brackets

With the increasing use of wide subpanels, it is frequently advisable to supply

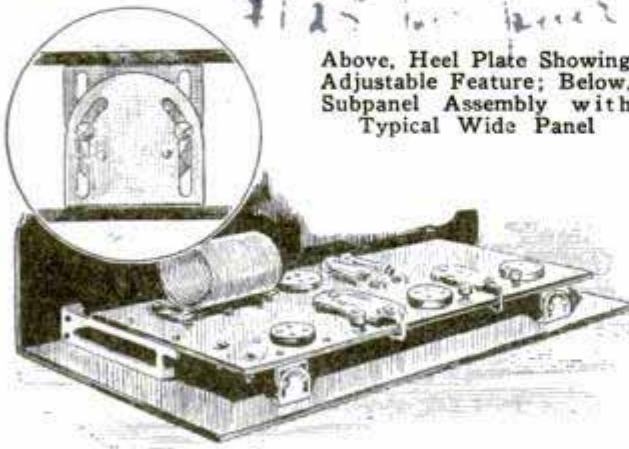

Above, Heel Plate Showing Adjustable Feature; Below, Subpanel Assembly with Typical Wide Panel

an additional support at the rear of the subpanel. To meet this condition, dowel pins or metal supports of various types have been employed. The illustration shows a new use for the adjustable heel plates supplied with a standard shelf-supporting bracket set. These provide ample auxiliary supports for the projecting sections of the wider subpanels.

### Reducing Interference from Farm Lighting Plants

Reducing interference from farm-lighting plants and from gasoline-electric generating stations in isolated communities has been a subject of considerable research, as well as cut-and-try methods which sometimes help and often fail. The ordinary causes are: spark at distributor, engine-plug sparks, sparks in relays and control apparatus, sparking commutator of generator and noises produced by the various appliances which are connected to the load. In the case of relay and switch contacts, interference can be successfully prevented by shunting the contacts with a 1-mfd. condenser and a 50-ohm resistance. Generator commutators may be shunted by two 2 or 4-mfd. filter condensers connected in series, with

the mid-point between the condensers grounded. There are several interference filters of this type now on the market. The center point of the filter unit being grounded, any high-frequency current generated will be grounded, preventing radiation from the electric wiring. Interference from both low and high-tension wiring may be reduced by proper shielding. As disturbance from spark plugs is greater on some wavelengths than on others, the wavelength or frequency of the disturbance may be changed by adding a shielded choke coil in series with the shielded spark-plug lead at the plug. This coil may consist of a few turns of No. 16 wire wound on a 1½-in. form, and the coil may be inclosed in a small metal can.

### Placing the Loud Speaker

The proper location of the set and loud speaker has much to do with obtaining quality reproduction. A reasonable volume is necessary for good reproduction, and it is not a good plan to cut down this volume as it automatically lowers the quality of the speaker output. If the set is of the console type with built-in speaker, the instrument should be located in a room adjacent to that in which the listener is seated. Do not place the console too near the wall; this also applies to a portable speaker. The latter type should be as far away from the set as possible, and a 25-ft. extension cord may be used for this purpose.

### Reflector for the Neon Lamp

The neon lamp, placed behind the scanning disk of the usual television receiver, loses much of its efficiency because the full strength of the light is not focused or reflected toward the observation window. The reflector shown in the illustration is a manufactured type described in a Danish radio publication. A similar reflector may easily be made of tin or other bright metal bent to the form indicated. It will add greatly to the brilliancy of the illuminated field.

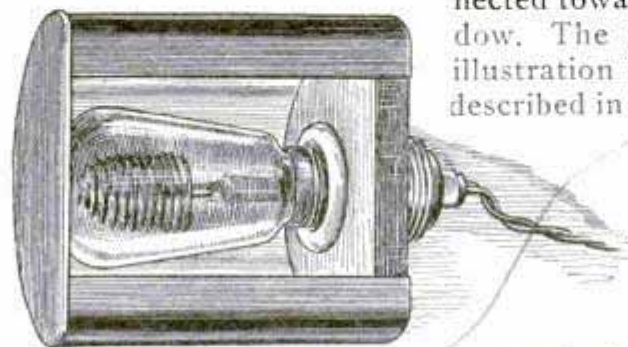

Above, Neon Lamp with Reflector for Directing the Light onto the Observation Window



# Radio; Past, Present and Future

ista

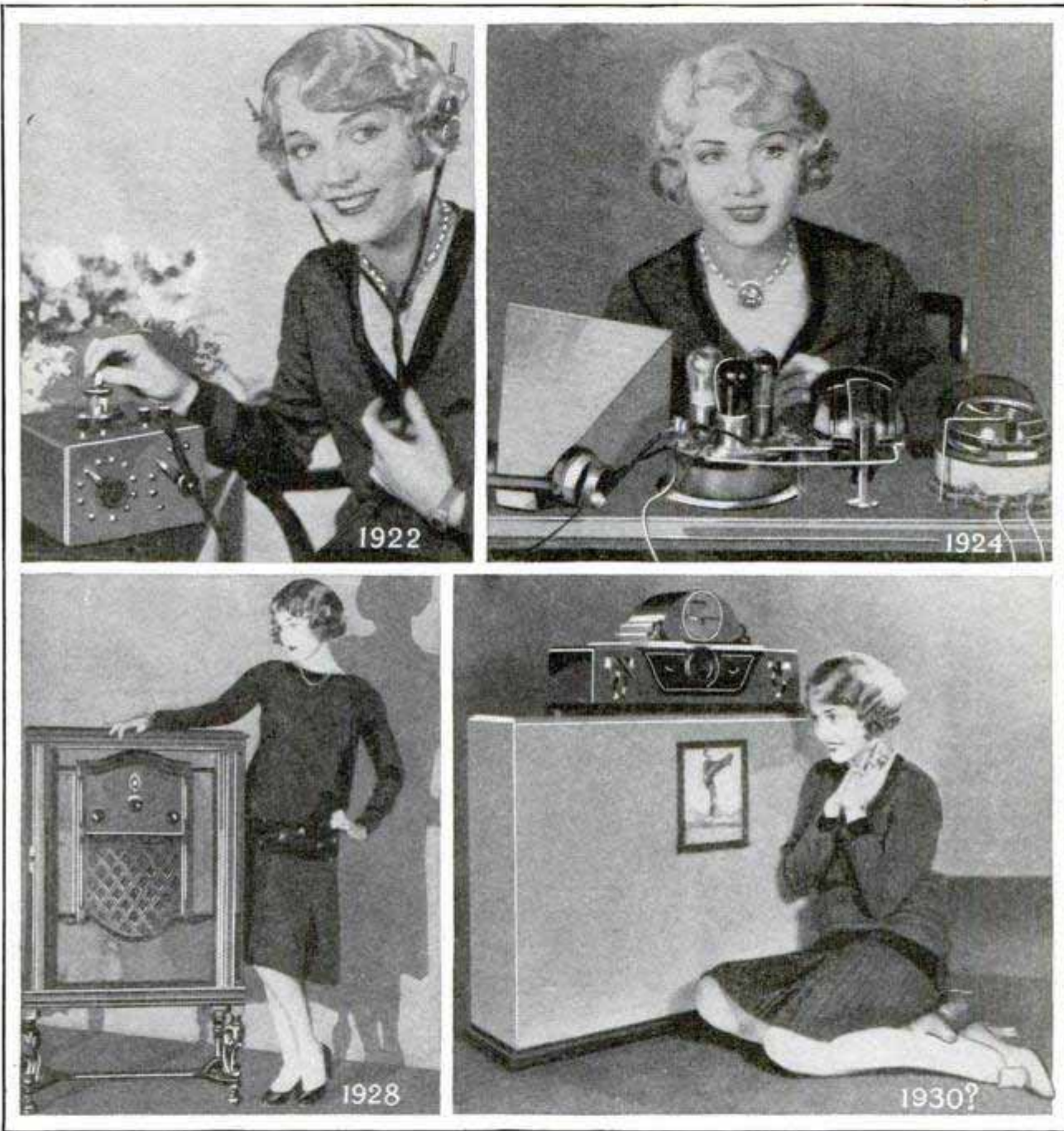

Remember 'Way Back When the Set Shown in the Upper Left Was the Ne Plus Ultra in Receivers? And When We Got the Bread-Board Layout Shown in the Next Picture? It's Quite a Step from the Set Shown for 1922 to the Modern Receiver Below. In 1930, Will the Feminine Football Fan See Her Hero as She Listens to the Broadcast of the Game?

### High-Voltage By-Pass Condensers

By-pass condensers of high capacity, such as are shunted across the high-voltage battery terminals or used in similar manner for by-pass work, are usually capable of standing up under a pressure of about 300 volts. Occasionally it is necessary to apply a higher voltage and, in this

case, it is possible to double the safe working voltage of the condensers by connecting two of them in series. This, however, will have the effect of reducing the effective capacity to half the original value if the condensers are alike. If a large and a small condenser are connected in series, the combined capacity is always less than the value of the smaller condenser.

# Tips Radio



Above, Wood Subpanels Elevated by Wooden Cleats at Each End Allow Wiring to Be Hidden Below and Also Provide Room for Mounting By-Pass Condensers; the Front Panel Is Easily Mounted with Wood Screws without the Aid of Metal Brackets

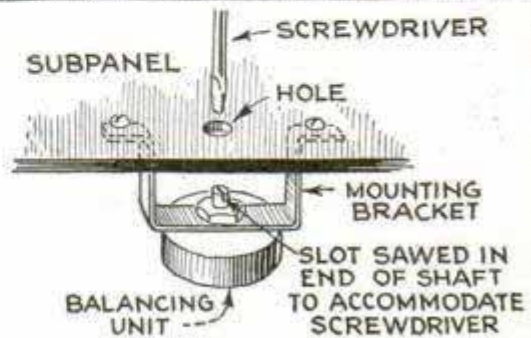

Above, Balancing Condensers May Be Mounted below the Subpanel to Prevent Tampering and the Hole Above Sealed After the Unit Is Adjusted for Best Results

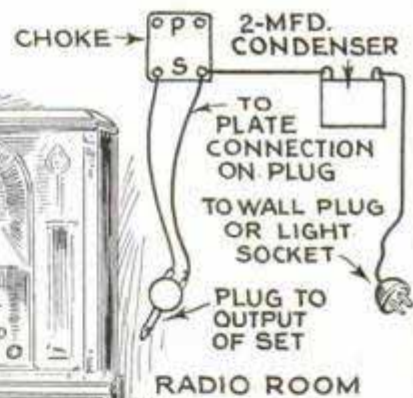
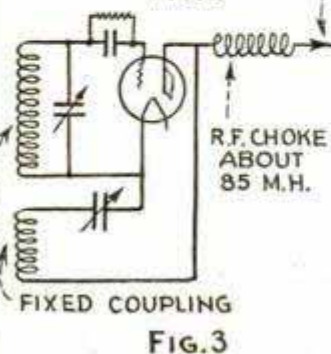
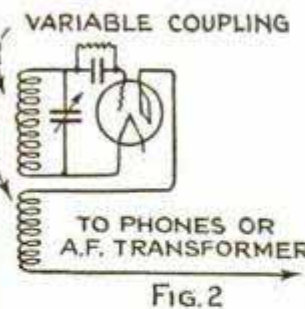
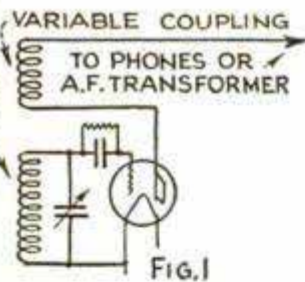

Left, Three Methods of Regeneration; Fig. 1 Shows Commonly Used Three-Circuit Tuner, Tickler Coil at High Potential End of Secondary; When Varied with Respect to Secondary, Mutual Inductance Alters Secondary Tuning Independent of Condenser Setting, So That Stations Tune at Various Points, Thus Preventing Logging; Fig. 2, Tickler at Low Potential End of Secondary Does Not Affect Tuning; Fig. 3, Best Plan; Smoother Regeneration Controlled by Lower Variable Condenser, and Set May Be Accurately Logged; Right, Extending Rheostat Range by Adding Fixed Resistor

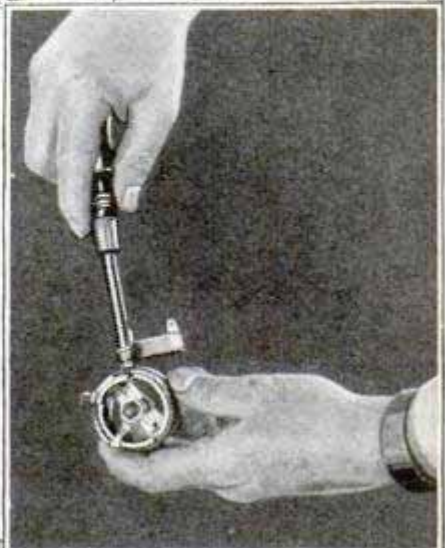

# from the Laboratory

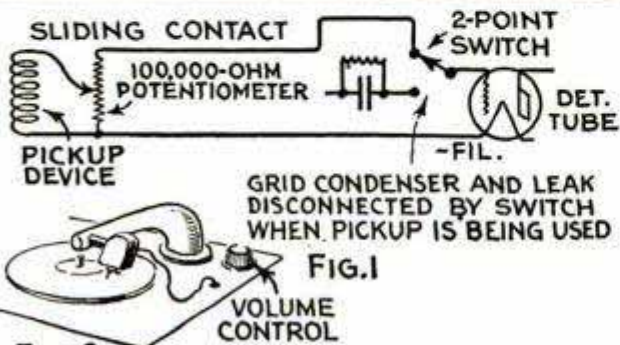
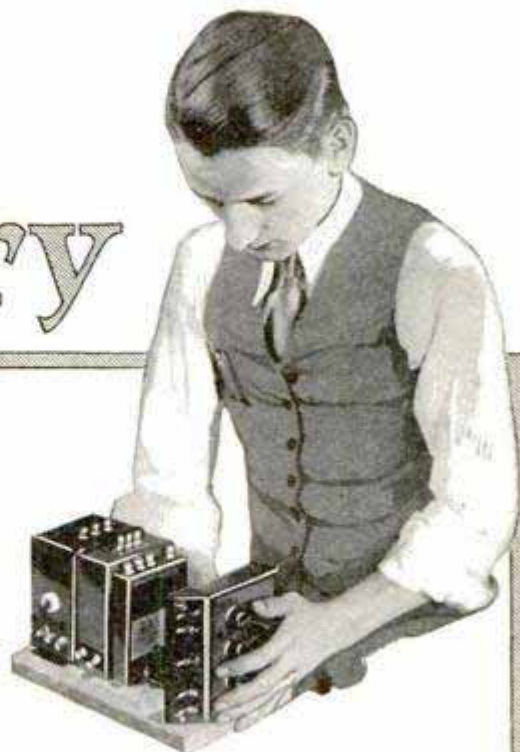

FIG. 2

Above, a Handy Volume Control for Phonograph Pick-Up; Switch, Fig. 1, Provides Quick Connection Directly to Detector-Tube Grid; Fig. 2, Control Unit Conveniently Mounted

Above, a Simple Adjustable-Voltage B-Eliminator to Be Described in an Early Issue; Below, Coil-Mounting Plugs Made from Prongs of Discarded Tubes; a Hot Iron Is Applied to the Prongs to Remove the Wire and Solder; Mount as Shown



SICK ROOM

Housewiring Carries Program to Remote Room; One Light Wire Is Used; Choke Is Secondary of Audio Transformer; See Opposite Page

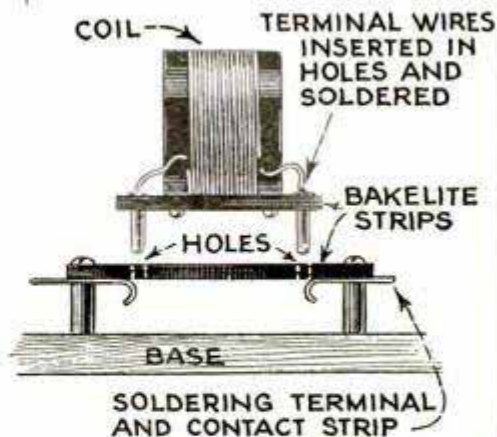
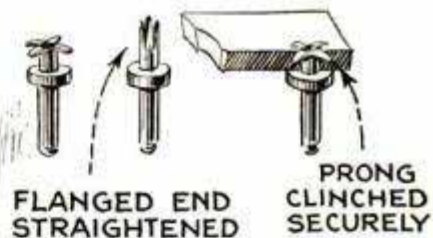

Above, a Handy Tool for Quickly Countersinking Screw Holes in Panels May Be Made from a Screwdriver; Heat and Flatten the End to the Desired Width, Then Grind to a Point and Sharpen the Edges; This Tool Also Makes a Handy Scriber and Center Punch; Left, a Tapered Reamer Is a Necessary Tool for the Set Builder When Large Holes Are Required, as a Small Hole May Be Quickly Enlarged to the Desired Size; Metal Washers of Various Sizes Placed on Reamer Make Handy Stops

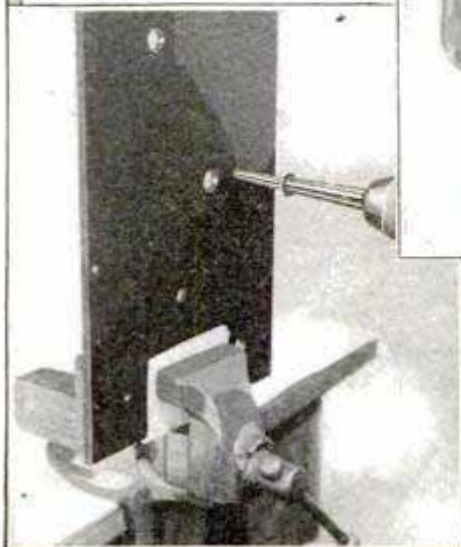

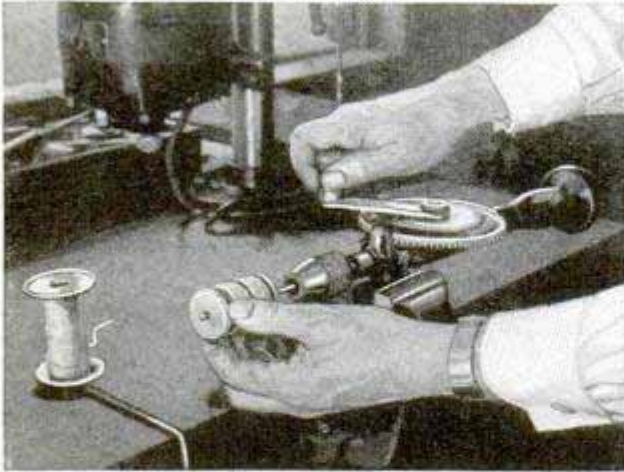

Homemade R.F. Choke Coils Are Not Difficult to Wind, and Greater R.F. Amplification May Be Obtained through Their Use in Any Broadcast Receiver Limited by Excessive Regeneration or Feed-Back Action in the R. F. Amplifier. A Certain Amount of Regeneration Is Necessary, but Too Much Causes the Amplifier to Go into Oscillation, Which Is Detrimental to Good Results. This Tendency toward Excessive Regeneration May Be Prevented by Shielding the R.F. Stages, and Also by Controlling the Grid Bias to the Tubes, or by Inserting Resistance in Each Tube Circuit. The Choke-Coil Method Accomplishes the Same Result More Efficiently by Separating the R.F. Stages. The Fact That the Plate Circuits of These Tubes Are Supplied by the B-Battery Common to All the Tubes, Is a Source of Resistance Coupling between the Tubes of the Amplifier if R.F. Current Is Permitted to Pass through This Battery. The R.F. Choke Coils Prevent the R.F. Current from Flowing through the Common B-Battery, Thus Reducing Resistance Coupling with Its Regenerative Tendencies. The R.F. Choke Coil Consists of a Small Inductance Which Has a High Impedance at Radio Frequencies, Retarding the Flow of R.F. Current; the Resistance to the Emission Current of the Tube Is Low so That Little B-Battery Is Wasted across It. The Impedance Offers No Hindrance to Voice

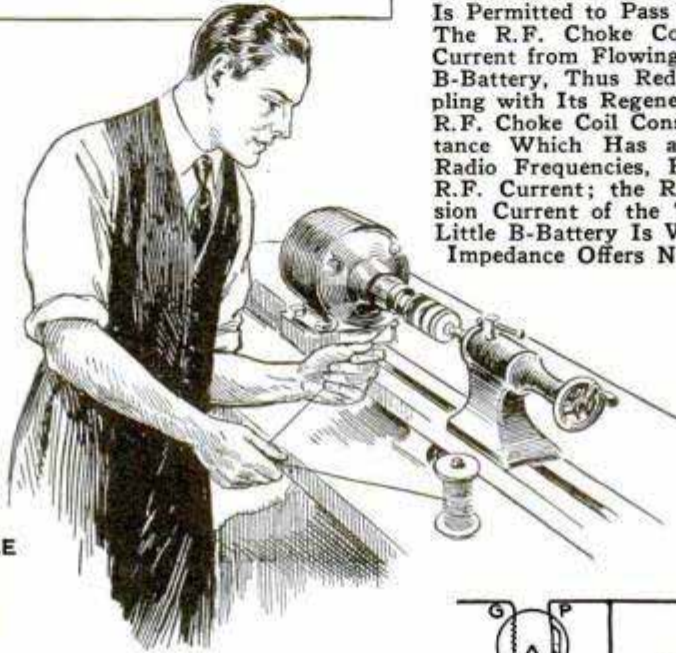
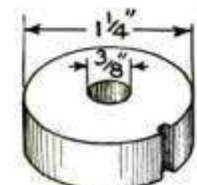
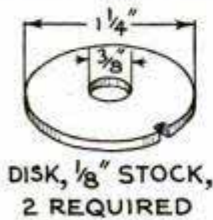

The Wooden Bobbins May Be Turned on a Lathe or Built Up from Disks, as Shown at the Left; Then Wound Either by Hand, Lathe, or by Mounting a Hand Drill in a Vise

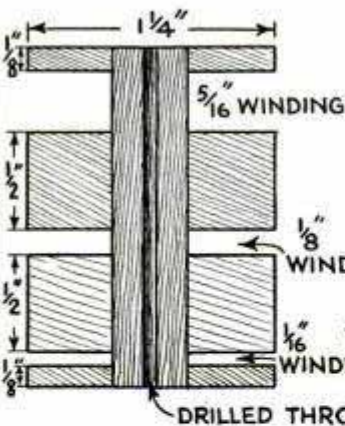

Number 34 Enamelled Wire Is Wound on the Bobbin, the Small Section End to Be Connected to the R.F. Side of the Circuit; the Inductance Is About 60 Millihenrys, Effective from 20 to above 550 Meters

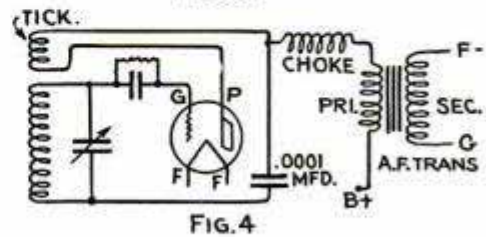
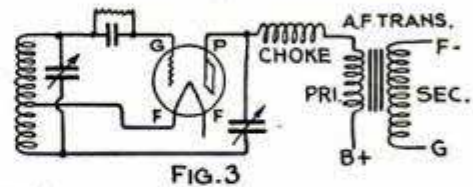
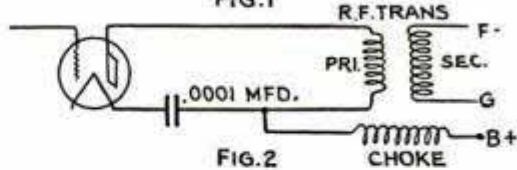
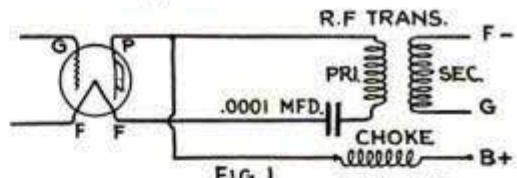
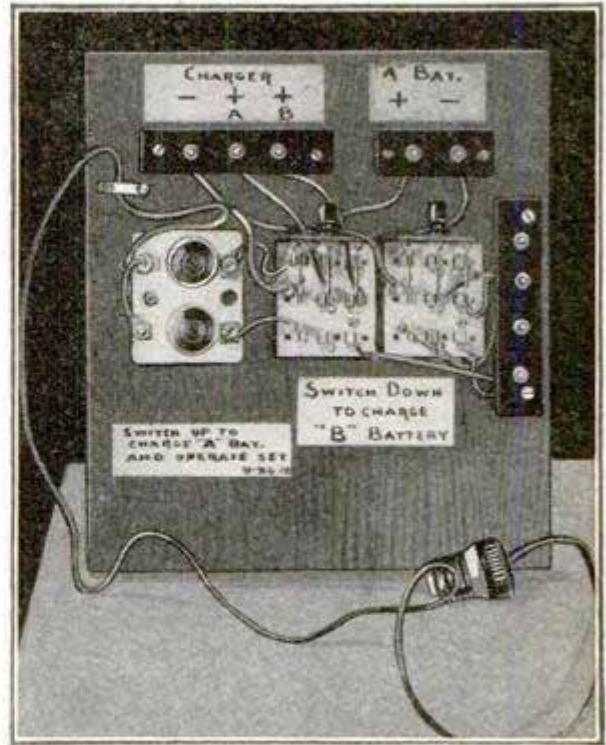
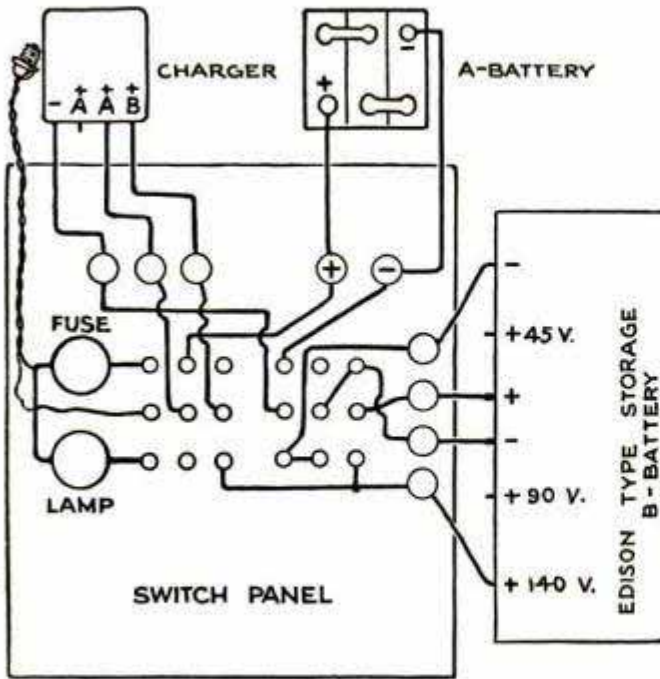

Figure 1 Shows Choke in Plate Circuit of R.F. Tube, Forcing R.F. Current to Pass through the Transformer Primary and Condenser Back to Tube Filament, While the Emission Current Passes through the Choke to B-Battery; Fig. 2 Is Practically the Same Except That Here the Emission Current Passes through the Transformer Primary; Fig. 3 Shows the Choke in a Regenerative Detector Circuit, to Keep R.F. Current Out of Audio Amplifier and B-Battery; the Emission Current of the Tube, Together with the Rectified A.F. Current, Passes through the Choke to the Audio Transformer; Fig. 4 Is Similar but Applied to Tickler-Coil Type



Left, Diagram Showing Panel Connections to Charger and A and B-Batteries; Right, Photo of Completed Charging Panel

### Charging Panel for Edison-Type Storage B-Batteries

A charging panel for those who built the Edison-type storage B-battery described in the July, 1928, issue of Popular Mechanics, was made by the writer and found very handy. The wiring diagram and photo clearly show the construction details. With very few alterations the switch-panel may be used for other types of storage batteries. The materials cost about 75 cents and may be obtained from any electrical shop. The parts include a pair of three-pole double-throw knife switches, a two-socket fuse block or two lamp sockets, nine binding posts, a few feet of lamp cord with a plug, and some flexible wire for the various connections. The panel is designed for use with chargers that require an incandescent lamp as a charging resistance and the changing of terminal wires when charging B-batteries. The plug connected to the board is screwed into the charger fuse receptacle, and the fuse is transferred to one of the sockets. With the switches thrown up, the batteries are connected for set operation, and the charger is connected for charging the A-battery when desired. When the switches are thrown down, the two units of the Edison-type B-battery are con-

nected in parallel for charging.—Walter E. Burton, Kenmore, Ohio.

#### FOR THE RADIO BUILDER

The simplified blueprints listed below include the best of Popular Mechanics tested circuits. When ordering, simply quote the numbers of the blueprints desired and inclose the proper amount in an envelope addressed to Popular Mechanics Magazine, Radio Dept., 200 E. Ontario St., Chicago, Ill. Back magazines containing full descriptions of the circuits can also be obtained. Inclose an additional 25 cents for each magazine desired, giving date of publication.

- |  |            |     |
|--|------------|-----|
| No. 111, Homemade Tube Tester                            | July 1926  | 25c |
| No. 115, 15 to 550-Meter Three-Tube Receiver             | Nov. 1926  | 25c |
| No. 116, Three-Tube Loop Set                             | Dec. 1926  | 25c |
| No. 117, Simple Electrolytic B-Eliminator                | Feb. 1927  | 25c |
| No. 123, Economy-Nine Superheterodyne                    | Nov. 1927  | 50c |
| No. 126, Homemade B-Battery and Charger                  | Jan. 1928  | 25c |
| No. 130, One-Tube Short-Wave Adapter                     | Mar. 1928  | 25c |
| No. 131, Five-Tube All-Electric Receiver                 | Apr. 1928  | 25c |
| No. 134, Edison Type B-Battery                           | July 1928  | 25c |
| No. 135, Screen-Grid Browning-Drake Receiver             | Sept. 1928 | 25c |
| No. 138, Screen-Grid Perfect-Tone Six Receiver           | Nov. 1928  | 25c |
| No. 139, Simple Television Receiver                      | Dec. 1928  | 25c |
| No. 140, Power Amplifier and B-Supply for Television     | Jan. 1929  | 25c |
| No. 141, Hammarlund-Roberts Hi-Q 29 Junior A.C. Receiver | Feb. 1929  | 25c |
| No. 142, Two-Tube Screen-Grid Short-Wave Adapter         | Mar. 1929  | 25c |
| No. 143, Four-Tube Screen-Grid Receiver                  | May 1929   | 25c |

**New Hum-Control Unit**

A compact adjustable center-tap resistance for controlling hum in a.c. sets is now

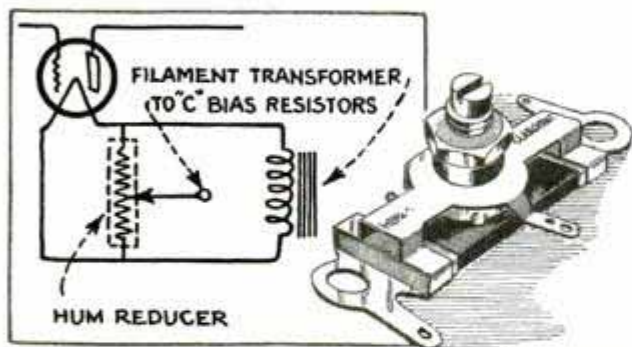

Hum Reducer, Showing Simple Connections across Filament Winding of Transformer

available. There is no longer any question regarding the advantages of the center-tap resistance method over the center-tap transformer winding in the operation of filament type a.c. tubes. The little device shown herewith may be mounted on a panel or subpanel by means of a single hole or on a baseboard by wood screws through holes in the end lugs. Connections are made to the three soldering tabs. The standard resistance value for the usual a.c. tube circuit is 30 ohms, but other resistance values are available within a range of 6 to 500. The main application of the unit is as a center-tap grid return for a.c. filament tubes, providing a simple means of compensating for circuit and filament unbalance.

**Double Resistor Saves Space**

A compact multiple variable resistance comprising two separate resistances, adjustable to any desired value, and contained in a stout metal case, is now available.

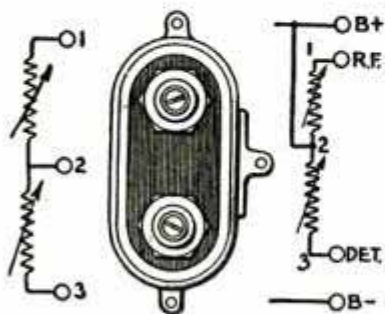

Two holes are necessary for mounting the unit on the panel or subpanel and adjustments are made with an ordinary screwdriver. The wiring diagram shows three terminals, 1 and 3 representing the outside terminals, and 2 the center terminal between the two resistors. The dia-

gram at the left shows two separate and distinct variable resistors with a common terminal, while the diagram at the right shows a resistance network with two variable voltage taps, simplifying the usual output circuit of a radio power unit. The device, when used in parallel, greatly increases current-handling capacity; it may also be used as a potentiometer or balancing resistance, with variable total resistance and variable mid-point to meet any circuit condition.

**Selectivity with One Dial**

The amateur, when making a single-dial set, generally imagines that the job is done when he puts all his condensers on the same shaft. However, while it is an easy matter to adjust the r.f. stages to the same resonance point, the antenna circuit is difficult to keep in tune, with the result that the set suffers a loss in both selectivity and volume. Many makeshifts have been devised to overcome this defect, but the simplest, and probably the best, is a trimming condenser, connected across the antenna-tuning condenser and controlled from the front panel.

**Automatic Dynamic-Speaker Control**

A new automatic control for the dynamic speaker is shown in the accompanying illustration. The device contains a thermostatic switch which automatically connects the speaker when the set switch is thrown. It also disconnects the speaker when the set is turned off, thus preventing current being left on the speaker when the set is not in use. The device is plugged into the usual wall socket, and the set and speaker into the designated receptacles, no wiring changes being necessary.



Ⓢ A hissing tube or one that causes sharp clicks may be improved by gently thumping or shaking it when the filament is heated; the trouble is caused by the filament touching the grid element.

*Handwritten notes:*  
 Clarinet mfg. Co. N.B. Unit  
 52 Willow St. A pump feed. These  
 The Clarinet mfg. Co.

*Handwritten footer:*  
 Clarinet mfg. Co. Laboratory, 215 N. 6th St.

# AMATEUR MECHANICS



## Golf in Your Own Backyard

By SAM BROWN,

*157 Carhart St  
Marion Ohio*

FOR SOME reason or other, many people associate golf with men of such occupations that their office hours are from late morning to early afternoon; they never consider the excellent sport in this game as something which they can enjoy themselves.

But why not? Two or three clubs and a course that you can lay out yourself, and there you are. Of course, you may not have the technique of a Hagen, Jones or Barnes, but in your own way you can

lay out in a pasture or large vacant lot if you live in the country or suburbs; but if not, then your own backyard can be converted into something quite "golfy." Get a number of tin cans of the variety which come with lids. Dig a few holes here and there and plant your tin cans in these, patting the dirt down smoothly around each hole.

In the relative arrangement of these cans, you must exercise your ingenuity by



The Holes for Putting Practice in the Backyard Course Are Tin Cans, Buried in the Ground, and Covered with the Lids When Not in Use

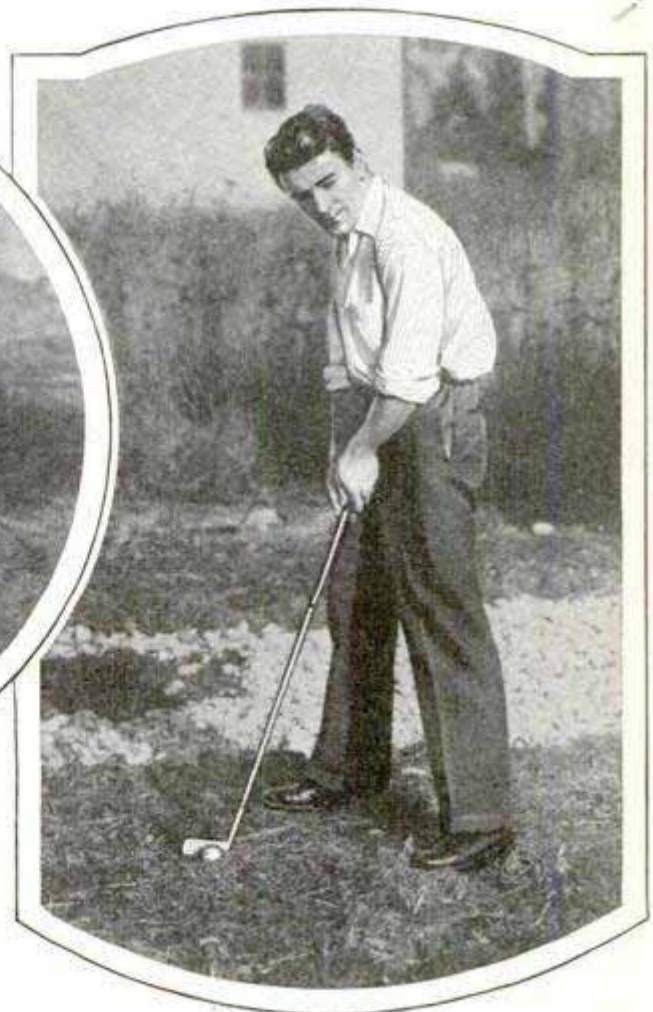

get much fine sport and exercise out of the game in this fashion.

First of all, the course: This can be

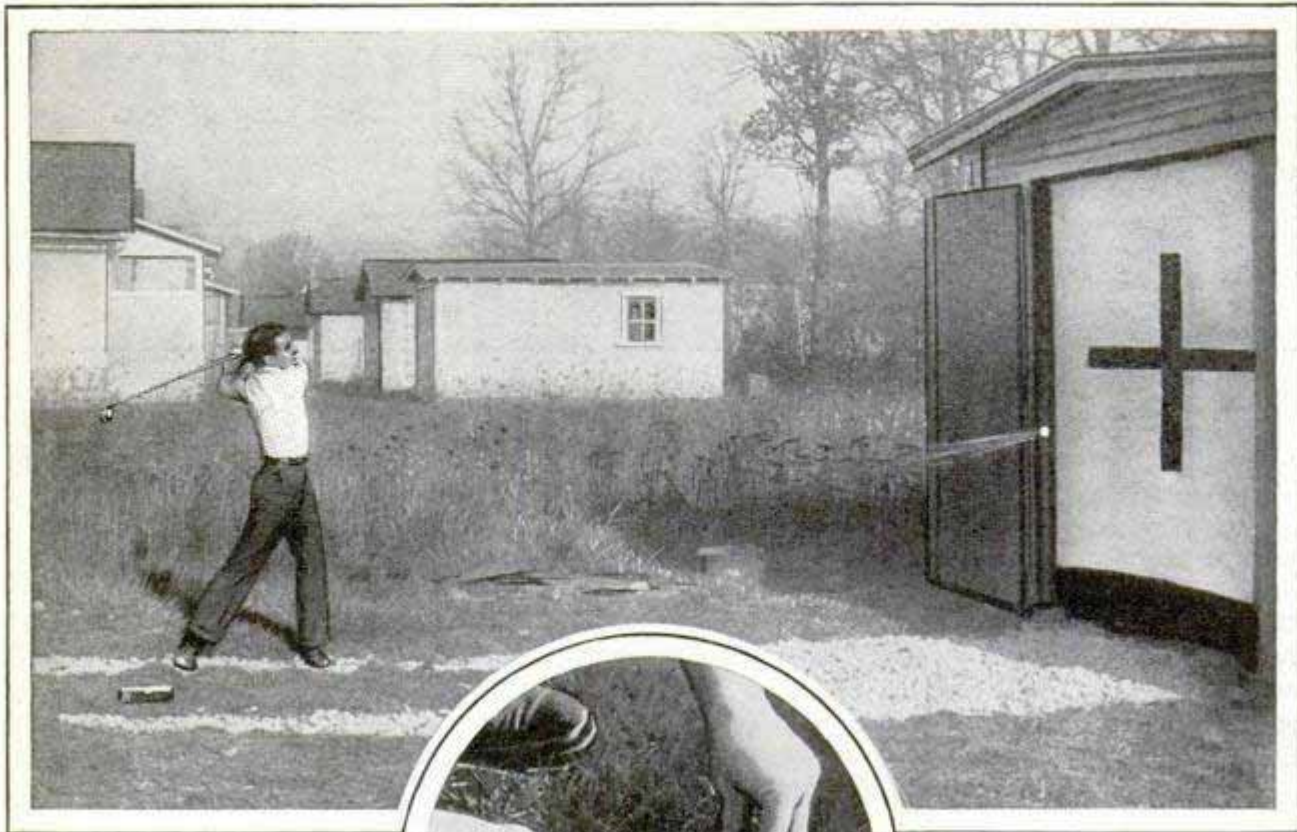

placing them so as to take advantage of natural hazards in the shape of streams of water, clumps of low trees, etc. In one vacant-lot "club," the course is composed of five holes, spaced at from 125 to 200 yd. apart, and in the complete round the player must drive over a small stream of water twice, as well as skirt three areas of low timber. It is not likely that your golf site will duplicate this arrangement, but by taking advantage of the natural lay of the ground in the placement of your holes, you can readily map out something equally good or better.

Small homemade flags should be used to designate each hole, as the drive from one hole to another would be impossible if there were not some form of marker at which to direct the ball. The lids of the cans should be put in place when the course is not in use in order to keep the holes clean and water-tight.

Lacking the pasture or



Excellent Practice in Driving Is Obtained with a Target Fastened in the Garage Doorway, the Placing of the Shots on the Target Being Used to Determine Where the Ball Is to Be Placed for Putting

large lot, the amateur golfer can lay out an equally sport-giving course in his own backyard; and all this without disturbing the position of the garden or the wife's rose bushes.

The procedure, however, differs somewhat. The average backyard can easily accommodate two or more of the tin-can holes described before, but due to the limitations of the ground these are only available for putting. If you wish something at which to drive, a large stretch of canvas (the fly from a tent does the trick nicely) can be painted with a target and hung in the door of the garage. The manner of using this target is as follows: Tee up your ball about 10 ft. back, after having dipped it lightly into some white chalk or flour, which you should keep conveniently placed in a small can. Let





drive! Your ball will zoom forward, smack into the canvas (a miss being almost impossible), and the white powder on the ball will leave its mark on the target. A direct hit entitles you to place your ball at a certain point on the two or three-hole course, readily accessible to holing out in one or two shots, while poorer hits place the ball in more difficult approaches. For a complete miss of the target or ball, a sand trap consisting of a box of sand can be used, and the ball buried halfway in this.

After completing the first hole, the drive for the second hole may be made, or, if desired, the complete two or three-hole course can be played with but one drive, the succeeding holes being made in the usual putting manner. It is golf on a small scale, certainly, but with care in placing the holes so that they can be played in various manners, the sport becomes something almost equal to that played on the full-sized links, and it affords splendid practice.

As to the clubs used to play these miniature courses, two are sufficient. These should be a driver and a putter, and any sporting-goods store can furnish you with inexpensive yet serviceable clubs for as little as \$1.25 each. Other clubs, especially a brassie, may be added if your pocketbook allows, but these are not absolutely essential, since the two clubs mentioned will take care of almost any shot which can be laid out in these miniature links.

#### Holder for Conical Paper Cup

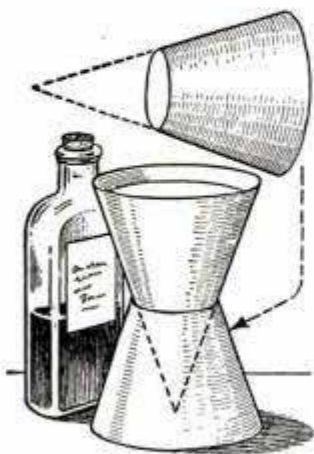

the top opening. This has been found valuable also in administering medicine.

It is often rather inconvenient to use conical paper cups, as they cannot be set down when filled with liquid. This difficulty can readily be overcome by cutting off the end of another cup, setting it upside down on the table and then placing the filled cup into

#### Serviceable Canoe Jig for Boat House

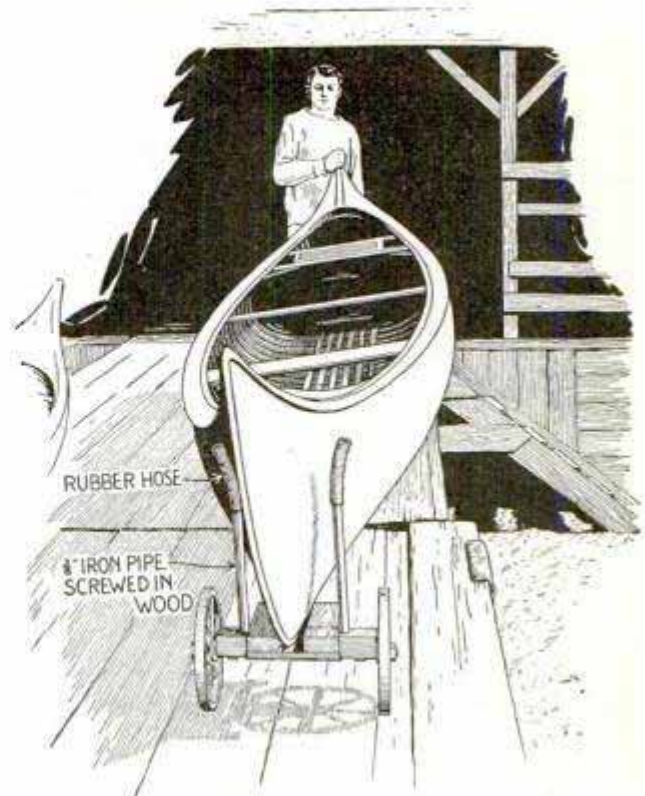

Two-Wheeled Jig Facilitates Transportation of Canoes in Boat House

For running canoes in and out of a boat house, it will be hard to beat the illustrated jig. It has been in use at a shore resort in Connecticut and has given complete satisfaction under rough usage. It consists of a wooden frame mounted on two cart wheels. Two lengths of iron pipe are set vertically in the frame, the tops being bent outward a trifle and covered with lengths of rubber hose, as indicated. In use, the bow of a canoe is set loosely on the jig between the pipe supports, the keel fitting in a slot cut to receive it. By tipping the opposite end of the canoe when transporting it, the jig can readily be steered. As it is small, the jig can be hung overhead within easy reach. The rubber bumpers on the ends of the pipe supports prevent marring the canoes. The construction details are plainly indicated in the drawing.—Henry S. Laraby, New Haven, Conn.

☛ If you have to pour gasoline into your tank and have no funnel at hand, take a short piece of inner tube, stuff one end into the tank and have someone hold the other end open so that you can pour in the gasoline.

4/13 W. Adams, Alhambra, Calif. Hogg.

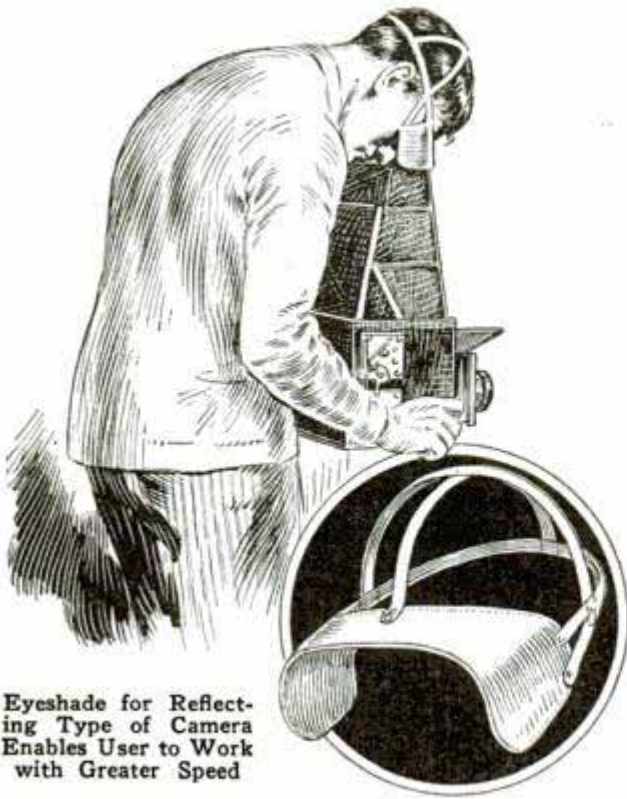

Eyeshade for Reflecting Type of Camera Enables User to Work with Greater Speed

**Eyeshade for Reflecting Cameras**

Efficient use of the reflecting type of camera is largely dependent on complete darkening of the hood when focusing. In years of practice, I have sought some method of obtaining instant and complete darkness within the hood, and after various trials and errors, I developed the eyeshade shown in the illustration. It works so well that it has enabled me to take pictures in much less time than is usually required. When not in use, the eyeshade is worn tipped back on the head and thus is easily brought down.—John Edwin Hogg, Honolulu, H. I.

**Tape Repair for Garden Hose**

To cut out the bad portion of a garden hose and then connect the two good ends by a sleeve to which they are securely held by means of clamps, is good practice in case of a very bad break or cut, but not for the numerous leaks of an old hose. For a few cents, enough material can be had to make repairs that will stop the leaks and make the hose last a long time. Get a roll of ordinary electricians' friction tape, a tube of tire-patching cement and some thin rubber, from toy balloons, for example. The leaky place on the hose is first wiped clean, and a piece of rubber

is cut or torn to fit over the bad spot. Both the patch and the surface of the hose where the patch is to be applied are given an application of the cement, which must be allowed to become apparently dry before the cemented surfaces are put together. After the patch has been put on, wrap tape around the repaired section of the hose. Shellac or ordinary paint applied to the tape will prevent it from becoming loose.

**Mouse-Proof Desk Drawer**

When looking through the lower drawer of my desk for a manuscript, I found that a mouse had gnawed a hole in it and begun to build a nest, using some of my manuscripts as material. Fortunately, much damage had not been done, and I at once took steps to prevent the mouse from entering again. To this end, I tilted the desk so that the bottom was exposed and tacked a piece of fly screen over the whole underside. This proved entirely satisfactory, as it could not be seen, did not interfere with the movement of the drawers, and effectively kept the mice out.—H. H. Siegele, Emporia, Kans.

**Keeping Casting-Rod Guides in Line**

When bait-casting with a steel rod, I had trouble in keeping the guides in line, so I flattened the brass joints slightly by tapping them with a hammer. The joint between the handle and the first guide is

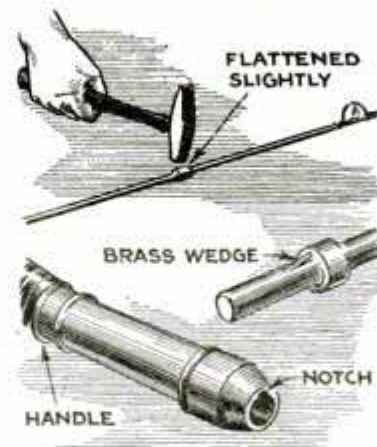

not flattened, however. A better method is to notch the inside of the handle with a file, as shown in the lower detail, and to solder a short piece of wire or a strip of brass, about the length of a

shingle nail, to the end of the first section to fit the notch. When soldering, care must be taken not to hold the iron on the soldered seam so long that it will loosen.—Adolph Reiter, Marinette, Wis.

Reiter,  
P. O. #1, Box 272



# Better Window Gardens

**T**HERE are very few rules necessary to remember for the successful growing of plants in window boxes, but neglect of the simple rules leads invariably to failure. Many people, for example, think that the ne plus ultra in window or flower boxes is a discarded water tank, cut in half and filled with any old earth. Aside from the questionable taste exercised in the selection of such a receptacle, it is really a miracle that flowers are able to grow at all in it, for no provision is ever made for drainage, and without drainage, the soil becomes waterlogged and sour, and plants, if they grow at all, grow feebly and are never healthy.

The window box should seldom be deeper than 9 in., about 12 in. wide, and as long as necessary, although, unless it is to be a permanent part of the house structure, the amateur gardener will find that a 3-ft. box is about as long as he can handle with comfort. Do not make the box too narrow, which seems to be necessary sometimes to fit a scanty window sill. A narrow box, or one that is too shallow, will not hold enough earth, and will require much more frequent watering than it is apt to get, with the

consequence that the plants are always on the verge of dying for want of water. The first rule, therefore, is to leave plenty of room for the soil, even if it is necessary to go to some trouble in providing a suitable support for the box.

Second is the matter of drainage. One man who had trouble with a large window box, running across the front of the house, found that his plants were always feeble, and when he planted bulbs in the fall, for spring flowering, that the bulbs were always rotted in the spring, and produced no flowers. He called in a gardener, who, after looking the box over, told him that the whole trouble was lack of drainage. "How can that be?" said the owner, "I filled the bottom of the box with broken flowerpots!" Many amateurs seem to have the same idea, that the presence of a few broken pieces of pots has

the magical property of providing adequate drainage. The broken pottery has a very valuable use, but it is not that of providing drainage; it is of protecting the drainage. Through the bottom of your

boxes, drill some 1-in. holes, right through the wood, and through the metal, if the box is

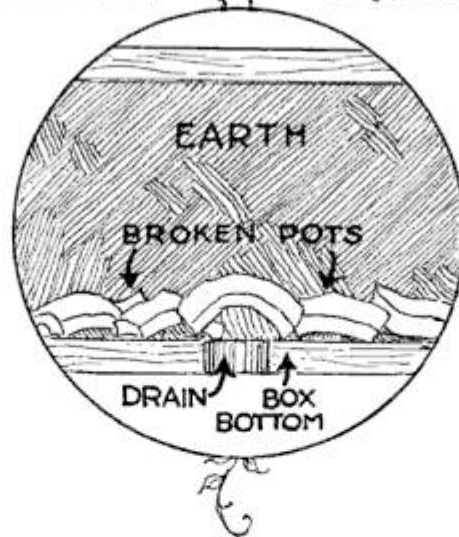

**A** LINE to the Amateur Mechanics department, Popular Mechanics Magazine, will bring you a list that will help you in selecting plants for your window boxes.



zinc-lined. Over these holes, place broken pieces of flowerpots, as shown in the illustration. The holes provide the drainage for excess water, and the broken pots keep the holes from being stopped up by particles of soil and trash washed into them. That is all there is to it. The hole in the bottom of an ordinary flowerpot should be covered with a broken piece of pottery for the same reason.

Use good soil. If there is none in your immediate neighborhood suitable for use, go to the florist and buy enough to fill the box. Flowers will not grow in clay or ashes. Having obtained the soil, keep its quality up by occasional fertilizing, remembering that soil cannot be allowed to remain in the same state for years without losing its fertility. Bonemeal, liberally spaded in, is about as good a window-box fertilizer as any, although, for quick results, any good commercial fertilizer sold for flower gardens may be used with excellent results. Feed the soil, so that it can feed the plants.

When you water, drench the plants. Two good drenchings every week are better

than a dribble of water every day. There are some good types of "self-watering" boxes on the market that minimize the attention required, but it does not take much time to give the boxes a thorough watering twice a week, in hot weather. If a box is large enough, it will be found that, in many cases, once a week is enough. A little hint, in this connection: Where a box rests on the sill, and is not supported by brackets, elevate it a little above the sill on a couple of strips of wood. If the bottom of the box rests directly on the sill, it quickly rots.

Lastly, do not keep flowers on the north or shady side of the house that are suitable for use only in sunny locations. Some flowers will not grow in the shade. A postcard dropped to Amateur Mechanics department will bring you a list of flowers suitable for use in sunny and shady locations.

A simple and attractive method of handling the flower problem in a house that has an iron balcony is shown in one of the accompanying illustrations. Ordinary flowerpots are used, hung in wire or flat-iron rings fastened to the balcony rail. The dull red of the pots is very attractive, and the flowers grow well.

#### Easily Made Wood-Bit Extension

A wood-bit extension is often needed unexpectedly and if you do not carry one in your tool kit, quite a delay may be caused in getting one. However, you can



easily improvise an extension from a length of  $\frac{1}{4}$ -in. pipe. Take a hacksaw and split the pipe at one end for about 1 in. Repeat this operation by making another split at right angles to the first one. You will then have four grooves for the bit shank to fit in, the latter being pressed firmly into place so that its own weight will not cause it to slip out

again. The other end of the pipe is split for several inches and the halves are bent down to form a handle. The writer has found it necessary to resort to this makeshift several times and has found it entirely satisfactory.—Frank W. Bentley, Jr., Missouri Valley, Iowa.

### Mucilage Stops Leak in Gas Connection

A leak started in the ground-joint connection between the gasoline-supply pipe and the carburetor on my automobile. It was in a place where it could not be re-ground easily, although I tried to stop it in this manner. Soap and other lubricants were used to no avail. The thought came to me that some liquid which gasoline would not dissolve might do, and I used a small portion of old mucilage which had become thick, applying it to the connection and letting it stand to harden, then screwing the joint together. This stopped the leak effectively.—Bert H. Stanley, Portage, Wash.

### Homemade Rotary Stamp

For addressing tags, envelopes, etc., a simple rotary stamp can be made from a small spool with the flanges removed, a length of heavy galvanized-iron wire, with the ends bent to fit into the hole of the spool as indicated, serving as a handle. Cut a strip of felt from an old hat and



wrap it tightly around the cylinder, tacking the ends down. This is the inking pad and over it a sheet of stencil paper is wrapped. The stencil is, of course, prepared on a typewriter or by means of a stylus if a typewriter is not available. Thumbtacks are used to hold the edges of the stencil to the cylinder, which permits its removal for reinking the pad. However, a large number of copies can be made before this is necessary.—Harry Frye, Tullahoma, Tenn.

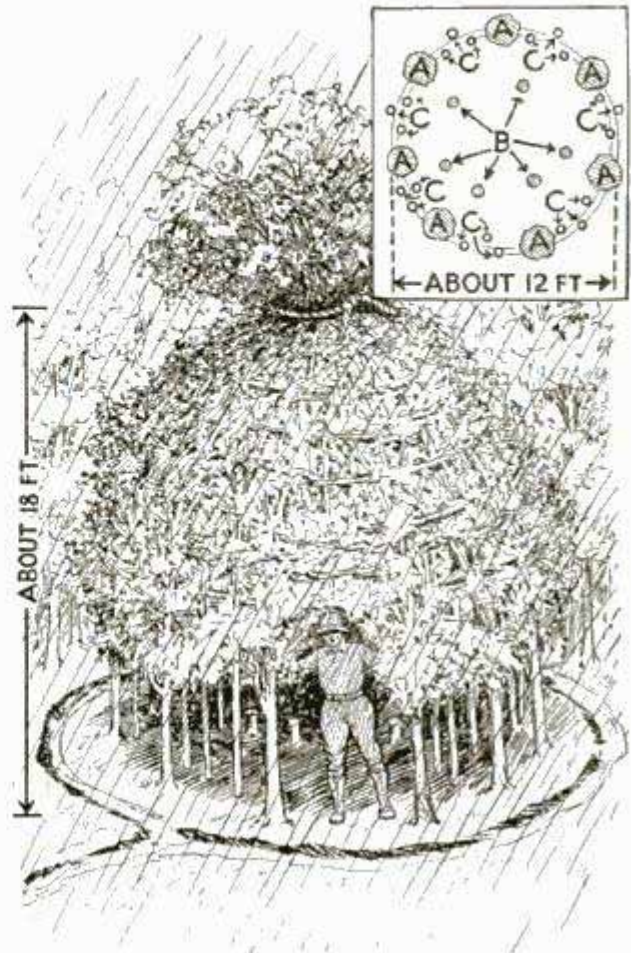

Rainproof Inclosure for the Camp Made from a Number of Saplings Which Are Tied Together as Shown

### Rainproof Inclosure Made from Saplings

In the absence of a tent, a simple and effective rainproof inclosure for the camper can be made from a cluster of saplings as shown in the illustration. A length of rope and a hatchet are all that is required to do the work, so that the cost of the inclosure is merely the labor in building it. Choose a well-drained site, covered thickly with suitable saplings. The inner ones are removed and the outer ones tied together near the top. Pine or cedar limbs are hooked on the outside, point downward, to shed the rain better.—Paul Berry, Birmingham, Ala.

### Holding Films for Drying

For suspending films to dry in a room brass "O. K." paper fasteners have been found satisfactory. A strong twine, stretched across the room, will hold a large number of rolls or packs. The fasteners have a good grip, are too small to damage the film, and will not leave rusty marks.—George Parke, Chicago.

### Simple Homemade Check Protector



Deeply Knurled Steel Disk, Attached to Dating-Stamp Handle, Makes Good Check Protector

This check protector consists of a knurled steel disk about the size of a nickel. The knurl should be deep so that the diamonds will project as sharp points. Mount the disk on the handle of a dating stamp, as shown in the drawing, using a small brass pin to retain it. In use, the check is laid on a blotter and the disk rolled over it. This, of course, should not be done until after the ink has thoroughly dried.—G. A. Luers, Washington, D. C.

### Wear on Touring-Car Top Prevented with Rubber Strip

Touring-car tops show the first signs of wear at points over the crossbows. I have found that such wear can be eliminated to a great extent by gluing a strip of rubber, cut from a discarded inner tube, to the underside of the top, at points where the latter makes contact with the

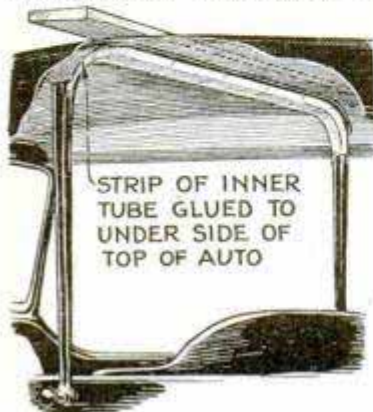

crossbow, as shown in the illustration. Rubber cement is, of course, used for this purpose. The strip should be about 2 in. wide and a trifle longer than the bow. The glue is applied to both strip and top, and is allowed to become apparently dry, after which the strip is applied. A length of 1 by 4-in. wood is used to press the strip firmly against the top without risk of puncturing the latter.—Louis B. Jones, Augusta, Ga.

crossbow, as shown in the illustration. Rubber cement is, of course, used for this purpose. The strip should be about 2 in. wide and a trifle longer than the bow. The glue is applied to both strip and top, and is allowed to become apparently dry, after which the strip is applied. A length of 1 by 4-in. wood is used to press the strip firmly against the top without risk of puncturing the latter.—Louis B. Jones, Augusta, Ga.

### Novel Washbasin for Camp

One camper found that the crown of an old felt hat can be used as a washbasin if it is saturated with paraffin. This is done by soaking it with a mixture of one part of melted paraffin and four parts of gasoline. When filled with cold water, this container is literally as stiff as a board. Before packing it away, it may be warmed up for a few seconds before a fire, to soften the paraffin so that the hat can be rolled into a small cone.

### Cabinet for Drying Films and Prints

To dry films and prints in a short time without using special machinery, they are often exposed to a strong draft of clean air. This can be done by placing the films near an open window or by using an electric fan to direct a current of air against them. With these methods, however, dust particles are likely to settle on the gelatine and will show in the prints as fine, white spots. Another disadvantage is that many small insects may be caught on the film. All this can be avoided by inclosing the films or prints in a cabinet like that in the drawing. The front and back are layers of fine gauze, which allows the air to sweep through unhindered, yet excludes dust and insects. For the frame a stout box can be used, after

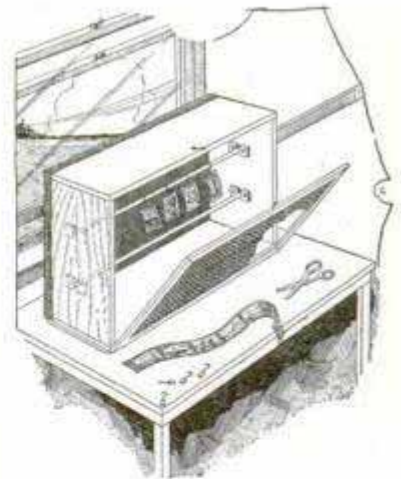

the frame a stout box can be used, after

2355 Raymond Place. Md.

the lid and bottom are removed. If a box of suitable dimensions is not available, one can be made from four boards. To the front of the cabinet a cover is hinged, so that it will lie down flat on top of the table or other surface on which the cabinet is placed. It may be necessary to raise the cabinet slightly by fitting a strip of wood under each side to let the cover lie perfectly horizontal. The cover is also provided with a pin and catch to hold it in the closed position. Gauze is then tacked over it and also over the open back. If the mesh of the gauze is not fine enough, fold the gauze double. The films or prints are suspended from small metal clips inside of the cabinet, the clips sliding on brass rods, which are in turn supported by small wooden blocks fitted to the sides of the cabinet. One of the blocks has a hole and the other a slot, like roller-towel holders, to facilitate the insertion and removal of the rods.—C. A. Oldroyd, Barrow-in-Furness, Eng.

#### Holding Grease-Cup Covers in Place

On engines or other machinery which are subject to strong vibration, grease-cup covers often turn off and are lost. A good method of preventing this trouble is shown in the drawing. Simply get a strip of brass, double it over at the end and drill it to fit the base of the grease-cup shank. Bend the top so that it will bear heavily against the cover when it is in place. Almost any available piece of sheet brass can be used for this purpose, and it takes only a few minutes of spare time to make the holders.

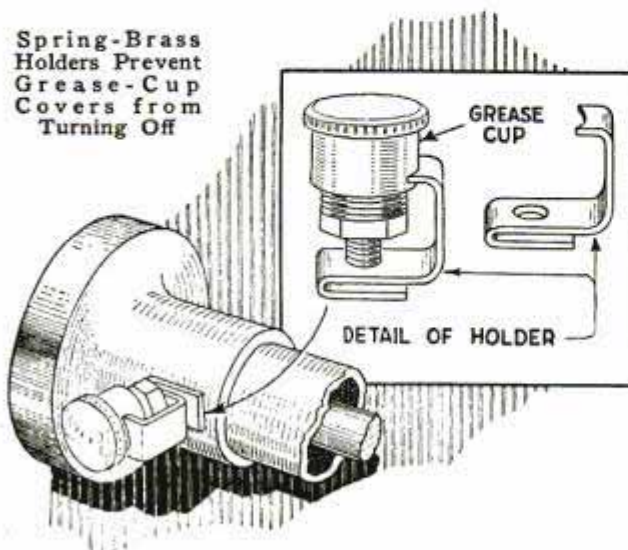

#### Wooden Mud Shoes



Wooden Mud Shoes Resembling Snowshoes Enable Fast Progress over Marshes

Walking in marshes with ordinary hip-boots proved to be quite tiresome, so I made the mud shoes shown in the drawing. They are constructed of wood and are made to resemble snowshoes. In use, they are strapped to the feet as indicated. The large surface provided in this way prevents the user from sinking into the mire and thus enables him to cover the ground in much less time and with less fatigue than would be possible otherwise. Hunters and trappers who do considerable tramping in marshes will find these shoes a great convenience.—Harrie F. Talbot, Peru, Ill.

#### Workbench Vibration Stopped

My wife frequently complained of the noise caused by working on my workbench, which was located in the attic. The noise of hammering or of running any of my bench machines could be heard throughout the house. To remedy this trouble, I sawed about 6 in. off each leg of the bench and then set each leg in a crock partly filled with wet sand. This effectively stopped transmission of the vibration to the floor. Wooden boxes would undoubtedly serve the purpose just as well as crocks.—Richard P. Cole, Los Angeles, California.



Circular Flower Bed, Built Up in Terrace Formation, Affords Good Display of Flowers

### Novel Flower Garden

When space is limited, a small cone-shaped bed like that shown in the drawing will give an excellent display of flowers. It is built up in circular tiers or terraces, the lowermost one being 6 ft. in diameter, the second 4½ ft., the third 3 ft., and the fourth 1½ ft. All are about 12 in. high and are formed from coarse wire mesh, tacked to two hoops, as indicated. Sod is laid against the mesh on the inside and then the interior is filled with rich soil. In course of time, the grass in the sod will completely hide the mesh. —Dale R. Van Horn, Lincoln, Nebr.

### How to Make an Envelope Book

A handy book for keeping bills, receipts or other valuable papers and tickets can be made from a number of unused envelopes. Simply paste or seal together all the flaps of the envelopes, as shown in the drawing. Insert the flaps into another envelope of the same size but stronger and seal the flap of this to the back of the others. Stretch



a rubber band around the book to keep it closed and prevent loss of the contents. —Arthur G. Hultquist, Lake Nebagamon, Wisconsin.

### A Waste-Paper Burner

In many places the regulations do not permit paper to be put among the garbage. If placed with ashes or other refuse, the landscape is likely to be marred, as the papers are blown about alleys and back lots. Attempts to burn the paper in the furnace only serve to interfere seriously with the success of the fire, as the ashes of the paper clog up the air space between the coals and thus prevent sufficient draft. Rubbish burners made of material similar to woven-wire fencing are much used, but the ashes and partly burned paper often will escape to be blown about by the wind. For two years, one man has used a rubbish burner that has none of these disadvantages. It consists of a 12 by 15-in. flue, or chimney lining, set in the ground to its full length, as shown in the drawing. The tile rests on half bricks at each corner. These are set back into the ground in order to project only a little beyond the inner surface of the tile. At one side a similar tile, 6 by 12 in. in size, is set. This also rests on bricks, which serve to raise it above the bottom of the hole and thus allow air to enter. The paper is placed in the larger tile. The upper paper is lighted and the fire burns from the top down. The burning takes place slowly and the flame is never high enough to injure objects close at hand. The air passes down the smaller tile through the hole under the two tiles and up the larger one in which the paper is burning. The combustion is perfect and no dense smoke is produced. A cover of

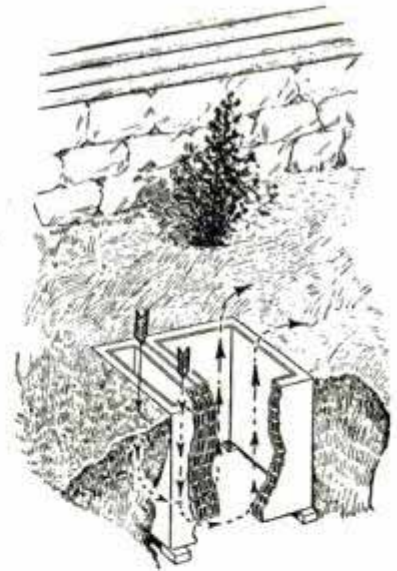



galvanized iron should be placed over it when the burner is not in use. The ash can be allowed to accumulate until the tile is one-third full, without interfering in any way, as long as it does not get wet.

### Screen for Amateur Movies

Spectators at amateur movie shows find the best point to view the picture is directly in front of it. This is due to the flat surface of the screen. Professionals use screens with a sanded or rough surface in order to break up direct reflections. A screen of this kind can be made by the amateur by using a heavy window shade coated with a mixture of paint and beads. Flat white paint is best, and the beads should be half white and half transparent glass of very small size. The paint is applied in a heavy coat, and the mixed beads pressed into the wet surface. When dry, the curtain can be fitted into a folding frame or case, or it may be hung on a wall, but in either case it must be absolutely flat when in use. A dark frame should be fitted around the screen to absorb wayward light at the margins.

### Rack Holds Tools of Many Shapes

The simple rack shown in the drawing will be found suitable for holding tools of practically any shape. It consists of a length of  $\frac{3}{8}$ -in. iron rod, bent at right angles about 3 in. from each end and with eyes formed at the ends for attachment to the wall by means of screws. A number of pieces of  $\frac{1}{8}$ -in. sheet iron, with one edge rolled over the rod so that they pivot and slide on it, are provided, a slot being filed or cut in the other end to accommodate the shanks of the tools. When a tool is suspended in the slot, its lower end will rest against the wall.

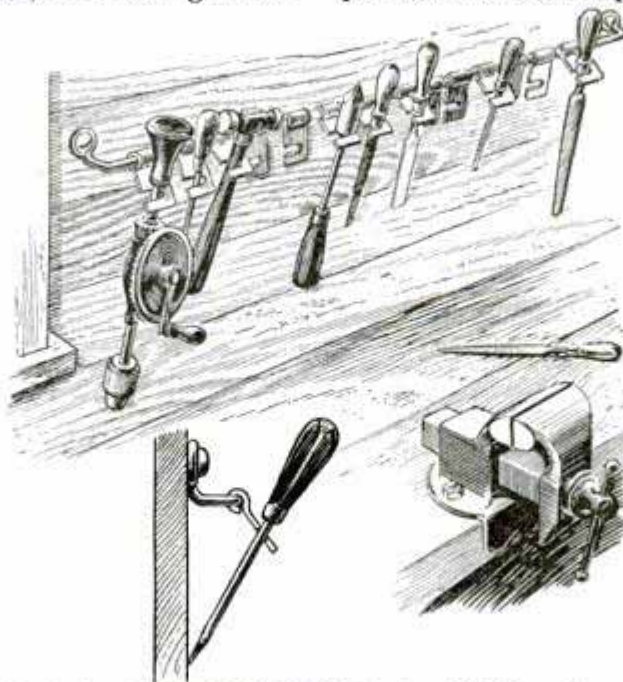

Rack Attached to Wall Holds Tools of Various Shapes and Sizes

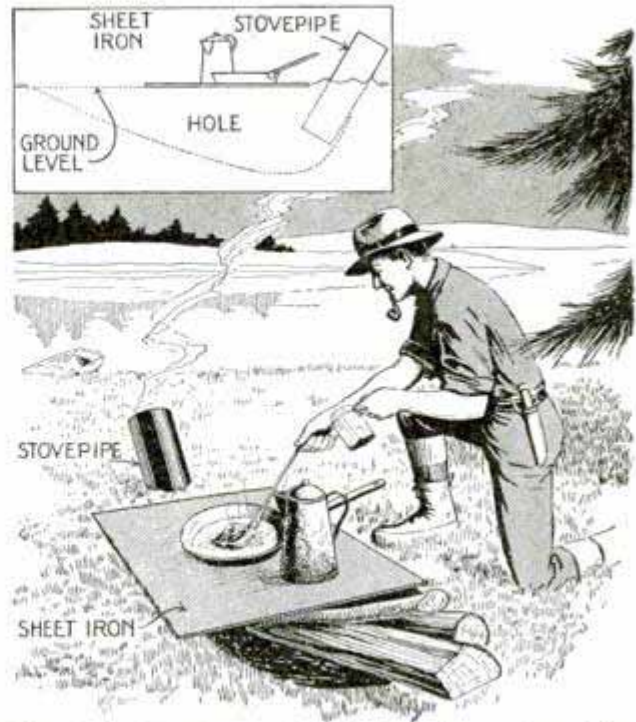

Simple Outdoor Stove, Which Burns Large Logs, Has Stovepipe to Carry Off the Smoke

### An Outdoor Stove

Campers will find this fireplace to be very similar to a stove, as it has both an intake and an outlet for the draft. It works best in clay soil, because the heat of the fire will not cause this soil to crumble and cave into the fire pit as is the case with sandy soil. Merely dig a hole in the ground, as shown in the detail, lay a piece of heavy sheet metal over the center and arrange a stovepipe at one end. The opposite end is left open as a draft entrance.

The latter should be sloping so that the fire can be fed with fair-sized logs, which can be shoved in as the end burns off. The stovepipe should project at least 1 ft. above the ground so that smoke will not annoy the person doing the cooking, and a 4-ft. pipe is still better if the wind is from such a direction that it tends to drive the smoke on the fireplace.—Robert Rollins, Berkeley, Calif.

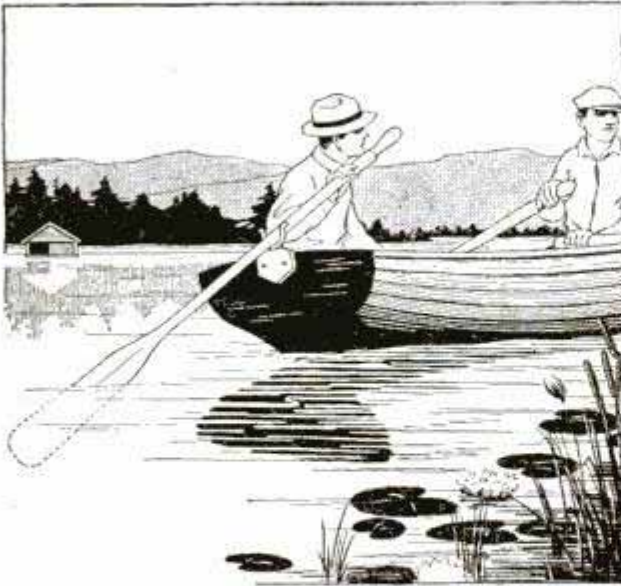

Oarlock Attached to Stern of Boat Permits the Use of an Oar for Rudder

### Oar Used as Rudder for Rowboat

I have found that by fastening an oarlock to the center of the transom of a rowboat, and putting an oar in it, a good rudder is provided. Besides the advantage of the simplicity of attachment, this rudder can be used in very shallow water.—Roger Altpeter, Baraboo, Wis.

### Drilling Glass

While making a frictional electricity machine, I had occasion to drill several holes in glass. An ordinary hand drill was found useless for the purpose, so I devised the drill shown in the drawing. It consists of a flat-iron frame having two arms that extend horizontally, one over the other. Holes were drilled through the ends to receive a metal rod in a vertical position, the holes serving as bearings. The rod is turned by means of a bow, the cord of which is wrapped once or twice around a wooden spool driven on the end of the rod. A coupling at the

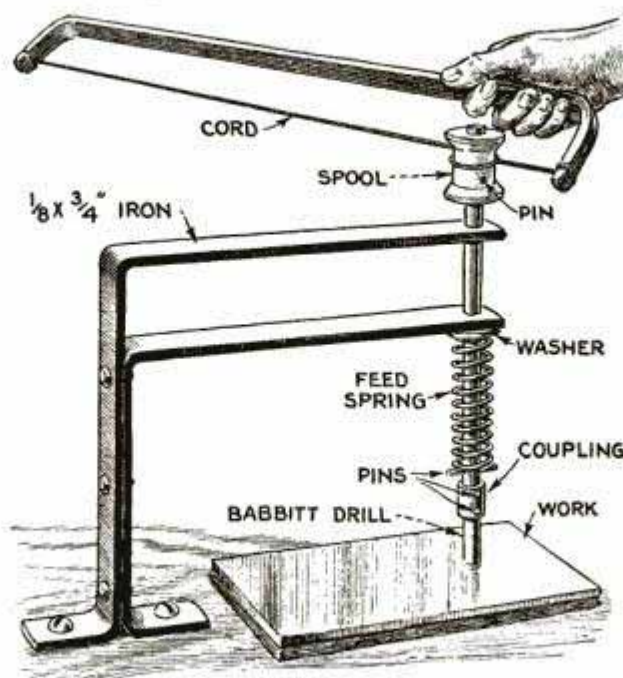

This Outfit, Actuated by Means of a Bow, Facilitates Drilling of Glass

lower end of the rod serves for the attachment of a drill. I used a copper drill at first, but found babbitt worked much better. The drill was fed with fine emery. A coil spring provides downward pressure. A mixture of camphor and turpentine was used as a drilling compound.—M. Andrews, Chicago, Ill.

### Play Safe While Working on Your Car

The first thing to do when adjusting one of the bearings of an auto is to disconnect one battery lead, so that you will be in no danger if a child or some careless person inadvertently steps on the starter while you have your hands inside of the crankcase. When working under the car, many people make the mistake of placing themselves in such a position that their hands are right over their face. If you do that, do not blame the car or anyone else if you get some dirt or oil in your eyes, or worse still, drop a pair of pliers, wrench or other part on your nose. When installing new pistons or piston rings, it is advisable to wear a pair of canvas gloves while handling the rings, as the edges are very sharp and may cause deep cuts. If any oil or gasoline gets on the floor, be careful not to throw a lighted match or cigaret on the spot. A warning against such an obviously foolish act may seem unnecessary, but these things hap-

pen so often that it may well bear repetition. Also take care that live electrical wire cannot make contacts that may cause a short circuit and result in a fire. Always lock a car when jacked up so that it will be supported without any danger of slipping off. Remember that a rope hoist and even a chain hoist is not always safe; keep yourself out of positions where you will be injured in case it falls.

# Wood Joints for the Amateur

## PART V

**N**O MATTER what the type of framing in which the mortise-and-tenon joint is to be used, the first thing necessary to do with the stock is to plane the face side and edges of the wood true and out of wind. Plane the face side first, and mark it, then plane the best edge and place the edge mark (X) on it. If the wood is

Now set the two stiles with their face sides together, as shown in the upper detail, Fig. 22, and mark the length of the individual mortises with square and marking knife, carrying the marks across both pieces, so that they will be marked exactly alike. The horn, or extra length at the end of the stiles, is important, because the excess wood here prevents the wood beyond the end of the mortise from being burst out when cutting or fitting the mortise. Note that provision is made for haunching the tenon, and that lines denoting the length of the haunching are squared across the work. Set a mortise gauge to the width of the chisel

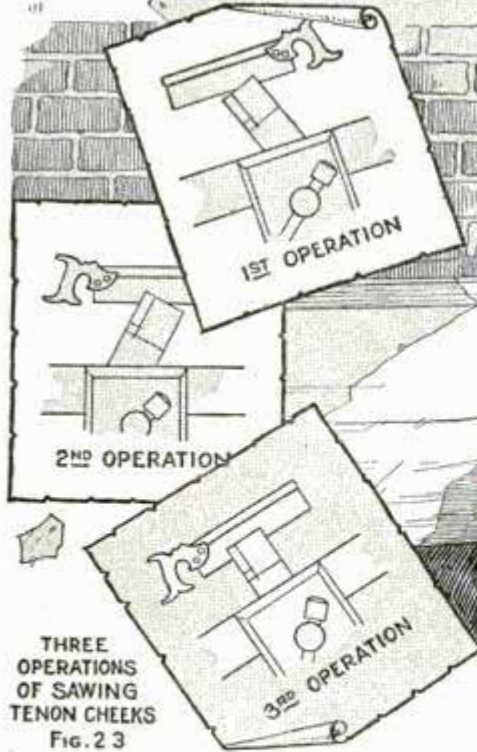
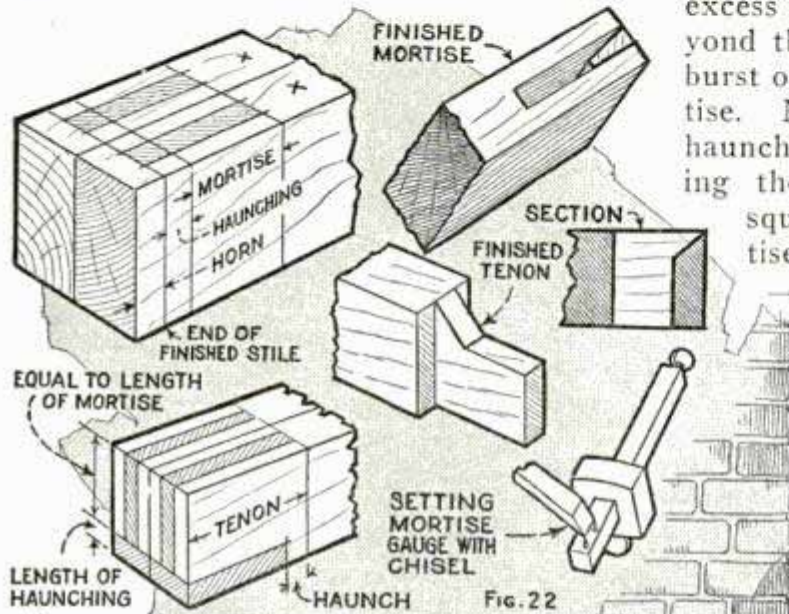

too thick or wide, set a marking gauge to the desired width and thickness, mark the wood, gauging always from the face side and edge, and plane down to size.



Fig. 24

to be used for cutting the mortise, and gauge the width of the mortises on the work, gauging from the face sides. Mortises are usually cut one-third the thickness of the stock, so, when setting the gauge, the inner marking point is first set to one-third the thickness, then the outer point is set to the chisel. An ordinary marking gauge, of course, may be used, but it necessitates two settings and markings. If a number of frames are to be made up at the same time, all similar parts of the work should be done at once. That is, the stock should all be planed at once, cut to length at the same time, the stiles paired, marked and laid out at the same time, and so on; thus one setting of the gauge will serve for all the pieces, and much time and confusion is saved.

Then set the two rails together as shown in the lower detail, Fig. 22, and lay out the length and width of the tenons, the length and depth of the haunches, and lastly the thickness of the tenons, gauging marks for the latter down the ends of the rails as well as on the edges, and taking care always to use the gauge from the face side. Next, take a rail, grip it in the vise as shown in the upper sketch, Fig. 23, and saw the cheeks of the tenon down to the line marking its length, keeping the saw kerf in the waste. Turn the rail around and saw down the opposite edge, as shown in the center sketch, and finally set the rail upright in the vise and saw down straight. The saw kerfs first made will guide the saw, and the amateur will find this method of sawing much easier than that of trying to saw straight down at once. Cut along the line for the haunch in the same fashion. Lay the rail down on a bench hook, as shown in Fig. 24, and cut the shoulders, making a starting groove for the saw as described in Fig. 1, Part II. Finally, cut the shoulder on the haunch.

There are several methods of cutting mortises by hand, a popular one being shown in Fig. 25. Select a drill bit, about  $\frac{1}{16}$  in. less in diameter than the width of the mortise, and drill out the waste as shown, taking care that the drill is kept square in both directions. After most of the waste has been removed in this manner, the sides of the mortise are pared with a keen chisel and lastly the ends.

The other two methods shown are similar in that the chisel alone is used to cut the mortise, but the method of using the chisel in each is different. Some workers swear by one method, and some by the other; the amateur is advised to try both, and to stick to the one he finds the easier.

In either case, the work is gripped solidly in the vise, or clamped firmly to the bench. Now take a chisel of the same width as the finished mortise is to be, and drive it in slantingly, as shown at A, Fig. 26. Pull the chisel out and drive it in as shown at B, thus releasing a chip. Drive in again as at C, remove, and release another chip, as at D. Use a mallet, or the side of the hammer, for driving in the chisel. Take chip after chip in this manner until the cut has reached about the center of the mortise. The section to the right shows how these slanting cuts are made at A, B, C, D, E and F. Now, holding the chisel vertically, drive it down along the line of the cut numbered 1 in the sectional sketch, pry out the chip and take cut No. 2, then 3, and so on, until the end of the mortise is reached. Make similar cuts (7, 8, 9, etc.) toward the other end of the mortise, then turn the work over and proceed in the same way to cut out the other half. The whole thing takes less time to do than to describe, and is not nearly so difficult as it looks. It is advisable, however, to practise a little on scrap wood before using either method on a member intended for a fine piece of furniture.

In the second method, Fig. 27, the chopping out of the mortise is started at the end instead of at the center. Stand at one end of the work, and drive the chisel down into the wood, bevel away from you, about  $\frac{1}{16}$  in. from the farther end of the mortise. The reason for keeping the bevel toward the end of the mortise (see A, Fig. 27) and away from the worker is that, when the chisel is driven into the wood, the bevel forces it to move forward a little, and if the bevel were turned toward you, the chisel would move toward the end of the mortise, and might damage what will later be the edge of the latter. Now, still keeping the bevel toward the end, take a cut as shown at B, and pry out the chip. Take another cut as at C, then a vertical cut along the line of the first one, and continue, prying out the chips and cutting, as

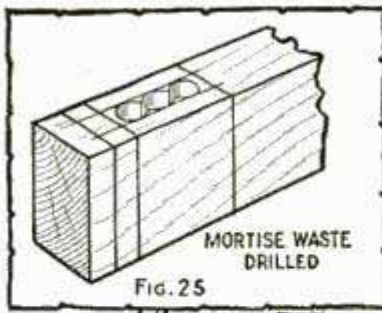
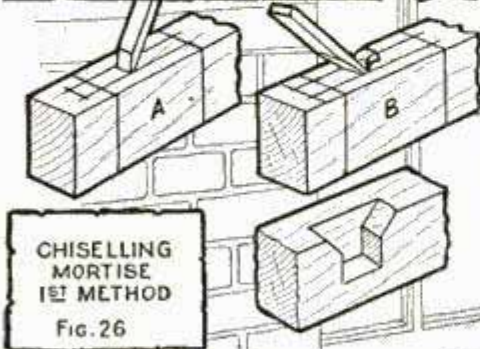
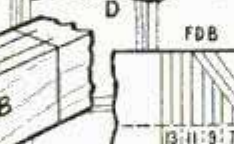
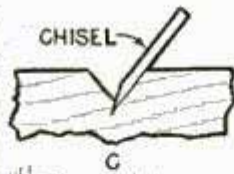
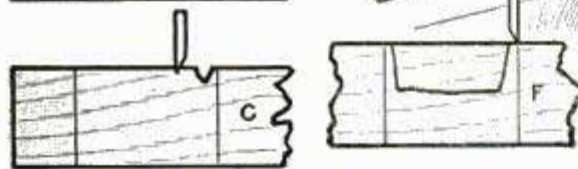
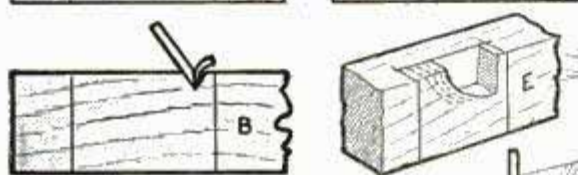

Fig. 25



CHISELLING MORTISE 1ST METHOD  
Fig. 26



CHISELLING MORTISE, 2ND METHOD  
Fig. 27

indicated by the dotted lines in D and E. When halfway through the work, take vertical cuts, as at F, to square up the ends of the mortise, then turn the work over and complete the mortise from the other side.

There are several variations of both the above methods, but the principle is the same in all. Be sure to keep the final cuts square with the edges, so that the ends of the mortises will neither have humps nor hollows in the center of the work. The fitting of the haunch on the tenon to the haunching in the mortise, and the cutting of the latter, is a simple job for the paring chisel.

Fig. 28 shows a variation of the tenon, which is useful for framing work that must be knocked down occasionally, and yet be firm and solid when assembled. Its

construction is obvious, but the wedge should not have too much taper, neither should the amount of bevel on the dovetail be too great;  $10^\circ$  from the hori-

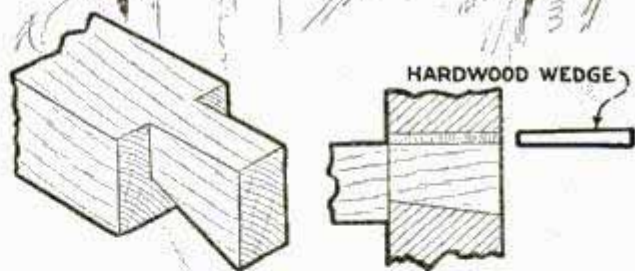
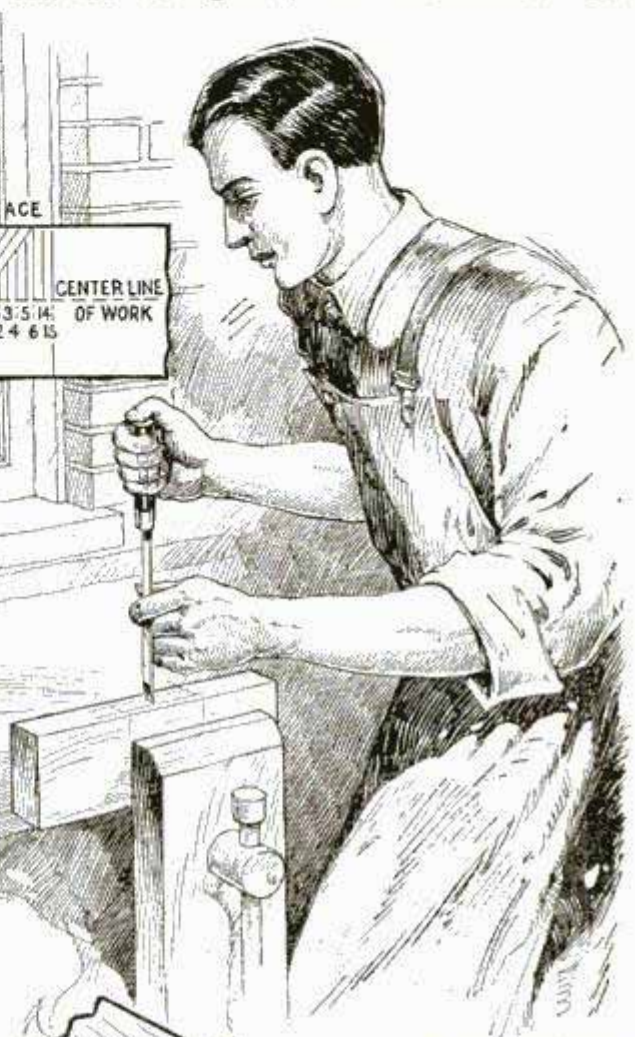

DOVETAILED AND WEDGED TENON  
Fig. 28

zontal is sufficient. The tenon is laid out and sawed as for an ordinary joint, then the dovetail may be laid out on the cheeks with a bevel gauge, and sawed or pared to shape. The mortise should be cut to the smaller size of the opening, then pared to fit the bevel gauge.

Waterproof cement can be made from bichromate of potash, 8 oz. by weight, gelatine size, 11 oz., and alum, 1 oz.; dissolve the gelatine in a little water, then add the bichromate and alum.

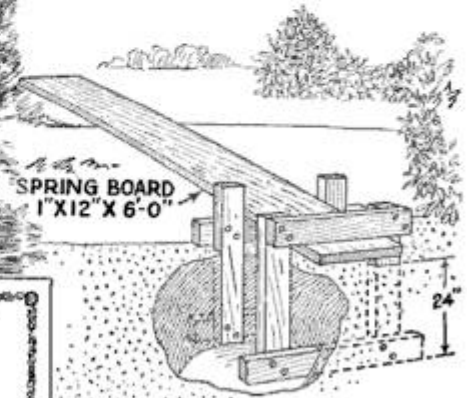
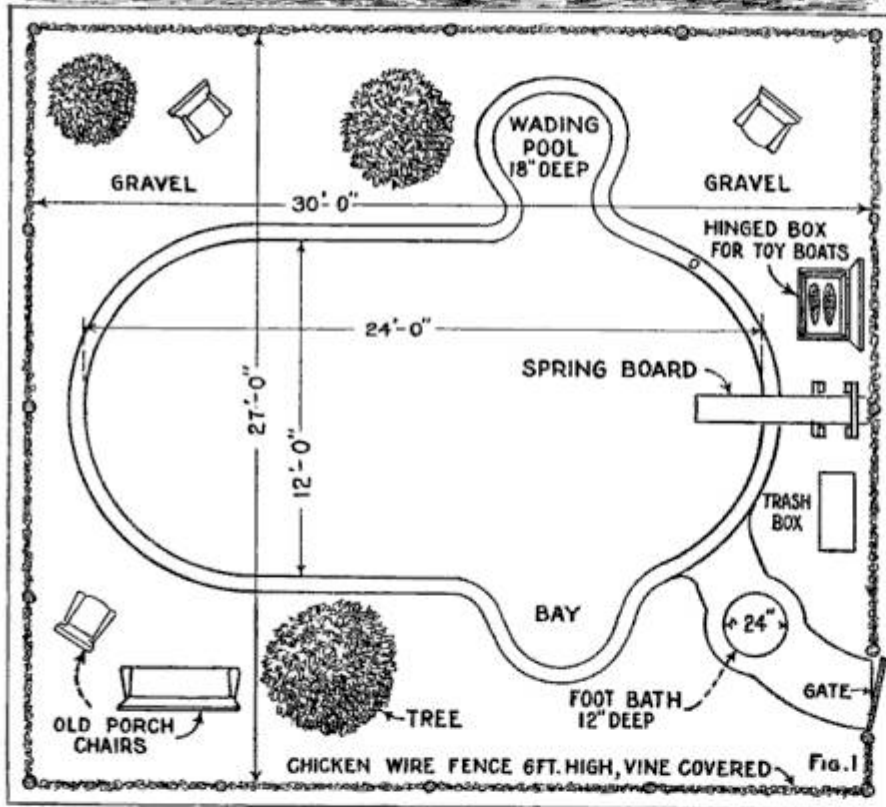

Fig. 2

necessary, since so many capable boys in the neighborhood clamored to have a hand in it. They proved good workers.

Incidentally, the pool has made a very attractive corner out of what seemed destined to become a rubbish heap.

Any location, within reach of a water supply, is satisfactory, though if you have any choice, always select the highest ground. This facilitates draining. Our

**S**WIMMING pools are generally assumed to be luxuries reserved for those of ample means. Here is one the rest of us can afford. The materials for the original illustrated cost only \$17.20, which covered eight bags of cement and four yards of sand and gravel. The price of cement at 65 cents per bag and sand and gravel at \$3 per yard was secured through a friendly contractor building a house next door, but even purchased direct, they cannot be much higher elsewhere in the country.

No outside labor was hired. It wasn't

pool has no drain at the bottom, and the water is dipped out by means of a well-sweep, a process which may seem slow at first glance, but which proved by far the best method. Besides, it eliminates the costly complication of a sewer connection. Located high enough, the water can be siphoned out, but if on low ground, it cannot be distributed to garden and lawn. The efficiency and convenience of the well-sweep will be explained later.

Having selected the location, mark out your desired outlines. The irregular shape of the writer's pool—the neighborhood

1954 Budget Use  
Paradise  
Calif

# Swimming Pool

## Hi Sibley

pool, that is, for they all use it—was designed thus to get around trees on the plot. (See Fig. 1.) Any shape may be chosen, though irregular lines are more pleasing than the conventional rectangle.

In case the soil is dry and hard, scoop out enough to hold a puddle of water. Let this soak in two or three days, and then dig, distributing the dirt removed around the edges of the hole. Thus you will be obliged to dig only 3 or 4 ft. for a 5-ft. depth. Grade off this loose soil around the edges so that it slopes away from the pool. This will carry the water off to the vines which are to be planted around the borders of the plot. A 45° slope is not too steep for a child to climb out, and will hold the fresh concrete nicely. However, you can work at even a 60° angle. At the deep end, make a slight depression so that, in cleaning, sediment can be washed into this pocket and bailed out easily.

When excavating is completed, sprinkle the sides with a fine spray but take care not to wash it down. See that the edges are also packed down well by tramping on them. Otherwise your parapet will crack when the soil beneath begins to settle from the moisture splashed out of the pool.

Before beginning the concrete work,

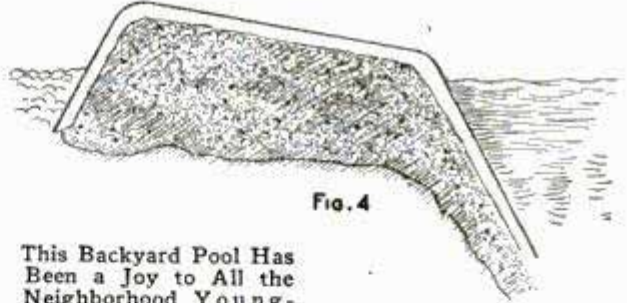

FIG. 4

This Backyard Pool Has Been a Joy to All the Neighborhood Youngsters; the Gang Shown in the Head Have All Learned to Swim in It

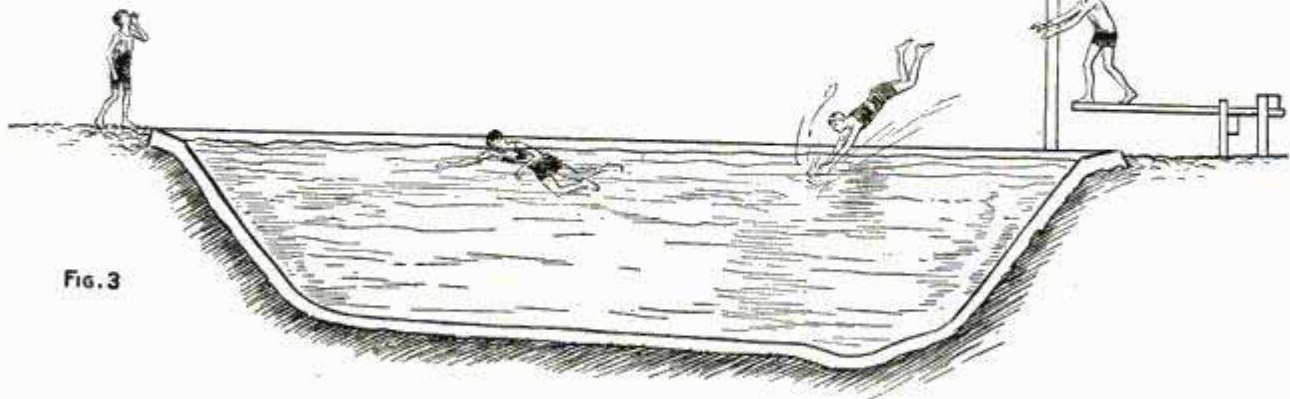
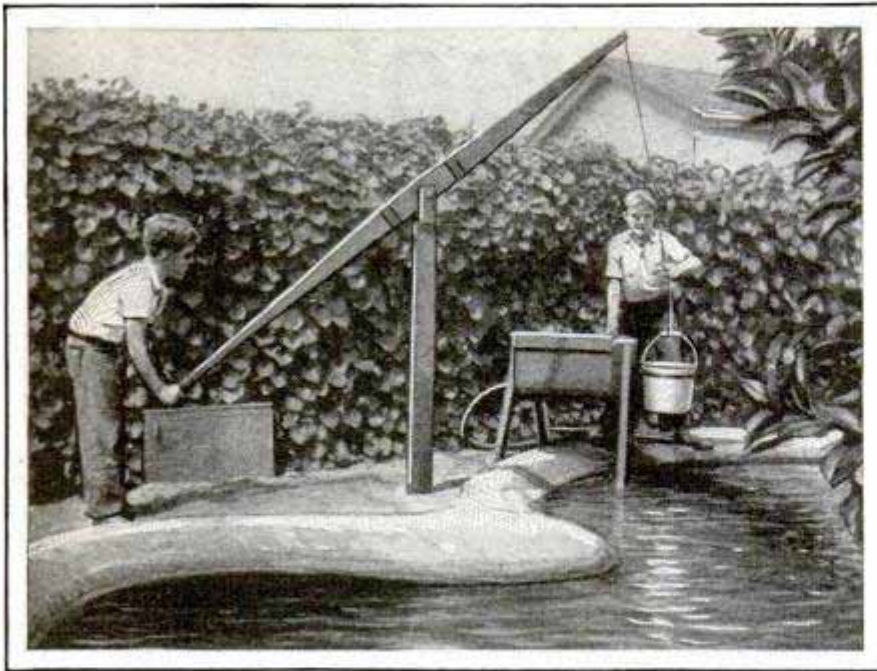

FIG. 3

make a small mixing boat as shown in Fig. 6. You will find it handy for many other jobs thereafter. One with a galvanized

sheet-iron bottom is preferable to wood.

It may interest and encourage the beginner to know that the writer never



mixed a trowelful of concrete before beginning on this job. The result, however, has proved satisfactory after a summer of daily use. In fact, the legion of young water dogs that have sprung up in this vicinity indulged in a daily plunge all through last October.

Mix Portland cement in the proportion of one shovelful to seven of coarse sand and gravel, with enough water to make it of a mushy consistency. Lay it about 2 in. thick, as indicated in the sections, Figs. 3 and

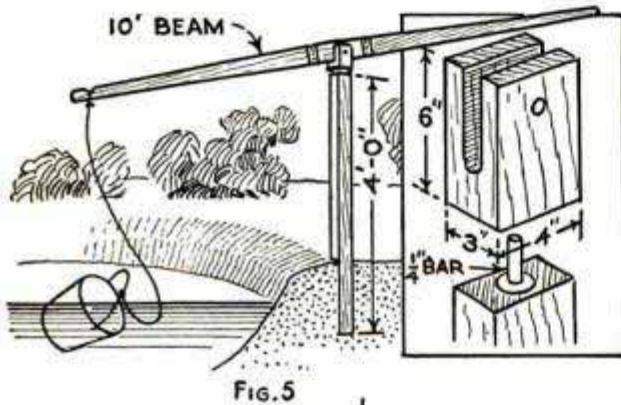

FIG. 5

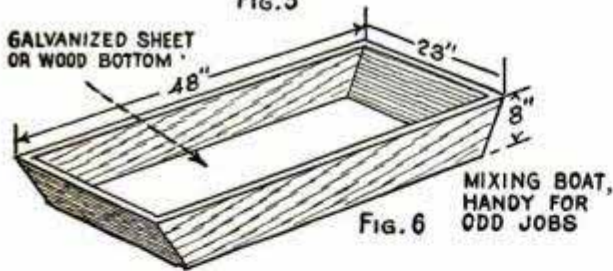

FIG. 6

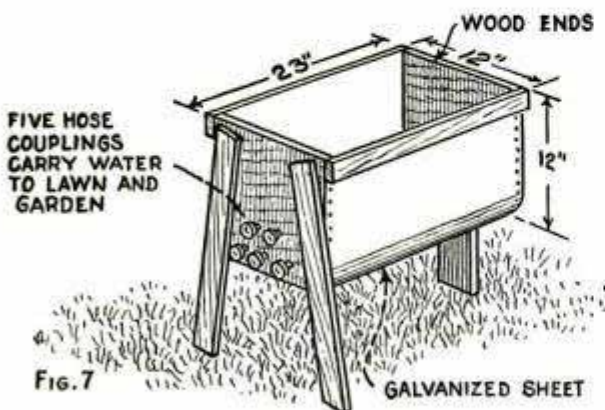

FIG. 7

4. Experienced concrete workers predicted this would not be thick enough, but in practice it has withstood a long, hard season, and there are no signs of cracking. On this job, we began at the top and worked toward the bottom; you may find it more convenient the other way around. The parapet should be 5 or 6 in. thick. A mason's straightedge with level is the proper instrument for getting the parapet level, but not having this equipment, we constructed a makeshift device, as shown in the sketch, Fig. 8. By means of this we were able to stake out strings, criss-cross and along the parapet, which were fairly level.

The first rough course was allowed to set for two days, being frequently sprinkled on the second day. On the third day, work commenced with the second course, consisting of one part cement to five of fine sand, and water. This was laid about 1/2 in. thick, allowed to set two days and kept moist in the meantime. While this is green, make it as smooth as possible with the trowel, as ridges and humps are uncomfortable to the feet. For the final coat, mix waterproof cement and water to a soupy consistency, and paint the entire surface, using a long-handled calcimine brush. This, too, should be sprinkled on the second or third day, or as soon as it will take water without running.

Spread loose gravel around the pool to a depth of 2 or 3 in. This is to prevent dirt being tracked into the pool. Don't

The Wellsweep and Distributing Tank Shown in the Photo Serve the Double Purpose of Bailing Out the Pool and Watering the Lawn and Garden



make the mistake the writer did at first, of putting sod around the parapet. It looked well, but soon after bathers began running around and splashed water over it, it became a morass. All of it had to be taken up and replaced with gravel. The latter allows the water to drain off to the edges without any mud.

The foot bath, a small pool built 3 or 4 in. lower than the parapet, is a great help in keeping the water clean. It is located between the entrance and pool, so that all bathers must step in it first. Around the plot a 6-ft. chicken-wire fence was erected, and fast-growing vines, such as morning glory and Japanese hop, were planted. The fence is almost a necessity, as the pool is such an attraction that uninvited guests will make use of it at all times if it is accessible. Water splashed from the pool assures a most luxuriant growth of

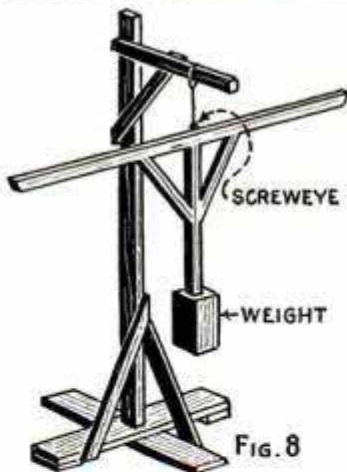

vines. A neat packing box, with a hinged lid and perforated in the bottom to drain, is a great convenience for storing toy boats and water toys, and a trash box will take care of the leaves, sticks and general rubbish that are bound to accumulate. These, as well as the fence, were painted moss-green. Discarded wicker porch chairs provide comfort for spectators and bathers.

A short springboard (Fig. 2) at the deeper end will help the beginner in diving. This can be firmly anchored by pieces of two-by-fours, arranged as in the diagram and buried about 2 ft. deep. If you have plenty of material left over from the pool, set the two-by-fours in concrete and they are there to stay. A piece of al-



Bird's-Eye View of the Completed Pool, Which Is Never Without Its Quota of Enthusiastic "Water Babies"

most any available lumber, 1 by 12 in. by about 6 ft. long, makes a good springboard. Don't locate this too high above the surface of the pool, unless all your swimmers are practiced shallow divers.

Under normal conditions the water in the pool will keep fairly clear for about two weeks. Copper-sulphate crystals in a cloth bag should be swished through the water every morning—just enough to give a faint blue tint. This is done to prevent the growth of algæ, the greenish plant present in all stagnant water.

About 24 hours were required for siphoning with a 1-in. hose. This, of course,

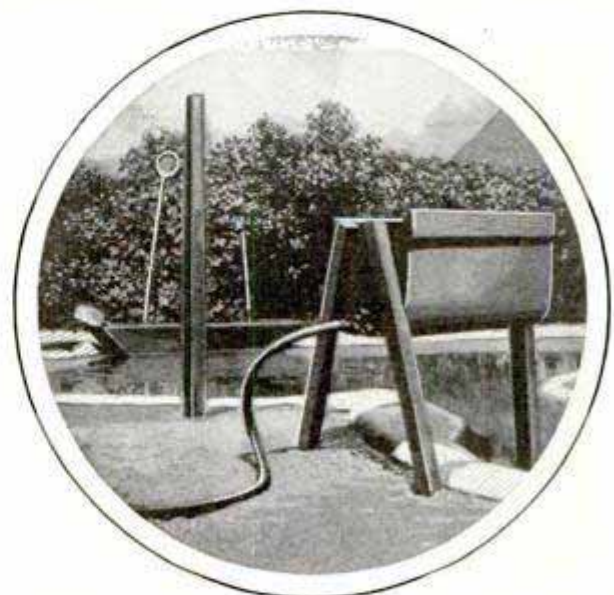

Close-Up of the Distributing Tank, with One Hose in Place; the Sweep Is Removed from Post in This View

involved no labor, but all the water was lost because the only place low enough was some distance from the pool. In order to apply this useful water to our own plants, a wellsweep and distributing tank, Figs. 5 and 7, were made.

This might seem a laborious process, but it is not. We have unlimited man power. By working the sweep, the boys earn their right to use the pool, and take turns at beam or bucket. We always have more help than can be used on the bi-monthly bailing.

When making the pool, set a post, about 3 by 4 in., in the concrete parapet at the deep end, so that about 4 ft. is above the surface. Bore a hole in the top to receive a piece of  $\frac{5}{8}$ -in. bar iron. A bolt, with head cut off, or section of cold-rolled steel, will do. The swivel or beam fork is sawed out from a wood block, as shown.

The distributing tank consists of two wooden ends, 12 by 12 in. by about 1 in. thick, to which is nailed a single sheet of galvanized iron, forming sides and bottom. The lower corners of the ends are rounded in order to fit the sheet iron snugly at these points. Only three legs are used so that the tank will stand level wherever placed. In one end, install five hose couplings, which number will drain the water as fast as the tank can be filled with wellsweep and bucket. Hot tar is poured into corners where galvanized iron joins the wood ends, and a piece of wire screen is tacked in the draining end. Do not place the screen flat against openings, as it will soon clog with leaves and debris. Bend the screen out so that it bulges 2 or 3 in.

The object of the raised distributing tank is to give gravity to carry water through the five lengths of hose to various parts of lawn and garden. Three days before

draining, discontinue the copper-sulphate treatment, as it is well not to run off too strong a solution on delicate plants. However, although we have been careless on this point, we have not yet detected the slightest damage to any of our plants or grass.

Maintenance, as well as construction, has been very inexpensive. With two fillings per month, our water bill has averaged only \$5.50, which included a liberal use in the house and on the front lawn, during our five months of dry weather.

In many ways this pool has been a great success. Six young boys of the neighborhood learned to swim here the first week, a feat none of them had been able to achieve at the various sea beaches, on account of the surf. It is a certain means of keeping adventurous children at home, and even in colder weather is a popular "proving ground" for toy craft of all types. Shipbuilding has developed amazingly in our workshop, and no investment we ever made returned such dividends in wholesome recreation.

### Iceless Refrigerator for Campers

An iceless refrigerator can be made easily and cheaply by any camper. It consists of a cylinder, about 12 in. in diameter and 24 in. long, made of reasonably heavy canvas. Two wooden disks, 12 in. in diameter, are placed in the cylinder as shown in the sketch. The bottom disk is provided with ventilation holes covered with fly screen, and the canvas is attached to it, preferably with copper tacks. The middle disk, located 15 in. from the bottom, has a deep groove in its circumference, and is held in place by binding the canvas tightly to it with several turns of soft cotton cord, such as



Collapsible, Iceless Refrigerator, Made of Canvas, Keeps Food Cool in Camp

chalk line. The canvas wall of the lower compartment is cut to provide an opening, about 6 by 10 in. in dimensions. Hems are stitched in the top and bottom of the door and a removable wire frame is inserted to hold the door in shape. When the door is closed, an overlapping flap of rubber, cut from an old inner tube, effectively seals all openings against flies. The upper compartment, which is also fitted with a wire ring and a bail at the top, is filled with water. The capillary action of the water keeps the entire canvas moistened, and the resulting evaporation keeps the contents of the lower compartment cool. If the cooler is suspended by two strands of reasonably long rope which are twisted a number of turns, it will revolve back and forth for quite a while by the untwisting and retwisting of the strands, which action will increase the cooling effect considerably. When the wire frame is removed from the door, the cooler collapses into a compact bundle.

#### Light to Illuminate Motometer

At night, a motometer cannot be seen by the driver unless the car is fitted with cowl lights. It is highly important, however, that the engine temperature should be known at all times, especially during winter driving when a hand-operated shutter is used to regulate the cooling of the motor. It is a simple matter to provide a lamp behind the motometer to enable the driver

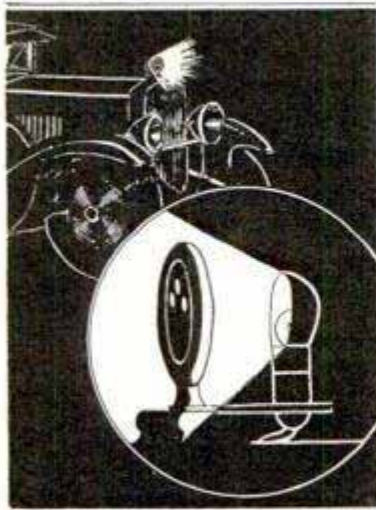

to see it. Mount an ordinary dash lamp on a bracket extended from the radiator cap or motometer, and run a length of insulated wire underneath the hood from the lamp to a switch on the instrument board, then connect the other side of the switch to the live terminal of the ammeter.—Irving C. Valentine, Winsted, Conn.

#### Manipulating Lawn Mower on Terraces



Driving Reins Provided on Lawn Mower Help Manipulate It on Steep Terraces

A simple hitch for your lawn mower that will help cut the grass on terraces, consists of a length of clothesline to guide the mower. The ends of the rope are tied to the fork of the mower, and the rope is then looped around the handholds, as shown. The user stands on the crest of the terrace and can direct the mower up and down, no matter how steep the terrace may be.—G. H. Dacy, Bethesda, Md.

#### Easy Method of Replacing Auto Rear End

When replacing a rear end under a car, it is usually quite difficult to lift the driveshaft tube and guide the end of the shaft into the universal joint. If a long plank or piece of timber is put over the rear axle and under the driveshaft tube, the end that hangs over at the back will balance the rear end, so that all you have to do is to guide the end of the shaft into place.

☛ A label paste for bottles can be made by soaking strong glue in strong vinegar, boiling and then adding flour; this adhesive will not decompose.

### Homemade Slide for the Children

A slide, practically as good as the coveted one on the school ground, can be made

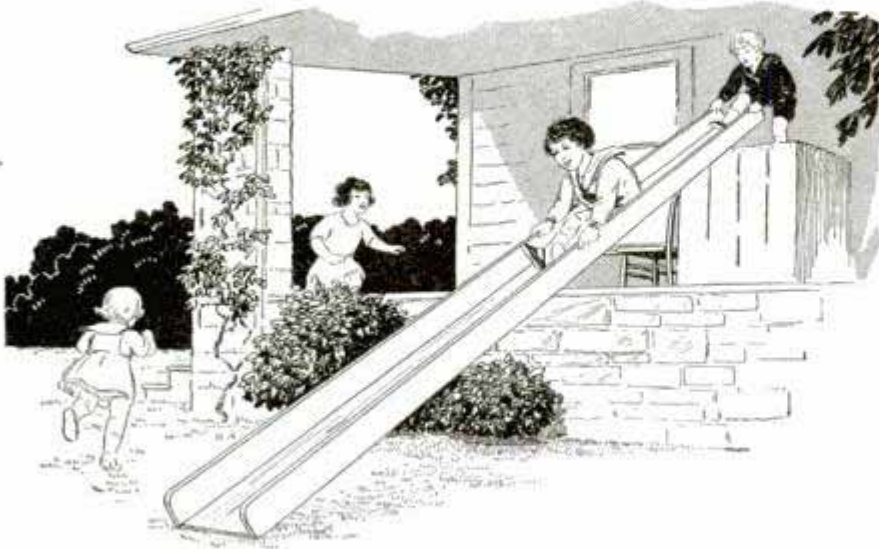

Simple Wooden Slide, Costing Less Than Two Dollars, Provides Amusement for the Young Children

at home at low cost. Get a board, 1 ft. wide and 10 ft. long, and nail 5-in. strips on both sides. Spruce is the best wood to use for this purpose, but pine also will do. Of course, it is absolutely necessary that the wood is very smooth, to avoid the danger of splinters. After sanding it and removing all the rough edges, apply floor wax. The top part of the side rails should be rounded with a plane. This slide can be adjusted for safety for children of various ages, one end being elevated to the desired height. When not in use, place the slide on the porch or in the garage to keep it out of the sun and rain.—Emma K. Hulburt, Kirksville, Mo.

### Safety Cistern Cover

The drawing shows a safety cistern cover which was made by the father to prevent his three-year-old boy, who was more than ordinarily inquisitive, from falling into it. As the cistern wall neared the top of the ground and converged to form the neck, a cylinder of galvanized iron was shaped and put in place for the inner form of the

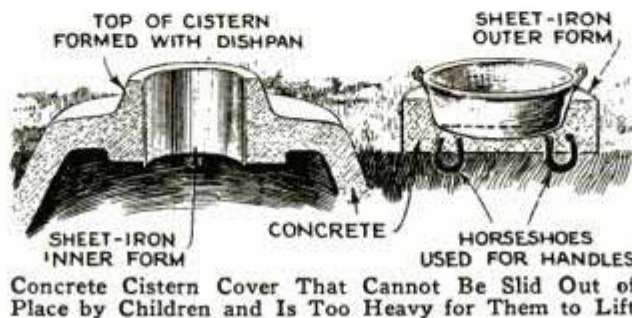

neck. The soft concrete was brought up to a level all the way around the cylinder, which was left to project above the surface of the concrete as much as the depth of a large dishpan. Additional concrete, mixed quite soft, was then shaped about the top of the neck and the dishpan was turned over it, upside down, and rotated to smooth the concrete. After thirty minutes, it was slowly turned and lifted off. The dishpan was then used for the inside form for the top, which was cast in another short cylinder of galvanized iron, having a diameter 8 in. larger than that of the dishpan.

A plot of ground was leveled off and two horseshoes set in it with the ends projecting about 3 in. The outer form was set directly over them and the concrete was shaped about the pan, which was placed right side up. When cured, the cover fitted snugly over the neck of the cistern. The horseshoes are used to lift the cover off.—Dale R. Van Horn, Lincoln, Nebr.

### How to Handle Hot Outboard Motor

It is often necessary to remove an outboard motor from a boat while the motor is still hot. A strap, or rope, looped around the cylinders will facilitate the handling, but as this may burn or scorch if it comes in contact with the hot exhaust pipe, a better method is to obtain a 5-ft. length of motorcycle brake lining and rivet the ends together to form an endless loop. This loop can be shaped to form an "S" under and around the pair of cylinders, and the motor can easily be lifted and carried. Brake lining, besides being exceptionally strong, is composed of an asbestos base and is not easily damaged by heat.

# SHOP NOTES



## Supercharger for Outboard Motor

By DICK COLE

**T**HE APPLICATION of a supercharger tends to remedy an inherent fault of the two-cycle motor. While it does not give added compression, as in the four-cycle motor, it does provide a cleaner, less diluted charge in the cylinder, which results in a marked increase in power.

This will be of particular interest to outboard-motor fans, for it is in that field that the two-cycle motor is used extensively—almost exclusively.

This article describes a simple supercharger which can be made by the amateur mechanic. It is not an engineering

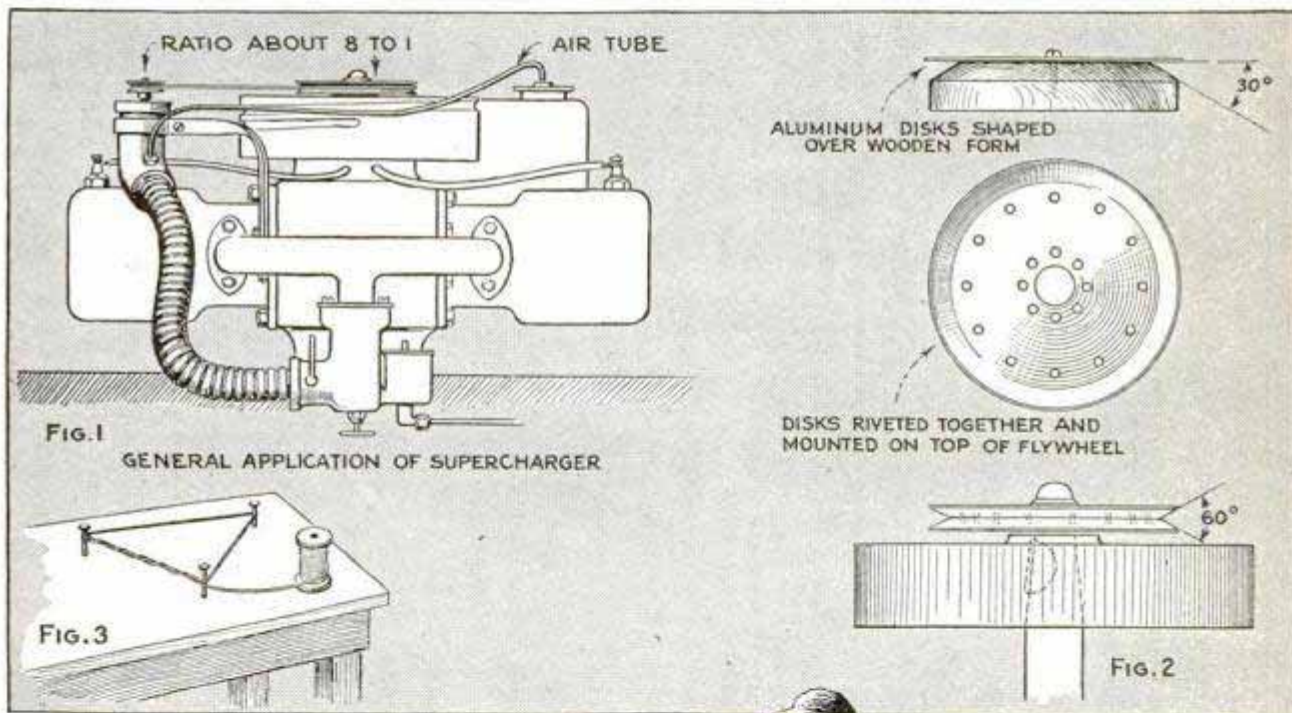

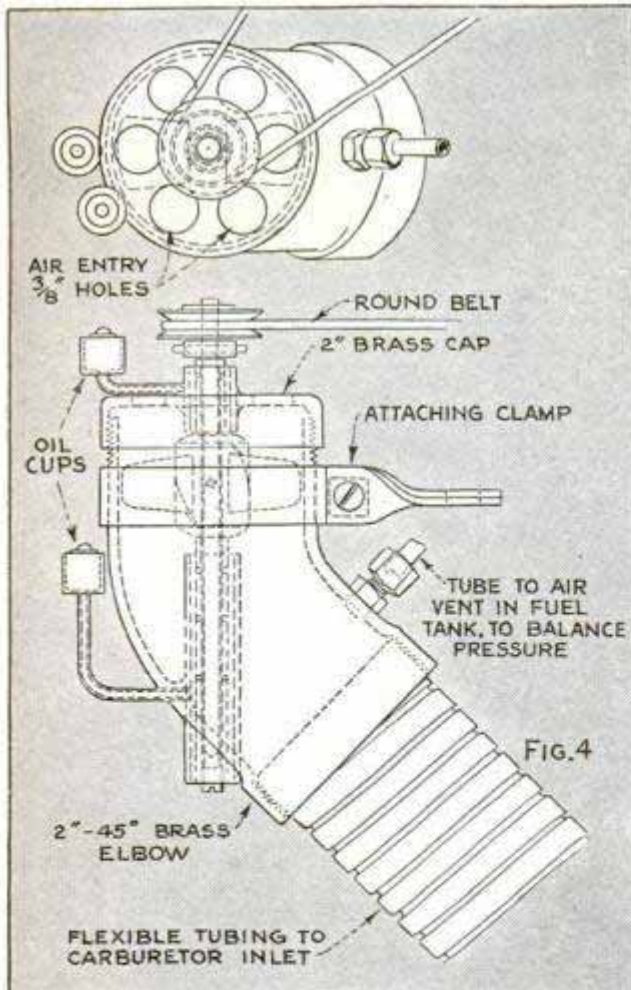
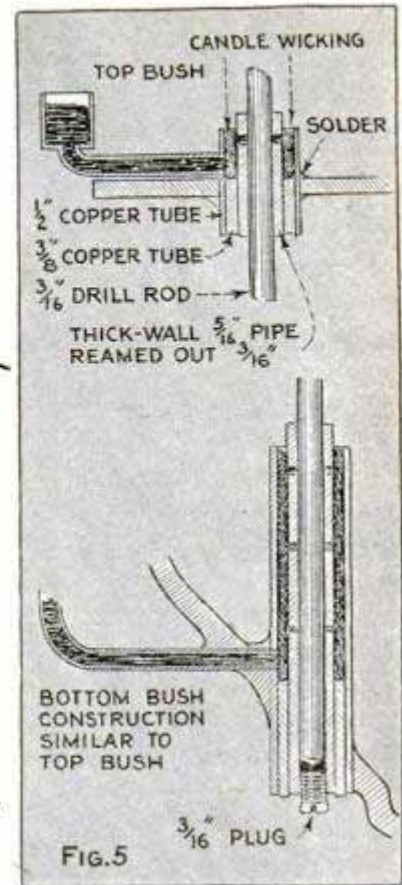
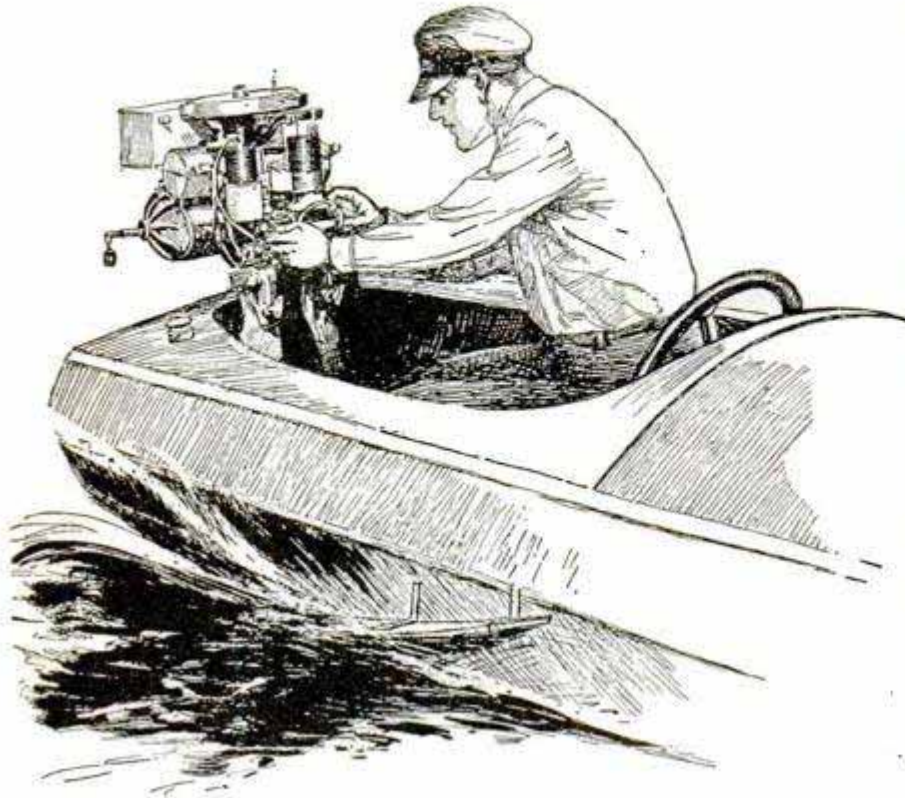

masterpiece, but it fulfills its purpose very well. Its application to an outboard mo-

tor will show, not only more actual piston power, but also a much greater range of engine speed. This will permit the fitting of a higher-speed propeller, and more miles per hour can be attained.

Fig. 1 shows the application of the supercharger. Its construction is self-apparent. No fixed dimensions for the whole assembly can be given, because the 2-in. brass elbow used for the main body of the supercharger varies with different manufacturers. Fig. 4 shows a 45° elbow used, but a 90° elbow may be more adaptable to some outboard motors. A male and female elbow (street elbow) is most suitable. A cap, drilled for bushing and for air vents, is fitted to the male end. The threads in the female end can be scraped down so as to receive the end of the flexible metal tubing leading to the carburetor inlet. To drill accurately the lower bushing hole, it is suggested that a hardwood plug with a pilot center hole be placed in the elbow to guide the drill. The rotor shaft is of 3/16-in. drill rod. The rotor hub is of 3/4-in. brass. With a hacksaw, this is slotted deeply at an angle of 45° to center line. Brass or copper blades are then soldered into the slots. Owing to the speed at which the shaft turns, the

rotor must be accurately balanced. This can be determined by rolling the rotor-shaft on two knife-edges.

Positive lubrication of the rotor-shaft bearings is absolutely essential. A very satisfactory way to achieve this is illustrated in Fig. 5. Note how lengths of copper tubing of different diameters are sweated together to form an oil well around each bush. Small holes in the bushes lead the oil to the shaft. Oil cups keep the wells replenished.

The size of the pulley on the rotor shaft depends upon the driving pulley. This, in turn, depends upon the design of the outboard motor to which the supercharger is to be attached. An 8-to-1 ratio will provide ample speed. At 2,500-revolution motor speed, the supercharger will rotate 20,000 r.p.m.

It is well, when using a supercharger, to balance the pressure of the air in the fuel tank with the pressure against the jet in the carburetor. So, a small rubber tube is led from a nipple in the supercharger body to the fuel tank. A short piece of copper tubing, soldered to the filler cap, will receive the rubber tubing.

The manner of attaching the supercharger is suggested in Fig. 1. First, a pulley must be made to fit under the fly-wheel nut. Two disks of fairly heavy sheet aluminum can be shaped over a wooden form, and then be riveted together, forming a 60° V-pulley, as shown in Fig. 2. The size of the pulley depends upon the make of the outboard motor. On some motors using a rope starter, the pulley, of necessity, must be small. However, a correspondingly small pulley on the supercharger shaft will establish an 8-to-1 ratio.

A bracket must be constructed to support the supercharger with the two pulleys in line. There always are bolts on a motor which can be utilized for this.

The best high-speed belt the writer has been able to evolve is made of shoemakers' twine. The length of the belt required is determined with a piece of string. Then three nails are driven, with a triangular boundary equal to the length of the belt, Fig. 3. Six complete turns of the twine are made around the nails, the twine being wrapped around itself at the same time. About three wrappings between the nails

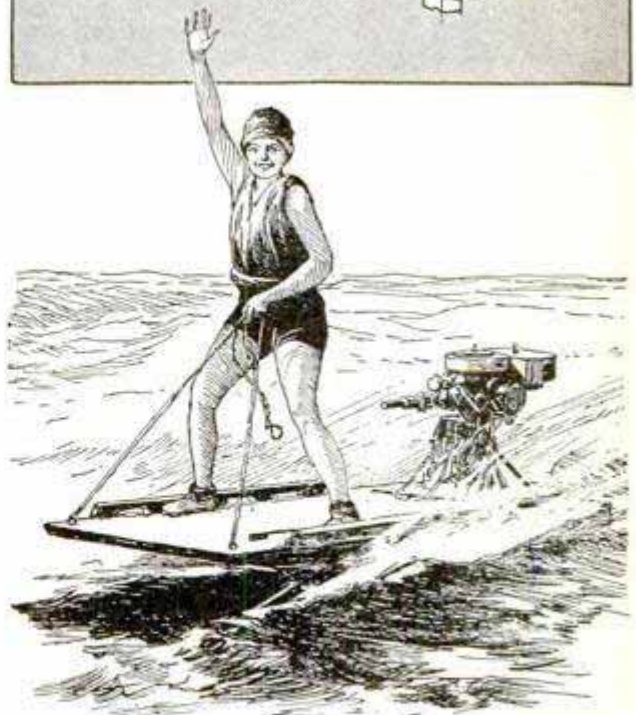
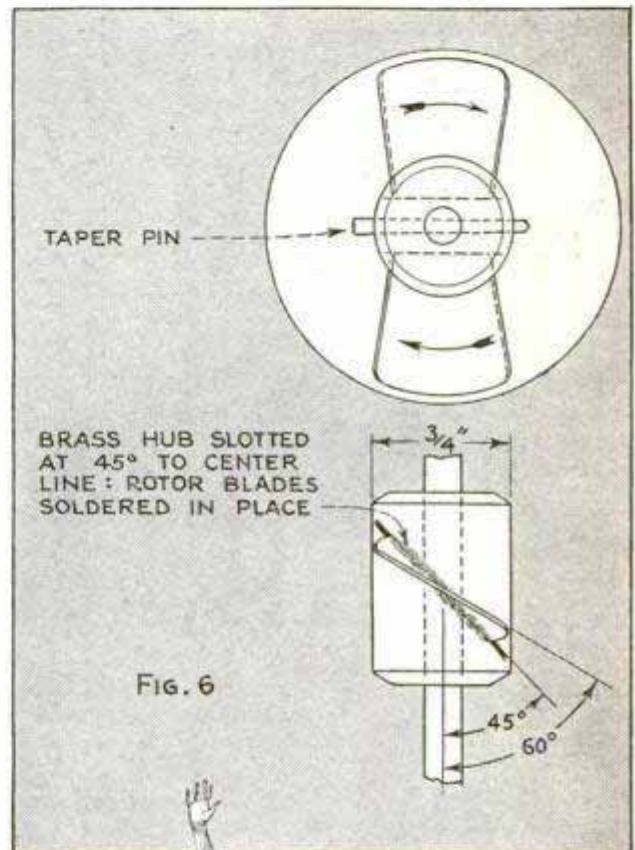
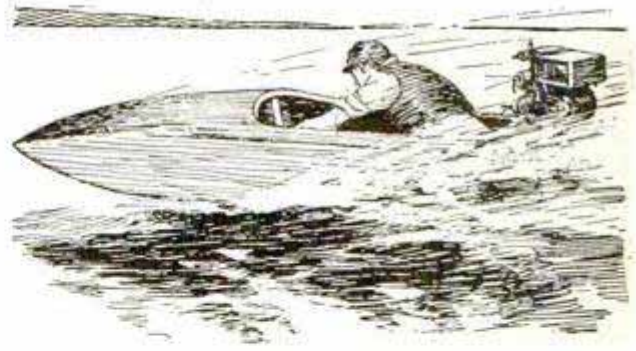

are ample. The ends are tied with a barrel knot, and the endless loop treated with

shoemakers' wax. Such a belt will give much longer service than any leather belt. It is obvious that the belt will interfere with starting the motor. So it is removed and slipped on after the motor is running.

The crude supercharger herewith described will positively give additional power to any outboard motor. Let anyone who doubts it make one with two rotors, one with reversed blades, and try each out. A remarkable difference in power will instantly be noticed. Obviously, one-half of this difference is the additional power above normal provided by the supercharger.

### Short-Circuiting Leading Wires of Blasting Apparatus

Electric firing of explosives is undoubtedly the most efficient and the safest method, and it is being widely adopted where well-regulated blasting in coal mining and other industries is done. However, it is not entirely danger-proof. Accidents with electric firing can and do occur if proper precautions are not observed. One of the chief hazards from the outset, and especially after electric cutting and loading machines were introduced in the

mines, is that the wires of an electric detonator or electric blasting circuit accidentally come in contact with some source of electric current or with a stray current, which causes a premature explosion of the detonator alone or of a loaded charge. In one case, a miner who had primed his charge and was taking it into the place where he was to shoot, allowed the wires to dangle. The loose ends came into contact with the mine track, through which a stray current was passing, the charge exploded and the man was killed. Thereafter manufacturers short-circuited the blasting caps by twisting the ends of the wires together. Although this practice greatly reduces the danger, it is not all-sufficient. It does not remove the hazard of stray currents getting into the circuit after the detonator wires have been connected to the leading wires. For years, it has been my instruction to shot-firers, and others who do blasting by the electric method, to twist together the ends of the leading wires that are to be connected to the blasting machine, or other source of current, in order to short-circuit them until the moment comes to make this connection, and as soon as the shot is fired, to disconnect them and twist them together again, thus keeping the

leading wires short-circuited while not in use. Many blasters forget to take this precaution or consider it too troublesome. Consequently two simple devices were introduced. The first, shown in Fig. 1, consists of two pieces of strong steel spring, about  $\frac{1}{2}$  in. wide and 4 in. long, with a 6-in. length of copper wire securely fastened against the outer side of each spring by means of a winding of copper wire and a copper sleeve, and with a wooden or fiber block, covered with adhesive tape, placed between the steel springs and bound firmly in place with tape. When the steel springs are fastened in this position, the two ends will automatically come together and remain in contact. The copper wires extending below the wooden block are connected to the leading wires, the latter being then effectively short-cir-

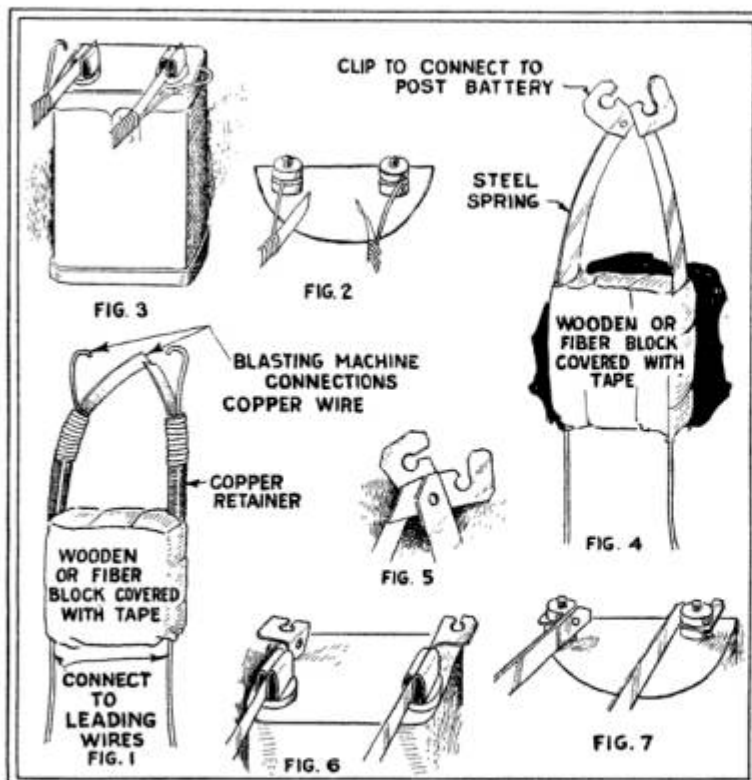

Methods of Short-Circuiting Leading Wires of Blasting Apparatus to Prevent Premature Explosions



cuted. When the time comes to fire the shot, the curved ends of the copper wires are hooked around the binding posts of the blasting machine, as shown in Fig. 2. This separates the springs and breaks the short circuit. When a blasting machine having the spring type of binding post shown in Fig. 3, is in use, the connections are made by slipping the steel springs themselves into the binding posts. This device affords a reliable short circuit for the leading wires and a quick and easy method of connecting them to a blasting machine. It is also cheap and easy to make. The original was made in less than half an hour, and can be duplicated readily by any blaster. Figs. 4 and 5 show another form of the same device, in which the wires end under the taping around the block, and two clips are riveted to the springs for making connections with the blasting-machine posts of the ordinary type. The method of connecting this form of short-circuiting device with the two types of posts used on pocket blasting machines is shown in Figs. 6 and 7.—S. C. Jones, Drexel Hill, Pa.

### Spacer for Building Construction

In the construction of any kind of frame building, difficulty is often experienced in nailing up the studs. As a rule, the spacing between them is not as even as it should be, but the simple spacer shown in the drawing will eliminate this trouble. It consists of a piece of sheet metal, with two arms projecting from one side, the space between their inner edges being equal to the desired space between the studs. The arms are bent to form hooks by which the spacer can be suspended from the top plate. After the first stud is nailed on, the spacer is slid over to find the correct point to nail the second stud, and so on.—John B. Roswick, Sturgis, Mich.

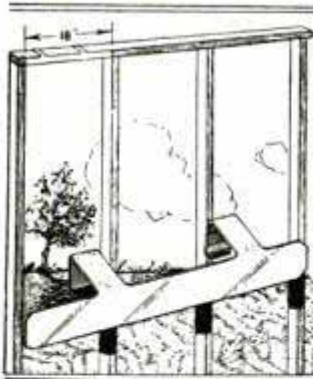

☛ Lima beans can be shelled quickly in a properly adjusted clothes wringer.

### Ground Clamp for Electric Welding

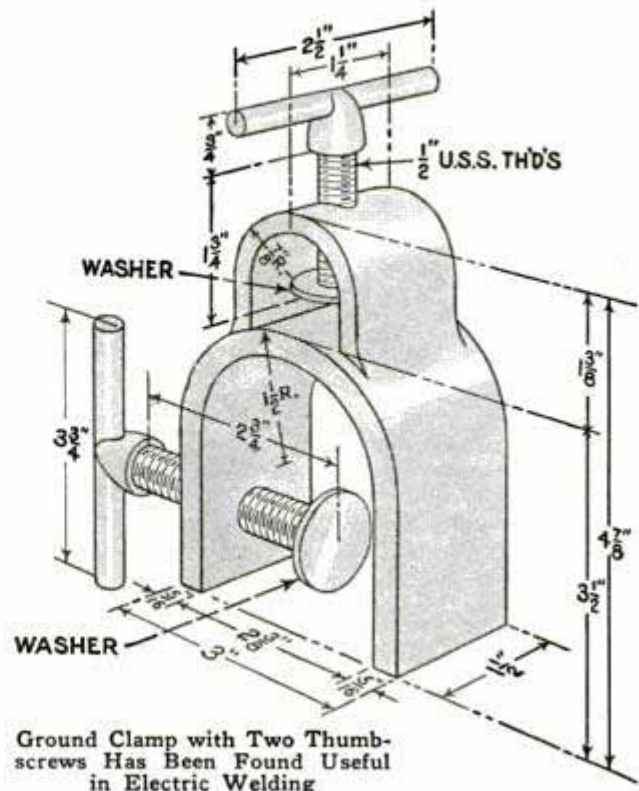

Ground Clamp with Two Thumb-screws Has Been Found Useful in Electric Welding

The illustrated ground clamp can be used with one or more welding machines at the same time. The wires are held in place by the small thumbscrew at the top and cannot get loose or slip out when the screw is securely tightened. The clamp is attached to the work by means of the large thumbscrew, which insures a good electrical contact if the work is clean.—Robert Dinsmore, New York City.

### Quickly Removable Cotter Pin

A quickly removable cotter pin, which is useful in places where a pin must frequently be removed from a clevis for adjustment, is shown in the drawing. A coil spring, with one end straightened, is slipped over the clevis, and the far end is rested against a washer placed between the clevis and locknut. When the pin is removed, the coil spring is pulled back out of the cotter-pin hole.—E. Gunderson, Jr., Humboldt, Iowa.



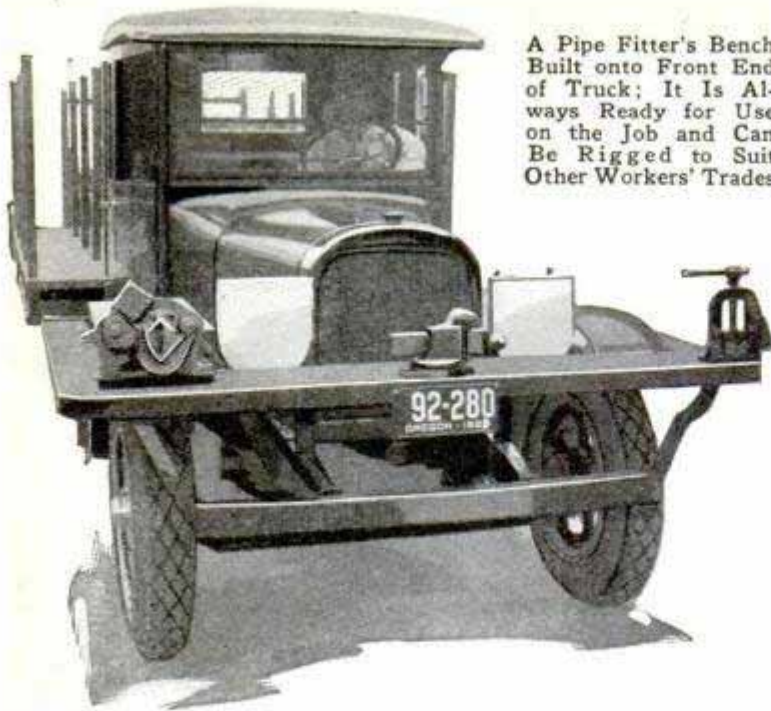

### Workbench on Front of Truck

Here is a handy workbench for the plumber, electrician or other workman who has a truck. It is built right onto the front end, does not hinder loading or unloading and eliminates the need of improvising some sort of bench on the job. The vises for pipe are in line so that they will accommodate pipes or rods drawn lengthwise from the truck.

### Making Stereotype Matrices

Practically every country newspaper possesses an outfit for casting from paper stereotype matrices, but some of the workmen who do the work have the idea that the operation is a difficult one. As a matter of fact, it is quite easy to make good molds from type or electros provided the formula for compounding the stereo paste is known. Without it, good results are impossible. The paste is compounded from dextrine, 8 parts; gum arabic, 1 part, and water to make a thick mixture, which must be strained through wire gauze to free

it from all lumps. The flongs, or paper molds, are made from three sheets of smooth, tough tissue paper and a backing of thin blotter or porous newsprint, well pasted together and smoothed to an even thickness. These flongs can be dried and preserved for an indefinite period if a few drops of carbolic acid are added to the paste. Previous to use, the flongs are thoroughly dampened until limp and then beaten on the face of the type, which must be well oiled to avoid adherence of the mat. Wood type should be covered with sheets of lead or tinfoil (not aluminum), which will later melt as the cast is poured into the mat. The brush used can be made level-faced by scorching

it on a hot plate and brushing off the burnt tips. After beating in the flong, the hollows should be filled with a mixture of half flour and plaster of paris, the whole topped off with a sheet of soft paper, and then the mat can be dried under a copying press or in the casting box of the stereo outfit. Two or three thicknesses of cotton blanket or heavy cloth must be placed on top of the flong to absorb the moisture, and should remain until the mat is bone-dry. Screw pressure or a heavy weight must be maintained on the mat while it is drying in contact with the type. This mat will often permit casting half a dozen plates before it begins to peel.

### Emergency Internal Calipers

In an emergency repair job the writer had to take some internal measurements accurately without the aid of calipers. The illustrated makeshift method was found accurate and satisfactory in every way. Two pins were stuck into opposite ends of a small cork which was forced on a pointed match.—F. W. Bentley, Missouri Valley, Iowa.

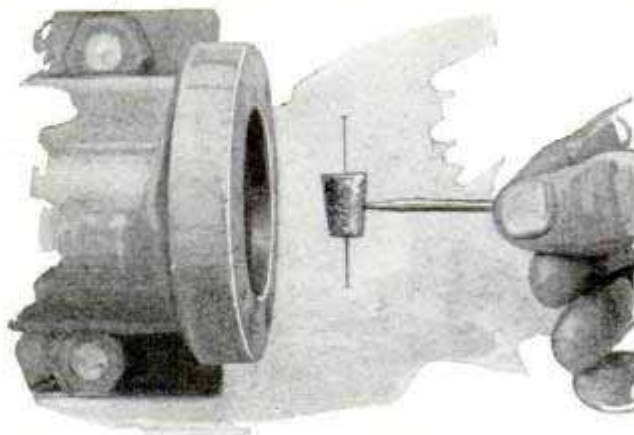

Quickly Improvised Internal Caliper Takes Accurate Measurements

# Better Wings for Model Planes

By HI SIBLEY

A COMMON defect in practically all model airplanes is the tendency of the wing fabric or paper to sag between the ribs. Besides being detrimental to the appearance of the wing, this loss of smooth contour lessens the lifting power.

By building in a paper honeycomb, as shown in Fig. 1, the difficulty is entirely overcome, and a smooth, tight covering is assured for the life of the plane. Fewer ribs are required—spaced about 8 in. apart—and in patching torn fabric, the honey-

not a quick job. The care you use in building up the honeycomb will be reflected in the smoothness of the wing. Most any light, thin and stiff paper will do for the cellular core, architects' tracing paper being particularly suitable.

For the purposes of illustration, we will assume that we are making a wing of 6-in. chord by 16 in. long (right wing only), of rectangular design. This will require three ribs, a round-section main spar, a leading spar and a rear spar. White pine is recommended for the ribs, as well as spars, since it is stiffer than balsa wood. Plane the rib pieces down to  $\frac{1}{16}$ -in. thickness, cut notches for front and rear spars and very carefully bore hole for the main spar.

Before starting the honeycomb, make a

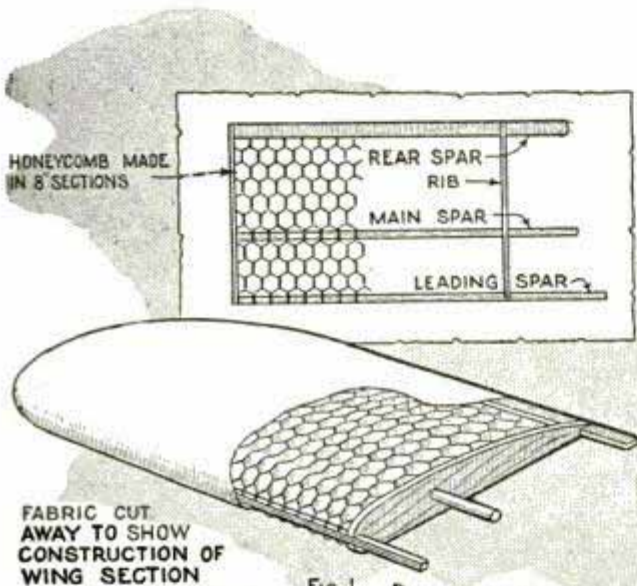

FABRIC CUT AWAY TO SHOW CONSTRUCTION OF WING SECTION

Fig. 1

SLOTTED TIN GUIDE INSURES UNIFORM WORK IN GLUING

ALTERNATE LAYERS ARE GLUED BETWEEN BY MOVING GUIDE HALF A NOTCH

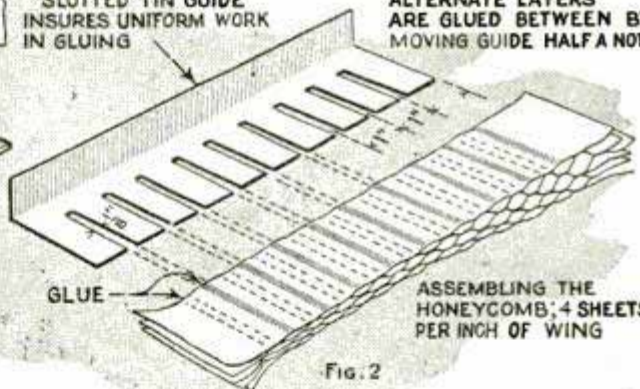
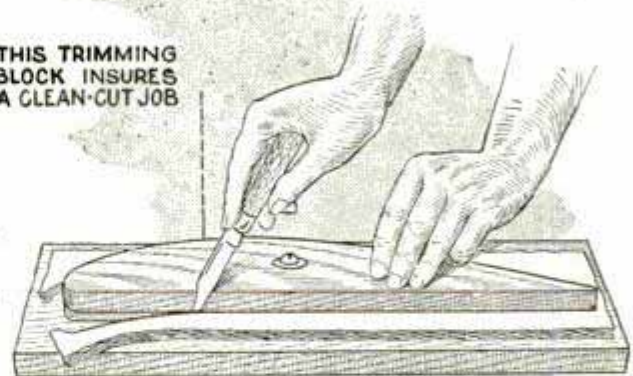
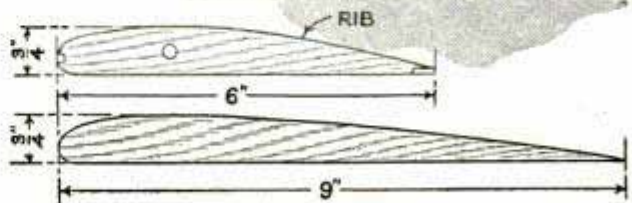

Fig. 2

THIS TRIMMING BLOCK INSURES A CLEAN-CUT JOB



CUTTING THE HONEYCOMB



TRIMMING BLOCK

Fig. 3

comb permits pressing down on the patch. The cellular construction demands careful workmanship, but no more so than the multi-rib design. It is, however, best adapted to the larger models with wings of 5-in. chord by 30-in. span and up.

First of all, bear in mind that this is



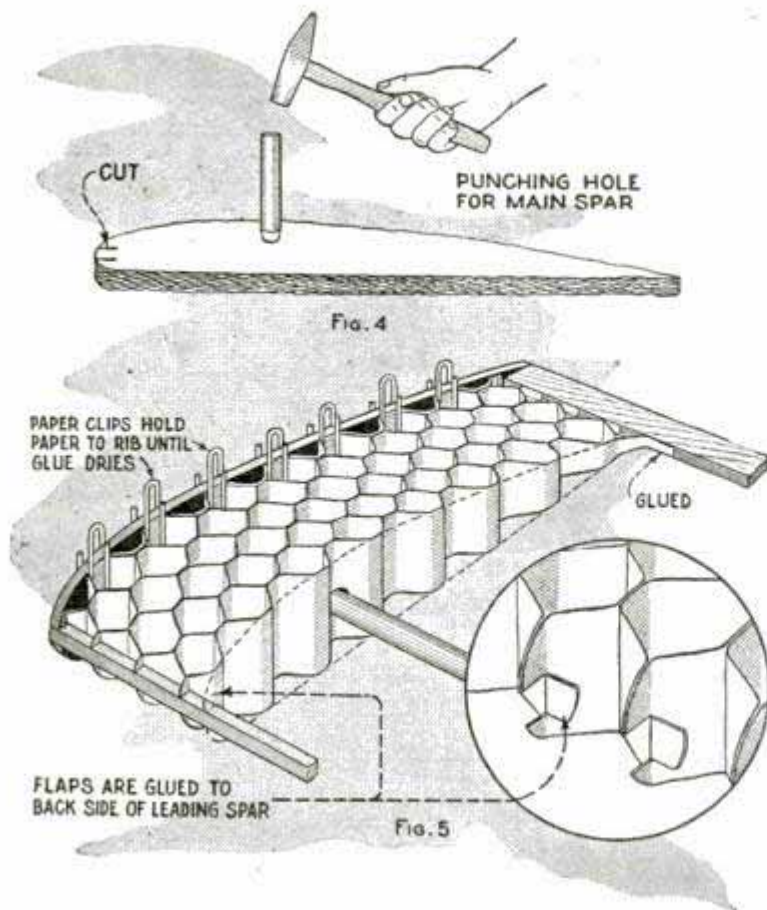

gluing guide, as shown in Fig. 2, either of tin or pasteboard. This insures uniform gluing, though after some practice one can glue better and faster freehand.

Cut out 32 strips of paper, 10 in. long by  $1\frac{1}{2}$  in. wide. This is just enough for one 8-in. section, there being four paper strips per inch of wing length. Cover strip No. 1 with the guide and glue through the slots. Use a small pointed brush, such as a water-color brush, and apply a thin line of glue, just enough to stick securely. Too much glue will squeeze out over a larger area and affect the symmetry of the honeycomb.

Now lay paper strip No. 2 on this, and move your guide along half a space, so that the small notch in the guide will be even with the end of the paper strip, and apply the glue. The idea is to have the glue lines on each successive strip come between those on the sheet below. Press down on the glued portions every three or four strips. When the section of 32 sheets is completed, allow the glue to dry thoroughly.

Trimming the honeycomb is next. This is most easily accomplished by making a trimming block, Fig. 3, which can be screwed down on a flat board. The trim-

ming block has the same shape as the rib, but is  $1\frac{1}{2}$  times its length. For instance, the trimming block for the 6-in. rib should be 9 in. long, but the same depth, and the holes in both should be one-third the distance from the front. Sharpen your knife well.

Make a punch, the size of your main spar, by filing the end of a piece of tubing to a cutting edge. Punch holes in the honeycomb by laying the strips on a heavy block and driving the punch through with a hammer. See Fig. 4.

Having trimmed the honeycomb pad to the elongated rib shape, stretch it out gradually, a little at a time, until it will stay approximately in its final shape. Assemble the spars to the end rib, securing them with glue and pins, cut to about half their length, using the headless ends. Slip the honeycomb over the main

spar and glue one end to the rib, holding it with paper clips, Fig. 5, until dry.

Next fasten another rib, 8 in. from the end. Glue the other end of the honeycomb to this. The front ends of the honeycomb are fitted over the leading spar and the flaps glued to the back of the spar. The rear tapering ends are folded at right angles and glued to the front edge of the rear spar. We repeat, patience will be required to do this well, but the results are worth all the pains you take. The same process is followed with the remaining sections.

With the honeycomb in position, firmly glued and dry, you can put on the fabric. Japanese rice paper is good material and easy to handle, and thin silk even better, if you know how to stretch it tightly. Glue your paper first to the front edge of the leading spar, pull firmly over the top surface and glue on underside of rear spar, as well as to the edges of the ribs, drawing it tight on all sides. Glue the bottom surface to the bottom side of the rear spar. When completed, you will be pleasantly surprised at the smoothness and graceful contour of the wing.

The same construction can be applied to tapering wings, that is, those which

have a narrower chord at the wing tip than at the body, by contorting the honeycomb. This article, however, is not intended to illustrate the best proportions of the wing; that depends entirely on the type of plane you are building. Here we are concerned only with the cellular construction.

### Method of Building Up Broken Parts in Welding

When it is necessary to repair a broken part by oxyacetylene welding at a point where there is a hole or opening in it, as for instance a crank, and some metal around the hole has been lost, it is an easy matter to build it up in the following way: Get a piece of carbon rod that is a little larger than the hole in the broken part and grind it down to fit the hole snugly. Then begin to weld to the broken edges and work toward the center until all the parts meet and are as heavy as the surrounding metal. The welding will not adhere to the carbon and the carbon will not melt. When complete, pull out the carbon, and the repaired part will be found as good and strong as it was before it was broken.—W. C. Loy, Rochester, Ind.

### Substitute for Small Nut

It is often rather difficult to replace a small nut of odd size and thread, but a good substitute can be made from the end of an old film spool (which is easily procured). The end having the hole, not the key slot, is used for this purpose. Cut the spool close to the ferrule and bend the metal flange up, to form a thumbnut as shown. It is an easy matter to turn this nut substitute on the

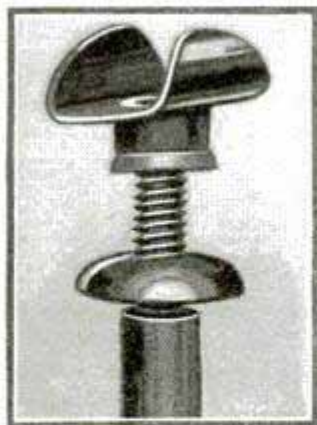

threads of the screw or bolt. The wood catches the thread and it is held from spreading by the crimp of the ferrule. You will find this entirely satisfactory.—F. W. Bentley, Jr., Missouri Valley, Iowa.

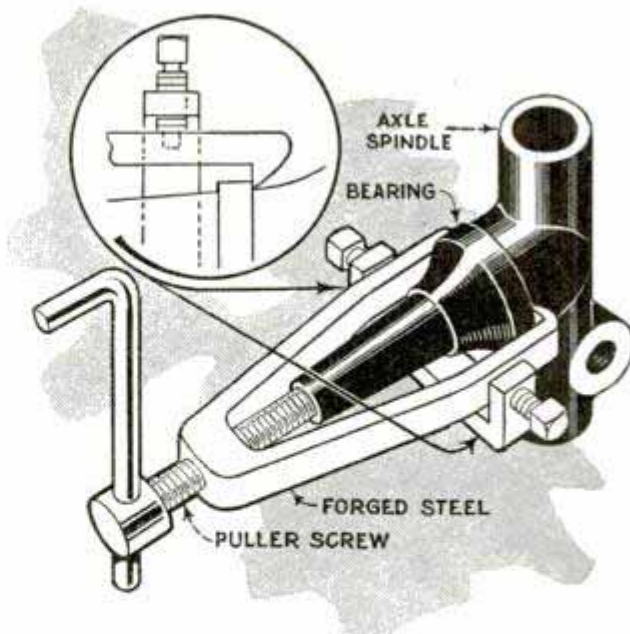

Tool for Pulling Force-Fitted Bearings from Auto-Axle Spindles

### Tool for Removing Bearings from Axle Spindles

Force-fitted bearings on the front-wheel spindles of autos are difficult to remove, and the usual gear pullers are not serviceable for this work, as the bearing rests close to the shoulder of the spindle and only the edge can be gripped by the puller. Where much of this work is done, it will be found worth while to make a special puller like that shown in the illustration. The body is a steel forging having hook jaws to engage the edges of the bearing. A clamp is provided to straddle the jaws of the tool to prevent them from spreading. Setscrews are used to hold the clamp to the jaws, small depressions being drilled in the latter to receive the ends of the setscrews. The body of the tool is drilled and tapped for a puller screw to which a small crank is attached. Turning the crank causes the tool to pull the bearing off with very little effort and without distorting the ball races.—G. A. Luers, Washington, D. C.

#### SHOP NOTES IN BOOK FORM

For the convenience of readers who desire a permanent collection of these notes indexed for quick reference, we publish in book form all the articles that have appeared in these pages during the year. Send 50 cents to our Book Department for latest issue; information regarding earlier issues available gladly sent upon request.

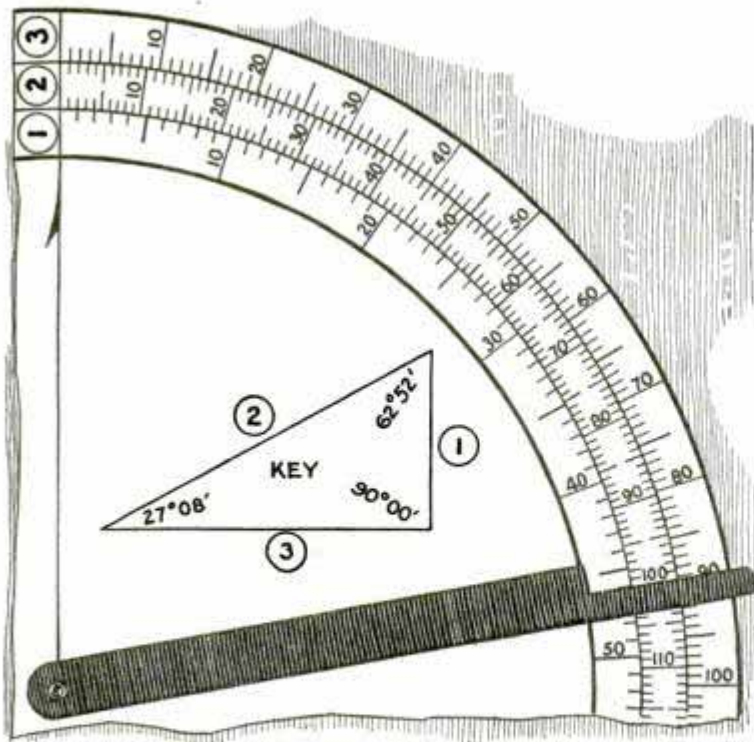

Table for Engineers and Draftsmen Who Have Many Angles to Be Checked on the Same Bearing

### Simple Instrument Aids Draftsmen's Work

Having from 300 to 600 angles to check every three months, I have found the protractor shown in the illustration quite a timesaver. It is laid out on a circle having a radius of 8 in. The arm is pivoted at the exact center of the circle, and checks within .1 to .2 ft. Any person or concern having many distances on the same bearing should find it worth while to construct a table of this kind adjusted to their particular requirements.—D. W. Wetzel, Huntington, W. Va.

### Pails Help Irrigate Orchard

As he did not wish to go to the expense of a cement-pipe overflow system, a California orchardist hit upon the idea of using a dozen ordinary galvanized-iron pails for irrigation purposes. He punched holes in the sides of the pails and soldered on adjustable spouts as shown in the photo. The pails can be set anywhere and at any distance from



Pails Provided with Adjustable Spouts Help Irrigate Orchard

the hydrants by using garden hose. They are removed after the irrigation.—Malcolm J. Rogers, Escondido, Calif.

### Care of Oxyacetylene Tips

Blowpipe tips should always be kept free from dirt and other foreign material, for if this gets into the orifice or other passages, it prevents the free flow of the mixed gases in the right proportions necessary to produce a steady, neutral flame. Tips should therefore be held far enough away from molten metal so that the end of the inner cone just clears it. Smoky acetylene flames blacken the tip, and the carbon thus formed will in time clog the opening. To prevent this, welders should never light their blowpipes with only the acetylene

turned on. A small quantity of oxygen should first be let out and then the acetylene turned on. Many operators file the blowpipe tip down when it becomes ragged and picks up metal from welding, but this practice is not advisable, as it alters the length of the tip and this, in turn, affects the adjustment of the flame. If back fire occurs, which is often caused by the tip touching molten metal, by dirt in the orifice or by a loose head, the blowpipe is likely to be burned and consequently damaged. Therefore, when it does happen, close the oxygen valve immediately and keep it closed a few moments before relighting the tip. Neglect is the chief reason for dirty tips. Never allow them to lie around on the welding table, bench or floor. Keep them in a clean box especially provided for this purpose. As the

tips are usually made of copper or brass, which are much softer metals than steel, extreme care must be taken when cleaning the orifice. Never use a nail, file tang, needle or similar metal tool for this purpose, as this may

enlarge the hole and damage the tip. Only soft copper or brass wire should be used for cleaning and, even with this, care must be taken; the wire should be free from kinks and the end should be blunted so that it will not damage the orifice wall. Pliers, alligator wrenches or other wrenches with rough jaws should never be used to remove the blowpipe tips. Keep a small wrench on hand for this purpose. Occasionally the tips must be adjusted, but do not tighten them while hot, as the threads are likely to be stripped.

### Jig for Layout of Cams

The illustration shows a simple jig which has been found very convenient for laying out cams for Brown & Sharpe automatic screw machines. In principle, it is a trammel with micrometer adjustment. Anyone who is experienced with the B. & S. machines can readily see the advantage of this device. It consists of a horizontal screw,  $\frac{1}{2}$  in. in diameter, having 20 threads to the inch and a dial on the screw, the dial being graduated in .05 in. A keyway is cut on each side of the screw, and pins are set in the frame holding both screw and dial, the pins running in the keyways to prevent the screw from turning. An adjustable scriber point is attached to the other end of the screw, while an adjustable trammel point is fitted to the dial frame. The first layout marks, of course, are made

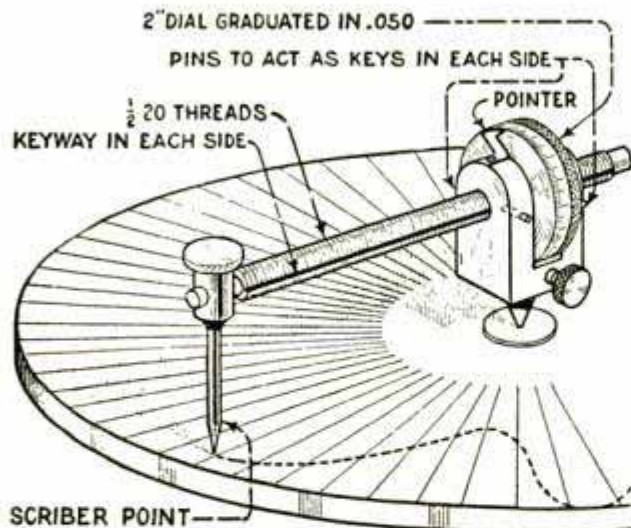

Any Machinist Can Make This Jig Which Facilitates Laying Out Cams

on the radial lines, the cam contour being afterward scribed as indicated by the dotted line in the drawing.

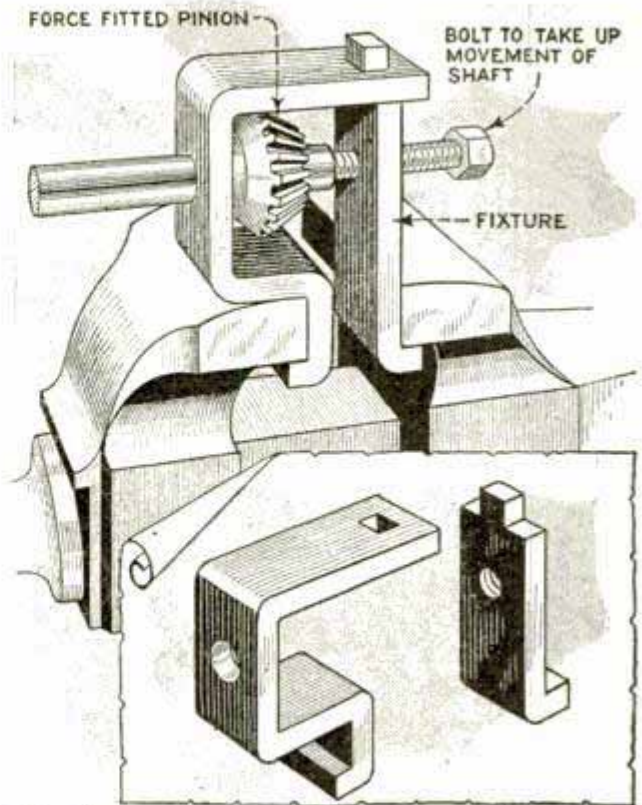

Vise Fixture for Removing Force-Fitted Pinions from Shafts

### Fixture for Removing Pinions from Shafts

Force-fitted pinions, such as those on automobile driveshafts, should never be removed with a hammer, as the driving swells the end of the shaft and makes the final removal difficult if not impossible without filing down the shaft. A special fixture for doing the work without damaging the shaft is shown in the illustration. It consists of two forged steel parts, made to the shape shown. The smaller part is tapped to receive a bolt. The shaft is slipped through a hole in the other part, and after the two are hooked together, the bolt is driven up against the end of the shaft. By compressing the vise in which the fixture is set, the pinion can be forced off the shaft.

### Reaming Brass and Bronze Bushings

Under no conditions should one attempt to ream a brass or bronze bushing with a reamer used on iron and steel. The cutting edges of the brass and bronze reamers must be specially ground, and the manufacturers will do this at a slight, if any, extra cost. It is false economy to use one reamer for different classes of work.—R. L. Simons, St. Paul, Minn.

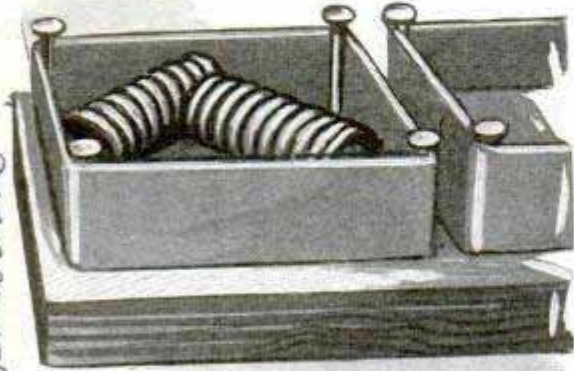

These Containers Are Made from Sections of Inner Tube Stretched over Four Nails

**Small Containers Improvised from Rubber Bands**

When one needs several trays or boxes to hold small parts temporarily, while working on a machine, the improvised containers shown, which are made from rubber bands, will be found useful. Simply drive four nails into a piece of 1/2 or 3/4-in. wood and stretch a 1-in. section of inner tube around them. The nails must, of course, be spaced apart to suit the size of inner tube to be used. Several containers of this kind can be mounted on a piece of wood about a foot long.

**Preserving Fence Posts**

While visiting on a farm, I witnessed a very effective method of preserving wooden fence posts. The ends of the posts, which were to be put into the ground, were soaked in lime water. Next they were dried and painted with diluted sulphuric acid. The posts became as hard as stone. My farmer friend showed me some fence posts that

*The ends of the posts as far as they extend underground should be immersed in the solution*

had been in the ground for 25 years. Apparently their condition was as good as the day that they had first been put in. Only thoroughly dry posts should be treated in this way.—Vernon V. Johnson, Spokane, Wash.

*Vernon V. Johnson*

**Alining Auto Wheels**

Thousands of cars are losing from 5 to 20 per cent of their efficiency because the front wheels are not in alinement, and this condition also causes excessive wear on the tires. Trouble also is experienced from too much "camber," a term which indicates that the front wheels are leaning out at the top. This has the effect of reducing the strain on the "stub," or steering, axles in a vertical direction, and in the direction of thrust. When the axles are cambered in this way, they would, if unrestricted, run in circles. With the usual 3 to 5° of camber, the circles would be large, but circles none the less. You can picture the circle if you imagine the axle continued down to the ground in a case of excessive camber. If you care to make a simple experiment, you can demonstrate this readily. Stick a long axle through a wheel, and try to roll it along on a straight line while leaning it over to one side. You will find that you can only do this by dragging it sideways unless you set the axle at an angle to the line you wish to roll it, which is not the 90° angle of a vertical wheel. This experi-

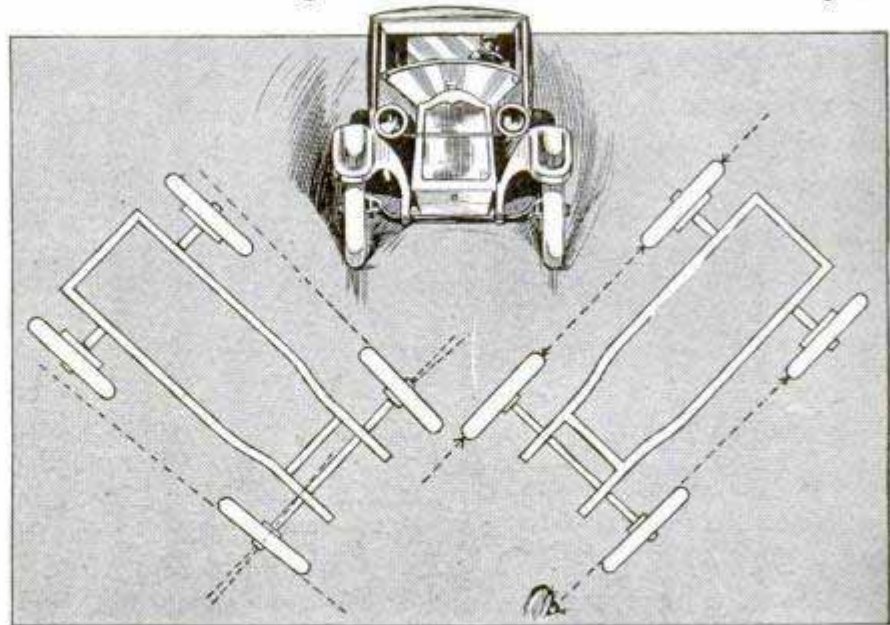

If the Front Wheels of Your Car Are Not "Toed In" Properly, Loss of Power and Excessive Tire Wear Will Result



ment shows that as the wheels are cambered in opposite directions, the angles of the wheels will also be opposite, and the result will be that they will be "toed in." Although this condition is necessary, you cannot be generous by giving more, to get better results. That would be as bad an error as too little. Wheels should be toed in not more than  $\frac{3}{8}$  in. each for best results. In a test, an electric car would make 82 miles on a freshly charged battery, the result being accurately checked on meters, while a maximum of only 62 miles could be obtained if the front wheels were set perfectly parallel instead of toeing them in. If you suspect a wobble in a wheel, jack it up and spin it around, using a piece of chalk to mark the high spots. The detail at the left side of the drawing shows the front wheels toed in about three times the normal distance. The left side of the right-hand detail shows the front wheel lined up true with the rear wheel, and the right side the correct angle of toeing in the front wheel, the dotted line passing along the inside edge of the front wheel and ending at the center point of the rear wheel. Sighting along the wheels can be resorted to if a straightedge is not available.—R. W. Youngash, Vancouver, Can.

#### Gauging Size of Ball without Tools

The writer wanted several extra balls for use in an oil-feeding device. He had no tools to take the measurements, and the feed could be stopped for only a few minutes at a time. A wad of tinfoil was made and the ball firmly pressed into it as shown. Stock balls of various sizes were dropped into the depression thus formed until the correct size was found.—Frank W. Bentley, Jr., Missouri Valley, Iowa.

☞ To keep tools from rusting, apply a hot solution of benzine, 10 oz., and white wax, 5 oz., with a brush.

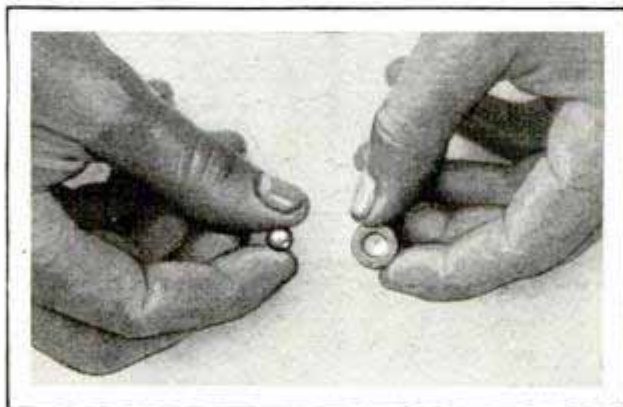

Taking an Impression of a Steel Ball in a Wad of Tinfoil

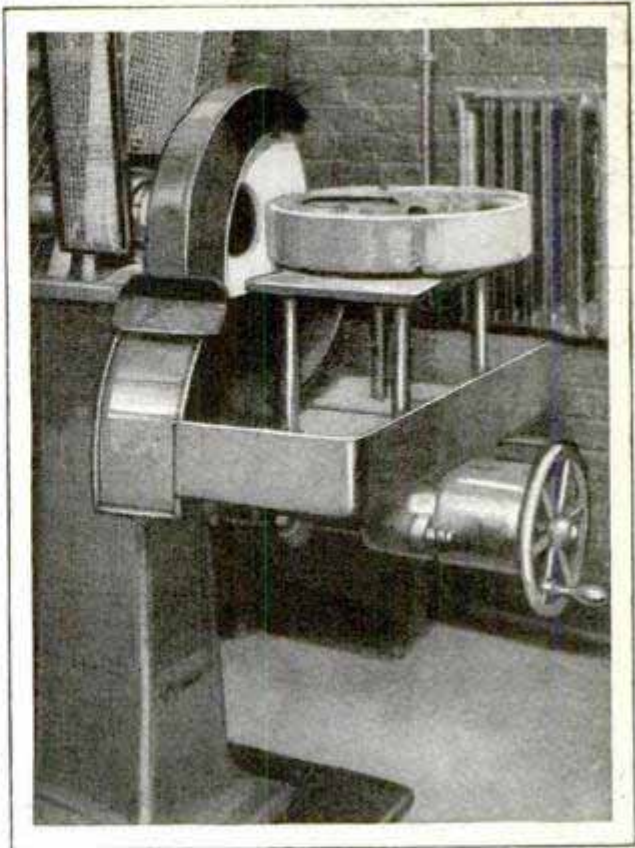

Jig Used in Brake-Service Station for Surfacing New Brake Lining

#### Surfacing New Brake Lining

Although new brake lining may be perfectly smooth before it is applied to the brake bands, the drilling and countersinking of the holes and the subsequent riveting cause the surface to become uneven, and this entails some trouble in getting the brakes properly adjusted. The uneven places soon wear down and it is then necessary to readjust the brakes. In one shop the linings were surfaced before the bands were installed by using a simple jig in conjunction with the grinder, as shown in the photo. The band, with the lining attached, is pivoted on a pin on top of a small table, set on a special mounting which can be moved toward and away from the emery disk. It is adjusted so that the wheel just takes off the high spots when the band is rotated against it.—A. E. Granville, La Grange, Ill.

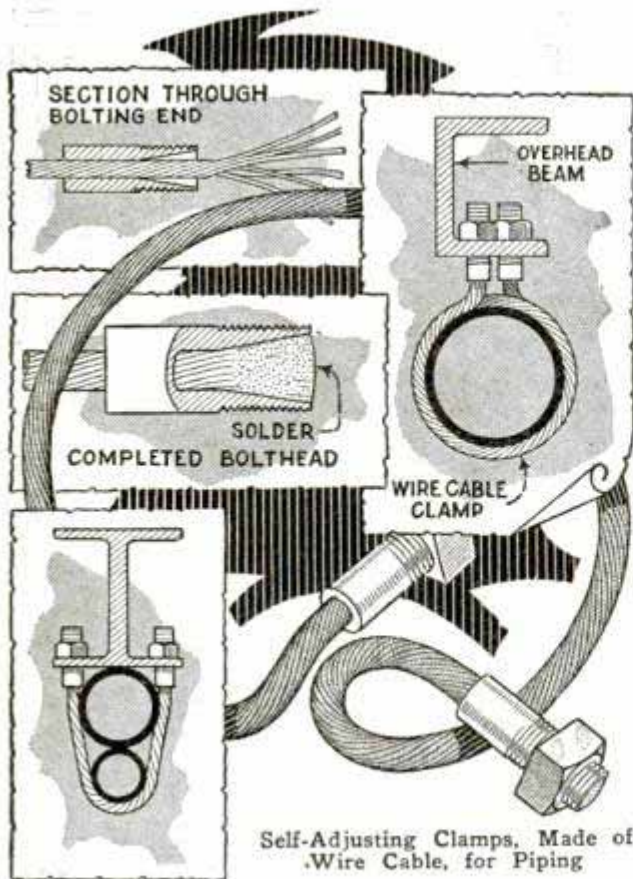

### Clamps Made of Wire Cable

Clamps of the U-type, used for fastening overhead piping, are more or less inflexible and require special fitting, which often necessitates forge work. In cases where a solid U-clamp is used over several pipes, or where the piping is run diagonally to the support, there is considerable work and time lost in making the clamp conform to the irregular shape of the piping. A clamp that saves time and adapts itself to the shape of the piping, can be made up of steel cable, as shown in the drawing. Cold-rolled-steel thimbles are drilled and threaded for the cable, which is cut to length and is fixed in the conical ends of these thimbles with lead. To do this, the cable is drawn through, the ends are bent slightly to separate the strands, whereupon the cable is pulled back flush with the

thimble and molten lead is poured in. The details show how a clamp of this kind is used.—G. A. Luers, Washington, D. C.

### Carrying Ladders on an Auto

If you have occasion to carry a ladder or a long pole on your pleasure car, a good method is to hang the ladder or pole underneath it. It is entirely out of the way and there is no risk of marring the finish. A painter who uses his sedan for his work carries his ladders in this way and has provided special wire hooks on the front and rear axles so that the ladders can be put on and taken off quickly.—Glen F. Stillwell, Canton, Ill.

### Depth-Indicating Thread Gauge

A thread gauge that not only gauges the thread but also indicates the depth of a tapped hole is a timesaving tool for many kinds of work. A hole may be drilled much deeper than necessary, but if the tap is not run in far enough it is useless. It is difficult to measure the depth of tapped holes of medium size in the ordinary way, and a gauge of this kind will be found handy. To make one, the thread and gauge body are of equal length and a knurled sleeve is made a sliding fit. The body is drilled from the back to take the measuring rod, which has a pin driven through it that slides up and down in a slot in the body and is a tight fit in the sleeve. When all parts are assembled, the end of the sleeve and the thread are flush, and the end of the measuring

rod is flush with the body at the other end. Thus, when the thread gauge is turned into a piece, the sleeve is pressed back and the rod protrudes the same distance, so that the depth that the gauge has entered can be measured on the rod. When the gauge is not in use, the sleeve is pushed forward to protect the threads.

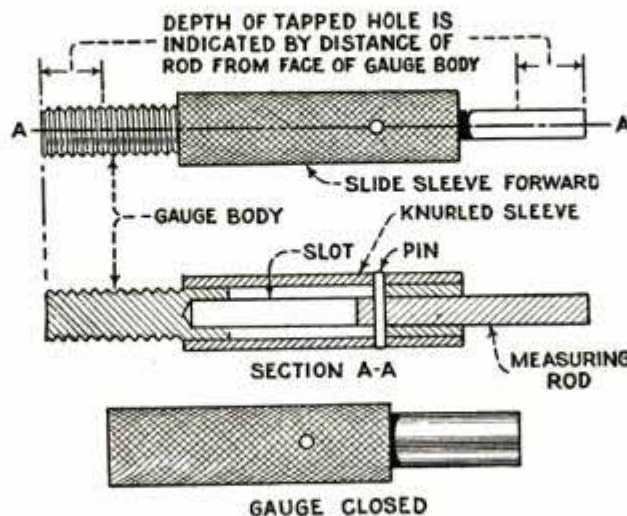

Thread Gauge That Indicates Depth of Tapped Hole Besides Gauging the Thread

# Power Hacksaw *for* Small Shops

by Paul Leo

SOME years ago, the writer, who has a small experimental workshop, but did not then possess a power hacksaw, had to find some means of rapidly and economically cutting a large number of heavy steel bars and structural shapes. Immediate delivery could not be obtained on a commercial machine, so the outfit described here was made of scrap material on hand, and cold-rolled stock, etc.

Although built in haste, its performance and durability have far exceeded the most sanguine hopes of the designer. The saw has been in use for over eight years, and continues to render

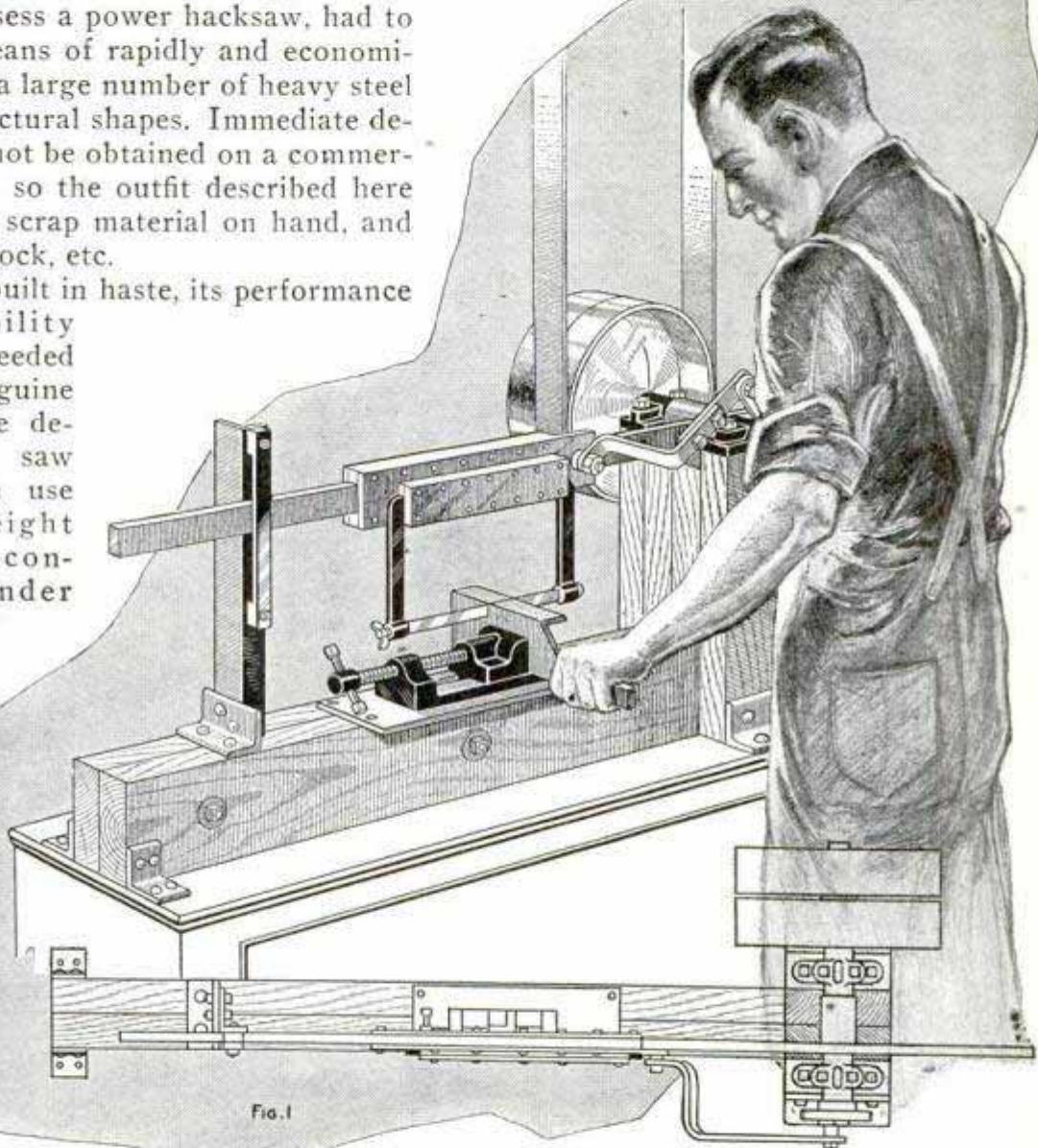

most satisfactory service, never having cost a cent for repairs.

Fig. 1 shows a perspective view and plan of the machine. The bed or frame shown, which is detailed in Fig. 7, is made of straight, seasoned spruce, dressed to 2 by 6 in., the bed proper being made of two 4-ft. lengths. The uprights at the rear are of the same stock, the outside pieces being  $16\frac{3}{8}$  in. long and the filling pieces 9 in. In cutting, it is desirable to use a miter

box, to insure squareness. It is also advisable to clamp the pieces together solidly before drilling for the bolts. When drilling the holes in the bottom of the uprights, it is better to locate them from the holes drilled in the angle-iron feet (Fig. 4), which are 6 in. long.

The bearings for the 1-in. shaft are known as common flat babbitted boxes, and may be obtained from any dealer in mill supplies for about 70 cents apiece.

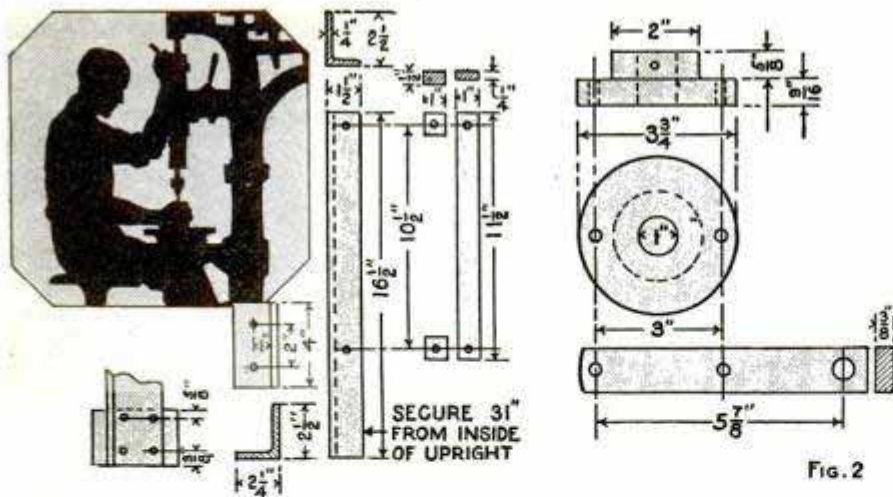

FIG. 2

move the hub and drill and tap for  $\frac{1}{4}$ -in. by 20 flat-head screws. Countersink the holes in the slide bar, and assemble with 1-in. screws. Try the shaft in place and make it run free. Drill an oil hole in the hub.

Now fit the shaft through the boxes and hub, making sure that the inner faces of the boxes

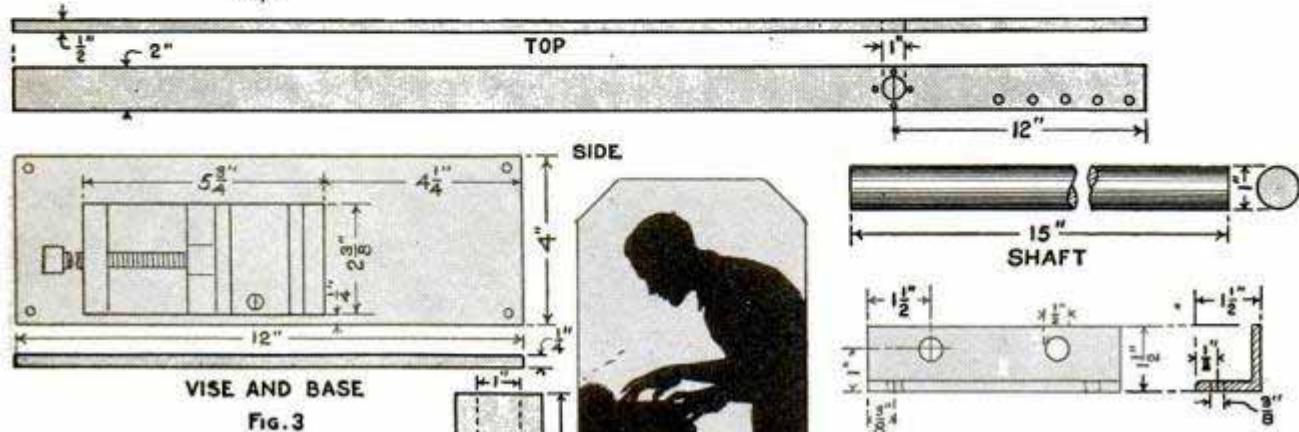

FIG. 3

They are held down to the tops of the uprights by four  $\frac{5}{16}$ -in. lagscrews, 3 in. long. When installing, bolt the caps firmly down over the shaft, and see that there is no play between shaft and bearing.

Before installing, however, the slide-bar assembly, with its hub, must be made. Fig. 3 details the slide bar, shown in perspective in Fig. 1. It is a piece of  $\frac{1}{2}$ -in. cold-rolled steel, 54 in. long. The five holes at the right are  $\frac{1}{2}$  in. in diameter,  $1\frac{1}{2}$  in. center to center, starting  $\frac{3}{4}$  in. from the right end of the bar. The 1-in. hole is 12 in. from the end, and around it are four  $\frac{1}{4}$ -in. holes,  $90^\circ$  apart, drilled on a radius of  $\frac{3}{4}$  in. from the center of the 1-in. hole. Remove all burrs. The hub, Fig. 5, is cast iron or bronze, 2 in. in diameter by 3 in. long, with a 1-in. hole to fit the shaft. Clamp it to the slide bar, with the shaft through the holes, mark off the four holes, place witness marks on hub and bar, re-

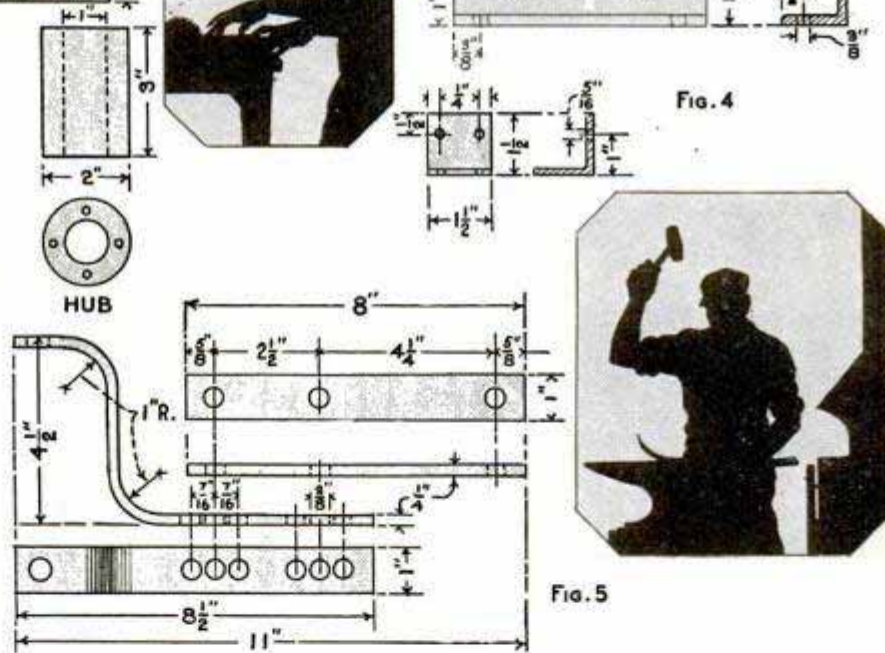

FIG. 4

FIG. 5

are close to the hub, and bolt the boxes to the tops of the uprights. Care must be taken to keep the slide bar parallel to the bed of the machine. Bed down the shaft in the bearings by spotting with Prussian blue and scraping to fit.

The crank, Fig. 2, is made from a cast-iron faceplate casting, sometimes called a chuck flange and obtainable from mill-supply houses. Drill and ream for the 1-in. shaft, face the flange and turn the outer edge down to size. Two  $\frac{5}{16}$ -in.

holes are drilled as shown and tapped  $\frac{3}{8}$  in., U. S. S. thread, for the  $\frac{3}{8}$ -in. cap-screws that hold the crank arm shown below the flange. Drill and tap the flange hub for a  $\frac{5}{16}$ -in. setscrew. The crank arm is a straight piece of  $\frac{3}{8}$  by 1-in. cold-rolled stock,  $6\frac{5}{8}$  in. long. Drill for the cap-screw as shown, and drill a  $\frac{1}{2}$ -in. hole for the crankpin. The latter is detailed in Fig. 6.

The vertical guide for the slide bar is detailed at the left in Fig. 2, and consists principally of structural shapes. The construction is quite clear from Figs. 1 and 2, but be sure that the spacers are so set in as to allow the slide bar an easy fit. The guide is secured to the bed with  $\frac{3}{8}$ -in. lagscrews, and care must be exercised to keep the vertical member square with the foot, and also that the slide bar is maintained parallel to the bed.

The slide box, Fig. 8, which includes the clamp for the saw frame, is built up of  $\frac{1}{4}$  by 3-in. cold-rolled stock, held together with  $\frac{3}{16}$ -in. stove bolts. The spacers, forming the top and bottom, are of  $\frac{1}{2}$  by  $\frac{5}{8}$ -in. stock,  $15\frac{1}{2}$  in. long. Select cold-rolled stock as straight and true as possible, and remove all burrs. Fit the assembly carefully to the slide bar, making witness marks on all pieces, and make sure that it slides freely on the bar, but without play. The small box that is the clamp for the saw frame is formed in a similar manner to the main slide box. The saw frame used by the writer is a Starrett No. 148,

with the handle removed. This takes work,  $7\frac{1}{4}$  in. deep from teeth to inside of frame, and uses 12-in. blades. The frame stock is  $\frac{1}{4}$  by 1 in., and is very rigid. See that the top plate on the saw box clamps the saw frame firmly in place. The forward end of the connecting rod pivots on a steel bushing and screw, shown in Fig. 6. The screw is driven from the back into a countersunk hole drilled for it in the slide box, at the right, and a nut run down tight on it. When the connecting rod is assembled, the bushing is slipped on, then the rod, and last another nut to hold the rod in place.

The connecting rod is made in two pieces, as shown in Fig. 5. The bend in the offset piece is made  $5\frac{1}{8}$  in. from the end. The two sets of three holes each seen in the offset part are drilled to correspond to the two bolt holes in the straight bar, and allow some adjustment in the position of the saw frame in relation to the work.

The vise used is a Yankee No. 990 drill vise, costs about \$3.30, and is fastened to a  $\frac{1}{4}$ -in. steel plate as shown, the plate be-

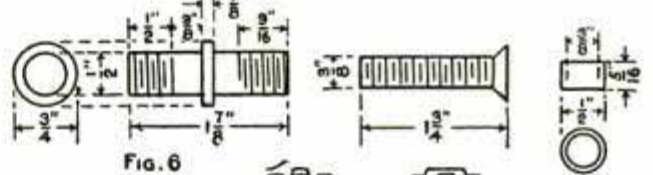

FIG. 6

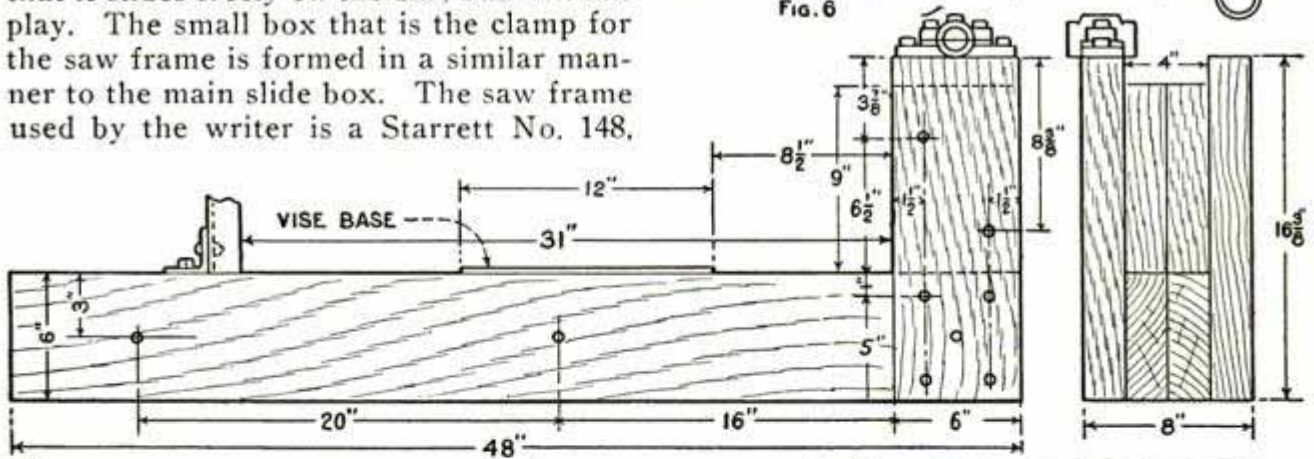

FIG. 7

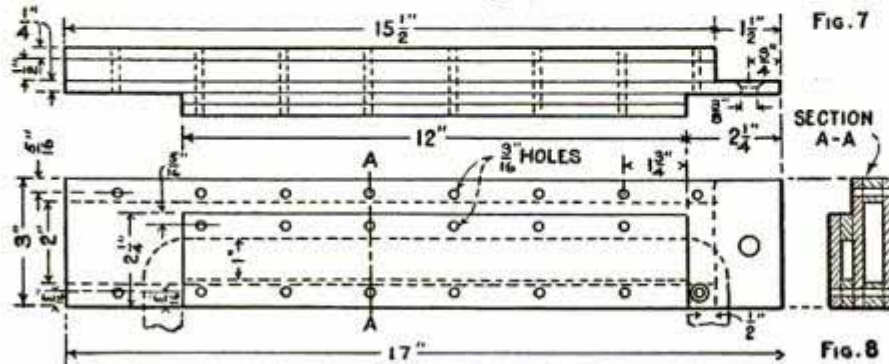

FIG. 8



ing screwed to the machine bed. Leave  $\frac{1}{4}$  in. between the edge of the vise jaws and the saw blade.

Four 10-lb. sash weights may be hung with S-hooks to the  $\frac{1}{2}$ -in. holes drilled in the rear of the slide bar. The number and position of these weights govern the bite of the saw, more bite being needed for brass and soft material, for wide stock and also when the blade is dull. Less bite

is needed when the stock is narrow and also when the blade is sharp. Work should always be gripped in the vise so as to present the widest possible surface to the teeth of the saw. Light pressure should be used on new sharp blades.

A tight and loose pulley complete the machine. Belt the machine so as to produce a speed of not more than 50 strokes per minute.

### Increasing the Lift of a Hand Suction Pump

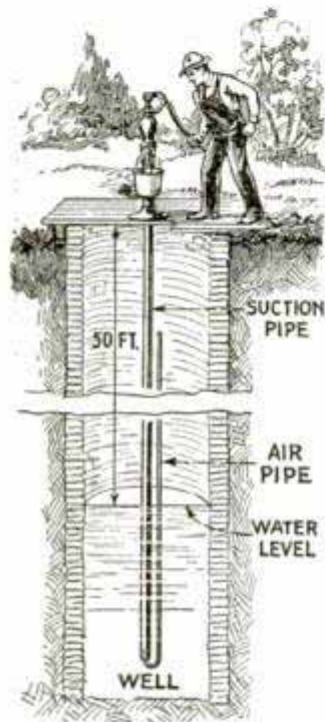

Theoretically 34 ft. is the maximum lift of an ordinary house or farm hand-suction pump. The illustration shows how the lift can be increased from 15 to 20 ft. without using an air-lift pump, although the principle of the latter is used. A small pipe, having an internal diameter of  $\frac{1}{4}$  or  $\frac{3}{8}$  in., is fastened to the suction pipe, one end of the pipe being allowed

to project above the water level in the well, and the other end bent upward to project into the suction pipe as indicated. When the pump is worked rapidly, some air is drawn down the small pipe into the suction pipe, the column rising in the suction pipe being a mixture of air and water the density of which is less than that of water. To operate successfully, it is necessary that the speed of the pump plunger shall be greater than the speed of ascension of the air bubbles.

### A Protection for the Acid Bottle

The bottle used as a container for nitric acid, that is kept in a shop for etching steel, is subject to being struck with some piece of metal and broken. As this is a dangerous acid when not confined, it is

well to be careful and use all caution possible in handling the liquid. A good safeguard is to glue a cardboard disk to the bottom of the bottle, then coat the outside surface with glue, and, when it becomes tacky, roll it in small particles of cork. The cork may be obtained from a dealer in imported grapes. When the glue hardens to hold the cork, it makes a very satisfactory guard against breakage.

### Remedy for Engine Leakage and Clutch Troubles

Many cases of engine oil leakage and clutch troubles can be avoided by using a manifold attachment to the breather pipe, as shown in the illustration. A length of copper tubing with two screw connections is used for the purpose. The breather-pipe opening should be tightly closed, using a felt or leather washer under the cap. When the motor is in operation, the oily vapor that usually comes out of the breather pipe is drawn into the

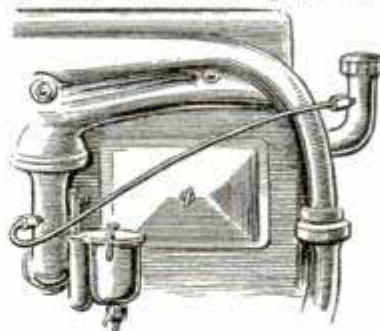

motor and is burned along with the other fuel. The gasoline, that gets into the oil, vaporizes readily and is quickly drawn off, preventing oil dilution. In one case, this attachment remedied oil leakage at the ends of the crankshaft, the oil finding its way into the clutch and causing slipping. Besides, the deposit of oil vapor on the motor is entirely eliminated.—G. A. Luers, Washington, D. C.



# Does Insulation Pay

Copyright, Popular Mechanics

Plan 4-W-3

**D**OES insulation keep heat in and cold out? Are insulated houses warmer in winter and cooler in summer? Does insulation save on fuel? What are the facts?

Recent figures by the national lumber manufacturers association show the average house without special insulation and weather stripping loses twenty-five to thirty-five per cent heat through attic roof and ceiling; from twenty-five to thirty-five per cent through side walls, and from thirty to forty per cent around windows and door openings.

Figuring the lowest of these percentages you will see that as high as eighty per cent heat loss may occur in a house not insulated and not weather-stripped.

The United States

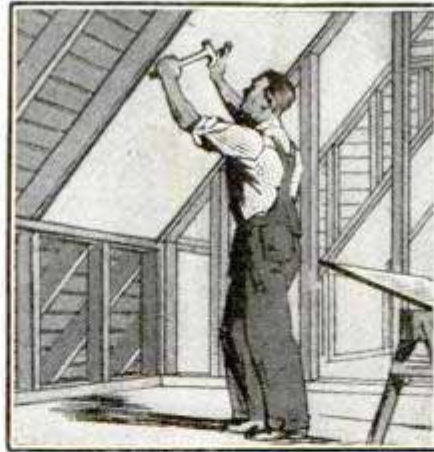

### A SPECIAL OFFER

To help our readers get started on one of life's most glorious experiences—building and owning a home—Popular Mechanics Magazine will supply readers a one-sheet blueprint of this plan for \$1 (regular price \$2), if ordered before June 1. This blueprint does away with the necessity of first purchasing a complete set of plans to find out whether you can afford to build. It contains floor plans, elevations, a section detail, size of joists, studs, etc., and also a brief specification. Submit it to tradesmen and dealers for building estimates.



bureau of standards states that a one-inch insulation on side walls and roof and weather stripping applied to windows and doors may prevent as high as fifty per cent heat loss.

What do these tests mean to home builders? Just this: Dollars saved on fuel and increased comfort and health for the family.

Let us be specific and apply insula-

tion to the little house above. This is what may be called the average house. Under normal conditions it builds for something less than \$4,000. That price is the average for houses throughout the United States.

There are plenty of standard insulating materials for side walls and roof that would not cost more than \$100, possibly less, for this house. Suppose they reduce heat loss from twenty-five to forty per cent? To be on the safe side, let us say twenty per cent.

If it costs \$100 a year to heat this house without insulation and \$80 a year with insulation, you make a \$20 saving on fuel. This is profit that insulation earns you. It is a twenty-per-cent dividend on your \$100 insulation investment. There are mighty few gold securities that yield twenty per cent interest rate. In five years' time the insulation pays for itself. After that it goes on earning. There are other profit-making arguments for insulation, such as reduction in size of heating plant, decreased radiation, etc.

What about old houses? Can they be insulated? To a large extent, yes. Statistics show about forty-per-cent heat loss through the roof of an old house. Practically all forms of insulation can be applied to roof rafters or above the second-floor joists. You can do this work yourself. It is an easy way to save part of every dollar you spend for fuel. The time to insulate is now, when summer is at hand and new construction is going on. Remember there's no guesswork about insulation. You can put your finger on the savings.

The little house in this issue is easy to build, easy to live in and easy to pay for. Perhaps you can do some of the work yourself. It is not so large but what a handy man with an experienced carpenter could make a considerable savings in labor.

While one bedroom is shown down-

stairs, there is space for sleeping quarters on the second floor. Perhaps the sun porch may be used as a sleeping porch. The "dinette" is large enough for a small family. If you need more space for dining purposes, use one end of the living room.

You may not care to finish the second floor now. This would save money. On the whole, here is a compact yet roomy small house where every foot of space is used to excellent advantage. The construction is frame, fully insulated; wide-siding exterior; full basement; shingle roof, and the style is Colonial. It will cost \$4,000 in round numbers under normal conditions. If you can do some work

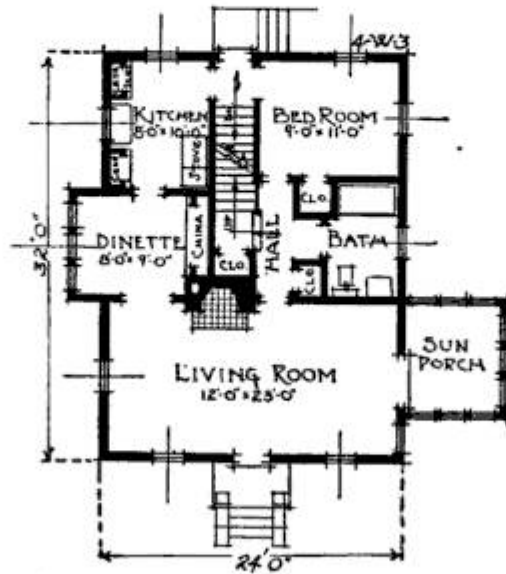

yourself, you may bring the cost down to considerably less.

Remember this about the cost to build: Costs vary, depending on where you live and the materials you select. Luxurious equipment costs more than simple equipment. For example, there are several grades of hardwood flooring. The lower grades cost less and, when finished or stained, they not only look well but wear well. Carry this principle through in your house and you will save many dollars.

To help you in getting costs, Popular Mechanics Magazine offers you an inexpensive blueprint service announced on the previous page. Use it. It saves you time and money.

#### PLAN BOOKS FOR READERS

**A NEW BUNGALOW BOOK.** Just off the press. Sixteen selected low-cost bungalows in popular styles. Latest space, labor and money-saving ideas. Bungalows actually lived in. \$5,000 and less. Some as low as \$2,000. Book is beautifully illustrated and each house fully described. Send 10 cents in stamps to cover postage. Address Building Editor.

**TWENTY POPULAR LOW-COST HOMES** and Ten Commandments for Home Builders and Home Buyers. Selected houses showing variety of types, styles, materials and sizes. All planned to fit average pocketbook. Some as low as \$2,000. Send 10 cents in stamps to cover postage. Address Building Editor.



# Have you pride in ownership of fine tools?

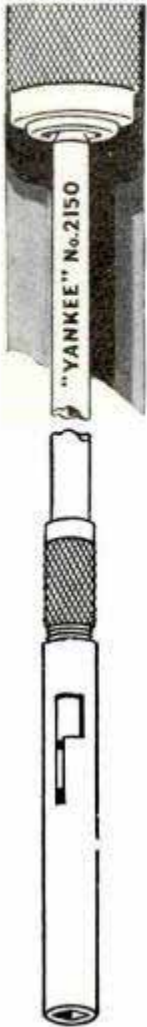

"Yankee" Chuck will not loosen. Patented quick centering. Ball bearing. Any bit, round, square, any taper, held accurately.

"YANKEE" toolmakers served their apprenticeship long before the art of cheapening was known.

Their standard — now, and always — is the utmost quality and efficiency that can be built into a tool; the utmost saving of time and labor for the user of "Yankee" Tool!

The "Yankee" Brace is unlike any other brace. Its position in tooldom is like that of a fine car in the auto industry. Its appeal is to those who take pride in ownership of finer things . . . appreciate precision and finish in tool-making . . . understand the long-run economy of paying a little more for quality and efficiency.

It is being bought on sight by men who thought they did not need another bit brace. And by men making sure they will never have to buy another.

No. 2100. Four sizes: 8-, 10-, 12- and 14-inch. Price, with 10-inch sweep, \$8.20.

This "Yankee" Bit Extension holds bit in socket. No jaws to break or jam. Bit can't loosen in work; can't pull out of socket. Fits any brace. Followsthrough.

"Yankee" Bit Extension No. 2150 15", 18", 21", 24", \$2.25 to \$2.40.

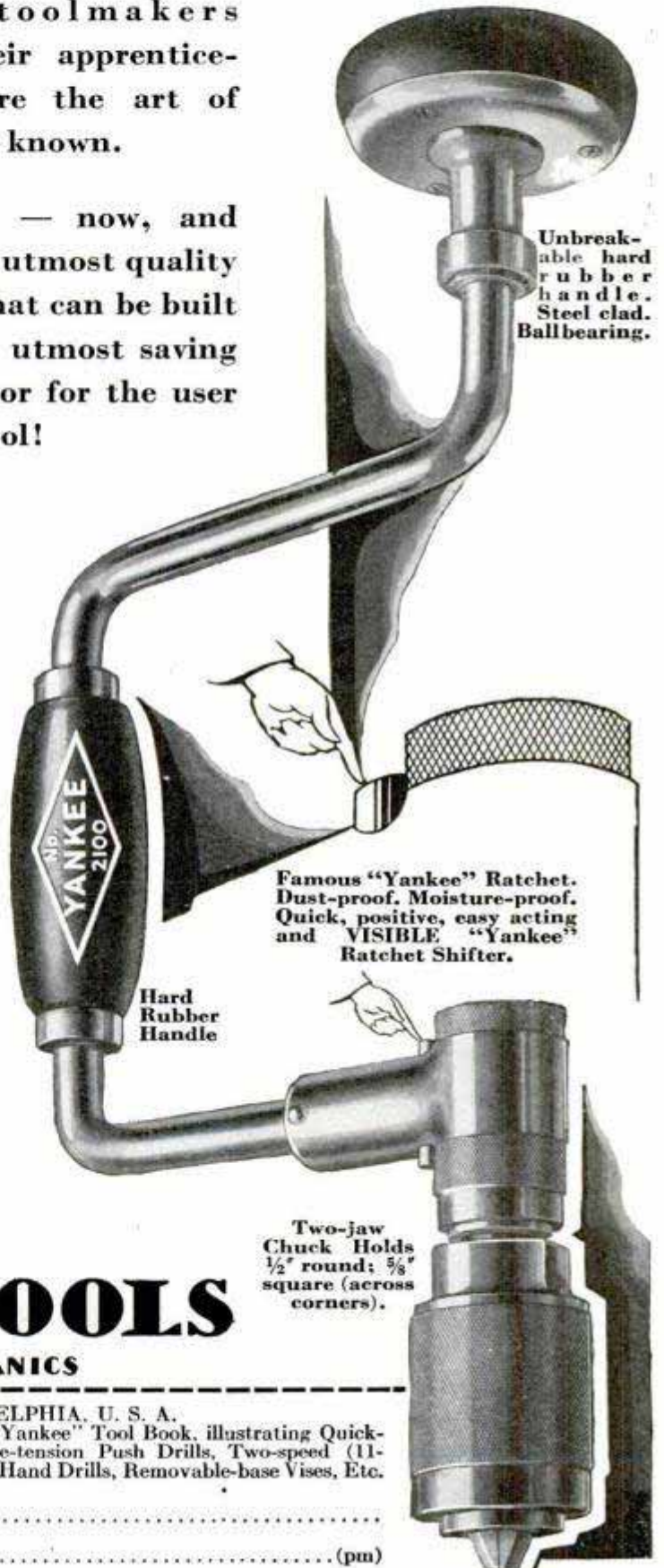

Unbreakable hard rubber handle. Steel clad. Ballbearing.

Famous "Yankee" Ratchet. Dust-proof. Moisture-proof. Quick, positive, easy acting and VISIBLE "Yankee" Ratchet Shifter.

Hard Rubber Handle

Two-jaw Chuck Holds 1/2" round; 5/8" square (across corners).

## "YANKEE" TOOLS

MAKE BETTER MECHANICS

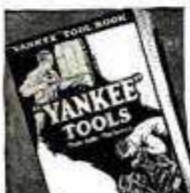

NORTH BROS. MFG. CO., PHILADELPHIA, U. S. A.  
Yes; I like to own fine tools. Send me "Yankee" Tool Book, illustrating Quick-return Spiral Screw-drivers, Adjustable-tension Push Drills, Two-speed (11-inch) Hand Drills, Ratchet Breast and Hand Drills, Removable-base Vises, Etc.

Name .....

Address .....

(pm)



# 2¢ to insure used car satisfaction

**B**Y investing 2¢ in this free book, "How to judge a used car," you *make sure* of getting the most for your money in a good used car.

Here is trade information on used car buying gleaned from experts who have spent years in gaining their knowledge. Some of this information is made public for the first time in "How to judge a used car." There are 32 pages of text, abounding in money-saving pointers on used car buying. Pictures illustrating many of these points make clear just what to look for in the used car you buy.

Can you tell anything from speedometer readings? Do you know what code prices mean? Can you tell the model year of a used car? How would you set a fair price on a used car offered by a friend? How do you avoid "orphans"? Get the answers to all these questions—and many more by sending the coupon below for your copy of "How to judge a used car."

**Pay 2¢ for insurance  
against \$200  
mistakes!**

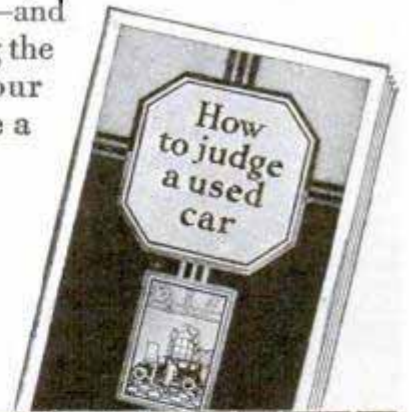

## Pledge to the Public on Used Car Sales

- 1** Every used car is conspicuously marked with its lowest price in plain figures, and that price, just as the price of our new cars, is rigidly maintained.
- 2** All Studebaker automobiles which are sold as CERTIFIED CARS have been properly reconditioned, and carry a 30-day guarantee for replacement of defective parts and free service on adjustments.
- 3** Every purchaser of a used car may drive it for five days, and then, if not satisfied for any reason, turn it back and apply the money paid as a credit on the purchase of any other car in stock—new or used. (It is assumed that the car has not been damaged in the meantime.)

© 1928 The Studebaker Corporation of America

THE STUDEBAKER CORPORATION OF AMERICA  
Dept. 156, South Bend, Indiana

Please send me copy of "How to Judge a Used Car"

Name .....

Street .....

City..... State.....

# STUDEBAKER

Builder of Champions

# How to Use a Circular Saw

*Told by the World's Foremost Saw Makers*

**Y**OU know Disston as the maker of the great saws used in the lumber industry. And Disston also makes circular saws and band saws for you: for every type of portable rig and bench outfit. Small circular saws of the same quality as the 110-inch saws (largest in the world) made by Disston for cutting giant logs of the West Coast.

Small band saws of the same quality as the great Disston Band Saws famous among lumbermen for their hardness, toughness and temper. Saws made possible only by Disston Steel, from Disston's own steel furnaces. Ask for "Disston"! Hand Saws, of course; but also Disston Circular Saws, Band Saws, Tools and Files.



**Files for the Wood Worker**

Disston Cabinet Files (fine teeth) for smoothing and finishing wood surfaces. Disston Wood Rasps (coarse teeth) for rough and fast cutting, enlarging holes, etc. Half-round 8" Cabinet File, 65c. Flat 8" Wood Rasp, 50c.

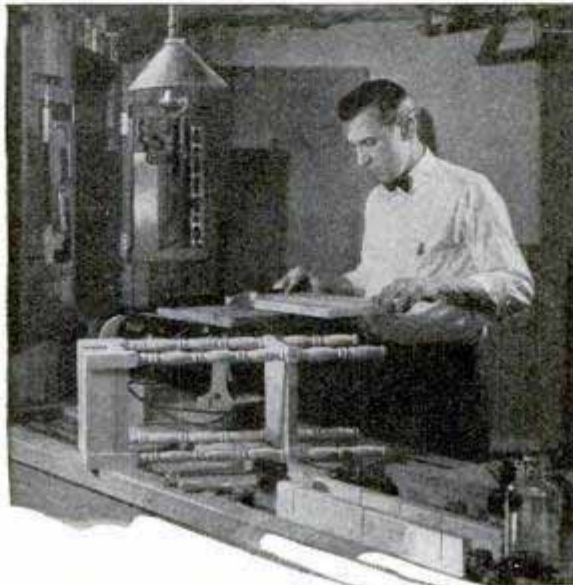

**MA**KE sure arbor hole in saw fits mandrel snugly and that collar and nut are tight, to prevent saw wobbling in the cut or turning on the shaft.

Before starting, see that saw has ample clearance at sides and ends of table slot. Test by turning by hand. If table can be moved up and down, set it so cut will come as near center of saw as possible. This gives best cutting angle on saws up to 8", and lessens tendency of material to "ride" over the top of the saw.

Get enough speed. Have belt tight. Don't adjust table when saw is running.

Stand to *left*, not back of, board to be cut. Hold down work with left hand, just ahead of right. Push work through with right hand. When gauge is close to saw, use a "push stick," notched on the end. Do not "crowd" the saw: if it binds, ease up on the feed.

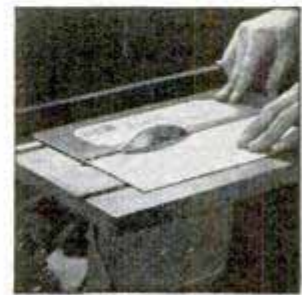

**For Cutting Soft Metals**

You can use a Disston Metal-Slitting Saw on your power outfit. Cuts sheet brass, zinc, copper, etc. Disston makes metal-cutting circular saws from 1/2" to 90" diameter. Write for information and prices.



**Handiest of Pocket Levels**

For truing up construction work, levelling shelves, etc., use a Disston Featherweight Pocket Level. It is the lightest and handiest level made. Length, 9"; weight, 2 oz. Aeroplane aluminum. Three proved glasses, \$1.25.



**Band Saws for Better Work**

Disston "Thin Gauge" Narrow Band Saws are made 2 to 3 gauges thinner. They run better on machines with wheels up to 24" diameter. Saw 9' 8" long 1/2" wide, 25-gauge, brazed, \$2.17. Other sizes in proportion.



**For Cutting Dovetails, etc.**

Wherever a fine joint is needed, and for careful cabinet work or pattern making, use a Disston No. 68 Dovetail Saw. Blade extra thin, with fine teeth. The 8" blade, 17 points to inch, is most popular. \$1.60.



Use Disston Circular Saws for better work on any machine. Cross-cut (left), for cutting across grain; Rip Saw (center), for cutting with grain, or a Disston Combination Saw (right), which cross-cuts, rips and miters perfectly.

Your hardware dealer has in stock, or can get for you quickly, any size or style of Disston Circular Saw.



**"The Saw Most Carpenters Use"**

The two handiest saws for the home work-shop are the 26-inch 8-point for cross-cutting, and the 26-inch 5 1/4-point for ripping. You will need these on almost every job. The popular "D-8" Lightweights cost \$3.45.

# DISSTON

Makers of "THE SAW MOST CARPENTERS USE"



Every saw user will enjoy reading "The Disston Saw, Tool and File Book," an illustrated manual on the selection, care, and use of tools. It tells how to file and set saws, etc., and contains helpful information on circular saws. Use the coupon, or write for it.



Henry Disston & Sons, Inc., Philadelphia, U. S. A.  
(In Canada, Henry Disston & Sons, Ltd., Toronto)

Please send me "The Disston Saw, Tool and File Book."

Name and Address.....

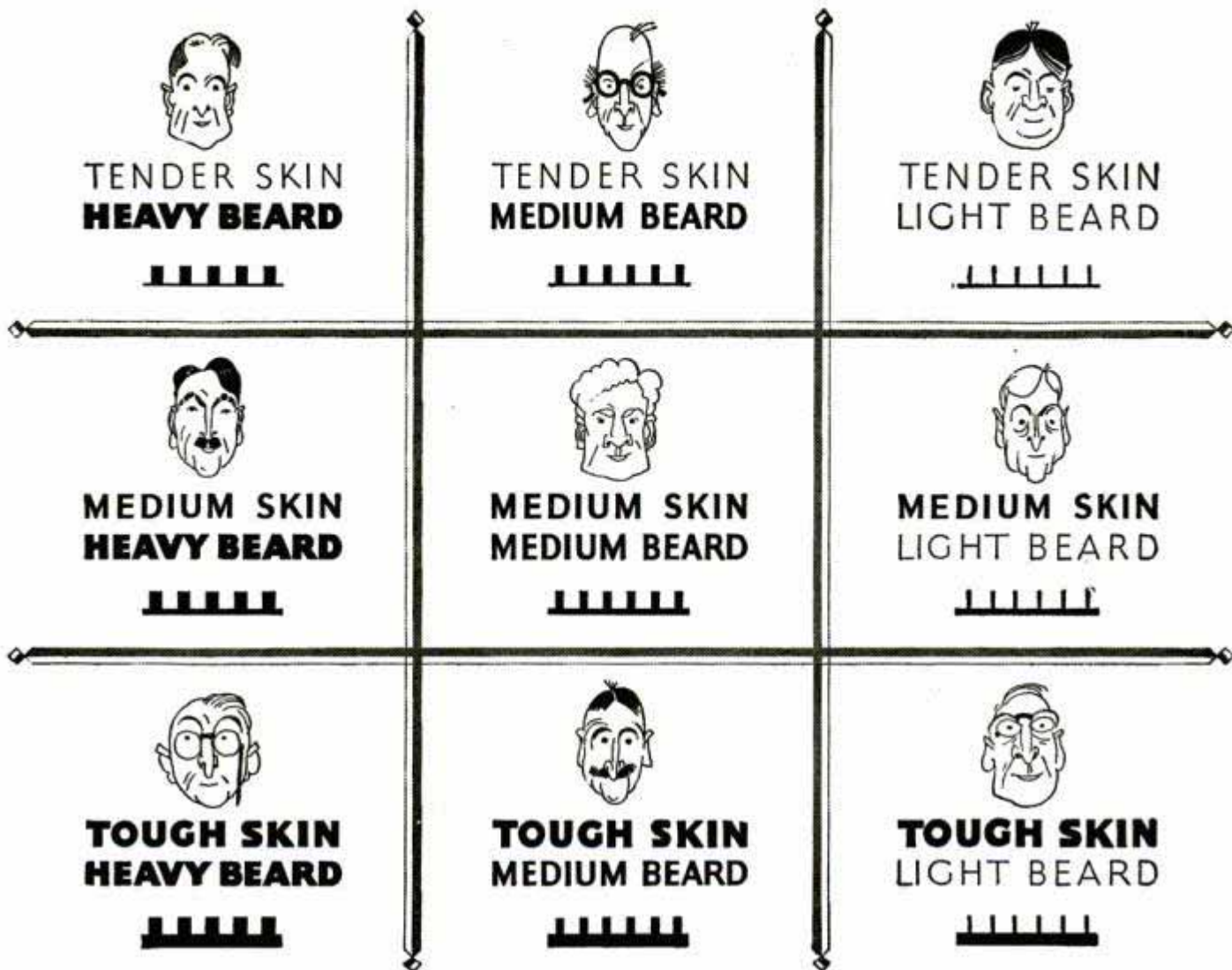

## Name your beard, gentlemen

**B**EARDS are past reforming. Blue and bristly or blond and silken, they're all hard to shave—at least you can't tell their owners otherwise.

We don't try to.

It's easier to put the burden on the blade; to use the best and most expensive steel and to spend, as we have, some \$12,000,000 in the past ten years to develop precise and delicate machines that hone and strop that fine steel far beyond the limits of human craftsmanship. It's easier to pay a bonus to workers for every blade they reject which

does not come up to the high Gillette standard.

True, it makes some difference whether your beard is heavy or silken, your skin sensitive or tough; whether the water is

hot or cold, hard or soft; whether you slept well or badly the night before.

But even under the worst possible conditions you can count on the Gillette Blade to do its job smoothly, surely and well. It's the one constant factor in your daily shave. Gillette Safety Razor Co., Boston, U.S.A.



**THE NEW FIFTY-BOX.** Fifty fresh double-edged Gillette Blades (10 packets of five) in a colorful chest that will serve you afterward as a sturdy button box, cigarette box or jewel case . . . Ideal as a gift too. Five dollars at your dealer's.

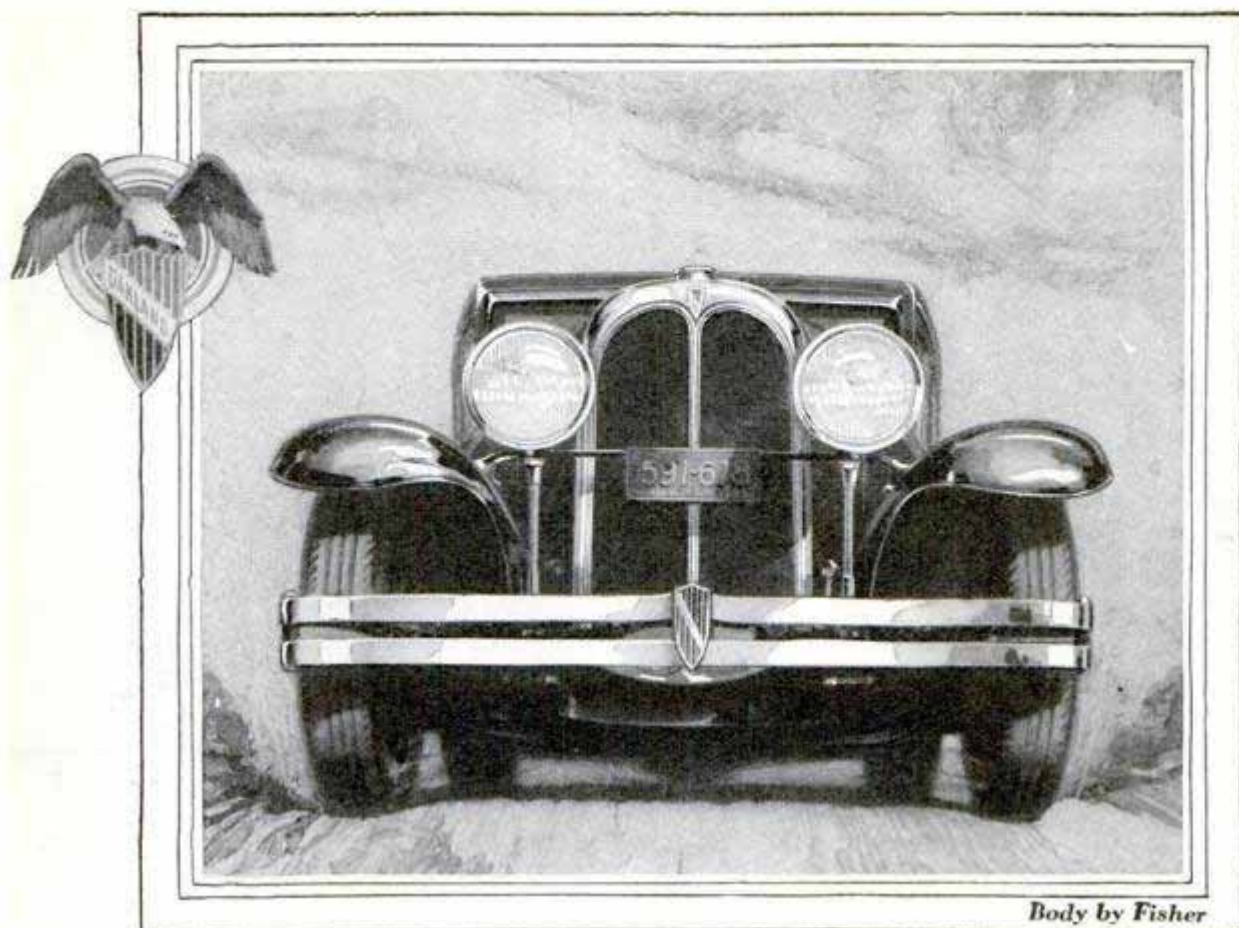

# Gillette

*Body by Fisher*

## *Brakes* - another All-American feature that arouses owners' enthusiasm

In thick traffic . . . where quick, sure deceleration is imperative. On slippery pavements . . . where equalized action is the crying need. In hilly country . . . where ordinary brakes heat up and drag and even stall the engine. Under all these conditions the brakes of the New Oakland All-American have proved their superiority.

Internal-expanding . . . they are fully protected. Unaffected by mud or rain or ice. As a result they maintain their high efficiency in any weather. They are always positive and smooth in action . . . always exceptionally quiet.

Their design is extremely simple and

unusually free from "floating shafts," "compensators" and the like. No equalizers are required. Braking does not interfere with steering. No lubrication is needed and a single adjustment is good for 10,000 or more miles.

Yes . . . Oakland's brakes are far from ordinary. But the same is true of everything else in the New All-American Six. Call on your Oakland-Pontiac dealer . . . and he will show you how much more it offers for its price.

---

*Oakland All-American Six, \$1145 to \$1375, f. o. b. Pontiac, Mich., plus delivery charges*

OAKLAND MOTOR CAR COMPANY  
PONTIAC, MICHIGAN

*The New* OAKLAND  
All-American Six

PRODUCT OF GENERAL MOTORS

## C &amp; L 70

*This is the Clayton & Lambert No. 70 fire-pot with tinner's hood. Produces a working flame in ninety seconds. Flame controlled as easily as a lamp. The burner orifice cannot be enlarged by tightening the needle valve. No chance of ruining the fire-pot that way—that's an exclusive C & L feature. Will heat a pair of soldering coppers and melt a pot of metal at the same time.*

## It does a lot in 90 seconds

You can prime and light a Clayton & Lambert fire-pot and have a working-hot flame in ninety seconds! Then turn the flame down—retaining the heat—and watch the metal melt along with your fuel bill. That's what you do in ninety seconds with a No. 60 or 70 Clayton & Lambert. And you do it every time regardless of winds or draughts or cold weather. You can use them indoors without annoying a soul, for they're noiseless, odorless and smokeless.

Such quick, positive action comes from an exclusive Clayton & Lambert improvement. A unique method of mixing air and gas vapor in the proper proportions—*always*. That with the exclusive baffling cup assures rapid-fire starting. Another exclusive Clayton & Lambert feature is the "spider" welded to the tank. It keeps the top-structure properly aligned and all working parts in perfect true. And the uprights which give them additional strength are drop-forged and practically indestructible.

Another part made to last a lifetime is the multi-ribbed flame plate. It's built particularly strong and there's practically no chance of it breaking. If that should

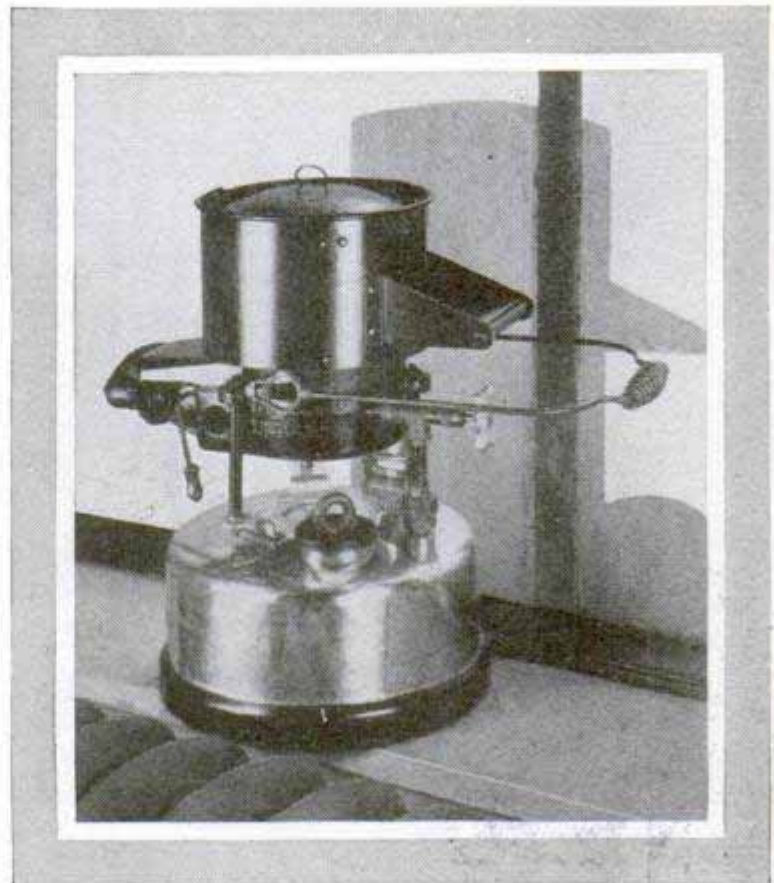

happen the plate is easily replaced. Fire-pot No. 22, which is a powerful and popular coil type, has a feature that you'll appreciate. To remove the coil you loosen one nut and draw the coil through a door in the cup. That saves you a lot of troublesome work when the coil needs changing.

You're familiar enough with tools to know what these improvements mean. The satisfaction and longer service which they give have made Clayton & Lamberts the largest selling fire-pots in the world. For your greatest money's worth insist that you get a Clayton & Lambert. Look for the red band around the base of the tank. That's the sign of a Clayton & Lambert. But look for the C & L trade-mark too—just to be sure! Sold at nearly all hardware and electrical houses.



# CLAYTON & LAMBERT

MANUFACTURING COMPANY, Detroit, Mich.

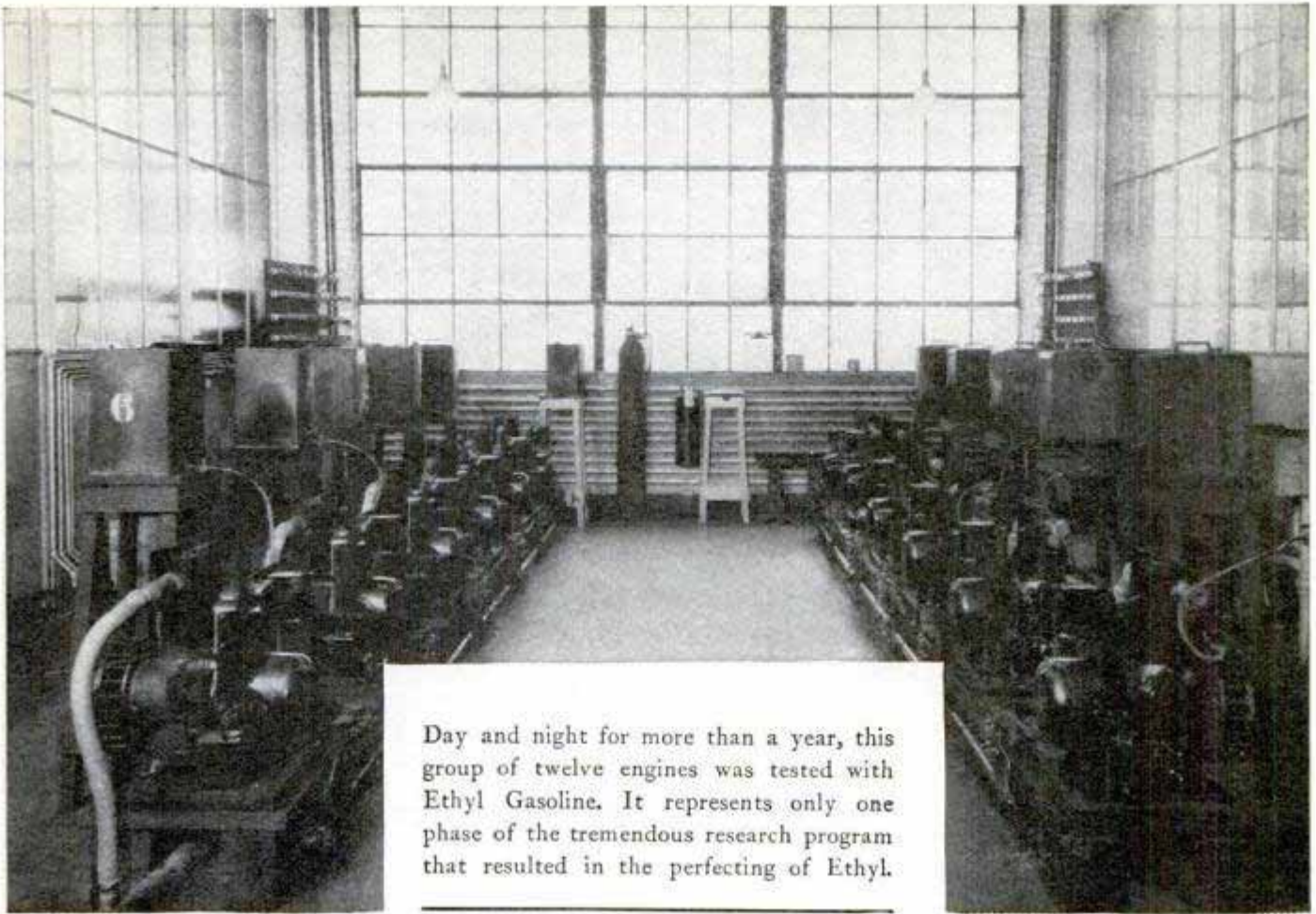

Day and night for more than a year, this group of twelve engines was tested with Ethyl Gasoline. It represents only one phase of the tremendous research program that resulted in the perfecting of Ethyl.

## *The long search for A Better Motor Fuel*

**E**VEN among technically minded people, there are very few who realize the infinitely painstaking research which must precede any positive contribution to the improvement of a motor fuel.

Before Ethyl Gasoline was offered to the public, tests like the one illustrated were carried on for more than seven years in the Research Laboratories of General Motors.

Then Ethyl was subjected to ruthless experimentation by the laboratories of the outstanding oil companies of the United States, Canada and the British Isles. Having proved its worth for

themselves, they now mix Ethyl fluid—containing tetraethyl lead—with their good gasoline to form Ethyl Gasoline.

The country-wide distribution of Ethyl has encouraged automobile manufacturers to build cars of higher compression. The combination of high compression engines and Ethyl Gasoline has created a new standard of motoring comfort and efficiency.

Whatever your car will do on ordinary gasoline, it will do better on Ethyl.

ETHYL GASOLINE CORPORATION, 25 Broadway, N. Y. C.  
56 Church St., Toronto, Can. 36 Queen Anne's Gate, London, Eng.

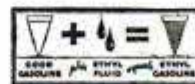

# ETHYL GASOLINE

**Rule Depth Gauge No. 615**  
with a rod  
This depth gauge uses a 4" or 6" rule and also a 5/64" rod, especially desirable in measuring the depth of small holes.

**Toolmakers' Clamp No. 756**  
Pieces that an ordinary clamp cannot hold are easily dealt with, thanks to the extra long jaw with its unique auxiliary screw.

**Rule Depth Gauge No. 616**  
The blade of this new gauge may be adjusted to any angle, making a convenient protractor of the tool. The six inch blade is graduated in 32nds and 64ths of an inch.

**Universal Dial Indicator Set No. 740**  
This is an accurate indicator of conveniently small size and extreme durability. The design of the set and its attachment enables the user to adjust it to almost any position.

**Twist Drill and Machine Screw Tap Gauge No. 707**  
Tells at a glance the correct drill to use with any common size of machine screw tap. Legible figures tell the size of tap, pitch of thread, size of drill required, etc.

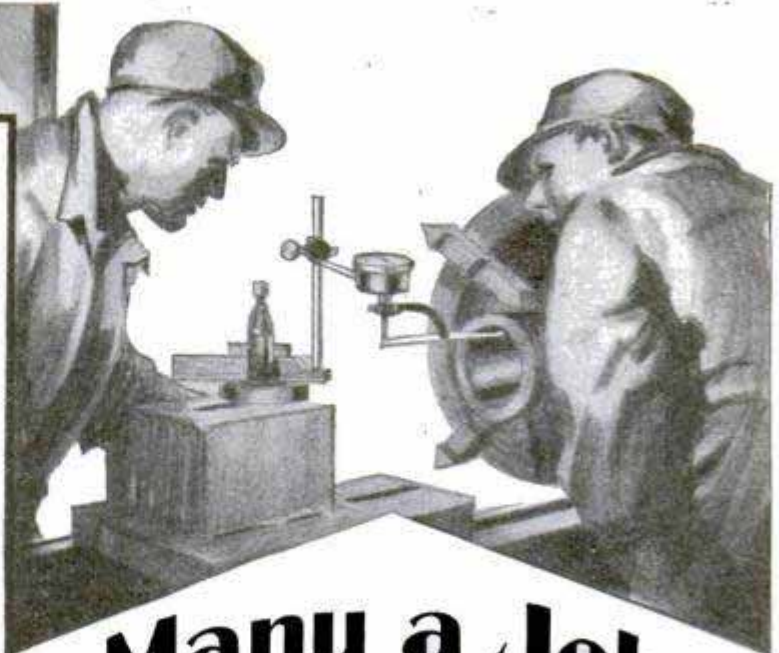

# Many a Job Simplified

## 5 New Tools

Look at the tools shown — all new, all different. Each can do easily jobs which you have probably done with some difficulty in other ways. Ease in doing work is a characteristic quality of Brown & Sharpe tool design.

And these 5 new tools have the same high qualities that have made a Brown & Sharpe the standard of comparison the world over and are well fitted to take their place in the complete Brown & Sharpe line of over 2300 tools.

Examine these new Brown & Sharpe tools at your dealer's and obtain at first hand an idea of their full value and handy design. You'll want some of them in your kit so that you can use them frequently. If your dealer cannot show them to you let us send you a catalog. Department P.M., Brown & Sharpe Mfg. Co., Providence, R. I., U. S. A.



*"WORLD'S STANDARD OF ACCURACY"*

# BROWN & SHARPE TOOLS



# New Model SOUTH BEND LATHES

BACK GEARED SCREW CUTTING LATHES

LATHE BUILDERS FOR 23 YEARS - 43,000 LATHES IN USE



9" x 2 1/2' Junior Back Geared Screw Cutting Bench Lathe with Counter-shaft and Equipment **\$163**



**Prices of 9-inch Junior Bench Lathes**

Size of Lathe	Shipping Weight	Counter-shaft Drive	Horizontal Motor Drive
9" x 2 1/2'	350 lbs.	\$163.00	\$244.00
9" x 3'	375 lbs.	169.00	250.00
9" x 3 1/2'	400 lbs.	175.00	256.00
9" x 4'	425 lbs.	182.00	263.00

**EASY PAYMENTS**  
as Low as \$13.04 a Month

Our Easy Payment Plan allows you to install a South Bend Lathe in your shop, by making one payment with the order; the balance to be paid month by month, the amount depending upon the size of lathe. Write today for Catalog No. 90-P which describes Easy Payment Plan. Mention size of lathe desired.

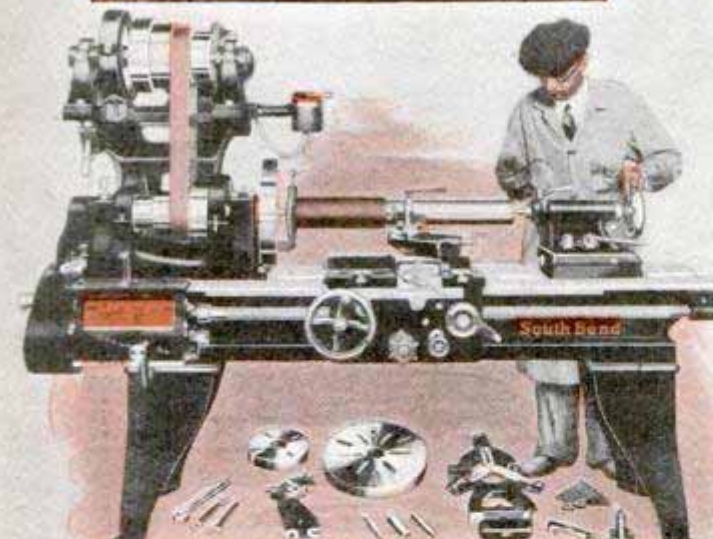

18" x 8' Quick Change Gear Silent Chain Motor Driven Lathe.....\$991.00

**Prices of Popular Sizes of Quick Change Gear Lathes with Equipment**

Size of Lathe	Shipping Weight	Counter-shaft Drive	Silent Chain Motor Drive
9" x 3'	490 lbs.	\$294.00	\$395.00
11" x 4'	725 lbs.	359.00	494.00
13" x 5'	1110 lbs.	443.00	598.00
15" x 6'	1550 lbs.	543.00	716.00
16" x 8'	2035 lbs.	638.00	813.00

For the

Manufacturing Plant  
Tool Room  
General Repair Shop  
Machine Shop  
Service Station  
Electrical Shop  
Engineering Shop and Laboratory

Used by Manufacturers of

Automobiles  
Electrical Parts  
Machinery  
Aircraft  
Textile Machines and Government Departments  
National and State

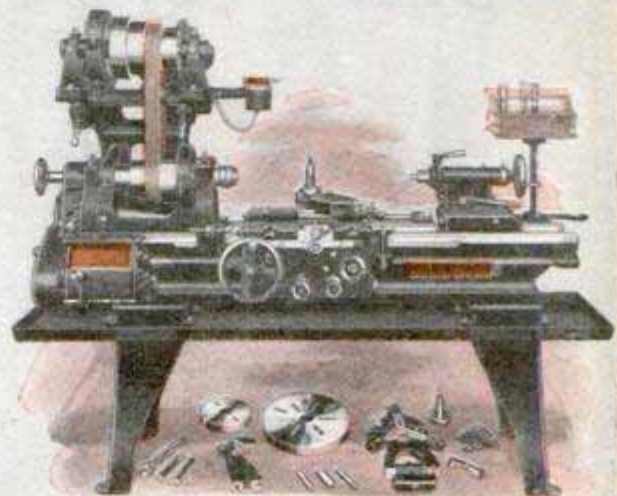

16" x 6' New Model South Bend Silent Chain Motor Driven Tool Room Lathe.....\$773.00

**96 Sizes and Types**

Countershaft Driven Lathes, Motor Driven Lathes, Quick Change Gear Lathes, Standard Change Gear Lathes, Tool Room Lathes, Gap Bed Lathes, Brake Drum Lathes and Bench Lathes.

**New Free Catalog No. 90-A**

Illustrates and describes the New Model South Bend Lathes in various Types and Drives. A copy will be mailed free on request. Write for it.

**South Bend LATHES**

**Catalog No. 90-A**

**South Bend Lathe Works**  
606 E. Madison Street, South Bend, Ind., U. S. A.

Gentlemen: I would like your net factory price on a Screw Cutting Lathe. Size \_\_\_\_\_ for (check kind of work)

Manufacturing  
 Electrical Work  
 Catalog No. 90-A

Name \_\_\_\_\_  
Address \_\_\_\_\_  
City \_\_\_\_\_ State \_\_\_\_\_

Machine Shop  
 Garage  
Send free Catalog No. 90-P

## South Bend Lathe Works

606 E. Madison St., South Bend, Ind., U. S. A.  
New York, J. E. Beggs Co., 183 Center St. Chicago, C. B. Burns Mach. Co.

# "How Rock Thunder died in flames *to save his tribe*"



Told by  
Buffalo  
Child Long Lance:

Full-blooded Blackfoot Indian Chief. Trick rider with Buffalo Bill, Tackle, Carlisle football team. Captain, World War (wounded, decorated for bravery). Author of "Long Lance."

"He begged us to build him a pyre and finally our warriors consented. They gathered logs and brush and he took his seat in the middle of the pile. With his own flints he lighted the brush beneath him. Thus he perished as a true stoic,

chanting his death song—and the only movement he made was to run the back of his hand once over his forehead—to keep the sweat from running into his eyes.

"The Americans of today live far different lives than we did—the earlier Americans. Yet I believe that sturdiness of foot and leg, developed in childhood, is as important to your general health as it was to our very lives.

"This object I believe is best attained by the wearing of canvas rubber-soled shoes—when-  
ever and wherever possible."

*By Long Lance*

**D**EMAND Goodrich Sport Shoes by name. Otherwise how can you be sure of getting the best that Indian lore and modern science offer you? You'll be amazed how much style can be built into such sturdy canvas rubber-soled shoes!

The B. F. Goodrich Rubber Company, Established 1870, Akron, Ohio. Pacific Goodrich Rubber Company, Los Angeles, Calif. In Canada: Canadian Goodrich Co., Kitchener, Ont.

The Pontiac. Stylish light grey, khaki or white, with snappy-looking dark grey "saddle."

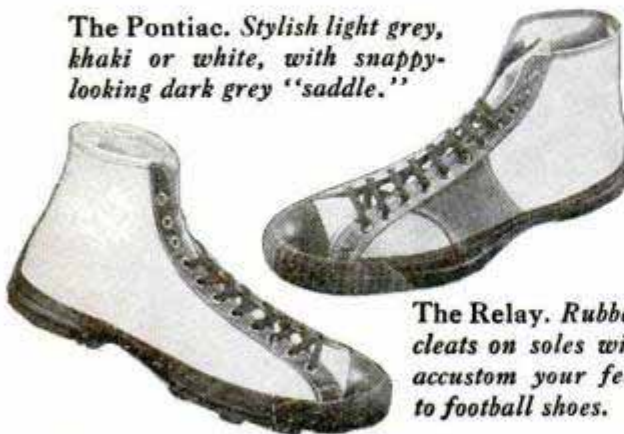

The Relay. Rubber cleats on soles will accustom your feet to football shoes.

# Goodrich Sport Shoes

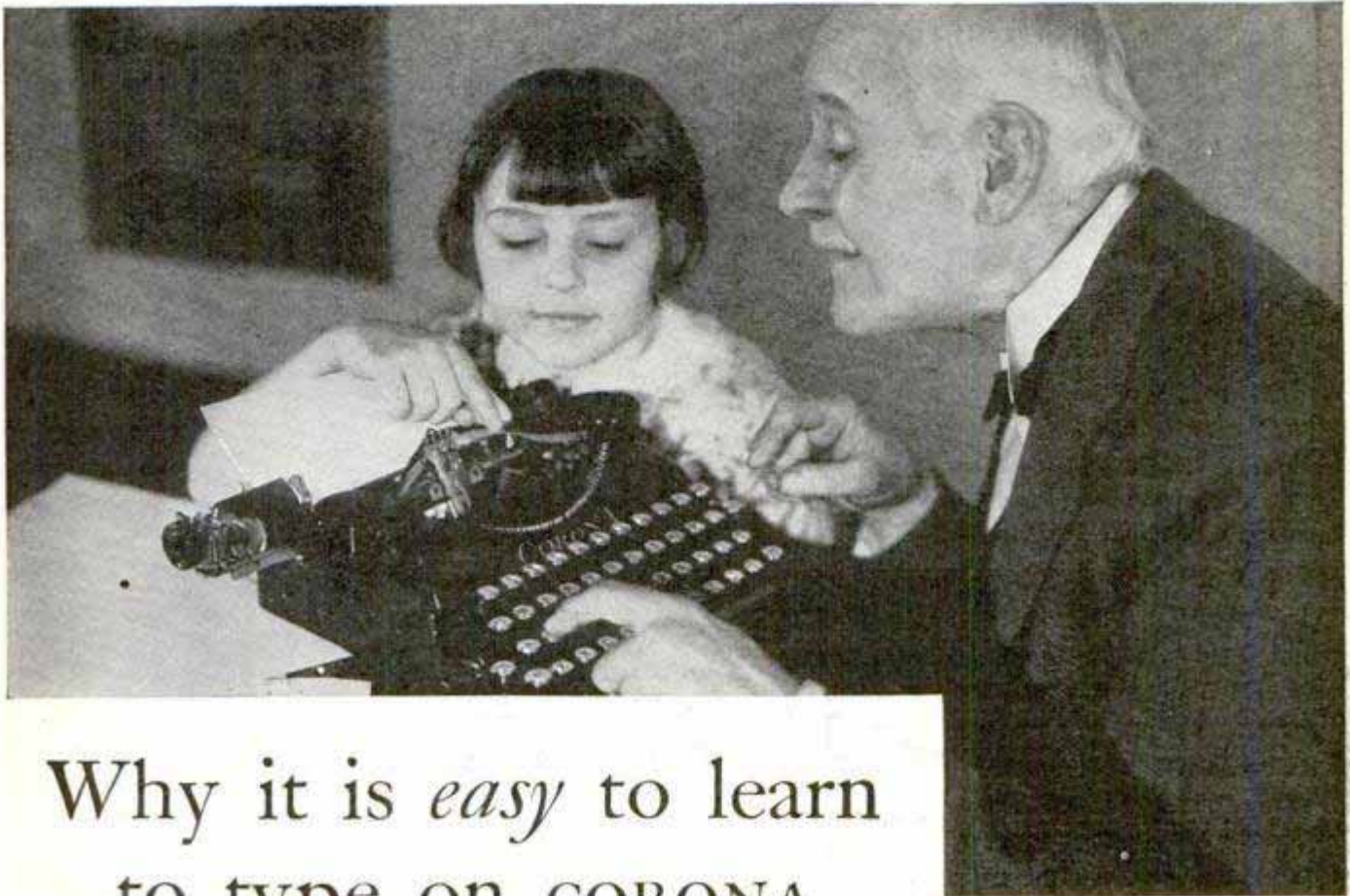

## Why it is *easy* to learn to type on CORONA

"OUR little boy has loved Corona ever since he was big enough to notice the letters."

"I learned to use Corona when I was sixty-eight. It is much easier than writing by hand."

Scores of letters like the above have come to us. They show how easy it is to use Corona. If children too young to hold a pencil can use Corona, anybody can. If old people whose handwriting has grown shaky can use Corona, anybody can.

In the very beginning, Corona was designed with the idea that it would be used by people who had no typewriter experience.

That was twenty years ago. Corona is still built with the beginner in mind. All the needs of the amateur typist have been studied by Corona engineers. Every year we have improved Corona—made it more convenient. Here are a few advantages which make it the easiest typewriter in the world to operate:

**Adjustable Key Action**—The touch can be made light or heavy to suit your requirements.

**Adjustable Paper Guide**—Insures

uniform margin on all pages of a manuscript.

**Back Spacer and Margin Release**—These are conveniently located on the keyboard.

**Carriage Return Lever**—This is made extra large and convenient. It enables you to perform the two operations of spacing and returning the carriage to the starting point with one sweep of your hand.

**Extreme Visibility**—Holds paper at correct reading angle.

**Key Spacing**—Same as on office typewriters.

**Standard Keyboard**—Four rows of keys, exactly like a big office machine.

In making Corona easy for beginners to operate we accomplished another result—an unforeseen result. The very features which enable beginners to write more easily, enable accomplished typists to *greatly increase their speed*.

You owe it to yourself to drop into a store where typewriters are sold and see Corona. The minute you lay eyes on it you will

realize why a million people use it—why Roosevelt took one to Africa—why 30,000 Coronas were used in the World War—why more novelists, more newspaper men, more business men, more schools and colleges use Corona than all other portables put together.

For a small down payment you can take a beautiful new Corona home with you today. Don't neglect this opportunity. Don't let another day pass without doing something about it. Know *now* the joy of owning a sturdy, speedy, smooth-operating Corona—the World's Champion Portable.

An interesting illustrated booklet called "Corona Typewriters," which describes Corona in detail, and contains beautiful illustrations of the new color models, will be sent you upon request. No obligation. Simply mail the coupon below.

L C SMITH & CORONA TYPEWRITERS Inc  
51 Madison Ave., New York, N.Y.

Please send me the free booklet,  
"Corona Typewriters."

Name.....

Street.....

City..... State.....

612

**CORONA**  
The PORTABLE TYPEWRITER



# Air-cooled comfort for whirlwind feet!

Camp life doesn't wait on hot days. From early in the morning till late at night, those high-powered feet of yours are *in motion—and how!* Give your feet a chance to get their breath! Wear cool *Keds* in games and on the trail.

Keds are light, springy, tough shoes, made especially for sports and play wear. They are much more than ordinary "sneakers." For example—Keds are made with specially designed safety-soles which grip the smoothest surfaces, and absorb the roughest shocks.

With Keds on your feet, you won't skid when you take turns on the dead run. You can lace Keds tight, too—so your feet can't slip or chafe.

For years, Keds have been endorsed by leading physicians and coaches.

Keds offer the most complete assortment of styles and models for all indoor and outdoor sports activities. Keds are made by the world's largest specialists in canvas rubber-

soled footwear. You'll find Keds in the best shoe stores in town—at all prices, too, from \$1.00, \$1.25, \$1.50, \$1.75 up to \$4.00.

Keds—Keds—Keds—Look for that name stamped on all genuine Keds.

Write for our new free booklet containing information on games, sports, camping, and other interesting subjects. Dept. KM-69, 1790 Broadway, New York City.

United States



Rubber Company

Makers of U. S. Raynster raincoats, U. S. Giant Chain bicycle tires, U. S. Spring-Step heels, as well as

# Keds

REG. U. S. PAT. OFF.

The more you pay, the more you get  
—but full value whatever you spend.

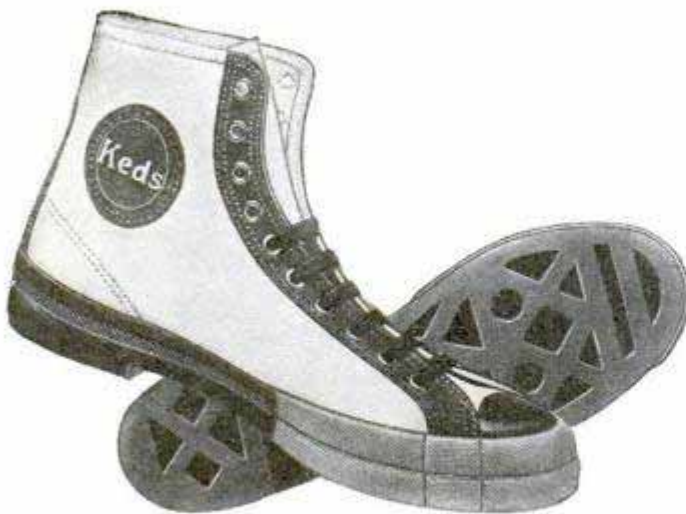

**Keds "Gladiator"**

A medium price, sturdy shoe for all-round use. Patented "Feltex" insole keeps the foot cool and comfortable. Reinforced toe gives extra protection at point of hardest service. Special anti-skid sole.



**Keds "Shortstop"**

This handsome shoe puts lightning in your feet and protects you against slipping! Note the special safety-sole. Keeps your feet cool and gives them protection whether you're playing baseball or taking the jolts of the trail.



# MEN!

**Place this Master Key Case Display on 20 Store Counters and Collect \$20.00 a Day Profits**



**\$20.00 EVERY DAY—\$140.00 a week CLEAR PROFIT**—that's what you or any other live wire can earn by simply placing these astonishing new "Automatic Salesmen" of newly patented **MASTER KEY CASES** on store counters. Here is a new way of raking in profits from **AUTOMATIC SALES AT WHOLESALE**, using our successful, tested selling plans. Profits 100% **SELLING THROUGH** dealers—over 200% selling direct to consumer in full or spare time. This amazingly clever Key Case—retails for only 25c, although it is better made and better designed than ordinary cases selling at a dollar, at five dollars, or even more. Notice that the Genuine Leather is beautifully colored—comes in Cowhide finish, Scotch Grains, Black and Brown, Pebble Stone and other attractive colors; then you will know why several are bought at a time in different colors for separate sets of Keys. It has no sharp edges or points to catch or tear the pockets. It cannot rattle or scratch when on the dashboard of an automobile. Holds six keys, always in the same position. Works like a jackknife. Opens and shuts in an instant, with snap fasteners. See all these selling features for yourself—and then you'll **KNOW** why it is a **cinch** to earn \$20.00 a day—and more.

**\$1.50 Investment Pays You \$1.75 Clear**

Here's a big business that pays you absolutely astounding profits. Yet you get in it with practically no investment—the cost of half a dozen good cigars starts you, and lets you see for yourself that **THIS IS THE BUSINESS YOU HAVE BEEN LOOKING FOR!** For an investment of \$1.50 you get sales of \$3.25—**ABSOLUTE NET PROFIT OF \$1.75.** And when you have gotten started, and buy in big quantities like scores of my successful wholesalers, your profits are very much greater.

**It Sells Everywhere—It's New!**

When this key case was first put on the market, its instant popularity soon showed that the market for it was as big as the United States. You can place the Master Key Case Display with automobile and auto accessory dealers, drug stores hardware stores, grocers, novelty shops, cigar stores, men's furnishings stores—hundreds of different places where the dealer is glad to accept your unusual offer.

13 Master Key Cases to Each Display Card

**A Lifetime Opportunity with This Automatic Profit Maker**

Just walk into a store and say, "Mr. Smith, let me put this beautiful Automatic Salesman of genuine leather key cases on your counter. Doesn't cost you a cent. I'll be round in a few days to collect for the Key Cases that your customers buy. Not a cent of investment for you, no trouble, and you receive a mighty sweet profit into the bargain." Can that dealer refuse? You bet he won't—he'll grab at the chance—he won't let you get out of the store without leaving at least one Automatic Salesman. And when you come around again, it's a hundred-to-one shot that every Key Case is sold. **WE PACKED 13 KEY CASES ON A CARD, INSTEAD OF JUST A DOZEN.** The 13 cases, at 25c each, bring the dealer \$3.25, leaving him a clear profit of \$1.25 on every card—and making YOU a clear profit of one dollar. You can **EASILY** place 20 cards with dealers every day—60 cards every 3 days. Your cost in lots of 60 is only \$1 per card. Selling to dealers at \$2.00 per card, you make 100% profit or

\$20 a day. And you don't even have to do all the placing yourself. You can easily employ other salesmen to place some of the cards for you, boosting your profits way up. And another thing—we haven't said a word about the **repeat business.** After dealers see what a whirlwind seller the Master Key Case is, they will want to buy from you outright, and will order again and again. Many retailers order from our wholesalers in six-dozen or gross lots. Believe me, that piles up the profits sky high!

**THE IDEAL PREMIUM GIFT**

You can also get orders in big quantities by calling on users of advertising gifts, as the Master Key Case can be imprinted in gold, at small cost, with the advertiser's name.

**HAVE YOU THE COURAGE to get out of the rut and build a BIG, PROFITABLE BUSINESS OF YOUR OWN?** If you have, mail the coupon today—NOW—before you turn this page.

Holds Six Keys Compact and Secure.

Ideal for the Auto. Keys can't rattle nor scratch the dashboard.



Comfortably fits the vest pocket.

**I guarantee your sales—You just CAN'T lose!**

I GUARANTEE that you will sell these Key Cases and make \$20 a day. If you should fail to do so, return them and I will refund your money.

**Exclusive Territory to Producers Send Coupon Now!**

Why delay? Rush the coupon NOW—and get started in the most amazingly profitable business you ever heard of. Show us you are a live wire—send in your order now—and we will protect you immediately in your territory. Remember, you have everything to gain and nothing to lose. Act at once—before somebody else gets your territory.

Gordon Mfg. Co. (Dept. KF-19),  
110 East 23rd Street, New York.

I enclose \$..... for which please RUSH me the order checked below and reserve the following territory for me exclusively:—

mention territory.....

- 12 Automatic Key Case Salesmen, each containing 13 Key Cases, for \$15.00. I am sending you \$5.00, balance to be C. O. D.
- 1 Automatic Key Case Salesman containing 13 Key Cases, for which I am sending you \$1.50 (Money Order, Check or Stamps).
- 1 Sample Key Case and further particulars, for which I enclose 25c (coin or stamps).

Name.....  
Address.....  
City..... State.....

**GORDON MFG. CO. Dept KF19, 110 E 23<sup>RD</sup> St., N.Y.**



No slipping, no chattering with the new Millers Falls Planes. Instead a smooth firm stroke that means finer work with less effort, that removes completely the constant irritation of a chattering plane.

## STOP *that* CHATTERING

This age-old cause of plane trouble was tackled scientifically by Millers Falls engineers. Smoother cutting depends on the pressure with which the blade is held at the correct cutting angle. So a 3-point bearing of the lever cap was added. This bearing, by keeping the cutter flat the entire length of the seat, holds and completely overcomes chatter.

The improved Millers Falls cutting edge is the result of a new process of tempering the cutters electrically giving the edge greater uniformity and longer life. Think what this means—more time spent in productive work, less time spent in sharpening and reconditioning.

But don't take our word alone. Test out one of these improved planes. Then note the difference. Sold by leading hardware dealers everywhere.

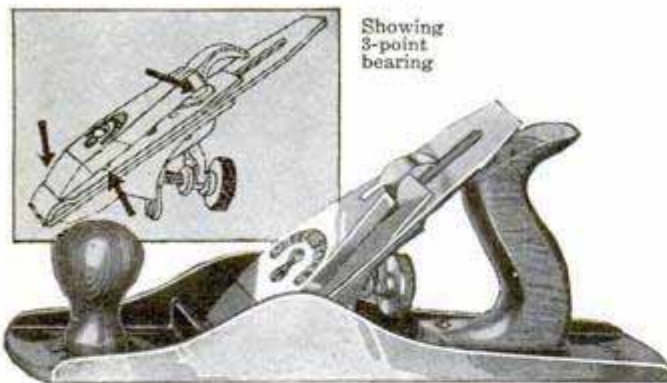

Showing 3-point bearing

Sizes in bench planes from 7 to 24 inches, smooth and corrugated bottoms. 21 block plane models.

Send today for the new catalog. Complete information on the Millers Falls major tool lines. There is no charge.



**MILLERS FALLS CO.**  
MILLERS FALLS, MASS.

NEW YORK: 28 Warren St. CHICAGO: 9 S. Clinton St.

## Profit & Pleasure

*Spare Time*  
or  
*Full Time*

**New!**  
**and...**  
**Better!**

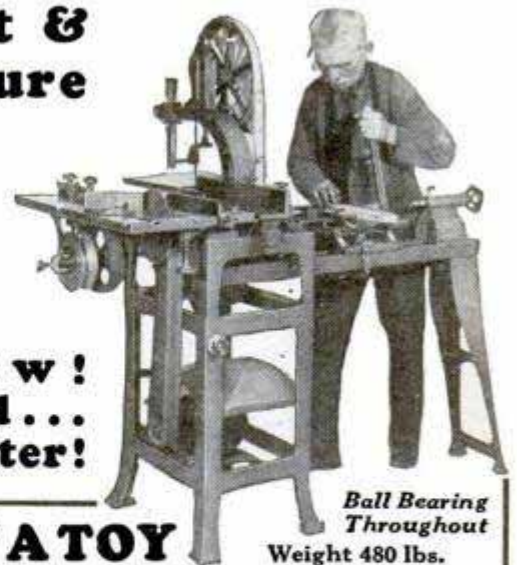

Ball Bearing Throughout  
Weight 480 lbs.

### NOT A TOY

The machine you've been hoping some one would make. Lets Home Craftsmen turn out fine work. Ideal for the man who wants to make money on screens, millwork, etc. Saws 3 1/4" thick. Rips 12" wide. Lathe swings 10". Rugged iron frame: no warping, twisting, or vibration.

### The Electric Carpenter

Runs from any Light Socket

**7 Machines in One**

8" Circular Saw	Reversible Shaper
14" Band Saw	1/2" Hollow Chisel
36" Lathe	Mortiser
10" Swing	Sander
4" Jointer	

Does 35 Woodworking Operations

Write today for New Folder P-69

We also build a complete line of single-purpose machines

**THE WOODWORKING MACHINERY CO., INC.**  
Eleventh and Vine Sts., Philadelphia, Pa.

## Big Profits Charging Batteries

**Starts You.** Let me show you how to make big money in the battery charging business. I've prepared a free book explaining all details. My charger is years ahead of ordinary chargers—will handle 50 per cent more batteries. Get into a business of your own with a very small investment. Write for my book today.

**C. F. Holmes, Chief Engineer**  
**INDEPENDENT ELECTRIC WORKS**  
Dept. P. M., 5116 Ravenswood Ave., Chicago

**Write for FREE BOOK**

## 25 POWER \$1 GERMAN POCKET MICROSCOPE

A marvelous German 25 power microscope, size of pencil. Enlarges diameter 25 times, area 625 times. Fine lenses give extra large field and great lig. it. Only 4 3/4 inches x 3/4 inch; weighs but 1/2 ounce. Used in schools and colleges throught the country. Fine for biology, geology, botany nature study, examining stamps, finger prints, insects, cloth, metals, photographs and thousands of other things. Equip with handy fountain pen clip.

**\$1 prepaid. Money back guarantee. Discount for 6 or more**  
**BINOCULARS** Over 200 Glasses All Makes—\$1-\$110

Everything in binoculars, field glasses, telescopes and optical instruments. The finest and largest assortment in America. Catalog gives all information how to choose the best for your individual needs at the **LOWEST PRICE**. Try America's Leading Binocular House First DuMaurier Co., Dept. 206, Elmira, N. Y.



VICAM STANDARD

## MOVIE CAMERA

Make your own action movies of events, trips, parades, etc. Takes 25 feet of standard film. Equipped with F.5 universal lens. Loads in daylight. Films developed free.

**\$13.50**  
F.O.B. Phila.

Film can be projected from any standard projector. Order today C. O. D. or send 10c in stamps for illustrated booklet.

**VICAM PHOTO CO.** 1224 Belmont Ave. PHILA., PA.

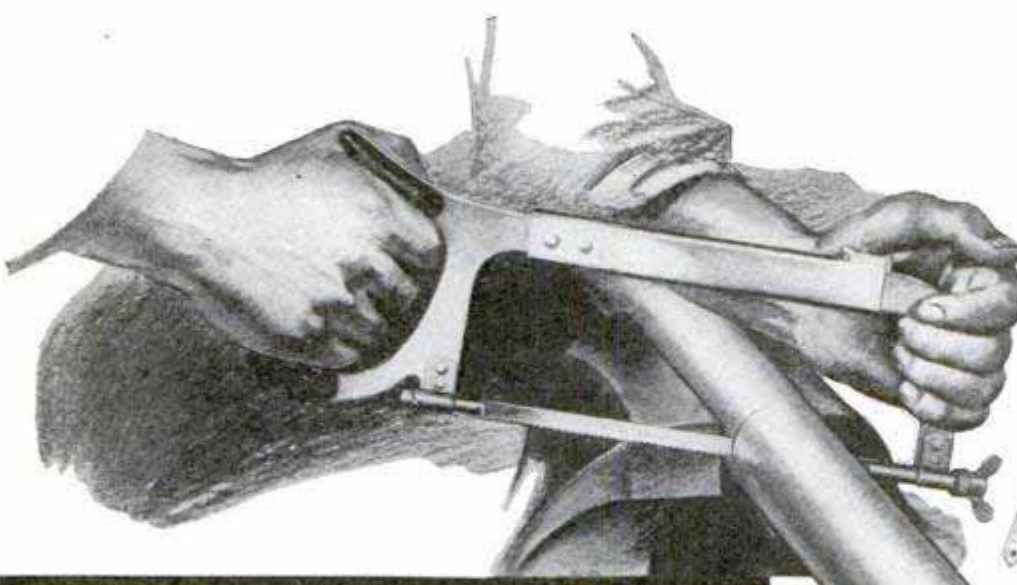

No. 151 Hacksaw Frame, excellent for work in close quarters.

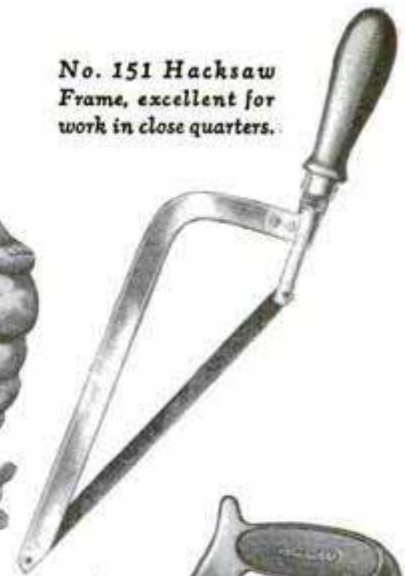

No. 153 Pistol Grip Frame. Sturdy, convenient, low in price.



No. 146, a popular and substantial frame.

No. 169 Easy Grip Frame of exceptionally fine design adjustment, rigidity and 'hang'

# Starrett Hacksaws

## Cut Quicker—Last Longer

There is a Starrett Blade and a Starrett Frame that will give you the one best combination for *low cost per cut*.

Ask your tool dealer to show you Starrett Hacksaws and Frames. Try them. See for yourself why it pays to insist on Hacksaws bearing the name of the world's greatest toolmakers — Starrett. Also ask for a copy of the Starrett Catalog No. 24 "AP" — sent free on request.

**THE L. S. STARRETT CO.**  
 World's Greatest Toolmakers  
 Manufacturers of Hacksaws Unexcelled  
 Steel Tapes—Standard for Accuracy  
 ATHOL, MASS., U. S. A.

2264



The blades for super service — Starrett High Speed Hacksaws. Have you tried them?



# Use Starrett Hacksaws



## Where's the can of PLASTIC WOOD?

(Reg. U. S. Pat. Off.)

For the screws no longer hold! The old screw holes have served their usefulness. You can move the hinges, perhaps, but a simpler and better way by far is to fill the old holes with Plastic Wood. Let it harden overnight, and there'll be solid wood to hold the screws as firm as when the door was new. For Plastic Wood is real wood in putty form, that hardens on exposure in the air to solid wood that will not disintegrate, split or crumble.

It is waterproof and weatherproof, for use indoors or out, takes paint, varnish or lacquer perfectly, and adheres lastingly to wood, metal, stucco, stone, plaster or fabric. For rebuilding rotted wood, repairing broken pieces, filling cracks or splinters, holding loose casters, Plastic Wood will accomplish amazing results.

### Plastic Wood Solvent

To soften Plastic Wood, to clean it from the hands or tools, and to prevent it from hardening through too frequent opening of the can, use Plastic Wood Solvent. In 25 and 50 cent cans.

Handles  
Like  
Putty



Hardens  
Into  
Wood

1 lb. can \$1.00

¼ lb. can 35 cts.

At Hardware and Paint Stores

ADDISON-LESLIE CO., 416 Bolivar St., Canton, Mass.



**A touch  
and it's  
done**

**FREE** See how easy!  
Send for sample

Like Magic! A touch of heat . . . a touch of Kester Metal Mender . . . the job's done. No fuss . . . no muss . . . for Kester is the wire solder with the flux right inside. You, too, can do your own metal repairs and make things with solder . . . just like thousands of other men, women and children. No need now to wait for a repair man, or throw useful things away. Write for a free sample! Try it yourself! Your hardware, auto accessory, electrical supply, general and other stores sell it in the handy metal tins.

**Use Kester for:**

Kitchen Utensils Pots and Pans  
Wash Boilers Automobiles  
Many other uses

**K E S T E R**  
**Metal Mender**  
**The Household Solder**



**CHICAGO SOLDER COMPANY**  
(Est. 1899) 4206-04 Wrightwood Ave., Chicago

## Do the Finest of Pattern or Cabinet Work



With  
This **H & A JOINTER**

A ball bearing motor-driven equipment of finest construction and absolute accuracy for all planing, jointing, beveling and rabbeting operations. Plug into the nearest lamp socket. Reasonably priced. Write  
**HESTON & ANDERSON**  
606 Market St., Fairfield, Iowa

## MOTORCYCLES



Price \$10 and up purchased through our Co-Operative Plan for as low as \$1.00 down and \$1.00 per week  
**Indians Harley-Davidsons Ace Henderson and Clevelands**

Send ten cents for Bulletin A.  
Motorcycles shipped to all parts of the world

**WALKER-INDIAN CO., 78 Brookline Ave., BOSTON**

## PIN A DOLLAR BILL TO THIS

Get this genuine leather 5 window card case, with gold corners, Masonic emblem stamped in heavy gold. Your name or other stamping 35c extra, per line. Money back guarantee.



Please send catalogue

No. 10. Books, Monitors, Jewelry

No. 11. Lodge Supplies

Established 1859

**Redding Masonic Supply Co.**  
200 Fifth Ave., Dept. P. M., New York

"Everything Masonic"



## HEAR EUROPE on YOUR radio



**Make Your Radio Up-to-Date  
With Dresner Shielded Short  
Wave Converter**

**Complete with 5 Coils \$16.50  
Unusually Low Priced**

Amaze yourself and your friends by getting this wonderful attachment. Enables you to get programs broadcast on short waves by many powerful stations throughout U. S. and Europe. Attaches in a minute on any set; requires no extra tubes or batteries. Only converter with wave length range of 15 to 550 meters. New 1929 model built in beautiful mahogany finished metal cabinet; completely assembled. **SEND MONEY ORDER DIRECT**, and we will ship at once. **GUARANTEED.** (When ordering unit, be sure to specify whether to be used on AC or DC set.)  
Dresner Radio Mfg. Corp., 640 Southern Blvd., Dept. M5, New York, N. Y.



**This 260 Page  
Wholesale Radio Catalog  
A Liberal Radio-Edu-  
cation Within Itself!**

# FREE

Containing 75 radio  
hook-ups, 1,000 illustra-  
tions, 6,000 articles.

**Build your own with Rasco parts.  
Positively lowest prices in the country.**

## Radio Specialty Company

98E Park Place      NEW YORK, N. Y.

**ELECTRIC OR BATTERY**      **TRY IT 30 DAYS FREE BEFORE YOU BUY**

Factory to you. Save 50% on latest AC Electric or Battery Radio. Free return privilege. Big choice of cabinets.

**Ultra 8 \$49.88**      **MIRACO**      **Lighted 1 dial**

Radio's most amazing bargains direct from big, old, reliable maker. Don't buy unless 30 days' use proves entire outfit unobtainable at 2 to 3 times the price, for tone, selectivity, distance, volume.

**Free**      **BIG DISCOUNTS to User Agents**

Catalog and BIG SPECIAL OFFER  
MIDWEST RADIO CORPORATION  
9th Successful Year  
407-UJ Miraco Bldg., Cincinnati, O.

**\$10.00 PER MONTH BUYS  
Fibre-Life Limbs**

NEXT TO NATURE. BRACES MADE TO ORDER. AGENTS WANTED. FREE FIGURE SAMPLE

**WORMAN CO.**      252-P HENNEPIN AVE.      MINNEAPOLIS, MINN.

## EASY to Play!



The first day, with a Conn instrument, you play tunes. Exclusive features give quick mastery. Soon social and professional engagements are open to you—popularity, the chance to make money!

**FREE Trial; Easy Payments** on any Conn instrument for band or orchestra. Write now for free literature and details. Mention instrument.

**C. G. CONN, Ltd.**  
631 Conn Bldg., Elkhart, Ind.

# CONN

BAND INSTRUMENTS

## Book of 100 Homes FREE!



**Get Our Mill Prices**

**Easy Payments—Save up to \$2,000—Write!**

We furnish lumber, millwork and other materials. Plan-Cut at mill, shipped to your station. Each piece sawed, cut and notched to fit—Save 30% labor cost and 18% lumber waste. Gives you stronger, tighter home. Easy to build—many put up own homes. Architect's plans and full instructions furnished Free. One guaranteed price covers all materials. Send for Free Book of 100 Home Plans, 15-year payment plan, and lowest wholesale, mills-to-you prices.

**Gordon-Van Tine Co.,**  
1353 Case St., Davenport, Iowa

Please send free catalogs and easy monthly payment plan.

I expect to build.....

Name.....

Address.....

**Aero-Call**      **FREE**

Free booklet on request giving details of Aero-Call, new factory-built short-wave converter that plugs into any radio set. Shielded—filtered—no motorboating. A. C. & D. C. Models \$25. Write today.

**AERO PRODUCTS, INC.,**      4611 E. Ravenswood Ave.      Chicago, Ill.  
Dept. 469

## A BIG MACHINE at a LOW PRICE!

**DOES 20 DISTINCT WOODWORKING OPERATIONS**

**TURN YOUR HOBBY INTO INCOME!**

No trick at all with this amazingly low price Woodworker, which you may try, and pay for, on terms, to turn idle hours into profit. Does 20 wood-working operations. Ideal size, capacity for shop, home or the job. Economical to operate. The best buy in the market!

**BRINGS IT TO YOU**      **FREE TRIAL**

**COMES COMPLETELY EQUIPPED!**

Comes complete with 8-in. Cross Cut, 8-in. Rip Saw; 12 in. Band Saw; Jointer, Lathe, Borer, Sander, Guides, Electric Motor. Investigate it!

**FREE**      **60**      **Working Drawings**  
**with Saw**      **of Items You**  
**Can Make**

**SEND FOR FULL DETAILS!**

**A. S. ALOE CO.**  
1831 Olive St.,  
St. Louis, Mo.

Without obligation, send me details on the Woodworker, and the Free Trial and Easy Terms Plan.

NAME.....

ADDRESS.....

**CASH OR CREDIT**  
THE OLD RELIABLE CREDIT JEWELERS

**LOFTIS** Dept. A-894  
BROS. & CO. 108 N. State St. Chicago, Ill.

# DIAMONDS-WATCHES

**Beautiful Diamonds at Moderate Prices!**

The loveliest, most appreciated gift a man can make—a Diamond Ring from Loftis! Our direct importing and quantity buying necessary for our chain of stores, insures you better quality at lower prices. Our Diamonds are all sparkling blue white gems of finest color and brilliancy, set in solid 18-k white gold mountings, beautifully pierced and engraved. Other gifts in complete variety—values beyond expectations. Order NOW!

Satisfaction guaranteed, or money back. Goods sent for your free examination on request. Credit terms: Pay one-tenth down; balance weekly, semi-monthly, or monthly at your convenience. ALL GOODS DELIVERED ON FIRST PAYMENT.

**SEND FOR FREE CATALOG**  
Write for big free book of 2000 Illustrations and descriptions of Diamond Rings in Platinum and Solid Gold, Dinner Rings, Pins, Brooches, all Standard Makes of Pocket Watches, Pearls, Dresser Sets, Silverware, Clocks, Kodaks, Leather Goods. Also many inexpensive novelties.

**No. 901 "Venus" \$50 \$1.25 a Week**

**No. 849 "Maeda" \$100 \$2.50 a Wk.**

**No. 900 "Leila" \$37.50 \$1.00 a Week**

**No. 904 "Senator" \$150 \$3.75 a Wk.**

**No. 27 "Muriel" \$75 \$1.75 a Wk.**

**No. 859 "Coral" \$125 \$3.25 a Week**

**WEDDING RINGS!**  
No. 824—The "Elite" \$800 solid 18-k white gold . . . Set with 8 Diamonds, \$22.50; 5 Diamonds, \$42.50; 7 Diamonds, \$42.50; 9 Diamonds, \$52.50; 12 Diamonds, \$67.50. All platinum, \$25. All Platinum Wedding Rings set with brilliant blue white Diamonds, from \$50 to \$200.

**Diamond Wrist Watch No. 870**  
Solid 18-k white gold set with 4 brilliant blue white Diamonds, 15 Jewels . . . \$43.75  
\$4.37 Down and \$4.37 a Month

**Man's Strap Watch No. 905**  
15 Jewels, fancy white case, Sterling silver bracelet included, \$14.75  
\$1.47 Down and \$1.47 a Month.

**Standard Railroad Watches on Credit at Cash Prices**  
All Guaranteed to Pass Inspection  
Hamilton No. 992, \$55 — Elgin's Latest Raymond, \$55 — Illinois "Bunn Special," \$50  
We carry all standard American make Pocket Watches in white gold or yellow gold cases.  
Terms to Suit Your Convenience

Our References:  
Any Bank or Banker in U. S. A.

**DO YOU** WANT a new business profession of your own, with all the trade you can attend to? Then become a foot correctionist, and in a few weeks earn big income in service fees,—not medical nor chiropody—easy terms for home training, no further capital needed, no goods to buy, no agency. Address  
Stephenson Laboratory, 1 Back Bay, Boston, Mass.

**AIRPLANE**  
12-inch scale model of Lindbergh's Spirit of St. Louis. Scientifically designed and very realistic. Rises from ground by own power and flies 40 ft. or more. Stays in air 8 to 10 seconds. Easily built in 2 or 3 hours.

No tools needed. Construction set, with all parts and full directions, postpaid in U.S., only 50c. (no stamps). Satisfaction or money back. Send today and print your address plainly. Mann & Benton, Box D, Chillicothe, O.



**NEW VEST POCKET ADDING MACHINE**

ADDS, SUBTRACTS, MULTIPLIES, DIVIDES  
Does work of \$300 machine. Guaranteed 5 years. NOT A TOY.  
Made of steel and indestructible. Million dollar capacity. Fits in pocket. Will not make mistakes. So simple child can operate it. Instructions furnished. Everybody should carry one for figuring.

**FREE TRIAL \$2.50 Total Cost**

SEND NO MONEY—Just name and address. We will ship Calculator immediately. On delivery pay postman \$2.50 (Plus few cents Postage). (If outside U. S. send cash.) 10c additional in Leatherette Case. If not satisfied after 10 days trial you get your money back. THOUSANDS OF SATISFIED USERS.  
This is lowest priced practical calculator made. "Why pay more for inferior imitations?" Order from this ad.

**Guaranteed**

Mail Coupon Today  
BABY CALCULATOR SALES CO., (MANUFACTURERS)  
Dept. 41, P. O. Box 1118, CHICAGO, ILL., U. S. A.  
 I am enclosing \$2.50—send adding machine prepaid.  
 Send Adding Machine C. O. D. \$2.50 plus postage. (10c additional in Leatherette Case)

Name.....  
Address.....  
City..... State.....

**AGENTS** Write for big commission and territory proposition.

**AGENTS 500% PROFIT**  
**GENUINE GOLD LEAF LETTERS**

guaranteed to never tarnish. Anyone can put them on stores and office windows. Enormous demand, large profits. Paul Clark says: Smallest day \$28.70. R. L. Reel made \$920 in two months. Write today for free sample and liberal offer to general agents.  
METALLIC LETTER CO. 433-B N. Clark St., CHICAGO

**Do Your PRINTING**  
Cards, stationery, circulars, tag, labels, paper. Complete Outfits, \$8.85 up, Job Presses \$11 up, Rotary \$149. Card Cutters, \$3. Save money. Print for others, big profits. All easy rules sent. Write for catalog presses, type, paper, cards, ink etc. THE KELSEY CO., T-37, Meriden, Conn.

**WE START YOU IN BUSINESS**  
Eakins Co., 628 High St., Springfield, O.  
Mail at once your free catalog about how to make big profits in the Crispette business with little capital.

Name.....  
Address.....

**\$1000 a Month Profits Possible**



# EVERY MOTORIST needs this CRESCENT KIT



The Crescent Kit provides three necessary automobile tools in a neat duck case. Every motorist should carry one in the car, especially when touring or on extended trips.

The tools consist of an 8-inch Crescent wrench, a pair of thin nose pliers and an all-steel screw driver with a handle which may be turned at right angles for heavy work. Ask your hardware dealer to show you the Crescent Kit.

CRESCENT TOOL CO.

210 Harrison St. Jamestown, N. Y.



## CRESCENT and Smith & Hemenway TOOLS

Made under the supervision of and guaranteed by the originators of the Crescent Wrench.

### A Genuine Robbins & Myers



**1/4 H. P. Electric Motor**  
for 110 V., 60 Cycle light circuit at the low cost of \$9.50. A tool that will lighten your chores, connected to your lathe, grinder, pump, washer, etc. Always ready for service.

ROBBINS & MYERS, Inc.  
Department A, Springfield, Ohio



**MACHINISTS and TOOL MAKERS** save time and tools. Use a GERSTNER Tool Chest for orderly arrangement of your tools. Choose from the many sizes and styles shown in Free Catalog.

*Gerstner Tools*  
466 Columbia Street, Dayton, Ohio

### THE KING OF THEM ALL

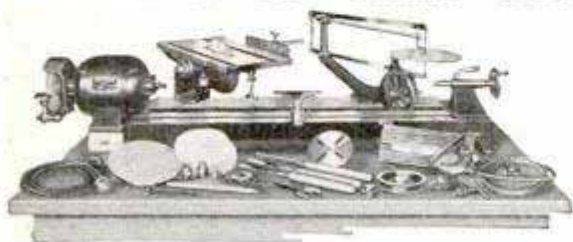

#### AR-CON UTILITool

Excels in power, strength and stamina. Send for fully illustrated circular, with prices and terms.

THE AR-CON TOOL COMPANY  
500 Fassett Street Toledo, Ohio

# ATKINS

## SILVER STEEL SAWS

for your home  
WORKSHOP



When you start a home workshop or need new tools, it will pay you to select ATKINS Saws. Only in ATKINS Saws do you get the world-famous "Silver Steel" which takes a sharper cutting edge and holds it longer. Ask your Hardware Store, or write us about the ATKINS Saws shown below, for home workshops. Three booklets sent free.

ATKINS "400" Hand Saw is the finest saw made. Silver Steel, Ship Point blade. Perfection handle; no wrist strain.



This Atkins Hack Saw has nicked steel adjustable frame, Non-Breakable or Silver Steel Blue-End Blades.

This Back Saw has Rigid Silver Steel blade, 8 to 18 inch. Applewood handle.



Knives for small workshop planers, up to the largest machine-knife cutting job.

Silver Steel Narrow Band Saws for small machines. All lengths and widths.



Circular Rip Saws for fast, accurate work on any machine. Made of "Silver Steel."

A perfect file for every purpose. Silver Steel does your filing faster, easier, better!

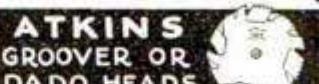

Groover or Dado Heads—The simple, easy way to cut grooves from 1/2" to 4" width. Does even, accurate work.

This specially designed Mc-Kam Tooth Circular Saw is ideal for smooth cutting, with or across the grain.



This Mitre Saw is for fine, smooth cabinet work. It planes as it saws. Silver Steel.

Circular Saws in many sizes for metal-cutting machines.



\$10 for Best Photo of a Home Workshop. Write for details



### E. C. ATKINS & CO., Est. 1857

426 S. Illinois St., Indianapolis, Ind.

Please send me "Saws in the Home," "Mill Saws" and "Saw Sense," free; also information on your offer of \$10 for best workshop photo each month.

Name.....  
Address.....  
My Dealer is.....



**A New Lightweight Electric Drill**

**Only \$18.75**

Weights Only 4 Pounds  
—  
Universal Motor  
—  
Write for our catalog showing complete line.

A sturdy, practical electric drill, fully guaranteed for one year. Specially designed for light and intermittent work. Weighs only 4 pounds. Built to use in even the tightest corners. Many of the large industrial plants are buying this drill by the dozen.

Uses direct or alternating current, and is supplied to you for 110 to 125 volts, 200 to 250 volts or 32 volts. Fitted with a special Jacobs Chuck. Bore up to 1/4". Stop and start switch in the handle. Comes complete with 10 feet of cord and socket. Price post-paid anywhere in the U.S.A.—\$18.75.

Send check or money order. If not satisfied return in 5 days and money will be gladly refunded. In ordering, be sure to specify voltage used.

**Jones Motrola Sales Co.**  
Dept. 6, 370 Gerard Avenue,  
New York.

**CORNWELL QUALITY TOOLS**  
*in Convenient Kits*

A KIT of "CORNWELL" tools is a prized possession of the expert mechanic. Valued not alone for their high quality but because they do better work in less time than any other tools. 65 different tools for almost every purpose. Their remarkable performance in difficult work is simply amazing.

**There Is No Substitute for CORNWELL QUALITY**

Every CORNWELL tool is hand made under our exclusive CORNWELL processes from Swedish or Chrome Molybdenum steels.

**Tools of Amazing Strength**

No other tools are like them. They withstand the most severe tests to which any tools can be put. Try them at our risk.

**Let Us Demonstrate**

Ask for salesman to call and show you many startling demonstrations of CORNWELL QUALITY TOOLS. Or send for free catalog, order tools, and make these tests yourself.

**COUPON BRINGS CATALOG-FREE**

The Cornwell Quality Tools Co., Dept. K, Mogadore, Ohio. (Formerly at Cuyahoga Falls, Ohio)

Send me new illustrated catalog with prices on full line of CORNWELL Hand-made Tools.

..... Where Employed  
Name.....  
Address.....  
City..... State.....

# ENGINES

LIFETIME GUARANTEE

ALL SIZES AND STYLES

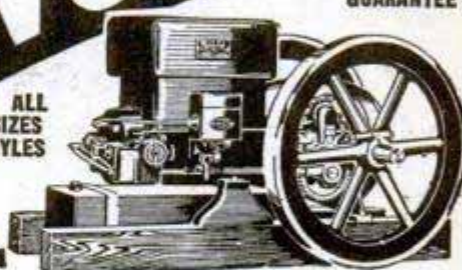

**Wico Magneto Equipped**

**300,000 In Use All Over the World**

A wonderful engine for the home, farm, shop or mill. The cheapest reliable power for pumping, feed grinding, shelling, sawing, cream separating, churning and similar work. Put one to work for you and watch it pay for itself.

Send for Big Free Catalog

**WITTE ENGINE WORKS**  
174 A Oakland Avenue, KANSAS CITY, MO.

**ENGINE BUILDERS SINCE 1870**

# Chesterfield

The MILD cigarette that SATISFIES

**RAISE CHINCHILLA AND NEW ZEALAND WHITE FUR RABBITS**

Make Big Money and pay you following prices for all you raise: Chinchillas average \$3 each—New Zealand Whites \$2 each. 32-page illustrated book, catalog and contract, also copy of *Fur Farming* magazine, tells how to raise rabbits for big profits, all for 10c. Address **OUTDOOR ENTERPRISE CO., Box 1021 Holmes Park, Missouri**

**BURN YOUR NAME ON TOOLS WITH THE ARKOGRAF**



**PROTECT YOUR TOOLS FROM THEFT**

Write with electricity any name or design on the hardest and finest tools and instruments, or any metal, like writing on paper with pen or pencil. **Complete Outfit \$3.50**—Prepaid Anywhere. Interesting illustrated circular free. Write today. Agents wanted. **ARKOGRAF PEN CO., 1171 E. Stark St., Portland, Oregon**

# ASBESTOS

All grades of Crudes and Fibres in large or small quantities

Sold by

**KEASBEY & MATTISON COMPANY**  
Ambler, Pennsylvania  
Branches in Principal Cities

# PARKS

WOODWORKING MACHINES

Cabinet Shop  
Special No. 10

**\$290**

With Motor

You ought to have this handy Parks in your shop. Compact, complete machine designed like a big production outfit at 1/2 the cost. Floor space required only 42x72 in. Does any kind of cabinet and joinery work. Write for circular

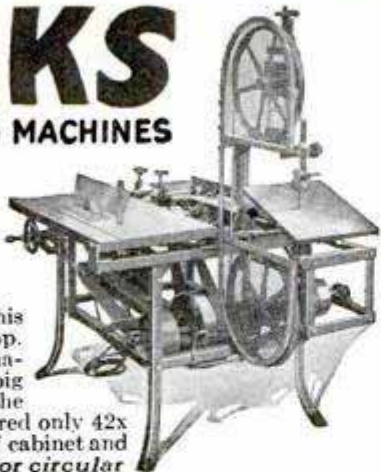

**The Parks Woodworking Machine Co.**

1500-40 Knowlton St. Cincinnati, Ohio

Canadian Factory: 338 Notre Dame East, Montreal

## SALESMEN WANTED!

SELL COX HOLDFAST SCREW DRIVERS



Sells on sight to mechanics for Auto, Radio and Electrical Work. Self Holding, Self Releasing.

Send 50c for sample and ask how to get Salesman's Outfit Free. S. J. COX Dept. F, FRANKLIN, PA.

## The Handy Tool - Torit Torch "23"

Uses acetylene only from a Presto auto tank. Finest thing you ever saw for Radiator and Battery Repairing, Soldering, Light Brazing, Heating, etc. Complete with 4 tips, soldering copper, hose, connections. PRICE (except tank) **\$7.50**

ST. PAUL WELDING & MFG. CO.  
177 W. THIRD ST. ST. PAUL, MINN., U. S. A.



### Engines & Motors

## Big Catalog No. 30

Illustrating Electrical, Mechanical and Model Maker's Supplies, Small Steam & Gasoline Engines, Motors, Generators, Lathes, Drill

Presses, Bench and Band Saws, etc., 16-32 & 64 Watt Dyna-Motors, School Projects, Engine Castings, Motor Parts, etc., Books, Blue prints, Brass and Steel Tubing, Gears, Pulleys, Hangers, Experimental Material. Send for Copy. Mailed anywhere for 10 cents, refunded first order. LOOMIS ELECTRIC & MFG. CO., 2822 N. CALIFORNIA AVE., CHICAGO, ILL.

## OTTAWA LOG SAW



GREATEST OFFER EVER MADE

only **\$39**

PUTS THIS OTTAWA TO WORK FOR YOU

**Make Money!** Wood is valuable. Saw 15 to 20 cords a day. Does more than 10 men. Ottawa easily operated by man or boy. Falls trees - saws limbs. Use 4-hp. engine for other work. **30 DAYS TRIAL.** Write today for **FREE** book. Shipped from factory or nearest of 10 branch houses.

OTTAWA MFG. CO., 1741-W Wood Street, Ottawa, Kansas

## SOLDERALL

METAL IN PASTE FORM

The only convenient metal solder

Every Electrical Connection needs Solderall for perfect reception

**25c**

The SOLDERALL CO., NEWARK, N.J.

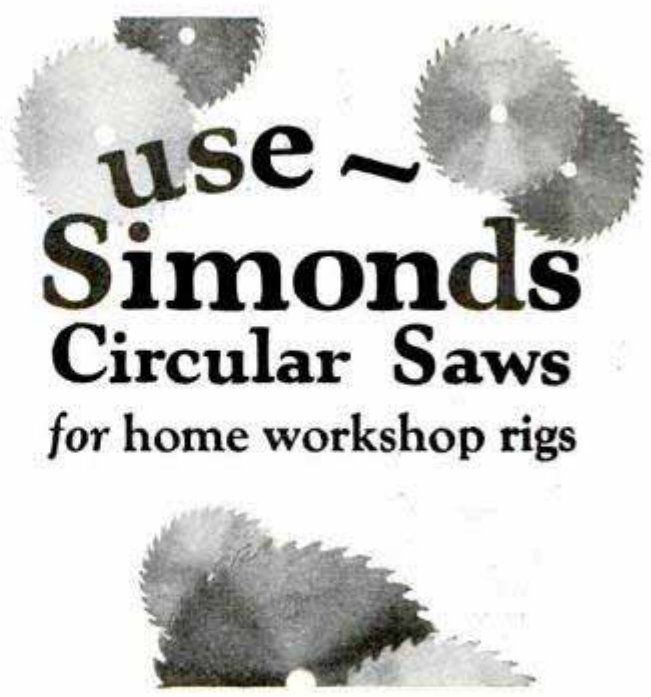

use ~  
**Simonds**  
**Circular Saws**  
for home workshop rigs

**N**O matter what make sawing outfit you use in your workshop, a Simonds Circular Saw will stand lots of grueling service and give you results that exceed your expectations.

Simonds Saws are made from the toughest steel known - heat-treated steel, specially tempered to hold cutting edges. They stay sharp; they are fast cutting and accurate. Every Simonds Saw is an excellent specimen of fine workmanship.

Leading manufacturers of portable rigs and home electric outfits will supply you with Simonds Circular Saws. Look for the name Simonds. Free booklet on woodworking saws sent on request. Write for it.

SIMONDS SAW AND STEEL CO.  
"The Saw Makers" Established 1832  
Fitchburg, Mass.

BRANCH OFFICES AND SERVICE SHOPS IN PRINCIPAL CITIES

SIMONDS  
Circular Saws  
fit all types  
of portable  
rigs

**SIMONDS**  
**SAWS** FILES  
KNIVES  
STEEL



# Clean Hands in 58 Seconds



Men—you who love to tinker—here's just the soap you need. Lava Soap cleans quickly and thoroughly the toughest-looking pair of hands that ever fussed around a work bench. Makes more lather in 15 seconds than ordinary soap in 60, and even hard or cold water won't discourage it. Millions use it. "Good old Lava," they call it. Gets hands *clean!* Not just "surface clean," but clean 'way down deep. As easy on your hands as fur-lined gloves—because it's made from pure vegetable oils and pulverized Italian pumice that's almost as fine as talcum powder. All grocers and druggists sell it.

Mail this coupon for free sample  
of Lava Soap

Procter & Gamble (Dept. W-629)  
Cincinnati, Ohio

Please send me a sample cake of LAVA, the hand soap that removes *all* the dirt and grease.

Name.....  
Street.....  
City.....  
State.....

Cash Priced -  
**Diamonds**  
60% Of Market  
**WHY Pay Full Prices**

10 large loan firms combined (world's oldest, largest association of its kind - rated over \$1,000,000.00), loans money on diamonds at a mere fraction of real values. Of course not all loans are repaid. These the real opportunities to buy at prices you can try to match at full 60% more. Every liberal privilege, with examination free without obligation to buy.

**Detailed List Free—NOW!**  
See this 3/4-1/16 ct., sparkling solitaire at \$69.50. Try to match at \$115.00. Radically low prices for any quality, any size diamonds. This dependable house plainly lists, describes and guarantees each and every quality. The exact grade you want unquestionably in latest list of Unpaid Loans. Diamonds also from other unusual European cash deals. Free, all details; guaranteed amounts you can borrow; other guarantees, etc. Examine diamonds free at our risk. Lists limited—write at once.

**Unpaid Loans—Low as \$60 per Carat**

Name.....  
Address.....

For Free List clip this now, fill in and mail to—  
Jos. DeRoy & Sons, Opp. P.O. 1981 DeRoy Bldg., Pittsburgh Pa.

Note: These offers made by a 3/4 Century Old Firm. Bank References by permission:—Bank of Pittsburgh; Union Trust Co.; 3rd Nat'l Bank; Any Mercantile Agency.

# SHOOT THE REAL THING!

Here is that famous genuine pump boys everywhere are turning to. Single stroke outshoots all others. Two to three strokes now give full shooting force. New rear peep sight, leak-proof valves, fully enclosed action. A beauty. Amazing accuracy. Full factory guarantee for one year. Uses regular air rifle lead shot. Photo shows flattening power at 80 ft. on steel target. The biggest money's worth in genuine air rifles ever offered.

**"The Shooter's Art" FREE**  
Tells how to hold, aim and handle rifles; helps you guide others in correct knowledge of guns. Gives facts that make crack shots. Contains safety and common sense instructions every parent and boy should have. Helps to make boys leaders. Your copy free. Write at once.

**SEND TODAY!**

**\$5** at your dealer's or sent postpaid  
**NEW MODEL "G"**

# BENJAMIN

Genuine Pump Air Rifle  
BENJAMIN AIR RIFLE & MFG. CO., 645 N. Broadway, St. Louis, Mo.

## AGENTS AND SIGN MEN

Now Making \$50.00 to \$100.00 and Up Per Week Selling Our **GOLD LEAF SIGN LETTERS**

**R** For store and office windows, board signs, trucks and glass signs. We also make to order script signs and business emblems singly or by the thousands. A permanent business. No capital or experience required. Big demand in every city. Samples and Literature Free.

CONSOLIDATED SIGN LETTER CO. 71-X W. Van Buren CHICAGO, ILL.

**\$4.99** 22 Cal. Blank Automatic  
**WITH 100 CARTRIDGES FREE!**

You need no license or permit to own this 6-shot Automatic. Use for fun or self-defense, keeps away tramps, frightens thieves, scares away dogs—a real home protector. Fool your friends. Same as an expensive automatic in construction, finish, appearance, durability; automatic magazine loading and ejection of cartridges, instant and powerful report. Guaranteed absolutely safe. Send no money. Pay expressman \$4.99 and small shipping charge for automatic with 100 cartridges. JENKINS, 621 Broadway, New York, Dept. 6-T-23

No Permit Required  
**6 SHOT**

**YOU**

## Sell this Amazing Belt to Men!

Made-to-Individual Order  
With Personal Initials!

Sell Hook-Fast—the marvelous belt with *Personal Raised Initials* (beautifully hand made). Popular emblems and patented catch that prevents slipping. Clubs, lodges, associations, teams, order in large quantities. *Big profits.* Write to-day for full facts, **FREE BELT OFFER** and **SURE SUCCESS PLAN.** Big season right ahead.

NATIONAL CRAFTS COMPANY  
20 W. 27th St., Dept. F-20, New York

# Your Family's Happiness Is at Stake

*Each Day Is Another Chance for Death to Win*

What if you lose tomorrow? Think what the consequences may be: a grief-stricken family . . . but worse, a home ruined for want of an income, and your loved ones hurled penniless to the mercy of the streets. A BUFFALO LIFE POLICY WILL PUT AN END TO THIS GAMBLE TODAY.

## Life Insurance at Cost

You do not need to burden your income, and do without, in order to hold adequate life insurance. Buffalo Life is offered to you without profit—AT COST. The Buffalo Life Association is a mutual society which has been operating 57 years solely for the benefit of its policy holders.

### Show Them You're a GOOD Dad!

Take out a Buffalo Life Policy at once. We can supply you with a policy fitted to your special needs. Perhaps it is the Step-Rate Plan of insurance (designed especially for the younger man). This policy form gives you full protection at a cost which is small at first and increases gradually as your earning ability grows.

Mail the coupon now before you forget it. We'll answer promptly.

## BUFFALO LIFE ASSOCIATION

(Formerly Masonic Life Association) Est. 1872  
Nelson O. Tiffany, President

452 Delaware Ave. Room 37 Buffalo, N. Y.

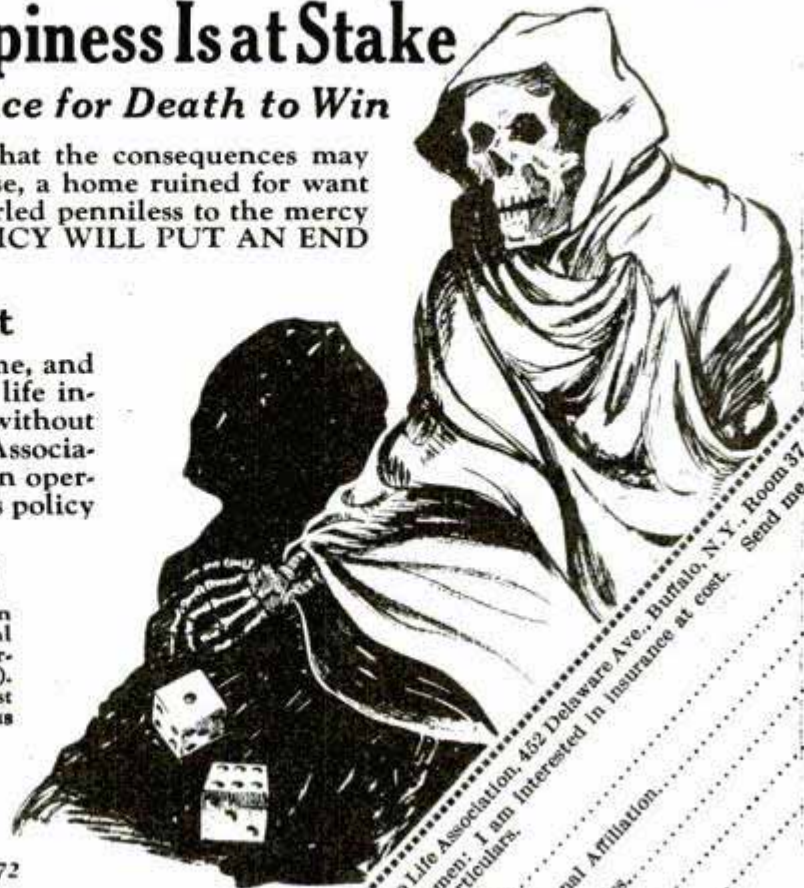

Buffalo Life Association, 452 Delaware Ave., Buffalo, N. Y., Room 37  
Gentlemen: I am interested in insurance at cost. Send me full particulars.  
Name.....  
Fraternal Affiliation.....  
Address.....  
Age.....

## MAKE YOUR FORD Into The "LARK"

\$5.00 Red-I-Kut life size patterns Class—Snap



Famous sure-fit RED-I-KUT life-size patterns and picture instructions show how you can easily convert your Ford into this Fast, Saucy, Sport-Car as thousands have done with easily obtained materials. No need to lay up the car. Rear seat folds, making 4-passenger car. Send 10c coin for actual body photo

and new manual of other distinctive sport body patterns from \$3.50 up—"REO" Steel "Swing-La" irons, Tops and Windshields. ORDER RIGHT NOW

KUEMPEL COMPANY, 109 Kuempel Bldg., GUTTENBERG, IOWA

## Beautiful HOUSES \$900 and BUNGALOWS

CAN BE BUILT FOR AND UP  
This and many others in my new book, Building Plans for Modern Homes, will save you hundreds of dollars. One of the most complete and comprehensive books of plans ever published by any architect. New edition just off the press. Nearly 600 floor plans and photographs of Colonial houses, bungalows, etc., costing from \$200 up; gives sizes and cost to build. Sent postpaid for \$3.00.



FREDERICK H. GOWING ARCHITECT  
101 Tremont St., BOSTON, MASS.

## LE PAGE'S GLUE

HOW TO MAKE YOUR OWN ATTRACTIVE FURNITURE  
Send 10 cents for LePage's New Third Home Work Shop Book, containing complete directions for making 20 different projects. LePage's Craft League, 622 Essex Ave., Gloucester, Mass.



**I'll Pay YOU \$100 a Week**

Make \$100.00 a week and up, selling our fine made-to-measure, all-wool suits, direct to wearer. **Biggest values—positively sell on sight.** Biggest commissions paid in advance. We attend to delivery and collections. 6x9 cloth samples—over 100 styles—furnished **FREE.** Ambitious men write at once.  
W. Z. GIBSON, Inc., 532 Throop, Dept. F-516 Chicago

## Build a CLOCK for Pleasure or PROFIT



### FREE BOOK shows how YOU can Make Fine Clocks Right at Home

Chock full of Clock-Making and Money-Making ideas. Gives full details, descriptions, prices of movements and parts. Write NOW for your copy.

THOUSANDS of men have built our Clocks. For their own use—or to sell at money-making prices. It's easy, fascinating. Only ordinary tools needed. We furnish plans, instructions, parts. Works all assembled, ready to install, as low as \$1.65; others with chimes at all prices. You make the case, or simply assemble knock-down parts. Cash-in on the demand for craftsman-built Mantel Clocks, Banjo Clocks, Grandfather's Clocks. Here's a hobby that PAYS—in pleasure, in ownership and in spare-time or full-time PROFITS!

Write for FREE Catalog and Special Blue Print Offer

American Chime Clock Company  
1670-F Ruffner St., Philadelphia, Pa.

SPIRIT OF TIME BANJO CLOCK

## "SHE'S BUILT, DAD!"

Now all the fellows at school say they want a 20' Flying Cloud. No, it wasn't hard to build. Hancock parts give me a sanded hull, blocks, steering wheel, anchor, bell, mast, spar material, rigging line for \$11, plus 5 lbs. postage.

**Boats Ready to Sail**  
Sloop "Captain" wins in any regatta—price \$10.

**ROY HANCOCK**  
323 Douglas Ave.  
Portsmouth, Va.

- Send catalog and "She's a Clipper" 10¢ enclosed.
- Mail Flying Cloud—Check enclosed.
- Rush Sailboat "Captain," \$10.

Name.....  
Street.....  
City..... State.....



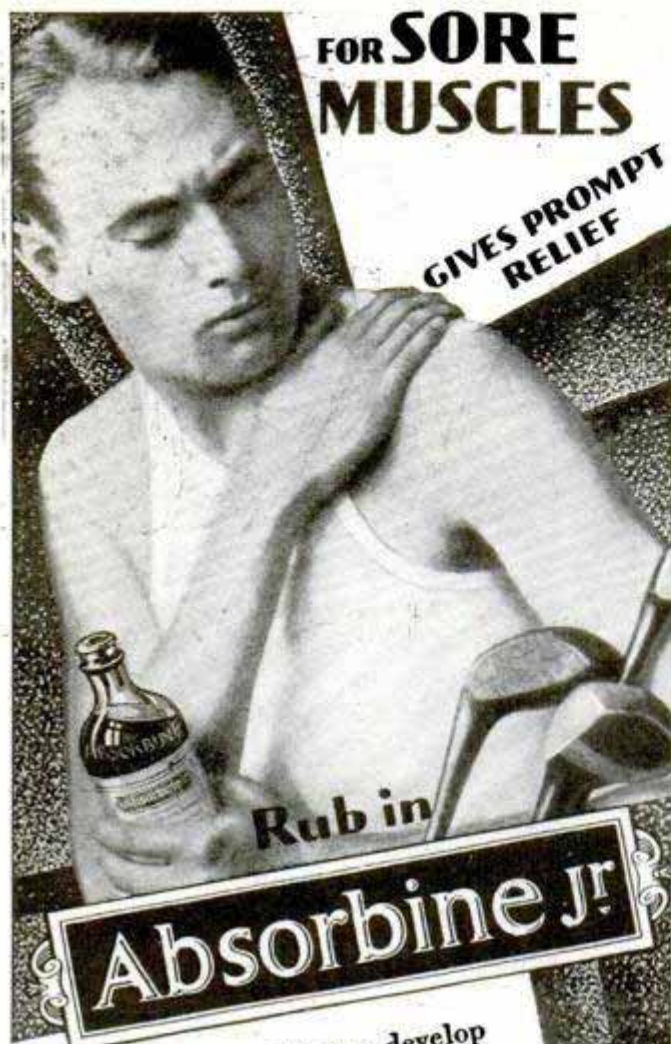

**FOR SORE MUSCLES**

**GIVES PROMPT RELIEF**

Rub in

**Absorbine Jr.**

**T**HE activities of Spring develop many unexpected and unwelcome aching muscles. Keep Absorbine, Jr. handy—rub it in at the first indication of soreness. Relief will come at once. A few applications of Absorbine, Jr. will invigorate the lazy, winter-bound muscles, and round them into mid-season form. Keep a bottle in the locker for tired feet—or a vigorous rub down when you have been out in the rain—it's great for that. Absorbine, Jr. is not greasy. It does not stain the skin. It has many other uses. Read "Timely Suggestions."

AT ALL DRUGGISTS, \$1.25  
Send for Free Trial Bottle

W. F. YOUNG, INC.  
Springfield, Mass.



*This motor-driven boat is ideal for your family's summer camp*

WHAT'S a summer camp without a boat? And you couldn't get a better boat for the whole family than this square-stern Old Town, especially designed for a portable motor. Light, yet built to carry heavy loads. Swift, yet sturdy, dependable and safe. Graceful and easy to handle too. Comes with or without spousons.

Write today for free catalog. It shows and prices many light, water-tight models. Paddling, sailing and square-stern canoes, extra-safe Sponson models, dinghies and sturdy family boats. Also speedy craft for outboard motors—racing step planes and hydroplanes. Old Town Canoe Co., 1966 Middle Street, Old Town, Maine.

*"Old Town Boats"*

**MOTORCYCLES**

Direct to you at wholesale prices Send 10c today for the latest Illustrated Bulletin and Confidential Price List of Guaranteed Indians Harleys Hendersons SuperX etc.

*(Sold on easy terms if desired)*

**CRANDALL CYCLE CO.** 826-28 State St. Shipments to all parts of the world  
Springfield, Mass. Motorcycles Since 1905

**30 Days' Free Trial**  
on all MEAD Bicycles

New Models now ready for delivery direct from our factory. Astonishing new prices and terms. Do not buy until you get them.

**RIDER AGENTS WANTED** to ride and exhibit sample. Save big money. Many models, styles.

**Tires** wheels, lamps, horns, equipment at half usual prices. Send no money. Write for our marvelous prices and terms.

**Mead CYCLE COMPANY** Write us today for free catalog  
DEPT. K 109 CHICAGO



**Makes Old Ford a Tractor**

Now you can convert that old Ford car into a useful farm tractor without altering any Ford parts. We furnish the traction wheels, drive gears and auxiliary axle and mountings, ready to clamp on to the Ford frame. Pulls 16' plow.

We supply a Belt Pulley also



Write for Free Particulars.  
Shaw Mfg. Co., Dept. PM6, Galesburg, Kan.

**FREE RADIO CATALOG**

Since the dawn of Radio, Barawik has been known the world over as headquarters for radio set builders and fans. Here, under one roof, is everything you need—sets, parts, supplies—thousands of products—ready to ship to you the same day your order arrives. Barawik prices save you money. Barawik service saves you time. Barawik merchandise always pleases. A quarter million satisfied customers say, "Barawik is Best." Let us send you the Big Barawik Book free and prove it to yourself.

**BARAWIK CO., 106 Canal St., CHICAGO, U. S. A.**





# The Outboard Motor

"That Folds Like a Jackknife"



**Snap!** When the Elto Lightweight is through for the day, you snap it "closed" — simple as shutting a pocket knife! Then it measures only 22" by 11" by 11"—easy to carry and stows anywhere.

## The Super Elto Lightweight

It's the most compact outboard motor in the world, and the most practical for average needs. Catalog mailed on request. Write Elto Division, Outboard Motors Corporation, Mason St., Dept. AA, Milwaukee, Wisconsin.

The Lightweight weighs only 33 pounds, develops 8 horsepower. Drives average boats 7 to 10 miles an hour. Easy to start, extremely quiet.



## FLY THIS ARMY PURSUIT SHIP!

Light and fast, this one-foot model is a realistic copy of a single-seater military pursuit plane. Will rise from ground by own power and fly 60 ft.



Can be used indoors or out. Has air service insignia on wings, in colors. Construction set includes ready-made aluminum propeller, shaft, rubber band motor, stream-line wood wheels, pre-cut balsa wing ribs and all other parts, with clear directions. Can be assembled in 3 hours by average 14-year old boy, without tools. Complete set, packed in unbreakable mailing tube, only 75¢, postpaid in U. S. Send check or money order today (no stamps). Print address plainly. Satisfaction or money refunded.

LOGAN TOY WORKS, 35 E. Gay St., COLUMBUS, O. (We cannot make C. O. D. shipments. No retail catalogue issued)

## Stop that Gas Eater!

**USE Electro GasSaver on your car and save half your gasoline.** Aurora engineer invents new, dependable and electrically controlled accelerative gasoline saver which saves its cost many times over. An article of merit selling at \$12 and not to be confused with cheaper types with absurd claims. Nothing like it on the market. One model fits all cars. Works automatically. Combines vaporizing principle using generator as current for heating and controlling. Increases gasoline mileage  $\frac{1}{4}$  to  $\frac{1}{2}$  thru efficient combustion. Gives faster getaway. More power. Eliminates hard carbon. Lasts a lifetime. Installed in 15 minutes. Exclusive territory to agents. Big money maker. Write now for sample offer.

**ELECTRO GASSAVER, Mfrs., Aurora, Ill.**

Dept. A-40

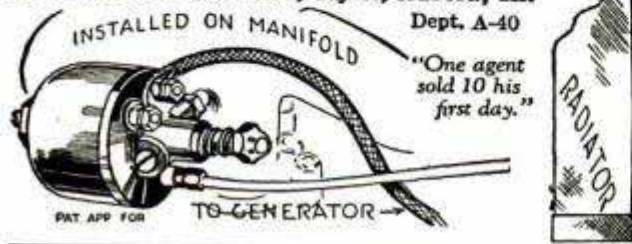

"One agent sold 10 his first day."



## Small bubbles vs. big bubbles

**T**HIS news is spreading fast: Colgate chemists, time has proved, have achieved a shaving cream of unique superiority. Its success lies in the creation of a lather with small bubbles.

*A new principle so easy to understand.  
So easy to compare with  
ordinary shaving*

The minute you lather up with Colgate's, two things happen: 1. The soap in the lather breaks up the oil film that covers each hair. 2. Billions of tiny, moisture-laden bubbles seep down through your beard . . . crowd around each whisker . . . soak it soft with water.

Instantly your beard gets moist . . . easier to cut and pliable . . . scientifically softened right down at the base . . . then your razor can do its best work.

Better grooming — the utmost in shaving comfort. A world of critical men, after various experiments with big-bubble lathers, have found that Colgate's is supreme. You, too, will agree. Let us help you in deciding — note our offer below.



*A week's shaves  
**FREE***

COLGATE, Dept. B-1778, 595 Fifth Avenue, New York  
Please send me, FREE, the seven-day trial tube of Colgate's Rapid Shave Cream; also a sample bottle of "After-Shave."

Name \_\_\_\_\_  
Address \_\_\_\_\_

# BURNING FEET *ended* IN 3 SECONDS

**E**ND those agonizing foot pains in *three seconds*. End the burning and soreness that bring sleepless nights and tortured days.

Coolene, a new kind of ivory-white, vanishing foot cream actually ends all foot pains in a few seconds. It contains soothing oils and healing unguents which are absorbed by the feet, making them cool and refreshed in a jiffy. It draws out every bit of pain and fire like magic — brings lasting relief to your swollen, inflamed feet. Corn, bunion and blister pains usually disappear after the first application of Coolene. No need for messy foot baths, powders or plasters that irritate the skin. Try Coolene tonight! Relief from sore, tired, burning feet guaranteed—or money back. At all good drug and department stores.



Made by Coolene Labs., 27 W. 20th St., N. Y. C.

# COOLENE MOVIES AT HOME



Many models of genuine MOVIE MACHINES, some as low as \$3.75, all using standard size big theatre films. Our stock of films is the most complete and lowest in price—with an exchange service. Films of leading stars and religious subjects are available. **DON'T DELAY. WRITE FOR FREE INTERESTING CATALOGUE NOW!**

**PARAMOUNT MFG. CO.**  
Dept. G-16 BOSTON, MASS.

## \$1 Brings this BULOVA Watch



**\$29.75**  
10 Months to Pay

No. 26 - This new Bulova: guaranteed 15 Jewels, radium dial, leather strap; will come for 15 day trial. Pin \$1.00 to this ad and state: Age, How long at address, Employer; Nature of work. **Everything confidential.** Satisfaction or money refunded. \$2.85 a month. Jewelry Book sent FREE to any Adult.

**L.W. SWEET Inc.**  
DEPT. [69-L] 1660 BROADWAY NEW YORK

# New Model Homes

Direct From  
**ALADDIN MILLS**  
AT AMAZING  
LOW PRICES!



See them in the new, 1929 Aladdin catalog! Many beautiful designs, just out. Aladdin Read-Cut system saves you \$200 to \$800. All lumber is cut-to-fit at mill on huge labor-saving machines instead of on the job where labor and lumber waste costs dearly!

**Prices Include:** All materials for a complete home, together with instructions and plans for erecting, also **Plumbing, Heating and Lighting Equipment. WE PAY FREIGHT.**



**7 Room Aladdin**  
**\$2597**

All Materials Read-Cut Just one of many new prize-winning model homes in the 1929 Aladdin Line!



**Write for FREE Catalog**

Just out. Profusely illustrated. Overflowing with interest! Address nearest Office **today** for your FREE Copy—ask for Catalog No. 779. Send NOW. **The ALADDIN CO., Bay City, Mich. Wilmington, N.C., Portland, Ore.**



## BOW LEGS?

THIS GARTER (Pat'd) Makes Trousers Hang Straight If Legs Bend In or Out

Free Booklet—Plain Sealed Envelope  
**THE T. GARTER CO., Dept. E**  
South Bend, Ind.



Beautifully Illustrated **Aviation and Marine Supply Catalog** Postpaid 25c

Features Aviation and Aviators' Supplies and Equipment, Marine Supplies, MODEL AIRPLANE SUPPLIES and MODEL AIRPLANES and PARTS, Seaplane-type Speedboats, Seaplane Floats, Ice Boats and Snowsleds, Outboard Motor Boats, SKIBOARD, the self-propelled aquaplane, German Air Gliders, Shop Tools and Equipment. Will save you hundreds of dollars. Gives you information unavailable elsewhere on how and where to obtain supplies and materials for constructing your own speed crafts. Send quarter for your copy of this Catalog AT ONCE.

**INTERNATIONAL ENGINEERING CORP.**  
707-B, Westory Bldg., Washington, D. C.

**Thompson**  
**BEATS**  
**the World**  
**on BOATS**

**THOMPSON**  
**BOATS**

**CATALOG**  
**FREE!**



**OUTBOARD MOTOR BOATS**—A complete line of strictly up-to-date racing models. Also some entirely new models for general pleasure use with speed of a racer. Built strong, staunch and durable, and absolutely safe.

**Rowboats \$44.00 and up**—

The most complete line ever offered, at real money-saving prices.

**Canoes \$48.00 and up**—

Some all wood, others canvas covered. Light, swift, safe, strong and durable. Choice of many distinctive color combinations.

**Motor Boats**—

With or without Engine. Fast, handsome craft at money-saving prices.

**CATALOG FREE — SAVE MONEY — ORDER BY MAIL**  
Please state the kind of boat you are interested in (30)

→ **TWO LARGE FACTORIES** ←  
**THOMPSON BROS. BOAT MFG. CO.**  
213 Ann St. **PESHIGO WISCONSIN** (Write to Either Place) 113 Elm St. **CORTLAND NEW YORK**

**DEAFNESS IS MISERY**



Multitudes of persons with defective hearing and Head Noises enjoy conversation, go to Theatre and Church because they use Leonard Invisible Antiseptic Ear Drums. Tiny Megaphones fitting in the Ear entirely out of sight. No wires, batteries or head piece. They are Unseen Comforts and inexpensive. Write for booklet and sworn statement of the inventor who was himself deaf.



**A. O. LEONARD, Inc., Suite 699, 70 5th Ave., New York**

**MAKES NEW PHONOGRAPH OUT OF YOUR OLD ONE!**

**PRODUCES THRILLING LIFE-LIKE TONES WONDERFULLY RICH, DEEP, POWERFUL**

New Superphonic Tone-Arm and Reproducer brings old type phonographs up-to-date. Latest scientific air column and metallic diaphragm produce music of astonishing naturalness. Brings out low bass notes and high trebles on new electrical records. The warmth and depth of tone, the tremendous volume, will amaze you. Fills room like living singers or real orchestra. Fits any type machine.



**Agents Earn \$50 to \$100 Weekly**

"Superphonic" makes sensational demonstration. Prospects everywhere among over 10,000,000 old type phonographs now obsolete. Their owners welcome eagerly this great invention. New low direct-to-consumer price brings this outfit within reach of all. 100% commission to agents. Write for FREE details! Today. Be first in your territory.

**WRITE TODAY**

**SAUL DISTRIBUTORS**  
Room 116, 430 S. Wabash Ave., Chicago

**WURLITZER**  
REG. U.S. PAT. OFF.

**"Bill Carola"**  
**Landaus**  
**Serenaders**



**Couldn't Play a Note—Now Makes**

**\$100**  
**a week**

"When I sent for your catalog, I didn't know a note of music. A few months after I bought my Wurlitzer instrument, I had taken my place in a professional orchestra. Now I am making \$100 a week, three times what I made as clerk. I wish everybody knew how easy it is—anyone who can whistle a tune can learn to play a musical instrument."

—Bill Carola

**Free Trial**  
**Easy Payments**

You may now have any Wurlitzer instrument for an ample free trial in your own home. Examine the instrument, note the fine workmanship, the full, rich tone value and especially how easy it is to play. No obligation to buy—no expense for the trial. We make this liberal offer because we want you to try for yourself a genuine Wurlitzer instrument, the result of 200 years' experience in musical instrument building. Easy payments are arranged to suit your convenience. This is your opportunity to try a famous Wurlitzer instrument in your own home. Send for

**Free Book**

Illustrates and describes every known musical instrument—more than 3000 articles, many of them shown in full colors. All genuine Wurlitzer instruments—buy direct from Wurlitzer and save money. Special offers on complete outfits.

We also give you our Free Trial, Easy Payment Plan. No obligation.

**Send Coupon Today!**

**The Rudolph Wurlitzer Co., Dept. A177**

117 E. 4th St., Cincinnati

Send me your Free Book on musical instruments. Also your Free Trial, Easy Payment Plan. No obligation.

Name .....

Address .....

City ..... State .....

Instrument .....

# PATENT

## Protect Your Ideas

### Take the First Step Today

If you have a useful, practical, novel idea for any new article or for an improvement on an old one, you should communicate with a competent Registered Patent Attorney AT ONCE. Every year thousands of applications for patents are filed in the U. S. Patent Office. Frequently two or more applications are made for the same or substantially the same idea (even though the inventors may live in different sections of the country and be entirely unknown to one another). In such a case, the burden of proof rests upon the last application filed. Delays of even a few days in filing the application sometimes mean the loss of a patent. So lose no time. Get in touch with me at once by mailing the coupon on the opposite page.

### Prompt, Careful, Efficient Service

This large, experienced organization devotes its entire time and attention to patent and trade mark cases. Our offices are directly across the street from the U. S. Patent Office. We understand the technicalities of patent law. We know the rules and requirements of the Patent Office. We can proceed in the quickest, safest and best ways in preparing an application for a patent covering your idea. Our success has been built on the strength of careful, efficient, satisfactory service to inventors and trademark owners located in every state in the Union.

### NO CHARGE for Information On How to Proceed

The booklet shown here contains valuable information relating to patent procedure that every inventor should have. And with it I will also send you my "Record of Invention" form on which you can sketch your idea and establish its date before a witness. Such evidence may later prove valuable to you. Simply mail the coupon and I will send you the booklet, and the "Record of Invention" form, together with detailed information on how to proceed and the costs involved. Do this NOW. No need to lose a minute's time. The coupon will bring you complete information entirely without charge or obligation.

My Patent Law Offices  
Just Across  
Street From  
U.S. Pat. Office

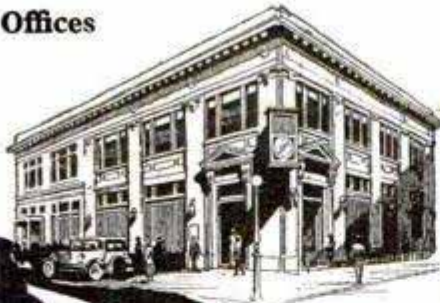

Above is a view of my drafting and specification offices where a large staff of experienced experts are in my constant employ. All drawings and specifications are prepared under my personal supervision

# NEWS

Inventors  
Write for these Free Books

**Strict Secrecy Preserved**

All communications, sketches, drawings, etc., are held in strictest confidence in strong, steel, fireproof files, which are accessible only to authorized members of my staff. Feel free to write me fully and frankly. It is probable that I can help you. Highest references. But **FIRST**—clip the coupon and get my free book. Do **THAT** right now.

**Clarence A. O'Brien**

*Registered Patent Attorney*

Member of Bar of: Supreme Court of the United States; Court of Appeals, District of Columbia; Supreme Court, District of Columbia; United States Court of Claims. Practice confined exclusively to Patents, Trade marks and Copyrights

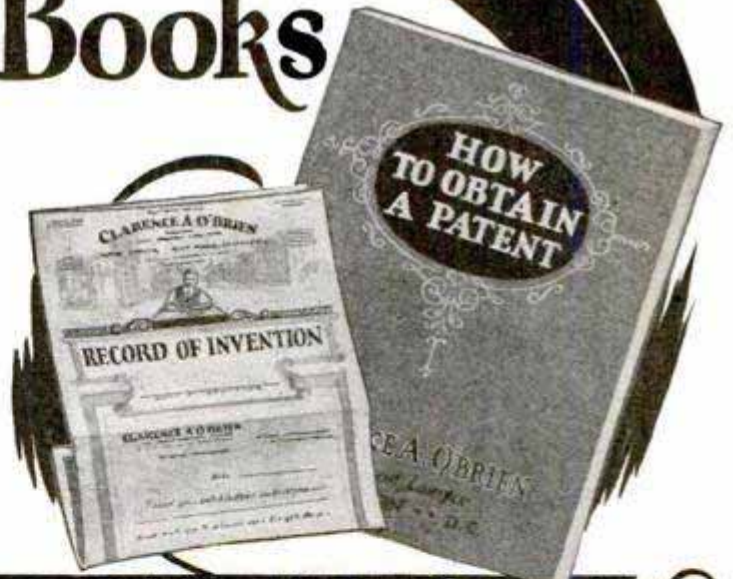

**Clip this Coupon and Mail it Now!**

**CLARENCE A. O'BRIEN, Registered Patent Attorney**

70-R Security Savings and  
Commercial Bank Bldg.,  
Washington, D. C.

OR

Suite 1106 Woolworth Bldg.,  
New York City

Please send me your free book, "How to Obtain a Patent," and your "Record of Invention" form without any cost or obligation on my part.

Name.....

Address.....

(Important—Write plainly and address office nearest you)

# PATENTS TRADE MARKS COPYRIGHTS

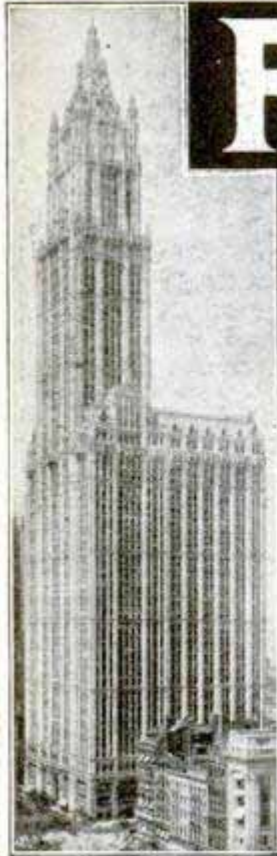

Our New York Office  
Suite 1007 Woolworth Bldg.



Our Philadelphia Office  
Suite 518-519 Liberty Bldg.



Our Washington Office, Victor Bldg.

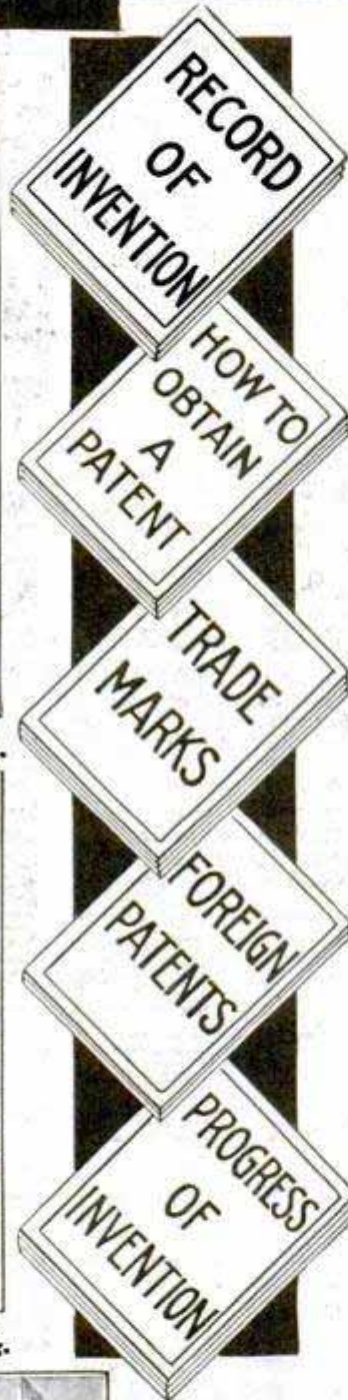

**Have You An Idea ?**

**Our Offer:** FOR THE PROTECTION OF YOUR INVENTION

## YOUR FIRST STEP

The inventor should write for our blank form

### "RECORD of INVENTION"

This should be signed and witnessed and returned to us together with model or sketch and description of the invention for

**INSPECTION AND ADVICE**

*No Charge for the Above Information*

**Our Five Books Mailed**

**Free to Inventors**

*Our Illustrated Guide BOOK*

### How to Obtain a Patent

Contains full instructions regarding U. S. Patents. Our Methods, Terms, and 100 Mechanical Movements illustrated and described.

### Our Trade Mark Book

Shows value and necessity of Trade Mark Protection. Information regarding *Trade Marks and unfair competition in trade.*

### Our Foreign Book

We have Direct Agencies in Foreign Countries, and secure Foreign Patents in shortest time and lowest cost.

### Progress of Invention

Description of World's Most Pressing Problems by Leading Scientists and Inventors.

### Payment of Fees in Installments

It is not necessary that the total cost for the preparation and prosecution of a patent be paid in one payment. Our custom is to permit our clients to pay for their applications in three installments as the preparation of the application progresses in our office. This plan makes the payments easy for the inventor.

*We Regard a Satisfied Client* as our best advertisement, and furnish anyone, upon request, lists of clients in any state for whom we have secured patents.

**Highest References—Prompt Service  
—Reasonable Terms**

## VICTOR J. EVANS & CO.

Patent Attorneys, Established in 1898

Main Offices: 789 9th St., N. W., Washington, D. C.

*Nearly Opposite U. S. Patent Office*

# DELAYS ARE DANGEROUS IN PATENT MATTERS

## IMPORTANT! To Avoid Delay!

YOU SHOULD HAVE YOUR CASE MADE SPECIAL IN OUR OFFICE to save correspondence, secure protection and early filing date in the Patent Office. To secure **special preparation** of your case send \$25.00 on account with model or sketch and description of invention.

**ACT NOW**—Often two or more inventors file applications for practically the same idea. In such cases the burden of proof rests upon the last application filed. Therefore, delays often cause the loss of a patent.



Our Chicago Office  
Suite 1110 Tacoma Building



Our Pittsburgh Office  
Suite 514 Empire Building

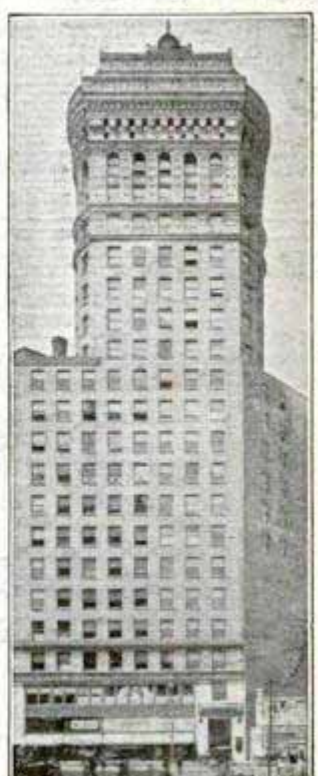

Our San Francisco Office  
Suite 1010 Hobart Building



MAIN OFFICE, VICTOR J. EVANS & CO.—VICTOR BUILDING, WASHINGTON, D. C.

Our Large, Comprehensive Organization has been established for 30 years and offers Prompt, Efficient and **Personal Service** by experienced Patent Lawyers and Draftsmen. Every case is in charge of a Specialist who has been selected for his knowledge and experience in certain lines of invention. Our Lawyers practice in all U. S. Courts and defend clients in suits involving Patents, Trademarks and Copyrights. **All Communications and Data** strictly Secret and Confidential. We shall be glad to have you consult us or to answer any questions in regard to Patents, Trademarks or Copyrights without charge or obligation.

**FREE  
COUPON**

**VICTOR J. EVANS & CO.**  
**PATENT ATTORNEYS** *Established in 1898*

NEW YORK OFFICES  
1007 Woolworth Bldg.

CHICAGO OFFICES  
1110 Tacoma Bldg.

PHILADELPHIA OFFICES  
518-519 Liberty Bldg.

PITTSBURGH OFFICES  
514 Empire Bldg.

SAN FRANCISCO OFFICES  
1010 Hobart Bldg.

MAIN OFFICES: 789-9th Street, N. W., WASHINGTON, D. C.

Gentlemen: Please send me *Free of Charge* your books as described on preceding page.

Name .....

Address .....

# PATENTS

Booklet Free Highest References  
Promptness Assured Best Results

Send drawing or model for preliminary examination and advice.

## ALL BUSINESS GIVEN PROMPT AND PROPER ATTENTION

Listed Patent Lawyer in the latest editions of the Rand-McNally Directory of Bankers and Bonded Attorneys, published by Rand-McNally & Co., Chicago, Ill.; The Baggott & Ryall Directory of Guaranteed Attorneys, published by the Ryall Legal Directory Company, New York City; Flugel's List, published by the Legal Directory Publishing Co. of St. Louis, Mo.; the American Lawyers Annual, published in Cleveland, Ohio; Eyre's Law List, Bush Terminal Building, New York City.

**WATSON E. COLEMAN,**  
REGISTERED PATENT LAWYER

Victor Building, 724 Ninth Street, N. W.  
**WASHINGTON, D. C.**

# PATENTS

## To the Man with an Idea

**PATENTS** Procured. Trade Marks Registered. —A comprehensive, experienced, prompt service for the protection and development of your ideas. Preliminary advice gladly furnished without charge. Booklet of information and form for disclosing idea free on request.

**IRVING L. McCATHRAN,** Patent Lawyer  
Formerly with and successor to RICHARD B. OWEN  
704 International Bldg., Washington, D. C.  
41-E Park Row, New York City

**TRADE-MARKS**  
REGISTERED

## JOIN THE AMATEUR INVENTORS OF AMERICA

**YOUR IDEAS** through united effort bring **SUCCESS.** Receive with membership yearly **SUBSCRIPTIONS** to **TWO Scientific and Mechanical magazines** also, four books:—"Creating Ideas," \$1.00; "Patenting Ideas," \$1.00; "Developing Ideas," \$1.00; "Selling Ideas," \$1.00. The four books are written in lesson form and compose a practical course on spare time invention. Send \$2.00 for all above items and **ONE YEAR'S MEMBERSHIP** during this **SPECIAL OFFER.**  
**AMATEUR INVENTORS OF AMERICA**  
204 No. Mason Ave., Chicago, Ill.

**PATENTS** Write for **FREE** Instructions. Send Drawing or Model for Examination.  
**CARL MILLER,** Patent Attorney  
former member examining corps U. S. Patent Office  
260 McGill Building Washington, D. C.



# PATENTS

## TRADE-MARKS

Don't Lose Your Rights  
To Patent Protection

Before disclosing your invention to anyone send for blank form "EVIDENCE OF CONCEPTION" to be signed and witnessed.

**LANCASTER & ALLWINE**  
480 Ouray Bldg. WASHINGTON, D. C.  
Originators of forms "Evidence of Conception."



# PATENTS

Send us sketch or model for advice and exact cost of patent. Our book "How to Obtain a Patent" sent free. It tells how to apply for Patents, Trade Marks, Foreign Patents, Copyrights, etc.; gives information on Patent Procedure; tells what every inventor should know. Thousands of inventors, who are our clients, are our reference.

**CHANDLER & CHANDLER,** 25 Years' Experience  
910 F Street Washington, D. C.

## MASON, FENWICK & LAWRENCE

### PATENT LAWYERS

600 F St., N. W., Washington, D. C.

*Estb. over sixty years. Send sketches.*  
Electrical and Chemical Inventions carefully handled.  
Practice before the U. S. Courts and the Patent Office.  
Prompt and careful service. **WRITE US.**

**TRADE MARKS REGISTERED**

# INVENTORS PROTECT YOUR IDEAS

Send for our Guide Book, **HOW TO GET A PATENT**, and Evidence of Invention Blank, sent Free on request. Tells our terms, methods, etc. Send model or sketch and description of your invention for **INSTRUCTIONS.** No charge for the above information.

**RANDOLPH & CO.**  
301 Victor Bldg., WASHINGTON, D. C.

NAME.....

STREET.....

CITY..... STATE.....



# PATENTS

TRADE-MARKS · DESIGNS  
FOREIGN PATENTS

**MUNN & CO.**  
PATENT ATTORNEYS

*Associated since 1846 with the Scientific American*

SCIENTIFIC AMERICAN BUILDING  
24 W. 40th St., New York City

SCIENTIFIC AMERICAN BUILDING  
Washington, D. C.

TOWER BUILDING  
Chicago, Ill.

VAN NUYS BUILDING  
Los Angeles, Cal.

HOBART BUILDING  
San Francisco, Cal.



Books and Information on Patents and Trade-Marks by Request.  
Associates in All Foreign Countries.



**This Needed Invention Paid  
\$135,000**

*a year.* Beverage manufacturers immediately adopted this simple crimped tin cap. This invention would have made you independently wealthy. Fortunes await inventors working along right lines. Concentrate on things that are NEEDED. Get Raymond Yates's new book

## "1000 NEEDED INVENTIONS"

Costs only \$1.25 and may lead to a big idea. Find out what industry needs and the public wants. *That's* where the money is! Mr. Yates's book tells you what these things are. Send no money. Just write postal. Pay mail man \$1.25 plus postage when book arrives. Your money back if you want it. This offer limited. Write now and get on the right track. (Outside U. S. \$1.45 cash with order.)

**BUREAU OF INVENTIVE SCIENCE**  
36 Wisner Building, ROCHESTER, N. Y.

# PATENTS

ON  
EASY PAYMENTS

**M. S. CAYNE**

REGISTERED PATENT ATTY.

— [ FORMER ASS'T EXAMINER ] —  
U. S. PATENT OFFICE

INFORMATION RELATING TO PATENTS  
and MY EASY PAYMENT PLAN SENT ON REQUEST

MAIN OFFICE

BANKERS BLDG.—105 W. ADAMS ST.  
CHICAGO, ILL.

## PATENTS

Trade Marks, Copyrights, Patent Litigation Handbook with illustrations. 100 mechanical movements. Sent free on request.

**ALBERT E. DIETERICH**  
formerly member Examining Corps U. S. Patent Office

REGISTERED  
PATENT LAWYER and SOLICITOR  
621-A, Ouray Bldg.  
30 Years' Experience Washington, D. C.

## INVENTORS

who derive largest profits know and heed certain simple but vital facts before applying for Patents. Our book *Patent-Sense* gives those facts; sent free. Write **LACEY & LACEY**, 646 F St., Washington, D. C. Established 1869.

## The Waco Wonder Shop



### Make Things at Home

A set of Red Jacket Electric tools brings a powerful Master Drill Motor, Waco Craftsman's wood turning lathe, compound and 18-inch rest, tilting saw table, scroll, jig and bandsaws, and all accessories for drilling, buffing, grinding and cleaning. Attaches to light socket and gives you private machine shop. **ONLY \$10.00 DOWN.**

**Free Crafts Course and Blueprint Service**  
Send Coupon for Interesting Literature. You will be surprised. Instructive, Fascinating, Beautiful.  
**WACO TOOL WORKS, Inc.**  
5216 W. Kinzie St., Chicago, Dept. 106.  
Please send me all information **FREE.**

Name.....

Address.....



# The SEA-HORSES

**MAKE** no mistake. There is a vast difference between outboard motoring of a year ago and SEA-HORSE motoring of today. With the *Johnson Underwater Exhaust*, exhaust noises and gases are eliminated. With the *Johnson Release Charger* starting is made at once simple and positive. Women and children can start even the bigger SEA-HORSES with ease. With the *Johnson Rotary Valve* and complementary developments, power is increased 50% per cubic inch displacement!

Write for Catalog

## JOHNSON MOTOR COMPANY

2485 Pershing Road, Waukegan, Ill.

In Canada: Canadian Johnson Motor Co., Ltd.  
Peterborough, Ontario

Distributors for British Columbia, Hoffer's Ltd., Vancouver, B. C.

# Johnson Outboard Motors

Certainty  
and Ease  
of  
Automobile  
Starting

No  
Exhaust  
Noise  
No Exhaust  
Fumes

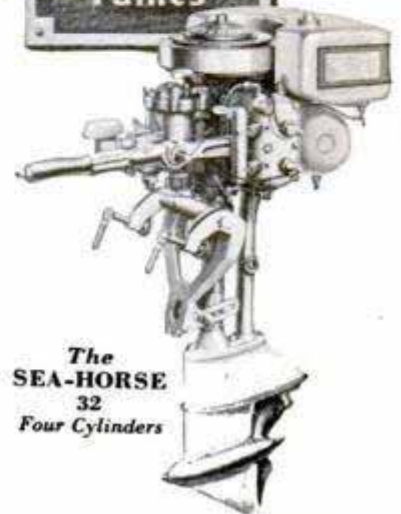

The  
SEA-HORSE  
32  
Four Cylinders

The SEA-HORSE 32 made the amazing speed of 43.76 m.p.h. for the official American Time Trial Record in Class D at Miami Beach, March 23. See your dealer for a demonstration. 6 models. Sold on free trial and easy payment plan.

WORLD'S LARGEST MANUFACTURER OF OUTBOARD MOTORS

## NEW AUTO HAT RACK HAT RACK WHILE YOU DRIVE



Now you can safely park your hat in your auto, and ride bare-headed. NEW auto hat rack holds either a felt or straw hat. No more crushed, soiled, or lost hats—saves hat, pocket-book, disposition. Black enamel—lasts lifetime—attached in 1 minute. Also for home, office, closets.

**FREE OFFER to Agents**  
—sell to users or new plan to dealers—big money. Write

LITTLE BEAR SPECIALTIES CO. 3000H—1509 Campbell  
KANSAS CITY, MO.

## STRANGE INVENTION! PAYS YOU \$90 A WEEK NEW FIELD for AGENTS

Sell only device in the world that prevents kinking, snarling and tangling of telephone and electric iron cords. Housewives and business men buy 1 to 50.

### NEW KIND OF CORD SET FREE

Every Neverknot Salesman is given FREE the complete Neverknot Switch Plug Cord Set pictured. This new kind of ironing cord automatically coils itself out of the way and a new kind of switch plug prevents scorching and saves electric bills. This set is a "gold mine" for house-to-house workers. It's different and it's yours free if you work for us. Don't delay! Send now for free offer.

**NEVERKNOT CO.**

Dept. 6-V, 4503 Ravenswood, Chicago

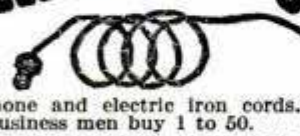

Saves  
Electric  
Bills

## LIGHTING FIXTURES Ready to Hang



Direct from the manufacturer. Completely wired, including glassware. Send for new catalogue No. 29. Just Reduced Prices. *Special Proposition to Dealers.*

**Erie Fixture Supply Company, Inc.**  
Station A  
ERIE, PA.



## Start a Welding and Battery Shop at Home

Outfits sold on the payment plan.

Welding outfits.....	\$25.00 up
Lead burning outfits.....	18.00 up
Soldering outfits.....	8.00
Lead burning torches.....	6.00
Welding torches.....	10.50 up
Cutting torches.....	30.00 up
Regulators and gauges.....	9.50 up
Paint sprayers.....	14.00 up

Welding Supplies.

**SUPERIOR OXY-ACETYLENE MACHINE CO.**  
P. O. Box 285  
Hamilton, Ohio

## NOW INVENTED A Shaving Machine that Gives Razor Blades Free

A St. Louis inventor is now distributing samples of an uncanny little hand machine that actually means no more blades to buy. This invention has already caused a nationwide sensation. Over a million men now use it. Users report up to 1500 shaves from one old razor blade when processed by this amazing invention. Entirely unlike ordinary blade-sharpeners. Introduces new sharpening principle that makes perfect blade edge an automatic certainty. The makers offer to send samples for test with results absolutely guaranteed. They also offer free a new-type razor as revolutionary as this razor blade machine. A few territories are still open for agents. \$20 to \$40 a day are easy earnings, full time or spare hours. Write without obligation for full details. Charles Perry, Dept. G-3713, 1418 Pendleton Ave., St. Louis, Mo.

# Stops Autoists Running on Partly Deflated Tires

**Increases Tire Mileage**

Proper air pressure constantly maintained in tires gives maximum mileage—saves tire money. A simple new invention automatically signals the auto driver when a tire needs air and makes it easy to keep tires up to standard pressure at all times and get increased mileage.

Now, running on under-inflated tires is unnecessary, and, a motorist may drive with confident feeling that his tires are inflated for best possible tire mileage. The worry of broken down casings or rim cuts is banished forever. Users report they would not be without this tire saving invention for twenty times its small cost.

**Easily and Quickly Installed** Anyone can easily put a set on his own tires in a few minutes—no special tools required.

**FREE TRIAL OFFER**

Try a set **AT OUR RISK** on **YOUR OWN TIRES**—see for yourself how automatically the signal works only when your tires need air—see how it banishes running on under-inflated tires and hence prevents accidents, saves tires, tubes and increases tire mileage. You will be delighted with results or **THE TRIAL COSTS YOU NOTHING**. Mail coupon now and get guaranteed **FREE TRIAL OFFER** by return mail.

**SIMPSON MFG. CO., 3000H-307 W. Douglas, WICHITA, KANSAS**



**NEW Tire Attachment**  
Signals Driver When Tire Needs Air

**BIG MONEY to HUSTLERS**

**Distributors, Salesmen, Agents**

We desire live-wire state and county agencies, part or full time, to make \$350 to \$1500 monthly saving autoists tire money.

**NEW rapid seller.** Nothing ever like it. Going **BIG**. One man sold 14 out of 15 first morning. Strong demonstration. Mail coupon now—

find out all about this **NEW, SENSATIONAL SELLER**—get **FREE TRIAL** and **MONEY MAKING OFFER** at once.

## MAIL this COUPON

**Simpson Mfg. Co.**

**3000H—307 W. Douglas, Wichita, Kans.**

Rush me **FREE TRIAL** and **BIG MONEY MAKING OFFER** on your **NEW** and **SENSATIONAL SELLER**,

Name.....

Address.....

## Big Profits in Paint Spray Contracting

Only \$20 Monthly—Brings \$300 Profit

Earn 5 painters' wages and earn a reputation for highest quality work with an **HB Paint Spray**. Get into this money making field right, and be in a position to get the money-making painting business in your locality. Hundreds have done it. Dye of Missouri, paid for outfit on first job. Easy terms let it pay for itself. No experience required to operate. Gas engine or electric. Send your name with this adv. for full particulars to

**Hobart Bros. Co., Box M691, Troy, Ohio**



## Write Today For Amazing Free Outfit

Sell three Guaranteed **Bostonian Shirts**—\$9.00 Value—for only \$6.95. You get \$1.50 on each sale.

No investment or experience necessary. Remarkable Values. **Bostonian's** famous guaranteed quality and unusual **New Sales Plan** mean immediate profits for you. 82% of all men buy. 24-hour delivery. Repeat business sure. No dull seasons. We have been makers of fine shirts since 1863.

Get your **FREE OUTFIT** and full instructions by return mail.

**BOSTONIAN MFG. CO.**  
Dept. F-128 89 Bickford St.  
Boston, Mass.



## Lucky You Get A Complete Woodworking Shop for only 3 Machines Priced Separately—Buy What You Want—Add as You Need

### The Complete Outfit

The **Wonder Combination Bench Saw** (18 Tools in One), the **Wonder Three-Speed Lathe** with three step pulleys and countershaft combined, making lining up of pulleys unnecessary, and the **Wonder Scroll Saw**, a practically vibrationless machine, with which you can do delicate scroll work on either light or heavy material. The **Scroll Saw** has a blower attachment which always works, a 45° tilt top table, and the blades can be faced in any direction, giving greater clearance when wanted.

**Scott-Bansbach Co., 140 So. Clinton St., Chicago, Ill.**

**3 Machines**  
Shaffing & Hangers  
at \$62 included  
**\$77.00**  
Without Motor

**Sevens**  
Now you don't have to waste time with just one so-called combination. Here is a real combination. No need to tear down and re-set every time you have a different duty to perform. You can have these 3 machines as a complete bench combination, working on one line shaft—or you can have the 1 one at a time separately.



A combination of machines on which you and a couple of helpers can work and turn out anything desired in the wood-working line. Write for details about this **WONDER** outfit. Sold on 15 days approval, money back guarantee.

**Representatives and Dealers Wanted!**

**\$25 to \$30  
A DAY  
In Your Own  
Business**

That is what Woodmancy, of Minnesota, and many others have done during the season with the Foley Electrakeen Lawn Mower Sharpener. Start your own business in your garage, basement, attic, or any place. **Three days' profits pay for the machine!** You can make more money during the summer than many men make in a whole year. Others have done it, and YOU can too.



### Foley Electrakeen Lawn Mower Sharpener

Don't let this WONDERFUL OPPORTUNITY go by! Don't hesitate for lack of money—VERY LITTLE CAPITAL NEEDED. Get started at once, early in the season and make BIG MONEY this summer.

### Easy Work—Simple to Operate No Experience Necessary

This simple little machine sharpens all kinds of lawn mowers. Turns out a perfect job in a short time. You can learn to operate it quickly. Adjustments are few and simple. It will make BIG MONEY for you.

**Get Started NOW!** There are hundreds of lawn mowers right in your vicinity that will be sharpened this summer. YOU can do it, and EARN A STEADY INCOME. Write for complete information QUICK—DON'T DELAY. In two weeks you will be making a FINE INCOME. Get started in the BIG MONEY. Write for complete catalog NOW!

**Foley Saw Tool Co., Inc.**  
Mower Dept. C, 11 Main St. N. E., Minneapolis, Minn.

**Men!** AN AMAZING NEW VENDING MACHINE  
1600% PROFIT FOR MERCHANT  
**POSITIVELY LEGAL**  
Sensational demonstration! Imagine—1600% profit for merchants—\$50 a day easy. Patented. Just starting. Write quick.  
**ACME PRODUCTS CO.**  
Dpt. 110, 4554 Broadway, Chicago, Ill.

**\$5 EVERY CALL YOU MAKE**  
POSITIVELY LEGAL

**New!  
A Flying Plane**

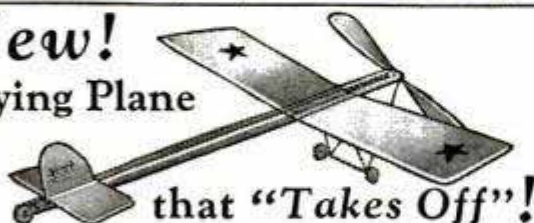

that "Takes Off"!

AT last—a toy plane that actually "takes off." The Kingsbury "Silver Arrow"—new thriller of the air. Just wind up the propeller and let 'er go! She's off like a flash.... faster.... faster.... then—ZOOM!—and she's into the air on a long, continuous flight. A fully-bull plane—not a construction toy. A few moments to assemble and it's ready to fly. Wings and body of light Balsa wood reinforced with aluminum braces; aluminum propeller; strong elastic motor. Four models: Racing Types (as illustrated), \$1, \$2; Cabin Types, \$2.50, \$3.50. (West of Miss. \$1.10, \$2.20, \$2.75 and \$3.85.) Ask your toy dealer. If he hasn't these Kingsbury thrillers, order direct. **Kingsbury Mfg. Co., 83F Myrtle St., Keene, N. H.** Send 10c for Novel Disc Wheel Eraser. Toy Catalog Free.

**KINGSBURY MOTOR TOYS**  
DRIVEN

## Hardware Dealers are Showing a NEW STANLEY SCREW DRIVER

OUR NEW "One Hundred Plus" screw driver is a typical Stanley tool, having that strength of construction which you instantly associate with the Stanley name.

The handle is made of tough hickory, and is guarded with leather washers. The blade is fashioned from one piece of steel and tempered its entire length.

You can depend upon the tip not to chip, even when used on the most stubborn screws.

Ask your hardware dealer to show you the new Stanley 100 Plus screw driver. Made in four convenient sizes for occasional or continuous use. 4", 5", 6" and 8" blades.



## STANLEY TOOLS

The Choice of Most Carpenters

**MOTORCYCLES**

**WE WILL TRUST YOU**  
Pay As Low As \$2.00 per Week  
Hendersons, Harley-Davidsons, Indians  
Slightly used and rebuilt. Hundreds to select from.  
Send 10c for list today.  
**MYEROW BROS. CO., 15 Berkeley St., Boston, Mass., U. S. A.**

.. **Vacation Tours** ..  
**to BERMUDA**  
**Eight Days . . . \$102 up**  
**Including All Expenses**

Transportation, hotel and side trips all included in fare. Sailings twice weekly on new 20,000 ton motorship "Bermuda" or famous "Ft. Victoria."

5 Days DeLuxé with room and bath on MS. Bermuda—\$175 up.

**FURNESS**  
*Bermuda Line*

34 Whitehall St. . . . 565 Fifth Ave., New York

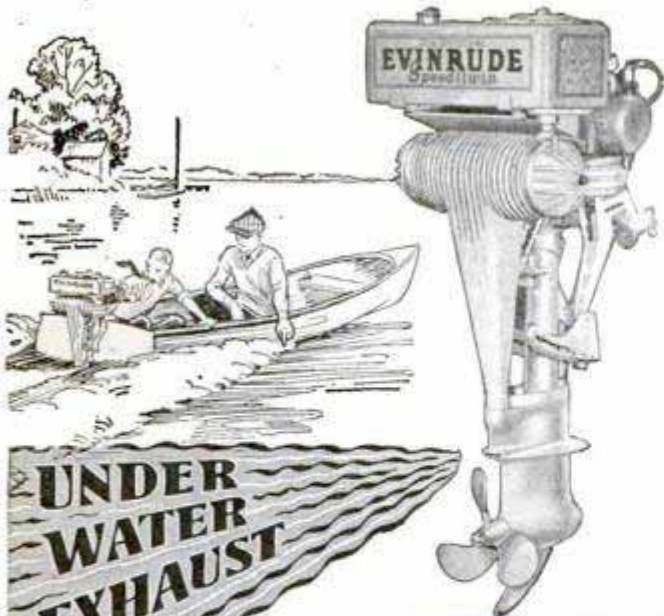

**UNDER WATER EXHAUST**

**MORE SPEED IMPROVED QUIETNESS**

Now, the high staccato tone of last year's quiet Evinrude Speeditwin and Fastwin is transformed into a low, pleasing drone. Burned gases are not only water-muffled, but also atomized, completely eliminating exhaust fumes. The turning propeller, and the water friction at the underwater outlet literally suck gases out of the motor, giving as much speed as if no muffling were used.

Four twin cylinder models, 2½ to 20 H. P., from canoe to cruiser sizes. Easy time payments as low as \$31.10 down.

Write for new free Evinrude Year Book.

EVINRUDE DIVISION, Outboard Motors Corp.  
2429-27th Street Milwaukee, Wis.

**EVINRUDE**  
3 to 45 Miles Per Hour

**EARN A DAYS PAY IN AN HOUR**

Never was there an Electric Flashing Sign like this! So low in price, yet so effective.

**\$75 TO \$100 A WEEK EASY**

Thousands of storekeepers, merchants and business everywhere need this wonderful Electric Sign with interchangeable letters. Sells on sight. Salesmen wanted everywhere. You can even start spare hours without interfering with your present vocation. Write today for particulars.

**ACCURATE MFG. WORKS**  
Dept. 35-A 2432 Milwaukee Ave. CHICAGO, ILL.

**8" COMBINATION SAW OUTFIT \$35 F.O.B. Phila.**

**OUTFIT** includes necessary attachments to rip, cross-cut bevel, grind, mitre, groove, sand, mortise, tenon, and polish. Table tilts to 45° angle. Base for saw and motor makes it portable.

Base 25" long by 8" wide. Table top 16" by 12"

Makes 2¼" cut. ½ H. P. double extension shaft motor. Complete ready to plug into any light socket.

Send 10c in stamps for Catalog giving details of Saw, Bench Lathes, Complete Workshop and other Hardware Specialties. With it you'll receive a credit slip of \$1.00 toward purchase of Saw.

**THE WILBAR CO., Inc.**  
2020 E. Arizona St., Phila., Pa.



# SAIL ON THE GREAT LAKES

The Detroit & Cleveland Navigation Company, operating lines between Detroit, Cleveland, Buffalo and Chicago, will be pleased to assist you in planning a vacation in the Great Lakes country.

Booklets containing pictures and descriptions of many delightful summer resorts including Niagara Falls, Mackinac Island, St. Ignace, Les Cheneaux Islands and Coryell Islands will be mailed you, without cost, upon request.

**FOUR-DAY ALL-EXPENSE CRUISE,** Detroit, Mich., to Chicago, Ill., and return, via Mackinac Island and St. Ignace. Hostess, music, dancing, bridge, teas, deck games; three hours at Mackinac Island. Round trip fares including meals and berth, between Detroit and Chicago, \$60; Mackinac Island and St. Ignace and Chicago or Detroit, \$30; Buffalo and Chicago, \$79; Cleveland and Chicago, \$71.50.

**DETROIT AND CLEVELAND,** overnight service, daily. Fare, \$3.00 One Way; \$5.50 R. T. **DAYLIGHT STEAMERS,** June 25 to Sept. 3, daily, except Sundays, July 4, and Labor Day. Fare, \$2.50 One Way.

**DETROIT AND BUFFALO,** overnight service, daily. Fare, \$5.00 One Way. Concerts by Finzel's orchestra, dancing, radio programs. Visit Niagara Falls and witness the wonderful illumination.

Autos carried on all steamers; wireless; meals and berth extra; no surcharge; unlimited stopovers. Fast Freight Service on all Divisions.

For information or reservations, address E. H. McCracken, G. P. A., 8 Wayne Street, Detroit, Mich.

**DETROIT & CLEVELAND NAVIGATION CO.**





## INSTANT Kerosene Flame No Pre-heating

**N**O pumping! No priming! No pre-heating! Turn the valve, strike a match! Instant kerosene flame! The hottest blue flame you ever worked with is on the job.

Actually 30% more heat from common kerosene than others produce from costly high test gasoline. Safe, no dangerous dripping. Efficient, no carbon to dull performance. Reliable, no weather condition—cold, wind, or rain—can affect it. Burns any fuel effectively and safely with instantaneous, perfect combustion.

THE ELECTRIC SPRAYIT CO., known the world over as leaders in the science of pressure breakup, now successfully applies this scientific principle to blow torches in its simplest, safest, most economical form. This outstanding engineering achievement now makes it possible for you to use your airline, any compressed air supply, to get the kind of blow torch you've always wanted. Only, **\$19.75.**

### Sprayit Combination Set for All Blow Torch and Paint Spraying Work

The SPRAYIT BLOW TORCH is equally well adapted for use with the well-known Agitator Type ELECTRIC SPRAYIT, of which thousands upon thousands are in daily use. Plugs in at any light socket.



Agitator Type  
Electric Sprayit

With the Agitator Type ELECTRIC SPRAYIT, at only \$39.50, you can now buy for less than \$60.00, a compact, portable Combination Set for better—quicker—cheaper blow torch and paint spraying work.

Enter your order immediately. Workmanship and material fully guaranteed. Leading jobbers and dealers will supply you; or if you prefer, use the coupon below.

**The ELECTRIC SPRAYIT CO., Inc.**  
206 E. Colfax Ave., South Bend, Ind.

- |   |  |
|---|--|
| <input type="checkbox"/> Send me the new Sprayit Blow Torch at \$19.75, f.o.b. South Bend.      | <input type="checkbox"/> Send me the Agitator Type Electric Sprayit at \$39.50, f.o.b. South Bend. |
| <input type="checkbox"/> Send me the new Sprayit Combination Set at \$59.25, f.o.b. South Bend. | <input type="checkbox"/> Send me the complete information only.                                    |

**Mail This Coupon Now!**

## Every Handy Man needs SMOOTH-ON NO. 1



for stopping leaks in steam, water or gas pipes, mending cracks, or leaks in furnaces and boilers, radiators, tanks, sinks, pots and pails, making loose handles tight, tightening loose screws, hooks, locks, door knobs, etc., stopping leaks in automobile engine water jackets, in radiator, hose connections, gas tank and gas, oil and exhaust lines, making a fume-proof joint between exhaust pipe and tonneau heater, keeping grease cups, hub caps and nuts from loosening and falling off, etc. Hardens like iron and stays everlastingly tight.

## To Make Wet Cellars Dry Use Smooth-On No. 7

the one practical waterproofing that you can apply yourself, easily, from the inside, to wet or dry surface and with every assurance of thorough watertightness, even in the wettest seasons. Effective in wet boiler pits, at cracks and porous spots and also excellent for patching and waterproofing any concrete, brick or stone surface to keep water out or in.

About 25 lbs. of Smooth-On No. 7 are required for each 100 square feet of surface covered, and no experience is necessary.



Write for  
**FREE BOOK**



To get perfect results, write to us for and use the Smooth-On Repair Book. Free if you return the coupon.

Get Smooth-On No. 1 in 7-oz., 1-lb. or 5-lb. tins and Smooth-On No. 7 in 5-lb. tin or 25, 50 or 100-lb. keg at any hardware store, or if necessary, from us direct.

# Do it with SMOOTH-ON

SMOOTH-ON MFG. CO., Dept. 37,  
574 Communipaw Ave., Jersey City, N. J.

Please send the free Smooth-On Repair Book.

Name.....

Address.....  
6-29

**factory prices!**

on Nationally Popular  
21-JEWEL—Thin Model

**STUDEBAKER**

*The Insured Watch*

**The only high-grade watch sold direct from factory!**

Imagine being able to purchase these magnificent thin model watches at lowest factory prices on easy payments out of your income, or for cash! Let us send you one of these marvelous watches—you are under no obligation to keep it. You'll agree it is the world's greatest watch value. Write for free 6-color book and learn the true facts!

**FREE**  
**6-Color Book**

If you write at once we will send beautiful style book, showing lowest factory prices on these lifetime insured watches. Thousands save money this way. Write today!

**WRITE!**

Luxurious strap and bracelet watches at remarkably low prices! Write for free style book TODAY!



**STUDEBAKER WATCH COMPANY**

*Directed by the Studebaker Family—known for Three-quarters of a century of fair dealing*

**Dept. N.I. 103 South Bend, Indiana**  
Canadian Address: Windsor, Ont.

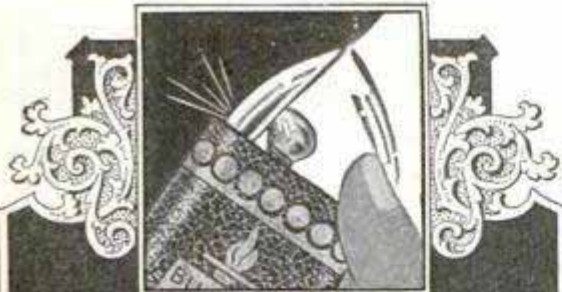

**BURGESS**  
**SNAP LITE**  
**VEST-POCKET**  
**FLASHLIGHT**

A COMPLETE FLASHLIGHT  
**39¢**  
NOTHING ELSE TO BUY

Silvery Sparkling Color! Designs of Red, Blue, Green, Brown, Black

For sale in these stores: drug; hardware; electrical; automotive; department, and others

**Burgess Battery Company, Chicago**

# LIGHTNING CALCULATION MADE EASY

with a

**RUXTON**  
**MULTI-VIDER**  
*Multiplies-Divides*

WITH this remarkable pocket calculator, you can solve mathematical problems *instantly*—save time by the same short-cut that engineers use.

The Multi-Vider is a combination slide-rule and automatic pencil—designed by an engineer. With a few minutes' practice, anyone can learn to multiply and divide rapidly, without tedious figuring. Just set the Bakelite scale—the answer is as easy to read as the hands of a clock.



You can get proportions, percentages, unit costs, averages and stock yields in the twinkling of an eye. To the student, business man or engineer, this may mean a saving of thousands of dollars in time.

And the Multi-Vider sets the answer down as well. It's as fine an automatic pencil as money can buy.

The new improved Executive model—with all outside metal parts gold-filled, in handsome gift box—is only \$10.00. The Standard model, silver filled, is \$5.00. Complete instruction booklet with each. If you can't get a Multi-Vider from your dealer, mail the coupon direct to us today.

✓ *An Inspired Gift*

**RUXTON MULTI-VIDER CORPORATION**  
4055 Graybar Building, New York City

I enclose \$..... Please send me:

..... Executive Model Multi-Viders at \$10.00 each  
..... Standard Model Multi-Viders at \$5.00 each

Name .....

Address .....



# Cutawl

**Opens  
Up  
BIG  
Op-  
portunities  
In a Fascinating Field!**



This magical tool completely revolutionizes old methods of cutting.

Thousands of people—you yourself, perhaps—are laboring with knife or handsaw, tediously, painfully, on some kind of cutout work which the Cutawl would do easily, accurately, in almost no time at all.

The Cutawl provides two methods of cutting—with a chisel for soft materials, or with a saw for hard materials, and is convertible for either use by the substitution of one blade for the other.

Window Display men the world over, sign makers and theaters use the Cutawl professionally. Those marvelous displays you often stop to admire are in all probability the work of the Cutawl. It has thousands of uses. Did you read the article describing this device in the February issue of Popular Mechanics on Page 289?

Write today for our interesting booklet showing what it does—how it works—what it offers you.

**THE INTERNATIONAL REGISTER CO.**  
29 South Throop St. Chicago

## You Can Make \$50 A DAY Without Selling!

If you are ambitious and want to build a big, profitable and permanent business that is all your own—this is your opportunity.

I need men to act as my exclusive distributors for Blue Ribbon Chewing Gum—the new, highest quality and delicious chewing gum sold only through Blue Ribbon automatic machines. You will act as my partner by placing these marvelous machines in good locations in your territory. You have only to keep your machines supplied with Blue Ribbon gum and take out your money. Our sensational premium plan guarantees big profits from every one of your machines.

I take all the risk—to prove to you that you can make \$50 every day in this profitable business. You don't have to gamble a penny of your own money! Reserve your territory now before someone else beats you to it. Write TODAY for full particulars.

**BLUE RIBBON GUM CO., Inc.**  
395 Broadway, Dept. 25, New York City

## ANNOUNCING SPORS GUARANTEED NO. 1 PEN

SELLS FOR \$1.25  
SEND ONLY

**39¢**

(Sent Post-paid)

"Writes  
Like a  
\$7 Pen."

Use 60 Days  
Money Back If Not  
Pleased



WRITE FOR  
FREE WHOLESALE  
CATALOG SHOWING  
OVER 400 ARTICLES  
F. SPORS & CO., 429 Main St., LESUEUR CENTER, MINN.

## BUSINESS OPPORTUNITY

### Did you weigh yourself today?

Perhaps you did not, but literally millions of people did. Tons of pennies are dropped into the familiar penny scales in drug and other stores each year. Now comes a new and better scale that prints the weight and fortune on a ticket. It gives a private personal weighing service. If you owned a chain of these scales, working for you day and night, you would have a steady, sure source of income, and a business that would require little of your time. An unusual opportunity is offered now to get the unusual returns which will come to those who first show these scales. The business is easy and simple. Full details concerning all phases of it are given in a booklet which we will be glad to send on request to any financially responsible person. Write Dept. 114, International Ticket Scale Corporation, 17 E. 45th St., New York, N. Y.

## Marvelous NEW Portable Trap



Gives You  
**Trap Shooting  
Wherever You Go**

A new inexpensive, folding trap—lightweight, compact, automatic. Ideal for camp, for farm, aboard yacht—for every outing. Slips easily into your car—always ready for use. Trap comes complete with special mold for making your own birds. At your sporting goods or hardware dealer; or,

Write for Illustrated Folder No. 6  
DUVROCK CO., 245 S. Main St., Los Angeles, Cal.

## World's Wonder Wrench Banishes Old Style Wrenches!

New! Different! Never a nut wrench like "Speednut." Automatic Rate-ets! Can't slip! The harder it's pulled, the tighter it grips! A whole kit of wrenches in one. Has 23 wonder features. Priced low.

**FREE** Demonstrator Offer starts you writing orders from tool users, car owners, part time, full time. We deliver.  
SPEEDNUT CORP., 190 N. State St., Dept. 19, Chicago





# The "Delta" Electric Handi Shop

Patented Jan. 2, 1929

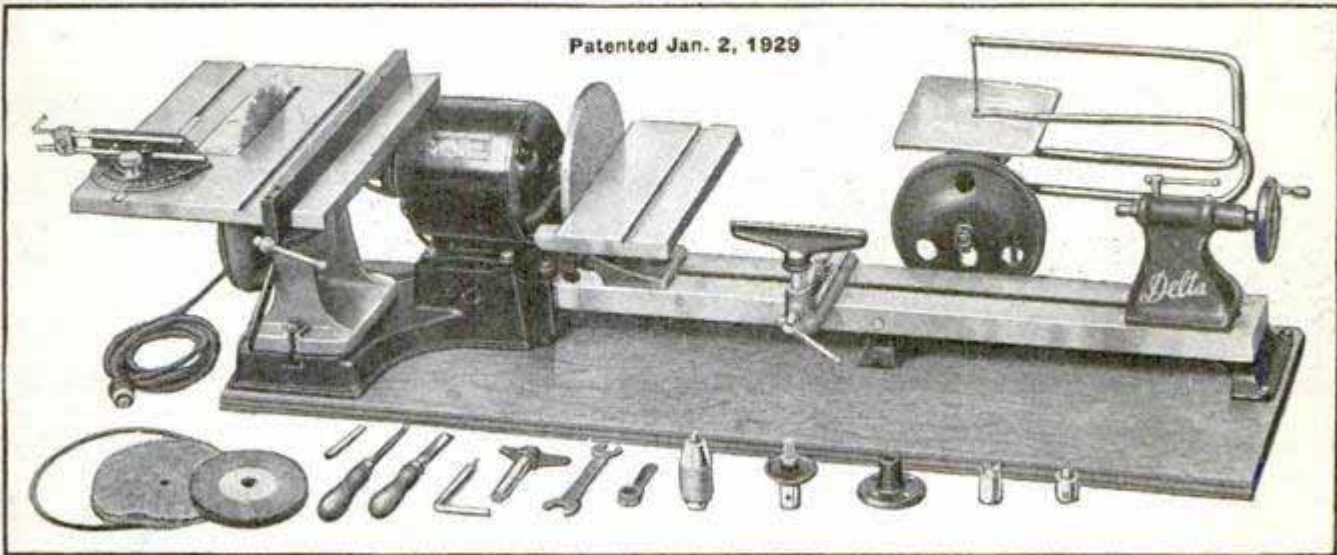

## Designed for Efficiency in Operation

Practical craftsmen appreciate this man-sized, motorized workshop with its carefully planned, efficient design. The "Delta" is equipped with a smooth-running, powerful, two-shaft motor. Permits carrying on two or three important operations at one time without continually dismantling set-up. Much-needed Circular Saw available 90% of the time! Also has heavy Triple Foundation Lathe Bed (no rods), guaranteed not to chatter; Improved Patented Tilting Tables on Circular Saw and Sanding Disc; Automatically Oiled Bronze Bearings. Comes completely assembled, thoroughly tested, on heavy veneered wooden base. Many new exclusive features in 1929 model—new low price.

## Enjoy the thrill of Working with Quality Machinery

Make the things you have always wanted to make, with this sturdy, full-sized equipment. Save money on repair work—earn money in spare time. It is so easy—so quick, with the "Delta." Complete Handi-Shop includes all necessary equipment for Circular Sawing, Wood Turning, Scroll Sawing, Sanding, Drilling, Grinding and Buffing. Full instructions and complete set of working blue-prints furnished.

## Sent on 10 Days Trial Easy Terms

Without obligation, you can test the Handi-Shop under actual working conditions for 10 days in your own home. Send at once for FREE illustrated literature, giving complete description of the new 1929 Model "Delta" Handi-Shop, and full details of 10-Day Trial Offer and Easy Payment Plans. Dept. A. 69

**Delta Specialty Co.**  
1661-1667 HOLTON STREET  
MILWAUKEE, WISCONSIN



### BLUE PRINTS INCLUDED

With each Handi-Shop, at no extra cost, is furnished a complete set of working drawings. Above are a few of the hundreds of useful articles you can make quickly and easily with this practical workshop.

Delta Specialty Company, Dept. A. 69  
1661-67 Holton St., Milwaukee, Wis.

Please send me, FREE, illustrated literature describing 1929 model "Delta" Handi-Shop. Also details of 10 Day Trial Offer and Easy Payment Plans

Name.....

Address.....

## DANDRUFF

Millions Use Lucky Tiger

for Hair and Scalp and Whyte-Fox (1 and 2) for skin ailments. Ask your barber for Whyte-Fox Medicated Massage. Valuable booklet free on request. Money-Back Guarantee. At Barbers, Druggists, Beauty Parlors.



Kansas Dept. City, Mo. A LUCKY TIGER REM. CO.



**Ford Owner** Stop that ruinous chatter on your car. **MAKE THIS TEST**—take out your floor boards, pull your emergency brake back and forth. If you notice play at the ball joint, you need Bredar's Ball Shim. Price \$50. Ask your Dealer or order direct. Demand Bredar's Shim.  
**NIC BREDAR'S SON MFG. CO., Rock Island, Ill.**

Cal. 30-40 Six Shot



**KRAG CARBINE**

All the qualities of a high price rifle. In fine used condition, all working parts guaranteed for one year. Send today for our Free 50-page illustrated catalog of money saving values; Guns, Ammunition, Cutlery, Sports and Gov't goods. Terms Cash. No C. O. D.

Price  
**\$9.75**

W. Stokes Kirk, Dept. P.M. 6, 1627 No. 10th St., Philadelphia, Pa.

# Fastest, Finest Outboard Motor for Runabouts, Cruisers, Racers



Hi-Speed Quad Price, \$325

Service Quad Price, \$295

ENJOY big-boat pleasures at a fraction of old-time costs. Snappy runabouts, roomy, seaworthy cabin cruisers give surpassing speed and dependability when equipped with the great 4-cylinder Super Elto Quad. The last word in outboard motor engineering. New 1929 model far faster, 60% more powerful than last year's model, official world champion. Send for complete catalog of Super Elto motors. Elto Division, Outboard Motors Corporation, Ole Evinrude, President, Mason Street, Department AA, Milwaukee, Wisconsin.

The **Mighty 4-Cylinder Super Elto Quad**



## NEW AUTOMATIC WINDOW WASHER

Washes-Cleans-Dries-Polishes in ONE Quick Operation.



Amazing new invention completely revolutionizes window washing. Carries its own water supply! It eliminates all the drudgery and unpleasantness. Five times as fast as old methods! No pail. No brush. No sponge. No chamols. Your hands never touch water with the NEW AUTOMATIC. Can be used with or without pole. Every housewife, auto-owner, storekeeper and factory owner a live prospect. Sensational demonstration. Sells at sight. Big repeat business. Year 'round seller.

**MAKE \$90 TO \$150 A WEEK!**

Agents coin tremendous profits. Going like wild-fire. Sells for only \$1.95. Liberal profits for agents. \$10 to \$25 a day easy; \$200 to \$300 a week possible.

**WRITE FOR OUR FREE SAMPLE OFFER**

You risk nothing. Don't delay. Write for money making proposition today.

NATIONAL INDUSTRIES, 67 E. Lake St., Dept. 156, CHICAGO

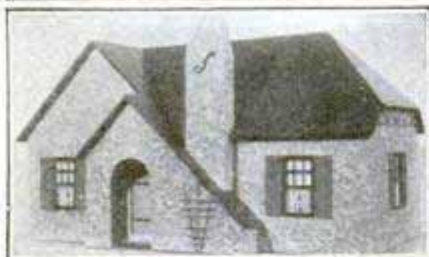

**BOYS WITH SISTERS DADS WITH DAUGHTERS**

Build This Modern Toy House 33" long x 18" high. Brown stucco with blue shutters. All finished inside. Modern in design and looks real. Complete plans and instructions for building with 26 illustrations demonstrating step-by-step assembling. \$1. Any boy can build it. Make money building and selling them in your neighborhood. Complete parts ready cut for assembling if desired.

C. C. STANLEY, Dept. A, 191 Lake St., Brighton, Mass.



## BIG MONEY

easily made by floor surfacing contractors who average \$40 per day. The New "American High Production" Machine does the work—makes you the money and builds you a business of your own. No dull seasons—no large capital nor experience required. Complete information free without obligation—write today.

THE AMERICAN FLOOR SURFACING MACHINE COMPANY  
523 So. St. Clair St. TOLEDO, OHIO

## New Complete "Wonder" Workshop Outfit saves you \$15.00



Now you can have this new, amazing 8-in. Combination Saw (18 tools in one) shipped on 15 days' approval, at manufacturer's risk. A complete ideal machine shop for factory, workshop or home; will rip, cross cut, bevel, miter, mortise, drill, groove, tenon, grind, rabbet, buff and polish. 1/2 H. P.-A. C. motor included with all attachments.

Write quick for special 10 day offer.

SCOTT-BANSBACH CO. CHICAGO  
142 So. Clinton Street

## RACING AND SPORT EQUIPMENT

Direct from Manufacturers  
Bodies for Ford and Chevrolet \$18.75 and up

Hi-Compression Heads, underslung Parts, Racing Gears, Cowl Lamps, Roadlites, Seat covers. Also Boats, Canoes, Portable Radio, Bicycles, and Camping Outfits. Send 10c for Catalog showing bodies of rare beauty and complete equipment.

SPORT FACTORIES



Build a Real Auto from Used Chassis  
Dept. K-2 AURORA, ILL.

## Now! Do Your Own Electric Nickel Plating

Introductory Offer

ONLY \$6.50 Plus Postage



For Plating Nickel, Brass, Copper, Silver, Gold, etc.

See the Nickel Flow

Make \$150 to \$500 a Week

New Scientific Invention Enables Anyone to Nickel-Plate Anything, Anywhere

Do YOUR OWN Electro-Plating in Your Home, Garage, Office, or Place of Business. Electrically Deposit Metal—Nickel, Brass, Copper, Silver, or Gold. You can successfully do all the plating on your Automobile, Electric Fixtures, Faucets, Spoons, Forks, Chandeliers, Tools, Coffee Urns, Surgical and Dental Instruments, Utensils large or small, Iron Stoves, Music Instruments; recondition worn plating or plate New Work; do it Instantly without interrupting the Service or without removing the parts to be plated with the

## ALADDIN PORTABLE ELECTRO-PLATER

Simple and Economical to operate. Not a toy, but a practical Plating Outfit with which Perfect and Durable Work can be done. Positively Guaranteed to do as we claim. BE YOUR OWN BOSS! Build up a Profitable Aladdin Electro-Plating Business of your Own. This offers wonderful ECONOMY to users and BIG MONEY-MAKING possibilities to AGENTS. Thousands in Service since 1924. Write for FREE Booklet and Testimonials Today.

P. J. F. BATENBURG Dept. 70 RACINE, WISCONSIN

AGENTS WANTED EVERYWHERE

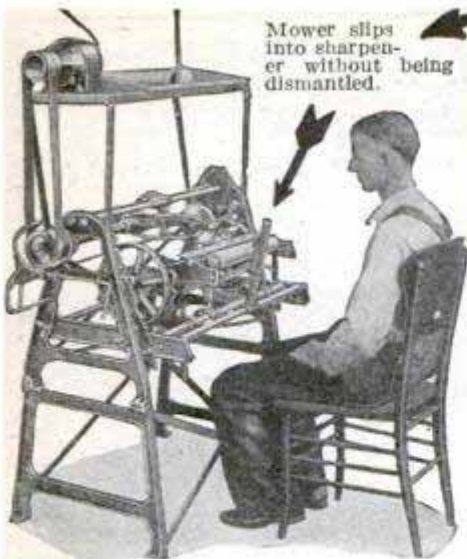

**THIS MAN IS MAKING  
\$4.00 to \$6.00 an hour!**

**SHARPENING LAWNMOWERS in Spare Time  
With the "IDEAL" LAWNMOWER SHARPENER  
Man, Why Don't You Do That?**

You've got the chance—the same chance as W. T. Moore, Twin Falls, Idaho, who made \$1200 net profits in 90 days—the same chance as Walter Wever, Middletown, N. Y., who made \$1000 in 4 months—the same chance as hundreds of others who have reaped rich rewards with this amazingly efficient lawnmower sharpener.

**Use Your Spare Time.** If you work at a trade, put an Ideal in your basement and earn \$4 to \$6 an hour evenings and Saturday afternoons. E. W. McCormick, Saginaw, Mich., writes: "Five years ago I bought an Ideal Sharpener on which I have ground over 5,000 lawnmowers. In the last few weeks I worked at my trade, machinist, full time 9 hours a day. I also ground 97 mowers which netted me \$114.10 clear gain."

**Pays for itself and makes big profits:** C. S. Coburn, Little Rock, Ark., writes that his "Ideal" Sharpener earned enough in 18 months to pay for itself and \$1857.00 worth of additional machinery.

**Our Free Book Tells You How—** these men and many others have made themselves independent—built substantial, permanent, BIG PAYING businesses with this Ideal Sharpener. Send for this book today—It's Free.

**SIGN THIS AND MAIL TODAY**



**THE FATE-ROOT-HEATH CO.  
918-944 Bell St., Plymouth, Ohio.**

Send me the book that tells me how I can make my spare time worth \$4 to \$6.00 per hour.

Name.....  
Address.....

**FREE  
BOOK TELLS HOW  
OTHERS DO IT!**

THE "IDEAL" LAWNMOWER SHARPENER is a wonderfully simple machine that sharpens all makes of mowers perfectly, scientifically, without taking the mowers apart. Just pick up the mower, set it in the "Ideal," make a few simple adjustments and proceed to sharpen. In 15 minutes the mower is ready for the lawn, and you have made \$1.50 to \$2.00—depending upon the charge you fix. No training required, and machine set up in a few minutes. Plug into light socket and start to sharpen. Hundreds of dull mowers in your locality are waiting to be sharpened. Owners are looking for a place to get them sharpened. Sharpens skates—all kinds—perfectly.

**Amazing NEW BOOK  
WORTH \$300  
TO \$2000  
TO YOU  
FREE!**

If you want to bank an extra \$300 to \$2000 a year from your farm, write today for this amazing new book. It will show you how to get more money from cattle, poultry, sheep, and hogs; how to save the cost of hired hands; how to save 3 to 4 hours a day. Delco-Light saves \$985.50 a year for Henry Zumbel; it makes \$3 a day for Mrs. Gibson. And this big FREE book shows how YOU can get these savings and these profits now. Write for it today. Delco-Light Company, Subsidiary of General Motors Corporation, Dept. Q-4r, Dayton, Ohio.

**DELCO-LIGHT  
FARM ELECTRIC POWER AND LIGHT**

**New Kind of Phonograph  
Has Amazing "Dynamic" Tone**



"Bluebird" Portable has new scientific tone system. Reproduces electrical records with astonishing naturalness. Has deep, rich tone, thrillingly life-like, and tremendous volume. Sold direct from manufacturer at

**Startling Low Price**

never before equalled. Beautiful in appearance. Fully guaranteed. Ideal for homes, outings and radio amplification.

**AGENTS**

"Bluebirds" sell on sight. Agents make big money—even on part time. Write for sample offer and quick money making proposition.

**SAUL DISTRIBUTORS  
430 S. Wabash Ave.  
Room 156 Chicago, Ill.**

Plays  
All  
Standard  
Records

**A \$100.00 SHIP MODEL FOR \$4.98**



Build the historic Santa Maria, LaPinta or the Mayflower. We send you C. O. D. the parts cut to fit, ready to assemble for \$4.98, plus a few cents postage. No tools needed except a small hammer. Parts for model of Constitution sent C. O. D. for \$6.98, plus postage.

Write for illustrated catalogue

MINIATURE SHIP MODELS INC.—P. 3216 BARING STREET, PHILA., PENNA.

**DEALER and  
SET-BUILDER Bargains**

Used 5 tube sets, \$14.90. Guaranteed. A. C. Dynamic Speakers, \$14.75. B Eliminators, \$4.90, requires minor adjustments. Transformers, 75c. Condensers, 50c. Rheostats, 25c. Potentiometers, 35c. Vogue loop antennas, 95c. Crosley Cone Units, \$2.00. Fidelity Horn Units, \$1.90. 4-inch Dials, 10c. Crystal Sets, \$1.75. 1 Tube Sets, \$1.75. Used 4 Tube Sets, \$8.90. Send money order with order. Complete list upon request.  
**CHAS. HOODWIN CO., 4240 Lincoln Ave., Dept. 623, Chicago.**  
Dealers in Bankrupt Radio Stocks.



**WADE AMATEUR MECHANICS, REPAIR SHOPS, INVENTORS, STUDENTS  
BENCH  
LATHE**  
A real machine tool for the home work bench—capacity 4" dia. x 12" length. For Metal-Wood-Composition materials. Turning—Facing—Boring—Drilling—Winding—Thread Cutting. Accurate—Strong—Quiet—Compact. Slide-rest has travel entire length of bed. Leadscrew inside bed. No. 1 Lathes, plain headstock, \$28.00. No. 2 Lathes, back-gear headstock, \$58.00. Extra for lathes with 18 inches between centers, \$7.00. Complete line of accessories at equally low prices. Write for free catalog.  
**THE GEROLD CO. Dept. P-53 120 Liberty St. New York**

## Here's a Saw That's a "Wiz" For Cutting Wood, Stone, Tile



You will get the surprise of your life when you operate this new electric hand saw—the only tool that is **Completely Safe!** It has "GUTS" for real work—amazing power, speed, accuracy, convenience. Imagine—this 10 lb. 1/2 H.P. Junior SKILSAW does the work of 20 men! It is the fastest cutting saw on the market—rips 2 inch plank 12 feet long in 35 seconds!

**\$60**

Where can you buy a powerful electric tool at this price that will actually save you so much time, money, labor? Four sizes to choose from!

Plug SKILSAW into the nearest lamp socket in house, garage, or factory—press the trigger—Zip! Your wood is cut, straight, clean. You'll like to use it.

SKILSAW rips, cross-cuts, bevels, miters, grooves. Also used as table saw.

*You must see SKILSAW for yourself! Ask your Hardware Dealer to show you. Write us today for complete information.*

**SKILSAW INC.** Dept. F, 3319 Elston Av. CHICAGO, ILLINOIS

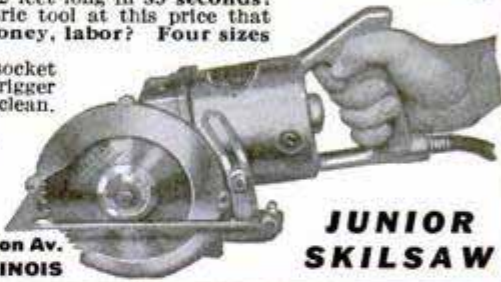

**JUNIOR SKILSAW**

## This Man Made \$257.00 in 3 Weeks!

Over \$85 weekly profit averaged by Fauley, W. Va. Shedrick, Ohio, made \$177 in 4 days. Jones, W. Va., cleaned up \$517 in 3 weeks. These are typical examples of earnings with this most amazing, gorgeous and beautiful line of electric signs. No experience needed to take orders for



W. D. FAULEY

### DAZZLER Electric Signs

Gorgeous, colorful signs with Rainbo Glow flasher. Sizes and styles to suit any kind of store, garage, theatre, etc. Cash or time sales. Commission of \$12.50 to \$50.00 per order. Unlimited field.

**You Can Earn \$100 a Week!**



Only a few a week puts you in the \$7,000.00 class. We work with our men—give them detailed instructions—show them in an easy, understandable manner how to figure and quote prices—and help them sell through our intensive cooperation. Commissions on sales are paid promptly. This is a dignified proposition—a permanent connection—and the money earning possibilities are unlimited.

**Write Today** Let us send you our beautifully illustrated book of Dazzler Electric Signs and full details of big money making proposition. Some exclusive territory available. Write or wire at once!

**Dazzlers Are the Lowest Price High Grade Electric Signs on the Market And Are Sold to Merchants on Easy Terms.**

**Chicago Sign Sales Co.**  
Dept. 75, Charlotte, N. Carolina

## MODEL SHIPS

Would you like to build a real fine ship model?

We can supply construction sets and all sorts of parts such as semi-finished hulls, blocks, deadeyes, special flags, anchors, steering wheels, capstans, figureheads, blue prints, books, etc., for building a Flying Cloud, Constitution, Spanish Galleon, Mississippi River Steamboat, Sovereign of the Seas, Half Moon and many others. Also special construction sets for racing sail boats, power boats, model steam engines, propellers, etc., and fine tools for the model maker. Our large 48-page photographically illustrated booklet contains valuable information and hints for building ship models in addition to prices and full description of the above articles. Many people only slightly interested in models have become greatly enthused upon receiving this booklet. A copy will be sent postpaid upon receipt of 15 cts. (coin preferred).

**At Last** A real appropriate watch charm or coat lapel ensign for ship model makers or boat enthusiasts. This miniature steering wheel is made of heavily plated 18 Kt. gold spokes and hub. The rim is made from eucalypto (a Porto Rican hard red wood). Made in two styles. For the charm, one spoke has a small ring attached. The lapel style illustrated has a threaded hub and nut for fastening. Can also be worn on yachting caps. Packed in a handsome case. Price \$1.50 postpaid. Be sure to mention style when ordering.

**Model Ship Supply Co.**  
Dept. K Mineola, N. Y.



## 1 Brings This 8 Diamond Wedding Ring 10 MONTHS TO PAY \$19.50

No. 58 - New 15K white gold wedding ring with 8 blue-white diamonds will come for 15 day trial. Pay \$1.00 to this ad and state: Age, How long at address, Employer, Nature of work. **Everything confidential.** Satisfaction or money refunded. \$1.85 a month.

**L. W. SWEET, Inc.**  
Dept. 69-L 1660 Broadway, New York, N. Y.



## Catch Fish!

Eels, Mink, Muskrats with our new folding galvanized **STEEL WIRE TRAP.** Write for our **FREE TRAP OFFER** and Bargain Catalog. \$1 Box of our famous Fish Bait FREE to introduce our traps. **WALTON SUPPLY CO., 3502 JUNIATA AVE., ST. LOUIS, MO.**



**Buy Now Pay Later**

## Boice Bargains Can't Be Beat

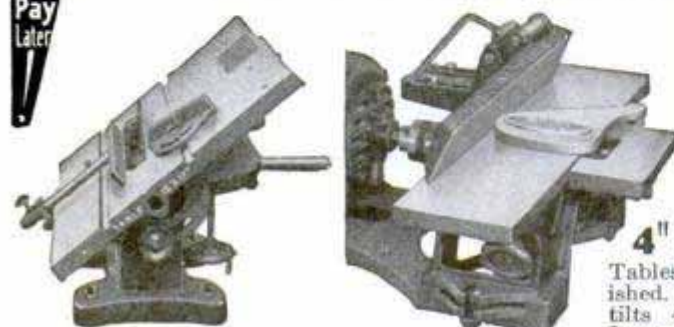

**\$30.00 Universal Handisaw**  
Table elevates for grooving. Cuts 2 1/4-inch stock. Takes 6x1-inch dado head, 8-inch sand disc, sand drum, 2-inch Jointer attachment, Boring table.

Send 10c in stamps or coin for Boice's latest catalog, describing the finest collection of Bench Woodworking Machines ever offered. Boice-Crane Bench Circular Saws, 12 inch and 14 inch Band Saws, 4 inch Jointer, Lathes, Jig Saw, and Books of Designs.

### 4" Handi Jointer Universal Jig Saw

Tables 20-inch ground and polished. Planes 1/4 x 4-inch. Fence tilts 45 degrees both ways. Improved rabbet arm. Bronze bearings. Safety guard \$3 . . . **\$25.**

**\$12.00** Table 8 inch dia., tilts 45 degrees both ways. Saw to frame 10 inches. Uses 1-16 inch fret blades, and heavy power blades 1-8 inch wide. Unexcelled in the volume and variety of work it will do.

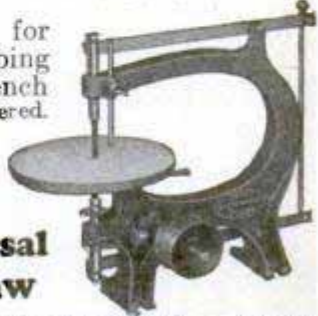

**W. B. & J. E. Boice, Dept. P. M. 6-E, Toledo, Ohio**

# move PEP!

for your car with



Vacuums out exhaust gases, relieving back pressure on piston heads, giving motor added speed, power, pick-up. Open, this super by-pass muffler roars like a racer. Saves its cost in gas economy. Leading cars have by-pass mufflers standard.

At your dealer or direct. \$9.50 postpaid.

**Send For This Story**

**GOERLICH'S, Inc.**  
381 Phillips Avenue  
TOLEDO, OHIO

**NEW LIFE FOR YOUR CAR**

## TYPEWRITERS

ALL STANDARD

SENT WITHOUT DOWN 1¢

10 days FREE Trial at 1/2 PRICE

Underwood, Remington Royal, etc. ONLY 14¢ A DAY

All late models, completely refinished brand new. GUARANTEED for ten years. Send no money—big free catalog shows actual machines in full colors. Get our direct-to-you easy payment plan and 10 days' trial offer.

International Typewriter Ex., 186 W. Lake St., Dept. 694, Chicago, Ill.

## Raise Canaries FOR PROFIT

Singers and Mating Pairs. Send 10c for booklet on breeding canaries. Also have tropical fish, aquariums and supplies.

**CANARY BREEDER'S CO.,** Box 34-I La Grange, Ill.

**Up-to-Date Home Craftsman Shop** For the man or boy who enjoys working with well-equipped electrically driven wood working machinery. Complete in every detail. Every purchaser given FREE OF CHARGE 12-months' course in Wood Craftsmanship and 27 blue-prints of various pieces of furniture, toys, models. Full details and illustrations sent without obligation. 10-day FREE trial. Can be purchased on monthly payment plan. Write today.

**Up-to-Date Machine Works, Dept. 35, 2915 S. Wabash Ave., Chicago, Ill.**

## Be Your Own Boss In This Big-Profit Business

Make \$120 a week. Get a New Ford Touring Car as bonus. Many salesmen easily do it placing these "Self-Selling" Counter Display Cabinets of ELCOR Aspirin Tablets with retailers. They sell fast because they sell for less. Retail price, only 10c for 12 full 5-grain pure aspirin tablets. Yet, you and the retailer both make over 100% profit on ELCOR Aspirin. Each carton you sell nets you \$2.00. Millions use aspirin every day in the year. Therefore, your repeat sales profits come in automatically. You'll find it easy to get retail stores, news stands, hotels, barber shops, etc., to handle ELCOR Aspirin Tablets. The attractive Counter Display Cabinet sells them on sight. Give this full time or part time proposition a chance to make money for you. Write today for full information. ELCOR PRODUCTS CO., Dept. N-1, Washington, D. C.

# No Selling!

A Fine Paying Business Of Your Own Started In Spare Time

Make \$2 to \$4 An Hour While Starting

**MEN!** Never before have you had such a wonderful chance to get into a fine paying CASH BUSINESS of your own. Here is a pleasant, easy way to make BIG MONEY. Very little capital is required to start. NO STOCK TO CARRY. Start in your spare time and you can soon work up a PERMANENT, SUCCESSFUL BUSINESS, filing all kinds of saws on the Foley AUTOMATIC Saw Filer.

## FREE PLAN Starts You

Hundreds of men like yourself have started on the road to SUCCESS and INDEPENDENCE. Free plan shows you how you can get all the business you can handle. NO CANVASSING. You will get business from miles around and plenty of REPEAT BUSINESS.

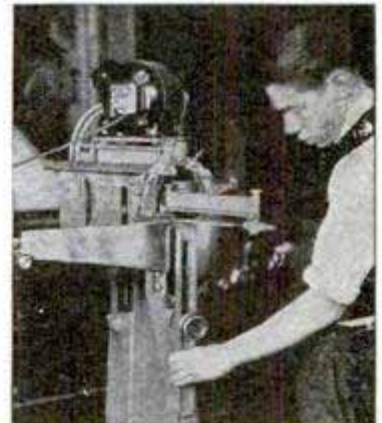

### Steady, Year 'Round Business

Make a fine, steady income. No dull seasons. A CASH BUSINESS every month in the year.

## No Experience Necessary

You can easily learn to operate the Foley AUTOMATIC Saw Filer in a short time. Few, simple adjustments are clearly explained. You can quickly learn to turn out PERFECT CUTTING SAWS with a little practice. No other machine like this for putting saws in perfect cutting condition.

## Be Independent—Start Now!

An INDEPENDENT INCOME is waiting for five men who can realize this wonderful opportunity. DON'T DELAY—get started at once! BIG PROFITS await YOU!

**MAIL THIS COUPON for FREE PLAN**

Foley Saw Tool Co., Inc.,  
240 Foley Bldg., 11 Main St. N.E.,  
Minneapolis, Minn.

Send me your FREE PLAN and complete information about how I can start my own business and make BIG MONEY with the Foley AUTOMATIC Saw Filer.

Name.....

Street.....

City..... State.....

**BOYS!**  
**EVERY \$10.00 SALE**  
**means \$3.50 in**  
**Your POCKET!**

*Can you beat it?*

**D. W. KNAPP**  
 The Daddy of 'em all is giving you the Greatest Money-Making Opportunity in the History of Direct Selling

**DEMONSTRATE THE NATIONALLY ADVERTISED KNAPP SEDAN FAN!**

*The orders follow without any effort on your part*

**THE** greatest summer item ever developed. Operates from the storage battery of any automobile. Uses less current than a single head light. Keeps any closed car C-O-O-L in the hottest weather—no matter if the windows are closed when it rains. No more sitting in an oven after leaving the car parked for a few minutes. Makes driving in traffic a pleasure—even on the hottest day.

**Every Closed Car Owner a Prospect**  
 All you have to do is demonstrate the Knapp Sedan Fan—We tell you how in our big sales manual—which is worth \$5,000 of any one's money. No experience necessary.

**What These Men Have Done—You Can Do**  
 D. H. W. of Florida averages \$85.00 a week.  
 F. H. C. of Texas made \$190.00 the first week.  
 R. U. P. of Miss. made \$260.00 the first two weeks.

*These are not the Top-Notchers*

**Get your FREE Demonstration OUTFIT**  
 Rush me your name and address—don't hesitate. Don't ask yourself, "Can I sell?" I'll show you how—just follow my instructions—the result of 51 years' selling—and you'll be in the \$10,000 class. Don't delay—now is the time for action.

D. W. Knapp, Pres.  
**KNAPP ELECTRIC, Inc.**  
 Division of P. E. Mallory & Co., Inc.  
 3017 East Washington Street, Indianapolis, Ind.





## New Life for Your Old Set!

A radio set is no older than it acts. By a small expenditure you can sharpen the tuning, increase the sensitivity, provide power amplification, and even replace batteries. Remember, **There's a Clarostat for Every Radio Need!** Ask your dealer how to rejuvenate that old set with Clarostats. Or write us direct for literature on Clarostats and how to apply them. Better still, send 25c in stamps or coin for "The Gateway to Better Radio"—a big book with 20,000 words and 88 pictures on practical radio aids.

**CLAROSTAT MANUFACTURING CO.**  
 Specialists in Radio Aids  
 286 N. 6th St.  
 Brooklyn, N. Y.

## Stops Radio Squealing

When your radio squeals or oscillates, not only is your reception spoiled but your neighbors' also. This Hammarlund Equalizer will correct the trouble. Write Dept. PM6 for descriptive circular.

**HAMMARLUND MFG. CO.**  
 424-438 W. 33rd St., New York

For Better Radio  
**Hammarlund**  
 PRECISION  
 PRODUCTS



## Silver Ace Flying on Chicago's Lake Front

*"The best flying model made in America."*

*"It was easy to build."*

*"My model has already stood 200 crack-ups."*

*"I flew my model 978 feet in Central Park."*

*"SILVER ACES won both first and second prizes in the commercial class in the Miami Junior Air Meet."*

These voluntary comments from our large file show why SILVER ACE models, construction sets and supplies, designed and built by real aero engineers, are the wisest investment for your time and money.

Better dealers nearly everywhere sell them. If your dealer does not, send 10c for beautiful new 32 page catalog telling history of flight, picturing real planes, describing complete 1929 SILVER ACE line.

**AERO MODEL COMPANY**

Dept. M 6

111 North Wacker Drive  
 CHICAGO, ILLINOIS



**For the Answer to Your Radio  
 Resistance Problems Write Dept. PM6.  
 175 Varick St., New York, N.Y.**

**ELECTRAD**  
 INC.

## Send for WESTERN RADIO New 1929 Catalog

LATEST and FINEST, nationally known A. C. sets, consoles, cabinets, speakers and accessories at LOWEST PRICES. Catalog sent FREE on request.

**WESTERN RADIO MFG. CO.**  
 128 W. Lake St. Dept. RPM-6 Chicago

## SAVE MONEY Install Your Own!

Just mail us a rough pencil sketch. That brings you lowest wholesale costs on highest quality—Grade "A" equipment. Any handy man can install it. NEW EASY METHOD.

**Save 1/2 On Your PLUMBING HEATING**

**We Show You How**

Get our new bargain catalog—just issued. Our cut-to-fit systems guarantee big saving on waste and high labor costs. 50 years' prompt service to builders, home owners, farmers and mechanics. Write for your Free copy of our New Book Today.

Million Dollar Bonded Guarantee Protects You

**HARDIN-LAVIN CO.**

122-32 West Pershing Road Chicago, Ill.

**FREE BOOK**



# HEATH Super Parasol

America's Most Popular Sport Plane

**BUILD IT  
YOURSELF  
FOR  
\$199.00**

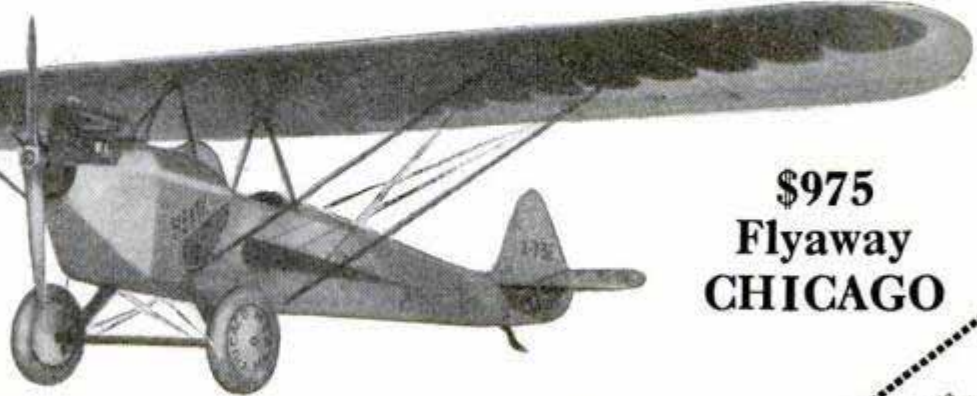

**\$975  
Flyaway  
CHICAGO**

Heath Light Planes are the pioneers, having been produced for 21 years. The Heath Super Parasol is backed by this long experience. Heath Light Planes have won every National Race in recent years.

Complete detailed Blueprints \$5.00 per set.  
Send 10c for large Booklet

**HEATH AIRPLANE COMPANY**

1727 Sedgwick Street Dept. P CHICAGO, ILL.

HEATH AIRPLANE CO., Dept. P, Chicago, Illinois  
1727 Sedgwick St., Dept. P, Chicago, Illinois  
Gentlemen: Enclosed find five or stamps for which send me your large illustrated booklet on the Heath Super Parasol.

## \$150<sup>00</sup> a Week Surfacing Floors

New electric floor surfacing machine does work of five men. Pays National men as high as \$30.00 to \$40.00 a day. Prospects everywhere you look. Factory wants branch managers at once to open stations in your community. Very small investment required. Easy payments let proposition pay for itself out of profits. You need no experience. We instruct you in every detail and build business up for you. We train you to be a National floor engineer without any cost to you. Write at once.

**NATIONAL SANDING MACHINE CO., 4551 Diversey, Chicago, Ill.**



**\$10<sup>00</sup>  
DOWN  
Brings  
this Lathe  
to You**

Lathes \$6.00 to \$75.00. Largest line of small lathes in America. Send six cents for 32 page catalog of lathes, drill presses, bench saws, jig saws, band saws, etc.

**SYPER MANUFACTURING COMPANY  
Dept. D Toledo, Ohio**

## WILL BUY PRODUCTS OR INVENTIONS

We will make liberal all cash or cash and royalty offer for complete rights on products or patented inventions. Household, automotive or other specialties with eye catching demonstration preferred. Prefer type of article not sold in stores, easy and economical to manufacture, sold at low price. Product must be completely protected with patents or be patentable, have real novelty and merit, and meet an existing or potential demand in big market. Give complete facts in letter, including product's selling history (if any). If interested, will close deal at once. P. O. Box 288, Pukwana, So. Dak.

**START  
to  
PLAY  
Very  
First  
Day!**



**Extra Money—Hosts of Friends—Loads of Fun Within Your Reach**



Fame and Money Broadcasting



Center of Attraction at Gatherings



Big Money at Dances

**HAPPY DAYS** are in store for you if you will only act on this suggestion! Cheery evenings playing catchy music alone or with sweetheart, wife or sister; proud moments as center of interest at gatherings; nights of joy making **\$5 to \$25** for work that is "play."

The Deagan Xylorimba is your Opportunity! Wonderful for home, in demand at dances and entertainments, *yet easiest of all instruments to play.* No teacher necessary—you actually play simple melodies the very first day even if you cannot read a note of music right now!

**Earns \$60 a Week**—Ralph Smith, Chicago, says: "Played 20 minutes at wedding. Received \$20." L. E. Hallmann, Reading, Pa., writes: "Made \$300 in 5 weeks, spare time. Had never played instrument before."

**SEND FOR BIG FREE BOOK!** Our new book tells all about the delightful lessons furnished with each instrument; the five-day trial that removes risk; the wonderful Deagan easy-payment plan. No obligation—simply fill in and mail the coupon.

J. C. Deagan, Inc., Dept. A-145, 1770 Berleau Ave., Chicago  
Send me, without obligation, full details of Free Trial offer and easy-payment plan on the Deagan Xylorimba.

Name \_\_\_\_\_  
Address \_\_\_\_\_

One of the

# Time-Saver

Tools Mechanics Need

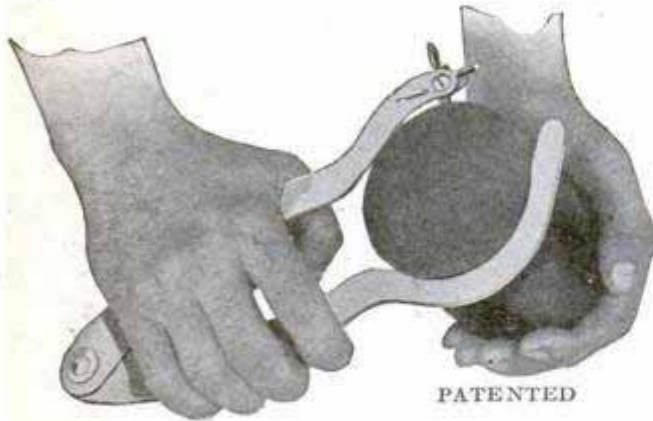

PATENTED

## The new ART Piston-Ring-Groove Cleaner

Cleans grooves in a fraction of the ordinary time. Less work, less muss. Recommended by leading Piston Ring and Car manufacturers. Fits sizes  $\frac{1}{8}$ ",  $\frac{3}{16}$ ",  $\frac{1}{4}$ ",  $\frac{5}{16}$ ",  $\frac{3}{8}$ " by simple adjustment of revolving cutter. Order yours NOW from your Jobber (or direct—enclosing check, cash or M.O.).

**\$1<sup>25</sup>**

**FREE** Send for illustrated folder on other ART Time-Saver Tools needed by all garages, service shops, and car mechanics. It's FREE.

**THE ART TOOL MFG. CO.**

330 Lakeside Ave., West Cleveland, Ohio

## COOKS DINNER WHILE YOU DRIVE!

### KYSOR CAR COOKER

This marvelous stove of steel and aluminum, attached to rear bumper of your car, is fed with heat from the motor exhaust; contains a standard Steam Pressure Cooker, into which is placed a complete meal (meat, vegetables and dessert). After one hour's driving, meal is cooked, ready to eat. No fire building—No waiting. Great for camping tourists!

6qt. size, \$22.50; 10qt. size, \$27.50.

Write for circular. Wonderful proposition for agents.

**KYSOR HEATER CO.**  
Dept. 62., Cadillac, Mich.

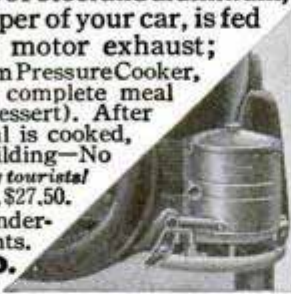

## NOW—Electric Light in Home or Summer Camp!

**Only \$147.50**  
for Complete  
110 Volt Plant  
Including All Fixtures,  
Wiring, etc.  
**for 7 Rooms!**

Almost unbelievable, yet it is true—at the very low price of \$147.50 you can have this practical, dependable 110 Volt Plant (full 350-watt capacity), including all fixtures, wiring and lamps for 7 rooms. It is the popular ONAN Ten-Lite Electric Plant (plant only \$130). Will operate fourteen 25-watt lights—also runs household electric appliances, charges radio battery, etc. Simple; durable; easily installed. Requires no storage battery. Inexpensive to operate. Unsurpassed for camps, summer homes, farms. Why deny yourself this comfort now so inexpensive? Write for descriptive literature.

**D. W. ONAN & SONS**  
16 ROYALSTON AVE. MINNEAPOLIS, MINN.



### WE PAY CASH

for OLD GOLD, SILVER, PLATINUM, JEWELRY, Dental work. Write for information today!  
L. Polcer, 2408 So. Cicero Ave., Cicero, Ill.

## GET INTO BUSINESS

MAKE \$100-\$200 A WEEK AT ONCE!

SELL BY MAIL

SELL THRU AGENTS

SELL TO STORES

### PRIVATE BRAND

Toilet, household specialties, furnished in bulk or packed under your own name. Wash you how to sell by mail, thru agents, or to stores. Plan guaranteed. Many making fortunes in mail order business. So can you. Little capital needed. Very low wholesale prices make big profits sure. Start in spare time. Make \$25 a day at once. Big repeat business. Write today.

Advertisers Products Co.  
Box P, Ferndale, Mich.

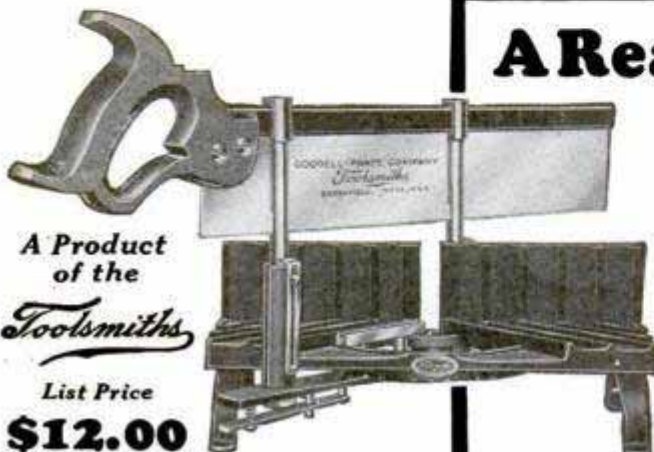

A Product of the

**Toolsmiths**

List Price

**\$12.00**

## A Real He-Man Mitre Box at a Popular Price—

For mechanic or home workshop.

Large enough for all ordinary work—light enough to be carried easily in the tool box.

Strong, well built, perfectly finished. Furnished with high grade 16x2 $\frac{1}{2}$  inch back saw.

Ask your dealer for No. 1625 or write  
**GOODSELL-PRATT COMPANY**  
Greenfield, Mass., U. S. A.

Write for a copy of our full line booklet. It's free.



# WIN AIRPLANE

(3 Passenger 90-h.p.) and Actual Pilot's Flying Course!

## or \$3,745.00 in CASH!

If You Prefer

HERE is the offer of the century! Amazing! New! Absolutely the first big free offer of its kind ever given. A new way for us to advertise and boost aviation. Last year we awarded to over 800 puzzle fans, automobiles and other valuable prizes, and in the next few months will give away between 200 and 300 more marvelous prizes to advertise in YOUR locality and elsewhere. Mrs. D. H. Ziter, Lewis J. Link, Mrs. Margaret Needham, C. F. Wieting, Mrs. R. A. Dobbins, each won automobiles or cash prizes from \$750.00 to \$3,500.00 in our last big advertising offers. Every year we spend over \$150,000.00 in this way, and this time we are giving away absolutely free a genuine 1929 90-horsepower Waco Airplane and free flying instruction at one of the best flying schools in the world—or \$3,745.00, all in cash! This greatest offer is now



## Open to Women, Men, Boys and Girls!

This is YOUR chance—NOW! Learn to fly, and have your own Airplane or take this stupendous prize in cash! Think of it! You can make a world of money with your own Airplane, and we want to give you this marvelous Waco Airplane FREE and pay every cent to teach you how to fly at a great flying school. (You can have the cash if you prefer, however. Decide when you are announced winner.)

Someone who writes us will win this new Waco Airplane and the complete flying course, or \$3,745.00 in cash if preferred. That's not all. There are dozens of other wonderful prizes, including 5 marvelous aviation courses valued as high as \$1,000.00. So just send us your name and address now with the Prize Coupon below. Don't send any money. There is no obligation and nothing to buy now, later, or ever.

YOU

## \$500.00 Cash Extra for Promptness!

Therefore, act this minute! Don't delay a second. I am going to give a big special prize of \$500.00 for promptness, so hurry now. Rush! There's a fortune at stake. No matter what your age or occupation, you positively can win one of these big prizes if you act! The most startling advertising plan ever heard of. Just imagine being enabled to win \$500.00 in cash by acting quick right now. Learn about this sensational new prize plan. It's positively free. Everyone taking an active interest LIBERALLY rewarded. Send your name and address on the coupon right this minute so that it will reach the Judges in a hurry. There are no puzzles to solve or things like that—but act now!

L. S. RENO, Room 155  
54 West Illinois St., Chicago, Illinois.

Dear Sir: I have read your advertisement, and am submitting my name as a candidate for the First Grand Prize, a new Waco Airplane and complete flying instruction, or \$3,745.00 in cash, AND ALSO PROMPTNESS PRIZE OF \$500.00. It is understood there is no cost or obligation to me, and it is not necessary to buy anything now, later, or ever.

Name .....

Address .....

Town ..... State .....

### EASY \$100 a Week

## FUGO FIRE EXTINGUISHER

Unusual opening for live agents in every locality. Make \$5000 or more a year—easily. Fugo—the instantaneous automatic fire extinguisher—is needed and wanted in every home, store, theatre, garage, shop, school, automobile, etc. Cheapest fire protection available today. Within reach of all.

**1 Qt. Size \$5.00    2 Qt. Size \$7.50**

Recharged in a *MINUTE*

Amazing 30-second demonstration clinches sale—each one sold sells others. Territory going fast. Write at once for wonderful proposition that will make you big money.

**THE NATIONAL FORMETAL CO.**  
6535 Metta Ave., N. E.    Cleveland, Ohio

## Auto Seat Covers \$2.95

Special Price Offer

**Agents Make \$20 a Day**

Write orders fast for this excellent Quality line Auto Seat Covers. Amazing values—quick sales. Cash daily. We deliver. Write for handsome, Free Leatherette Sample Outfit. **Quality Sales, 515 S. Dearborn St., Dept. 618, Chicago**

WRITE NOW!

**Complete Outfit \$9.65**

## PAINT WITH AIR

### New Simplified Easy Way!

with improved Payntgun! Quickest, easiest way to paint ever discovered. Anyone can put perfect smooth brilliant surface on car, furniture, woodwork, etc., with lacquer, varnish, paint or enamel. No experience needed—years of painting skill built into the Payntgun. New exclusive features cut painting time in half. Sturdily built—compact—convenient. Powerful spray specially designed for easy sure control. Turns painting jobs into play. Fully guaranteed.

**FREE Folder on Skillful Home Painting—Write for yours today!**

**HAYWOOD EQUIPMENT COMPANY**  
2345-H Ogden Avenue,    CHICAGO, ILL.

**AGENTS WANTED**

**NEW MODEL WALTHAM of ELGIN** SENT FOR \$1.00



**12 MONTHS TO PAY**

Send \$1.00 with order and tell us a little about yourself: (A) How long at present address, (B) Age, (C) Married or Single, (D) Name of employer, (E) Position, (F) How long at that work. All information held **strictly confidential**.—We make no direct inquiries of anyone—not even from your employer.

**10 Days' Free Trial Satisfaction Guaranteed**

Watch comes to you postage paid—no C. O. D. to pay on arrival. You take no risk—satisfaction guaranteed or money back.

Established 1895

**ROYAL DIAMOND & WATCH CO.**  
ADDRESS DEPT. 11-T 170 BROADWAY, N.Y.

**Catalog FREE To Adults**

New catalog of genuine diamonds, standard nationally advertised watches, fine jewelry. Write for it now.

**DC 15—A New Sport model.** White or Green Gold filled case warranted 20 yrs.; guaranteed accurate Elgin or Waltham movement. Gold filled "Wristocrat", flat wrist band. \$29.50 \$1. down, \$2.37 a month.

# Play Your Way to BIGGER PAY!



**and Popularity —with a Buescher**

The Saxophone has brought big money to many stars. As Orchestra features—as Orchestra leaders—as stage soloists—as recording artists and in other ways—hundreds of musicians have played their way to big pay and stardom on the

## BUESCHER

**True-Tone Saxophones**

Only a Buescher Gives You All These:

- Patented Snap-on Pads—greatest improvement for beauty of tone; easy to replace—no more cementing.
- Patented Automatic Octave Key—always positive.
- Hands never moved from one playing position.
- 6 Days' Trial In Your Home on any Buescher Saxophone, Cornet, Trumpet, Trombone or other instrument. Try the fingering arrangement—play it—hear its true, rich, clear tones, without obligation to buy.

**Easy to Play—Easy to Pay**

Besides being easy to play we make it easy to pay. A small down payment and a little each month. Write today for full information on our liberal offer. Give name of instrument in which you are interested.

**BUESCHER BAND INSTRUMENT CO.**  
2794 Buescher Block Eikhart, Ind.

**HARDWOOD LUMBER** PANELS, VENEERS and INLAY WOODS CUT TO SIZE

**CRAFTSMAN WOOD SERVICE**

715 E. 62nd Street CHICAGO, ILL.

**METAL TURNING LATHE \$35.00**



Also 7 in. swing 3 speed cone pulley Speed Lathes \$8.75

**Goodwin Mfg. Co.** 435 Keota St., OTTUMWA, IOWA

**New! SCREW-HOLDING SCREW DRIVER!**

.. absolute necessity for those tough jobs!

Amazing new patented invention! Removes and inserts screws instantly with one hand from inaccessible places. Then does work of ordinary screw driver. Grips any screw tightly by its slot. (Non-magnetic.)

Garages, factories, machinists, electricians, radio, auto owners buy on sight!

2 sizes—9" length, 5/16" blade for large screws. \$1.50 only.  
8" length, 3/16" blade for small screws. \$1.25 only.

Worth three times its price as labor and temper saver the first day used.

Either or both sizes sent post-paid receipt check or money order.

**DISTRIBUTORS.** genuine opportunity earn big money! Exclusive territory! Write or wire quick for full details.

**1.50**

**JIFFY-TITE MFG. CO.**  
8 Spring Lane Boston, Mass.



**SOLD ON EASY TERMS**

**WORKACE Electric WOODWORKER**

Complete Outfit Including Planer, Saw, Lathe, Electric Motor and Many Useful Attachments



Planer Motor Saw Lathe Buffing, Grinding, Attachments

**Fast—Accurate—Complete**

Price complete, \$89.00. Easy Terms. Write for complete information.

**J. D. Wallace & Co.,** 2845 Adams St., Chicago  
11 W. 42nd St., New York 268 Market St., San Francisco

**Establish a Good Future**

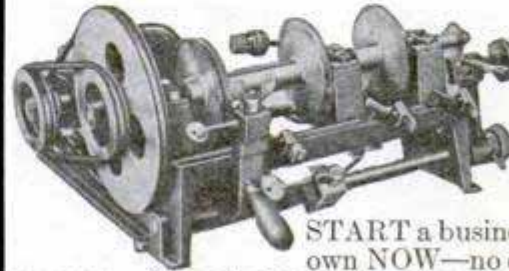

**DON'T BE A SHOP WORKER**

**START a business of your own NOW—no experience necessary.** The only key machine that cuts ALL kinds of keys. No hand-filing. Make first keys by number without taking locks apart. Instructions furnished free.

**WRITE TODAY.**

**BEISSER KEY MACHINE COMPANY**  
407 Fort St. East Detroit, Mich., U. S. A.

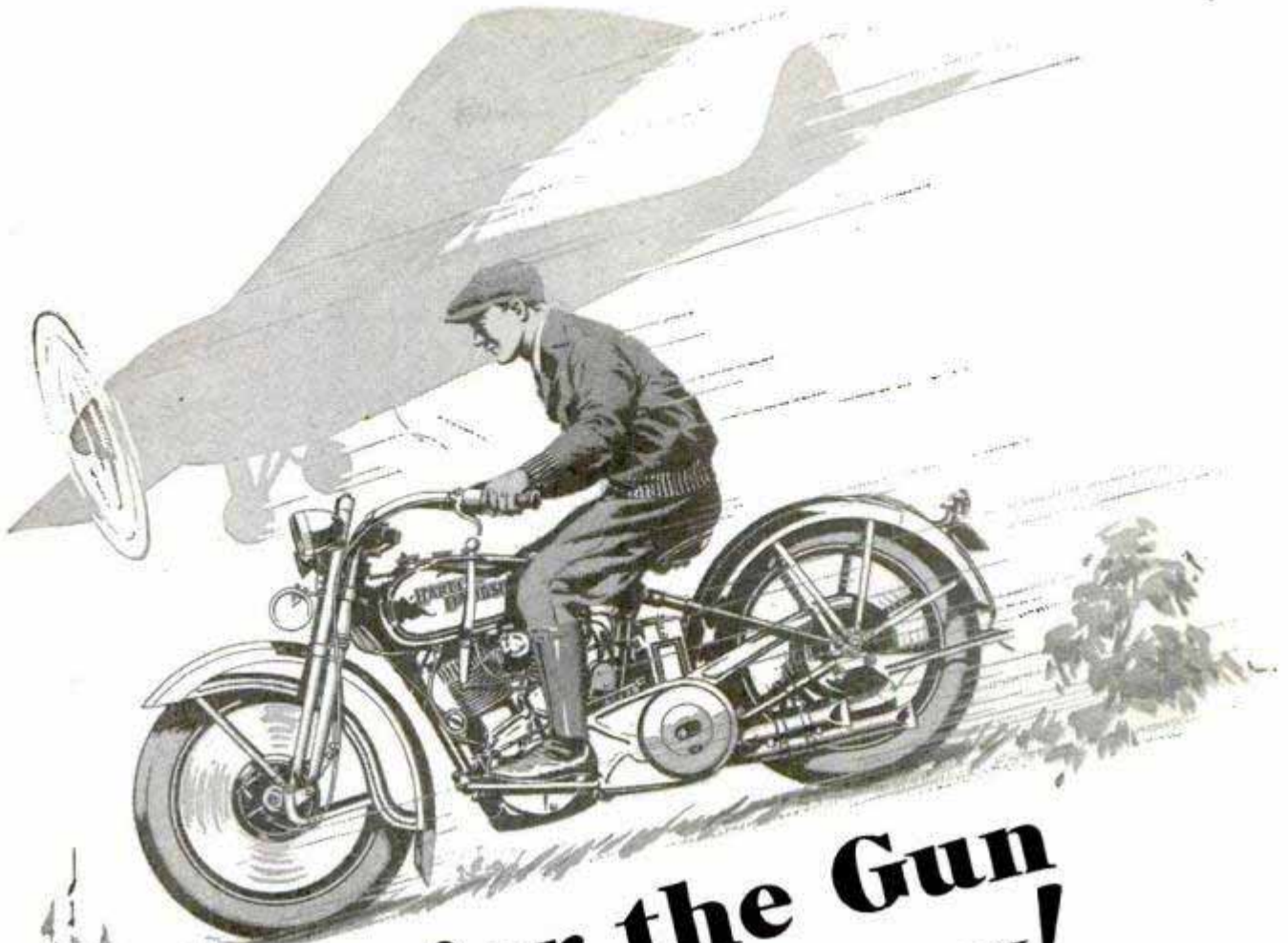

# Give'er the Gun -and ZOOM Away!

**S**WOOPING like an airplane, soaring over hills, skimming along beckoning roadways—motorcycling truly is the "Sport of a Thousand Thrills".

Astride a Harley-Davidson, any road is your road—for hours or days of joyous travel, at a cost too low to bother about. Glorious vacation trips. Week-end jaunts to lakes and streams. Tours to distant cities or frontier wilderness. Just jump into the saddle and GO!

See the 1929 Harley-Davidsons at your local dealer's today. Ask about his Pay-As-You-Ride Plan. Mail the Coupon for literature showing our full line of Twins and Singles.

## HARLEY-DAVIDSON Motorcycles

Model shown above is our Big Twin, famous the world over — favorite of riders everywhere. We also build a wonderful "45" Twin that costs only \$290 f. o. b. factory. And Singles at \$235 and \$255.

HARLEY-DAVIDSON MOTOR CO., Dept. P., Milwaukee, Wis.  
Interested in your motorcycles. Send literature.

Name.....

Address.....

My age is  12-15 years  16-19 years  20-30 years  
 31 years and up. Check Your Age Group.

**Mail this  
Coupon!**

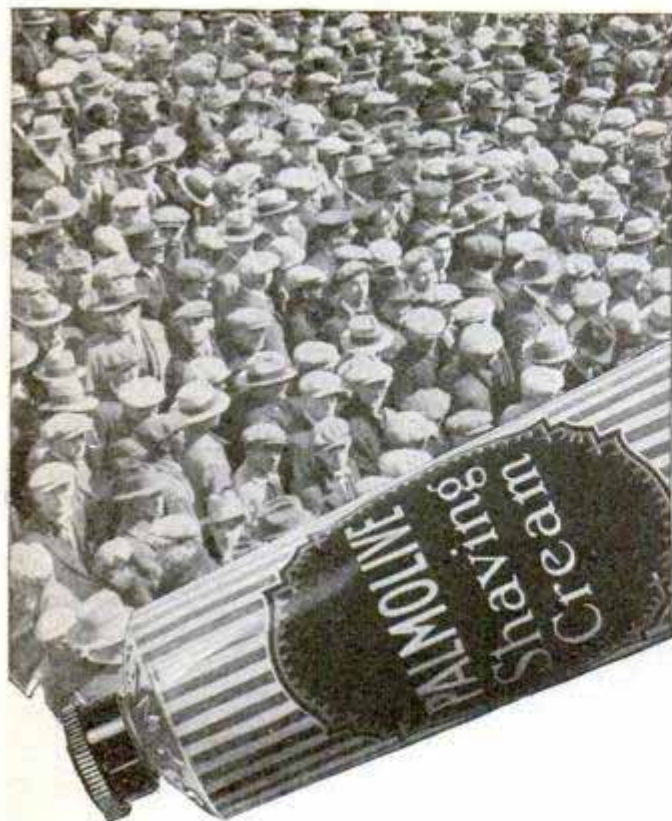

**We have Sent**  
**3,000,000 men this free 7-day tube**  
*86% of those who try it discard their old-style methods. Will you send the coupon for your test? It's free.*

GENTLEMEN: Some time ago we asked 1,000 men to advise us in creating a new shaving preparation—Palmolive Shaving Cream. They told us 5 important ways old methods failed to please. After much experimenting we've finally succeeded—and millions of men have acclaimed the cream we make.

- 1: Multiplies itself in lather 250 times.
- 2: Softens the beard in one minute.
- 3: Maintains its creamy fullness for 10 minutes on the face.
- 4: Strong bubbles hold the hairs erect for cutting.
- 5: Fine after-effects due to palm and olive oil content.

### Our free test offer

Probably you will find we have anticipated your desires in our unique new cream. So we ask you, in fairness to yourself—and to us who have tried to please you—to mail the coupon now. A generous 7-day test will come to you by return mail. Act now.

To add the final touch to shaving luxury, we have created Palmolive After Shaving Talc—especially for men. Try the sample we are sending free with the tube of Shaving Cream.

**PALMOLIVE RADIO HOUR**—Broadcast every Wednesday night—*from 9:30 to 10:30 p. m., eastern time; 8:30 to 9:30 p. m., central time; 7:30 to 8:30 p. m., mountain time; 6:30 to 7:30 p. m., Pacific Coast time*—over station WEAJ and 37 stations associated with The National Broadcasting Company.

## 7 SHAVES FREE

and a can of Palmolive After Shaving Talc

Simply insert your name and address and mail to Palmolive, Dept. B-3070, 595 Fifth Avenue, New York City.  
 In Canada, address Palmolive, Toronto 8, Ont.

(Please print your name and address)

**You Too Can Add Profits of \$150 to \$300 Monthly**

Mechanics, Repair Men, Garages and Battery Shops are adding customers and profits without expense to them. Start in business yourself with HB One Day Battery Service. You'll get the business by charging batteries in one-third the time required by other methods. HB does better charging—at lower cost to you. Comes to you for

### ONLY \$16 MONTHLY

Check No. 1 in the coupon below for full information.

### HB TEST BENCH

Another Big Profit branch of automotive service is Starting-Lighting-Ignition Service. You can do it with practically no investment. ONLY \$20 MONTHLY for this HB—priced \$100 to \$150 below anything near its quality.

Check No. 2 in the coupon below for full information.



### BRING CUSTOMERS TO YOUR DOOR

Better Air Service than the other fellow's is yours for only \$12 monthly. Dependable Day and Night Service keeps car owners coming to your door day after day. Only HB quantity production makes possible the low price on this Silent, Beltless, Upright, Ball Bearing, Twin Cylinder HB Automatic Air Service.

Check No. 4 in the coupon below for full information.



### HB PORTABLE PAINT SPRAY

Enables you to underbid every competitor, yet makes more profit for yourself on every job. Does the work of five brush painters and does it better. Paint automobile, houses, barns, garages, furniture.

Check No. 3 in coupon below for full information.



**HOBART  BROTHERS**  
*Successful manufacturers since 1893*

BOX M69

TROY, OHIO

### Tear off Coupon and Mail Today

HOBART BROTHERS CO.  
 Box M69, TROY, OHIO.

Send me complete information on the items I've checked with your 30 day trial offer, easy payment terms, and information on how HB equipment will increase my earnings.

- 1  One Day Battery Service Profits
- 2  Electrical Test Bench Opportunities
- 3  Portable Paint Spray Business
- 4  Better Automatic Air Compressor

NAME.....

ADDRESS.....

*Special! My 1929 Offer to You*

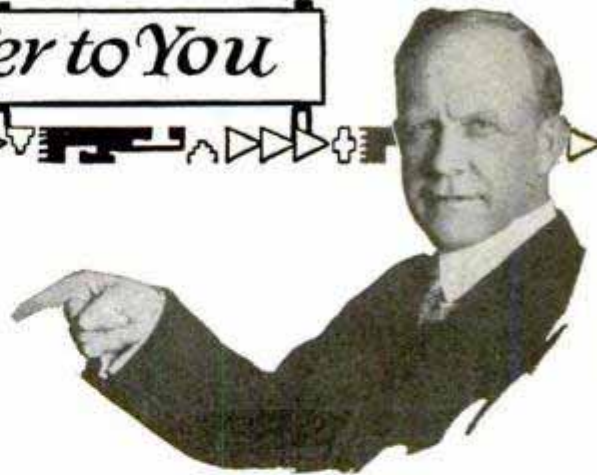

**I Will Save  
You Money**  
*Read my 1929 Offer to You*

**FREE**

Your choice a gold watch chain or beautiful strand of pearls with every watch sold. Offer good for limited time only.

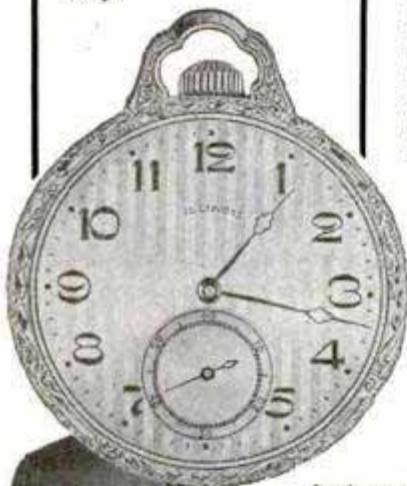

In addition to our New Low Price, I will send for your approval one of these Standard Watches, guaranteed for a lifetime of satisfactory service, not only by the Santa Fe Watch Company, but by the Great Illinois Watch Factory. They are found in the pockets of men in the service on every railroad in this country. Senators, Congressmen and Governors keep their official appointments by "Santa Fe Special" time. Army Officers and Privates carried them all through the Greatest War in history—thousands of these splendid watches are in use all over the World. If you want one on my liberal new **LOW PRICE PLAN**, you had better write for my Free Watch Book today and make your selection without delay. I will send the Watch for you to see **WITHOUT ONE PENNY DOWN**—I will even allow you to wear the Watch 30 days **FREE**—then sell it to you on a binding money-back guarantee.

**Save 1/3 to 1/2 of Your Money  
Most Liberal Offer Ever Made**

Our "Direct-to-you" low wholesale terms and **EXTRA SPECIAL DISTRIBUTION PLAN** is fully explained in the New Santa Fe Special booklet just off the press. The "Santa Fe Special Plan" means a **BIG SAVING** of money and you get the **BEST** watch value on the market today. I want you to see all the newest designs in the new thin model Santa Fe Special in both white and green gold—the handsome sturdy case models designed for our famous Santa Fe Mogul Watch—the very newest creations in Men's Strap Watches, sturdy in design and beautifully engraved in both white and green gold and the artistic Ladies' Bracelet Watch, in many shapes and designs in white gold, some with diamond and sapphire settings. No matter what your choice of a watch may be, there is a Santa Fe Watch for you.

**Write for FREE Watch Book Today**

shows newest watch case designs in 4 colors. **READ** the so-called **SECRETS** of watch making. **READ** how you can save from **ONE THIRD** to **ONE HALF** of your money—Buy "Direct." The wise man will act quickly if he wants a watch.

**EASY PAYMENTS TO SUIT YOU**—Don't delay—Fill out and mail the coupon below for the **FREE** Watch Book.

**SANTA FE WATCH COMPANY**  
**66 THOMAS BUILDING TOPEKA, KANSAS**

**SANTA FE WATCH COMPANY,**  
**66 Thomas Building, Topeka, Kansas.**

Please send me the New Watch Book with the understanding that this request does not obligate me in any way.

Name.....

Address.....

City.....State.....





## “How we saved our first \$500”

“MARY and I had been married four years, but we couldn't save a cent. Fact is, we were constantly in debt and I was always worried for fear I would lose my position.

“Then one night I saw that something must be done, so I told Mary I was going to take a course with the International Correspondence Schools. ‘I've been hoping you would do that,’ she said. ‘I know you can earn more money if you really try.’

“So I started studying after supper at night, in the spare time that used to go to waste. It wasn't hard and pretty soon I began to see it was helping me in my work. In three months a new position was open and the Boss gave me a chance at it because he'd heard I was studying with the I. C. S.

“Well, that was the start. Before the end of the year I received another raise and we began to save. We've got \$300 in the bank now and we're going to have a lot more soon.”

For thirty-five years the International Correspondence Schools have been helping men to win promotion, to earn more money, to get ahead in business and in life. You can do it too.

At least, find out how by marking and mailing the coupon printed below. It doesn't cost you a penny or obligate you in any way to do this, but it may be the means of changing your entire life. Do it now.

### Mail This Coupon for Free Booklet

INTERNATIONAL CORRESPONDENCE SCHOOLS  
Box 5620-F, Scranton, Penna.

Without cost or obligation, please send me a copy of your booklet, “Who Wins and Why,” and full particulars about the course before which I have marked X in the list below:

#### TECHNICAL AND INDUSTRIAL COURSES

- |  |   |
|--|---|
| <input type="checkbox"/> Architect               | <input type="checkbox"/> Automobile Mechanic                                |
| <input type="checkbox"/> Architectural Draftsman | <input type="checkbox"/> Aviation Engines                                   |
| <input type="checkbox"/> Building Foreman        | <input type="checkbox"/> Plumber and Steam Fitter                           |
| <input type="checkbox"/> Concrete Builder        | <input type="checkbox"/> Plumbing Inspector                                 |
| <input type="checkbox"/> Contractor and Builder  | <input type="checkbox"/> Foreman Plumber                                    |
| <input type="checkbox"/> Structural Draftsman    | <input type="checkbox"/> Heating and Ventilation                            |
| <input type="checkbox"/> Structural Engineer     | <input type="checkbox"/> Sheet-Metal Worker                                 |
| <input type="checkbox"/> Electrical Engineer     | <input type="checkbox"/> Steam Engineer                                     |
| <input type="checkbox"/> Electrical Contractor   | <input type="checkbox"/> Marine Engineer                                    |
| <input type="checkbox"/> Electric Wiring         | <input type="checkbox"/> Refrigeration Engineer                             |
| <input type="checkbox"/> Electric Lighting       | <input type="checkbox"/> R. R. Positions                                    |
| <input type="checkbox"/> Reading Shop Blueprints | <input type="checkbox"/> Highway Engineer                                   |
| <input type="checkbox"/> Telegraph Engineer      | <input type="checkbox"/> Chemistry  |
| <input type="checkbox"/> Telephone Work          | <input type="checkbox"/> Pharmacy   |
| <input type="checkbox"/> Mechanical Engineer     | <input type="checkbox"/> Coal Mining Engineer                               |
| <input type="checkbox"/> Mechanical Draftsman    | <input type="checkbox"/> Navigation <input type="checkbox"/> Assayer        |
| <input type="checkbox"/> Machine Shop Practice   | <input type="checkbox"/> Iron and Steel Worker                              |
| <input type="checkbox"/> Toolmaker               | <input type="checkbox"/> Textile Overseer or Supt.                          |
| <input type="checkbox"/> Patternmaker            | <input type="checkbox"/> Cotton Manufacturing                               |
| <input type="checkbox"/> Civil Engineer          | <input type="checkbox"/> Woolen Manufacturing                               |
| <input type="checkbox"/> Surveying and Mapping   | <input type="checkbox"/> Agriculture <input type="checkbox"/> Fruit Growing |
| <input type="checkbox"/> Bridge Engineer         | <input type="checkbox"/> Poultry Farming                                    |
| <input type="checkbox"/> Gas Engine Operating    | <input type="checkbox"/> Mathematics <input type="checkbox"/> Radio         |

#### BUSINESS TRAINING COURSES

- |  |   |
|--|---|
| <input type="checkbox"/> Business Management                     | <input type="checkbox"/> Business Correspondence      |
| <input type="checkbox"/> Industrial Management                   | <input type="checkbox"/> Show Card and Sign Lettering |
| <input type="checkbox"/> Personnel Management                    | <input type="checkbox"/> Stenography and Typing       |
| <input type="checkbox"/> Traffic Management                      | <input type="checkbox"/> English                      |
| <input type="checkbox"/> Accounting and C. P. A. Coaching        | <input type="checkbox"/> Civil Service                |
| <input type="checkbox"/> Cost Accounting                         | <input type="checkbox"/> Railway Mail Clerk           |
| <input type="checkbox"/> Bookkeeping                             | <input type="checkbox"/> Mail Carrier                 |
| <input type="checkbox"/> Secretarial Work                        | <input type="checkbox"/> Grade School Subjects        |
| <input type="checkbox"/> Spanish <input type="checkbox"/> French | <input type="checkbox"/> High School Subjects         |
| <input type="checkbox"/> Salesmanship                            | <input type="checkbox"/> Cartooning                   |
| <input type="checkbox"/> Advertising                             | <input type="checkbox"/> Illustrating                 |
|  | <input type="checkbox"/> Lumber Dealer                |

Name.....

Address.....

City..... State.....

Occupation.....

If you reside in Canada, send this coupon to the International Correspondence Schools Canadian, Limited, Montreal, Canada



## Taylor Compasses

A walk through the woods or following a trail may lead one miles away from camp, but there is no danger of getting lost if you carry a Taylor Compass. You are sure to find your way back to camp or out of the woods.

Taylor Compasses have been the favorites of sportsmen for many years. They will be found at leading hardware and sporting goods stores everywhere.

There's a Taylor Compass for every price and requirement

Leedawl Compass.....	\$1.50
Magnapole Compass.....	1.75
Flodial Compass.....	1.75
Litenite Compass.....	2.00
Gydawl Compass.....	3.50
Auropole Compass.....	4.00
Merldial Compass.....	4.00
Ceebynite Compass.....	4.50
Usanite Compass.....	5.00

Your dealer can supply you, or write direct to us, enclosing price, plus 10c postage, and we will send any of the above, safe delivery guaranteed. Taylor Compass Booklet sent free upon request.

### Taylor Instrument Companies

ROCHESTER, N.Y., U. S. A.

Canadian Plant  
Tycos Building  
Toronto

Manufacturing Distributors  
in Great Britain  
Short & Mason, Ltd., London



### WOOD LATHE with 1/4 H. P. Motor Built in Head

For Cabinet Makers, Schools and Amateur Mechanics; a correctly designed, exceptionally well built, substantial lathe, 34" between centers; 9" swing over bed (8" over tool rest). Motor head stock has speed of 1750 R. P. M. Motor is controlled and protected by combination switch and circuit breaker. The Crescent line comprises many kinds of wood working machines, portable and for mills, quality made, moderately priced.

THE CRESCENT MACHINE CO.  
93 Columbia St., Leontia, Ohio

Send for FREE BULLETINS

### INSTALL YOUR OWN PLUMBING AND HEATING

Write for our big free book containing 4,000 wholesale bargains showing exactly how you can save all labor costs and one-half on material. No experience necessary. Our amazing plan explains everything.

Address—Burke (4) Brothers, 418 Liberty Avenue, Pittsburgh, Pa.

## Mac WORKSHOP Electrically Operated



### This Complete Mac Workshop Now Sent on 10-Days Free Trial

Send now for details about this big, powerful, sturdy equipment. 36" lathe, 8" saw, 4" Jointer, 1-3 Horse Power Motor, Jig Saw, and all units for a complete motorized workshop. Easy to operate. Shipped on approval, ready to plug into light socket. Plans and instructions furnished. Unusually low prices and convenient monthly terms. GET DETAILS QUICK!

Midland Appliance Corporation

Dept. 610 225 N. Michigan Avenue Chicago

Please send details.

Name.....

Address.....

# If You're Paid Less than \$7000 a YEAR

## Get into FLORKRAFTSMANSHIP



**Remarkable New Profession—over 1300 Popular Mechanics Readers now earn \$25 to \$75 a day. Make This Your Regular Pay**

**S**INCE we've told Popular Mechanics Readers of Clarke FlorKraftsmanship, over 1300 men like you have entered this big pay work. Are they skilled mechanics and carpenters? No. Just men like you, some low paid shop workers, some young fellows just out of school, some carpenters, some men fifty or sixty.

\$25 to \$75 a day—\$5,000 to \$10,000 a year—can be yours. It's inside work, finishing floors in new and old houses the amazing Clarke Vacuum Portable Sander way. Weather can't hold up your jobs. Neither can Winter. You get steady work—work almost as easy as running a vacuum cleaner.

### What FlorKraftsmen Say

If you don't think there's money in Clarke FlorKraftsmanship, ask any man now in it. Read here what a few of these write us:

*"My machine is working wonderful and I keep it busy most all the time. Please rush this order for sandpaper as fast as you can.—A. E. Sweeney, Alturas, California." "Getting along fine and plenty of work. Sure am well satisfied with the Sander and the work it does.—Jesse A. Miller, Maquoketa, Iowa."*

*"I have operated your Sanding Machine for the first time today, and found it satisfactory in every way. I was very glad to see that its advantages were according to your statements."*

*"Today was a real holiday for me, because operating your Sanding Machine was a real treat. It did three days work and gave me eight hours of enjoyment. I only regret that I haven't purchased this machine of wonders sooner.—Alphonse Renaud, Dover, N. H."*

*"The machine is a fine piece of mechanism and is very satisfactory to me.—S. J. Breckler, Columbus, O."*

### CLARKE SANDING MACHINE CO.

Dept. T-26, 3831 Cortland St.  
CHICAGO, ILL.

Originators, and, for 12 years,  
Manufacturers of Portable  
Sanding Machines.

*"I received the sanding machine in good shape. Have been sanding the floors in my house. It sure does good work.—H. B. Potter, Carthage, S. D."*

*"I am getting good results out of my machine. Would not want to be without it any more.—H. W. Gernert, Fullerton, Pa."*

*"The machine is a little wonder. Am well pleased with it.—J. S. Zirkle, Newell, W. Va."*

### Big Salary Increases

So many write us about their new independence—the new car they have bought or the better house they now live in—that we can't tell you all about it in this brief ad.

But the same opportunity is open to you. Become a FlorKraftsman and earn this big pay yourself. You need only about \$100 to start. No office or shop required. The Clarke and some sandpaper puts you in FlorKraftsmanship.

### Figure Your Earnings

The Clarke sands 800 to 2000 square feet of new floor in 8 hours. Pay is 3 to 5 cents per foot. That's \$25 a day. Old varnished floors are sanded at the rate of 300 to 1000 sq. ft. a day, and the pay here is 7 to 15 cents a foot. The Clarke runs off a light socket. You carry it around by hand. No cost for trucking, because it weighs only 31 pounds complete. An hour teaches you to use it.

You want to make money? Then sit down and fill out this coupon, as these other readers have, and mail it direct to Clarke, the largest producer of sanders in the country. The full facts will reach you at once. No cost. No obligation. Mail coupon NOW.

## MAIL THIS

### Special Reader's Coupon free information

CLARKE SANDING MACHINE CO.,  
Dept. T-26, 3831 Cortland St., Chicago, Ill.  
Gentlemen: Please tell me, without obligation, how I can make \$25 to \$75 a day as a FlorKraftsman.

Name.....

Address.....

City.....State.....

### They Have Succeeded— You Can Do As Well

W. G. Roe, Clarke FlorKraftsman, Richmond Hill, L. I., N. Y.—"My Clarke is my 'Lindy'—he sure can fly over the work. In fact, I have made money: I have made from \$40.00 to \$45.00 per eight hours with it. I would never be without a Clarke, and with more work I will soon have two."

Chas. T. Rose, Dixon, Calif.—"Recently my Clarke sanded and finished 4500 square feet of maple floor in 3½ days—or 26 hours, and turned out the best job I have ever seen after a sander."

H. O. James, Mt. Sterling, Ky.—"I have already taken in \$348.00 for work and have 1,100 feet of old floors to do yet and some new ones too."



**THE CROSLY AC LINE for 1929!**

Thru the use of the superior Mershon condenser Crosley has developed electric light socket operation to a high degree of excellence and presents the trade with a line of AC sets for 1929 that set entirely new standards of radio performance!

**AC Electric 7-tube Gembox operating dynamic power speaker**

This amazing receiver contains the latest and best radio refinements—new neutrodyne circuit—3 stages of radio amplification—detector—2 stages of audio—171-A power tube in last audio stage—full voltage on plates of output tube—power supply self-contained—illuminated dial—beautiful case black crackled finish highlighted with white gold. Price without tubes \$65

# CROSLY

ANNOUNCES THE GREATEST RADIO VALUE EVER OFFERED!

**The AC Electric 7-tube GEMBOX (Without Tubes) \$65**

New Full Neutrodyne circuit—New Chassis—New Volume control of exceptional smoothness—New Switch on front of case—New Added stage of radio frequency amplification—New 3 tuning condensers—New Elimination of regeneration in the detector tube

—combined with these modern, superior Crosley features so essential to complete radio satisfaction—

Proven Illuminated dial  
Proven Self contained power supply

Proven Mershon condenser  
Proven AC Electric socket operation

7-tube Radio { 3 radio amplification tubes  
1 detector tube  
2 audio tubes  
1 rectifier tube

# RADIO

THE CROSLY RADIO CORPORATION

Powel Crosley, Jr., Pres.

Department 15, Cincinnati, Ohio

Owners of WLW — the Nation's Station



The Crosley Dynamic DYNACONE—A power speaker of entirely different principle of operation producing all tones over the entire scale in true relation to each other—\$25

**The 7-tube AC GEMCHEST**

A cabinet of Chinese Chippendale design with new 7-tube GEMBOX and Dynacone built in—optional in 3 colors, red—green or black with metal trimmings—\$94



The Crosley Console DYNACONE—Console cabinets equipped with Crosley DYNACONES offer amazing value to the trade.

**Crosley 8-tube AC Electric Showbox**

This remarkable set, unusually selective, contains 3 stages of radio amplification, detector, 3 stages of audio with two 171-A power tubes in the last stage, rectifier tube—8 tubes in all. There is a full 180 volts on the plates of the last tubes which insures clear, rich volume of reproduction. The set is sharp, sensitive, powerful. Case is finished in black crackled effect highlighted with white gold. Price without tubes \$80



**Crosley 8-tube AC Electric Jewelbox with tuned antenna circuit and power detector**

A new powerful receiver employing a tuned antenna circuit, power detector tubes and use UY 227 tubes in all circuits except last audio stage and rectifier. The set contains a new and improved audio system with push-pull amplification and two 171-A power tubes in the last stage. This set is truly called "The World's Finest Receiver." Its selectivity and sensitivity are amazing. Combined with the dynamic Crosley DYNACONE performance is assured equal to the finest radio reception money can buy. The case is finished in black and highlighted with white gold or rich brown with yellow gold high lighting. All the improved Crosley features such as illuminated dial, Mershon Condenser, complete shielding, self contained power supply, etc. are incorporated in this wonderful value. Price without tubes \$105. Montana, Wyoming, Colorado, New Mexico and West prices slightly higher.



# 42 Miles on 1 Gallon of GAS

WILL YOUR CAR DO IT?

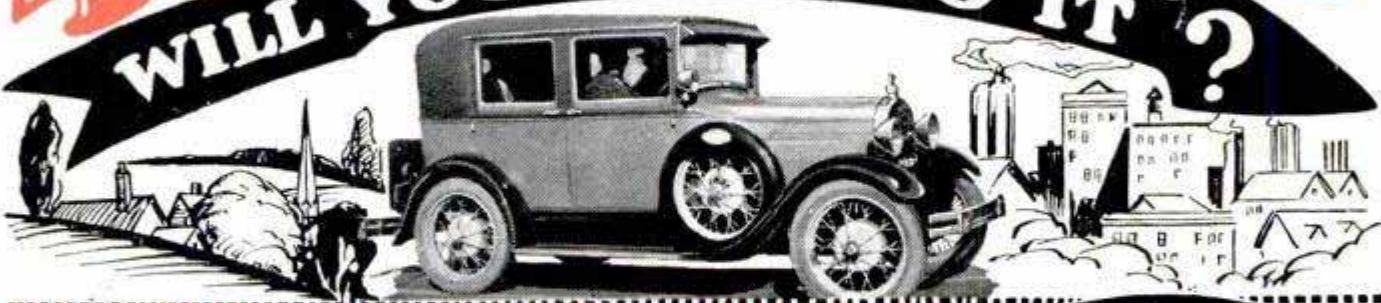

## New Moisture Humidifier & Carbon Eliminator

for all Makes of Cars, Trucks, Tractors and Engines

An amazing Scientific Humidifier has been patented throughout the World that beats any ever got out. It makes engines run ALL THE TIME with the same wonderful efficiency they do on a cool moist night. It gives MORE pep and power, HIGHER top speed, eliminates hard carbon, and gives AMAZING mileage. Fords report 28 to 42 miles per gallon. Other makes (both American and Foreign) report marvelous increases of 1/4 to double mileage. Some of the best records are:

Miles	Miles	Miles	Miles
Buick.....28 1/2	Ford (Model T) 42	Oakland.....31	Pierce Arrow...22
Cadillac.....21 1/2	Ford (Model A) 40	Oldsmobile...34 1/2	Pontiac.....31
Chevrolet.....41	Hudson.....23 1/2	Overland.....41	Reo.....26 1/2
Chrysler.....30 1/2	Hupmobile...24 1/2	Packard.....21 1/2	Star.....41 1/2
Dodge.....31 1/2	Marmon.....21 1/2	Plymouth.....29	Studebaker...29
Essex.....32	Nash.....30	Graham-Paige 23 1/2	Willys-Knight 29

And Hundreds of Other Wonderful Records on ALL American and Foreign Makes

## Big Profits

to Man with Car Spare or Full Time

\$350 to \$1500 a month

1 man \$4,939.66 in 3 1/2 months  
Another \$1,656.60 in 58 days  
\$5,150.00 in 5 months to another. BIG MONEY can be—IS being made

Fitting Motors With Vix  
One man sold 8 first morning  
Another sells all 3 men can install

Another's profits as high as \$100.00 a day

Vix sells itself by 8 STARTLING demonstration—BIG STUNNING. ASTOUNDING DEMONSTRATIONS. Successful VIX men make MORE MONEY than they ever made before.

## Free Trial TRY This New Principle Gas Saver AT MY RISK

Try this wonderful VIX Moisture Humidifier and Carbon Eliminator AT MY RISK on YOUR OWN CAR to prove that VAPOR MOISTURE (drawn from Radiator to Engine) gives you that wonderful night driving effect ALL THE TIME with MORE mileage from gas and oil—eliminates hard carbon accumulation—gives MORE power, a SNAPPIER, PEPPIER motor, FASTER acceleration, a SMOOTHER, QUIETER running engine and HIGHER top speed.

VIX will PROVE ITS MONEY SAVING MERIT on your own car by 8 DEMONSTRATIONS—conducted by yourself AT MY RISK—the most SENSATIONAL, most ASTOUNDING, most CONVINCING DEMONSTRATIONS you ever saw. If you don't find from your tests that it does MORE than I claim; return it and it COSTS YOU NOTHING. I want wide-awake hustling, County, State, Province and National Agencies everywhere, part or full time, to make \$350 to \$1500 per month filling the great DEMAND for this wonderful invention wherever introduced. Write for my FREE TRIAL and MONEY MAKING OFFER. Use coupon below.

WALTER CRITCHLOW

Inventor and Manufacturer, 4P-805 Street, WHEATON, ILL., U. S. A.

**FREE VIX Mail Now offer**

WALTER CRITCHLOW, INVENTOR and MANUFACTURER, 4P-805 Street, Wheaton, Ill., U. S. A.

Please send me without obligation or charge your FREE TRIAL and MONEY MAKING VIX OFFER.

Name.....

Address.....

Town..... State.....

Pictures here and at top show Model "B" VIX attached to my own New Model A Ford. This car is wonderfully improved in performance with the VIX Moisture Humidifier. So is every Auto, Truck, Tractor, Taxi, Bus, Marine, Stationary and Aircraft Engine, both American and all Foreign makes.

**GUARANTEED TO SAVE** { 1 4 to 1 2 Gas Carbon Cleaning Engine Repairs or Costs You Nothing



**FORD**  
40 Miles on  
a Gallon

**BUICK**  
36 Miles on  
a Gallon

**OLDSMOBILE**  
1300 Miles of  
Free Gasoline

**CHEVROLET**  
43.8 Miles Per  
Gallon

**STUDEBAKER**  
32 Miles on  
Gallon

**SAVED \$340**  
in Gasoline

**OAKLAND**  
30 Miles Per  
Gallon

**REDUCES CARBON**  
Without Touching  
the Engine

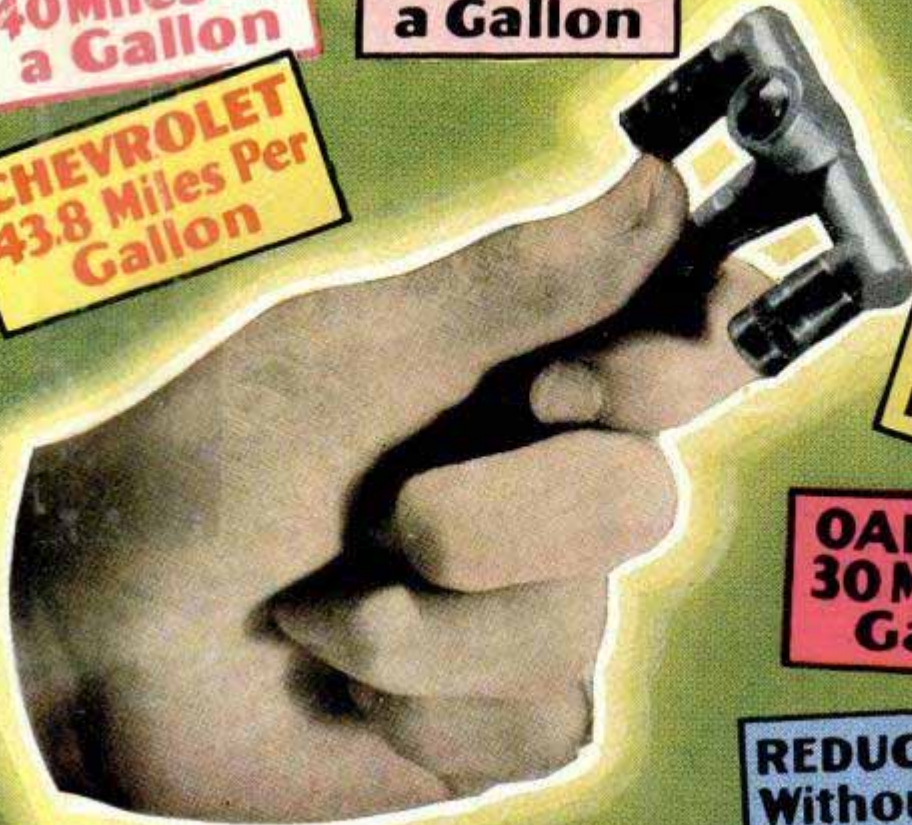

# Who Else Wants to Save Gasoline?

## FORD

"I have used one on my Ford for over five years and have traveled over 35,000 miles. Never had any spark plug trouble. Have averaged 28 to 30 miles on a gallon."

J. H. Alruth, Iowa.

## CHEVROLET

"You people claim a saving of 25% and more. I found I was obtaining 43.8 miles to a gallon on a Chevrolet. Actual test surpasses your claim."

M. E. Miller, Kansas City.

## BUICK

G. M. Rathburn, Charleston, W. Va., has a Buick Six. Having an old engine, he was getting only 8 or 9 miles to a gal. On a 287 mile trip he got 19 miles to a gal. He says it has saved him \$40.00 on one trip.

## NASH

"I had a large Nash Six. I drove from Los Angeles to San Francisco on 20 gals. of gas. Vaporizer paid for itself the first trip."

H. T. McCallon, California.

**A** SOUTH DAKOTA man has discovered an amazing gas-saving invention now installed on over three million cars of every make. Already over ten thousand car owners say it increases gas mileage and saves an astonishing amount of money in gasoline and repair expense. There is a model for every car, truck, tractor or gasoline engine. Anybody can install it in a few minutes.

This invention is based on newly-discovered facts about potential gasoline power that few car owners know about. For example, it is now found that the average man wastes at least 20% to

30% of his gasoline through improper combustion. And many more interesting discoveries, too detailed to mention here.

Read on the left what other car owners say about it. Then accept the inventor's special introductory offer. He will send you samples to test without obligation to buy. If you find it doesn't do for you what it has done for other car owners, he will pay a cash forfeit for the few minutes you've spent in testing it. Don't send a penny now. Simply send your name in coupon below. J. A. Stransky Mfg. Co., G-10 Stransky Block, Pukwana, S. D.

## Men Wanted

vaporizers sell themselves. where. Full or spare time.

Herrick made \$157 in a day, letting Stransky Territories open everywhere. Check coupon at right.

J. A. STRANSKY MFG. CO.,  
G-10 Stransky Block, Pukwana, S. D.

Yes, send me full description of this new way to save gasoline. This request does not obligate me in any way.

My name is.....

Street.....

City.....State.....

( ) Check here if you want agent's proposition.