

# POPULAR MECHANICS

## MAGAZINE

WRITTEN SO YOU CAN UNDERSTAND IT

REGD TRADE MARK GREAT BRITAIN No. 410425

REGD U.S. PAT OFF



SEE PAGE 370



# GENUINE MODEL T CORONA

**1/3 OFF REGULAR PRICE**



**H**ERE'S your chance to own that genuine Model T Corona you've wanted—on the easiest terms ever offered — at ONE-THIRD OFF regular price! Complete in every detail; back spacer, etc., **NEW MACHINE GUARANTEE**. Recognized the world over as the finest, strongest, sturdiest, portable built.

**\$2<sup>00</sup> DOWN**  
**BALANCE EASY TERMS**

**Yours for 10 Days FREE**  
*Send No Money*

Only a limited number of these splendid machines available. To get one, you must act now! Experience the joy this personal writing portable typewriter can give you! Use it 10 days free! See how easy it is to run and the splendidly typed letters it turns out. Ideal for the office desk, home, traveling. Small, compact, light, convenient. Don't send out letters, manuscripts, reports, bills in poor handwriting when you can have this Corona at such a low price or on such easy terms.

**Carrying CASE**

**Included—If You Act Now**

Leatheroid carrying case, oiler, instructions free on this offer. Send no money—just the coupon. Without delay or red tape we will send you the Corona. Try it 10 days. If you decide to keep it, send us only \$2—then \$3 a month until our special price of \$39.90 is paid (cash price \$36.40). Now is the time to buy. This offer may never be repeated. Mail coupon now.

**Smith Typewriter Sales Corp.**

Corona Division

Dept. 33, 469 E. Ohio St.

Chicago, Ill.

**MONEY SAVED  
BY USING THIS COUPON**

**Smith Typewriter Sales Corp.**  
[Corona Division]  
469 E. Ohio St., Chicago, Dept. 33

Ship me the Corona, F. O. B. Chicago. On arrival I'll deposit \$2 with express agent. If I keep machine, I'll send you \$3 a month until the \$37.90 balance of \$39.90 price is paid; the title to remain with you until then. I am to have 10 days to try the typewriter. If I decide not to keep it, I will repack and return to express agent, who will return my \$2. You are to give your standard guarantee.

Name.....

Address.....

Employed by.....



**Modernistic Fire Screen**

See LePage's Book, page 13

**Modernistic Table**

See LePage's Book, page 11

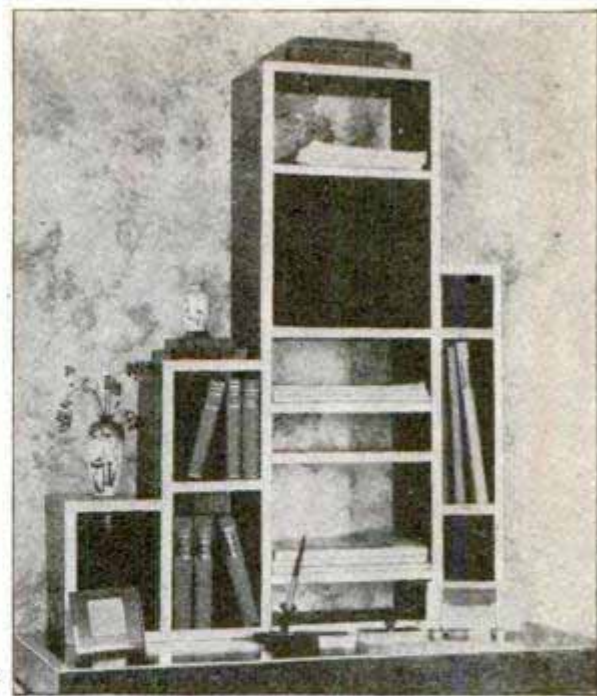
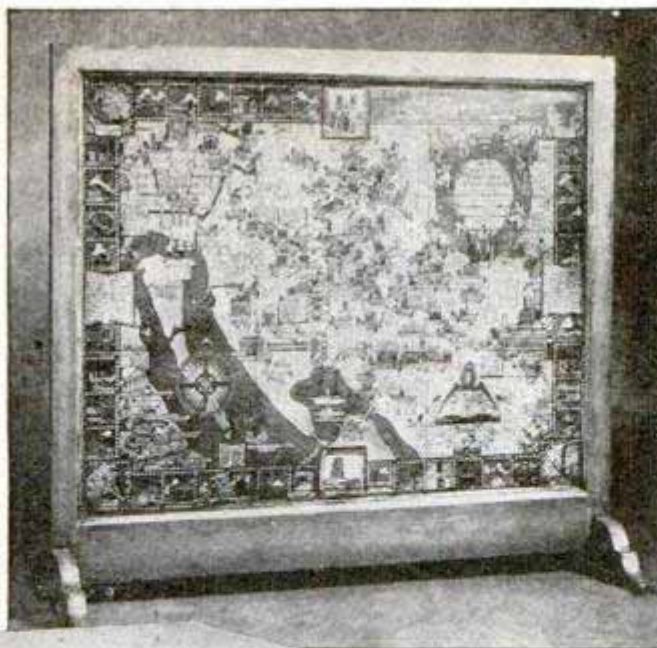

**Modernistic Book Shelves**  
See LePage's Book, page 9

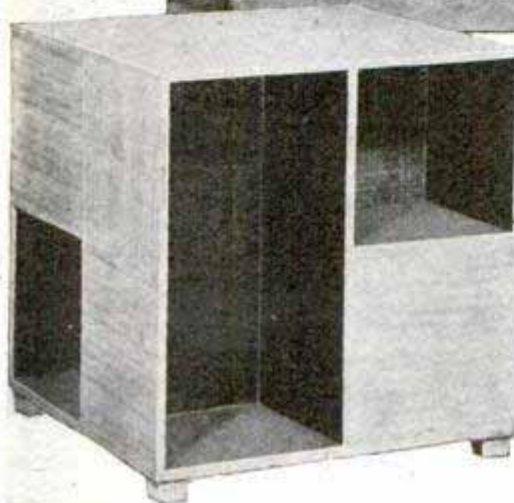

# Now You Can Make Your Own Modernistic Furniture

At a Fraction of Store Prices

## LEPAGE'S New Book Shows How

### 12 NEW Job Plans, Too!

There is, of course, a limit to what we can give in LePage's New Third Home Work Shop Book for only a dime. But we realize many men want additional projects. Hence our 12 new Job Plans. These also were made by Mr. Klenke. They are projects that require more elaborate presentation than we can give in our book. Each Job Plan presents one project on a single large sheet of paper. Each is well worth its price, one dime. Look over these projects and order those you want by number (see coupon), enclosing 10 cents for each.

- |                                  |                                |
|----------------------------------|--------------------------------|
| 16 Sheraton Writing Desk         | 22 Telephone Cabinet           |
| 17 Sheraton Desk Chair           | 23 Stool for Telephone Cabinet |
| 18 Colonial Hanging Book Shelves | 24 Manual Training Work Bench  |
| 19 Smoking and Reading Cabinet   | 25 Home Worker's Tool Cabinet  |
| 20 Colonial Mirror               | 26 Spanish Galleon             |
| 21 Tea Wagon                     | 27 Vanity Table                |

LePage's latest book, "The Third Home Work Shop Book," contains complete directions for making 20 attractive pieces of household furniture, 5 of which are modernistic in design, so popular today. These include the 3 shown above, and in addition, a Modernistic Desk and Modernistic Folding Screen. Or, if you prefer, you can make reproductions of 5 famous old Colonial pieces—Cape Cod Chest of Drawers, Alexandria Nest of Tables, Old Salem Ship's Cupboard, Plymouth Built-In China Closet and Lady Washington Sewing Cabinet.

#### Expert Instruction

Any man handy with tools can make any or all of these 20 pieces of furniture, for a fraction of their retail price, which a careful check in shops showed would be about \$1000 for the 20. You have expert instruction to guide you. The designs, dimension drawings, photographs, step by step directions and the actual furniture itself were made by William W. Klenke, Instructor in Woodworking, Central Commercial and Manual Training High School, Newark, New Jersey.

#### MAIL THIS COUPON

LEPAGE'S CRAFT LEAGUE  
620 Essex Ave., Gloucester, Mass.

Gentlemen: Enclosed please find 10 cents (coin or stamps) in payment for LePage's New Third Home Work Shop Book. Please send a copy of this book to:

Name.....  
Street.....  
City..... State.....

Please also send the following Job Plans..... (indicate by number those you want. See column at left), for each of which I enclose an additional 10 cents.

His experience as an expert gives assurance that each project and the directions for making it are thoroughly practical.

The other popular 10 pieces which this LePage's Book shows you how to make, are: Chess and Checkers Table, Smoking Table, Caned Side Chair, China or Book Cabinet, Book Trough and Magazine Stand, Magazine Carrier, Vanity Case, Book Stand, Fernery Stand and Folding Sewing Screen. Where else could you get complete directions for making all these for only 10 cents?

#### Send 10 cents for this NEW LePage's Home Work Shop Book

Simply use the coupon below, sending it to us with 10 cents in coin or stamps, and we will at once send you a copy of this latest LePage's Book, postage paid.



# LE PAGE'S GLUE

HANDIEST TOOL IN YOUR WORKSHOP



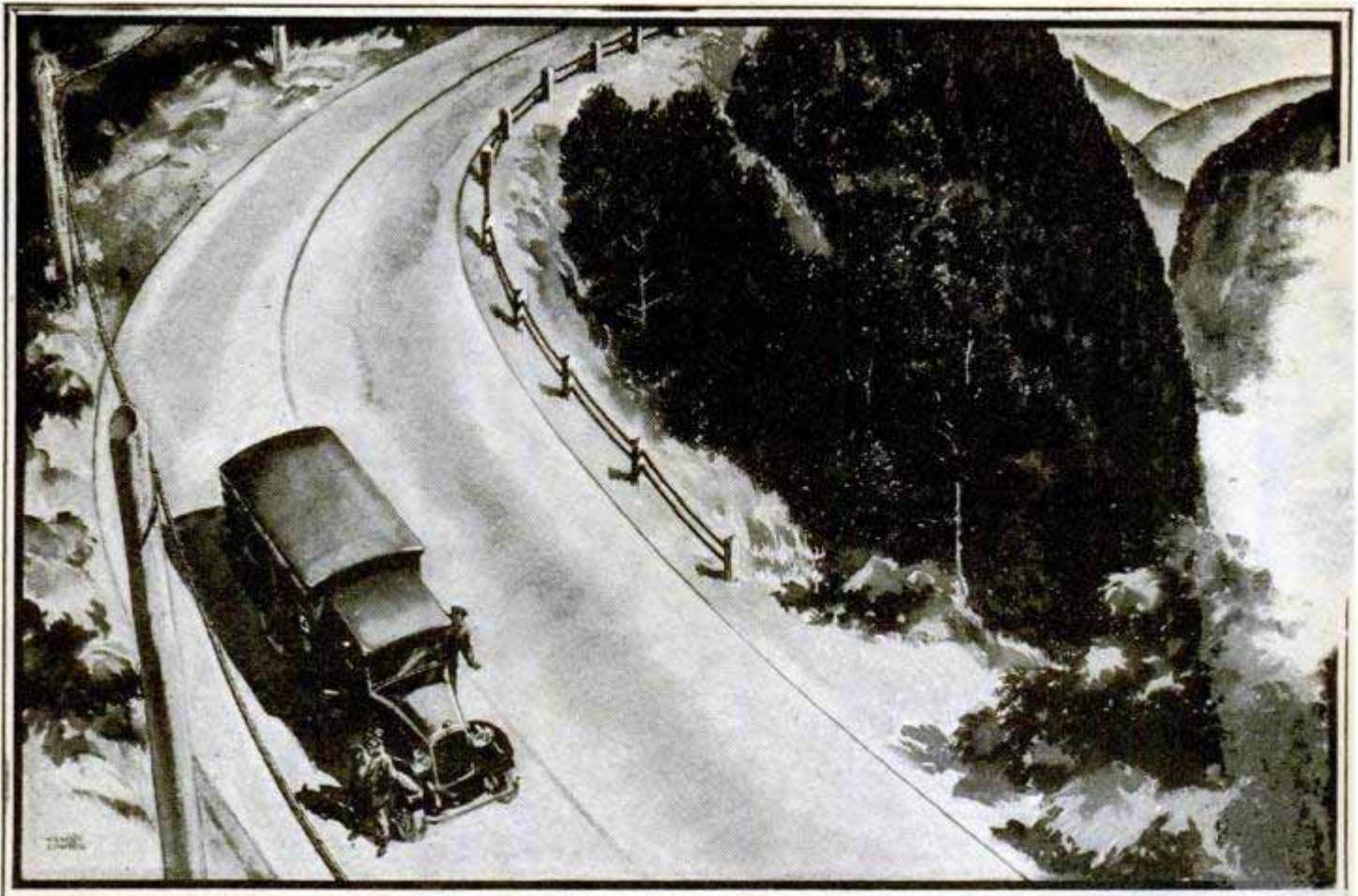

# Getting there ahead of the trouble

*An Advertisement of the  
American Telephone and Telegraph Company*

DURING the afternoon of March 17, 1928, an alarm bell rang in a telephone test station in the heart of the Alleghany mountains. This meant that a puncture had been made in the airtight sheath of a busy inter-city cable. The men on duty knew that the injury was somewhere within 50 miles.

Highly developed locating devices were instantly applied and in sixty-five minutes the trouble spot was located. By 7.15 in the evening, before the break in the sheath had affected service on any of the 248 pairs of wires in the cable, the repairs had been made. Because of the preliminary warning on the indicator wire and the locating devices that enabled the test station to tell the repair crew where it would find the trouble, not one conversation was interrupted. This



special alarm system is one of the many mechanical and electrical wonders developed by Bell System engineers to guard telephone conversations. The apparatus is placed along the cable routes at intervals of 100 miles. It gives instant warning day or night of any disturbance to the cable within 50 miles in either direction.

Automatic warning signals, electrical locating devices, constant testing of all switchboard apparatus and circuits—these are some of the ceaseless efforts that so effectively reduced interruptions to service on Bell lines in 1928.

There is no standing still in the Bell System. Constant progress in accuracy and better and better service at the lowest cost is its goal.

"THE TELEPHONE BOOKS ARE THE DIRECTORY OF THE NATION"



# Popular Mechanics Magazine

200 E. Ontario Street, Chicago, U. S. A.

H. H. WINDSOR, Founder

H. H. WINDSOR, Jr., Editor and Publisher

London: Hachette & Cie.,  
16-17 King William Street, Charing Cross, W. C. 2

Paris: Hachette & Cie.,  
111 Rue Reaumur

Melbourne: Gordon & Gotch  
509-513 Little Collins St.

ISSUED MONTHLY

SUBSCRIPTION:

SINGLE COPY, 25 CENTS

In United States and its possessions, also Canada, Cuba, and Mexico, per year, postpaid . . . \$2.50

To all other countries in the Postal Union . . . . . 3.00

All subscriptions are discontinued at expiration. Please examine the date printed on your wrapper.

Entered as Second Class Matter Sept. 15, 1903, at the Post Office at Chicago, Illinois, under Act of March 3rd, 1879.

Entered as Second Class Matter at the Post Office Department, Canada.

Published monthly by POPULAR MECHANICS CO.

Copyright, 1929, by Popular Mechanics Co.

Copyright in Australia. Copyright in France

Vol. 51

Contents for March, 1929

No. 3

## Special Features

|  |     |
|--|-----|
| More Speed . . . . .   | 370 |
| Will She Fly? . . . . .  | 378 |
| Rain Made to Order . . . . .                                       | 386 |
| Exploring Davy Jones' Locker . . . . .                             | 394 |
| Training the Trotters . . . . .                                    | 402 |
| Meehanite—a New Metal . . . . .                                    | 415 |
| Are You Another Babe Ruth? . . . . .                               | 418 |
| If They Were Larger . . . . .                                      | 427 |
| Adventures in Wonderland . . . . .                                 | 434 |
| Where House Heat Goes . . . . .                                    | 443 |
| Taming the Father of Waters . . . . .                              | 450 |
| From Sputter-Spatter to Water Speedster . . . . .                  | 486 |
| Advertising—window display on wheels . . . . .                     | 425 |
| Agriculture—vacuum cleaner for grain . . . . .                     | 417 |
| Air-Mail—first envelopes prized by collectors . . . . .            | 377 |
| Airplanes . . . . .  |     |
| automatic steering gear for . . . . .                              | 414 |
| carries torpedo weighing one ton . . . . .                         | 440 |
| lands in drag sail . . . . .                                       | 423 |
| model of rocket, controlled by radio . . . . .                     | 459 |
| refueled in flight for endurance run . . . . .                     | 401 |
| Airship—all-metal to test construction theories . . . . .          | 447 |
| Animals—ship mink in special crates . . . . .                      | 457 |
| Archæology—"Norse" ruins laid to Eskimos . . . . .                 | 465 |
| Automobiles—windows reveal inner secrets of engine . . . . .       | 424 |
| Automobiles—Accessories . . . . .                                  |     |
| gauge in radiator cap shows water level . . . . .                  | 449 |
| safety brake release . . . . .                                     | 412 |
| signal on choke . . . . .  | 458 |
| starting lever for Fords . . . . .                                 | 432 |
| wrench for hub caps . . . . .                                      | 413 |
| Automobiles—Driving . . . . .                                      |     |
| autoists required to speed across viaduct . . . . .                | 433 |
| glare screen on windshield . . . . .                               | 466 |
| moving map for driver . . . . .                                    | 460 |
| Aviation . . . . .   |     |
| airplanes of slower speed demand of . . . . .                      | 376 |
| gas tank as airplane guide . . . . .                               | 471 |
| landing lights set in ground show wind's direction . . . . .       | 461 |
| Bees—measure of breath shows insect's health . . . . .             | 449 |
| Blanket—army, resists water . . . . .                              | 447 |
| Boats and Boating . . . . .  |     |
| speedboat motor lies flat to lower gravity center . . . . .        | 369 |
| yacht fitted with gun for shooting big fish . . . . .              | 397 |
| Bridge . . . . .   |     |
| float span into place . . . . .                                    | 376 |
| grooved track for autos . . . . .                                  | 449 |
| Buildings—tall like obelisk to guide aviators . . . . .            | 466 |
| Cable—new, sends eight messages at one time . . . . .              | 460 |
| Cafe—stove and blankets in, draw winter patrons . . . . .          | 465 |
| Cement—sprayed with metal to make it waterproof . . . . .          | 417 |
| Chimney—felled from inside to protect buildings . . . . .          | 425 |
| Clamp—spring, holds work . . . . .                                 | 446 |
| Coal—pipe stems made from . . . . .                                | 459 |
| Coaster—for snow or ground . . . . .                               | 432 |
| Crime—anti-burglar window catch . . . . .                          | 412 |
| Disease—gas mask for asthma victim . . . . .                       | 465 |
| Dogs—suit and boots for pet . . . . .                              | 471 |
| Door—spring tag for key foils burglar . . . . .                    | 449 |
| Earth—interior now known to science . . . . .                      | 377 |
| Electric Power—Edison explains cost factors in producing . . . . . | 448 |
| Electric Switch—with pilot light . . . . .                         | 471 |
| Electricity—muscular movements produce . . . . .                   | 458 |
| Fish and Fishing . . . . .   |     |
| electric shocks keep fish from irrigation canal . . . . .          | 432 |
| lookout on tower fishes with telephone . . . . .                   | 377 |
| Flowers . . . . .  |     |
| geraniums kill beetles . . . . .                                   | 432 |
| keep longer without chemicals . . . . .                            | 448 |

*Filter, hot air register 350*

*Burglar alarm selenium 389*

*Anti-burglar window catch 465*

*asthma gas mask*

[Contents—Continued]

*Bicycle Car in 1900*

*Cigaret case and lighter 458*



45

Israin. Cleaner for

Photo 399

|  |     |
|--|-----|
| Fur—raising Karakul sheep new industry                         | 431 |
| Games—buzzer to answer questions                               | 461 |
| Homes—roof-bungalows on skyscrapers                            | 410 |
| Horses—racing light rays for                                   | 458 |
| Household Devices  | 462 |
| House Plan   | 527 |
| Ink—new fireproof  | 433 |
| Lamp—bridge, adjustable at press of button                     | 431 |
| Lawn Sprinkler—hidden, keeps grass green                       | 461 |
| Leather—made transparent                                       | 426 |
| Lettering Guide—for drawing letters                            | 456 |
| Light—how invisible serves to prevent crime                    | 399 |
| Lighthouse—sends radio beam to guide ships in fog              | 460 |
| Mail Bag—wheel carrier for                                     | 417 |
| Maps—sticks and loaves guided early sailors                    | 414 |
| Metals   | 415 |
| hand decorator for   | 457 |
| magic, resists wear and hardens iron                           | 466 |
| Milk—lifter for bottle caps                                    | 464 |
| Mirror—hand, with anchor                                       | 431 |
| Money—new designs on paper money                               | 446 |
| Moon—skating on frozen alcohol possible on                     | 401 |
| Moving Pictures  |     |
| movie voice follows actor in screen movements                  | 425 |
| talking movies sent by radio                                   | 433 |
| Ocean—shotguns fired under, to measure its depth               | 440 |
| Oil Well—pillar of fire marks first Australian                 | 456 |
| Paints and Painting  |     |
| harmless luminous, to light homes                              | 457 |
| spray gun operated by automobile motor                         | 423 |
| Paper—used for blasting after chemical bath                    | 491 |
| Patterns—electro process for eliminates shrinking              | 447 |
| Periscope—for golf fans  | 425 |
| Photography  |     |
| hunting goats with camera requires disguise                    | 448 |
| photos serve as sculpture for bridge statues                   | 423 |
| Plants   |     |
| breathe only by day, light tests show                          | 412 |
| spread pollen by electricity                                   | 417 |
| Potatoes—gas treatment for cause early sprouting               | 414 |
| Pressure—artificial, eggs are "boiled" under                   | 409 |
| Printing—type set by telegraph automatically                   | 441 |
| Radio  |     |
| cutting down resistance stages                                 | 484 |
| shopping tips for fans   | 472 |
| travel beyond moon echo tests show                             | 461 |
| Radio—Aerials  |     |
| attractive lamp forms  | 474 |
| clamp for  | 474 |
| Radio—Applications   |     |
| automatic sea beacon has wide range                            | 456 |
| song sent by photo across Atlantic                             | 391 |
| Radio—Coils—making short-wave                                  | 479 |
| Radio—Eliminators  |     |
| compact a.c. converter   | 474 |
| new combination A-supply                                       | 484 |
| Radio—Installation   |     |
| handy kink for set builders                                    | 474 |
| hints from the laboratory                                      | 482 |
| solder in tape form  | 484 |
| Radio—Loud Speaker—battery-operated dynamic converted to power | 481 |
| Radio—Receivers  |     |
| a screen-grid short-wave adapter                               | 475 |
| correct coupling for   | 480 |
| Radio—Reception  |     |
| improving tone quality   | 485 |
| regeneration necessary for DX                                  | 484 |
| Radio—Repairing push-pull amplifier kink                       | 481 |
| Radio—Television—projecting pictures                           | 485 |
| Radio—Tubes  |     |
| heat in voltage regulator                                      | 474 |
| unit protects a.c. tubes                                       | 480 |
| Radium—seek curb on deaths caused by                           | 412 |
| Railroads  |     |
| model railway which obeys voice                                | 376 |
| night train signal on track                                    | 369 |
| Rats—gas attack routs  | 456 |
| Rays, Ultraviolet—from sun now on increase                     | 414 |
| Rubber Stamp—jointed grip improves                             | 397 |
| Rug—serves as game board                                       | 464 |
| Saws and Sawing—lumber waste is reduced by thinner             | 464 |
| Seeds—live forty years in deep soil                            | 465 |
| Shaving Accessories—brush holds soap and sptyic                | 408 |
| Smokers' Accessories   |     |
| combined case and lighter                                      | 458 |
| lighter fits in lamp socket                                    | 426 |

|   |     |
|---|-----|
| Spray Gun—electric run from light socket        | 471 |
| Store—self-feeding shelves                      | 459 |
| Submarine—safety inventions                     | 360 |
| Sugar—from peanut shells                        | 385 |
| Surfboard—run by motor gives water thrills      | 408 |
| Telegraph—wires connected on pole               | 397 |
| Telescope—giant, planned for California college | 426 |
| Tennis—racket string guards help improve game   | 391 |
| Toaster—electric, opens up like a book          | 432 |
| Traffic   |     |
| operate electric policeman by sound of voice    | 409 |
| sidewalk lanes for shoppers                     | 408 |
| Travel—town's history under roof                | 426 |
| Trees   |     |
| in tropics gives milk like that of cow          | 433 |
| transplantation aided by drugging               | 369 |
| Tricks—at the billiard table                    | 467 |
| Warehouse—in cave for storing potatoes          | 413 |
| Welding—silent on hospital addition             | 471 |
| Well—artesian, water from heats rail station    | 413 |
| Windows—that tip inward easily cleaned          | 447 |
| Wood—rare pink, found in Zululand               | 440 |
| <i>Ar. located by radio</i>                     |     |
| <i>Catch, anti-burglar</i>                      |     |
| AMATEUR MECHANICS 367                           |     |
| Automobile                                      |     |
| ash receiver and hand straps for                | 500 |
| auxiliary gasoline tank prevents stalling       | 502 |
| oil distributor shaft                           | 510 |
| Bed—warming the, on sleeping porch              | 501 |
| Bird House—novel                                | 493 |
| Catamaran—old auto propels                      | 493 |
| Ceiling—applying plaster patch to               | 492 |
| Chisel—sharpening wood                          | 500 |
| Dynamic Speaker—a stand for the                 | 495 |
| Fishing—collapsible fishline drier              | 503 |
| Furniture—how to refinish your old              | 504 |
| Garage—raising with auto jack                   | 509 |
| Golf—handy place for score card                 | 501 |
| Guns—handy pistol shell remover                 | 494 |
| Ice Box—electric light in the                   | 510 |
| Lap Board—has many uses                         | 501 |
| Lathe—boring bar for the home                   | 509 |
| Paints and Painting                             |     |
| finishing plaster walls with                    | 503 |
| plastic paint made from white lead              | 510 |
| Poultry—cleaning ducks quickly                  | 492 |
| Pump—running with farm engine                   | 502 |
| Scissors—magnetizing a pair of                  | 509 |
| Shoulder Pads—made from old auto tires          | 503 |
| Skates—racing blades fitted to clamp            | 492 |
| Tricks—clever handkerchief                      | 494 |
| Walls—repairing leaky cellar                    | 494 |
| Wash Boiler—protecting bottom                   | 492 |
| Wood—removing dents in soft                     | 509 |

SHOP NOTES

|  |     |
|--|-----|
| Automobile Bus—scrapers on eliminates ruts | 526 |
| Automobiles                                |     |
| one way to save gasoline                   | 515 |
| worn shackles cause backlash in            | 524 |
| Bookcase—making a modern                   | 520 |
| Bottle—handy tipper for distilled water    | 519 |
| Concrete—preparing lintels for trim        | 525 |
| Door—repair for lock keyholes              | 519 |
| Fence—circular passage in                  | 518 |
| Grinding—a sphere                          | 526 |
| Ice Cutter—homemade engine driven          | 515 |
| Joint, Wood—for the amateur                | 516 |
| Linotype—permanent line gauge              | 525 |
| Oilstone—taking care of your               | 518 |
| Reamer—wedge tool centers                  | 525 |
| Saws and Sawing                            |     |
| a ball-bearing scrollsaw                   | 511 |
| weighted saw cuts faster                   | 525 |
| Scriber—multiple, surface gauge            | 513 |
| Toolbox—field, for the farm                | 519 |
| Trapdoor—flush handle for                  | 515 |
| Well—safety hook on digger's rope          | 518 |
| Windmill—homemade remote control for       | 526 |

Locates are 367



# PAINTERS-DECORATORS SIGNISTS-SIGN MAKERS

## Here's Help for You

We publish books that help men do better work and make more money. EACH BOOK IS AN ENTIRE COURSE OF INSTRUCTION IN ONE VOLUME. They will raise your pay. Written in plain language, and with many illustrations.

### STUDY THE LIST:

|  |        |
|--|--------|
| The Lacquer System of Sign Painting.....                     | \$3.00 |
| How to Draw Funny Pictures.....                              | 3.00   |
| Layouts for Advertising.....                                 | 3.00   |
| Practical Estimating for Painters and Decorators.....        | 2.00   |
| Furniture, Furniture Finishing, Decoration and Patching..... | 5.00   |
| Studio Handbook—Letter and Design.....                       | 3.00   |
| Interior Wall Decoration.....                                | 4.00   |
| Mixing of Colors and Paints.....                             | 2.00   |
| Wood Finishing, Plain and Decorative.....                    | 2.00   |
| House Painting Methods.....                                  | 2.00   |
| The Art of Sign Painting.....                                | 4.00   |
| Scene Painting and Bulletin Art.....                         | 4.00   |
| "A Show at" Sho' Cards.....                                  | 4.00   |
| Art of Show Card Writing.....                                | 4.00   |
| Strong's Book of Designs.....                                | 4.00   |
| New Stencils and Their Use.....                              | 1.25   |
| Automobile Painting.....                                     | 1.50   |
| Modern Painter's Cyclopaedia.....                            | 2.00   |
| Estimates, Costs and Profits.....                            | 1.50   |
| New Hardwood Finishing.....                                  | 1.50   |
| The Signist's Modern Book of Alphabets.....                  | 1.50   |
| The Amateur Artist.....                                      | 1.50   |
| The Ross Crane Book of Home Furnishing and Decoration.....   | 3.00   |
| Owens' Paint Guide.....                                      | 1.00   |
| Chalk Talk and Crayon Presentation.....                      | 1.25   |
| Graining and Marbling.....                                   | .75    |

### 200 MORE PRACTICAL HOME STUDY BOOKS

each a complete treatise of its subject, covering Radio, Electricity, Carpentry and Building, Steam Engineering and 20 other Trades. All fully described in our big FREE CATALOG. You will find some that fit your work. Send the coupon now.

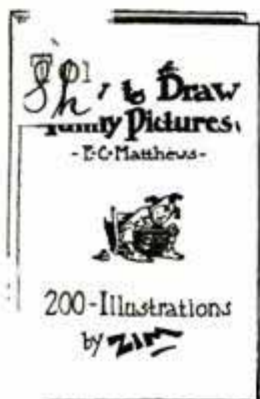
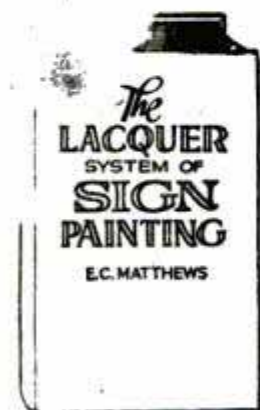
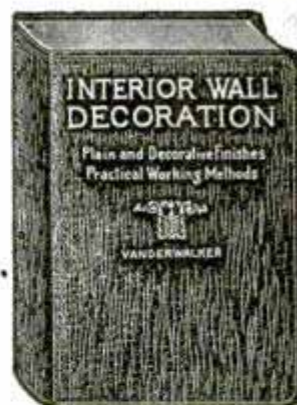
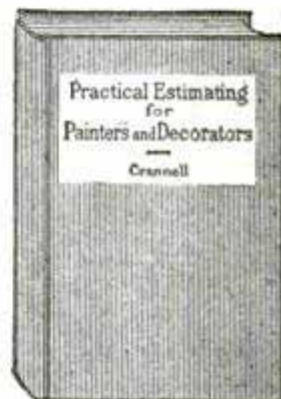

**Make Up Your Order from** this page and mail direct to us. We will send the books postpaid. Satisfaction guaranteed.

**FREDERICK J. DRAKE & CO., Publishers**  
Room 508—179 No. Michigan Blvd.  
**CHICAGO, U. S. A.**  
*Drake Books Are For Sale at All Book Stores*

(COUPON)

**Frederick J. Drake & Co.,**  
Room 508-179 No. Michigan Blvd.,  
Chicago, U. S. A.

I enclose \$..... Please send me the books marked.

Please send me FREE CATALOG

**This One**

Name

Address

City

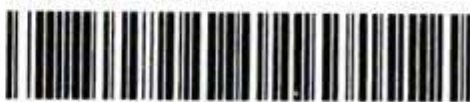

PUE5-J7N-YZ10



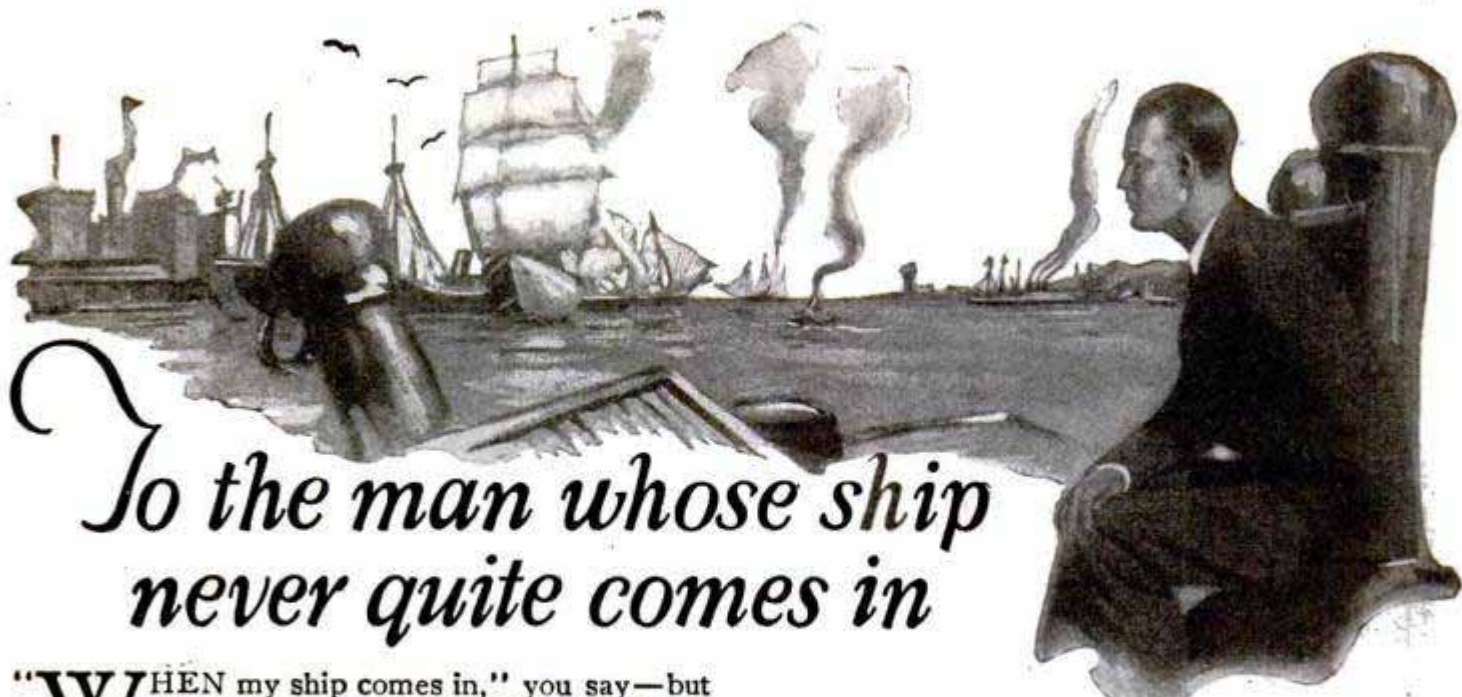

## To the man whose ship never quite comes in

"WHEN my ship comes in," you say—but your smile cannot hide the worry gnawing at your heart—

A fine sea-going vessel you had thought that ship of yours when you launched it on the business ocean—

Yet the days and months and years slip by—and though others see their ships ride triumphantly to harbor, still you scan the horizon anxiously for a ship that never quite makes port.

No one's fault, perhaps—but what a misfortune that so many business ships should founder on a hidden reef or a treacherous shoal, when the channels to Success are plainly charted and a chart for every channel is available to every thinking man!

### How the Right "Chart" Increased E. T. Orcutt's Income 500%

Certainly *my* ship-of-fortune seems far off its course, said E. T. Orcutt, in effect, when as railroad clerk at \$20 a week he enrolled with LaSalle for home-study training in Traffic Management.

Before he had completed the training, however, came an opportunity with Hitchings & Co., Elizabeth, N. J., one of the largest manufacturers of greenhouses in the world.

Training had set his "ship" on the right course. Later, as sales manager, he kept on training with LaSalle—in Business Management.

Since taking his first course, his salary has increased more than 500 per cent.

Recently he has organized his own company, capitalized at \$100,000, of which he is president.

### How G. W. Clason Placed His "Ship" on the Right Course

No bands were playing when G. W. Clason launched his "ship" on the business ocean.

Clason had left school at 14, and at 19 his job was to take care of the horses in the barn of a laundry.

"Never mind," said G. W. Clason, "I'll make my opportunity right where I am!"

So he learned the laundry business, and at 28 was operating his own plant. When fire wiped his business out, he started again. Unable to finance properly—through lack of business understanding, as he testifies—he sold out and became superintendent of the Ideal Laundry Company, Spokane.

Right then he made up his mind to remedy his lack—and enrolled with LaSalle for training in Business Management.

Today, at 47, he is vice-president and a director of this successful company, and commands an income several times as large as when he started with LaSalle five years ago.

"I give all credit to my LaSalle training," writes Mr. Clason. "It has proved by far the most profitable investment I ever made."

### No More Drifting!

#### Send for These Free Books—Today

Are you letting your ship-of-fortune drift where it will—or are you charting its course to the Harbor of Success?

There's a route that will take it straight to its destination. LaSalle can help you find it.

Without cost or obligation, the coupon will bring you a special 64-page booklet fully describing the opportunities in the business field that most appeals to you, and showing you how you can fit yourself to grasp them.

As you value your future—fill in, clip and mail the coupon NOW!

— — — — Find Yourself Through LaSalle! — — — —

## LaSalle Extension University

The World's Largest Business Training Institution

Dept. 364-R Chicago  
I would welcome an outline of the LaSalle plan, together with a copy of "Ten Years' Promotion in One," all without obligation.

- Business Management
- Modern Salesmanship
- Higher Accountancy
- Traffic Management
- Railway Station Management
- Law: Degree of LL. B.
- Commercial Law
- Industrial Management
- Modern Business Correspondence
- Credit and Collection Correspondence
- Telegraphy
- Banking and Finance
- Modern Foremanship
- Personnel Management
- Expert Bookkeeping
- Business English
- Commercial Spanish
- Effective Speaking
- C. P. A. Coaching
- Stenotypy—Stenography



Name.....  
Present Position.....  
Address .....



# POCKET EDUCATORS

For all BUILDERS AND MECHANICS



Read Audels Pocket Educators for advancement and profit in your work. Every mechanic in the building trades should have this inside trade information at his fingers' ends. Learn the scope and possibilities of your profession. Any job can be done better if you are well informed. To earn more, learn more.



## AUDELS CARPENTERS AND BUILDERS GUIDES—4 VOLS. \$6



Inside Information for Carpenters, Builders, Joiners, Building Mechanics—all Wood-workers. **1600 pages; 3700 diagrams; flexible; pocket size.** Short-cut instructions, new methods, ideas, solutions, plans, systems—money saving suggestions. An easy progressive course for the apprentice. A practical daily helper and Quick Reference for the master worker. A Helping Hand to Easier and Better Work and Better Pay. To get this aid for yourself, simply fill in and mail the FREE COUPON below.

### INSIDE TRADE INFORMATION ON:

How to use steel square; How to file and set saws; How to build furniture; How to use mitre box; How to use chalk line; How to use rules; How to make joints; Carpenters' arithmetic; Mensuration problems; Estimating strength of timbers; How to set girders and sills; How to frame houses and roofs; How to estimate costs; How to build houses, barns, garages, bungalows, etc.; How to read and draw plans; Drawing up specifications; How to excavate; How to use settings 12, 13 and 17 on the steel square; How to build hoists and scaffolds—skylights; How to build stairs; How to put on interior trim; How to hang doors; How to lath—lay floors; How to paint.

"Audels Guides worth four times their price—handy too as I carry them in pocket for reference." **W. J. Bates, Knoxville, Pa.**



## AUDELS PLUMBERS AND STEAMFITTERS GUIDES—4 VOLS. \$6

A new set—just out! A practical, illustrated, Reference Library and Study-Course for Master Plumbers, Journeymen and Apprentice Steamfitters, Gas Fitters and Helpers, Sheet Metal Workers, Draughtsmen, Master Builders, Engineers and all Building Trade Students. **1670 pages; 3642 diagrams; flexible; pocket size.** Guides explain all the principles, advances and short cuts of the Plumbing and Heating trade. Contains instructions on how to figure and estimate jobs. Use FREE COUPON below to examine, without obligation, this valuable work.

### INSIDE TRADE INFORMATION ON:

Soldering, tinning, joint wiping, bending, beating, Pipe—iron—steel, threading, Mathematics, tables, physics, Materials—iron, steel, copper, brass, lead, tin, antimony, Sheet metal—galvanized—plate. Sanitation, syphonage, tanks, Drainage, sewage, purification. Fixtures—bath—kitchen. Pipe fittings, soil pipe, tools. Laying out work. Roughing, Screwed fittings, flanges, joints. Pipe bending, examples. Elbows. Heating, ventilation, refrigeration. Water supply, mains, wells, tanks. Gas-fittings. Underwriters. Sheet metal work, problems, methods, brazing, heating, lead burning. Welding, various welds, methods. Blacksmithing, forges, tools.

"Audels Guides are practical, easy to understand, reliable. Cover the field in plain language." **W. F. Arminger, Annapolis, Md.**



## AUDELS MASONS AND BUILDERS GUIDES—4 VOLS. \$6

A new, complete, illustrated trade reference library, for Bricklayers, Cement Workers, Plasterers, Tile Setters and Stone Masons, including a practical outline of Steel Construction. **1100 pages; 2067 diagrams; flexible; pocket size.** A practical Trade Assistant explaining modern methods of masonry construction. Easy to understand and apply. A reliable and authentic reference work and study-course for Master Journeyman and Young Mechanic. Use FREE COUPON below and find out for yourself, without obligation, whether this set will benefit you.

### INSIDE TRADE INFORMATION ON:

Bricklaying, tools, materials; Brick designs, patterns, bonds; Setting frames and foundations; Mortars, scaffolds, estimating; Mortars and mortar mixing; Tile setting, mosaic, hollow tile; Straight edge test, trowelling; How to figure brick work; Safe loads, piers, chimneys; Boiler settings, anchors, fire stops; Labor tables; Concrete, forms; How to figure concrete work; Stucco—on old and new buildings; Plastering—wood lath—metal; Plasterers agreement; Plastering on various surfaces; Stonemasonry; Cutting, finishing, estimating stone; Derricks, rigging; Steel construction; Fire proof; How to read blue prints.

"Audels Masons Guides are the best books on the subject I have laid brick 12 years and am able to judge." **H. A. Sonnett, Corliss, Pa.**



## PRACTICAL ELECTRICITY — 1 VOL. \$4

Audels Handy Book of Practical Electricity is a simplified Ready Reference and Study Course in one pocket size, leather bound volume—for Engineers, Professional Electricians and Students. **1040 pages; 2600 diagrams; flexible red leather bound.** A reliable authority and handy helper for every electrical worker. Contains important and valuable wiring diagrams, calculations, machine sketches, helps on maintenance and repair. Use this FREE COUPON today and find out, without obligation, how this handy book will help you in your daily work.

Complete in one handy, red leather bound volume



### INSIDE TRADE INFORMATION ON:

Electro-Therapeutics, X-Rays, Shoeks, Welding, Brazing, Radio Hook-ups, Motion Pictures, Telephone, Telegraph, Cranes, Bells, Elevators, Pumps, Tools, Ship Drive, Railways, Vehicles, Automobile Electric Systems, Ignition, Generation, Lighting, Plant Management, Power Plans, Armature Winding, Repairing, A. C. Motors and Apparatus, D. C. Motors and Apparatus, Alternator Construction, Dynamos, Wiring Diagrams, Sign Flashers, Cable Splicing, Power Wiring, Outside Wiring, Switches, Lightning, Rectifiers, Converters, Transformers, Fuses, Circuit Breakers, Rheostats, Electro Plating, Electrolysis, Storage Batteries, Magnetism, Electrical Energy, Conductors, Insulators, Static, Dynamic, Radio Electricity, Applications, Ready Reference and Index Covering the entire field of Modern Electricity.

## Learn More and You Will Earn More!

Know your job and you'll never be without one. The skilled man is always in demand. Knowledge is power. Learn your trade thoroughly by easy reading. This coupon is your opportunity for advancement and better pay. You risk nothing in sending for Audels Guides for free examination. Send it NOW!

FREE EXAMINATION COUPON

THEO. AUDEL & CO., 65 W. 23 ST., NEW YORK CITY

Please mail me for free examination the books marked (x) below. If I find them satisfactory, I agree to mail \$1 in 7 days, on each set ordered, and to further mail \$1 monthly on each set until I have paid the purchase price.

4 CARPENTERS GUIDES \$6  4 PLUMBERS GUIDES \$6

4 MASONS GUIDES \$6  1 ELECTRICIANS HANDY BOOK \$4

NAME .....

ADDRESS .....

OCCUPATION .....

EMPLOYED BY.....ST30



# Answer This Ad!

## If You Want Quick Success and Big Pay In AUTOS



**Morriston Did!**

When Morriston of Parkersburg, West Virginia, wrote for my auto book he was working in a steel mill for low pay. In six short months he doubled his earnings and got into business for himself—even before he finished his "Job-Way" Training. You can have the same book that started Morriston on the road to success. Clip the coupon—and mail it today.

### Earn Up to \$100 a Week

Get YOUR share of the \$5,000,000,000 spent every year on auto upkeep. Just think of it—more than 23,000,000 autos in the U. S. No wonder there are so many big pay jobs! Get into this fascinating game, now. Don't put it off another day. Get the facts. Mail coupon for big, FREE auto book. Learn of the countless opportunities in the World's Biggest Business where real jobs and big pay come quick. See how \$50—\$75—\$100 a week is possible for you now. Learn how "Job-Way" Training has brought big money—promotion—shops of their own to scores of men. Find out about my Employment Department—how it helps you get a good job in the auto business.

**AVIATION COURSE**  
also included FREE of extra charge if you act quick!

### Learn at Home in Spare Time

"Job-Way" Training is the short cut to Auto Success. No need to quit your present job—no need to leave home—just use your spare time to prepare for a brilliant future—a real job paying up to \$100 a week. All you need is common schooling. I don't care if you never touched an auto before, I can train you at home. You should be able to make extra money quick—a few weeks after starting. Men from all walks of life who worked

long, hard hours for low pay are becoming garage owners, foremen and superintendents. If you like autos—if you're between 15 and 55—get the facts now. "Job-Way" Training covers everything about autos—Mechanical and Electrical Work, Starting, Lighting, Ignition, Welding, Vulcanizing, etc.—Everything you need to get in line for a big money job as an Electrical and Mechanical Auto Expert. It's the trained man who gets the good jobs and "Job-Way" Training is COMPLETE, yet so simple, so easy that you get it quick.

### Send Coupon for FREE Auto Book

Get my FREE Auto Book. Learn how "Job-Way" Training has brought success to hundreds. See what it can do for you. Find out how my Employment Department helps you get a good job—about the three big outfits you get. Read my money-back agreement, my aviation course offer and many other features.

**B. W. Cooke, Directing Engineer**  
**Chicago Motor Training Corporation**  
1916 Sunnyside Ave., Dept. 1163  
Chicago, Ill.



**Do It NOW!**

Don't delay another day. Clip the coupon before you turn this page. Take the first step to a big-pay auto job. Now.

**B. W. Cooke, Directing Engineer,**  
Chicago Motor Training Corporation,  
1916 Sunnyside Ave., Dept. 1163, Chicago.

Send me your free auto book. I want to succeed in the auto business. Tell me about "Job-Way" Training—about your Employment Department and your 3 testing and repair outfits offer. No obligation on my part whatever.

Name.....  
Address.....  
Town..... State.....  
Age..... Occupation.....





# "ANOTHER \$10 RAISE!"

"WHY, that's the third increase I've had in a year! It just shows what special training will do for a man."

Every mail brings letters from some of the thousands of students of the International Correspondence Schools, telling of advancements and increased salaries won through spare time study.

How much longer are *you* going to wait before taking the step that is bound to bring you more money? Isn't it better to start *now* than to wait for years and then realize what the delay has cost you?

One hour after supper each night spent with the I. C. S. in the quiet of your own home will

prepare you for the position you want in the work you like best.

Yes, it will! Put it up to us to prove it. Without cost, without obligation, just mark and mail this coupon.

-----  
**INTERNATIONAL CORRESPONDENCE SCHOOLS**  
*"The Universal University"*

Box 5600-F, Scranton, Penna.

Without cost or obligation, please send me a copy of your booklet, "Who Wins and Why," and full particulars about the subject before which I have marked X in the list below:

**BUSINESS TRAINING COURSES**

- |  |   |
|--|---|
| <input type="checkbox"/> Business Management                     | <input type="checkbox"/> Salesmanship                                     |
| <input type="checkbox"/> Industrial Management                   | <input type="checkbox"/> Advertising                                      |
| <input type="checkbox"/> Personnel Management                    | <input type="checkbox"/> Business Correspondence                          |
| <input type="checkbox"/> Traffic Management                      | <input type="checkbox"/> Show Card and Sign Lettering                     |
| <input type="checkbox"/> Accounting and C. P. A.                 | <input type="checkbox"/> Stenography and Typing                           |
| Coaching   | <input type="checkbox"/> English <input type="checkbox"/> Civil Service   |
| <input type="checkbox"/> Cost Accounting                         | <input type="checkbox"/> Railway Mail Clerk                               |
| <input type="checkbox"/> Bookkeeping                             | <input type="checkbox"/> Common School Subjects                           |
| <input type="checkbox"/> Secretarial Work                        | <input type="checkbox"/> High School Subjects                             |
| <input type="checkbox"/> Spanish <input type="checkbox"/> French | <input type="checkbox"/> Illustrating <input type="checkbox"/> Cartooning |

**TECHNICAL AND INDUSTRIAL COURSES**

- |   |  |
|---|--|
| <input type="checkbox"/> Electrical Engineering                         | <input type="checkbox"/> Architect                                       |
| <input type="checkbox"/> Electric Lighting                              | <input type="checkbox"/> Architects' Blueprints                          |
| <input type="checkbox"/> Mechanical Engineer                            | <input type="checkbox"/> Contractor and Builder                          |
| <input type="checkbox"/> Mechanical Draftsman                           | <input type="checkbox"/> Architectural Draftsman                         |
| <input type="checkbox"/> Machine Shop Practice                          | <input type="checkbox"/> Concrete Builder                                |
| <input type="checkbox"/> Railroad Positions                             | <input type="checkbox"/> Structural Engineer                             |
| <input type="checkbox"/> Gas Engine Operating                           | <input type="checkbox"/> Chemistry <input type="checkbox"/> Pharmacy     |
| <input type="checkbox"/> Civil Engineer <input type="checkbox"/> Mining | <input type="checkbox"/> Automobile Work                                 |
| <input type="checkbox"/> Surveying and Mapping                          | <input type="checkbox"/> Airplane Engines                                |
| <input type="checkbox"/> Plumbing and Heating                           | <input type="checkbox"/> Agriculture <input type="checkbox"/> Navigation |
| <input type="checkbox"/> Steam Engineering                              | <input type="checkbox"/> Mathematics <input type="checkbox"/> Radio      |

Name.....

Street Address.....

City..... State.....

Occupation.....

*Persons residing in Canada should send this coupon to the International Correspondence Schools Canadian, Limited, Montreal, Canada*





# Speechless...When a Few Words Would Have Made Me!

*But now I can face the largest audience without a trace of stage fright*

**T**HE annual banquet of our Association—the biggest men in the industry present—and without a word of warning the Chairman called on me to speak—and my mind went blank!

I half rose from my seat, bowed awkwardly and mumbled, "I'm afraid you'll have to excuse me today," and dropped back in my chair.

Speechless—when a few words would have made me! The opportunity I had been waiting for all my life—and I had thrown it away! If I could have made a simple little speech—giving my opinion of trade conditions in a concise, witty, interesting way, I know I would have been made for life!

Always I have been a victim of paralyzing stage fright. Because of my timidity, my diffidence, I was just a nobody, with no knack of impressing others—of putting myself across. No matter how hard I worked, it all went for nothing—I could never win the big positions, the important offices, simply because I was tongue-tied in public.

And then like magic I discovered how to overcome my stage fright—and I was amazed to learn that I actually had a natural gift for public speaking. With the aid of a splendid new method, I rapidly developed this gift, until, in a ridiculously short time, I was able to face giant audiences—without a trace of stage fright!

Today I am one of the biggest men in our industry. Scarcely a meeting or banquet is held without me being asked to speak. My

real ability, which was hidden so long by stage fright, is now recognized by everyone. I am asked to conferences, luncheons and banquets as a popular after-dinner speaker. This amazing training has made me into a self-confident aggressive talker—an easy, versatile conversationalist—almost overnight.

\* \* \* \*

## What 20 Minutes a Day Will Show You

- How to talk before your club or lodge
- How to address board meetings
- How to propose and respond to toasts
- How to make a political speech
- How to tell entertaining stories
- How to make after-dinner speeches
- How to converse interestingly
- How to write better letters
- How to sell more goods
- How to train your memory
- How to enlarge your vocabulary
- How to overcome stage fright
- How to develop self confidence
- How to acquire a winning personality
- How to strengthen your will-power and ambition
- How to become a clear, accurate thinker
- How to develop your power of concentration
- How to be the master of any situation

No matter what work you are now doing nor what may be your station in life; no matter how timid and self-conscious you now are when called upon to speak, you can quickly bring out your natural ability and become a powerful speaker. Now, through an amazing new training you can quickly shape yourself into an outstanding influential speaker, able to dominate one man or five thousand.

## In 20 Minutes a Day

This new method is so delightfully simple and easy that you cannot fail to progress rapidly. Right from the start you will find that it is becoming easier and easier to express yourself. Thousands

have proved that by spending only 20 minutes a day in the privacy of their own homes they can acquire the ability to speak so easily and quickly that they are amazed at the great improvement in themselves.

## Send for this Amazing Booklet

This new method of training is fully described in a very interesting and informative booklet which is now being sent to everyone

mailing the coupon below. This booklet is called *How to Work Wonders with Words*. In it you are told how this new, easy method will enable you to conquer stage fright, self-consciousness, timidity, bashfulness and fear. Not only men who have made millions but thousands of others have sent for this booklet and are unstinting in their praise of it. You are told how you can bring out and develop your priceless "hidden knack"—the natural gift within you—which will win for you advancement in position and salary, popularity, social standing, power and real success. You can obtain your copy absolutely free by sending the coupon.

**Now Sent Free**

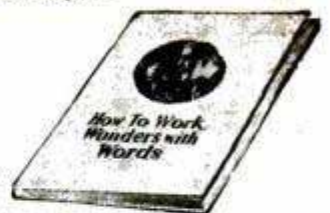

**NORTH AMERICAN INSTITUTE**  
3601 Michigan Ave.

Dept. 1353 Chicago

North American Institute  
3601 Michigan Avenue  
Dept. 1353, Chicago

Please send me FREE and without obligation my copy of your inspiring booklet, *How to Work Wonders with Words*, and full information regarding your course in Effective Speaking.

Name.....  
Address.....  
City..... State.....



# SAY FELLOWS — LEARN ELECTRICITY



H. C. LEWIS —  
President

Let me tell you in my big free book how I can train you quickly for jobs leading to salaries of \$60.00 to \$200.00 a week. NOT BY CORRESPONDENCE NOT BY BOOKS. But, on real Electrical machinery in 90 DAYS you don't need advanced education or electrical experience. EARN WHILE YOU LEARN. Free employment service for life after you graduate. AVIATION electrical course included free if you enroll now. Clip coupon mail it to me for my BIG FREE BOOK. It tells you an amazing way to get into a big pay field



## COYNE ELECTRICAL SCHOOL

H. C. LEWIS, Pres., Dept. 39-72 Est. 1899  
500 So. Paulina St., Chicago

**FILL OUT - MAIL TODAY!**

Mr. H. C. Lewis, Pres.  
COYNE ELECTRICAL SCHOOL, Dept. 39-72  
500 So. Paulina Street, Chicago, Ill.

Dear Mr. Lewis: Without obligation send me your big free catalog and all details of Free Employment Service, Aviation, Radio and Automotive Electrical Courses that are included and how many "earn while learning." I understand I will not be bothered by any salesman.

Name.....  
Address.....  
City..... State.....



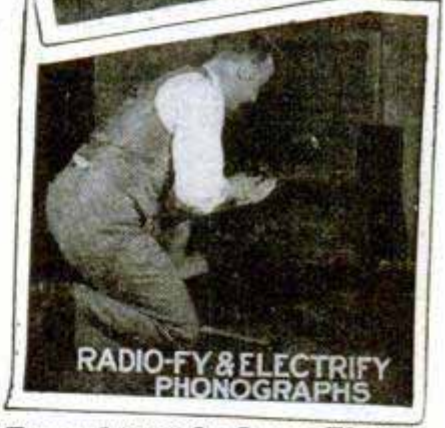
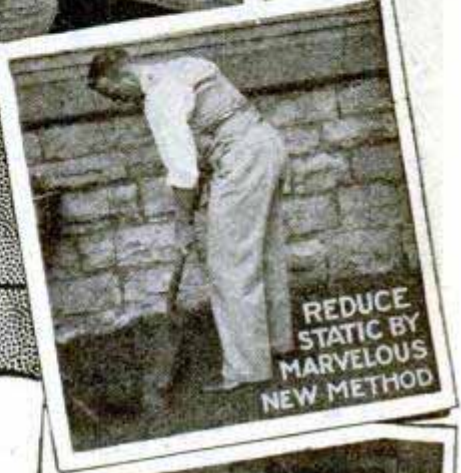

# 5 Easy Ways to Make \$3.00 an hour in Your Spare Time in RADIO

Each of these plans, developed by the Radio Association of America, is a big money-maker. Set owners everywhere want to get rid of static, to have their sets operate from the electric light socket, the tone improved, and the volume increased, and transformed into single-dial controls. Phonograph owners want their machines electrified and radiofied. If you learn to render these services, you can easily make \$3.00 an hour for your spare time, to say nothing of the money you can make installing, servicing, repairing, building radio sets, and selling supplies.

Over \$600,000,000 is being spent yearly for sets, supplies, service. You can get your share of this business and, at the same time, fit yourself for the big-pay opportunities in Radio by joining the Association.

## Join the Radio Association of America

A membership in the Association offers you the easiest way into Radio. It will enable you to earn \$3.00 an hour upwards in your spare time—train you to install, repair and build all kinds of sets—start you in business without capital or finance an invention—train you for the \$3,000 to \$10,000 big-pay radio positions—help secure a better position at bigger pay for you. A

membership need not cost you a cent

The Association will give you a comprehensive, practical, and theoretical training and the benefit of its Employment Service. You earn while you learn. Our cooperative plan will make it possible for you to establish a radio store. You have the privilege of buying radio supplies at wholesale from the very first.

**Earned \$500 in Spare Time**  
Frank J. Deutsch, Penn.: "I have made over \$500 out of Radio in my spare time."

**Radio Engineer in One Year**  
Claude DeGrave, Canada: "I knew nothing about Radio when I joined a year ago. I am now a member of a very exclusive organization of Radio Engineers, and my income is 225% greater than it was."

**Doubles Income in 6 Months**  
W. E. Thon, Chicago: "Six months after I enrolled I secured the managership of large Radio store and doubled my income."

**Radio Association of America**  
Dept. PM-3, 4513 Ravenswood Ave., Chicago

Gentlemen: Please send me by return mail full details of your Special Membership Plan, and also copy of your Radio Handbook.

Name \_\_\_\_\_  
Address \_\_\_\_\_  
City \_\_\_\_\_ State \_\_\_\_\_

## ACT NOW—If You Wish the No-Cost Membership Plan

To a limited number of ambitious men, we will give Special Memberships that may not—need not—cost you a cent. To secure one, write today. We will send you details and also our handbook filled with dollars-and-cents radio ideas. It will open your eyes to the money-making possibilities of Radio.

**Radio Association of America**  
4513 Ravenswood Ave., Dept. PM-3 Chicago, Ill.



**SALES JOBS  
RADIO JOBS**

**EXACTLY THE  
KIND OF JOB YOU WANT**

# ELECTRICITY!

**Fastest Growing, Best Paying Industry on Earth—Has a Place for You**

**ELECTRICAL OFFICE JOBS - POWER PLANT JOBS - ELECTRIC AUTOMOTIVE JOBS - AVIATION JOBS - STORE - BATTERY JOBS  
ELECTRICAL DRAFTING JOBS - MANUFACTURING JOBS - BUILDING CONSTRUCTION JOBS - SWITCHBOARD JOBS - SIGNAL JOBS  
ELECTRIC RAILWAY JOBS - TELEPHONE AND TELEGRAPH JOBS - ELECTRIC LIGHT JOBS**



## Get my Contract of a JOB and a RAISE!

**Mechanics—Office Men,  
Beginners, Clerks!  
Men in all lines WANTED  
At Once, for Promotion in  
ELECTRICITY!**

Most of us think of Electricity as dealing entirely with the manufacture of machinery, the production and transmission of power, and work like that of the "Electrician."

Perhaps you do not realize that Electricity has become the biggest, and the fastest-growing industry on earth. That it is a HUNDRED giant industries, not one—employing MILLIONS of men and BILLIONS in capital. With positions for office men, salesmen, draftsmen, building-construction men, engineers and executives. And that it has a *place for you*—no matter what kind of work you are doing today, or prefer to do!

**ELECTRIFY Your Future!  
Earn \$35 to \$100 a Week!**

I am looking for ambitious young men who are dissatisfied both with their present pay and future prospects. I want to show them how easily they can get into Electricity—how they can increase their earning capacity and multiply their chances to get ahead *many times*—simply by switching over to *similar* work in Electricity.

Perhaps you are doing routine *office work* today in a line where your progress is slow and limited. Then let me show you how you can get one of the many office positions in the Electrical line. And how, with your present business experience, *plus a knowledge of Electricity*, you can earn a much bigger salary and advance rapidly to highly-paid executive positions.

Or if you are a mechanic—wondering how you can avoid remaining a mechanic all your life—I'll tell you how to become first, an *Electrical* mechanic, and then show you how you'll be in line for quick promotion to Expert, Engineer or Superintendent.

So when I say "*ELECTRIFY your future*" I mean here's the winning combination: Add a knowledge of Electricity to what you already have learned in factory or office or store. Then take that knowledge into *ELECTRICITY*—where you can sell it for the *biggest salary* and the *brightest future*.

### ELECTRICAL ENGINEERING (At Home in 2 Years)

Prepared by DUNLAP and 29 Noted Engineers

With the cooperation of some of the biggest Electrical Corporations in America, we have developed a new method of home-training in Electricity—easier, simpler, faster and more practical. *Here is specific preparation for highly-paid Electrical positions.* Actual practice work with standard electrical tools and materials is just one feature. Built especially so men with ordinary schooling can understand it readily. Built by executives, engineers and educators from:

- |                           |                           |
|---------------------------|---------------------------|
| General Electric Co.      | Westinghouse Electric Co. |
| Mass. Inst. of Technology | Underwriters' Lab.        |
| Commonwealth Edison Co.   | Cutler-Hammer Mfg. Co.    |
| American Tel. & Tel. Co.  | Western Electric Co.      |
|                           | (and others)              |

### An Electrical Job and Raise for You

Send for our agreement to take you as you are, supply you with the Electrical training you need, and then help get you a fine Electrical position at a substantial increase in salary, or no cost. You may wonder how this is possible. But the ex-

**The American School**  
Dept. E-374, Drexel Ave. & 58th St., Chicago, Ill.

planation is really simple: The Electrical industries are growing so rapidly that the supply of trained men cannot keep up with the demand. There are more good jobs open, always, than men capable of filling them. We are in close touch with many big employers and they tell us they can place all the trained men we can supply.

And because we know all this, and how amazingly Electricity continues to grow into new fields, and because we know the *right kind of training* equips a man to get and keep a good Electrical job—we have dared to make this contract and to back it with our entire resources of over \$2,000,000.00. Get in touch with me, and I'll show you that you can get an Electrical job and a raise—*without risking a penny of your money.*

### All These FREE!

If you would like to know exactly how you can get into this greatest and most interesting of all lines—if you would like facts and figures to prove that in Electricity, salaries are bigger



and opportunities greater—if you want to see just *how* you can fit in and *where*—*mail the coupon below.* And without cost or obligation I'll send you our 36-page book about Electricity—our famous plan and contract of an Electrical Job and Raise—and some of the first lessons and job-tickets, as a sort of "sample" of the new, easy, simplified way you can learn Electricity—right in your home, in spare time. Do this now, while you think of it.

Electrical Division, The American School  
Dept. E-374, Drexel Ave. & 58th St., Chicago, Ill.

I am interested in Electrical position. Please send without cost or obligation:  
1—36-page Electrical Book, 2—Contract of Electrical Job and Raise, 3—Bunch of Lessons and Job-tickets to show me how easily I can prepare for Promotion in Electricity.

Name.....  
St. No. or R. F. D.....  
City..... State.....



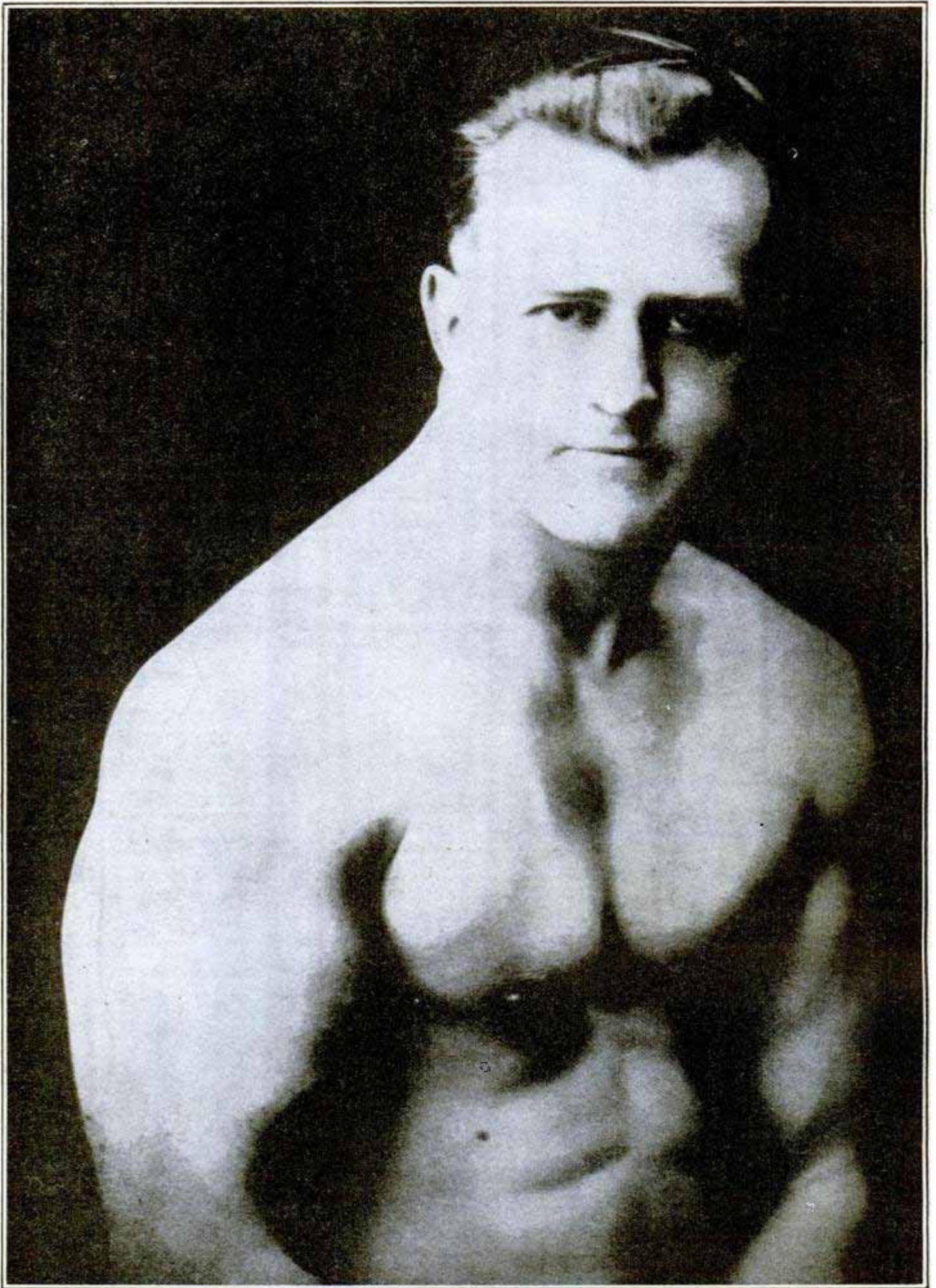

**EARLE LIEDERMAN, *The Muscle Builder***

*Author of "Science of Wrestling," "Muscle Building," "Secrets of Strength," "Here's Health," "Endurance," etc.*



# MUSCLES! 5¢ a piece!

Wouldn't it be great if we could buy muscles by the bag—take them home and paste them on our shoulders? Then our rich friends with money to buy them sure would be socking us all over the lots.

But they don't come that easy, fellows. If you want muscle you have to work for it. That's the reason why the lazy fellow never can hope to be strong. So if you're lazy and don't want to work—you had better quit right here. This talk was never meant for you.

## I Want Live Ones

I've been making big men out of little ones for over fifteen years. I've made pretty near as many strong men as Heinz has made pickles. My system never fails. That's why I guarantee my works to do the trick. That's why they gave me the name of "The Muscle Builder."

I have the surest bet that you ever heard of. Eugen Sandow himself said that my system is the shortest and surest that America ever had to offer.

Follow me closely now and I'll tell you a few things I'm going to do for you.

In just 30 days I'm going to increase your arm one full inch. Yes, and add two inches to your chest in the same length of time. But that's nothing. I've only started: get this—I'm going to put knobs of muscles on your shoulders like baseballs. I'm going to deepen your chest so that you will double your lung capacity. Each breath you take will flood every crevice of your pulmonary cavity with oxygen. This will load your blood with red corpuscles, shooting life and vitality throughout your entire system. I'm going to give you arms and legs like pillars. I'm going to work on every inner muscle as well, toning up your liver, your heart, etc. You'll have a snap to your step and a flash to your eye. You'll feel the real pep shooting up and down your old backbone.

You'll stretch out your big brawny arms and crave for a chance to crush everything before you. You'll just bubble over with vim and animation.

Sounds pretty good, what? You can bet your old ukulele it's good. It's wonderful. And don't forget, fellow—I'm not just promising all this—I guarantee it. Well, let's get busy, I want some action—So do you.

Send for My New  
64 Page Book

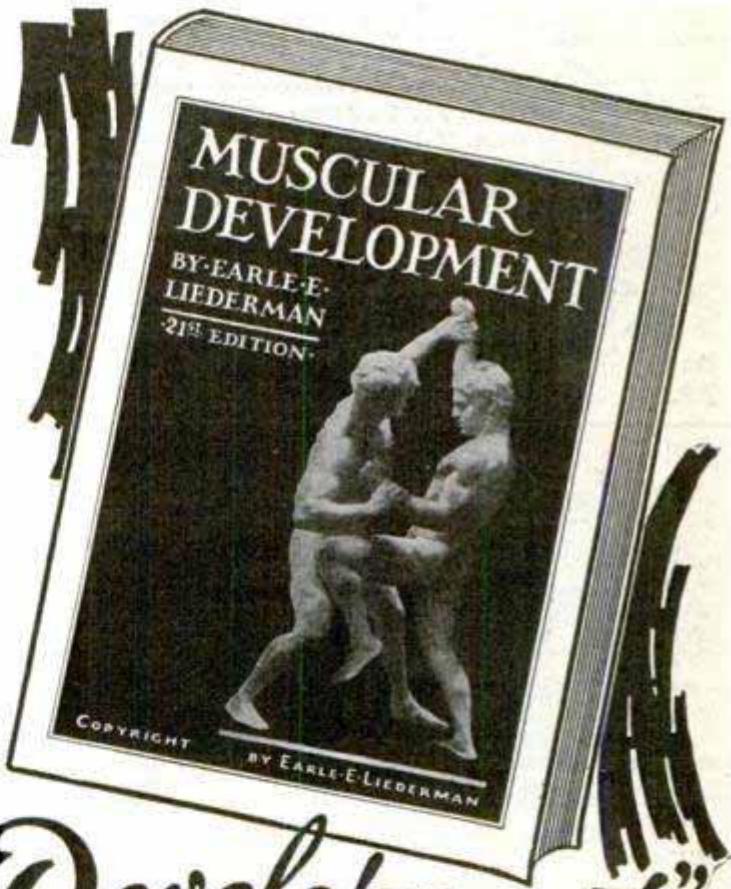

# "Muscular Development"

IT'S FREE

Do you get that? It's free. I don't ask a cent. It's yours with my compliments. Take it and read it. It's the peppiest piece of literature you ever flashed your glimmers on. And 48 full-page photos of myself and some of my numerous prize-winning pupils. This is the finest collection of strong men ever assembled into one book—look them over—doctors, lawyers, merchants, mechanics and every line of trade you can think of. I swear you'll never let this book get out of your hands again. And just think—you're getting it for nothing. Don't hesitate—there's no strings attached to it. Grab it.

Take your pen or pencil and fill out the coupon, or even your name and address on a postal will do—do it now before you turn this page.

**EARLE LIEDERMAN**

**Dept. 2003 305 Broadway New York City**

**EARLE LIEDERMAN**  
Dept. 2003, 305 Broadway, New York City

Dear Sir:—Please send me absolutely free and without any obligation on my part whatever, a copy of your latest book, "Muscular Development." (Please write or print plainly.)

Name.....  
Address.....  
City..... State.....



# - takes only 8 weeks to get a big job



George Smith owns an agency and repair shop in West Alexandria, Ohio. He makes \$200 a week.

## Earn \$75 to \$125 a Week as Auto Expert

Learn the auto and tractor business by the Ohio State method, then step out and get a good job at \$75 to \$125 a week or open your own repair shop and make up to \$10,000 a year. Trained men are needed everywhere. Opportunities galore! Eight weeks training fits you to open repair shop or to go with one of the big firms waiting for trained men. Read what George Smith and C. E. Gillespie have done. Hundreds of other Ohio State trained men can tell as interesting facts. Every month Ohio State men who complete their training are taking the place of half-trained and incompletely self-trained men.

### Money Back Guarantee

If, after completing my training, you are not satisfied, if you are not qualified to accept a big-pay job, your tuition will be refunded.

## AVIATION Course

AVIATION is paying tremendous incomes to trained men! Coupon brings complete details about complete course in Aviation Mechanics. Learn on real airplane engines under experienced instructors. Ask about special course in FLYING. Don't miss this remarkable opportunity. Save by enrolling at once. The sooner you start the sooner you will be ready to earn big pay or get into business for yourself.

### Learn in Only 8 Weeks

Simple, thorough, practical shop methods. You learn the "why" of everything you do, then learn to do it right. You do real work with real tools and real equipment. No book studying. Very little schooling necessary. Any man from 16 to 60 can learn. Write today for Big Special Limited Time Tuition Offer, including—

### SPECIAL! R. R. FARE PAID!

Also FREE course in AUTOMOBILE ELECTRICITY to those who enroll soon. Don't delay—write at once for complete details and BIG AUTO BOOK FREE. Mail coupon NOW.



C. E. Gillespie has charge of a fleet of trucks and tractors for the State Highway Commission, due to Ohio State training.

### MAIL COUPON FOR FREE BOOK

OHIO STATE AUTO SCHOOLS,  
Dept. 11-H, 654 E. McMillan St., Cincinnati, O., or  
Dept. 11-H, 1815 E. 24th St., Cleveland, O.  
Without cost or obligation, send me your big FREE book on Autos and Aviation; also, full details of your special tuition offer including R. R. Fare.

Name.....  
Street.....  
Town..... State.....



Book FREE

## OHIO STATE AUTO SCHOOLS

654 E. McMillan St., Cincinnati, Ohio or 1815 E. 24th St., Cleveland, Ohio

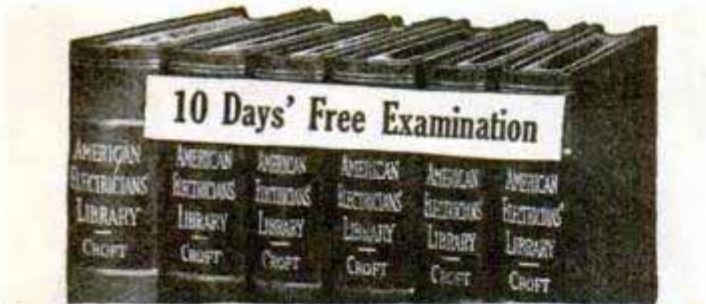

10 Days' Free Examination

### Get into the electric wiring field—big demand—big money!

THE whole wiring field covered. Kinks; helps; short cuts; practical, on-the-job electrical data, written particularly to help wiremen, trouble shooters, maintenance men, armature winders, electrical contractors and students.

**American Electricians' Library**  
6 volumes, 2000 pages, illustrated, \$17.50 payable \$1.50 in ten days and \$2.00 a month

The books tell you all you must know about conduit wiring, armature winding, wiring for lighting circuits and switches, wiring for machinery, circuit troubles, circuit testing, or electrical machinery erection. Through a study of this great set you can push yourself into a big-pay job for life.

See it FREE—Send no money—ACT

### FREE EXAMINATION COUPON

McGraw-Hill Book Co., Inc.  
370 Seventh Avenue, New York

Send me the American Electricians' Library for 10 days' free examination. If satisfactory, I will send you \$1.50 in 10 days and \$2 monthly until the full price, \$17.50, is paid. If not wanted, I will return the books at your expense.

Name.....  
Address.....  
City and State.....  
Position.....  
Company..... P. M.-3-29

## LAW

STUDY AT HOME  
Become a lawyer. Legally trained men win high positions and big success in business and public life. Be independent. Greater opportunities now than ever before. Big corporations are headed by men with legal training. Earn \$5,000 to \$10,000 Annually. We guide you step by step. You can train at home during spare time. Degree of LL.B. conferred. LaSalle students found among practicing attorneys of every state. We furnish all text material, including fourteen-volume Law Library, Low cost, easy terms. Get our valuable 64-page "Law Guide" and "Evidence" books FREE. Send for them NOW. LaSalle Extension University, Dept. 364-L Chicago. The World's Largest Business Training Institution

### Learn to PAINT SIGNS and SHOW CARDS

We quickly teach you by mail, or at school, in spare time. Enormous demand. Big future. Interesting work. Oldest, foremost school. EARN \$50 TO \$200 WEEKLY. John Vassos, N. Y., gets \$25 for single show card. Crawford, B. C., says: "Earned \$200 while taking course." Send today for free information, samples and guarantee. DETROIT SCHOOL OF LETTERING. 154 Stinson Ave. Est. 1899 Detroit, Mich.

### WHY NOT spend Spring, Summer and Fall gathering butterflies, insects? I buy hundreds of kinds for collections. Some worth \$1 to \$7 each. Simple outdoor work with my instructions, pictures, price-list. Send 10 cents (not stamps) for my illustrated Prospectus before sending butterflies. MR. SINCLAIR, DEALER IN INSECTS. Dept. 6. Box 1424. San Diego, Calif.

### Learn Watchwork, Jewelrywork and Engraving

A fine trade commanding a good salary, and your services always in demand. Address Horological, Dept. P, Bradley Institute, PEORIA, ILLINOIS, for our latest catalog.

Wonderful, new device; guides your hand; correct your writing in few days. Big improvement in three hours. No failures. Complete outline FREE. Perfect Penmanship Inst. D-34, St. Louis, Mo.



# The Most Amazing Offer Ever Made

## To Men Who Want to Earn More Money



**700% INCREASE**  
as compared to \$1,000 a year previously is what N. S. T. A. helped F. J. Walsh, Springfield, Mass., to earn. Now a star salesman.



**\$7500 A YEAR**  
is what C. W. Birmingham of Dayton, O., reported. Some years ago he was working in a shop for \$25 a week. N. S. T. A. helped him succeed.



**\$8080 INCREASE**  
When I started the N. S. T. A. course, I was making \$160 a month. Today my salary runs into 5 figures.—R. B. Hansen, Akron, Ohio.

**I Will Give You a Definite, Guaranteed Addition to Your Income**  
*... Or This Training Costs You Nothing*

**T**HOUSANDS of men all over the country are living examples of how this plan works. I could fill this page with their names. R. B. Hansen of Akron, Ohio is one case. Not long ago he was a foreman in the rubber-curing room of a big factory at a salary of \$160 a month. Today his salary actually exceeds \$10,000 a year. Another man, Wm. Shore of Neenach, California now makes as high as \$525 a week. O. D. Oliver of Norman, Oklahoma jumped his earnings from \$200 a month to more than \$800 a month. I could go on indefinitely, reciting case after case. But I want to bring this message right down to you.

### World's Highest Paid Profession

Let's get right down to your individual case. You want to earn more money—for the better things in life. A comfortable home, a snappy car, membership in a good club, good clothes, advantages for your loved ones. All right. You are the type of man this message is intended for.

There is one profession that has more men in it earning \$5,000, \$7,000, \$10,000 a year and up than any other. You know what profession that is—it is salesmanship. Now fortunately, scientific salesmanship is probably the easiest of all professions to learn—when it is taught right. You may be one of the skeptical kind. You may have believed that sales-

As president of a million dollar concern—the oldest and largest institution of its kind in the world—I now present to ambitious men a new, thoroughly tested and practical salary-increasing plan . . . an amazing Double Money-Back Bond that you will earn a definite, fixed sum over and above your present wages—or my plan costs you nothing.

By Charles Michel

**Where Shall We Send Your Copy FREE?**

men were "born," not made. It may be natural for you to think this and that is just why we are today making an offer so sensational that it is being commented on by business men in every section of the country.

I will give you a positive, Double Money-Back Bond that if you do not add a definite, fixed sum to your income within three months after completing the printed portion of this training—the cost to you is absolutely nothing. Space on this page does not permit the detailed explanation of how this new plan works—how it actually pays you while learning—how it entitles you to the services of an employment department that is today

placing men in jobs that pay \$4,000 to \$12,000 a year.

These details are all explained in a remarkable little book called "The Secrets of Modern Dynamic Salesmanship." This book comes to you absolutely free, without obligation. This free book has raised more men's pay than all the pull and luck in the world.

### Just Read This Free Book

Your copy of "The Secrets of Modern Dynamic Salesmanship" is waiting for you. It is probably the most illuminating human document you have ever read. It may prove the turning point in your life just as it has for thousands of others. Mail the coupon now for your free copy.

**CHARLES MICHEL, Pres.**

N. S. T. A. Dept. C-101  
21 W. Elm St., Chicago, Ill.



Charles Michel, President, N. S. T. A. Dept. C-101, 21 W. Elm St., Chicago, Ill.

Please send me free and without obligation your new book "The Secrets of Modern Dynamic Salesmanship." Also full details of the training that comes to me under the guarantee that it costs me nothing unless it brings a definite addition to my income.

Name.....  
Address.....  
City..... State.....  
Occupation..... Age.....



# Hawaiian Guitar

## GIVEN

Worth  
\$20

to our Students

This Hawaiian Guitar expert and professor wants the opportunity to welcome you as a student so you will quickly learn how to play a Hawaiian Guitar—yes, you will be able to play just like the native Hawaiians. To get you started and help your musical success, which will bring you popularity, you will receive a beautiful Hawaiian Guitar, the same as the one pictured, when you enroll. Our short cut method of instruction will enable you to play a piece almost from the first lesson. Rush coupon for full particulars today and we will reserve a Hawaiian Guitar for you.



### Learn to Play Quickly

With our short cut method of instruction you will quickly learn how to play Hawaiian Guitar, which will bring you popularity and social success. You learn to play from notes. If you never had any musical training, you will quickly get on, because our experts have perfected a course of home instruction which is as simple as learning A, B, C's.



**PICTURE and PHONOGRAPH RECORD METHOD EASY** We don't depend upon printed lessons only for your success, but we furnish pictures of our professors playing, diagrams, charts and phonograph records for each lesson. This practically brings our professors from our studio to your home and enables you to listen to their playing just as if they were actually in front of you. To prove this is easy, we will send you your first lesson free.

### RUSH COUPON—Send No Money

So positive are we that you will become one of our students, we will send free, without obligation, our first lesson. Also receive our free big book which gives particulars about our course. Write for your free book and your free lesson today.

HAWAIIAN STUDIO No. 52039  
of New York Academy of Music,  
100 Fifth Avenue, New York, N. Y.

Please rush your free book, "How to Learn Hawaiian Guitar," and my first free lesson. Also reserve a Hawaiian Guitar for me. This obligates me in no way whatever.

Name.....

Address.....

## THE CHICAGO DAILY NEWS School and College Bureau

### Offers You Its Specialized Services in Choosing a School

Last year the School and College Bureau of The Chicago Daily News saved many busy parents and questioning boys and girls both time and worry by sending them prompt, reliable information about just the kind of school they wanted—personal requirements as to location and tuition charges being considered in each individual case.

Again this year many young people will be perplexed by the problem of finding the right school. Why not let us help you?

The Chicago Daily News maintains this service absolutely free of charge to you. No need to hurriedly select a school on mere hearsay when expert advice can be obtained by telephoning Dearborn 1111, writing or calling for a personal interview at

**THE CHICAGO DAILY NEWS**  
*School and College Bureau*  
Dept. K, 15 N. Wells St., Chicago, Illinois



# DRAFTING

## BOOKS SENT FREE!

### For Beginners

Written so you can understand every word, by 18 famous Engineers and Architects. Deluxe, flexible binding. 1750 pages, 1050 blue prints, charts and diagrams. Prepares you for a good Drafting job in mechanical or architectural lines. Sent for 15 days' free use, if you mail coupon immediately.

Only fifteen minutes a day with these WONDER BOOKS will prepare you for a good Drafting job in less than a year! Mechanical and Architectural Drafting from simple straight lines to important, complex plans, a step at a time! Built especially for beginners, for men with only grammar schooling. Drafting room practice plus engineering made easy and clear!

### Big Field—Big Demand—Big Pay!

Competent Draftsmen are urgently needed right now in all building and manufacturing lines at \$50 to \$100 a week. That's just the beginning—for draftsmen have the best chances for advancement! Pleasant, fascinating work, easy to learn and do. Learn quick with these books—send coupon for a set FREE, and see for yourself!

A year's Consulting Membership in the American Technical Society now given free to all readers of this famous Cyclopaedia of Drafting. Many say that's worth more than cost of books.

American Technical Society  
Dept. D-319, 58th & Drexel Ave., Chicago



## Modern American Homes FREE!

American Technical Society  
Dept. D-319, 58th & Drexel Ave., Chicago

Send for 15 days' free use 4-volume set of DRAFTING. In return for mailing this coupon promptly send absolutely FREE "Modern American Homes," 112 plates, exteriors, interiors and plans. I will pay the few cents delivery charges. If I wish I may return books in 15 days and owe you nothing. But if I prefer to keep them I will send \$1.50 after 15 days, then \$2.00 a month until \$14.80 (special reduced price) is paid.

Name.....

Address.....

Employed by.....

Address.....



# Don't Pay Me a Cent If I Can't Give You a *Magnetic Personality* -5 Days FREE Proof!



**N**O matter how lacking you are in qualities of leadership, no matter how colorless, timid, unsuccessful and discouraged you may be, I GUARANTEE to so magnetize your personality that your whole life will be completely transformed.

I can give you poise that banishes self-consciousness, charm that makes you irresistibly popular, personal power that will indelibly influence the minds of others and amaze your friends.

I'll make you a fascinating force in social life, a powerful, dynamic, commanding figure in your profession. You'll become more popular, more prosperous, more gloriously successful than you ever dreamed possible!

Let me send you the proof—absolutely free! If within 5 days you do not experience a decided change in your personality, if you do not find yourself making new friends with ease, if you do not discover yourself already on the way to social popularity, business success and personal leadership—just say so. Tell me my principle of personal magnetism can't do every single thing that I said it would do. And you won't owe me one penny!

## What is Personal Magnetism?



### What Is Sex Magnetism?

What is that magnetic powerful influence that draws one man to one woman—forever, irresistibly? What is that strange never-failing spark that awakens love? What is it, in man or woman, that seems to draw and fascinate—the hypnotic power that no one can resist?

You have it. Everyone has it. *But do you use it?*

What is this marvelous force that raises the sick to glowing, vibrant health, the timid to a new confident personality, the unsuccessful to positions of wealth and astonishing power?

You have it—everyone has it—but *not one person in a thousand knows how to use it!* It is not a fad nor a theory. It is simply you, yourself—your manner—your own marvelous personal force, released and magnified a hundredfold in an amazingly clear-as-crystal, scientific way! More necessary than good looks. More valuable than money. For without it a salesman is

handcuffed! Without it a business man is powerless to command! No actor, no teacher, no orator, no statesman can long hold his audience spellbound without this supremely influential magnetic force!

Personal magnetism! How easy to release it! How wonderful its results! No long study or inconvenience. Not the slightest self-denial. Just a simple, clear, age-old principle that taps the vast thought and power resources within you, releases the full sweep of your magnetic potentialities and makes you almost a new person from what you were before!

Personal Magnetism is not hypnotism. Hypnotism deadens. Magnetism awakens, inspires, uplifts. Personal Magnetism is not electricity. It is *like* electricity in one way—while you cannot see it, you can observe its startling effects. For the moment you release your Personal Magnetism you feel a new surge of power within you. You lose all fear. You gain complete self-confidence. You become almost overnight the confident, dominant, successful personality you were intended to be—so fascinating that people are drawn to you as irresistibly as steel is drawn to a magnet!

## The Facts are Free

The fundamental principles of Personal Magnetism have been put into an extra large volume under the title of "Instantaneous Personal Magnetism." It is bound in beautiful dark burgundy, with the title gold embossed. Its scope is as broad as life itself. "Fires of Magnetism," "Sex Influences," "The Magnetic Voice," "Physical Magnetism," "The Magnetic Eye," "Oriental Secrets," "Rapid Magnetic Advancement," "The Magnetic Mind," and "Magnetic Healing," are only a few of the subjects covered in this amazing book. A magnificent book that tells you just how to cultivate the magnetic influence of your nature.

You can sway and control others. You can command success. You can influence people to do the things you want them to do. Through this amazing book you gain the key to a magnetic personality in 5 days—or you don't pay one penny! That is my free offer to you.

## Send Coupon Today

You must see this wonderful volume—examine it—let it influence indelibly your own personality. You send no money with the coupon—you pay no C. O. D. You get the book first. If you aren't stirred and delighted in the 5-day period, return it and pay us nothing. Otherwise keep it as your own and remit \$3 in full payment. You are the sole judge. You do not pay unless you are absolutely delighted. And then only \$3.

You simply can't delay! Clip and mail the coupon NOW.

Ralston University Press, Dept. 13-F, Meriden, Conn.

### RALSTON UNIVERSITY PRESS DEPT. 13-F, MERIDEN, CONN.

All right—I'll be the judge. You may send me the volume "Instantaneous Personal Magnetism" for 5 days' FREE EXAMINATION in my home. Within the 5 days I will either remit the special low price of only \$3.00 or return the book without cost or obligation.

Name.....

Address.....

City.....State.....

Special cash price \$2.00 if payment accompanies coupon. This saves heavy bookkeeping and clerical expense. Money refunded if dissatisfied and book is returned within five days.





# Says Good-bye to \$200 a Month Now He Earns Better Than \$10,000 a Year

At 45, C. J. Farris, of Memphis, Tenn., was earning \$200 a month as Credit Manager.

For years," he writes, "I did general accounting work for a large corporation, doing the physical work without an understanding of the underlying principles, which caused me untold worry and a constant unsatisfied position in connection with my service. Finally, as a way out, I enrolled for LaSalle home-study training in Higher Accountancy, and with the daily study of principles, and the solving of practical problems in Higher Accountancy under specialized instruction, came a rapid broadening of ability—a new self-confidence that put to rout the elements of fear and indecision."

And how quickly his income mounted! Within a year came a "raise" to \$3,000—one year later, a more responsible position commanding \$5,000 salary—then, with the winning of his degree as Certified Public Accountant, his entrance into a highly profitable profession, and the building of his own highly successful accounting firm.

## Send for Free Book—"Accountancy, the Profession that Pays"

"I wish I could cry from a mountain top to young men everywhere, 'Educate yourself—prepare—qualify—for tomorrow your opportunity may come.'"

So writes Mr. Farris—and well he may, for right in his own experience he has proved the tremendous power of home-study training as an aid to progress. Are you ambitious to make a real success in business—to fit yourself for positions paying \$3,000, \$5,000, \$10,000 a year, and even better? You do not need a knowledge of book-keeping to make your start. LaSalle trains you from the ground up, according to your individual needs. Low cost; easy terms.

If you are dissatisfied with your present equipment, you will find LaSalle's 64-page book, "Accountancy, the Profession that Pays," of the greatest help and inspiration—and—LaSalle will send it to you FREE. For the sake of a brighter future, clip and mail the coupon NOW.

— — — Find Yourself Through LaSalle! — — —

### LaSalle Extension University

The World's Largest Business Training Institution

Dept. 364-HR Chicago I should be glad to have details of your salary-increasing plan as applied to my advancement in the business field checked below. Also a copy of "Ten Years' Promotion in One," all without obligation.



- Higher Accountancy
- Business Management
- Modern Salesmanship
- Traffic Management
- Railway Station Management
- Law—Degree of LL.B.
- Commercial Law
- Industrial Management
- Banking and Finance
- Personnel Management
- Credit and Collection Correspondence
- Modern Business Correspondence
- Modern Foremanship
- Expert Bookkeeping
- C. P. A. Coaching
- Business English
- Commercial Spanish
- Effective Speaking
- Stenotypy—Stenography
- Telegraphy

Name .....

Present Position .....

Address .....

# CHRISTIAN PSYCHOLOGY



A SIMPLE Scientific System of Christian thought and life. Gives Christianity the power of godliness as well as the form. Puts into it the living vibrant force which brings prosperity, love, achievement, health, happiness, peace and more abundant life. Not a religion, nor a sect, but a movement within the churches, loyal to their work and ministry. Based squarely upon the teachings of Jesus as verified, explained and practically applied by modern scientific Psychology. Prepared by Judge Daniel A. Simmons, world-famed psychologist, jurist, author and teacher. Judge Simmons has set forth the fundamental working principles of Christian Psychology in a wonderful lecture entitled "The Kingdom of God." This lecture will be

## SENT COMPLETE AND FREE

as a work of loving personal service on our part, rendered in the name and spirit of Him who said: "Freely ye have received, freely give." Send for it today.

The AMERICAN INSTITUTE of PSYCHOLOGY  
3303 Law Exchange Building, Jacksonville, Florida

I POSITIVELY GUARANTEE that you can produce wonderful, sweet music in three days and quickly play popular and classical selections.

Complete Outfit Sent on Trial

No notes to read. No dreary practice. Just three short, simple lessons revealing every secret of my 12 years' success as a professional saw musician. Amaze your friends with this sensation of radio, vaudeville, orchestra and lodge entertainment. Send 10c for photograph record of two beautiful Musical Saw solos which also entitles you to complete information about my special introductory offer of Saw, Bow, Hammer, and Resin, FREE with Course of Instruction.

MUSSEHL & WESTPHAL  
113 So. 3rd St. Fort Atkinson, Wis.

# CHIROPODY

MAKE \$5,000 TO \$15,000 A YEAR

In dignified profession. Doctors of Surgical Chiropody needed everywhere. Best known College in America gives you full course, prepares you for practice in 2 years. Largest foot clinic in the world. Faculty of leading physicians, chiropodists. Finest equipment. 15th year. Study in Chicago. Varied interests of city life—opportunities all around. Earn while you learn. Write for catalog. No obligation. Dept. 1211.

Illinois College of Chiropody, 1327 N. Clark St., Chicago

# LEARN ELECTRICAL TRADES

Practical Training on Massive Lay-Out of Expensive Electrical Equipment. Armature Winding, House Wiring, Electric Welding, Electric Refrigeration, Power Plants, Switchboards, Transformers, Motors, Generators, Radio Batteries. Automobile Course included without extra cost. Write Today for Free Catalog.

COLEMAN ELECTRICAL SCHOOL, 1628 Main St., Kansas City, Missouri

# MINSTRELS

Musical Comedies and Revues. Unique Minstrel First - Parts for complete show with special songs, opening choruses, etc. Full line of plays, stage songs, crossfire, monologues, afterpieces, vaudeville acts and make-up. CATALOGUE FREE.

T.S.DENISON & CO., 623 So. Wabash, Dept. 19, Chicago

# Learn Photography at HOME

Make money taking pictures. Prepare quickly during spare time. Also earn while you learn. No experience necessary. New easy method. Nothing else like it. Send at once for free book, OPPORTUNITIES IN MODERN PHOTOGRAPHY and full particulars

AMERICAN SCHOOL OF PHOTOGRAPHY  
Dept. 1353 3601 Michigan Ave. Chicago, U. S. A.



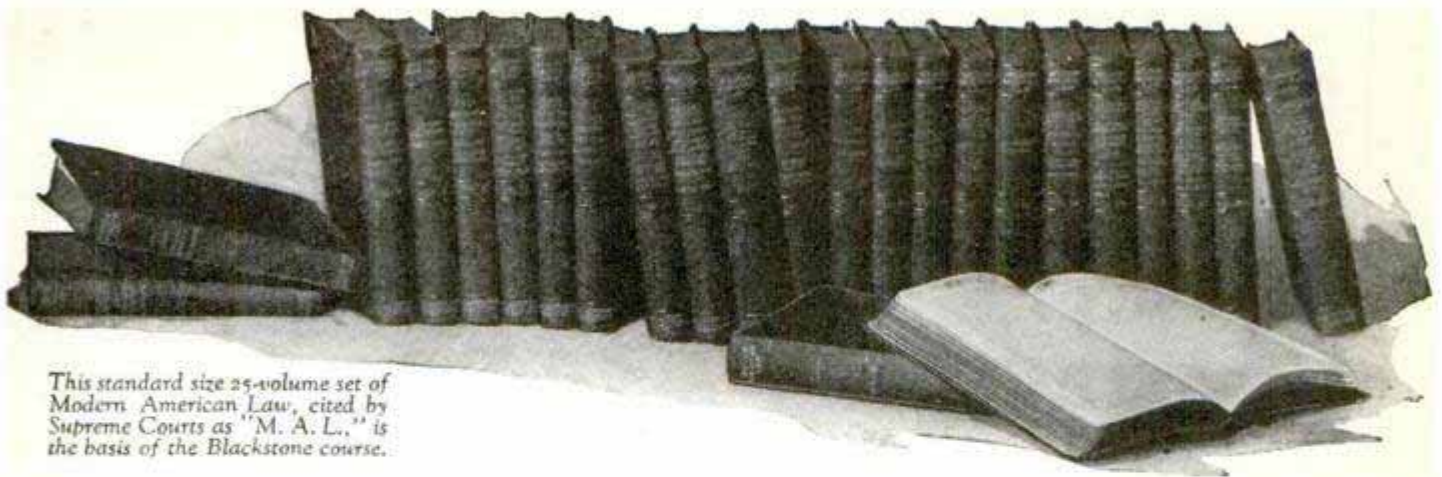

This standard size 25-volume set of *Modern American Law*, cited by Supreme Courts as "M. A. L.," is the basis of the Blackstone course.

# LAW TRAINING=SUCCESS

**T**HIS message is directed to the man who is contemplating the study of law—  
And where is the man who has not at some time yearned for law training and the certainty of success it brings?

## The Aristocrat of Studies

Law is the aristocrat among training courses. Law students are stamped as men of discernment and dignity. They are looked upon with respect.

A knowledge of law is an absolute necessity in every line of business or professional activity. Law enhances earning power and serves as the means of certain advancement. The demand for a law training is growing constantly.

For years the Blackstone Institute, through its home-study law course and service has been meeting and satisfying this demand. Today the Institute can point to more than 50,000 people, among them being corporation officials, business executives, bankers, lawyers, public accountants and others, who have received financial, personal or business benefits from this training. Graduates of the course are practicing law in every state.

## The Outstanding Course

The Blackstone Institute delivers to its students immediately upon enrollment the complete set of text books for the entire course—not one volume at a time.

This is the famous 25-volume *Modern American Law* library, cited as standard and authoritative by the courts of last resort. (See illustration in miniature above.) This library forms the basis of the course and serves immediately as a valuable reference work upon the entire field of modern-day law. Many students have said that the library alone is worth the modest tuition fee asked for the entire course.

## Elaborate Lesson Material

But the set of text books is only one part of this rather unusual course. There is, in addition, the elaborate lesson material mailed at regular intervals. The lessons direct the student's study efforts care-

fully, provide him with the written work to be done, and call his attention to rules of law pertaining to his regular daily affairs. LL. B. degree conferred.

This text and lesson material was prepared by a group of eighty of the most prominent law authorities in the United States. Included in the list of authors are Justices Taft and Sutherland of the United States Supreme Court, the deans of eight leading resident law schools, university law professors, and state supreme court judges.

## No Exaggerated Claims

The Institute makes no claim that the study of its course will bring a startling increase in income to every student. Yet most students have reported increases, some as high as 200% before completing the course.

Neither does the Institute claim that a law training will enable you to earn from \$10,000 to \$35,000 a year, yet a great many law-trained men earn in excess of that.

The Institute does claim that a law training is the best foundation for a successful business or professional career, and that its course is without a peer in the field of non-resident law instruction.

## Mail Coupon Today

The Institute prides itself on the value in text and lesson material delivered and the quality of educational service rendered. Full details may be had by asking for a copy of the Institute's 64-page book, "The Law-Trained Man."

Here again is definite value and full recompense for the effort involved in writing for your copy, for this little book contains some valuable legal tips and pointers which you can apply at once in your daily business affairs.

There is no charge for the book. It is free, and you may have a copy with our compliments if you will send a post card request or use the convenient coupon below. Address Blackstone Institute, Dept. 53, 307 N. Michigan Ave., Chicago, Ill.

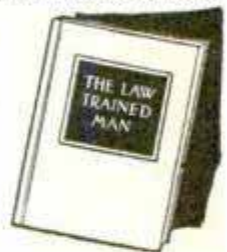

## GOOD REASONS

- 1 Blackstone Institute teaches one subject only—Law, and its present course is based on 36 years of experience in non-resident educational work.
- 2 The instruction method is a combination of text reading and study of leading illustrative cases—a method recognized as the best and most thorough plan yet devised.
- 3 The authors of the Blackstone course are outstanding authorities in the field of law. They know what law you need and how to teach it to you.

## BLACKSTONE INSTITUTE

Dept. 53, 307 N. Michigan Ave., Chicago, Ill.

Please send me by mail, and without obligation, a copy of your 64-page book, "The Law-Trained Man," and details of your law course and service.

Name \_\_\_\_\_  
 Business Position \_\_\_\_\_  
 Business Address \_\_\_\_\_  
 City \_\_\_\_\_ State \_\_\_\_\_





## "I Knew You'd Make Good"

"I ALWAYS felt you had it in you to get ahead. But for a time I was afraid your natural ability would be wasted because you had never trained yourself to do any one thing well.

"But the minute you decided to study in your spare time I knew you'd make good. You seemed more ambitious—more cheerful—more confident of the future. I knew your employers couldn't help but notice the difference in your work.

"Think what this last promotion means! More money—more comforts—more of everything worth while. Tom, those hours you spent on that I. C. S. course were the best investment you ever made."

HOW about you? Are you always going to work for a small salary? Are you going to waste your natural ability all your life? Or are you going to get ahead in a big way? It all depends on what you do with your spare time.

Opportunity knocks—this time in the form of that familiar I. C. S. coupon. It may seem like a little thing, but it has been the means of bringing better jobs and bigger salaries to thousands of men.

Mark and mail it today and without cost or obligation, learn what the I. C. S. can do for you.

### INTERNATIONAL CORRESPONDENCE SCHOOLS "The Universal University"

Box 5603-F, Scranton, Penna.

Without cost or obligation, please send me a copy of your booklet, "Who Wins and Why," and full particulars about the subject before which I have marked X in the list below:

#### BUSINESS TRAINING COURSES

- |  |   |
|--|---|
| <input type="checkbox"/> Business Management                     | <input type="checkbox"/> Salesmanship                                     |
| <input type="checkbox"/> Industrial Management                   | <input type="checkbox"/> Advertising                                      |
| <input type="checkbox"/> Personnel Management                    | <input type="checkbox"/> Business Correspondence                          |
| <input type="checkbox"/> Traffic Management                      | <input type="checkbox"/> Show Card and Sign Lettering                     |
| <input type="checkbox"/> Accounting and C. P. A.                 | <input type="checkbox"/> Stenography and Typing                           |
| Coaching   | English <input type="checkbox"/> Civil Service                            |
| <input type="checkbox"/> Cost Accounting                         | <input type="checkbox"/> Railway Mail Clerk                               |
| <input type="checkbox"/> Bookkeeping                             | <input type="checkbox"/> Common School Subjects                           |
| <input type="checkbox"/> Secretarial Work                        | <input type="checkbox"/> High School Subjects                             |
| <input type="checkbox"/> Spanish <input type="checkbox"/> French | <input type="checkbox"/> Illustrating <input type="checkbox"/> Cartooning |

#### TECHNICAL AND INDUSTRIAL COURSES

- |   |  |
|---|--|
| <input type="checkbox"/> Electrical Engineering                         | <input type="checkbox"/> Architect                                       |
| <input type="checkbox"/> Electric Lighting                              | <input type="checkbox"/> Architects' Blueprints                          |
| <input type="checkbox"/> Mechanical Engineer                            | <input type="checkbox"/> Contractor and Builder                          |
| <input type="checkbox"/> Mechanical Draftsman                           | <input type="checkbox"/> Architectural Draftsman                         |
| <input type="checkbox"/> Machine Shop Practice                          | <input type="checkbox"/> Concrete Builder                                |
| <input type="checkbox"/> Railroad Positions                             | <input type="checkbox"/> Structural Engineer                             |
| <input type="checkbox"/> Gas Engine Operating                           | <input type="checkbox"/> Chemistry <input type="checkbox"/> Pharmacy     |
| <input type="checkbox"/> Civil Engineer <input type="checkbox"/> Mining | <input type="checkbox"/> Automobile Work                                 |
| <input type="checkbox"/> Surveying and Mapping                          | <input type="checkbox"/> Airplane Engines                                |
| <input type="checkbox"/> Plumbing and Heating                           | <input type="checkbox"/> Agriculture <input type="checkbox"/> Navigation |
| <input type="checkbox"/> Steam Engineering                              | <input type="checkbox"/> Mathematics <input type="checkbox"/> Radio      |

Name.....  
Street Address.....  
City..... State.....  
Occupation.....  
Persons residing in Canada should send this coupon to the International Correspondence Schools Canadian, Limited, Montreal, Canada

## \$25<sup>00</sup> DRAWING \$2<sup>98</sup> COURSE for



Haven't you often wished that you could draw cartoons, illustrate some idea, sketch some pretty face, etc.? You can do all of these things. One of America's most famous Cartoonists and Illustrators has developed a great, simple system for success in all branches of Commercial Art. This system has revolutionized the entire theory of drawing. It means that drawing can be as easy for you as writing—much simpler than learning shorthand, bookkeeping or typewriting. We are now placing this original system for learning Drawing, Art and Cartooning, consisting of 34 lessons with over 500 illustrations, within reach of every one. If you will devote a few hours each week to the Course WE ABSOLUTELY GUARANTEE that you will learn to draw and draw well before you have half finished the Course. If we fail to make this claim good, we will refund every cent paid us. By eliminating a large office force for answering correspondence, expensive catalogs, etc., we are enabled to make a price of \$2.98, the cheapest price ever known for a high-grade, home study course. Many have sent us letters similar to that of Rob't P. Davis of Detroit, who wrote: "I can't see how you ask so little. It is more than I expected." Learn to draw. It is a big asset, no matter what field you are in.

### Send No Money

Just order the course and \$2.98 on arrival pay postman plus a few cents postage, payment in full for the entire Course and Drawing Outfit. If not entirely satisfied, return within five days and we will Refund Money. Address:

If you order the course at once, we will include a drawing outfit, consisting of artist's pencils, pens, paper, erasers, thumb tacks, etc., enabling you to go to work without any additional cost.

LEDERER SCHOOL of DRAWING, Dept. 524-Y, Chattanooga, Tenn. Orders from outside the U. S. A. are payable \$3.28 cash with order.

## AVIATION Information FREE

Send us your name and address for full information regarding the Aviation and Airplane business. Find out about the many great opportunities now open and how we prepare you at home, during spare time, to qualify. Our new book *Opportunities in the Airplane Industry* also sent free if you answer at once.

AMERICAN SCHOOL OF AVIATION, Dept. 1353, 3601 Michigan Ave., CHICAGO



A powerful electric motor equipped with driving pulley, and two-blade fan, mounted on polished wooden base, binding posts, control switch. Runs mechanical toys beautifully from battery. A little gem, you may have it free.

With

### The Open Road for Boys Magazine

A Whole Year of Breathless Reading

50 pages a month crammed with thrilling fiction and action stories, written for real live, red-blooded boys. It is the hit of the year. Regular subscription price \$1 a year. We will send you 12 issues—a year's subscription—and this great electric motor all for \$1. Order now. Just drop a dollar bill to us, we pay shipping charges.



Both for \$1

Name.....  
Street.....  
Town or City.....  
State.....  
FOR BOYS MAGAZINE.  
OPEN ROAD FOR BOYS Magazine, Dept. 709 (Feb.) 130 Newbury St., Boston, Mass. Friends: Here's my \$1. Rush me the electric motor and put me down for one year for the OPEN ROAD



# AUDELS ENGINEERS & MECHANICS GUIDES

EXAMINE FREE!

For Every

Engineer  
Mechanic

Machinist  
Electrician

Fireman; Oiler  
Engineer Student



\$12

Complete Set 8 Guides

**T**his Master Set is a gold mine of daily, practical helps for workers in every branch of engineering. A self-educating study course for the student; the standard reference work for the chief. Thousands of rules, tables, calculations and diagrams make it easy to read and learn. Latest inside information on theory and practice of modern engineering for reference study and review. Thousands of new short-cuts that make the job easier. Examine free! Pay \$1 a month (less than 4c a day) if satisfied that this set will help you to a better job—or make your present job easier.

## AUDELS STANDARD LIBRARY

With Questions and Answers That Solve Your Problems

EASY TERMS

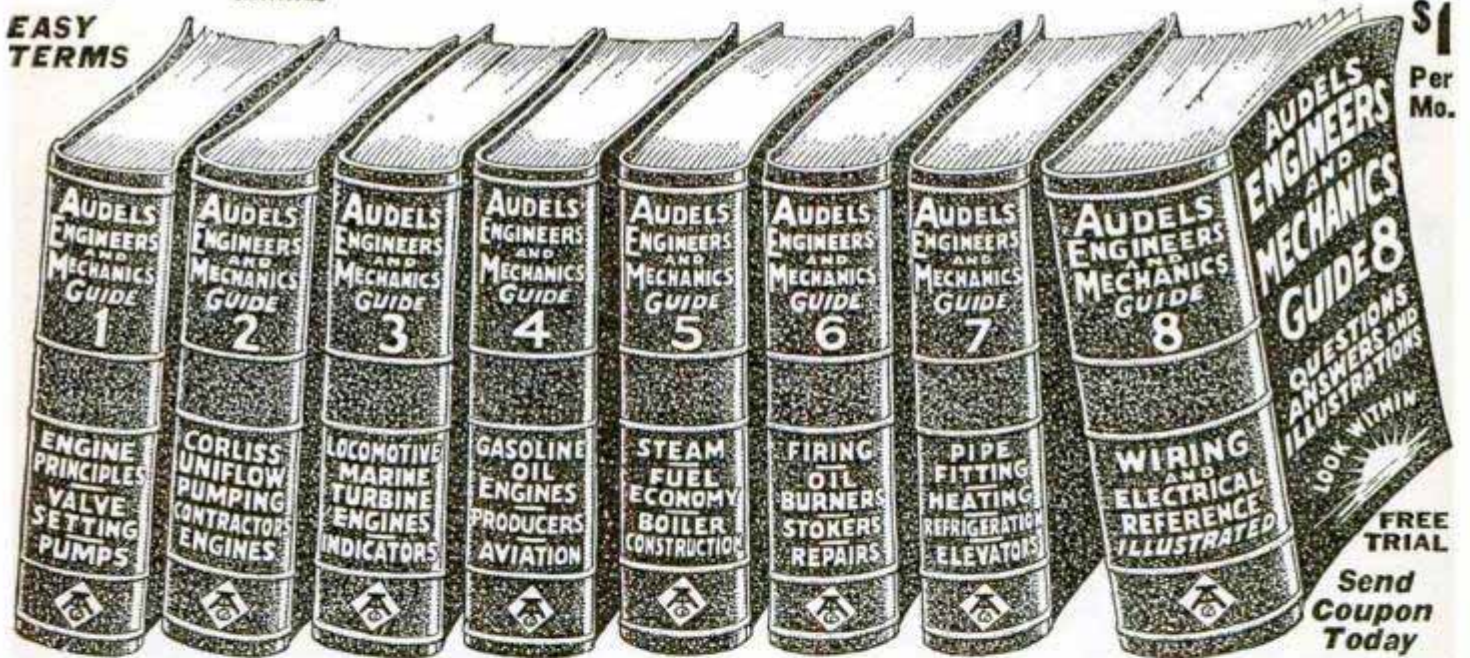

**8 GUIDES 8754 PAGES—4750 ILLUSTRATIONS—POCKET SIZE**

8 pocket numbers with Ready Reference Index. 8754 pages. 4750 illustrations. Easy to read. Highly endorsed. A good help in securing Engineer's License. Price \$12; terms. \$1 per month. Free Trial.

**INFORMATION: — In A Handy Form.** Answers to Your Questions and Problems. Here is a partial list of the subjects covered:—**Engine Principles, Valve Setting, Pumps, Corliss Engines, Uniflow Engines, Pumping Engines, Contractors Engines, Locomotives, Marine Engines, Turbine Engines, Gas Engines, Oil Engines, Indicators, Producers, Aviation, Steam, Fuel Economy, Boiler Construction, Firing, Oil Burners, Stokers, Boiler Repairs, Pipe Fitting, Heating, Refrigeration, Elevators, Dynamos, Motors, Lighting, Wiring, Electrical Diagrams, Radio, Electrical Reference and Calculations.**

**FREE BOOK—FOR LIMITED TIME.**

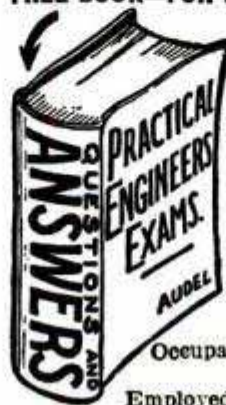

While the edition lasts, "Audels Answers" will be included with each set of Audels Guides. Contains special information for those who want to go before the board to get a license. Makes Engineers exams. easy. Send this coupon at once.

**THEO. AUDEL & CO., 65 West 23rd St., New York City**

Send me AUDELS ENGINEERS AND MECHANICS GUIDES, 8 numbers, \$12 and "Audels Answers" for free examination. If satisfactory, I will send you \$1 in 7 days, then \$1 monthly until \$12 is paid.

Name.....

Address.....

Occupation.....

Employed by.....



# You can play the HAWAIIAN GUITAR just like the Hawaiians!

Play all the latest hits just as the Hawaiians do. Be the most popular member of your set, a happy crowd always around you, everybody enjoying and admiring you playing. Get in on all the good times. Entertain your friends—or play professionally. We will help you.



## Native Hawaiian expert directs you

You get expert instruction, directed by a world-famous player and teacher, Prof. Walter Kolomo-ku. He quickly reveals to you the secrets of this fascinating instrument.

## Complete Conservatory Course

You get 52 complete printed lessons. Nothing is omitted. Pictures explain every move. And no matter how

little you know about music when you begin, no matter if you have never touched a musical instrument, you can positively learn to play by our plain, easy picture method. You are sure to learn! What we can do for others we can do for you. 51,000 successful students. This record assures your success.

## Learn at home in spare time

Study in spare time—in absolute privacy—when you like—as long as you like. Even if you don't know one note from another, our method is so simple you begin a piece your first lesson. In half an hour you can play it!

## Only 4 motions to learn

Then you can play any music—popular songs, classical, old-time melodies, native Hawaiian airs—or real jazz—separately or with accompaniment. You'll never be lonesome after you learn to play on this beautiful Hawaiian Guitar.

**GIVEN** when you enroll—  
**\$18 to \$20**  
**Hawaiian Guitar**

With Genuine Seal Grain Fabrikoid Cover and Complete Playing Outfit

Reliable retailers ask \$18 to \$20 for a similar instrument and outfit without the fine Fabrikoid Case, which alone is valued at \$3.50. Yet you receive this sweet-toned splendidly built Hawaiian Guitar, case and entire playing outfit, including picks, steel playing bar, tuning pipe, etc., without one penny of expense, as soon as you enroll.

## Pay as you play

We make it easy for you. Start any time with a small first payment—then pay while learning. It comes to only a few cents per lesson. And bear in mind: Your only investment is the cost of the course—we furnish everything else.

## No waiting—begin now

No waiting for a class to form—begin at once. The sooner you do, the sooner you will realize your ambition to become a real Hawaiian Guitarist. ACT!

OTHER COURSES: Tenor Banjo, Violin, Tiple, Tenor Guitar, Ukulele, Banjo Ukulele—well-known instructors.

## FIRST HAWAIIAN CONSERVATORY of MUSIC, Inc.

9th Floor Woolworth Bldg. Dept. 648 New York, N. Y. Approved as a Correspondence School Under the Laws of the State of New York. Member of National Home Study Council.



## Send This Coupon for Liberal Offer!

FIRST HAWAIIAN CONSERVATORY OF MUSIC, Inc. 9th Fl., Woolworth Bldg., Dept. 648, New York, N. Y.

Please send full information about your 52-lesson Hawaiian Guitar Course. I am not obligated to enroll unless I want to.

Name \_\_\_\_\_  
Address \_\_\_\_\_  
City \_\_\_\_\_ State \_\_\_\_\_

# NEW WAY TO GET A HIGH SCHOOL EDUCATION



Right at home you can now quickly make up the high-school education you missed. Thousands are doing it through the most ingenious method ever devised—the QUESTION AND ANSWER METHOD. No other method so interesting, so simple, so inexpensive, so practical. 12,000 teachers endorse this new plan. Nothing hard. More like a game. You merely read fascinating Questions and Answers in Fifteen High School Subjects: English, Biology, Geography, Physics, Literature, Arithmetic, Spelling, Physiography, Algebra, Ancient, Modern and American History, Economics, Civics, Latin—only \$19.85. Easy terms. Certificate awarded. FREE booklet, "New Way to Get Your High School Education at Home" tells exactly how to remove this lifetime handicap through a few minutes pleasant reading daily. Write for it TODAY. No obligation. Address: HIGH SCHOOL HOME STUDY BUREAU Dept. 253, 31 Union Square, New York City

**STAMMERING**  
easily, permanently corrected. Win happiness and success. Ask for full information and special phonograph record. Send dime for postage  
12972 Woodward Ave., LEWIS INSTITUTE, Detroit

**Pathfinder** TRIAL  
EVERY WEEK, 13 WEEKS  
\$1 A YEAR, 15 CENTS  
Your neighbors know the Pathfinder and you will like it—the every week news digest from the Nation's Center. Bright, interesting, dependable, different—nothing else like it. Washington gossip, politics, science, travel, fun, lots of pictures, instruction, entertainment. Trial 13 weeks—13 big issues—only 15c or \$1 for full year—52 issues. Send now. Address Pathfinder, Dept. 25, Washington, D. C.

# GOV'T. POSITIONS

\$35 TO \$75 WEEKLY

**NEW MEN - WOMEN** AGE 18 to 55

|                       |                         |
|-----------------------|-------------------------|
| ( ) Ry. Mail Clerk    | ( ) Steno-Typist        |
| ( ) Prohibition Inv.  | ( ) Immigrant Inspector |
| ( ) R. F. D. Carrier  | ( ) Seamstress          |
| ( ) Special Agent     | ( ) Auditor             |
| ( ) (investigator)    | ( ) Steno-Secretary     |
| ( ) City Mail Carrier | ( ) U. S. Border Patrol |
| ( ) Meat Inspector    | ( ) Chauffeur-Carrier   |
| ( ) P. O. Clerk       | ( ) Watchman            |
| ( ) File Clerk        | ( ) Skilled Laborer     |
| ( ) General Clerk     | ( ) Postmaster          |
| ( ) Matron            | ( ) Typist              |

OZMENT INSTRUCTION BUREAU, 111 Arcade Bldg., St. Louis, Mo. Send me FREE particulars how to qualify for positions marked "X". Salaries, locations, opportunities, etc. ALL SENT FREE.

NAME.....  
ADDRESS.....



# NOW FREE



*The SHORT CUT  
to POPULARITY*  
by Arthur Murray

*The book that has shown thousands how to become brilliant finished dancers — sought-after, popular, at home, in one evening!*

**T**HOUSANDS of men and women who used to sit at home and miss all the fun are now having the time of their lives! Countless folks everywhere who used to feel ill at ease and "out of place" at parties are now the center of attraction at social affairs!

What is the reason? These men and women sent for my book, "The Short Cut to Popularity"—and discovered a quick, easy way to become *good* dancers! And accomplished dancers, who know all the newest, smartest steps, are always in demand!

For learning to dance well does far more than merely teach you to go through a few steps correctly. It banishes timidity and self-consciousness—turns awkwardness into grace. It enables you to make friends easily—to be well liked, sought after—and often opens the door to important business and social contacts.



## Amazing New Method

You, too, can become a brilliant, finished dancer—at home, without music, partner, or teacher—through my remarkable new method!

For I have discovered that all modern dancing is based upon *five simple movements*. Once these fundamental movements are mastered, *anyone*—even if he has never been on a dance floor in his life—can quickly learn to do *any* new dance, no matter how complicated, with ease and assurance!

You practice in your spare time. There is no one to watch you and embarrass you. No expensive private teacher to pay. And my method is so easy to understand that *you can learn any of the latest steps in one evening!* Almost before you realize it, you will be ready to take your place among the best dancers of your set!

**Book and Five Lessons—FREE**

Over 400,000 men and

women have already learned to dance through my easy at-home lessons. And I'm so positive that you, too, can become an accomplished dancer right in your own home, without music or partner—that you, too, can get your full share of fun and popularity through my amazingly simple method—that I am willing to send you five lessons from my remarkable course, together with a copy of "The Short Cut to Popularity," *absolutely FREE!*

Just send the coupon, with 25c to cover cost of printing and mailing, and these valuable lessons and book will be forwarded at once. Don't wait—you owe it to yourself to clip and mail the coupon **NOW**. ARTHUR MURRAY, Studio 885, 7 East 43rd Street, New York City.

ARTHUR MURRAY, STUDIO 885,  
7 East 43rd Street, New York City.

To prove that I can learn to dance at home you may send the FIVE FREE LESSONS. I enclose 25c (stamps or coin) to pay for postage, printing, etc. You are to include free "The Short Cut to Popularity."

Name.....

Address.....

City..... State.....



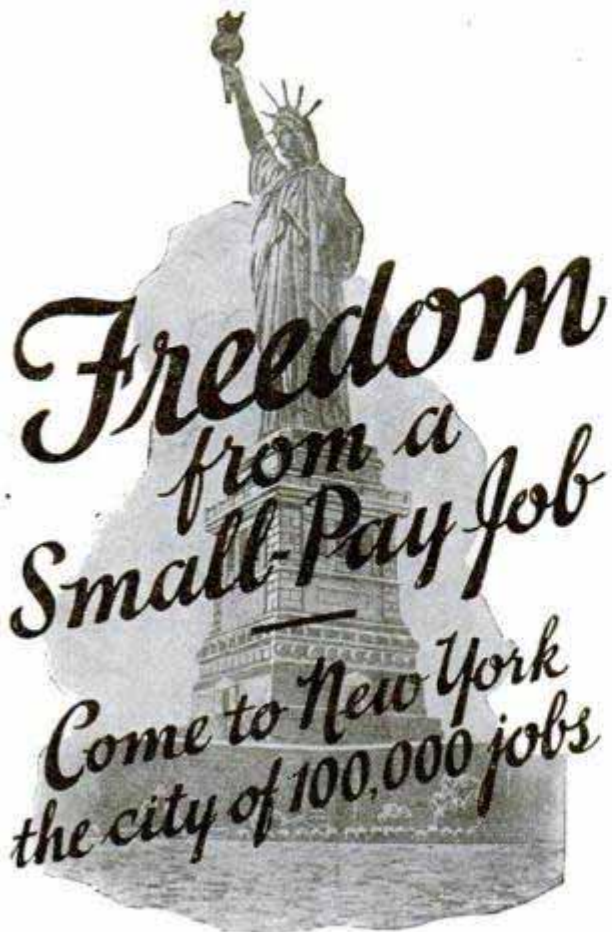

**A**NY MAN who can read and write and use a pair of pliers can become an electrical expert and free himself forever from the long hours and drudgery of a small pay job.

And you can learn the **BIG PAY** profession of electricity right in New York City—the heart of the electrical world—the city of 100,000 jobs. At the same time you are learning the **BIG PAY** profession you can be enjoying the sights and wonders of New York, the modern Bagdad.

**Be An Electrical Expert**

Graduates of the **NEW YORK ELECTRICAL SCHOOL** are in demand by all the big electrical companies. Or, if you prefer the independence of a business of your own, there are thousands of opportunities for efficient, **dependable** men to become electrical contractors. When you are your own boss the money you can make is limited only by your own energy and ability.

**Personal Instruction**

The **NEW YORK ELECTRICAL SCHOOL** is not a correspondence school. You learn by doing—by personal instruction on full size standard electrical equipment under the personal supervision of trained instructors.

At **N. Y. E. S.** you train your hands and mind at the same time. You learn the theories of electricity—and then you are shown how to put the theories into actual practice by solving the problems with your own hands.

The man who has learned electricity by actually doing electrical work under intelligent personal instructors can go to any part of the world and be sure of a good living. There are **N. Y. E. S.** graduates in all the countries of the world.

Write today for the 48-page booklet giving full information about the **N. Y. E. S.** Course and showing pictures of the equipment available for your personal use in our two seven-story buildings. Mail coupon *now!* **The New York Electrical School, 44 W. 17th Street, New York.**

**The New York Electrical School,  
44 W. 17th Street, New York.**

Please send me **FREE** your 48-page booklet. It is understood that this request puts me under no obligation.

Name.....

Address.....

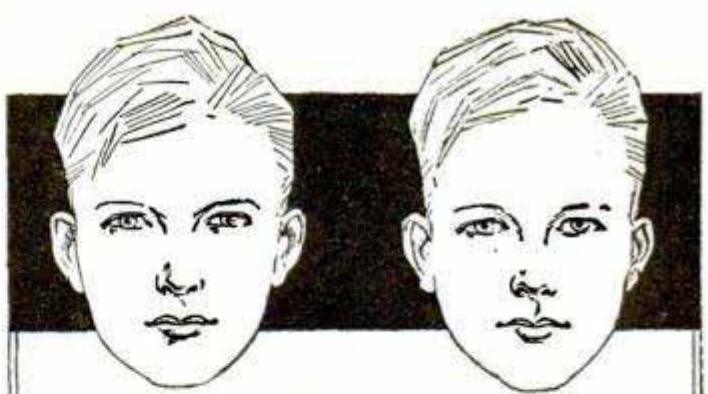

**One of these Boys Will Fail - IF**

Both possess equal health and intelligence, both have qualities for success—but one stammers. Where the one will succeed the stammerer will fail.

He will dread to meet people, he will lack the self-confidence so necessary in business. The humiliation of his disability will impair his nervous system—a condition often the beginning of ill health.

This handicap can be removed. As hundreds of other stammerers have been cured permanently at Bogue Institute, so he can be cured. The Institute was founded in 1901 by Benjamin N. Bogue, who cured himself after stammering twenty years.

Instruction is based on the principle of co-ordination between the mind and speech organs. No drugs or medicines. Endorsed by physicians. The history of the Bogue Institute and description of its methods embodied in Mr. Bogue's book, "Stammering—Its Cause and Its Cure," furnished on request. Address

**Bogue Institute for STAMMERERS**

1115 Bogue Bldg. 1147 No. Illinois St. INDIANAPOLIS, IND.



**1,000 Hotel Positions Open!**

**H**OTELS, restaurants, clubs, apartments, hospitals, institutions, schools and colleges everywhere need trained men and women. Over 70,000 high-class positions paying \$2,500 to \$10,000 a year open annually in the hotels of the United States. Nearly one and three-quarter billions of dollars' worth of **NEW HOTELS, CLUBS AND INSTITUTIONS** being built this year will need over 200,000 trained men and women. Hotels start you at salaries up to \$3,500 a year, with living usually included. At any time there are over 1,000 hotel positions open.

**Previous Experience Unnecessary**

You can have one of these fascinating, big-pay positions. Thru our Simplified Study Plan we give you the valuable knowledge that it has taken some of the most successful hotel men years to obtain. Age is no obstacle—young and old alike have equal chance for success. Past experience absolutely unnecessary. A common school education is all you need. We train you in your spare time and put you in touch with big opportunities. All of your training under the personal supervision of Clifford Lewis who has been appointed Managing Consultant for over 300 hotels thruout the United States. Our students employed by leading hotels everywhere. Send coupon today for Free Book, "Your Big Opportunity," showing how we can train you for one of these splendid positions and explaining our Money-Back Agreement.

**FREE BOOK COUPON**

**LEWIS HOTEL TRAINING SCHOOLS,  
Room BJ-385, Washington, D. C.**

Send me without obligation the Free Book "Your Big Opportunity."

Name.....  
Address.....  
City..... State.....



# "What? Learn Music by Mail?" they laughed



## "Yes," I cried, "and I'll bet money I can do it!"

ONE day after lunch the office crowd was in the recreation-room, smoking and talking, while I thumbed through a magazine.

"Why so quiet, Joe," some one called to me. "Just reading an ad," I replied, "about a new way to learn music by mail. Says here any one can learn to play in a few months at home, without a teacher. Sounds easy."

"Ha, ha," laughed Fred Lawrence, "do you suppose they would say it was *hard*?"

"Perhaps not," I came back, a bit peeved, "but it sounds so reasonable I thought I'd write them for their booklet."

Well, maybe I didn't get a razzing then! Fred Lawrence sneered: "The poor fellow *really* believes he can learn music by mail!"

"Yes, and I'll bet money I can do it!" I cried. But the crowd only laughed harder than ever.

During the few months that followed, Fred Lawrence never missed a chance to give me a sly dig about my bet. And the boys always got a good laugh, too. But I never said a word. I was waiting patiently for a chance to get the *last* laugh *myself*.

### My Chance Arrives

Then came the office outing at Pine Grove. After lunch it rained, and we had to sit around inside. Suddenly some one spied a piano in the corner. Fred Lawrence saw a fine chance to have some fun at my expense.

"Ladies and gentlemen," he cried, "our friend Joe, the music-master, has consented to give us a recital."

That gave the boys a good laugh. Some of them got on either side of me and with mock dignity started to escort me to the piano.

"Play 'The Varsity Drag,'" shouted Fred, thinking to embarrass me further. I heard a girl say, "Oh, let the poor fellow alone; can't you see he's mortified to death?"

### The Last Laugh

I smiled to myself. This was certainly a wonderful setting for my little surprise party. Assuming a scared look, I began fumbling the keys, and then . . . with a wonderful feeling of cool confidence . . . I broke right into the very selection Fred asked for. There was a sudden hush in the room as I made that old piano talk. But in a few minutes a fellow jumped to his feet and shouted, "Believe me, the boy is *there!* Let's dance!"

Tables and chairs were pushed aside, and soon the whole crowd was having a whale of a time. I played one peppy selection after another until I finished with "Crazy Rhythm" and the crowd stopped dancing and singing to applaud me. As I turned around to thank them, there was Fred holding a ten-spot right under my nose.

"Folks," he said, "I want to apologize to Joe. I bet him he couldn't learn to play by mail, and believe me, he sure deserves to win the money!"

"Learn to play by mail!" exclaimed a dozen people. "That sounds impossible! Tell us how you did it!"

I was only too glad to tell them how I'd always wanted to play but couldn't afford a teacher, and couldn't think of spending years in practice. I described how I had read the U.S. School of Music ad, and how Fred bet me I couldn't learn to play by mail.

"Folks," I continued, "it was the biggest surprise of my life when I got the first

lesson. It was fun right from the start, everything as simple as A-B-C. There were no scales or tiresome exercises. And all it required was part of my spare time. In a short time I was playing jazz, classical pieces, and in fact, anything I wanted. Believe me, that certainly was a profitable bet I made with Fred."

### Play Any Instrument

You, too, can *teach yourself* to be an accomplished musician—right at home—in half the usual time—through this simple new method which has already taught almost half a million people. Forget that old-fashioned idea that you need special "talent." Just read the list of instruments in the panel, decide which one you want to play and the U. S. School will do the rest. And bear in mind no matter which instrument you choose, the cost averages just a few cents a day.

### Send for Our Free Booklet and Demonstration Lesson

If you are in earnest about wanting to play your favorite instrument—if you really want to gain happiness and increase your popularity—send at once for the Free Booklet and Free Demonstration Lesson which explains all about this remarkable method. The booklet will also tell you all about the amazing new *Automatic Finger Control*. No cost—no obligation. Sign and send the convenient coupon now. Instruments supplied when needed, cash or credit. U. S. School of Music, 73 Brunswick Bldg., New York City.

U. S. School of Music,  
73 Brunswick Bldg., New York City.

Please send me your free book, "Music Lessons in Your Own Home," with introduction by Dr. Frank Crane, Free Demonstration Lesson and particulars of your easy payment plan. I am interested in the following course.

Have you Instr? .....

Name.....

Address.....

City..... State.....

### What Instrument for You?

- |                          |                  |
|--------------------------|------------------|
| Piano                    | Piccolo          |
| Organ                    | Hawaiian         |
| Violin                   | Steel            |
| Clarinet                 | Guitar           |
| Flute                    | Drums and        |
| Harp                     | Traps            |
| Cornet                   | Mandolin         |
| Cello                    | Sight Singing    |
| Guitar                   | Trombone         |
| Ukulele                  | Piano            |
| Saxophone                | Accordion        |
| Banjo (Plectrum, 5-      | String or Tenor) |
| Voice and Speech Culture | Automatic        |
|                          | Finger Control   |



# 90 Days the PRACTICAL WAY... then an

## ELECTRICAL

Complete  
RADIO  
COURSE

# JOB

COMPLETE  
AUTOMOTIVE  
ELECTRICAL  
COURSE

## at Big Pay

### \$40 to \$200 a Week

MAIL COUPON TO-DAY FREE BOOK  
for Big, Illustrated, 64-PAGE

Not a Correspondence Course — No Books — No Lessons

# McSWEENEY

## ELECTRICAL SCHOOLS

DEPT. 51-Y, CLEVELAND, OHIO

## HOT PIANO

Ultra-modern Piano  
Jazz taught by mail. Note or ear. Easy rapid lessons for adult beginners. Also Self-instruction system for advanced pianists. Learn 358 Bass Styles, 976 Jazz Breaks, hundreds of Trick Endings, Hot Rhythms, Sock, Stomp and Dirt Effects; Symphonic and Wicked Harmony in latest Radio and Record Style. Write for Free Booklet.  
WATERMAN PIANO SCHOOL, 1826 W. Adams St., Los Angeles, Calif.

Remarkable  
Tuition Offer  
for Short  
Time Only



J. H. McSweeney, Pres.,  
McSweeney Electrical Schools,  
Dept. 51-Y, Cleveland, O.  
Dear Mac: Without obligation, send me a copy of your big book on ELECTRICITY; also details of Special Limited Tuition Offer.

Name.....  
Address.....  
Town..... State.....

## Watch Your ENGLISH

"Different than  
"Can't hardly"  
"It's him"

### New Invention Ends Mistakes

You may make errors in English and never know it. Mistakes in spelling, grammar, punctuation, pronunciation make others think you uneducated and may be handicapping your success.  
Correct your bad habits in English through Sherwin Cody's remarkable new method. Only 15 minutes a day required. Over 65,000 already helped. Fascinating as a game. Get free book about this spare-time method. Write today.  
Sherwin Cody School of English, 53 Searle Bldg., Rochester, N.Y.



## LEARN CARTOONING

AT HOME DURING SPARE TIME

with the course that has trained HUNDREDS of beginners successfully. The Landon Picture Chart Method of teaching ORIGINAL drawing by mail makes cartooning easy to learn. This school is a Member of The National Home Study Council. Write today for sample picture chart to TEST YOUR ABILITY and examples of the work of successful students now earning from \$50 to \$200 and more per week.  
Enclose 6c in stamps and STATE YOUR AGE.

THE LANDON SCHOOL, 2838 National Bldg., Cleveland, Ohio



# PATENTS

Booklet Free Highest References  
Promptness Assured Best Results

Send drawing or model for preliminary examination of Patent Office records.

ALL BUSINESS GIVEN PROMPT AND PROPER ATTENTION

Listed Patent Lawyer in the latest editions of the Rand-McNally Directory of Bankers and Bonded Attorneys, published by Rand-McNally & Co., Chicago, Ill.; The Baggott & Ryall Directory of Guaranteed Attorneys, published by the Ryall Legal Directory Company, New York City; Flugel's List, published by the Legal Directory Publishing Co. of St. Louis, Mo.; the American Lawyers Annual, published in Cleveland, Ohio; Eyre's Law List, Bush Terminal Building, New York City.

**WATSON E. COLEMAN,**  
REGISTERED PATENT LAWYER

Victor Building, 724 Ninth Street, N. W.  
**WASHINGTON, D.C.**



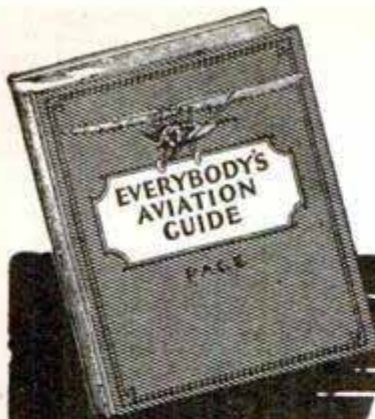

# "AVIATION GUIDE" Given Free!

For a limited time only we will give Major PAGE'S sensational "best seller" among aviation books—absolutely free with our Auto Encyclopedia.

Thousands of men have each paid \$2.00 in cold cash for this great flying hand-book, but you can have one WITHOUT COST if you act promptly. Mail coupon, send no money.

# AUTO

## 5 AUTO BOOKS SENT FREE!



### AVIATION for BEGINNERS!

256 pages, 140 illustrations, 600 questions and answers on aviation. Everything about ships and flying explained in simple language, pictures and diagrams. All aeronautical terms explained. Airplanes and airships, balloons and dirigibles. Elementary aerodynamics, how an airplane flies, airplane parts and functions, fuelage forms, landing gear, wing design and construction, power requirements, airplane engines, propellers, equilibrium and control, etc., written in lesson form. Prepares for positions in ground-work, paves the way for flying. The most instructive and interesting book on aviation on the market.

Mail the coupon and we will send you a set of these remarkable auto books, just off the press. Whether you are mechanic or helper, expert or student, owner or driver—if you're interested in autos by all means take advantage of this opportunity to see and USE the latest and most complete reference work on autos ever published. Built by eighteen of America's greatest Automotive Engineers. So simple, so clear, so fully illustrated with pictures, charts, diagrams and blue prints that even men with little schooling can understand every fact. Yet in daily use by thousands of engineers, service-station superintendents and shop foremen as the most dependable reference encyclopedia available. The new edition includes straight eights, four-wheel brakes of all types, high compression engines and other features of the newest models. 5 volumes, 2400 pages, over 2000 illustrations, charts, diagrams and blue-prints.

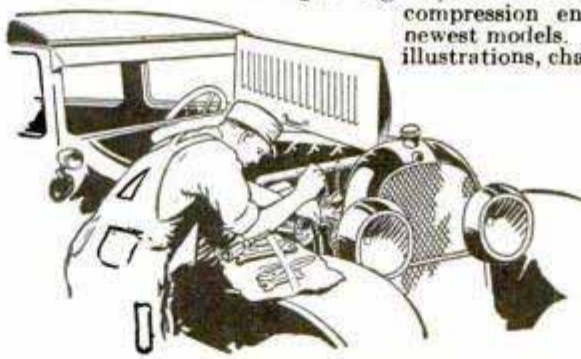

## Can You FIX IT?

## These Books Tell HOW!



The ten-billion-dollar a year auto industry offers rich prizes to men with gumption enough to really learn all branches of Automotive mechanics. A better job—bigger pay—the chance to go into business for yourself and get a share of the huge profits, are waiting for any man who even half tries to improve his ability to deliver service. And here's the quickest, easiest, cheapest way—no studying, no memorizing, no "lessons" or examinations. At a small fraction of the cost of a trade-course. **Just LOOK UP the facts you seek!** You'll find the answer to any auto problem literally at your finger tips in the remarkable **JIFFY INDEX**, now a feature of this encyclopedia. Mail coupon quick, and get "AVIATION GUIDE," free with these books.

Can you take the "play" out of differentials? Can you kill the SHIMMY in steering? Can you reset TIMING? Can you put your finger on ENGINE TROUBLE instantly without guessing or tinkering? Can you pull the STARTER off and fix it? Can you adjust and repair transmissions, rear-axes, engines and electrical systems? Can you make emergency repairs on the road or are you helpless when some little thing goes wrong? Is your hand always in your pocket, **paying, paying, paying?**

## DON'T SEND A PENNY!

American Technical Society,  
Dept. A-319,  
Drexel Ave. and 58th St.,  
Chicago, Ill.

**AVIATION BOOK FREE**

I would like to see the new 5-volume edition of your AUTO BOOKS, but without obligating me to buy them. I will pay the few cents delivery charges only and if I choose to, I will return them express collect. If after 15 days' use I prefer to keep them, I will send you \$2 and pay the balance at the rate of only \$3 a month, until \$24.80 is paid. Please include a year's consulting membership free, and send "AVIATION GUIDE" without cost after I notify you I will keep the books.

Name.....  
Address.....  
Employer's Name.....  
Employer's Address.....



**American Technical Society**  
Dept. A-319, Drexel Ave. & 58th St.,  
Chicago, Illinois





**Before Kenneth McCarty  
Mailed that Coupon  
He was an  
\$18<sup>00</sup> Clerk~**



**Today  
His  
Income  
is  
\$85<sup>00</sup>  
a Week**

**Play for Fun or  
\$5,000 a Year**

Whether a salary of \$65 to \$100 a week—or spare time playing at \$5, \$10, \$15 or more a night—interests you or not—think of the fun in store for you. In one to three months we can train you at home to play this marvelous, melodious instrument with a fine easy skill that will make you the envy of all other eyes. Think, too, of the pleasure of being able to express yourself musically when alone! You're passing up the **best times** of your life if you pass up an opportunity like this to learn at slight cost and with no inconvenience at all the world's most popular instrument. **DON'T DO IT!** Decide NOW to learn more about The Play-Way—the quickest, surest short-cut ever devised to social and professional success.

**FREE Book  
Tells How**

Send at once for "The Play-Way to Popularity and Big Pay." Learn all about our unique method of training you at home, about the big, professional size Tenor Banjo, Phonograph Records and complete Outfit that we send you along with your very first lesson. Undreamed of possibilities for pleasure, popularity and big pay are open to you the minute you "become good." The book below is your first step. Take it now. Clip the coupon while it's here before your eyes.

**Get Big Free Book**

**A. F. Bloch, President,  
NEW YORK ACADEMY OF MUSIC,  
Studio 1039, 100 Fifth Avenue,  
New York City.**

Send me the book that started McCarty.  
No obligation whatsoever on my part,  
understand.

Name.....

Address.....

After completing the course he wrote us: "Yours is the finest course ever presented for the Tenor Banjo. Before I enrolled with you, I knew nothing whatever about music. I was earning \$18.00 weekly clerking in a store. **Little did I realize the opportunity that had come.** I took up the course just for fun. But here I am playing in one of the best orchestras in Western Michigan and **making \$85.00 a week.** Your course and your kind cooperation have made me a professional Tenor Banjoist."—*Kenneth McCarty, Parkview Hotel, South Haven, Mich.*

**You Get Phonograph  
Records, Too**

Every selection of the course, fifty-five in all—comes to you on a phonograph record. You hear the instructor's playing just as though he were right at your side. The Play-Way is different, interesting, **FOOL PROOF.** Get the good news the coupon brings. **SEND FOR IT NOW!**

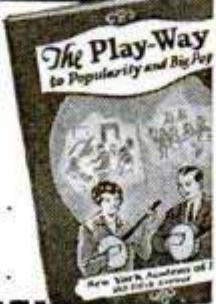

**LEARN TO FLY~**



**WHERE  
LINDBERGH LEARNED!**

**G**ET the same complete, thorough, foundational training that Lindbergh received. Get it now—under greatly improved facilities—at the Lincoln Airplane School. Much better than when Lindbergh learned here. Get the best training now available. Here competent, experienced instructors teach you *practical* Flying and Ground Work. You go right up into the sky in our famous Lincoln Page Government Licensed Planes—with transport pilots. Learn on actual planes and motors supplied by the Lincoln Aircraft Factory. Write for full information today!

**LINCOLN AIRPLANE SCHOOL  
202 Aircraft Bldg., LINCOLN, NEBR.**

**FOR YOUR FUTURE**



**INVESTIGATE THIS  
VOCATIONAL TRADE OPEN TO ALL  
WHETHER 18 OR 50**

The opportunity of a lifetime to become financially independent. Earn up to \$5,000 a year. Great demand and always will be because it is a human necessity. Easily learned in three to six months by actual practice with the regular tools of the trade. No previous training required. Business of your own if desired. Oldest establishment in this field is now ready to train an additional number of men for this work. Remarkably low cost—starting fees as low as \$15. R. R. Fare to nearest school included. Earn while you learn if necessary—regular arrangement for part time positions. Investigate this opportunity. The facts are convincing. Write today for Bulletin No. 2 which gives complete information.

**BODEE INSTITUTE**

New York  
1755 Broadway

Philadelphia  
1305 North Broad Street

Brooklyn  
85 Court Street

**Giant Muscles  
in 90 days**



**Quick  
Strength from this Exerciser  
New**

Become the strongest man in your town in a few short weeks. Perform feats of strength that will amaze your friends. Bend horse-shoes, tear decks of playing cards in two, chin yourself with one hand. Get this marvelous new exerciser with complete FREE Course of Instructions and the strength of a Hercules can be yours. \$1.98 for 5 cable exerciser, \$3.98 for 10 cable exerciser. **SEND NO MONEY**—Simply clip and mail this coupon.

**only  
\$1<sup>98</sup>**

**GIBRALTAR EXERCISER CO.  
Dept. G4003, 225 W. 34th St., New York, N. Y.**

Gentlemen:  
Please send me your marvelous new.....Cable Exerciser,  
for which I am to pay postman plus postage, on delivery.

Name.....

Address.....

City..... State.....



# Learn AVIATION at GREER COLLEGE

## Come into Aviation

**Man's Dream Is Answered—Aviation Is Here**

**Transport Flyers will train you**

Chief Pilot Meyer, operator of Meyer Air Transport, supervises all Flying instruction. He has for 14 years been an Instructor, Transport and Photographic Flyer, and has never had an accident to Student or Passenger.

**Capt. Bryan superintends ground training**

Captain Bryan—with years of Army

and Civilian Aviation Experience—supervises all ground schooling. He has been in Aviation and actual Flying for over twelve years.

**Earn Big Money in a 4 Hour Day**

What are a Flyer's hours? **Four Hours**—not work—but fun—nevertheless those are usually the hours for him.

And the pay! Many make \$300 on a single Sunday. My Free Book gives astonishing details. Send for it now!

**Adventure—Prestige—Thrills—BIG PAY—Easy, Fascinating work that IS Aviation.**

**I'll pay your fare to Chicago**

Come to Chicago. I'll pay your fare when you enroll. Here is the real hub of the Aviation Industry. The World's finest and biggest Airport is here. Get my Free Book—tells all remarkable facts.

**LEARN DAYS OR EVES  
A Job while Learning**

You can attend the Great Shops of Greer College and learn Aviation either days or eves. We even help get you a job so you earn as you learn—in short—what does this wonderful training cost? Nothing!



Erwin Greer



### HOW!

I offer you a \$100 a week opportunity, perhaps more. But you must prepare. \$100 a week jobs mean nothing unless you can hold those jobs—so Prepare. I make it easy—26 years doing it—proves it, so when those jobs arrive—be ready—I'll help you get them—but be able to hold them.

**TODAY**

Tomorrow is just a day—but think—is it to be a day **wasted** or a day **rushing** to success? Think of it. Tomorrow, may be just the second day to your real triumph—but tomorrow can't possibly come before today. I ask you to do nothing but find out for yourself. My Book is Free. Look at it at least, it costs you nothing and it **will** help you if you enroll or don't.

Sincerely,

**ERWIN GREER, Pres.**

**GREER COLLEGE**

**Dept. 301**

**2024 So. Wabash Ave.**

**CHICAGO**



**SCISSORS FOR FREE BOOK**

**ERWIN GREER, President**  
Dept. 301  
2024 So. Wabash Avenue,  
Chicago, Illinois

Send Free Book and details of Special offer, without obligation to me.

Name .....

Address..... Age.....



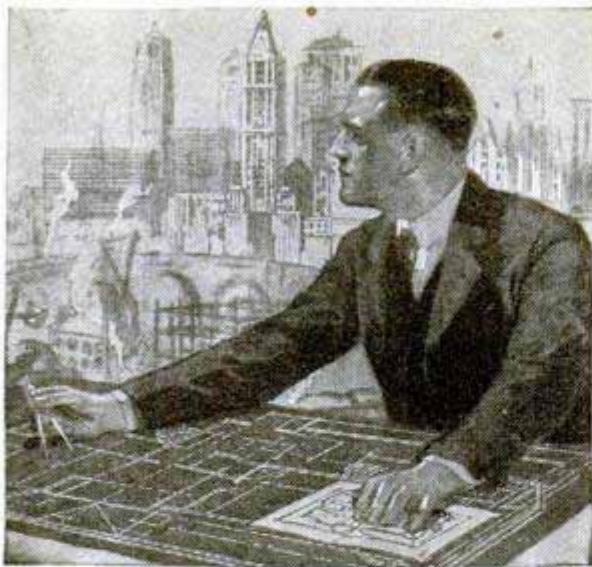

## Former Plasterer Now Earning \$12,000 a Year

"When I enrolled with the International Correspondence Schools, I was a plasterer and I didn't know a thing about blueprints. Today I have my own contracting business and I am able to figure the most difficult jobs and execute them to the satisfaction of everyone concerned. My income is between \$12,000 and \$15,000 a year. It certainly was a lucky day for me when I sent in that I. C. S. coupon."

That's a true story of what just one student of the International Correspondence Schools has done. Every mail brings letters from other ambitious men and women telling of promotions and increases in salary due directly to spare-time study.

One hour a day spent with the I. C. S., in the quiet of your own home, will prepare you for success in the work you like best.

### Mail Coupon for Free Booklet

#### INTERNATIONAL CORRESPONDENCE SCHOOLS

"The Universal University"

Box 5601-F, Scranton, Penna.

Without cost or obligation, please tell me how I can qualify for the position, or in the subject, before which I am marking X:

- |  |   |
|--|---|
| <input type="checkbox"/> Architect                                 | <input type="checkbox"/> Navigation                                       |
| <input type="checkbox"/> Architectural Draftsman                   | <input type="checkbox"/> Salesmanship                                     |
| <input type="checkbox"/> Contractor and Builder                    | <input type="checkbox"/> Advertising                                      |
| <input type="checkbox"/> Building Foreman                          | <input type="checkbox"/> Window Display                                   |
| <input type="checkbox"/> Concrete Builder                          | <input type="checkbox"/> Show Card and Sign Lettering                     |
| <input type="checkbox"/> Structural Engineer                       | <input type="checkbox"/> Business Management                              |
| <input type="checkbox"/> Structural Draftsman                      | <input type="checkbox"/> Industrial Management                            |
| <input type="checkbox"/> Plumber and Steam Fitter                  | <input type="checkbox"/> Secretarial Work                                 |
| <input type="checkbox"/> Heating and Ventilation                   | <input type="checkbox"/> Business Correspondence                          |
| <input type="checkbox"/> Plumbing Inspector                        | <input type="checkbox"/> Bookkeeper                                       |
| <input type="checkbox"/> Foreman Plumber                           | <input type="checkbox"/> Stenographer and Typist                          |
| <input type="checkbox"/> Sheet Metal Worker                        | <input type="checkbox"/> Higher Accounting                                |
| <input type="checkbox"/> Civil Engineer                            | <input type="checkbox"/> Common School Subjects                           |
| <input type="checkbox"/> Surveying and Mapping                     | <input type="checkbox"/> Mathematics                                      |
| <input type="checkbox"/> Reading Architects' Blueprints            | <input type="checkbox"/> Illustrating <input type="checkbox"/> Cartooning |
| <input type="checkbox"/> Electrical Engineer                       | <input type="checkbox"/> Railway Mail Clerk                               |
| <input type="checkbox"/> Electric Lighting                         | <input type="checkbox"/> Civil Service <input type="checkbox"/> English   |
| <input type="checkbox"/> Electric Wiring                           | <input type="checkbox"/> Mining Engineer                                  |
| <input type="checkbox"/> Telegraph Engineer                        | <input type="checkbox"/> Gas Engine Operating                             |
| <input type="checkbox"/> Practical Telephony                       | <input type="checkbox"/> Textile Overseer or Supt.                        |
| <input type="checkbox"/> Mechanical Engineer                       | <input type="checkbox"/> Traffic Manager                                  |
| <input type="checkbox"/> Mechanical Draftsman                      | <input type="checkbox"/> Automobiles                                      |
| <input type="checkbox"/> Toolmaker                                 | <input type="checkbox"/> Airplane Engines <input type="checkbox"/> French |
| <input type="checkbox"/> Machine Shop Practice                     | <input type="checkbox"/> Agriculture <input type="checkbox"/> Spanish     |
| <input type="checkbox"/> Chemist <input type="checkbox"/> Pharmacy | <input type="checkbox"/> Poultry Raising <input type="checkbox"/> Radio   |

Name.....

Street Address.....

City.....State.....

Occupation.....

Persons residing in Canada should send this coupon to the International Correspondence Schools Canadian, Limited, Montreal, Canada

# How To Secure A Government Position

Why worry about strikes, layoffs, hard times? Get a Government job! Increased salaries, steady work, travel, good pay. I'll help you become a Custom House Clerk, Railway Postal Clerk, Post Office Clerk, City Mail Carrier, Rural Carrier—or any other Government job you want. I was a Secretary-Examiner of Civil Service Commission for 8 years. Have helped thousands.

## Now FREE

My 32-page book tells about the jobs open—and how I can help you get one. Write TODAY. ARTHUR R. PATTERSON, Civil Service Expert, PATTERSON SCHOOL, 83 Wisner Building, Rochester, N. Y.



## PREPARE FOR AN

# ART CAREER

—thru the only art school operated as a department of a large art organization, who have actually produced over a quarter million drawings for leading advertisers. Where else can you get so wide an experience? Home study instruction. Write for illustrated book telling of our successful students.

**MEYER BOTH COMPANY**  
Michigan Ave. at 20th St. Dept. 16, Chicago, Ill.

## LEARN WATCH REPAIRING



You can learn by our modern and original system of instruction every part of the **Watch Repairing Trade** at home as good or better than at a shop. You can earn money while learning and secure a well paying position or start in business after completing our course of instruction. Good watch repairers are always in demand and earn from \$50 to \$75 per week. For particulars apply to the **Wisconsin School of Watch Repairing** 166 Mason St., MILWAUKEE, WIS.

## Don't Envy The Plumber — BE ONE!

**\$11.00-\$16.00 PER DAY** and work EVERY day, is the Plumber's wage.

**LEARN IN 8 to 12 WEEKS** without previous experience.

If you are making less than \$60.00 a week you owe it to yourself to investigate. Get FREE catalog that tells in pictures and words how we teach this trade. Special rates now.

UNIVERSAL PLUMBING SCHOOL, 2030 Troost Avenue, KANSAS CITY, MO.

## Learn Watchwork, Jewelrywork and Engraving

A fine trade commanding a good salary, and your services always in demand. Address **Horological**, Dept. P, Bradley Institute, PEORIA, ILLINOIS, for our latest catalog.

## ILLINOIS COLLEGE of PHOTOGRAPHY

Prepares you in from 6 to 8 months to earn \$200 to \$500 a month as a photographer or photo-engraver. Thorough practical training. Expenses low. Constant demand for our graduates. 35th year. Enroll immediately. Free catalog. **Box 439, Effingham, Illinois.**

## MUSIC LESSONS IN YOUR HOME



Write today for our **FREE booklet**. It tells how to learn to play Piano, Organ, Violin, Mandolin, Guitar, Banjo, etc. Beginners or advanced players. Your only expense about 3c per day for music and postage used. **American School of Music, 51 Manhattan Bldg., Chicago.**



# GREAT NEWS

## If You Want a Real Pay Job

# IN DRAFTING!

A New Easy Method Doubles The Earning Possibilities For Ambitious Men In This Great Field. Now—Right At Home—You Can Receive College Training In Drafting—From An Old Established College Known and Recognized Throughout The World—Chicago Tech. Yet The Cost Is Only A Fraction Of Ordinary College Training.

### Chicago Tech Now Brings College Training in Drafting To You—At Home

HERE'S great news for every wide-awake man who wants to get into a big-money drafting job! An easy, practical home-study method has been developed which enables you to get the famous College-Training-In-Drafting as taught at Chicago Technical College—without leaving your home. This is the kind of training that employers are looking for in the men they hire. Training from a school that has real prestige wherever you go. Now you, too, can master professional drafting in your spare time and quickly prepare yourself for a position paying \$5,000 to \$7,000 a year and more!

### New Easy Practice Method

Realizing that many ambitious men cannot afford to go to college, this famous school, noted for its plain, practical, easily-mastered instruction, has worked out a plan whereby everyone can get actual College Drafting Training at home. As a result the top-notch jobs of this profitable profession are now within your easy reach. Think of it! The same fine drawing outfits, the same simple lessons and the same practical training as prepared and taught at the college!

### Fascinating—Simple As A. B. C.

It's just like playing a fascinating game. No hard textbooks—no involved problems to solve. This astonishing new course is so different from ordinary "schooling" and so easy to master that you will be surprised and delighted with your progress.

### Drawing Outfits FREE of Extra Cost

A full set of fine drawing instruments in handsome pocket case, special drawing table and valuable drawing outfit are included without extra cost. You are furnished with everything necessary to big-pay training.

### Don't Delay—Act Now!

If you are sincere in your desire to get out of the rut and step into a high-salaried drafting position, investigate this new home-study method at once. The coupon brings free trial lesson and full details that will prove to you that here is just the certificated training you want. Mail it now—no obligation.

## CHICAGO TECHNICAL COLLEGE

Dept. C-202, Home Study Division  
118 E. 26th St. Chicago, Ill.

*If you live nearby, visit the College. See how we train Draftsmen for Big Pay Jobs. More than 1000 attend every year.*



**NOW FREE**  
**Sample Lesson and Book**

If the news of this wonderful home study College Training in Drafting sounds too good to be true, mail the coupon below for free trial lesson and interesting literature. Convince yourself of the merits of this approved training that will prepare you for a top-notch drafting job in a short time. No obligation—so act at once.

**Mail The Coupon**



**CHICAGO TECHNICAL COLLEGE,**  
Dept. C-202, Home Study Division,  
118 E. 26th St., Chicago, Ill.

Please send me at once the sample lesson and complete facts about your new system that enables men to master College Drafting Training at home just as you teach it at College in Chicago. This does not obligate me in any way.

Name.....

Address.....

Town..... State.....

Age..... Occupation.....

( ) Check here only if you prefer to come to Chicago for our short course in Drafting at Chicago Tech. Opportunities to earn while learning.



# Magic

**Learned  
Easily At  
Home**



**Dr.  
Harlan  
Tarbell**  
Master of Magic  
who has mystified  
magicians  
as well as lay-  
men with his  
marvelous tricks.

## Astonish Your Friends

Gain that magnetic popularity that makes you the center of any crowd. Business and social success is assured the man who can perform mystifying tricks. You can earn big money either on the side or as a professional, as well as being the most popular person in your crowd. Why envy others' skill? You can learn Magic yourself, quick and easy.

## Earn \$250 to \$1000 a Month

Even sleight-of-hand, generally supposed to require long practice, is NOW made simple to learn. For Dr. Harlan Tarbell, one of the really Great Magicians, has finally opened up the secrets of his profession in a completely illustrated course offered at a merely nominal cost. Through the wonderful Tarbell System you will be able to mystify and entertain your friends with simple tricks taught in your very first lesson. After that Dr. Harlan Tarbell takes you through the entire maze of sleight-of-hand, card tricks and elaborate stage diversions. The apparently superhuman doings of the accomplished magician become as simple as ABC when you just know how.

## Free Literature

There is a tremendous demand for magic entertainment. Clubs, Lodges, Charity and Social affairs—all will pay high fees to the man who knows Magic. Dr. Harlan Tarbell really gets as high as \$250 for an hour's work right now. Opportunity everywhere to make money aside from your regular occupation. Salesmen find it a tremendous asset. Write today for free Magic Literature telling all about the amazing Tarbell course in Magic. Get our low prices and EASY Terms. Mail coupon today!

## Tarbell System, Inc.

1926 Sunnyside Ave., Studio 13-53, Chicago

### Tarbell System, Inc.

1926 Sunnyside Ave., Studio 13-53, Chicago

Tell me all about Dr. Tarbell's new and simple system by which I can learn the secrets of MAGIC. No obligation on my part.

Name.....

Address.....

## MEN ARE WANTED

### IN RAILWAY TRAFFIC INSPECTION



**Earning  
\$192 per Month  
—and Likes His  
Work**

I am earning \$192.00 per month and I have the knowledge and satisfaction that my work is highly satisfactory to my superiors. I am far more than satisfied and received far more than I expected when I first subscribed for your course. Considering you the greatest benefactor that has come into my life,  
I am

(Signed) JOE ETTLE

Many men are needed in Railway Traffic Inspection to fill salaried positions. It's fascinating, outdoor work with rapid advancement. You travel—or remain near home. For ten years this school has trained men and placed them in Railway Traffic Inspection, Railway everywhere look to us for Inspectors. It only requires 3 months spare time home instruction, and you're qualified to step into a salaried position that will, with experience, pay \$175, \$200, \$250 per month. We'll train you for Traffic Inspection, and upon completion, assist you to a position paying at least \$120 per month, plus expenses, or refund your tuition.

Send for Free Booklet now! It tells all about Traffic Inspection—how it has started hundreds of men to big pay jobs—what it can do for you—how we can assist you to a salaried position with rapid advancement.  
Send for it today.

**STANDARD BUSINESS TRAINING INSTITUTE  
DIVISION 2  
BUFFALO, N. Y.**

**EARN UP TO \$250 per month SALARY**

## Electrical Engineering

Course for men of ambition and limited time. Over 5000 men trained. Condensed course in Theoretical and Practical Electrical Engineering including the closely related subjects of Mathematics and Mechanical Drawing.

Students construct motors, install wiring, test electrical machinery. Course designed to be completed in one college year. Prepare for your profession in the most interesting city in the world. Est. 1893. Catalog on request.



## Bliss Electrical School

133 Takoma Ave., Washington, D. C.



## WANT THIS JOB?

\$1700 to \$2300 a Year

**MAIL CARRIERS—POSTAL CLERKS**

Men 18 up

**Steady Work**

**Paid Vacation**

Write immediately for FREE list of positions and full particulars telling how to get a position.

**FRANKLIN INSTITUTE**

Dept. N-312

Rochester, N. Y.

**earn money AT HOME**

Men or women earn \$25 to \$50 a week at home. All or part time. Fascinating work. Nothing to sell. We teach you at home. Furnish all tools and materials. ARTCRAFT STUDIOS, Dept. 50, 427 Diversy Parkway, Chicago.

## BE A MAGICIAN!

**I WILL TEACH YOU, FREE!**



Be popular in any crowd. Give exhibitions at clubs, parties and lodges. I can teach you hundreds of entertaining tricks in just a few hours so you can delight your friends and be invited everywhere.

**12 MAGIC TRICKS SENT FREE**

To prove how quickly you can learn, I will send you 12 amazing magic tricks and teach you how to do them—ABSOLUTELY FREE. Send only 25c to cover postage, packing, etc. Write today to  
**A. P. FELSMAN, Dept. 45, 154 No. Clark St., Chicago, Ill.**



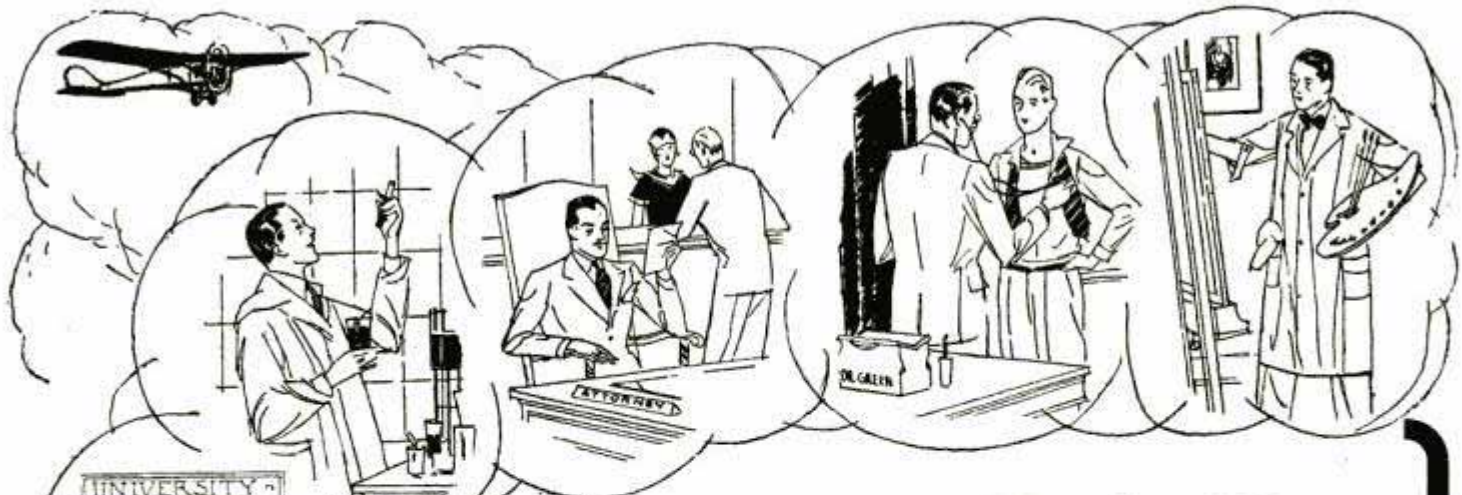

# Let Me Help You

No Matter What Your Aim May Be, Barbering Will Help You to It. Saturday Work Alone Will Make Your Living While Preparing for a Future—

*Easy to Learn—Quick to Earn*

**YOU** may never want to go beyond this Splendid Paying Work—probably will not when you know its possibilities, but if—

**AVIATION**  
IS YOUR HEIGHT  
**ELECTRICITY**  
YOUR SPARK  
**LAW**  
YOUR PLEA

**MEDICINE**  
YOUR DOSE  
**ART**  
YOUR EYE  
**MUSIC**  
YOUR CHORD

# BARBERING WILL HELP YOU TO IT

## Barbering Has Other Appeals

You Can Be Your Own Boss—Travel and See the World—South in Winter—North in Summer.

## Moler Made Barbers

Have Exceptional Opportunities on De Luxe Trains—on Ocean Steamships—in Hospitals—in Universities, Office Buildings, etc.

*Moler Shop Owners—the Big Majority—Employ Moler Graduates*

Send Coupon Today for Booklet B

## MOLER SYSTEM OF COLLEGES

## As a Moler Barber

You Are Standardized by the Educational Council of the Master Barbers of America and Employed in Organized Shops Everywhere. You Are Placed in Your Own Community, If Desired, Through Our Publicity Contest, the Most Original Plan of Placing Graduates Ever Thought of.

**You Are One of 60,000 Successes**

*What's Your Aim?*

**MOLER COLLEGE**

BEAUTY CULTURE BARBERING

### THE STANDARDIZED BRANCHES

- |                  |                 |                    |
|------------------|-----------------|--------------------|
| New York, N. Y.  | Cleveland, Ohio | New Orleans, La.   |
| Chicago, Ill.    | Detroit, Mich.  | Atlanta, Ga.       |
| St. Louis, Mo.   | Denver, Colo.   | Memphis, Tenn.     |
| Kansas City, Mo. | Omaha, Nebr.    | Dallas, Tex.       |
| Cincinnati, Ohio | Milwaukee, Wis. | Minneapolis, Minn. |

### MOLER SYSTEM OF COLLEGES

Address Nearest Branch (Street Address NOT Needed)  
Please send me without obligation on my part your Booklet B.

Name .....

Address .....

City ..... State .....



**I'll Refund your R-R-Fare to Chicago**

# Learn Electricity

## Men Wanted

I can help place 20 TO 40 men a day, in JOBS, while learning and after. Never before such unusual opportunities. Get my free book now. Learn about the big pay in ELECTRICITY—the Big Pay BUSINESS of today. That's why GREER College selected this Great Field. Coupon brings you amazing facts.

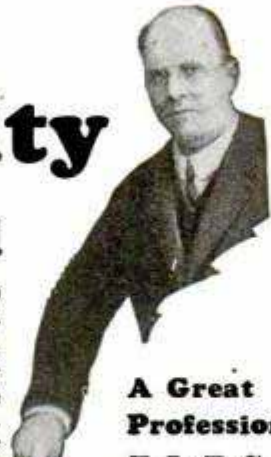

### A Great Profession

**ELECTRICITY** now pays hundreds of Greer trained men up to \$200 A WEEK. Here

**Earn up to \$150.00 a week**

is a most wonderful business. One hundred million is spent annually to keep it going. Get your share—clip the coupon.

Greer trained men are NEEDED. I HAVE MADE hundreds of \$10,000 A YEAR MEN. 90,000 in the last 26 years have come to Greer.

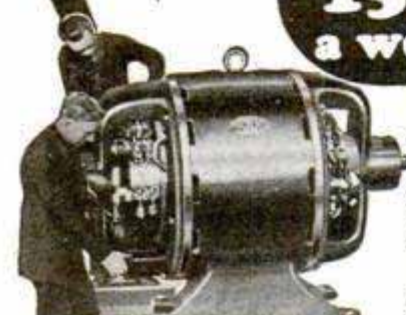

## Only 3 Months

Learn in ONLY 3 MONTHS in GREAT GREER SHOPS on large live equipment. I'LL PAY YOUR FARE HERE Free of extra cost, then help you to a job while learning. Then I not only FIT YOU to GET the big pay job, but I'll help YOU HOLD IT. Young and Old, Educated and Uneducated, Inexperienced and Experienced have found GREER SHOPS training easy, fascinating and valuable.

### COUPON BELOW BRINGS YOU BIG FREE BOOK

Don't let money hold you back. Get my Free Book. Find out NOW how I PAY YOUR FARE HERE. let YOU ATTEND either days or evenings and help you find DAY OR EVENING WORK to PAY YOUR EXPENSES while learning. Then when trained we help you find the real big pay job. Learn about amazing opportunities in Electricity, and GREER COLLEGE. Right now, if you act quick, I can make you a most unusual short time offer. Address me personally

Erwin Greer, President, GREER COLLEGE  
Dept. 301E, 2024 So. Wabash Av., Chicago.



# FREE BOOK

Erwin Greer, President  
Dept. 301E, 2024 So. Wabash Avenue, Chicago, Illinois

Send Free Electrical Book and details of Special offer without obligation to me.

Name.....

Address.....Age.....

## "Height Increasing"

Is Report of Hundreds



Results have been remarkable. Letters from all over tell of decided height increase gained in a few months. They tell of improved health, more pep and life, greater efficiency, more joy in living because of better physical condition. Nothing like our course. Based on sound, proven, scientific principles.

### No Drugs—No Dope

We have no magic medicine to sell. Only a system of simple exercises and special diet, assisted by a simple apparatus. Takes but a few minutes each day. The Glover system helps overcome the flattening of the vertebrae and the sagging of the supporting muscles. Permits cartilage cushions in spinal column to expand. Strengthens muscles. Stimulates nerves. Results have been permanent because based on true physiology. Unusually successful in under-developed young men and women.

**EASY—INEXPENSIVE—CERTAIN**  
Write today for FREE Information  
**GLOVER INSTITUTE — Dept A24**  
508 S. Dearborn St. Chicago, Illinois

## NO JOKE TO BE DEAF

—EVERY DEAF PERSON KNOWS THAT



I make myself hear, after being deaf for 25 years, with these Artificial Ear Drums. I wear them day and night. They stop head noises and ringing ears. They are perfectly comfortable. No one sees them. Write me and I will tell you a true story, how I got deaf and how I make you hear. Address



**GEO. P. WAY, Artificial Ear Drum Co. (Inc.)**  
80 Hoffman Bldg., Detroit, Mich.

# FREE TRIAL Grows Hair



### AMAZING NEW ELECTRICAL DISCOVERY

A noted surgeon has discovered an amazing way to grow hair, called Dermo-Ray. In 30 days no more dandruff. Scalp tissues are given new life. Then within a few weeks, luxuriant new hair! The startling discovery of the almost magic effect of Infra-Red Rays on the hair-growing tissues was made by a leading surgeon. Two years ago he was himself bald. Today his hair is full and thick.

### FAMOUS SURGEON'S DISCOVERY

Here is his own personal, home treatment, called Dermo-Ray. At last a home method endorsed by science. Guaranteed to bring you these same results in 30 days—or you pay nothing. You can use Dermo-Ray in any home with electricity. The warm, soothing Infra-Red Rays vitalize the scalp while you rest—a few minutes each day is all the time required.

**SEND NO MONEY** Complete facts about this astounding new scientific discovery, opinions of authorities, incontrovertible evidence, and details of special trial offer sent free, if you mail the coupon below. To end your scalp and hair troubles, act at once. Print your name and address plainly—and mail the coupon NOW!

### -----FREE TRIAL OFFER-----

The Larson Institute  
216 N. Wabash Ave., Dept. 439, Chicago, Ill.

Send me at once, without obligation, full particulars—in plain envelope—of your 30-day Free Trial of DERMORAY.

Name.....

Address.....

City.....State.....



EARN UP TO  
**\$125**  
a Week  
**!**

# WE WILL TRAIN YOU IN A FEW MONTHS



Enter this uncrowded field of limitless possibilities—big demand for trained mechanical dentists—we teach you in a few months of personal instruction without books, how to make crowns, plates, bridge-work, etc., for dentists. Day or night laboratory schools in Chicago, Detroit, Cleveland, Philadelphia and Boston.

## BIG DEMAND for MECHANICAL DENTISTS

Mechanical Dentistry is the laboratory bench work which the dentist turns over to the laboratory worker. Master this profession and help meet the demand of dentists for laboratory work.

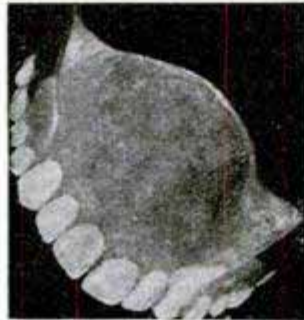

### Rubber Plates

Learn to make partial upper or lower plates with soldered, cast or wire clasps, with palatal bars; with lingual bars, etc.

### Crowns

Here's only a small part of your practical training in Crown-work: Two-piece, seamless, open-face, Richmond, cast-base porcelain, Carmichael, split-pin, carved (swaged) cusp, cast cusp, etc.

### Bridge Work

Complete training in both fixed and removable bridgework.

### Metal Base Dentures

Cast bases of Aluminum, Watt's metal, etc., are included in your training. Both centrifugal and air pressure casting machines are used. Free Book contains complete list of subjects in course.

### Send for Interesting Book

Read absorbing facts about mechanical dentistry—the laboratory benchwork that the dentist turns over to the laboratory worker, the making of plates, crowns, bridge work, etc.—why 64,000 dentists need laboratory work—how we train you in a few months, day or night for this growing, money-making field! Mail coupon today and get free copy of this handsomely illustrated interesting book giving complete details on Mechanical Dentistry—our low rates and easy terms.

**McCarrie School of Mechanical Dentistry**  
1338 S. Michigan Ave., Dept. 205, Chicago, Illinois

One graduate writes that he earns \$400 monthly profit. Another that he makes as high as \$45 a day. A former bookkeeper after receiving our training earned \$150 a week in his own laboratory. You can enter this fascinating profession. We have hundreds of success letters from students telling how they made money after graduating from our schools.

## 64,000 Dentists Need Laboratory Work!

Only a few hundred Laboratories in all the U. S.—most of them in the larger cities. Dentists can't afford to do their own mechanical jobs. They can secure the services of a Laboratory Expert for about \$3.00 an hour and receive for their own time \$6 to \$15 an hour. Dentists will encourage you to learn mechanical Dentistry, start a "Lab" of your own, give them quicker service than sending their work to other cities. Dentists can't wait and keep their patients waiting.

### Work Your Way Thru School

Some of our students work during the day and attend school at night. Others attend day school and secure spare time employment in the evening. There is always a way for the ambitious man and we assist you to secure employment that will help you to pay your way thru school. No matter what your occupation may be, this opportunity is open to you. Mechanical Dentistry paves the way to a successful career. Your name and address on the coupon is your next step.

McCARRIE SCHOOL of MECHANICAL DENTISTRY  
1338 S. Michigan Ave., Dept. 205, Chicago.

Without cost or obligation, send me your illustrated book on Mechanical Dentistry, and complete information as to my opportunities in dental laboratory work.

Name.....

Address.....

**SCHOOLS**  
IN  
**Chicago**  
**Cleveland**  
**Detroit**  
**Boston**  
&  
**Phila.**  
**MAIL**  
**THIS**  
**COUPON**



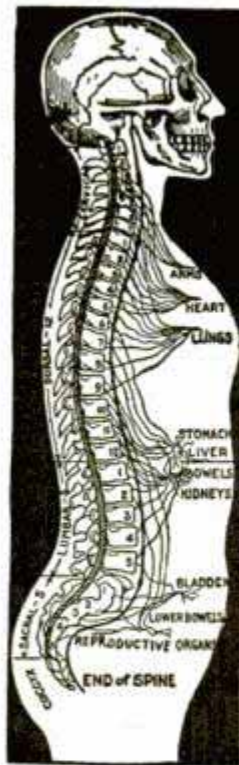

# FREE!

## This Nerve Chart

If you will mail the coupon below, this nerve center and vertebrae chart, showing how the nerves radiate from your spinal column to all organs of the body, will be mailed to you without one cent of expense. It is a chart which should be in every home.

### Where is that PAIN?

It may be in the neck, back, hips, stomach, liver, legs or arms—wherever it is the chart will help to show you the location and cause of your ailment.

# Stop that Pain

By Relieving the Cause with

**Violet Ray – Vibration  
Ozone – Medical Electricity**

The Four Greatest Curative Powers Generated by This

## Great New Invention!



Elco Health Generators at last are ready for you! If you want more health—greater power to enjoy the pleasures and delights about you, or if more beauty is your desire—write! Ask for the book on these inventions which has just been prepared. It will be sent to you without cost. It tells you how Elco Health Generators aid you in leaving the lethargy and hopelessness of bad health and weakness behind forever. Re-vitalize yourself. Bring back energy. Be wholly alive. Write today!

Here's What Elco Users Say—

"Wouldn't take \$1000 for my Elco."  
"Has done me more good in 2 weeks than doctors did in three years."



"Cured my Rheumatism." "My Eczema gone." "Cured my stomach trouble." "Cured my weakness." "Now I sleep soundly all night." "Thanks to Elco my strength and vigor are back." "No more pain." "Colds never bother me now."

These great new inventions generate Violet Ray, Vibration, Electricity and Ozone—combined or separate. They operate on the electric light in your home or on their own motive power at less than 50 cents per year. Elco Health Generators are positively the only instruments which can give you in one outfit Electricity, Violet Ray—Vibration and Ozone—the four greatest curative agents. Send the coupon below. Get the Free Book NOW!

## MAIL COUPON for FREE BOOK

Do not put this paper down without sending the coupon. Don't go on as you are with pains and with almost no life and energy. You owe it to yourself to be a better man or woman. You were put here to enjoy life—not just to drag through it. So do not rest another day until you have put your name on the coupon here. That will bring the whole story of these great new inventions. Do it today—now.

**Lindstrom & Co.** [Makers of Therapeutic Apparatus since 1892]  
2322 Indiana Avenue Dept. 18-53 Chicago  
Please send me your free book, "Health—Power—Beauty" and full information of your 10-day Free Trial Offer.

Name.....  
Address.....



# Learn to Dance

## This New Easy Way

You can learn all the modern dances—Charleston, Black Bottom, Valencis, Canter, French Tango, St. Louis Hop, Latest Waltzes, Fox Trots, etc., at home easily and quickly. New chart method makes dancing as simple as A-B-C. No music or partner required. Learn anywhere, anytime. Win new popularity. Be in demand at parties. Same course of lessons would cost \$20 if taken privately.

### Send No Money

Just send your name and address. We'll ship the complete course—323 pages, 49 illustrations—with-out one cent in advance. When package arrives, hand postman only \$1.98, plus delivery charges, and this wonderful course is yours. Try for 5 days. Money back if not delighted. Send your name NOW.

FRANKLIN PUB. CO., 800 N. Clark St., Dept. 9421, CHICAGO



## LOWER PLATES WORN WITH COMFORT

Make your lower false teeth comfortable as natural teeth! PLATEX ASEPTIC SUCTION CUSHIONS let you chew and speak without pain or embarrassment. PLATEX soothes tender gums, holds plate in place, stops all discomfort. Made of treated, compressed cotton. Fits right in groove of lower plate. Far better than powders. Thousands of users. 40c and \$1 packages at druggists or MAILED DIRECT postpaid. Order today for real comfort. State if your plate fits loose or tight. Patented by PLATEX LABORATORIES, Inc., 200 Masonic Building, Chattanooga, Tennessee.



## Deafness OVERCOME

And perfect hearing restored in cases of deafness and poor hearing resulting from Flu, Scarlet Fever, Catarrhal Troubles, Blows, Explosions, Defective Ear Drums, Discharges, etc. Relief comes from the use of the tiny, invisible

### Wilson Common-Sense Ear Drums

In use for 36 years by hundreds of thousands, the world over. They replace what is lacking in the natural ear drums, without medicines, operations, or being seen or felt. Easy for wearer to put in and remove without any discomfort.

**FREE BOOK** on deafness and copies of voluntary letters from many of the thousands of grateful users, will be sent postpaid by the WILSON EAR DRUM CO. Inc. 333 Todd Building, Louisville, Ky.

# TOBACCO HABIT STOPPED or Money Back!

For more than 50 years The Keeley Treatment has been successful.... in thousands and thousands of cases. It has been tried and tested, and it offers you the easiest, quickest, surest way on earth of stopping the use of tobacco without inconvenience or unpleasant effects. Will you try it?

**Thousands Praise Keeley Treatment**  
Heavy, inveterate tobacco users are amazed at the ease with which this wonderful treatment enables them to stop using tobacco. It is the safe, reliable method—known to and endorsed by the medical profession for half a century.

**Take Treatment at Our Risk**  
If, after you have taken this treatment, you are not satisfied, it will not cost you a cent. The Keeley Treatment seldom fails; that is why we can make such an unqualified guarantee. You are judge and jury. Will you try it at our risk?

**This Booklet FREE**  
Every tobacco user should read the amazing facts in this booklet. It tells you what physicians have found out about the harmful effects of tobacco; what insurance statistics reveal, and other interesting facts. It is free. Send today. The Keeley Institute, Dept. A-919, Dwight, Ill.



**write Quick for SPECIAL OFFER!**



# Is there a Job and a Future for Me in AVIATION?



**"My Answer is YES!"**  
Walter Hinton

**T**HERE'S more than that! There's a *better* job and a *better* future for *you* in Aviation than in any other industry.

The reason is this: Aviation is **just beginning** its period of *big growth*.

Aviation is going to be America's *next* gigantic industry. And if you get into it *now*—while it's still uncrowded—you can grow as *Aviation grows*.

A lot of men saw **their** opportunity in radio when it was young. They got in **early** and literally "cleaned up." Today thousands of those "early birds" of radio are wealthy.

The same was true of the automobile industry. It was the men who got in "on the ground floor" who made the biggest successes.

That's the **kind of a chance** *you have* in Aviation today. During the next few years Aviation is going to pick its bosses, its high priced specialists, its leaders and executives. And *you*—by *looking ahead* and *acting ahead*—can be one of them.

What is more, to fit yourself for an important place in AVIATION—it isn't necessary for you to leave your home, give up your present job or spend a lot of money.

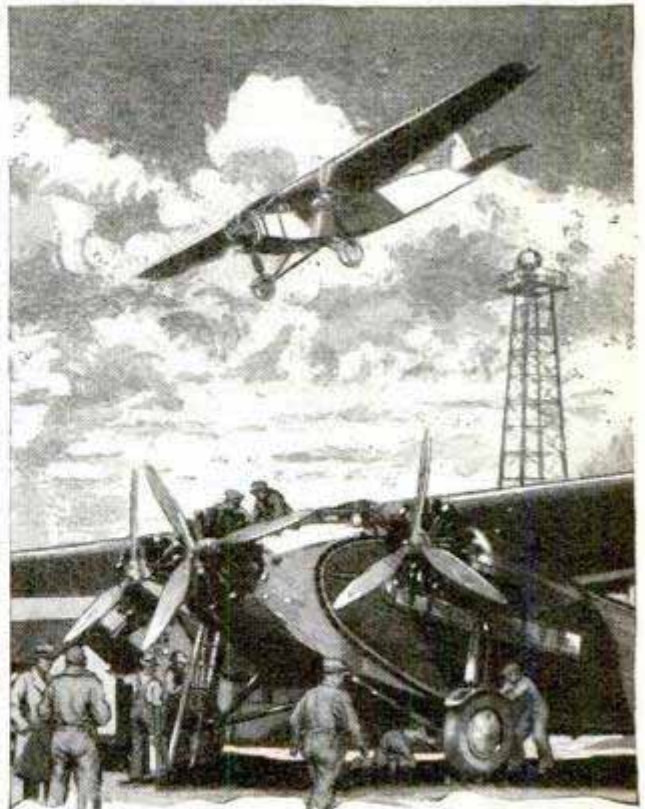

Instead, give me just a part of your spare time during the **next few months**, and I'll give you the kind of training that employers need and are paying *real cash* to get.

I'll do **even more!** I'll actually help you get a job.

You will receive the **free** assistance of my Employment Department. I'm getting calls from transport companies, airports, airplane manufacturers asking for trained men to fill "ground jobs" and "flying jobs" that pay *real money* and offer *real futures*.

## Get My FREE Book!

I have an idea that the only reason I'm not training *you right now*—just as I'm training hundreds of other ambitious men who don't propose to let this chance of a life-time get away from them—is because you haven't begun to appreciate what a tremendous opportunity Aviation offers you. •

If that's so, I want you to have a copy of my book, "Rich Rewards in Aviation." You'll find it crammed with interesting *facts*, that are **vital** to *your future*.

Before you tell yourself that there isn't any sensible, practical, *easy* way for *you* to get into Commercial Aviation—read this book.

Before you decide to sit by and let Aviation grow up *without* you—clip that coupon and tell me where to send *your copy*.

**Aviation Institute of U. S. A.**  
Walter Hinton, Pres.  
1115 Connecticut Ave., Washington, D. C.

**WALTER HINTON** was the pilot of the famous NC-4, the very first plane to fly across the Atlantic; he was first to fly from North to South America; first to fly over the head waters of the Amazon River. During the war he was one of the crack flying instructors for the U. S. Navy. Today, through a remarkable course of practical training which you take right at home, he gives you the knowledge you need to succeed in any branch of Aviation. If you are sixteen years of age, or older, send now for a free copy of his book.



**Rush to Washington!**

Walter Hinton, President.  
Aviation Institute of U. S. A.,  
1115 Connecticut Avenue, N. W.,  
Washington, D. C. 1-R

Send my FREE copy of "Rich Rewards in Aviation." I'd like to know what kind of a future Commercial Aviation offers ME.

Name.....

Address.....Age.....  
(Must be over 16)

City.....State.....



# LEARN AUTOS IN LOS ANGELES

**Jobs Open Now—\$40 to \$100 a Week**

You are urgently needed to help repair the one and a half million autos in California. Trained auto repair men are also needed badly in every other state. The rapidly increasing number of cars means prosperity and big pay for auto men—more garages, tire shops, battery stations are needed. You can be one of the highly paid men in this fastest growing industry—if you get the right training.

**YOU CAN BE An Auto Expert!**

National Automotive special, practical Shop Training makes it easy for you to become an Auto Expert. In a quarter century this great institution has trained

20,000 men for bigger pay. It will help YOU make more money by giving you individual instruction on repairing Packards, Buicks, Cadillacs, Fords, etc., all types of electrical equipment, machine shop equipment, etc. You learn everything RIGHT at National.

**Paul Briggs Earns \$4000 a Year**

"I want to thank you for the big part National has played in helping me to success in auto work. I am now assistant sales manager and made \$4,000 this year—which is more than I would have made in three years at my former work."—Paul Briggs, Portland, Ore.

**Money-Making Book—FREE**



**Earn While You Learn**

Free employment service. Spare time jobs help pay expenses while training. All tools included. No extras. Send for big free illustrated catalog explaining how National trains you for bigger pay. Learn the opportunities for you in California. Mail coupon now.

**Million Dollar Training Headquarters for Auto Experts**



**NATIONAL AUTOMOTIVE, Dept. 720, 4006 Figueroa St., Los Angeles, Calif.**

Send me, absolutely free, your big illustrated catalog of Automotive Opportunities showing how I can train for a Big-Pay Auto Job.

Name.....

Address.....

Age..... City..... State.....

# FOREMEN!

FACTORY WORKERS AND ALL MECHANICS



**\$1.98** (Worth \$25)  
Lecture Course Complete in 1 Volume

**SEND NO MONEY**

Every foreman, factory worker, manager and ambitious mechanic will find a gold mine of inside information in "The Modern Foreman" by Robt. Grimshaw. The 28 chapters of this great work are shop talks pointing the way to success, efficiency, better pay and the job higher up. A complete study course in leadership; a handy, daily reference and guide.

**SUBJECTS COVERED INCLUDE:**—The Magic Wand of Efficiency, The New Type of Foreman, Teamwork, The Kicker, The Agitator, Bonus Plans, Self Improvement, How to Handle Men, Hiring and Firing, Assigning Men to Jobs, How to Keep Records, How to Cut Out Waste of Time and Materials, New Inventions, Modern Methods, The Inspector, Health and Character Requirements, What the Foreman Should Know, Mathematics, Business Law, The Foreman as "Top Sergeant," Factors of Success, Leadership, What is "Labor"? Time and Idleness, Knowledge is Power, "Morale," The Value of Mistakes.

"The Modern Foreman" has 297 pages, quick reference index, many tables, diagrams, illustrations and forms; big type, easy to read and understand; rich binding, gold stamped. Size 6 x 9 x 1 1/4. Reg. price \$2.50. Our special sale price \$1.98. Send no money. Satisfaction guaranteed. Mail this coupon TODAY!

**GREGG PUBLISHING CO., 20 W. 47 St., New York, N. Y.**

Send me "The Modern Foreman." I will pay postman \$1.98 and postage on arrival. My money is to be refunded if I am not satisfied.

Name.....

Address.....

# ELECTRICITY

**Graduates in Constant Demand at Big Salaries**

Intensive, practical training. **Low Tuition Rates.** Diploma in 1 year. Engineering degree in 2 years. Also special 12 weeks' courses. No time wasted. Expert instructors. Personal attention. Extensive modern equipment. Free employment service for graduates. Part-time work secured during training. 27th year. **Write Today for Free Illustrated Catalog.** FINLAY ENGINEERING COLLEGE, 1001-B Indiana Ave., Kansas City, Mo.

# STAMMER



Write for my free book "Millard's Advanced Natural Corrective Course" and a free copy of my speech magazine. 10,000 cases successfully treated. Est. 24 years. Largest school for stammerers in world. **Millard Inst. of Normal Speech, 2317 Millard Bldg., Milwaukee, Wis.**

# Play the Harmonica "No-Hands"

Be a "one-man-band!" Play harmonica "no-hands" with table, banjo or guitar! Amaze your friends! 50c (Money Order) brings instruction book and songs, blues etc. **HARRY MONICA, Box 252, Dept. 4, WOODSOCKET, R. I.**

# MOTION PICTURE PROJECTION

**A BIG-MONEY PROFESSION—\$2,000 TO \$4,000**  
We Assist Students to Earn While Learning

**MCVIE OPERATORS SCHOOL**  
61 Sproat Street Detroit, Michigan



# BIG VALUE FOR 10 Cts.

6 songs, words and music; 25 Pictures Pretty Girls; 40 Ways to Make Money; 1 Joke Book; 1 Book on Love; 1 Magic Book; 1 Book Letter Writing; 1 Dream Book and Fortune Teller; 1 Cook Book; 1 Base Ball Book, gives rules for games; 1 Toy Maker Book; Language of Flowers; 1 Morse Telegraph Alphabet; 12 Chemical Experiments; Magic Age Table; Great North Pole Game; 100 Conundrums; 3 Puzzles; 12 Games; 30 Verses for Autograph Albums. All the above by mail for 10 cents, and 2 cents postage.  
**ROYAL SALES CO., Desk 320, Norwalk, Conn.**



# You Can Be Raised to the Heights of Glorious Manhood—

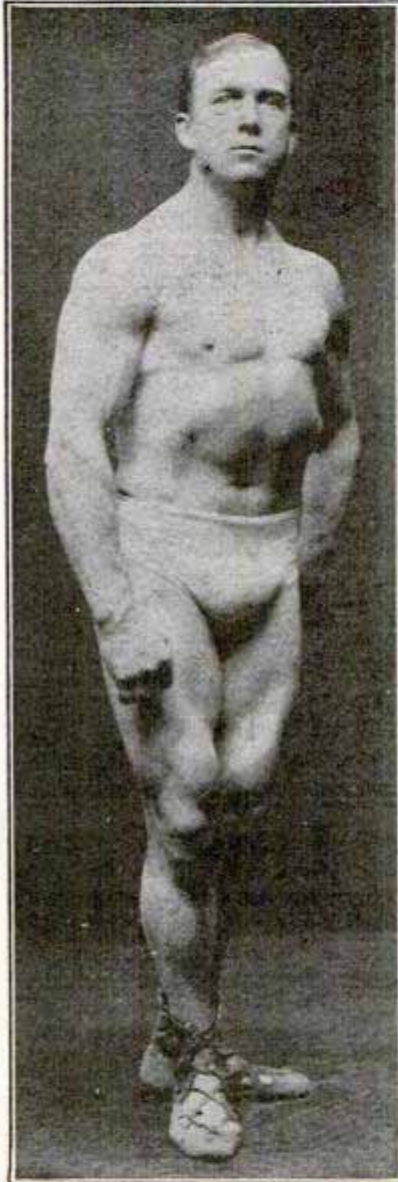

**LIONEL STRONGFORT**  
Dr. Sargent, of Harvard University, U. S. A., declared Lionel Strongfort to be unquestionably the finest specimen of physical development he had ever seen.

## Send For My FREE BOOK

Send for your copy of my extraordinary book and you will learn facts that will astonish you and help you out of your sorry plight. The experience and research of a lifetime are contained in this wonderfully instructive book, "Life's Energy Through Strongfortism"—in English, German or Spanish. Just check the edition you want and subjects on the consultation coupon on which you want special confidential information and send to me. Send for my FREE book right now—TODAY.

## STRONGFORT INSTITUTE

LIONEL STRONGFORT, DIRECTOR.

Physical and Health Specialist for over 27 years.

Dept. 673, NEWARK, NEW JERSEY, U. S. A.

**I**F you want to succeed in life—if you want to get recognition in business, in industry, in sports, in social life—you must have health and energy. You won't get anywhere without it. Thousands fail miserably because of physical weakness and mental cowardice. If you would win life's prizes, brace up. **BE A MAN!**

*Build up your body*—if you are weakened from excesses, neglect, stimulants or disease. Get rid of annoying ailments that disgust everybody with you—Catarrh, Constipation, Chronic Colds, Indigestion, Rheumatism, Rupture, Weak Heart, Bad Blood, Nervousness, etc.

## Do You Want These Things?

Restful, peaceful sleep; eagerness for work; sustaining energy throughout the day; better earning power, desire for pleasure and athletics; a springy step; bright eyes; a hearty hand clasp; a more cheerful outlook on life; optimism; hopefulness; happiness?

These come with health—all of them, just as sure as sunrise. If you have a healthy body—full powered, muscular, energetic, manly—you will make good—in your work, in business, in society and in athletics. You will be happy. You will attain complete success.

## Don't Be Discouraged

You need not be discouraged and down with the blues because of your weakened physical condition, your ailments, your lack of manliness. **STRONGFORTISM** put thousands on their feet after they had been dragged down so deep they thought they could never be real men again. It gave them stamina, pep, vigor, energy, ambition. It built them up inch by inch—internally and externally—by my original methods until they became outstanding men, full of snap and "go" and steam. And tens of thousands of letters in my office tell of their restoration to health, the rejuvenation of their whole muscular system, the awakening of their mentality and the joy and happiness and success that came through all these.

## STRONGFORTISM Will Make a He-Man of You

Don't stand by and see your body tottering and growing weaker and flabbier day by day, unfitting you for every physical function, making a sorry spectacle of you in everything you undertake. Don't do it—if you want to be a man—a real he-man—a man who will be noticed in a crowd by both men and women. Don't be a weakling when you can be a healthy, powerful, muscular fellow with a grip like iron, a chest that denotes strength, and a face that pictures buoyant health and happiness.

Send this Coupon

### Free Confidential Consultation

Mr. Lionel Strongfort, Strongfort Institute, Dept. 673, Newark, N. J.—Please send me absolutely free my copy of your book, "LIFE'S ENERGY THROUGH STRONGFORTISM" printed in.....English.....German.....Spanish. This does not place me under any obligation and no salesman is to call on me. I have marked (x) before the subjects in which I am most interested.

- |            |                |                        |
|------------|----------------|------------------------|
| ..Catarrh  | ..Constipation | ..Lung Troubles        |
| ..Colds    | ..Rheumatism   | ..Round Shoulders      |
| ..Asthma   | ..Nervousness  | ..Stomach Disorders    |
| ..Headache | ..Overweight   | ..Increased Height     |
| ..Rupture  | ..Weak Back    | ..Muscular Development |
| ..Thinness | ..Weak Eyes    | ..Great Strength       |
| ..Pimples  | ..Short Breath |                        |
| ..Insomnia | ..Weak Heart   |                        |

Other Ailments.....

Name.....

Age.....

Occupation.....

Street.....

City.....

State.....





## "The Boss Didn't Even Know My Name"

"He said my face was more or less familiar and he remembered seeing me around, but he didn't even know my name until the I. C. S. wrote him that George Jackson had enrolled for a course of home study and was doing fine work.

"Who's George Jackson?" he asked. Then he looked me up. Told me he was glad to see I was ambitious. Said he'd keep his eye on me.

"He did too. Gave me my chance when Frank Jordan was sent out on the road. I was promoted over older men who had been with the firm for years.

"My spare-time studying helped me to get that job and to keep it after I got it. It certainly was a lucky day for me when I signed that I. C. S. coupon."

How much longer are you going to wait before you take the step that will bring you advancement and more money?

It takes only a moment to mark and mail this coupon and send it to the International Correspondence Schools at Scranton, but that one simple little step may change your entire life. Isn't it better to do this today than to wait a year or five years and then wish you had?

Mail the Coupon for Free Booklet

### INTERNATIONAL CORRESPONDENCE SCHOOLS

"The Universal University"

Box 5602-F, Scranton, Penna.

Without cost or obligation, please send me a copy of your booklet, "Who Wins and Why," and full particulars about the course before which I have marked X in the list below:

#### BUSINESS TRAINING COURSES

- |  |   |
|--|---|
| <input type="checkbox"/> Business Management                     | <input type="checkbox"/> Business Correspondence      |
| <input type="checkbox"/> Industrial Management                   | <input type="checkbox"/> Show Card and Sign Lettering |
| <input type="checkbox"/> Personnel Management                    | <input type="checkbox"/> Stenography and Typing       |
| <input type="checkbox"/> Traffic Management                      | <input type="checkbox"/> English                      |
| <input type="checkbox"/> Accounting and C. P. A. Coaching        | <input type="checkbox"/> Civil Service                |
| <input type="checkbox"/> Cost Accounting                         | <input type="checkbox"/> Railway Mail Clerk           |
| <input type="checkbox"/> Bookkeeping                             | <input type="checkbox"/> Mail Carrier                 |
| <input type="checkbox"/> Secretarial Work                        | <input type="checkbox"/> Common School Subjects       |
| <input type="checkbox"/> Spanish <input type="checkbox"/> French | <input type="checkbox"/> High School Subjects         |
| <input type="checkbox"/> Salesmanship                            | <input type="checkbox"/> Cartooning                   |
| <input type="checkbox"/> Advertising                             | <input type="checkbox"/> Illustrating                 |
|  | <input type="checkbox"/> Lumber Dealer                |

#### TECHNICAL AND INDUSTRIAL COURSES

- |  |   |
|--|---|
| <input type="checkbox"/> Architect               | <input type="checkbox"/> Automobile Work                                    |
| <input type="checkbox"/> Architectural Draftsman | <input type="checkbox"/> Airplane Engines                                   |
| <input type="checkbox"/> Building Foreman        | <input type="checkbox"/> Plumber and Steam Fitter                           |
| <input type="checkbox"/> Concrete Builder        | <input type="checkbox"/> Plumbing Inspector                                 |
| <input type="checkbox"/> Contractor and Builder  | <input type="checkbox"/> Foreman Plumber                                    |
| <input type="checkbox"/> Structural Draftsman    | <input type="checkbox"/> Heating and Ventilation                            |
| <input type="checkbox"/> Structural Engineer     | <input type="checkbox"/> Sheet-Metal Worker                                 |
| <input type="checkbox"/> Electrical Engineer     | <input type="checkbox"/> Steam Engineer                                     |
| <input type="checkbox"/> Electrical Contractor   | <input type="checkbox"/> Marine Engineer                                    |
| <input type="checkbox"/> Electric Wiring         | <input type="checkbox"/> Refrigeration Engineer                             |
| <input type="checkbox"/> Electric Lighting       | <input type="checkbox"/> R. R. Positions                                    |
| <input type="checkbox"/> Electric Car Running    | <input type="checkbox"/> Highway Engineer                                   |
| <input type="checkbox"/> Telegraph Engineer      | <input type="checkbox"/> Chemistry  |
| <input type="checkbox"/> Telephone Work          | <input type="checkbox"/> Pharmacy   |
| <input type="checkbox"/> Mechanical Engineer     | <input type="checkbox"/> Mining Engineer                                    |
| <input type="checkbox"/> Mechanical Draftsman    | <input type="checkbox"/> Navigation <input type="checkbox"/> Assayer        |
| <input type="checkbox"/> Machine Shop Practice   | <input type="checkbox"/> Iron and Steel Worker                              |
| <input type="checkbox"/> Toolmaker               | <input type="checkbox"/> Textile Overseer or Supt.                          |
| <input type="checkbox"/> Patternmaker            | <input type="checkbox"/> Cotton Manufacturing                               |
| <input type="checkbox"/> Civil Engineer          | <input type="checkbox"/> Woolen Manufacturing                               |
| <input type="checkbox"/> Surveying and Mapping   | <input type="checkbox"/> Agriculture <input type="checkbox"/> Fruit Growing |
| <input type="checkbox"/> Bridge Engineer         | <input type="checkbox"/> Poultry Farming                                    |
| <input type="checkbox"/> Gas Engine Operating    | <input type="checkbox"/> Mathematics <input type="checkbox"/> Radio         |

Name.....

Address.....

City..... State.....

If you reside in Canada, send this coupon to the International Correspondence Schools Canadian, Limited, Montreal, Canada

# BEDFORD YMCA TRADE SCHOOL

Auto Mechanic  
Aviation Mechanic  
Starting, Lighting, Ignition  
Electric Welding  
Oxy-Acetylene Welding  
Machine Shop. Battery Repair  
Electrical Course. Radio Mechanic  
Plumbing, Brick-laying  
Plastering, Tile Setting  
Mechanical, Architectural Drawing  
Blue Print Reading  
Building Estimating  
Show Card Writing  
Window Dressing. Sign Painting  
Commercial Art. Fine Art  
Write for Catalog 50  
Brooklyn Engineering Institute  
(Operated by Bedford Y. M. C. A.)  
1125 Bedford Avenue, Brooklyn  
New York City

## Poor English!

How much is it costing you in wasted opportunity?

Every day your associates are judging you — by what you say and how you say it! Hazy ideas, ill-chosen words, halting sentences, crude, slovenly speech—these mark a man as loose in thinking. Thoughts clear-cut, words that give true shape and color, sentences aflame with power and originality—these are the things that proclaim ability, that win for their users swift advancement. Stop apologizing for poor English—it's inexcusable! In the quiet of your home—with LaSalle's help—you can learn to speak and write with real distinction, learn to make the words you utter and the letters you compose stamp you as educated, cultured, a power to reckon with in the business world. Complete details in an attractive 32-page book, "Effective Business English," sent you free upon request. Ask for it TODAY.

LaSalle Extension University, Dept. 364-BE Chicago

## Book on Law Free



Write today for this new book. It tells you how a law training will shorten your road to success. It also carries a vital and inspiring message to every ambitious man! Find out about the opportunities that await the law trained man. Find out how you can learn law right in your own home. No obligations. Book is absolutely free. Write Today while low tuition fee is in force.

American Correspondence School of Law  
3601 Michigan Avenue Dept. 1353 Chicago, Illinois



## Commercial Cartooning NEW INSTRUCTION

Owing to the increased demand by business firms for cartoons for advertising, sales promotion letters, house-organs, bulletins, etc., we have added new special instruction in commercial cartooning to Cartoonist W. L. Evans' regular course.

If you like to draw send 6c in stamps for portfolio of cartoons and full information. You can earn while you learn.

THE W. L. EVANS SCHOOL OF CARTOONING  
521 Leader Bldg. Cleveland, Ohio

## RADIO LEARN THE TELEGRAPH CODE MORSE



AT HOME WITH THE Omnigraph

The best, easiest, quickest way known for over 20 years. Operators licensed by U.S. Gov't are tested by it. Schools and scientific institutions use it. Ask for catalog.

Omnigraph Mfg. Co., 810 E. 39th St., P.M. Brooklyn, N.Y.

## STOP HUNTING JOBS

GET ONE YOU LIKE. Men-women, 18-55, earn \$95 to \$300 a Month in Post Office, Railway Mail and other branches of U. S. Government. Get Big List and requirements FREE. Write, Ozment Institute, 111-B, St. Louis, Mo., IMMEDIATELY.





# A Fascinating New Way To Make Money Through The Arts!

*free of extra cost*

Our amazing new plan tells how you can get every one of the beautiful gift-wares illustrated here with all instructions for decorating. Mail coupon for Free Book and Offer.

**Want Some Money?** Here's a wonderful way to get it. Our beautifully illustrated book tells how. It tells all about our new methods of art decoration,

art treatment, and how anybody can learn without previous experience. It tells how you can get the full assortment of giftwares and objects d'art shown on this page without one cent of extra cost, how we start you with this assortment and set you up in business. Contains page after page of color illustrations of what you can make and sell. You can make good money and this book is—

**FREE** Our system is amazingly easy to learn and the profits are larger than in almost any other business. You can produce beautiful objects almost from the start. Best of all you don't have to know how to draw for we show you the famous "3-Step Method." Begin making money now! All supplies are sent by us with instructions and many have made from \$10 to \$25 a week. Many society women do this work for their own amusement. But either way—pleasure or profit—it's the most delightful home work you can imagine. Don't miss this opportunity to get all these giftwares free of extra charge. Send now for your copy of this valuable book. It's FREE.

**FIRESIDE INDUSTRIES**

Dept. 66-C

ADRIAN, MICH.

**Fireside  
Industries**

Dept. 66-C,  
Adrian, Mich.

**GOOD  
for  
OFFER**

*Gentlemen:* Send me free book and complete plan for making money.

Name.....

Address.....

City..... State.....

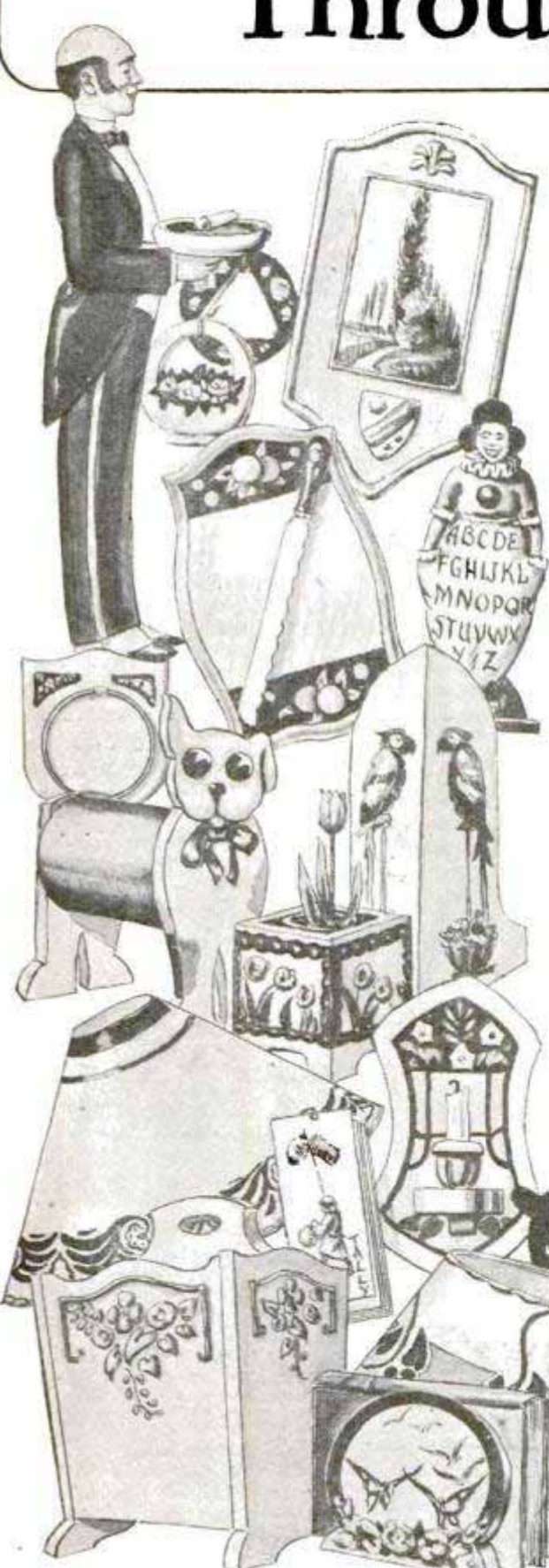



# PAIN and DISEASE

Quickly Conquered by  
**VIOLET RAY**



Let us tell you how thousands of men and women suffering from rheumatism, neuritis, paralysis, nervousness, skin diseases, headaches, constipation, sprains, prostate trouble, goitre and many other ailments, even hay fever and asthma, have found quick relief—new health and vitality with this marvelous, scientific invention. Pains vanish almost instantly.

## Violetta

Ten Days FREE

For Health—Beauty—Vigor **Trial**

Endorsed and used by hospitals, sanitariums and physicians. Every home can now have one. Saves hours, days, months of suffering. No medicine. Painless, pleasant treatment. Only the violet ray can penetrate to every nerve affected. Simple, safe, painless—anyone can use VIOLETTA. Why suffer pain and poor health when you can try VIOLETTA 10 days FREE.

### This Book FREE

Tells all about violet rays—how this marvelous discovery by Nikola Tesla, the electrical wizard, now brings this mysterious curative power to all. Contains many astounding testimonials from our thousands of satisfied users. Send for the facts and our liberal trial offer today. Mail the coupon now.

VI-REX CO., Dept. 331  
2304 Warren Avenue, Chicago



VI-REX CO., 2304 Warren Ave., Dept. 331 Chicago

Please send me your free book on Violet Rays and details of your 10 days' free trial offer.

Name.....

Address.....

City..... State.....

Ailment.....

## Heal Your Rupture

In This New, Scientific Way  
You Can Try It Free



Thousands of men, women and children have been healed of rupture by this marvelous new discovery, when all types of trusses and appliances had failed. Thousands of grateful letters will attest this fact.

Light, clean and comfortable, it retains with safety and at the same time heals the rupture.

So small it cannot be noted beneath the lightest clothing; planned so it can be worn both day and night—constantly it works for your cure. Write for free trial offer—sent you in plain sealed envelope.

Brooks Appliance Co., 107B State Street, Marshall, Mich.

## Skin Troubles

Cleared Up—Often In 24 Hours

Pimples, Blackheads, Acne Eruptions on the Face or Body, Barbers Itch, Eczema, Enlarged Pores, Oily or Shiny Skin. "Clear-Tone" has been tried and tested in over 300,000 cases. Used Like Toilet Water. It is simply magical in prompt results. At All Druggists, with proven directions.

ASK YOUR DRUGGIST—You Can Rely On

## Clear-Tone

TRADE MARK REG.

FOR THE SKIN AND COMPLEXION



Beautify your NOSE

to shapely proportions—while you sleep!



Gold Medal Won 1923

ANITA NOSE ADJUSTER

is SAFE, painless, comfortable. Speedy, permanent results guaranteed. Doctors praise it. No metal to harm you. Small cost.

Write for FREE BOOKLET



BEFORE-AFTER

ANITA INSTITUTE, C-12 Anita Bldg., NEWARK, N. J.

## Save Your Feet

When all else fails, end your suffering with the

Heefner Arch Support

No Metal



Fully patented. It re-adjusts the entire foot. Write for free book and statements from doctors and users.

Heefner Arch Support Co. 669 M. E. Taylor Bldg. Louisville, Ky.



## ZIP-ZIP SHOOTER

BOYS; join a Zip-Zip Shooter's club, everywhere boys are forming these clubs, fine sport using this shooter which is scientifically and practically made. Zip-Zip Shooter is the best buy we know of for 35c or 3 for \$1. We will ship to you if your dealer can't supply you.

Automatic Rubber Co. Columbia, S. C.







"I might say that I have netted \$950.00 with your charging outfit during the past five weeks."—Trego.



"I made \$425.00 the first eighteen days with your charger. The equipment cannot be licked."—Whalen.



"Jumped my earnings to \$85.00 a week. Know there is lots more in sight. Am tickled pink."—McDermott.



"Am now averaging \$110.00 a week. This is what you might call some boost in my earnings."—Fox.

# New Kind of Business Offers You \$5,000 to \$10,000 a Year

Here's your chance, fellows, to get into something that is more than a job. And there's no weary months of studying before you start to clean up a real-he-man's earnings.

You start to make money the day you uncrate the marvelous new Service Station Charger—an invention that saves 40% to 60% on current and one that handles

50% to 70% more batteries than similar outfits.

## START AT HOME Experience Unnecessary

I don't care what you are now doing I guarantee you can start right to expertly operate my amazing Charger. Keep your present job for a while and make \$15 to \$20 a day on the side. Just hook up the batteries in the morning and they will be loaded when you come home.



**I Pledge You My Word** that you can make good right from the start. I'll stand back of you as far as humanly possible—help you with advertising, etc. Ask any of the boys who have put their future in my hands.

If you are the kind of a chap who wants to step into big pay then I am the kind of a fellow who will see that you do it. Take my word for it you'll have my personal attention. Let's go!

C. F. Holmes.

## Rush Coupon For Big FREE BOOK

Don't delay. Get the coupon into the mail at once. Without cost I will ship you an illustrated book that tells the entire story. It is your chance to earn the biggest money of your life. Snap into it. You don't have to be a wage slave.

C. F. HOLMES, Dept. 1C 5116 Ravenswood Ave., Chicago, Ill.

## TREMENDOUS PROFITS

Think of it—you net nearly one dollar on each battery charged. And with thousands of batteries needing charging daily in all sections you don't have to solicit orders—they come to you.

## Hundreds Now Cleaning Up

Our files are full of real stories of success from men who have joined with me in this business. But look what the four men above have to say. Real money! And how!

**7 BIG FREE OUTFITS for Quick Action**

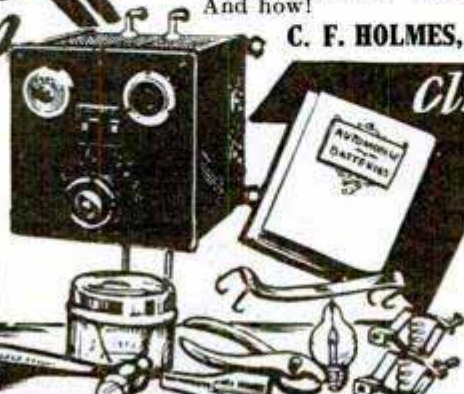

Clip Coupon Quick ~ ~

C. F. Holmes, Dept. 1C, 5116 Ravenswood Ave., Chicago, Ill. No obligation, but I am interested. Shoot along the free book and all details.

Name .....

Address .....

City..... State.....

*If you are earning less than \$90.00 a week mail coupon*



# SAVE YOUR BODY

Conserve Your Health and Efficiency First

**"I Would Not Part with it for \$10,000"**

So writes an enthusiastic, grateful customer. "Worth more than a farm," says another. In like manner testify over 100,000 people who have worn it.

## The Natural Body Brace

Overcomes **WEAKNESS** and **ORGANIC AILMENTS** of **WOMEN AND MEN**. Develops **erect, graceful figure**.

Brings restful relief, comfort, ability to do things, health and strength.

### Wear It 30 Days Free at Our Expense

Does away with the strain and pain of standing and walking; replaces and supports misplaced internal organs; reduces enlarged abdomen; straightens and strengthens the back; corrects stooping shoulders; develops lungs, chest and bust; relieves backache, curvatures, nervousness ruptures, constipation, after effects of flu. Comfortable and easy to wear.

**Keep Yourself Fit** Write today for illustrated booklet, measurement blank, etc., and read our very liberal proposition.

**HOWARD C. RASH, Pres. Natural Body Brace Co.**  
123 Rash Building SALINA, KANSAS



**For Boys and Girls Also**

## BIG PAY

### CAMERA MEN PHOTOGRAPHERS

**BE A MOVIE OPERATOR**  
Projector Given  
We teach you at home. Big demand by Movie, Vaudeville Theatres.

You can soon qualify for the wonderful opportunities in this big pay profession. **FREE BOOK** explains opportunities as Motion Picture Camera Man, Portrait, Commercial or News Photographer or in your own business. Learn at Home or in our great New York Studios.

Write for Free Book and Job Chart.

**N. Y. INSTITUTE OF PHOTOGRAPHY**  
Department 49

10 West 33rd Street, New York

## LEARN WATCHMAKING AND ENGRAVING

**BY OUR PROFIT-SHARING PLAN OUR GRADUATES SUCCEED**

One of our Iowa students started in a very small way—now doing over \$30,000 a year. Another in Wisconsin, over \$10,000 the first year. Day or night classes. Call or write for **FREE BOOK**.

Chicago School of Watchmaking, Dept. 5001, 549 W. Randolph St., CHICAGO

## TELEGRAPHY

(Morse and Wireless) and **RAILWAY ACCOUNTING**, taught thoroughly. Big salaries; great opportunities. Oldest, largest school. Endorsed by Telegraph, Railway, Radio, and Government officials. Expenses low—opportunities to earn large portion. Catalog free. **DODGE INSTITUTE**, Jones St., Valparaiso, Ind.

## 10c NEW SCIENTIFIC WONDER

### "X-RAY" CURIO

3 for 25c **SILVER ONLY**

**BOYS** You apparently see thru Clothes, Wood, Stone, any object. See Bones in Flesh. **FREE—PKG. RADIO BIG FUN PICTURE FILMS.** Takes pictures without camera. "You'll like 'em." 1 pkg. with each 25c order.

**MARVEL MFG. CO. Dept. 31 NEW HAVEN, CONN.**

## BASHFUL?

"Shame on you!" Are you nervous, embarrassed in company of the other sex? Stop being shy of strangers. Conquer the terrible fear of your superiors. Be cheerful and confident of your future! Your faults easily overcome so you can enjoy life to the fullest. Send 25c for this amazing book. **RICHARD BLACKSTONE, BB-473, FLATIRON BLDG., NEW YORK**

## 6 Ft. LONG GIVEN

Boys! Here's the great navy model Airship. Large 6-foot air bag with inflators, parachute with automatic release and complete instructions for flying. Will fly for miles at height of 1000 feet. Great chance to study aerial navigation. Send name and we'll send 6 of our new art pictures to dispose of on special 25c offer. Send the \$1.50 you collect and as a reward for this service we will send this wonderful Airship with full instructions free.

**C. M. THOMAS, 337 W. Madison St., 3-K-91, CHICAGO**

## LEARN WATCHMAKING

and become independent. We help you secure a position. Easy to learn. Send for **FREE CATALOG**.  
**ST. LOUIS WATCHMAKING SCHOOL Dept. 5, ST. LOUIS, MO.**

## DRAW CARTOONS

**TURN YOUR TALENT INTO MONEY**

Cartoonists earn from \$50 to \$250 per week—some even more. Remarkable **Circle System of Drawing** teaches you in half the usual time. Students from all parts of the world are enrolling for this exceptional instruction. *Personal* criticism service and up-to-the-minute instruction make it easy for National students to attain success. Send for interesting **BOOKLET** and **SAMPLE LESSON PLATE** explaining full details of the Course and what National students are accomplishing. No salesman will call.





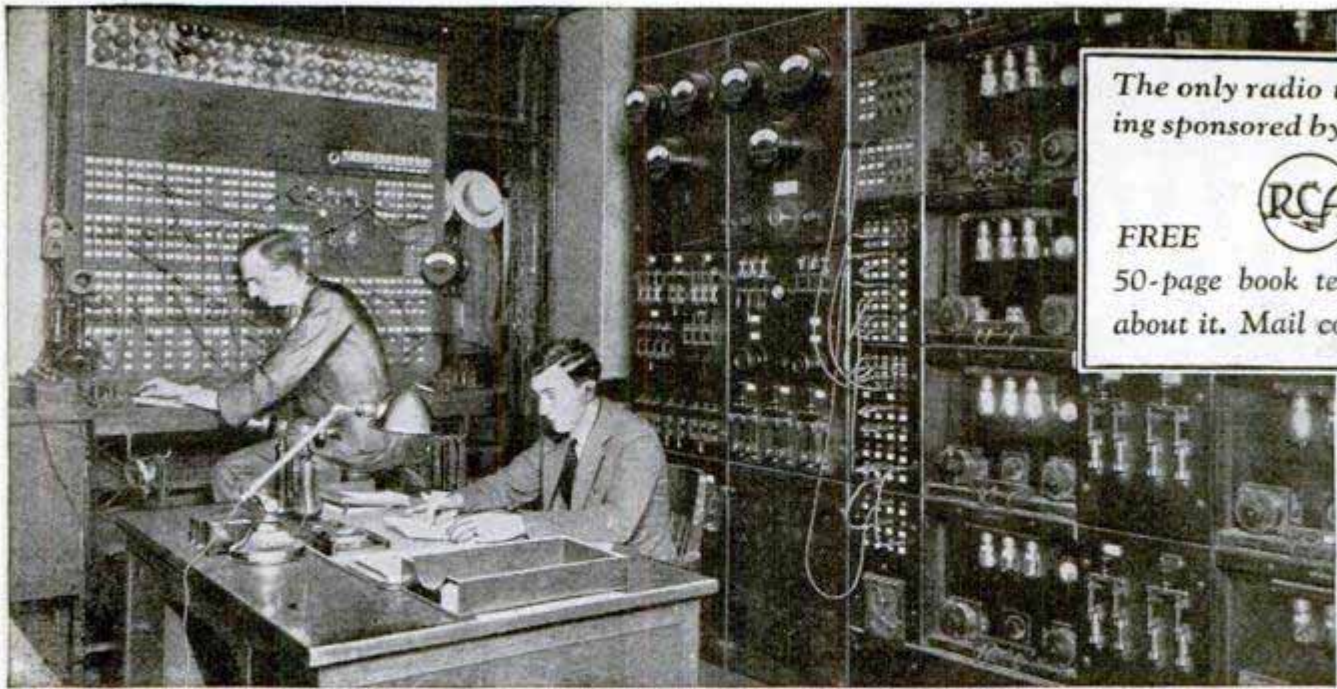

The only radio training sponsored by



FREE  
50-page book tells all about it. Mail coupon.

# “I found the Short Cut to SUCCESS in RADIO through this amazing home-laboratory method!”

By Frank Halloran

I got hungry to get into Radio when I learned about the big money it was bringing my next door neighbor.

He owned a fine car, dressed in expensive clothes, took week-ends off to go hunting and fishing, and was one of the most popular fellows in town!

“Charlie,” I asked him one day, “how did you become a radio expert?”

“A cinch,” he smiled. “I took it up in my spare time at home.”

“What?” I asked in surprise, “you actually took a radio course by mail?”

“No,” he shot back. “Not just a mail order course, but the only technical home-laboratory training conducted under the auspices of the Radio Corporation of America. Believe me, this ‘big-league’ organization not only knows what’s what in Radio, but it knows how to teach it!”

## A Great Piece of Luck

Taking Charlie’s advice was the luckiest thing I’ve ever done. It’s bringing me more money in a week than I’ve often earned in a month! I never dreamed that learning Radio at home was so easy and so fascinating. I didn’t know the first thing about it when I started, yet before many months I was able to solve

scores of problems which now help me command big money. The lessons took me step by step through trouble-finding, repairing, ship and shore broadcasting, photoradiograms, television, beam transmission, radio salesmanship, store operation and executive work. What a course!

## Success—In Spare Time!

I didn’t have to give up my regular job. I learned at home in spare time. And I learned by doing! With the course came an outlay of the finest standard apparatus. With this I was able to build radio circuits and sets of almost every description . . . yet it cost me absolutely nothing extra.

Even before I had completed the course I was able to earn good money doing odd radio jobs. And it wasn’t long after that I was able to give up my regular job and branch out as a full-fledged radio expert.

Today, my income is more than doubled . . . and I’ve only just started! I’m certainly happy that I found this short cut to success!

## Read This Thrilling FREE Book

Frank Halloran’s achievement is just another typical example of the success which the Radio Institute is bringing to hundreds of men everywhere through its wonderful home-laboratory training . . . the only offi-

cial radio training based on the inside knowledge of radio developed in the great experimental laboratories of the Radio Corporation of America.

Find out all about it. The Institute has prepared an illustrated booklet telling you all you want to know about this vast industry and about the remarkable home-study course that can fit you for a brilliant Radio career. Just mail the coupon below. This valuable booklet is absolutely free! Radio Institute of America, Dept. P. M. 3, 326 Broadway, New York.

Mail  
this  
coupon



Radio Institute of America  
Dept. P. M. 3,  
326 Broadway, New York, N. Y.

Gentlemen: Please send me your FREE 50-page book which tells all about the great opportunities in Radio and about your famous home-laboratory method of guaranteed Radio instruction.

Name.....

Address.....



# Swear Off Tobacco



Tobacco Tells on Nervous System



Tobacco Ruins Digestion



Tobacco Stunts Boy's Growth



Tobacco Robs Man of Virility



Tobacco Steals from You the Pleasures, Comforts, Luxuries of Life

## Tobacco Habit Banished Let Us Help You

### Quick Results

Trying to quit the tobacco habit unaided is often a losing fight against heavy odds, and may mean a serious shock to your nervous system. So don't try it! Make the tobacco habit quit you. It will quit you if you will just take **Tobacco Redeemer** according to directions.

It doesn't make a particle of difference whether you've been a user of tobacco for a single month or 50 years, or how much you use, or in what form you use it. Whether you smoke cigars, cigarettes, pipe, chew plug or fine cut or use snuff—**Tobacco Redeemer** will positively remove all craving for tobacco in any form in a few days. Your tobacco craving will usually begin to decrease after the very first dose—there's no long waiting for results.

**Tobacco Redeemer** contains no habit-forming drugs of any kind and is marvelously quick, scientific and thoroughly reliable.

### Not a Substitute

**Tobacco Redeemer** is in no sense a substitute for tobacco, but is a radical, efficient treatment. After finishing the treatment you have absolutely no desire to use tobacco again or to continue the use of the remedy. It helps to quiet the nerves, and will make you feel better in every way. If you really want to quit the tobacco habit—get rid of it so completely that when you see others using it, it will not awaken the slightest desire in you—you should at once begin a course of **Tobacco Redeemer** treatment for the habit.

### Results Absolutely Guaranteed

A single trial will convince the most skeptical. Our legal, binding, money-back guarantee goes with each full treatment. If **Tobacco Redeemer** fails to banish the tobacco habit when taken according to the plain and easy directions, your money will be cheerfully refunded upon demand.

### Let Us Send You Convincing Proof

If you are a slave of the tobacco habit and want to find a sure, quick way of quitting "for keeps" you owe it to yourself and to your family to mail the coupon below or send your name and address on a postal and receive our free booklet on the deadly effect of tobacco on the human system, and positive proof that **Tobacco Redeemer** will quickly free you from the habit.

**Newell Pharmacal Company**  
Dept. 300, Clayton Station, St. Louis, Mo.



### Free Book Coupon

**NEWELL PHARMACAL CO.,**  
Dept. 300, Clayton Station, St. Louis, Mo.

Please send, without obligating me in any way, your free booklet regarding the tobacco habit and proof that **Tobacco Redeemer** will positively free me from the tobacco habit or my money will be refunded.

Name.....

Street and No.....

Town..... State.....



# Have You the COURAGE To Take It?



## This \$2,000,000.00 Contract of a JOB and RAISE?

Of course you'd like to earn \$50 or \$75 or \$100 a week—you'd like to do more interesting work—you'd like to get into a line that offers a real future—but do you know how to go about getting these things?

If you have been thinking of "taking a course" but have held back because you were afraid you didn't have education enough to learn better-paid work—if you have hesitated to take the risk that it would actually land you in the better position and increase your salary—then here's the best news you ever heard in your life!

I want to tell you about DRAFTING, and show you that it offers you everything in pay and opportunity that you could hope for. I want to show you that a fine Drafting job is now easily within your reach. And I want to set before you an amazing plan which we have worked out with the co-operation of some of the biggest employers and engineers in America, to prepare you at home, in spare time, help you get the job and raise your pay—absolutely without risk of a penny on your part.

Thousands of men—not a bit smarter than you, with no more schooling or experience have gone from poorly paid positions as clerks, mechanics, building trade workers and laborers into Drafting positions paying \$50.00 to \$100.00 a week, with our help. Now with a job and a raise waiting for you as soon as you are ready for it, all it takes is the COURAGE to go after it—now if you remain in the rut it's because you choose to, not because you have to.

### Come Into DRAFTING!

I wish I had the room here to tell you all about DRAFTING—how it has become the most important branch of every kind of manufacturing and building construction work—how fascinating the work is—the fine bunch of fellows you'll work with—the big salaries paid—the wonderful chances for advancement. How, while Drafting is white-collar office work, it is hooked up closely with big projects and big men, and offers the thrill that goes with making plans which govern every move of the men who do the work. All this inside dope takes a 36 page book to describe and I'll be glad to send you a copy free when you mail the coupon for my no-risk job and raise plan.

O. C. MILLER, Director Extension Work.



## 3 Drafting Lessons Actually FREE

To Show You How Interesting and Simple DRAFTING Is

Maybe you think Drafting is "over your head"—that it takes artistic talent or some ability you haven't got. In that case you have a pleasant surprise coming to you. For I'll be glad to send you the first three lessons from our home-training to show you that the drawing of plans is purely mechanical, easily learned and the most interesting kind of work you ever tackled. It takes little enough courage to look into this wonderful opportunity—just mail the coupon and see for yourself how you like Drafting and our guaranteed way to get into it.

**The American School,**  
 Dept. D-374, Drexel Ave. & 58th St.,  
 Chicago, Ill.

Please send without cost or obligation 3 Drafting Lessons, 36 page book with the inside dope about Drafting and your no-risk plan and contract to prepare me, to see that I am placed and my pay raised or no cost.

Name.....  
 St. No.....  
 City.....State.....  
 Age.....Occupation.....



"Only one other man and I, of six taking California State Board examination for Architect passed. Then I realized the thorough and practical training given by American School. In 18 months I have gone from tracer to Chief Draftsman, in charge of all architectural and engineering work in one of the oldest offices here." R. L. WARNER, Los Angeles, Cal.



"When I started American School training in the Spring of 1915 I was working 14 hours a night, seven nights a week, for \$1.92 a night. That Fall I got a job in the Engineering Department of a large firm near here. Today I work 5 1/2 days a week and my salary is larger than I ever dreamed of when I began that course in Mechanical Drafting." B. H. SEAVERN, South Bend, Ind.

## THE AMERICAN SCHOOL

Dept. D-374, Drexel Ave. and 58th St., CHICAGO, ILLINOIS





**NOW** → **ONLY \$2.00**

# Giant Chest Expander

and

## Progressive Exerciser

Be a muscular marvel. Have the muscles of a superman. Become strong for your health's sake or to astound your friends with extraordinary feats which only men of giant strength can do. In a few short weeks you will easily do stunts which now seem difficult—then real

**Send No Money  
Use This  
Money  
Saving  
Coupon**

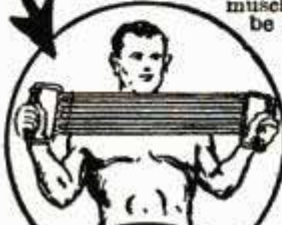

muscles and strength will be yours—and yours to keep. If you want exercise to just keep in good shape you can reduce the strength of the Progressive Exerciser by eliminating as many cables as you wish. If you want great resistance so as to build up big solid muscles then use the full strength.

### How the Giant Chest Expander and Progressive Exerciser is Made

The Giant Chest Expander and Progressive Exerciser is made with new live, springy rubber so as to give it long wearing and great resisting qualities. Do not pay more for an exerciser that has forty or less rubber strands to each cable. Get the best and most durable. The Giant Progressive Exerciser has 50 strands of the finest rubber procurable to each cable.

### Free Instructions

We do not think it enough to send you an exerciser worth double what we ask, so for a limited time, we will also include instructions absolutely free. These instructions are interesting and simple to follow—they show you the short cut to health and strength. Order today before this wonderful offer is withdrawn.

### Your Guarantee

The Giant Chest Expander is sold with a guarantee that you will say it is the finest you ever saw or your money back.

**5 Cables or double 10 Cables for strength for \$2**

**The double strength exerciser has resistance of over 200 lbs. \$4**

### How to Order—Send No Money

Sign your name and address to coupon below and get your Giant Exerciser at the present low introductory price by return mail. The price is made low because we want everyone to enjoy muscles and strength at the lowest possible cost. Don't pay more—order from us—get the most for your money. Use coupon now.

**PROGRESSIVE EXERCISER CO.,**  
4003 Langdon Bldg.,  
Broadway and Duane Street, New York

Please send  Your 10 cable Progressive,  
 Your 5 cable Exerciser.

Check the Exerciser you want, and it will be sent you by return mail. Pay postman introductory price, plus few cents postage on arrival. It is understood that if you are not entirely satisfied with your exerciser you may return it within 5 days and get your money back.

Name.....

Street.....

City..... State.....

If you live outside the United States, send cash with order.

## Books on 65 Practical Subjects

Popular Mechanics Press specializes in supplying the outstanding best books on many subjects. As new books of merit appear, we will revise the list accordingly.

|  |        |   |        |
|--|--------|---|--------|
| <b>AIR NAVIGATION AND METEOROLOGY</b><br>(Just Out).....                       | \$3.00 | <b>INVENTIONS</b><br>How to Make Pay.....   | \$2.50 |
| <b>AIRCRAFT ENGINES</b><br>Dyke's New Instructor<br>Latest Types.....          | \$5.00 | <b>INVESTOR</b><br>Beating the Stock Market.....  | \$2.00 |
| <b>ARCHITECTURAL</b><br>Drawing and Lettering.....                             | \$2.00 | <b>JOINT WIPING</b><br>(New Edition).....   | \$1.00 |
| <b>ARMATURE WINDING</b><br>and Motor Repairs.....                              | \$3.00 | <b>LACQUERING</b><br>(Practical). Valuable<br>New Book for Metal<br>Working Industry..... | \$3.50 |
| <b>AUTO ENCYCLOPEDIA</b><br>Dyke's. (Covers New<br>Model A Ford).....          | \$6.00 | <b>LANDSCAPING</b><br>Practical.....  | \$2.50 |
| <b>AVIATION</b><br>Everybody's Guide.....                                      | \$2.00 | <b>LATHE WORK (METAL)</b><br>and Drilling and Thread<br>Cutting.....                      | \$1.00 |
| <b>BIRD HOUSES</b><br>How to Make.....   | \$1.00 | <b>LEATHER WORKING</b><br>Making Artistic Arti-<br>cles.....                              | \$1.00 |
| <b>BLUE PRINTS</b><br>How to Read.....   | \$2.00 | <b>LETTER WRITING</b><br>Effective Business.....  | \$3.00 |
| <b>BOAT BUILDING</b><br>Outboard Motor Type<br>30 Designs.....                 | \$3.00 | <b>MACHINIST</b><br>419 Kinks for.....  | \$1.50 |
| <b>BOY MECHANIC</b><br>4 Vol. Library, Covers<br>4000 Things to Make.....      | \$7.00 | <b>MAGIC</b><br>200 New Tricks for Am-<br>ateurs.....                                     | \$1.00 |
| <b>BUILT-IN FURNITURE</b><br>How to Make.....                                  | \$2.50 | <b>MAKING THINGS<br/>YOURSELF</b><br>900 Different Articles.....                          | \$3.00 |
| <b>CARPENTRY</b><br>Handbook of Kinks.....                                     | \$1.50 | <b>MATHEMATICS</b><br>Made Easy for the Prac-<br>tical Man.....                           | \$1.50 |
| <b>CIVIL SERVICE</b><br>How to Prepare for.....                                | \$3.00 | <b>MECHANICAL DRAWING</b><br>Practical Course in.....                                     | \$1.00 |
| <b>COLOR SIMPLIFIED</b><br>Practical (for Color<br>Users).....                 | \$3.50 | <b>MODEL AIRCRAFT</b><br>Building and Flying for<br>Boys.....                             | \$2.25 |
| <b>CONCRETE</b><br>173 Ways of Using and<br>Home Mechanics.....                | \$1.00 | <b>MOVIE MAKING</b><br>for Amateurs.....  | \$3.00 |
| <b>CONTRACTOR</b><br>Building Cost Estimator.....                              | \$2.00 | <b>OUTDOOR OPPOR-<br/>TUNITIES</b><br>for Making a Living.....                            | \$2.00 |
| <b>DICTIONARY (ENGLISH)</b><br>New, Simplified, 1500<br>Pages, 3000 Illus..... | \$5.00 | <b>OUTDOOR SPORTS</b><br>for All Year 'Round.....   | \$1.50 |
| <b>DIESEL ENGINES</b><br>(New Work). Best Au-<br>thority.....                  | \$5.00 | <b>PAINTING</b><br>House (Best Methods).....  | \$2.00 |
| <b>DOGS</b><br>Care and Raising.....   | \$2.00 | <b>PLUMBING</b><br>Repair Your Own.....   | \$1.50 |
| <b>ELECTRIC LIGHTING</b><br>25% More Light at No<br>Increase in Cost.....      | \$1.00 | <b>POULTRY RAISING</b><br>for Profit.....   | \$2.00 |
| <b>ELECTRICIAN</b><br>214 Practical Kinks.....                                 | \$1.50 | <b>POWER WIRING (D. C.)</b><br>Electrical (Just Out).....                                 | \$3.50 |
| <b>ELECTROPLATING</b><br>Practical Results Easily<br>Obtained.....             | \$1.00 | <b>PUZZLES</b><br>Amusing Mathematical.....   | \$1.50 |
| <b>ENAMELING</b><br>and Japanning (Baked<br>Finishing).....                    | \$3.50 | <b>RADIO</b><br>Trouble Shooting.....   | \$3.00 |
| <b>ENGLISH</b><br>Self-Improvement in.....                                     | \$2.50 | <b>ROPE SPINNING</b><br>Only Book on Subject.....   | \$1.50 |
| <b>ETIQUETTE</b><br>New 560-Page Book.<br>Only.....                            | \$1.00 | <b>SHEET METAL WORKER</b><br>1000 Valuable Aids for.....                                  | \$5.00 |
| <b>FARMER'S BOOK</b><br>of 861 Kinks and Book<br>for Farmers' Wives.....       | \$1.00 | <b>SHIP MODEL</b><br>Making.....  | \$2.50 |
| <b>FLY (HOW TO)</b><br>Written So a Boy Can<br>Understand It.....              | \$2.50 | <b>SHOP NOTES</b><br>16 Vols. of 6000 Valu-<br>able Kinks.....                            | \$5.00 |
| <b>FORMULAS</b><br>10,000 Money Making.....                                    | \$4.00 | <b>TAXIDERMISTRY</b><br>Best Book of Methods.....   | \$3.50 |
| <b>FURNITURE</b><br>Homemade (3 vols.).....                                    | \$3.00 | <b>TELEVISION</b><br>and Wireless Pictures.....   | \$2.50 |
| <b>GARAGE</b><br>Money Making Methods<br>in Management.....                    | \$3.00 | <b>TOY MAKING</b><br>Speed (for Boys).....  | \$1.25 |
| <b>HEATING</b><br>Systems (Practical) and<br>Ventilation.....                  | \$4.00 | <b>WELDING<br/>ENCYCLOPEDIA</b><br>All Methods.....                                       | \$5.00 |
| <b>HOME REPAIRS</b><br>Practical Book of.....                                  | \$2.50 | <b>WIRING</b><br>House (New Book).....  | \$2.50 |
|  |        | <b>WOOD TURNING (LATHE)</b><br>Practical Course in.....                                   | \$1.50 |

## Books sent C. O. D. anywhere in U.S.

Just clip the ones you want, write your name and address below, and mail with coupon. It is your order blank. When postman hands you books, pay him the price and the postal charges. If outside the U. S. remit when ordering and include 10 cents per book extra for postage. We have many other books on these and 2,000 other subjects. Catalog free.

Name.....

Address.....

City..... State.....

Mail to **Popular Mechanics Press,**  
Room P3—200 East Ontario St., Chicago, Ill.



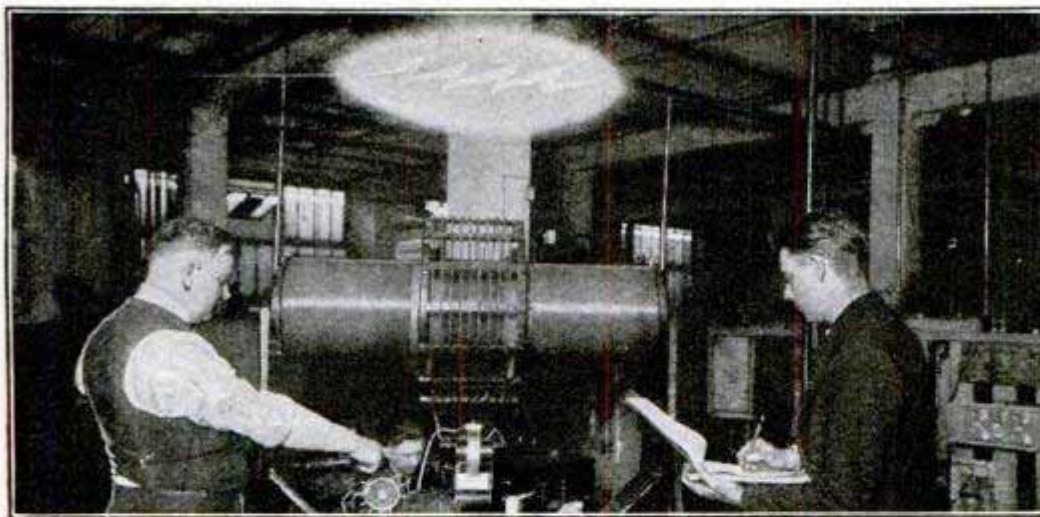

# 500,000 VOLTS

"Artificial lightning" being developed in Coyne School. Spark of 500,000 volts is shown jumping 30 inches. This gigantic Tesla Coil is the same as that used by Steinmetz, absolutely harmless, because of high frequency.

# Learn Electricity By Doing - Not Books in 12 Weeks!

By **ACTUAL WORK** - in the Great Shops of Coyne



ANYONE with common schooling who can see and understand the English language can learn electricity in 90 days. I teach you with as complete an outlay of electrical apparatus as was ever assembled in any institution—30-foot control board—transmitting stations—skeleton houses, huge motors—dynamos—sub-stations—automobiles—switchboards. In one department we generate enough electricity to supply a small city!

**No Books—No Classes**

**Enter anytime.** Experts teach you on electrical machinery and *not books*. They guide you every step of the way with individual attention. You do the actual work on real full-size machinery in full operation. Take motors for instance. Instead of learning from books and charts—you actually build motors. You can't help but know all about them. Anyone can learn this fascinating way.

### No Experience Necessary

That's how my methods teach you electricity in 12 wonderful weeks. You don't need experience—Coyne training starts from the very beginning. You don't need advanced education—you learn by doing. Age is no handicap—Coyne students range from 16 to 45.

Not a Correspondence School

# COYNE Electrical SCHOOL

H. C. Lewis, President Dept. 39-72C  
500 So. Paulina St., Chicago

### Triple Your Earning Power

I don't need to tell you about the opportunities in electricity. They are too many and too amazing to mention. Ordinary jobs run \$50—\$60 and up a week. And Coyne training leads to the biggest positions. Many Coyne men are making up to \$500 a month. Demand for Coyne men often exceeds the supply. Our employment bureau gives you lifetime service after graduation.

### Earn While You Learn

We help many students who haven't much money to secure part-time jobs to earn a good part or all of living expenses while training.

### All Details Sent Free

This school is 29 years old—Coyne training is tested—proven beyond all doubt—endorsed by electrical industry. You can find out everything absolutely free. Simply mail the coupon and let me send you the big, free Coyne book of 150 photographs—facts—jobs—salaries—opportunities. See what Coyne training can do for you in just 90 days! This does not obligate you. So act at once. Just mail the coupon.

### Get This FREE Book

**Fill In And Mail To Day**

Mr. H. C. Lewis, Pres. Dept. 39-72C  
COYNE ELECTRICAL SCHOOL,  
500 S. Paulina St., Chicago, Ill.

Dear Mr. Lewis: Without obligation send me your big free catalog and all details of Free Employment Service, Radio, Aeroplane and Automotive Electrical Courses, and how many "earn while learning." Also tell me about your offer of railroad fare to Chicago.

Name.....  
Address.....  
Town..... State.....

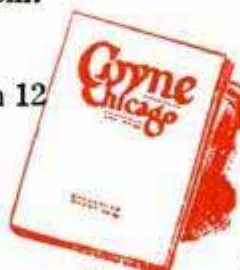



# There's Quicker, Bigger MONEY for YOU in POULTRY RAISING!



Wherever You Live—  
Whatever You Do Now—  
\$1000 to \$5000 a Year  
Can Be Yours!



Spare Time or Full Time  
YOU Can Cash-In BIG

Instead of knocking at your door, Opportunity is waiting for you in your back yard! Hundreds, thousands of my students have turned to Poultry Raising for PART TIME EXTRA MONEY or FULL TIME BIG PAY. Many start off in just a small way—with a back-yard or vacant-lot flock. Only a few hens—but my profit-producing methods make them pay. Whether you live in a city, town or on the farm—and no matter what kind of work you're doing now—I will show you how to start and how to keep going successfully. *Mighty successfully!* The Poultry Market is growing by leaps and bounds. Eggs and poultry meat are commanding real prices, high prices—prices that mean a handsome margin of profit on every egg or bird you can produce. There's not a doubt or question about it—YOU CAN CASH-IN BIG. Why wait—why lose? I'LL PROVE that I can put YOU among the big money makers—QUICK.

My Proved Methods Assure  
Success Right from START

All the "mystery," all the "secrets," all the guesswork are taken out of Poultry Raising by my sure, tested, *proved* successful methods. I will teach them all to you. Nothing left out, nothing for you to have to figure yourself. I make it easy for you. It's fascinating, healthful, pleasant, profitable. You'll be your own boss—I'll show you how to make \$1.00 to \$3.00 for every hour of your spare time. What's more, I'll show you the way to a salary of \$5,000 a year AND UP! Start as small as you want; my methods will get the maximum profits out of your flock and make it grow *automatically* into a sure source of steady, big income for YOU.

FREE BOOK Shows Way to BIG PROFITS

My big new FREE book, "How to Raise Poultry for Profit," will amaze you! It brings evidence a-plenty—absolute *proof*—of what I have done for thousands of others. My forty years experience as Commercial Poultryman and former Senior Poultryman in the U. S. Dept. of Agriculture is yours for real Success and Independence. The Poultry Business needs you—and you need the profits that the poultry business brings. You need my book. Get it now for QUICKER, BIGGER MONEY. Do it this minute—don't delay a day. Get this coupon into the very next mail!

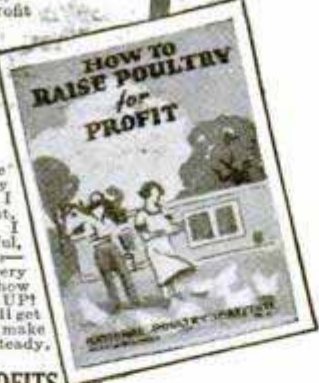

48 Pages  
of Money-  
making FACTS

Get this FREE Book NOW!

Harry M. Lamon, Pres.,  
NATIONAL POULTRY INSTITUTE  
Dept. 411-G, Washington, D. C.  
Dear Mr. Lamon: Send me your FREE Book, "How to Raise Poultry for Profit." I want to know more about MY opportunity to make \$1,000 to \$5,000 a year, spare time or full time.

Name.....  
Address.....  
City..... State.....

YOU Can Do  
What They Have  
Done

"Your Course on Poultry Raising is the most practical and complete in the country. You have opened up a pleasant and profitable way for me to gain an independent living."—S. Anderson, Barrington, R. I.

"I have a back-yard flock that has improved fully 100% since I have been following your methods. I am of the opinion that a poultryman cannot be successful without taking your Course."—David Tognarelli, Chicago, Ill.

# FROM DRUDGERY \$5200.00 TO A YEAR FOR DRAWING

"I feel as though my old days of drudgery were a bad dream. Now I am earning \$5200.00 a year and I have just started. Commercial drawing is the work I love to do. If it had not been for the opportunity of studying art in my spare time, and the kindly interest of the Federal faculty, I would never have gotten out of the rut I was in. The practical, thorough, short course I took with the Federal School made my success possible."

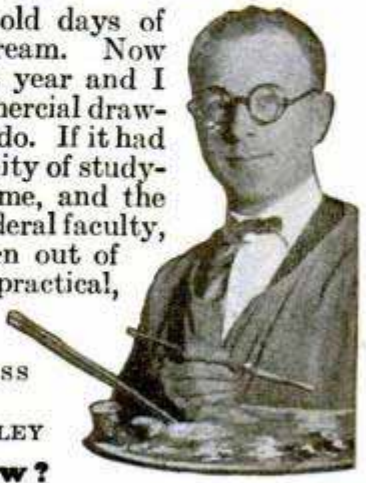

LLOYD SHIRLEY

Do You Like To Draw ?

If you like to draw, you can develop your talent quickly with this short, practical training. Hundreds of other Federal students will tell you how the Federal Course has helped them on the way to a successful art career and big money. Write for our book, "YOUR FUTURE" and find out what the right art training will do for you.

Federal School of Commercial Designing  
641 Federal Schools Bldg., Minneapolis, Minn.



## FREE to BOYS

Sample Copy of OPEN ROAD for BOYS Magazine, 60 pages thrilling stories, pictures, sports, mystery, etc. Free membership in WINNIT CLUB, badge button, big outfit, catalog and new plan for getting easy money and swell prizes. Big surprise, too! ALL FREE! No obligation.

Writes today to WINNIT CLUB 2  
Open Road For Boys  
130 Newbury Street, Boston, Mass.

# CHEMISTRY



Complete, practical home-study courses prepared by some of the best-known chemists in this country, including ALLEN ROGERS, B.S., M.S., Ph.D.—Head of Department of Industrial Chemistry, Pratt Institute; L. M. TOLMAN, Ph.D.—Formerly Chief Chemist, Wilson & Co. Now Vice-president, United Chemical and Organic Products Co.; BRADLEY STOUGHTON, B.S.—Head of the Department of Metallurgy, Lehigh University, and OWEN L. SHINN, Ph.D.—Professor of Applied Chemistry, University of Pennsylvania.

Mail Coupon for Free Booklet

INTERNATIONAL SCHOOL OF CHEMISTRY  
Associated with the International Correspondence Schools  
Box 5606-F, Scranton, Penna.

Without cost or obligation, please send me full details of your home-study course in

Analytical Chemistry     Metallurgical Chemistry  
 Chemical Engineering     Short Chemistry Course  
 Industrial Chemistry        Pharmacy

Name.....  
Address.....



# I Will Train You at Home to Fill a Big-Pay Radio Job

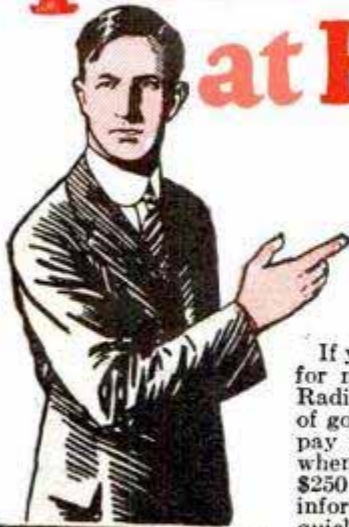

If you are earning a penny less than \$50 a week, send for my book of information on the opportunities in Radio. It's FREE. Clip the coupon NOW. A flood of gold is pouring into Radio creating hundreds of big pay jobs. Why go along at \$25, \$30 or \$45 a week when the good jobs in Radio pay \$50, \$75 and up to \$250 a week? "Rich Rewards in Radio" gives full information on these big jobs and explains how you can quickly learn Radio through my easy, practical home-study training.

**Salaries of \$50 to \$250 a Week  
Not Unusual**

The amazing growth of Radio has astounded the world. In a few short years three hundred thousand jobs have been created. And the biggest growth is still to come. That's why salaries of \$50 to \$250 a week are not unusual. Radio simply hasn't got nearly the number of thoroughly trained men it needs

**You Can Learn Quickly and Easily  
in Spare Time**

Hundreds of N. R. I. trained men are today making big money—holding down big jobs—in the Radio field. You, too, should get into Radio. You can stay home, hold your job, and learn in your spare time. Lack of high school education or Radio experience are no drawbacks.

**Many Earn \$15, \$20, \$30 Weekly  
On the Side While Learning**

I teach you to begin making money shortly after you enroll. My new practical method makes this possible. I give you SIX BIG OUTFITS of Radio parts and teach you to build practically every type of receiving set known. M. E. Sullivan, 412—73rd St., Brooklyn, N. Y., writes, "I made \$720 while studying." G. W. Page, 1807—21st Ave., S., Nashville, Tenn., "I picked up \$935 in my spare time while studying."

**Your Money Back If Not Satisfied**

My course fits you for all lines—manufacturing, selling, servicing sets, in business for yourself, operating on board ship or in a broadcasting station—and many others. I back up my training with a signed agreement to refund every penny of your money if, after completion you are not satisfied with the lessons and instructions I give you.

**Act NOW—64-Page Book is FREE**

Send for this big book of Radio information. It has put hundreds of fellows on the road to bigger pay and success. Get it. See what Radio offers you, and how my Employment Department helps you get into Radio after you graduate. Clip or tear out the coupon and mail it RIGHT NOW.

J. E. SMITH, President, Dept. 9PP  
**National Radio Institute**  
Washington, D. C.

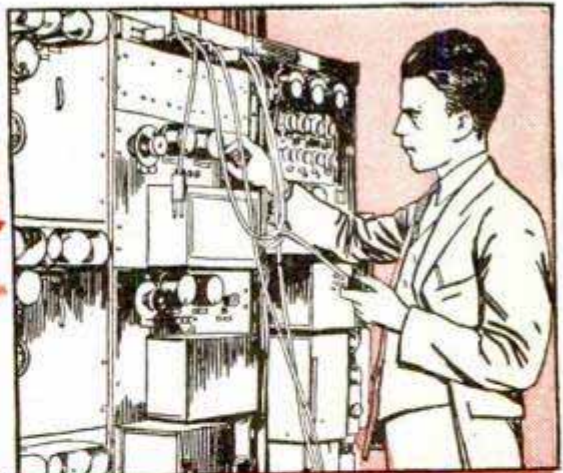

**You can build  
100 circuits with  
the six big outfits  
of Radio parts  
I give you**

**3 of the 100 you  
can build**

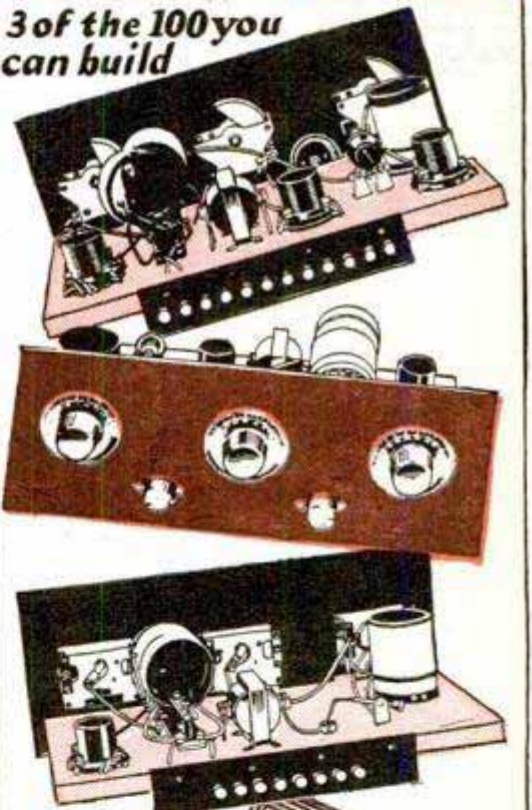

**Find out quick  
about this  
practical way  
to big pay**



**Mail This FREE COUPON Today**

J. E. Smith, President,  
Dept. 9PP, National Radio Institute,  
Washington, D. C.

Dear Mr. Smith: Send me your Free book "Rich Rewards in Radio" giving information on the big-money opportunities in Radio and your practical method of teaching with six Radio Outfits. I understand this places me under no obligation.

Name.....Age.....  
Address.....  
City.....State.....  
Occupation.....

**Here's the  
PROOF**



**\$375 One  
Month in  
Spare Time**

"Recently I made \$375 in one month in my spare time installing, servicing, selling, Radio Sets."

Earle Cummings,  
18 Webster St.,  
Haverhill, Mass.



**\$450 a Month**

"I work in what I believe to be the largest and best equipped Radio shop in the Southwest and also operate KGFI. I am averaging \$450 a month."

Frank M. Jones,  
922 Guadalupe St.  
San Angelo, Tex.

**Employment Service to all Graduates**  
**Originators of Radio Home Study Training**



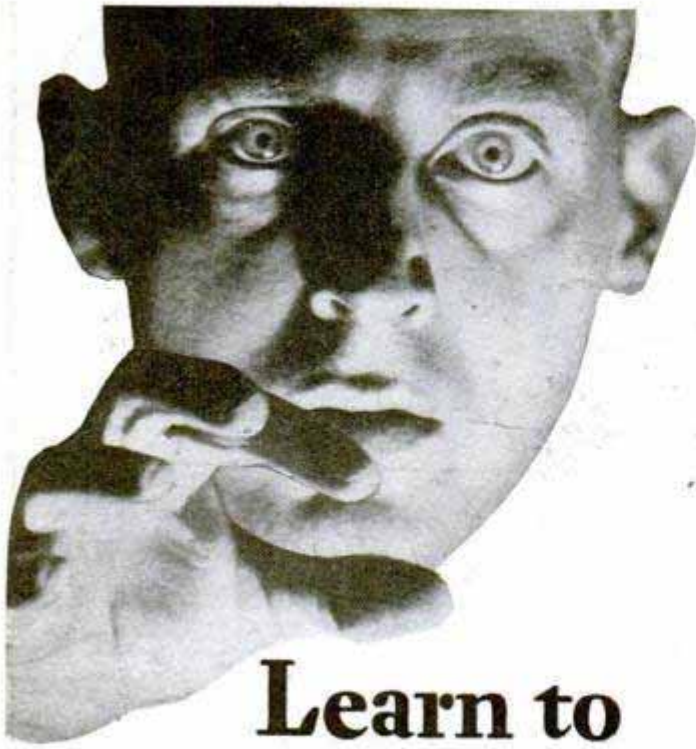

# Learn to HYPNOTIZE

**5 DAY TRIAL - NO COST  
IF NOT SATISFIED**

## Gain New Power!

**Q**UIT being just one of the crowd! Stand out—dominate—make others admire and obey you! Learn how to bend people to your will; how to develop a winning, magnetic personality; how to gain popularity, success, big money—by the USE OF HYPNOTISM.

In just a few hours, I'll show you the inner secrets of this mysterious force or the **Five Days' TRIAL IS FREE!** I'll show you how to develop the hidden germ of this magic power within yourself. Once you know how, you can use it in overcoming obstacles, achieving your fondest ambitions and becoming MASTER of yourself, friends and acquaintances—either sex. See for yourself how Hypnotism can banish fear, worry and opposition—improve your memory—**increase your earnings**—and force others to give you the good things in life that you desire!

In his startling **NEW** book "The Science of Hypnotism," the world famous hypnotist—Prof. L. E. Young—reveals the most carefully guarded secrets of this fascinating subject and TELLS ALL! He not only explains the methods of noted hypnotists, step by step—but tells clearly all about the nine stages of hypnotism, The Hypnotic Mirror, Mental Telepathy, how to select your subjects, magnetic healing, methods of hypnotizing, how to waken subject, how to make money out of hypnotism!

- SEE**
- How to Hypnotize at a Glance
  - How to Hypnotize By Telephone
  - How To Give An Entertainment
  - How To Make Others Obey You
  - How To Do Dozens of Hypnotic Feats



### Try 5 Days Free—Send No Money

So confident are we that Prof. Young and his great book will quickly teach you the science of hypnotism, that we will send you a copy without one cent in advance! Simply clip and mail the coupon below. When the book arrives, pay the postman the special low price of \$2.50 plus few cents postage. Then test the powers of Hypnotism 5 days! If not amazed and delighted, return the book and money will be refunded at once! Mail the coupon now.

Franklin Pub. Co., Dept. C-70

800 N. Clark St., Chicago, Ill.

Franklin Pub. Co., Dept. C-70  
800 N. Clark St., Chicago, Ill.

Please send me your amazing new book—"The Science of Hypnotism"—by Prof. Young. When the book arrives, I'll pay the postman only \$2.50 plus postage. If I am not satisfied after 5 days' trial, I may return the book and you are to refund my money.

Name.....

Street and No.....

Town..... State.....

If you are likely to be out when postman calls, send \$2.50 (with coupon and we'll pay delivery charges. Customers outside U. S. must send cash with order.

*Learn to Write*

## I Teach by Mail

**I CAN** make a good penman of you at your home during spare time, no matter where you live or how poorly you now write. My simplified system has shown thousands of others the way to good penmanship during the past twenty years — it can and will do the same for YOU!

**Beautifully Illustrated Book**

### "How to Become a Good Penman" **FREE!**

It contains general information, with testimonials and beautiful specimens of penmanship showing what others have accomplished by the Tamblin System. (Your name elegantly written on a card if you enclose stamp for postage.) **WRITE TODAY.** Address

**F. W. TAMBLIN**  
418 Ridge Bldg., Kansas City, Mo., U. S. A.

# Play "JAZZ" on the Saxophone

Become a musician so quickly as to astound everyone. Learn by playing real music—instead of tiresome "exercises." You'll soon become the most popular person in your "set."

## New Easy Method

is a revelation. Nothing else like it for thoroughness and rapidity. So simple that young and old find it easy to play with amazing skill. No "trick music"—but actual notes, learned quickly right in your own home.

### FREE BOOK and Demonstration Lesson

offers this wonderful musical opportunity. Send for them today before copies are exhausted. You'll be astounded, thrilled, fascinated, at this easy, rapid way to become a veritable master of your favorite instrument. Instruments supplied when needed, cash or credit.

**LEARN TO PLAY ANY INSTRUMENT**

|                                     |                          |
|-------------------------------------|--------------------------|
| Piano                               | Guitar                   |
| Organ                               | Mandolin                 |
| Violin                              | Drums and Traps          |
| Clarinet                            | Sight Singing            |
| Flute                               | Ukulele                  |
| Harp                                | Piccolo                  |
| Cornet                              | Trombone                 |
| Cello                               | Saxophone                |
|                                     | Voice and Speech Culture |
|                                     | Automatic Finger Control |
|                                     | Piano Accordion          |
| Banjo (Plectrum, 5-String or Tenor) |                          |

**U. S. SCHOOL OF MUSIC, 73A Brunswick Bldg., New York City**

Send me your amazing free book, "Music Lessons in Your Own Home," with introduction by Dr. Frank Crane, also Free DEMONSTRATION LESSON. This does not put me under any obligation. (Please Write Plainly.)

NAME.....

ADDRESS.....

INSTRUMENT.....

Have you this inst.?



# TRAVEL FOR "UNCLE SAM"



## RAILWAY POSTAL CLERKS

**\$158 Month First Year**

**Raise to Maximum of \$225 Month**

**Many other U.S. Government Jobs Open to Men and Boys 18 and up**

**POST OFFICE CLERKS  
RURAL MAIL CARRIERS**

**CITY MAIL CARRIERS  
PROHIBITION AGENTS—INVESTIGATORS**

These are steady positions. Strikes, poor business conditions, lockouts or politics do not affect them. U. S. Government employees get their pay for full twelve months every year. There is no such thing as "HARD TIMES" in the U. S. Government Service.

### A STEADY BIG PAY JOB

Railway Postal Clerks now get \$1900 the first year regular, being paid on the first and fifteenth of each month. \$79.16 each pay day. Their pay is increased \$100 and \$150 a year. The maximum is \$2700 a year. \$112.50 each pay day. They get extra allowance for hotel expenses when away from home.

### PAID VACATIONS

Railway Postal Clerks, like all Government employees, are given a yearly vacation of 15 working days (about 18 days). When on runs they usually work 3 days and have 3 days off duty or in the same proportion. During this off duty and vacation, their pay continues just as though they were working. When they grow old, they are retired with a pension. As Railway Postal Clerks are continually traveling, they have an excellent chance to see the country.



### City Mail Carriers—Post Office Clerks

Clerks and Carriers get \$1700 the first year regular and automatically increase \$100 a year to \$2100 with further special increase to \$2300. They also have 15 days' vacation. City residence is unnecessary.

### What Will You Earn 5 Years from Now?

Compare these conditions with your present or your prospective condition, perhaps changing positions frequently, kicking around from post to pillar, no chance in sight for PERMANENT employment; frequently out of a position and the year's average salary very low. DO YOU EARN \$1900 EVERY YEAR? HAVE YOU ANY ASSURANCE THAT A FEW YEARS FROM NOW YOU WILL GET \$2700 OR MORE A YEAR, EVERY YEAR?



### Get Free List of Positions

Fill out the coupon. Tear it off and mail it today—now, at once. DO IT NOW—This investment of two cents for a postage stamp may result in you getting a U. S. Government Job.

**FRANKLIN INSTITUTE,  
Dept. N-173,  
ROCHESTER,  
N. Y.**

Rush to me entirely free of charge 32 page book with (1) a full description of the position checked below; (2) a list of U. S. Government jobs now obtainable; (3) tell me how to get the position checked.

- Railway Postal Clerk... (\$1900-\$2700)
- Post Office Clerk..... (\$1700-\$2300)
- City Mail Carrier..... (\$1700-\$2100)
- Rural Mail Carrier..... (\$2100-\$3300)
- Clerk in Government Offices... (\$1260-\$2100)
- Prohibition Agent—Investigator. (\$2300-\$3400)

Name.....

Address.....

Use This Coupon Before You Mislays It—Write or Print Plainly.

MAIL COUPON TODAY



# Step INTO A BIG-PAY HOTEL JOB



**Earn \$2,500 to \$10,000 a Year**

IN America's 3rd Largest Industry. Hotels, Clubs, Restaurants, Institutions, Schools, Colleges, Hospitals, etc., are daily calling for Lewis-Trained Men. Over 70,000 high-class positions paying \$2,500 to \$10,000 a year open annually in hotels alone. Salaries up to \$3,500 to start.

### We Put You in Touch with Positions

Without cost let us show you how big pay, fascinating work, quick advancement can be yours in the great hotel industry. Age is no obstacle—young and old alike have equal chance for success. A common school education is all you need with the amazing Lewis System of Sparetime Training in Hotel Operation.

### Previous Experience Unnecessary

Hundreds of Lewis students are winning success. Totally unacquainted with hotel work before taking the Lewis Course, N. Frank Hills is now Assistant Manager of a \$250,000 Apartment House in Los Angeles, Cal. Elwood V. Matlack rose from Elevator Boy to Manager of an Akron, Ohio, Hotel, in less than two years, due to the training he received from the Lewis Schools. YOU can do as well. Low cost—easy terms—money-back agreement. Write today for Free Book, "Your Big Opportunity," and complete details, mailed without obligation.

### These Lewis Students "Made Good"

**D. A. Robinson**—"I am Manager of a Country Club in Teumseh, Ont., at double the salary I earned before taking the Lewis Course. One of my deepest regrets is that I didn't know about the Lewis Schools twenty years earlier."

**Julius M. Winslow**—"Now Assistant Manager of a 15-story hotel in New York City. I knew nothing of hotel work until I began your course 6 months ago."

**Earnest Crowder**, Indianapolis, Ind.—"The Lewis Schools are entirely responsible for my appointment as Assistant Manager."

**1000 HOTEL POSITIONS OPEN**

**Lewis Hotel Training Schools**  
Room BJ-339  
Washington D. C.



**LEWIS HOTEL TRAINING SCHOOLS,**  
Room BJ-339, Washington, D. C.

Send me the Free Book, "Your Big Opportunity," without obligation.

Name.....  
Address.....  
City..... State.....

**OPPORTUNITY COUPON**

## The MOCAR

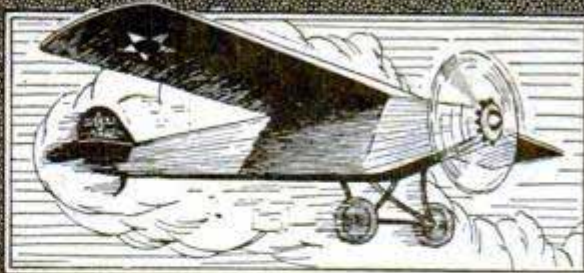

### Model Airplanes That FLY BOYS

Here is the Greatest Value You've Ever Seen—  
A Genuine Aluminum Model Airplane That Really Flies, at a Small Price.

The "Mocar" monoplane—Set No. 1—is a copy of Lindbergh's famous Spirit of St. Louis. Wing spread 18 inches, fuselage 12 inches, powerful motor, special propeller, rubber tired disc wheels. Weight complete only about 2 1/2 oz. This is a practical, simple, real model plane that gives you a whole lot of fun at a very moderate cost. The all metal construction makes a sturdy plane that will stand a lot of abuse. The outfit is mounted on cardboard with all parts plainly marked and full instruction, for assembly. Pliers only tool necessary. Construction set No. 1. Complete with rivets, bolts, wheels, wing and fuselage covering material, only \$1.50 postpaid (3 for \$4.00). Model L made up ready to fly \$2.25 (3 for \$6.00) postpaid.

Great fun, learn how to make and fly airplane  
Order now—or see your dealer

**THE MOUNT CARMEL MFG. CO.**

Dept. M

NEW HAVEN, CONN.

Construction

Set No. 1  
Only

**\$1.50**

Complete  
Postpaid



## GIVEN TO YOU

A Brand New High Grade Fine Tone

**VIOLIN, TENOR BANJO, HAWAIIAN GUITAR, BANJO, CORNET, UKULELE, BANJO UKULELE, GUITAR OR MANDOLIN**

We will give you without extra charge when you enroll, any instrument you select and teach you to play it by our NEW copyrighted easy to learn home-study course. Over 500,000 men, women, boys and girls have learned to play by our simplified method. Cost is only a few cents a day for lessons. No other charge. You pay while you learn. Instrument and first lessons sent on FREE trial. Write today. **CHICAGO CORRESPONDENCE SCHOOL OF MUSIC, INC.** 1632 No. Halsted St., Dept. 764 Chicago, Ill.

## Learn to PAINT SIGNS and SHOW CARDS

We quickly teach you by mail, or at school, in spare time. Big demand. Big future. Interesting work. Oldest, foremost school. **EARN \$50 TO \$200 WEEKLY** Otto Wiegand, Md., home-study graduate, made \$12,000 from his business in one year. John Vassos, N. Y., gets \$25 for a show card. Crawford, B. C., writes: "Earned \$200 while taking course." Write for complete information.

**DETROIT SCHOOL OF LETTERING**  
150 Stimson Ave. Est. 1899 DETROIT, MICH.



## Learn Watchwork, Jewelrywork and Engraving

A fine trade commanding a good salary, and your services always in demand. Address **Horological**, Dept. P, Bradley Institute, PEORIA, ILLINOIS, for our latest catalog.

## BE AN ARTIST

WE CAN TEACH YOU DRAWING in your own home during your spare time. Twenty-five years of successful teaching proves our ability. Artists receive large salaries.

Write Today for Art Year Book

**SCHOOL OF APPLIED ART**  
ROOM NO. 2 BATTLE CREEK MICH.





# Money Making Tools

**ALL are Regular Draftsman's Tools SENT AT ONCE**

Sent to **YOU**  
Become a **BIG PAY MAN**  
with My Help

COMPLETE OUTFIT

ALSO DRAFTING TABLE

**Earn as You Learn**

I tell you how to start earning extra money a few weeks after beginning my training.



Copy me and get Iorine Rule Free. — Jack

**Copy this Jack and Get this Draftsman's Rule**

**FREE**

Automobiles—Electricity—Motor Busses—Aviation—Building Construction. There are jobs for Draftsmen in all of these industries and in hundreds of others. Aviation is expanding to enormous proportions. Electricity is getting bigger every day. Motor Bus Building is becoming a leading world industry. Building of stores, homes, factories and office buildings is going on all the time. No structure can be erected without plans drawn by a draftsman. No machinery can be built without plans drawn by a draftsman. I train you at home, in Drafting. Keep the job you have now while learning drafting. I will train you in drafting right where you are in your spare time. I have trained men who are making from \$3,500 to \$9,000 a year. There is a big future for draftsmen because you plan and supervise the work of others, or you go into business for yourself. Get started now toward a better position, paying a good, straight salary, the year around. Comfortable surroundings. Inside work.

**Employment Service** After training you I help you to get a job without charging you a cent for this service. Employers of Draftsmen come to me for men because they know that Dobe Trained Men make good as they have learned drafting by actually doing the work themselves, in a practical way. Employers know they are not taking chances on men trained by me.

**Money-Back Agreement**  
I train you at home under a positive Money-Back Agreement. If my training does not satisfy you after you have finished, you get every penny back.

**Age or Lack of Education No Drawback**

Previous experience is not necessary. You do not need to be a college man or high school graduate.

**Get My Pay-Raising Plan —also FREE**

If you will mail sketch at once I'll send you also FREE "My Pay-Raising Plan"

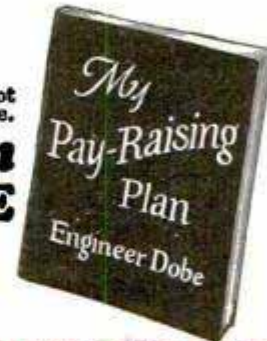

I'll train you at home. —Engineer Dobe

**If You Earn Less Than \$70 a Week—Write Me Today!**

Mail this coupon, at once with copy of Jack. Get "My Pay Raising Plan" and "Successful Draftsmanship". Both of them point the way to Success. You owe it to yourself to find out what a big opportunity there is in practically all industries, for Draftsmen. These two books are Free. They come to you post-paid. Mail the Coupon for them TODAY.

**Engineer Dobe, 1951 Lawrence Ave. Div. 1353 Chicago**

**MONEY-MAKING TOOLS COUPON**

**ENGINEER DOBE, 1951 Lawrence Ave., Div. 1353, Chicago**  
Here's my copy of Jack. Send me free of all cost your book, "Successful Draftsmanship", also plan to earn money while learning and proof of big money paying positions. Also your new book "My Pay-Raising Plan." Also tell me about your Money-Making Tools which you furnish. Send the free Pocket Rule.

Name..... Age.....  
Address.....  
Post Office..... State.....



**I'll Refund Your R.R. Fare to Chicago**

# Auto Experts

Get

# BIG PAY!

## Men Wanted

I can help place 20 TO 40 men a day, in JOBS, while learning and after. Never before such unusual opportunities. Get my free book now. Learn about the big pay. AUTOS lead WORLD'S BUSINESS. That's why GREER College selected this Field. Coupon brings you amazing facts.



## Be Your Own BOSS

**Earn up to \$150.00 a week**

AUTOS now pay hundreds of Greer trained men up to \$200 A WEEK. Here is a most wonderful business. BILLIONS—not millions, but BILLIONS of dollars are spent in it every year. Greer trained men are NEEDED. I HAVE MADE hundreds of \$10,000 A YEAR MEN. 90,000 in the last 26 years have come to Greer.



Learn to Boss the Job

## Only 3 Months

Learn in ONLY 3 MONTHS in GREAT GREER SHOPS on large live equipment. I'LL PAY YOUR FARE HERE Free of extra cost, then help you to a job while learning. Then I not only FIT YOU to GET the big pay job, but I'll help YOU HOLD IT. Young and Old, Educated and Uneducated, Inexperienced and Experienced have found GREER SHOPS training easy, fascinating and valuable.

### COUPON BELOW BRINGS YOU BIG FREE BOOK

Don't let money hold you back. Get my Free Book. Find out NOW, how I PAY YOUR FARE HERE, let YOU ATTEND either days or evenings and help you find DAY OR EVENING WORK to PAY YOUR EXPENSES while learning. Then when trained we help you find the real big pay job. Learn about amazing Auto opportunities and GREER COLLEGE. Right now, if you act quick, I can make you a most unusual short time offer. Address me personally

Erwin Greer, President, GREER COLLEGE  
Dept. 301 AT, 2024 So. Wabash Ave., Chicago



# FREE BOOK

Erwin Greer, President  
Dept. 301 AT, 2024 So. Wabash Avenue, Chicago, Illinois.

Send Free Auto Book and details of Special offer without obligation to me.

Name.....

Address..... Age.....

# Make Yourself a Popular Favorite with the TENOR BANJO

Easy to Play—Learn at Home in Spare Time

**\$18 TENOR BANJO GIVEN with case When You Enroll**



### Play for Fun or Money

Don't be a wallflower. Entertain your friends. Be popular. Play at dances, parties, etc. Form an orchestra. Earn extra money. Our 52-lesson course will soon make you a real Tenor-Banjo player. Everything explained clearly.

### Our Simple Method Makes It Easy

Even if you don't know the first thing about music, even if you can't read a single note, you are sure to learn by our simple, easy method of teaching. In 30 minutes you play a complete piece! You study in spare time—your lessons always before you. 61,000 successful students.

### Pay as You Play

We make it easy for you to obtain the many advantages of this Conservatory. Our course is low in cost—only a few cents a day. No class to wait for. Start any time with a small first payment—then pay while learning.

### Write for Special Offer

Sweet toned professional style TENOR BANJO, in genuine Seal Grain Fabrikoid Case, valued at \$18 to \$20 given when you enroll. Write for full information and special offer. A postal will do. ACT! **FIRST HAWAIIAN CONSERVATORY OF MUSIC, Inc.** 9th Floor, Woolworth Building, Dept. 22 New York, N. Y. Approved as a Correspondence School Under the Laws of the State of New York—Member National Home Study Council

# Anyone CAN LEARN



No talent or experience necessary. Fascinating work. Pays Big Money. Complete instruction book tells about: Alphabets, Colors, How to Mix Paints, Show Cards, Window Board and Wall Signs, Ready made letters, Gilding, Tricks of the Trade, also gives 100 Alphabets and Designs. Book bound in flexible imitation leather—gold edges, and four ball bearing Show Card Pens. Sent postpaid \$3.00. (C.O.D.) 10c ex. Ogilvie Pub. Co., 57 Ross St., Dept. 20, N. Y. City



**EARN MONEY IMMEDIATELY—WE FURNISH EQUIPMENT TO START!!**

# Make Much Money

Making and Selling Your Own Goods. Formulas by experts. Manufacturing Processes. Trade-Secrets. All Kinds. All Lines. Send for interesting catalog, special circulars, free. **W. THAXLY CO., Washington, D. C.**

# Learn Advertising at HOME

Send your name and address for free booklet giving interesting information and vital facts about Advertising. Find out how we prepare you at home, in your spare time, for the opportunities open in this fascinating business. Practical work. No text books. Old established school. Successful graduates everywhere. Just the plan you have always wanted. Write today. No obligation.

**PAGE-DAVIS SCHOOL OF ADVERTISING**  
Dept. 1353 3601 Michigan Ave. Chicago, U. S. A.

## ALWAYS Ask For DENISON'S—53 Years of Hits

Comedy-Dramas, Farces, Musical Comedies, Revues, Musical Readings, Comedy Songs, Black-face Skits, Make-up Goods. Catalog FREE. **T. S. DENISON & CO., 623 S. Wabash. Dept. 9, CHICAGO**

# LEARN TO Mount Birds



We teach you At Home by Mail to mount Birds, Animals, Heads, Taxidermy, Taxidermy artist. Easily, quickly learned by men, women and boys. Tremendously interesting and fascinating. Decorate home and den with beautiful art. Make Big Profits from Spare Time Selling Specimens and Mounting for Others. **Free Book—Yes absolutely Free—beautiful book** telling all about how to learn taxidermy. Send Today. You will be delighted. Don't Delay! **Northwestern School of Taxidermy 3373 Elwood Bldg. OMAHA, NEB.**



*Bald Men Look!*

**FREE**



*One Full Ampoule of my amazing hair fluid which I discovered myself and which grew hair on my head.*

This Ampoule is absolutely free. Don't send any money. There is no C. O. D. No charge whatsoever. All I want is an opportunity to show you how easily I grew hair on my own and hundreds of other men's heads. Merely mail the coupon below for Free Ampoule.

**Here is How I Used to Look**

I was just as bald as this picture. It is a true photograph without any tampering or retouching. It is exactly like I used to look. Then look at the full head of hair I have in the picture on the left!

As I have stated so often, I don't know whether I am the first man who discovered this great secret, but I do know I have it, that I grew my own hair and that I am growing hair on the heads of other men all the time.



**Bald Men Grow Hair Quick!**

I grew my own hair just as it shows here.

I will prove to you **FREE** that I can grow hair, quick.



**Here is Brennan**  
Brennan while he was bald.



And Brennan after Vreeland grew his hair. Write and I will tell you Brennan's story and give you his address.



**Here is Wiseman**  
Wiseman was bald like this.



But Wiseman grew this head of hair with my wonderful hair growing fluid. All about Wiseman and how he did it, if you write. You'll get his address too.

What I accomplished on my own head and on other heads I can do for you, provided you are under 45 years of age and loss of hair was not caused by burns or scars. Anyhow, I must succeed or you pay nothing. No apparatus. My home treatment is simple, quick, inexpensive.

**Mail this FREE Coupon**

Mail the coupon today—Right Now—I will send you, immediately, one full Ampoule of my marvelous fluid which I discovered, of which I hold the secret and which grew my own hair on my own bald head. Besides the Free Ampoule of Fluid, I will send photographs, names and addresses of men and women who successfully used my Wonder Fluid for Dandruff, Falling Hair and particularly for Baldness.

**VREELAND** 13-53 Euclid-Windsor Bldg. CLEVELAND, OHIO

**FREE COUPON**  
 13-53 Euclid-Windsor Bldg. CLEVELAND, O.  
 Please send me, entirely free, one full Ampoule of the same Wonder Hair Fluid which grew your hair.  
 My Name \_\_\_\_\_  
 My Address \_\_\_\_\_  
 State \_\_\_\_\_





# High School Course in Two Years!

## You Want to Earn Big Money!

And you will not be satisfied unless you earn steady promotion. But are you prepared for the job ahead of you? Do you measure up to the standard that insures success? For a more responsible position a fairly good education is necessary. To write a sensible business letter, to prepare estimates, to figure cost and to compute interest, you must have a certain amount of preparation. All this you must be able to do before you will earn promotion. Many business houses hire no men whose general knowledge is not equal to a high school course. Why? Because big business refuses to burden itself with men who are barred from promotion by the lack of elementary education.

### Can You Qualify for a Better Position

We have a plan whereby you can. We can give you a complete but simplified high school course in two years, giving you all the essentials that form the foundation of practical business. It will prepare you to hold your own where competition is keen and exacting. Do not doubt your ability, but make up your mind to it and you will soon have the requirements that will bring you success and big money. **YOU CAN DO IT.**

Let us show you how to get on the road to success. It will not cost you a single working hour. Write today. It costs you nothing but a stamp.

### American School

Dept. H-374 Drexel Ave. and 58th St., Chicago

### American School

Dept. H-374 Drexel Ave. and 58th St., Chicago

Send me full information on the subject checked and how you will help me win success.

- |                             |                           |
|-----------------------------|---------------------------|
| ....Architect               | ....Business Law          |
| ....Building Contractor     | ....Lawyer                |
| ....Automobile Engineer     | ....Machine Shop Practice |
| ....Automobile Repairman    | ....Mechanical Engineer   |
| ....Civil Engineer          | ....Shop Superintendent   |
| ....Structural Engineer     | ....Employment Manager    |
| ....Business Manager        | ....Steam Engineer        |
| ....Cert. Public Accountant | ....Foremanship           |
| ....Accountant and Auditor  | ....Sanitary Engineer     |
| ....Bookkeeper              | ....Surveyor (& Mapping)  |
| ....Draftsman and Designer  | ....Telephone Engineer    |
| ....Electrical Engineer     | ....Telegraph Engineer    |
| ....Electric Light & Power  | ....High School Graduate  |
| ....General Education       | ....Wireless Radio        |
| ....Vocational Guidance     | ....Undecided             |

Name.....

Address.....

30 MINUTES AND 30 SECONDS  
**Makes Old Cars Look Like New!**

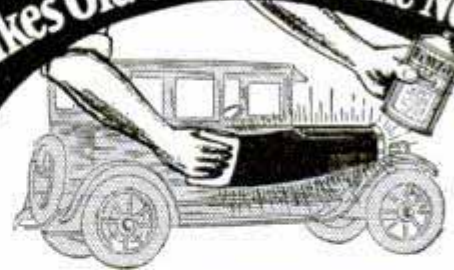

### The Greatest Automotive Discovery of Scientists in Recent Years

You just flow ReNUZit onto any automobile with a piece of cheesecloth, and instantly the ORIGINAL color and lustre of that car is like new again! NOT A POLISH, CLEANER, WAX, OR PAINT. No tiresome rubbing or polishing; harmless, lasting, sure. **GUARANTEED NOT TO TURN WHITE.**

### AGENTS' NEW PLAN

### Make \$50.00 a Day

#### ReNUZit Service Stations Bring \$1000 a Month

It is easy to see why so many men can get into the big money class operating ReNUZit Service Stations. Write for the thrilling story of ReNUZit and your wonderful opportunity to make \$12,000.00 a year. **DO IT NOW!**

Millions are waiting to buy ReNUZit. That is why ReNUZit Agents all over the country can make almost unbelievable profits. And our PROPOSITION is so GOOD that you should have no trouble making \$50.00 a day and up.

#### Test ReNUZit FREE!

You have the privilege of trying ReNUZit yourself right now without risk. Prove to yourself what miracles it accomplishes. Write TODAY for full details and Free Test Offer.

### The ReNUZit System

154 E. Erie St.,

Dept. 805-C.R.

Chicago, Ill.



**LUCKY POCKET PIECE**, triple horse shoe puzzle, always keep one with you—10c, 4 sets 25c pp., with secret solution.—Western Puzzle Works, St. Paul, Minn.



**WANT A STEADY GOVERNMENT JOB?**



**\$1260 to \$3400 YEAR**

**Men—Women—18 Up**

**STEADY WORK**

**Paid Vacations**

Common education usually sufficient

Mail coupon today—**SURE**

### FRANKLIN INSTITUTE

Dept. N175, Rochester, N. Y.

Gentlemen: Rush to me, FREE of charge, list of U. S. Government big pay positions now obtainable. Send me FREE 32-page book describing salaries, hours, work, vacation and giving full particulars on how to get a position.

COUPON

Name.....

Address.....



# Prizes for Boys

## Make Your Selection NOW

### Mail the Coupon

Hi! Buddy! How would you like to have a pair of boxing gloves, bicycle, wrist watch or baseball equipment?

These are the kind of prizes Crowell Juniors are given. They are regular fellows like yourself—full of pep and ambition. In their spare time they deliver to regular customers *The American Magazine*, *Woman's Home Companion* and *Collier's*, *The National Weekly*.

You need no experience to start. We will show you how to find readers of these well-known magazines. This work will in no way interfere with your school or your fun.

If you act at once you can be the boy selected from your part of town. It's your chance to get in with this group of fellows who always have the things they want and their own spending money. Don't delay another minute. Send your name and address on the coupon now.

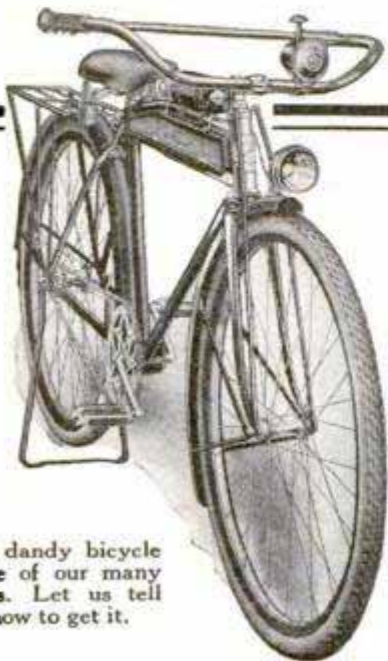

This dandy bicycle is one of our many prizes. Let us tell you how to get it.

Every month many of our boys are getting bikes like this one. Are you going to be the next? Your name and address mailed on the coupon is the first step. Do it now.

Mr. Jim Thayer, Dept. 84,  
The Crowell Publishing Company,  
Springfield, Ohio.

Dear Jim: I want to get started toward prizes.  
Please start me off as a salesman.

My Name.....

Address.....

Town..... State.....

**Clip and mail  
coupon at once**



# “E”very 3,000 Miles Device Buys Me a

“**The** money I save on gasoline more than keeps me in new tires. Figure it out . . . I was using gas at a rate that cost me \$46 to drive 3,000 miles. Now I’m getting better than 26 miles per gallon. It saves \$23 to \$25 every 3,000 miles—more than the price of a new tire.”

No matter what make of car you drive, the Stransky Vaporizer is unconditionally guaranteed to give you more miles per gallon or it costs you nothing. As a matter of fact, it is not uncommon for the Stransky Vaporizer to greatly increase gasoline mileage!

## Note These Records

Forty-three miles per gallon from a Chevrolet, reported by F. S. Carroll. He also reports 40 miles a gallon in a Ford. Forty miles per gallon in a Dodge from Brownsville, Tex., to Tampico, Mex., reported by T. L. Brown.

## Three Million Owners

Records like these are reported in every mail for every make and model car . . . from 72 different countries . . . the world over. More than three million Stransky Vaporizers have been installed.

## Easily Installed

No bigger than a dollar coin—no more expensive than a good wrench—no more trouble to attach than a fan



### 43.8 Miles Per Gallon

Mr. M. E. Miller, Kansas City, writes: “I have subjected the Vaporizer to a severe and thorough test. After installing one on a Chevrolet, I found I was obtaining 43.8 miles to a gallon. The actual test surpasses your claim.”

### \$4 an Hour for Salesmen, Agents and Spare Time Workers

Men are making wonderful earnings showing the Stransky Vaporizer to car owners in spare time and full time. Sells fast under our guarantee. Foster made \$357 in two weeks. G. F. Fuller earned \$114 in 5 days. Eberlein sold 23 Vaporizers in 35 minutes! J. W. Cronk actually earned \$51 in an hour. You should be able to earn at least \$3 every hour you put in. We offer demonstrators one Vaporizer FREE, under our unusual offer. Get full details. Simply mail coupon at once.



# This Amazing Little New Tire...**FREE**"



belt! Attaches to the intake manifold of any car in five minutes. Any one can do it.

## Less Gasoline—More Power

The Vaporizer mixes air with your gasoline after it leaves the carburetor. Vaporizes the gasoline more thoroughly. Under this ideal condition you get more compression out of less gasoline and a more complete explosion. Starting is not interfered with as the Vaporizer automatically shuts itself off when the motor is idle.

## Make This Test

Test the Stransky Vaporizer on your car—and expect results that will amaze you! Increase your mileage—forget carbon trouble, sluggish motor and fouled spark plugs from over-rich mixture—and save enough on your gasoline to more than keep you in tires. These results are guaranteed or the test costs you nothing.

Mail the coupon below for full details, guarantee, and amazing trial offer, which is even more remarkable than we can tell you here. There is no obligation whatever.

## J. A. STRANSKY MFG. CO.

C-10 Stransky Block,  
PUKWANA, SOUTH DAKOTA

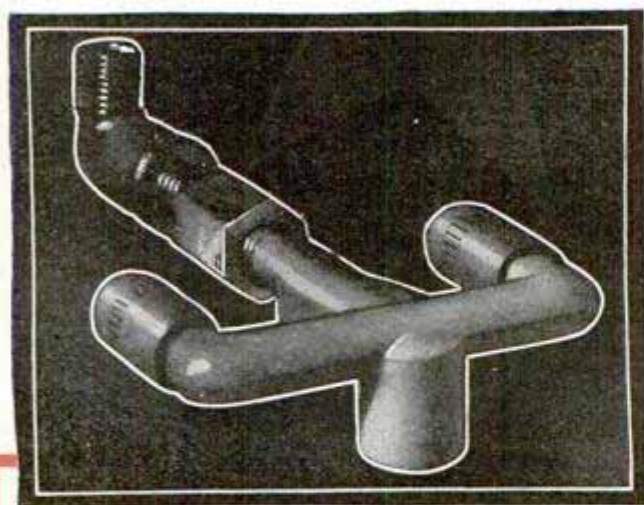

### Fits Any Car in 5 Minutes

Any one can install this device in 5 minutes. Simply loosen one connection to the intake manifold with a wrench. You can do the rest with your fingers.

J. A. Stransky Mfg. Co., C-10, Stransky Block,  
Pukwana, S. Dakota.

Without obligation send me full details of your free trial offer.

Name.....

Address.....

City.....State.....

Check here for Distributor's Sample Offer and the selling plan.



# DON'T

—enroll for home-study training of any kind until you see what L. L. Cooke has to offer, in Practical Electricity or Engineering Drafting.

It's pretty well known that the "Cooke" trained man is the Big Pay man,—everywhere and always.

There is a reason.

Investigate! Find out why this is so.

Get particulars now by mailing coupon below.

L. L. Cooke.

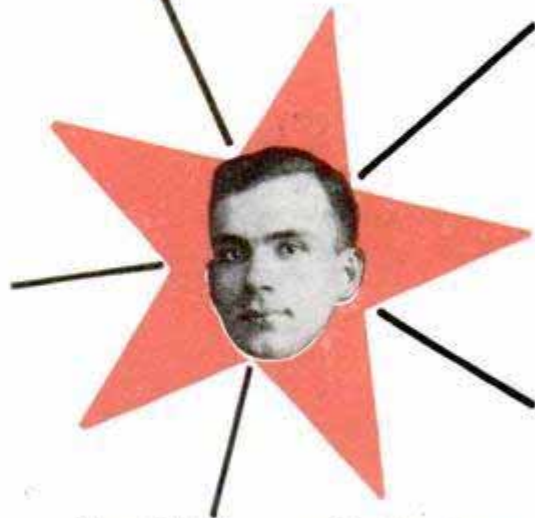

**Promoted to Foreman—Now Owns Business**

Mr. Cooke:  
When I started with you I earned only \$16.50 a week; but with my course finished I was promoted to foreman and now have my own electrical business and make more than \$16.50 in a day. Your training did it.

CHARLES FINCH  
8 Maryland Avenue,  
Middletown, N. Y.

## From \$12.50 Job to Senior Engineer

Dear Chief:

Not long ago I was earning \$12.50 a week, at that time I enrolled as a Cooke student, today I am the Senior Engineer of a large Corporation. This advancement was due to the training I received from you.

OTIS D. ALLEN, A-21227  
2509 Prospect Street,  
Indianapolis, Indiana.



## Gets Job As Chief Electrician

Dear Mr. Cooke:

Without your help I would not have been able to hold the fine position paying me \$75 per week, which I am now giving up for an even better one as Chief Electrician for B. F. Keith's Fordham Theatre. Thanks to you and your course.

SIDNEY KALINER, B-7033,  
2473 Valentine Avenue,  
Bronx, N. Y. City, N. Y.

L. L. Cooke, Chief Engineer,  
L. L. Cooke Schools, Dept. 13,  
2132-2158 Lawrence Ave., Chicago.

Please send me complete information about your home study training in the line I have checked. I understand this request does not obligate me in any way. (Please check only one subject.)

Practical Electricity.

Engineering Drafting.

Name.....

Address.....

City.....

State.....

**MAIL THIS COUPON for  
FULL INFORMATION**



# Classified Advertisements

## WORLD'S BEST WANT AD MEDIUM

Advertisements in this section, 30 cents per word, each insertion, minimum 10 words, payable in advance. To be inserted under proper classification in April issue, copy should be in our office February 18th

### ADVERTISING AGENCIES

**ADVERTISE** In 24 Big Sunday News-papers, 24 words \$15.00. Excellent for securing agents, salesmen and business opportunities. Catalog listing 1,000 leading dailies, weeklies, mail order magazines. Everything. Free. Wade Advertising, Baltimore Bldg., Chicago.

**BEFORE** Advertising get our catalog. No charge. 25 years in business. The largest classified agency in the world. Ankrum Advertising Agency, 100 No. LaSalle St., Chicago, Ill.

**GET** Into advertising. Learn quickly at home. Experience unnecessary. New easy plan. No text books used. Practical work. Old established school. Send name and address for interesting free booklet. Page-Davis School of Advertising, Dept. 3431, 3501 Michigan, Chicago.

**FREE**—New 1929 Advertisers Rate Guide, 44 pages. Includes everything. Lowest rates. E. H. Brown Advertising Agency, 140 S. Dearborn, Chicago.

**ADVERTISE** 50 Magazines 5c word; \$4.00 Inch. 5,000 country weeklies 1c line, per paper; lists free. Evans King Co., 672P, Wilmington, Del.

**20 WORDS**, 50 Pulling magazines \$1.00; three \$2.00. "Maywood Advertiser," P-921 Broadway, New York.

**ADVERTISING**: 24 Words 8 newspapers \$5; ten farm papers \$15. List free. M. Le-Grand Agency, 150 Nassau St., New York.

**TIME** Counts in applying for patents. See pages 154 and 155. Clarence A. O'Brien, Registered Patent Attorney, Washington, D. C.

**INCH** Display 50 Monthlies Thrice \$8.00. Meyer Agency, 4112M Hartford, St. Louis, Mo.

### FOR ADVERTISERS

**ADVERTISE**, 25 Words 50 monthlies 100 weeklies \$5.00. Lists free. Allen, 234 Bound Brook, N. J.

**ADVERTISE** 300 Country newspapers, 28 words, \$10. Business getter. Lists free. Keator, Hartford Bldg., Chicago.

**ADVERTISER'S** Manual, 1929 edition, Postpaid 25c. Owl, Times Bldg., New York.

**40 WORDS** Insert 50 magazines \$2.00. Empire Agency, Shawano, Wis.

### SALES PROMOTION

**\$50 TO \$50,000** Daily Sales Developed during 28 years for clients by our direct mail plans, copy, campaigns. One product, 1923, an idea; this year \$100,000 orders booked. Fifty year old concern desired 50 national representatives in 1925; we produced 40 in three months. 700 dealers in 10 months at \$3 each, for another. Ten years Sales Promotion Manager Larkin Co. Submit sales problems for free diagnosis. James C. Johnson, 118A Woodbridge Ave., Buffalo.

**DON'T** Experiment! Dollar-doubling letters, circulars, literature, campaigns. Long, successful experience. Moderate charges. Finkel-Advertising, 131-P, Glenwood, Jersey City, N. J.

**MARKET** Analysis of your product and sales program. Formerly with Crosley Radio. George Banning, Times Bldg., Watertown, N. Y.

### BUSINESS ADDRESSES

**CHICAGO**—8 No. Michigan Ave. A real address. Write Russell Albin.

### LETTER SPECIALISTS

**"THE** Master Letter Writer." Including 500 successful letters, by Ad-Man Davison, world-famous letter expert; 704 pages, \$3. Circular sent. Opportunity Press, Westport, Conn.

**DISTINCTIVE**, Modern, sales letters. George C. Banning, Times Bldg., Watertown, N. Y.

**AD-Man** Davison writes letters, folders, booklets; success by mail; send your literature for Free Suggestions. Ad-Man Davison, Westport, Conn.

**SALES** Creating letters written. G. Anderson, P. O. Box 1244, Phoenix, Ariz.

### AUTOMOBILES

**TIME** Counts in applying for patents. See pages 154 and 155. Clarence A. O'Brien, Registered Patent Attorney, Washington, D. C.

### AUTOMOBILE SUPPLIES

**SAVE** Money on auto and truck repairs. Gears, axles, bearings, motor and transmission parts at 50 to 75% off factory list prices. Satisfactory parts guaranteed. Prompt service. Price lists free. Century Parts Co., 1712 Lafayette Ave., St. Louis, Mo.

**AUTO** Parts new and used. Lowest prices. Bankrupt supplies, motors, wheels, radiators, transmissions, generators, gears, carburetors, touring tops complete \$15. Brakelining 50% off. Brightman, 2065 Main St., Hartford, Conn.

**RADIATORS** At wholesale prices. All standard makes. Satisfaction guaranteed. Send for prices, stating make and model. Independent Radiator Co., 1119 S. Wabash Ave., Chicago.

**MECHANICS** Get out of the grease, travel, and make real money selling our electrical tools to garages and mechanics, easy sales, very liberal commissions. Barker Specialty Co., Girard, Pa.

**ASK** For our booklet "Drive a Good Looking Automobile." Tells how and why. Jewell Polish Company, 15 State St., Pasadena, Calif.

**FOR** Sale—Used auto parts for all makes and models. J. Trockman & Sons, Inc., Evansville, Ind.

**KOO-KOO**—Newest sound novelty, for all cars, independent, \$2.50. Koo-Koo Mfg. Co., Box 323, Hollywood, Calif.

**42 MILES** On 1 gallon. Wonderful moisture gas saver. All autos, 1 free. Critchlow, 01-805, Wheaton, Ill.

**SEND** One dollar for secret formula of "Hopped Up" gasoline used by leading race drivers. Menzie, 11530 Woodmont, Detroit.

### AUTOMOBILE SERVICE EQUIPMENT

**USED** Constant potential outfit—120 amperes fully equipped. Guaranteed like new, overhauled and repainted. A wonderful bargain. Will ship on trial and allow plenty of time. E. M. Connor, Box M-394, Troy, Ohio.

**YOU** Are wanted to resilver mirrors at home. Immense profits plating autoparts, tableware, etc. Write for information. Sprinkle, Plater, 77, Marion, Ind.

**BARGAINS** In repossessed battery chargers, rectifiers of all kinds and a few constant potential 8-hour chargers, several of them practically new. Lowest prices, terms if wanted, 30 days' trial. Write today to I. C. Helmick, Box M-395, Troy, Ohio.

**GLOVER'S** Seal-tite puncture patch, your ad on each can, wholesale distributors wanted. Glover Rubber Co., Rome, Ga.

**SAVE** Money—Garage equipment reconditioned and guaranteed like new. Unusual bargains in test stands, car washers, battery chargers, air compressors, etc. Shipped on trial, easy terms. What do you need to complete your equipment? E. C. Galbreath, Box M-396, Troy, Ohio.

### FOR FORD OWNERS

**LEARN** The secrets of Model A engineering. Get this new book "The Model A Ford Car." Scores of question-answering diagrams. Every page lays bare the engineering secrets of the new Ford. Price \$1.00 postpaid. Trade Press Publishing Co., Montgomery Bldg., Milwaukee, Wis.

**42 MILES** On 1 gallon. Wonderful moisture gas saver. All autos, 1 free. Critchlow, 02-805, Wheaton, Ill.

**FORD** A and T high speed oversize carburetor with down draft manifold \$16.00. Formula racing fuel \$1.00, stops preignition. Racing cars, boats, motors, speed specialties. Catalog 10c. Green Motor Works, Dayton, Ohio.

**AURORA** Understung parts and 3.1 racing gears, speedster bodies, headlights, hi compression head. See Sport Factories ad, page 144.

### MOTORCYCLES, BICYCLES AND SUPPLIES

**MOTORCYCLES** \$25 To \$50. Easy terms. Tires \$2.50, frames \$3, forks \$3, tanks \$5, wheels \$4, chains \$2, saddles \$5, handle bars \$5, engines \$15, side cars \$25, transmissions \$12, belts \$6, airplane engines \$15, airplane wheels \$5, bicycle tires \$1.25, velocipedes \$7.50, bicycles \$9.50, new auto tires \$3, used auto tires \$2.50. Send 50c for catalogs. Price Cutter Deninger, Rochester, N. Y.

**SPECIALIZED** Harley-Davidson service depot. Harley-Davidson parts, accessories, oil. Send us your motors and parts and we will rebuild them like new. Let us overhaul your motorcycle. All work guaranteed. Send 25c in stamps for our flat rate repair costs and parts and accessories book. Knuth's Harley-Davidson Agency, 2525 Fond Du Lac Ave., Milwaukee, Wis.

**PRICES** Slashed! Send for catalog showing bargains in genuine rebuilt Harley-Davidson motorcycles. Some as low as \$50.00. Fully guaranteed to look, act and last like new. Special easy-payment plan. These bargains won't last long. Write today. Heinz Motor Company, 609 West North Ave., Baltimore, Md. (Authorized Harley-Davidson Distributors).

**FINE** Harley-Davidson bargains, \$50.00 and up. Order your motorcycle now for spring delivery. Send for our new catalog, "Money-Saving Motorcycle Bargains." Knuth's Harley-Davidson Agency, 2525 Fond Du Lac Ave., Milwaukee, Wis.

**USED** Motorcycles, all makes, lowest prices; price list free; used parts half price and less. Rochester Harley Davidson Corp., 129 West Main St., Rochester, N. Y.

**BARGAINS** in used motorcycle parts for all makes. No Catalogs. J. B. Dahl, 3661 Archer Ave., Chicago, Ill.

### AVIATION

**HOME** Study aviation course by pioneer school at new low price. Covers motors, meteorology, nomenclature, aviation, design, flying and 100 other fascinating subjects. Endorsed by experts. Diploma given. Free employment service. Complete details sent free. National Aviation Training, Dept. 114, 1031 So. Broadway, Los Angeles, Calif.

**AIRPLANE**, Boat, motors, propellers, fuselages, wings, parts. Free Aircraft Wks., Richmond, Ind.

**FOR** Sale: Light parasol monoplane suitable for Henderson or other light motor. First \$300.00 takes it. Chas. Fasig, Moundsville, W. Va.

**CURTISS** O. X. 5 aviation engines, excellent condition, \$275.00 and up. Specht's Automotive Service, 117 S. 1st St., W. Cedar Rapids, Iowa.

**AVIATION'S** Greatest invention makes flying safe. Get into business yourself. Send 10 cents for booklet. Tell how. Gyropter, Blueash, Ohio.

**THE** Plane with the \$10,000 performance. Heath super parasol, America's most popular sport plane. Build it for \$199. Send 10c for large 1929 booklet just off the press. Heath Airplane Co., 1727 Sedgwick St., Chicago, Ill.

**FOR** That aerial driven sled or boat—a Heath propeller will give performance you never dreamed of. Send 4c for propeller booklet. Heath Airplane Co., 1727 Sedgwick St., Chicago, Ill.

**JUST** Out—Booklet and blue prints on construction of sportplane. Contains also flight instruction, motors to use, etc. All for one dollar. Russell Aero Company, Box 455, Toledo, Ohio.

**EAGLE** Model airplanes. Ready-to-fly. Knocked down. Best models obtainable. Real low prices. Catalogs 5c coin. Eagle Model Airplane Co., Box 152, North Haven, Conn.



**MODEL** Airplanes, supplies. Send stamp for price list. Junkers "Bremen" blueprint 25c. Hawthorne Model Aero Co., Hawthorne, N. J.

**BUILD** A whizbang monoplane and fly with Ford motor. Blue prints \$5. Plane, motor and propeller circulars 10c. Storms Aviation Co., Spartansburg, S. C.

**PROPELLERS**—4', \$8.75; 5', \$13.25; 6', \$16.50; Special Henderson propeller, \$15.00; Aerodrive boat or sled blueprints, 50c each. Engines, fuselages, helmets, \$3.00; goggles, \$3.00; both only \$5.00. Ostergaard Aircraft, 4303 North Narragansett, Chicago.

**BLUE** Print for building ice sled, 60-75 M.P.H. with motorcycle engine, \$1.00. Sensesich Bros., Littitz, Pa.

**AVIATORS'** Wing pins, silver \$1.00; gold, \$1.50. Genuine airplane propellers 8' long, \$5.00. Air Transport, Garden City, N. Y.

**CLINTON** Airplanes—The best performing and most true to life models obtainable. All types; send dime for catalog of ready-to-fly models and construction outfits. The Clinton Toy Corp., North Haven, Conn.

**FOR** Sale—L. S. 5 standard airplane without motor. Also 3 place Travelair, like new. A. J. Simpson, P. O. Box 583, We-woka, Okla.

**JOIN** A flying organization. Send \$2.00 for silver wings and membership card. Associated Aviation Clubs of America, 315 East Kingsbridge, New York City.

**MODEL** Airplanes, supplies of high quality. List 10c coin. Cleveland Model & Supply Co., 1866PM West 57th St., Cleveland, Ohio.

**MODEL** Airplane supply. August Schaefer, 45 North Ave., New Rochelle, N. Y. Send for free catalog.

**FOR** Sale, new Monocoupe, perfect condition, never been flown. We are taking on new line of planes. \$2,100 our field. Wonderful bargain. Chesapeake Aircraft Co., 1309 N. Charles St., Baltimore, Md.

**FOSTER'S** Model Airplane & Supply Co. Send 5 cents for manual. Teaches building and flying. Full stock parts, plans, Bass, Balsa, Reed, Fresh Para Rubber Ideal Construction sets. Prompt shipments. 5503 Hudson Boulevard, North Bergen, N. J.

**NEW** Type scale model aeroplanes. Motor and rubber driven 3 and 4 1/2 foot. Send 10 cents for catalog. K. A. Pouch, 83 Low Terrace, New Brighton, N. Y.

**BOYS**—Get an Eagle model airplane. Eagle racer flies 500 feet, only \$1.00 prepaid. Catalog 5c coin. Eagle Model Airplane Co., Box 152, North Haven, Conn.

**YOUNG** Fellows, write! I can help you to get your plane. Al Hiller, Box 396, Bridgeton, N. J.

**STUDENTS** and commercial flyers write for catalog on flying togs and equipment. The Detroit Aero Motors Co., 5055-59 Townsend Ave., Detroit, Mich.

**THE** American School of Aviation announces a new correspondence course in mechanics of aviation. A thorough training in practical aeronautics. American School of Aviation, Dept. 1872, 3601 Michigan Ave., Chicago, Ill.

**PROPELLERS**, Toothpick high speed. For snow and ice sleds, small airplanes. Blueprints for aero sleds \$1.00. Crawford Propeller Manufactory, Seal Beach, Calif.

**BOYS!** Build model Zeppelins. Blue prints of 4 foot Graff, 75c. Los Angeles, 50c. Both \$1.00. No stamps. Otto E. Balke, 1421 No. Washington Ave., Dallas, Tex.

**9"** PROPELLER Correctly carved to the proper degree and angle. This is truly a miniature propeller. 55c each. Rubber tire disc wheels, 2 1/2" in. dia., 50c per pair. Will shortly announce complete list. Advance Aircraft, 114 Oliver Ave., Yonkers, N. Y.

**TIME** Counts in applying for patents. See pages 154 and 155. Clarence A. O'Brien, Registered Patent Attorney, Washington, D. C.

**BLUEPRINTS**, For light two place cabin monoplane. Easy to build. Plans \$5.00. Circular 10 cents. Roland Aircraft Company, 921 Baltimore, Kansas City, Mo.

**SIMPLEX** Air Model Co., Auburn, Mass. Send five cents for supply booklet.

**VARIOUS** Sizes wood, reeds, bamboo, rubber band, wheels, propeller, onion skin covering and other supplies. Big bundle for 25c, five for \$1.00. No stamps. Will also send circular on free three foot model. Aero Shop, 3050 Huribut Ave., Detroit, Mich.

**BUILD** Your own glider. Complete plans \$7.50. Special price list 25c. J. P. Schroeter, 445 Milwaukee St., Milwaukee, Wis.

**BIGGEST**, Best Catalog Model Airplanes, Parts, Supplies; 5c postpaid. Ideal Company, 19 West 18th Street, New York.

**"SKYWARD** Ho!" Wonder book on aviation—32 pages, 150 illustrations. Shows you complete training for flying career, fame, fortune! Sent free. Write today! Parks Air College, 213 Mo. Theatre Bldg., St. Louis, Mo.

**BYRD'S** Antarctic plane scale model construction outfit, quarter, postpaid. Casson-Craft, Framingham, Mass.

**BUILD** Our wonderful one-place monoplane adapted to motorcycle or other small aircooled motors. Detailed blueprints \$2.00. Literature dime. Hawley Aircraft, Box 121, Sta. C., San Diego, Calif.

#### BOOKS AND PERIODICALS

**SECRET** Society rituals—"Handbook of Free Masonry" shows how to open and close lodge and conduct meetings. Reveals every detail of conferring entered apprentice, fellowcraft and master Mason degrees. Tells and shows every action and word including signs, grips, pass-words, etc. 284 pages, 85 illustrations. Pay postman \$2.35 upon delivery; or send \$2.00 cash. Franklin Publishing Company, 800 No. Clark St., Dept. 172, Chicago.

**4TH EDITION**, revised "Radio Theory and Operating," by Mary Texanna Loomis. The standard radio text and reference book of America. 992 pages, 800 illustrations, flexible binding. Price \$3.50 postage paid. For sale by hundreds of book dealers throughout America and many foreign countries. Or may be purchased direct from the publishers. Send check or money order to Loomis Publishing Company, Dept. 18, Washington, D. C.

**"CARTOONING** For Profit." Illustrated, contains selling plans, cartoon pointers, shortcuts, syndicate work, commercial cartooning, getting the professional touch, best markets, syndicates, cartoon contests, etc., \$1. postpaid. Smith's Service, PK1194, Wenatchee, Wash.

**HYPNOTISM** Easily learned. Lessons guaranteed. Postpaid, \$1.10. Smith Pub. Co., Dept. 3, Springfield, Mass.

**INDUSTRIAL** Alcohol. Wright's book. Full directions for making, fully illustrated. \$2.50. Spon & Chamberlain, 120 P.M. Liberty Street, New York, N. Y.

**CURIOUS** Books, unique novelties, stunning pictures. Samples, 10 cents prepaid. Linds, 214 W. 34th St., New York.

#### PICTURES AND POSTCARDS

**FREE** Book—"What men know about women?" Humorous and interesting. Kind men like. 10 snappy cards. Red hot pocket novelty. Copy America's greatest illustrated cartoon book. All for 25c. White Mule, Beaver Dam, Wis.

**BEAUTIFUL** Colored views of southern California, Los Angeles, Hollywood, etc. Sample package assorted 25 cents. Lists for stamp. Charlesad-Smith, Box 1108, Los Angeles.

**ART** Pictures—220 all different. 160 samples \$1.00. Particulars 10c. Howard Sales Co., Dept. 15, Box 529, San Francisco, Calif.

#### MAGIC TRICKS, BOOKS AND JOKER NOVELTIES

**"THE** Book of 1,000 Wonders" will be sent postpaid for 10c. Explains many mystifying tricks with coins, cards, handkerchiefs, etc., you can do. Also, contains complete catalog of magic tricks, jokes, puzzles, books, escapes, mindreading acts, spiritualistic effects, illusion plans, curios and imported novelties from many foreign lands. Large assortment, lowest prices. You will amaze and mystify your friends! Send 10c today. Lyle Douglas, Station A-5, Dallas, Tex.

**FREE** With \$25 order die box. Send 20c for our large catalog of tricks, wigs, sensational escapes. Oaks Magical Co., Dept. 548, Oshkosh, Wis.

**LATEST** French model pocket mirror and set of transparent art cards all for \$1.00. World Service Co., 336 Marcy Ave., Brooklyn, N. Y.

**MAGIC**—Tricks, Books and Supplies. For amateurs as well as the great professionals. Anyone can learn through our instructions. Feature Acts in Mind-Reading, Spiritualism, Rope Ties, etc. Large illustrated professional catalog. 20c. Chicago Magic Co., 140 So. Dearborn St., Dept. B, Chicago, Ill.

**TRICKS** With cards. Mystify your friends. Easy to do. Produce any card called for. Name any card drawn from pack. Six tricks for 25c, including large catalog. Wizard Magic Co., Dept. 15D, Box 1055, Station "C," Los Angeles, Calif.

**FREE** Card trick with every catalog 10c. A. B. C. Stamp Novelty Co., 3801 Woodland Ave., Kansas City, Mo.

**MAGIC** Tricks, card tricks, coin tricks, hypnotism, ventriloquism. Instructive 64-page books 10c each. All five 40c. Geo. Fenner, 2401 Jefferson, Louisville, Ky.

**FREE**—250 Tricks, with 10c catalog. Superior Specialties, 112 West 42nd, New York.

**ELECTRIC** Fun! Seventy stunts, 110 volts, \$1. Cooper Sons, Campbell, Calif.

**SEVEN** Magical Delusions and catalogs—25c. Gilmaglio, Morgan Park, Ill.

**MAGIC** Catalog 20c. Lynn's, 105 Beach, Dept. 3, Jersey City, N. J.

#### GAMES, ENTERTAINMENTS AND PLAYS

**PLAYS**, Musical comedies and revues, minstrels, comedy and talking songs, black-face skits, vaudeville acts monologs, dialogues, recitations, entertainments, juvenile plays and songs, musical readings, make-up goods. Catalog free. T. S. Denison & Co., 623 So. Wabash, Dept. 11, Chicago.

**PLAY** The new indoor bowling game. Very fascinating and exciting for both young and old. Send 25c for complete outfit. Agents wanted. Reliance Trading Company, Loew Bldg., Syracuse, N. Y.

**LEARN** Ventriloquism by mail—small cost, 2c stamp brings particulars. Geo. W. Smith, Room S-329, 125 N. Jefferson St., Peoria, Ill.

#### CHALK TALKS

**LAUGH** Producing program, \$1.00. Catalog free. Balda, The Cartoonist, Oshkosh, Wis.

**BECOME** Chalk talk wizard in one evening. Make crayon, clay, sand and smoke pictures. New method. No talent needed. G. E. Hendrickson, Argyle, Wis.

#### STAMP COLLECTING

**SAMPLE** Copy free. In order to introduce the readers of this magazine to Scott's Monthly Journal, philately's liveliest magazine, we will send a copy free to all who write us and ask for it. Scott's Monthly Journal is not only a very interesting and up-to-date philatelic journal, but it is also a monthly supplement to the Standard and the specialized U. S. catalogs, listing new issues, price changes, etc. Ready Feb. 18, 1929. "Stamp Collecting Why and How," or Riding a Hobby with Prescott H. Thorp. People who have read advance copies say that this is the most unusual book on stamp collecting ever written. Write us for a descriptive circular, or ask your dealer (book, department or stamp store) to show you a copy. Approvals. The world-wide connections of this company have made it possible for us to build up, and keep on hand, one of the finest assortments of fine approvals in the world. Write us for approval circular. Scott Stamp and Coin Co., 1 West 47th St., New York, N. Y.

**ANCHERS** \$\$\$ Outfit—only 12c! Fine triangle stamp; set German stamps with (pre-war) value forty million dollars (interesting!); perforation gauge, mime scale; airmail set; scarce stamp from smallest republic on earth; newspaper set; packet good stamps and Travancore, Malay, Dutch Indies, etc. Entire outfit for 12c to approval applicants! (Nice pocket stock book, value 25c, with every order!) Ancher Stamp Co., Box 126, Rutherford, N. J.

**FREE**—Six Cretes. Sets and approvals, 60% discount. Charles Cleveland, 806 No. Humphrey Ave., Oak Park, Ill.

**1,100** UNUSED Stamps, cataloging nearly \$25.00. Only 95c. Forty page illustrated price list free. West Coast Stamp Company, Alhambra, Calif.

**SEND** A 2c stamp and get our illustrated price list of sets and packets. Approval circular, details of our profit-sharing plan, and a credit slip good for 5c on your first purchase. Write Dept. 2, Argonaut Stamp Co., New Canaan, Conn.

**100** STAMPS Free for subscribers to Pacific Stamp News at 25c per year. 17 So-telo, Piedmont, Calif.

**CAPE** Verdi: 25 varieties 25c. Lists free. Allison, Angola, Ind.

**UNITED** States, 24 varieties 1/2c to \$2 current catalog, \$1.25 for 25c. Leduc, Red-Hon, Penna.



**MYSTIC "Queer Country" Packet!** Contains scarce stamps from the following strange lands: San Marino, Antioquia, Congo, Cyprus, Fiji Islands, Gwalior Hyderabad, Iceland, Jhind, Kenya, Uganda, Lebanon, Monaco, North Borneo, Nyassa, St. Thomas Prince, Eastern Roumelia, Siam, Sierra Leone, Tanganyika, Trinidad Tobago, Ubangi, Upper Volta, Wallis Futuna, Alaouites. Get this wonderful packet of "freak countries" and make your friends envious! Price only 10c to approval applicants! Write today. Mystic Stamp Company (Dept. 8), Camden, N. Y.

**500 DIFFERENT Stamps for 25c.** Big collection from Bosnia, Crete, Epirus, Honduras, Iceland, Kenya, Liberia, Malta, Nyassa, Quelimane, Stam, Zambesia and other "hard" countries. Catalog value \$10. Price 25c to approval applicants! Bargains, 1,000 different 79c; 15 triangles 49c; 100 Africa 45c; 100 Asia 50c; 100 Balkans 35c; 100 British Colonies 30c; 100 French Colonies 35c; 100 Portuguese Colonies 50c. Eight packets for \$3.00! Illustrated lists free. Loma Stamp Co., 3926 32nd St., San Diego, Calif.

**\$1.00 FREE.** Black U. S. postage, given away with each order. Pioneer Stamp Album with 500 illustrations. 150 different stamps from 40 countries, Syria, Lebanon, Hejaz, Liberia, New French Colonies, British, Portuguese Colonies, South Africa, Australia, 500 hinges, 36 page illustrated catalog. All for 15c. Big commission to agents for the best approval sheets of stamps ever offered. Write for sample outfit. Hussman Stamp Co., Dept. M, 620 Olive St., St. Louis, Mo.

**MOVIE Envelopes.** 100 different foreign from all over world with stamps attached addressed to Hollywood movie stars postpaid \$1.15, 40 for 60 cents. Edwin Van Wart, 1827 Cahuenga, Hollywood, Calif.

**MOVIE Mixture** foreign only. Large packet 20 cents. Tyson, 1825 Cahuenga, Hollywood, Calif.

**200 COUNTRIES!** All different, one stamp from each, also valuable premium offers, only \$1.50, with approvals. Murray, 515 Tower Bldg., St. Louis.

**ONLY 25c** For a five months' subscription to The Stamp Collector, America's finest stamp magazine. 100 all different stamps given free to each subscriber. Money refunded if you are not more than pleased. The Stamp Collector, Dept. P. M., 719 Lodi St., Syracuse, N. Y.

**FREE—20 Different Argentine.** Approvals. List. Send 4c today for postage, etc. Reuter, Santa Ana, Calif.

**33 1-3c COMMISSION.** Sell stamps. Unsold stamps returnable. No investment required. References necessary. Lux Stamp Co., 805 Fairmont Place, Bronx, New York.

**FREE Surprise packet** with bargain lists, postage 2c. Rheame, Dept. 75, 7748, Henri Julien, Montreal, Can.

**70 DIFFERENT U. S. stamps,** including \$1.00 postage-stamp and many commemoratives, 25 cents. Mountain City Stamp Co., Box 335, Mannington, W. Va.

**50 DIFFERENT United States 5c** to approval applicants. Special bargain: 1,000 mixed foreign 35c. Glendale Stamp Co., 1311 Linden, Glendale, Calif.

**FREE 25 Different French colonies.** Reference, 2c postage. Beall, 1209 Park Road, Washington, D. C.

**WATERMARK Detector** free. Send 2c postage. Howard McIntosh, Mittineague, Mass.

**300-300-300 ALL Different stamps** (6.00 catalog); 300 hinges; 5 approval sheets; duplicate stamp album; perforation gauge; millimeter scale and ruler to approval applicants for only 20c. Edgewood Stamp Company, Milford, Conn.

**1,000 MIXED Stamps 10c.** Homer Boster, Summit Hill, Ohio.

**BIG Value!** 25 airmails 10c; 25 Roumania 10c. Free premium. 50% approvals request. Webster Stamp Co., Box 11, Tremont Sta., New York.

**FREE! 50 Good foreign stamps** to approval applicants. Reference please. Send 2c for postage. Samuel L. Fox, 1200 Park Ave., Baltimore, Md.

**300 DIFF. Foreign, album, hinges and gauge.** 25c. Lakota, La Plant, S. Dak.

**FREE.** One scarce set of Jugo Slavia cataloging \$1.06 to applicants for our new, low priced approvals. Send 4c postage. Paul Bayer, 269 Jewett Ave., Jersey City, N. J.

**GET Acquainted!!** Hidden treasure 6c. Cyclone blow 11c. Approvals. Golden Rule Stamp Co., Box 1248, Chicago.

**VIKING "De luxe packet"!** Contains excellent stamps (no European) from Liberia, Kouang-Tcheou, Rhodesia, Bermuda, Siam, Trinidad Tobago, Nyasaland, Alaouites, Orange River Colony, Hyderabad, St. Lucia, many British and French Colonies, scarce stamp cataloging 40c, triangle stamp, and useful premium. Price 10c with our famous approvals. Viking Stamp Co., P. O. Box 18, Sheepshead Bay Station, Brooklyn, N. Y.

**100 DIFFERENT Foreign stamps** from 100 different foreign countries, including Africa, Asia, Australia, Europe, West Indies, etc., for only 20c. Free with each order, our pamphlet which tells "How to Make a Stamp Collection Properly," together with our price lists of albums, supplies, and hundreds of bargains in sets, packets, etc. Queen City Stamp & Coin Co., Room 36, 604 Race St., Cincinnati, Ohio.

**SELLING Out!** Good stamps dirt cheap. 12 scarce Azerbaijan to approval applicants enclosing references. Penna Stamp Co., Greensburg, Pa.

**BEGINNERS Big surprise packet.** Approvals 2c. Superior Stamp, Midland, Ontario, Can.

**1,000 NICELY Mixed stamps,** 25c post-free; 1,000 hinges 10c; 2,000 17c. Approvals. Price lists. Sunshine Stamp Co., 549 East Maryland St., St. Paul, Minn.

**ASTOUNDING Packet** combination: Triangle, aeroplane, Liberian, Nyassa, general packet. 10c to approval applicants. Great Eastern, 1014 Eastern Parkway, Brooklyn, N. Y.

**BEAUTIFUL New set 2c** with approvals. Send reference. Edgewater Stamp Co., Box 2731, Cleveland, Ohio.

**SET OF 20 Algeria 1/2c-60c;** catalogs 60c for 10c to approval applicants. Hovey, 17384 Beaverland, Detroit, Mich.

**FREE, 6 Different Luxemburg** to approval applicants. E. D. Stamp Co., 3903 Forest Park Ave., Baltimore, Md.

**STOCK Clearance—Every stamp different.** 550, 35c; 1,100, 85c; 2,000, \$2.50. Hotchkiss, 7742 S. Shore Drive, Chicago.

**TWO First flight airmail covers,** 25c. Chapin, 3684 Concord, Detroit.

**FREE Hawaiian stamp** to approval applicants. Postage 2c. Eastern Stamp Co., 1809 Kilbourne Place, N. W., Washington, D. C.

**100 FOREIGN Stamps 3 cents.** Lufberry, Route 3, Branford, Conn.

**ILLUSTRATED Price list** of 1,000 different sets. Free. Bier Co., 91 69th St., Brooklyn, N. Y.

**300 ALL Different stamps 5c.** \$1.00 black U. S. Postage free with approvals. L. W. Hudson, 1439 East 7th St., Plainfield, N. J.

**111 DIFFERENT Stamps,** including Iceland, French Colonies, etc., free to approval applicants. Postage 2c. Leader Stamp Co., 2056 East 24th St., Brooklyn, N. Y.

**200 ALL Different stamps** free postage 4c. Peabody Co., 3846 No. Dupont, Minneapolis, Minn.

**55 DIFFERENT,** including scarce countries, to approval applicants only 4c. Richard P. Lamprecht, Valparaiso, Ind.

**FREE! 5 Rare Siam** to approval applicants. Winthrop Smith, 3611B, Cedardale Rd., Baltimore, Md.

**AZERBAIJAN And Honduras** sets free; enclose 2c postage. V. Algin, 8651 Baltimore, Chicago, Ill.

**NYASSA Triangles.** 9 big beauties and 1,000 imported stamp mounts for only 25c. Weber, 1377 Park Ave., Plainfield, N. J.

**FREE! Triangles, airmail, Iceland** and 50 others to approval applicants inclosing 2c postage. Hawkeye Stamp Co., Cedar Rapids, 39, Iowa.

**NEWFOUNDLAND Postage.** Send want list. Will quote bargain prices. Rev. Butler, St. Georges, Newfoundland.

**DANZIG Stamps free—Interesting packet** from Danzig with big catalog free for 2c. Midland Stamp Company, Toronto, Can.

**1/2c APPROVALS—5,000 Borneo, Liberia,** etc. References. Philatelic Exchange, Huntington, W. Va.

**BEAT This—500,000 stamps** at 1-6 catalog, no duplication; cash with order. Postage two cents. No approvals. Pkts 500 diff, 30c; 2,000 diff, \$3.00. Rev. G. W. Welsh, Spring Grove, Penna.

**STAMPS—50 Different foreign stamps;** illustrated album; stamp hinges; perforation gauge; big illustrated catalog—send 10c for complete outfit. W. Betts, Clearfield, Pa.

**6 DIFFERENT Crete** with approvals 3c. Iowa Stamp Co., Cedar Rapids, Iowa.

**FREE, 12 Diff. British Colonies** for a request for my popular approvals of large showy picture stamps, at 50% discnt. Postage 2c. Chas. Bushnell, 4728 Princeton Ave., Tacony, Phila., Pa.

**FREE—31 Different stamps** to applicants for Royal approvals. 2c return postage. Royal Stamp Company, 1728 S. 58th St., Philadelphia, Pa.

**SEND Your name, address, references—** have interesting approvals 50% and more off list. Elser, 9 Twombly Place, Jamaica, N. Y.

**FREE—115 Stamps** to approval applicants sending 2c. Prospect Stamp, Prospect St., Charlestown, Mass.

**111 DIFFERENT, Arabia, Azerbaijan,** Zanzibar, etc., 10c to approval applicants. Floyd Marsh, 524 Hamilton Ave., Indianapolis, Ind.

**FREE, 12 Diff. large, showy picture** stamps for a request for my popular approvals. Postage 2c. Premiums with every purchase. A. Bauer, Palmyra, N. J.

**110 DIFFERENT Stamps,** many unused, high values, free to collectors requesting our net approvals. Postage 2 cents. Christensen, Milwaukee, Wis.

**25,000 VARIETIES** in stock, 1/2c up. Keiswin, B775, Fernandina, Fla.

**STAMPS, 100 Varieties, Africa, Brazil,** Peru, Cuba, Mexico, etc., 10c; 25 different U. S. 25c; 1,000 mixed, 40c; 1,000 hinges, 15c. List free. C. Stegman, 5941 Cote Brillante, St. Louis, Mo.

**FREE Souvenir and packet** to approval applicants 4c postage. Huffman, 405 Pennsylvania Ave., Brooklyn, N. Y.

**100 VARIETIES, Foreign stamps 10c** to honest collectors. C. Taylor, Cross St., Newport, R. I.

**ONLY 5c! 10 Airmail stamps,** including scarce Estonian triangular stamp; Portuguese Red Cross set and 10 different Central Lithuanian stamps. Approvals and free lists with each order. Curhan Stamp Company, Gloucester, Mass.

**CANADA—25 Different 10c,** including Confederation stamp and 5 Newfoundland, to approval applicants. Price lists of Canada, etc., free. We list 250 countries in dime packets. Specials: 500 different 25c; 1,000 different 75c; 2,000 different \$2.50. Victoria Stamp Co., Dept. 4, London, Can.

**FRENCH Colonies free—Jungles, Tigers,** Native Chiefs. 2c postage. Empire Stamp Co., Toronto, Can.

**DANDY Mint stamps 2c** to those requesting approvals. Harvey Teeple, Decatur, Ind.

**STAMPS sent on approval** at 70% discount. Reference required. Emory Renoll, Hanover, Pa.

**FREE Germany air mail (5 var.)** for new applicant of my 1, 2c and 3c approvals and also my 50% discount. Chas. W. Schmidt, P. O. Box 4832, Frankford Sta., Philadelphia, Pa.

**FREE! 115 Different stamps** to approval applicants, 2c postage. Paige Stamp Co., Oak Park, Ill.

**24 VARIETIES Cuban stamps,** 10 cents. List of 6,000 low-priced stamps free. Address Chambers Stamp Co., 111P, Nassau St., New York City, N. Y.

**200 DIFFERENT stamps 10c > 1,000** Hinges 10c. R. H. Carlton, 380 W. So. Temple, Salt Lake, Utah.

**300 DIFFERENT, 20c; 600, 50c; 1,100,** \$1 2.00, \$3.50. Fred Onken, 630 79th St., Brooklyn.

**100 DIFFERENT 3c** if approvals are requested. Glenn R. Knight, Box 3, Sausalito, Calif.

**101 DIFFERENT Free** with 50% Approvals, 2c postage. Noemus Stamp Co., 312 East 23rd St., New York.

**PENNY Approvals that Satisfy.** Neil Gronberg, Box 5441, Philadelphia, Pa.

**150 GOOD Mixed foreign stamps 3 cents.** Stanton, Niantic, Conn.

**LIBERIA Snake Triangle** and two other triangles in our packet of 53 genuine foreign stamps for five cents. Crowder Company, Waverly, Baltimore, Md.

**IRAQ, U. S., Albania, Kenya, Ubangi 60** diff. stamps only 8c to approval applicants. J. Dennis, 7763 Logan, Detroit, Mich.

**110 NEW Europe All Different,** a wonderful collection cataloging several dollars, free to collectors requesting our Net Approvals. Postage 2 cents. Badger Stamp Co., Milwaukee, Wis.



**ANNIVERSARY OFFER!** 15c six beautiful sets: "Occupation," "Commemorative," "Air-mail," "Charity," "Pictorial," "War." Also three packets: (International), (British) French, Portuguese Colonies, (Bulgaria). Approvals, lists, discounts. Deering, Fairmount, Marlborough, Mass.

200 DIFFERENT Stamps, Zanzibar; Al-bum, 12c. Liberty, 3974 Arsenal, St. Louis, Mo.

40 DIFFERENT United States 10c. 60% approvals. Seidenberg, Baroda, Mich.

500 STAMPS 17c, 3,000 Hinges 25c. Ask about special approval discount. Elmer, 61 Court St., Boston.

**FREE!** Loose leaf postage stamp album at rate of 8 pages each month given with subscription to monthly journal. Send 2c stamp for prospectus. United Stamp Co., Marquette Bldg., Chicago, Ill.

STAMPS, 100 all different. Postage 2c. Lists free. P. M. Quaker Stamp Co., Toledo, Ohio.

**REVENUES—Telegraphs—Every country. Pretty—Intriguing—Cheap. Mint \$5.00** revenue free to applicants with references. Vanderhoof, 1114 Logan, Denver, Colo.

**FREE 50 British Colonials**, if approvals requested. Postage 4c. Berkeley Stamp Co., South Berkeley, Calif.

**BEST One cent approvals in America.** F. P. Hand, 1117 So. 60th St., Philadelphia, Pa.

**APPROVAL Stamp packet sent on request.** Paul Cornish, Schenectady, N. Y.

**FREE Stamp collection from 12 foreign countries to all sending 4c for price list.** Dept. 12, Argonaut Stamp Company, New Canaan, Conn.

100 STAMPS 50 Diff. countries 10c. Luf-bery, Port Orange, Fla.

20 BEAUTIFUL Scenery stamps, 10c to approval applicants. McColgan, Onondaga, Mich.

**GENUINE Mexican \$1 bill free with 20** different unused stamps for a dime. B. Nagle, 1101 Marion, Reading, Pa.

**"MYSTERY" Packet only 25c to appli-**cants for our eye-opening approvals. Martin Huet, Box 245, Chicago.

**ARGENTINE Postoffice commemorative set** for 12 cents. Other fine Latins. Sandwich Stamp Shop, Sandwich, Ill.

#### RARE COINS

**OLD Money wanted.** Do you know that coin collectors pay up to \$100.00 for certain U. S. cents? And high premiums for all rare coins? We buy all kinds. Send 4c for large coin folder. May mean much profit to you. Numismatic Co., Dept. H, Ft. Worth, Tex.

100,000 MARKS And list 3c. Greenclay, 1626 Washington, Denver, Colo.

**\$2 TO \$500 Each paid for hundreds of old** coins. Keep all old money, it may be very valuable. Send 10 cents for illustrated coin value book, 4x6. Prices guaranteed. Get posted. We buy and sell. Clarke's Coin Office, Box 5, Le Roy, N. Y.

**OLD Coins, large spring selling catalog of** coins for sale free to collectors only. Catalog quoting prices paid for coins, ten cents. William Hesslein, 101A Tremont St., Boston, Mass.

**GET Profit and pleasure in collecting old** coins. Send 10c for large illustrated coin catalog. You'll be delighted with it. Send for it right now. B. Max Mehl, Numis-matist, Mehl Bldg., Dept. P, Fort Worth, Tex. Largest Rare Coin Firm in the U. S.

44 DIFFERENT Coins \$1.00. 20 coins and bills 25c. Oddehon, Box 681, Kansas City, Mo.

40 OLD Coins all different \$1.00. 100 different coins \$3.00. 100 mixed foreign coins \$1.00. 5 Mexican bills 25c. Claud Denney, Box 315, Dallas, Tex.

**UNITED States.** Large cent, two-cent bronze, three-cent nickel and bargain list, 25c. Thirteen dates large cents, \$1.00. George Coffin, Greenwood Mountain, Me.

**RARE United States and foreign coins,** war medals and decorations. Chinese coin and catalog 10c. Alexis Mengelle, Colorado Springs, Colo.

**CALIFORNIA Gold—Quarter size, 27c;**  $\frac{1}{2}$  size, 53c; 3c piece and catalog, 10c. Norman Shultz, Box 746, Salt Lake, Utah.

#### FOR BOYS

**MOUNTED Propeller.** 12 inch. Sample and prices 25c. Aero Shop, 3050 Huribut Ave., Detroit, Mich.

**"THE Boy Electrician,"** pocket size, 75 illustrations, 30c. J. Tillbergh, Proctor, Vt.

**YOUNG Electricians, inventors, wood-**workers, students! Earn money at home. 25 reliable plans, guaranteed. No capital needed. No selling. Complete for \$1.00. Boys Mechanical Association, 7 Morris St., Brighton, Mass.

**SELL Your neighborhood.** Vapor Jelly for colds. Pfeiffer, 267 Sharline, Ohio.

#### CAMERAS AND PHOTO SUPPLIES

**FREE Bargain book listing hundreds of** slightly used cameras, kodaks, lenses and photographic supplies at great savings. A few sample bargains:  $3\frac{1}{4} \times 5\frac{1}{2}$  Seneca De Luxe roll film camera with f:6.3 Anastigmat lens universal shutter \$22.75. Bausch and Lomb 5x7 Tessar f:4.5 lens in volute shutter \$51.50. Revolving back ser. B Grafex  $3\frac{1}{4} \times 4\frac{1}{4}$  camera with kodak f:4.5 Anastigmat lens \$71.50. Send for your copy at once; it will pay you, as our prices are extremely low. If you want a brand new outfit send for our complete catalog. Everything guaranteed fully. Central Camera Co., 112 South Wabash Ave., Dept. PM-3C, Chicago, Ill.

**KODAK Finishing prices smashed—Six** glossy prints 18. Send any size roll, or negatives. Young's Studio, Sedalia, Mo.

**CASH For pictures!** List 100 markets \$2.00. Oakley, Geneva, N. Y.

**REAL Glossy prints 3c. Rolls 5c. Beau-**tiful 8x10 enlargement, oil colored, 60c. Photo Artist, Box 35, St. Paul, Minn.

**FREE Souvenir calendar.** Send ad. Falls Foto Finishers, Glens Falls, N. Y.

**KODAK Films developed 5c roll. Prints** 3c each. Trial offer. Beautifully mounted 8x10 enlargement 40c. Overnight service. Young Photo Service, 405 Bertha St., Albany, N. Y.

**MAKE Money in photography.** Learn quickly at home. Spare or full time. New plan. Nothing like it. Experience unnecessary. American School of Photography, Dept. 3432, 3601 Michigan Ave., Chicago.

**TIME Counts in applying for patents.** See pages 154 and 155. Clarence A. O'Brien, Registered Patent Attorney, Washington, D. C.

**\$50.00 FOR Photographs—This price paid** for photographs meeting our requirements. Perhaps one of yours will bring this amount. Full particulars free. Redkrafs, Denver, Colo.

**ENLARGEMENTS.** Best ever, 8x10 50c. Send film or negative. Price list other sizes. Jengar Photographic Laboratory, 478-79 Simon Long Bldg., Wilkes-Barre, Penna.

**BIG Money in photography, motion pic-**ture projection. Catalog 49A free. New York Institute of Photography, 10 W. 33d St., New York.

**HAVE You a Camera? Write for Free** sample of our big magazine, showing how to make better pictures and earn money. American Photography, 116 Camera House, Boston, 17, Mass.

**FILMS Developed.** Special Trial Offer. Any Size Kodak film developed 5c, prints 3c each. Trial 6x10 Enlargement in handsome folder 40c. Overnight Service. Roanoke Photo Finishing Co., 209 Bell Ave., Roanoke, Va.

**EARN Big money with your camera in** your spare time, using Halldorson Home Portrait Lamp. Write for booklet "Home Portrait Photography" and catalog—both free. The Halldorson Company, 4747 N. Western Ave., Chicago.

**SAMPLE Enlargement—dime, and nega-**tive (returned). Trial roll, glossy prints, 25c silver. Brown, Warsaw, N. C.

#### MOTION PICTURES

**FILMS.** 250 Feet \$1.00. Bargain. Lists. Eastin Films, Galesburg, Ill.

**FILMS, 10 Inch reels, \$1.35 post paid.** Adolph Werner, High Ridge, Mo.

**BE A theatre manager or owner.** Complete training at home. Catalog M. Moving Picture Theatre Managers Institute, Elmira, N. Y.

**MOVING Picture Film.** Features, west-erns and others \$10.00 to \$15.00 for complete feature. Progressive Pictures, 3320 Lindell Blvd., St. Louis, Mo.

**FILMS: 250 Feet \$1.00 postpaid.** Ex-change privileges. Eureka Films, 804 South Wabash, Chicago, Ill.

**NOW Ready—The famous Pasadena "Tour-**namment of Roses" exclusively filmed New Year's day 1929 and reduced for your 16mm. projector. 100 feet of undecipherable beauty. Sent postpaid on receipt of \$7.50. James Matthews, 225 West Seventh St., Long Beach, Calif.

**NEW Film bargains.** Searles, 130 Fisk St., Providence, R. I.

**PRACTICALLY New 35mm., DeVry** motion picture camera equipped with Gundlach f:1.9 Anastigmat lens, \$139.50. Eastman Cine model A 16mm., kodak equipped with f:3.5 lens, \$72.50. Cooke f:4.5 Telephoto 6" focus lens in barrel, \$69.50. Send for our free bargain book listing hundreds of other still and motion picture camera bargains or for our complete catalog if you prefer brand new merchandise also listed at money-saving prices. Central Camera Co., 112 South Wabash Ave., Dept. PM-3C, Chicago, Ill.

**STARTLING Bargains in motion-picture** cameras, projectors, apparatus. Send stamp for the 192nd issue of the Bass Bargain-gram. Never in history has such startling bargains been offered in guaranteed apparatus. Write for your copy now. Remarkable motion-picture exposure meter, \$2.00. Sixty-six page catalog. Send stamp. Bass Camera Company, 179 W. Madison St., Chicago, Ill.

**\$1250.00 FOR A photoplay story by an** unknown writer and sold through our sales department. We revise, copyright and market. Located in the heart of the motion picture industry. We know the demand. Established 1917. Postal brings free booklet with full particulars. Universal Scenario Company, 206 Western and Santa Monica Bldg., Hollywood, Calif.

**JUST Out! Fourth edition Motion Picture** Projection by Cameron, 1,248 pages. Largest work ever published. Includes 150 pages on talking movies. Covers all known makes of projectors, including amateur. A liberal education. Yours for \$6.00 postpaid anywhere in the United States. Foreign, \$8.25. Circular on request. Bass Camera Company, 179 West Madison St., Chicago.

**\$150 SPRING Motor camera \$27.50.** Negative film  $2\frac{1}{2}$  cents foot. Projector \$30. 16M camera \$45. 16M projector \$25. 100 feet 16M negative \$4.50. Ray, 296 5th Ave., New York.

**EXCELLENT Westerns, features.** \$2.50 per reel. Stewart Marshall, Rome, Ga.

**BE A movie exhibitor—Big opportunity—**Only moderate capital required—Complete equipment at remarkably low prices. Write. Atlas Moving Picture Co., 624 South Michigan Ave., Chicago, Ill.

**MOVIE Films, 1,000 ft. reels, \$2.50 each;** shipped anywhere on receipt of remittance. Particulars on request. Independent Films, 177 Golden Gate Ave., San Francisco, Calif.

**TIME Counts in applying for patents.** See pages 154 and 155. Clarence A. O'Brien, Registered Patent Attorney, Washington, D. C.

**NEW And rebuilt projectors for theaters,** schools, churches, traveling shows. Supplies and complete theater equipments. Bargain prices. Free catalog. Monarch Theatre Supply Co., Memphis, Tenn.

**FILMS: 200 Feet \$1.00. Reels \$2.50. List.** Edgeworth Sales, Box 155, Blue Island, Ill.

**FILMS—250 Feet for \$1.00 postpaid.** Hoffman Film Service, 57 Broad, Albany, N. Y.

**BIG Money in photography, motion pic-**ture projection. Catalog 49A free. New York Institute of Photography, 10 W. 33d St., New York.

#### SCENERY TO RENT

**WORLD'S Most Beautiful Settings for** operas, plays, minstrels. Amelia Grain, Philadelphia.

#### RADIO SETS AND SUPPLIES

**DISCOUNT All standard makes.** Mention kind wanted. Write Radioman, Lake, N. Y.

**WANTED: Men to work with National** Radio Service organization. No selling scheme. Radio Doctors, Inc., Dept. M, Essex St., Salem, Mass.

**DEALERS And set builders write for low-**est prices on A and B power devices. D. L.G. Mfg. Co., 2941 West Lake, Chicago.

**UNMOUNTED 2,000v. Transformers \$8.75,** adjustable core chokes 125MA \$5.50. Write for lists of complete line. Radio Parts Sales Co., Orange, N. J.

**BARGAINS.** Used radios. Guaranteed perfect working order. Blue Ribbon 5 tube, 2 dial, Console \$19.95. Freshman \$14.95. Atwater Kent \$19.50. Many famous makes. Send money order with order. Bargain list on request. Surplus Radio Co., Dept. 1-C, 549 S. Wells, Chicago.

**TIME Counts in applying for patents.** See pages 154 and 155. Clarence A. O'Brien, Registered Patent Attorney, Washington, D. C.



**DEALERS**, Set builders, bargains. Used 5 tube sets, \$9.99. In table model cabinets. Require slight adjustment. Crosley cone units, \$2.00. UX228 a.c. tubes, \$1.00. UX227 tubes, \$1.75. Fully guaranteed UX280 eliminator tubes, \$1.75. 201A tubes 60c. Glo dials, 85c. Vogue loop antennas without base 95c. 2 Microfarad Western Electric condensers, 65c. 30 henry chokes, 90c. Battery cables 25c. Panels 7x10, 25c. Speaker plugs, 20c. Rheostats, 25c. Condensers, 50c. Transformers, 75c. Send money order with order. Chas. Hoodwin Co., Dept. 10, 4240 Lincoln Ave., Chicago. Dealers in Bankrupt Stocks.

\$10.95! "THE Wonder set of Radio." \$10.95! New long distance radio sensation. Experts amazed! You can hear programs on this "Wonder Radio" that you would listen to on high priced sets! (Only \$10.95 delivered direct by mail to you) "World's Greatest Radio Bargain." Just the radio you want—at a price you can afford! Descriptive folder and picture of this amazing new radio set sent free. Write for it today. American Sales Co., Dept. 600, Springfield, Ill.

NEW 300-Mile "Pocket" radio, \$2.00. No tubes or batteries required. Useful and practical, over 40,000 users. Order direct. Spencer Laboratories, 116 Atlas, Akron, Ohio.

MURDOCK Electric set \$29. Speaker \$4. Six tube set \$18. Mele Station A, New Haven, Conn.

**TRADE AND TECHNICAL SCHOOLS**

**DRAFTSMEN!** Be an expert. By our method we train you quickly. Books and tools furnished. Write for illustrated catalog. Columbia School, 204P Drexel Bldg., Philadelphia.

WANT A foreman's job? You may be a good mechanic but if you can't read blueprints you haven't a chance. I train you quickly. Write me your trade. Carroll Rumsey, 266 Drexel Building, Philadelphia.

**TELEGRAPHY**—Both Morse and wireless—taught thoroughly. Big salaries. Wonderful opportunities. Expenses low; chance to earn part. School established fifty-four years. Catalog free. Dodge's Institute, Fern St., Valparaiso, Ind.

OUR Commercial radio operating and junior engineering course pays our graduates \$150 to \$300 monthly from start. Rapid advancement. Winter term begins in January. Write for catalog of course including Extension Course. Loomis Radio College, Dept. 5-E, Washington, D. C.

MEN—Boys learn auto mechanics and electricity. Big pay. Big demand. Free catalog. Stevinson School, 2008A Main St., Kansas City, Mo.

BECOME Watchmaker, diamond setter, own your business. Paying job. Standard Watchmaker's Institute, 111 West 111th, New York.

**BUSINESS OPPORTUNITIES**

SUCCEED With your own business. Manufacture a popular product. No experience necessary. \$5.00 supply sells for \$50.00. Sample 25c. Buskett, Joplin, Mo.

SUPPLIES For making chipped glass house numbers and signs. Tinfoils, glass and frames. Also, agents to sell signs. Osborne Sims, 13580 Tuller, Detroit, Mich.

BIG Mails. Mailorder—Spartime proposition; magazines, catalogs. Your name listed six months 50c. Month 20c. Larson, T-3410 North Ave., Chicago.

HAIR Curling liquid. Immense profits. Guaranteed. Formula and process \$1. W. Norton, Edwards, Miss.

NEED More money? Free particulars. Superior Specialty, 112 West 42nd, New York.

SIX Hours a week spare time and twelve numbered gum venders placed with good merchants will earn you \$500.00 monthly. Sample \$18.00. Write for territory. Sanders Mfg. Co., Nashville, Tenn.

BUSINESS Profession of your own and earn income in service fees. See Stephenson Laboratories, display ad page 150.

LEARN Marbleizing, with Cowell's vitreous cement process. Garden furniture, anything concrete. Wonderful business. Demo brings folder and samples. John Cowell, Grayling, Mich.

START In business for yourself. Free sample; particulars. Defrees, 1036 W. 90th St., Los Angeles, Calif.

FREE Booklet describes 67 plans for making \$20-\$100 weekly; home, office. Your own business. Elite Co., 84 Elizabeth St., New York.

READ The Mail Order News—America's pioneer mail trade journal. Quarter century old. Approximately 600 pages yearly of valuable information for beginners and established mail-order houses. Analyzes mail-order business, its opportunities. Practical mail-order ideas, legitimate money-making schemes, instructive articles. Tells how to start, what to sell. Published monthly. Subscription \$3.00 yearly. Send 25c for sample copy. None free. Mail Order News, 360 Bristol Bldg., New York.

WE Start you in business, furnishing everything Men and women, earn \$40 to \$100 weekly operating our original "New System Specialty Candy Factories." Begin home spare time. Unlimited opportunity. Valuable booklet free. W. Hillyer Ragsdale, Drawer 4, East Orange, N. J.

WANTED—Partner to invest about \$5,000 in manufacturing new patented flower pot. Inquire Frank Luipersbak, 235 Paterson Ave., E. Rutherford, N. J.

MAKE Candy: A \$15 course in candy making only \$2.00. Lo Belle Lab., 812 Superior, Fort Wayne, Ind.

PARTNER—Wanted to help finance meritorious automobile invention. Already patented. W. H. Ruth, Greensburg Kans.

OPERATE A profitable mail order business; explanatory booklet 10c. Command Nygoon Company, Akron, Ohio.

MANUFACTURE And sell, latest novelties, toys, wooden and molded articles, foods, beverages, preparations. Free list of reliable patterns, processes. Manufacturers, 397 Tracy, Kansas City, Mo.

GOLD, Silver and nickel plating. Big profits. \$1.00 (bill) for formulas. Electro Plater, 2022 High St., Portsmouth, Ohio.

KING System mail order business. It's new! Different! Honest! Big profits! Details 25c. Satisfaction guaranteed. Evans King Co., 672PC, Wilmington, Del.

COMPOSITION Floor making earns industrious men \$12 and more daily if used as trade. Or make business of it with profits up to \$10,000 yearly. Openings everywhere. Semi-Tile, Box 43, Hollis, N. Y.

MIRRORS Resilvered at home. Costs less 5 cents per square foot; you charge 75 cents. Immense profits plating, like new, brassy, worn-off auto parts, reflectors, tableware, stoves, etc. Outfits furnished. Details free. Sprinkle, Plater, 127, Marion, Ind.

READ "Advertising and Selling Ideas" monthly magazine, crammed full of latest business ideas. One subscriber says: "We assembled dollar's worth of ideas in one issue." One year \$1, refunded if dissatisfied. Ideas, 504B, 52nd St., Milwaukee, Wis.

QUICK "Mailorder Success" guaranteed. Instructions free. K. Home, 3949 Metropolitan, Chicago.

LIVE Reliable Sales Co. wants exclusive selling agency for dependable lines in New England. Whitman Sales Co., Orange, Mass.

WANT More money? Write to National Cutlery Sta. V, Los Angeles.

\$20.00 PER 100 Stamping keytags. Sample and instructions 25c. Dallas Ruth Co., Wheelersburg, Ohio.

TIME Counts in applying for patents. See pages 154 and 155. Clarence A. O'Brien, Registered Patent Attorney, Washington, D. C.

GIGANTIC Mail: Over 100 pieces guaranteed if you list your name in my directory; one month 10c, 3 months 25c. Edward Armour, 136 East 28th St., New York.

A BUSINESS of your own making—Sparkling Glass Name and Number plates, Checkboards, signs. Big book and sample free. E. Palmer, 540, Wooster, Ohio.

MAKE Big profits with a fur farm in your backyard. Chinchilla rabbits, muskrat, mink. Write for facts. 252 Conrad's Ranch, Denver, Colo.

SUCCEED With your own products. Make them yourself. Formulas, processes, trade-secrets. All lines. Catalog, circulars free. B. Thaxly Co., Washington, D. C.

\$200 WILL Start your own business; chance to enlarge; unlimited money-making possibilities; you manage, distribute and collect; experience unnecessary. For particulars, address Manager, 603 N. Eutaw St., Baltimore, Md.

FREE Book. Start your own little business anywhere, selling novelties by mail. My beginner's outfit contains everything required, novelties, circulars, instructions, etc. Descriptive book free. Hadwil, 3A-74 Cortlandt St., New York.

LOIDLAC Wonderful, new, amazing discovery ends polishing and repainting. Restores colors—makes the old car look like new in 30 minutes! Not a polish, paint, cleaner or wax. Make it yourself, have hundreds selling it. \$14.00 gallon profit. Write for exclusive manufacturing rights. Miller, Chemist, 706 Jetton, Tampa, Fla.

MEXICAN Curios, Indian baskets, over 200 items. Non-competed virgin field. Deal direct. Save money. Fifty cents brings bargain introductory list and attractive samples. Address G. Medina, 78-P, La Rosa St., Mexico City, Mex. Substantial references furnished.

START A Crispette shop. Delightful confections. Everybody likes them. Make a lot of money. Adams reports \$364 profits in two days. We start you. Write, Long Eakins, 1962 High St., Springfield, Ohio. (Samples 10c.)

MAKE Your own antifreeze solution for radiators. Costs only five to ten cents gallon. Instructions one dollar. Guaranteed. Effie Wilson, Rotan, Tex.

MAKE \$75 Weekly placing boxed Neverun on store counters. Write for unique plan. Establish steady income. Neverun Corp., Dept. 915, 185 N. Wabash, Chicago.

\$100 STARTS Route automatic vending machines. Large steady profits. Write Chewit Corp., Dodworth St., Brooklyn, N. Y.

ASH Trays are good advertisers. Let me quote on your needs. Sample 30c. C. W. Platts, Box 366, Thomaston, Conn.

CARPENTERS Make money, selling and installing Duplex Adjustable Sash Balances. Write Department "B," General Water Heater Corporation, Los Angeles, Calif.

GET Exclusive agency city or state. Clever invention, "pneumatic suction door cushion," stops rattles, squeaks, slam on auto, house, office doors. Retails 25c. 400% profit. Free sample. Milhander, 1421 East 38th St., Los Angeles, Calif.

300% PROFIT. Article sells to women, by mail, or through agents. Advertising literature furnished free. Send for copy of letter that sold over 10,000 orders. Gordon, Dept. 304, 63 E. Lake St., Chicago.

YOU Can make \$35 weekly, spare time, "resilvering mirrors" or "collecting and selling names." Both only 10c. Rush for yours now. Toney Sowin, 245 Sheridan Ave., Albany, N. Y.

LEARN To paint sign outfit, complete \$2.00. A. C. Garcia, Rosenberg, Tex.

STOP Renting, build rammed earth house with common labor. Stronger than concrete. Instruction, full information, two dollars. Mrs. Effie Wilson, Rotan, Tex.

MILLIONS—Waiting to buy the wonder patented-combination auto tool-wrench-pry-clawhammer; indispensable to every autoist, no springs, no screws, quick ratchet adjustment, drop forged, steel, indestructible. Salesmanship unnecessary; just show it, it's sold. Agents, big money. Territory free. Write Auto Tool Company, 12 South Canal St., Chicago, Ill.

"SCHEMER" Subscribers surely succeed. One reports \$50,000 from one tip; another \$25,000 from three Schemes; another \$10,000 from one formula. Try your luck! Year, \$1.00; three months, 30c. Patterson, Publisher, Alliance, Ohio.

CHEMICAL Expert will furnish formulas and trade secrets. All lines. Lists free. W. L. Cummings, Ph. D., 228 Gordon Ave., Syracuse, N. Y.

DON'T Sell for others. Employ agents yourself. Make your own products. Toilet articles, household specialties, etc. 500% profit. Valuable booklet free. National Scientific Laboratories, 1984W Broad, Richmond, Va.

CHARTERS: Delaware; best, cheapest; free forms. Colonial Charter Co., Wilmington, Del.

SELL by Mail! Books, novelties, bargains! Large profits! Particulars Free! B-Elfco, 525 South Dearborn, Chicago.

UNPATENTED Ideas can be sold. I tell you how and help you make the sale. Free particulars (Copyrighted). Write W. T. Greene, 810 Baltic Building, Washington, D. C.

SELL Latest imported novelties. French model pocket mirror and transparent art cards. Samples of all postpaid \$1.00. World Service Co., 336 Marcy Ave., Brooklyn, N. Y.

LEARN the collection business. Good income, quick results. Interesting booklet, "Skillful Collecting" free. National Collectors Assn., Long St., Newark, Ohio.



**ARTIFICIAL Marble sanitary flooring** instructions, covering wood or cement flooring  $\frac{1}{2}$  inch thick, fireproof, waterproof, all colors, low cost. Ornamental casting, concrete, plaster, papier-mache decorations, garden furniture, statuary, flexible molds. 18 years instructing the public; particulars and illustrations free. Chris. Mahler, Huntington, N. Y.

**MECHANICS, Painters, carpenters, start furniture refinishing, painting, handyman shop on nearly nothing; winning plan brings customers quickly.** John Braceland, 1439 So. Ninth, Philadelphia, Pa.

**MAIL Order business your opportunity.** Breniser's famous hand books by expert 28 years' experience show how to start selling articles you make or buy—all or part time—small capital. Fascinating, profitable. Set eleven books, \$3.25. Breniser Company, 1607 P. Sansom, Philadelphia. Sample book, 25c, pay \$3 for other ten if satisfied.

**DELAWARE Incorporator.** Charters; fees small; forms. Chas. G. Guyer, 901 Market St., Wilmington, Del.

**I MADE \$30 a Week Home.** French Breadmaking. 15 years' experience; Free Booklet tells. Ashbrook 87, Marengo, Ohio.

#### TELEGRAPHY

**TELEGRAPHY—Both Morse and wireless—taught thoroughly. Big salaries. Wonderful opportunities. Expenses low; chance to earn part. School established fifty-four years. Catalog free. Dodge's Institute, H St., Valparaiso, Ind.**

#### CHEMISTRY

**1929 BOOKLET** Of chemical experiments. Illustrated, 15c. General Chemical Company, Box 397, Reading, Penna.

**CHEMICAL Analysis, Processes, technical information.** Robert Henderson, Laboratory, Madison, Me.

**YOUR Chemical problems solved and working formula or process furnished for \$5.00.** Write me. W. Stedman Richard, Industrial Chemist, Box 2402, Boston, Mass.

#### FORMULAS AND TRADE SECRETS

**TRY Using a proven anti-knock compound and get results.** Formula \$1.00. James P. Holler, Odenton, Md.

**SAWDUST.** Chemicals makes sanitary flooring in colors. Directions \$1.00. Universal Supply Co., 777 Boulevard, Bayonne, N. J.

**INDUSTRIAL Chemist furnishes and develops formulas, processes; all lines. Moderate charges. Inquiries invited.** L. Clore, Industrial Chemist, Crawfordsville, Ind.

**BAKED Enamel remover** 20c per car. E. M. Reighard, 4437 Finley Ave., Los Angeles, Calif.

**CANTRUN Prevents runs in silk stockings.** Formula 50c. Any formula 50c. Bernard Wells, 852 George, Chicago.

**DICTIONARY** Of drugs 25c. Formula catalog free. Western Chemical, Salem, Oreg.

**GUARANTEED Formulas 50c; toilet preparations specialty.** Richard Bastien, Plymouth, Mass.

**EVERCLEAR Windshields \$1.** Guaranteed. Auto formulas \$2.00. Szabo, 579 Seventh, Sheridan, Wyo.

**PLASTIC Wood, liquid leather, brake juice, thermoline.** Formulas \$1.00 each. Moscato, 757 East 107th St., Brooklyn, N. Y.

**GUARANTEED Formulas \$1.00 each.** Chemical analysis of your sample and formula prepared \$5.00. Expert attention. Stenton Laboratories, 2122 Griffith St., Philadelphia, Penna.

**FIVE Regular \$5.00 formulas and our 1929 catalog. Tested formulas 10c.** Grinstead Company, Oswego, Kans.

**OIL—Make big profits collecting and refining used crank case oil by my process.** Enormous demand, process \$1.00. R. W. Barker, 1706 So. Michigan, Chicago.

**WHAT Is it? Not paint. Not polish. Not wax. A transparent liquid. Refinishes your car and renews it to delightful showroom lustre.** Formula \$2.00. Donahoo, 2621 Jackson, Wilmar, Calif.

**INDUSTRIAL Chemist furnishes formulas, plans, trade secrets. All lines. Work guaranteed. Lists free.** J. F. Mazur, 941 20th, Lorain, Ohio.

**GUARANTEED Formulas, best science can produce for making popular, biggest-selling specialties all lines. Don't buy formulas till you've received valuable eye-opening literature.** Miller, Chemist, 706-F Jetton, Tampa, Fla.

**MAKE Honey without bees.** Good as the bees make four cents pound. Formula one dollar. Frame, Rockland, Ohio.

**CHEMICAL Consultation and analysis. Manufacturing ideas made practical. Money-making formulas. Charges moderate.** Write Associated Chemists, Indianapolis, Ind.

**FORMULAS—170 Money makers and big illustrated catalog 20c.** Ideal Book Shop, (K) Park Ridge, Ill.

**SUCCEED With your own products. Make them yourself.** Formulas, processes, trade-secrets. All lines. Catalog, circulars free. B. Thaxly Co., Washington, D. C.

**DON'T Sell for others. Employ agents yourself.** Make your own products. Toilet articles, household specialties, etc. 500% profit. Valuable booklet free. National Scientific Laboratories, 1984W Broad, Richmond, Va.

**3,000 FORMULAS \$1.00, 500 25c.** National Service, 3937 Marburg, Cincinnati, Ohio.

**FORMULAS: Guaranteed, catalog free.** Restovall Laboratories, 6720 Oecento, Ave., Chicago.

#### AGENTS WANTED

**NO Dull times in the food business.** Selling Federal Pure Food Products is the greatest, surest and safest business in the world today, and here is your opportunity to get into it. You can make \$3,000, \$5,000, \$10,000 or more per year—the only limit is your ability to take care of the business. You will need no experience or money to get into this business. We teach you everything you need to know. We furnish you with license. No dull times, for the people must eat, and our food products are the fastest selling, surest and quickest repeat order goods in the world. Sell on sight in every home where food is used—repeat orders immediately and every week thereafter. A real big business all your own. Every new customer adds a great deal to your weekly income. Your business once established, has a market value just like a store and can be easily sold. The greatest money-making opportunity of your lifetime because you risk absolutely nothing. Remember! Guaranteed! Best products, biggest sellers, surest repeat orders. No capital or experience is required. We furnish capital and everything necessary for you to become a Federal distributor. Exclusive territory will be given honest men or women who write at once. Federal Pure Food Company, A2307 Archer Ave., Chicago, Ill. Largest packers of pure food specialties in the world. Reference, any bank, Dun or Bradstreet Rating Agency, Express or Railway Company in America.

**OH Hello! Why didn't I see this before? Christy's Iron Rust and Stain Remover sells like blazes.** Write for free sample. Christy, Inc., 5067 Canal, Newark, N. Y.

**AGENTS. Send for free sample.** "Fretnot" washes clothes snow white without rubbing. \$5.00 daily and more easily made. Credit given. Empire, 1549 N. Wells, Dept. 201, Chicago.

**REPRESENTATIVES: Enormous profits. No investments. Neither selling.** Meriden Dyeing Works, Meriden, Conn.

**AMERICA'S Greatest tailoring line, free, 175 large samples all wool tailored to order, union made, sensational low price. Big commissions paid daily. Cash bonus besides. Exclusive territory to producers. Hustlers making \$100 a week and up. Get outfit at once.** Address Dept. 49, Goodwear, 844 Adams, Chicago.

**MAKE \$20 To \$35 a day selling Imprint Book Matches, spare or full time. Big repeat business—no investment—every merchant a prospect.** Write Imprint Book Match, Dept. 113, 877 Meigs St., Rochester, N. Y.

**NEW Invention—100% profit. Liquid quick mend for fabrics and hosiery.** Stops runs. Every woman buys. Hundred other fast sellers. J. E. Johnson Co., Dept. 475, 6129 Wentworth, Chicago.

**NEW! \$10-\$15 Daily showing patented article of unusual merit, \$1.50 up. Real comfort.** Endorsed by leaders in business and sports. Free sample. Flexible Buckle Belt, F20 E. Jackson, Chicago.

**\$25 DAILY Selling newest Damask tablecloths, no laundering, ironing, full line slickers, raincoats, leatherettes, trenchcoats, umbrellas.** Free outfit. American, 2724 Roosevelt, Chicago.

**3,000 VALUABLE Formulas prepaid \$1.00.** National Sales Service, 3937 Marburg, Cincinnati, Ohio.

**AGENTS Buy direct. Hosiery, lingerie, neckwear at lowest mill prices.** Men's heavy silk hose, doz. pairs, \$2.25. Latest novelty hose, doz. \$1.65, \$2.35 and \$3.50. Men's silk knitted ties, doz. \$1.40. Latest cut silk ties, doz. \$3.50. Ladies, hose, silk to top, doz. \$3.75 and \$6.50. Latest Pointex silk hosiery, doz. \$4.50, \$7.50 and \$8.50. Genuine full-fashioned silk hose, doz. \$11.50. Ladies' pure Rayon silk bloomers, doz. \$8.50. Vests, doz. \$7.25. Silps, doz. \$13.50. All merchandise strictly first quality, 10% required with order. Balance C. O. D. Satisfaction guaranteed or money refunded. Act at once. Superior Knitting Co., Dept. 12, New Haven, Conn.

**PRIVATE Brand toilet articles, household specialties, perfumes, soaps, extracts, etc.** We pack these goods for you under your private label. With your name on the goods you get all the repeat business. Don't sell for others but build up a profitable business for yourself. Highest quality merchandise. Extremely low prices. Quick shipments on both large and small orders. Write immediately for lowest wholesale prices and complete information regarding our amazing offer. Address Supply Department, National Scientific Laboratories, 1903W Broad, Richmond, Va.

**WANTED: Women who need quick money.** "New Idea" imported ladies' necessity; sells on sight; everyone buys; representatives everywhere cashing in big. Miss Ely has made \$1,900, Mrs. Hart \$2,200. New sales plan puts you in business without capital or experience. Samples free. Write Mary P. Coleman, Meriden, Conn.

**GOLD Leaf Window Letters and script signs; no experience; 500% profit.** Sample free. Dearman made \$19.50 first 2 hours. Consolidated, 69T West VanBuren, Chicago.

**42 MILES On 1 gallon.** Wonderful moisture gas saver. All autos. 1 free. Critchlow, O1-805, Wheaton, Ill.

**GENUINE Gold Leaf Letters anyone can put on store windows. Guaranteed to never tarnish. Large profits. Enormous demand.** Free samples. Write today. Metallic Letter Co., 438-D North Clark, Chicago.

**BIG Ohio corporation has county position open. \$50.00 weekly commission. Earnings start immediately. Good for \$5,000.00 yearly.** We furnish everything, deliver and collect. Capital or experience unnecessary. Fyr-Fyter Co., 1866 Fyr-Fyter Bldg., Dayton, Ohio.

**FREE—Complete selling outfit free.** We furnish honest and industrious men and women complete selling outfits free. Start a toilet and household specialty business of your own. Exclusive territory. Write today. W. C. Johnson Co., Dept. 22, Atlantic Highlands, N. J.

**ELECTRICAL Invention, absolutely legitimate; storekeepers amazed, buy immediately.** Costs 29c, sells \$1.00. Send 29c for sample. Patented Products, 912 Trinity Ave., New York.

**CAN You sell? Try our easily sold crystal plate glass house numbers and signs.** 35 cents brings you sample to sell by. Reliable House Number Co., 2539 S. State St., Chicago, Ill.

**CASH Paid for Butterflies, Insects.** See Sinclair Display Advertisement on page 16.

**PROFITABLE Little business.** Operate our plans! Write Makary, D-339 Mountain St., Pittsburgh, Pa.

**AGENTS. Enormous profits selling \$5.00 to \$10.00 pen and pencil sets for 50c and 75c. Guaranteed five years.** Nassau Pen & Pencil Corp., 111 Nassau St., New York City.

**BROUGHT From Holy Land. Fascinating, inspiring religious novelty. Christians buy on sight. Big commissions.** Write Jadet, 1472 Broadway, New York.

**HANDYMAN Shop; painting, fixing; start on nothing.** I did. Braceland, 1457 So. Ninth, Philadelphia, Pa.

**EARN \$10 To \$15 daily, \$5 evenings, showing startling new trouble light.** Sticks anywhere on car by electro-magnetism. Just demonstrate, motorists grab it. Big cash commission and extra bonus. Best season just starting. Write quick. Lea Sales Co., 426 Shell Bldg., St. Louis, Mo.

**EASY As pie, to make big money with Christy's Polishing Cloth.** Works like magic. Sells like wildfire. Big profits. Write for free sample. Christy, Inc., 6467 Canal, Newark, N. Y.

**\$10-\$25 DAILY Simply showing new Polly wrench.** 10 wrenches in one. Guaranteed seller. Sample free. Gellman Mfg. Co., Dept. 6-C, Rock Island, Ill.



**DISTRICT Managers! Crew managers! General agents! Wanted:** Men and women to appoint saleswomen to sell "New Idea" imported sanitary necessity. New feature never before used; sells on sight. Every woman buys and repeats. Without capital new salesplan nets you big commission on new sales plan nets you big commission on producers. Write Box J-708, Meriden, Conn.

**IT Rings the bell for salesmen who must have big money.** Krystal Kleen actually sells 100% on calls. Its demonstration is irresistible, its field is three-fold. Fifty-fifty deal. Write today. Fenton Chemical Company, Jackson Heights, New York.

**WE Have the finest needle case, self threading needles, needle threaders.** \$50.00 to \$200.00 weekly. Samples 25c; particulars free. Empire, 1549 N. Wells, Dept. 201, Chicago.

**12 MILES On 1 gallon.** Wonderful moisture gas saver. All autos. 1 free. Critchlow, O3-805, Wheaton, Ill.

**DON'T Sell for others.** Employ agents yourself. Make your own products. Toilet articles, household specialties, etc. 500% profit. Valuable booklet free. National Scientific Laboratories, 1984W Broad, Richmond, Va.

**AGENTS \$300 Month.** Dri-Kleanit makes any car look like new. Removes mud, grease, road oil, all one operation. No soap or water used. Cleans any car for 10c. Wonderful seller. Make \$5,000 year. Free demonstrating sample. American Accessories Co., Desk 4431, Cincinnati, Ohio.

**MAKE \$15.00 Daily!** Simply show rhinestone initial buckles, fountain pens, etc. We deliver. No competition. No investment. Write quick for special free sample outfit. Chaston Novelty Co., Dept. C, 606 Blue Island, Ave., Chicago.

**AGENTS—Two biggest 1929 profit makers.** Rubber kneeling pad and latest patent guaranteed razor blade sharpener, sharpen any blade. Quick sellers. Sample and territory furnished. Ideal Utensil Company, Otis Bldg., Chicago.

**SELL Fountain pens through stores.** No canvassing. Counter displays furnished. Brooking, Warren, Ark.

**AGENTS! Just think, a dust cap that's air tight yet tires are filled and tested without removing cap.** Price 20c. Handee Air Appliance Co., Box 494, Kalamazoo, Mich.

**DISTRIBUTORS Wanted—For new, patented specialty selling through dealers.** Exclusive territory is now available on a fast selling, low-priced specialty which is taking the country by storm. If quick sales and enormous profits interest you and if you can finance and organize your own territory we have a wonderful proposition to offer. Write for particulars and mention details. Gordon Manufacturing Co. (Dept. D-4), 110 E. 23rd St., New York City.

**\$15 DAILY** Paid men, women to show finest neckwear. Biggest values. Experience unnecessary. Free samples sent first 500 applicants. Nawco, Desk YC-105, Covington, Ky.

**STATE And crew managers to handle agency for new electric water heater.** Sells for \$5.95. Jiffy Electric Water Heater Co., 812 Maxlow, Detroit.

**MANUFACTURE At home—Pure food products; popular household, toilet, automobile specialties, etc.** Particulars, 1929 catalog free. Grinstead Company, Oswego, Kans.

**FREE Booklet describes 67 plans for making \$20-\$100 weekly, home; office.** Your own business. Elite Co., 84 Elizabeth St., New York.

**SELL Books on etiquette.** Sample 50c. J. Daurer, Route 3, South Bend, Ind.

**"WHERE To buy 500,000 articles at lowest wholesale prices."** 1929 directory. Distributors wanted. Pruitt System, Brookfield, Ill.

**FREE Booklet describes 67 plans for making \$20-\$100 weekly, home; office.** Your own business. Elite Co., 84 Elizabeth St., New York.

**MAN In each town to plate auto parts, reflectors, bathroom fixtures, refinish beds, mirrors, chandeliers; by new method.** No capital or experience required. Simple plan of manufacturing at home starts you in big money-making business. Outfit furnished. Free particulars and proofs. Gun Metal Co., Ave. H, Decatur, Ill.

**NEW Kind of metal polishing cloth.** No odor, no oil. Absolutely dry, but polishes like magic! Agents making big profits. Sample free! Ludlow Laboratories, Dept. 223, 331 W. Ohio, Chicago.

**WANTED—County distributors to handle sales privilege on popular, quick-selling auto accessory.** Big profits. Quick sales. Real demand. Fits all makes of cars. Low retail price. You can sell wholesale and retail. Endorsed by A. A. A., Motor associations, magazines, newspapers and motorists everywhere. A positive necessity. This is real opportunity for the right man to become independent. Write today for descriptive literature. Address Room 396, % Popular Mechanics, Chicago.

**GENERAL Agents—Something new.** Whirlwind seller. "Repeat" washing powder. Washes clothes without rubbing. Women throw away washboards. Big profits. Exclusive territory. Write today free package. Kiltredge Co., 82 Putnam St., Tunkhannock, Pa.

**WE Offer the selling agency for the world's largest, most complete direct to wearer men's wear line; consists of 145 large cloth samples, shirts, neckties, underwear, pajamas, waterproof trench coats and lumberjacks; spare or full time; experience unnecessary; outfit free.** Howard, 1213 VanBuren St., Factory 223, Chicago.

**40 CENTS Profit on every \$1.00 sale.** Our article is a repeater. Excello Sales Co., Shreveport, La.

**SELL Ties—Make big profits.** Get big sample selling outfit absolutely free. Wonderful patterns; splendid values; liberal commissions. Write today to Public Mills, 4927CE Hudson Boulevard, North Bergen, N. J.

**AGENTS: Magic hot pads, sponge rubber mats, Damaaskold table covers, adjustable rubber aprons, ironing board pad and covers, and fifty other big profit producers.** Write B & G Rubber Manufacturing Co., Dept. 395, Pittsburgh, Pa.

**SHARPENER For scissors and knives.** Has flat, movable, re-versible, and re-newable sharpening surface. Live seller at 300% profit. Sample 25c. Lake Mfg. Co., Clarendon, Va.

**SAVE Those old shoes.** Three minutes and 50 cents taps any shoes or rubbers twice. Spreads on with knife like butter, wears like leather, waterproof and easy to apply. Agents wanted. Large size sample \$1.00. Eastern Supply House, Bangor, Me.

**ANXIOUS To hear from lady interested in starting little home dress shoppe.** Madame Isabelle, PM65 Times Square, New York.

**ALUMINUM Solder saves thousands of dollars in restoring to full value "All articles made of Aluminum" formerly junked.** Sample and selling plan 25 cents. No acid or flux required. M & D Aluminum Solder Co. of America, 1664 Washington St., Boston, Mass.

**AGENTS: Buy for one cent a package fifty-cent size, extracts, pie-fillings, toilet articles.** "Holland," Harvey, Ill.

**SELL Famous fashions from Fifth Avenue.** \$95 weekly. 100% virgin wool suits, ramshorn wool, camel's hair topcoats, \$19.75, \$4 commission; special numbers \$13.75; commission \$3.50. Free outfit. Dept. PM-3, Avenue Tailors, 140 Fifth Ave., New York.

**WANT A bigger income? Write now for the fastest-selling line in America.** Get my free outfit, latest shirt fabrics. Full year guarantee with every shirt. Free initials 48-hour delivery. Biggest commissions in advance. Leonard Gould, 1237B3 Broadway, New York.

**\$5.00 HOURLY.** Mercerized Damask scalloped table cloths 75c! Tremendous demand. Other bargains. Experience unnecessary. Big sample line free. American Braiding, W-329 W. Monroe, Chicago.

**\$90.00 WEEKLY** Wearing and showing my beautiful new free raincoat and giving away free hats. Write today for yours. Robert King, 230 S. Wells, Dept. AB-3, Chicago.

**WELLS Cleared \$620.00 in one month with "Business Guide" and free legal service.** Outfit absolutely free! Prof. Nichols, Dept. 47, Naperville, Ill.

**\$15.00-\$25.00 DAILY** Easy representing manufacturer Instant Weld, marvelous new rubber repair. Dealers-individuals everywhere buy on sight. Write for free sample. Tourists Pride Manufacturing Co., Desk E, Minneapolis, Minn.

**UNUSUAL Opportunity—\$100 weekly selling better-quality, all-wool, union-made-to-measure suits and topcoats at \$23.50 and \$31.50.** Build big repeat business. Liberal bonus for producers. Large swatch samples free. W. Z. Gibson, Inc., 500 Throop, Dept. C-517, Chicago.

**SELL Kohler's 9x11 blue signs.** Kohler, 717 North Fourth, St. Louis, Mo.

**SELL Durable rubber namats.** \$6.00 an hour easy—all business places buy. Men! Sell these Durable Rubber Namats either as a side line or full time. Store dealers, banks, apartments, hotels and all buy on sight. Show samples and pictures and how their name will look and get the order and pocket your liberal cash commission. Attractively made and has great advertising value for the user. Show them our line and make an easy \$6.00 an hour. Write for outfit and start taking orders at once. Durable Rubber Co., Dept. E, 1140 Broadway, New York.

**AGENTS—I'll pay your bills, give you steady income for rest of your life if you will take care of my business in your locality, full or spare time.** You be my partner, make \$15 a day, ride in Chrysler sedan. Distribute teas, coffees, spices, extracts, things people eat. I furnish everything, world's finest super sales outfit containing 30 full sized packages; low prices, big repeat business; \$25,000 guarantee on quality. I go 50-50 with you. Get my amazing offer. C. W. Van de Mark, Health-O Building, Dept. 193-C, Cincinnati, Ohio.

**ARE You old at forty? See our advertisement on page 169 of this issue.** The Electro Thermal Company, 2115 Morris Ave., Steubenville, Ohio.

**SELL Stores carried 5c breathlets.** Cost you 1c per package, 150% profit. S. H. Carroll Co., Albany, N. Y.

**AT Last, Diamond rival discovered.** Amazing blue white Egyptian diamond astounds and deceives. Greatest spare time side line article ever known. Write quick. The J. A. Powell Co., 406 Main St., Dept. K. E., Houston, Tex.

**AGENTS—Rapid fire seller to mechanics, machinists, tool makers.** Big profits. Sample and terms 25c. Roman Arndt, Box 1401, Detroit, Mich.

**ARTICLES Of merit. Repeat sellers.** Big profits. For information write Lightnin' Products Co., 616 W. Kinzie St., Chicago.

**AGENTS, Distributors; whirlwind seller; gas stations, dealers, drivers.** "Miracle" windshield cloth; one wiping defies rain 24 hours; amazing results; retails 50c. Celco Chemical Co., 2225 Lawrence Ave., Toledo, Ohio.

**NEW Automatic window washer, washes, cleans, dries, polishes in one operation.** Carries own water supply. Sensational demonstration. Agents reaping harvest! Write for free sample offer. National Industries, 67 E. Lake St., Dept. 153C, Chicago.

**BIG Pay every day taking orders for dress and work shirts, pants, overalls, sweaters, underwear, hosiery, pajamas, play-suits!** Experience unnecessary. Outfit free! Nimrod Co., Dept. 8, 4922-28 Lincoln Ave., Chicago.

**DON'T Sell for others.** Employ agents yourself. Make your own products. Toilet articles, household specialties, etc. 500% profit. Valuable booklet free. National Scientific Laboratories, 1984W Broad, Richmond, Va.

**AGENTS \$300 Month.** Brand new hot bag, 3 spoonfuls cold water gives 10 hours heat. Use it anywhere. No competition. Write quick. American Accessories Co., Room 631, Cincinnati, Ohio.

**BRAND New—Clever 8-in-1 household device mops, scrubs, waxes, polishes, dusts, wrings, cleans walls and ceilings.** Housewives wild over it. Popular price. Big commission. Make \$15 daily. Kleanezzy Co., Dept. G-29, Delphos, Ohio.

**\$80-\$200 A WEEK.** Genuine gold letters for store windows. Easily applied. Free samples. Liberal offer to general agents. Metallic Letter Co., 438-B North Clark Chicago.

**\$100.00 WEEKLY** Selling "Storm King" clear vision windshield cloths. Phenomenal triumph in chemistry. Prevents blurring of windshields in fog, rain, snow, sleet. Make them yourself. Costs 4c; retails 50c. Unlimited demand. Complete instructions \$1.00. G. Weinman, 414 Sherman, Elkhart, Ind.

**CAN You appoint agents? If you have had experience in traveling and hiring lady agents to sell toilet articles, food products, etc., we have a real proposition to make you.** Territory open in various states. Davis Brothers Company, Dept. C, Greenfield, Ind.

**AGENTS—\$10-\$25 Daily** showing newest trench coats, all colors, \$5.95. Other fast sellers. Men's, women's, children's. Outfit free. Pontiac Sales Co., 711E, Pontiac Bldg., Chicago.



**AGENTS: \$240 Month.** Bonus besides. Earn auto to travel in. Introduce finest line guaranteed silk hosiery you ever saw. 126 styles, colors. Guaranteed to wear 7 months or new hose free. High class proposition. New sales plan. No experience needed. No license to pay. Credit given. Silk hose for your own use. Samples furnished. Write quick. Wilkmit Hosiery Co., Dept. 6631, Greenfield, Ohio.

**AGENTS—New lines just out.** Everything in hosiery, lingerie and underwear for men, women, children. Beautiful, irresistible. Catalog and samples now ready. Two new special big-money plans. Cash bonus, service awards. No capital needed. Choice territories going. Write quick. World's Star Knitting Company, 7353 Lake St., Bay City, Mich.

**\$13.00 DAILY** Installing nifty stair corners. Details free. M. Ruth Company, Wheelersburg, Ohio.

**AGENTS—Best seller: Jem Rubber Repair** for tires and tubes; supersedes vulcanization at a saving of over 800 per cent; put it on cold. It vulcanizes itself in two minutes, and is guaranteed to last the life of the tire or tube; sells to every auto owner and accessory dealer. For particulars how to make big money and free sample, address Amazon Rubber Co., Philadelphia, Pa., Dept. 505.

**AGENTS \$12 To \$15 daily.** Something new. Fast seller. Cee-Dar Kills Moths, chases insects. New form hangs on hooks. Repeater. Women buy one to six. Free particulars. Cee-Dar, H77 W. Washington St., Chicago. Live territory open for distributors to earn \$400 to \$600 monthly.

**AGENTS Wanted** in every town for the greatest foot relief discovered in 50 years. Liberty Corn Freedom is absolutely guaranteed; sent anywhere for 25c postpaid. Made exclusively by The Liberty Chemical Co., 729 Race St., Philadelphia, Penna.

**MAKE \$50-\$75 A week.** Everyone needs shoes. Sell Mason's all-leather shoes, amazingly low prices. 85 styles—men's, women's, children's. No experience needed. Big outfit free. Mason Shoe Mfg. Co., Dept. 223, Chippewa Falls, Wis.

**IMPORT Your own goods.** German export magazine published in English, offers numerous bargains latest novelties; opportunities for obtaining profitable agencies. Copy 60c. Square Deal Supply, P-246 Fifth Ave., New York.

**\$8 DAILY Extra;** free equipment; free sample caps, hats. Amazing new money-making opportunity. Write quick for outfit. Fits-U Caps, Dept. EC-75, Cincinnati, Ohio.

**MANUFACTURE Auto specialties:** Battery charging electrolyte, radiator seal, hand soap, gasoline dye pep, puncture plugger, silk life, glass cleaner. Get my free list. John Mickman, Chemist, St. Paul, Minn.

**A PAYING position** open to representative of character. Take orders shoehosiery direct to wearer. Good income. Permanent. Write now for free book "Getting Ahead." Tanners Shoe Mfg. Co., 2002 C St., Boston, Mass.

**\$100 WEEKLY—Appointing agents** Mother Hubbard Foods. No canvassing, delivering or investment. Mother Hubbard Products, 554-U Congress, Chicago.

**CHICAGO Expert** valued \$3 stone at \$900. The diamond's only guaranteed rival! Greatest spare time, side-line article ever known. Amazing profits. \$5 pocket sample case free. Write quick. Mexican Gem Company, Dept. PM, Monterey, Calif.

**SALES Agents—Take orders** high grade tailored neckwear. Hand made. Guaranteed for 6 months. Insured never to roll, twist, stretch or bunch. Not sold in stores. Patented. Samples furnished. Write quick. Better Made Cravat Co., Wholesale Dept. 6, Columbus, Ohio.

**MIRRORS Resilvered** at home. Costs less 5 cents per square foot; you charge 75 cents. Immense profits plating autoparts, reflectors, tableware, stoves, refinishing metalware, etc. Outfits furnished. Details free. Write Sprinkle, Plater, 128, Marion, Ind.

**\$100 WEEKLY!** Amazing new auto invention! Big sensation. Accurately registers oil and grease changes. Low cost. Free offer! La-Barometer Co., A-229 S. Market, Chicago.

**\$2.95 AUTOSEAT Covers.** Cash daily. Amazing. All America. Postcard brings leatherette sales outfit. "Quality." JJ513 So. Dearborn, Chicago.

**PROTECT Any radio set,** tubes, attachments. Protector complete with directions 30c. 5958 Washington, Chicago.

**AGENTS** Become a regular established McConnon dealer! Buy on credit; sell for cash or credit. 228 absolute household necessities; all repeaters. Enjoy a sure income 52 weeks per year, year after year, city or country trade. Capital, experience unnecessary. McConnon & Co., Dept. M-903, Winona, Minn.

**\$50.00 WEEKLY.** Men wanted to demonstrate and take orders daily direct from motorists. Amazing Magnetic Trouble Light. Sticks anywhere! More orders, bigger pay. Write for demonstrator and particulars. The Magno Co., 6 Beacon St., Dept. 163, Boston, Mass.

**MAKE \$20 Daily** selling merchant's changeable letter show window signs. Experience unnecessary. Send for free sample offer. Maze Company, 542 W. Washington St., Chicago.

**HOUSEWIVES** Buy duplex sifters on sight. Magnus sold 120 first 24 hours. Profit \$54.40. Jackson sold 72 in 5 afternoons. Profit \$35.00. Retails \$1.00. Sifts and resifts without removing flour. Sample outfit 60c. Uneek, 4533 Lexington, Chicago.

**BECOME Your home town leading business man.** Sell full line of groceries, motor oils, paints. Everybody a customer. No capital or experience necessary. Selling outfit free. Write Loverin & Browne, 1602C, So. State, Chicago.

**MEN Wanted** to canvass farmers. \$160 monthly and expenses. Opportunity for advancement. Bigler Co., M-17, Springfield, Ill.

**STRANGE Invention!** Pays \$25 daily. Keeps telephone and iron cords from tangling and kinking. Prevents scorching. Saves electricity. Samples free. Neverknot, Dept. 3-A, 4503 Ravenswood, Chicago.

**MARVELOUS Product** and selling plan will bring you over \$100 weekly. 500% profit! Big repeat business. Samples free. Write now. Ever-Ready, 52 East 9th St., Dept. C-8, New York.

**\$15 DAILY Paid** men, women to show finest neckwear. Biggest values. Experience unnecessary. Free samples sent first 500 applicants. Nawco, Desk YC-105, Covington, Ky.

**AGENTS Cleaning up** with Lanowa combination. 65c clear profit every dollar sale. Write for free sample. Great Western Industries, 4125 D Penn, Kansas City, Mo.

**AGENTS Free sample fast selling mail-order and agency specialty.** Repeater. Big profits. Going strong. Flinger, 5003 W. Gateway, Kansas City, Mo.

**MAKE Big money.** Be the sign man in your town. New process. Beats them all. Particulars free. Swanson's, Inc., Mankato, Minn.

**CARTER Window washer.** Cleans, dries, polishes. One operation. Carries its own water. Exclusive distributor wanted. Big profits. Carter Products, 989 Front Ave., Cleveland, Ohio.

**Be Independent, make, sell your own goods.** Immense profits. Catalog dependable formulas, special selected agents' best sellers free. R. Lustro, 626 Reaper Block, Chicago.

**WOULD You like** to receive a beautiful ladies' or gentlemen's white gold filled wrist watch, Eastman folding kodak, 26 Pe Rogers silverware set, bungalow clock 3 Pe fancy toilet set and many other valuable premiums. Any of the above given for only an hour of your spare time. Write Home Sales Co., Box 473, Memphis, Tenn.

**AGENTS—Make a dollar an hour.** Sell new kind of sharpeners. Sharpens all knives and tools quickly. Demonstrating sample 10c. Premier Mfg. Co., Dept. 89, Detroit, Mich.

**AGENTS: Free catalog** 200 household specialties, toilet preparations, food products, portraits, frames, pillow tops, medallions, religious goods, pictures. Credit. James C. Bailey Co., Station C-3, Chicago.

**AGENTS: Earn \$16 day** and new Bulk auto. Sell groceries. Over 400 items used daily every home. Steady all year job. Your own groceries about half price. Send for samples. Harley Company, Dept. C-2015, Dayton, Ohio.

**AGENTS—90c An hour** to advertise our goods and distribute free samples to consumers. Write quick for territory and particulars. American Products Co., 2513 Monmouth, Cincinnati, Ohio.

**AGENTS—Make \$10 daily.** Latest Ford sedan given. Finest line 200 guaranteed extracts, pure foods, toiletries, remedies. Agents and district manager wanted. Write today. Perkins Products, M-12, Hastings, Nebr.

**\$75 WEEKLY.** Man or woman wanted with ambition and industry, to distribute Rawleigh's Household Products to steady users. Fine openings near you. We train and help you so you can make up to \$100 a week or more. No experience necessary. Pleasant, profitable, dignified work. Write today. W. T. Raleigh Co., Dept. C-53-PPM, Freeport, Ill.

**JUST Out—New patented apron.** No strings or straps—\$20.00 a day every day; over 100% profit; commissions daily. Write for free offer. Sta-Put Co., Dept. 203, St. Louis, Mo.

**AGENTS: Gold-eyed needle cases.** Beautiful cases at factory prices. Wonderful sellers, immense profits, \$50 to \$100 weekly. Proof free. Sample 10c. Paly Needle Co., College Ave., Somerville, Mass.

**TIME Counts** in applying for patents. See pages 154 and 155. Clarence A. O'Brien, Registered Patent Attorney, Washington, D. C.

**NO Experience necessary.** You'll sell Wonder Changeable Signs fast. We show you how. Write Currier Mfg. Co., 31 Northwestern Terminal, Minneapolis, Minn.

**BIG Profits.** No splash 4 strainer water filter; brass or nickel; ship quick; pay postage; free plugs when ordered; 6 doz., \$2.40, with bumpers \$4.50. Jones Mfg. Co., 243B2 Franklin St., Boston, Mass.

**FIBRE Brooms—detachable handles,** fine finish. Good profits, repeat sales. The Fibre Broom People, 147-C New Jersey Ave., Brooklyn, N. Y.

**GOOD Profit** selling our easy back spring seat for tractors and farm implements. Dependable Mfg. Co., Streator, Ill.

**AGENTS Make \$3.00 an hour** taking orders for our 40 fascinating kitchen specialties. No competition. Write quick. General Products Co., Dept. 207, Newark, N. J.

**WE Start you** without a dollar. Soaps, extracts, perfumes, toilet goods. Experience unnecessary. Carnation Co., 641, St. Louis, Mo.

**DON'T Sell** for others. Employ agents yourself. Make your own products. Toilet articles, household specialties, etc. 500% profit. Valuable booklet free. National Scientific Laboratories, 1984W Broad, Richmond, Va.

**FLAVORING Extracts—Bottle yourself!** Concentrated, add water. Free labels. 600% profits! Whirlwind money-making opportunity! Hurry! Thomas Manufacturing Company, Indianapolis, Ind.

**AGENTS—Mosco Corn and Callous Remover** will build you a steady repeat business. Send today for pocket-size trial outfit. The Moss Company, 424 Searle Bldg., Rochester, N. Y.

**\$12.00 DAILY** Showing new table cloth. Looks like linen. Wash like oilcloth. No laundering. You just take orders. We deliver. Pay daily. Sample free. Bestever, 152 Irving Park Station, Chicago.

**PORTRAIT Agents** make more money than any other class of agents. Write for our new catalog—Portrait enlargements, medallions, etc. Adam J. Kroll & Co., 2543 South State St., Chicago, Ill.

**MONOGRAM Automobiles.** \$1.35 Profit ten minutes' work; every owner wants them; millions without; particulars free. Motorists Accessories Co., Mansfield, Ohio.

**"HOW to Secure Agents,"** a specially prepared booklet, tells of one of the most inexpensive methods in which to secure good live producing agents. It is free; write for your copy today! M. L. Rund, Mgr. Classified Advertising, Popular Mechanics Magazine, 200 E. Ontario St., Chicago, Ill.

**32 SECONDS** Complete tire change by Detmer, Ohio, with Morey Quick Action Rim Tool. Sold, singly, 49 three days, cleared \$100. Anderson, Mont., sold 1,400 in 14 weeks. Get details for good territory. Harvest time now. M. Morey Rim Tool, Buffalo, N. Y.

**AGENTS, Canvassers, grab this!** Mexican curios, Indian room fixtures, drawn work. Non-competed line. Easy territory terms. Fastest selling goods. Fifty cents brings bargain list and attractive samples. Write G. Medina, 78-P La Rosa St., Mexico City, Mex. Satisfactory references furnished.

**SOMETHING New!** Every motorist buys our Electro Magnetic Emergency Wonderlamp. One minute's demonstration makes a sale. Experience unnecessary. \$5 an hour easily made. Full time or evenings. Write for sample. Wonderlamp Co., Fisk Bldg., Dept. 10A, New York.



**ELECTRIC Cigar lighters.** Make \$100 week. Brilliant flashing advertisements. Three beautiful models. Used by dealers everywhere. Write Drake Mfg. Company, Dept. M, Milwaukee, Wis.

**AGENTS—Clever Invention!** Inkspoon makes every pen a fountain pen. Fast office seller; big profit, demand increasing everywhere. Exclusive territory offered. Sample free. H. Marui Company, Tribune Bldg., New York, N. Y.

**MAKE AND sell your own goods.** No machinery. Guaranteed formulas. Catalog free. Clover Laboratories, (E) Park Ridge, Ill.

**A BUSINESS of your own—Making sparkling glass name and number plates, check-boards signs.** Big book and sample free. E. Palmer, 512, Wooster, Ohio.

**PORTRAIT Men:** Why not Pasco portraits? We refund your money for all you cannot deliver. Frame catalog free. Portrait Agents' Supply Co., Dept. F, La Porte, Ind.

**SUCCEED With your own products.** Make them yourself. Formulas, processes, trade-secrets. All lines. Catalog, circulars free. B. Thaxly Co., Washington, D. C.

**\$50.00 WEEKLY Easy,** applying gold initials on automobiles. No experience needed, \$1.45 profit every \$1.50 job. Free samples. "Raleo Monograms," X1043 Washington, Boston, Mass.

**REPLATE Brassy worn-off automobile parts, reflectors, bath room fixtures, worn spoons, forks, etc., with pure silver.** Looks like new. Use U-Kan-Plate Polish. Positively no mercury. \$1.00 half pints. Post paid. Satisfaction guaranteed. Agents wanted. Dept. A, U-Kan-Plate Co., Philadelphia.

**WORKERS Buying and applying Axtell Metal Weather Strips to door bottoms** make \$1.00 to \$3.00 hourly. Prices, territory, etc. E. L. Church Co., Whitman, Mass.

**AGENTS Sell household brushes.** Over 100% profit. Sample case outfit containing fifty different kinds of brushes sent on approval. National Fibre Broom Co., St. Louis, Mo.

**BIG Profits! Fast sales!** \$9.75 automatic washing machine. Guaranteed. Write Storm Royalty Co., 3601 Enright, St. Louis, Mo.

**DON'T Sell for others.** Employ agents yourself. Make your own products. Toilet articles, household specialties, etc. 500% profit. Valuable booklet free. National Scientific Laboratories, 1984W Broad, Richmond, Va.

**GET Our free sample case—Toilet articles, flavorings and specialties.** Wonderfully profitable. LaDerma Co., Dept. A, St. Louis, Mo.

**SELL Men's neckwear: wonderful proposition.** Astor, 318-M Broadway, New York.

**AUTOMOBILE Specialties.** Guaranteed formulas for all latest money makers. Lowest prices. Write for free lists. Murphy, Chemist, Tujunga, Calif.

**AGENTS, Our cigar lighters and sales-boards sell quick.** Large wholesale catalog free. Joseph Sales Company, 223 Madison St., Chicago.

**GOLD-LEAF Sign letters; copyrighted manufacturing instructions; profits 1,000%.** Johnston Co., Quincy, Ill.

**\$1,000.00 REWARD** If this is not the greatest money-making house to house proposition ever known. N. R. G. tablets wash clothes in 10 minutes without rubbing. Free samples. N. R. G. Co., H 500 W. Division, Chicago.

**TWO Money makers for agents.** "Francis" Pocket Adding Machine retails \$4.85. To you \$1.00. "Excelligraph" Rotary Stencil Duplicator \$37.50 retail. Write Typewriter Supply, 102 Hersch Bldg., Pittsburgh, Pa.

**POLMET Polishing Cloth** removes tarnish from metals without the use of liquid, paste or powder. Our agents say it sells like "hot cakes." Retails 25c; sample free. Gale & Co., Inc., 15 Edinboro St., Boston, Mass.

**OUR Luminous Crucifix Shines in the Dark.** Every one amazed at the wonderful effect. Easily demonstrated—easily sold. W. G. Hannan Co., 2543 So. State St., Chicago.

**AGENTS—Engraved name plates, signs, numbers, etc., easily sold, profits large.** Brett Bros., Roxbury Crossing, Boston, Mass.

**CALIFORNIA Perfumed beads** selling like hot cakes. Agents coining money. Big profits. Catalog free. Mission Factory P, 2328 W. Pico, Los Angeles, Calif.

**PHOTO Medallion Men and Women,** the largest line of Photo Novelties in the world. Lowest prices, quickest service. Send for catalogue showing over 200 money makers. Photo medallions, photo medallion clocks, photo mirrors, photo fountain pens, photo powder compacts, photo jewelry and photo buttons. Gibson Photo Jewelry Co., 608-614 Gravesend Ave., Brooklyn, N. Y.

**REMNANT Store, Bethel, Ohio.** Greatest Dry Goods Bargains on Earth. Agents and Dealers.

**AGENTS: Stamping names on pocket-key protectors.** Sample check with your name and address, 25c. Stamping outfits. Emblem checks, check-fobs, name plates. Hart Mfg. Co., Desk 2, 303 Degraw St., Brooklyn, N. Y.

**AGENTS—\$50 Weekly selling shirts.** No capital or experience needed. Commissions in advance. Samples free. Madison Company, 566 Broadway, New York.

**\$3.90 PER Hour** selling a service to keep stairways clean. Every housewife interested. Write today. Ideal Stairway Equipment Co., Dept. PM, Canton, Ohio.

**WANT Distributing agent for Handslick, powdered hand soap; removes anything from hands; everybody a customer; sample free.** Solar Products Co., J-2142 S. Troy, Chicago.

**START The new year right!** Manufacturing these popular specialties yourself. Have salesmen everywhere. Investment small. Profits great! Get my eye-opening literature explaining all. Mystery Polishing Floss, Loidlac, guaranteed automobile refinishing; Thermaxx Eveready Anti-Freeze; twenty-six new unusual carded specialties, many other wonderful necessities. Here's an exceptional opportunity. Miller, Chemist, 706-B Chemical Building, Tampa, Fla.

**BIG Money and Fast Sales.** Every owner buys Gold Initials for his auto. You charge \$1.50; make \$1.35. Ten orders a day easy. Write for particulars and free samples. American Monogram Co., Dept. 40, East Orange, N. J.

**AUTO Owner tire agent** wanted each locality to use free demonstrating tires and take orders for new heavy duty Mellinger tires, guaranteed 15 months against all road trouble. Shipped on free trial. Get your own tires and earn \$300 monthly—no capital or experience needed. Write Mellinger Tire Co., Dept. 282, Kansas City, Mo., Warren, Ohio, Oakland, Calif.

**HIGH-GRADE SALESMEN WANTED**

**SALESMEN:** Be you minister, farmer, clerk, bookkeeper, laborer, mechanic, policeman, fireman, college or high school student, regardless of where you live, you can increase your earnings from \$5.00 to \$30.00 daily without interfering with your present duties, demonstrating and selling the "Adams Magnetic Auto Light." Sticks and stays put anywhere on metal. Sold on satisfaction guaranteed or money refunded basis. Sells in U. S. for \$3.00, Canada \$3.50. Big commissions. Exclusive territory to producers. This is not an endless-chain selling plan. For demonstrator and sales equipment write at once as territory is going fast. Adams Merchandise Company, Inc., P.M., Williamsport, Penna.

**JUST Out!** Amazing new vending machine! Pays merchant 1,600% profit! Sensation wherever introduced. \$50.00 daily! Dept. 9, Acme, Room 360, Old Colony Bldg., Chicago.

**TRAVELING Salesman's chance** for permanent connection with leading specialty manufacturer. High commissions year round. Box E222, Boonville, N. Y.

**ALUMINUM Advertising calendars and specialties.** Sideline, thirty pocket samples. Outfit weighs only five pounds. Big commissions promptly paid. Write Wilson Hurd Co., Wausau, Wis.

**HAVE Wonderful proposition** on new hand soap—tools and supplies. Need man with car to make deliveries. Can earn \$2.00 an hour. Work is near home. No experience required. Write for free sample and full particulars. The Connecticut Can Co., Hartford, Conn.

**A PAYING position** open to representative of character. Take orders shoes-hosiery direct to wearer. Good income. Permanent. Write now for free book, "Getting Ahead." Tanners Shoe Mfg. Co., 2002 C St., Boston, Mass.

**WONDERFUL Invention.** Seals fifty envelopes minute. Sells on sight at \$3.50. Attractive proposition. Square deal. Bank references. Kendall Sealer Co., C-9 East Jaffrey, N. H.

**SALESMEN: New—Different.** Instead of asking a merchant to spend money in advertising you show him a plan that will positively make his business bigger, better and at the same time make him several hundred dollars profit. The country's most remarkable selling success. No competition. Fascinating work with splendid commissions, averaging from \$10.00-\$260.00 each sale-advanced. Some of our men averaging four sales daily. Pocket outfit free. Highly rated, old established company. Factory 710 Wythe Ave., Brooklyn, N. Y.

**FEW \$1,000 Monthly earnings** ads are truthful. Our men actually earn \$300 to \$500 regularly selling our lines. Adelite, the newcomer in electric window salesmen, is making a big hit. More for the money than anybody gives. Business posters for every line. Changeable letter system too. Permanent business for you working with us. Territory protected and repeats credited. Fat commissions. Full details will prove very interesting. Display Products, Ltd., 409-A East 31st St., Kansas City, Mo.

**SALESMEN—Become independent.** Own your business; experience unnecessary, selling our \$10,000 Accidental Death; \$50 Accident; \$25 Sick Weekly Benefits—\$10.00 yearly. Other amounts proportionate. Guaranteed steady income from renewals. \$250,000 deposited Insurance Department, Universal Policy, Dept. A, 10 Clinton St., Newark, N. J.

**BUSINESS Stationery—Largest line,** highest quality, quickest delivery, biggest commissions. Liberal bonuses. Free copyrighted cuts every business. Experience unnecessary. Instructions and outfit free. David Lionel Press, Dept. 24, 406 S. Sangamon, Chicago.

**\$18 TO \$25 Daily; biggest selling line** of 2-piece suits, \$9.95 and \$12.50; 3-piece wool suit, \$17.95 (regular \$28.00 value). All-wool overcoats \$18.50. Splendid rain-coats, slickers and boys' suits. Biggest commission. Free outfits. "Jim" Foster, Inc., Dept. 23, 2250 S. Spaulding Ave., Chicago, Ill.

**SALESMEN For carbon solvent:** No more spark plug trouble; valve grinding; motor overheating and excessive cylinder oil. Removes carbon in fifteen minutes. 100% profit. St. Clair Sales Bureau, Tolland, Colo. Box 26.

**EVERY Home a prospect.** Make big money. Take orders tree, shrubbery. Experience unnecessary. No dull season. Commissions paid weekly. We deliver, collect. Write Perry Nurseries, Dept. R-3, Rochester, N. Y.

**IOWA Salesman** made \$78.00 first day selling new hot dog machine at \$18.50. Commission \$6.50; direct factory connections. Leonard E. Dickerson, Dept. E-10, Springfield, Mo.

**\$282.80 COMMISSION** on a \$21.50 original sale. Every merchant a prospect. Absolutely new and different. Exclusive territory. Ben Braude, 337 W. Madison, Chicago.

**SELL Nothing! \$170 weekly** empty handed. Punchboard headquarters announce amazing new plan. No investment. We even pay express. K&S Sales Co., 4378 Ravenswood, Chicago.

**IT'S Legal.** New and aplenty different! "Gypsy." It's whirling wheels fascinate everybody. Merchants buy eagerly. Clean up \$100-\$150 week. Cigar Stores, Dept. 18-T, Peoria, Ill.

**GOLD Leaf Window Letters** and script signs; no experience; 500% profit. Samples free. Dearman made \$19.20 first 2 hours. Consolidated, 69-V West VanBuren, Chicago.

**POOL Shooter; new, fascinating** vending machine. Merchants everywhere buy. Sideline men make \$200 weekly. Free pocket outfit. Specialty Mfg. Co., Dept. 1, 617 W. Division, Chicago.

**NEW Invention—Sells every business** and professional man; used by Bell Telephone Co., Armour & Co., etc.; costs \$2.50; retails \$7.50. Walker made \$165 first day. Write Adjustment Service, Dept. PM, Mobile, Ala.

**SALESMEN—\$4 In your pocket** every half hour. Write orders for Hollywood News. New idea advertising service for store windows. No competition; every store prospect. Permanent repeat business. Free sales outfit. Retail Stores Service Corp., 1165 Broadway, Dept. J-1, New York.

**WOW Of a sideline! Make \$200 monthly** extra. Show new, exclusive line coveralls and shop coats. Advertising embroidered on back. Every business prospect. Outfit free. Master Co., 4734 Dorchester, Dept. A-3, Chicago.



**OH! What a sideline. Gigantic money-getter.** \$4.00 commission every \$5.00 sale. Collects accounts so fast—storekeepers, doctors get dizzy. Brooks, Texas, sold (20) first day—commission \$80.00. We deliver and collect. Full commissions all reorders. Sample free. Federal Association, 17th St., Hartford, Conn.

**SALESMEN!** Sixty year old New England concern manufacturing high quality broadcloth shirts is opening new territories. Big, unusual opportunity for permanent, profitable business with steadily increasing income. Write today for sales proposition. This is a real money maker. Bostonian Mfg. Co., 106 Bickford St., Boston, Mass.

**SELL** Union label printing—Brand new proposition. Copyright cuts and elaborate outfit free. 40% commissions advanced. Beats all competition. Meyerson, R1132 So. Racine, Chicago.

**\$40.00 SUITS** For \$23.50! Union made to special order, of finest quality virgin wool. You don't have to know anything about selling clothing. We guarantee your success if you are honest and willing to work. Write at once, Madison Brothers, 133 South Peoria, Dept. 642, Chicago.

**BIG Money** taking orders for printing. We ship everywhere. 43 standard items every business man buys. Low prices, hundreds free cuts insure quick sales, repeat orders. 40% commissions. Experience unnecessary. Outfit and complete instructions free. Kaeser & Blair, Dept. 58, Cincinnati, Ohio.

**SALESMEN \$75 To \$125 weekly.** Established line coveralls, shopcoats, autoseat covers, garage fabric accessories. Red hot seller. Every garage, storekeeper, and auto owner are buyers. No investment. Valuable territory open. Write today for complete selling outfit. John Leeding Co., 314 W. 33rd, Dept. SH-3, Chicago.

**\$150.00 PER WEEK!** This ad is actually worth \$150.00 per week or more to you. Write us at once for full details on latest selling item ever produced. Absolutely new. 20 million will buy on sight. All classes of retailers will buy for resale, also advertisers. Act quick. The Lyco Co., 2637 Canton St., Chicago.

**SALESMEN:** Cash in \$24 a day with new salesboard. Marvelous seller; big profit maker. Place boards with stationery and cigar stores, barber shops, poolrooms, etc. Quick sales, big profits. Write for free outfit. D. Gordon Corp., 110 E. 23rd St., New York City.

**SELL** Neon daylight signs. Uses no electricity, batteries or wires. No competition because of patented features. Priced low. Unusually liberal commission. American Store Sign Company, 228 North LaSalle St., Chicago, Ill.

**EARN \$20 A day.** Establish income for life selling for \$1 a year \$1,500 accident policy. Write W. C. Stone, 11 So. LaSalle, Chicago.

**BIG Pay every day,** selling men's shirts and work clothing—complete line. Also sweaters, hosiery, underwear, pajamas, play-suits! Experience unnecessary. Outfit free! Nimrod Co., Dept. 65, 4922-28 Lincoln Ave., Chicago.

**AUTOTOOL Salesman:** Get prices on 20 piece ignition sets; other tools, it pays. Electrotool Works, 11521 132d St., Ozone Park, N. Y.

**REBUILD** Spark plugs, Bendix drives, ignition coils. Sell other supplies. 5958 Washington, Chicago.

**SALESMEN:** New line, new prices, bigger slice for you. America's best known, biggest value suit line. Something extra for producers. Write J. B. Simpson, 843 Adams, Dept. 118, Chicago.

**PUNCHBOARD Salesmen.** New deals \$25 daily profit! Great assortment. No selling. Repeat. Free outfit. Manager, G-4334 West Harrison, Chicago.

**NEW Item** for retail stores. Repeat business. Box 160, Norfolk, Va.

**STATE Mgr.** Marvelous invention sells 3,000 envelopes hourly! Sells \$4.50 only; equals work expensive electric machines. Offices buy 1-100. Exclusive territory. Opportunity earn \$7,000 yearly. Free trial offer. Write quick! Rede, 29 Winthrop Bldg., Boston.

**ALL-YEAR-ROUND** Profitable business selling wonderful new water softener and cleaner. Removes grease, oil, ink and dirt quickly. Every home and business place a live prospect. 100% profit. Big repeat orders. Exclusive territory. Write for free sample. Seacoast Laboratories, Sea Bright, N. J.

**COVERALL Salesmen—**Make \$20 daily selling new \$3.50 improved coveralls, also service coats with customer's name embroidered on back. Unusual construction. Commission 75c. Wonderful advertising value. Lowest priced; highest commission. Free outfit. Am. B. Co., AK-329 W. Monroe, Chicago.

**A NEW deal** by an old house for men seeking big opportunity and pay. Union made-to-measure all-wool suits at \$23.50 up. Double ordinary size samples. Big commissions and bonus. Write for details or give experience and references for return action. Pioneer Tailoring Co., Congress and Throop, Dept. C-1117, Chicago.

**SIDELINE Men wanted—**Tell us what you sell, your territory. References. We manufacture over a thousand novelties and can always give you a line. Reliable house, 25 years in business. Bradford & Company, Inc., St. Joseph, Mich.

**\$60-8200 A WEEK.** Genuine gold letters for store windows. Easily applied. Free samples. Liberal offer to general agents. Metallic Letter Co., 438-A North Clark, Chicago.

**ADVERTISING Salesmen** in every state. Year around position, selling merchants and manufacturers, booklets, calendars, novelties. Commissions weekly. Plenty repeat business. Matson Pub. Co., Main St., South Whitley, Ind.

**PUNCHBOARD Men!** Sideline salesmen! Sensational merchandise catalog just added to famous "Lincoln Line"! No more closed territory! \$200 weekly. Easy repeat commissions paid daily. Smashing color catalog free. Samples unnecessary. Best season now. Get busy! Lincoln Sales, 9 So. Clinton, Chicago, Dept. D.

**PUNCHBOARD Salesmen.** \$200 weekly. Liberal plan assures sales. Latest assortments. Nothing to carry. Full commissions on repeats. M&L Sales Co., 301 W. Adams, Chicago.

**SALESMEN—**Four \$15.00 sales to merchants net you \$40.00 daily. Sayers Systems, 2813 Sheffield, Chicago, Ill.

**SALESMEN—\$75-\$100** Weekly selling high grade signs, calendars, fans and novelties; full or part time. Big commissions paid promptly. Sample outfit supplied. Write today. Scioto Sign Co., Dept. L, Kenton, Ohio.

**TO Market** 3A garage door holders, simple automatic action, quickly installed, instantly attracts garage owners, builders, dealers. Write for exclusive territory proposition. Knowlson-Stevenson Co., 1118 Packard, Ann Arbor, Mich.

**NEWEST, Finest** and most complete line of novelties and pencils for 1929. State experience. Advertising Novelties Company, Newton, Iowa.

**SALESMEN—**Calling on stationery department, drug, novelty trade. New "Twin Pencil," popularly priced. Sells immediately and repeats. Liberal commission. References. Multipoint, Corona, N. Y.

**PUNCHBOARD Salesmen.** 2 hours daily, \$100 every week. New line. Lowest prices. Full commission on repeat business. Catalog free. Puritan Novelty Co., 1409 Jackson, Chicago.

**BANG-UP** Good new sideline! Sells everywhere, all merchants, banks, mfrs. Big comms. advanced daily. Pocket outfit free. Carroll, 319 N. Albany, Dept. 346, Chicago.

**SUCCESS** is no accident! You will fully understand this slogan when you examine our automatic credit and collection plan. Copyrighted, brand new, unusual. You make 250% on original sale. Half cash on repeats without call-backs. Commonwealth J. Publishing Company, 508 So. Dearborn St., Chicago, Ill.

**DON'T Sell** for others. Employ agents yourself. Make your own products. Toilet articles, household specialties, etc. 500% profit. Valuable booklet free. National Scientific Laboratories, 1984W Broad, Richmond, Va.

**SELL** Printing: 40% commission daily. Lowest prices, with or without deposit. Copyright cuts free. Inquiry brings pocket outfit. Salesmanager, 1522 Wells-VanBuren, Bldg., Chicago.

**HELP WANTED**

**WE Start** you in business, furnishing everything. Men and women, earn \$10 to \$100 weekly operating our original "New System Specialty Candy Factories." Begin home spare time. Unlimited opportunity. Valuable booklet free. W. Hillyer Ragsdale, Drawer 350, East Orange, N. J.

**YOU Are invited** to resilver mirrors at home. Immense profits plating autoparts, tableware, etc. Write for information. Sprinkle, Plater, 287, Marion, Ind.

**DO You need more money?** Let me add \$20 a week to your pay without interfering with your present occupation. Interesting, pleasant work. Particulars free. Albert Mills, 2514 Monmouth, Cincinnati, Ohio.

**GOOD Wages** and steady work interest you. Get list of 180 big construction jobs, costing up to \$20,000,000. Send stamped addressed envelope for details. M. Roberts Service Bureau, Box 1051, Denver, Colo.

**CASH Paid** for Butterflies, Insects. See Sinclair Display Advertisement on page 16.

**ARE You old at forty?** See our advertisement on page 169 of this issue. The Electro Thermal Company, 2115 Morris Ave., Steubenville, Ohio.

**SILVERING Mirrors,** French plate, patented process, easily learned. Immense profits. Plans free. Wear, Excelsior Springs, Mo.

**BETTER Jobs** are easy to get anywhere. Write for free advice P22. Allard, 4724 Des Erables, Montreal, Can.

**OBTAIN Employment!** Get positions you want, quickly, anywhere. Use clever "Ways That Win." One person was offered 70 jobs! Complete methods, 50 cents. Money promptly returned if wanted. New Idea Service, Box 39-1, Station K, New York.

**MEN—Big money.** Free samples. Pop-Goo, Box 471, New York.

**EDUCATIONAL AND INSTRUCTION**

**YOU Are wanted—Men—women 18 up.** Get U. S. government life jobs. \$105.00 to \$280.00 month. Steady work. Short hours. Paid summer vacation. Common education usually sufficient. Many February examinations. We coach you without leaving home. 32 page book with full particulars free. Write immediately. Franklin Institute, Dept. N-3, Rochester, N. Y.

**FIREMEN, Brakemen, baggagemen** (white or colored), sleeping car, train porters (colored). \$150-\$250 monthly. Experience unnecessary. 810 Railway Bureau, East St. Louis, Ill.

**AMATEUR Cartoonists:** Sell your cartoons. New market. Smith's Service, PR-1194, Wenatchee, Wash.

**DOUBLE Entry** bookkeeping 60 hours with 8 keys; guaranteed. (Diplomas.) International Bookkeeping Inst., 8 Springfield, Mo.

**INVESTIGATING** And tracing. Work home or travel. Experience unnecessary. Write American System, 2188 Broadway, New York.

**LEARN** Rudiments retail shoe selling, 8 size codes taught, tricks of trade, \$25-\$75 week. Full, part time openings plentiful. Send \$1. Beales Shoe Information, 2135 No. Clark St., Chicago, Ill.

**\$400 TO \$700** Monthly selling real estate my way. We qualify you for a real estate expert or refund your money. Write for free booklet. National Real Estate Institute, Dept. 600, Fort Smith, Ark.

**WANTED—Boys—Men.** Become automobile mechanics. \$1,800 year. Sample training free. Franklin Institute, Dept. N-400, Rochester, N. Y.

**LINOTYPE** Operating easily learned; home or college; small cost; big wages. Free catalog. Linotype Institute, Maumee, Ohio.

**YOU Are wanted.** Men—boys 18 up. U. S. government jobs. \$105.00 to \$280.00 month. Steady, short hours. Vacation. Experience unnecessary. Many February examinations. Applicants coached. 32 page book with particulars free. Write today sure. Franklin Institute, Dept. N-14, Rochester, N. Y.

**STUDY** A scientific profession. Microbiology. Bacteriology. Sanitation. Extension-residential course. Diplomas degrees granted. Urinalysis outfit-prospectus free. College of Microbiology, 722 Calumet, Hammond, Ind.

**TRACE** Missing people. Excellent paying work. Open to all. Write National Headquarters, 169 East 83rd, New York.

**BECOME** A landscape architect. Uncrowded profession; wonderful opportunity for money-making. Easily mastered by mail. Earn while you learn. Est. 1916. Write for details. American Landscape School, 29 Plymouth Bldg., Des Moines, Iowa.

**BIG Money** in photography, motion picture projection. Catalog 49A free. New York Institute of Photography, 10 W. 33d St., New York.



**U. S. GOVERNMENT** wants men, \$1,700-\$1,900 and up at start. Railway mail clerk examination coming. Let our expert (former government examiner) prepare you for this and also rural carrier, post office, customs, internal revenue, and other branches. Write today for free booklet. Dept. 8, Patterson School, Rochester, N. Y.

**BIG Demand** for photoplay and magazine stories. We revise, develop and copyright. Sell on commission. Established 1917. Booklet free. Universal Scenario Company, 406 Western and Santa Monica Bldg., Hollywood, Calif.

**WANTED** Immediately, men-women, 18-55 qualify for government position, \$125-\$250 month. No experience required. Steady work. Vacations with full pay. Write, Ozment Inst., 101, St. Louis, Mo.

**INFORMATION**

**TECHNICAL** Information, anything \$1. Money refunded if we cannot answer. Commercial Service Co., 235 E. 15th St., Portland, Oreg.

**DETAILED** Information, advice, any subject, 25c coin. Satisfaction guaranteed or money refunded. Julius Goldin, 926 Southern Boulevard, New York City.

**TRACING.** Make secret investigations. Work home or travel. Experience unnecessary. Write American System, 2188 Broadway, New York.

**TYPEWRITERS AND SUPPLIES**

**TYPEWRITERS**, all standard makes, \$10 up. Fully guaranteed. Free trial. Write for complete illustrated lists. Northwestern Typewriter Exchange, 121 N. Francisco Ave., Chicago.

**TYPEWRITERS**—Factory Rebuilt Royals, Remingtons, Underwoods, New Royal, Remington and Corona Portables. New "Excellograph" Rotary Stencil Duplicator \$37.50. Terms. Catalog Free. Pittsburgh Typewriter Supply, 945-339 Fifth Ave., Pittsburgh, Pa.

**TYPEWRITERS**—All makes, \$6 to \$29. Fully guaranteed. Dee Typewriter Exchange, Manitowoc, Wis.

**TYPEWRITERS.** Motorcycles, radios \$4.98-\$29.98. Knights, 1512 Locust, St. Louis, Mo.

**PRINTING, ENGRAVING AND MULTIGRAPHING**

500 **LETTERHEADS** Or 300 envelopes, \$1.25 delivered. Maywood, P-921 Broadway, New York.

**BEAUTIFUL** Bond letterheads 8½x11 \$3.95m; envelopes \$2.95m. Clyde Hart, 540 East Fifth, Brooklyn.

**IF** Particular get samples "Neargravure" —"Neargravuremboso" processes business stationery. Solldays, Knox, Ind.

**GET** Our prices and samples. Moulton Press, 1410-P. E. 8th, Kansas City, Mo.

**PRINTING**—Lowest prices in America. Samples free. F. A. Pitz, Amana, Iowa.

**FREE**—Samples of our printing and pricelist. Letter Service, 4019 East 15th, Kansas City, Mo.

10,000 **ELEGANT** Enamel folders \$21.75; envelope slips, \$8.00; 5½x8½ circulars, \$16.00. All printing low prices. Samples. Goodprint, Harrisonburg, Va.

**FINEST** Bond letterheads 8½x11, \$3.95m. Envelopes, \$2.95m. Oberman Company, Box 1042, Chicago.

**LETTERHEADS.** Envelopes, circulars, folders. Everything in printing. Bargains. Samples. Battlefield Press, Gettysburg Penna. Free battlefield souvenir.

200 **LETTERHEADS** And 100 envelopes \$1.00. 200 letterheads, 8½x11, 150 envelopes \$2.00. 250 cards \$1.00. Hoosier Print Shop, Portland, Ind.

**QUALITY** Printing! Reasonable Prices! Send for Free Standardized samples and prices. Folders, Circulars. Catalogs our specialty. Earnest Fantus, 525 South Dearborn, Chicago.

**MULTIGRAPHING** Business correspondence two dollars thousand. Hammermill letterheads, four dollars; inexpensive quality, three dollars. Miscellaneous printing. Mayera Corporation, Monmouth, Ill.

250 **BOND** Letterheads, Envelopes, Billheads, Cards, \$1.35 each. Economic Press, Leonia, N. J.

**WE** Print stationery, booklets, catalogs, circulars. Samples. Commercial Press, Batavia, Ohio.

**QUALITY** Stationery—500 8½x11 bond letterheads, 250 No. 6½ envelopes, \$3.25. Samples. H. Curtis, 811 Harrigan, Kalamazoo, Mich.

**FINE** Printing—Low prices. Large modern plant (thirty employees) in small town, low operation cost. Special prices on stationery, circulars, pamphlets, ruled forms, catalogs, large or small orders. Write for samples and prices. Shenandoah Publishing House, Inc., Box 1050, Strasburg, Va.

**LETTERHEADS** 8½x11, Envelopes, 200, \$1.25; each 500, \$2.00, 6 blotters free. Other printing reasonable. Samples. Lincoln Printshop, 230 East Lincoln Ave., Mt. Vernon, N. Y.

500 **BUSINESS** Cards 98c. Other printing reasonable. Samples free. Hanzer's, 1039 S. Cleveland, Philadelphia, Pa.

**JOB** Printing. Samples and pricelist. Robert Chase, Earlville, N. Y.

**PRINTING OUTFITS AND SUPPLIES**

**PRINT** Your own stationery, cards, bookplate. Christmas cards, circulars, books, pamphlets, etc.; complete outfits, \$8.85; larger, \$11. \$29 rotary \$149. Print for others. Easy and interesting rules sent. Write for catalog presses, type, paper, etc. Kelsey Company, K-11, Meriden, Conn.

**PRINTING** Outfits—Presses, type supplies, type novelties. Send stamp for catalog. Model Press, York, Penna.

**RUBBER STAMPS**

**RUBBER** Stamps: Name, address two lines 25c, three lines 35c. Newman & Son, Auburn, Nebr.

**DUPLICATORS AND DEVICES**

**YOU** can make 50 to 100 copies of a letter, notice, etc., at a cost of three cents on a Hoyer Quality Duplicator. Write for free trial offer. The Hoyer Duplicator Co., 909 Jackson Blvd., Chicago, Ill.

**"EXCELLOGRAPH"** Portable rotary stencil printing duplicators \$39. Terms. Description, testimonials, printed samples, free. Pittsburgh Typewriter Supply Co., Dept. 531, Pittsburgh, Pa.

**MAKE** Your own stencil duplicator! Particulars, description, specimens, free. Grinstead Company, Oswego, Kans.

**ADDING MACHINES**

**NEW** \$3.50 Automatic adding machine. Adds, subtracts, multiplies, absolutely accurate. Capacity \$999,999.99. Fully guaranteed. 75,000 pleased users. Makes adding easy, positive, quick. Eliminates mistakes. Saves time. Postpaid \$3.50. Bassett Co., 1458-Y, Hollywood Ave., Chicago.

**FOR THE HOME**

**GRANDFATHER'S** Clock Works. \$5.00. Build your own case; instructions free; make good profits selling your friends. Clock works with chimes for old or new cases. Write for full particulars. Clock Co., Ruffner St., Philadelphia.

**CEDAR** chests only \$11.65—"Red-i-Kut" complete with rich copper trim—you assemble and save half—send for pictures. Kuempel Furniture Company, Guttenberg, Iowa.

**NEED** Xtra money? Weave rugs at home. Loom book free. Union Looms, Boonville, N. Y.

**FOR MEN**

**GARTER** Relief! Patented bandless hose supporters. Send for free sample. H. Bain Co., 479 W. 25th Place, Chicago.

**GUNS, FISHING TACKLE AND SPORTING GOODS**

**TESTED** Fish bait receipt and instructions 25c. Henry Bergman, Box 5, Springfield, Mo.

**FOR SMOKERS**

**CIGARETTE** Machine rolls, glues 50 for 10 cents. Ask illustrated folder. Postpaid \$2.50. Automatic Cigarette Machine Works, 6247 Broadway, Chicago.

**NEW** Pencilite—Popular pencil cigar lighter, it writes and lights, mailed prepaid upon receipt of \$1.00. Agents wanted. Edwards Co., Box 272, Oak Park, Ill.

**BOATS AND LAUNCHES**

**BOATS** More popular than ever; be up to date, build your own boat during your spare time this winter using our knockdown materials and save money. 55 new designs. Send 10c for 1929 catalog. Brooks Boat Co., Inc., Rust Ave., Saginaw, Mich.

**HUBBELL** Marine Coolers convert Ford engine into marine motors. Booklet free. Ford speedboat easily built, large blueprint and directions one dollar. C. C. Hubbell, Perry Ave., Norwalk, Conn.

**PROPELLERS.** Pumps, stuffing boxes, bearings, etc. Wm. H. Baker, Pond St., Quincy, Mass.

**WATCH REPAIRING**

**EXPERT** Repairing. Cheap. Price list free. Frank Riese, Bloomington, Wis.

**UNBREAKABLE** Watch crystals; any shape; guaranteed not to discolor; fitted day received. Send case and 50c. Watch repairing by experts. Average \$2.50. Estimate free. Swiss Watch Repair Co., Fort Wayne, Ind.

**RAZORS AND BLADES**

**ALL** Makes razor blades sharpened, 1c each. Satisfaction guaranteed. Petter Wetterquist, Rockford, Ill.

**ANTIQUES, WAR RELICS AND INDIAN GOODS**

**GENUINE** Sioux Indian costumes and beadwork. Buying direct from Indian. Prices reasonable. Free price list. Lyon Curio Store, Clinton, Nebr.

**OLD** Arms, Indian relics, miscellaneous curios, illustrated lists, ten cents. N. Carter, Elkhorn, Wis.

**SEND** 5c For fine new list Indian relics, antique firearms. F. E. Ellis, Webster Groves, Mo.

**FOR** Dens. Relics and medals from Europe's battlefields. Illustrated catalog, 25c. International, 885 Flatbush Ave., Brooklyn, N. Y.

**PHONOGRAPHS AND RECORDS**

**BUILD** Your own photograph. Parts catalog and instructions to build new horn, mailed for 10c. American Phonograph Co., 4116 West 24th Place, Chicago.

**MUSIC AND MUSICAL INSTRUMENTS**

**SONG** Poems arranged for publication. Submit poems. Brennen, Song Specialist, 11656 Broadway, New York.

**SONG** Poem writers: "Real" proposition. Hibbeler, D1, 2104 N. Keystone, Chicago.

**COMPOSERS**—Verse or music. Write at once. Brilliant opportunity. Burrell VanBuren, 1819 McClurg Bldg., Chicago.

**SONGWRITERS:** Submit your song-poem or complete song. Will return it immediately if not accepted. Chester Escher, Music Publisher, 125 W. 45th St., New York City.

**FREE**—"Song Writers Guide." Beaver, 1257 Elm, Green Bay, Wis.

**SONG-POEM** Writers: Address Monarch, 236 W. 55th, Dept. 304, New York.

**SONGWRITERS.** Substantial Advance royalties are paid on publishable work. Anyone having original ideas for songs may submit poems for examination and free advice. Walter Newcomer, 1674 Broadway, New York.

**POEMS** Wanted, 50-50 plan. Great Eastern Song Bureau, Dept. 27, Thomaston, Me.

**SONG** Writers: Send for our "Publishing Agreement." McKinley Music Printers, 1501 E. 55th St., Chicago.

**SONG** Poems solicited. A different proposition. Richard Broughton, Sioux Falls, S. Dak.

**VIOLINS.** Deep, mellow, soulful—on credit. Easy terms for wonderful instrument. Get details today. Gustav F. Henning, 302 University Building, Seattle, Wash.

**CORNETISTS**—Trombonists—Saxophonists—Clarinetists. Get "Free Pointers." Name instrument. Virtuosi School, Buffalo, N. Y.

**PLAY** Piano by Ear. A Sound System. Booklet free. Boucher's Harmony Studio, Ottawa, Can.

**SONG** Poem Writers. Write Sequoia Songwriters' Service, Sherman Branch, Los Angeles, Calif.

**I WANT** Song Poems. Casper Nathan, 3544 N. Racine, Chicago.

**"BANJOS"** Should interest all musicians on account of the popularity of the Banjo, as it easily increases a Player's income. Illus. Catalog of 48 pages free. The Bacon Banjo Co., Inc., Groton, Conn., U. S. A.

**"MUSIC** Composed" to words. Bauer Bros. (formerly of Sousa's Band), Oshkosh, Wis.

**WRITE** Songs. Big money and reputation. Write for information. J. Gordon Pub. Co., 201 N. Hoyne Ave., Chicago.

**PATENT ATTORNEYS**

**PATENTS** Procured at reasonable rates with time to pay. Sales negotiated. Staff of registered attorneys and engineers. A complete service for inventors. Write for particulars. Inventors Service Bureau, Dept. B, Union Trust Bldg., Washington, D. C.

**LACEY'S** Patent Sense. Valuable book free. See ad page 159.



**PATENTS**—Write for our free book, "How to Obtain a Patent" and Record of Invention Blank. Send model or sketch of invention for inspection and instructions free. Terms reasonable. See advertisements on pages 156 and 157. Victor J. Evans & Co., 934 Ninth, Washington, D. C.

**TIME** Counts in applying for patents. See pages 154 and 155. Clarence A. O'Brien, Registered Patent Attorney, Washington, D. C.

**PATENTS**, Trade-marks and designs secured through Frank O. Parker, Barrister Bldg., Washington, D. C. Send sketch or model of invention for consideration.

**PATENTS** Procured, prompt service, personal, careful and efficient service. Highest references. Moderate fees. Send sketch or model for actual search and advice. George P. Kimmel, Master of Patent Law, 54-C Legal Bldg., Washington, D. C.

**INVENTORS**, Why pay more? H. M. Plaisted, registered patent attorney; 30 years' experience patents and trademarks. 4413 Page Blvd., St. Louis, Mo.

**UNPATENTED** Ideas can be sold. I tell you how and help you make the sale. Free particulars (Copyrighted). Write W. T. Greene, 806 Baltic Building, Washington D. C.

**INVENTOR'S** Advisor with mechanical movements sent free. Labiner, Three Park-row, New York.

**INVENTOR'S** Guide, valuable information, free. Frank Ledermann, Registered Attorney-Engineer, 1712 Woolworth Bldg., New York.

**PATENTS**—Write for free instructions. Send drawing or model for examination. Carl Miller, Registered Patent Attorney (former Patent Office examiner), 259 McGill Bldg., Washington, D. C.

**PATENTS**—Free instructions. Former patent office examiner. Moderate terms. Booklet. Albert Jacobs, 727 Barrister Bldg., Washington, D. C.

**PERCY S. WEBSTER**, 203 Saving and Loan Building, Stockton, Calif. Patent booklet free.

**INVENTORS**: Send for booklet telling how to patent and sell your inventions at lowest cost. Ralph Burch, Patent Lawyer, 900 F St., Washington, D. C.

**PATENTS**, Booklet free. Highest references. Best results. Promptness assured. Send model or drawing for preliminary examination. Watson E. Coleman, Patent Lawyer, 724 Ninth St., Washington, D. C.

**PATENTS**, Trade-marks, Copyrights. Reliable services by an experienced practitioner devoting personal attention to each case. Inquiries invited. References furnished. B. P. Fishburne, Patent Lawyer, 525-A McGill Bldg., Washington, D. C.

**PATENTS**, Prompt personal service. Write for information. Albert E. Dieterich, Registered Patent Lawyer, 621½ Ouray Bldg., Washington, D. C.

**LANCASTER** and Allwine, 221 Ouray Bldg., Washington, D. C. "Originators of the Form Evidence of Conception." Before disclosing your invention to anyone send for blank form to be signed and witnessed. Form and patent information bulletin free.

**PATENTS** Procured: Trade marks registered—A comprehensive, experienced, prompt service for the protection and development of your ideas. Preliminary advice gladly furnished without charge. Booklet of information and form for disclosing idea free on request. Irving L. McCathran, 704 International Bldg., Washington, D. C., or 41-B Park Row, New York.

**INVENTORS**: Send sketch or model for advice and exact cost of patent. Ask for our free book: "How to Obtain a Patent." Tells what every inventor should know. Established twenty-eight years. Highest references. Prompt service. Reasonable charges. Chandlee & Chandlee, 414 Seventh, Washington, D. C.

**MONROE E. MILLER**, Ouray Bldg., Washington, D. C., Patent Lawyer; Mechanical, Electrical Expert. Booklet and Priority Record blank gratis.

**ESTABLISHED 1864**, Milo D. Stevens Company. Free Booklet. Patents, Trade-Marks, Copyrights. Offices, Monadnock Block, Chicago; Barrister Building, Washington, D. C.

**INVENTORS**—Write for our Guide Book, "How to Get Your Patent," and Evidence of Invention Blank. Send model or sketch of your invention for our prompt examination and instructions free. Randolph & Co., Dept. 430, Washington, D. C.

**PATENTS, Trade-Marks, Designs**. This firm has 27 years' experience and gives expert personal service at reasonable rates. We properly protect your invention. Write for free information and exact cost of procuring patent before proceeding. John B. Thomas & Co., 902 F St., N. W., Washington, D. C.

**SELL** Your invention before patenting. Write for free particulars. W. T. Greene, 801 Baltic Bldg., Washington, D. C.

#### FOR INVENTORS

**THIS** Company has made a phenomenal success in merchandising, through its twenty-six established branches, a patented article to industrials and the building, electrical, plumbing, and allied trades. We are now in a position to consider one more article of exceptional merit which will appeal to the same trade. Will either purchase outright or make a favorable royalty arrangement. Give full details in first letter addressed personally to the president, The Rawplug Co., Inc., 66 West Broadway, New York City.

**PATENT** Applications and drawings expertly prepared for the inventor's filing. Lowest fees. Sales negotiated. Williams Engineering Service, Pacific Bldg., San Francisco, Calif.

**INVENTORS**—Ideas developed and working models built. Electrical problems solved. Lowest charges and confidential service. Industro Electric Tools Co., Petersburg, Va.

**LACEY'S** Patent Sense. Valuable book free. See ad page 159.

**MANUFACTURER** Will buy outright patented article preferably a small metal stamping or screw machine job. Room 304, % Popular Mechanics, Chicago.

**TOY** And game inventions wanted. Hattan Manufacturing Co., Kansas City, Mo.

**WE** Sell patents by calling personally on manufacturers any part United States. Write for terms. Birk & Green, 105 West Monroe, Chicago.

**JOIN** The American Inventors Association, Cedar Rapids, Iowa. Protection, consultation, capitalization.

**MANUFACTURERS** Want new articles to make (sheet metal). Either outright or on a royalty basis. Virginia Welding Co., 934 Charleston, W. Va.

**INVENTIONS**—Write for our free book "How to Obtain a Patent" and Record of Invention Blank. Send model of sketch of invention for inspection and instructions free. Terms reasonable. See advertisements on pages 156 and 157. Victor J. Evans & Co., 157 Ninth, Washington, D. C.

**TIME** Counts in applying for patents. See pages 154 and 155. Clarence A. O'Brien, Registered Patent Attorney, Washington, D. C.

**I** SELL patents. An experienced, dignified, efficient service, widely known and long established, for the inventor with a good patent to sell. Charles A. Scott, 173PM Garson Ave., Rochester, N. Y.

**PATENTS**—Write to B. P. Fishburne (a South Carolinian), Registered Patent Lawyer, 525-E McGill Bldg., Washington, D. C.

**SELL** Your invention before patenting. Write for free particulars. W. T. Greene, 802 Baltic Bldg., Washington, D. C.

**INVENTIONS** Developed and commercialized. Frank G. Buffum Mfg. Co., Louisiana, Mo.

**WANTED**: Useful articles, novelties, toys, formulas for mail order business. Can arrange for manufacturing patented articles of merit. Send particulars and samples immediately. Joseph H. Provost, Stamford, Conn.

**INVENTORS**—Cash in on your invention now! Don't delay the sale any longer! Send for a free copy of our specially prepared booklet, "Turn Your Patent Into Money," today! It contains helpful information for all inventors. M. L. Rund, Mgr. Classified Advertising, Popular Mechanics Magazine, 200 E. Ontario St., Chicago, Ill.

**INVENTIONS** Wanted—Patented, unpatented. If you have an idea for sale, write Hartley, Box 928, Bangor, Me.

**ESTABLISHED** Manufacturer wishes new articles to make and sell on royalty basis, stampings and light assembly preferred. Box 473 % Popular Mechanics, Chicago.

**UNPATENTED** Ideas can be sold. I tell you how and help you make the sale. Free particulars (Copyrighted). Write W. T. Greene, 807 Baltic Bldg., Washington, D. C.

**WANTED**—Patents for sale from inventors. Box 52, Gig Harbor, Wash.

**PATENTS**. If you have an invention which you wish to patent you can write fully and freely to Munn & Co., for advice in regard to the best way of obtaining protection. Please send sketches, or a model of your invention and a description of the device, explaining its operation. All communications are strictly confidential. Our Hand-Book on Patents is sent free on request. This explains our methods, terms, etc., in regard to patents, trade marks, foreign patents, etc. "Scientific American" contains patent office notes, decisions of interest to inventors and particulars of recently patented inventions. Munn & Company, Solicitors of Patents, 1523 Scientific American Building, 24 W. 40th St., New York City; 524 Scientific American Bldg., Washington, D. C.; 1313 Tower Bldg., Chicago, Ill.; 666 Hobart Bldg., San Francisco, Calif.; 521 Van Nuys Bldg., Los Angeles, Calif.

**INVENTORS** Universal - Educator—contains 900 mechanical movements; 50 perpetual motions. Tells how to obtain and sell patents. Suggests new ideas. Explains how to select your attorney and avoid patent sharks. Price (revised edition) \$1.00 post-paid. Albert E. Dieterich, 621 Ouray Bldg., Washington, D. C.

**GET** your own patents. Legal blanks, complete instructions \$1. Cutting Sons, Cambell, Calif.

#### PATENTS FOR SALE

**FOR** Sale—Patent on non-skid tire chain. Box 613, Greenfield, Mass.

**PATENT** Weeder for orchards, vineyards, farms. Easily manufactured, undersells all. T. Carlsen, 553½ East 7th St., Salt Lake City, Utah.

**OUTRIGHT** Or royalty. Patent game of skill, very novel and attractive, practical commercial specialty. F. Goldbach, Marysburg, Sask., Canada.

**FOR** Sale—Sportsman game carrier; most complete game carriers ever invented; demand by sportsmen. Will sell patent or place on royalty. J. F. Calvert, England, Ark.

**OUTRIGHT**—Apricot and peach splitter. Cuts fruit into halves. Fred Petersen, 266 Gates St., San Francisco, Calif.

**AUTO** Inner tube tester, tests tubes under high pressure; outright or royalty. Geo. Manco, Rt. 2, Richmond, Va.

**OUTRIGHT** Or royalty. Match safe; expels discards. Hughes, 1320½ Quarrier, Charleston, W. Va.

**OUTRIGHT** Or royalty a real onion weeding machine; actually picks weeds out right amongst the onion and automatically lays them between rows. Henry Ploetz, North Judson, Ind.

**COMBINATION** Motor truck, concrete and mortar mixer; establishing a new mixing principle and will prove a big money maker to manufacturer. Chas. Payne, 27 Fulton Ave., Waukegan, Ill.

**ELECTRIC** Hair waver. Five times as fast as any iron on the market. C. W. Mikaelson, 5002 No. Paulina St., Chicago, Ill.

**ATTENTION** Mfgs: Connecting rod attachments, perfecting true turbine running balance; wanted everywhere. U. S., Canadian, French, British patents for sale royalty or outright. Herbert A. Strupp, 1616 First Ave., Evansville, Ind.

**A** COMBINED crushing and grinding mill. To sell outright or place on royalty. Frank Gross, P. O. Box 740 Colorado Springs, Colorado.

**NEW** Kind of puzzles, copyrighted, for sale, usable as contests. Write G. Poulon, 6 N. King St., Hampton, Va.

**FOR** Sale or royalty, new accelerator pedal fits all cars. L. J. Cole, Greenville, Pa.

**FOR** Sale—Parlor bowling device, something new. It's great; cheap to make. Alois L. Baumann, Box 1163, Kellogg, Idaho.

**IDEAS** For sale—Your mechanical problems solved at your price. What do you need? Mennle, 11330 Woodmont, Detroit.

**TIME** Counts in applying for patents. See pages 154 and 155. Clarence A. O'Brien, Registered Patent Attorney, Washington, D. C.

**FOR** Sale—Recent patent on pneumatic bumper; protects cars from dents and scratches; protects pedestrian from serious injury; manufacturing cost low; new and slightly; appearance and utility should commend its sale to motoring public. For full particulars address E. Watson, 233 Lowell Ave., Floral Park, Long Island, N. Y.



**YOUR** Idle patent can be turned into ready cash, quickly! One inventor sold his patent at a cost of only \$3.50. Send today for a free copy of our booklet, "Turn Your Patent Into Money." M. L. Rund, Mgr. Classified Advertising, Popular Mechanics Magazine, 200 E. Ontario St., Chicago, Ill.

### SURVEYING INSTRUMENTS

**GUARANTEED.** Rebuilt transits and levels. All makes. Sold on approval. Cash or easy terms. Write today for descriptive list M-33. Warren-Knight Company (Makers of Sterling Levels and Transits), 136 N. 12th St., Philadelphia, Pa.

**LARGEST** Stock of new and used surveying instruments in the country direct from factory. Satisfaction guaranteed or money refunded. Also farm levels. Wissler, 619 N. Broadway, St. Louis, Mo.

### MODELS AND MODEL SUPPLIES

**TIME** Counts in applying for patents. See pages 154 and 155. Clarence A. O'Brien, Registered Patent Attorney, Washington, D. C.

**MODEL** Owners—Will you sell or rent your models and miniatures to the motion picture industries? Write for rental rates and particulars. Almost any kind of models and miniatures are required in pictures, such as boats, trains, planes, autos, army equipment, trick props, sound effects, etc. W. J. Butler & Son, 847 Evergreen St., Burbank, Calif.

A \$100,000 SHIP model for \$4.98. Build the historic Santa Maria, LaPinta or the Mayflower. We send you C. O. D. the parts cut to fit, ready to assemble for \$4.98, plus a few cents postage. No tools needed except a small hammer. Parts for model of Constitution sent C. O. D. for \$6.98, plus postage. Write for illustrated catalog. Miniature Ship Models, Inc., Dept. P, 3216 Baring St., Philadelphia, Pa.

**DEADEYES,** 1/8", 3-16", 5-32", 3/8", \$3.50 hundred; belaying pins 18c dozen. C. Libby, Tuckahoe, N. Y.

**THREE** Ship model plans for \$1. Catalog 6 cents. Richter's, 3217 Walnut St., Milwaukee, Wis.

**MODEL** Steam engines and boilers for miniature power boats. Boat and boiler fittings. New catalog 15c. Model Machine Shop, 212 Price St., Rahway, N. J.

**MODELS.** Experimental work. Equipped for complete machine construction any description. Hult & Company, Machinists, 115 South Clinton, Chicago.

**MODELS.** Punches, dies, tools. Jigs and fixtures for manufacturing. Schmidt, 61 Park Place, New York, N. Y.

**THE Modelmaker,** a magazine for all interested in making working models, boats, etc. Sample 10c. Modelmaker, 122 Liberty St., New York.

**MODEL** And experimental work at lowest cost. Wagar Model & Machine Works, 115 So. Clinton St., Chicago.

**SPECIAL** Machine builders, tool and die makers, inventors' models production work of all kinds. Dept. L. Quality Hardware & Machine Corporation, Ravenswood and Thorndale Aves., Chicago, Ill.

**LET** Our experience be your guide. Models that are models; tools and equipment for economic manfg. Patterns of all types; manufacturing in all branches. Satisfaction guaranteed. United Machinery Company, Cincinnati, U. S. A.

**SHIP** Model Fittings: Send Dime for booklet. A. J. Fisher, 1002 Etowah Ave., Royal Oak, Mich.

**MODELS.** Tools, dies and quantity manufacturing. Logan Machine Co., 652 W. Lake St., Chicago, Ill.

**WORK** With master machinist; 15 years experimental experience, well equipped shop. Albert Weiss, 161 W. 21st St., New York City.

**WE** Make working models for inventors and do experimental work and carry a complete stock of brass gears and model supplies. Send for catalog. The Pierce Model Works, Tinley Park, Ill.

**BASEWOOD** Blocks, deadeyes, 1/8", 5-32", 3-16", 3/8" 25c dozen. Doubles 35c. Steering wheels 25c. G. Anderson, 44 Butterworth Ave., Toronto, Ont.

**MODEL** Ship supplies about half price. 5/8" steering wheel 75c. Price list nickel. Ship Shop, Mooresville, N. C.

### MANUFACTURING

**SPECIALTY** Manufacturing, including models, dies, stamping, casting, welding, screw machine, wire products, plating, enameling, assembling, boxing and printing. Our increased facilities make it possible to manufacture a few more products complete at surprisingly low cost. Estimates promptly furnished on products acceptable to our engineers and factory supt. Majestic Products Mfg. Company, Lock Box 877, Chicago.

**SPECIAL** Machinery or parts, dies, tools, metal specialties, models, special gears, stock gears and model supplies. Send for Catalogue. The Pierce Model Works, Tinley Park, Ill.

**ECONOMICAL** Manufacturing from sheet, bar, wire or tubing. Models, dies, special machinery. Swanberg, 5124 N. Kildare Ave., Chicago.

**WIRE** goods made to order. Cooley Mfg. Co., 530 N. Western Ave., Chicago.

**LET** Us make your dies and do your punch press work. Co-Operative Eng. Co., 32 South St. Clair St., Dayton, Ohio.

### FOR MECHANICS

**ATTENTION**—Home mechanics: We sell unusual cabinet hardware, chest trimmings, tea wagon wheels and casters, big line small hinges, locks, etc. Upholstering supplies, electrical hardware, knocked down cedar chests, etc. Send ten cents stamps for catalog. Thurston Manual Training Supply Company, Jobbers and Manufacturers, Anoka, Minn.

**THE** Midget slide rule instantly solves any mathematical problem. Price \$1.50. Catalog free. Gilson Rule Co., Stuart, Fla.

### MACHINERY, TOOLS AND SUPPLIES

**NO.** 14 1/2 Becker universal milling machine, with dividing head, complete, \$425.00; 16"x8" Prentice engine lathe, \$175.00; No. 60 Heald grinder, \$275.00; 20" Hendy shaper, \$225.00; 24" Barker back geared crank shaper, \$400.00; 20"x8" Bradford engine lathe, complete, \$215.00; 24" Hamilton drill press, complete, \$135.00; Quincy air compressor with tank and hose, \$65.00; 10" bench drill press, \$19.00. Terms to suit. Write for catalog. Cincinnati Machinery & Supply Co., 27 West Second St., Cincinnati, Ohio.

**CONCRETE** Building block machines and molds. Catalog free. Concrete Machine Co., 5 North Main St., St. Louis, Mo.

**STEEL** And brass rod assortment. Eighteen sizes steel 3-32 to 3/4 dia., three ft. long \$2.55. Seven sizes steel squares, 1/2 to 1/2, two ft. long 90c. Twelve sizes brass 3-32 to 1/2 dia., three ft. long, \$3.60. Highest grade drawn stock. Thompson Manufacturing Co., Meadville, Pa.

**PORTABLE** Electric saw tables, band saws, scroll saws, jointers, mandrels, etc. Factory to user. Circulars. Peter M. Hoof, 3013 15th Ave., So. Minneapolis, Minn.

**WOODWORKERS.** New accessory for circular saw. Makes tenon joints quickly. Guaranteed. Price \$2. Particulars 2c stamp. Clayton's Workshop, Port Huron, Mich.

**WOOD** Turning lathes, \$17.50. Hallin Machine Co., Parkers Prairie, Minn.

**COMPRESSORS,** Twin cylinder, for small tire shops. Duco spraying. J. Trockman & Sons, Inc., 110-112 Lincoln Ave., Evansville, Ind.

**ELECTRIC** Drills 1/4" portable, universal 110 \$12.00 each. Refund guarantee by manufacturer. H. F. Gustin, 180 East Huron St., Pontiac, Mich.

**START** business of your own, small investment required, doing nickel, copper and silver plating. This work in big demand. Information free. Electro Platers Supply Co., 547 Considine Ave., Cincinnati, Ohio.

**NEW** Six volt soldering iron. Economical, redhot point, guaranteed. Price \$1.50. Soldering Co., Republic, Kans.

### ENGINES, MOTORS AND DYNAMOS

**ELECTRIC** Motors, reconditioned equal to new. A.c. or d.c. 1/4 hp. \$5.50; 1/2 hp. \$16.00. 3/4 hp. \$18.50, 1 hp. \$24.00. Others to 10 hp. Also motors rebuilt, repaired, armature winding. Tell us your motor problems. Temps Brothers Motor Company, One Martin Ave., Glendale, Long Island, New York.

**NEW** 1/4 horse, 110 volt, alternating motors, cord, plug and pulley, \$7.00. New 32 volt, General Electric, 500 watt generators, \$18.50. New 1/2 horse 110-220 volt, 1,750 speed, repulsion-induction alternating motors, \$22.50. 1/2 horse, induction, alternating motors, \$16.50. Large stock all kinds. Write us for quotations. Electrical Surplus Company, Dept. 12, 1911 West Chicago Ave., Chicago.

**BARGAINS**—Electric drills, \$11.95; bench saw outfit, \$7.35; electric bench grinders, \$13.20; combination lathe, \$8.15; scroll saw, \$5.60; motors, generators, farm plant equipment; flexible shafts; 100 other bargains. Send for several bargain bulletins. Acme Tool Co., 627 W. Washington, Chicago.

**FOR** Sale: 1-6 1/4 h.p. motors, 60 cycle, alternating current, slightly used, first class condition; all motors tested before shipping \$4.50 and \$5.00 while they last. Cash with order. The Maytag-Chicago Co., 337 W. Madison St., Chicago, Ill.

500 NEW 1/4 Hp., a.c., double shaft grinders, \$12.75. Cash with order. Wm. M. Miller & Sons, 2553 Madison St., Chicago, Ill.

**WANTED:** Small turbine, Diesel or steamer auto-engine. Rumor, 1949 W. 34th Place, Chicago.

**FOR** Sale motors 1-6 to 100 h.p. Single or three phase, motors bought, sold, re-wound and exchanged. R. R. Roby, Truro, Iowa.

**BRAND** New 1/4 hp. 110v. a.c. motors \$7.00 with cord, plug pulley. 1/2hp. \$16.00. 1 hp. \$36.00. 32v. motors 1/4hp. \$7.50; 1-6 hp. \$6.50. 32v. motors with emery, buffer and drill chuck \$6.50. Large stock motors and generators. Queen City Electric, 1736 Grand Ave., Chicago.

**NEW** 750 Watt, ball bearing generators, \$28.00; 1250 watt, 32 volt lighting plants with engine, \$169.75; 1/4hp. 32 volt motors, \$9.75; 1/2hp. General Electric, repulsion, a.c. motors, \$27.00. All brand new. Write for bargain catalog. Do not buy, consult us first. General Distributing Company, Duluth, Minn.

**NAVY** Surplus 800 new radio generators, d.c. and 500 cycle. Unusual prices. Literature. Henry Kiengle, 501 East 84th St., New York.

**STEAM** Engines—One H. P. \$18.00; 1/2, \$12.00. James Chambliss, Bessemer, Ala.

**TIME** Counts in applying for patents. See pages 154 and 155. Clarence A. O'Brien, Registered Patent Attorney, Washington, D. C.

**EDISON** And Graphophone electric universal motors with speed governor and idler \$5.00 plus express on 10 lbs. Geo. Schulz, Calumet, Mich.

**AUTO** Engines make excellent power plants in the shop, mine, mill or farm, but they need governing. We make the governors for \$10 up. Fit any make of engine. See advertisement below.

**GOVERNORS** For auto engines when used for power plants. Circulars. Candee-Smith Governor Co., 215 W. Manchester Ave., Los Angeles, Springville, N. Y., or St. Catharines, Ont.

### WANTED—MISCELLANEOUS

**MAIL** Us your discarded jewelry, gold, crowns and bridges, watches, diamonds, silver, platinum. Money promptly mailed. Goods returned if offer refused. United States Smelting Works (The Old Reliable), Dept. 71, Chicago.

**HUNDREDS** Of people have sent their old gold, silver, platinum jewelry, dental work to me. Why not mail yours today? Highest prices paid. Satisfaction guaranteed or goods returned. F. Polcer, 2408 South Cicero Ave., Cicero, Ill.

**EXCHANGE**—Newspaper course, cost \$80.00. Want automatic concertina encyclopaedia. C. L. Swan, Galva, Ill.

### BENDING MACHINES

**THE** Famous Hossfeld "Wrenchless" Universal Iron Bender is the last word in bending machines. Bends metal, cold or hot, into most any conceivable shape, including Eye Bolts and Automobile Spring Eyes. Bends up to 1" bars or 1 1/2" pipe cold. Thousands in use by all classes of trade, from the smallest shops to the largest railway systems. Write for circular and prices. Hossfeld Mfg. Co., Winona, Minn.



**FOR SALE—MISCELLANEOUS**

**ADDRESSOGRAPHS**, Letter folders, multi-graphs, envelope sealers, duplicators, less than half price. Guaranteed. Pruitt Co., 117 No. Wacker Drive, Chicago.

**LUMBER**

**HOME Craftsmen:** All kinds of clear lumber free from knots and other defects, cut to size, planed or rough. Guaranteed kiln dried. Craftsman Wood Service, 1715 E. 62nd, Chicago.

**FARMS AND FARM LANDS**

**CANADA** Tax sale. Seized and sold for taxes. \$45.00 buys 10 acres for summer home. \$64.80 buys 20 acres on main road. \$100.80 buys 2 1/2 acres 800 feet lake front. \$189.00 buys 78 acres farm on river. \$279.00 buys 175 acres good hunting. \$360.00 buys 160 acres western farm. \$585.00 buys 300 acres, sporting-materials. These properties, with several hundred others, are offered at the prices stated, no mortgage, no further payments. Beautifully situated hunting camps and fishing lodges where there is real hunting and fishing. Summer cottage sites; heavily wooded acreages situated in Muskoka, Highlands of Ontario, and the new north; also farms in old Ontario, Quebec, Prairie Provinces and British Columbia. Our 12th annual list just issued in the form of a 20 page illustrated booklet describes these properties and gives full particulars. It is mailed free on application. Now is the time to invest in Canada's minerals, forests and farms. Don't delay. These properties won't last long at these prices. Send no money but send for booklet today so you will have first choice. Tax Sales Service, Room 613, 72 Queen St. West, Toronto 2, Can.

**LAND** Sale \$5 down \$5 monthly buys 40 acres southern Missouri. Price \$200. Send for list. Box 22-N, Kirkwood, Mo.

**GET** Quick cash sale for your property anywhere. Details free. Write Fisher Agency, Hannibal, Mo.

**CALIFORNIA** Fruit and poultry farms on hard surfaced streets with gas, electricity, water and all city conveniences at Muscoy adjoining city limits of San Bernardino, population 43,000, east of Los Angeles. Send for 36 page book free. J. B. Roof, Inc., Owners, 708 Quinby Bldg., Los Angeles, Calif.

**FOR** Sale—Farms, 40 a., Mo., \$5 mo. Own a home. Jarrell, Mount Vernon, Ill.

**FREE** Books, descriptive of the opportunities offered homeseekers and investors in Minnesota, North Dakota, Montana, Washington and Oregon. Low round-trip homeseekers' tickets every Tuesday. E. C. Leedy, Dept. 157, Great Northern Railway, St. Paul, Minn.

**CALIFORNIA**—Small fruit and poultry farms in community of 6,000 near Los Angeles; 5 advisers. U. S. rabbit exp. station; co-operative buying and marketing. Free illustrated booklets. Write owner, Fontana Farms Co., 631 (R) S. Spring, Los Angeles, Calif.

**SELL** your property quickly for cash, no matter where located. Don't pay big commission. Particulars free. Real Estate Salesmen Co., Desk B, Lincoln, Nebr.

**MONEY** made in Mich. potatoes. \$10 down now and easy terms buys land near markets, lakes, streams. Write today, Swigart & Co., P-1276, 1st Nat'l Bank Bldg., Chicago.

**PECAN**-Orange-Fig groves "On the Gulf" Monthly payments. Guaranteed care. Big, quick returns. Suburban Orchards, Dept. M, Ocean Springs, Miss.

**OZARKS**—10 acres near White river and proposed power dam. \$100, \$5 monthly. Alvin Zimmerman, 1802 N. 5th, Kansas City, Kans.

**SEEDS, PLANTS AND TREES**

**KODOTA** Figs. Plants only twelve inches high will bear. Interesting, beautiful plant for yard, window or conservatory. Nice plant mailed \$1. Nut and fruit tree catalog free. Fitzgeralds Nursery, Stephenville, Tex.

**ROOTS AND HERBS**

**MEDICINAL** Roots and herbs. Over 1,000 varieties. Catalog free! Botanics, 145 West 112th St., Chicago.

**MUSKRATS**

**MAKE** Money From Muskrat Fur—Raise Muskrats in dry land pens or hutches. Get the facts. 652, Conrad's Ranch, Denver, Colo.

**RABBITS**

**MAKE** big profits with Chinchilla Rabbits. Real Money-makers. Write for facts. 552 Conrad's Ranch, Denver, Colo.

**DOGS AND PETS**

**RAISE** Guinea pigs; easy to raise; little space required; very profitable. Particulars and booklet how to raise free. Cavies Distributing Co., 3102 C. C. Station, Kansas City, Mo.

**ST. BERNARD** Puppies, also Chows. Registered thoroughbreds, priced reasonable, duty free. Photos submitted. Write Helvetia Kennels, 181-P McKenna, Montreal, Can.

**HUNTING** Hounds cheap; trial. Literature free. A7, Dixie Kennels, Herrick, Ill.

**FOR** Sale. Minks, squirrels, raccoons, foxes, ferrets, muskrats, ginseng, rabbits, skunks, wolf pups, opossums. B. Tippman, Caledonia, Minn.

**PEDIGREED** St. Bernard pups, large rough coated prize winning strain. Melvin O. Brown, Russell, Iowa.

**HEALTH**

**SAFEST**, Cheapest, surest cure known. "Nature's Way," 25c. Nature Health Bureau, 205 Wood Bldg., Glenside, Pa.

**PERSONAL**

**THE "Sanatory Physician,"** an 80-page book teaching natural laws of health, also suggests reliable self-treatment of disease. Appreciated by every reader. Mrs. S., Denver, Colo., says: "I owe my regained health to that dear little book." Postpaid 20c. Address Author, 320 James St., Seattle, Wash.

**TOBACCO** Or snuff habit cured or no pay. \$1.50 if cured. Remedy sent on trial. Superba Co., N3, Baltimore, Md.

**ADVICE**, Information, any subject, 25c coin. References. Fred Klotz, Reading, Pa.

**DRY** Clean your brain. Results amazing. Money back if not satisfied. Morris, 3608 Warren St., Philadelphia.

**MAYFERN** Biological research laboratories will give complete instruction to regain your health in shortest possible time. Be one of the thousands we have aided to enjoy perfect health. State your case and enclose \$1.00 for individual advice from our consulting physician. Write Mayfern, Inc., 512 Railway Exchange Bldg., Seattle, Wash.

**ARE** You old at forty? See our advertisement on page 169 of this issue. The Electro Thermal Company, 2115 Morris Ave., Steubenville, Ohio.

**HIGH** Blood pressure inexpensively overcome, without drugs. Send address. Franklin Stokes, Mohawk, Fla.

**DANCING**—Full instructions 50c. Stewarts, 3446 North Third St., Philadelphia, Penna.

**BUNIONS** Or ingrowing nails, prompt relief and real correction without knife or pain. Information free. Write Eugene Eaton, D106, Bandon, Oreg.

**SUCCESS**—Do you want it? Words (productive) properly used will bring it to you. Do you know how? Let us tell you. Attain your desire by sending for free circular today. Associates, Box 265, Winnipeg, Can.

**SUCCESS** Is yours. Valuable information free. Write to Luck, Dept. 36, Box 240, Huguenot Park, N. Y.

**SICK** Headache relieved in thirty minutes. No drugs. Instructions one dollar. Washing fluid one cent per week; wash without rubbing. Instructions one dollar. Effie Wilson, Rotan, Tex.

**AIR** Navigation and meteorology—New, simple, nontechnical book needed by every flyer. Nothing else on the subject like it. Written by Captain Duncan who has over 3,000 hours of flying to his credit. 225 pages. Flexibly bound. 80 pictures, maps, etc. Pay postman \$3.00 when he delivers book. Popular Mechanics Press, Room 803, 200 E. Ontario St., Chicago.

**MISCELLANEOUS**

**SKELETON** Keys—3 kinds 25c. Key ring tag, name and address 25c. C. Flebig's Sons, Rock Island, Ill.

**MIRRORS** Resilvered at home. Costs less 5 cents per square foot; you charge 75 cents. Immense profits plating autoparts, reflectors, tableware, stoves, refinishing metalware, etc. Outfits furnished. Details free. Write Sprinkle, Plater, 288, Marion, Ind.

**PLANS** Drawn. Every type building. Mid-City Architectural Service, 5029 Maple, St. Louis.

**ASTROLOGY** Will reveal your future. Special 15-page astronomical forecast gives predictions—month by month—with exact days, dates and happenings for 1929 based on your sign of the Zodiac. Consult it before making any change in home or business affairs, signing papers, love, marriage, employment, travel, speculation, "lucky days," etc. Know what to expect. Send exact birthdate with \$1.00. Franklin Publishing Company, 800 No. Clark St., Dept. 173, Chicago.

**CASH** Paid for Butterflies, Insects. See Sinclair Display Advertisement on page 16.

**HOME** Workshop designs. Twelve working sizes \$1.00. Address Designer, 121 Hall St., Rockford, Ill.

**ARTISTS:** Make comic art pay! Our plan—your opportunity. Kaas, Box 281, Hermosa Beach, Calif.

**AMATEUR** Cartoonists: Sell your cartoons. New market. Smith's Service, PN-1191, Wenatchee, Wash.

**ASTRONOMICAL** Mirror. Reasonable price. H. Lynn Bloxom, Fort Dodge, Iowa.

**HORNED** Frogs from Texas, mysterious, harmless, \$1.00 each delivered; send \$1.00 now. W. T. Renfro, Hillsboro, Tex.

**TENT** Poles at the price of fire wood, just the thing for making your wood products, also can be used for fences and hundreds of other uses. Made to meet government specifications. Four ft., 1 1/4" diameter, \$4.00 per C; 6 ft., 1 1/4" diameter, \$5.00 per C. Cash with order. General Distributing Company, Duluth, Minn.

**BLUEPRINTS**—Make your own. Complete instructions and materials 50c. Standard Blueprint Service, 2167 Vestal Ave., Los Angeles, Calif.

**FIVE** Rabbit skins tanned, soft, fluffy, beautiful, mothproof. Only one dollar. Five weasel, five muskrat, three skunk, mink, coon or opossum, one dollar; three wildcat, coyotes or foxes, two dollars. Heist's Fur Dressers, Tanners, 1793 Mission, San Francisco, Calif.

**TIME** Counts in applying for patents. See pages 154 and 155. Clarence A. O'Brien, Registered Patent Attorney, Washington, D. C.

**I** CATCH from 45 to 60 foxes in from 4 to 5 weeks' time. Can teach any reader of this magazine how to get them. Write for particulars. W. A. Hadley, Stanstead, Que.

**MODELING** Clay, 5 pound sample postpaid, \$1.00. The Artclay Co., Box 293, Scranton, Iowa.

**AN** Investment in good appearance, a custom tailored blue serge suit. Send for sample, etc. Wilson Tailors, 2405 Wilson Ave., Chicago, Ill.

**TATTOOING**—Learn how with my outfits. Descriptive circulars sent anywhere. Sergt. Bonzey, 367 South Main, Providence, R. I.

**WEEDS**—Cut them with cutter bar on Shaw Garden Tractor. Also plows, cultivates and runs belt machinery. Low prices. Immediate delivery. Shaw Manufacturing Company, Dept. C, Galesburg, Kans.

**CUTS** Anybody can make. Simple, cheap process, \$1. Specimens, particulars. 2c stamp. M. Day, Windfall, Ind.

**ARTISTS** And art students are printing 250 signs or pictures an hour without machinery. Sample and particulars 10c. Straco, 1013 Mulberry, Springfield, Ohio.

**TATTOOING** Outfits, supplies. Illustrated list free. "Waters," 965 Puttnam, Detroit.

**HOMEOPATHIC** And Biochemic preparations sent postpaid to all parts of the world. Manual and booklet free. Halsey Bros. Co., 5547 Ravenswood Ave., Chicago, Ill. Established 1855.

**EMBOSS** Your stationery with hand embosser. Circular free. Midwest, Box 47, Springfield, Ill.

**MEXICAN** Made holsters, lariats, horsehair articles; rattlesnake belts. Send four cents for illustrated list. Tex-Mex Leather Co., 309 Esperson Bldg., Houston, Tex.

**TELL** An army of 3,000,000 live readers all about your offer! If you have anything to sell, buy or exchange, or if you have any reasonable proposition, tell our readers all about it—they'll respond quickly. Our booklet "How to Create More Business" contains some very interesting, helpful facts. Write today for your copy—it's free. M. L. Rund, Manager Classified Advertising, Popular Mechanics Magazine, 200 E. Ontario St., Chicago, Ill.



# If YOU Were Down and Out



**A**ND I agreed to start you in a big, new, money-making business of your own—WITHOUT CAPITAL OR EXPERIENCE—a business in which I have helped other ambitious men and women double, triple and QUADRUPLE their earnings, would you jump at it? You BET YOU WOULD!

Well, you may not be down and out. But if you are earning A CENT LESS than \$100 a week—\$5,000 a year—here is your chance to break into real estate MY WAY—build a big profit business of your own—right at home—in your spare time—without capital or experience. My free book tells the whole story. Get it now!

## From Failure to Success

I like to get hold of the down-hearted—the discouraged—the “has-beens” and the “also-rans.” It gives me a big “kick”—a real thrill—every time I help a man or woman who felt they were failures. It’s easy enough to make successful men more successful. But give me the man who is struggling along—trying to make both ends meet—who has never had a real “look-in” on business success. The most fun I get out of life is turning such men into happy, contented, prosperous, independent business men. And I’m doing it right along! There’s E. G. Baum, past 50, lost his job as book-keeper, sick, discouraged, down-hearted. I got Baum started and he cleaned up \$8,000.00 his first year. And J. M. Patterson. He’d just landed in Texas with a baby, a sick wife and only \$10.20 in his pocket. He started to use my Successful Real Estate System, and writes me he will clean up \$20,000.00 in profits this year. Send for my free book. Learn how I am helping others—and how I can help you—win big business success.

## New Lives for Old

I teach ambitious men and women my way of making big money in the Real Estate Business, without capital or previous experience. I give them new lives for old. I transform them from low-salaried employees to successful employers—in business for themselves—independent—prosperous—contented—men and women from 21 to 79—from all walks of life—former mill-hands, clerks, railroad men, barbers, hotel employees, grocers, salesmen, bookkeepers, teachers, ministers, printers, musicians, insurance solicitors, etc., etc. Take “Bill” Dakin for example. He worked for fifty years in Buffalo, N. Y., steel plant. Never had any schooling to speak of. Never had any real estate experience. Bill jumped at my offer. Writes me that last month he earned \$1,125.00 my way. Write for a free copy of my book today. Learn how wide-awake men and women are changing their jobs—trading old lives for new—with my System for Becoming a Real Estate Specialist. Address President, American Business Builders, Inc., Dept. C-44, 18 East 18 St., New York.

## Amazing Profits

### \$17,000 IN ONE DEAL

Eugene Walrath, formerly in the clothing business. Got my scientific System for making money in real estate. Cleaned up \$17,000 in one deal. Free book tells how he did it.

### \$5,500 IN 1 WEEK

Evalynn Balster, Chicago widow, school teacher, three children to support, got my System, made \$5,500 in one week on her first real estate deal. Free book tells how!

### \$8,500 IN 17 WEEKS

That’s the big money Chas. F. Worthen, Fall River, Mass., made with my successful Real Estate System. Free book tells you how I helped him to do it!

### \$14,400 IN 6 MONTHS

That’s the fat profit H. G. Stewart, Baltimore, Md., made with my remarkable System for making big money in real estate. Stewart is a live wire. Are You? Get my free book and find out!

### \$248 FIRST PROFIT

That’s the first pin-money Mrs. J. H. Hastings, Jackson, Mich., made with my System for Becoming a Real Estate Specialist. She has a fine business lined up. Free book tells how!

### 200% MORE MONEY

Alfred J. Bennett, Ford Salesman, was earning \$300 a month. Got my Real Estate System. Increased income 200%. Has well equipped office. Just bought new Chrysler Sedan. Free Book tells how!

## \$1,000 Reward

Here’s the proof that this is the biggest money-making opportunity of all: **ONE THOUSAND DOLLARS IN GOLD** will be paid to anyone who shows us any other business course of any kind that has helped as many men and women make as much money in as short a time as our remarkably successful Real Estate Course.

American Business Builders, Inc.

## FREE “How To Become A Real Estate Specialist”



Pres. American Business Builders, Inc. (Authorized Capital, \$500,000.00)

Dept. C-44, 18 East 18 St., New York

Send me—without cost or obligation—your free illustrated book “How to Become a Real Estate Specialist.”

Name.....  
(Please print or write plainly)

Address.....

City.....State.....



# See the World FREE!



## Taste Romance and Adventure In the Far Lands of the Earth.

How often you've longed to see for yourself the awe of Egypt's pyramids—the beauties of the gorgeous Mediterranean sunset—the squalor of China's ancient cities!

Spend a few years, or the rest of your life, tasting high adventure on the seven seas and in all the world's great ports—roving the earth's highways and byways! You can do it FREE—all your expenses paid—and earn a good salary besides!

Only one profession will carry you around the world at will, travelling like a gentleman, but that's the most interesting and pleasant work there is—Radio Operating! Easily and quickly learned, there's no other profession like it for the man who wants the experiences and pleasures of world-travel. Radio operators are needed—all sea-going ships like the one shown here must carry from one to half a dozen or more.



## Take a Look Beyond the Skyline Without a Penny's Expense

Radio operators aboard ocean liners live luxuriously—they rank as officers of the ship. Meals, a private cabin, all other living needs are furnished free, and besides the operator draws a good salary. You can learn quickly and easily at home in your spare time to be a Radio operator through our practical training methods. Take a look at the FREE BOOK which tells how—mail coupon below.

This U. S. Government-recognized school has been training successful operators since 1914. Our graduates are all over the world. We maintain an Employment Department to help put you on your own ship. The famous NACOMETER, a patented home code teacher, given our students, is recognized as the best and easiest way to learn the Radio code at home. A few short months, with the aid of the famous Nacometer and our quick home training, and you too can be a fully qualified Radio operator, sitting in your cabin like the one shown above, bound out for Liverpool or Nagasaki!

Read the Free Book that tells all about this fascinating profession and our practical Government-recognized methods of training you for it. Send coupon TODAY—no obligation. Special tuition offer now on, includes the Nacometer, famous code teaching machine. Find out what Radio offers you. Act at once. Mail the Coupon.

**NATIONAL RADIO INSTITUTE**  
Dept. 9PPP  
WASHINGTON, D. C.

### SPECIAL OFFER COUPON

National Radio Institute,  
Dept. 9PPP, Washington, D. C.

Gentlemen: Without obligating me in any way send me your free book and information about your Nacometer, the Home Code teaching machine given with your course.

Name.....

Address.....

Occupation.....



"Be the Life of the Party"

## Play a Tune in 10 Minutes

Anyone can play the Ukulele, Tenor Banjo, Guitar, Banjo Uke or Mandolin with an amazing new invention. NO knowledge of music required. Play tunes from the start by numbers instead of notes, or by notes if you wish. Simple as 1-2-3, "just press the keys and play."

Astonish your friends by playing latest "hits" and old favorites. NO more costly lessons! NO weeks of tiresome practice! So simple a child can use it. Over 50,000 delighted Users—young and old, men and women now playing.

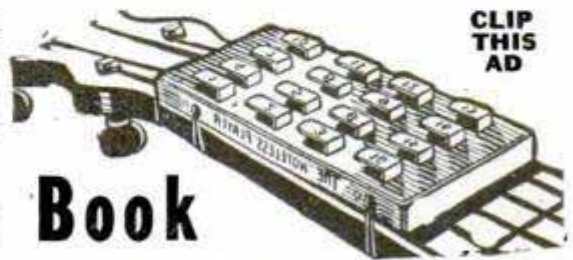

CLIP THIS AD

## Free Book

Send for free book telling the amazing story of this marvelous device. Contains letters from hundreds now playing who could never play before. E-Z Player can be attached to your own instrument in a jiffy. Or we'll send you choice of instruments with Player attached on easy payment terms. Satisfaction guaranteed. "No play, no pay!" Have more fun, popularity, money-making chances, more friends—send today for free book. No obligation.

**FERRY & CO., Manufacturers**

1750 N. Robey St. Dept. 1773 Chicago, U. S. A.

Information on any book free. Write Popular Mechanics Press, Chicago, Ill.

# BIG Demand for Skilled Mechanics!

The entire country is calling for skilled mechanics! Good pay—steady work—good opportunities for advancement! Master this fascinating trade with the aid of the

## AMERICAN MACHINISTS' LIBRARY

6 volumes—2,000 pages—2,500 illustrations

(A combined home-study course and reference library)

This library of machine shop practice was written for practical men. It gives you the best methods for every kind of machine shop work. It explains machine tools and their operation, tool work, gears and grinding, jigs and fixtures, automatic screw machines, their tools, punches, dies, etc. Plainly written—completely illustrated—the best kind of help to the machine-shop man who wants to advance himself

Free TRIAL

No money down—only 7c a day

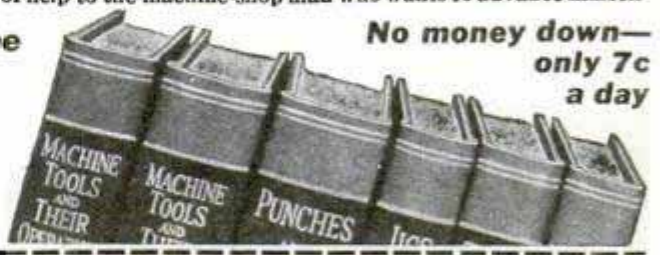

### FREE EXAMINATION COUPON

McGraw-Hill Book Co., Inc., 370 Seventh Ave., New York

Send me for 10 days' free examination the AMERICAN MACHINISTS' LIBRARY. If satisfactory, I will send \$1.50 in 10 days and \$2 monthly until the special price of \$17.50 is paid. If not wanted, I will return the books at your expense.

Signed.....

Address.....

City and State.....

Position.....

Company.....



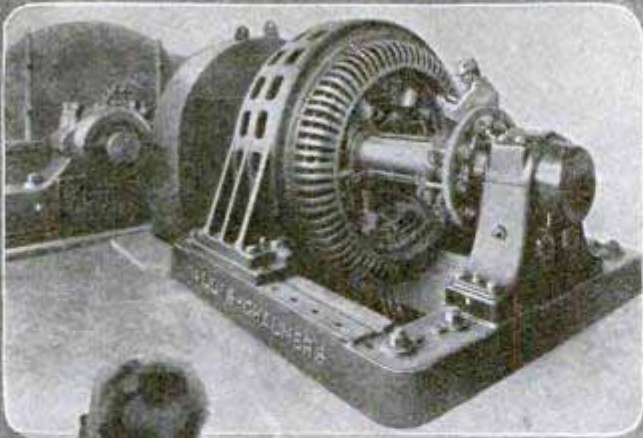

# Big Pay Jobs

for You in

# ELECTRICITY

*You Learn by Seeing it Work*

**N**OW you can fit yourself for a big pay job in electricity by watching real motion pictures in your own home! Easy and fascinating as seeing a show at the theater! You see electrical machinery *in operation*. Moving diagrams make all the facts easy to understand.

*This New Way is Easier, Quicker, Surer*

At home, in spare time, you can fit yourself to make more money in electricity. This giant industry is constantly calling for men to fill jobs

paying from \$70 to \$200 and more weekly! Practical electrical men, holding down big jobs, praise this new way, *as the easiest and best way to learn how to do electrical work.*

### You Get this DeVry \$75 Projector

Every student is given a standard school model DeVry Motion Picture projector to keep, at no extra cost. Thousands of feet of motion picture film are supplied for use during the course. You show them on the wall or on a screen in your home. *Projector is so simple anyone can operate it without experience.* Used with regular light socket, farm lighting equipment, or automobile battery. Think of it, you own a projector for showing all kinds of movies right in your own home!

### You Get This Pledge in Writing

We promise in writing to give you the training and employment service necessary to get you a better job and more money *or you need not pay a cent.*

**FREE** Our Big New Book, "The Film-Way to Bigger Pay"

Tells all about how we use moving pictures to train you for bigger pay. Get your copy now. No obligation. Send the coupon TODAY!

Mail This Coupon

**THE NATIONAL SCHOOL of VISUAL EDUCATION**  
 (The Film Way to Bigger Pay)  
 537 S. Dearborn Street, Chicago, U. S. A. Dept. 3H  
 Send your book "The Film Way to Bigger Pay" and full facts about this new, easier way to master electricity.

### What a Practicing Engineer Says:

"I am amazed at how clearly and simply you explain the facts about electricity. The points are so much easier to grasp than by the usual instruction methods that the student must make quicker, surer progress. This is by far the best method of getting thorough preparation for practical electrical work." Charles E. Fitz, M. E., E. E., formerly associated with Steinmetz.

### Film-Way Trained Men in Demand

"We will gladly co-operate with you, not only in employing your students when vacancies occur in our organization but also by recommending that our employees take your course."  
 Electric Material Co., South Bend, Ind.

Representatives with School Experience Write



**TAKE THE FILM WAY TO Bigger Pay**



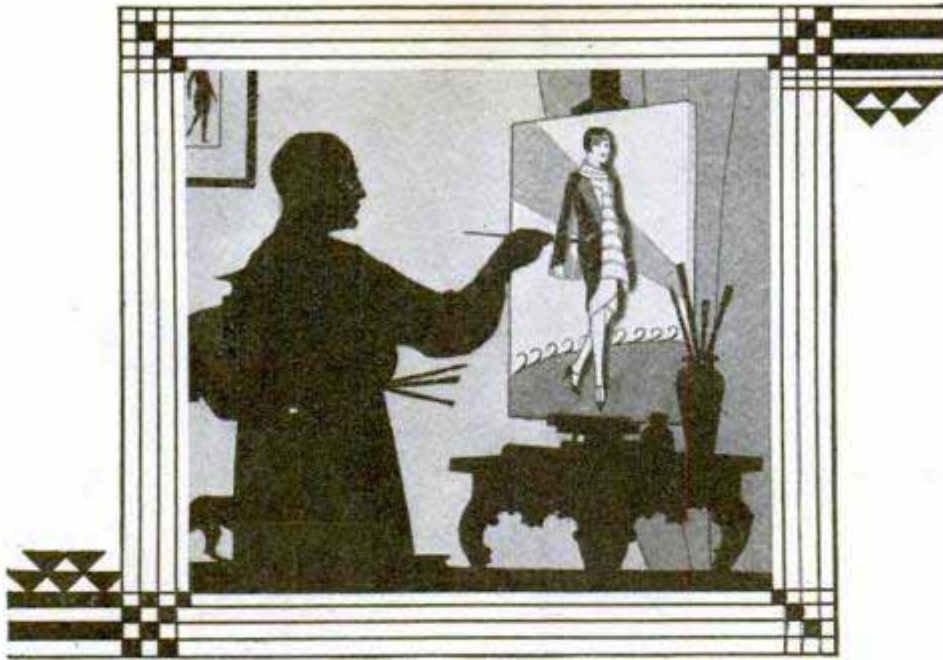

## ARTISTS EARN MORE

**W**HILE you are dreaming of making money . . . enjoying life . . . why not train your talent for drawing? A fortune may be at your finger tips if you train them now. Many people do not realize they have artistic ability. Through art, you may find the way to a famous name and a large income.

Artists are paid more today than ever before. Since the war, rates for art work have increased tremendously. Advertisers and publishers are paying millions of dollars annually to those who are trained in Modern Art.

Think of the money paid to artists for the illustrations in this magazine alone. Hundreds of successful students of the Federal School of Illustrating are now making from \$2500 to \$6000 a year and some are making even larger incomes.

More than fifty famous artists . . . earning big money themselves . . . have contributed

their drawing secrets to the Federal Course. Clare Briggs, Neysa McMein, Sid Smith, Norman Rockwell and many others know the way to make money through art. The Federal Course teaches you their methods of Illustrating, Cartooning, Lettering, Poster Designing, Window Card Illustrating, etc. Through this course you can learn at home during your spare time.

### TEST YOUR TALENT FREE

Why be content with a small income at routine work when art training offers such possibilities? Write your name, age and address on the coupon and get the Free Book, "A Road To Bigger Things" illustrated below. It gives details about how famous artists of today started their careers and shows examples of our students drawings. With it, you will receive our Free Vocational Art Test. Clip and sign this coupon now. It may be the beginning of an art career which will enable you to clip bond coupons and sign big checks later.

# FEDERAL SCHOOL OF ILLUSTRATING

3139 Federal Schools Building



Minneapolis, Minnesota



Federal School of Illustrating,  
3139 Federal Schools Building,  
Minneapolis, Minnesota.

Please send me free book "A Road to Bigger Things" and Standard Art Test.

Name \_\_\_\_\_ Age \_\_\_\_\_ Occupation \_\_\_\_\_  
Address \_\_\_\_\_



# This New, Easy Blue Print Way Prepares You for These 9 Big Pay Jobs!

1 Building Superintendent \$5,000 to \$12,000

2 Building Inspector \$4,800 to \$8,000

3 Appraiser \$6,000 to \$10,000

4 Material Buyer \$5,000 to \$7,500

5 Material Salesmen \$5,000 to \$12,000

6 Building Estimator \$6,000 to \$10,000

7 Real Estate Expert \$5,500 to \$12,000

8 Construction Foreman \$4,500 to \$8,500

9 Contractor and Builder in Own Business \$5,000 to \$12,000

**Make**  
**\$4,800 To \$12,000 A Year!**

**H**AVE you ever stopped to consider what stands between you and a big-pay job? Simply a lack of training on the "Headwork" side of Building and Contracting—that's all! The men who command the high-salaried positions know how to read blue prints—how to lay out and run jobs.

There is no reason why you, too, can't bridge this narrow gap between you and the jobs that pay up to \$12,000 a year. You need only to equip yourself with this essential knowledge to win a better position or a business of your own. With the Building Trades calling frantically for practical men who can read blue prints—with this training so easily available to you the Chicago Tech "Blue Print Way"—the opportunity is yours to take NOW!

## Get This Big-Pay Training

The day when a tradesman could get practical "headwork" training only on the job is gone forever. The records of thousands of Chicago Tech graduates have proved that the idea is no longer true. That it's easy to learn how to read blue prints by the Builders' Course, the "Blue Print Way To Big Pay." This practical method is quick, easy and it's certain. You learn right at home in your spare time with real blue prints and les-

sons as simple and easy to understand as a story book. Everything is explained in every day language and worked out by practical, experienced building experts. No text books. No grinding study. Simple as A. B. C.

## Mastered In A Few Weeks

And the beauty of this wonderful course is that it teaches you plan reading in amazing short time. Yet this valuable knowledge is just what you need to equip yourself for one of the big indoor or outdoor jobs that yield \$4,800 to \$12,000 annually!

Take this positive, easy way to make your ambitions materialize. Simply mail the coupon at once. It brings a complete set of actual working blue prints and a valuable, instructive book, "How to Read Blue Prints" free, *absolutely* FREE! Get these true facts before you as soon as possible. See what fun it will be to learn the fascinating "Blue Print Way." Know what wonderful opportunities await you in the seven billion dollar building field! Don't delay!

## If You Live Nearby

Visit our big day or evening school attended by over 1,000 builders. You get this training at home by mail—same plans, lessons and instructions.

# FREE

## BLUE PRINTS AND BOOK!

We will send you absolutely FREE a full set of practical working Blue Prints, also valuable book, "How to Read Blue Prints." We want you to see for yourself how easily and quickly you can now master blue print plan reading—the "Blue Print Way." Mail the coupon NOW—don't delay!



Chicago Technical School for Builders, Dept. C-142, Chicago Tech Bldg., 118 E. 26th St., Chicago, Ill.

Please send your Free Books and Blue Prints which I understand are mine to keep without obligation. It is also understood that no salesman will call on me.

Name.....  
Address.....  
City..... State.....

**Chicago Technical**  
**SCHOOL for BUILDERS**

Dept. C-142, 118 E. 26th St., Chicago, Ill.





# Learn Electricity IN LOS ANGELES

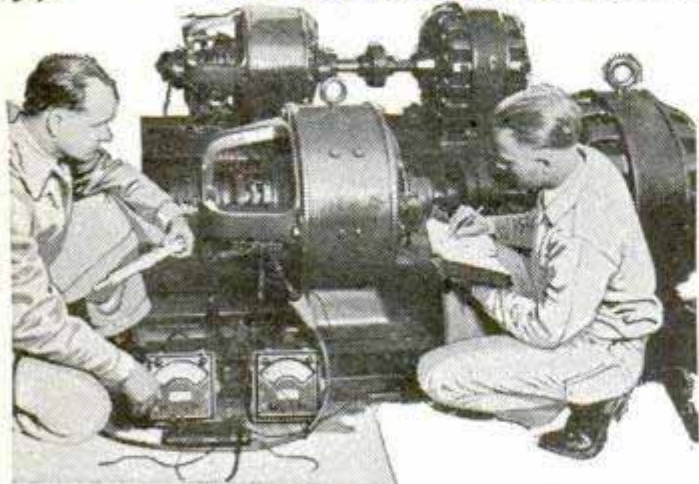

## FREE Employment Service!

### Plenty of Good Electrical Jobs Open Now

There are more calls for "National-Trained-Electrical-Men" than we can supply. Jobs are open now paying \$50 to \$200 a week—but you must first get the right training. Get it at National—a world-famous institution with a quarter century record of success in training big pay men. Learn in Los Angeles. The center of Electrical activity. Special tuition rates now. Earn Room and Board while learning.

#### All These Advantages:

1. Unlimited Training Until Competent.
2. Free Employment and Welfare Service.
3. Million Dollar Training Shops.
4. Personal, Individual Training Guaranteed.
5. You actually perform work that employers pay big money for.

6. Official Diploma and certified record of work performed.

## FREE

### New Illustrated Catalog.

Read how National insures your success. Send for this free Electrical catalog—illustrated by actual photos of students training under instructors on a half million dollars' worth of new electrical equipment. Mail coupon now. Book will be sent FREE—Postpaid.

## Electricity- YOUR Opportunity!

This Big, Free  
Book Shows You  
How to Quickly  
Make BIG PAY



# National Electrical School

Dept. 528, 4006 Figueroa St.,  
Los Angeles, California.

Send me your big free illustrated catalog of Electrical Opportunities showing how I can learn quickly and get a Big-Pay Electrical Job.

Name.....  
Address.....  
Age..... City..... State.....

## AMAZING BURNER

Use  
Ordinary Kerosene

The most startling heat producing burner ever made. Indispensable on the farm, in factory, for boiling, cooking, and heating. Ideal for butchers, dairies, repair shops, stoves, boilers, ovens, cooking equipment and numerous other uses. Will boil any quantity desired in half the usual time.

BOILS  
50  
GALLONS  
IN LESS  
THAN  
HOUR

## TERRIFIC HEAT!

SILENT BLUE FLAME  
NO NOISE  
SMELL  
SMOKE  
SOOT



Think of it! Improved oil burner produces twice the heat of city gas at half the cost. Regulate to any degree desired. So simple. Easily installed and operated. Double generator assures continuous operation without shut-downs. Nothing to wear out. Starts in a jiffy. Will last a lifetime. Every burner guaranteed fully to give complete satisfaction.

"I would not take \$500 for it if I could not get another," writes J. H. Cox, Mich. "It is worth its weight in gold and is the best on the market," J. B. Ashcraft, O. "Produces terrific heat and saves lots of kerosene," H. C. Kistler, Pa.

Also Burners for Cook Stoves and Heaters  
Let us send you our catalog of Improved Therm-O-Gas Burners.  
HOME MFG. CO., Dept. 2913, 20 E. Kinzie St., Chicago



## FREE!

The rare, valuable secret book which has astounded the world. Reveals the secrets of hypnotism, telepathy, personal magnetism, mesmerism, clairvoyance, mind reading, etc. This book—called the wonder of the 20th Century—worth \$3 but sent Free to you if you order our remarkable course in Practical Hypnotism—teaches you how to control others—make everybody obey your every wish and desire—conquer bad habits, enemies, win success in life and Love, obtain power, wealth, social position. Explains the greatest force in the history of man. The most perfect, complete and easily learned system. Pay only \$2.45 on arrival, including the "Hypnotic Eye," greatest aid to beginners.

EDUCATOR PRESS, 19 Park Row, NEW YORK Dept. H-24

# 10 Inches Off Waistline In 35 Days

"I reduced from 48 inches to 38 inches in 35 days," says R. E. Johnson, of Akron, O., "just by wearing a Director Belt. Stomach now firm, doesn't sag and I feel fine."

The Director Belt gets at the cause of fat and quickly removes it by its gentle, kneading, massaging action on the abdomen, which causes the fat to be dissolved and absorbed. Thousands have proved it and doctors recommend it as the natural way to reduce. Stop drugs, exercises and dieting. Try this easy way.

## Sent on Trial

Let us prove our claims. We'll send a Director for trial. If you don't get results you owe nothing. You don't risk a penny. Write for trial offer, doctors' endorsements and letters from users. Mail the coupon NOW!

**LONDON & WARNER**  
332 S. La Salle St., Chicago, Ill.

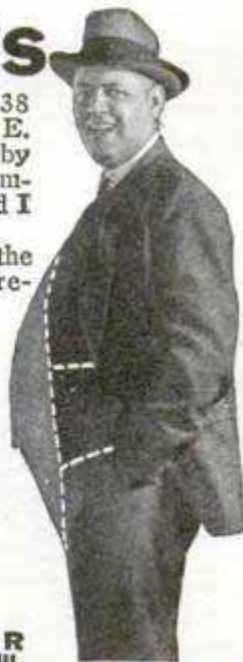

Landon & Warner, Dept. M-3, 332 S. La Salle, Chicago

Gentlemen: Without cost or obligation on my part please send me details of your trial offer.

Name.....

Address.....



# AN OPEN LETTER to Ambitious Young Men

T. BRALEY, Chief Ground School  
O. P. HARRAN, Operation Manager  
JOHN FLOURNOY, Chief Flying Instructor

TED BRALEY, President  
J. E. AKERS, Business Mgr.

FOREST LEATHERS, Field Manager  
F. W. HARMON, Chief Mechanic  
WARD BRALEY, Chief Drafting Engineer

## BRALEY SCHOOL OF FLYING



TELEPHONE MARKET 1479  
DOWN TOWN OFFICE  
331 YORK BITE TEMPLE

FLYING FIELD  
MUNICIPAL AIRPORT  
TELEPHONE 84972

U. R. Ambitious,  
Home City, U.S.A.  
My Dear Sir:

Do you know why Wichita is called "The Air Capital"? There's a reason. It is because here are seven aircraft factories humming with industry, manufacturing 25% of all the air-planes used in America today.

Do you know why the Braley School of Flying is the outstanding institution of its kind in the great Southwest? There's a reason for this, too. It is because we are pioneers in aviation, and are the first Flying School in the world to help build and establish Wichita as "The Air Capital."

Do you know that in Wichita we have ideal flying weather the year 'round? Do you know we teach you to fly in new ships, safe and speedy? Do you know that we teach you to design, build and repair all makes of Aircrafts?

Send me the Coupon and we will promptly give you information and full details of training and terms.

Yours truly,  
*Ted Braley*  
President.

The BRALEY SCHOOL OF FLYING, Inc.  
P.S. Do you know that over 20000 pilots will be needed in the next 24 months.

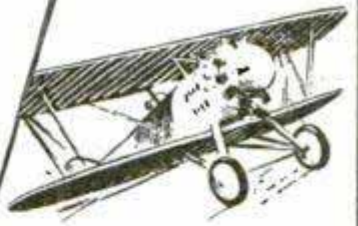

**Ted Braley**  
Aviation authority; Pilot, Instructor, President and Owner of The Braley School of Flying; Associate of Walter Beech, E. M. Laird, Clyde Cessna, in making Wichita the "Air Capital."

Clip this Coupon  
**TODAY**

The Braley School of Flying,  
Temple Bldg., Wichita, Kansas.  
Please send me full information about how I can earn my living expenses while learning to fly at your school.  
Name \_\_\_\_\_  
Address \_\_\_\_\_  
City or Town \_\_\_\_\_ State \_\_\_\_\_



# Become a Trained RADIOTRICIAN



## RADIO INDUSTRY PLEADS for "Registered" Radio Experts



**MICHAEL ERT,**  
Pres. Michael Ert,  
Inc., and Pres.  
Wis. Radio Trade  
Assoc. and First  
V. Pres. Federated  
Radio Trade Assoc.

Opportunity beckons as never before in the Radio Industry. Good-paying positions, interesting work, a chance to become independent—radio offers all this and more to ambitious men who seize the opportunity NOW! Last year the radio industry took all our graduates and clamored for more. Thousands of trained men are needed for Radio Service, Radio Engineering, Radio Broadcasting, Television, Station-operation, and Radio Merchandising. And still radio is in its infancy. Great expansion is ahead. Get in this wonderful fast-growing field NOW!

### Radio Trades Association Approve S. of E. Radio Graduates

The Wisconsin Radio Trades Ass'n now compels every radio service man to pass severe examinations, and become registered. Dealers are tired of expensive incompetent help. Radio trade associations the country over are planning to follow Wisconsin's example. **The School of Engineering is the only institution in the country whose course is approved by a radio trade association.** Graduates of the S. of E. are "registered" without examination.

### Most Thorough Practical Radio Course in America

Here in this big splendidly equipped electrical school (from which Station WISN is operated) you can secure in three months the most thorough, the most compact and practical radio training offered anywhere. Covers entire field of radio! Complete Course includes Radio Laboratory Practice, Radio Telephony Theory, Radio Transmission, Code Instruction, Electrical Mathematics, Service and Installation, Radio Sales & Merchandising. Daily broadcasting from WISN. All training is 100% PRACTICAL. You learn everything in three short months!



### TELEVISION INCLUDED

Complete Radio Course also includes study of fundamentals of Television and latest developments in that gigantic new field. Enables anyone to keep up with progress of this new industry.

### EARN WHILE YOU LEARN

Not only do we help place our men after graduation, but we can arrange for part-time employment that will cover part if not all of your living expenses while you are taking the Radio Course at the School of Engineering.

### Send for FREE BOOK

Send today, without obligation, for FREE catalog describing the wonderful opportunities in radio, the three month Radio Course, and details of our Earn While You Learn Plan.

## SCHOOL of ENGINEERING of Milwaukee

Founded 1905 PM 329A Milwaukee, Wis.

School of Engineering of Milwaukee,  
Dept. PM 329A.  
Without obligation, please send me FREE Book describing your 3-months "Radiotrician" course and full details of your "Earn While You Learn Plan."

Name.....Age.....  
Address.....  
City.....State.....

## Recharge Your Dry "B" Batteries

With Amazing New Invention



Recharges RUN-DOWN OR WEAK "B" Batteries (dry) overnight. Makes them last three times as long. Uses less current than 25-watt lamp. For DC or AC any cycle. Don't throw away your "B" batteries—invest \$1.00 in this guaranteed charger, renew their life and save money. No extras to buy.

### No Harmful Acids—No Tubes to Burn Out

Only  
**\$1.00**  
Complete

Send \$1.00 currency, stamps, check or money order, plus 10c to cover mailing cost. Charger will be sent postpaid. If not satisfied, return within 5 days and your money will be refunded.

Order today—NOW! You can't lose—we guarantee you satisfaction or money back.

### ROLL-O RADIO COMPANY

Dept. M-23, 3rd and Sycamore Sts., Cincinnati, Ohio

## FREE BOOK ON MIND TRAINING

An instructive book which explains an amazing system of mind training already used by more than 650,000 people.

Let us send you a free copy of "Scientific Mind Training". It will show you how and why Pelmanism is the only system of teaching for developing all the mental powers at the same time. Endorsed by such distinguished men as Judge Ben B. Lindsey, Sir Harry Lauder, Jerome K. Jerome, Prince Charles of Sweden and hundreds of others. Write TODAY to

### THE PELMAN INSTITUTE OF AMERICA

71 WEST 45th STREET DEPT. 63 N. Y. C.

## SHOWCARD CARTOONIST

A New Book just chock full of ideas, better methods, short cuts,—shows you how to make cartoons and comics that give show cards and posters a real selling punch. You'll use it.—write now for Show Card Cartoonist, \$1.25 postpaid. Another good one—"Their Best Stunts," by 25 successful chalk talkers, \$1.25 postpaid. Two new catalogs: A—Art Supplies, S—Show Card Supplies.



**BART SUPPLIES, 516 EUSTIS BLDG., MINNEAPOLIS, MINN.**

## LAW HIGH-GRADE INSTRUCTION BY CORRESPONDENCE

College, Post Grad. and Bar Ex. Rev. Courses. Law has attracted more keen, brainy men than any other calling. Send today for catalog. Low cost, easy terms. Standard texts, Degrees.

**Chicago School of Law Dept. 801, Reaper Block Chicago, Ill.**

## MAKE MONEY AT HOME!

Painting photos and miniatures. No talent required. Fascinating work. **Make \$35-\$100 a week.** Earn while learning. We teach you at home. Professional artist's outfit, employment service, given. Write for FREE book TODAY. **NATIONAL ART SCHOOL, 1008 N. Dearborn, Dept. 24-3, Chicago.**

## "AERONAUTICAL Executive Training in Addition to the Finest Flying Course in the Country."

Write for Free Catalog

**MARSHALL FLYING SCHOOL, Marshall, Missouri**

## PAINT SHOW CARDS

and SIGNS. LEARN AT HOME IN SPARE TIME. WE TEACH YOU QUICKLY FASCINATING WORK. \$75 WEEKLY. SEND 6c IN STAMPS FOR INTERESTING BOOK. **Universal School of Lettering WATERBURY, CONN.**

## Learn Art EARN MONEY

Our method of Oil painting Portraits, Landscapes, Miniatures, requires no experience. Painting Outfit and Employment service included. Write for booklet. **Pictorial Art Studios, Inc., Dept. M.P., 2926 Broadway, Chicago.**

## 2-YEARSTO ENGINEERING DEGREE!

Be a Civil, Electrical, Mechanical Administrative or Chemical ENGINEER in 96 weeks. No entrance examinations or high school diploma required. Low tuition expenses. Degrees conferred by State authority. Catalog FREE.

**TRI-STATE COLLEGE Box E-3113, Angola, Ind.**





**Cuts  
Shave  
Costs  
83%**

**365  
Keen Shaves  
A Year  
From The  
Same Blade**

**KRISS-KROSS  
Fits All Makes  
of Blades**



**AGENTS!**

Make excellent money with KRISS-KROSS. H. King made \$66 in one day. N. C. Paige made \$104 in 3 days! Others average \$350 and up to \$750 a month! Spare-time workers, Office and Factory men make up to \$6 and \$12 extra a day showing KRISS-KROSS to friends and fellow employees. Get details at once. Check bottom of coupon and mail it tonight!

**No More Razor Blades to Buy!**

**THINK** of it! 365 keen, cool shaves a year from the same blade! That's what the revolutionary invention of a St. Louis man is doing for American shavers everywhere!

KRISS-KROSS marks the beginning of a new era in shaving comfort and economy. Its performance is so sensational that it seems hardly fair to call it a stropper. Rather it is a super-stropper or blade-rejuvenator! Almost literally, it makes a new blade out of an old one every day. No longer do you find that your blades "die" after five or six shaves. KRISS-KROSS "brings 'em to life" a surprising way, week after week and month after month—and endows them with a keenness that they seldom possess when brand-new!

**Magic Diagonal Stroke**

KRISS-KROSS employs the famous diagonal stroke, same as a master barber uses. Never before has anyone captured the secret of reproducing it automatically. Eight "lucky leather grooves" do the trick in 11 seconds with a precision it takes a master barber years to attain.

But that's not all. KRISS-KROSS embodies still another feature that has hitherto baffled mechanical reproduction. It stropps from heavy to light. It's absolutely uncanny the way the strokes start with strong pressure and grow lighter and lighter until an adjustable, automatic jig files up and notifies you that your blade is ready—ready with the keenest cutting edge that steel can take!

**Fits All Blades**

KRISS-KROSS produces unbelievable sharpness and prolongs the life of any razor



**3-Way Razor Free**

Most astonishing razor you ever saw. Really 3 razors in one. Adjustable to any shaving position. Novel feature reduces beard resistance 45%.

blade for months and even years. Fits all brands and makes except Durham. Eliminates 83% of shaving costs and ends all bother about remembering to buy new blade! No more "raking" and scraping with dull ones, either! KRISS-KROSS solves your blade problem for all time and gives you keen, velvet-smooth shaves forever!

**Sensational Offer**

And now for my surprising offer. To introduce KRISS-KROSS to those who have not yet seen it, I am giving with it Free a new kind of razor. Possesses remarkable features. Instantly adjustable to any shaving position. A flip of the finger makes it (1) T-shape; (2) straight (old style); or (3) diagonal (new way). Gives a sliding instead of pulling stroke. Simply zips right through the toughest crop of whiskers and leaves your face satin-smooth and cool. Comes with 5 special-process blades and is entirely unlike anything you ever saw before! Send Coupon To-day!

Rhodes Mfg. Co., Dept. C-373,  
1418 Pendleton Ave., St. Louis, Mo.

Without obligation, please send me illustrated description and full details of your special introductory offer on KRISS-KROSS super-stropper and FREE 3-way razor.

Name.....  
Address.....  
City..... State.....

( ) Check here if interested in making money as authorized KRISS-KROSS representative.

**Rhodes KRISS KROSS**

Rhodes Mfg. Company, Dept. C-373  
1418 Pendleton Ave., ST. LOUIS, MISSOURI **STROPPER**

Canadian Address: CANADIAN KRISS-KROSS CO., 39 Wellington Street East, Toronto 2, Canada  
Largest Manufacturers of Mechanical Stoppers in the World



# Learn AVIATION

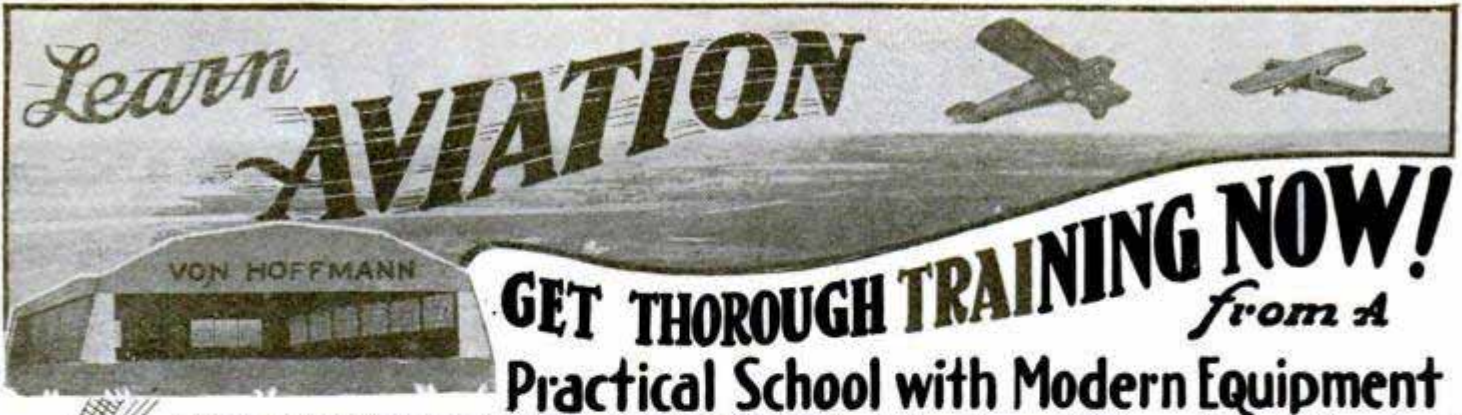

## GET THOROUGH TRAINING NOW!

From A Practical School with Modern Equipment

There is money for you in Aviation, if—you get thorough training NOW! Our courses will give you this training—they are taught under the direction of U. S. Licensed Transport Pilots and Mechanics and cover everything about planes, motors, their maintenance and construction. Everything a pilot or mechanic must know to secure a good paying position. Our equipment is new and of modern design, subject to daily U. S. Gov't Inspection.

**THOROUGH INSTRUCTION AT LOW COST**

We teach you by actual flying and practical instruction; no long course needed. We guarantee sufficient hours in the air to make each student master of his ship; pilot it safely and efficiently by himself. No student bond required. Our ground course gives thorough instruction in ground work and qualifies you for a position as motor and plane mechanic, rigger, electrician, welder or any other ground position, or you can take the course combining ground instruction and flying which will qualify you for an industrial, limited commercial or transport pilot. The cost is low considering daily flying and thoroughness of theoretical and ground instruction on latest modern type planes, Wright Whirlwind and other standard motors. Our big new book "AVIATION and YOU" tells all the facts.

Know The Facts!



Get This FREE BOOK

Fill out the coupon and mail it at once—no obligation DO IT NOW!

**Von Hoffmann Aircraft School**  
 115 Lambert-Saint Louis Flying Field  
 ANGLUM, MISSOURI

**Trained Men Are Needed**

The training which the Von Hoffmann student receives is the exact training which he must have to qualify for immediate positions on the ground or in the air. Our courses have been laid out with a single object in view—to give thorough training in all branches of aviation. Commercial aviation needs men and there is an ever increasing demand ONLY for those who have been properly trained—Von Hoffmann gives you this training. If you are interested in Aviation, you should know the necessary physical qualifications and what is required by the Government for a mechanics or pilots license. Our new book, "AVIATION and YOU," tells all. Learn these vital facts.

**VON HOFFMANN AIRCRAFT SCHOOL**  
 115 Lambert-Saint Louis Flying Field  
 (Lindbergh's Own Field), Anglum, Missouri

Send me your big, new book "AVIATION and YOU," giving all the facts about your ground and flying courses. I assume no obligation.

Check... I am interested in GROUND COURSE.  
 Here... I am interested in FLYING COURSES.

Name.....  
 Address..... Age.....  
 Town..... State.....

## Learn MECHANICAL DENTISTRY

**EARN UP TO \$5000 A YEAR**

WHY spend the best years of your life at uncertain jobs at small pay? You can EARN WHILE LEARNING this modern money making business and become your own boss. BIG DEMAND. You LEARN BY DOING PRACTICAL work. DAY AND NIGHT SCHOOL. INDIVIDUAL instruction. Easy terms. Railroad Fare Allowed—No Extra Cost. Address SECRETARY, N. Y. SCHOOL OF MECHANICAL DENTISTRY, 147 W. 33rd Street, NEW YORK, N. Y.

Write or Mail Coupon.

Name.....  
 Street.....  
 City..... State.....

SEND FOR FREE BOOK

YOUR SUCCESS

## OIL HEAT

in Your Stove or Range



So easy, so safe, so dependable. A LACO No. 2 Oil Burner will give unsurpassed service in heating-stoves, parlor-furnaces, cooking-stoves or ranges. No soot, smoke or odor. Will not clog. Manufactures its own gas from liquid fuel.

LACO Oil Burners are Low in Cost  
 The New LACO No. 2 Natural Draft Burner can be used wherever you have a good draft. Has the patented LACO indestructible mineral wick, and many other mechanical advantages. Thousands in use. LACO No. 2 sells for only \$18.00. Other sizes proportionately low. Order direct from ad or write for descriptive literature.

**DEALERS**  
 Be the leading oil burner dealer in your territory. Sell the complete LACO line. Write us today for full details.

LACO OIL BURNER CO., 117 Union Str., Griswold, Iowa

## Win Nash Sedan Or \$2,750.00 in Cash

Someone who answers this ad will receive, absolutely free, a fully equipped 7-Passenger, Advanced Six Nash Sedan, or its full value in cash (\$2,000.00). We are also giving away a Dodge Sedan, a Brunswick Phonograph and many other valuable prizes—besides Hundreds of Dollars in Cash. This offer is open to anyone living in the U. S. A. outside of Chicago.

**Solve This Puzzle**

There are 7 cars in the circle. By drawing 3 straight lines you can put each one in a space by itself. When you do this send me your answer right away and receive full particulars.

**\$750.00 Extra for Promptness**

In addition to the many valuable prizes and Hundreds of Dollars in Cash, we are also giving a Special Prize of \$750.00 in Cash for Promptness. First prize winner will receive \$2,750.00 in cash, or the Nash Sedan and \$750.00 in cash. In case of ties duplicate prizes will be awarded each one tying. Solve the puzzle right away and send me your answer together with your name and address plainly written. \$4,500.00 in prizes—EVERYBODY REWARDED.

John T. Adams, Mgr. Dept. 1773 323 S. Peoria St., Chicago, Ill.



Clip This Ad

Send Answer Today



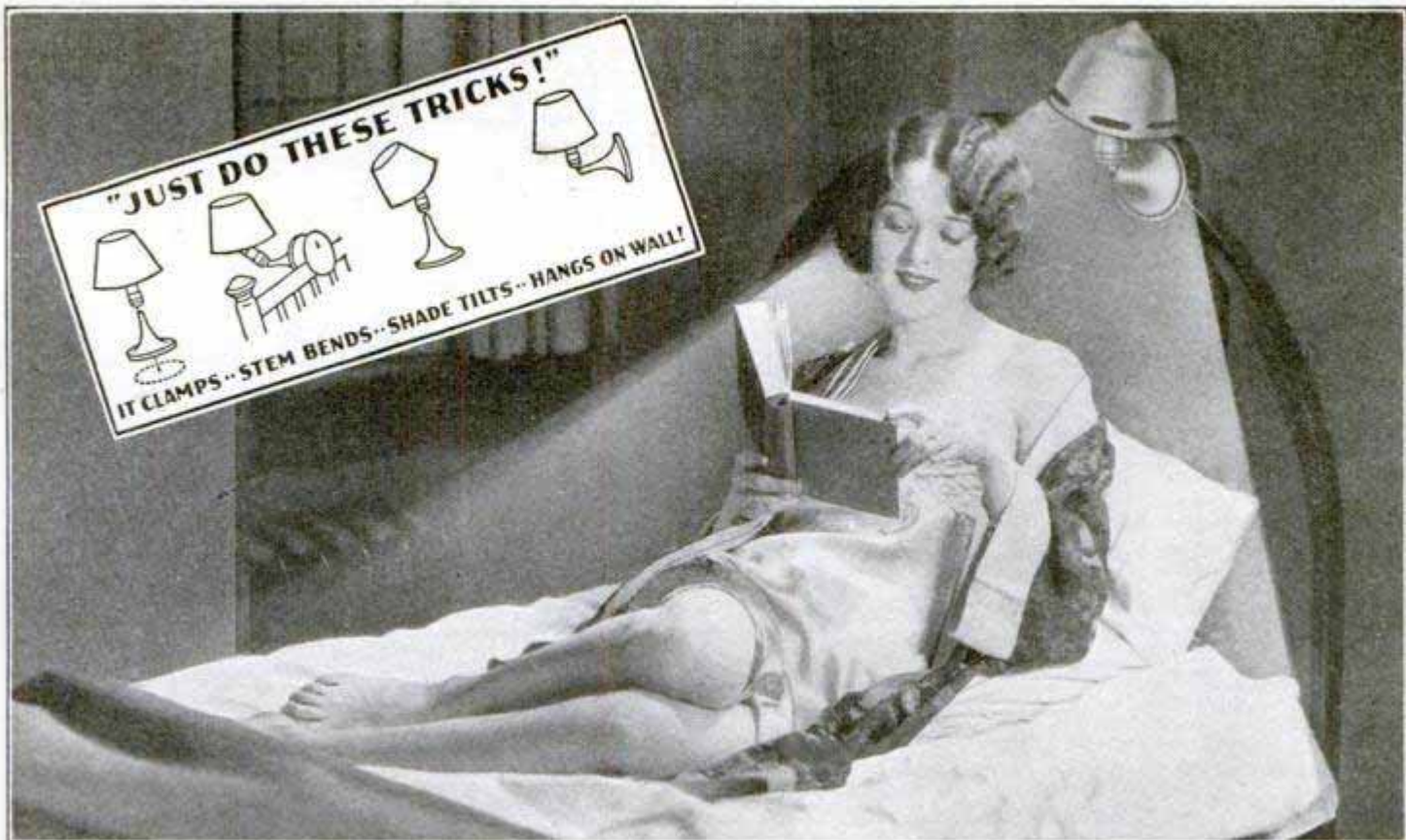

# 19 Lamps Combined in One Brings Sensational Profits to Agents!

"WHY didn't some one think of this long ago!" That's what hundreds of agents are hearing from women who see the amazing demonstration of this new kind of lamp. In one large office Adley made \$22! Miller, Penn., canvassed only eight homes and collected \$12.00. Zinn of Texas has sold half the people in his county. A woman, Mrs. St. Germain of New York, made \$82 in spare hours.

## Amazing 10-second Demonstration

And no wonder! For this astonishing lamp does everything but move itself. A flip of your finger unscrews the base and clamps it anywhere—on the bed, shaving mirror, work bench, the running board of a car. A gentle touch tilts the shade to throw full light when reading, sewing, searching in dark bedrooms, etc. Bend the stem and hang it on the wall. Or stand it up straight on an end table.

## Startling Low Prices

No wonder agents call it "the nineteen in one lamp." In every home there are at least nineteen places where a Falcon serves to better purpose than the old-fashioned stiff necked eye straining lamp. Then realize the utter

beauty of these lamps at the amazing low price. You offer six choices to suit every taste; the Parchmentex type or the ivory or bronze tinted metal lamp. Bases are rich ivory or statuary bronze. Size, 11 1/2 inches high. The most amazing combination of lamp beauty and utility ever offered at such a low price.

## New Direct Selling Plan

The Falcon money-making plan is one of the most simple, yet powerful, methods known in direct selling. Every angle of it has been worked out to bring agents' profits up to steady \$20 days. Veteran salesmen are delighted with the big commissions, "repeat" sales possibilities, territory arrangements, etc.

Mail coupon now for free descriptive catalog, beautifully illustrated in color. Read and compare the Falcon money-making plan, either full time or sideline, with any proposition in direct selling. Expect many pleasant surprises! Coupon brings you full details without obligation.

## FALCON MFG. CO.,

Dept. C-90, 2550 Sullivan Ave., St. Louis, Mo.



## An Electric Lamp

Above is shown the Falcon ivory-tinted metal lamp with leaf design embossed in color, and ivory metal base. Same available in statuary bronze metal. Size 11 1/2 inches high.

**\$22 in  
2 Hours!**

Falcon agents often sell 10 to 25 lamps in one demonstration. Adley, who made \$22 in 2 hours, collected all this money in one office, selling to stenographers who need such an adjustable lamp for typing.



Falcon Mfg. Co., Dept. C-90,  
2550 Sullivan Ave., St. Louis, Mo.

Without obligation, send me your color catalog of Falcon Lamps. Also complete details of your money-making plan for demonstrators.

Name.....

Address.....

City.....State.....





# "Mary, I Owe It All to You"

"MR. WILLIAMS called me into his office today and told me he was going to raise my salary \$50 a month.

"I am glad to give you this opportunity," he said, "for the best reason in the world. You deserve it.

"You may not know it, but I've been watching your work ever since the International Correspondence Schools wrote me that you had enrolled for a course of home study. Keep it up, young man, and you'll go far. I wish we had more men like you."

"And to think, Mary, I owe it all to you! I might still be drudging along in the same old job at the same old salary if you hadn't urged me to send in that I. C. S. coupon!"

How about you? Are you always going to work for a small salary? Are you going to waste your natural ability all your life? Or are you going to get ahead in a big way? It all depends on what you do with your spare time.

More than 180,000 men are getting ready for promotion right now in the I. C. S. way. Let us tell you what we are doing for them and what we can do for you.

**Mail the Coupon for Free Booklet**

## INTERNATIONAL CORRESPONDENCE SCHOOLS

"The Universal University"

Box 5605-F, Scranton, Penna.

Without cost or obligation, please send me a copy of your booklet, "Who Wins and Why," and full particulars about the course before which I have marked X in the list below:

### BUSINESS TRAINING COURSES

- |  |   |
|--|---|
| <input type="checkbox"/> Business Management                     | <input type="checkbox"/> Business Correspondence      |
| <input type="checkbox"/> Industrial Management                   | <input type="checkbox"/> Show Card and Sign Lettering |
| <input type="checkbox"/> Personnel Management                    | <input type="checkbox"/> Stenography and Typing       |
| <input type="checkbox"/> Traffic Management                      | <input type="checkbox"/> English                      |
| <input type="checkbox"/> Accounting and                          | <input type="checkbox"/> Civil Service                |
| C. P. A. Coaching  | <input type="checkbox"/> Railway Mail Clerk           |
| <input type="checkbox"/> Cost Accounting                         | <input type="checkbox"/> Mail Carrier                 |
| <input type="checkbox"/> Bookkeeping                             | <input type="checkbox"/> Common School Subjects       |
| <input type="checkbox"/> Secretarial Work                        | <input type="checkbox"/> High School Subjects         |
| <input type="checkbox"/> Spanish <input type="checkbox"/> French | <input type="checkbox"/> Cartooning                   |
| <input type="checkbox"/> Salesmanship                            | <input type="checkbox"/> Illustrating                 |
| <input type="checkbox"/> Advertising                             | <input type="checkbox"/> Lumber Dealer                |

### TECHNICAL AND INDUSTRIAL COURSES

- |  |   |
|--|---|
| <input type="checkbox"/> Architect               | <input type="checkbox"/> Automobile Work                                    |
| <input type="checkbox"/> Architectural Draftsman | <input type="checkbox"/> Airplane Engines                                   |
| <input type="checkbox"/> Building Foreman        | <input type="checkbox"/> Plumber and Steam Fitter                           |
| <input type="checkbox"/> Concrete Builder        | <input type="checkbox"/> Plumbing Inspector                                 |
| <input type="checkbox"/> Contractor and Builder  | <input type="checkbox"/> Foreman Plumber                                    |
| <input type="checkbox"/> Structural Draftsman    | <input type="checkbox"/> Heating and Ventilation                            |
| <input type="checkbox"/> Structural Engineer     | <input type="checkbox"/> Sheet-Metal Worker                                 |
| <input type="checkbox"/> Electrical Engineer     | <input type="checkbox"/> Steam Engineer                                     |
| <input type="checkbox"/> Electrical Contractor   | <input type="checkbox"/> Marine Engineer                                    |
| <input type="checkbox"/> Electric Wiring         | <input type="checkbox"/> Refrigeration Engineer                             |
| <input type="checkbox"/> Electric Lighting       | <input type="checkbox"/> R. R. Positions                                    |
| <input type="checkbox"/> Electric Car Running    | <input type="checkbox"/> Highway Engineer                                   |
| <input type="checkbox"/> Telegraph Engineer      | <input type="checkbox"/> Chemistry  |
| <input type="checkbox"/> Telephone Work          | <input type="checkbox"/> Pharmacy   |
| <input type="checkbox"/> Mechanical Engineer     | <input type="checkbox"/> Mining Engineer                                    |
| <input type="checkbox"/> Mechanical Draftsman    | <input type="checkbox"/> Navigation <input type="checkbox"/> Assayer        |
| <input type="checkbox"/> Machine Shop Practice   | <input type="checkbox"/> Iron and Steel Worker                              |
| <input type="checkbox"/> Toolmaker               | <input type="checkbox"/> Textile Overseer or Supt.                          |
| <input type="checkbox"/> Patternmaker            | <input type="checkbox"/> Cotton Manufacturing                               |
| <input type="checkbox"/> Civil Engineer          | <input type="checkbox"/> Woolen Manufacturing                               |
| <input type="checkbox"/> Surveying and Mapping   | <input type="checkbox"/> Agriculture <input type="checkbox"/> Fruit Growing |
| <input type="checkbox"/> Bridge Engineer         | <input type="checkbox"/> Poultry Farming                                    |
| <input type="checkbox"/> Gas Engine Operating    | <input type="checkbox"/> Mathematics <input type="checkbox"/> Radio         |

Name.....

Address.....

City..... State.....

If you reside in Canada, send this coupon to the International Correspondence Schools Canadian, Limited, Montreal, Canada

# Both only

# \$3<sup>95</sup>



A guaranteed 10-Cable CHEST PULL (the most powerful one ever manufactured), adjustable up to 200 lbs., that will quickly develop muscles of shoulders, arms, chest, abdomen and back—and a pair of patented HAND GRIPS for developing powerful grip and forearm—both for only \$3.95.

5-Cable Chest Pull and pair of Hand Grips for only \$1.95

Take advantage of one of these limited offers immediately—before it is too late. No such bargains ever given by any manufacturer.

FRED A. KORTH, 1139 Tiffany St., New York City

# WAKE UP!

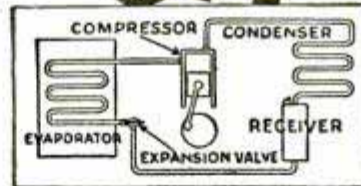

## Amazing Opportunities in ELECTRIC REFRIGERATION

WHY look for big pay in crowded industries? Get into the newest and fastest growing industry in America—Electric Refrigeration. Millions of dollars being invested by Wall Street in factories and advertising. Urgent need for scientifically trained men in manufacture, installation, sales and service. Jobs pay \$200 to \$1,000 a month. And now a new easy method trains you at home to fill a big pay job. Learning Electric Refrigeration simplified amazingly. This course sponsored by Kelvinator, and praised by Servel and other leading manufacturers. Our Employment Dept. helps you find big jobs, FREE.

### BIG BOOK FREE

Mail coupon now for big book free "The New Giant Industry—Electric Refrigeration." See how easy it is to quickly become a highly paid refrigeration expert. No obligation. Utilities Engineering Institute, Dept. 13, 3120 N. Clark St., Chicago, Ill.

"Your Institute should be of great interest to young men wishing to get into the service and sales end of this business. It will be a pleasure to co-operate with you." Col. F. E. Smith, President, Servel, Inc.

Utilities Engineering Institute, Dept. 13, 3120 North Clark Street, Chicago, Ill.

Without obligating me, send free book "The New Giant Industry—Electric Refrigeration."

Name.....

Address.....

City..... State.....



# A Million Dollar Can Opening Machine

## BRAND NEW INVENTION BRINGS FORTUNES TO AGENTS!

Here's Something Brand New! An Amazingly Simple Invention—Yet, Absolutely Revolutionary! For Now, At One Sweep, Millions Of Old Style Can Openers Are Doomed To The Scrap Heap! Think Of It, Men! A Tremendous New Opportunity For Quick Profits In Every Home In America! No Wonder Agents Are Making Astonishing, Almost Incredible Sums—\$75, \$100, \$150 A Week Easily Right Along. So Mail The Coupon For All The Facts And Full Details Of My Remarkable FREE TEST OFFER!

ABOUT once in a "Blue moon" some genius pops up with a new invention that everyone has been waiting for. Then, presto! Almost like magic, agents' profits go soaring overnight to tremendous heights! And now the cold, hard-boiled facts about this amazing new can opener bear convincing proof!

### More Than a Can Opener

This queer new device doesn't just cut a ragged hole around the edge of the can. It lifts the entire top completely out, clean as a whistle! The machine holds the can—opens it—flips up the lid so you can grab it—and gives you back the can without a drop spilled, without any jagged edges to hack your fingers—all in a couple of seconds! You just put the can in the machine—turn the handle—and almost instantly the job is done! Built to do the job better than anything ever devised! Will last a lifetime! It's far more than just a can opener, it's a real can-opening machine!

### The Secret of Big Money

Women hate the old style can opener—and with good reason, too. It's the last relic of barbarism in the modern kitchen. Yet every day millions of women have to open cans the dangerous, laborious old-fashioned way. Food is spilled and wasted. Fingers are cut and torn—often followed by infections and blood poisoning that result in expensive doctor bills. Opening cans the old way is a job nasty enough to make most any man swear—this amazing new way—it's so easy a ten year old child can do it with perfect safety! No wonder women—and men, too—simply go wild over it!



**AGENTS!**  
**FULL TIME—**  
**\$265**  
**in a week**

"Here is my record for first 30 days with Speedo:  
—June 13, 60 Speedos;  
June 20, 84 Speedos; June 30, 192 Speedos; July 6, 288 Speedos. Speedo sells to 9 out of 10 prospects."  
M. Orloff, Va.

**SPARE TIME—**  
**\$9 First half day**  
"The first afternoon I received my Speedo outfit I made \$9."

Mrs. R. Spain, Kans.  
**PART TIME—**  
**\$20 in 3 hours**  
"I worked about three hours and took 25 orders. This is certainly a money-maker."  
O. C. Gregg, Wyo.

### A Spectacular New Sales Plan

I want you to see this surprising new invention with your own eyes. I want you to know why everyone, man or woman, falls for it the instant they see it. Whether you are an experienced salesman, or never sold a penny's worth of anything in your life—I want to tell you about a remarkable new sales plan that wins you a profit on every call you make. This plan is made possible by another spectacular money maker in the Speedo line and guarantees you a steady income of up to \$150 a week!



### Free Trial— Act Quickly!

If you are ambitious—if a new, but tested and proved opportunity to make \$75 to \$150 a week interests you—act at once before some other live wire beats you to this lifetime opportunity. Without obligation, learn about these amazing new patented inventions, and get my FREE TRIAL OFFER. Just mail the coupon today—NOW!

**CENTRAL STATES MFG. CO.**  
4500 Mary Ave. Dept. C-702 St. Louis, Mo.

**SPEEDO**

Central States Mfg. Co.,  
4500 Mary Ave., Dept. C-702,  
St. Louis, Mo.

Yes, rush me the facts and details of your FREE TEST OFFER.

Name .....

Address .....

City ..... State .....

Check here if interested only in one for your home.



# Discovered!

## The Scientific Secret of Caruso's Amazing Vocal Power

*A post mortem of Caruso's throat showed superb development of his Hyo-Glossus muscle—again proving the soundness of Eugene Feuchtinger's theories of voice production.*



*Eugene Feuchtinger, A. M., Musician-Scientist, who discovered this scientific method for developing the voice.*

*The arrow points to the all-important Hyo-Glossus muscle, the "keynote" of the Physical Voice Culture method.*

## The Great Discovery

Professor Feuchtinger, A.M.—famous in the music centers of Europe—discovered the secret of isolating the Hyo-Glossus muscle. He devoted years of his life to scientific research and finally perfected a system of voice training that will develop your Hyo-Glossus muscle by simple, silent exercises right in your own home. Since the Professor brought his discovery to America—over 10,000 happy pupils have received his wonderful training.

### 100% Improvement Guaranteed

The Perfect Voice Institute guarantees that Physical Voice Culture will improve your Voice 100%. You are to be your own judge—take this training—if your voice is not improved 100% in your own opinion, your entire tuition will be refunded.

**Inspiring Book FREE** Send the coupon below and we'll send you FREE this valuable work, "Physical Voice Culture". You assume no obligation. It may be the first step in your career. Do not delay.

**Perfect Voice Institute**  
1922 Sunnyside Ave., Studio 13-53 Chicago

**Perfect Voice Institute** 1922 Sunnyside Ave. Studio 13-53 Chicago

Please send me a copy of your new book, "Physical Voice Culture", FREE. I understand that it is mine to keep and there is no obligation on my part. I am interested in

- Singing
- Speaking
- Stammering
- Weak Voice

Name .....

Address .....

Age .....

### FREE TRIAL PLAPAO

PLAPAO CO., 951 Stuart Bldg., St. Louis, Mo.

Send me a 10 day trial Plapao, and 48 page book on Rupture. No charge for it now or ever.

Name.....

Address.....

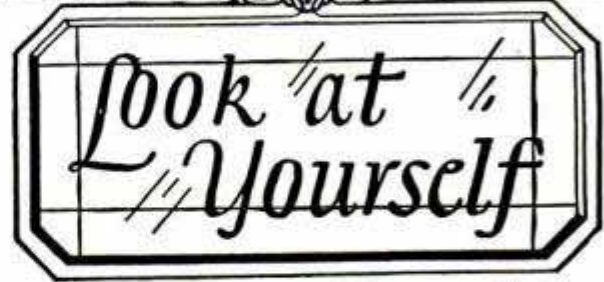

## Rupture Curable

Success or failure? Real or weak counterfeit? You cannot enjoy life's pleasures enslaved to steel or rubber bands. If a rupture has held you down, now is the time to get rid of it and to—

### —THROW AWAY THE TRUSS

Those weakened and atrophied muscles need to be strengthened—not continuously shut off from the normal blood supply through severe truss pressure. The Mechanico-Chemico System as embodied in the Plapao-Pads provides remedial nourishment for the weakened muscles. Upon restoration to normalcy, the unsightly blemish disappears, and such recovery in harmony with Nature should be permanent.

### HAPPINESS TO MULTITUDES

Because of a health restoration more valuable than much fine gold. That's why this original system of self treatment was awarded Gold Medal at Rome, Grand Prix at Paris and Honorable Mention at the Panama Pacific Exposition—actual cures, over a fifth of a century had proved the truth.

### FREE TEST

At our expense, prove to your satisfaction that health and happiness are within your grasp. A request will bring you a ten day test of the remedial factor—Plapao. Make a start TODAY to say good-bye to trusses and rupture. Mail Coupon above.

## ACCOUNTING



The uncrowded, highly paid profession of Accountancy offers marvelous opportunities to ambitious men and women. Send for our 80-page book, "How to Learn Accounting," and the first easy lesson. Both will be sent free.

**INTERNATIONAL ACCOUNTANTS SOCIETY, Inc.**  
A Division of the  
**Alexander Hamilton Institute**  
Dept. 21, 3411 South Michigan Ave., Chicago, Ill.

## BE AN OIL EXPERT!

Trained men needed! Geologists, Drillers, Refiners, (Chemists and Still Men) Oil Salesmen, earn 2 to 10 times more than in other fields! Write today! FREE Booklet!

PETROLEUM ENGINEERING UNIVERSITY, Dept. 223, FORT WAYNE, IND.



### RAISE CANARIES

A good strain of domestic raised birds make big money. Here is a galvanized wire breeding cage—wood frame—18"x9"x13"—sanitary solid wire bottom—under galvanized sliding drawer pan—equipped with cups and nest \$3.75 prepaid. Female canary to mate with your male selected from our healthy and popular Seifert Roller strain \$3.75 prepaid. Write for information on Seifert Roller Males.

Canary Breeder's Co., Box 25, LaGrange, Ill.



# FROM NOW ON— Aviation Mechanics' training *must meet* *a new standard!*

**EVERY** graduate of Parks Air College Airplane and Engine Mechanics' School is fully qualified by training for Department of Commerce licenses as Airplane and Engine Mechanic!



Here is a great forward step in aviation mechanics' training. No longer need you accept less than a complete course of training, less than a course of study that actually fits you for a responsible well-paid job.

Parks Air College sets this new standard in maintaining its leadership as one of the largest and most completely equipped air schools in the United States. It is in keeping with the front-rank position to which this school has advanced. When you graduate from Parks every airline operator, airplane factory executive, and airport manager will know that you are thoroughly trained—not a half-taught amateur. And there are plenty of jobs waiting for you—NOW!

Our mechanical course gives you every class of work necessary to qualify for a Federal Airplane and Engine Mechanics' license and in addition gives you the academic background that you will need as a factory superintendent or airline executive.

**Largest Civilian Aviation School  
in the World** 15 minutes from the downtown hotel  
and theatre district of St. Louis.



Parks equipment includes everything in modern power plants—Whirlwind, Liberty, Caminez, Velie, Hispano-Suiza, OX-5, and other famous engines. You tear them down, rebuild them, test them under the eyes of experienced instructors. You learn every operation of complete shop practice, including welding, brazing, metal working, and wood work.

You learn all about airplanes. You actually build them. You learn factory production methods, qualify yourself for field duty, factory positions, or places as foreman or superintendent.

The moment you get to Parks you'll realize why other men have come from every part of the United States. The bustling activity, the enthusiasm and spirit that pervade the institution, fire you with a new thrill. You are at a school where you can prepare for a definite future.

Come to Parks Air College! Your opportunity today is twice as great as it will be a year from now. Let 1929 mark the turning point in your life—let it be the date of your entrance into the fastest-growing profession in the world. Don't hesitate—come at once, or send for our illustrated book "The Man Who Tunes the Plane." It describes and pictures Parks Air College thoroughly. Use the coupon now!



234-N Missouri Theatre Bldg.  
ST. LOUIS, MO.

Parks Air College, Inc.,  
234-N, Mo. Theatre Bldg., St. Louis, Mo.

Send me "The Man Who Tunes the Plane," with complete information about your Aviation Mechanics' Course.

Name.....

Address.....





# Choose as Your Profession Electrical Engineering

Electricity offers a brilliant future to the young man who is about to choose his career. Never before has there been such a wonderful opportunity in this great field. Big paying positions in electrical work the world over are open to trained men—men who possess specialized, practical knowledge. Come to the School of Engineering of Milwaukee—the foremost and best equipped electrical school in America. Here you are trained in both theory and practice by a faculty of experts. You learn in large, completely equipped laboratories. If you have 14 high school credits or equivalent, you can become an Electrical Engineer with a Bachelor of Science degree. Any credits you may lack can be made up in the short intensive course, covering Electricity and technical high school subjects.

**B.S. Degree  
in 3 Years**

## A Complete, Practical, Electrical Education

Learn by the thorough, approved scientific methods which our 24 years of specializing enable us to give you. In addition to Electrical Engineering, the following complete courses are given: **A. C. and D. C. Armature Winding—Wiring and Testing—Commercial Electrical Engineering—Automotive Electricity—Radio Sales Service and Broadcasting—Electrical Refrigeration.**

## Earn While You Learn

By our special system you may earn part of your way while learning. Our Employment Men will secure you a position to which you may devote a part of each day, spending the remainder at the school. Co-operation with large Milwaukee electrical industries affords Students splendid opportunities. Low tuition fee. Board and room reasonable. Daily Broadcasting, School Orchestra, Fraternities.

**New Term  
Begins Now**

## Write for FREE Catalog

Write today for our free, illustrated catalog. Read about this wonderful institution and the great opportunities that lie before you. Find out about our specialized method of training and the details of our "Earn While You Learn" Plan.

# SCHOOL of ENGINEERING of Milwaukee

School of Engineering of Milwaukee,  
Dept. PM-329, Milwaukee, Wis.

Without obligating me in any way please mail free Photostory book, "Rise to Success Through Electricity" (just off the press), and NEW Bulletin regarding the course I have marked with an X.

- |  |   |
|--|---|
| <input type="checkbox"/> Commercial Elec. Eng. for High School Grad. 1 year. | <input type="checkbox"/> Elec. Refrigeration.   |
| <input type="checkbox"/> Commercial Elec. Eng. others 1 to 2 years.          | <input type="checkbox"/> Radio.                 |
| <input type="checkbox"/> Elec. Eng. B. S. Degree 3 yrs.                      | <input type="checkbox"/> Armature Winding.      |
| <input type="checkbox"/> Automotive Elec.                                    | <input type="checkbox"/> Light. Heat & Power.   |
| <input type="checkbox"/> I am interested in your Earn While You Learn Plan.  | <input type="checkbox"/> Practical Electricity. |
|  | <input type="checkbox"/> Home Lab. Service.     |

Name.....Age.....

Address.....

City.....State.....

Education.....

# You Can Play TRAP DRUMS easy extra money

Learn  
at  
Home



## Play in 10 Minutes!

Now you can have the joy of being a trap drummer—the thrill of popularity—new friends—more money-making opportunities, if you wish. These are just a few of the things the idolized dance, theatre or stage orchestra trap drummer enjoys today. Trap drumming is natural! Easy! It is simply the carrying out of natural rhythmic instincts. Our instruction book makes it easy. You can play trap drums in 10 minutes.

## 10 Days Free Trial—Easy Payments

We want to make it as easy as possible for you to learn to play trap drums. Try one of the famous Ludwig Trap Drum outfits in your own home for 10 days, absolutely free. If you keep it, send us the balance in small monthly payments. A Ludwig Trap Drum Outfit fit every purse. All built to the same high standard of workmanship. Don't waste time! Don't delay! If you are eager to learn to play trap drums, if you honestly yearn for popularity and money making opportunities, act at once. Write today for our big 2-color circular describing Ludwig Trap Drum Outfits—the world's standard for 22 years. Mail coupon now!

## Mail Coupon Now!

Ludwig & Ludwig, Dept. 8-3,  
1611 N. Lincoln St., Chicago, Ill.

Gentlemen: Without obligation, please send me one of your Big Illustrated Catalogs showing Ludwig Trap Drum Outfits, along with details about your 10-day Free Trial Offer, Free Instruction Book, Drummers' Magazine, and Easy Payment Plan.

Name.....

Address.....

City.....State.....

# Be An Auto Paint CHAIN-SHOP MANAGER

## EARN \$90 A WEEK

We are organizing a nation-wide chain of auto paint shops and need reliable men to manage them. We will open one in your section. If you are honest and ambitious, with a good reputation we want you to manage it.

Prefer men with no painting or executive experience. We want to teach them our own way.

### Big Market for Our Service

25 million autos in U. S. need repainting—not 1/20 enough real shops to do the work! We'll train you in a few months, at very small cost, during spare time to do the work and to be the boss. YOU MAKE THE BIG MONEY! We even have a plan for refunding the small training fee, so that it need cost you nothing to prepare for this job.



G. King Franklin  
Superintendent

These Men Now Making Good As A Result of A. A. P. S. Training: Henry LeFebvre's Shop in Wellsburg, W. Va. paying him \$500 a month. C. J. Shine's Shop in Springfield, Mass. nets him \$20 a day. W. A. Davis makes his shop in Swanton, Ohio pay him \$85 a week. Ben Ives of Chateaussey, N. Y. clears \$400 a month from his shop.

Get details now of this remarkable plan whereby we train men at home, quickly and when qualified set them up in business as managers of profitable A. A. P. S. Chain Shops.

Be the first in your community to get the facts.

American Auto Paint Shops, Inc.,  
427 S. Ashland Avenue,  
Dept. 2401, Chicago, Ill.

## MAIL THIS COUPON NOW!

G. King Franklin, Supt., American Auto Paint Shops, Inc.,  
Dept. 2401, 427 S. Ashland Ave., Chicago, Ill.

Send me without obligation, details of how I can learn to manage a Chain Auto Paint Shop, and tell me about your plan for refunding the service fee so that the training will cost me nothing.

Name.....

Street.....

City.....State.....



# WINS \$10000



**BEFORE** Here's how Daniel Gully used to look—stoop-shouldered, flat-chested, scrawny and ungainly. Scarcely a muscle on his body—just soft, flabby flesh. He was as weak as a cat—no pep, no energy, no ambition.

**F**ELLOWS, it was a wow! On December 31st my 1928 muscle-building contest ended with a bang. I wish you could have been there when the winner was selected. It was a great occasion! Famous authorities of the physical culture world were present as the records of thousands of applicants were presented to the jury.

Man, you should have seen those records! Photographs of my pupils and actual measurements "before and after." I developed them. Talk about building muscles!

Well boys, 1928 is past and now we're off on our 1929 Prize Contest. Are YOU going to be the WINNER? Never mind what your present condition may be. Say! I've taken **cripples** and changed them into perfect specimens of manhood. Leave it to me—I'll make 1929 the greatest year of your life.

Here's my prize winner for 1928! What do you think of him? \$1,000.00 in cash and solid gold medal awarded to Daniel Gully, for the greatest *improvement* in physical development. Nationwide contest proves another amazing demonstration of **MIRACLES in MUSCLES!**

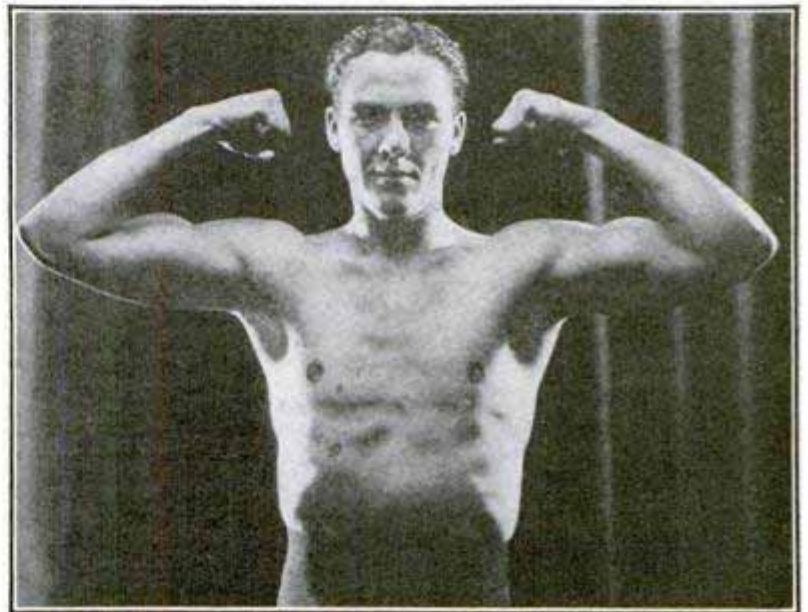

**And Only 30 Days AFTER**

Yes—after just one short month of Titus Training, Daniel Gully was a **NEW MAN**. Look at that build! Look at those muscles! Almost overnight Danny changed from a weakling to a **PRIZE WINNER**.



**SAXTON**  
World-Famous  
Strong Man Says:

"My feats of strength on the stage have brought me hundreds of inquiries asking how I developed such extraordinary strength. I tell them all to write to Titus; he'll show them how to develop physical power that will amaze them. Every red-blooded man should send for that marvelous book: **"MIRACLES IN MUSCLE."**

## YOU'RE NEXT Now Watch YOUR Muscles

Almost overnight the man you see above changed from a puny weakling into a physical **GIANT!** Looks like magic, doesn't it? But it's just an example of what **TITUS Training** has done for **thousands**.

30 days—that's all I want—and just 20 minutes a day. I'll cover your body with wads of solid muscle. **PANTHER MUSCLES**—packed with **SPEED** and **POWER**. The kind of muscles that make **CHAMPIONS!**

**I Guarantee:** to put 2 inches of solid muscle on your arms; to increase your chest five inches; to develop your neck to a size larger collar; to add three inches of powerful development to your thighs two inches to your calves; to give you a trim, slim waist-line. I don't just **promise** these things, I back every statement with an iron-clad written **GUARANTEE**.

## Amazing Book FREE

Tear off that coupon! Mail it today! It will bring you **FREE** the greatest book you've ever seen—a book filled with astounding photographs of men rebuilt—a book packed full of Titus's own secrets of making muscles **GROW**. No cost or obligation—just rush coupon to Dept. M-136.

The One **TITUS** 105 E. 13th St.  
and Only New York City



### Wear This Medal

The treasured trophy of world champions of strength. Awarded in solid bronze to every Titus Trained Man—and in **SOLID GOLD** to winner of each year's Contest.

MAIL THIS TO-NIGHT

Titus (Dept. M-136)  
105 East 13th Street,  
New York, N. Y.

Dear Titus: Sure I'd like to have your book. Send it Free. Also details of your 1929 Prize Contest.

Name.....

Address.....

Town..... State.....



# Strong Men Are Not Born

## THEY ARE MADE!

### I Develop Muscular Giants —I Can Make You Strong

It is a proven fact that strong men are made—not born. Many of today's famous strong men, including myself, were forced to take up physical culture or some form of exercise for their health, because they were physical wrecks. With proper handling they soon developed into veritable giants of strength.

### You Can Be Strong

I have perfected a system of mail training which permits anyone to realize his life's ambition to be strong and muscular. Men have come to me in despair because they were ashamed of their weaknesses—needless to say with my method of body building they quickly improved and many of them developed into strong men who broke world's records.

### They Call Me

### "The CHAMPION of CHAMPIONS"

The title, "The Champion of Champions," was given to me by the men I have made. I have the longest list of champion strong men to my credit of any muscle builder in the world. Some of these men at first seemed hopeless yet after I took them in hand they became world beaters. Why? I'll tell you the reason. I do not try to change a man's natural self or nag him about what not to do. I let him follow his own individual taste and tell him what he should do. In other words, I give him the "know how" of getting strong and doing feats of strength. Regardless of what condition you are now in I know I can help you. My system never fails. I will make you fit and peppy. I will give you the body that you want and that nature intended you to have and I will do it in less than 90 days. After I get through with you, you will become popular and be sought after by both sexes. I will satisfy your hunger for love, strength and happiness. No matter if you want to put on yards or inches of muscle my proven method which has made thousands of men happy, healthy and strong, will do the trick without hard work or inconvenience. Don't wait another minute! Don't envy strong, healthy, popular men. Come to me! I will give you a body to be proud of. I guarantee to make a super-man out of you so that you will enjoy perfect manhood—I know I can do it. I work with you by mail and perform this miracle without interfering with your daily routine. Every week I visit you by sending instructions which take you step by step into a new world. When I get through with you, you will have a body to be proud of—you will have muscles like mine with a grip of steel and the strength to easily do feats that now seem impossible. From the first lesson you will notice the pickup and difference, you will walk differently—you will act differently—you take on that feeling of assurance that you are "there."

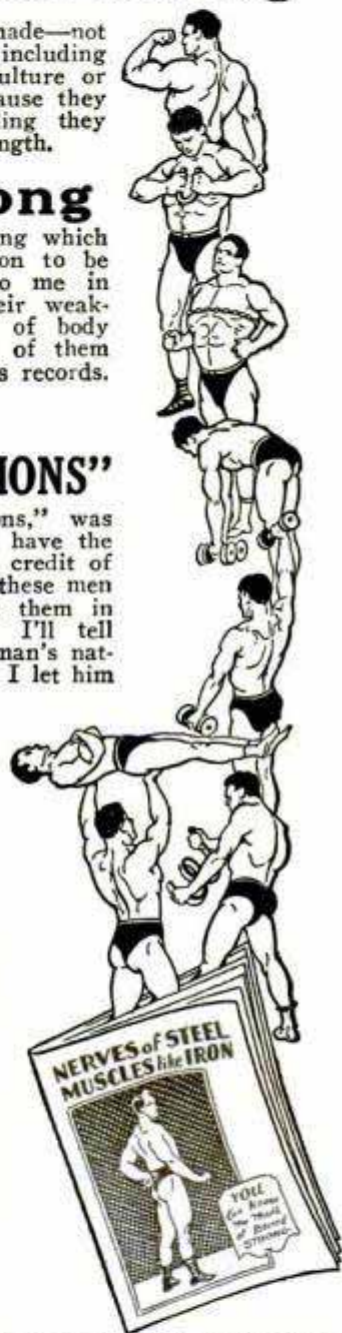

**GEORGE F. JOWETT**  
Champion of Champions

### Lend Me Your Body for 90 Days

After the first 30 days the new muscles on your arm will stand out like the village blacksmith's. Your legs from calf to hips will bulge with muscle, and your chest expansion will be the marvel of yourself and friends. This is no idle promise—I can do it, because I have done it for thousands of students and champions who thank me for the secrets of strength that I gave them.

### Send For My FREE Book

Send for my free book, "The Thrill of Being Strong." No obligation. You will get a real kick out of it. It tells what I have done for others—it shows many photographs of myself and my prize winning students and it tells how easily you too can have nerves of steel and muscles of iron. This book is yours absolutely free. Write for your copy and learn for yourself why they call Jowett "The Champion of Champions" and be convinced that I can help you.

### The Jowett Institute of Physical Culture

422 Poplar St., Dept. 4Q, Scranton, Penna.

DEAR MR. JOWETT:

Without any obligation send absolutely free your book, "The Thrill of Being Strong."

Name \_\_\_\_\_

Address \_\_\_\_\_



# Worth Money to Ruptured!

Send New **FREE BOOK** and  
Amazing **FREE SAMPLE**  
of **AIRTEX**  
Without Obligation

Name.....

Address.....

City.....State.....

Mail this coupon to  
New Science Institute,  
2158 Clay Street,  
Steubenville, Ohio

Here is an amazing offer to victims of rupture—an offer that has proved to be worth hundreds of dollars to many who have accepted it. Yet it costs you nothing.

A famous rupture specialist with a record of more than 20,000 cases will send you free of cost a newly-

edited book that contains amazing new discoveries about rupture relief . . . case histories galore . . . illustrated in detail. A few of the facts contained in this free book are given below. But do this right now. Tear out the coupon at the right and send for this unusual book!

## Can Rupture Be Exercised Away? Get Newest Book Now **FREE** to Ruptured

"It was twenty years ago when I first got ruptured. Today I consider myself entirely cured. Your system is nothing short of marvelous." John Miller, Jr. "Some months ago I ordered your outfit for the treatment of rupture of my son. Our doctor fitted it on him and he was skeptical it would help cure the condition, for it was one of the worst ruptures he had ever seen. Five months later I took the boy back to the doctor. He examined him and pronounced the rupture completely healed." D. E. Lytle, Orrville, Ohio.

These are but two of many astounding letters received from people, many of whom had despaired of obtaining relief from the torture and agony of rupture.

### Not a Truss

What is this wonderful device that has made thousands feel again the joy of living a full life? It is not a truss like men wore in the days of Lincoln. It has no steel springs, no leg straps, no bulky cushions. It can never slip off the rupture. Wearing it, you can still cough, run, jump, bend or sleep in any position. In fact, many are able to work every day—exercise as much as they desire—probably we should say truthfully actually **EXERCISING RUPTURE AWAY!**

Imagine a simple little device weighing less than a feather—little larger than a quarter—that rests firmly against the rupture without the need of strapping tightly. Think of a flesh-soft pad that yields with the slightest movement of your body—filled with millions of air-cells that breathe fresh, cool air into the spot around the rupture. And all the while blood circulation is more free

without a trace remaining—in unbelievable time. Incredible? Yet the facts are ready now!

### Now or Never!

Be fair to yourself. Get the complete facts about Magic Dot and the offer that permits you to feel this marvelous relief, before you decide to buy. Don't go through life in constant pain. Relief from rupture is certainly worth the 2c stamp it costs you to send the coupon above. Send it—not tomorrow or next week—but **NOW!**

**NEW SCIENCE  
INSTITUTE**

2158 Clay Street  
Steubenville, Ohio

Never Before a  
**FREE  
SAMPLE**  
Like This

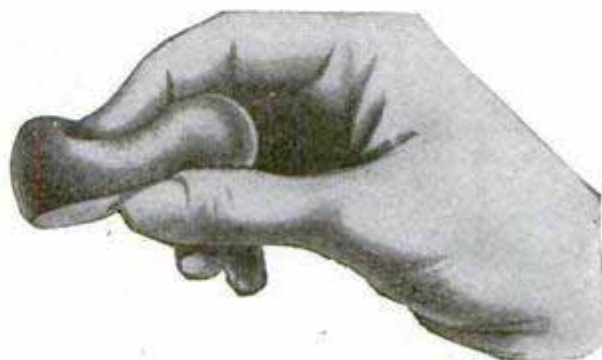



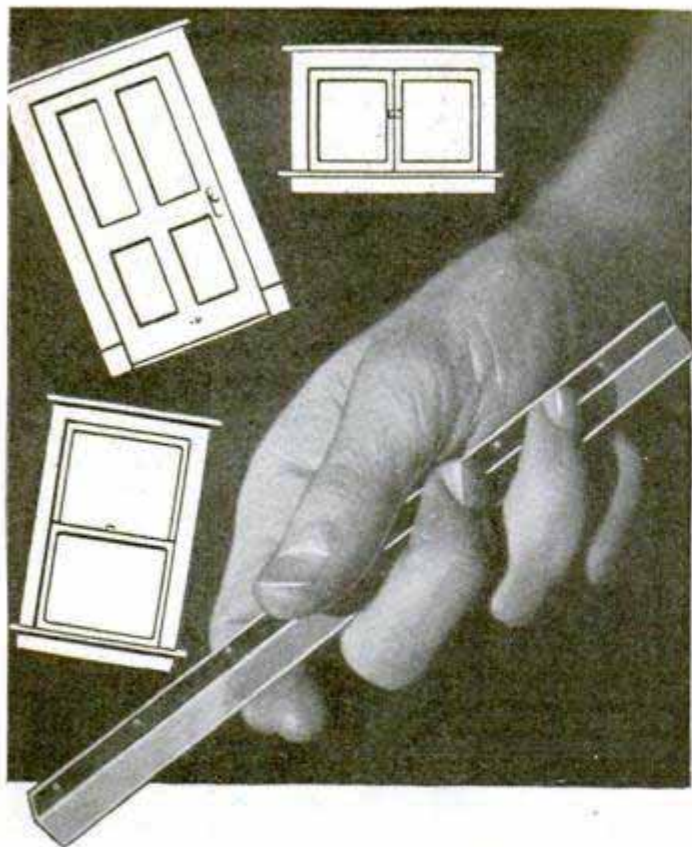

# Amazing New Bronze Weatherstrip Cuts Fuel Bills 1/2!

Now . . . Homes Weatherstripped A New Cheap Way. Snug Comfort and Amazing Economy Without Installation Expense. Red-D-Ply Quickly Tacked Around Doors and Windows. Keeps Cold Air Out, Warm Air In! Anyone Can Do It. Guaranteed To Save Cost In Fuel Alone Within 2 Years! Valuable Territory Open—\$100 a Week Is Easy! Mail Coupon For Amazing Details At Once!

## Agents—New Business Pays \$600 a Month All Year 'Round

A HAMMER, scissors, and a neat package of Red-D-Ply—that's all it takes now for anyone to make any door or window 100% weatherproof! Takes less than half an hour to close up the "clearance crack" permanently. Then you laugh at cold drafts, rain, dust and soot. Heating bills, cleaning and doctor bills take a quick tumble. Saves home owners \$30 to \$60 a year in fuel alone under money-back guarantee, so agents clean up sensational profits 12 months a year. Red-D-Ply is finest spring bronze, edges hemmed to prevent buckling, holes for tacks punched clear through. Will maintain its efficiency for the life of the house. Easy as A B C to apply. The fast-selling sensation of the age. Walter Vernohm of Mo., made \$142 in a single day!

This is your opportunity to get into a real worth-while business, with steady, increasing profits and big repeat business. For free sample and proof of big earnings—\$5,000 a year and more—just mail the coupon below. It costs nothing to get the facts. Discover this amazing opportunity NOW.

**RED-D MANUFACTURING CO., Dept. C-10**  
3711-15 Parnell Ave. ST. LOUIS, MO.

RED-D MANUFACTURING CO., Dept. C-10  
3711-15 Parnell Ave., St. Louis, Mo.

Send illustrated information on Red-D-Ply, free sample, and details of your special Distributor's Offer. I am not obligated.

Name.....  
Address.....  
City.....State.....

( ) Send me illustrated information and free sample. I am interested only in Red-D-Ply for my own home.

# Agents \$60 a Week! Make

WITH 5 TESTED SELLING PLANS and Newly Invented

## Master Suction Ash Receiver and Cigarette Holder

For Autos, Homes and Offices

Yes, I'll prove to you, you can make \$60.00 a week. My men are making that much and more right now with the handiest specialty created in recent years—Patented MASTER SUCTION GRIP ASH RECEIVER—sticks to any surface by a suction grip. Ideal for auto, home and office. Used as Cigarette Holder or Ash Tray. Made of beautiful Bakelite in six distinctive colors. Can be MONOGRAMMED WITH OWNER'S INITIALS. You don't miss one sale in a hundred. Retails for only 50c and YOU MAKE UP TO 200 PER CENT. PROFIT.



STICKS ANY PLACE BY ITS SUCTION GRIP

### Sells to Dealers or Consumers

Our five Amazing Fast Selling Plans show you how to get orders by mail—how to place Master Automatic Salesmen on store counters and make \$60.00 a week—how to put others to work for you and secure volume business.

### Send for Sample or a Dozen

Send 50c (stamps if you like) and receive by return mail beautiful Bakelite Ash Receiver, or better still, get started now. Order one dozen Ash Receivers in assorted colors, packed in display carton at our dozen price of \$3.00. Send full amount or \$1.00 deposit, balance C. O. D. You make \$3.00 profit on the dozen selling to consumers—or use sample dozen to take orders from dealers. You take no risk. We guarantee you sales or refund your money on this initial order. Our five amazing selling plans will be sent you at once with dozen or sample. Act now and get in line for territory.

Gordon Mfg. Co., Dept. C-19, 110 E. 23rd St., New York, N.Y.



## "BECOME A LIGHTNING TRICK CARTOONIST"

Send \$1.00 for Laugh Producing Program of 23 Trick Drawings with Instructions. Catalog of Chalk Talk Supplies Free. BALDA ART SERVICE, Dept. 1, Oshkosh, Wis.

## Write For This Thrilling Book



Read the stirring story of how young "Slim" Lindbergh made good in aviation as our Chief Air Mail Pilot and Instructor long before his name and fame flashed around the world. Read of his adventures here with the companion of his barnstorming days, "Bud" Gurney, who succeeded him as our Chief Air Mail Pilot and Instructor.

Read how a modern civilian flying school is conducted by the Army School System. See activities at famous Lambert-St. Louis Airport. "Making Good in Aviation" sent postpaid for 25c, stamps or coin.

### Air Mail Pilots Teach You to Fly

at Robertson School of Aviation. "Bud" Gurney and other active Air Mail Pilots instruct and check our advanced students. Twelve Licensed Transport Pilots on staff.

Robertson School of Aviation is one of the oldest, largest, best equipped and most favorably known in the country. 10 years—hundreds of graduates—no accidents. No bond required, no breakage charges.

Modern training ships of various types, government licensed and inspected. Mahoney "Ryan" and Curtiss-Robertson "Robin" manufactured here. Ford 12-Passenger Tri-Motored Planes in daily service. Write today.

Dept. O-8

## ROBERTSON FLYING SCHOOL

Lambert-St. Louis Airport, Anglum, St. Louis Co., Mo.

A Division of Universal Aviation Schools

ROBERTSON FLYING SCHOOL, Dept. O-3, Lambert-St. Louis Airport, Anglum, St. Louis Co., Mo.

Enclosed is 25c. Please send me copy of your new illustrated book, MAKING GOOD IN AVIATION.

Name.....  
Street Address, Box or R. R.....  
Town.....State.....

NRS



**L. L. COOKE**  
—the man who has trained and helped many thousands of other men into Big-Pay electrical jobs in all parts of the world.

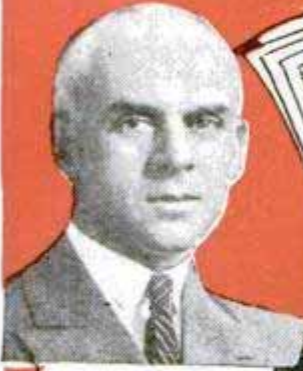

**I WILL TRAIN you at HOME**



# Learn to Make It in the big pay field Electricity

**\$30 A DAY!**  
"Dear Mr. Cooke: I was making \$25 a week, when I enrolled. Now with my own Electrical Shop I make as high as \$30 a day."  
A. J. Daigneault  
225 Worcester Southbridge, Mass.

**\$3,500 A YEAR!**  
"Dear Mr. Cooke: When I began with you I was just a common laborer. Now my salary is \$3,500 a year."  
C. O. Beckett  
108 Maple Heights New Lexington, Ohio

**DON'T** be a wage slave all your life—don't spend your best days in a miserable \$25 to \$35 a week job—pinching the pennies and barely making ends meet—when thousands of men no smarter nor luckier than you, are drawing down \$70 to \$200 every Saturday as "Cooke" Trained Electrical Men. It's your own fault if you don't do the same. Blame yourself if your pay is small when I've made it so easy for you to learn to earn \$3,500 to \$10,000 a year in Electricity!

### Be a "Cooke" Trained Man

I'll show you how—in your spare time—in the quiet of your own home—without losing a minute from your regular job! I'll train you in a clear, simple, quickly-grasped unforgettable way with my famous "Work Sheet" and "Job Ticket" Method—the same method that has landed more than 10,000 fellows like you in \$3,500 to \$10,000 a year jobs—the same method that Electrical men are praising and great Electrical concerns recommend to their employees.

### "Schooling" Not Necessary

Don't think for a minute that you need a college education or a high school diploma to become a "Cooke" Trained Big-Pay Man. You don't! Mighty few of my "boys" ever went farther than grade school. But that was no drawback. With the Six Big Outfits of tools and apparatus that I furnish without extra charge, they got

simplified, practical training along work shop lines. They learned by doing—they learned thoroughly—just as if I was constantly at their elbow. And in no time at all they were trained—commanding, and getting, Big-Pay!

### Make Money While Learning

Another amazing thing about "Cooke" Training is that it pays for itself as you go along. Yes, Sir! You'll hardly have begun the Course when I'll show you how to make your spare hours count for cash! I'll show you how to get jobs—how to do the work—what to charge! And all while you're still learning! Afterwards comes the Big Job—the Big Pay—the great opportunities that will make you independent the rest of your days.

### Investigate—Mail Coupon

Don't delay! Get started! Mail coupon right now for my Big Book—the same book that has raised the pay of thousands of men—the book that will show you—yes, prove to you—why "The COOKE Trained Man is The BIG-PAY Man"—always and everywhere! It's FREE—just mail coupon—at once!

**L. L. COOKE, Chief Instruction Eng.**  
**L. L. COOKE SCHOOL OF ELECTRICITY**  
Dept. 13  
2150 Lawrence Ave., Chicago, Ill.

There are Thousands of Big Pay Jobs to be had!

**GO OUTFITS at**

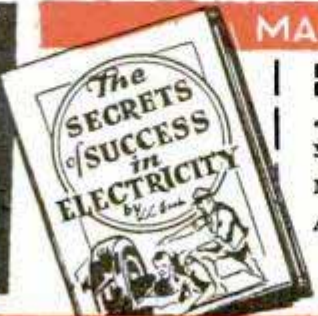

MAIL THE COUPON - Get this book free

**L. L. COOKE, Chief Instruction Engineer,**  
Dept. 13, 2150 Lawrence Ave., Chicago, Illinois  
You may send me, FREE and fully prepaid, your book "Secrets of Success in Electricity," with all particulars about your Home Study Course in Electricity.

Name.....  
Address.....  
City..... State.....  
Residents of Canada send coupon to R. A. Farrow, Special Representative, 7 Medbury Lane, East, Windsor, Ont., Canada.

**The "Cooke" Trained Man is the "Big Pay" Man**



# DRAFTING ARCHITECTURE ENGINEERING ELECTRICITY

## FREE BOOK COUPON

Chicago Technical College  
Dept. C-77, 118 E. 26th St., Chicago  
Please send me without obligation, your  
Free Book and other information about  
plan of training marked below.

Name.....

Address.....

City..... State.....

### Check One of these Plans

- 1—Complete College Training (2 year Diploma—3 yr. Degree) Engineering or Architecture at the College in Chicago.
- 2—4 months' Special Drafting Course at Chicago Tech. Earn while you learn.
- 3—Home Study—College training at home in Drafting. Your spare time is enough.

# Check one of these 3 Plans Then Mail Coupon

## It Starts you on your way to Big Pay in These Billion Dollar Fields

The Coupon brings all the facts about 4 fields where billions are spent annually. Millions go to men trained to lay out and superintend construction work. Industry needs trained Draftsmen, Engineers and Architects. Huge salaries are paid. Bonuses offered—for men are at a premium in Drafting, Architecture, Engineering and Electricity. All you need is training. The coupon starts you to a real position or a business of your own. Send it now.

### TRAIN

#### THE CHICAGO TECH WAY

Here at this school you get the specialized training you need to become a Drafting or Engineering expert. For 26 years we have been training men for big-pay.

#### 3 PLANS—TAKE YOUR PICK

No need to be without this training.

No matter what your circumstances these 3 plans make it easy for you.

1. Come to Chicago if you can. Enter our resident school in either the 2-year Diploma or 3-year B. S. Degree Course. Thorough, up-to-the-minute, practical training. Opportunities for self-support while studying. Mark Plan 1 on the coupon. It brings you our free 80 page "Blue Book".

2. If your time is limited, take our 4-months' course in Drafting. Mark Plan 2 on the coupon.

3. Finally, if you can't come to Chicago, then study at home. Mark Plan No. 3 on the coupon.

One of these plans holds the key to your future success. Fill in and mail the coupon—find out what Chicago Tech training can mean to you.

# CHICAGO TECHNICAL COLLEGE

Dept. C-77

Chicago Tech Bldg.

118 East 26th St., Chicago, Illinois



## BE AN OFFICER in the U. S. Coast Guard \$1700 Up to \$7,500 Yearly

\$780 yearly at the U. S. Academy while training. You rank Ensign to Captain in service. Age requirements 18 to 22. Write Dept. MP for information.

COAST GUARD PREPARATORY SCHOOL  
4000 Ga. Ave., N. W. Washington, D. C.

# NERVES?

Are You Always Excited? Fatigued? Worried? Gloomy? Pessimistic? Constipation, indigestion, cold sweats, dizzy spells and bashfulness are caused by **NERVE EXHAUSTION**. Drugs, tonics and medicines cannot help weak, sick nerves! Learn how to regain Vigor, Calmness and Self Confidence. Send 25c for this amazing book. **RICHARD BLACKSTONE, N-473 FLATIRON BUILDING, NEW YORK**

# WIN \$3,500.00!

Here's news for puzzle fans: C. W. Francis, Matilda Hkens, A. F. Holt, Miss Leola Markus, Alvin Smith won from \$1,400.00 to \$3,500.00 each in some of our last puzzles. Over 800 cash prizes awarded within a year. In Oct. 1928 alone we paid over \$11,000.00 in prizes and in the next few months will award between 300 and 400 cash prizes in our puzzles. Here's a new puzzle for you.

## Find the "Different" Picture

Here are twelve pictures of Charlie Chaplin, the world famous United Artists star. No, they're not all alike, even though they look alike. Eleven of them are exactly alike, but one and only one is different from all the others. That's the real Charlie Chaplin. Can you find him? The difference may be in the hat, shirt or tie.

**300 CASH PRIZES** 300 prizes totalling over \$7,900.00. \$3,500.00 to the winner of first prize and duplicate prizes in case of ties. If you can find the "different" figure complete instructions will be sent you.

**CERTIFICATE FOR \$1,000.00 TO APPLY ON GRAND PRIZE SENT AT ONCE AS BELOW IF YOU FIND "DIFFERENT" FIGURE**

If you find the real Charlie Chaplin we will send, as soon as correct answer is received, certificate for \$1,000.00 to add to the first prize of \$2,500.00, if you win, and directions for getting largest prize. We spend over \$150,000.00 this way each year to advertise our products locally. No cost or obligation. Nothing to buy now, later or ever. Everyone rewarded if actively interested. Just send the number of the "different" Chaplin in a letter or on a postcard. That's all. Send no money.

**F. A. HARRE, ADVERTISING MGR., DEPT. 661, 510 N. DEARBORN ST., CHICAGO, ILL.**





# LEARN AUTOS

New Easy Way to

**Earn UP TO \$100 a Week**

Say goodbye to low pay. Get into the Auto Business, where big pay—extramoney—raises come quick! A brilliant future awaits you in the World's Biggest Business. If you're earning a cent less than \$60 a week, clip that coupon. Learn how \$50—\$75—even \$100 a week is possible for you now! Find out about this training which boosted Yancy of Perla, Ark., from \$30 a week up to \$90!

**Open Your Own Auto Shop**

My Free Book tells how men make extra money while training, and then go into business with no further Capital. It's the training that counts, and it is complete training that I give you.

**Common Schooling All You Need**

Men between 15 and 60, with very little education, are becoming Garage Owners, Superintendents, Foremen. Whether you have had years of Auto Experience, or never touched a car before, send for this Free Book Now. I'll show you the quick way to get in line for real success in the Auto Business.

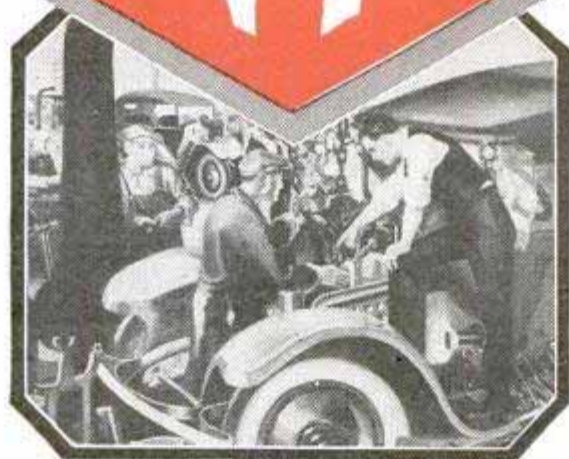

**AT HOME!**

Send coupon for Free Auto Book. See how I train you right at home, in every branch of Auto work—Learn how I prepare you, quickly and easily, for the Big Jobs, paying up to \$100 a week, and more. "Job-Way" Training includes all Mechanical and Electrical work—Starting, Lighting, Ignition—also Welding, Brazing, Vulcanizing—everything you need to get in line for a big pay Job as an Electrical and Mechanical Auto Expert.

**I'll Help You Get a Good Job**

My Employment Department will help you get a good Job whenever you want one. You don't have to wait until you have graduated to use this service. No sir, as soon as you have shown that you know enough about Autos to hold the Job I'll give you this help whenever you ask for it! What is more, you can use it as long as you live!

**Get All the Facts!**

Send for my new Free Book now! See what "Job-Way" has done for hundreds. See what it can do for you. Learn all about my legal money-back agreement—and the many added features. Clip coupon now!

**B. W. COOKE** *Directing Engineer*  
 Dept. 9163  
 Chicago Motor Training Corp.  
 1916 Sunnyside Ave., CHICAGO

**AVIATION COURSE**

and many other valuable features included FREE of any extra charge to you NOW, if you act QUICK! Mail coupon below today!

**Money-Back Agreement**

My Money-Back Agreement gives you absolute protection. You must be satisfied or "Job-Way" Training costs you nothing.

**MAIL THIS COUPON**

**FREE Auto Book!**

B. W. COOKE, Directing Engineer, Chicago Motor Training Corporation, 1916 Sunnyside Ave., Dept. 9163, Chicago, Ill. Send me your Book, "Auto Facts", Free of charge. Also full particulars of your Aviation Course offer and of "JOB-WAY" Training. This obligates me in no way whatever.

Name.....  
 Address.....  
 Town..... State.....  
 Age..... Occupation.....



## Here's the Answer

to every question about the principles, methods, or apparatus of radio transmitting and receiving.

# THE RADIO MANUAL

**A Complete Course in  
Radio Operation  
In a Single Volume**



**A Handbook for  
Students, Amateurs,  
Operators, Inspectors**

For the first time an entire course of training in one book—the most complete and up-to-date work on radio. Developed simply and clearly from the elementary stage right through all phases of principles, practice, and apparatus so that a beginner with no knowledge of electricity may get all he needs either for amateur operation or to qualify for a government license as operator or inspector.

### Prepared by Official Examining Officer

The author, **G. E. Sterling**, is Radio Inspector and Examining Officer, Radio Division, U. S. Dept. of Commerce. The book has been edited in detail by **Robert S. Kruse**, for five years Technical Editor of QST, the Magazine of the Radio Relay League. Many other experts assisted them.

**16 Chapters Cover:** Elementary Electricity and Magnetism; Motors and Generators; Storage Batteries and Charging Circuits; The Vacuum Tube; Circuits Employed in Vacuum Tube Transmitters; Modulating Systems; Wavemeters; Piezo-Electric Oscillators; Wave Traps; Marine Vacuum Tube Transmitters; Radio Broadcasting Equipment; Arc Transmitters; Spark Transmitters; Commercial Radio Receivers; Radio Beacons and Direction Finders; Radio Laws and Regulations; Handling and Abstracting Traffic. Much new information never before available.

### FREE EXAMINATION

"The Radio Manual," has just been published. Nearly 700 pages. Profusely illustrated. Bound in Flexible Fabrikoid. The coupon brings the volume for free examination. If you do not agree that it is the best Radio book you have seen, return it and owe nothing. If you keep it, send the price of \$6.00 within ten days.

### Order on This Coupon

**D. Van Nostrand Co., Inc.,  
6 Warren St., New York**

Send me THE RADIO MANUAL for examination. Within ten days after receipt I will either return the volume or send you \$6.00, the price in full.

(Pop. Mech. 3-29)

Name.....  
St. & No.....  
City and State.....

## Study Flying NOW!

### ABC of AVIATION

Gives complete flying foundation in simple language. By Major V. W. Pagé, America's leading instructor and engineer, 160 pages. Illus. Sent C. O. D., if desired. Only \$1.00.

**3 new  
BOOKS**

### MODERN AIRCRAFT

Veritable encyclopedia of well-written explanation of everything in connection with planes and flying. Used in schools everywhere. Also by Major Pagé. \$55 pages. 500 costly illustrations. Sent C. O. D., if desired. Only \$5.00.

### EVERYBODY'S AVIATION GUIDE

Major Pagé, famous instructor, asks and answers 600 questions. Covers everything you should know about planes and flying. 256 pages. Illustrated. Sent C. O. D., if desired. Only \$2.00.

### CATALOG Free!

Get our FREE catalog covering all Henley books on more than fifty different practical and scientific subjects. Books shipped to any U. S. address C. O. D. plus postage, or postpaid if you enclose remittance. Order now.

**Norman V. Henley Co., Dept. 8**

**2 West 45th St.**

**New York, N. Y.**

## FRENCH and SPANISH Demonstration Record



A condensed lesson. Printed text furnished with the record. A practical demonstration of how easily you can learn a language by this new conversational method. Endorsed by French and Spanish Embassies. Mail only 25c. Check language wanted  French  Spanish. International Correspondence Schools, Box 5607-F, Scranton, Penna.

only  
**25¢**

## This is the BANJO

YOU have been wanting—brilliant, powerful, musical tone, easy-playing qualities, expert craftsmanship, handsome appearance. Beginners and professionals choose the Gibson Mastertone.

Payment plan makes it easy to own a Gibson. Send the coupon for details.



Gibson stringed instruments are today's most popular instruments. Mention which interests you: Banjo; Mandolin; Guitar; Ukulele.

**Gibson**

**GIBSON, Inc. 303 Parsons St. Kalamazoo, Mich.**  
Gentlemen: Send Free Book and details of payment plan on

[Instrument]

Name.....  
St. or R.F.D.....  
City..... State.....



# Complete Your Education with This ONE Book

*A New and Easy Way to Obtain a Modern Education at a Ridiculously Low Price*

Prepares you for greater responsibility and much increased income—

Provides you with the culture necessary for the best social contacts—

Broadens your mind and vision.

## This Is Your Golden Opportunity

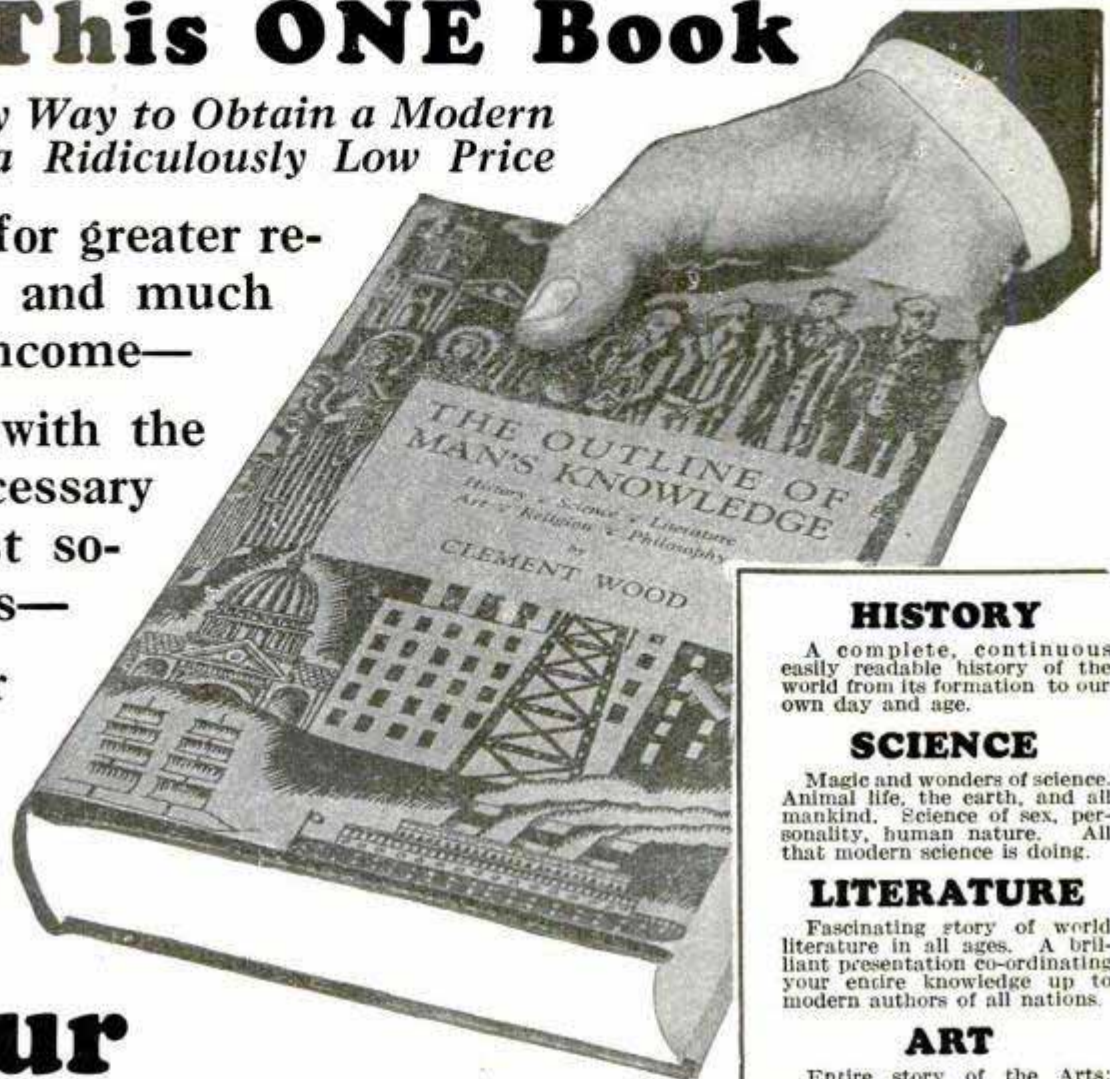

### HISTORY

A complete, continuous easily readable history of the world from its formation to our own day and age.

### SCIENCE

Magic and wonders of science. Animal life, the earth, and all mankind. Science of sex, personality, human nature. All that modern science is doing.

### LITERATURE

Fascinating story of world literature in all ages. A brilliant presentation co-ordinating your entire knowledge up to modern authors of all nations.

### ART

Entire story of the Arts: Painting; Sculpture; Architecture, Music, Dancing. Brings you a new appreciation of all arts.

### RELIGION

Man's first spiritual aspirations. Mysteries of religious beginnings up to the story of all modern sects and their beliefs.

### PHILOSOPHY

The story of Philosophy and Philosophers. The wisdom of the ages.

ALL IN THE OUTLINE OF MAN'S KNOWLEDGE. Send this coupon and examine it FREE.

NOW you can have at your command what man has learned in the six greatest branches of human knowledge and culture. Six great romantic outlines that will bring you—compressed into one 700-page volume—the thrilling story of the world's HISTORY down to date—the stirring march and trends of RELIGION—the thought and wisdom of man's PHILOSOPHY—the intriguing beauty of the ARTS—the all-embracing survey of every branch of SCIENCE—and a complete pan-

orama of the world's LITERATURE from the first Neolithic scribblings to the work of modern authors of all nations.

THE OUTLINE OF MAN'S KNOWLEDGE, by Clement Wood, is the ONE book, the only book, that gives you the fascinating story of what man has learned and accomplished from the world's birth in a flare of meteoric splendor up to

the arrival of radio, aviation and television. Here is the whole story—all of it—Science, Art, Literature, History, Philosophy and Religion—in one large, beautiful volume.

**Send No Money — BORROW It at Our Expense**

Clip and mail the convenient coupon and it will bring you, prepaid, a copy of THE OUTLINE OF MAN'S KNOWLEDGE. Examine it. See for yourself how fascinating is the story of knowledge. Read it freely for a week. See how much you have missed in the realm of things you OUGHT TO KNOW. If you are not completely satisfied send the book back within seven days. Otherwise, keep it as your very own and remit the astoundingly low price of only \$1.50 and two dollars a month for two months. Send no money. Just clip and mail the coupon. Do it now—before the present edition is exhausted. Lewis Copeland Company, Dept. 82, 119 West 57th St., New York, N. Y.

**Tear Off Along This Line and Mail Today**

Lewis Copeland Company, Dept. 82,  
119 West 57th St., New York City.

Kindly send me THE OUTLINE OF MAN'S KNOWLEDGE, by Clement Wood, 700 pages, illustrated, handsomely bound. Within 7 days I will either return the book or remit \$1.50 as first payment and then \$2.00 per month for two months, a total of \$5.50. (Ten per cent discount for cash with order. Same return privilege.)

Name .....

Address .....

City ..... State .....

If outside the limits of Continental United States, enclose \$5.00 with order.

"More dramatic than drama, more interesting than fiction." — *Birmingham News*.

"A University in itself." — *Pittsburgh Sun-Telegraph*.

"The ONE book to read and know." — *Philadelphia Public Ledger*.



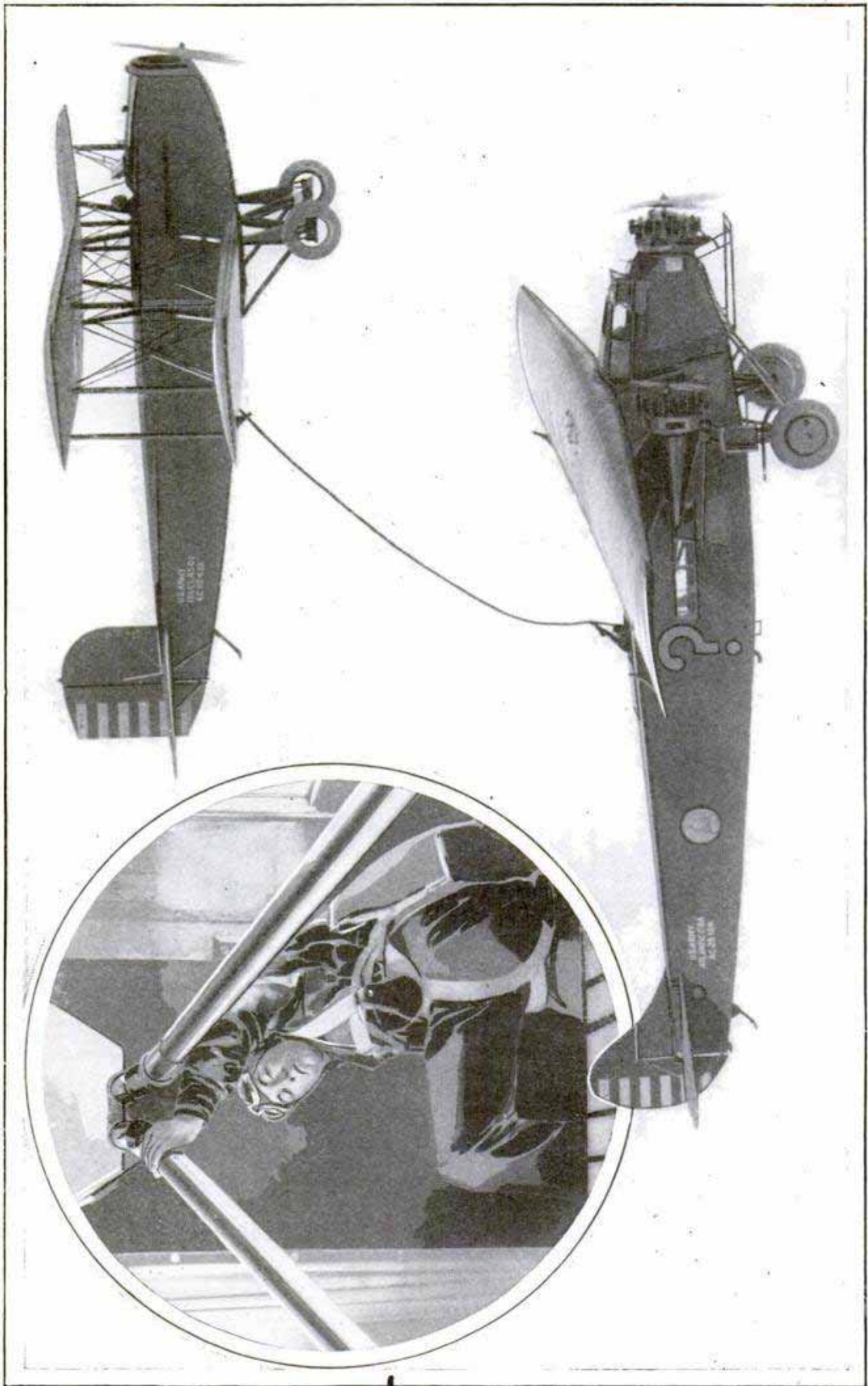

The Big Tri-Motor Fokker "Question Mark," Refueling in the Air over San Diego; the Gasoline Hose, Dropped from Above, Is Caught through a Hatchway in the Cabin Roof; Inset, Lieutenant Quesada of the Record-Breaking Crew Looking After the Gas Lines

Wide World Photos



# Popular Mechanics Magazine

REGISTERED IN U. S. PATENT OFFICE

WRITTEN SO YOU CAN UNDERSTAND IT

Vol. 51

MARCH, 1929

2076

No. 3

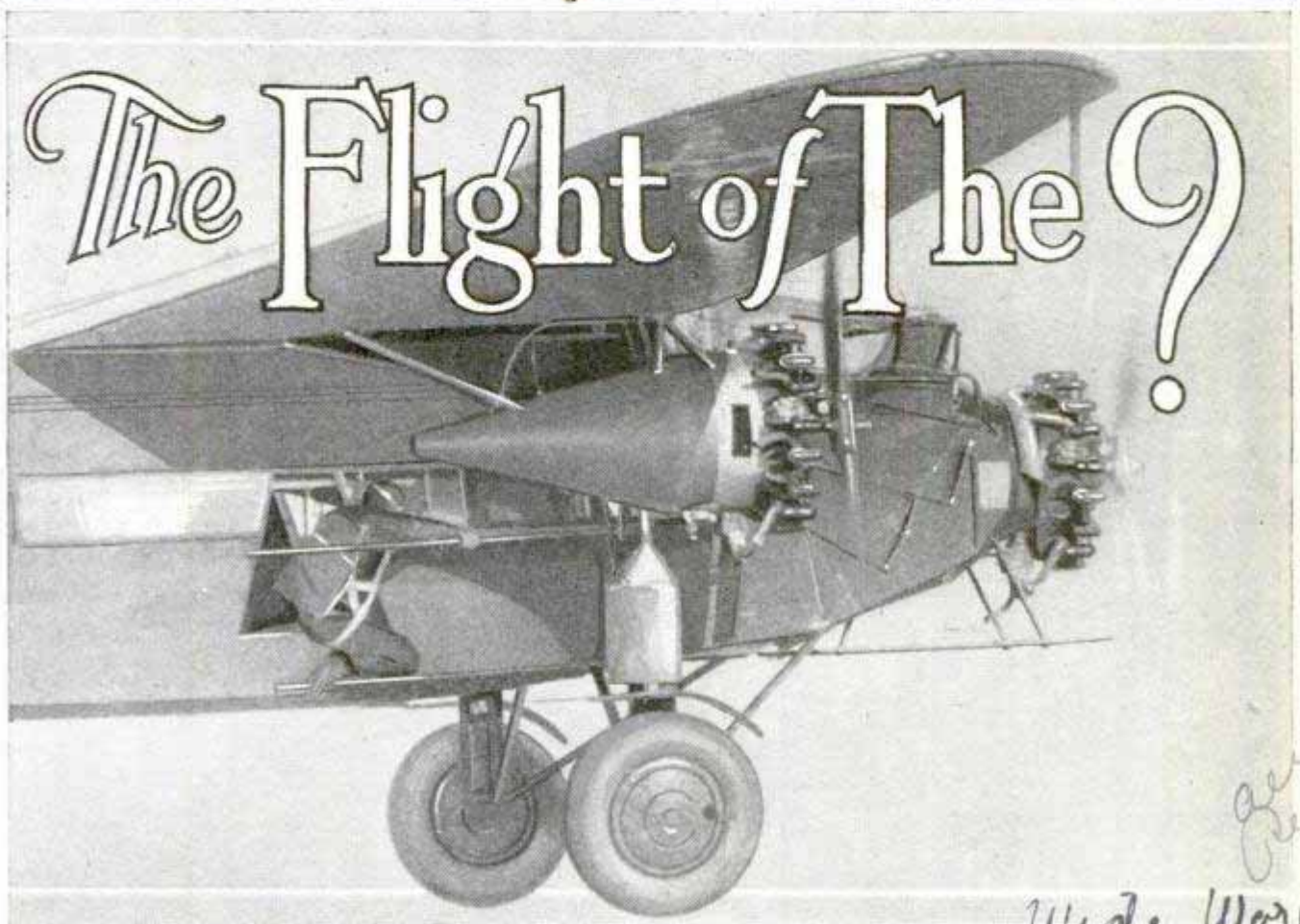

Sergt. R. W. Hooe, Wearing Both Back and Front-Type Parachutes, Starting Out the Catwalk to Look Over the Starboard Engine of the "?" While Flying above San Diego, California

*Gene Buford*  
*Wide World*

**F**IVE weary flyers, their faces grimy and smudged with oil, stepped out of a great tri-motored airplane at the Metropolitan Airport, Los Angeles, and jumped into waiting ambulances to be speedily transported to food and baths and rest. Their huge machine had been aloft 150 hours and 40 minutes; which meant that they had broken every aviation endurance record in history.

A few minutes earlier, a forced landing had averted what might have been a tragic fall to the earth. For a night and a day, all hands had fought fiercely against engine failure in every motor. And at a time when once again the craft had seemed to be in ship-shape condition, it was found that the left motor was missing, a situation calling for but one procedure—immediate descent.

Nearly five days previously the giant

plane, refueled at stated intervals by means of an especially devised hose attached to a plane that flew to within a few feet of the "Question Mark," had broken the American refueling record of 37 hours and 15 minutes, made at San Diego in 1923 by Lieuts. Lowell Smith and Paul Richter. Having shattered this mark, a few days later the "Question Markers" broke the world's refueling record of 60 hours and 7 minutes made by two Belgian airmen, in 1928. Later the intrepid American flyers proceeded to break the world's record of the "Graf Zeppelin," which soared 3,967 miles in its flight to America last fall while remaining in the air 111 hours and 34 minutes.

The "five musketeers," as they are affectionately known in air-corps circles, were Maj. Carl Spatz, flight commander, Capt. I. C. Eaker, Lieut. H. A. Halverson,



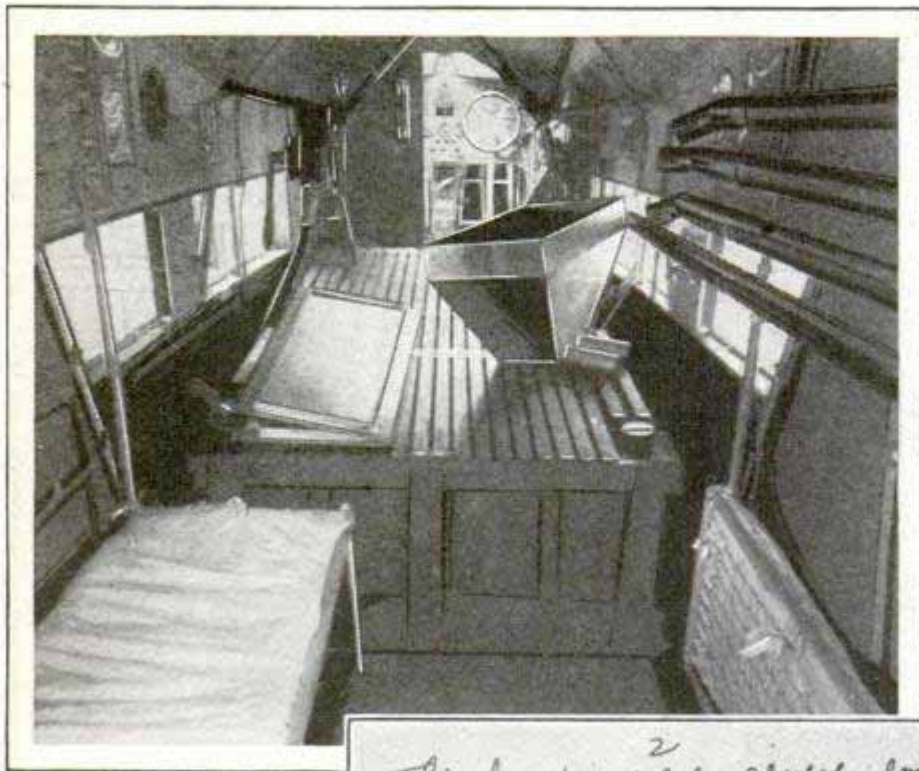

Lieut. E. R. Quesada, and Sergt. Roy Hooe.

The method of transferring fuel from the air was unique in aviation history. In this connection Maj. Gen. James E. Fechet, chief of the air corps, says: "The manner in which the refueling apparatus was installed and perfected is marvelous. Watching the actual operation previous to the flight, I was astonished to find that there was no difficulty at all in attaching the hose to the fuel pipe of the endurance plane (going at about seventy miles an hour) and when the gasoline was being delivered the pressure was such that the hose became an integral part of both planes. No effort on the part of Major Spatz was required when the delivery

The humps were severe enough to cause a difference in distance between the two airplanes of 20 or 30 feet in a fraction of a second. The piloting by both men. Eaker in the C2 and Moon in the C1 was superb. spatz.

Refuelled with 150 gallons gas.  
 35 gallons oil food + supplies - 9:42 - 9:48 am.  
 over San Fernando valley - Fog still creeping up toward airport.

of the fuel took place."

As emphasized by the air-corps experts at the outset, the purpose of the flight was not only to put modern airplane engines to the acid test of absolute endurance and to determine the strain of flight on the human system over a protracted period, but also—in fact primarily—to investigate the practical value of refueling in both military and commercial aviation. Bombing planes, for instance, would be given a wider range of action,

while commercial planes, owing to decreased fuel weight, would be able to carry greater payloads, if refueling could be demonstrated as a successful routine function in aviation.

Both the refueling plane and the endurance ship were equipped with two gas tanks and



Interior of the "?" Showing the Berths and the Big, Square Refueling Funnel; Center, a Sheet from Major Spatz' Log; Bottom, Chalking Messages on the Messenger Plane, Which Flew Alongside to Deliver Them



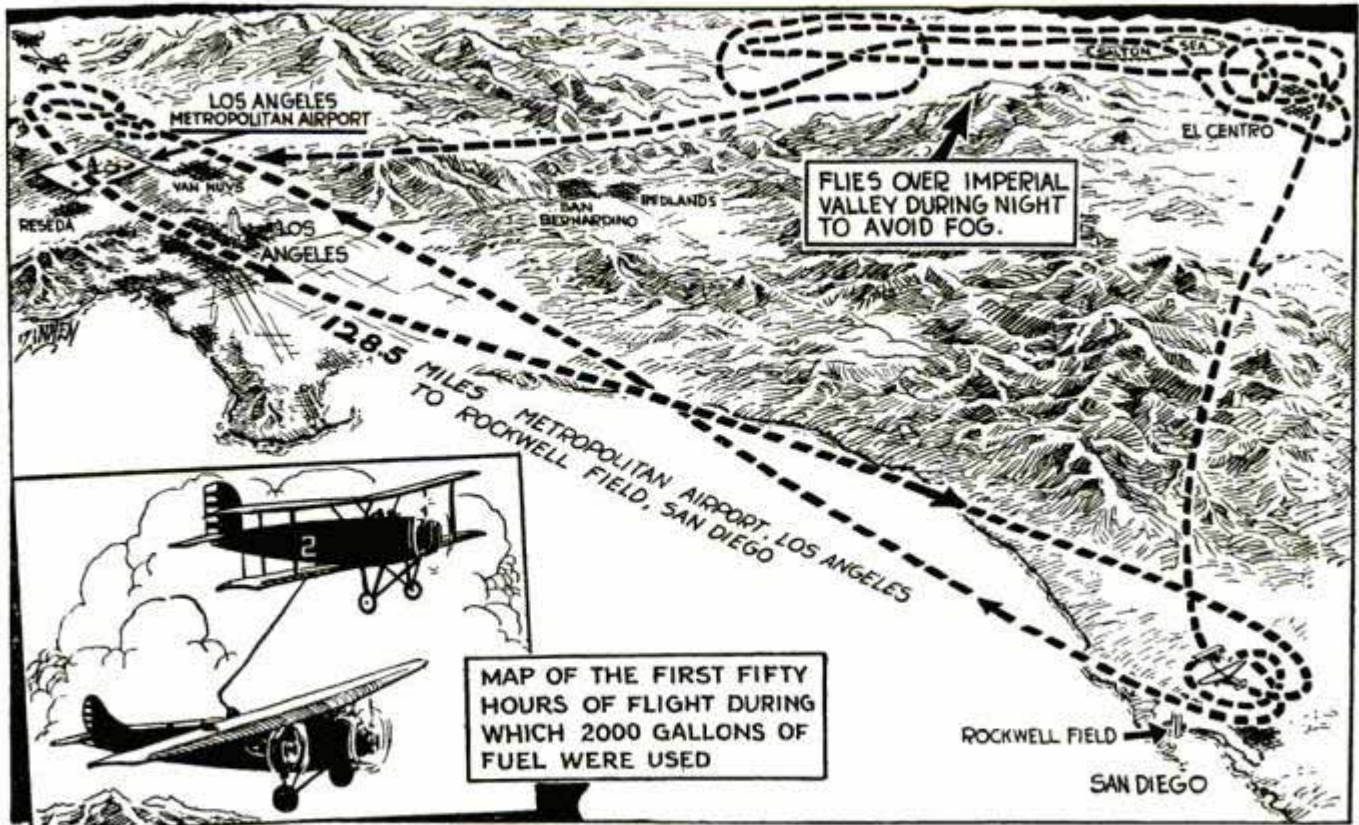

The Map of the Epoch-Making Six-Day Flight, Which Broke All Records; Because of Fog on the Coast, the Plane Spent One Night Inland Flying over the Desert Waste of the Salton Sea

an oil container. The tanks in the former are joined with a pipe to which is attached a fifty-foot hose with a two and a half inch diameter. A similar hose is attached to the oil tank, while ropes were provided also for lowering food, water, messages and other supplies. On top of the gas tank in the "Question Mark" is a berth with two other beds of the folding variety in the rear of the cabin. The gasoline is pumped by hand from the special tank in the refueling ship's cabin.

During refueling periods, the two ships came within about seventeen feet of each other, the endurance plane flying beneath and slightly behind the supply ship. Major Spatz, wearing goggles, rubber face mask, rubber gloves and a raincoat, stood on a small platform built in the entrance compartment of his ship. Thus he was about shoulder-high in the opening cut in the top of the ship at this point. As the hose was lowered from the plane above, he caught it, pulled it through the opening and turned a valve; whereupon the gasoline poured into a reception funnel just beneath the mouth of the hose, at the rate of seventy-five gallons per minute.

A complete log of the ship tells a graphic story. In its earlier stages, it tells buoyantly of luxurious repasts of roast chicken,

ham and eggs and hot coffee, pleasant lounging about the cabin and perusal of the very latest magazines and newspapers. But there are, too, Major Spatz' entries about his experiences when the refueling hose slipped during its speedy journey and spread gasoline all over the interior of the cabin; for instance: "The refueling last night was the most severe test we could have had. Air was very bumpy. Our batteries were low and gave only a faint light. Moon, Jopkins and Solter (in the refueling plane) stuck to their guns nobly. The bumps were severe enough to cause a difference in the distance between the planes of between twenty and forty feet in a fraction of a second."

Late in the flight, in fact the day before the forced landing, Lieut. Elwood R. Quesada, one of the four pilots in the "Question Mark," wrote: "One motor sounds all right but doesn't look so good. It is slowing up. We can't trust our ears any more. It looks as though the human being would outlast the motors. They are going fast."

One of the unsung heroes of the epochal flight is Sergt. Roy G. Hooe, chief aviation mechanic at Bolling field, Washington, whose task on the "Question Mark"



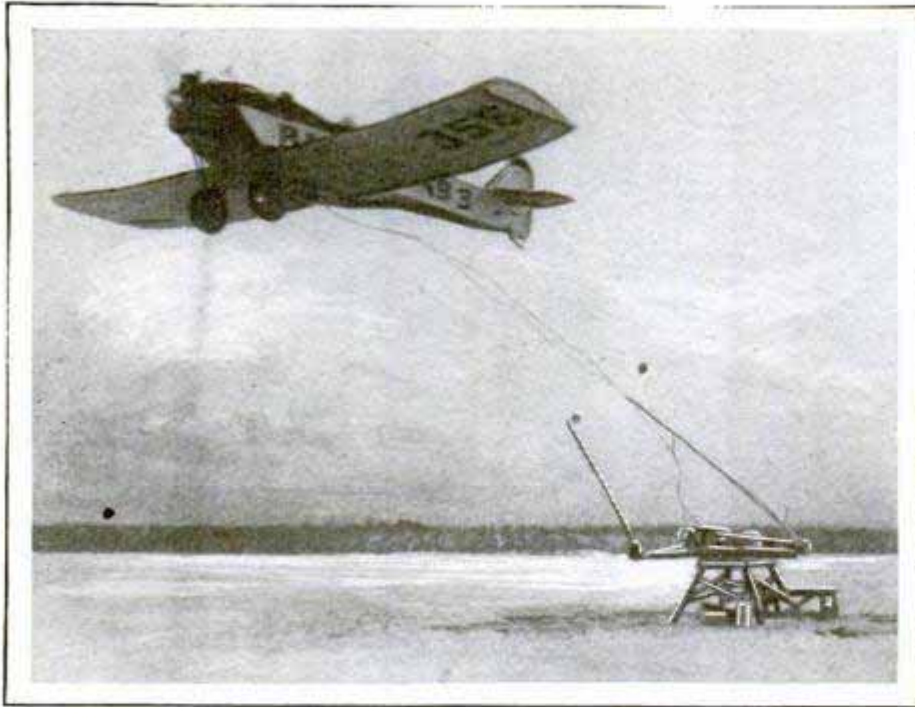

A Refueling Flight That Failed; Blaine Tuxhorn's "Barling" Taking Gasoline from a Catapult That Hurlled ~~Cans~~ into the Air

was to maintain at all times the steady beat of the engines. If any of the three great 225-horsepower motors happened to skip or falter, Hooe had to repair it at once, and to say that his was a man-sized job in the midst of the terrific speed and frequent cold weather, is to express the situation mildly. Many a time he had to climb out on the fuselage and repair an engine. Along with the four tireless pilots he made aviation history.

No objective was set concerning the length of time the plane was to remain aloft. The problematical feature of the mission is best indicated by the naming of the ship the "Question Mark." Air-corps heads early emphasized the point that a minor mishap, which means little in ordinary flying, can put a most effective though temporary brake on any non-stop experiment. However, every precaution was taken to have plane, engines and equipment as flawless as possible. Nothing was left to chance.

Regarding the earlier refueling test, Major General Fechet says: "Preliminary research along these general lines was made five years ago when Capt. Lowell H. Smith and Lieutenant Richter conducted experiments which had their climax in a border-to-border flight along the Pacific coast. This flight furnished opportunity for the transfer of the largest quantity of gas then on record."

However, the tests of 1923 and those conducted by the "Question Mark" differ in certain marked respects. In the first place, the 1923 endurance plane had only one motor while the record breaker has three. The largest quantity of gas transferred at the earlier date was 125 gallons while hundreds more had to be poured into the tanks of the 1929 endurance ship between dawn and dusk every day. Two men sat in open cockpits in 1923, while five men enjoyed a far greater share of comfort in the "Question Mark," which includes

among its special equipment three berths, two comfortable wicker chairs, books, radio and a small electric stove.

The plane in the recent flight was to have two officers on duty in the pilot's compartment at all times. Major Spatz attended to the transfer of supplies and Captain Eaker was at the wheel during the contact periods, of which there were from three to six each day. That is to say, these two officers took charge by day while Lieutenants Halverson and Quesada took their places by night.

Many and enthusiastic were the expressions of opinion about the probable effects of the record-breaking flight from men high up in the war department or air corps. Major General Fechet said: "I believe that within a few years we will have commercial planes capable of a cruising speed of 150 miles an hour crossing the continent from New York to San Francisco and Los Angeles without stopping and picking up their fuel in the air."

F. Trubee Davison, assistant secretary of war in charge of aeronautics, called the feat, "a new and thrilling chapter in man's conquest of the air." He added: "Several important problems were solved in preparation for the flight, all of which make for materially increased safety and reliability. Many other lessons have undoubtedly been learned which a study of the details of the flight will reveal."



*Chemical Engineer,*  
*Paramount Studios, Hollywood,*  
*Calif*

# CHEMICAL SKATING RINK SMOOTHED BY HOT IRON

Synthetic ice, made from chemicals, places skating in the list of summer sports where an artificial pond is practical. It is warm instead of cold and does not melt, and when it becomes rough after too much use, it is smoothed out with a hot

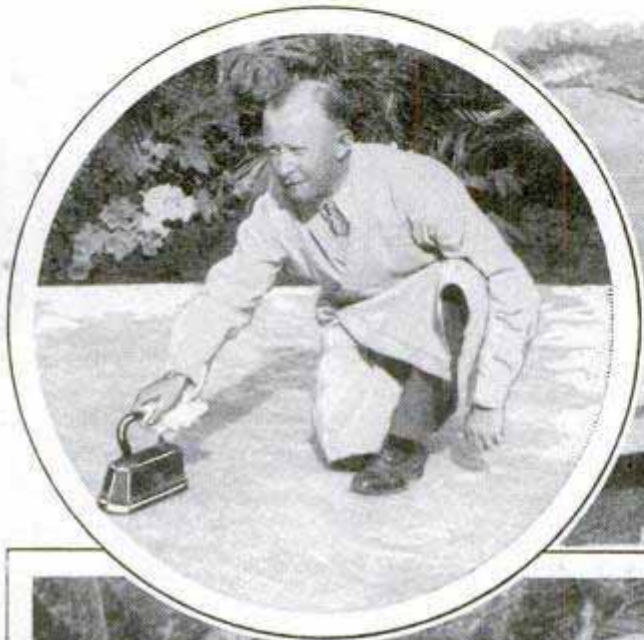

Pouring the Chemical into the Frame of Rink, Smoothing Rough Places with Iron, and Skaters Enjoying the Thrills of a Winter Sport in Tropical Surroundings

iron. The formula for the composition of the artificial ice is the invention of a chemical engineer of Los Angeles, and the rink illustrated is installed, amidst

tropical surroundings, in a Hollywood studio, for use by the actors during recreation hours. For skating, the ice has all the properties of the natural product.

*A. B. Maas Chemical Co 3082 8 11 14*

*Prof Arthur B. Maas, Industrial Chemist University of Southern California*

*6. 817 49. 14. 15. 16. 17. 18. 19. 20. 21. 22. 23. 24. 25. 26. 27. 28. 29. 30. 31. 32. 33. 34. 35. 36. 37. 38. 39. 40. 41. 42. 43. 44. 45. 46. 47. 48. 49. 50. 51. 52. 53. 54. 55. 56. 57. 58. 59. 60. 61. 62. 63. 64. 65. 66. 67. 68. 69. 70. 71. 72. 73. 74. 75. 76. 77. 78. 79. 80. 81. 82. 83. 84. 85. 86. 87. 88. 89. 90. 91. 92. 93. 94. 95. 96. 97. 98. 99. 100.*



*University of Florida Gainesville Fla*

**COAL STOVE FOR AUTO ENGINE PREVENTS FREEZING**

*2044 Berlin N.W. Germany*  
*Ulro Motor and Truck*  
*Zubebar A. So. Kaiserling*  
*Augusta Illinois*

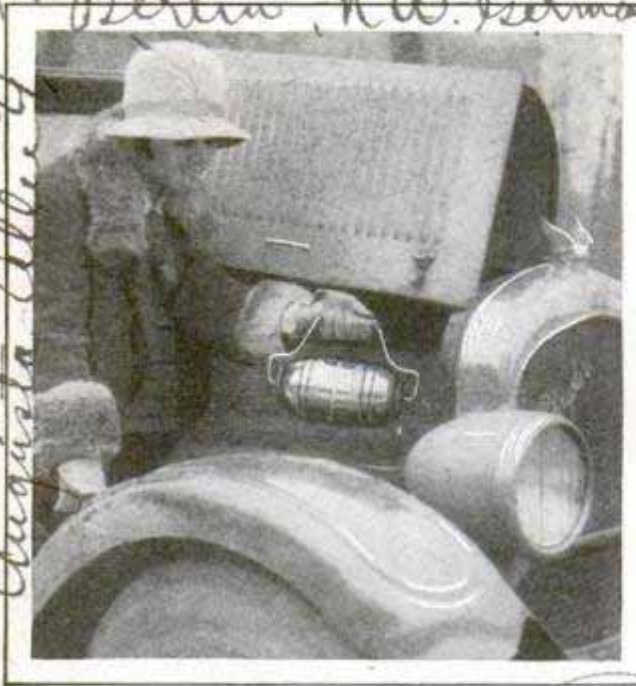

© P. & A.

Placing the Stove under Hood, to Keep the Engine Warm; the Degree of Heat Can Be Regulated

To keep the automobile engine and radiator warm while the car is parked in cold weather, a portable coal-burning stove has been introduced. It is said to be entirely safe, has an arrangement for regulating the degree of heat desired and can be carried under the hood when it is not needed.

**PRAYER WHEEL RUN BY WIND PUT ON EXHIBIT**

*2018*

Devout natives of Tibet have an easy way of saying their prayers. The supplication is written out on a long strip of paper something like stock-ticker tape, then placed in a wheel or cylinder which is spun at a rapid rate, sometimes for days. Each revolution, the worshipers believe, is equivalent to an oral repetition of the prayer; therefore many spinnings make it more effective, it is thought. Some of the cylinders have a tin propeller to produce the revolutions when the wind blows. Dr. Berthold Laufer, noted orientalist of the Field Museum of Natural History, who has collected a number of the prayer wheels for the museum's exhibits, points out that it is curious that a people so backward and slow-moving in other things, should have devised a mechanical means of saying their prayers. The idea, he sug-

gests, seems more in keeping with the more mechanically minded people of the west. Near the villages, and in the galleries of some of the temples of Tibet, are huge barrels, thirty or forty feet high and fifteen to twenty feet in diameter, turned by windmills or waterpower. In these are placed complete collections of the books of Lamaism, the native religion.

**CHEMICAL IN GRAPEFRUIT PEEL FORMS GOOD FERTILIZER**

*2005*

Grapefruit peelings contain chemicals that make good fertilizer, tests at the Florida experiment station have shown. Nitrogen, potash and phosphoric acid are among the substances they release to the soil. In certain producing centers, where large quantities of the offal are available, the peelings can be used for fertilizer with but little expense, the tests indicate.

**BILLIARD AND DINING TABLE COMBINED IN ONE**

*2022*

Entertainment and utility are combined in a table that has a removable top with space for playing billiards beneath. When the top is on, the table cannot be told from an ordinary living or dining-room article, and the cover is made in sections so that it can be removed easily. Drop aprons conceal the billiard rails and pockets.



Table Top Slides Back in Sections, and Is Removed for Playing Billiards on Base Underneath

*Brunswick. Baker*



**PLANTS SNEEZE AND TAKE COLD  
SCIENTIST FINDS** 2090

Plants and flowers are afflicted with a form of sneezing and catching cold, according to H. H. Whetzel, of the New York state agricultural college. Professor Whetzel has photographs of a plant sneezing. A certain kind of destructive fungus has cup-shaped seed holders and at the bottom of each seed-pod bag is a charge of starch which ferments and explodes. This causes the seeds to blow out in all directions. They float through the air and lodge on the leaves of other plants, taking root there and causing effects similar to those produced by colds. Among the plants, however, the "colds" are not contagious. Each variety has its own kind of cold and these do not attack other plants not even in the same garden. A photograph, taken at the instant of the explosion of a seed bag, shows tiny seeds swirling like a dust cloud from the cup.

*Dr. Joseph C. Marcelais, 60 Safety Clear Vision Co. Fitchburg, Mass.*

**WINDSHIELD WIPER IS HEATED  
AND ALSO REDUCES GLARE** 2049



To prevent the formation of snow and ice on the windshield, an eastern inventor has devised a heating chamber, installed with the wiper. It is wired to afford different

degrees of heat and can be swung out of the way when not needed. The heat chamber itself is of tinted glass, which is said to reduce the glare from approaching headlights and also protects the eyes from the glare of the snow in winter driving.

**SHARKS TO YIELD PROFITS  
IN OIL AND LEATHER** 2010

To reclaim valuable products from the tons of sharks that are caught every week during the whaling season, an Australian concern plans to erect a factory at Two-fold Bay, New South Wales. It is estimated that nearly \$1,500 will be reclaimed each week in oils, leather and other substances produced from the sharks and other inedible fish.

*Conk. K. E. Chute  
Box 407, Route 4*



Outlets Installed in Office, and Close View of the Single and Double Types

**ELECTRIC OUTLET ON FLOOR  
SIMPLIFIES WIRING**

Adapted especially for stores and offices, an electric outlet is set up near a desk or table for lights, telephone, dictating machines or other equipment. It is made in single or double-connection styles, is easily installed and has a brass housing that protects the wires. With a number of these outlets in place, various combinations of service can be worked out with practically no extra wiring, and the floor connections are often more easily made than those from wall sockets.

**FILTER FOR HOT-AIR REGISTER  
KEEPS WALLS CLEAN** 2052

To prevent dust and dirt from soiling the walls and ceilings in homes that are heated by hot-air furnaces through floor registers, a filter pad has been designed to be installed just below the register. It is made of a finely woven, chemically processed steel wool and is thick enough to cleanse the air of soot and smoke without appreciably hindering the heat from rising into the room. It is easily removed for cleaning.

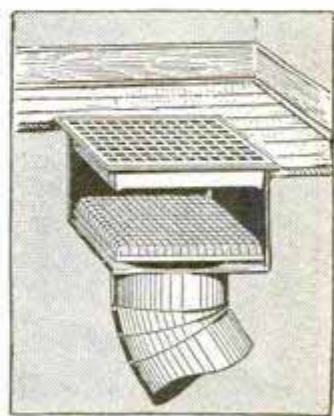

*Fettle Register  
H. C. ...*

*Chicago, 53 Jackson Blvd.  
Frank H. ...*



# INVENTORS SAVE

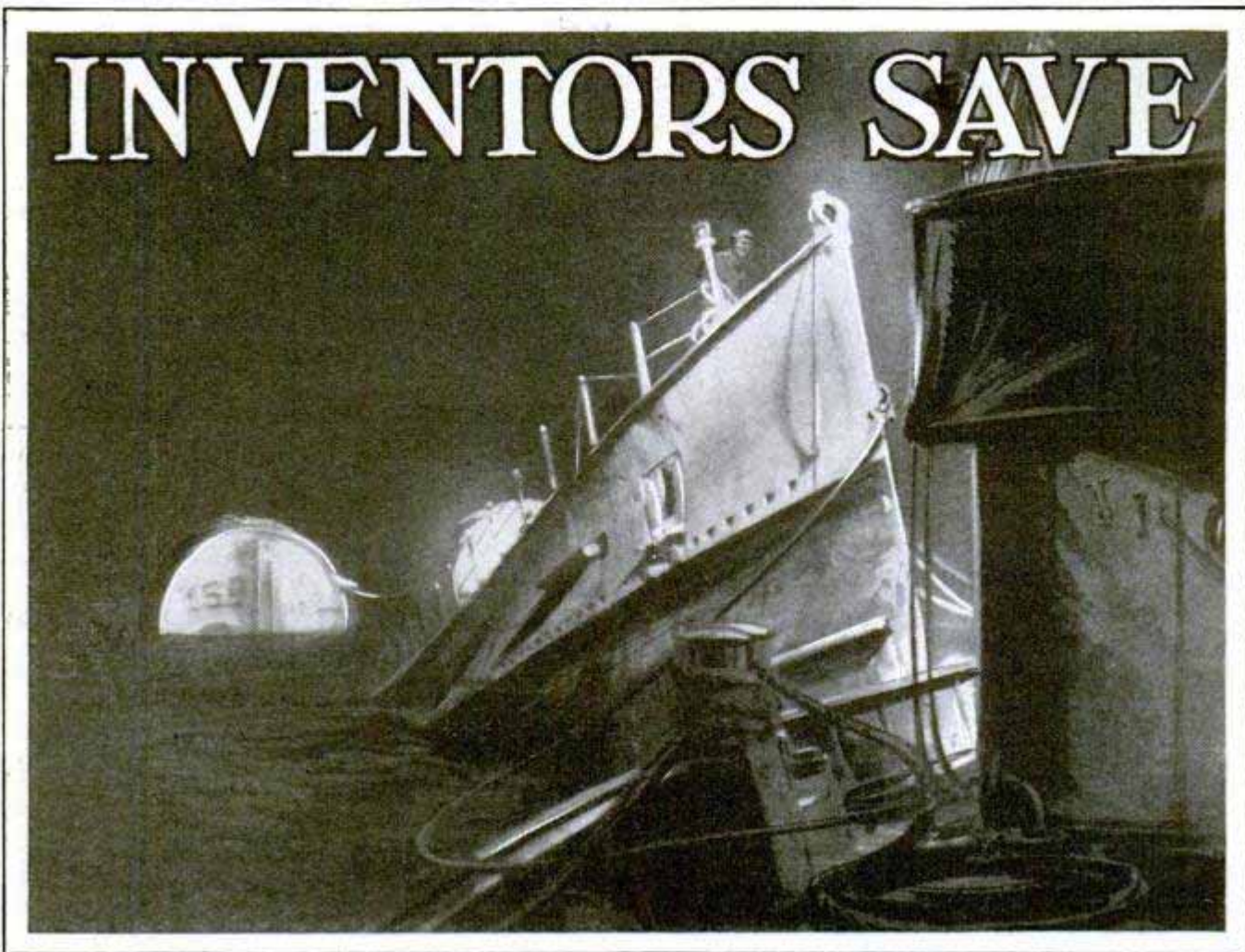

The Bow of the "S-4," Supported by Two Pontoons under the Lights of the Salvage Tugs, After It Broke the Surface Following Forty-Nine Hours on the Bottom of the Atlantic

**T**ESTING the best of more than 5,000 submarine-rescue devices proposed to the navy during the last year, the "S-4," which was rammed by the coast guard destroyer "Paulding," on Dec. 16, 1927, is now undergoing trials as the world's first experimental rescue submarine.

Raised and repaired, after the removal of the bodies of her forty dead—six of whom lived for seventy-two hours in the torpedo room before their air supply was exhausted—the "S-4" was sent to the bottom again on the first anniversary of her fatal accident in the first of the series of experiments which may continue for many months. Her engines had been removed and the apparatus that remained aboard concentrated in two main compartments, leaving three sections which may be flooded at will to simulate conditions on a damaged submarine.

The first test was not an unqualified success. It took forty-nine hours to bring the boat to the surface after sinking her in sixty feet of water, and that was with the rescue equipment ready alongside to start

rescue operations the moment she reached the bottom. Had it been necessary to gather the pontoons, chains, divers and rescue craft, and tow the heavy pontoons to the scene, it would have been impossible to bring the boat up in the seventy-two hours that six men had survived aboard her. The first device tried was a set of "pad eyes"—huge eyebolts built into the hull—to which the chains of the lifting pontoons could be shackled without tunneling under the sunken boat, as is necessary when chain slings must be passed around the hull.

It took ninety minutes to attach the first of the four chains. After the two forward chains were fastened, water ballast was blown from one of the side tanks to make the submarine list over at an angle of twenty-five degrees, so that one of the after pad eyes was almost buried in the mud and the other elevated on the sloping side of the craft. This was done to test the ability of the divers to reach the eyes under adverse conditions. Despite the change, the two after chains were



# SUNKEN "SUBS"

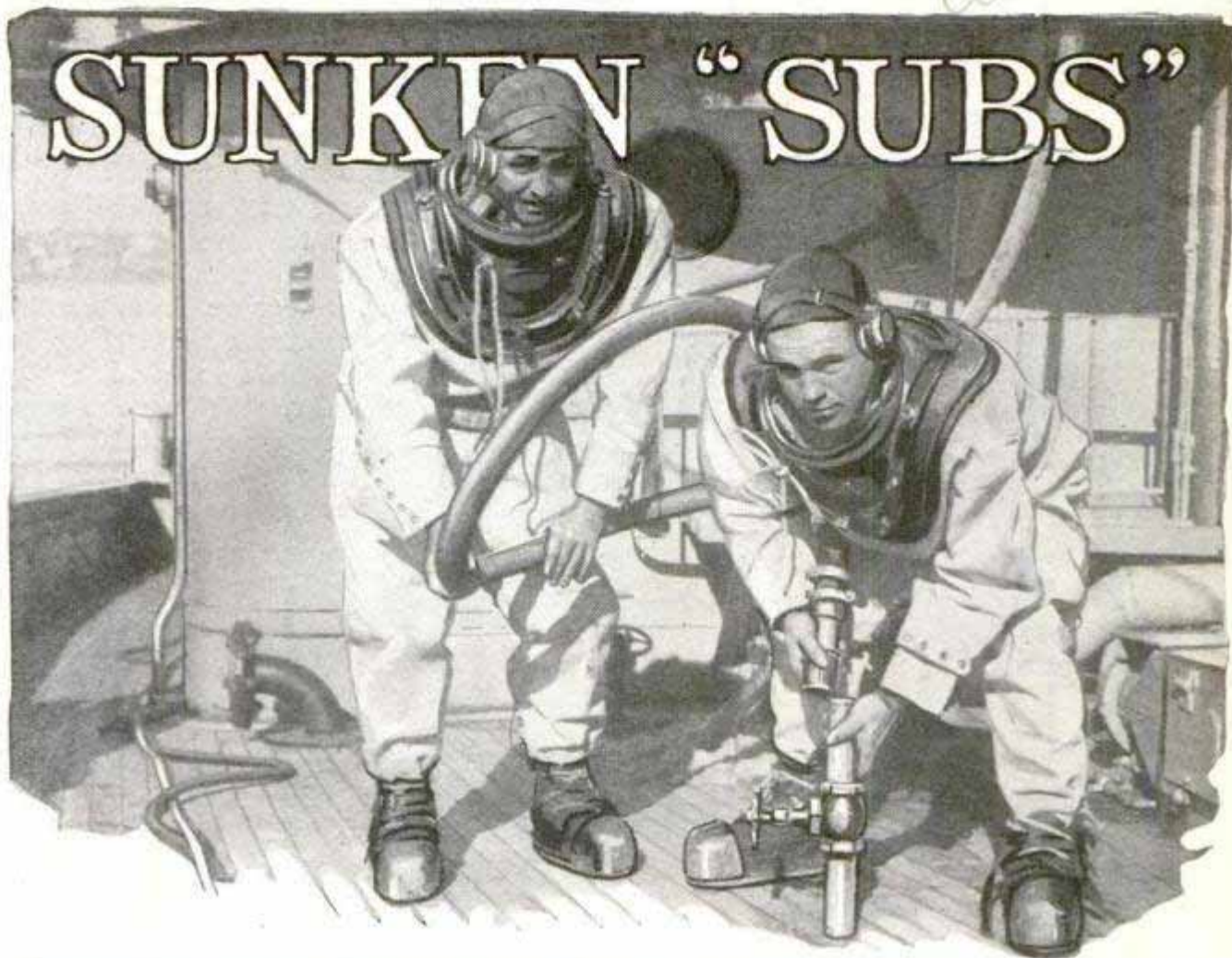

Clarence Knight and George Boone, Two of the Divers on the "Ortolan," Submarine Rescue Ship of the Pacific Fleet; the "Ortolan" Can Put Twenty-Four Divers over the Side at One Time

attached in about the same time as those to the forward eyes.

The submarine rescue ship "Falcon" then began blowing the water out of the pontoons and flooded compartments by sending down air at high pressure, but instead of coming up, as expected, the bow of the submarine broke the surface while the stern remained on the bottom.

After a consultation, it was found that two errors in designing the rescue devices were to blame. One was that the single air line was forked in order to supply the three main ballast tanks, and the second was that the escape vents for water in both forward and stern compartments were all placed at the forward end of the sections. With the boat resting on an uneven bottom, the bow being higher than the stern, the air line could only force out a certain amount of water in the stern, and too much remained to restore buoyancy. The navy experts decided that individual air lines, as built in the navy's new V-class submarines, and the location of forward vents at the forward end of for-

ward compartments and after vents at the aft end of stern compartments would solve that difficulty.

Following the first experiment, the submarine was towed to Key West, where tests will be continued in warmer waters. One of the first things to be tried there is a submarine diving bell, built to fit a special escape hatch on the deck of the submarine. The hatch is provided with a coaming over which the diving bell comes to rest, forming a watertight joint. The divers descending inside the bell can guide it into place and then open the escape hatch and take a number of the crew into the bell. It was estimated that three hours would suffice to rescue forty men.

Another form of escape, is the concentration of all the available air in the submarine in one compartment by flooding the others, to provide a reserve supply for the crew while they don the navy's new rescue helmet, called a "lung," and escape singly through a special hatch. The lung is a small face mask attached to an air supply in a container that closely



2061

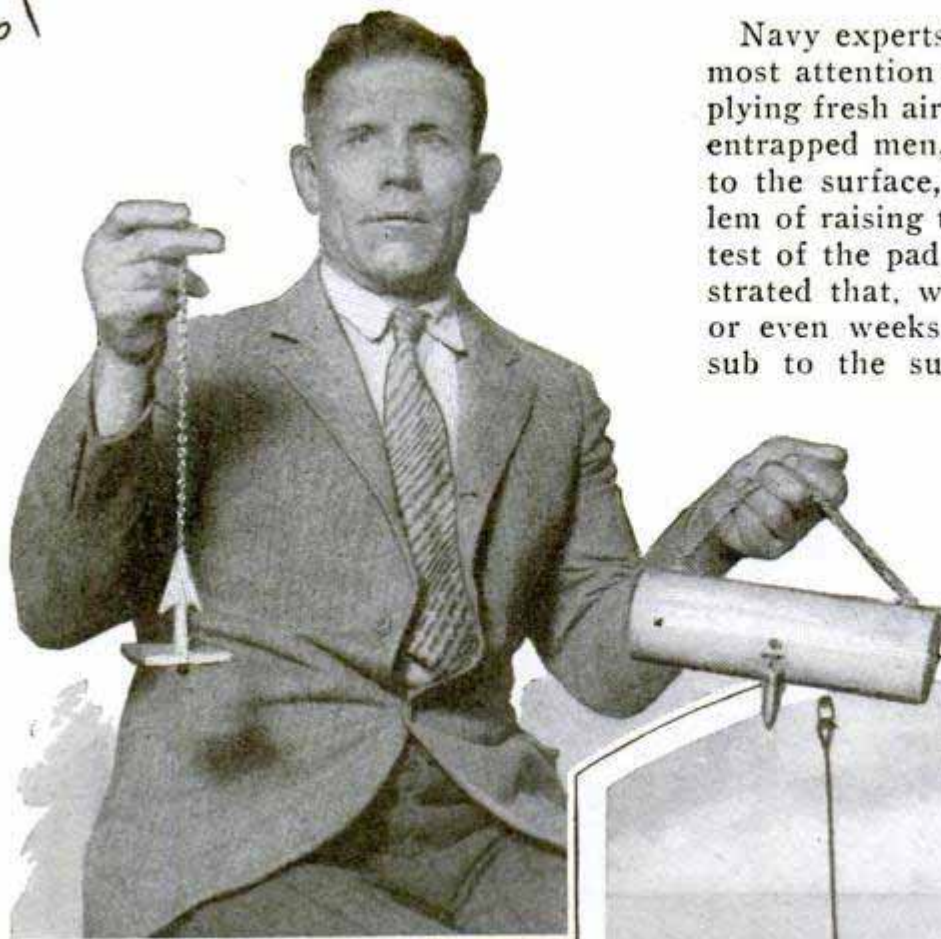

Navy experts are generally agreed that most attention should be devoted to supplying fresh air, and, possibly, food, to the entrapped men, and effecting their escape to the surface, before tackling the problem of raising the sunken craft. The first test of the pad eyes on the "S-4" demonstrated that, while they would save days or even weeks of effort in bringing the sub to the surface, there is still small chance of collecting the pontoons and rescue gear, reaching the scene of an accident, and getting the submarine up before the crew had died from lack of air.

resembles a rubber hot-water bottle. Experiments already made show that even inexperienced men can rise 155 feet without discomfort, and without suffering from the dreaded diver's cramps, or "bends."

Simultaneously with the "S-4" tests, experiments started with the old submarine "Defender," one of Simon Lake's early boats, which has been rebuilt as an under-sea salvage boat. As rebuilt, the "Defender" has an air lock on the underside of the bow through which a diver can reach the water. The first experiments were made in raising a sunken pontoon, but it is planned to carry out thorough tests with a submarine. The "Defender" will be able, the builders believe, to drop to the bottom alongside a sunken craft and send over divers to couple on air lines or hook on lifting chains much faster than it can be done from the surface. Lying on the bottom, the boat will be independent of weather conditions.

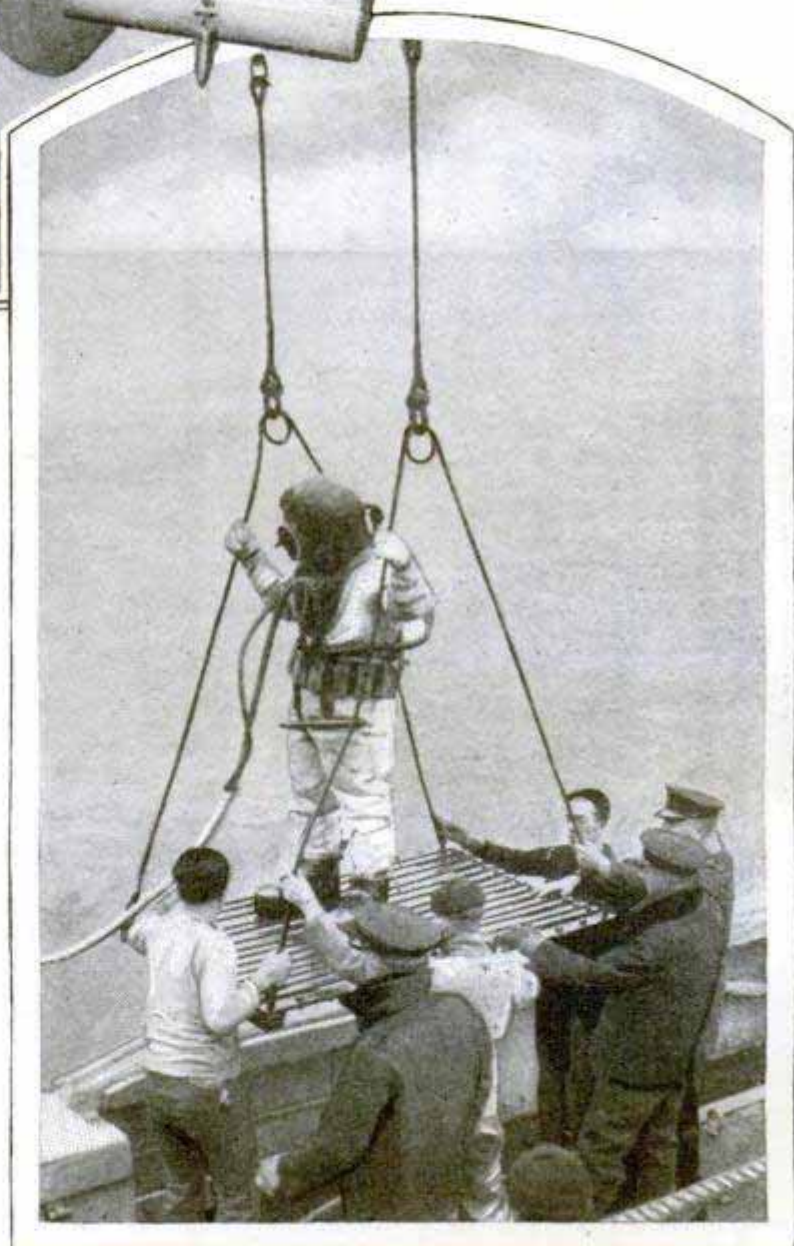

A Diver on the Stage, and Henry Lotz with His Model Hook and Pontoon Which Eliminates Divers Entirely

While the rescue crews on the east coast were experimenting with the "S-4"



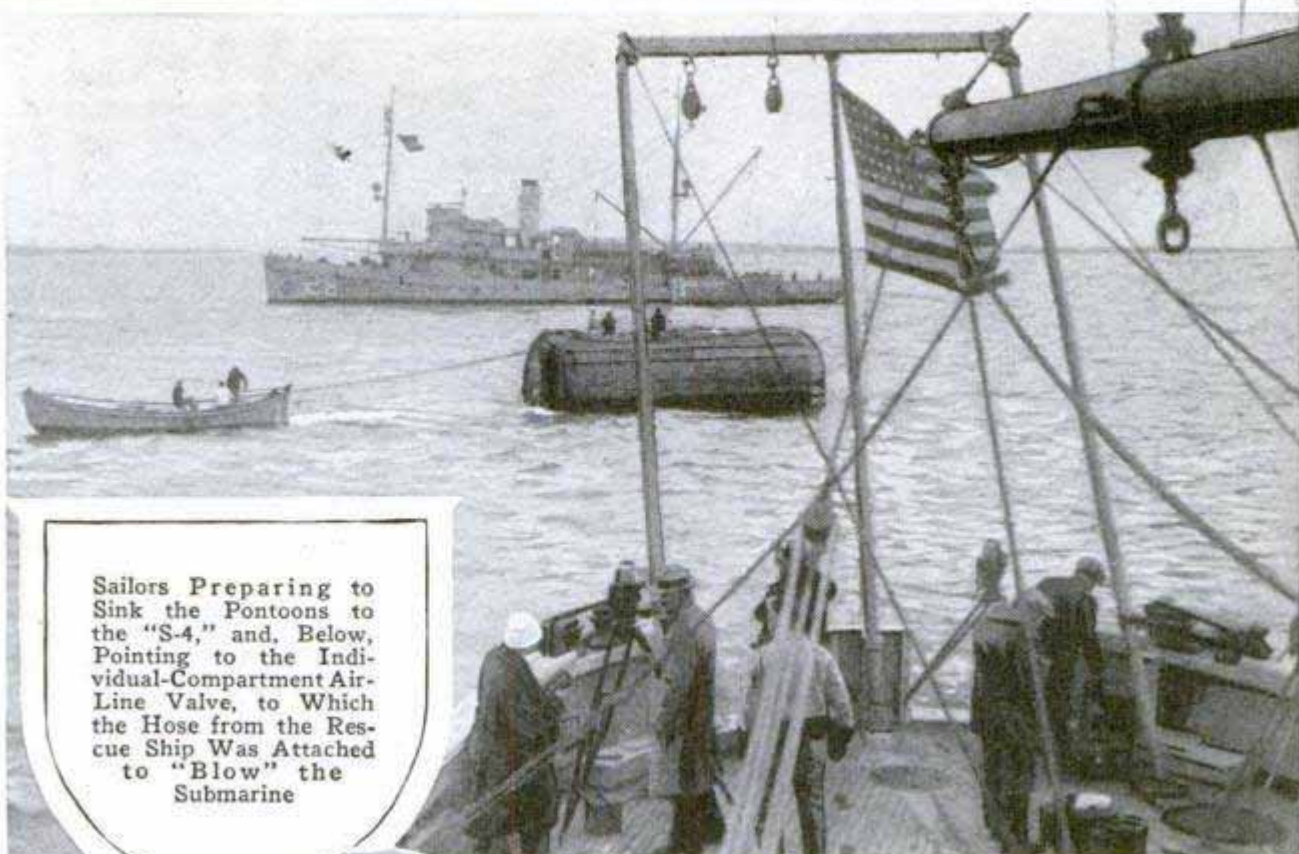

Sailors Preparing to Sink the Pontoons to the "S-4," and, Below, Pointing to the Individual-Compartment Air-Line Valve, to Which the Hose from the Rescue Ship Was Attached to "Blow" the Submarine



Sailor, on Right, Holding to One of the Pad Eyes Built into the "S-4's" Hull





Diver in the Recompression Chamber, Preparing to Test an "Artificial Lung," Which Has Proved Practical at Depths of 155 Feet

and "Defender," a successful attempt at supplying both fresh air and food to a crew on the bottom was carried out by the Pacific fleet off the southern California coast. Special valves, developed under the direction of Rear Admiral Ridley McLean, were installed in each compartment of the "S-29," and the submarine then put to sea. Acting the part of a surface ship which had rammed a submarine, the sub sent out a radio call for help, giving its position, and then dived and came to rest on the bottom in ninety feet of water.

Ten miles away, the rescue ship "Ortolan" received the radio call and steamed at full speed to the position given. As it approached, an air "slick" was sighted. The "Ortolan" put out a pair of motor launches equipped with sweep wires and grapnel, and while they patrolled the sea, the listening device down in the bow of the rescue ship began to signal the submarine. Back came a code reply, tapped

out on the "S-29's" hull with a hammer.

With the spot well marked, the rescue ship anchored directly overhead, lowered hose lines, and the divers prepared to couple on to the valves in the hull. Eight hours after the submarine had submerged, Lieutenant Karns, looking through the eyepoint of his conning tower, saw a diver clamber along the deck and through the faceplate of his helmet recognized Diver Knight, a Sioux Indian. Knight saluted and began coupling on the first hose. A moment later the submarine crew heard muffled words as another diver expressed his heated opinion of a balky coupling. Within a few minutes the "Ortolan" was ready to send down air, or use the hose lines to furnish fresh water or hot soup. The "S-29" had eleven hose connections.

In a report of the bureau of construction and repair, the tremendous difficulties in the way of any form of special apparatus is emphasized. Unlike a surface ship, a submarine is a delicately balanced thing in which the available buoyancy, when operating submerged, is practically zero. To add equipment means that something else must be taken out. In the building of new submarines, it is possible to assign any desired proportion of weight to the necessary rescue equipment, but when it comes to re-equipping the existing ships, the problem is entirely different. Part of the weight of the rescue equipment can be compensated for by reducing the weights in the ballast keel, but any such reduction cuts down the reserve stability of the ship, and therefore increases the danger to both submarine and crew, making an old refitted sub actually more dangerous than one without the new safety devices.



V. J. Surmeli, Keppawh N. J.  
POPULAR MECHANICS  
Office, 247 Park Ave  
New York



Twenty-Passenger Metal Monoplane with Its Wide Cabin, Shaped like the Wing Itself, to Afford More Room for the Occupants and Decrease Air Resistance

### METAL PLANE WITH WIDE CABIN CARRIES TWENTY PERSONS

A cabin, fourteen feet wide and having accommodations for twenty passengers, is one of the chief features of an all-metal monoplane which has been designed for fast service between New York and Chicago. The broad, flat shape of the cabin, conforming to the pattern of the wing, is expected to contribute to the ship's sailing qualities. The plane has two motors of 650 horsepower each; its landing wheels fold up into recesses in the bottom of the cabin while in flight, to decrease wind resistance, and a powerful hinged searchlight, which may be adjusted to different angles, has been installed in front to aid in night landings. A speed of 175 miles an hour is expected. The plane has been designed to afford pilots and passengers exceptionally unobstructed vision.

*Sky Lines, Inc.*

that the gods were angry with him, the worker confessed the next morning and handed the mask to his superior. The relic was discovered in a grave and represents a high degree of craftsmanship.

### IODINE INJECTOR FOR TEETH TO ELIMINATE PULLING

To cure abscesses and so make it unnecessary to pull teeth afflicted with them, a southern engineer has devised an injector which drives iodine far down into the roots of the affected member. It is compactly constructed and has been successfully tested, according to reports.

2036

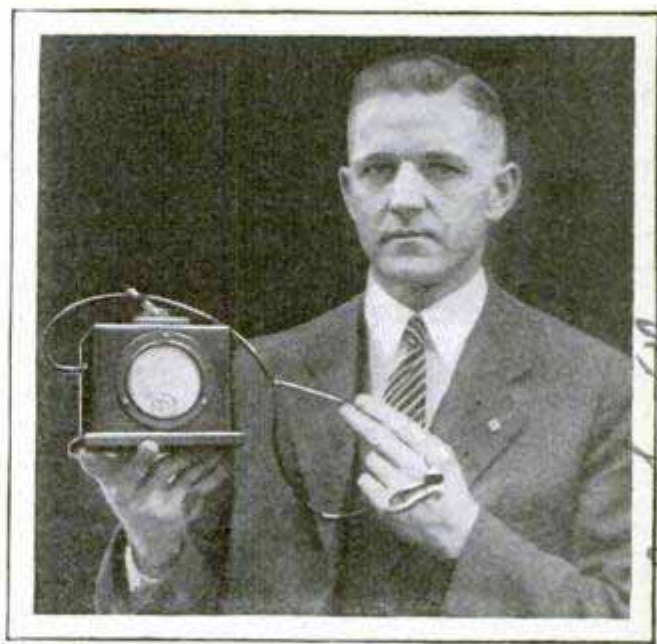

Injector for Forcing Iodine to the Roots of the Teeth in Order to Cure Abscesses

### INDIAN SCARED BY EARTHQUAKE RETURNS STOLEN TREASURE

Because an earthquake frightened an Indian excavation worker, helping British scientists uncover Maya ruins in Honduras, the British museum is now the owner of a prized death mask that it otherwise might not have received. The mask had been stolen by the Indian while his overseers were not watching. That night, a severe earthquake occurred. Thinking

2066

*La change St.*  
*Dr. H. Clayton - 31*

*Com. H. J. Williams, Esq.*



2045

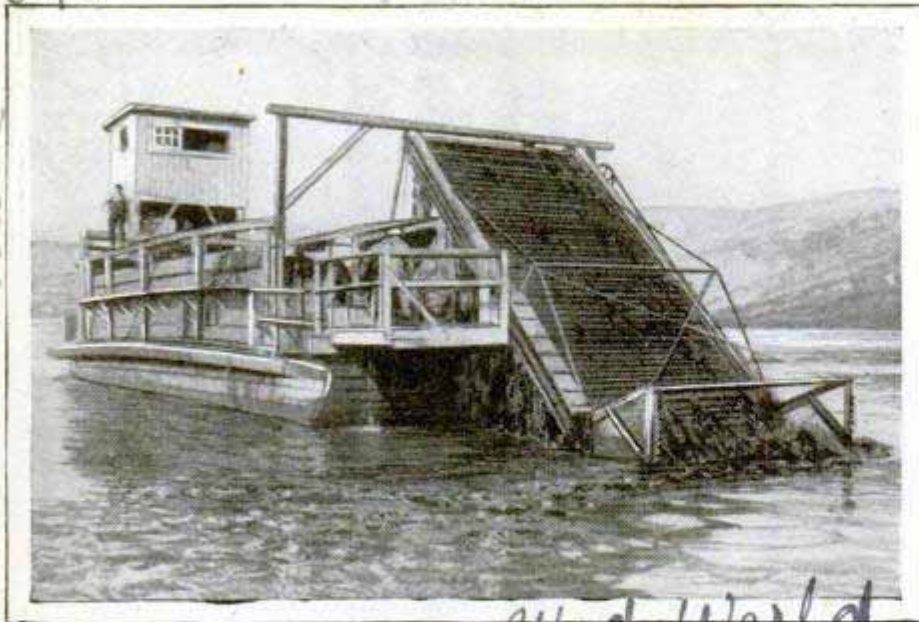

Mowing "Grass" from the Bottom of the Sea; Cutter Which Clears Kelp from the Los Angeles Harbor in Operation

### "LAWN MOWER" FOR SEA KEEPS OCEAN HARBOR FREE

The floor of the Los Angeles harbor is kept free from kelp by means of a marine "lawn mower" with blades on an endless chain. The growth is cut and ground for stock food after being dried.

### "WHEN IS IT REALLY COLD?" SCIENCE ASKS

In Siberia, the mercury commonly goes down to ninety degrees below zero during the winter; test balloons, sent to high altitudes have recorded temperatures four degrees colder, and sixty degrees below zero is not uncommon at the poles. Much lower temperatures are reached in the laboratory. In the production of liquid air, a mark of 320 degrees below zero is reached and liquid hydrogen has a temperature of 422 degrees below. Articles such as pieces of metal, paper, meat or other solids are shattered like china by a slight blow after they have been plunged into a vessel of liquid air. What scientists regard as the ultimate degree of coldness is the absolute zero, 459.6 degrees below the familiar zero of the Fahrenheit thermometer. Such is the cold of space through which the earth and other planets move. Atmospheres shield many from this terrific cold, but the mark is reached on the dark side of the moon, although boiling temperatures are experienced during the day on the side turned to the sun.

### MILE-LONG TRAINS GO BY FERRY TO CUBA

Ninety-five freight cars, enough to make a train a mile long, can be carried at one time in a huge ferry recently placed in operation between New Orleans and Havana. The craft is nearly 430 feet long, has a beam of more than sixty-three feet and differs chiefly from other units of its kind in that cars are carried throughout the holds, between decks and

on the superstructure, instead of only upon one deck. The loaded cars are handled by an immense crane at each terminal. The ferry will take about fifty-two hours for the transit between the two ports.

### "MOUNTAIN" BUILT OF SPOONS FOR FAIR DISPLAY

One of the most attractive exhibits at the Leipzig trade fair in Germany was a huge mound of 25,000 spoons. The display represented passageways, tunnels,

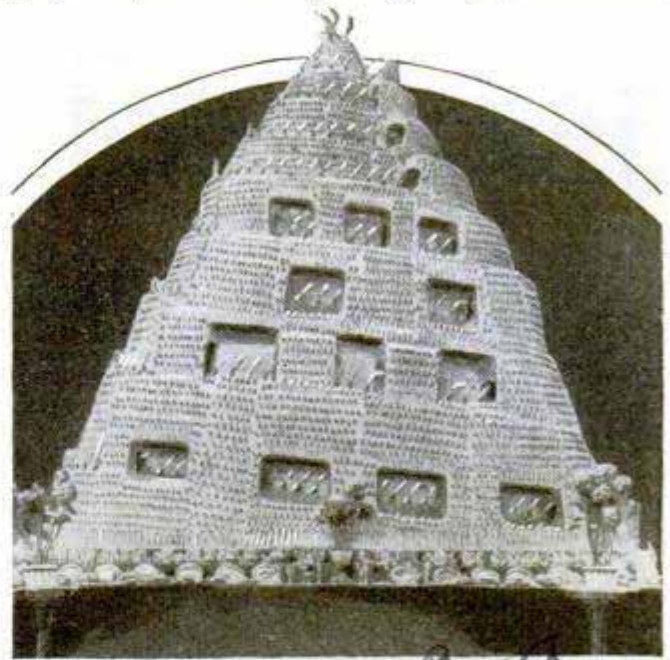

A Mountain of Spoons; Interesting Display Constructed for the Leipzig Trade Fair

foliage and other details, all worked out in spoons.

W. C. C. Co. Wash. D. C. Frigues Wash. D. C. 1620. A. St. N. W.

Wide World

new Orleans, La. 2017  
Seatrax  
2017  
Ninety-five freight cars, enough to make a train a mile long, can be carried at one time in a huge ferry recently placed in operation between New Orleans and Havana. The craft is nearly 430 feet long, has a beam of more than sixty-three feet and differs chiefly from other units of its kind in that cars are carried throughout the holds, between decks and on the superstructure, instead of only upon one deck. The loaded cars are handled by an immense crane at each terminal. The ferry will take about fifty-two hours for the transit between the two ports.  
Built by J. W. Richardson, Walling, & Co.



# RADIO LOCATES ORE HUNDREDS OF FEET IN EARTH

*see article Feb 1925-189*



Transmitter and Direction-Finding Apparatus, Two Essential Parts of the Radio Outfit Used in Prospecting for Ores; It Has Located Veins 500 Feet Deep



*British Empire - Radio Co. of Canada. Transportation*

Prospecting by radio has been simplified by the introduction of improved apparatus, which already has located veins of ore to a depth of 500 feet. Trained engineers are required to operate the outfit, but it is not difficult to handle, and its accuracy has been tested repeatedly. It employs the principle of electromagnetic induction. An electromagnetic field is sent out from a transmitter to a depth of several hundred feet. If an ore vein is within the radius of the field, a current is set up in the conductor, which, in turn, sets up a secondary field, and this is detected by direction-finding apparatus. By further observations, the extent of the ore vein is determined. The outfit consists of a radio transmitter, a power box and the direction-finding set. A crew of four men is generally employed with it. This method of radio prospecting is not intended for hunting lost treasures or small quantities of minerals, but for locating ore veins or bands of minerals and to pick up lost veins due to faulting. It does not determine the type of ore or the quantity of it, although it does show its depth and the length of the veins. The method is being used widely in Canada, where weather conditions and the roughness of the coun-

*dated all countries*

try make ordinary surveys difficult. The radio prospector can work in snow or rain, as his apparatus is not affected by these elements.

## POCKET ATOMIZER FOR SCENT FITS VANITY BAG

*2060*

A pocket-size atomizer, using a plunger pump instead of the bulb arrangement, has been placed on the market in Germany and likewise patented in the United States. The device, about the size of the usual lipstick container for the vanity bag, is finished in gold, leathers and snake skin, in various styles. The top pushes in, to eject atomized perfume through a small nozzle in the side. To close the nozzle after use, the pressure on the top is released, causing a spring to push the top out and seal the vent.



*the U-S Agent known.*

*Maurice Macovitz*



2043

**X-RAYS DETECT ART FAKES  
BY REVEALING AGE**



Studying a Painting before Subjecting It to X-Rays, to Test Its Genuineness

Spurious paintings are sometimes detected by X-rays which show a difference in the structure of new and old materials. For instance, an old painting has been re-touched by a modern artist to make it resemble the work of a recognized master, or some other method has been followed to disguise a subject. If materials of widely varying age have been employed, the difference is likely to be detected by the penetrating rays and the photograph that is taken with their aid. If a recent painting is reputed to be old, the fraud can often be discovered by the X-ray comparison with a genuine ancient painting.

**MYSTERIOUS TUNNEL IN CHINA  
MAY LEAD TO TREASURE**

Discovery of a mysterious tunnel, seven feet high and a yard wide, in a hill near Nanking, China, has interested explorers, as the passage, they believe, may give a clue to the whereabouts of a great treasure, buried 500 years ago with the coffin of the first Ming emperor. The secret of the horde of gold, jade and jewels entombed with the ruler has puzzled generations of historians and treasure seekers. When the emperor died, Nanking, his capital, had thirteen gates. Through all of these, coffins were borne simultaneously, and thirteen tombs were erected

at as many different places, it is recorded, so that his enemies and treasure hunters might be baffled in their search for his remains and the hidden gold. The tunnel is lined with blocks of stone and was found by workers constructing a new road.

**BEAUTY IS TRACED TO LONG  
USE OF THE JAWS 2083**

Constant use of the jaws, during a period of millions of years, has been largely responsible for the beauty of the human face, according to Dr. Martin Dewey, an eastern authority. He declares that the use of the jaw muscles has caused part of the development of the underlying structures of the face and that the exercise of those muscles has contributed to the broadening of the skull with the consequent increase in the size of the brain chamber.

**FLUID MASK KEEPS LACQUER  
FROM CAR WINDOWS**

To protect glass and other surfaces from being spotted or streaked while applying lacquer, a fluid mask has been introduced. It is applied to the area which is to be shielded, dries and hardens quickly and is then peeled off when the lacquering or painting is done. The mask may be painted or lacquered over without danger to the surface beneath. As shown in the accompanying illustration, a film or mask

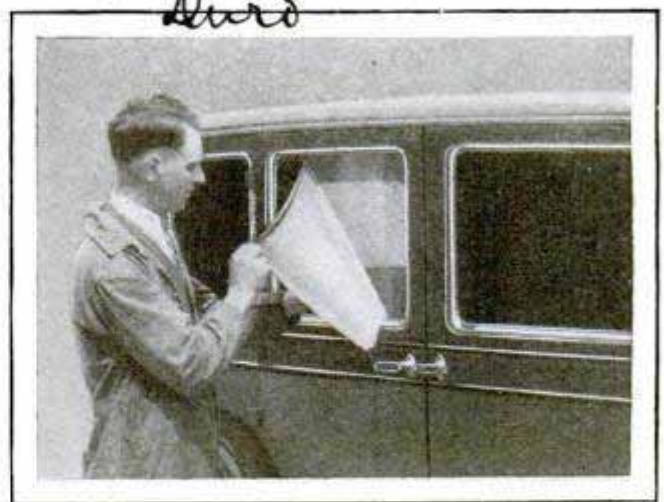

Car Window Has Been Lacquered Over, But Is Kept Clean by the Mask Which Peels Off

is being removed from a car window. The material is also used in striping or other forms of decorative work, the design being cut through it and the lacquer or paint then brushed over the entire surface.

2065

Carl H. S. Wilkins

O'Neil Shuro Co. 295 211



### TRANSPLANTATION OF TREES AIDED BY DRUGGING

1988

*Herald Tribune 12/23/28*

That trees react to chloroform and other drugs in somewhat the same manner as do animals, is the report of an English naturalist who believes that trees have many powers not commonly associated with them, such as the tendency to be attracted or repulsed by the presence of human beings. He points out that full-grown trees with mutilated roots have been successfully transplanted after they had been put under the influence of certain drugs, whereas other trees, not treated, died. Their response to human beings, he declares, can be indicated by various instruments that are attached to them to record their reactions. An outstanding example of "nerves" in vegetable growth is the sensitive plant which shuts its small leaves tight at the slightest touch. This action is suspended when the plant is drugged.

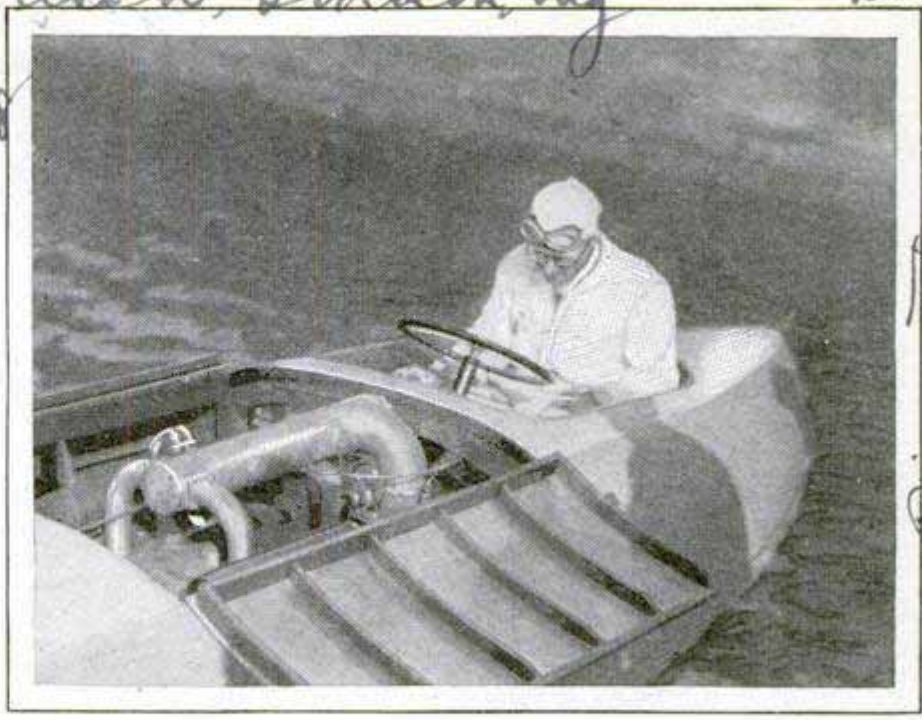

Speedy Motorboat of Improved Design, Showing Arrangement of the Engine to Afford a Low Center of Gravity

### SPEEDBOAT MOTOR LIES FLAT TO LOWER GRAVITY CENTER

Cylinders, and other parts of a specially constructed motor for a speedboat, lie flat so that the center of gravity of the craft is lowered to six inches above the water line. The arrangement of the cylinders is also said to equalize the strain more nearly than is done by other motors. This particular craft, with all the care and thought expended in its construction, proved a failure because of an unfortunate accident. In a test run of seventy miles

### NIGHT TRAIN SIGNAL ON TRACK PROMOTES RAIL SAFETY

1982

So that trains may be able to signal their approach at a considerable distance down the track, on sections where ordinary block systems are not in use, a special warning device has been introduced. It is attached to the rails and affords contact with a passing train whereby another signal is shown at a point farther down the line. The system is intended for service at night.

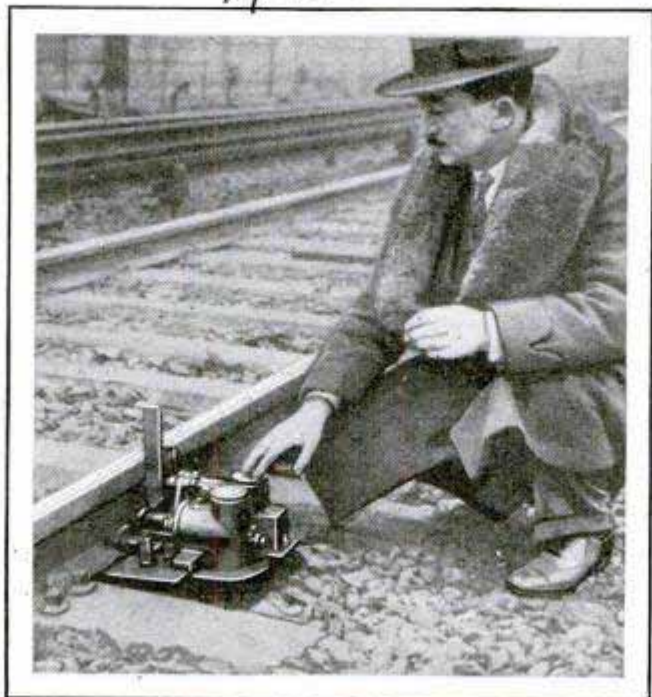

Railroad Track-Signal Unit That Gives Notice of Approaching Trains at Night

an hour, a hole was broken in the bottom of the hull when the boat leaped from one wave to another. It sank and divers spent fifty hours before they could locate and raise it. After repairs, oiling troubles developed, and the pilot had the disappointment of seeing the race won by a motorboat that developed far less speed; in fact, something under fifty miles an hour.

*Mrs. Bioco III  
Owner: James A. Talbot  
Emb. George H. White  
110 Broadway, San Diego*

*ch. n. exarde*



International Bldg  
Washington, D.C.

More

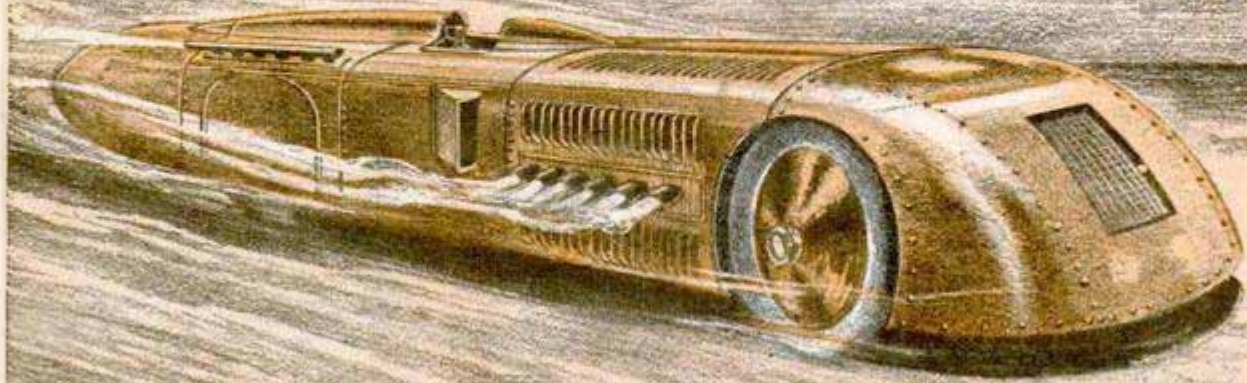

The 1,000-Horsepower Sunbeam Car in Which Maj. H. O. D. Segrave Set a Record of Nearly 204 Miles an Hour at Daytona Last March, Only to Have an American Break It

**M**AJ. H. O. D. Segrave is coming back to Daytona Beach to try and regain his lost speed laurels, this time with a thousand-horsepower car designed to travel at 240 miles an hour, with a possible maximum speed of 260.

Flight Lieut. D. D'Arcy A. Greig, of the British royal air force, on Nov. 4, flew a seaplane with the same kind of engine over a measured course at 319.57 miles an hour, slightly better than a mile an hour faster than the speed record held by Maj. Mario de Bernardi, of Italy.

Gar Wood, down in Florida, is preparing to tune up "Miss America VII," with which he made a world's record of 92.834 miles an hour last September, and will go out to try and boost the speed record on water above 100 miles an hour, as the boat is expected to make 105 to 107 miles when properly tuned.

And a pleasure car has just been shown at the New York auto salon, which, with a touring top and windshield up, does 120 miles an hour in high gear and ninety miles an hour in second speed.

What have these four events to do with each other?

Three or four years ago, it was gener-

ally said that the automobile had about reached the ultimate in development, and any future changes would be in the nature of little refinements in equipment and body appointments, rather than major developments. Some manufacturers had begun to advertise the fact they no longer made yearly models, and, save for an occasional sport roadster, cars generally had come to look very much alike, in the same shades of blue or done in sober black.

Just about that time the speed field produced the small, eight-cylinder engine; engineers turned out the four-wheel brake and balloon tires; color experts produced spraying lacquers in bright colors; body designers got some new and original ideas, and in a space almost of months, the automobile had been revolutionized.

As usual, the major engineering development turned up on the speedways long before it was adopted for general use. Eight-cylinder engines of small displacement were proven at Indianapolis, Atlantic City, Los Angeles and on other speedways.

It is interesting to note that one of the leaders in their development, Fred Duesenberg, has gone back to the big engine in

Duesenberg, Inc.



*Wagner engine auto 1816*

# Speed

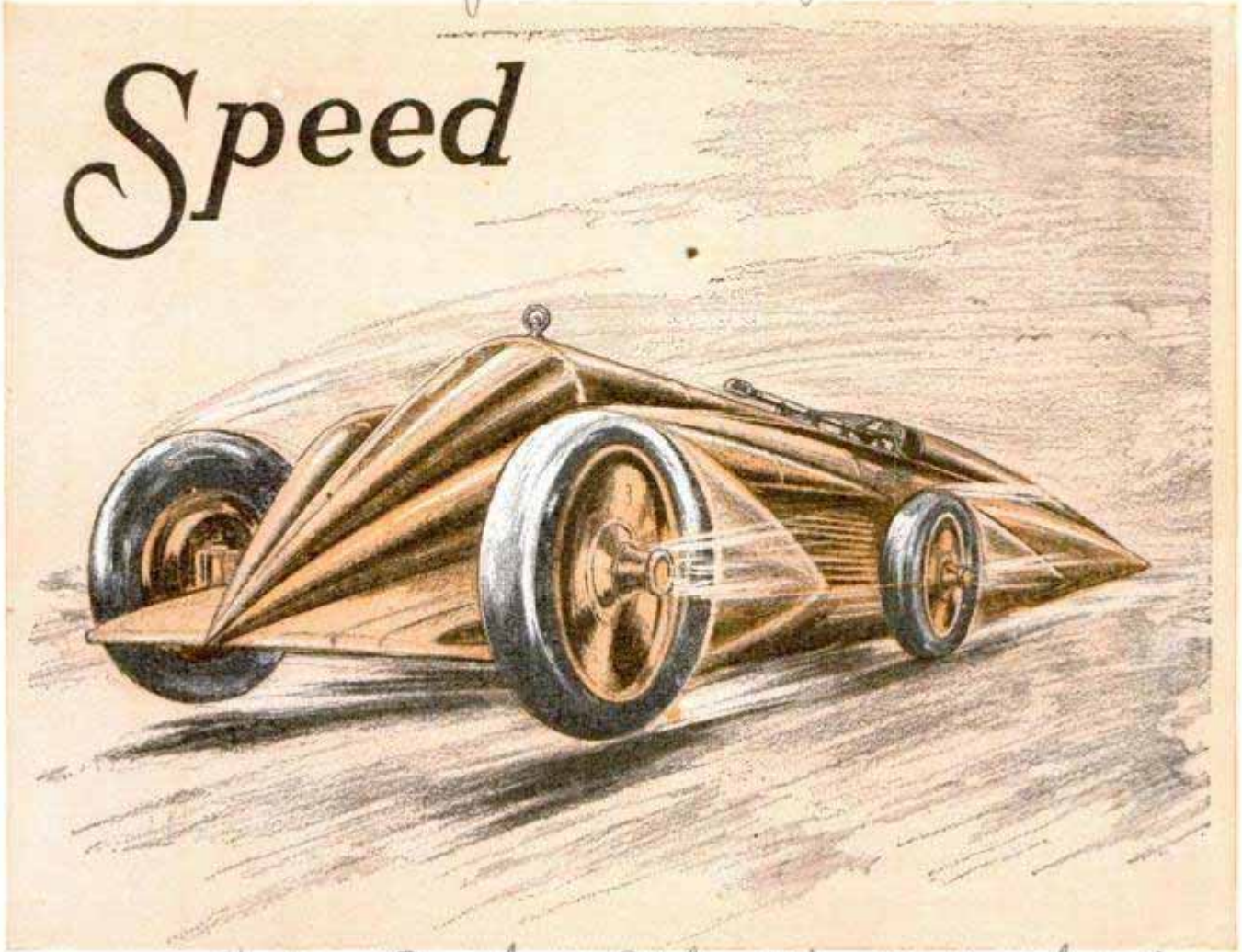

© The Motor

Major Segrave's "Golden Arrow." Steered by Rifle Sights. Built to Make a New Attempt to Regain the World-Speed Crown for England at Daytona Beach This Year

*Photos - Pacific + Atlantic 25 Park Place New York*

his latest car, a 265-horsepower job that, with touring body, has done 120 miles an hour on the road. The big engine, with three and three-quarter inch bore and four and three-quarter stroke, has a displacement of 420 cubic inches, as compared with the little ninety-two and a half cubic inch racers. At 4,200 revolutions per minute, the engine develops 265 horsepower, and when driving the car at ninety miles an hour in second gear, it turns up to 5,200 r.p.m.

Two men led in the revolution in car design which associated bright colors with good looks, luxury appointments and more speed. One was Walter Chrysler, and the other E. L. Cord. Mr. Cord was twenty-nine years old when he took over the Auburn plant in 1924. While Mr. Chrysler had come into the automobile business by way of a railroad machine shop, Mr. Cord had grown up with automobiles, being successively proprietor of a wash rack on the coast, part owner of a desert trucking outfit, salesman of used

and new cars, manufacturer, at the age of nineteen, of rebuilt and "hotted up" Ford racers, and automobile salesman and distributor in Chicago and Milwaukee. Bright colors and bodies that "look different," he maintains, were a natural development.

"Color was coming into the daily life of everyone, along with modernistic design," he says. "Furniture of radically new style, decorated in bright lacquers, was finding a vogue. Drapes and other decorations in the new colors were replacing the more somber furnishings of the past. Clothes were brighter. You only have to look at the shirts and collars men wear today and recall what they wore four or five years ago to appreciate the change.

"We started out to make a car that would look different, on the theory that there are enough people who will pay for something that is a bit different from what the neighbors have, to make their business worth while. When we created the new mold line in the hoods of our cars,

*Auburn Automobile Co*



there was a serious question whether the public would like it. Some people didn't, but a lot did, and even those that didn't talked about the Auburn, for we had a distinctive appearance that made the car attract the eye.

"That little mold pressed into the hood and the distinctive two-tone color combinations were the outward symbols of the change, but we made a lot of others

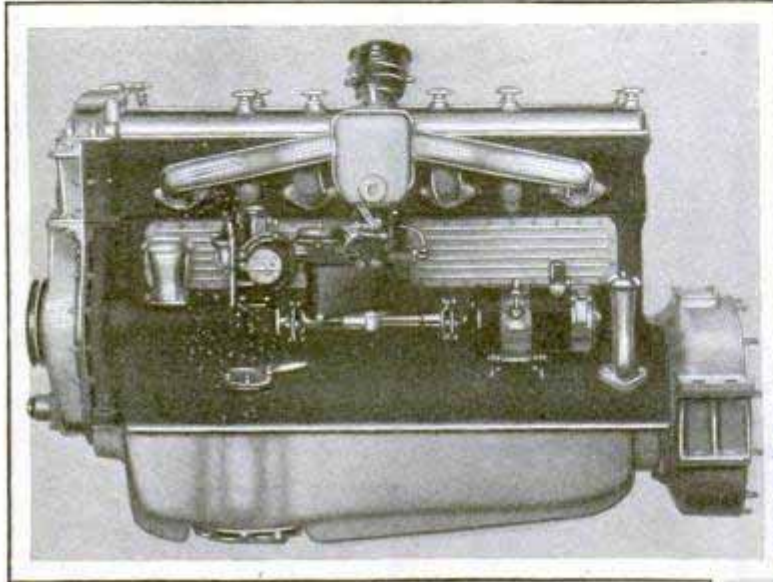

Fred Duesenberg's New 265-Horsepower Engine and, Right, the "Shimmyless" Spring Shackles Developed by Packard

that didn't appear at the first glance. The trouble with so many automobiles is that they are built from blueprints, and look it. I am not an engineer, and when engineers come to me with a set of prints and say there is enough leg room under this instrument board, and that this rear door is wide enough for even an extra-plump woman to get through, they may be right, but I want to know that they are.

"So we build up full-sized body models out of wood and clay, complete to the last bit of decoration, and we study them. We fit them out with seats and dummy steering column, and doors that work, and I can climb in and try the leg room myself. We studied what the women wanted, and as a result put the starter button up on the instrument board, where you don't have to hunt around for it; moved the light switches to the steering column, where they are easily accessible, and switched to a big rubber-covered accelerator pedal that won't scuff or mar the leather on a pair of fancy slippers.

"Another thing that has helped revo-

lutionize automobiles is a study of what the customer wants, the things he complains about, and the things he asks for. We try to build the kind of cars customers want, rather than the kind engineers think they ought to have. I found in my car-selling days on automobile row that a lot of complaints that were made could have been avoided by little changes that might have cost no more than a few cents per car. Engineers usually are stubborn about making such changes because, in their driving, they do not need them. They know their cars and drive them carefully, and don't always realize that the average buyer is not an expert."

One of the developments which

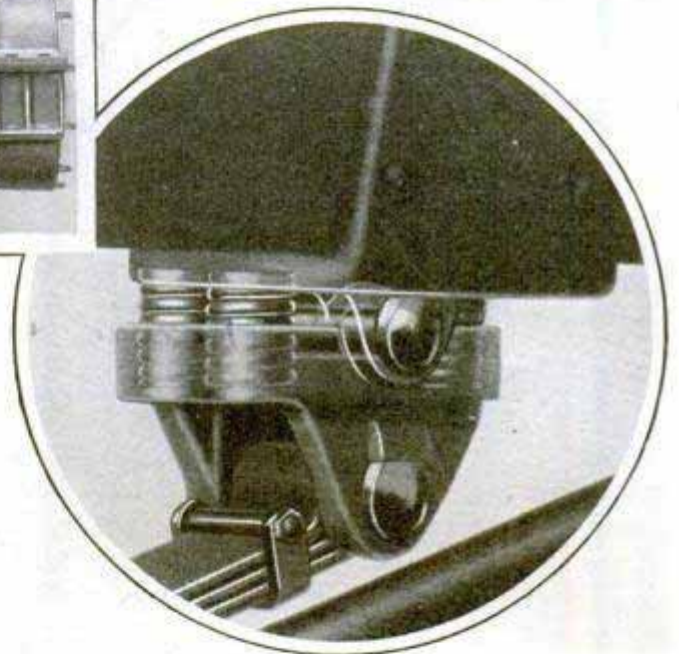

the modern trend in design is going to emphasize in the coming year or two is lower and more perfectly streamlined cars. The bureau of standards has discovered that, if cars were as perfectly streamlined as airplanes, their speed would be doubled, with no increase in power. Speed of stock cars is determined almost exclusively by the resistance offered by the air. A car with a speed of fifty miles an hour would have to have eight times as much power to make 100 miles an hour, with no change in the body.

The trouble with streamlining has been that a perfectly designed body would be so futuristic that few motorists would care to buy it. The new racing car being brought over by Major Segrave, called







18/16

Co S Main St  
Auburn, Ind

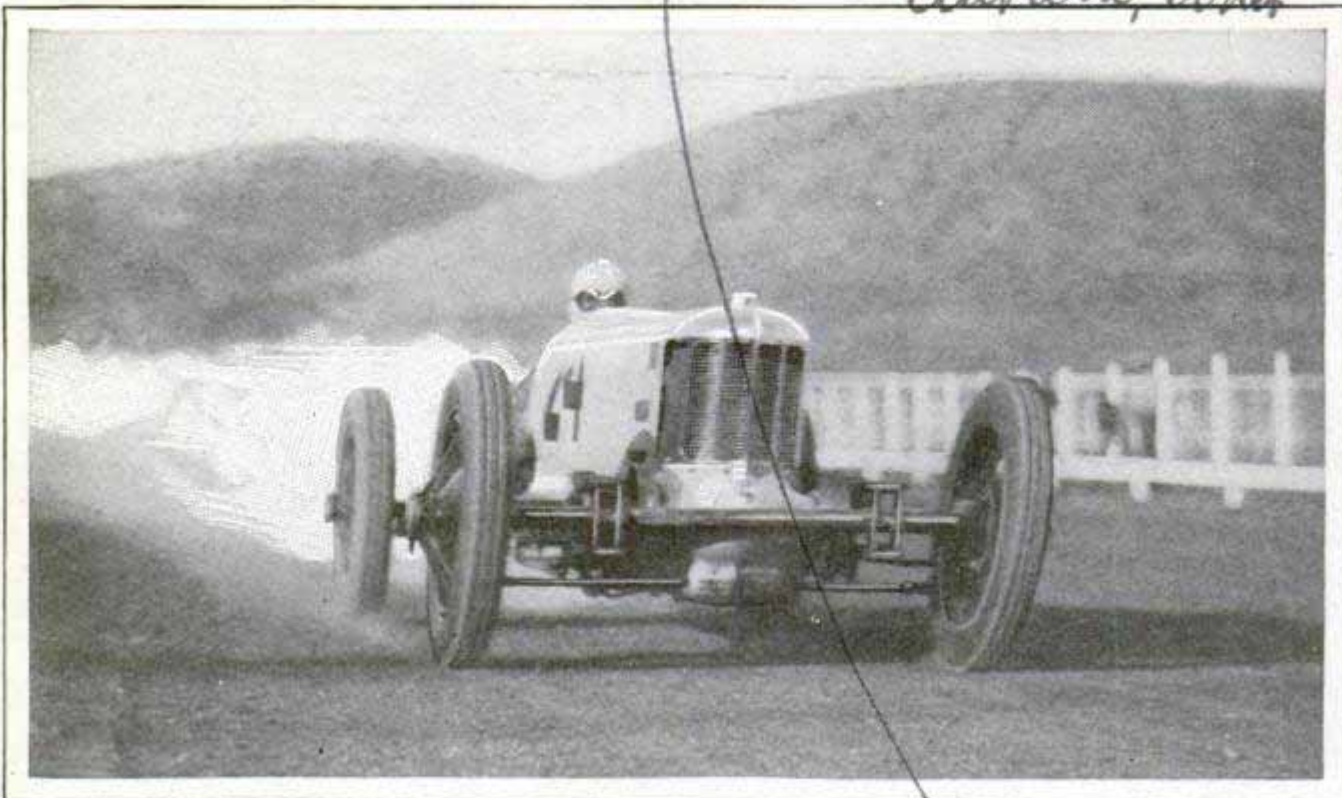

Proven on the Speedways in Recent Years, Harry Miller's Front-Wheel Drive Is to Make Its Appearance on a Stock Car Shortly; It Permits Even Lower Bodies

the "Golden Arrow," is one of the finest streamlined bodies yet made. The car is so fast that it is to be steered by sights, just as a rifle is fired. Two huge bull's-eyes will be erected above the course, and the pilot will "aim" his car at the first, and as he passes under it pick up the second. At 240 miles an hour, his estimated speed, the car travels four miles a minute or the length of the mile course in fifteen seconds. The slightest wavering from a straight line might carry the car into the sea before the driver could correct it. It is impossible, according to Major Segrave, to steer by ordinary objects, as the flags marking the course become a blurred line and the timing posts are too far away at the start, which must be made four and a half miles away in order to get up full speed.

One major development of the speedways, which is to appear this year on a production passenger car, is front-wheel drive, following the system proven by Harry Miller's racing cars in recent years. While the car which is to employ it has not been named or built, it is understood the designs call for an exceptionally low car, with streamlined body closely resembling, in some models, the fuselage of a cabin airplane. One model is reported to be but fifty-eight inches high—two inches less than five feet—yet has sufficient head-room for tall people.

The front-wheel drive proved exceptionally safe on the speedways. It gets the power back where the horse used to be, pulling the load, and as a result, the car can take sharp turns at higher speed, climb over obstacles, and is claimed to be



The New Duesenberg's Instrument Board Includes Brake-Pressure Gauge, Tachometer, Altimeter, and, in the Corners, Four Telltale Lights to Warn When Attention Is Needed

Harry A Miller



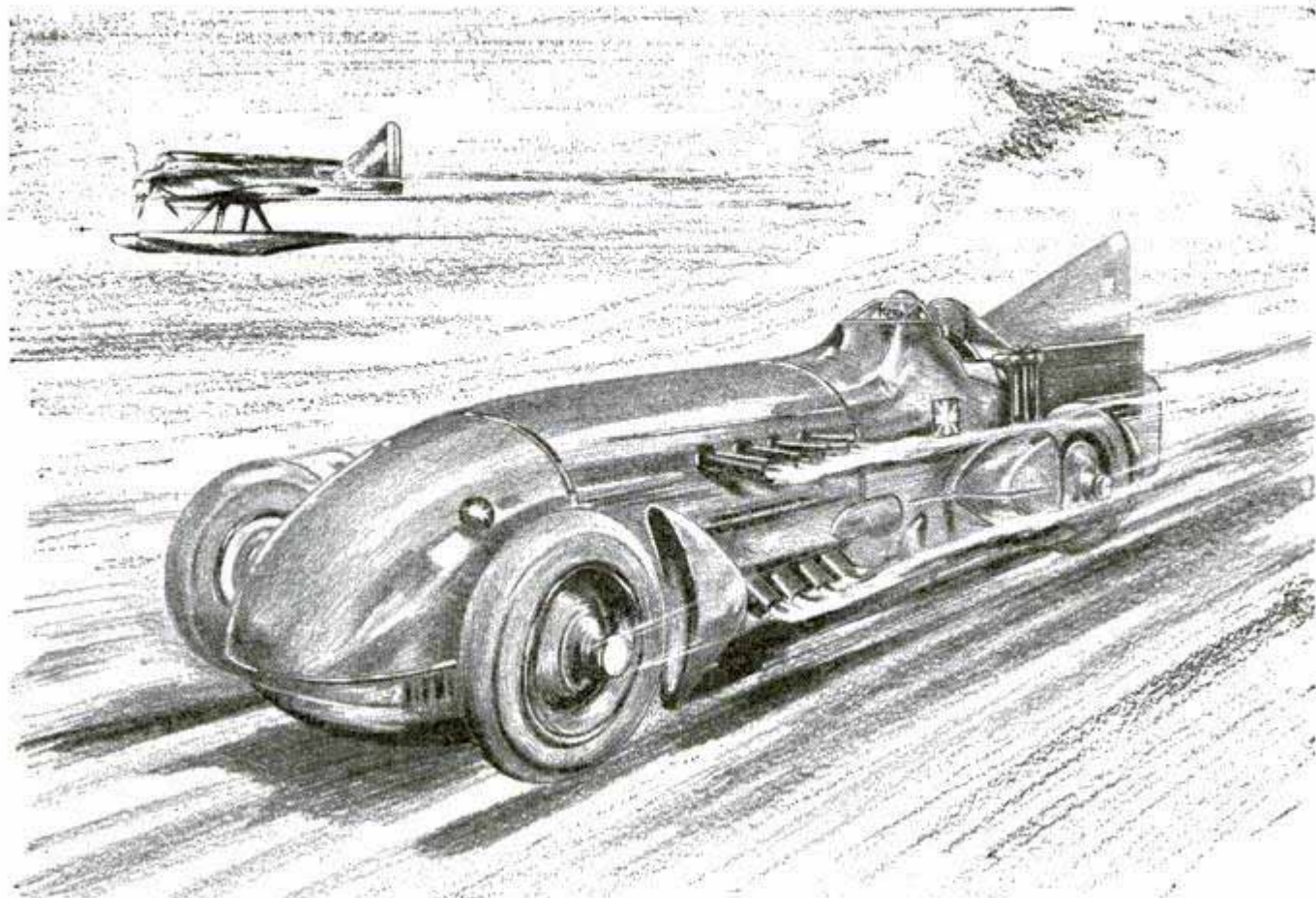

Capt. Malcolm Campbell's "Blue Bird," Which Uses the Mate to the Twelve-Cylinder Napier Engine That Won the Schneider Trophy in the Plane Shown on Page 373

generally safer. Engineers have often contended that the proper place to apply the power was as close as possible to the point at which it was generated, but with rear-wheel drive this meant moving the engine to the back, with a resulting body design so radically different that it would not be acceptable to the average driver, accustomed to a long hood projecting in front of him.

The return of Duesenberg to a big engine probably marks the end of experiments with superchargers for small high-speed motors, at least for general use. The supercharger proved inefficient at the average operating speed of pleasure cars. The new Duesenberg, with its high power, is designed for quick acceleration in traffic, rather than for exceptionally high speed in ordinary use. It has a gasoline consumption of seventeen miles to the gallon at twenty miles an hour; eleven to fourteen miles, at forty miles an hour, and four miles to the gallon at 104 miles.

One of the most interesting things about the car is an automatic system of chassis lubrication, which functions every seventy miles. A telltale light on the instrument board indicates whether or not the oiler

pump is working, and another light indicates when the reserve oil tank is empty. Another pair of lights come on, one every 700 miles, to tell when it is time to change the oil in the crankcase, and the other every 1,400 miles as a signal to fill the battery with distilled water. In addition to the usual instruments, a speedometer calibrated to 150 miles an hour, ammeter, and oil and gasoline gauges, the instrument board has a pressure gauge for the hydraulic four-wheel brakes, an aneroid barometer to indicate altitude, a tachometer to give engine speed, and a clock.

The engine has four valves to each of the eight cylinders. It also is equipped with a vibration dampener consisting of two cartridges, each containing a pound of mercury. Practically every part of the chassis except the frame, parts of the motor and the spokes and rims of the wheels are chromium-plated.

☐ The Popular Mechanics' Bureau of Information offers its free service to all readers of this magazine. Names and addresses of manufacturers and dealers in articles described, and any other details in our possession, will be promptly furnished.



# FLOAT BRIDGE SPAN INTO PLACE TO SAVE LABOR



One of the Huge Spans of French Bridge Being Floated into Position; It Is Nearly 600 Feet Long, the Chief Link in the Structure, Which Reaches a Mile across the River Elorn at Brest

In constructing a mile-long bridge across the Elorn in France, a huge span was built at a distant point and floated into position. Although the task was a difficult one, it was considered simpler than forming the span in the usual manner. Each span is nearly 600 feet long. The bridge will serve the city of Brest.

## ELECTRIC TRAIN OBEYS VOICE TO START AND STOP

Spoken commands govern the movements of a model electric train demonstrated in New York. The word "Stop" brings the engine to a halt; "Back Up" causes it to reverse, and some such phrase as "Get Along There" will cause it to go forward. The action is the result of the vibrations of the voice through a microphone.



Testing Model Railway Which Obeys Voice

## AIRPLANES OF SLOWER SPEED DEMAND OF AVIATION

Development of airplanes capable of slow speed is necessary for the promotion of civil aviation, according to Lord Thomson, former secretary of state for air in Great Britain. He points out that the high speed of military craft is not necessary for commercial flying; that slower speed and safe operation at lower altitudes would promote the security factor in flying, and that such planes would become increasingly popular among businessmen and others who would use them for distances of 150 miles and less. Greater economy in operation would also be possible for slower craft, it was suggested by Lord Thomson, who was the chief of the British delegation to the recent aeronautic conference at Washington.

From Brest to Longastel

2037



## EARTH'S INTERIOR NOW KNOWN TO SCIENCE

With the aid of special instruments, scientists have been able to explore the inner earth to a depth of 2,000 miles and more, according to Dr. Bailey Willis, retiring president of the Geological Society of America. The latest findings indicate, he said, that there are two parts of the earth, an envelope 2,000 miles thick which consists of elastic rock, and a core that is 2,000 miles in radius and evidently unelastic. This core is exceedingly hot and may be molten, but it is sluggish and viscous because of the tremendous pressure of the outside envelope upon it. Doctor Willis has advanced the theory that continents are formed by "blisters" which occur as the heat from the core of the earth, unable to penetrate immediately through the envelope of rock, is sent sideways and forms, beneath the earth's surface, an immense blister several hundred miles wide and more than twenty miles deep. In time, these blisters have burst through the surface with the result that the land areas have been formed.

## FIRST AIR-MAIL ENVELOPES PRIZED BY COLLECTORS

Envelopes used in the first run of air-mail lines, are in great demand among collectors. Good prices are received for some varieties, and whenever a new air-mail route opens, collectors throughout the world arrange to obtain some of the envelopes. They are doubly valuable when they have special air-mail stamps attached to them.

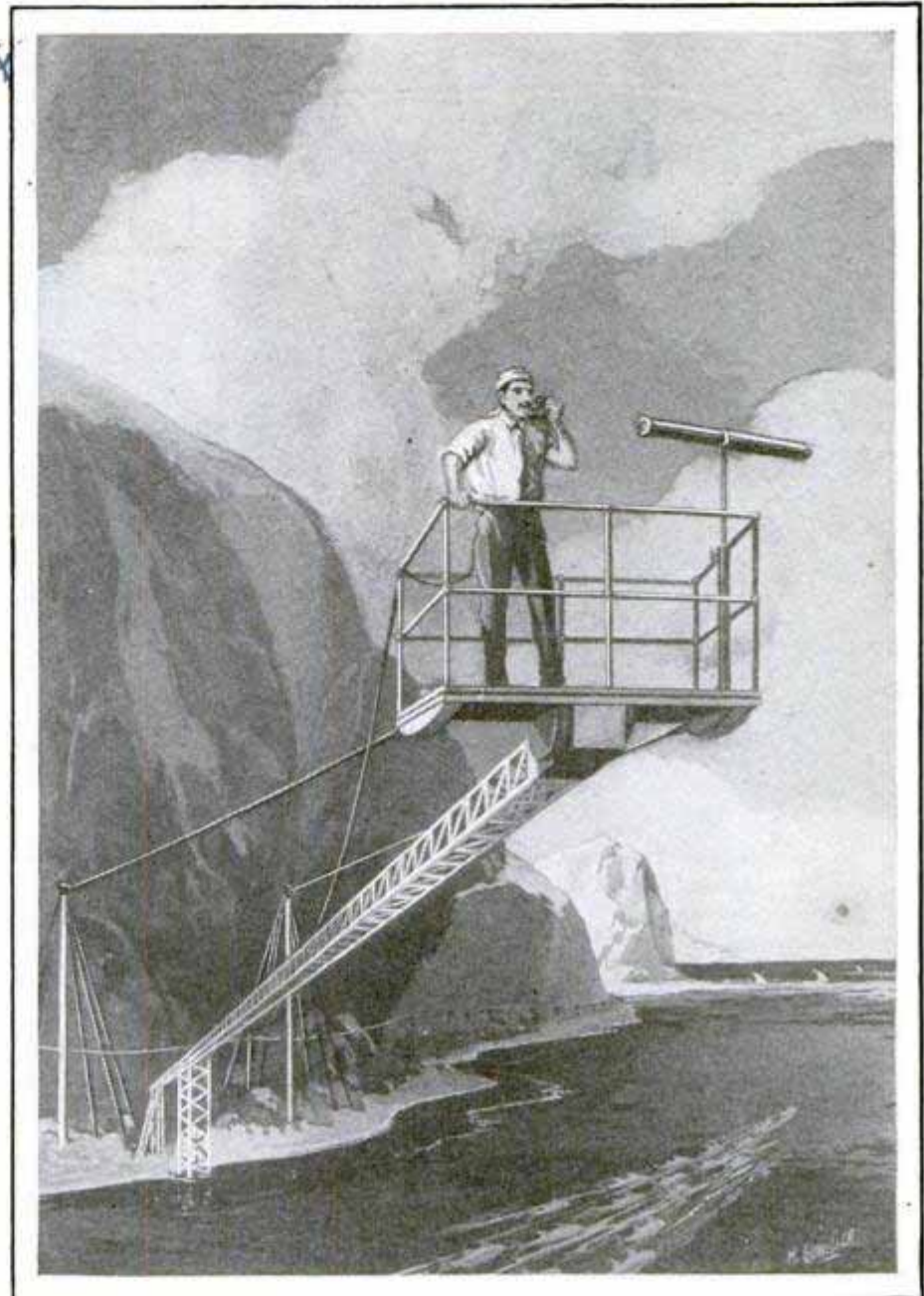

Watch Tower near Village on Mediterranean Coast, Where Observer Seeks Schools of Fish with Telescope and Relays Word by Telephone

## LOOKOUT ON TOWER FISHES WITH TELEPHONE

Near a small village on the Mediterranean coast is an odd-looking steel framework, supported by braces and leaning far out over the water. At the upper end, in a small cage, stands a man with a telephone at his side. He is a watcher, on the alert for schools of fish that can be seen at some distance from his lofty elevation. When a school of fish is sighted, he telephones to the village and the men hurry to their nets and boats.

Ⓞ During calm weather, the average speed of the worker bees' flight is a little less than fifteen miles an hour.



1789

# Will She



Looking through a Wind Tunnel; in the Background Is a Model Plane, Mounted in the Test Chamber Ready for Measurement, and in the Foreground the Propeller That Furnishes the Gale



1906 Ft. Detrick, Md.  
Washington, D.C.

# Fly?

By A. M. JACOBS

**I**T WAS flyers' weather, clear of sky, winter snap in the air, and a sun that penetrated even heavy flying togs. The air above Uncle Sam's big mid-west test field was full of roaring craft. Two parachute planes were making test drops of the mammoth silk parasols from low altitudes. A target glider spiraled down from 3,000 feet, the big DeHaviland to which it had been attached following it, a photographer in the rear

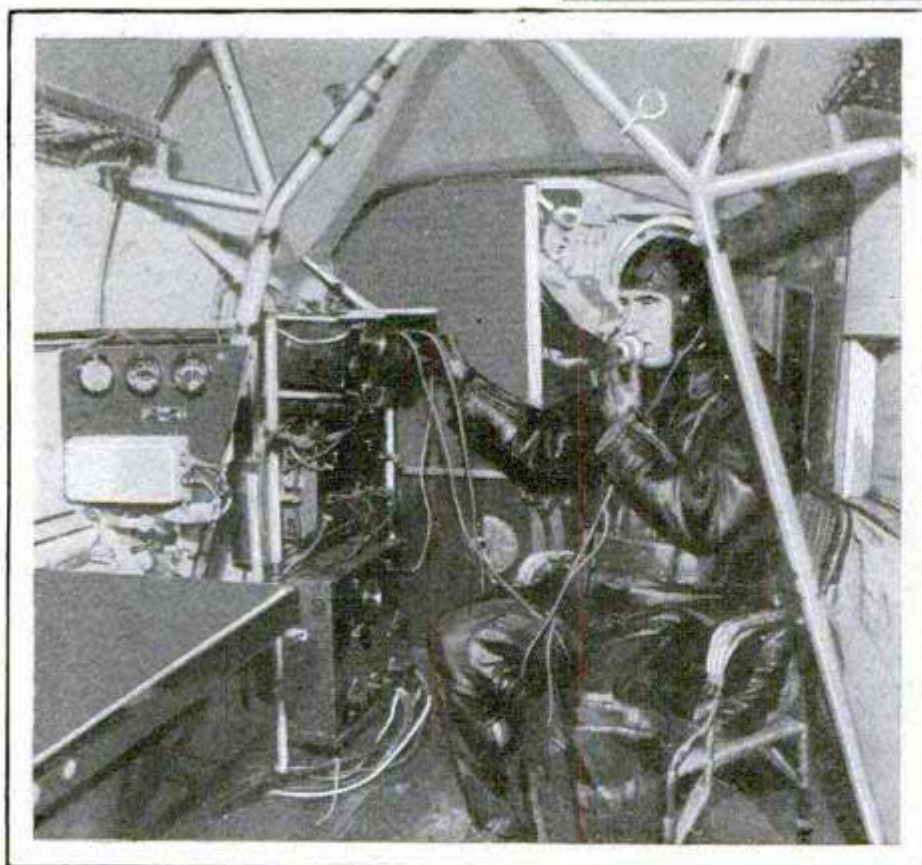
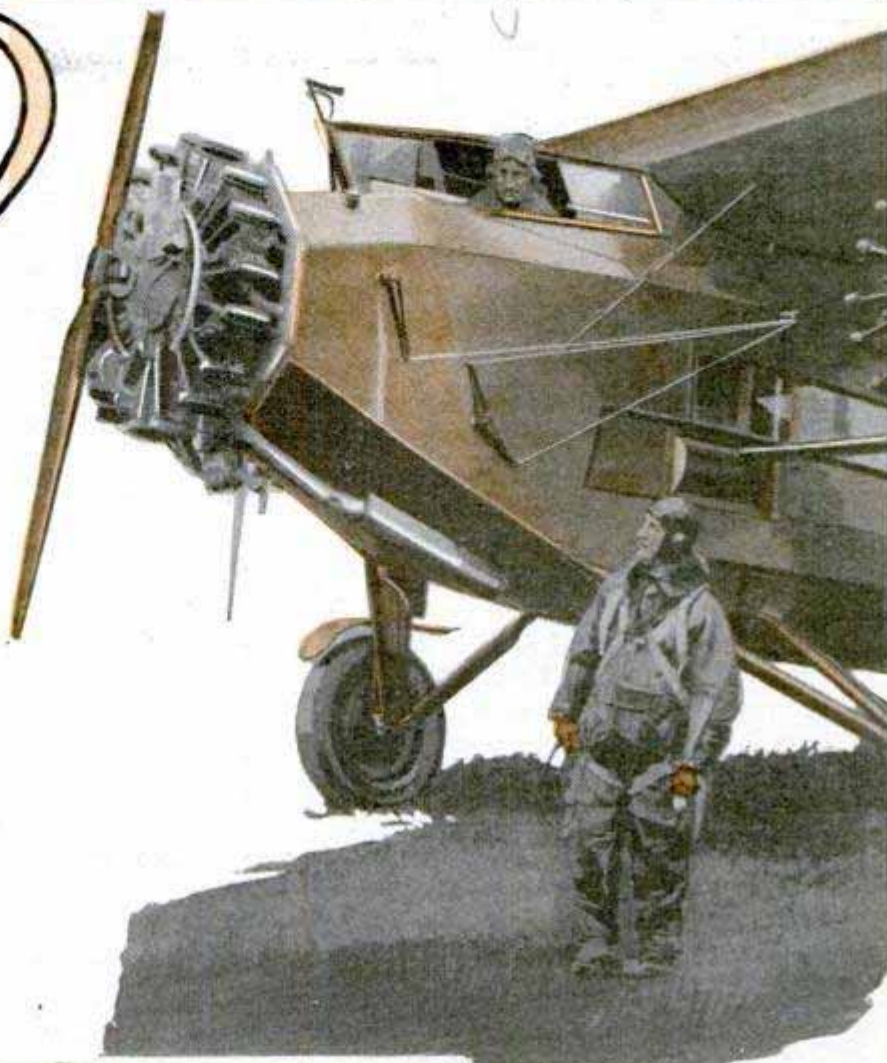

cockpit grinding out motion pictures of its maneuvers.

At 8,000 feet, a twirling point of light in the sun, a plane being put through a series of spinning tests. A huge bomber left the earth, none too briskly with its heavy load, but soon was climbing, its great wing sharp against the blue. A supercharged altitude plane, due for a climb to 25,000 feet, had engine trouble at 17,000 feet, and came down, the pilot hedging carefully into the field with a dead stick. Low over the speed course, an observation plane was skimming with steady speed.

All test flights! Either

The Army's Flying Radio Laboratory, a Tri-Motor Fokker, Top, and the Interior of the Experimental Cabin Where New Radio Ideas Are Tested under Actual Flight Conditions



the planes themselves new and experimental, proving their worth to serve as standard in the U. S. army air corps, or some special equipment in them on trial. Almost everyone carried a story of adventure or daring on the part of the flyers who do the testing for Uncle Sam, and whose reports are determining factors in gauging the value of the articles in question to the service.

And these flyers? As the sun dropped low in the winter sky, they landed the planes and drifted into the flight office. They are a physically fit, capable-looking group of army officers, most of them come into aviation during the war. Big planes little planes, swift, light, sensitive, pursuit planes, heavy bombers, only a man with skill and daring at flying all types can be admitted to their ranks. Even then it takes about six months to become efficient in the various types of testing. A pilot new to the work may think he is coming along magnificently, but quite frequently, unknown to him, one of the

others is repeating his tests to be sure of getting correct results and also to learn just how accurate and dependable as a test pilot he shows promise of becoming.

Day after day, they take into the air new and experimental types of planes, or old planes equipped with new and untried installations, sure to effect the flying qualities to an uncertain degree. Purposely they throw a plane into all the maneuvers into which it might accidentally slip in flight, in order that they may study its behavior under each condition and may know whether it is going to respond to the controls for the pilot throughout the service. Usually they can place a fault and it is corrected. If the fault cannot be corrected, the plane never reaches the service, and in learning that it is not fit, the pilot must now and then save his life by parachute—or lose it.

Such a tragedy occurred at the field about two years ago. One of the test pilots had thrown an observation plane into a spin, which developed a strange



Lieut. Leroy M. Wolfe and Capt. P. S. Edwards in the Flying Laboratory at Wilbur Wright Field; Experimental Work Is Carried On While in Flight, to Test Radio Beacons, Two-Way Voice Conversations, Long and Short-Wave Code Transmitters and Receivers, and Various Types of Radio-Operated Signals



vicious flatness from which it was almost impossible to level out. He reported this experience in conference next morning, and, as is customary, a second pilot took the plane up to check the finding. He brought in a similar report. Lieut. E. H. Barksdale, better known as "Hoy," his middle name, or "High Pockets," because of his long-legged slimness, a southerner, much loved for his sunny temper and respected for his remarkable flying ability, was chief of the test pilots at the time. None of the test pilots is ever called upon to do anything that his chief would not do,

and Lieutenant Barksdale decided that he would be the third to investigate the mystery and see if he could fathom its cause.

Taking the plane up to 6,000 feet, considered a safely high altitude for such tests, he pulled the nose up into a stall and kicked on right rudder. The plane came to 2,000 feet in a flat right spin before he could level it out. He started climbing again to learn if it was as unmanageable in a left spin. This time the nose rose flatly out of control, the gyrations developing into a maddening speed. Lieutenant Barksdale, struggling with the unresponsive controls, knew he'd have to jump for his life. That held no terror for him, however, for it was not the first time he had to escape a doomed plane in mid-air. But the force of the spin was so great that, in leaving the plane, he was thrown violently out into the wing-brace wires, which sheared the cords of his parachute, letting him fall free to the ground.

Grief went broadcast through the field and the great company of flyers throughout the country, for the like of Hoy Barksdale was not often found. For a time, no one cared what happened to that particular plane and its spins. But there it was—a problem and a mystery—and aviation has achieved its present degree of safety only because problems have been unflinch-



Ready for a High-Altitude Test, with Report Books Strapped to Their Knees and Stop Watch Hung about the Neck

ingly tackled and mysteries ferreted out. Attempts were made to solve this one in the wind tunnel with small models of the plane. But the wind-tunnel test results did not explain the behavior of the planes tested, since there was not in existence sufficient information on spinning upon which to base sound theories. The thing would have to be fought out in the air.

About this time, Lieut. Harry Sutton, who had been much interested in the project from the first, volunteered to attempt a solution. The flat spin developed, it was fairly certain, only when the plane was carrying military load. Therefore it seemed reasonable that if the equivalent of this load could be carried in droppable form, such as bombs, and the plane went into one of those irrecoverable spins, he could drop the load and bring it under control once more. There was no surety that this was so, of course. It was a highly experimental proceeding. There was, too, a second purpose to the movable load; he would change its position, move it backward and forward on the fuselage center. They would experiment and find out, if possible, in just which location it most affected the spinning characteristics.

So quietly did Lieutenant Sutton go about his preparations, so quietly embark on those first hazardous flights, that the



majority of people on the field were unaware of the courageous task being undertaken in their midst. For more than a year, he made flights to 10,000 feet, his plane a mere twirling point of light in the sun as it came down the sky. But the moving-picture camera on the ground, equipped with a special telephoto lens, which photographed the spins in order that the engineers might study them thoroughly, accurately, and repeatedly, registered sometimes as many as twenty-two successive spins before the plane leveled out. Often the weight had to be dropped before Lieutenant Sutton could regain control. Once the same swift flatness of spin that had thrown Lieutenant Barksdale into the wing, threw a bomb, upon release, through the wing fabric, tearing a great hole. Those watching expected him to jump then, but he brought the plane in, making a breath-taking landing at ninety miles an hour. After that, for the bombs they substituted tanks, the bottom of which could be opened at will, and they placed in the tanks the equivalent of the load in shot, which would fall through the bottom of the tanks when released. The information on spinning garnered by Lieutenant Sutton as "just his job," has proved invaluable, and the whole project has been regarded proudly

by older flyers as a daring piece of special test work performed with thoroughness and intelligence.

Back in the flight office, they are not discussing the spinning tests of today, however, for the solving of a more recent puzzle has taken their place. Earlier in the week, a test pilot new to the ranks brought in a complaint of something wrong with a new bomber he had been flying. When you moved the rudder, he complained, everything else in the ship moved along with it. The older men smiled. Among themselves they were inclined to believe that the youngster although a seasoned flyer was probably not familiar with the severe vibrations set up in flight in that particular experimental ship. They would check the report. One day they went up—three of them; one to pilot, one beside him to watch the forepart structure, and one behind to observe the rear. At 2,000 feet, the pilot started the test by seesawing on the rudder bars. Immediately there was an alarming distortion of the whole plane. The youngster was right. This was something more than vibration. He tried it again, the observers searching about diligently. After several repetitions, the observer in the rear cockpit suddenly, in the language of the small boy, "threw a fit,"

looking scared and pointing to the left longeron. Undoubtedly he had found something. The pilot started to fishtail once more, to enable him to check observations thoroughly, whereupon the observer almost went wild, pointing again to the longeron, making motions as of snapping a stick and gesturing for a landing. It then dawned upon the two in front that the rear observer was telling them that the upper-left longeron, a main member of the fuselage skeleton, had broken. In that case only the fabric and cowling strips would be holding the ship intact there.



The Test Pilot Completes His Report Immediately after Landing, While the Details Are Still Fresh



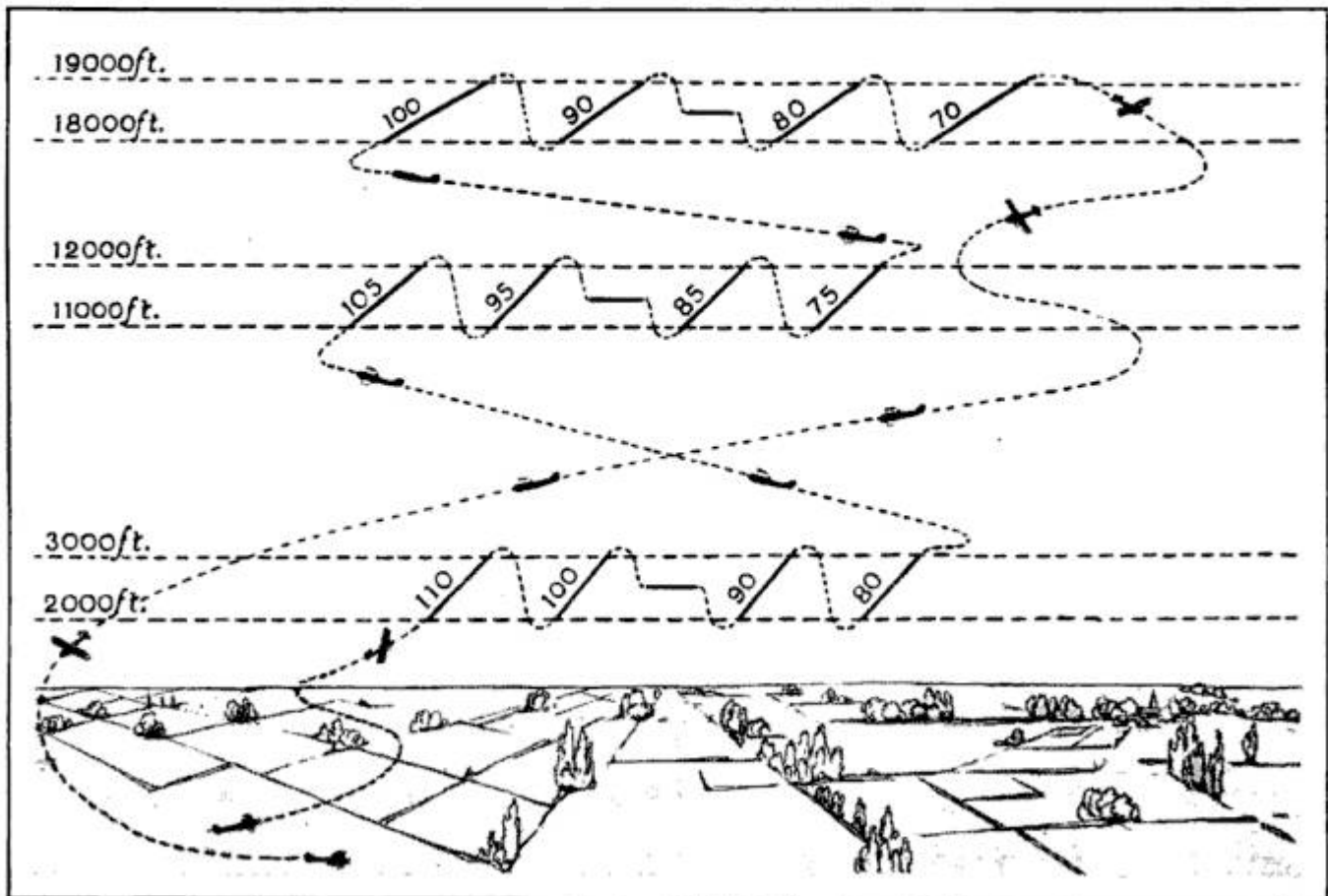

Graphic Chart of a Test Flight, Showing How the Plane's Climbing Speed Is Repeatedly Measured at Various Altitudes All the Way Up to 19,000 Feet

Simultaneously they looked over the side to gauge the altitude and sought their parachute rings. But the plane was under full control, and since it showed no tendency to go out of it, the pilot brought it in, in a clean easy landing. But he lost no time and tried no more "rough stuff" with the rudder. The break, which had undoubtedly occurred during the flight of the younger test pilot, had escaped detection by the ground inspector because of its location behind the bombs which had remained mounted in the plane through all tests.

That topic is supplanted by news of a new plane ferried in from a manufacturer's plant that afternoon. All listen interestedly to the comments upon it made by the pilot who has flown it in. All will have to fly it, partake in some phase of its testing, give their opinions upon it. A very few years ago, this ferrying of a new plane to the field for flight testing would scarcely have happened. It would have been shipped in, assembled at the field, and a great deal of speculation would have been rife as to whether it would really fly or not. New planes didn't always. They had been known to refuse to lift, or now

and then they had been nose-heavy and come crashing down, or the controls had been improperly balanced and flight in them therefore dangerous. Because of this uncertainty, there had usually been a certain amount of thrill not only in the first flight, but in the pilot, who was sometimes named for the job by the chief test pilot, or might be chosen by the drawing of a name from a hat. So far has aviation progressed in the last few years, however, that unless a plane represents a radical departure, it is seldom shipped in for assembly at the test field, but receives its preliminary try-outs at the manufacturer's plant and is flown to the field.

The question is no longer, "Will it fly?" That is presupposed. The interest centers in, "How will it fly?" Will it live up to the specifications set down for its performance? How convenient are its equipment installations, how comfortable is it as a flying vehicle for pilots and crew? Will the power plant in that particular design cause such heavy vibrational characteristics in the structure as to cause the fracture of the main supporting member, as discovered in the bomber? Or, if an observation or pursuit type, will it be fully



maneuverable and at the same time easily controllable in all possible maneuvers? These fighting planes would be twisted all over the sky in battle and, if they failed to respond to the pilot's will, he would be lost. The system of inspection and flight testing in force in the army today is planned to answer such questions.

The first flight step in this system for a new plane, after a pilot has given it preliminary runs to get thoroughly the "feel" of his ship, is taking it over the "speed course." This is a two-mile straightaway, permanently laid out on the test field, set off by markers and with a long black line down the middle. These tests require more expert piloting than any others flown, for in order that he may safely see the markers, and fly directly in line with the black line, holding his plane at an even level, where the air is quietest, the speed course is flown low—a mere ten to twenty feet off the ground. A calm day is always chosen. Braced steadily in his seat behind the windshield, tense against any slightest movement, with one hand the pilot grasps the control stick, with the other, the engine throttle, while a stop watch in one of the hands is held from slipping by having the cord wrapped between the fingers. No chance of escape by parachute should anything go wrong. The pilot could only land, hurtling at the ground, and probably crash.

The main purpose of these tests is to calibrate the air-speed indicator, that is to check the time taken to fly the two miles as shown on the air-speed indicator against the stop-watch time, and to learn the plane's low and high speeds, and its

flying qualities at various other speeds. In the high-speed tests, the pilot opens the throttle wide and strikes his level about a mile before entering the course. As he approaches the first marker, he compresses the stem of the stop watch almost, but not quite, to the clicking point. As the forward edge of the wing reaches the marker, he clicks the stem in, starting the hands around, clicking it in again as the final marker is passed. If he has been flying a pursuit plane with the wind in his favor, the time taken to cover those two miles has perhaps been forty-three seconds. The mere flash of an arrow!

The course is then flown in the opposite direction. The average speed of three of these round-trip flights is taken as the plane's high speed. A series of round trips follows, each with the same extreme accuracy and care, and each timed exactly ten miles slower than its predecessor, until the plane is moving over the course as slowly as possible, just flirting with stalling speed. This, the pilots call "taking it over the hump," and it represents the plane's low speed. With the plane seeming scarcely to move against the background of the great field, this test is quite as picturesque to watch as the high-speed test, and requires as firm and practiced a hand on stick and throttle and as great a nicety of judgment. Although not of long duration, each minute on the speed course is one of extreme strain, and it is with a feeling of relief that the pilot finally climbs to safer flying altitudes, preparatory to bringing his plane in and placing the information



The Radio Plane at Wright Field; to Keep the Slipstream of the Nose Propeller from Interfering with the Wing Screws, It Has Three Blades, Thereby Making a Smaller Diameter Possible



he has gathered into the hands of the engineers.

There are also the "saw-tooth" test and the "check-climb" test, in which the pilot usually goes high enough to meet subzero temperatures and to use artificial oxygen; the "oscillations" test, in which by alternate diving and climbing, sometimes with hands off the controls, the inherent stability of a plane is determined; the "accelerations" test, the purpose of which is to learn the stresses upon the plane surfaces in dives, loops, spins, and other extreme maneuvers of flight.

"If it has wings, we'll fly it," might be considered typical of the test pilot's attitude toward the ships that come for test. Difficult, brilliant, at times, dangerous work—and a cigaret and banter at sundown in the flight office. Now and then, for some special feat, such as landing a burning plane instead of taking a parachute, a letter of commendation slips into the files. And for a mistake, such as bad landing, getting lost on a long flight, or any of the variety of personal slips possible in such work, there is the "Dumb Bell Trophy" or the "Alibi Trophy," or another, which, presented by his fellows, the recipient must keep displayed on his desk until he can find a new offender to pass it to.

In the army air corps, Uncle Sam places high responsibilities. Planes may fail him now and then—but his flyers, never!

*operating with Alabama d. industrial development board*

### SUGAR FROM PEANUT SHELLS

Experiments are being made aiming toward the commercial production of a kind of sugar from peanut shells and cottonseed bran. The product sells for about \$100 a pound and is useful not only as a food but for textiles and leather industries. A plant has been built in Alabama for its manufacture.

*Bureau of Standards, Alabama Polytechnic Institute*

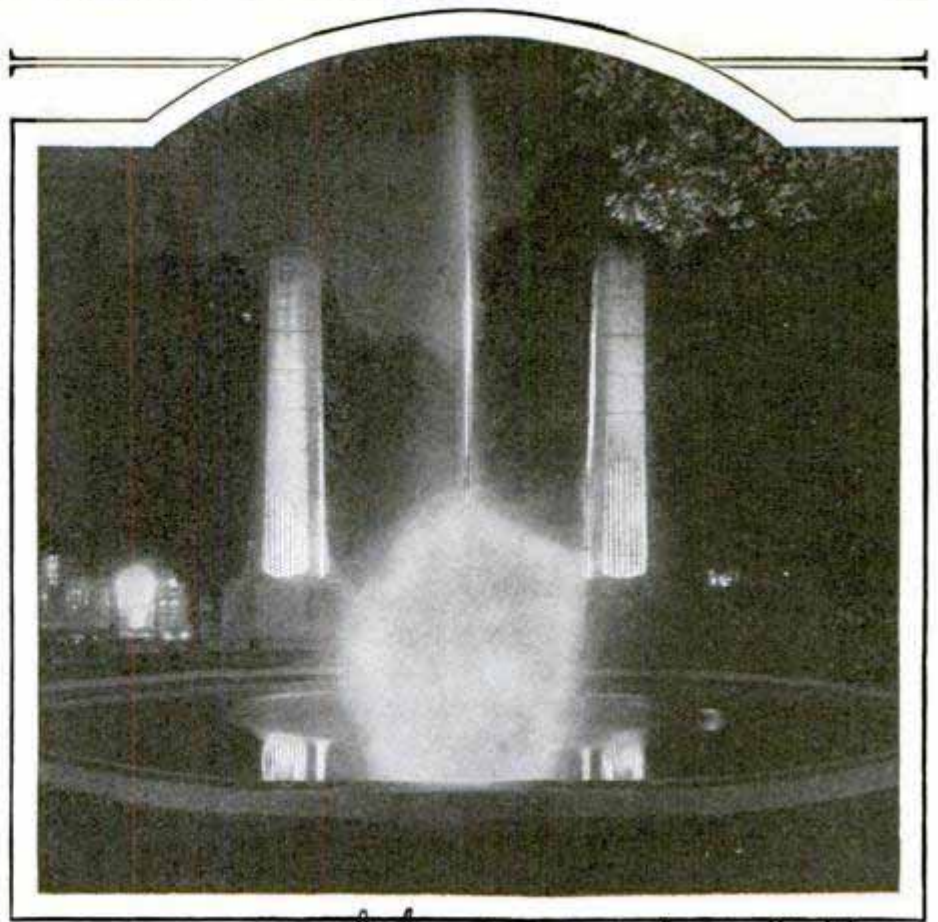

Courtesy General Electric Co. Schenectady, NY  
Illuminated Fountain and Colorful Background, Showing the Effect of Carefully Placed Floodlights

### TINTED LENS ON FLOODLIGHT ADDS TO NIGHT DISPLAY

Effects that were impossible a few years ago are now attained in night floodlighting by the introduction of improved reflectors and tinted lenses for the lamps. Doorways, fountains and other units are beautifully illuminated during the hours of darkness and at a considerable saving over what would have been required with older forms of equipment. Projectors with clear glass, stippled and colored lenses are sometimes used in combination for special blends and tones.

### GROW COTTON READY-COLORED TO SAVE DYEING 2039

In Peru is a plant that produces cotton of a reddish tint; a yellow cotton grows in China; India produces a gray shade, and, in Egypt, a brownish-colored variety is gathered. The plants breed true to type, the colors are fixed and do not change with variations in soil or climate. By crossing suitable kinds, scientists see a way of growing cotton of various hues, dyed by nature and of fast colors.

*Answers 12/22/28*



1899



Capt. A. I. Eagle, Bolling Field, Filling the Sand Box before a Flight in an Attempt to Disperse Fog with Electrified Sand

# Rain

is called the "dew point," the water vapor forms a cloud. Exactly what is the temperature of the dew point depends on the amount of moisture in the air. The more moisture, the higher the dew point. But no matter how much moisture there is in the air and how low the temperature, there can be no formation of cloud and no precipitation unless there are particles of dust or other nuclei about which the moisture can condense into drops.

So, in his experiment, Professor Knipp introduces tobacco smoke into a tiny glass tube containing the saturated air which he has expanded. The microscopic particles of matter which form the smoke are large enough for the water to form about, and immediately drops of water run down the sides of the tube.

In his second experiment, instead of introducing bits of dust into the air, Professor Knipp forces the saturated air to pass in front of a bit of radioactive substance. This substance, radium bromide, sends out rays, called alpha rays, which have the peculiar property of splitting up the air into tiny electrically charged particles. And these charged particles, acting exactly as though they were bits of dust, give the water vapor the nuclei upon which it can condense into droplets. Because the rays extend horizontally over the glass tube, the droplets, instead of falling as in normal rain, also extend across the top of the tube, each droplet, according to Professor Knipp, representing a charged bit of air or ion.

What is the possibility of applying these experiments to the production of rain?

Like most scientists—though not all—Professor Knipp is inclined to doubt.

"The idea of producing rain by shooting a cannon into humid air is not altogether poppycock," he told me, however.

By VICTOR RUBIN

Harwell Co. Chicago 1549

ALTHOUGH attempts to produce rain artificially have generally been regarded as wild dreams by scientists, two experiments recently conducted by Prof. Charles T. Knipp, of the department of physics of the University of Illinois, have removed the subject of rain making from the realm of the fantastic.

Both experiments, adapted from somewhat more elaborate tests by C. T. R. Wilson, of London, winner of the Nobel prize in physics for 1927, reproduce in miniature the conditions present in nature just before a thunderstorm. In both cases, the air is saturated and suddenly expanded. And then, in the first experiment, minute particles of dust, in the form of tobacco smoke, are introduced.

In nature, this expansion takes place when the moisture-laden air is warmed and rises from the earth's surface. As it ascends, it gradually cools—one degree for every 300 feet. When it reaches what



2079

# Made to Order



A Composite Photograph, Showing How It Was Proposed That Clouds Be Forced to Give Up Their Moisture by Spraying Them with Electrified Sand Particles, Dropped from Airplanes





These conditions, Professor Knipp pointed out, limit rain making too severely for practical application. As demonstrated in his second experiment, one could theoretically cause a downpour by sending a powerful electric current through water-saturated air during a falling barometer to ionize the air.

"In fact that is what happens when a stroke of lightning brings on a shower," he explained. "The practical objection to this plan is the impossibility of getting enough electrical power. The energy in a stroke of lightning traveling between a cloud and the earth a half mile below is greater than the entire Commonwealth Edison company has available!"

While the explanation of why the lightning flash or the sudden introduction of smoke—especially noticeable after forest fires or volcanic eruptions—produces rain has only recently been discovered, it has been guessed at more or less ingeniously.

"There is a certain element of truth in it.

"We know that before we can have rain two conditions are necessary: first, the air must be supersaturated; second, it must contain enough particles of dust on which the drops can form.

"So, theoretically, in a region where the air is practically dustless, the introduction of smoke—say from a passing locomotive or the shooting of a cannon—would provide the bits of dust on which the drops could form.

"That is, of course, provided all the other conditions were favorable—the saturation and the sudden expansion of air (a condition which occurs when the barometer falls) at the very moment the smoke was introduced."

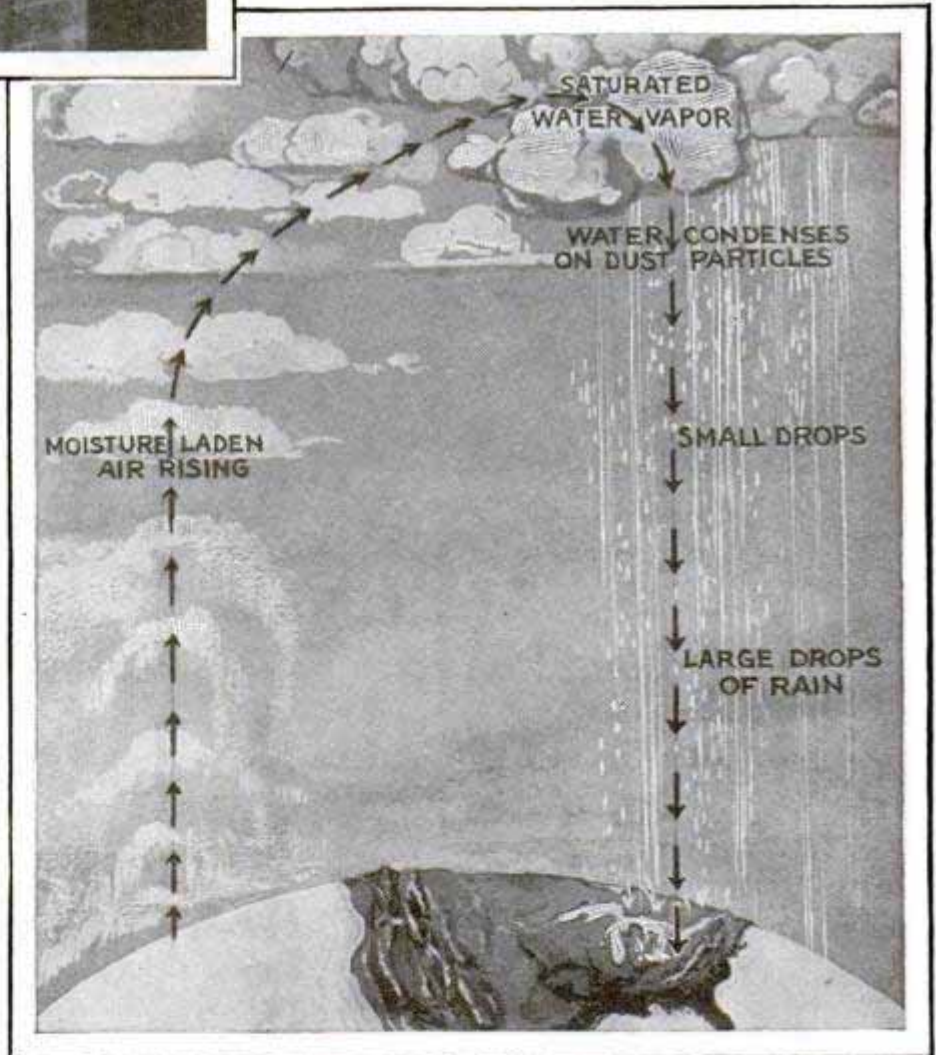

Dr. Chas. T. Knipp with His Simplified Cloud Apparatus, and Diagram of How Nature Produces Its Rainstorms by the Condensation of Moisture on Dust Particles in the Upper Air



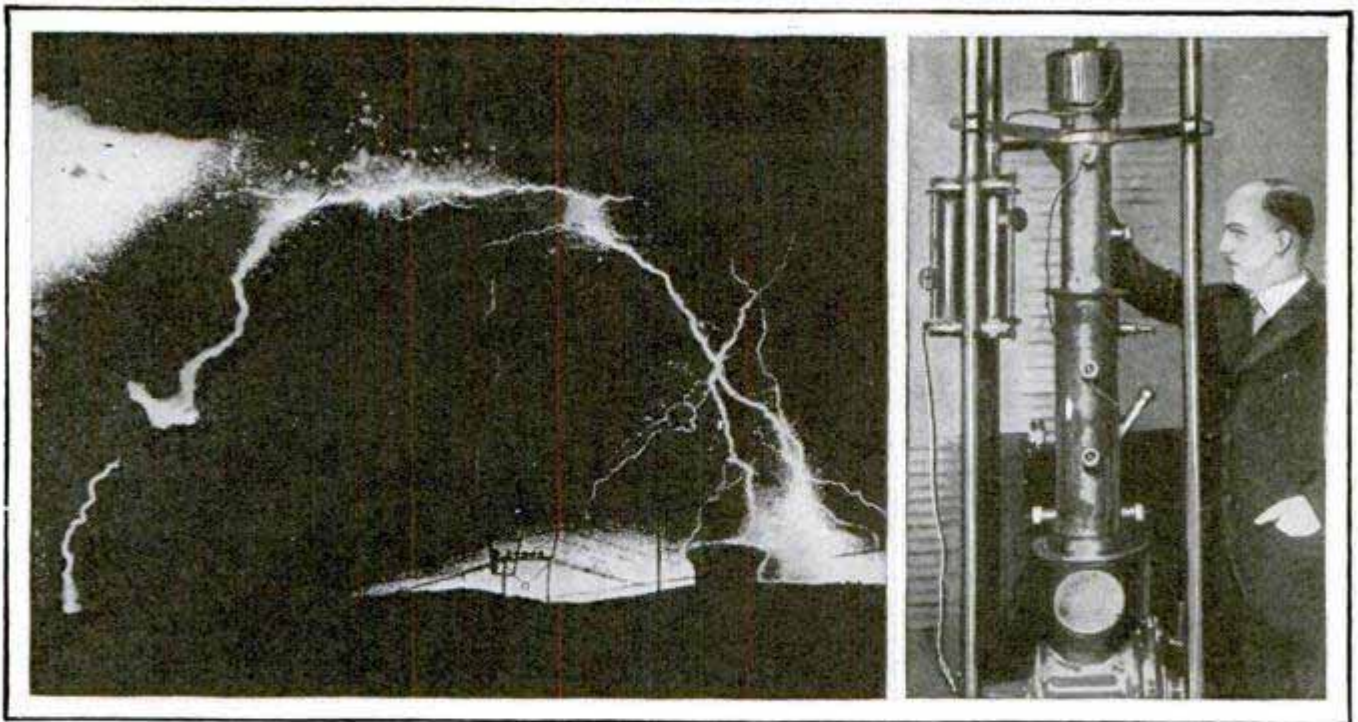

A Natural Lightning Flash near a Power-Transmission Line and, Right, an Oscillograph to Be Used by Westinghouse Engineers in a Study of Lightning in the Tennessee Hills

The occurrence of showers after battles, led Edward Powers, in 1871, to begin a campaign to induce congress to appropriate money for extensive experiments in producing rainfall by firing cannon into the clouds.

In his book "War and Weather" Powers showed, among other things, that the battle of Waterloo was followed by rainstorms for two days and that the battle of Buena Vista, fought in the midst of the dry season, was followed by two showers. In all, he studied fifty battles.

Powers' theories have since been discredited. At least one scientist has pointed out that no one has yet been able to cause steam from a teakettle to precipitate by clapping his hands in it, although he would be jostling the drops more violently than would an explosion one-fourth of a mile away.

At any rate congress, in 1891, appropriated \$20,000 to carry out the experiments suggested by Powers, and General Dyrenforth was appointed to superintend them. After preliminary trials, the experimenters went to a ranch near Midland, Tex., where balloons filled with a mixture of hydrogen and oxygen, and dynamite carried up by kites were exploded in the air.

Although the principle on which Powers based his experiments is now generally considered fallacious—namely that the concussion would be sufficient to cause the

warm water-bearing air to rise to the colder air above—General Dyrenforth reported that the cannonading actually did produce precipitation, drops often commencing to fall within twelve seconds of the first explosion. But Dr. W. K. Curtis, who was with General Dyrenforth's party, declared that the only rainfall which followed the explosions was that which would have fallen or had actually begun to fall anyway.

At the beginning of the World War, followers of the Powers theory expressed apprehension that a series of devastating storms would sweep Europe. As we now know, the rainfall during the four years of the war was normal for that part of the world. While this clearly disposed of the concussion theory, it by no means disposed of the smoke theory.

Declaring that Indians started prairie fires to produce rain, James P. Espy, the naturalist who discovered how rising air is cooled by expansion, suggested, in 1845, a novel means of ending drouth. He proposed to burn forty acres of timber for every twenty miles, along a line extending 600 to 700 miles from north to south in the western part of the United States. Such fires once a week, throughout the summer, he said, would cause the air to rise, cool by expansion and condense the water vapor into rain.

Espy's theory is apparently confirmed



by the observation that clouds commonly gather above burning forests. But the cure would be far worse than the disease. For, even so tremendous a conflagration as the Chicago fire of 1871 was accompanied by only a moderate shower, most of the storm clouds which hung over the city—whether caused by the fire or not—having been swept away by strong winds.

One of the most spectacular attempts at rain making was made a few years ago when airplanes, circling above Bolling field, Washington, scattered heavy clouds by discharging into them a steady stream of electrically charged sand. Prof. E. L. Chaffee, assistant professor of physics at Harvard University, directed the experiment on the invitation of L. Francis Warren, a business man.

Again at McCook field, near Dayton, Ohio, in the presence of army officers and aerial experts, including Wilbur Wright, army planes charged clouds with a stream of sand flowing between two electrodes, and a small shower followed. Although the area affected was too small to prove of practical benefit, the event was hailed in the newspapers as the first artificial rainfall in history. Most meteorologists, however, refused to accept this verdict.

Probably the most successful rain maker of modern times is "Prof." Charles

M. Hatfield. Newspaper records show that, since 1905, rain has fallen uniformly following his operations. In 1905, he was paid \$1,000 for producing eighteen inches of rain in southern California, in the winter and spring. In 1922, he collected \$3,000 from the farmers of Medicine Hat, Alberta. Among his other successes reported in the newspapers was a 2.29-inch fall of rain at Hanford, Calif., in March and April, 1924, for which he received \$8,000.

In April, 1926, a group of farmers, perhaps in a spirit of irony, gave Hatfield a section of land in the arid and unirrigated Tulare Lake region of California as compensation for his services. And although the rain did not fall until ten days after the date he predicted, it finally fell in sufficient quantities to save his crop, according to newspaper reports at the time.

Physicists and meteorologists have uniformly condemned Hatfield's methods as scientifically valueless. They have declared that rain would have fallen without his presence and did actually fall elsewhere in surrounding territory following the long periods of drouth he was engaged to break.

Hatfield himself never revealed the mysterious "chemicals" which he used, although he said that his process was the

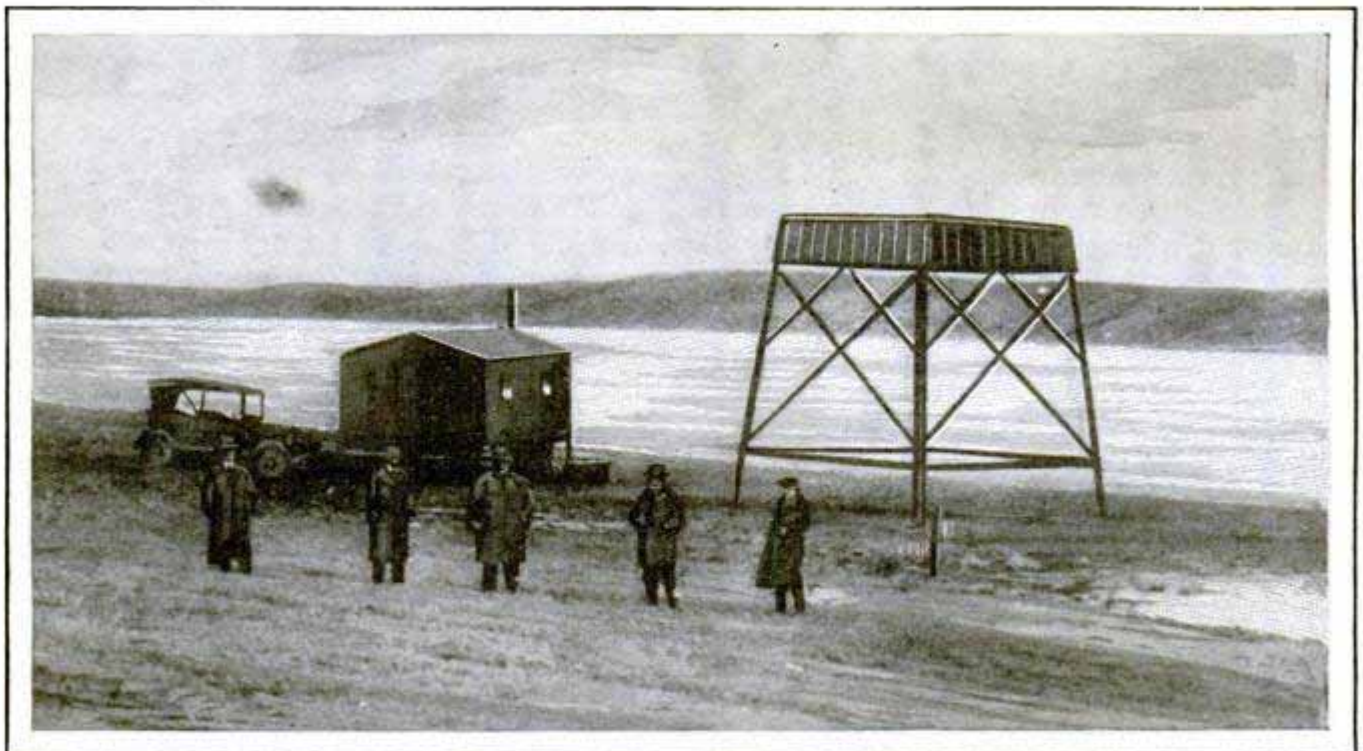

© Kadel & Herbert

A Successful Rain Maker, Charles M. Hatfield, Got \$3,000 When a Deluge Followed the Erection of His Mysterious Chemical Tower



result of ten years' study and three years' practical experimentation. He asserted that he had discovered the power of his chemicals to attract moisture by accident, when he observed that steam from a tea-kettle followed a mixture of them as he moved it about the kitchen of his home.

His method of getting the mysterious substance into the air was to erect a square wooden tower mounted on supports fifty feet high and varying in diameter from fourteen feet at the bottom to twelve at the top. The tower was sheathed with tar paper and inside were 104 galvanized-iron evaporation pans filled with chemicals and water. The tower, provided with an opening at the bottom to produce a draft, acted as a chimney through which the evaporating chemicals were carried into the air. At night, when there was no sun to heat the tower and evaporate the chemicals, they were burned. The result was eerie clouds bellowing into the sky and illuminated from beneath by the colored fire.

Whether or not rain making will ever be placed on a practicable basis, man has apparently wrested its secret from nature. Like all other scientific discoveries that have first been successfully worked only in the laboratory and under ideal conditions, the artificial production of rain may eventually be developed to the point where drouth will be a thing of the past and abundant rainfall assured every plot of farm land in the world.

But how stupendous the problem is may be gathered from the fact that the average annual rainfall of the United States is approximately 6,055,245,753,000 tons. The energy furnished by the sun to evaporate and transport this enormous quantity of water has been estimated to be not less than 7,000,000,000 horsepower operating continuously.

Professor Knipp, with the conservatism of the scientific research worker, admits the possibility of producing artificial rain only under special conditions. But so eminent a physicist as Sir Oliver Lodge recently declared that the problem of electrifying the atoms of humid air in clouds and forcing them to fall in drops is no more difficult than the problem of controlling contagious disease at one time appeared to be.



Receiving Radio-Photo Transmission of Popular Song in London from New York

**SONG HIT SENT BY RADIO PHOTO ACROSS ATLANTIC OCEAN**

So that it could be used in time for a ball, a late song hit was sent by wireless photo from New York to London, recently, and was received a few minutes after it was delivered to offices in this country. Words and notes were successfully transcribed for the London singers, who were to render the song at the Three Arts ball.

**TENNIS-RACKET STRING GUARDS HELP IMPROVE GAME**

To protect the strings of the tennis racket, small rubber guards, easily attached, have been devised. They grip the bottoms and sides of the strings at their crossings in the center playing area of the racket, distributing the strain and making the pull of the strings more effective. At the same time, the guards are said to help grip the ball, giving better control to the stroke.

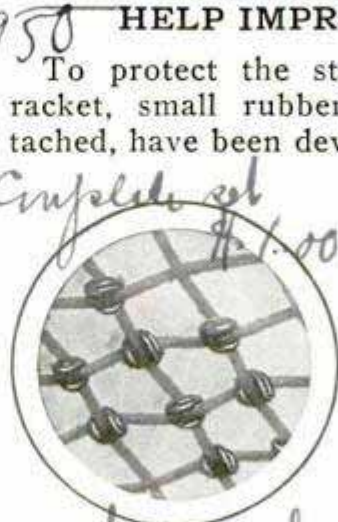

*Tennis Specialties Co.,  
220 California St.,  
San Francisco, Calif.*



264

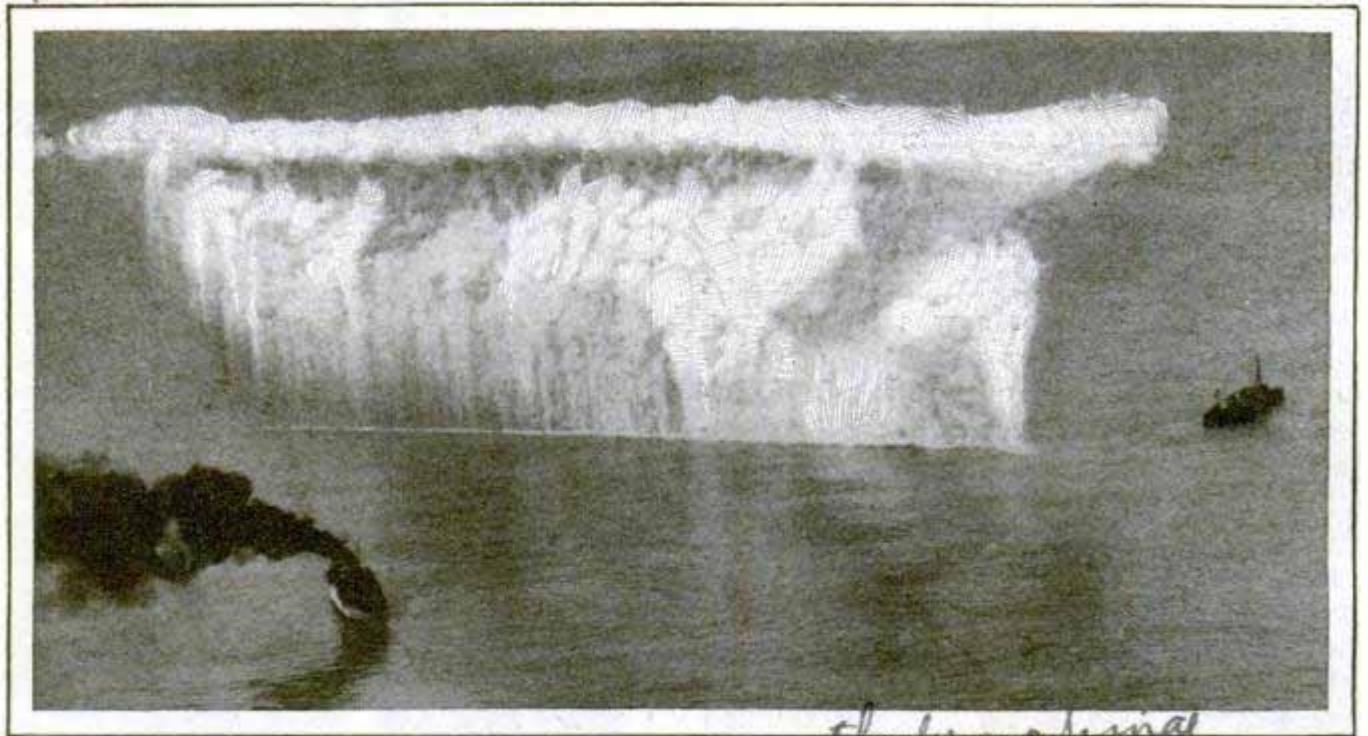

Lowering a Curtain from the Skies; Smoke Screen from Airplane, Laid Down to Show How Effective It Would Be for Operations against a Battle Fleet

*International*

**SMOKE BARRAGE FROM PLANES TO FIGHT FOREST FIRES**

Controlling forest fires by means of a barrage of chemicals from airplanes is one of the plans under consideration by the chemical service and the air corps. Recent experiments in laying smoke screens and gas barrages from planes over the sea have shown that the work can be done at altitudes as low as 200 feet.

**CABINET FOR DRYING CLOTHES ALSO WARMS PLATES**

For drying clothes or warming plates, an electric cabinet has been introduced for house and apartment use. It is set into operation simply by turning a switch and has a means for ventilating the contents at the same time. Heated air is pulled from the top of the drier, down through the clothes, but the action is accomplished without fans or other moving parts.

**PIANO HAS BUILT-IN CABINET TO PROTECT MUSIC**

Two patented improvements have been added to the piano by a German manufacturer. One is a built-in cabinet to hold the music where it will not easily become disarranged or dusty, and the other is a built-in lighting unit so arranged that it

illuminates the music and the keyboard without a glare. It is controlled by a push button concealed near the keyboard. Another button raises the top lid of the piano case when greater volume is desired.

**CELL BOARD FOR RADIO VISION HAS MANY LIGHTS**

More than 2,000 tiny light-sensitive cells are contained in a board devised by C. Francis Jenkins for an improved radio-vision apparatus intended for broadcasting baseball games and other outdoor

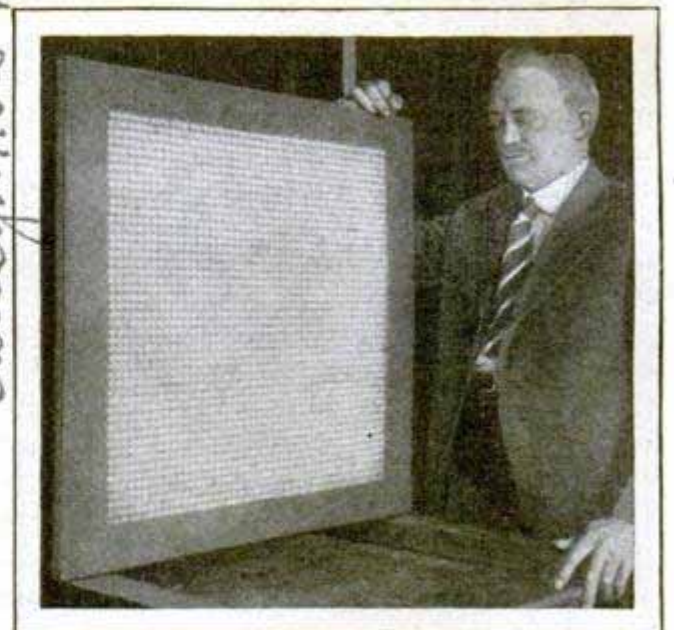

© Harris & Ewing  
C. Francis Jenkins with Multi-Cell Board for Radio Vision and Reporting Outdoor Events

*Canton Clothes & Dryer Co  
Canton Ohio*

*Chicago 116 S Michigan 1996*

*U.S. agent  
Knaum*

*Stichel Leipzig*

*1519 Connecticut Ave  
Washington*



*Chiswick, England*

events. As a receiver, the unit will be suited to use in a theater.

**LEVERS STOPPING TRAIN PREVENT COLLISIONS**

By means of a lever installation which he has devised for railroad trains, an English inventor expects to prevent collisions. Levers are placed at intervals of half a mile and are interconnected. The locomotive sets them in operating position as it passes, thereby protecting successive track sections as it enters them. Should another train run into the guarded area, the projecting lever would automatically apply the locomotive's brakes and halt the train. According to reports, the installation of the system is comparatively inexpensive, costing only a few dollars per mile.

**PORTABLE HUMIDIFIER IN HOME RUNS FROM LIGHT SOCKET**



Operated by current from a lighting socket, a portable humidifier for the home or office helps keep the air at healthful moistness and may also be used as a means to spread disinfectants or deodorants. It is shaped and decorated in the form of an attractive urn, and the connections are so adjusted that the current is turned off automatically, if the container goes dry.

[Popular Mechanics Magazine does not publish the name of the maker or seller of any device described in its pages, but this will be furnished free upon application to our Bureau of Information.]

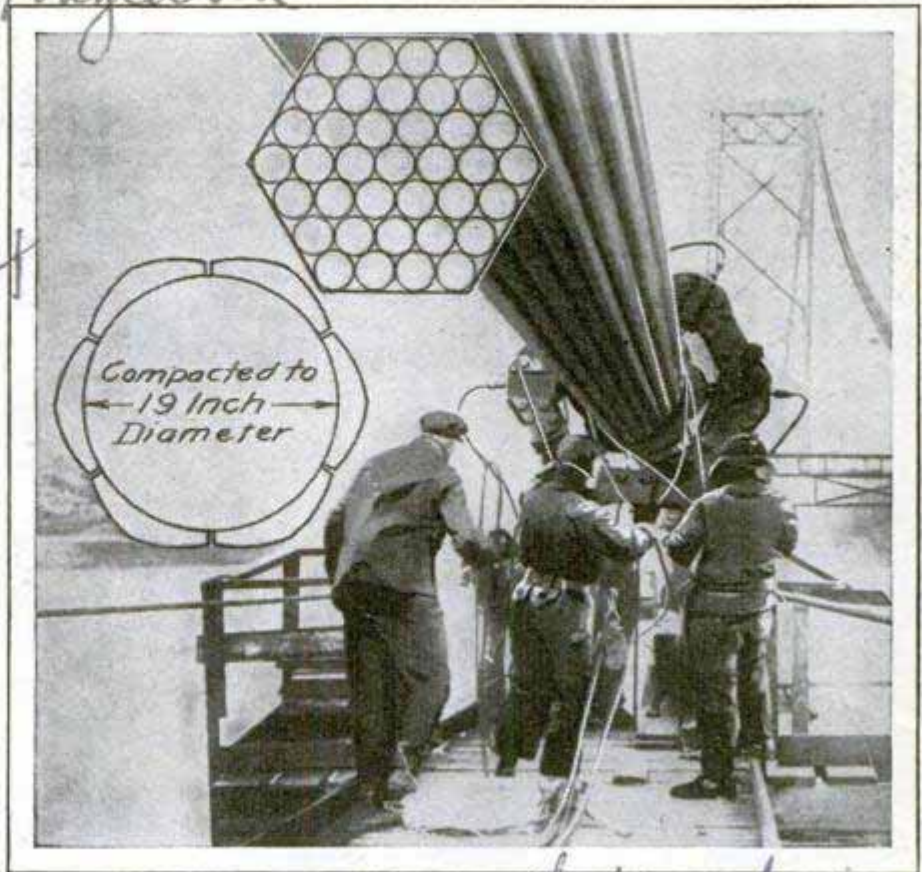

Preparing Cables for the Big Bridge, and Drawing of Section Before and After Being Compressed with Jacks

**WIRES SQUEEZED INTO CABLES TO HOLD BIG BRIDGE**

Six hydraulic jacks, each capable of exerting a pressure of thirty tons, have been used to compress the wires that make up the cables for the Ambassador bridge, linking the United States with Canada at Detroit, into round cables. Each cable is composed of 7,622 wires, which are compacted to form a circular line nineteen inches in diameter. The cables are wrapped to hold them in the round shape and to protect them against weathering. There are thirty-seven cables to support 12,000 tons, the weight of the bridge structure so suspended.

**FARMER RAISES HORNED TOADS TO DEVOUR INSECTS**

Near Abilene, Tex., a farmer is conducting a profitable business by raising horned toads for zoos and shows, and for other farmers who keep them to devour insects that damage crops. Since the reported finding of a horned toad that was said to have slept in a cornerstone for thirty years, the specimens have attracted unusual interest among visitors at zoos.

*American Radiator Co.*



# Exploring Davy Jones' Locker

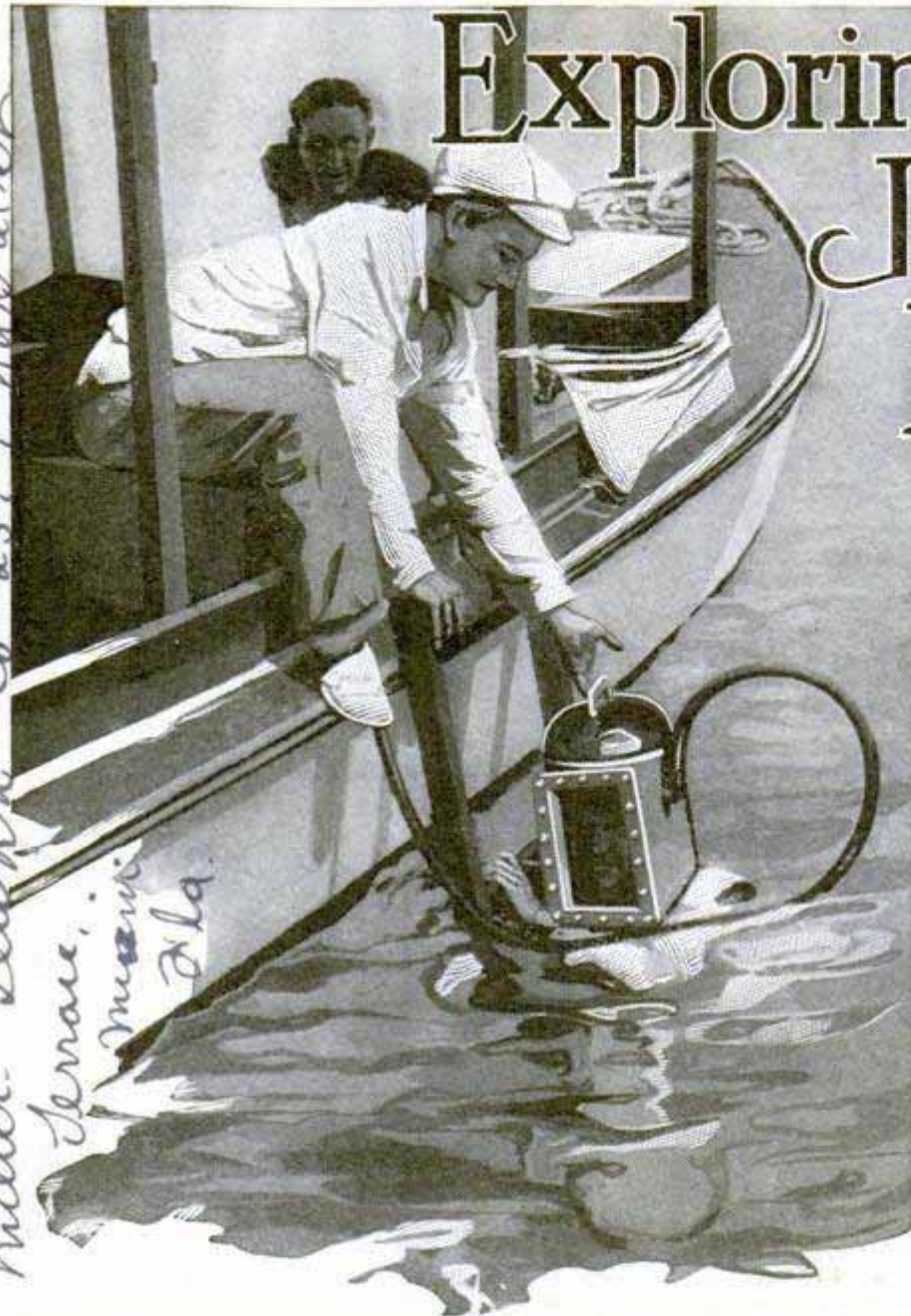

ladder is hung over the side. If you reach the last rung, before stepping out into water-filled space, the hose is attached to a copper helmet, in the front of which a square of plate glass is securely fitted.

Carefully, John Mills, the engineer, lowers the helmet over your head until its weight rests firmly upon your shoulders. An assistant takes his stand at the air pump. You are told to let go, to proceed where you please. When your breath clouds the glass, Mills warns, tip your head, letting the water run inside the helmet and the glass will clear. Follow the hose back to the boat when

Helmet with Large Window Used for Shallow-Water Diving; with It the Wearer Can Stay Down Four or Five Hours at a Time

By C. MORAN

SCIENTISTS wearing under-sea helmets are exploring submarine life in the Gulf of Mexico. Carrying cameras, they proceed leisurely at their work of observing and recording fish and plant activities. One of these explorers, Prof. W. H. Longley, of the Carnegie Institution of Washington, has spent more than 3,000 hours under water.

A stroll on the bottom of the sea is a thrilling experience. A small launch, equipped with air pump and coils of rubber hose, is anchored over a spot twenty to thirty feet deep off Loggerhead Key, seventy miles west of Key West. A short

you wish to return.

Gently as a feather you come to rest on the ocean floor. You may strain your ears but will hear no sound. You look upward but see no sky. You gaze outward, but even under the most favorable conditions, fifty feet marks the limit of your horizon. No sharp contrasts of light and shade are to be observed, for the all-pervading illumination softens every outline and angularity and shrouds every object in a peculiar haze.

The water, transparent and constantly moving as seen from above, seems no longer to be water, but a queer encompassing medium without motion. You are not conscious even that it is wet. You

helmet for shallow water diving -  
 Miller Electric Co 2517 N.W. 21st  
 Terrace,  
 Miami  
 Fla.

Washington D.C. 3825-13th St NW





Sitting at the Submarine Window Watching the Fishes Flash By in a Coral Forest

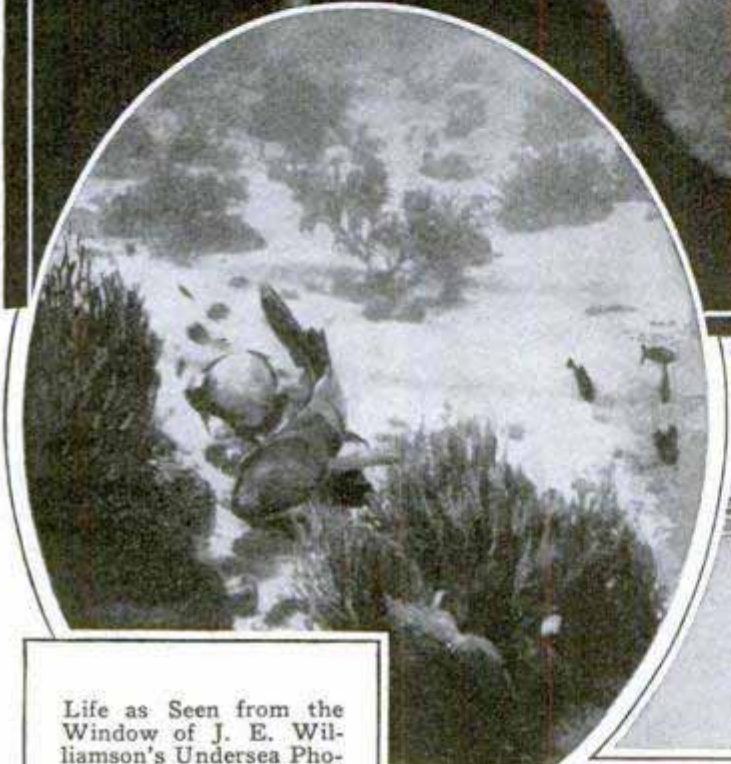

Life as Seen from the Window of J. E. Williamson's Undersea Photographic Studio, a Huge Steel Ball, Suspended from a Flexible Steel Tube, Originally Invented by His Father as an Aid in Salvage Work; These Pictures Were Made by Williamson on a Recent Trip in the West Indies

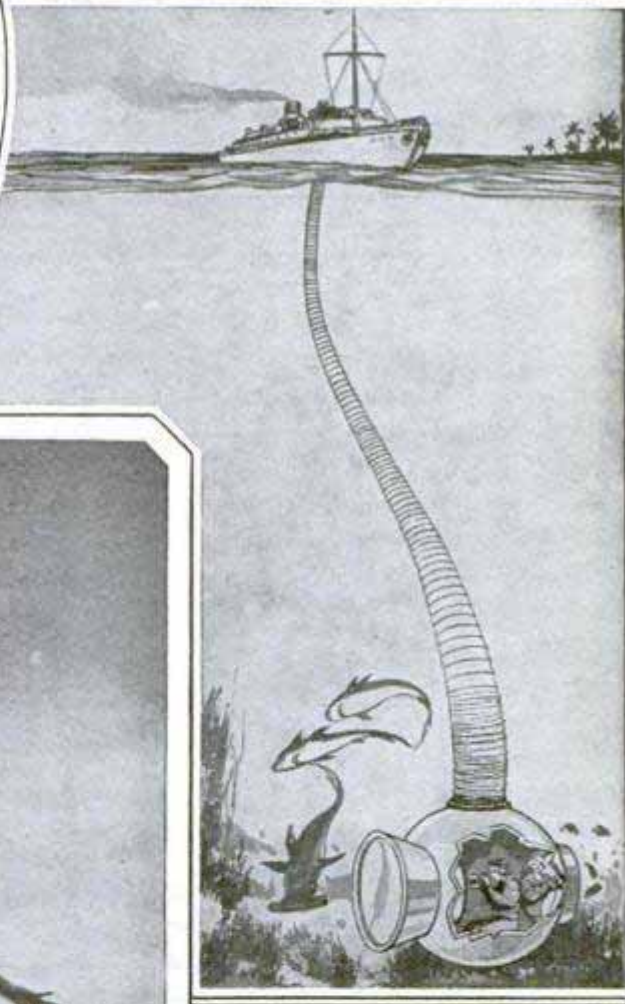

The Tube from the Ship Above Incloses a Ladder, Telephones and the Air Duct, and Can Be Lengthened or Shortened

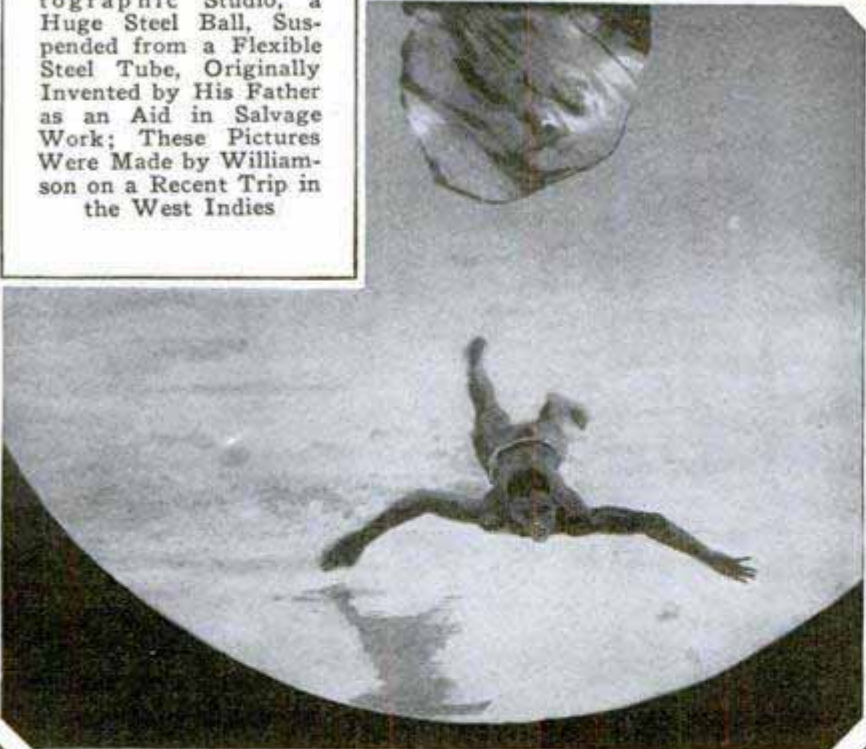

How a Diver Looks on the Sea Bottom; Williamson Has Photographed Thrilling Fights with Sharks and Other Big Fish through the Circular Window of His Diving Chamber

*70 Hotel Berkeley*  
*170 7th St*



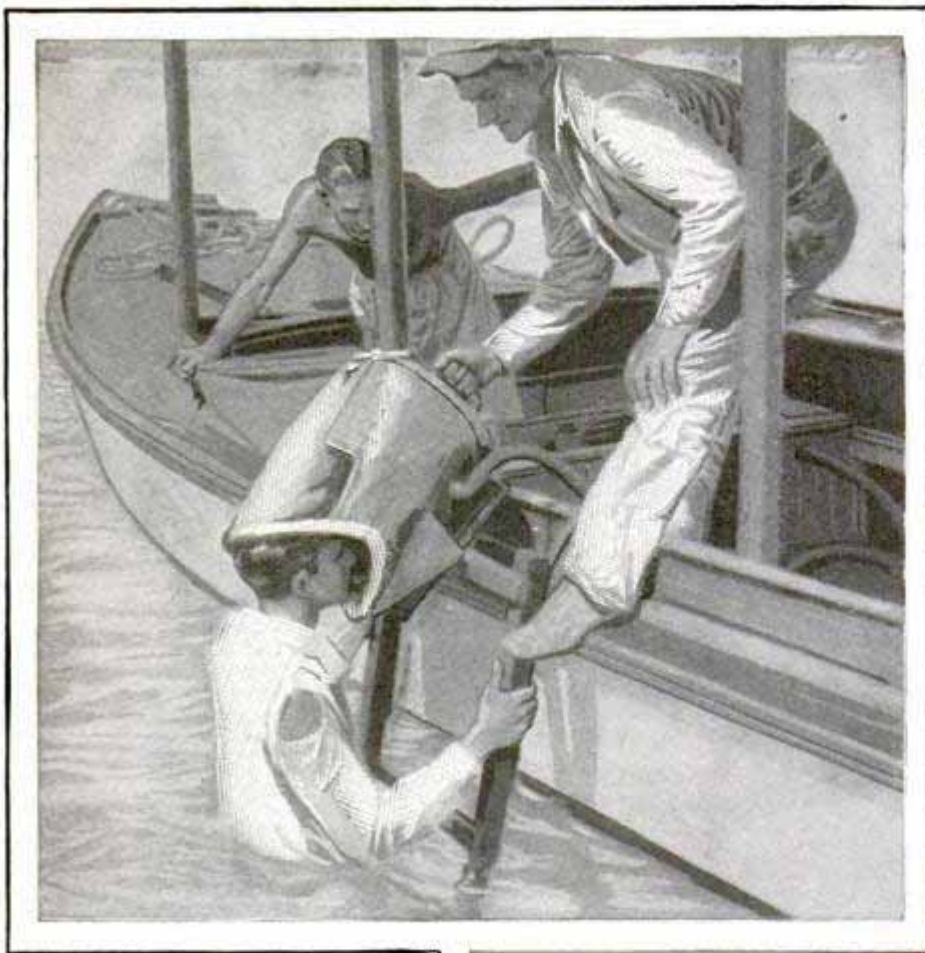

a dreaded barracuda, the "tiger of the sea," treats the astonished stranger with good-natured consideration, inspects him casually, and swims slowly away.

Professor Longley, who frequently spends four to five hours on the sea bottom, gives the following description of his experiences:

"Except when the light is strongest and the water itself most free from sediment, one is denied sight of all but the immediate surroundings, the world being resolved into a diminutive hollow hemisphere, pervaded with silence and on all sides fading

stretch your hand toward a great coral head towering beside you. It is beyond the sweep of your arm. You attempt to place your foot on a bit of jutting coral but miss it entirely. Gorgonians, a corallike form, and other growths, ankle-high when viewed from the boat, strike you at waist or shoulder or overtop you altogether. Declivities which seemed slight before are often seen to run off into huge depressions, and sometimes into real gorges.

Your movements at sea bottom are like the slow-motion pictures at the movies. The fishes appear suspended lightly in their investing fluid, a quiver of fin or tail propelling them with equal ease in any direction, up or down. They exhibit a mild curiosity at the presence of a man, swim lazily about you and idly nose you over. Even

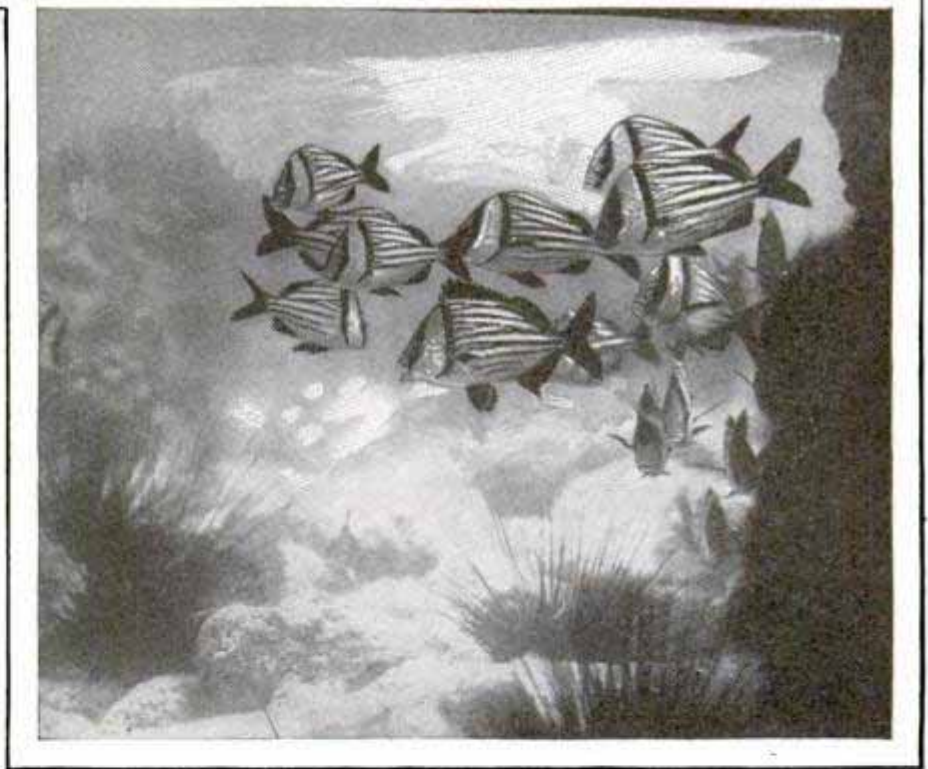

The Simple Diving Helmet Used for Shallow-Water Work, and a Close-Up of a School of Pork Fish Swimming, as Airmen Say, in Formation

into nothingness. One's narrow field, however, if wisely chosen, may teem with life. It is more than probable that long-spined sea urchins infest the place, twiddle their spines if one approaches, or make off at a surprising rate of speed to shady



*Suggest kayaker gun. Abercrombie & Fitch, Madison Ave & 95th, New York*

places if disturbed. Yellow, brown or purple gorgonians, heavy with expanded polyps, stand on every side, with an occasional coiled basket star close-wrapped about their branches, where its inertness completely belies its power of motion.

"Large spiny lobsters, torn between distrust and greed, from under mushroomed heads of coral protrude their antennæ and wave them frantically over proffered food. Hermit crabs with heavy shells sit aloft on purple sea fans. With their spoon-shaped fingers, spider crabs, ensconced in safe retreats, grub off the encrusting growth of plants and fill themselves to repletion.

"The variety in coloration of fishes is an unfailing source of delight. Whether one looks down upon them through the glassy water or whether they float into one's field of view through the circumambient haze, they provoke recurrent expressions of admiration. One is thrilled as by the beauty of Aladdin's garden.

"Particular colors are correlated with specific habits. Red, for example, is almost wholly restricted to nocturnal fishes which lie hidden by day. The greens, on the other hand, characterize such species as live upon the green reef flats, or swim near the surface in open water.

"Equipped with diving hood, one may walk about freely and thus lead carnivorous forms from point to point by offering them food. It is possible under such circumstances to evoke their various color phases at will by selecting the spot to which the creatures are led.

"The movements of herbivorous forms are not subject to quite such definite control, but one may walk up to browsing schools of tangs or parrot fish, follow them about, and procure information with little effort. All the creatures may be photographed amid perfectly natural and typical surroundings with little difficulty."

**YACHT IS FITTED WITH GUN TO SHOOT BIG FISH**

Mounted on the forecastle of a sportsman's Diesel-engined yacht, is a one-pound gun for shooting fish that may be found on cruises in the south seas. The equipment may also be employed for hurling harpoons at whales.

*A. K. Macomber's*

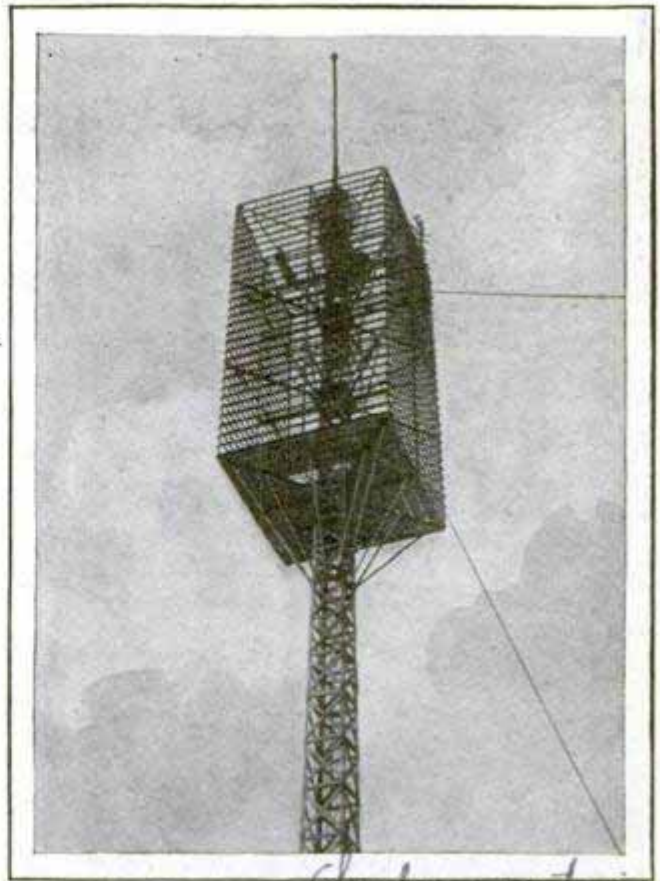

Distributor Box for Telephone and Telegraph Lines in Valparaiso, Chile

**PHONE AND TELEGRAPH WIRES CONNECTED ON POLE**

Both telephone and telegraph connections can be made on a boxlike unit at the top of a high pole in Valparaiso, Chile. The distributor section is as large as a good-sized room and is adapted for quick changes in the lines.

**JOINT GRIP ON RUBBER STAMP IMPROVES PRINTING**

So that clearer impressions may be made without blurring, a rubber stamp just put on the market has a jointed handle, allowing



free play between the grip and the base of the article. This prevents disturbing the impression when pressure is being applied. The base is of bakelite, and the rubber is firmly attached to it by an especially strong cement.

*Lake Mfg Co*

*1910 Caddis Sh*

*Chicago, Ill. 178th St. 1919*

*1992*

*Aug 30, 1912*



1984

Tried on Canadian Pacific boat

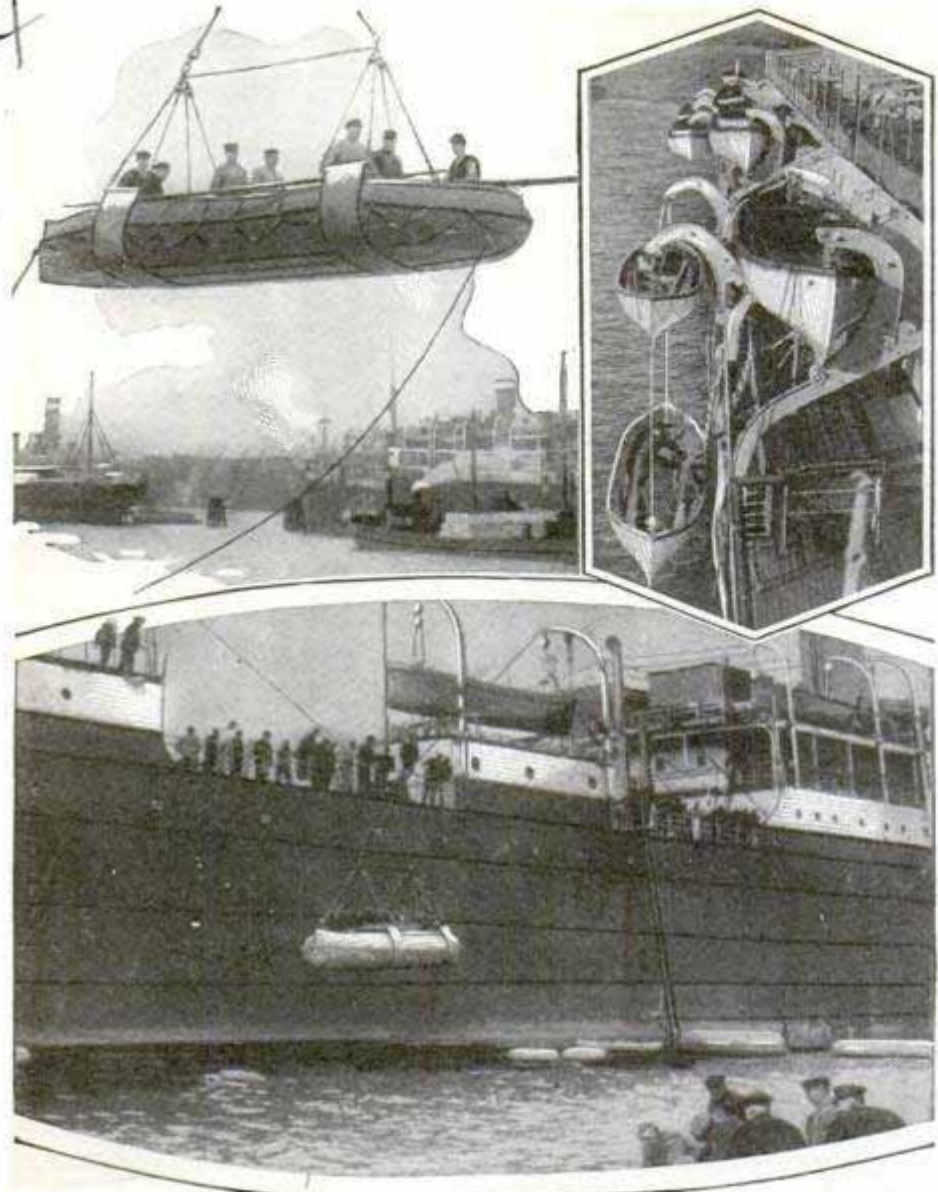

Making Tests with the Collapsible Lifeboats, and, at Upper Right, Inset of the Davits That Roll Down Vessel's Side

### BETTER LIFEBOATS TO CURB TOLL OF SEA ACCIDENTS

Loss of life in the "Vestris" disaster and in similar accidents has placed renewed emphasis on the question of proper lifeboats for vessels. Just recently, interesting experiments have been made with improved forms of the craft. One has movable davits that slide down the side of the boat on rails, insuring the safe launching of the boat without tipping over or the breaking of ropes. Another is a raft-shaped boat that may be quickly inflated or collapsed. It cannot capsize and will hold several persons.

Names and addresses of manufacturers of articles described in this magazine will be promptly furnished, free, by our Bureau of Information.

### PLANES TO CARRY DIAMONDS TO LONDON

2067

A ton of gold and many diamonds are to be carried each week by all-metal flying boats and airplanes from South Africa to India and London, it was announced recently. The boats will be used on the area between Cairo and the Central African great lakes. Beyond this district, trimotored planes will fly to the Cape of Good Hope. Well-equipped landing fields and hangars have already been established between Cairo and Capetown. One advantage of this transport system will be a saving in interest charges which now are about \$750 a day on an annual shipment of \$70,000,000 in gold.

### FOOT CLAMP AIDS IN REPAIRING BATTERY

2026

Quickly adjusted to storage batteries, a clamp is offered battery-repair and service shops to save time and work. It is slipped on and held by footplates when changing the cells and making other repairs; is practically universal in use as a slight pressure on the footplates makes it adjustable to almost any battery. It also does good service in reinsulating a battery as the connecting bars on each cell do not have to be drilled off, but all three cells can be removed at once. The tool is easily portable, and patents have been applied for.



R. W. S. Co.  
 100 W. 1st St. St. Louis, Mo.



# HOW INVISIBLE LIGHT SERVES TO PREVENT CRIME

*26 Coventry St London W 1 Eng*

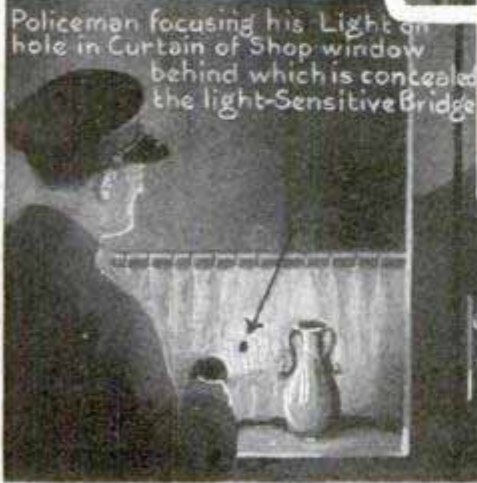
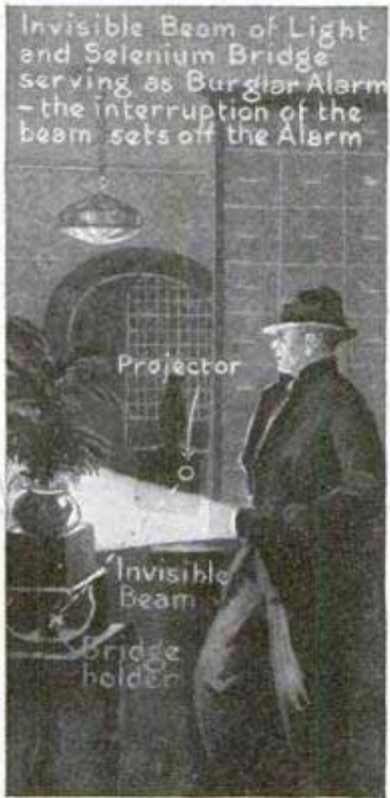
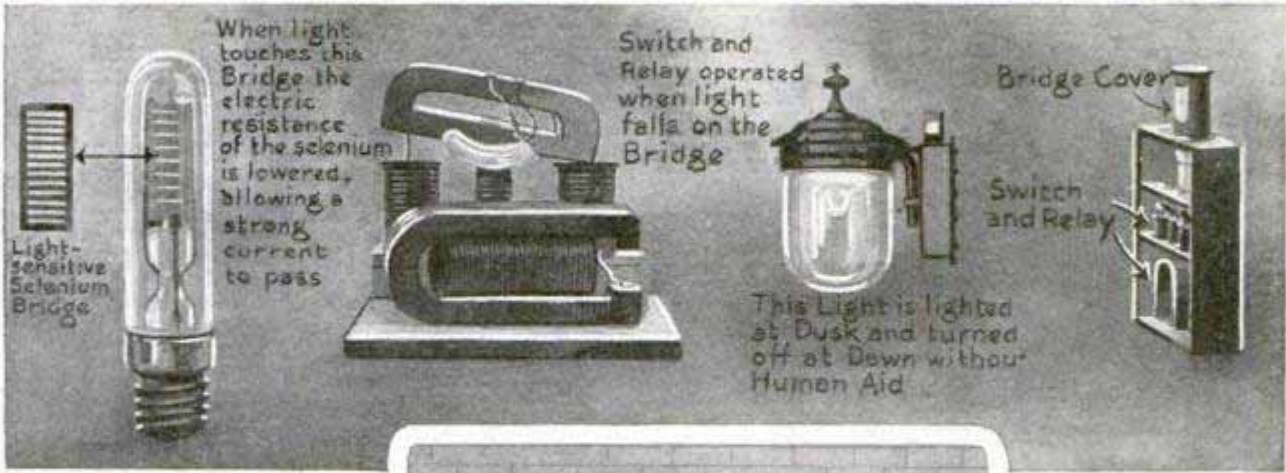

© The Illustrated London News.

*11/17/28 P-907*

The Development of Cheap and Practical Light Cells for Television and Other Radio Uses Has Opened a New Field in Burglar Alarms; Lights Can Be Turned On by Playing a Beam on a Sensitive Cell, or Alarms Can Be Sounded by the Breaking of an Invisible Light Beam When Some Solid Object Passes across It

*Radivision Parent, Ltd*



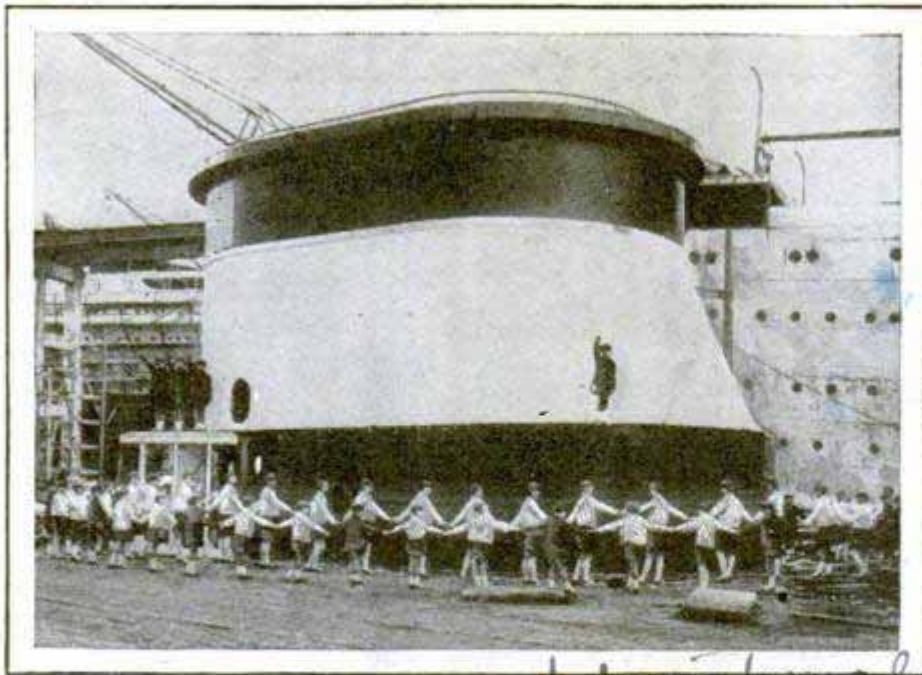

Children of Shipbuilders Celebrating the Completion of the Huge Funnel for the Motorship "Vulcania"

**FUNNEL ON ITALIAN MOTORSHIP ONE OF WORLD'S LARGEST**

What is said to be one of the largest funnels in the world was built for the Italian motorship "Vulcania." Before the vessel started on its maiden voyage to New York and before the funnel was installed, a number of Italian school children celebrated the completion of the giant craft by exercises in the shipyard. In some of the steamers that have been converted into oil burners, the funnels are not all used for smoke, some being employed as ventilators or as storage places.

**SELF-WATERING FLOWERPOT HAS DOUBLE WALLS**

Plants are automatically irrigated in a self-watering flowerpot recently introduced. It has double walls, the inner being of a porous material and the outer one of a waterproof substance. The two are united at the top by means of a flanged rim, and the space between is filled with water. The pot has been carefully tested and has been pronounced a success.

**SPREAD SALT ON FLYING FIELD TO LAY THE DUST**

Salt, sprinkled over a Michigan flying field was effective in laying dust and also improved the visibility of the area, as the salt became a glistening white, especially

after a rain. The material has been used successfully on roads and, purchased in large quantities, is by no means prohibitive in cost.

**COIN-IN-SLOT LOCK FOR CYCLES TO FOIL THIEVES**

Persons who ride bicycles in Berlin are afforded an efficient means of securing their vehicles against thieves by a coin-in-the-slot locking arrangement. Depositing a coin releases a chain with a lock and key. The rider fastens his bicycle, pockets the key and goes on his way, knowing that his property is protected against theft. The locks are conveniently placed in public places and are reported to be



Lock Box for Bicycle, Which Gives Owner Stout Chain and Key for His Vehicle

earning a revenue for the owners as well as affording protection for bicyclists.

*Mr. J. Blair Wilson, Esq. 1915  
Chicago, Ill.  
1915*

*International*

*International*

*Mr. Miss J. A. Harris*

*Can't locate map*



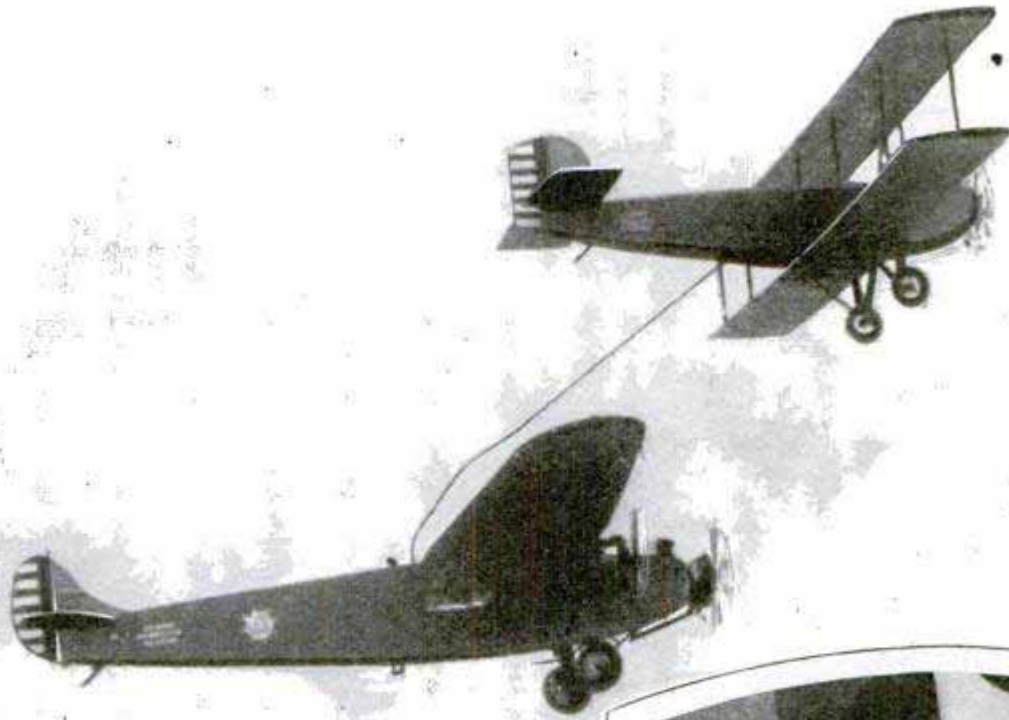

© Henry Miller

Releasing Fuel into the Tri-Motored Plane from the Smaller Ship Above, While Flying at High Speed, and a Close View of the Supply Hoze and Nozzle

### PLANE REFUELED IN FLIGHT FOR ENDURANCE RUN

Flying at a speed of ninety miles an hour, a tri-motored plane was refueled from a smaller ship sailing just above it. The test was made to further prove the feasibility of replenishing aircraft while in motion, and was directed particularly toward preparations for a coast-to-coast endurance tour. The most difficult part of the operation, it is said, was the lowering and connecting of the fuel hose. The nozzle weighs fifteen pounds. Food has been successfully passed from a service ship to a moving plane with a hose.



### SKATING ON FROZEN ALCOHOL POSSIBLE ON MOON

Taking baths in molten sulphur at noon time and skating on frozen alcohol at night would be possible for persons dwelling in the moon if they could survive there. Scientists have been measuring the temperatures of the satellite with improved apparatus and have found further evidence of the extremes of temperature experienced there. When the sun is directly over a point on the moon's surface, that is, at noon, the temperature

reaches about 265 degrees Fahrenheit, higher than the boiling point of water and high enough to melt sulphur. Some indication as to conditions that probably prevail on the unilluminated side of the moon was found from measurements made during a recent eclipse. Before it began, the temperature was 156 degrees Fahrenheit. At the end of the total phase, it had dropped to 196 degrees below zero, the freezing point of alcohol. Half an hour after the eclipse was over, the temperature had returned to 135 degrees, nearly as hot as at the beginning.

*See Seth B. Nicholson, Mr. Wilson*

*Science Service 404 8/12/28*



1639

# TRAINING *The*

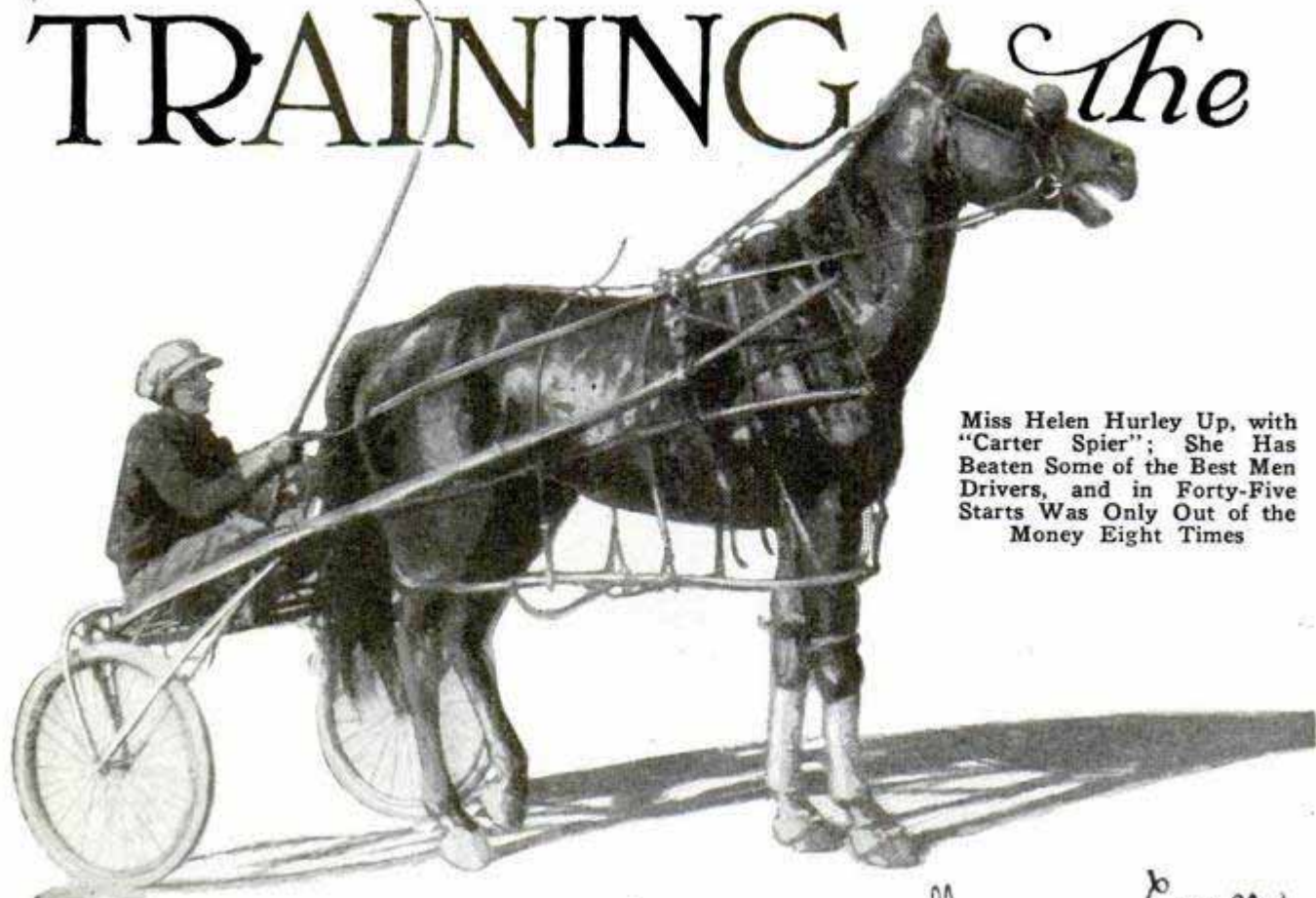

Miss Helen Hurley Up, with "Carter Spier"; She Has Beaten Some of the Best Men Drivers, and in Forty-Five Starts Was Only Out of the Money Eight Times

By EARL CHAPIN MAY, *Sharon, Conn*

**A**MONG the 12,000 light-harness-horse fanciers who saw "Grattan Bars" win the \$25,000 New England pacing derby at Windsor, Conn., were some strangers to the trotting tracks who wondered that the big Canadian stallion came under the winning wire without a break.

It was a "driving finish" in horsemen's vernacular, which meant that Vic Fleming, from his sulky seat, plied his whip. Reinsmen behind other horses in that race also lashed their light harness horses. But not one of the fast steppers broke into a gallop under punishment. Each stuck to its side-wheeling gait and did the best it could to win the race.

Part of this willingness to stick to pacing under punishment was properly ascribed to the hobbles each racer wore. Hobbles are straps which hang over the horse's back and encircle each horse's legs. Pacers have been prominent in light-harness racing since "Hero" and "Pocahontas" won mile events and purse money on Long Island tracks in the early fifties. But hobbles did not come into general use until the nineties. Now nearly every fast pacing horse wears them. They hasten the development of pacing horses by

making an unusual gait more practicable. Pacers are frequently termed side wheelers because the pacer's legs on each side of it move forward and backward in unison. During 1928, when more than 1,500 light-harness racing meets were held in the United States and Canada and about 10,000,000 persons were spectators, more pacers than trotters were entered in the events. "Grattan Bars," from Canada, won first money in three of these \$25,000 races in three weeks, something no other horse has done. But this new world's record was made possible because of the skillful training given him.

So carefully had the year's sensation been trained that he didn't break into a gallop under the whip—he flattened out and paced his fastest, which was what he was taught to do through three years of careful tutelage. About 10,000 pacers are being schooled in this manner. About 10,000 trotters are similarly schooled. In light-harness vernacular, all of them are "trotting horses," to distinguish them from the "gallopers," or running horses.

Breeding, training and racing all horses is a specialty—or two specialties, to be exact. For, with a few exceptions, those



# TROTTERS

who specialize in light harness horses have nothing to do with the gallopers, which they refer to as "bang-tails." Those who follow bang-tail racing speak contemptuously of light harness horses as "turkey feet."

More time, patience, money and intelligence are required to develop a light harness horse, that is, a trotter or pacer, than are required to make a running horse. Also, it requires more skill and more mature judgment to win a light-harness race than a running race. That is why you very seldom see a mere boy in a sulky seat. It takes a man's brains and muscle to get the best out of a light harness horse. Galloping is a natural gait. Most horses run, in pasture or on the road or track, naturally. Once in a blue moon a colt is born

to the trotting or pacing gait—"lot trotters" or "lot pacers" they are called. But ninety per cent of these natural-gaited ones are failures on the racing tracks until they have been manipulated.

Colts bred for track life are halter-broke almost as soon as they are foaled, whether destined for harness or saddle racing. Once the soft halter is on a colt's head it stays there until it is replaced by a bridle and a soft rubber bit—a teething ring, in other words. From that point, methods of training diverge. Light harness horses and running horses enter different schools after they are six months old.

The school for the light harness horses is much more exacting. It is the result of a century's experience, for the trotting or pacing horses are strictly American products, while the running thoroughbreds are English in origin, although many great



The Trotter "Great Forbes," with H. H. Hellman in the Saddle of the Racing "Bike," So-Called from Its Bicycle Wheels

ones have been developed in this country. The training of the light harness racer is much the more complicated.

After the future trotter has become accustomed to the soft bit by guiding it around its nursery grounds with reins held in the light hands of a pedestrian, a light steel bit is substituted. Constant care is exercised to avoid hurting the tender mouth of the baby horse. Well-bred stock is too valuable to take any chances with its flesh or spirit. The days of rough handling passed long ago.

When the colt has learned its first lesson and responds to gentle pulls to right or left, it is made whip-wise as well as bridle-wise. A long lash is snapped in front of it or behind it or at one side of it. But the whip does not touch the gangling colt, so the latter does not shy at it. Then comes the lesson on the breaking cart,



which is a sulky having a heavy frame. This cart is rattled along the ground; its thills are dropped close to the youngster's legs. The wheels are rolled noisily along the stones. But nothing harms the nervous colt. By and by the pupil understands that the cart will not injure it. Then it is hitched and gently jogged on the track a quarter mile. It is on its way to being a racing horse. It has passed through the first preliminaries. It has also passed through its first year.

The professional trainer now takes a hand and takes it very gingerly. Each yearling is an infinite possibility. It may be a world's champion and win a fortune for its owner or it may be a dud, a total loss. It is the trainer's job to find what is in the animal. He studies its gait and "personality."

Back of the yearling is the trainer who holds the reins. Back of the trainer-driver is trotting-track history. He knows that from the time the first trotting track

was opened—on Long Island in 1828—down to 1874, when the great reinsman, Bud Doble, drove "Goldsmith Maid" to her record mile, trotting, in 2:14, little attention was paid to horses' shoes.

Among Bud Doble's fellow reinsmen were two blacksmiths, Peter V. Johnston and James D. McMann, who banked the fires of their forges and drove to many a race-track victory. But neither they nor their driving contemporaries paid any attention to improving the shoes. "Goldsmith Maid" won more money during the ten years she was racing than any other racing horse until the runner, "Zev," in this generation, piled up \$313,000 of money won. Yet Doble sent "Goldsmith Maid" to the nearest blacksmith shop when he thought she needed reshoeing. She wore a pound of iron on each foot until she wore her shoes down to where she had to have new ones or go barefooted.

But Dan Mace and other old-time reinsmen began to experiment with shoes of

different weight on different feet. Mace proved conclusively that a then famous trotter, "Lady Thorne," went faster when he changed the weight of her iron shoes. From that experiment light-harness horsemen began to study balancing, by which is meant varying the number of ounces in each shoe, usually by making the front pair lighter or heavier than the hind pair, and thus assisting the motion of the horse's feet.

Whole volumes have been written about balancing. Fortunes have been made and lost by it. Six ounces on any trotter's feet is now considered heavy. Four ounces is close to orthodox. A Kansas trainer, named Charles Marvin, drove a pacer known as "Smugler" with indifferent success until, by putting toe weights on the pacer's



The Trotting-Race Winner Is Decorated with a Floral Wreath at the End of Three Victorious Heats



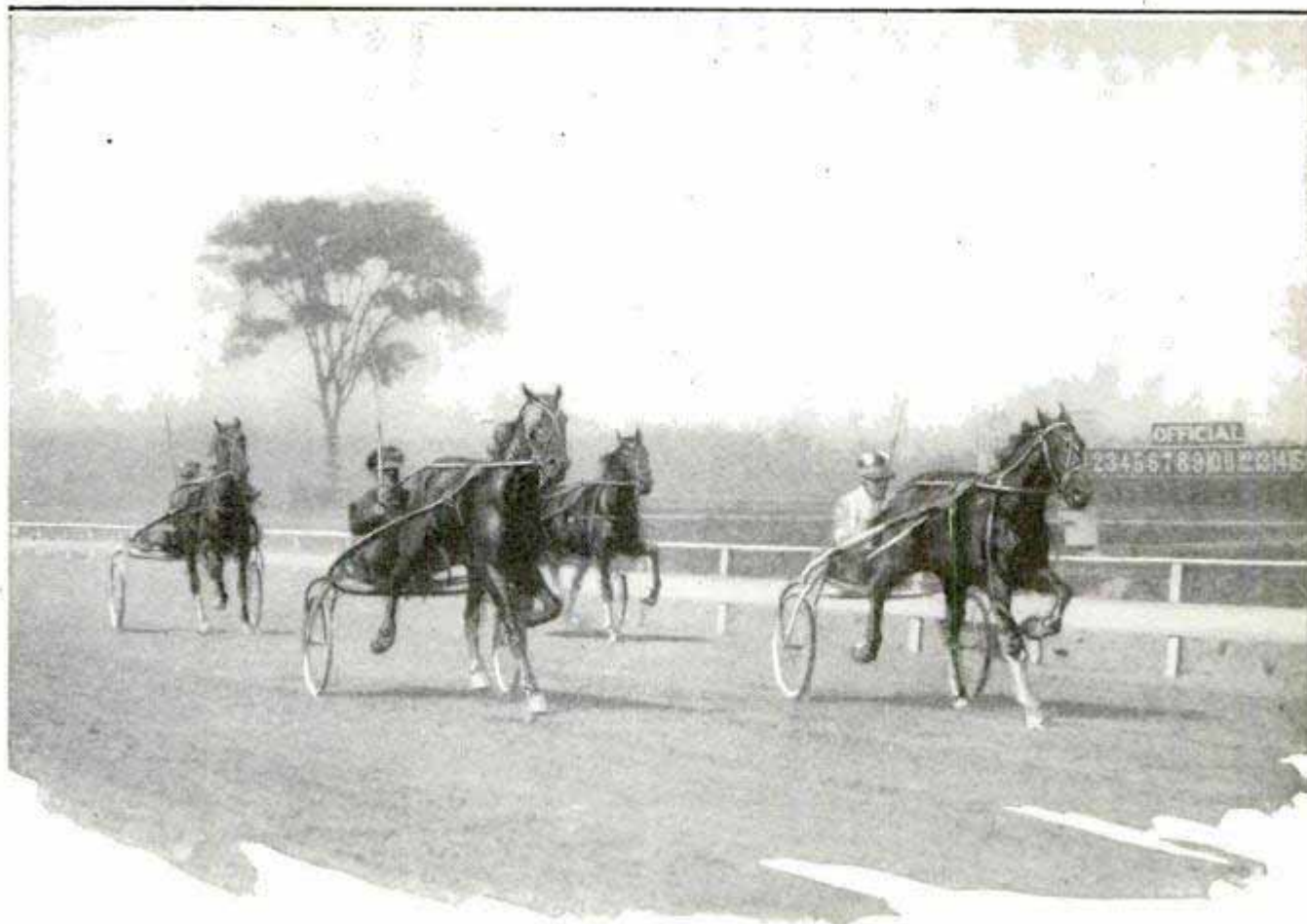

The Great "Miss Morris" Leads the Field Home in the 2:22 Trot; Harness Racing. Because of Its Close Connection with Practical Driving, Always Had a Great Hold in America

feet and making other changes in shoes and rigging, the "Smuggler" became a champion trotter, a "converted pacer" as the horsemen say.

As years went by and the call for speed sent horses past the 2:30 mark and gradually into the "Golden Circle" of trotters or pacers which could go a mile in two minutes or less, horsemen learned that changes in shoeing would prevent knee knocking and that boots would also remedy this difficulty. They also learned that in many cases a trotter or pacer went better if his head was held high with an overdraw instead of a side checkrein. Dan Mace discovered that goggles corrected the faulty vision of a stallion named "Fearnought." Blinkers for shying racers came into vogue.

Certain trotters and pacers are inclined to jump and break at shadows such as are cast across the track by quarter poles. Some genius evolved the shadow roll, which looks like a long sponge and is stretched across the racer's face a short distance below its eyes. Many a layman wonders what it is for. Another genius learned from experiment that if his trotter

or pacer was inclined to side-rein, or not go straight, especially when rounding the turn of a trotting track, a billiard cue or other small pole, fastened to the horse's bridle and its bellyband, between the reins, would help materially in eliminating that difficulty.

Then came the era of light-handed driving. The first of the old masters of the reins was Hiram Woodruff who reigned between the forties and the eighties. He and many of his contemporaries depended for success on main strength and awkwardness. The modern masters, such as Thomas W. Murphy, Walter Cox and Vic Fleming, put very little pressure on the reins. They depend more on delicacy of touch and feeling and control their steppers with a minimum of muscular effort. With a kind of magic they "lift" their racers to victory, though lifting is a physical impossibility.

Up to 1892 the high-wheeled sulky, with wooden spokes and iron-bound wooden rims, was all the vogue. In some of the earlier ones, the driver's seat was six feet from the ground. In many of the later ones, the driver's head and body were



above his horse. In such a sulky John and James Goldsmith could really lift their horses' heads by holding the reins high in air. This was possible with some of the first "bike" or pneumatic-tired sulkies, which, by the way, reduced the average light harness-horse mile by about four seconds and made the two-minute mile less difficult.

But as science entered into racing, the sulky seat was lowered until now the driver is down behind his horse and hence does not increase wind resistance with his body. Yet, sitting at the low level, a skillful driver can still so rein a tired horse that it will brush or spurt under the wire to first money. That is what the reinsmen call lifting it.

These are only a few of the things the trainer knows when he starts out with a yearling horse. He begins by jogging the pupil slowly, gradually increasing the speed and distance. During these training miles he learns the nature and capabilities of his pupil. If the yearling trots naturally by putting its feet down in one, two, three, four fashion; if it gathers its hind feet quickly from beneath the sulky; if it does not throw the hind feet wide, but gets its front feet up in time to place the hind feet under them, then it is the trainer's job to shoe his youngster lightly but without any fancy work and to develop its manners and stamina.

But if, as a trotter, the pupil does not go so well, then experiments are made in weight changing. If it interferes or knocks its knees, boots are put on its feet and legs. Its feed is always watched religiously. Rigging and feed are the subjects most often discussed by light-harness men. Mr. Murphy, who drove trotting and pacing horses into more than \$2,000,000 of stake and purse money and has more speed records to his credit than any other light-harness man, made a big winner out of a discard, named "Hetty G.," by mixing ground carrots with cracked wheat and corn, whereupon she picked up in flesh and speed. But his favorite food for trotting horses is cut-up clover, oats and bran, to which he adds a pinch of senna leaves and a half cup of olive oil. This combination is a prime conditioner.

The able and industrious trainer who wants to drive his stable into the money on the Grand Circuit or anywhere, gets up at daylight winter and summer and sits in a sulky for a hundred miles before the day's work is ended. During the rest of the day he studies horses, his own and those of his competitors. At night he dreams of faster horses. That is the life of the light-harness man.

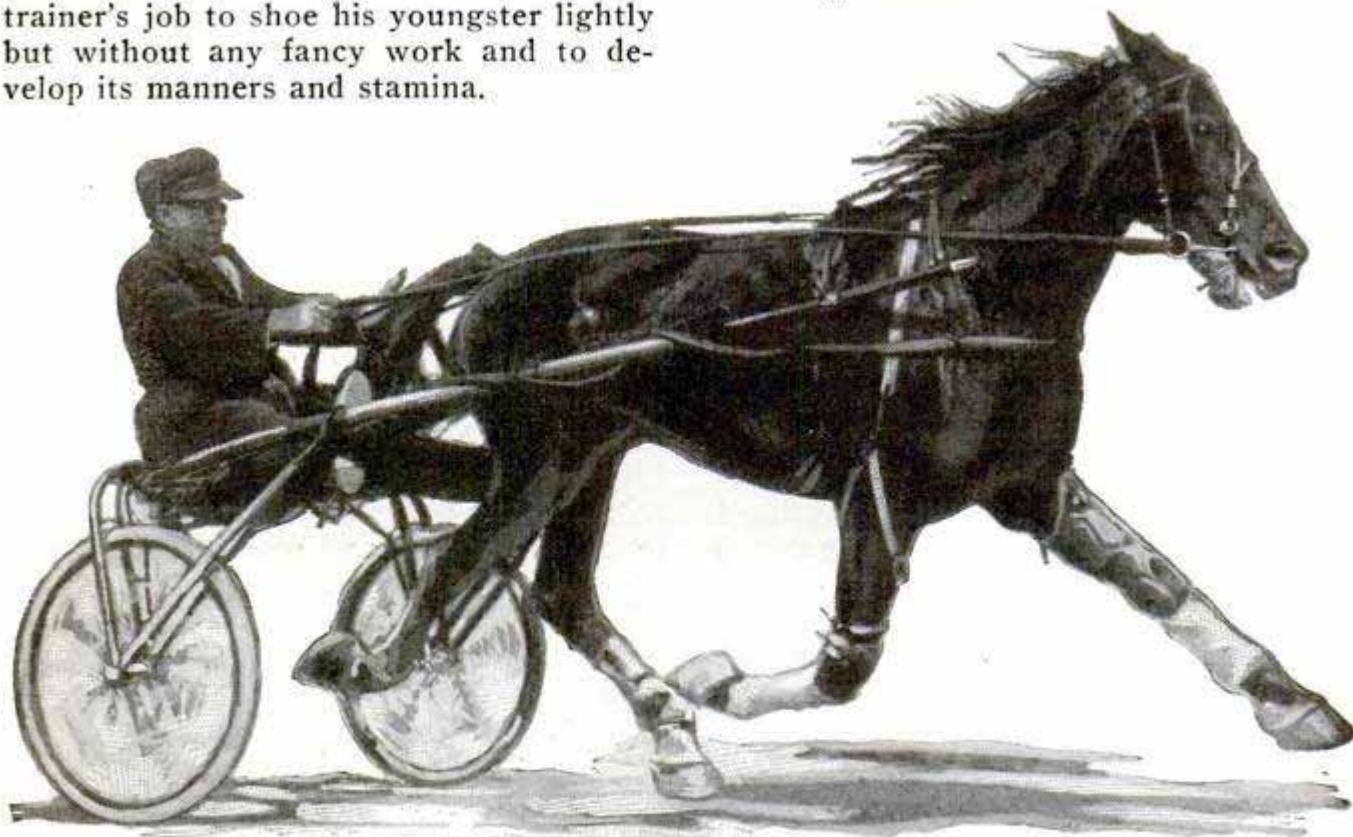

"San Peder Girl," an American-Born and Trained Horse, Was Taken to Sweden and Offered Some Stiff Competition to the Swedish Harness Horses on the Stockholm Track



Once he has decided that some particular pupil shall be a trotter with suspenders on its front legs—suspenders look a little like half hobbles and help the trotter get its stride—he enters the horse in its proper class. This is fixed on certain courses, after the horse has won its first race, by the time in which it won the contest, or, on other courses, by the money it won. If long experiments convince the reinsman that his pupil is faster at the pacing gait, either with hobbles or as a free-legger, into a pacing race it goes.

Then the man at the reins of the new hopeful has to decide whether he better trail some other driver who breaks the wind resistance and thus take a chance on coming out from behind and going around at the home stretch to make a winning, or whether he should take the lead and head the field along the route.

Above all and everything, he must know whether the horse he drives is so trained and constituted that it can be rated at top speed throughout the mile or whether, after it has trailed to the three-quarters pole, it will have enough speed left to brush by those that have led the way. He must also know how much pressure he can put on his horse before the horse will forsake its artificial gait and go to galloping. The latter is disastrous, for the judges may disqualify a breaking horse.

There's a tremendous lot to the trotting game. That is why men and not boys must follow it, professionally. But among the non-professionals, it has had its millions of followers since the gray mare, "Lady Suffolk," first trotted a mile in less than 2:30 in 1845. The world's record for trotting a mile, in the open, that is, without a wind shield, was made by "Peter Manning," with Murphy up, at Lexington in 1922. That mile was covered in 1:56 $\frac{3}{4}$ . The fastest mile ever paced in the open was by "Directum I," with Murphy up, at Syracuse in the same fast time. "Dan Patch," the pacer, made the fastest mile alone in harness, at Hamline, Minn., in 1906, behind a wind shield.

These records indicate what progress has been made in fixing light-harness-horse gaits. But faster trotters and pacers will be developed. Trotting and pacing are American sports and more people watch them than ever before.



To Make Haircuts More Pleasant for the Children; Barber's Chair in Form of Toy Automobile

**TINY AUTO AS BARBER'S CHAIR HELPS QUIET CHILDREN**

Children are induced to forget the terror of the barber's shears and clippers in a chair that is made to resemble an automobile. It is comfortable and attractive and, like the ordinary chair, can be regulated as to height.

**HEAT GUARD ON ELECTRIC PLUG SAVES CURRENT**

Electrical appliances are heated to varying degrees by means of a disk control on the attachment plug. It provides a range of "medium" and "hot" temperatures as well as a shut-off, preventing overheating and enabling the operator to have the flat-iron, toaster or other unit heated to the most efficient point. The control eliminates the necessity of pulling out the iron plug.



*Safeguard Electric Co. 1015*

*with cord \$2.25*



*72 Hubbard St. Brooklyn N.Y.*

*1946  
pat. pending  
With motor  
\$225.00  
board only - \$60.00*



*No Chicago - can be bought thru boat engine dealer*  
Surfboards Pulled behind Fast Motorboats Are Common, but Here Is One That Is Pushed, and by an Outboard Motor - Leaning to the One Side or the Other Steers the Board

### SURFBOARD RUN BY MOTOR GIVES WATER THRILLS

Riding a surfboard is becoming increasingly popular among persons who like water sports, but its possibilities have been somewhat limited as it has been necessary to have some sort of boat to tow the board. This need has been eliminated in a unit that has its own power plant, an outboard motor attached to the end. The board is wide, is fitted with ropes for holding onto and attains a speed of thirty miles an hour. No steering mechanism is needed as the board is guided by the rider simply leaning his body in the direction he wishes to go. If the rider falls off, the board will stop at once.

### SIDEWALK LANES FOR SHOPPERS TO AID PEDESTRIANS

Special lanes for window shoppers and for other pedestrians have been tested by the Detroit police department in an effort to expedite sidewalk traffic. Persons who wish to loiter along by the shops have one lane while two others are provided for

"through" traffic. The plan helps keep pedestrians to the right and avoids confusion. To supplement the traffic lights at some of the downtown intersections, loud speakers were installed to give directions and warning as to the proper time to cross.

### SHAVING BRUSH HOLDS SOAP AND POWDERED STYPTIC

Besides a tube of cream, a fountain shaving brush holds a cup of powdered styptic, and also has replaceable bristles. The assembly takes up but little space in the traveling kit.

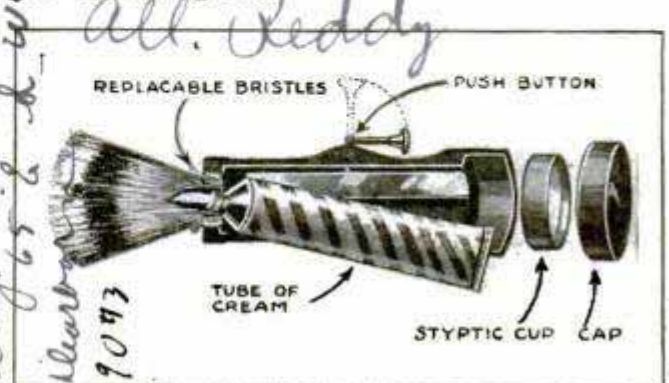

Parts of the Shaving-Brush Kit, Showing the Feeder Button, and Cup for Styptic

*2006*

*Christian Science*

*Chicago S. Shyber & Co.,*



**EGGS ARE "BOILED" UNDER PRESSURE IN ICE WATER**

Artificial pressure of 600,000 pounds to the square inch, the highest so far produced, has been attained by Prof. Percy W. Bridgman, of Harvard University, with an apparatus of his own invention. This pressure corresponds to what would be found at the bottom of an ocean 250 miles deep. Under its force, steel tends to spread, paraffin becomes harder than machine steel and rubber turns so hard that it can be used as a die to cut steel. Mercury froze at room temperature under a pressure of 200,000 pounds, although it normally freezes at forty degrees below zero or lower. The outfit Professor Bridgman developed is described as relatively simple. What appears to be an ordinary hand pump is used to create the pressure required.

Materials to be compressed are held in a small hole bored in a solid piece of steel, five inches thick. This is stopped by a small steel plug which spreads under pressure to keep the contents and air from escaping. During one of the experiments the compression cham-

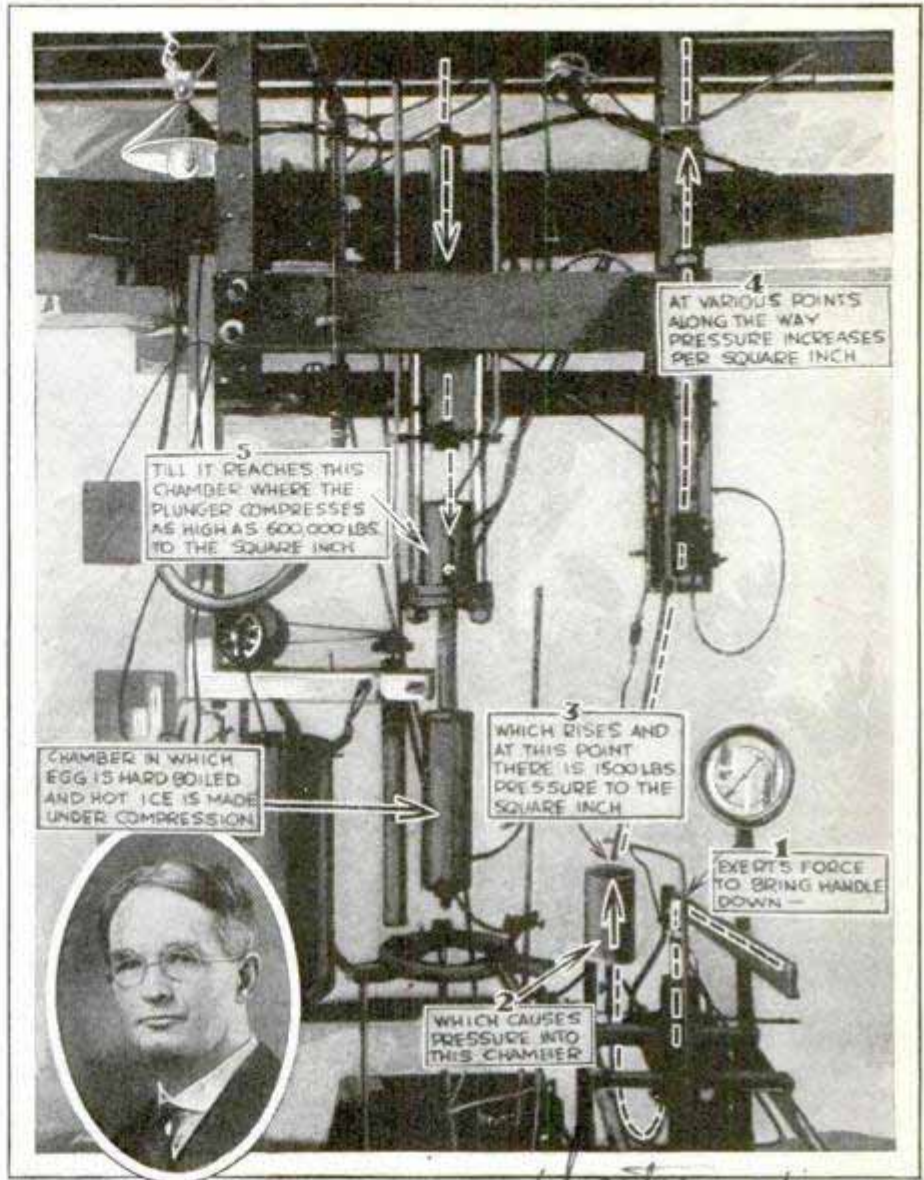

Some of the Chief Details of the Pressure Apparatus and an Inset of the Inventor, Professor Bridgman

ber exploded and fragments were imbedded six inches deep in hard-pine planking back of the apparatus. In another test, eggs taken out of ice water that had been heated by subjecting it to a pressure of 100,000 pounds were found to be hard-boiled.

**OPERATE ELECTRIC POLICEMAN BY SOUND OF VOICE**

"Mr. Televox," a mechanical policeman installed near a street intersection in a California city where it operates a winking light and warning arms by the effect of vibrations from automobile horns, has been thrown into confusion by small boys. They discovered that they could successfully imitate the sound of the horn by their own voices. A yell of the proper

volume and pitch caused "Mr. Televox" to wink an eye and wave an arm when no signals should have been produced. The inventors are now trying to readjust the "policeman's" mechanism so that untimely signals cannot be given. The device is intended especially for the protection of cars being driven from a side street across the main intersection. By tooting their horns, the drivers can cause the mechanical policeman to halt traffic on the main street until they have passed it.

*at Peninsula Highway*

*International  
Wesley Electric  
9110 1st Ave  
San Francisco*



## LIVING IN LUXURY HIGH ABOVE CITY STREETS

1963



An Elaborate Roof-Top Bungalow and Garden in New York, Where Such Skyscraper Homes May Cost Anywhere from \$2,500 to \$300,000; at the Left Is a Vista of a Charming Garden, with Rustic Paling Fence, Which Might Be a Suburban Home, but Actually Is High above Manhattan; Below Is Another of the Lofty Penthouse Homes, with Bushes and Flowers Lining the Stone Coping; Tile Floors and Gay Awnings Make the "Yard" Attractive





## IN BUNGALOWS BUILT ON SKYSCRAPER ROOFS

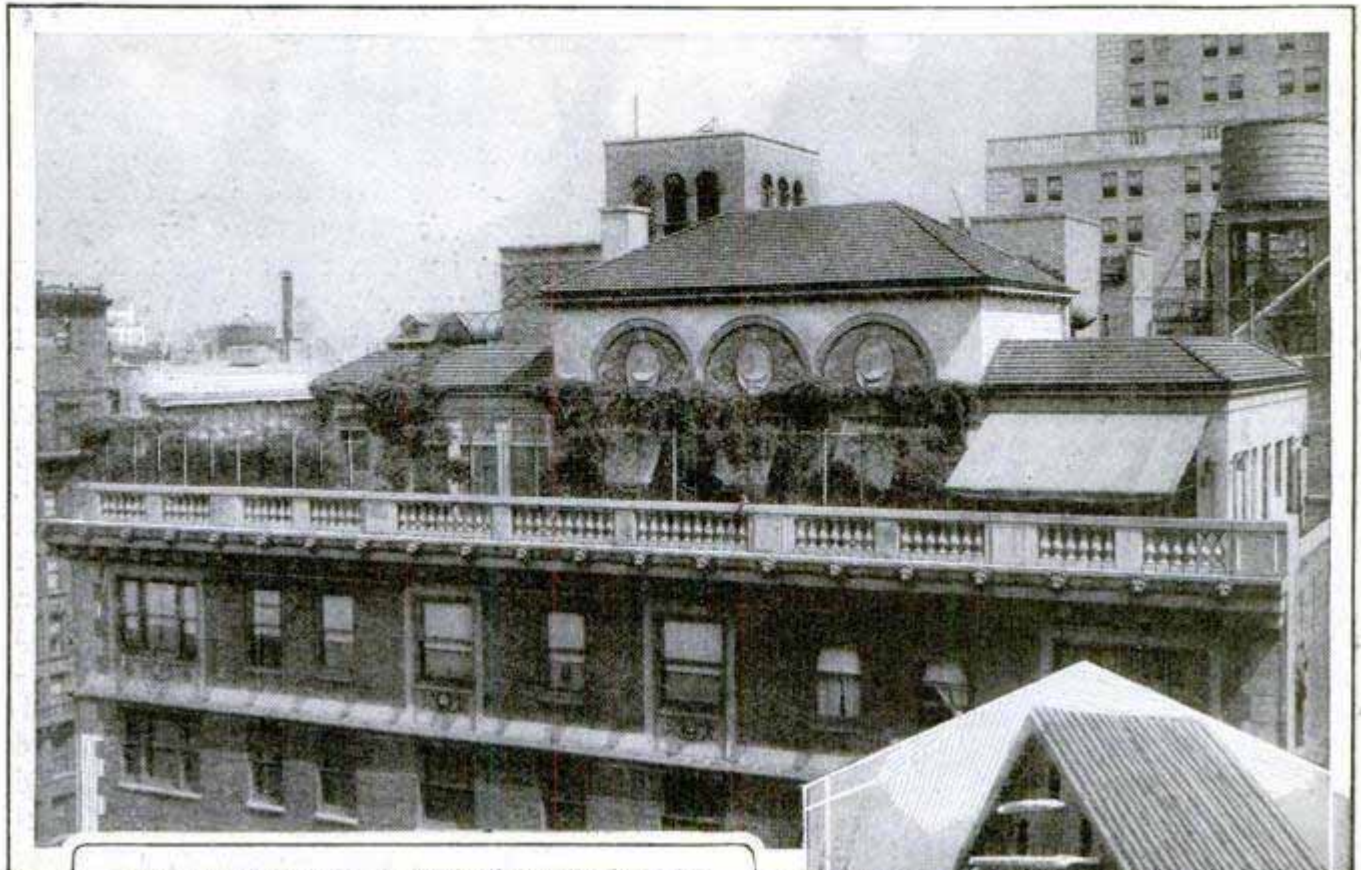

How a Roof-Top Home Looks from the Opposite Side of the Street; the Usual Penthouses, Covering Elevator Machinery and the Like, Are Concealed within the Bungalow's Walls; Many of the Lofty Homes in New York Have Magnificent Views over the Harbor and Lower Bay, or up the Hudson; at the Right Is a Pigeon Cote in the Garden of a Skyscraper Bungalow, and Below, a Corner of the Yard in One Famous for Its Garden and Rustic Picket Fence

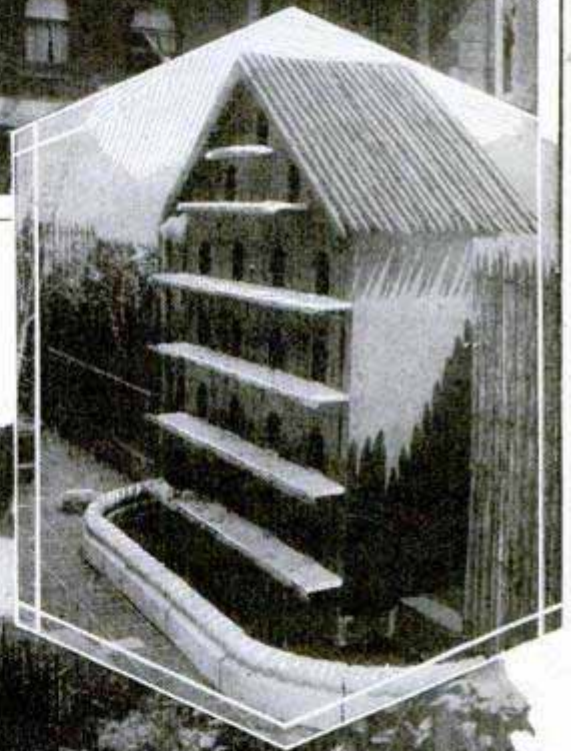



SEEK CURB ON RADIUM DEATHS TO PROTECT WORKERS

Scientists are seeking ways whereby hazards may be reduced for those who work with luminous paints and other materials containing radioactive substances. Seventy-five chemists and industrial officials met in Washington not long ago to consider the matter, the action following the death of several persons who had been engaged in painting luminous dials and figures on clocks and watches. Some observers of the malady have declared that the principal cause of radium poisoning was the "eating" of the substance, that is, the workers' tendency to place paint brushes dipped in the material, between their lips to moisten the tip. It has been suggested that substitution of a stylus or die for the brush would solve the problem. This theory has been discredited, however, since some persons have died from the poisoning even though they did not use the paint brushes in any way. According to Dr. A. B. Moore, dean of science at Purdue University, the real cause of some of the deaths attributed to radium poisoning is still unknown. He said he had experimented extensively with radium without ill effects.

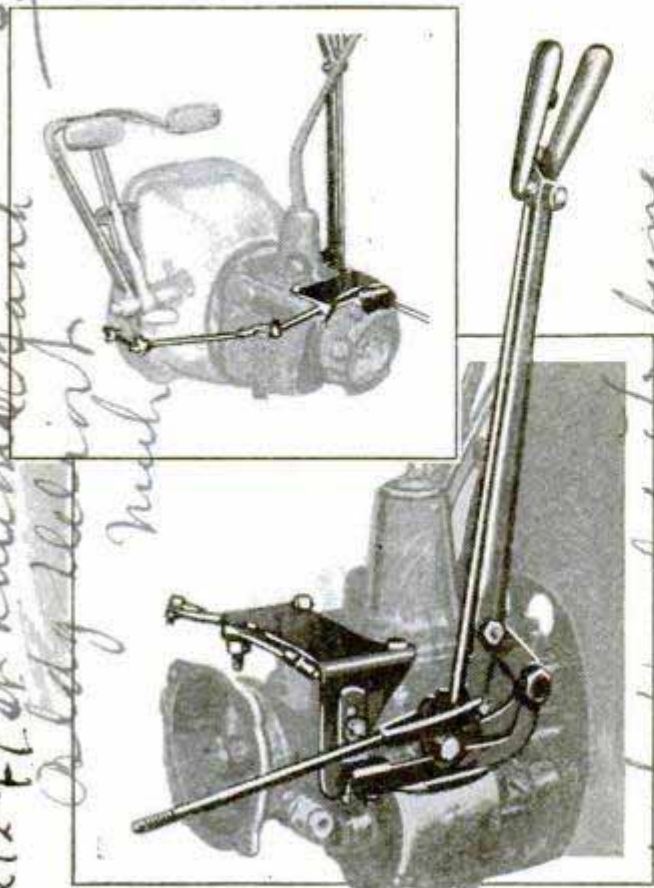

Photo Diagrams to Show Installation of the Automatic Safety-Brake Release

AUTO SAFETY-BRAKE RELEASE HELPS PREVENT ACCIDENTS

Many motorists have experienced difficulty in shifting gears when the car is stopped on a hill with the emergency brake on. The tendency is to let the auto roll back and possibly collide with a car behind before starting forward. This difficulty is eliminated with an automatic release for the safety brake. It frees the emergency at the proper moment, leaves the right foot to operate the accelerator and prevents running, or attempting to run, the car with the emergency on, a big saving for the linings.

PLANTS BREATHE ONLY BY DAY LIGHT TESTS SHOW

Plants open their breathing pores only under the influence of daylight or its equivalent, Dr. J. D. Sayre, of the Ohio agricultural-experiment station, recently told plant experts. The "invisible light" beyond the red end of the spectrum has no effect on the leaves, he declared. The longest-wave light rays to which they would respond are just inside the limits of the visible red.

ANTI-BURGLAR WINDOW CATCH ALSO PREVENTS RATTLING

Intended to make windows burglar-proof, a steel wedge, with sharpened points for holding it in place, also keeps the windows from rattling and may be used as a door-stop. It can be adjusted without nails or screws.

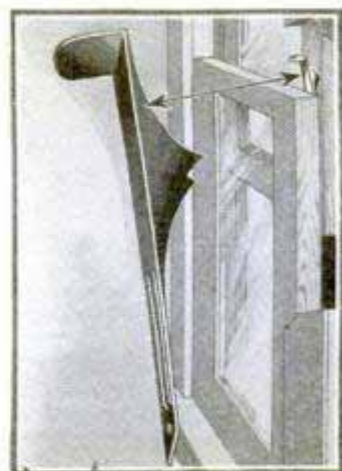

The Popular Mechanics' Bureau of Information offers its free service to all readers of our magazine. Names and addresses of manufacturers and dealers in articles described, and any other details in our possession, will be promptly furnished by addressing the bureau.

*U.S. Auto Safety Brake, Inc. 1859*  
*212 9th St. National Bldg. Wash. D.C.*  
*to. sayre*  
*much.*  
*1979*  
*meeting of Amer. Society Plant Physiol.*  
*Woster*  
*Ohio*

*General*  
*Cummins U.S. Public Health Service*  
*1986*  
*newish heralding*  
*1957*  
*Heat pend.*  
*Science News Bulletin Staloh Co.*



BIG WAREHOUSE BUILT IN CAVE FOR POTATO CROP

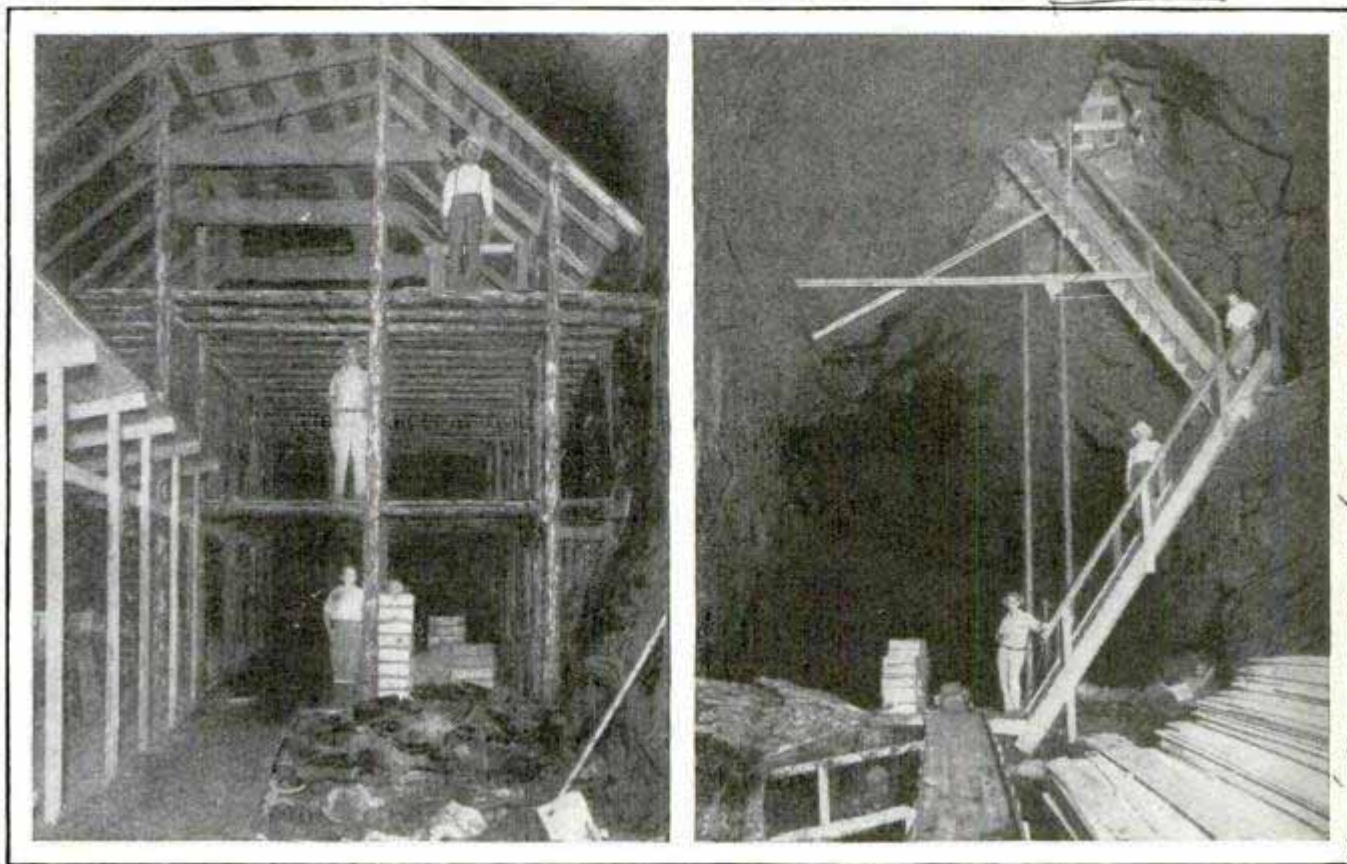

Views inside the Cave Warehouse Where Quantities of Potatoes and Other Crops Are Stored; the Cavern Was Formed during a Volcanic Eruption Many Years Ago

In a section of the potato-producing area of Washington, a three-story warehouse has been constructed in a natural cave formed by a volcanic eruption many years ago. Surplus potatoes are stored there, the temperature remaining at about thirty-seven degrees Fahrenheit the year around. The warehouse is equipped with an elevator and there is room for many more buildings, as the cave is about a mile long and forty feet high. Geologists believe that it was formed by a huge air bubble that gathered during a flow of molten lava.

foam. By cooling and by the addition of a special compound, this trouble was eliminated. Later, a chemical was found which made cooling unnecessary, so that the water could be piped into the engines directly from the well.

**HOT WATER FROM DEEP WELL HEATS RAIL STATION**

Water from an artesian well, nearly 1,700 feet deep, at Capa, S. Dak., is used to heat the railroad station and also in the locomotives, for it comes spurting out of the ground at a temperature of about 120 degrees Fahrenheit, and at a rate of 100 gallons per minute. Some experimenting was necessary before the water could be employed in the boilers because it contained mineral substances that produced

**WRENCH FOR AUTO HUB-CAPS FITS ALL MAKES**

Hub caps on all makes of cars, including the 1929 models, are easily removed with a universal wrench now on the market. Hexagon and octagon jaws are adjusted with a slight twist of the wrist, and the tool is said to be especially adapted for damaged or tightly wedged caps.

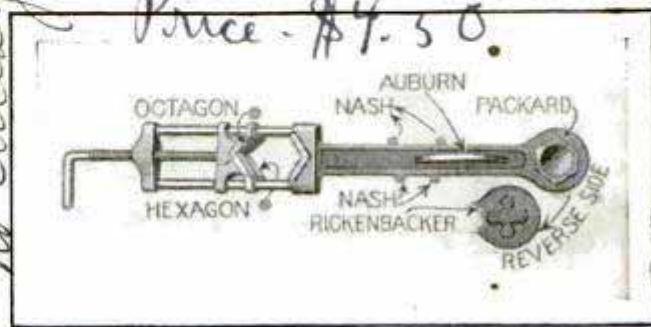

Hub-Cap Wrench, Showing Different Makes of Cars for Which It Is Adjusted

*Conl. Marichio & Birdston  
 Price 215  
 Seattle Wash  
 1829  
 Chicago  
 Golden  
 Prof. H. C. Baker - Beling*

*Christian Science Monitor. 12/20/28  
 Bingo Mfg. Co. 466 Wren Drive*



ULTRAVIOLET RAYS FROM SUN NOW ON INCREASE

Ultraviolet emanations from the sun are on the increase, according to reports from scientists who have been keeping close watch on the body. Dr. Edison Pettit has been making measurements of the intensity of the sun's ultraviolet light at Mt. Wilson observatory, for four years. Since the first measurements were made in June, 1924, the monthly average intensities, have, on two occasions, been half again as great as they were in that month. That was in October, 1925, and February, 1927. The variation closely follows the number of sunspots, Doctor Pettit announced, and now seems to be increasing.

STICKS AND LEAVES AS MAPS GUIDED EARLY SAILORS

Among the most curious maps in the world are those fashioned by certain tribes of island dwellers, and used as recently as sixty years ago. One of these is simply a framework of sticks from the center ribs of palm leaves, tied together with palm fiber. The islands are represented on the map by small shells. The curving lines of the sticks are thought to designate the ocean currents and winds a traveler would be likely to meet in going from one spot to another. The maps were used for many years by the natives.

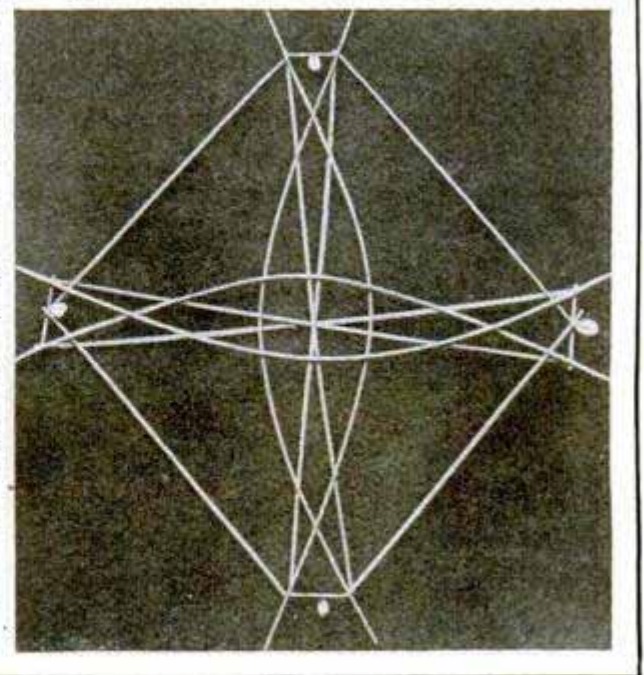

Curious Map Made By Early Sailors; the Objects at Each Corner Represent Islands

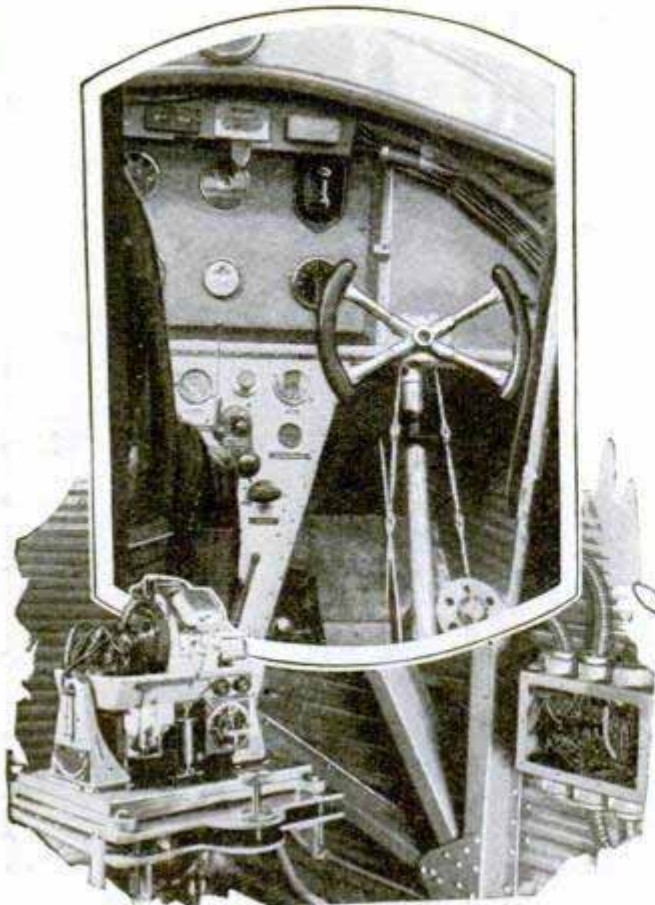

View of Automatic Steering Gear as Installed in Cockpit of Plane for Safer Flying

STEERING GEAR FOR AIRPLANES WORKS AUTOMATICALLY

Successful tests with an automatic steering gear for airplanes are reported from Germany. The device, it is said, frees the pilot from keeping his hands on the controls, yet does not interfere with operating the ship in the usual manner.

GAS TREATMENT FOR POTATOES CAUSES EARLY SPROUTING

Potatoes are made to sprout in three weeks by dipping them in a chemical substance, and then gassing them in air-tight containers for twenty-four hours. The method, developed at the Nebraska agricultural station, is expected to be of great aid to the growers, as it will make seed potatoes suitable for earlier shipping to southern markets, where planting is possible long before farther-north conditions permit, and it also allows experimental work with different grades to begin much earlier than is ordinarily possible. Potatoes usually lie dormant about four months before beginning to sprout. The treatment is also effective in ridding the potatoes of certain diseases.

10/08

University of Nebraska  
State College Nebraska

Engineering  
1961  
South China Sea  
Museum of Science

at h... ..

News Collection  
12/21/28



*Chattanooga Tenn*



Three Kinds of Iron; Gray Cast Iron, with Coarse Graphite Flakes, at Left; Pure Iron and Carbide of Iron, Center, and, at Right, Crystals of Pure Iron Imbedded in Carbide

## MEEHANITE—A New Metal

*Dec. 1928-977*

It Has the Structure of Fine Steel and Promises to Replace Cast Iron in Motor Cars

A LARGE automobile company recently brought out a new model with an engine having thirty-five per cent more power than its predecessor. Offhand, it would be expected that proportional enlargement of transmission and rear-axle parts would be required to withstand the greatly increased turning effort of the engine.

But, with minor exceptions, the dimensions of these parts are unchanged, yet they are much more than thirty-five per cent stronger than those of the previous model.

It sounds like magic, but, like all sleight-of-hand performances, the explanation is simple, for the greater strength was obtained by using improved alloy steels. In adopting this course, the manufacturer realized many advantages. The new transmission and axle parts could be made on the same machinery used last year, thus avoiding the large expense and trouble involved in putting new designs into production. Much weight was saved because obviously the new parts weigh no more than the old. The service-parts problem was greatly simplified, for nearly all the new parts will fit the old chassis, thus making it unnecessary for dealers to carry separate sets for the old and the new models.

This illustration is merely one of many which could be quoted to show how improved steels have greatly assisted in devel-

oping the modern automobile. But in spite of the great advances made in metallurgy during the past twenty years, automotive engineers expect even greater improvement in the next decade.

In the beginning, steel consisted fundamentally of an alloy of carbon and iron with a tensile strength of about 100,000 pounds per square inch. Then it was discovered that, by alloying this material with various metals and by proper heat treatment, the strength and other desirable properties could be greatly enhanced, incidentally raising the tensile strength up to 280,000 pounds in some cases.

Generally speaking, hardness, brittleness and strength go together, as do softness, ductility and low strength. Thus a steel with .15 per cent carbon is soft, ductile and relatively weak, while a steel with 1.25 per cent carbon is hard, brittle and strong. Between these limits, hardness, brittleness and strength increase as more carbon is added. With any given percentage of carbon, these three qualities are brought to a maximum by rapid cooling from the right temperature, while softness and ductility with reduced strength are secured by slow cooling.

Broadly speaking, the addition of nickel to a carbon steel gives toughness; chromium, hardness; chromium and nickel, hardness and toughness combined; vanadium or molybdenum, shock resistance; silicon, resiliency. And the best of it is

*Meehanite Metal Copy Chattanooga Tenn.*

*Emil Harold J. Blanchard 39 Read*

*Ans. H. J. Meehan Foundries*





that, by selecting a suitable combination of alloys properly heat-treated, a steel with almost any desired properties may be obtained.

Now here is a curious fact: An automobile chassis is largely composed of steel and cast iron. The reader is fully aware of the great progress that has been made in the metallurgy of automotive steels. But what of cast iron? Steels have been growing better but it is rather shocking to realize that progress in the development of cast iron has been almost negligible. In twenty years, the strength of steel has nearly trebled and its other properties have been similarly improved. During the same period, the strength of cast iron has only increased from about 20,000 to 30,000 pounds per square inch, and its other properties roughly in proportion.

Fortunately, however, metallurgists all over the world are beginning to give cast iron the attention it deserves, for it is a very important material. In fact, very encouraging progress has already been made, and this brings us logically to a discussion of a wonderful new material, Meehanite, named after its inventor, G. F. Meehan.

Chemically, cast iron differs from steel in that it has considerably more carbon, 3.4 to four per cent. Meehanite likewise is composed of iron and two to three per cent carbon, and while it is designed to replace cast iron, it has the structure of fine steel, whereas the structure of cast iron is an uncertain hodgepodge, as will presently be explained.

Meehanite has three times the tensile strength of gray cast iron, that is, its strength runs up to 100,000 pounds per square inch. It has twice the stiffness of cast iron. It may be heat-treated like steel. By this means it can be made as soft and ductile as malleable iron or as hard as chilled cast iron. It has unusual strength at high temperatures and is very resistant to corrosion. It machines as readily as gray iron, but with long, curved chips like steel.

Meehanite may be used anywhere cast iron is used,

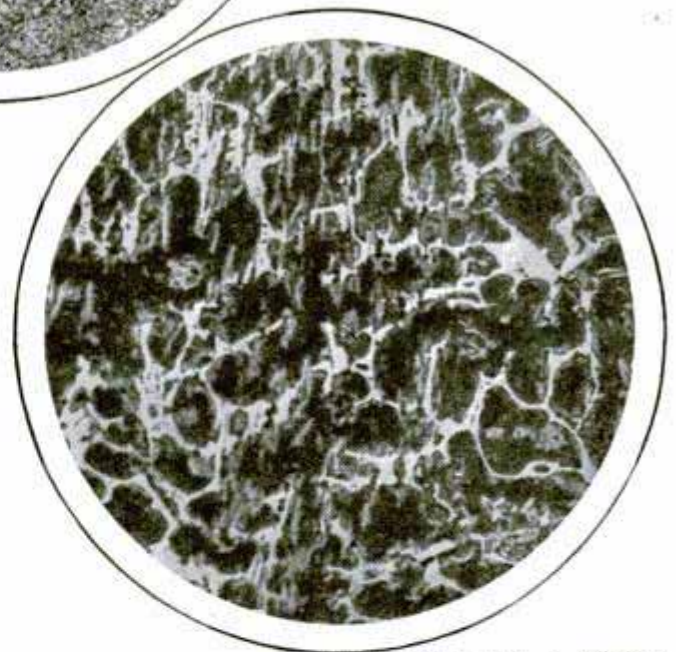
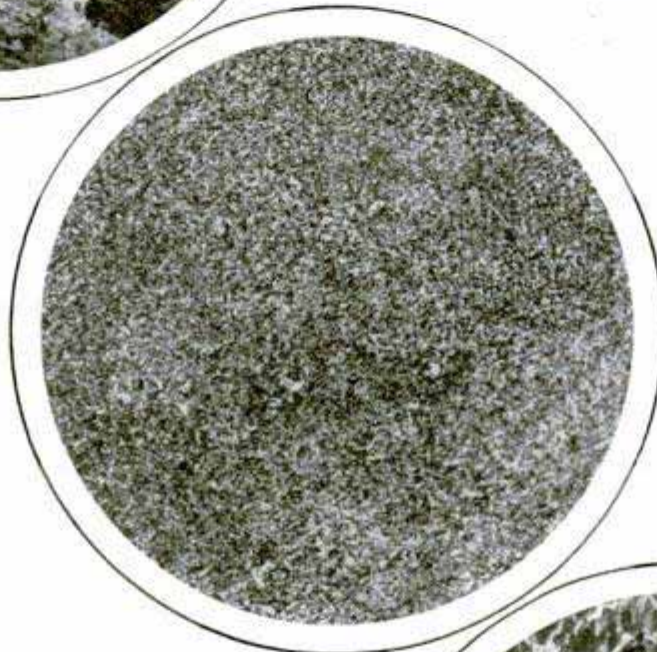

Courtesy Prof. Robt. S. Williams  
A Hard Tough Steel, Top; a Fairly Hard and Tough Sample, Produced by Hardening and Tempering, and, Bottom, a Sample of Meehanite, Magnified 100 Times.

and, in some cases, successfully replaces steel. The material looks particularly promising for cylinder blocks, because of its greater hardness and resistance to ab-



reason. Tests already made indicate that wear on cylinders and other surfaces is likely to be cut in half.

The utility of the material is also indicated by the recent manufacture of some air-cooled airplane-engine cylinders. By correct heat treatment, the air-cooling fins were made as soft as malleable iron to resist accidental breakage, the cylinder bore was made hard to give exceptional wear quality, while the metal between the cylinder bore and the fins was treated to give high tensile strength. Thus these cylinders are not only stronger and lighter, but have superior wearing qualities.

### SPREAD POLLEN BY ELECTRICITY TO AID PLANT CULTURE

In raising tomatoes under glass, a western grower simplifies the task of spreading pollen by using a vibrator operated with current from small batteries. It taps the blossoms lightly but with a frequency many times greater than is possible by hand. The pollen is seen to shower forth, and the entire operation is done in about one-third the time required by ordinary methods.

### VACUUM CLEANER FOR GRAIN TO IMPROVE CROPS

Better grading and testing of seed is said to be possible with an electrically operated vacuum unit, developed by the department of agriculture. It can also be used for removing foreign substances from other material than grain. The seed to be treated is placed in a hopper from which the rate of flow is controlled by means of a cone valve. Suction, produced by a vacuum-sweeper fan and governed by an air valve, lifts light particles away from the heavy ones so that the cleaned grain falls into one compartment and dust and the like, into another.

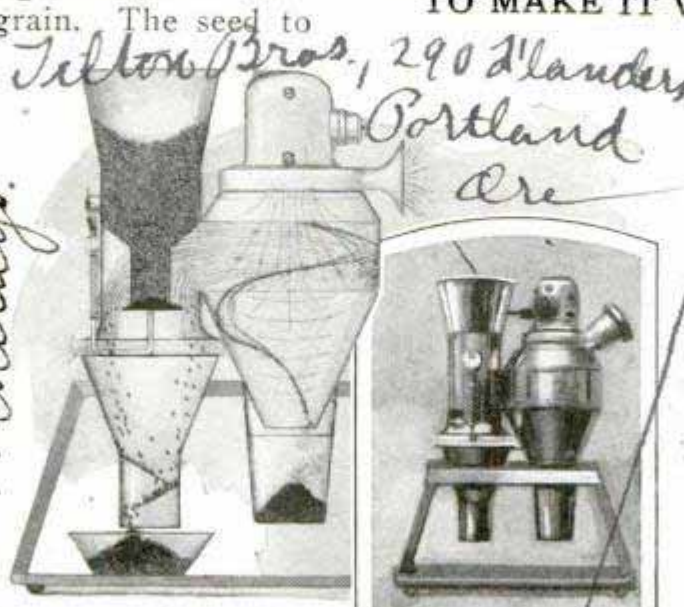

Vacuum Grain Cleaner



Wheeled Cart for Carrying Mail Bag; It Takes a Load from the Postman's Shoulders

### WHEEL CARRIER FOR MAIL BAG EASES POSTMAN'S LOAD

Letter carriers in Washington, D. C., tested a wheel carrier for the sacks during the Christmas rush. Instead of carrying the bag from the shoulder, the postman placed it on the wheeled holder and pushed it along. A brace kept the sack upright when left on the sidewalk.

### CEMENT SPRAYED WITH METAL TO MAKE IT WATERPROOF

Reports from Germany state that a scientist there has developed a process for covering cement objects with a spray of molten zinc, tin or lead to make them waterproof. The method has been applied to cement and concrete slabs, pipe and tanks and is said to be equally successful with all forms of artificial stone.



Brass with the Bee Brand San Francisco

Tilton Bros., 290 2<sup>nd</sup> Avenues  
Portland Ore

mfrs, Tilton Bros.  
290 2<sup>nd</sup> Avenues  
Portland Ore.

International  
Metals Coating Company of America  
497 20<sup>th</sup> St  
San Francisco

San School



1817

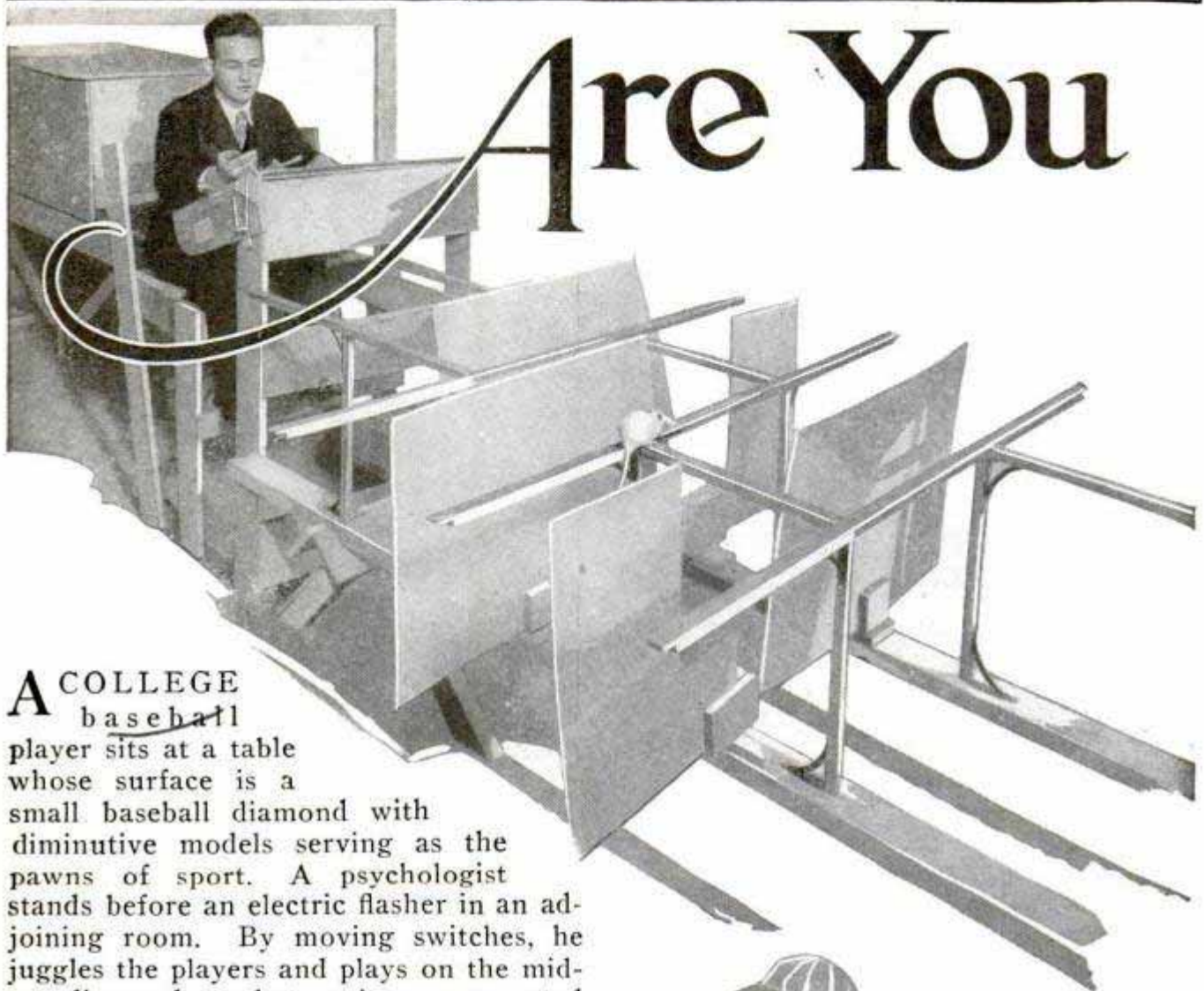

# Are You

## A COLLEGE baseball

player sits at a table whose surface is a small baseball diamond with diminutive models serving as the pawns of sport. A psychologist stands before an electric flasher in an adjoining room. By moving switches, he juggles the players and plays on the mid-gem diamond so that various unexpected situations are developed.

The campus athlete who is undergoing tests to ascertain his baseball knowledge and reactions to emergencies in the game, solves the various sport puzzles as they are presented on the imitation diamond. A careful record is kept of the time required by each candidate in working out the diamond problems. These data aid in culling the misfit from the fit baseball candidates at the University of Illinois, long famed as a hatchery of champion college nines.

When the candidates take the field in early spring, they use a remarkable electrified bat in hitting practice. This scientific bludgeon is equipped with electrical contacts linked directly by telephonic connections with recording devices in the psychological laboratory, which is an important feature in the new university gymnasium. Similar electrical contacts are imbedded in the batter's box and at first base. A special time recorder registers



Exercising a Rat on a Boardwalk "Maze," Top, as Part of the Study of the Effects of Over and Under-exercise on Living Tissues



# Another Babe Ruth?



A Test for Mental and Muscular Co-ordination; the Athlete Attempts to Make Regular Contact with the Electrified Hammer as It Is Moved by the Hidden Mechanism

the exact second when bat meets ball, while it also keeps tab on the instant the batsman leaves the batter's box and when he arrives at first base.

This electrified detective of baseball-player defects explains definitely the failure of many players to make the "varsity" and to win their coveted college letters. It demonstrates that certain unsuccessful candidates consume as much time in hitting the ball and covering the first ten feet to first base as they do in negotiating the remainder of the distance to the initial sack. These men lack the qualifications of satisfactory co-ordination. They fail because they are unable to shift swiftly from the status of baseball batter to track sprinter in the sudden scurry to first.

Dr. C. R. Griffith takes regular technical measurements of the rates of development of pitchers, catchers, infielders and outfielders at the University of Illinois, which recruits its baseball nine from a student body of 13,000. He graphs and diagrams the baseball practices, paying particular attention to the natural hitting range of the different players. These diagrams enable him to ascertain where any given

player will naturally hit a ball. If the natural inclination of the player is to hit consistently to left field and into the hands of the opposing fielder, the coaches, on the recommendation of the psychologist, change the batting stance of that particular athlete so that he will hit naturally into safe territory. A stop watch is used in timing the intervals required by different players to field balls and to throw to first base.

Tests of athletic candidates bring to light the individual adaptations and propensities of certain students for particular sports. They may identify an unsuccessful sprinter as a superior broad jumper. They may prove that a man who tries out for baseball would have a better chance for athletic success on the wrestling mat or in the squared circle. The series of tests divulge athletic secrets. They aid, so to say, in untangling the scramble into which some modern coaching systems have futilely massed their athletes.

The timing factor, as well as form or habit, is of vital importance in many sports such as golf, boxing, discus throwing, shot putting and hammer tossing. Professional



1817



that it records the mental lapse of the baseball or football player, runner or golfer under test. In response to a signal—light, sound or human voice—the athlete presses a response button. The interval between the original signal and his reply is the measure of his reaction time. This test is a keynote to the athlete's response to future field-of-play emergencies.

In another test which aids in the accurate determination of a student's athletic aptitude, the subject sits directly in front of a perpendicular board equipped with an electrified apparatus. This equipment provides ten distinct and separate appliances which serve as a scientific proving ground for the eye, ear and hand co-ordination of the would-be athlete.

A bell rings and the student under test immediately presses a button in response. Then a pair of weights fall. The subject restores them as rapidly as may be to their original position. A white light flashes.

pugilists who remain out of the ring for long periods become rusty and lose one of their most treasured assets—efficient timing. The undergraduate runner wins keenly contested races because of his stamina, speed—and perfect timing.

Doctor Griffith employs an ingenious slotted maze in his experiments to determine the timing attributes of different athletes. The candidate takes hold of an electrified handle and attempts to move it uniformly and correctly from one end of the maze to another and through its complicated twists, turns, bends and curlicues. At regular intervals throughout the maze, this handle touches electrical contacts and writes the scientific history of the candidate's timing qualifications. A student gifted with good co-ordination and timing will complete this astonishing timing test five times quicker than the athlete whose sense of timing is vague and undeveloped.

A unique reaction-time apparatus is used to measure the muscular quickness of the athletes. This device is so arranged

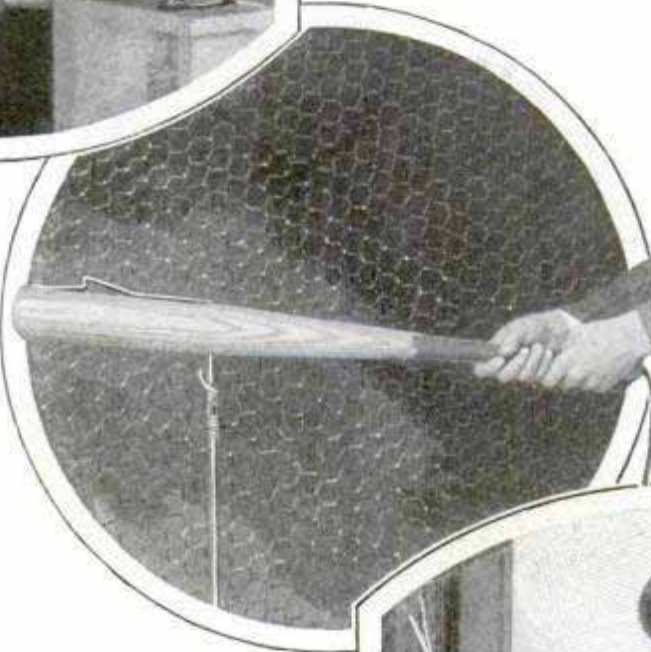

Dexterity Is Tested, at the Top, by Sticking a Contact Pointer in Holes; Center, a Wired Baseball Bat, and, Bottom, an Electric Maze



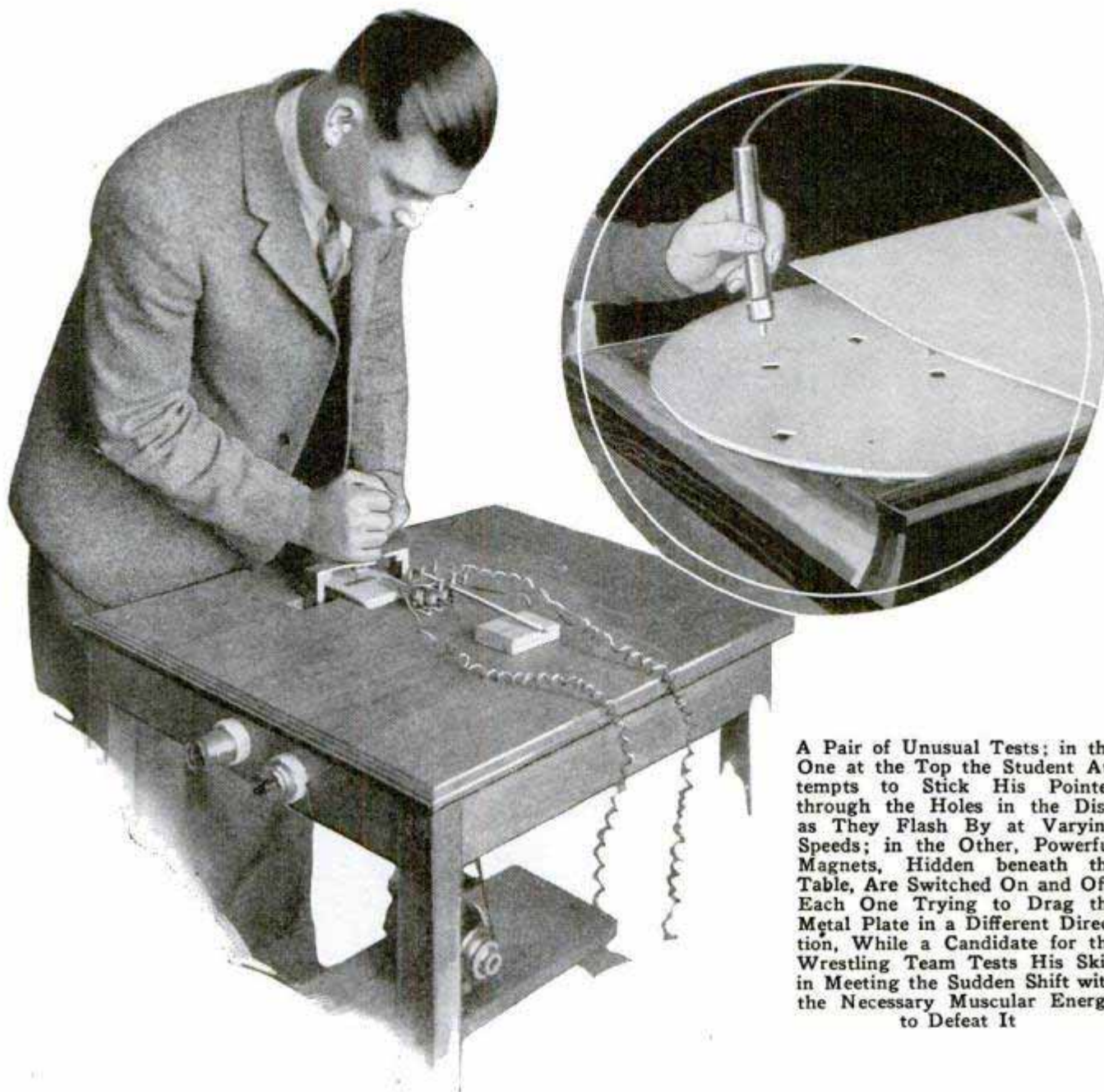

A Pair of Unusual Tests; in the One at the Top the Student Attempts to Stick His Pointer through the Holes in the Disk as They Flash By at Varying Speeds; in the Other, Powerful Magnets, Hidden beneath the Table, Are Switched On and Off, Each One Trying to Drag the Metal Plate in a Different Direction, While a Candidate for the Wrestling Team Tests His Skill in Meeting the Sudden Shift with the Necessary Muscular Energy to Defeat It

He turns a switch in answer. And thus the automatic examination is continued. A supplementary chart recorder graphs the reaction time of the athlete to this round robin of tests, which demonstrate his rapidity of action, concentration, reaction to orders and similar information.

The dexterity of the gymnast, swimmer or basket-ball player is studied by means of an electrical contraption consisting of a peg or pin which fits very loosely in a certain hole in the device. The athlete grasps the pin in his hand, quickly inserts it in the plug hole and then removes it and repeats the process for several minutes. It is a reliable test of hand-eye co-ordination. Each time the pin strikes the sides of the opening instead of the center of the hole, the subject is faulted corre-

spondingly, while he is credited with all the clear-cut "bull's-eyes" he scores.

The co-ordination of one's hands and mind is examined technically in another test, in which the athlete holds an electric pencil in each hand and attempts to guide them simultaneously through two mazes without touching the sides. Another novel test features the use of a specialized appliance to disclose the individual muscular tension, if any, which is characteristic of a certain subject. For example, a baseball pitcher unknown to coach and captain may be handicapped in his effectiveness by some unusual condition of muscular tension. The apparatus brings to light such condition. Its detection can then be followed by emergency control measures. The test itself is simple, as the



pitcher is asked merely to hold an electrified hammer so that it makes contact with a swinging arm mounted above a glass plate. This efficacious detective registers the baseball player's peculiarities as related to muscular tension.

Another apparatus measures a man's muscular time reactions. It is particularly valuable in making a survey of wrestling and boxing candidates. The athlete is asked to hold a handle in a stationary position at the center of a limited surface. Two powerful magnets are mounted under the table below this handle. They are employed to pull the handle in different directions. The subject does not know at any moment in what direction the pull will be directed. This is a laboratory simulation of the ruses and fake movements to which the college wrestler is exposed in a competitive match. He has to outguess the test machine and outmaneuver it in the same way that he would handle a tricky adversary on the mat.

An athlete's accuracy of movement and alertness are gauged by a revamped talking machine, geared for extraordinary purposes. The revolving dial of the automatic speaker is covered and

has only three small copper-based apertures exposed. The arrangement is such that the disk can be revolved at various speeds. The psychologist gives the athlete under test an electrified pointer and asks him to touch the various openings in the rapidly turning dial. Each contact is recorded automatically. The machine measures the athlete's rapidity of action in this eye-to-hand test.

White rats are being used as athletic actors in an original experiment which Doctor Griffith has inaugurated recently, to determine the effects of exercise on well-being and longevity. The rats are divided into groups of uniform age, size, development and intelligence. A complicated maze is used to develop rat intelligence as learning is essential to athletic

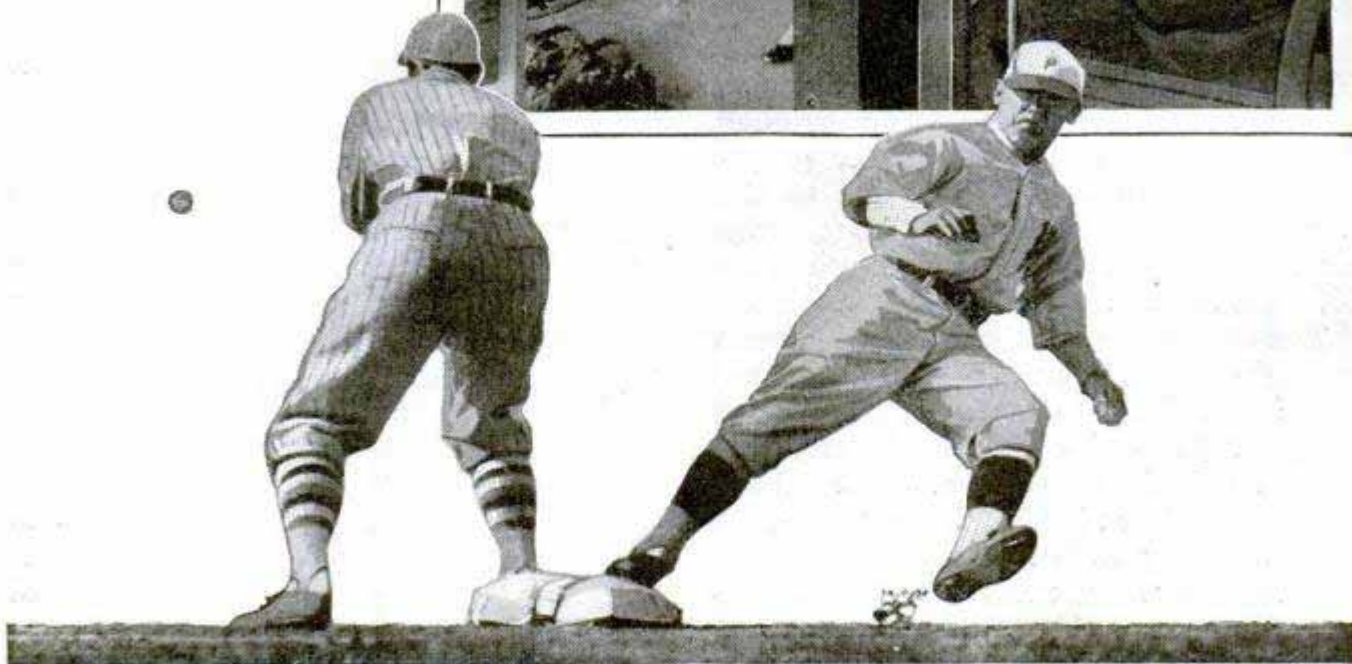
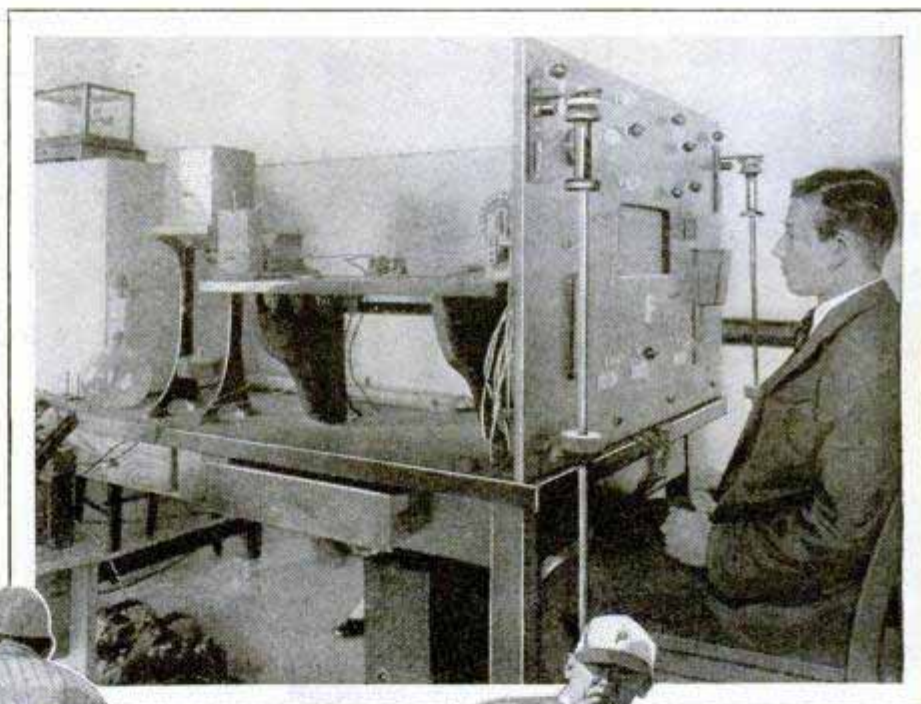

On the Test Board at the Top, the Candidate for Athletic Honors Undergoes Ten Different Reaction Tests to Prepare Him for Scenes like This, with a Runner Safe at First



skill. Brawn must be supplemented by brain for success in modern sports.

The only definite data now available pertaining to the benefits or evil effects of athletic training consist of statistics compiled at several leading universities. For the most part, these figures cover only the collegiate life of the athletes and do not provide information about their after-college days.

Doctor Griffith, by the use of novel rat exercisers, such as revolving cages operated tread-power fashion, is overexercising some rats, while other rodents are given average exercise, and additional groups are underexercised. The research will cover at least one generation.

Experts are co-operating with Doctor Griffith in the experiment, which is expected to be productive of data on the results of regular, irregular and excessive exercise—moot points whose conclusive solutions will interest millions of sport lovers.

**POWER PAINT SPRAY OPERATED BY AUTOMOBILE MOTOR** 1912

Operated by power from the auto's motor, an efficient spray gun for applying paints, lacquers and other liquids is now on the market. The outfit includes twenty-five feet of hose and an equalizing filter tank, and is attached simply by removing one spark plug and screwing in the compressor unit. The device may also be used to inflate tires, to clean upholstery and to oil the springs.

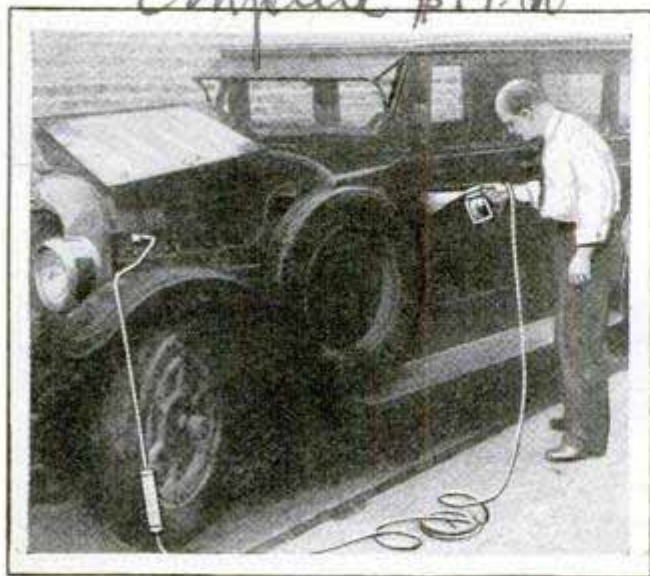

Spraying Auto from Gun Operated by Power from the Car's Own Motor

*Complete \$14.50*

*Eschick & Co,*

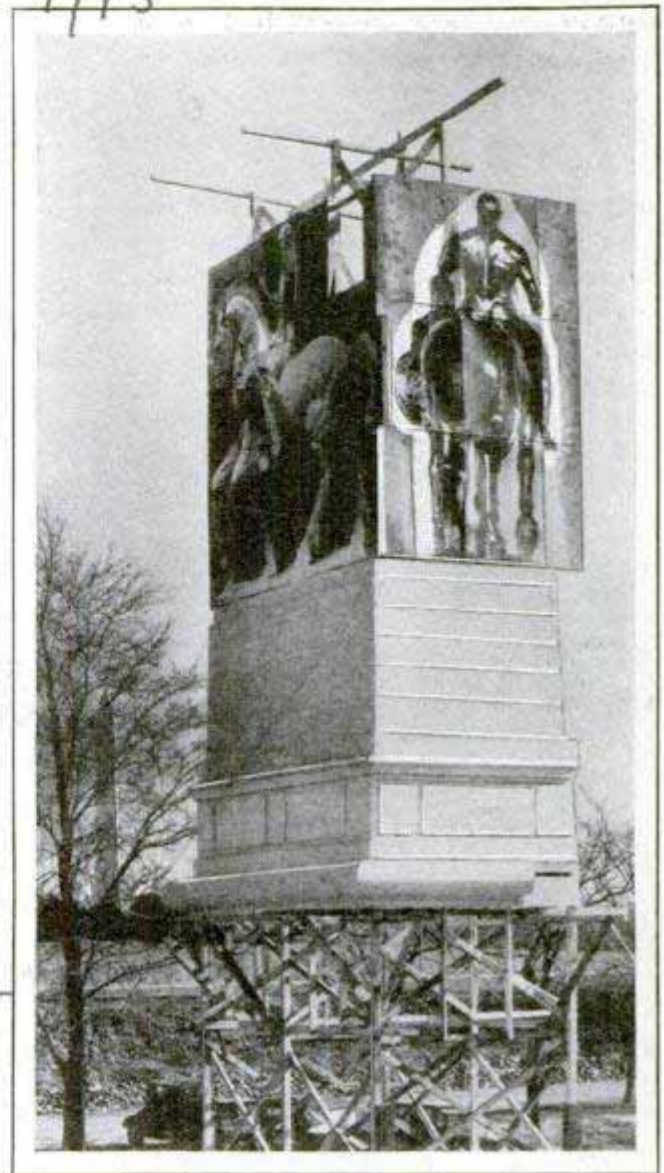

© U. & U. Photographs Mounted on Replica of Bridge Pylon, to Show How Finished Sculpture Will Appear

**PHOTOS SERVE AS SCULPTURE FOR BRIDGE STATUES**

In choosing the equestrian statues for the Arlington memorial bridge pylons at Washington, huge photographs of the proposed designs were mounted in the position that the sculptures will take later, so that the commission could determine the appearance of the finished structure. The photographs are said to be the largest ever made by the signal corps.

**PLANE LANDS IN DRAG SAIL** 1901

Successful tests with a huge sail, dragged from a moving vessel and used as a landing for hydroplanes, are reported from Germany. The plane repeatedly started and landed on the sail, an advantage of the plan being that the canvas presents a smoother area than the water itself.

*St Joseph News Press*



## WINDOWS REVEAL INNER SECRETS OF AUTO ENGINE

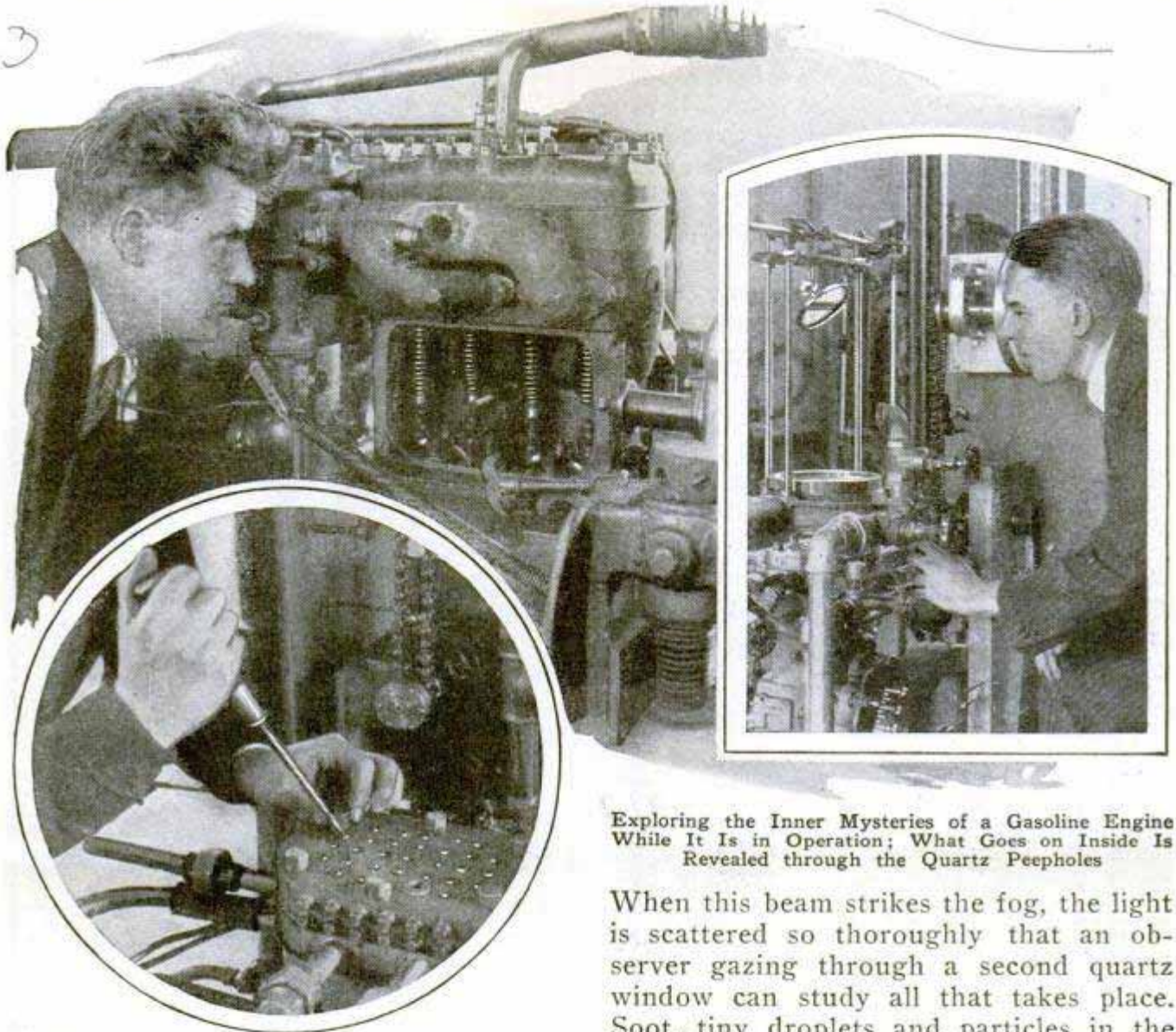

Exploring the Inner Mysteries of a Gasoline Engine While It Is in Operation; What Goes on Inside Is Revealed through the Quartz Peepholes

If there is one thing known to science which is darker than the inside of a cow, it is the interior of a gasoline engine. Uncle Sam has attacked the problem in a novel manner by equipping two engines with peepholes of quartz through which engineers are studying what goes on in the combustion chamber. The layman who visits the laboratory can peep through a device known as a stroboscope and watch the engine operation from the inside out and from the outside in. The stroboscope slows down swift motion so that the eye can see what previously was unseen. It is a sort of simulation of the slow-motion picture idea applied to the study of mechanical activity. When you step on the starter of your motor car, a condition of fog exists in the intake manifold. The federal experts have capitalized this fact by throwing light through one of the openings into the manifold.

When this beam strikes the fog, the light is scattered so thoroughly that an observer gazing through a second quartz window can study all that takes place. Soot, tiny droplets and particles in the intake manifold or in the combustion chamber also operate to scatter light similarly, when its revealing rays are focused at such points. The arc is thus used to cast its beam into the experimental cylinder of one of the test engines. A glass lens, seven inches in diameter, is mounted above the engine head and the series of quartz windows, so that all beams of light from the combustion chamber which penetrate these peepholes are brought to a focus at the stroboscope. A mirror is also used to reflect the image to the side of the engine where the stroboscope is attached. Each quartz window is one-eighth of an inch in diameter. These openings are distributed so that the rate of flame propagation in the combustion chamber may be computed by watching the illumination spread from one row of the holes to the next. The rate of flame development with different fuels, mix-



tures and varying engine-operating conditions are being studied. The phenomena of spark production, ignition of the charge and the resultant explosion are yielding new facts about old engines which have never previously been understood thoroughly. Potentially, airplanes, speed boats and motor cars will be operated more efficiently and economically as a direct result of Uncle Sam's tests with "windowed" gas engines.

1944 WINDOW DISPLAY ON WHEELS HELPS DRAW CUSTOMERS

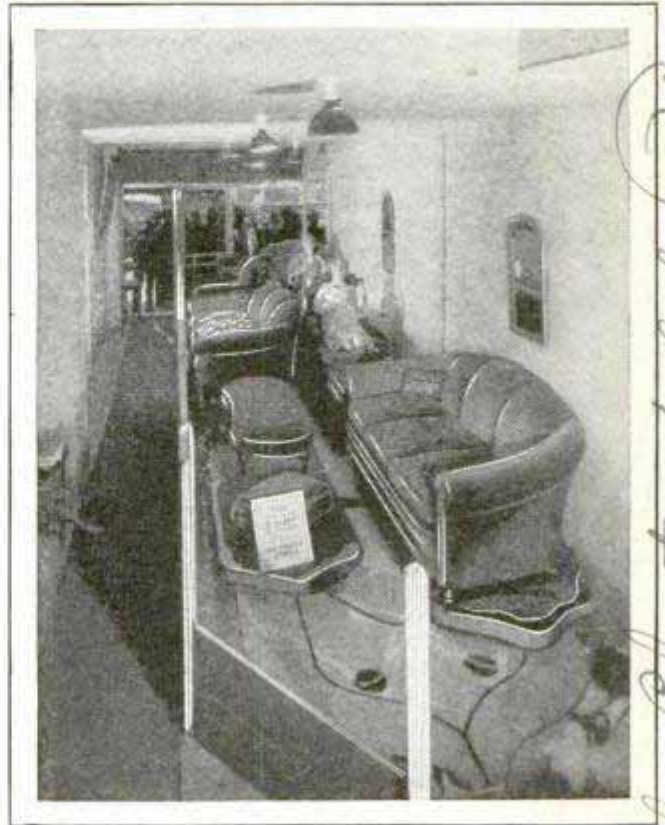

Furniture Display on Moving Platform; the Show Window Is Seen at the Far End

12/10/28 CHIMNEY FELLED FROM INSIDE TO PROTECT BUILDINGS

1970 Wrecking a 155-foot chimney in London without letting a brick fall on neighboring buildings was the task of a skilled steeplejack. He erected a scaffold on top of the shaft and a staging reaching half-way down the inside. Bricks were thrown down to the bottom of the interior into a seven-foot hole that was cleared at intervals. The first part of the work was more difficult because of the overhanging top section of the chimney.

PERISCOPE FOR GOLF FANS CARRIED LIKE CANE

1937 So that golf enthusiasts may be able to see over the heads of others at matches, a leather-incased periscope has been devised. It may be swung as a cane by its strap, when not in use, and is quickly inverted to be employed as a periscope. It is said to give a clear view.

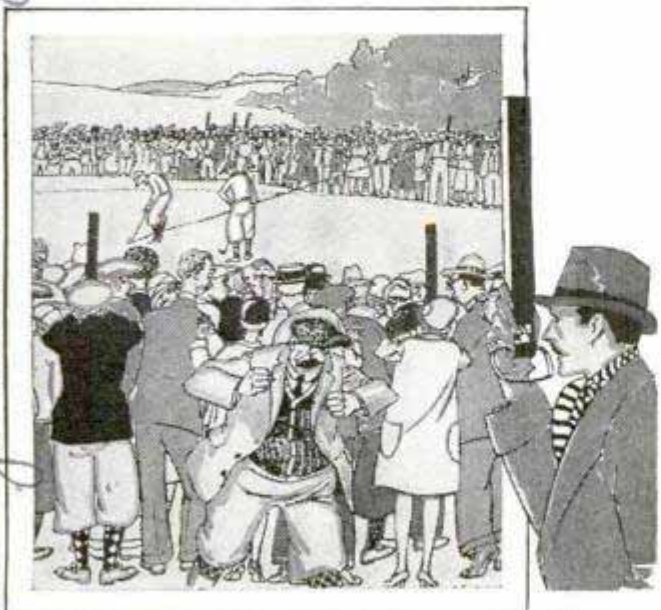

Using the Golf Periscope Which Permits Spectators to Look over the Heads of Persons Near By

Realizing that moving objects attract the eye more readily than fixed ones, the proprietor of a western furniture company devised a novel form of display for his windows. The goods were placed on a moving platform, or series of carriages which rolled in endless-chain fashion the full length of the window, so that the display was completely changed every few minutes. As the articles moved, they were turned about so that all sides of them could be viewed from the street. This method of display is patented.

MOVIE VOICE FOLLOWS ACTOR IN SCREEN MOVEMENTS

1964 Talking motion pictures have been improved, it is asserted, with an apparatus which causes the actors' voices to follow them as their shadows move across the screen. This does away with the fixed-tone effect under the usual "talkie" arrangement and gives a more realistic interpretation of the action. It also is said to eliminate distortion. The apparatus is fitted to the camera taking the pictures and recording the voices.

Chicago 304 & Michigan

1944 Chesterfield Seed Co

Kaschel + Kaschel

Chas. Capt. Alban



11 W. 42nd St. New York

LIGHTER FITS IN LAMP SOCKET FOR SMOKER'S EASE



Lighter Attached to Lamp, and Close View of the Cord and Sockets, Showing the Push Button

Screwed into a lamp socket in the same way as a bulb, a lighter for cigars, cigarets or pipes has a long cord and also contains a lamp switch. It gives a decorative touch to the room and is always in a convenient position for use.

CANDLE SIXTH OF WAY TO MOON SEEN BY GIANT TELESCOPE

If a lighted candle could be placed 41,000 miles from the earth, about one-sixth the distance to the moon, its flame would still be visible through the 200-inch telescope planned for the California Institute of Technology. Dr. Walter S. Adams, director of the Mt. Wilson observatory, recently explained this and other features of the huge instrument, which will reveal many more of the secrets of the heavens. Its mirror, he explained, will collect about 1,000,000 times as much light as the human eye. Stars from five to ten times fainter than can now be registered on the 100-inch telescope on Mt. Wilson, will be shown. So far, astronomers have been able to determine that there must be a million or more nebulae, mysterious systems of stars lying far out in space. The

new glass will probably show that there are many more, and it will doubtless enable scholars to learn more of the nature of the stars that compose them. Some of the interesting things about the nebulae are illustrated by Andromeda, 870,000 light years from the earth. Its light is about a billion and a half times as great as that of our sun, and its mass probably five hundred million or a billion times as great as astronomers have estimated.

LEATHER MADE TRANSPARENT FOR AUTO HOODS

By a special tanning and chemical treatment, a kind of transparent leather is being produced by an English expert. It is said to be stronger than canvas and especially suited for automobile hoods, tobacco pouches, raincoats and similar articles. It is also used as a substitute for gut in sewing leather, and as small belts for lathes, looms and sewing machines.

TOWN HISTORY UNDER ROOF GUIDES TRAVELERS

Persons passing through the village of Bentley, England, are likely to remember it, for in the center of the main street is a thatched pavilion under which is a large replica of a book bearing the important facts of the town's history since 41 A. D.



English Town's "Name Plate" Consists of a Big Book under Thatched Canopy Giving Historical Facts

The marker has proved a helpful guide to motorists and attracts wide attention.

Lamp. C. Lighter 1911  
1969  
4046 12/19/27  
Came from

Useless Appliances,  
% George H. Holden,  
High field New  
Chester, N. H.



1995

Zimmerstrasse 35.41  
Berlin SW 68, Germany

# If They Were Larger



Courtesy Die Woche

10/13/28

Imagine a Little Three-Inch Garden Lizard, Enlarged to the Size of a Dinosaur of Old, Chasing You through the Woods, and You Get the Effect of This Composite Photograph

**WHAT** would happen to civilization if the little garden lizard ever grew up to be the size of his ancient relative, the ichtyosaurus, and all the other insects and reptiles assumed the size of the monsters from whom they descended?

That is hardly apt to happen, for nature, millions of years ago, discovered the monsters were inefficient and in the process of evolution finally came down to the ant as the highest type of insect development, and man as the best of the mammals. From the beginning of time the process of creating the world as we know it today has been one of unending experiment, nature discarding one form after another, of plants, insects and mammals, until she found the types best fitted to survive, and the proper balance to insure a food supply for all.

The problem of food supply is the chief reason why there is small chance that future evolution may ever go back toward the monsters of the past, just as it is the problem that some day will face the constantly growing human race. Once there was a dinosaur that grew to be 150 feet

long, stood twenty feet high at the shoulder, had a neck reach of thirty feet or more, and weighed, according to the best calculations, somewhere around thirty or forty tons. Even his little brother, the brontosaurus, scaled around sixty feet from the tip of his nose to the tip of his tail, waddled along leaving yard-square footprints in his wake, and would have tipped the scales, had scales been invented then, at 40,000 pounds, which is half the capacity of a good-sized freight car.

But the dinosaur and the brontosaurus, the trachodon and the tyrannosaurus, the mammoth and all the rest of the strange beasts and reptiles that once roamed the earth and the air—for there were giant flying reptiles then—discovered one day they had eaten themselves out of house and home, so they laid themselves down and died.

In South America there is a valley of the giants where that final tragedy of great size was enacted. There the types peculiar to South America, moving northward in search of new feeding grounds, met the tourist monsters which had drifted





In the far north, similarly, a seal-blubber diet and the necessity of keeping indoors as much as possible to keep warm, have made the Eskimo another of the world's smaller races. In between the two extremes, the restless races have developed, fed by a well-balanced diet, made restless by a comfortably brisk climate, and stimulated by habit and habitat.

The rise of man as the highest type of mammal,

down from Asia on the same mission, and today the valley is studded with the bones of the two groups.

Science is just beginning to appreciate what an important bearing food supply has on life, whether animal, insect or human. For one thing, stature itself, according to R. Bennett Bean, of the laboratory of anatomy, University of Virginia, depends on food, water, habit and habitat, and he puts food first. There are pygmies and undersized people in the tropics and in the cold latitudes, while the taller races originate in the more temperate climes where food is most abundant and most diversified.

The picture of the tropics as a land where the native need only lie under the right tree to have his dinner drop in his mouth is greatly overdrawn, for, while fruits and some other foods are abundant in the torrid zone, they are not particularly good body-building types, nor is the indolence born of heat conducive to the activity that makes for greater growth.

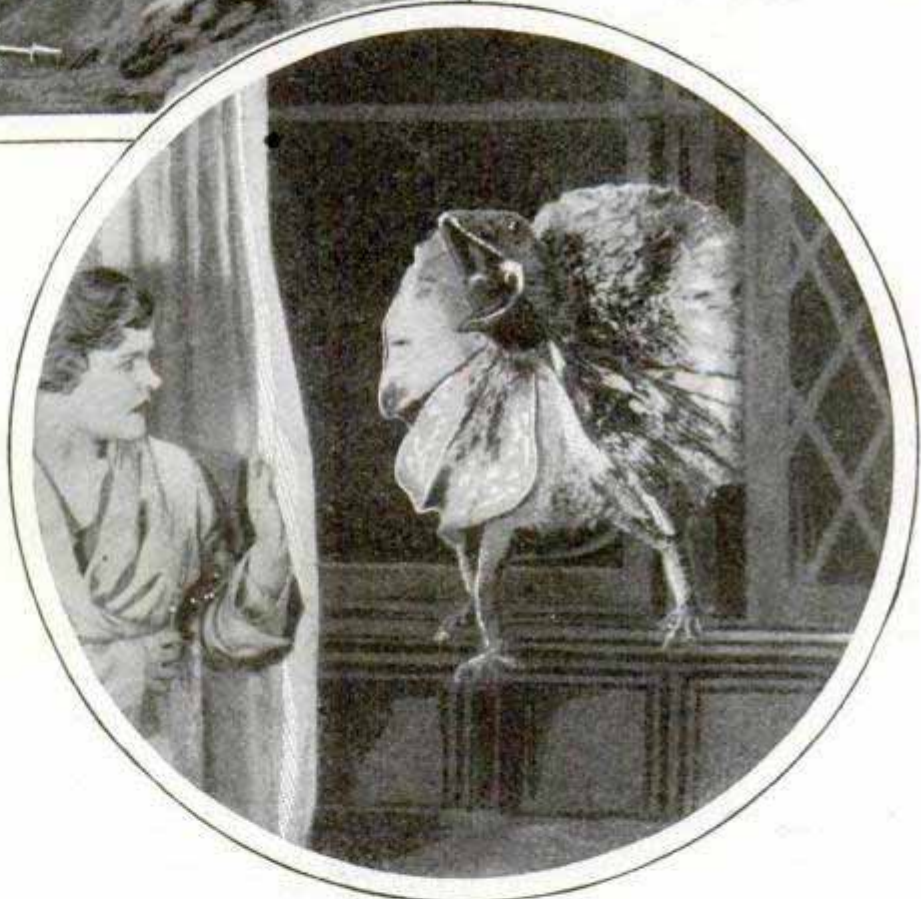

If Turtles Were Giants, It Would Take Hand Grenades to Stop Them; the Lady Is Entertaining a Ruffled-Neck Bat

with the intelligence to grow part of his own food and capture and kill the rest, may have been the natural result of changing conditions in food supplies. Nature took care of the insects and reptiles by scaling them down until their appetites balanced with the food available.

The paramount goal, a German scientist points out, was always to keep an exact balance between hunter and prey, eaters and food supply, in order not to put an end to organic life when the last victim





should be devoured. For this reason, he adds, and to make possible for man a future development that would include such luxuries as radio and television, the wild animals were gradually reduced in size and numbers. Today the elephant is the largest survivor, but even he has been largely domesticated and put to work.

"But imagine if you can," he adds, "the lowly garden inhabitant, a grasshopper, the size of an elephant! What if an ant as large as a tiger, a ferocious panther on six legs, with monstrous fangs and burning breath, broke out of the jungle? Thanks be to the Providence that spared us the necessity of contending against an insect world of such dimensions. No further proof is needed that ants, four or five feet in length, would

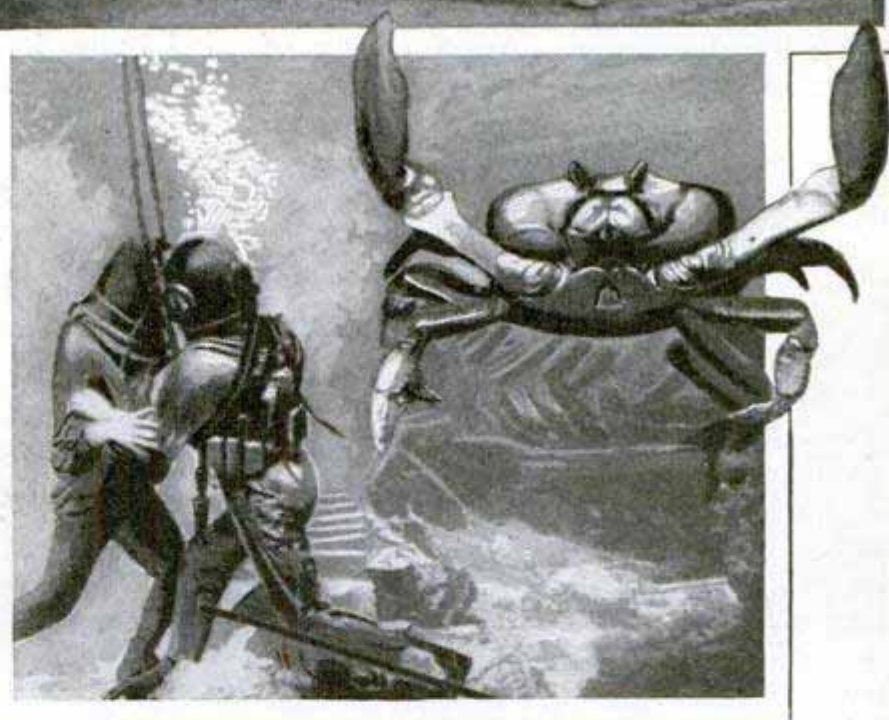

A Hawk Enlarged to the Proportions of an Ancient Flying Lizard, and a Crab as He Might Have Been Long Ago

then have become the masters of the world. Look at nature through the microscope. A horned beetle is a rhinoceros in size, a veritable nightmare. What would become of our philosophy of life? It would be bankrupt, fear and horror would be the only emotions awakened in



us by a contemplation of nature. Civilization was made possible on our earth by the balanced relation of human and other life and their interdependence. But on another planet the insect world may have won out. The mammals, perhaps, expired on Mars, and its world may be ruled by scaly creatures, wise in their way but armed with claw and fang."

What the future is going to hold for insects, animals and man on earth can only be foretold by examining the past, and it is there that the zoologist, the anthropologist and the other scientific research leaders come in. The question most often asked the scientist by the layman is, "what good does your work do?" Piecing together the discoveries of this group furnishes a fascinating picture of the rise and fall of life through the centuries.

The gigantic reptiles of a few million years ago didn't come into being as monsters. They started out, undoubtedly, on a small scale. Roaming through a young world, with plenty to eat, they gradually grew in size. Nature helped them along in their fight for survival by gradually adding scales and bony armor to resist their natural enemies. With plenty of food, there was no limit to their growth. But as they grew in size, and as their pro-

tective armor reduced losses from natural causes, they slowly filled up their territory until eventually there was an excess of population over food supply. Exactly the same thing can be seen happening today. Rabbits, for example, will increase rapidly in a period of good years, until lack of food, disease, epidemic, or a corresponding increase in their meat-eating enemies, brings them down again, and the cycle starts all over.

Most of the early monsters were hybrid land and water beasts, and the great size and ponderous movements of all the species, with the possible exception of the mammoth, rather limited the zone of their feeding activity. Eventually they had to begin spreading out in search of more food. Probably the older and stronger kept crowding the younger and the weaker away. If, as seems probable, the reptilian life originated in what is now the Gobi desert, but was then a rich tropical jungle, the animals eventually went far afield, for they crossed the land bridge from Siberia to Alaska before Bering strait was formed in a later ice age, and shoved southward through Canada, leaving myriad bones in Alberta, down through the United States, with a trail of carcasses in Montana, Utah, Colorado, Arizona and

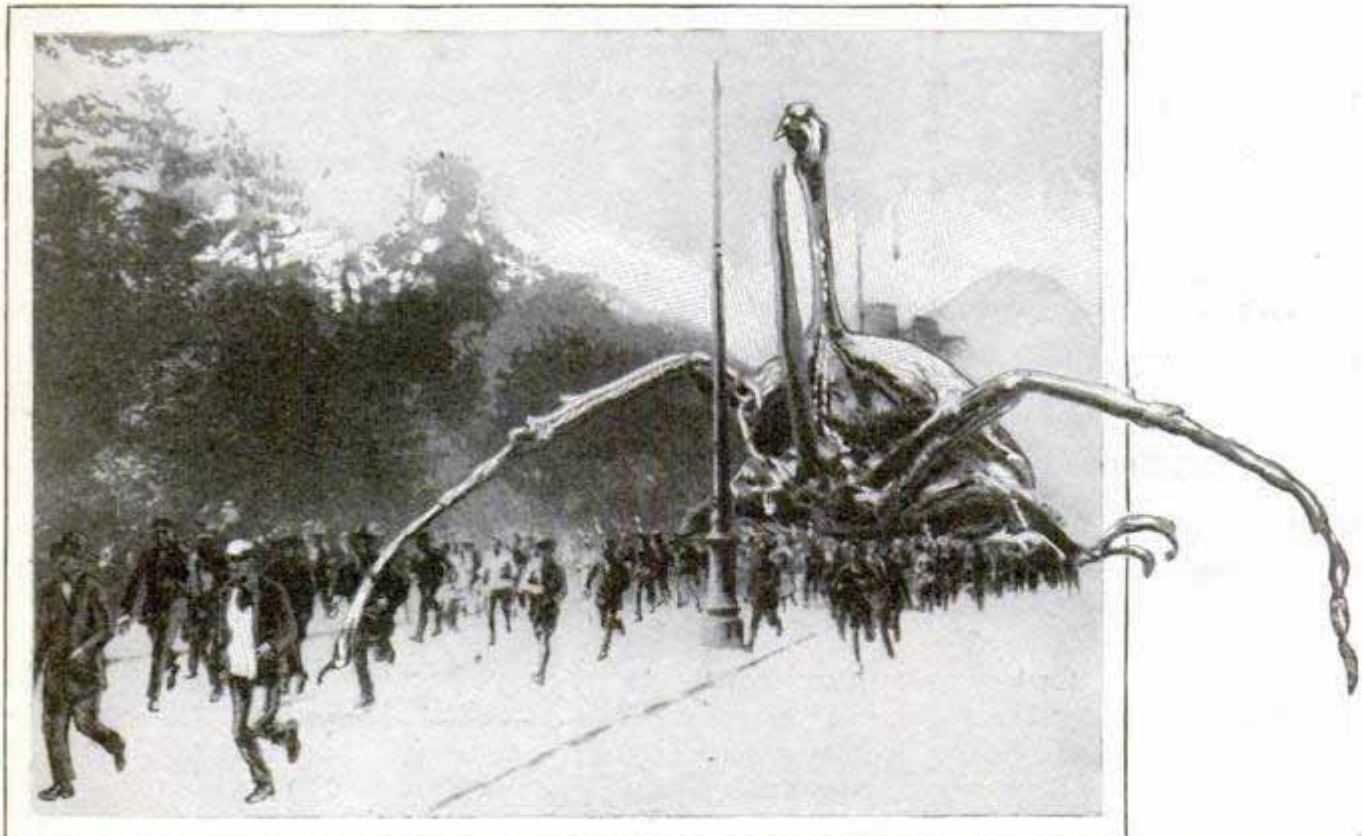

Just a Little Water Beetle in His Native Element, But a Fearsome Monster When His Picture Is Enlarged to Giant Proportions and Overprinted on This Berlin Street Scene



Texas, through Mexico, Central America and into South America. There they met the northward-moving horde of distinctly South American species and the final battle with starvation was staged.

That is the picture of what happened a few million years ago, as science has pieced it together. First, nature, by armoring the giant vegetarians against the meat eater, brought about overpopulation, upsetting the balance that nature usually maintains, and then exhaustion of the available food supply, particularly after the advance of the next glacial age which cut down the semitropical jungle area of the northern latitudes, did the rest.

The human race at times suffered just as severe changes, and science has begun to study them. The west coast of South America, down in the windswept, barren, rainless district from which Chile exports a large share of the world's nitrate supply, was once one of the most prolific garden spots in the world.

It is now a treeless desert, a lonely waste in which virtually no rain falls, where the hillsides are bleak and brown, one of the most monotonously lonesome coasts in all the world. But recent excavations in vast graveyards which show the region once supported a vast population, have uncovered burial urns containing corn, wheat and other grains, remnants of cotton cloth that show a great cotton-growing industry flourished there, and other relics of prosperous, well-fed times.

**HAND MIRROR WITH ANCHOR  
LATEST TRAVELER'S AID**

For the railroad or auto tourist, a hand mirror that can be attached to almost any surface by a vacuum cup, has been introduced. It is instantly adjusted or taken down and has an arm that can be turned to different angles. It is held in a strong frame of rust-proof metal.

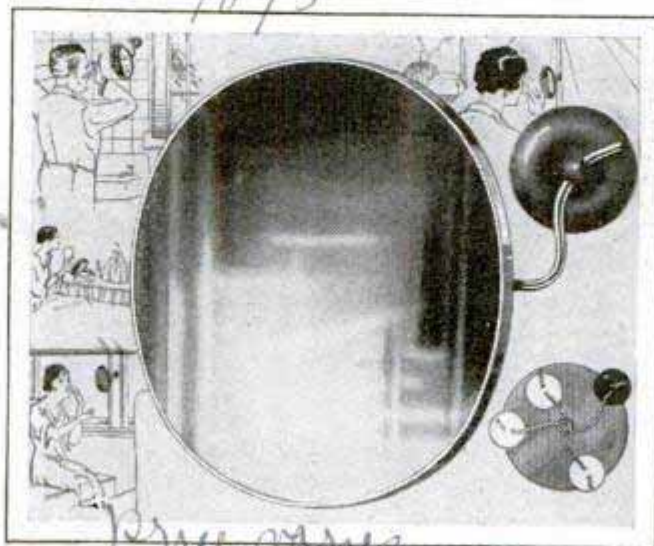

Close View of Mirror with Its Cup and Some of Its Many Uses



A Turn of the Wrist Adjusts Shade and Bulb of This Handy Bridge Lamp to Different Angles

**BRIDGE LAMP IS ADJUSTABLE  
AT PRESS OF BUTTON**

Two lamps are combined in one for the convenience of the home in a stand that has a shade and bulb which may be tipped down or set erect by pressing a button. The lamp has two intensities of light, for close use or for general illumination.

**RAISING KARAKUL SHEEP FUR  
NEW U. S. INDUSTRY**

Near Goldfield, Nev., a number of karakul sheep are being raised for their fur which is used in making coats and other garments. Until recently, practically all the world's karakul sheep have been produced in Bokhara, which before the World War had flocks numbering 1,800,000, but they seem to thrive in the climate of southern Nevada, and this activity promises to become a profitable industry. The karakul is the only sheep that produces fur instead of wool. The lambs are born with a heavy coat of glossy black or brown and their pelts are used early.

*Meriden, Conn.*

*also Karakul Fur 148*  
*George (Brahm) Indragie*  
*syndicate headed by*

*Specialty Mfg. Co.*  
*Ranch at*



Bulletin 404 12/20/28

1947 Canton, Ill. Clark Ave. & 4th St.

elements, are opened and closed by means of a small lever on the base of the unit.

**GERANIUM KILLS BEETLE THAT IS FLOWER PEST**

Japanese beetles, one of the dreaded pests of the gardener, are fatally affected by the leaves or flowers of ordinary geraniums, Charles H. Ballou, of the department of agriculture, has discovered. Dissection has shown that the geranium destroys a part of the beetle's digestive tract within twenty-four hours, and that all the soft contents of the body cavity are disintegrated within forty-eight hours. The insects manifest a peculiar fondness for



A Roller Coaster in Summer and a Sled in Winter; the Adjustable Rig with Its Pusher That Gives Good Exercise

**COASTER FOR SNOW OR GROUND GIVES GOOD EXERCISE**

Quickly convertible into a roller or a runner coaster for ground or snow, a speedy sled, propelled by pulling and pushing a lever, has been placed on the market. It can be changed from one form to the other in a few minutes, small rubber-tired wheels being attached for ground operations. The pusher, which works on a collapsing extension arm like a folding hat tree, has a sharp point for gripping snow or ice and an effective gripper for the ground or sidewalk. The sled itself folds up for easy carrying, weighs but a few pounds and is so strongly built that two large men can ride upon it in safety.

the plant, in spite of its fatal results, and will fly hundreds of yards to find baits which have been scented with geraniol, the basis of the geranium odor.

**STARTING LEVER FOR FORDS LEAVES FEET FREE**

Easily installed and handy to reach, a starting lever for Model-A Fords replaces the usual button or rod. It is bracketed to the steering-column support, is operated by simply lifting the finger and leaves the feet free for brake and clutch. The installation of the lever requires no alterations or drilling of extra holes.

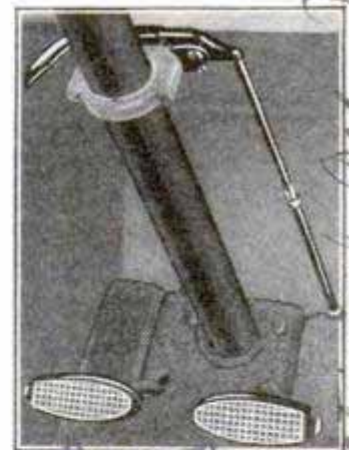

**AUTOMATIC TOASTER OPENS UP LIKE A BOOK**

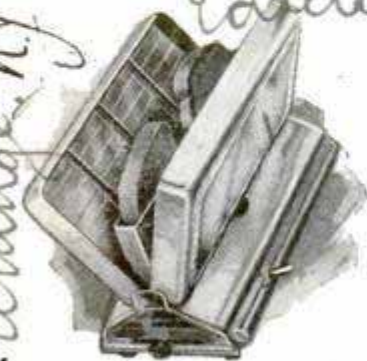

An automatic toaster, which browns both sides of the bread at the same time and has the novel feature of opening like a book, is one of the latest electrical appliances on the market. The sides which contain the two heating

**ELECTRIC SHOCKS KEEP FISH FROM IRRIGATION CANAL**

Electrified screens have been erected at the openings to irrigation canals in various parts of the west to keep fish from entering the channels. A low-frequency current is used and does not injure the fish, but gives them a distinct warning to keep away from the headgates.

the rabbit sled

normal wire Milwaukee

Thomas A. Edison Chicago, Ill.

The Fulton Co 75th &

Cont. (1 way & 2 way) 11



**TALKING MOVIES SENT BY RADIO FROM ORIGINAL NEGATIVE**

2059  
Talking movies, which, it is claimed, can be reproduced on any size screen, are transmitted by radio by a new device invented by a Luxemburg scientist. The apparatus is expected to be particularly adaptable to quick transmission of news-reel subjects, as the original negative is used, eliminating the delay while a positive film is made. The transmission and reproduction do not necessarily take place at the same time, as a transmitted picture can be stored for future use. The film is transmitted in the usual way, but at the receiving end is recorded on a series of fine metal ribbons, so it can be "played" later, just as a phonograph record is used. The accompanying sounds of a "talkie" can be registered at the same time. The quality of the reproduced image is said to increase with the size of the screen.

**AUTOISTS REQUIRED TO SPEED ACROSS MIAMI VIADUCT**

2032  
Speed of less than thirty-five miles an hour is prohibited to motorists while driving across a viaduct at Miami. This rule is to prevent traffic congestion and is said to have had a beneficial effect in this respect. Violators of the rule are charged with parking.



Sign on the Miami Viaduct, Warning against Driving at Less Than Thirty-Five Miles an Hour



Testing the Sap of the "Cow" Tree; the Liquid Tastes like Milk, Explorers Say

**TREE IN TROPICS GIVES MILK LIKE THAT OF COW**

3 + a  
Sap from a tree that grows in a certain part of Guatemala, looks and tastes like cow's milk, Prof. Samuel J. Record, of Yale University, and a member of a recent expedition from the Field Museum of Natural History, reports. He says that the natives use it in coffee and for making desserts. It sours easily, like real milk.

**NEW FIREPROOF INK PROTECTS LEGAL DOCUMENTS**

2015  
For the use of attorneys and others desiring a material not affected by blazes, a fireproof ink has been prepared by an English expert. He employs a mixture of chemicals with varnish and a specially treated lampblack. If fire attacks a paper on which the liquid has been used, the ink is not obliterated but turned to a brownish-black tint. Used on fireproof paper, it becomes transparent after a fire. The paper is mainly of asbestos and fiber.

The Secretary, Vescova

*Barrios*  
*destru*  
*Cherterfeld*  
*End*  
*Resub*  
*to let on this road*



1735

207 E Ohio Chicago

# Adventures in



Testing Automatic Sprinkler Heads to Determine Whether Corrosion, Suffered during Use in Industrial Plants, Is Sufficient to Prevent Their "Popping" at the Correct Temperature

By J. EARLE MILLER 207 E Ohio Chicago

A HUGE door of steel and firebrick rolls upward, opening the portal to the fiery pit. The roar of gas-fed flames, after raging for hours, has died away, leaving behind red-hot bricks, and, in the center of the furnace, a big steel office safe. Workmen tug at a block and tackle, and the safe and its iron platform come rolling out on a track laid in the floor.

Shielding faces with upraised arms while their clothing smokes and steams, two men dash in, shove an iron grating beneath the safe and affix chain slings. There is a rattling of tightening links and the glowing mass disappears up a smoke-grimed shaft rising through the center of the building. The iron cart is wheeled aside and the floor opens up to uncover a vast slab of reinforced concrete.

From the moment the furnace opened, a watcher has been counting off the seconds. At 120 he calls "time," a workman pulls a trip line and the red-hot mass of steel plunges thirty feet back to earth, landing on the cement with a thud that shakes the building.

A madhouse? No, just the Under-

writers' Laboratories getting under way for the day's business. Chicago

Over in the corner a little group surrounds a miniature roller coaster. A torpedo-shaped steel Juggernaut on wheels, weighing a ton, rolls down the inclined track, picks up speed, and smashes with terrific force into a bright new automobile bumper which bends under the blow, then springs back with such force that the flying weight rebounds on its track. Instruments have measured the effects of blow and rebound, and over them bend young men with notebooks and pencils.

In the next room, a fine big fire window of steel frame and wired glass is fixed into a strong brick wall. Behind the glass, flames are raging, and, as you watch, the molten glass begins to run and little tongues of fire dance through. At a signal, the flames die away, the wall, window and all, rolls away on an overhead track, a man in overalls turns a fire hose on the still glowing window, and a group of observers watch to see what happens when water at sixty pounds' pressure strikes the incandescent glass



# Wonderland



One of the Most Unusual Fires on Record; the Top Floors of the Fireproof Building on the Right Were Set Ablaze by Heated Air from the Conflagration across the Street

Upstairs, an automatic machine is sticking three keys into as many automobile locks, turning them, turning them back again, and then withdrawing them, only to repeat the performance with monotonous regularity.

Down in the basement a board, hinged at one end, reclines against the wall, with a big copper fire extinguisher strapped to it. An arm on a traveling belt comes around, pulls the board out from the wall, then lets it fall back with a thud, comes around and repeats the performance, time after time, hour after hour and day after day, while an automatic counter registers the shocks the extinguisher's glass insides can stand.

Scattered around through several acres

of floor space, a couple of hundred expert destructionists are busy earning a living breaking up the things other men have built.

If you have ever bought an electrical appliance or fitting, examined an automobile accessory, purchased some fire hose, had your house wired against lightning, installed a burglar alarm, bought a penny box of safety matches, built a fireproof building, purchased an oil burner or a mechanical refrigerator, or done any one of a hundred and one other things that may affect your fire, burglar or accident insurance rates, you have come in contact with the Underwriters' Laboratories.

Most everything that affects your safety from fire or accident, or your burglar





risk, has come under the scrutiny of the laboratories. If you want to build a business structure, the architect knows not only what loads the columns and walls will bear under normal conditions, but what they can stand when assailed by flames. A combination press and furnace that cost \$35,000 to build tells him that. Your architect will know what kind of fire walls, fire doors and fire windows to install, and when it comes to burglar insurance for your tenants, the laboratories have not only examined and approved them, but they pass on and supervise the equipment of the watchman's service that answers your alarm.

This testing has involved engineering and inventive problems that often surpass those of the builders of the original device. When you press a button, turn a switch or pull a chain and the electric light flashes on, you do not give the matter a thought. But just as part of the day's work a testing engineer built a machine that takes either or all three of those types of electric switches and turns them on and off, day and night for week after

week, until they wear out, while an automatic counter keeps track of their life span. Because of that one machine, there is built into your electric-light fixtures the maximum of life and safety.

When domestic oil burners began to appear, an entirely new problem in fire hazards was presented. A battery of furnaces was set up at the laboratory and the manufacturers' samples began to pour in for testing. For weeks, a crew of scientists lived in the heat of a dozen furnaces and watched the performance of the burners. They were not interested in economy of oil consumption or heat produced, but solely in the possibility of fire or explosion—two things the purchaser might never inquire about. The oil burners that got by the grueling test were awarded "approved" labels.

At about the same time, domestic mechanical refrigerators began to challenge the ice man's supremacy. They involved placing in untrained hands a highly complicated plant. Some

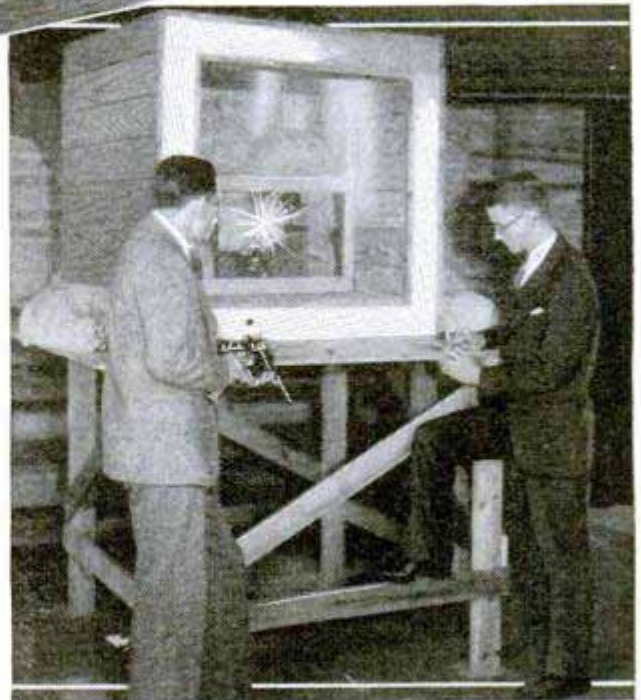
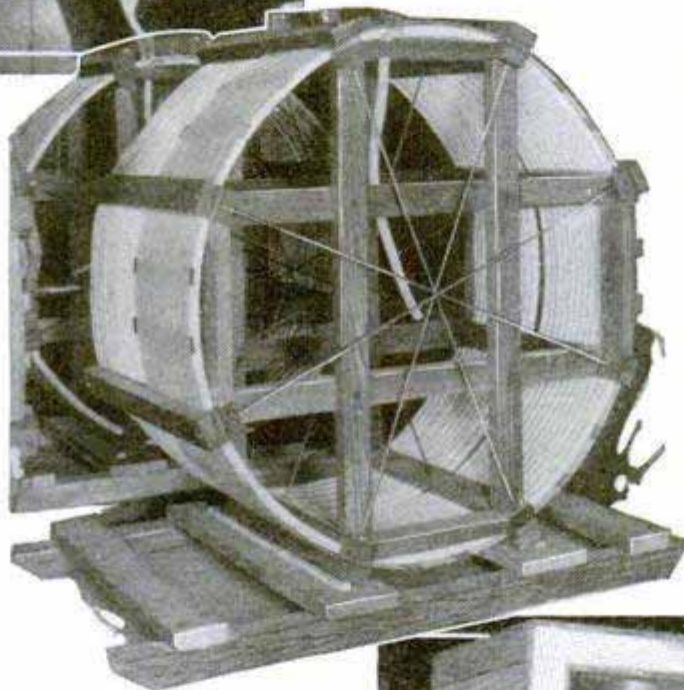

Testing an Office-Vault Lock; a Giant Air-Cooled Test Coil, Five Feet High, and, Bottom, the Bullet-Proof-Glass Testing Range



of them used gases that, under certain conditions, are explosive. Others used poisonous gases. The underwriters had to know that neither type would develop a leak and release the contents. And they had to know that the electrical pumping equipment and its automatic control switch were safe against fire.

So, another corner of the fire and life-hazard department was cleared out, rules drawn up to describe a safe refrigerator, and the testing started. It still continues, as more and more makes and models appear from time to time, and as samples of makes formerly approved are brought in for a check-up test.

All sorts of things come in for test, and many a manufacturer has escaped great loss by finding out the weakness of his device before spending money to put it on the market. They still chuckle in testing circles over the hopeful inventor who solved the automobile-theft problem for all time—to his own satisfaction—by devising a combination lock and siren, the latter supposed to set up a terrific clamor if anyone attempted to tam-

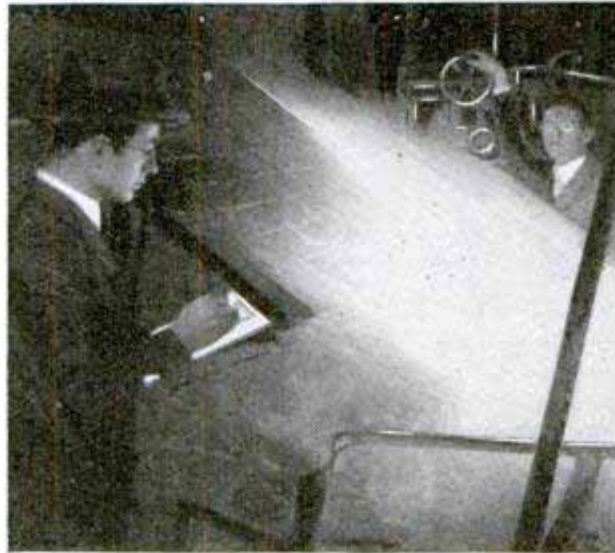
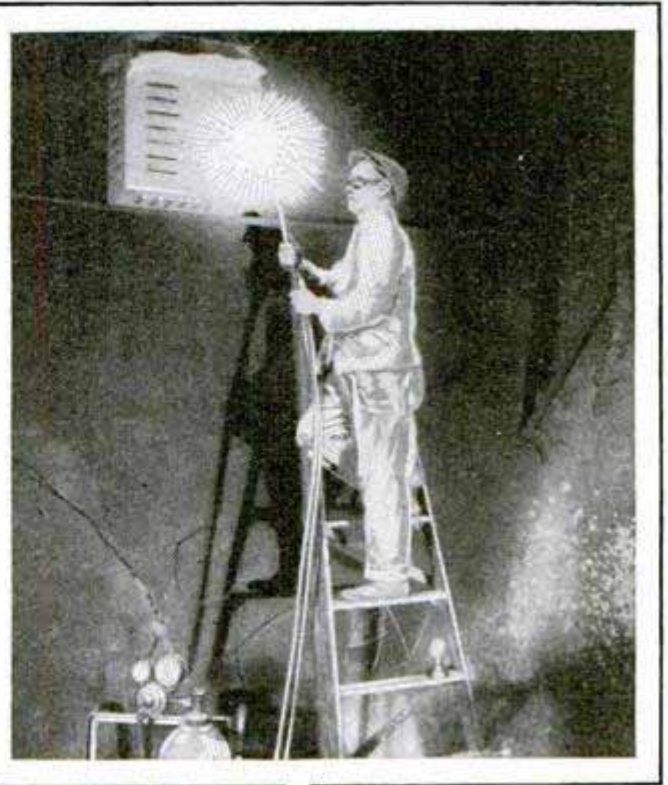

per with the car, and keep on screeching for the police until the owner appeared to stop it.

The inventor equipped his own car, and then drove it around to the laboratory to be tested. He pointed out the car, standing in the street, and stated his wants. The head of the burglar depart-

ment excused himself for a moment, stepped outside to speak to an assistant, returned and completed the arrangements. Then he announced the test was concluded and invited the inventor to look out the window. His car was gone!

The assistant had gone out, picked the lock and driven the car around the corner. Another good invention had been revealed as the possessor of a flaw. If the laboratory had not discovered the weakness, the inventor might have been ruined, and automobile-theft insurance rates all over the country might have taken an upward jump.

A machine shop is maintained in the laboratory just to turn out testing machines. Each problem presented requires

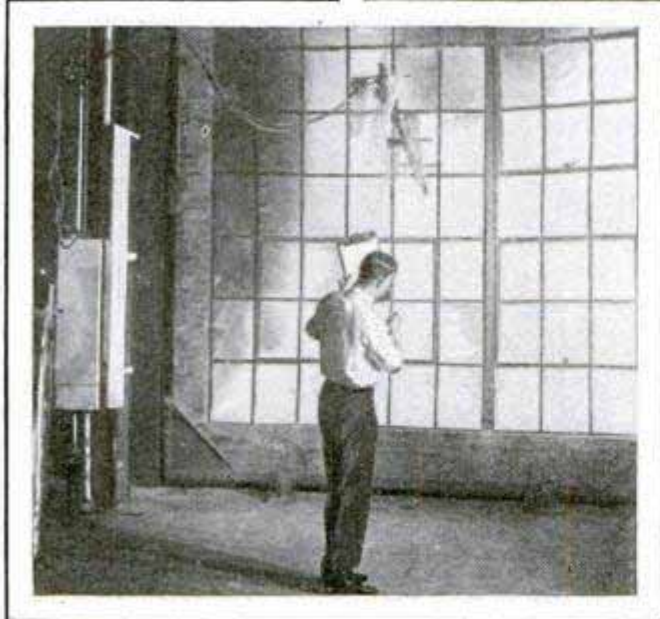

Attacking a Burglar-Alarm Guard with a Torch; a Flame Test on Roofing, and, Bottom, One of the Fire-Window Furnaces





An Experiment to Find Whether the Gas Pump Is Safe from Cigaretts and Carelessly Tossed Matches

ratory wonderland reaches the heights of the spectacular. There is one device on which sections of composition roofings can be laid, just as in actual service, and then long tongues of flames sent swirling up the surface to see how well the material withstands fire. There is a vat in which gallons of gasoline can be poured, a match applied, and the efficiency of chemical fire extinguishers measured by timing how long it takes to smother the fire. There are all kinds of gas-fired furnaces for every kind of test. A pair of them will each take a twenty-foot-square slab of floor and subject it to any desired degree of heat for any required length of time.

When a class-A safe, the best, is to be tried by flame, it is first loaded with old books, newspapers and magazines, to see whether it will preserve its contents intact; then a hole is drilled through the top and a thermocouple introduced within, to make sure the internal temperature never exceeds the permitted maximum of 300 degrees, and another hole bored and a pipe line installed to draw off samples of the

its own means of solution. A device that will sell for a few cents may necessitate the investment of hundreds of dollars to perfect just the machine that will subject it to the wear and tear which, within a few days or weeks, represents years of service.

Did you ever see the inside of an automobile muffler? Few people have, but when the insurance men began writing automobile insurance they wanted to know all about the fire danger, particularly from the hot and sometimes flaming gases that pass through the muffler and exhaust line. In the laboratory, a pair of engines mounted on massive concrete stands form the testing equipment. Not satisfied with ordinary backfires, the testers install spark plugs in the mufflers and ignite charges of explosive gas in them to see whether a powerful blast will tear the muffler to pieces.

It is in the flame tests, though, the labo-

air for chemical analysis, to make sure the fireproofing compound generates no explosive gases under the heat.

The first test is by fire alone, lasting four hours and reaching 2,000 degrees at the end. Then the flames are turned off, and the red-hot mass of steel is allowed to cool for a day or two until a "burglar" squad can force an entrance with steel bars and oxygen torches and examine the contents. Next, piece by piece, the battered safe is torn down until every part can be scrutinized, particularly the condition of the fireproofing between the double steel walls.

If the safe gets by the first ordeal, a duplicate, fresh from the maker's factory, is fitted up the same way, save for the gas-pipe line and inside thermocouple, subjected to the flames for an hour, taken out, hoisted thirty feet into the air, dropped onto a hard concrete floor, and then allowed to cool, so the stresses and strains of contraction may have a chance



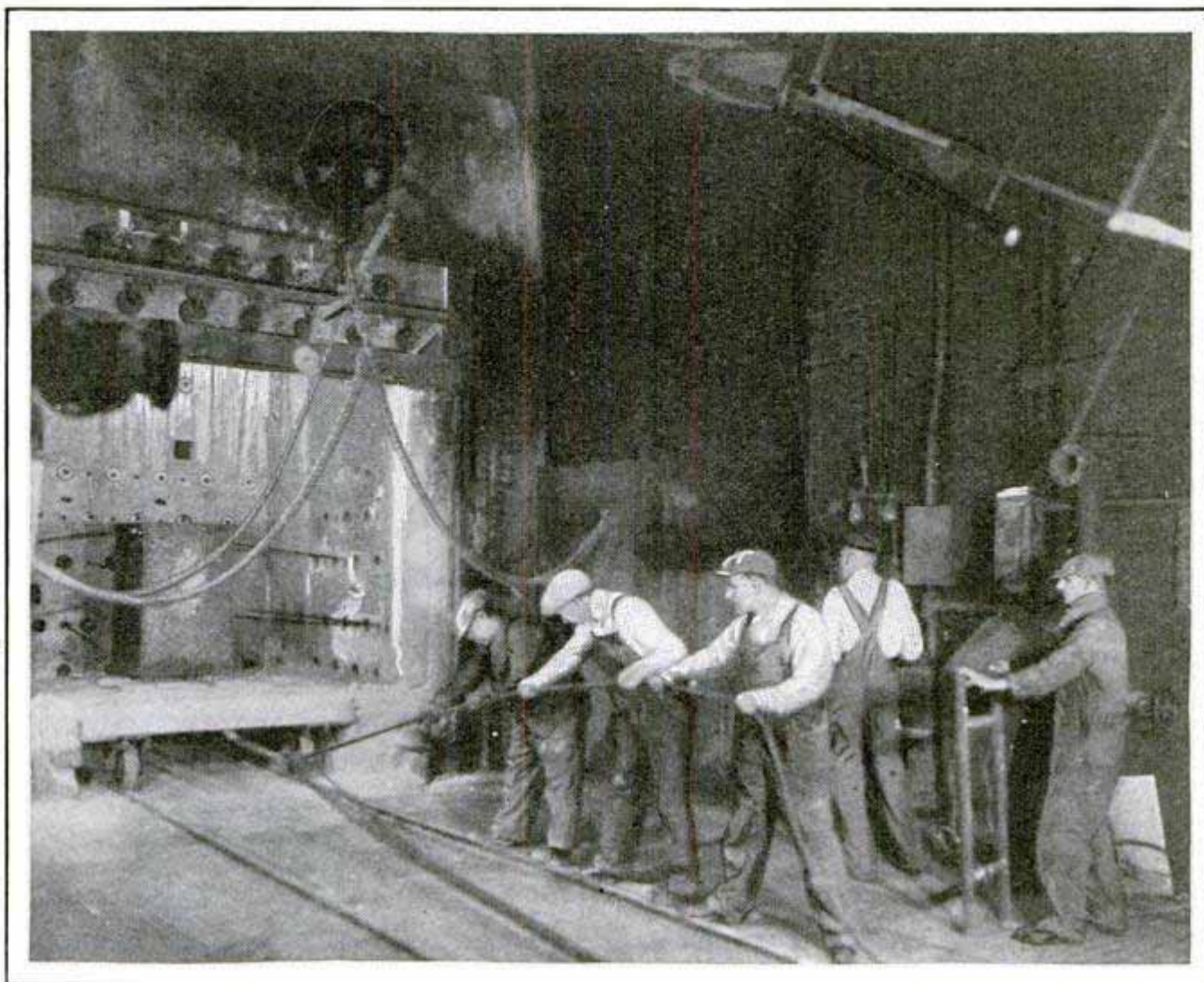

Pulling a Safe from the Furnace, after an Hour of Intense Heat Preparatory to the Drop Test, When It Will Fall Thirty Feet to Duplicate the Drop into a Basement

to rip its joints apart, if they can. When it is cool, it goes back into the furnace, this time upside down, and stands another hour of fire, following which it is opened and the books inspected.

The ceaseless fight against burglars is as thrilling as the battle against fire. First science "perfects" an unbeatable safe, then craft finds a way to destroy it. Science studies the method, and comes back with a superior product, proof against the latest attack. Criminal cunning starts all over again, and the cycle is repeated.

Years ago, the manganese-steel safe was hailed as the last word in burglar-proofness, for it was too tough for the hardest drill, and without a drill the "yegg" could not get an opening in which to plant his nitroglycerin. Then came the oxyacetylene torch, which could burn through even manganese in a matter of minutes. So safes were designed with the idea that, if an enterprising torchman tried to burn

his way in, he would destroy the contents before he could effect an entrance, an argument that was expected to keep the most enterprising yegg away.

But one morning a Michigan banker came down to work and found his fine new safe had been looted during the night—a supposedly impossible achievement. His complaint, relayed by telegraph, brought a platoon of burglar and safe experts to the scene. They found that a master crook had melted a tiny hole through the top of the safe with a torch, inserted a funnel, filled the safe with water, and then proceeded to burn out a section large enough to lift the loot through, while the water protected the paper money from the destructive heat.

In recent years, the manufacturers have concentrated not on building safes that can't be burglarized—for they agree that is impossible—but on safes that will require more time and tools than the burglar can bring to bear.



Photographed While Making a Steep Bank, the Big War Plane Reveals Its Huge Projectile, the 2,000-Pound Torpedo Carried on the Underside of the Fuselage

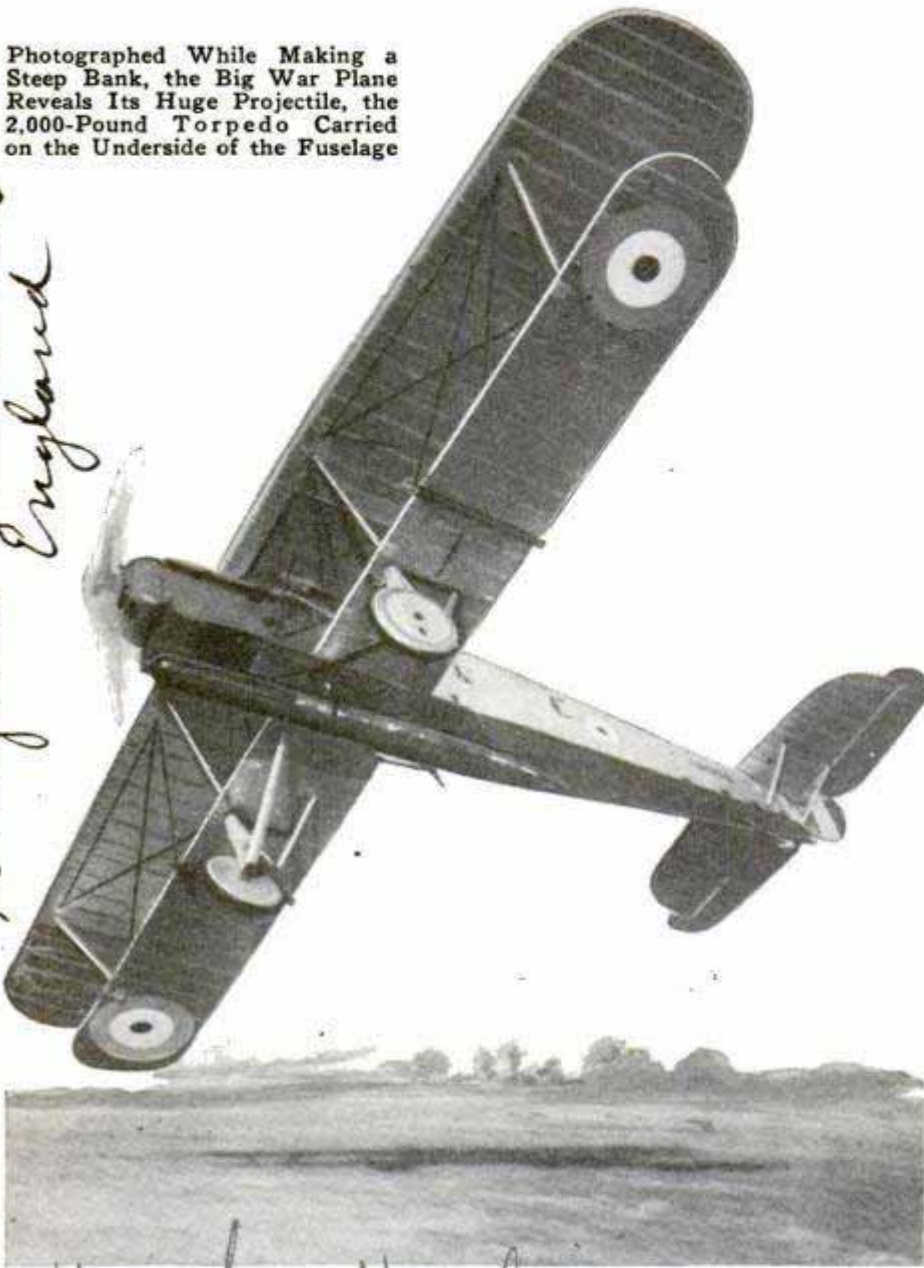

*Makers - Probably H. S. Hawker Mfg Co. Kingston-on-Thames England*

**BIG AIRPLANE CARRIES TORPEDO WEIGHING ONE TON**

A torpedo, weighing 2,000 pounds and capable of sinking a battleship if exploded at the right spot, is the formidable weapon carried by a huge English airplane. The projectile is attached to the bottom of the fuselage and is launched with special apparatus. In spite of its heavy load, the plane is a fast one and is easily handled in the air.

**SHOTGUN FIRED UNDER OCEAN TO MEASURE ITS DEPTH**

How a shotgun served the cause of science is the story recently reported from the non-magnetic yacht "Carnegie," which is now making a scientific tour of the

south Pacific. The vessel's oscillator, which sends out sound waves from the keel to the bottom of the ocean so that a measure of the water's depth may be obtained by timing the return of the echo, was out of commission, and, for a time, the scientists were at a loss for a substitute. Finally, a shotgun was attached to the end of a pipe which was extended twenty feet below the surface of the water. When the gun was fired, the sound waves traveled to the bottom and returned as an echo, just as they did with the regular apparatus. Capt. J. P. Ault, commander of the "Carnegie," said that the shotgun method checked well with depth measurements made by lowering a sounding wire to the bottom.

**RARE PINK WOOD IS FOUND IN ZULULAND**

A sample of rare wood is now on display at the Field Museum of Natural History. In days past, possession of the material by anyone except a king was an offense punishable by death in Zululand, where the wood was found by Bruno Lessing after a search of three years. Its rarity is indicated by the fact that the whole country was combed for a bit of it two years ago when the Prince of Wales wanted a piece suitable for a cane, but none was found. The museum sample was presented by Prof. Samuel J. Record, research associate in wood technology. The wood is of a delicate shade of pink and in hardness and appearance is like ivory. Spears of it were symbols of regal authority among the Zulu leaders.

China is one among the best of America's customers for dyes.

2038

2013

*Science Museum Letter*







2018



Safety Belt for Traffic Policemen with Its Red Reflector in the Center

### RED-SPOT BELTS FOR POLICE GUARD THEM FROM AUTOS

Policemen in an eastern city are being equipped with belts that have red reflectors on them so that motorists, driving at night, will be less likely to run into the officers. The plan was devised by a sergeant of the city's police department and also recommends that spotlights have red lenses to give the traffic men additional warning of cars. These reflectors are commonly known as "cat's eyes."

### SEA DIVER HELPS BUILDERS DIG FOUNDATIONS

To help sink foundations for the new department of commerce building in Washington, D. C., a deep-sea diver was engaged. He descended several feet below the water at the bottom of the excavation to dig a well from which water was pumped to reduce the pressure in the surrounding area. So far as known, this was the first time a diver had been employed on a building at the nation's capital.

*Emil Aronberg*

### GOLD FOUND IN THE ANTARCTIC TO BE MINED WITH STEAM

Rich deposits of gold that may be mined with steam jets are likely to be discovered in the Antarctic, according to Sir T. W. David, an engineer who is familiar with the lands far to the south. He found seams of coal in the cliffs of the great Beardmore glacier, and under the coal are formations of granite and clays where gold often is found. Should the metal be discovered, there would be abundant coal to make steam for mining operations. In ages past, the Antarctic regions enjoyed a mild climate and were covered with dense forests of pines and ferns and with swamps, geologists believe. Gold fields are now being worked at Tierra del Fuego, at the tip of the South American continent. They are a part of a formation that extends far into the Antarctic.

### AWNING AND SCREEN IN ONE PREVENTS DRAFT

Window awnings and two screens have been combined by a western inventor to keep out rain and drafts when the sash is raised. The entire outfit is collapsible and easily taken off or installed. The

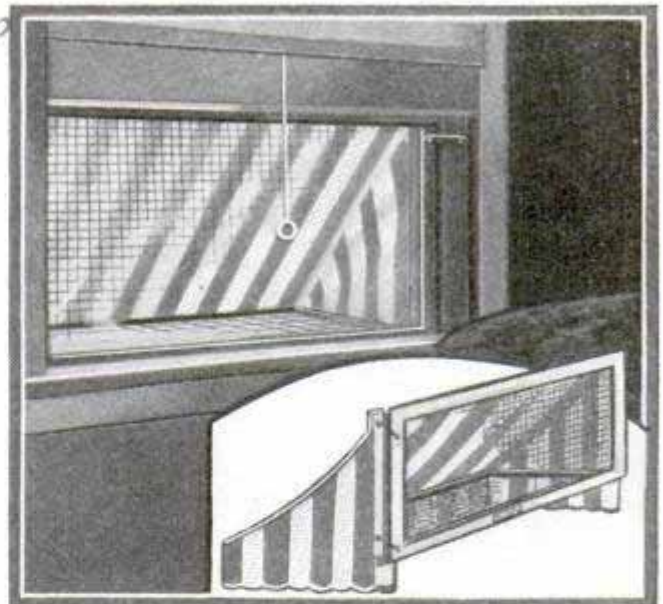

Awning and Screens Combined Allow Window to Remain Open When It Rains

awning may be used at the top or the bottom of the window as desired.

Many kinds of insects injurious to crops are devoured by sparrows.

*Frank E. Holzman*  
926 Twin Peaks Blvd

*Chicago Warming Unit*

1995



Montgomery Ave  
Bethesda, Md

# Where House Heat Goes

**M**ISTER Average Householder does not realize complete home-heating, efficiency from the winter supply of costly fuel that he burns because his residence is not properly insulated.

Downstate in Illinois, where one of the largest universities in the world is located, eminent engineering experts have built a remarkable low-temperature testing plant which is being used in part to determine where house heat goes and how to save it.

If you doubt that losses of heat occur through walls, floors and ceilings in uninsulated homes, scan the following facts carefully and change your opinion on this subject.

A recent tabulation of the heat losses from 200 average uninsulated American homes, located in New York, Michigan and Ohio, explains concisely how Boreas, Jack Frost and King Winter apparently conspired unintentionally with ordinary builders to waste valuable heat with which these home owners hoped to keep their houses warm and comfortable in the coldest weather. The loss of heat through walls averaged twenty-seven per cent, while the loss through glass windows and doors amounted to 25.8 per cent. Another 24.6 per cent of the heat units stole away by infiltration—the leakage of heat through air cracks and crevices. The ceiling as a wastrel of house heat allowed 16.2 per cent of the warmth to filter outside instead of keeping the home family comfortable. A final loss of 4.3 per cent of the heat supply through doors ended this disagreeable picture of fuel extravagance.

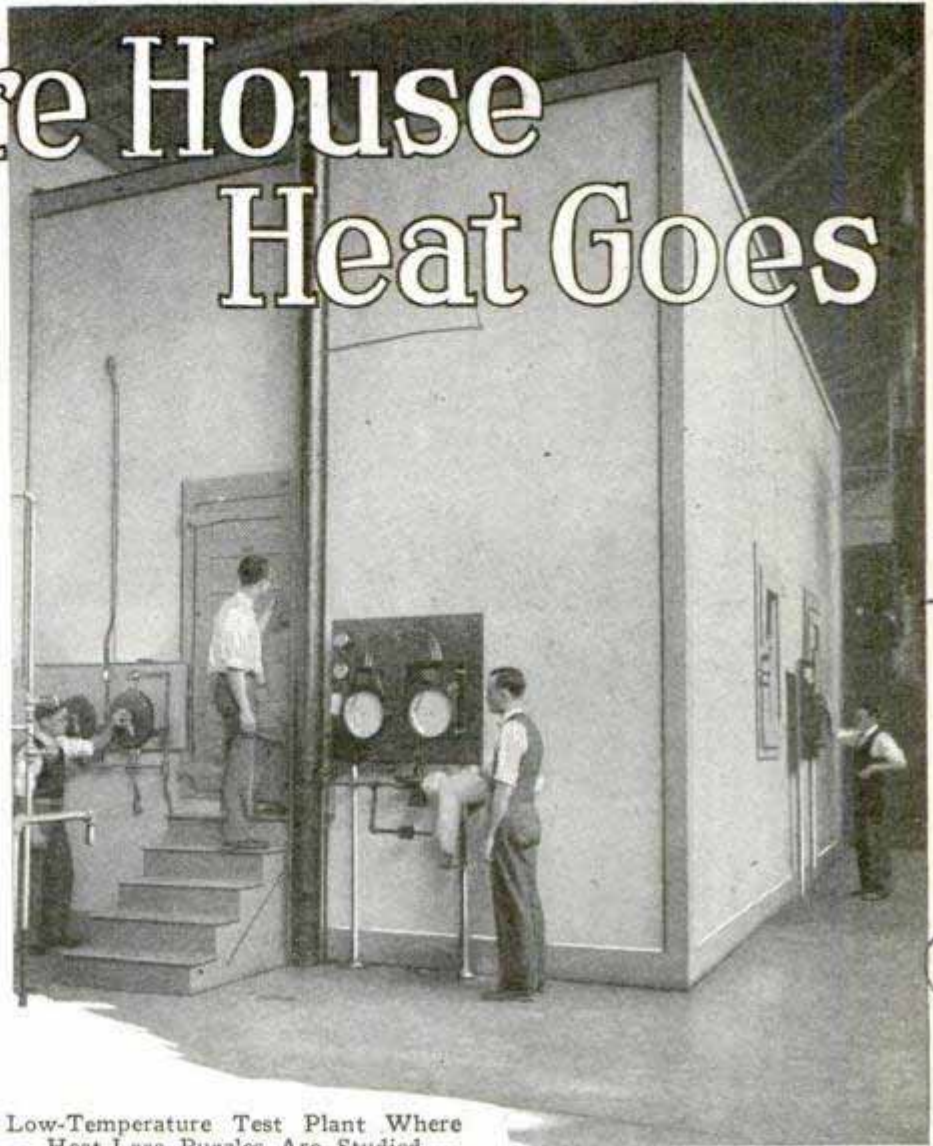

Low-Temperature Test Plant Where Heat-Loss Puzzles Are Studied

In co-operation with the National Boiler and Radiator Manufacturers association and the Illinois Master Plumbers association, the University of Illinois is now making tests of steam and hot-water heating systems in a modified constant-temperature chamber built in the form of a house within a house.

The novel low-temperature testing plant has been erected in a large engineering laboratory. The outside walls of this proving ground of heat distribution are composed of six inches of corkboard—efficient insulating material. Two walls of standard construction for the two identical test rooms, respectively, with large air spaces under the floors and above the ceilings, are incased within the insulated structure so that the heat that filters from them under varying conditions may be measured. The insulated walls of the large refrigerated room form the two remaining walls of each of the test rooms.

National Boiler and Radiator Manufacturers Association  
29th Street  
St. Louis, Mo.

Engineering Dept. Cooper. 443





The exposed inner walls can be changed on the completion of each experiment. In this way, all types of building material and insulation can be tested thoroughly. Accurate knowledge of the efficiency of every material will result from the research, which will be continued for several years, or longer, until all the riddles of house insulation and the prevention of heat losses have been ferreted out.

The basement and attic spaces aid in exposing the floors and ceilings of the twin test rooms—each is nine by eleven feet in dimensions and nine feet high—to air of any desired temperature. The basement spaces resulted from elevating the floors of the two “scientific cells” two and one-half feet above the floor of the refrigeration chamber, while the attic space was obtained by building the test-room ceilings three feet below those of the cold-insulated chamber. These overhead and underfloor spaces, as well as the other unoccupied space in the cold chamber, can be heated to any desired temperature.

By means of the system of refrigerating coils, the series of electric heaters and an adequacy of ventilating fans, placed at key positions within the cold chamber, the scientists can duplicate any range of conditions which might exist in a house, while they also can simulate practically all outdoor conditions except rainfall. The simple readjustment of control devices can shift the temperature from arctic cold to tropical heat in record time. The weather generated in this testing plant is capable of constant control and regulation to the fraction of a degree.

The various points in the test rooms where heat escapes during any of the experiments are “spotted” forthwith by reliable “patrolmen”—the many electrical temperature recorders which are distributed here, there and everywhere throughout the walls,

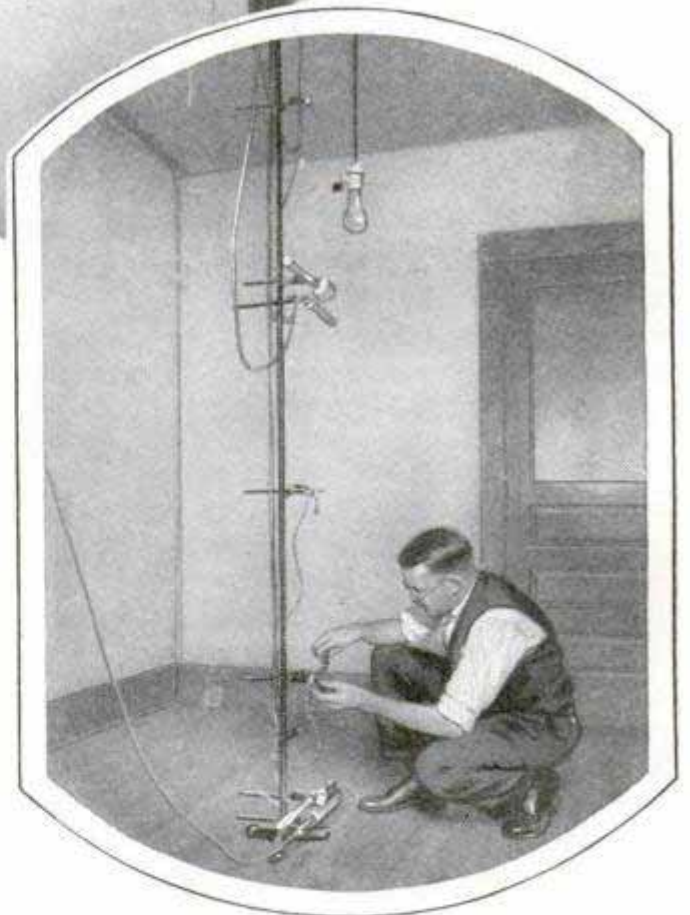
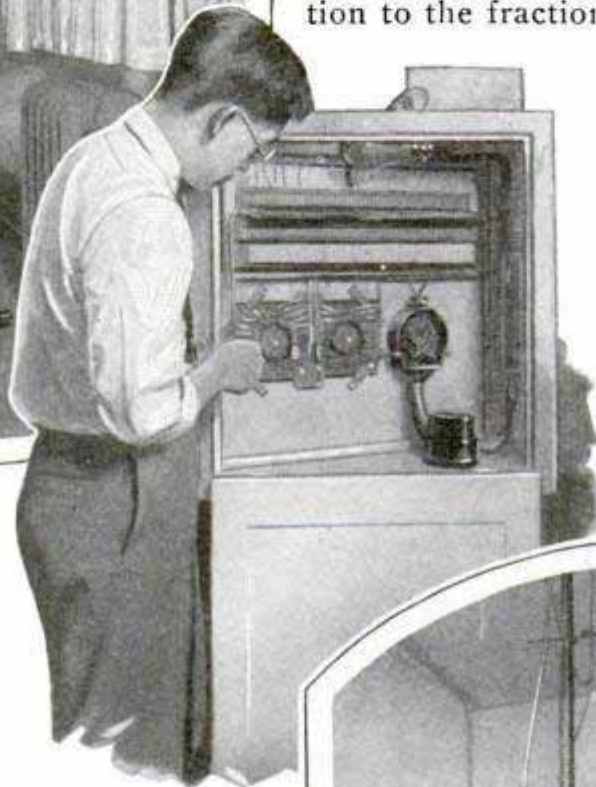

Tracing Air Currents with Fumes; Examining Heat Recorders, and Adjusting Thermocouples at Different Distances above the Floor



floor spaces, ceilings and in other strategic positions where they may detect run-away heat. The customary practice during one of the tests is to maintain a standardized temperature of zero in the cold chamber while the thermometer stationed at the normal breathing line within either of the test rooms simultaneously records seventy degrees Fahrenheit. In a word, the experimental radiator or other heating unit under test is made of such size and heat-distributing capacity as to maintain that temperature constantly.

A temperature as low as five degrees below zero can be maintained in the cold chamber as long as desired, while the efficient utilization of electric fans facilitates the accurate imitation of wind action on and in the walls of the research rooms. Ordinarily, the tests are conducted under still-air conditions, but in a certain test, if a miniature wind storm is desired, all that is necessary is to switch on the battery of electrical fans and to study their effects on the normal heat losses which occur under such conditions.

An interesting feature hinges on the "smoke tests," which are made to observe and register the movements of air currents in the test rooms during the multiplicity of heat-loss experiments which are being carried on. By use of a metal stand with adjustable shelves for dishes of chemicals, which can be raised or lowered as desired, white fumes are liberated at various distances above the floor and below the ceiling. The drift of these fumes produces a tangible record of the direction in which the air currents are moving.

There are two windows in each test room, located in one of the exposed walls which face the cold chamber and its icy blasts of winter weather. There is also a door leading into each room and a central passageway between the two rooms. The outer door is insulated and of heavy

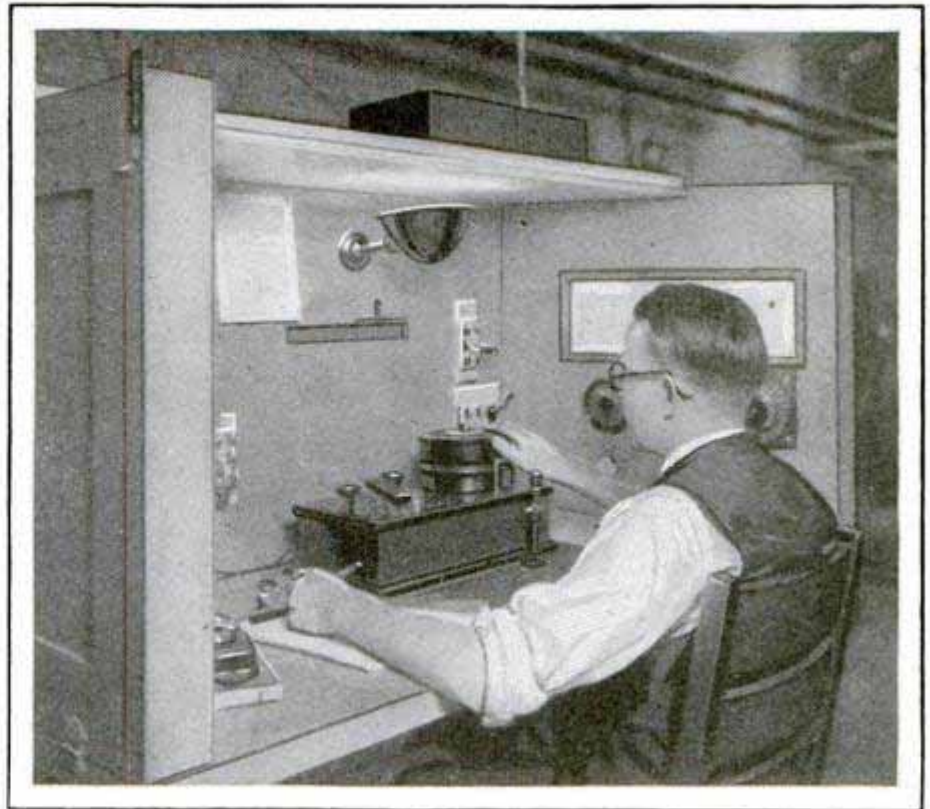

Tabulating the Records as They Come In by Wire during One of the Heat-Loss Experiments

refrigerator construction, as it is the outlet through the cold chamber. The test radiator, shown in the accompanying illustrations, is located in the usual position directly underneath the windows. The plant is adapted, however, for testing any type of house-heating equipment placed at various locations in the room, or in the exposed walls as invisible sources of heat.

In certain homes which appear well-built and comfortable, as much as one-half of the average winter fuel supply is wasted in vagrant heat which shirks indoor work and flows away through uninsulated floors, ceilings, walls, windows and doors, it has been shown. A thorough insulation of the ceiling may cut down one-half the normal heat loss through that part of the house at once, but it may represent only one-tenth of the total heat loss from the room.

Plaster-and-lath construction for walls and ceilings, so builders say, is only about one-half as retentive of heat as similar construction where the dead-air spacing between the studding is filled with satisfactory insulating material. This is true where wall area alone is considered without any reference to window openings. Storm windows are more satisfactory in reducing heat losses through windows



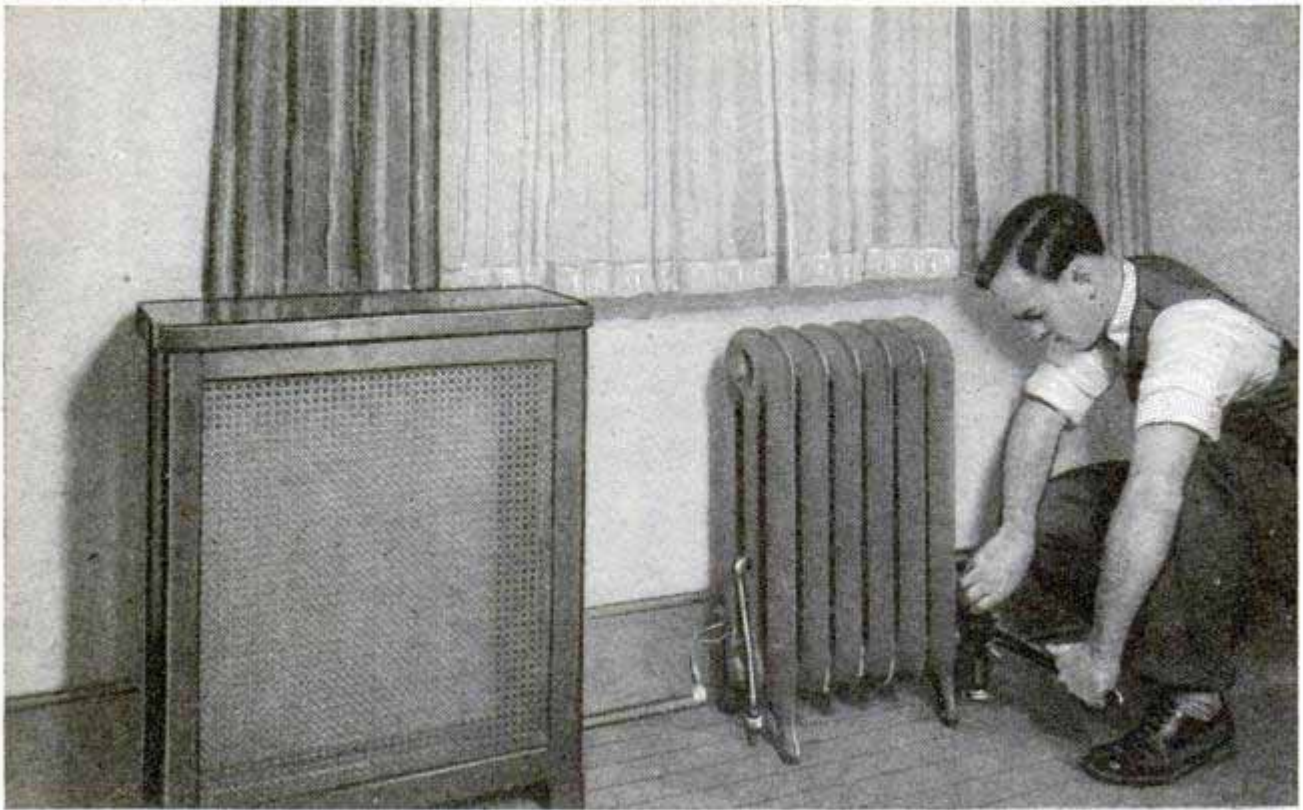

Installing a New Heating Unit in One of the Test Rooms; the Exact Amount of Heat Produced Is Measured by a Simple Steam-Condensation System

than the ordinary metal weatherstrips, because the latter only check the flow of air through cracks while the former reduce the heat transmission through the single pane of glass by providing a dead-air space between the two glass surfaces.

It is safe to say that the heat losses in the 200 typical homes in the cold-weather belt, referred to previously in this article, could be reduced from one-third to one-half by practical modern insulation methods, the use of storm windows, calking the window frames and door frames with oakum or similar material, and filling the dead-air spaces in walls and above ceilings with suitable insulation.

The important research at the University of Illinois will yield facts and figures which will aid potentially in stamping heat losses and costly fuel waste from the calendar of winter worries of the average householder. This will in the future save billions of tons of coal. Our homes will be maintained at stable temperatures during cold weather and, under normal circumstances, a measurable reduction in mysterious drafts will be apparent.

Engineering research, by its remarkable heat-loss tests in the house within a house, adds another scalp of worth-while achieve-

ment to its many trophies of successful accomplishments.

### CLAMP TO HELP HOLD WORK LEAVES HANDS FREE

To hold strips in place for nailing, and for many similar tasks, a spring clamp is al-

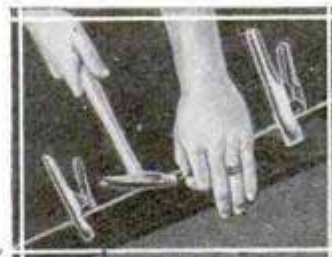

most as useful as an extra man, for it leaves the hands free. It snaps in place in a second, has a strong grip and is handy on many occasions.

### DESIGNS ON NEW PAPER MONEY TO CURB RAISING BILLS

Fraudulent alteration of bills will be practically impossible with the new, smaller paper money soon to be placed in circulation. The principal reason is that the designs are restricted. For example, George Washington's portrait, which has been on both one-dollar and twenty-dollar gold certificates, will appear only on one-dollar bills of the new issue. Other designs will be confined wholly to certain



*Levy - Michael Harry Wiener*

denominations. According to careful estimates, the new money will save the government at least half a million dollars in its paper bill annually. Four additional notes will be made from a sheet of paper. In the opinion of W. H. Moran, chief of the secret service, the new bills will not stop counterfeiting although they will make the task no easier, for it is just as difficult to counterfeit a small note as a large one.

*Quartermaster Corps*

### ARMY BLANKET RESISTS WATER AND IS TWICE AS WARM

Said to have twice the warmth of the usual kind and be more resistant to water, an improved blanket has been developed for the army. In a test, one was subjected to water for sixty hours, but was not penetrated although no waterproofing compound was used. The material is light in weight, can be manufactured in any worsted mill and will make excellent lining for trench coats.

*1909  
see Oct. 1919 506*

### WINDOWS THAT TIP INWARD MORE EASILY CLEANED

Both upper and lower sash of improved windows pull inward from the top and lie flat, locking at a convenient height for washing from the inside. In an upright position, they move up and down freely. The sash can

*1587 1/2*



Window in Various Positions, to Show Ease of Cleaning It from the Inside

be installed in old or new frames.

*The Car Mfg. Co.*

### ALL-METAL AIRSHIP TO TEST CONSTRUCTION THEORIES

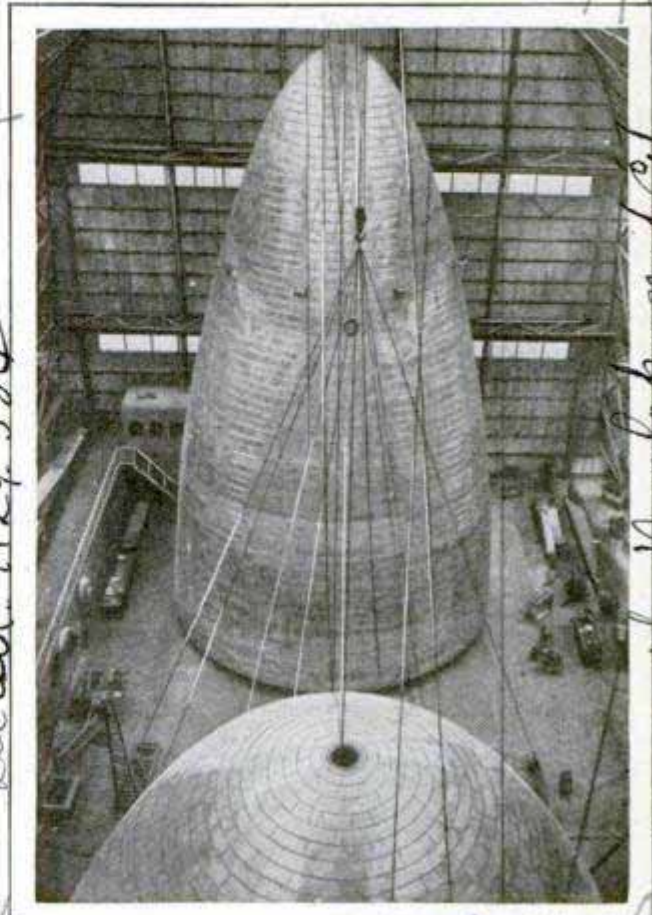

Sections of the All-Metal Airship, Being Prepared for Assembly and Trial Flight

Flying engineers are awaiting with interest the completion of the navy's all-metal dirigible, scheduled for launching at an early date at a Detroit plant. It is 150 feet long, fifty feet in diameter and is made of duralumin instead of fabric. The "bag" part was made in two huge sections, as shown in the accompanying illustration, and then fitted together.

### ELECTRO PROCESS FOR PATTERN ELIMINATES SHRINKING

Patterns for making metal objects are prepared in copper by a recently developed electric process for which several advantages are claimed. Among them are an elimination of shrinking as now occurs when making a pattern in the ordinary way from a master pattern of wood or metal; economy of time and labor when many patterns are made; elimination of machining, and greater accuracy. It is stated that the error in patterns made by this process is within .003 of an inch.

*Electro-Chemical*

*1919*

*Aircraft Development Corp  
Det. Detroit Aircraft Corp*

*Wide World*

*3975 Beard Tail Ave.*



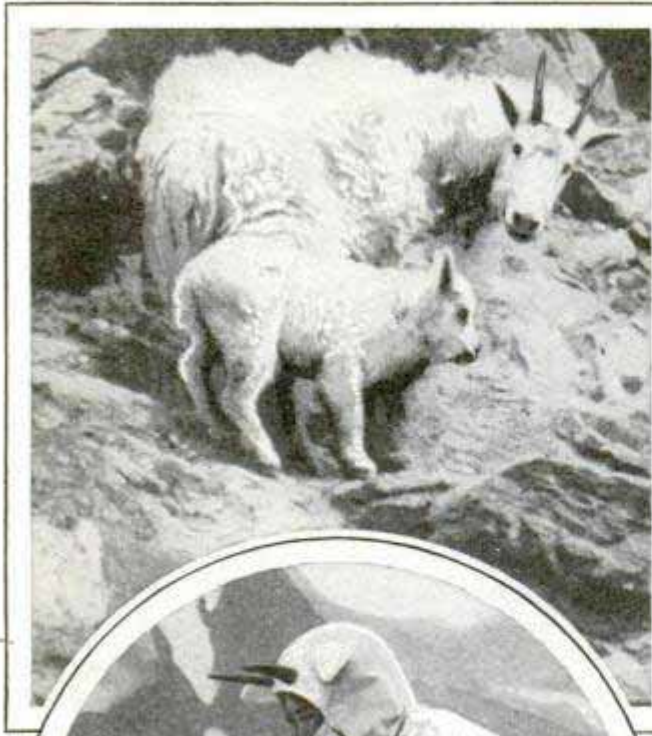

Rare Snapshot of Mother Goat and Young, with Views of Photographers in Disguise

### HUNTING GOATS WITH CAMERA REQUIRES DISGUISE

Photographers with a recent expedition in the Rockies wore white costumes with horns and whiskers while stalking mountain goats with their cameras. The disguise was of aid in helping the men to approach the animals, which are exceedingly wary and difficult to photograph.

### FLOWERS KEEP FRESH LONGER WITHOUT CHEMICALS

Cool, fresh water, without the addition of chemicals, is the best medium for preserving the freshness of cut flowers, tests at the Boyce Thompson institute for plant research have shown. More than forty-three chemicals were used in the experiments, but comparison with flowers that were kept in plain water clearly indicated

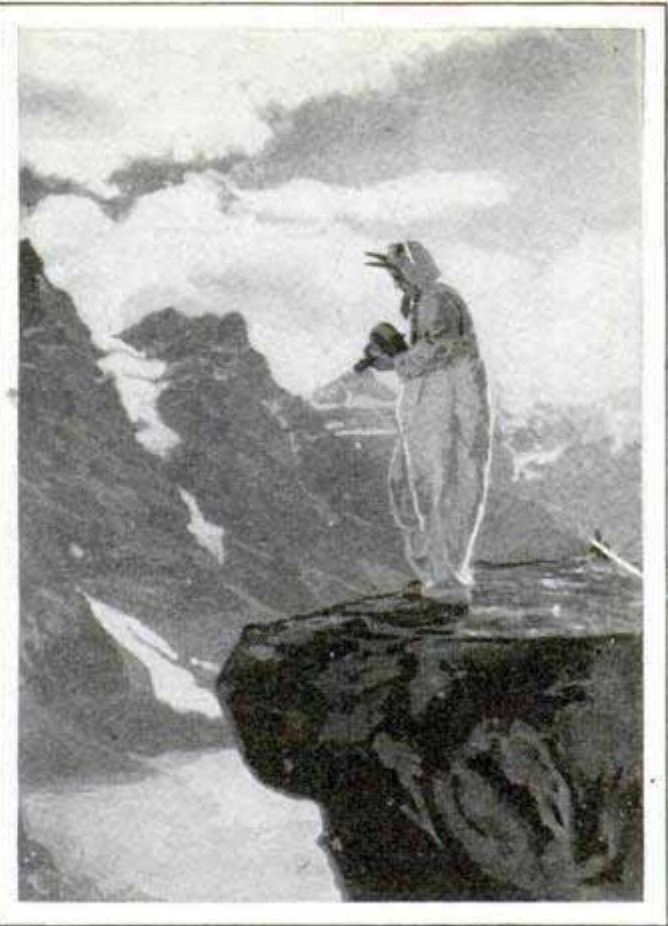

that the substances did not add to the life of the flowers.

### EDISON EXPLAINS COST FACTORS IN PRODUCING POWER

Generating electric power at a hydroelectric plant is but a small part of the total cost, Thomas A. Edison recently explained. Often, from seventy to ninety per cent of the total expense comes in delivering the electricity to the consumer after it has left the generating station. The real test of economy in electric-power production lies in the final cost of the energy when it is delivered to market, he pointed out. "Approximately eighty per cent of the undeveloped water power of the country lies in the Rocky mountains and in the Pacific coast region," he said. "The large market for power, unfortunately, is east of the Mississipi. Great as have been the advances in transmission of electricity, the art has not yet reached a stage when it is probable, or even possible, that electrical energy can be transmitted from the Pacific to the Atlantic." He showed that about seventy-two per cent of the country's water power is in territory embracing only twenty-one per cent of the country's power requirements.

started by A.S. Hitchcock. The more I read of the animal society

11-11-11

4-12-12 Santa

Public Service news 12/24/18 - Texas Publi







# Taming the

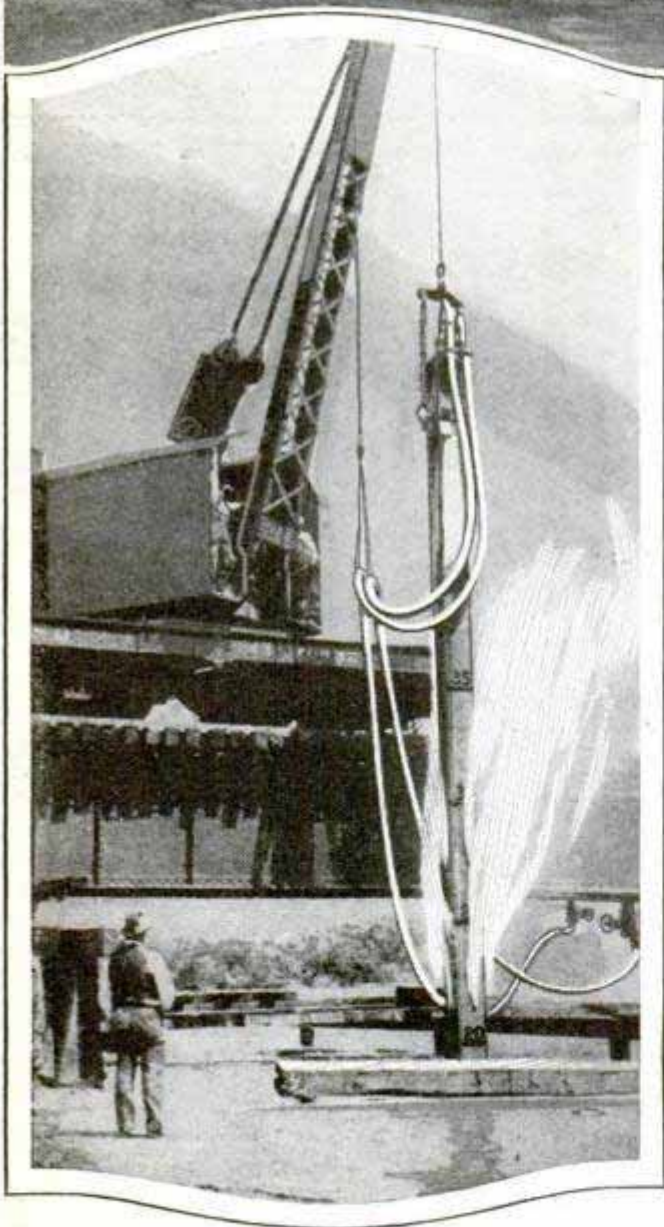
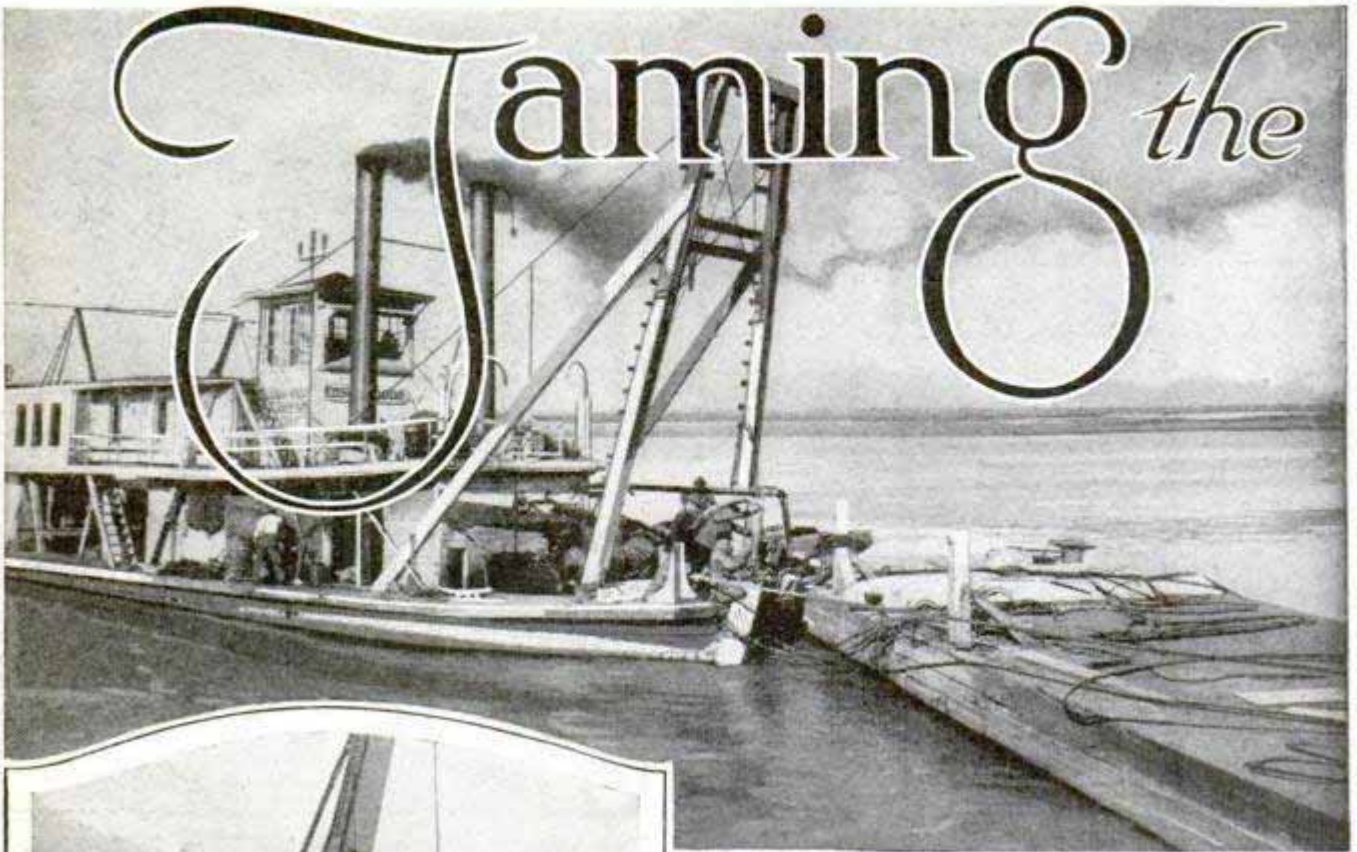

Sinking Bignell Pile from A-Frame Derrick and from Railroad Viaduct; Note Side Jets of Water

By PAUL D. PADDOCK

A PERPLEXED engineer stood watching a pile driver at a bridge site on the Platte river. With every stroke of the big hammer, the pile would go down several inches, but, to the engineer's disgust, it would bounce back again. Quicksand! It held the pile as in a mass of sponge rubber. Caissons were out of the question. The engineer pondered and then necessity gave birth to an idea.

For some time, on jobs such as this, engineers had been using a pile with a hole running the full length of the center, through which a column of water was forced at high pressure to clear away sand at the bottom, but this plan worked only moderately well, for, in quicksand especially, the material closed tightly about the body of the pile along the sides. Edward Bignell, the worried engineer, made a great improvement. He was unaware of the fact at the time, but his idea was to prove an important factor in one of the most romantic undertakings of all ages—man's struggle to control the mighty Mississippi system, that great network of rivers which drains more than forty per cent of the United States all the way from



# Father of Waters

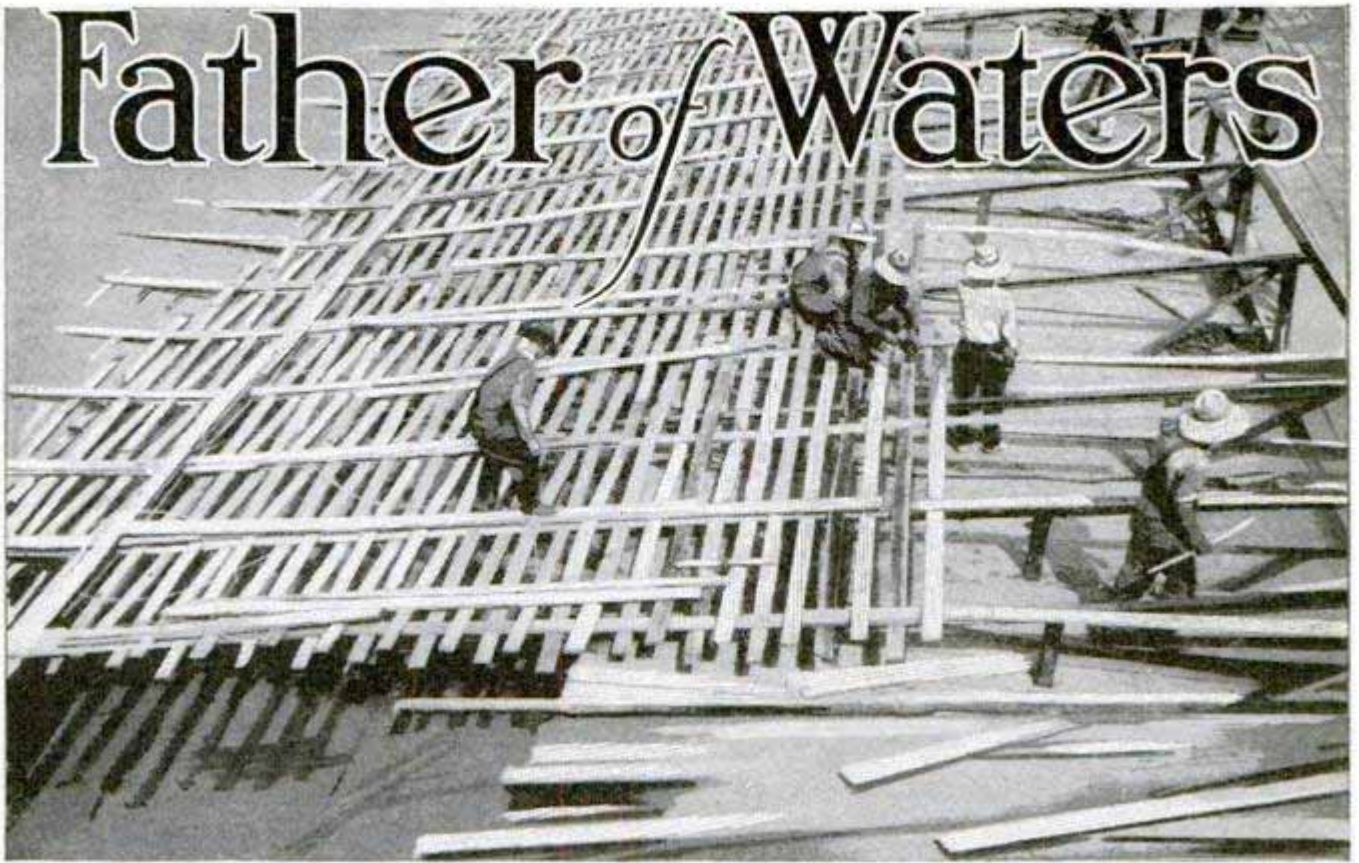

Weaving Timbers to Form Retevment for Strengthening a River Bank: This Mattress Is Spread Well Up on the Shore and Out in Stream, Weighted with Rock and Sunk

the Alleghenies to the Rocky mountains.

He bored crossholes in the pile at intervals of about four feet, forming side apertures leading from the central passage. Water, gushing out of these openings, surrounded the pile with a film of liquid, keeping the sand from squeezing around it. He made a still further improvement. He projected the side jets upward by attaching upturned nozzles to the openings. The result was something like a downward-speeding skyrocket that burrowed its way through the sand and kept on going until it came to rest on a hard stratum to help form a stanch foundation for the bridge.

He wisely patented the pile, and shortly occurred the second episode in this interesting chain of events that were to have such an important effect on America. He called one day at the office of a friend, Mark Woods, president of the largest organization in the country engaged in the protection of property along river and other water fronts. It happened that Mr. Woods had purchased a Missouri bottom farm that was disappearing in chunks at the rate of 100 acres a year as the river gouged out the banks and swept them to

the Gulf. In Bignell's pile he saw a means of permanently anchoring retards to slacken the river's speed and thus make it dump part of its load and build up the land instead of tearing it away. For years, the retard idea had been employed, but the structures did not last. They had insufficient anchorage. A flood or an ice jam—and out they went, carrying with them the land that had been piled up, plus a few acres of the richest soil on earth. Careful measurements have shown that, between its mouth and Sioux City, Iowa, the Missouri river alone is carrying away more than 10,000 acres of land every year.

Mr. Woods hired men to place retards along his farm and anchor them with Bignell piles. They held. His land stopped slipping away and began to grow. Bank erosion was effectually counteracted. Before long, his company was installing these retards for other property owners and for railroads whose tracks and bridge crossings were constantly in danger of slipping into the stream. The business grew by leaps and bounds.

Today, the Woods organization employs between 1,500 and 2,000 men on its river

Woods Bros. Construction Co.



projects and uses 120 river craft of various kinds, including a dozen steamers, interesting stern-wheelers of the packet days, now busy at the useful task of helping to subdue the streams over which they have struggled for so many years. Just recently, the company has completed more than forty projects along the Missouri alone, while work has been done or is under contract on nearly every important river in the United States where similar conditions demand protective measures. The company has a six-passenger airplane for inspection and survey work over sites of operations. In an hour, engineers in the plane can learn more of the require-

and the location of works in relation to each other can be determined accurately and quickly.

The Bignell pile, purchased by Mr. Woods primarily to save one of his farms, has thus turned out to be a magic-working aid for the entire country. Along the Mississippi and Missouri rivers, the piles are often sunk to a depth of forty to sixty feet below the stream bed. The river piles are like gigantic needles, fifteen or twenty feet long, sixteen inches square and weighing from 3,600 to 3,800 pounds each, threaded with 1,600 feet of inch or inch and one-half steel cables which, in turn, are securely lashed to the retard itself, a

barrier of trees tied together with the butts pointing upstream and the branches down.

These barriers, or retards, are placed in series at proper intervals, from three or four to twenty-five or thirty being used at the same locality, depending upon conditions.

The first one, that is, the one farthest upstream, may extend fifty

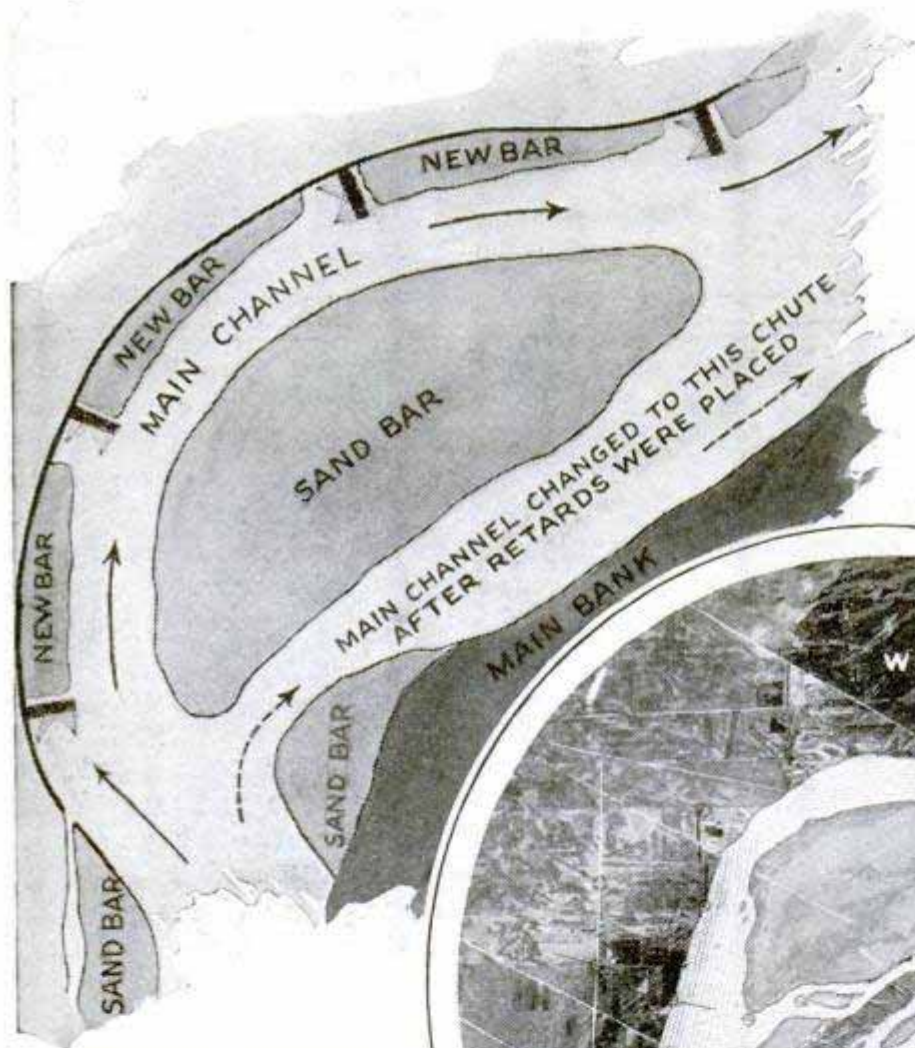

Drawing to Show How Retards on Concave Side of the River Bend Cause Formation of Land to Prevent Further Destruction, and Aerial Photograph of Missouri River near Lexington, Missouri

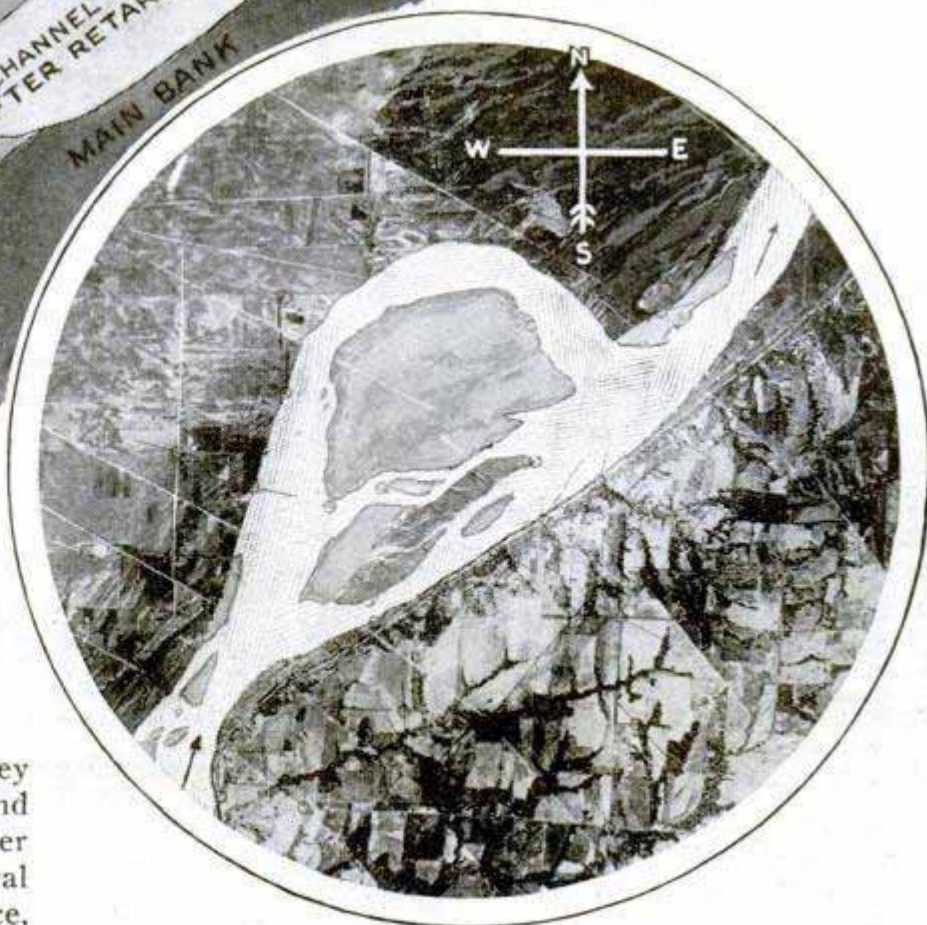

ments of a project than they could in days of ground surveys, because the river can be seen over several miles of its course at once,



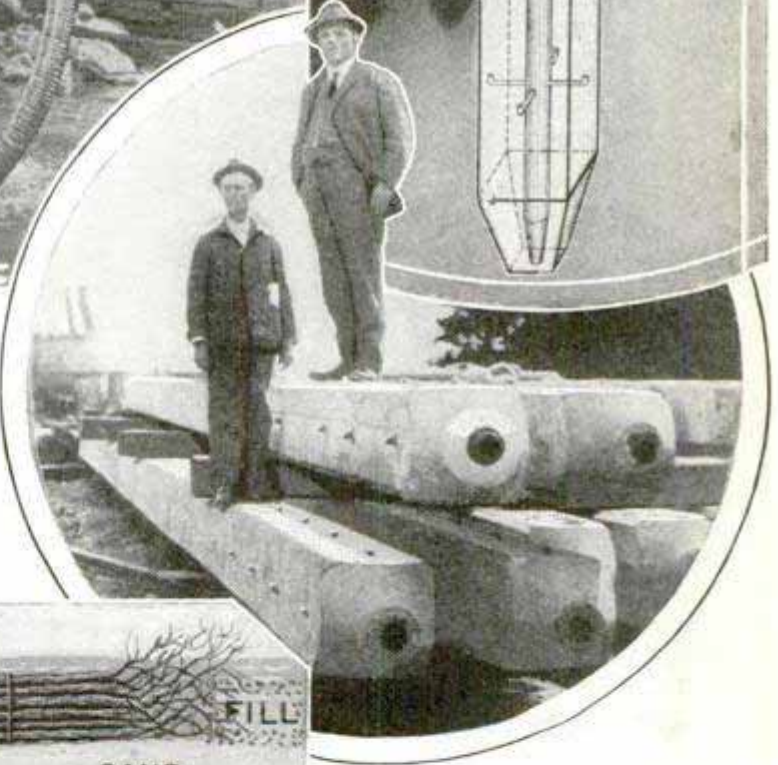
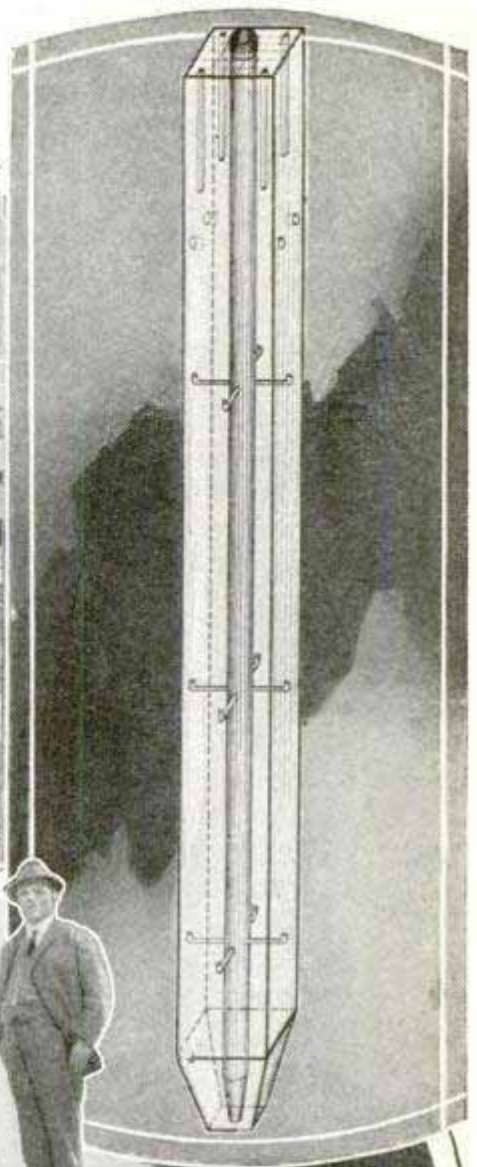
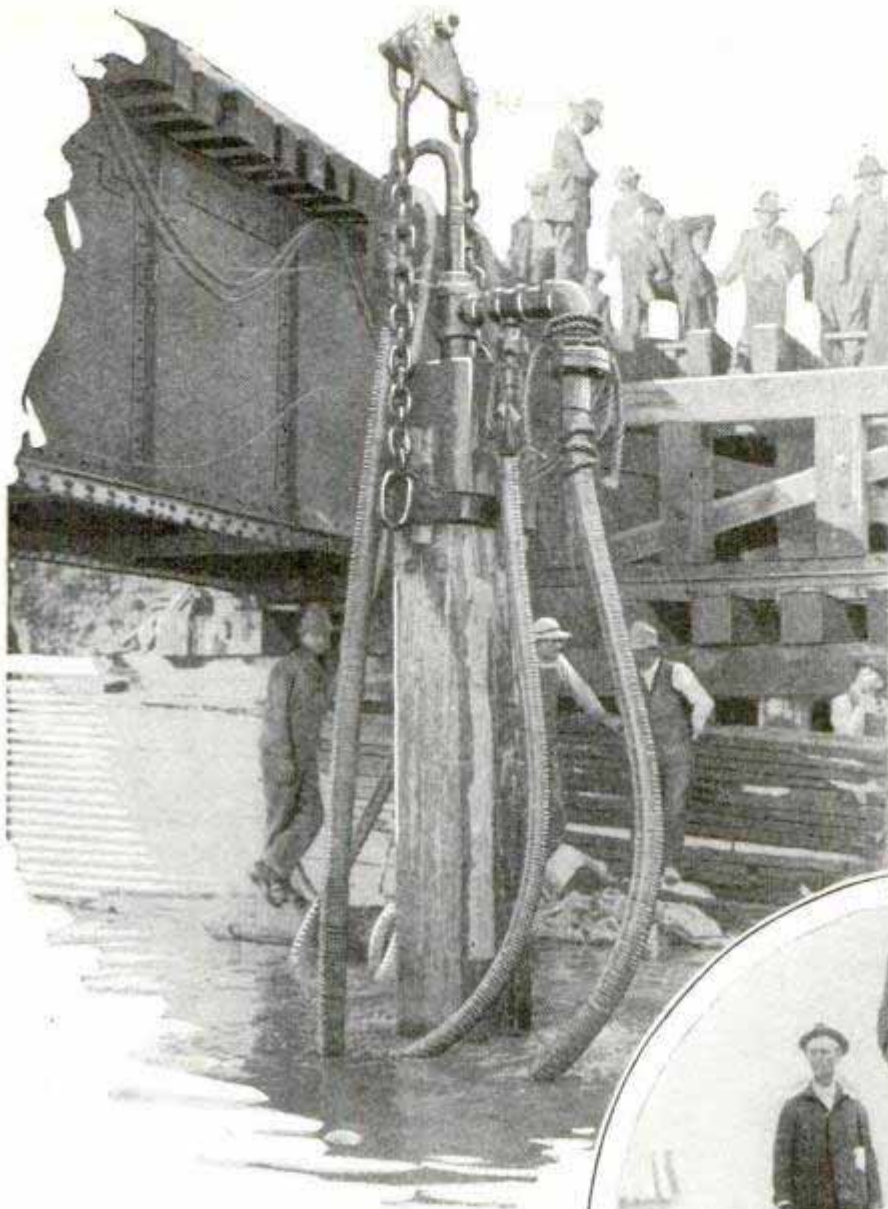

Hose Connections for Forcing Water through Pile; Drawing to Show Water Ducts in Pile; in Circle, Edward Bignell, the Inventor, Is Standing on Top of Pile, and, Below, Drawing That Explains the Secret of Retard's Effectiveness; Note How Far the Pile Is Sunk below the Possible Level of the River's Scour; Retard So Anchored and Tied to Cables Cannot Wash Away

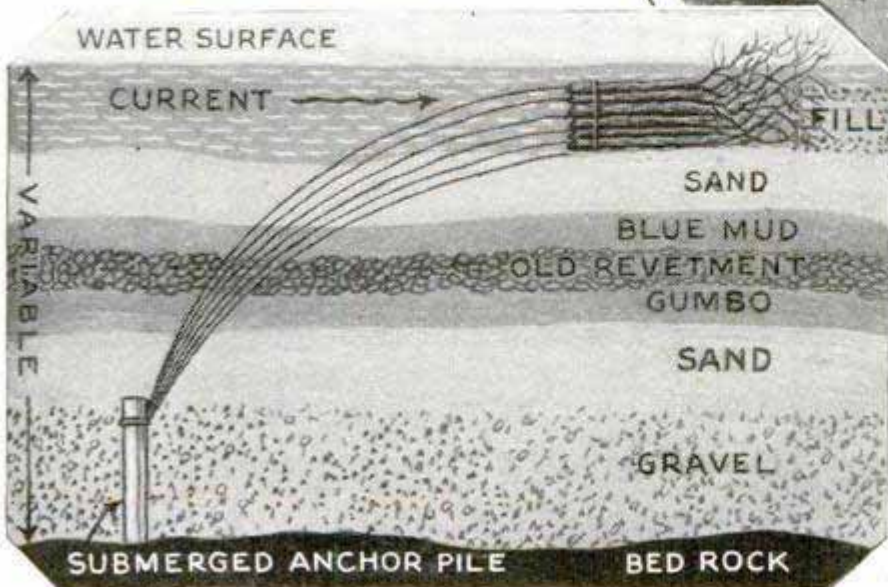

feet from the bank, the next 100 feet, the next 150 feet, and so on, the bank ends always being built highest, with the rest of the barrier sloping off as it projects into the stream. The trees that form the retard are lashed together in big raftlike units, each from ten to thirty feet high, and are anchored to



the pile with steel cables. The pile is set 150 feet or so above the spot where the retard is to rest. The barrier is in no sense a dam. It is essentially a brake on the river's speed. Fifty per cent of the retard's upstream face consists of openings between the logs. The water flows in, but, detained by the sievelike obstruction, its speed is slackened and then, due to the natural law of gravity, a lot of the river's burden of silt falls to the bottom. More accumulates. Gradually, just below the retard, a fill develops. The river is actually making land instead of destroying it, and at the same time, the bank that was threatened with complete destruction is being fortified with an earth barrier that will stand for all time.

Besides its permanence, the Bignell pile has several other advantages, all of which help to simplify the big problem of river control. Under ordinary conditions, it can be sunk to a depth of fifty feet or more in less than ten minutes. It is not shattered as sometimes occurs when driving wooden piles, and the equipment needed is simple—an A-frame derrick to hoist it in position and a pump with suitable con-

nections to force water at a pressure of 150 to 250 pounds to the square inch through the hole in the center and out of the side openings.

With this effective concrete needle, ragged river banks all over the country are being sewed up permanently and at a great saving over previous methods. This simple unit, born of quicksand and an engineer's inspiration, has cast an entirely new light on the problem of flood control and the construction of inland waterways. The situation today, as regards flood regulation and inland waterways, is essentially this: A valuable new tool has been found for the work, a huge organization is equipped to use this tool, the various agencies that have been working more or less at crosspurposes are united as never before under a big, comprehensive plan, outlined by the United States corps of engineers, and finally, congress has passed two generous appropriations to help put the projects well on the road to realization.

Briefly, the essential problem to be solved before floods can be controlled or inland waterways become a reality, is to



Revetment of Woven Willows Ready for Rock Covering; Protections Such as This Are Spread along Areas Where River Is Weakening Its Own Banks and Those of Levees



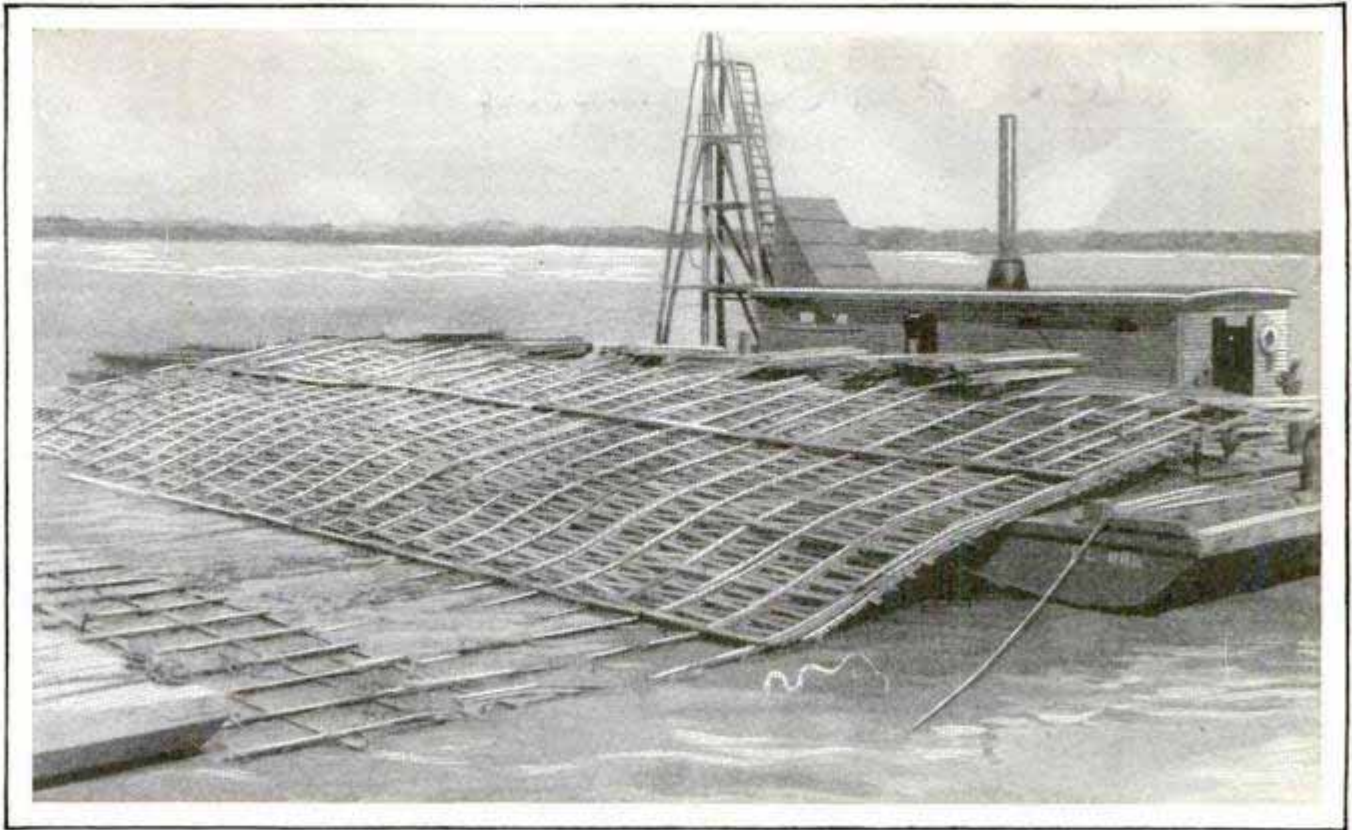

Laying a Timber Mattress from a Barge to Strengthen a Bank and Guard It from the River's Force; Concrete Mats Have Been Used with Good Effect for This Purpose

squeeze the river into a fixed channel and hold it there. A big task—the biggest of its kind ever attempted in human history—but, engineers declare, a relatively simple one after all. Once the streams have been directed into this channel and their speed accelerated, they will automatically keep the silt from piling in the passage and will cease their disastrous wanderings. Floods are bound to happen. But engineers hope to keep them under control also. The disaster in 1927 when the levees broke in 253 places, drowning 240 persons and flooding 23,000 square miles of productive land and cities, was directly due, of course, to the big, swollen tributaries of the Mississippi, all pouring their individual overflow into the main channel at approximately the same time. But indirectly, the terrible state of affairs was the penalty paid for years of compromising with the river instead of taking it in a firm hand and making it stay where it belonged. Such a course was impossible, because the means were not available to accomplish such an end. Levees, 1,800 miles of them, costing more than \$238,000,000 have, up to now, been man's best answer to the flood question. They are still to be of aid, but an attack is now to be made in a big way, at the heart of the

trouble, the lack of a fixed river channel. To help in this, congress passed the Jones-Reid bill, carrying an appropriation of \$325,000,000 for an extensive program of river-control work. The other important measure, the Deneen-Denison bill, provides \$10,000,000 for the further development of the federal barge lines.

The big program of river control as outlined by the United States corps of engineers and now going forward at various points, involves six main attacks: First, the construction of floodways from Cairo to New Madrid, from the Arkansas river through the Tensas basin in the Red river and from the Red river, through the Atchafalaya basin, to the Gulf of Mexico to relieve the main channel of waters it cannot carry; second, a controlled spillway to hold the levels down to a safe stage at and near New Orleans; third, local setting back of the levees in the Mississippi river at "bottle necks"; fourth, greater protection and strengthening of levees; fifth, revetment of caving banks; sixth, improved channels for river traffic, not less than 300 feet wide and from six to nine feet deep, to be obtained by dredging and by contracting the rivers at strategic points so that they will keep their own channels clear.



*new market Buena*  
*1921*  
*the first*  
PILLAR OF FIRE MARKS FIRST AUSTRALIAN OIL WELL

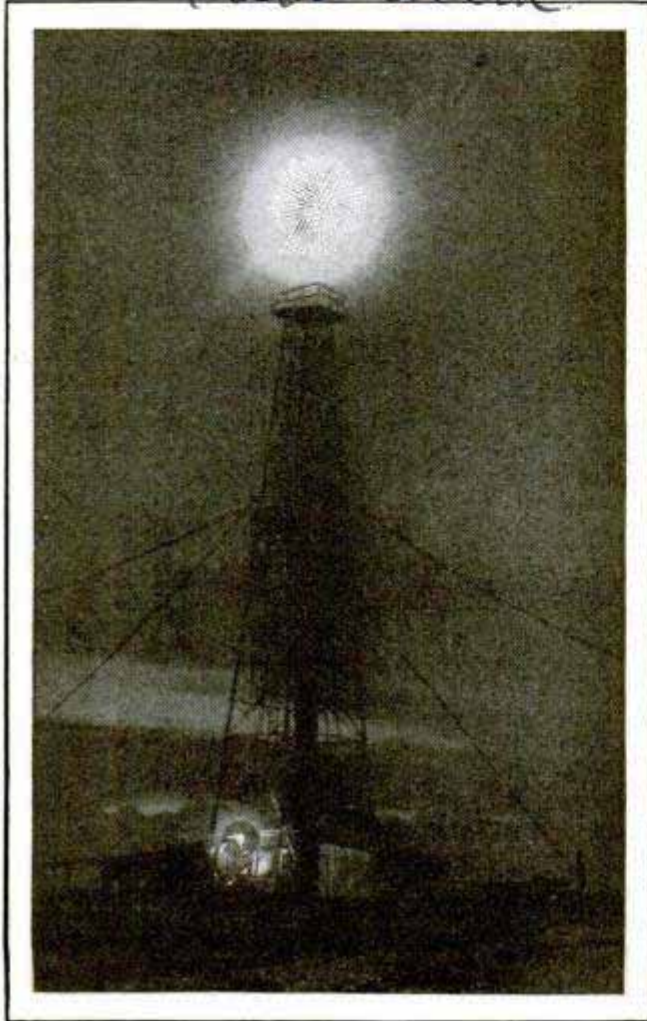

Flaming Gas at 550 Pounds' Pressure from Australian Well over 3,000 Feet Deep

The quest for oil and gas in Australia, which has been prosecuted since 1907, was successful when an American firm of oil drillers, from California, struck both oil and gas at a depth of 3,078 feet. The gas, which became ignited, had a pressure of 550 pounds at the start, and the oil flow which followed was remarkably clear. Owing to the scarcity of firewood in some parts of Australia, gas and oil for heating and cooking purposes are coming into more general use.

### GAS ATTACK ROUTS RAT ARMY TO PROTECT CITY

When hordes of plague-infested rats threatened to descend upon the city of Johannesburg, South Africa, authorities laid down a gas attack over a wide area on the outskirts in an effort to halt the advance. Arsenic and poison gases of various kinds were pumped into holes on

farms, and other places where the rodents were numerous, and inspectors were stationed to check the spread of the plague.

### AUTOMATIC SEA RADIO BEACON HAS WIDE RANGE

*1965*  
Sweeping a radius of 200 miles and requiring no operator, an automatic radio beacon installed at Orfordness on the coast of the North sea, is regarded as an improvement over other devices of this kind. Listeners on ships or airplanes, need only a stop watch and a radio receiver, and the apparatus is said to be free from night errors and interruptions which interfere with many radio light-houses. A revolving loop rotates mechanically and sends out signals on a wavelength of 1,040 meters. The receiver registers the maximum effect when the loop points directly at it and a minimum report when the loop is at right angles. Rotation is at a known rate of speed and from a known bearing. By listening to the signal changes and noting the time required, for the signal to reach its maximum or minimum, the receiving operator can calculate his own bearings.

### GUIDE FOR DRAWING LETTERS MAKES FIFTY STYLES

*1951*  
Aluminum guides for quickly drawing letters, numerals and other characters are made in one piece and each makes more than fifty different styles and sizes. They are especially useful to sign painters and decorators, are helpful in teaching children and require but little skill.



Using the Lettering Guide Which Makes Fifty Styles and Sizes and Requires Little Skill

*with them*

*master*

*Consolidated sign*



*Madison Wis.*

*Chemical ready  
illumination 457 Pa.  
Pittsburgh Pa.*

### HARMLESS LUMINOUS PAINT TO LIGHT HOMES 1932

Within the next few years, the interiors of homes may be illuminated at night without the aid of electricity, in the opinion of Prof. J. H. Mathews of the University of Wisconsin. A new kind of luminous paint, non-poisonous and capable of being made in colors, dull in the daytime and brilliant at night, is being developed, although the chemical process by which light is stored up in the paint in the day and released at night is not fully understood. Hallways of a home could be a light brown in the daytime and a brilliant green at night; the bathroom, a white by day and violet at night. The paint furnishes sufficient light to make possible passage through the rooms without electric light, but, for the present at least, there is not sufficient illumination from it for reading. The substance is not injurious, since it does not contain radioactive materials. Its use already has been applied to the stage, where costumes have been treated with it to give novel effects when the lights are turned off.

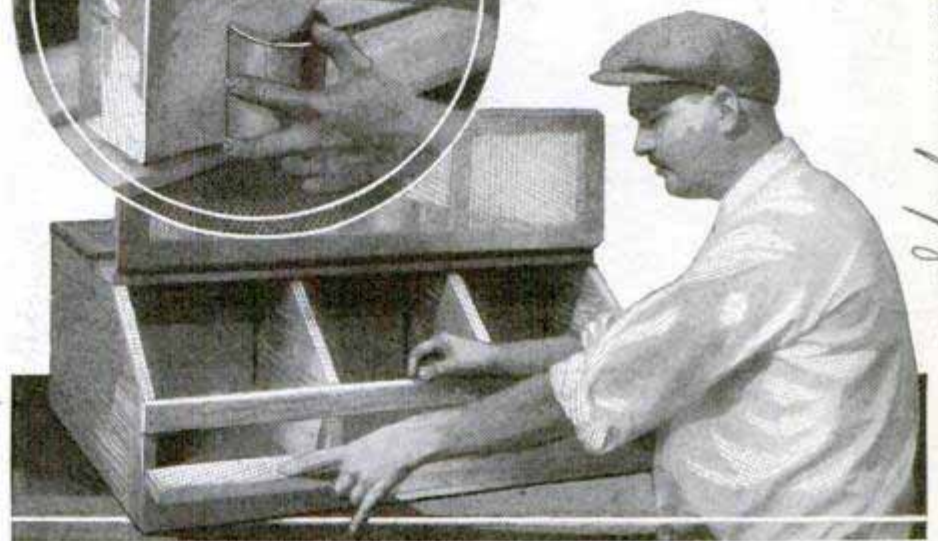
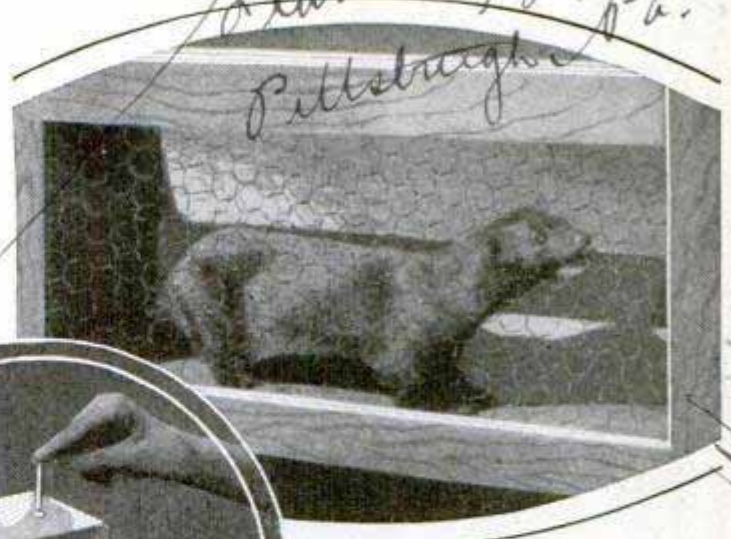
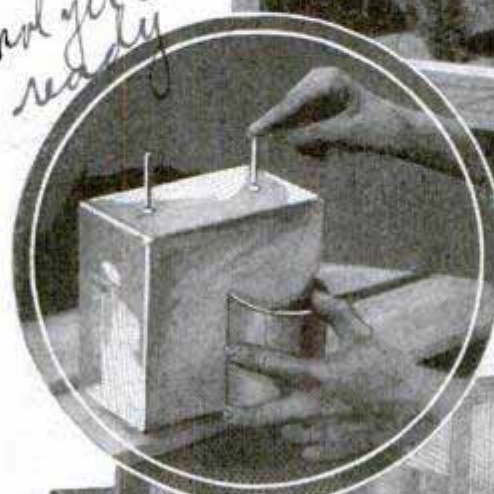

Mink in Special Cage, the Watering Can, and a View of the Three Compartments with Punched-Steel Lid

### SHIP MINK IN SPECIAL CRATES TO AID FUR INDUSTRY

Raising wild animals for their fur has become an important industry and required the development of special shipping crates to care for the animals on journeys between breeding farms and points where they are tended until the fur is ready for market. A three-compartment crate has been devised especially for mink, one of the shyest of all animals raised, and one that has suffered the most on railroad journeys. This box is covered with a punched metal screen instead of wire, a special type of watering can that prevents spilling has been provided, and a false bottom simplifies cleaning the cage. One of the compartments is a "nest box" and is well ventilated so that the animal cannot cut off the air by stuffing the openings with bedding as sometimes occurred with ordinary crates.

### HAND DECORATOR FOR METAL REQUIRES LITTLE SKILL

Spotting or decorating metal is done many times faster and more uniformly with the aid of a hand tool which unskilled persons can operate with good results. It is simply pushed across the work, a small wheel serving to keep the tool on the track of the guide which is designed to give a rocking action to the blade. This produces crescent-shaped designs on the metal.

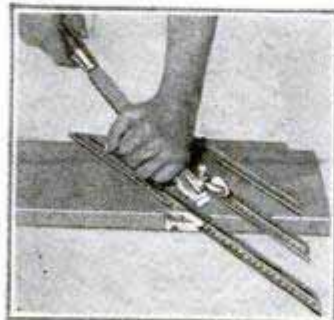

*Cont. 20 U.S. Harbor 106 Prospect Ave. Madison*

*Farm at Sheboygan, Wis.*

*address man...*

*Madison, Wis. 1932*



*Dr. Schumann  
Munich*

*1939 Cary, Ill.*

*Horse owned by Mrs. John Kaestly*

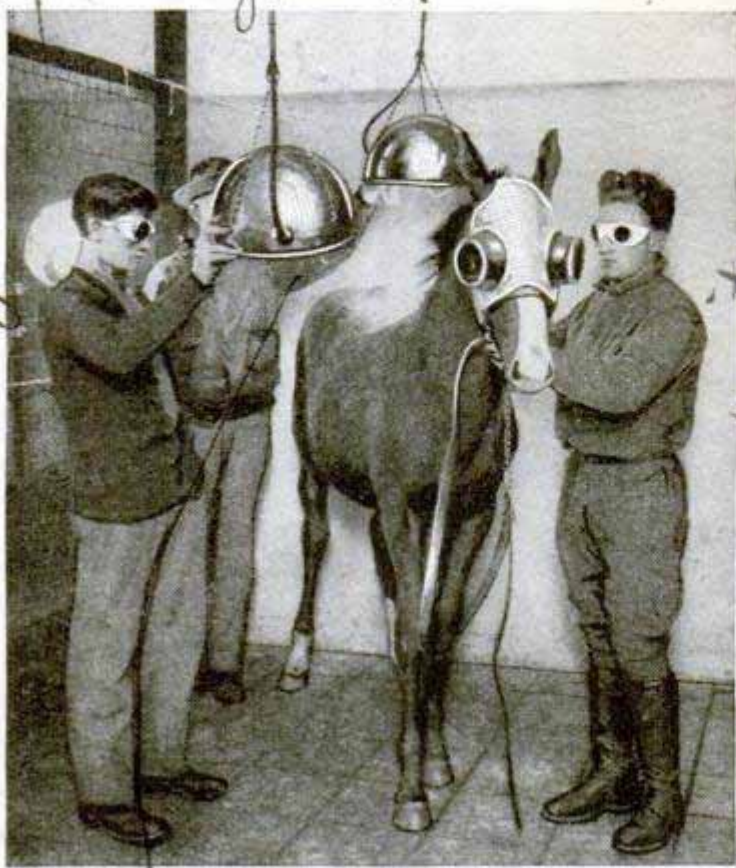

Giving Colt Its Daily Treatment of Ultraviolet Rays to Insure Health and Proper Growth

### MUSCULAR MOVEMENTS PRODUCE ELECTRICITY TESTS INDICATE

*1927*

Interesting tests that seem to indicate still further the close relationship between life and electricity have been conducted recently in Germany. By using amplifiers and other apparatus, a record was made of the electricity developed on the skin or immediately below its surface. The person used for the tests was placed in a large metallic cage and careful checks were made to determine that the electricity came from the subject's muscular movements and not from any other source. A striking record was obtained, indicating fluctuations in the electric force during the muscular efforts, according to reports. A rise to a peak was found to occur by degrees in several rapid stages, and, in the event of a continuous effort, the electric response declined somewhat, before the person was fatigued, but this was believed due to the fact that the skin became moist with perspiration. While the test showed a connection between electricity and muscular work, the origin and other factors of the electric currents still remain more or less of a riddle.

*End. Dr. A. Schumann*

### LIGHT RAYS FOR RACE HORSES WARD OFF DISEASE

*Suggest Frank & Betty*

Thoroughbreds in a racing stable near Chicago receive ultraviolet-ray treatments every day, as it is believed that they need artificial sunlight when the natural supply is unavailable, as much as do human beings. A short exposure to the special lamp is said to give an effect equivalent to that from a whole day in the sun. The treatment is of special benefit in winter when the animals are confined indoors.

*Cashed*

### SIGNAL ON AUTOMOBILE CHOKE PREVENTS MOTOR ILLS

To remind motorists to regulate the choke properly, a warning signal has been devised. It consists of a small light that glows when the knob is out but is extinguished when the choke is in. This eliminates the likelihood of forgetting to push the choke in, an oversight that often results in fouled spark plugs, damaged bearings and other troubles caused by an excessive use of gas and oil. Back of the lens on the knob light is a semitransparent disk on which a monogram or other legend may be printed.



### COMBINED CASE AND LIGHTER SAVES POCKET ROOM

Cigaret case and lighter are combined in one attractive article, saving the bother of two units with the demand for extra space. The case holds ten cigarets and the lighter is said to be a dependable type, and is not likely to get out of order.



*The Shepley Co.*

*E.C. Wilson Corp*



### PIPE STEMS MADE FROM COAL BY DISTILLING PROCESS

Materials for the manufacture of pipe stems, umbrella handles, cue balls and many other articles will be prepared from coal products derived by a special distilling process, according to a recent announcement. Synthetic furniture is predicted as a result of the development in this field. The method is new to the United States and differs from other processes chiefly in the quantity of by-products that are obtained. It produces about two and one-half times as much tars from which synthetic resins are made. From these latter substances, chemists have made a wide variety of articles, including brilliantly colored pens and pencils, bathroom tiling, tops and stoppers for bottles, radio parts and automobile accessories. Gasoline made by the new method of coal distillation is said to produce less "knock" than that obtained by other processes.

### MODEL OF ROCKET AIRPLANE CONTROLLED BY RADIO

Designed to be propelled by rockets, a monoplane in model form has been tested by a western inventor. In demonstrating the craft, he used a radio-control outfit, manipulated by a keyboard. The completed ship is expected to contain eighty-six rocket "barrels" to furnish power.



Inventor Demonstrating Radio Control for His Model Airplane to Be Propelled on the Rocket Principle

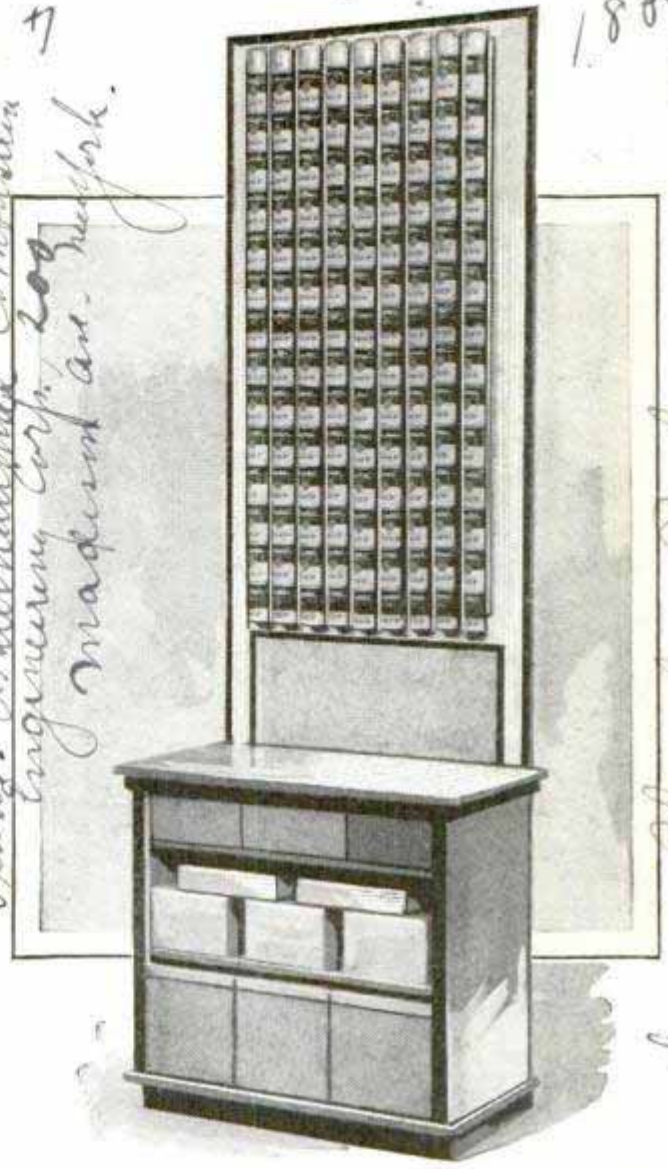

Section of the Self-Filling Shoppers' Shelves; Cans Removed at Bottom Are Replaced from Top

### SELF-FEEDING STORE SHELVES LATEST AID TO SHOPPER

Adapted especially for canned goods, a special shelf arrangement has been introduced for the convenience of the shopper. It is filled at the top and, as cans are pulled out at the bottom, others slip into their place. This eliminates difficult reaching and keeps cans from being pulled out on the floor. Another innovation, used in connection with the shelves, is a basket with rollers which the customer pushes along on a counter at the base of the shelves, instead of carrying.

Popular Mechanics Magazine does not publish the name of the maker or seller of any device described in its pages, but this information is kept on file and will be furnished free upon application to our Bureau of Information.

Chicago-1300 N Branch

1927

Clark International Combustion  
Engineering Corp. 200  
Madison Ave. New York

1889

Dr. Charles Poles  
Amant's

1929-1930

Wick Wald

Maurice Pomeroy



*Colborne Barnhurst Road, Berley Heath, nr. London, England*

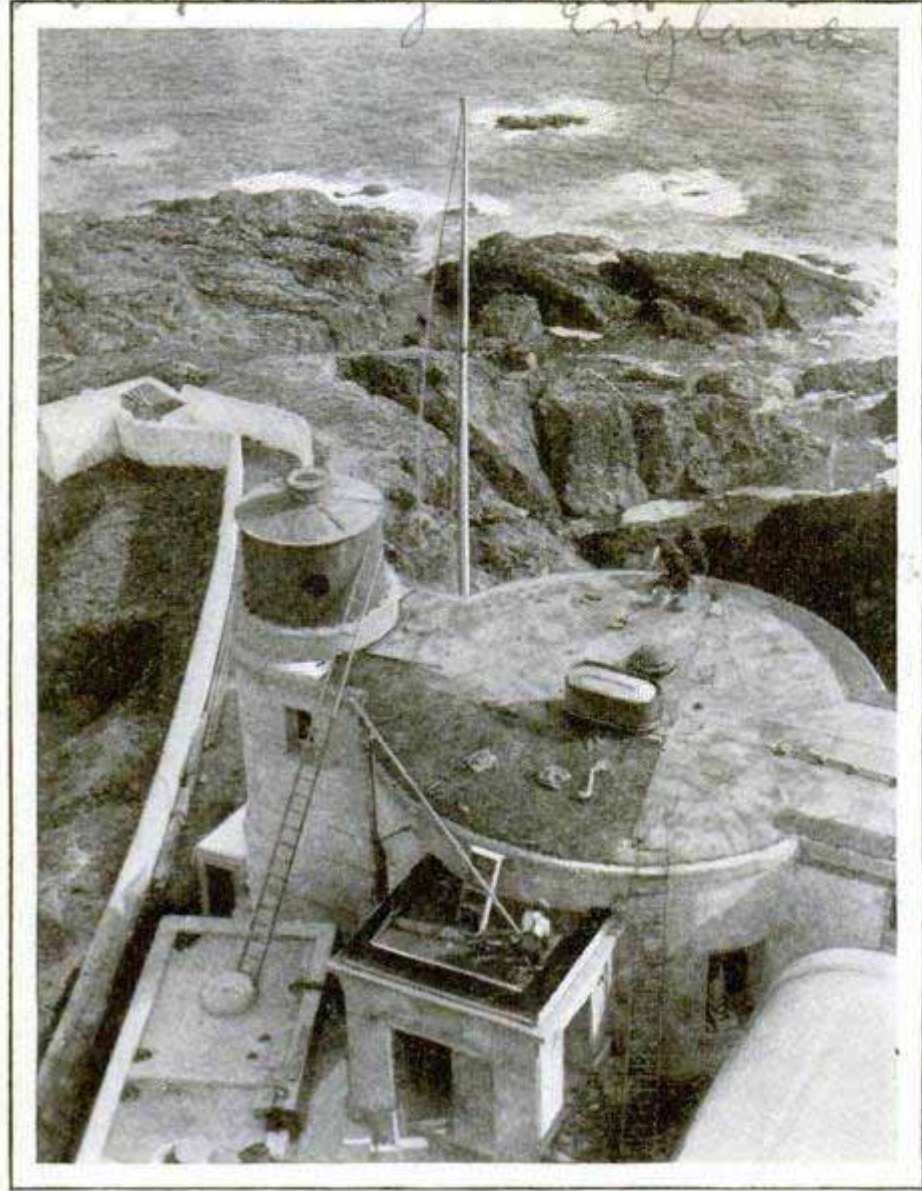

© Daily Press

Radio Lighthouse at Start Point, England; Beams Are Transmitted through Hole in Turret to Guide Ships

### LIGHTHOUSE SENDS RADIO BEAM TO GUIDE SHIPS IN FOG

Wireless beams are transmitted from a hole in a turret of a radio lighthouse at Start Point, Eng., off the steamship route from Plymouth to London. The range of the apparatus is about 100 nautical miles under normal conditions, and the turret helps to overcome some of the difficulties that otherwise would be encountered in sending from a station built on rocks. The code is sent automatically, at in-

tervals or continuously, depending upon the weather. All running machinery is duplicated in case of a breakdown, and if a tube should fail, an alarm is sounded.

### NEW CABLE SENDS EIGHT MESSAGES AT ONE TIME

Eight messages are dispatched simultaneously over the latest Atlantic cable from Bay Roberts, Newfoundland, to the Azores. Four are sent in each direction at one time. What happens is that the time on the wire is divided equally between four different sending machines. For instance, there are four messages, the first word of each in order being, cat, rat, boy and dog. The first letter to go on the cable would be "c," the next "r," the next "b" and the next "d." The second letters of each word would follow, and so on until the messages were completed. At the re-

ceiving end, a device separates the various messages and diverts each to an instrument that registers the message properly.

### MOVING MAP FOR AUTO DRIVER PREVENTS GETTING LOST

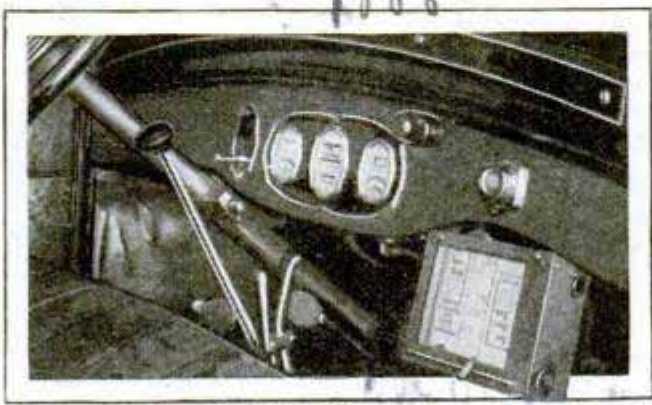

Moving Map at Right Unrolls as Auto Proceeds, and Pointer Tells Exact Location of the Car

Motorists traveling over strange roads or driving at night, are guided by a moving chart installed under the dash. It is keyed to synchronize with the speed of the car, unrolling as the vehicle progresses. The position at all times is indicated

*Marconi Company*

*Product to 200 ft. cable, with 1000 ft. of wire.*

*1888*

*make unknown.*



by a pointer, so that, if landmarks do not agree with the moving map, the driver will quickly know that he is off the way.

**RADIO TRAVELS BEYOND MOON  
ECHO TESTS SHOW** 1922

Radio waves travel far beyond the moon, recent tests have shown, so that communication with the satellite would not be impossible were someone there to receive the signals. Dr. Carl Stormer, a Norwegian scholar, experimenting with a thirty-one-meter wavelength, observed echoes from signals back as much as fifteen seconds after the original impulse had been transmitted. Since radio waves travel at the rate of about 186,000 miles a second, the echo tests indicated that they had gone more than a million miles out and back again, much farther than the distance of the moon from the earth. Doctor Stormer believes that the echoes are caused by a layer of electrons which come from outside the earth.

**LANDING LIGHTS SET IN GROUND  
SHOW WIND'S DIRECTION** 1916

Airplane landing-field lights, installed in protected depressions where they cannot be damaged by the ships, have appeared at an eastern airport. They are



Landing-Field Lights in Small Wells Are Protected against Breakage and Serve as Wind Indicator

so set that lines of them may be turned on to indicate the direction of the wind as well as to show the runways.

Now built John S. ...  
Constructed by Park



Turning the Dial That Causes Buzzer to Sound When Answer to Question Is Reached

**BUZZER TO ANSWER QUESTIONS  
LATEST QUIZ GAME**

Resembling a small radio cabinet and loud speaker, a buzzer set that answers a wide variety of questions has been introduced for the instruction and entertainment of children and others. A card, bearing the questions and answers, is slipped over the two knobs in front of the box. The one at the left is set opposite the question selected. The other is turned until the buzzer, concealed in the loud speaker, sounds. The proper answer will be found opposite the arrow on the "tuning dial." A small electric battery inside the cabinet provides current for the buzzer. The set of cards furnished gives a large number of interesting and amusing questions with answers, and children enjoy some of the thrills of operating a real radio set while learning facts about science, history and many other topics.

**HIDDEN SPRINKLERS IN LAWN  
KEEP GRASS GREEN** 1917

Ninety acres of lawn in New York's Central park are to be kept fresh and green by a hidden irrigation system recently tested. Pipes and disks that give an effective spray, are concealed in the grass, and water may be turned on for the whole area or for just a small part that needs a special amount. The spray disks have gravity caps that fall back when the water is turned off, to prevent the nozzles from becoming clogged.

Constructed by Park

Handwritten notes on the right margin: '1893', '3.75', 'Radio Quiz Corp. Jackson Blvd. Baltimore, Md.', 'Roosevelt Field', 'Feb. 21', '118-8261', 'New York Herald', '12/10/17', 'Constructed by Park'.



138

# Time and Money for your

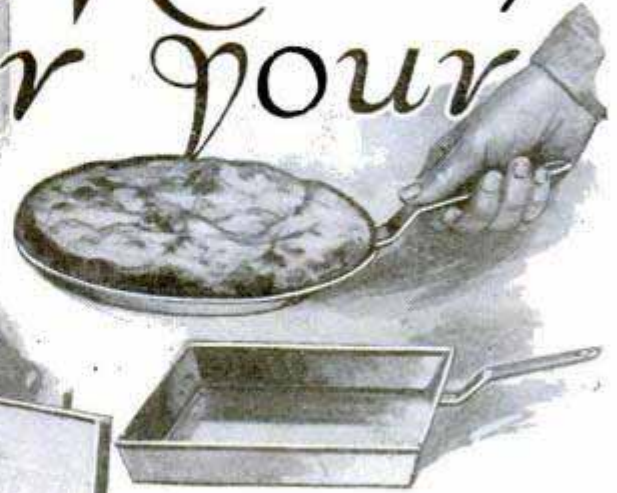

Pie and Cake Pans with Handles Are More Easily Placed in Oven and Removed without Burning the Fingers or Dropping; They Are Furnished in Several Different Sizes; at Left, Dust and Moisture-Proof Envelopes for Garments Fold Flat for Convenience in Traveling

Below Is a Bag with Small Outer Side Pocket for Loose Change, to Save Opening and Fumbling through the Main Compartments; It Is Just Large Enough to Hold a Small Number of Coins



At Right Is a Washing Machine Operated by a Small Gasoline Engine Instead of an Electric Motor; Its Wood and Steel Construction Reduce Vibration to a Minimum So That It Is Said to Be Nearly as Smooth-Running as the Usual Kind

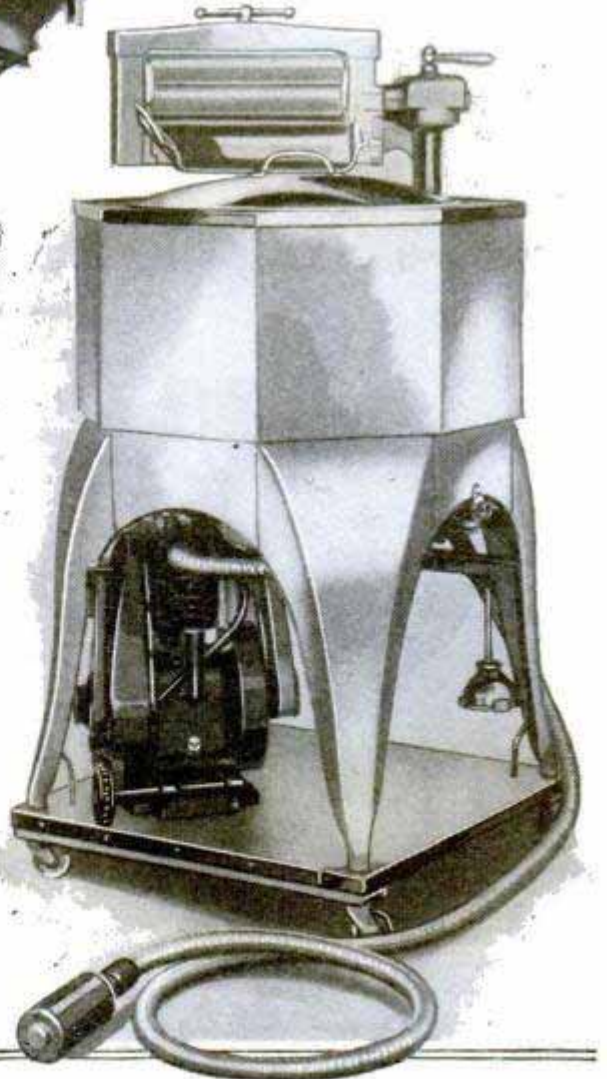



# Saving Things home

Ver  
Pat  
P  
Fry  
Mi.  
Be

Hose  
O. W  
Mir

Wash  
Sun  
Det  
Oil H  
Stov

Hai  
A  
\$

Dust  
Gene  
Cal

Pie  
Co

Man



This Oil Heater Has a Patented Floor Tray Attached, to Prevent Its Tipping Over and to Protect the Floors



Serviceable Hair Drier Is Connected to the Vacuum Cleaner, and, Below, a Specially Shaped Frying Fork Which Simplifies Turning Bacon and Other Foods without Dropping

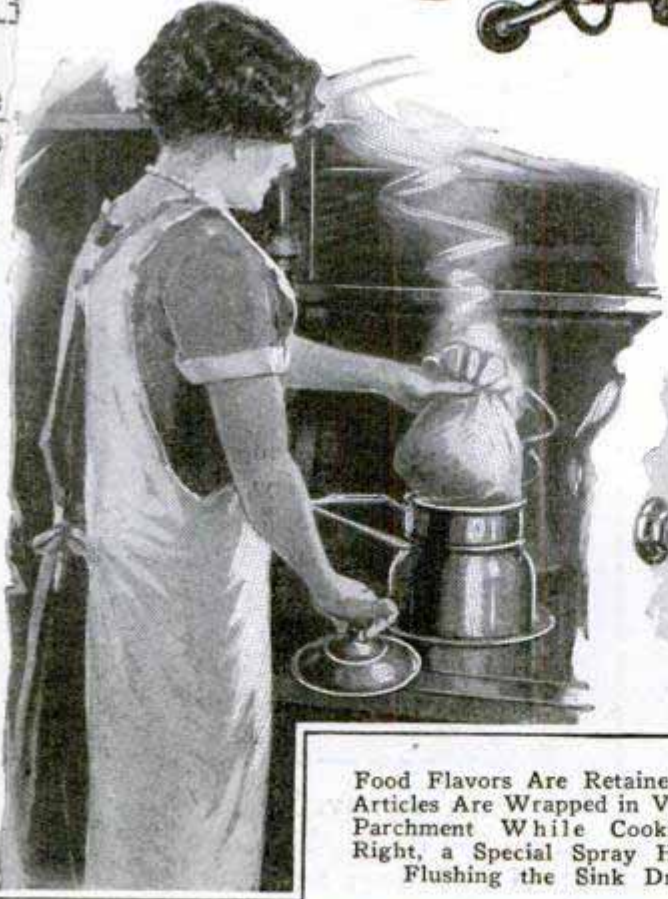

Food Flavors Are Retained When Articles Are Wrapped in Vegetable Parchment While Cooking; at Right, a Special Spray Hose for Flushing the Sink Drain





Chicago. Uses & padding & cover.

2.1102-464  
1948

347-5th Ave  
POPULAR MECHANICS  
New York City

12/11/28

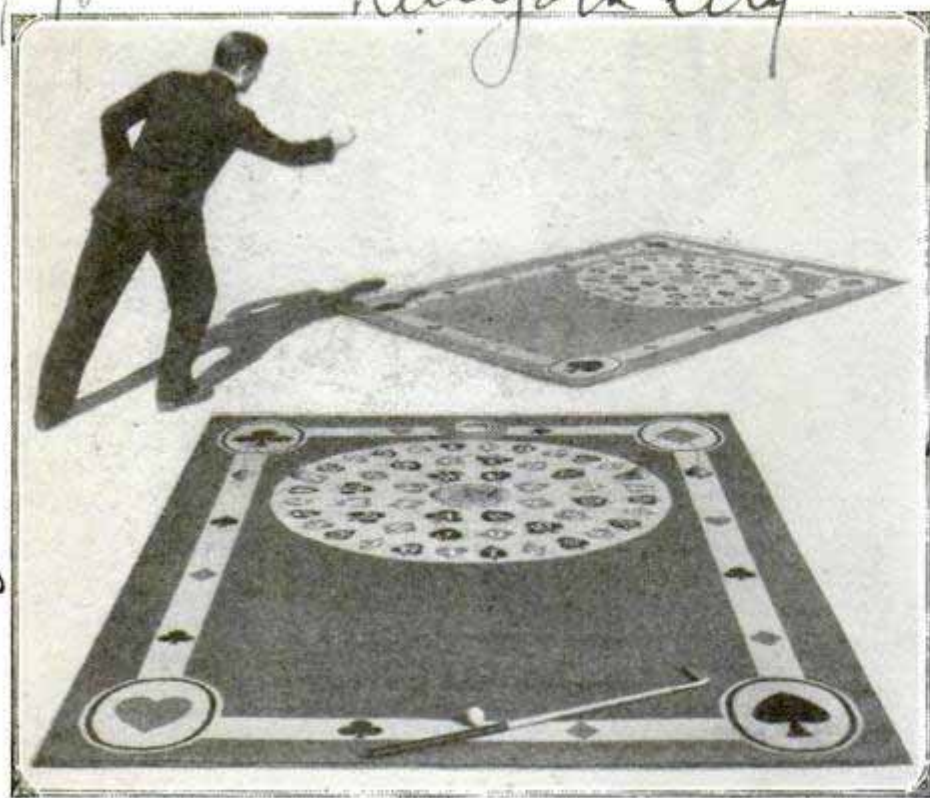

Playing the Quoit Poker Game, and a Close View of the Rug, to Show the Design and Arrangement for Golf

### RUG SERVES AS GAME BOARD FOR GOLF OR CARDS

Double service is afforded from a novel rug now on the market. Besides its normal function as a floor covering, it serves as a field for two interesting games, a form of poker and indoor golf. The pattern consists of an arrangement of the symbols on playing cards. To play poker, a pitching quoit is used, the object being to throw the quoit upon the joker, the central figure in the design, and so fill out the hand to the best advantage. Five quoits are used in this game, the landing place of each being determined by a hole in its center. If a line between two or more "cards" shows through the hole, the higher card is scored. In the golf game, a putting disk is placed on the joker and a regulation golf ball and putter are used. Here, the main object is to land the ball in the disk or joker and so fill out the hand. The figures on which the ball stops are also used as in the poker game, to determine the hand. Both games require considerable skill, help steady the eyes and nerves, and the putting practice improves the real game on the links. The rug is made of durable material and is handsomely colored. A pleasing variation of the putting game is played with the aid of

wickets placed before the disk, the object being to get the ball through the wickets and into the disk in as few strokes as possible.

### LUMBER WASTE IS REDUCED BY THINNER SAWS

1954 By using thinner saws, lumbermen could save some \$60,000,000 annually in this country, engineers have estimated. Reducing the thickness of the cut as little as one-sixteenth of an inch would effect this economy, the experts declare. They point out that with the present saws not less than \$30,000,000 is wasted

yearly in preparing the saw logs and about \$33,000,000 in converting the logs into boards. This is the annual bill for sawdust, only a small part of which is salvaged for useful purposes. Efficient standardization of blades would result in the saving, a report made to the American Society of Mechanical Engineers stated, and the economy is recommended in view of the none too abundant supplies of timber.

### LIFTER FOR MILK-BOTTLE CAPS PREVENTS WASTE



Paper caps are removed from milk bottles without spilling the contents with the aid of a simple lever device recently introduced. It fits around the neck of the bottle, the cap is attached to a sharp prong,

and is then removed simply by prying down on the lever. The device is quickly adjusted and does not mutilate the cap, which can be used repeatedly.

Chas. Robert



*Oberlin*  
465  
*Germany*

1945

**"NORSE" RUINS LAID TO ESKIMOS  
MUSEUM EXPLORER SAYS**

1914

Norsemen may have landed in America long before Columbus did, but, so far, no tangible evidence has been found to support this belief, Dr. William Duncan Strong, assistant curator of North American ethnology and archæology, recently declared after research into the question of alleged Norse ruins by the Rawson-MacMillan subarctic expedition of the Field Museum of Natural History. Ruins on Sculpin island, near Nain on the Labrador coast, which had been regarded as relics of an ancient Norse settlement, proved, upon examination, to be only the remnants of an old Eskimo whaling camp, it was found. The stonework did not resemble the authenticated Norse ruins in Greenland, and no Norse implements were found, whereas the material discovered closely resembled that which is commonly found in Eskimo burial grounds and camp sites in other regions.



Gas Mask for Asthma Victims Affords Treatments While the Wearer Is at Work

**GAS MASK FOR ASTHMA VICTIM  
WORN WHILE AT WORK**

German engineers have devised a lightweight gas mask that is said to be effective in the treatment of asthma. It can be worn about the house or other place while at work, has wide glasses to permit unobstructed vision and is quickly adjusted or taken off.

*see June 1930 953*

**STOVES AND BLANKETS IN CAFE  
DRAW WINTER PATRONS**

1941

Coke stoves and blankets are provided patrons of a German cafe when the weather is cold. The innovation has already proved popular in France, where permanent heating facilities are not installed and outdoor dining is common.

Sidewalk Dining Is Now Comfortable Even in Winter with the Aid of Stoves and Blankets



*Oberlin*

**SEEDS LIVE FORTY YEARS  
IN DEEP SOIL**

1916

That the seeds of weeds and other plants will grow even though they have been buried forty years, was shown recently by Prof. O. A. Stevens, of the North Dakota agricultural college. Nearly seventy per cent of the seeds of pigweed germinated after this long burial, and about the same results were obtained with the evening primrose. Seeds of some varieties of grass did not grow after five years. The tests showed that there is comparatively little to fear from seeds of weeds buried deeply.

Of the world's volcanoes sixty-five are active.

*State College*



**TALL BUILDING LIKE OBELISK TO GUIDE AVIATORS**

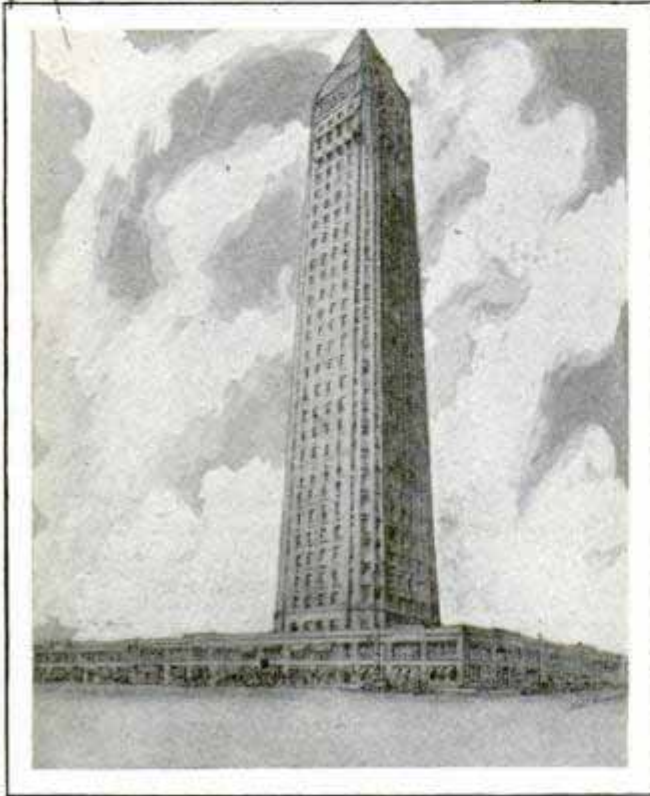

The Foshay Tower in Minneapolis; Unique Office Structure Modeled after the Washington Monument

The Washington monument is said to have been the inspiration for an obelisk-shaped business building now nearing completion in Minneapolis. There are thirty-two stories reaching 450 feet in height, with five stories underground. Two of these will be used as a garage with a storage capacity of 250 cars. At the tip of the building is a wide observation balcony. A radio broadcasting station and an aerial beacon will be installed there.

**MAGIC METAL RESISTS WEAR AND HARDENS IRON**

Aelium, a strange mineral discovered about three years ago, possesses many remarkable qualities that fit it for special service, an expert reports. It fuses lead and copper with any other metal, he declares. It reduces the flowing temperature of molten metals, making possible die-casting and the molding of metals of high melting point into intricate patterns. It increases the tensile strength of iron, steel and other metals, and also increases the capacity of copper and aluminum to carry electric current. One of its most peculiar properties is that, under certain

conditions, it provides a natural film of oil so that other lubrication is not necessary. In fact, Thomas J. Clark, a Utah stockman who discovered it, thought at first that it was an oil shale and was experimenting with it in the belief that it would yield oil. Harry Miller, auto racer, made a shop test with an aelium bearing, running it for four hours at 5,000 revolutions per minute without oil. It was then clamped down and run for twenty-eight hours without heating or shaft injury, according to reports. A bearing in an automobile clutch was run for twenty-four hours under a pressure of 1,500 pounds to the square inch without lubrication and showed no signs of wear. According to engineers, an automobile with bearings of this material would probably need but ten per cent of the oil required on the usual car and burned-out bearings would be practically eliminated.

**GLARE SCREEN ON WINDSHIELD PROMOTES SAFE DRIVING**

To protect the eyes from the glare of approaching headlights, an adjustable shade of transparent material is attached to the windshield. It is also effective against the rays of the sun and is said to promote visibility in fogs. It may be used effectively for shades on the headlights of the same car, to lessen the glare in the eyes of other drivers.



Glare Screen in Place on Windshield, Showing How It Protects the Eyes from Approaching Headlights

*1849*  
*Tests made by Jean & Joris, Los Angeles, Calif. 1833 Wilson, Los Angeles, Calif.*

*924*  
*no change*

*Drive with safety*



51 Carhart St  
Marion, Ohio

# Tricks at the Billiard Table

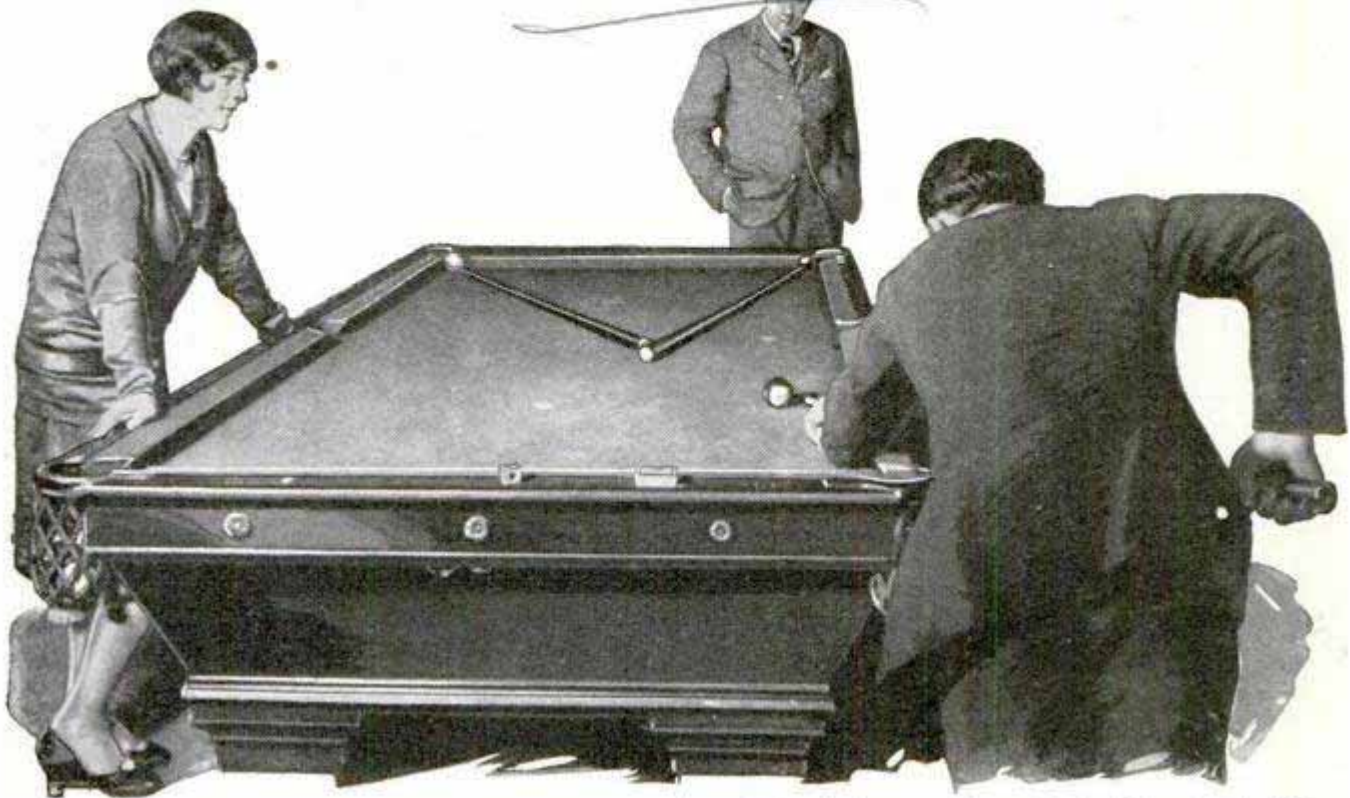

All Three Balls Can Be Pocketed at One Shot by Using a Pair of Cues to Transmit the Blow to the Pair Placed in Front of the End Pockets, the Cue Ball Going to the Side

**P**ERHAPS you can neither shoot a good game of "Kelly," nor run up an imposing string at three-cushion billiards, but it is well within the ability of any person to present a few diverting tricks on the green table.

Such as this: The performer places a ball in the mouths of the two end pockets, and sets his cue ball at the opposite end of the table. The trick is to pocket all three balls in one shot.

A tall order? Not at all! The performer merely places two cues in the position shown and then shoots his cue ball so that it strikes the butt end of the nearest cue. That's all! A trial will show you that the seemingly impossible is quite easy.

Did you ever go rabbit hunting? And laugh a little, cruel as it may seem, at the funny way a shot rabbit flops over when hit? You can demonstrate the same quaint toppling-over effect on the billiard table by shooting a ball into the open end of a heavy, fur-lined

glove, as shown. It is really very funny.

One of the old stand-bys in magic is the sudden disappearance of some object; at the billiard table, the magician does it with a billiard ball. Like this: He takes a ball



The Imitation of a Shot Rabbit, Done by Shooting the Cue Ball into a Fur-Lined Glove



603

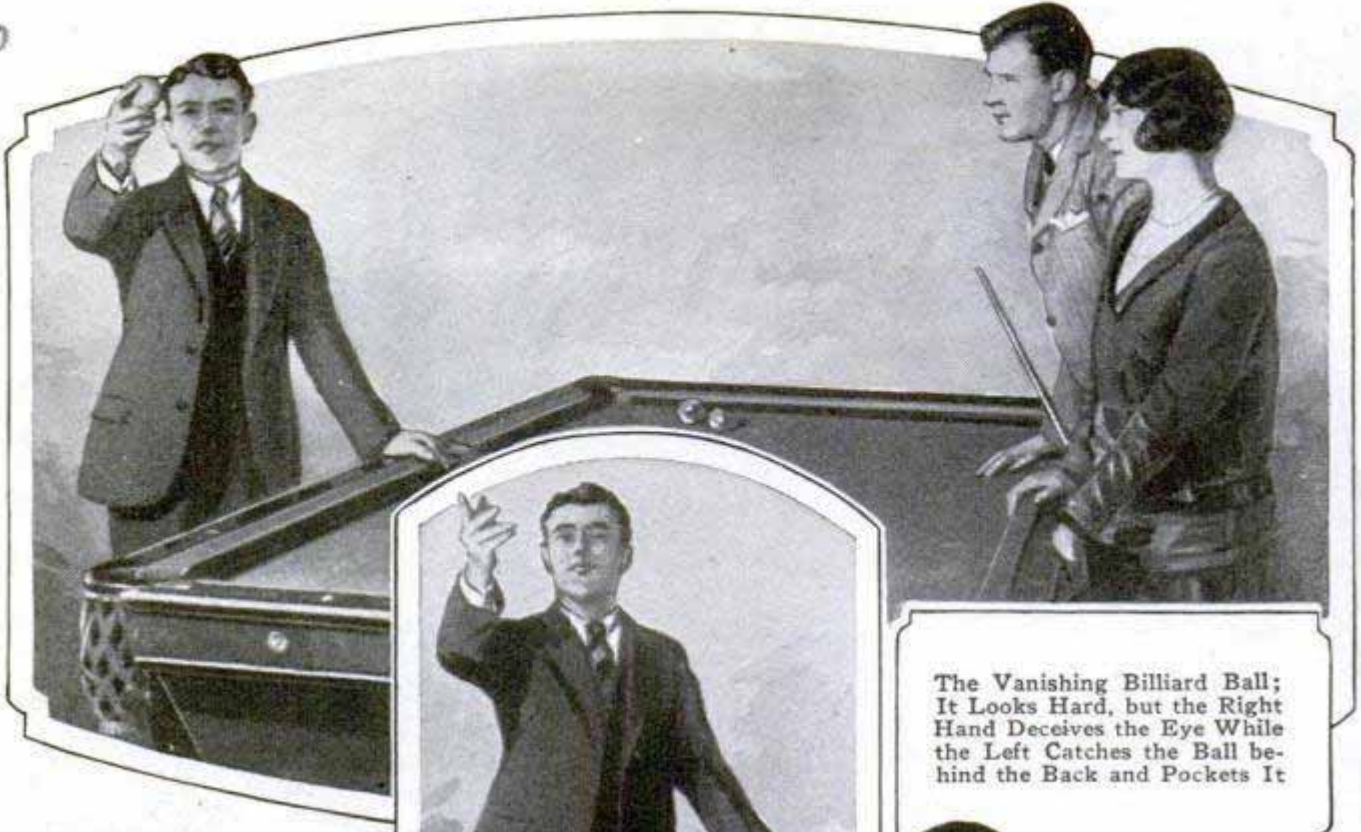

The Vanishing Billiard Ball; It Looks Hard, but the Right Hand Deceives the Eye While the Left Catches the Ball behind the Back and Pockets It

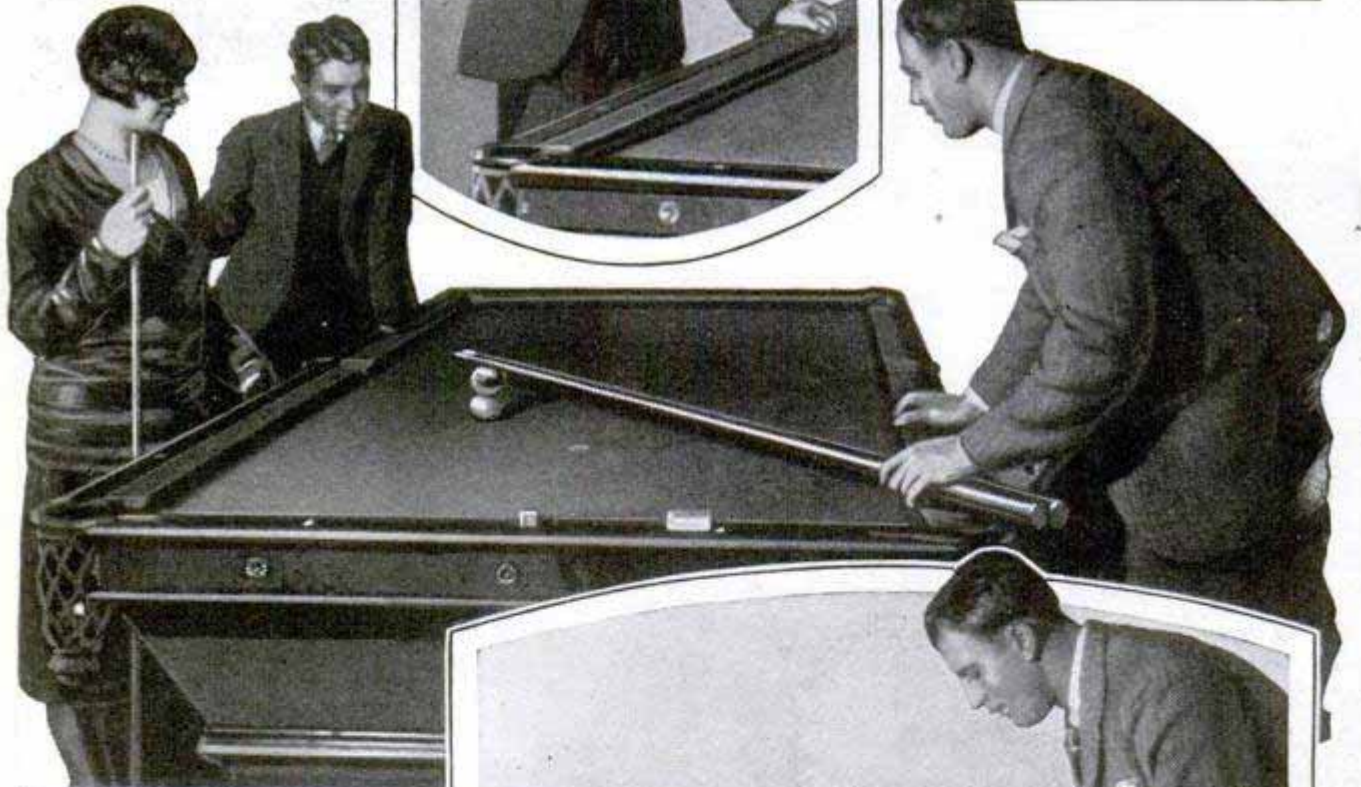

Rolling Two Balls across the Table, One on Top of the Other, Looks Like a Difficult Feat; the Trick Is Accomplished by Using Two Cues to Keep the Top Ball in Position; the Start Is Shown at the Right, and, Above, the Balls Have Almost Reached Their Destination, Propelled by the Force Exerted by Pressing Down on the Pair of Cues





in his right hand, and swings his hand up three times, as illustrated. On the third time, the ball obligingly melts away into thin air.

Of course, the ball didn't really melt. It was merely caught behind the back on the third swing, and the left hand slyly slipped it into the side pocket. Try it! And don't worry about anyone gluing their eyes on your left hand; the misdirection is too powerful.

There is a trick, and a good one, too, in which one billiard ball is balanced on top of another. But, here's a better one: The balls are not only balanced but they run the length of the table in their two-high majesty.

You do it with two cues. The picture shows the start of the operation, the balls being held in place until the cues are properly adjusted. Notice that the cues point upward. Now, if you release the balls and press down on the butt ends of the cues, you will demonstrate what appears to be quite a difficult trick—the balls running the full length of the cues in this position.



In the next effect, the performer takes a tumbler, and wagers anyone he can pocket it in the side pocket on the very first trial, the tumbler to be rolled from the side of the table, as shown.

You're on! But, doggone it, he did it—on the first trial, too, the glass describing an arc and ending in the side pocket. Of

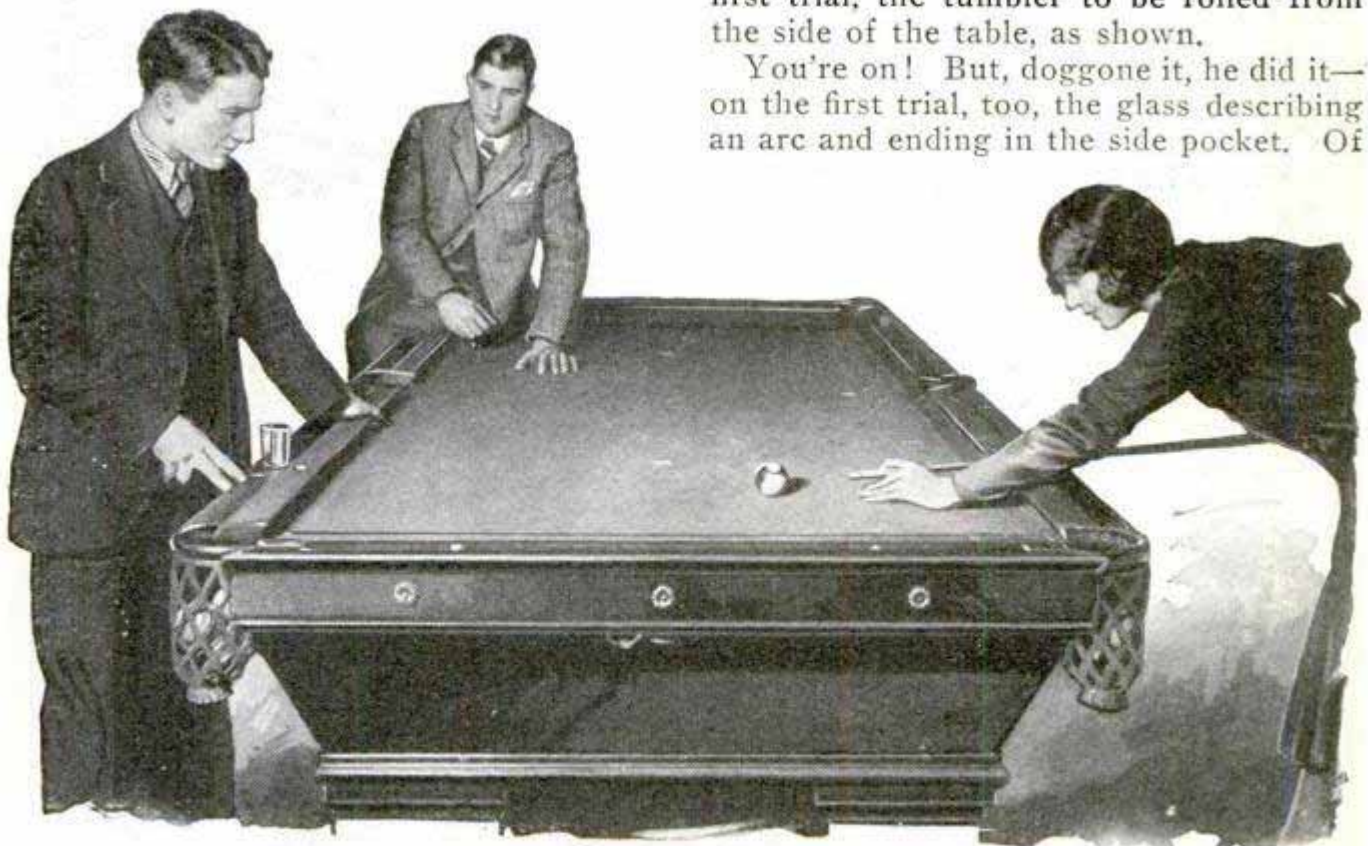

Two Tumbler Tricks; Above, Rolling the Glass into the Pocket, and Below, Pocketing the Dime in the Tumbler by Jarring the Inverted Glass Forward over the Coin



course, no one is supposed to be wise to the preparation, which consists in placing the tumbler in the pocket, and then rolling it up the table and marking the exact spot from which the glass must be started in order to reach the pocket in its curve.

Another excellent trick with the tumbler also is

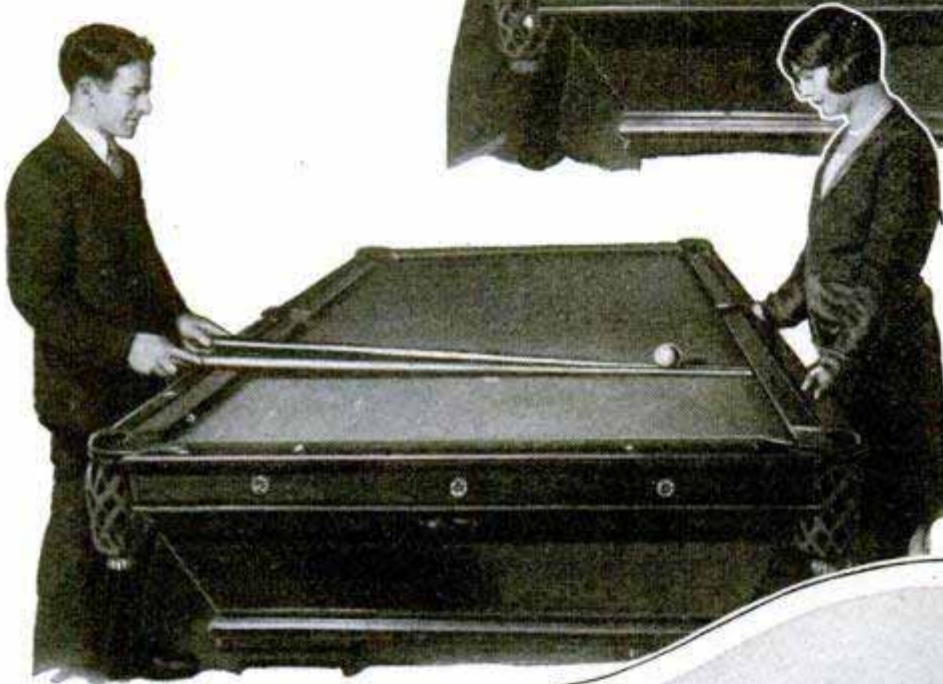

Making a Ball Run Uphill Looks More Difficult Than It Is; the Ball Is Started by Separating the Butts of the Cues and Squeezing the Tips Together behind the Ivory; When It Gets under Way, the Ends in the Hands Are Suddenly Squeezed Together and the Ball Jumps from Between Them and Rolls up and off the Ends; If the Trick Is Performed Lengthwise of the Table, It Will Be Found Much Easier to Do

illustrated. The tumbler is placed on the ledge of the table, as shown, and a dime is placed on the cushion in front of it. The trick is to pocket the dime in the tumbler. This can be easily done by shooting a ball from the opposite side of the table. The shot must not be too hard, and the ball must strike in a direct line with the dime and tumbler.

Place two cues together, and set a ball on them at the tip end, as shown. The problem is to make the ball run off the butt end of the cues.

It's quite a stunt, even when you're in on the "how." The how consists in separating the cues slightly, until the ball gains momentum, and then closing them sharply so that the ball jumps suddenly forward and rolls off the





2698 & all use  
 Detroit, Mich  
 POPULAR MECHANICS  
 maker not seller;  
 Von Lengerke • Anton  
 471  
 33 S. Wabash  
 Chicago  
 need drawings  
 of food  
 1916

butt ends. By performing the feat lengthwise of the table, and thereby eliminating the extra height caused by the cushion, the problem is greatly simplified

A trick known to our grandfathers, and one which appears to be entirely forgotten by the younger generation, is "The Pressed Ball" The problem is to press a finger down on a ball and make it go the full length of the table. The uninitiated person doing this will send the ball away with too much backspin, and it will only go half the distance, but if you moisten your finger slightly before attempting the feat, it rolls merrily along to the other cushion.

**SPRAY RUN FROM LIGHT SOCKET DEVELOPS EVEN PRESSURE**

For applying lacquers, paints, disinfectants and other liquids, an electric spray gun is operated with current from the house-lighting circuit. The compressor unit is said to develop an even pressure at all times, an essential on many jobs, and it may be carried over the shoulder with a strap or placed on the floor or bench. Only the paint container and the gun itself are held in the hand, so that vibration is reduced and there is less weight to support. The nozzle controls the spray's density.



placed on the floor or bench. Only the paint container and the gun itself are held in the hand, so that vibration is reduced and there is less weight to support. The nozzle controls the spray's density.

**GAS TANK AS AIRPLANE GUIDE HAS FIFTY-THREE LAMPS**

On top of a 418-foot gas tank, recently erected in Chicago, is a tower seventy feet high with several high-powered lights that serve as an airplane beacon. Other lamps, making a total of fifty-three for the entire tank, are provided. They are lighted automatically by an astronomical clock, and a photo-electric device turns them on during the day if fogs or smoke obscure the sun. The tank has a capacity of 20,000,000 cubic feet. It contains 5,500 tons of steel and nearly 2,000,000 rivets. A sign on top points to the landing field.

Review was right



What the Well-Dressed Dog Is Wearing; Kid Boots for All Four Feet and a Handsome Coat

**SUIT AND BOOTS FOR PET DOGS HELP GUARD HEALTH**

Pig-skin boots for all four feet and a slip-on sweater of special pattern have been devised for pet dogs. They keep the animal warm and comfortable.

**SILENT WELDING ON HOSPITAL PROTECTS PATIENTS**

Inmates of a West Virginia hospital were undisturbed although a steel addition to the structure was built recently. Electric-arc welding instead of riveting was the process used, so that practically all noise was eliminated. At one time, the welding was in progress only fifteen feet from an operating table, but the surgeons went on without annoyance.

**SWITCH WITH PILOT LIGHT ALSO HAS OUTLET**

Switch tap, pilot light and electric outlet are combined in a unit adapted to the operation of various appliances, radio, and remote-control lights. The current is controlled by the finger, and the jewel is lighted when it is on.



Harvey Hubbell, Inc

\$7.00 for set of four  
 \$37.50  
 1926  
 1925  
 1892  
 need drawings of food  
 created by J. H. C. Kitchener & Co  
 Wheeling, W. Va.  
 Cleveland, Ohio  
 Welding  
 Supply Electric Co



# Shopping Tips for

854 Blackhawk  
Chicago  
2012 - R. # 5.00

2005 - R. Alkon works here

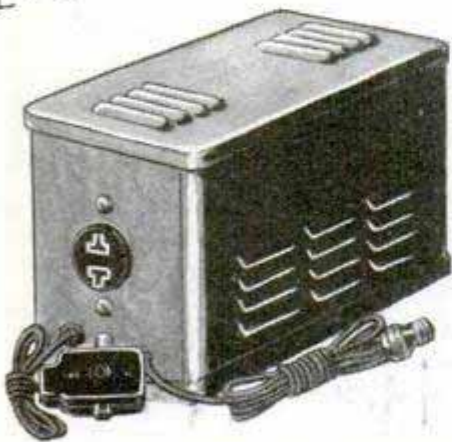

Above, New Device, for Regulating Line Voltage for A. C. Sets or A and B-Eliminators, Automatically Reduces the Line Voltage If Too High and Increases It If Too Low



Wichau n g

Below, a New and Decidedly, Different Type of Console Radio Cabinet Equipped with Glasses, Decanters and Silver Service; the Cellarette Compartment Is Lined with White Lacquer and the Drop Leaf Is White Enamel on Metal

Left, Dry Rectifier Unit of Plug-In Type, Said to Have Extra-Long Life, Replaces Full-Wave Rectifier Tubes in B-Eliminators; Below, Handy Unit Combines Light-Socket Antenna and Supply Outlets for Dynamic Speaker, Eliminators or A. C. Receiving Sets

Potley Cabinet Co. 1620 Independence Ave.  
 Philadelphia, Pa.

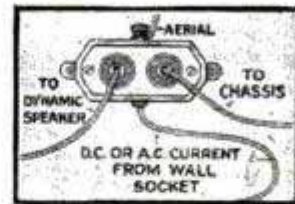
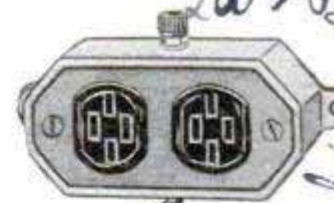

Below, New Push-Pull Amplifier of Excellent Design Can Be Used Equally Well with Radio Receiver or Phonograph Pick-Up; Small Switch Provides Quick Change-Over

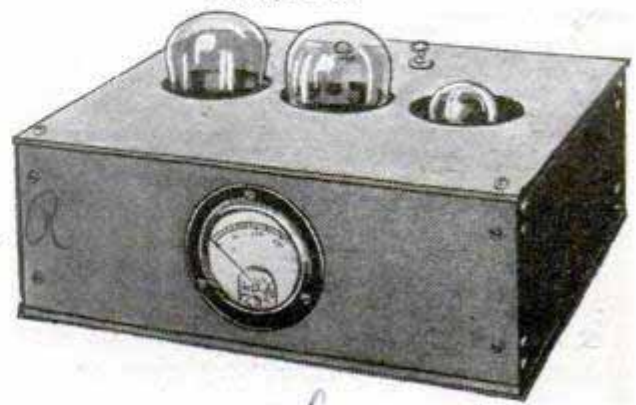

Herrenty che.



# Radio Fans



Above, New A-Power Unit of Popular Make Has Improved Filter System Employing Three 1,500 Mfd. Condensers and Improved Choke Coils; It Is Claimed to Be without the Slightest Trace of Hum



Left, Unit of Compact Design Provides Efficient Antenna and Ground Connections as Well as a Means of Controlling Line Voltage; Two Outlets Are Also Furnished for Set and Dynamic Speaker; the Unit Is Well Fused to Prevent Burn-Outs in the Receiver; Right, a Compact Short-Wave Adapter, Now Available for Use with Any Receiver, Covers All Short-Wave Bands without Changing Set Wiring



*2008- Raym Co. Dayton*  
*2008- Raym Co. Dayton*  
*2008- Raym Co. Dayton*

Below, Clock Installed in New A. C. Receiver Operates from Light-Socket Current and Automatically Winds Itself Once a Minute; It Keeps Accurate Time



Right, Complete Television Receiver Now Available Is Equipped with Sliding Visor and Combination Scanning Disk for Either 24 36 or 48-Line Pictures

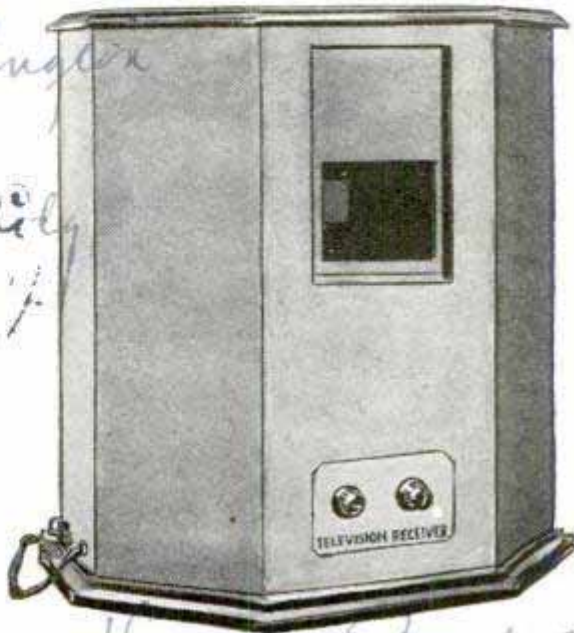
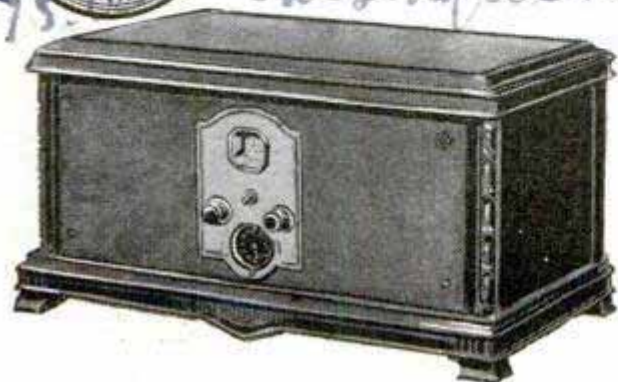

*20060*



*duchana poles. in d*

*Parts Corporation  
733 Virginia Ave. Duchana, Ind.*

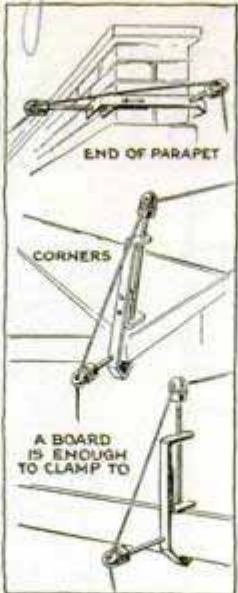
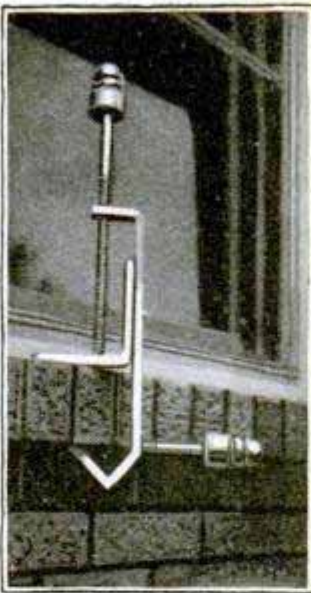
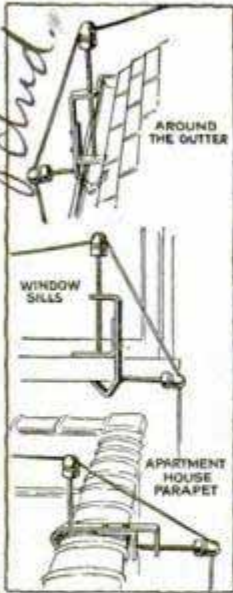

Insert Photo Shows Clamp Fastened to Building Near Window for Lead-In

**Clamp for Aerial and Lead-In**

The clamp shown in the illustration replaces unsightly sticks and poles, requires no nailing or bracing and is easily attached and removed. The only tool necessary for its installation is a screwdriver, and the various applications shown in the sketches illustrate its adaptability to all sorts of situations. The threaded shaft is of cadmium-plated rust-proof steel, and the clamp itself is of heavy channel iron similarly plated. Separate lead-in insulators are also available at small cost. These are mounted on short rods which screw into threaded holes provided for them in the clamp. Anyone who has erected antennas will appreciate the handy methods illustrated for running the aerial and lead-in wire around corners, etc.

**Attractive Lamp Forms Antenna**

A pleasing combination of an efficient antenna and a lamp is shown in the illustration. The antenna is of the light-socket type, and the outfit is provided with a length of lamp-cord, for connecting to the house-lighting supply, as well as a binding post, for the antenna connection



to the set. The lamp is useful in checking a.c.-operated radio devices, where it is necessary to turn them off with separate switches, and may be connected in the line as a warning or pilot lamp for this purpose.

**Handy Kink for Set Builders**

The use of ordinary quilt-frame clamps, for holding paper templates, small wires to be carefully soldered, and other emergencies, where the operator could well use three hands, has solved many difficult situations for the writer. These clamps are cheap and should be of the 2-in. variety.

Corrugate the jaws by making a few shallow cuts with a hacksaw, to prevent shifting of paper templates. Clamps of this type do not mar expensive panels and may be wedged with small blocks of wood.

*2015 R.*

**Compact A. C. Converter**

The compact unit shown in the illustration converts 110-volt 50 to 60-cycle alternating current to 6-volt d.c., and when used with a B-eliminator, combines the convenience of electrical operation with the desirable characteristics of standard d.c. tubes. No changes in tubes or set wiring are required, and the device takes up less room than a 6-volt storage battery.

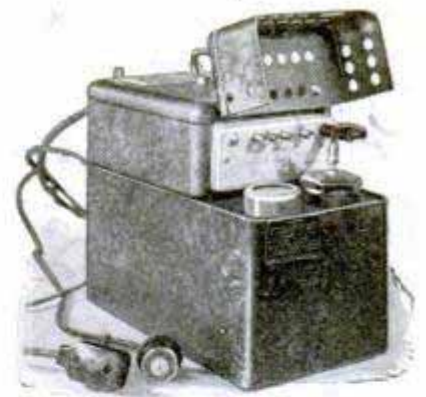

*Wetzel Co. 514 - 2nd St. - Chicago*

**Heat in Voltage Regulator**

The ordinary regulator used to protect a.c. tubes from excessive line voltage, when plugged into the electric outlet, will often become warm. This is not an indication that the unit is defective; it is a condition to be expected because such devices will dissipate heat, and simply indicates that the unit is doing its work normally.

*Green Bay Wis*

*Abor Co*



# A SCREEN-GRID S.W. ADAPTER

## for YOUR SET



THE LAST few months have witnessed a renewal of interest in short waves, due to the overcrowded long-wave channels, coupled with the fact that television is a field which brings out the advantages of short-wave transmission and reception. A good television transmitter requires a band from 40 to 80 kilocycles wide, which represents from four to eight long-wave broadcasting channels. These cannot be afforded in the broadcast band, so the newer transmitters are working between 30 and 80 meters. The short waves are valuable, because "side-band cutting," with consequent loss of picture definition, is less severe. The width of the side bands is determined by the number of "dots" sent for each picture and the number of complete pictures per second. The definition of the picture will depend on the number of dots to each picture and the continuity or smoothness of motion on the number of complete pictures sent every second. High-quality transmitters have side bands 40 or more kilocycles wide, and future circuits especially designed for television reception must eventually tune uniformly to this wide frequency band.

The best method of doing this will be in the use of r.f. circuits of the band-selector type, with regeneration used sparingly or not at all.

However, the widest interest in short waves at the present time is confined to the excellent programs transmitted by twenty or more stations in the United States and a much larger group employ-

ing code. The simple adapter described in this article is suitable for all three types of reception, but is not especially designed for television, as a compromise must be made in this case.

Byrd's expedition to the south pole; the flight of the "Southern Cross" to Australia, and similar instances, where short waves have enabled a transmission link with civilization, show the value of these short wavelengths.

Great progress has been made with short-wave apparatus. Further advancement in the ultra-short wave bands, below 5 meters, is limited, since the lower end of the ultra-short band merges with the upper end of the heat-wave band, although electrical oscillations have been produced which are near the border line. Short-wave transmitters costing only some thousand dollars have in many instances replaced long-wave transmitters costing hundreds of thousands of dollars. They are not only less expensive and much more compact, but they provide reliable communication over enormous distances and during daylight hours when consistent operation on long waves is ordinarily difficult.

The trend of short-wave receiver design follows closely that of broadcast receivers, and the development of satisfactory short-wave receivers and adapters has been greatly advanced by the new screen-grid tubes, which were used experimentally in short-wave transatlantic reception for over a year before they appeared on the market.



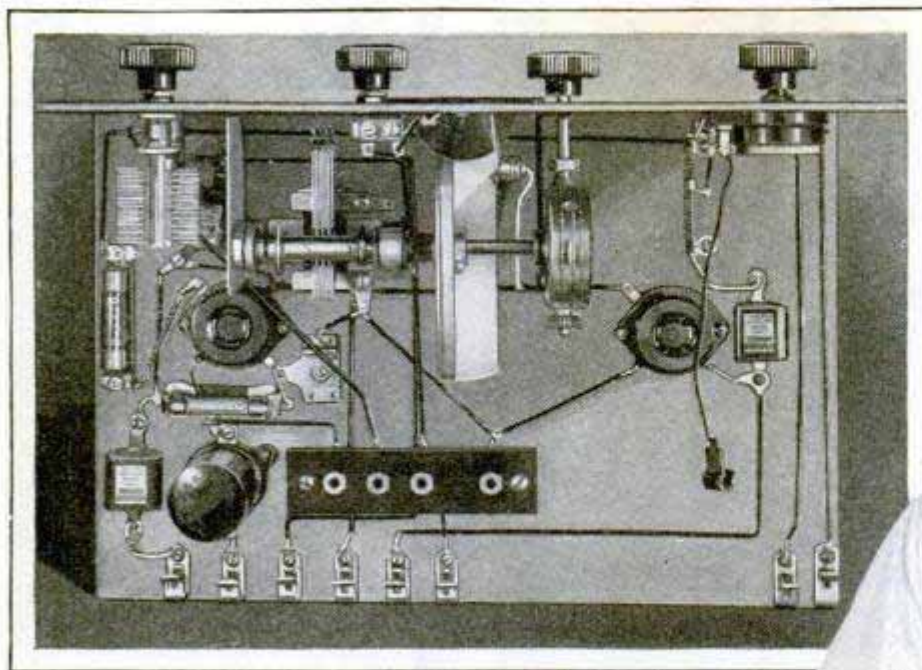

The two-tube adapter described and illustrated in this article employs the screen-grid tube, and greatly increases r.f. amplification without complicating the operation in any way. In fact, the operation is actually improved over that of the standard broadcast receiver, because the regenerative detector is not directly coupled to the antenna, and the antenna coupling does not have to be varied to prevent "dead spots." An adapter of this type does not re-radiate, as the screen-grid tube acts as a "blocking tube" and prevents direct radiation into the antenna. Some years ago, when oscillating receivers became numerous, there was a crusade against them. The necessity for a similar crusade can be eliminated by the use of circuits employing the screen-grid tube.

The model illustrated in this article was built and tested in Popular Mechanics radio laboratory and brought in eastern short-wave television and voice broadcasts with loud-speaker volume during the daylight hours. Reception at night included short-wave stations in all parts of the United States at good loud-speaker volume. These tests were made with the adapter plugged into a standard broadcast receiver. The detector tube in the receiver is transferred to the adapter, and the adapter plug is then plugged into the detector socket in the set. All tuning is done with the adapter-unit dial, as noth-

ing but the audio amplifier in the broadcast set is in use. A schematic diagram for a two-stage audio-frequency amplifier is given for those who

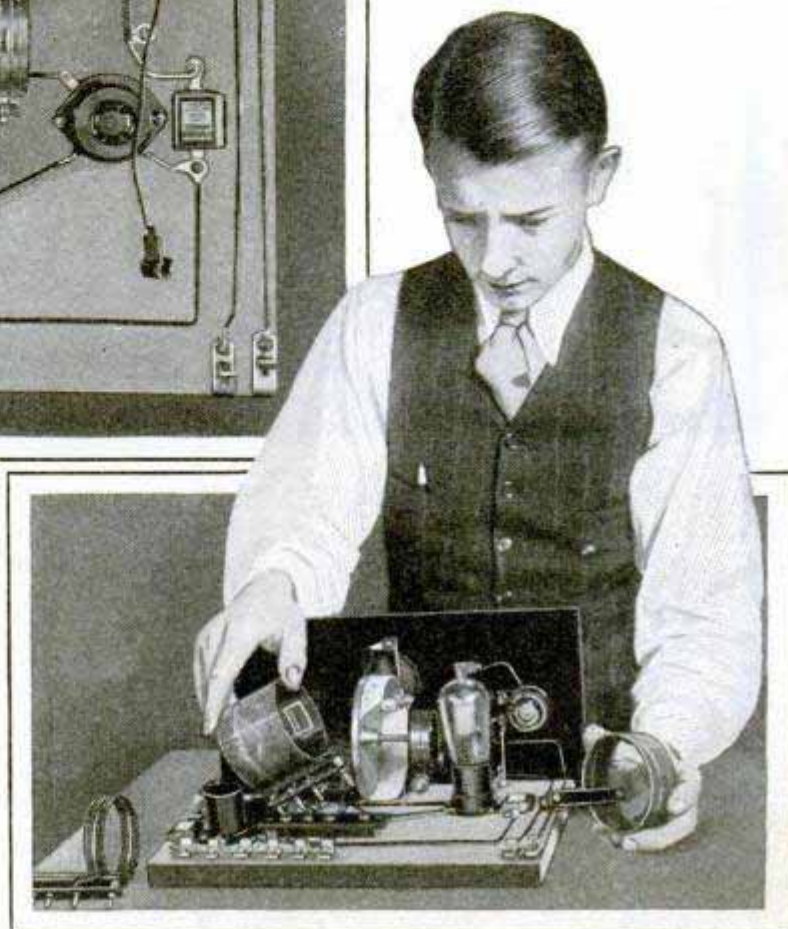

wish to include the amplifier with the tuner instead of using it in combination with the standard receiver. The terminal marked "plate lead" is connected to the binding post which goes to the r.f. choke, and the B-positive terminal is connected to the 45-volt tap of the B-battery. Any high quality a.f. transformers may be used. The first jack is for the use of headphones, and the output jack for the loud speaker.

The construction of the adapter unit is very simple, as shown in the simplified wiring diagram. The front panel is 7 by 14 in. and the wood baseboard  $\frac{3}{4}$  by  $8\frac{3}{4}$  by 13 in. Solder every connection carefully, as perfect electrical and mechanical connections are absolutely necessary in short-wave adapters and receivers. See that the small setscrew on the 100-mmfd. condenser is tightened so as to give a good wiping contact for the rotor. The wiring in short-wave receivers deserves more attention than is accorded it in broadcast receivers. All leads should be as short and



direct as possible, that is, bee-line wiring should be used. Wires carrying r.f. current should cross at right angles and should clear each other as much as possible. A slight increase in lead length may be permitted to make this possible. Capacities between the grid and plate circuits are especially important and should be reduced to an absolute minimum.

Batteries are recommended because of the high sensitivity of the adapter, although it may also be used with sets having an A and B-eliminator by disconnecting the detector-supply lead (positive 45 or 67) from the set and connecting a small 45-volt B-battery in its place. The B-battery 45-volt positive terminal should go to the receiving set and the negative terminal to the B-negative binding post on the set.

Complete a.c. operation of short-wave receivers and adapters has not been found altogether satisfactory, owing to the fact that the B-eliminator introduces extraneous noises on short waves. If the receiver employs a.c. tubes, four separate No. 6 dry cells, connected in series, with a 301-A or 112-A detector, are recommended for filament supply. Where a two-stage power-pack type of amplifier is available, it is a simple matter to arrange a switch to throw the input of the first transformer from the detector of the broadcast receiver to the detector of the short-wave receiver. If the adapter is to be used in connection with a superheterodyne, it should be plugged

into the first-detector socket and the oscillator tube in the superheterodyne must be removed; the converter is then made to oscillate and is operated in this condition. Where the intermediate frequency is high, above 150 kilocycles, the adapter will work better when plugged into the second detector and operated in the usual manner.

The A-battery leads should be permanently connected to the adapter unit; if the a.f. amplifier is combined with the adapter, making a complete receiver, the A-positive leads should be connected direct to the A-battery positive terminal and the set side of the battery switch so that this switch turns off all tubes. Ordinarily 112-A detector and screen-grid r.f. tubes are recommended for short-wave receivers. The 112-A is more sensitive and is a stable oscillator. The 301-A is almost as satisfactory as a detector and may be used when the effective input capacity must be low; for example, when working at the minimum wavelength of the circuit. The 200-A detector tube is very sensitive but noisy. A 199 tube may

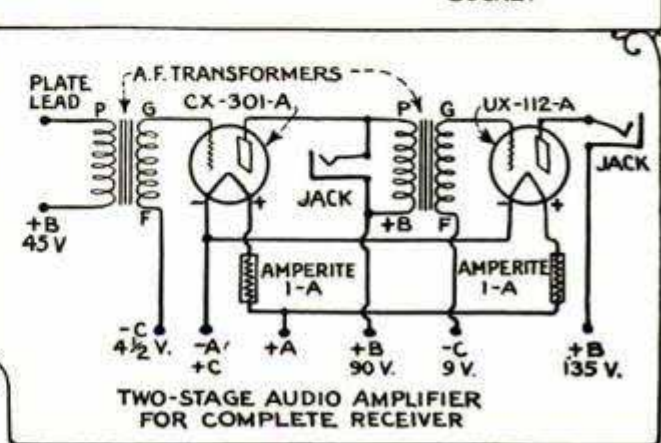
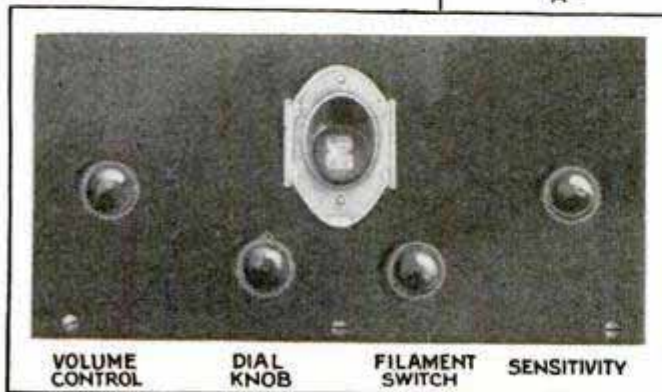
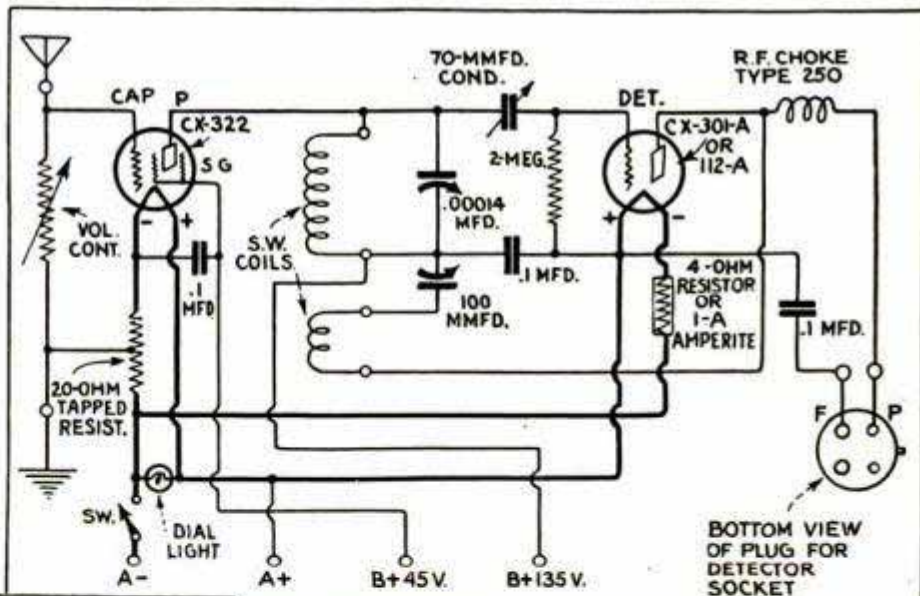







# Making Short-Wave Coils

By L. B. ROBBINS

THE INTERESTING programs now available on the short waves have created a demand for short-wave sets and adapters, which are not expensive and are quickly assembled. Suitable short-wave coils can be purchased for from \$5 to \$10 a set, but many experimenters would like to make their own if the data for their construction were available. The purpose of this article is to show the reader how to make a good set of short-wave coils of the plug-in type to be used with standard-tube sockets, suitable for covering the 150, 80, 40 and 20-meter bands at a minimum cost.

The materials required consist of the following items: some stiff cardboard mailing tubes, 3 in. in diameter; a few strips of bakelite, 8 in. wide; four UX-tube bases from burned-out or discarded tubes; a small bottle of orange shellac, a ¼-lb. spool of No. 18 enameled-copper wire, and an assortment of machine screws and nuts.

As these coils are designed with a fixed secondary and tickler, each pair is to be wound on a single piece of tubing and their terminals connected to the four prongs of a single tube base, as shown in the sketch.

The tube for the 150-meter coil should be 4 in. long; for the 80-meter coil, 3½ in. long, and for the 20 and 40-meter coils, 2½ in. The mechanical construction is so clearly shown in the diagrams that little further comment is necessary. The coils (secondary at the left and tickler at the right) must both be wound in the same direction, the turns being spaced ⅛ in. apart, and the space between the coils should be about ¾ in. Punch a pair of holes in the tubing at the start and finish of each coil and thread the wire through them to hold the winding. The ends of the coils are then brought down through small holes drilled in the bakelite strip, as shown.

To prepare the four prong bases cut the tube base off with a hacksaw, severing the wire leads at the same time. The leads may then be removed from the prongs by

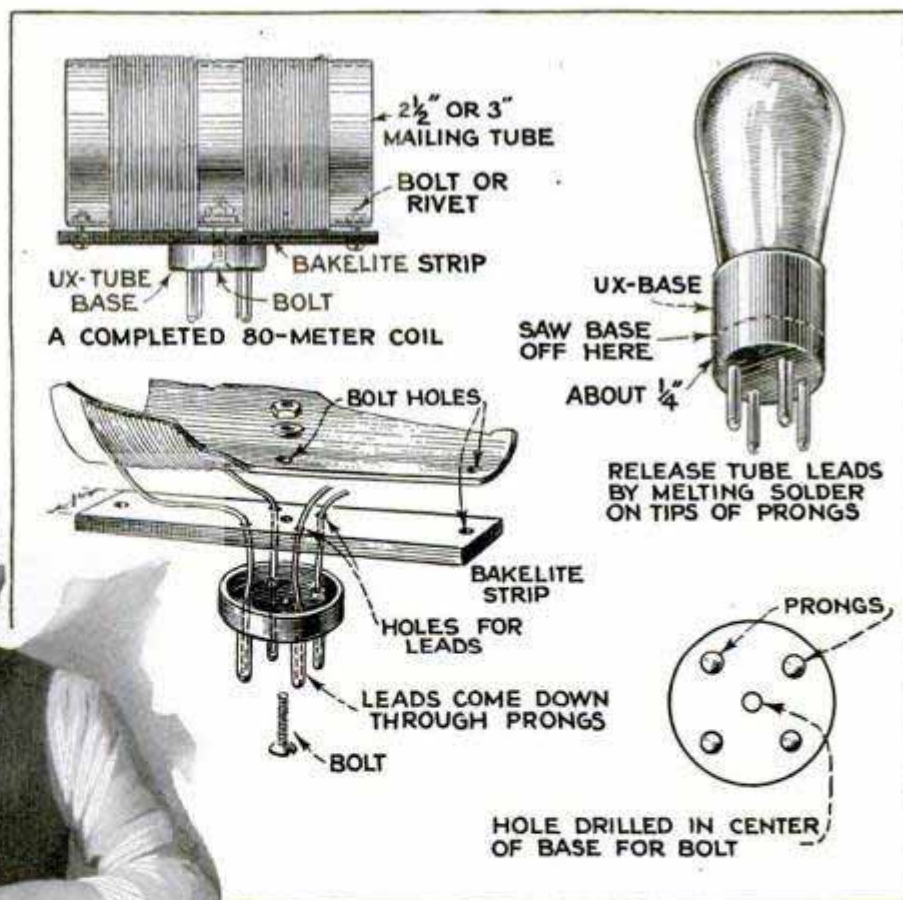

heating the tips of the latter with a soldering iron. Drill out the prongs and also drill and countersink a ⅛-in. hole in the center of each base.

Each pair of coils will cover a range



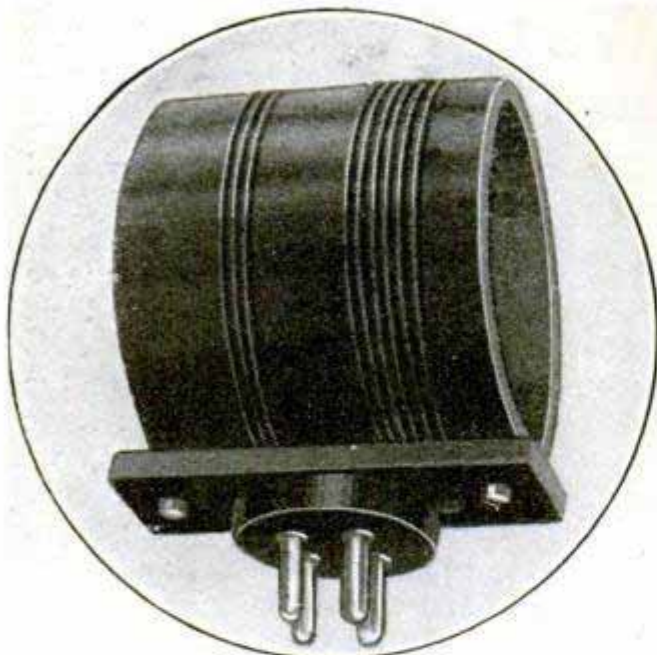

Completed 20-Meter Coil

well above and below the band for which they are designed. If an adjustable primary coil is to be used in the circuit employed, one size only is required, and this may consist of 10 turns of No. 26 double-silk-covered wire wound on a tube  $2\frac{3}{4}$  in. in diameter. A variable high resistance may be used across the antenna and ground posts, eliminating the primary coil.

Using .00025-mfd. variable condensers in the circuit, the following number of turns will be found about right for the various short-wave bands: for 20 meters, secondary 3 turns, tickler 6 turns; for 40 meters, secondary 7 to 8 turns, tickler 9 to 10 turns; for 80 meters, secondary 15 turns, tickler 10 turns; and for 150 meters, secondary 25 turns and tickler 20 turns. For smaller condensers, use one or two more turns in the secondary depending upon the total number used. No change is required in the tickler coils or the primary coil.

When using the coils, the idea is to get a number of turns in the secondary that will place the middle of the band somewhere near the middle of the condenser setting for best results.

### Correct Coupling for Receiver

The degree of coupling between the primary and secondary coils in a receiver should be carefully adjusted in order to obtain both sensitivity and selectivity. Because of varying local conditions, the distance between these two inductances will not be the same in every receiver. For

this reason, a little experimenting is necessary. If the coupling is too tight, the local stations will cover a large part of the tuning dial, or even be heard faintly over the entire dial, being present as a disagreeable background while distant broadcasters are tuned in. If the coupling is too loose, distant stations will be eliminated. Because of the extreme weakness of the signals, they cannot be transferred to the secondary coil. In the case of the local station, the oscillations are so strong they easily induce a current into the secondary, even when the two circuits are not in resonance. There is a critical degree of coupling between the two extremes which will not eliminate the weak stations but will sharpen the tuning of the locals, so that the former stations may be received. To find this critical value, tune in a distant station, one that is found near 50 on the dial, and slowly move the primary away from the secondary. At the point where the station begins to fade out, securely fasten the primary in place. It may be necessary to retune the set during this operation.

2014-02

### Unit Protects A. C. Tubes

A simple voltage-control device for protecting a.c. tubes from high line voltage is now available. The need for such a device in some localities where the supply voltage is often as high as 130 volts is very real, as the life of a.c. tubes is very short in such cases, regardless of the type of filament transformer employed in the receiver.

No tools are required to install the unit, which is simply plugged into any convenient outlet. The local power company will advise the user as to the maximum line voltage in the locality. The a.c. set is then plugged into

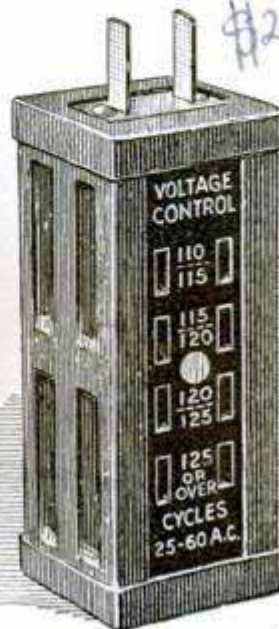

Master Engineering Co



the outlet marked to correspond with that voltage and thereafter requires no further attention. A.c. tubes such as the 226 and 227-types must not be operated above their rated filament specifications and may be further protected by means of suitable filament ballasts in the line to each tube.

**Push-Pull Amplifier Kink**

If you are one of the many who would like to try out push-pull amplification, the idea illustrated in the circuit diagram is an economical method of changing the old a.f. transformer so that it will serve the purpose. This form of amplification has many advantages, especially in the output stage, and will be found in many of the latest sets. Bridge the secondary of the first a.f. transformer with two 100,000-ohm resistances as shown at  $R_1$  and  $R_2$ ; these provide a means of finding the center tap, or zero point, of the a.c. voltage in the secondary winding of the transformer  $T_1$ . This point is necessary for the application of the negative bias to each tube. Resistances  $R_3$  and  $R_4$  are each of the 50,000-ohm heavy-duty type, ordinary grid resistors being unsuitable because they will not pass the necessary current for the correct operation of the tubes. The B-battery is led

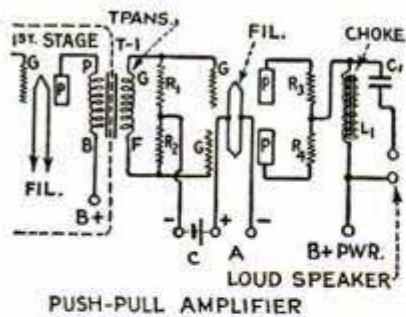

to the center point formed by these two resistances through an impedance  $L_1$ , which may consist of the primary of an old trans-

former or a standard 30-henry choke. This choke and the 2-mfd. condenser  $C_1$  act as a coupling impedance or output filter which keeps the B-supply out of the speaker winding. Two of the 171-type tubes are advised, the results being faithful reproduction and better volume.

☐ Popular Mechanics' radio department offers its information service free to all readers of our magazine.

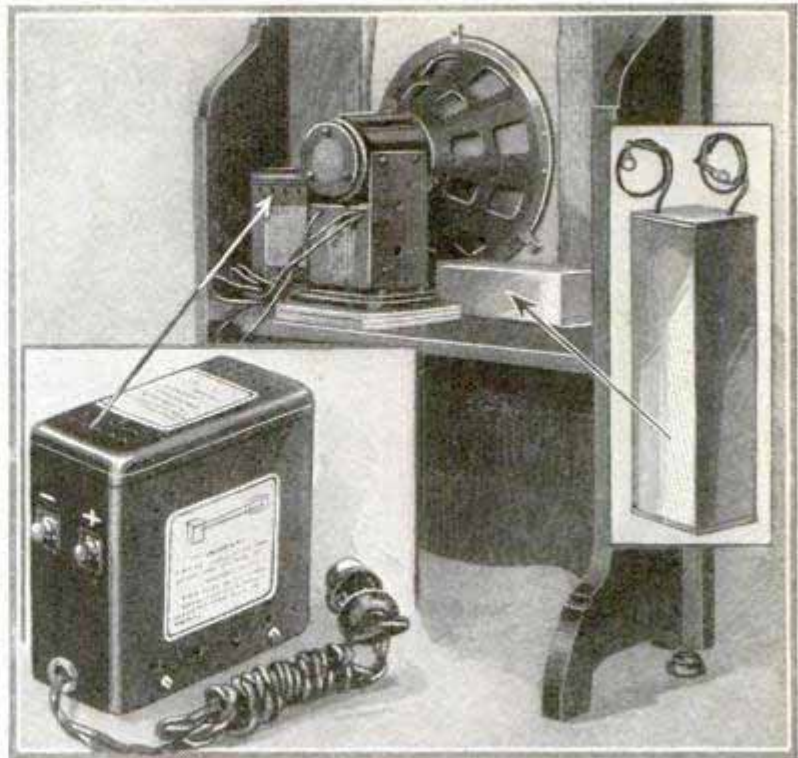

Above, Complete Installation in Small Space; Lower Left, Dry Trickle-Charger Unit; Insert, Right, 1,500-Ohm Condenser

**Battery-Operated Dynamic Speaker Converted to Power**

Alternating-current operation for the dynamic speaker of the 6-volt battery-operated type is a simple matter for those who wish to eliminate the storage battery. The illustration shows a dynamic speaker arranged for operation directly from the a.c. 110-volt, 60-cycle line. As the drain of a speaker of this type is only .6 amp., a dry trickle charger is used to supply the necessary d.c. current. This unit is shown at the lower left, and the reader will note that the polarity is carefully marked. It is very important that the red cord from the speaker unit be connected to the positive terminal of the trickle charger. The condenser, shown in the insert, is one of the new low-voltage high-capacity types rated at 1,500 mfd. It is connected directly across the positive and negative posts of the charger unit and effectually reduces the a.c. hum to a minimum. These units take up little space and will work satisfactorily with any of the dynamic speakers designed for 6-volt d.c. operation. With some makes of speakers, it has been found that filament-control units in series shunted across the output terminals of the trickle charger, can be used instead of the condenser. This is, in fact, an experiment, but is worth trying.

*Edison Works*



202  
2028-R

480 Lexington Ave  
New York

# Hints from the



A Small Variable Resistor Provides a Simple Means for Controlling Speaker Volume and Sensitivity When Connected Either in Series with the Antenna or across the Antenna and Ground, as Shown in the Sketch at Right

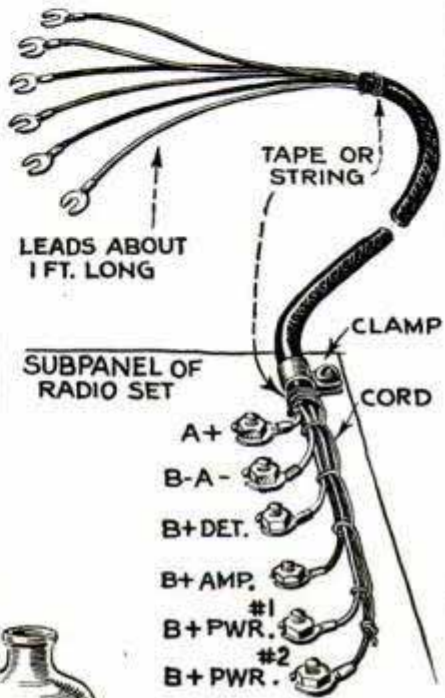
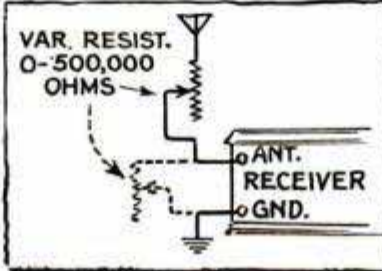

CORE STAMPINGS

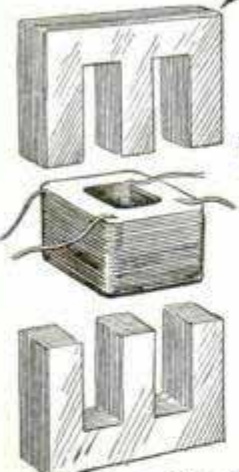

PRIMARY AND SECONDARY WINDINGS

Secondary Winding of Audio Transformer May Be Used as R. F. Choke; Remove Core Laminations, Cap with Bakelite and Mount with Long Machine Screw as Shown

BAKELITE TUBE



SECONDARY

SHEET OF PAPER

PRIMARY



Right, Front View of Dynamic Speaker Baffle, Rear View of Which Is Shown on Opposite Page

Machine Screws Make Inexpensive Binding Posts; Left, Low-Loss Primary Coil for R. F. Transformer Is Wound on Bottle of Size to Fit Inside Secondary at Filament End, 15 to 20 Turns No. 28 S. C. Wire Being Used; Coil Is Painted with Collodion before Being Removed

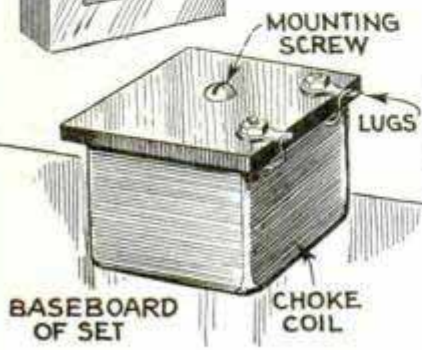

BASEBOARD OF SET

CHOKE COIL





# Radio Laboratory

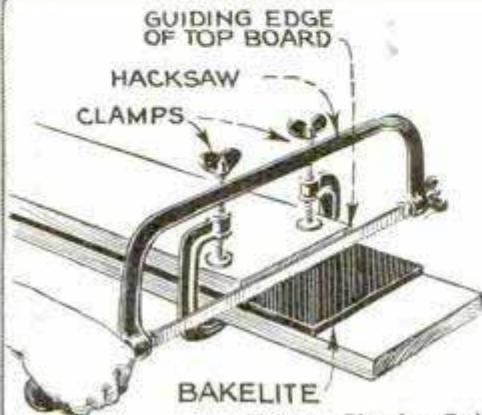
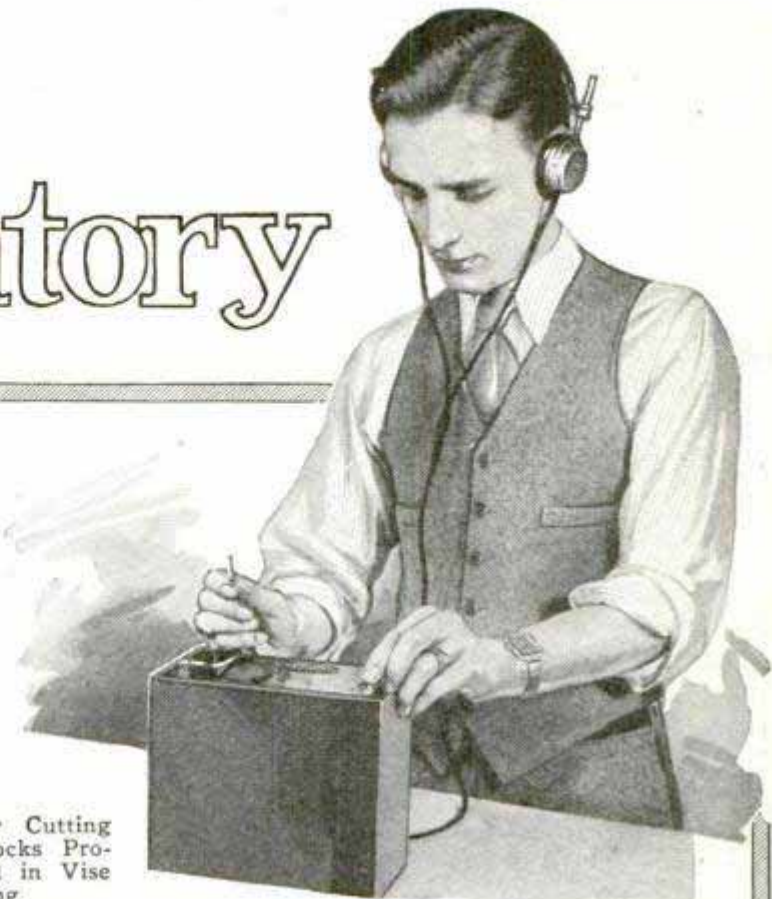

Above, Simple Guide for Cutting Panels; Below, Wood Blocks Protect Panel When Clamped in Vise for Drilling or Filing

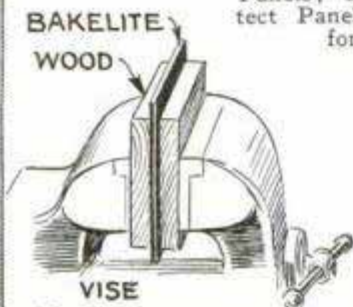

Right, Two Simple Methods of Controlling Receiver Volume

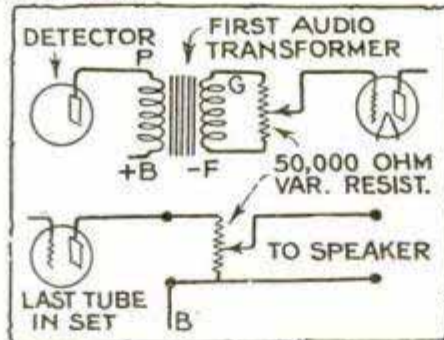

In Testing for Noisy B-Battery, Connect One Phone Tip, Hold the Other and Touch Opposite Battery Terminal

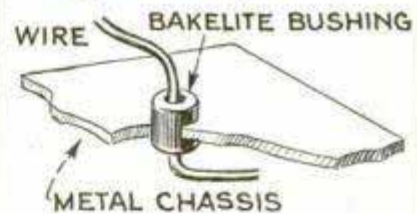

HOLE IN CHASSIS

Left, Rear View of Dynamic-Speaker Arrangement Suitable for Small Theaters; the Baffle is About 4 Ft. Square and May Be Made of Celotex; Smaller Single Speakers Give Excellent Results in Home

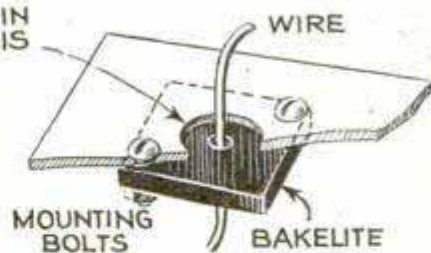

Above, Two Simple Kinks of Insulating Leads Passing through Metal Chassis of Receiver

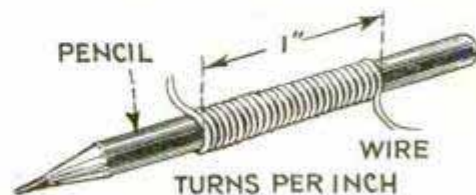

Above, a Quick Method of Determining the Number of Turns of Wire per Inch for Any Coil; Wind the Wire Selected on a Pencil and Check the Distance with a Ruler, Then Count the Turns





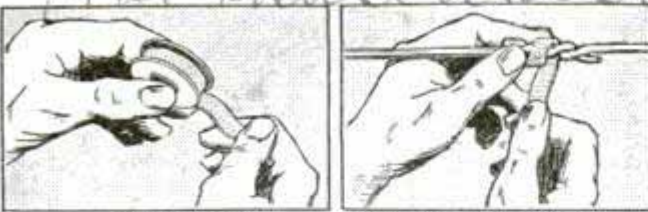

TEAR OFF SMALL STRIP

WRAP THE STRIP AROUND THE SPLICE

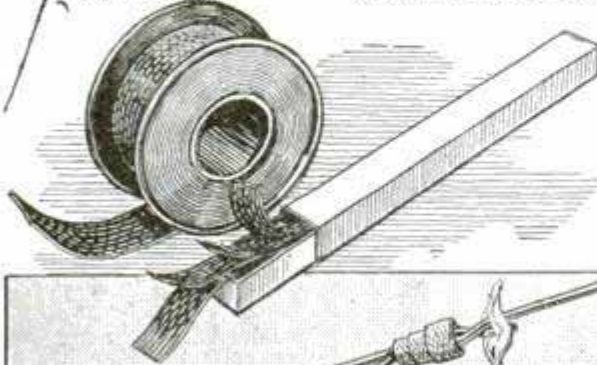

THEN APPLY HEAT NEAR BUT NOT ON THE TAPE SOLDER

The Successive Steps in Using the New Tape Solder Illustrate Its Handiness and Freedom from Waste

### Handy Solder in Tape Form

A solder in tape form has recently made its appearance on the market, and is available in 60-in. rolls and also in packages containing five 5-in. strips. No iron or torch is necessary, as the heat from a match or cigar lighter will make a good soldered connection. There is no waste in solder of this type, as just enough is torn off for each job. It is claimed to be non-corrosive and is, therefore, ideal for radio purposes.

### Regeneration Necessary for DX

Real DX-results are only possible when some form of regeneration is employed. Care must be taken, however, in order not to interfere with the pleasure of others in the vicinity. The real DX-fan ordinarily listens in after everyone has gone to bed and knows how much regeneration he can use without creating a miniature broadcasting station. Regeneration may be obtained in various ways, and as the modern r.f. circuit is invariably equipped with some means for stabilizing to prevent regeneration, this device can be easily located and temporarily altered for DX-reception. This will permit regeneration to approach maximum sensitivity and is easily kept under control.

### Cutting Down Resistance Stages

The usual practice of using three stages of resistance-coupled amplification was necessary to obtain the same result as with two stages of the transformer-coupled type. The third stage may be omitted if high- $\mu$  tubes, known as the CX-340 type, are employed. The higher amplification factor of this tube makes up for the lack of step-up in resistance coupling and provides just as much volume as two stages of transformer-coupled amplification.

### New Combination A-Supply

A new A-supply unit supplies up to 2½ amp. of current, which is sufficient to operate ten ¼-amp. tubes. Power tubes, such as the 171 or 112-type, drawing ½ amp. each, must be counted as two of the ¼-amp. tubes. The unit eliminates the 6-volt storage battery for the operation of practically any set employing standard d.c. tubes, making possible light-socket operation of the entire set if a B-eliminator is used. A receptacle is provided for plugging in the B-eliminator, and the entire power supply to the set is then controlled by the small pendant switch shown. A tap switch is provided in order to meet the requirements of the set and the voltage conditions in various localities. This switch is set at the lowest point at which normal reception is obtained. Only two units of this A-supply device can possibly be affected by prolonged heavy duty, the rectifier and condensers, which are easily replaced even by a novice. The unit is complete and ready to plug in.

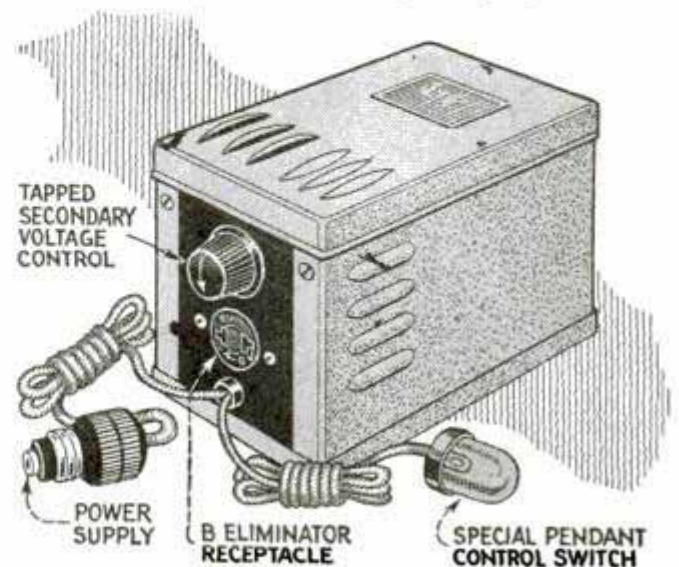

A-Eliminator Housed in Well-Ventilated Container, Showing the Various Controls

+ Radio Corp.  
 142+ Laurel Street  
 Campbell mfg Co. St. Louis Mo.  
 60-in. 2 spools - 50 cents  
 25-in. in strips, 25 cent  
 3961 Alvic

*John Deutschmann*



229 W. 43rd  
New York

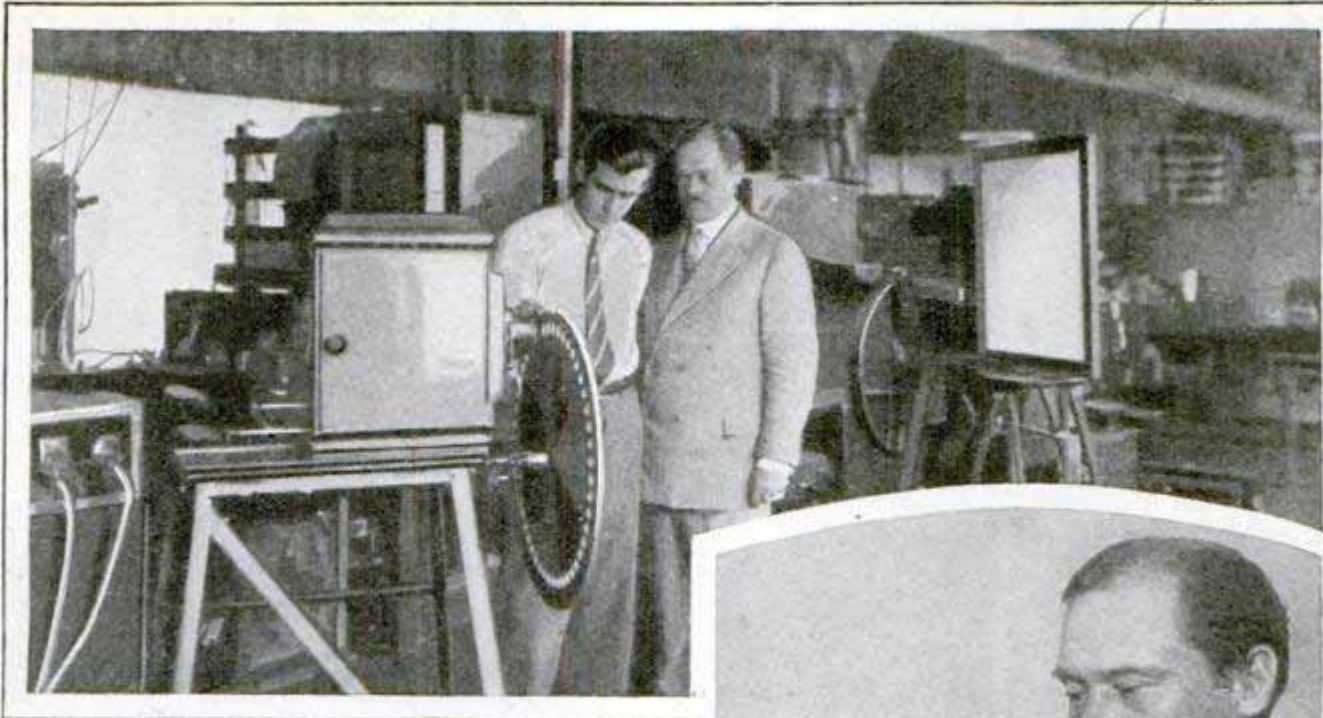

Laboratory Installation Showing the Projector and Disk at the Left and the Screen at the Right; Right, Doctor Alexanderson with the Filament and Tube Used in the Television Apparatus

### Projecting Television Pictures

Television pictures projected on a screen by Dr. Ernest F. W. Alexanderson, of the General Electric company, in recent public demonstrations show a rapid advance in the new art. The screen employed is similar to that used for home movies and the pictures are remarkably clear, with good half-tone definition. The projector includes a disk with 48 lenses, and the picture or image is thrown through a ground-glass screen. One of the projectors was demonstrated at the last radio show in New York City, where sound and pictures were synchronized with satisfactory results considering the experimental nature of the apparatus. The results are far in advance of similar television demonstrations where the picture is only about  $1\frac{1}{2}$  in. square, and the rapid progress made within the past year promises an early solution of many of the problems involved.

### Improving Tone Quality

The common practice of supplying all the tubes in a receiver from the same B-battery or eliminator is not by any means the ideal arrangement from the standpoint of tone production. A separate B-supply for the audio tubes will prevent much distortion and also reduce the trouble experi-



enced as motorboating. This is not a new idea, but the cost of an extra B-supply has discouraged its adoption in the past. In the present day of combined audio amplifiers and high-voltage B-eliminators, the objection against a separate B-supply for r.f. and detector tubes has not so much point, and a simple eliminator for this purpose can be built at low cost, or B-battery units can be employed.

☐ When making alterations in a receiver, it is always best to remove the tubes first.



Sharon, E. A.

# From Sputter-Spatter

NEARLY 4,000 outboard motorboat races were held last year in North America, and more than half a million skippers piloted some kind of outboard craft on our inland and coastal waters. Young and old have "outboarditis"—a disease which rages by reason of the many recent developments in hull and marine-engine building.

In the slang of our most active navigators, an "outboard" is any boat from seven

boards travel across this and other countries on or trailing behind motor cars so argonauts of the automobile may pause and navigate on casual water. Motorists thus tour by land and water alternately and find the water not quite so crowded



to seventeen or even twenty feet in length to the stern of which is clamped a light gasoline engine, propeller shaft and propeller—the pushing power. This power plant is one unit which can be easily attached, detached and lifted by one individual. Hence it is a "portable."

Because this small boat and power plant form the most convenient and economical combination for aquatic sport, outboards speed over the surface of almost every bay, sound, lake, pond, canal, river and creek in this country and astonish the heathen occasionally. Thousands of out-

as the road. But dyed-in-the-wool outboarders are the maddest of racing fans.

On a windy, sleety, snowy April day, young Earl Widegren of Locust Valley, Long Island, steered an outboard shaped like a large watermelon along the wave-tossed Hudson river from Albany to New York City, to win the Hudson Outboard Marathon of 133 miles at an average speed of thirty miles an hour.

Young Widegren's craft, named "Baby Olds," was twelve and a half feet from stem to stern and fifty-four inches across the waist. It had a high-arching deck of tarpaulin, streamlines and longitudinal body steps and a nose like an airplane's fuselage. It was in the air about half the time and was designed and built in an air-



# to Water-Speedster

plane factory. It crossed the finish line all wet but winning because it had the design and a dauntless navigator, plus a

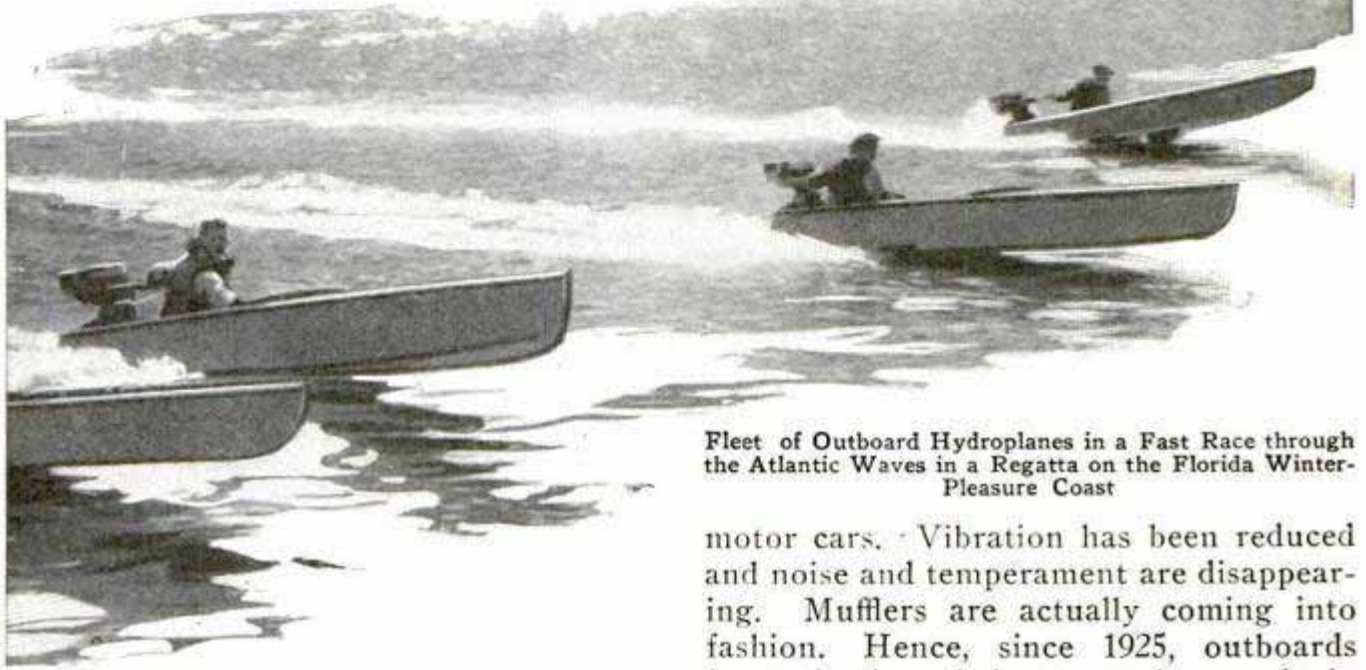

Fleet of Outboard Hydroplanes in a Fast Race through the Atlantic Waves in a Regatta on the Florida Winter-Pleasure Coast

power plant weighing less than 150 pounds that worked faster than most airplane engines. "Baby Olds" was one of the latest things in outboard boats during the spring of 1928.

It is a far cry from the 1913-model, single-cylindered outboard motor that pushed a flat-bottomed or clinker-built rowboat through still water at eight miles an hour, to the scientifically constructed power plant which rushes a transverse-stepped hydroplane over the waves at thirty miles an hour. Since the days of the "one-lungers," sealed coils and condenser casings have eliminated short-circuiting. Separate feed pipes and cooling tubes now keep fresh and salt water out of lubricants. Two, three and four cylinders insure steadiness. Larger piston displacement gives more power.

Costly and more serviceable alloys have displaced cast iron and common steel in the combustion and propulsion departments. Outboard metal is often of higher grade than that used for similar parts in

motor cars. Vibration has been reduced and noise and temperament are disappearing. Mufflers are actually coming into fashion. Hence, since 1925, outboards have dominated larger racing craft in many events on protected waters.

This change has been gradual. Judge Aaron B. Cohn, of Toledo, caused a sensation during the Detroit regatta of 1924 when he won the American Power Boat association's outboard championship by speeding nearly twelve miles an hour! That performance broke down official resistance so effectively that "kickers," "putters" and "sputter-spatters" were admitted to the exclusive Gold Cup regatta on Manhasset bay. Then the outboards registered a sensation by covering nearly twenty miles in one hour during the 1926 regatta of the Mississippi Valley Power Boat association, at Louisville. Now outboards are welcomed at the Newport-Naragansett competitions for large and small power boats. The once despised "water bugs" are speeding forward steadily.

Outboard plants, once merely "kickers" for fishing trips, are still depended on for long cruises, but, whereas the spark plugs on Lindbergh's "Spirit of St. Louis" fired from 800 to 900 times a minute, the aver-



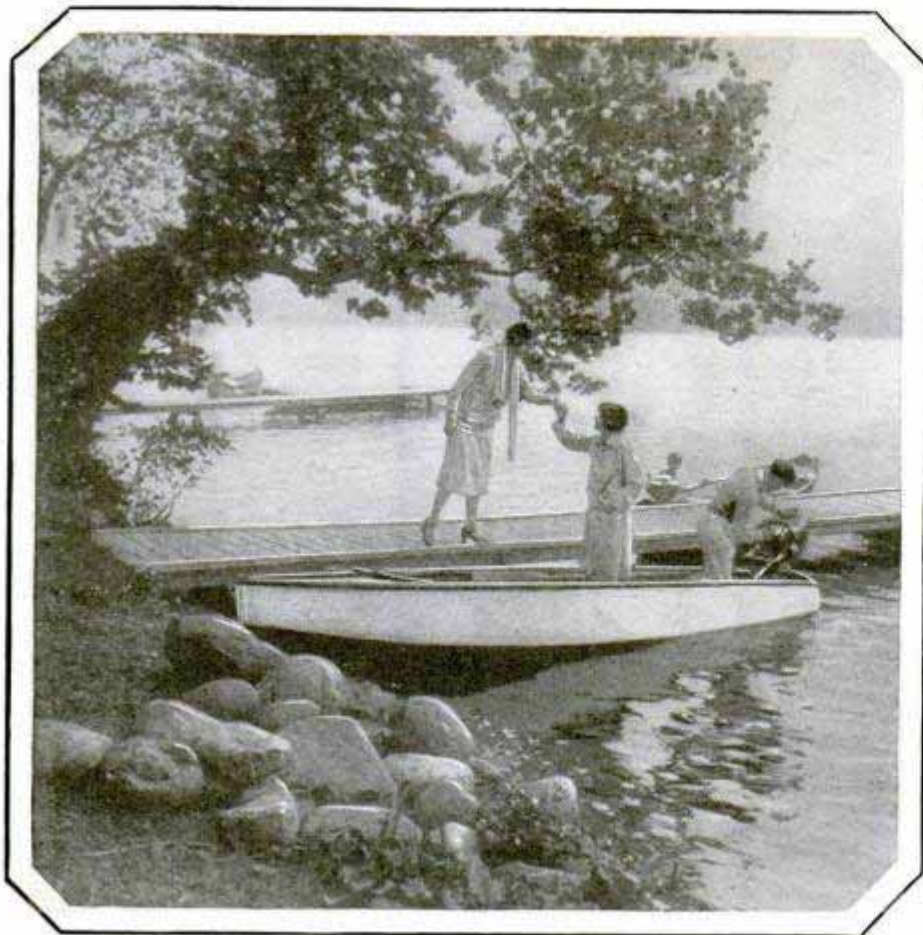

**Making a Motorboat of Any Canoe or Rowboat, the Outboard Has Been Adopted by Thousands on Lakes and Rivers**

age outboard spark plugs fire from 3,500 to 5,000 times in sixty seconds. This is one reason why seven outboards, none of them more than seventeen feet long, bucked Lake Michigan and flood conditions in the Illinois and Mississippi rivers from Chicago to New Orleans and finished the 1,750-mile voyage at an average speed of twenty-two miles an hour.

This improvement in mechanism, plus a gift for tricky navigating, permitted fifteen-year-old Mary Alcott Richardson of Glen Ellyn, Ill., to win a handsome silver trophy by driving her tiny, thin-shelled craft along ninety-six miles of rough Lake Michigan to win the Milwaukee-Chicago Outboard Marathon.

A few months later thirty-five outboard devotees started from Boston for New York City, via Cape Cod canal and Long Island sound. C. P. Stevens, Jr., of Albany, won \$1,000 by negotiating the 260 miles five minutes and six seconds ahead of the runner up, Al Buffington, of Fall River, Mass.

Helen Hentschel, of Flushing, N. Y., graduated from a swimming class to command of an outboard in the 1925 Gold Cup

meet. Within two years, she was hailed as our leading lady outboard navigator. Yet she had hard luck in the Hudson River Marathon. The first time she tried to buck the winds and waves and currents between Albany and the great metropolis, her motor was killed by sleet and rain, she drifted helplessly to the eastern shore and reached her destination, soaked, in the caboose of a local freight train. Under the rules, she tried again. When the motor's vibration started the seams in her cockleshell, she bailed and purred southward pluckily. Time and again rain or spray wetted the spark plugs of her engine, but she sucked salt from the wire ends and

started her motor hopefully. Forced to lean across the steering wheel to pump air into her auxiliary fuel tank, the boat's pounding so agitated her stomach that she was nearly as dead as the motor, when kind rivermen towed her into Garrison.

But though Helen did not win that marathon, she did win against famous European outboarders on Lake Tremplin, Germany, by doing 28.7 miles an hour. Then she hurried back to try for outboard honors in California and Rhode Island.

The boys and girls who pilot outboards, against mature men in many cases, run many risks in their erratic speedsters. The "Driftwood Derby" of July 4, 5 and 6, at St. Louis, is an example. Officially it was the twenty-first annual regatta of the Mississippi Valley Power Boat association, witnessed by 30,000 people, but, between snags and river steamers, it resembled a log-rolling contest.

Two boats of the 151-class sank to the river bottom permanently. That didn't discourage the dozens of outboard speedsters. H. M. Frazier of Auburndale, Fla., got his water bug into a backwash



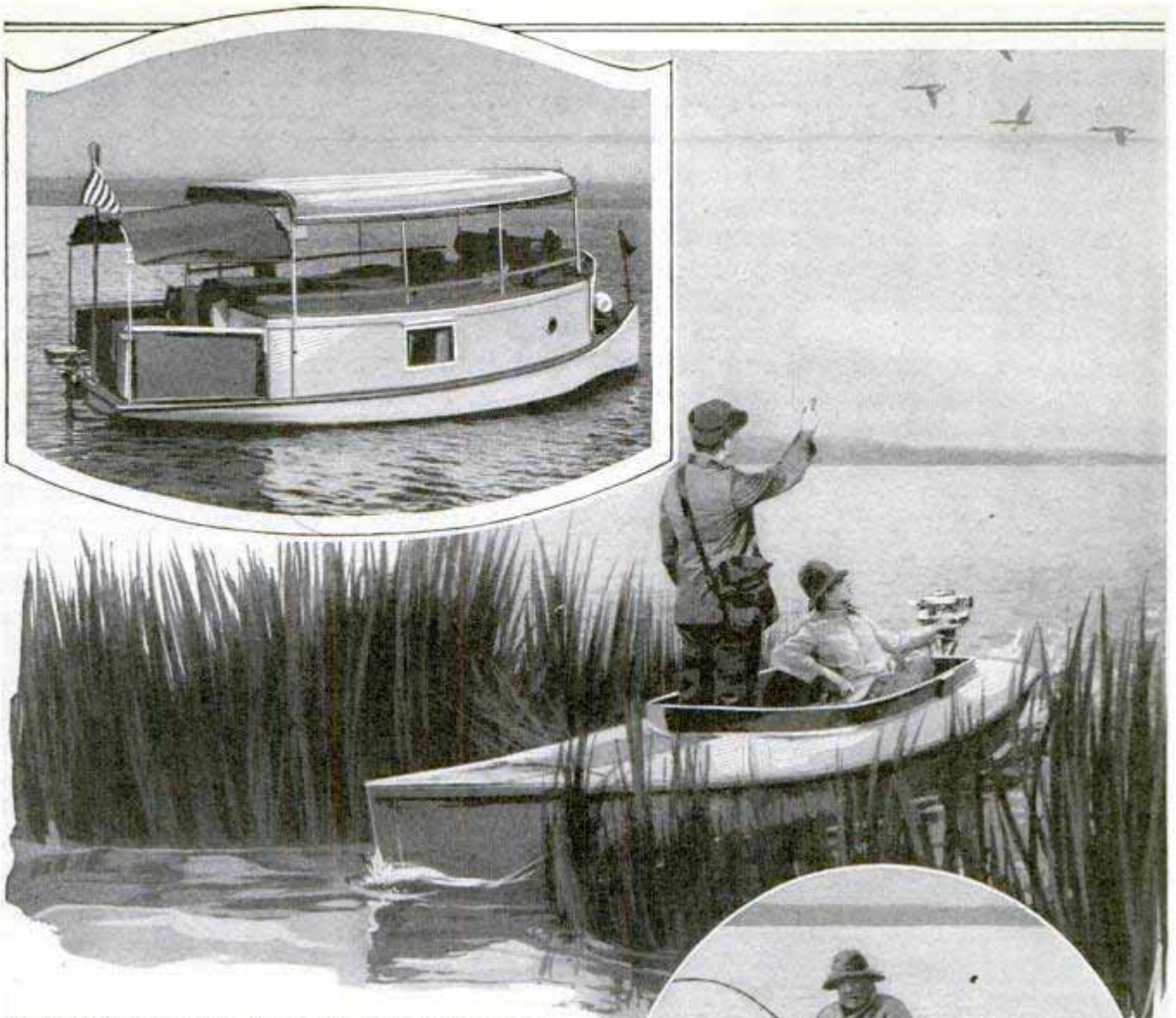

A Houseboat Pushed by a Six-Horsepower Engine, Top; Duck Hunter, and a Fisherman at Fish Lake, Saskatchewan, Canada

which jammed his head against a stone bridge pier. But, like entrants from Detroit, Cleveland, Birmingham, Kansas City, Houston and Wilmington, N. C., and other cities, Frazier stayed with it, to applaud an outboard record of 33.33 miles an hour made over a course referred to as "a practice for the River Styx."

Naturally outboard racing creates excitement and develops the industry just as motor-car racing developed motor cars. But thousands of miles are traveled annually by amateurs who "putt" for pleasure in their water flivvers. After nineteen years in his local courts, four terms in his state legislature, nine trips to Labrador and various experiences as a state's attorney and a world-war aviator, Judge William J. Malone, of Bristol, Conn., loaded his family and friends on his twenty-foot outboard cruiser and explored the Ohio and lower Mississippi from Pittsburgh to New



Orleans. The same spirit of aquatic adventure sent Mr. and Mrs. Rockwell Stevens clear across France, in an outboard boat, much to the astonishment of the natives. But the water flivver is solving engineering problems as well as giving pleasure to the traveler.

Not long ago the mine manager, A. B. Norris, had to get some six-ton boilers from Quebec to the Melartic gold mines, 433 miles in the Canadian wilderness. The mines were forty miles from the nearest



railroad. Pack horses were out of the question and the roads were impossible. So he made his boilers air-tight, tied them to large canoes, equipped the canoes with outboard motors and floated the boilers up forty miles of winding stream.

This feat could not have been accomplished but for a recent improvement in outboard equipment through which a propeller shaft is not bent or broken when the propeller strikes a stone or other unyielding obstruction, but is tipped upward and backward unharmed. The only part damaged is a small brass sheer pin. A new pin is put in place and the voyage proceeds. During the Norris adventure, the propellers often hit river bottom but no material damage followed. Nothing suffered but the sheer pins.

Outboards also go in for dramatics. Through the blackness of a winter's night, between cakes of ice and over white-capped waves, Ralph Anderson steered an open boat, pushed by an outboard, from Isle Royal, in Lake Superior, to the Michigan mainland and a doctor. Anderson's companion was a fellow trapper who had been seized with acute appendicitis. Anderson had the option of operating with a fish

knife or getting his companion to a doctor.

During a sudden flood which submerged a large part of North Sacramento, Calif., the Wilbur family rescued 300 marooned fellow citizens in the Wilburs' water flivvers. That was an all-night job, also.

Inexpensiveness as well as versatility increases the outboards' popularity. Following the custom with auto motors, the outboard engines are classed according to piston displacement. Class A, in outboards, has less than fourteen inches of displacement; Class B, from fourteen to twenty inches; Class C, from twenty to thirty inches; Class D, from thirty to forty inches; Class E, from forty to fifty inches; Class F, from fifty to sixty inches; Class G, from sixty to eighty inches and Class H from eighty to a hundred or more inches.

Of course, most outboarders have to buy their motors, though one can rent and sometimes borrow a motor. Capt. Elmer E. Dunn, of St. Petersburg Fla., rented one for fifty cents, rented a boat for \$10, tuned up a bit to get experience, for he was the rawest kind of outboarder, and cleaned up at the Miami Beach Regatta of the Florida Outboard Racing as-



The Flivver of the Lakes; Speeds of Fifteen to Twenty-Five Miles an Hour Are Not Unusual for Outboard Boats Capable of Carrying Four to Six Passengers in Comfort



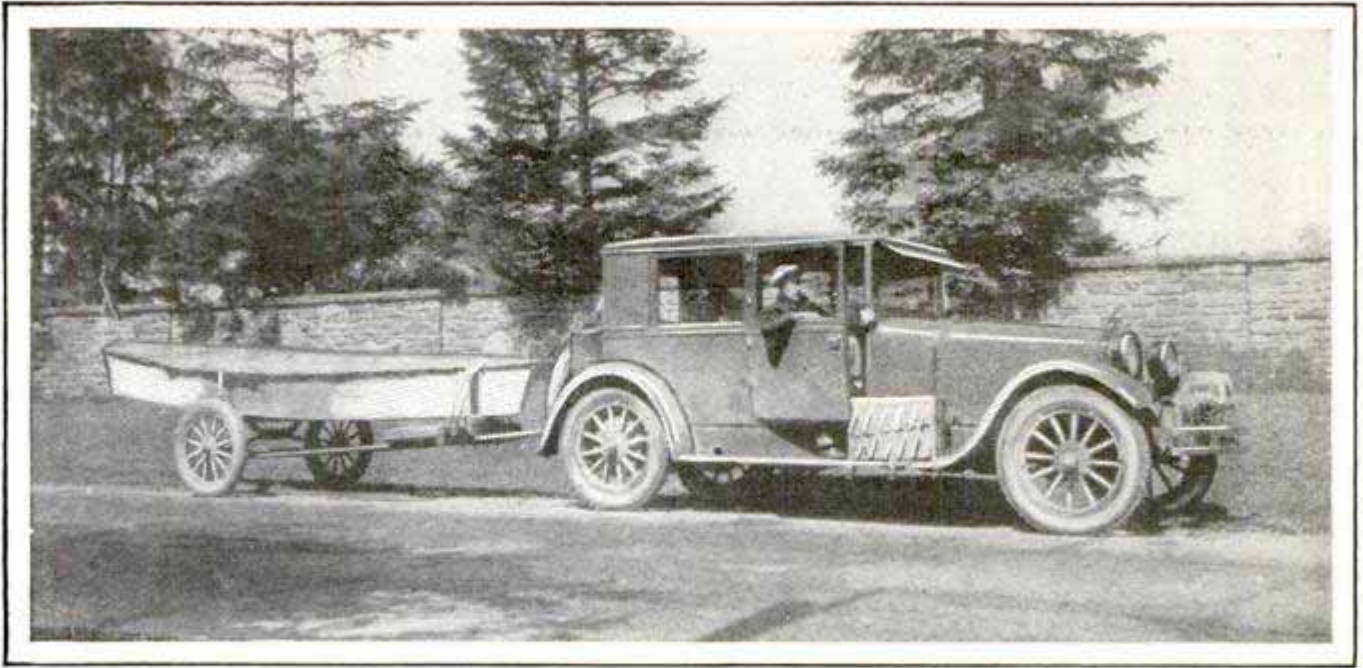

A Pair of Secondhand Wheels and Ties, an Old Axle and a Few Odds and Ends Provide a Trailer and Eliminate the Necessity of Storing the Boat or Owning a Boat House

sociation last winter. It does not take years of training to make a successful outboard racer. The manufacturer helps the amateur. The modern outboard motor is the only marine engine using ball bearings and roller bearings for internal working parts.

If an outboard fan does not feel like investing in a fancy hull with transverse bottom steps (which make it a hydroplane) with streamlines and brass finishing, he can build his own for a few dollars. Ovide Siouxi, great chief of the Huron Indian tribe, built one from working plans that weighed 140 pounds and cost \$75, and made a speed of thirty miles an hour. But lots of boys build cheaper ones, called "punkin seeds," "tubs," "crates" and "strawberry boxes." In one of these crude small ships, about as pretty as a slab of wood, eleven-year-old David Leonard beat some of the season's most skillful skippers to the Class-B championship at Winter Haven, Fla.

Having won so many peace-time victories, the captains of our "water bug navy" are getting ready for war-time work. At the rate the outboards' speed increases they will be "cracking" fifty miles an hour in a year or so. And if we engage in another war, the mosquito fleet of water flivvers will do their bits in many a naval engagement.

Each fleet outboard will be canvas-covered like a kayak and will head straight for the enemy ship or transport. Each

outboard will bear a torpedo. As each captain of a tiny craft gets within striking distance of the enemy, he will go overboard in his life belt, leaving his ship to keep its course on the surface or beneath the surface of the water. The deadly torpedo will do its work.

There will be plenty of skippers for these infant outboard destroyers. Probably Malcolm Pope will be one of them. Malcolm lives at Winter Haven, Fla. He starts the outboard on one of his home town's hundred lakes, attains a speed of thirty or more miles an hour, shoots his boat up a wooden incline, soars forty feet straight through the air, splashes safely on the water again, and then, for good measure, gets up to high speed once more and skids his light vessel up the sand beach to dry land.

Malcolm proposed the mosquito fleet of outboard destroyers. You'll have to keep an eye on these young skippers. No telling what the outboarders will accomplish now that they try almost anything.

#### PAPER IS USED FOR BLASTING AFTER CHEMICAL BATH 2014

Intended especially for the use of farmers and quarrymen, a kind of paper, similar in appearance to ordinary blotting material, has been prepared for blasting. It is coated with a hot mixture of chemicals and water, dried and then cut into strips, which are rolled into cartridges.

Write The Secretary

c/s woman H. Holden. Highfield, Va. Jackson View Road Chesterfield Va



### Applying Plaster Patch to Ceiling

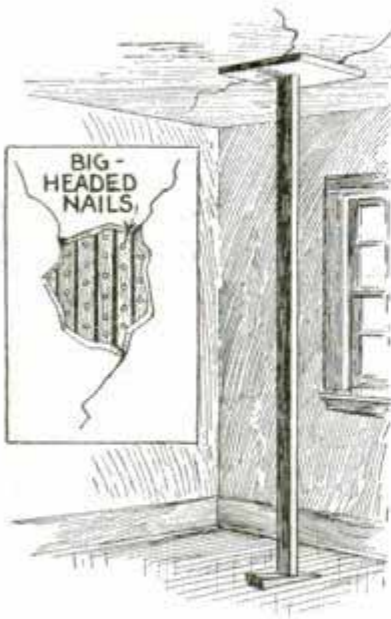

When redecorating an old ceiling, I found a section of it was badly cracked. Most of the cracks converged to one point where the plaster had broken away entirely. I removed all the loose plaster around this spot and then

drove large-headed roofing nails into the lath, letting them project about  $\frac{1}{4}$  in., to serve as anchors for the plaster of paris with which I mended the place. Then I took a smooth board, about 1 ft. square, and held it against the soft plaster by means of a length of 2 by 4-in. wood, set on the floor, a wedge being used between the floor and the pole to force the board firmly against the repaired section. When the plaster had set and the support was removed, the patch not only was smooth but held the surrounding plaster securely. —Dan Courtney, Chicago.

### Racing Blades Fitted to Clamp Skates

Racing blades can easily be fitted into the runners of ordinary clamp skates by sawing or filing a groove in the runner, setting the racing blade in place and then soldering it in the groove, using muriatic acid cut with zinc as a flux to make the solder adhere to the metal. Of course, care should be exercised to cut the groove accurately. It may be necessary to shorten the racing blades one or two



inches so that they will not project too far beyond the end of the runner, for, if they do, they may easily be bent. I have found skates

altered in this way highly satisfactory; they can be more easily handled than ordinary skates and the clamping feature is quite an advantage.—Sam Weidman, Lowell, Wash.

### Cleaning Ducks Quickly

Picking wild ducks is a task that most sportsmen gladly leave to their wives. The large feathers are not so hard to remove but the down is very annoying. An easy method is to pour melted paraffin over the bird before picking the down and allow it to congeal. It is then easy to rub the down off with a rotary motion of the palm, leaving the skin clean. Another method is to dip the hand in partly melted paraffin and then massage the feathers off. Either method practically eliminates the need of singeing. Certain kinds of ducks, such as bluebills, butterballs, golden eyes and coots are better skinned than picked, as the objectionable fishy or oily taste disappears with the skin and the fat adhering to it.

### Protecting Wash-Boiler Bottom

Leaks in wash boilers usually occur near the edge and are caused by sliding them on and off the stove. A length of lightweight angle iron, fitted around the edge of the boiler as shown in the drawing, greatly increases the life of the boiler by eliminating wear on the bottom. The angle iron should be a

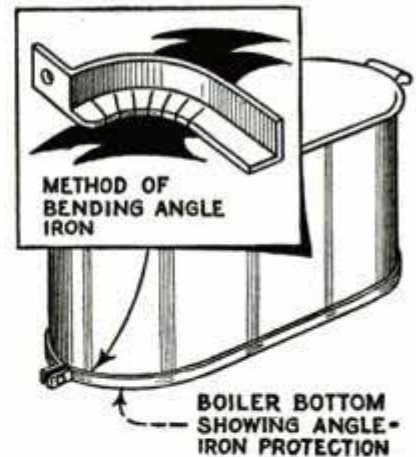

few inches longer than the distance around the boiler as measured with a tape, is bent to fit snugly and securely clamped at one end as indicated. It is necessary to make saw cuts in one side of the angle iron where it is to pass the rounded ends of the boiler, as shown in the upper detail. The angle iron also reinforces the boiler so that it is dented less easily.—Wendell Mitchell, Rogers, Nebr.



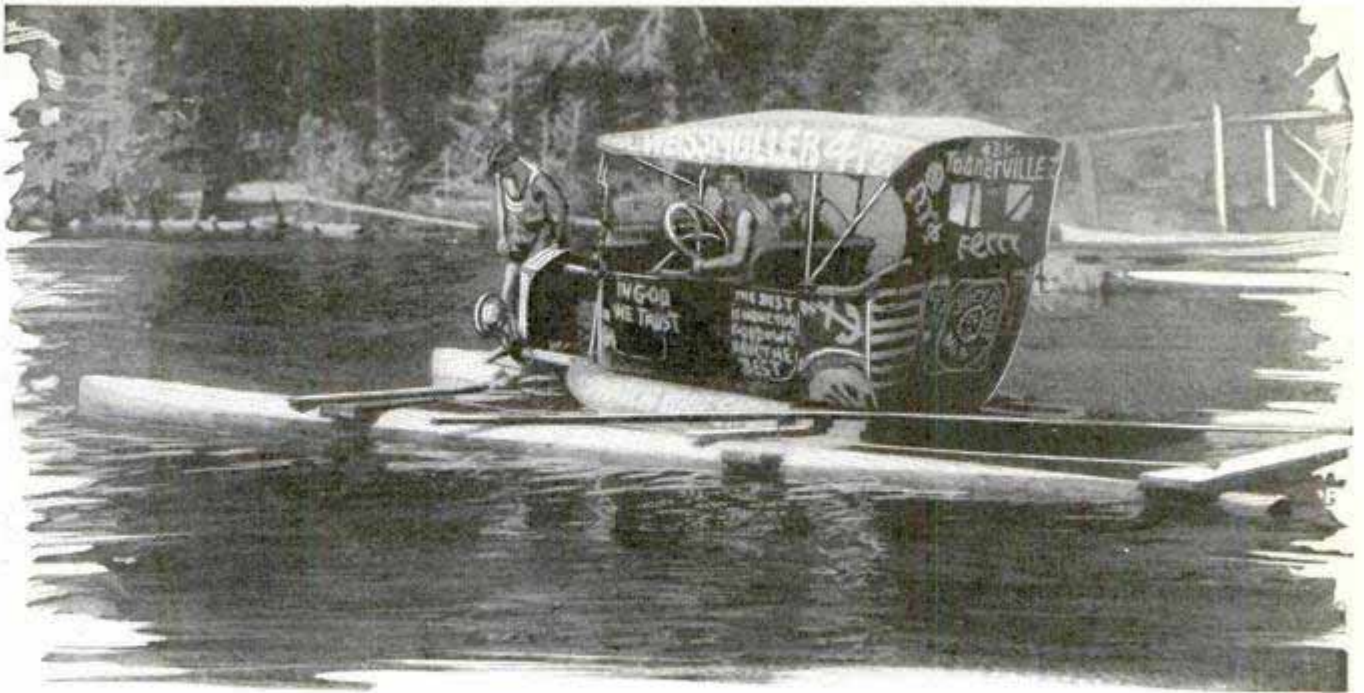

Old Auto Having a Propeller Attached to the Driveshaft Runs Log Catamaran on California Lake

### Old Auto Propels Catamaran

At Lake Almanor, in California, an old auto has been used successfully for propelling a catamaran made of logs. The auto is securely mounted on the cross members, and a propeller is attached to the end of the driveshaft, which is arranged so that the screw is submerged. Running the motor slowly furnishes ample power and surprising speed, enabling the catamaran to travel all over the lake.—Grace E. Grohman, Stockton, Calif.

*Box 802*

### Novel Bird House

Bird-house contests held in New York rural schools brought out many new ideas. Many peculiar houses were entered in the contest, and one that won first prize was made from the large fungi found growing on certain trees. Cut-off pieces of this growth were found to become very hard when dry. The house shown on the left in the photo is a home for a song sparrow, the measurements, according to the contest rules, being approximately 6 by 6 in., with all sides open. The top and bottom consisted of pieces of fungus, and were held together by means of lengths of hickory twigs

about as thick as one's thumb. Three-penny nails were used to fasten the top and bottom to these posts, the nails being driven into the ends of the posts for a distance about equal to half of their length. The heads were then cut off, and the ends sharpened so that they could be pushed into the fungus. A daub of glue was also put on the end of each post, or on the fungus at the points where the posts were to stand. Stout cord was wrapped around the house after it had been assembled, and it was laid away to dry. After several days, the fungus was hard and the posts were firmly in place. Instead of trimming these posts, a few branching twigs had been left on to provide a place for the birds to alight. The feeding station was also made from fungus, two pieces being rigidly attached to a short board to hold them.—Cora Hamilton, Binghamton, N. Y.

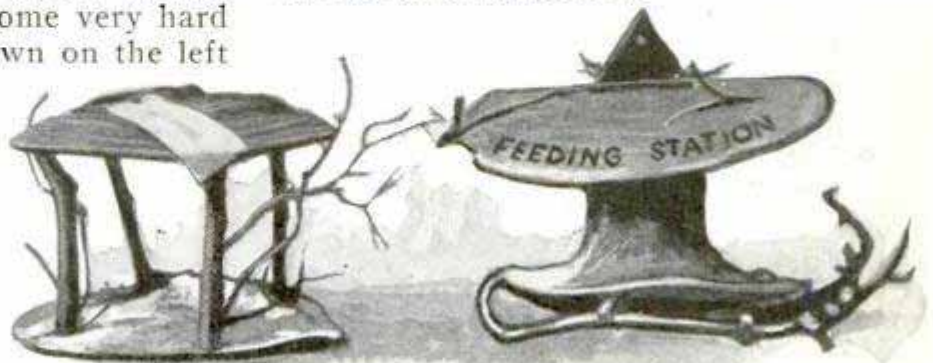

Novel Bird Houses Made from Tree Fungi Win First Prize at School Contest



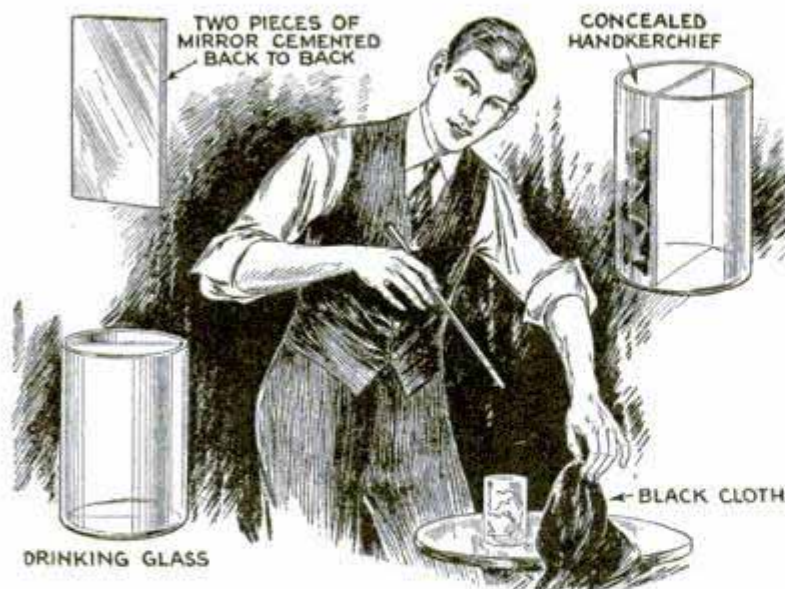

Simple Trick with Handkerchief Which Can Be Easily Performed by an Amateur

### Clever Handkerchief Trick

For parlor magic, the clever handkerchief trick described in this article will be found amusing. The performer takes an ordinary drinking glass, of the thin variety and with straight side, in his hand, and while standing before his audience, turns it to show that it is empty. Then he places a small red handkerchief in it, and covers the glass with a black cloth. He tells the audience that he will make the red handkerchief turn white without removing the black cloth, and upon removing the black cloth this appears to have happened. The handkerchief can be passed around among the audience for inspection, after which it is again placed in the glass, covered with the black cloth, and it is turned red again. Prepare for the trick in the following way: Be sure to use a glass of the description given, as the trick will not work with any other shape. Take two pieces of mirror, the exact width and height of the inside of the glass. Cement them together back to back, place them in the glass, thus dividing the latter into two compartments. The mirrors cannot be noticed by the spectators as the glass is held so that they look into one mirror, which gives the impression of a plain glass and makes the tumbler look empty. The red handkerchief is placed on one side of the mirrors and a similar white handkerchief on the other side. When, in performing the trick, the black cloth is placed over the glass, the performer turns the glass around unnoticed. Thus, if the

red handkerchief is placed in the compartment facing the audience, the white handkerchief will come into view when the black cloth is removed, and so on.—E. A. Hoppman, Dumont, N. J.

### Repairing Leaky Cellar Walls

At times cellar walls will leak and the condition seems to get worse if neglected. A simple method of repairing a leaky wall is to drive one or more pipes through it at the points where the leakage is worst. The pipes should be calked with fibrous material or lead, so that there will be no leakage between the wall and the pipe. After all the water has drained and the wall has dried out thoroughly, the inside surface is given a coat of waterproofing compound. When this has dried, the pipes are removed and the holes plugged tightly.—L. H. Georger, Buffalo, N. Y.

### Handy Pistol-Shell Remover

Trappers will appreciate the handy pistol-shell remover shown in the illustration. It is made by grinding off the end of a key, as indicated by the dotted line. Plunging the shank of the key into the empty pistol shell will quickly force it out. It should be kept on the key ring

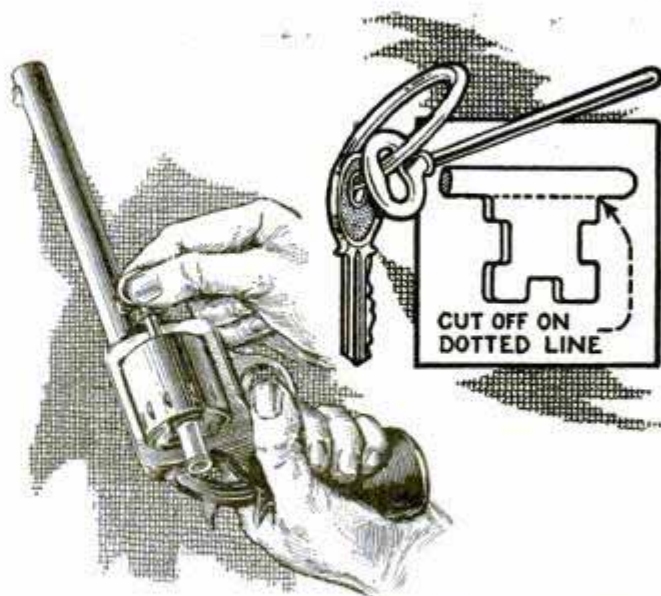

Door Key with the End Cut Off Makes Handy Pistol-Shell Remover

in order to be always available for use.—Harold Eckebrecht, Chicago, Ill.



# A Stand for the Dynamic Speaker



**T**O THE man who has not a console, or other cabinet, large enough to contain a baffleboard, the mounting of the dynamic speaker presents something of a problem. It is easy, of course, to build up a small frame with a shelf across the back; fit a wallboard panel on the front, and, if this assembly can be hidden from sight in some way, nothing more elaborate is necessary. Where the speaker mounting is visible, however, something more decorative is essential, and the stand described in this article is ideal for the purpose, as it is not only simple to construct, but forms a very pretty piece of furniture when properly finished. As may be noted in the head illustration, when the stand is in use set in front of a fireplace or near the wall of the room, nothing of the speaker itself is visible, and the stand resembles only a decorative screen.

The materials necessary for the construction of the stand proper are two pieces of five-ply veneer,  $\frac{3}{4}$  in. thick, 24 in. wide and 32 in. long. One side of the veneers should be of nicely figured walnut or mahogany. The maker can choose any of the four designs shown in Figs. 1

and 2, and none of them presents any difficulty in laying out; the only thing to be borne in mind is that the circular hole in the front of the screen, for the speaker cone, must not be placed centrally, but should be a little higher than the center of the front. In the stand shown in the illustrations, the center of the hole is 12 in. from the top of the screen. In Figs. 1 and 2, the left half of the drawings represents the shape of half the front, and the right half, the supporting brackets, and it will be noted that the brackets are cut so that their length is slightly less than that of the front, at the edges.

The pieces may be cut to shape either on the jigsaw or with a hand coping saw, and the only precaution to observe is to use sharp blades in the saw, so that there will be no tendency to flake off the edges of the walnut or mahogany veneer. The brackets, of course, should be laid out so that the face veneer will be on the outside on the finished stand; this seems an unnecessary warning, but it is very easy to make a mistake and lay them out so that, when cut to shape, one finds that there are two right-hand or two left-hand brackets, instead of a right and a left.

After cutting to shape, finish the edges by filing and sanding dead smooth, then mold the edges of the screen front. Note that the molding on the edges is not carried down to the feet, but is stopped about 3 in. from the bottom. The molding may be a simple bevel or a hollow on the edge, and, in this case, it may be done with the chisel or gouge, on the shaped parts, and with the molding plane on the sides, but if any of the more elaborate moldings is desired, the maker will find it advisable to take the piece to the nearest cabinet shop and have them run the moldings on the shaper, since, although it is easy to run the moldings on the straight edges with the molding plane, it is difficult to mold



the shaped edges. Also, the edge of the circular hole should be molded the same as the outer edges, and this can be done in a few minutes on the shaper. If the reader cannot have the molding done as

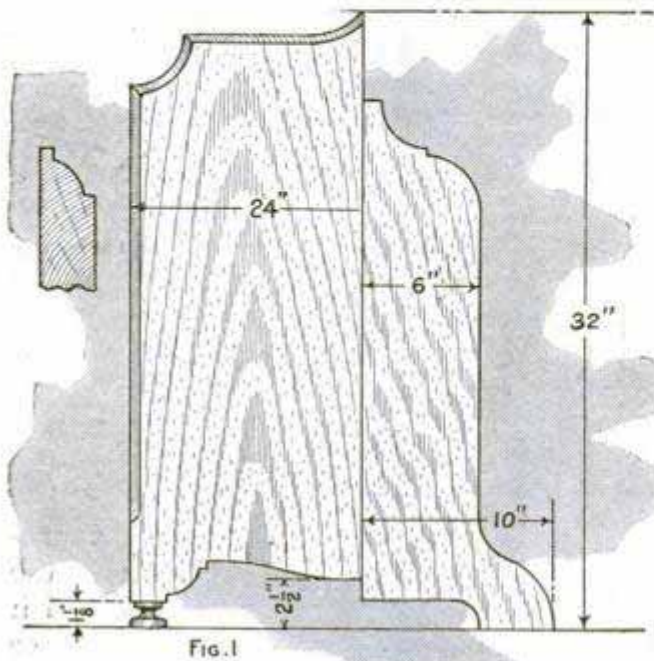

described, it is advised that he simply bevel or round the edges of the front, and make the grill for the hole as described later, so as to avoid the necessity of molding the edges of the hole. The edges of the brackets may be left square, or just

rounded a trifle by means of sandpaper.

Since the screen is to be fitted with a grill, and since the grill would be too far back if it were simply fastened to the back of the screen, which is  $\frac{3}{4}$  in. thick, it is necessary to sink a recess in the back of the screen so as to bring the grill forward. Before describing this, however, we will tackle the grill.

The maker, of course, can use a wood grill if he chooses, but the one illustrated in the photos was made of sheet lead. This may seem to be too weak and soft, but as a matter of fact, it makes a very satisfactory grill, and one that is decidedly novel and effective. As shown in Fig. 4, the lead is cut to represent a landscape, and, when backed with gold cloth, the effect is quite striking. The lead used is  $\frac{1}{16}$ -in. sheet, which can be obtained from the nearest plumber's shop. The size of the opening in the screen, of course, depends on the size of the speaker cone, and consequently the size of the grill depends on this also, but a 14 by 14-in. piece is amply large enough even for a 10-in. cone. Lay out a circle of the size of the opening on a sheet of paper, rule it off into 1-in. squares, as in Fig. 4, then sketch in the landscape by referring to the squares in the illustration. Flatten out the lead

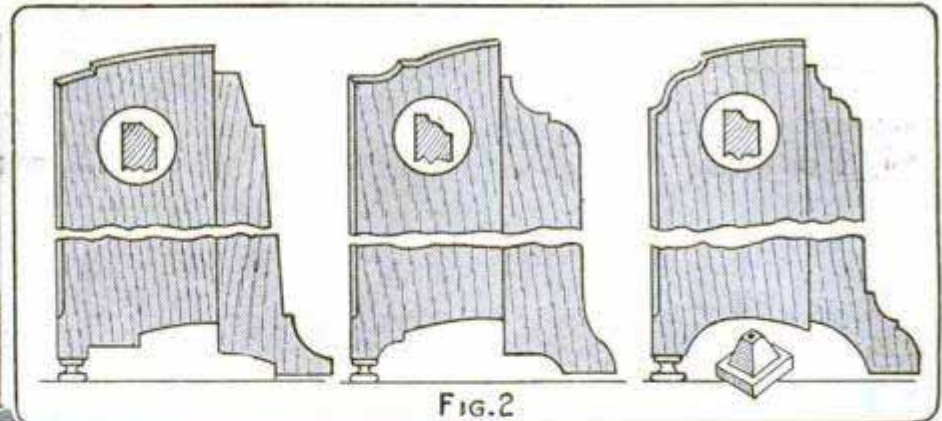

FIG. 2

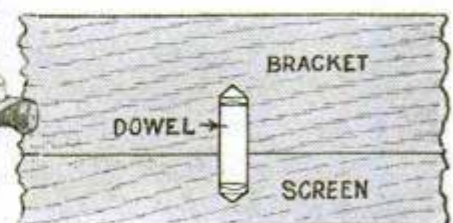
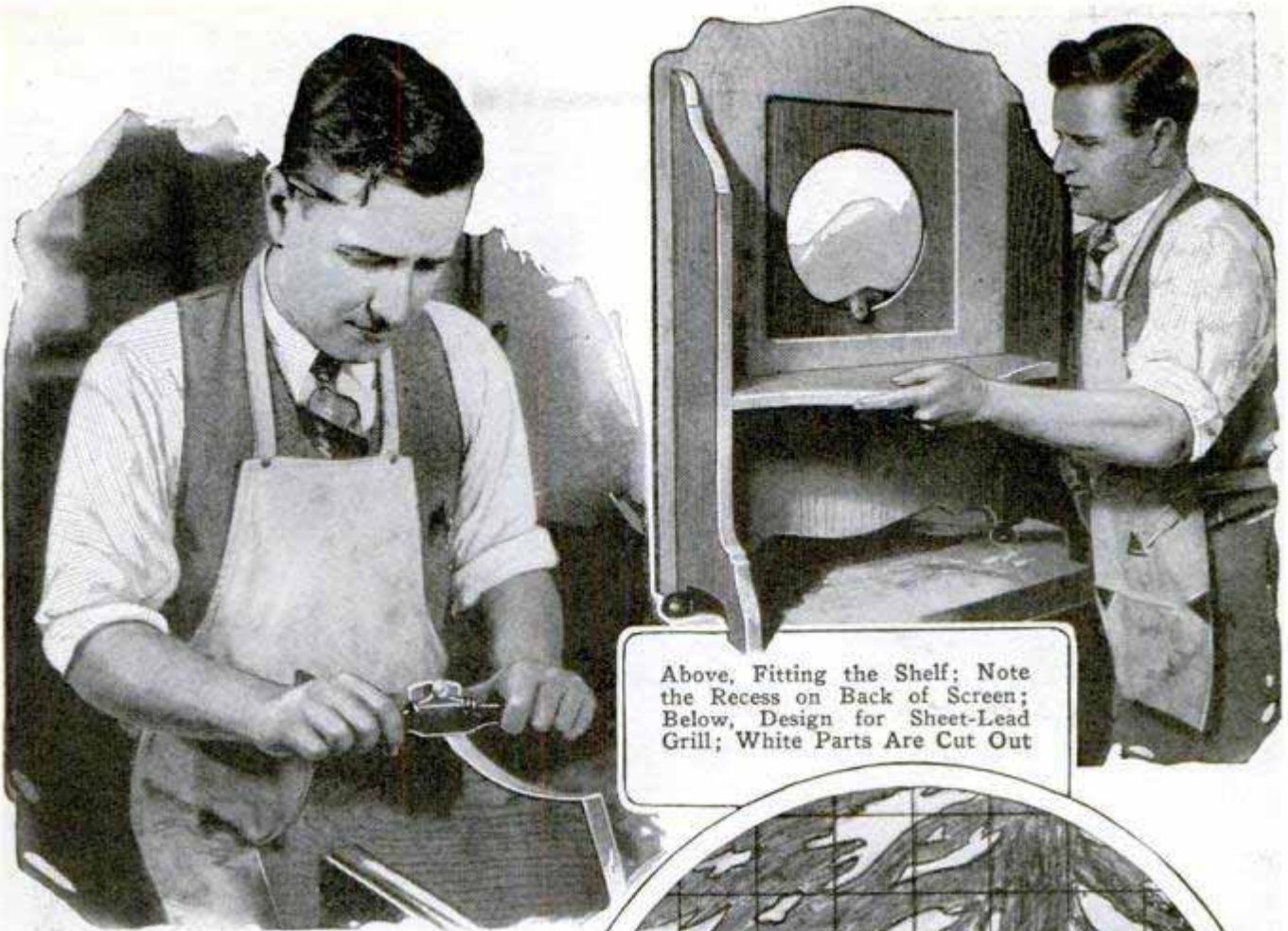

FIG. 3

Left, Gluing a Bracket to the Front; Above, Alternative Designs for Stand; Below, Detail of Joint between Bracket and Front





Above, Fitting the Shelf; Note the Recess on Back of Screen; Below, Design for Sheet-Lead Grill; White Parts Are Cut Out

sheet, pin the paper centrally over it, then trace over the design with a fairly sharp, but round-pointed scribe, so as to impress the design on the soft lead. Remove the paper, and cut out the design with a knife, taking care to make the cuts clean and sharp. Now take a small screwdriver, and "texture" the trunks of the trees by striking the screwdriver lightly with a hammer, varying the impression and direction of the screwdriver point so as to simulate as closely as possible the bark of the tree. The same tool will do for making the leaves of the pines. If the reader has an assortment of small punches, he will find that it is an easy matter to grain and texture the surface of the landscape to produce a very creditable effect, but a small screwdriver, a couple of nail sets and a small round-nose chisel will enable him to do a very good job of landscape "painting."

If the edge of the hole has been molded, this is all there is to do to the grill. If, however, the reader has not been able to mold it, then a sort of ornamental border, about  $\frac{3}{8}$  in. wide, should be punched all

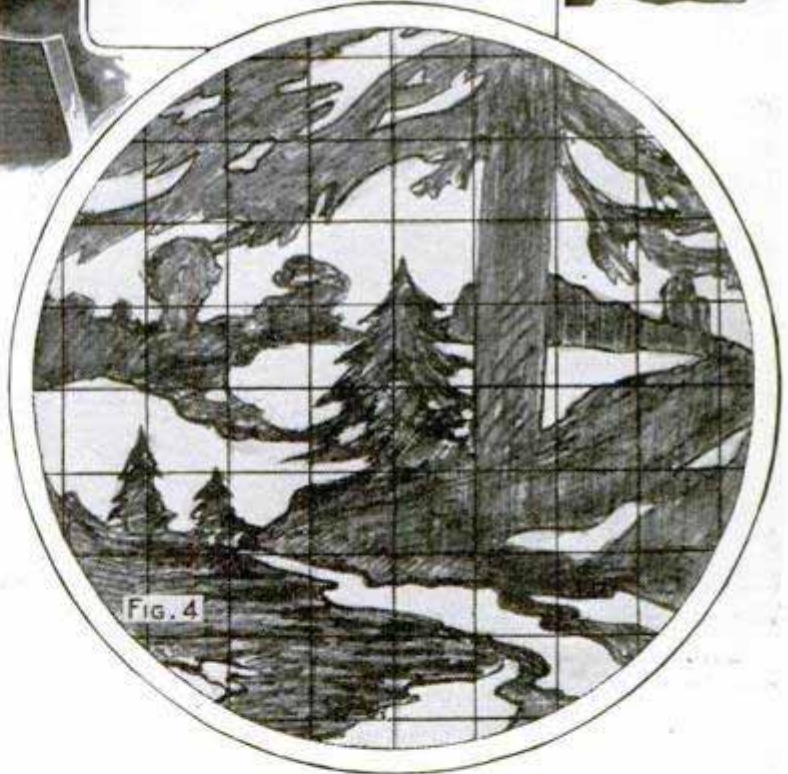
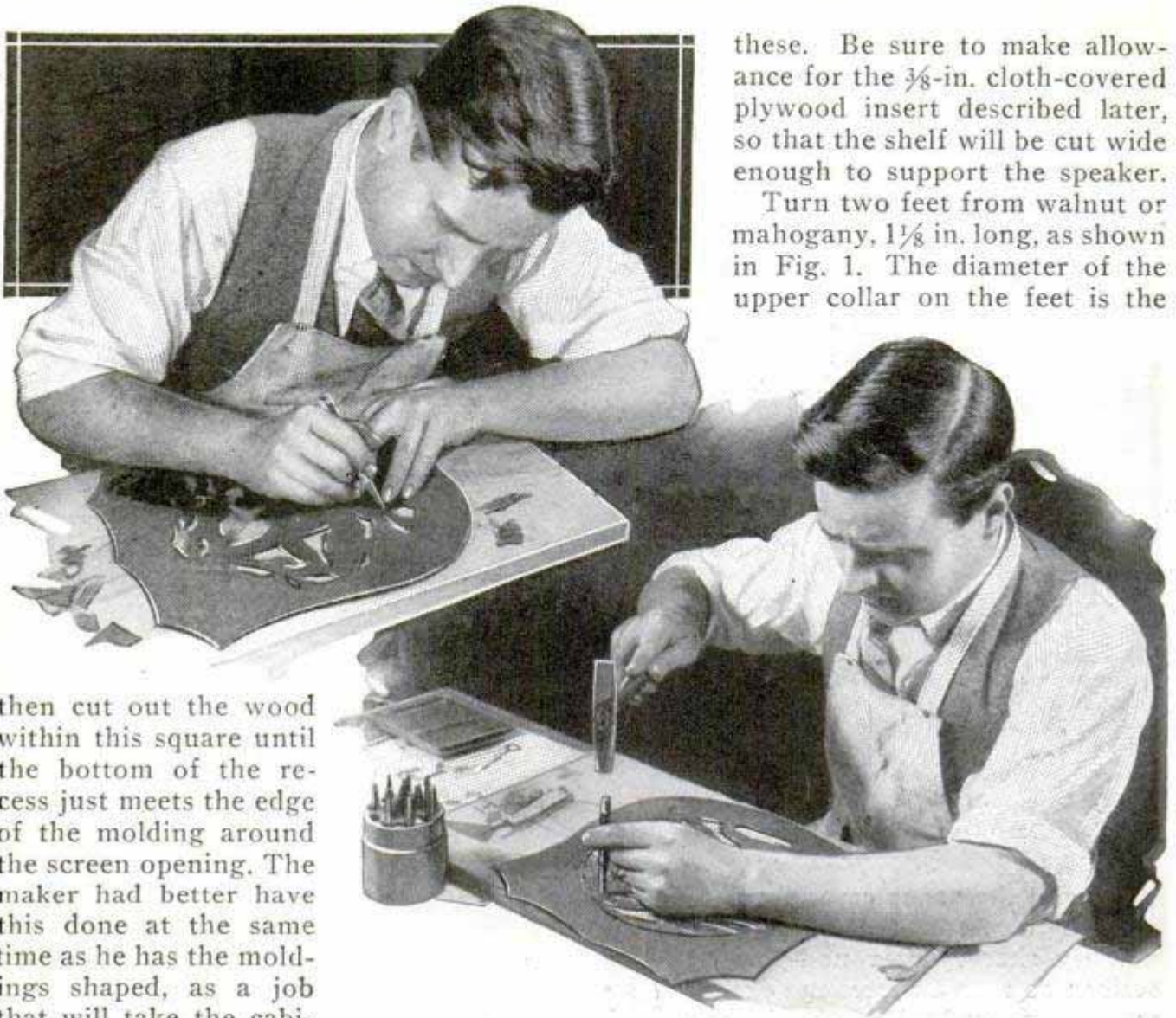

Fig. 4

around the circular rim of the design, and the edge of the sheet lead should be cut to form a shield, as shown in the illustrations. An ornamental border can then be punched around the edge of the shield, and the whole grill may be fastened with gimp tacks over the opening in the screen, thus hiding the edge of the hole. Setting the grill in from the back, with the opening molded, however, makes a much better-looking job.

For the recess, centering on the opening, at the back, lay out a 12-in. square,





then cut out the wood within this square until the bottom of the recess just meets the edge of the molding around the screen opening. The maker had better have this done at the same time as he has the moldings shaped, as a job that will take the cabinetmaker only a short time to do on his router will be found rather tough with hand tools, although it can be done. If done by hand, see that the bottom is smooth and flat, also that the "sight edge" around the molded opening is even all the way.

The height of the shelf that supports the speaker at the back depends on the dimensions of the speaker used, so no measurements can be given for this, or for the width of the center of the shelf. Any piece of wood, about  $\frac{3}{4}$  in. thick, will do for the shelf. It slides into dados or grooves cut in the brackets, and the maker will find it advisable to fit the shelf a little lower than is actually needed, and to shim the speaker up afterward. In this way, it is easier to center the cone of the speaker over the opening in the front. If no means of cutting the dados for the shelf is at hand, simply screw two strips of wood at the proper height on the inside of the brackets, and screw the shelf to

these. Be sure to make allowance for the  $\frac{3}{8}$ -in. cloth-covered plywood insert described later, so that the shelf will be cut wide enough to support the speaker.

Turn two feet from walnut or mahogany,  $1\frac{1}{8}$  in. long, as shown in Fig. 1. The diameter of the upper collar on the feet is the

Left, Cutting Out the Design on the Grill; Right, Punching or Texturing the Design

same as the thickness of the wood front,  $\frac{3}{4}$  in., and the diameter of the foot is  $1\frac{1}{4}$  in. Drill the feet and the bottom of the stand front for  $\frac{1}{4}$  or  $\frac{3}{8}$ -in. dowels, and dowel and glue the feet in place. The brackets are set back from the edges of the front 1 in. Mark a line down the back of the screen  $1\frac{3}{8}$  in. from each edge, and, along each line, lightly drive in four small brads; cut off the heads of the brads, and sharpen the projecting points. Now set the brackets in place, with their lower ends even with the bottom of the feet on the screen, and with their thickness centering on the line, and press them down on the sharpened brads; this marks the position of the dowel holes. Withdraw the brads, and drill for the dowels, taking care that the holes go only three-fourths of the way through the screen. (See Fig. 3.) Dowel and glue the brackets in place and clamp; leave until the glue is hard.



The screen should lean back from 1 to 1½ in. at the top, so, when the glue is hard, mark and cut off the feet of the brackets to secure this effect. Now sand the faces of the screen and brackets very carefully.

Stain the work walnut or mahogany to suit the veneer used, then, after the stain has set, give a coat of walnut or mahogany paste filler, wipe off across the grain, and

leave to dry. When dry, sand down again, working the sandpaper in the direction of the grain, dust off, and apply a coat of thin shellac. When this has set, sand down with "Wetordry" garnet paper, used wet on a felt pad, dry off and give another coat. Sand this down as before, then give one or two coats of cabinet-finishing varnish, rubbing down between coats with pumicestone and oil, on a felt pad. The last coat may be simply dulled with the pumice and oil, rubbing lightly lengthwise, or, after rubbing, it may be polished by using rottenstone and oil.

Now cut a piece of ⅜-in. plywood to fit the recess in the back of the screen, and cut a hole in the center the same size as the one in the screen. Cover the plywood with gold cloth, carrying the latter over the edges of the wood and gluing it to the back. Tack the grill in the recess, then place the cloth-covered plywood over it and fasten it with brass screws. Set the speaker on the shelf, shim with cardboard until it is centered over the opening, then screw or clamp the edge of the cone ring to the wood. Three brass clamps will fasten the speaker very nicely to the screen.

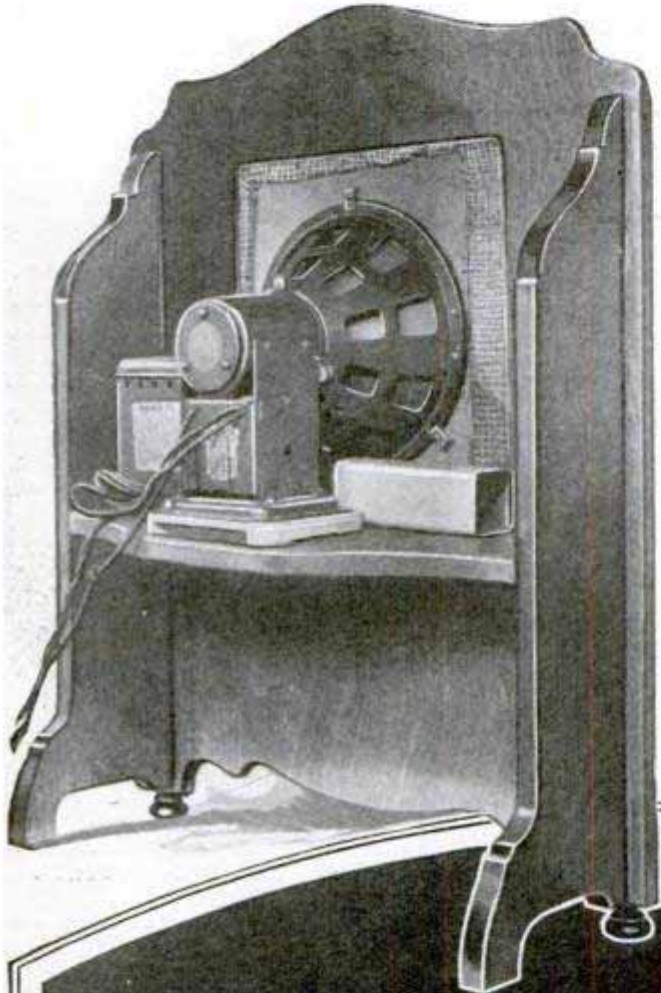

Above, Finishing Stand, Showing Cloth-Covered Insert behind Grill; Below, Grill in Shield Form for Use on Face of Stand



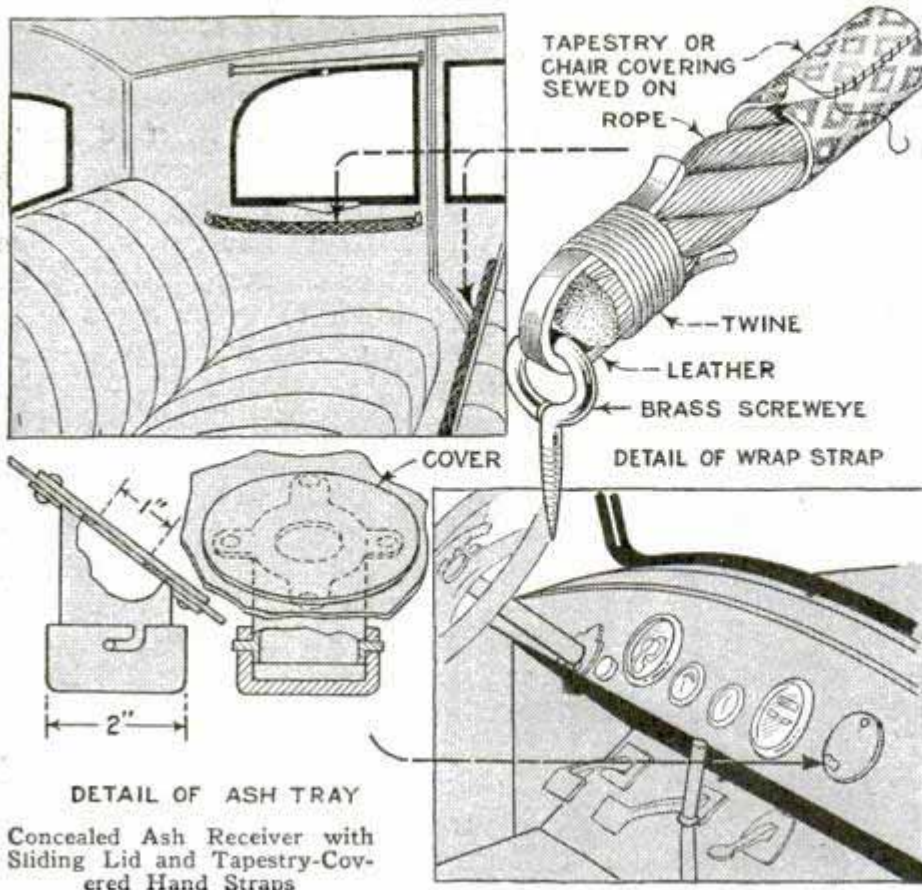

DETAIL OF ASH TRAY  
Concealed Ash Receiver with  
Sliding Lid and Tapestry-Cov-  
ered Hand Straps

### Ash Receiver and Hand Straps for Auto

Auto owners will appreciate both the concealed ash receiver and the hand straps shown in the illustration. The former is attached to the instrument board, and all that is visible is a sliding cover. An ordinary tin can is used to make it, small bayonet pins being soldered to one end for attachment of a bottom, which is made from a slightly larger can and is slotted to fit the pins. The other end of the can is cut so that four projecting ends are formed, and these are bent outward at right angles to the body of the can. Holes are drilled through these ends and corresponding holes through the instrument board, the latter being countersunk so that the can may be fastened with short flat-head screws. Mark off the center between the holes in the instrument board and cut a large hole through which the ashes are to be deposited, the burr being taken off the edge of the hole with a file. The cover consists merely of a sheet-metal disk pivoted at a point above the hole and having a pin or knurled knob attached near the bottom edge to serve as a handle. It should be large enough to conceal the screw heads.

Hand straps are made from lengths of

$\frac{3}{4}$ -in. rope with narrow strips of leather securely tied to the ends, for which strong twine is used. Before wrapping the twine on one end, a brass screw-eye is slipped over the strip. Tapestry, which can be obtained at any upholstering shop, is sewed around the rope for the sake of appearance. After one screw-eye is driven into the body of the car at the point where the strap is to be located, another screw-eye is driven in at the point where the other end of the strap is to be attached. Then a strip of leather, similar to the first, is slipped through it and is fastened to the rope in the same

way. Do not make the mistake of attaching both screw-eyes to the rope first, as it is then impossible to drive them in without twisting the rope and the leather strips.—G. A. Luers, Washington, D. C.

### Sharpening a Wood Chisel

Ordinarily it takes a skilled mechanic with a steady hand to hold a chisel flat without a guide, when sharpening it on an oilstone. The amateur can do just as good a job by following the method shown in the illustration, which involves the use of an improvised guide consisting of a piece



of wood with a slot cut in it as indicated, and a screw to tighten it on the chisel. With this clamp touching the oilstone, you have two points of contact, which makes it easy to hold the chisel at the proper angle all the time.



## Warming the Bed on the Sleeping Porch

When going to bed on the sleeping porch during the winter time, more comfort is assured, if the bed is warmed just before retiring. Here are a few simple methods which have been found successful: In one case where the porch was located directly over the living room, the owner cut a hole through the floor, directly under the bed, and installed a floor register, so that the warm air from the living room would come up under the bed. To prevent the heat from being lost in the cold room, a piece of canvas was placed over the mattress and extended down to the floor on all sides, thus completely inclosing the space under the bed. Another method consists in putting an electric heater under the bed shortly before retiring, and placing blankets over the bed so that they touch the floor on all sides, thus keeping the heat under the bed. Of course, it is necessary to be careful when using an electric heater to avoid fire. A third method consisted in providing a hot-water coil underneath the bed, the coil being connected to the hot-water tank in the kitchen, which was located next to the sleeping porch. When such a system is installed, the possibility of freezing should be considered in case the fire in the range is not kept up; it is advisable, therefore, to install a drain valve in the pipe to empty it.—Harold E. Benson, Boulder, Colo.

## Handy Place for the Golf Score Card

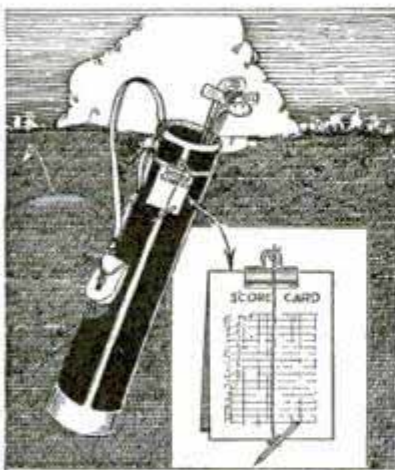

my golf bag and tied a pencil on with a length of heavy string. Both card and pencil are then handy.—R. J. Plaisted, Cleveland, Ohio.

When hurrying around a golf course, I have often wasted time fumbling through my pockets for the score card and a pencil. To avoid this, I took a small paper clip and attached it to



Lap Boards Are Easy to Make and Can Be Used for Many Purposes about the House

## Lap Board Has Many Uses

One of the most useful and convenient articles about the house, and one which is easy to make, is a lap board. I have made a number of these for my friends, who find new uses for them every day. The exact dimensions may be varied to suit the maker, but a satisfactory size for general use is one 20 by 30 in. in dimensions and  $\frac{3}{4}$  in. thick, with a semicircular portion, about  $4\frac{1}{2}$  in. deep, cut out at the front edge, as shown. Cleats should be screwed or nailed across the back, but a neater job can be done by tonguing and grooving the end strips against the body of the board in the same way as drawing boards. I made some of the boards in the finest Honduras mahogany, embellished with a fancy border inlay, and the owner's monogram executed in marquetry of rare woods. The surface was given an application of paste wood filler, varnished and rubbed down. Lacquer can be applied if cheaper wood is used and beauty is not considered.—R. L. Simons, St. Paul, Minn.



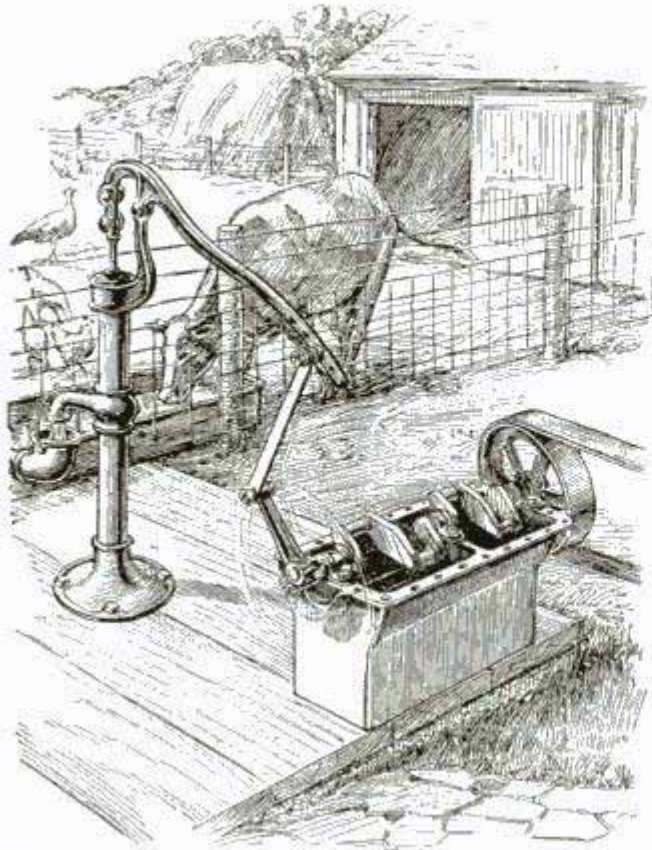

Efficient Pump Jack Can Be Made from an Old Auto Crankcase

### Running the Pump with Farm Engine

A good, inexpensive pump jack can be improvised from an old auto crankcase in which the shaft has been left intact. The crankcase is inverted, as shown in the illustration, and is placed so that one end of the shaft lines up with the handle of the pump. An old connecting rod is securely fastened to this end of the shaft, while a pulley is keyed to the other end. The pulley should be large enough to keep the pump speed at about forty strokes per minute. A length of flat iron is pivoted to both pump handle and connecting rod as indicated. Although the drawing shows the pan removed from the crankcase, it is better to leave it in place, especially if there are children who are

likely to come near the pump while the engine is being operated.

### Auxiliary Gasoline Tank Prevents Stalling

With the auxiliary tank shown in the drawing it is impossible to knowingly run out of gasoline while driving a car. When the main tank is exhausted, it is only necessary to lift the hook, open the shut-off valve, and the contents of the auxiliary tank will take you to the nearest filling station, provided it is of sufficient capacity. It is automatically kept full at all times, and requires no attention after it is once installed. The construction is simple and the cost should not exceed \$2. It can be installed on any car having a vacuum or electric-suction system from the main gasoline tank. The parts required are: one small galvanized-iron tank which can be made to the desired shape and size at almost any tin shop; two short lengths of copper tubing of the same diameter as that used in the gasoline system of the automobile; two brass compression-fitting elbows; one brass compression-fitting shut-off cock, and one brass compression-fitting tee. These items can be obtained at any auto-supply house. The tank should have straps soldered securely to the front and sides, the ends of the straps being bent, as shown, to permit attachment to the dash. The size and shape of the tank depend

on the space where it is to be mounted. The two elbows are soldered to the top of the tank and the shut-off cock to the front, near the bottom, care being taken that all connections are leak-proof. Fasten the tank securely to the dash near the vacuum tank. Disconnect the main feed pipe from the vacuum tank and connect it to one of the elbows, as shown. Connect the other elbow to the inlet on the vacuum tank

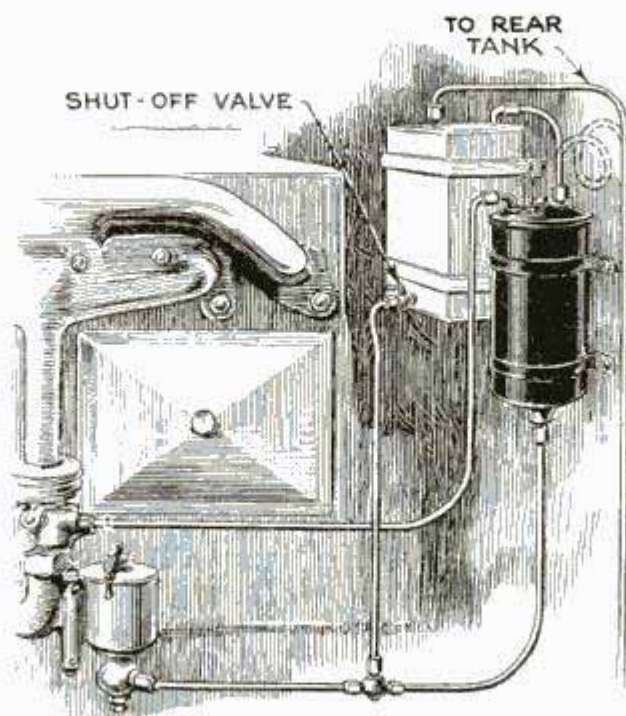

Auxiliary Gas Tank Is Automatically Kept Filled for Emergency When Gas Is Needed



(where the feed pipe was formerly). Cut the tube leading from the vacuum tank to the carburetor and insert the tee, which is then connected to the cock on the bottom of the auxiliary tank. The cock is kept closed all the time, except when the gasoline in the auxiliary tank is needed. The vacuum tank draws gasoline from the main tank through the auxiliary tank, keeping the latter full all the time. When the main tank runs dry, the vacuum tank will not draw the gasoline out of the auxiliary tank, but the supply in this tank can be released by opening the cock that controls the flow into the carburetor.—Albert D. Sayer, San Pedro, Calif.

### Collapsible Fishline Drier

Many fishermen, who have good lines and know the advisability of drying them thoroughly before putting them away, will appreciate the collapsible fishline drier shown in the drawing, which can be folded up and put away with the rest of the fishing tackle when not in use. It consists of four strips of wood, of which two are a trifle less than half the length of the others. The longer strips have holes drilled in each end and the shorter ones have a hole drilled in one end only. The assembly is clearly indicated, two screws fitted with

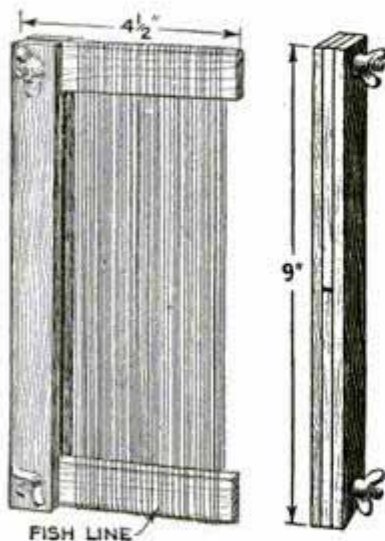

tightened to hold them securely in this position.—W. A. Murphy, Marshall, Tex.

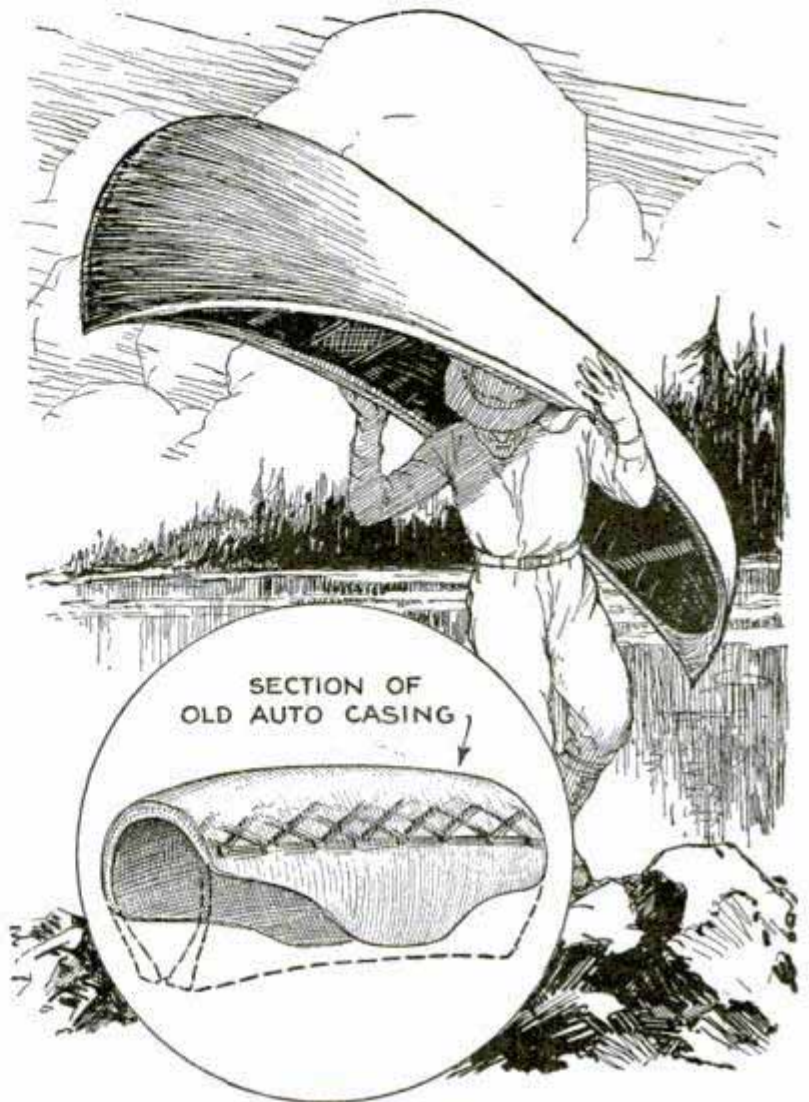

Heavy Rubber Pad Made from Old Auto Casing Protects the Shoulders When Carrying Heavy Loads

### Shoulder Pads Made from Old Auto Tire

A comfortable shoulder pad can be made from a section of an old tire as shown in the drawing. By stripping off a greater or less number of layers of the fabric, its thickness may be varied. Workers who carry heavy loads will find it useful, and to sportsmen it will be serviceable for carrying canoes or equipment, or when it is necessary to haul a boat through fast water by means of a drag line.

### Finishing Plastered Walls with Paint

Many amateur craftsmen, who have undertaken the painting of newly plastered walls, have been of the opinion that the wall must be sized with glue or some other similar substance before it can be given the finishing coats of flat tints. A better method of preparing the wall is to apply a priming coat of paint on the plaster instead of the size.



# How to Refinish

The Use of Varnish Stain

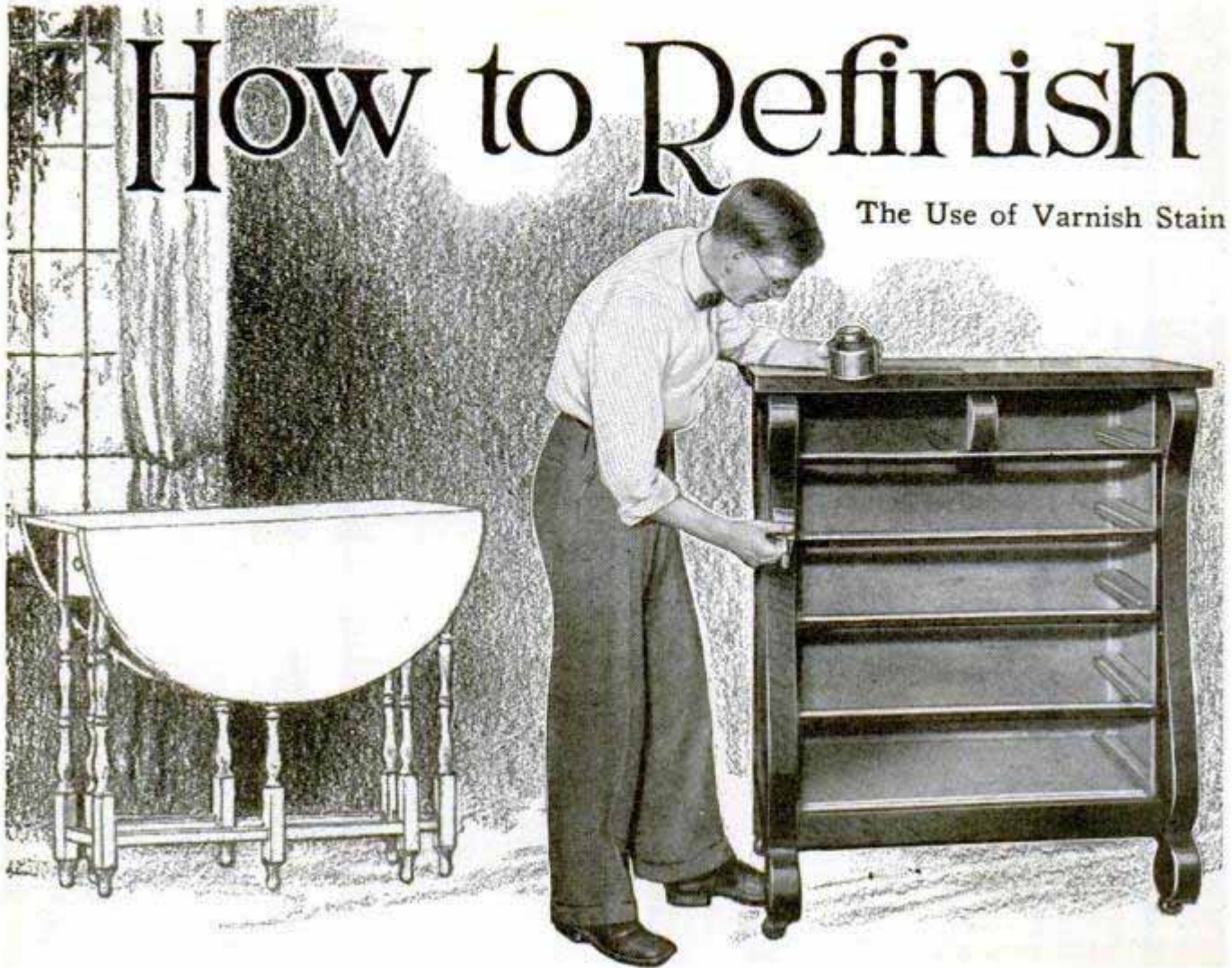

**T**HE STAINED finish is the accepted high-grade finish of today, correct in taste, reflecting dignity and used in the expensive suites. Walnut and brown mahogany, the popular finishes of the past few years, grace the interior of the more modernly furnished residence, but there are still countless homes with the golden-oak furniture of a decade ago, and comparatively few which are not "blessed" with at least some pieces in this once popular finish. These can easily be changed to the modish walnut and brown mahogany. The work is interesting, it is a profitable use of spare time, and there is a great deal of satisfaction in the attainment of fine results to the man who enjoys producing things with his own hands.

There are two ways to do this finishing. One is to color the wood with stain, and then apply coats of varnish. Practically all new furniture is treated at the factory in this way. For the finest refinishing, the old finish is removed and a new one built up from the wood with stain and varnish coats. The other method is to

use varnish stain (stain and varnish combined) over the old coating.

In this issue we will describe the quick method of varnish-stain finishing without the removal of the old finish. Much realistic and beautiful work has been done in this way, and a really nice finish may be produced, suited for any except very fine pieces. We will take, for instance, a dresser in golden oak finished with gloss varnish, and follow the operation of changing it to a walnut finish. (The procedure will be the same for any of the dark-stain finishes; and light-stain effects, such as silver-gray, cannot be satisfactorily produced over a darker finish.)

The first step is, of course, to clean the surface by washing with soap and water, followed by a rinse-off with clear water. Wipe the surface with a cloth wet with gasoline, naphtha or benzine, to cut and remove any greasy substances that may be present from handling, or from the use of greasy or oily polishing preparations or of wax.

The next step varies somewhat accord-



# Your Old Furniture

by Berton Elliott

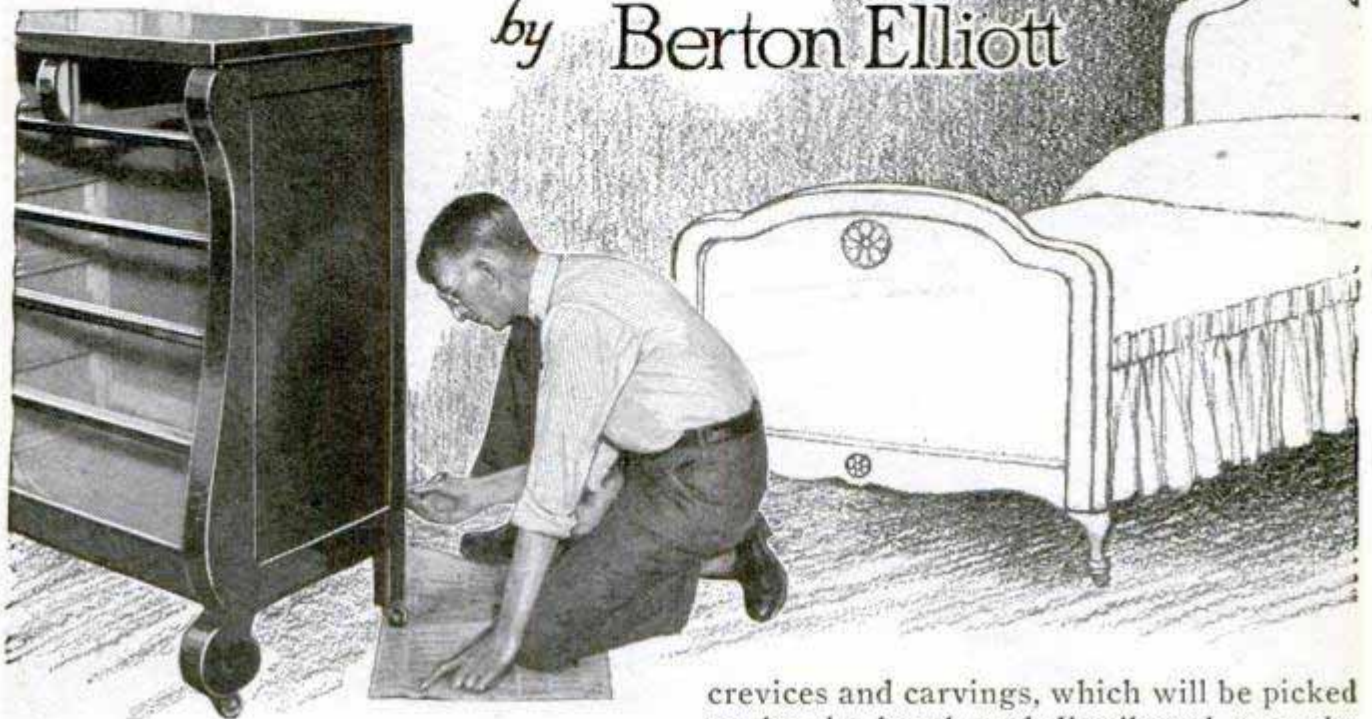

ing to the condition of the old finish. If good, a light sandpapering to cut the gloss is all that is necessary. If it has been chipped off so there are depressions in the surface, the edges around the depression should be feathered or tapered with sandpaper. In case the old varnish finish is badly checked or "alligatored," there is nothing that will prevent the checks showing through the refinishing coats. These will actually magnify and emphasize the checks and cracks. In such cases, the only way to do a really first-class job is to remove the old finish. If this is not desired, the checked finish should be sanded down thoroughly, especially on all conspicuous surfaces, such as the dresser top, fronts of drawers, etc. This, although it will not remove all trace of the checks, will sand them out to some extent.

After the sandpapering has been completed, the surface should be dusted clean from all particles of sand and sawdust, immediately before starting to apply the finishing coats. When using varnish products, it is important that every bit of dust be removed from the surface, as every speck shows through the transparent varnish. Watch out for dirt in corners,

crevices and carvings, which will be picked up by the brush and distributed over the surface.

Our dresser is now ready for the actual application of the refinishing materials. Drawers should be removed. (If desired, the mirror and the uprights supporting it may be removed and left off entirely, or the mirror hung on the wall from the picture molding just above the dresser.)

The first application is an evenly brushed-on coat of walnut varnish stain. As the shade of any stain material varies according to the surface over which it is applied, it will be a good idea to try out the finish on some inconspicuous part of the dresser, to see if the effect is satisfactory. This can perhaps be done on the back of one of the legs, or on an edge next to the wall. If the effect is too dark, it can be lightened by adding a little turpentine. If too light, an additional coat may give the desired effect. Each succeeding coat of a varnish stain darkens the surface perceptibly, and three or four coats may give you just the effect you want.

After the try-out, the required number of coats of the stain should be applied over the entire surface. In doing the top or other large panels, do a strip 3 or 4 in. wide the full length of the panel; then



Some Crude Oil, Pumice-stone and a Piece of Thick Felt Are the Only Things Necessary for Producing a Rubbed Finish

grain without refilling the brush, and finally brushing with the grain again, with long, sweeping strokes.

Dirty work is one of the principal causes of defects to be guarded against in varnishing. Nothing spoils a beau-

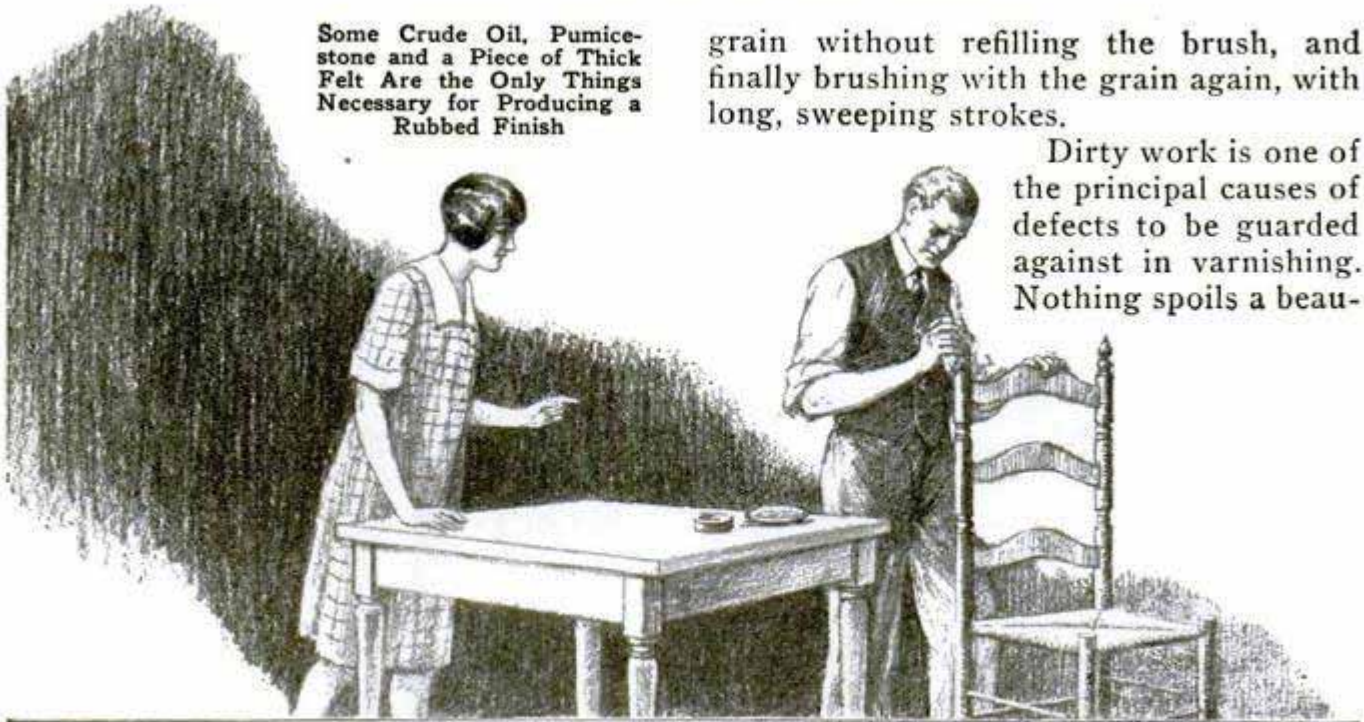

take another strip of the same width, and so on over the entire surface, working quickly to prevent the edge from setting before you get back over the next lap, which would cause streaking at the overlap. If the material drags a little under the brush and goes on with a blotchy appearance, add a little turpentine. The more conspicuous larger surfaces should be left until the last, so you will be sure the material is working right when you do them. If more than one coat is applied, each coat should be allowed to dry at least forty-eight hours and then sandpapered lightly before applying the next coat.

When the varnish-stain treatment is completed, a finishing coating of varnish should be applied. This may be of gloss varnish, either left in full gloss effect or rubbed to a semi-dull finish, or it may be of flat-drying varnish.

Varnish is applied in about the same way as enamel, with the cross brushing method described fully in the December, 1928, issue of this magazine, flowing it on with the grain, then brushing across the

tiful varnish finish more than dust or grit in the surface, and failure to get a clean finish is, in the great majority of cases, due to the brush, the varnish cup, or the surface not being absolutely clean. Varnish brushes must be kept thoroughly clean clear up to the root ends. Dried skins, and particles of the finishing material left in the heel of the brush, work their way down, and it is almost impossible to get a brush that has been allowed to get "lousy," to use the painter's term, clean enough again to use for varnishing.

Varnish (and varnish stain) should always be applied in a room which is just as free from dust as possible, and care should be taken that no dust is raised in the room during and for several hours after application, until the material has set dustfree. People walking will stir up enough dust to ruin a job. It is also important that varnish be applied in a warm room, that the surface on which it is applied be warm, and that the varnish itself be warm; other-



wise it will not flow properly and level itself to a smooth, even surface. If varnish has been kept in a cold room for any length of time, it should be warmed by setting the can in hot water, or by placing it near (but not on) a hot radiator. If possible, varnishing should always be done on a dry day, as it dries very slowly in damp weather, sometimes causing trouble and affording a greater opportunity for dust to settle on the work before it has dried, and also a greater chance for someone to get against the work and spoil it. Windows should be kept closed while applying varnish and until it has set dust-free; then opened, if practicable, except in extreme cold weather, to provide ventilation and good drying conditions.

If varnish from a previously opened can is used, even though it has been kept tightly corked, it will be found that a skin has formed over the top. This should be punctured carefully and the varnish strained through cheesecloth to filter out any small pieces of dried skin. If the varnish has become too thick to spread easily, it should be thinned with a little pure turpentine.

In the application of varnish, there are certain defects of workmanship which should be continually guarded against. Skipped places is one of these, and the finisher should keep looking across toward the light, down close to the surface, which will readily show up any missed places. He should also be on the watch out for sags or beads of varnish running down over the work, especially at the corners, and immediately on seeing one pick it up

These should be worked out as much as possible with the fingers, and by dipping the brush in turpentine or in the varnish itself and brushing it out on a clean board or piece of paper. When a hair is shed into the work, it should be poked out with the end of the brush, and the surface then smoothed out. Varnish brushes ought to be kept for use only with varnish, and should be cleaned only with turpentine or benzine (never gasoline).

While on the subject of brushes, a word about the kind to use for varnishing is in order. A good-quality 1½-in. chiseled varnish brush will be found very satisfactory for the average furniture-finishing requirements. Expert finishers generally prefer what is termed a "flowing" brush, but these are rather high-priced, and good work can be done with a regular varnish brush. It is important, however, that a high-grade brush be used, as one should not expect to do good work with a cheap brush. Get a good brush and keep it in good condition. It is also desirable to have a small 1-in. brush for small surfaces.

Decalcomania Transfers, Pastefully Selected and Applied, Add Much to the Appearance of the Finished Work

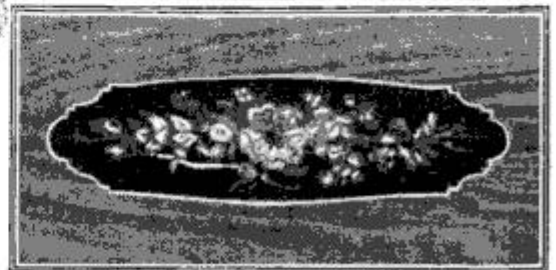
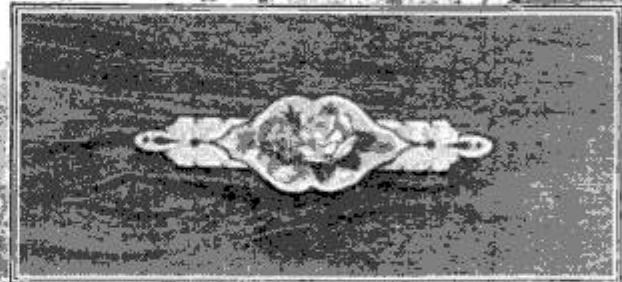
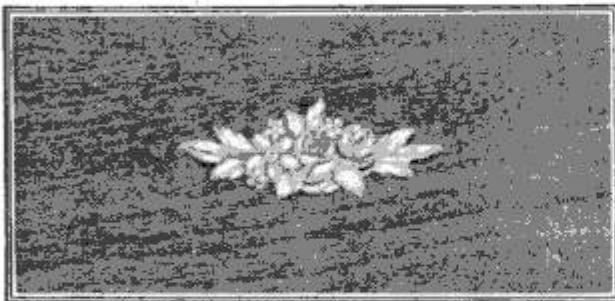

with a corner of the brush. Another thing to be constantly watched for is loose hairs shed into the work. These are especially common when new brushes are used, for, no matter how high-grade the brush, there are always a few loose hairs.

*Thurston's Varnish*  
*Shurston's Varnish*  
*Wm. Campana Co.*  
*318 S. Michigan St.*



chair rounds, etc. This may be a regular varnish-brush type, but for fitting rounded surfaces a camel's-hair brush is preferred by many.

For the finest finish, a coating of gloss varnish should be applied, and rubbed, about three or four days after application, with pumicestone and oil. Full directions for producing a rubbed effect, by dipping a pad of rubbing felt or soft cloth first in rubbing oil or sewing-machine oil, then in powdered pumicestone, and rubbing over the surface, were also given in the December issue.

For the finest rubbed job, two coats, or preferably three coats, of gloss varnish should be applied, rubbing the first coats lightly with No. 00 sandpaper (or for the best possible job, with pumicestone and water) and the finishing coat with pumicestone and oil to the desired effect. However, one coat of clear varnish over a coat of varnish stain may be rubbed to a reasonably good job, if care is taken not to rub too much, so as to cut through, especially at the sharp edges. Wipe and examine the surface often to note progress.

Another method sometimes employed by home finishers, which will be found very satisfactory for any except the very finest work, is to apply a coat of gloss varnish over the varnish stain, and rub it lightly, after drying three or four days, with fine steel wool (No. 00) wet with linseed oil. This will be found a simpler operation than pumice rubbing, and there will be less chance of the novice rubbing through the finish.

Here it might be mentioned that in case rubbing with any material should not

turn out satisfactorily, and the surface seem to be blurred or streaked, it can generally be corrected by applying a thin coat of prepared wax (floor wax), and polishing briskly with a soft cloth. Many people, also, are especially fond of a waxed finish, and prefer to wax over a varnished finish to obtain the typical wax sheen, but it should be remembered that a wax finish requires more attention, and must be polished frequently to keep looking well.

The other method of finishing—and the easiest one—is to apply one finishing coat

of flat-drying varnish over the varnish-stain coat. This closely approximates a rubbed effect, although it has not the depth and richness of the real hand-rubbed finish. When applying flat varnish, it is important to shake the container immediately before using, as, unlike gloss varnishes, part of the content of flat varnish ordinarily settles to the bottom and should be reincorporated with the liquid before using.

If desired, a finishing touch may now be added with applied decoration. Transfer patterns (decalcomanias) may be obtained

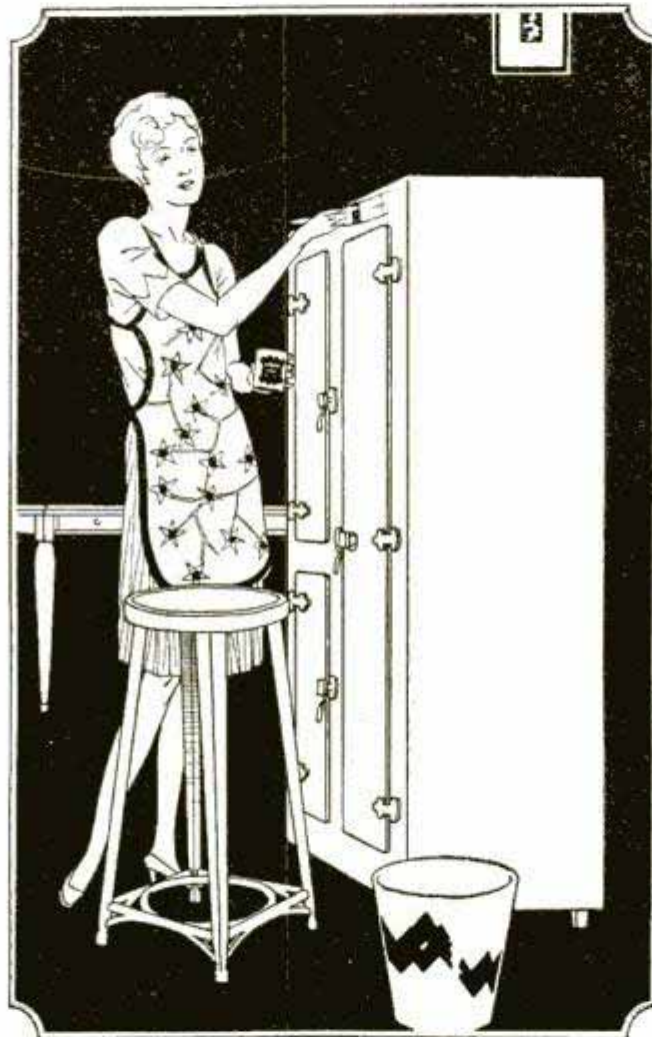

simulating wood inlays, designed especially for use on stain-finished furniture. These are easily applied and impart a note of richness to the piece that is worth while. Stenciling is sometimes used as a last finishing touch, but care must be taken to use designs and colorings that are appropriate to stain-finished wood.

☞ Any old canvas water bag, slit open at the top, makes an ideal creel for carrying fish and will keep them moist and fresh all day.



### Removing Dents in Soft Wood

When working with soft wood or medium hardwood, the hammer may occasionally slip, making dents on the surface, which, of course, spoil the appearance of the job. To take out such dents pour on a few drops of alcohol and light it. The heat will swell the wood and raise it to the original surface, the alcohol burning out so quickly that no charring will result.—L. B. Robbins, Harwich, Mass.

### Boring Bar for the Home Lathe

The drawing shows a simple boring bar which I made for use on a small lathe in my home workshop. The cutting tool is held securely in a sleeve keyed to a shaft, which is driven by the chuck or the faceplate of the lathe, a dog being used in the latter case. With this arrangement it is necessary for the sleeve to slide lengthwise on the shaft so that it can be moved back and forth while revolving. This movement is made possible by the provision of a ball-and-socket joint at the other end of the sleeve, indicated in the upper right-hand detail of the illustration. The joint permits attachment to the tailstock, which is used to feed the tool. The work is

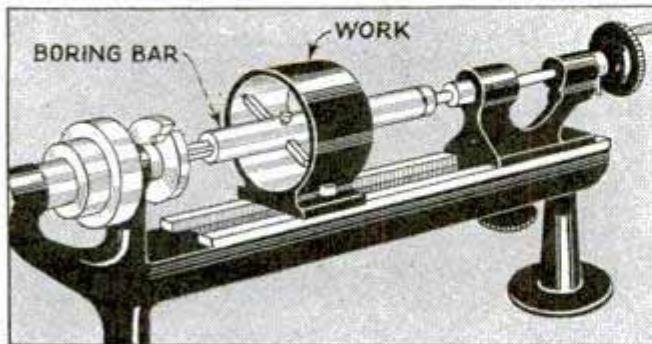
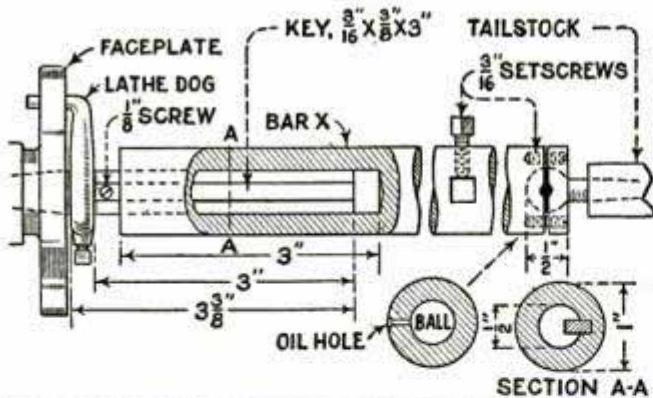

Simple Boring-Bar Attachment on a Small Lathe in the Home Workshop

mounted on the lathe bed as shown.—Ed. M. Wyland, Rapid City, S. Dak.

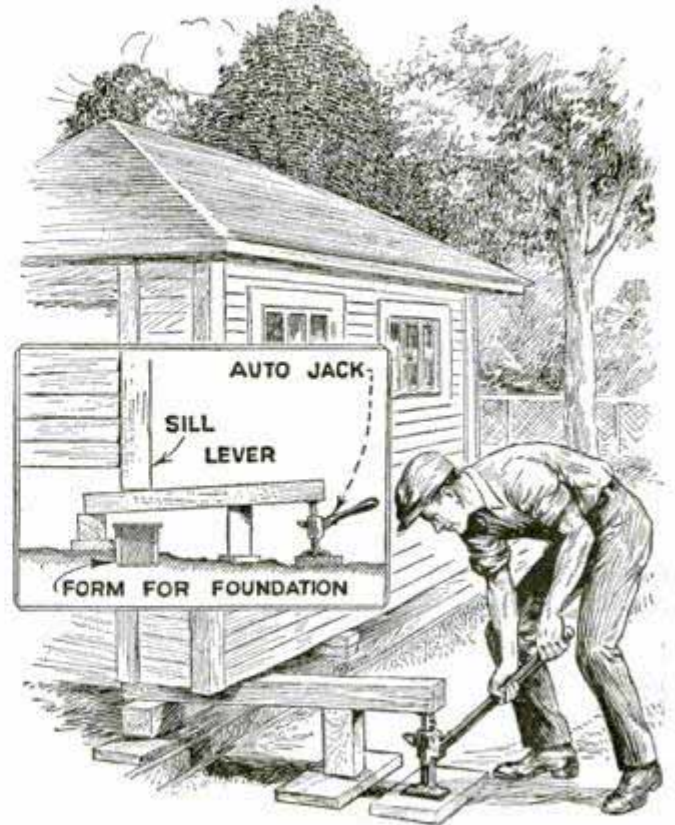

Raising a Garage Single-Handed with an Auto Jack before Laying Concrete Foundation

### Raising Garage with Auto Jack

When it is desired to raise a garage that is set on posts, in order to put a concrete foundation under it, an auto jack will be found useful. A number of lengths of 4 by 4-in. stock are obtained, for use as lifting bars, and they are pushed under the sill at right angles to it. A block and plank are set under one end of these and the auto jack under the other. After the jack has raised the bar, a block is pushed under it to hold the load, and then the jack can be used to raise the next bar, a few feet away. Repeat the operation until the whole garage is raised to the desired height. The foundation is then laid, and after it has set for several days, the garage can be let down on it by reversing the method.

### Magnetizing a Pair of Scissors

To make it easy to pick up a needle when it falls on the floor, in water, or places that are hard to get at, I have magnetized a pair of scissors. Anyone can do this by merely stroking the scissors in one direction over a pole of an electromagnet or ordinary steel magnet of sufficient strength.—Andrew Veng, Philadelphia, Pa.



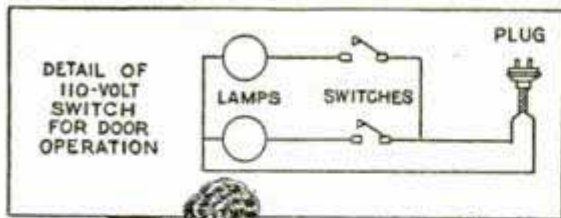

Electric Lamps in Refrigerator Are Automatically Lighted When Doors Are Opened

### Electric Light in the Ice Box

Our refrigerator is located on the rear porch and the light is so far away that it provides very little illumination for the refrigerator. Two small door switches, which close a circuit when a door to which they are attached is opened, were installed on the refrigerator doors. A lamp was provided in each compartment, and a length of lampcord was used to connect the circuit with a near-by wall plug.—Miss Jane Rider, Washington, Ill.

### Oiling Auto-Distributor Shaft

Distributor shafts on some auto motors receive insufficient oiling, due to the fact that the grease or oil cup located at the top of the distributor shaft is forgotten. To insure proper lubrication for this part, without special attention, the method shown in the illustration will be found satisfactory. It consists in getting the oil supply from the pipe running to the oil

gauge on the instrument board. Cut this pipe and install a tee and a needle-valve sight-feed lubricator as indicated, and run a length of copper tubing from the needle valve to the distributor shaft. Adjustment of the needle valve controls the amount of oil fed to the shaft, and as long as there is any oil in the crankcase, the distributor shaft will not run dry. The oil should be allowed to pass only in drops.

### Plastic Paint Made from White Lead

Textured walls are now quite popular and there are several high-grade plastic paints on the market for treating plastered walls. It is not generally known, however, that a white-lead plastic paint can be readily made at little cost, which will give entirely satisfactory results. Plastic paint must be thick enough to allow designs and figures to be worked in it, should dry hard and quickly enough so that it may be glazed over if desired, and have some oil content to give permanency. It consists of the following ingredients: white lead, 19 lb.; dry whiting, 4 lb.; flattening oil, 1 qt., and drier,  $\frac{1}{4}$  gill. The best method of compounding it is to use one-half of the oil to break up the white lead, and mix the other half with the whiting. Then mix the two together and add the drier, which will result in a thick paint, about twice as heavy as the average white-lead paint, which can be applied with a brush. It should be applied heavily. The above quantity will cover about 30 sq. yd. Color can be added to the mixture or it can be applied dry with the brush, giving the desired rough and streaky appearance. As soon as the paint is on the wall, it is ready for the working in of the designs,

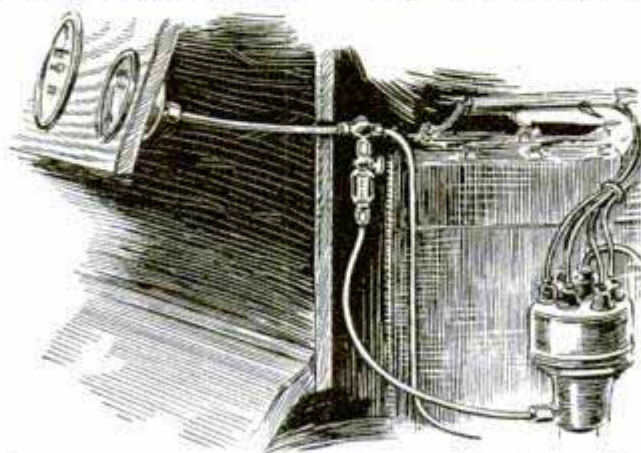

Insuring Proper Lubrication on the Distributor Shaft of an Auto Motor

which may be of various kinds. Expensive tools are not required; a graining comb is handy for some designs, and a kitchen spoon is useful for making circular figures. Crumpled paper is sometimes used as well as wadded rough cloth for texture designs.



# SHOP NOTES



All Shop Notes published in 1928, in book form—Fifty Cents—from our Book Department

## A Ball-Bearing Scrollsaw

By W. CLYDE LAMMEY

**I**N TIMES past the writer has made several attempts to construct a scroll saw that would be suitable for a wide range of work, and all have been more or less of a

equal any of like capacity in practical features.

The ball-bearing assemblies in the skate wheels are used in the saw arms and in the pitman and driving wheel, making an easy-running mechanism that may be operated at high speed. The skate wheel is used intact in the saw arms and driving wheel, but only the assembly in the pitman rod.

If no discarded skate is available, get four wheels with the regular threaded bolts. These may be obtained at any hardware store where repair parts are carried. Make sure that the wheels are of the



CUTTING OUT TABLE

failure, owing to the difficulty of making a smooth, easy-running assembly. In every instance, the driving mechanism was faulty and soon went to pieces under the strain of driving even small fine-toothed blades.

However, it happened one day, while cleaning the basement, that a discarded pair of roller skates was found, and, after some cogitation, these rusty skates became the nucleus of an idea which in essential is the project described, namely, a ball-bearing scroll saw. Though lacking in refinements perhaps, it has been found to

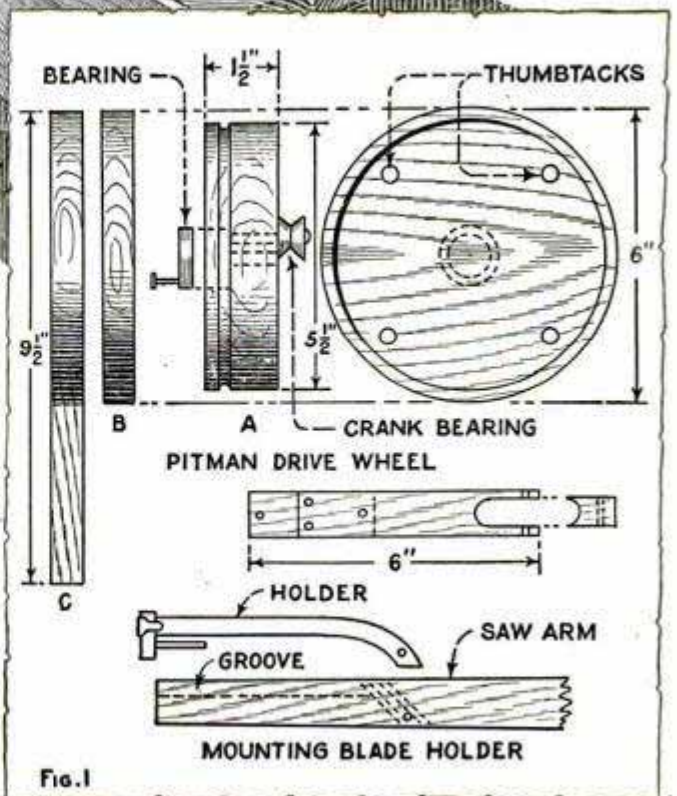



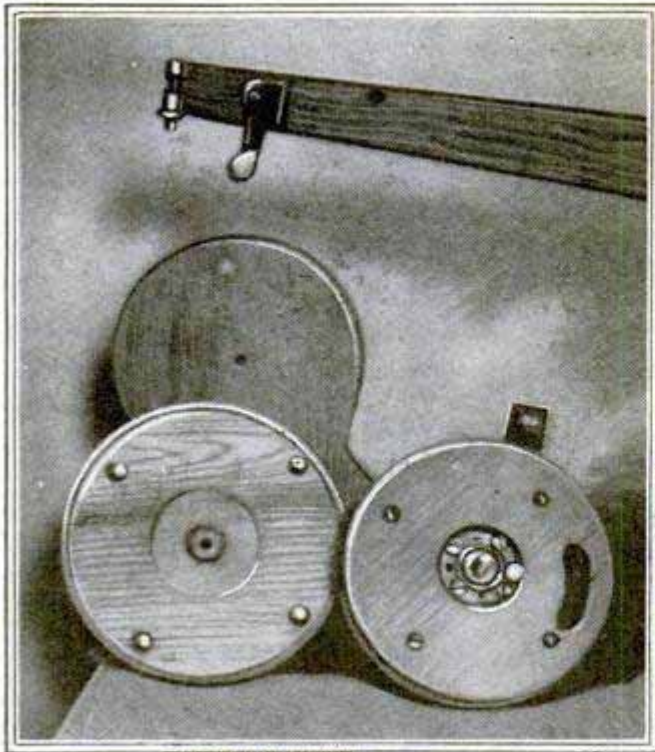

ing saw as shown in Fig. 1. Chisel a groove of suitable size and depth in the end of the saw arm (in the upper edge of the top arm, the reverse in the lower), bore several slanting holes and chisel out to take the curved portion. Rivet the holder in place, using washers; then fill the groove with plastic wood, and, when dry, sand smooth.

A turnbuckle with two fairly heavy screweyes is used to provide a quick means of adjusting the blade tension. The screweyes are turned into the wood and a  $\frac{3}{16}$ -in. rivet put through close to the end, to prevent splitting. Centering 10 in. from this end and  $1\frac{3}{8}$  in. from the lower edge in the upper arm, and the reverse in the

double ball-race type, as these are more certain to run true and are best suited to the purpose.

Rip the stock for the arms and the upright arm supports from 1-in. oak to the dimensions and form shown in the drawings, and true the edges with the jointing plane. Cut two pieces, 28 in. long, from 2 by 4-in. stock for the base. Half-lap the ends over the uprights (Fig. 5), taking care to have the shoulders of the halves square. Use a 1 by 4-in. piece, about 9 in. long, to space between the uprights and for rigidity. Use two hand clamps to hold this assembly square while boring the three  $\frac{1}{4}$ -in. holes for the bolts. Give a liberal application of glue to the joining surfaces and tighten the bolts on washers. If desired, the upright arm supports may extend to the floor to make a floor mounting.

After the stock for the arms has been prepared, the turnbuckle, bearings and blade holders are placed in position. The holders for a pin-end blade are adapted by cutting the frame of a small hand cop-

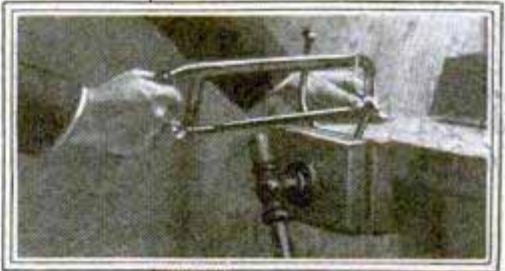
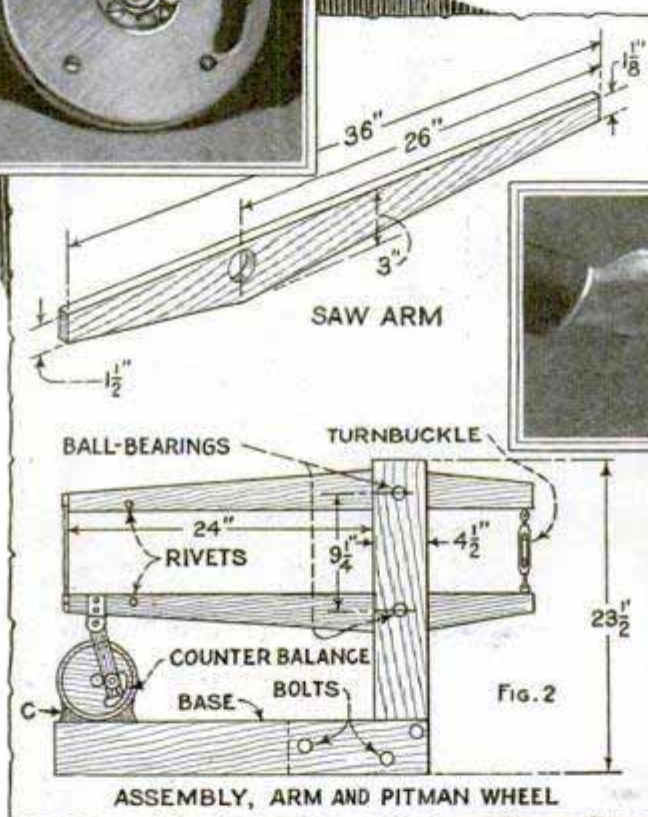

lower, bore a hole for the bearing with an expansion bit, first testing the setting on a piece of waste stock until the skate wheel is a tight driving fit. In driving the wheel to position, use a large nail set on the rim, rather than striking it directly, as this is likely to damage the bearing.

Before laying the arms aside, obtain a piece of common strap iron (or any other that happens to be adaptable)  $\frac{1}{8}$  by 1 in., and cut from it two pieces, 3 in. long;  $\frac{7}{8}$



in. from one end bend at right angles and  $\frac{3}{8}$  in. farther bend again, making an offset of  $\frac{3}{8}$  in. in each piece. Bore a  $\frac{1}{4}$ -in. hole through the offset ends and two  $\frac{3}{16}$ -in. holes in each opposite end. Rivet the pieces to the lower saw arm, one on each side and 2 in. from the end taking the blade. These form the upper connection for the pitman.

The saw table is best built up from 1-in. yellow pine in the manner shown above Fig. 1. Cut a piece, 33 in. long, from 1 by 10-in. yellow pine, and rip another,  $2\frac{1}{2}$  in. wide and 3 ft. 8 in. long, from the same stock. Cut this last in four pieces, two 1 ft. long and two 10 in. long. Square all edges carefully with the plane, and dowel and glue the pieces, two on each side, in such a position as to get a circle of  $8\frac{1}{4}$ -in. radius about the end. Scribe a circle about the end, rounding off where it meets the center-piece; saw to the

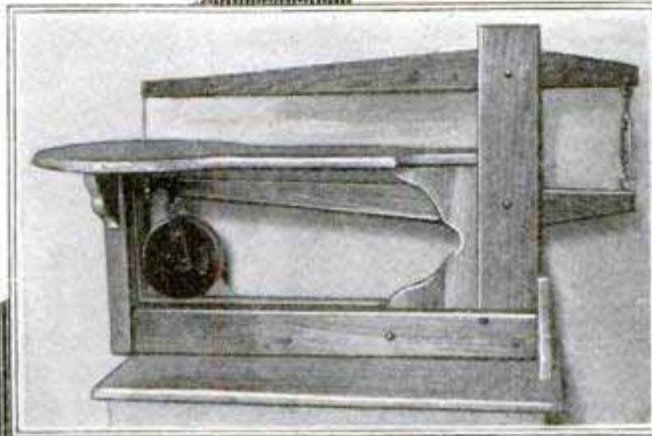
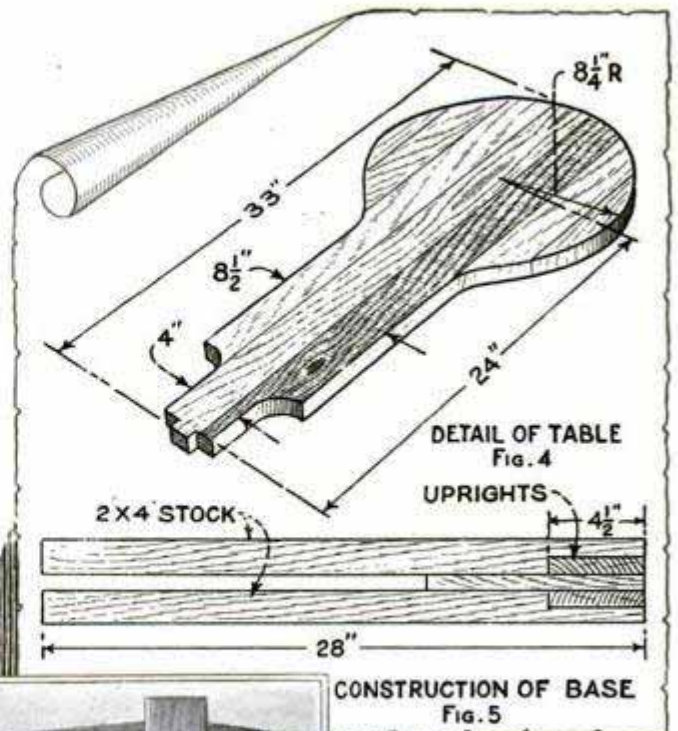

which in turn is secured to the support C. This method of construction has been found to overcome the tendency to run out of true owing to the short bearing surface of the skate wheel.

For the driver, saw two pieces of hardwood to 6-in. diameter, each  $\frac{3}{4}$  in. thick, and glue together with the grain running at right angles. Use screws to save the wait for the glue to harden. Turn out on the faceplate to  $5\frac{1}{2}$ -in. diameter and true the outer face carefully. Cut a groove for a  $\frac{1}{4}$ -in. round belt, having the center of the groove about  $\frac{3}{8}$  in. from the inner face of the wheel, so that the belt will run directly over the bearing. Sink a recess centered on the face of the wheel, to take in the skate bearing flush with the surface. Use the greatest care in this operation to have the bearing fit tightly. Sand the wheel smooth.

In the standard skate wheel with iron tread, there is a series of small holes through the inner face just below the tread. Before driving the bearing in place, bore several of these holes through both sides of the rim and countersink for screws. Center a  $\frac{3}{8}$ -in. hole in the recess for the bolt head, and bore through the wood. Take care to have it true. Drive

outline, and plane and sand smooth. Handling the stock will be greatly facilitated if the table is given two coats of thin shellac and rubbed smooth. This makes a hard surface that is well worth the extra labor.

The pitman drive-wheel assembly consists of three parts, A, B and C, Fig. 1. The drive wheel A carries the bearing and is made to run in a recess in the plate B,

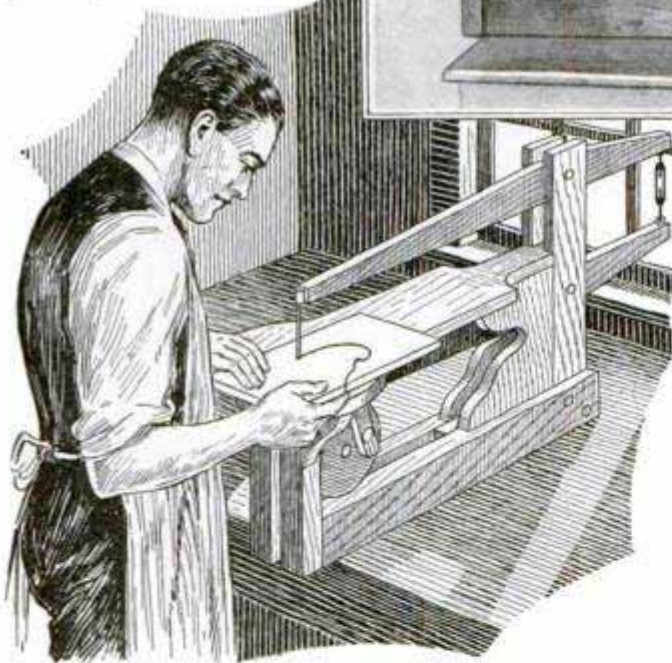



the bearing in place and tighten with screws. As close to the tread as possible (in the metal), bore a  $\frac{1}{4}$ -in. hole for the bolt holding the pitman bearing. This will give a stroke of approximately  $1\frac{1}{2}$  in. The position and relation of the component parts will be readily seen from the drawings and photos.

Turn the plate B from a single disk of hardwood to exactly 6-in. diameter, and, beginning a trifle less than  $\frac{1}{4}$  in. from the edge, recess the surface  $\frac{3}{16}$  in.;  $\frac{3}{4}$  in. from the center, sink a deeper ring to accommodate the head of the pitman bolt. Drive four ordinary thumbtacks into the inner surface of the plate as shown. Mark the outline of this disk on a piece of hardwood, 1 by 6 by  $9\frac{1}{2}$  in. Saw a three-quarter circle to the line and bring the edges around in a curve as shown in the assembly, Fig. 2.

Tighten a skate wheel in the vise and, with a hacksaw, cut through the tread down to the cones that form the inner half of the ball races, and pry the rim apart. This will release the bearing. Using one of the threaded bolts, with a thin washer next to the wood, tighten the pitman bearing in place. Centering  $\frac{7}{8}$  in. over this bearing and in approximately the same arc as the wheel rim, bore six  $\frac{3}{8}$ -in. holes and chisel out the waste as in a mortise. On the average, this will remove sufficient weight to counterbalance the wheel.

The pitman is made from a piece of maple, planed to  $\frac{3}{4}$  in. in thickness,  $1\frac{3}{8}$  in. in width, and  $4\frac{1}{2}$  in. in length, into one end of which is let a 3-in. length of  $\frac{1}{8}$ -in. iron. Make two saw kerfs as closely together as possible in one end of the wood to a depth of  $1\frac{1}{2}$  in. and rivet the iron in place in this slot. Bore a  $\frac{1}{4}$ -in. hole through the outer end of the iron. Center a  $\frac{7}{8}$ -in. hole  $1\frac{3}{4}$  in. from the end in the wood, and saw down tangent to the circle, removing the piece as shown (Fig. 1). Slip the open end over the pitman bearing and insert the short piece. Hold in place with

a clamp and bore a hole for a small stove bolt, to clamp the loose piece.

Assemble the arms in the frame first, using  $\frac{1}{4}$ -in. bolts. Punch washers from tin, and shim the bearings until the saw arms move freely when the bolts are tightened. Bolt the pitman-wheel assembly together, using thin washers between the plate and the wheel, until it turns easily without binding against the heads of the thumbtacks. Bolt in place as shown in Fig. 2, and connect the upper end of the pitman to the arm, using a small bolt. If the parts have been carefully made, this assembly will be found to run with remarkable ease and smoothness, the ball bearing adding immeasurably to the elimination of friction.

Center a  $\frac{3}{8}$ -in. hole in the circular end of the table for the blade. Raise the arms to the highest point in the stroke, measure, and allow about  $\frac{1}{2}$  in. for clearance. Mark this measurement on the arm supports, and at this height fasten a small piece with screws to support the rear of the table. Measuring an equal height, cut two pieces from 2 by 2-in. stock and secure to the ends of the base with lag screws. Be sure that the pieces are even at the top. Lay the table in place, insert a blade in the holders and test with the square. If the table is square with the blade, lock it down with screws.

Mount a  $\frac{1}{8}$  or  $\frac{1}{4}$ -hp. motor just back of the pitman drive wheel and use a pulley of 1-in. diameter on the motor. The saw will make about 900 strokes per minute with a 1,750 r.p.m. motor and with a coarse-toothed blade will do clean and speedy sawing. The blade continually

recedes from the work on the upstroke, the advantage of which will at once be apparent in use, as this action precludes the annoying tendency to jerk the work upward. In machines with a blade moving straight up and down, it is necessary

to fit some kind of "foot" that will hold the work down when the blade is on the upstroke.

#### MATERIAL LIST

- 2 pieces, 2 by 4 by 28 in., yellow pine.
- 1 piece, 1 by 10 by 33 in., yellow pine.
- 1 piece, 1 by  $2\frac{1}{2}$  by 44 in., yellow pine.
- 2 pieces, 1 by 3 by 36 in., oak.
- 2 pieces, 1 by 4 by 24 in., oak.
- 2 pieces, 1 by 6 in. square, birch or maple.
- 1 piece, 1 by  $6\frac{1}{2}$  in. square, yellow pine.
- 1 piece, 1 by 6 by  $9\frac{1}{2}$  in., oak.
- 2 pieces, 2 by 2 by 16 in., yellow pine.
- 4 standard roller-skate wheels with iron treads and threaded bolts and nuts.
- 1 hand scrollsaw with 6-in. blade and 5-in. frame.



### One Way to Save Gasoline

A substantial saving of gasoline can be made by anyone having a car equipped with a vacuum windshield wiper which has a dash control. Before starting on a drive of any distance, disconnect the small hose connection on the wiper. After the car is started, turn on the dash control, which ordinarily would cause the wiper to operate. This procedure supplies the gas mixture with more air, thus thinning it and effecting a saving of gas. In some actual tests with a Chevrolet coach of the 1928 model, I averaged better than 30 miles per gallon. This idea cannot be used when the wiper control is built into the wiper, as, in this case, the amount of air entering the inlet manifold cannot be regulated.—H. L. Braly, Shamrock, Tex.

### Flush Handle for Trapdoor

In a manufacturing plant having a number of steel trapdoors, cheap, flush door handles were made and found as good as the commercial articles. Each handle is made from a piece of round stock, bent to a U-shape and threaded at both ends for

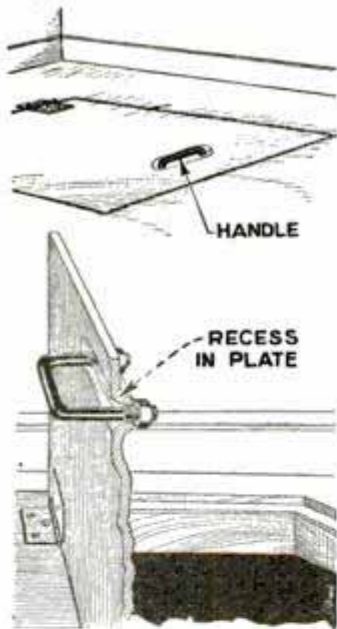

nuts. The holes in the door for the ends should be a trifle larger than the diameter of the handle, and the portion of the door between the holes is grooved so that the handle will drop flush with the surface when the door is closed. It can readily be pulled out to open the door.—G. A. Luers, Washington, D. C.

### Homemade Engine-Driven Ice Cutter

Any farmer who wishes to have an engine-driven ice cutter can easily make it himself as there is no difficulty involved in its construction. The sled is made of 2 by 6-in. stock, firmly braced and equipped with a handle for pushing. A stationary gas engine is mounted on the sled and a



Harvesting Ice with a Simply Constructed Engine-Driven Cutter That Can Be Made at Home

suitable 2 by 6-in. frame, to hold a circular ice-cutting saw, is pivoted to the front end of the sled as shown, a lever being provided to permit raising or lowering the saw. The saw shaft is fitted with a pulley in line with the pulley of the engine, to which it is belted.—Clay L. Gorrell, Belair, Md.

### Multiple-Scriber Surface Gauge

When castings are to be laid out in lots, as they generally are in any large plant, the multiple-scriber surface gauge will be found a valuable aid. Once the scribers are set to the correct measurements, the entire lot of castings can be laid out without disturbing the setting of the gauge. This simple device will help increase production and will eliminate many errors in laying out the work.—C. Kugler, Philadelphia, Pa.

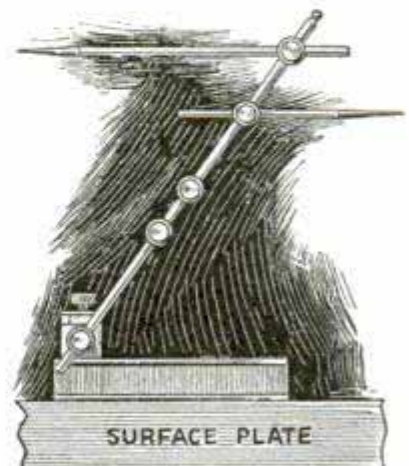



# Wood Joints for the Amateur

## PART II

WHEN the amateur, after watching the skillful craftsman make and fit a joint, starts in to do the job himself, he finds, to his surprise, that the thing is not quite so simple as it looked. In spite of the most careful work with the tools, the joint is not exactly right when it is finished. The fact is that there are many little things done by the craftsman while he is making a joint which go unobserved by the amateur, yet are essential to the success of the work. In addition to this, the professional, by long practice, has acquired a degree of skill in handling his tools that the amateur cannot hope to duplicate for some time, and consequently he must modify his methods to make up for his lack of facility in tool handling. Let us take the making of a cross-lap joint for example.

The first step is to square up a face side

ing them together, and square the marks across the face edges. Now square across the other edge, singly, keeping the stock of the square against the face side. Set a marking gauge to half the thickness of the stock, and gauge the depth of the recesses, gauging always from the face sides.

Now comes a little trick that the amateur will find of use. Take a chisel, and, slanting it toward the waste, as shown in Fig. 1, cut a little groove right up to the line on either side. If the knife marks have been made fairly deep, severing the fibers of the wood, the chips will come away clearly, and the groove will make it possible to start the saw square across the work, and just inside the line. Another tip is to start the saw as shown in the lower drawing in Fig. 1, holding it slanting, and sawing down on one side until the saw teeth just touch the line marking



and edge on each piece, and mark them (see Fig. 1). After measuring and marking the position and width of the joint on one, lay the pieces side by side, as shown, and square the marks, with the knife, across both faces. Turn them edgewise, keep-

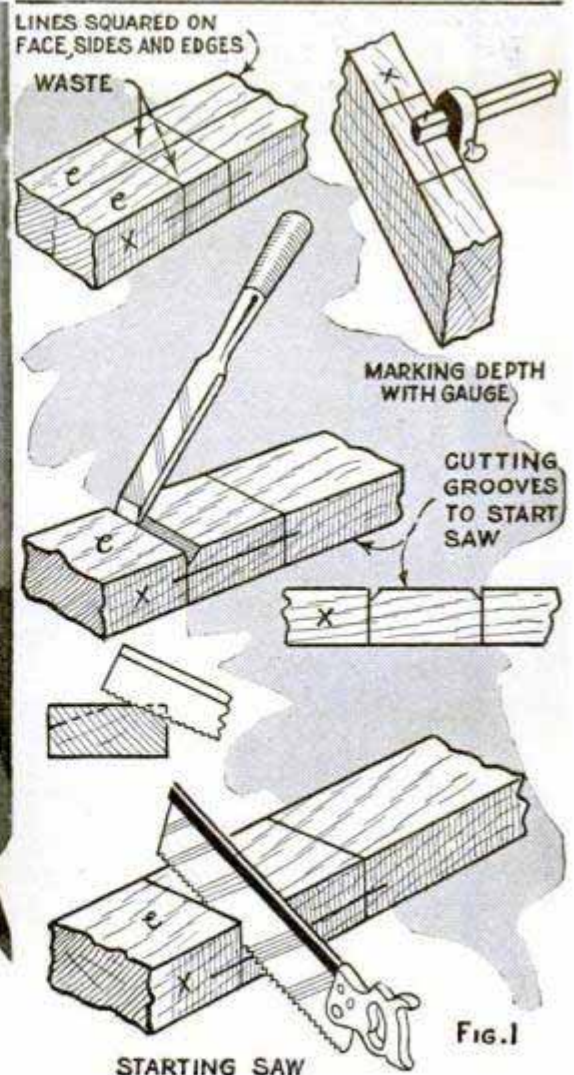



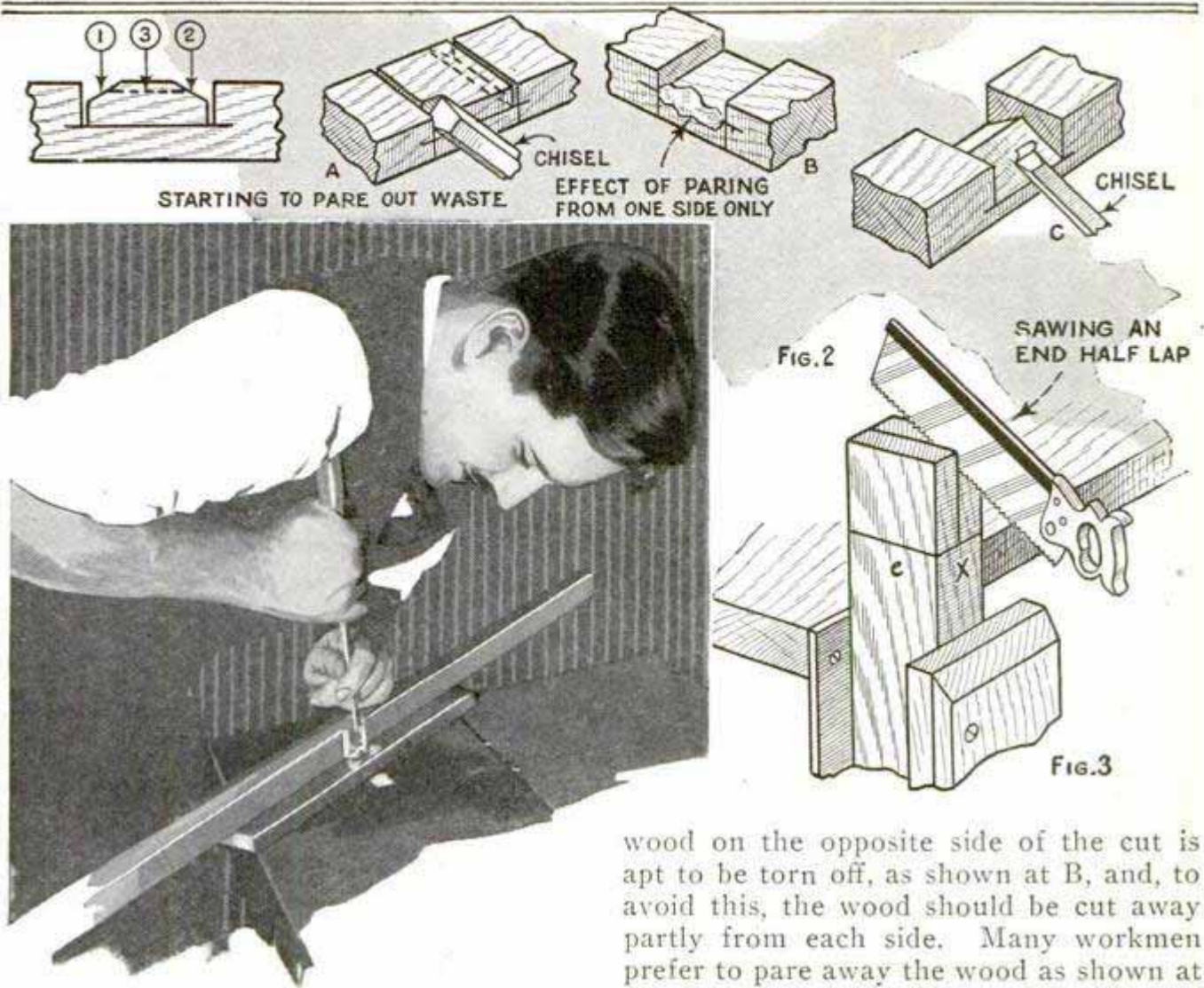

the depth of the recess. The saw can then either be brought up gradually until it is horizontal and the cut continued, or else the work may be reversed, and a similar slanting cut made from the other edge; if this is done, the two saw kerfs will keep the saw straight, and it will become easy to cut down horizontally and keep the cut square.

The next thing is the paring out of the waste. Some workmen like to do this sort of paring horizontally, as shown in the photo accompanying Fig. 1; others, again, prefer to pare vertically, as shown below Fig. 2. The amateur will probably find the first method the easier. With either method, the procedure is the same. Sharpen the chisel; good work cannot be done with a dull tool. Pare away the wood on a slant at one saw kerf, as at A, Fig. 2, then take a similar cut at the other kerf, and next cut off the top of the "hill"; these cuts are numbered 1, 2 and 3 at A, Fig. 2. If the chisel is thrust all the way across the work, from one side only, the

wood on the opposite side of the cut is apt to be torn off, as shown at B, and, to avoid this, the wood should be cut away partly from each side. Many workmen prefer to pare away the wood as shown at C, slanting the chisel upward, and paring halfway from each side, so that the cuts end in the center; there is then no danger of wood being broken off at either edge.

When sawing an end half-lap, or any similar, joint, mark off as described before, then fasten the piece endwise in the vise, and, starting the saw as in Fig. 3, saw down along the depth line until the saw teeth touch the line marking the length of the lap. Turn the work around in the vise, and saw similarly on the other side. Finally hold the saw horizontally and cut down the center. It will be found a great deal easier to keep the saw to the depth line by using this method than by sawing straight with the saw down horizontal while trying to keep the saw square in two directions. Of course, with either method, one must watch the line on the end of the work as well as that on the side, but it is decidedly easier by the first method than by the second. With normal care, using this method, it will be found unnecessary to employ a chisel to make the parts of the joint fit properly.



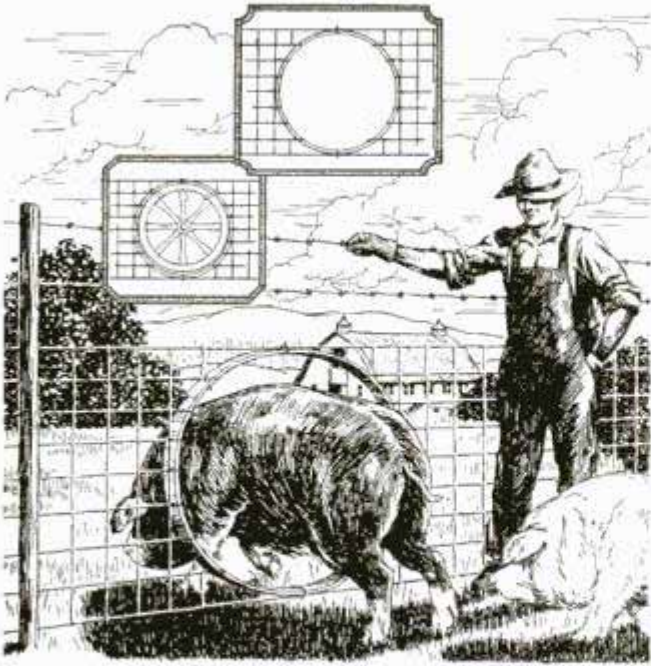

Circular Passage in Fence Consists of an Iron Wagon Rim Wired in Place Securely

### Circular Passage in Fence

When it is necessary to cut an opening in a fence as a passage for hogs, sheep or calves, you will find the idea indicated in the illustration of exceptional merit, as it makes a neat job and does not cause the fence to sag, as often happens when the fence is cut vertically and two posts are set up a few feet apart. Get the rim of a wagon wheel and cut a circular hole in the fence so much smaller than the wheel that the wire can be turned around the rim, and the ends twisted securely to hold it in place and to prevent scratching the animals.—Luther Strosnider, Onaga, Kan.

### Cover Attached to Clip Aids Mechanic

While working on an auto, or other piece of machinery, I have frequently

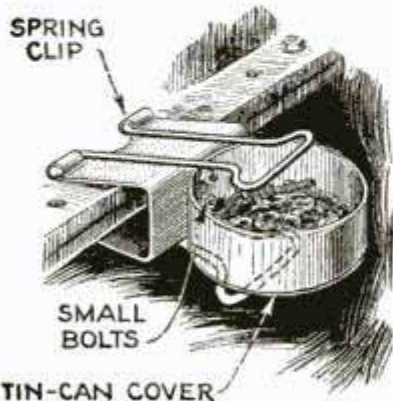

TIN-CAN COVER

dropped small parts on the floor and spent quite a bit of time in recovering them. I now use a small tin-can cover, attached securely to a strong spring

clip as shown in the drawing. The container thus made can be clipped to any convenient part of the machine where it

is handy for the worker to reach, and will hold small parts without risk of losing them.—Ross J. Plaisted, Cleveland, Ohio.

### Safety Hook on Well Digger's Rope

When digging wells, the bucket used for hauling up the earth sometimes slips off the hook on the end of the rope and may cause serious injury to the worker in the pit. To avoid this danger, a Nebraska well digger provided a safety hook as shown in the illustration. It is really a large snap hook from which the bucket, full or empty, cannot be dislodged when there is a slack in the rope, and the snap can only be opened intentionally. Hence the man in the pit can work in safety without worrying about the bucket over his head. If a snap hook of this kind cannot be obtained, fasten a strip of spring steel to the hook, which is done by drilling and tapping the hook and spring for screws to hold the latter securely in place on the shank of the hook. It may be necessary to remove the temper from the end of the spring where the screw holes are to be drilled, then re-tempering it. The spring must be arranged so that it closes the hook when pressure on it is released.—Frank S. Reynolds, Fort Morgan, Colo.



### Taking Care of Your Oilstone

A good oilstone, whether it is natural or of the artificial variety, commands a good price and is therefore worth proper care. The surface of the stone must be kept uniformly flat and even, and a glazed condition must be prevented. To let an oilstone become dry will harden it. It should be clean and moist, and, if kept in a dry place, a few drops of fresh, clean oil should be left on the surface, to prevent glazing. The fluid floats off the particles of steel removed from the tool. If no oil or water is used, these will become



lodged in the pores of the stone, greatly impairing its efficiency. All coarse-grained natural stones should be used with plenty of water, while medium and fine-grained natural stones, and all artificial stones, should be used with oil. In order to prevent further glazing of a stone, that is already more or less dirty, wipe the surface clean after using it. If this is not done, the oil soaks into the stone and carries with it the particles of steel. A glazed stone can usually be restored by a thorough cleaning with gasoline or ammonia. If this does not entirely remedy the condition, the stone can be scoured with loose emery or a sandpaper block. A new oilstone should be soaked in oil for several days before it is used.

### Field Toolbox for the Farm

To eliminate the trouble of taking farm tools home after each day's work, because they cannot be left outdoors in wet weather or during the winter months, it is a great convenience to have a portable box of sufficient size to accommodate a large saw besides other tools. When working for several days on one spot, the toolbox is brought there and left until the work is finished. The box is built to stand on end, as shown in the photo, instead of being laid on the ground where it would soon be snowed under. The hinged door is fitted with a hasp and padlock, to minimize the risk of having the tools stolen. The outside is covered with roofing paper.—J. R. Koontz, Bremen, Ind.

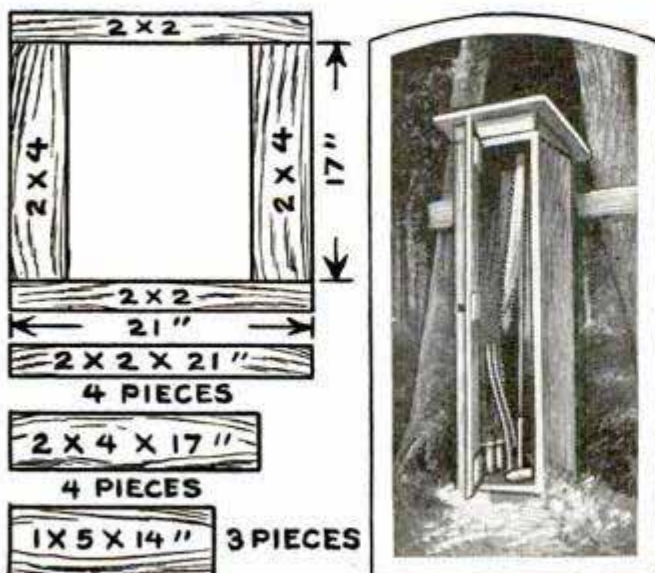

Portable Field Toolbox for the Farmer Keeps Tools on the Job and Protects Them against Weather



Window-Raising Mechanism Taken from Auto Door Makes Good Bottle Tipper

### Handy Tipper for Distilled-Water Bottles

The window-raising apparatus from an old auto door, built up on a wooden box as shown in the photo, has been used to make a convenient device for holding and tipping 10-gal. distilled-water bottles for filling storage batteries. Turning the crank tilts the bottle to any degree necessary for filling a small container, without the risk of spilling any water. The crank mechanism is arranged on a strap-iron frame, which is screwed to the box and supports the bottle.

### Repair for Door-Lock Keyhole

Frequently a good door lock is discarded because the keyhole is worn to an oval shape, which allows the key to drop out of its correct working position. An easy way to remedy this trouble is to obtain two thin washers, with holes the same size as the shank of the key, file a slot in each washer from the edge to the hole, the slot being of sufficient width to take the web of the key. Clean and tin one surface of each washer and sweat them to the plates of the lock.—John Bell, Alton, Eng.

☐ A guard for a circular saw can be made from a discarded auto-brake drum.



# MAKING A

By ~

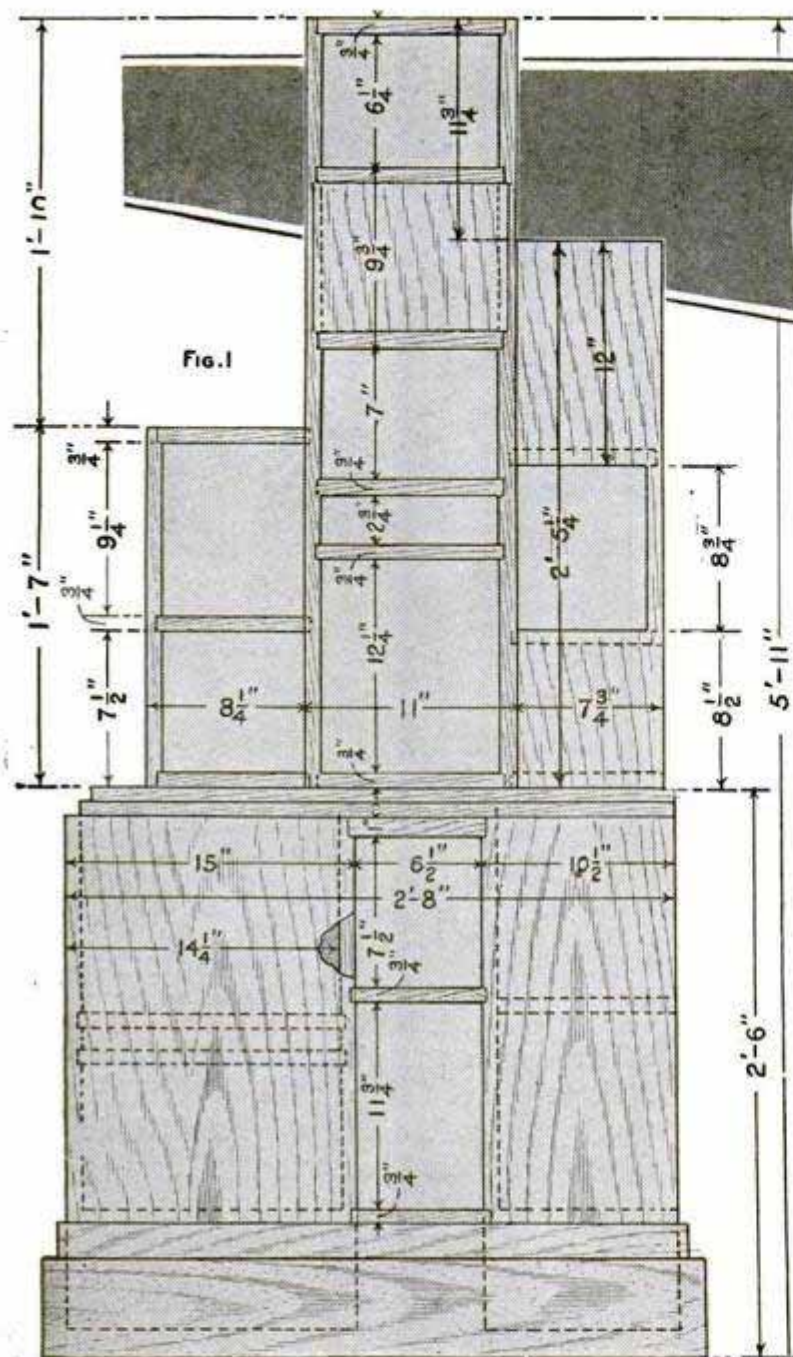

## PART I

**L**ARGE capacity and economical use of space are features of the modernistic bookcase described in this article. It is 5 ft. 11 in. high, 2 ft. 8 in. wide and 1 ft. 9 in. deep. Not only is it an interesting piece complete, but the base, if desired, can be used alone as a stand.

Since solid stock, through shrinkage and warping, would rack the case apart in a few months, five-ply  $\frac{3}{4}$ -in. material should be used.

There are many joints dependent for their appearance on the squareness of the ends of the various parts, so the use of a template in the form of a square block held against the saw blade is advised.

Elevations of the base are shown in Figs. 1 and 2, and details in Fig. 3. The top is a rectangle, 2 ft.  $6\frac{5}{8}$  in. by 1 ft.  $6\frac{7}{8}$  in. Rabbet the underside edges,  $\frac{1}{4}$  by  $\frac{3}{4}$  in., on sides and front, to receive a  $\frac{3}{4}$  by  $1\frac{3}{8}$ -in. strip glued and nailed in for a nosing. This, however, extends around the left side and front only, ending  $\frac{3}{4}$  in. from the right side. Miter the corner joint.

Make the back 2 ft. 8 in. by 2 ft.  $5\frac{1}{4}$  in. Notch the left upper corner  $2\frac{1}{8}$  by  $\frac{1}{2}$  in., and cut a  $\frac{1}{4}$  by 1-in. rabbet in the bottom of the notch. The right upper corner is rabbeted  $\frac{3}{4}$  by  $1\frac{3}{4}$  in.,  $\frac{1}{4}$  in. deep. (See Fig. 4.) The inner face is then dadoed  $\frac{3}{4}$  in. wide and  $\frac{1}{4}$  in. deep, to take the back edges of the left partition, and the left rear and bottom shelves. The partition groove is 1 ft.  $2\frac{1}{4}$  in. from the left edge of the back, and the bottom dado is 7 in. above the lower edge. The upper shelf dado is  $10\frac{1}{2}$  in. above the lower.

The laying out and cutting of the dadoes are somewhat tedious and exacting, but there are a few tricks that simplify the labor. First, square the piece accurately, and mark an edge and side from which to measure and square. Next, lay out a stick with the necessary dimensions, marking the points with a knife (not a pencil). Make the end marks  $\frac{1}{4}$  in. or more from the ends of the stick. By using this as a pattern, all pieces belonging to the same assembly can be laid out.

Mark the long dadoes with a straight-edge, scoring the lines with a knife point. Clamp a straight strip of wood to the work, the edge centering on the line, and



# MODERN BOOKCASE

E.M. Love

*3607 Luyana St. Calif  
San Diego.*

guide the saw against it, holding the blade with the thumb, or a piece of wood. If the dado is across the grain, start with a crosscut saw. When the surface is cut through, the use of a rip-saw will expedite matters. Instead of a single strip of wood clamped to the work, a guide consisting of two strips bolted at the ends can be used. This is slipped in place with one strip above and the other below and cinched tight with bolts.

Chisel the waste wood out to as uniform a depth as possible. This can easily be done with a router, but if one is not available, the depth can be fairly accurately regulated by means of a nail driven squarely through a block, the point projecting  $\frac{1}{4}$  in. With this tool scratch the high spots, leaving only shreds of wood for the chisel to pare.

The left upper shelf is  $11\frac{1}{4}$  in. by 1 ft.  $2\frac{1}{4}$  in. The bottom shelf of the lower section assembly is in one piece, 2 ft. 8 in. by 1 ft. 8 in. Near the center, the front edge projects  $\frac{1}{2}$  in. for a width of 8 in., 1 ft.  $2\frac{1}{4}$  in. from the left edge, bringing that part flush with the front of the cabinet when it is put together. Cut the left side partition 1 ft.  $2\frac{1}{4}$  in. by 1 ft.  $9\frac{1}{2}$  in. To allow for the top nosing, notch the left upper corner  $2\frac{1}{8}$  by  $1\frac{1}{4}$  in. Dado the front face full width,  $7\frac{1}{2}$  in. above the lower edge, and the back face  $10\frac{1}{2}$  in. above the lower edge.

The left front shelf is  $8\frac{1}{2}$  in. by 1 ft.  $2\frac{1}{4}$  in. The left center partition is 1 ft.  $8\frac{1}{4}$  in. by 1 ft. 9 in. A vertical dado,  $\frac{1}{4}$

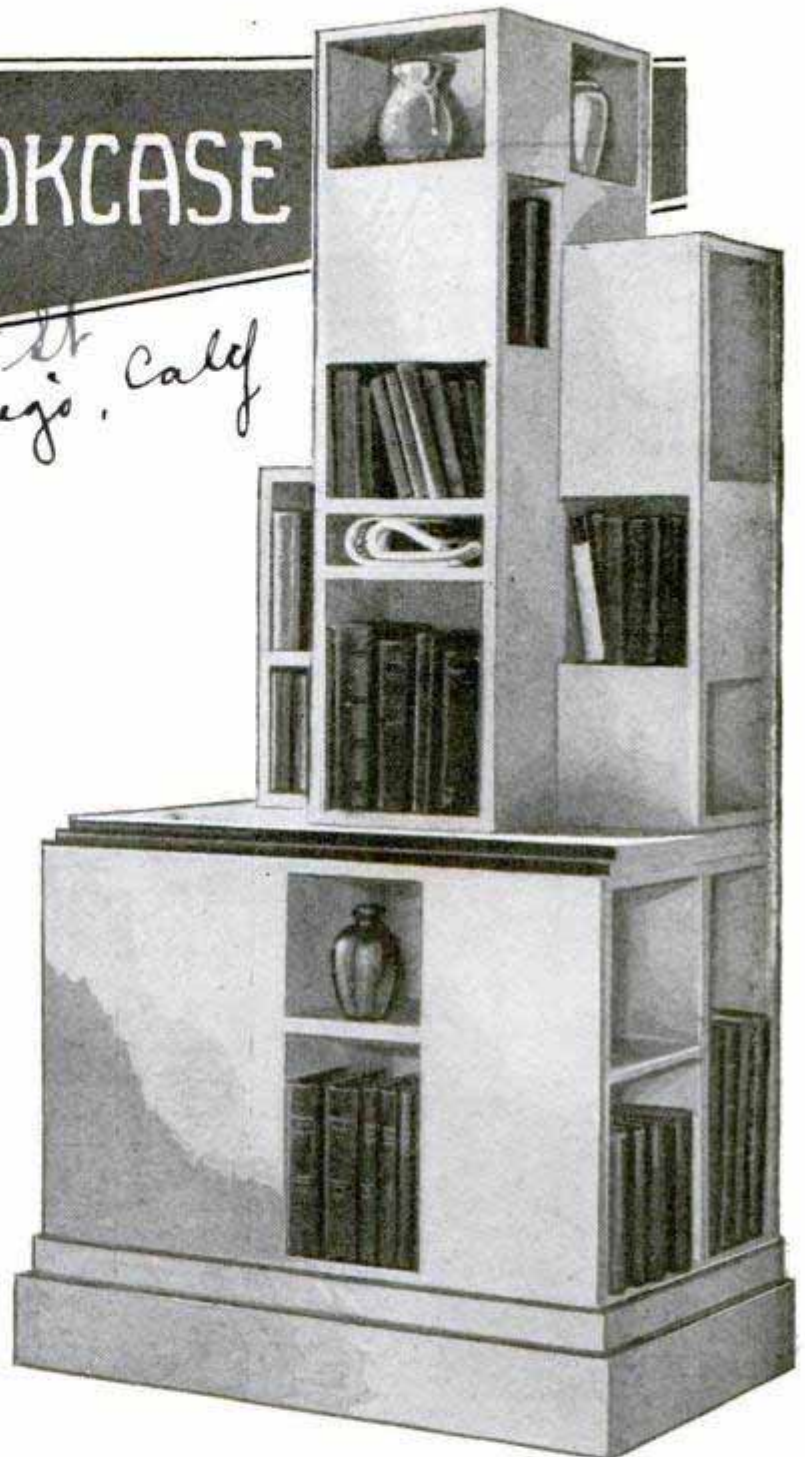

by  $\frac{3}{4}$  in., is made on the left side,  $8\frac{1}{2}$  in. from the front edge, and one on the right face,  $11\frac{1}{4}$  in. from the front. The lower dado on the left is  $7\frac{1}{2}$  in. above the lower edge, and the other is  $10\frac{1}{2}$  in., while the dado on the right is  $11\frac{3}{4}$  in. from the lower edge.

The right center partition is  $11\frac{1}{2}$  in. by 1 ft. 9 in., with a dado full width of the left face,  $11\frac{3}{4}$  in. from the lower edge. The right side partition is 1 ft. 6 in. by 1 ft.  $9\frac{1}{2}$  in., and extends back to the left center partition. It has a vertical dado on the front face,  $10\frac{1}{2}$  in. from the front edge, into which the back edge of the right center partition fits.



Make the front center shelf  $8\frac{1}{2}$  by  $11\frac{1}{4}$  in. The left front side is 1 ft. 3 in. by 2 ft.  $2\frac{3}{4}$  in. Rabbet the upper left corner  $\frac{1}{4}$  by 1 in. by  $2\frac{1}{8}$  in. on the inner face, and notch the right upper corner  $\frac{1}{4}$  by  $\frac{3}{4}$  in. Rabbet the right edge inside,  $\frac{1}{4}$  by  $\frac{3}{4}$  in., and cut a dado across the inside,  $12\frac{3}{4}$  in. below the upper edge, and another  $7\frac{1}{2}$  in. below this. The rabbet must be notched  $\frac{1}{4}$  by  $\frac{3}{4}$  in., to fit the center shelves. The right front side is  $10\frac{1}{2}$  in. by 2 ft.  $2\frac{3}{4}$  in., with the left edge rabbeted  $\frac{1}{4}$  by  $\frac{3}{4}$  in. The lower dado on the inner face matches that on the other front piece, and the upper groove is  $9\frac{3}{4}$  in. from the top.

Before attempting to assemble the section, try all joints separately. They should

go together snugly, yet without need of undue pressure, since it is possible to use clamps very little. If a shelf is too thick to go into the dado, take a shaving or two off the lower side. If the joint will not close tightly, a shaving or chip in the groove may be to blame, or the dado corners may be so rounded that they interfere. Much final cleaning up can be avoided if the parts are sponged with warm water to raise the grain before assembling. When dry, sand smooth.

In putting together, smear glue on both meeting members. The following is a good order to follow: Lay the back on the floor; enter first the bottom shelf, and then the small upper shelf and the left center partition. Bring these joints up

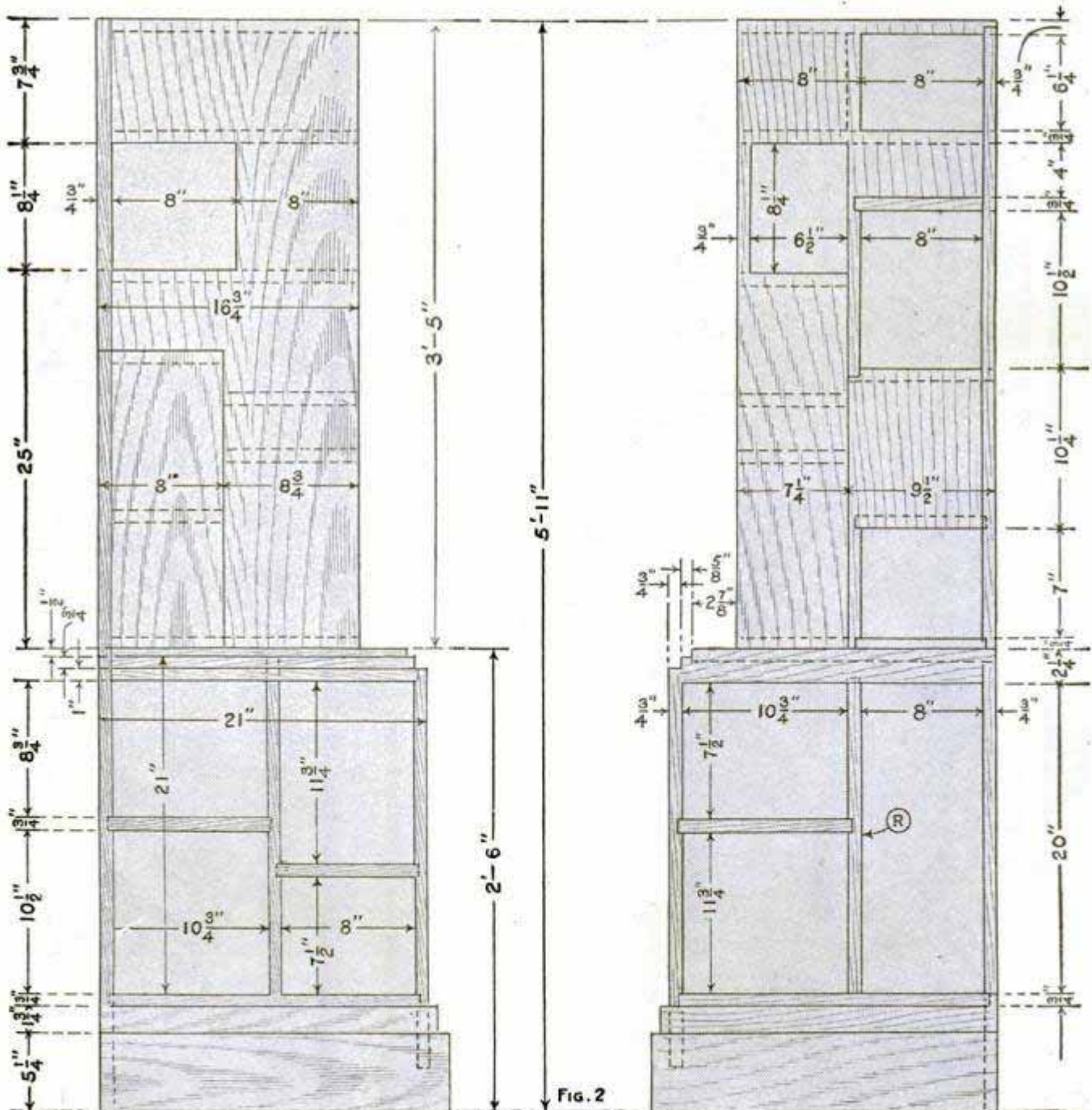







tight, nailing through back and partition into the shelf edges with six-penny finish nails. Next add the left partition and the right side partition, following with the small center shelf, nailing all solidly to each other. The partitions merely butt against the lower shelf, so their distance from the back and sides must be carefully checked. Put in the right side shelf, and nail and glue on the fronts. The left top is joined with a rail, 1 by  $2\frac{1}{8}$  in. by 1 ft. 8 in., and the right with a  $\frac{3}{4}$  by  $1\frac{3}{4}$ -in. rail placed vertically in the rabbets provided. Fit the top next. The assembly should be rigid and square by this time. If it is seriously out of square, see if the joints have sprung open.

Notch the right upper rail end, making it flush with the top nosing. Put a 1 by 1 by 7-in. rail at the top of the front opening, clean off all glue squeezed out of the joints, and fill the nail holes with plastic wood.

The base is put on in two members. The upper is a  $\frac{3}{8}$  by  $2\frac{1}{2}$ -in. strip mitered

the left side, cutting the piece a little longer than necessary and mitering the front end. Nail in place. Fit the mitered end of the front strip to that already on, and tack it up, so that the length can be accurately marked. Then cut the other end and glue and nail this front strip to the cabinet. The piece on the right side is fitted in the same way. The ends projecting beyond the back are sawed off. In

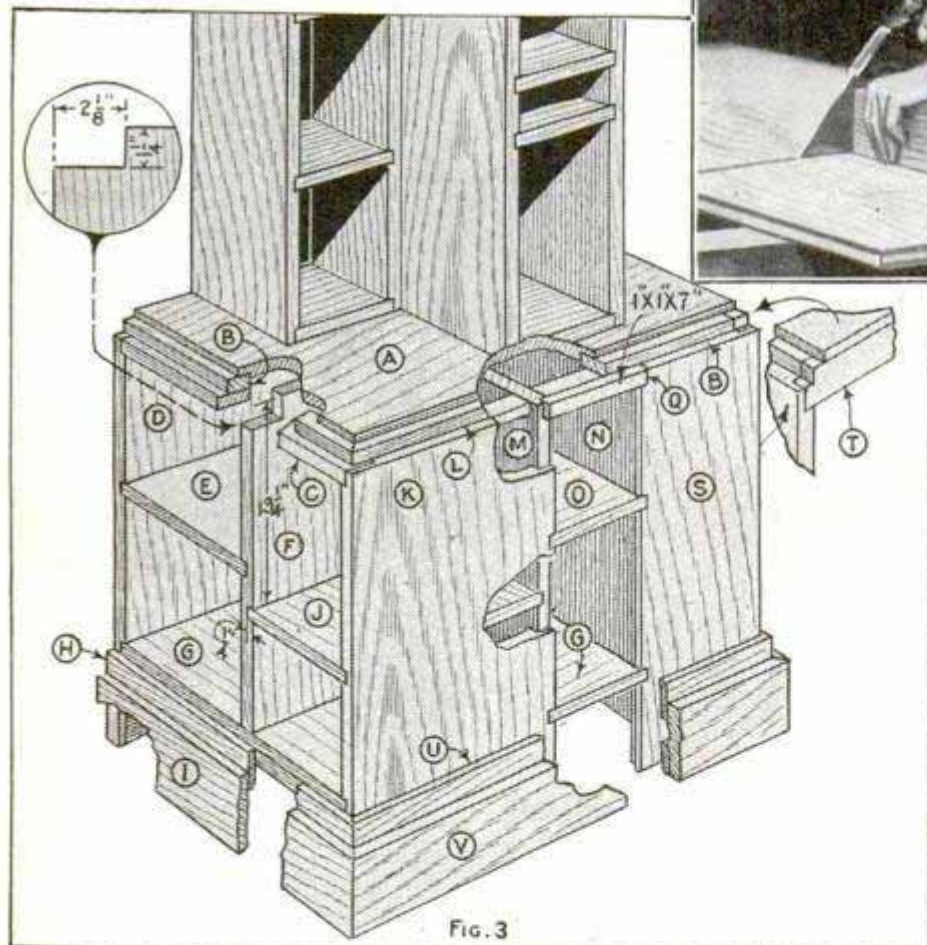

FIG. 3

around the case, the upper edge being flush with the lower side of the bottom shelf. To give it backing, glue and nail a wooden cleat under the shelf. Begin at

the same way add the heavier lower member, a piece  $\frac{3}{8}$  by  $5\frac{1}{2}$  in. The lower edge should be backed with blocks tacked to the front pieces and the back edges.

#### Worn Shackles Cause Backlash in Auto

When searching for the cause of backlash and knocking in the Ford rear axle, do not neglect to examine the rear-spring shackles, since these, when worn, allow

the whole axle to move forward and backward as the speed changes. The ball joint on the front end of the drive-shaft tube also wears and adds to the knocking.



## Preparing Concrete Lintels for Trim

There is often more or less trouble in the building of brick or hollow-tile walls where solid concrete lintels are used to attach inside trim. The drilling of holes in the concrete and setting in of plugs to hold the nails takes much time and is not entirely satisfactory. The use of solid blocks, placed at intervals on the inside of the form, has been tried, to the regret of the builder, for the wood expands or contracts, and in some cases cracks the concrete. The problem was solved by cutting laths into 4-in. pieces, then fitting a strip of composition roofing between two pieces of lath and tacking them together with small nails. The roofing material, being pliable, allows for the contraction and expansion of the wood and keeps the concrete from cracking. These pieces are tacked on the inside of the form, about 18 in. apart, so that, when the forms are removed, the pieces will be left imbedded in the concrete lintel. Before the plastering is done, the frames should be marked to show the position of the blocks. This method has been used successfully in lintels from 4 to 9 ft. long, and not only were time and money saved, but the lath and felt blocks seem to grip the nails that hold the trim much better and tighter than plugs or wood blocks.

## Wedge Tool Centers Reamer

When it is necessary to hand-ream two bushings in line, the illustrated jig for centering the tool will be found useful. It consists of six steel wedges of the shape shown, drilled and slipped on a key ring. They are spaced evenly on the latter, and copper wire is wrapped around the ring between the wedges to keep them in position. When reaming the spindle bushings of automobiles, the lower one is reamed out first, using the centering tool as indicated.—Dick Cole, Los Angeles, California.

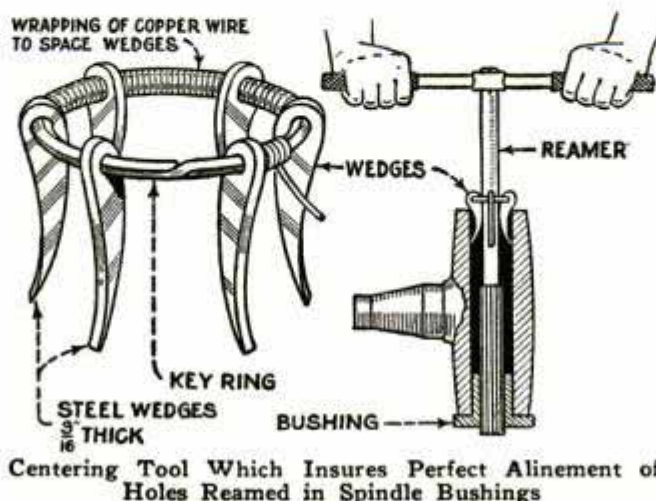

Centering Tool Which Insures Perfect Alinement of Holes Reamed in Spindle Bushings



Weighting End of Saw Blade with Lead Disks Makes It Cut Faster

## Weighted Saw Cuts Faster

In cutting logs, which I do with a 3½-ft. saw, I found that lead disks, weighing about ½ lb. and fastened to the end of the blade, as shown, made the saw cut faster. The disks are held on the blade by means of a bolt and nut. Weighted in this way, the saw cuts about one-third faster than it did before, and without any more effort.—Sam Weidman, Lowell, Wash.

## Permanent Linotype Line Gauge

Having had quite a bit of trouble in keeping a line gauge available for immediate use on the linotype machine, I duplicated the gauge graduations on the fulcrum bar. The graduations were laid out carefully by means of a pair of dividers, and the lines were made with a knife-edge file. Numbers were stamped with a steel punch.—Jas. H. Rodgers, Toronto, Can.



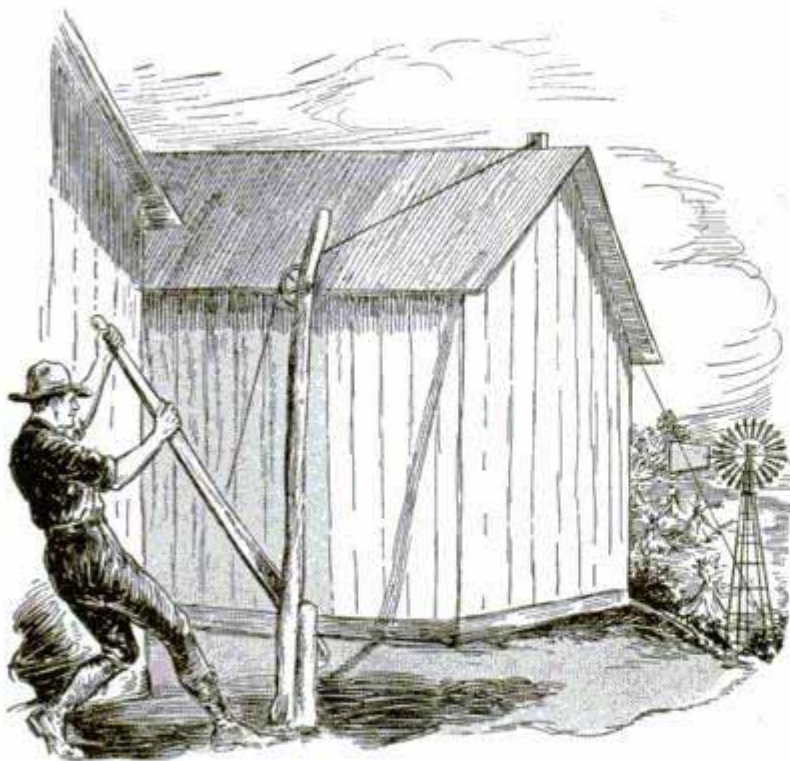

This Remote Control for Shutting Off Windmill on a Nebraska Farm Has Proved Successful

### Simple Homemade Arrangement for Remote Control of Windmill

On a Nebraska farm, the windmill was erected quite a distance from the farm buildings in order to avoid a stratum of hard rock. This location was, of course, rather inconvenient, but the trouble was partly overcome by providing a control by which the windmill could be shut off from a position near the house. A length of heavy galvanized-iron wire was run from the lower end of the shut-off handle at the mill, over one pulley mounted on the machinery-shed roof, and another at the top of a 10-ft. post, to a 2 by 4-in. lever pivoted near the bottom of the post as shown. This arrangement has given satisfactory service for two years, and in that time has required no repair.—Dale R. Van Horn, Lincoln, Nebr.

### Scrapers on Busses Eliminate Ruts

Several times during last winter, complaints were made to the Canadian government that the interurban busses cut deep ruts in the ice and snow on the country roads. After trying out several ideas, a mechanic suggested attaching a heavy piece of angle steel by means of two lengths of chain to the rear of each bus. The chains were attached to the chassis by clevises and were sufficiently long

to prevent the angle steel from getting caught under the rear wheels when the bus was backed up. Hooks were attached to the rear bumper to sling the bar up out of the way when not needed. After a whole season's use, it has been found that the bars removed nearly every rut in the roads. In fact, the appliance was found so successful that it has been made part of the winter equipment of several bus lines.

### Grinding a Sphere

A novel method of grinding a sphere on the end of a shaft, devised in our shop, is illustrated in the drawing. A tool grinder was used for the purpose, the work being rotated on its surface by means of an improvised jig as shown. The jig consisted of a lathe chuck driven by a small motor, both being mounted on a wooden base, which was pivoted at a point directly beneath the center of the ball to be ground. The shaft on the end of which the ball was to be ground, was first turned down in the lathe to the proper size, and was then set in the chuck of the jig. By rotating the base with a handle provided for the purpose, the end was ground to a perfect sphere.—C. Kugler, Philadelphia, Pa.

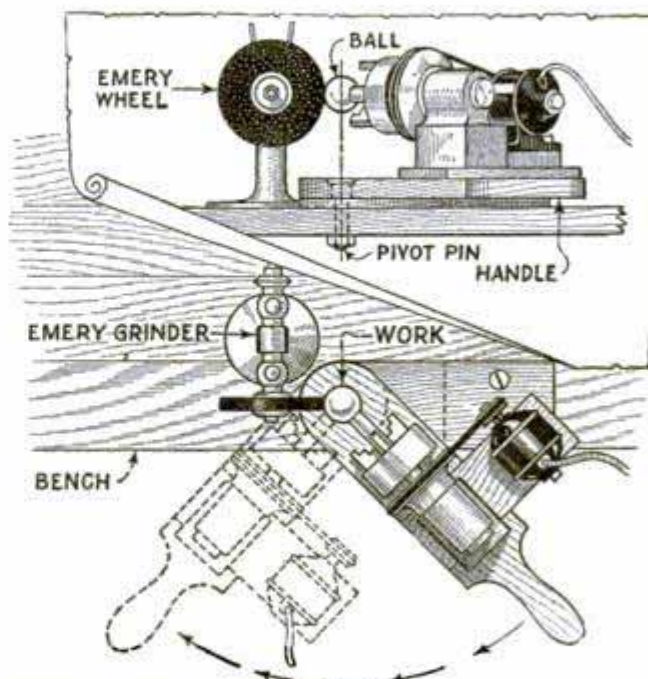

Novel Method of Grinding a Sphere on the End of a Driving Shaft



The U. S. Hotel  
249 Pearson St. Chicago

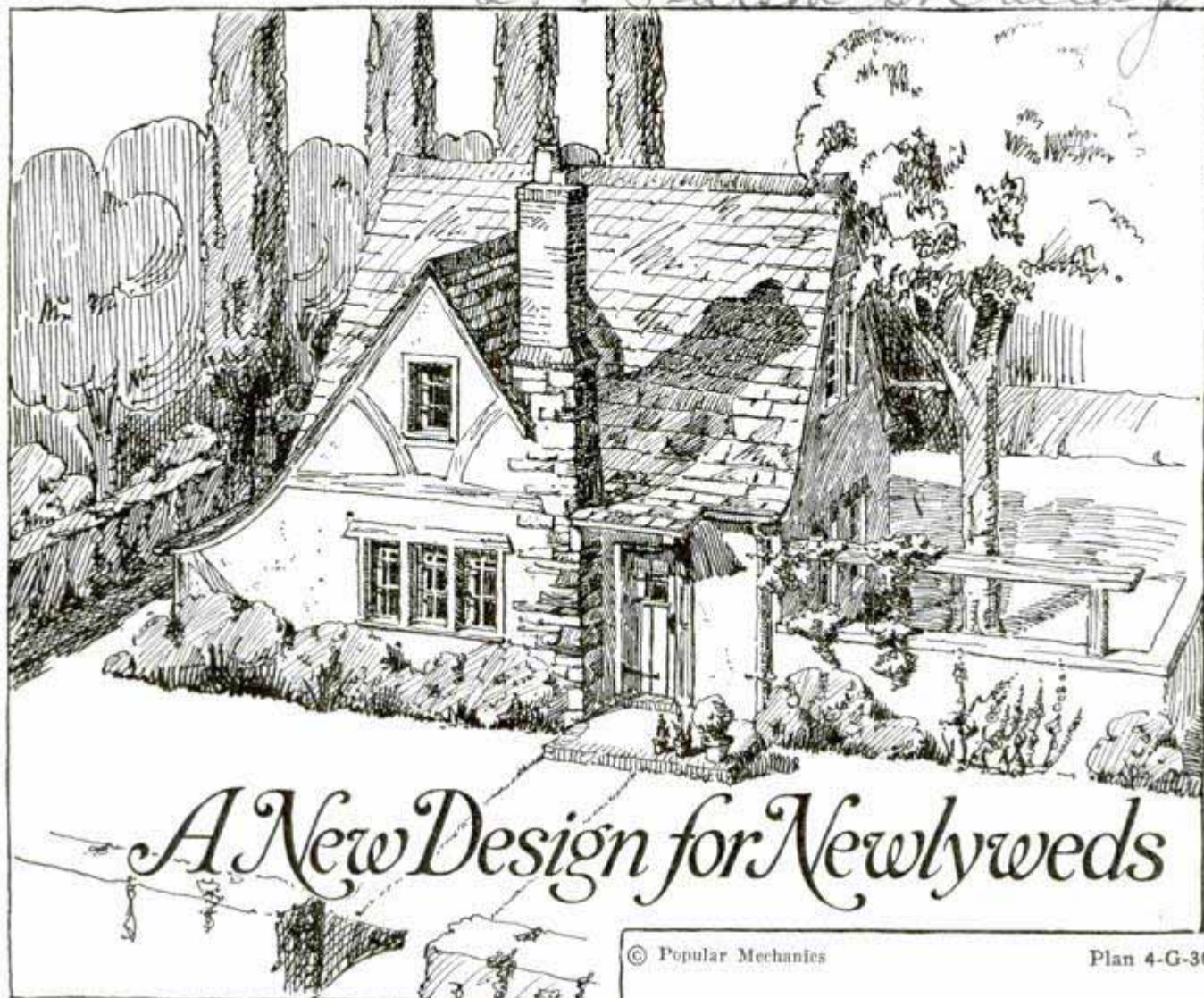

## A New Design for Newlyweds

© Popular Mechanics

Plan 4-G-30

**N**EWLYWEDS planning a stepping stone to home ownership, and others trying to make a small amount of money buy a large amount of comfort, service and convenience in a small house, will be interested in this tabloid plan.

Two thousand dollars should build this miniature English cottage under average conditions, according to estimates by the designer. That's a cost so low you may wonder if the house can possibly contain more than "standing room only." Studying the plan will show how cost has been cut.

Compressed into space hardly larger than a two-car garage, there is all the efficiency, time and labor-saving equipment equivalent to the latest type of scientifically designed city apartment, the difference

being that you have it in a detached home of your own on ground level and at the surprisingly low rent of around \$25 per month under normal conditions. In a city skyscraper apartment, you might have to pay the landlord anywhere from \$75 to \$175 for the same service up fifteen or twenty floors in the air.

If this appears too grand and glorious a picture for renters or raises high hopes in the hearts of cliff dwellers, then take the time to inspect the plan and see how ingeniously the designer has clipped corners, saved space and used every device

possible to "split pennies" and pull the cost down to considerably less than the average cost of the average house in more than sixty principal cities, which, according to statistics, is \$3,750.

### A NEW SERVICE

To help our readers get started on one of life's most glorious experiences—building and owning a home—Popular Mechanics Magazine will supply readers a one-sheet blueprint of the house here illustrated for \$2. This blueprint does away with the necessity of first purchasing a complete set of plans to find out whether you can afford to build. It contains floor plans, elevations, a section, detail, size of joists, studs, etc., and also a brief specification. Submit it to tradesmen and dealers for building estimates.



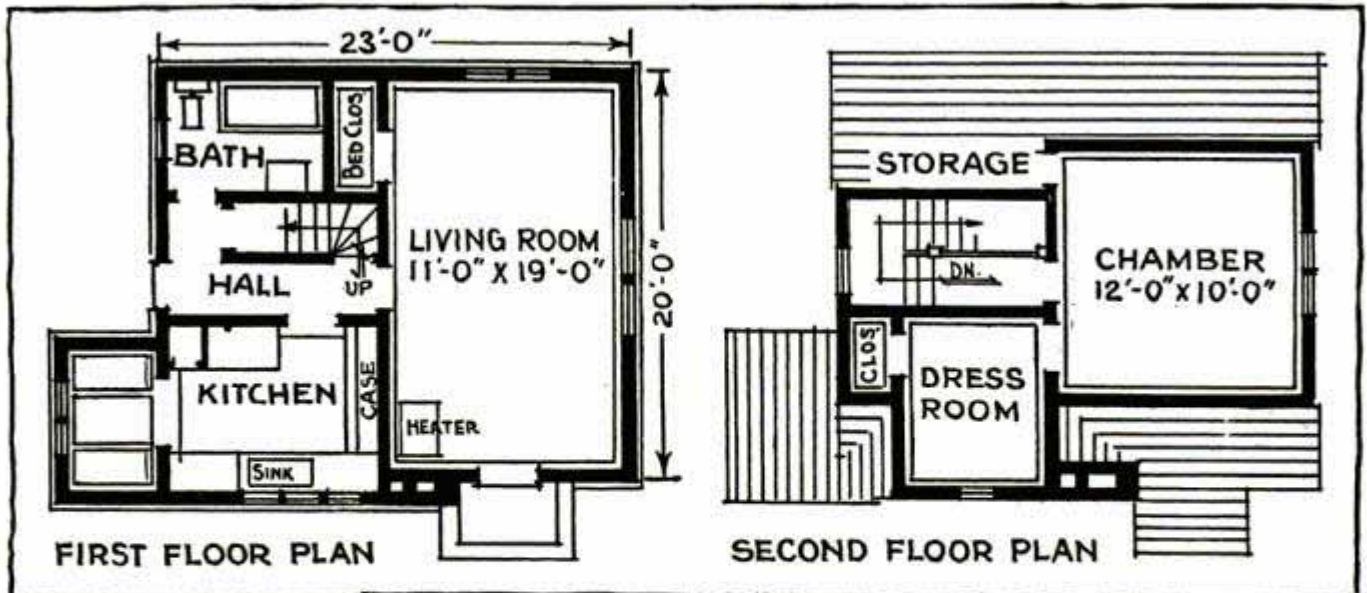

Here is how costs have been lowered. There is no basement. This means a saving of \$300 to \$500. A breakfast alcove replaces the customary dining room. Here's another \$500 to \$700 saved. A concealed, or closet-type, bed in the living room not only provides complete bungalow service on the lower floor, but clips off \$500 to \$1,000 which wall-bed makers say is the cost for an extra bedroom.

Wallboard with plastic-paint finish, or, in fact, any of the rigid forms of board insulation nailed directly onto the studs, gives you satisfactory interior finish and three operations at little more than one price. You not only get a substitute for lath and plaster, but insulation at the same time, and also a decided saving in labor.

Stock kitchen fixtures, linoleum floors and fiber tile for bathroom walls, replacing more costly ceramic tiles, save still more money. Simple but attractive bathroom fixtures and inexpensive stained-fir trim complete the interior equipment.

Savings like these may net you a total of from \$1,800 to \$2,000, possibly more.

Getting back to how rent money may buy this home, suppose your lot cost \$500. To be conservative, let us say the house, under average conditions, will cost \$2,500.

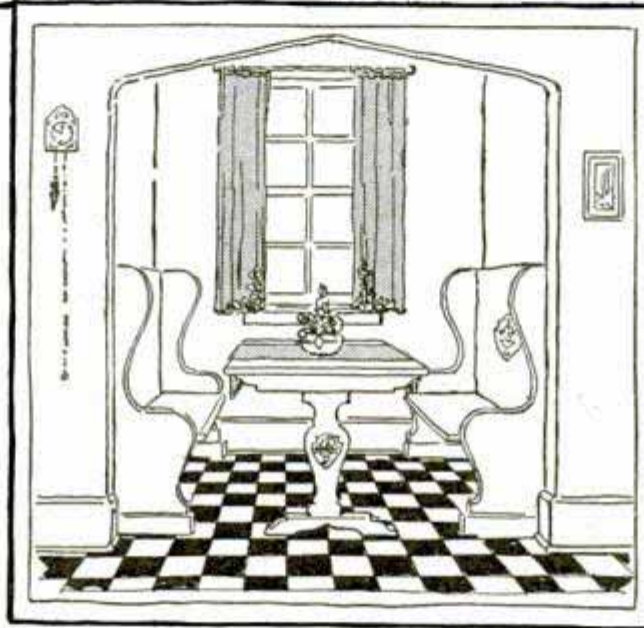

There is a cash investment of \$3,000. This sum of money put into six-percent income-producing securities would yield you \$180 per year. This amount is properly charged to yourself as rent. In addition, there are taxes, upkeep, insurance, depreciation, etc. A fair average in most communities would be \$130 per year to

cover these items. You have therefore a total yearly expense of \$310, or a monthly rental charge of \$25 in round numbers.

No doubt you can finance a little house like this through local building-and-loan associations.

A word or two about building costs; they vary with localities, choice of materials, labor, etc. Recent figures show that a \$5,500 house in Chicago costs less than \$3,000 in St. Louis. In some communities costs may be lower than these figures; in others, somewhat higher.

**EDITOR'S NOTE:** Popular Mechanics Magazine has prepared a new plan book, "Twenty Popular Low Cost Homes and Ten Commandments for Home Builders." These are selected homes and show labor, space and time-saving ideas. They are \$5,000 homes and less. Send 10 cents in stamps to cover postage. Address Building Editor.





# Every Blade Tested

"... a long row of experts, who test 'Yankee' screw-driver blades—each and every one of the hundred of thousands."

**W**HEN is a test, a *test*? When one in every so many is tested, as in some industries? OR,—when *every* one made, without exception, is tested?

The "Yankee" Screw-driver you buy from your dealer has a tested blade. The *very* one you get!

Every "Yankee" blade is tested by "Yankee" toolmakers. Individually tested—and *twice* tested!

Blade won't twist, crack, break, or bend on the edge; and it can't be loosened in the handle by use or even abuse.

Dependable, well balanced, and with "Yankee" comfort-grip handles "Yankee" Plain Screw-drivers make work easier.

**No. 90.**—Standard Style: Fifteen sizes, 1½" to 30" blades. Price for 5" blade, 50c; 6", 55c; 7", 65c; 8", 75c; 9", 85c; 10", 95c.

**No. 95.**—Cabinet Style: Eleven sizes, 2½" to 15½" blades. 4½" blade, 40c; 5½", 45c; 6½", 50c; 7½", 60c; 8½", 65c; 9½", 70c.

WRITE for "Yankee" Tool Book, showing uses of tools that are unlike any other tools—such ingenious tools as this "Yankee" Vise (No. 1993), which lifts off its base, and, holding work, goes from bench to press drill or other machine.

North Bros. Mfg. Co., Philadelphia, U. S. A.

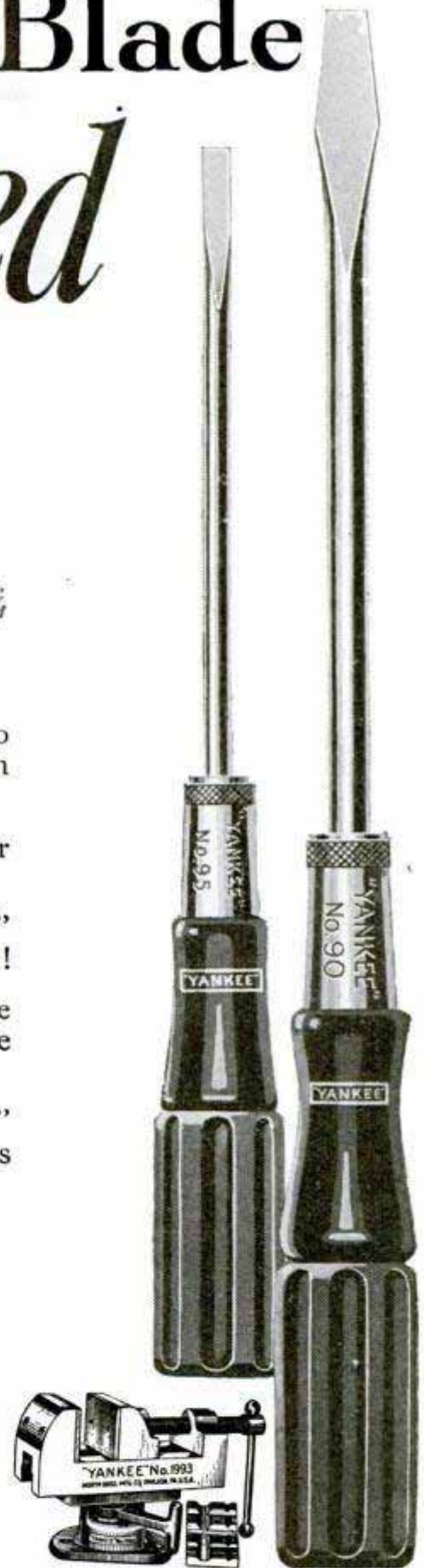

**"YANKEE"** — "*That's the best there is!*" says the tool dealer



for Economical Transportation



# This

Advanced  
Engineering  
Feature—

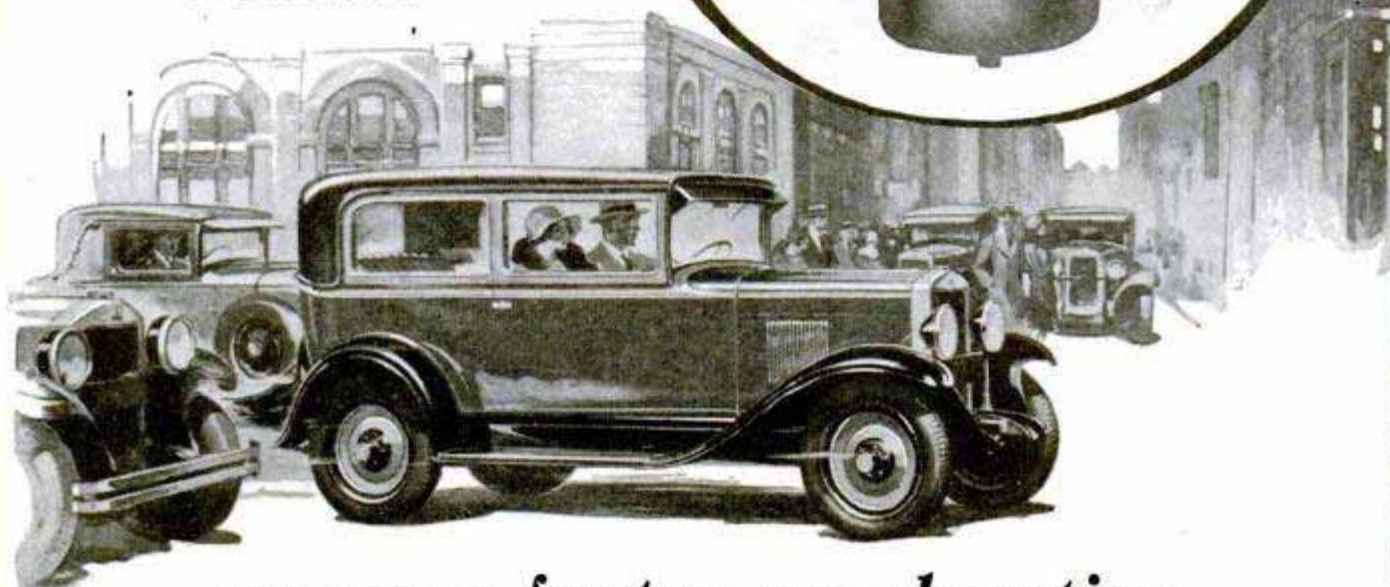
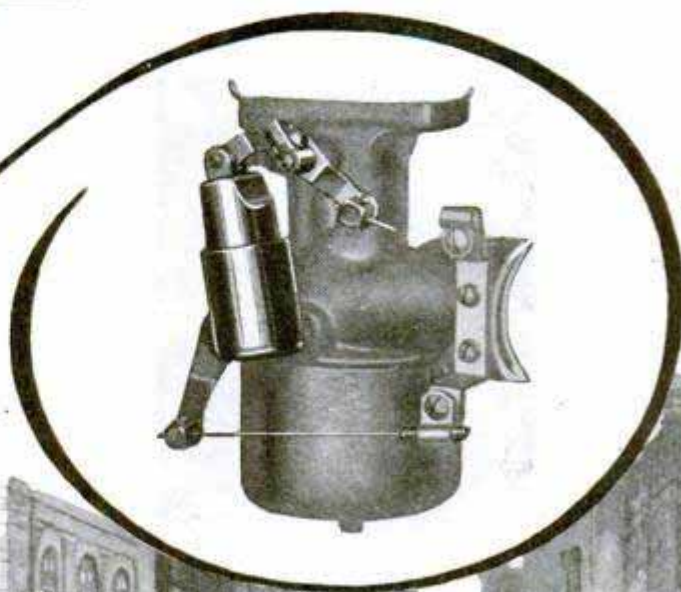

*—assures faster acceleration  
and greater economy*

The remarkable acceleration of the new Chevrolet Six amazes everyone who takes the wheel. This exceptionally smooth, fast getaway is one of the outstanding features afforded by the brilliant performance of this remarkable new car.

Designed as an integral part of the carburetor assembly, the automatic acceleration pump sprays an extra quantity of gasoline into the mixing chamber

whenever the accelerator is suddenly depressed—giving added power the instant it is needed.

This outstanding feature likewise permits a finer adjustment of the carburetor—resulting in greater gasoline economy.

Go to your Chevrolet dealer's today and drive this sensational car. Learn how its higher speed, greater power and marvelous smoothness are made even more thrilling by its brilliant acceleration!

*The Roadster, \$525; The Phaeton, \$525; The Coach, \$595; The Coupe, \$595; The Sedan, \$675; The Sport Cabriolet, \$695; The Convertible Landau, \$725. All prices f. o. b. factory, Flint, Mich.*

CHEVROLET MOTOR COMPANY, DETROIT, MICHIGAN  
Division of General Motors Corporation

*— a Six in the price range of the four !*



# They all KNOW the meaning of Starrett Quality



No. 94

"Every building or carpentry job is the better for Starrett accuracy."



No. 436

"I use tools for pleasure in my home shop. That's why I buy only the finest—like Starrett's."



No. 153

**EVERY** man who uses tools is able to appreciate at first hand the genuine satisfaction as well as true economy of tools built to Starrett standards of materials and workmanship. For there are more than 2500 Starrett Tools, Tapes and Hacksaws, every one of them made to give more than a full measure of accurate, dependable service.

Your tool dealer has them. Be sure to ask him for Starretts and look for the name or "The L. S. S. Co." on every tool. Ask us to send you a free copy of the great Starrett Catalog No. 24 "AP."

**THE L. S. STARRETT CO.**  
World's Greatest Toolmakers  
Manufacturers of Hacksaws Unexcelled  
Steel Tapes—Standard for Accuracy  
ATHOL, MASS., U. S. A.

"Expert machinists and auto repair men will tell you it pays to stick to Starrett's."

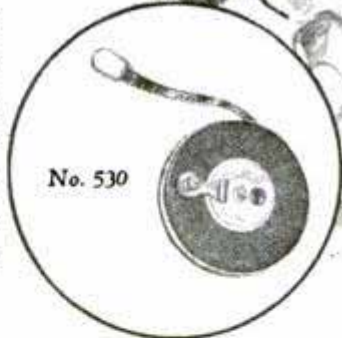

No. 530

"Out on road or construction jobs Starrett Tapes and Transits give us lasting satisfaction."



# Use Starrett Tools





# Chester

*MILD enough for anybody*



## What a cigarette meant there

*Ten seconds to go—* and raw nerves fighting wearied muscles, driving them on into that fearful unknown beyond the wire. What man will *ever* forget the steadying solace of that last sweet stolen smoke?

## What a cigarette means here

*Two years to go—* the slow "ageing" by which tobaccos for Chesterfield lose all bite and harshness ...

Mysterious, this chemistry of Nature! Endless rows of great hogsheads, stored away in darkness; choice tobacco, tightly packed ... just waiting. And as if on signal, twice each year the leaf goes through a natural "sweat"—steeps in its own essences, grows mild and sweet and mellow.

Selected leaf, costly patience, endless care—that's what a cigarette means *here*. But right there is *exactly* the reason why Chesterfield means what it does to you!

*Liggett & Myers Tobacco Co.*

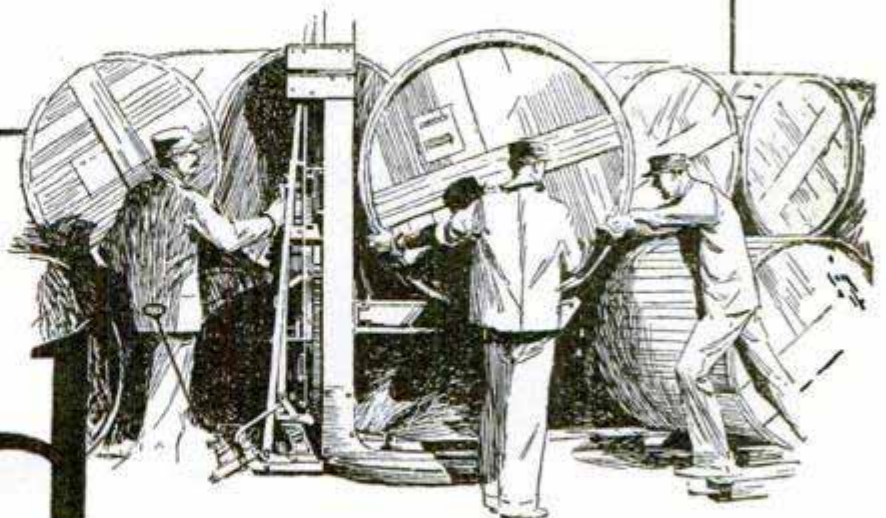

Millions of pounds of choice tobacco from each crop are stored away in great warehouses to "age."

# field

.... and yet **THEY SATISFY**



# NEW MODEL SOUTH BEND

LATHE BUILDERS FOR 22 YEARS

## For the Manufacturing Plant

Tool Room  
General Repair  
Shop  
Machine Shop  
Service Station  
Electrical Shop  
Engineering Shop  
and  
Laboratory

## Used by Manufacturers of

Automobiles  
Electrical Parts  
Machinery  
Aircraft  
Textile Machines  
and  
Government De-  
partments  
National and  
State

## 96 Sizes and Types

Countershaft  
Driven Lathes  
Motor Driven  
Lathes  
Quick Change Gear  
Lathes  
Standard Change  
Gear Lathes  
Tool Room Lathes  
Gap Bed Lathes  
Brake Drum Lathes  
Bench Lathes

All illustrated  
and described  
in

Catalog No. 89-A

Write for  
Free Copy.

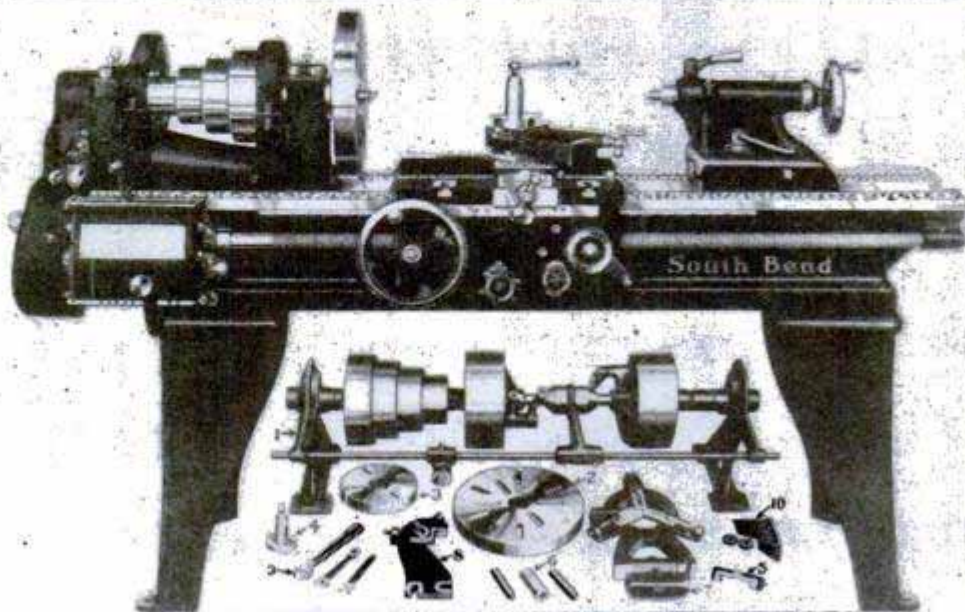

16" x 6' Quick Change Gear New Model  
South Bend Lathe.....\$540.00

## Prices of Popular Sizes of Quick Change Gear Lathes

| Size of<br>Lathe | with Lathe Equipment<br>Shipping*<br>Weight | Countershaft |                             |
|------------------|---|--------------|-----------------------------|
|                  |   | Drive        | Silent Chain<br>Motor Drive |
| 9" x 3'          | 490 lbs.                                    | \$270.00     | \$371.00                    |
| 11" x 4'         | 725 lbs.                                    | 335.00       | 455.00                      |
| 13" x 5'         | 1110 lbs.                                   | 402.00       | 537.00                      |
| 15" x 6'         | 1550 lbs.                                   | 490.00       | 643.00                      |
| 16" x 8'         | 2035 lbs.                                   | 570.00       | 725.00                      |

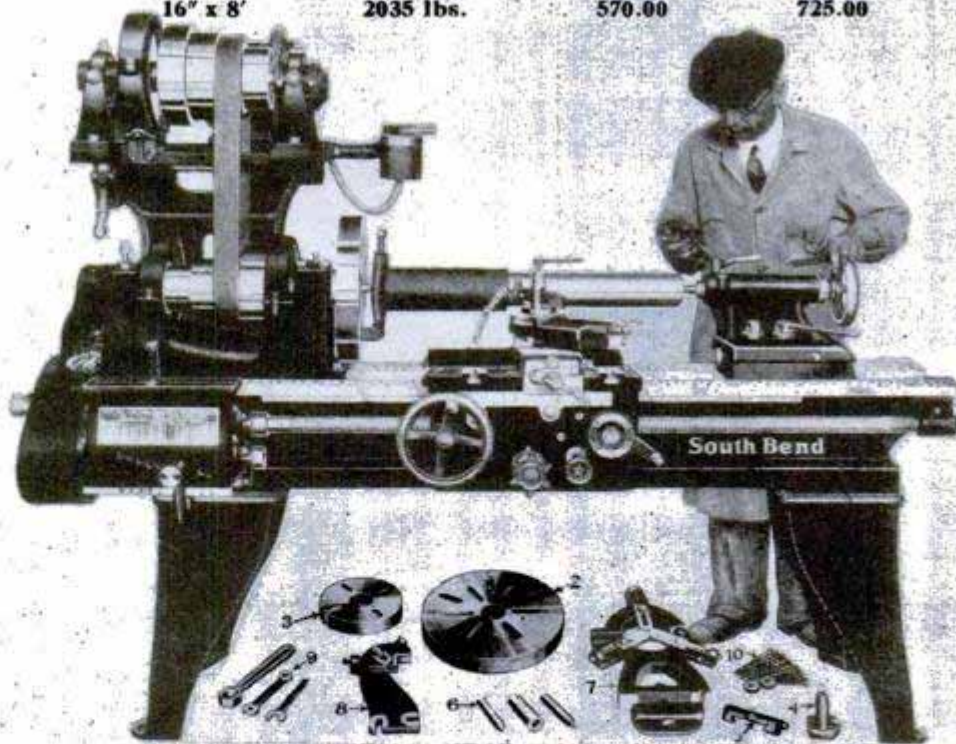

18" x 8' Quick Change Gear Silent Chain  
Motor Driven Lathe.....\$908.00

# SOUTH BEND

603 East Madison Street  
New York City, J. E. Beggs Co., 183 Center Street



# SCREW CUTTING LATHES

OVER 43,000 LATHES IN USE

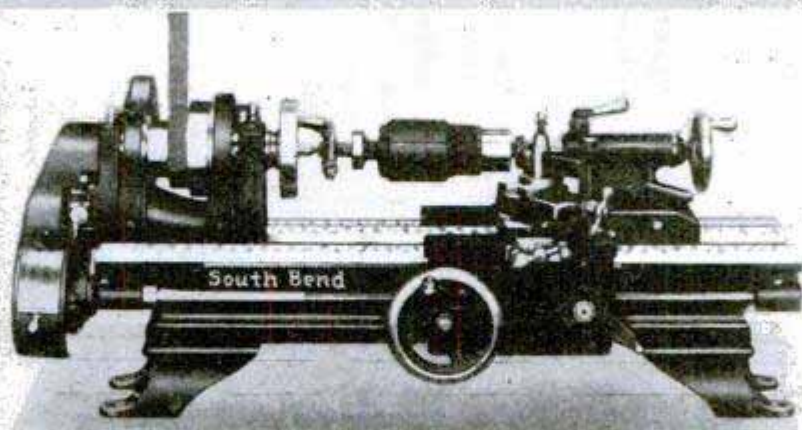

Weight  
375 Pounds

**9" x 3'**

Junior New Model  
South Bend Bench Lathe  
with Countershaft and Equipment

**\$155**

## Easy Payments as low as \$12.40 a Month

Our Easy Payment Plan allows you to install a South Bend Lathe in your shop, by making one payment with the order; the balance to be paid month by month, the amount depending upon the size of the Lathe.

Write today for Catalog No. 89-P, which describes the Easy Payment Plan. Mention size of lathe desired.

The New Model South Bend Lathe is a remarkable tool and is practical for handling the finest and most accurate work. 96 sizes from 9" to 18" swing are available in various types and drives.

These New Model Lathes are used in the plants of the Western Electric Co., General Electric Co., Victor Talking Machine Co., Packard Motor Co., Oldsmobile Co., International Harvester Co. and thousands of other plants.

Operates from  
Light Socket

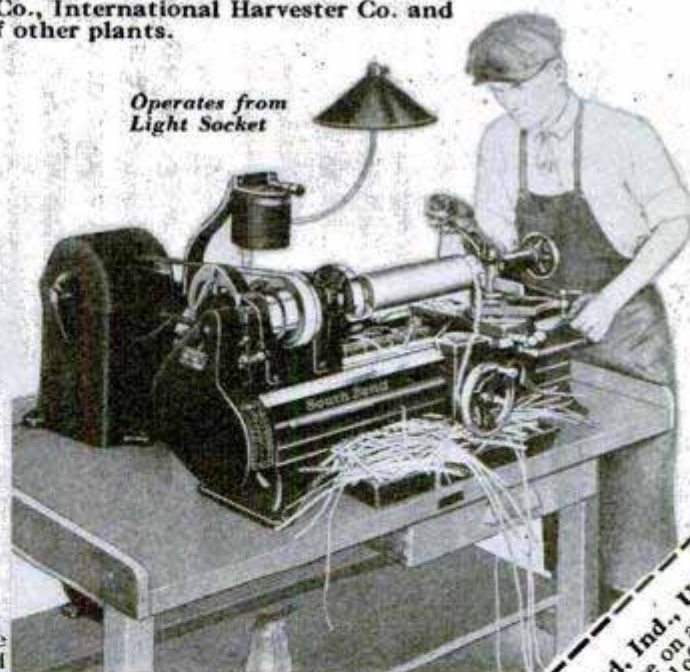

## Other 9-inch Junior Lathes

The Prices include Lathe Equipment

| Size of Lathe | Shipping Weight | Counter Shaft Drive | Horizontal Motor Drive |
|---------------|-----------------|---------------------|------------------------|
| 9" x 2 1/2'   | 350 lbs.        | \$150.00            | \$221.00               |
| 9" x 3'       | 375 lbs.        | 155.00              | 226.00                 |
| 9" x 3 1/2'   | 400 lbs.        | 160.00              | 231.00                 |
| 9" x 4'       | 425 lbs.        | 165.00              | 236.00                 |
| 9" x 4 1/2'   | 450 lbs.        | 170.00              | 241.00                 |

Write for this 20-page booklet, illustrating and describing the 9-inch Junior New Model South Bend Lathe in all sizes and types. A copy mailed free on request.

9" x 3' Junior New Model  
South Bend Horizontal  
Motor Driven Bench  
Lathe complete,  
\$226.00.



# LATHE WORKS

South Bend, Indiana, U. S. A.

Chicago, Ill., C. B. Burns Mach. Co., 541 Wash. Blvd.

SOUTH BEND LATHE WORKS, South Bend, Ind., U. S. A.  
603 E. Madison Street, for (check kind of work)  
Gentlemen: I would like your net factory price on a Screw  
Cutting Lathe, Size \_\_\_\_\_ Send me  
 Manufacturing  Machine Shop  Garage Work  
 Electrical Work  Catalog 89-A  Catalog 89-P  Catalog 23

Name \_\_\_\_\_  
Address \_\_\_\_\_  
City \_\_\_\_\_  
State \_\_\_\_\_



**C & L 70**

*This is the C & L 70 fire-pot with tinner's hood. Produces a working flame in ninety seconds. The burner orifice cannot be enlarged by tightening the needle valve. Heats a pair of coppers and melts a pot of metal at the same time.*

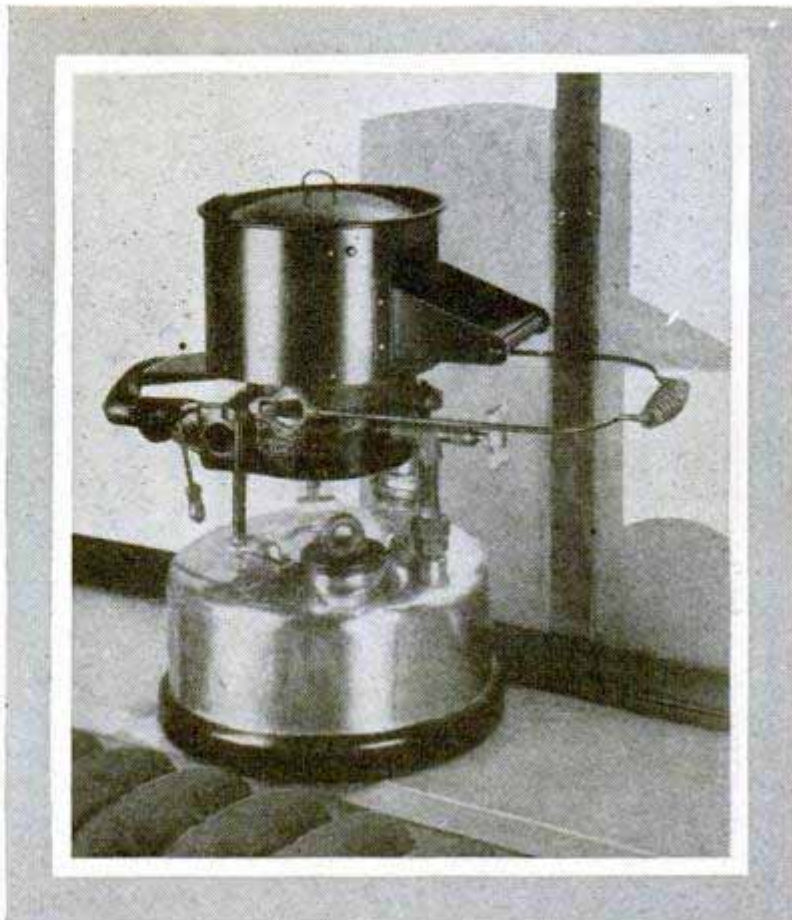

# Always on its toes

A CLAYTON & LAMBERT won't cry for time-out—it's always on its toes. Its solid construction and ingenious mechanism withstand rigorous, long-time use. You get years of service from a Clayton & Lambert fire-pot—it's the product of constant improvement.

An example of that is the spider construction welded to the tank. It keeps the top structure properly aligned and firm. A Clayton & Lambert takes a mighty hard jar without being the worse for wear. And the multi-ribbed flame plate is another part almost indestructible. It's made to last a lifetime. If an extreme accident should occur—the plate is easily replaced.

The method of mixing air and gas vapor is a unique Clayton & Lambert feature.

The proper proportions are always assured. And that, with the exclusive baffling-cup, gives you *ninety seconds* starting. There's no "popping" or back-firing with a Clayton & Lambert. No matter how windy or draughty or unfavorable the conditions—your Clayton & Lambert performs just right! Certain types have a patented orifice that can't be enlarged by carelessness. Such exclusive improvements as those keep your Clayton & Lambert fit for action.

Be particular about your next fire-pot. Insist on a Clayton & Lambert. You can identify it by the bright red protective band around the base of the tank. You'll be buying the most popular fire-pot in the world. Sold at nearly all hardware stores.

**C & L 22**

*No. 22 is deservedly popular because of its easily understood design and powerful blast. Recent improvements make No. 22 particularly desirable. It has a door in the coil cup to easily remove the coil and burner for cleaning.*



# CLAYTON & LAMBERT

MANUFACTURING Co., Detroit, Michigan





THE KING OF THEM ALL

# AR-CON

## UTILITOOL

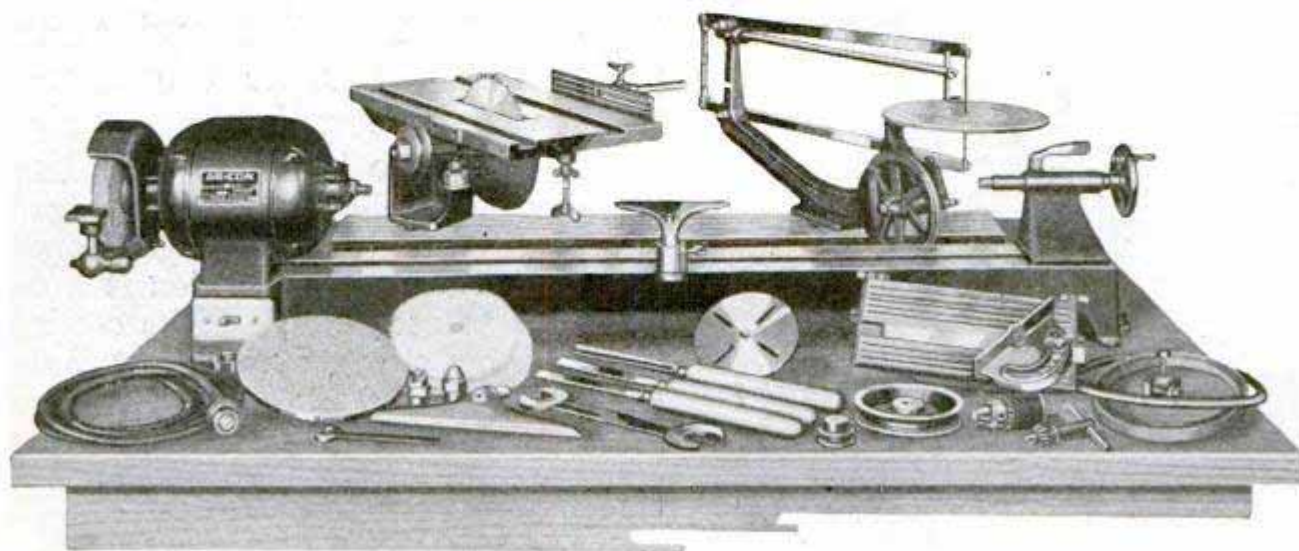

## All the Qualities a Work Shop Should Have

It takes more than mere profusion of tools and equipment to make a work-shop that will bring complete and lasting satisfaction to you. Back of this must be well-thought-out design and high manufacturing standards to assure, in every unit and part, the strength, the rigidity, the accuracy and the operating efficiency **essential** to quality workmanship.

With the Ar-Con Utilitool you have an outfit that will prove equal to every demand you put upon it. From the  $\frac{1}{2}$  HP, ball-bearing, repulsion-induction type motor—the most efficient type built—to the wing screws and lock nuts of drop-forged steel, every detail of the Ar-Con Utilitool is designed and built to assure an ample margin of power and strength and the maximum of accuracy and dependability. Truly it is deserving of the title "King of Them All."

Send for the circular which illustrates and describes this super-efficient work-shop in detail. Compare the specifications, point by point, with **your** ideals of what a work-shop should be. Note the workmanlike design and sturdy construction of the lathe—31 inches between centers—which serves also as the foundation unit for circular saw, jig and scroll saw, and sander. Note the equally substantial construction of these units, the ease with which they are mounted or dismantled, and the powerful, positive drive. Note the completeness and quality of accessory equipment.

Then, if you are one who takes pride in speed and accuracy of workmanship, you will be content with nothing less than the full measure of satisfaction which the Ar-Con Utilitool brings to you.

**THE AR-CON TOOL COMPANY, 500 Fassett Street, TOLEDO, OHIO**

### Easy to Buy!

Ar-Con Utilitool units may be purchased singly or in any combination of units if the complete outfit is not required at the start. Moreover, purchase can be made by convenient time payments, if desired. Mail the coupon **now** for fully-illustrated descriptive circular and complete information on prices and terms.

The Ar-Con Tool Company  
500 Fassett Street, Toledo, Ohio

Mail descriptive circular on Ar-Con Utilitool, with prices and terms.

Name .....

Street Address .....

City and State .....

M





## nurses know

Capable—and careful—the trained nurse administers our comfort. If there is pain, she gives a tablet to relieve it. That tablet is Bayer Aspirin. Experience has taught her it is quickest. The doctor has told her it's quite harmless. So it is safe to use in everyday life, any time you have an ache or pain. Take Bayer Aspirin at the first sign of a headache, cold, neuralgia, etc. Don't wait until the suffering has become severe. Be sure, though, to get Bayer. *There is only one genuine Aspirin.*



# ASPIRIN

Aspirin is the trade mark of Bayer Manufacture of Monoaceticacidester of Salicylicacid

## Establish a Good Future

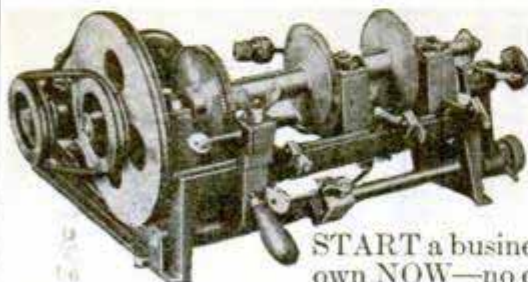

**DON'T  
BE A  
SHOP  
WORKER**

**START** a business of your own **NOW**—no experience necessary. The only key machine that cuts ALL kinds of keys. No hand-filing. Make first keys by number without taking locks apart. Instructions furnished free. **WRITE TODAY.**

**BEISSER KEY MACHINE COMPANY**

407 Fort St. East

Detroit, Mich., U. S. A.

# Soothes irritated eyes!

Men whose work exposes their eyes to irritation and strain will find *Murine* a godsend. Applied several times daily, it rids the eyes of irritating particles, relieves strain and prevents an unsightly bloodshot condition. This harmless lotion is a delight to use because of its cooling, soothing, strengthening effect. Write Murine Co., 9 E. Ohio St., Chicago, for valuable free book on the care of the eyes.

## MURINE FOR YOUR EYES



## MOTORCYCLES

**WE WILL TRUST YOU**  
Pay As Low As \$2.00 per Week  
Hendersons, Harley-Davidsons, Indians

Slightly used and rebuilt. Hundreds to select from.

Send 10c for list today.

MYEROW BROS. CO., 15 Berkeley St., Boston, Mass., U. S. A.

## Get Half Your Gasoline Free

Amazing invention gives from 25% to 100% Increase in Gas Mileage. 9 other valuable results guaranteed.

**AGENTS Make \$250 to \$750 a Month**

in profitable territories. Get new plan and Free Test Offer. Act Quick. Write **Blanche Auto Devices Co., Dept. 805-CB, 154 E. Erie St., Chicago**



## FREE RADIO CATALOG

Since the dawn of Radio, Barawik has been known the world over as headquarters for radio set builders and fans. Here, under one roof, is everything you need—sets, parts, supplies—thousands of products—ready to ship to you the same day your order arrives. Barawik prices save you money. Barawik service saves you time. Barawik merchandise always pleases. A quarter million satisfied customers say, "Barawik is Best." Let us send you the Big Barawik Book free and prove it to yourself.

**BARAWIK CO., 103 Canal Sta., CHICAGO, U. S. A.**



Mail This Coupon Now for Free Radio Guide

Name \_\_\_\_\_

Address \_\_\_\_\_



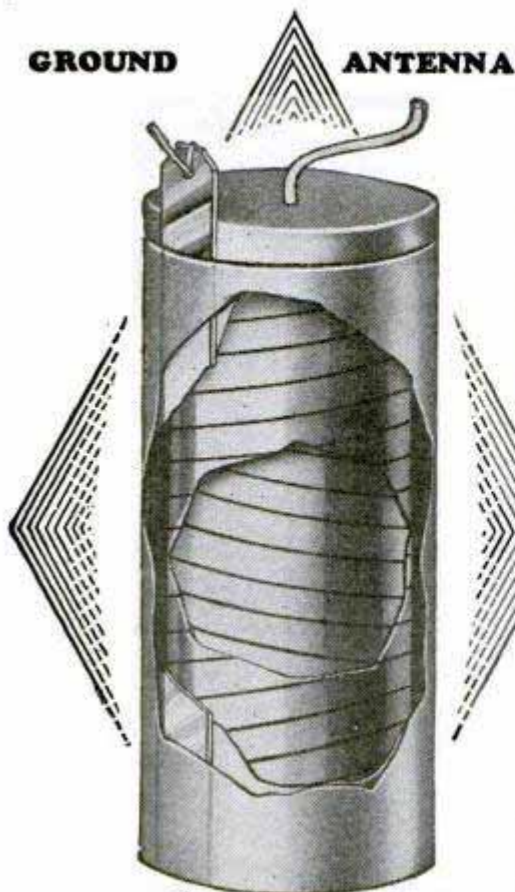

# NEW

## ANTENNA and GROUND *Combined in one convenient Unit*

A wonderful thing has happened in radio! Convenience never before dreamed of! Clearer, sweeter-toned reception! Radio pleasure with less interruption! These things are brought to you by the amazing, tested, approved EARTH ANTENNA.

Many set owners have come to realize the importance of using a dependable antenna, also the value of perfect grounding in getting good reception. Now science has gone a step further; it says that the LOCATION of the antenna is an equally important factor in getting best results. Because the radio wave goes right into the earth—where obviously there is less atmospheric disturbance and interference—it is claimed the logical place for the antenna should be the EARTH, not the air. This important conclusion allowed Radio Engineers to work out the EARTH ANTENNA.

### SHIELDED ANTENNA GETS BETTER RECEPTION

The antenna is insulated or "shielded" against electro-static disturbances as are the most advanced, expensive receivers and their various parts. Science declares that the earth itself "shorts" the electro static capacity before it reaches the Antenna. This acts as another shield. The ground element is constructed of copper, undisputed as the most effective material for obtaining a perfect ground connection. This section of the unit is separated from the antenna by the insulation which shields the antenna. So in the EARTH ANTENNA you have a scientific ground and an antenna of modern shielded construction combined in one compact unit. You can test it yourself right now at our risk. Hear the wonderful results!

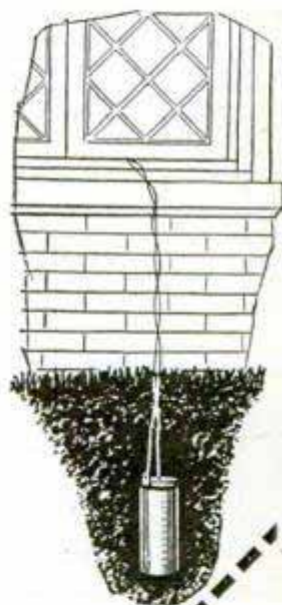

**Reduces Static**

**Gets Clearer, Sweeter Tone**

The new Scientific successful EARTH ANTENNA is designed to give you clearer, better, more dependable reception—and it costs no more than the old inefficient aerial—in fact less than many.

EARTH ANTENNA is so easy to install that soon people will wonder how they ever put up with the old, dangerous, slow methods. You simply dig a small hole only two feet below the surface of the ground, drop the EARTH ANTENNA into it and attach the lead-in wires to your set.

Now you are ready to listen to earth-clared, sweeter toned ground wave reception. You never need to touch the EARTH ANTENNA again.

## Test EARTH ANTENNA at Our Risk

Don't remove your old aerial and ground until you've compared the old and modern methods and hear the vast improvement with the new. If possible pick a time when static is bad. Then if you are not convinced that EARTH ANTENNA is the greatest discovery you've ever found for your radio—if not enthused over the improvement—you don't pay us a cent. The thrilling details of this important development—illustrated—will be sent immediately on receipt of this coupon. Mail it NOW!

The Modern Antenna Co., Dept. 805-C.E., St. Clair Bldg., cor. St. Clair and Erie Sts., Chicago, Illinois

Rush literature on EARTH ANTENNA and Free Trial Offer. No obligation.

### THE MODERN ANTENNA COMPANY

Dept. 805-C.E., St. Clair Bldg., cor. St. Clair and Erie Sts., CHICAGO, ILLINOIS

Name.....

Address.....

City.....

State.....

**EARTH ANTENNA**  
THE MODERN  
COMBINED ANTENNA AND GROUND





## Where's the can of PLASTIC WOOD?

(Reg. U. S. Pat. Off.)

The North Wind doth blow, and keeps blowing right through the edges of the window casing. Stop the drafts with Plastic Wood—force it in the cracks around the frame. No matter what the house construction—wood, tile, brick, stone—Plastic Wood will hold permanently fast. It handles like putty and hardens into wood.

Use it for cracks around the baseboard, too—under door sills, in floors, in doors—wherever the cold air seeps in. It is waterproof and weatherproof, and takes paint or varnish perfectly.

### Plastic Wood Solvent

When working, it sometimes is desirable to soften or thin Plastic Wood, and because of its adhesiveness it will stick to tools or fingers. To soften or remove it use Plastic Wood Solvent, in 25 and 50 cent cans.

Handles Like Putty



Hardens Into Wood

1 lb. can \$1.00

1/4 lb. can 35 cts.

At Hardware and Paint Stores

ADDISON-LESLIE CO., 413 Bolivar St., Canton, Mass.



On a new principle—keeps both needle and lead vertical—no digging in the paper. Accurate settings right on the beam. Makes circles up to eight inches across—yet fits easily in your vest pocket.

Only 50c—at your stationer's, or direct prepaid, from Esterbrook Pen Company, Camden, New Jersey.



## YOU CAN EARN \$15 to \$25 DAILY

Representing Manufacturer

Simply take orders from Stores, Homes, Garages, Vulcanizers, Miners, and Farmers, for INSTANT WELD, the marvelous chemically prepared rubber repair for tubes, rubber boots, hot water bottles, etc. Saves Auto owners 900%! ONCE ON—ALWAYS ON. Guaranteed to outwear the article repaired. Big Repeater! Get sub-agents working for you! No experience necessary. Write quick for free sample, and territory.

ASK ABOUT OUR OTHER BIG MONEY MAKERS

**TOURISTS PRIDE MFG. CO.,** Dept. 25-C, Minneapolis, Minn.

## KINKADE GARDEN TRACTOR AND POWER LAWNMOWER

A practical, Proven Power Cultivator for Gardeners, Suburbanites, Truckers, Florists, Nurserymen, Fruit Growers, Poultrymen.

**AMERICAN FARM MACHINE CO.**  
1058—33rd Ave. S. E., Minneapolis, Minn.



Catalog Free

## NEW AUTOMATIC WINDOW WASHER

Washes-Cleans-Dries-Polishes in ONE Quick Operation.



Amazing new invention completely revolutionizes window washing. Carries its own water supply! It eliminates all the drudgery and unpleasantness.

Five times as fast as old methods! No pail. No brush. No sponge. No chamois. Your hands never touch water with the NEW AUTOMATIC.

Can be used with or without pole. Every housewife, auto-owner, storekeeper and factory owner a live prospect. Sensational demonstration. Sells at sight. Big repeat business. Year 'round-seller.

**MAKE \$90 TO \$150 A WEEK!**

Agents coin tremendous profits. Going like wild-fire. Sells for only \$1.95. Liberal profits for agents. \$10 to \$25 a day easy; \$200 to \$300 a week possible.

Patent Pending

**WRITE FOR OUR FREE SAMPLE OFFER**

You risk nothing. Don't delay. Write for money making proposition today.

**NATIONAL INDUSTRIES, 67 E. Lake St., Dept. 153, CHICAGO**



# Doubles Light on Road Penetrates Glare

**NEW INVENTION** Throws Light of **38,000 Candle Power**  
without Glare, Dimming or Tilting

**Most Powerful Auto Headlight Known**



**NEW TRIPPE REFLECTOR** throws a light 100% to 300% MORE POWERFUL which CUTS RIGHT THRU ONCOMING LIGHTS, and penetrates far down the road.

**ORDINARY HEADLIGHTS** throw light not only DOWN by reflection from TOP of reflector—but also UP and INTO THE EYES of approaching driver from low part of reflector.

Here's the only REAL IMPROVEMENT in Electric Headlights for Autos—the invention of Graham Trippe, an Illuminating Engineer. It doubles the light on the road, yet is so non-glaring to cars approaching that the lights seem to be dimmed. It throws a powerful light of 38,000 candle power 300 to 500 feet ahead that makes the road as light as day. It CUTS RIGHT THRU ONCOMING LIGHTS and clearly shows up the road and pavement edge instead of leaving it "DARK" ahead. Night driving is now made as easy and safe as day driving.

## Two Sizes Fit all Cars—Easily Installed

Comes complete; made in just two sizes; fits any size headlight. Instantly replaces the entire headlight reflector even to the bulbs—no focusing necessary—any one can easily install.

## Makes Night Driving Safe

Thousands are killed every year by plunging into ditches or crashing head-on due to weak lights or glare. Scientists tried for years to banish the blinding glare but they only succeeded in eliminating the light.

At last, Mr. Trippe, after years of work, hit upon an optical principle. This wonderful scientific principle of two offset parabolic reflectors—one a full reflector, and the other a semi-circular reflector—so positioned in respect to each other that they project a long, low, level beam of powerful light, not only ELIMINATES THE GLARE and DOES NOT BLIND oncoming motorists, but INCREASES THE LIGHT on the road 100% to 300%. Legally adopted in many states. MAIL COUPON today for FULL DETAILS and make night driving safe and a pleasure.

# Mail Coupon Now!

**FREE TEST OFFER** Try a pair of Trippe Offset Reflectors on your own car AT MY RISK. See for yourself how Trippe Light CUTS RIGHT THRU ONCOMING LIGHTS, floods the road and side ditches with the LIGHTNESS OF DAY, YET GIVES NO GLARE to bewilder approaching drivers and MAKES NIGHT DRIVING SAFE and ENJOYABLE. If it does not IT COSTS YOU NOTHING, you're to be the judge. Mail coupon NOW. Wonderful opportunity for Agents, Salesmen and Distributors to make \$350 to \$1500 per month introducing it. Know the full details about this greatest and most necessary auto accessory ever brought out. Man alive, here's the opportunity of a life time—nothing like it! Get my FREE TEST and BIG MONEY MAKING OFFER NOW. Mail Coupon Today.

Graham Trippe, President

**AERIAL ELECTRIC CO.**

331 W. Ohio Street

Chicago, Ill., U. S. A.

**\$273<sup>00</sup>**  
**made in 1 Day**

25,000,000 Auto Owners need this strongest non-glaring auto light ever known. Livewire distributors and heman hustlers are grabbing it.

A. E. Martin clears \$275.00 First Deal.  
Absolutely must have 2,000 sets a month to fill orders. Please advise about prompt deliveries.

NORTHWEST HEADLIGHT CO.

By F. R. HAMILTON

"Wired you \$420 today on account. Ship J. J. Kane 200 sets Trippe Reflectors." A. L. BRADLEY

"Cramer & Kirkwood took entire first shipment of 100 sets today. Rush another 100 sets at once." C. E. BEVILL

"Just closed Public Service Company to equip 500 cars." MCLEAN

"Got 18 orders first two afternoons." JONES

"Closed deal today to equip 62 New Ford Model A for Dempster Mfg. Co." H. C. FOSTER

"Every set I have installed leaves perfect satisfaction and have sold three more sets for every one I have installed." D. E. WARREN

Get the full details—and FREE TEST OFFER. Act at once—MAIL COUPON NOW.

Wonderful Demonstration of Trippe Light Makes Sales & Money Fast

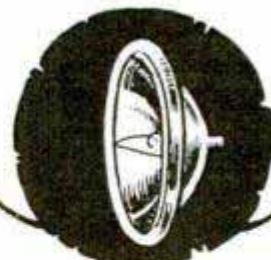

Graham Trippe, President.

Aerial Electric Co.,  
331 W. Ohio Street, Chicago, Ill., U. S. A.

Please send me your Trippe Offset Reflector FREE TEST and BIG MONEY MAKING OFFER.

Name.....

Address.....

City..... State.....



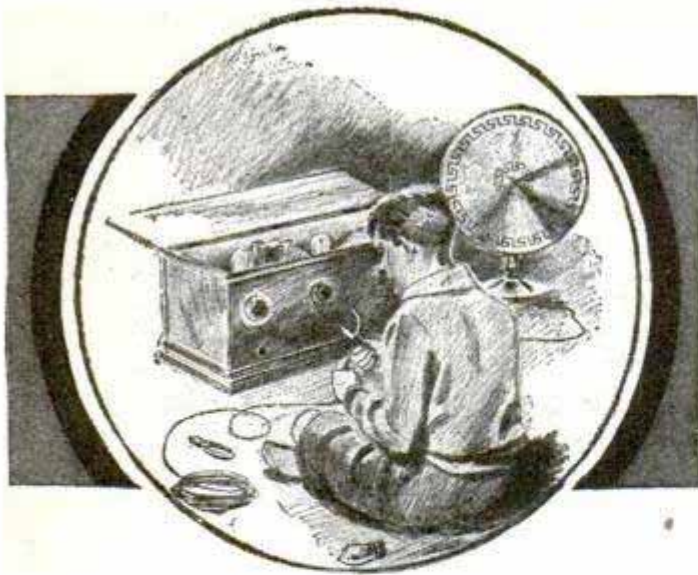

## The Radio Knife Electrician's Favorite

**H**ERE'S a fine practical tool for the professional electrician or mechanic, and for every man or boy who tinkers with a radio or other electrical equipment.

The screw-driver locks in place when open. It can't shut on your fingers. This blade has an edge for scraping the insulation off wires.

Then there is a good sturdy sheepfoot blade for all 'round use. It's razor-sharp—hand-honed at the factory. Made of high-carbon steel that holds a biting edge. Handsome Cocobola handle — nickel-silver bolsters and shield.

This knife belongs in every tool kit. At your dealer's. If he hasn't it in stock send us his name and \$2.00 for R4548. It will be mailed promptly.

REMINGTON ARMS COMPANY, Inc.  
Originators of Kleanbore Ammunition

25 Broadway

New York City

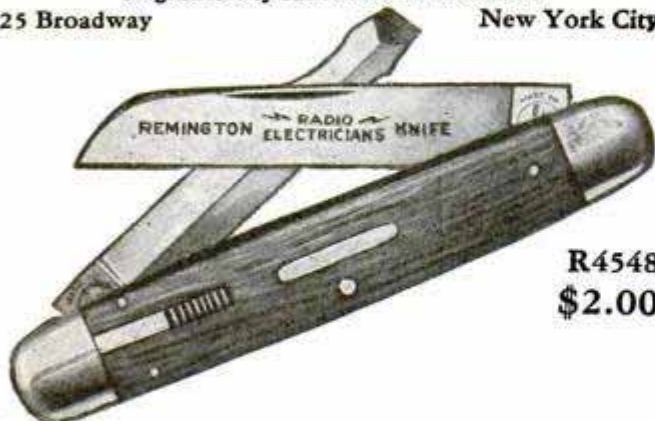

R4548  
\$2.00

# Remington



## OXO-GAS Oil Burners

**Will Heat** Stoves, Ranges, Coffee Urns, Steam Tables, Tanks, Boilers, Vulcanizers, Water Coils, Rendering Kettles, Bake Ovens, Griddles, Lead Pots, Pressing Machines, etc.

**No Noise—No Smoke—No Soot—No Ashes**  
**Require No Mechanical Skill to Operate**  
**Can be Installed in 30 Minutes**  
**Last a Lifetime**

Responsible Distributors Wanted

Write for illustrated catalog.

**DORAN OIL BURNER CO.**  
111-3 No. May St. CHICAGO, ILL.

## Chemical Tricks for Boys

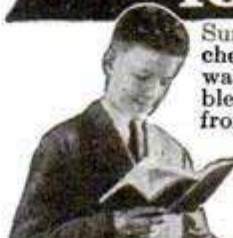

Surprise and puzzle your friends with magic chemical tricks; make ink, dye cloth, test water and soil; write secret letters with invisible ink; pour blue, brown and black liquid from a pitcher of water. All these and many more chemical stunts are easy with ChemCraft Junior. It's the best box of fun you ever had! Get yours now.

**ONLY 25c POSTPAID**

**FREE Catalog**

and ChemCraft Magazine sent to every boy who writes for it now. Full of new ideas and chemical stunts. Ask for yours!

**The Porter Chemical Co.**  
113 Summit Ave. Hagerstown, Md.

## AGENTS AND SIGN MEN

Now Making \$50.00 to \$100.00 and Up Per Week Selling Our  
**GOLD LEAF SIGN LETTERS**

# R

For store and office windows, board signs, trucks and glass signs. We also make to order script signs and business emblems singly or by the thousands. A permanent business. No capital or experience required. Big demand in every city. *Samples and Literature Free.*

**CONSOLIDATED SIGN LETTER CO.** 71-X W. Van Buren  
CHICAGO, ILL.

## MOTORCYCLES



Price \$10 and up purchased through our Co-Operative Plan for as low as \$1.00 down and \$1.00 per week  
**Indians Harley-Davidsons Ace Henderson and Clevelands**  
Send ten cents for Bulletin A.  
*Motorcycles shipped to all parts of the world*

**WALKER-INDIAN CO., 78 Brookline Ave., BOSTON**

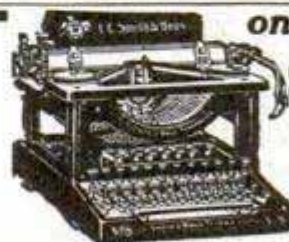

only

# \$1.00

**DOWN**

**10 Day FREE Trial**

You can have a genuine L. C. Smith (the world's only ball bearing typewriter) for \$1 down. Lowest price ever offered! Easiest terms. All the 1928 operating attachments. Re-newed, **GUARANTEED FOR FIVE YEARS**, \$1 down and we ship. No delay. No red tape. 10 day Free Trial. Free Typewriter Course, Tools, Waterproof Cover if you act now. Write for \$1 down offer and free manual.

**Smith Typewriter Sales Corp., 113-469 E. Ohio St., Chicago, Ill.**



# Special! My 1929 Offer to You

## I Will Save You Money

Read my 1929 Offer to You

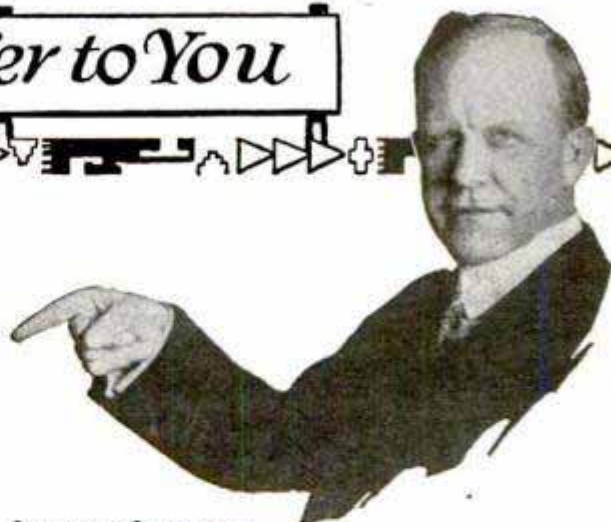

My sole aim, during the year 1929, shall be to place as many standard, dependable Watches as I can in the hands of men throughout the land REGARDLESS OF PRICE OR PROFIT. To do this I have cut the price to ABSOLUTELY ROCK BOTTOM. I know that if I can distribute 5,000 "Santa Fe Specials" this year on this NO-PROFIT PLAN, that every Watch will be a salesman and sell at least one more. I am making this STARTLING AND UNHEARD OF OFFER to those who will tell their friends of this remarkable Watch value, if they find the Watches all and more than I claim for them.

*Alouzo Thomas*

President, Santa Fe Watch Co.

## Save 1/3 to 1/2 of Your Money Most Liberal Offer Ever Made

Our "Direct-to-you" low wholesale terms and EXTRA SPECIAL DISTRIBUTION PLAN is fully explained in the New Santa Fe Special booklet just off the press. The "Santa Fe Special Plan" means a BIG SAVING of money and you get the BEST watch value on the market today. Watch sent to you to see without one penny down. These Watches are NOW in the service on practically every Railroad in the United States and in every branch of the Army and Naval service. Thousands of them are distributed all over the world.

### Write for FREE Watch Book Today

shows newest watch case designs in 4 colors. READ the so-called SECRETS of watch making. READ how you can save from ONE THIRD to ONE HALF of your money—Buy "Direct." The wise man will act quickly if he wants a watch.

EASY PAYMENTS TO SUIT YOU—Don't delay—Fill out and mail the coupon below for the FREE Watch Book.

### SANTA FE WATCH COMPANY

36 THOMAS BUILDING

TOPEKA, KANSAS



SANTA FE WATCH COMPANY,  
36 Thomas Building, Topeka, Kansas.

Please send me the New Watch Book with the understanding that this request does not obligate me in any way.

Name.....

Address.....

State.....



## THERE ARE THRILLS A PLENTY ON THE SHORT-WAVES

Let Hammarlund help you enjoy them. Whether you build your radio receiver for short-wave broadcast or code reception, remember that Hammarlund parts are approved by radio experts the world over.

Your dealer can supply you with Hammarlund Short-Wave Condensers, Plug-in Coils, Chokes, Shields and Equalizers. *You Can't buy better.*

Send 10c for the Hammarlund Short-Wave Manual. Chock full of useful information. Dept. PM3.

**HAMMARLUND  
MFG. CO.**

424-438 W. 33rd St., New York

For Better Radio  
**Hammarlund**  
PRECISION  
PRODUCTS

# GET THIS BIG GREEN BOOK NOW!

New!  
AERO  
KITS  
1929

The Big Green Book gives the very latest details on Aero Coils and Kits, Short Wave Radio, newest broadcast radio receivers, short wave converters, telephone transmitters, coil kits, adapters and a host of new wrinkles for 1929.

### 24 Different New Kits Shown for 1929

The kits everyone is talking about are fully described in the new 1929 Aero Green Book—Aero 7-29, Aerodyne 6-29, Chronophase, Metropolitan, Trio, International, Standard, Radiophone—in Shield Grid, A.C. and D.C. models. Be sure to send for your copy of this 25c Big Green Book—worth \$25.00 to anyone who wants to keep up with the latest radio wrinkles.

Mail coupon for your copy today—NOW!

**AERD PRODUCTS**  
INCORPORATED

4611 E. Ravenswood Ave., Dept. 439  
CHICAGO, ILL.

MAIL THIS COUPON NOW

AERO PRODUCTS, INC. Dept. 439  
4611 E. Ravenswood Ave., Chicago, Ill.

Send me your Big Aero Green Book, 25c, giving the latest information on What's New in radio, short wave, etc.

Name \_\_\_\_\_

St. and No. \_\_\_\_\_

City \_\_\_\_\_ State \_\_\_\_\_

Get  
Eng-  
land  
every  
day,  
Aus-  
tralia  
on  
Thurs-  
days,  
Hol-  
land  
on  
Fri-  
days.  
Gets  
every-  
thing  
on  
the  
Air

## A Tube NECESSITY -Not an Extra

There is no choice. You must use Amperite to automatically control variations in the "A" current supply to your tubes. A type for every tube—A. C. or D. C. \$1.10 with mounting (in U. S. A.) at all dealers.

PREVENTS  
CURRENT  
WABBLE

This symbol  
in a radio  
diagram  
means—



The "SELF-ADJUSTING" Rheostat

Radiall Company  
50 Franklin St., New York  
Write Dept. PM3.

FREE "Amperite Blue Book"  
of modern circuits and  
valuable construction data.

**AMPERITE**  
REG. U. S. PAT. OFF.



## Radio Pep!

No matter what your set—new or old, homemade or factory built, one-tube or ten-tube, head-phone or loud-speaker—you can improve it with Clarostats. There's a type for every purpose. Ask your dealer how. Or write us for literature. Better still, send a quarter in stamps or coin for "The Gateway to Better Radio"—20,000 words and 88 pictures of real radio dope!

CLAROSTAT MFG. CO., Inc., 286 N. 6th St., Brooklyn, N. Y.

**CLAROSTAT**  
Reg. U. S. Pat. Off.

## SOLDERALL

METAL IN PASTE FORM



The  
only  
convenient  
metal  
solder

Every Electrical  
Connection needs  
Solderall for perfect reception

25c

The SOLDERALL CO., NEWARK, N. J.

## Send for WESTERN RADIO New 1929 Catalog

LATEST and FINEST, nationally known A. C. sets, consoles, cabinets, speakers and accessories at LOWEST PRICES. Catalog sent FREE on request.

**WESTERN RADIO MFG. CO.**

128 W. Lake St. Dept. RPM-3 Chicago



New  
1929  
Edition

This 260 Page  
Wholesale Radio Catalog  
A Liberal Radio-Edu-  
cation Within Itself!

**FREE**

Containing 75 radio  
hook-ups, 1,000 illustra-  
tions, 6,000 articles.

Build your own with Rasco parts.  
Positively lowest prices in the country.

**Radio Specialty Company**  
98E Park Place NEW YORK, N. Y.



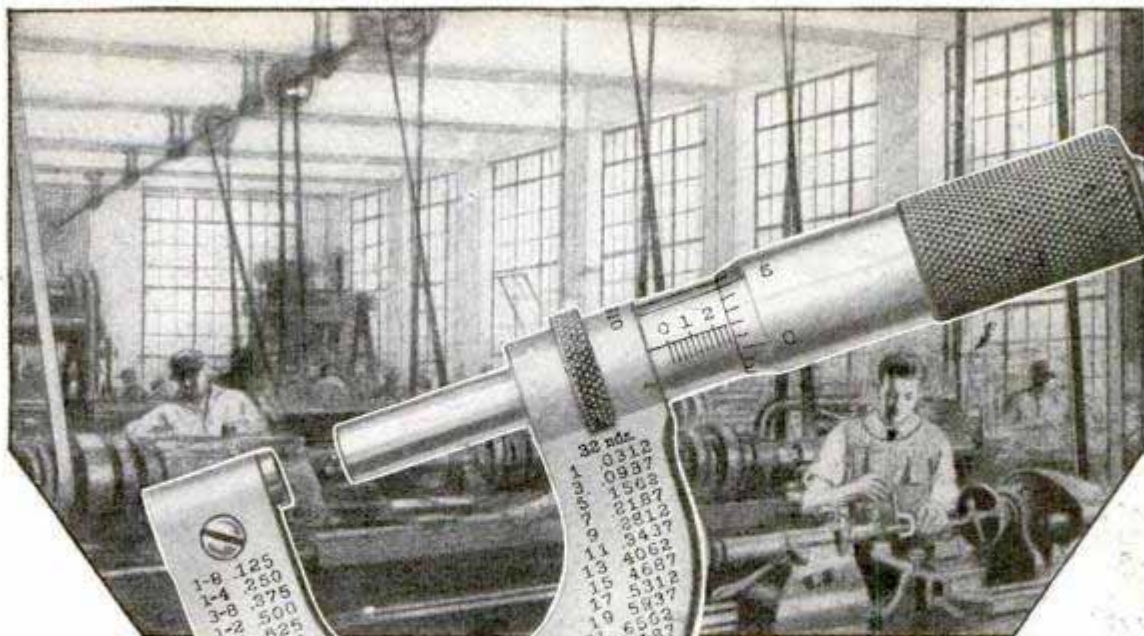

## Essential to Modern Methods

Modern factory methods step up the output of men and machines. One machine today does the work formerly done by many. One man does a job that used to require several. But the need for accuracy never diminishes. Rather it increases with the increased speed of production.

That is why in modern machine shops you will find more and more precision instruments—such as the Micrometer illustrated above. And the general preference shown for Brown & Sharpe measuring tools is industry's way of saying that no finer guarantee of accuracy can be obtained.

Ask for a free copy of Catalog No. 30 listing over 2300 Brown & Sharpe Tools, including Micrometer Caliper No. 10 RS (range 0 to 1" by ten thousandths of an inch) shown above. At your hardware dealer or from us direct. Dept. P. S., Brown & Sharpe Mfg. Co., Providence, R. I., U. S. A.



"World's Standard of Accuracy"



Caliper  
No. 811



Surface Gauge  
No. 620



Combination Square  
No. 401



Rule  
No. 350



Micrometer  
No. 11 RS



Try Square  
No. 540

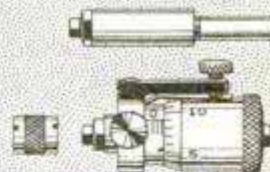

Inside Micrometer  
No. 263



Drill Gauge  
No. 705

# BROWN & SHARPE TOOLS



# How To Repair a Cracked Water Jacket

with Smooth-On No. 1

No disassembling and no heat!

- A. **Simple crack.** Force Smooth-On No. 1 into the crack and give it a few minutes to metallize.
- B. **Long crack.** Put the Smooth-On under a metal plate, held with cap screws.
- C. **Piece broken out.** Fit the piece back with Smooth-On in the break, and bind with metal straps.
- D. **Holes or thin spots.** Cut weak metal away bevel, back, fit with manhole plate, and force the Smooth-On in tight with screw. To make an extra neat job, cut off outer end of screw.

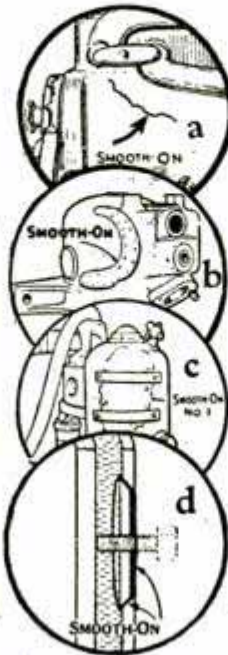

Use Smooth-On also for stopping all water, oil, gasoline or exhaust gas leaks and for tight hold at screw threads of nuts, hub caps, etc.

Get Smooth-On No. 1 in 7 oz., 1-lb. or 5-lb. tins at any hardware store or if necessary direct from us.



Write for **FREE BOOK**



**Do it with SMOOTH-ON**

## FREE

**THIS** booklet tells how to stop not only water leaks in radiators, cracked water jackets, and at loose hose connections, but also how to stop gas leaks from the tank, gasoline lines and exhaust system, and oil leaks at gaskets and at cracks in crank or gearcase. It also tells how to make headlight posts, nuts, hub caps and bolts and grease cups stay tight, and shows dozens of simple money saving Smooth-On repair jobs. Sent free if you return the coupon.

SMOOTH-ON MFG. CO., Dept. 37,  
574 Communipaw Ave., Jersey City, N. J.  
Please send the free Smooth-On Repair Book.

Name.....  
Address.....

# Old Cars Made NEW in 30 Magic Minutes



**NO POLISH-NO PAINT-NO WORK**

**Amazing KoTAL** gives the **BEAUTY** and **LUSTRE** of an Expert **REPAINT JOB** at **1/20th the Cost**

This Amazing New Liquid, discovered in a famous industrial research laboratory has startled the Motor World. Just flow KoTAL on with a cheesecloth pad as easy as wiping a car with a chamolis. **NO Rubbing** — **NO Hard Work.** Results are Amazing — with one sweep of your hand you restore

**BOTH the COLOR and Original Bright Mirror-Like FINISH to Dull — Drab — Faded Cars.** Gives a glass hard protective coat that does not hold dust and the Lustre Lasts for months. Makes shabby OLD cars look like the day they were driven NEW off the dealer's floor. Words cannot describe the startling transformation. Warranted harmless to any finish. Manufactured by a long established highly rated, financially responsible concern and sold under the **STRONGEST GUARANTEE** ever put on any product.

**\$1000 Would Not Buy the Start We Give You FREE. Get the Facts**

We furnish **FREE** every sales help conceivable. We back you to the limit. *Man Alive!* Here is the **Biggest** thing in the motor industry today—it's going over like a house afire. Everybody claims big money—**KoTAL men** actually make it. Hustlers laugh at \$100 per week. Millions of cars need this Quick — Economical — Magic finish which adds

**AGENTS EARN \$5 to \$10 Every Hour You Work \$200 a Week is Easy Money**

25 to 40% to resale values. Demonstrates itself instantly. No Talking Needed. Men who have tried to sell everything on earth and failed are making good with KoTAL. Even inexperienced country boys make money hand over fist. Strike while the Iron is Hot. Get the facts and get them now. We will send you our **Big FREE BOOK** illustrated in colors, and Agents' **FREE TRIAL OFFER.** Good territory is going fast. Act **NOW**—Act

**E. RICHWINE & CO., 17 W. Jackson Blvd., Dept. 151, CHICAGO**  
IN CANADA: 18 Grand Ave., St. GAULT, ONT.

## LIGHTING FIXTURES

Ready to hang

Direct from the manufacturer. Completely wired, including glassware. Send for new catalogue No. 29. Just Reduced Prices. *Special Proposition to Dealers.*

**Erie Fixture Supply Company, Inc.**  
Station A  
ERIE, PA.

# Auto Runs 40 Miles on Gallon of Gas

Automobile engineers who worked for years in an effort to reduce gasoline consumption have found the solution in a marvelous invention that fits all cars. An actual test made by one of the engineers showed forty miles on a gallon of gas. Thousands of car owners have already installed this new invention. They not only report amazing gas savings, but are also surprised to find quicker pick-up, instant starting, smoother running motors and disappearance of carbon. E. Oliver, 999-879 Third St., Milwaukee, Wisc., for a limited time is offering a free device to those who will help introduce it. They also need men everywhere to make over \$100 weekly in their own territory taking care of local business. Write him at once for free sample and big money making offer.—Adv.



# Now - Make Things at Home with this Wonder Working Shop

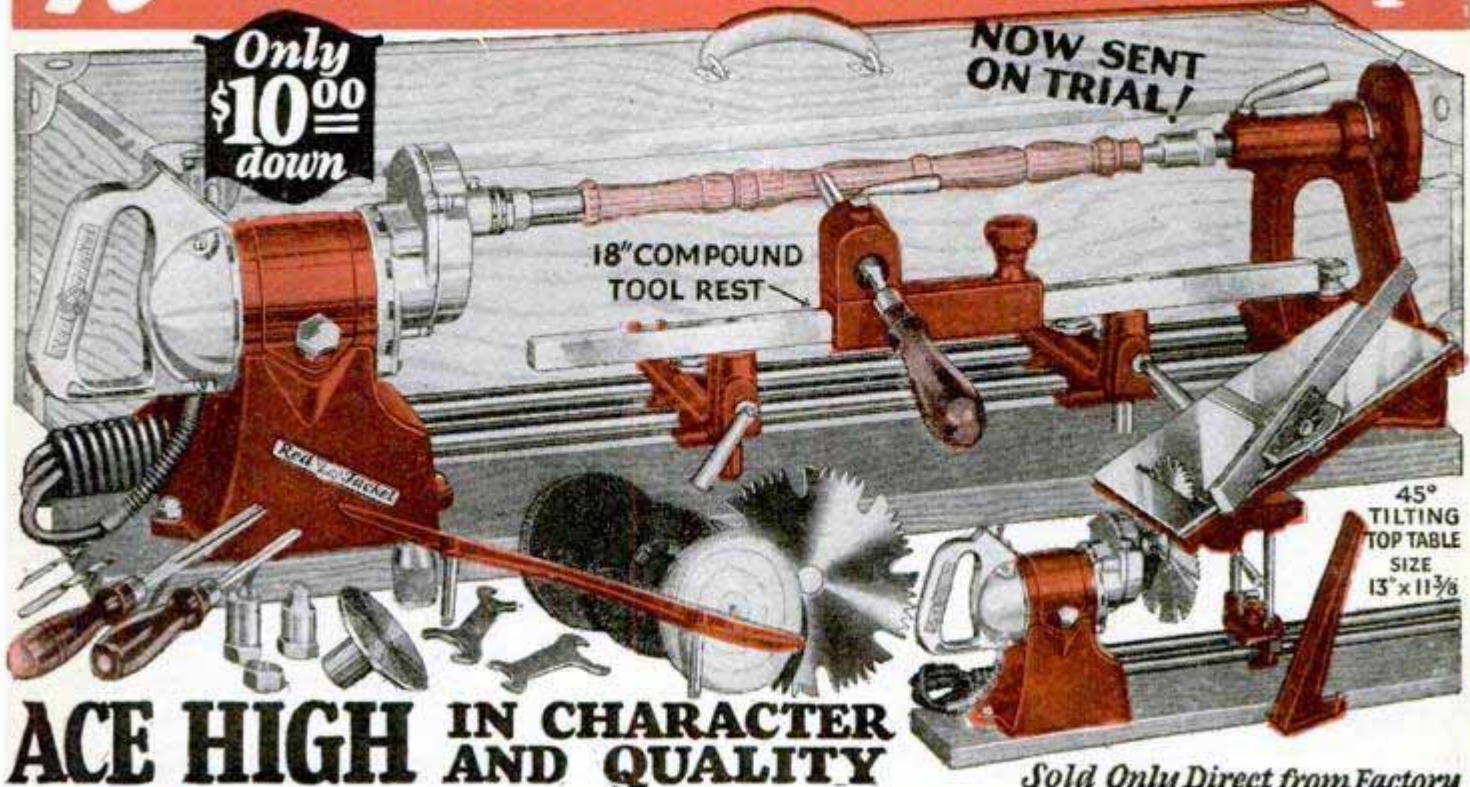

**Only \$10.00 down**

**NOW SENT ON TRIAL!**

18" COMPOUND TOOL REST

45° TILTING TOP TABLE  
SIZE 13" x 11 3/8"

## ACE HIGH IN CHARACTER AND QUALITY

*Sold Only Direct from Factory*

3 years of testing, experimenting and improvement is wrapped up in each new Red Jacket Home Work Shop. The finest tools and accessories that can be made go with each assembly order. Red Jacket equipment is designed, tested, approved and guaranteed by Wm. L. Aylward, a nationally known craftsman and manufacturer, who has developed his hobby into a co-operative association of thousands of craftsmen.

### Portable - Interchangeable - Complete RED JACKET Home Work Shop

The new Red Jacket Combination of Electric tools brings you a Red Jacket Band Saw and in addition the powerful Red Jacket Master Drill Motor with direct drive to the Waco Craftsman's wood turning lathe (capacity 9"x36"), also compound and 18" rests, a tilting top mitre saw with both depth and side gauges, scroll and jig saw, and all accessories for both portable and stationary power drilling, buffing, grinding and cleaning. Attaches to light socket and converts your work bench into a complete private tool and machine shop. It is a complete chest full of electrically driven tools designed for the private use of tool lovers and men who create, repair and appreciate handy tools at home.

### Make It Yourself!

Exclusive Features with WACO-

- All Aluminum Master Drill Motor
  - Perfect Tilting Saw Table 13 x 11 1/8 in.
  - Patented Compound Tool Rests
  - Finest Quality Hand Tools
  - Unconditional Guarantee
  - Unlimited Service
- Read Our Code of Business Ethics—  
Ask 7000 Happy Waco Owners



## Mail Coupon for Interesting FREE Literature

Send coupon at once for information valuable to those interested in beautiful handiwork. It is FREE. It tells you now easy it is to operate a Red Jacket set of tools and lists the advantages and privileges that are free to member craftsmen. Don't miss knowing all about Waco. You are invited. **Look out for imitations.** There is only one Red Jacket—one Waco—you will not find WACO TOOLS sold by retailers. All sales made direct from factory.

**The WACO Guarantee**  
If it is not what you want when you get it—send it back.

**SPECIAL CRAFTS COURSE FREE**  
SPECIAL CRAFTS COURSE and blueprint service is free to Red Jacket Shop owners—all there is to know about handicraft methods, raw materials, woods, carving, sawing, turning, designing, carpentering, decorating, is taught by special correspondence.

**BUY ON YOUR OWN TERMS** Only \$10.00 down. Liberal discount for cash. Easy monthly payment plans. It is no hardship to own a Red Jacket.

**SEND THE COUPON--Interesting Literature Free** You will be surprised with all it contains. Beautiful, Instructive, Fascinating, Interesting. Fill In and MAIL TODAY.



Loving Cup Won by Waco Grand Prize of American Master Craftsmen's Assn.

45° Tilt Top Table



The most elaborate and unusual drill motor ever designed for driving power.

**free BLUE PRINTS**



This Headstock furnished where no electricity is available.

**Red Jacket MASTER DRILL**

**WACO TOOL WORKS, Inc.,**  
5216 W. Kinzie St., Chicago

Manager, Dept. 103. Please send me all free information and literature on Red Jacket Assemblies and FREE Services.

Name.....

Address.....



The Old  
Reliable  
Credit  
Jewelers

**LOFTIS**  
BROS. & CO. EST'D 1859

Dept. L-894  
108 N.  
State St.  
Chicago, Ill.

**DIAMONDS — WATCHES**

Genuine Diamonds Guaranteed **CASH OR CREDIT**

For 71 years Loftis Bros. & Co. have served the American public with better gifts at lower prices. Let us help you make some loved one happy. Our Diamonds are exquisitely beautiful gems set in solid 18-k white gold hand engraved rings. Buy from a house of established reputation—our prices defy competition.

**Diamonds Win Hearts**

**Win Her with a Diamond**

No. 883 \$75 **\$1.75 a week**

No. 880 \$37.50 **\$1.00 a week**

No. 12 \$50 **\$1.25 a week**

No. 886 \$100 **\$2.50 a wk.**

No. 830 \$97.50 **\$2.50 a week**

Satisfaction guaranteed or money back. Goods sent for your free examination on request. Credit terms: Pay one-tenth down; balance weekly, semi-monthly, or monthly at your convenience. All goods delivered on first payment.



**WEDDING RINGS**

No. 824—The "Elite" \$8.00 solid 18-k white gold  
Set with 3 Diamonds, \$22.50; 5 Diamonds, \$32.50; 7 Diamonds, \$42.50; 9 Diamonds, \$52.50; 13 Diamonds, \$67.50.  
Men's strap watch, nickel, cushion shape, high-grade movement, fine leather strap ..... \$8.50

**Wrist Watch No. 866**

Solid 14-k white gold. High grade 15-Jewel movement. Fancy corners; \$15.00. \$1.50 down and \$1.50 a month.

**Men's Diamond Ring No. 860**

Solid 18-k white gold—finest white Diamond. Special bargain! \$75.00. \$1.75 a week.  
All makes of Railroad Watches, guaranteed to pass inspection. Credit at Cash Prices.  
All standard makes thin model watches, green or white gold to suit your needs—\$10 and up.



**DIAMOND CATALOG FREE!**

Write for big free book of 2000 illustrations and descriptions of Diamond Rings in Platinum and Solid Gold, Dinner Rings, Pins, Brooches. All Standard Makes of Pocket Watches, Pearls, Dresser Sets, Silverware, Clocks, Kodaks, Leather Goods. Also many inexpensive novelties.

**Catch Fish**

Eel, Mink, Muskrats etc. with my New, Folding, Galvanized **STEEL-WIRE TRAP.**

It catches them like a fly-trap catches flies. Made in all sizes. Big money-makers for trappers and fishermen. **Get One Free to Introduce Our Goods.** Write today for price list, and my special free trap and bait offer. **J. F. GREGORY, Dept. 208, Lebanon, Mo.**



**Hoist Anchor!**

and you'll find prize parts for your ship. Imagine the joy of building Donald McKay's real clipper ships. Quality parts and full rig from top spars to keel. "Flying Cloud" in 20" model with hull block, wheel, bell, anchor, capstan, flag, rails, cabin and deck house, complete with drawing \$10. Sanded hull \$1 extra. Figure head 50c. Or "Constitution," "Mayflower," Galleons.

Also rigged sailboats ready to race! Will not sink or capsize. Main sheet steered. Sloop "Captain" or schooner "Bowdoin," 30" beam, are sure winners of regattas.

**ROY HANCOCK**  
323 Douglas Ave., Portsmouth, Va.

- Here's 10c for illustrated catalog
  - Send "Flying Cloud." Enclosed \$.....
  - Mail "How to Paint Ship Models," 10c enc.
- Name.....  
Street.....  
City.....State.....



**\$351.00 CLEARED IN ONE DAY**

So writes W. H. Adams of Ohio. Letter from California man reports \$11275 sales in three months; New Jersey \$4000 profits in two months; Pa. \$3000

profits in four months. Ira Shook \$365 sales in one day. Bram bought one outfit April 5 and 7 more by August. Iwata bought one outfit and 10 more within a year. J. R. Bert says "only thing I ever bought that equaled advertisement." John Culp says: "Everything going lovely. Crispette wrappers all over

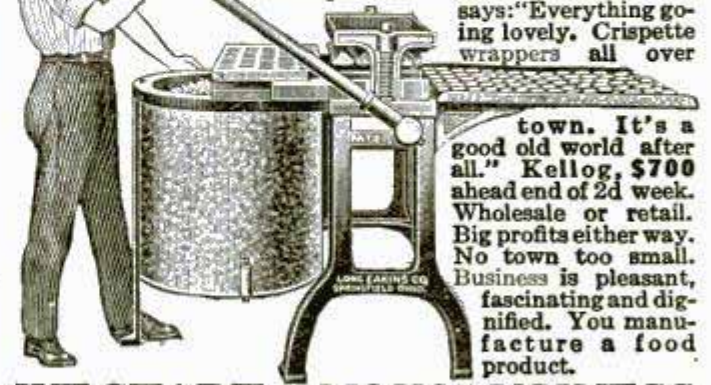

town. It's a good old world after all." Kellogg, \$700 ahead end of 2d week. Wholesale or retail. Big profits either way. No town too small. Business is pleasant, fascinating and dignified. You manufacture a food product.

**WE START YOU IN BUSINESS**

Furnish secret formulas, raw material and equipment. Little capital required; no experience needed.

**Build a Business of Your Own**

No limit to the sale of Crispettes. Everybody likes them. It's a delicious food confection. Write for facts about a business that will make you independent. Start now, in your own town.

**PROFITS \$1000 MONTH EASILY POSSIBLE**

Send postal for illustrated book of facts. It contains enthusiastic letters from others—shows their places of business, tells how and when to start, and all information needed. Free. Write now!

**LONG-EAKINS COMPANY**

328 High Street

Springfield, Ohio

**BABY STANDARD**

**MOVIE CAMERA**

Make your own action movies of events, trips, parades, etc. Takes 25 feet of standard film. Equipped with F.5 universal lens. Loads in daylight. Films developed free. Film can be projected from any standard projector.

**\$13.50**  
F.O.B. Phila.

Send 10c in stamps for illustrated booklet.

**VICAM PHOTO CO. 1224 Belmont Ave. PHILA., PA.**

**22 Cal. Blank Automatic**

**\$4.99**

**Free!**

WITH 100 shot Automatic. Use for CART-tun or self-defence. Keeps away tramps, RIDGES. Frightens thieves, scares away dogs—a real home protector. Fool your friends. Same as an expensive automatic in construction, finish, appearance. Customer satisfaction magazine loading and ejection of cartridges instantly and powerful report. Guaranteed absolutely safe. Send no money. Pay expressman \$4.99 for automatic with 100 cartridges. **JENKINS, 621 Broadway, New York, Dept. 3-J-23**

**No Permit Required**

**6 SHOT**

**\$23.50 FOR ALL WOOL SUITS**

**BIG PAY**

Make big money showing Pioneer all-wool, tailored to measure clothes. Amazing values at \$23.50 and \$33.50. Big commissions in advance with liberal bonus. Customer satisfaction assures fast growing repeat business. No experience necessary. We train you. Ambitious men who want to make money steady, send for our attractive sales outfit. Most complete and effective double size swatch line ever offered. **FREE.** Write now for full details of this unusual opportunity.

**Pioneer Tailoring Co. Dept. Congress and Throop Sts. Chicago**

**SPARE OF FULL TIME**



FACTORY TO YOU—SAVE 50%—COMPARE WITH COSTLIEST OUTFITS BEFORE YOU BUY

# Enjoy a powerful new Miraco <sup>set or complete outfit</sup> 30 DAYS FREE

AC Electric or Battery

Get Our  
Send No  
Money  
9th  
Anniversary  
Offer!



View of marvelous new, 3-year guaranteed, lighted 1-dial control. All Metal Super Shielded AC-9 chassis with front switch, built-in AC power section, phonograph pick-up connection and all latest features removed from cabinet. AC tubes and cabinet extra.

**NEW LOW FACTORY PRICES**  
**SAVE 50%**

**Choice of Cabinets AC or Battery Sets**  
30 Days' Trial

Richly designed genuine walnut console of finest type. Electro-dynamic or magnetic power speaker.

Graceful Spinet console, genuine walnut. Choice of speakers. Also comes in Radio-Phonograph Comb'n.

A Lo-Boy Console that costs little. Dynamic Power Speaker.

Popular inexpensive combination. Set on table speaker.

New-type arm-chair console of genuine walnut—latest speakers.

**MIRACO Radio gets 'em Coast to Coast**

Latest • Powerful • New

# MIRACO

TRADE MARK REGISTERED

Cathedral Toned, Super Selective, Long Distance Getters

## Battery or Electric AC Sets

Celebrating its 9th successful year, America's big, old, reliable Radio Corporation springs a genuine sensation in high-grade sets. With its latest, Super-powered, 1-dial Miracos—the All Electric wholly self-contained, hum-free, AC-8 and AC-9, using AC tubes or the new 8-tube Ultra for batteries or Eliminators—you are guaranteed the greatest values and savings in the fine set field.

Compare a Miraco with highest-priced radios, for 30 days in your home. Surprise and entertain your friends—get their opinions. Unless 100% delighted, don't buy it! Return everything—the complete outfit—at our expense. Your decision is final—absolutely!

Only exceptionally fine radios, of the very latest approved type, at rock-bottom prices, could possibly back up so liberally unconditional a guarantee. Send coupon now for Amazing Special Factory Offer!

### Don't Confuse with Cheap Radios

With its rich, clear Cathedral tone, hum-free operation, tremendous "kick" on distant stations and razor-

edge selectivity—with its costly sturdy construction, latest features, including phonograph pick-up connection, ease of tuning, beauty, and economy—a Miraco will make you the envy of many whose radios cost 2 to 3 times as much!

### BIG DISCOUNTS

Exclusive Territory to User-Agents on BATTERY OR AC ELECTRIC Outfits

Many thousands of Miracos—bought after 30 day home comparisons—are cutting through locals and getting coast to coast, Canada, Cuba, Mexico, with the tone and power of costly sets. Miracos are laboratory-built with finest parts, and embody 9 years' actual experience in constructing fine sets. Approved by Radio's highest authorities.

### Deal Direct with Big Factory

Everything reaches you splendidly packed and rigidly tested to insure your instant enthusiasm. Enjoy the outfit 30 days—then decide. Liberal 3-year guarantee on each set. Play safe, save lots of money, and insure satisfaction by dealing direct with Radio's old, reliable builders of fine sets—9th successful year

Ultra 8  
**\$49<sup>88</sup>**

Electric AC-8  
**\$71<sup>50</sup>**

Electric AC-9  
**\$83<sup>75</sup>**



Metal or wood compact style cabinets. Wood cabinets in walnut or new shaded silver-chrome finishes. Cathedral Electro-Dynamic or Magnetic-Power Speaker to match!

**MIDWEST RADIO CORP'N, 407-RM Miraco Bldg., Cincinnati, Ohio, U. S. A.**  
**BEAUTIFULLY ILLUSTRATED CATALOG, AMAZING SPECIAL FACTORY OFFER**

Testimony of Nearby Users—All the proof you want—of our honesty, fairness, size, financial integrity, radio experience and the performance of our sets—including Amazing Factory Offer—sent with catalog.



**Free!**

**MIDWEST RADIO CORPORATION**  
Pioneer Builders of Sets—9th Successful Year  
407-RM Miraco Bldg., Cincinnati, Ohio

**THIS COUPON IS NOT AN ORDER**

WITHOUT OBLIGATION, send free catalog, Amazing Special Factory Offer, testimony of nearby users, etc.  User  Agent  Dealer

Check here if interested in an EXCLUSIVE TERRITORY PROPOSITION  
NAME ADDRESS



**Champion X**—For Model T Fords—Packed in the Red Box—60c. **Champions**—For all other cars, including Model A Ford, and trucks, tractors and stationary engines—75c.



## A New Improved CHAMPION for Every Type of Engine

**DESIGNED** and made to meet the stresses of the most advanced modern engines the new improved Champion is far in advance of the Champion Spark Plug of even six months ago. The new and exclusive sillimanite insulator is as vast an improvement over all previous insulators as the original sillimanite over porcelain. A remarkable new sillimanite glaze remains practically impervious to carbon and oily deposits.

The advanced new solid copper gasket seal remains absolutely gas-tight against the much higher compression of today's engine. The special analysis electrodes have been greatly improved to resist pitting and burning.

**Remember**—it is a genuine economy to install new Champions every 10,000 miles. A complete new set of improved Champions installed in your car will show actual savings in gas and oil which will more than offset their cost.

# CHAMPION

## Spark Plugs

Toledo, Ohio

Windsor, Ontario

**Thompson**  
**BEATS**  
the World  
on **BOATS**

**THOMPSON**  
**BOATS**

**CATALOG**  
**FREE!**



**OUTBOARD MOTOR BOATS**—A complete line of strictly up-to-date racing models. Also some entirely new models for general pleasure use with speed of a racer. Built strong, staunch and durable, and absolutely safe.

**Rowboats**  
\$44.00  
and up—

The most complete line ever offered, at real money-saving prices.

**Canoes**  
\$48.00  
and up—

Some all wood, others canvas covered. Light, swift, safe, strong and durable. Choice of many distinctive color combinations.

**Motor**  
**Boats**—

With or without Engine. Fast, handsome craft at money-saving prices.

**CATALOG FREE — SAVE MONEY — ORDER BY MAIL**

Please state the kind of boat you are interested in (30)

→ **TWO LARGE FACTORIES** ←

**THOMPSON BROS. BOAT MFG. CO.**

213 Ann St.  
PESHIGO  
WISCONSIN

(Write to  
Either Place)

113 Elm St.  
CORTLAND  
NEW YORK

### SPEEDO-PLANE FLYER



Rises from the ground, soars to great heights; comes down in a graceful glide to a perfect landing. Wing spread 16 in. Motor stick 14 in. 7 in. carved wood propeller. Match its performance against your \$5 plane. Fully assembled. Only 50 cents postpaid in U. S.

### SPEEDSTER AIRPLANE

Fast flyer. Rises from ground under its own power. Speeds beautifully thru the air. 11 in. wing spread. 9½ in. long. 4½ in. carved wood propeller. Only 25 cents postpaid in U. S.

**Both Models Guaranteed to Fly or Money Refunded**  
Special for this month—Snappy, live rubber, 1-8 in. flat, ½ cent per foot; 3-16 in., 1 cent per foot. Postage 5c extra.  
**SPEEDO MANUFACTURING COMPANY, Dept. M, 253 Albany Avenue, BROOKLYN, N. Y.**

## MOVIES AT HOME

Many models of genuine MOVIE MACHINES, some as low as \$3.75, all using standard size big theatre films. Our stock of films is the most complete and lowest in price—with an exchange service. Films of leading stars and religious subjects are available. **DON'T DELAY. WRITE FOR FREE INTERESTING CATALOGUE NOW!**

**PARAMOUNT MFG. CO.**  
Dept. G-12 BOSTON, MASS.

## Photos ENLARGED

Size 16x20 inches  
Same price for full figure or bust, groups, landscapes, or pet animals etc., enlargements of any part of group picture. Safe return of your own original photo guaranteed.

**SEND NO MONEY** Just mail photo or snapshot (any size) and within a week you will receive your beautiful life-like enlargement size 16x20 in., guaranteed fadeless. Pay postman 98c plus postage or send \$1.00 with order and we pay postage. **SPECIAL** With each enlargement we will send FREE a hand-tinted miniature **FREE OFFER** reproduction of photo sent. Take advantage now of this amazing offer -- send your photo today.  
**UNITED PORTRAIT COMPANY**  
1652 Ogden Ave. Dept. C-369 Chicago, Ill.





PRODUCT OF

GENERAL MOTORS

THE NEW  
**PONTIAC**  
**BIG 6**

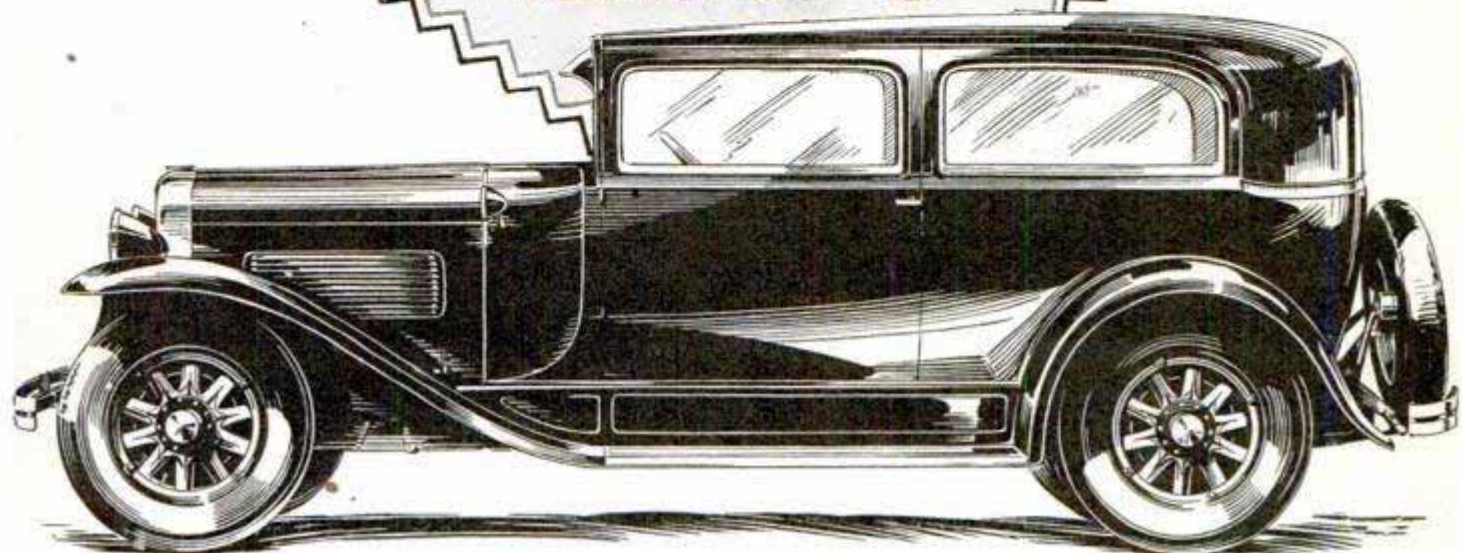

2-Door Sedan • Body by Fisher

# An Engineering Triumph..

## A True Achievement for \$745



Progressive Americans recognize in the New Pontiac Big Six a car which reveals new horizons of accomplishment in advanced automotive engineering and body-building design. This newest General Motors product meets exactly the needs of that great class of motorists who are eager to *step up* the quality of their motor cars without departing from the low-priced field.

The New Pontiac Big Six has the big car smoothness, power and speed developed by a big, new L-head engine with a dynamically balanced, counter-weighted crankshaft, the famous Har-

monic Balancer and the G-M-R cylinder head. It has the cold weather performance advantages of the cross-flow radiator. Dirt-and-weather-proof internal-expanding four-wheel brakes provide big car safety. New, stunning, richly appointed bodies by Fisher, with adjustable drivers' seats, offer big car luxury, comfort and style.

These refinements, and many more just as important, set the New Pontiac Big Six sharply apart from all other offerings in the low-priced six-cylinder field.

*Pontiac Big Six, \$745 and up f. o. b. factory, plus delivery charges.*

OAKLAND MOTOR CAR COMPANY, PONTIAC, MICH.



# PUT THIS WORKSHOP IN YOUR HOME

## FREE For 10 Days-No Deposit!

### A New and Improved Workshop

Here is a workshop built to a standard of perfection—accurate in operation—most durable in construction—easy to operate. It is absolutely dependable and will withstand severe constant service. Try it for ten days at our expense and you will be convinced of its superiority.

### Suitable for Carpenters, Home Workers, Pattern Makers, Etc.

Furniture manufacturers use MAC—the Popular Mechanic Workshop—for making furniture models. Manual Art Schools use it for instruction. Home workers use it for pleasure and profit. Carpenters use it for making repair parts, spindles, chair legs, cabinets. It is ideal for making all kinds of furniture.

### The Lowest Price for Such a Sturdy, Complete Workshop

MAC, THE POPULAR MECHANIC, represents the utmost in value and dependability. Now you can have an accurate, practical workshop at a big saving. Once you use MAC you will be convinced of its superior qualities. That's why we want you to try it for 10 days at our expense.

**NO DEPOSIT**

**A YEAR TO PAY**

**GET DETAILS QUICK**

**MIDLAND APPLIANCE CORPORATION**  
Dept. 310, 219 N. Michigan Ave.  
CHICAGO, ILL.



#### MODEL NUMBER 70

Wagner 1/2 H. P. Motor, 8 1/2 inch Sander Disc, Circular Saw, Jig Saw, 30 inch Lathe with 9 inch swing, Black & Decker 1/2 inch Drill, Electric Glue Pot, Accessories include 5 inch Dia. Face Plate, Spur and Cup Type Wood turning Centers, 1/2 inch Three-jaw Geared Chuck, Arbor and Flange, 6-inch Cotton Buffs, 6 inch Wire Brushes, 5 inch Emery Wheel, Adjustable Tool Rest and Tool Supports with Bed Clamp, Two Turning Tools and Socket Wrenches.



**Complete Outfit \$9.65**

## PAINT WITH AIR

### New Simplified Easy Way!

with improved Payntgun! Quickest, easiest way to paint ever discovered. Anyone can put perfect smooth brilliant surface on car, furniture, woodwork, etc., with lacquer, varnish, paint or enamel. No experience needed—years of painting skill built into the Payntgun. New exclusive features cut painting time in half. Sturdily built—compact—convenient. Powerful spray specially designed for easy sure control. Turns painting jobs into play. Fully guaranteed. Sent on ten-day trial. Get special offer.

**FREE** Folder on Skillful Home Painting—Write for yours today!

**HAYWOOD EQUIPMENT COMPANY**  
2345-D Ogden Avenue, CHICAGO, ILL.



**AGENTS WANTED**



**5 1/4**

**A New Size**

*in the*  
**Genuine  
Stanley Bailey  
Plane**

*The Standard Plane  
of the World*

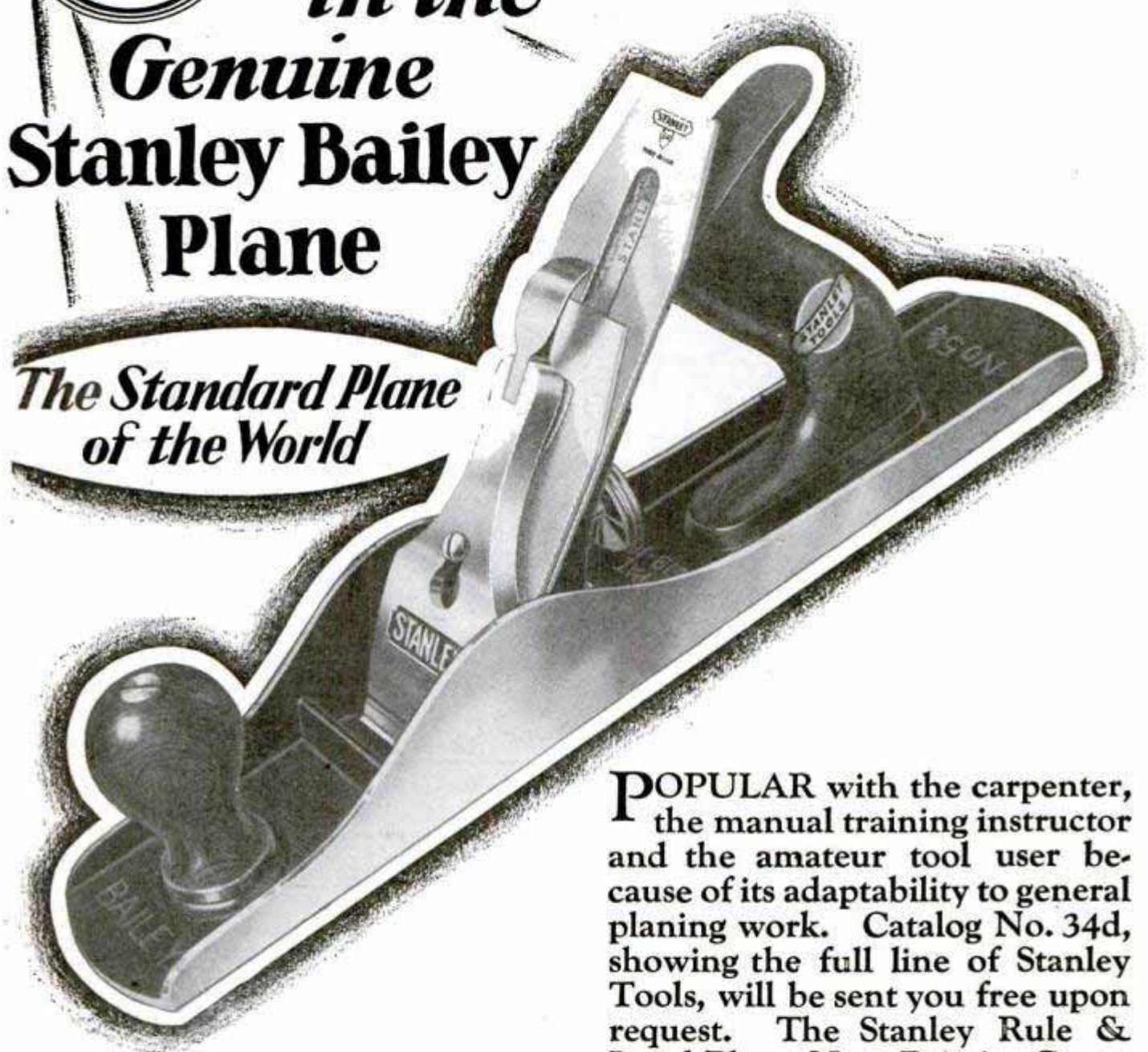

**P**OPULAR with the carpenter, the manual training instructor and the amateur tool user because of its adaptability to general planing work. Catalog No. 34d, showing the full line of Stanley Tools, will be sent you free upon request. The Stanley Rule & Level Plant, New Britain, Conn.

*Other Stanley Tools maintaining the same standard  
of quality as Stanley Bailey Planes*

**RULES  
HAMMERS**

**SCREW DRIVERS  
BIT BRACES**

**LEVELS  
CHISELS**

**STANLEY TOOLS**

*The Choice of Most Carpenters*



# Now! Do Your Own Electric Nickel Plating

Introductory Offer

ONLY \$6.50 Plus Postage



For Plating Nickel, Brass, Copper, Silver, Gold, etc.

## Make \$150 to \$500 a Week

New Scientific Invention Enables Anyone to Nickel-Plate Anything, Anywhere

Do YOUR OWN Electro-Plating in Your Home, Garage, Office, or Place of Business. Electrically Deposit Metal—Nickel, Brass, Copper, Silver, or Gold. You can Successfully do all the plating on your Automobile, Electric Fixtures, Faucets, Spoons, Forks, Candeliers, Tools, Coffee Urns, Surgical and Dental Instruments, Utensils large or small, Iron Stoves, Music Instruments; recondition worn plating or plate New Work; do it Instantly without interrupting the Service or without removing the parts to be plated with the

## ALADDIN PORTABLE ELECTRO-PLATER

Simple and Economical to operate. Not a toy, but a practical Plating Outfit with which Perfect and Durable Work can be done. Positively Guaranteed to do as we claim. BE YOUR OWN BOSS! Build up a Profitable Aladdin Electro-Plating Business of your Own. This offers wonderful ECONOMY to users and BIG MONEY-MAKING possibilities to AGENTS. Thousands in Service. Write for FREE Booklet and Testimonials Today.

P. J. F. BATENBURG

Dept. 67

RACINE, WISCONSIN

—AGENTS— WANTED EVERYWHERE

## MASONS

Latest style genuine selected leather, gold trimmings; 5 window card case, Masonic emblem stamped in heavy gold.

Who would be without for only

\$1

Sent for \$1 to help cover cost, just to get our catalogue in the hands of Masons. The case is a beauty. Your name or other stamping 35c a line extra. Pin a dollar to this. Money back if not entirely satisfied. Larger and better cases from \$2, up to \$5. Masonic Books, Monitors, Jewelry and Lodge Supplies for over 69 yrs.

REDDING MASONIC SUPPLY CO. INC.  
200 Fifth Ave. - Dept. P.M., New York



## Miller's American Poultry Guide FREE

Tells all about chick's-care, feeding and raising for profit. Also describes Hot Water & Electric

"Ideal" Incubators \$11.50 Up

With Original Patented EGG TURNING TRAYS

"Ideal" Brooders -- \$6.90 Up

Coal, Oil, and Electric Brooders, Poultry Supplies, Baby Chicks. Special LOW PRICES! Write Today!

J. W. MILLER CO., Box 12, Rockford, Ill.



70 BREEDS Chickens, ducks, geese and turkeys. Pure bred hardy, northern raised and most profitable. Fowls, eggs, baby chicks, incubators; low prices. America's great plant. 36th year. Valuable new 100 page Poultry book FREE.

R. F. Neubert Co., Box 908, Mankato, Minn.



## FOY'S BIG BOOK, in Colors

A complete guide to successful Poultry and Squab Raising. Low prices on CHICKS, Breeding Stock and PIGEONS.

Write Today! FREE!

FRANK FOY, Box 18, Clinton, Iowa



## SQUAB BOOK FREE

Breed squabs and make money. Sold by millions at higher prices than chickens. Write at once for free 48-page book beautifully printed in colors telling how to do it. You will be surprised. PLYMOUTH ROCK SQUAB CO., 634 H Street, Melrose Highlands, Mass.

## PLANS for Poultry Houses

All styles, 150 illustrations; secret of getting winter eggs, and copy of "The Full Egg Basket." Send 25 cents. INLAND POULTRY JOURNAL, Dept. 514 Indianapolis, Ind.



## RAISE CHINCHILLA AND NEW ZEALAND WHITE FUR RABBITS

Make Big Money We Supply Stock and pay you following prices for all you raise; Chinchillas average \$3 each—New Zealand Whites \$2 each. 32-page illustrated book, catalog and contract, also copy of Fur Farming magazine, tells how to raise rabbits for big profits, all for 10c. Address

OUTDOOR ENTERPRISE CO., Box 1021 Holmes Park, Missouri



## 68 BREEDS Valuable New Poultry Book Free—100 Pages

Fine Pure-bred Northern raised chickens, ducks, geese, turkeys, eggs, baby chicks, incubators & brooders at lowest prices. America's great industry. My 47th year.

W. A. Weber, Box 28, Mankato, Minn.



## ARTISTIC PORTRAIT ENLARGEMENTS only 98¢ each

FROM ANY PHOTO or SNAP-SHOT SIZE 16 x 20 INCH (or smaller if desired)

The usual price of this work is \$5.00 but by taking advantage of this Special

Offer you can get a beautiful life-like enlargement of that favorite picture of mother, dad, sweetheart, baby or any friend for only 98 cents.

**SEND NO MONEY**—Just mail us the photo—any size (Full figure, bust or group) and in about a week you will have your enlargement guaranteed never to fade. It comes to you C.O.D. On arrival pay postman 98c plus a few cents postage, or send one dollar cash with order and we pay postage. Money back if not delighted. You can send us your most treasured photograph, it will be returned to you unharmed.

**FREE** In order to advertise this remarkable offer we send free with every enlargement ordered, a Highly-Glazed Hand Painted miniature reproduction of the photo sent. These miniatures alone are worth the whole price charged for the enlargement. Take advantage of this really Amazing Offer and send your order today. **DO IT NOW.**

ALTON ART STUDIO, Dept. 46  
5654 West Lake St., Chicago, Ill.

Please enlarge artistically the enclosed photo. Return enlargement and FREE Hand Painted miniature, C.O.D. 98c plus postage. (If \$1.00 is enclosed you are to send postage paid.)

Name \_\_\_\_\_

Address \_\_\_\_\_

Town \_\_\_\_\_

State \_\_\_\_\_

Check Size Wanted

- 16 x 20 in.  
 10 x 16 in.  
 11 x 14 in.  
 8 x 10 in.



## ELITE DIAMONDS

A Beauty—Full of Fire

Latest Sterling engraved 1929 Design, set with White Elite Diamond and Blue Sapphires on sides. If you can tell it from a \$250 Diamond, send it back.

Don't Send a Penny!

Just send name, address and ring size. On arrival pay postman special offer price \$2.98 and pstge. Satisfaction Guaranteed!

Order Today! Foreign Orders Cash

ELITE JEWELRY HOUSE

6343 South Ashland Avenue  
Dept. M63 CHICAGO, ILLINOIS



**Only \$188.00**

# A Complete Machine Shop 5 Machines in ONE

**LATHE-DRILL-UNDERCUTTER-VALVEGRINDER-GRINDER**

With this new and practical machine, you can handle all jobs of turning, grinding, drilling and repairing in metal and wood. Fast, accurate, sturdy and guaranteed by the makers of the famous C-O Garage Tools and Shop Equipment, known the world over.

Without Valve Grinder \$158.00

**USED BY**

- Garages
- Electric Shops
- Small Machine Shops
- Builders
- Inventors
- Model Makers
- Home Mechanics
- Farmers
- Storekeepers
- Radio Shops
- Battery Stations
- Air Ports, etc.

Operates from any Electric Light Socket

Weight, 200 lbs.  
Size, 38" long, 27" high, 12" wide

**Lathe**—6" swing, 14" between centers. Adjustable tail stock. 1/2" Universal chuck, 3" face plate, center plate, tool post, 3/8" chuck dog, cutting tools, special wrench to fit all nuts and screws. 2 speeds, 500 and 1000 R. P. M.

**Drill**—Drills holes 0 to 3/8". Adjustable head with 7 1/2" travel on column. Drills to 9" circle and has 2 1/2" up and down spindle run. Speed is 1100 and 2200 R. P. M. 3-jaw chuck furnished with 1/2" chuck wrench. 3/16", 1/4", 5/16" and 3/8" bits.

**Undercutter**—Instantly adjustable and does accurate work. Equal to any separate and more expensive undercutter.

**Valve Grinder**—Grinds valves with 45 degrees up to and including 3/8" diam. stem.

**Grinder**—1/2 and 3/4" emery wheels with guards. Operates at speeds of 1100 to 2200 R. P. M.

The C-O Master Mechanic comes complete with all necessary equipment, including belts, drill bits, wrenches, dogs, face plates, also a small vise. Price includes 110 volt, 60 cycle, single phase motor, ready for use. Also furnished in other voltages and cycles; prices on request. Write for circular and details of our liberal Time Payment Plan.

**CANEDY-OTTO MFG. CO.**

Dept. P. M.

CHICAGO HEIGHTS, ILL.

Write for Circular Today

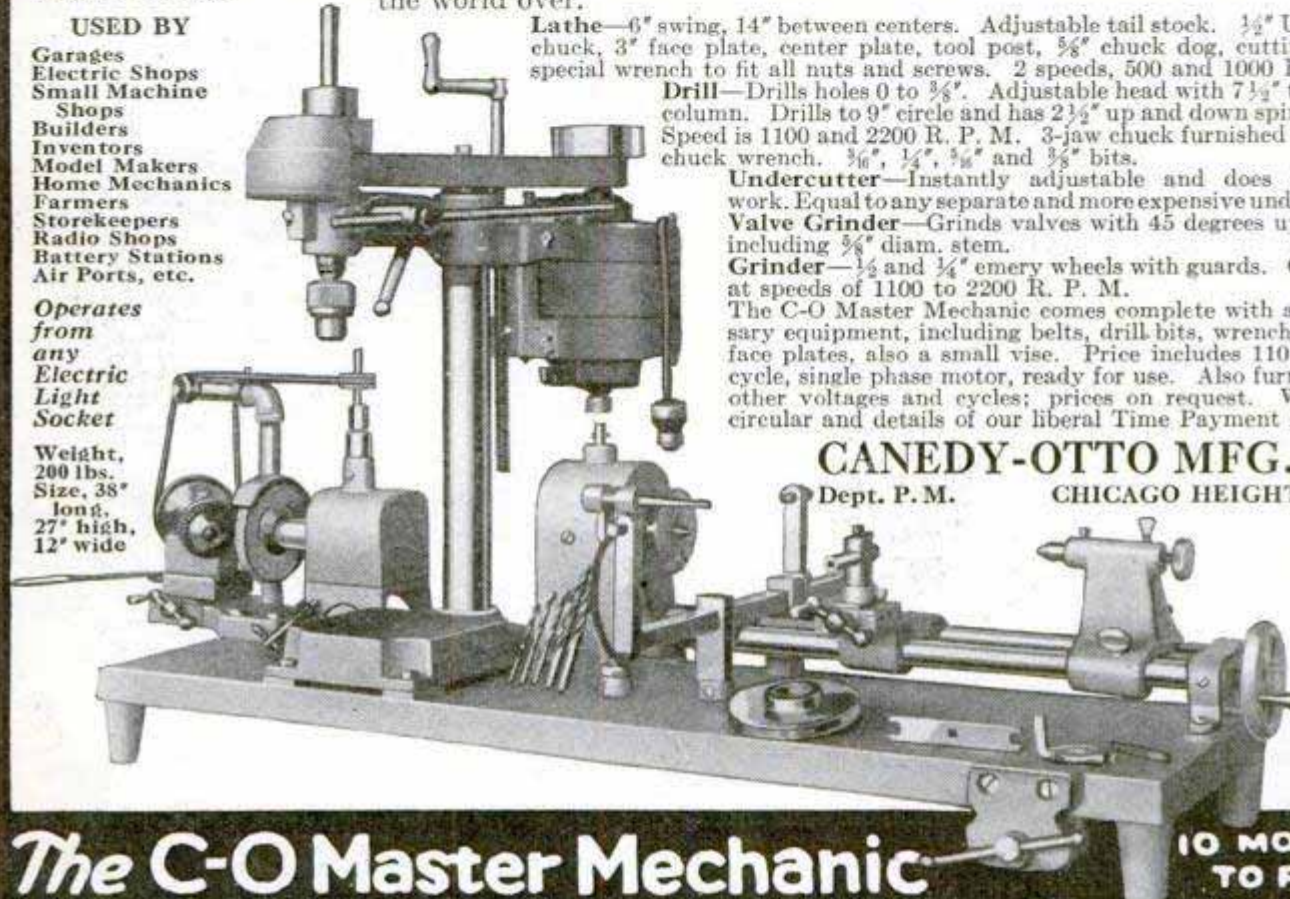

## The C-O Master Mechanic

**10 MONTHS TO PAY**



**BUCHSTEIN'S FIBRE LIMB**

Is soothing to your stump—strong, cool, neat, light. Easy payments. Braces for all deformities. D. BUCHSTEIN CO. 610 3rd Ave., So. MINNEAPOLIS, MINN.

Send for Catalog Today



**MODEL AIRPLANE MOTOR**

Compressed air. Only motor of kind on market. A powerful job, fly 4 to 6 ft. wing span. Blue prints. Send for circular, Amalgamated Sales & Service Corporation 549 West Washington Boulevard Chicago, Illinois

**\$4.50**



## Build Your Scale Model Airplane the IDEAL way!

IDEAL Models are accurate, scale-reduction copies of famous Airplanes; perfect duplicates in appearance and construction details, with many realistic parts and fittings not found on other models. They make long, perfect flights and are controllable by movable ailerons, elevators and rudder. Build an IDEAL Model—it's the easiest, quickest and safest way to construct a strong, reliable Model that is guaranteed to fly correctly.

"SPIRIT OF ST. LOUIS" shown at left. 3 ft. Model. **\$7.50** Complete Construction Outfit

Also Models of FOKKER, DEHAVILLAND, CURTISS and other aircraft. Ask Your Dealer for IDEAL Model Airplanes, or send for our catalog.

**Plans for Model Airplanes—25c Each**

Accurate, 1/4-size Plans, with Building-Flying Instructions for any one of the following: New York-Paris; FOKKER; DeHavilland; Curtiss; NC-4 Seaplane; Bleriot, Taube or Nieuport Monoplanes; Cecil Peoli Racer—25 cents each. Catalog Free with Plans.

**64-page Catalog—5c**

Biggest, best listing of everything for building all kinds of Models; also much other Aviation information. Send for yours now!

**IDEAL AEROPLANE & SUPPLY CO., Inc.**

Headquarters for 18 Years!

26 West 19th Street

New York City







## LUMINOUS PAINT

**Make Your Watches, Clocks, Etc., Visible by Night**

The very latest discovery in the scientific world. Hitherto, practically unobtainable except at an exorbitant price, we have at last succeeded in producing this remarkable LUMINOUS PAINT, which, applied to the surface of any article, emits rays of white light, rendering it perfectly visible in the dark. THE DARKER THE NIGHT, THE MORE BRILLIANT IT SHINES. Quite simple to use. Anyone—you can do it. A little applied to the dial of your watch or clock will enable you to tell the time by night. You can coat the push buttons or switch plates of your electric lights, match boxes, and innumerable other articles; make your own Luminous Crucifixes, Luminous Rosaries, etc. Small bottle, price 25c. Larger sizes, 50c and \$1 postpaid. JOHNSON SMITH & CO., Dept. 833 RACINE, WIS.



### CIGARETTE MAKER

Roll your own and save money. Better and quicker; saves more than half. Use your favorite brand of tobacco. Neat, useful, handy. Pocket size, weighs 3/8 oz. Made entirely of metal, nickel plated. 25c, 3 for 65c postpaid anywhere.



### GOOD LUCK RING

Very striking, quaint and uncommon. Silver finish; skull and crossbones design, two brilliant, flashing gems sparkle out of the eyes. Baited, bring good luck. Only 25c postpaid.



### Exploding Cigarettes

JUST LIKE ORDINARY CIGARETTES, BUT SUCH REAL STARTLERS! The box contains ten genuine cigarettes of excellent quality. They appear so real, but when each cigarette is about one-third smoked, the victim gets a very great surprise as it goes off with a loud BANG! A great mirth provoker yet entirely harmless. Price 25c box.

### NOVELTY BADGES



**Kissing Permit 10c** Two very novel metal badges, nickel plated, that you can wear, giving you fun out of all proportion to their trifling cost. 10c, each badge, 3 for 25c, or 75c per doz. postpaid anywhere.

**Garter Inspector 10c** Same as above.

### MIDGET BIBLE

**GREAT CURIOSITY** Smallest Bible in the World. Size of a postage stamp. 200 Pages. Said to bring good luck to the owner. A genuine work of art. Must be seen to be appreciated. Makes good money selling them to friends, church acquaintances, etc. PRICE 15c each, 3 for 40c, 12 for \$1.35, 100 for \$7.50. Also obtainable in Leather Binding, with gold edges. Price 50c each, 3 for \$1.25, \$4.50 per doz. Magnifying Glass for use with Midget Bible 15c.

### STAGE MONEY

With a bunch of these bills, it is easy for each person of limited means to appear prosperous by flashing a roll of these bills at the proper time and peeling off a genuine bill or two from the outside of the roll, the effect created will be found to be all that can be desired. Prices, postpaid: 40 Bills 20c, 120 for 50c, or \$3.50 thousand postpaid.

### MAGIC NOSE FLUTE

The Magic Nose Flute, or Humantone, is a unique and novel musical instrument that is played with nose and mouth combined. There is just a little knack in playing it which, when once acquired after a little practice, will enable you to produce very sweet music that is somewhat resembles a flute. There is no fingering, and once you have mastered it you can play all kinds of music with facility and ease. When played as an accompaniment to a piano or any other musical instrument, the effect is as charming as it is surprising.

## JOHNSON SMITH & CO.

Dept. 833 RACINE, WIS. A De Luxe Edition of our new 1929 CATALOG mailed on receipt of 25c. Handsome binding. Bigger and better than ever. Only book of its kind in existence. Nearly 600 pages of all the latest tricks in magic, the newest novelties, puzzles, games, sporting goods, rubber stamps, unusual and interesting books, curiosities in seeds and plants, etc. Unobtainable elsewhere. Remit by Coin, Money Order, Check or unused U. S., Canadian and Foreign Stamps for all articles listed above.

## BLANK CARTRIDGE PISTOL

Protection against Burglars, Tramps, & Dogs. Special Offer 1 Blank Cartridge Pistol 100 Blank Cartridges 1 650-page Novelty Catalog ONLY \$1.50

The Lot Shipped by Express Only Cash With Order Only

Well made and effective, modeled on latest type of Revolver; appearance alone is enough to scare a burglar. When loaded it may be as effective as a real revolver without danger to life. It takes standard .22 Cal. Blank Cartridges—obtainable everywhere. Special cash with order offer: 1 Superior quality Blank Cartridge Pistol, 100 Blank Cartridges, and our new 650 page De Luxe Catalog of latest novelties; all for ONLY \$1.50. Shipped by Express only. Cannot go by parcel post. Extra Blank Cartridges 50c per 100. Special Holster (Cowboy Type) for pistol 50c. No C.O.D. shipments.

## LOOK 35c LOOK Wonderful Instrument.

Greatest thing yet. Nine separate articles in one. Everybody delighted with it. Odd, Curious and interesting. Lots of pleasure as well as very useful. It is a double Microscope for examining the wonders of nature. It is also an Opera Glass, a Stereoscope, a Burning Lens, a Reading Glass, a Telescope, a Compass, a pocket Mirror, and a Laryngoscope—for examining eye, ear, nose and throat. It is worth all the cost to locate even one painful cinder in the eye. Folds flat and fits the pocket. Something great—you need one. Don't miss it. Sent by mail. Only 35c or 3 for \$1.00.

JOHNSON SMITH & CO., DEPT. 833, RACINE, WIS.



It is made in the shape of and looks like a regular Automatic Pistol. No one is likely to stop and ask you whether it is real or not. Thus it is likely to prove itself very handy in an emergency. On pressing the trigger it opens up as shown in the illustration at the right, revealing nine most useful articles—Opera and Field Glass, Telescope, Mirror, Magnifying Glass and Burning Lens, Reading Glass, Sun Dial, Sun Compass, etc. In the handle of the revolver there is a place for various pocket necessities, such as First Aid Articles, Buttons, Pins, etc. The Pistol is of about metal, blood finish, that can be carried comfortably in pocket. PRICE \$1.00 postpaid.

## Watch Charm Pistol \$1.75

Exact reproduction of a real pistol; actually fires REAL BLANK CARTRIDGES of miniature size. Illustration is actual size. 1 1/4 inches long, with ring at end for attaching to watch chain. Loads like a regular pistol. Pull the trigger and it goes off with a loud bang. Pistol is break open type; illustration shows position for loading. Made entirely of high grade steel, nickel plated, octagon barrel, hand engraved handles, complete in box with cleaning rod. PRICE \$1.75. Also furnished with pearl handles, \$2.50. BLANK CARTRIDGES, 50c per box of 25. JOHNSON SMITH & CO., DEPT. 833, RACINE, WIS.

## MICROPHONE TRANSMITTER BUTTON



You can easily make a highly sensitive detector-telephone by using this Transmitter Button to collect the sound waves. You can build your own outfit without buying expensive equipment. It is simple and inexpensive. You can install an outfit in your home and hear conversations being held all over the house. You can connect up different rooms of a hotel. This outfit was used by secret service operatives during the war. It is being used on the stage. It is ultra-sensitive and is the greatest invention in micro-phones. You can mount the button almost anywhere—card board boxes, stove pipes, stiff calendars, on the wall behind a picture frame, etc. Button is so light and small it cannot be detected. Persons can be overheard without suspecting it. You can listen in on conversations in another room. A deaf person in the audience can hear the speaker. Connected to phonograph, piano or other musical instrument, music can be heard hundreds of feet away. Button may be used to renew telephone transmitters; often makes an old line "talk up" when nothing else will. The ideal microphone for radio use; carries heavy current and is extremely sensitive. Amplifies radio signals. Countless other similar uses will suggest themselves. Experimenters find the button useful for hundreds of experiments along the lines of telephones, amplifiers, loud speakers, etc. Many fascinating stunts may be devised, such as holding the button against the throat or chest to reproduce speech without sound waves. PRICE \$1.00. JOHNSON SMITH & CO., DEPT. 833, RACINE, WIS.

## SURPRISE MATCHES

More fun than fighting with your wife. Look just like ordinary matches. Put up in boxes just like regular Safety Matches. As the victim tries to light one he gets quite a surprise. Price 10c per box, 3 boxes for 25c, 12 for 75 cents.

## INVISIBLE INK

The most confidential messages can be written with this ink, for the writing makes no mark. Cannot be seen unless you know the secret. Invaluable for many reasons. Keep your posts and other private communications away from prying eyes. Great fun for playing practical jokes.

Only 15c a Bottle; 3 for 40c. JOHNSON SMITH & CO. DEPT. 833 RACINE, WIS.

## Wonderful X-Ray Tube

A wonderful little instrument producing optical illusions both surprising and startling. With it you can see what is apparently the bones of your fingers, the lead in a lead pencil, the interior opening in a pipe stem, and many other similar illusions. A mystery that no one has been able to satisfactorily explain. Price 10c, 3 for 25c, 1 dozen 75c. JOHNSON SMITH & CO.

## NOSE BLOWER

When some men blow their noses it sounds like a trombone. Now the NOSE BLOWER has come to torment us. It is a starter! It is ingeniously concealed in the handkerchief. Proceed to blow your nose and your friend will think they heard a steam engine or something. You can blame the hideous noise to your having a very bad cold and keep up the fun as long as you like. PRICE 10c, 3 for 25c, or 75c doz. postpaid.

## Serpent's Eggs

Box contains 12 eggs. When lit with a match, each one gradually hatches itself into a snake several feet long, which curls and twists about in a most life-like manner. Price per box, 10c postpaid, 3 for 25c.



# BOYS! BOYS! BOYS! Throw Your Voice

Into a trunk, under the bed, under a table, back of the door, into a desk at school, or anywhere. You get lots of fun fooling the teacher, policemen, peddlers, and surprise and fool all your friends besides.

## THE VENTRILO

is a little instrument that fits in the mouth out of sight. Cannot be detected. It is used in connection with the above, and with the aid of this wonderful **DOUBLE THROAT**, or **VENTRILO**, you can imitate many kinds of birds, animals, etc. Remember you get everything for **ONLY TEN CENTS**—a booklet giving you full instructions how to become a ventriloquist and throw your voice, the **Double Throat**, or **Ventrilo**, and our big 600 page catalog of novelties, tricks, puzzles, masks, books, etc., **10 cents**  
**ALL SENT POSTPAID TO ANY ADDRESS FOR ONLY 10 cents**



**LEARN TO PITCH** By the world's greatest pitchers. Prepares you mentally, morally and physically to become a great baseball player and a great athlete. Special course of lessons by **CHRISTY MATHEWSON**, who explains the secret of how to throw the great "FADEAWAY" ball, so much feared by the great batters; **ED WALSH**, the pitcher who discovered the secret of throwing that famous, mystifying, and unhitable "SPIT BALL"; **JOE WOOD**, the "Smoke Ball" marvel, next to the speediest pitcher in the world; **WALTER JOHNSON**, the man who has struck out more league batters in a single season than any other pitcher known; **NAP RUCKER**, inventor of the "Knuckle Ball"; and **DOC WHITE**, who teaches you the art of **Shadow Pitching** by which you can develop control and speed necessary to become a star pitcher. Carefully described and illustrated by 56 pictures. Everything complete for **ONLY 25 cents** postpaid anywhere. Nothing more to buy.

## MAGICIAN'S BOX OF TRICKS

Apparatus and Directions for a Number of Mysterious Tricks, Enough for an Entire Evening's Entertainment. **\$1.00**  
**ANYONE CAN DO THEM**  
It is great fun mystifying your friends. Get the **Cutpurse's Cabinet**, and you will be the cleverest fellow in your district. It contains the apparatus for **500 first-class tricks**, including the **MAGIC BALL AND VASE TRICK** (a wooden ball is placed inside, and upon replacing the lid has disappeared and is found in someone else's pocket); the **HINDOO TRICK CARDS** (can be made to change completely no less than five times); **DISAPPEARING COIN BOX** (is coin placed in the wooden box, vanishes entirely or changes into a coin of another denomination); the **GLASS GULL-LET TRICK** (is coin dropped into a glass of water and when the water is poured out the coin has vanished and is found somewhere else); the **HIBBON FACTORY FROM THE MOUTH TRICK** (a seemingly endless supply of colored paper ribbons comes out of your mouth); the **DISAPPEARING HANDKERCHIEF** (a handkerchief held in the hand mysteriously vanishes); the **WIZARD'S RING COIN TRICK**; the **ENCHANTED BOTTLE** (no one but yourself is able to make it lay down); the **GREAT HAT AND DICE TRICK** (a large die is placed on top of a hat, disappears, and is found underneath yet no one has touched the hat); and last, but not least, the **GREAT PHANTOM CARD TRICK**, or two from five leaves nothing. Full instructions are sent for performing each trick. In addition to the above, a number of other tricks and illusions are fully explained for which you can easily make or procure the necessary apparatus. **Price complete \$1.00 postpaid. JOHNSON SMITH & CO.**



**U. S. BABY TANK** It goes with real Yankee Pep—by its own power. Most remarkable toy ever invented. By drawing the Tank backward, either with the hand or over the floor or table and then placing it down, it will crawl along, overcoming all obstacles, in the same life-like manner as the larger Tank that proved so deadly in the great war. What makes it go is somewhat of a mystery, for there is no mechanism to wind up as is usually understood with mechanical toys, yet this tank will keep plodding along ten times longer than the ordinary run of toys. It will perform dozens of the most wonderful stunts; 2 1/2 inches long. **Price only 25c prepaid. Stamps accepted. JOHNSON SMITH & CO.**

**15c Card Sailer Pistol** POSTPAID. It shoots small squares of cardboard, sending them spinning and sailing through the air to great distances. Length 8 3/4 inches. Wood barrel, metal handle, heavy rubber band. Plenty of ammunition and extra rubber with each gun in neat box. More ammunition can be made as desired. Can use without the ammunition as a fly killer. **PRICE ONLY 15c each, 3 for 40c, or \$1.35 per doz. postpaid. Stamps accepted. JOHNSON SMITH & CO., Dept. 833, Racine, Wis.**

**Great Fire Eater** A great trick by which you can apparently breathe fire from mouth, to the horror and consternation of all. Quite harmless. All apparatus necessary sent complete in box for **ONLY 30c, p. p.** **JOHNSON SMITH & CO.**

**SQUIRT ROSE** 25c. A REAL STARTLER. This is the most popular of all squirt tricks. The flower in your coat looks so fresh and sweet that everyone is tempted to inhale the delightful perfume. Then is the moment to press the bulb. Geowhilkens. Don't they jump? There is a very long rubber tube that easily reaches to the pocket of your coat or trousers, and the bulb is large enough to make a dozen shots with one loading. **PRICE 25c each, or 3 for 65c postpaid.**

**SEEBACKROSCOPE** Place this clever instrument to your eye, you see what is going on behind your back. Very interesting things sometimes occur when no one thinks you are looking. Just like having eyes at the back of your head. **PRICE 25c POSTPAID**

**WONDER FOR THE 20th CENTURY**

## RESURRECTION PLANT

Great curiosity. Place in water, plant opens up and starts to grow in few minutes. Taken out it dries up and goes to sleep until put in water again. **PRICE 10c, 3 for 25c, 75c dozen, postpaid.**



## DISSOLVING VIEWS

You may have a lot of fun with this little peep-show. A 3 1/2 inch diameter starter. Made entirely of metal, having a microscopic lens fitted into one end. While the victim is absorbed in admiration of the pretty picture, and turns the button in the confident expectation of seeing something interesting, a spring syringe is brought into action, and the observer experiences a very great surprise. **50c p. p.** **Johnson Smith & Co., Dept. 833, Racine, Wis.**



**Comical Motto Rings**

Lots of harmless fun and amusement wearing these rings. Made in platinumoid finish (to resemble platinum), with wording on enameloid, as illustrated. **Price only 25c Postpaid.**

## The "Little Giant" Typewriter

A First Class Writing Machine For \$1.50  
A perfect little typewriter for \$1.50. There are thousands of persons who would like to use a typewriter but whose needs and business do not warrant the expense attached to the purchase and use of a fifty or seventy-five dollar machine. To such persons we confidently recommend our Little Giant. It is strongly made, but simple in construction, so that anyone can quickly learn to operate it, and write as rapidly as they would with pen and ink. The letters of the alphabet most frequently used are so grouped as to enable one to write rapidly, the numerals 1 to 9, and the punctuation marks being together. With this machine you can send your best girl typewritten love letters, address envelopes, make out bills, and do almost any kind of work not requiring a large, expensive machine. With each typewriter we send a tube of ink and full printed instructions for using the machine. **Price complete \$1.50 by mail postpaid to any address in the world.**



**JOHNSON SMITH & CO. Dept. 833 Racine, Wis.**

Send remittance (Postage Stamps accepted) for all articles listed above also in our other ad on previous page



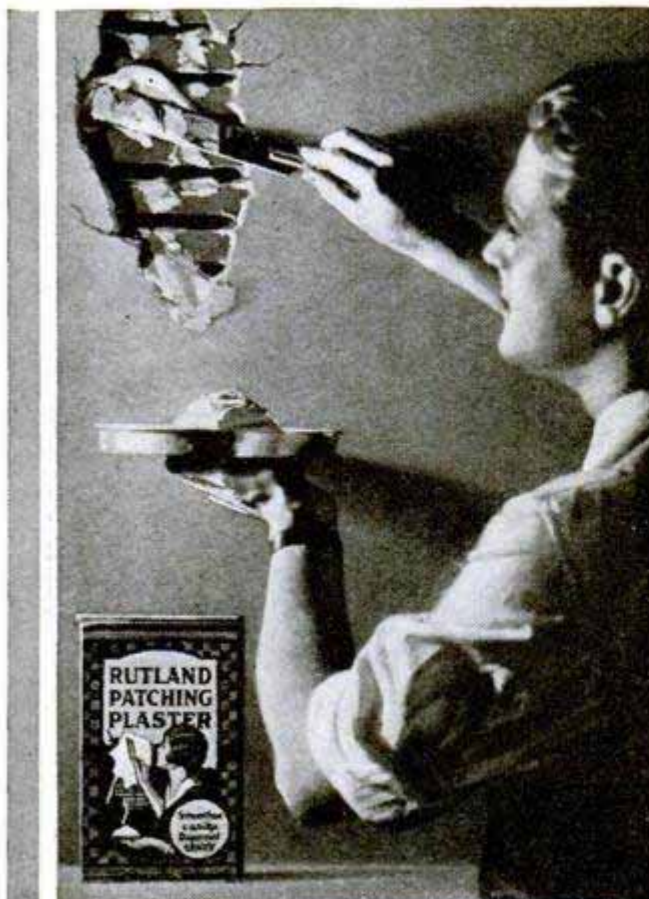

*Astonishing* what a perfect patch — as lasting as the wall itself — you can make with Rutland Patching Plaster. And so easy to use! Just mix with water, then fill the crack or hole. Anyone can do it in a few minutes. At all paint, wall-paper and hardware stores. Rutland Fire Clay Company, Rutland, Vermont.

## Rutland Patching Plaster

### SPORS LATEST No. 1 FOUNTAIN PEN

SELLS FOR \$1.25 8 Different Colors  
SEND ONLY Money Back If Not Pleased.

**39¢** "Writes Like a \$7 Pen."  
(SENT POST-PAID)



WRITE FOR FREE WHOLESALE CATALOG SHOWING OVER 400 ARTICLES.

F. SPORS & CO., 129 Main St., LESUEUR CENTER, MINN.



### WADE AMATEUR MECHANICS, REPAIR SHOPS, INVENTORS, STUDENTS

**BENCH LATHE**  
A real machine tool for the home work—capacity 4" dia. x 12" length. For Metal-Wood-Composition materials. Turning—Facing—Boring—Drilling—Winding—Thread Cutting. Accurate Strong—Quiet—Compact. Slide-rest has travel entire length of bed. Leadscrew inside bed. No. 1 Lathe, plain headstock, \$28.00. No. 2 Lathe, back-gear headstock, \$58.00. Extra for lathes with 18 inches between centers, \$7.00. Complete line of accessories at equally low prices. Write for free catalog.

THE GEROLD CO.

Dept. P-51

120 Liberty St.

New York

## BE OUR AGENT

### FOR THE NEW 1929 RAMBLER RECEIVER

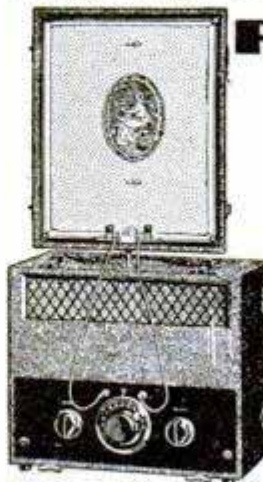

HERE is your chance to make a real clean-up on the double quick. Think of it! A new, completely self-contained one dial receiver that is instantly portable. Compact, equipped with loop and speaker, requires no exterior connections. Selectivity, volume, wonderful tone quality. Made by the world's largest portable radio manufacturer and sold for less than any other standard radio set.

Write today for discounts and full details of this outstanding money-making proposition. You will be glad you did!

STANDARD RADIO COMPANY  
756 Roscoe Street, CHICAGO, ILLINOIS

## GO IN BUSINESS FOR YOURSELF

Make \$50 to \$100 a Week

Stop building fortunes for others and build one for yourself. Clean suits, coats, dresses, etc., at amazing speed. Big demand—everybody has clothes cleaned! Public spent \$168,000,000 for cleaning in 1918; estimated \$350,000,000 in 1928.

### THE GRAND Dry Cleaning System

has made thousands of dollars for others and will do the same for you. Clean, easy work! No experience necessary! Small investment. We teach you business! Tailor shops, barber shops, pressing shops, etc., can add big profits. Write today!

GRAND MFG. CO.  
1623 Bates St. Indianapolis, Ind.

## BIG PROFITS!

# BASHFUL?

"Shame on you!" Are you nervous, embarrassed in company of the other sex? Stop being shy of strangers. Conquer the terrible fear of your superiors. Be cheerful and confident of your future! Your faults easily overcome so you can enjoy life to the fullest. Send 25c for for this amazing book. RICHARD BLACKSTONE, 8-473, FLATIRON BLDG., NEW YORK





Finest saw made. Silver Steel, Ship Point blade. Perfection handle.



Handy, high-grade saw for boys or men. 20 in. polished blade.



Rtgd Silver Steel blade. Apple wood handle. 8 to 18 in. lengths.



Adjustable handle with compass. keyhole and metal-cutting blades.



Nickel steel adjustable frame. Non-Breakable or Silver Steel Blades.



"Silver Steel." Makes the best Scraper you ever used. All sizes.

# ATKINS SILVER STEEL SAWS

## for Your Workshop

IN thousands of workshops where clever home-craftsmen are making things for pleasure or profit—you'll find ATKINS Saws and Tools cutting and working wood or metal, and doing it quicker, easier and more accurately.

Make ATKINS Saws your choice when you start a home-workshop or need new tools. Only in ATKINS Saws do you get the world-famous "Silver Steel" which takes a sharper cutting edge and holds it longer. Ask your Hardware Store for ATKINS Saws.



### Saw Books FREE

"Saws in the Home" has suggestions for making things at home, and shows the best saws to use. "Saw Sense" tells about saws and their care. Both free, just use coupon.

**E. C. ATKINS & CO., Est. 1857**  
426 S. Illinois St., Indianapolis, Ind.

*Atkins Makes the Highest Grade Saws for Every Use; Saw Tools, Saw Specialties, Plastering Trowels, Machine Knives, Grinding Wheels and Files.*



Silver Steel Narrow Band Saws for small machines. All lengths.



Circular Rip Saws for fast, accurate work on any machine.



A perfect file for every purpose. Makes faster, easier filing.



The simple, easy way to cut grooves from 1/8" to 4" width.

### E. C. ATKINS & CO.

Est. 1857  
426 S. Illinois St., Indianapolis, Ind.

Please send me "Saws in the Home" and "Saw Sense," free; also information on your.....Saws.

Name.....

Address.....

## BIG MONEY

easily made by floor surfacing contractors who average \$40 per day. The New "American High Production" Machine does the work—makes you the money and builds you a business of your own. No dull seasons—no large capital nor experience required. complete information free without obligation—write today.

**THE AMERICAN FLOOR SURFACING MACHINE COMPANY**  
523 So. St. Clair St. TOLEDO, OHIO

## Makes Old Ford a Tractor

Now you can convert that old Ford car into a useful farm tractor without altering any Ford parts. We furnish the traction wheels, drive-gears and auxiliary axle and mountings, ready to clamp on to the Ford frame. Pulls 16" plow.

*We supply a Belt Pulley also*

Write for Free Particulars.  
Shaw Mfg. Co., Dept. PM3, Galesburg, Kan.

## BOW LEGS?

THIS GARTER (Pat'd) Makes Trousers Hang Straight If Legs Bend In or Out

Free Booklet—Plain Sealed Envelope

**THE T. GARTER CO., Dept. E**  
South Bend, Ind.

# ASBESTOS

All grades of Crudes and Fibres in large or small quantities

Sold by

## KEASBEY & MATTISON COMPANY

Ambler, Pennsylvania

Branches in Principal Cities

## BOYS! Make Big Money

### BUILD BIRD HOUSES

Boys! Here's a real money maker. With my simple instructions any boy can build and erect Grandpa Bird Houses. They sell at \$2 to \$30 each. \$2,000 worth sold in Oak Park, Ill. in one year. Send \$1 for 16 Blue Print Drawings showing correct building plans so you can build my famous bird houses. Valuable book on song birds with tips and advice on making sales included free.

**GEO. J. BREIDERT, 1040 N. Elmwood Ave., Oak Park, Ill.**

## MAKE THINGS AT HOME—SAVE MONEY

### PARTRIDGE WOOD TURNING LATHE

Buy the finished completely assembled lathe. Build bed at home. A real tool. 6-inch diameter capacity. Shipping weight 21 lbs. Make radio parts, floor lamps, toys and numerous other practical and valuable articles. Also made in sizes to swing 8, 11, 13, and 16-inch diameters.

## AN IDEAL LATHE FOR FATHER OR SON

Only \$16<sup>50</sup> f.o.b. Chicago

Send today for descriptive circular.

**E. O. PARTRIDGE, Dept. M-29, 2039-49 W. Lake Street, CHICAGO, ILL.**



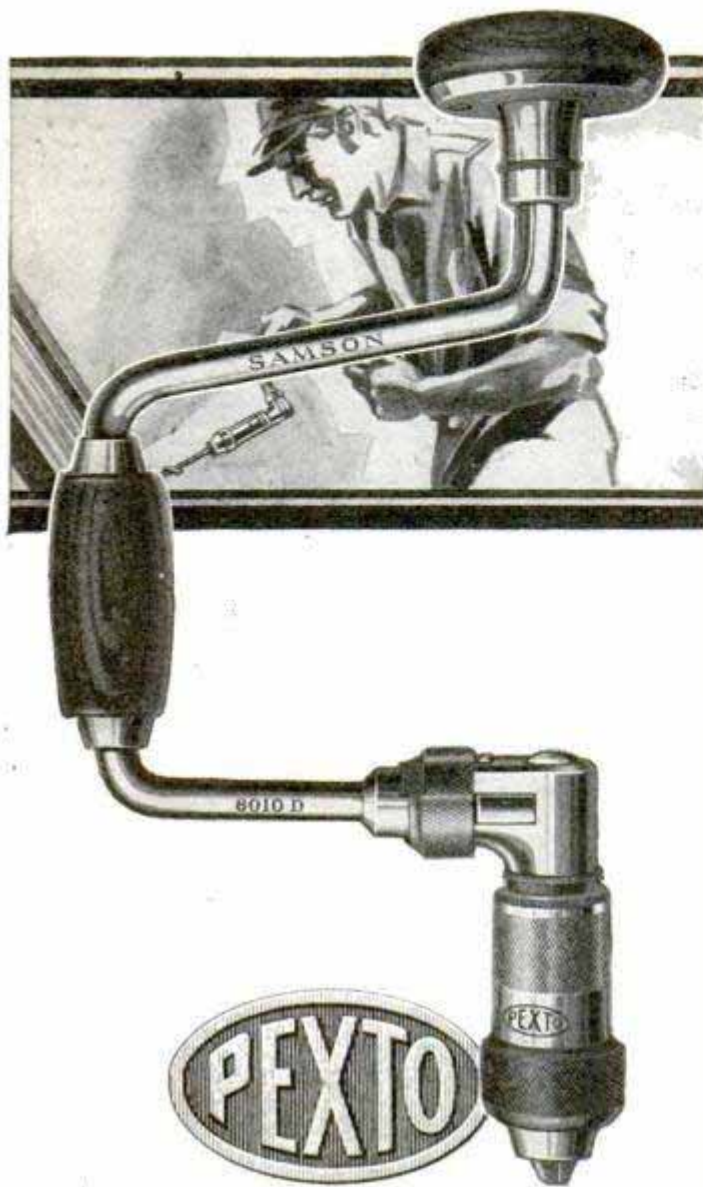

**PEXTO**

## Necessarily—

you choose high grade tools when you do work of a difficult and exacting nature. In the selection of tools, it is best to know something of the manufacturer. Pexto Tools are the result of many years of fine tool making, and have earned an enviable reputation for fine quality, exact balance and lasting material. Look for the Pexto trade-mark when you buy.

Among the numerous popular items in the Pexto Line are Braces, Bits, Chisels, Pliers, Hammers, Screw Drivers, Wrenches and Snips.

Send for booklet "M"

The Peck, Stow & Wilcox Co.  
Southington, Conn., U. S. A.



## Nary a traffic cop!

You've watched soft fleecy clouds in a blue sky, and wished you could drift upon a cloud bank. Floating over cool quiet waters in an Old Town Canoe is about as near as you can come to realizing that delightful day-dream. No bit of errant thistledown could rest more lightly on the stream.

Get away from the dusty road! Enjoy the relaxation of canoeing in an Old Town. Old Town Canoes have the grace and beauty of real Indian lineage. Easy to handle, and perfectly balanced. Priced as low as \$67. From dealer or factory.

Write today for free catalog. It shows and prices many light, water-tight models. Paddling, sailing and square-stern canoes, extra-safe Sponson models, dinghies and sturdy family boats. Also speedy craft for outboard motors—racing step planes and hydroplanes. Old Town Canoe Co., 1963 Middle Street, Old Town, Maine.

## "Old Town Canoes"



### THREAD CUTTING LATHE

A REAL Lathe. 9" swing; 30" between centers. Speedy and accurate. Special attachments and tools available. Write today for Circular and

#### 12" Band Saw

Powerful, practical. Not a toy. Prices on these and other machines, only \$30.

Bronze bearings. **only \$30**.  
Rossbacher Machine Co., 1516 Fernwood Ave. TOLEDO, OHIO

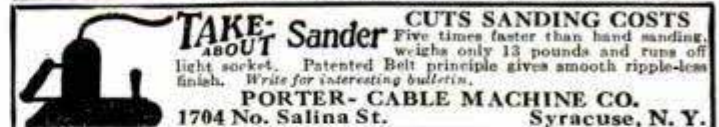

### TAKE-ABOUT Sander CUTS SANDING COSTS

Five times faster than hand sanding, weighs only 13 pounds and runs off light socket. Patented Belt principle gives smooth ripple-less finish. Write for interesting bulletin.

PORTER-CABLE MACHINE CO. Syracuse, N. Y.  
1704 No. Salina St.



### SPRAYIT ELECTRICALLY New Agitator Type

Revolutionizes paint spraying performance and results. Constant fluid agitation, instantaneous control of spray, many other new features. Hold 1-lb. gun only—put rotary compressor unit on floor or ladder. Price \$39.50 Write for complete details.

THE ELECTRIC SPRAYIT CO. Inc.  
203 East Colfax Avenue  
South Bend, Ind.

### SPORT BODIES FOR FORDS

at FACTORY PRICES

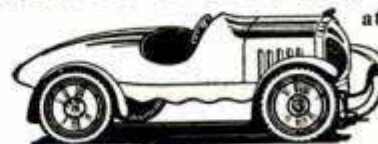

This Model in Grey Prime **\$38<sup>50</sup>**

Hi-compression heads, underslung parts, 3:1 gears, headlights, cowl lamps, etc. for Fords. Seat Covers for all cars.

SPORT FACTORIES, Dept. A-3, AURORA, ILL.



# PARKS

WOODWORKING MACHINES

Cabinet Shop  
Special No. 10

**\$290**

With Motor

You ought to have this handy Parks in your shop. Compact, complete machine designed like a big production outfit at 1/2 the cost. Floor space required only 42x72 in. Does any kind of cabinet and joinery work. Write for circular.

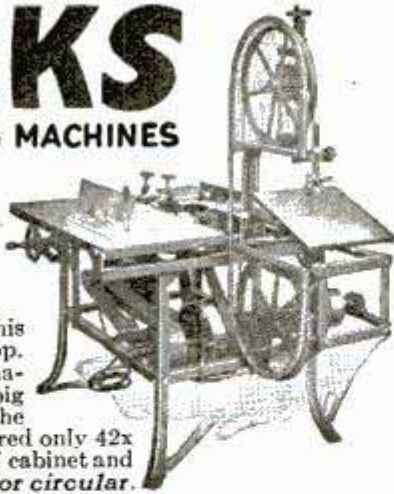

**The Parks Woodworking Machine Co.**

1500-40 Knowlton St.

Cincinnati, Ohio

Canadian Factory: 338 Notre Dame East, Montreal



## TOOL CHESTS OF QUALITY

for Machinists and Tool makers are shown in free catalog. Write to-day for a copy.

*H. Gerstner & Sons.*

463 Columbia St., Dayton, Ohio

## A Genuine Robbins & Myers



**1/4 H. P. Electric Motor**  
for 110 V., 60 Cycle light circuit at the low cost of \$9.50. A tool that will lighten your chores, connected to your lathe, grinder, pump, washer, etc. Always ready for service.

**ROBBINS & MYERS, Inc.**  
Department A, Springfield, Ohio

## The Handy Tool - Torit Torch "23"

Uses acetylene only from a Presto auto tank. Finest thing you ever saw for Radiator and Battery Repairing, Soldering, Light Brazing, Heating, etc. Complete with 4 tips, soldering copper, hose, connections. PRICE (except tank) **\$7.50**

**ST. PAUL WELDING & MFG. CO.**  
177 W. THIRD ST. ST. PAUL, MINN., U. S. A.



## PAYMENT PLAN

Buy Welding, Soldering and Lead Burning Outfits on payment plan.

Write for particulars.

Welding Outfits . . . \$25.00 to \$69.20

Lead Burning and Soldering Outfits . . . \$8.00 to \$25.00

Torches, Regulators and Gauges.

Welding Supplies—Paint Sprayers.

**THE SUPERIOR OXY-ACETYLENE MACHINE CO.**  
Box 285, Hamilton, Ohio

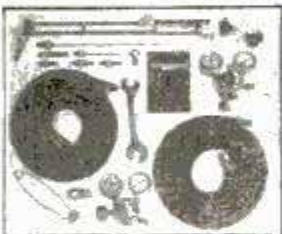

## OTTAWA LOG SAW



only **\$39**

GREATEST OFFER  
EVER MADE

PUTS THIS  
OTTAWA  
TO WORK FOR YOU!

**Make Money!** Wood is valuable. Saw 15 to 20 cords a day. Does more than 10 men. Ottawa easily operated by man or boy. Falls trees—saws limbs. Use 4-hp. engine for other work. **30 DAYS TRIAL.** Write today for **FREE** book. Shipped from factory or nearest of 10 branch houses.

**OTTAWA MFG. CO., 1741 -W Wood Street, Ottawa, Kansas**



No. 414  
\$30.00

# MORE VALUE from your DRILL DOLLARS

99% of all electric portable work . . . from light bench jobs and automotive valve grinding to heavy industrial drilling and cylinder honing . . . can be handled with the eight drills listed below.

In power output and staying qualities, these Millers Falls Electric Drills challenge every drill made.

In the larger sizes where every extra ounce means greater fatigue, they have been lightened without sacrifice of power. To the man on the job this means greater ease of handling . . . more work accomplished in a given time.

Ventilation in these Millers Falls Tools has been so perfected that they do not overheat.

For more value test before you invest. Write today for full information and catalog.

- |                         |                           |
|-------------------------|---------------------------|
| No. 678 3/8" Heavy Duty | No. 312 1/2" Standard     |
| No. 734 3/4" Heavy Duty | No. 516 1 1/8" Heavy Duty |
| No. 634 3/4" Standard   | No. 514 1/4" Heavy Duty   |
| No. 658 5/8" Heavy Duty | No. 414 1/4" Standard     |



## MILLERS FALLS COMPANY

Millers Falls, Massachusetts

New York: 28, Warren St.

Chicago: 9 S. Clinton St.

## MILLERS FALLS Electric Drills

A Complete Line from 1/4" Standard  
to 7/8" Heavy Duty



# CORNWELL

## forged Socket Wrenches

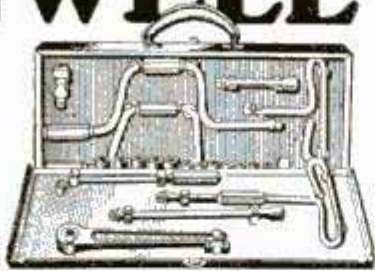

THE only wrenches of their kind now being made and sold. They are forged from our special formula Chrome Molybdenum Alloy, individually hardened and heat treated. Walls are very thin, permitting use in very close places. They are of amazing strength and durability. Sold in convenient kits or separately as required.



### There Is No Substitute for Cornwell Quality

The long record of CORNWELL tools for strength and durability, for utility and practicability, and for amazing performance under the severest difficulties has convinced tool users of their absolute quality. No other tools are like them. A trial order will convince you.

*This Catalog Sent-FREE*

The Cornwell Quality Tools Co.,  
Dept. H, Mogadore, Ohio.  
(Formerly at Cuyahoga Falls, Ohio)

Send me new illustrated catalog with prices on full line of CORNWELL Handmade Tools.

..... Where Employed  
Name.....  
Address.....  
City..... State.....



### HOLLAND PRINTS

Wonderful new way of binding kodak pictures. Keep a photographic record. Sample Holland print from your negative for 10c.  
FRANK SCOBIE, 43-H, SLEEPY EYE, MINN.

## A BIG MACHINE at LOW PRICE!

DOES 20 DISTINCT WOODWORKING OPERATIONS

TURN YOUR HOBBY  
INTO INCOME!

No trick at all with this amazingly low price Woodworker, which you may try, and pay for, on terms, to turn idle hours into profit. Does 20 wood-working operations. Ideal size, capacity for shop, home or the job. Economical to operate. The best buy in the market!

Just  
**\$25.00**  
BRINGS IT  
TO YOU  
**FREE TRIAL**



### COMES COMPLETELY EQUIPPED!

Comes complete with 8-in. Cross Cut, 8-in. Rip Saw; 12 in. Band Saw; Jointer, Lathe, Borer, Sander, Guides, Electric Motor. Investigate it!

**FREE**  
with Saw

60 Working Drawings  
of Items You  
Can Make

A. S. ALOE CO.  
1831 Olive St.,  
St. Louis, Mo.

Without obligation, send me details on the Woodworker, and the Free Trial and Easy Terms Plan.

SEND FOR FULL DETAILS!

NAME.....

ADDRESS.....

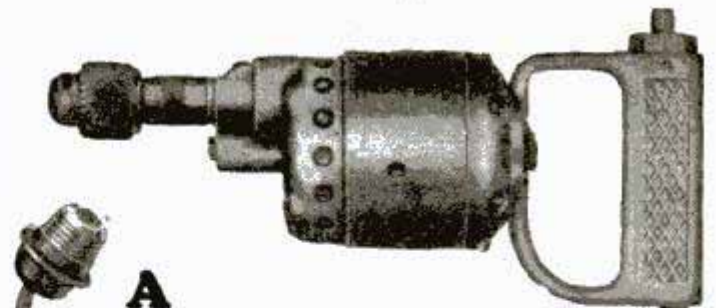

## A New Lightweight Electric Drill

Only  
**\$18.75**

Weights  
Only 4  
Pounds

—  
Universal  
Motor

—  
Write for  
our catalog  
showing  
complete line.

A sturdy, practical electric drill, fully guaranteed for one year. Specially designed for light and intermittent work. Weighs only 4 pounds. Built to use in even the tightest corners. Many of the large industrial plants are buying this drill by the dozen.

Uses direct or alternating current, and is supplied to you for 110 to 125 volts, 200 to 250 volts or 32 volts. Fitted with a special Jacobs Chuck. Bore up to 1/4". Stop and start switch in the handle. Comes complete with 10 feet of cord and socket. Price postpaid anywhere in the U.S.A.—\$18.75.

Send check or money order. If not satisfied return in 5 days and money will be gladly refunded. In ordering, be sure to specify voltage used.

**Jones Motrola Sales Co.**

Dept. 3, 370 Gerard Avenue,  
New York.

### BURN YOUR NAME ON TOOLS

## WITH THE ARKOGRAF

**PROTECT YOUR TOOLS FROM THEFT**  
Write with electricity any name or design on the hardest and finest tools and instruments, or any metal, like writing on paper with pen or pencil. **Complete Outfit \$3.50**—Prepaid Anywhere. Interesting illustrated circular free. Write today. Agents wanted.  
ARKOGRAF PEN CO., 1171 E. Stark St., Portland, Oregon



## STANDARD GARDEN TRACTOR

**Plows Seeds Cultivates Mows Hay and Lawns** A Powerful Tractor for Small Farms Gardeners, Florists, Nurseries, Fruit Growers and Poultrymen

**DOES 4 MEN'S WORK**  
Walking & Riding Equipment  
Free Catalog. Does Belt Work

**STANDARD ENGINE COMPANY**  
3221 Como Ave. Minneapolis, Minn.



**\$21.15**



9" swing, 25" centers, wt. 60 lbs. Biggest Lathe value yet. Send 6 cents for 48 page catalog on lathes, saws, etc. Largest line of small lathes in America.  
SYEPHER MFG. CO., Dept. D, TOLEDO, OHIO

## \$19.85 CONCRETE MIXER ON SKIDS

Or \$6.85 down and \$5 a month for three months. Improved for easy, speedy, quality work. Hand crank or engine. Order now or write for particulars.

**BADGER KWIK-MIX CO.,**  
1074 Cleveland Ave. Milwaukee, Wis.





## A NEW SIDE CUTTING SLIP JOINT PLIER



**75¢**

A thin pointed nose and narrow jaws make this plier extremely handy in awkward places. It is equipped with a keen, specially tempered side cutter and has a wobble-proof slip joint giving it great range and capacity. The LS 26 is a fine tool, heavily nicked, and fully guaranteed. 75¢ at hardware stores. Write for Crescent catalog.

No. LS 26

CRESCENT TOOL COMPANY  
JAMESTOWN, N. Y.

# CRESCENT and Smith & Hemenway TOOLS

## SALESMEN WANTED!

SELL COX HOLDFAST SCREW DRIVERS

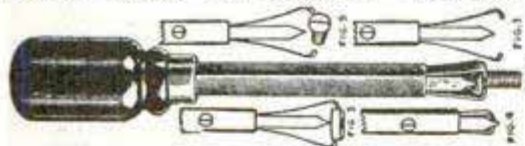

Sells on sight to mechanics for Auto, Radio and Electrical Work. Self Holding, Self Releasing.

Send 50c for sample and ask how to get Salesman's Outfit Free.  
S. J. COX Dept. F, FRANKLIN, PA.

## \$25 To \$50 Make \$25 to \$50 per day and be Your Own Boss! Per Day Drilling Wells!

Cash in on demand for good wells in every community! Any man with mechanical turn of mind can easily operate one of our drills, make big money, be independent, work the year 'round! A few hundred dollars starts you in this big paying business—pay balance out of earnings! Write for FREE CATALOG describing ARMSTRONG ALL STEEL WELL DRILLS—gasoline traction or non-traction models.

Write now—today—Armstrong Mfg. Co., 810 Chestnut St., Waterloo, Iowa.



## \$1500 WITHOUT MOTOR SCHROETERS No. 15 Motor Driven SCROLL SAW for Home or Small Shop

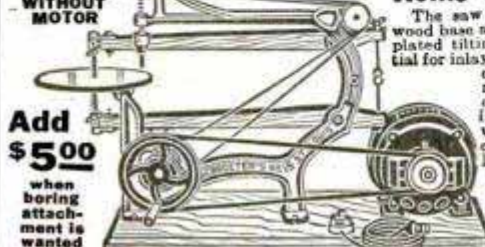

Add \$500 when boring attachment is wanted

For More Information Write for Our Scroll Saw and Tool Catalog  
SCHROETER BROS. HARDWARE CO.  
810 Washington Ave., ST. LOUIS, MO.

The saw is mounted on a neat wood base and has a 7 1/2-inch nickel plated tilting table which is essential for inlay work. The work which can be accomplished is marvelous. Has a range of work from the finest inlay up to 7/8-inch white pine. A practical machine for sawing Radio panels such as bakelite, sheet brass, hard rubber, bone, fibre, etc. Has 16-inch swing. Weight only 21 pounds without motor. We supply a catalog of 250 miniature scroll saw designs with each machine.

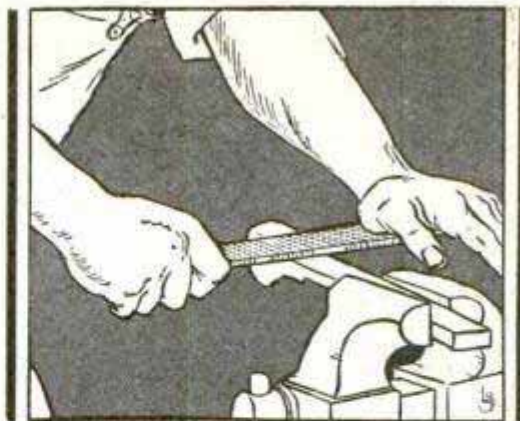

## SIMONDS FILES help you do a good job better

**N**O matter how much or how little you use files, you'll find a Simonds File a necessary member of your tool family.

Simonds Files are made from tough, edge-holding steel. The teeth are sharp, perfectly placed and uniform throughout the entire cutting surface. Expert workmanship plus wear-resisting steel make Simonds Files bite into the metal with snap and vigor — produce a surface unsurpassed for smoothness — retain good cutting qualities throughout an unusually long life.

Examine your tools today and make sure that your assortment of Simonds Files is complete. Good files make precious minutes count most. Tell your dealer you want Simonds Files.

"File Facts", a booklet that tells all about files, is yours free for the asking. May we send you a copy?

SAWS **FILES** KNIVES STEEL

# SIMONDS

SIMONDS SAW AND STEEL COMPANY

"The Saw Makers" FITCHBURG, MASS. Established 1832

Branch Offices and Service Shops in Principal Cities





# "Lava-clean" hands are clean!



Men—you who love to tinker—here's just the soap you need. Cleans quickly and thoroughly the toughest-looking pair of hands that ever fussed around a work bench. Makes more lather in 15 seconds than ordinary soap in 60, and even hard or cold water won't discourage it. Millions use it. "Good old Lava," they call it. Gets hands clean! Not just "surface clean," but clean 'way down deep. As easy on your hands as fur-lined gloves—because it's made from the finest of vegetable oils. All grocers sell it.

Full size cake of Lava Soap FREE!

Mail this coupon

Procter & Gamble (Dept. W-329)  
Cincinnati, Ohio

Please send me, FREE, a full size cake of LAVA, the hand soap that removes all the dirt and grease.

Name.....  
Street.....  
City.....  
State.....

## NEW VEST POCKET ADDING MACHINE



ADDS, SUBTRACTS, MULTIPLIES, DIVIDES  
Does work of \$300 machine. Guaranteed 5 years.  
NOT A TOY.  
Made of steel and indestructible. Million dollar capacity. Fits in pocket. Will not make mistakes. So simple child can operate it. Instructions furnished. Everybody should carry one for figuring.

**FREE TRIAL \$2.50**  
Total Cost

SEND NO MONEY—Just name and address. We will ship Calculator immediately. On delivery pay postman \$2.50 (Plus few cents Postage). (If outside U. S. send cash.) 10c additional in Leatherette Case. If not satisfied after 10 days trial you get your money back. THOUSANDS OF SATISFIED USERS.  
This is lowest priced practical calculator made. "Why pay more for inferior imitations?" Order from this ad.

Mail Coupon Today

BABY CALCULATOR SALES CO., (MANUFACTURERS)  
Dept. 41, P. O. Box 1118, CHICAGO, ILL., U. S. A.  
 I am enclosing \$2.50—send adding machine prepaid.  
 Send Adding Machine C. O. D. \$2.50 plus postage. (10c additional in Leatherette Case)

Name.....  
Address.....  
City..... State.....

**AGENTS** Write for big commission and territory proposition.

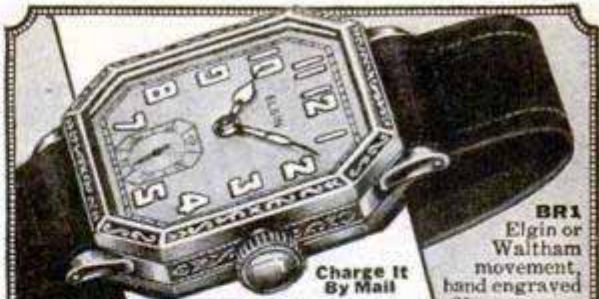

Charge It By Mail

SENT FOR \$1 NO C. O. D. TO PAY

BR1 Elgin or Waltham movement, hand engraved, 20 year guaranteed gold filled case. \$2.12 a month. **\$26.50**



FREE A FULL YEAR TO PAY

Wear this standard American watch and take a full year to pay—Send \$1 with order and this watch comes to you prepaid—no C. O. D. to pay on arrival. After examination and 10 day free trial, pay balance in 12 equal monthly payments. No interest. No extras. All transactions strictly confidential. You take no risk—satisfaction absolutely guaranteed or money back. Established 1895

10 DAYS FREE TRIAL

**ROYAL DIAMOND & WATCH CO.**

ADDRESS DEPT. 11-Q 170 BROADWAY, N.Y.

## Do Your Own Printing!

Cards, stationery, circulars, tags, labels, advertising, movie titles menus, book, etc. Save money.

### Print for Others BIG PROFITS

A big opportunity to turn your spare time into cash, or develop a full time business of your own at small cost. Easy rules given with every outfit. **Now and popular Raised Printing like Engraving** done with any of our presses. Complete Outfits \$8.85 up; Job presses \$11.29; Rotary \$149. Write for catalog 637 of presses and full information. **THE KELSEY CO., MERIDEN, CONN.**

## Walsh Garden Tractor and Power Mower



Plows, Seeds, Cultivates, Mows Lawns & Hay  
For Gardeners, Florists, Fruitmen—Walk or ride  
**SPECIAL FACTORY PRICE**  
Single & Twin Engine-Belt Jobs. Catalog Free.  
**WALSH TRACTOR CO.** Minneapolis, Minnesota  
3328 Talmage Av., S. E.

## Part-Time Men Get This Suit FREE

**Make \$45 a Week and up**  
Cash profits paid daily  
No question about it, any man can easily earn \$45 a week and up, just showing our wonderful outfit and taking orders for our high-grade tailoring. Never before such low prices and beautiful styles.

**Your Own Clothes FREE**

To introduce our unbeatable values, classy styles and perfect tailoring, we make this introductory free suit offer—something different, better, bigger, more liberal than any offer ever made. **New Style Outfit** of large real cloth samples—everything furnished FREE. Write today for free suit offer and big money-making plans.  
**PROGRESS TAILORING CO. Dept. C-216 CHICAGO**





# CAMPBELL'S

## INFRA-RED RAY LAMP



**Have You  
Some  
Troublesome  
Ailment?**

Infra-Red Rays relieve congestion or troubles causing aches and pains in the body. The Campbell Infra-Red Ray Lamp concentrates a mild beam of Infra-Red Rays upon any part of the body.

These rays penetrate deeply into the tissues. As they penetrate they create an active circulation of the blood. Most ailments are due to congestion—relieve the congestion and you relieve the ailment. Nature herself does the healing by active, normal blood circulation.

### Why Suffer Needless Pain?

If you or some friend have a troublesome ailment, a lamp like this is a blessing. May be used safely by anyone.

Relieve bronchial trouble, Neuralgia, Neuritis, Rheumatism, Lumbago, Flu and many other ailments.

### Tell Us Your Trouble

Get Our Book on Infra-Red Rays

Quotes leading authorities as well as users

Infra-Red Rays have brought wonderful results for others. Let us send you their letters. Write today for our book giving details.

**THE WILLIAM CAMPBELL COMPANY**  
1040 Union Avenue • Alliance, Ohio

## Introduce 40 Handy Things \$75 to \$125 Every Week! FOR THE KITCHEN



Even beginners made sensational earnings with our line of 40 fascinating "Handy Things" for the kitchen. New, novel, practical, and low priced. Women buy on sight. You show samples we furnish and walk off with a good profit. 100 per cent to 200 per cent CLEAR PROFIT. That's what you earn. And agents report that 9 out of 10 calls pay a profit. \$1 to \$3 an hour easy for part time workers. No experience required. Rush name today for details of amazing proposition and FREE SAMPLE OFFER. Good territories going fast, so write today.

**GENERAL PRODUCTS CO.**  
Dept. 7 Newark, N. J.

**FREE Samples to Agents**



### Match Your Coat and Vest With New Trousers. FREE SAMPLE

DON'T DISCARD YOUR OLD SUIT. Wear the coat and vest another year by getting new trousers to match. Tailored to your measure. With 90,000 patterns to select from we can match almost any pattern. Send vest or sample of cloth today, and we will submit FREE best match obtainable.

**AMERICAN MATCH PANTS CO.,**  
Dept. F. N. 6 W. Randolph St., Chicago, Ill.

## FLY THIS ARMY PURSUIT SHIP!

Light and fast, this one-foot model is a realistic copy of a single-seater military pursuit plane. Will rise from ground by own power and fly 60 ft. Can be used indoors or out. Has air service insignia on wings, in colors. Construction set includes ready-made aluminum propeller, shaft, rubber band motor, stream-line wood wheels, pre-cut balsa wing ribs and all other parts, with clear directions. Can be assembled in 3 hours by average 14-year old boy, without tools. Complete set, packed in unbreakable mailing tube, only 75c, postpaid in U. S. Send check or money order today (no stamps). Print address plainly. Satisfaction or money refunded.



**LOGAN TOY WORKS, 35 E. Gay St., COLUMBUS, O.**  
(We cannot make C. O. D. shipments. No retail catalogue issued)

# WURLITZER

Trade Mark Reg.  
THE WORLD'S LARGEST MUSIC HOUSE



**200 Years Ago** in the little Saxon town of Shoeneck lived Hans Adam Wurlitzer, Master Violin Maker. His shop was a gathering place for musicians of the time, for he was a true craftsman.

When he died his shop passed into the hands of his eldest son, and for seven generations, down to the present day, the descendants of Hans Adam Wurlitzer have carried on his work.

Today in every Wurlitzer instrument you will find a quality, a character, that could not come from mere excellence of manufacture. It is the heritage of these seven generations of music craftsmanship.

## Try any Wurlitzer Instrument in your Own Home

YOU may now have any Wurlitzer instrument for a generous free trial in your own home. Examine the instrument, show it to your friends, play it as much as you wish. No obligation to buy—no expense for the trial. We make this liberal offer because we want you to try for yourself these wonderful instruments, the result of 200 years' experience in musical instrument Building. Easy payments are arranged to suit your convenience. This is your opportunity to try a famous Wurlitzer instrument in your own home.



### Send for New Catalog

The greatest musical catalog ever published. Over 3,000 articles—every known instrument described and illustrated; many of them shown in full colors. Gives you lowest prices and all details of Free Trial, Easy Payment plan. All sent FREE—no obligation.

### Send this Coupon

**THE RUDOLPH WURLITZER CO., Dept. 1773**  
117 E. 4th St., Cincinnati

Send me absolutely free, your new illustrated catalog, with prices and description of every known musical instrument. Also tell me how I may try any instrument in my own home and pay for it in small monthly sums. No obligation.

Name.....

Address.....

City..... State.....

Instrument.....  
(State instrument in which you are interested)



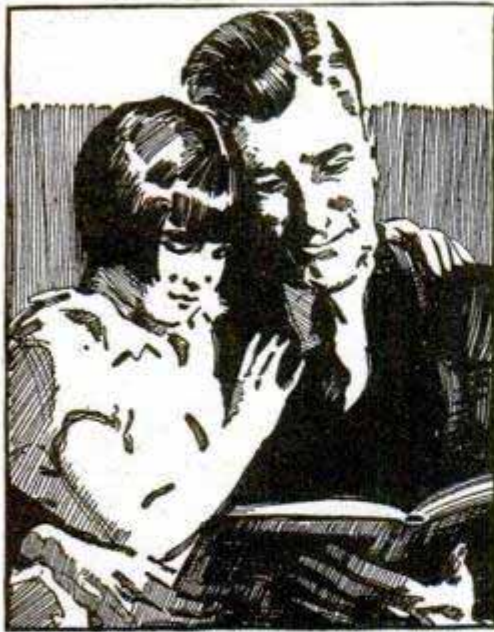

## Makes Life Sweeter

Too much to eat—too rich a diet—or too much smoking. Lots of things cause sour stomach, but one thing can correct it quickly. Phillips Milk of Magnesia will alkalize the acid. Take a spoonful of this pleasant preparation, and the system is soon sweetened.

Phillips is always ready to relieve distress from over-eating; to check all acidity; or neutralize nicotine. Remember this for your own comfort; for the sake of those around you. Endorsed by physicians, but they always say *Phillips*. Don't buy something else and expect the same results!

## PHILLIPS Milk of Magnesia

**RADIO** LATEST CATALOG OF NEWEST SETS AND KITS **FREE**  
Fresh from the press. Shows all the newest standard parts, sets, kits at big savings. Most complete line in America.  
Big discounts to set builders. Send name and address at once.  
**BARAWIK COMPANY** 103A Canal Sta., CHICAGO, ILL.

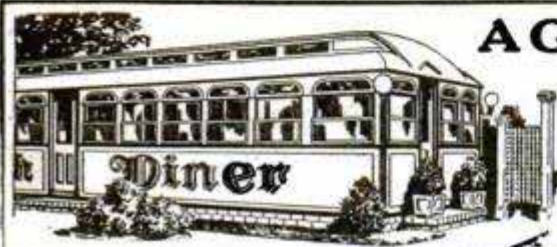

## A Good Profit—365 days in the year!

Rain or sunshine, hard times or good, summer or winter, is all the same to the man who owns a JERRY O'MAHONY LUNCH CAR. These attractive, business-getting Dining Cars have all the conveniences of the modern restaurant and cost far less. They can be shipped anywhere by rail. Business good every day of the year. Many owners are making \$10,000 a year profit and over.

Only small cash payment down. We help you finance and tell you how to start. Write today for our big illustrated catalog showing profits others are making.

**JERRY O'MAHONY, Inc.—Dining Car Manufacturers**  
983 W. Grand St. Elizabeth, New Jersey

## "Drive" the Waters this Year



**F**OR about half the cost of a low priced car you can "drive" the waters this year. It's more fun than flying, with a powerful, smooth running Evinrude at the stern of a sleek, trim runabout! Room for the whole family. Away from crowds, traffic.



Four twin-cylinder Evinrudes to choose from — 20, 14, 6, and 2½ H. P., with light weights of 95, 75, 58 and 44 lbs., respectively. A size for any craft from canoe to small cruiser. Waterproof ignition, easy starting made still easier, torpedo-streamline and many other new 1929 features fully described in new Evinrude Year Book.

Send for free copy today.

**EVINRUDE MOTOR COMPANY**  
2426 27th Street Milwaukee, Wis.



**DO YOU** WANT a new business profession of your own, with all the trade you can attend to? Then become a foot correctionist, and in a few weeks earn big income in service fees,—not medical nor chiropody—easy terms for home training, no further capital needed, no goods to buy, no agency. Address  
**Stephenson Laboratory, 1 Back Bay, Boston, Mass.**

**CLASS PINS 35¢**  
FREE CATALOG SHOWING 200 DESIGNS  
EITHER DESIGN SHOWN, SILVER PLATE 35¢ EA.; 12 OR MORE, \$3.50 DOZ.; STERLING SILVER OR GOLD PLATE, 50¢ EA.; 12 OR MORE, \$5.00 DOZ.; 1 OR 2 COLORS ENAMEL, ANY 3 LETTERS AND DATE.  
**BASTIAN BROS. CO., 893 BASTIAN BLDG. ROCHESTER, N. Y.**

**AGENTS 500% PROFIT**  
**GENUINE GOLD LEAF LETTERS**

**S** guaranteed to never tarnish. Anyone can put them on stores and office windows. Enormous demand, large profits. Paul Clark says: Smallest day \$28.70. R. L. Reel made \$920 in two months. Write today for free sample and liberal offer to general agents.  
**METALLIC LETTER CO. 433-B N. Clark St., CHICAGO**



# FREE New Book FACTORY PRICES

Save  $\frac{1}{3}$  to  $\frac{1}{2}$

New FREE book quotes **Reduced Factory Prices. Lower terms—year to pay.** Choice of 5 colors in New Porcelain Enamel Ranges. New Circulating Heaters—



Ranges \$37<sup>75</sup> up

\$33.75 up. 200 styles and sizes. Cash or easy terms. 24-hour shipments. 30-day FREE trial. 360-day test. Satisfaction guaranteed. 28 years in business. 750,000 customers. Write today for FREE book.

**KALAMAZOO STOVE CO.**  
391 Rochester Ave.  
Kalamazoo, Mich.

**"A Kalamazoo Direct to You"**  
Trade Mark Registered

## The International Motor Saw



does every sawing job from straight cutting to intricate scroll and design work; crosscuts, rips, miters, bevels, inside and outside jig sawing and scroll cutting. One saw instead of several.

Write for full description. Dept. S. The International Stamping Co., 400 N. Leavitt St., Chicago, Ill.

## Beautiful HOUSES \$900 and BUNGALOWS

CAN BE BUILT FOR AND UP

This and many others in my new book, Building Plans for Modern Homes, will save you hundreds of dollars. One of the most complete and comprehensive books of plans ever published by any architect. New edition just off the press. Nearly 600 floor plans and photographs of Colonial houses, bungalows, etc., costing from \$200 up; gives sizes and cost to build. Sent postpaid for \$3.00.



**FREDERICK H. GOWING**  
ARCHITECT  
101 Tremont St., BOSTON, MASS.

## Build a CLOCK for Pleasure or PROFIT

**FREE BOOK** shows how YOU can Make Fine Clocks Right at Home

Check full of Clock-Making and Money-Making ideas. Gives full details, descriptions, prices of movements and parts. Write NOW for your copy.

**T**HOUSANDS of men have built our Clocks. For their own use—or to sell at money-making prices. It's easy, fascinating. Only ordinary tools needed. We furnish plans, instructions, parts. Works all assembled, ready to install, as low as \$1.65; others with chimes at all prices. You make the case, or simply assemble knock-down parts. Cash-in on the demand for craftsman-built Mantel Clocks, Banjo Clocks, Grandfather's Clocks. Here's a hobby that PAYS—in pleasure, in ownership and in spare-time or full-time PROFITS!

Write for FREE Catalog and Special Blue Print Offer

**American Chime Clock Company**  
1670-C Ruffner St., Philadelphia, Pa.



SPIRIT OF TIME BANJO CLOCK

for sprains and bruises

relieve pain quickly

**Absorbine Jr.**

**R**UB in Absorbine, Jr. as quickly as you can. It will relieve the pain and reduce any inflammation which may have set in, and materially shorten the time of recovery. Its prompt use will prevent the stiffness and lameness usually following a sprain or bruise. If the skin has been broken, Absorbine, Jr. will reduce to a minimum any danger of infection. Use it full strength. It is cooling, soothing, and a reliable anti-septic. There are many uses for Absorbine, Jr. in the home and when traveling. Read "Timely Suggestions." Send for free Trial Bottle and "Timely Suggestions."

At All Druggists, \$1.25  
**W. F. YOUNG, INC.**  
Springfield, Mass.





# STRANGE INVENTION!

## PAYS YOU \$90 A WEEK

### NEW FIELD for AGENTS

**ABSOLUTELY NO COMPETITION**

Sell only device in existence that prevents kinking, snarling, and tangling of telephone and electric iron cords. Makes cord last longer.

**NOTHING IN WORLD LIKE NEVERKNOT**

Housewives and business men buying 1 to 50. Large companies equipping all phones. Sales of 10 to 150 with immense profit to salesmen not uncommon. Used on telephones of Federal Reserve Bank, General Electric Co., Mellon National Bank and many other big companies.

**EVERY NEVERKNOT SALESMAN IS GIVEN FREE A COMPLETE NEVERKNOT SWITCH PLUG CORD SET LIKE THE ONE SHOWN.**

**THIS NEW CORD SET PREVENTS SCORCHING - SAVES ELECTRICITY!**

Every new kind of ironing cord automatically coils itself out of the way, yet every inch of its seven feet is available for use. A new kind of switch plug prevents scorching and saves electric bills. **THIS SET IS A "GOLD MINE" FOR HOUSE-TO-HOUSE WORKERS FOR YOU HAVE NO COMPETITION.** Ladies buy instantly as they see it saves its own cost. Agents without experience are making \$90 to \$125 weekly with these new and different inventions so don't delay. Send now for free proposition.



**NEVERKNOT CO.**  
Dept. 3-V, 4503 Ravenswood, Chicago, Ill.

# Shoot the Best Gun

The NEW BENJAMIN is the finest air rifle ever made. Unlike all others. Has amazing accuracy—shoots hard and far. It's the original American genuine AIR operated rifle. One to six pump strokes compress air to any desired degree of power. Same force as in air drills and air hammers except you control the shooting force. Never loses force—no springs or levers to get out of order. Makes crack shots quickly, inexpensively. Gives years of delightful recreation with utmost safety. At your dealer's, or sent postpaid for \$5.00.

**Shoot 5 Days FREE**

We give you five days, ammunition supplied, to test the NEW BENJAMIN. If in this time you don't believe it to be the finest air rifle you've ever seen or used, and if you don't believe it is the one and only air rifle for you, return it, postpaid, and your money will be refunded at once.

# The NEW BENJAMIN AIR RIFLE

America's Original Air Rifle

**\$5** at your dealer's or sent postpaid direct from factory on FREE Trial as above if dealer does not handle it—write for our wonderful offer.

**Get This Book and Details FREE**

**BENJAMIN AIR RIFLE & MFG. CO.**  
645 N. Broadway, St. Louis, Mo.

Please send your amazing offer and free copy of "The Shooter's Art," telling how to become a crack shot, how to hold, aim, and handle guns and guide others in use of guns.

Name \_\_\_\_\_

Address \_\_\_\_\_





# SELL PAINT

## MAKE \$100 a Week

Be our agent in your locality. Take orders for Adams Paints and Liquid Roofing direct from factory, saving users 40%. You sell on credit, allow the freight and give a money-back guarantee. You can easily make \$100 weekly in advance.

**No Experience—No Investment**

We show you how and post you on everything you need to know about paint. You do not have to invest a penny and we even furnish your selling outfit and necessary samples FREE. No collecting either. You call on property and factory owners and just write the order and pocket your profit. We do the rest. Send today for details and free Sample Outfit.

**Adams Paint For Every Purpose**

House—Barn  
Liquid Roofing  
Enamels—Varnishes  
Industrial Paint  
Wall and Floor Paint

**THE ADAMS PAINT CO.**  
Dept. F3, 1906 West 80th St., Cleveland, Ohio

# AIRPLANE

12-inch scale model of Lindbergh's Spirit of St. Louis. Scientifically designed and very realistic. Rises from ground by own power and flies 30 ft. or more. Stays in air 8 to 10 seconds.

Easily built in 2 or 3 hours. No tools needed. Construction set, with all parts and full directions, postpaid in U.S., only 50c. (no stamps). Satisfaction or money back. Send today. **Mann & Benton, Box D, Chillicothe, O.**



# Catch Fish!

Eels, Mink, Muskrats with our new folding galvanized **STEEL WIRE TRAP.** Write for our **FREE TRAP OFFER** and Bargain Catalog. **\$1 Box** of our famous Fish Bait **FREE** to introduce our traps. **WALTON SUPPLY CO., 3502 JUNIATA AVE., ST. LOUIS, MO.**



# The Musical Sensation ACCORDEON

Played by Music Rolls

Without any knowledge of Music or Notes you play in a few minutes, perfect like an artist, latest hits, songs and dances. No study or practice. Nobody can see the arrangement. Musical Entertainers wanted everywhere, making easy money. Three models. Every instrument guaranteed. Interesting circular No. 1 and roll list mailed free.

**TREASURE SALES COMPANY, 1690 Boston Road, New York**



# \$50 and up Weekly

## Making Amazing Demonstration

Commission checks mailed every Saturday to our men. Work full or spare time making amazing demonstration that will save prospects thousands of dollars.

**Demonstrator Furnished**

We will furnish outfit for sensational demonstration. No investment for stock—no deliveries or collections. Every one a prospect. Show in homes, stores, garages, schools, offices, and to farmers, etc. Many of our men now making \$300 to \$600 a month. Write at once to

**FYR-FYTER COMPANY**  
90-P Fyr-Fyter Bldg., Dayton, Ohio

**IN ONE MINUTE**

Ten of these sensational demonstrations a day should pay you \$50 a week. No experience necessary—we show you how.







**THIS MODERN 6 ROOM HOME NOW ONLY \$1024**

**PAY ONLY \$15.65 Per Month**

Why not live in a modern new home of your own instead of in an old and shabby rented house that is costing you a fortune every year? You can build a new home on the **STERLING PLAN** and pay for it with your rent-money—as low as \$8.10 per month for a 6-room house. We even advance cash to help you build, if you own a well located city lot.

**Build Now and Save Money!**

We ship you any home you select, ready to erect—lumber cut to fit, **FREIGHT PAID TO YOUR STATION**. No high interest or financing charges. Lowest prices in the history of our company. Big discounts for cash. Send 25c in coin today for beautiful Color Book of Sterling Home Plans and select the home that you want us to ship you.



**International Mill & Timber Co.**  
934 S. Wenona Ave., Bay City, Mich.

**MAKE YOUR FORD Into The "LARK"**

**\$5.00 Red-I-Kut life size patterns Class—Snap**



Famous euro-fit **RED-I-KUT** life-size patterns and picture instructions show how you can easily convert your Ford into this **Fast, Saucy, Sport-Car** as thousands have done with easily obtained materials. No need to lay up the car. Rear seat folds, making 4-passenger car. Send 10c coin for actual body photo.

and new manual of other distinctive sport body patterns from \$5.50 up—**"RKO" Steel "Swing-Lo" fenders, Tops and Windshields. ORDER RIGHT NOW**  
**KUEMPEL COMPANY, 106 Kuempel Bldg., GUTTENBERG, IOWA**

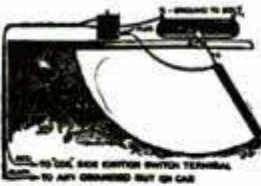

**SNOW—ICE—MIST VANISHES "SLEETOFF"** works inside automatically. Simply attached to your present windshield wiper.

**TEN DAYS' TRIAL** If your dealer does not carry "SLEETOFF," send us \$3.50. Try it ten days. If not satisfactory, return it to us, and we will refund the money.

Pat'd **WINDSHIELD WARMER**

**THE GREB COMPANY, 193 State Street, Boston, Mass.**

# The perfect boss



**SOME** men never seem to have any trouble in keeping stenographers. They're pipe smokers, too, but they've discovered Sir Walter Raleigh, the mildest, mellowest smoke that ever came out of the South. Stoke that strong old briar with Sir Walter Raleigh, men, and not even the sniffiest steno will object to it. By the way, we line the tin with gold foil to keep Sir Walter fresh and fragrant to the last pipeful.

**LIMITED OFFER** (for the United States only)  
If your favorite tobacconist does not carry Sir Walter Raleigh, send us his name and address. In return for this courtesy, we'll be delighted to send you without charge a full-size tin of this *milder* pipe mixture.  
Dept. 176, Brown and Williamson Tobacco Corporation, Louisville, Kentucky



# SIR WALTER RALEIGH

Who discovered how good a pipe can be

It's *milder*



## Easy with a PAN-AMERICAN

**EASY TO PLAY!** A few short weeks of practice and you'll play popular tunes on your true-toned Saxophone, Trumpet, Clarinet, or whatever instrument you choose.  
**EASY TO TRY!** FREE Trial on any PAN-AMERICAN.  
**EASY TO PAY FOR!** Pan-Americans are moderately priced. Sold on EASY TERMS.  
**EASY TO DO!** Write today for beautifully illustrated catalog.

**PAN-AMERICAN BAND INSTRUMENT & CASE CO.**  
303 Pan-American Building  
Elkhart, Indiana





# PATENT

## Protect Your Ideas

### Take the First Step Today

If you have a useful, practical, novel idea for any new article or for an improvement on an old one, you should communicate with a competent Registered Patent Attorney AT ONCE. Every year thousands of applications for patents are filed in the U. S. Patent Office. Frequently two or more applications are made for the same or substantially the same idea (even though the inventors may live in different sections of the country and be entirely unknown to one another). In such a case, the burden of proof rests upon the last application filed. Delays of even a few days in filing the application sometimes mean the loss of a patent. So lose no time. Get in touch with me at once by mailing the coupon on the opposite page.

### Prompt, Careful, Efficient Service

This large, experienced organization devotes its entire time and attention to patent and trade mark cases. Our offices are directly across the street from the U. S. Patent Office. We understand the technicalities of patent law. We know the rules and requirements of the Patent Office. We can proceed in the quickest, safest and best ways in preparing an application for a patent covering your idea. Our success has been built on the strength of careful, efficient, satisfactory service to inventors and trademark owners located in every state in the Union.

### NO CHARGE for Information On How to Proceed

The booklet shown here contains valuable information relating to patent procedure that every inventor should have. And with it I will also send you my "Record of Invention" form on which you can sketch your idea and establish its date before a witness. Such evidence may later prove valuable to you. Simply mail the coupon and I will send you the booklet, and the "Record of Invention" form, together with detailed information on how to proceed and the costs involved. Do this NOW. No need to lose a minute's time. The coupon will bring you complete information entirely without charge or obligation.



My Patent Law Offices  
Just Across  
Street From  
U.S. Pat. Office



Above is a view of my drafting and specification offices where a large staff of experienced experts are in my constant employ. All drawings and specifications are prepared under my personal supervision.

# NEWS

*Inventors  
Write for these*

## Free Books

### Strict Secrecy Preserved

All communications, sketches, drawings, etc., are held in strictest confidence in strong, steel, fireproof files, which are accessible only to authorized members of my staff. Feel free to write me fully and frankly. It is probable that I can help you. Highest references. But **FIRST**—clip the coupon and get my free book. Do **THAT** right now.

### Clarence A. O'Brien

*Registered Patent Attorney*

Member of Bar of: Supreme Court of the United States; Court of Appeals, District of Columbia; Supreme Court, District of Columbia; United States Court of Claims. Practice confined exclusively to Patents, Trade marks and Copyrights

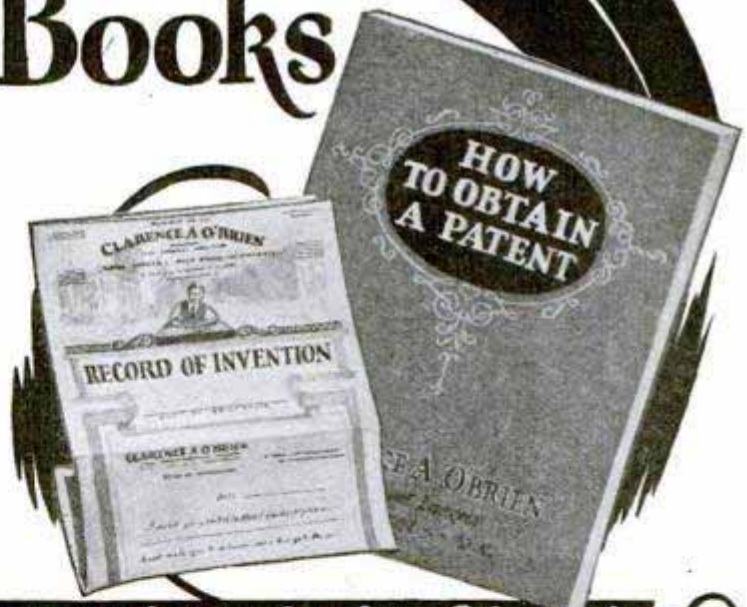

**Clip this Coupon and Mail it Now!**

**CLARENCE A. O'BRIEN, Registered Patent Attorney**

70-L Security Savings and  
Commercial Bank Bldg.,  
Washington, D. C.

OR

Suite 1106 Woolworth Bldg.,  
New York City

Please send me your free book, "How to Obtain a Patent," and your "Record of Invention" form without any cost or obligation on my part.

Name.....

Address.....

(Important—Write plainly and address office nearest you)



# PATENTS TRADE MARKS COPYRIGHTS

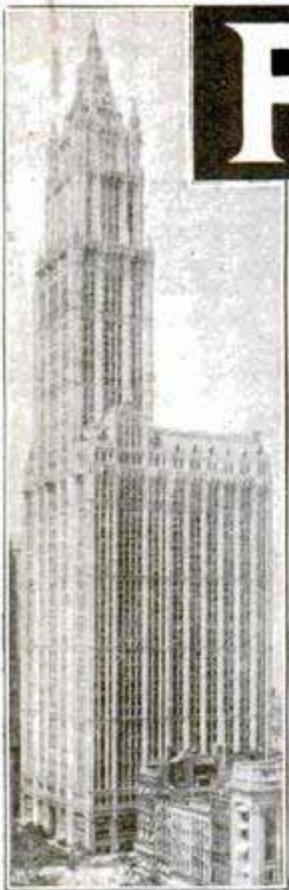

Our New York Office  
Suite 1007 Woolworth Bldg.



Our Philadelphia Office  
Suite 518-519 Liberty Bldg.



Our Washington Office, Victor Bldg.



**Have You An Idea?**  
**Our Offer:** FOR THE PROTECTION  
OF YOUR INVENTION

## YOUR FIRST STEP

The inventor should write for our blank form

### “RECORD of INVENTION”

This should be signed and witnessed and returned to us together with model or sketch and description of the invention for

### INSPECTION AND ADVICE

*No Charge for the Above Information*

### Our Five Books Mailed Free to Inventors

*Our Illustrated Guide BOOK*

### How to Obtain a Patent

Contains full instructions regarding U. S. Patents. Our Methods, Terms, and 100 Mechanical Movements illustrated and described.

### Our Trade Mark Book

Shows value and necessity of Trade Mark Protection. Information regarding *Trade Marks and unfair competition in trade.*

### Our Foreign Book

We have Direct Agencies in Foreign Countries, and secure Foreign Patents in shortest time and lowest cost.

### Progress of Invention

Description of World's Most Pressing Problems by Leading Scientists and Inventors.

*We Regard a Satisfied Client* as our best advertisement, and furnish anyone, upon request, lists of clients in any state for whom we have secured patents.

*Highest References—Prompt Service  
—Reasonable Terms*

## VICTOR J. EVANS & CO.

Patent Attorneys, Established in 1898

Main Offices: 789 9th St., N. W., Washington, D. C.

*Opposite U. S. Patent Office*



# DELAYS ARE DANGEROUS IN PATENT MATTERS

## IMPORTANT! To Avoid Delay!

YOU SHOULD HAVE YOUR CASE MADE SPECIAL IN OUR OFFICE to save correspondence, secure protection and early filing date in the Patent Office. To secure **special preparation** of your case send \$25.00 on account with model or sketch and description of invention.

**ACT NOW**—Often two or more inventors file applications for practically the same idea. In such cases the burden of proof rests upon the last application filed. Therefore, delays often cause the loss of a patent.



Our Chicago Office  
Suite 1110 Tacoma Building



MAIN OFFICE, VICTOR J. EVANS & CO.—VICTOR BUILDING, WASHINGTON, D. C.

Our Large, Comprehensive Organization has been established for 30 years and offers Prompt, Efficient and **Personal Service** by experienced Patent Lawyers and Draftsmen. Every case is in charge of a Specialist who has been selected for his knowledge and experience in certain lines of invention. Our Lawyers practice in all U. S. Courts and defend clients in suits involving Patents, Trademarks and Copyrights. **All Communications and Data** strictly Secret and Confidential. We shall be glad to answer any questions in regard to Patents, Trademarks or Copyrights without charge or obligation.



Our Pittsburgh Office  
Suite 514 Empire Building



Our San Francisco Office  
Suite 1010 Hobart Building

**FREE COUPON**      **VICTOR J. EVANS & CO.**  
**PATENT ATTORNEYS**      *Established in 1898*

|   |  |  |
|---|--|--|
| NEW YORK OFFICES<br>1007 Woolworth Bldg.      | CHICAGO OFFICES<br>1110 Tacoma Bldg.   |  |
| PHILADELPHIA OFFICES<br>518-519 Liberty Bldg. | PITTSBURGH OFFICES<br>514 Empire Bldg. | SAN FRANCISCO OFFICES<br>1010 Hobart Bldg. |

**MAIN OFFICES: 789-9th Street, N. W., WASHINGTON, D. C.**

Gentlemen: Please send me *Free of Charge* your books as described on preceding page.

Name \_\_\_\_\_

Address \_\_\_\_\_



# PATENTS

Booklet Free Highest References  
Promptness Assured Best Results

Send drawing or model for preliminary examination of Patent Office records.

## ALL BUSINESS GIVEN PROMPT AND PROPER ATTENTION

Listed Patent Lawyer in the latest editions of the Rand-McNally Directory of Bankers and Bonded Attorneys, published by Rand-McNally & Co., Chicago, Ill.; The Baggott & Ryall Directory of Guaranteed Attorneys, published by the Ryall Legal Directory Company, New York City; Flugel's List, published by the Legal Directory Publishing Co. of St. Louis, Mo.; the American Lawyers Annual, published in Cleveland, Ohio; Eyre's Law List Bush Terminal Building, New York City.

**WATSON E. COLEMAN,**  
REGISTERED PATENT LAWYER

Victor Building, 724 Ninth Street, N. W.  
**WASHINGTON, D. C.**

# PATENTS

## To the Man with an Idea

PATENTS Procured. Trade Marks Registered. —A comprehensive, experienced, prompt service for the protection and development of your ideas. Preliminary advice gladly furnished without charge. Booklet of information and form for disclosing idea free on request.

**IRVING L. McCATHRAN,** Patent Lawyer  
Formerly with and successor to **RICHARD B. OWEN**  
704 International Bldg., Washington, D. C.  
41-E Park Row, New York City

TRADE-MARKS  
REGISTERED

**LAME PEOPLE**



Old Way      OUR WAY

**Ideal Extension Shoe**  
for any person with one short limb. It costs less. No more unsightly cork soles, irons, etc. Worn with ready-made shoes. Write for booklet.

THE NATURAL WALK

**Robert M. Eisinger, 976 Lexington Ave., N. Y. C.**

## BLUE BOOK ON PATENTS

AND PRIORITY RECORD BLANK GRATIS  
**MONROE E. MILLER, PATENT LAWYER**  
411-2 Ouray Building, WASHINGTON, D. C.  
ELECTRICAL AND MECHANICAL EXPERT



# PATENTS

## TRADE-MARKS

*Don't Lose Your Rights  
To Patent Protection*

Before disclosing your invention to anyone send for blank form "EVIDENCE OF CONCEPTION" to be signed and witnessed.

**LANCASTER & ALLWINE**  
480 Ouray Bldg. WASHINGTON, D. C.  
*Originators of forms "Evidence of Conception."*



## GEARS ALL KINDS SMALL

The most accurate made and prices reasonable. We carry a complete line of gears in stock for immediate shipment. Can also quote on special gears of all kinds. Send us your inquiries. WRITE FOR CATALOGUE 10  
**CHICAGO STOCK GEAR WORKS**  
105-109 S. Jefferson St., CHICAGO

## PATENTS

Trade Marks, Copyrights, Patent Litigation Handbook with illustrations, 100 mechanical movements. Sent free on request.  
**ALBERT E. DIETERICH**  
formerly member Examining Corps U. S. Patent Office  
**REGISTERED**  
**PATENT LAWYER and SOLICITOR**  
621-A, Ouray Bldg.  
30 Years' Experience Washington, D. C.

# INVENTORS PROTECT YOUR IDEAS

Send for our Guide Book, **HOW TO GET A PATENT**, and Evidence of Invention Blank, sent Free on request. Tells our terms, methods, etc. Send model or sketch and description of your invention for **INSTRUCTIONS**. No charge for the above information.

**RANDOLPH & CO.**  
301 Victor Bldg., WASHINGTON, D. C.

NAME.....

STREET.....

CITY..... STATE.....



# PATENTS

TRADE-MARKS & DESIGNS  
FOREIGN PATENTS

**MUNN & CO.**  
PATENT ATTORNEYS

*Associated since 1846 with the Scientific American*

SCIENTIFIC AMERICAN BUILDING  
24 W. 40th St., New York City

SCIENTIFIC AMERICAN BUILDING  
Washington, D. C.

TOWER BUILDING  
Chicago, Ill.

VAN NUYS BUILDING  
Los Angeles, Cal.

HOBART BUILDING  
San Francisco, Cal.



Books and Information on Patents and Trade-Marks by Request.  
Associates in All Foreign Countries.



## PATENTS

Send us sketch or model for advice and exact cost of patent. Our book "How to Obtain a Patent" sent free. It tells how to apply for Patents, Trade Marks, Foreign Patents, Copyrights, etc.; gives information on Patent Procedure; tells what every inventor should know. Thousands of inventors, who are our clients, are our reference.

**CHANDLEE & CHANDLEE, 25 Years' Experience**  
410 Seventh St. Washington, D. C.



**This Needed Invention Paid**  
**\$135,000**

a year. Beverage manufacturers immediately adopted this simple crimped tin cap. This invention would have made you independently wealthy. Fortunes await inventors working along right lines. Concentrate on things that are NEEDED. Get Raymond Yates's new book

## "1000 NEEDED INVENTIONS"

Costs only \$1.25 and may lead to a big idea. Find out what industry needs and the public wants. That's where the money is! Mr. Yates's book tells you what these things are. Send no money. Just write postal. Pay mail man \$1.25 plus postage when book arrives. Your money back if you want it. This offer limited. Write now and get on the right track. (Outside U. S. \$1.45 cash with order.)

**BUREAU OF INVENTIVE SCIENCE**  
33 Wisner Building, ROCHESTER, N. Y.

## MASON, FENWICK & LAWRENCE PATENT LAWYERS

600 F St., N. W., Washington, D. C.

*Estb. over sixty years. Send sketches.*

Electrical and Chemical Inventions carefully handled. Practice before the U. S. Courts and the Patent Office. Prompt and careful service. WRITE US.

**TRADE MARKS REGISTERED**

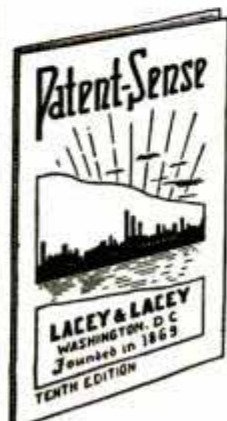

# Patents

Inventors who derive largest deserved profits know and heed certain simple but vital facts **BEFORE** applying for patents. Our book **PATENT SENSE** gives these facts. Sent **FREE**.

**LACEY & LACEY**

WASHINGTON, D. C.

**ESTABLISHED 1869**

.....  
**Lacey & Lacey, 646 F St., N. W. Washington, D. C.**  
Please send me your **FREE** book **PATENT-SENSE**.  
Name.....  
Address.....  
City.....  
State.....



# Taylor Ceebynite Compass



(Actual Size)

Price \$4.50

Visible at night without the aid of matches or flash light. The North and South points are prepared with a radioactive compound, permanently luminous and plainly seen in the dark. The dial is of floating design, the magnetic needle being attached to its under side. Jeweled center. Hunter-style case with automatic dial stop. A reliable, handsome compass that any man will be proud to own. Your sporting goods dealer has them, or if remote from a dealer, Ceebynite will be sent direct by us upon receipt of price, plus 5c postage. Send for free compass booklet.

## Taylor Instrument Companies

ROCHESTER, N. Y., U. S. A.

CANADIAN PLANT  
TYCOS BUILDING  
TORONTO

MANUFACTURING DISTRIBUTORS  
IN GREAT BRITAIN  
SHORT & MASON, LTD., LONDON

# Is Your Car..... A Gas Eater

## New Invention Increases Mileage on Auto Gas Eater from 13 1/2 to 34.6 Miles on a Gallon

An astonishing new device has been perfected that is amazing car owners everywhere. Goerzen reports increase from 13 1/2 to 34.6 miles on his Dodge. Thousands have been installed and users report 30-40 and more miles on a gallon of gas. In addition power is increased, instant starting and flashy pick-up is noticed and carbon formation disappears. Every car owner in the country needs this new invention. Its cost is so trivial it pays for itself in a few days' time, yet it will save hundreds of dollars for its owners in gasoline.



## \$100 a Week Territory Open

\$5.00 an hour for spare time. Men are needed in every locality to take care of the tremendous local demand. Sales ability is not required. Every car owner will buy on sight. **Ideal for spare time workers.**

**FREE** Offer enables our workers to obtain this marvelous Whirlwind gas saver for their own cars without cost. Quick action is necessary. Be the one in your locality to cash in on this device which every auto owner will buy. Send today for full particulars and free sample offer.

**Whirlwind Mfg. Co.,** 999 878 Third Street, MILWAUKEE, WISC.



NO ONE CAN BEAT

the enjoyment of building your own substantial and safe 20-mile SPEED boat, requires but little spare time. We furnish the materials machined ready to fasten. **\$29.75**

Also larger boats at corresponding attractive prices. **TRUSCOTT BOAT CO. - ST. JOSEPH, MICHIGAN**

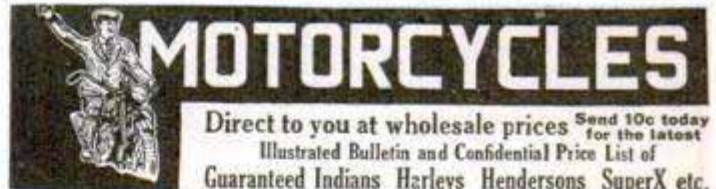

Direct to you at wholesale prices Send 10c today for the latest  
Illustrated Bulletin and Confidential Price List of  
Guaranteed Indians Harleys Hendersons SuperX etc.  
(Sold on easy terms if desired)

**CRANDALL CYCLE CO.** 826-28 State St. Springfield, Mass. Shipments to all parts of the world  
Motorcycles Since 1905

## 30 Days' Free Trial

New Models now ready for delivery direct from our factory. **ASTONISHING LOW PRICES AND TERMS.** Do not buy until you get them.

**RIDER AGENTS WANTED** to ride and exhibit sample. Make big money. Many models \$21.50 up. **Tires** Guaranteed \$1.50 each, wheels, lamps, horns, equipment at **very usual prices.** Send No Money. Write for our marvelous prices and terms on RANGER Bicycles.



**Mead CYCLE CO. Dept. F-109 CHICAGO**

# Going to Build Remodel or Repair?

**DON'T** think of building a new home or repairing an old one without a copy of our free woodwork catalog.

To those who contemplate building or remodeling, this book is a valuable work of reference. In it are found the latest ideas and most advanced styles for everything in millwork. It illustrates and describes windows and sash of all kinds, including porch and storm sash, doors, frames, mouldings, screens, porchwork, stairwork, hardwood flooring, interior finish, cabinet work—in fact, practically everything in manufactured millwork.

Every article in the book shows a low money-saving price direct to you.

### FREE ESTIMATES

Send us your lumber and millwork bills for a free estimate. Let us quote prices on your material and tell you the exact amount of freight. Then compare our prices with others. This service costs you nothing and places you under no obligation whatever.



**CHICAGO MILLWORK SUPPLY CO., 1444 W. 37th St., Chicago, Ill.**  
PLEASE SEND ME YOUR FREE BOOK

Name \_\_\_\_\_  
Town \_\_\_\_\_  
State \_\_\_\_\_  
Occupation \_\_\_\_\_

St. No. \_\_\_\_\_

**Book is Free**

# Get Into The Shoe Business Without Investment!



We start you. Inexperienced workers earn \$5,000 yearly with our direct-to-wearer plan. Easy to take orders. Just show the famous Tanners line of shoes and hosiery for Men, Women and Children. We tell how and where to sell. Patented measurement system insures perfect fit. Big facilities guarantee prompt deliveries. You collect your pay daily. We furnish \$40.00 out-of-pocket containing actual shoes and actual hosiery—a larger variety of styles and sizes than any store. Send for free book 'Getting Ahead' and full particulars. No obligation. Write now!



**Experience Unnecessary!**

**Tanners Shoe Manufacturing Co.**  
513 So. C Street Boston, Mass.



The  
"Ashton"  
6 Rooms,  
Bath



## BUY DIRECT FROM MILLS!

New! Plan-Cut homes have modern appointments, including oak floors, throughout, linen closets, medicine cases, phone nooks, clothes chutes, built-in features and colorful kitchens. Enjoy all year comfort: Warm quilt insulation saves one-fourth fuel cost. Plan-Cut homes are guaranteed 20 years. Matchless quality marks every detail. Check these: California Redwood or 100% Cedar shingles for siding; Yellow Pine framing and shiplapped sheathing, etc. Everything furnished according to specifications. No extras! Extraordinary savings. Material comes machine-sawed, specially notched, and ready

for exact fitting. No costly hand-sawing. Cuts labor 30% and lumber waste 18%. Actually eliminates 2940 hand-saw cuts. Meets local building codes.

Easy monthly payments, \$23 to \$90. Low interest, 6%. All you need is a lot and a little cash. If you help build, you may not need cash.

Build yourself and save \$2000 and up! Our easy-to-follow plans and instructions simplify erection.

Wholesale, mills-to-you prices. Write for facts.

Build  
Your Own  
**HOME**  
and Save

\$ 2,000 UP

Get Free  
INFORMATION  
and BOOK  
of  
100  
HOME  
PLANS!



Gordon-Van Tine Co.  
1312 Case Street,  
Davenport, Iowa  
Please send me Free Plan Book.  
I am interested in:

Homes Remodeling Garages

Name.....

Address.....

### Garages

Easy to \$87  
put up  
AND  
your own UP  
garage.



## Gordon-Van Tine

(Established 1865)

PLAN-CUT GUARANTEED HOMES

### Portable ELECTRIC Light Plant

110 Volt — Complete with all wiring, fixtures and lamps for seven rooms . . . \$147.50

for Farms, Camps and Summer Homes  
Install it yourself. Write for direct to you prices. Immediate delivery.

D. W. ONAN & SONS  
3 Royalston Ave., Minneapolis, Minn.



### "Interlox" MASTER SLIDE RULE

Speeds up all measuring. Slides in and out—no folding. Direct-reading for instant inside measurements, as well as outside. Any length, 2 to 8 ft., 20c lineal ft. If not at dealers, sent postpaid.



MASTER RULE MFG. CO., 813 E. 136th Street, NEW YORK  
Dealers and Agents: Write for attractive proposition.

### New Food Idea Pays Big Profits!

Men! Women! Investigate the wonderful NEW Brown Bobby GREASELESS Doughnut. Sells like wildfire! You can easily make \$50 week spare time; \$5000 to \$8000 year full time. Investment small! No experience needed. Write today for big special offer. Food Display Machine Corp., Dept. 1353, 500-510 N. Dearborn St., Chicago

**PATENTS** Write for FREE Instructions. Send Drawing or Model for Examination.  
**CARL MILLER, Patent Attorney**  
former member examining corps U. S. Patent Office  
260 McGill Building Washington, D. C.

## Build It with a Boice Workshop!

No matter what you want to build of wood, Boice-Crane can help you. He'll send you this heavy-duty Saw-Jointer-and-Lathe motorized workshop on easy monthly payments with an ironclad guarantee of satisfaction or money back.

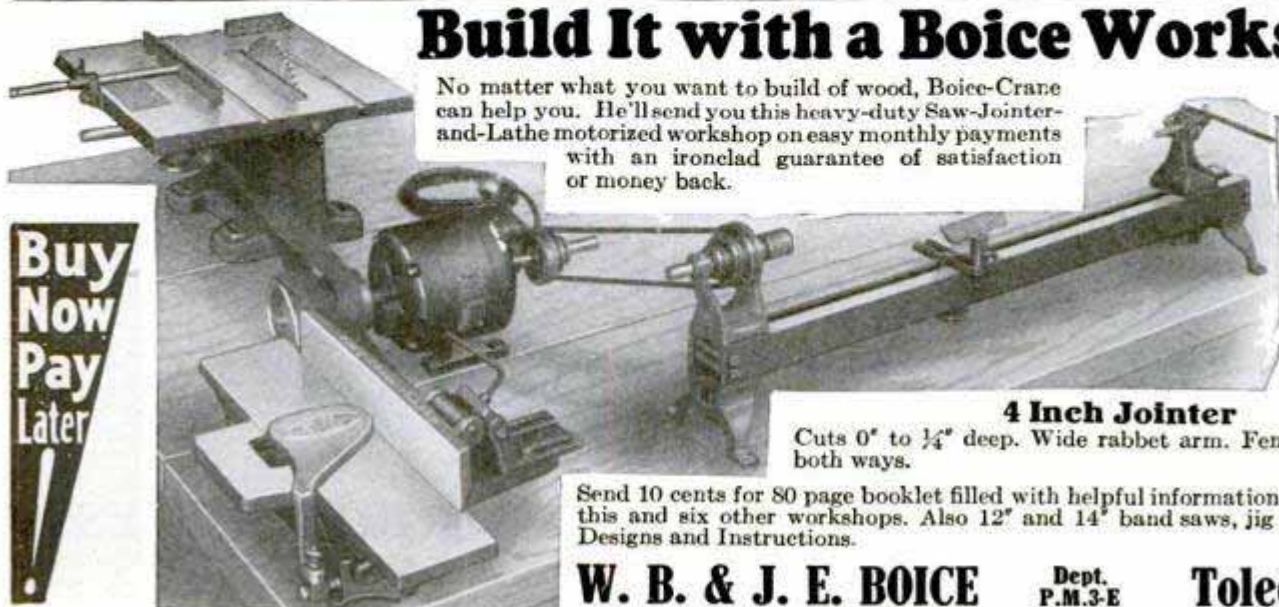

### Universal Handisaw

15"x17" tilting table. 9" saw cuts 2 1/2" stock.

### 7 Inch Lathe

Rigid bed, 3 speeds, 40" C. to C.

### 4 Inch Jointer

Cuts 0" to 1/4" deep. Wide rabbet arm. Fence tilts 45 deg. both ways.

Send 10 cents for 80 page booklet filled with helpful information and describing this and six other workshops. Also 12" and 14" band saws, jig saws, Books of Designs and Instructions.

**W. B. & J. E. BOICE**

Dept.  
P.M.3-E

**Toledo, Ohio**

Buy  
Now  
Pay  
Later  
!





# We win 85 times out of 100

Men find this new shaving creation so exactly what they seek, that 85% who try it buy it regularly thereafter.

## Make this 1-Week's Test FREE

GENTLEMEN: From a scratch beginning a few years ago, to top place in one of the highly competitive fields that men know, is the record of Palmolive Shaving Cream.

It was a hard job. Most of its users had to be won away from the habits of years in using rival preparations.

That is why we send 7-day tubes for free trial. 85% of those who try this creation, keep on using it. We believe you, no matter how firmly you hold to another preparation, will, after a trial, adopt it.

Will you not, in fairness to us both, accept a tube to try? 60 years of soap study stand behind its creation. 129 formulas were developed and discarded in perfecting it. It is different in five major ways from any other preparation you have ever used.

### These 5 advantages

- 1: Multiplies itself in lather 250 times.
- 2: Softens the beard in one minute.
- 3: Maintains its creamy fullness for 10 minutes on the face.
- 4: Strong bubbles hold the hairs erect for cutting.
- 5: Fine after-effects due to palm and olive oil content.

### Just send the coupon

Your present method may suit you well. But still there may be a better way. This test may mean much to you in comfort. Send the coupon before you forget

4282

## 7 SHAVES FREE

and a can of Palmolive After Shaving Tale  
Simply insert your name and address and mail to Dept. B-2023.

Palmolive, 595 Fifth Ave., New York City.

(Please print your name and address)

# Profits Buy \$9,000. Home!



"Your plant hasn't cost me a cent for repairs. Today I have a \$9,000 home, my own business property, well stocked, and nothing to worry about."

Arthur O. Wallace.

## BE YOUR OWN BOSS

What Wallace is doing you, too, can do. Tire Surgery Stations needed everywhere. Earn \$9,000—or more—per year. Own your own business. Be independent—your own boss. No experience necessary. I train you absolutely free. You can earn as you learn.

### WRITE FOR BIG FREE BOOK

Over 100,000,000 tires now in use. Tire Surgery Stations are flooded with work—working overtime filling the demand for guaranteed tire repair jobs. Be a big-pay man. Join the ranks of over 16,000 successful Haywood Men! A Tire Surgery Station is needed in your town NOW. Be the one to take advantage of this opportunity. Let me tell you how you, too, can become independent. Small capital. Big earnings. Write for my big free book "Steps To Success." Get complete details of the big money-making opportunity in Tire Surgery and how I train you free. Write TODAY.

**HAYWOOD TIRE  
EQUIPMENT CO.**  
J. A. Schreiber, Pres.  
2330-C Ogden Ave.  
Chicago, Ill.

**WE  
TRAIN  
YOU  
FREE**

**YOU  
can earn  
\$9,000.00  
a year  
with this  
Machine**



## BE Popular

Play a Conn band or orchestra instrument and you're welcome everywhere. Win pleasure and profit playing part or whole time. With a Conn you play tunes the very first day. Easy playing features and new instruction methods make it fun from the start.

**FREE TRIAL, Easy Payments** on any Conn. Write for literature, details. Name instrument. No obligation.

**C. G. CONN, Ltd.**  
2331 Conn Bldg. Elkhart, Ind.

**CONN**  
BAND  
INSTRUMENTS

## An Airport

### All your own!

WATCH the gleaming metal monoplane go taxiing out of its hangar—all three propellers spinning—then go "banking" round and round the field. Just like life! Can you think of any toy an up-to-date boy or girl can have more fun with? Both toys strongly built, all of steel. Plane has 15-in. wing spread. Long-running speed motor. Disc wheels, real rubber tires. Hangar 18 in. wide. Ask to see them at your toy dealer's. If he hasn't them in stock, order direct. We will ship parcel post paid, at above prices. Kingsbury Mfg. Co., 83C Myrtle St., Keene, N. H.



Hangar, \$3  
(West of Miss. \$3.30)  
Tri-Motor Plane \$2.00  
(West of Miss. \$2.20)  
Both Toys \$4.50  
(West of Miss. \$4.95)

## KINGSBURY Motor Driven TOYS

SEND 10c for unique Eraser. A Kingsbury Monoplane wheel with tire of eraser rubber. Toy Catalog Free.



# "Delta" Electric Handi-Shop

Patented Jan. 1, 1929

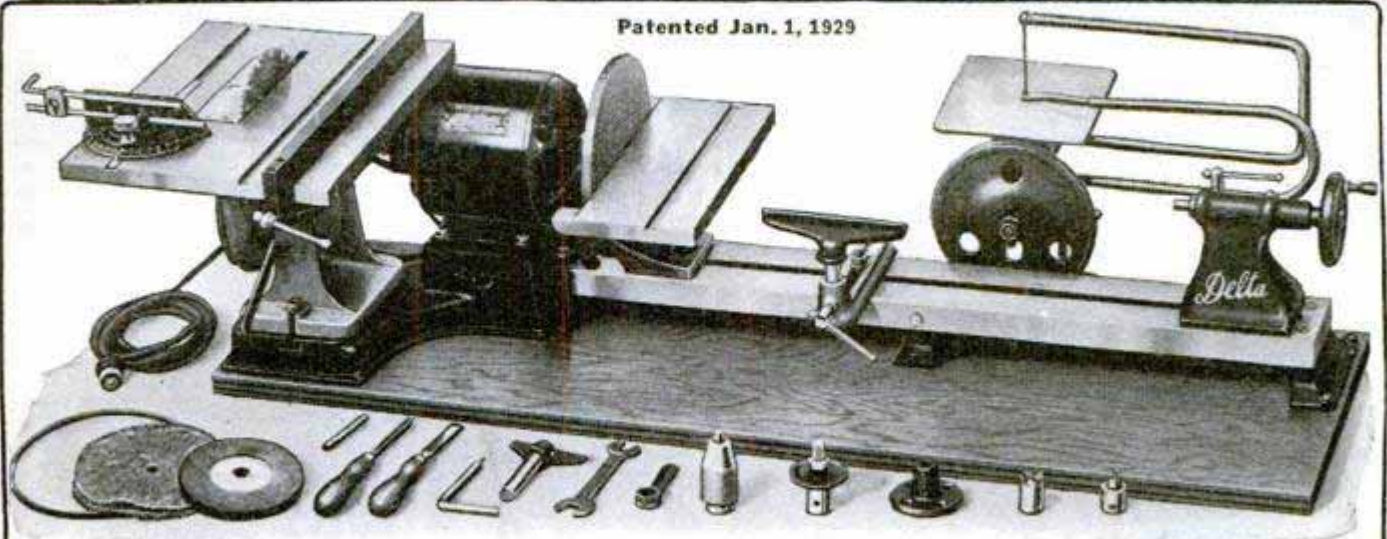

## Make the Things You Have Always Wanted To Make Quickly and Easily

with this complete, sturdy, efficient, man-sized motorized workshop. Takes all the drudgery out of wood craftsmanship. Enables you to save money on repair work—earn money in spare time. Includes all necessary equipment for Circular Sawing, Wood-turning, Jig Sawing, Sanding, Drilling, Grinding and Buffing.

### Blue Prints Included



### Many Basic Advantages

are found in the "Delta" Handi-Shop such as the powerful, constant-speed two-shaft Motor and the heavy U-shaped Lathe Bed, the improved Circular Saw, Jig Saw and Sanding Disc—each with special improved Tilting Table, and automatically-oiled bronze bearings. The new 1929 model has in addition a score of important improvements.

## 10 DAY TRIAL

Without obligation, you can see how this big, practical workshop stands up under actual working conditions.

### Easy Terms

Mail coupon now for FREE, beautifully illustrated literature giving complete description of New 1929 Model Delta Handi-Shop, and pictures of its many features. Also full details of 10-Day Trial Offer and your choice of three convenient methods of payment.

Dept. A. 39



The TWO-SHAFT motor is the practical motor for the workshop. Permits you to carry on two or three important operations at one time without continually dismantling set-up.



Heavy Triple Foundation U-Shaped Lathe Bed (not rods or rails) is guaranteed not to spring or chatter.

Delta Specialty Company, Dept. A. 39, 1661-67 Holton St., Milwaukee, Wis.

Please send FREE illustrated literature on new Delta Handi-Shop. Also full details of 10-Day Trial Offer and Easy Payment Plans.

Name.....

Address.....

**DELTA SPECIALTY CO.**  
1661-67 HOLTON ST. MILWAUKEE, WIS.

**MAIL THIS COUPON NOW!**

**EASY \$100 a Week**

**FUGO FIRE EXTINGUISHER**

Unusual opening for live agents in every locality. Make \$5000 or more a year—easily. Fugo—the instantaneous automatic fire extinguisher—is needed and wanted in every home, store, theatre, garage, shop, school, automobile, etc. Cheapest fire protection available today. Within reach of all.

**1 Qt. Size \$5.00    2 Qt. Size \$7.50**

Recharged in a jiffy

Amazing 30-second demonstration clinches sale—each one sold sells others. Territory going fast. Write at once for wonderful proposition that will make you big money.

**THE NATIONAL FORMETAL CO.**  
6535 Metta Ave., N. E.    Cleveland, Ohio

**AGENTS \$20 A DAY**

Ten-in-one Furniture Puzzle. A real money-maker if there ever was one. Sells any time of the year. A children's puzzle that grown-ups are just crazy about. Many salesmen cleaning up on this new number. Marked to sell for \$1.00 each. Our price to you

**\$15.00 per gross**    F. O. B. Los Angeles

Cash with order. Sample dozen, prepaid anywhere \$2.50. Sample block, prepaid 50c. Made of California Redwood. Size 6x3x3. Weight 8 oz.

**AXELROD SPECIALTY CO.**  
Dept. P. 501 Southwest Bldg., 130 S. Broadway, Los Angeles





ACTUAL SIZE

## BURGESS SNAP LITE FLASHLIGHT

The Vest-Pocket Flashlight

(Size: Height  $2\frac{3}{4}$ " ; Width  $1\frac{3}{8}$ " ; Depth  $\frac{1}{16}$ " )

A caseless flashlight that is durable and practical—dainty and exquisite. Lasts an amazingly long time. Silvery, sparkling color designs: red, blue, green, brown, black.

This amazing innovation in flashlights will be indispensable to you, once you are accustomed to its wonderful convenience. In your pocket or purse, under your pillow, in the garage and basement . . . you will find scores of uses for this handy little miniature flashlight.

Its long life is due, partially, to Chrome—the preservative which guards power when the battery is not in use and which is a patented feature of all Burgess batteries: radio, ignition and flashlight.

**BURGESS BATTERY COMPANY**  
General Sales Office: Chicago  
Mfrs. of Radio, Ignition and Flashlight Batteries

**Sold in These Stores:**

**DRUG;  
HARDWARE;  
ELECTRICAL;  
AUTOMOTIVE;  
DEPARTMENT;  
and others.**

**Go to the Nearest One  
and Ask for It**

# One Year To Pay

**No. 310—\$61**  
**\$2 Down—\$1.25 Week**

7, fine quality, well matched, genuine blue-white diamonds full of sparkling brilliance are set in a SOLID PLATINUM disk. They are set so expertly that even at a short distance they resemble a blazing solitaire worth \$600. 2 emeralds or sapphires (specify) set in sides of the gorgeously engraved 18 Kt. solid white gold mounting add to the beauty of this magnificent ladies' ring.

**18 KT.**

**SEND NO MONEY** When you get the ring, pay only \$2.00 to the postman. If you keep it, pay only \$1.25 a week for one whole year. All credit dealings kept strictly confidential—No credit orders accepted from persons under 20 years of age.

We are an old **Money Back** firm of diamond importers. **GUARANTEE** You take no risk. If you are not satisfied that the ring is the biggest bargain you ever got, return it and we will refund every cent that you paid.

**PRICE CUT TO \$61.00—WORTH \$100.00** You can now buy this gorgeous ring at the wholesale price. Compare it with similar rings at \$100. We guarantee it to stand any test or comparison. Greatest bargain offered by any Diamond Importer. We allow 8% annual increase in exchange for a larger diamond ring.

**Write for FREE Illustrated Catalog** It brings our large Jewelry Store right into your home. Gives weights, grades and complete description so you can buy diamonds like an expert. Gives you information that other jewelers dare not tell.

*Genuine Blue-White Diamonds as low as \$197.00 a Carat.*

AGENTS WANTED—EARN \$100 WEEK. Write for details.

**STERLING DIAMOND & WATCH CO. INC.**  
DIAMOND IMPORTERS—\$1,000,000 STOCK—ESTABLISHED 1879  
1540 BROADWAY DEPT. 2591 NEW YORK

## A \$100<sup>00</sup> SHIP MODEL FOR \$4<sup>98</sup>



Build the historic Santa Maria, LaPinta or the Mayflower. We send you C. O. D. the parts cut to fit, ready to assemble for \$4.98, plus a few cents postage. No tools needed except a small hammer.

Parts for model of Constitution sent C. O. D. for \$6.98, plus postage.

Write for illustrated catalogue

MINIATURE SHIP MODELS INC.—P, 3216 BARING STREET, PHILA., PENNA.

## Cut the Family Barber Bills



### Belle City Home Electric Hair Clipper

Anyone can trim or bob hair, shorten bangs, clip neck or underarms in a shape almost impossible with hand clippers or shears. Operates on direct and alternating current. Will not clog or cut the skin, and cuts as cleanly as a razor. Thousands in use. Rigidly guaranteed.

**Fits Any Light Socket**

**TEN DAYS' FREE TRIAL**

If your hardware or electrical dealer can't supply you, write for interesting booklet, or order from this ad. Send no money—pay postman \$8.75. Return it in ten days if not satisfactory. State whether 110, 220 or 32 volt current is used.

Dealers and Representatives Wanted

Belle City Appliance Co., 1022 12th St., Racine, Wis.





# This Man's Income is \$700<sup>00</sup> A Month *and it's* GETTING BIGGER

*You can get into  
his profession—*

**CLARKE**  
FlorKraftsmanship  
*—and Earn  
as Much!*

**I**F you are earning less than \$25.00 a day at your present job, this message is for you. It's a plain statement of the facts about FlorKraftsmanship—facts that have made thousands of men financially independent—that can raise your income to from \$500 to \$1000 a month.

Clarke believes in talking straight. Let's leave out the bunk. Read every word here,—it's the record of what men are actually doing today, and what they get paid for it, as Clarke FlorKraftsmen.

**No Schooling—  
No Tuition**

You don't have to go to school to become a Clarke FlorKraftsman. Go into this work right from your present job—whether you're a clerk in an office, a mechanic or a carpenter; whether you are 25 years old or 50 years old.

There's no tuition for you to pay. A day's work teaches you to surface new floors smooth as glass or to sand off old varnished floors so they look like new. One day's practice—that's all. The Clarke does the work—your job is as easy as running a vacuum cleaner.

**OVER 1000  
Popular Mechanics  
Readers are now  
FlorKraftsmen**

Among Popular Mechanics readers are over one thousand men who

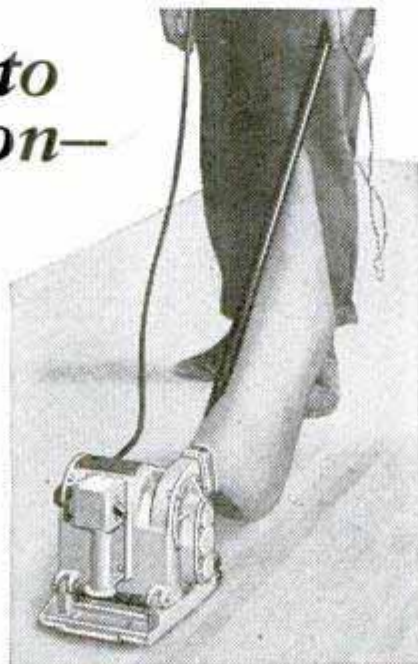

have already grasped this opportunity. Clarke FlorKraftsmanship has raised their pay till they're making from \$25 to \$75 a day. And they're busy all the time.

The same opportunity that brought success to them is offered to you in this advertisement. Stop and think what this big pay will mean. A better car—a home of your own—financial independence! No boss who can fire you! A business of your own.

**\$25 to \$75 a Day**

With the Clarke Vacuum Portable Sander you can do the work of eight men sanding floors the old back-breaking way. 800 to 2000 square feet of new floor in 8 hours is the speed at which the Clarke works. The price paid for sanding new floors is 2 to 5 cents a square foot.

Then on refinishing old varnished floors, the Clarke sands 300 to 1000 square feet a day—without the use of varnish re-

**CLARKE SANDING  
MACHINE CO.**

Dept. T-22

3831 Cortland St., Chicago, Ill.

*Originators and, for 12 years, Manu-  
facturers of Portable Sand-  
ing Machines.*

*Read what  
others are  
Earning*

A. E. Sweeney, Alturas, Calif., says: "I have had the machine almost a week and want to say it has paid me \$76.00. That is doing pretty well, I call it—two months payment in one week."

mover. You get 7 to 15 cents a foot on this work. Think what these prices mean! There's no material for you to buy except a little sandpaper. Your income is nearly 100 per cent *velvet*.

**Full Facts FREE**

Remember you don't need to be a carpenter or a painter to use the Clarke Sander. Men just like you are making these big incomes with it. They've read these ads in Popular Mechanics just like you are reading this one now. They've written for the facts and gone into the business just as you can.

Get the facts. Every day's delay is money out of your pocket. Write direct to Clarke, using the coupon placed here for your convenience. No cost to you to find out what others are doing in this business. You're under no obligation. Tear out this coupon and mail it today.



**CLARKE SANDING MACHINE  
COMPANY,**  
Dept. T-22, 3831 Cortland St.,  
Chicago, Ill.

Tell me, without obligation, how I can make \$25 to \$75 a day as a FlorKraftsman.

Name.....

Address.....

City.....State.....





**"Play" WITH YOUR BOY**

Keep step with your boy—make him feel you are his pal—stimulate his ambition and develop his musical talent by playing duets with him. He likes to do the things you do. Your "company" and help will boost him over the rough spots and prevent discouragement at critical times.

Help your boy to learn to play a

**BUESCHER**

**True-Tone Saxophone**

In only a few weeks he'll be playing the popular airs with you and having loads of fun. Then come the classical pieces. Beautiful duets that will thrill him—the kind pianists practice years to play—operatic scores and familiarity with the real Music Masters will all be accomplished. Social opportunities are always before the boy or girl who can play a Buescher and it makes it possible to earn money on the side if desired.

**Easy to Play—Easy to Pay**

Besides being easy to play, we make it easy to pay for a Buescher Saxophone. A small amount down and a little each month if preferred.

Only a Buescher gives you these extra features: Snap-on Pads, greatest improvement, easy to replace, no cementing—Patented Automatic Octave Key—perfect Scale Accuracy—convenient key arrangement.

**6 Days' Trial** on any Buescher Saxophone, Cornet, Trumpet, Trombone or other instrument. Fill out and mail coupon for full information. Mention instrument in which you are interested.

**BUESCHER BAND INSTRUMENT CO.**  
2741 Buescher Block ELKHART, IND.

BUESCHER BAND INSTRUMENT CO., (521)  
2741 Buescher Block, Elkhart, Ind.

Gentlemen: Without obligating me in any way please send me your free literature.

I am interested in the following instrument.....

Name.....

Address.....

## New—Revolutionary! ...World's Most Compact Outboard

THIS new Super Elto motor measures, folded, only 22 inches by 11 inches by 11 inches — weighs only 38 pounds — develops liberal 3 horsepower. Rugged Elto construction throughout. Easiest starting of all outboard motors. Famous Elto Battery ignition.

### It Folds!

Just a few turns on a single nut unlocks sturdy hinge (patent applied for) on shaft housing—permits lower housing to be snapped back under muffler — instantly — as simple as closing a pocket knife. Write for details on this and other Super Elto models. Elto Outboard Motor Co., Mason St., Dept. AA, Milwaukee.



**Super Elto Lightweight**

**I Pay \$18 a Day**

New proposition offers steady employment and chance to pocket \$18 cash every day. No experience needed. Simply demonstrate and take orders for new Comer Raincoats in your locality. You risk nothing. Keep present job and try in spare time. Smith, spare time worker, made \$14 in 2 hours. No investment. Sample outfit free. Write today.

COMER MFG. CO.

Dept. W-5140

DAYTON, OHIO

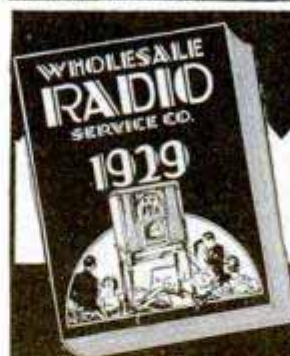

**GET THIS  
BIG 1929  
RADIO  
CATALOG  
FREE!**

WHOLESALE PRICES on nationally-known merchandise! Biggest discounts on standard equipment. TREMENDOUS SAVINGS. Everything shown in our newest 1929 Catalog Guide—just out! Nothing to compare with it. Immediate personal service on all your orders.

**SPECIAL PROPOSITION FOR DEALERS AND AGENTS ON LAFAYETTE ALL-ELECTRIC RADIO RECEIVERS**

Dealers and Agents—Write for this book of money-saving bargains, showing confidential price lists and special proposition on the famous Lafayette All-Electric Radio Receivers. ABSOLUTELY FREE. But you must act at once as supply is limited. Print name and address in coupon. Mail TO-DAY!

Mail to WHOLESALE RADIO SERVICE CO., Dept. 305, 6 Church Street, New York City.

Name

Address

Town

State



## POINTING THE WAY TO FINANCIAL INDEPENDENCE

An amazing investment opportunity for those with a little money and some spare time.

The ownership of a chain of International Ticket Scales on location in drug and cigar stores and other places, constitutes what is to all intents and purposes a real investment, yielding a handsome return.

You put out to work for you 50 or 100 or 1000 highly developed mechanical workers. There is chain store safety in that each hundred scales have a hundred different locations. There are chain store profits in that the average profit per scale is multiplied by the number of scales in your chain. Unlike the chain store, you have no payroll. Scales neither eat nor sleep. They take no days off. Day and night they work and serve you, smiling at interested passers-by, holding their coats while they step on inviting platforms, and then give them, printed on a neat ticket, their weight and fate for a small copper penny. They earn and earn and earn while you sleep or play.

Chains of International Ticket Scales should earn 40% to 50% of their cost annually. Purchased on the deferred payment plan, the scales should readily pay for themselves out of profit, and show in addition, a return of 25% on the down payment until paid for in two years.

Not only is this business profitable and safe, but it is easy and simple. There is little to learn, and little to do. An evening or two a week will care for the average chain of scales. The necessity for mechanical knowledge or the knowledge of scales

To Chain Store Executives: An International Ticket Printing Scale in each of your stores will add a substantial amount to your net profits. For full information, write the Chain Store Manager of the International Ticket Scale Corp., 17 E. 45th St., New York, N. Y.

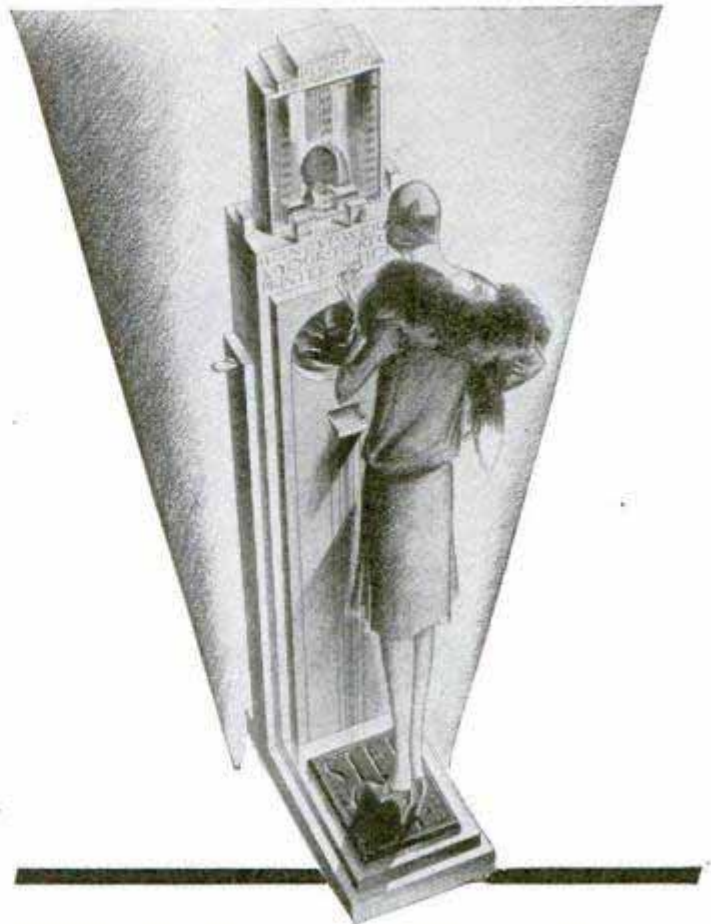

has been eliminated by our provision for a national service organization with service men in every city and town of importance in the United States.

The owner of a chain of International Ticket Scales operates under an unusual franchise plan, and is furnished with every possible co-operation. We have prepared a booklet which tells the full story concerning the profit possibilities in a chain of International Ticket Scales. It tells step by step how a chain of these scales may be acquired and operated. It tells how you, if you have the necessary qualifications, can with the greatest ease, assure your financial future. It is a booklet for those with a little money and some spare time; for the capitalist; for the individual or group who can control capital.

Write for it today. The coupon below is for your convenience.

International Ticket Scale Corporation, Dept. 103,  
17 E. 45th St., New York, N. Y.

# International

TICKET SCALE CORP., Department 103,  
17 East 45th Street, New York, N. Y.

Please send me your proposition.

Name \_\_\_\_\_

Address \_\_\_\_\_





## FLIES STRAIGHT UP!

SEE THIS HELICOPTER—75 feet high, coming down in a parachute! The boys below have just sent it up and are waiting to catch it when it comes down.

### PARACHUTE OPENS AUTOMATICALLY

Wind it up—let 'er go—straight up, 50 to 75 feet or more, then, when it starts down, and not before, the parachute opens automatically, permitting the model to float gently to the ground, thus protecting it from the fall. Get the thrill of a vertical flight and a parachute jump, all in one craft!

### LATEST INVENTION IN MODEL AIRCRAFT

"Spirit of Zenith" is a scientific achievement recently invented by a former U. S. expert aviation mechanic who made a special study of aeronautics in America and Europe during the World War. If you are of an inventive turn of mind it may inspire you to develop a new idea to meet the urgent demands of aviation. Think of the ease with which General Nobile and his men could have been rescued from the Arctic wastes, and how Commander Byrd could make a landing at the South Pole, with a perfected helicopter of a larger type! Its advantages in warfare are too numerous to mention. This model was first devised by the inventor for the amusement of his own son. It is now causing a sensation everywhere it is seen.

### GUARANTEED TO FLY

Made of aluminum, "Spirit of Zenith" has two 14-inch propellers and a large silk parachute. It will last a long time when properly handled, and is guaranteed to fly when directions are followed. You will have more thrills with it than with many model aircrafts costing from \$5.00 to \$10.00.

### ALTITUDE TOURNAMENTS

Boys have a lot of fun in seeing who can fly their crafts the highest. This is going to be a big year for helicopters. Altitude tournaments are getting popular in many places. It takes practice to make the best altitude score, so get yours now. Be the first to get one in your neighborhood.

For younger boys, under 12 years of age, we recommend that Dad fly it and let the boys catch it when it comes down.

### LIMITED OFFER—ONLY \$1.00

This offer positively expires March 30, 1929. It will pay you to get a "Spirit of Zenith" now and save the difference. This is a regular \$3.00 model which we are offering for a limited time at this special price to help introduce it. If you will get one of these, learn to fly it real well and show it to your friends, we will appreciate your order.

-----USE THIS COUPON FOR SPECIAL OFFER-----

Unique Model Aircraft Co.,  
Dept. H, 5725 Oram St., Dallas, Texas.

Gentlemen: Enclosed find money order (or check) for \$1.00, for which rush me a "Spirit of Zenith," with full directions for flying.

Name.....

Address.....

City..... State.....

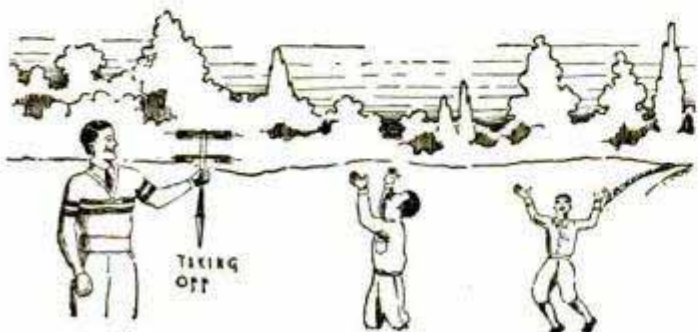

## THE LATEST DEVELOPMENT UP-TO-DATE 12" BAND SAW

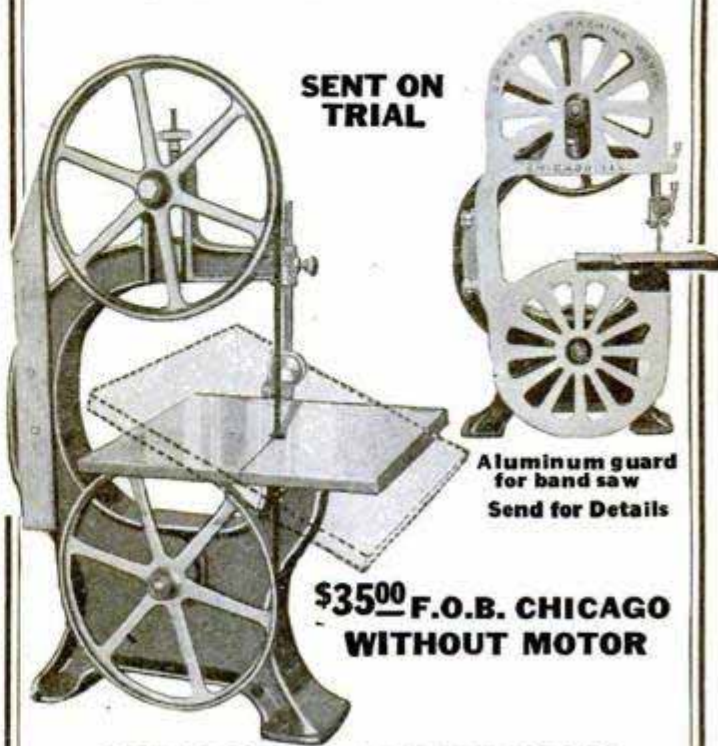

SENT ON  
TRIAL

Aluminum guard  
for band saw  
Send for Details

**\$35.00 F.O.B. CHICAGO  
WITHOUT MOTOR**

### FOR EVERY HANDY MAN

This 12" Band Saw is positively the latest thing in design and construction and is exactly the tool for which every he-man mechanic has an absolute need. It is made of one solid casting, shafts are hardened and ground. All wearing surfaces are likewise hardened. This machine is built for real work and will stand up under the wear and tear of a Home Workshop or factory. It has a 10½"x14" tilting table giving an angle of 45 degrees.

We challenge anybody to produce, on the retail market, a product so finished and perfected at the price of \$35.00. Send for details and complete description. Do it now!

Write Now to Department 31

**UP-TO-DATE MACHINE WORKS  
2915 SO. WABASH AVE., CHICAGO, ILL.**

## Remarkable Metal Tile Offers Big Money

Beautiful tiled bathrooms and kitchens are now within the reach of all. Chromite, the astonishing tile wall covering, slashes all previous costs to one-third. Has all the glow, beauty, lustre and permanence of clay tile. Greeted by exclamations of surprise and praise wherever shown. The sensation of the building material industry. No other product like Chromite ever offered before through direct selling. Homes, stores, institutions are eager buyers. A big money-making opportunity for a live, aggressive salesman. Write today for Free sales plan.

**CHROMITE COMPANY**  
228 N. LaSalle St., Dept. PM-3 CHICAGO

Write  
Now!



**Looks Like Clay Tile  
COSTS 1/3 AS MUCH**

## FREE

This handsome selling kit of actual samples is given Free to men who qualify as Chromite representatives.



# A Successful Method of Drugless Gland Stimulation *Has Been Found*

A pioneer scientist . . . in the field that has recently achieved discoveries of world wide importance . . . now offers an amazing new treatment for men past forty. Already fifty thousand men have used this treatment . . . victims of prostate trouble . . . bladder sufferers . . . victims of other symptoms common to men past forty. Not a medicine, vibrator or violet ray. Remarkably easy to secure for a no-risk trial in your own home.



**A** NEW type of treatment is now being used by physicians, specialists and health institutions in all parts of the world for those torturous symptoms so common to men past a certain age.

A noted sanitarium has advised a wonderful new appliance—the discovery of an Ohio scientist—for home use.

This revolutionary treatment is simple and easy to use, harmless and convenient. Fifty thousand men have used it. While going to the direct region of the trouble, it also acts as a general tonic for the whole body. Unlike certain drugs, it has no harmful effects on the heart or other vital organs. Men 90 years old have used it successfully.

Thousands of users say they feel 10 and 20 years younger. Many tell of having avoided a painful gland operation. Score upon score tell of relief from the painful conditions that reach to every part of the body when the prostate gland goes wrong—often when all other methods had failed. Millions of men suffer with prostate disorder without knowing it. Your chances are 6 out of 10 of having prostate disorder if you are past a certain middle age, say medical authorities. Many wrongly attribute their suffering to disordered kidneys or bladder.

Are you aging too soon—getting up 5 to 10 times at night . . . is vitality ebbing steadily away? Are you on the down grade, half living, blue, nervous, subject to chronic fatigue, constipation? Weakness in back, legs or feet? You should not delay a minute in finding out full details of this remarkable discovery—so easy to use in your own home, so remarkable in its results.

You incur absolutely no obligation by mailing the coupon now. It will bring you full information including an interesting illustrated free book. The edition of this vitally interesting little book is limited so mail the coupon at once to be sure of getting a copy.

**W. J. KIRK, President**  
2115 Morris Ave. Steubenville, Ohio

If you live West of the Rockies, mail your inquiry to  
The Electro Thermal Co.  
303 Van Nuys Building, Dept. 21-R  
**LOS ANGELES, CALIF.**

**W. J. Kirk, President,**  
2115 Morris Ave., Steubenville, Ohio.

Please mail at once a **FREE** copy of the booklet, "Why Many Men Are Old at 40," and all details about the new treatment. I'm not obligated in any way.

Name.....  
Address.....  
City.....State.....

**SAVE 1/2**  
on plumbing, heating, hardware, paint, roofing and millwork supplies. Large quantity buying enables us to offer Grade "A" merchandise at great savings. Send today for free catalog—over 120 pages of enormous bargains.

**STANLEY PLUMBING SUPPLY CO., Inc.**  
400 N. 12th St. Philadelphia, Pa.

## Own This Better H & A Saw Table



A sturdy, powerful, large capacity machine that will handle wide material. Accurate, speedy, reasonably priced. Use it for ripping, cross-cutting, mitering, grooving, rabbeting or dadoing. Equipped with tilting fence for bevel sawing; 1/2 or 3/4 H. P. motor; ball bearing spindle. Write for catalog of wood-working tools.

**HESTON & ANDERSON, 603 Market St., Fairfield, Iowa**





## JAPANESE ROSE BUSHES

### The Wonder of the World

Japanese Rose Bushes bloom all the year round. Just think of it. Six weeks after planting the seed, the plants will be in full bloom. It may not seem possible, but we positively guarantee it to be so. They will bloom every ten weeks, Summer or Winter, and when three years old the bush will be a mass of roses, bearing from five hundred to a thousand roses on each bush. The flowers are in three shades—white, pink, and crimson. The plants will do well both in and out doors. We guarantee at least three bushes to grow from each packet of seed. Price, 10c packet, 3 pkts. for 25c postpaid.

### Chinese Fragrant Tree Fern



Just introduced; noted for its rapid growth. An exceptionally pretty ornamental plant. Foliage rich dark green. Forms grand pyramidal bushes about 5 feet high. Branches very desirable for decorative purposes, wreaths, etc. Seeds 15c pkt., 3 for 40c.

### Weather Plant



NATURE'S WEATHER PROPHECY By mysterious changes that take place, this remarkable plant accurately forecasts the weather many hours in advance. Will grow anywhere all the year around. An interesting house plant. Bears large, fragrant, pink, butterfly shape flowers. Seeds, 15c packet, 3 for 40c, postpaid

## GROUND ALMONDS

Amazingly Prolific—Easily Grown From Seed The Ground Almond has a flavor that is MOST EXCELLENT, resembling the cocoanut. The meat is snow white, covered with a shell or skin of brown color. It grows close to the surface and anything from 200 to 300 Almonds may be expected from a single nut. There is no trouble whatever in growing anywhere and in any kind of soil. May be planted any time, and in eight or ten weeks from time of planting you will have an ENORMOUS CROP of the MOST DELICIOUS ALMONDS YOU EVER TASTED. Seeds 15c Pkt.



### Perfume Plant

Blooms only at night, giving forth the most delightful scented fragrance for quite a distance. Causes much comment. For house or garden. Also valuable because of rare perfume made from it. SEEDS, 10c pkt., 3 for 25c.

### Calabash or Pipe Gourds

A luxuriant and rapid growing climber; thrives anywhere. Produces the ornamental gourds from which the famous African calabash pipes are made. Grow this interesting vine and make your own. Seeds, with instructions, 15c pkt., 3 for 40c.

## MAMMOTH PEANUTS

Peanuts can be easily cultivated. Their culture is very simple and exceedingly interesting. Mammoth Peanuts grow to an astonishing size. It is a good producer, very prolific, and the giant nuts have a thick, heavily ribbed protecting shell. The plant is very attractive, the leaves being of odd shape and a handsome green shade, tinted through the center with white. You will derive much pleasure cultivating this interesting species. Seeds 15c pkt., 3 pkts. for 40c.

### Musk Plant

A universally admired favorite for house, flower garden or greenhouse. A very fine house plant. Lives for years. Is of the sweet scented variety, giving forth much fragrance. Also valuable on account of the perfume that can be made from it. Seeds 15c pkt., 3 for 40c.

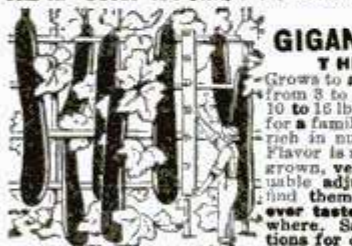

### Japanese Climbing Cucumber

Unusually strong and vigorous growing vine. Attains twice the size of ordinary varieties. Grows readily on fences, poles, trellises, etc. One hill will keep an entire family supplied all summer. Seeds 15c packet, 3 for 40c, postpaid.

### GIGANTIC BUTTER BEANS

THE NW EDIBLE VEGETABLE WONDER Grows to an astonishing size, the Beans measuring from 3 to 6 feet long, and weighing anything from 10 to 15 lbs. and even more. One Bean is sufficient for a family for several meals. Very palatable and rich in nutritious material. The delicate Buttery Flavor is much appreciated. The Vines are easily grown, very prolific, and a most welcome and valuable adjunct to your garden. Try them; you will find them the most delicious vegetable you have ever tasted. Imported direct. Unobtainable elsewhere. Sample package of Seeds with full directions for cultivating and cooking. 25c, postpaid.

### Yard Long Bean

Produces enormous crop of long, slender, round pods, of excellent quality for snap beans. Pods grow from 2 to 3 feet in length. Very tender and fine flavor. The Vines are rampant growers; an interesting curiosity. Seeds 15c pkt., 3 for 40c.

Kudzu Vine Most rapid growing vine known. Will grow 20 feet in one week. Luxuriant foliage, lovely purple flowers, very fragrant. Nothing to equal it for shade purposes and quick growth. Seeds 15c packet, 3 for 40c.

## THE REMARKABLE FIREFLY PLANT



A Vine that Blooms at Night Fills the Atmosphere with Fragrant Aroma One of the most rapid growing vines known. Under favorable conditions this vine has been known to grow OVER 25 FEET IN A SINGLE WEEK. In a very short space of time indeed the Vine has climbed to a great height, and is covered with IMMENSE FLOWERS, from 5 to 7 inches in diameter. It is, indeed, a great novelty for, unlike other plants, the flowers OPEN IN THE EVENING, and remain open until about noon the following day. In dull weather they will remain open all day. It is a most INTERESTING SIGHT to watch the opening and closing of the flowers as the clouds appear and retire. As the flowers open they give forth the most DELICIOUS AROMA and the whole atmosphere around is full of scented fragrance. It is always the object of favorable comment, and much curiosity is aroused by people passing at night time as to the cause of the charming aroma, frequently stopping in an endeavor to satisfy their curiosity. PRICE, 19 CENTS packet, two packets for 35 CENTS, POSTPAID. JOHNSON SMITH & CO.

### The Great Wunderberry

A luscious berry that may be grown and ripened from seed in any soil or climate in 3 months. The flavor is fine and unsurpassed for eating raw, cooked, canned or preserved in any form. The fruit is blue-black in color, and tastes like a luscious, rich blueberry. One bush will produce an enormous amount of fruit, yielding great masses of rich fruit all Summer and Fall. Packet, 10c, 3 pkts. for 25c, postpaid.

### Bush Musk Melon

A vineless Musk Melon, grows in bushes, and thus can be cultivated in the smallest garden. The fruit is of the popular "Jenny Lind" type, but larger, averaging 5 inches in diameter. The flesh is very deep, edible almost to the rind and is colored light green, flushed with a tinge toward the center. The quality is superb, lusciously sweet and juicy. Packet of seeds, with full directions for culture, 15 cents, 3 packets for 40 cents, postpaid.

### The Great Umbrella Palm

A Graceful House or Conservatory Plant The Japanese Umbrella Palm is a semi-aquatic plant. It is easily grown from seed either in a bowl of water or in very damp soil. Probably the most usual, as well as the most interesting method, is to cultivate the plant in a bowl or jardiniere filled with water, with two or three inches of good garden soil at the bottom. The seeds soon commence to germinate, and the plant shoots up stems two to three feet high and rapidly assumes a most pretty palm-like appearance, as shown in the engraving. The tops of the stems are surmounted by a whorl of umbrella-shaped leaves, of a waxy appearance. We will send a package of this seed, with full instructions for culture, for only 15c or three packets for 40c postpaid.



### Butterfly's Own Bush

This plant is a veritable refuge or haven for butterflies, and it attracts all the most beautiful species of butterflies to the neighborhood. Bees, too, are very fond of it. It is a pretty plant bearing perfectly double flowers, ranging from white to rich crimson, deep red and pink lilac and other delicate shades. Packet 10 cents, 3 for 25 cents postpaid.

## FAMOUS MEXICAN FIREFLY PLANT

Beautiful hedge plant, grows 2 to 2 1/2 feet high and resembling a closely clipped evergreen. The globe-shaped bushes are close and compact, and of pleasing light green color. May be grown singly or in the form of a hedge or background. In early autumn the whole bush becomes carmine or blood red, hence the name of Mexican Fire Plant, or "Burning Bush" as it is sometimes called. Selected Seeds, 10c

## Asparagus Sprengeri

The best plant for hanging baskets. Masses of rich, gleaming foliage droop in a very graceful manner. The foliage when cut for decorative purposes will last for weeks in water. The seed pods are very pretty red berries adding to its beauty. Packet, 25c, 3 pkts. for 65c postpaid

## TREE OF HEAVEN

This splendid ornamental tree is a native of China, and is called the Tree of Heaven, on account of its great beauty. Very hardy, thrives in any soil, no matter how poor, and grows from 6 to 10 feet high from seed the first summer. The leaves are from 5 to 6 feet in any length, giving it a grand appearance. Nothing outside the tropics can rival it for lawn decoration. Large panicles of bloom, followed in season by great clusters of colored seed pods, make the tree a real thing of beauty. Packet, 15c; 3 packets 40c

### CROWN OF THORNS

A very curious clover-like plant, can be cultivated indoors or outdoors, the three red blotches on the leaves representing the three wounds of Christ. Has curious thorny seed ball; if loosened at tip the hull is found to consist of a long prickly-edged band wound spirally around the seed cluster, giving the plant its name. Seeds 15c packet, 3 for 40c.

### "Wong-Bok" Chinese Cabbage

Novelty from China and should be grown in every garden. Seems to be a cross between Celery and Cos Lettuce. Flavor is more mild than any other cabbage. Can be served on the table and eaten raw or cooked like cabbage, spinach or lettuce or made into salad. Grows very rapidly, easy to cultivate. You can create quite a sensation by cultivating this remarkable novelty. Seeds, 15c packet, 3 pkts. for 40c.

## SURPRISE FLOWER GARDEN

Over Hundred Varieties of Mixed Flower Seeds MANY RARE AND CURIOUS NOVELTIES An Abundance of Flowers Assured Throughout the Season A mixture of easily grown annuals that bloom very soon after sowing the seed; others vary in their time of blooming. Those who cannot give the constant care necessary for finely arranged flower beds will be delighted with the Surprise Wild Flower Garden. Will prove a continual surprise and pleasure, as new varieties and the old garden favorites flower successively throughout the season. There are over a hundred varieties of seeds. Many of the plants may be taken inside as house plants and will bloom during the winter. Fine for children, also teachers for school gardens. Packet, 15 cents, three packets for 40 cents, postpaid. J. S. & CO.



# Making Real Money!

## \$4.00 to \$6.00 an hour

You can do it too with the **IDEAL** Lawnmower Sharpener

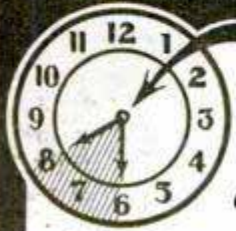

A days pay ~  
for  
2 hours work!

### And That's What You Can Do!

Herman Barber, 1505 E. Carter Ave., Ashland, Ky., writes: "I have sharpened to date 459 mowers, receiving \$988.30. These were sharpened in evenings and in spare time. I have seen other machines, but this is the most perfect one I have seen yet."— And hundreds of others are cashing in with this efficient machine. **OUR FREE BOOK TELLS YOU HOW**—It tells how others have made themselves a business of their own—built permanent businesses on spare time work which has helped to buy the extras for the home, etc., that everyone wants. Send for this book—It's Free.

**Use Your Spare Time** If you work at a trade, put an Ideal in your basement and earn \$4.00 to \$6.00 an hour evenings and Saturday afternoons. E. W. McCormick, Saginaw, Mich., writes: "Five years ago I bought an Ideal Sharpener on which I have ground over 5,000 mowers. In the last few weeks I worked at my trade, machinist, full time 9 hours a day. I also ground 97 mowers which netted me \$114.10 clear gain."

**A Nice All Year Business** S. E. Raup, 1312 N. Cameron St., Harrisburg, Pa., writes: "I have been using two Ideal and one Peerless grinders for four years with fine success and have been able to build up a nice all-year business. At present I am employing one man and a boy to help me."

**Same Customers Each Year**— D. N. Wood, Winchester, Ky., writes: "This is the third year I have been using your machine and I have built up a nice repeat trade. Evidently the work is satisfactory or I would not get the same customers each year; also each one generally sends a new one."

**Profits Year After Year** C. S. Coburn, Little Rock, Ark., writes that his "Ideal" Sharpener earned enough in 18 months to pay for itself and \$1857 worth of additional machinery.

Zeno Brandon, Middletown, Ohio, writes: "I have made \$820.70 in 55 days with my 'Ideal'. Have made as high as \$38.70 in one day."

W. F. Kendt, Buffalo, writes: "I have sharpened 994 lawnmowers last season and the receipts were nearly \$2100—not bad for a side line."

### Hundreds of Dull Mowers Waiting For You

to sharpen them right in your locality—and no town is too small. William G. Mercier, 178 E. Mohawk St., Oswego, N. Y., writes: "We have our shop on a truck and we travel all over the county." W. W. Dresser, Sanford, Florida, writes: "I live five miles out of town so have no rent to pay. Collect and deliver mowers. Get \$2.00 or better. Buy up old mowers and repair same and therefore make from \$4.00 to \$10.00 on same, which counts up in a season. Am well pleased with the machine."

**Here Is Your Chance** Send for the book. "Let George Say It"—It's the proof of what we advertise. We also show you the best ways to get the mowers to sharpen.

**THE FATE-ROOT-HEATH CO.**  
Dept. M. Plymouth, Ohio, U. S. A.

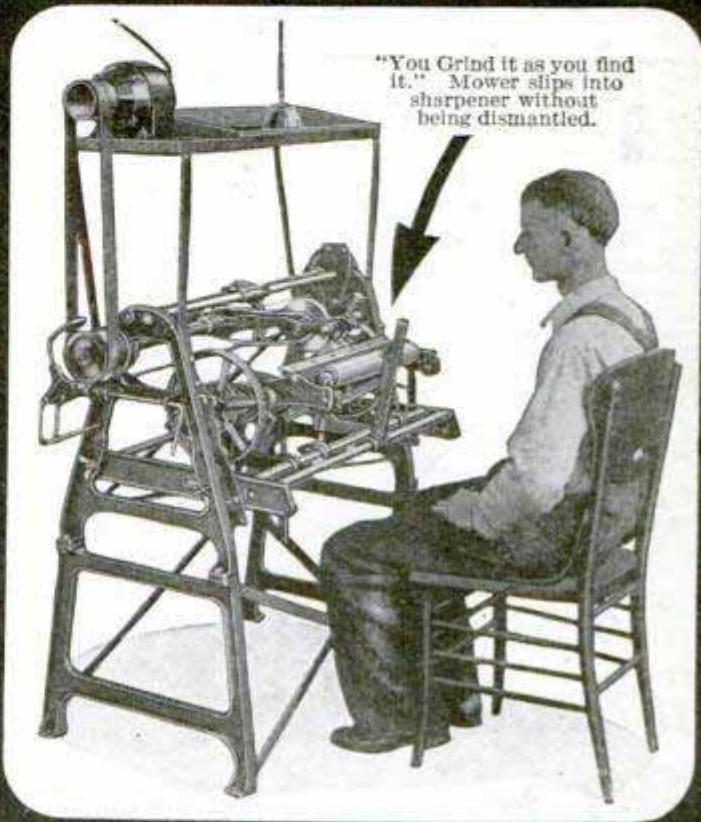

#### Sharpens Lawnmowers to Razor Edge

The Ideal Lawnmower Sharpener is a wonderful, but simple, machine that sharpens lawnmowers perfectly, scientifically, without dismantling the mower. Sharpens them as emery dust, files and obsolete methods never could.

#### Sharpens Any Mower in 20 Minutes

Just pick up any mower, set it in the Ideal, make a few simple adjustments and proceed to sharpen. In 15 to 20 minutes after you pick up the mower it is ready for the lawn, and you have made \$1.50 to \$2.00, depending on the charge you fix.

#### No Training Required

You don't have to be a mechanic to use the Ideal. Its operation is simple and practically automatic once you start to grind.

#### Set Up Ready to Grind in a Few Minutes

Shipped practically completely assembled. Uncrate it, place in position, plug into a light socket and it is ready to start earning for you.

#### Special Grinding Wheel Attachment

For sharpening grass shears, hedge shears, sickles, scythes, axes, etc., etc. Will add many dollars to your income.

#### Skate Sharpener Attachment Included

Sharpens all makes of skates—including hockey with shoe attached. The "Ideal" earns money all the year round.

#### Uses Little Power

Operated by 1/4-H.P. Motor attached to light socket or can be run direct from line shaft.



Here's what you'll want to read  
Send for it NOW!

Sign and Mail This Today

**The Fate-Root-Heath Co.,**  
Dept. M, Plymouth, Ohio.

You'll have to prove that I can make real money with the "Ideal" Sharpener. Send me your FREE BOOK.

Name.....

Address.....

City.....State.....



# Don't Have Colds Flu...Anemia Rheumatism!

Let Sunshine Protect Your Family From Tonsillitis, Bronchitis, Catarrh, Nervousness, Rundown Condition, Rickets, Asthma, Pleurisy, Boils, Skin Diseases, Neuralgia, Sciatica, and Sinus Trouble. Doctors Say Our Sunlight Starvation Causes Lack of Energy and Vitality, and Our Ready Surrender To Colds, Flu and Pneumonia.



## A Genuine Ultra-Violet Lamp

AN amazing new low price on the new Twin-Arc Ultra-Violet Lamp developed by one of the country's leading manufacturers of electrical equipment for physicians. A new engineering feat makes possible this remarkable low price—only 1/2 to 1/3 usual cost. Produces health-giving Ultra-Violet and Infra-Red Rays, especially needed by babies and growing children.

for Only  
**\$48<sup>50</sup>**  
Easy Payments

Send at once for details of our FREE Trial Offer which enables you to use this amazing new Twin-Arc Sun Lamp for Ten Days in your own home without obligation. We also will send you our FREE Book *Health, Vitality and Beauty Thru Sunlight*. Just mail the coupon.

National Health Appliance Corp., 1676 N. Claremont Ave., Dept. C-160, Chicago.

## Big Money for Agents

Our representatives make \$200 to \$1500 a month taking orders for this marvelous lamp and our splendid low price Body-Building Vibrator. If you want a permanent position with exceptional earnings check coupon below.

National Health Appliance Corp.,  
1676 N. Claremont Ave., Dept. C-160, Chicago.

Please tell me how I can secure the new Twin-Arc Sun Lamp for FREE Trial. Also send me your book.

Name.....

Address.....

City..... State.....

( ) Check here if interested in becoming our Representative.

# Used RADIOS

as low as

**\$9.90**

UNHEARD of  
VALUES!

5 tube

Here it is! Positively the greatest offer ever made in Radio. For only a few dollars, you can own a set that will prove amazing for quality and performance. Our low prices are made possible only because we buy for spot cash—because we have exclusive contracts for all sets taken in trade by dealers—because we buy manufacturers surplus merchandise—and because we are dealers in bankrupt stock.

### TAKE YOUR CHOICE

**LOT 1** Here are included many famous make radios. All have been thoroughly tested and are guaranteed to be in perfect condition. Can hardly be told from new. Formerly sold at very high prices. **\$1490**

**LOT 2** In this lot are some very excellent receivers, all in perfect working order. You'll agree they are worth far more and could not be duplicated at twice the price. **\$1290**

**LOT 3** If you are handy with tools, you can make a still greater saving. Just a few minutes of your time in making some minor adjustments and you'll have a set that you will be proud to own. This lot sold as is. **\$990**

### 100% MONEY BACK GUARANTEE

As one of our customers you must be satisfied. If upon receipt of your set, you do not feel that it is the biggest bargain you ever bought, return the set and we will promptly refund your money. Could anything be more fair?

### SEND NO MONEY—ORDER TODAY

Take advantage of these amazing values now! Orders filled in order of receipt. We ship promptly. Upon arrival pay price of set ordered plus a small delivery charge. (Foreign countries send Money-Order with order)

**CHAS. HOODWIN CO.**

**4240 Lincoln Ave., Dept. AC. Chicago**

Dealers in Bankrupt Radio Stocks

## Add \$150 to \$300 Monthly PROFIT

Johnson added \$125 monthly with 8-Hour Battery Charging. Wayne's Test Bench brought him \$275 month. Bruce doubled battery sales with

HB Tester. No investment required as fraction of profits paid for equipment.

**Only \$16 Monthly**

Try HB 30 days at our risk on absolute money back guarantee. Also make Air Compressors, Car Washers and Paint Sprays — all money makers for you. Underline the item you are interested in and mail for full particulars without obligation to

**HOBERT BROS.**  
Box M 391 TROY, OHIO

## It's Easy

YOU PLAY tunes the first day with an easy-playing Conn instrument and the fascinating new instruction methods. No long drudging over scales. Conn gives you the exclusive features found in no others. Choice of famous artists.

**FREE TRIAL, Easy Payments.** Write now for literature; mention instrument.

**C. G. CONN, Ltd.,**  
331 Conn Bldg. Elkhart, Ind.

# CONN

BAND INSTRUMENTS



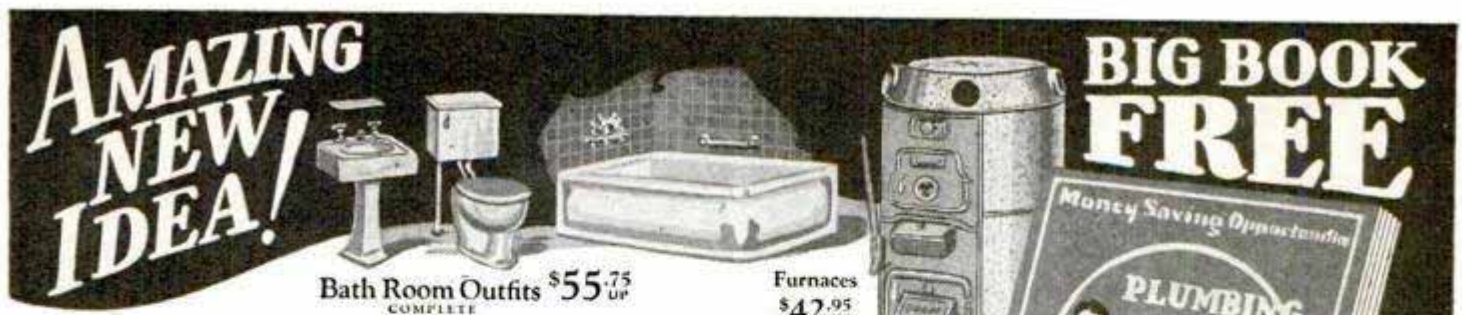

**AMAZING  
NEW  
IDEA!**

Bath Room Outfits \$55.75  
COMPLETE UP

Furnaces \$42.95  
UP

**BIG BOOK  
FREE**

**Save 1/2 on Material  
Save ALL Labor Cost**

We Show How You Save Hundreds  
of Dollars Installing Your Own



**PLUMBING and HEATING**



6 Room  
Steam Heating  
Plant  
\$165.00  
Complete

6 Room  
Hot Water  
Heating Plant  
\$225.00  
Complete

**MAIL** the coupon today and get this wonderful, Big FREE Book that lists 4000 great bargain offers and shows every little detail for installing your own plumbing and heating. Nothing like it ever printed before. Everything new, modern and up-to-date. Homes everywhere follow our instructions and save hundreds of dollars. You can do it too!

**New, Low Factory Prices**

You get the rock-bottom, wholesale, factory price on absolutely everything including fittings, accessories, supplies and tools. You make enormous savings here. No reliable firm ever undersells us. If our prices go down after you get catalog, we apply credit on your orders.

**HIGHEST QUALITY GUARANTEED**

**Everything Sent On Approval**

You never run the slightest risk buying from us. Not only do we guarantee highest quality and lowest prices but you are the sole judge. Your money always sent back at once if you are not completely satisfied.

**Startling Plan Explains How You Can "Be Your Own Plumber"**

If you can use a wrench you can be your own plumber. Our amazing, simple and easy plan explains everything. No experience necessary. We help you in every way possible. Thousands of our customers do their own plumbing and heating work.

**Small, Easy Payments**

Many offers in our Big Catalog sold on small, easy payments. Goods shipped in 24 hours. We carry largest stock and variety in U. S. covering two solid acres of floor and shelf space.

**MAIL THIS COUPON - TODAY**

Don't delay! Don't wait another minute to investigate the most successful home savings, plumbing and heating plan ever devised. Mail the coupon—now!

**BURKE (4) BROS., 421 Liberty Ave., Pittsburgh, Pa.**

Largest Stock of  
Accessories, Supplies  
and Fittings  
in the U. S. A.



**GET  
FREE  
BOOK  
Now**

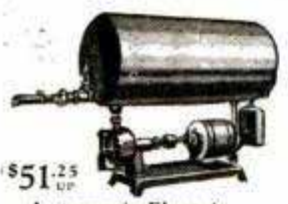

\$51.25  
UP  
Automatic Electric  
Water Systems



Boiler  
Tanks  
\$6.50  
UP



\$9.75  
UP  
Laundry Tubs



Hot  
Water  
Heaters  
\$4.60  
UP



Parlor  
Heaters  
\$39.00  
UP



Pumps  
\$1.45  
UP



Lowest Prices on  
Every Kind of Tools

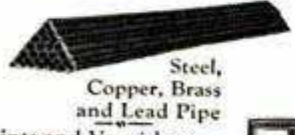

Steel,  
Copper, Brass  
and Lead Pipe

Paints and Varnishes  
Remarkably low prices on  
all kinds of Paints, Enamels,  
Varnishes, etc.



- Bathroom Outfits
- Steam and Hot Water Heating Plants
- Pipe & Pipeless Furnaces
- Pumps and Septic Tanks
- Plumbing Supplies

Burke (4) Bros.,  
421 Liberty Ave., Pittsburgh, Pa.

Send your Big FREE Catalog of 4000 Wholesale Bargains explaining how I can install my own plumbing and heating. (Check subjects in which you are specially interested).

Name.....

Address.....

City..... State.....



# READY CASH In This NEW Business

You can make **BIG MONEY WITHOUT CANVASSING.** Our **FREE PLAN** shows you how to build up a permanent, repeat business of your own filing saws for carpenters, mechanics, contractors, hardware stores, factories and many others, with the **Foley AUTOMATIC Saw Filer.** The Foley beats the best hand-filing, and there is no other machine like it.

## \$2 to \$4 An Hour In Spare Time

Others are doing it, why don't you? Fuller made \$3 in 40 minutes. Harper made \$52 extra in one week. Smith filed 200 saws and everyone is satisfied. You can start in spare time. **BE YOUR OWN BOSS**—investigate the

### FOLEY AUTO MATIC SAW FILER

Saw users want their saws filed on the Foley because they cut better and stay sharp longer. **EASY TO OPERATE.** Files all kinds of hand saws, band saws  $\frac{1}{8}$ " to  $4\frac{1}{2}$ " wide, and cross-cut circular saws 3" to 24" diameter.

Send coupon for **FREE PLAN** and complete information **AT ONCE!**



## Mail This Coupon!

Foley Saw Tool Co., Inc., 237 Foley Bldg.,  
11 Main St., N. E., Minneapolis, Minn.

Please send me **FREE PLAN** showing how I can make **BIG MONEY** in my spare time filing saws on the Foley.

Name.....  
Street.....  
City..... State.....

# Silver Ace Flying



## "Great Sport!" Says War Ace

Major Reed Landis, former war Ace and aviation leader today, says: "Silver Ace Flying is great sport because real aero engineers design and build them. Children and grownups learn many aviation fundamentals by building and flying the fine Silver Ace. They have flown many hundred feet." It pays to insist on Silver Ace models and supplies; used successfully and endorsed by thousands.

**PRICES:** Deluxe Monoplane ready to fly (Cabin or Spirit of St. Louis type), \$12.50; partly assembled, \$9.00; knocked down, \$8.00; contest kit, \$5.00; pair Biplane Wings, \$3.50; pair of Pontoons, \$4.00; Tri-motor Fokker construction set, \$9.00. Add 50c for shipping in U. S. if your dealer cannot supply you with a Silver Ace. Send 10c for catalog.

## AERO MODEL CO.

Dept. M 3  
329 Plymouth Court Chicago, Ill.



### MODEL SHIPS

Would you like to build a real fine ship model?

We can supply construction sets and all sorts of parts such as semi-finished hulls, blocks, dead-eyes, special flags, anchors, steering wheels, capstans, figureheads, blue prints, books, etc., for building a Flying Cloud, Constitution, Spanish Galleon, Mississippi River Steamboat, Sovereign of the Sea, Light-

ning and many others. Also special construction sets for racing sail boats, power boats, model steam engines, propellers, etc., and fine tools for the model maker. Our large 48-page photographically illustrated booklet contains valuable information and hints for building ship models in addition to prices and full description of the above articles. Many people only slightly interested in models have become greatly enthused upon receiving this booklet. A copy will be sent postpaid upon receipt of 15cts. (coin preferred).

**At Last** A real appropriate watch charm makers or boat enthusiasts. This miniature steering wheel is made of heavily plated 14-Kt. gold spokes and hub. The rim is made from coco-bola (a Porto Rican hard red wood). Made in two styles. For the charm, one spoke has a small ring attached. The lapel style illustrated, has a threaded hub and nut for fastening. Can also be worn on yachting caps. Packed in a handsome case. Price \$1.50 postpaid. Be sure to mention style when ordering.



Model Ship Supply Co.  
Dept. C Mineola, N. Y.



### BE A RAPID-FIRE TRICK CARTOONIST

**\$2** BUYS COMPLETE COURSE, including 40 Clever Cartoon Stunts, "How to Give a Performance," "How to Originate Ideas." Fun—Profit—Popularity! Send \$2 or pay C. O. D. Educator Press, 19 Park Row, New York, Dept. O-24.

### New Model Men's Strap Watch

**\$3.85**

### CUT PRICE SALE

Two years written guarantee given with this full jeweled elegant Swiss watch. Your choice in square, tonneau or cushion shape—same price. Radium dial, tells time in dark. Accurate timekeeper, tested and adjusted. Rush your order. Quantity limited. Send no money, pay postman \$3.85. JENKINS, 621 Broadway, New York, Dept. 3-F-23





## Their vacation fare bought this fine car

**L**AST YEAR the Lymans went to a summer resort on the train. This year the family invested their vacation railroad fare in a good Pledge-backed car and will drive through Canada on their vacation—as well as enjoy short trips many week ends.

Hundreds of thousands of automobiles are

being purchased this year by second owners! For the same price, these careful purchasers buy unused transportation at a bargain price. Every car on the street is a "used" car. Don't let false pride prevent your family from enjoying a good car.

### Free Book Tells How

Send the coupon below *now* for valuable free book, "How to Judge a Used Car." Experts who buy hundreds of cars for resale tell you in plain words and pictures what to look for and what to avoid.

This free buyer's guide may easily save you \$200.00. Spend 2c for a stamp and mail this coupon **NOW!**

*130,000 people saved money by mailing this coupon*



### Pledge to the Public on Used Car Sales

- 1** Every used car is conspicuously marked with its lowest price in plain figures, and that price, just as the price of our new cars, is rigidly maintained.
- 2** All Studebaker automobiles which are sold as **CERTIFIED CARS** have been properly reconditioned, and carry a 30-day guarantee for replacement of defective parts and free service on adjustments.
- 3** Every purchaser of a used car may drive it for five days, and then, if not satisfied for any reason, turn it back and apply the money paid as a credit on the purchase of any other car in stock—new or used. (It is assumed that the car has not been damaged in the meantime.)

© 1928 The Studebaker Corporation of America

THE STUDEBAKER CORPORATION OF AMERICA  
Dept. 153, South Bend, Indiana

Please send me copy of "How to Judge a Used Car."

Name.....

Street.....

City..... State.....

# STUDEBAKER

**Builder of Champions**



# 3 "Wonder" Outfits sent to you on 15 Days Approval *Money Back Guarantee*

**FREE** \$5.00 Book of Blue Prints, Showing 46 PRIZE PROJECTS with purchase

Price Includes 1/3 H. P. A. C. Motor

THE S&B 8 in. COMBINATION SAW (18 tools in one) is the ideal machine for the shop, factory or the home: will rip, cross cut, bevel, miter, mortise, groove, drill, tenon, grind, rabbet, buff and polish. Motor is mounted on a base that is a part of the machine proper. Run from any light socket, also provides power for other purposes when the saw is not in use. Complete with attachments and price includes 1-3 H. P. Motor, 60-cycle, 110-Volt A. C. Price \$35.00 F. O. B. Chicago. Shipping Weight 100 lbs.

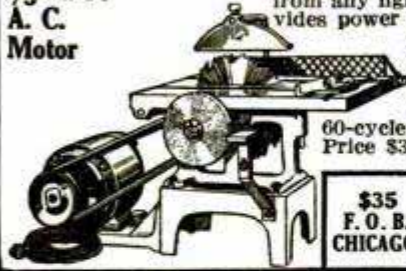

\$35 F. O. B. CHICAGO

The S&B "Wonder" Lathe Outfit is the biggest value in lathes you can find. Heavy channel iron bed makes lathe rigid and prevents vibration. Head and tail stock in perfect alignment permits of fast and accurate work. This lathe is built for long service and hard use. Accessories to complete the S&B "Wonder" Lathe (as illustrated) \$16.60 extra.



\$35 F. O. B. Chicago

12" Band Saw—At this LOW PRICE you can NOW do the 1001 things you wanted quickly and easy. This 12" BAND SAW has a tilting table and sturdily built. Ideal for the shop or home. \$35 F. O. B. Chicago. Motor \$15 extra.



Write for Complete Illustrated Folder—Dealers Wanted.

**SCOTT-BANSBACH MACHINERY CO.**  
130 So. Clinton St., Dept. 102, CHICAGO, ILL.

## HAVE YOU AN INVENTION?

A large American manufacturer, highest rating, equipped for producing small metal stampings, drawn articles, and screw machine products, desires new articles to manufacture. Preference will be given to products applicable to the automotive industry. Every idea submitted will be carefully considered, preference being given to patented articles. Will pay outright or pay royalty for acceptable ideas. Send complete information in first letter, and if possible a sketch or sample of your product.

Address ROOM 503, care of POPULAR MECHANICS MAGAZINE  
200 E. ONTARIO STREET, CHICAGO, ILLINOIS

**Eight Instruments In One!**

The new Regal Octofone can be tuned and played like a "uke," tenor banjo, mandolin, tenor guitar and other plectrum instruments.

**\$15.00**

**OCTOFONE**

*Uke Players*

Pick up the Octofone and play it right off! No lessons or relearning. The Octofone tunes and plays like a uke, but you get a finer, more mellow tone than a "uke" gives. The Octofone has the harmony qualities of eight instruments in one!

*FREE Instruction Booklet with Each Instrument*

**REGAL MUSICAL INSTRUMENT CO.**  
CHICAGO

Regal Musical Instrument Co.  
3207 W. Grand Ave., CHICAGO. PM-3

I am interested in the Regal Octofone. You may send FREE complete information.

Name.....

Address.....

**600 Mile Radio only**

Works without any batteries  
**300,000 people already use them**

**\$2.95**

Write for catalog No. 18 with letters giving lists of stations heard by users.  
**LEON LAMBERT & CO., Wichita, Kans.**

**Learn the Code with Teleplex!**

Be an expert Morse or Continental code operator! **BIG PAY—TRAVEL—FUN—ADVENTURE.** After a few short weeks of practical study with Teleplex you will be an expert operator. This amazing instrument teaches you right in your own home. Works like a phonograph. No knowledge needed—beginners learn at once! **Not a school. Free 10 days trial. Write for free booklet C-10.**

**TELEPLEX COMPANY, 72 CORTLANDT ST., NEW YORK CITY**



**Save 1/2 PLUMBING-HEATING**  
Install Your Own  
**Buy Now Pay Later "New Easy Method"**

Lowest wholesale prices on Highest Quality, Grade A Goods. Any Handy Man can install his own Plumbing and Heating BY OUR NEW EASY METHOD. Get the best and pay only a little each month.

**"We Show You How" BOOK**  
New bargain catalog just **FREE** issued. With our cut-to-fit systems you save waste material and high labor cost. 50 years of economical service to builders, home owners, farmers, and mechanics.

**FREE ESTIMATE Send Sketch**  
FREE book gives you the whole story. Write for your copy today.  
**Million Dollar Bonded Guarantee Protects You**

**OVER 50 YEARS** **HARDIN-LAVIN CO.** EST 1876  
122-32 West Pershing Road, Chicago, Ill.





# Enjoy the Thrill of Electrified RADIO at Small Cost!

Why discard your present good set when you can electrify it for only \$6.85, and also banish forever all the annoyance and expense of buying new "B" Batteries?

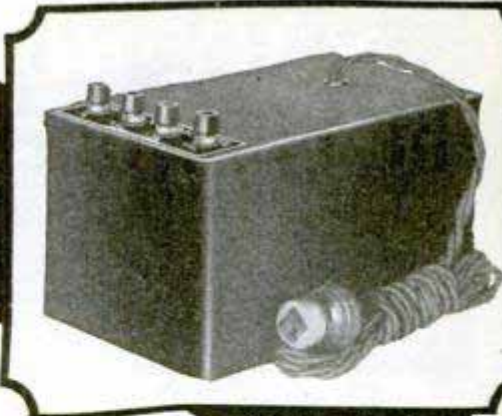

## HEAR IT! TEST IT! COMPARE IT!

### RESULTS

Your Eliminator has been in use for two years an average of six hours daily on my 5-tube Stewart-Warner and am well satisfied with it.  
**CLIFTON E. PALMER,**  
*Highland Park, Mich.*  
 Have used your Eliminator for two years and it is as good as ever. I enclose check for another which is for a neighbor.  
**JNO. A. GREEN,**  
*Hulls, Ill.*  
 I don't see how you can make such a good power unit at such a low price. I would not sell mine for \$25.00.  
**RUSSELL TATE,**  
*Muskogee, Okla.*  
 Your Eliminator beats any \$30.00 one I have yet seen.  
**E. M. BARRETT,**  
*West Graham, Va.*  
 Have used your Eliminator for over a year. Am well satisfied with it and have recommended it to many in this city.  
**DONALD J. SCOTT,**  
*Lansing, Mich.*

Electrified radio is what everyone wants now. Forget noisy, interrupted reception. You will see how easily you can electrify your set when you write us for proof and the truth about all electric radio.

### OVER 100,000 TOWNSEND "B" POWER UNITS NOW IN USE

Hooked up in a few minutes. Use same tubes—No changes. You will be amazed at the improvement in reception. Pure, even tones. Crystal clarity. Plenty of volume. Surprising distance. Freedom from hum and line noises. New radio enjoyment.

### TRY IT FREE!

We are so sure the Townsend will do all we claim for it that we give you the privilege of testing it out for ten days at our risk. A new radio joy awaits you. Don't put up with second rate reception any longer. You don't have to—when you can have electric reception with a Townsend "B" Power Unit for the astounding low cost of \$6.85. Mail coupon for complete information TODAY!

**Approved** and passed by the rigid laboratory tests of Radio News, Popular Radio, and Other Authorities.

ONLY \$6.85 @ Complete

TOWNSEND LABORATORIES, 3/29  
 Dept. 15, 713 Townsend St., Chicago, Ill.

Please send me full information on the Townsend "B" Power and Free Trial Offer.

Name.....  
 Address.....  
 City..... State.....

TOWNSEND LABORATORIES, Dept. 15, 713 Townsend St., Chicago, Ill.

Cal. 30-40 Six Shot



### KRAG CARBINE

All the qualities of a high price rifle. In fine used condition, all working parts guaranteed for one year. Send today for our Free 50-page illustrated catalog of money saving values; Guns, Ammunition, Cutlery, Sports and Gov't goods. Terms Cash. No C. O. D.

Price \$9.75

W. Stokes Kirk, Dept. A-2, 1627 No. 10th St., Philadelphia, Pa.

## GIANT TELESCOPE \$1.85

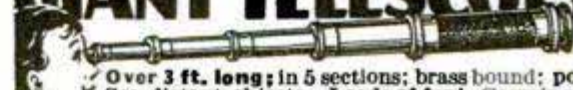

Over 3 ft. long; in 5 sections; brass bound; powerful lens. See distant objects. Loads of fun! Carrying Case FREE. Send No Money Postpaid only \$1.85 or C. O. D. plus postage. Satisfaction guaranteed or money back. Ferry & Co., Dept. 9773, Chicago.

## BUICK 4door SEDAN

## 4 CARS GIVEN

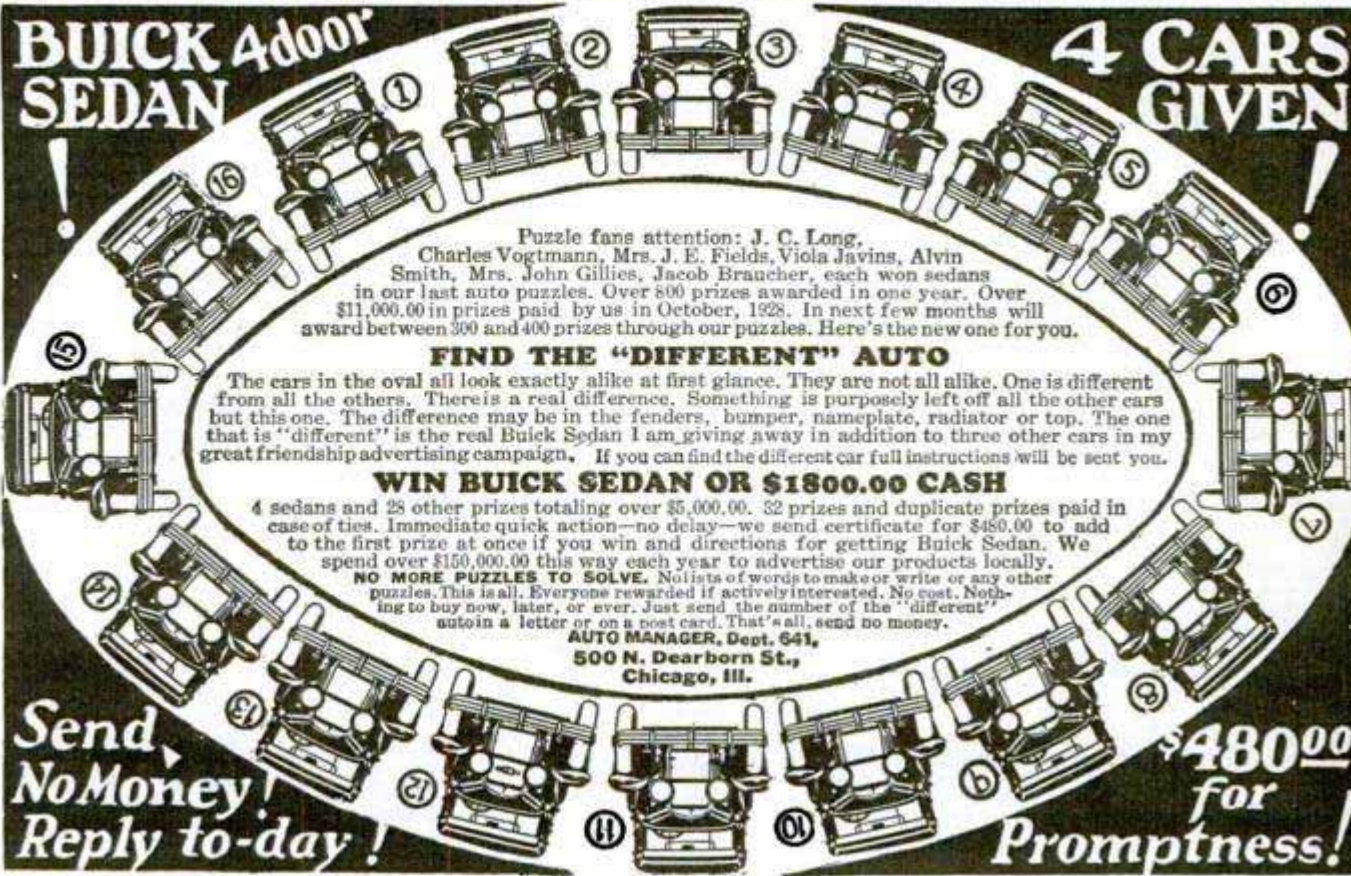

Puzzle fans attention: J. C. Long, Charles Vogtmann, Mrs. J. E. Fields, Viola Javins, Alvin Smith, Mrs. John Gillies, Jacob Brancher, each won sedans in our last auto puzzles. Over 800 prizes awarded in one year. Over \$11,000.00 in prizes paid by us in October, 1928. In next few months will award between 300 and 400 prizes through our puzzles. Here's the new one for you.

### FIND THE "DIFFERENT" AUTO

The cars in the oval all look exactly alike at first glance. They are not all alike. One is different from all the others. There is a real difference. Something is purposely left off all the other cars but this one. The difference may be in the fenders, bumper, nameplate, radiator or top. The one that is "different" is the real Buick Sedan I am giving away in addition to three other cars in my great friendship advertising campaign. If you can find the different car full instructions will be sent you.

### WIN BUICK SEDAN OR \$1800.00 CASH

4 sedans and 28 other prizes totaling over \$5,000.00. 32 prizes and duplicate prizes paid in case of ties. Immediate quick action—no delay—we send certificate for \$480.00 to add to the first prize at once if you win and directions for getting Buick Sedan. We spend over \$150,000.00 this way each year to advertise our products locally. NO MORE PUZZLES TO SOLVE. Notices of words to make or write or any other puzzles. This is all. Everyone rewarded if actively interested. No cost. Nothing to buy now, later, or ever. Just send the number of the "different" auto in a letter or on a post card. That's all, send no money.

AUTO MANAGER, Dept. 641,  
 500 N. Dearborn St.,  
 Chicago, Ill.

Send No Money! Reply to-day!

\$480.00 for Promptness!



# WHY NOT Be Comfortable

when you read?



**CHILDREN** are enabled by the Mitchell Table to sit upright. Harmful humping eliminated.



**INVALIDS** especially appreciate the Mitchell Table. Permits them to read without eye-strain—to eat comfortably.



**PROFESSIONAL MEN** now read, write and edit in their comfiest chair.

**5 Days FREE TRIAL in your own HOME**

Ease and Relaxation Never Felt Before

**IF YOU LIKE TO READ**, here is a convenience you have long been looking for. Now you can sit back in your favorite chair, adjust the Mitchell Lap Table to exactly the proper position, and read in solid comfort! No eye-strain. No tedious holding of the book or magazine. Your body muscles are at rest; your energy is concentrated on the message before you. One of life's most pleasant recreations is made even more pleasant!

### DOZENS OF USES

Read or breakfast comfortably in bed. Write, figure or draw in your comfiest chair. A blessing to invalids; a distinctive and useful gift. Size of panels, 12x18 in. Beautifully finished; substantially made. Felt bottom prevents slipping, protects furniture.

### FIVE DAYS' TRIAL

Send no money. Try the Mitchell Table for five days in your own home. If not delighted, return the table; otherwise, send us \$6.50, and it is yours for a lifetime of service! The coupon is for your convenience. Won't you send it in today?

Mitchell Moulding Co., Dept. 2203, Forest Park, Ill.

Send me, postpaid, a Mitchell Lap Table in  Mahogany  Walnut Finish, complete with two book clips and detachable metal supports for bed use. Five days after receiving it, I will either return it or send you \$6.50.

Name.....  
Street Address.....  
City..... State.....

**MORE than a BARGAIN 5 TUBE Radio ONLY \$11.95**

There's a buy that smashes all records for value giving. Think it! A brand new 5-tube receiver, tuned radio frequency circuit, a beautiful walnut or mahogany finished cabinet (25 in. x 11 in. x 10 in.), all wired and ready to put into use. A regular \$40.00 value for only \$11.95.

### MONEY BACK GUARANTEE

Buy this set in your own home and be convinced. You'll agree that this is without a doubt the biggest bargain ever offered. If you are not satisfied return the set at once and your money will be immediately refunded.

Surplus Radio Company, Dept. 100-C, 549 S. Wells St., Chicago

Send for **FREE BULLETINS**

### CRESCENT WOOD WORKING MACHINES

Crescent Wood Working Machines make money for you by turning out work accurately, fast and easily. Portable machines operate from any light socket. Big line of heavy machines for factories, all quality made, moderately priced.

Send for Free Bulletin

The Crescent Machine Co., 93 Columbia St., Leetonia, O.

## Earn 5 Men's Wages Every Day

HB portable paint spray lets one man without experience do the work of five and earn 5 men's wages every day—paints houses, barns, garages, cars, furniture, at lowest prices, with exceptionally large profits for you.

**Easy Payment Terms**  
Easy payment terms lets it pay for itself out of profits—practically no expense to you. Tear out and mail for complete information without obligation. Also ask about money-making Battery Chargers, Test Benches, Air Compressors, Car Washers. Underline if interested and mail to

**HOBART BROTHERS**  
Box M392 Troy, Ohio



## See the Craters in the MOON!

### Astronomical and Terrestrial TELESCOPE

Magnifies 30 Times

Own a genuine Astronomer's Telescope. See millions of miles away. Make sun, moon, planets, stars your next door neighbors. Moon Craters, Sun Spots, Eclipses, Comets enlarged 30 times. Strange thrill!

Price Only \$3.95

Hours of fun looking at scenery, games, bathing beauties. Great for trips and voyages. Made like telescopes used in observatories. Gerding wrote, "Moon seemed 10 yards away."

**EARN \$10 A DAY**  
Charge 25c to look at the moon.

45 inches long. Inside diameter 2 inches. Special friction adjustment for focusing. Adjustable bracket and clamp can be fastened to chair, fence, branch, etc. Finest materials. Will last lifetime.

**5 Days Free Trial**  
Rush only \$1.00 now. Pay balance (\$2.95 plus postage) when postman delivers. Keep 5 days. If not delighted, return telescope and money will be refunded.

**R. B. SPECIALTY CO.**  
Dept. J-305  
318 Sycamore Cincinnati, O.

## Agents! - Here's Something New



Make \$50 to \$90 A Week

Amazing new fast-selling invention—Crystal Home Filter for fruit juices and beverages. Patented. Nothing like it. Removes all sediment, pulp, fibres. Filters a gallon every 4 minutes. Perfect results guaranteed. Simple. Practical. Low priced. Every home a prospect. Big profits. Quick, easy sales.

**Write Today for FREE Sample Offer**  
500 more agents needed NOW. Make money fast. No experience needed. Write **quick** for Free Demonstrator and territory Offer. Send NOW.  
Home Filter Co., 423 Central Ave., Bay City, Mich.

What Do You Do When You Cannot Find the

## Book You Want?

Don't give up in despair. Send for a copy of the unique catalog published by Popular Mechanics Press. It contains 5000 books listed alphabetically under 2000 main subjects and sub-headings—literally from A to Z—Abrasives Manufacture to Zoologist and everything in between.

**FREE UPON REQUEST**  
Send for your copy today

**POPULAR MECHANICS PRESS**  
200 E. Ontario Street, CHICAGO



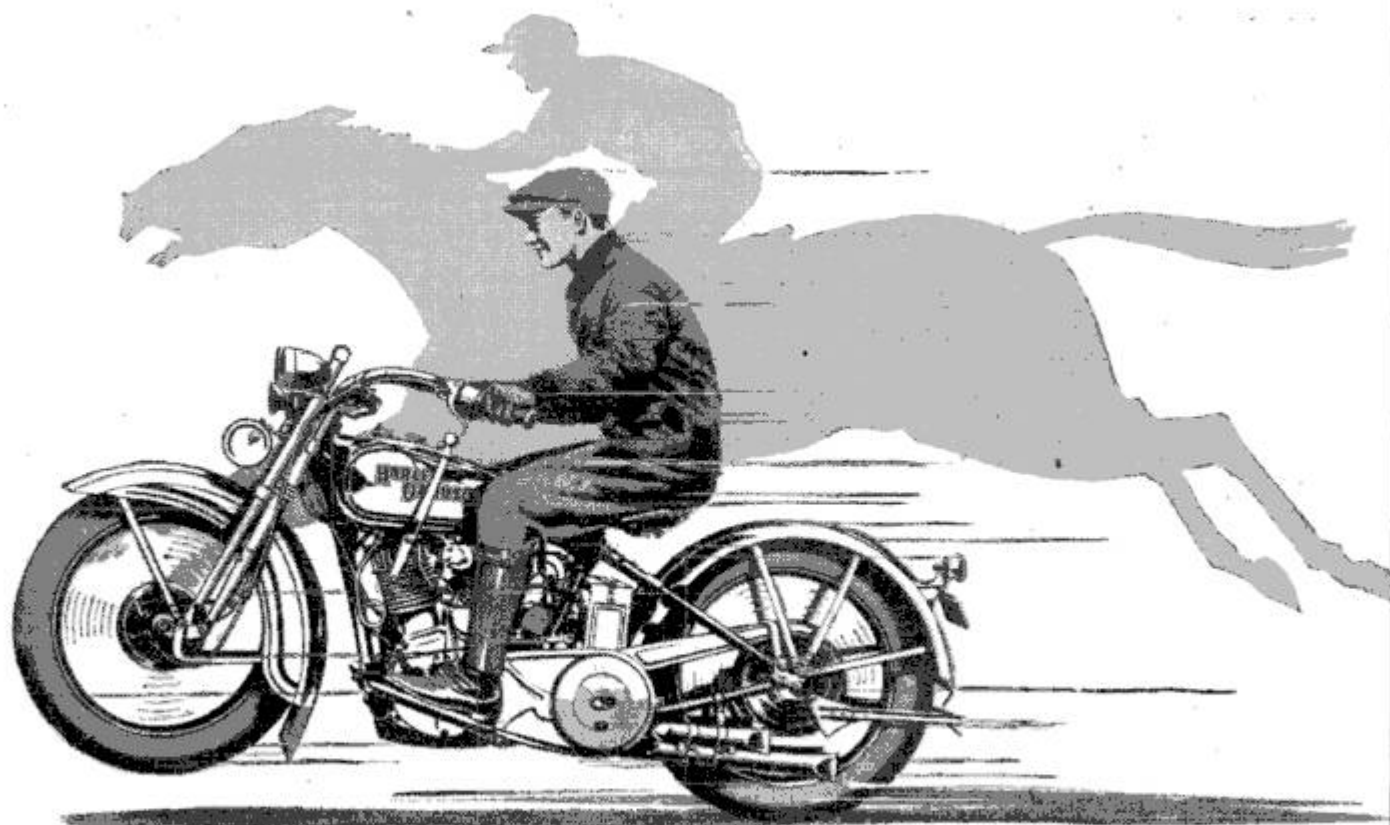

## *Thrilling to Ride as a Thoroughbred*

THERE is a zip and dash to motorcycle performance that is unmatched by anything else on wheels.

Harley-Davidson's eager speed on straightaways, its lightning acceleration, its smooth, quiet rush uphill are the joy of the seasoned rider and the amazement of the novice.

Shown above is the latest Harley-Davidson Big Twin — a wonderfully efficient, powerful, speedy motorcycle that gives sparkling performance at very low cost. Harley-Davidson Twins are priced from \$290 up, f.o.b. factory—Singles at \$235 and \$255.

*Ask your nearest Harley-Davidson Dealer about his Pay-As-You-Ride plan. Mail the Coupon for illustrated literature.*

# **HARLEY-DAVIDSON** *Motorcycles*

HARLEY-DAVIDSON MOTOR CO., Dept. P., Milwaukee, Wis.

Interested in your motorcycles. Send me free illustrated literature.

Name.....

Address.....





# BANK

## \$150 to \$300

### More Each Month

Easily earned from HB 8-Hour Battery Service—with practically **NO INVESTMENT** on your part

Charging batteries in  $\frac{1}{3}$  the time required by other shops brings you the business. Costs less to operate, making you more net profit on each battery. Requires no special experience and **PAYS FOR ITSELF** on easy monthly payments **WITH A PROFIT BESIDES**. Now is the time to start to get the Big Fall and Winter Business.

**Costs Only \$16 Monthly**  
**Comes on 30 Days' Trial**

For full information without obligation, check No. 1 in the coupon below.



Complete Automotive Electrical Service is also a Big Moneymaker with an HB Universal Test Bench in your shop. **ONLY \$20 MONTHLY** brings you advantages previously to be had only with equipment costing \$100 to \$150 more. For full information check No. 2 in coupon below.



Get five men's profits for one man's work with an HB Portable Paint Spray. The wonderful new paint method you read so much about. Paint automobiles, houses, barns, garages, furniture, etc. Inexperienced men doing better work than old-time brush painters. Check No. 3 in coupon for full information.



Better air service than the other fellows will bring more customers to any Automotive Shop. HB Upright, Beltless, Twin Automatic Air Service now available for as low as \$11 monthly. Check No. 4 in coupon for full information.



Any HB Equipment may be had on 30 Days' Trial—and on easy monthly terms that let it pay for itself with a handsome profit besides. Investigate now. Mail the coupon below.

# HOBART BROTHERS

Successful manufacturers ~ since 1893 ~

**BOX M39 TROY, OHIO**  
**Tear off Coupon and Mail Today**

**HOBART BROTHERS CO.**  
Box M39, Troy, Ohio.

Send me complete information on the items I've checked with your 30 day trial offer, easy payment terms, and information on how HB equipment will increase my earnings.

- 1  One Day Battery Service Profits
- 2  Electrical Test Bench Opportunities
- 3  Portable Paint Spray Business
- 4  Better Automatic Air Compressor

NAME.....  
ADDRESS.....

# New Model Homes

Direct From  
**ALADDIN MILLS**  
AT AMAZING  
**LOW PRICES!**



See them in the new, 1929 Aladdin catalog! Many beautiful designs, just out. Aladdin Read-Cut system saves you \$200 to \$800. All lumber is cut-to-fit at mill on huge labor-saving machines instead of on the job where labor and lumber waste costs dearly!

**Prices Include:** All materials for a complete home, together with instructions and plans for erecting, also **Plumbing, Heating and Lighting Equipment. WE PAY FREIGHT.**



**7 Room Aladdin**  
**\$2597**

All Materials Read-Cut  
Just one of many new prize-winning model homes in the 1929 Aladdin Line!



**Write for FREE Catalog**

Just out. Profusely illustrated. Overflowing with interest! Address nearest Office today for your FREE Copy—ask for Catalog No. 406. Send NOW. **The ALADDIN CO., Bay City, Mich. Wilmington, N.C., Portland, Ore.**



## Engines & Motors

### Big Catalog No. 30



Illustrating Electrical, Mechanical and Model Maker's Supplies, Small Steam & Gasoline Engines, Motors, Generators, Lathes, Drill Presses, Bench and Band Saws, etc., 16-32 & 64 Watt Dyna-Motors, School Projects, Engine Castings, Motor Parts, etc., Books, Blue Prints, Brass and Steel Tubing, Gears, Pulleys, Hangers, Experimental Material. Send for Copy, Mailed anywhere for 10 cents, refunded first order.

**LOOMIS ELECTRIC & MFG. CO., 2822 N. CALIFORNIA AVE., CHICAGO, ILL.**



**Ford Owner** Stop that ruinous chatter on your car. **MAKE THIS TEST**—take out your floor boards, pull your emergency brake back and forth. If you notice play at the ball joint, you need Bredar's Ball Shim. Price \$5.00. Ask your Dealer or order direct. Demand Bredar's Shim.  
**NIC BREDAR'S SON MFG. CO., Rock Island, Ill.**



## Great Fun Assembling This Ship Model

Why pay a retail price for your Ship Model—when we will send you all necessary parts of a beautiful Santa Maria—which you can put together by following our simple instructions, in a few hours, and have lots of fun doing it.

Here's the **SANTA MARIA** One of our very popular models, 24" high, 12" wide, 27" long. Send off this coupon today to

Every part accurately made to fit perfectly. Sails, flags, etc. artistically printed. Packed complete in neatly arranged kit, for **\$5.48**

**COLARK CO., Inc.,**  
2213 E. Susquehanna Ave., Phila., Pa.

Please send me a Santa Maria ready to assemble. I will pay postman \$5.48 plus a few cents postage.

Name.....  
Street or R. F. D.....  
City..... State.....

Please print name, etc. plainly



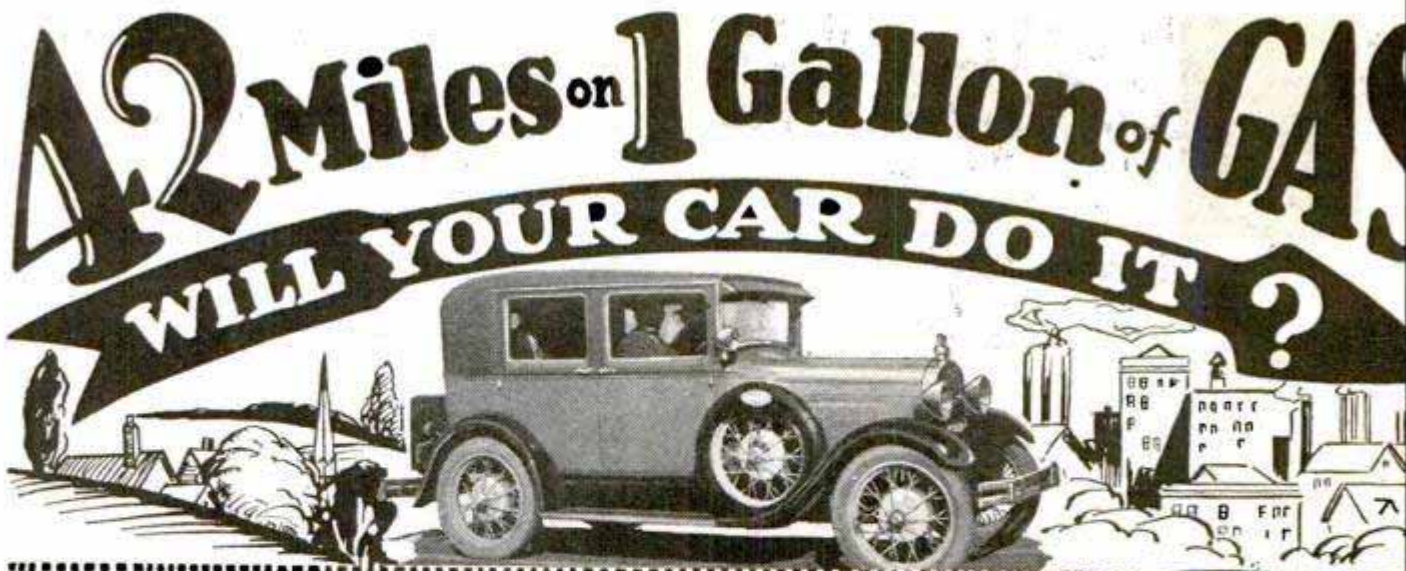

## New Moisture Humidifier & Carbon Eliminator

for all Makes of Cars, Trucks, Tractors and Engines

An amazing Scientific Humidifier has been patented throughout the World that beats any ever got out. It makes engines run ALL THE TIME with the same wonderful efficiency they do on a cool moist night. It gives MORE pep and power, HIGHER top speed, eliminates hard carbon, and gives AMAZING mileage. Fords report 28 to 42 miles per gallon. Other makes (both American and Foreign) report marvelous increases of 1/4 to double mileage. Some of the best records are:

| Miles               | Miles              | Miles               | Miles             |
|---------------------|--------------------|---------------------|-------------------|
| Buick.....28 1/2    | Ford (Model T) 42  | Oakland.....31      | Pierce Arrow...22 |
| Cadillac.....21 1/2 | Ford (Model A) 40  | Oldsmobile...34 1/2 | Pontiac.....31    |
| Chevrolet.....41    | Hudson.....23 1/2  | Overland.....41     | Reo.....26 1/2    |
| Chrysler.....30 1/2 | Hupmobile...24 1/2 | Packard.....21 1/2  | Star.....41 1/2   |
| Dodge.....31 1/2    | Marmon.....21 1/2  | Plymouth.....29     | Studebaker....29  |
| Essex.....32        | Nash.....30        | Graham-Paige 23 1/2 | Willis-Knight.29  |

And Hundreds of Other Wonderful Records on ALL American and Foreign Makes

## Big Profits

to Man with Car Spare or Full Time

\$350 to \$1500 a month

1 man \$4,939.66 in 3 1/2 months  
Another \$1,656.60 in 58 days  
\$5,150.00 in 5 months to another. BIG MONEY can be—IS being made

Fitting Motors With Vix  
One man sold 8 first morning  
Another sells all 3 men can install

Another's profits as high as \$100.00 a day

VIX sells itself by 8 STARTLING demonstrations—BIG, STUNNING, ASTOUNDING, DEMONSTRATIONS. Successful VIX men make MORE MONEY than they ever made before.

# Free Trial TRY This New Principle Gas Saver AT MY RISK



Pictures here and at top show Model "B" VIX attached to my own New Model A Ford. This car is wonderfully improved in performance with the VIX Moisture Humidifier. So is every Auto, Truck, Tractor, Taxi, Bus, Marine, Stationary and Aircraft Engine, both American and all Foreign makes.



Try this wonderful VIX Moisture Humidifier and Carbon Eliminator AT MY RISK on YOUR OWN CAR to prove that VAPOR MOISTURE (drawn from Radiator to Engine) gives you wonderful night driving effect ALL THE TIME with MORE mileage from gas and oil—eliminating hard carbon accumulation—gives MORE power, a SNAPPIER, PEPPIER motor, FAST acceleration, a SMOOTHER, QUIETER running engine and HIGHER top speed.

VIX will PROVE ITS MONEY SAVING MERIT on your own car by 8 DEMONSTRATIONS—conducted by yourself AT MY RISK—the most SENSATIONAL, most ASTOUNDING, most CONVINCING DEMONSTRATIONS you ever saw. If you don't find from your tests that it does MORE than I claim; return it to me—it COSTS YOU NOTHING. I want wide-awake hustling, County, State, Province and National Agencies everywhere, part or full time, to make \$350 to \$1500 per month filling the great DEMAND for this wonderful invention wherever introduced. Write for FREE TRIAL and MONEY MAKING OFFER. Use coupon below.

**WALTER CRITCHLOW**

Inventor and Manufacturer, 3M-805 Street, WHEATON, ILL., U. S. A.

## FREE VIX Mail Now offer



**WALTER CRITCHLOW, INVENTOR and MANUFACTURER**  
3M-805 Street, Wheaton, Ill., U. S. A.

Please send me without obligation or charge your FREE TRIAL and MONEY MAKING VIX OFFER.

Name.....

Address.....

Town..... State.....

**GUARANTEED TO SAVE** { 1/4 to 1/2 Gas  
Carbon Cleaning  
Engine Repairs  
or Costs You Nothing





# There's the new Ned Tyson

He's making \$6500 a year now

USED to know him when he was a kid—we went to grammar school together. Then his father died and he had to go to work. Got a job with Brooks & Watson as a clerk, but couldn't seem to get ahead. Then something seemed to wake him up. We could see that he was doing better work. Then Old Man Brooks became interested—wanted to know how Ned happened to know so much about the business. Ned told him he'd been studying at home at night through the International Correspondence Schools. 'I'll remember that,' said Mr. Brooks. 'He did too. Put Ned out on the road as a salesman a year or so and then brought him into the main office as a sales manager. He's getting \$6500 a year now and everybody calls him 'the new Ned Tyson.' I've never seen such a change in a man in my life.' An International Correspondence Schools course will help you just as it helped Ned Tyson. It will help you to leave the happy home—the bigger salary—the comforts you'd like to have. At least find out how.

Mail the Coupon for Free Booklet

INTERNATIONAL CORRESPONDENCE SCHOOLS  
"The Universal University"  
Box 5604-F, Scranton, Penna.

Without cost or obligation, please send me a copy of your booklet "Who Wins and Why," and full particulars about the subject or subjects which I have marked X in the list below:

**BUSINESS TRAINING COURSES**

- Business Management
- Industrial Management
- Personnel Management
- Traffic Management
- Accounting and C. P. A.
- Coaching
- Cost Accounting
- Bookkeeping
- Secretarial Work
- Spanish  French
- Salesmanship
- Advertising
- Business Correspondence
- Show Card and Sign Lettering
- Stenography and Typing
- English  Civil Service
- Railway Mail Clerk
- Common School Subjects
- High School Subjects
- Illustrating  Cartooning

**TECHNICAL AND INDUSTRIAL COURSES**

- Electrical Engineering
- Electric Lighting
- Mechanical Engineer
- Mechanical Draftsman
- Machine Shop Practice
- Railroad Positions
- Gas Engine Operating
- Civil Engineer  Mining
- Surveying and Mapping
- Plumbing and Heating
- Steam Engineering
- Architect
- Architects' Blueprints
- Contractor and Builder
- Architectural Draftsman
- Concrete Builder
- Structural Engineer
- Chemistry  Pharmacy
- Automobile Work
- Airplane Engines
- Agriculture  Navigation
- Mathematics  Radio

Name.....  
Street Address.....  
City..... State.....  
Occupation.....  
Persons residing in Canada should send this coupon to the International Correspondence Schools Canadian, Limited, Montreal, Canada

# Kills Glare of Bright Lights

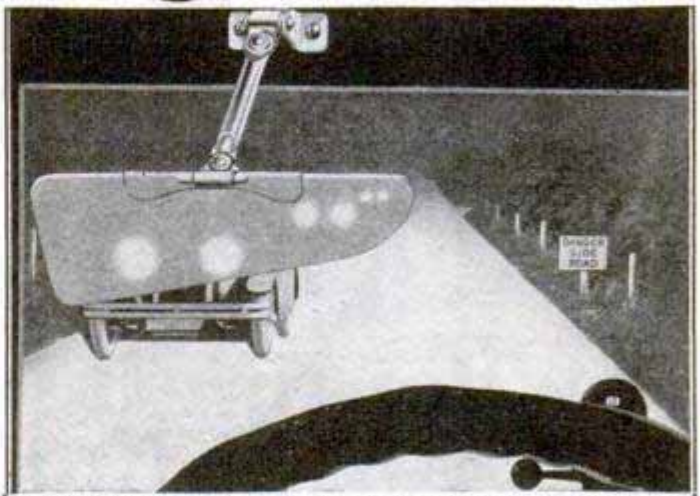

The amazing new Liberty Glare Shield actually dims the bright lights of approaching cars so perfectly that it is as safe to drive at night as in the day. It is adjustable to all angles and a touch of the finger operates it. Gives perfect protection against the sun as well as bright lights. When not in use it can be folded up against the roof of the car. It is scientifically slanted and placed. Statistics show that thousands have lost their lives in auto accidents due to glaring headlights. The Liberty Glare Shield banishes this danger and makes driving a safe pleasure.

**\$5.00 AN HOUR TO MEN WHO WILL HELP INTRODUCE IT**

Men are needed in every locality to take care of local business. The money making possibilities are tremendous. Every car owner is a prospect. Full time or part time workers will find this the biggest money maker they ever handled. Sales experience is absolutely unnecessary. The Liberty Glare Shield and our sales instructions do the selling for you.

**FREE SAMPLE OFFER**

Our workers are furnished with a Liberty Glare Shield for their own cars so that they will be able to make demonstrations. Send for full particulars of our sales proposition and free offer.

Liberty Manufacturing Company Dept. 231  
West Allis, Wisconsin

## TYPEWRITERS

ALL STANDARD

10 days FREE Trial at 1/2 PRICE

Underwood, Remington Royal, etc. ONLY 14¢ A DAY

All late models, completely refinished brand new. GUARANTEED for ten years. Send no money—big free catalog shows actual machines in full colors. Get our direct-to-you easy payment plan and 10 days' trial offer.

International Typewriter Ex., 186 W. Lake St., Dept. 394, Chicago, Ill.

# 8" COMBINATION SAW OUTFIT \$35 F.O.B. Phila.

OUTFIT includes necessary attachments to rip, crosscut, bevel, grind, mitre, groove, sand, mortise, tenon, and polish. Table tilts to 45° angle. Base for saw and motor makes it portable. Makes 2 1/4" cut. 1/3 H. P. double extension shaft motor. Complete ready to plug into any light socket. Send for free folder of Saw Details, also Bench Lathes, Complete Work Shop and other Hardware specialties.

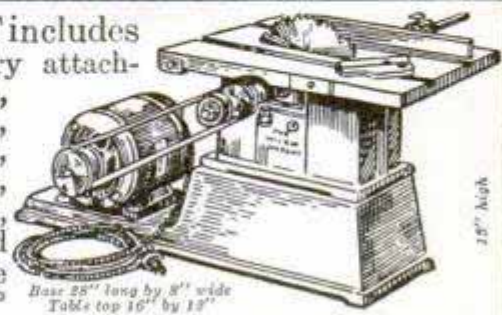

THE WILBAR CO., Inc. 2020 E. Arizona St. PHILA., PA.



**START TO PLAY VERY FIRST DAY**

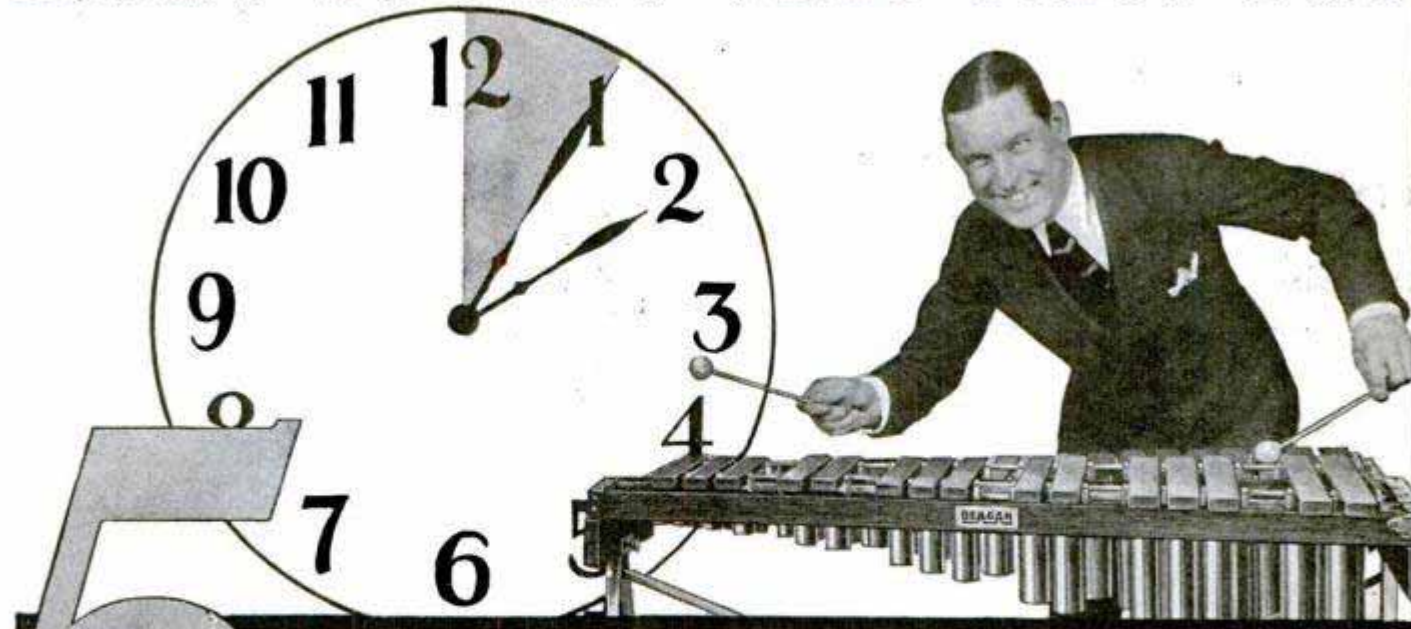

**5 Minutes after I unpacked my Xylorimba I started playing!**

**F**RANKLY, I was doubtful. I had always wanted to play some musical instrument. To be the center of interest at parties; to make \$5 to \$25 a night for work that is "play"; to know the joy of creating music—



who isn't interested in these things? But I had always dreaded the hours of exercise that most musical instruments require—"scale" practice in learning piano, finger exercises in learning violin, lip exercises in learning wind instruments. *It never occurred to me that the most spectacular of all instruments—the xylorimba—was also the EASIEST TO PLAY!*



**First Step Toward Musical Happiness**

Then one day I saw an ad like this one, wrote for the big FREE book, selected the instrument I liked best and ordered it on a strict 5-day trial basis—and on such easy terms that I hardly noticed the payments.

*Five minutes after I unpacked my xylorimba, I was playing the notes of "Old Black Joe."*

It was a simple melody, to be sure—but it proved that I would actually be playing *real music* from the very start, without the tiresome finger or lip exercises. How much more pleasant, under these conditions, to take up the wonderfully simple lessons, one by one, and gradually learn to play more intricate selections! How much more pleasant, too, to learn in the privacy of your own home without a teacher. Never have I had such fun—such cheery evenings—such a feeling of

progress. The whole family have become xylorimba enthusiasts. Already, I am teaching my sweetheart to play. What a happy pupil she is!

**Friends Amazed!**

Friends and relatives are amazed at my progress. To "dash off" a snappy fox-trot or dream waltz and then hear them shout for more, is a thrill that simply must be felt to be appreciated.

**BIG BOOK FREE!**

How would you like to play the xylorimba—to have your presence demanded at gatherings—to make extra money playing at parties, dances, radio studios and perhaps even on the stage? Hundreds have done it. You can, too, even if you can't read a note of music right now! On receipt of this coupon we will send our big FREE book telling all about the Deagan instruments—their easy payments—the delightful fully simple free lessons. Five days' free trial in your own home—and a year to pay! No time like the present, no day like today, when fun and profit are involved. Send in this coupon NOW.



J.C. Deagan, Inc., Dept. 1453, 1770 Berteau Av., Chicago

Send me, without obligation, full details of Free Trial offer and easy-payment plan on the Deagan Xylorimba.

Name \_\_\_\_\_

Address \_\_\_\_\_



# Mount your athletic chassis on rubber

— and save yourself the jolts that rock the "ole framework"

Aren't gym floors slippery as ice, sometimes, and just as hard? And don't you come down *ker-plunk* now and then when you land off the "horse", or when you're hurdling or tumbling? Say, boy, that's when you need Keds with their specially made, "shock-absorber" soles and sturdy canvas uppers. They're unbeatable when it comes to saving wear and tear on your good athletic chassis!

Keds are more than ordinary "sneakers". Yes sir! Keds are extra-fine, rubber-soled, canvas-topped shoes. Each pair of Keds is made over a special foot-health last—and Keds' tough safety-soles are specially designed to grip the smoothest surfaces, and to absorb the roughest shocks.

The SPRING-STEP model, for basketball, has strong-grip eyelets which don't pull

## *Keds Short-Stop*

Note the special safety-sole. Keeps your feet cool and gives them protection whether you're playing baseball or taking the jolts of the trail.



out. And you'll find that Keds lace tight, too, so your feet can't slip or chafe.

Keds offer the most complete line of models for every indoor sport and outdoor activity, and are made by the world's largest specialists in canvas rubber-soled footwear. You'll find Keds in the best shoe stores in town—at all prices, too, from \$1.00, \$1.25, \$1.50, \$1.75 up to \$4.00.

KEDS—KEDS—KEDS—Look for that name stamped on all genuine KEDS.

United States  Rubber Company

# Keds

REG. U. S. PAT. OFF.

The more you pay, the more you get  
—but full value whatever you spend.

## *Keds Conquest*

This handsome shoe puts lightning in your feet and protects you against slipping! Made with the popular crepe sole, famous for wear. A special toe cap reinforcement that will let you scuff to your heart's content. "Feltex" insole.





The Same  
Fast, Accurate

# COMPLETE OUTFIT

for home use and  
profitable commercial work, including  
planer, saw, lathe  
and electric motor  
and many useful  
attachments

Every kind of woodworking operation

## Make everything out of wood with the famous

# WORKACE

## Electric

# WOODWORKER

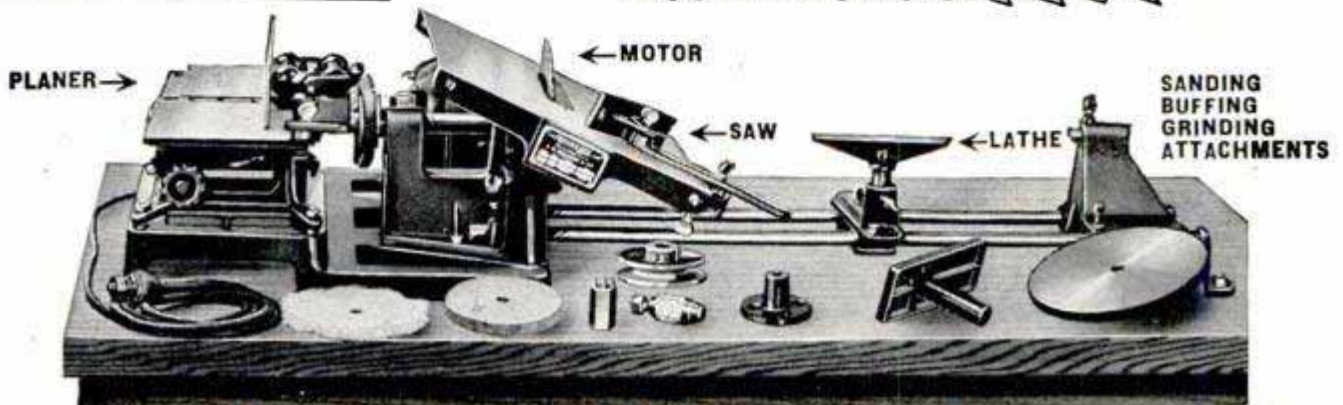

Amazing low price includes everything

This complete all-electric shop costs less than most other outfits and gives you **the biggest value per dollar!** You can prove it at home by actually using the Workace in every kind of woodworking operation, making furniture or other useful and decorative things for your own home and to sell at a handsome profit. The Workace is fast, accurate and easy to work with. Planing, sawing, turning, drilling, grinding, sanding or buffing—you save time on every operation, do better, cleaner work, too!

There's ample power, strength and capacity in The Workace Woodworker to do any job quickly and economically . . . mitering, tapering, rabbeting, beveling, slotting, cross-cutting, ripping—anything! Every unit works from the G. E. motor. All parts are sturdy and well fashioned. The regular Wallace UNQUALIFIED GUARANTEE assures replacement of defective parts for one year. This is a simple straightforward offer—no exaggeration, no red tape—just plain facts that you yourself can prove. If you want to make woodworking your real hobby—or a real source of income—send this coupon for all details of this unusual proposition.

### EASY TERMS

Small Down  
Payment

**\$9** Per  
Month

Our terms are all in your favor, a new and revolutionary method of purchase. Many pay for their Workace Shop out of the profits it makes . . . A small down payment brings the Workace complete and ready to set up for immediate use. The monthly payments are so small you'll scarcely miss the money . . . Send the coupon now—today—and we'll see that you get full details and a complete description by return mail!

**\$89**

Includes all this:

4' Planer  
8' Circular Saw  
6'x36" Lathe  
8' Disc Sander  
6' Buffing Wheel  
5' Emery Grinder  
1/4" Drill Chuck  
1/4 H.P. G.E. Motor,  
110-Volt, A.C., 60  
Cycle.  
Endless V-Belt, two  
4' and one 2 1/4" V-  
Belt Pulleys, Cast  
Iron Sub Base and 10  
ft. Cable with sep-  
arable Plug.  
The Planer and Cir-  
cular Saws are each  
complete units and  
may be purchased  
separately at the cor-  
respondingly low  
price of \$25.00 each.



WORKACE 14' BAND-  
SAW. Speedy, accurate,  
economical. Price, \$75.

**SEND TODAY GET OUTFIT  
RIGHT AWAY**

J. D. Wallace & Company,  
Adams St. and California Ave.,  
Chicago, Illinois.

That Workace Electric Woodworker sure looks good to me. I want to know ALL about it, including your easy terms, right away.

Name . . . . .  
Kind of Business . . . . .  
Address . . . . .  
City . . . . . State . . . . .



H A V E A C A M E L

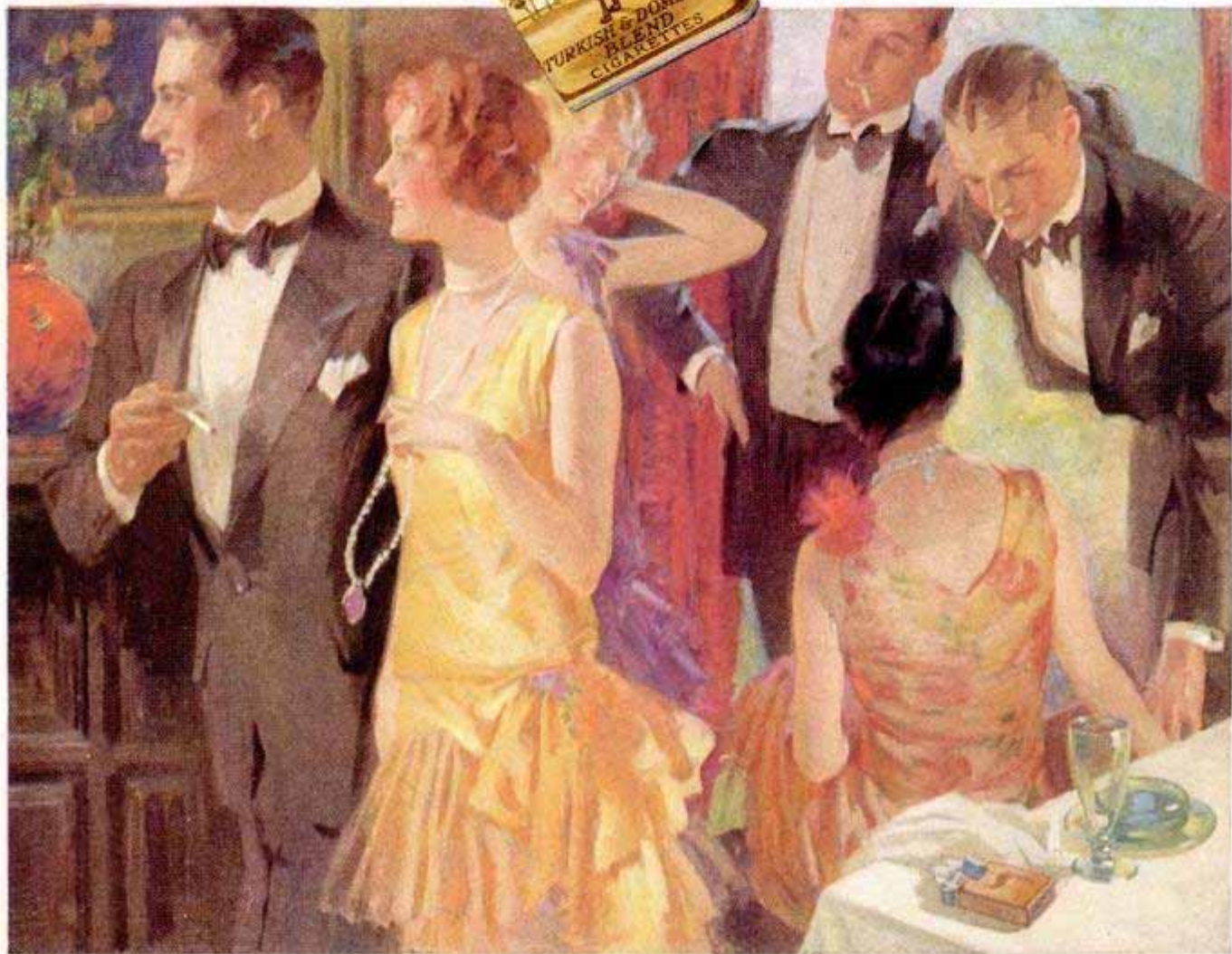

*A social success*

Camels come to the aid of the party . . . *any*  
party where the main idea is to be  
joyous and carefree.

**CAMELS**