

POPULAR MECHANICS

MAGAZINE

WRITTEN SO YOU CAN UNDERSTAND IT

REGD. TRADE MARK GREAT BRITAIN NO. 810422

REG. U.S. PAT. OFF.



SEE PAGE 886

Make an Electric A.C. Set of your Present Radio!

**NO CHANGES IN WIRING
NO HARNESS OR ADAPTERS
USE YOUR OLD TUBES**

OF course you want electric operation of your radio. Everybody does! Radio was never so convenient, never so carefree as now when its only demand on you is the snap of an electric switch.

But if you have a good radio now, don't discard it. A good time-tried circuit, using efficient time-tried tubes is naturally better than new untried circuits and tubes. There isn't a better A. C. set made than your present radio converted to use A. C. power.

And Kuprox has made conversion so easy! You don't have to change a single wire or alter the set in any way. No harnesses or adapters . . . no tricky wiring . . . not even new tubes are necessary. Just connect the Kuprox A. C. Power Pack to the battery terminals of your set, plug it into the nearest lamp socket, and your radio operates entirely from A. C.

Then compare your radio with the best A. C. set you ever heard. Compare the tone, the power, the dis-



tance getting ability, the selectivity and ease of control! In your set there's not the slightest hum, no distortion or crackling because of faulty tubes, none of the failings that variations in electric current can cause in A. C. sets. A good battery set, Kuprox equipped, is A. C. reception at its finest!

The Kuprox A. C. Power Pack contains no moving parts, nothing to wear out or break down. It is a permanent addition to your radio that does away with all attention. Several models are offered, some supplying filament (A) current only for those who already have a "B" eliminator, some supplying plate (B) current only, and several compact units that supply all current (A, B, and C) and make the entire set A. C. They are priced from \$32.50 up, and any good radio dealer can show you the various models.

In case you first desire more information, or specific information about your own set, fill in the coupon, tell us exactly what set you have and the number of tubes. We'll recommend the proper model Power Pack you need, and send you literature giving a full description.

TELEVISION! Kuprox A. C. Power Packs are necessary for operating television receptors, which require perfectly smooth D. C. current for motor supply, filament, plate and glow circuits.

The Kodel Electric & Mfg. Co. 517 E. Pearl Street
Cincinnati, Ohio
Formerly the Kodel Radio Corporation

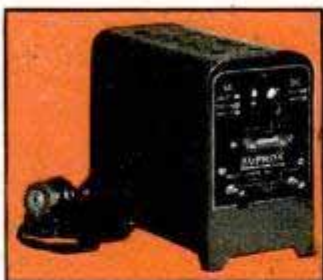

Kuprox Multi-rate Rectifier, for trickle charging, dynamic speaker operation, etc. Adjustable rate up to 1-ampere. Price \$11.50



Kuprox Replacement Unit, eliminates acids, liquids, bulbs on all standard trickle chargers. Price \$5.00

USE THIS COUPON

Please give me full information on Kuprox A. C. Power Pack

The Kodel Electric & Mfg. Co., Cincinnati, Ohio

Name.....

Address.....

City.....

Make of Set..... State.....

No. of Tubes.....

KUPROX

A.C. POWER PACK

Gets dark early and light late

-these *are* Radiolite
nights and mornings



Two watches in one . . . a day watch and a night watch . . . time service during every hour of the twenty-four . . . that's what you get in an Ingersoll Radiolite. It tells time in the dark, besides having the Ingersoll qualities of sturdiness, dependability and good looks. Now that nights are long and mornings dark your Radiolite will be more useful than ever.

If any watch or clock illustrated is not at your dealer's, it will be sent postpaid.



Waterbury Radiolite \$6.00
Jeweled movement. Handsome engraved design. Smart 12-size. Chromium finish case. Plain dial model, \$5.00—"the best watch \$5.00 will buy."

Wrist Radiolite, \$4.00

A wrist watch made to keep its dependability and good looks under conditions of hard service. Millions in use. Plain dial model, \$3.50.

Alarm clocks, too
Ingersoll alarm clocks have the Ingersoll qualities of sturdiness, dependability and good looks. The TYPE-T in plain dial at \$1.50 comes in four charming colors to harmonize with the popular kitchen color schemes. Radiolite \$2.25.

And for bedroom use there is the dainty little TYPE-R Jr. (not illustrated). It comes in delicate jade green and rose pink moiré finish as well as nickel. Other Ingersoll Alarm Clocks up to \$4.50.

INGERSOLL WATCH CO., Inc.
New York Chicago
San Francisco



Ingersoll

RADIOLITES

Tell Time in the Dark

Yankee Radiolite \$2.25

Illustrated at left

The "Old Reliable." Sturdy—dependable, with many good looks features. Plain dial model, \$1.50.



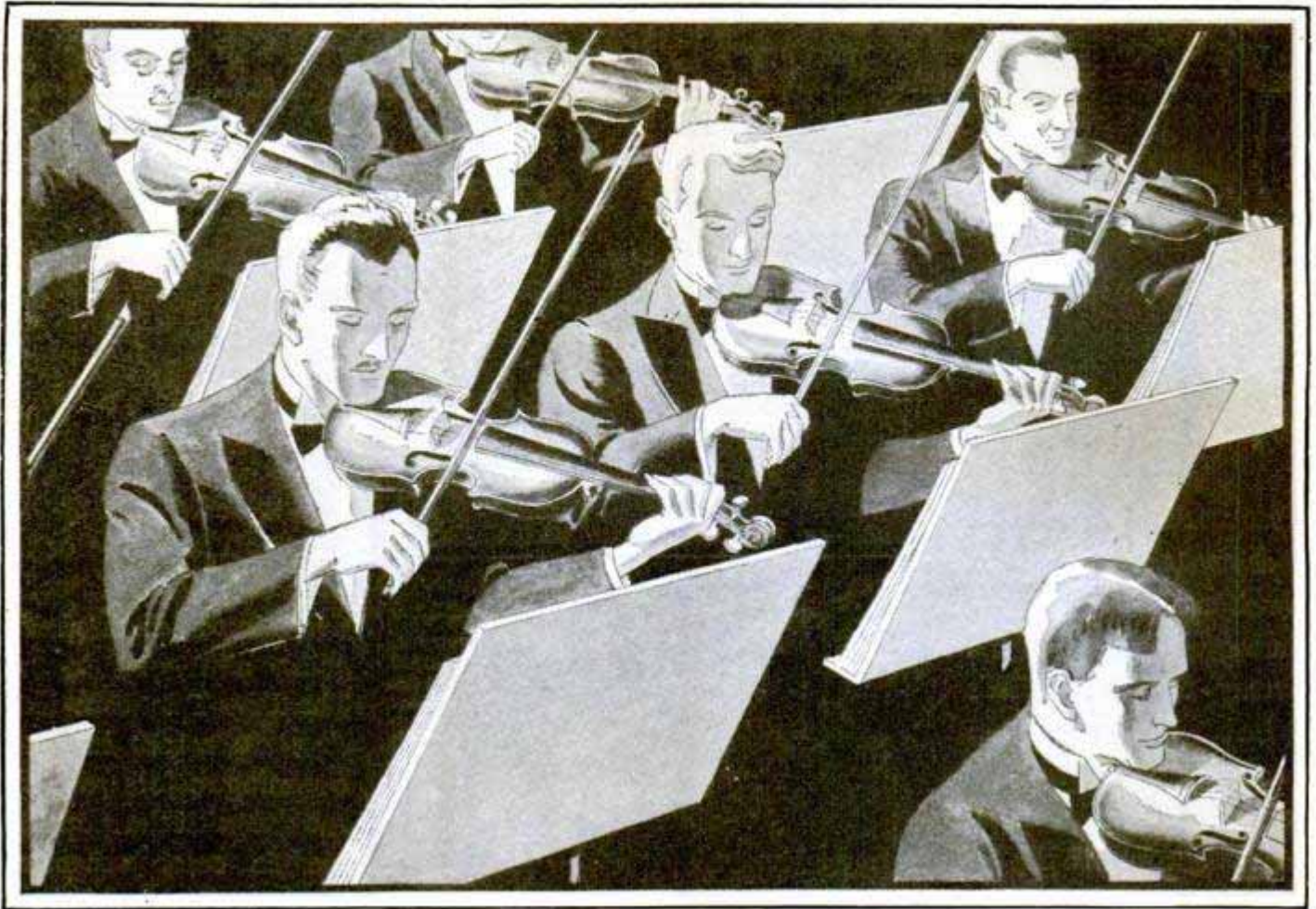

Where working together is everything

*An Advertisement of the
American Telephone and Telegraph Company*

IT IS the aim of the Bell System that anyone anywhere in the country can pick up a telephone and talk to anyone anywhere else clearly and without delay. That is the meaning of universal service. To provide it, the means of telephoning must be uniformly good. Each of the 24 operating companies of the Bell System has full access to all the improvements and methods that are continually being made.

There are 5000 workers on the staffs of the American Telephone and Telegraph Company and the Bell Laboratories whose sole occupation is to develop constantly improving methods and equipment for the 350,000 employees of the Bell System to use in



serving the public. The results of the efforts are evident, not only in the extension of telephone service across the Atlantic, but in the constantly improving local and long distance service at home.

The very nature of the telephone business necessitates a single interconnected system. The American Telephone and Telegraph Company accepts its responsibility for a nationwide telephone service as a public trust.

It is fundamental in the policy of the Company that all earnings after regular dividends and a surplus for financial security be used to give more and better service to the public.

Popular Mechanics Magazine

200 E. Ontario Street, Chicago, U. S. A.

H. H. WINDSOR, Founder

H. H. WINDSOR, Jr., Editor and Publisher

London: Hachette & Cie.,
King William Street, Charing Cross, W. C. 2

Paris: Hachette & Cie.,
111 Rue Reaumur

Melbourne: Gordon & Gotch
509-513 Little Collins St.

Air

Air MAILED MONTHLY

SUBSCRIPTION:

SINGLE COPY, 25 CENTS

In United States and its possessions, also Canada, Cuba, and Mexico, per year, postpaid - \$2.50

To all other countries in the Postal Union - 3.00

All subscriptions are discontinued at expiration. Please examine the date printed on your wrapper.

Entered as Second Class Matter Sept. 15, 1903, at the Post Office at Chicago, Illinois, under Act of March 3rd, 1879.

Entered as Second Class Matter at the Post Office Department, Canada.

Published monthly by POPULAR MECHANICS CO.

Copyright, 1926, by Popular Mechanics Co.

Copyright in Australia. Copyright in France

Vol. 50

Contents for December, 1928

No. 6

Special Features

From Wood Burners to Steel Giants	898
Lighthouses of the Air	907
The World's Most Famous Yachts	915
Glass House to Save Your Eyes	930
Amazing Story of the Talkies	938
Corn Flour to Run Autos	946
The Mystery of the Tides	954
Have You a Ninth Sense?	962
The Romance of Modern Logging	970
Uncle Sam to Show Talking Cow	978
Here Is Your Television Receiver	1004

Airplanes	
air yacht has all comforts of railroad pullman	937
"Baby Bullet" breaks speed marks	983
Diesel engine for in successful flight	926
double-deck, to carry thirty-five passengers	1001
midget plane without tail	992
six-mile-a-minute plane built in England	986
Airships	
"R-100" built for transatlantic passenger service	987
Aloes—gathering is bitterest job	966
Ants—red to fight boll weevil	967
Army, German—fake tanks screen snipers	912
Automobiles	
fire fighters to get coffee from service car	949
folding foot-power develops high speed	925
shaking table tests quality of car	984
Automobiles—Accessories	
motor air cleaner	952
neon tubes tell spark-plug troubles	905
Automobiles—Driving	
gear-shift indicator aids beginners	945
grip plate for wheels helps out of ruts	905
Aviation	
airplane takes non-stop record from birds	929
German air lines operate 40,000 miles daily	937
neon aerial beacon on skyscraper	999
Bicycle—for children has sidecar	961
Boats and Boating	
boat and boots combined	959
circular metal, won't tip over	976
electric elevator simplifies storing of	945
rubber life ring for rowboats	950
speed boat built like wingless seaplane	1000
Boxing—disappearing ring in arena	935
Bridges	
across Grand Canyon	989
Ambassador, links U. S. and Canada	914
Eads, tests show strong as new	952
hand-operated balance, still used in England	929
Camera, Aerial—portable for still pictures	992

Camping—kit holds chairs and serves as table	897
Cemetery—for pets displays monuments to animals	928
Chain—links easily parted	935
Churn—spring mounted, mixes food, etc	975
Clothing—made of cork	986
Coins—Hawaiian half dollar a rare prize	989
Deaf—sound-absorbing walls help to hear	912
Dentistry—probes wrapped by motor	961
Diamonds	
big, life story of to be filmed	935
diving for in sunken liner	934
red, eighteen-carat found in South Africa	936
Dictaphone—words recorded on wire	977
Earth—shape under sea gauged by submarine	968
Electrical Machinery—cooled with gas, more efficient	925
Electricians' Supplies—wire connector eliminates tape and solder	913
Elevators—vacuum tubes give automatic control for	1000
Engines, Diesel—solid fuel used to run	988
Fire Escape—automatic rope holds 1,000 pounds	925
Firemen—walk in water with rubber suit	926
Flashlight—worn on coat leaves hands free	988
Fort McHenry—restored by army	985
Fountain—shaped like Christmas tree	986
Fruit	
easy tricks with	994
squeezer saves juice and protects hands	911
Furniture	
chairs slide easily over any floor	903
combination desk and piano	999
Furs—electric comb and iron for	959
Games—bowling, rubber-tired disks used for	934
Garage—turntable in front of	1000
Garage—Equipment—brush washes auto top	975
Gas—made from garbage to heat homes	992
Gas Mask—"sniffer" in factory tests	999
Geology—earth is slipping westward	904
Golf	
scorer worn on wrist	1001
stroke meter measures length of drive	975

[Continued on Page 4]

Top Washer

Station like Windmill

[Contents—Continued]

Grape Vine—over century old	993
Heater	
keeps show-window glass clear	914
solar-heat machine	951
Household Devices	990
Icebergs—coast-guard patrol tracks to lair	967
Insects—wire fence bar to	950
Island—pirate, in Gulf of Mexico, to be modernized	927
Lamp—Posts—concrete, are spun	904
Lamp Shade—green-disk fits bulb	983
Logs—for paper, water "watch dogs" guard	968
Lumbermen—model city for affords many luxuries	905
Mail—collapsible case for	937
Mail Box—waterproof	929
Meat Carver—holds joint while slicing	986
Mechanical Man—that moves and talks	960
Memorial—war, chimney used as	951
Metal—new, for auto used	977
Milk—in sheet form	951
Mines and Mining—electrical prospecting holds hope for new mines	992
Motor—valveless for airplanes, has few moving parts	897
Moving Picture—move wheat fields to get picture effect	953
Neon Lamp—solves problem of high-speed machines	988
Oil—yields flavor of peaches and kind of soap	950
Oysters—Uncle Sam guards	929
Paints and Painting—electric paint-spray gun	993
Pancakes—automatic machine for	953
Parachute—jumper broadcasts during his descent	936
Petroleum—world's, will last 3,000 years	905
Pipe—steam, seven-foot made by arc welding	966
Poison—oxygen chamber saves cats affected by carbon monoxide	913
Radio	
helpful hints from experts	1010
increasing range of voltmeter	1008
telephoto of dirigible "Count Zeppelin"	927
to improve your set	1002
Radio—Aerial—mounting loop on portable set	1014
Radio—Batteries	
reducing charger noises	1014
testing, and power units	1009
Radio—Coils—r.f. chokes prevent distortion	1014
Radio—Construction—kink for starting nuts	1008
Radio—Installation—wire holder simplifies soldering	1009
Radio—Reception—improving the tone of old sets	1007
Radio—Television—latest apparatus in	1013
Radio—Tubes	
homemade line voltage control	1009
screen-grid requirements	1008
Railroads	
baggage car to carry autos	989
train to control wheat smut	945
Railway—in front yard attracts visitors	928
Razor	
blade stropper uses two steel balls	952
rest helps blades regain edge	993
Safety Devices and Measures—chains for shoes to prevent winter accidents	976
School—shop for boys of old street cars	961
Seesaw—spring operated for babies	953
Ships and Shipping	
special boats for autos	937
whaler hauls carcasses aboard	969
Silk—made from cotton lint	975
Siphon—automatic	984
Ski—water skiing, new summer sport	985
Stereopticon—combined with phonograph	936
Sugar Cane—new, flyers find in New Guinea	977
Telephone—ounce of metal saves millions	960
Toys	
electric auto follows fence for power	926
hobbyhorse that walks, newest	913
Vaporizer—electric, automatic	988
Walls—circular, of concrete	977
Warfare—"magic curtain" of chemical hides city from air	897
Ways—movies show bone knitting	912

AMATEUR MECHANICS

Auger—spring prevents from "running"	1018
Automobiles	
care of your auto generator	1028
use correct type of spark plug	1036
Automobiles—Accessories—celluloid on windshield prevents steaming	1028
Automobiles—Radiators—shield prevents spilling alcohol on	1026

Automobiles—Repairing—emergency repair on brake linings	1030
Automobiles—Tires—shields protect balloon or oversize	1018
Bottles—emergency method of opening	1022
Brush—homemade, for applying tar	1018
Chairs—how to tighten cane seats	1031
Chimney—drain tile is substitute for	1024
Christmas—make your own decorations	1019
Clothesline—hoist for	1017
Concrete—white paint for	1018
Corn Popper—improvised	1036
Earthenware—repairing small cracks in	1022
Fans, Electric—fitting brushes on	1030
Floors—remedy for squeaking	1025
Galoshes—how to get more wear from	1026
Games—"jitney golf" played with old auto tires	1027
Guitar—method of bracing	1026
Heater, Gas—preheating water for	1016
Hinge—lock for loose pins	1029
House Numbers—preventing from discoloring paint	1036
Ink—clip prevents blots when ruling	1031
Key Ring—serves as picture frame clamp	1030
Knots—you should know	1032
Linen Closet—pull-out shelf for	1030
Measures and Measuring Instruments—measuring half capacity of containers	1017
Paints and Painting	
luminous paint on keyhole	1029
whitewash for various purposes	1030
Paper—made transparent for tracing	1035
Photographs—stage scenes from vacation pictures	1015
Photography	
five photos in one exposure	1031
flashlight used in taking pictures at night	1029
Pipes, Water	
electric flatiron thaws frozen	1029
thawing out frozen	1025
Polish—homemade stove	1022
Poultry	
automatic fountain for	1023
easy method of cleaning nests	1027
Ship Models—shaping sails of	1025
Soldering—oil lamp heats iron	1024
Splicing—ends of short wire	1018
Wall—calculating number of studs required	1026
Windlass, Spanish—pulls auto out of mud	1023
Wood—water glass as filler	1027
Wood, Kindling—barrel hoop holds wood while chopping	1028

SHOP NOTES

Automobiles	
auto used as tractor on ice	1047
cover keeps steering wheels clean	1054
Automobiles—Radiators—preventing from freezing	1042
Automobiles—Repairing	
useful tools for tire-chains	1052
valve-seating tool made from old valve	1041
Bananas—cover keeps frost from	1053
Belts—emergency lacing for	1041
Calipers—rough and finish	1048
Draftsmen—simple rack for	1041
Excavation—cellar door idea employed in	1042
File—weighted handle prevents breakage	1054
Furniture	
combination seat, cabinet and workbench	1043
how to refinish	1044
Gear—repair for broken tooth	1040
Glass—working in machines	1043
Hose—on street protected by pipe	1051
Iron—structural, fixture for bending	1042
Lamp, Table—an unusual	1049
Machinery—an inexpensive universal joint	1051
Oilstone—refacing old	1053
Pipe Fitting—facing	1040
Planer—used as a press	1048
Poultry—burlap used on nests and roosts	1054
Pulleys—overhead, measuring	1051
Pump—inclosure prevents from freezing	1048
Screw—holder made from clock spring	1053
Ship Model—hints for builders	1037
Soldering—lead joints	1047
Tap—acid helps remove broken	1039
Tape—adhesive, curtain rod holds	1039
Tracks—portable, useful in driving over soft lawns	1040
Wallpaper—how to make washable	1051
Workbench	
collapsible, made of pipes	1054
double, handy drawer for	1041

895
 Table folding with bench
 994
 Tractor with 27 in

DRAKE'S PRACTICAL MECHANICAL BOOKS

Lumb
Oil-
Pea
Pla

THEY WILL RAISE YOUR PAY—

ORDER ON 5-DAY TRIAL

The books listed below will perfect you in your chosen trade—pave the way to the big positions. Written in non-technical language—easy to read and understand. Every book covers its subject completely. An entire course of instruction condensed into one volume. Your choice sent postpaid—you benefit 5 days—money refunded in full if not entirely satisfactory. Order direct from this page.



Automobile Books

- Automobile Starting, Lighting and Ignition, by Manly... 700 pp. \$3.00
Brookes' Automobile Handbook... \$2.00
Ford Motor Car, Truck and Tractor, by Manly... Cloth \$1.50
Auto and Radio Battery, Care and Repair, by Manly... Leatherette \$2.00
Motorecycle Handbook, by Manly... \$1.50



Shop Practice Books

- Practical Heating Systems, Trouble Jobs and Ventilation... \$4.00
Sheet Metal Workers' Manual... \$2.00
Oxy-Acetylene Welding and Cutting... Cloth \$1.25
Slide Rule and Logarithmic Tables... \$2.00
Handbook for Millwrights... Cloth \$2.00
Machine Shop Practice... Cloth \$2.00
Mechanical Drawing and Machine Design... Cloth \$2.00

ORDER DIRECT FROM THIS PAGE—ON OUR MONEY-BACK PLAN

The books listed above are only a few of the many in our catalogue, which you will receive promptly after filling out and mailing us the attached coupon. For quick action order direct from this page—cross name of each book wanted and send in with price quoted. We prepay postage and send the books on our money-back plan.

FREDERICK J. DRAKE & CO.

Publishers

R508—179 No. Michigan Ave. CHICAGO

Drake Books Are For Sale at All Book Stores

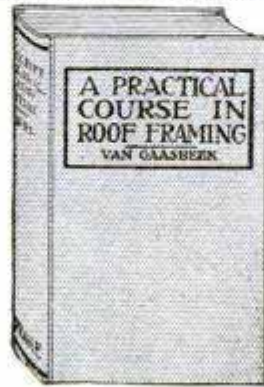

Carpentry Books

Cloth Binding

- Modern Carpentry, 2 vols... \$3.00
The Steel Square, 2 vols... \$3.00
Modern Estimator... \$1.50
Timber Framing... \$2.00
Builders' Architectural Drawing... \$2.00
Concretes... \$1.50
Practical Bungalows... \$1.00
Roof Framing, by Van Gaasbeek... \$1.50

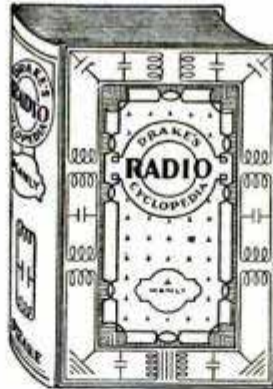

Drake's Radio Cyclopedia

June, 1928 Edition
By H. P. Manly

920 Pages, 1025 Illustrations, 1700 Subjects, arranged alphabetically. For Service and Repair Men, Dealers, Salesmen, Experimenters and Designers. Bound in Art Buckram. Price... \$6.00



Painting and Decorating

- Practical Estimating for Painters and Decorators... Cloth \$2.00
How to Draw Funny Pictures—a Complete Course in Cartooning... Cloth \$3.00
Layouts for Advertising... Lea. \$3.00
Furniture, Furniture Finishing, Decoration and Patching... \$5.00
Ross Crane Book of Home Furnishing and Decoration... Cloth \$3.00
House Painting Methods with the Brush and Spray Gun, by Vanderwalker... Cloth \$2.00
Interior Wall Decoration, by Vanderwalker... Leatherette \$4.00
The Mixing of Colors and Paints, by Vanderwalker... Cloth \$2.00
Studio Handbook—Letter and Design... \$3.00
A Show at Sho' Cards... Cloth \$4.00
Sign Painting, by Atkinson... Cloth \$4.00
Strong's Book of Designs, Leatherette \$4.00
Modern Painters' Cyclopedia, Cloth \$2.00
Automobile Painting... Cloth \$1.50
New Hardwood Finishing... Cloth \$1.50
Wood Finishing, Plain and Decorative... Cloth \$2.00
Owen's Paint Guide... Cloth \$1.00

Steam Engineering

- Swingle's Handbook for Steam Engineers and Electricians... Leatherette \$4.00
Examination Questions and Answers for Marine and Stationary Engineers... Leatherette \$2.00
Steam Boilers... Leatherette \$2.00
Swingle's Catechism of Steam, Gas and Electrical Engineering... Leatherette \$1.50

Modern Languages

- By Prof. P. S. Allen, U. of Chicago
French without a Teacher... Cloth \$1.25
Spanish without a Teacher... Cloth \$1.25
German without a Teacher... Cloth \$1.25
Everyday French... \$1.25
Everyday Spanish... \$1.25

FREDERICK J. DRAKE & CO.
R508—179 No. Michigan Avenue
Chicago, Ill.

GENTLEMEN:—Please send me free, postage paid, your illustrated catalogue which lists and describes 200 Practical Mechanical Books for Home Study.

My name is

and my adc

This one



BB2W-KKT-SW98

Mail Coupon For Free Catalogue
Your Guide to Home Study

Are YOU a Business Coward?

—and—does it show in your pay-check?

"You've had your chance!" It was the General Manager speaking . . .

"Two years ago I warned you that the only man who could hope to get ahead in this organization was the man with training.

"Merwin was only a bookkeeper then, you remember, but in his spare time he was studying Higher Accountancy. I knew what he was doing, and I told you then to keep your eye on Merwin.

"He's had three raises since. He has more than doubled his salary—and he earns every dollar I pay him.

"Last week I recommended him for Assistant Treasurer, and the Board elected him without a dissenting vote. We're mighty glad to have him in the group.

"But you, Jarvis—I hate to say it—you're a business coward. You knew what you would have to do to get out of the small-pay class. You were simply afraid to face the kind of effort and responsibility that could get you a substantial salary.

"And now it's too late. We've got to cut our overhead, and you're one of about fifty men that we can get along without. We could replace the lot of you tomorrow.

"For your own sake, Jarvis, take a tip from a man who has been through the mill, and this time get busy and learn to do something better than the other fellow.

"Jarvis, there's no end of opportunity in business; but the only man who cashes in these days is the man with the courage to get special training. The offices of this country are simply cluttered up with business cowards. It's easy for the man who trains—because the business coward is through before he starts."

* * *

Are YOU one of several million routine men who have been drifting along in a "low-pay" job—always wishing for more money, never acting?

Are YOU a business coward?

Over 640,000 ambitious men have asked themselves this question during the past nineteen years—and replied with a ringing "NO!"

In the quiet of their own homes, without losing an hour from work, these men have mastered the principles of business by working out the actual problems of business—under the direction of some of the ablest business men in their respective fields in America. Their record of achievement, under the "LaSalle Problem Method," is one of the most thrilling chapters in the romance of business.

These men were able to progress more rapidly by means of the "LaSalle Problem Method" than they could have done in any other way, because in their training they faced continually the very problems they must later face on the bigger job. They learned by doing.

Moreover, studying alone under the direct supervision of an expert instructor, they progressed as



rapidly as their capacity allowed—and that progress was further speeded by the fact that every day they could see themselves developing. This fact took all the hardship out of study—changed it into a fascinating game, with always the goal ahead of increased opportunity and greater pay.

Whatever attitude you may have taken in the past, resolve today to face the problem of your business future squarely.

Within reach of your hand is a LaSalle coupon—and a pen. If the pen isn't handy, a pencil will do just as well. The coupon, checked and signed, will bring you without obligation a complete outline of the training you are interested in, together with full particulars of our convenient payment plan; also your free copy of the inspiring book, "Ten Years' Promotion in One."

It costs you nothing to get the facts—except the exercise of business courage. Will you put it off?—or put it over? Mail the coupon NOW.

— — — Find Yourself Through LaSalle! — — —

LaSalle Extension University

The World's Largest Business Training Institution

Dept. 1264-R

Chicago

I would welcome an outline of the LaSalle plan, together with a copy of "Ten Years' Promotion in One," all without obligation.

- | | |
|---|---|
| <input type="checkbox"/> Business Management | <input type="checkbox"/> Law—Degree of LL.B. |
| <input type="checkbox"/> Modern Salesmanship | <input type="checkbox"/> Commercial Law |
| <input type="checkbox"/> Higher Accountancy | <input type="checkbox"/> Credit and Collection Correspondence |
| <input type="checkbox"/> Traffic Management | <input type="checkbox"/> Industrial Management |
| <input type="checkbox"/> Railway Station Management | <input type="checkbox"/> Modern Foremanship |
| <input type="checkbox"/> Banking and Finance | <input type="checkbox"/> Personnel Management |
| <input type="checkbox"/> Modern Business Correspondence | <input type="checkbox"/> Expert Bookkeeping |
| <input type="checkbox"/> Business English | <input type="checkbox"/> Commercial Spanish |
| <input type="checkbox"/> Effective Speaking | <input type="checkbox"/> C. P. A. Coaching |
| <input type="checkbox"/> Telegraphy | <input type="checkbox"/> Stenotypy—Stenography |

Name

Present Position

Address

ELECTRICITY

Complete Study Course and Pocket Library \$10



SHIPPED FREE

A set of **HAWKINS GUIDES** is a true friend to the electrical worker. It tells you how to do any job the right way—without guessing or taking chances.

Hawkins Guides put all the facts about modern electrical engineering at your finger tips. Therefore your chances for advancement in the electrical field are unlimited.

HAWKINS GUIDES DOUBLE YOUR VALUE



Electricity is king! It is the ruling force of today—transportation, communication, light, heat, power—indeed every modern activity is dependent on electricity. Industry is crying for electrical men that know their jobs!

Hawkins Guides teach you all you need to know about electricity in easy, step-by-step lessons. Daily spare time reading of the Guides will greatly increase your value to yourself and your employer in a few weeks. **Hundreds of our friends have written us and told us this!**

READERS OF HAWKINS GUIDES KNOW HOW



"You can't stump him on an electrical job." "He certainly knows his business." "Certainly have to hand it to him for knowing how." —These are the things employers say about our friends who are readers of **Hawkins Guides**. No matter what question or problem comes up the Ready Reference Index enables you to give an expert answer at once.

HAWKINS STARTS YOU WHERE OTHERS LEFT OFF

Why should you work at low wages when easy reading of **HAWKINS GUIDES** will give you the money-making knowledge of the expert? Easy daily reading of the Guides will teach you in a few months what it has taken the expert a lifetime to learn!

With **HAWKINS GUIDES** in hand you have a running start to success in the electrical field. You will actually begin where others left off!

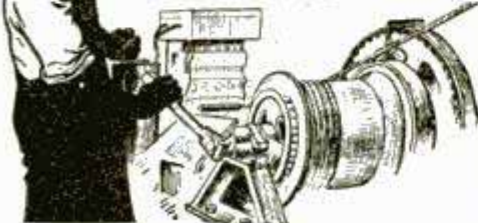

NOW!

This coupon is your golden opportunity. Tear it out—send it now!

FOR EXAMINATION!

REAL ELECTRICAL EDUCATORS

"Hawkins Guides at \$10 is the best investment I have ever made. Am able to take up almost any electrical job and have never gone to an electrical school."—**B. Roessler, Oenaville, Texas.**

AS EASY AS A. B. C.

"Everything in Hawkins Guides is very plain and anybody can read and understand them as easy as A. B. C."—**J. Knight, Tobyhanna, Pa.**

OTHER ENTHUSIASTIC READERS SAY

"Worth ten times their price." "Helped me to two raises in four months." "Better than a school of instruction." "Studied them when I was laid up and got further ahead than if I had been on the job."

Hawkins Guides Explain These Points So You Can Easily Understand:—

Magnetism—Induction—Experiments—Dynamos—Electric Machinery—Motors—Armatures—Armature Windings—Installing of Dynamos—Electrical Instrument Testing—Practical Management of Dynamos and Motors—Distribution Systems—Wiring—Wiring Diagrams—Sign Flashers—Storage Batteries—Principles of Alternating Currents and Alternators—Alternating Current Motors—Transformers—Converters—Rectifiers—Alternating Current Systems—Circuit Breakers—Measuring Instruments—Switch Boards—Wiring—Power Stations—Installing—Telephone—Telegraph—Wireless—Bells—Lighting—Railways. Also many Modern Practical Applications of Electricity and Ready Reference Index.

Hawkins Guides—10 POCKET SIZE NUMBERS

Each number easy to carry around and read in spare time. Big type and clear diagrams. Easy to study and learn. Durable, flexible binding—gold edges. 3,500 pages—4,700 illustrations. Shipped free for examination. Pay only \$1 a month if satisfied. Price of set, complete, \$10.



EXAMINE GUIDES FREE! \$1 PER MO.

Let the Guides themselves demonstrate their practical value to you—as a study course, reference work and complete electrical library. You are the judge. Simply send this coupon. No obligation unless you are entirely satisfied. Tear out on dotted line—fill in—mail it NOW!

FREE EXAMINATION COUPON

Theo. Audel & Co., 65 W. 23rd St., New York City

Please send me (postpaid) for my approval **Hawkins Electrical Guides**, 10 numbers (price \$1 each). If satisfactory I will mail you \$1 in 7 days and further mail \$1 monthly until purchase price of \$10 is paid.

Name:

Address:

Occupation:

Employed by: 12T30

Learn AUTOS



up to **EARN**
\$5000
A YEAR

Start to Make Money Quick Like Morriston

M. J. Morriston, Parkersburg, W. Va. (photo at right), never had a day's experience on cars before starting my training. Read what he says when less than half-way through his "JOB-WAY" course. "What I have already learned is worth over \$500 to me. I have gone into business and I'm making over \$50 a week clear, with wonderful prospects." And what Mr. Morriston and hundreds of others have done I will help you to do!



M. J. MORRISTON,
Parkersburg., W. Va.

I Train You
At HOME



Clip this Coupon
Now for my Big
FREE AUTO BOOK

The World's biggest, most fascinating business needs you!

You needn't slave away at small wages another minute—mail coupon and I'll tell you how I train you at home in your spare time for positions paying up to \$150 a week. Unlimited opportunities for trained Electrical and Mechanical Auto Experts. Let me show you how my "JOB-WAY" training has prepared hundreds of men just like yourself for a quick, brilliant success in the Auto business.

Earn Up to \$150 a Week!

Don't sell your time for low pay! You don't need to when you have my "JOB-WAY" training. As Directing Engineer of this Institution I know what training you need to succeed, AND I GIVE YOU THAT TRAINING right in your own home. MASTER every branch of Auto, Truck and Tractor work. I train you with JOBS—not books. I bring the original "JOB-WAY" training TO YOUR HOME!

Read My Agreement!

Ten agreements in my big free Auto Book. No. 1 is "I will refund every cent of your money if after receiving my training you are not absolutely satisfied." This and nine other wonderful agreements make my "JOB-WAY" course the training for you! Be sure to get my book and read all ten agreements.

Experience, Education Not Needed!

I don't care how little schooling you have, I will train you to become an Auto Mechanic or refund your money! Boys and men of all ages have become Garage owners and managers, Superintendents, Foremen, Auto Experts, BIG PAY executives, after completing Cooke "JOB-WAY" training. I prove to you that I will prepare you to take advantage of the many wonderful opportunities of the great auto business!

Get My Big Book Quick!

I will send it to you without one penny of cost. Read all the facts, find out about the demand for trained Auto Experts. Let me tell you how easily and quickly you, too, may become an Auto Expert. Splendid offer right now to ambitious men. Coupon brings complete information. Mail it today!

No Other "JOB-WAY" Training!

My training includes ALL Electrical work—Ignition, Starting, Lighting—ALL Mechanical end, Welding, Brazing, Vulcanizing—also Business Course—also Monthly Magazine, also 3 Testing and Repair Outfits. Nowhere else I know of, can you get ALL this.

Six Billion dollars spent each year to repair 18 Million Autos, Trucks, Tractors—it's the world's biggest business. Amazing money opportunities everywhere for trained men. My Employment Service helps you to get into business for yourself.

AVIATION Training FREE of extra cost

Coupon brings full details of complete Aviation Training. I am offering FREE of extra charge. Send it now.

3 repair & testing OUTFITS INCLUDED

Address Me Personally **B. W. COOKE** DIRECTING ENGINEER
CHICAGO MOTOR TRAINING CORPORATION
1916 Sunnyside Ave., Dept. 1169 CHICAGO, ILL.

MAIL THIS COUPON NOW!

Free Auto Book

B. W. COOKE, Directing Engineer,
Chicago Motor Training Corp.,
Dept. 1169, 1916 Sunnyside Avenue, Chicago.
Send me FREE your Big Auto Book "Auto Facts" and proof that you will train me in spare time at home. Also reserve Complete Aviation Course and 3 Testing and Repair Outfits without obligating me.

Name.....

Address.....

City..... State.....

FORMER PLASTERER NOW MAKING \$12,000 A YEAR



Worked for Small Salary

Henry J. Bellman had little education and little opportunity to get ahead, but he refused to give up. Deep within him was the longing to make something of his life before it was too late—to build a building some day instead of tinkering around it as a plasterer or bricklayer.



Resolves to Earn More Money

"If spare time study can help other men to get out of the rut," he said, "it can help me. I'm going to take up a course with the International Correspondence Schools and study at home. It's the only way I can ever hope to put myself on a par with technically trained men."

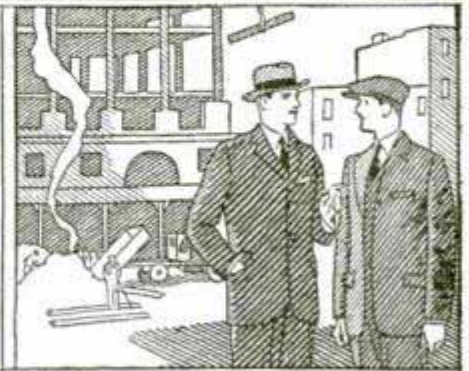

Gets Offer from Contractor

Bellman's friends laughed at him and said he was wasting his time, but he kept right on studying, for he could see how the course was helping him in his work. Soon one of the leading contractors heard about "this bright young man" and made him superintendent at a fine increase in salary.



Secures Big Contract

Bellman went ahead so rapidly that he decided to start a business of his own. He met with unusual success from the very start and today his income is "more than \$12,000 a year." Recently he handled the contracting work of the new \$800,000 Chamber of Commerce building in Scranton.



Glad He Studied at Home

"I give the International Correspondence Schools full credit for my success," Mr. Bellman writes; "there is nothing better for the man who has been deprived of the advantages of a college education. Many of my friends also give the I. C. S. full credit for their ability to do their work efficiently and well."



The Secret of His Success

Henry J. Bellman is a successful man today because he had vision—ambition—and perseverance. He realized that he had to learn more before he could earn more. Instead of just drifting along, he picked a definite goal and then worked and strived until he made his dreams come true.

INTERNATIONAL CORRESPONDENCE SCHOOLS, Box 5579-F, Scranton, Penna.

"The Universal University"

Without cost or obligation, please send me a copy of your booklet, "Who Wins and Why," and full particulars about the course before which I have marked X in the list below:

BUSINESS TRAINING COURSES

- Business Management
- Industrial Management
- Personnel Management
- Traffic Management
- Accounting and C.P.A. Coaching

- Cost Accounting
- Bookkeeping
- Secretarial Work
- Spanish French
- Salesmanship
- Advertising

- Business Correspondence
- Show Card and Sign Lettering
- Stenography and Typing
- English Civil Service
- Railway Mail Clerk

- Mail Carrier
- Common School Subjects
- High School Subjects
- Cartooning
- Illustrating
- Lumber Dealer

TECHNICAL AND INDUSTRIAL COURSES

- Architect
- Architectural Draftsman
- Building Foreman
- Concrete Builder
- Contractor and Builder
- Structural Draftsman
- Structural Engineer
- Electrical Engineer
- Electrical Contractor
- Electric Wiring
- Electric Lighting

- Electric Car Running
- Telegraph Engineer
- Telephone Work
- Mechanical Engineer
- Mechanical Draftsman
- Machine Shop Practice
- Toolmaker Patternmaker
- Civil Engineer
- Surveying and Mapping
- Bridge Engineer
- Gas Engine Operating

- Automobile Work
- Airplane Engines
- Plumber and Steam Fitter
- Plumbing Inspector
- Foreman Plumber
- Heating and Ventilation
- Sheet-Metal Worker
- Steam Engineer
- Marine Engineer
- Refrigeration Engineer
- R. R. Positions

- Highway Engineer
- Chemistry Pharmacy
- Mining Engineer
- Navigation Assayer
- Iron and Steel Worker
- Textile Overseer or Supt.
- Cotton Manufacturing
- Woolen Manufacturing
- Agriculture Fruit Growing
- Poultry Farming
- Mathematics Radio

Name..... Address.....

City..... State.....

Do Unseen Hands Keep You Dumb..

When You Ought to Talk?



How often have you wanted to talk, but held back, silent, because you felt unequal to the other people present? How many times have you passed up, or avoided the chance to talk in public—before your business associates, your club or lodge, because of your fear of stage fright? Are you afraid of your own voice—instead of being able to use it as one of the greatest business and social assets in your possession? And yet you might be surprised to hear that many of the most brilliant public speakers we have today felt exactly this way—before they learned how to develop their “hidden knack” of powerful speech—a knack which authorities say seven men out of every ten actually possess. And the chances are that you, too, have in you the power of effective speech—which, if unlocked, would be almost priceless to you in a social or business way. Find out if you have this natural gift—read every word of the message below.

Discover These Easy Secrets of Effective Speech

PROBABLY you have never pictured yourself being able to sweep a giant audience off its feet—to win the applause of thousands. Yet, the men who are doing such things know that it is all astonishingly easy once you are in possession of the simple rules of effective speech. Before you learn these secrets you may be appalled at the thought of even addressing a small audience. Still it all seems so ridiculously easy when you know how to banish stage fright, and exactly what to do and say to hold an audience of one or a thousand in the palm of your hand.

Yet what a change is brought about when a man learns to dominate others by the power of effective speech! Usually it means a quick increase in earnings. It means social popularity. You yourself know how the men who are interesting talkers seem to attract whomever they wish and name their own friends—men and women alike.

There is no magic, no trick, no mystery about becoming a powerful and convincing speaker — a brilliant, easy fluent conversationalist. One of America's eminent specialists in effective speech has developed

a method that has already raised thousands from mediocre, narrow ruts to positions of greater prestige and wider influence. This new method is so delightfully simple and easy that by spending 20 minutes a day in the privacy of your own home you cannot fail to make rapid progress.

How you can use this method, how you can banish stage fright, self-consciousness and bashfulness, quickly shaping yourself into an outstanding influential speaker, is told in an interesting book, *How to Work Wonders with Words*. Not only men who have made millions but thousands of others have

sent for this book and highly praise it. You can receive a copy absolutely free by simply mailing the coupon below. Act now to discover your priceless “hidden knack”—the natural gift within you. Fill out and mail the coupon at once.

What 20 Minutes a Day Will Show You

- How to address business meetings.
- How to propose and respond to toasts.
- How to make a political speech.
- How to tell entertaining stories.
- How to write better letters.
- How to enlarge your vocabulary.
- How to develop self-confidence.
- How to acquire a winning personality.
- How to strengthen your will power.
- How to be the master of any situation.

North American Institute

Dept. 1359
3601 Michigan Ave. Chicago, Ill.

North American Institute
3601 Michigan Ave., Dept. 1359,
Chicago, Illinois.

Please send me free and without obligation a copy of your inspiring booklet, *How to Work Wonders with Words*, and full information regarding your course in Effective Speaking.

Name.....

Address.....

City.....State.....



FREE

“How to Work Wonders
With Words”

Mail Coupon Today

Learn Electricity

in Great Shops!



Not by Correspondence
All **PRACTICAL** Work at

COYNE

IN 12 WEEKS

EARN BIG PAY

Learn to Earn \$200 to \$800 a Month

Why work for small pay? Why make \$25.00 or \$30.00 or even \$40.00 a week in a hard job doing dirty, disagreeable work, and never sure of your job? As a **TRAINED ELECTRICAL EXPERT** you can command \$200.00 to \$800.00 a month. You will do pleasant work, and many jobs give you an opportunity to travel. Advancement will be quick—steady work the year around. **YOUR SERVICES WILL ALWAYS BE IN DEMAND** any place, or you can own your own business.

Not by Books—You Do Actual Work

I don't teach you a lot of useless theory. I give you a useable knowledge on the same kind of Electrical Machinery as used in Power Houses, plants and big industrial businesses.

You Don't Need Education or Previous Experience

I don't require that you have a lot of book learning. You don't need advanced education or any previous education to master my course. Put your faith in me and I'll make you independent and happy.

COYNE ELECTRICAL SCHOOL

Dept. 98-72, 500 S. Paulina St.
CHICAGO, ILL.



H. C. Lewis, Pres.

My Employment Department will assist you in securing a part time job to earn living expenses while training, and will assist you to a big pay job on graduation and any time thereafter for life.

Get My Free Book

This big handsome new book size 12x15 with over 150 actual photographs will be sent absolutely Free if you send coupon now.

SPECIAL OFFER NOW

For a short time I will include my **RADIO and Automotive Electrical Course**. All given Free with my big **NEWLY ENLARGED ELECTRICAL COURSE** for a short time only.

Earn While You Learn

H. C. Lewis
President
COYNE
Electrical School
500

S. Paulina St.

Dept. 98-72, Chicago, Illinois

Dear Sir:—Please send me absolutely **FREE** your big new book and full particulars of your special offer of two extra courses **FREE**

RAILROAD FARE INCLUDED

Name.....

Address.....

Town.....

State.....

MAIL THIS COUPON NOW!

You can make the BIG Money



in Auto Painting

Average \$75 a Week for Yourself!

Are you satisfied with your present work and income? If you are beginning to see how utterly impossible it is to get along in this tough old world without training—then I have the best proposition you have ever heard of. I'll take you just as you are and in a short while I'll have you ready to manage and own one of my chain of auto-paint shops. Auto painting is the best end of the great auto industry. Short hours—easy work—big pay.



G. King Franklin
Superintendent

We Furnish All Equipment

While you are preparing for this big chance as owner and manager of a paint shop in your locality—I am going to furnish you with every bit of equipment you will need to learn—13 BIG OUTFITS FREE of extra cost. And every outfit complete so you get the actual practice in every operation. This is not just theory—no long, tiresome book reading—every move you make is interesting and practical.

Own Your Own Business

Don't worry about money—I'll furnish that. What I want is men who will learn to manage and operate a shop in their town according to my system. I'll have your name on a growing, profitable auto paint shop in no time if you mean business.

Here's 3 Free Lessons! in Auto Painting



Just to prove that this isn't too good to be true—I want to send you absolutely FREE of charge or obligation, 3 free lessons in auto painting. I want you to see how easy my new system is—I want you to know how interesting it is. I want you to realize that anyone with the knowledge to read or write ordinary English can master this training quickly and easily.

LEARN AT HOME!

You don't have to give up any of the things you are doing at present. Keep your job. Have your fun. All I want is a few minutes a day of your time—no more. I find I can get better results training a man in his own home—where there is nothing to divide his attention.

I haven't the space here to tell you all about this wonderful opportunity, but I do say that if you are a normal red-blooded fellow with ambition and desires for the better things in life here is the biggest and best chance you've ever had to make your dreams come true.

Just mail the coupon—filled in with name and address—and I'll send you a big book outlining this proposition fully and 3 Lessons All FREE. Be fair to yourself and get complete details. Come on—do it NOW.

G. King Franklin, Supt.

AMERICAN AUTO PAINTING SCHOOL
Dept. 2101, 425 S. Ashland Ave., Chicago

GET THE PROOF

G. King Franklin, Supt.
American Auto Painting School
Dept. 2101, 425 S. Ashland Ave., Chicago

Send sample shop-tickets free and information on how I may learn auto painting and Duco at home in spare time, also details about your chain shop Plan.

Name.....

Street No.....

City..... State.....

FREE

"AVIATION GUIDE" Given Free!

For a limited time only we will give Major PAGE'S sensational "best seller" among aviation books—absolutely free with our Auto Encyclopedia.

Thousands of men have each paid \$2.00 in cold cash for this great flying hand-book, but you can have one WITHOUT COST if you act promptly. Mail coupon, send no money.

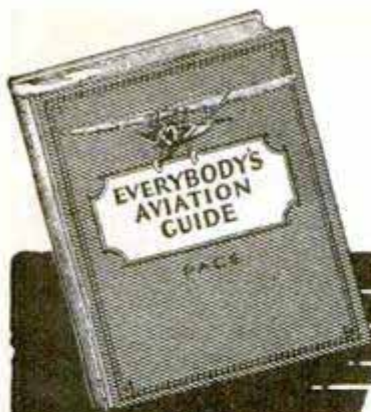

AUTO

5 AUTO BOOKS SENT FREE!



AVIATION for BEGINNERS!

256 pages, 140 illustrations, 600 questions and answers on aviation. Everything about ships and flying explained in simple language, pictures and diagrams. All aeronautical terms explained. Airplanes and airships, balloons and dirigibles. Elementary aerodynamics, how an airplane flies, airplane parts and functions, fuelage forms, landing gear, wing design and construction, power requirements, airplane engines, propellers, equilibrium and control, etc., written in lesson form. Prepares for positions in ground-work, paves the way for flying. The most instructive and interesting book on aviation on the market.

Mail the coupon and we will send you a set of these remarkable auto books, just off the press. Whether you are mechanic or helper, expert or student, owner or driver—if you're interested in autos by all means take advantage of this opportunity to see and USE the latest and most complete reference work on autos ever published. Built by eighteen of America's greatest Automotive Engineers. So simple, so clear, so fully illustrated with pictures, charts, diagrams and blue prints that even men with little schooling can understand every fact. Yet in daily use by thousands of engineers, service-station superintendents and shop foremen as the most dependable reference encyclopedia available. The new edition includes straight eights, four-wheel brakes of all types, high compression engines and other features of the newest models. 5 volumes, 2400 pages, over 2000 illustrations, charts, diagrams and blue-prints.

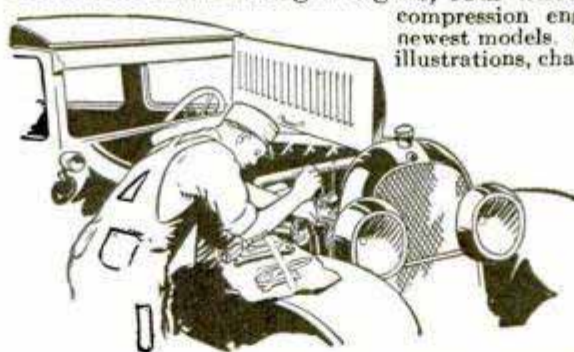

Can You FIX IT?

Can you take the "play" out of differentials? Can you kill the SHIMMY in steering? Can you reset TIMING? Can you put your finger on ENGINE TROUBLE instantly without guessing or tinkering? Can you pull the STARTER off and fix it? Can you adjust and repair transmissions, rear-axes, engines and electrical systems? Can you make emergency repairs on the road or are you helpless when some little thing goes wrong? Is your hand always in your pocket, paying, paying, paying?

These Books Tell HOW!



The ten-billion-dollar a year auto industry offers rich prizes to men with gumption enough to really learn all branches of Automotive mechanics. A better job—bigger pay—the chance to go into business for yourself and get a share of the huge profits, are waiting for any man who even half tries to improve his ability to deliver service. And here's the quickest, easiest, cheapest way—no studying, no memorizing, no "lessons" or examinations. At a small fraction of the cost of a trade-course. Just LOOK UP the facts you seek! You'll find the answer to any auto problem literally at your finger tips in the remarkable JIFFY INDEX, now a feature of this encyclopedia. Mail coupon quick, and get "AVIATION GUIDE," free with these books.

DON'T SEND A PENNY!

American Technical Society,
Dept. A-919,
Drexel Ave. and 58th St.,
Chicago, Ill.

AVIATION BOOK FREE

I would like to see the new 5-volume edition of your AUTO BOOKS, but without obligating me to buy them. I will pay the few cents delivery charges only and if I choose to, I will return them express collect. If after 15 days' use I prefer to keep them, I will send you \$2 and pay the balance at the rate of only \$3 a month, until \$24.80 is paid. Please include a year's consulting membership free, and send "AVIATION GUIDE" without cost after I notify you I will keep the books.

Name.....

Address.....

Employer's Name.....

Employer's Address.....



American Technical Society
Dept. A-919, Drexel Ave. & 58th St.,
Chicago, Illinois

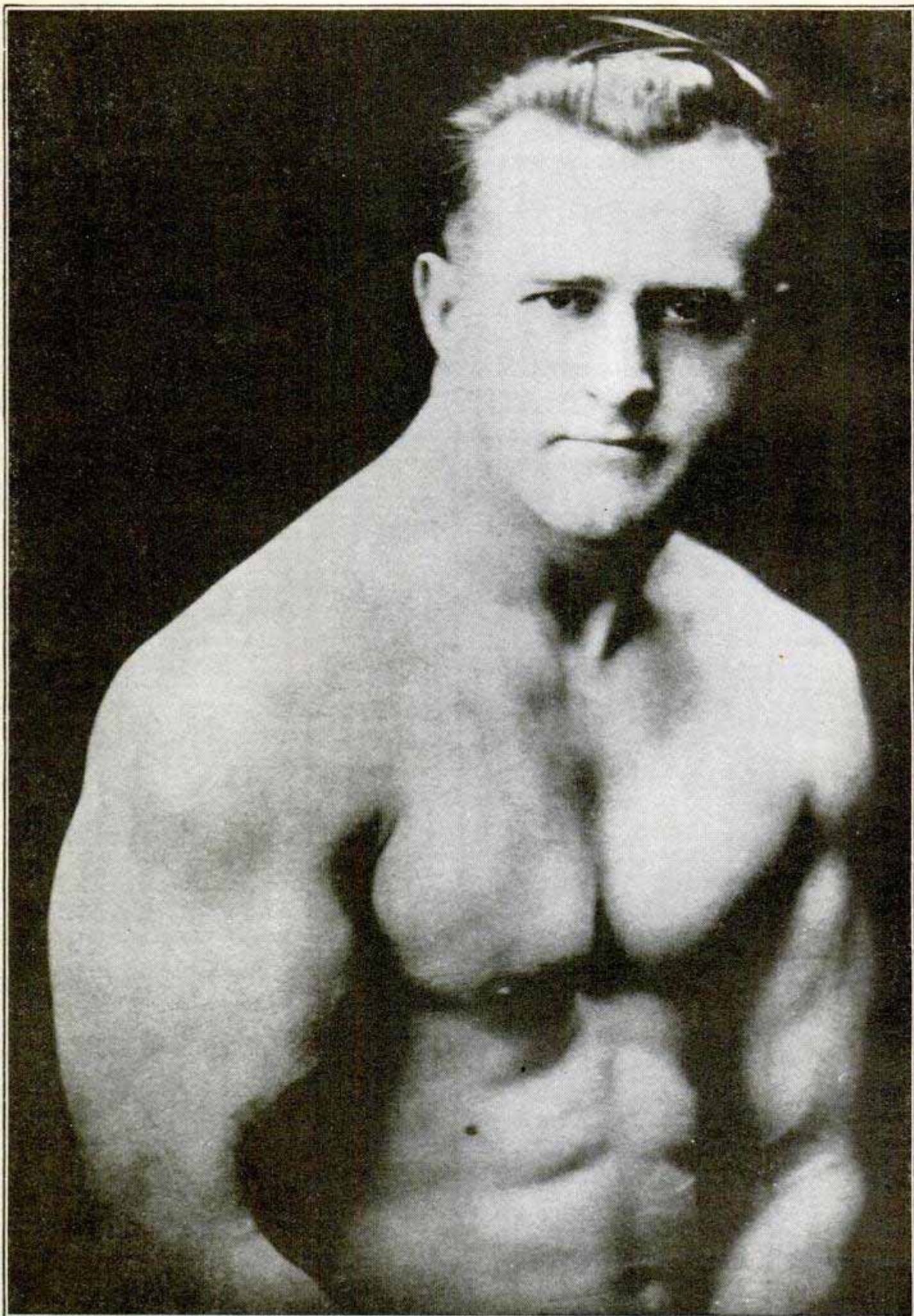

EARLE E. LIEDERMAN, *The Muscle Builder*

Author of "Science of Wrestling," "Muscle Building," "Secrets of Strength," "Here's Health," "Endurance," etc.

Kill This Man!

THERE'S a devil inside of you. He's trying to kill you. Look out for him! He tells you not to work so hard. What's the use? the boss only piles more work on you. He tells you not to bother with your body. If you're weak—you always will be weak. Exercise is just a lot of rot. Do you recognize him? Of course you do. He's in us all. He's a murderer of ambition. He's a liar and a fool. *Kill him!* If you don't, he will kill you.

Saved

Thank your lucky stars you have another man inside of you. He's the human dynamo. He fills you full of pep and ambition. He keeps you alive—on fire. He urges you on in your daily tasks. He makes you strive for bigger and better things to do. He makes you crave for life and strength. He teaches you that the weak fall by the wayside, but the strong succeed. He shows you that exercise builds live tissue—live tissue is muscle—muscle means strength—strength is power. Power brings success! That's what you want, and gosh darn your old hide! you're going to get it.

Which Man Will It Be?

It's up to you. Set your own future. You want to be the Human Dynamo? Fine! Well, let's get busy. That's where I come in. That's my job. Here's what I'll do for you:

In just 30 days I'll increase your arm one full inch with real live, animated muscle. Yes, and I'll add two inches to your chest in the same time. Pretty good, eh? That's nothing. Now come the works. I'll build up your shoulders. I'll deepen your chest. I'll strengthen your whole body. I'll give you arms and legs like pillars. I'll literally pack muscle up your stomach and down your back. Meanwhile I'll work on those inner muscles surrounding your vital organs. You'll feel the thrill of life shooting up your old backbone and throughout your entire system. You'll feel so full of life you will shout to the world, "I'm a man and I can prove it!"

Sounds good, what? But listen! That isn't all. I'm not just promising these things. *I guarantee them!* It's a sure bet. Oh, boy! Let's ride.

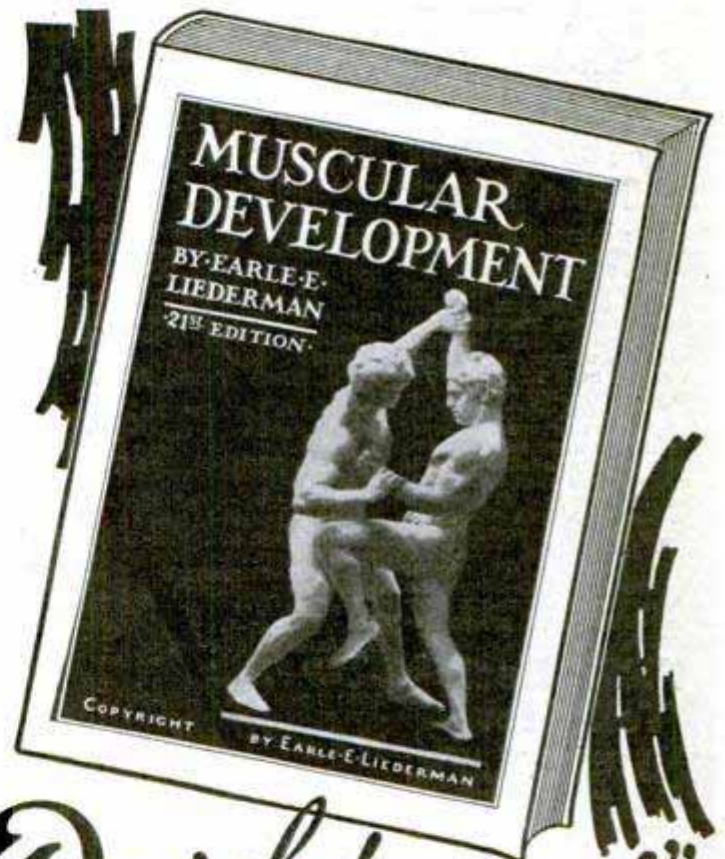

Send For My New
64 Page Book
"Muscular Development"
IT IS FREE

What do you think of that? I don't ask one cent. And it's the peppiest piece of reading you ever laid your eyes on. I swear you'll never blink an eyelash till you've turned the last cover. And there's 48 full-page photos of myself and some of my prize-winning pupils. This is the finest art gallery of strong men ever assembled. And every last one of them is shouting my praises. Look them over. If you don't get a kick out of this book, you had better roll over—you're dead. Come on, then. Take out the old pen or pencil and sign your name and address to the coupon. If you haven't a stamp, a postal will do. But snap into it. Do it *now*. Tomorrow you may forget. Remember, it's something for nothing and no strings attached, no obligation. *Grab it!*

EARLE E. LIEDERMAN

Dept. 2012, 305 Broadway, New York City

**It
Is
F
R
E
E**

**DON'T
SEND ONE
PENNY
—
YOUR
NAME AND
ADDRESS
ON A
POSTAL
WILL DO**

EARLE E. LIEDERMAN
Dept. 2012, 305 Broadway, New York City

Dear Sir: Please send me, absolutely FREE and without any obligation on my part whatever, a copy of your latest book, "Muscular Development."

Name.....

Street.....

City..... State.....

(Please write or print plainly.)



**Before Kenneth McCarty
Mailed that Coupon
He was an
\$18.00 Clerk~**



**Today
His
Income
is
\$85.00
a Week**

After completing the course he wrote us: "Yours is the finest course ever presented for the Tenor Banjo. Before I enrolled with you, I knew nothing whatever about music. I was earning \$18.00 weekly clerking in a store. **Little did I realize the opportunity that had come.** I took up the course just for fun. But here I am playing in one of the best orchestras in Western Michigan and **making \$85.00 a week.** Your course and your kind cooperation have made me a professional Tenor Banjoist."—*Kenneth McCarty, Parkview Hotel, South Haven, Mich.*

**Play for Fun or
\$5,000 a Year**

Whether a salary of \$65 to \$100 a week—or spare time playing at \$5, \$10, \$15 or more a night—interests you or not—think of the fun in store for you. In one to three months we can train you at home to play this marvelous, melodious instrument with a fine easy skill that will make you the envy of all other eyes. Think, too, of the pleasure of being able to express yourself musically when alone! You're passing up the **best times** of your life if you pass up an opportunity like this to learn at slight cost and with no inconvenience at all the world's most popular instrument. **DON'T DO IT!** Decide **NOW** to learn more about The Play-Way—the quickest, surest short-cut ever devised to social and professional success.

**FREE Book
Tells How**

Send at once for "The Play-Way to Popularity and Big Pay." Learn all about our unique method of training you at home, about the big, professional size Tenor Banjo, Phonograph Records and complete Outfit that we send you along with your very first lesson. Undreamed of possibilities for pleasure, popularity and big pay are open to you the minute you "become good." The book below is your first step. Take it now. Clip the coupon while it's here before your eyes.

**You Get Phonograph
Records, Too**

Every selection of the course, fifty-five in all—comes to you on a phonograph record. You hear the instructor's playing just as though he were right at your side. The Play-Way is different, interesting, **FOOL PROOF.** Get the good news the coupon brings. **SEND FOR IT NOW!**



Get Big Free Book

**A. F. Bloch, President,
NEW YORK ACADEMY OF MUSIC,
Studio 1128, 100 Fifth Avenue,
New York City.**

Send me the book that started McCarty. No obligation whatsoever on my part, understand.

Name.....

Address.....



**THE CHICAGO DAILY NEWS
School and College Bureau**

**Offers You Its Specialized
Services in Choosing a School**

Last year the School and College Bureau of The Chicago Daily News saved many busy parents and questioning boys and girls both time and worry by sending them prompt, reliable information about just the kind of school they wanted—personal requirements as to location and tuition charges being considered in each individual case.

Again this year many young people will be perplexed by the problem of finding the right school. Why not let us help you?

The Chicago Daily News maintains this service absolutely free of charge to you. No need to hurriedly select a school on mere hearsay when expert advice can be obtained by telephoning Dearborn 1111, writing or calling for a personal interview at

**THE CHICAGO DAILY NEWS
School and College Bureau
Dept. K, 15 N. Wells St., Chicago, Illinois**

**Big Money for You as an
Automobile Mechanic**

These four practical books, written by five well known teachers of automobile practice, will teach you right in your own home during your leisure time just what you need to know about automobile troubles and repair. They will teach you automobile construction, maintenance and repair as practiced by experts and will help you to earn an expert's pay.

Practical Automobile Library: Four Books—\$1.50 in 10 days and \$2 monthly for 6 months—only \$13.50 in all!

Hundreds of question-answering diagrams—hundreds of clearly-marked illustrations—make the books plain and readily understandable. All the explanations and descriptions are clear, simple, direct. Every chapter is packed with definite, step-by-step, how-to-do-it information. Here is your opportunity to enter a big-pay field.

FREE TRIAL

**Send No Money
Mail the Coupon**



FREE EXAMINATION COUPON

McGraw-Hill Book Co., 370 Seventh Ave., New York

Send me for 10 days' free examination the New Practical Automobile Library. If satisfactory, I will send you \$1.50 in 10 days and \$2.00 monthly until the special price of \$13.50 is paid. If not wanted, I will return the books at your expense.

Signed.....

Address.....

City and State.....

Position.....

Employer.....

A Coupon That Has Meant Real Money To More Than 20,000 Ambitious Men!



\$7200 A YEAR

"I feel that my increase from \$1800 to over \$7200 per year is mostly due to your excellent training methods."

L. D. Mather,
Richmond, Va.



Over \$10,000 A YEAR

"When I started the N. S. T. A. course, I was making \$160 a month. To-day my salary runs into 5 figures."

R. B. Hansen,
Akron, O.

National Salesmen's Training Ass'n., Dept. W-101,
N. S. T. A. Building, Chicago, Illinois.

Without cost or obligation, send me a free copy of your book—
"Modern Salesmanship."

Name.....

Address.....

City..... State.....

Age..... Occupation.....



\$1000 A WEEK

"Before taking the N. S. T. A. Course, I was making \$200 a month, but could see no future. Last week my earnings amounted to over \$1000."

O. D. Oliver,
Norman, Okla.

Who Else Wants to Raise Their Pay 700% or More?

Can It Be An Accident When Man After Man Raises His Pay—Each One Taking The Same Identical Steps? If You Are One Who Aspires To Earn REAL Money—If You Want

To Get Out Of A Monotonous, Low-Pay Job—Find Out About This Tested Plan For Increasing Incomes. It Has Raised More Salaries Than All The "Pull" And Luck In The World!

Get a Copy of This Amazing Book Free

LET'S be practical. You want to make more money . . . A few years ago the three men pictured above were in the same situation. They had the urge to increase their pay—but didn't know how to do it.

Take Mark Barichievich of San Francisco as a typical example. Not long ago he was working in a restaurant, struggling along on a salary that was actually as low as \$8 a week! Naturally he was keenly dissatisfied—but like so many other men caught in blind-alley jobs, he could see no way out.

And then something happened! A certain book fell into his hands. Between its covers he discovered certain facts and secrets he had never dreamed of! Within a short time his pay jumped to \$50 a week. And to-day he makes as high as \$125!

Remarkable Salary Increase

A lucky accident? Not a bit of it! OTHER men who have increased their salaries after reading these vital facts are numbered in the thousands! For example, C. W. Birmingham of Ohio read it and his salary raised from \$15 a week to \$7500 a year . . . Wm. Shore of

California made \$3000 his first 5 months . . . and C. V. Champion of Illinois became president of his company at over \$10,000 a year!

The Secret of Big Pay

How did they do it? What did the book show them? Just this:—Every one of these men realized that Salesmanship offers BIGGER rewards and delivers them QUICKER than any other line of work under the sun. This vital book, "Modern Salesmanship," revealed to them the real TRUTH about the art of selling. It blasted dozens of old theories and told them exactly how the great sales records of nationally-known star salesmen have been achieved. And not only that, it outlined a simple plan that will enable almost any man to master scientific salesmanship without losing a day or dollar from his present position.

A Few Weeks—Then Bigger Pay

There was nothing "different" about these men when they started. Salesmanship is just like any other profession. It has certain fundamental rules and laws—that you can master just as easily as you learned the alphabet. And through the NATIONAL DEMONSTRATION METHOD—an exclusive feature of the N. S. T. A. system of SALESMANSHIP training—you can acquire the equivalent of actual experience while studying.

Free to Every Man

If we were asking several dollars a copy for "Modern Salesmanship" you might hesitate. But it is now FREE. So get your copy now. Learn the real facts about the selling profession, and about the tremendous demand for trained salesmen in every line, to fill city and traveling positions paying up to \$5000 and \$19,000 a year. (Last year this association received calls for over 50,000 N. S. T. A. members from Wholesalers, Manufacturers and Jobbers.) A copy is yours for the asking, and your request entails no obligation. Simply fill out and mail the coupon above. Do it now!

NATIONAL SALESMEN'S TRAINING ASSOCIATION

Dept. W-101, N. S. T. A. Bldg.,
CHICAGO, ILL.



Now Free

MAIL COUPON ABOVE

We Will Train You in a Few Months



Day and Night Schools in Chicago, Detroit, Cleveland, Boston, Phila.

Tune in WBBM (389.4 Meters) for McCarrie hour each Monday at 8:30 P. M. Central Standard Time

Experts Earn Up To **\$125 A WEEK**

as MECHANICAL DENTISTS

We teach you to make rubber plates, crowns, bridge work, metal base dentures, etc., for dentists. After graduating you are ready for a job or can open your own laboratory. We assist you.



Big Demand for Men!

Mechanical Dentistry is the laboratory bench work which the dentist turns over to the laboratory worker. Master this profession and help meet the demand of 64,000 dentists for laboratory work. Every city and every town where dentists are located offers work to the mechanical dentist. We train you in a few months in day or night school for this uncrowded field—no classes—no books—no mechanical experience necessary.

Work Your Way Thru School

We will help you find a job to meet your expenses while taking our training. And we will help you find satisfactory living quarters when you arrive.

Schools located in Chicago, Detroit, Cleveland, Boston, Philadelphia. Day and night schools.

INTERESTING FREE BOOK

Our illustrated free book on Mechanical Dentistry will acquaint you with some surprisingly interesting facts. It tells about the thriving profession of Mechanical Dentistry—the way to swift and certain success. And it tells about the progress of many of our graduates—men who have succeeded beyond their expectations, also full details of our liberal offers. Mail the coupon and find out more about this fascinating opportunity.

McCarrie School of Mechanical Dentistry
1338 S. Michigan Ave., Dept. 192, Chicago, Ill.

McCARRIE SCHOOL OF MECHANICAL DENTISTRY
1338 S. Michigan Ave., Dept. 192, Chicago.

Without cost or obligation, send me your illustrated book on Mechanical Dentistry, and complete information as to my opportunities in dental laboratory work.

Name.....

Address.....

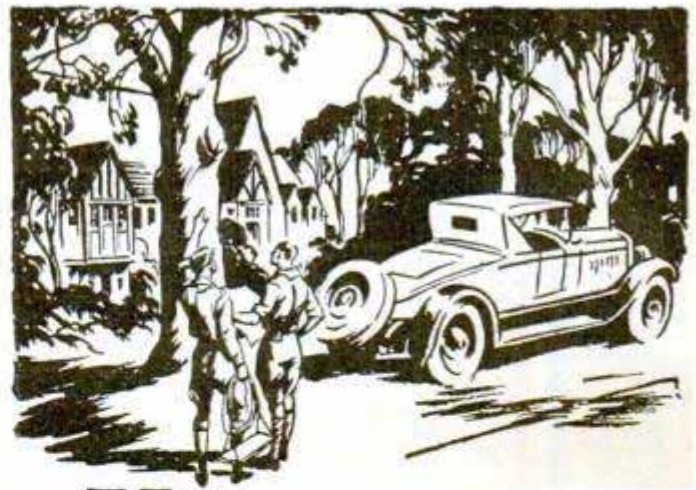

Young men needed by Davey Tree Expert Co.

Interesting, vigorous outdoor work in a growing organization where merit wins advancement. Good starting wages. Permanent positions and a real future for men who make good. Our present field force of Davey Tree Experts cannot meet the increasing demand. So we are selecting now, to enter our employ, a few sturdy, clean young men, thorough Americans, single, between 20 and 30 years old, free to travel, industrious, with good practical education, and able to give good references. Write for qualification blank to serve in place of personal interview. The Davey Tree Expert Co., Inc., 142 Federal Bldg., Kent, Ohio.

Electrical Engineering

Course for men of ambition and limited time. Over 5000 men trained. Condensed course in Theoretical and Practical Electrical Engineering including the closely related subjects of Mathematics and Mechanical Drawing.

Students construct motors, install wiring, test electrical machinery. Course designed to be completed in one college year. Prepare for your profession in the most interesting city in the world. Est. 1893. Catalog on request.



Bliss Electrical School

122 Takoma Ave., Washington, D. C.

Learn Watchwork, Jewelrywork and Engraving A fine trade commanding a good salary, and your services always in demand. Address **Horological**, Dept. P, Bradley Institute, PEORIA, ILLINOIS, for our latest catalog.

IF YOU STAMMER

Write for my free book "Millard's Advanced Natural Corrective Course" and a free copy of my speech magazine. 10,000 cases successfully treated. Est. 24 years. Largest school for stammerers in world. Millard Inst. of Normal Speech, 2317 Millard Bldg., Milwaukee, Wis.

Anyone CAN LEARN

No talent or experience necessary. Fascinating work. Pays big money. Complete instruction book tells about: Alphabets, Colors, How to Mix Paints, Show Cards, Window Board and Wall Signs, Ready made letters, Gilding, Tricks of the Trade, also gives 100 Alphabets and Designs. Book bound in flexible imt. leather-gold edges, and four half bearing Show Card Pens. Sent postpaid \$3.00. (C.O.D.) 10c ex. Gilvie Pub. Co., 57 Rose St. Dept 20, N.Y. City

EARN MONEY IMMEDIATELY—WE FURNISH EQUIPMENT TO START!!

How to Paint SIGNS and Show Cards \$3

\$16 the first night for playing!

MOST of the world works for a living—works hard, too. But that doesn't mean you have to. Why not play for a living? Do something you like to do, and make it pay you big money. Plenty of men and women who had a hard time to get along six months ago—are now making from \$50 to \$100 a week—playing their Hawaiian Guitars. And they didn't know how to read a single note of music when they came to me.

America's Most Popular Music

The haunting, soft, melodious strumming of the Hawaiian Guitar is America's most popular music. Everywhere orchestras are looking for men and women who can play the Hawaiian Guitar. Everywhere those who have mastered the Hawaiian Guitar are getting paid more and more money. Roy Reibane writes in, "I have made \$200 extra money in 6 weeks playing my Hawaiian Guitar." Carelton E. Scarbro recently wrote me, "I have made \$1000 since I took your course." Granville Smith writes, "I make \$8 a night and play only 4 hours."



One of the Dozens of Photo helps sent with each Course

Dozens of such letters have come in. But let me tell you about my short-cut to good times and big pay—my simplified method of learning to play the Hawaiian Guitar at home in a few weeks. A new method—so easy to understand—so much fun to learn—that even a child can pick it up. (We have successfully taught children only 8 years of age.)

Pictures Instead of Words, Teach You

All I ask is that you like music. I don't care if you have never read a note in your life, or even know what a Hawaiian Guitar looks like. My methods are so clear and easy to understand that you will actually play a real melody after the very first lesson. Sounds un-nanny, doesn't it? Here's how I do it.

With your lessons I send dozens of photographs showing just how to place your fingers, how to strum the strings. My Know-All Chart teaches you to read notes almost automatically. It's as simple as learning your A B C's over again. Some of our students become finished musicians the first month, others take a little longer, but they all learn with surprising speed.

Lonesome? It's a Sure Cure!

Once you have mastered the Hawaiian Guitar, the world lies waiting at your feet. You can travel anywhere, meet the best people, live in real style and comfort, and gain a host of friends. All this is yours, waiting for you, if you are willing to spend a few minutes a day with me for a few short weeks.

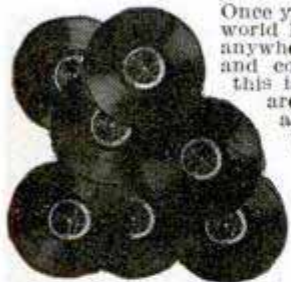

We Send You Regular Phonograph Records of Every Piece in the Course

And we don't miss a single bet. To make sure that you can't go wrong, we send you a whole set of regular phonograph records, on which are recorded every melody you learn to play while taking the course. These aid you to correct minor mistakes, and make you sure that your technique is perfect. With these records to guide you—the tiniest error in your playing is quickly corrected. These records come absolutely free with the course, and are an excellent addition to your home music as well.



This is what Prutzman Did

"A friend asked me if I could play the Hawaiian Guitar. I told him I'd only been playing for a few weeks, but he said, 'Come along anyway, and play at the dance.' I made out very well, and was paid \$16 for my first night's work. And I see more opportunities ahead." — RALPH PRUTZMAN, Lehigh-ton, Pa.

We Give You this genuine HAWAIIAN GUITAR WORTH \$20



Send for FREE BOOK IT SHOWS YOU HOW

Everything is explained. Every last bit of proof is given you. It shows you just how you can master the Hawaiian Guitar at home in double-quick time. How you risk absolutely nothing to learn. How I send everything you need. Get on the road to Big Pay and Pleasure Today. Write Now!

A. F. Bloch, President,
 Hawaiian Studios, 52128 of
 New York Academy of Music,
 100 Fifth Avenue, New York City.
 Without obligation, send me FREE
 Book "How to Learn Hawaiian Guitar," with
 facts on how I can make BIG MONEY,
 spare-time or full-time.
 Name.....
 Address.....



"Mary, I Owe It All to You"

"Mr. WILLIAMS called me into his office today and told me he was going to raise my salary \$50 a month.
 "I am glad to give you this opportunity," he said, "for the best reason in the world. You deserve it.
 "You may not know it, but I've been watching your work ever since the International Correspondence Schools wrote me that you had enrolled for a course of home study. Keep it up, young man, and you'll go far. I wish we had more men like you."
 "And to think, Mary, I owe it all to you! I might still be drudging along in the same old job at the same old salary if you hadn't urged me to send in that I. C. S. coupon!"

How about you? Are you always going to work for a small salary? Are you going to waste your natural ability all your life? Or are you going to get ahead in a big way? It all depends on what you do with your spare time.
 More than 180,000 men are getting ready for promotion right now in the I. C. S. way. Let us tell you what we are doing for them and what we can do for you.

Mail the Coupon for Free Booklet

INTERNATIONAL CORRESPONDENCE SCHOOLS
 "The Universal University"

Bex 5582-F, Scranton, Penna.

Without cost or obligation, please send me a copy of your booklet, "Who Wins and Why," and full particulars about the course before which I have marked X in the list below:

BUSINESS TRAINING COURSES

- | | |
|--|---|
| <input type="checkbox"/> Business Management | <input type="checkbox"/> Business Correspondence |
| <input type="checkbox"/> Industrial Management | <input type="checkbox"/> Show Card and Sign Lettering |
| <input type="checkbox"/> Personnel Management | <input type="checkbox"/> Stenography and Typing |
| <input type="checkbox"/> Traffic Management | <input type="checkbox"/> English |
| <input type="checkbox"/> Accounting and C. P. A. Coaching | <input type="checkbox"/> Civil Service |
| <input type="checkbox"/> Cost Accounting | <input type="checkbox"/> Railway Mail Clerk |
| <input type="checkbox"/> Bookkeeping | <input type="checkbox"/> Mail Carrier |
| <input type="checkbox"/> Secretarial Work | <input type="checkbox"/> Common School Subjects |
| <input type="checkbox"/> Spanish <input type="checkbox"/> French | <input type="checkbox"/> High School Subjects |
| <input type="checkbox"/> Salesmanship | <input type="checkbox"/> Cartooning |
| <input type="checkbox"/> Advertising | <input type="checkbox"/> Illustrating |
| | <input type="checkbox"/> Lumber Dealer |

TECHNICAL AND INDUSTRIAL COURSES

- | | |
|--|---|
| <input type="checkbox"/> Architect | <input type="checkbox"/> Automobile Work |
| <input type="checkbox"/> Architectural Draftsman | <input type="checkbox"/> Airplane Engines |
| <input type="checkbox"/> Building Foreman | <input type="checkbox"/> Plumber and Steam Fitter |
| <input type="checkbox"/> Concrete Builder | <input type="checkbox"/> Plumbing Inspector |
| <input type="checkbox"/> Contractor and Builder | <input type="checkbox"/> Foreman Plumber |
| <input type="checkbox"/> Structural Draftsman | <input type="checkbox"/> Heating and Ventilation |
| <input type="checkbox"/> Structural Engineer | <input type="checkbox"/> Sheet-Metal Worker |
| <input type="checkbox"/> Electrical Engineer | <input type="checkbox"/> Steam Engineer |
| <input type="checkbox"/> Electrical Contractor | <input type="checkbox"/> Marine Engineer |
| <input type="checkbox"/> Electric Wiring | <input type="checkbox"/> Refrigeration Engineer |
| <input type="checkbox"/> Electric Lighting | <input type="checkbox"/> R. R. Positions |
| <input type="checkbox"/> Electric Car Running | <input type="checkbox"/> Highway Engineer |
| <input type="checkbox"/> Telegraph Engineer | <input type="checkbox"/> Chemistry |
| <input type="checkbox"/> Telephone Work | <input type="checkbox"/> Pharmacy |
| <input type="checkbox"/> Mechanical Engineer | <input type="checkbox"/> Mining Engineer |
| <input type="checkbox"/> Mechanical Draftsman | <input type="checkbox"/> Navigation <input type="checkbox"/> Assayer |
| <input type="checkbox"/> Machine Shop Practice | <input type="checkbox"/> Iron and Steel Worker |
| <input type="checkbox"/> Toolmaker | <input type="checkbox"/> Textile Overseer or Supt. |
| <input type="checkbox"/> Patternmaker | <input type="checkbox"/> Cotton Manufacturing |
| <input type="checkbox"/> Civil Engineer | <input type="checkbox"/> Woolen Manufacturing |
| <input type="checkbox"/> Surveying and Mapping | <input type="checkbox"/> Agriculture <input type="checkbox"/> Fruit Growing |
| <input type="checkbox"/> Bridge Engineer | <input type="checkbox"/> Poultry Farming |
| <input type="checkbox"/> Gas Engine Operating | <input type="checkbox"/> Mathematics <input type="checkbox"/> Radio |

Name.....
 Address.....
 City..... State.....
 If you reside in Canada, send this coupon to the International Correspondence Schools Canadian, Limited, Montreal, Canada

Be a Time Study Engineer!

BIG PAY

awaits ambitious time study men who have had practical training. Learn at home in spare time under guidance of practical engineers with 5 to 25 years' experience teaching men for National Cash Register, Delco-Remy, Frigidaire and Delco-Light. Complete home study courses in Time Study Engineering, Mathematics, Mechanical Drawing, Tool Designing, Blue Print Reading. Easy payments. Special rates to students enrolling now. Write for full details.

Earn \$3,000.00 to \$10,000.00 a Year!

MICHAEL'S SCHOOL, INC.
 Dept. 11, Miami Savings Bldg.
 DAYTON, OHIO

Be a Doctor of Surgical CHIROPODY

Dignified professional field. Call for doctors everywhere. Make \$5000 to \$15,000 a year. Course only 2 years at best known College of Chiroprody in America equips you for practice. 15th year. You are ready to enter with 4 years high school or equivalent. Largest foot clinic in world—large faculty physicians, surgeons, chiroprodists—study in Chicago—you can earn while you learn. Write for catalog. No obligation. Dept. 911.

ILLINOIS COLLEGE OF CHIROPODY
 1327 North Clark Street Chicago

ELECTRICITY

Graduates in Constant Demand at Big Salaries. Intensive, practical training. Low Tuition Rates. Diploma in 1 year. Engineering degree in 2 years. Also special 12 weeks' courses. No time wasted. Expert instructors. Personal attention. Extensive modern equipment. Free employment service for graduates. Part-time work secured during training. 27th year. Write Today for Free Illustrated Catalog.

FINLAY ENGINEERING COLLEGE, 1001-B Indiana Ave., Kansas City, Mo.

Study **LAW** AT HOME

Lincoln did it! Also thousands of other great lawyers, politicians and business men. YOU, too, can become a lawyer or law trained businessman through home study guided by the successful practicing lawyers of our faculty. Write today for free book.

AMERICAN CORR. SCHOOL OF LAW
 3601 Michigan Ave., Dept. 1329, Chicago

LEARN WATCHMAKING AND ENGRAVING

BY OUR PROFIT-SHARING PLAN OUR GRADUATES SUCCEED

One of our Iowa students started in a very small way—now doing over \$30,000 a year. Another in Wisconsin, over \$10,000 the first year. Day or night classes. Call or write for FREE BOOK.

Chicago School of Watchmaking, Dept. 4701, 549 W. Randolph St., CHICAGO

GOV'T. POSITIONS

\$35 TO \$75 WEEKLY

MEN - WOMEN

<input type="checkbox"/> Ry. Mail Clerk	<input type="checkbox"/> Steno-Typist
<input type="checkbox"/> Prohibition Inv.	<input type="checkbox"/> Immigrant Inspector
<input type="checkbox"/> R. F. D. Carrier	<input type="checkbox"/> Seamstress
<input type="checkbox"/> Special Agent (investigator)	<input type="checkbox"/> Auditor
<input type="checkbox"/> City Mail Carrier	<input type="checkbox"/> Steno-Secretary
<input type="checkbox"/> Meat Inspector	<input type="checkbox"/> U. S. Border Patrol
<input type="checkbox"/> P. O. Clerk	<input type="checkbox"/> Chauffeur-Carrier
<input type="checkbox"/> File Clerk	<input type="checkbox"/> Watchman
<input type="checkbox"/> General Clerk	<input type="checkbox"/> Skilled Laborer
<input type="checkbox"/> Matron	<input type="checkbox"/> Postmaster
	<input type="checkbox"/> Typist

AGE 18 TO 55

GOVERNMENT INSTRUCTION BUREAU, 111 Arcade Bldg., St. Louis, Mo. Send me FREE particulars How To Qualify for positions marked "X". Salaries, locations, opportunities, etc. ALL SENT FREE.

NAME.....
 ADDRESS.....

Blue Print Plans

and 24 Page Book

"How to Read Blue Prints"

Sent FREE

Our gift to every man in the building game. Sent absolutely free. For we want you to see for yourself . . . at our expense how easily and quickly you learn to read blue prints . . . and can get the knowledge that will make you more money. Don't send a penny. Just mail the coupon.

The Book Tells How

"How to Read Blue Prints" is written in plain, every day English. It is easy to understand . . . and will prove to you immediately how quickly you can get the training that has given other men the chance to work with their heads . . . and to make more money than just the wage scale.

We know this is true. For 22 years we have been training men . . . in their spare time, at home . . . to advance and succeed in the building field. Many have now got good contracting or building businesses of their own. Many are salaried men, foremen or superintendents.

This book is really a Free Trial Lesson in Plan Reading . . . written by a practical building expert. It costs you nothing . . . will teach you how to read Blue Prints . . . and may point the way for you to big money. It will show you how easy our instruction is . . . how quickly you can become an expert . . . can get the practical knowledge that you must have to get ahead quick.

Another Book FREE

We will send you also a book about the Chicago Technical School for Builders. It is free, too. It tells you all about our method of training by correspondence. It shows you how you can make your spare time pay you a handsome profit in a very short while. It tells all about our practical instructors . . . shows every branch and department of our Builder's Courses . . . gives you photo-

graphs of our men and departments . . . tells what others have done and what you can expect to do.

Chicago Technical School for Builders is one of the oldest and best equipped schools of its kind in America. Many big builders owe their first steps to success to our training. Hundreds of practical men from the building trades attend our day and evening classes at our school for builders here in Chicago. You get this same training . . . from the same practical instructors . . . in your own home by mail.

Train by Mail

Go right on with your work. Your spare time . . . as little or as much as you wish . . . is all you need. Our practical lessons and actual blue print building plans come to you by mail. And the cost is little.

Send the coupon . . . today. It will bring you with the free Blue Print Plans and the two books, full information about the Chicago Technical School for Builders. Shows what we have done for hundreds of other men, gives the facts about their success. Tells how some became superintendents in a few months. How others established contracting businesses of their own. Gives all details of this practical builder's course with descriptions, photographs and illustrations.

Start now. It costs you nothing to find out what this practical builder's course is . . . and what it can do for you. If you want to make more money in the building game . . . get the facts about the Chicago Technical School for Builders.

Mail the Coupon - NOW

CHICAGO TECHNICAL SCHOOL FOR BUILDERS

Dept. R-141, Chicago Tech. Bldg.,
118 East 26th St., Chicago, Ill.

Please send me your Free Books and Blue Prints for men in the Building Trades. Send postpaid to my address below. It is understood that no salesman will call on me.

Name

Address

City State



You Can Become a Building Expert

Plan Reading. Every man who has got very far ahead in any building trade can read blue prints. No man can expect to be a first rate foreman or superintendent until he knows what every line on a plan means and how to lay out and direct work from the architect's plans. By the Chicago Tech. Method you quickly learn to read any plan as easily as you read these words.

Estimating. Of course a man who wants to be a contractor or to hold a big job in a contracting organization must know how to figure costs of labor, material, and everything else that goes into any kind of building. The Chicago Tech. Course covers every detail of this important branch—shows you just how it is done from actual blue print plans.

Superintending. How to hire and direct men, how to keep track of every detail of construction as it goes on, how to get the work done in the least time at the lowest cost is also fully covered in the Chicago Tech. Builder's Course.

Also special courses in Architectural Drafting for builders, taught by practical men. These explained in Special Catalog "D" sent on request.

CHICAGO TECHNICAL SCHOOL FOR BUILDERS

CHICAGO TECH. BUILDING

Dept. R-141 118 E. 26th St., CHICAGO, ILL.



High School Course in Two Years!

You Want to Earn Big Money!

And you will not be satisfied unless you earn steady promotion. But are you prepared for the job ahead of you? Do you measure up to the standard that insures success? For a more responsible position a fairly good education is necessary. To write a sensible business letter, to prepare estimates, to figure cost and to compute interest, you must have a certain amount of preparation. All this you must be able to do before you will earn promotion. Many business houses hire no men whose general knowledge is not equal to a high school course. Why? Because big business refuses to burden itself with men who are barred from promotion by the lack of elementary education.

Can You Qualify for a Better Position

We have a plan whereby you can. We can give you a complete but simplified high school course in two years, giving you all the essentials that form the foundation of practical business. It will prepare you to hold your own where competition is keen and exacting. Do not doubt your ability, but make up your mind to it and you will soon have the requirements that will bring you success and big money. YOU CAN DO IT.

Let us show you how to get on the road to success. It will not cost you a single working hour. Write today. It costs you nothing but a stamp.

American School

Dept. H-974, Drexel Ave. and 58th St., Chicago

American School

Dept. H-974 Drexel Ave. and 58th St., Chicago

Send me full information on the subject checked and how you will help me win success.

- | | |
|-----------------------------|---------------------------|
|Architect |Business Law |
|Building Contractor |Lawyer |
|Automobile Engineer |Machine Shop Practice |
|Automobile Repairman |Mechanical Engineer |
|Civil Engineer |Shop Superintendent |
|Structural Engineer |Employment Manager |
|Business Manager |Steam Engineer |
|Cert. Public Accountant |Foremanship |
|Accountant and Auditor |Sanitary Engineer |
|Bookkeeper |Surveyor (& Mapping) |
|Draftsman and Designer |Telephone Engineer |
|Electrical Engineer |Telegraph Engineer |
|Electric Light & Power |High School Graduate |
|General Education |Wireless Radio |
|Vocational Guidance |Undecided |

Name.....

Address.....

FOR YOUR FUTURE



INVESTIGATE THIS VOCATIONAL TRADE OPEN TO ALL WHETHER 18 OR 50

The opportunity of a lifetime to become financially independent. Earn up to \$5,000 a year. Great demand and always will be because it is a human necessity. Easily learned in three to six months by actual practice with the regular tools of the trade. No previous training required. Business of your own if desired. Oldest establishment in this field is now ready to train an additional number of men for this work. Remarkably low cost—starting fees as low as \$15. R. R. Fare to nearest school included. Earn while you learn if necessary—regular arrangement for part time positions. Investigate this opportunity. The facts are convincing. Write today for Bulletin No. 2 which gives complete information.

BODEE INSTITUTE

New York
1755 Broadway

Philadelphia
1305 North Broad Street

Brooklyn
85 Court Street

PREPARE FOR AN ART CAREER

—thru the only art school operated as a department of a large art organization, who have actually produced over a quarter million drawings for leading advertisers. Where else can you get so wide an experience? Home study instruction. Write for illustrated book telling of our successful students.

MEYER BOTH COMPANY Michigan Ave. at 20th St. Dept. 16, Chicago, Ill.

LEARN WATCH REPAIRING



You can learn by our modern and original system of instruction every part of the **Watch Repairing Trade** at home as good or better than at a shop. You can earn money while learning and secure a well paying position or start in business after completing our course of instruction. Good watch repairers are always in demand and earn from \$50 to \$75 per week. For particulars apply to the **Wisconsin School of Watch Repairing** 166 Mason St., MILWAUKEE, WIS.

YMCA TRADE SCHOOL

Learn Auto Mechanic, Auto Electrical, Battery, Machine Shop, Electrical, Radio Mechanic, Aviation Mechanics, Tiling, Brick-laying, Plastering, Plumbing, Electric Acetylene and Airplane Welding, Drawing Estimating, Show Card, Sign Painting, Window Dressing, Fine and Commercial Art.

Write for Catalog 50.

BROOKLYN ENGINEERING INSTITUTE
(Operated by Bedford Br. Y. M. C. A.)
1125 Bedford Ave., Brooklyn, New York City.



Wonderful, new device, guides your hand; correct your writing in few days. Big improvement in three hours. No failures. **Complete outline FREE.** Perfect Penmanship Inst. D-34, St. Louis, Mo.

Learn Photography at HOME

Make money taking pictures. Prepare quickly during spare time. Also earn while you learn. No experience necessary. New easy method. Nothing else like it. Send at once for free book. **OPPORTUNITIES IN MODERN PHOTOGRAPHY** and full particulars

AMERICAN SCHOOL OF PHOTOGRAPHY
Dept. 1359 3601 Michigan Ave. Chicago, U. S. A.

AUDELS ENGINEERS & MECHANICS GUIDES

EXAMINE FREE!

For Every

Engineer
Mechanic

Machinist
Electrician

Fireman; Oiler
Engineer Student



\$12

Complete Set 8 Guides

THIS Master Set is a gold mine of daily, practical helps for workers in every branch of engineering. A self-educating study course for the student; the standard reference work for the chief. Thousands of rules, tables, calculations and diagrams make it easy to read and learn. Latest inside information on theory and practice of modern engineering for reference study and review. Thousands of new short-cuts that make the job easier. Examine free! Pay \$1 a month (less than 4c a day) if satisfied that this set will help you to a better job—or make your present job easier.

AUDELS STANDARD LIBRARY

With Questions and Answers That Solve Your Problems

EASY TERMS

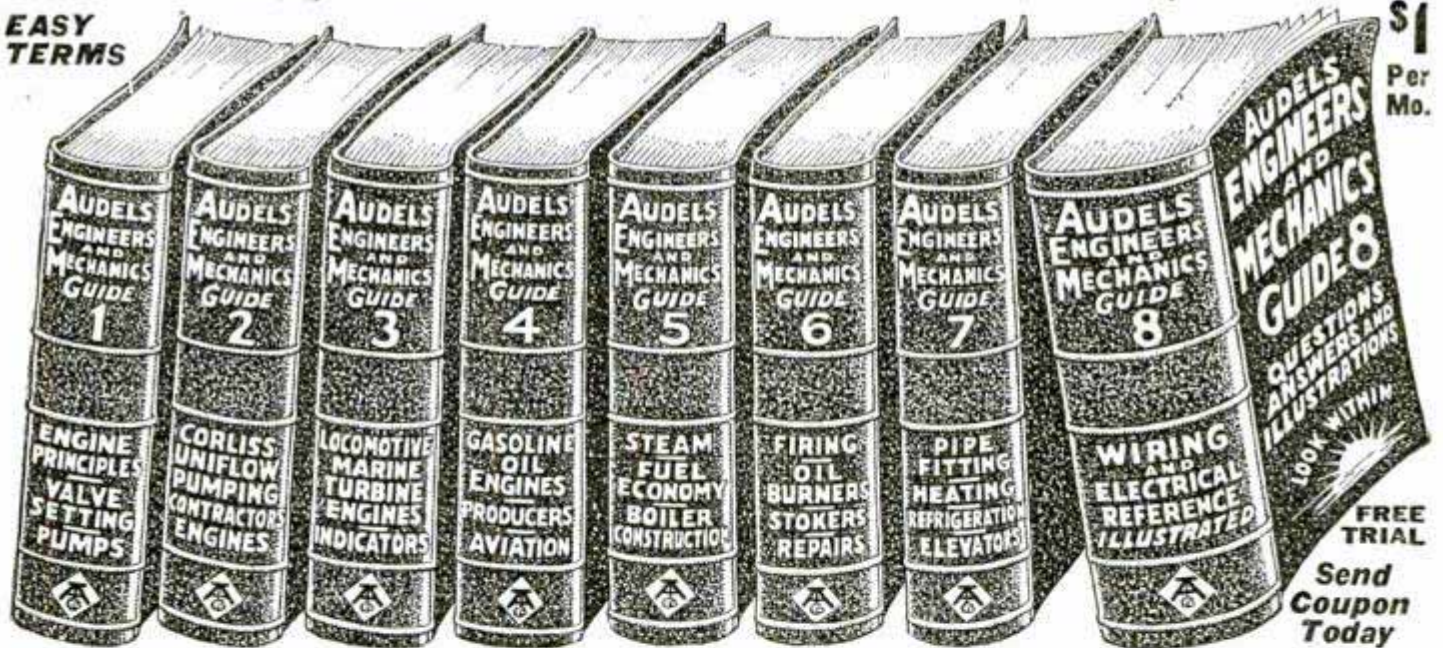

\$1 Per Mo.

FREE TRIAL
Send Coupon Today

8 GUIDES 8754 PAGES—4750 ILLUSTRATIONS—POCKET SIZE

8 pocket numbers with Ready Reference Index. 8754 pages. 4750 illustrations. Easy to read. Highly endorsed. A good help in securing Engineer's License. Price \$12; terms, \$1 per month. Free Trial.

INFORMATION: — In A Handy Form. Answers to Your Questions and Problems. Here is a partial list of the subjects covered:—**Engine Principles, Valve Setting, Pumps, Corliss Engines, Uniflow Engines, Pumping Engines, Contractors Engines, Locomotives, Marine Engines, Turbine Engines, Gas Engines, Oil Engines, Indicators, Producers, Aviation, Steam, Fuel Economy, Boiler Construction, Firing, Oil Burners, Stokers, Boiler Repairs, Pipe Fitting, Heating, Refrigeration, Elevators, Dynamos, Motors, Lighting, Wiring, Electrical Diagrams, Radio, Electrical Reference and Calculations.**

FREE BOOK—FOR LIMITED TIME.

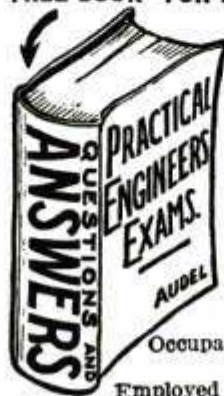

While the edition lasts, "Audels Answers" will be included with each set of Audels Guides. Contains special information for those who want to go before the board to get a license. Makes Engineers exams. easy. Send this coupon at once.

THEO. AUDEL & CO., 65 West 23rd St., New York City

Send me AUDELS ENGINEERS AND MECHANICS GUIDES, 8 numbers, \$12 and "Audels Answers" for free examination. If satisfactory, I will send you \$1 in 7 days, then \$1 monthly until \$12 is paid.

Name

Address

Occupation

Employed by

12T30



"I Won't Be Clerk Any Longer!"

—so said P. S. Blessing, and through Higher Accountancy increased his salary 250 per cent.

For four years Philip S. Blessing worked hard as a clerk and got nowhere. He saw opportunities for promotion and salary increase, but they went to other men because he wasn't ready for them. He learned what every successful man knows—opportunity without trained ability means nothing. He decided to get that trained ability!

Within fifteen months after he started with LaSalle in Higher Accountancy, Mr. Blessing was made Assistant Treasurer of the Lancaster Brick Company, Lancaster, Pa., and his salary was increased 137 per cent. Since then it has increased even more, until now it is 250 per cent larger than when he enrolled. His employer, Clarence B. Horning, General Manager, adds the vital point: "We believe he has many successful years ahead of him. His business progress has only begun."

Send for Free Book— "Accountancy, the Profession that Pays"

Is Mr. Blessing's swift promotion exceptional among LaSalle-trained men? Not at all. His record is typical of what hundreds of others have accomplished. Harry J. Williams, for example, was clerk with the Lehigh Valley Railroad. Through Higher Accountancy he won the position of Accounting Engineer, with a salary increase of better than 60 per cent. John H. Lansing—now Public Accountant and Income Tax Specialist at Amsterdam, N. Y.—was 43 when he took up Higher Accountancy training. It increased his income more than 500 per cent.

Higher Accountancy training will not interfere with your present work; nor do you need bookkeeping experience in order to make your start. Our free book, "Accountancy, the Profession that Pays," will tell you everything you want to know about LaSalle training and the opportunities in the Accounting field. The coupon will bring it without cost or obligation.

— — — Find Yourself Through LaSalle! — — —

LaSalle Extension University

The World's Largest Business Training Institution

Dept. 1264-HR Chicago

I would welcome details of your salary-increasing plan, together with copy of "Accountancy, the Profession that Pays," also a copy of "Ten Years' Promotion in One," all without obligation.

Higher Accountancy

Training for positions as Auditor, Comptroller, Certified Public Accountant, Cost Accountant, etc.

Other LaSalle Opportunities

LaSalle opens the way to success in every important field of business. If more interested in one of the fields indicated below, check and mail now.

- | | |
|---|---|
| <input type="checkbox"/> Business Management | <input type="checkbox"/> Banking and Finance |
| <input type="checkbox"/> Modern Salesmanship | <input type="checkbox"/> Modern Business Correspondence |
| <input type="checkbox"/> Traffic Management | <input type="checkbox"/> Telegraphy |
| <input type="checkbox"/> Railway Station Management | <input type="checkbox"/> Expert Bookkeeping |
| <input type="checkbox"/> Law: Degree of LL.B. | <input type="checkbox"/> C. P. A. Coaching |
| <input type="checkbox"/> Commercial Law | <input type="checkbox"/> Business English |
| <input type="checkbox"/> Industrial Management | <input type="checkbox"/> Commercial Spanish |
| <input type="checkbox"/> Modern Foremanship | <input type="checkbox"/> Effective Speaking |
| <input type="checkbox"/> Personnel Management | <input type="checkbox"/> Stenotypy—Stenography |
| <input type="checkbox"/> Credit and Collection Correspondence | |



Learn AVIATION

WHERE LINDBERGH STARTED!

GET TRAINING

THAT ASSURES SUCCESS!

COME to the Lincoln Airplane School—where Lindbergh started. Get the same thorough, complete instruction—now under greatly increased facilities. Here you get practical Ground and Flying Training. You work on real planes and motors supplied by the Lincoln Aircraft factory. You go right up into the sky in our famous Lincoln Page planes. Competent, experienced instructors. Write at once for full information!

LINCOLN AIRPLANE SCHOOL

Successors to the Lincoln Standard Aircraft School
2417 O Street, Lincoln, Nebraska

BE AN ARTIST

WE CAN TEACH YOU DRAWING in

your own home during your spare time. Twenty-five years of successful teaching proves our ability. Artists receive large salaries.

Write Today for Art Year Book

SCHOOL OF APPLIED ART
ROOM NO. 2 BATTLE CREEK MICH.



LEARN ELECTRICAL TRADES

Practical Training on Massive Lay-Out of Expensive Electrical Equipment. Armature Winding, House Wiring, Electric Welding, Electric Refrigeration, Power Plants, Switchboards, Transformers, Motors, Generators, Radio Batteries. Automobile Course included without extra cost. Write Today for Free Catalog.

COLEMAN ELECTRICAL SCHOOL, 1628V Main St., Kansas City, Missouri



DRAFTING

BOOKS SENT FREE!

For Beginners

Written so you can understand every word, by 18 famous Engineers and Architects. Deluxe, flexible binding. 1750 pages, 1050 blue prints, charts and diagrams. Prepares you for a good Drafting job in mechanical or architectural lines. Sent for 15 days' free use, if you mail coupon immediately.

Only fifteen minutes a day with these WONDER BOOKS will prepare you for a good Drafting job in less than a year! Mechanical and Architectural Drafting from simple straight lines to important, complex plans, a step at a time! Built especially for beginners, for men with only grammar schooling. Drafting room practice plus engineering made easy and clear!

Big Field—Big Demand—Big Pay!

Competent Draftsmen are urgently needed right now in all building and manufacturing lines at \$50 to \$100 a week. That's just the beginning—for draftsmen have the best chances for advancement! Pleasant, fascinating work, easy to learn and do. Learn quick with these books—send coupon for a set FREE, and see for yourself!

A year's Consulting Membership in the American Technical Society now given free to all readers of this famous Cyclopaedia of Drafting. Many say that's worth more than cost of books.

American Technical Society
Dept. D-919, 58th & Drexel Ave., Chicago



Modern American Homes FREE!

American Technical Society
Dept. D-919, 58th & Drexel Ave., Chicago

Send for 15 days' free use 4-volume set of DRAFTING. In return for mailing this coupon promptly send absolutely FREE "Modern American Homes," 112 plates, exteriors, interiors and plans. I will pay the few cents delivery charges. If I wish I may return books in 15 days and owe you nothing. But if I prefer to keep them I will send \$1.80 after 15 days, then \$2.00 a month until \$14.50 (special reduced price) is paid.

Name.....
Address.....
Employed by.....
Address.....

Name.....
Present Position.....
Address.....

Why good dancers are popular

Good dancers are good mixers. They create a favorable impression—have ease of manner, a pleasing assurance that wins. No wonder people find them interesting—seek their company!

by **ARTHUR MURRAY**
World-Famous Dancing Authority

GOOD dancers are always popular — always sure of a good time wherever they go!

And dancing is great fun—wonderful exercise. It takes your mind off your worries and cares. Keeps you happy and healthy—always on your toes and full of pep. Develops self-confidence—gives you poise—helps you overcome timidity and awkwardness. It enables you to make friends easily—to be well-liked—and often opens the doors to important business and social contacts.

And it's so easy now to be a good dancer, able to do all the newest, smartest steps! It's so easy now to get some real fun out of life—to be a good mixer—to be popular, sought-after, admired!

Amazing New Method

For I have developed a remarkable new method of teaching dancing by mail which is so simple that *you can learn any of the latest steps in one evening*—right at home, in the privacy of your own room, without music or partner!

It makes no difference if you've never been on a dance floor in your life—my new method makes learning to dance *just as easy as taking one step after another!*

With my amazingly simple lessons you start right at the beginning and go through the entire field of social dancing. Nothing is omitted—nothing taken for granted. You learn to master every step from the simple waltz to the newest, smartest steps and all their variations.

Learn at Home Without Music or Partner

The best feature of my easy lessons is that you study them in the comfort of your own home whenever you find time. No one to watch and embarrass you. No expensive private teacher to pay. You need no partner and no music—just the lessons. Yet, almost before you realize it, you will be able to step on the floor with the best dancers of your set—and with as much ease and assurance as if you had been dancing for years!

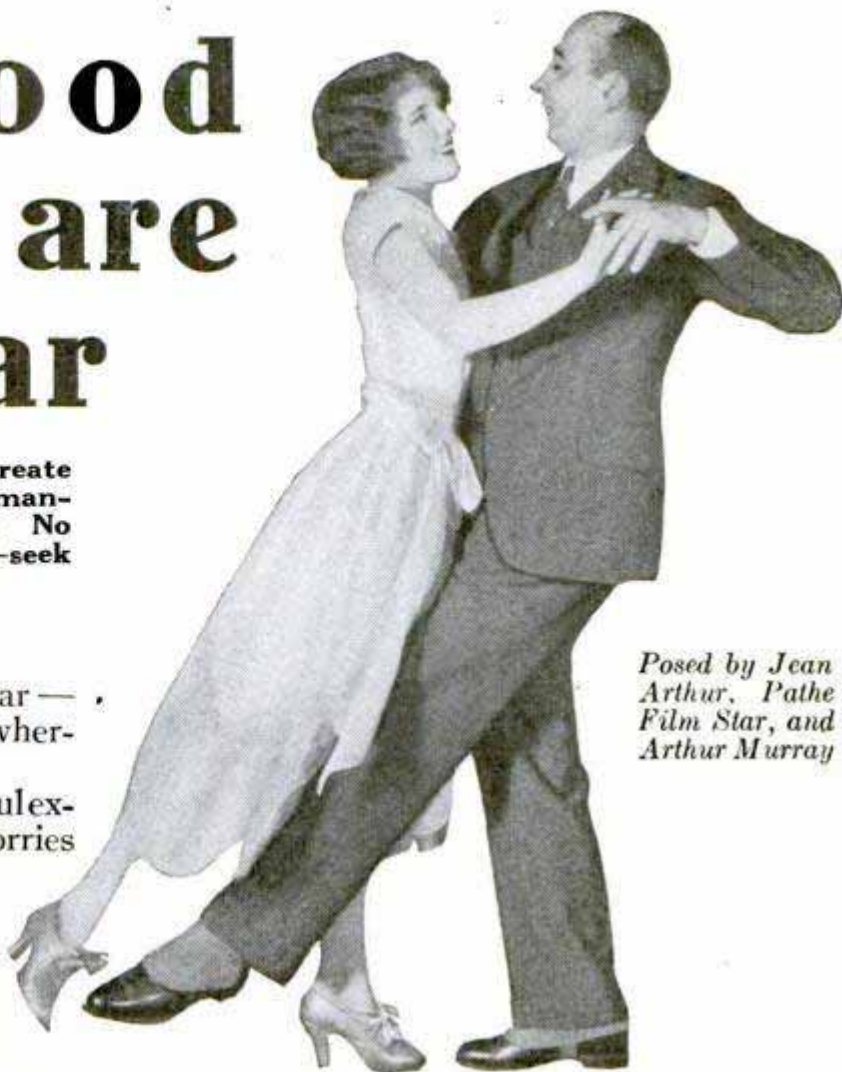

Posed by Jean Arthur, Pathe Film Star, and Arthur Murray

Five Lessons FREE

I have already taught 400,000 men and women how to dance through this amazingly simple method. Thousands of folks everywhere who used to stay home and miss all the fun are now having the time of their lives. They make friends easily—they're welcome and popular wherever they go.

And I'm so positive that you, too, can become a good dancer and get your full share of fun and popularity through my new easy method that I'm willing to send you five lessons from my remarkable course, *absolutely free.*

Just send the coupon, with 10c to cover cost of printing and mailing, and these valuable lessons will be forwarded at once. Also a free copy of my new booklet, "The Short Cut to Popularity."

Don't wait—you owe it to yourself to clip and mail this coupon NOW. Arthur Murray, Studio 851, 7 E. 43rd Street, New York City.

**Arthur Murray, Studio 851,
7 East 43rd Street, New York City.**

To prove that I can learn to dance at home you may send the FIVE FREE LESSONS. I enclose 10c (stamps or coin) to pay for postage, printing, etc. You are to include free "The Short Cut to Popularity."

Name.....

Address.....

City.....State.....

BIG Demand for Skilled Mechanics!

The entire country is calling for skilled mechanics! Good pay—steady work—good opportunities for advancement! Master this fascinating trade with the aid of the **AMERICAN MACHINISTS' LIBRARY** 6 volumes—2,000 pages—2,500 illustrations

(A combined home-study course and reference library)

This library of machine shop practice was written for practical men. It gives you the best methods for every kind of machine shop work. It explains machine tools and their operation, tool work, gears and grinding, jigs and fixtures, automatic screw machines, their tools, punches and dies, etc. Plainly written, completely illustrated—the best kind of help to the machine-shop man who wants to advance himself.

Sent

**F
R
E
E**

No money down—
only 7c
a day

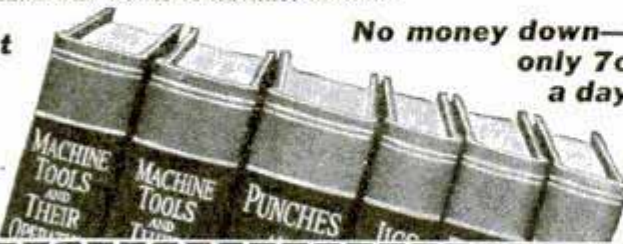

FREE EXAMINATION COUPON

McGraw-Hill Book Co., Inc., 370 Seventh Ave., New York

Send me for 10 days' free examination the AMERICAN MACHINISTS' LIBRARY. If satisfactory, I will send \$1.50 in 10 days and \$2 monthly until the special price of \$17.50 is paid. If not wanted, I will return the books at your expense.

Signed.....

Address.....

City and State.....

Position.....

Employer..... P. M. 12-28



J. H. WADE made \$200 in 2 weeks. A. G. MASON earned \$617 for a few days' work. You, too, can soon qualify for the wonderful opportunities in this fascinating, big pay profession. **CAMERA FREE BOOK** tells how famous experts teach you money-making secrets of photography, in your spare time at home, or in our great New York Studios—how we help you get a fine position or start your own business—how we give you a professional camera.

Write today for Book and Job Chart.

N. Y. INSTITUTE OF PHOTOGRAPHY, 10 W. 33rd St., NEW YORK, Dept. 49

BE A MOVIE OPERATOR

We give projector and teach you at home. Big demand by movie and vaudeville theatres. Write for folder.

LEARN A TRADE Be Independent

Easy to Learn Watchmaking and watch and clock repairing by our practical method of individual training.

Earn Up to \$100 A WEEK

FREE BOOK Learn in few months to fill big pay job or start your own business. Big shortage of trained watchmakers. Day or evening school. No books or classes. You can earn part of your tuition on actual repair work you do in school. Write for Free Book Today!

NATIONAL SCHOOL OF WATCHMAKING
1340 S. Michigan Ave. Dept. 42 CHICAGO, ILL.

Learn Watchwork, Jewelrywork and Engraving A fine trade commanding a good salary, and your services always in demand. Address **Horological**, Dept. P, Bradley Institute, PEORIA, ILLINOIS, for our latest catalog.

LEARN CARTOONING

AT HOME DURING SPARE TIME

with the course that has trained HUNDREDS of beginners successfully. The Landon Picture Chart Method of teaching ORIGINAL drawing by mail makes cartooning easy to learn. This school is a Member of The National Home Study Council. Write today for sample picture chart to TEST YOUR ABILITY and examples of the work of successful students now earning from \$50 to \$200 and more per week. Enclose 6c in stamps and STATE YOUR AGE.

THE LANDON SCHOOL, 2838 National Bldg., Cleveland, Ohio



Stop Making Mistakes in English

Wonderful new way to improve your English. No rules to learn. No hard study. Grammar, spelling, punctuation, and expression, taught in 15 minutes a day—at home. Self-correcting feature makes it fascinating as a game. Write today for free book "How to Speak and Write Masterly English." Address



SHERWIN CODY SCHOOL OF ENGLISH
512 Searle Building Rochester, N.Y.

Pathfinder

TRIAL

EVERY WEEK 13 WEEKS
\$1 A YEAR 15 CENTS

Your neighbors know the Pathfinder and you will like it—the every week news digest from the Nation's Center. Bright, interesting, dependable. Different—nothing else like it. Washington gossip, politics, science, travel, fun, lots of pictures, instruction, entertainment. Trial 13 weeks—13 big issues—only 15c or \$1 for full year—52 issues. Send now. Address Pathfinder, Dept. 25, Washington, D. C.

TRAVEL—for 'UNCLE SAM'

RAILWAY POSTAL CLERKS

MAIL CARRIERS—POSTOFFICE CLERKS
PROHIBITION AGENT—INVESTIGATOR

\$1700 to \$3400 a Year for Life

No "lay-offs" because of strikes, poor business, etc.—sure pay—rapid advancement. City and country residents stand same chance. Common sense education usually sufficient.

STEADY WORK

Cut coupon and mail it before turning the page.

MEN—BOYS 18 to 45

Use Coupon Before You Lose It

COUPON

FRANKLIN INSTITUTE, Dept. K-175, Rochester, N. Y. Rush to me, entirely free of charge. (1) A full description of the position checked below; (2) 32-page book, with list of positions obtainable and sample coaching; (3) Particulars telling how to get the position checked.

Railway Postal Clerk (\$1900 to \$2700) General Clerk (\$1260 to \$2100)
 Postoffice Clerk (\$1700 to \$2300) Prohibition Agent (\$1860 to \$3400)
 City Mail Carrier (\$1700 to \$2100) Rural Mail Carrier (\$2100 to \$3300)

Name

Address.....

90 Days the PRACTICAL WAY...then an ELECTRICAL JOB at Big Pay

NOT A Correspondence Course

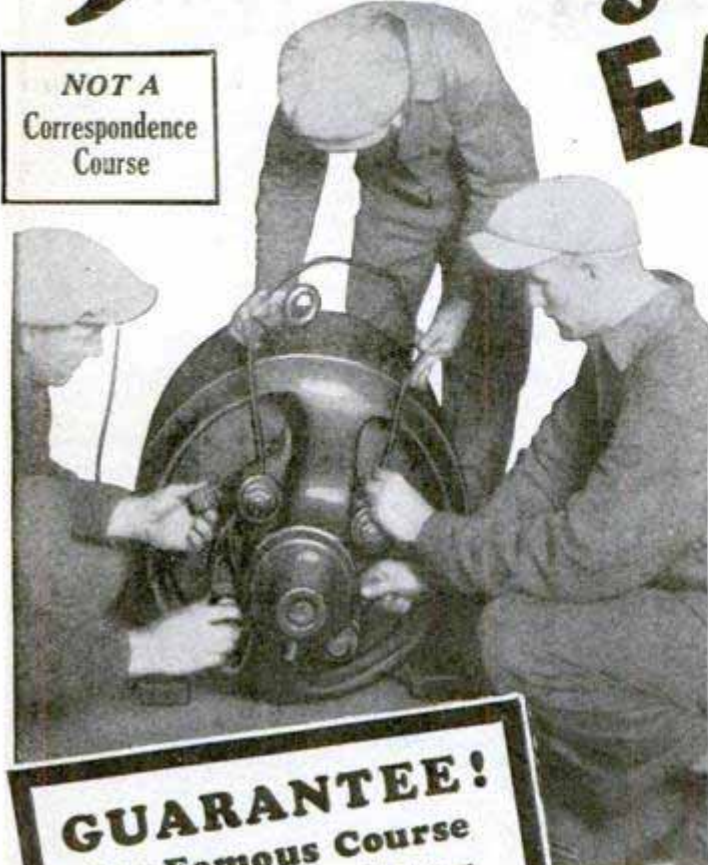

\$40 to \$200 a Week

Right now over 40,000 jobs are crying for trained Electrical Men. They pay from \$40 to \$200 a week. Prepare yourself in 90 days, and get one. Practical electrical training on real machines in my famous school is the easiest, quickest, shortest way to big pay. Learn Electricity—you can whether you're 16 or 60. Previous experience and advanced education absolutely not necessary. I prove it.

NOW Course Includes Radio, Television, Automotive Electricity, Batteries!

Special extra courses given to students who enroll now. No extra charges. One lowest tuition covers everything. You learn latest developments in Electrical Field. Last-minute discoveries made clear and practical to you.

No Books — No Dry Lectures — Anyone Can Learn Easily!!!

McSweeney Students grab off big paying jobs because they are trained the practical Shop-Plan way. You learn by doing. You work on actual motors, generators, transformers, batteries, power plants, radio sets, etc., etc. Expert instructors show you how—then you do the work yourself. When you graduate you KNOW electricity, and can tackle any job.

My 60-Page Book FREE

Mail coupon now for my expensive 60-page book on Electricity. See scores of photographs. Read how other fellows have succeeded with McSweeney Training. FREE TO YOU. Mail coupon. "Mac."



Rush This Coupon to Me

GUARANTEE!

My Famous Course Must Satisfy You—OR MONEY BACK

You are fully protected by my famous Money-Back Guarantee of Satisfaction. You are the only judge of McSweeney Training. I will refund every penny of your tuition if you're not satisfied. You don't risk a dime.

A CHALLENGE!

I challenge every red-blooded man who wants to make big money to take me up on this straight-from-the-shoulder offer! Mail coupon for FREE BOOK now, and see for yourself. No obligation.

AMAZING R. R. FARE OFFER

I will allow your railroad fare from your home town to Cleveland, and ALSO FARE BACK TO YOUR HOME TOWN!

McSWEENEY

ELECTRICAL SCHOOLS

DEPT. 51-T, CLEVELAND, OHIO

J. H. McSweeney, Pres.,
McSweeney Electrical Schools,
Dept. 51-T, Cleveland, O.
Dear Mac: Without obligation, send me a copy of your big book on ELECTRICITY; also Special Railroad Fare offer, and details of FREE Radio Course.

Name.....
Address.....
Town..... State.....



SHOW CARD LETTERING

Learn at Home

HERE is the very course you need if you want to get a good paying position as a Show Card Letterer or Sign Letterer, or have a business of your own. This course is complete and practical and especially arranged to meet the needs of the student who studies at home. It was written by E. L. Koller, Principal of the School of Art of the International Correspondence Schools, member of the American Federation of Arts, and The National Society of Craftsmen.

Mr. Koller has had twenty years' teaching experience, and his success in helping other men and women is an indication of what he can do for you.

H. L. Wood, a clerk, made more than \$700 "on the side" before he had completed his course and also won \$125 in prizes. Harry William Lord writes that he has more than doubled his salary as a result of studying this I. C. S. course in spare time. William Whitman, a former wagon builder, now has a sign painting business of his own and is earning nearly three times as much as he did before enrolling with the International Correspondence Schools.

There is no doubt that Show Card Lettering and Sign Lettering offer a real opportunity to ambitious men and women. Just mark and mail the coupon and we'll gladly send you a booklet telling all about the I. C. S. course in Show Card Lettering, or any other subject in which you are interested.

INTERNATIONAL CORRESPONDENCE SCHOOLS

"The Universal University"

Box 5583-F, Scranton, Penna.

Please send me one of your booklets containing information about the position before which I am marking an X:

SHOW CARD LETTERING

ILLUSTRATING

CARTOONING

- Business Management
- Industrial Management
- Traffic Management
- Accounting and C. P. A. Coaching
- Cost Accounting
- Bookkeeping
- Spanish

- French
- Secretarial Work
- Salesmanship Advertising
- Stenography and Typing
- Railway Mail Clerk
- English
- Civil Service
- Common School Subjects

TECHNICAL AND INDUSTRIAL COURSES

- Electrical Engineering
- Electric Lighting
- Mechanical Engineer
- Mechanical Draftsman
- Machine Shop Practice
- Railroad Positions
- Gas Engine Operating
- Civil Engineer
- Surveying and Mapping
- Mining Radio
- Steam Engineering

- Architect
- Architects' Blueprints
- Contractor and Builder
- Architectural Draftsman
- Concrete Builder
- Structural Engineer
- Chemistry Pharmacy
- Automobile Work
- Navigation Mathematics
- Airplane Engines
- Agriculture and Poultry

Name.....

Street Address.....

City..... State.....

If you reside in Canada, send this coupon to the International Correspondence Schools Canadian, Limited, Montreal

Learn to Write

I Teach by Mail

I CAN make a good penman of you at your home during spare time, no matter where you live or how poorly you now write. My simplified system has shown thousands of others the way to good penmanship during the past twenty years — it can and will do the same for YOU!

Beautifully Illustrated Book
"How to Become a Good Penman"

It contains general information, with testimonials and beautiful specimens **FREE!** of penmanship showing what others have accomplished by the Tamblin System. (Your name elegantly written on a card if you enclose stamp for postage.) WRITE TODAY. Address

F. W. TAMBLIN
 418 Ridge Bldg., Kansas City, Mo., U. S. A.

YOU CAN DO IT!

Famous Violin Maker sells genuine "Strad" Patterns, Instruction Book, Fine Woods, etc. Simple! Wonderful!

C. C. FRASER, Box 14, Sta. C, Grand Rapids, Mich.

Learn Furcraft

Learn by mail, evenings at home, to Renew, Repair and Make-up all kinds of fur garments. Learn glazing, ironing and storage. Big demand, big need for your service in every neighborhood. \$3 an hour in your spare time or a real business now and a fur shop later. We teach you secret processes. Earnings start in 30 days. Uncrowded field for men and women. **FREE BOOK**—Send now for free book giving details. No obligation.

Northwestern Fur Co. 3379 Sunderland Bldg. OMAHA, NEBRASKA

STAMMERING

easily, permanently corrected. Win happiness and success. Ask for full information and special phonograph record. Send dime for postage

12972 Woodward Ave., LEWIS INSTITUTE, Detroit

LEARN WATCHMAKING

and become independent. We help you secure a position. Easy to learn. Send for **FREE CATALOG**.

ST. LOUIS WATCHMAKING SCHOOL, Dept. 5. ST. LOUIS, MO.

Learn Advertising at HOME

Send your name and address for free booklet giving interesting information and vital facts about Advertising. Find out how we prepare you at home, in your spare time, for the opportunities open in this fascinating business. Practical work. No text books. Old established school. Successful graduates everywhere. Just the plan you have always wanted. Write today. No obligation.

PAGE-DAVIS SCHOOL OF ADVERTISING
 Dept. 1358 3601 Michigan Ave. Chicago, U. S. A.

"He can't play... turn on the radio" they all shouted

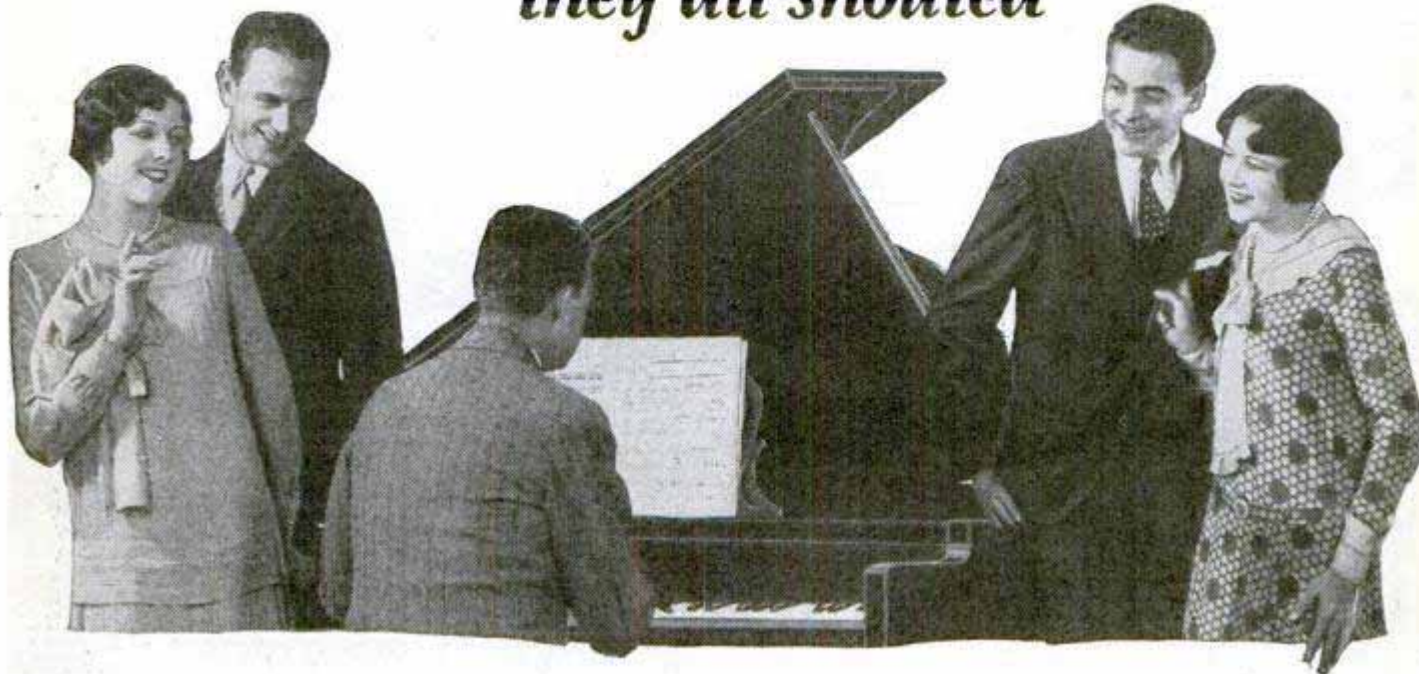

but my revenge was sweet

NOW that everyone is here, let's tune in on a good station and get some snappy dance music."

Olive Murray was full of pep as she adjusted the dials of her radio. "Shucks," she said as she discovered someone making a speech. "Let's try another station." But there wasn't a note of dance music on the air. "Something like this would happen the night of my party," she moaned. "Never mind, there'll be a good orchestra on at 10:30."

You could see disappointment written all over the guests' faces. Suddenly I bucked up my courage and took Olive aside.

"What's the piano closed for?" I asked. "Why not? No one here plays. I only wish somebody could play, though."

"I'll try to fill in for a while, Olive." "You're joshing, Dick! You never played before at parties."

"That's right, Olive, but I'll play tonight," I assured her.

I could tell she didn't believe me. And what a roar the crowd let out when I sat down.

"He can't play," called out a voice good-naturedly from the rear. "Let's turn on the radio and listen to the speeches."

"Sure," added one of my friends, "I know that he can't tell one note from another. It's all a lot of Greek to him."

I said nothing. But my fingers were itching to play. "Give him a chance," said Olive, "maybe he can play."

A Dramatic Moment

That settled it. There was no maybe about it. I played through the first bars of Strauss' immortal Blue Danube Waltz. A tense silence fell on the guests as I continued. Suddenly I switched from classical music to the syncopated tunes from "Good News." Everyone started to dance. They forgot all about the radio. But soon, of course, they insisted that I tell them all about my new accomplishment. Where I had learned . . . when I had learned . . . how?

The Secret

"Have you ever heard of the U. S. School of Music?" I asked.

A few of my friends nodded. "That's a correspondence school, isn't it?" they exclaimed.

"Exactly," I replied. "They have a surprisingly easy method through which you can learn to play any instrument without a teacher."

"It doesn't seem possible," someone said.

"That's what I thought, too. But the Free Demonstration lesson which they mailed me on request so opened my eyes that I sent for the complete course.

"It was simply wonderful—no laborious scales—No heartless exercises—no tiresome practising. My fear of notes disappeared at the very beginning. As the lessons came they got easier and easier."

Then I told them how I had always longed to sit down at the piano and play some old sweet song—or perhaps a beautiful classic, a bit from an opera or the latest syncopation—how when I heard others playing I envied them so that it almost spoiled the pleasure of the music for me.

"Music was always one of those never-come-true dreams until the U. S.

School came to my rescue. Believe me, no more heavy looking-on for me."

Half a Million People Can't Be Wrong!

You, too, can now *teach yourself* to be an accomplished musician—right at home—in half the usual time. You can't go wrong with this simple new method which has already shown over half a million people how to play their favorite instruments. Forget that old-fashioned idea that you need special "talent." Just read the list of instruments in the panel, decide which one you want to play, and the U. S. School will do the rest. And bear in mind no matter which instrument you choose, the cost in each case will average the same—just a few cents a day.

Send for Our Free Book and Demonstration Lesson

Our wonderful illustrated Free book and our Free demonstration lesson explain all about this remarkable method. They prove just how anyone can learn to play his favorite instrument *by note*, in almost no time and for just a fraction of what old slow methods cost.

Read the list of instruments to the left, decide which you want to play, and the U. S. School of Music will do the rest. Act NOW. Clip and mail this coupon today, and the fascinating free book and Demonstration Lesson will be sent to you at once. No obligation. U. S. School of Music, 712 Brunswick Bldg., New York City. (Please write plainly.)

U. S. School of Music,
712 Brunswick Bldg., New York City.

Please send me your free book "Music Lessons in Your Own Home" with introduction by Dr. Frank Crane, Demonstration Lesson and particulars of your easy payment plan. I am interested in the following course:

..... Have you instrument?.....
.....
Name.....
Address.....
City..... State.....

PICK YOUR COURSE

Piano	Violin
Organ	Clarinet
Ukulele	Flute
Cornet	Saxophone
Trombone	Harp
Piccolo	Mandolin
Guitar	Cello
Hawaiian Steel Guitar	
Sight Singing	
Piano Accordion	
Voice and Speech Culture	
Drums and Traps	
Automatic Finger Control	
Banjo (Plectrum, 5-String or Tenor)	

Also for Advanced Pianists a special course, including 24 famous classics . . . a distinctive addition to any pianist's repertoire.



Here's **FUN** and **SPENDING MONEY**

How'd you like to have a pocketful of spending money all the time—\$5 or \$10 or even \$15 every week—all your own—and a lot of real fun at the same time! It would be great, wouldn't it? Well, you can have it! Hundreds of boys still in school are getting it! And they're no different from you except that they are "Cooke" Trained—they know how to do little electrical jobs in their spare time, after school hours, for which they get real money. I showed them how. And I'll show you, too, just as easily!

I Will Train You at Home

With my easily learned, fascinating Electrical Course, I'll train you at home like I've trained hundreds of other boys who are now successful men with jobs paying \$70 to \$200 a week! It's all done after school hours, without interfering with your school work or with your regular job if you're working. And it's more like play than study. But it's practical. It's sound. It's up-to-the-minute. It fits you thoroughly to land a Big-Pay job when school days are over. And it pays for itself as you learn and gives you plenty spending money besides, through the spare-time work I tell you how to get, how to do and what to charge for.

Tools—Apparatus and Radio Course— Given Without Extra Charge

You'll need tools to do Electrical work with, so I give them to you—six big outfits of instruments and apparatus, and a real electric motor—a dandy layout that you can do any kind of spare-time work with—and it's all yours for "keeps." And not only that, but I also give you a brand new Course in Radio! All without extra cost!

Makes \$200 a Month

"Dear Mr. Cooke: When I began with you I was a sophomore in High School. Was making \$40 a month as grocery clerk. Now I am a \$200 a month electrician. Not so bad for a 17 year old boy, eh?"
Oliver P. Cooper
1131 Middle St.
Ashland, Pa.

Mail Coupon Now!

You want lots of spending money! You want a Big-Pay job when you're through school! Sure, you do! Then don't wait a minute—don't hesitate a second—get into this Big-Pay field where you can make \$2 or \$3 or more spare-time money every day while learning. Mail coupon at once and I'll send you my big 72-page book and a sample lesson: too—All FREE. See for yourself how easy it is. Fill in and mail coupon this minute!

**6 BIG
WORKING
OUTFITS
NO EXTRA
CHARGE**

Use this FREE BOOK COUPON

L. L. COOKE, Chief Instruction Engineer,
L. L. COOKE School of Electricity,
Dept. O19, 2150 Lawrence Ave., Chicago, Ill.

Send me your big Electrical Book, Sample Lesson and particulars about your Electrical Course and extra Radio Course. This does not obligate me in any way.

Name.....

Address.....

(This Coupon only for boys 15 years old or more)

CHICAGO TECHNICAL COLLEGE

25th Year

**Engineering
Architecture
Electricity
Drafting**

Intensely practical training. 2 year Diploma; 3 year B. S. Degree; special 3 and 4 months' short courses. Courses adapted to your needs. No time wasted. Expert instructors. Graduates in constant demand. Opportunities for self-support while studying. Day and evening classes. Athletics. Enter any time. Low tuition—easy terms. Write today for your copy of 80-page illustrated "Blue Book," mailed free.

Dept. R-76
118 E. 28th St
Chicago Technical College
Chicago

Learn to Dance

This New Easy Way

You can learn all the modern dances—Charleston, Black Bottom, Valencia, Canter, French Tango, St. Louis Hop, Latest Waltzes, Fox Trot, etc., at home easily and quickly. New chart method makes dancing as simple as A-B-C. No music or partner required. Learn anywhere, anytime. Win new popularity. Be in demand at parties. Same course of lessons would cost \$20 if taken privately.

Send No Money

Just send your name and address. We'll ship the complete course—323 pages, 49 illustrations—with-out one cent in advance. When package arrives, hand postman only \$1.95, plus delivery charges, and this wonderful course is yours. Try for 5 days. Money back if not delighted. Send your name NOW.

FRANKLIN PUB. CO., 800 N. Clark St., Dept. 9419, CHICAGO



LEARN MECHANICAL DENTISTRY

Earn up to \$5,000 a year

You can **EARN WHILE LEARNING** this modern money making business and become *Your Own Boss*. Big demand. Age no barrier and no previous experience required. You learn by doing actual work in rubber and gold. Easy terms. Individual instruction. Day and night school. Write NOW for Catalog P. Railroad fare allowed—no extra charge.

NEW YORK SCHOOL OF MECHANICAL DENTISTRY
147 W. 33rd Street
NEW YORK

SEND FOR FREE BOOK

Your Success

FREE 352-Page Catalog of BOOK BARGAINS!

Authoritative, reliable, completely indexed 352-page 34th Annual Illustrated Catalog sent FREE. Assists in selecting best books of all publishers. Lists over 25,000 books. Any selection at bargain prices. Used by schools, colleges, librarians, individuals. Save money. Special discounts and credit terms. A postcard will bring a catalog FREE.

THE BOOK SUPPLY COMPANY, Dept. 13
564-566 West Monroe Street, CHICAGO, ILLINOIS

Learn to PAINT SIGNS and SHOW CARDS

We quickly teach you by mail, or at school, in spare time. Enormous demand. Big future. Interesting work. Oldest and foremost school.

EARN \$50 TO \$200 WEEKLY

John Vassos, N. Y., gets \$25 for single show card. Crawford, B. C., writes: "Earned \$200 while taking course. Don't delay. Send today for complete information, samples and guarantee."

DETROIT SCHOOL OF LETTERING
150 Stimson Ave. Est. 1899 DETROIT, MICH.

MUSIC LESSONS IN YOUR HOME



You can read Music like this quickly

Write today for our **FREE booklet**. It tells how to learn to play Piano, Organ, Violin, Mandolin, Guitar, Banjo, etc. Beginners or advanced players. Your only expense about 3c per day for music and postage used. **American School of Music, 51 Manhattan Bldg., Chicago.**

LEARN AUTOS IN LOS ANGELES

Many N. A. S. Graduates earn up to \$5000 per year
Thousands easily earning \$40 or more per week

When you complete your course of training at National Automotive School you can handle a job paying \$40 per week or more. Our records prove that during the first year after completing N. A. S. training most students earn \$40 or more per week. Pay increases according to ability of student. Many N. A. S. graduates earning as high as \$5,000 per year. YOU can increase your present pay by learning autos in this magnificent Los Angeles institution.

A few months' Training increases your Wages for Life!

Los Angeles is the place to learn Autos right!

Now is the time to come to California where you can learn the auto trade under ideal circumstances. N. A. S. occupies one of the most magnificent buildings in California; reinforced concrete construction; scores of departments involving an investment of several hundred thousand dollars. Situated across from beautiful Exposition Park. No other school in America has such a perfect setting for automotive-minded men who are ambitious to earn more pay.

Jobs plentiful for N. A. S. Trained Men

Right now we have a waiting list for N. A. S. graduates. This condition will probably exist for years to come. The biggest garages and auto companies are anxious to obtain N. A. S. graduates and willing to pay \$40 or more per week for men qualified according to N. A. S. standards. We help graduates secure positions. We have aided many students in starting up business. Thousands now own their own garages, service stations and electrical businesses.

Jimmie Dunn gets big Pay increase

Jimmie Dunn is not an exception. He is a N. A. S. graduate who is employed by J. A. Nadeau, owner of one of the biggest Los Angeles Ford agencies. Nadeau says, "Jimmie Dunn is my best man." Jimmie Dunn says, "I owe my success to N. A. S. training. It increased my pay 450%. I certainly advise any man entering the auto industry to enroll at N. A. S." Thousands of N. A. S. graduates recommend this school without restriction.

Special Training— Practical Instruction by master mechanics

It has always been the N. A. S. policy to offer the most complete equipment for the training of students. Every year thousands of dollars worth of new chasses, motors, and machinery are installed to replace equipment that might be considered out of date. N. A. S. instructors are high priced men with years of experience in giving individualized training. One nominal enrollment fee gives you unlimited life scholarship in auto courses including care and repair of every type of motor, trouble shooting, complete instruction on chasses, transmissions, differentials, ignition systems, generators, brakes—in fact all training required by the most experienced auto man. Nothing lacking. Training also includes lectures, shop management, machine shop work, garage experience, cost finding, short cuts to profits, how to charge for work—all the necessary knowledge required.

Biggest School On Entire West Coast

National Automotive School covers four acres, filled with complete equipment. It is conceded to be the largest school on the West Coast. Automotive authorities look upon National as one of the finest technical training schools to be found anywhere in the World. Profits earned during the past 24 years have been turned back into the school to be reinvested in equipment, constantly increasing the standard of training so that every student shares in the profits by obtaining advanced training. More than 17,000 successful graduates guarantee your success.

Special Offer

For the next 90 days a special inducement will be offered you—an opportunity that you cannot afford to overlook. When you request the catalog full details will be given. We reserve the right to withdraw the offer prior to 90 days.

YOU EARN WHILE LEARNING

If you feel that you are not able to finance your expenses while taking the complete course our Employment Department can make arrangements whereby you EARN while learning. We help get you a job that will pay for your room and board so that it is unnecessary for you to worry about living expenses. Right now we have more jobs waiting than applicants and this condition will probably exist for some time. Hundreds of students, during the past year, have taken advantage of this wonderful opportunity to earn while learning. Request more information about the jobs available.

At N. A. S. you perform actual repair work on late model machines under supervision of master instructors who give personal attention just as if you were hiring them individually.



We Qualify You to Master ANY Auto Job— big or little

It has never been the policy of National Automotive to "rush" a student through training. The high standing of the school will not permit this. Every student can enroll for as long as he desires, without extra cost. Graduates are given diplomas that assure their qualifications and help land big-pay jobs anywhere. You tackle the most complicated auto repair job without fear of "falling down." You can earn approximately \$40 immediately upon graduating and can earn frequent increases in pay according to your ability and ambition. No age limit. Enroll at any time.

24 Years of Auto Training Service

N. A. S. is one of the oldest schools in America. Special day and night classes organized every fortnight.

Note—In addition to offering complete training in auto work, we offer special courses in electricity and aviation training. If you desire information regarding electricity and aviation, please indicate on your request for literature.

SEND NO MONEY Parents Attention for De Luxe Auto Book

At a cost of over \$10,000 we have prepared an elaborate and instructive book on automotive instruction. It is in great demand. Only a limited supply remains. Your copy will be sent without charge if you fill in the coupon below and mail immediately. This book tells all about the school, what you will learn, how long it takes to obtain the training, etc.

Is your boy floundering from job to job without the foundation of experience, or disinterested in school work? If so, why not have him enroll in National Automotive School amidst congenial surroundings, amongst students of high moral standing, where he will learn one of the most profitable trades and be equipped for life with a dependable trade experience. Special information regarding student body activities and personnel of school will be furnished upon request.

NATIONAL AUTOMOTIVE SCHOOL
 Dept. 717, 4004 So. Figueroa, LOS ANGELES, CAL.

FREE Catalog—Mail Coupon

J. A. ROSENKRANZ, President,
 National Automotive School,
 Dept. 717, 4004 S. Figueroa, Los Angeles, Cal.

Please send me, absolutely free, your big, 84-page illustrated auto catalog.

Name.....
 Address.....
 City..... State.....

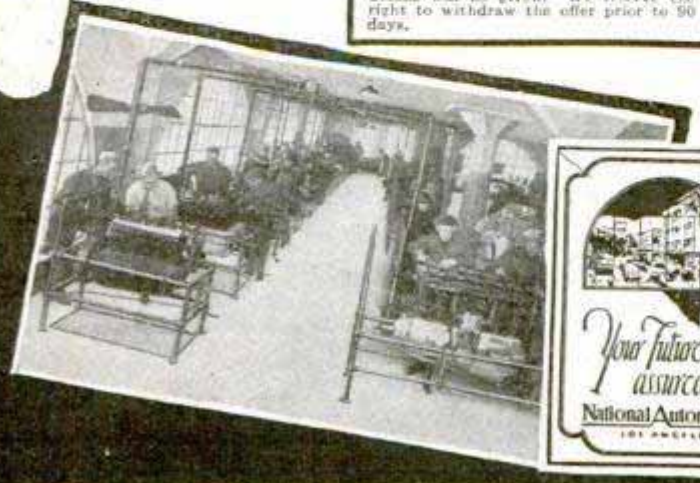

You can play the HAWAIIAN GUITAR just like the Hawaiians!

Play all the latest hits just as the Hawaiians do. Be the most popular member of your set, a happy crowd always around you, everybody enjoying and admiring your playing. Get in on all the good times. Entertain your friends—or play professionally. We will help you.



Native Hawaiian expert directs you

You get expert instruction, directed by a world-famous player and teacher, Prof. Walter Kolomo-ku. He quickly reveals to you the secrets of this fascinating instrument.

Complete Conservatory Course

You get 52 complete printed lessons. Nothing is omitted. Pictures explain every move. And no matter how little you know about music when you begin, no matter if you have never touched a musical instrument, you can positively learn to play by our plain, easy picture method. You are sure to learn! What we can do for others we can do for you. 51,000 successful students. This record assures your success.

Learn at home in spare time

Study in spare time—in absolute privacy—when you like—as long as you like. Even if you don't know one note from another, our method is so simple you begin a piece your first lesson. In half an hour you can play it!

Only 4 motions to learn

Then you can play any music—popular songs, classical, old-time melodies, native Hawaiian airs—or real jazz—separately or with accompaniment. You'll never be lonesome after you learn to play on this beautiful Hawaiian Guitar.

GIVEN when you enroll—
\$18 to \$20
Hawaiian Guitar

With Genuine Seal Grain Fabrikoid Cover and Complete Playing Outfit

Reliable retailers ask \$18 to \$20 for a similar instrument and outfit without the fine Fabrikoid Case, which alone is valued at \$3.50. Yet you receive this sweet-toned splendidly built Hawaiian Guitar, case and entire playing outfit, including picks, steel playing bar, tuning pipe, etc., without one penny of expense, as soon as you enroll.

Pay as you play

We make it easy for you. Start any time with a small first payment—then pay while learning. It comes to only a few cents per lesson. And bear in mind: Your only investment is the cost of the course—we furnish everything else.

FREE Our new illustrated book, "The Romance and Enchantment of Hawaii—Its Music and Its People." A book you will want to keep. You won't lay it down until you have read it from cover to cover. Send for your copy today.

OTHER COURSES Tenor Banjo, Violin, Tiple, Tenor Guitar, Ukulele, Banjo Ukulele—well-known instructors.

FIRST HAWAIIAN CONSERVATORY OF MUSIC, Inc.

9th Floor Woolworth Bldg., Dept. 548, New York, N. Y.
Approved as a Correspondence School Under the Laws of the State of New York.
Member of National Home Study Council.

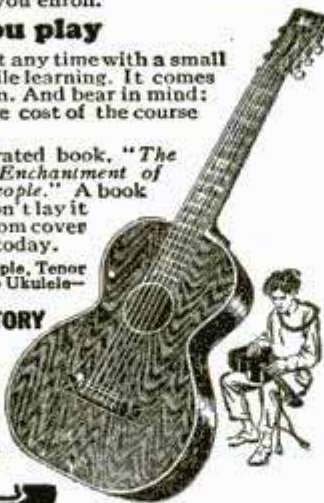

Send This Coupon for Liberal Offer!

FIRST HAWAIIAN CONSERVATORY OF MUSIC, Inc.
9th Fl., Woolworth Bldg., Dept. 548, New York, N. Y.

Please send full information about your 52-lesson Hawaiian Guitar Course. I am not obligated to enroll unless I want to.

Name _____

Address _____

City _____ State _____

Learn How to BOX

JIMMY DeFOREST BOXING COURSE

Teaches by mail the Same System he taught Champion JACK DEMPSEY



In 20 weeks, under the System of Jimmy DeForest, **WORLD'S GREATEST TRAINER AND MAKER OF CHAMPIONS**, you will master the priceless knowledge that made Jack Dempsey his millions, and fortunes for a host of other Jimmy DeForest-trained ring stars. Boys who were once rank amateurs are today earning big money; weaklings have been made strong, courageous; men have learned the art of self-defense. Send today for the now famous book, "THE GOLDEN AGE OF BOXING," greatest look of its kind ever written; full of valuable information, photos of great fighters and pupils who became successes over night. Enclose 10c to cover cost of mailing, etc. **WRITE NOW.**

JIMMY DeFOREST BOXING COURSE
347 Madison Avenue, Box 137, New York City

DEVELOP POWER

AT HOME

to initiate, persevere, achieve; carry on through life your education; earn credit toward a Bachelor degree, by using the 450 courses

The University of Chicago
Gives by Correspondence

Inquire, or check the advertisement to show desire and mail to 327 Ellis Hall, University of Chicago, Chicago, Illinois.

LAW

STUDY AT HOME
Become a lawyer. Legally trained men win high positions and big success in business and public life. Be independent. Greater opportunities now than ever before. Big corporations are headed by men with legal training. Earn **\$5,000 to \$10,000 Annually** during spare time. Degree of LL.B. conferred. LaSalle students found among practicing attorneys of every state. We furnish all text material, including fourteen-volume Law Library. Low cost, easy terms. Get our valuable 64-page "Law Guide" and "Evidence" books **FREE**. Send for them **NOW**.
LaSalle Extension University, Dept. 1264-L Chicago
The World's Largest Business Training Institution

"STAMMERING

Its Cause and Cure"

You can be quickly cured if you stammer. Send 10 cents coin, or stamps, for 288 page cloth bound book on Stammering and Stuttering. It tells how I cured myself after Stammering and Stuttering for 20 years. **BENJAMIN N. BOGUE**
11112 Bogue Building, 1147 N. III. St. Indianapolis

MEN TO LEARN

MOTION PICTURE PROJECTION

A BIG-MONEY PROFESSION—\$2,000 TO \$4,000
We Assist Students to Earn While Learning

MOVIE OPERATORS SCHOOL

61 Sproat Street

Detroit, Michigan

YOU CAN OIL PAINT

Amazing new method teaches men or women to earn after first lesson. **OIL PAINT** photos—portraits, landscapes or art subjects. Earn \$18 to \$50 and more a week. **OIL PAINT** OUTFIT GIVEN. Send now for free illustrated book. **PICTORIAL ART STUDIOS Inc.** Dept. MP, 2928 Broadway, Chicago, Ill.

MINSTRELS

Musical Comedies and Revues. Unique Minstrel First—Parts for complete show with special songs, opening choruses, etc. Full line of plays, stage songs, crossfire, monologues, afterpieces, vaudeville acts and make-up. **CATALOGUE FREE.**

T.S. DENISON & CO., 623 So. Wabash, Dept. 19, Chicago

BASHFUL?

"Shame on you!" Are you nervous, embarrassed in company of the other sex? Stop being shy of strangers. Conquer the terrible fear of your superiors. Be cheerful and confident of your future! Your faults easily overcome so you can enjoy life to the fullest. Send 25c for this amazing book. **RICHARD BLACKSTONE, 88-4712, FLATIRON BLDG., NEW YORK**



\$500⁰⁰ IN ONE MONTH DRAWING

Careful, conscientious training by members of our faculty made this possible. Today, trained illustrators who draw pictures for magazines, newspapers, etc., both men and women, earn \$200.00 to \$500.00 a month or more. The present splendid opportunities in this field have never been excelled. Thousands of publishers buy millions of dollars' worth of illustrations, like the one shown here, every year. Illustrating is the highest type of art. If you like to draw, let your talent make your fortune. Develop it. It takes practice, but so does anything worth while. Learning to illustrate is fascinating to anyone who likes to draw.

THE Federal School, one of the oldest and largest art schools in America, has trained hundreds of successful illustrators. It was originally founded by the Bureau of Engraving to supply artists for its own needs. Since then the

Federal School graduates have become so distinguished for their high quality work that they are in great demand by publishers and art organizations. The reason for this was plainly because of the thorough training given by the school, instruction which was not duplicated by any other institution in the country.

The Federal Course Is a Proven Result-Getter

Federal School Graduates are employed by publishers and commercial organizations all over the country. The usual salary for the beginner is from \$35.00 to \$50.00 a week and, with increasing experience, promotion is rapid. No previous experience is necessary in order to take this course. Every step is plain and you will be led gradually from simple sketches to complex illustrations having a high market value. At all times contact with you is direct and personal and every effort is made to develop your own individual style. What this style is can only be determined after thorough training in the fundamentals of draftsmanship.

Study at Home in Your Spare Time

In studying with the Federal School you can take as long as you like to finish each piece of work. The fact that you are busy during the daytime makes no difference. The course may be completed in your own home at night or during any spare time you have. Earn while you work if you wish. Many students find a market for their drawings long before they finish the course. Some earn the price of the course several times over before they finish. Moreover, when you graduate your connection with the school is not terminated. We take a personal interest in the success of our graduates and our business connections enable us to offer many fine opportunities. In our files are hundreds of letters from students telling what the Federal School has done for them.

Send for Free Book

Our free illustrated book, "A Road to Bigger Things," contains some of these. It also shows the work they have done and gives all the details of the course.

If you like to draw, do not give it up for something you do not like so well. You owe it to yourself to develop the ability you possess. Fill in the attached coupon, mail it today and start up the "Road to Bigger Things."



Federal School of Illustrating

FEDERAL SCHOOL OF ILLUSTRATING
12138 Federal School Building, Minneapolis, Minn.

Name..... Age.....
Occupation.....
Address.....
Town.....

Why the Federal "Master Course" Excels

A strictly up to date and practical art course and comprehensive training in many different subjects such as illustrating, serious and comic cartooning, lettering, poster designing, window card illustrating, etc. No one artist is competent to give instruction in all these branches. For this reason the Federal School has established its "Master Course" in which every subject is covered by a specialist, an artist who has made a success in that one particular field. No other school can offer a course of instruction which is nearly comparable. No other institution in the country has such an array of artists as are on the Federal Staff.

The Federal Authors

The Federal Authors include such nationally known artists as Sid Smith, Neysa McMeln, Fontaine Fox, Charles Livingston Bull, Clare Briggs, Norman Rockwell, Fay King, Frank King, Charles Russell, Herbert Johnson, Walter Wilwerding, Charles Bartholomew and over fifty others. Exclusive original lessons and drawings especially prepared by these famous artists are included in the Federal Home Study Course. They teach you everything you need to know about illustrating so that when you finish the course you will not find anything new to you. You will be prepared for any problem or emergency which may arise.



SIDNEY SMITH



HERB JOHNSON



CLARE BRIGGS



NORM ROCKWELL



FONTAINE FOX



BART



NEYSA MCMELN



FAY KING



CHARLES L. BULL



FRANK KING



CHAS. M. RUSSELL



W.J. WILWERDING

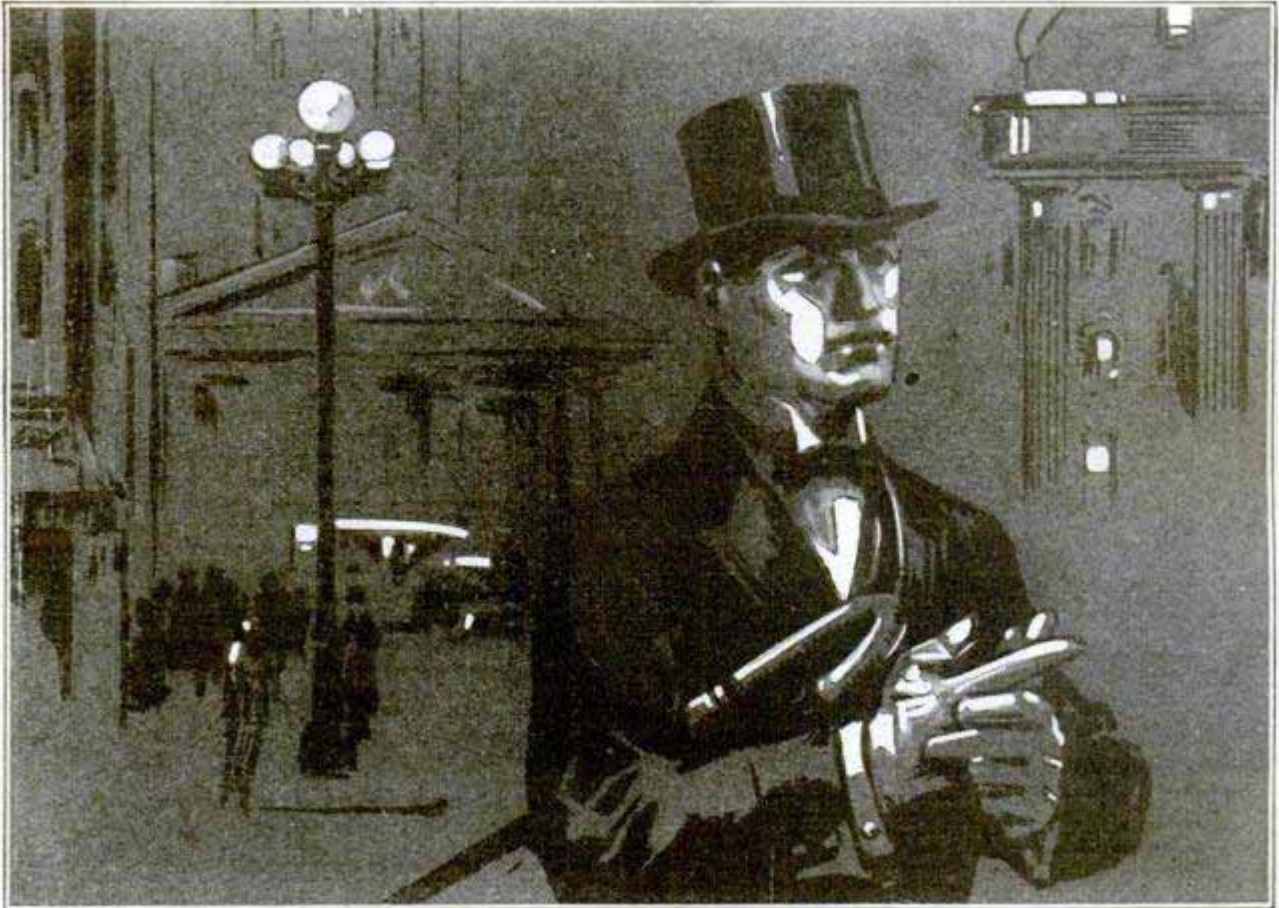

Follow this Man!

Secret Service Operator 38 Is on the Job

Follow him through all the excitement of his chase of the counterfeit gang. See how a crafty operator works. Telltale finger prints on the lamp stand in the murdered girl's room! The operator's cigarette case is handled by the unsuspecting gangster, and a great mystery is solved. Better than fiction. It's true, every word of it. No obligation. Just send the coupon.

FREE The Confidential Reports No. 38 Made to His Chief

And the best part of it all is this. It may open your eyes to the great future for YOU as a highly paid Finger Print Expert. More men are needed right now. This school has taken men just like you and trained them for high official positions. This is the kind of work you would like. Days full of excitement. Big salaries. Rewards.

UNIVERSITY OF APPLIED SCIENCE
1920 Sunnyside Ave., Dept. 13-59 Chicago, Illinois
Gentlemen:—Without any obligation whatever, send me your new, fully illustrated Free book on Finger Prints, also FREE copy of operator No. 38's confidential report. Tell me about your low prices and easy terms.

Name.....
Address.....
.....Age.....

Earn \$2500 to \$10000 a Year
You study at home in spare time

No advance education is needed. Any man who can read and write, and think can make good. A wonderful book tells all about what others have done. Shows pictures of real crimes and the men who solved them. We'll send you a FREE copy with the free reports. Get our low prices and easy terms. Mail the coupon.

UNIVERSITY OF APPLIED SCIENCE
1920 Sunnyside Ave., Dept. 13-59 Chicago, Illinois

MOVIES

Teach You Electricity for a Bigger Paying Job

Here is a *new, amazingly simple and practical way* of learning to do electrical work—so sure of results that we agree to give you training and employment service that will help get you a better job and more money or you don't pay a cent!

Think of it! You take no chance. You are assured of thorough preparation for the many opportunities in this great industry which is constantly calling for more trained men. We not only train you, we help you get a job. How can we do it? *By a wonderful new method of teaching which makes everything about electricity easy to understand.*

Learn at Home, Quickly

We furnish you with the projector, so simple anyone can operate it, and thousands of feet of film. You see all types of electrical machinery in operation, animated diagrams which make the facts about electricity as plain, easy to grasp and enjoyable as looking at a movie in your favorite theatre.

You are personally guided in this live, fascinating instruc-

tion by practical engineer-educators with W. N. Littlewood, formerly instructor in University of Wisconsin, chief instructor.

An Engineer Says:

Here's what a practical electrical engineer says: "I am amazed at how simply you explain the facts about electricity. The points are so much easier to grasp than by the usual methods, that the student must make quicker, surer progress." Charles E. Fitz, M. E., E. E., formerly associated with Steinmetz.

Employers Want Film-Way Trained Men

Our employment service helps you locate a big pay job in the branch of electricity interesting you most: Radio, Switchboard Work, Power Plant Operation, Wiring, etc. Here is an extract from a letter written by an employer:

"We will gladly co-operate with you, not only in employing any of your students when vacancies occur in our organizations, but also by recommending that our employees take your course."
Electric Material Co., South Bend, Ind.

FREE Three Lessons and New Book, "The Film Way to Bigger Pay in Electricity"

Mail the coupon for three actual lessons showing how we use real motion pictures to make the facts about electricity easy to grasp. Our new book describes the wonderful opportunities for a better job in electricity and gives the complete details of this fascinating way to learn. Start now to move into the bigger pay class. Sending coupon is the first step. Do it now, get the things you want in life.

You Use This Real DeVry Projector

Anyone can operate this standard school model DeVry projector (value \$75) which is furnished every student for use during course at no extra cost. Uses ordinary light connection, farm lighting equipment or automobile battery. Gives clear, brilliant and flickerless motion pictures right in your own home.



set of professional instruments shown, drawing-board, T-square, paper, rules, scales.

Drafting Set Given

Course includes instruction in drafting and complete

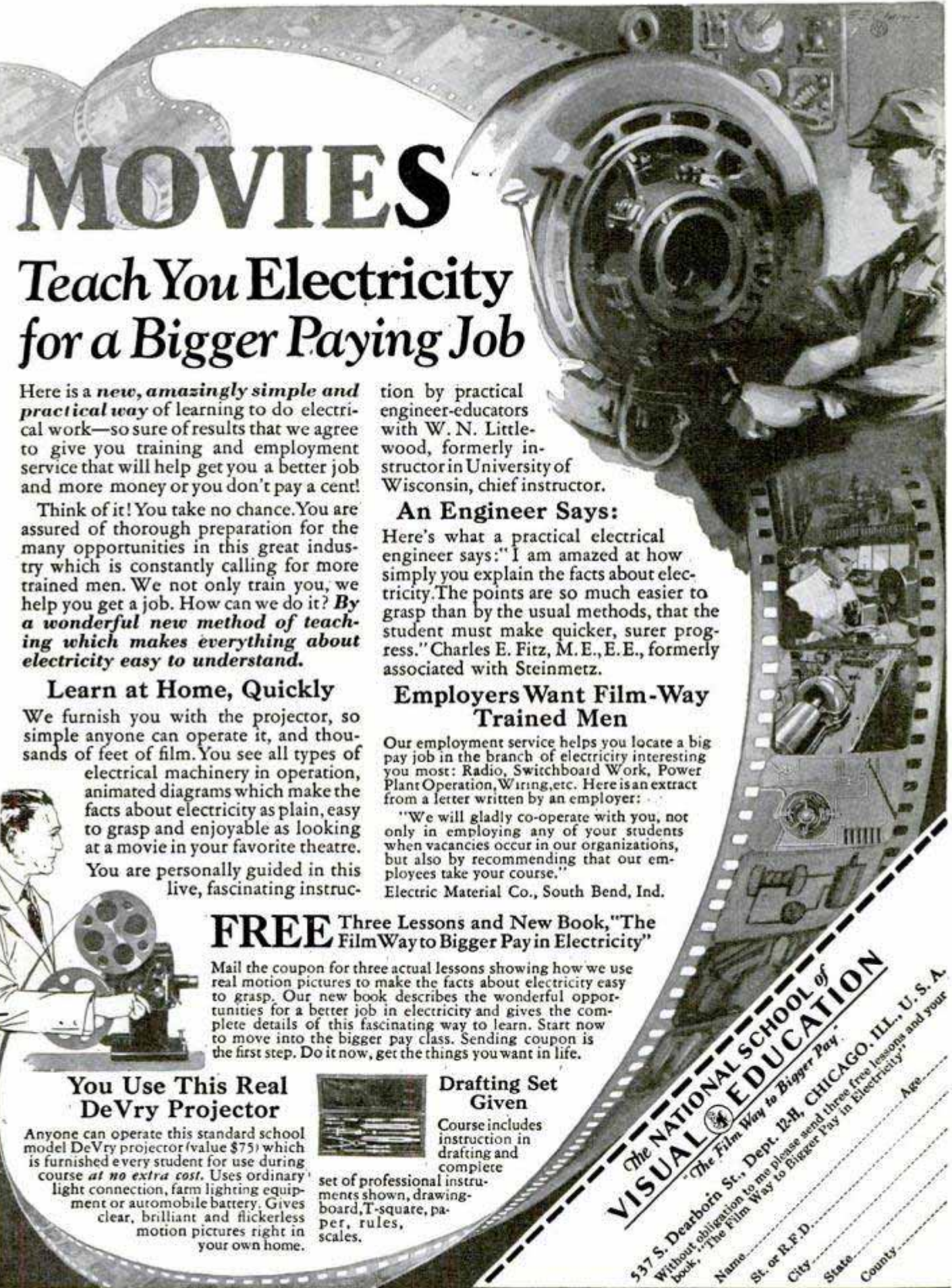
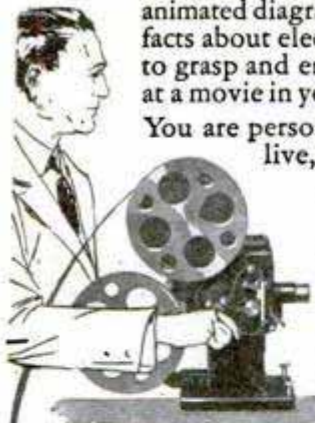

THE NATIONAL SCHOOL of VISUAL EDUCATION
"The Film Way to Bigger Pay"

537 S. Dearborn St., Dept. 12B, CHICAGO, ILL., U. S. A.
Without obligation to me please send these free lessons and your book, "The Film Way to Bigger Pay in Electricity".

Name.....
St. or R.F.D.....
City.....
State.....
County.....
Age.....

TAKE THE FILM WAY TO Bigger Pay

Send Coupon Below for
FREE
Radio Idea Book

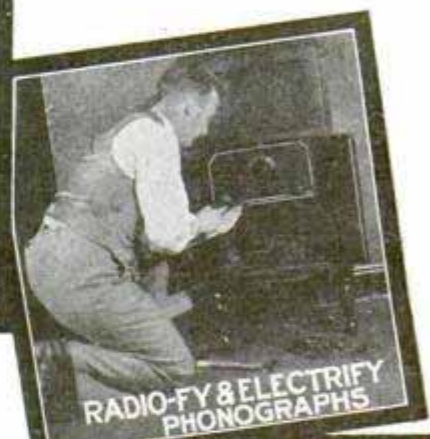
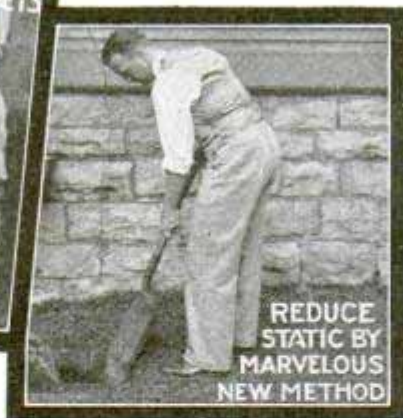

5 Easy Ways to Make \$3⁰⁰ an hour in Your Spare Time in **RADIO**

Earned \$500 Spare Time

Frank J. Deutsch, Penn.: "I have made over \$500 out of Radio in my spare time. Yours is a great plan for ambitious men."

Becomes Radio Engineer in One Year

Claude DeGrave, Canada: "I knew nothing about Radio when I joined the Association a year ago. I am now a member of the engineering staff of the DeForest Company and my income is 225% greater than at the time I joined."

Doubles Income in 6 Months

W. E. Thon, Chicago: "You have an excellent plan. Six months after I enrolled I secured the managership of large Radio store and doubled my income."

EACH of these Association-developed plans a big money-maker. Set owners everywhere want their sets modernized, freed from static, made to operate electrically, transformed into single dial controls. Learn to render these services and you can easily make \$3.00 an hour spare time, to say nothing of the money you can make installing, servicing, repairing, building radio sets and selling supplies. Our members cleaning up! You can do the same.

Join the Radio Association

A membership in the Association will give you the training you need to render these services,—that will enable you to earn \$25 to \$75 a week spare time—train you to install, repair, build all kinds of sets—start you in business without capital—prepare you for the \$3,000 to \$10,000 big-pay radio positions—help you secure a better position at bigger pay for you—give you the privilege of buying supplies at wholesale. **A membership need not cost you a cent.**

RADIO ASSOCIATION OF AMERICA,
Dept. P. M.-12, 4511 Ravenswood Ave., Chicago.
Gentlemen: Please send me by return mail full details of your Special Membership Plan and a copy of your Radio Idea Book.

Name.....

Address.....

City.....State.....

Act NOW—IF YOU WISH NO-COST MEMBERSHIP PLAN

To limited number, we will give Special Memberships that may not—need not—cost you a cent. To secure one, write today. With the details we will send you copy of our Radio Idea Book that will open your eyes. Mail the coupon now.

RADIO ASSOCIATION OF AMERICA

Dept. P. M.-12 4511 Ravenswood Ave. Chicago, Ill.

Earn \$75 to \$100 a Week as AUTO MECHANIC —

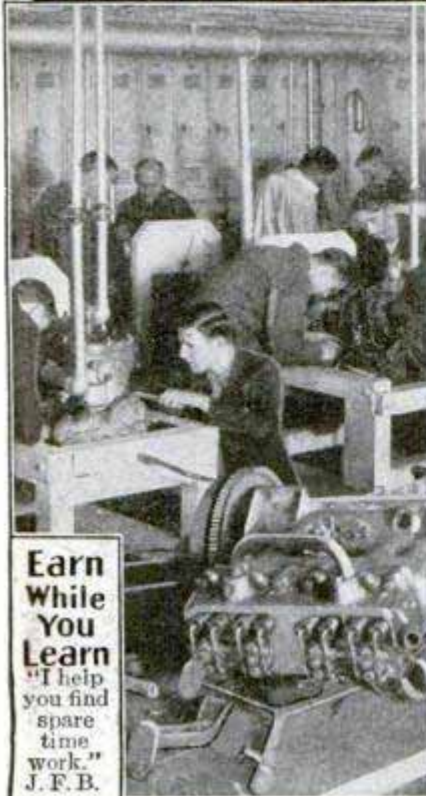

Earn While You Learn
"I help you find spare time work."
J. F. B.

Learn Easily in 8 Weeks on Real Machinery — No Dry Books No Lectures

Eight short weeks of pleasant, fascinating, practical auto work in my big shops—and then a real job paying \$75.00 to \$100.00 a week! You can step right out of low pay, long hours, and no future into the job of a high-salaried auto mechanic. Everywhere jobs are waiting for men trained as I train them. Change the whole course of your life in 8 weeks!



"I'll Pay Your R. R. Fare"
J. F. Butler
President

Not a Correspondence Course

Come to my shops. I will make you a mechanic able to handle the hardest auto jobs quickly and easily. I'll teach you to know autos inside out. You don't need education. You don't need previous experience. All you need is ambition. You learn by doing—by working on actual cars with real tools. This is not a correspondence course.

Money Back Guarantee

If, after completing my training, you are not satisfied, if you are not qualified to accept a big-pay job, your tuition will be refunded.

Short Cut to Big Pay

Learn how easy it is to get a steady, big-pay job in the great auto field. Learn what other fellows like you have done with CLEVELAND Auto Training.

Mail Coupon for Book

CLEVELAND
AUTO SCHOOLS
1815 E. 24th St.,
Cleveland, Ohio

J. F. Butler, Pres.,
CLEVELAND AUTO SCHOOLS,
1815 E. 24th St., Dept. D-11, Cleveland, O.

Please send me FREE BOOK on Auto Mechanics, and details of spare-time work and Employment Help.

Name.....

Address.....

City..... State.....

SPORTSMEN

Read This Offer!

Send the COUPON and receive a magnificent Sportsmen's Book telling you how to learn to MOUNT GAME-HEADS, BIRDS and ANIMALS. You can NOW be your own Taxidermist. Our school has over 100,000 graduates throughout the world. You can now learn AT HOME in SPARE TIME.

Mount Your Own Trophies!

Hunting and Fishing have entered a new era. All true sportsmen now kill fewer specimens, but DOUBLE their interest by mounting their trophies. The secrets of Taxidermy (mounting birds and animals) are now revealed. YOU CAN NOW LEARN TAXIDERMY FOR YOURSELF. Be a Taxidermy artist. Mount birds, animals, game-heads, fishes, tan skins and make beautiful rugs and robes. Easily and quickly learned in your own home. Adorn your home and den with nature's finest ART. If you enjoy hunting—you will enjoy Taxidermy MORE.

Big Profits Do you want to MAKE MORE MONEY? Then give your SPARE TIME to Taxidermy. Make \$50 to \$250 a month by mounting for others or selling your mounted specimens, or go into business—open a Taxidermy shop of your own, and earn \$3,000 to \$6,000 a year.



This Book FREE

Every Sportsman should have this marvelous book. You can right now, while this edition lasts, get a copy Free and prepaid by mailing the coupon NOW. Only limited number free—Send Today. Nothing like it. Just off the press. Contains 48 large pages and cover in brilliant colors. More than 100 photos of splendid game specimens and masterpieces of the National Museum at Washington. Brim full of interest to every sportsman. And think of it, this valuable unique and artistic book can be had now, by Sportsmen for the asking.

Mail the Coupon!

If you want to preserve your trophies; if you desire to make money from your spare time, if you are a nature lover—send the coupon and receive your copy by return mail.

N.W. School of Taxidermy, 3379 Elwood Bldg., Omaha, Neb.

N. W. School of Taxidermy

3379 Elwood Bldg., Omaha, Neb.

Send me your free illustrated book "Sportsmen and Their Trophies." Also tell me how I may learn this fascinating art easily and quickly by mail. No obligation.

Name.....

Address.....

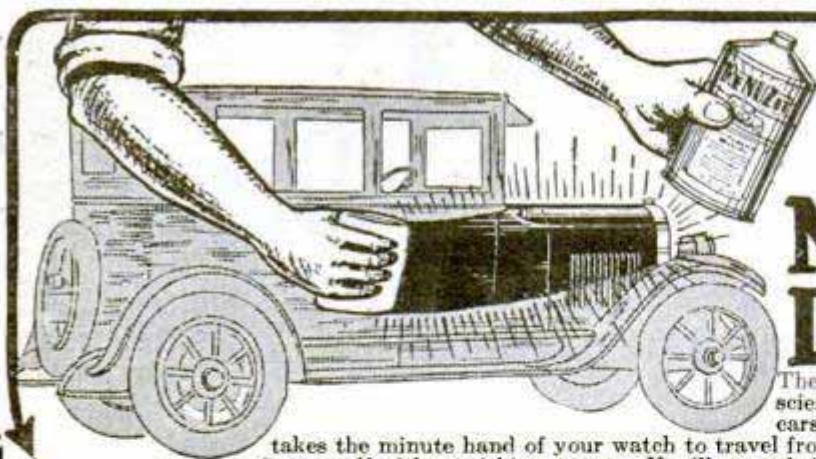

30 MINUTES AND RENUZIT Makes Old Cars Look Like New!

The Motor World is astounded at this marvelous scientific Fluid that transforms old, run-down looking cars into smartly gleaming new ones in the time it takes the minute hand of your watch to travel from "12" to "6"—not more than 30 minutes! Try it yourself without risking a cent. You'll get a thrill you won't forget!

AGENT'S NEW PLAN—MAKE \$50.00 A DAY

Millions are waiting to buy ReNUZit. For every one of the thousands of new cars on the streets today there are at least 20 OLD ones—and more are losing the bloom of youth every day. That is why ReNUZit Agents all over the country can make almost unbelievable profits. ReNUZit is the big sensation they are all talking about and eager to try. And our proposition is so GOOD that you should have no trouble making \$50.00 a day and up. It costs nothing to investigate. You can't afford not to.

How This Miracle Fluid Works

You just flow ReNUZit onto any automobile with a piece of cheesecloth and instantly the ORIGINAL color and lustre of that car are like new again! Restores the sparkling beauty of any automobile or any painted, lacquered or enameled surface in the twinkling of an eye. No tiresome rubbing or polishing. Harmless—Lasting—Sure. Simple to apply as "A B C"—Dries almost immediately. No trouble—No bother—No mess. **GUARANTEED NOT TO TURN WHITE.**

ReNUZit Service Stations Bring \$1,000 a Month

It is easy to see why so many men can get into the big-money class operating ReNUZit Service Stations. Car owners are crying for just such a LASTING finish as ReNUZit. The need is far greater than the number of service stations. This is YOUR chance to get into a big paying business. Send coupon for the thrilling story of ReNUZit and Your wonderful opportunity to make \$12,000.00 a year. Do it Now!

Test ReNUZit FREE! You have the privilege of trying Re-NUZIT yourself right now without risk or obligation. Prove to yourself what miracles it accomplishes. See your own car being transformed to a thing of dazzling beauty. Send coupon TODAY for full details and Free Test Offer.

The ReNUZit System, 154 E. Erie St., Dept. 805-T. R., Chicago, Ill.

Not a
Polish
Not a
Paint
Not a
Cleaner
Not a
Wax

The ReNUZit System,
154 E. Erie St., Dept. 805-T. R.,
Chicago, Ill.

Rush full details of ReNUZit, with Free Trial offer, and Agent's New Plan on how I can make \$50.00 a day. No obligation.

Name.....
Address.....
City.....
State.....

Get Into AVIATION!

MEN wanted at every airport and factory. Big pay jobs await trained Airplane Mechanics. Our recognized Extension Course in Practical Aviation—prepared and directed by prominent airplane manufacture—trains you quickly for this thrilling, profitable career.

LEARN RIGHT AT HOME

Tear out this coupon—sign and mail it *at once* for our FREE Book which tells all about opportunities in aviation, describing our practical Diploma Course of simple lessons, free employment service and easy payment plan.

Now Sent Free

Use Coupon to Receive Book Without Cost

.....**OHIO AERO SCHOOL**.....
1453 South Avenue YOUNGSTOWN, OHIO
Send me your Free Book entitled "The Call of Aviation," and full particulars concerning your Extension Course and easy payment plan.
Name.....
Address.....
City..... State.....

LAW

Free Book

Write today for FREE 128-page book, "THE LAW-TRAINED MAN," which shows how to learn law in spare time through the Blackstone home-study course prepared by 80 prominent legal authorities, including law school deans, lawyers, and U. S. Supreme Court justices. Combination text and case method of instruction used. All material necessary furnished with the course, including elaborate 25-volume law library, which is delivered immediately upon enrollment. Many successful attorneys among our graduates. LL. B. degree conferred. Moderate tuition, low monthly terms. Money-Back Agreement.

Write for free book today

BLACKSTONE INSTITUTE, 307 N. Michigan Ave. Dept. 59 Chicago

Learn Watchwork, Jewelrywork and Engraving

A fine trade commanding a good salary, and your services always in demand. Address **Horological, Dept. P, Bradley Institute, PEORIA, ILLINOIS**, for our latest catalog.

See the Craters in the MOON!

Astronomical TELESCOPE

Magnifies 70 Times

Own a genuine Astronomer's Telescope. See millions of miles away. Make sun, moon, planets, stars your next door neighbors. Moon Craters, Sun Spots, Eclipses, Comets enlarged 70 times. Strange thrilling Hours of fun!

Only **\$4.95**

for this splendid instrument. Made like telescopes used in observatories. Gerding wrote, "Moon seemed 10 yards away."

EARN \$10 A DAY
(Charge 25c to look at the moon)

45 Inches In Length—Not a Folding Pocket Telescope—All 1 Piece

Inside diameter 2 inches. Eyepiece has screw adjustment for focusing. Adjustable bracket and clamp can be fastened to chair, fence, branch, etc. Finest materials. Will last lifetime.

10 Days Free Trial

Rush only \$1.00 now. Pay balance (\$3.95 plus postage) when postman delivers. Keep 10 days. If not delighted, return telescope and money will be refunded.

R. B. SPECIALTY CO.
Dept. E-305
318 Sycamore, Cincinnati, O.

If You Pledge Yourself To Secrecy I'll Teach You



Dr. Harlan Tarbell
Master of Magic
who has mystified magicians
as well as laymen with his
marvelous tricks.

Secrets of Magic! At Home—By Mail

Baffling secrets of the world's greatest magicians—mysteries never before divulged—supernatural effects of the Orient—massive stage illusions—the most priceless, most treasured Secrets of the Magic Profession now—for the first time—disclosed to YOU in the great Tar-

bell Course in Magic. Learn to perform like a real magician in a short time—in your spare time—at home. Be the life of every party—the center of every crowd, wherever you go. Business and Social Success are YOURS when you know Magic. And it's EASY with the Tarbell System!

Earn \$250 to \$1000 a Month!

There is a tremendous demand for Magic Entertainment. Clubs, churches, schools, conventions, theaters are on the lookout for Magicians—pay \$25 to \$100 for perhaps half an hour's program. Keep your job. Make EXTRA MONEY on the side. Salesmen—business men—professional men—all can use Magic to gain popularity and profits. Easy for YOU to make \$250 to \$1000 a month!

Astonish Your Friends Study the first lesson and your friends will be amazed at your wonderful Magical powers. You will have that Magnetic power that gives you instant popularity in any crowd. Everyone will marvel at your apparently supernatural, psychic power. YOU possess this talent now! Surprisingly easy to bring it out. Send the coupon below now—find out how easily you can do it.

Send for Big Free Magic Book

Write! Mail coupon now for big free Magic Book telling all about the great Tarbell Course in Magic. Find out how you can learn to be a real magician—easily and quickly!—at home!—by mail! Learn what I have done for others—people just like yourself. Get our Prices and Easy Payment Plan. Mail coupon NOW!

Tarbell System, Inc., Studio 13-59
1926 Sunnyside Avenue, Chicago, Ill.

Tarbell System, Inc., Studio 13-59
1926 Sunnyside Avenue, Chicago, Illinois

Please send me your big FREE Illustrated and colored booklet giving full information on the Tarbell System of Magic. No obligation on my part whatever.

Name

Address

Age.....

City and State.....



AVIATION has a Place for YOU

New Training Equips You
For the Position You Want

Choose the position you want—pilot, mechanic, designer, aircraft business man, field superintendent, airport manager, aircraft manufacturer—countless big positions are open for the trained man in every line of aviation. Take the training that will equip you for any one of those positions—get the newest features of aeronautical training at the College of the Air.

The "jack of all trades" has no place in aviation—masters are wanted. You need a specialized training. Marshall Flying School has new courses, new equipment and new methods of instruction to give you the help you need; all courses are offered now.

Complete Aviation Course Now Only \$245.00

This course which gives you all the principles of flying and every needed requisite to make you a successful flyer, has been reduced within the reach of every young man. This course will be the big step you want to take to start into the aeronautical field—the field of so many opportunities. Decide today to commence your new career by enrolling for this course.



One class of the Marshall fall term students.

Straight Flying Course. Price (without ground course), \$75.00
 Primary Flying Course. Advances students to crosswind landings and take-offs. Including Mechanic's and Engineer's Ground Course. \$150.00
 Intermediate Flying Course. Student can be soloed if ability is shown. Price, including Mechanic's and Engineer's Ground Course. \$200.00
 Complete Aviation Course. Everything needed to make you a successful flyer. Solo guaranteed. No bond required. Price, including Mechanic's and Engineer's Ground Course. \$245.00
 Private Pilot's License Course. Price, after solo. \$150.00
 Special 50-Hour Course. Price including ground course, \$600.00.
 Limited Commercial Course. Qualifies you under the Department of Commerce for the Government Limited Commercial Pilot's License. \$700.00
 Mechanic's and Engineer's Ground Course. 300 hours of training. Price. \$75.00

This course is given free with all our flying courses with the exception of the Straight Flying Course.

NEW CATALOG FREE!

Mail this coupon for the new catalog which shows you the equipment, buildings and the many training planes used at our school—explains all about the new courses—tells how you can make your start and win your way.



Former Marshall student, now holding big job.

MARSHALL FLYING SCHOOL, Inc.

630 North English Street

MARSHALL, MISSOURI

Gentlemen:—Please send me without obligation your new catalog.

Check the instruction you want.

- Pilot
 Mechanic
 Designer
 Aircraft Business

Name

Address

HERE IS THE WAY to more pay

If you are a mechanic, woodworker, carpenter, sheet metal worker, millwright, etc. **This Short, Practical Course Will Put More Pay Into Your Envelope**

Learn blueprint reading and elements of drafting. Put yourself in line for promotion. **Turn your spare hours into profitable investment.** Our course is easy, pleasant and interesting. No complicated problems, no dreary book reading. **Practical men teach you.** No theory. Just matter-of-fact instruction. Endorsed by employers.

WRITE FOR THIS LOW PRICED OFFER

Get our wonderful proposition. Our low price and easy terms make it possible for you to **learn in a few weeks what many men have spent years to learn.** Full drawing equipment sent the minute you enroll.

BLUE PRINT READING SCHOOL, Inc.
 1721 Nicholas Bldg. TOLEDO, OHIO

AVIATION INFORMATION FREE

Send us your name and address for full information regarding the Aviation and Airplane business. Find out about the many great opportunities now open and how we prepare you at home, during spare time, to qualify. Our new book *Opportunities in the Airplane Industry* also sent free if you answer at once.

AMERICAN SCHOOL OF AVIATION, Dept. 1359, 3601 Michigan Av., CHICAGO



I POSITIVELY GUARANTEE

to increase your arms one-half inch in size, chest one full inch, strength 25%, health 100% in one week's time, by following my instructions and using my exerciser 10 minutes mornings and at night. Send \$1 for complete course and exercisers. Satisfaction guaranteed or \$1 refunded. Prof. J. A. DRYER, Box 1850-P, Chicago, Ill.

A PERFECT LOOKING NOSE

Can Easily Be Yours

Trados Model No. 25 corrects now ill-shaped noses quickly, painlessly, permanently and comfortably at home (excepting cases caused by improper bone structure). It is a safe and guaranteed patent device of precise adjustment that will actually give you a perfect looking nose. Over 90,000 satisfied users. For years recommended by physicians. 16 years of experience in manufacturing Nose Shapers is at your service. **Model 25 Junior** for children. Write for testimonials and free booklet, which tells you how to obtain a perfect looking nose.

M. TRILETY, Pioneer Noseshaping Specialist
 Dept. 3070 Binghamton, N. Y.



HAIR GROWS!

when our **Vacuum Cap** is used a few minutes daily. Sent on 60 days' FREE trial at our expense. No drugs or electricity. Stops falling hair, cures dandruff. A postal brings illustrated booklet.

MODERN VACUUM CAP CO.

557 Quincy Denver, Colorado

Athletes Heal Rupture In a New Scientific Way Make this FREE Test



Ruptured athletes everywhere have found a way to retain rupture with comfort and safety and at the same time to allow the rupture to heal. Weighing but a few ounces, this new discovery gives absolute freedom in movement. It cannot be detected beneath the tightest fitting clothes; planned so that it can be washed daily.

It has healed thousands, hundreds of people who take an active part in athletics. Send for free trial offer, sent in plain, sealed envelope.

BROOKS APPLIANCE CO., 107B State Street, Marshall, Mich.

Strongfort Puts Pep Into the Weakling



STRONGFORT
Builder of Men.

I Want to Send You MY FREE BOOK

This book of many pages and dozens of pictures tells of my wonderful experience—how I became the outstanding athlete of the world, performing feats others dared not attempt; how I turned the knowledge gained through developing my own body to the benefit of others, and then how STRONGFORTISM was evolved. It tells what I have done for others, what I can do for you. It doesn't mince words. It tells plain truths. "Promotion and Conservation of Health, Strength and Mental Energy," points the way from disease and weakness to health and strength. It is priceless. I'll send it to you on request—FREE. Write for your copy today.

STRONGFORT INSTITUTE
LIONEL STRONGFORT, DIRECTOR.

Physical and Health Specialist
DEPT. 635 NEWARK, NEW JERSEY, U. S. A.

It's the man with the punch who battles his way to the front in life—he's the chap who gets on, is sought for the good jobs and is respected and admired wherever he goes. You needn't be a pugilist, or a wrestler, or a professional athlete. You can be just an every-day fellow like Lindbergh and young men of his type, with plenty of sand and courage and manly strength and vigor, to stand out in the crowd and carry off life's prizes.

Muscular Strength and Perfect Health Go Together

You can attain strength through Lionel Strongfort's scientific muscular development—internally and externally—and vigor and health and a full-functioning body comes as sure as sunrise.

I've taken thousands of young fellows, skinny, weak, and built them up into strapping, powerful men who commanded respect and admiration wherever they went. Some of these chaps had set too fast a pace for themselves, others had wasted their vitality and broken down their manhood, others had gone stale from neglect of their bodies. No matter how despondent their state of mind or how physically broken they were they quickly came back when they adopted

STRONGFORTISM

The Science of Health and Strength

STRONGFORTISM works wonders with run-down, weakly, skinny men. It builds them up to health through internal muscular development, then rounds them out into robust physical specimens, by bringing into play every muscle and making every muscle do its work as Nature intended. You'll be astonished how quickly you'll feel the benefits of this best of all health and strength Courses. You'll feel like a new man almost from the first day you start under my instructions. You'll be surprised at the lazy muscles you wake up when you begin, and they'll wake you up in turn. You'll quickly realize that a new day has dawned for you as you feel the red blood coursing through your whole body like a bounding mountain stream. That old, stupid, sluggish feeling will disappear like magic. That gloomy outlook will vanish as though a heavenly hand had brushed it away. Oh, it's a great feeling! Great to feel like a man! And you surely will when you adopt Strongfort as your instructor and guide—Strongfort, "the builder of men."

Send this FREE Consultation Coupon ABSOLUTELY CONFIDENTIAL

Mr. Lionel Strongfort, Strongfort Institute, Dept. 635, Newark, N. J.—Please send me absolutely free my copy of your book, "PROMOTION AND CONSERVATION OF HEALTH, STRENGTH AND MENTAL ENERGY." I have marked (x) before the subjects in which I am most interested.

- | | | |
|-----------------------------------|---------------------------------------|---|
| <input type="checkbox"/> Catarrh | <input type="checkbox"/> Overweight | <input type="checkbox"/> Great Strength |
| <input type="checkbox"/> Colds | <input type="checkbox"/> Constipation | <input type="checkbox"/> Lung Troubles |
| <input type="checkbox"/> Asthma | <input type="checkbox"/> Weak Back | <input type="checkbox"/> Round Shoulders |
| <input type="checkbox"/> Headache | <input type="checkbox"/> Weak Eyes | <input type="checkbox"/> Stomach |
| <input type="checkbox"/> Rupture | <input type="checkbox"/> Rheumatism | <input type="checkbox"/> Disorders |
| <input type="checkbox"/> Thinness | <input type="checkbox"/> Nervousness | <input type="checkbox"/> Increased Height |
| <input type="checkbox"/> Pimples | <input type="checkbox"/> Short Breath | <input type="checkbox"/> Muscular |
| <input type="checkbox"/> Insomnia | <input type="checkbox"/> Weak Heart | <input type="checkbox"/> Development |

Other Ailments.....

Name.....

Age.....Occupation.....

Street.....

City.....State.....

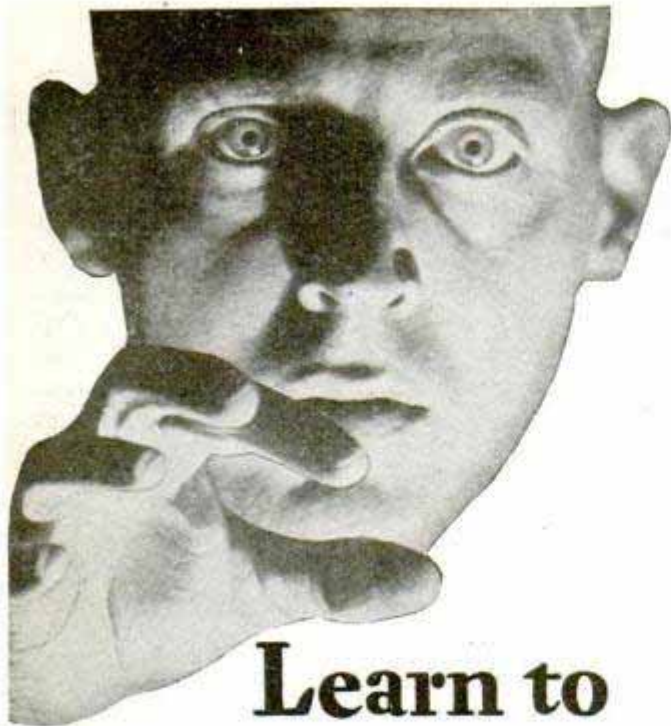

Learn to HYPNOTIZE

**5 DAY TRIAL - NO COST
IF NOT SATISFIED**

Gain New Power!

QUIT being just one of the crowd! Stand out—dominate—make others admire and obey you! Learn how to bend people to your will; how to develop a winning, magnetic personality; how to gain popularity, success, big money—by the USE OF HYPNOTISM.

In just a few hours, I'll show you the inner secrets of this mysterious force or the **Five Days' TRIAL IS FREE!** I'll show you how to develop the hidden germ of this magic power within yourself. Once you know how, you can use it in overcoming obstacles, achieving your fondest ambitions and becoming MASTER of yourself, friends and acquaintances—either sex. See for yourself how Hypnotism can banish fear, worry and opposition—improve your memory—**increase your earnings**—and force others to give you the good things in life that you desire!

In his startling NEW book "The Science of Hypnotism," the world famous hypnotist — Prof. M. Young — reveals the most carefully guarded secrets of this fascinating subject and TELLS ALL! He not only explains the methods of noted hypnotists, step by step—but tells clearly all about the nine stages of hypnotism, The Hypnotic Mirror, Mental Telepathy, how to select your subjects, magnetic healing, methods of hypnotizing, how to awaken the subject, how to make money out of hypnotism!

Try 5 Days Free—Send No Money

So confident are we that Prof. Young and his great book will quickly teach you the science of hypnotism, that we will send you a copy without one cent in advance! Simply clip and mail the coupon below. When the book arrives, pay the postman the special low price of \$2.50 plus few cents postage. Then test the powers of Hypnotism 5 days! If not amazed and delighted, return the book and money will be refunded at once! Mail the coupon now.

**Franklin Pub. Co., Dept. W-70
800 N. Clark St., Chicago, Ill.**

**Franklin Pub. Co., Dept. W-70
800 N. Clark St., Chicago, Ill.**

Please send me your amazing new book—"The Science of Hypnotism"—by Prof. Young. When the book arrives, I'll pay the postman only \$2.50 plus postage. If I am not satisfied after 5 days' trial, I may return the book and you are to refund my money.

Name.....

Street and No.....

Town..... State.....

If you are likely to be out when postman calls, send \$2.50 with coupon and we'll pay delivery charges. Customers outside U. S. must send cash with order.

SEE

- How To Hypnotize at a Glance
- How To Hypnotize By Telephone
- How To Give An Entertainment
- How To Make Others Obey You
- How To Do Dozens of Hypnotic Feats



Save Your Feet

When all else fails, end your suffering with the

Heefner Arch Support

No Metal

Fully patented. It re-adjusts the entire foot. Write for free book and statements from doctors and users.

Heefner Arch Support Co. 667 M. E. Taylor Bldg. Louisville, Ky.



NO JOKE TO BE DEAF

—EVERY DEAF PERSON KNOWS THAT

I make myself hear, after being deaf for 25 years, with these Artificial Ear Drums. I wear them day and night. They stop head noises and ringing ears. They are perfectly comfortable. No one sees them. Write me and I will tell you a true story, how I got deaf and how I make you hear. Address



**GEO. P. WAY, Artificial Ear Drum Co. (Inc.)
80 Hoffman Bldg., Detroit, Mich.**



Medicated Ear Drum



LUCKY POCKET PIECE, triple horse shoe puzzle, always keep one with you—10c, 4 sets 25c pp., with secret solution. Western Puzzle Works, St. Paul, Minn.

Skin Troubles

Cleared Up—Often In 24 Hours

Pimples, Blackheads, Acne Eruptions on the Face or Body, Barbers Itch, Eczema, Enlarged Pores, Oily or Shiny Skin. "Clear-Tone" has been tried and tested in over 300,000 cases. Used Like Toilet Water. It is simply magical in prompt results. At All Druggists, with proven directions.

ASK YOUR DRUGGIST—You Can Rely On

Clear-Tone

TRADE MARK REG.

FOR THE SKIN AND COMPLEXION

Stop Using a Truss

STUART'S ADHESIF PLAPAO-PADS are entirely different from trusses—being mechanico-chemico applicators made self-adhesive purposely to keep the muscle-tonic "PLAPAO" continuously applied to the affected parts, and to minimize painful friction and danger of slipping.

No straps,
buckles
or springs
attached



Soft as
velvet—easy
to apply—
inexpensive

For almost a quarter of a century satisfied thousands report success without delay from work. Stacks of sworn statements on file. Process of recovery natural, so no subsequent use for a truss. Awarded Gold Medal and Grand Prix. Trial of "PLAPAO" will be sent you absolutely **FREE** No charge for it now or ever. Write name on coupon and send **TODAY.**

PLAPAO CO., 588 Stuart Bldg., St. Louis, Mo.

Name.....

Address.....

FREE—Trial Plapao—FREE



The Most Amazing Auto
Discovery in 10 Years!

Astonishing Magic Fluid Restores Original Finish To Old Cars in 60 Minutes!

THINK of it! Old cars restored to their original color and showroom lustre. Just a sweep of your hand—and the dullest surface becomes a thing of beauty! This remarkable fluid discovery actually *draws forth* the original color and lustre of any kind of finish—whether painted, lacquered or enameled.

For NAVON is truly "liquid Magic"! Experts call it "the most surprising auto discovery of the decade." It is not a wax . . . not a polish . . . not a cleaner . . . not a paint! Nothing like it has ever been seen before. Yet its results are as *lasting* as they are astonishing!

Works Like a Charm

But perhaps best of all is the ease with which NAVON can be applied. You just put it on the car right out of the can—guiding its flow with a pad of cheese cloth. No fussing with brushes or tiresome rubbing. (It's more like pleasure than work—especially when you see your car actually regaining its

original color and mirror-like gloss right before your very eyes!) . . . And then before you realize it, the trick is done! There stands your old car, glistening with its new coat of NAVON like the day when you first climbed back of the wheel and pushed the starter button.

Safe—Durable—SURE!

Results with NAVON are absolutely certain! You don't have to be an expert to get 100% perfection. It's almost as easy as washing—dries smooth as glass without streaks. No harmful ingredients. Resists wear and weather. Can't crack or peel—and lasts for *months!* Ends need for bothersome polishing and users write that it increases re-sale value \$150 or more!

Test It Without Risk!

Right now we are making a special introductory offer which allows you to test NAVON without risking a penny! See for yourself what this amazing discovery can really do! No obligation. Just clip the coupon below and mail it to-day!

AGENTS! \$100 to \$300 A WEEK

So astonishing is NAVON that demonstrators and agents everywhere are simply coining money for just a few hours' work. H. Geiss (Ill.) cleared \$300 in a single week! And J. Porter (Wisc.) made \$98 in one day!

All you have to do is let car owners see what NAVON does! 9 out of 10 want to order instantly! And every order means *real cash* in your pocket! Even spare-time workers often make \$10—\$25 on Saturday afternoons, etc., just showing NAVON to friends, neighbors, etc. Wonderful opportunity to build permanent, profitable business as NAVON Service Station Operator, too. Write to-day for generous offer to order-takers—and extra-special test offer for agents! Check bottom line of coupon and mail it now!

NAVON

INSTANT REFINISH
FOR ALL SURFACES

FLOWS ON—STAYS ON—EASY TO APPLY

Consolidated Specialties Corp.

21 W. Elm St., Dept. 56-W, Chicago, Ill.

Mail
This
NOW!

Consolidated Specialties Corporation (NAVON Division)
Dept. 56-W, 21 W. Elm St., Chicago, Ill.

Without obligation, send me particulars of NAVON, together with
NO-RISK TEST OFFER.

Name.....

Address.....

Town..... State.....

() Check here if interested in NAVON as a money-maker.



FREE To Men Past 40

A WELL-KNOWN scientist's new book about old age reveals facts which, to many men, will be amazing. Did you know that two-thirds of all men past middle age are said to have a certain seldom mentioned disorder? Do you know the frequent cause of this decline in vitality?

Common Old-Age Symptoms

Medical men know this condition as hypertrophy of the prostate gland. Science now reveals that this swollen gland—painless in itself—not only often cheats men of vitality, but also bears on the bladder and is often directly responsible for sciatica, back-ache, pains in the legs and feet, frequent nightly risings, and dizziness denoting high blood pressure. When allowed to run on it is frequently the cause of the dreaded disease cystitis, a very severe bladder inflammation.

THE ELECTRO THERMAL COMPANY
2112 Morris Ave., Steubenville, Ohio.

Please send me Free, and without obligation, a copy of your booklet, "Why Many Men Are Old At 40." Mail in plain wrapper

Name.....

Address.....

City..... State.....

**\$10.00 PER MONTH BUYS
Fibre-Life Limbs**



NEXT TO NATURE. BRACES MADE TO ORDER. AGENTS WANTED. FREE FIBRE SAMPLE **WORMAN CO.** 252-P HENNEPIN AVE. MINNEAPOLIS, MINN.

DEAF? READ THIS

VIBRAPHONES revive hearing by utilizing and intensifying sound waves through the small silver devices that fit the ears perfectly. Powerful vibrators and intensifiers are built inside the small and almost invisible instruments. No wires. No batteries. Nothing like them. A new and scientific triumph that produces marvelous results. They stop head noises and improve hearing—often restoring it to its normal functions. Don't be handicapped or embarrassed another day.

Send \$10.00 for a pair of Vibraphones
Satisfaction guaranteed or your money back

VIBRAPHONE COMPANY [Reg.]

Dept. 8 Central Nat'l Bank Bldg. St. Louis, Mo.

65% Have This Gland Disorder

Prostate trouble is now reached immediately by a new kind of home treatment—a new, safe hygiene that goes directly to the gland itself, without drugs, medicine, massage, lessons, diet or the application of electricity. It is absolutely safe. 50,000 men have used it to restore the prostate gland to normal functioning. The principle involved in this treatment is recommended by practically all the physicians in America. Amazing recoveries are often made in six days. Another grateful effect is usually the immediate disappearance of chronic constipation. Usually the entire body is toned up as much of your youthful vigor is restored. These results are guaranteed. Either you feel ten years younger in six days or the treatment costs nothing.

Send for FREE Book

If you have this gland trouble or if you have any of the symptoms mentioned above, you should not lose a day in writing for the scientist's free Book, "Why Many Men Are Old At 40." It will enable you to ask yourself certain frank questions that reveal your true condition. Every man past 40 should make this test, as insidious prostate disorder often leads to surgery. This book is absolutely free, but mail coupon immediately, as the edition is limited. Address

THE ELECTRO THERMAL COMPANY
2112 Morris Ave., Steubenville, Ohio

[If you live West of the Rockies, address The Electro Thermal Co., 303 Van Nuys Building, Dept. 21-M, Los Angeles, Calif. In Canada, address The Electro Thermal Co., Desk 21-M, 44 Yonge St., Toronto, Can.]

Information on any book free. Write Popular Mechanics Press, Chicago, Ill.

QUIT TOBACCO



No man or woman can escape the harmful effects of tobacco. Don't try to banish unaided the hold tobacco has upon you. Join the thousands of inveterate tobacco users that have found it easy to quit with the aid of the Keeley Treatment.

KEELEY TREATMENT STOPS Tobacco Habit

Quickly banishes all craving for tobacco. Write today for Free Book telling how to quickly Free yourself from the tobacco habit and our Money Back Guarantee.

THE KEELEY INSTITUTE
Dept. A 916 Dwight, Illinois

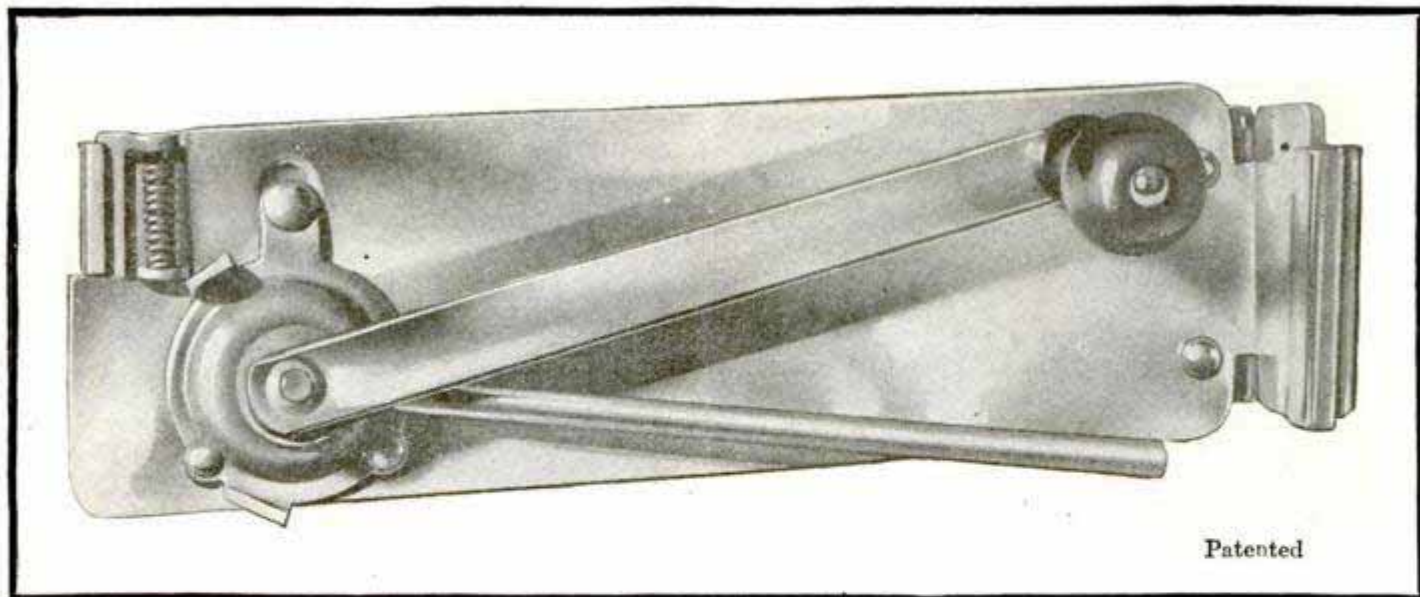

Patented

New Kind of Can Opener Astounds Experts.. ..Ends All Danger

There never has been a can opener even remotely like this new invention. It has been approved by household economy experts and thousands of housewives. Salesmen in America are literally becoming rich through it. For Free Test Offer and complete details mail the coupon.

Old-style, dangerous can openers must go! No longer can any woman afford to risk infections that may endanger life itself. Speedo ends fuss and muss, banishes danger forever. That's why women everywhere welcome Speedo as a literal godsend.

IT is no secret that women hate to open cans with the wasteful, dangerous, old-fashioned can opener. It's risky even for a man to saw the top out of a can with the old "jab-and-hack" type opener. Yet everything from sardines to asparagus is eaten from cans. People hate can openers but must use them. Briefly, that's the condition presented to Speedo agents today—and it's a situation almost unprecedented in the selling field from a big-profit standpoint.

Approved by All Authorities

Practically every noted domestic science authority in America has tested and approved Speedo—the amazing new automatic can-opening machine. Facsimiles of the stamps of approval of some of these authorities are shown on this page. Every housewife knows what it means to have the approval of Good Housekeeping Institute, for example. It means that they can buy

Agents—\$2,200 in a Month

Some profit records with Speedo are so huge as to be almost beyond belief. Yet the facts absolutely speak for themselves. For example: Dickinson, Idaho, sold \$2,200.00 Speedos in a month (his profit over \$300 every week!) Barclay, N. Y., reports \$117 clear profit in just 2 days. Mrs. Homelow, O., made \$7 her first hour. Scores of others are making money the same quick, easy way. A "twin" Speedo invention makes this possible anywhere. Get the facts. Act at once. **FREE TEST OFFER—MAIL COUPON.**

with absolute confidence—and tests made from Maine to California now prove that 4 out of 5 prospects will buy this new invention on 2-minute demonstration.

Every home welcomes you with open arms when you show them this truly modern method of doing the job they now detest. Speedo surprises everyone. It takes hold of the can—cuts the top out slick and smooth inside the rim—flips up the lid so you can grab it—then hands the can back to you without any jagged edges to snag your fingers—all in a couple of seconds, at the turn of a crank. Just think what an amazing demonstrator such a device must be!

There is nothing else like Speedo. It is made of heavy steel and will last a lifetime. The manufacturer guarantees it in writing for five years! Agents make real profits on every sale. Mail the coupon for full details and special money-making offers.

Central States Mfg. Co., Dept. W-702,
4500 Mary Ave., St. Louis, Mo.



No More Cut Fingers



Works Like Magic



Open Square, Round or Oval Cans

Amazing Incomes for Agents!

THIS unique invention is called Speedo Can Opener. It has been so much talked about that nearly everyone has heard of the almost magical way it works. Speedo is sold only through local representatives and agents. Already men, and women, too, report incomes ranging from \$3 to \$7 and \$8 an hour both spare and full time. Simply mail coupon for details of exclusive territory, national advertising, complete sales training, also **FREE SALES OUTFIT** and **FREE TEST OFFERS**. Mail it today.

MAIL THIS COUPON TO-DAY

Central States Mfg. Co. Dept. W-702
4500 Mary Ave., St. Louis, Mo.

Please rush me the facts about Speedo and your **FREE TEST OFFER**.

Name.....

Address.....

Town.....State.....

Check here if interested only in one for your home.



NO JAGGED EDGES



FOOD POURS RIGHT OUT

Speedo cuts the top out (not off). Leaves can rim slick, smooth and clean. All done automatically.

Lid is cut out inside rim. Juices can't spill. Yet all food pours out—even foods frozen in the can.



**With Violet Ray Vibration
Ozone Medical Electricity**

*The Four Greatest Curative Powers
Generated by This*

Great New Invention!

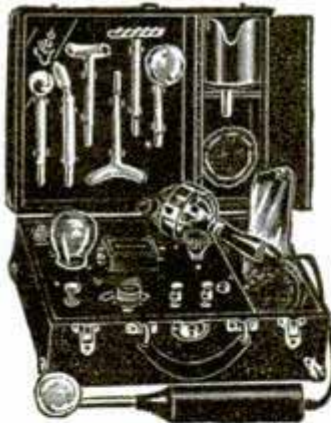

Elco Health Generators at last are ready for you! If you want more health—greater power to enjoy the pleasures and delights about you, or if more beauty is your desire—write! Ask for the book on these inventions which has just been prepared. It will be sent to you without cost. It tells you how Elco Health Generators aid you in leaving the lethargy and hopelessness of bad health and weakness behind forever. Re-vitalize yourself. Bring back energy. Be wholly alive. Write today!

Here's What Elco Users Say—

"Wouldn't take \$1000 for my Elco."
"Has done me more good in 2 weeks than doctors did in three



years." "Cured my Rheumatism." "My Eczema gone." "Cured my stomach trouble." "Cured my weakness." "Now I sleep soundly all night." "Thanks to Elco my strength and vigor are back." "No more pain." "Colds never bother me now." "Chronic Constipation banished."
These great new inventions generate Violet Ray, Vibration, Elco-tricity and Ozone—combined or separate. They operate on the electric light in your home or on their own motive power at less than 50 cents per year. Elco Health Generators are positively the only instruments which can give you in one outfit Electricity, Violet Ray—Vibration and Ozone—the four greatest curative agents. Send the coupon below. Get the Free Book NOW!

**MAIL COUPON
for FREE BOOK**

Do not put this paper down without sending the coupon. Don't go on as you are with pains and with almost no life and energy. You owe it to yourself to be a better man or woman. You were put here to enjoy life—not just to drag through it. So do not rest another day until you have put your name on the coupon here. That will bring the whole story of these great new inventions. Do it today—now.



Lindstrom & Company
2322 Indiana Ave. Dept. 13-59 Chicago
Please send me your free book, "Health—Power—Beauty" and full information of your 10-day Free Trial Offer.

Name.....
Address.....



**Learn
AVIATION**

**Get Complete Training In
One of America's Largest and Most
Elaborately Equipped Air Schools**

What counts in Aviation? Training! Ordinary methods mean nothing today. Only skilled instructors and up to date equipment can fit you for success.

When you take the **Complete Pilot's Course** at Parks you'll see our fleet of 26 new-production ships, large and small, open and cabin types. You'll see Whirlwind, OX5, Caminez, Hispano, Velle, Liberty and other motors. Our fifteen licensed transport pilots will teach you all branches of flying. You'll get Air Navigation, Meteorology, Airport Management,

Maintenance and Repair of planes and engines. Theory of Flight, Aerodynamics—every important subject. We'll turn you out a real pilot ready for success!

Big-pay jobs are waiting for graduates of our **Advanced Mechanics Course**. We use over \$150,000 worth of plant and equipment to teach you design, building, maintenance, and service of airplanes and engines. You learn by factory production methods; you qualify for field duty, factory jobs, foreman's and superintendent's positions. We teach under actual factory and transport conditions. Immediate action will get a special rate on either a flying or a mechanic's course, and gets you the training that leads to salaries of from \$300 to \$2,000 per month!



234-K Mo. Theatre Bldg. ST. LOUIS, MO.

FREE BOOK
Send for the latest edition of "Skyward Ho!" over 32-page profusely illustrated catalog that gives all information, sent free. Write today.

STATEMENT OF THE OWNERSHIP, MANAGEMENT, CIRCULATION, ETC., REQUIRED BY THE ACT OF CONGRESS OF AUGUST 24, 1912, of Popular Mechanics Magazine, published monthly at Chicago, Ill., for October, 1928.

Before me, a notary public in and for the state and county aforesaid, personally appeared H. H. Windsor, Jr., who, having been duly sworn according to law, deposes and says that he is the editor and business manager of the Popular Mechanics Magazine and that the following is, to the best of his knowledge and belief, a true statement of the ownership, management, etc., of the aforesaid publication for the date shown in the above caption, required by the Act of August 24, 1912, embodied in section 411, Postal Laws and Regulations, printed on the reverse of this form, to wit: First, That the names and address of the publisher, editor, managing editor, and business manager are: Publisher, Popular Mechanics Co., 200 East Ontario St., Chicago, Ill. Editor, H. H. Windsor, Jr., 200 East Ontario St., Chicago, Ill. Managing Editor, L. K. Weber, 200 East Ontario St., Chicago, Ill. Business Manager, H. H. Windsor, Jr., 200 East Ontario St., Chicago, Ill. Second, That the owner is: (If owned by a corporation, its name and address must be stated and also immediately thereunder the names and addresses of stockholders owning or holding one per cent or more of total amount of stock. If not owned by a corporation, the names and addresses of the individual owners must be given. If owned by a firm, company, or other unincorporated concern, its name and address, as well as those of each individual member, must be given.) L. B. Windsor, 200 East Ontario St., Chicago, Ill.; H. H. Windsor, Jr., 200 East Ontario St., Chicago, Ill. Third, That the known bondholders, mortgagees, and other security holders owning or holding 1 per cent or more of total amount of bonds, mortgages, or other securities are: (If there are none, so state.) None. Fourth, That the two paragraphs next above, giving the names of the owners, stockholders, and security holders, if any, contain not only the list of stockholders and security holders as they appear upon the books of the company but also, in cases where the stockholder or security holder appears upon the books of the company as trustee or in any other fiduciary relation, the name of the person or corporation for whom such trustee is acting, is given; also that the said two paragraphs contain statements embracing affiant's full knowledge and belief as to the circumstances and conditions under which stockholders and security holders who do not appear upon the books of the company as trustees, hold stock and securities in a capacity other than that of bona fide owner; and this affiant has no reason to believe that any other person, association, or corporation has any interest, direct or indirect, in the said stock, bonds, or other securities than as so stated by him. H. H. WINDSOR, Jr., Editor and Publisher. Sworn to and subscribed before me this 28th day of September, 1928. J. GRAHAM, Notary Public. (My commission expires June 16, 1932.)

TELEGRAPHY

(Morse and Wireless) and RAILWAY ACCOUNTING, taught thoroughly. Big salaries; great opportunities. Oldest, largest school. Endorsed by Telegraph, Railway, Radio, and Government officials. Expenses low—opportunities to earn large portion. Catalog free. DODGE INSTITUTE, Jones St., Valparaiso, Ind.

WANTED!

Ornamental Iron and Bronze Draftsmen. \$50.00 to \$65 a week to trained men—up to \$500.00 a month to experienced men. We train you at home and help place you when ready. Demand greater than supply. Get out of the rut—write today for full information and booklet "Knowledge—Your Greatest Asset."

American Institute of Ornamental Iron & Bronze
3075 Hennepin Avenue, Minneapolis, Minn.

Please Mention Popular Mechanics

- takes only 8 weeks to get a big job



George Smith owns an agency and repair shop in West Alexandria, Ohio. He makes \$200 a week.

Earn \$75 to \$125 a Week As Auto Expert

Learn the auto and tractor business by the McSweeney method, then step out and get a good job at \$75 to \$125 a week or open your own repair shop and make up to \$10,000 a year. Trained men are needed everywhere. Opportunities galore! Eight weeks training fits you to open repair shop or to go with one of the big firms waiting for trained men. Read what George Smith and C. E. Gillespie have done. Hundreds of other McSweeney trained men can tell as interesting facts. Every month McSweeney men who complete their training are taking the place of half-trained and incompletely self-trained men.

Money Back Guarantee

If, after completing my training, you are not satisfied, if you are not qualified to accept a big-pay job, your tuition will be refunded.

Learn on Real Machines

C. E. Gillespie has charge of a fleet of trucks and tractors for the State Highway Commission, due to McSweeney training.

Learn in Only 8 Weeks

Simple, thorough, practical shop methods. You learn the "why" of everything you do, then learn to do it right. You do real work with real tools and real equipment. No book studying. Very little schooling necessary. Any man from 16 to 60 can learn. Write today for Big Special Limited Time Tuition Offer, including—

SPECIAL! R. R. FARE PAID!
Also FREE course in AUTOMOBILE ELECTRICITY to those who enroll soon. Don't delay—write at once for complete details and BIG AUTO BOOK FREE. Mail coupon NOW.

AVIATION COURSE INCLUDED

AVIATION is paying tremendous incomes to trained men! Now eight weeks' course also includes complete course in Aviation Mechanics. Learn on real airplane engines under experienced instructors. Ask about special course in FLYING. Don't miss this remarkable opportunity. Save by enrolling at once. The sooner you start the sooner you will be ready to earn big pay or get into business for yourself.

MAIL COUPON FOR FREE BOOK

McSweeney Auto, Tractor and Aviation School, Dept. 11-T, Cincinnati, Ohio.
Without cost or obligation, send me your big FREE book on Autos; also, full details of your big offer including R. R. Fare and New Course in Aviation.

Name.....
Street.....
Town..... State.....

McSweeney Schools

Auto, Tractor and Aviation Department
11-T Cincinnati, Ohio



Step INTO A BIG-PAY HOTEL JOB

Earn \$2,500 to \$10,000 a Year

IN America's 3rd Largest Industry. Hotels, Clubs, Restaurants, Institutions, Schools, Colleges, Hospitals, etc., are daily calling for Lewis Trained Men and Women. Over 70,000 high-class positions paying \$2,500 to \$10,000 a year open annually in hotels alone. Salaries up to \$3,500 to start.

BE A HOTEL HOSTESS

We Put You in Touch with Positions

Without cost let us show you how big pay, fascinating work, quick advancement can be yours in the great hotel industry. Age is no obstacle—young and old alike have equal chance for success. A common school education is all you need with the amazing Lewis System of Sparetime Training in Hotel Operation.

MANAGE AN APARTMENT HOTEL

Previous Experience Unnecessary

Hundreds of Lewis students are winning success. Totally unacquainted with hotel work before taking the Lewis Course, N. Frank Hills is now Assistant Manager of a \$250,000 Apartment House in Los Angeles, Cal. Lena Blair became Manager of a Tulsa, Okla., Apartment House even before she completed the Lewis Course! YOU can do as well. Low cost—easy terms—money back agreement. Write today for Free Book, "Your Big Opportunity," and complete details, mailed without obligation.



LEWIS HOTEL TRAINING SCHOOLS, Room BE-339, Washington, D. C.
Send me the Free Book, "Your Big Opportunity," without obligation.

Name.....
Address.....
City..... State.....

THESE LEWIS STUDENTS "MADE GOOD"

Jos. T. Freed, Phila., Pa.—"Without the training of the Lewis Schools I could never have secured the position of Assistant Superintendent of Service."
Editha Thompson—"Am Manager of a Chicago Apartment Hotel. My work with you enabled me to secure this fine position."
Julius M. Winslow—"New Assistant Manager of a 15-story hotel in New York City. I knew nothing of hotel work until I began your course 6 months ago."
Mrs. Ida Hartman—Stamford, Conn. "I am Housekeeper in the Hospital where your Employment Bureau placed me, and am very pleased with my new home."

OPPORTUNITY COUPON

LEARN AVIATION IN

DETROIT

The
is the AVIATION CENTER
LOGICAL PLACE
TO LEARN



Of course you will learn Aviation,—that's the business of the future greats. Where to learn?

The answer is quick and easy . . . Detroit! The aviation center of the whole wide world. In Detroit the aviation Pay Roll is highest of all cities. That's what counts,—not the number of companies, or even the number of planes, but the *pay roll*. Here the great ones are,—Ford, Packard, Stinson, Warner, and others. The leaders.

LEARN AT THE HEART OF THE INDUSTRY!

Two more mammoth airports now being established. Every day there's a *step ahead* in Detroit,—the marvelous motor city. Take your place NOW in aviation,—this thrilling, profitable business with its tremendous future.

THOROUGH GROUND COURSE

Thorough training is the key to success. The old reliable "Michigan State" . . . with its twenty years of training experience,—offers you a thorough, intensive training course. Ground work alone, or ground work and flying. Under experts. Over 400 hours in our ground course alone; fits you from A to Z to go into this business. Michigan State Aviation School is not a correspondence school, but a practical, actual training school. Students come here from practically every state and several foreign countries, because the M. S. A. S. in Detroit, the aviation center, offers training which cannot be obtained elsewhere.

CLIMB HIGH

ACT NOW

SERVICE MEN NEEDED

"Aviation in the service field," says executive of Aircraft Development Corporation, Detroit, "wants fellows willing to learn the game from the ground up. The fellow who masters the care of planes from the smallest detail, can go far." 20 trained service men needed to every flyer.

ENDORSED BY LEADERS

The great Eddie Stinson, other business leaders and flyers, highly endorse this Michigan State Aviation School training,—and the opportunity for properly qualified men.

Write us today for details. Or just write your name on the blank below and mail it.



A. G. ZELLER, President and General Manager

MICHIGAN STATE AVIATION SCHOOL

32 Aviation Building, 3719 Woodward Ave., Detroit, Mich.

INFORMATION

Name..... 32

Street or R. F. D. No..... Town..... State.....

BARBERING

Now One of the Highest Paid Professions!

\$90 to \$150 Every Week!



William McClintock, President Master Barbers' Ass'n of Chicago and proprietor of the highest priced rented shop in the world, says, "My son, who learned at Moler's, is top man in my shop every week. I gladly recommend the Moler System as the proper place for men to become successful barbers."

—WM. McCLINTOCK.

BE A "WHITE-COLLAR" MAN— Earn \$90-\$150 a Week—CLEAN Money!

What's the use of doing dirty, greasy, hard work, when you can NOW make TWICE as much money in a manly profession that is CLEAN, profitable and full of opportunities?

Easy to Learn— Quick to Earn!

That's BARBERING for YOU! And the best part of all it is this—scientific barbering, as taught the modern MOLER way, makes YOU a Master Barber in a short course of intensive training, at small expense! You soon step out as your own Boss, if you wish, in your own Shop, which we will gladly help you equip.

See the World, Too!

Or, if you prefer, we will help you step into a real job, with good pay the first day, after you graduate. Ocean Liners, crack trans-continental passenger trains, big luxurious hotels and skyscrapers all over the world, as well as thousands of Barber Shops everywhere, demand MOLER trained men.

MOLER Graduates Are Always Busy!

MOLER trained Men are always given the preference, for they alone possess the valuable, thor-

ough MOLER training in the application of all the latest scientific Barbering methods including the Electric hair cutter, the mechanical massage, and the latest vogues in ladies' hair bobbing. MOLER also gives special training in ladies' marcelling and an easy practical course in the treatment of skin diseases.

Earn While Learning!

"Where there's a Will there's a Way" to earn BIG pay! Write to the nearest MOLER College, there is one near you, and learn how you can earn while you learn the barber trade. Ask for the new FREE MOLER Barbering Booklet B. Find out HOW MOLER helps you help yourself AFTER you graduate, as well as BEFORE! Find out why MOLER Men are making DOUBLE the money others made last year, before Ladies' Shingle Bobbing became so popular. You're NEXT in line for big pay—the MOLER way. Send Coupon TODAY for Booklet B.

MOLER SYSTEM OF COLLEGES

30 Branches in United States and Canada

New York, N. Y.
Chicago, Ill.
St. Louis, Mo.
Kansas City, Mo.
Cincinnati, Ohio.

Cleveland, Ohio.
Detroit, Mich.
Denver, Colo.
Omaha, Nebr.
Milwaukee, Wis.

New Orleans, La.
Atlanta, Ga.
Memphis, Tenn.
Dallas, Tex.
Houston, Tex.



"The XXth Century," "Oriental Limited" and other crack trans-continental trains carry barbers.



The Majestic, Leviathan and U. S. Shipping Lines all carry barbers.

NEXT! For BIG Pay

Mail THIS

MOLER SYSTEM OF COLLEGES

← Address Nearest Branch

(Street Address NOT Needed)

Please send me without obligation on my part your Booklet B.

Name.....

Address.....

City..... State.....

O. C.
MILLER

Director
Extension
Work
American
School



The American School

A two million Dollar *No-Profit* Educational Institution, now offers men a *double service*—training for a specific job, then help in finding the job. For one small price, on terms of only \$6.00 a month, you are now assured of definite benefits, both in position and salary. Write for complete information—*today!*



No machine can be built until the Draftsman first builds it on PAPER. This training prepares you for this work.



Never has the world seen anything like the building boom of today. This has created enormous demand for real Draftsmen.

3 Drafting

to prove you can

We have invented a new, simplified way to teach Drafting —the first real improvement in Drafting home instruction in history. We want you to see a few of these new Job-lessons, try them, test your own ability to master them—without one penny of cost or obligation. For instance, you will see how we get away from the "copying" methods used in the past, so you develop into a DRAFTSMAN, instead of a "tracer." See for yourself the ingenious new method which compels you to think, to solve problems, to do actual Drafting-room jobs from the very first lesson!

A New, Rapid, Simplified Training

Copying drafting lessons prepares you to be only a "tracer." This new "Job-Method" gives you actual drafting-room jobs in a new one-step-at-a-time way. With pictures which you can understand almost without reading the "lessons." And that is why the American School-trained Draftsmen can qualify for a good job at big pay when they graduate.

5 BIG-PAY Branches

The big money in Drafting goes to men who specialize in Machine Design, or Electrical Drafting, or Architectural Drafting, or Structural, or Automotive. It is not enough merely to know *general* Drafting practice. You must know how to calculate and design and plan original work. You need many Engineering subjects to fill the kind of a Drafting position that pays \$40 to \$100.00 a week. The American School now includes this specialized training in its *Drafting course.*

Win Success Thru Drafting

Drafting is easy, fascinating work. Short hours. Big pay. And the Draftsman is always in line for promotion to executive positions. This training is *complete.* It includes high school subjects (if you need them) and all the Engineering and Mathematics Drafting experts require.

FREE Job Service!

The American School now offers its students and graduates, without cost, the services of an efficient employment department keeping in constant touch with employers of Draftsmen all over the U. S. We have placed hundreds of men in good, big-pay Drafting positions. We've made this training so complete, so practical, so easy to master, that our students are bound to *make good.* And so, because the demand for real Draftsmen continues to exceed the supply and because this training actually prepares men for good Drafting positions we back it with a *Free Employment Service.*

The American School

Dept. D-974
Drexel Avenue and
58th St., CHICAGO

Lessons *Actually* FREE

learn at home in spare time!
Draftsmen Wanted!
\$40 to \$100 a Week!

yourself. Plan your future in Drafting. Even if you have only common schooling, even if you know nothing of Drafting, we guarantee to make you a real Draftsman or to refund your money!
 Coupon brings complete information.

70,000 fine jobs advertised last year. Get ready to fill one. Get out of the rut. Make something of

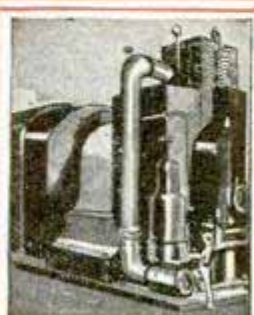

Electricity needs draftsmen who know Electrical principles as well as general Drafting practice. I give you this training.



The demand for Draftsmen experienced in concrete and structural steel work is enormous. Many big-pay positions open.



Every great Auto factory employs Draftsmen who specialize in Automotive work—men who design bodies, plan engines, etc.

I Will Make This Contract With You

WHEN you enroll for our home-training in Drafting, we agree to give you:

1. Complete Drafting training, by the new Practice-Method.
2. We will help you get a good Drafting position at a substantial increase in pay,
3. or we'll refund every cent of your money.

O. C. Miller
 Director Extension Work



American School
 —the two Million Dollar Educational Institution



Coupon Brings 3 Lessons FREE!

Get them. Test your own ability to learn Drafting and get ready for a fine job and big pay. Coupon also brings complete information about your opportunities for success in Drafting. *Mail It Today!*

Read These Letters!

City of Chicago
 Department of Buildings
 Gentlemen: The same day I received my diploma I got word that I was one of the two candidates who had successfully passed the examination for Deputy Commissioner of Buildings of the City of Chicago, a position paying \$3600 per year.

There were eight applicants examined besides myself, all men well known to the architectural and engineering profession. Seven of these failed to obtain a passing grade of 70%. My grade was 84.69.

Inasmuch as I failed to pass this same examination three years before, my present success is mainly due to the knowledge gained through your School.

Yours very truly,
ROBERT KNIGHT

Liberty High School
 Bethlehem, Pa.

Dear Sirs:—This is to thank the American School for all that you have done for me since I signed up for the Drafting and Design Course.

In the eight years since then, I have gradually climbed from the position of tracer to that of Head of the Department of Machine Drawing and Design in our magnificent new \$2,000,000 High School here, at many times the salary which I received at that time.

The officials of the Pennsylvania State Department, and Dr. Wm. C. Ash of the University of Pennsylvania, all claim that our Course in Drafting and Design is the best now being taught in this state. Every drafting graduate that we have turned out has proved successful, and one is now Chief Draftsman in a local steel concern. Yours sincerely,
J. S. LEAR

Got His Draftsman's Job

"I wanted to let you know how I came out in getting that job at the Brownell Co., Dayton, Ohio. I was to start and have a trial at Drawing, and I am still in the Drawing room. The engineer seems to like the work I make, and also the other draftsmen. I thank the school very much for getting me in at this place, because your letter of recommendation helped me a whole lot to get the job."

BERNARD WEBER,
 730 St. Nicholas Ave., Dayton, O.

Has Charge of Large Jobs

"Even before I had finished my course, I was put in charge of large construction jobs in different cities. I have been doing that ever since, and the jobs are getting larger all the time. I owe my success to the American School because of the knowledge I gained in mathematics and calculations."

ELMER L. LAMB,
 1306 Smith St., Peoria, Ill.

3 Drafting Lessons *Actually* FREE

O. C. MILLER, Director Extension Work
AMERICAN SCHOOL
 Dept. D-974, Drexel Ave. and 58th St., Chicago.

Rush 3 Free Drafting Lessons, Job and Raise Offer, complete information, money-back guarantee, etc., to prove I can become a real Draftsman at home in spare time.

Name.....
 Street No.....
 City..... State.....
 Age..... Occupation.....

THE RED BOMBER COMBAT PLANE



FREE!

Positively a sensational offer. Here's the Red Bomber Combat Model Plane, a twin propeller model that flies amazingly. And you can have it free! Boys everywhere are flying model planes. Now is the time to get yours. This sensational plane will fly 600 feet easily, often further. Wings made of special fibre, two powerful rubber motors, two cleverly fashioned propellers. Not a glider—a real model plane.

Assembled in two minutes

Best of all no tedious hours of toil constructing. This plane can be put together ready to fly by any boy in less than two minutes—positively! Two minutes after the postman delivers your plane, you can send it into the air diving and dipping, zooming, banking, then soaring to greater heights. Every boy will envy you. Order your plane right now!

THRILLING BOYS' MAGAZINE

12 Fat Issues

THE OPEN ROAD for BOYS has 50 pages crammed with stories of aviation, mechanics, sport, high adventure, great serials, jokes and humor. Correspondence club. Contests galore for all. "Golden Medallion," mystery serial smash now starting—breathless reading! We will send you the Red Bomber Combat Plane and a subscription to The Open Road for Boys Magazine—12 fat issues—both for \$1. Send the coupon now.



BOTH FOR ONLY \$1

Pilot O'Hare,
Open Road for Boys Magazine,
130 Newbury Street, Boston, Mass.
Friend:
By all means I will grab this offer. Enclosed is \$1. Please rush me the Red Bomber Combat Model Plane. Enter my name to receive a year's subscription—12 issues—to The Open Road for Boys Magazine beginning with the very next number.

Name.....
Street.....
Town or City.....
State.....

You'll Get a pleasant Surprise

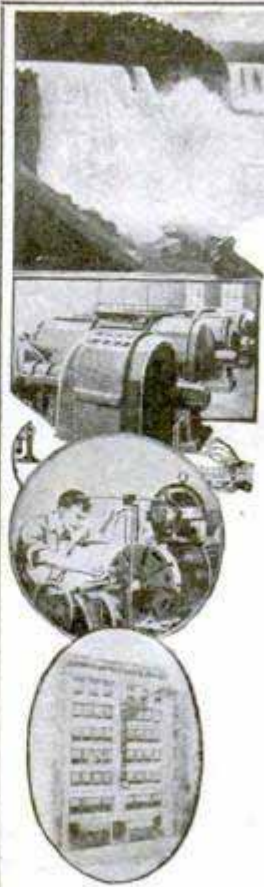

LEARN BY DOING

Every phase of all branches of

ELECTRICITY

taught by

Actual Practice

In one of America's foremost institutions for trade training

ESTABLISHED 1902

No Books Used

Individual Instruction
Start Any Day

Write for FREE 64-page catalog

THE NEW YORK ELECTRICAL SCHOOL

44 West 17th St., New York City

GIVEN TO YOU



A Brand New
High Grade Fine Tone

VIOLIN, TENOR BANJO, HAWAIIAN GUITAR,
BANJO, CORNET, UKULELE, BANJO UKULELE,
GUITAR OR MANDOLIN

We will give you without extra charge when you enroll, any instrument you select and teach you to play it by our NEW copyrighted easy to learn home-study course. Over 500,000 men, women, boys and girls have learned to play by our simplified method. Cost is only a few cents a day for lessons. No other charge. You pay while you learn. Instrument and first lessons sent on FREE trial. Write today.

CHICAGO CORRESPONDENCE SCHOOL OF MUSIC, INC.
1632 No. Halsted St., Dept. 737 Chicago, Ill.

ALWAYS Ask For DENISON'S—53 Years of Hits

Comedy-Dramas, Farces, Musical Comedies, Revues, Musical Readings, Blackface Skits, Make-up Goods.

PLAYS

Vaudeville Acts, Monologs, Dialogs, Entertainments, Books, Minstrels.

Catalog FREE.

T. S. DENISON & CO., 623 S. Wabash, Dept. 9, CHICAGO

PATENTS

**Booklet Free Highest References
Promptness Assured Best Results**

Send drawing or model for preliminary examination of Patent Office records.

ALL BUSINESS GIVEN PROMPT AND PROPER ATTENTION

Listed Patent Lawyer in the latest editions of the Rand-McNally Directory of Bankers and Bonded Attorneys, published by Rand-McNally & Co., Chicago, Ill.; The Baggott & Ryall Directory of Guaranteed Attorneys, published by the Ryall Legal Directory Company, New York City; Flugel's List, published by the Legal Directory Publishing Co. of St. Louis, Mo.; the American Lawyers Annual, published in Cleveland, Ohio; Eyre's Law List, Bush Terminal Building, New York City.

WATSON E. COLEMAN,

REGISTERED PATENT LAWYER

Victor Building, 724 Ninth Street, N. W.
WASHINGTON, D. C.

\$350 a month

"I feel proud of my success in Radio to date. My profit during the last two months amounts to \$700. I am making good and I have not finished my N. R. I. course yet. I am grateful for your training and co-operation to date and look forward to still bigger success when I graduate."

Clarence Heffelfinger,
Temple, Penna.

**\$500 a month**

"When I enrolled with the N. R. I., I was a motorman on a trolley car. Now I have a fine, fast-growing Radio business. When only half way through the course started bringing in extra money. I made \$420 in my spare time. Now I have a bank account of \$2800 and about \$300 worth of stock. It has all come from Radio since graduating less than six months ago. I cannot begin to express my thanks to you and all those connected with N. R. I. for what you have done for me."

Richard Butler, 3535 Sheffield St.,
Philadelphia, Pa.

**\$450 a month**

"In addition to my regular work in what I believe to be the largest and best equipped Radio Shop in the Southwest, I am now operating KGFI. I am proud of the fact that I installed and put KGFI on the air without help of anyone except the N. R. I. I am averaging \$450 per month."

Frank M. Jones,
922 Guadalupe St.
San Angelo, Tex.



READ what Big Money my men make in RADIO

\$350, \$450, \$500 a month. That's making real money. What business other than Radio offers such opportunities after six to twelve months training? None that I know of. More proof—last year electricians, farmers, mechanics, clerks, railroad men, bookkeepers, preachers, doctors, and men from 78 other trades and professions enrolled with me to prepare for the Radio field.

Big Growth Making Many Big Jobs

A WONDERFUL business, you will say, to make men trained for other fields, give them up for Radio. Yes, but they had their eyes wide open. They know what you and I know—that big growth makes big jobs and many opportunities to earn big money. Heffelfinger, Jones, and Butler couldn't make anything like this money before, although they probably worked just as hard—maybe harder. Trained men are needed for the big jobs the amazing growth of Radio is creating.

Salaries Up To \$250 a Week

WHY go along at \$25, \$30, \$35 a week when the good Radio jobs pay \$50 to \$250 a week? Cut loose from drudgery, small pay, no-future jobs. Get into a live-wire field that offers you a real chance. You don't need a high school or college education to become a Radio Expert. Many of my most successful graduates didn't finish the grades.

Practical Experience With Course

I GIVE you six big outfits of Radio parts. With them you can build and experiment with one hundred different circuits—learn the "how" and "why" of practically every type of set made. This makes learning easy, interesting, fascinating, your training complete. Nothing else equals my method.

TELEVISION also Included

YOUR knowledge of Radio will be right up to the minute with Radio's progress and inventions when you take my training. Television, the new field for Radio experts, is included. Not one system for sending and receiving pictures by Radio, but all of them—Jenkin's, Cooley's, Bell's, Baird's, Belin's, Alexanderson's.

Television can easily and quickly become as large as the whole Radio industry is today. Broadcasting stations will soon need trained men, so will manufacturers for the designing and building of sending and receiving sets. It won't wait for you. Get ready quick.

I GIVE YOU THE RADIO PARTS FOR A HOME EXPERIMENTAL LABORATORY

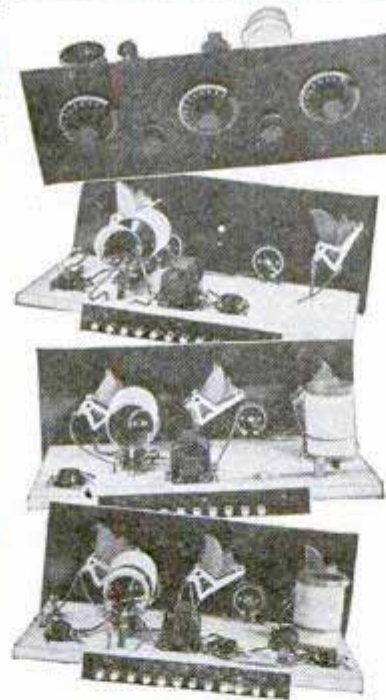

WITH THEM YOU CAN BUILD 100 CIRCUITS. 4 YOU BUILD ARE SHOWN HERE. MY BOOK EXPLAINS THIS PRACTICAL FASCINATING WAY OF LEARNING RADIO

Get a copy Free

I Will Train You at Home in Your Spare Time

NO NEED to leave home. Hold your job, give me one-half to one hour a day of your spare time. In six to twelve months you can be a trained Radio Man, ready to step into a new job with a real future.

\$10 to \$30 a Week While Learning

MANY of my students make \$10, \$20, \$30 a week extra while learning. I teach you to begin making money shortly after you enroll. G. W. Page, 1807 21st St., Nashville, Tenn., made \$935 in his spare time.

Money Back If Not Satisfied

I KNOW the kind of training you need. I have put hundreds of men and young men ahead. I am so sure that I can satisfy you too that I will agree to refund your money if you are not satisfied when you complete my course.

Find Out What Radio Offers You

MY 64-page book explaining where the big jobs are and what you can make is FREE. Mail coupon. No obligation.

Address: Dept. 44HH
J. E. Smith, Pres.,
Nat'l Radio Institute,
Washington, D. C.



Send this Coupon

J. E. Smith, President,
Dept. 44HH, National Radio Institute,
Washington, D. C.

Dear Mr. Smith:—Send me your book. I want to know about the opportunities in Radio and your practical method of teaching at home with six big outfits of Radio parts. This request does not obligate me to enroll.

Name Age.....
Address
City State.....

THIS IS RADIO'S BIGGEST YEAR

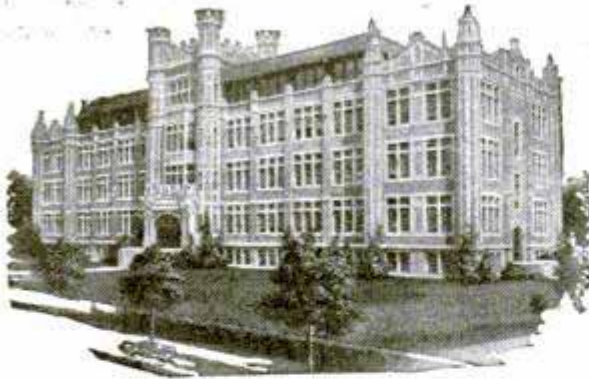

Go to High School at Home

You can secure a high school education right at home by studying the splendid new courses recently prepared by the International Correspondence Schools.

These courses are equivalent to the courses given in resident high schools. They have been specially arranged for men and women who wish to meet college entrance examinations, to qualify for a business position, or to make up the education they missed when forced to leave school too soon.

The College Preparatory Course, the High School Commercial Course and the High School English Course include English, algebra, ancient, medieval, modern and U. S. History, physiology, literature, geography, Latin, bookkeeping, drawing, geometry, shorthand, physics, chemistry, salesmanship, advertising, civics, trigonometry, economics, American business law, corporation finance, money and banking, business and trade economics, etc. A diploma is given at graduation.

The lessons are easy to understand and you will make rapid progress because you will be *in a class by yourself* and you will study under the guidance of instructors who are sincerely interested in helping you to get ahead and achieve the bigger things of life.

Just mark and mail the coupon and we will gladly send you interesting free booklets describing the High School Courses of the International Correspondence Schools or any other subject in which you are interested.

INTERNATIONAL CORRESPONDENCE SCHOOLS

Box 5580-F, Scranton, Penna.

Without cost or obligation, please tell me how I can qualify for the position or in the subject before which I have marked an X:

- College Preparatory Course
- High School Commercial Course
- High School English Course
- High School Vocational Course
- High School Agricultural Course

- | | |
|--|---|
| <input type="checkbox"/> Business Management | <input type="checkbox"/> Salesmanship |
| <input type="checkbox"/> Industrial Management | <input type="checkbox"/> Advertising |
| <input type="checkbox"/> Personnel Management | <input type="checkbox"/> Business Correspondence |
| <input type="checkbox"/> Traffic Management | <input type="checkbox"/> Show Card and Sign |
| <input type="checkbox"/> Accounting and C.P.A. | <input type="checkbox"/> Lettering |
| Coaching | <input type="checkbox"/> Stenography and Typing |
| <input type="checkbox"/> Cost Accounting | <input type="checkbox"/> English <input type="checkbox"/> Civil Service |
| <input type="checkbox"/> Bookkeeping | <input type="checkbox"/> Railway Mail Clerk |
| <input type="checkbox"/> Secretarial Work | <input type="checkbox"/> Common School Subjects |
| <input type="checkbox"/> Spanish <input type="checkbox"/> French | <input type="checkbox"/> Illustrating <input type="checkbox"/> Cartooning |

TECHNICAL AND INDUSTRIAL COURSES

- | | |
|--|--|
| <input type="checkbox"/> Electrical Engineering | <input type="checkbox"/> Architect |
| <input type="checkbox"/> Electric Lighting | <input type="checkbox"/> Architects' Blueprints |
| <input type="checkbox"/> Mechanical Engineer | <input type="checkbox"/> Contractor and Builder |
| <input type="checkbox"/> Mechanical Draftsman | <input type="checkbox"/> Architectural Draftsman |
| <input type="checkbox"/> Machine Shop Practice | <input type="checkbox"/> Concrete Builder |
| <input type="checkbox"/> Railroad Positions | <input type="checkbox"/> Structural Engineer |
| <input type="checkbox"/> Gas Engine Operating | <input type="checkbox"/> Chemistry <input type="checkbox"/> Pharmacy |
| <input type="checkbox"/> Civil Engineer | <input type="checkbox"/> Automobile Work |
| <input type="checkbox"/> Surveying and Mapping | <input type="checkbox"/> Airplane Engines |
| <input type="checkbox"/> Plumbing and Heating | <input type="checkbox"/> Navigation |
| <input type="checkbox"/> Steam Engineering | <input type="checkbox"/> Agriculture and Poultry |
| <input type="checkbox"/> Radio <input type="checkbox"/> Mining | <input type="checkbox"/> Mathematics |

Name.....
 Street Address.....
 City..... State.....

NEW INDUSTRY NEEDS MEN

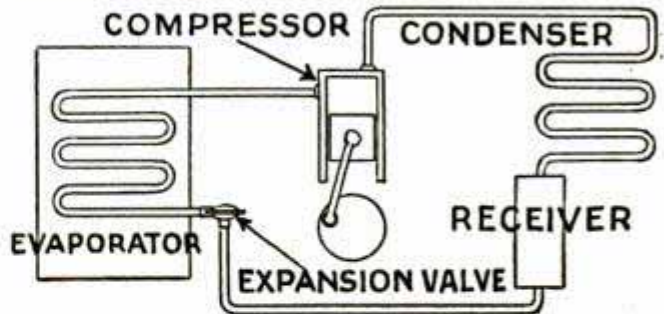

ELECTRIC REFRIGERATION

Calls You! Newest American industry needs men for \$200 to \$1,000 a month jobs in production, service, installation and sales. Fastest growing money-making field—backed by General Motors, General Electric, etc. New easy home training qualifies you for big pay job. This training is endorsed by Servel, Kelvinator and other large manufacturers. **FREE BOOK.** "Opportunities in Electric Refrigeration" reveals amazing plan to ambitious men. Sent free. No obligation. Be the first in your neighborhood to get into this new magic industry. Write today.

Utilities Engineering Institute,
 Dept. 112, 3120 N. Clark St., Chicago, Ill.



Make Much Money

Making and Selling Your Own Goods. Formulas by experts. Manufacturing Processes. Trade-Secrets. All Kinds. All Lines. Send for interesting catalog, special circulars, free.
W. THAXLY CO., Washington, D. C.



Play "JAZZ" on the Saxophone

Become a musician so quickly as to astound everyone. Learn by playing *real music*—instead of tiresome "exercises." You'll soon become the most popular person in your "set."

New Easy Method

is a revelation. Nothing else like it for thoroughness and rapidity. So simple that young and old find it easy to play with amazing skill. No "trick music"—but actual notes, learned quickly right in your own home.

LEARN TO PLAY ANY INSTRUMENT

- | | |
|---|--|
| <input type="checkbox"/> Piano | <input type="checkbox"/> Guitar |
| <input type="checkbox"/> Organ | <input type="checkbox"/> Mandolin |
| <input type="checkbox"/> Violin | <input type="checkbox"/> Drums and Traps |
| <input type="checkbox"/> Clarinet | <input type="checkbox"/> Sight Singing |
| <input type="checkbox"/> Flute | <input type="checkbox"/> Ukulele |
| <input type="checkbox"/> Harp | <input type="checkbox"/> Piccolo |
| <input type="checkbox"/> Cornet | <input type="checkbox"/> Trombone |
| <input type="checkbox"/> Cello | <input type="checkbox"/> Saxophone |
| <input type="checkbox"/> Voice and Speech Culture | <input type="checkbox"/> Automatic Finger Control |
| <input type="checkbox"/> Piano Accordion | <input type="checkbox"/> Banjo (Plectrum, 5-String or Tenor) |

FREE BOOK and Demonstration Lesson

offer this wonderful musical opportunity. Send for them today before copies are exhausted. You'll be astounded, thrilled, fascinated, at this easy, rapid way to become a veritable *master* of your favorite instrument. Instruments supplied when needed, cash or credit.

U. S. SCHOOL OF MUSIC, 712A Brunswick Bldg., New York City
 Send me your amazing free book, "Music Lessons in Your Own Home" with introduction by Dr. Frank Crane, also, **FREE DEMONSTRATION LESSON.** This does not put me under any obligation. (Please Write Plainly.)

NAME.....
 ADDRESS.....
 INSTRUMENT..... Have you this inst.?

The "MOVIE WAY" Replaces Old-Fashioned Methods

**DRAFTSMEN
PAID
\$60 to \$100 a week**

Get Into This
WORK

BIG PAY with my
amazing, new, simple
MOVIE-METHOD

At last—a quick, complete, fascinating way to learn Drafting, and learn it **right!** Experts acknowledge my new, simple, easy "Movie Method," without the use of dark rooms or projectors, to be the first new idea in teaching Drafting in 30 years. It's the most easily-grasped, sound and sensible plan ever devised for Home Study instruction—so clear, so interesting, so practical that almost before you know it, you're through—have finished—and are ready to go to work on a Big Pay Job.

Learn to Earn—\$60 to \$100 a Week

That's what the expert draftsman gets. And he's never out of work the year 'round—for he's the King-Pin of Industry—the man they've got to have. Not a wheel can turn, not a brick can be laid, not a wire can be strung, until the job has first been planned and drawn on paper by a draftsman. Why don't you get into work like that? Why don't you be a man they can't get along without—a Big Pay Man with a year 'round Big Pay Job? You can—it's easy—I'll show you how!

I'll Quickly Prepare You for Drafting

With my new copyrighted "Movie Method," I'll help you get ready for a Big Pay Draftsman's job so quickly you will be astonished. Spare time only needed. With my method—just like "slow motion movies," which are sent to you on printed pages—you see how it's done, and you do it yourself almost **automatically.** It's amazingly simple—yet so thorough and complete you learn Drafting from A to Z—learn it so you can sit in with the best of them on the Jobs that pay Big Money.

Sample Lesson FREE

Don't sign up for any Drafting Course until you've investigated my amazing new "Movie Method." Mail coupon for Big FREE Book and Sample Lesson. See my great Earn-while-Learning Plan—see the big Professional Drafting Outfit you get at no extra cost—learn about my Nation-wide Job Service—my positive Money Back Agreement. Mail coupon NOW!

MAIL COUPON FOR FREE BOOK

K. M. Boyd, Chief Drafting Engineer
L. L. COOKE SCHOOL OF DRAFTING
Dept. 19, 2132 Lawrence Ave., Chicago, Illinois.
Send me your book "Draw Big Pay in Drafting" and tell me more about your "Movie Method." This does not obligate me in any way.

Name.....
Address.....
City.....State.....



This professional outfit FREE!



ASSOCIATED WITH THE **L. L. Cooke School of Electricity** IN HELPING THE WORKING MAN EARN MORE MONEY

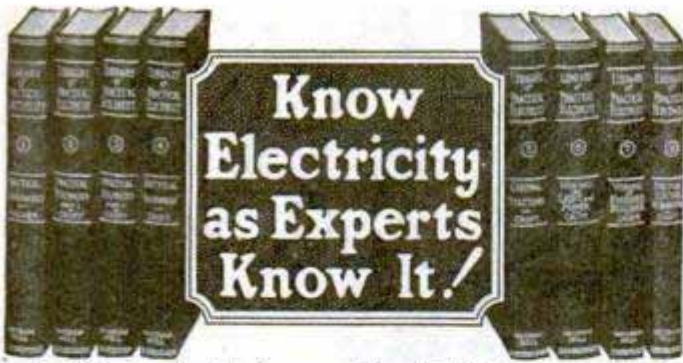

**Know
Electricity
as Experts
Know It!**

THIS is the electrical age, with unlimited opportunities for the man who has educated himself in the finer points of electrical practice.

Fit yourself for a big-pay job by knowing electrical practice complete, including inside and outside work, central stations, and the whole subject. With the aid of the Croft books you can know electricity as experts know it and put yourself in line for an expert's pay.

The Croft Library of Practical Electricity

A reference library and self-training course in eight volumes. 3000 pages—2100 illustrations

In these volumes Croft teaches you electrical practice complete. He takes you in quick, easy steps from the simplest principles to the complete and economical operation of a great central station. He tells you all that he has learned in twenty years of shirt-sleeve practice. With these books at his elbow a man can learn as much about electricity in six months—good practical "bread and butter" stuff—as he would ordinarily learn in a lifetime of practice.



Flexible binding for easy handling

**59,000
Croft
Sets
NOW
IN USE**

The Standard in Practical Electrical Training

The Croft Library is a complete electrical educator. It is founded on practice—on work as it is actually done. It is jammed from cover to cover with the kind of hard-headed facts you want. Written so that the beginner can easily understand it, yet so sound, so thorough, that it is the daily guide of 59,000 highly paid electrical workers and engineers.

Croft tells you the things you need to know about motors, generators, armatures, commutators, transformers, circuits, switchboards, distribution systems—electrical machinery of every type—wiring for light and power—wiring of finished buildings—underwriters and municipal requirements—illumination in its every phase—the latest and most improved methods of lighting—lamps and lighting effects, etc.—how to do a complete job, from estimating it, to completion.

NO MONEY DOWN SMALL MONTHLY PAYMENTS

Fill in and mail the coupon attached and we will send you the entire set of eight volumes for ten days' Free Examination. We take all the risk—pay all charges. You assume no obligation—you pay nothing unless you decide to keep the books. Then \$1.50 in ten days and the balance at the rate of \$2.00 a month. Send the coupon NOW and see the books for yourself.

**10 Days
FREE
TRIAL
Just Mail
The
Coupon!**

FREE EXAMINATION COUPON

McGraw-Hill Book Co., Inc., 370 Seventh Ave., New York

Send me for 10 days' free examination the Croft Library of Practical Electricity. If satisfactory I will send you \$1.50 in 10 days and \$2.00 monthly until the special price of \$19.50 is paid. If not wanted, I will return the books at your expense. (To insure prompt shipment write plainly and fill in all lines.)

Name.....

Address.....

City and State.....

Position.....

Company..... P. M. 12-28



**Happy Because They
Make \$60 a Day**

**With This Newly Invented
Suction Ash Receiver and
Cigarette Holder
For Autos, Homes and Offices**



Slicks any place by its suction grip

Yes, you can make \$60 00 a day. My men are making that much and more right now with the handiest specialty created in recent years—Patented MASTER SUCTION GRIP ASH RECEIVER—sticks to any surface by a suction grip. Ideal for auto, home and office as Cigarette Holder or Ash Tray. Made of beautiful Bakelite in six distinctive colors. CAN BE MONOGRAMMED WITH OWNER'S INITIALS. You don't miss one sale in a hundred. Retails for only 50c and YOU MAKE UP TO 200% PROFIT.

SELL TO DEALERS OR CONSUMERS

Our five Amazing Fast Selling Plans show you how to get orders by mail—how to place Master Automatic Salesmen on store counters and make \$60 00 a day—how to put others to work for you and secure volume business.

SEND FOR SAMPLE OR A DOZEN

Send 50c (Stamps if you like)—or better still,

start right off making \$60.00 a day—send \$3.00 for a sample dozen, in display box. Use it to take orders from dealers or sell direct to consumers and pocket \$3.00 profit in half an hour, receive by return mail beautiful Master Ash Receiver—together with five successful sales plans, showing many ways of making big money with this whirlwind seller. Order today!

GORDON MFG. CO., Dept. NM-9 110 E. 23rd St., New York, N.Y.

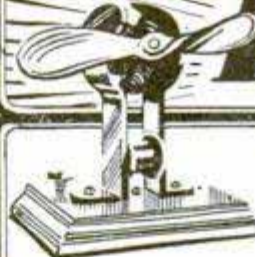

A wonderful, powerful electric motor equipped with driving pulley, and two-blade fan, mounted on polished wooden base, binding posts, control switch. Runs mechanical toys beautifully. A little gem, you may have it free.

The Open Road for Boys Magazine has 50 pages a month crammed with thrilling fiction and articles. It is the hit of the year. Regular subscription price \$1.00 a year. We will send you 12 issues—a year's subscription—and this great electric motor all for \$1. Order now.

**A Whole
Year of
Breathless
Reading**



**Both for
\$1 for**

Open Road for Boys Magazine, Dept. 530
130 Newbury Street,
Boston, Mass.

Friends:
Here's my \$1. Rush me the electric motor and put me down for one year for The Open Road for Boys Magazine.

Name.....

Street.....

Town or City.....

State.....

It's only a matter of *hours* now before you can get started in -- **AVIATION**



Hundreds of Men are Proving it ~ *this Tested way*

THERE'S a Job and Future for YOU in Aviation! A better job than you could ever hope to have in any older industry. And a bigger future—packed with opportunity, rich with real rewards. What's more, it doesn't call for "pull" or for a big outlay of cash to get started in Aviation NOW. Lieut. Walter Hinton—one of America's outstanding Aviators; one of Aviation's outstanding Instructors—is training men *at home* to share in the growth and the profits of the Industry. Already hundreds of level-headed men have taken his training, gotten the *knowledge* that employers are eager to

Walter Hinton

pay for, and today they are right in the thick of all that Aviation is doing, all that it means!

Hinton's Background Helps Clinch YOUR FUTURE

Hinton has done some of the most amazing things that Aviation has ever seen. He piloted the first plane across the Atlantic—the NC-4. His plane was the original trail-blazer from North to South America. Until he soared over 12,000 square miles of Brazil jungle, no white man had ever seen the Upper Amazon River. Then during the War he instructed flying recruits for the Navy—skilled "warbirds" who quickly proved the worth of Hinton Training.

And NOW—to cap the climax—Hinton Training is available to *every* man who has vision enough to ACT FAST! Furthermore, this tested training dovetails with your spare-time. You can keep your present job, stay at home, and *prepare yourself* for a real place and a real future in Aviation.

Get Hinton's FREE Book

This book tells exactly how Hinton trains you in every branch of the Industry. How it's only a matter of *hours* before you can be *ready* for Aviation! For every spare-time hour of study that you give his clear, easy Course, he'll repay you many fold with a complete, comprehensive knowledge of plane design and construction, motors, ignition, theory of flight, principles of navigation, instruments, commercial management—every last fact you need to really make something of the Aviation opportunity that's ready for you as soon as you are ready for it!

Men with only a little time to spare—men with no more than a grade school education—men are whipping themselves into *money-making* shape QUICKLY, accurately, reliably with this proved method. Then our Employment Dept. is helping place them in the real jobs. And for those who want to learn Flying, we get reduced rates at their nearest fields.



Hinton and companion repairing plane on upper Amazon, surrounded by friendly natives.



There's a Job Here for YOU

Here's YOUR quick, proved way to *learn* Aviation, *know* Aviation and SUCCEED IN AVIATION. If you've had experience in any other industrial or commercial work, Aviation needs you and Hinton's Course teaches you how to apply yourself. Wood workers, metal workers, plane and motor mechanics, craftsmen of every kind, airport and factory and office managers—the list goes on and on; men in *more than 50* trades, once they have this specialized training, are finding higher pay and bigger opportunities in the Air and on the Ground in this fastest-growing Industry of all. Now it's *your* turn to CASH-IN. Your first step is the coupon below. Clip it—sign it—SEND IT TODAY!

AVIATION INSTITUTE OF U. S. A.
Walter Hinton, President
1115 Connecticut Ave. Washington, D. C.

Rush to Washington

WALTER HINTON, Pres. I-M
AVIATION INSTITUTE OF U. S. A.
1115 Connecticut Avenue,
Washington, D. C.

All right!—send me that FREE Book showing how you'll turn my spare hours into money-making Aviation Training.

Name.....
Street..... Age.....
City..... State.....

Thanks Hinton for Best Job He Ever Had

"At present I am employed with one of the largest builders of Aircraft on Long Island, and I can truthfully say that it was from knowledge I received through Walter Hinton's Complete Course of Aviation that I secured this position, which I consider the best I have ever held."
—Carl Schneider,
4215 Graham Ave., Astoria,
Long Island, N.Y.

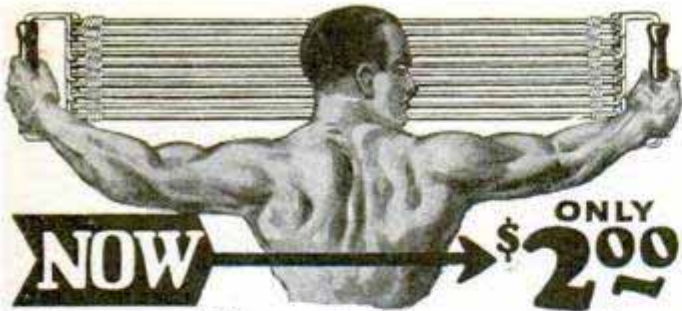

NOW → ONLY \$2.00

Giant Chest Expander

and

Progressive Exerciser

Be a muscular marvel. Have the muscles of a superman. Become strong for your health's sake or to astound your friends with extraordinary feats which only men of giant strength can do. In a few short weeks you will easily do stunts which now seem difficult—then real muscles and strength will be yours—and yours to keep. If you want exercise to just keep in good shape you can reduce the strength of the Progressive Exerciser by eliminating as many cables as you wish. If you want great resistance so as to build up big solid muscles then use the full strength.

Send No Money Use This Money Saving Coupon

How the Giant Chest Expander and Progressive Exerciser Is Made

The Giant Chest Expander and Progressive Exerciser is made with new live, springy rubber so as to give it long wearing and great resisting qualities. Do not pay more for an exerciser that has forty or less, rubber strands to each cable. Get the best and most durable. The Giant Progressive Exerciser has 50 strands of the finest rubber procurable to each cable.

Free Instructions

We do not think it enough to send you an exerciser worth double what we ask, so for a limited time, we will also include instructions absolutely free. These instructions are interesting and simple to follow—they show you the short cut to health and strength. Order today before this wonderful offer is withdrawn.

Your Guarantee

The Giant Chest Expander is sold with a guarantee that you will say it is the finest you ever saw or your money back.

5 Cables or double 10 Cables for strength for

\$2 The double strength exerciser has resistance of over 200 lbs. \$4

How to Order—Send No Money

Sign your name and address to coupon below and get your Giant Exerciser at the present low introductory price by return mail. The price is made low because we want everyone to enjoy muscles and strength at the lowest possible cost. Don't pay more—order from us—get the most for your money. Use coupon now.

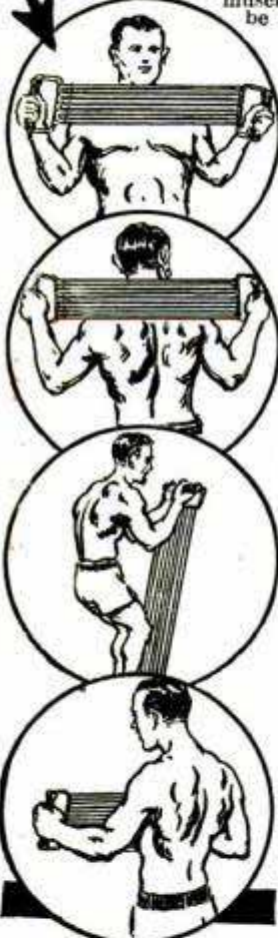

PROGRESSIVE EXERCISER CO.,
4012 Langdon Bldg.,
Broadway and Duane Street, New York

Please send Your 10 cable Progressive.
 Your 5 cable Exerciser.

Check the Exerciser you want, and it will be sent you by return mail. Pay postman introductory price, plus few cents postage on arrival. It is understood that if you are not entirely satisfied with your exerciser you may return it within 5 days and get your money back.

Name.....

Street.....

City..... State.....

If you live outside the United States, send cash with order.

New Book on Voice

Sent FREE—No Obligation to Buy!
NO MONEY DOWN

If you act quick!—we will send you, post-paid—for 30 days free reading—new Voice Book disclosing startling FACTS that may save hundreds of dollars to every man or woman seeking a strong, rich voice for either singing or speaking. A REVELATION! Remember—sent for 30 days FREE reading. Then, if you keep it, send only \$1.00. Otherwise, just return it—that's all!

PROF. E. FEUCHTINGER Dept. 13-59
Suite 29, 1810 Wilson Ave., Chicago, Ill.



Play Piano BY EAR

—IN 90 DAYS!



Play anything—jazz to classical! Even if you know nothing about piano music—I'll have your fingers dancing over the keyboard with confidence in 90 days. If you can hum or whistle a tune you can play it! My students are broadcasting—making money. MAKE ME PROVE IT! Without puzzling notes! Without practicing tedious scales! I've found the way to bring out your musical instinct. New and original system does away with years of work. YOU WANT THE PROOF? I'll send it. Write me now.

D. M. SUTTLE, Director
ILLINOIS SCHOOL OF MUSIC
1801 Byron, Dept. 715, Chicago, Ill.

Send NOW for PROOF!

Learn to PAINT SIGNS and SHOW CARDS

We quickly teach you by mail, or at school, in spare time. Enormous demand. Big future. Interesting work. Oldest, foremost school. **EARN \$50 TO \$200 WEEKLY** John Vassos, N. Y., gets \$25 for single show card. Crawford, B. C., says: "Earned \$200 while taking course." Send today for free information samples and guarantee.

DETROIT SCHOOL OF LETTERING
154 Stinson Ave. Est. 1899 Detroit, Mich.



ILLINOIS COLLEGE of PHOTOGRAPHY

Prepares you in from 6 to 8 months to earn \$200 to \$500 a month as a photographer or photo-engraver. Thorough practical training. Expenses low. Constant demand for our graduates. 35th year. Enroll immediately. Free catalog. **Box 4128, Effingham, Illinois.**

10c NEW SCIENTIFIC WONDER

3 for 25c **"X-RAY" CURIO**

SILVER ONLY **BOYS** You apparently see thru Clothes, Wood, Stone, any object. See Phones in Flesh. FREE—PKG. RADIO BIG FUN PICTURE FILMS. Takes pictures without camera. "You'll like 'em." 1 pkg. with each 25c order.

MARVEL MFG. CO. Dept. 31 NEW HAVEN, CONN.



ZIP-ZIP SHOOTER

THOUSANDS of boys are made happy with this wonderful Zip-Zip shooter, something every boy wants and never gets tired of. Zip-Zip shooter is scientifically and practically

made; if you like hunting and outdoor sports, get a Zip-Zip shooter with plenty of pep and force. If your dealer happens not to have them, order from us. Zip-Zip shooter 35c or three for \$1.00; send stamps, coin or money order.



AUTOMATIC RUBBER CO., Dept. B. B., COLUMBIA, S. C.

I'll Pay Your Railroad Fare to Chicago Without Extra Cost

UP TO \$15,000 a year for GREER GRADUATES

ELECTRICITY, AUTOS, AVIATION now pay hundreds of trained men up to \$200 A WEEK. Here are THE 3 WORLD'S GREATEST BUSINESSES. BILLIONS—not millions, but BILLIONS of dollars are spent in them every year. CHOOSE ONE OF THESE THREE, HERE and NOW.

GREER trained men are NEEDED. I HAVE MADE hundreds of \$10,000 A YEAR MEN. 90,000 in the last 26 years have come to GREER. THOUSANDS MORE in the future will likely come here. BE ONE OF THEM. Send coupon to me for openings.

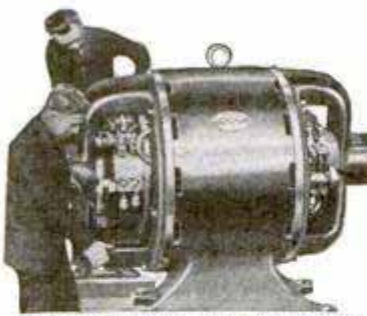

Rotary Converter, used by students for testing.

Amazing Opportunities for you in one of World's 3 Biggest Businesses

MEN WANTED

I will help you get a position while learning, also after graduation. Never before such unusual opportunities. GET MY FREE BOOK NOW. LEARN ABOUT THE BIG PAY. ELECTRICITY, AUTOS, AVIATION lead WORLD'S BUSINESS. That's why GREER Colleges selected these fields and ONLY THESE.



Learn to Boss the Job

ELECTRICITY AVIATION AUTOS

Learn in Only 3 Months in GREAT GREER SHOPS ON LARGE LIVE EQUIPMENT

Mine is NOT A CORRESPONDENCE COURSE. You can start any day or any evening. It is PRACTICAL, EASY, QUICK, FASCINATING training. You learn on Great, running, live Equipment in tremendous GREER SHOPS. AUTO Business is BIGGEST BUSINESS in the world. ELECTRICITY is FASTEST GROWING, and yet in its Infancy. AVIATION, most fascinating, alluring business today, is already a Billion Dollar Industry.

Choose one of these 3 wonderful professions today. Trained men are needed by scores, for positions up to \$200 a week and up. Find out now, about my great Shops training.

full of HARD THEORY—NO HEADACHES in GREER PRACTICAL SHOPS TRAINING. You learn to DO BY DOING. You learn to Fly by Flying.

You Get Real Help to BIG JOBS!

TWELVE PEOPLE are in my Big EMPLOYMENT DEPARTMENT getting jobs for Greer men. You get their help AS OFTEN AS YOU NEED IT, both BEFORE and AFTER Graduation.

Get My FREE BOOK NOW

Don't let money hold you back. Get my Free Book. Find out NOW, how I PAY YOUR FARE HERE, let YOU ATTEND EITHER DAYS or EVENINGS and help you find DAY or EVENING WORK to PAY YOUR EXPENSES while learning. Then when ready we help you find the real BIG PAY JOB. LEARN how I get you ready so Employers WANT YOU, and GLADLY pay you what you are worth.

Quickest, Easiest of Ways to Become Expert

I'LL PAY YOUR FARE HERE FREE of extra cost, then help you to a JOB WHILE LEARNING. Then I not only FIT YOU to get BIG PAY JOB, but I'll help YOU HOLD IT. Young and Old, Educated and Uneducated, Inexperienced and Experienced have found GREER SHOPS training EASY, FASCINATING and VALUABLE. Coupon below brings details.

Not Correspondence Course

Here at GREER SHOPS you learn on BIG, ACTUAL FULL SIZE Machinery, like you will work on out on the Big Pay Job. You get close personal supervision. NO Guess work—NO books

Erwin Greer



GREER COLLEGE

Electricity—Autos—Aviation
Dept. 901
2024 So. Wabash Ave.
CHICAGO, ILL.



90,000 Students
26 Years Tremendous Success

Above is the important history of GREER COLLEGE. Note the steady 26-years growth, thru genuine SERVICE, from the tiny Shops on the left to the tremendous Building on the right, filled with GREAT TRAINING Equipment. These

moves to always greater quarters mean GROWTH—PROGRESS and SERVICE. What is it you like—ELECTRICITY—AUTOS—or fascinating AVIATION? GREER will train you in EITHER, as YOU SHOULD BE TRAINED.

Get My Big Offer Now!

Would an offer of \$100 a week be OPPORTUNITY or DISAPPOINTMENT for you? If you could HOLD THE JOB it would truly be OPPORTUNITY. If you can't hold the \$100 a week job, PREPARE. Be ready. Don't invite disappointment. Learn about GREER SHOPS. Right now if you act quick, I can make you a most unusual short time offer. Clip coupon NOW and find out. Address me personally

ERWIN GREER, President

SCISSORS FOR FREE BOOK

ERWIN GREER, President
Dept. 901
2024 So. Wabash Avenue,
Chicago, Illinois
Send Free Book indicated below and details of Special offer, without obligation to me.
 Autos Electricity Aviation

Name.....

Address.....

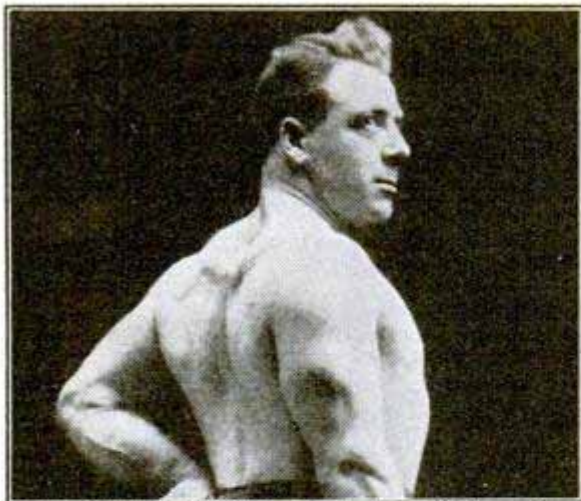

GEORGE F. JOWETT, *Champion of Champions*

"I will give you muscles like mine"

I WILL make you a TWO-FISTED FIGHTING MAN with nerves of steel and muscles like iron. I will send the good red blood coursing through your veins like the onrush of electricity. In 90 days I will build you a new body that every man will envy and make you feel like a lion, ready to tackle anything.

I Was Once a Weakling

I built my own body and I can build yours. My methods are endorsed by HERMAN GORNER, the strongest man in the world; ARTHUR DANDURAND, the Canadian Sandow; HENRY STEINBORN; JIM LONDOS, the Greek god; and ARTHUR GAY, winner of the first prize in America's Most Perfect Man Contest.

My lessons are physiologically and scientifically correct. They build without strain. They build from the inside out. They put new life and vitality into your internal organs as well as in your biceps. You'll be strong, but you won't be muscle bound—as pliant as a whip and as strong as a steel trap.

Pair of Dumbbells Free

To every person who takes my course I will give a pair of the patented Jowett Progressive Disk Dumbbells. They cannot be equaled for workmanship and muscle building. Here's another point—my course is laid out personally for each pupil. Every week you receive a new set of exercises in order of progression. You get Twelve Courses covering the Twelve Principles of Life and on conclusion of your course receive an emblem as a graduate of the Jowett Institute of Physical Culture. I guarantee to build you over in 90 days or return every penny you have paid me. My easy payment plan provides a way for every person to be a Jowett Pupil.

Get My Big Free Book

All I ask is this: Send for my big free book, "The Thrill of Being Strong." You'll get a real kick out of it because of the photographs and because it shows how easily you, too, can have nerves of steel and muscles of iron. If you would like to lay your case before me in a personal letter, I will give you a personal reply without cost. Let me show you how you can become as well built and as strong as America's greatest.

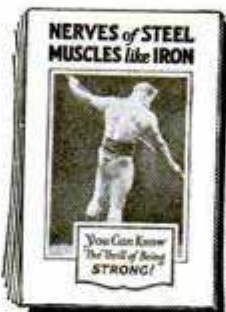

JOWETT INSTITUTE OF PHYSICAL CULTURE

Dept. 4-M
422 Poplar Street, Scranton, Pa.

Dear Mr. Jowett:

Without cost or obligation, please send me a copy of your illustrated booklet, "The Thrill of Being Strong."

Name.....

Address.....

BE A RAILWAY TRAFFIC INSPECTOR

PAYS UP TO \$250

per month

SALARY

plus expenses

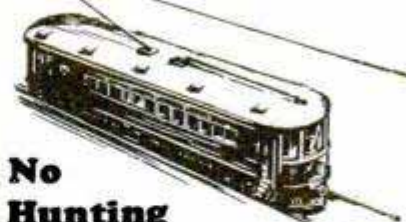

No Hunting for a Position after

Completing your Training



Read what R. H. Kruger says: "Having completed your course in Traffic Inspection, I find that it is very interest-

ing work; also it is one of the most interesting studies of today. The work is very fascinating, and I would be glad to advise anyone wishing to take up this course, as it is sure wonderful work, with a splendid future."

If you are a normal man over 19— You can earn as high as \$250 per month salary with expenses paid, in the fascinating, uncrowded profession of Railway Traffic Inspection. You'll be out in the open, away from dingy shop or monotonous desk, meeting new people, seeing new places. You'll be practically your own boss—dressed in good clothes—reporting only to high railway officials. Promotions are rapid—your future is as big as you care to make it.

We'll train you for Traffic Inspection and upon completion assist you to a position at a definite salary, or refund your tuition.

There's no gamble—no hard selling—no hunting for a job. Traffic Inspectors start after completion of 3 months' spare time home study, at \$120 or more per month salary. During the last nine years, we have placed hundreds of men in this profitable profession. Don't chase a rainbow—learn a profession that will pay you a salary, as soon as you start, and will quickly increase to \$185 to \$250 a month.

SEND FOR FREE BOOKLET

Send for our booklet "A Profession of Protection" now! Read our employment agreement which shows how we are able to assist our graduates to salaried positions.

Standard Business Training Institute, Div. 2, Buffalo, N. Y.



There's Quicker, Bigger MONEY for YOU—in POULTRY

No Matter Where You Live—You Can Make \$1000 to \$5000 a Year—EXTRA!



A Big money-making opportunity is waiting for YOU right NOW—in your own back yard! Thousands of my students are cashing in BIG, the way you can—in part or full time. Start with a small flock—small investment, and make a good profit. Eggs and poultry meat are in big demand at high prices. I'll PROVE that I can put YOU among the big money-makers QUICK!

Spare Time or Full Time You Can Cash-in BIG

No matter where you live—city, town or country—or what you do now, my proved methods will assure your success right from the start. I give you all the "secrets"—all the "short cuts." You'll be your own boss and I'll show you how to make from \$1000 to \$5000 a year—and UP!—and how to make your tiny investment multiply itself automatically. What I've done for thousands of others—I can do for you.

FREE Book Shows Way to Success and BIG Profits

Mail coupon below TODAY—for my BIG NEW FREE Book, "How to Raise Poultry for Profit." My forty years of experience are yours. The Poultry Industry needs YOU. You need my book. Get it—and get in line for the BIG Money that's waiting for you in POULTRY.

Mail NOW for FREE Book

National Poultry Institute, Dept. 411-D,
Washington, D. C., Att'n: Harry M. Lamon, Pres.

Dear Mr. Lamon: Send me your FREE Book, "How to Raise Poultry for Profit." I want to know more about my opportunity to make \$1000 to \$5000 a year, spare or full time.

Name.....

Address.....

FREE



This Genuine
Draftsman's
Pocket
Rule



Copy me
and get
Ivoryine Rule
Free.—Jack

Get this
Rule for
copying
this Jack

Can you copy it? Try it. How you copy it may give me some idea of what kind of a draftsman you would be. If you are 16 years old or older and will mail me your sketch at once. I will send you free, and prepaid, a draftsman's Pocket rule just like the one shown here.

This will go to you entirely with my compliments. I will send you also my Pay-Raising Plan and Successful Draftsmanship. Don't wait. Copy sketch now, mail to me.

Draftsmen Needed in all These Industries—Get A Job In

<p>Auto Work The automobile industry is one of the greatest in America. Thousands of draftsmen are needed. I'll train you for the work.</p>	<p>Electricity Electricity is the coming motive force of the world. Draftsmen are needed in every department of this fascinating work. I'll train you at home. Get a job here.</p>	<p>Aviation Aviation is just in its infancy. It is bound to expand to enormous proportions. Draftsmen are essential to it. I'll train you quick at home for drafting position.</p>	<p>Motor Bus Work Motor bus building and motor bus transportation have become leading world industries. Hundreds of draftsmen engaged in this work. I'll show you the way.</p>	<p>Building Work There will always be building. No structure can be erected without plans drawn by draftsmen. I'll make you an architectural draftsman.</p>
--	---	---	---	--

FREE—My Pay-Raising Plan

Write to me. I will send you this new book. Not a catalog. My Pay Raising Plan and Money Making Advice. I can prove that John Savadge, trained by me, makes \$300 a month. Earl J. Dupree, trained by me, refused \$600 a month because he makes more in his own business. A. H. Bernier, trained by me earns \$7000 to \$9000 a year. Arthur Dewalt, trained by me, makes more than \$400 a month. D. C. Stroop, trained

by me, makes \$475 a month. L. V. Broughten, trained by me, makes \$300 a month... I can give you many more names of Dobe trained draftsmen who are making big salaries. They wrote to me just as I am asking you to write. They asked for my Free Book. They saw that opportunities in all the great industries were tremendous for draftsmen. Through drafting you can get into almost any industry you want.



These Money-Making Tools Furnished by Me!

You GET THESE FINE QUALITY, GENUINE, IMPORTED DRAFTSMAN'S TOOLS, just as soon as you become student. No finer tools can be made for practical drafting work.

I Train You at Home, New, Quick, Sure Way

My practical working method makes every step in learning drafting, as clear as a moving picture. That's why I train you so fast to be a draftsman.



You get these tools as my student



"If You Earn Less Than \$70 a Week, Write Me Today I Will Train You At Home"
Engineer Dobe

Write before you put this Magazine Down. Let me send you my books "Successful Draftsmanship" and "My Pay Raising Plan". Remember Draftsmen are needed everywhere. That's the kind of profession to get into. Get started now. Get into a better position, paying a good straight salary the year around. Mail this coupon.

Engineer Dobe 1951 Lawrence Avenue Div. 13-59 Chicago, Ill.

Age or Lack of Education No Drawback

You do not need previous experience. You do not need to be a high school graduate. My practical, home study course gives you just the kind of training you need to become successful. Your spare time is all that is necessary.

Earn While You Learn

You can start earning extra money a few weeks after beginning my training. I give you special work and tell you how to make money.

Employment Service

After training you I help you to get a job without charging you a cent for this service. Employers of draftsmen come to me for men because they know men I train make good.

Money Back If Not Satisfied

What could be fairer than that? I don't ask you to take any chance. I train you under a positive Money Back Agreement. If my training does not satisfy you get every penny back.

Mail Sketch—Get Free Rule

ENGINEER DOBE

1951 Lawrence Ave., Div. 13-59 Chicago

Here's the sketch. Send me free rule; also send me free of all cost books "Successful Draftsmanship" and my "Pay-Raising Plan"—how to earn money while learning and proof of big money paying positions.

Name Age.....

Address.....

Post Office..... State.....

Learn Electricity IN LOS ANGELES

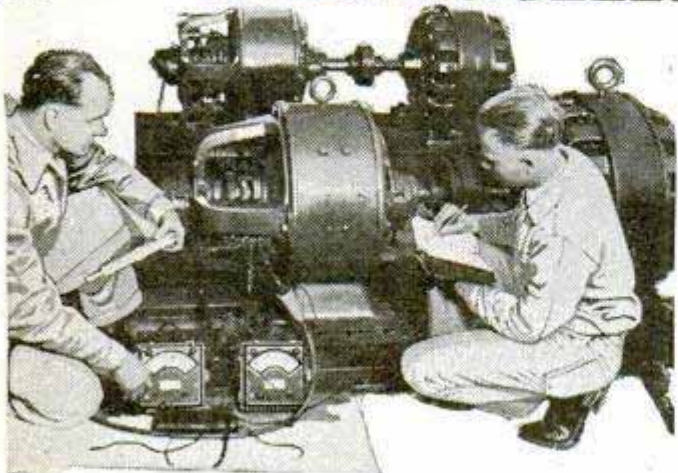

FREE Employment Service!

There are more calls for "National-Trained-Electrical-Men" than we can supply. Jobs are open now paying \$50 and up a week—but you must first get the right training. Get it at National—a world-famous institution with a quarter century record of success in training big pay men.

All These Advantages:

1. Unlimited Training Until Competent.
2. Free Employment and Welfare Service.
3. Million Dollar Training Shops.
4. Personal, Individual Training Guaranteed.
5. You actually perform work that employers pay big money for.
6. Official Diploma and certified record of work performed.
7. Unexcelled training; 32 instructors.

FREE!

Read how National insures your success. Send for this free Electrical catalog—illustrated by actual photos of students training under instructors on a half million dollars' worth of new electrical equipment. Mail coupon now.

Electricity— YOUR Opportunity!

This Big, Free Book Shows You How to Quickly Make BIG PAY

Address: _____
City: _____



National Electrical School

Dept. 525, 4006 Figueroa St.,
Los Angeles, California.

Send me your big free illustrated catalog of Electrical Opportunities.

Name.....

Address.....

Age..... City..... State.....

The MOCAR

Model Airplanes

that
FLY!

AN
IDEAL
GIFT

Set No. 1
Only \$1.50

Complete

All
Aluminum
Construction

BOYS—at last, here is a genuine aluminum model airplane that really flies. And at a small price.

The "Mocar" monoplane—Set No. 1—is a copy of the famous Spirit of St. Louis. Wing spread 18 inches, fuselage 12 inches, powerful motor, ball bearing propeller, rubber tired disc wheels. Weight complete only about 2½ oz. This is a practical, simple, real model plane that gives you a whole lot of fun for the moderate cost. The all metal construction makes a sturdy plane that will stand a lot of abuse. The outfit is mounted on cardboard with all parts plainly marked and full instruction for assembly. Pliers only tool necessary. Complete with rivets, bolts, nuts, wheels, wing and fuselage covering material, only \$1.50 post paid (3 for \$4.00).

Great fun, learn how to make and fly airplanes. Order now. Jobbers, dealers and schools write for discounts.

THE
MOUNT
CARMEL
MFG.CO.

Dept. M

Mount
Carmel,
Conn.



"BECOME A LIGHTNING TRICK CARTOONIST"

Send \$1.00 for Laugh Producing Program of 23 Trick Drawings with Instruction catalog of Chalk Talk Supplies Free. BALDA ART SERVICE, Dept. 1, Oshkosh, Wis.

BE A JAZZ MUSIC MASTER

Play Piano By Ear

Play popular song hits perfectly. Hum the tune, play it by ear. No teacher—self-instruction. No tedious ding-dong daily practice—just 20 brief, entertaining lessons, easily mastered.

At Home in Your Spare Time

Send for FREE BOOK. Learn many styles of bass and syncopation—trick endings. If 10c (coin or stamps) is enclosed, you also receive wonderful booklet "How to Entertain at Parties"—and many new tricks, stunts, etc.

Niagara School of Music
Dept. 300, Niagara Falls, N. Y.

Send for this Free Book



BIG NOVELTY BARGAIN! 10c

Throw Your VOICE

Into a trunk, under the bed or anywhere. Lots of Fun fooling the Teacher, Policeman or Friends. Barrels of Fun.

THE VENTRILO—

a little instrument, fits in the mouth out of sight, used with above for Bird Calls, etc. Sent with full instructions; anyone can use it. NEVER FAILS.

Also 32 PAGE BOOK ON VENTRILOQUISM. Formula for Secret V Writing, 12 Money Making Secrets and the marvelous

NOVELTY X-RAY WONDER

With it you can apparently see the bones in your fingers, lead in pencil, etc.; lots of fun with this outfit. Also 10 Big Magic Tricks Free with every order. All the above Novelties by prepaid mail for 10c



Ventrilo Company, Dept. 609, Norwalk, Conn.
LARGEST and OLDEST Mail Order House in Connecticut



I Will Train You at Home to Fill a Big-Pay Radio Job

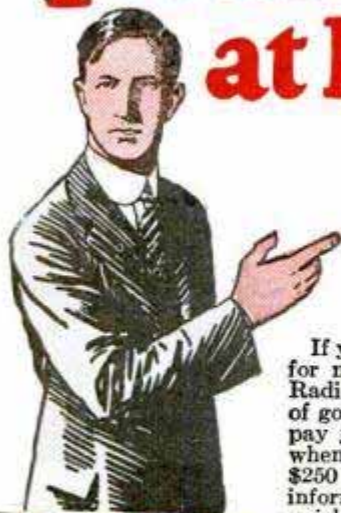

**Here's the
PROOF**



**\$375 One
Month in
Spare Time**

"Recently I made \$375 in one month in my spare time installing, servicing, selling, Radio Sets."

Earle Cummings,
18 Webster St.,
Haverhill, Mass.



\$450 a Month

"I work in what I believe to be the largest and best equipped Radio shop in the Southwest and also operate KGFI. I am averaging \$450 a month."

Frank M. Jones,
922GuadalupeSt.,
San Angelo, Tex.

If you are earning a penny less than \$50 a week, send for my book of information on the opportunities in Radio. It's FREE. Clip the coupon NOW. A flood of gold is pouring into Radio creating hundreds of big pay jobs. Why go along at \$25, \$30 or \$45 a week when the good jobs in Radio pay \$50, \$75 and up to \$250 a week? "Rich Rewards in Radio" gives full information on these big jobs and explains how you can quickly learn Radio through my easy, practical home-study training.

**Salaries of \$50 to \$250 a Week
Not Unusual**

The amazing growth of Radio has astounded the world. In a few short years three hundred thousand jobs have been created. And the biggest growth is still to come. That's why salaries of \$50 to \$250 a week are not unusual. Radio simply hasn't got nearly the number of thoroughly trained men it needs.

**You Can Learn Quickly and Easily
in Spare Time**

Hundreds of N. R. I. trained men are today making big money—holding down big jobs—in the Radio field. You, too, should get into Radio. You can stay home, hold your job, and learn in your spare time. Lack of high school education or Radio experience are no drawbacks.

**Many Earn \$15, \$20, \$30 Weekly
On the Side While Learning**

I teach you to begin making money shortly after you enroll. My new practical method makes this possible. I give you SIX BIG OUTFITS of Radio parts and teach you to build practically every type of receiving set known. M. E. Sullivan, 412-73rd St., Brooklyn, N. Y., writes, "I made \$720 while studying." G. W. Page, 1807-21st Ave., S., Nashville, Tenn., "I picked up \$935 in my spare time while studying."

Your Money Back If Not Satisfied

My course fits you for all lines—manufacturing, selling, servicing sets, in business for yourself, operating on board ship or in a broadcasting station—and many others. I back up my training with a signed agreement to refund every penny of your money if, after completion you are not satisfied with the lessons and instructions I give you.

Act NOW—64-Page Book is FREE

Send for this big book of Radio information. It has put hundreds of fellows on the road to bigger pay and success. Get it. See what Radio offers you, and how my Employment Department helps you get into Radio after you graduate. Clip or tear out the coupon and mail it RIGHT NOW.

J. E. SMITH, President, Dept. 44H
National Radio Institute
Washington, D. C.

**RADIO
NEEDS
TRAINED
MEN!**

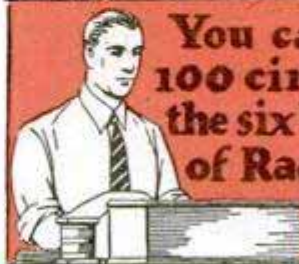

**You can build
100 circuits with
the six big outfits
of Radio parts
I give you**

**3 of the 100 you
can build**

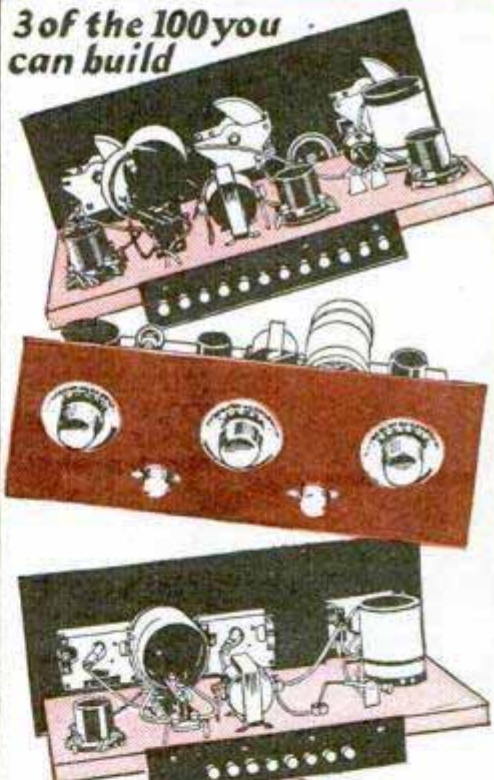

**Find out quick
about this
practical way
to big pay**



Mail This FREE COUPON Today

J. E. Smith, President,
Dept. 44H, National Radio Institute,
Washington, D. C.

Dear Mr. Smith: Send me your Free book "Rich Rewards in Radio" giving information on the big-money opportunities in Radio and your practical method of teaching with six Radio Outfits. I understand this places me under no obligation.

Name.....Age.....
Address.....
City.....State.....
Occupation.....

Employment Service to all Graduates

Originators of Radio Home Study Training

Electrical Experts are in Big Demand!
—L.L. Cooke!

I Will Train You at Home to fill a Big-Pay Job!



L. L. COOKE
Chief Engineer

It's a shame for you to earn \$15 or \$20 or \$30 a week, when in the same six days as an Electrical Expert you could make \$70 to \$200—and do it easier—not work half so hard. Why then remain in the small-pay game, in a line of work that offers no chance, no big promotion, no big income? Fit yourself for a real job in the great electrical industry. I'll show you how.

Be an Electrical Expert Earn \$3,500 to \$10,000 a Year

Your Satisfaction Guaranteed
So sure am I that you can learn Electricity—so sure am I that after studying with me, you, too, can get into the "big money" class in Electrical work, that I will guarantee under bond to return every single penny paid me in tuition, if, when you have finished my Course, you are not satisfied it was the best investment you ever made. And back of me in my guarantee, stands the Chicago Engineering Works, Inc., a two million dollar institution, thus assuring to every student enrolled, not only a wonderful training in Electricity, but an unsurpassed Student Service as well.

Get Started Now — Mail Coupon
I want to send you my Electrical Book and Proof Lessons, both Free. These cost you nothing and you'll enjoy them. Make the start today for a bright future in Electricity. Send in Coupon—NOW.

L. L. COOKE, Chief Instruction Engineer
L. L. COOKE SCHOOL OF ELECTRICITY
Dept. 19 2150 Lawrence Av. Chicago

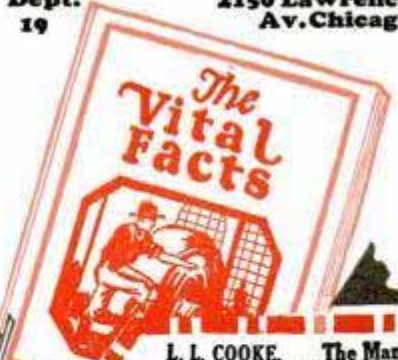

L. L. COOKE, The Man Who Makes "Big-Pay" Men
Dept. 19
2150 Lawrence Ave., Chicago

Send me at once without obligation your big illustrated book and complete details of your Home Study Course in Electricity, including your outfit and employment service offers.

Look What These Cooke Trained Men are Earning



Makes \$700 in 24 Days in Radio
"Thanks to your interesting Course I made over \$700 in 24 days in Radio. Of course, this is a little above the average but I run from \$10 to \$40 clear profit every day; you can see what your training has done for me."
FRED G. McNABB,
848 Spring St., Atlanta, Ga.



\$70 to \$80 a Week for Jacquot
"Now I am specializing in autoelectricity and battery work and make from \$70 to \$80 a week and am just getting started. I don't believe there is another school in the world like yours. Your lessons are a real joy to study."
ROBERT JACQUOT,
2005 W. Colorado Ave.,
Colorado Springs, Colo.



\$20 a Day for Schreck
"Use my name as a reference and depend on me as a booster. The biggest thing I ever did was answer your advertisement. I am averaging better than \$500 a month from my own business now. I used to make \$18 a week."
A. SCHRECK,
Phoenix, Ariz.



\$3500 A Year For Beckett
"When I began with you I was just a common laborer, going from one job to another, working for anything I could get, and that wasn't much. Now my salary is \$3,500 a year and the Company furnishes me with an automobile."
C. O. BECKETT,
108 Maple Heights,
New Lexington, Ohio

Today even the ordinary Electrician—the "screw driver" kind—is making money—big money. But it's the trained man—the man who knows the whys and wherefores of Electricity—the Electrical Expert—who is picked out to "boss" the ordinary Electricians—to boss the Big Jobs—the jobs that pay \$3,500 to \$10,000 a Year. Get in line for one of these "Big Jobs." Start by enrolling now for my easily learned, quickly grasped, right-up-to-the-minute, Spare-Time Home-Study Course in Practical Electricity.

Age or Lack of Experience No Drawback

You don't have to be a College Man; you don't have to be a High School Graduate. As Chief Engineer of the Chicago Engineering Works, I know exactly the kind of training you need and I will give you that training. My Course in Electricity is simple, thorough and complete and offers every man, regardless of age, education or previous experience, the chance to become, in a very short time, an "Electrical Expert," able to make from \$70 to \$200 a week.

No Extra Charge for Electrical Working Outfit

With me, you do practical work—at home. You start right in after your first few lessons to work at your profession in the regular way and make extra money in your spare time. For this you need tools, and I give them to you—5 big complete working outfits, with tools, measuring instruments and a real electric motor.

MAIL COUPON FOR MY FREE BOOK

5 big outfits given to you — no extra charge

The "Cooke" Trained Man is the "Big Pay" Man

Name

Address

Occupation

Classified Advertisements

WORLD'S BEST WANT AD MEDIUM

Advertisements in this section, 30 cents per word, each insertion, minimum 10 words, payable in advance. To be inserted under proper classification in January issue, copy should be in our office November 19th

ADVERTISING AGENCIES

FRANK W. LENHOFF Advertising Agency, 66 East Lake St., Chicago, Ill. (Established 1897). Chicago's most progressive agency, will mail free on request their new 60 page Advertiser's Rate Book, with United States map in colors. Gives complete information of best paying newspapers and magazines in the United States and Canada. Our copy department has seasoned advice to give on advertising and selling. No obligation.

ADVERTISE in 24 Big Sunday Newspapers, 24 words \$15.00. Excellent for securing agents, salesmen and business opportunities. Catalog listing 1,000 leading dailies, weeklies, mail order magazines. Everything. Free. Wade Advertising, Baltimore Bldg., Chicago.

BEFORE Advertising get our catalogue. No charge. 25 years in business. The largest classified agency in the world. Ankrum Advertising Agency, 20 W. Jackson Blvd., Chicago Ill.

FREE—New 1928 Advertisers Rate Guide, 36 pages. Includes everything. Lowest rates. E. H. Brown Advertising Agency, 140 S. Dearborn, Chicago.

INCH Display 50 Monthlies Thrice \$8.00. Meyer Agency, 4112M Hartford, St. Louis, Mo.

ADVERTISE 50 Magazines 5c word; \$4.00 inch; 5,000 country weeklies 1c line, per paper; lists free. Evans King Co., 672P, Wilmington, Del.

TIME Counts in applying for patents. See pages 154 and 155. Clarence A. O'Brien, Registered Patent Attorney, Washington, D. C.

FOR ADVERTISERS

ADVERTISE—28 Words in 277 rural newspapers \$10; lists free. Roberts' Agency, Forrester, Ill.

ADVERTISER'S Manual, 1929 edition. Postpaid 25c. Owl, Times Bldg., New York.

40 WORDS Insert 50 magazines \$2.00. Empire Agency, Shawano, Wis.

ADVERTISE in weekly papers. Lists free. Keator, Hartford Bldg., Chicago.

SALES PROMOTION

\$50 TO \$50,000 Daily Sales Developed during 28 years for clients by our direct mail plans, copy, campaigns. One product, 1923, an idea; this year \$100,000 orders booked. Fifty year old concern desired 50 national representatives in 1925; we produced 40 in three months. 700 dealers in 10 months at \$3 each, for another. Ten years Sales Promotion Manager Larkin Co. Submit sales problems for free diagnosis. James C. Johnson, 118A Woodbridge Ave., Buffalo.

LETTER SPECIALISTS

DON'T Experiment! Mailorder letters, circulars, campaigns scientifically written. Guaranteed! 1,000 satisfied clients. Long experience. Consultation free. Finkel-Advertising, 131P Glenwood, Jersey City, N. J.

BUSINESS ADDRESSES

IN The heart of New York—New York mail address \$2.00 month; forwarded daily, \$3.00 month. Edward Armour, M-1, 136 East 28th.

BUSINESS SERVICE

RECEIVE Mail from mailorder houses everywhere. Your name listed 20c. Larson, K-3410 North Ave., Chicago.

AUTOMOBILE SUPPLIES

TOP Dressing. Durable and elastic. Costs \$1.50 gallon. Instructions \$1. Wilson, 1830 Seminole Boulevard, St. Petersburg, Fla.

AUTO Parts new and used. Lowest prices. Bankrupt supplies, motors, wheels, radiators, transmissions, generators, gears, carburetors, touring tops complete \$15. Brakelling 50% off. Brightman, 2065 Main St., Hartford, Conn.

SAVE Money on auto and truck repairs. Gears, axles, bearings, motor and transmission parts at 50 to 75% off factory list prices. Satisfactory parts guaranteed. Prompt service. Price lists free. Century Parts Co., 1712 Lafayette Ave., St. Louis, Mo.

RADIATORS At wholesale prices. All standard makes. Satisfaction guaranteed. Send for prices, stating make and model. Independent Radiator Co., 1119 S. Wabash Ave., Chicago.

TOOL Salesmen and mechanics with some sales ability sell our line electrical tools to auto mechanics and garages. Easy sales, and very liberal commissions. Barker Specialty Co., Girard, Pa.

ECONOMIZER Saves gasoline. Guaranteed. Write Economizer Manufacturing Co., Rome, Ga.

42 MILES On 1 gallon. Wonderful moisture gas saver. All autos. 1 free. Critchlow, L1-805, Wheaton, Ill.

AUTOMOBILES

TIME Counts in applying for patents. See pages 154 and 155. Clarence A. O'Brien, Registered Patent Attorney, Washington, D. C.

AUTOMOBILE SERVICE EQUIPMENT

BARGAINS in reprocessed battery chargers, rectifiers of all kinds and a few constant potential 8-hour chargers, several of them practically new. Lowest prices, terms if wanted. 30 days' trial. Write today to L. C. Helmick, Box M1283, Troy, Ohio.

PRICES Reduced! Order a battery charger now at these low prices. Scioto Battery Chargers with capacities of from 1 to 17 batteries now sell at from \$9.50 to \$62.50. Send for dealer's catalog. It's free. Adams-Barr, Columbus, Ohio.

YOU Are wanted to resilver mirrors at home. Immense profits plating autoparts, tableware, etc. Write for information, Sprinkle, Plater, 77, Marion, Ind.

SAVE Money—Garage equipment reconditioned and guaranteed like new. Unusual bargains in test stands, car washers, battery chargers, air compressors, etc. Shipped on trial, easy terms. What do you need to complete your equipment? E. C. Galbreath, Box M1284, Troy, Ohio.

BATTERY Aid positively prevents corrosion on batteries. Sample 25c. Aid Chemical Co., Milwaukee, Wis.

USED Constant potential outfit—120 ampere fully equipped. Guaranteed like new, overhauled and repainted. A wonderful bargain. Will ship on trial and allow plenty of time. E. M. Connor, Box M1282, Troy, Ohio.

FOR FORD OWNERS

AURORA Underslung parts and 3.1 racing gears, speedster bodies, headlights, hi compression head. See Sport Factories ad, page 136.

42 MILES On 1 gallon. Wonderful moisture gas saver. All autos. 1 free. Critchlow, L2-805, Wheaton, Ill.

MOTORCYCLES, BICYCLES AND SUPPLIES

MOTORCYCLES Cheaper than bicycles. \$25 to \$50. Easy terms. Tires \$2.50; Frames \$3; Forks \$3; Tanks \$5; Wheels \$4; Chains \$2; Saddles \$5; Handle Bars \$5; Engines \$15; Motorcycle Tires \$2.50; Truck Tires \$7; Airplane Engines \$15; Bicycles Tires \$1.25. Send 50c for catalog. Price Cutter Deninger, Rochester, N. Y.

SLASHING Price Reduction! Fine Harley-Davidson motorcycle bargains. New, used and rebuilt motorcycles, \$50.00 and up. Send for our new free bargain bulletin just off the press. Knuth's Harley-Davidson Agency, 2525 Fond du Lac Ave., Milwaukee, Wis. Exclusive Harley-Davidson Distributors.

MOTORCYCLES, Typewriters \$5 to \$50. Knights, 1512 Locust, St. Louis, Mo.

USED Motorcycles, all makes, lowest prices; price list free; used parts half price and less. Rochester Harley Davidson Corp., 129 West Main St., Rochester, N. Y.

BARGAINS in used motorcycle parts for all makes. No Catalogs. J. B. Dahl, 3661 Archer Ave., Chicago, Ill.

BICYCLES, Tandems, reducing, training machines, tricycle delivery. Lakewell Bicycle Store, 175 W. Lake, Chicago.

AVIATION

NEW Book "Making Good in Aviation" tells you how to fit yourself for marvelous opportunities open to flyers and mechanics. Contains stirring story of Col. Lindbergh as our chief air mail pilot and instructor. Rise of "Bud" Gurney from barnstormer to chief pilot. Published by well known Robertson School of Aviation, 9½ years old, hundreds of graduates, no accidents. Army school system of flying taught by active air mail pilots. Government licensed and inspected training ships. No bond, no breakage charges. 700-acre field. "Ryan" and "Robin" factories on site. Send 25c for book, "Making Good in Aviation." Robertson Flying Services, Inc., Dept. O, Lambert-St. Louis Airport, Anglum, St. Louis Co., Mo.

HOME Study aviation course by pioneer school at new low price. Covers motors, meteorology, nomenclature, aviation, design, flying and 100 other fascinating subjects. Endorsed by experts. Diploma given. Free employment service. Complete details sent free. National Aviation Training, Dept. 19, 1031 So. Broadway, Los Angeles, Calif.

AVIATORS, Pilots, mechanics, riggers, salesmen and factory workers needed. We are expanding and need men and we are going to train them ourselves. Opportunity to earn while you learn. Wire or write at once if interested. Varney Aircraft Corp., Peoria, Ill.

MODEL Airplane supplies. Send dime for propeller and price list. Model Airplane Co., 161 Royal Ave., Hawthorne, N. J.

STUDENTS, Send one dollar for pair of wings and card entitling you to free counsel service of the Acme Airman. Acme Airways, 82 Proctor Bldg., Troy, N. Y.

FLYING Instruction book for one dollar. Complete, simple, understandable. Written by Cleveland, one of America's oldest pilots. Send for "Modern Flight." Alexander Aircraft Company, Dept. PM1, Colorado Springs, Colo.

TIME Counts in applying for patents. See pages 154 and 155. Clarence A. O'Brien, Registered Patent Attorney, Washington, D. C.

SPECIAL ¼" rubber strand for model airplanes—fresh stock—200 feet \$1.09 postpaid. Catalog of ready to fly airplanes and supplies 10 cents. The Clinton Toy Corp., Box 141, North Haven, Conn.

JUST Out—Booklet and blue prints on construction of sportplane. Contains also flight instruction, motors to use, etc. All for one dollar. Rent or buy a rib mold; easy to make ribs. Free literature. Russell Aero Co., Stadium Pl., Ft. Wayne, Ind.

AVIATION Booklet sent for 25c (coin). Nelphin, Dugal, Strong, Ark.

STEER Your course correctly! Read Air Navigation and Meteorology by Capt. Richard Duncan. \$3.50 postpaid. Write to T. Marr, Distributor, 729 Greenwich St., New York.

DURATION Model airplanes: 20", 85c; 36" twin, \$3.00. Beautiful flyers. Catalog 2c. Marx Aircraft, 668 East 8th South, Salt Lake, Utah.

VARIOUS Sizes wood, reeds, bamboo, rubber band, wheels, propeller, onion skin covering and other supplies. Big bundle for 25c, five for \$1.00. No stamps. Will also send circular on free three foot model. Aero Shop, 3050 Hurbut Ave., Detroit, Mich.

"SKYWARD Ho!" Wonder book on aviation—32 pages, 150 illustrations. Shows you complete training for flying career, fame, fortune! Sent free. Write today! Parks Air College, 213 Mo. Theatre Bldg., St. Louis, Mo.

AEROPLANES: Model construction sets; finished models; from 25c to \$25. Make fine Christmas gifts. Send 10c for big catalog "P." Broadfield Aeroplane Co., Hempstead, N. Y.

SIMPLEX Air Model Co., Auburn, Mass. Send five cents for supply booklet.

9" PROPELLER 55c; Rubber tire disc wheels 50c pair. Advanced Aircraft, 114 Oliver Ave., Yonkers, N. Y.

THE Heath Super Parasol, America's only practical sport plane. Easier to fly than a training plane. Costs no more than a motorcycle to build or maintain. Ten cents brings our large illustrated folder. Heath Airplane Co., Chicago, Ill.

BUILD And fly your own monoplane—20-foot wing spread, 72 mph with only 12 hp. motor. Plans and working drawings complete. \$10.00. Descriptive folder ten cents. Warner Co., 311 Edwards Bldg., Cincinnati, Ohio.

BUILD Our wonderful one place monoplane. Adapted to motorcycle or other air-cooled motors to 35 h.p. Detailed blueprints \$2.00. Hawley Aircraft, Box 121, San Diego, Calif.

BUILD Your own glider. Complete plans \$7.50. Special price list 25c. J. P. Schroeter, 445 Milwaukee St., Milwaukee, Wis.

AIRPLANE Propellers and motors, 28 to 200 hp. Smith, Box 1343, Houston, Tex.

BLUEPRINTS For building carefully designed sportplanes that really fly: monoplane, \$2.50; biplane, \$5; circular 20c. Allison Airplane Co., Lawrence, Kans.

PROPELLERS: 3', \$5.50; 4', \$8.75; 5', \$13.25; 6', \$16.50; others proportionately. Aerodrive boat and sled blueprints 50c each. \$8.25 value aviator's helmet and resistal goggles only \$5.00 set. Ostergaard Aircraft, 4309 N. Narragansett, Chicago.

THE American School of Aviation announces a new correspondence course in Mechanics of Aviation. A thorough training in Practical Aeronautics. American School of Aviation, Dept. 1871, 3601 Michigan Ave., Chicago, Ill.

NEW Aircraft magnetos, 6 or 8 cylinders, cost government \$75.00, sacrificed \$7.50. Real airplane propellers, 8 foot long, given away, \$5.00. Air Transport Co., Carle Place, N. Y.

BIGGEST, Best Catalog Model Airplanes, Parts, Supplies; 5c postpaid. Ideal Company, 19 West 18th Street, New York.

FLY! With motorcycle engine. Build your own airplane at small cost. Booklet with five drawings tells how to build fuselage, wings, controls, etc. Price one dollar. Hodgdon, 324 Bay St., Springfield, Mass.

IT'S New! The modern airplane, 12b pages, 49 illustrations, tells everything you want to know about flying. Recommended by leading pilots and flying schools. Sent postpaid for \$1.00 or write for free descriptive circular. Roth Downs Airways, 2502 University, St. Paul, Minn.

BOOKS AND PERIODICALS

4TH EDITION Just off press, "Radio Theory and Operating," by Mary Texanna Loomis. The standard radio text and reference book of America. Nearly 900 pages, over 700 illustrations, flexible binding. Price \$3.50 postage paid. For sale by hundreds of bookdealers throughout America and many foreign countries. Or may be purchased direct from the publishers. Send check or money order to Loomis Publishing Company, Dept. 18, Washington, D. C.

BOOKS, 6th and 7th Book of Moses, 75c; Albertus Magnus, 75c; Pow-Wow, 60c; Silent Friend, \$1.00; Book of Luck, 25c. The F. & R. Co., 87 Fourth Ave., Dept. "J," New York.

"MASTER Key," 400 pages psychology, inspiration, success. Handsome binding \$2.75. Phines, 1014 Belmont, Chicago.

FREE To you—Interesting catalog of unique books and novelties. Address S. Musial & Co., 10-12 Lincoln St., Yonkers, N. Y.

INDUSTRIAL Alcohol, Wright's book. Full directions for making, fully illustrated. \$2.50. Spou & Chamberlain, 120 P.M. Liberty Street, New York, N. Y.

HYPNOTISM Easily learned. Lessons guaranteed. Postpaid, \$1.10. Smith Pub. Co., Dept. 3, Springfield, Mass.

PICTURES AND POSTCARDS

LIVING Pictures! Oo La La! Pretty European Girls Wiggle-wink. Something sensationally new. Only 50c. Tip Top Sales, East Dedham, Mass.

CHRISTMAS Greeting card assortment 21 beautiful cards and folders with envelopes postpaid \$1.00. Clifford Hoffman, 57 Broad St., Albany, N. Y.

SIX Months' big mail—Samples Magazines, opportunities, 25c. Larkin, 453 27th Ave., Milwaukee, Wis.

FREE Book—"What men know about women?" Humorous and interesting. Kind men like. 10 snappy cards. Red hot pocket novelty. Copy America's greatest illustrated cartoon book. All for 25c. White Mule, Beaver Dam, Wis.

ART Pictures—500 all different. Particulars 10c. Howard Sales Co., Dept. 15, Box 529, San Francisco, Calif.

MAGIC TRICKS, BOOKS AND JOKER NOVELTIES

"THE Book of 1,000 Wonders" will be sent postpaid for 10c. Explains many mystifying tricks with coins, cards, handkerchiefs, etc., you can do. Also, contains complete catalog of magic tricks, jokes, puzzles, books, escapes, mindreading acts, spiritualistic effects, illusion plans, curios and imported novelties from many foreign lands. Large assortment, lowest prices. You will amaze and mystify your friends! Send 10c today. Lyle Douglas, Station A-5, Dallas, Tex.

MAGIC—Tricks, Books and Supplies. For amateurs as well as the great professionals. Anyone can learn through our instructions. Feature Acts in Mind-Reading, Spiritualism, Rope Ties, etc. Large illustrated professional catalog, 20c. Chicago Magic Co., 140 So. Dearborn St., Dept. B, Chicago, Ill.

Kellar's Wizards' Manual—Secrets of magic, black art, ventriloquism and hypnotism fully explained and illustrated. 50c postpaid. Circulars free. Box 218, City Hall Station, New York.

CARD Tricks, hypnotism, 64 page books, complete guides, 10c each. Geo. Fenner, Louisville, Ky.

6 WONDERFUL Magic tricks, with apparatus, directions, professional magicians' catalog, complete 25c. Weber, 647-K East 62nd St., Chicago.

ILLUSION And trick catalog 20c. Lynn's, 105 Beach, Jersey City, N. J.

MAGIC Taught. New method. A new trick every week. Particulars free; trick book 10c. Lindhorst Magic Co., Room 208, 3618 Olive, St. Louis, Mo.

SIX Mystifying card tricks, done with ordinary pack cards. Easily learned. 25c including large catalog. Wizard Magic Co., Dept. 15A, Box 1055, Station C, Los Angeles, Calif.

LATEST French model pocket mirror and set of transparent art cards all for \$1.00. World Service Co., 336 Marcy Ave., Brooklyn, N. Y.

FREE with \$25 order die box. Send 20c for our large catalogue of tricks, wigs, sensational escapes. Oaks Magical Co., Dept. 548, Oshkosh, Wis.

ELECTRIC Fun! Seventy stunts, 110 volts, \$1. Cooper Sons, Campbell, Calif.

SEVEN Magical Delusions and catalogs—25c. Gilmagic, Morgan Park, Ill.

NEW Pocket tricks, 50c; three for \$1.00. Catalog free. Professional 10c. Eagle Magic, Minneapolis, Minn.

MAGICAL Tricks, puzzles, novelties. Catalog 5c. Matz Novelties, Reading, Pa.

GAMES, ENTERTAINMENTS AND PLAYS

PLAYS, Musical comedies and revues, minstrels, comedy and talking songs, black-face skits, vaudeville acts monologs, dialogues, recitations, entertainments, juvenile plays and songs, musical readings, make-up goods. Catalog free. T. S. Denison & Co., 623 So. Wabash, Dept. 11, Chicago.

BLOCK-BALL An athletic game played upon a new checkered board. Price \$2. S. Terry, 2223 E. 37th St., Cleveland, Ohio.

FOLKS Nearly die laughing, playing "Hollywood Burlesque"; hilarious movie game. Society in convulsions. \$1 postpaid. Hollywood Games, Box 690, San Jose, Calif.

NEW Christmas game. You can play the World's Series on this parlor baseball game board. Send \$2.50 for sample. Chester Brown, 510 Van Buren, Chicago.

LEARN Ventriloquism by mail—small cost, 2c stamp brings particulars. Geo. W. Smith, Room S304, 125 N. Jefferson St., Peoria, Ill.

NOVELTIES, CURIOS, ETC.

"THE Book of 1,000 Wonders" will be sent postpaid for 10c. Explains many mystifying tricks with coins, cards, handkerchiefs, etc., you can do. Also, contains complete catalog of magic tricks, jokes, puzzles, books, escapes, mindreading acts, spiritualistic effects, illusion plans, curios and imported novelties from many foreign lands. Large assortment, lowest prices. You will amaze and mystify your friends! Send 10c today. Lyle Douglas, Station A-5, Dallas, Tex.

STAMP COLLECTING

500 DIFFERENT Stamps for 25c! Big collection 500 different stamps from Bosnia-Herzegovina, Crete, Epirus, Hong Kong, Iceland, Kenya and Uganda, Liberia, Malta, Nyassa, North Borneo, Orange River Colony, Siam, Wallis and Futana, and other "hard" countries. Catalog value \$10.00. Price only 25c to approval applicants! Special bargains, 1,000 different 79c; 15 triangle stamps 49c; 100 Africa 45c; 100 Asia 50c; 100 Balkan States 35c; 100 British Colonies 25c; 100 French Colonies 30c; 100 Portuguese Colonies 50c. All 8 packets for \$3.00! Illustrated lists free. Loma Stamp Co., 3926 32nd St., San Diego, Calif.

MYSTIC "Queer Country" Packet! Contains scarce stamps from the following strange lands: San Marino, Antioquia, Congo, Cyprus, Fiji Islands, Gwalior Hyderabad, Iceland, Jhind, Kenya, Uganda, Lebanon, Monaco, North Borneo, Nyassa, St. Thomas Prince, Eastern Roumelia, Siam, Sierra Leone, Tanganyika, Trinidad Tobago, Ubangi, Upper Volta, Wallis Futana, Aiaouties. Get this wonderful packet of "freak countries" and make your friends envious! Price only 10c to approval applicants! Write today. Mystic Stamp Company (Dept. 8), Camden, N. Y.

NOW On sale—1929 (85th) edition, Scott's standard postage stamp catalog. In one volume; every stamp ever issued by any stamp issuing country, illustrated, numbered, and described by date of issue, color, perforation, paper, watermark denomination, type of printing, surcharge, etc., and priced, used and unused. Cloth cover \$2.00, with thumb index \$2.50, shipping weight 3 lbs. For sale at stamp department, book and stationery stores or from Scott Stamp & Coin Co., 1 West 47th St., New York, N. Y.

\$1.00 FREE. Black U. S. Postage. Given away with each order. Pioneer Stamp Album with 500 illustrations. 150 different stamps from 40 countries, Syria, Lebanon, Hejaz, Liberia, New French Colonies, British, Portuguese Colonies, South Africa, Australia, 500 hinges, 36 page illustrated catalogue. All for 15c. Big Commission to Agents for the Best approval sheets of stamps ever offered. Write for sample outfit. Hussman Stamp Co., Dept. M, 620 Olive St., St. Louis, Mo.

ANCHERS \$\$\$ Outfit—only 12c! Fine triangle stamp; set German stamps with (pre-war) value forty million dollars (interestless!); perforation gauge, name scale; airmail set; scarce stamp from smallest republic on earth; newspaper set; packet good stamps and Travancore, Malay, Dutch Indies, etc. Entire outfit for 12c to approval applicants! (Nice pocket stock book, value 25c, with every order!) Ancher Stamp Co., Ramsey, N. J.

FREE—Beautiful complete mint set 18 stamps and two stamps, catalog \$1.15 to approval applicants. Postage 4c. Iron Spring Stamp Co., Iron Springs, Pa.

HANDY "Guide to Correct Advertising." Used by leading dealers. Indispensable yet free on request. American Stamp Dealers Agency, Detroit, Mich.

U. S. STAMPS On approval, all grades. Reference please if you mean business and state your wants. We price according to condition. Small coll. of 30 varieties, 10c; 50 varieties, 20c; 100 varieties, 60c. Larger if desired. Park Stamp Co., 589 Beacon St., Boston, Mass.

ROYAL Gift-box contains exciting cut-rate stamp assortment for beginners, \$1.25. Philatelic Mission, Santa Rosa, Calif.

500 MIXED U. S., old and new, 10c. Weatherby, Lakewood, Ohio.

78 FAR-OFF Countries only 10c. Angola, Dahomey, Travancore, Jamaica, St. Pierre, Schleswig, Martinique, Ivory Coast, Esthonia, Luxemburg Peru, Newfoundland, South Africa. Marvelous packet 78 different stamps from 78 different countries, including all above and 65 more. Bargain price 10c. Big lists and approvals with each order. C. D. Reimers Company, 6, Flatiron Bldg., Fort Worth, Tex.

A SNAP—300 different foreign and 60 different U. S. stamps, including \$1 and \$2 revenues, all for only 25c. Free, with each order, our pamphlet which tells "How to Make a Stamp Collection Properly," together with our price lists of albums, supplies and hundreds of bargains in sets, packets, etc. Queen City Stamp & Coin Co., Room 36, 604 Race St., Cincinnati, Ohio.

LINDBERGH Air mail and 25 different other air mail only 15c to approval applicants. Special bargains: 100 British colonies 25c; 100 Africa, 45c; 100 French colonies, 30c; 1,000 different from all over the world, 75c. All 4 packets for \$1.50. L. W. Hudson, 1439 East 7th St., Plainfield, N. J.

ONLY 5c! 10 Airmail stamps, including scarce Estonian triangular stamp; Portuguese Red Cross set and 10 different Central Lithuanian stamps. Approvals and free lists with each order. Curhan Stamp Company, Gloucester, Mass.

BIG Value packet 15c. Select approvals. Fred Loeffler, 3275 46th St., Long Island, N. Y.

PICTURE Stamps, 105 different, beautiful, with premium, 19c. Central News, Watertown, S. Dak.

1,100 UNUSED Stamps, cataloging nearly \$25.00. Only 95c. Forty page illustrated price list free. West Coast Stamp Company, Alhambra, Calif.

5,000 STAMPS All world containing good British Colonials, Fiji, Papua, Australia, New Guinea, Hebrides, Solomon, Malay States, Borneo, etc. Many stamps \$2. Big value Post free \$10. Vincent, Box 261, Haymarket, Sydney, Australia.

UNITED States 1/2c to \$2 present issues, complete; 24 varieties, catalog value \$1.25, for 25c. This amazing offer for approval buyers only. State size of collection, countries interested. Leduc, Redlion, Penna.

10 RARE Colombian Republic, Antioquia, free to approval applicants. Richard L. Willing, 3095 Midvale Ave., Philadelphia, Pa.

300-300-300 ALL Different stamps (\$6.00 catalog); 300 hinges; 5 approval sheets; duplicate stamp album; perforation gauge; millimeter scale and ruler to approval applicants for only 20c. Edgewood Stamp Company, Milford, Conn.

CANADA—25 Different 10c, including Confederation stamp and 5 Newfoundland, to approval applicants. Price lists of Canada, etc., free. We list 250 countries in dime packets. Specials: 500 different 25c; 1,000 different 75c; 2,000 different \$2.50. Victoria Stamp Co., Dept. 4, London, Can.

FREE: Stamp collection from 20 different countries to all sending 5c mailing cost for price list. Argonaut Stamp Co., Dept. 213, New Canaan, Conn.

TRIANGLE: 75% Discount special approvals with 10c packet containing triangle, war tax sets, airplanes, early U. S. stamp, etc., over 100 different stamps. Murray, 515A Tower Bldg., St. Louis.

FRENCH Colonies free—Jungles, Tigers, Native Chiefs, 2c postage. Empire Stamp Co., Toronto, Can.

105 DIFF. Foreign postage 25c. Napp, 413 Oak Grove, Beloit, Wis.

1,000 MIXED 20c; 100 Var. precancels, 15c. Charles Peugh, Elma, Wash.

100 FOREIGN Stamps 3 cents. Lufbery Stamp Co., North Branford, Conn.

ATTENTION: 1929 Price list of U. S. stamps; 1929 price list of foreign stamps. Most complete ever issued. Free on request. Highest prices paid for U. S. and foreign postage stamps and collections of medium and high grade. F. Marquis, 15 Park Row, New York City.

FIRST Flight air mail covers and 29 stamps from 29 countries for 79c. To applicants for approvals. Brooks, 19 Pleasant St., Beverly, Mass.

500 MIXED 17c; 35 Different U. S. 12c. Glenwood Stamp Co., 30 Athol St., Springfield, Mass.

WORLD'S Greatest values: 215 diff. Congo, Airmails, Nigeria, high value U. S., 10c to approval applicants, 100 diff. U. S. 30c, 1,000 hinges 9c. Lists. Hawkeye Stamp Co., Cedar Rapids, 39, Iowa.

STAMPS—50 Different foreign stamps; illustrated album; stamp hinges; perforation gauge; big illustrated catalog—send 10c for complete outfit. W. Betts, Clearfield, Pa.

SEND For list of postage stamps attractively priced. E. T. Parker, Bethlehem, Pa.

100 WORLD-WIDE, including British, French, Portuguese colonies, and 10c catalog value from approvals, only 10c to new customers. Bell Co., Box 455, Washington, D. C.

REGULAR 25c Packet, including Monk and Monkey, 10c to applicants for World-Wide approvals. Martin Huet, Box 245, Chicago.

PREMIUM To serious applicants for British Colonials on approval. Thorndike, Box 472, Wesleyan Station, Middletown, Conn.

FREE—Hidden treasure packet to approval applicants. Donner, Roosevelt St., Far Rockaway, N. Y.

100 DIFFERENT Turkey 75c. approvals. Rubin Huffman, 405 Pennsylvania Ave., Brooklyn, N. Y.

12 SNAPS, Washington, D. C., \$1.00. C. R. Ramsey, 4001 Mirimar Drive, St. Petersburg, Fla.

AIRMAIL—25 Different 25c, 1,000 O.K. Hinges 10c, 3,000, 25c. O. K. Stamp Co., Box 581, Utica, N. Y.

50 DIFFERENT U. S. postage 5c to applicants for U. S. and foreign approvals. 100 British colonies 25c; 25 Guatemala 20c; 1,000 hinges 10c, 3,000 25c. Glendale Stamp Co., 1341 Linden, Glendale, Calif.

MAGNIFICAROCIOUS Packet foreign stamps, beauties from distant lands. (Many richly colored, unusual designs), free for 2c. Gray Stamp Company, Toronto, Can.

FREE 50 British Colonials, if approvals requested. Postage 4c. Berkeley Stamp Co., South Berkeley, Calif.

FREE, 12 Diff. large, showy picture stamps for a request for my popular approvals. Postage 2c. Premiums with every purchase. A. Bauer, Palmyra, N. J.

STAMPS—15 Different varieties free. Try our 1c specials. Send 2c. Wood Patterson Stamp Co., P. O. Box 565, Pecos, Tex.

STAMPS On approval 1/2c up. Free premium. Herbert Keigwin, Middletown, N. Y.

500 DIFFERENT 40c, 1,000 Diff 90c. Anderson, Gouverneur, N. Y.

"WASHINGTON Stamp News" tells about new United States stamps and first day covers. Sample copy free. A. M. Nickles, 213 Seaton, Washington, D. C.

FREE—Send for sample copy world's most beautiful stamp magazine. Stamp Collector, Dept. P. M., 719 Lodi St., Syracuse, N. Y.

FREE Five fine Congo to approval applicants. Bernard Karch, Bengles, Md.

500 WORLD Stamps, old and new, commemoratives, 10c. Arco Stamp Co., 3206 W. 95th, Cleveland, Ohio.

FREE 100 Diff. to approval applicants. Postage 2c. C. R. Tempe, 1310 Gaffey, San Pedro, Calif.

MALAY States: 10 different 15c. Lists free. Allison, Angola, Ind.

100 DIFFERENT Danzig 45c to approval applicants. Importer, Box 156, Needham, Mass.

1,000 UNITED States and foreign mixed 25c. Johnel, 3114 Seminary, Chicago, Ill.

FREE 25 Canada to approval applicants. Prall, Somerville, N. J.

PREMIUM 25 U. S. only with approvals. Refer, please. F. E. Gaerte, 4740 No. Western Ave., Chicago, Ill.

50 UNITED States, 50 foreign, 15 British, 15 Portuguese colonies, for 10c and premium to approval applicants. Theo. Nelson, 3439 North Halsted, Chicago, Ill.

THREE Complete sets for 10 cents. Bosnia 1917, Honduras 1865, Prussia 1903. S. E. Saxe, 1427 No. 58th St., Philadelphia, Pa.

BIG Value! 25 airmails 10c. Free! 100 stamps with 50% approvals. Webster Stamp Co., Box 11, Tremont Station, New York.

LIBERIA Viewcards with Liberian postage stamp cancelled at Monrovia, 12 different one dollar. Sample 12 cents. Plainfield Stamp Company, Plainfield, N. J.

ANNIVERSARY OFFER! 15c six beautiful sets: "Occupation," "Commemorative," "Airmail," "Charity," "Pictorial," "War." Also three packets: (International), (British) French, Portuguese Colonies), (Bulgaria). Approvals, lists, discounts. Deering, Fairmount, Marlborough, Mass.

250 DIFFERENT Stamps, with free premium only 10c. Skillman, Titusville, N. J.

LINDBERGH Cuba airmail stamp unused only 10c. Skillman, Titusville, N. J.

FREE—Choose one. All different, 200 foreign, 50 France, 15 Newfoundland, 30 Switzerland, 10 Iceland, 100 Austria, 25 airmail with Mekeel's Stamp Weekly, Beverly, Mass., three months. Remit 25c.

150 GOOD Mixed foreign stamps 3 cents. Stanton, Niantic, Conn.

UNITED STATES—Send on approval. Send me your want list. Ref. please. M. Hanna, New Kensington, Pa.

200 DIFFERENT Stamps, Zanzibar; Album, 12c. Liberty, 3974 Arsenal, St. Louis, Mo.

EXTRAORDINARY Packet! 60 different stamps from Nyasaland, Persia, Natal, Transvaal, Rhodesia, Montenegro, Nigeria, etc. Only 5c! with excellent approvals. Viking Stamp Co., P. O. Box 18, Sheepshead Bay Station, Brooklyn, N. Y.

FREE! Loose leaf postage stamp album at rate of 8 pages each month given with subscription to monthly journal. Send 2c stamp for prospectus. United Stamp Co., Marquette Bldg., Chicago, Ill.

100 BRITISH Colonials, all different, including some of the older varieties, for 25 cents. Approvals of the better grade stamps for advanced and medium collectors. Also beginner's selection. Lists free. Your name on our mailing list guarantees you satisfaction. Humber Stamp Co., 401 Quebec Ave., Toronto 9, Canada.

AMATEURS Attention! Low priced sets on approval. Wickham Stamp Co., Secaucus, N. J.

LIBERIA Snake Triangle and two other triangles in our packet of 53 genuine foreign stamps for five cents. Crowder Company, Waverly, Baltimore, Md.

50 DIFF. Soviet Russia 25c. Approvals if you wish. Glenn R. Knight, Box 3, Sausalito, Calif.

40 DIFFERENT United States 10c. 60% approvals. Seidenberg, Baroda, Mich.

109 DIFFERENT, Arabia, Azerbaijan, Zanzibar, etc, 10c to approval applicants. Floyd Marsh, 524 Hamilton Ave., Indianapolis, Ind.

300 DIFFERENT, 20c; 600, 50c; 1,100, \$1 2,000, \$3.50. Fred Onken, 630 79th St., Brooklyn.

500 STAMPS 17c, 3,000 Hinges 25c. Ask about special approval discount. Elmer, 61 Court St., Boston.

105 CHINA, Etc., 2c. Album (500 illustrations) 3c. Bullard, Sta. BB, Boston.

110 DIFFERENT Stamps, many unused, high values, free to collectors requesting our Net Approvals. Postage 2 cents. Christensen, Milwaukee, Wis.

STAMPS, 100 all different. Postage 2c. Lists free. P. M. Quaker Stamp Co., Toledo, Ohio.

REVENUES—Telegraphs—Every country. Pretty—Intriguing—Cheap. Mint \$5.00 revenue free to applicants with references. Vanderhoof, 1114 Logan, Denver, Colo.

HIGH-CLASS Approvals. References Required. Pikes Peak Stamp Co., Colorado Springs, Colo.

110 NEW Europe All Different, a wonderful collection cataloging several dollars, free to collectors requesting our Net Approvals. Postage 2 cents. Badger Stamp Co., Milwaukee, Wis.

BEST One cent approvals in America. F. P. Hand, 1117 So. 60th St., Philadelphia, Pa.

DANDY Mint stamps 2c to those requesting approvals. Harvey Teeple, Decatur, Ind.

1,000 ALL Different stamps \$1.00. New price list of all United States stamps free. Voorhees, 7 South Dearborn St., Chicago.

STAMPS sent on approval at 70% discount. Reference required. Emory Renoll, Hanover, Pa.

505 DIFFERENT Stamps, cat. \$14.00 for 25c to those requesting approvals. 50 different Sweden 35c, 1,000 different stamps and 1,000 hinges 75c. Hudson County Stamp Co., 68 Hudson, Hoboken, N. J.

FREE Germany air mail (5 var.) for new applicant of my 1, 2c and 3c approvals and also my 50% discount. Chas. W. Schmidt, P. O. Box 4832, Frankford Sta., Philadelphia, Pa.

FREE! 115 Different stamps to approval applicants, 2c postage. Paige Stamp Co., Oak Park, Ill.

STAMPS, 100 varieties, Africa, Brazil, Peru, Cuba, Mexico, etc., 10c; 25 different U. S. 25c; 1,000 mixed, 40c; 1,000 hinges, 15c. List free. C. Stegman, 5941 Cote Brillante, St. Louis, Mo.

24 VARIETIES Cuban stamps, 10 cents. List of 6,000 low-priced stamps free. Address Chambers Stamp Co., 111P, Nassau St., New York City, N. Y.

200 DIFFERENT stamps 10c; 1,000 Hinges 10c. R. H. Carlton, 380 W. So. Temple, Salt Lake, Utah.

LINDBERGH Panama issue complete, 50c. Wirth, 139 Shepherd Ave., Brooklyn, N. Y.

STAMP Album free, spaces for 1,200 stamps with purchase of 50 stamps from 50 different countries for 25 cents. B. Nagle, 1101 Marion, Reading, Pa.

JUNGLE Packet, tropical and odd countries, animals, birds, etc. Scarce stamps cataloging to 60c each all 10c to approval applicants. Wolf, 2962 West 24th, Brooklyn, N. Y.

APPROVAL Stamp packet sent on request. Paul Cornish, Schenectady, N. Y.

THIRTY Canadian stamps, including commemoratives fifteen cents to approval applicants. Reid, 608 Yonge St., Toronto.

15c FOR 50 Different stamps. Grant, 6317 18th Ave., Brooklyn.

COLLECTORS. Try our mission mixture, heavy in precancel, \$1.00 lb. Yorton, B-373-PM, Syracuse, N. Y.

BEAUTIFUL Set free with bargain approvals. Van's Stamp Co., Box 31, Eugene, Oreg.

FREE, British colonial packet cataloging \$1, with lists for 2c stamp. Reuter, Fullerton, Calif.

FREE—True-Blue Book. Exchange stamps, postcards. Ericson, Elroy, Wis.

SPLENDID Packet free. Approvals. Postage 2c. Atlas, 5044 Drake, Chicago.

NEWFOUNDLAND Postage. Send want list. Will quote bargain prices. Rev. Butler, St. Georges, Newfoundland.

LANDSLIDE Packet with \$1.00 Lincoln. \$1.00. Franklin, 10c. Approvals. Golden Rule Stamp Co., Box 1248, Chicago.

COVERTCO Packet, 100 different stamps 10 cents, with 60% discount approvals. Covert Stamp, 39 State, Rochester, N. Y.

101 DIFFERENT Free with 50% Approvals, 2c postage. Noemus Stamp Co., 312 East 23rd St., New York.

UNITED States and Canadian 32-page price list free. Stamps bought. Stanley Gibbons, Inc., 38p Park Row, New York City.

THOUSAND Foreign stamps 50c; twenty foreign coins \$1. Prof. McCreery, Chatham, Ontario.

PENNY Approvals that Satisfy. Neil Gronberg, Box 5441, Philadelphia, Pa.

RARE COINS

40 OLD Coins all different, \$1.00; 100 different coins, \$3.00; 20 different coins over 100 years old, \$1.00; 20 different silver coins, \$1.00; 100 mixed foreign coins, \$1.00; Stone mountain half-dollars uncirculated, 75c; 300 different Germany war bills, \$1.00; 300 different Austria war bills, \$1.00. Claud Denney, Box 315, Dallas, Tex.

AMERICAN 2c, German 20 Pen Silver France 10c, 2 crisp bank notes and catalog 20c. George Best, Cedar Rapids, Iowa.

UNITED States. Large cent, two-cent bronze, three-cent nickel and bargain list, 25c. Thirteen dates large cents, \$1.00. George Coffin, Greenwood Mountain, Me.

RARE Coin book, 65c. 700 illustrations. Money refunded if not satisfactory. Coin Bulletin \$1.00 per year. Coins appraised for estates. Gutttag Bros., 16 Exchange Place, New York.

GET Profit and pleasure in collecting old coins. Send 10c for large illustrated coin catalogue. You'll be delighted with it. Send for it right now. B. Max Mehl, Numismatist, Mehl Bldg., Dept. P, Forth Worth, Tex. Largest Rare Coin Firm in the U. S.

RARE United States and foreign coins, war medals and decorations. Chinese coin and catalog 10c. Alexis Mengelle, Colorado Springs, Colo.

OLD Coins, large Fall selling catalog of coins for sale free to collectors only. Catalog quoting prices paid for coins, ten cents. William Hesslein, 101A Tremont St., Boston, Mass.

20 ASSORTED Foreign coins, postpaid 25c. Oddehon, Box 681, Kansas City, Mo.

CALIFORNIA Gold—Quarter size, 27c; $\frac{1}{2}$ size, 53c; 3c piece and catalog, 10c. Norman Shultz, Box 746, Salt Lake, Utah.

OLD Money wanted. Do you know that coin collectors pay up to \$100.00 for certain U. S. cents? And high premiums for all rare coins? We buy all kinds. Send 4c for large coin folder. May mean much profit to you. Numismatic Co., Dept. H, Ft. Worth, Tex.

FOR BOYS

"THE Book of 1,000 Wonders" will be sent postpaid for 10c. Explains many mystifying tricks with coins, cards, handkerchiefs, etc., you can do. Also, contains complete catalog of magic tricks, jokes, puzzles, books, escapes, mindreading acts, spiritualistic effects, illusion plans, curios and imported novelties from many foreign lands. Large assortment, lowest prices. You will amaze and mystify your friends! Send 10c today. Lyle Douglas, Station A-5, Dallas, Tex.

DE LUXE Doll house plans \$1.00. Anyone can build for Christmas. C. W. Noller, 41-67 Forley St., Elmhurst, L. I.

EARN Christmas money. Order 50 sets Christmas Seals. Sell for 10c set. When sold return \$3.00, you keeping \$2.00. No work—just fun. St. Nicholas Seal Co., Dept. 43PM, Brooklyn, N. Y.

DO You own a scroll or jig saw? We supply thin lumber. White pine, basswood or whitewood $\frac{1}{4}$ ", 3-16" or $\frac{1}{4}$ " x 7" x 30". Five pieces \$1.00 postpaid. Gardner Wood Products, Gardner, Mass.

BOYS: Make easy money! Sell "Book-Name Plates" to friends. Send 10c for samples. Rosebud Art, 237 Lafayette St., New York.

CAMERAS AND PHOTO SUPPLIES

PROTOFORMS—Latest product in the picture field. Absolutely new and different—no competition—sensational seller. Replaces old fashioned out of date photo specials. All picturemen should send for details at once. Others including beginners will find it a wonderful opportunity. Amazing new sales plan. Exclusive territory. Get in on ground floor. Hurry application. National Photoform Co., 448 N. Wells St., Dept. 20, Chicago, Ill.

PHOTOGRAPHIC Equipment and accessories of every description are listed and illustrated in our 228-page catalog. It will pay you to secure a copy which is issued free, as our prices are low. We also deal in used goods which are sold under the same guarantee as new goods. Ask for our Bargain Book. Central Camera Co., Dept. E136, 112 S. Wabash Ave., Chicago, Ill.

BIG Money in photography, motion picture projection. Catalog 49A free. New York Institute of Photography, 10 W. 33d St., New York.

TIME Counts in applying for patents. See pages 154 and 155. Clarence A. O'Brien, Registered Patent Attorney, Washington, D. C.

IMPORTED Developer. Sample for dime. McKenzie, 122 Fifth Ave., New York.

SAMPLE Enlargement—dime, and negative (returned). Trial roll, glossy prints, 25c silver. Brown, Warsaw, N. C.

EARN Big money with your camera in your spare time, using Halldorson Home Portrait Lamp. Write for booklet "Home Portrait Photography" and catalog—both free. The Halldorson Company, 4747 N. Western Ave., Chicago.

MAKE money in photography. Learn quickly at home. Spare or full time. New Plan. Nothing like it. Experience unnecessary. American School of Photography, Dept. 3431, 3601 Michigan Avenue, Chicago.

HAVE You a Camera? Write for Free sample of our big magazine, showing how to make better pictures and earn money. American Photography, 116 Camera House, Boston, 17, Mass.

FILMS Developed. Special Trial Offer. Any Size Kodak film developed 5c, prints 3c each. Trial 6x10 Enlargement in handsome folder 40c. Overnight Service. Roanoke Photo Finishing Co., 209 Bell Ave., Roanoke, Va.

GERMAN Cameras, lenses. Bartiro, 6436 La Riba Way, Los Angeles, Calif.

MOTION PICTURES

FILMS—Five reel westerns \$12. New bargain list. Alton Films, 205 Brush Creek, Kansas City, Mo.

SWAP 16mm Films. Standard films \$2.50 reel. Stewart Marshall, Rome, Ga.

1,000 FEET Of motion picture film, \$2.00. No lists. Sunset Film Exchange, 298 Turk St., San-Francisco, Calif.

NEW \$150 Spring movie camera, \$29.50; 35mm film, 2 $\frac{1}{2}$ foot; Filmo Camera \$100; Cine Kodak 16mm camera, \$50; 16mm, 100 ft. negative film \$4.50 postpaid; 100 ft. complete 16mm comedy, western travel, or war reel, \$4.50. Cameras, projectors and films bought and exchanged. New twin arc movie lamps \$40. 3 $\frac{1}{4}$ x5 $\frac{1}{2}$ Kodak, \$9; Remington typewriter, \$16. Ray, 296 Fifth Ave., New York.

\$1,250.00 FOR A photoplay story by an unknown writer and sold through our sales department. We revise, copyright and market. Located in the heart of the motion picture industry. We know the demand. Established 1917. Postal brings free booklet with full particulars. Universal Scenario Company, 206 Western and Santa Monica Bldg., Hollywood, Calif.

JUST Out! Fourth edition Motion Picture Projection by Cameron, 1,248 pages. Largest work ever published. Includes 150 pages on talking movies. Covers all known makes of projectors, including amateur. A liberal education. Yours for \$6.00 postpaid anywhere in the United States. Foreign, \$6.25. Circular on request. Bass Camera Company, 179 West Madison St., Chicago.

STARTLING Bargains in motion-picture cameras, projectors, apparatus. Send stamp for the 192nd issue of the Bass Bargaingram. Never in history has such startling bargains been offered in guaranteed apparatus. Write for your copy now. Remarkable motion-picture exposure meter, \$2.00. Sixty-six page catalogue. Send stamp. Bass Camera Company, 179 W. Madison St., Chicago, Ill.

MOVING Picture machine. DeVry portable. Cost \$250. Guaranteed like new. Sell half price. Alton Films, 205 Brush Creek, Kansas City, Mo.

TIME Counts in applying for patents. See pages 154 and 155. Clarence A. O'Brien, Registered Patent Attorney, Washington, D. C.

BIG Money in photography, motion picture projection. Catalog 49A free. New York Institute of Photography, 10 W. 33d St., New York.

MOTION Pictures for home use, 1,000 foot rolls \$3.50. Send for list. Toy Film Company, 804 South Wabash Ave., Chicago, Ill.

FILMS, 100 Feet 50c postpaid, listed. W. E. Temple, Dept. A, 13 Chester Ave., Somerville, Mass.

WANTED To buy—Second-hand Power's, Simplex and Motograph machines. Also extra mechanisms and stands. Must be bargains. P. O. Box 202, Birmingham, Ala.

BE A movie exhibitor—Big opportunity—Only moderate capital required—Complete equipment at remarkably low prices. Write. Atlas Moving Picture Co., 624 South Michigan Ave., Chicago, Ill.

NEW and Rebuilt Projectors for Theaters, Schools, Churches, Traveling Shows. Supplies and Complete Theater Equipments. Bargain Prices. Free Catalog. Monarch Theatre Supply Co., Memphis, Tenn.

MOVIE Films, 1,000 ft. reels, \$2.50 each; shipped anywhere on receipt of remittance. Particulars on request. Independent Films, 177 Golden Gate Ave., San Francisco, Calif.

MOTION Picture enthusiasts. Join Universal movie and stage fans. Write for information. International, 157 W. Santa Barbara, Los Angeles, Calif.

SCENERY TO RENT

WORLD'S Most Beautiful Settings for operas, plays, minstrels. Amelia Grain, Philadelphia.

EDUCATIONAL AND INSTRUCTION

FIREMEN, Brakemen, baggagemen (white or colored), sleeping car, train porters (colored), \$150—\$250 monthly. Experience unnecessary. 810 Railway Bureau, East St. Louis, Ill.

TRACE Missing people. Excellent paying work. Open to all. Write National Headquarters, 169 East 83rd, New York.

U. S. GOVERNMENT Jobs. \$1,260—\$3,400 year. Men—women, 18—50. Steady jobs. No "lay offs." Pleasant work. Paid vacation. Short hours. Experience unnecessary. Thousands appointments yearly. Full particulars with sample coaching, free. Write today sure. Franklin Institute, Dept. K-14, Rochester, N. Y.

U. S. GOVERNMENT wants men. \$1,700—\$1,900 and up at start. Railway Mail clerk examination coming. Let our expert (former Government examiner) prepare you for this and also Rural Carrier, Post Office, Customs, Internal Revenue, and other branches. Write today for free booklet. Dept. 8, Patterson School, Rochester, N. Y.

LADIES: Complete instructions for recoloring women's shoes and pocket books, 2 or 3 tone effects, easily applied after you learn trade secrets. Profits \$10.00 daily. Reid, Box 2092, Miami, Fla.

BIG Money in photography, motion picture projection. Catalog 49A free. New York Institute of Photography, 10 W. 33d St., New York.

STUDY A Scientific Profession. Sanitation—Bacteriology—Microbiology. Extension—Residential courses. Diplomas—Degrees granted. Urinalysis outfit and prospectus free. Int. College of Microbiology, 722 Calumet Ave., Hammond, Ind.

DON'T Prepare for any civil service examination without seeing our catalog. Free. Columbian Correspondence College, Washington, D. C.

WORK For "Uncle Sam." Postoffice clerks, carriers, railway postal clerks. \$1,700—\$2,700. Men 18—45. Sample coaching free. Write immediately. Franklin Institute, Dept. K-3, Rochester, N. Y.

BIG Demand for photoplay and magazine stories. We revise, develop and copyright. Sell on commission. Established 1917. Booklet free. Universal Scenario Company, 406 Western and Santa Monica Bldg., Hollywood, Calif.

WANTED Immediately, men-women, 18-55 qualify for government position, \$125-\$250 month. No experience required. Steady work. Vacations with full pay. Write. Ozmet Inst., 101, St. Louis, Mo.

HOME Studies, 50 subjects; best stenography or bookkeeping, 25c. Marr, Teacher, P. O. B. 605, Nashville, Tenn.

LEARN The theatrical business! Duties of a show manager, advance agent, etc., fully explained by Phil York. Postpaid \$1.00. Lindner Company, 745 Seventh Ave., Room 403, New York.

WILSON Private Boarding School, Dayton, Ohio. Write for information.

SHORTHAND In 30 days. Big field. \$35-\$45 week. Send for catalog. Chicago Home Study Schools, 801 Reaper Block, Chicago, Ill.

NEWSPAPER Linotype operators highest paid craftsmen. Easily learned, home or college. Free catalog. Linotype Institute, Maumee, Ohio.

MECHANICAL Dentists earn up to \$125 week. Big demand. Learn at Los Angeles in 3 to 9 months. Day or night classes. Practical, individual instruction. No book study. Free employment service. Write for free book. Smith Dental Institute, Dept. 8, 747 South Hill St., Los Angeles, Calif.

MEN-Boys learn auto mechanics and electricity. Big pay. Big demand. Free catalog. Stevinson School, 2008 A Main St., Kansas City, Mo.

ELECTRICITY Easily learned from Hawkins Illustrated Electrical Guides. Write for free electrical question book. Audel, 65 W. 23d St., New York.

DOUBLE Entry Bookkeeping mastered in 60 hours with 8 keys; guaranteed; diplomas. International Bookkeeping Institute, Dept. 8, Springfield, Mo.

BOYS—MEN 16 Up. Become auto mechanics. \$1,000 year. Particulars free. Franklin Institute, Dept. K-400, Rochester, N. Y.

STUDY Law at home. Lawyers earn \$5,000 to \$10,000 yearly. Send for catalog. Chicago School of Law, Reaper Block, Chicago, Ill.

BECOME A landscape architect. Un-crowded profession; wonderful opportunity for money-making. Easily mastered by mail. Earn while you learn. Est. 1916. Write for details. American Landscape School, 56, Newark, N. Y.

STUDY Mechanical dentistry and earn up to \$125 per week. Learn at home in spare time to make crowns, inlays, etc. Write for information. Modern Dental Institute, 49 South Main St., Salt Lake City, Utah.

RADIO OUTFITS AND SUPPLIES

CHEMRAD Radio chemical outfit. Experimenters, you should know radio chemistry, the alluring, thrilling, new science. Complete outfit includes chemicals, metals, apparatus, instructions sufficient to carry on chemical radio experiments, even television. Send \$4.98 money order, or sent C. O. D. Satisfaction guaranteed. Chemical Radio Co., 4730C, Drexel Blvd., Chicago.

TIME Counts in applying for patents. See pages 154 and 155. Clarence A. O'Brien, Registered Patent Attorney, Washington, D. C.

NEW Long distance "pocket" radio \$2.00. No tubes or batteries required. Useful and practical, loud-speaker volume, order direct. Spencer Laboratories, 116 Atlas, Akron, Ohio.

FIVE Tube sets \$9.90. In table model cabinets. Require repairs. See our display advertisement on page 172. This issue. Chas. Hoodwin Co., 4240 Lincoln Ave., Dealers in bankrupt stocks.

TRANSFORMERS 2,000-v., \$800; 650, 7½ and 7¼, \$5.50; 550v., 5-5, \$4.00; chokes 250MA, \$7.50; 100MA, \$5.00; 100MA, \$2.00. Write for specifications. Radio Parts Co., Orange, N. J.

NEW B-Battery Eliminators, 135 vts., only \$7.90 C. O. D. Money back if dissatisfied. Nat'l Co., 2309 Lawrence, Toledo, Ohio.

WANTED: Men to work with National Radio Service organization. No selling scheme. Radio Doctors, Inc., Dept. M, Essex St., Salem, Mass.

TRADE AND TECHNICAL SCHOOLS

OUR Commercial radio operating and junior engineering course pays our graduates \$150 to \$300 monthly from start. Rapid advancement. Winter term begins in January. Write for catalog of course including Extension Course. Loomis Radio College, Dept. 5-E, Washington, D. C.

LEARN Decorating, sign painting, paper-hanging, card writing. Practical training, oldest school in United States. Chicago Painting School, 448-A North Clark St., Chicago, Ill.

YOUNG Men—No experience. Become R. R. Station agents, telegraphers, or radio operators. Earn \$150 to \$300 monthly; no layoffs; rapid advancement. For free information write Illinois Telegraph, Room 711 117 N. Dearborn St., Chicago, Ill.

WANT A foreman's job? You may be a good mechanic but if you can't read blueprints you haven't a chance. I train you quickly. Write me your trade. Carroll Rumsey, 266 Drexel Building, Philadelphia.

TELEGRAPHY—Both Morse and wireless—taught thoroughly. Big salaries. Wonderful opportunities. Expenses low; chance to earn part. School established fifty-four years. Catalog free. Dodge's Institute, Fern St., Valparaiso, Ind.

LICENSED Radio doctors earn \$75.00-\$100.00 per week. Big demand; investigate at once. Free booklet. Radio Doctors, Inc., Dept. A, Essex St., Salem, Mass.

BUSINESS OPPORTUNITIES

TOOL Salesmen—Sell to auto mechanics, guaranteed line of 120 Oldforge tools—wrenches, pliers, chisels, screw drivers, punches, tool boxes. Exclusive territory. Give complete information about yourself, first letter. Quality Tools Corporation, New Wilmington, Pa.

SHAVE Without a razor—Yes, absolutely harmless. Send one dollar for three large packages, enough for 60 clean shaves. (Agents wanted.) Cervenec System, Box 4, Buffalo, N. Y.

HE Men only. Send one dollar currency for information regarding United States Patent No. 1,559,886. Particulars mailed promptly upon receipt of above. Address Midwest Promotion Co., 5 North Main, Hutchinson, Kans.

NO Peddling. Start own business. Home, office. Free folder describes 67 money-making opportunities. No outfits. Elite Co., 84 Elizabeth St., New York.

BUSINESS Profession of your own and earn big income in service fees. See Stephenson Laboratories, display ad page 148.

\$8,500 IN 17 Weeks—That's what Charles Worthen made. Do as he did, specialize in real estate. Use my successful system, begin at home in spare time, few dollars starts you. Full information free. Address American Business Builders, Inc., Room C5, 18 East 18th St., New York City.

CANDIES Homemade are only business where "Little Fellow" has the "Big Fellow" at a disadvantage. Turn your kitchen into small candy shop. Many now rich, started with no capital. Trade secrets taught by man who made big success himself. Free catalog. Capitol Candy School, Desk AH-5947, Washington, D. C.

FREE Samples: Will interest mechanics, carpenters, masons, common laborers, anyone that is progressive. Address J. W. Cowell, Grayling, Mich.

START Mail order business. Learn how. Write for details. Mail Order News, 500 Fifth Ave., New York.

MIRRORS Resilvered at home. Costs less 5 cents per square foot; you charge 75 cents. Immense profits plating like new, brassy worn-off autoparts, reflectors, tableware, stoves, etc. Outfits furnished. Details free. Sprinkle, Plater, 127, Marion, Ind.

COMPOSITION Floor making earns industrious men \$12 and more daily if used as trade. Or make business of it with profits up to \$10,000 yearly. Openings everywhere. Semi-Tile, Box 43, Hollis, N. Y.

MANUFACTURE Paint, varnish about 60c gallon. Formula \$1.00. Louis Martinek, Corona, N. Y.

MAKE Your own products. Formulas, processes furnished, \$1.00. Satisfaction guaranteed, or money refunded. Clore, Industrial Chemist, Crawfordsville, Ind.

EXTRA Money and a chance to establish your own independence can be made with well chosen spare-time occupation. We help you find it. Write Vocational Service, 316 Third St., New Westminster, B. C.

NEW Candy formulas, all kinds for home, shop, factory. Originating, my specialty. Pelmo Guillory, 2 Loop St., San Antonio, Tex.

FREE Book. Start your own little business anywhere, selling novelties by mail. My beginner's outfit contains everything required, novelties, circulars, instructions, etc. Descriptive book free. Hadwil, 3A-74 Cortlandt St., New York.

KING System mail order business, co-operation idea. It's new! Honest! Different! Big profits. Details free. Evans P. King Co., Wilmington, Del.

ANYONE, Anywhere, may earn good pay raising muskrats in pens in their back yards. Bulletin free. International Fur Co., Box 638, Dept. 7, Inglewood, Calif.

MAIL Order business information. We divulge actual supply source of American-made goods, how to sell locally, by mail or through agents. Chemical analysis, formulas, money-saving information, opportunities. Service catalog 10c. Business Information Syndicate, Box 1071A, Knoxville, Tenn.

TIME Counts in applying for patents. See pages 154 and 155. Clarence A. O'Brien, Registered Patent Attorney, Washington, D. C.

OPEN Toilet goods shop anywhere. We furnish everything. Samples and details free. Write quick. Liebig's, Beaver Dam, Wis.

DAYLIGHT Signs for trucks, stores, can make you rich. Make them yourself. Blue Print and Business Information, two dollars. Free-Ray Laboratories, 2019 Willow St., Chicago, Ill.

FOR Best business opportunities read Dolsen Herald, 24th year, copy 10c. Mail Order Business Guide, 28pp., 6x9, free. Advertise inch once \$4.00; 3 times, \$8.00. Circular mailing, \$2.50 thousand, 5,000 monthly. 23 years' experience. Paying imprint circulars supplied. 36 Liberty St., Brooklyn, N. Y.

MAIL Order business is your opportunity. Free particulars. Pruett System, Brookfield, Ill.

BIG Mails from everywhere, 10c. Free with order for Mail Dealers, Agent's Wholesale Directory, 60 pages, entirely revised, 40c. Reliance, 6618 Quimby, Cleveland, Ohio.

25c WILL Bring Porter's Postal Success (for mail order dealers and beginners) one year to you, and help you succeed. Copy 5c. Porter's Publications, 9416a 115th St., Richmond Hill, N. Y.

GOOD Positions are easy to get, anywhere. Write for free advice P22. Allard, 4724 Des Erables, Montreal, Can.

\$100 STARTS Profitable route of peanut and chewing gum machines. Particulars free. Chewit Corp., Dodworth St., Brooklyn, N. Y.

NEED More money? Our method for mail order business offers unlimited opportunities. Particulars for stamp. Zoll Service, Box 870, Lead, S. Dak.

ACCOUNT Collection business your opportunity. Free particulars. Bamos Renfrow, Canon City, Colo.

START A Crispette shop. Delightful confections. Everybody likes them. Make a lot of money. Adams reports \$364 profits in two days. We start you. Write, Long Eakins, 1962 High St., Springfield, Ohio. (Samples 10c.)

LOID-LAC—Make this new, wonderful, amazing discovery; restores color, new finish to old cars in sixty minutes! Not a polish, cleaner, paint or wax. With my simple guaranteed formula you can easily manufacture Loid-Lac, clearing \$14.00 gallon profit! Clean up thousands with this guaranteed instant refinishing. Miller, Chemist, 706 Miller Chemical Bldg., Tampa, Fla.

MILLIONS—Waiting to buy the wonder patented-combination auto tool-wrench-pry-clawhammer; indispensable to every autoist, no springs, no screws, quick ratchet adjustment, drop forged, steel, indestructible. Salesmanship unnecessary; just show it, it's sold. Agents, big money. Territory free. Write Auto Tool Company, 12 South Canal St., Chicago, Ill.

SHOE Shiners and tailors—Learn how to clean hats and make more money. Something new. Write Scientific American Hat Renovator, 432 Tenth St., New Kensington, Pa. Enclose stamp.

ATTENTION! Establish for yourself new system real estate, brokerage and insurance agency; office at home; earn \$5,000 year. Stamp free booklet. Hayes Realty Association, Cincinnati, Ohio.

"SCHEMER" Subscribers surely succeed. One reports \$50,000 from one tip; another \$25,000 from three Schemes; another \$10,000 from one formula. Try your luck! Year, \$1.00; three months, 30c. Patterson, Publisher, Alliance, Ohio.

IF You are interested in saving 30 to 35% on your postage bill, mail me 5c for usable samples of my covered envelopes and cards; none free. Edward Armour, M2, 136 East 28th St., New York.

CAPITAL Seekers—Put your project before 260 live wire brokers—cost trifling. Details free. Amster Leonard, East Orange, N. J.

MAKE Big Profits with a Fur Farm in your backyard. Chinchilla Rabbits, Muskrat, Mink. Write for facts. 252 Conrad's Ranch, Denver, Colo.

EARN More money—We show you how. Catalog free. Herman Service, 706 Calhoun, Fort Wayne, Ind.

SIGNS And showcards easily painted with letter patterns. Large variety of styles and sizes. Samples for stamp. John Rahn, a2120 Neva Ave., Chicago.

MAKE Money selling my beautiful sea shell watch charms. Sample by mail 20c. Dozen \$1.25. Box 2868, Miami, Fla.

SELL Latest imported novelties. French model pocket mirror and transparent art cards. Samples of all postpaid \$1.00. World Service Co., 336 Marcy Ave., Brooklyn, N. Y.

15c BRINGS Big bunch mail year. Kentucky Agency, Covington, Ky.

DELAWARE Incorporator. Charters; fees small; forms. Chas. G. Guyer, 901 Market St., Wilmington, Del.

BUSINESS Opportunities: Men and women—something new. Big profits. E. A. Barr Co., Desk 1, Shamokin, Pa.

SIXTY Successful mail order propositions. K. Home, 3949 Metropolitan, Chicago.

SELL by Mail! Books, novelties, bargains! Large profits! Particulars Free! B-Elfo, 525 South Dearborn, Chicago.

I MADE \$30 a Week Home. French Breadmaking. 15 years' experience; Free Booklet tells. Ashbrook 67, Marengo, Ohio.

MAIL Order business your opportunity. Brenner's famous hand books by expert 28 years' experience shows how to start selling articles you make or buy—all or part time—small capital. Fascinating, profitable. Set eleven books, \$3.25. Brenner Company, 1607 P. Sansom, Philadelphia. Sample book, 25c, pay \$3 for other ten if satisfied.

CHEMICAL Expert will furnish formulas and trade secrets. All lines. Lists free. W. L. Cummings, Ph. D., 228 Gordon Ave., Syracuse, N. Y.

DON'T Sell for others. Employ agents yourself. Make your own products. Toilet articles, household specialties, etc. 500% profit. Valuable booklet free. National Scientific Laboratories, 1984W Broad, Richmond, Va.

CHARTERS: Delaware; best, cheapest; free forms. Colonial Charter Co., Wilmington, Del.

UNPATENTED Ideas can be sold. I tell you how and help you make the sale. Free particulars (Copyrighted). Write W. T. Greene, 810 Baltic Building, Washington, D. C.

A BUSINESS of Your Own Making—Sparkling Glass Name and Number plates. Checkerboards, Signs. Big book and sample free. E. Palmer, 540, Wooster, Ohio.

MECHANICS, Painters, carpenters, start furniture refinishing, painting, handyman shop on nearly nothing; winning plan brings customers quickly. John Braceland, 1439 So. Ninth, Philadelphia, Pa.

ARTIFICIAL Marble sanitary flooring instructions, covering wood or cement flooring 1/2 inch thick, fireproof, waterproof, all colors, low cost. Ornamental casting, concrete, plaster, papier-mache decorations, garden furniture, statuary, flexible molds. 18 years instructing the public; particulars and illustrations free. Chris. Mahler, Huntington, N. Y.

WE Start you in business, furnishing everything; men and women, \$30.00 to \$100,000 weekly operating our "New System Specialty Candy Factories" anywhere. Opportunity lifetime; booklet free. W. Hillyer Ragsdale, Drawer 4, East Orange, N. J.

SUCCEED With Your Own Products. Make them yourself. Formulas, Processes, Trade-Secrets. All lines. Catalog, circulars free. B. Thaxly Co., Washington, D. C.

LEARN the collection business. Good income, quick results. Interesting booklet, "Skillful Collecting" free. National Collectors Assn., Long St., Newark, Ohio.

TELEGRAPHY

TELEGRAPHY—Both Morse and wireless—taught thoroughly. Big salaries. Wonderful opportunities. Expenses low; chance to earn part. School established fifty-four years. Catalog free. Dodge's Institute, H St., Valparaiso, Ind.

CHEMISTRY

SUBSCRIBE To the new Popular Chemistry! A monthly magazine containing latest chemical news, experiments, formulas, recent advancements in medicine, new uses for X-rays, ultra-violet light, radium, etc. Three trial copies (back issues), 30 cents. \$1.00 per year. Free solubility chart and book catalog to immediate yearly subscribers. Popular Chemistry, Dept. DP, Swedesboro, N. J.

BOOKLET Of experiments and chemical catalog 10c. George Ott, 1218 Chestnut, Reading, Penna.

YOUR Chemical problems solved and working formula or process furnished for \$5.00. Write me. W. Stedman Richard, Industrial Chemist, Box 2402, Boston, Mass.

FORMULAS AND TRADE SECRETS

ANY Formula 50c. Catalog 10c. Bernerd Wells, 852 George, Chicago.

FREE Formula, catalog, describing all lines. Western Chemical, Salem, Ore.

TRANSFERRING Photographs on cloth, etc.; formula 25c. "Erie," Waukegan, Ill.

OUR Tested detailed formulas are making others wealthy. Particulars and new 1929 catalog free. Grinstead Company, Oswego, Kans.

LATEST Imported money-maker out. Sample 25c. August Scheiderer, R. F. D. 2, Marysville, Ohio.

INDUSTRIAL Chemist furnishes formulas, plans, trade secrets. All lines. Work guaranteed. Lists free. J. F. Mazur, 941 20th, Lorain, Ohio.

LIQUID Cold solder. Miracle spot remover. Sales \$90.00 per afternoon. Both formulas, with instant demonstrations, \$5.00. Write Associated Chemists, Indianapolis, Ind.

FORMULAS, Processes furnished by experienced industrial chemist, \$1.00. Satisfaction guaranteed or money refunded. Clore, Industrial Chemist, Crawfordsville, Ind.

MONEY Makers—Formulas. Any kind. Moody Chemical, 1621 Plymouth, Bronx, N. Y.

FORMULAS: Guaranteed, catalog free. Bestovall Laboratories, 6720 Oconto, Ave., Chicago.

DON'T Sell for others. Employ agents yourself. Make your own products. Toilet articles, household specialties, etc. 500% profit. Valuable booklet free. National Scientific Laboratories, 1984W Broad, Richmond, Va.

SUCCEED With Your Own Products. Make them yourself. Formulas, Processes, Trade-Secrets. All lines. Catalog, circulars free. B. Thaxly Co., Washington, D. C.

FORMULAS—170 Money makers and big illustrated catalog 20c. Ideal Book Shop, (K) Park Ridge, Ill.

3,000 VALUABLE Formulas prepaid \$1.00. National Service, 3937 Marburg, Cincinnati, Ohio.

FORMULAS—High grade trustworthy processes for producing popular guaranteed best selling specialties; all lines. Don't buy formulas till you've received my literature. Miller, Chemist, 706 E. Jetton, Tampa, Fla.

AGENTS WANTED

NO Dull times in the food business. Selling Federal Pure Food Products is the greatest, surest and safest business in the world today, and here is your opportunity to get into it. You can make \$3,000, \$5,000, \$10,000 or more per year—the only limit is your ability to take care of the business. You will need no experience or money to get into this business. We teach you everything you need to know. We furnish you with license. No dull times, for the people must eat, and our food products are the fastest selling, surest and quickest repeat order goods in the world. Sell on sight in every home where food is used—repeat orders immediately and every week thereafter. A real big business all your own. Every new customer adds a great deal to your weekly income. Your business once established, has a market value just like a store and can be easily sold. The greatest money-making opportunity of your lifetime because you risk absolutely nothing. Remember! Guaranteed! Best products, biggest sellers, surest repeat orders. No capital or experience is required. We furnish capital and everything necessary for you to become a Federal distributor. Exclusive territory will be given honest men or women who write at once. Federal Pure Food Company, A2307 Archer Ave., Chicago, Ill. Largest packers of pure food specialties in the world. Reference, any bank, Dun or Bradstreet Rating Agency, Express or Railway Company in America.

PRIVATE Brand toilet articles, household specialties, perfumes, soaps, extracts, etc. We pack these goods for you under your private label. With your name on the goods you get all the repeat business. Don't sell for others but build up a profitable business for yourself. Highest quality merchandise. Extremely low prices. Quick shipments on both large and small orders. Write immediately for lowest wholesale prices and complete information regarding our amazing offer. Address Supply Department, National Scientific Laboratories, 1903W Broad, Richmond, Va.

AGENTS—I'll pay your bills, give you steady income for rest of your life if you will take care of my business in your locality, full or part time. You be my partner, make \$15 a day. Ride in Chrysler sedan. Distribute teas, coffees, spices, extracts, things people eat. I furnish everything, world's finest super sales outfit containing 30 full sized packages low prices, big repeat business; \$25,000 guarantee on quality. I go 50-50 with you. Get my amazing offer. C. W. Van de Mark, 117 Duane St., Dept. 102-P, Cincinnati, Ohio.

42 MILES On 1 gallon. Wonderful moisture gas saver. All autos. 1 free. Crithlow, L3-805, Wheaton, Ill.

\$50 TO \$100 Weekly. Men wanted to demonstrate the "fastest selling automobile accessory in the world"—Brite-Lite—the electro magnetic safety and emergency lamp. It's also a perpetual flashlight. No batteries to buy. It sells itself on sight. County rights now being allotted to live salesmen. Write for demonstrator and sales information to National Electric Corporation, 222 High St., Newark, N. J.

OUR Sewing kits offer more for the money than any other article on the market. Contents: eight spools of thread, assorted colors to match stockings, lingerie and apparel worn by women, assortment of needles, thimble, needle threader, premium coupon. Assembled in an attractive, decorated box. Retail 25c, profit 150%; sample 25c. Other fast selling side lines. Prentice Lee, 128 East 23rd St., New York.

AGENTS—\$13.80 Daily in advance, introducing new insured hosiery for men, women, children. Must wear or replaced free. 57 styles, 39 colors including latest "Silk to the Top" ladies' hose. Nyland made \$595 in one month. Edwards, \$460.60. Mrs. Bone, \$425.45. Why not you? Even spare time should pay you \$3.00 an hour. No experience needed. We furnish samples. New plan. Write quick. Macochee Company, Park 25612, Cincinnati, Ohio.

MAKE These guaranteed biggest selling products yourself. Have others selling them. Investment small; profits immense! Loid-Lac Instant Automobile Refinish. Tuf-Nit prevents hosiery runs. Kazok automobile dry wash cloth. My "Eye Opening" literature of these and many other automobile, food, household, cleaners, soaps, polishes free. Make your own goods for one-fourth what "Private Brand" and other goods cost you. Miller, Chemist, 706-A Chemical Bldg., field, Ohio.

REPRESENTATIVES Everywhere sell internationally known trade-mark protected "Keelocks" for mortise locks. Easily demonstrated. Easily sold. Send 25 cents for sample. Special wholesale rate to representatives. Keelock Manufacturing Co., 529 56th St., Brooklyn, N. Y.

IMPORT Your own goods. German export magazine published in English, offers numerous bargains latest novelties; opportunities for obtaining profitable agencies. Copy 60c. Square Deal Supply, P-246 Fifth Ave., New York.

SELL Men's neckwear; wonderful proposition. Astor, 318-M Broadway, New York.

CLEAN Up on pearls; every woman a customer; good money maker. Write Oriental Pearl, 925 Broadway, New York.

IT'S New and better! Lemon pie filling flavored with pure lemon juice. That's just one of the 300 quality items in the great Blair line of household necessities. Samples free. Big profits full or spare time. Territory now open. Write quick. Blair Laboratories, STCI Commerce St., Lynchburg, Va.

\$21 DAILY. Genuine DuPont Fabrikoid Tablecloths. No laundering—wash on the table—look like linen. Also other DuPont products. Doll-Ette Corporation, 1018 Wabash, Chicago.

CHRISTMAS Specialty. Make \$3.00 hourly selling stores and homes our beautiful Christmas window display cards; also Christmas sales cards: "Useful Holiday Gifts" and 20 other wordings. Free literature. Write today. Consolidated, 65-Q, West Van Buren, Chicago.

AGENTS: \$20 Daily! Latest patented ironing board pad and cover combination. Guaranteed. Low price. Sample for yourself free. American Braiding, 329 AS, West Monroe, Chicago.

INDOOR Racing—Fascinating new game. Make \$5.00 an hour. Big season ahead. Year-round entertainment. Ideal gift. Sample 50c postpaid. Write quick. Manowar, F-220 N. State, Chicago.

AGENTS—Make a dollar an hour. Sell new kind of sharpeners. Sharpens all knives and tools quickly. Demonstrating sample 10c. Premier Mfg. Co., Dept. 86, Detroit, Mich.

SACRIFICING Showroom samples, expensive fall dresses. Peddlers, storekeepers, home dress parlor people, write Hirschlar Dress Jobbers, 249 West 34th, New York.

BRAND New Xmas proposition. Chance to clean up. Everybody buys. Collect your commission in advance. Free outfit. A & J Jewelry & Novelty Co., G163 W. Washington, Chicago.

EXCLUSIVE Agents, either sex, can build a steady repeat business with Darn E-Z Adhesive Fabric Cement, 100% profit. Money back guarantee. Write quick. Dept. PM 2, Darn E-Z Laboratories, Dayton, Ohio.

TIME Counts in applying for patents. See pages 154 and 155. Clarence A. O'Brien, Registered Patent Attorney, Washington, D. C.

AGENTS—Best seller; Jen Rubber Repair for tires and tubes; supersedes vulcanization at a saving of over 800 per cent; put it on cold; it vulcanizes itself in two minutes, and is guaranteed to last the life of the tire or tube; sells to every auto owner and accessory dealer. Full particulars how to make big money and free sample, address Amazon Rubber Co., Philadelphia, Pa., Dept. 505.

WANT Distributing Agent for Handslick, powdered hand soap; removes anything from hands; everybody a customer; sample free. Solar Products Co., J-2142 S. Troy, Chicago.

GENUINE Gold Leaf Letters anyone can put on store windows. Guaranteed to never tarnish. Large Profits. Enormous Demand! Free Samples. Write today. Metallic Letter Co., 438-D North Clark, Chicago

DON'T Sell for others. Employ agents yourself. Make your own products. Toilet articles, household specialties, etc. 500% profit. Valuable booklet free. National Scientific Laboratories, 1984W Broad, Richmond, Va.

AGENTS \$240 Month. Bonus besides. Producers earn auto. Introduce new guaranteed hosiery—126 styles, colors. Finest silks. Credit given. Samples furnished. Wilknit Hosiery Co., Dept. 6031, Greenfield, Ohio.

AGENTS—If you need money write for free sample So Easy Mystery Polishing Cloth. Mohler, Box 453-F, Chicago.

\$15-\$35 A DAY Easy. Sensational invention. Positively new. Pierce Vapo Valve Oilier. Every auto owner interested. Makes any motor run better and quieter. Sold on 30 days' trial. No selling experience necessary. Wonderful opportunity. W. C. Pierce Co., 2432 Prairie Ave., Chicago, Ill.

\$15 TO \$25 Day E. Z. Just patented. Master Mfg. Co., 2430 No. Tripp Ave., Chicago, Ill.

\$20 DAILY Selling box assortment 20 engraved Christmas cards with interlined envelopes to match. Sells \$1.00, costs you 45c. Sample box sent free upon request. MacDonald Company, Vineyard Haven, Mass.

MAKE \$75 Weekly applying genuine gold leaf window signs. Our lower prices give larger profits. Scripts 80c foot. Free samples. Premier P-179 N. Wells, Chicago.

EARN More money. 31 page catalog tells how. free. Brookins, Warren, Ark.

GET Our free sample case—Toilet articles, flavorings and specialties. Wonderfully profitable. LaDerma Co., Dept. A, St. Louis, Mo.

AGENTS—Sell raincoats. (34) samples furnished. Write for free raincoat offer. Barton Co., 8, Marshfield, Mass.

NO Peddling. Start own business. Home office. Free folder describes 67 money-making opportunities. No outfits. Elite Co., 84 Elizabeth St., New York.

WANTED—Agents to sell snow lugs to automobile and truck owners. Britzius Mfg. Co., Dover, Minn.

AGENTS—Best health garment men and women ever patented; keep \$2, remit us \$1. Satisfaction guaranteed. Liberty Brace-Belt, Inc., 2929 Broadway, New York.

NEW Baseball game board. Makes all the plays of regular games. Quick sales, large profits. Send \$1.58 for agents' sample. Chester Brown, 510 Van Buren, Chicago.

BIG Money in Christmas display signs. Merchants buying for holiday business. 500% profit. Free sample. EverReady, 52-A East Ninth St., New York.

MAKE \$2.00 Every hour. Sell every home wonderful preparation; mends hosiery and clothing without sewing. Invisible. Results guaranteed. Send for free sample of work. Queen City Laboratories, PM-12, Cincinnati, Ohio.

\$20 TO \$40 A day selling amazing Gifts on cards to stores, Banks, garages. Large companies buy in thousand lots. We imprint names. Easy sales, big profits. Free sample outfit. Gits Co., E5419 W. Chicago Ave., Chicago, Ill.

MY Agents make \$90 a week wearing and showing my beautiful new free raincoat and giving away free hats. Write today for yours. Robt. King, 230 So. Wells, Dept. AB-12, Chicago.

NEW Invention—400% profit. Liquid quick mend for fabric and hosiery. Stops runs. Every woman buys. 100 other fast sellers. J. E. Johnson Co., Dept. 472, 6129 Wentworth, Chicago.

AGENTS: Fall and winter line ready. Men's and boys' overcoats. Sheeplined coats. Leather vests. Dress and flannel shirts. Ladies', men's and children's underwear, sweaters, raincoats and hosiery. Outfit free. Northern Sales Co., 101 So. Wells, Chicago.

RAINCOATS: Full line including latest trench coats, sheeplined coats, leather jackets, shirts; popular prices. Outfit free. Commission 25% with bonus. Hydro Raincoat Co., Dept. 45, 718 Independence, Chicago.

\$100 WEEKLY Appointing agents Mother Hubbard Foods. No canvassing, delivering or investment. Mother Hubbard Products, 554-F, Congress, Chicago.

BE Independent, make, sell your own goods. Immense profits. Catalog dependable formulas, special selected agents' best sellers free. R. Lusto, 626 Reaper Block, Chicago.

AGENTS, Portraits, photo-pillow tops, frames, sheet pictures, medallions, photo-jewelry, soaps, perfumes, laundry tablets, food products, toilet preparations, luminous crucifixes. Catalog 200 specialties free. 30-days' credit. Jas. C. Bailey Co., Station C-12, Chicago.

GENERAL Agents: Something new. Whirlwind seller. "Repeat" washing powder. Washes clothes without rubbing. Women throw away washboards. Big profits. Exclusive territory. Write today free package. Kittredge Co., 82 Putnam St., Tunkhannock, Pa.

BIG Xmas seller! Merchants need colored embossed signs. Everyone buys. Extra large profit. Dime brings fifty cents worth of samples. Franklin, 3322 Third Ave., New York.

SOMETHING New: \$15-\$25 daily, new product costs 15c, sells 50c. Repeats all year round. Write Reliable Products Co., 8 S. Dearborn St., Chicago.

AGENTS—Latest patent guaranteed bread knife. \$1.00 seller. Sample furnished. Territory open. Ideal Utensil Co., Otis Bldg., Chicago.

BIG Pay every day, showing Nimrod's All-Year Sellers! Dress, work and flannel shirts, overalls, pants, sweaters, underwear, pajamas, leather coats, lumberjacks, playsuits, etc. Experience unnecessary. Big outfit free. Nimrod Co., Dept. 8, 4922-28 Lincoln Ave., Chicago.

WRITE For free catalog phonographs, records and supplies. Orthophonola Mfg. Co., 757-F, Broadway, New York.

COMBINATION Ironing-table-stepladder. Agents' harvest. C. R. Smith, Freeport, Ohio.

MARVELOUS Seller—War Souvenir Memorial. 273 Columbia, Portland, Oreg. Samples 25c.

ARE You old at forty? See our advertisement on page 44 of this issue. The Electro Thermal Company, 2112 Morris Ave., Steubenville, Ohio.

IT'S New—It's great. Sells everywhere—and how! Metal polish in tubes. An opportunity you can't afford to miss. Trial tube free. P. M. Reid, 1619 Clark, St. Louis.

\$10-\$25 DAILY Simply showing new Polly wrench, 10 wrenches in one. Guaranteed seller. Sample free. Gellman Mfg. Co., Dept. 6F, Rock Island, Ill.

\$800.00 BEFORE Xmas taking orders for Rhinestone Initial Buckles; other fast sellers. Experience unnecessary. Pay daily. No investment. Outfit free. Chaton, 600C Blue Island, Chicago.

ENERGETIC Agents wanted everywhere for article appealing to men and women. Richard Lavery, Asbury Park, N. J.

INVESTIGATE Our unique sales plan—250 household favorites, quick sales. 100% profit, steady business. Davis Household Products, Dept. 510, 234 W. North Ave., Chicago.

HUSTLER Agents: Men, women. Earn fifty dollars a week. New staple article year round seller to all classes. Foamadent Co., Jamaica, N. Y., Box 19.

AGENTS: \$75 Weekly in spare time, introducing "Chieftain" silks, sandy, plain broadcloth shirts. You take orders. We deliver and collect. New group sales plan. Brand new style book and samples, mailed free. Cincinnati Shirt Company, Shop 15812, Cincinnati, Ohio.

AGENTS \$300 Month. Sell guaranteed silk hosiery. Must wear 7 months or replaced. Producers earn auto. New selling plan gives you silk hosiery for your own use. Write for samples. Betterknit Hosiery Co., Silk 3831, Greenfield, Ohio.

DON'T Sell for others. Employ agents yourself. Make your own products. Toilet articles, household specialties, etc. 500% profit. Valuable booklet free. National Scientific Laboratories, 1984W Broad, Richmond, Va.

MYSTERIOUS Fluid mends hosiery and fabrics instantly. Make \$100 weekly introducing it. Free outfit to workers. New Way Laboratories, Dept. 134, Mt. Healthy, Ohio.

\$15 A DAY Sure. Sell guaranteed solid leather shoes. Unequaled low prices. 85 styles; men's, women's, children's. Free Outfit offers complete line shoes, raincoats, leather coats, puttees. Consolidated Shoe System, Dept. 1115, Eau Claire, Wis.

WELLS Cleared \$620.00 in one month with "Business Guide" and free legal service. Write for free outfit. Prof. Nichols, Dept. 34, Naperville, Ill.

SELLING Like blazes! 11 piece toilet goods assortment at \$2.25 with 2 piece carrying set free to your customers. 100% profit. E. M. Davis, Dept. 511, 234 W. North Ave., Chicago.

AGENTS—Men's all-purpose suits! \$9.65! Workmanship, fit guaranteed! \$2.50 commission in advance. Free kit. Fix-U-Tailoring Co., Dept. 172-C, South Whitley, Ind.

AGENTS—Make \$3.00 an hour taking orders for our 40 fascinating kitchen specialties. No competition. Write quick. General Products Co., Dept. M-207, Newark, N. J.

42 MILES On 1 gallon. Wonderful moisture gas saver. All autos. 1 free. Critchlow, LA-805, Wheaton, Ill.

WILLING To work for \$1.50 to \$3.00 an hour? Buy, sell and apply Axtell Metal Weather Strips to door bottoms. Million used. Church Co., Whitman, Mass.

AGENTS—Easy to sell my fine merchandise for 1/2 what they pay. Bargain sales for stores. Easy money raising plan for ladies, schools and churches. Ray, 296 5th Ave., New York.

OUR Patent handy-hangers sell on sight. Send \$3.00 for box of 100, make \$7.00 profit. Auto-Body Shop, 42 Ninth East, Salt Lake City, Utah.

SELL 9x11 Blue signs. Koehler, Fourth & Morgan, St. Louis, Mo.

YOUR Favorite Products: Manufacture them yourself. Guaranteed manufacturer's formulas supplied. All lines. Latest specialties. Romig, Box 103-X, Station W, New York.

\$12.00 DAILY Showing new table cloth. Looks like linen. Wash like oilcloth. No laundering. You just take orders. We deliver. Pay daily. Sample free. Bestever, 152 Irving Park Station, Chicago.

HOUSEKEEPERS Dislike to clean stair-corners; earn big money selling Corner Dust Shields; write today. Ideal Stairway Equipment Co., Dept. PM, Canton, Ohio.

SELL Beautiful "Style Tailored" shirts, pajamas, lumber jackets and neckties direct to wearer at factory prices. Many beginners earn \$50 first week in spare time. \$100 weekly full time easy. Selling outfit free. Howard Shirts, 1213 Van Buren, Factory 37, Chicago.

PORTRAIT Agents make more money than any other class of agents. Write for our new catalog—Portrait enlargements, medallions, etc. Adam J. Kroll & Co., 2543 South State St., Chicago, Ill.

AGENTS—Highest commission-bonus selling dress goods at wholesale prices. Full-spare time. Sample outfit furnished. North American Importing Co., 1123A Broadway, New York.

NO Peddling. Start own business. Home office. Free folder describes 67 money-making opportunities. No outfits. Elite Co., 84 Elizabeth St., New York.

A NECESSITY For every home. The Safeguard Automatic Heat Control makes electric irons, waffle irons, percolators, etc., automatic. No more fires from overheated irons. Ironing revolutionized. Guaranteed. \$2.00 starts you in profitable business. \$7.50 to \$15.00 a day. Territory protected. Write today. M. Moreland, 1015 Chestnut St., Philadelphia, Pa.

SOMETHING New! Every motorist buys our Electro Magnetic Emergency Wonderlamp. One minute's demonstration makes a sale. Experience unnecessary. \$5 an hour easily made. Full time or evenings. Write for sample. Wonderlamp Co., Flisk Bldg., Dept. 10A, New York.

AMAZING New hygienic invention. Sells to every woman. Three sure-fire selling plans. Inventors, 1902 San Pablo, Oakland, Calif.

\$50,000 PICTURE Man Friedman made canvassing. Beginners can make \$100.00 weekly with my sales talk. Experienced men make more. Free book. "Profits in Portraits" explains. Sample free. Picture Man Friedman, Dept. 8-B, 109 W. Austin Ave., Chicago.

JUST Out—New patented apron. No strings or straps—\$20.00 a day every day; over 100% profit; commissions daily. Write for free offer. Sta-Put Co., Dept. 212, St. Louis, Mo.

BECOME your home town leading business man. Sell full line of groceries, motor oils, paints. Everybody a customer. No capital or experience necessary. Selling outfit free. Write Lovrin & Browne, 1662L So. State, Chicago.

WE Start you in a protected business of your own, \$100 to \$200 weekly easily made, without capital or canvassing, no agency. New introduction plan. District managers, men or women for new facial massage instrument; enormous demand and profits; few dollars for equipment starts you. For particulars, write quick to Massaway Company, 687-D Boylston St., Boston, Mass.

DAY-Light signs. Sensational money-makers. Write. General Stamping Works, 235 E. 24th St., New York City.

AGENTS \$300 Month. Dri-Kleanit makes any car look like new. Removes mud, grease, road oil, all one operation. No soap or water used. Cleans any car for 10c. Wonderful seller. Make \$5,000 year. Free demonstrating sample. American Accessories Co., Desk 3831, Cincinnati, Ohio.

BIG Profits; your own business, subagents, stores; newest, greatest quarter seller ever; sells itself; we trust you. Allen A. Burns, Niagara Falls, N. Y.

STRANGE Invention! Pays \$25 daily. Keeps telephone and iron cords from tangling and kinking. Prevents iron scorching. Saves electricity. Samples free. Newerknot, Dept. 12-A, 4503 Ravenswood, Chicago.

FLAVORING Extracts—Bottle yourself! Concentrated, add water. Free labels. 600% profits! Whirlwind moneymaking opportunity! Hurry! Thomas Manufacturing Company, Indianapolis, Ind.

REPRESENT Factory. \$20.00 daily selling changeable letter signs. Every merchant wants. 300% profit. Write for \$9.00 day guarantee offer. Maze Co., 542 Washington, Chicago.

COMPLETE Fall line fascinating raincoats. Newest trench models. Factory prices. Biggest commission advanced. Large outfit free. Jeffrey Mfg., 716 Madison, Chicago.

\$25 DAILY Selling \$2.85 latest raincoats. Hat free. Outfit featuring fifty numbers free. American Waterproof, 3724 Roosevelt, Chicago.

DON'T Sell for others. Employ agents yourself. Make your own products. Toilet articles, household specialties, etc. 500% profit. Valuable booklet free. National Scientific Laboratories, 1984W Broad, Richmond, Va.

\$60-\$200 A WEEK. Genuine Gold Letters for store windows. Easily applied. Free samples. Liberal offer to general agents. Metallic Letter Co., 438-B North Clark, Chicago.

LOWER Prices on gold-eyed needle cases. Finest agent's article; sell fast. Immense profits. \$50 to \$300 weekly. Proof free. Sample 10c. Paty Needle Co., College Ave., Somerville, Mass.

ARTOGRAPHOL? Agents say. collect \$1.00. Artographol, 128 Octavia, San Francisco.

AMAZING Scientific discovery offers you \$15 a day sure. No-Frost keeps auto windshields, show windows, mirrors, eyeglasses, etc., absolutely clear of rain, sleet, snow, frost, mist and steam. Quickly demonstrated. Motorists, bus drivers, motormen, storekeepers, hotels, restaurants, housewives buy on sight. Pocket package; large profits; tremendous field. Write for special introductory offer. No-Frost Co., 2194 Monmouth, Cincinnati, Ohio.

MIRRORS Resilvered at home. Costs less 5 cents per square foot; you charge 75 cents. Immense profits plating autoparts, reflectors, tableware, stoves, refinishing metalware, etc. Outfits furnished. Details free. Write Sprinkle, Plater, 128, Marion, Ind.

WEN—Make money. Sell Fifth avenue fabrics, dress trimmings, pattern service, semi-made dresses that almost make themselves. No experience needed—we show you how. Reserve your samples. Write today. Dept. P-12, Princess Silk Mills, 244 5th Ave., New York.

AGENTS—Here's a new one. "Bestever Powdered Hand Soap." Sells like wildfire. Marvelous discovery. Removes grease, paint, ink, oil, in fact anything from hands. Cannot harm skin. 150% profit. Great repeater. Agents simply coining money. "Free Samples Get the Business." Write immediately. Bestever Products Co., 207 Irving Park Station, Chicago.

ELECTRIC Cigar lighters. Make \$100 week. Brilliant flashing advertisements. Three beautiful models. Used by dealers everywhere. Write Drake Mfg. Company, Dept. M, Milwaukee, Wis.

AGENTS—We start you in business and help you succeed. No capital or experience needed. Spare or full time. You can easily earn \$50-\$100 weekly. Write Madison Company, 566 Broadway, New York.

DOUBLE Your income. Duo Quality Products call for more. Wonder cleaner, double strength extracts, toilet preparations, many household specialties. We co-operate fully. Beautiful premiums for customers. Splendid car for you. Write today. Duoform Co., C-1 Attica, N. Y.

GOLD Leaf Window Letters and script signs; no experience; 500% profit. Samples free. Our letters made Hazelhurst \$200 week. Consolidated, 63T West VanBuren, Chicago.

STOP: 300 Fast selling specialties from many parts of world. Proposition hard to beat. Write for free wholesale catalog. Spors Co., Lesueur Center, Minn.

MAKE Big money selling hair straightener to colored people. Write for free samples and terms to agents. Marcellene Chemical Co., 1906W Broad, Richmond, Va.

NEW: Just invented: Comb fastens anywhere. Send 10c for a 20c value. Comb Co., Lesueur Center, Minn.

AGENTS—100% Profit selling our low-priced, beautiful and attractive felt rugs. Perfect color combinations win instant admiration, insuring quick sales. Excellent opportunity to build substantial business. Eastern Mills, Everett, Mass.

AGENTS, Get ready for Christmas trade! Beautiful hand-decorated cards. Natural feathers. Mexican curls for dens, Indian rooms. Send 25 cents stamps, samples. G. Medina Rosa, 78 Mexico City, Mex.

BIG Profits selling useful holders. Capital unnecessary. Particulars free. Dow Mfg. Co., W. Lebanon, N. H.

32 SECONDS Complete tire change by Detmer, Ohio, with Morey Quick Action Rim Tool. Sold, singly, 49 three days, cleared \$100. Anderson, Mont., sold 1,400 in 14 weeks. Get details for good territory. Harvest time now. M. Morey Rim Tool, Buffalo, N. Y.

AGENTS—Big profits showing new ironing board pad and cover. Every housewife buys. Write for outfit offer! Burlington Blanket Co., Dept. F, Burlington, Wis.

AGENTS—Mosco Corn and Callous Remover will build you a steady repeat business. Send today for pocket-size trial outfit. The Moss Company, 418 Searle Bldg., Rochester, N. Y.

MAN In each town to plate auto parts, reflectors, bathroom fixtures, refinish beds, mirrors, chandeliers; by new method. No capital or experience required. Simple plan of manufacturing at home starts you in big money-making business. Outfit furnished. Free particulars and proofs. Gun Metal Co., Ave. H, Decatur, Ill.

AGENTS Wanted—To sell Electric Hair Clippers. Retail at \$8.75. Guaranteed. Useful in every home. The Master Appliance Co., Box 33, Racine Junction, Wis.

ARVEO Polishing cloths—they produce results. Be our local representative—big profits for you. Testing sample free. Arveo Industries, Dept. F, Grosse Ile, Mich.

AUTO Owner tire agent wanted each locality to use free demonstrating tires and take orders for new heavy duty Mellinger tires, guaranteed 15 months against all road trouble. Shipped on free trial. Get your own tires and earn \$300 monthly—no capital or experience needed. Write Mellinger Tire Co., Dept. 282, Kansas City, Mo., Warren, Ohio, Oakland, Calif.

BIG Money and Fast Sales. Every owner buys Gold Initials for his auto. You charge \$1.50; make \$1.35. Ten orders a day easy. Write for particulars and free samples. American Monogram Co., Dept. 40, East Orange, N. J.

MONOGRAM Automobiles. \$1.35 Profit ten minutes' work; every owner wants them; millions without; particulars free. Motorists Accessories Co., Mansfield, Ohio.

AGENTS—Clever Invention! Inkspoon makes every pen a fountain pen. Fast office seller; big profit, demand increasing everywhere. Exclusive territory offered. Sample free. H. Marul Company, Tribune Bldg., New York, N. Y.

WE Start You Without a Dollar. Soaps, Extracts, Perfumes, Toilet Goods, Experience Unnecessary. Carnation Co., 2480, St. Louis, Mo.

AGENTS: Stamping names on pocket-key protectors. Sample check with your name and address, 25c. Stamping outfits. Emblem checks, check-fobs, name plates. Hart Mfg. Co., Desk 2, 303 Degraw St., Brooklyn, N. Y.

DON'T Sell for others. Employ agents yourself. Make your own products. Toilet articles, household specialties, etc. 500% profit. Valuable booklet free. National Scientific Laboratories, 1984W Broad, Richmond, Va.

AUTOMOBILE Specialties. Guaranteed formulas for all latest money makers. Lowest prices. Write for free lists. Murphy, Chemist, Tujunga, Calif.

AGENTS. Our cigar lighters and salesboards sell quick. Large wholesale catalog free. Joseph Sales Company, 223 Madison St., Chicago.

\$1,000.00 REWARD If this is not the greatest money-making house to house proposition ever known. N. R. G. tablets wash clothes in 10 minutes without rubbing. Free samples. N. R. G. Co., H 500 W. Division, Chicago.

TWO Money makers for agents. "Francis" Pocket Adding Machine retails \$4.85. To you \$1.00. "Excelligraph" Rotary Stencil Duplicator \$37.50 retail. Write Typewriter Supply, 102 Hersch Bldg., Pittsburgh, Pa.

MAKE And sell your own goods. No machinery. Guaranteed formulas. Catalog free. Clover Laboratories, (E) Park Ridge, Ill.

AGENTS—Sell stores 5c candy Specialties. Lorrac Products, Albany, N. Y.

REPLACE brassy worn-off Automobile Parts, Reflectors, Bath Room Fixtures, Worn Spoons, Forks, etc., with pure silver. Looks like new. Use U-Kan-Plate Polish. Positively no mercury. \$1.00 half pints. Post Paid. Satisfaction Guaranteed. Agents wanted, Dept. A, U-Kan-Plate Co., Philadelphia.

\$50.00 WEEKLY easy, Applying Gold initials on Automobiles. No experience needed. \$1.45 profit every \$1.50 job. Free samples. "Raleo Monograms," X1043 Washington, Boston, Mass.

"HOW To Secure Agents," a specially prepared booklet, tells of one of the most inexpensive methods in which to secure good live producing agents. It is free; write for your copy today! M. L. Rund, Mgr. Classified Advertising, Popular Mechanics Magazine, 200 E. Ontario St., Chicago, Ill.

A BUSINESS of your own—Making sparkling glass name and number plates, check-boards signs. Big book and sample free. E. Palmer, 512, Wooster, Ohio.

CAN You sell a washing machine for \$9.75? Agents are making \$75.00 to \$300.00 weekly showing new automatic washer to housewives. Thoroughly cleans and sterilizes. No rubbing necessary. Write for protected territory. Storm Royalty Co., Inc., 3601 Enright, St. Louis, Mo.

SUCCEED With Your Own Products. Make them yourself. Formulas, Processes, Trade-Secrets. All lines. Catalog, circulars free. B. Thaxly Co., Washington, D. C.

FIBRE Brooms—detachable handles, fine finish. Good profits, repeat sales. The Fibre Broom People, 147-C New Jersey Ave., Brooklyn, N. Y.

REMNANT Store, Bethel, Ohio. Greatest Dry Goods Bargains on Earth. Agents and Dealers.

NEW Unusual necessities paying phenomenal profits. Make money as you've never made it. Unequaled, amazing detailed offer, free. Concentrated Products Co., Box 3772-P, Tampa, Fla.

POLMET Polishing Cloth removes tarnish from metals without the use of liquid, paste or powder. Our agents say it sells like "hot cakes." Retails 25c; sample free. Gale & Co., Inc., 15 Edinboro St., Boston, Mass.

OUR Luminous Crucifix Shines in the Dark. Every one amazed at the wonderful effect. Easily demonstrated—easily sold. W. G. Hannan Co., 2543 So. State St., Chicago.

AGENTS—Engraved name plates, signs, numbers, etc., easily sold, profits large. Brett Bros., Roxbury Crossing, Boston, Mass.

CALIFORNIA Perfumed beads selling like hot cakes. Agents coining money. Big profits. Catalog Free. Mission Factory P, 2328 W. Pico, Los Angeles, Calif.

PHOTO Medallion Men and Women, the largest line of Photo Novelties in the world. Lowest prices, quickest service. Send for catalogue showing over 200 money makers. Photo medallions, photo medallion clocks, photo mirrors, photo fountain pens, photo powder compacts, photo jewelry and photo buttons. Gibson Photo Jewelry Co., 608-614 Gravesend Ave., Brooklyn, N. Y.

HIGH-GRADE SALESMEN WANTED

\$273 PROFIT One day. That's what A. L. Bradley made without experience, just showing the most amazing automobile light you ever saw; 38,000 candle power without glare; fits inside regular reflector, easy to install; wonderful patented device; 100% more light; eliminates glare without dimming or tilting; pocket big money, waiting for you now; whirlwind seller makes astounding demonstration; low cost; agents cleaning up 300% profit; big repeater; sells on sight. Finch sold 1,398 sets in six months and will sell over 20,000 sets this year; 24,000,000 prospects want this light; write today. Aerial Electric Co., 326 West Ohio St., Chicago.

UNEMPLOYMENT. Elections, make slow collections for all merchants. Give them what they need. Not just collection system. Complete automatic credit and collection plan. Gets cash and keeps customer for merchant and for you. You get half cash on repeat orders for supplies without call-backs. Automatic income for you. 250% on original sale. Full or spare time. Judge by results! Commonwealth J Publishing Co., 508 So. Dearborn, Chicago.

FEW \$1,000 Monthly earnings ads are truthful. Our men actually earn \$300 to \$500 regularly selling our lines. Adelite, the new comer in electric window salesmen, is making a big hit. More for the money than anybody gives. Business posters for every line. Changeable letter system too. Permanent business for you working with us. Territory protected and repeats credited. Fat commissions. Full details will prove very interesting. Display Products, Ltd., 409-A East 31st St., Kansas City, Mo.

\$50 TO \$75 Weekly selling new improved coveralls and service coats with customer's name embroidered on back to garages, oil stations, etc. Advertising value and unusual construction gets the big orders. We pay biggest commission. Free outfit. Am. B. Co., 329 West Monroe, Chicago.

\$10-\$20 DAILY Selling printed stationery and new advertising specialties, blotters and envelopes. Good sideline. Liberal commission. Free sample outfit. Embograp, 4558-62 Elston, Chicago.

CHRISTMAS Cards—Start early. \$2.00 hourly, spare time. 87 samples free. Windermere Press (Established 1900), 6702 Dorchester, Chicago.

YOU Can make \$9 to \$15 daily with guaranteed home necessity. Sell dealers or direct. You are exclusive territory representative. Send 35c for sample and territory appointment. Moth-O-Way Distributing Co., Worcester Bldg., Portland, Oreg.

ABSOLUTELY New. 100% profit. Amazing check protector forgers and check raisers can't beat. Banks endorse it. Pocket size. Patented. Sells at only \$5, but does more work than \$150 machine. Needed by millions of depositors. Every check user buys at sight. Sample all you need. Write quickly for details and territory. Safety Check Protector Corp., Dept. E, North Chicago, Ill.

BEST Novelty out—"Cat's Me-ow." Cries just like a cat in post-cards. Everybody wants one. Going over big. Make \$20 a day easy. Pittle Supply Co., New Bedford, Mass.

PUNCHBOARD Salesman—\$250.00 per week easy. 90 complete deals. Slot machines of all kinds. The most gigantic line ever featured. Repeat commissions. Big beautiful 4 color catalog free. Lion Mfg. Co., 308 W. Erie, Chicago.

\$75-125 WEEK. New invention almost instantly sharpens safety razor blades without taking blade from razor. Sells to every self-shaver. Popular price. Over 150% profit. Quickest, easiest stropper ever invented. Hono-Strop Corporation, HC4, Baltimore, Md.

"SEVEN Eleven." Brand new. Punchboard. Sideline men \$200 weekly. Free catalog. Nothing to carry. Rudy, 339 Madison, Chicago.

SELL Nothing! \$170 weekly empty handed. Punchboard headquarters announce amazing new plan. No investment. We even pay express. K & S Sales Co., 4310 Ravenswood, Chicago.

IF You want \$6,000 the first year write me personally. Strong retail store line. Nationally advertised. Established company. Liberal weekly advance to producers. Busy season now. Geo. R. Williams, 2010 Euclid Ave., Dept. 1300, Cleveland, Ohio.

SALESMAN \$100.00 Weekly selling famous "Gilbrand" photo medallions, photo jewelry, photo fountain pens, etc. 400% profit. Quick sales. Write for free particulars. Gilbert Photo Novelty Co., 8 Cooper Square, Dept. J, 93, New York City.

A PAYING Position open to representative of character. Take orders shoes-hosiery direct to wearer. Good income. Permanent. Write now for free book "Getting Ahead." Tanners Shoe Mfg. Co., 10311 C St., Boston, Mass.

WALKER Made \$165.00 first day selling collection system to doctors and merchants. Costs \$2.50. Retails \$7.50. Write Adjustment Bureau, Mobile, Ala.

SALESMEN and distributors—To sell direct to banks, lawyers, dentists, merchants, garages, all business and professional men the new Deluxe Recording Tablet. Keeps permanent record of all transactions. Saves time, lost records, money. Salesmen average \$75 to \$100 weekly. Write for particulars and territory. Salesmanager, 655 Temple Court Bldg., Dept. 12, Minneapolis, Minn.

SELL Union label printing—Brand new proposition. Copyright cuts and elaborate outfit free. 40% commissions advanced. Beats all competition. Myerson, Q1132 So. Racine, Chicago.

EVERY Home a prospect. Make big money. Take orders tree, shrubbery. Experience unnecessary. No dull season. Commissions paid weekly. We deliver, collect. Write Perry Nurseries, Dept. R-12, Rochester, N. Y.

WONDERFUL Invention. Seals fifty envelopes minute. Sells on sight at \$3.50. Attractive proposition. Square deal. Bank references. Kendall Sealer Co., C6, East Jaffrey, N. H.

SELL Printing at 1/2 prices. Big commissions. Cloister Press, Cincinnati.

LIBERAL Commissions for selling advertising thermometers made by world's largest manufacturers of thermometers. Profitable proposition for energetic men. Write, giving past employment and references. Only few more men needed. Taylor Brothers Company, Division of Taylor Instrument Companies, Rochester, N. Y.

PROVEN Money-maker: New electric hot dog machine; sells \$18.50; commission \$6.50; buyers buy on sight. Leonard E. Dickerson, Dept. E-7, Springfield, Mo.

WANT Sideline income of \$4,750 a year? Write for free pocket sample kit of new advertising kitchen holder and average two easy orders a day from retail and other firms. Box E-222, Boonville, N. Y.

SALESMEN: Calling on manufacturers, department stores, institutions, schools, etc. Sell the building superintendent a giant pump, guaranteed product, removes stoppages in plumbing pipes. \$5.00 commission on each sale. Regular terms, may be placed on trial. No samples. Pocket selling outfit free. J. E. Kennedy Corporation, Key 4H, 79 Madison Ave., New York City.

SALESMEN—\$75-\$100 Weekly selling high grade signs, calendars, fans and novelties; full or part time. Big commissions paid promptly. Sample outfit supplied. Write today. Scioto Sign Co., Dept. L, Kenton, Ohio.

SALESMEN—Men's Rayon Swiss, Glosheen and Jacquard ties. New startling features; highest commissions. Wonder outfit free. National Service Mills, 2054 83rd St., Brooklyn, N. Y.

BIG Pay every day, showing Nimrod's All-Year Sellers! Dress, work and flannel shirts, overalls, pants, sweaters, underwear, pajamas, leather coats, lumberjacks, play-suits, etc. Experience unnecessary. Big outfit free! Nimrod Co., Dept. 65, 4922-28 Lincoln Ave., Chicago.

IT'S Legal. New and aplenty different! "Gypsy." It's whirling wheels fascinate everybody. Merchants buy eagerly. Clean up \$100-\$150 weekly. Cigar Stores, Dept. A, Peoria, Ill.

EARN \$20 A day. Establish income for life selling for \$1 a year, \$1,500 accident policy. Write W. C. Stone, 11 So. LaSalle, Chicago.

\$18 TO \$25 Daily; biggest selling line of 2-piece suits, \$9.95 and \$12.50; 3-piece wool suit, \$17.95 (regular \$28.00 value). All-wool overcoats, \$18.50. Splendid rain-coats, slickers and boys' suits. Biggest commission. Free outfits. "Jim" Foster, Inc., Dept. 212, 2250 S. Spaulding Ave., Chicago, Ill.

SALESMEN: If you are an average salesman and willing to work 5 days a week, we have a proposition that will net you \$100 to \$150 per week constantly. Credit on repeat business. 4911 Lincoln Ave., Chicago.

SELL Advertising lead pencils; splendid Christmas pencils and mailers; highest quality; prompt liberal commissions; dandy side-line. U. S. Advertising Pencil Works, Quincy, Ill.

\$100 WEEKLY Easily earned selling new patented electric water heater. Sells for \$6.50. You pay us \$3.00. Jiffy Electric Water Heater Co., 842 Maxlow, Detroit, Mich.

SALESMEN—Earn \$100 weekly taking orders for Dazzler and Rainbow glow electric signs. Big commissions. Exclusive territory. High grade proposition. Write Chicago Sign Sales Co., Dept. 43, Charlotte, N. C.

OH! What a sideline. Gigantic money-getter. \$4.00 commission every \$5.00 sale. Collects accounts so fast—storekeepers, doctors get dizzy. Brooks, Texas, sold (20) first day—commission \$80.00. We deliver and collect. Full commissions all reorders. Sample free. Federal Association, 17th St., Hartford, Conn.

BIG Money-making sideline! Make \$200 monthly extra. Show new, exclusive line coveralls and shop coats. Advertising embroidered on back. Every business prospect. Outfit free. Master Co., 4734 Dorchester, Dept. A-11, Chicago, Ill.

SELL Neon daylight signs. Uses no electricity, batteries or wires. No competition because of patented features. Priced low. Unusually liberal commission. American Store Sign Company, 228 North LaSalle St., Chicago, Ill.

SPLENDID Sideline. Excellent profits selling to trade finest complete line vending machines, etc. No samples, sell from catalog. Specialty Mfg. Co., B724 N. Racine, Chicago.

GOLD Leaf Window Letters and script signs; no experience; 500% profit. Samples free. Our letters made Hazelhurst \$200 week. Consolidated, 69-V West Van Buren, Chicago.

NEW! Fast seller! Make \$3.00 an hour daily. Sell "Advertising Work Suits." Every workman, business prospect. High-grade low-priced coveralls, shop-coats, 2-piece overalls. Firm name and advertisement woven on back. Outfit free. John Leeding Co., Dept. PM12, 70 E. 18th, Chicago, Ill.

\$60-\$200 A WEEK. Genuine Gold Letters for store windows. Easily applied. Free samples. Liberal offer to general agents. Metallic Letter Co., 438-A North Clark, Chicago.

ALL-YEAR-ROUND Profitable business selling wonderful new water softener and cleaner. Removes grease, oil, ink and dirt quickly. Every home and business place a live prospect. 100% profit. Big repeat orders. Exclusive territory. Write for free sample. Seacoast Laboratories, Sea Bright, N. J.

PUNCHBOARD Salesmen. 2 hours daily. \$100 every week. New line. Lowest prices. Full commission on repeat business. Catalog free. Puritan Novelty Co., 1409 Jackson, Chicago.

SELL Printing. Biggest line. 33 items. 600 free cuts defy competition. Largest commissions advanced. Pocket outfit free. Kaeser & Blair, Dept. 13, Cincinnati, Ohio.

LET Us help you build up a big, permanent, repeat order business handling groceries, auto oil, paint, poultry and stock supplies. No rent, no investment in goods. Big pay. Write Hitchcock Hill Co., Wholesale Grocers, 38 W. Kinzie, Dept. 1, Chicago.

SALESMEN: Earn 20% selling dealers our line newly patented "Sta-tite" hammer. This new, thoroughly practical idea eliminates competition, and low price makes sales easy. Nicholls Tool Co., Lemont, Ill.

PUNCHBOARD Salesmen: It's easy to earn repeat commissions with the "Lincoln Line." Merchants everywhere use punchboards. Someone sells them! Why not you? Big pay every day. Catalog free. Lincoln Sales Co., 9 South Clinton, Chicago, Dept. D.

DON'T Sell for others. Employ agents yourself. Make your own products. Toilet articles, household specialties, etc. 500% profit. Valuable booklet free. National Scientific Laboratories, 1984W Broad, Richmond, Va.

SALESMEN—Become Independent. Own your business; experience unnecessary, selling our \$7,500 Accidental Death; \$50 Accident; \$25 Sick Weekly Benefits—\$10.00 yearly. Other amounts proportionate. Guaranteed steady income from renewals. \$250,000 deposited Insurance Department, Universal Policy, Dept. A, 40 Clinton Street, Newark, N. J.

TO Market 3A garage door holders, simple automatic action, quickly installed, instantly attracts garage owners, builders, dealers. Write for exclusive territory proposition. Knowlson-Stevenson Co., 1118 Packard, Ann Arbor, Mich.

\$5 SALE—\$5 Commission with lifetime renewals. New combination life-accident policy. Write immediately. United Underwriters, PM-2, Willow Hill, Ill.

SELL Printing: 40% commission daily. Lowest prices, with or without deposit. Copy-right cuts free. Inquiry brings pocket outfit. Salesmanager, 1522 Wells, VanBuren Bldg., Chicago.

FURNACE Carburetor for any heating furnace or boiler. Eliminate 80% of smoke and soot. Reduces coal bill one-third. Easily installed and operated. We offer you a permanent business with a big profit. Give sales experience, reference and territory covered when answering. The Campbell-Hausfeld Company, Box 9, Harrison, Ohio.

NEW Profit sharing plan—150% profit. \$75 to \$200 weekly. Soaps, extracts, toilet articles, food products, etc. Free sample case. Experience unnecessary. Carnation Co., Dept. 2500, St. Louis, Mo.

SELL 365 Electric signs 7c apiece. \$8.50 profit every sale. Brilliant, blinking colors. Gilco, 217-CA N. Desplaines, Chicago.

PUNCHBOARD Salesmen. \$200 weekly. Liberal plan assures sales. Latest assortments. Nothing to carry. Full commissions on repeats. M&L Sales Co., 301 W. Adams, Chicago.

SALESMEN—Four \$15.00 sales to merchants net you \$40.00 daily. Sayers Systems, 2813 Sheffield, Chicago, Ill.

HELP WANTED

\$2.00 AN Hour for special advertising work among local families. Exceptional opportunity; pay starts immediately. American Products Company, 2195 Monmouth, Cincinnati, Ohio.

WHY Not sell us your spare time, \$2.00 an hour, \$19.70 daily easy full time. Introduce 12 months guaranteed hosiery—47 styles, 39 colors for men, women, children, including latest "Silk to the Top" ladies' hose and men's fancies. No capital or experience needed. We furnish samples. New plan. Maccochee Hosiery Company, Park 26012, Cincinnati, Ohio.

YOU Are invited to resilver mirrors at home. Immense profits plating auto parts, tableware, etc. Write for information. Sprinkle, Plater, 287, Marion, Ind.

ADVERTISING Work—\$5 to \$20 weekly. Everything furnished. Write W. M. Runion, New Market, Va.

MEN—Big money. Free samples. Pop-Goo, Box 471, New York.

SILVERING Mirrors, French plate. Patented process, easily learned. Immense profits. Plans free. Wear, Excelsior Springs, Mo.

PERMANENT Business your own; men and women, earn \$35 to \$100 weekly operating our original "Specialty Candy Factories." Few dollars starts you home spare time; we instruct and furnish everything. Booklet free. W. Hillyer Ragsdale, Drawer 350, East Orange, N. J.

OBTAIN Employment! Get positions you want, quickly, anywhere. Use clever "Ways That Win." One person was offered 70 jobs! Complete methods, 50 cents. Money promptly returned if wanted. New Idea Service, Box 39-1, Station K, New York.

INFORMATION

TECHNICAL Information, anything \$1. Money returned if we cannot answer. Commercial Service Co., Dekum Bldg., Portland, Oreg.

TIME And Labor-Saving Shop Kinks—hundreds of them—in our newest edition, Shop Notes for 1928, only 50 cents; also altogether there are 6,000 shop helps in the 15 volumes comprising the set. Price only \$4.50 postage prepaid. Send no money. Pay postman when he delivers package. Popular Mechanics Co., Room 810, 200 E. Ontario St., Chicago.

MAILING LISTS

99% GUARANTEED Mailing lists. Accurate. Reliable. Guaranteed. The kind that produces business; compiled for every possible business or individual. Lists of every kind of any business or individuals compiled for your individual needs anywhere. Catalog and information on request. National List, 847 Broad, Newark, N. J.

LATE Names—Opportunity seekers. Live, fresh, active. Guaranteed correct. Priced right. De Muth Company, Englewood, N. J.

1,000 1928 RURAL Women names, \$1.00. Sheasgreen, PM1427 North Penn, Minneapolis, Minn.

TYPEWRITERS AND SUPPLIES

TYPEWRITERS, all standard makes, \$10 up. Fully guaranteed. Free trial. Write for complete illustrated lists. Northwestern Typewriter Exchange, 121 N. Francisco Ave., Chicago.

TYPEWRITERS—Factory Rebuilt Royals, Remingtons, Underwoods, New Royal, Remington and Corona Portables. New "Excelsior" Rotary Stencil Duplicator \$37.50. Terms. Catalog Free. Pittsburgh Typewriter Supply, 945-339 Fifth Ave., Pittsburgh, Pa.

SIMPLEX Typewriters \$3-\$8; Remingtons \$12.00; catalog 5c. Demco, 114 Ford St., Prov., R. I.

TYPEWRITERS—All makes, \$6 to \$29. Fully guaranteed. Dee Typewriter Exchange, Ada, Okla.

TYPEWRITERS, Motorcycles \$3 to \$30. Knights, 1512 Locust, St. Louis, Mo.

PRINTING, ENGRAVING AND MULTI-GRAPHING

200 LETTERSHEETS And 100 envelopes \$1.00 postpaid. J. Ferreira, 249 Eugenia St., New Bedford, Mass.

200 LETTERHEADS And 100 envelopes \$1.00. 200 letterheads, 8 1/4 x 11, 150 envelopes \$2.00. 250 cards \$1.00. Catalog. Hoosier Print Shop, Portland, Ind.

MAKE A pleasing impression. 200 business cards \$1 postpaid. John Pokes, 2829 Elston Ave., Chicago.

100 ENVELOPES, 100 Business size letterheads, printed, \$1.00. Crane, 1111 E. 33d St., Kansas City, Mo.

PRINTING Presses, type, supplies. List 2c stamp. Bargains. Geo. Foster, 4342 North Robey, Chicago.

HAMMERMILL Printed social stationery; 200 sheets, 100 envelopes, \$1.00 delivered. Williamson Press, East Orange, N. J.

BUSINESS Stationery: 5m letterheads, \$12.50; 5m bill heads, \$11.25; 5m statements, \$10.00; 5m 6% envelopes, \$10.00. Printing of all kinds. Write for samples. Commercial Printing Co., Allendale, S. C.

50 EACH, Letterheads, envelopes, cards, \$1.00. Sherman, Printer, Merriam, Kans.

LETTERHEADS \$3.50 Thousand; envelopes, \$2.50; circulars colored bond, \$3.00; tags, cards, folders, books, publications. Low prices, superior work. Battlefield Press, Gettysburg, Penna. Free battlefield souvenir.

500 BOND Letterheads, cards, envelopes, statements \$2.00 each postpaid. Earl Kelley, Swanton, Vt.

PARTICULAR "Neagravure" processes business stationery. 'Nuf sed. Samples, prices (stamp appreciated); state business. Solidays, Knox, Ind.

MONOGRAM, 24 Boxes stationery \$20. 100 name cards \$1. P. Laflin, Coshocton, Ohio.

FINE Printing—Low prices. Large modern plant (thirty employees) in small town, low operation cost. Special prices on stationery, circulars, pamphlets, ruled forms, catalogs, large or small orders. Write for samples and prices. Shenandoah Publishing House, Inc., Box 1040, Strasburg, Va.

500 LETTERHEADS 8 1/2 x 11 and 250 Envelopes \$3.00 cash. Print anything lowest prices. Catalog free. National Printing, Goshen, Ind.

200 LETTERHEADS and 100 Envelopes, \$1.10, postpaid. Oberman Co., Box 1042, Chicago.

5,000 ELEGANT Envelope slips, \$5.00; 5 1/2 x 8 1/2 circulars, \$10.00. Folders, booklets, catalogs lowest prices. Samples. Goodprint, Harrisonburg, Va.

200 LETTERHEADS And 100 envelopes \$1.10 delivered. Cards, labels, circulars, catalogs, etc. Thiocomas, Martinsburg, W. Va.

NEOTYPED Form-letters on bond with printed letterhead: \$2.75, 500; \$4.25, 1,000. Printing, multigraphing, low prices. Samples free. Boggs, Box 826-P, Columbus, Ohio.

PHILATELIC Gossip — large 32-page weekly, three months with premium 25c. Gossip Print, Holton, Kans.

5,000 ENVELOPES, White (printed) 6% 24lb., \$8.50. We print anything. Lawrence Envelope Co., 700 So. Kedzie, Chicago.

250 BOND Letterheads, Envelopes, Billheads, Cards, \$1.35 each. Economic Press, Leonia, N. J.

QUALITY Printing! Reasonable Prices! Send for Free Standardized samples and prices. Folders, Circulars. Catalogs our specialty. Earnest Fantus, 525 South Dearborn, Chicago.

MULTIGRAPHING Business correspondence two dollars thousand. Hammerrill letterheads, four dollars; inexpensive quality, three dollars. Miscellaneous printing. Mayera Corporation, Monmouth, Ill.

WE Print stationery, booklets, catalogs, circulars. Samples. Commercial Press, Batavia, Ohio.

SAMPLES Raised letter printing with special prices free. LaClyde Service, Westfield, Mass.

1,000 6% Envelopes printed \$1.85. Free samples. Sports Printery, Lesueur Center, Minn.

500 BUSINESS Cards 98c. Other printing reasonable. Samples free. Hanzer's, 1039 S. Cleveland, Philadelphia, Pa.

500 BOND Letterheads, envelopes, cards, \$2.35 each. Quality, satisfaction, samples. H. Curtis, 811 Harrigan, Kalamazoo, Mich.

RUBBER STAMPS

RUBBER Stamps! Name, address, two lines 25c; three lines, 35c. DeLuxe Stamp Works, B572M, Auburn, Neb.

PRINTING, OUTFITS AND SUPPLIES

PRINTING Presses, type, etc. List free. Box 676, Wichita, Kans.

PRE-USED Printing presses. Type supplies. List for 2c stamp. Popular Bargains, Richland, Pa.

PRINT Your own stationery, cards, bookplate, Christmas cards, circulars, books, pamphlets, etc.; complete outfits, \$8.85; larger, \$11. \$29 rotary \$149. Print for others. Easy and interesting rules sent. Write for catalog presses, type, paper, etc. Kelsey Company, K-11, Meriden, Conn.

PRINTING Outfits—Presses, type supplies, type novelties. Send stamp for catalogue. Model Press, York, Penna.

DUPLICATORS AND DEVICES

YOU can make 50 to 100 copies of a letter, notice, etc., at a cost of three cents on a Heyer Quality Duplicator. Write for free trial offer. The Heyer Duplicator Co., 909 Jackson Blvd., Chicago, Ill.

ADDING MACHINES

NEW \$3.50 Automatic adding machine. Adds, subtracts, multiplies, absolutely accurate. Capacity \$999,999.99. Fully guaranteed. 75,000 pleased users. Makes adding easy, positive, quick. Eliminates mistakes. Saves time. Postpaid \$3.50. Bassett Co., 1458-N, Hollywood Ave., Chicago.

FOR THE HOME

GRANDFATHER'S Clock Works. \$5.00. Build your own case; instructions free; make good profits selling your friends. Clock works with chimes for old or new cases. Write for full particulars. Clock Co., Ruffner St., Philadelphia.

CEDAR chests only \$11.65—"Red-i-Kut" complete with rich copper trim—you assemble and save half—send for pictures. Kuempel Furniture Company, Guttenberg, Iowa.

LACQUER Your own furniture, save money. Hand sprayer, \$2.65. Ferretine, 226 Pine, Chicago.

WALNUT Boudoir clocks \$3.50. Guaranteed timekeepers. Box 221, Painesville, Ohio.

BOATS AND LAUNCHES

BOATS More popular than ever; be up to date, build your own boat during your spare time this winter using our knockdown materials and save money. 55 new designs. Send 25c for 1929 catalog. Brooks Boat Co., Inc., Rust Ave., Saginaw, Mich.

MAKE 16" Rowboat; blueprint 30c. Weesho-Uco, 31st Office, Detroit, Mich.

NEW Boat Book—Revised edition of Popular Mechanics boat building book contains valuable new information on building rowboats, speed boats and portable folding boats for tourists for use with out-board motor as well as other valuable articles on canoes, motor and sailing craft of various types. In addition a valuable book on Outdoor Sports the Year 'Round. Both for \$1.98. Pay postman price plus postage when he delivers package. Popular Mechanics Company, Room 810, 200 E. Ontario St., Chicago, Ill.

GUNS, SPORTING GOODS, ETC.

HUNTERS And trappers: See and try the "Screw-Bug," a mechanical ferret for routing rabbits, skunk and other burrowing animals. Sold direct by mail, allowing five days' trial with an absolute money back guarantee. Price \$4.00 each with order, or collect plus postage. Free circulars. The Grabow Co., Dept. A, Franklin Square, L. I., New York.

SHOTGUNS On monthly payments; all gauges; double barrel hammerless; full price \$25; single barrel hammer guns \$10; American manufacture known for 50 years. Write for catalog. Franklin Sporting Goods, Ampere, N. J.

KRAG Rifles—\$10.50; Springfields, \$27; Luger carbine stocks, \$1.50; exercisers, \$1.20. Write for complete catalog. Hudson Sporting Goods Co., W54 Warren St., New York.

ARCHERY

BOWS—Arrows, and all raw materials. Send for complete catalog. Stemmler Co., Queens Village, N. Y.

FIELD GLASSES, TELESCOPES AND MICROSCOPES

C-FAR Field glasses \$2. Consists of two rimmed lenses in neat leather case, slips into vest pocket, weighs only 1 1/2 ounces. Gives 6 diameters magnification. Money back if not satisfied. Send \$2 today to Buffalo Optical Co., Dept. PM-7, 574 Main St., Buffalo, N. Y.

USED Fieldglasses: \$2 to \$75. J. Alden Loring, Dept. J, O-we-go, N. Y.

FOR SMOKERS

AUTOMATIC Cigarette making machines. Rolls, glues 50 for 10 cents; illustrated folder. Postpaid \$2.50. For home use. Automatic Cigarette Machine Works, 6247-51 Broadway, Chicago.

SEND 10c Silver or stamps, for sample package 20 finest quality cigarettes. Large tin special smoking tobacco sent for 10c. Direct-to-smoker. French Tobacco Company, Dept. 65, Statesville, N. C.

RAZORS AND BLADES

SHARPEN Razor blades. Build a business for yourself. Easy, light work. Opportunities everywhere. Little experience necessary. Our machines produce perfect work, hollow-grinding, honing and stropping all blades. Established 1918. Write for free catalog. Velvet Edger Mfg. Co., 6001 Gramercy, Los Angeles, Calif.

ANTIQUES, WAR RELICS AND INDIAN GOODS

INDIAN Stone relics. 28-page catalog 5c. Grutzmacher, Mukwonago, Wis.

GENUINE Sioux Indian costumes and beadwork. Buying direct from Indian. Prices reasonable. Free price list. Lyon Curio Store, Clinton, Nebr.

SEND 5c For fine new list Indian relics, antique firearms. F. E. Ellis, Webster Groves, Mo.

FOR Dens, Relics and medals from Europe's battlefields. Illustrated catalog, 25c. International, 885 Flatbush Ave., Brooklyn, N. Y.

PHONOGRAPHS AND RECORDS

BUILD Your own photograph. Parts catalog and instructions to build new horn, mailed for 10c. American Phonograph Co., 4116 West 24th Place, Chicago.

MUSIC AND MUSICAL INSTRUMENTS

SONGWRITERS: Get in touch with me at once. Bell, D-6, 4718 So. Broadway, St. Louis, Mo.

NEW Patented bow and instructions for playing music on a common hand-saw. Postpaid \$1.08. H. O. Nichols, Lowell, Ind.

SONG-POEM Writers: Address Monarch, 236 W. 55th, Dept. 204, New York.

SONG Poem writers, "Real" proposition. Hibbeler, D1, 2104N, Keystone, Chicago.

MUSICAL Accessories, 3911 Ruckie St., Indianapolis, Ind. Get circulars, discounts.

SONGWRITERS, Substantial Advance royalties are paid on publishable work. Anyone having original ideas for songs may submit poems for examination and free advice. Walter Newcomer, 1674 Broadway, New York.

SONGWRITERS: Submit your song or poem. Same returned immediately if not accepted. Chester Escher, 1547 Broadway, New York City.

POEMS Wanted, 50-50 plan. Great Eastern Song Bureau, Dept. 27, Thomaston, Me.

FREE—"Song Writers Guide," Beaver, 1257 Elm, Green Bay, Wis.

SONG Writers: Send for our "Publishing Agreement." McKinley Music Printers, 1501 E. 55th St., Chicago.

SONG Poems solicited. A different proposition. Richard Broughton, Sioux Falls, S. Dak.

VIOLINS, Deep, mellow, soulful—on credit. Easy terms for wonderful instrument. Get details today. Gustav F. Henning, 302 University Building, Seattle, Wash.

CORNETISTS—Trombonists—Saxophonists—Clarinetists. Get "Free Pointers," Name Instrument, Virtuosi School, Buffalo, N. Y.

PLAY Piano by Ear. A Sound System. Booklet free. Boucher's Harmony Studio, Ottawa, Can.

SONG Poem Writers, Write Sequoia Songwriters' Service, Sherman Branch, Los Angeles, Calif.

"BANJOS" Should interest all musicians on account of the popularity of the Banjo, as it easily increases a Player's income. Illus. Catalog of 48 pages free. The Bacon Banjo Co., Inc., Groton, Conn., U. S. A.

I WANT Song Poems. Casper Nathan, 3544 N. Racine, Chicago.

"MUSIC Composed" to words. Bauer Bros. (formerly of Sousa's Band), Oshkosh, Wis.

WRITE Songs. Big money and reputation. Write for information. J. Gordon Pub. Co., 201 N. Hoyne Ave., Chicago.

PATENT ATTORNEYS

PATENTS—Write for our free book, "How to Obtain a Patent" and Record of Invention Blank. Send model or sketch of inventions for inspection and instructions free. Terms reasonable. See advertisements on pages 156 and 157. Victor J. Evans & Co., 934 Ninth, Washington, D. C.

TIME Counts in applying for patents. See pages 154 and 155. Clarence A. O'Brien, Registered Patent Attorney, Washington, D. C.

LACEY'S Patent Sense. Valuable book free. See ad page 159.

"INVENTOR'S Guide," valuable information, free. Frank Ledermann, Registered Attorney-Engineer, 1712 Woolworth Bldg., New York.

PATENTS Procured at reasonable rates with time to pay. Sales negotiated. Staff of registered attorneys and engineers. A complete service for inventors. Write for particulars. Inventors Service Bureau, Union Trust Bldg., Washington, D. C.

INVENTORS—Why pay more? H. M. Plaisted, registered patent attorney; thirty years' experience patents and trade-marks. 4413 Page Blvd., St. Louis, Mo.

PATENTS—Free instructions. Former patent office examiner. Moderate terms. Booklet. Albert Jacobs, 727 Barrister Bldg., Washington, D. C.

PERCY S. WEBSTER, 203 Saving and Loan Building, Stockton, Calif. Patent booklet free.

INVENTORS: Send for booklet telling how to patent and sell your inventions at lowest cost. Ralph Burch, Patent Lawyer, 900 F St., Washington, D. C.

PATENTS Procured, prompt service, personal careful and efficient service. Highest references. Moderate fees. Send sketch or model for actual search and advice. George P. Kimmel, Master of Patent Law, 54-L, Legal Bldg., Washington, D. C.

INVENTOR'S Advisor with mechanical movements sent free. Labiner, Three Park-row, New York.

JOHN PATTEN DUFFIE, Registered patent attorney, Victor Bldg., Washington, D. C. Reasonable rates. Advice free. Booklet.

PATENTS. Prompt personal service. Write for information. Albert E. Dieterich, Registered Patent Lawyer, 621½ Ouray Bldg., Washington, D. C.

PATENTS—Write for free instructions. Send drawing or model for examination. Carl Miller, Registered Patent Attorney (former Patent Office examiner), 259 McGill Bldg., Washington, D. C.

INVENTORS: Send sketch or model for advice and exact cost of patent. Ask for our Free book: "How to Obtain a Patent." Tells what every inventor should know. Established twenty-eight years. Highest references. Prompt service. Reasonable charges. Chandlee & Chandlee, 414 Seventh, Washington, D. C.

PATENTS Procured—Trade Marks Registered—A Comprehensive, experienced, prompt service for the protection and development of your ideas. Preliminary advice gladly furnished without charge. Booklet of information and form for disclosing idea free on request. Irving L. McCathran, 200 Owen Bldg., Washington, D. C., or 41-R Park Row, New York.

PATENTS, Trade-Marks, Designs. This firm has 27 years' experience and gives expert personal service at reasonable rates. We properly protect your invention. Write for free information and exact cost of procuring patent before proceeding. John B. Thomas & Co., 902 F St., N. W., Washington, D. C.

ADVICE Free! Patents procured—Reasonable—efficient Service. 25 years' experience. Chester W. Brown, Registered Patent Attorney, 510 Van Buren Street, Chicago.

PATENTS. Booklet free. Highest references. Best results. Promptness assured. Send model or drawing for preliminary examination. Watson E. Coleman, Patent Lawyer, 724 Ninth St., Washington, D. C.

PATENTS, Trade-marks, Copyrights. Reliable services by an experienced practitioner devoting personal attention to each case. Inquiries invited. References furnished. B. P. Fishburne, Patent Lawyer, 525-A McGill Bldg., Washington, D. C.

MONROE E. MILLER, Ouray Bldg., Washington, D. C., Patent Lawyer; Mechanical, Electrical Expert. Booklet and Priority Record blank gratis.

SELL Your invention before patenting. Write for free particulars. W. T. Greene, 801 Baltic Bldg., Washington, D. C.

ESTABLISHED 1864. Milo D. Stevens Company. Free Booklet. Patents, Trade-Marks, Copyrights, Offices. Monadnock Block, Chicago; Barrister Building, Washington, D. C.

INVENTORS—Write for our Guide Book, "How to Get Your Patent," and Evidence of Invention Blank. Send model or sketch of your invention for our prompt examination and instructions free. Randolph & Co., Dept. 430, Washington, D. C.

UNPATENTED Ideas can be sold. I tell you how and help you make the sale. Free particulars (Copyrighted). Write W. T. Greene, 806 Baltic Building, Washington D. C.

LANCASTER and Allwine, 221 Ouray Bldg., Washington, D. C. "Originators of the Form Evidence of Conception." Before disclosing your invention to anyone send for blank form to be signed and witnessed. Form and patent information bulletin free.

FOR INVENTORS

PATENTS. If you have an invention which you wish to patent you can write fully and freely to Munn & Co., for advice in regard to the best way of obtaining protection. Please send sketches, or a model of your invention and a description of the device, explaining its operation. All communications are strictly confidential. Our Hand-Book on Patents is sent free on request. This explains our methods, terms, etc., in regard to Patents, Trade Marks, Foreign Patents, etc. "Scientific American" contains Patent Office Notes. Decisions of interest to inventors and particulars of recently patented inventions. Munn & Company, Solicitors of Patents, 1523 Scientific American Building, 24 W. 40th St., New York City; 524 Scientific American Bldg., Washington, D. C.; 1313 Tower Bldg., Chicago, Ill.; 666 Hobart Bldg., San Francisco, Calif.; 521 Van Nuy Bldg., Los Angeles, Calif.

INVENTIONS—Write for our free book, "How to Obtain a Patent" and Record of Invention Blank. Send model or sketch of inventions for inspection and instructions free. Terms reasonable. See advertisements on pages 156 and 157. Victor J. Evans & Co., 157 Ninth, Washington, D. C.

TIME Counts in applying for patents. See pages 154 and 155. Clarence A. O'Brien, Registered Patent Attorney, Washington, D. C.

LACEY'S Patent Sense. Valuable book free. See ad page 159.

INVENTIONS Wanted. If you have patented or unpatented idea, write Chicago Metal Novelty Co., 8390 South Chicago Ave., Chicago.

INVENTIONS Developed and commercialized. Frank G. Buffum Mfg. Co., Louisiana, Mo.

I SELL Patents. A nationally respected service for the inventor. Charles A. Scott, 773M Garson Ave., Rochester, N. Y.

INVENTIONS Wanted—Patented, unpatented. If you have an idea for sale, write Hartley, Box 928, Bangor, Me.

INVENTORS—Cash in on your invention now! Don't delay the sale any longer! Send for a free copy of our specially prepared booklet, "Turn Your Patent Into Money," today! It contains helpful information for all inventors. M. L. Rund, Mgr. Classified Advertising. Popular Mechanics Magazine, 200 E. Ontario St., Chicago, Ill.

WE Sell patents by calling personally on manufacturers any part United States. Write for terms. Birk & Green, 300 So. Halsted St., Chicago.

PROFIT On your patent. 230 page book \$2 on approval. Tells how to profitably sell patents, new ideas. Patent Enterprises, California Bldg., Los Angeles, Calif.

GET your own patents. Legal blanks, complete instructions \$1. Cutting Sons, Cambell, Calif.

UNPATENTED Ideas can be sold. I tell you how and help you make the sale. Free particulars (Copyrighted). Write W. T. Greene, 807 Baltic Bldg., Washington, D. C.

WANTED—Patented medical or health device to manufacture on royalty basis. Cincinnati Automatic Machine Co., Cincinnati, Ohio.

INVENTORS Universal - Educator—contains 900 mechanical movements; 50 perpetual motions. Tells how to obtain and sell patents. Suggests new ideas. Explains how to select your attorney and avoid patent sharks. Price (revised edition) \$1.00 postpaid. Albert E. Dieterich, 621 Ouray Bldg., Washington, D. C.

PATENTS—Write to B. P. Fishburne (a South Carolinian), Registered Patent Lawyer, 525-E McGill Bldg., Washington, D. C.

SELL Your invention before patenting. Write for free particulars. W. T. Greene, 802 Baltic Bldg., Washington, D. C.

PATENTS FOR SALE

COMBINATION Cookie-doughnut dropper, proven practical. 150 in use. Rare opportunity for oven and doughnut kettle manufacturer. Humphreys, 815 Bayswater Ave., Burlingame, Calif.

OUTRIGHT Or royalty—Indicator for homes, offices and apartments. Pressing of door bell indicates whether occupants are at home, or set at any other desired indication. Paul Kosecki, 6627 23rd Av., Kenosha, Wis.

CASH Or royalty—Patent on flag pole and display devices. Ignatz Udoch, 0392 62d St., Milwaukee, Wis.

OUTRIGHT—Wonderfully improved collapsible shoe shiner. E. J. Young, 135 So. Main St., Tucson, Ariz.

OUTRIGHT, Morning Dew Hair Grower. Morning Dew Manufacturing Co., Guthrie, Okla.

OUTRIGHT—Line-up devices for crank shaft and cylinders for marine engines. Also new mechanics' horizontal and vertical level. Harvey Wescott, 132½ Noble St., Brooklyn, N. Y.

OUTRIGHT Or royalty: Patent pending; metal cigarette extinguisher and receiver; conceals butts and ashes; manufactured cheap. Richard B. Mattson, Bessemer, Mich.

A COLLECTION Of 3 safety window locks for sale on royalty basis. Call or write to Giuseppe Pitrone, 12550 Euclid Ave., Up. E. Cleveland, Ohio.

BABY Feeder of rubber covered wire, attachable high chair, crib, carriage; costs 20 cents, sells like lightning, 98 cents. Maurice Jaffe, Hotel Strand, New Haven, Conn.

METAL Safety seal for envelopes prevents tampering with contents. Louis Unger, 9071 Centerline Ave., Detroit, Mich.

COST Mark and selling price stamp for stores. A. McLean, Cedar Grove, W. Va.

TIME Counts in applying for patents. See pages 154 and 155. Clarence A. O'Brien, Registered Patent Attorney, Washington, D. C.

SWIVEL For all movable electric cords, including telephone receiver cords. Prevents twisting and wear caused thereby. Patented. R. B. Cunningham, 819 Quincy St., Topeka, Kans.

FOR Sale—Fisking machine run by water. Send for copy. Jose I. Suarez, 730 2nd Ave., New York.

LATEST Novelty—Atomizer concealed in airplane. Patent applied for. Address Box 28, Whitesboro, N. J.

OUTRIGHT—Self-operating dust-proof ash sifter for homes and hotels. P. Corley, 2103 67th St., Brooklyn, N. Y.

OUTRIGHT, Automobile heater. Henry Hubbard, 13823 Fernwood St., Cleveland, Ohio.

CORN Husker, outright or royalty basis. Something new. Earl McNeely, Waldron, Ind.

OUTRIGHT Or royalty—An opportunity for manufacturer. Extendable table. Cheap to manufacture. U. S. and Canada patents. Henry Starcker, 2 Vreeland Place, Jersey City, N. J.

EXTENSION Holder—Bit instantly engaged or released. Impossible to wedge it. Manufacturing cheap. Chas. W. Smith, 49 James St., Green Island, N. Y.

OUTRIGHT Or royalty. Sure-grip tongs. U. S.-Can. patents; many advantages. Perfectly engages and disengages object with one hand operation. J. Anton Nelson, Bertrand, Nebr.

PATENT Applied for. One-half cash and royalty. Automobile and aeroplane piston ring. Walter S. Shallenberger, 208 Meadow Ave., Charleroi, Pa.

AGENCIES WANTED

LISTEN! Manufacturers, mail order houses, I am interested in latest novelties. Carlos A. Suarez, Villegas 3, Havana, Cuba.

FOOD Products, spices, fruit syrups, sanitary rubber goods. Send me your proposition. Excellent market. Carlos A. Suarez, Villegas 3, Havana, Cuba.

MANUFACTURING

CONTRACT Manufacturing of metal parts, ideas developed, metal stampings, models, dies and screw machine products. Schroer Manufacturing Co., 2221 Campbell St., Kansas City, Mo.

ACME Model Works, 200 North Jefferson St., Chicago, Ill.—Working models, mechanical, electrical and optical apparatus designed and built. Screw-machine work. Stamping.

MANUFACTURING Models, dies, stampings, brass work, one or thousands. Circular free. Baum's Metal Specialties, Kansas City, Mo.

SPECIAL Machinery or parts, dies, tools, metal specialties, models, special gears, stock gears and model supplies. Send for Catalogue. The Pierce Model Works, Tinley Park, Ill.

ECONOMICAL Manufacturing from sheet, bar, wire or tubing. Models, dies, special machinery. Swanberg, 5124 N. Kildare Ave., Chicago.

WIRE goods made to order. Cooley Mfg. Co., 530 N. Western Ave., Chicago.

MACHINERY, TOOLS AND SUPPLIES

NO. 1 Brown & Sharpe universal miller with dividing head, \$175.00; 12"x5" Barnes engine lathe, \$95.00; No. 60 Health grinder, \$275.00; 24" Barker back geared crank shaper, \$400.00; 16" Walcott shaper, \$145.00; 20"x10" Flather quick change lathe, \$375.00; 24" Hamilton drill press, complete, \$135.00; Quincy air compressor with tank and hose, \$65.00; 10" bench drill press, \$19.00. Terms to suit. Write for catalog. Cincinnati Machinery & Supply Co., 28 West Second St., Cincinnati, Ohio.

COMBINATION Bench saw only \$9.80. Runs with ¼ horse power motor. Will rip and crosscut. Consists of 6 inch saw, grinding, drilling, polishing, sanding attachments. 100 other bargains. Washing machine motors, \$5.50. ½ H. P. \$15.75. Electric drills \$13.95, electric grinders \$7.55, etc. Send for bargain bulletin No. 633. Acme Tool Co., 627 Washington St., Chicago, Ill.

HEAVY Duty portable electric drills, cannot be stalled by two men; ½", \$22.00; ¾", \$48.00; 1", \$64.00; 1½", \$78.00. Ten dollars down, balance easy terms. Here is something new, just out. Refillable pencil and spark plug testers combined. Send \$1.00 for sample today. General Distributing Company, Duluth, Minn.

WOODWORKERS, New accessory for circular saw. Makes tenon joints quickly. Guaranteed. Price \$2. Particulars 2c stamp. Clayton's Workshop, Port Huron, Mich.

AMERICAN Steel split pulleys complete with bushings, any standard size. 50% discount from list price. Wire, write or phone. "Botwinik Brothers, Inc.," 67 Water St., New Haven, Conn.

CONCRETE Building block machines and molds. Easy payments. Catalog free. Concrete Machine Co., 5 North Main St., St. Louis, Mo.

COMPRESSORS, Twin cylinder, for small tire shops. Duce spraying. J. Trockman & Sons, Inc., 110-112 Lincoln Ave., Evansville, Ind.

START business of your own, small investment required, doing nickel, copper and silver plating. This work in big demand. Information free. Electro Platers Supply Co., 517 Considine Ave., Cincinnati, Ohio.

ENGINES, MOTORS AND DYNAMOS

EXCEPTIONAL Offer, absolutely new motors, 2 year factory guarantee; latest type ½ regular cost; ½hp., \$20.00; ¾hp., \$9.75; 1hp. double shaft grinders complete, \$14.50. Motors all a.c., 110v., 60 cycle, 1 phase, 1740 R.P.M., constant duty, plug and 9 ft. cord. For shop or home use. Shipped F.O.B. Chicago, cash with order. Maynard Miller, 518 No. Sawyer Ave., Chicago, Ill.

TIME Counts in applying for patents. See pages 154 and 155. Clarence A. O'Brien, Registered Patent Attorney, Washington, D. C.

MERITORIOUS Small, wood, wire, household article, extremely useful, valid patents. A. Wood, 3020 Magnolia St., Oakland, Calif.

ADJUSTABLE Measuring and sacking can, for commercial and household use. Patent pending. J. B. Fisher, 208 South Main St., Caldwell, Kans.

MANUFACTURERS Or promoters—First \$3,000 takes U. S. and Canada rights on garage device, U. S. No. 1,533,483. Great possibilities.

PATENT—Fortune in stop-direction signal on autos visible all around. Sale or royalty. F. Cox, 536 Rush St., Chicago.

OUTRIGHT—Method of mixing water and gasoline. Engines got 63 miles per gallon. J. W. Cook, 43 Benefit St., Ashtabula, Ohio.

FOR Sale outright or on royalty, patent on wind-power generator. For particulars write to G. Silvestrin, 320 Spofford, Port Arthur, Ont., Can.

OUTRIGHT—Simple mechanical dandelion remover, destroys plant permanently with one pull. Louis Mauch, 846 Corona St., Denver, Colo.

WINDSTORM Hat retainer. Louis Pichler, 670 E. 102, Cleveland, Ohio.

OUTRIGHT—Reasonable pipe joint for toilets, bathtubs, basins, sinks. Patented United States and Canada. Robert Dawson, Skillman, N. J.

FOR Sale—Patent on dirigible head lights for automobiles and trucks, very simple and efficient, also cheap to manufacture, a system everybody will want. Sell for cash and royalty. Arnold E. Daly, Mather, Manitoba.

PATENT Pending, attachment for deep well hand and power pumps; pump runs one-third easier, smoother, cheaper, inexpensive, practical, demand unlimited. Samuel McClay, 1300 25th St., N. W., Canton, Ohio.

YOUR Idle patent can be turned into ready cash, quickly! One inventor sold his patent at a cost of only \$3.50. Send today for a free copy of our booklet, "Turn Your Patent Into Money." M. L. Rund, Mgr. Classified Advertising, Popular Mechanics Magazine, 200 E. Ontario St., Chicago, Ill.

SURVEYING INSTRUMENTS

SAVE On transits and levels. Rebuilt instruments. All kinds and makes. Cash or terms. Write today for descriptive list M-12. Warren-Knight Co. (Manufacturers of "Sterling" Transits and Levels) 136 N. 12th St., Philadelphia.

LARGEST Stock of new and used surveying instruments in the country direct from factory. Satisfaction guaranteed or money refunded. Also furu levels. Wissler, 619 N. Broadway, St. Louis, Mo.

MODELS AND MODEL SUPPLIES

TIME Counts in applying for patents. See pages 154 and 155. Clarence A. O'Brien, Registered Patent Attorney, Washington, D. C.

MODEL Steam engines and boilers for miniature boats. Six cylinder radial engines for model airplanes. New catalog 15c. Model Machine Shop, 212 Price St., Rahway, N. J.

SPECIAL Machine builders, tool and die makers, inventors' models production work of all kinds. Dept. L. Quality Hardware & Machine Corporation, Ravenswood and Thorndale Aves., Chicago, Ill.

LET Our experience be your guide. Models that are models; tools and equipment for economic manufg. Patterns of all types; manufacturing in all branches. Satisfaction guaranteed. United Machinery Company, Cincinnati, U. S. A.

WE make working models for inventors and do experimental work and carry a complete stock of brass gears and model supplies. Send for catalogue. The Pierce Model Works, Tinley Park, Ill.

DEADWEYES—¼" 3-16" \$3.50 hundred, belaying plus 18c dozen. C. Libby, Tuckahoe, N. Y.

SHIP Model Fittings; Send Dime for booklet. A. J. Fisher, 1002 Etowah Ave., Royal Oak, Mich.

THE Modelmaker, a magazine for all interested in making working models, boats, etc. Sample 10c. Modelmaker, 122 Liberty St., New York.

MODEL And experimental work at lowest cost. Wagar Model & Machine Works, 115 So. Clinton St., Chicago.

NEW ¼ Horse, 110 volt, 60 cycle, 1750 speed, alternating motors with cord, plug, pulley and two-year factory guarantee \$7.00 each. ½ horse, 110-220 volt, 1750 speed. Wagner repulsion induction alternating motors \$22.50. Also other sizes alternating and direct current. Electrical Surplus Company, 1911 West Chicago Ave., Chicago.

NEW 750 Watt, ball bearing generators, \$28.00; 1250 watt, 32 volt lighting plants with engine, \$169.75; ¼hp. 32 volt motors, \$9.75; ½hp. General Electric, repulsion, a.c. motors, \$27.00. All brand new. Write for bargain catalog. Do not buy, consult us first. General Distributing Company, Duluth, Minn.

FOR Sale: ¼ hp. motors, 110 volt, 1,750 R.P.M., 60 cycle, alternating current, slightly used. Good running condition, \$5.00 each, while they last. Cash with order. The Maytag-Chicago Co., 337 W. Madison St., Chicago, Ill.

EDISON And Graphophone electric universal motors with speed governor and idler \$5.00 plus express on 10 lbs. Geo. Schulz, Calumet, Mich.

NEW ½hp. Westinghouse motors \$28.00. ¼hp., \$6.50; for direct current, \$6.50. 32 volt motors with emery wheel, buffer and drill chuck \$6.50. 8-day time switches, \$7.50. Many other bargains in larger motors, also generators. Queen City Electric Co., 1736 Grand Ave., Chicago, Ill.

AUTO Engines make excellent power plants in the shop, mine, mill or farm, but they need governing. We make the governors for \$10 up. Fit any make of engine. See advertisement below.

GOVERNORS For auto engines when used for power plants. Circulars. Candee-Smith Governor Co., 215 W. Manchester Ave., Los Angeles, Springfield, N. Y., or St. Catharines, Ont.

BARGAINS—Motors, machinery, wash. machine motors \$5.55 ¼hp., \$17.50; electric drills, \$14.75; electric grinders, \$7.45; farm plant motors, \$3.45; generators, \$15.95; electric vacuum cleaners, \$8.95. 100 other bargains. Send for bargain bulletin No. 636. Acme Tool Co., 627 Washington St., Chicago.

STEAM Engines—One H. P. \$18.00; ½, \$12.00. James Chambliss, Bessemer, Ala.

NEW Motors: General Electric ¼ hp., \$9.50; ½ hp., \$26; 1 hp., \$38.50. Mail \$3, will ship C. O. D. anywhere. Motor Specialties Co., Crafton, Penna.

MAKE your own—half and one horsepower electric motors. A. C. Induction motor model shows winding connections plain sight. Quick easy way. Gaines Bros., Box 481, Gainesville, Texas.

ELECTRIC Motors—Reconditioned equal to new. Money back guarantee. A.C. or D.C. ¼ H.P. \$16.00, 1 H.P. \$26.00, 2 H.P. \$35.00, 3 H.P. \$40.00. Others to 10 H.P. Tell us your motor problems Temps Brothers Motor Co., One Martin Ave., Glendale, Long Island, N. Y.

BENDING MACHINES

THE Famous Hossfeld "Wrenchless" Universal Iron Bender is the last word in bending machines. Bends metal, cold or hot, into most any conceivable shape, including Eye Bolts and Automobile Spring Eyes. Bends up to 1" bars or 1½" pipe cold. Thousands in use by all classes of trade, from the smallest shops to the largest railway systems. Write for circular and prices. Hossfeld Mfg. Co., Winona, Minn.

BLACKSMITHS

BE a Master Mechanic Blacksmith and Expert Tool Maker and Dresser with colored tempering charts. Price \$1.00. Valuable samples free. W. M. Toy, Sidney, Ohio.

WANTED—MISCELLANEOUS

MAIL Us your discarded jewelry, gold, crowns and bridges, watches, diamonds, silver, platinum. Money promptly mailed. Goods returned if offer refused. United States Smelting Works (The Old Reliable), Dept. 71, Chicago.

HUNDREDS of people have sent their old gold, silver, platinum jewelry, dental work to me. Why not mail yours today? Highest prices paid. Satisfaction guaranteed or goods returned. F. Polcer, 2408 South Cicero Ave., Cicero, Ill.

FOR SALE—MISCELLANEOUS

ADDRESSGRAPHS, Letter folders, multigraphs, envelope sealers, duplicators, less than half price. Guaranteed. Pruitt Co., 117 No. Market, Chicago.

DON'T Shovel ashes! Save coal. More heat, clean cellar. I invented concealed ash-can for hot water, hot air or steam. Any handy man can install in your old furnace. Full instructions for only \$1.00. P. O. Box 304, Cincinnati, Ohio.

FOR The Home. Add conveniences to your home at slight cost. Cozy breakfast nook, comfortable seats, bookcases, mantel shelves, clothes chute, linen closet or any other latest style built-in feature. With the easily followed instructions in the new Popular Mechanics book entitled "Built-in Furniture" the handy man will experience no difficulty whatsoever. Send no money. Write us to send book and when postman delivers it pay him the price \$2.50 and few cents postage. Popular Mechanics Press, Room 810, 200 E. Ontario St., Chicago.

FARMS AND FARM LANDS

5 ACRE Orange grove. C. Sauers, Fort Pierce, Fla.

CALIFORNIA, 2 Acre income homesites on paved streets adjoining town of 40,000 people, east of Los Angeles, with 4-room bungalows built to order with bath, gas, electricity and water; 1,000 bird poultry house and 2-car garage all for \$4,800. Terms \$1,200 down, balance like rent. Send for free illustrated booklets. J. B. Roof, Incorporated, Owners, 708 Quinby Bldg., Los Angeles, Calif.

ATTENTION! Get acquainted, cash for your property, farm, hotel or retail store, no matter where located, confidential service. Hayes Business Agency, Cincinnati, Ohio.

FOUR Hundred acre tidewater peninsula farm. Fenced. Two residences. Hogs, ducks, geese raised without feeding. Sportsman's paradise. Gatling, Lester Manor, Va.

GET Quick cash sale for your property anywhere. Details free. Write Fisher Agency, Hannibal, Mo.

LAND Sale—\$5 down, \$5 monthly buys 40 acres southern Missouri. Price \$200. Send for list. Box 22-N, Kirkwood, Mo.

CHOICE Cabin sites, Mantrap Lake, Itasca Park region, Minnesota. Terms. Write Guy E. Chinn, 1534 Searle, Des Moines, Iowa.

SMALL Fruit and poultry farms near Los Angeles. Ten years to pay. Send for free illustrated booklets. Fontana Farms Co., owners, Room 617, 631 S. Spring St., Los Angeles, Calif.

SELL your property quickly for cash, no matter where located. Don't pay big commission. Particulars free. Real Estate Salesmen Co., Desk B, Lincoln, Nebr.

MONEY made in Mich. potatoes. \$10 down now and easy terms buys land near markets, lakes, streams. Write today. Swigart & Co., P-1276, 1st Nat'l Bank Bldg., Chicago.

OZARKS—10 acres near White River and proposed power dam, \$100, \$5 monthly. Alvin Zimmerman, 1802 N. 5th, Kansas City, Kans.

PECAN-Orange-Fig groves "On the Gulf" Monthly payments. Guaranteed care. Big, quick returns. Suburban Orchards, Dept. M, Ocean Springs, Miss.

ROOTS AND HERBS

MEDICINAL Herbs, roots, barks, flowers, etc., for many ills. Over 1,000 varieties. Write for catalog. Botanic Co., 145 W. 112th St., Chicago.

MUSKRATS

MAKE Money From Muskrat Fur—Raise Muskrats in dry land pens or hutches. Get the facts. 652, Conrad's Ranch, Denver, Colo.

RABBITS

MAKE big profits with Chinchilla Rabbits. Real Money-makers. Write for facts. 852 Conrad's Ranch, Denver, Colo.

SWINE

OHIO Improved Chester White boars, sows (pigs no kin, \$10 each), vaccinated, pedigreed. Fred Ruebush, Scota, Ill.

DOGS AND PETS

ST. BERNARD Puppies, also Chows. Registered thoroughbreds, priced reasonable, duty free. Photos submitted. Write Helvetia Kennels, 181-P McKenna, Montreal, Can.

FOX Terriers, Collies, English, German Shepherds. Barnes Farm, Fairfield, Nebr.

HUNDRED Hunting hounds cheap. Supplies. Catalog. Kaskennels, K-62, Herrick, Ill.

ST. BERNARD Pups, pedigreed, prize winning stock. Melvin O. Brown, Russell, Iowa.

HIGH-CLASS Coonhounds and combination dogs, also puppies. Honest dealing. No Sunday visiting. Sam Levers, Wooster, Ohio.

RAISE Guinea pigs; easy to raise; little space required; very profitable. Particulars and booklet how to raise free. Cavies Distributing Co., 3102 C. C. Station, Kansas City, Mo.

GOLD Fish—Imported Japanese fish. Artistic aquariums, aquatic plants; interesting circulars free. Pioneer Aquarium Shop, Racine, Wis.

HUNTING Hounds cheap; trial. Literature free. A7, Dixie Kennels, Herrick, Ill.

FOR Sale. Minks, squirrels, raccoons, foxes, ferrets, muskrats, ginseng, rabbits, skunks, wolf pups, opossums. B. Tippman, Caledonia, Minn.

PERSONAL

DRUGLESS Home treatment for piles. Rid yourself of this horrible, painful ailment. Do it common-sense way without ointments or other drugs. Send \$1.00 now for full prepaid treatment. L. W. Hudson, 1439 East 7th, Plainfield, N. J.

OCCULTISM, Yoga, magic incense. Catalog 10c. Hindu Publishers, Garrick Bldg., Chicago.

FREE Contents. Expert playing cards. Genius, science, honest. Grady Yatbrough, General Delivery, Maywood, Ill.

ARE You old at forty? See our advertisement on page 44 of this issue. The Electro Thermal Company, 2112 Morris Ave., Steubenville, Ohio.

MEN—A handsome, healthy complexion assists you. "Sunbe Tan" gives this effect immediately, undetectable, confidential. Send for booklet. Manhattan Laboratories, 25 3d Ave., New York.

FREE. Valuable book telling the uses of roots and herbs. Box 29, Station L, New York.

INGROWING Nails corrected without knife or pain; information free. Eugene Eaton, D106, Brandon, Ore.

TOBACCO Or snuff habit cured or no pay. \$1.50 if cured. Remedy sent on trial. Superba Co., N3, Baltimore, Md.

ADVICE, Information, any subject, 25c coin. References. Fred Klotz, Reading, Pa.

YOU Need a better grip on mathematics? Tell us to send you a copy of "Mathematics for the Practical Man," only \$1.50. By common sense methods it removes the mystery and difficulties so algebra and calculus are made simple. Assuming your knowledge is limited to arithmetic you quickly and easily gain a working knowledge of algebra, geometry, trigonometry and calculus. Simply pay postman when he hands you the package. Address Popular Mechanics Press, Room 810, 200 E. Ontario St., Chicago, Ill.

PRECIOUS STONES

AUSTRALIAN Opals, black opals, fire opals, cabinet specimens. List free. Norman Seward, Optician, Melbourne, Australia.

MISCELLANEOUS

EXTENSION Clothes line poles: Adjustable 5½ to 10 feet. Positively cannot be pushed or blown down. Ideal for campers as tent pole. \$1.65. Agents wanted. O. Frantz, Nesquehoning, Pa.

EXPERIMENTAL Supplies, electrical, chemical, mechanical. List free. Research Supply Company, Box 1091, Chicago.

15,000 FORMULAS in "Scientific American Encyclopedia of Formulas." Includes following and many others: Accidents and emergencies, agriculture, alloys and amalgams, artist's materials, beverages, cements, glues, pastes, mullages, bleaching, renovating, coloring metals, dyeing, glass, heat treatment of metals, household formulas, ice cream, confectionery, chewing gum, lapidary work, exterminating vermin, lubricants, paints, varnishes, photography, condiments, canning formulas, rubber, soap, candles, soldering, toilet preparations, perfumes, waterproofing, fireproofing, writing materials. Send no money. Just write a postal. When postman hands you book pay \$5.50 and postal charges. Popular Mechanics Press, Room 810, 200 E. Ontario St., Chicago, Ill.

MIRRORS Resilvered at home. Costs less 5 cents per square foot; you charge 75 cents. Immense profits plating autoparts, reflectors, tableware, stoves, refinishing metalware, etc. Outfits furnished. Details free. Write Sprinkle, Plater, 288, Marion, Ind.

YOUR Favorite magazines, subscribed through us cost less. Lists free. Porter's Publications, 9416a 115th St., Richmond Hill, N. Y.

ARE You old at forty? See our advertisement on page 44 of this issue. The Electro Thermal Company, 2112 Morris Ave., Steubenville, Ohio.

WOOD For making toys. Send \$1.00 for samples. E. Brumbaugh, Suncrest, W. Va.

CARTOONISTS. Sell your drawings. Proven plan. Castle Studios, Independence, Mo.

PANAMA Hat from Panama. The "something different" for Xmas. Real hand-woven fiber. Only \$4.50, postage paid. Give size. L. S. Dennis, Box 431, Balboa, Canal Zone, Panama.

TIME Counts in applying for patents. See pages 154 and 155. Clarence A. O'Brien, Registered Patent Attorney, Washington, D. C.

MACHINE Big money maker embroiders names, initials on handkerchiefs, etc. Sample free. Particulars. Jed Company, 1200 Broadway, New York City.

GOLD, Silver, copper, lead, zinc ores 10c each. Buskett, Joplin, Mo.

TEAR Gas revolver, fountain pen size, makes them helpless. Non-injurious. \$4.75. Ferretine, 226 Pine, Chicago.

FLYING Squirrels—Pets supreme; rare handsome novelty; \$5 a pair, express paid, safe delivery guaranteed. Wildwoods Fur Farm, Woodville, Tex.

PATENTED Clinker removers at bargain prices. Write for free circular. Gust Carlson, 331 McPherson, Ottumwa, Iowa.

ELECTRIC Air brush; inexpensive. Plans 50c. Nelson, 1709 Brooklyn, Kansas City, Mo.

ARTIFICIAL Flowers, how to make for all purposes; millinery, stage, pageantry, outdoor decorations, gowns, auto decorations, display windows, stores and homes. Full instructions in Handbook for Women. Also instructions for easily-made metal articles, such as book ends, desk sets, paper knives, desk calendars, jewelry, desk clocks, candlesticks, etc. Both books for \$1.48. Sent C. O. D. Pay postman price plus postage. Popular Mechanics Press, Room 811, 200 E. Ontario St., Chicago.

I CATCH from 45 to 60 foxes in from 4 to 5 weeks' time. Can teach any reader of this magazine how to get them. Write for particulars. W. A. Hadley, Stanstead, Que.

AMATEUR Cartoonists—Sell your work. Write Smith's Art Service, Wenatchee, Wash.

ARTISTS And art students are printing 250 signs or pictures an hour without machinery. Sample and particulars 10c. Straco, 1013 Mulberry, Springfield, Ohio.

TATTOOING Outfits, supplies. Illustrated list free. "Waters," 965 Puttnam, Detroit.

HOMEOPATHIC And Biochemic preparations sent postpaid to all parts of the world. Manual and booklet free. Halsey Bros. Co., 5547 Ravenswood Ave., Chicago, Ill. Established 1855.

WEEDS—Cut them with cutter bar on Shaw Garden Tractor. Also plows, cultivates and runs belt machinery. Low prices. Immediate delivery. Shaw Manufacturing Company, Department C, Galesburg, Kans.

CUTS anybody can make. Simple, cheap process. \$1. Specimens, particulars. 2c stamp. M. Day, Windfall, Ind.

EMBOSS Your stationery with hand embosser. Circular free. Midwest, Box 47, Springfield, Ill.

MEXICAN Made holsters, lariats, horse-hair articles; rattlesnake belts. Send four cents for illustrated list. Tex-Mex Leather Co., 309 Esperson Bldg., Houston, Tex.

TELL An army of 3,000,000 live readers all about your offer! If you have anything to sell, buy or exchange, or if you have any reasonable proposition, tell our readers all about it—they'll respond quickly. Our booklet "How to Create More Business" contains some very interesting, helpful facts. Write today for your copy—it's free. M. L. Rund, Manager Classified Advertising, Popular Mechanics Magazine, 200 E. Ontario St., Chicago, Ill.

HENLEY'S HOME STUDY PAY RAISING BOOKS

Practical Mechanical Technical

Up-to-date Books on Aviation—Electricity—Recipes and Processes—Diesel Engines—Ship Models—Miniature Boat Building—House Wiring—Automobiles—Mechanical Movements—Heating—Plumbing—Machinery—Lathes and 50 other Practical Subjects.

If you want your information on practical, mechanical, technical or scientific subjects up-to-date—if you want it complete, thorough and authentic, then write for the free Henley BOOK catalog. It brings you a list of modern, well-printed, reasonably priced, authoritative books on every subject from aviation to soap making and automobiles to plumbing.

Here is a short list of twenty of these recognized authorities, books that are used in hundreds of schools and colleges and consulted and studied by workmen and experts everywhere. You can look at any one or more of these books for five days and make your decision of their value after you see them.

Enclose no money. Order BOOKS by Number

Read this list of titles. Check the books you want by drawing a circle around their numbers in the coupon. When the books arrive deposit the purchase price with your postman, and if not satisfied in every respect, return the books within five days and your deposit will be refunded at once and without question. Fill in and mail the coupon at once. Norman V. Henley Publishing Co., Dept., PM-3, 2 West 45th St., New York.

1 Modern Aircraft, by Major Victor W. Page. An 855-page indisputable authority by an expert. Every phase of the industry explained. Modern aircraft, its construction, maintenance, operation, control and repair. A book used at practically all flying fields and schools. A reference for experts in all branches. Beautifully bound. Well printed. 400 illustrations. Price, \$5.00.

2 Everybody's Aviation Guide, by Major Victor W. Page. 600 questions and answers to make the layman "air wise" and to give the beginner the proper foundation. Plain language. 247 pages, 140 illustrations. Cloth. Price, \$2.00.

3 A B C of Aviation, by Major Victor W. Page. 160 pages of simple, understandable, easily readable, well printed, profusely illustrated information that every layman and beginner ought to have. Handsome paper cover. Price, \$1.00.

4 Henley's 20th Century Recipe Book—Thousands of recipes, formulas and secret processes for manufacturing every day commodities. New revised edition. 807 octavo pages. Illustrated. Price, \$4.00.

5 Everybody's Electrical Hand Book. Practical, illustrated information on bells, burglar alarms, electric wiring, electric appliances, etc. A money-saving home book. 135 pages. Numerous diagrams. Pocket size. Price, \$1.00.

6 Diesel Engines, their application and operation—Marine—Locomotive—Stationary. 565 pages. 341 illustrations. Price, \$5.00.

Ship Model Making, by Capt. E. McCann. How to make simplified or particular scale models of decorative ships. Each volume beautifully illustrated. Price each, \$2.50.

7 How to Make a Model of the U. S. S. "Constitution."

8 How to make Worthwhile Models of Decorative Ships.

9 How to Make a Model of a Clipper Ship.

10 House Wiring. Full modern information for successful, safe house wiring. 208 pages. 106 diagrams, plans and illustrations. Revised. Price, \$1.00.

11 Miniature Boat Building, by A. C. Leitch, Naval Architect. How to build working models of sail and power boats that run. Includes building their steam power plants and boilers for blow torch firing. Shows every step. Five full sets of plans. Others fully described. 242 octavo pages. 500 progressive drawings. Price, \$3.00.

12 Modern Gasoline Automobile, by Victor W. Page, member S. A. E. Every phase of design, construction, operation, maintenance and repair of all model cars including the New Ford. 1130 pages. 1000 illustrations. Price, \$5.00.

13 Models T and A Ford Cars, their construction, operation and repair, by Victor W. Page. Complete practical principles of new and old model Fords and Fordsons. 223 special diagrams and photos. Unquestioned authority. Up-to-date. A real guide for owner and repairman. 572 pages. Price, \$2.00.

14 Mechanical Movements, Powers and Devices, by Gardner D. Hiscox. 17th Revised Edition. 1891 engravings of mechanical devices and appliances with complete descriptions. Extremely valuable to anyone interested in mechanics. 409 pages. Price, \$4.00.

15 Mechanical Appliances, Movements and Construction Novelties, by Hiscox. Illustrations and descriptions of many different intricate mechanical devices and method of operation. 412 octavo pages. 1000 illustrations. Price, \$4.00.

16 Practical Steam, Hot Water Heating and Ventilation. All systems, hot water, vacuum, vapor, etc., new systems of hot water circulation and ventilation. Revised up-to-date. 551 pages. 396 illustrations. Price, \$4.00.

17 Questions and Answers on Steam, Hot Water, Vapor and Vacuum Practice. 500 questions answered. Excellent text for apprentices and inexperienced fitters. Covers all modern heating and ventilating systems. 253 pages. 157 illustrations. Price, \$2.50.

18 Standard Practical Plumbing. 8th Revised Edition. Best ever written on modern plumbing. Excellent instruction for beginners, valuable reference for advance workers. A standard for many years. 444 pages. 100 full page plates and 264 additional illustrations. Price, \$4.00.

19 Modern Plumbing Illustrated. Latest approved methods of sanitary installation. 5th Enlarged Edition. 409 (6x9) pages. 67 full page illustrations. Price, \$5.00.

20 Lathe Work for Beginners. Opens up a new world for amateurs. A valuable aid for machinist or apprentice. It foresees all questions and overcomes all difficulties. Shows how to set up lathe, explains tools and correct way of using them. 240 pages, 167 illustrations. Price, \$2.00.

Tear this Out and Put it in the Mails Now

Norman V. Henley Pub. Co., Dept. PM-3, 2 West 45th St., New York, N. Y.

Draw a circle around the numbers you want shipped.

Gentlemen: Please send me copies of the books whose numbers I have checked at the left. When they arrive I will deposit the purchase price plus a few cents postage with the postman, and if not thoroughly satisfied will return either all or part of the shipment for complete refund within five days.

- 1 2 3 4 5
6 7 8 9 10
11 12 13 14 15
16 17 18 19 20

Send to.....

Street Address.....

City..... State.....

We will pay the postage if you enclose cash with your order.

Check here for catalog of all Henley books on more than fifty practical and scientific subjects. If outside of U. S. remit when ordering and add 15 cents per book to pay registration charges.

NORMAN V. HENLEY PUB. CO. 2 W. 45 ST. New York, N.Y.

Discovered!

The Scientific Secret of Caruso's Amazing Vocal Power

A post mortem of Caruso's throat showed superb development of his Hyo-Glossus muscle—again proving the soundness of Eugene Feuchtinger's theories of voice production.



Eugene Feuchtinger, A. M., Musician-Scientist, who discovered this scientific method for developing the voice.

The arrow points to the all-important Hyo-Glossus muscle, the "keynote" of the Physical Voice Culture method.

The Great Discovery

Professor Feuchtinger, A. M.—famous in the music centers of Europe—discovered the secret of isolating the Hyo-Glossus muscle. He devoted years of his life to scientific research and finally perfected a system of voice training that will develop your Hyo-Glossus muscle by simple, silent exercises right in your own home. Since the Professor brought his discovery to America—over 10,000 happy pupils have received his wonderful training.

100% Improvement Guaranteed

The Perfect Voice Institute guarantees that Physical Voice Culture will improve your Voice 100%. You are to be your own judge—take this training—if your voice is not improved 100% in your own opinion, your entire tuition will be refunded.

Inspiring Book FREE Send the coupon below and we'll send you FREE this valuable work, "Physical Voice Culture". You assume no obligation. It may be the first step in your career. Do not delay.

Perfect Voice Institute

1922 Sunnyside Ave., Studio 13-59 Chicago

Perfect Voice Institute 1922 Sunnyside Ave. Studio 13-59 Chicago

Please send me a copy of your new book, "Physical Voice Culture", FREE. I understand that it is mine to keep and there is no obligation on my part. I am interested in

Singing Speaking Stammering Weak Voice

Name

Address

Age

HEAT

with the Proved LACO

for Heating or Cook Stoves, Ranges or Parlor Furnaces

Here is a reliable, trouble-free and safe natural draft oil burner. It is just as easy to operate as a common kerosene lamp. Any child can light with a match. It makes its own gas from liquid fuel, producing an even, clean, white, hot smokeless flame.



Laco No. 2

It has the patented LACO mineral wick, indestructible, and guaranteed to give perfect satisfaction. Will resist 2,000 degrees of heat without breaking down. No noise—only sound is that of perfect combustion. Burner can be turned extremely low without smoke and without flame going out.

The LACO is distinctly in a class by itself. Far superior to others that you may have tried. Will give you many years of perfect service.

Be sure to write for full description of this superior, low-priced oil burner.

The New LACO No. 2 Natural Draft Oil Gas Burner for use in stoves, ranges, parlor-furnaces, etc.,—only \$18.00. Greatest bargain in this line ever offered.

DEALERS

LACO Oil Burners are manufactured to meet every need from the largest structure to the smallest residence. Get full information about the LACO line and the wonderful profit opportunity it offers. You can get exclusive rights in unoccupied territory. Write today.

Laco Gas Burner Co. 114 Union St., Griswold, Iowa

Wrestling Book FREE

Learn at Home



Be an expert wrestler. Learn at home by mail. The greatest wrestlers of all, Frank Gotch and Farmer Burns, both world's champions have prepared the most wonderful course of lessons ever written on Physical Culture and Expert Wrestling. Be strong and healthy! Handle big men with ease. This great free book tells you how. Don't delay. Write now. State your age. Farmer Burns School, 3379 Ry. Exchange Bldg., Omaha, Neb.

HOT PIANO Ultra-modern Piano

Jazz taught by mail. Note or ear. Easy rapid lessons for adult beginners. Also Self-instruction system for advanced pianists. Learn 358 Bass Styles, 976 Jazz Breaks, hundreds of Trick Endings, Hot Rhythms, Sock, Stomp and Dirt Effects; Symphonic and Wicked Harmony in latest Radio and Record Style. Write for Free Booklet.

WATERMAN PIANO SCHOOL, 1826 W. Adams St., Los Angeles, Calif.

Be a drummer!

Trap Drumming made easy in a short time. Our free instruction course furnished with genuine Ludwig Trap-Drum Outfit. Develop your natural sense of rhythm. Go to your nearest dealer or write for full details.

LUDWIG & LUDWIG, 1611 North Lincoln Street, Chicago

BIG VALUE FOR 10 Cts.

6 songs, words and music; 25 Pictures Pretty Girls; 40 Ways to Make Money; 1 Joke Book; 1 Book on Love; 1 Magic Book; 1 Book Letter Writing; 1 Dream Book and Fortune Teller; 1 Cook Book; 1 Base Ball Book, gives rules for games; 1 Toy Maker Book; Language of Flowers; 1 Morse Telegraph Alphabet; 12 Chemical Experiments; Magic Age Table; Great North Pole Game; 100 Conundrums; 3 Puzzles; 12 Games; 30 Verses for Autograph Albums. All the above by mail for 10 cents, and 2 cents postage.

LOYAL SALES CO., Desk 317, Norwalk, Conn.

AMBITIOUS MEN WANTED *for new field of* COMMERCIAL ELECTRICAL ENGINEERING

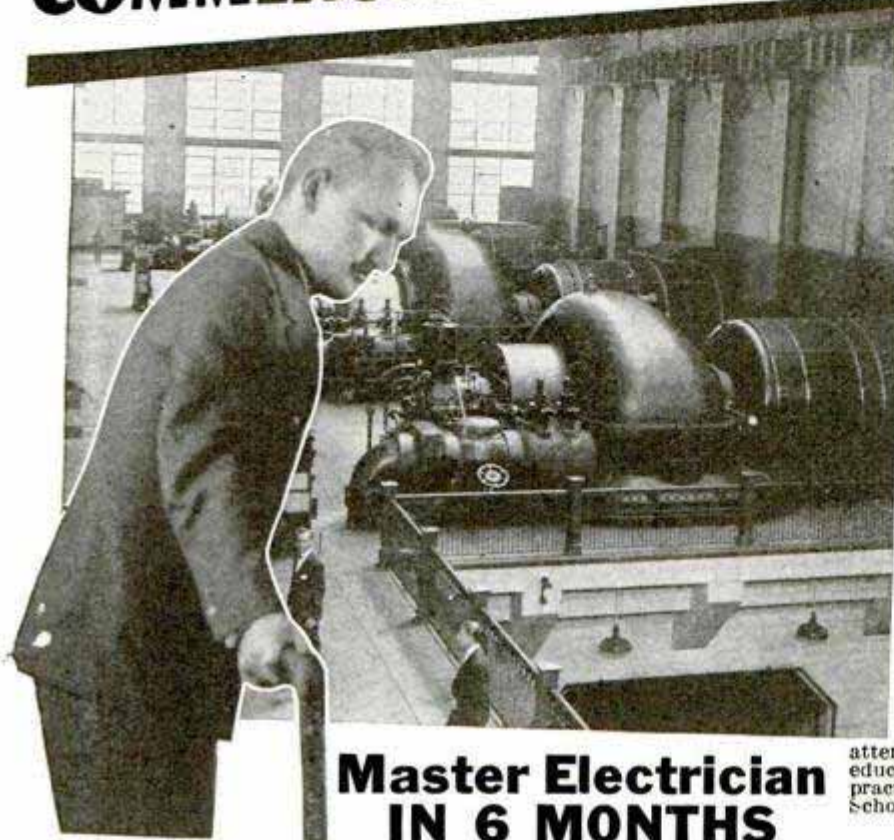

Master Electrician IN 6 MONTHS

Just 6 months and you are ready to enter the profitable business of Electric Contracting, Power Plant and Substation Operation. Course is complete—covering electric light wiring, motor wiring, meter testing and operation, A. C. and D. C. armature winding, motor generator characteristics, operation, and repair, transformer operation, etc.

Great Industrial Co-operative Program

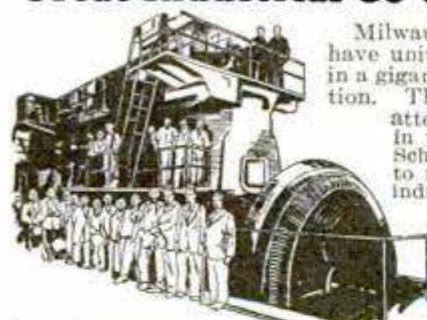

Milwaukee's leading electrical concerns have united with the School of Engineering in a gigantic program of Industrial Cooperation. This program, unlike anything ever attempted by any Engineering School in the country, insures students at the School of Engineering a practical training to fit the needs of the country's largest industrial concerns. More than that—this plan offers possibilities for actual employment both while attending the School of Engineering, and after graduation—even financial assistance for worthy students. Send coupon for FREE details.

U. S. Govt. requests S. of E. Students to assist in acceptance tests of 3 Diesel Engines for Panama Canal.

RADIO AND ELECTRICAL REFRIGERATION

Learn in three months—just 90 days! Radio and Electric Refrigeration are tremendous money-makers for the trained man who gets into the game early. Experts are needed for big, responsible well-paying jobs. We train you quickly and help place you in a good position. Daily broadcasting from WISN (formerly WSOE). ACT NOW.



SCHOOL of ENGINEERING
of Milwaukee
Founded 1905 PM 1228 Milwaukee, Wis.

Tremendous growth of the new giant industry—Electricity—has created overwhelming demand for **Commercial Electrical Engineers**. Large electrical concerns are actually pleading for men combining knowledge of electrical engineering with thorough commercial training. The Commercial Electrical Engineer is the "key-man" of the modern electrical concern. This big new field pays high salaries—offers wonderful opportunities for advancement.

Now—at the School of Engineering of Milwaukee, you can become a **Commercial Electrical Engineer** in 12 short months—or secure the Elec. Engineering Bachelor of Science degree in 3 years. Large, well-equipped school—for 24 years a leader in American electrical education. Our graduates are succeeding in all parts of the world. Our 12 months **Practical training**, we know fits men for big paying positions. **Practical Engineers teach you!** They know what to teach and how to teach it so you can earn money with it! Hundreds of thousands of dollars worth of actual commercial machinery to work on.



Electrical Engineering B. S. Degree in 3 years!

Earn Living Expenses

To men who are really sincere in their desire to enter this new and highly profitable field—we offer an opportunity to earn living expenses while attending the School of Engineering. Our plan reduces educational costs to a minimum and gives valuable practical experience. Low tuition fee. Radio Club. School Orchestra. Fraternities.

New Photo-story FREE

Write today for our FREE illustrated Photo-story and catalog. Contains over 120 colored actual photographs. Read about this wonderful institution and the great opportunities that lie before you. Find out about our specialized method of training and the details of our "Earn While You Learn" plan.



School of Engineering of Milwaukee, Dept. PM 1228, Milwaukee, Wis.

Without obligating me in any way please mail free Photo-story book, "Rise to Success Through Electricity" (Just off the press), and NEW Bulletin regarding the course I have marked with an X.

- | | |
|--|---|
| <input type="checkbox"/> Commercial Elec. Eng. for High School Grad. 1 year. | <input type="checkbox"/> Elec. Refrigeration. |
| <input type="checkbox"/> Commercial Elec. Eng. others 1 to 2 years. | <input type="checkbox"/> Radio. |
| <input type="checkbox"/> Elec. Eng. B. S. Degree 3 yrs. | <input type="checkbox"/> Armature Winding. |
| <input type="checkbox"/> Automotive Elec. | <input type="checkbox"/> Light, Heat & Power. |
| <input type="checkbox"/> I am interested in your Earn While You Learn Plan. | <input type="checkbox"/> Practical Electricity. |
| | <input type="checkbox"/> Home Lab. Service. |

Name..... Age.....

Address.....

City..... State.....

Education.....

Fat Men

This new self-massaging belt not only makes you look thinner INSTANTLY—but quickly takes off rolls of excess fat.

DIET is weakening—drugs are dangerous—strenuous reducing exercises are liable to strain your heart. The only safe method of reducing is massage. This method sets up a vigorous circulation that sees us to melt away surplus fat. The Weil Reducing Belt, made of special reducing rubber, produces exactly the same results as a skilled masseur, only quicker and cheaper.

Every move you make causes the Weil Belt to gently massage your abdomen. Results are rapid because this belt works for you every second.

Fat Replaced by Normal Tissue

From 4 to 6 inches of flabby fat usually vanish in a few weeks. Only solid, normal tissue remains. The Weil Reducing Belt is endorsed by physicians because it not only takes off fat, but helps correct stomach disorders, constipation, backache, shortness of breath and puts sagging internal organs back in place.

Special 10-day Trial Offer

Send no money. Write for detailed description and testimonials from delighted users. If you write at once, you will receive a special 10-day trial offer. The Weil Company, 912 Hill Street, New Haven, Conn.



THE WEIL COMPANY, 912 Hill St., New Haven, Conn.

Gentlemen: Please send me complete description of the Weil Scientific Reducing Belt, and also your Special 10-day Trial Offer.

Name

Address

City State

This is the GUITAR

you hear on the radio and records. The Gibson Mastertone Guitar, with its rich tone of such depth beauty and carrying power, embodies finest materials and most expert craftsmanship; acclaimed as world's finest guitar. Easy playing qualities make it easy to learn.



Send coupon NOW for FREE BOOK and details of Easy Payment plan. Mention which interests you: Guitar, Banjo, Mandolin, Ukulele.

Gibson

GIBSON, Inc. 1203 Parsons St. Kalamazoo, Mich. Gentlemen: Send Free Book and details of payment plan on

[Instrument]

Name

St. or R.F.D.

City State

\$2500 DRAWING \$298 COURSE for



Haven't you often wished that you could draw cartoons, illustrate some idea, sketch some pretty face, etc.? You can do all of these things. One of America's most famous Cartoonists and Illustrators has developed a great, simple system for success in all branches of Commercial Art. This system has revolutionized the entire theory of drawing. It means that drawing can be as easy for you as writing—much simpler than learning shorthand, bookkeeping or typewriting. We are now placing this original system for learning Drawing, Art and Cartooning, consisting of 34 lessons with over 500 illustrations, within reach of every one. If you will devote a few hours each week to the Course WE ABSOLUTELY GUARANTEE that you will learn to draw and draw well before you have half finished the Course. If we fail to make this claim good, we will refund every cent paid us. By eliminating a large office force for answering correspondence, expensive catalogs, etc., we are enabled to make a price of \$2.98, the cheapest price ever known for a high-grade, home study course. Many have sent us letters similar to that of Rob't P. Davis of Detroit, who wrote: "I can't see how you ask so little. It is more than I expected." Learn to draw. It is a big asset, no matter what field you are in.

Send No Money

Just order the course and \$2.98 on arrival pay postman plus a few cents postage, payment in full for the entire Course and Drawing Outfit. If not entirely satisfied, return within five days and we will Refund Money. Address:

If you order the course at once, we will include a drawing outfit, consisting of artist's pencils, pens, paper, erasers, thumb tacks, etc., enabling you to go to work without any additional cost.

LEDERER SCHOOL of DRAWING, Dept. 296-X, Chattanooga, Tenn. Orders from outside the U. S. A. are payable \$3.28 cash with order.



BE AN OFFICER in the U. S. Coast Guard \$1700 Up to \$7,500 Yearly

\$780 yearly at the U. S. Academy while training. You rank Ensign to Captain in service. Age requirements 18 to 22. Write Dept. D for information.

COAST GUARD PREPARATORY SCHOOL 4000 Ga. Ave., N. W. Washington, D. C.



PAINT SHOW CARDS

and SIGNS. LEARN AT HOME IN SPARE TIME. DEMAND INCREASING. \$75 WEEKLY. PREPARE NOW. FUTURE UNLIMITED. CIRCULAR FREE. Universal School of Lettering WATERBURY, CONN.

Miller's American Poultry Guide FREE

Tells all about chick's-care, feeding and raising for profit. Also describes Hot Water & Electric

"Ideal" Incubators \$11.50 Up

With Original Patented EGG TURNING TRAYS

"Ideal" Brooders - - \$6.90 Up

Coal, Oil, and Electric Brooders, Poultry Supplies, Baby Chicks. Special LOW PRICES! Write Today!

J. W. MILLER CO., Box 12, Rockford, Ill.



INCREASE YOUR POULTRY PROFITS!

By proper Breeding, Feeding, Housing, Culling and Marketing AMERICAN POULTRY JOURNAL tells how to do it, and in addition a series of

Colored Pictures

with explanatory text tell and show many things you should know. They are not just colored pictures of birds but pictures of an educational nature, something never before shown by a poultry paper. 12 Issues of American Poultry Journal contain about 1000 pages—Price 25c a

year—5 years for \$1. AMERICAN POULTRY JOURNAL, 14-536 S. Clark St., CHICAGO

RAISE BELGIAN HARES

NEW ZEALAND REDS—Chinchillas—Flemish Giants MAKE BIG MONEY—We supply stock and pay you following prices for all you raise: Belgian Hares \$2 each—New Zealand \$3 each—Chinchillas \$4 each—Flemish Giants \$5 each. \$2-page illustrated book, catalog and contract, also copy of Fur Farming magazine, tells how to raise skunk, mink, fox, etc., for big profits, all for 10c. Address

OUTDOOR ENTERPRISE CO., Box 25, Holmes Park, Mo.



FOY'S BIG BOOK, in Colors

A complete guide to successful Poultry and Squab Raising. Low prices on CHICKS, Breeding Stock and PIGEONS.

Write Today! FREE!

FRANK FOY, Box 18, Clinton, Iowa



PLANS for Poultry Houses

All styles, 150 illustrations; secret of getting winter eggs, and copy of "The Full Egg Basket." Send 25 cents. INLAND POULTRY JOURNAL, Dept. 514 Indianapolis, Ind.

The U.S. Government Job is a Good Job,

**\$1260 to \$3400
A YEAR**

STEADY WORK

**MEN—WOMEN
18 to 55**

**VACATION WITH
FULL PAY**

Is Your Job Steady?

Compare these conditions with your present condition. DO YOU GET \$1,900 EVERY YEAR? HAVE YOU ANY ASSURANCE THAT A FEW YEARS FROM NOW YOU WILL GET \$2,300 to \$2,700 A YEAR?

You Can Get a Job

These positions are not hard to get. Country residents and city residents stand equal chance. Experience is usually unnecessary, and political influence is not permitted. Let us show you how.

Get Free List of Positions

Fill out the following coupon. Tear it off and mail it today—now, at once. DO IT NOW—This investment of two cents for a postage stamp may result in you getting a Government Job.



(Not connected with U. S. Government)

FRANKLIN INSTITUTE,
Dept. K, 173, Rochester, N. Y.

PICK YOUR JOB

Rush to me, free of charge (1) a full description of the position checked below; (2) Free Copy of 32-page book, "How to Get a U. S. Government Job"; (3) A list of the U. S. Government Jobs now obtainable; (4) Tell me how to get the position I have checked. Send sample coaching.

- Railway Postal Clerk..... (\$1900-\$2700)
- Postoffice Clerk..... (\$1700-\$2300)
- City Mail Carrier..... (\$1700-\$2100)
- Rural Mail Carrier..... (\$2100-\$3300)
- General Clerk..... (\$1260-\$2100)
- Prohibition Agent-Investigator..... (\$2300-\$3400)

Name.....

Address.....

Use This Coupon Before You Mislays It.

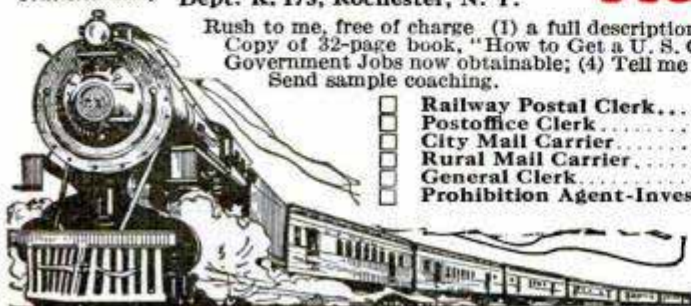

get into AVIATION

IMPORTANT! Train in a School that OPERATES BIG TRANSPORT FLEET

At last the average fellow now has a chance to get into aviation. At last the ordinary young man can train for jobs paying \$80.00 a week and up—get into the world's most fascinating profession—the field where men are in BIG DEMAND—where the demand is getting BIGGER and BIGGER—where OPPORTUNITY is positively the GREATEST!

Previous Experience Not Necessary

Our instructors are so efficient; our courses have been made so simple that you don't need to worry about previous experience. James Hall, one of our graduates, couldn't tell the difference between a monoplane and a biplane—but today he is making \$150.00 a week.

Don't Worry About An Education

You don't need advanced schooling, or a lot of mathematics to qualify. George Smith didn't even finish the grade schools. Today he is making \$110 a week as an aviation mechanic.

Free Employment Service

We maintain a remarkable employment department where every year we place thousands in big paying jobs. We do everything possible to get positions for our graduates. L. Dagan landed a job at \$150.00 a week one hour after he asked us to help him.

Fill In Coupon—Big Book Sent FREE

AVIATION SERVICE & TRANSPORT, Inc.
203 N. Wabash Ave., Dept. 13-59, CHICAGO, ILLINOIS

Personal Instruction from Famous Aces

You get personal flight instruction under famous aces. Only U. S. Licensed instructors and planes are used. You learn everything about aviation including navigation, plane construction, motor repairing—everything necessary to fit you for BIG PAY.

Fill in Coupon—Mail Today

First of all—fill in coupon and mail at once. Get all the facts. Learn how you can start the home study course NOW—without any special preparation—then when you have finished the home study course, you can come to Chicago and take up the practical work. But—don't fail to mail coupon today.

Get Our Big Book

We will send you absolutely FREE our big book "AIRWAYS" which tells you how easy it is to get into aviation and how hundreds of men who were doomed to small pay—are now making \$80.00 a week and up—ACT NOW.

It is important that you train with a company operating a regular transport service. This means that all planes are strictly up to the minute and efficiency is at its height. That is one reason why A. S. T. Students are in big demand. The A. S. T. is endorsed by the profession and is regarded as the largest financially responsible company in Chicago actually engaged in air transport service, with hangar and shops in Chicago's million dollar airport and

school using the latest equipment. The only one in Chicago with Ryan monoplane, Wright wheel and motor, Laird commercial and Swallow planes in its fleet. Waco and Simplex planes. You can readily see the great variety of planes A. S. T. students train on.

BIG FREE BOOK Tells how you can get BIG PAY!

Gentlemen:
I am interested in Aviation. Without obligation, please send me your big book on:
—Home Study.
—Practical Course in Chicago.

Name.....
Street or R. F. D.....
Town or State.....Ast.....



AUTOMATIC DRAFTING TABLES

The only ones that make drafting easy

These tables, used by professional engineers for speed and accuracy, are ideal for beginners.

For a limited time only, we will give complete and up-to-date mechanical, architectural or structural

DRAFTING COURSE FREE with each purchased table

Mr. F. W. Reinish, New York City, writes: "I owe my present \$5,000 position to the Automatic Drafting Table, which enabled me to draw neatly and quickly a suggestive layout to convince my prospective employer." Write today for literature and details of drafting course.

JEROME W. HURYCH MFG. CO.

24-31 Kindred St.

Astoria, Long Island, New York



Men! Extra Money Quick

Here's An Easy Way!

—to bring you a fine cash income! Without taking any time away from your job. Pleasant easy work at home. Decorate beautiful giftwares the Fireside way. You can do it—in spare moments. No previous training required. No special ability needed. No tedious study. No memorizing. With the Three Simple Steps sent you by Monsieur Petit the great artist—Director of Fireside Industries, it is just fun! We want men in every community. Be the first!

Fireside Industries, Dept. 66-W, Adrian, Mich.

Begin Right Now!

Thousands are making Fireside decorations—making from hundreds to thousands of dollars and doing their own work besides. We supply you with everything you need. Big Generous Complete Kit WITHOUT EXTRA COST. It's a cinch! We absolutely guarantee your success.

FREE!

Fill out and mail coupon at once. Without any obligation it brings you wonderful Fireside Book in colors. Explains everything.

Act now!



Fireside Industries, Dept. 66-W, Adrian, Mich.

Send me your wonderful Free Book in colors. This does not put me under any obligation.

Name.....

Address.....



J. A. STRANSKY

Here's My Guarantee to Car Owners...

FREE GASOLINE OFFER

I will send you samples of the Stransky Vaporizer to test in your car. If you are not convinced that it will save you $\frac{1}{4}$ to $\frac{1}{2}$ of the gasoline you now use, that it is absolutely harmless, and that it will utterly and delight you in every way—

If it does not live up to the above—if it is unsatisfactory for any reason whatsoever—you may return it and I will refund every penny of the low price you paid for it. What is more, I will pay a cash forfeit of one-half dollar if the test is unsuccessful, to compensate for the time you spend in testing it. This offer has already been accepted by over a million car owners.

L. G. Stransky, Vice-Pres.
J. A. Stransky Mfg. Co.
Pukwana, So. Dakota.
Resources over \$500,000.

J. A. Stransky

Save $\frac{1}{4}$ to $\frac{1}{2}$ Your Gasoline!

Or This Daring Trial is FREE

Accept this daring offer to test this amazing gas-saving device on your car—the test is free if unsuccessful in your opinion. Read below how it works—learn about money-making plan—Then mail coupon before offer expires.

\$75 TO \$200 IN A WEEK!

THINK of saving gasoline like this! J. R. Wood of St. Louis reports that he increased his gas mileage from 17 to 30 miles per gallon on an Oldsmobile, during a 3,000 mile trip. That would mean a saving of 1,300 extra gasoline miles! And thousands of car owners have reported mileage as follows: Ford, 20 to 40 miles a gallon; Chevrolet, 30 to 40; Nash, 19 to 22; Buick, 17 to 32—and so on. Many have used it for three to eight years and still praise its saving in gasoline, increased engine power and less carbon trouble. Over two million car owners have installed it.

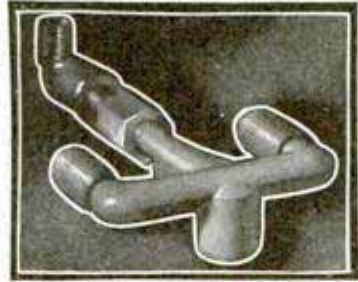

How It Works

The Stransky Vaporizer was invented by J. A. Stransky, former candidate for governor of South Dakota. It is based on a newly discovered scientific principle that has been tested thousands of times by car owners, dealers, mechanics and other authorities. It has no delicate parts to get out of order. You can attach it in about three minutes and it needs no further attention. And it also cleans out carbon an astonishing new way.

No wonder it sells so quickly that Williams made \$48 in 3 hours, Cronk \$51 in an hour, Herrick \$157 in one day! You can make big money in full or spare time just showing this amazing device to car owners and letting them test it themselves.

Mail Coupon Below

If you do not save gasoline with this amazing device—the test doesn't cost you a penny—and you win a cash forfeit besides. Over two million car owners have accepted this test offer. Mailing the coupon below will bring you full details. You will also learn a definite \$75 to \$200 in a week plan. Your request will not obligate you. Rush the coupon today.

\$48 in 3 Hours

My gas bill has been cut in half. My engine runs as good as new. I went out Saturday about three hours and secured 16 orders.

J. A. Williams.

The STRANSKY VAPORIZER

Saves Gasoline

J. A. STRANSKY MFG. CO. W-10 Stransky Bldg. PUKWANA, S. D.

J. A. Stransky Mfg. Co., W-10 Stransky Block, Pukwana, S. D.

Yes, send me full details without obligation.

Name

Address

City State

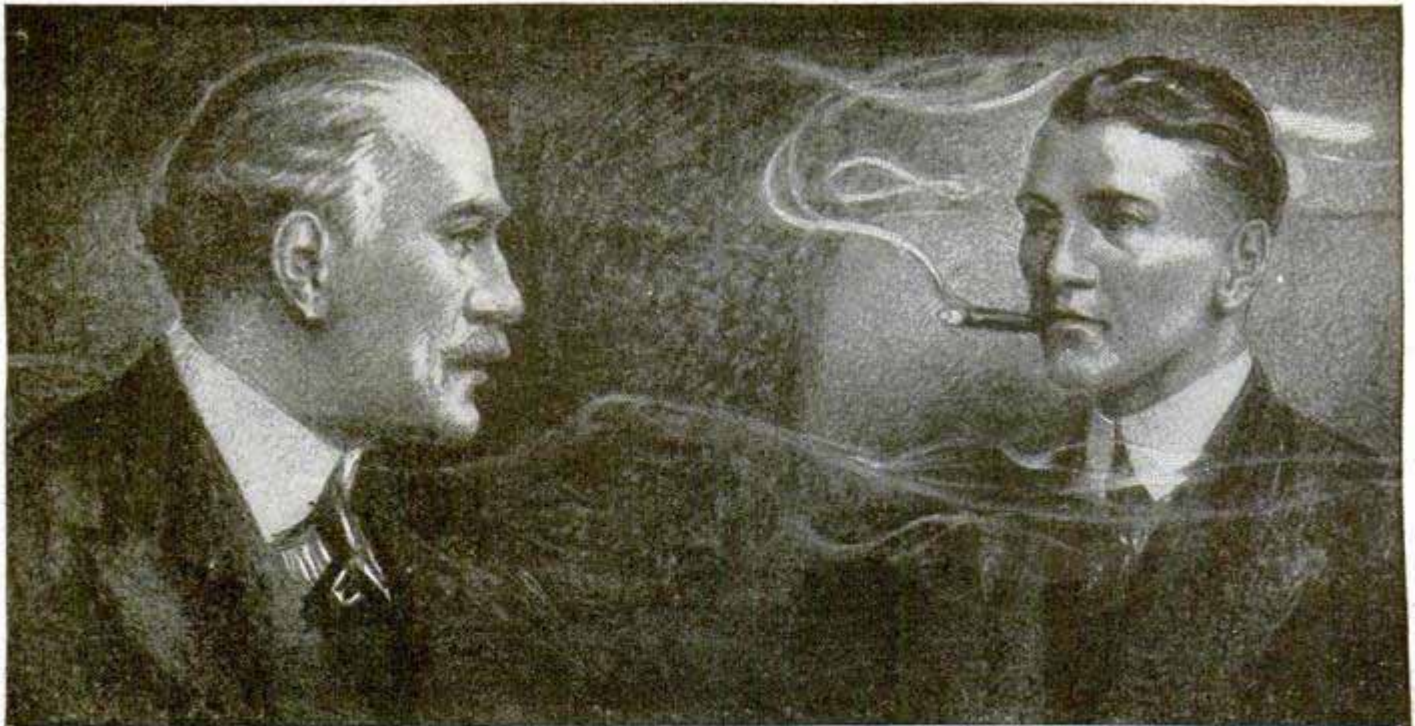

Tobacco Is Hurting You

Look at the facts square in the face, Mr. Tobacco User. You may think tobacco is not hurting you.

That is because you haven't as yet, perhaps, felt the effects of the nicotine poison in YOUR system. For you know that nicotine, as absorbed into the system through smoking and chewing tobacco, is a slow working poison. Slow, yes—but sure.

Tobacco is lowering your efficiency. It slows a man down. Makes it harder for you to concentrate your mind on your work. You haven't near the amount of "pep" and energy you would have if you stopped using it. There's many a man twice as old as you in years who's twice as young in energy, simply because he lets tobacco alone.

Some day you will realize to what an alarming extent tobacco has undermined your system.

When your hands begin to tremble—
and your appetite begins to fail—
and your heart seems to "skip a beat" now and then—
and slight exertion makes you short of breath—
then you have a right to suspect that
TOBACCO is getting the upper hand.

Any well-informed doctor will tell you that these are only a few of many symptoms of tobacco poisoning.

And YOU know that the use of tobacco in any form is an expensive, utterly useless habit. You know you ought to quit.

Tobacco Habit Banished Let Us Help You

It doesn't make a particle of difference whether you've been a user of tobacco for a single month or 50 years, or how much you use, or in what form you use it—whether you smoke cigars, cigarettes, pipe, chew plug or fine cut or use snuff—**Tobacco Redeemer** will positively remove all craving for tobacco in any form in a very few days. Not the slightest shock to the nervous system. Your tobacco craving will usually begin to decrease after the very first dose—there's no long waiting for results.

Tobacco Redeemer contains no habit-forming drugs of any kind and is marvelously quick, scientific and thoroughly reliable.

It is in no sense a substitute for tobacco. After finishing the treatment you have absolutely no desire to use tobacco again or to continue the use of the remedy. It helps to quiet the nerves and make you feel better in every way.

Results Guaranteed A single trial will convince you. Our legal-binding, money-back guarantee goes with each full treatment. We will refund every cent you pay for the treatment if after taking it according to the easy-to-follow directions, it should fail to banish the tobacco habit completely.

SEND Coupon for Free Proof Let us send you our free booklet on the deadly effects of tobacco, together with testimonial letters from men all over the country telling how they have been absolutely freed from the tobacco habit by this simple home treatment. You could not ask for stronger proof that **Tobacco Redeemer** will free you from the habit than the evidence we will gladly send on request. Just mail the coupon—or a postal will do.

NEWELL PHARMACAL CO.

Dept. 300

Clayton Station

St. Louis, Mo.



Free Book Coupon

NEWELL PHARMACAL CO.

Dept. 300 Clayton Station St. Louis, Mo.

Please send, without obligating me in any way, your free booklet regarding the tobacco habit and proof that **Tobacco Redeemer** will positively free me from the tobacco habit or my money will be refunded.

Name

Street and No.

Town..... State.....

Look! Bald Men



One Full Ampoule of my amazing hair fluid which I discovered myself and which grew hair on my head.

FREE

This Ampoule is absolutely free. Don't send any money. There is no C. O. D. No charge whatsoever. All I want is an opportunity to show you how easily I grew hair on my own and hundreds of other men's heads. Merely mail the coupon below for free Ampoule.

Here Is How I Used to Look

I was just as bald as this picture. It is a true photograph without any tampering or retouching. It is exactly as I used to look. Then look at the full head of hair I have in the picture on the left.

As I have stated so often, I don't know whether I am the first man who discovered this great secret, but I do know I have it, that I grew my own hair and that I am growing hair on the heads of other men all the time.



Bald Men Grow Hair Quick!

What I accomplished on my own head and on other heads I can do for you, provided you are under 45 years of age and loss of hair was not caused by burns or scars. Anyhow, I must succeed or you pay nothing. No apparatus. My home treatment is simple, quick, inexpensive.

Mail This

Free Coupon!

Mail the coupon today — Right Now — I will send you, immediately, one full Ampoule of my marvelous fluid which I discovered, of which I hold the secret and which grew my own hair on my bald head. Besides the Free Ampoule of Fluid, I will send photographs, names and addresses of men and women who successfully used my Wonder Fluid for Dandruff, Falling Hair and Baldness.

Vreeland

1359 Euclid-Windsor Bldg., Cleveland, O.



Here is
← **Brennan**
Brennan while he was bald.

And Brennan after Vreeland grew his hair. Write and I will tell you Brennan's story and give you his address.



Here is
Wiseman →
Wiseman was bald.

But Wiseman grew his head of hair with my wonderful hair growing fluid. All about Wiseman and how he did it, if you write. You will get his address, too.



FREE COUPON

Vreeland 1359 Euclid-Windsor Bldg.
CLEVELAND, OHIO

Please send me, entirely free, one full Ampoule of the same Wonderful Hair Fluid which grew your hair.

My Name

My Address

State

Pains

Vanish Almost Instantly

with Violet Ray

Scientific, Painless Treatment Used by Doctors, Hospitals, Sanitariums—Now Offered to Every Home



Thousands of men and women suffering from rheumatism, paralysis, neuritis, bronchitis, skin diseases, headaches, constipation, sprains, prostate trouble, goitre and many other ailments, even hay fever and asthma, have found quick relief, new health and vitality with this marvelous scientific invention. Try it.

Violetta

10 Days FREE Trial
For Health—Beauty—Vigor

Every home should have one. Saves hours, days, months of suffering. No medicine. Painless, pleasant treatment. Violet Rays penetrate to every nerve affected. Also generates pure oxygen—wonderful for pulmonary troubles. Simple, safe—anyone can use VIOLETTA. Don't suffer pain and poor health when you can now try VIOLETTA 10 days FREE.

This Book Free—Tells all about violet rays—how this remarkable discovery of Nikola Tesla, the electrical wizard, now brings this mysterious curative power to all. Contains many astounding testimonials from our thousands of satisfied users. Send for all the facts and our liberal trial offer.

VI-REX CO., Dept. 1231
2304 Warren Avenue, Chicago

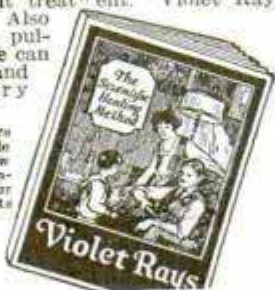

VI-REX COMPANY
2304 Warren Ave., Dept. 1231, Chicago.
Please send me your free book on Violet Rays and details of your 10-day free trial offer.

Name

Address

City State

Allment

His Eyes Will Bulge on Christmas Morning If You Give Him a Set of The Boy Mechanic



EVERY normal boy from 10 years of age and up will revel in the 4000 interesting and worth-while things to make and do that are described in the 4 mammoth volumes of the Boy Mechanic Library. He can learn how to make almost anything a boy could want by following the simple directions in these books and there is enough variety and scope to suit all tastes.

Each volume has 480 pages, 1000 articles and averages 3 pictures per page. Each book is 7x10 inches in size and 1 1/2 inches thick. Beautifully bound and printed. The set weighs 14 lbs.

The following few subjects have been selected at random from the 4000 just to give you some idea of the scope of contents:

- | | | |
|------------------|-----------------------|---------------------|
| Roats | Carpentry | Electrical devices |
| Winter sports | Painting | Photography |
| Camping | Toys | Music |
| Ice boats | Fishing | Outdoor games |
| Water sports | Fruit growing | Stoves |
| Toboggans | Entertainments | Furnaces |
| Tents | Automobile | Wireless |
| Skis | House decorations | Tricks |
| Indian snowshoes | Drafting | Puzzles |
| Skating | China painting | Bicycle |
| Gymnasium | Decorative metal work | Flowers |
| Wind wagons | Furniture making | Hunting |
| Motor sleds | Farming | Kites |
| Radio | Poultry | Metal working tools |
| Magic | Models | Secret locks |
| Trapping | Laboratory helps | Swings |
| Pets | Household helps | Slides |
| Leather work | Wood working | Power devices |

Price per set complete \$7. Single volumes \$2. Individual books must be ordered by number, 1, 2, 3 or 4.

It's Fun to Make Things

and there is nothing that you could give any man or boy that he would appreciate more than a copy of our new book called

Make It Yourself

There are attractive ship models, a great variety of toys that operate themselves by means of an ingenious application of mechanical principles, novel amusement devices for indoors and outdoors, for both water and land, unique designs in furniture for children, scores of useful appliances for the home, things of beauty and utility for lawn and garden, etc.

900 Articles—All Different

Special articles instruct the amateur mechanic in the care and use of tools, special tools for special purposes, how to read and use plans, how to solder, the making of a handy work bench, cuts, joints and methods in wood-working, automobile repairing, installing radio equipment, house wiring, fixture hanging, working in glass, leather, metal, celluloid, lathe work, utilizing parts of old machines to make equipment that would be expensive to buy, etc.

480 Pages — 823 Illustrations. Size 7x10x1 1/2 in. Cloth Binding. Price \$3

Any of the above books mailed postpaid upon receipt of price or will be sent C. O. D. anywhere in U. S. if you prefer. When sent C. O. D. postage is added to price of books.



Popular Mechanics Press
200 E. Ontario St.
Room P-12 Chicago, Ill.

Actually See- Rupture Shrink!



GOING

NO wonder over forty thousand people have dropped their cruel steel springs and hard cushions and pads in favor of this amazing rupture discovery---a remarkable system that actually tends to shrink your rupture in a new way! Send for a free sample of Airtex, the air-celled material that "breathes."

Breathes Air

Note above how you can squeeze this rupture invention in your fist. That's because it is made of air-cells and flesh-soft. Then when you open your fist, it regains its normal shape. But when you place it over the rupture, it becomes cup-shaped, thus tending to shrink the rupture area back to normal size!

Clever Sample Free

Write name and address on the coupon below. Mail it at once. It will bring you a free sample of these amazing air-cells and newly discovered facts about rupture that show you how to do away with truss torture.



GOING



GONE!

**NEW SCIENCE
INSTITUTE**

2155 Clay St., Steubenville, Ohio

ACT NOW!

NEW SCIENCE INSTITUTE,
2155 Clay Street, Steubenville, Ohio

Send New Free Book and Interesting FREE SAMPLE of
AIRTEX without obligation.

Name.....

Address.....

City.....State.....

Old Cars Made NEW in 30 Magic Minutes



KOTAL gives the BEAUTY and LUSTRE of an Expert Paint Job at 1/20th the Cost!

NOT A POLISH—NOT A PAINT
This Amazing New Liquid, discovered in a famous industrial research laboratory, has startled the Motor World. Just flow KOTAL on with a cheesecloth pad as easy as wiping a car with a chamois. **NO Rubbing—NO Hard Work.** Results are Amazing—with one sweep of your hand you restore BOTH the COLOR and Original Mirror-like FINISH to Dull—Drab—Faded Cars. Gives a glass hard protective coat that does not hold dust and the Lustre Lasts for months. Makes shabby OLD cars look like the day they were driven NEW off the dealer's floor. Words cannot describe the startling transformation. Warranted harmless to any finish. Manufactured by a long established highly rated, financially responsible concern and sold under the **STRONGEST GUARANTEE** ever put on any product.

**AGENTS
EARN**

\$5 to \$10

Every Hour You Work

\$200 a Week

is Easy Money

\$1000 Would Not Buy the Start We Give You FREE. Get the Facts

We Furnish FREE every sales help conceivable. We back you to the limit. **Man Alive!** Here is the **Biggest** thing in the motor industry today—it's going over like a house afire. Everybody claims big money—KOTAL men actually make it. Hustlers laugh at \$100 per week. Millions of cars need this Quick—Economical—Magic finish which adds 25 to 40% to resale values. **Demonstrates itself instantly.** No Talking Needed. Men who have tried to sell everything on earth and failed are making good with KOTAL. Even inexperienced country boys make money hand over fist. **Strike while the Iron is Hot.** Get the facts and get them now. We will send you our **Big FREE BOOK** illustrated in colors, and Agents' **FREE TRIAL OFFER.** Good territory is going fast. **Act NOW—Act at once. Send TODAY.**

E. RICHWINE & CO., 17 W. Jackson Blvd., Dept. 139, Chicago

YOU'RE NEXT Now Watch YOUR Muscles GROW!



BEFORE and AFTER

Transformed from a weakling into a perfect specimen of **MANHOOD!** All in 30 short days! That's what a few minutes a day of Titus Training did. Do YOU want **MUSCLE? HEALTH? STRENGTH? VITALITY?**

YOU see what I did for this man! Changed him into a **HERCULES.** I've done that for **thousands.** Let me do it for YOU. I don't care what your present condition may be. Or whether you're 20 or 50.

In 30 Days I'll Increase Your Muscles by INCHES Just give me a few minutes a day! Watch your muscles **GROW!** I'll broaden your shoulders, fill out your chest, cover your body with brawny layers of **LIVE** muscle.

FREE Amazing New Book "Miracles in Muscle"

Tear off that coupon! Mail it today! It brings you **FREE** the greatest physical culture book you've ever seen—filled with astounding photographs of men rebuilt—Don't miss it!

**Titus, Dept. M-133
705 East 13th Street,
New York, City.**

Dear Titus: Send Along your big new book, "Miracles in Muscle"—**FREE!**

The One and Only **TITUS**

105 East 13th Street
New York, N. Y.

Name.....

Address.....

Town.....State.....

Airplane DRAFTING



**50,000
MEN**

will make fortunes in Aviation. Airplane Drafting and Designing is the biggest job in the biggest industry of modern times. A new field of opportunity has been opened up by our improved method of training.

STUDY AT HOME

EASY TO LEARN

PAY AS YOU GO

EMPLOYMENT SERVICE

Write for booklet outlining interesting courses in Airplane Drafting, Aviation, Airport Management, Weems System of Navigation—endorsed by Colonel Lindbergh, Commander Dick Byrd, Lincoln Ellsworth, Admiral Moffett and others.

PACIFIC TECHNICAL UNIVERSITY

Dept. B

SAN DIEGO

CALIFORNIA

Earn money AT HOME

Men or women earn \$20 to \$50 a week at home. All or part time. Fascinating work. Nothing to sell. We teach you at home. Furnish all tools and materials. **ARTCRAFT STUDIOS, Dept. 50, 427 Diversey Parkway, Chicago.**



WANTED!

500 Dissatisfied Farmers and Sons to Stop Renting

And begin retailing Rawleigh's Good Health Products to Consumers. Start your own business. Make from \$100 to \$400 a month or more clear profit. Be your own boss. No selling experience required. We supply everything—Products, Outfit, Sales and Service Methods. Profits increase every month. No lay off. Steady year-round. Lowest prices. Best values. Most complete Service. Rawleigh Methods get the most business everywhere. For particulars write

**THE W. T. RAWLEIGH CO.
DEPT. L-18PPM FREEPORT, ILL.**

GENUINE MODEL T CORONA

1/3 OFF REGULAR PRICE



HERE'S your chance to own that genuine Model T Corona you've wanted—on the easiest terms ever offered — at ONE-THIRD OFF regular price! Complete in every detail; back spacer, etc., NEW MACHINE GUARANTEE. Recognized the world over as the finest, strongest, sturdiest, portable built.

\$2⁰⁰ DOWN
BALANCE EASY TERMS

Yours for 10 Days FREE
Send No Money

Only a limited number of these splendid machines available. To get one, you must act now! Experience the joy this personal writing portable typewriter can give you! Use it 10 days free! See how easy it is to run and the splendidly typed letters it turns out. Ideal for the office desk, home, traveling. Small, compact, light, convenient. Don't send out letters, manuscripts, reports, bills in poor handwriting when you can have this Corona at such a low price or on such easy terms.

Carrying CASE

Included—If You Act Now

Leatheroid carrying case, oiler, instructions free on this offer. Send no money—just the coupon. Without delay or red tape we will send you the Corona. Try it 10 days. If you decide to keep it, send us only \$2—then \$3 a month until our special price of \$39.90 is paid (cash price \$36.40). Now is the time to buy. This offer may never be repeated. Mail coupon now.

Smith Typewriter Sales Corp.

Dept. 3-C, 360 E. Grand Ave.

Chicago, Ill.

**\$15.10 SAVED
BY USING THIS COUPON**

Smith Typewriter Sales Corp.
[Corona Division]

360 E. Grand Ave., Chicago, Dept. 3-C

Ship me the Corona, F. O. B. Chicago. On arrival I'll deposit \$2 with express agent. If I keep machine, I'll send you \$3 a month until the \$37.90 balance of \$39.90 price is paid; the title to remain with you until then. I am to have 10 days to try the typewriter. If I decide not to keep it, I will repack and return to express agent, who will return my \$2. You are to give your standard guarantee.

Name.....

Address.....

Enclosed by.....

THESE BOOKS MAKE PROMOTION SURE!

HERE in seven handsome volumes is a complete education in power plant practice. Under the editorship of Terrell Croft, a staff of engineering specialists have put into the books everything the power plant man needs to know in order to get to the top.

Power Plant Practice 7 Volumes—2795 Pages 3706 Illustrations

With the aid of this library hundreds of ambitious men have stepped into bigger jobs. You have the same opportunity. With a little spare-time reading you can have the identical knowledge possessed by the highest paid engineers.

With these books to guide you, you can fit yourself for the big-pay jobs in the power plant field.

The library covers the entire field—boilers—valve setting—engine operation—turbines—injectors—foundations—electrical machinery—combination—refrigeration—fuels—governors—boiler stresses—fire tubes—feed water treatment—selection of boilers and engines—pumps and pump governors—steam traps—condensers—piping, etc.

Every page is packed with the kind of information that the power plant man needs in his daily work.

If you want to get ahead in your work—if you want to pass an examination for an engineer's license—if you want the big pay that comes with increased knowledge—get these books.

**Free Trial—No Money
Down—7c a Day!**



FREE EXAMINATION COUPON

McGRAW-HILL BOOK CO., Inc.
370 Seventh Ave., New York

Ship to me, charges prepaid, the seven volumes of the POWER PLANT LIBRARY, price \$10.00. If satisfactory, I will send \$1.50 in ten days and \$2.00 a month until the special price of \$17.50 has been paid. If not wanted I will return.

Name.....

Home Address.....

City and State.....

Occupation or Position.....

Firm or Employer.....

PM-12-28

A few cents a day brings you THOUSANDS OF DOLLARS

Sponsored by RCA, G-E and Westinghouse, this radio course qualifies you for big earnings and SUCCESS.

THE Radio Institute of America, conducted by RCA and sponsored by General Electric and Westinghouse offers you at low cost the training you need for success in radio.

Nothing so clear, comprehensive and up-to-date, nothing so generous in apparatus furnished has ever before been offered in radio training by any organization.

This is basically the same course that has enabled our thousands of graduates to advance to positions of importance and high remuneration in the respected profession of radio. But new and revolutionary changes make the instruction clearer and easier, permitting faster progress—and the course now embraces television, airplane radio equipment and photoradiograms.

You can study at home—when you please and as long as you please. Your rate of progress is limited only by your own ability.

MAIL THE COUPON BELOW. It brings you—free—an interesting illustrated booklet that shows the tremendous opportunities in the radio industry and outlines the Radio Institute of America's course of home study.



RADIO INSTITUTE OF AMERICA
Dept. P-12, 326 Broadway, New York City
Please send me your new booklet with full information about your Home Study Course of Radio Instruction

Name.....
Address.....
City.....

MEN WANTED FOR RAILROADS NEAREST THEIR HOMES—EVERYWHERE

Train to become a **LOCOMOTIVE ENGINEER** Also Clerks

—\$300 to \$500 monthly.

Begin as a Brake-

man or Fireman—

\$200 to \$250

monthly. Prom-

oted to Con-

ductor or

Engineer,

\$300

to

\$500

HIGHEST

PAID MEN

ON RAILROADS.

POSITIONS OBTAINED.

RAILWAY EDUCATIONAL ASSOCIATION

Estab. 29 Years. Desk D-1-12, BROOKLYN, N. Y.

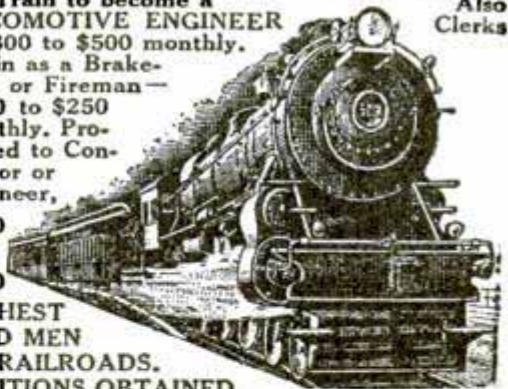

A COMPLETE COURSE IN CARTOONING IN ONE BOOK

"How to Draw Funny Pictures" by E. C. Matthews, with 200 new drawings by the world-famous Eugene Zimmerman. "Zim" has made the world laugh for forty years, and was for 25 years leading cartoonist on *Judge*. Learn from this master. 22,000 papers and magazines and advertisers everywhere want new drawings. This Complete Course prepares you. Lessons graded from simple sketches to complete cartoons. 160 pages, cloth-bound, 2-color jacket. Complete Course in one volume, postpaid, \$3.00.

FREDERICK J. DRAKE & CO., Publishers
Room 510, 179 No. Michigan Blvd., Chicago, U. S. A.

Don't Envy The Plumber—BE ONE!

\$11.00-\$16.00 PER DAY and work EVERY day, is the Plumber's wage.

LEARN IN 8 to 12 WEEKS without previous experience.

If you are making less than \$60.00 a week you owe it to yourself to investigate. Get FREE catalog that tells in pictures and words how we teach this trade. Special rates now.

UNIVERSAL PLUMBING SCHOOL, 2030 Troost Avenue, KANSAS CITY, MO.

LEARN TO FLY Commercial Aviation Needs Men

We teach by practical instruction and guarantee to make each student master of his ship. All instruction on U. S. Gov't. Licensed Aircraft by Gov't Licensed Transport Pilots. The cost is low considering the practical experience of daily flying, combined with ground work and theoretical instruction. Write us at once for further information. **DO IT NOW!**

VON HOFFMANN AIRCRAFT CO.

Distributors for Ryan Monoplanes, same as "The Spirit of St. Louis," also Eastrock Biplanes.

113 Lambert—St. Louis Flying Field, ANGLUM, MO.



GIVEN Boy! Here's the great navy model

Airship. Large 6-foot air bag with inflators, parachute with automatic release and complete instructions for flying. Will fly

for miles at height of 1000 feet. Great chance to study aerial navigation. Send

name and we'll send 6 of our new art pictures to dispose of on special 25c offer. Send the \$1.50 you collect and as a reward for this service we will send this wonderful Airship with full instructions free.

C. M. THOMAS, 337 W. Madison St., 12X81, CHICAGO

BART'S NEW CHALK TALK BOOK

"Their Best Stunts" from 25 chalk experienced talk artists. \$1.25 prepaid, 5-day trial. Also catalog "A", Art Supplies, or "S", Show Card Supplies.

BART SUPPLIES, 513 Eustis Bldg., Minneapolis, Minn.

REAL ESTATE EDUCATOR

A most comprehensive yet concise arrangement of useful facts about buying, selling, leasing and sub-letting of Real Estate, contracting, for erection or repairs, mortgaging, transferring, insuring, etc.

New revised edition. 288 pp. Price \$2.00, postpaid.
POPULAR MECHANICS PRESS, 200 E. Ontario St., CHICAGO

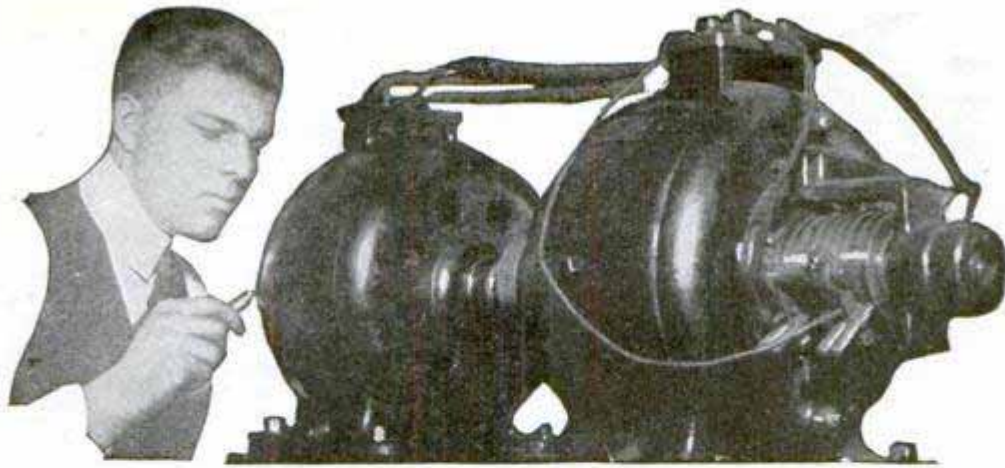

Amazingly Easy Way to get into ELECTRICITY

Don't spend your life waiting for \$5 raises in a dull, hopeless job. Now...and forever...say good-bye to 25 and 35 dollars a week. *Let me teach you how to prepare for positions that lead to \$50, \$60 and on up to \$200 a week in Electricity*—NOT by correspondence, but by an amazing way that teaches you Electricity in 90 days! Getting into electricity is far easier than you imagine!

Learn Without Books in 90 DAYS

Lack of experience—age, or advanced education bars no one. I don't care if you don't know an armature from an airbrake—I don't expect you to! It makes no difference! Don't let lack of money stop you. Most of the men at Coyne have no more money than you have. That's why I have worked out my astonishing offers.

Earn While Learning

If you need part-time work to help pay your living expenses I'll help you get it. Then, in 12 brief weeks, in the great roaring shops of Coyne, I train you as you never dreamed you could be trained...on one of the greatest outlays of electrical apparatus ever assembled...real dynamos, engines, power plants, autos, switch boards, transmitting stations...everything from doorbells to farm power and lighting...full-sized...in full operation every day!



Prepare for Jobs Like These

Here are a few of hundreds of positions open to Coyne-trained men. Our free employment bureau gives you lifetime employment service.

- Armature Expert . . . \$100 a Week
- Substation Operator, \$60 a Week
- Auto Electrician . . . \$110 a Week
- Inventor Unlimited
- Maintenance Engineer, \$150 a wk.
- Service Station Owner, \$200 a wk.
- Radio Expert . . . \$100 a Week

we help to make you a master electrician, teaching you far more than the average ordinary electrician ever knows and fitting you to hold big jobs after graduation.

Jobs, Pay, Future

Don't worry about a job, Coyne training settles the job question for life. Big demand for Coyne-trained men. Our employment department gives you lifetime service. Two weeks after graduation Clyde F. Hart got a position as electrician with the Great Western Railroad at over \$100 a week. That's not unusual. We can point to many Coyne men making up to \$600 a month. \$60 a week is only the beginning of your opportunity. You can go into radio, battery or automotive electrical business for yourself and make up to \$15,000 a year.

Get the Facts

Coyne is your one great chance to get into electricity. Every obstacle is removed. This school is 30 years old—Coyne training is tested—proven beyond all doubt—endorsed by many large electrical concerns. You can find out everything absolutely free. Simply mail the coupon and let me send you the big, free Coyne book of 150 photographs...facts...jobs...salaries...opportunities. Tells you how many earn expenses while training and how we assist our graduates in the field. This does not obligate you. So act at once. Just mail coupon.

Get this FREE Book



No Books - No Classes

No dull books, no baffling charts, no classes, you get individual training...all real actual work...building real batteries...winding real armatures, operating real motors, dynamos and generators, wiring houses, etc., etc. That's a glimpse of how



NOW IN OUR NEW HOME

This is our new fireproof, modern home wherein is installed thousands of dollars' worth of the newest and most modern Electrical equipment of all kinds. We now have the largest amount of floor space devoted to the exclusive teaching of practical electricity in the world. Every comfort and convenience has been arranged to make you happy and contented during your training.

H. C. LEWIS, Pres.
COYNE ELECTRICAL SCHOOL, Dept. 98-72c
500 S. Paulina Street, Chicago, Illinois

Dear Mr. Lewis:
Without obligation send me your big free catalog and all details of Free Employment Service, Radio and Automotive Courses without extra cost, and how I can "earn while learning." I understand I will not be bothered by any salesman.

Name.....
Address.....
City..... State.....

COYNE ELECTRICAL SCHOOL
H. C. LEWIS, Pres., Dept. 98-72c
500 S. PAULINA ST. Founded 1899 CHICAGO, ILL.

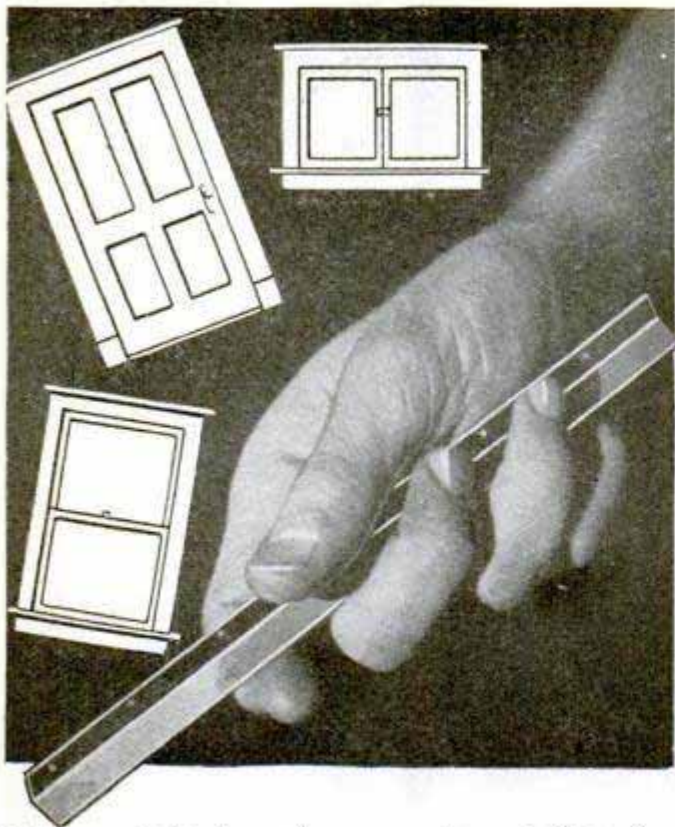

How This Amazing Strip of Lifetime Bronze Cuts Fuel Bills 1/2 to 1/3!

Now . . . Homes Weatherstripped A New Cheap Way. Snug Comfort and Amazing Economy Without Installation Expense. Red-D-Ply Quickly Tacked Around Doors and Windows, Keeps Cold Air Out, Warm Air In! Anyone Can Do It. Guaranteed To Save Cost In Fuel Alone Within 2 Years! Valuable Territory Open—\$100 a Week Is Easy! Mail Coupon For Amazing Details At Once!

A New Business Offered That Pays \$5000 to \$10,000 a Year

A HAMMER, scissors, and a neat package of Red-D-Ply—that's all it takes now for anyone to make any door or window 100% weatherproof! Takes less than half an hour to close up the "clearance crack" permanently. Then you laugh at cold drafts, rain, dust and soot. Heating bills, cleaning and doctor bills take a quick tumble. Saves home owners \$30 to \$60 a year in fuel alone under money-back guarantee, so agents clean up sensational profits. Red-D-Ply is finest spring bronze, edges hemmed to prevent buckling, holes for tacks punched clear through. Will maintain its efficiency for the life of the house. Easy as A B C to apply. The fast-selling sensation of the age. Walter Vernohm of Mo. made \$142 in a single day!

This is your opportunity to get into a real worth-while business, with steady, increasing profits and big repeat business. For free sample and proof of big earnings—\$5,000 a year and more—just mail the coupon below. It costs nothing to get the facts. Discover this amazing opportunity NOW.

RED-D-PLY

The Lifetime Bronze Weatherstripping That You Just Tack Light On
RED-D MANUFACTURING CO., Dept. W-10
 3711-15 Parnell Ave., St. Louis, Mo.

RED-D MANUFACTURING CO., Dept. W-10,
 3711-15 Parnell Ave., St. Louis, Mo.

Send illustrated information on Red-D-Ply, free sample, and details of your special Distributor's Offer. I am not obligated.

Name.....

Address.....

City.....State.....

() Send me illustrated information and free sample. I am interested only in Red-D-Ply for my own home.

How To Secure A Government Position

Why worry about strikes, layoffs, hard times? Get a Government job! Increased Salaries, steady work, travel, good pay. I'll help you become a Custom House Clerk, Railway Postal Clerk, Post Office Clerk, City Mail Carrier, Rural Carrier—or any other Government job you want. I was a Secretary-Examiner of Civil Service Commission for 8 years. Have helped thousands.



Now FREE

My 32-page book tells about the jobs open—and how I can help you get one. Write TODAY. **ARTHUR R. PATTERSON**, Civil Service Expert, PATTERSON SCHOOL, 812 Wisner Building, Rochester, N. Y.

\$8000^{in 4 Months} as REAL ESTATE SPECIALIST!

That's what Anthony C. Maurell made after getting my free book. Knew nothing about real estate until he learned my successful system. Men and women—young and old—are making big money my way. So can you.

FREE BOOK Tells How

Start at home in spare time. Build immensely profitable business of your own. No capital or experience needed. Send now for full details and positive proof of amazing money-making success. Address:

President, AMERICAN BUSINESS BUILDERS, Inc.
 Dept. 4412 18 East 18 St., New York



FREE BOOK ON MIND TRAINING

An instructive book which explains an amazing system of mind training already used by more than 650,000 people.

Let us send you a free copy of "Scientific Mind Training." It will show you how and why Pelmanism is the *only* system of teaching for developing *all* the mental powers at the same time. Endorsed by such distinguished men as Judge Ben B. Lindsey, Sir Harry Lauder, Jerome K. Jerome, Prince Charles of Sweden and hundreds of others. Write TODAY to

THE PELMAN INSTITUTE OF AMERICA
 71 WEST 45th STREET DEPT. 612 N. Y. C.

MAKE MONEY AT HOME!

Painting photos and miniatures. No talent required. Fascinating work. **Make \$35-\$100 a week.** Earn while learning. We teach you at home. Professional artist's outfit, employment service, given. Write for FREE book TODAY. **NATIONAL ART SCHOOL, Dept. 24-12, 1009 N. Dearborn, Chicago.**

BE AN OIL EXPERT!

Trained men needed! Geologists, Drillers, Refiners (Chemists and Still Men), Oil Salesmen, earn 2 to 10 times more than in other fields. Write today! FREE Booklet! Petroleum Engineering University, Dept. 232, Fort Wayne, Ind.



BARGAIN! ONLY 39¢ GUARANTEED RADIO TUBES

Why pay \$2.00 for new radio tubes? Get guaranteed high quality 201A type Barawik tubes for only 39¢ each. Send check or money order. These and thousands of other bargains are shown in Barawik's *Big Radio Guide*. Newest coast-to-coast radio sets, speakers, parts, short wave and television supplies, etc.—all at lowest prices. Send for free copy today—NOW **BARAWIK CO., 1012 Canal Sta., Chicago, U. S. A.** Mail This Coupon Now for Free Radio Guide



Name.....
 Address.....



\$2.95
costs you only
20¢ more

This is the Medium Size Eveready Layerbilt "B" Battery No. 485. 3 1/4 inches thick. 45 volts. \$2.95.

\$2.75. It's a fine battery of its type—cylindrical cell. BUT, just add 20 cents to your price and get the Eveready Layerbilt Medium Size "B" Battery No. 485. Same outside size as the older battery, but more active materials inside, and so you buy 25% longer life with your 20 extra cents. Another great battery bargain!

Both these Eveready Layerbilts are made of flat cells that fill all available space inside the battery case. This construction avoids the useless waste spaces between the cells of the older, cylindrical cell type of battery, and eliminates soldered connections between cells. The truly modern "B" battery is the Eveready Layerbilt. These two batteries, exclusive with Eveready, are longer lasting and more economical. Look for the name Layerbilt on the label when you go to buy "B" batteries.

NATIONAL CARBON COMPANY, INC.
New York  San Francisco

Unit of Union Carbide and Carbon Corporation

Never was so much
extra service
bought for so
few extra cents

EVEREADY Radio Batteries

Layerbilt construction is a patented Eveready feature. Only Eveready makes Layerbilt Batteries.

**TUESDAY NIGHT IS EVEREADY HOUR
NIGHT**

East of the Rockies

9 P. M. Eastern Standard Time

Through WEAJ and associated N. B. C. stations

On the Pacific Coast

8 P. M. Pacific Standard Time

Through N. B. C. Pacific Coast network

You are a "B" battery user. You are most probably interested in one of two popular sizes. You use, in the majority of cases, either the heavy duty size, or the medium size. If you use the heavy duty "B" batteries, which is the most economical thing to do, you can get the Heavy Duty Eveready No. 770, which contains cylindrical cells, for \$4. BUT for only 25 cents more you can have the famous Eveready Layerbilt No. 486, which is the same size, outside, but which contains more active materials, and lasts 30% longer. For your extra quarter you get from a quarter to nearly a third more service.

Never before did 25 cents buy so much battery service!

If you use the medium size, you can buy the Eveready Medium Size "B" Battery No. 772 for

This is the famous original Eveready Layerbilt "B" Battery No. 486. The longest lasting of all Evereadys. 4 7/16 inches thick. 45 volts. \$4.25.

\$4.25
costs you only
25¢ more

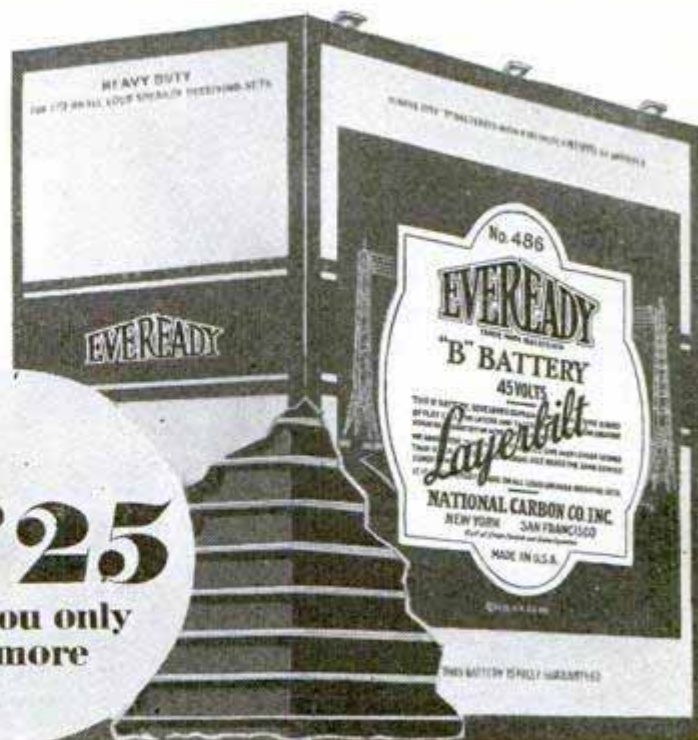

SEE AND HEAR THE NEW EVEREADY RADIO SETS

1592

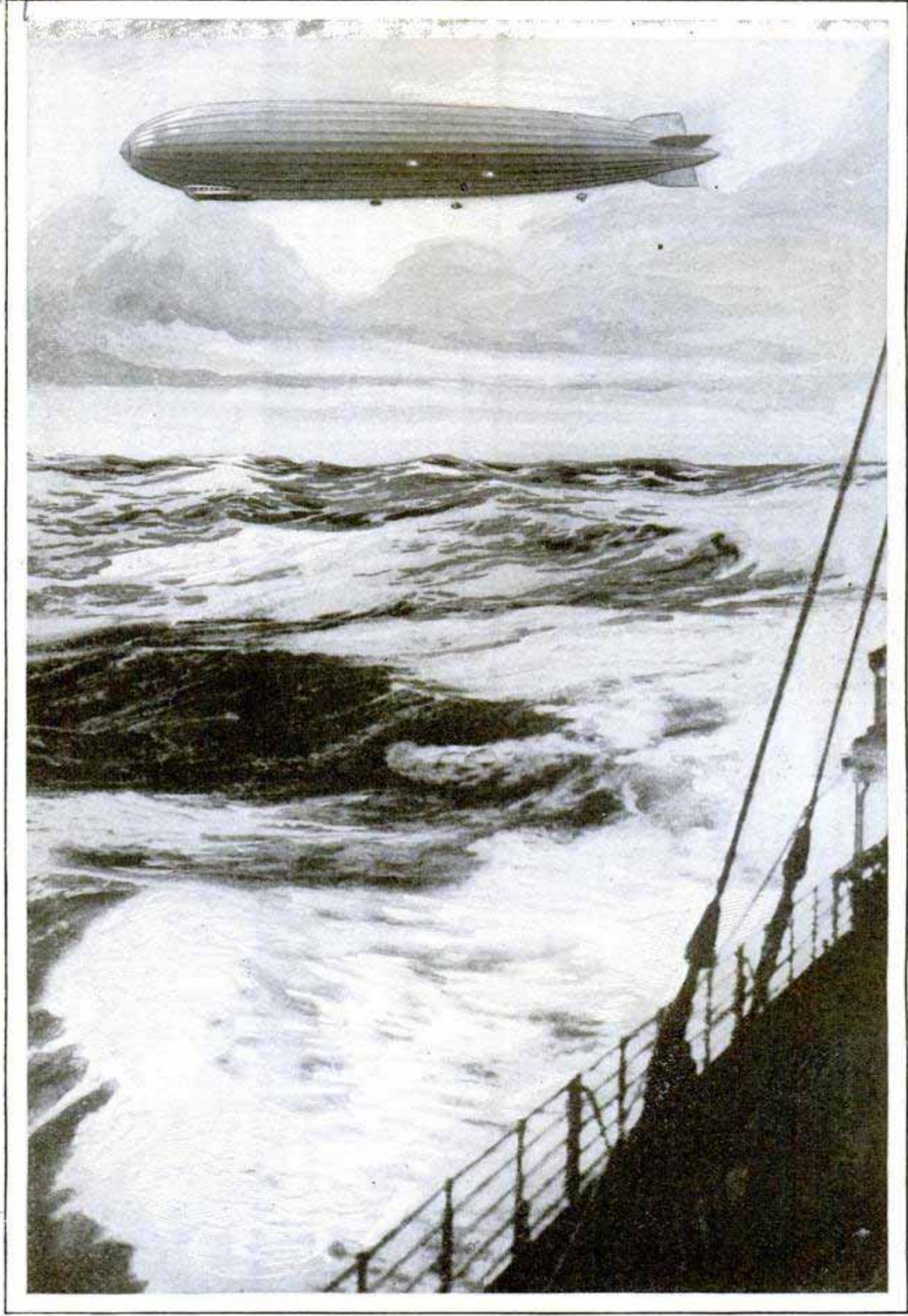

How the 762-Foot "Graf Zeppelin" Would Have Appeared to Passengers on a Steamer Deck; a Composite Photograph Showing the Huge Dirigible Somewhere over the Atlantic on Its Historic Voyage—See Page 889

Popular Mechanics Magazine

REGISTERED IN U. S. PATENT OFFICE

WRITTEN SO YOU CAN UNDERSTAND IT

Vol. 50

DECEMBER, 1928

No. 6



By THOS. M. NELSON,

*520 Aztec Bldg,
San Antonio, Texas*

“READY, station one?”

The man at the microphone flips the switch that transforms his broadcasting unit into a receiving set.

“Station one—O. K.,” the answer comes back with similar replies from stations two and three and then follows the sharp order:

“Shoot!”

The shooter takes a final and hurried glance at the numerous dials and switches before him and jabs down the plunger of the detonator. There is a split second of silence, then, with a deafening roar, the earth quivers and huge rocks and clods leap hundreds of feet into the air. Such is the latest phase in the eternal search for that black gold—oil.

But this is all mere surface display. The

facts of real value in the hunting of oil with dynamite are gathered only by the use of very delicate instruments: portable seismographs that record the subsurface vibrations set up by the explosion on strips of sensitized paper, which are later interpreted by trained men.

At isolated points, lying in a strip about fifty miles broad which extends along the Gulf coast, are found curious manifestations of geologic phenomena known as salt domes. These are actually columns of rock salt which have forced their way toward the surface through the fairly soft sediments that make up the underground structure.

Salt domes, with some exceptions, are too deeply buried to give surface indications of their presence. Those that do,

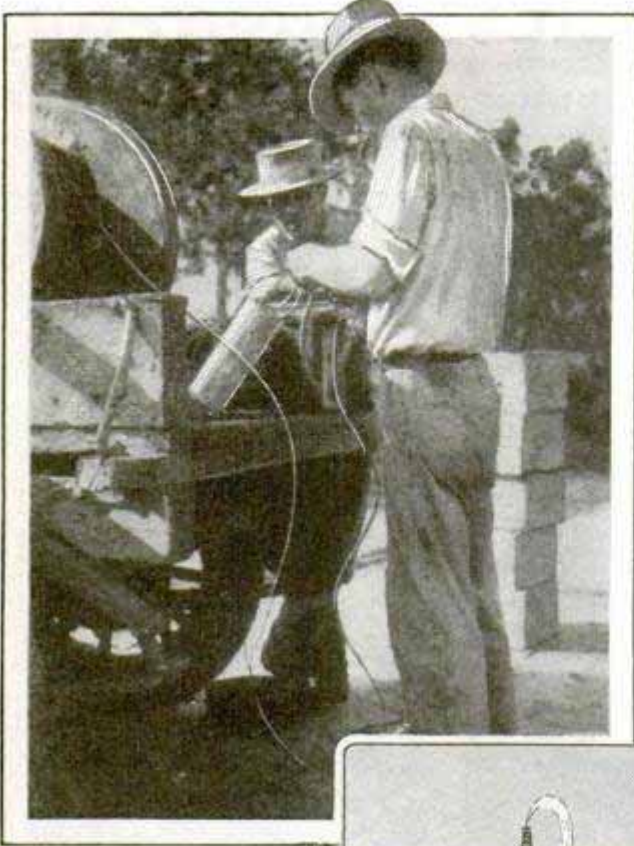

have long since been acquired by various oil companies, so that now it is necessary to use scientific methods to find those domes which lie so deep as to be unsuspected from the surface. Many methods have been devised, but the most successful and popular is the seismic, employing dynamite.

All salt domes do not produce oil, nor, in a strict interpretation, does any salt dome proper produce oil. The oil really comes as an aftermath of the salt dome in this manner: For oil to accumulate in paying quantities, it is necessary that the containing rock is so warped and twisted that it will act as a trap into which the oil may seep, but from which it cannot escape. A doming of the strata gives this condition in ideal form. Invert a bowl on a table top and you will have a good illustration of what is meant by doming. Underground, oil is always closely associated with water. Being lighter than the ground waters, it will always rise to the highest point in the stratum in which it is contained; so, if

that stratum is domed at any point, that will be the point where the oil will accumulate. In forcing its way upward a salt dome causes the surrounding layers of rock to tilt and bend, forming them into the desired structures. Hence the never-ending quest of these subterranean pillars of salt.

The organization and field methods of seismic surveys or dynamite parties differ slightly, but in the main they are all the same. Each party is composed of from ten to twenty men in charge of a chief who plans the shots, designates the seismograph locations and frequently computes and interprets the records. Each party generally uses three seismographs, so it is necessary to have three operators. Also there is a shooter and a loader. The former fires the shot at the time set and

operates the radio that is located at his station. The latter is concerned mainly with the loading of the holes and the handling of the high explosives used. Assisting him

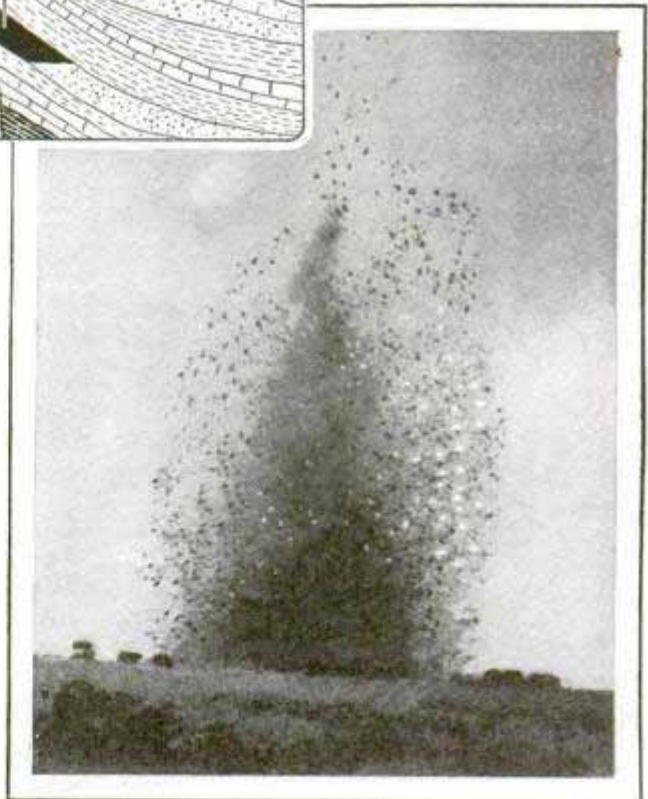
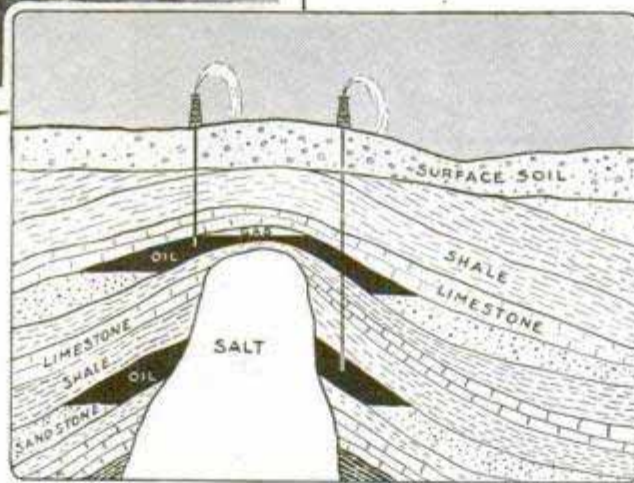

At the Top, the Shot Firer Is Preparing His Dynamite Bomb; in the Center, a Diagram to Illustrate the Relation between Salt Domes and Oil, and, Bottom, the Explosion of One of the Shots

are two laborers, who dig the holes for the dynamite. Lastly there is an advance man. He precedes the shooting party by a few days as it moves over the country, buying leases and getting permits from land owners to shoot on their property.

When a shot is to be recorded, the seismographs are set up about one mile apart, each in turn being about one mile from the point where the dynamite is exploded. With such distances between the various members of the party, it is necessary to have a system of communication if the work is to go off smoothly. Hence radio apparatus form a very important part of each seismograph party; radios that operate on a short wavelength. Each is within itself a masterpiece, small, compact and portable, with broadcasting and receiving set combined in one unit about the size of an ordinary suitcase.

The principle upon which seismographs work to locate salt domes is briefly this: The vibrations set up by exploding a large charge of dynamite travel through the sediments of the Gulf coast country at a speed of about 5,000 feet per second. If, however, the vibrations pass through a salt dome, they are speeded up until they travel about 15,000 feet per second. Hence, knowing the distance from the point of shot to the seismograph and the exact time at which the shot is fired, the computer can determine the exact speed at which the vibrations traveled when the instrument recorded them. If they show a speed in excess of 5,000 feet per second, the area is promising and the surrounding land is worked over with great thoroughness. If the speed is normal, the shooting party moves over a section or two and shoots again. In this way the entire country, or what is under it, is swept as though with a great broom.

Damage suits frequently come as a result of the dynamite blasts. In one instance a party was working through some extremely swampy country. A hole was loaded with 250 pounds of dynamite. The shot was fired; ripples formed in the jelly-like earth, and traveled on to a small town where they broke windows and shook down chimneys. Each adult citizen of the town claimed damages. When all the claims were settled, it was found that the shot had cost about \$20,000.

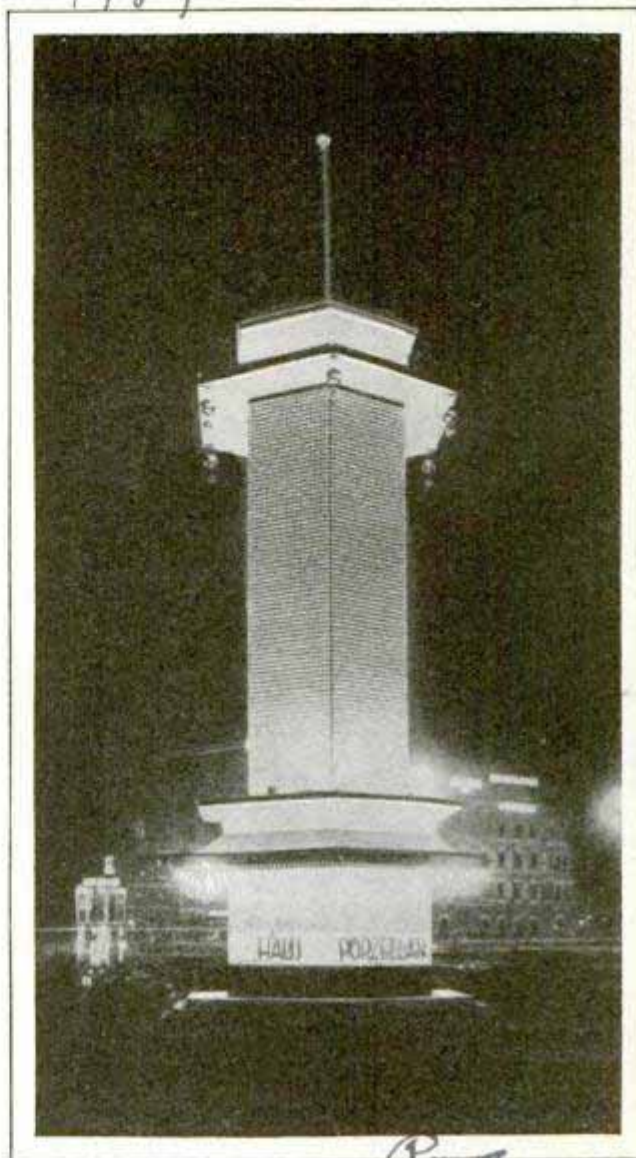

Tower of Porcelain Cups Furnishes Brilliant Exhibit under Floodlights at German Trade Fair

**TOWER OF PORCELAIN CUPS
FEATURE OF TRADE FAIR**

Porcelain cups, 1,200 of them, were arranged on the sides of a tower that formed one of the most effective exhibits at the recent Leipzig fair in Germany. Illuminated at night by powerful floodlights, the tower was visible for many miles.

**ELECTRIC-LIGHT COMPANY MAY
1540 ROCK BABY TO SLEEP**

The electric-light company may soon be in position to add the duties of nursemaid to its own services. A Milwaukee doctor has devised a motor-driven baby carriage which only needs to be plugged into the light socket to have the power company take over the work. The driving motor automatically provides a forward and backward movement of a few feet.

Trade
Dr. W. Frank Pycha,
Milwaukee, Wis

Prs
or c/o Milwaukee Ass'n. of Commerce

is part of the ... Wash.

Long Bell Lumber Co., O.R.A. Long Ridge, Kansas City, Mo. -504

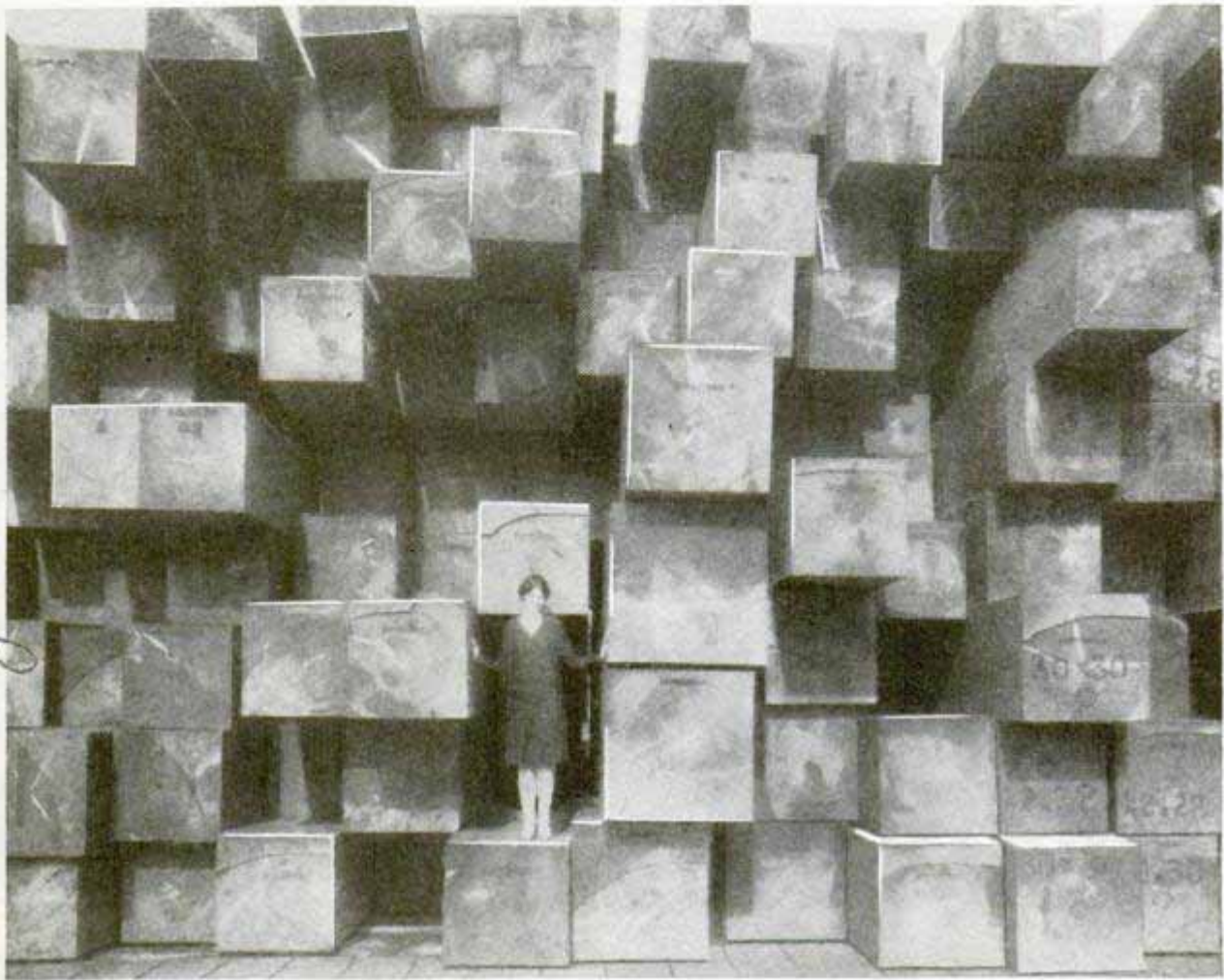

"Jap Squares," Big Timbers for the Orient, Stacked at a Western Mill before Shipment to Japan; Some of These Huge Pieces Contain 5,000 Feet of Lumber

ONE STICK OF LUMBER BUILDS TWO JAPANESE HOUSES

More than 5,000 feet of lumber, sufficient to build two Japanese homes of average size, is sometimes contained in a single huge timber, the "Jap square," shipped from a large western lumber yard. These pieces range from twelve to forty inches square and from twenty-four to forty feet long.

BEST WORK DONE IN AUTUMN FACTORY SURVEY SHOWS

Fall is the season at which many persons do their most efficient work. At least this is the conclusion of engineers who kept a four-year record of the performance at various factories in England. The workers were paid on a piece basis, and their average over the period showed that there was a much greater output during September and October than at other

times of the year. Monday is a poor day, from a production standpoint, the survey showed, but Tuesday is generally the best. Actually, the peak in output was not infrequently reached at that time.

FENDER SHIELD PROTECTS CAR FROM MUD AND TAR

A fender shield, a flexible extension to the regular equipment of the automobile, keeps the wheels from throwing up mud, oil, dust and tar on the bumpers, body or on persons in the rear. The shield is made of a double thickness of imitation leather and is attached to the bot-



tom of the fenders, the only tool needed being a pair of pliers.

-52

Oct. 9/29/28

Hampden Auto Togo
Spring Field

Lawrence, Kans. 885

**EXTRACT FROM ANIMAL GLAND
MAY SAVE FIRE VICTIMS**

Victims badly burned in fires may be saved by an extract from a tiny gland located at the base of the brain, according to a Detroit doctor. The extract would be obtained from animals. Its action, according to Dr. Oliver Kamm, is to help the body tissues retain water. Death from burns, according to the latest theories, results from drying out of the body tissue. Over or underactivity of this gland in human bodies, Dr. Kamm believes, may be responsible for a form of diabetes characterized by excessive thirst.

1539

1491

**TABLE AND SEATS FOLD AS ONE
TO SAVE ROOM SPACE**

Occupying only a few inches of space when closed; but affording ample room for four or six persons when open, a folding dining table, with benches attached, is one of the latest units devised for convenience in small apartments. The top folds down and one pair of legs, with the benches, swing under it. The table is opened or closed with a single movement and is solidly braced. When folded, the article serves as a convenient end table. The entire outfit weighs only a few pounds and consequently can readily be moved about the house.

1487

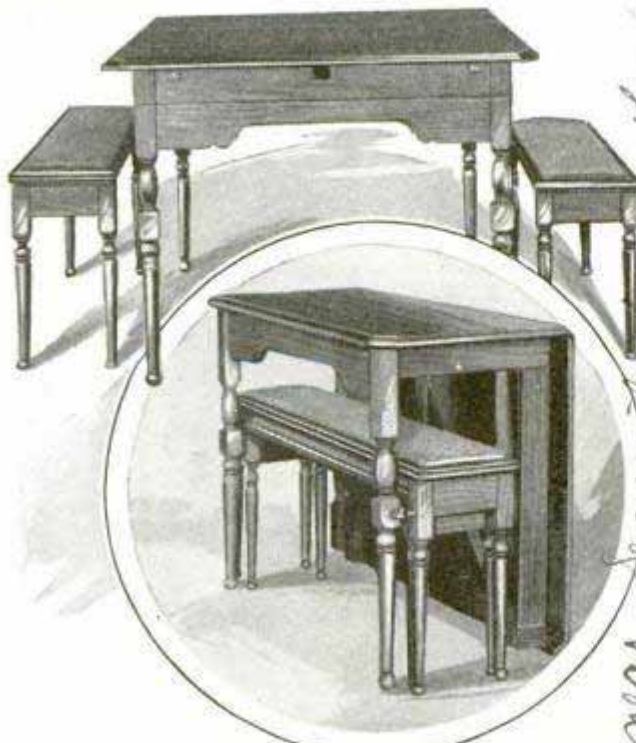

Folding Dining Table and Benches Occupy Small Space, Yet Open to Seat a Number of People

Miller System Folding Furniture



Combination of Gasoline Station and Dance Hall in a Replica of a Dutch Mill

**GAS STATION LIKE WINDMILL
ALSO HOUSES DANCE HALL**

One of the strangest automobile filling stations in Kansas is built to resemble an old-fashioned Dutch windmill. Attendants are dressed like Hollanders, and the building also contains a dance hall.

Comb. Ernest A. Slench Ho. Ho. Kans. N.J.

**TWO LOST GOLD MINES HUNTED
IN OKLAHOMA HILLS**

Somewhere in the hills of southeastern Oklahoma are two lost gold mines, one of which was never worked. Searching parties have prospected the hills for years, but only a few small nuggets have rewarded them. The gold mines are said to have been located by two Indians, who communicated the news to the Rev. W. J. B. Lloyd, a missionary. He and twelve Indians started to work the property, and all took an oath never to reveal the location. One mine was worked until all of the easily reached metal had been removed. Lacking equipment for blasting, the band prepared to open up the second mine when the interior department issued orders that development should stop. Eventually the thirteen in the company all died without revealing the location.

1543

near some of the Indian Territory (ask for Chief) ...

Comb. Basil B. Truby, Servant. Okla.

Letter recd 11/2/28

PICK-UP CHUTE FOR AIR MAIL SAVES LANDINGS

*Mr. Lytle S. Adams
Seattle Wash.*

Mail bags and other packages can be delivered and picked up without the plane landing, by means of an interesting trap arrangement a dental surgeon has invented. It promises to extend widely the benefits of transportation by air, as places not included as scheduled stops will enjoy the advantages of air-transport service, and it will reduce the cost of operating the lines as well as helping to increase the revenue. The unit consists chiefly of a wide-mouthed trap, mounted on a turntable so that it can be revolved to the most favorable position for the plane, flying as the wind direction dictates. The mail bag or package is placed at the narrow end of the trap. To make a pick-up, the pilot, before reaching the load, lowers a cable weighted by a ball, both of steel. The cable is wound and unwound on an electrically operated reel. The plane is brought down to a comparatively low altitude, the ball passes into the trap, is dragged to the V-shaped opening at the other end, where it engages a coupling arrangement, placed in a slot of the pick-up and to which the package is attached. As the connection is made, a catapult

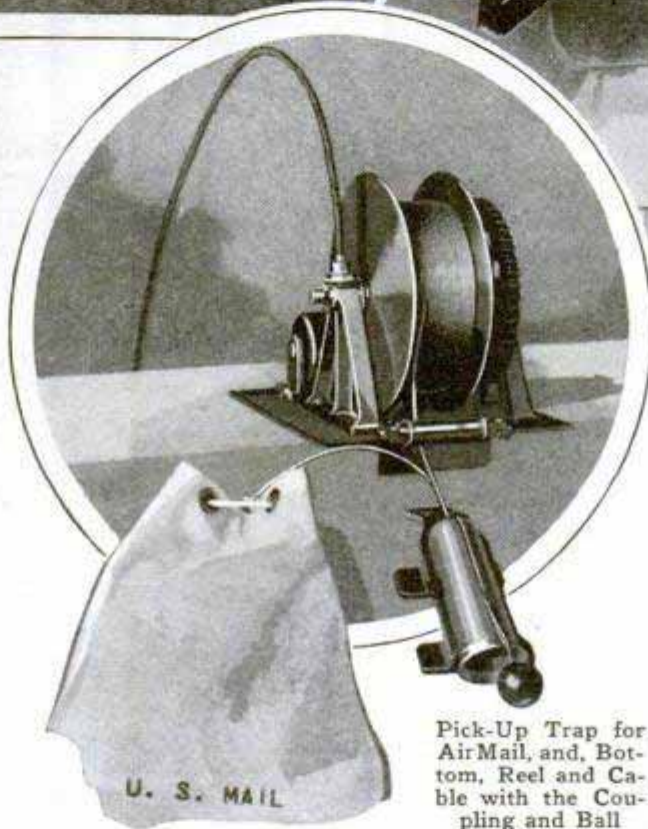
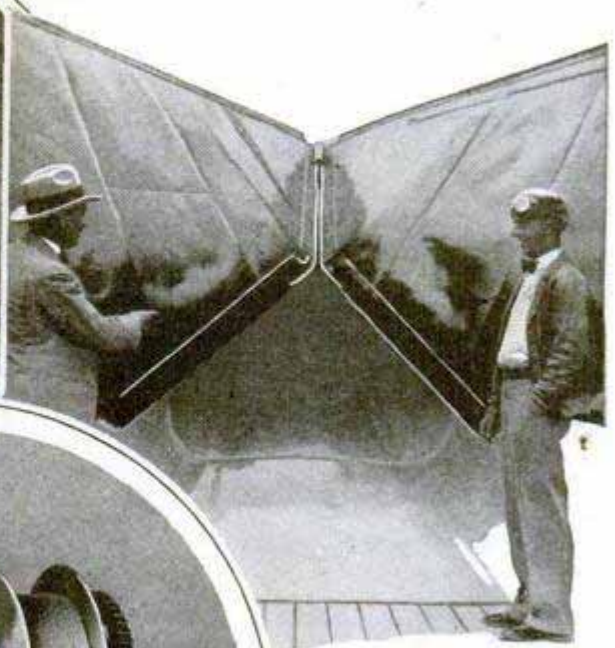
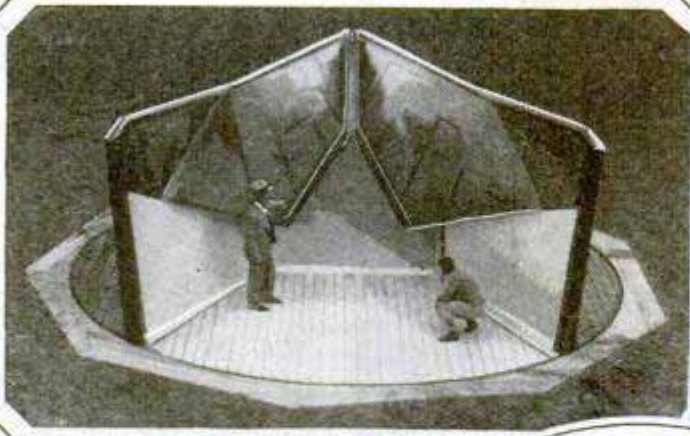

Pick-Up Trap for AirMail, and, Bottom, Reel and Cable with the Coupling and Ball

shoots the load forward to take up the jerk that otherwise would occur; the cable with its burden is quickly hauled up to the plane by the electric reel, and the package taken off and stowed away. Repeated tests were made with the apparatus at a western flying field, and not one failure was

reported. Pilots declare that the load can be "hooked" with little difficulty, and the great advantage of the system is that bags of mail or other articles can be picked up or delivered at the same time. This is accomplished by an ingenious coupling unit in the slot. Should the ball and cable become fouled for any reason, they would be pulled loose from the plane before any damage could be done, but the likelihood of such an occurrence is not considered great, as fields are free from obstructions and the trap is constructed in such a way that the line cannot become tangled in it. The inventor has succeeded in fashioning a reel-and-cable unit that weighs only a few pounds yet is very strong, so that but little burden is added to the plane.

**NOISES MADE BY OYSTERS
HAMPER SEA RADIO**

9/25/28

1519

Of all living creatures, the oyster has been popularly regarded as one of the quietest, and "shutting up like a clam" has been equivalent to a profound silence. But man has been stringing microphones at the bottom of the sea to help guide his ships, and now the bivalves are accused of creating noisy disturbances! The opening and shutting of their shells is registered on the sensitive wireless "ears," and the sounds interfere with the proper working of the apparatus, a radio expert recently reported. Something may have to be done, he suggests, for the microphone's service lies in its sensitiveness. It has broadcast the beats of the human heart, the sounds of beetles boring in a tree and of insects eating corn in a crib, and to decrease its "listening powers" would greatly impair its usefulness. Elimination of the sea noises would make the underwater radio outfit the greatest life-saving apparatus the world has ever seen, and would make it suitable for seas in any part of the world, the engineer points out.

Foreign

**BICYCLE FOLDS INTO SUITCASE
AND WEIGHS FEW POUNDS**

1483

Capable of making as much as twenty miles an hour, a folding bicycle that fits into a suitcase, has been introduced in France. It weighs but twenty pounds and saves the traveler the trouble of checking

Paris



Folding Bicycle for Adults; the Machine Can Be Carried on Journeys Packed into an Ordinary Suitcase

the vehicle, as it can be carried as an ordinary piece of luggage.

No information available.

J.W. Norman C. King
69 Marion St.
Seattle Wash
1490



Food Dispenser Which Keeps Bulk Semiliquids in Sanitary Containers Instead of Open Jars

**DISPENSER KEEPS FOOD CLEAN
AND REDUCES COST**

For the distribution of semiliquid foods such as jellies, jams and salad dressings, a patented dispenser is a substitute for individual glass or other containers. A gallon glass jar fits inside the dispenser and, when it is empty, it is shipped back to the wholesaler for refilling. Its contents are removed through a special gate cap when it is turned upside down.

**DIESEL ENGINES FOR RAILROADS
DECREASE FUEL COSTS**

1520

Three locomotives of the Diesel type, burning heavy oils, are being used successfully on Russian railways for hauling freight at relatively low speed. As compared with gasoline, their fuel consumption costs three to six times less, the weight of fuel carried is half that with gasoline and only about one-sixth as compared with coal, while the cost is much less than that of the latter fuel. According to a Russian engineer, the railroads in the future will have to meet the competition of Diesel engines as adapted to automobiles, and will be able to do so by adopting the same kind of motive power while specializing in the hauling of freight and passengers over long distances.

Kansas City Star
9/20/28

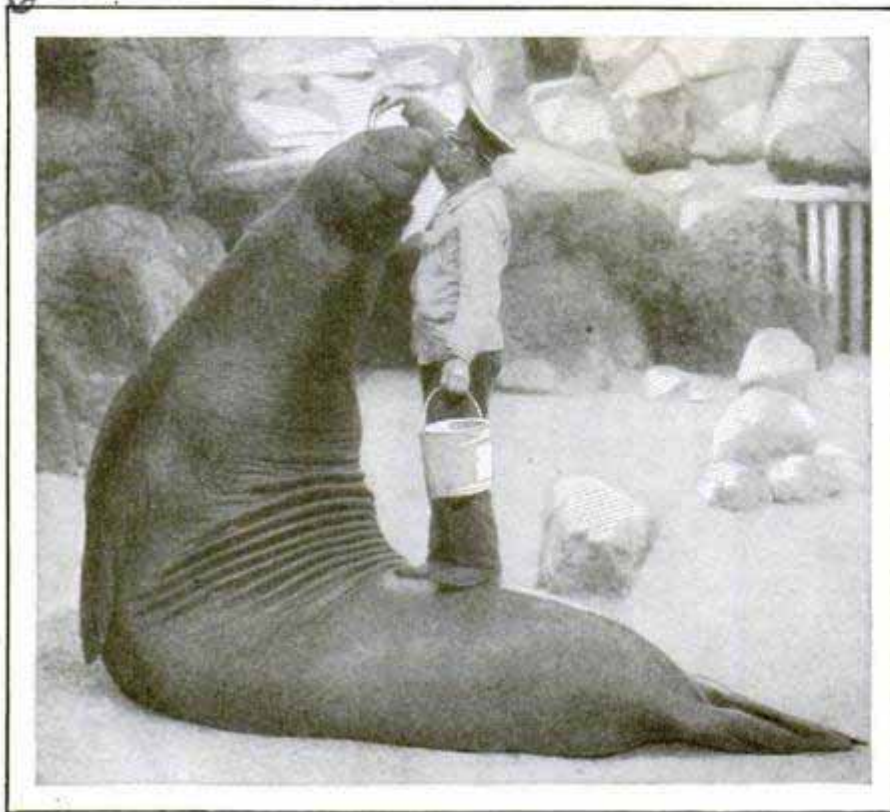

Feeding the Sea Elephant at the Berlin Zoo; the Keeper Stands on Its Back and Drops the Fish

SEA ELEPHANT LETS KEEPER STAND ON ITS BACK

The sea elephant has numerous interesting peculiarities, but none is stranger than the manner in which it is able to take its food. At the Berlin zoo, one of these huge pets permits its keeper to stand on its back, stretches its neck and head to the rear and the meal is dropped into the open mouth. A sea elephant of this size consumes more than 100 pounds of fish a day.

LEAVES SERVE AS WIND GAUGE TO AID FOREST RANGERS

1562

Estimating wind velocities is important in forest-ranger work, because their speed will determine, to some extent, how many men are needed in case a fire should break out. In conjunction with the weather bureau, the forest service has developed a means of judging velocities by observing the effects of the breezes on familiar objects. A light wind is one moving not more than seven miles an hour. It is felt slightly on the face, causes leaves to rustle and its direction may be told by smoke drift. Next comes the gentle wind with a speed of eight to twelve miles an hour. It

keeps leaves and small twigs in constant motion and will extend a small flag. Moderate winds range in speed from thirteen to eighteen miles an hour. They raise dust and litter and keep small branches moving. Fresh winds blow from nineteen to twenty-four miles an hour. Small trees in leaf will sway under their force and small waves will be induced on inland waters. Strong winds travel from twenty-five to thirty-eight miles an hour. They cause telephone wires to hum and make walking inconvenient. Gales vary from thirty-nine to fifty-four miles an hour. They break off small branches,

make walking progress difficult and do damage to buildings. Stronger gales blow from fifty-five to seventy-five miles per hour. They will uproot trees and do considerable damage. A wind of greater velocity than seventy-five miles an hour is commonly classed as a hurricane.

SAFETY SAW IS INSULATED TO GUARD ELECTRICIAN

For cutting live electric cables and performing other tasks where there ordinarily is considerable danger, a safety saw, recently introduced, is equipped with a



thoroughly insulated frame. It is of wood, specially treated with a filling and insulating varnish that prevents the material from absorbing moisture or oil. The far end of the frame is designed to keep the saw

from running over upon adjacent cables or other metal parts, an important feature when the work is being done in manholes, and the handle affords an effective grip.

Carl Verne Jenkins
Navy Dept Washington

Engineering Products
Corp., 25 Church St.

THE FIRST GREAT PASSENGER LINER OF THE AIR

*Isossaalstrasse 20, 8
Berlin-Friedenau
Germany.*



Members of the Crew of the "Graf Zeppelin" Before the Dirigible Took to the Skies for Its Voyage to Lakehurst from Friedrichshafen, Germany; the Photograph Gives a Clear View of the Forward Control Room and Its Comparative Size; Inset, One of the Big 520-Horsepower Rohrbach Engines Being Hoisted into Its Gondola; There Were Five of These Motors, Each Carefully Set so That the Propellers Would Not Interfere with Each Other When All Were Working; the "Graf Zeppelin" Was Designed Essentially the Same as Its Predecessor, the "Los Angeles," of the U. S. Navy, but It Is One and One-Half Times as Large and Differs Especially in the Matter of the Fuel It Used; Instead of All Gasoline, It Burned a Special Gas Which Has Approximately the Same Specific Gravity as Air

1592

SOME OF THE DETAILS OF GREAT RIVAL AIRSHIPS

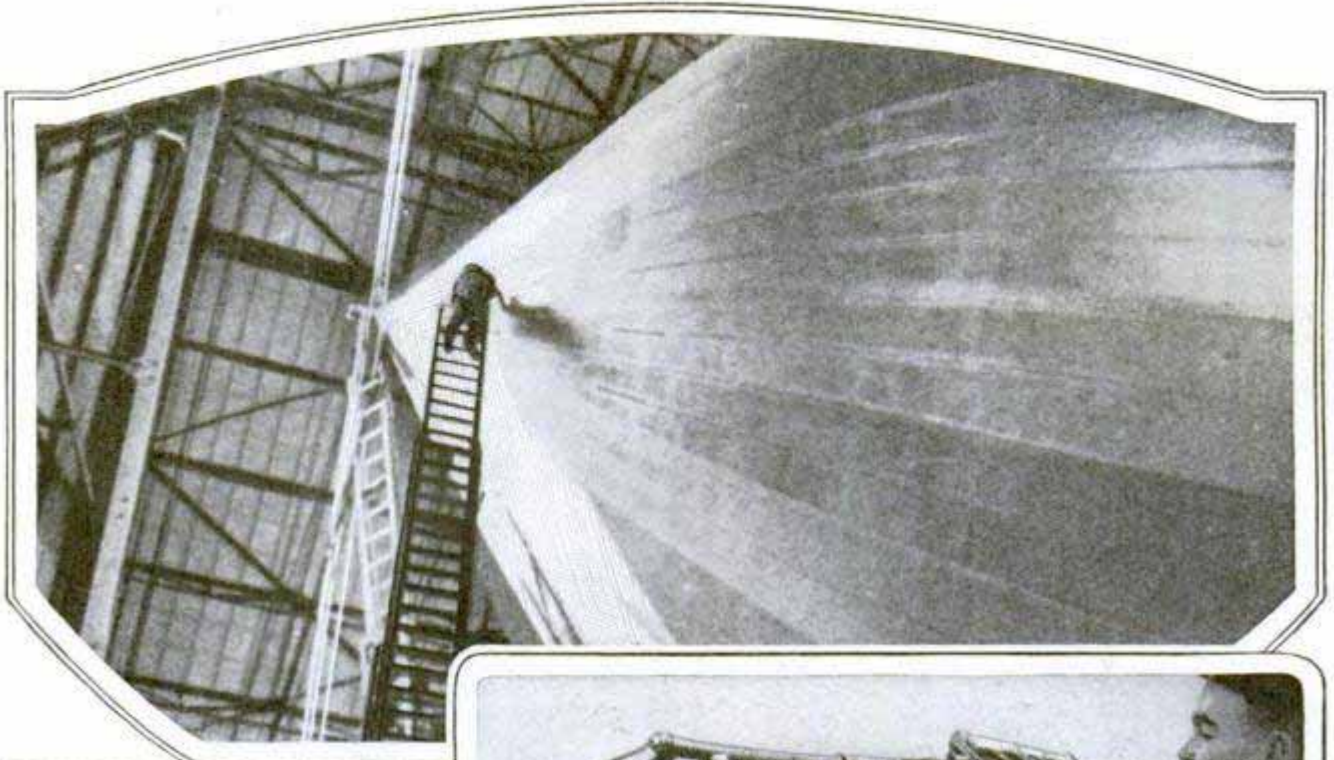

Putting Finishing Touch on the Fabric Close to the "Zeppelin's" Nose, and, at Right, Mechanic Inspecting One of the Motors Before It Was Installed; These Engines Burn Either the New "Blue" Gas or Gasoline

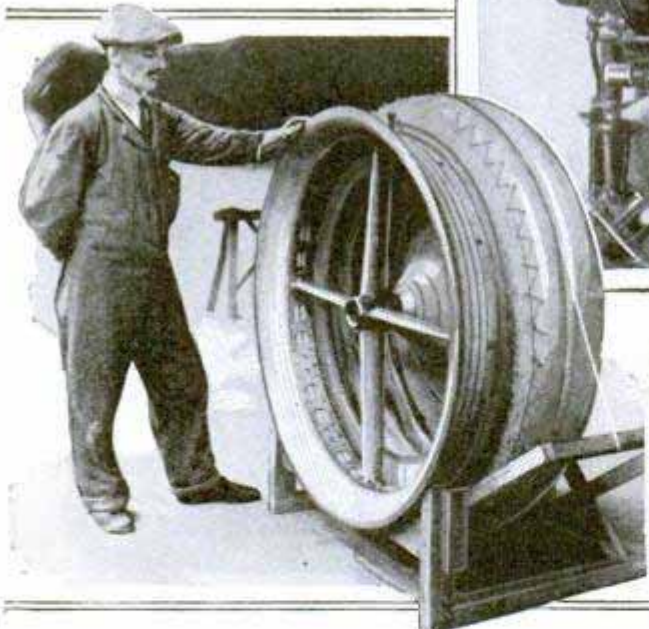
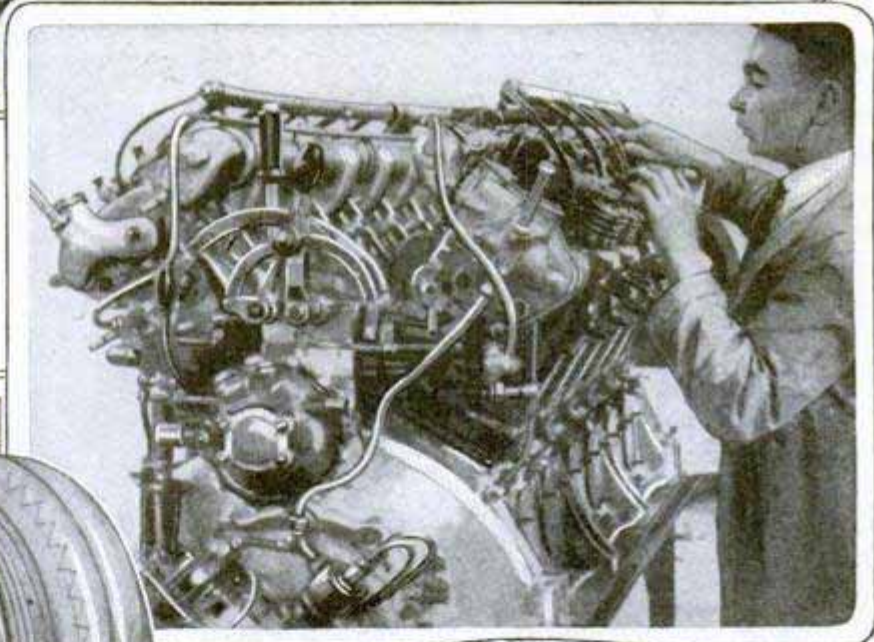

Above, a Rim of One of the Big Wheels of the "R-101," to Be One of the World's Largest Airships, Now near Completion at Cardington, Eng.; It Is for Service on the England-Egypt-India Route; Right, View of a Gas Valve of the "R-101"; This Ship Is 750 Feet Long and the Gas Bag Has a Capacity of Almost 5,000,000 Cubic Feet

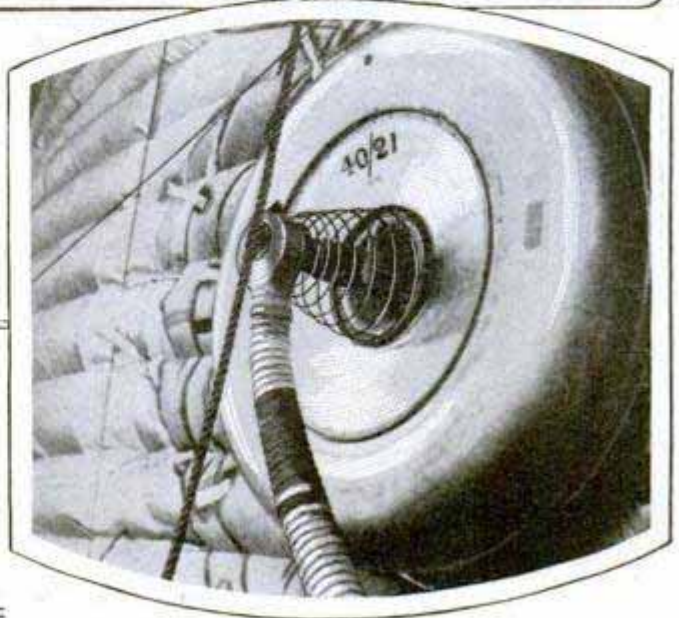

ZEPPELIN'S CONTROL CAR AND HOW IT WAS GASSED

Close View of the Control Room of the "Graf Zeppelin," with the Passenger Compartments toward the Rear; Note the Spaces for the Gas Bags, the Fuel, Freight and Baggage Storage, the Crew's Sleeping Quarters, Kitchen, Dining Room and Lounge; the Dining Room Is Large Enough for Forty Persons at One Time and Is Handsomely Furnished and Ventilated through Large Windows, a Special Convenience When the Ship Sails over the Tropics; Below, the Air Liner in Its Hangar at Friedrichshafen with the Gas Inlet Attached; Use of Gas Fuel of About the Same Weight as Air Made It Unnecessary to Have Water-Recovery Apparatus Such as Was Devised by American Government Engineers to Maintain Weight on the "Los Angeles," as Its Engines Burn Gasoline; the Recovery Units Condense the Exhaust

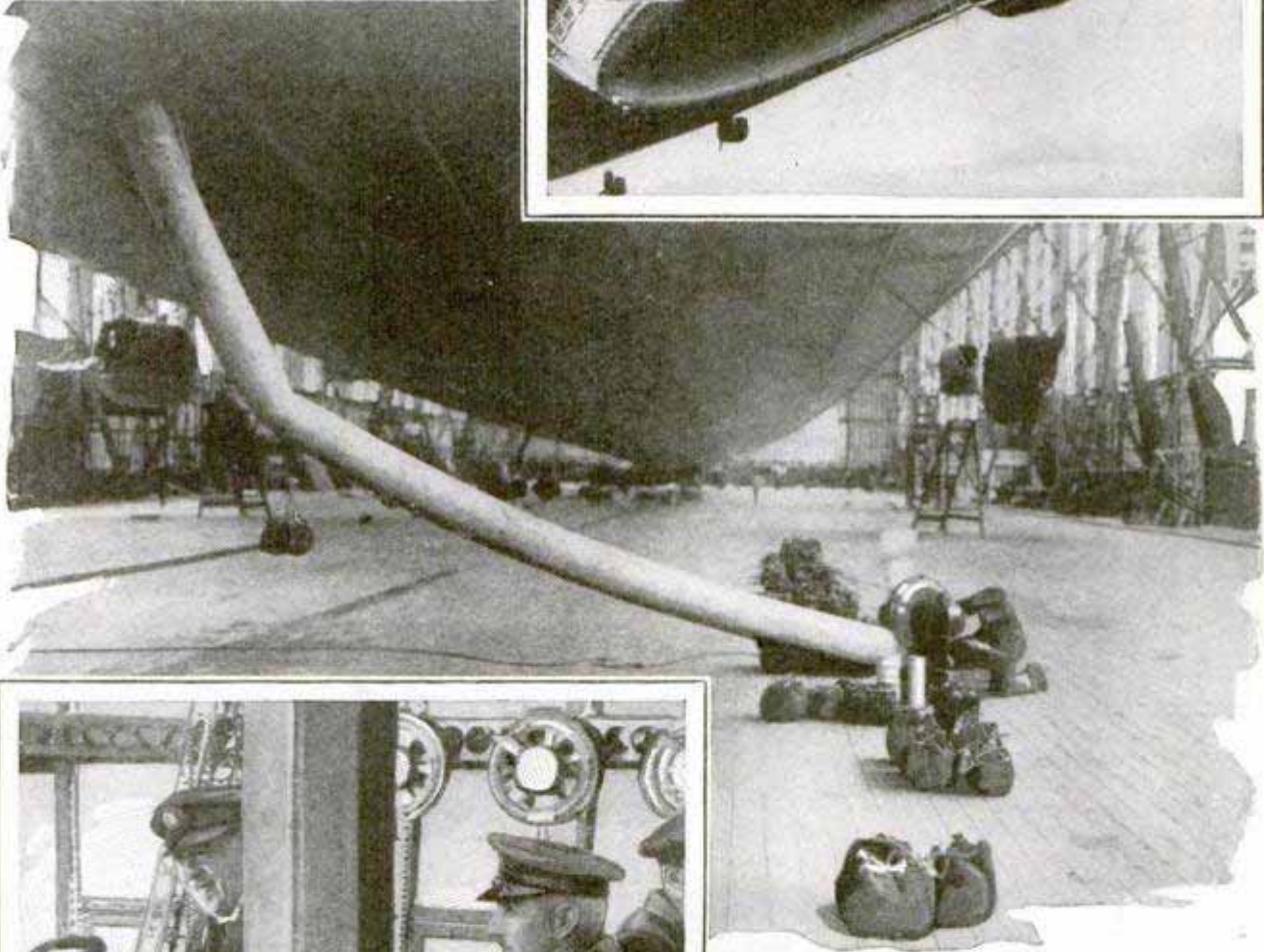
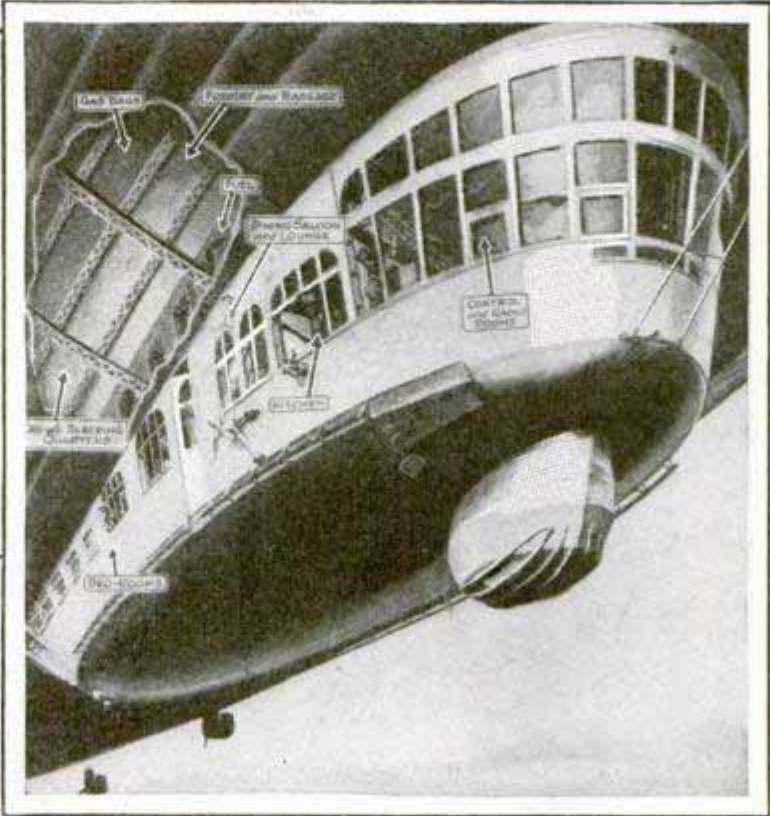

Dr. Hugo Eckener, Center, with Members of His Staff in the Pilot's Cabin of the "Graf Zeppelin" during the Last Test Flight of the Big Dirigible Before It Started for America; It Left at 12:52 A. M., October 11, and Arrived at Lakehurst, October 15, at 4:38 P. M., Having Traveled through the Air Nearly 6,000 Miles and Being Aloft About 112 Hours; It Beat the Best Steamer Time despite Several Mishaps

1592 AIR PILOTS AND VIEW OF EARTH FROM THE CLOUDS

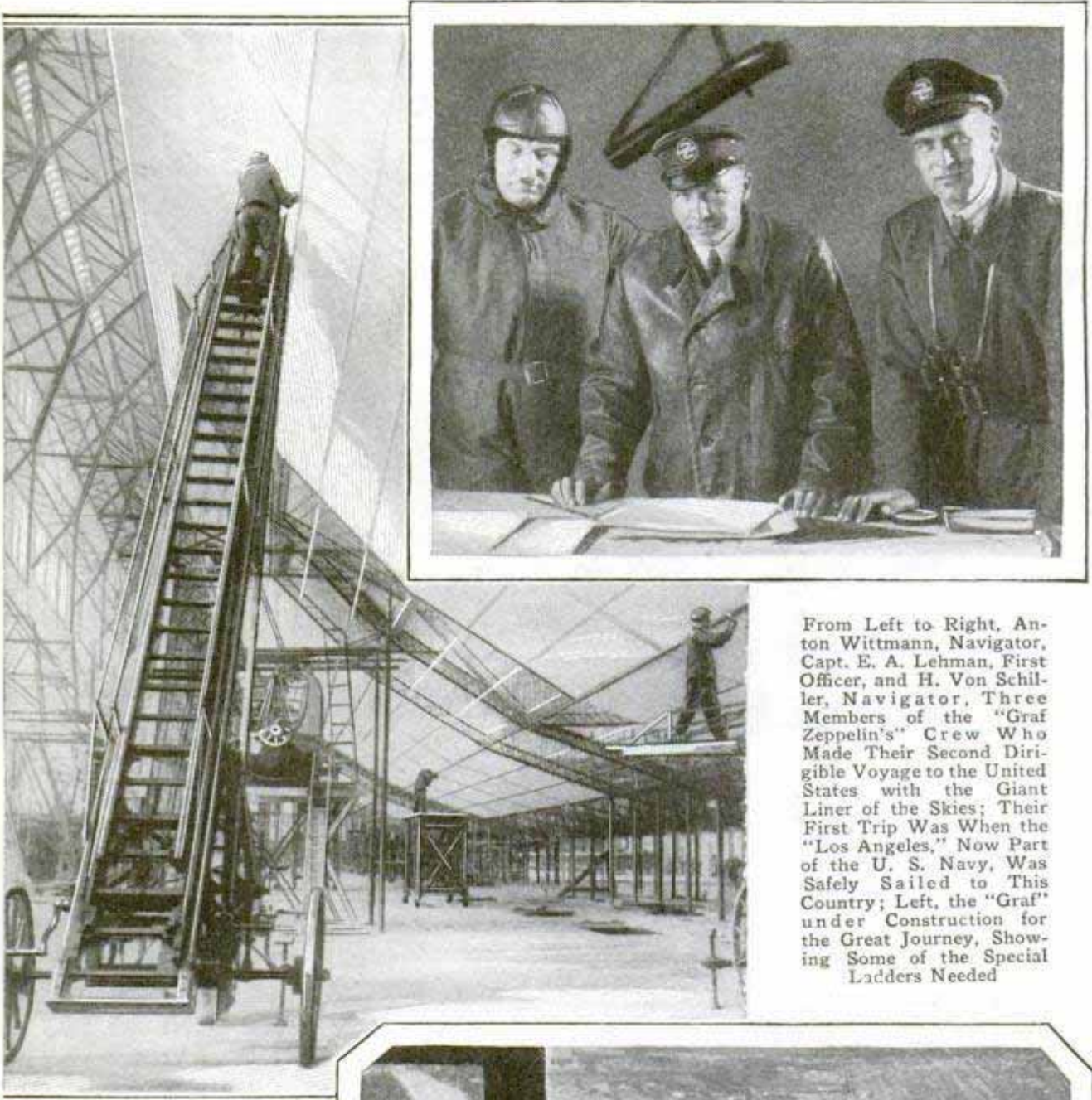

From Left to Right, Anton Wittmann, Navigator, Capt. E. A. Lehman, First Officer, and H. Von Schiller, Navigator, Three Members of the "Graf Zeppelin's" Crew Who Made Their Second Dirigible Voyage to the United States with the Giant Liner of the Skies; Their First Trip Was When the "Los Angeles," Now Part of the U. S. Navy, Was Safely Sailed to This Country; Left, the "Graf" under Construction for the Great Journey, Showing Some of the Special Ladders Needed

One of the Ship's Officers Peering from the Pilot's Cabin as It Passed over Berlin on Its Last Long Test Flight before the Actual Take-Off to America; Although the Huge Craft Encountered Unfavorable Weather over a Large Part of the Ocean Trip, It Showed That Dirigibles Can Successfully Dodge Storms as Well as Journey through Them; the Transatlantic Flight Took Longer Than Had Been Anticipated, but the "Graf Zeppelin" Had Fuel for over Forty Hours When It Landed at Lakehurst



GRAPHIC ILLUSTRATION OF GIANT ZEPPELIN'S SIZE

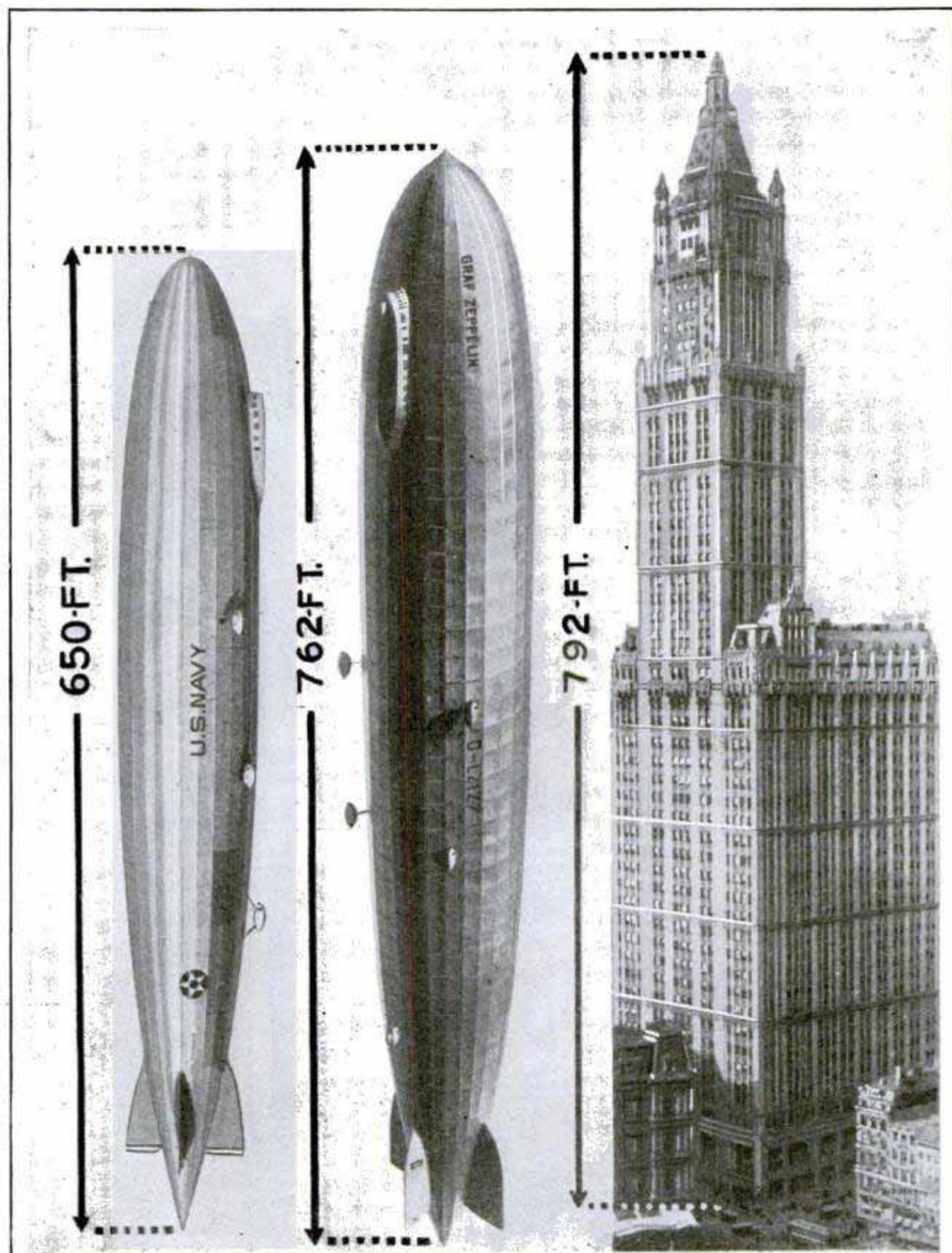

How the "Graf Zeppelin" Compares in Size with the "Los Angeles" and the Woolworth Tower; It Is Nearly 100 Feet in Diameter and Has a Gas Capacity of 3,750,000 Cubic Feet

DOCKING THE "ZEPP" AND ONE OF ITS GONDOLAS

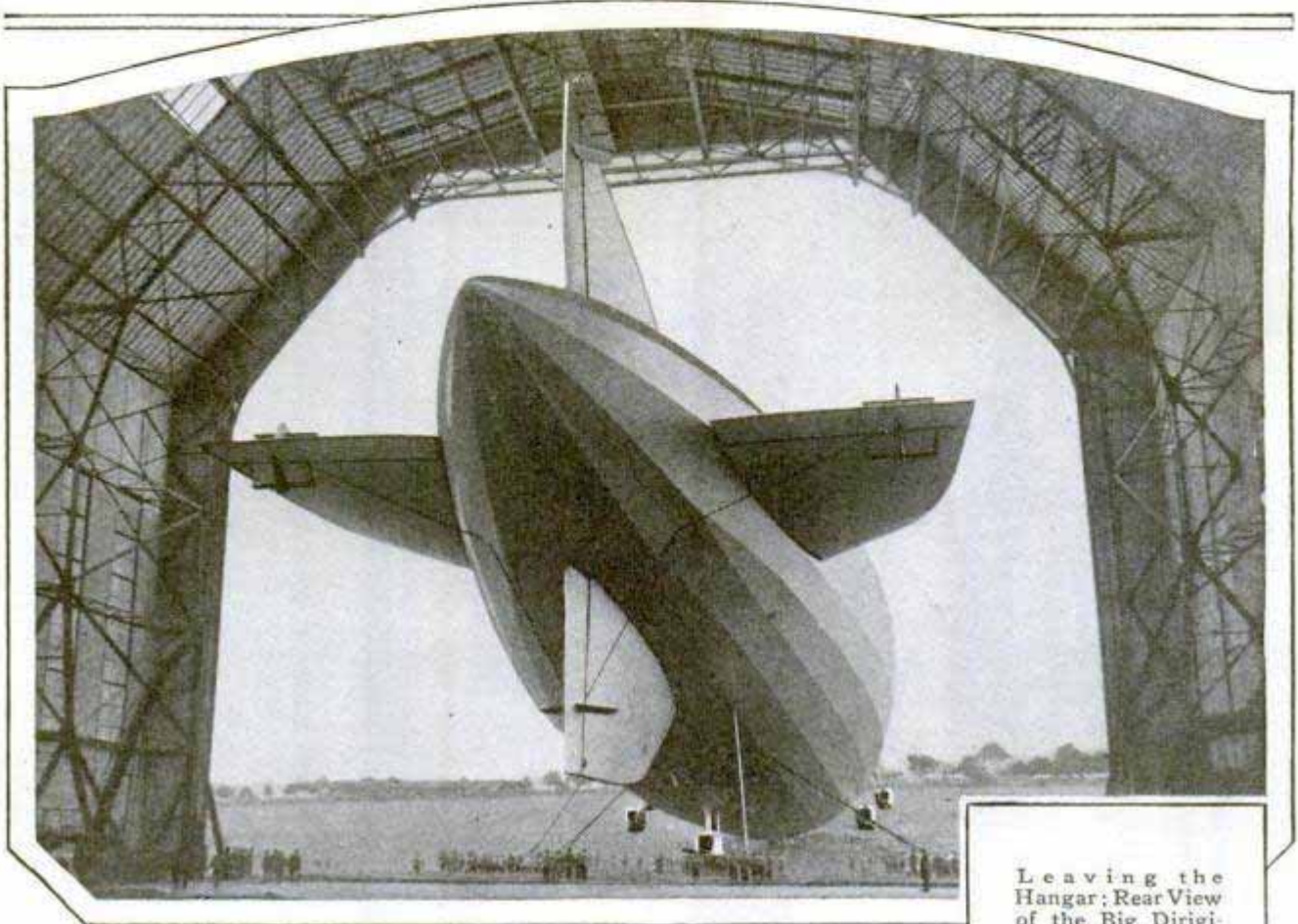

Leaving the Hangar; Rear View of the Big Dirigible, Showing the Huge Fins and the Rudder with Four of the Motor Gondolas in Sight Far Down the Ship's Cigar-Shaped Body; at the Left Is a Composite Photograph, to Show How the Dirigible Looked When Moored to the Mast at Its Destination

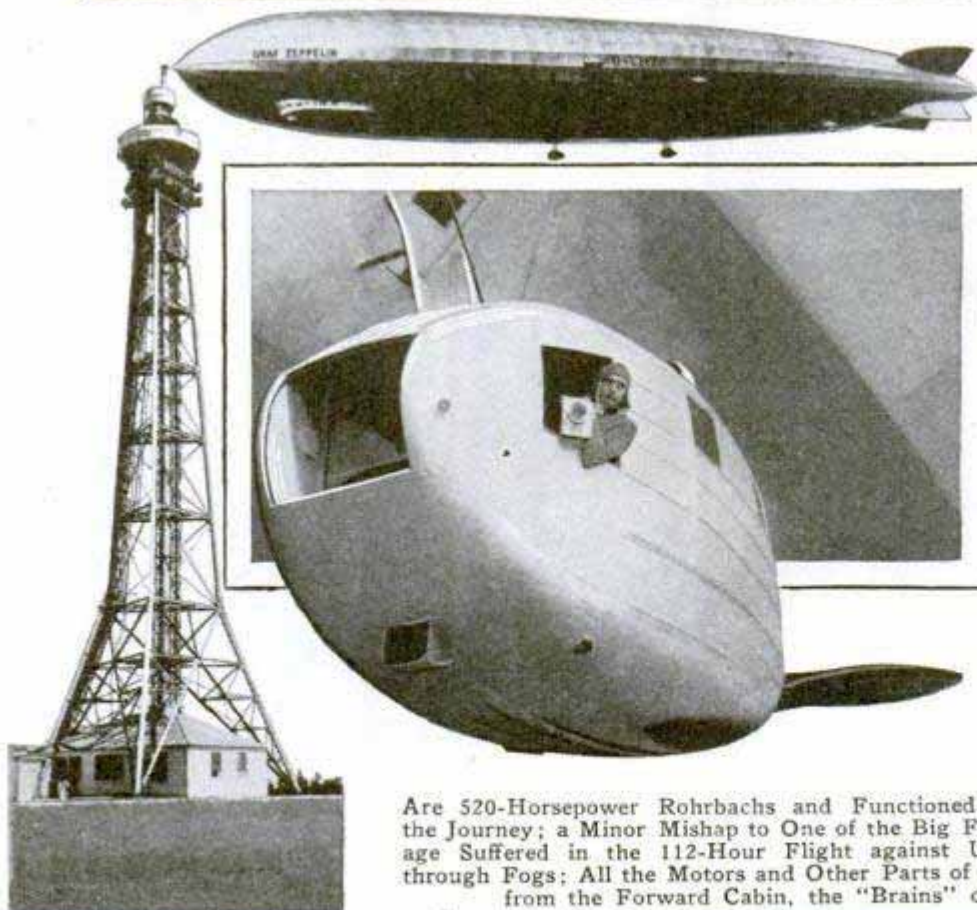

Close View, Showing Robert Hartman, a Camera Man, at the Window of One of the Gondolas of the Giant Ship Just before the Second Test Flight Which Proved It Worthy for the Trip across the Ocean; Note How the Gondola Is Streamlined to Decrease Resistance; the Motors

Are 520-Horsepower Rohrbachs and Functioned Splendidly throughout the Journey; a Minor Mishap to One of the Big Pins Was the Only Damage Suffered in the 112-Hour Flight against Unfavorable Winds and through Fogs; All the Motors and Other Parts of the Ship Are Controlled from the Forward Cabin, the "Brains" of the Dirigible

RADIO ROOM AND ITS WIND-DRIVEN GENERATOR



One of the Most Difficult Phases of Travel by Dirigibles Involves Handling the Big Bags When They Land; Here Is Part of the Expert Landing Crew of the "Graf Zeppelin" at the Ropes Just Before the Ship Took to the Air for Its First Flight; at Right, a View of the Wind-Driven Generator That Supplies Current for the Ship's Wireless System; When the Dirigible Slows Down, the Generator Slackens Speed, Too, Hampering the Performance of the Radio Apparatus.

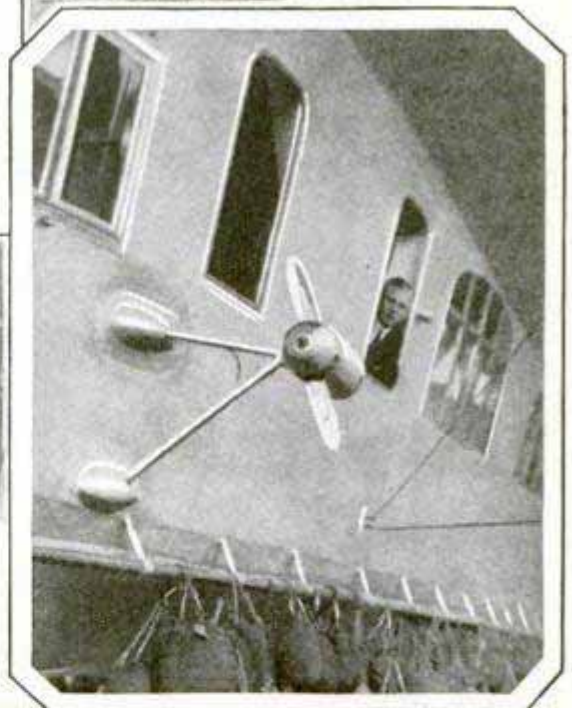

Radio Set in a German Commercial Airplane; the "Graf Zeppelin" Was Equipped with a Special Radio Cabin Fitted with the Latest Types of Receivers and Transmitters as Well as Radio Direction-Finding Apparatus; Batteries Were Provided for Operating the Ship's Wireless in Case the Wind Generator Was Not Running, but They Were Out of Commission at First and the Ship Was Cut Off from Communication Until the Battery System Was Repaired

Service. Inc. 519-13th St., N. W.
Washington
20-9

DIVERS' TESTS MADE BY NAVY IN "IRON-MAN" TANK

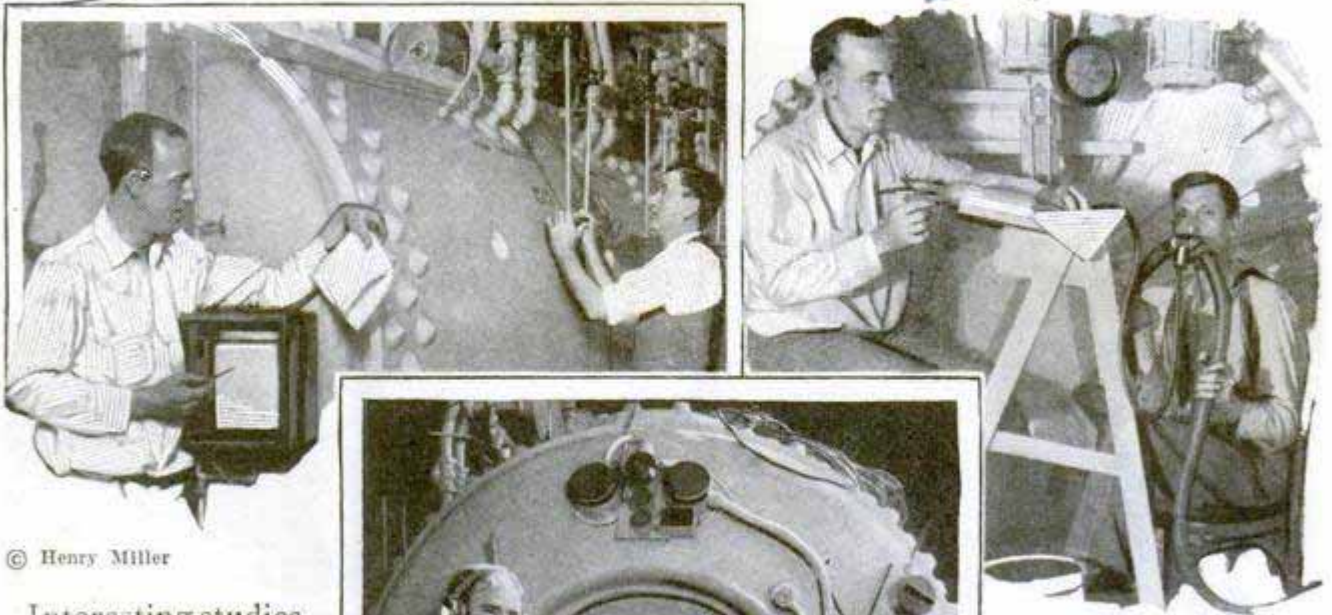

© Henry Miller

Interesting studies to determine the effects of underwater pressure on humans are being made at the Washington navy yard. One of the chief instruments used is a tank which is closed after a man has entered, and the pressure inside is then regulated to correspond to that experienced at any desired depth below the surface of the water. Moisture condensed from the subject's breath is collected and analyzed to reveal some of the results of the test on his system. The investigators have also been studying the effects of helium, mixed with oxygen, in treating divers suffering from the "bends," a serious ailment that often develops after remaining in high pressures. Another valuable aid is a telephone without batteries, more sensitive than the ordinary instrument.

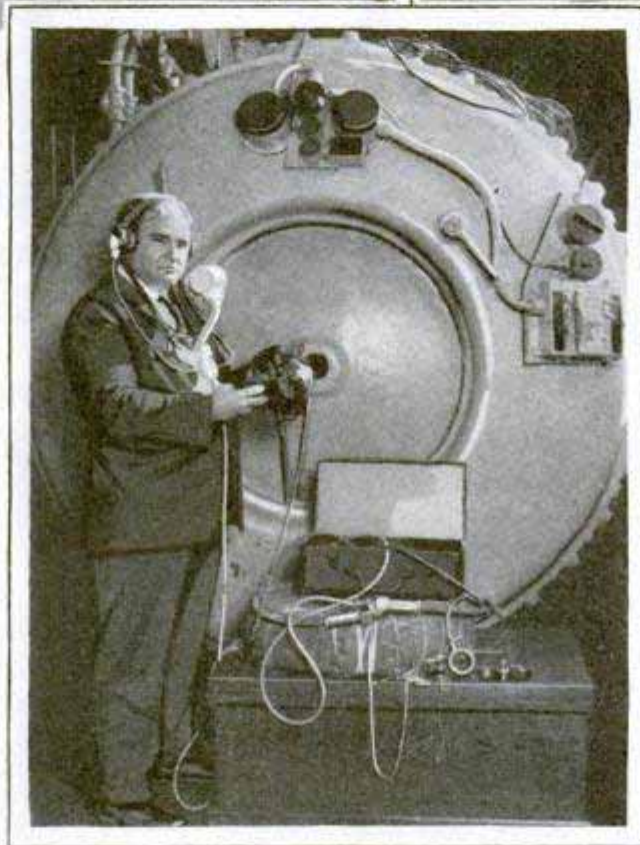

Using the Pressure Tank at Washington Navy Yard to Determine the Effects of the Deep Sea on Divers

in size and intensity. According to the weather bureau, this is due to the nature of the storms and also to the topography of North America. The winds are essentially swirling passages of broad and relatively cold polar currents west and north, and equally broad, but much warmer, equatorial winds to the south and east. The storm itself increases in intensity with the

contrast in temperature between the two currents. In the eastern part of the United States and Canada and over part of the western Atlantic, the storms move rapidly northeastward and in this region there is free access to the supplies of cold wind from the arctic regions, as there are no great mountain barriers. Warm air from the Gulf of Mexico and the lower areas of the Atlantic, reaching this more northern and colder district, presents a distinct temperature contrast to the chilly currents, and the difference increases as the two air streams move farther north. Thus the cyclonic storms that result naturally gain in violence as the disturbances pass over the eastern part of North America.

WHY CYCLONES GROW STRONGER AS THEY MOVE NORTHEAST

Cyclonic storms, moving northeastward across the United States or along the Atlantic coast, have a tendency to increase

la. news City Star
12/29/28

1260

From Wood Burners

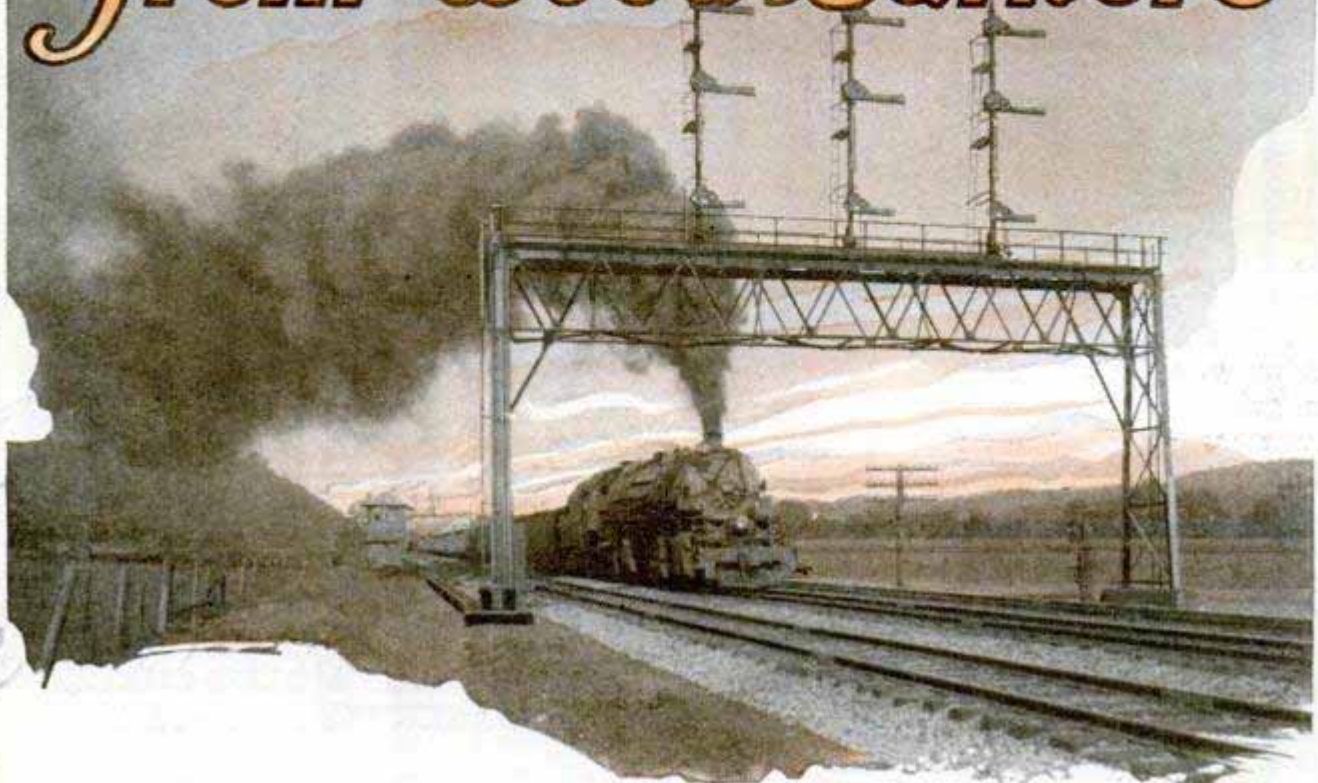

IN MY wildest dreams, I never expected to see anything like this!"

J. H. Baker, retired Pennsylvania railroad engineman, grinned as he bounced on the fireman's seat of engine 5480, hauling the "American" westward at a sixty-mile clip. He was having his first ride in the cab of a modern locomotive and over rails guarded by automatic train control, the magic wand that now rules traffic along more than 15,000 track miles of eighty railroads in the United States.

Cornfields stirred in the summer wind and the original "Old Swimmin' Hole" of Riley fame flashed by, but Baker was oblivious to the scenery. He was looking out on almost fifty years of railroad progress as the "American's" 240-ton engine shouldered up a gentle grade and skimmed down the other side.

"We hit seventy miles an hour for a few minutes," yelled Fireman J. P. Hartley, who was keeping the steam-gauge needle glued to the 200-pound mark with mighty swings of his skillful shovel, and the engine cab free from dust with liberal applications of the hose.

"They used to call us on the carpet when

we did more than thirty. Fifteen was the regular gait with the old wood burners," Baker shouted, as 5480's eighty-inch drivers took a curve as smoothly as an auto rounds a bend, and then settled down to a long, straight dash under the hand of Engineer S. H. Boyle, who used to be a fireman under Baker.

Two generations of enginemen were in 5480's cab. The representative of one had started service at about the time the old wood burners were disappearing from the lines, to be replaced by the swifter and more powerful coal burners. The other was in his prime now at a period when railroads are enjoying mechanical and other developments that put a modern train as far ahead of the one of fifty or seventy-five years ago as the horse and buggy was an advance over the oxcart.

As Engineer Boyle pulled the whistle cord and eyed the smooth stretch of track ahead, Baker was thinking of the days when passengers sometimes volunteered to get out and help the engine crew load the tender with wood. It carried but five or six cords, enough for a run of twenty miles or so, while the "American" was

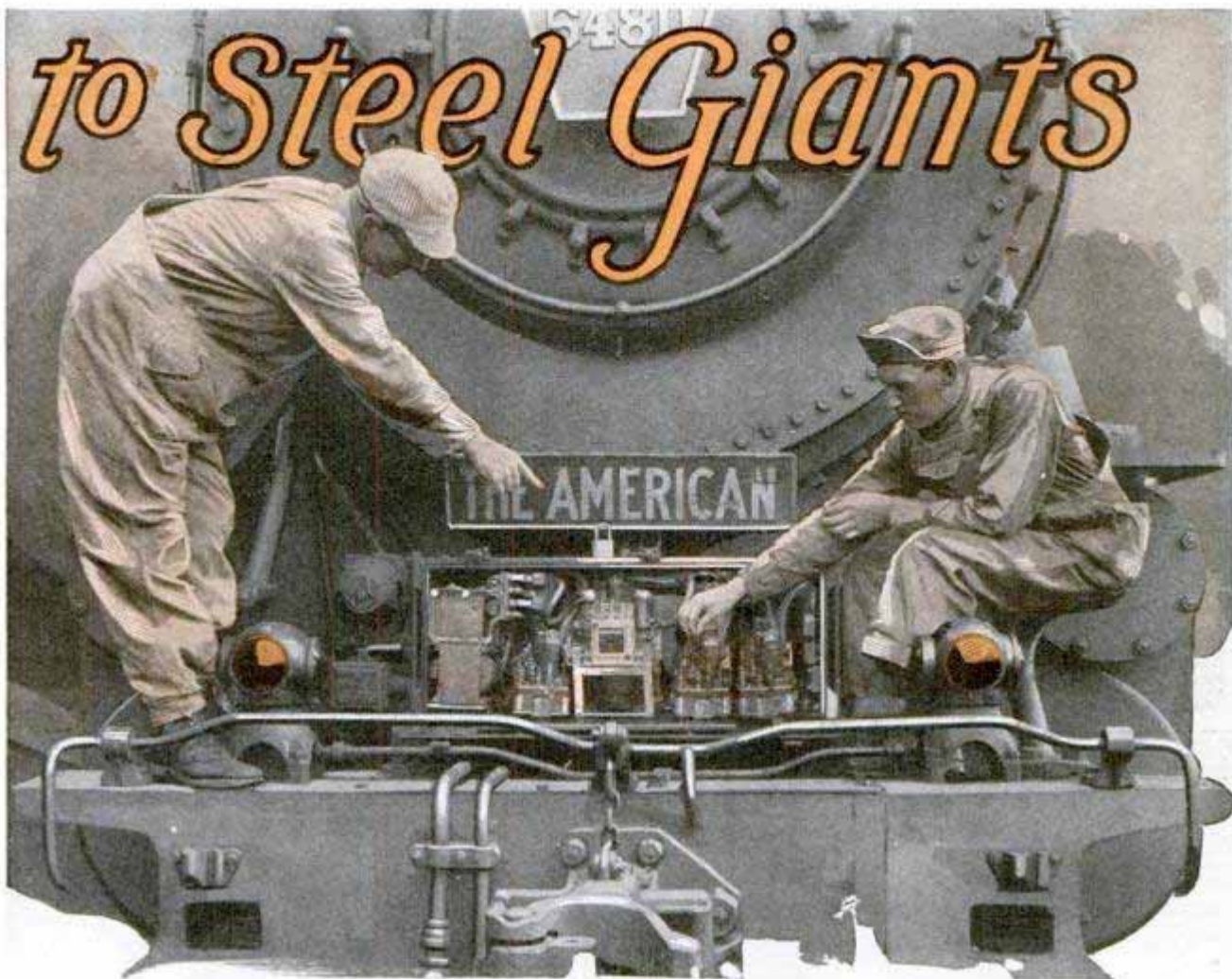

The Little Box That Runs the Train if the Engineer Should Fail; Radio Tubes and Apparatus Play an Important Part in the Automatic Train Control, Which Checks Human Errors

flying along with enough fuel to carry it 300 miles. Where the "American" was rolling on 130-pound rails, the trains of his day traveled on sixty-pounders, comparatively slender threads that quickly would have given way under the steel giants of today. Fast passenger engines in those times had a heating surface of only 1,900 square feet or so. The fire roaring under 5480 reached 4,050 square feet of heating surface and, besides that, the engine had a superheating surface of 1,215 square feet. The superheating feature alone, engineers regard as one of the most effective developments in railroading. By means of the apparatus, steam is raised to an extra-high temperature of 550 degrees Fahrenheit or more, and practically all the water is baked out of it so that it has tremendously greater efficiency.

Trains literally "ran wild" in Baker's day. Glance at the orders issued to J. Fred Wood, retired St. Louis division passenger engineman on his first trip, Dec.

16, 1872: "Run to Brazil wild. Look out for work train west of gravel pit." If the work train wasn't there, Wood was supposed to find it. "Meet train No. so and so the same place you did yesterday," was a not uncommon form of order. If one train went past the siding and met another, it often had to back up and enter the sidetrack from the other end, for many sidings were equipped with one switch only. The fast passenger engine of 1868 had a tractive force of 11,900 pounds, a modern engine, 65,000 pounds and more, while it carries 250 pounds or so of steam to the earlier locomotive's 125.

Engineer Boyle had his orders but they were written in position light signals every mile and a half along the right of way, and were duplicated in his cab on a panel of small circles, a separate signal in dots for each circle. Three lighted dots at the top of the panel showed that the track was clear. The same signal appeared on the big target guides that flashed past on

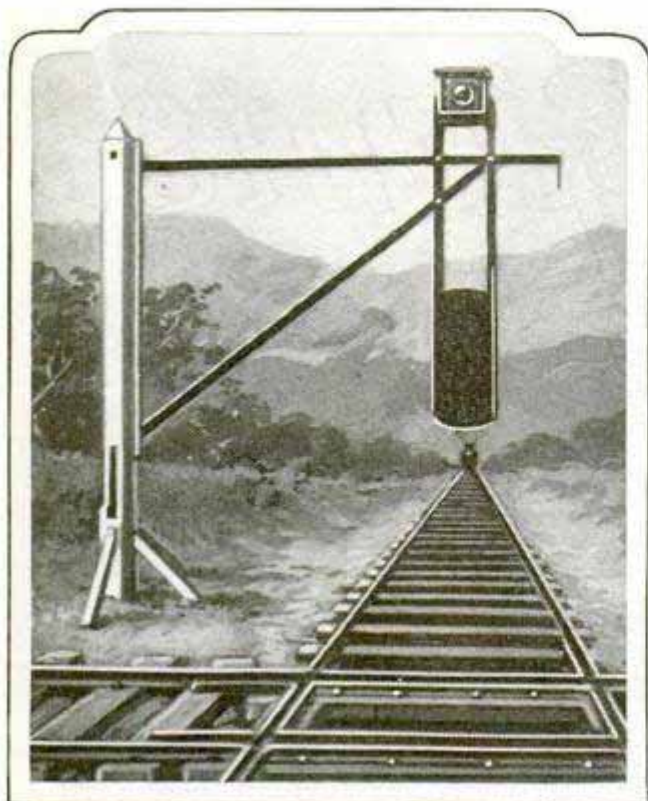

itself. This is located at the exit end of each track circuit and consists of an electric motor which turns a series of cams. Each one causes a certain number of interruptions in the current supplied to the track and the interruptions determine what signal will show in the cab and along the right of way. When the track is clear, the cam that gives 180 interruptions per minute causes the clear signal to show. Should the train enter a block but one behind another that is occupied, the coder is automatically shifted to interrupt the current 120 times a minute and the approach-restricting signal shows. At the next block, if the one ahead is still occupied, eighty interruptions per minute cause the approach signal to be given. Now if the train enters the block that is already

the right of way. By this system, both engineer and fireman have the signals directly in front of them, a few feet from their eyes.

The "American" was running over a section protected by what is known as the "coder" system of train control. Under this arrangement, a code of signals is automatically relayed through the track by electrical impulses and into the engine cab, where the code appears in visible form on the panels on each side of the cab. If the signal should change to require a reduction in the speed of the train, a shrill whistle blows four or five seconds to warn the engineer. He must heed this alarm and acknowledge it by turning a switch which cuts out the automatic-stop apparatus, otherwise the train's brakes will be applied automatically and it will come to an immediate stop.

The current that transmits the signals is picked up from the rails by a receiving bar on the engine, just ahead of the leading pair of wheels and a few inches above the rails. It passes through amplifying units in a box in front of the locomotive. An essential part of the system is the coder

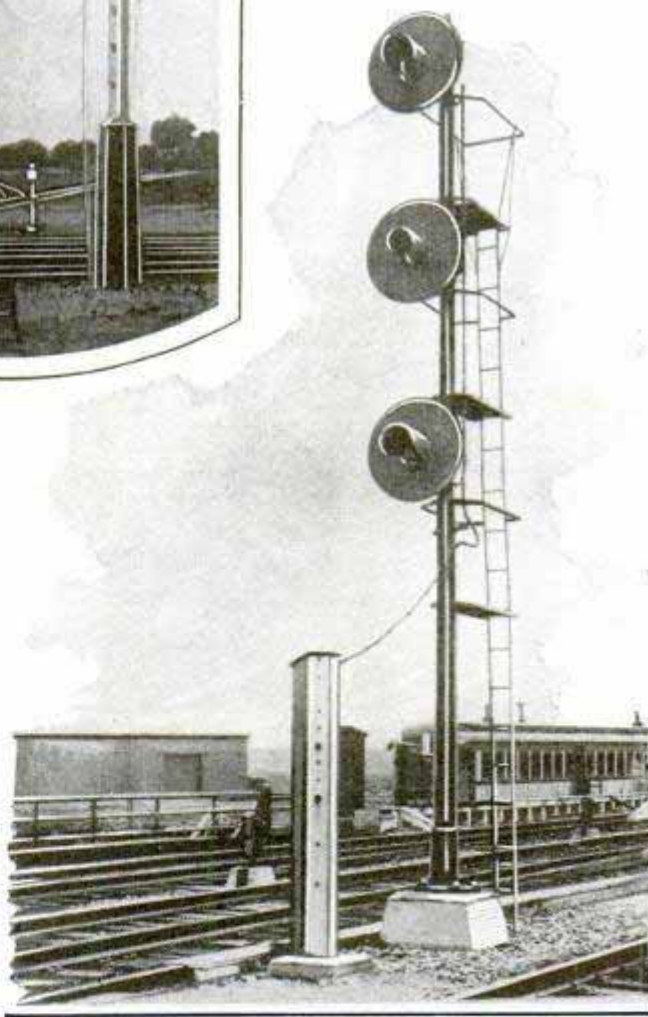
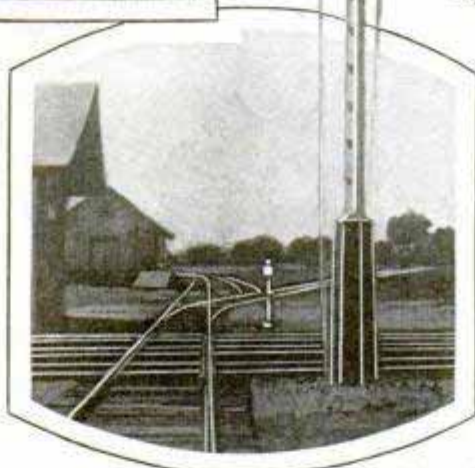

Evolution of Signals: the American Gate, Top, the English Ball Signal, Center, and One of the First Three-Color Lights on the New York Central

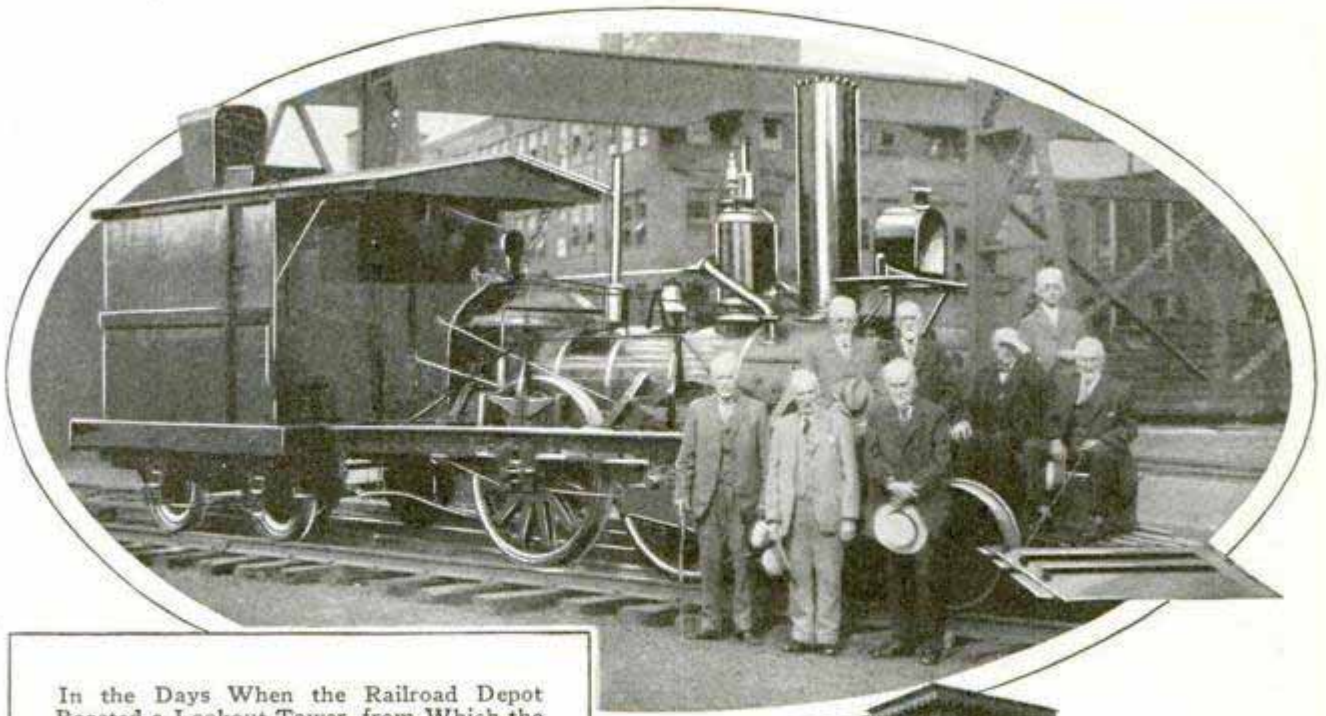

In the Days When the Railroad Depot Boasted a Lookout Tower, from Which the Station Agent, with a Telescope, Could Spy the Distant Plume of Smoke That Announced the Approach of a Train, the Locomotive Above Was Rendering Good Service on a Line Now among the Largest; Like Its Competitors It Was a Wood Burner and Had to Stop Frequently While the Crew Stepped Off and Raided the Wood Piles Kept Replenished along the Track at Frequent Intervals



Women in Hoopskirts and Voluminous Petticoats, Escorted by Frock-Coated Swains in Beaver Hats, Handed Their Carpet Bags to Bearded Porters While They Boarded the Marvel of the Age, Mr. Pullman's First Sleeping Cars, Built from Old Wooden Day Coaches

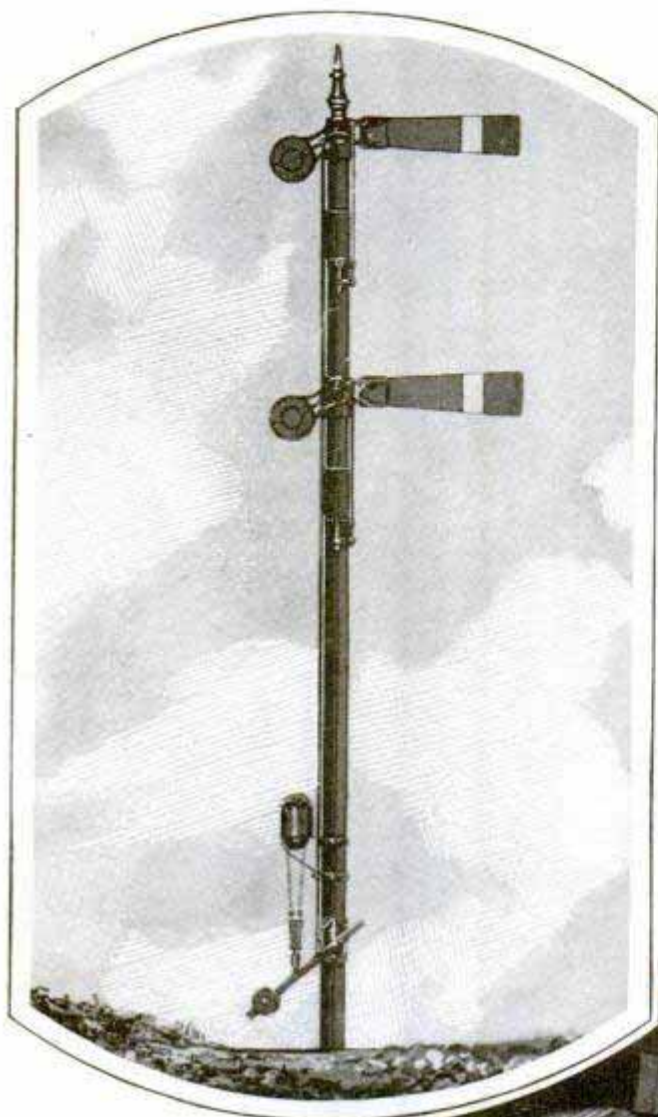

occupied, the coded signaling current cannot reach the engine. As soon as it stops, the caution, slow-speed signal appears and, unless acknowledged by the engineer, the brakes will be automatically applied after the warning whistle has blown. As soon as the block is cleared, the fact is registered on the cab signal panel and the engineer may proceed again.

The "American" had slowed down for a section of track where the coder apparatus had not fully energized the rails, and Baker was given an opportunity to see that human vigilance is fully as operative today as it was when engines were braked by hand, when run-wild orders often meant confusion and guessing, and

taking chances was a more or less common practice. A man appeared on the track not far from a signal tower. Hartley climbed part way down his side of the engine, hooked a loop of string over his arm from the waiting man and got back with a message from the station past which the train had thundered a few moments before. Engineer Boyle turned and others in the cab gathered around as Hartley opened the sheet. "Something dragging from your train. Better see what it is," the note read.

The train came to a smooth stop and Boyle got out to reconnoiter. Investigation developed that part of a leaf of a spring had broken off and dropped to the track, and it was this that attracted the attention of the alert station man as it bounded along the rock on the right of way. A minor trouble, and the "American" proceeded and rolled into Indianapolis on time to the second in spite of the short delay. It was a victory for the human eye, the detection of the flying fragment, but while the train was halted,



A Modern Semaphore Signal, and a Pennsylvania Fireman Pointing to the Five-Light Board Which Shows the Condition of the Track Ahead

the automatic train-control apparatus was functioning, the caution signals would have shown in the block immediately back of the one on which the "American" was standing, and a rear-end collision would have been practically impossible unless the

engineer of a train coming up behind had willfully ignored the slow-speed warning.

"Things are a lot safer now than they were in my day," said F. M. Williamson who recently retired after more than fifty years of continuous service with the Pennsylvania and who also was an interested passenger on the run of the "American" from Columbus, Ohio, to Indianapolis. "Whenever a train is flagged for any reason, I recall a certain day in September, 1893, when I was taking a train east from the world's fair at Chicago. McKinley, who was then governor of Ohio, and a number of French dignitaries were on board. A brush fire had been burning along the way, and the smoke partly obscured the track from time to time. Near Millgrove, Ind., I saw a little girl in the middle of the track. She was waving a red flag with all her might. I stopped the train and got out to investigate. Just a few rods farther on, a wooden bridge was burning. The timbers were almost severed and the structure was ready to collapse. The little girl had climbed over a fence and was running away. But I ran after her, brought her back and she was thanked by McKinley, the Frenchmen and all the rest of the passengers. We took up a collection for her. She had flagged the train with her red petticoat. A little later, the French government made her a member of the Legion of Honor."

Some of the romance has gone from railroading, both Baker and Williamson agreed, but in its place has come a new allurements in greater efficiency, better pay and far better working conditions.

"I never expected to see anything like automatic train control," Baker repeated

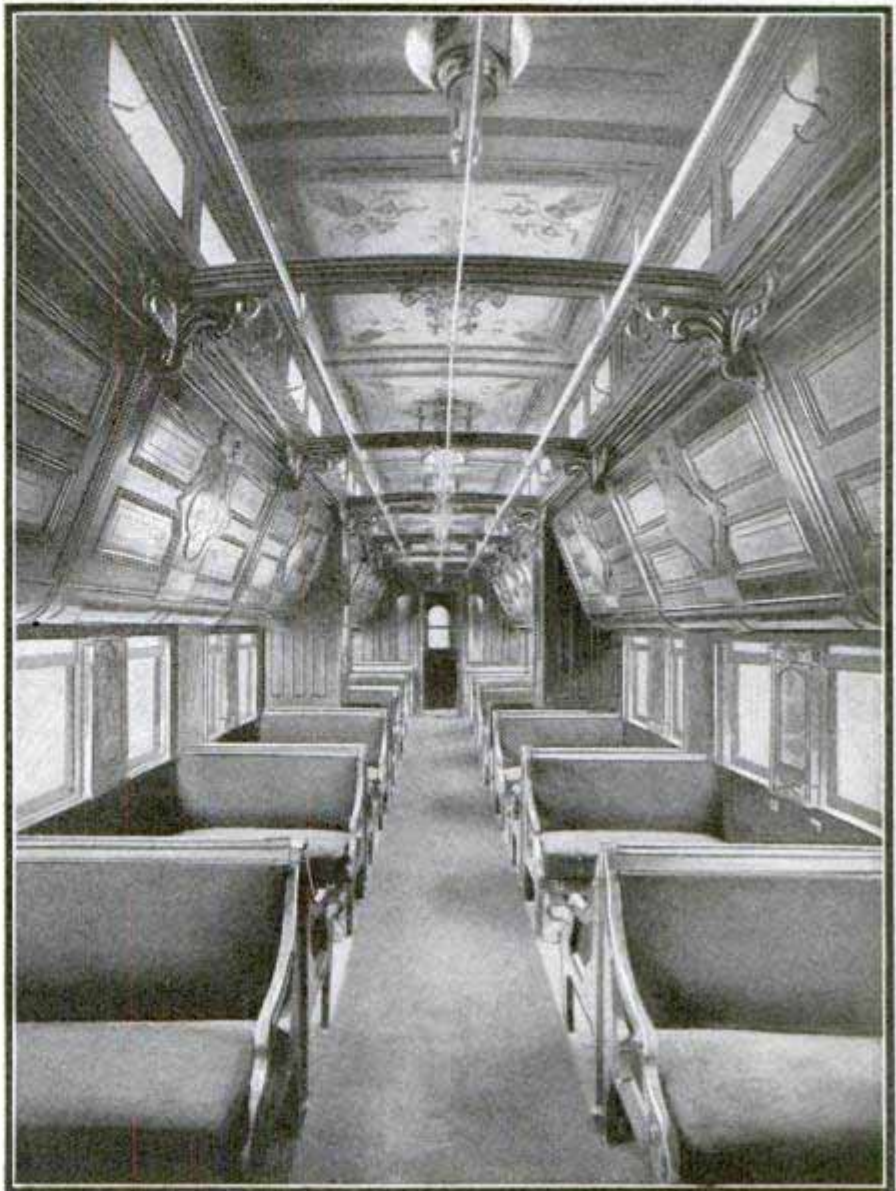

About the Time of the Chicago World's Fair, Pullman Cars Went In for Marvelous Inlay Work in Contrasting Colors of Rare Woods

after the run, "and a lot of other things have changed, too. Did you see Division Superintendent Rill helping me on with my overalls in the baggage car? Say, in my time, most of us were scared to even look at a division superintendent."

— *three* —

LEGLSS CHAIRS SLIDE EASILY OVER ANY TYPE FLOORS

1372

A new type of furniture has been introduced in France for office and home use. There are no legs in the ordinary sense. Instead, chairs and tables are mounted on a framework of nicked tubing, which slips easily over rugs or polished floors and leaves no marks. The office chairs are formed of a frame of bent tubing, with strips of leather slipped over the tubes to form the back and seat.

Daily mail 8/20/28

EARTH IS SLIPPING WESTWARD ON CALIFORNIA COAST

above the sea level, was originally part of this overlapping earth movement and is estimated to be more than twenty miles from the position it occupied 5,000,000 years ago, geologists assert. The peak has been cut off from the body of the thrust section by the erosion of streams. One proof the scholars have that an overlapping such as they picture did occur, is the fact that rock strata that were formed 45,000,000 years ago, are now on top of other strata developed at much later pe-

14



Left, C. L. Garner and Paul C. Whitney, of the Coast and Geodetic Survey, Examining a Fold in the Earth's Crust Showing That Westward Movement Is in Progress; Below, Measuring the Action at Government Monument on Mt. Diablo; the Slippage Is Estimated at About Twenty Miles in 5,000,000 Years

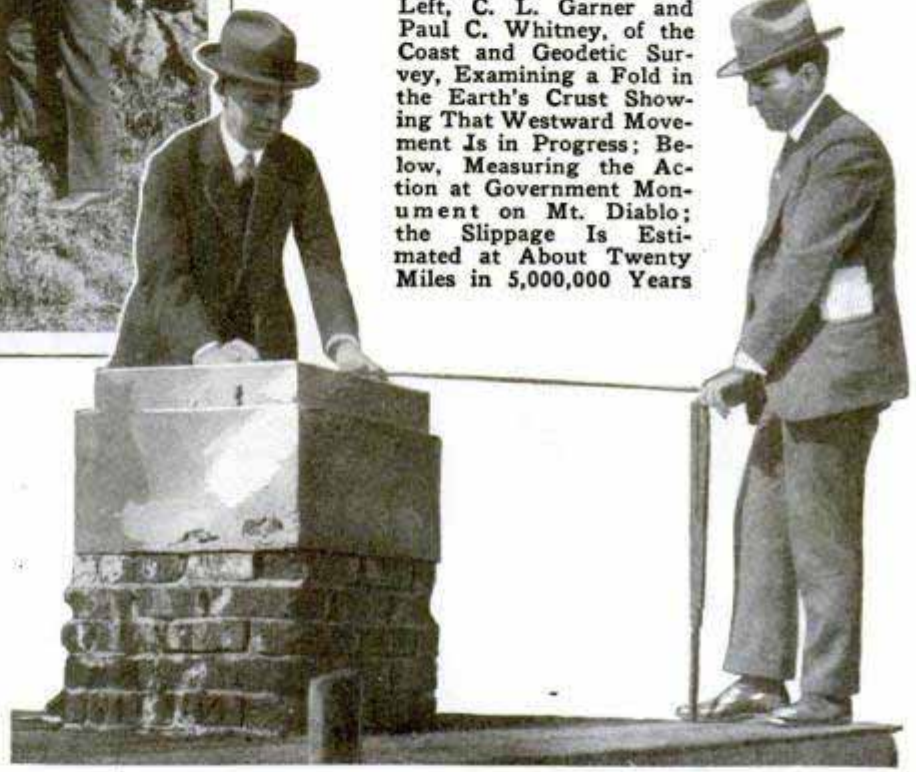

A part of the California coast, north of San Francisco bay and about 150 miles in extent, is slipping toward the Pacific ocean, but, geologists explain, there is no cause for alarm as the movement is at a rate of not more than twenty miles in 5,000,000 years. The phenomenon is believed to be due to a part of the earth's crust being pushed on top of the adjoining surface as one cake of ice is forced onto another. For some reason not fully understood, the action is still continuing. Mt. Diablo, 3,850 feet

riods. Another proof to the same effect, which they think convincing, is that mine shafts which were sunk in the early days of California have now been closed by the slow but continuous movement.

CONCRETE LAMP-POSTS "SPUN" TO GET HOLLOW FORM

Spinning concrete lamp-posts in order to provide a hollow form through which the wires can be run, is the method used in building the new street-lighting equipment of St. Louis. The poles were made in the local plant of the Westinghouse Electric company. A steel-and-wire reinforcing form was first assembled on a lathe mandrel and then placed in a pole form, made of two sections of metal. After

the form is locked together, it is stood on end and concrete poured into it. End blocks are then bolted in place and the filled form placed in a lathe and rotated for twenty minutes. The centrifugal force during the spinning throws the concrete outward against the form, so that, in setting, it leaves a hollow through the center.

Write our Bureau of Information, if you wish to know who makes or sells any article described in this magazine. Send no postage; the service is free.

Construction McClod 1476 10/28

engine
1462

DASH NEON TUBES
TELL TROUBLES
IN SPARK PLUGS

A new French car, said to have the smallest straight-eight engine built for an automobile, has solved the problem of telling the driver whether all the spark plugs are working properly. A set of eight small neon tubes are fitted on the instrument board, with a switch by which they can be thrown into circuit with the plugs. Failure of any tube to glow indicates a faulty plug. The eight-cylinder engine has a French rating of nine horsepower, or fifteen horsepower according to the English and American system of measuring. The cylinders are cast in a single block, with a bore of 1.11 inches and a stroke of 3.22 inches, and give thirty miles to the gallon. The gear box, like that of most foreign cars, provides four forward speeds in addition to the reverse. The car has a top speed of seventy miles an hour.

GRIP PLATE FOR AUTO WHEELS
HELPS CAR OUT OF RUTS

To provide traction for the wheels of the automobile in snow, ice or mud, metal grip plates have been introduced. They are made to fit various sizes of tires, the under side is ribbed to prevent slipping and the upper surface is also provided with circular ribs for the tire or the chains to secure a strong grip. The plate can also be used as a foundation for a jack in soft ground. They are practically indestructible, as they are made from malleable iron, and will afford even large trucks sufficient start to be run out of a rut.



☐ Clover roots are known to penetrate the earth to a depth of nine feet.



Model City Being Developed by Coast Lumber Company Has Unusual Street Layout for Its Garden Homes

MODEL CITY FOR LUMBERMEN
AFFORDS MANY LUXURIES

Workers in a lumber mill at Longview, Wash., live in a model village of some 350 homes, each with ample garden and lawn and private garage. Seen from the air, the settlement resembles a toy city, and its special features are clearly revealed. Streets are arranged to afford maximum space for the lots and to facilitate access to the yards. While the houses have the same general appearance, each has a distinctive style. The entire city has been built in a few years under the auspices of a large lumber company.

SAYS OIL WILL LAST WORLD
THREE THOUSAND YEARS

There is enough oil in known deposits to last the world another 3,000 years, even at the present rate of consumption, Dr. Gustave Egloff, of Chicago, told the recent World Fuel conference in London. Challenging an announcement from Washington two years ago that the oil supply might not last more than six years, Dr. Egloff said that, with only 2,000,000 acres of oil wells in production in the United States, this country alone had 1,100,000,000 acres of possible oil land waiting exploration and development.

William C. Mason
79 Broadway
New York City

Longview
Coast Lumber Co.
Longview, Wash.

William C. Mason

Universal Oil Products

1270
As to
Beacon

Light Houses

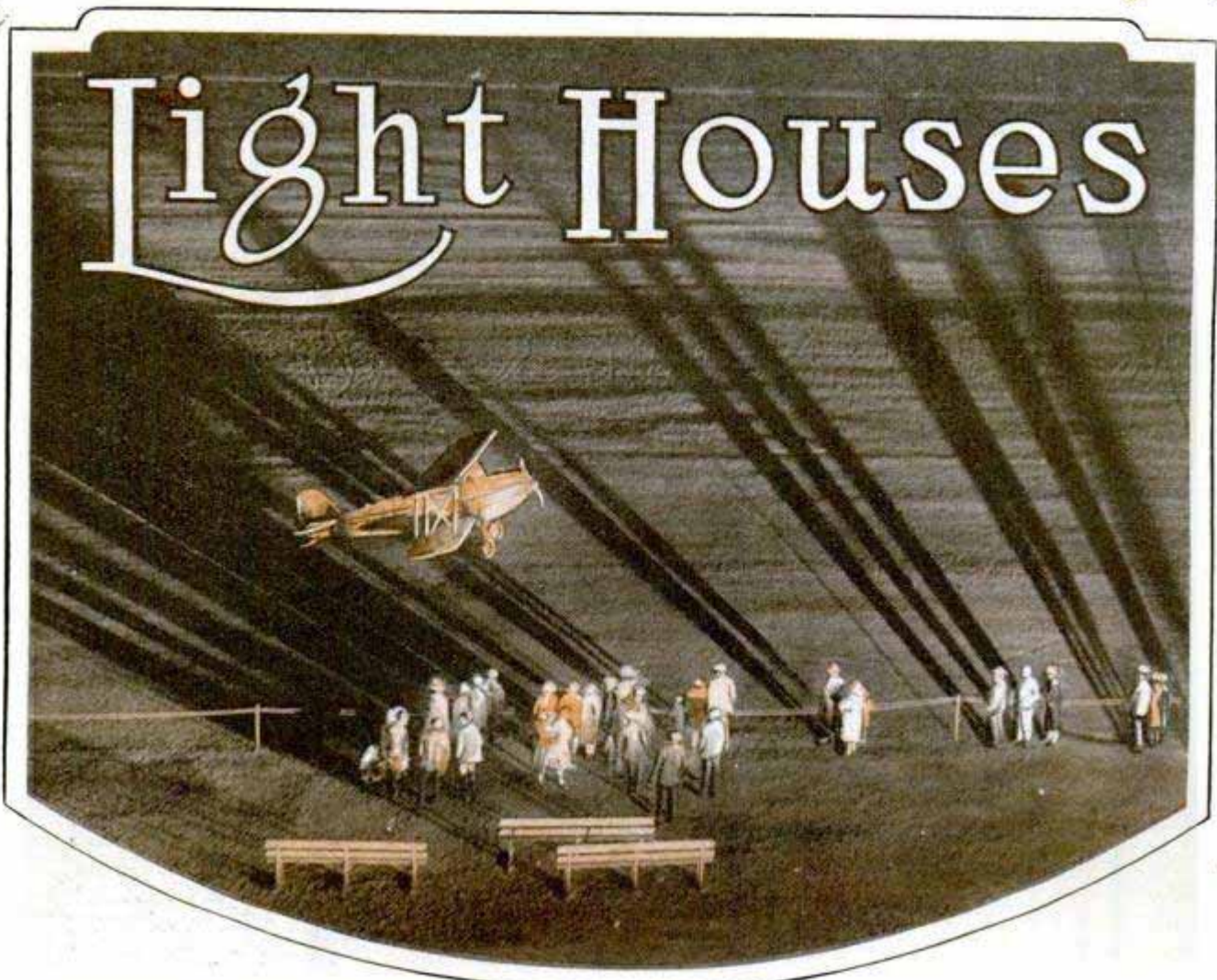

Landing under the Light of the 30,000,000-Candlepower Beacon at Oakland, Calif., Airport; the Fence at the Top of the Picture Is a Half Mile from the One in the Foreground

By H. H. DUNN, 1722 Orinda St. Berkeley, Calif.

UP AND DOWN invisible radio beams airplanes are flying over the Pacific ocean. Within the next year, probably; within two years certainly, the birdmen will be guided across the United States by silent radio waves, just as they are now guided by 10,000,000-candlepower lights in lofty beacons. Before the end of 1928, airplanes will be dispatched and received by radio telephone at least at one American airport.

Radio lighthouses will perform for ships of the air the service that land lighthouses give ships of the sea, except that, where the lighthouse sends its beams fifteen or twenty miles, the radio lighthouse will make itself known to the aviator from 1,000 to 1,500 miles away. The first radio lighthouse in the world is operating now from the hill of old Fort Scott, on the southern rim of the Golden Gate entrance to San Francisco harbor. The second is

located at Honolulu, and the third, if present plans are carried through, will stand near Washington, D. C. All are under control and operation of the United States signal corps, but the city of Oakland, Calif., is coming into the field soon with a radio-telephone equipment which will establish and maintain verbal connection with planes while they still are 100 miles or more away.

The present radio lighthouses keep the aviator on his course by means of signals in the international Morse code. Future lighthouses will send radio beams in such a manner that, so long as the aviator is on the true course, a green light will glow on the dash. When he deviates from that course, to left or right, the light becomes red. This will obviate the use of headphones by the pilot, leaving his ears free to listen to the song of his motor, or to gauge the intensity of the wind, by its

of the Air

whine among the struts of his wings.

Ultimately, there will be six of these radio lighthouses on the mainland of the United States, with another in Alaska and one in Manila, which, with the one at present operating in Honolulu, will give aviators guidance all over this country and far out at sea on both sides. In addition, a steamship company, operating liners on round-the-world service with home port in San Francisco, has prepared plans and appropriated funds for the construction of these lighthouses at the principal ports of call for its ships. While these stations, of course, will be used primarily to maintain constant touch with the corporation's ships at sea, they also will be of vital importance to aviators.

The government stations will maintain what is known as a "constant beam." This beam will be sent out at intervals of a few seconds, comparable to a "flashing light" in seaside lighthouses for the guidance of ships. The stations established by the private corporation will be operated at intervals, varying with the necessity of communicating with any one or more of the ships, or with other radio lighthouses. Each of the radio lighthouses so far designed will have a receiving set as well, and the adaptation of radio telephones to this use is only a question of time. In fact, the signal corps is now at work on the development of this feature, though radio-phone equipment at present is too heavy for carriage on the average airplane.

While the signal corps is reticent regarding details of the radio lighthouses now in operation at San Francisco and at

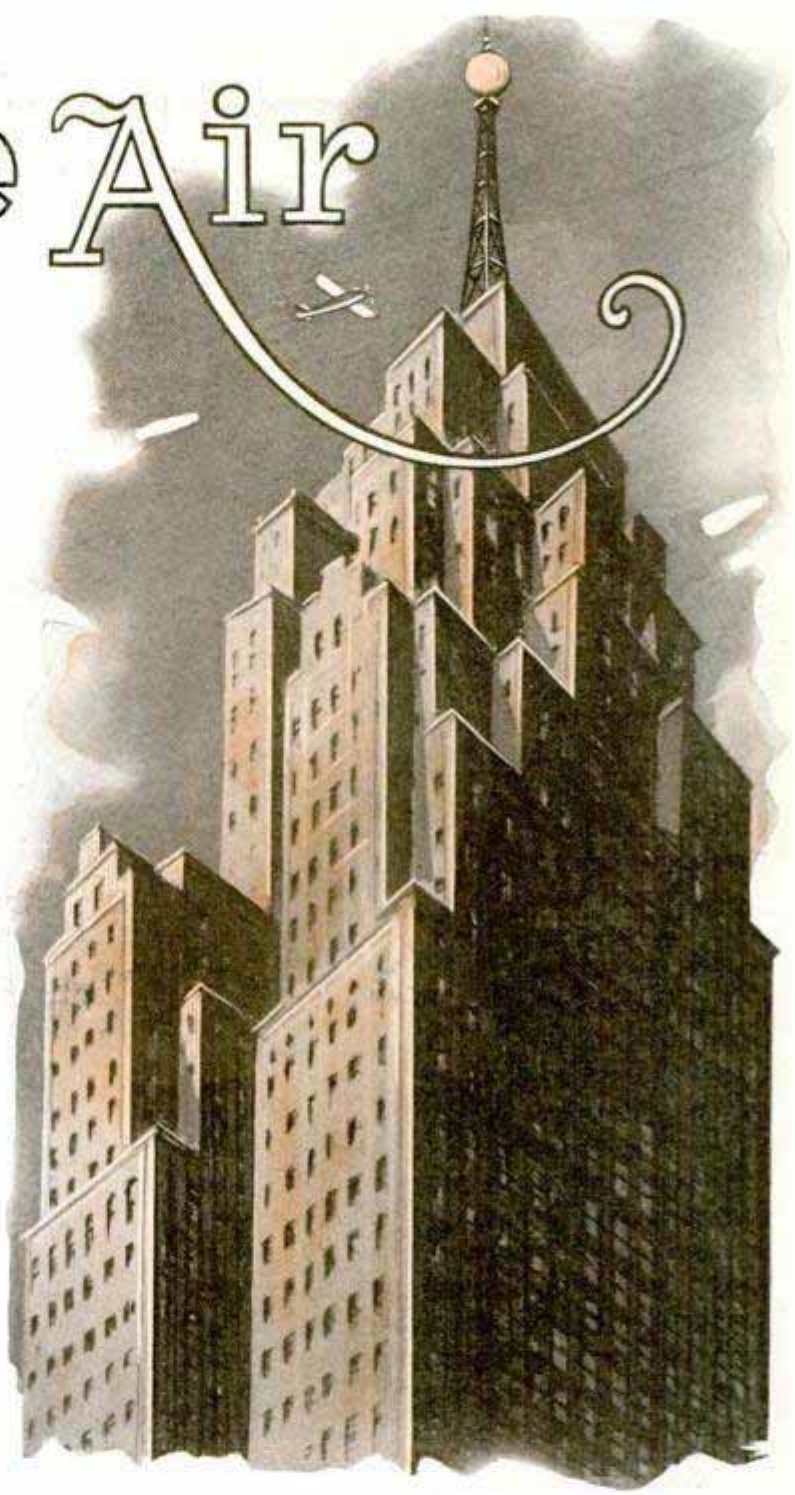

A Glowing Ball of Red by Night Is This Beacon atop the Penobscot Building, at Detroit

Honolulu, it is known that they operate through directional antennæ in umbrella form, raised on a single pole to a height of about 100 feet. They operate on a 1,037-meter wavelength, sending at intervals of about three seconds. The San Francisco signal has been heard in Honolulu, and the Honolulu signal in San Francisco, but the average range by night is 1,500 miles and by day about 1,250 miles.

The two radio lighthouses send out two beams, each about ten miles wide. The

1270
908

*Partlett Bldg
Los Angeles Calif*

lost on the South Pacific ocean. These radio lighthouses were of the greatest value in the flights from San Francisco to Honolulu and from Oakland to Australia, according to the pilots of the planes taking part. Yet they are merely somewhat crude forerunners of the stations which soon will be guiding aviators, silently yet effectively, all over the United States and all around the world.

One of the large oil-refining companies has appropriated \$5,000,000 for the estab-

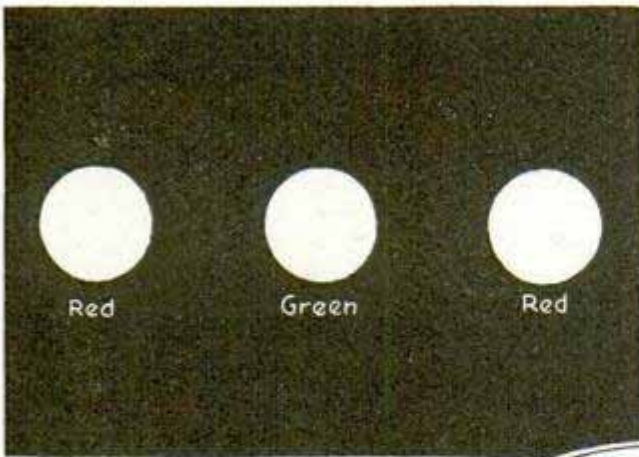
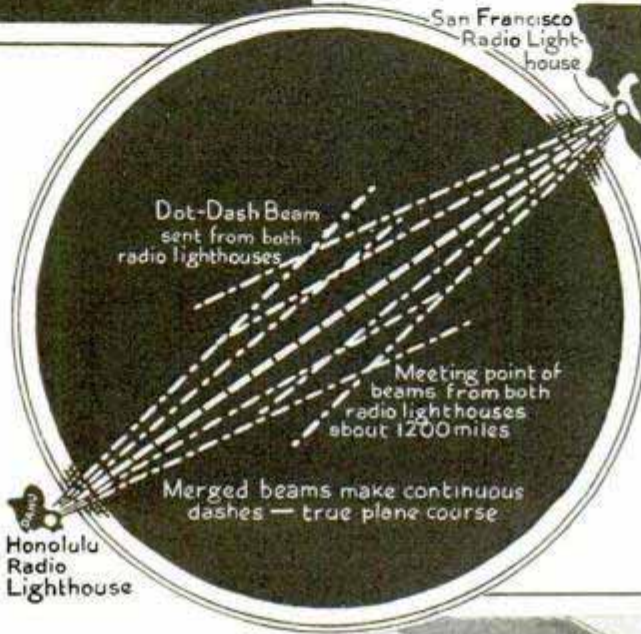

Diagram of the Radio-Beacon System, Which Sends Code Signals That Blend in a Central Path into a Continuous Chain of Dots, and, Above, Arrangement of the Visual Signal Lights Which Convert the Beacon Signals into Green and Red Lights on the Plane's Instrument Board

northern beam carries the dash and dot; the southern beam, the dot and dash. Between the two beams there is a space about ten miles wide, on a direct line between San Francisco and Honolulu. In this space, the signals combine to form a continuous series of dashes. So long as the aviator gets nothing but dashes through his earphones, he knows he is on his direct course, the shortest route over which he can fly between the two points. When he gets the dash and dot, he knows that he is to the north of his true course; when he gets the dot and dash, he is to the south, and he may guide himself easily back into the path of the dashes.

The beams from the two lighthouses meet at a point approximately midway between the two cities, that is to say, about 1,200 miles from each. Similarly, the signals sent out by the San Francisco radio lighthouse, go back in a northwesterly direction across the United States, and are of benefit to the aviator flying toward San Francisco from an area of about one-quarter of this country. Those beams sent from the reverse side of the directional antennæ in Honolulu, of course, are



lishment of thirty-two lighthouses for aviators and motorists, extending in an unbroken chain from Blaine, Wash., on the Canadian border, to San Diego, Calif., on the Mexican line. These land lighthouses, for the construction of which the contracts have been let and the sites purchased, will con-



Unloading Flying Express at the Oakland, Calif., Airport, Including Packages from New York and Chicago

sist of metal columns, 125 feet high, the legs forming an eighteen-foot triangle at the base. Surmounted with globular electric lights, their rays will be visible fifty miles in the air and thirty-five miles on

1270

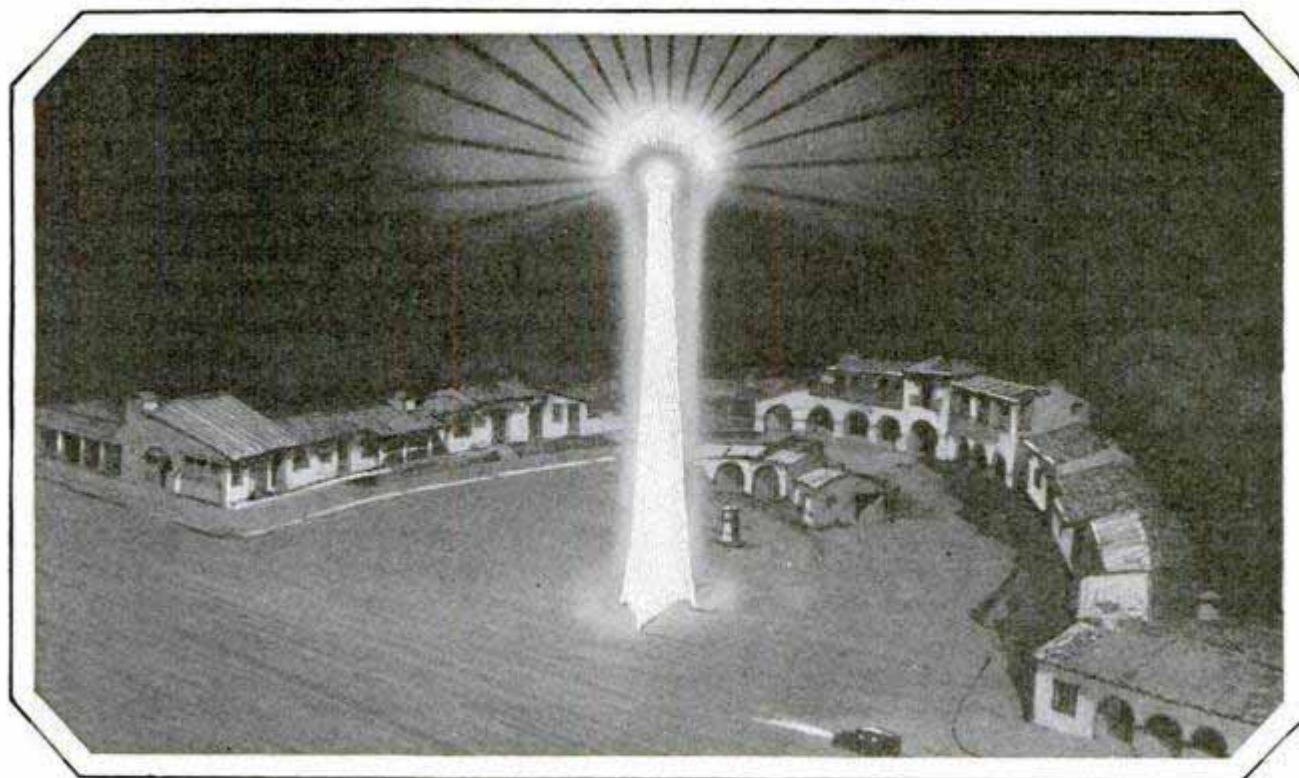

Hotels, Shops, Garages, Drug Stores, and Other Facilities, Are Grouped around a Chain of Flying Beacons Being Erected the Length of the California Coast by an Oil Company

the highways, in clear weather at night, and thirty-five miles and twenty-five miles, respectively, in fog. From ten feet above the base, the triangular tower is brilliantly illuminated with neon lights clear to the top. These will furnish complete illumination for the airplane-landing field and automobile-parking spaces which are to surround the towers.

These lighthouses are spaced approximately fifty miles apart, along state highways, but not in cities or towns. Twenty-nine of them will cover the main-traveled, north-and-south state highway in California, Oregon and Washington. One will be placed on the Columbia river highway, far eastward toward the eastern boundary of Oregon; a second will be located near Reno, Nev., on the California-Nevada line, and a third will stand at the point where the main southern highway crosses the Colorado river into California. These three will point the way to the main north-and-south chain, and to the large cities of the Pacific coast.

Surrounding each of these lighthouses, in addition to the airport and motor-parking spaces, will be a hotel, cottages, garages, service stations for airplanes and automobiles, with repair shops for both; drug stores, restaurants, automobile and airplane-equipment shops, and similar es-

tablishments necessary to travel by air or by land. All, including the hotels, will be operated on the chain principle, with standardized prices for all accommodations, meals and supplies. Similarly, flat rates for equipment, repairs and service will be established. Every traveler by airplane or by motor, following this chain, not only will be able to go on night and day, but will know when he starts just what everything will cost him at every station. In other words, a lane of light will be laid completely across the United States, north and south, from the Canadian to the Mexican borders.

While no radio equipment has been installed in these lighthouses, space and provision have been made in them for its use. They can be converted, in a very few days, to radio lighthouses, or radio beams can be added to their electric signals. It is announced that the greater part of the chain will be in operation before the end of 1928.

Recent experiments by the aircraft-radio laboratory of the United States army signal corps, at Wright field, Ohio, have developed the beam which produces the varying lights on the dashboard of the airplane, and have improved to a remarkable degree the so-called signal beam, such as is used by the radio lighthouses at San

Francisco and Honolulu. Formerly, the dash-dot and dot-dash signals were sent out at such intervals that, though they formed an indicator of the true course, they were audible to the pilot for only a second or two. Weak signals likewise often were lost. Now, under the new method, devised by C. C. Shangraw, civilian radio engineer at the laboratory, the signals are sent out constantly, one loop sending a dash and the other a dot, so that the two combined form an uninterrupted series of dashes along the true course. This also is reported to have increased materially the range of the transmitter.

Comes now the airplane dispatcher, following the radio lighthouse. This official, whose first plant is being installed at the Oakland, Calif., airport, will use radio telephone and telegraph, the former to send his messages to the plane, and the latter for the aviator's reply. Like the train dispatcher, the main task of the airplane dispatcher will be to keep the planes flying, and flying in the right direction. Further than this, he will be able to locate and send aid to any plane in trouble within the range of his radio instruments.

These radio telephones will be used principally at night, when the pilots have to depend on their compasses, or on regularly spaced beacons, in their cross-country flights. From a ground radio phone, the dispatcher will speak messages to the air pilot, and the latter will reply by international Morse code transmitted by a key. To locate a plane, the dispatcher will ask questions which can be answered by "yes" or "no," until he eventually finds, within five or ten miles, the position of the flyer. With landing fields, as planned, at intervals of thirty to fifty miles, radio lighthouses at central points, beacons of high visibility at each field, and radio communication with each airport, much of the isolation and danger will be removed from air transportation in the United States and on waters surrounding it.

Along with these improvements, fog—one of the greatest handicaps to aviation—is being conquered. The department of commerce, according to W. P. McCracken, Jr., assistant secretary for aviation, is experimenting with mechanical means for the dispersal of fog over airports. When this is accomplished, radio will guide flyers to the ports and they will have such a

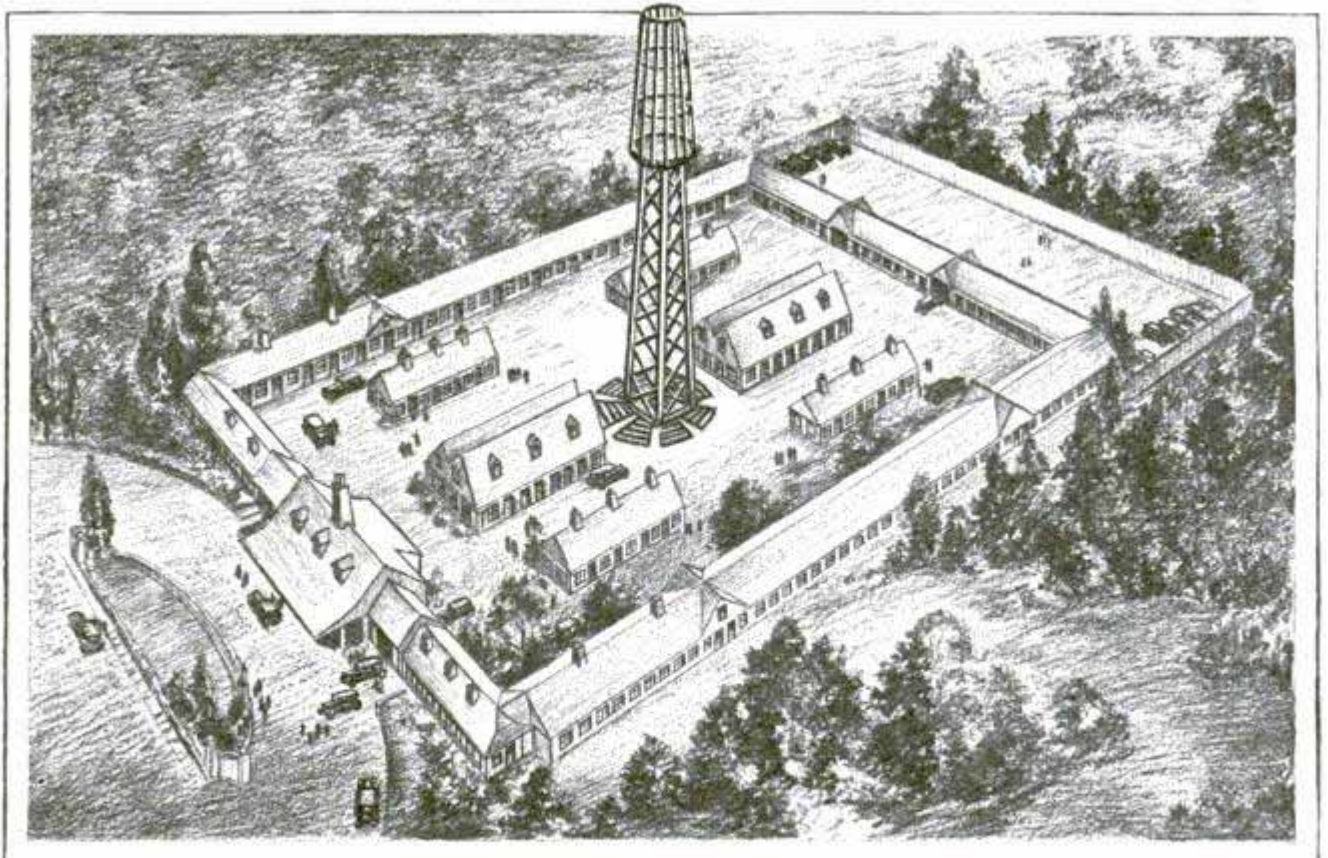

Architect's Drawing of a Neon-Tube Beacon for Flyers, with Service Facilities and Hotel and Shop Accommodations Erected around It; the Red Neon Light Is Fog-Piercing

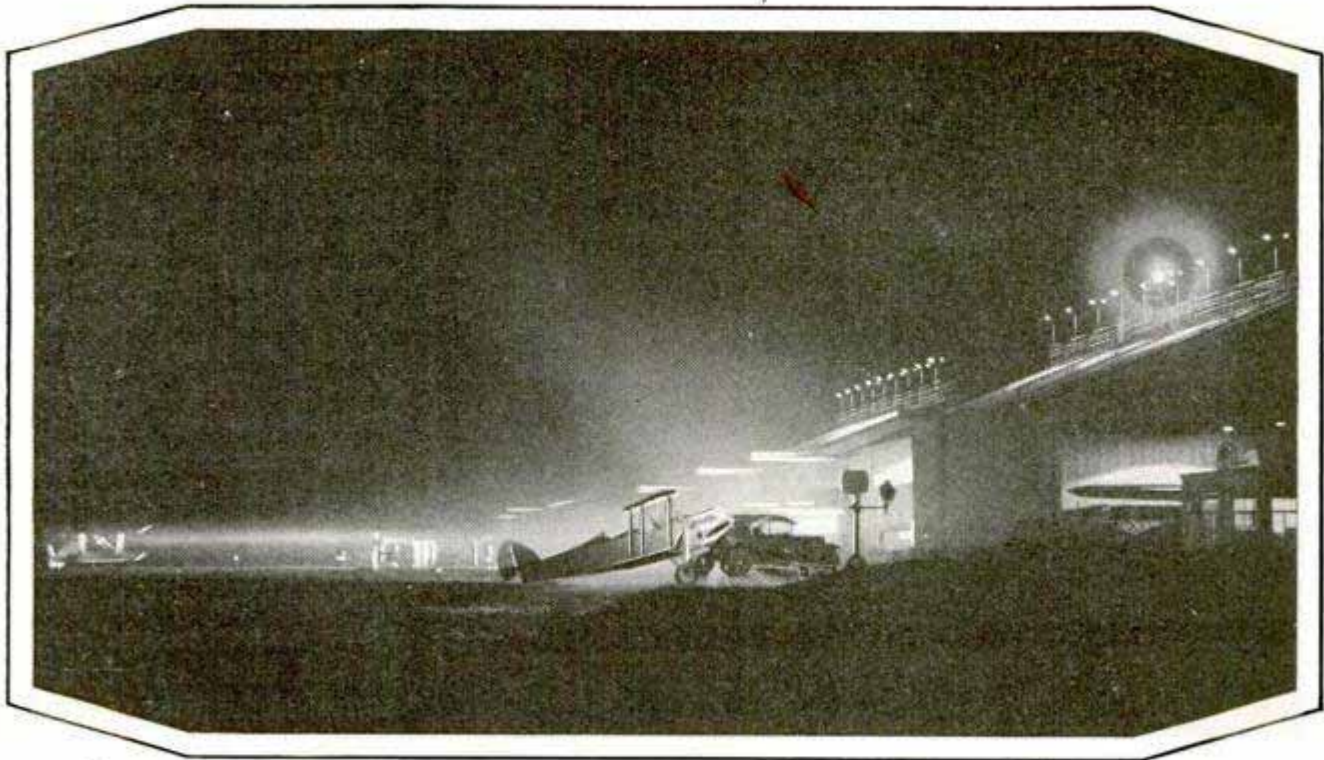

Night Lights On at the Oakland Airport; the Searchlight on Top of the Hangar Casts an 8,000,000-Candlepower Beam into the Air, While the Ground Light Is of 30,000,000 Candlepower

fogless area over each that they will be able to land without the risks that attend present landings, even with the benefit of abundant lighting. The experiments for the shattering of the fog blanket have been made along two lines, one by the sprinkling of electrically charged sand from balloons held captive above the fog, and the other by spraying the clouds with a solution which melts away the vapor. These experiments are being conducted privately, but with the assistance of the department of commerce.

To aid still further the radio lighthouses, by giving them daily reports on wind and weather over wide areas on the Pacific ocean, masters of vessels at sea out of California, Oregon and Washington ports are being organized to check air currents daily, and report them by radio to the airports all along the coast. The plan is for the navigating officer of each ship to take observations twice daily with captive balloons, such as are used by the weather bureau. This means that, eventually, the air currents over the Pacific will be charted just as accurately as the ocean currents are charted for mariners. The United States weather bureau has approved the plan, which was proposed by Capt. W. B. Voortmeyer, who plotted the Oakland-Sydney flight of the "Southern Cross."

Thus, with his transoceanic air lanes marked and their winds charted; with land routes marked by beacons visible for thirty-five to fifty miles; with wireless telephone further directing him on his course, and with the fog menace removed from airports, whence radio lighthouses constantly lay paths of safety through the night for him, the aviator of the near future will be as well protected, and as thoroughly safeguarded, as the master of the finest deep-sea liner.

FRUIT SQUEEZER SAVES JUICE AND PROTECTS HANDS

For extracting the juice from citrus fruits of all kinds, a reaming device now



in the squeezer and, with a few turns of a small handle, the contents of the half is thoroughly reamed out. The juice is then poured directly into the container.

*Chicago - Commonwealth Edison Co.
72 W. Adams. Chicago*

Handwritten notes and signatures at the bottom of the page, including 'C. L. ...' and 'Edison'.

14

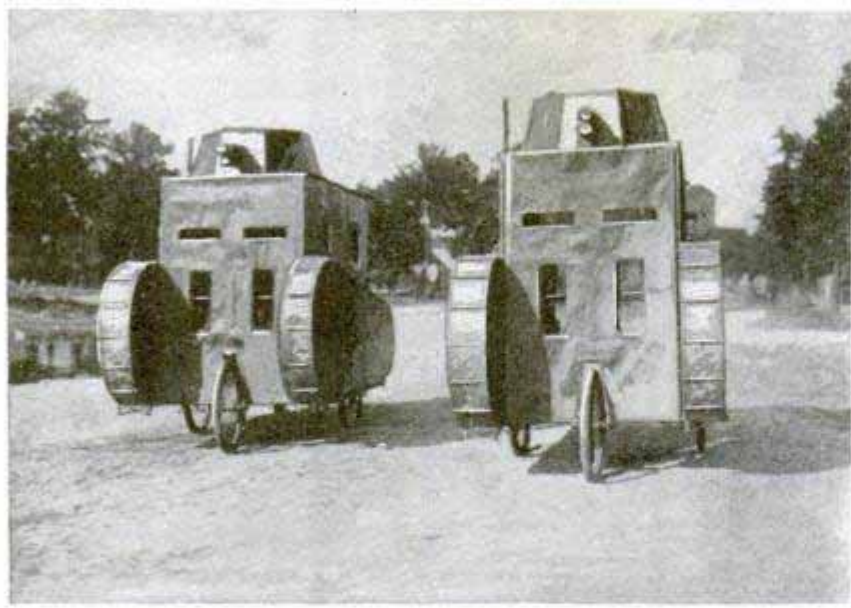

Fake Tanks Used as Shield for German Sharpshooters and to Fool the Enemy as to the Strength of the Attack

**FAKE TANKS SCREEN SNIPERS
— IN ARMY GAME**

Sharpshooters taking part in recent army maneuvers in Germany, were hidden behind fake tanks to deceive the "enemy." The camouflaged units were in line with real tanks, giving the appearance of a stronger attacking force, and, from a distance, could scarcely be told from the genuine. Soldiers pushed the blinds.

**SOUND-ABSORBING WALLS HELP
DEAF TO HEAR**

Rooms lined with sound-absorbing material may improve the hearing of partially deaf people, according to discoveries at Colgate Psychological laboratory. The

discovery was made by accident while showing a deaf visitor through the building. The visitor could hardly hear shouted remarks in most rooms, but when he came to a soundproof room, he was able to hear words spoken in an ordinary tone of voice. The solution seemed to be that the walls thus treated had taken up all the reverberation, and the deaf person heard only the voice and not the echoes. Further experiments confirmed the tests. The sound-absorbing material is made from the waste of sugar cane.

**X-RAY MOVIES TO
SHOW BONE
KNITTING**

1501

X-ray movies, showing a broken bone in the process of knitting and similar subjects heretofore outside the realm of photography, are made possible by a new camera developed by Dr. Arthur C. Pillsbury, naturalist and photographer of the

University of California. Dr. Pillsbury's experiments in photographing the life cycle of flowers were recently described in Popular Mechanics. His latest camera works on the same principle as the one used to photograph the unfolding of flowers, taking a series of single pictures at intervals, of a movement imperceptible to the human eye, and then running them off as a movie to show movement which took hours or days, all encompassed in a few moments. The first movie with the X-ray camera showed the growth in the interior of a rose. It took seventy-two hours to film, taking one picture at a time in intermittent exposures. Dr. William D. Coolidge, inventor of the Coolidge tube, designed a special X-ray tube in order that the rose might not be damaged.

*Account: Colton. 645 N. Michigan Chicago
Colton Co.*

Em. Russell & Howard

Berkeley, Calif.



Walking Hobbyhorse Moves over the Floor as the Rider Swings His Weight Back and Forth, Alternately Advancing the Walking Legs and the Body of the Horse

HOBBYHORSE THAT WALKS NEWEST CHILD'S TOY

A hobbyhorse that walks is the newest amusement device for the child. The horse is unusual in that it has six legs. The front and rear legs end in a short rocker arm. Between them are two other pairs of feet, joined by crossarms. In action, the toy is made to walk by the shifting of the body weight forward and aft and by this means advancing first the walking legs and then the horse.

OXYGEN CHAMBER SAVES CATS POISONED BY GAS 1410

Carbon-monoxide poisoning, suffered frequently by careless people who start automobile motors in closed garages, may be robbed of its terrors if a new process developed by Dr. Ludwig Schmidt-Kehl, of the University of Wuerzburg, works as well on humans as on cats. The deadly exhaust gas is dangerous because the red corpuscles of the blood, which normally carry oxygen, will absorb 250 times as much of the poison gas as of the life-giving one.

Experimenting with a small pressure chamber, Dr. Schmidt-Kehl found that cats rendered unconscious by the gas could be placed under pressure in the oxygen apparatus and revived by simply raising and lowering the pressure in time with their normal breathing rate.

WIRE CONNECTOR DOES AWAY WITH TAPE AND SOLDER

A device which does away with twisting, soldering and taping electric connections has been placed on the market. It is a small mechanical connector, provided with a hole into which the wires to be joined are pushed. The device is then twisted, just as though it were a nut. Inside, a copper-coated steel spring, of sufficient size to give it a carrying capacity equal to the wires being joined, threads in with the wires and makes a positive contact. The connectors are made in two sizes, one of which serves for connecting groups of wires ranging from two of No. 18 size to four of No. 14, the other for groups of from four No. 14 to three No. 10. The wires may be either solid or stranded.

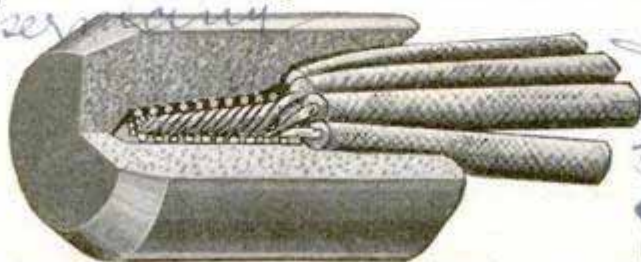

Cross Section of a New Connector for Electric Wires, Showing a Number United by Mechanical Joint

*Science Service
New Bulletin - 3 91. 4*

Tool
408
*Deal Communist Dresser Co,
Sydney, Ill.*
Chap. 5 B. W. Jackson

Mr. W. Mc...
1434 **POPULAR MECHANICS** *Nature and Kultur V. 25, No. 8 1928*

BRIDGE TO LINK TWO NATIONS WILL HAVE LONG SPAN

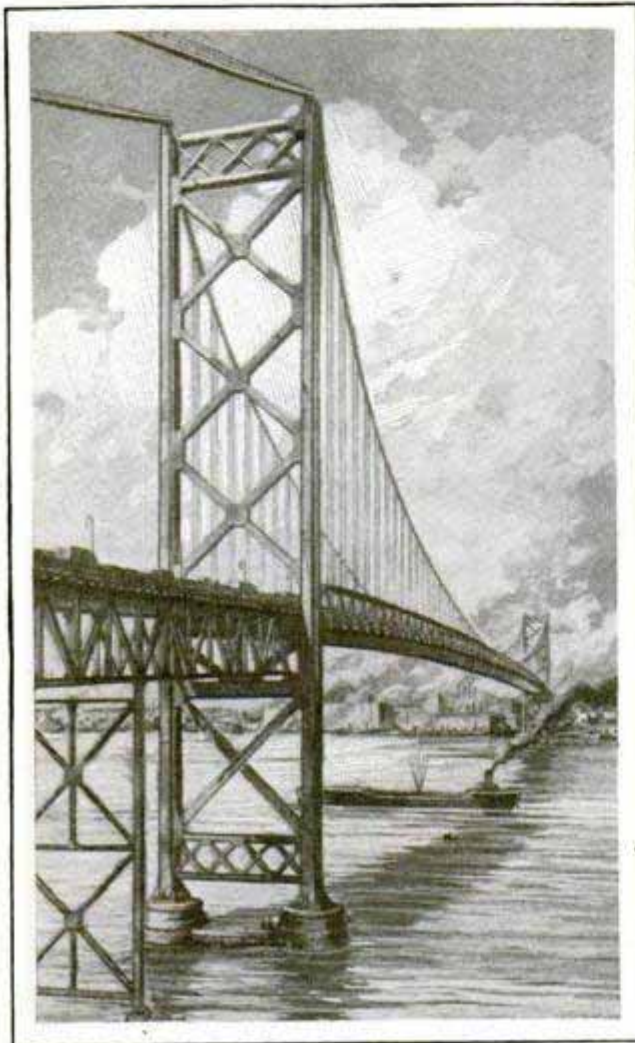

The Ambassador Bridge, Linking the United States and Canada, as It Will Appear When Completed

Two nations, the United States and Canada, will be linked by the \$20,000,000 Ambassador bridge between Detroit, Mich., and Sandwich, Ont., which is scheduled for completion by July 1, 1929. Work on the structure, which will have a main span of 1,850 feet between the two chief towers, longer than any bridge yet built, was started May 7, 1927, and construction has progressed so rapidly that the date for opening the bridge has been advanced more than a year. The link is the realization of plans that have been on foot for more than fifty years. The bridge proper will be 7,400 feet long, and the distance from entrance to exit slightly less than two miles. For a short space in the center, the clearance is 152 feet, so that vessels with stacks or masts twenty feet higher than those now commonly in use on the lakes, and sixty feet higher than those on

freighters, can pass under. A feature of the structure will be the custom and immigration terminals on each side. Parking spaces for many vehicles will be provided, and it is estimated that 5,000 cars can be handled each hour by the inspectors. Some idea of the magnitude of the bridge can be gained from the quantities of materials required. These included 24,000 tons of structural steel and cable wire, 25,000 cubic yards of concrete masonry, 40,000 barrels of cement, 60,000 square yards of roadway pavement and 8,000 square yards of sidewalk pavement. To protect the suspension cables from the weather, they are being covered with a film of special material, coated with zinc and several applications of paint, and are then wrapped with a layer of soft wire.

IMPREGNATED RUBBER WOOD MAKES BETTER VIOLINS

Modern violins rivaling the old masters' instruments in tone are possible if the wood is impregnated with rubber latex before varnishing, according to a German investigator named Ditmar-Graz. Describing the process, he says that the rubber has the effect of rendering the wood permanently elastic.

HEATER FOR SHOW WINDOWS KEEPS GLASS CLEAR

To prevent the formation of steam and frost on show windows, an electric radiator, operated from a lighting socket, has been introduced. It is of aluminum, does not obstruct the view and is designed to allow the heat to radiate from its full length up the side of the glass and to the top of the window. A steady circulation of warmed air is maintained, and the heater is thoroughly insulated to eliminate the fire hazard.



Electric Heater for Show Windows, to Keep Off Frost and Steam, Operates from Lighting Socket

Palat. 2/27/23
44,6703
Overland Electric Co
2410 Ogden Ave

1421
9/18/29
Scene Service Bulletin
391-B
1377
5,200
15.00
48
13,50
30-in.
42-in

1267

The World's Most Famous Yachts

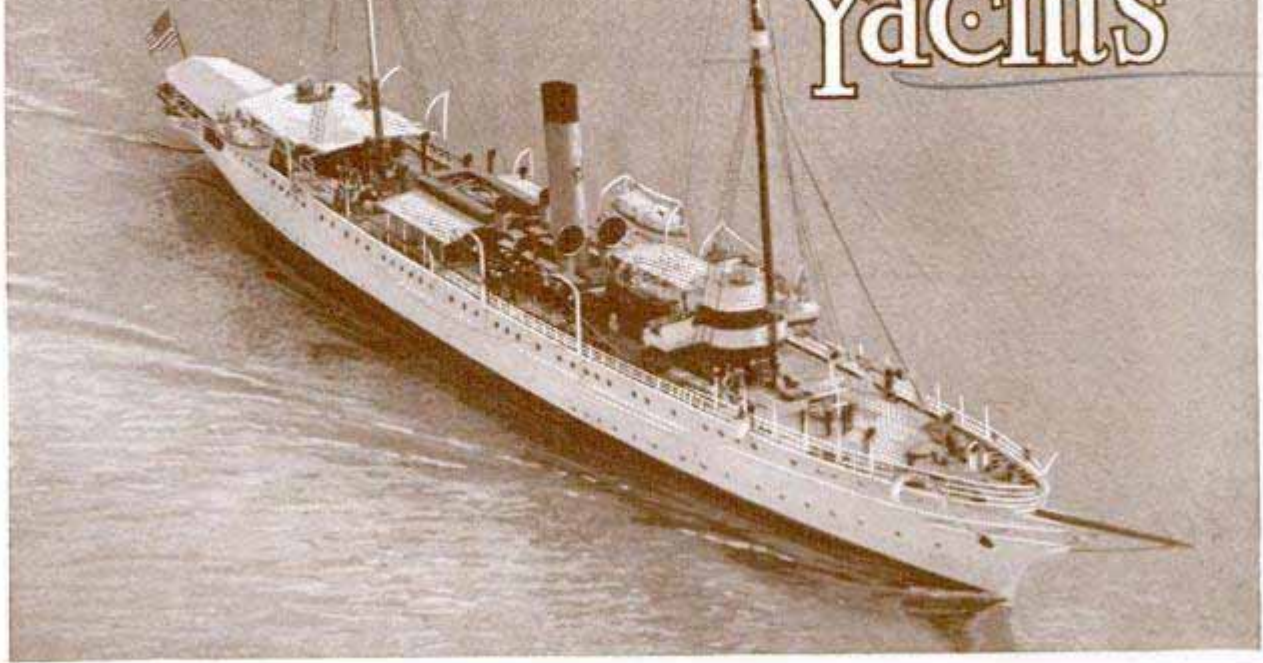

America's Premier Pleasure Boat Is the Presidential Yacht "Mayflower"; Manned by a Naval Crew, She Enables the Chief Executive to Take Week-End Cruises down the Potomac to the Sea

IF ALL the yachts of America ever gathered together for a regatta, the flagship of the fleet undoubtedly would be the "Mayflower," the yacht of presidents, but behind the big, comfortable steam vessel which has carried many White House occupants down the Potomac to the sea would come some of the world's finest pleasure craft.

There would be the world's biggest Diesel-motored yachts, a group of them ranging from 200 to 300 feet in length, fitted out with all the comforts of home, boats capable of cruising around the world or traveling 20,000 miles or more without refueling.

There would be the world's fastest big boats and the world's fastest little boats, seventy-five foot cruisers with speeds of forty miles an hour, like Gar Wood's "Gar Sr.," and little runabouts, seagoing automobiles, with forty, fifty and sixty-mile speeds.

And in the sailing division there would be the great bark "Aloha" of Commodore Arthur Curtis James, the cup defender "Resolute," and a host of others.

At the other extreme of size there might be a fleet of hydroplanes with out-board motors, little craft costing \$600 or less, yet capable of making thirty-five or more miles an hour and running circles around Vincent Astor's new \$600,000 "Nourmahal" or Richard Cadwalader's \$2,000,000 "Savarona," probably the two largest Diesel yachts.

"Nourmahal," finished a few months ago in the Fried-Krupp yard at Kiel, Germany, is one of the most unusual pleasure craft afloat, for straight stem and cruiser stern make her look more like a passenger liner than a pleasure craft. How straight stem and stern are is indicated by the fact that her over-all length, 263 feet, is only three feet more than the length on the water line. With two 1,600-horsepower Diesel engines, she can cruise at fourteen knots and make sixteen at full speed, while her fuel bunkers carry enough oil to keep her at sea forty-eight days without refueling. With a beam of forty-one and a half feet "Nourmahal" has plenty of room for comfortable quarters, including a living room 25 by 28 feet; a library 16 by 28 feet and a dining room 26 by 23 feet. She also has nine staterooms for owner and guests, each with private bath, rooms for two maids and one valet, and accommodations for a crew of forty men.

1269
916

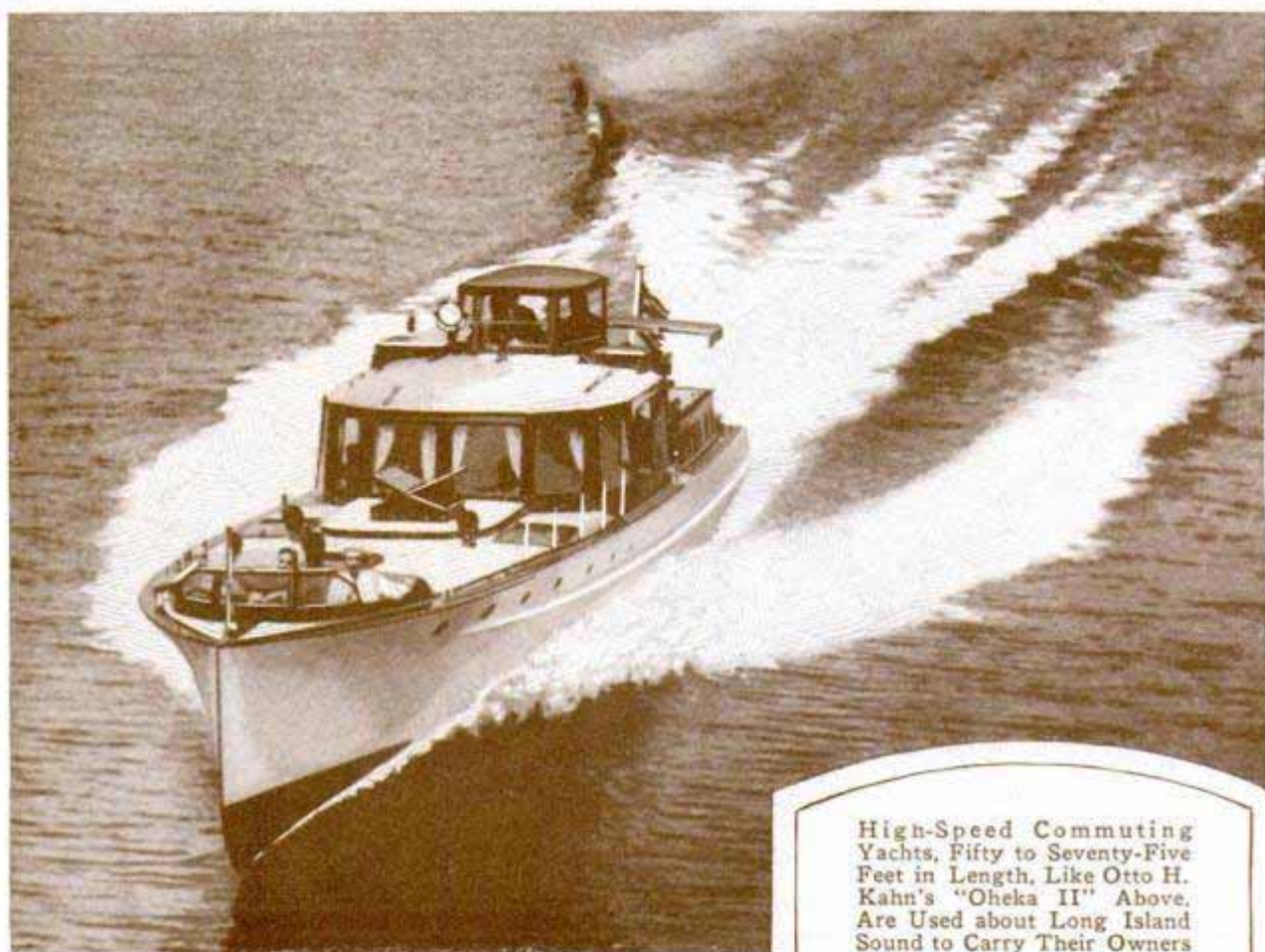

High-Speed Commuting Yachts, Fifty to Seventy-Five Feet in Length, Like Otto H. Kahn's "Oheka II" Above, Are Used about Long Island Sound to Carry Their Owners to Work in New York Each Day; Below Is a View of the Main Dining Salon of the "Mayflower," a Picture That Indicates the Luxury of the Nation's Yacht





Capt. G. Allan Hancock's "Oxaca" Leaving Los Angeles Harbor for a Cruise to Bering Sea; Above, at Right, King George and the Duke of Connaught Aboard the Royal Yacht "Britannia" during a Race at Cowes; Below, Senator Marconi's "Elettra," on Which He Has Carried Out Many of His Wireless Experiments, Particularly with the New Beam System

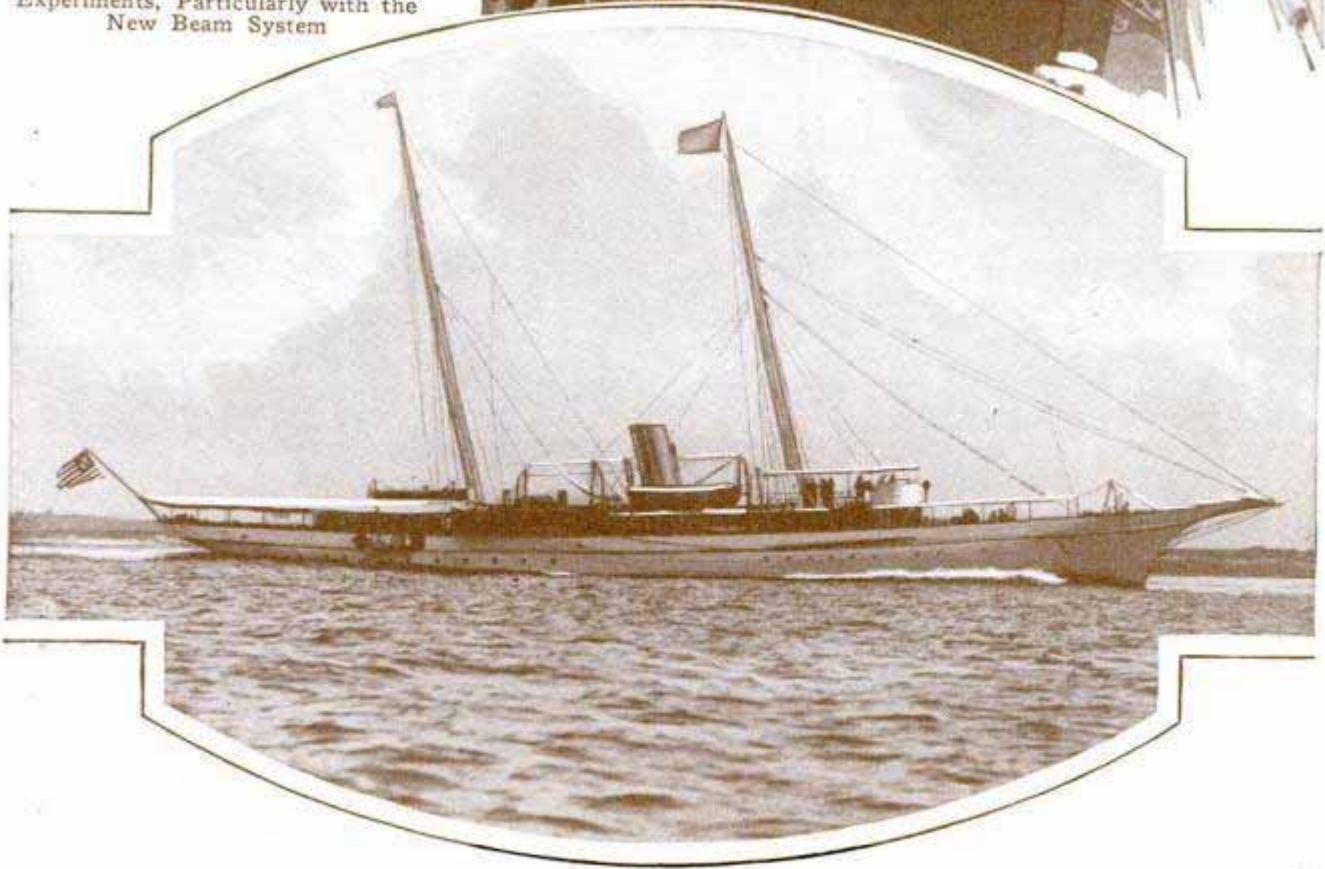

1269 918



Sails Still Keep Their Charm for Yachtsmen Who Like to Relive the Old Days of Wood Hulls and Canvas; Above Is Edward F. Huttin's Schooner "Humar" under Full Sail

1269

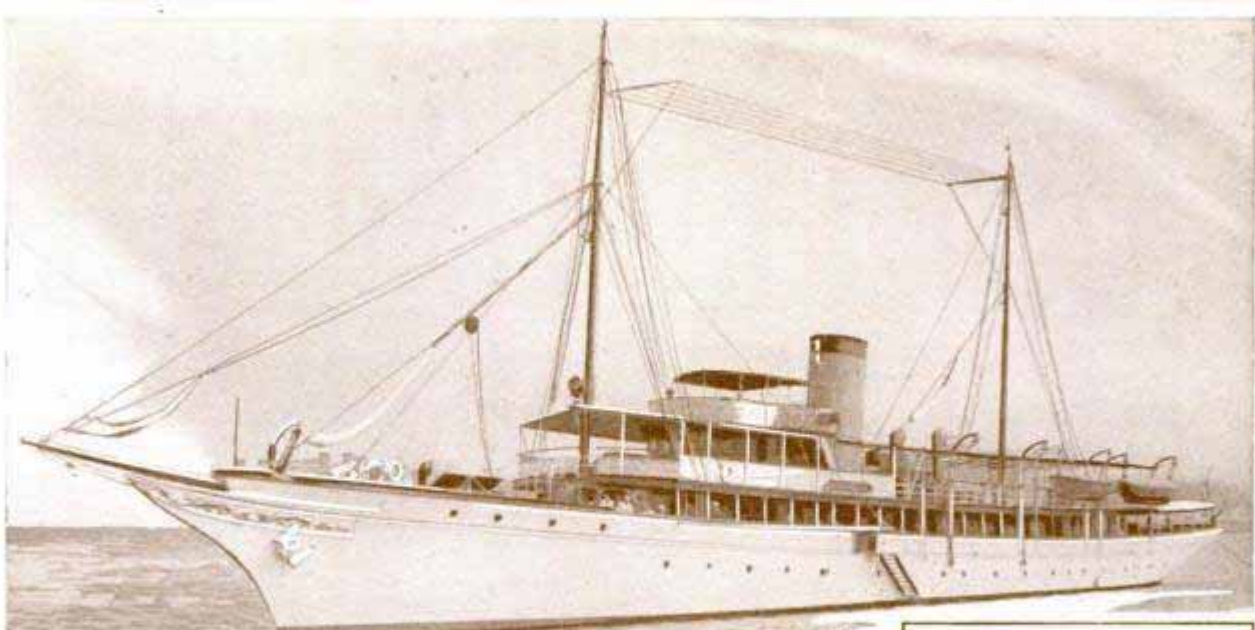

James K. Stillman's "Wenonah II" Anchored in Biscayne Bay, Miami, Fla., during the Winter Season at the Southern Resort; She Is of the House-Boat Type
© Henry Miller

Ambassadors and Ministers Were Entertained on "Lyndonia," Cyrus H. K. Curtis' Yacht, When Anchored in the Potomac

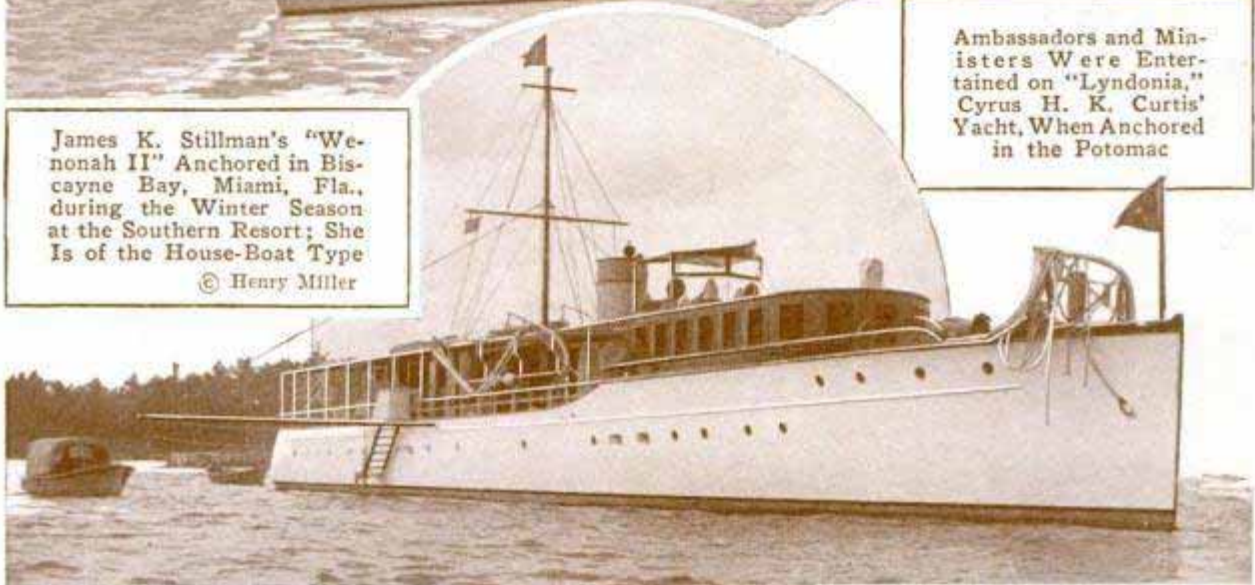

W. K. Vanderbilt's "Ara," a 214-Footer, Equipped with Diesel Engines, on Which He Made a Scientific Cruise to the Galapagos Islands to Gather Specimens of Rare Deep-Sea Fish
© Henry Miller

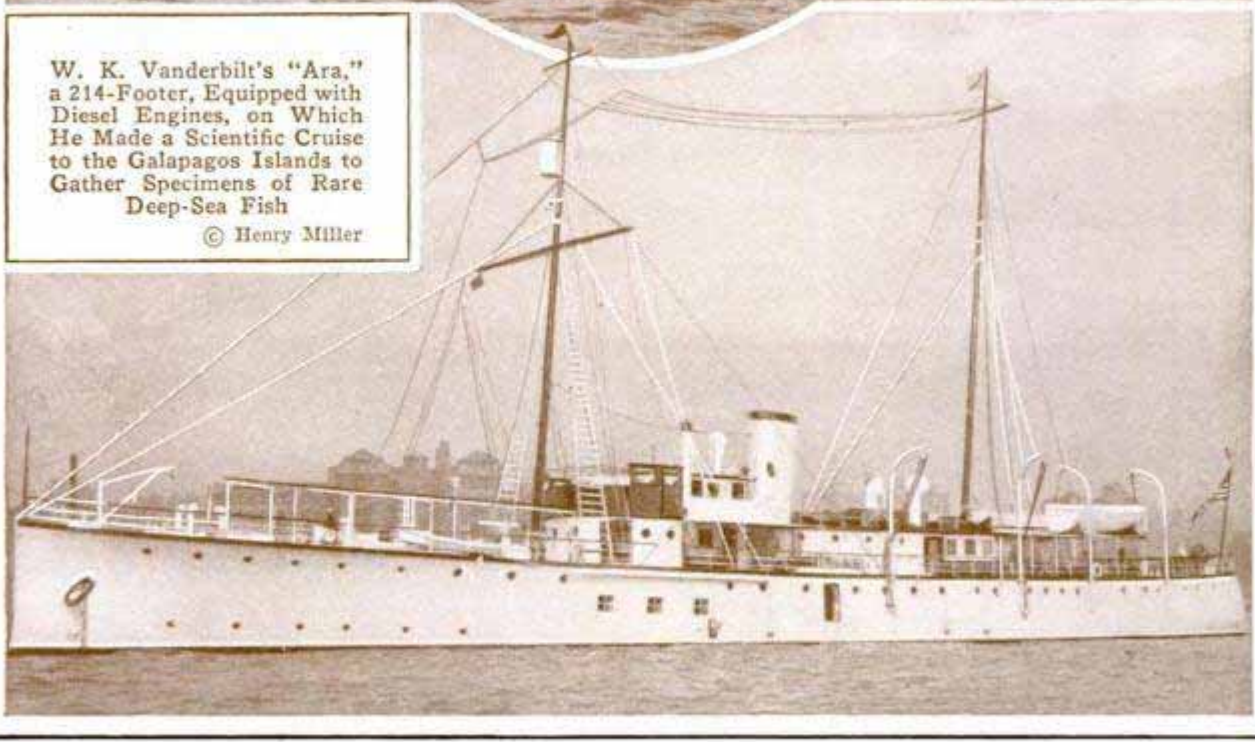

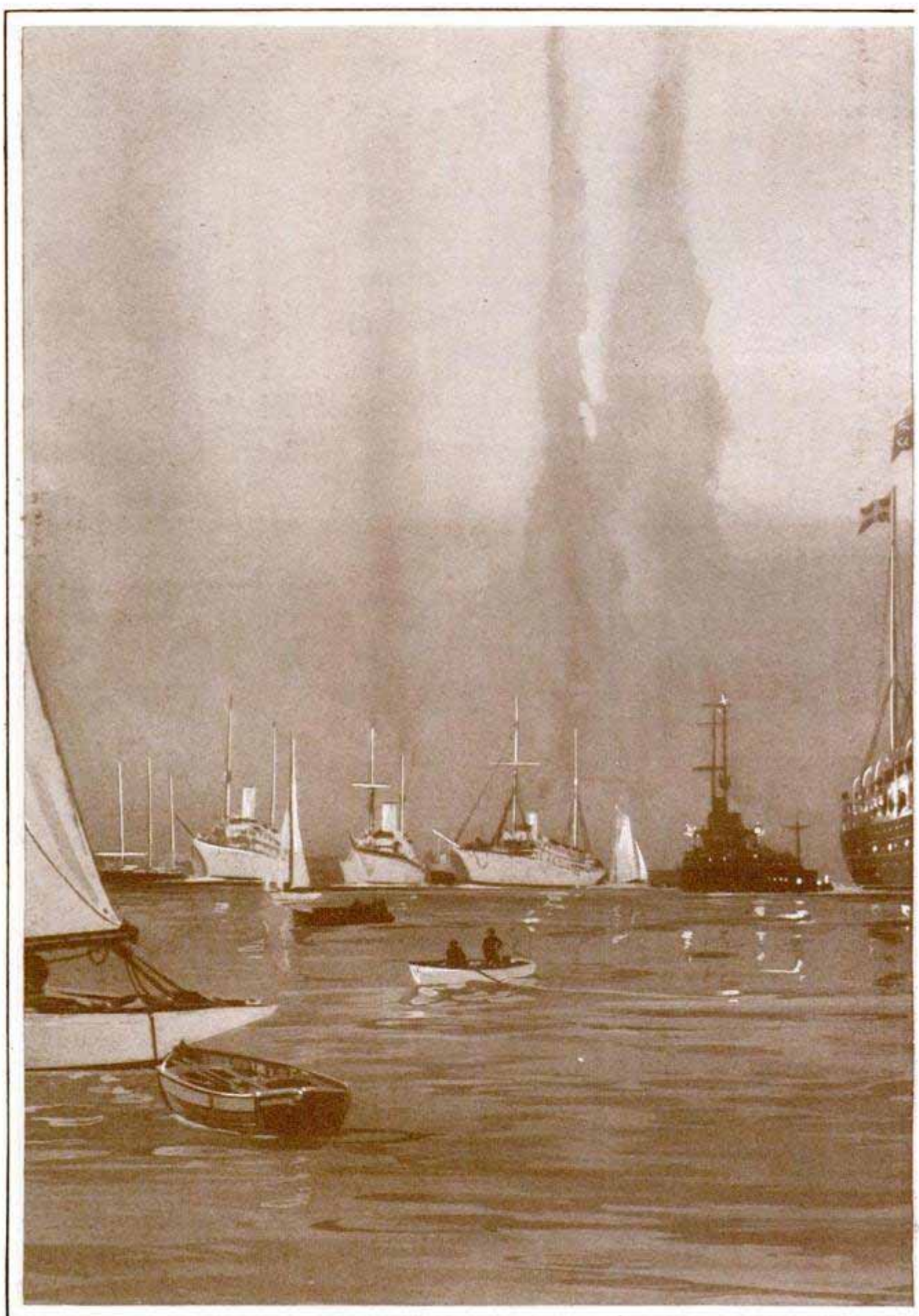

© The Illustrated

When Dusk Falls over the Yacht Anchorage at Cowes and the Royal Yacht "Victoria and Albert" Steams In to Its Moorings, the Famous Yachting Week Gets under Way

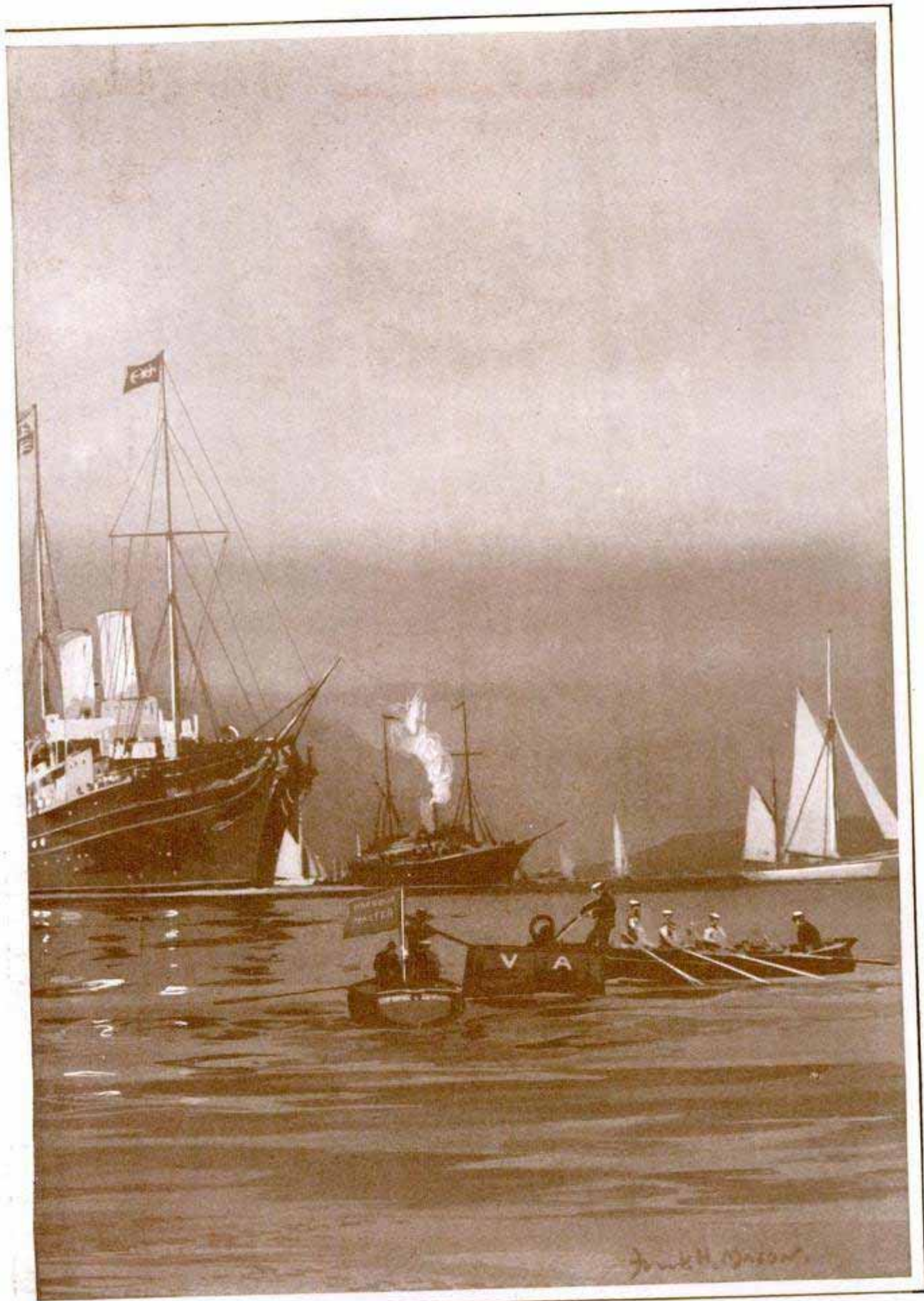

London News

With the Royal Ensign at the Mainmast Head; the King's Seagoing Steam Yacht Slips between the Anchored Fleet to the "V & A" Buoy, Where a Naval Crew Waits to Moor Her

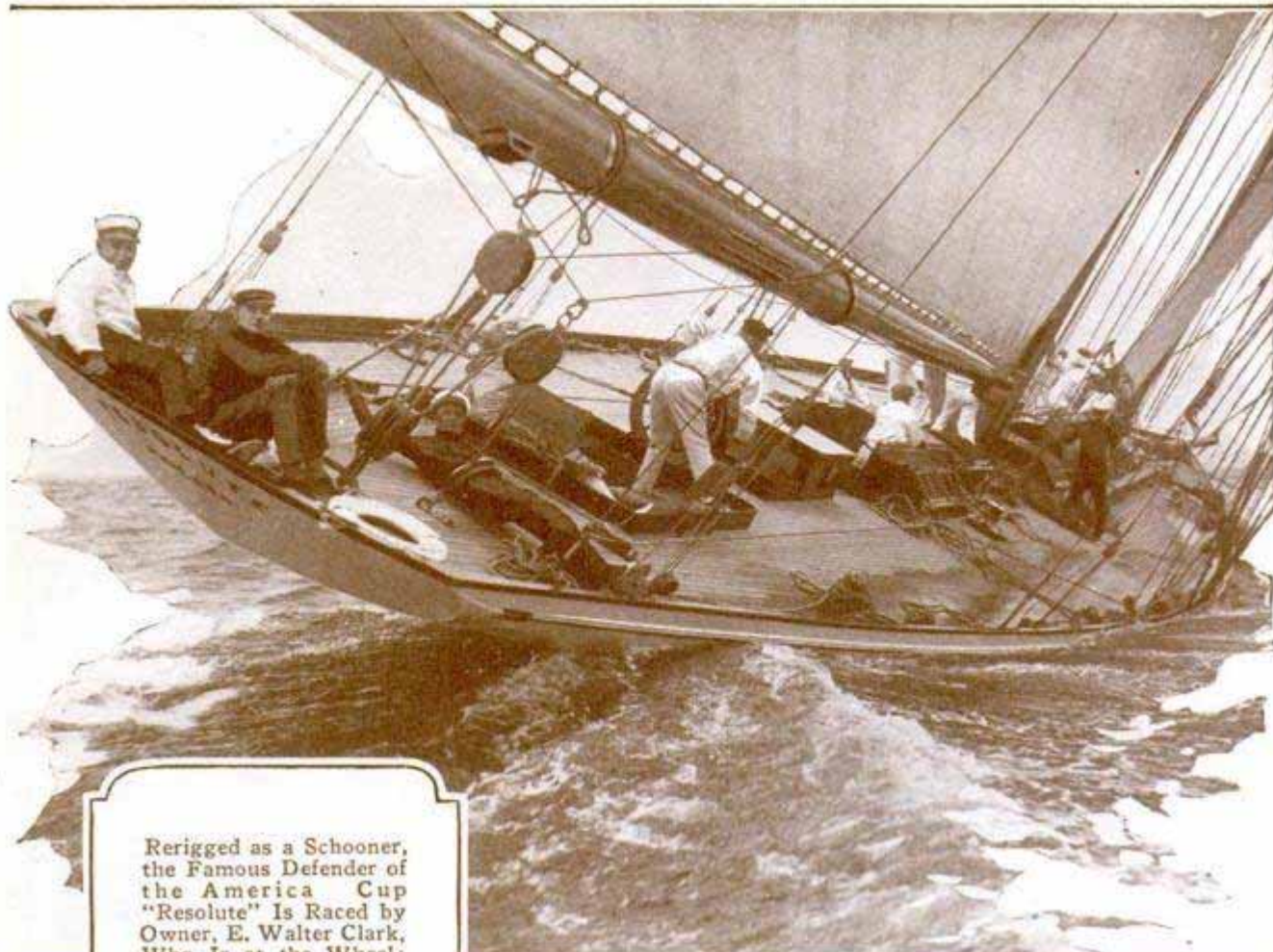

Rerigged as a Schooner, the Famous Defender of the America Cup "Resolute" Is Raced by Owner, E. Walter Clark, Who Is at the Wheel; Below, One of the Engine Rooms of Vincent Astor's New German-Built Boat "Nourmahal," Which Reached New York Recently

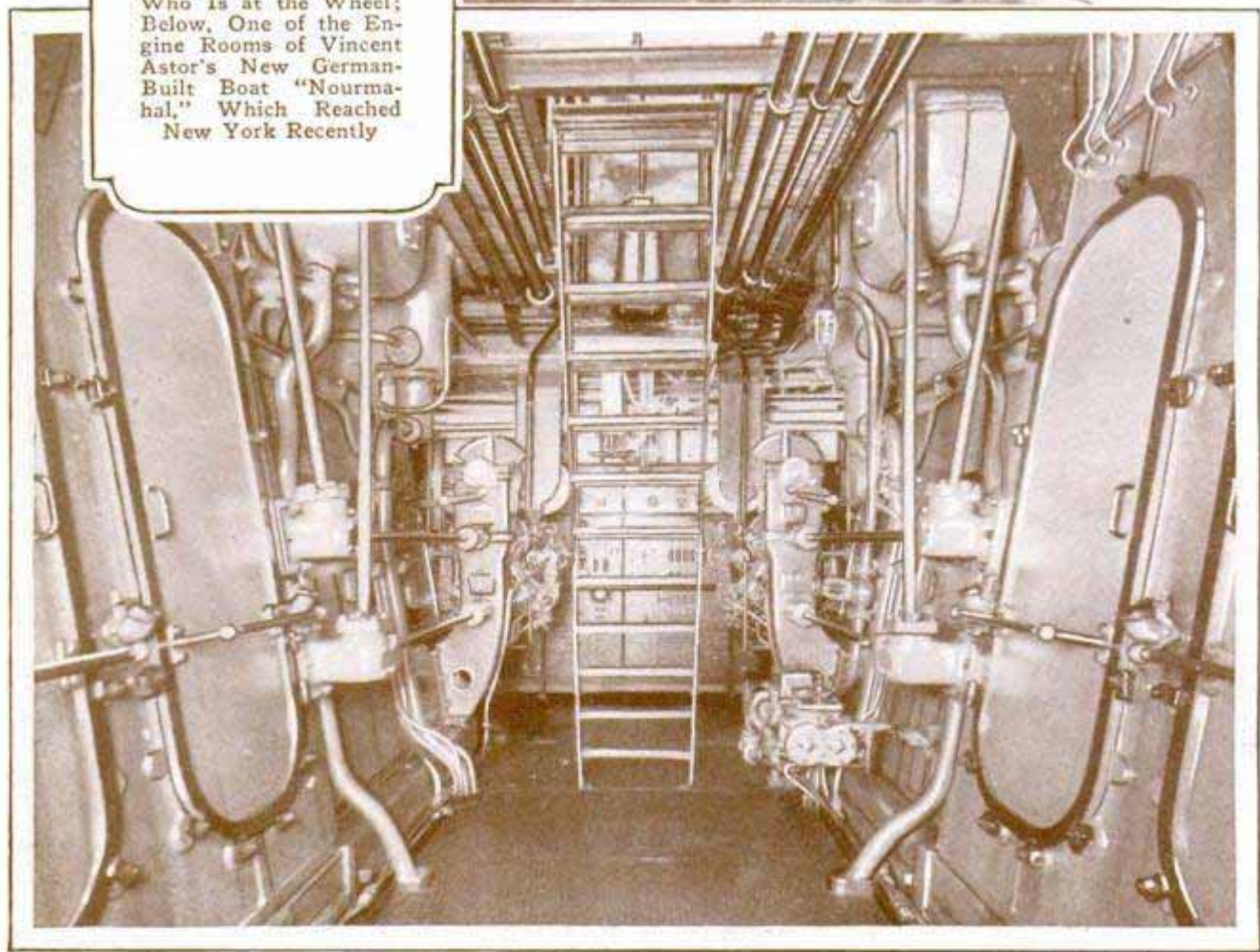

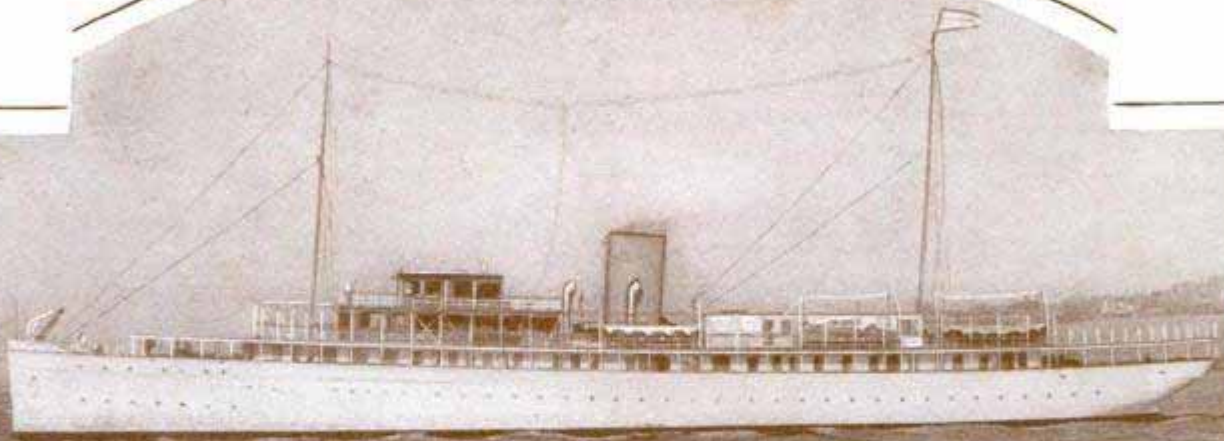

The World's Largest Diesel-Engined Yacht Is "Savarona," Designed by Gielow for R. M. Cadwalader, Jr., Philadelphia Banker

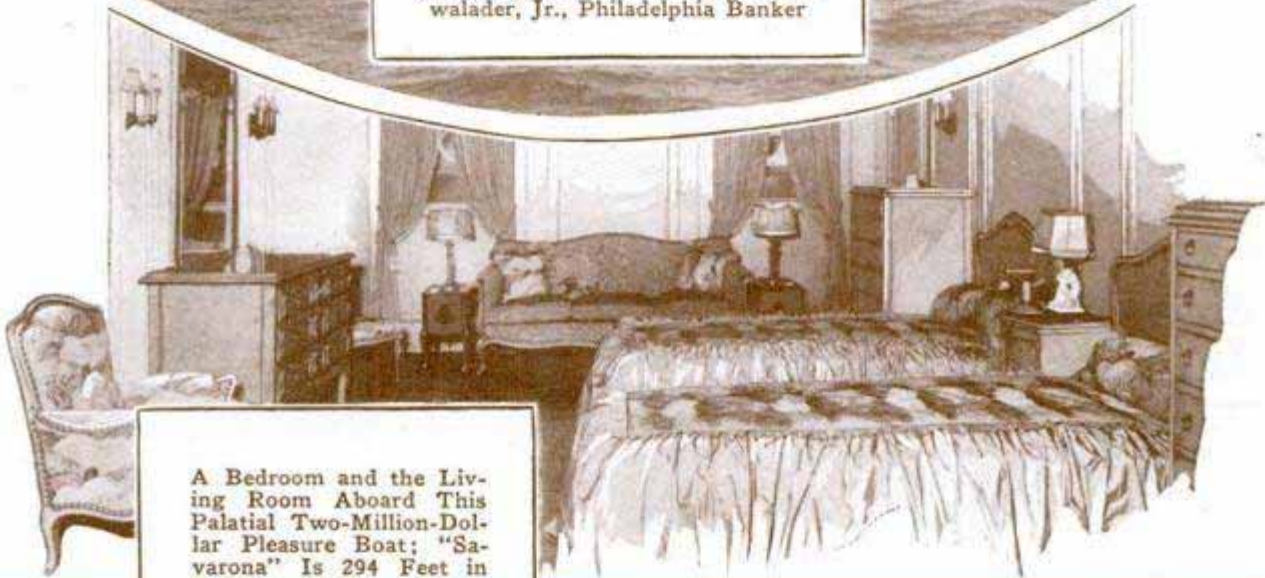

A Bedroom and the Living Room Aboard This Palatial Two-Million-Dollar Pleasure Boat; "Savarona" Is 294 Feet in Length and Has a Cruising Radius of 20,000 Miles



1269

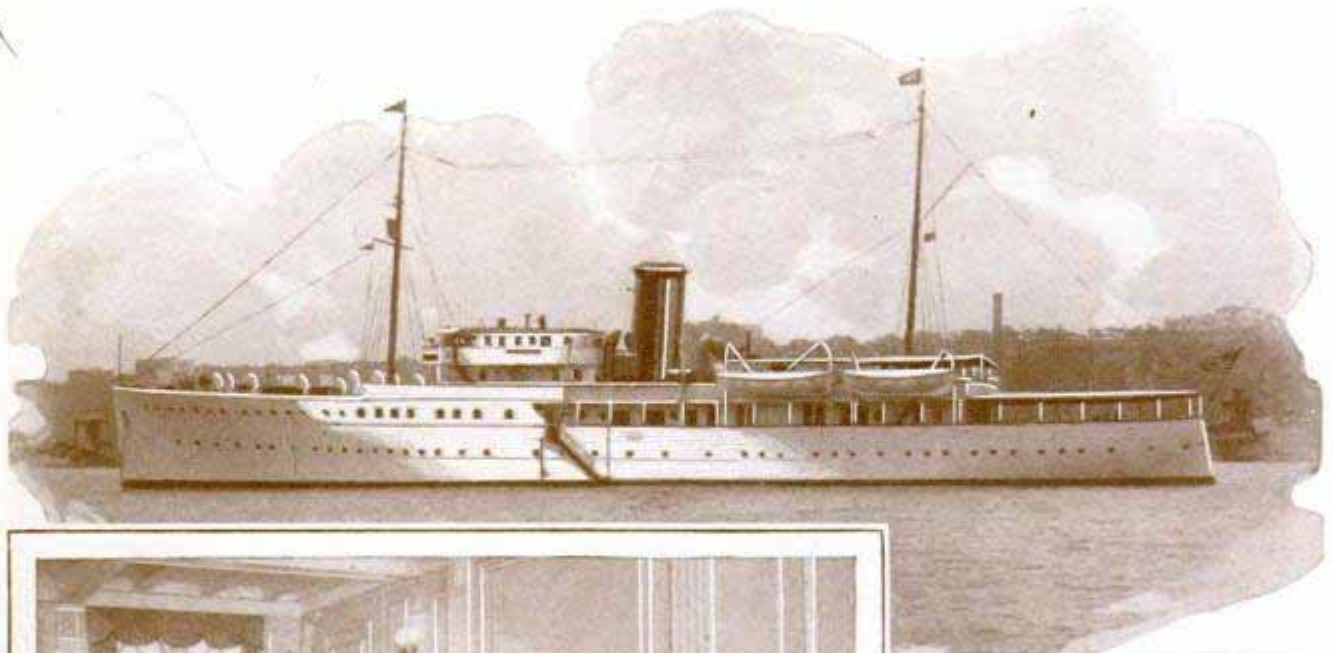

"Nourmahal," the New 294-Foot Diesel Yacht Built in Germany for Vincent Astor, Is Unusual Because Her Lines Bear Little Resemblance to the Usual Yacht; She Was Designed to Give Maximum Comfort on Long Deep-Sea Cruises

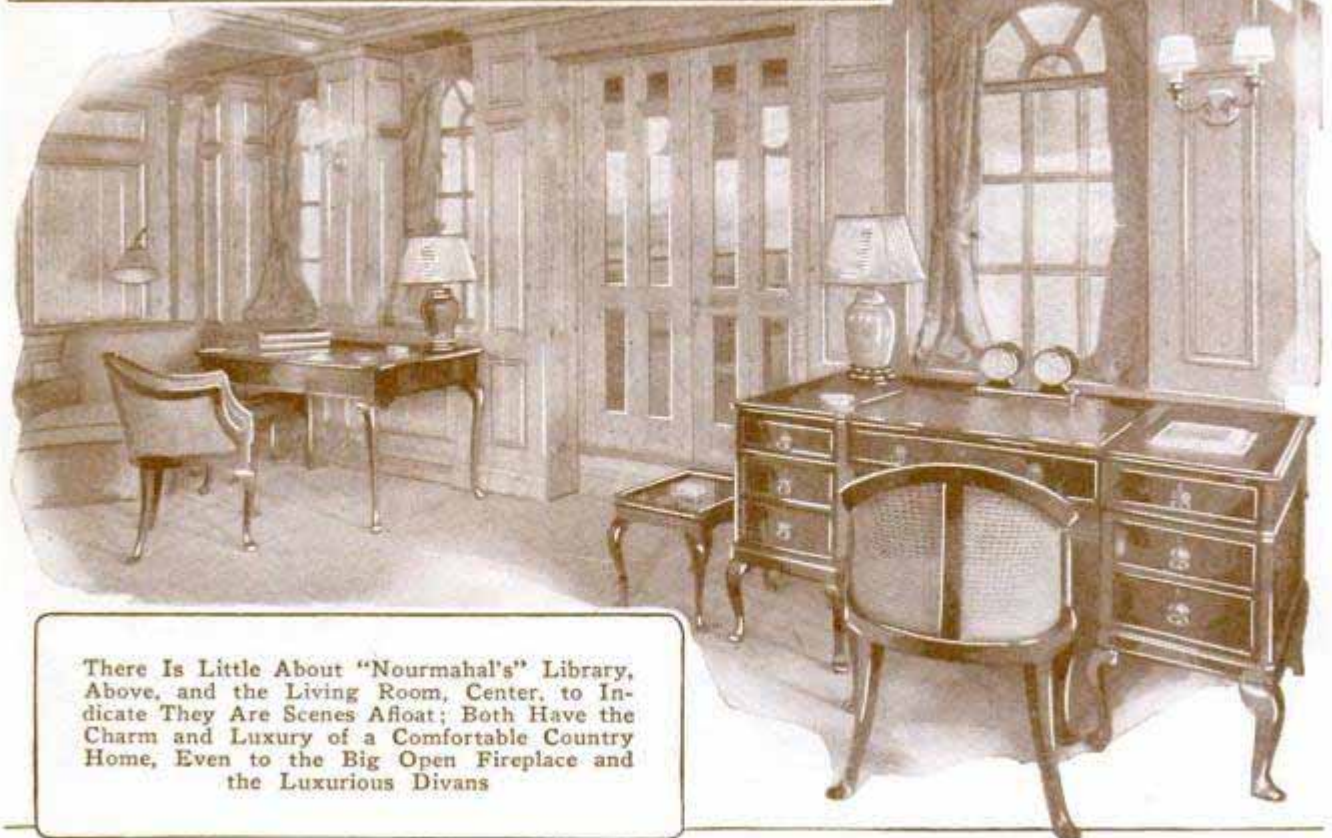

There Is Little About "Nourmahal's" Library, Above, and the Living Room, Center, to Indicate They Are Scenes Afloat; Both Have the Charm and Luxury of a Comfortable Country Home, Even to the Big Open Fireplace and the Luxurious Divans

ELECTRIC MACHINE COOLED WITH GAS MORE EFFICIENT

After extensive experiments, engineers have devised a way to cool electrical apparatus with gas. A rotary condenser at a large eastern plant, employed to increase the efficiency of alternating current, has been completely inclosed in an airtight casing and surrounded with hydrogen. The gas, being a good conductor, removes the heat almost as fast as it develops. It is then cooled by internal radiators supplied with circulating water and is used repeatedly. Other advantages, besides increased efficiency, are claimed for this arrangement. The gas is fireproof, unless mixed with a certain proportion of air, hence even a short-circuit blaze would be smothered quickly for lack of oxygen.

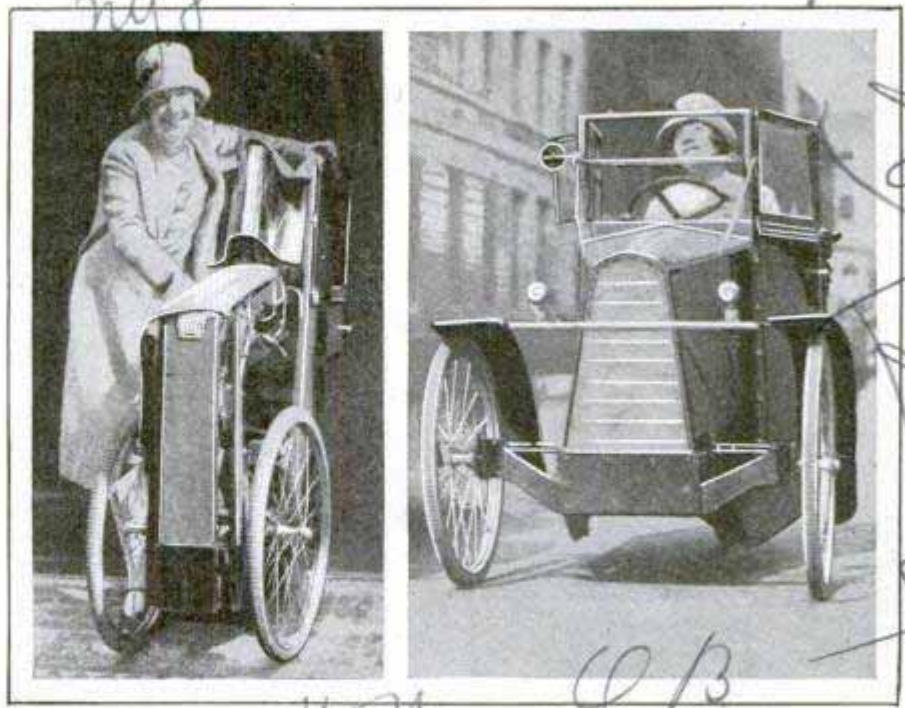

Foot-Power Automobile Folded and in Use; It Has Speeds of Twenty to Thirty Miles an Hour

FOLDING FOOT-POWER AUTO DEVELOPS HIGH SPEED

Operated by foot power, a folding automobile introduced in London develops a speed of twenty to thirty miles an hour and, when collapsed, is small enough to be taken through a door. It runs without great effort on the part of the operator, according to reports, has hand and foot brakes and side screens, and is not taxed.

MODEL RAILWAY IN FRONT YARD DRAWS MANY VISITORS

Passers-by in a western town halt at a certain front yard, the property of a railroad man, to admire the model railway system he has constructed. The miniature line itself is ninety-five feet long on which tiny electric locomotives haul trains. A six-foot trestle, supported on forty-five piles is a feature of the railway. A model town of ten buildings, small autos and trucks, 350 trees and mid-gt airplanes are other displays, and the whole has been carefully landscaped to make the assembly more realistic.



Ready to Descend with Escape Rope on Reel

AUTOMATIC FIRE-ESCAPE ROPE HOLDS THOUSAND POUNDS

Attached to a reel which permits it to unwind at a moderate rate of speed when needed, an automatic fire-escape cable has been tested with success at an English school. The line is of steel and capable of supporting 1,000 pounds safely. The reel is attached within the room at the side of the window or other exit, one or more being provided at each of them.

Claver - S. E. Peacock, B. Brooming, Aug.

S. E. Peacock, R. R. R.

Cannal locate 10/2/29/28

*1434
Schermady
C. B.
Pedelure Co. H. Claver Johny St.
London Eng. St. London W. I. Eng.
127/36
45
Curtis Bag Park Royal.
1468*

1444
FIREMEN WALK IN DEEP WATER WITH RUBBER SUIT

Fireman in Rubber Suit with Paddles about His Neck



© P. & A.

For firemen along the docks, a rubber suit that permits the wearer to walk about in deep water has been demonstrated in Germany. An inflated portion keeps the man afloat while the feet are weighted to aid in maintaining the balance.

1463
DIESEL ENGINE FOR AIRPLANES IN SUCCESSFUL FLIGHT

The Diesel-engine principle of using oil for fuel and exploding it under high compression instead of with a spark, has been adapted to airplanes and successfully demonstrated in a series of test flights. Recently, a plane which was equipped with such a motor flew for twenty minutes, landed and took off again without the engine being stopped, and again soared, the engine performing satisfactorily. It was of the radial, air-cooled type, developing 200 horsepower. One of the chief triumphs attained in the unit is the great reduction in weight. Formerly such motors weighed 100

Stinson-Electro-Richard motor monoplane. Electric motor

pounds and more to the horsepower, while this one weighed less than three. It has fewer parts than the ordinary gasoline engine, spark plugs, carburetor and the ignition system having been eliminated. Besides greatly reducing the fire hazard, an important factor when gasoline is used, a Diesel-motored plane can fly farther with the same fuel load, engineers declare; the cost of the fuel is less and there is less interference with radio apparatus. Though the engine's test satisfied its builders, it will not be put on the market until further trials have been made.

1464
PAPER PUNCHED FROM STAMPS SOLD BY GOVERNMENT

The tiny disks of paper punched from the perforations in postage stamps have assumed an unforeseen importance along with the government's policy of economy and are being sold to bidders for salvage as waste. They accumulate at the rate of 12,000 pounds a month and have been offered for sale over a period from last September to next June.

1422
TOY ELECTRIC AUTO FOLLOWS FENCE TO GET POWER

A toy racing automobile, driven by an electric motor, is the latest novelty for the child. Instead of a track, the automobile follows a fence, which carries two insulated strips to provide the power contacts. The car is provided with a steering arrangement so that it will follow the fence either on the inside or outside, depending on which way the rails are fitted together. A step-down transformer takes current from the house-lighting circuit.

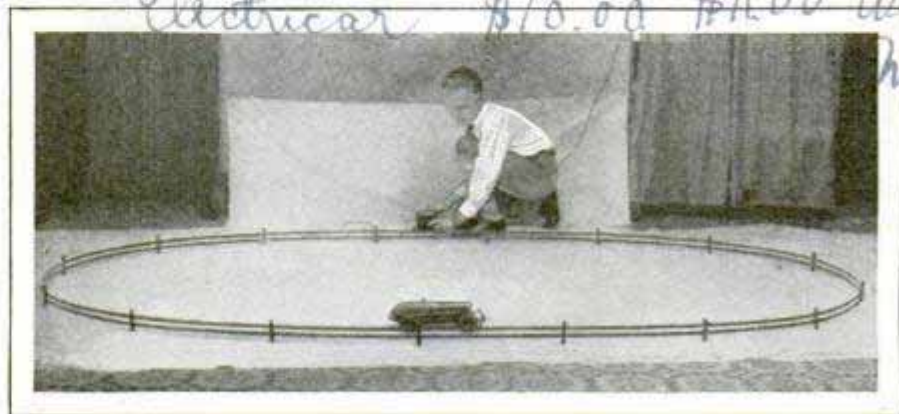

Tiny Fence Supplies Power for This Electric Racer, Fitted with Steering Arrangement That Keeps It near Rails

Kokomo Stamped Metal Co, Kokomo

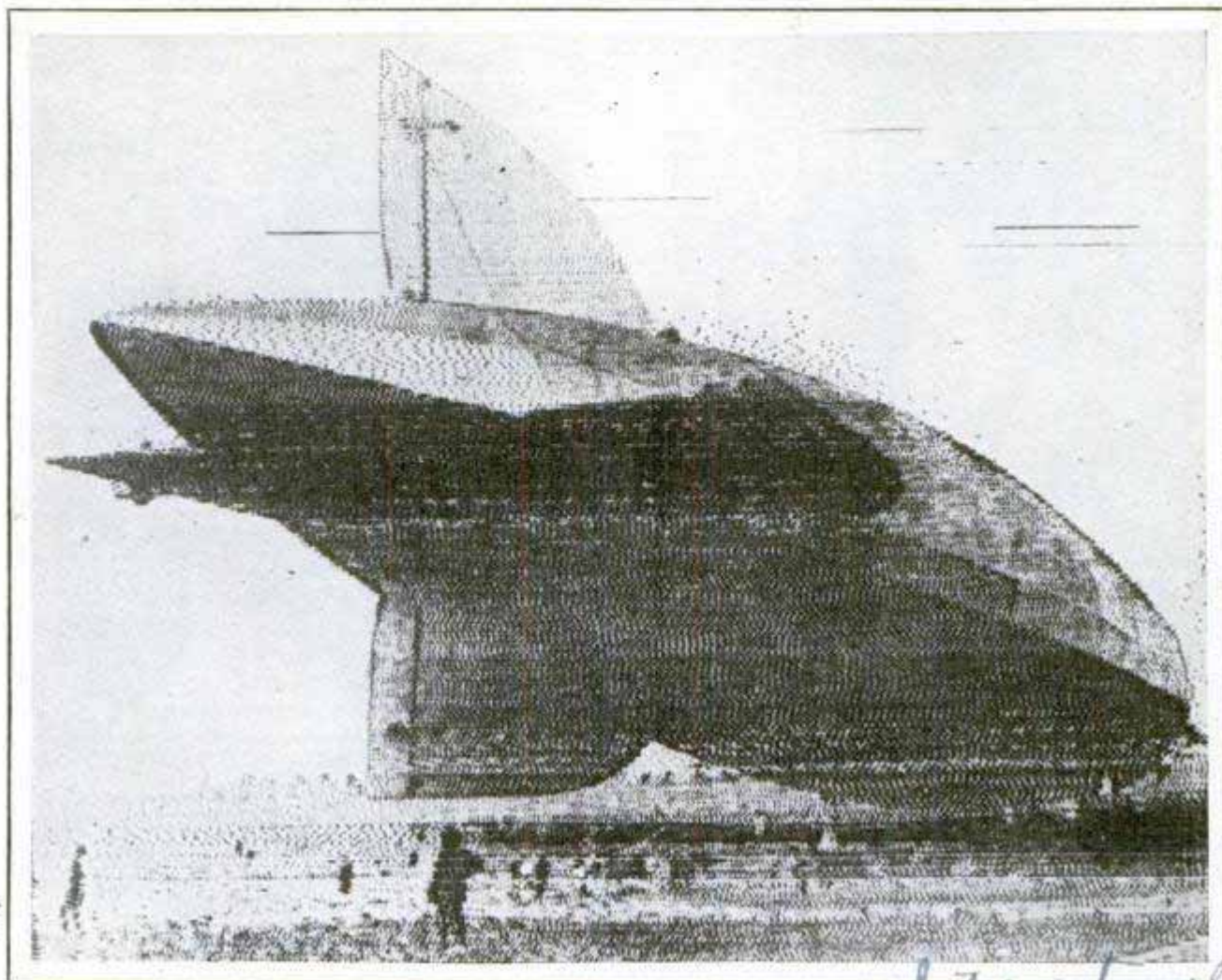

An Air Picture of an Air Giant; Radio Photo of the Huge German Dirigible "Count Zeppelin" at the Time of Its First Trial Flight When It Carried Eighty-Two Passengers

RADIO PHOTO OF DIRIGIBLE SHOWS TEST FLIGHT

Interesting photographs of the trial flight of the big German dirigible "Count Zeppelin," designed for transatlantic passenger service, were sent by wireless a few moments after the big bag had started on its first run. Eighty-two persons were carried on the first flight of two and one-half hours' duration.

PIRATE ISLE IN GULF OF MEXICO TO BE MODERNIZED

Linking an island fifty miles out in the Gulf of Mexico to the mainland by means of an automobile road, is one of the tasks the Louisiana state-highway commission is soon to undertake. The objective is Grand Isle, famous as a summer resort and celebrated in fiction as the scene of pirate and other adventure stories. The road will run from New Orleans, whence

travelers who now wish to visit the island set forth by canal boat through marsh grasses, drooping willows and other picturesque growths along the bayou district. At Grand Isle is a splendid seven-mile beach, pronounced the finest for surf bathing on the Atlantic coast. Oaks, now 300 years old, grow sturdily and there are homes more than 100 years old. The isle's geological history extends to the time when the Gulf of Mexico reached back to territory now occupied by the state of Michigan. It withstood the vast upheaval that practically fixed the present coast lines of the North American continent as they are today and has been inhabited since 1776. The proposed road, which was authorized recently by an act of the legislature, has been under discussion for several years. Not long ago, land on the island could be had for \$50 an acre but there were few buyers at that price until more recently, with the modern developments there, lots have advanced considerably.

New York Times 9/23/28

1417

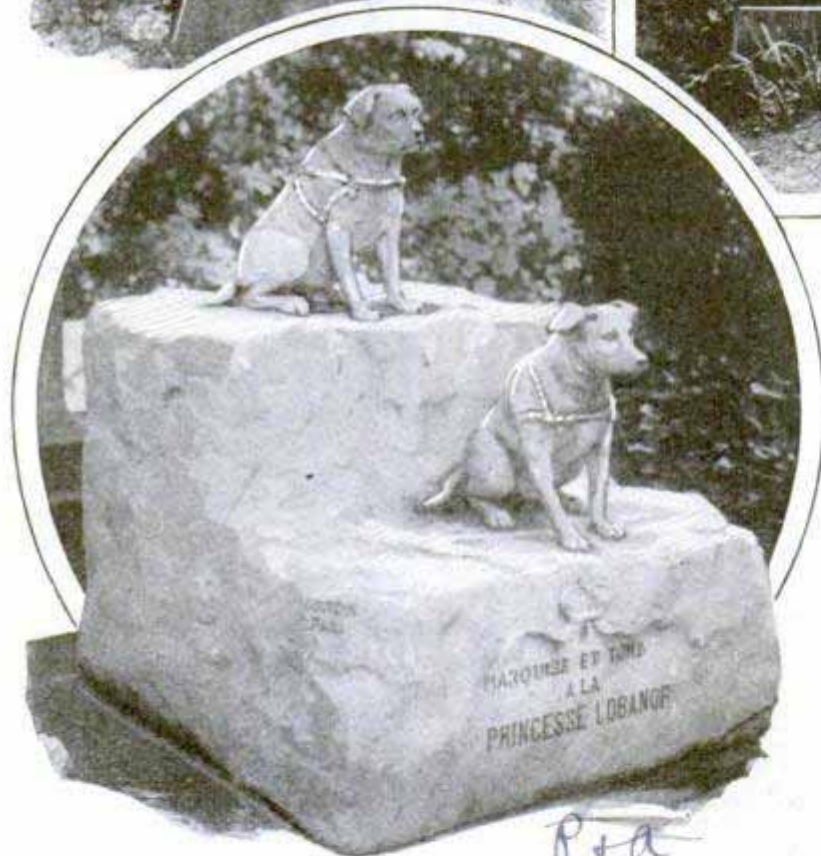

Some of the Marble Tombstones in the Cemetery for Pets, on a Small Island in the River Seine near Paris; Many of the Monuments Are Valuable Works of Art Carved by Noted Sculptors

The affection which was lavished on the departed pets is reflected in the fact that many of the graves are surmounted by tombstones which are rare works of art. Bizarre carved monuments, magnificent marble mausoleums, and, in many cases, life-size carved effigies of the pet, are quite common. It is not unusual to see luxurious limousines halt at the cemetery gates and their owners descend to place a sheaf of flowers on

PARIS PET CEMETERY DISPLAYS MONUMENTS TO ANIMALS

One of the strangest cemeteries in the world is located on a tiny island in the river Seine, near Paris. There, connected with the mainland by the Pont de Clichy, is the necropolis of Parisian pets—dogs, cats, doves, monkeys, and other animals.

one of the tombs. A regular, almost daily, visitor keeps fresh flowers on the grave of a little fox terrier that died recently from too much rich food, lack of exercise and complications due to inhaling too much rich perfume. In life, the little terrier had its own apartment, a private maid, cook and butler, as well as a "beautician" to look after its toilet. When it died, the re-

des Ravageurs

mains were buried in a casket of silver and ebony, placed in a marble vault, with a long inscription inlaid in gold to tell of its mistress' grief.

UNCLE SAM GUARDS OYSTERS

To protect the consumer of oysters shipped in interstate commerce, an elaborate inspection system has been built up, with the result that epidemics due to polluted shellfish are almost unknown. The oyster beds are watched by state authorities, the water examined and passed as free from taint, and the oyster gatherers and plants where they are prepared for shipment inspected. The plants which have the state approval are then certified to the United States public health service, and if the latter finds conditions are proper, the name is added to an approved list sent to all state health departments.

n.Y. James 9/16/28

HAND-LIFTED BALANCE BRIDGE STILL USED IN ENGLAND

An old hand-operated balance bridge is still in use over a canal at Rickmansworth, Buckinghamshire, within twenty miles of London. To open the draw, it is only necessary to give a slight tug on a chain hanging from the balancing beams, and to close it, a chain on the opposite side is pulled, or the beams may be lifted.

139

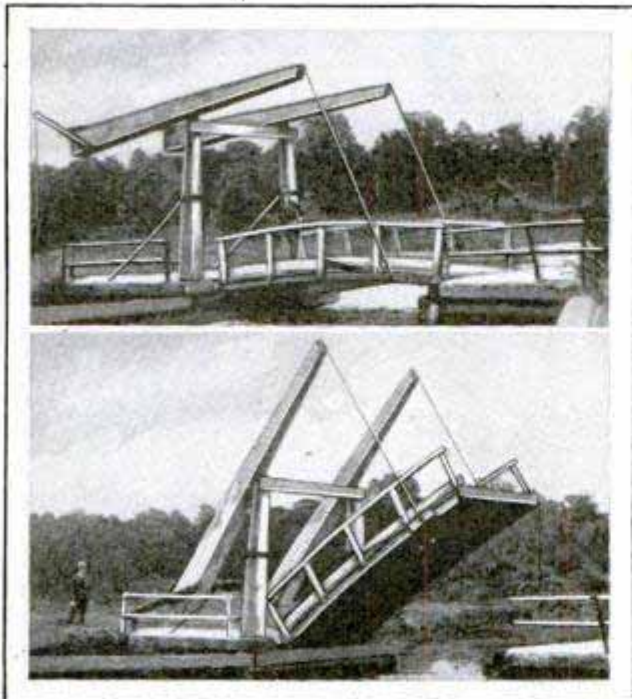

Old-Style Balanced Bridge Still in Use over a Canal within Twenty Miles of London, England

Cont. H.J. Watkins

WATERPROOF MAIL BOX SAVES CONTENTS FROM DAMAGE

1418



Inventor Pouring a Glass of Water into His Rainproof Mail Box, Built to Protect the Contents

A waterproof mail box with its interior so arranged that rain penetrating it is carried out through an opening in the back without coming into contact with the mail has been demonstrated before post-office officials by a Baltimore inventor. It is possible to pour a glass of water directly into the box without wetting the contents.

L. A. Stetson 1623 Orverhill Ave

AIRPLANE TAKES NON-STOP RECORD FROM BIRDS

1379

Man has at last outdistanced the birds, and now holds the undisputed non-stop flying record of the world. The late Arturo Ferrarin, Italian flyer, whose record-making flight from Rome to Brazil covered 4,736.7 miles, beat by about 700 miles the flight of a giant albatross which flew from the Crozet islands to Rottneist island, off the coast of Australia, carrying about its neck a frantic message from thirteen shipwrecked sailors of the French vessel "Tamarais." Proof that the bird had not stopped for food lay in the fact that the wire holding the message was drawn so tight it could not swallow. Aviators also hold both speed and altitude records over the birds. The highest a bird is known to have flown is 20,000 feet, while aviators have gone to more than 38,000. Birds never fly faster than sixty miles an hour, except before a gale.

Quince Service News Bulletin 390. B 9/11/28

Emb. by H. Macy, 4639 Montgomery Ave. Bethesda, Md.

Glass House to



down. The lighting of buildings, streets and industrial plants during that nocturnal respite when the sun sleeps is accomplished efficiently as a result of many years of investigation, but the problems of daytime illumination have been neglected.

Near the National Physical Laboratory at Teddington, England, British scientists several years ago started interesting daylight-illumination studies. They, however, experimented exclusively with the steel skeleton of a building minus inclosing sides, ends and roof. It remained for Uncle Sam to experiment exhaustively with the nor-

YOUR Uncle Samuel who tests out scientific theories in order to separate from them the cream of practical results has built a remarkable house of glass on the Virginia side of the Potomac river, but one at which nobody throws stones.

This test building, which you can see through, is being used in astonishing daylight-illumination experiments. The United States public health service decided it was time to call a halt on our ever-increasing impairment of human eyesight by unsatisfactory light conditions in homes, offices, factories, apartments and other habitations.

For years, national, state and private research agencies have focused intensive study on the mysteries of artificial light. The riddles of electricity, illuminating gas and even acetylene have been explored from the bottom up and from the top



A Movable Ceiling, Adjustable from Six to Fifteen Feet, and a Big Photo-Electric Cell, to Measure the Amount of Light, Are Features of the New Sunlight Test Building

mal illumination which can filter through glass and provide poor, medium or good reading conditions at various points within the house, factory or office.

Save Your Eyes

In order to eliminate as far as possible the effects of smoke, dust and other foreign material as well as the undesirable environments of adjoining buildings, the government experts built their amazing house of glass on a grassy knoll at Arlington Farm, Virginia—the proving grounds of the department of agriculture where plant-life conundrums are solved. The site is a part of the famous Park Custis estate where George Washington was a welcome guest and often followed fox and hounds.

The glass house looks somewhat like a cross between a rural school and an old-time country church. The test building is thirty feet square and is provided with a trick ceiling which can be raised or lowered at the desire of the experimenters, while the walls consist largely of open-faced glass windows, shaded inside by light-tight shutters of wall-board. By means of control ropes like those on awnings, four sections of the ceiling are adjustable at any height from six to fifteen feet. This permits of determining the best height of ceiling for various daylight exposures.

There are twenty-four windows, each five feet in width, which extend from a point three feet above the floor to the eaves. The total window-glass surface aggregates 1,440 square feet. By means of the adjustable interior shutters, the building can simulate the possible light exposure in any conceivable structure which might be built for human occupancy.

Wall color influences indoor illumination measurably, but previous to these national tests, nobody has known definitely what colors were most desirable. When the accompanying photographs were made, the ceiling, shutters and woodwork

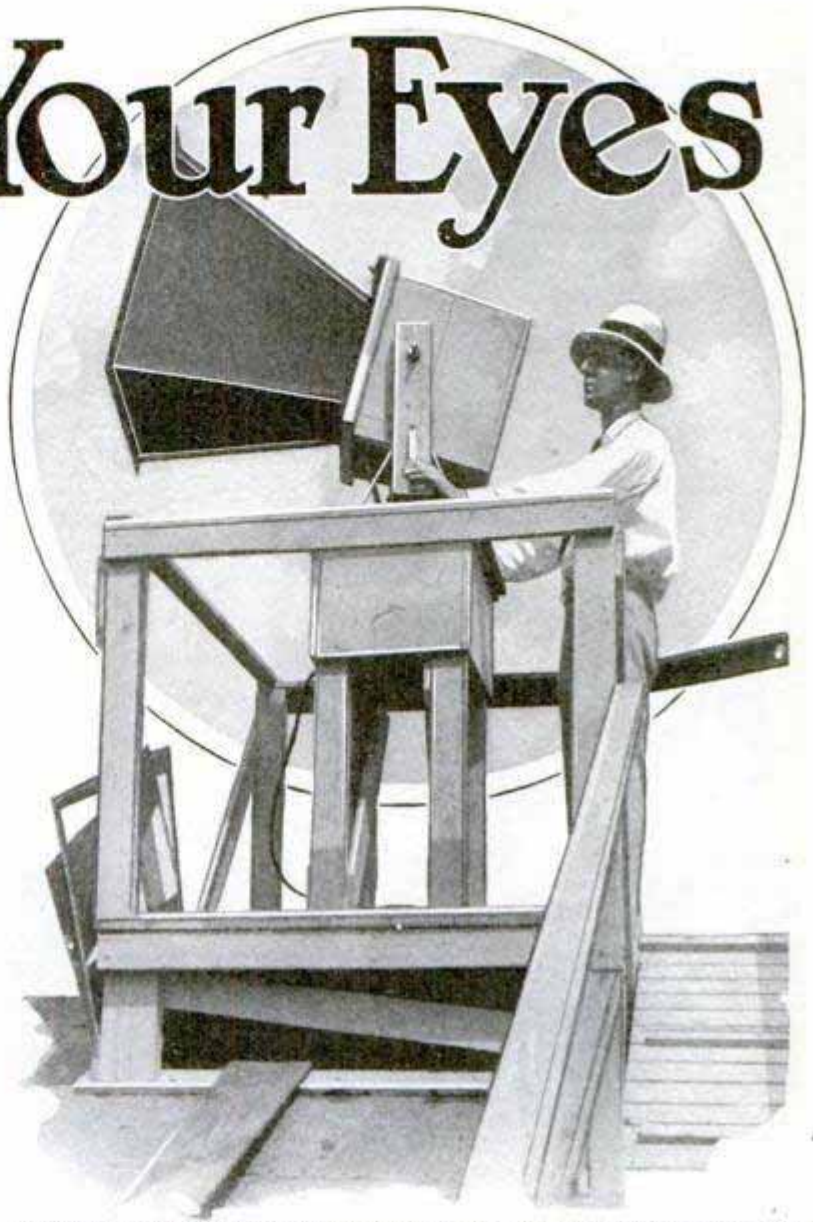

A Brightness Meter on the Roof Measures the Illumination Source in the Sky While Tests Are Made Within

in the glass house were white. However, as the research progresses, various other wall colors will be experimented with. Data of vital importance to builders and interior decorators will be obtained from this scientific research.

It will take from one to two years—possibly longer—for the government specialists to complete the research which they have outlined for the glass house. No news about the results will be available until the conclusion of the tests. It is Uncle Sam's invariable policy to make haste slowly in such fundamental experimentation. Tests are repeated, results are checked and rechecked and all sources of possible error are eliminated from the picture. Suffice to say that the data already obtained prove that the glass-house tests will revolutionize and standardize

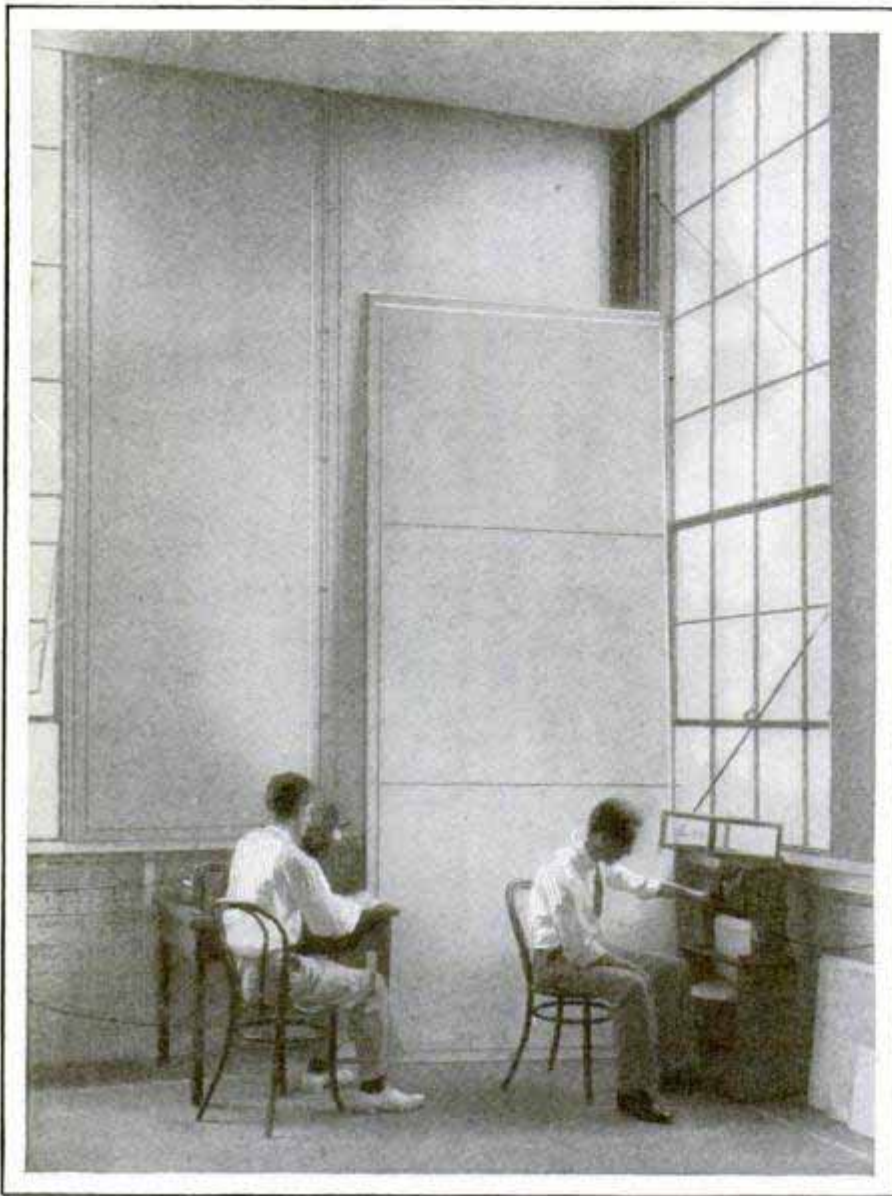

By Changing Indoor Shutters the Engineers Can Duplicate All Possible Light Conditions in Any Part of the Test Building

building design around the whole world.

The wooden floor of the experimental building is divided into thirty-six test stations identified by black lines. The stations are six feet apart. In each test of light exposure of varying amount and direction, technical readings are made at every station of the illumination at that particular spot at a distance thirty inches above the floor—the height of the ordinary desk or table.

Illumination observations are made only on bright and sunny or overcast cloudy days. Work is discontinued on days when the sun is alternately bright and shrouded by clouds. This is due to the fact that light values vary within a surprisingly wide range in brief intervals on such days. The influence of direct sunlight is also neglected on the assumption that the aver-

age occupant lowers the awning or pulls down the shades and thus protects the room against any glare from this source.

National scientists have originated a portable photo-electric cell somewhat similar to the one used in the pioneer television tests as a reliable recorder of light values. It registers the intensity of illumination at any point to which it is moved. This movable apparatus is linked by a coiled cable with a continuous chart recorder—a mechanical penman which inscribes in black and white the data derived from each experimental set-up. This automatic bookkeeper is as faithful as time, and more accurate than any human recording agency.

A shutter may be removed, for example, from one window on the north side of the building. The portable recorder is then moved from one to another of the floor stations until all have been covered.

The complete story of the possible light values in different parts of the room is had in the data recorded automatically in the form of diagrams and tables. Two shutters on the same exposure may then be lowered and the test repeated, or one shutter on the north and one on the east may be removed. Every possible combination of light ingress is being tested out.

The amount of illumination at any point in a certain room depends directly on the brightness of the sky visible from that station through the intervening window. Hence the brightness of the sky governs the daylight intensity in home, office, shop or school. Sky brightness varies widely, being from ten to twelve times greater at some points in the heaven than at others. Science reports that the brightest sections

are close to the sun while minimum brightness is found at locations ninety degrees from the sun. Brightness increases again markedly from this point of minimum to the horizon.

On the roof of the glass house near Washington, a brightness meter is mounted in order that the light intensity of that section of sky which is the source of indoor illumination in each test may be measured. This device consists of a photo-electric cell fitted in a revolving rectangular case and attached to a large metal hood which resembles the bellows of a camera. It is connected by insulated wires with a second chart recorder, within the glass house, which writes the record.

As a result of early tests in the campaign to prevent eyestrain, some states now specify that the window-glass area must be equal to at least one-fifth of the floor space in a schoolroom.

Modern factories that consist of huge shells of glass set in steel frames also are stepping stones of building progress. Future manufactories will be better lighted than ever because of the present glass-house experiments.

In the future, the health, size, stature and stamina of the human family may be increased correspondingly by the use of special glass in houses which lets the ultra-violet rays indoors. The normal health of the sedentary worker may be improved materially by the use of similar glass in factories, offices and warehouses.

The government plans to initiate some such experiments in its curious glass house. As a result, future generations may become a stronger race of human beings, more efficient workers, endowed with greater resistance against disease, and will live much longer than the normal man of the present age.

STEAM STORAGE IN FACTORIES INCREASES EFFICIENCY

Improved methods of storing steam generated to operate engines have been developed in England and Germany, enabling plants to operate at greater efficiency, according to reports. The basic idea of the system is to store up exhaust steam or that which would otherwise be wasted when more is being generated than is used.

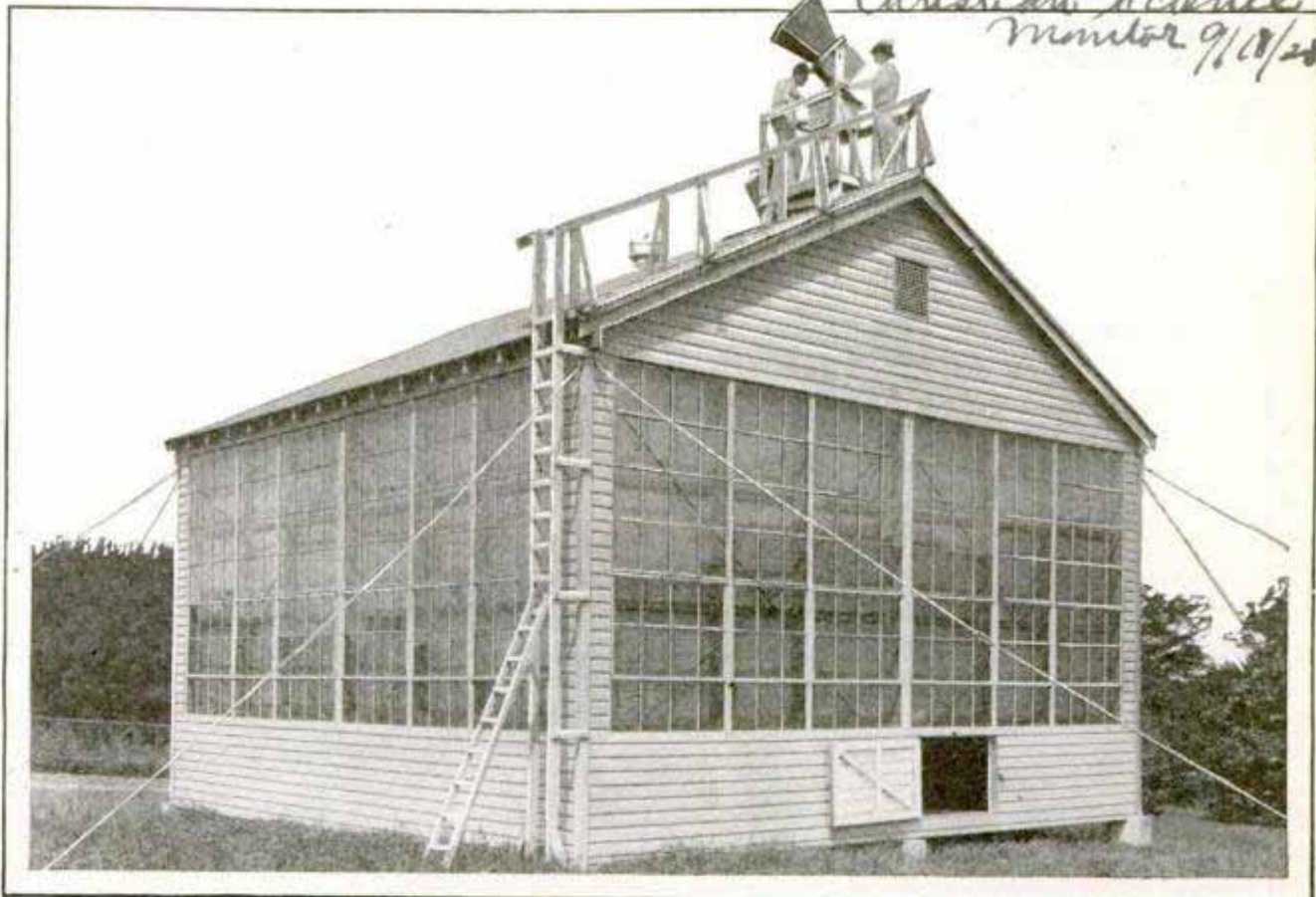

The Glass House in Which Uncle Sam Is Attempting to Solve the Problem of the Best Arrangement for Daylight Illumination; the Sunlight Recorder Is Shown on the Roof

Prof. A. S. Christie, Johns Hopkins University Baltimore, Md.

Christian Science Monitor 9/18/28.

Berley Heath nr. London Eng.

Italian salvage firm - Sorina Società Ricuperi Marittime Genova Italy

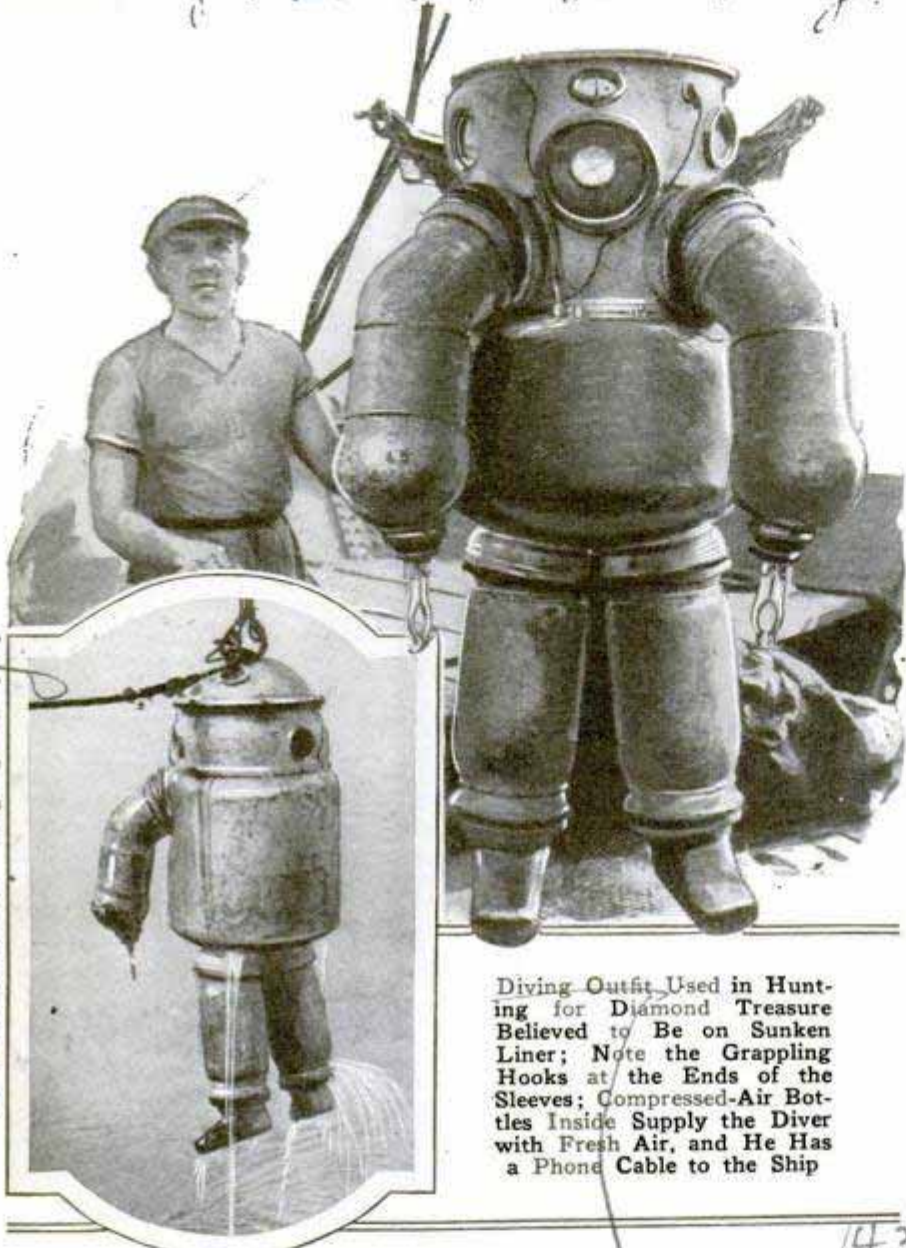

Diving Outfit Used in Hunting for Diamond Treasure Believed to Be on Sunken Liner; Note the Grappling Hooks at the Ends of the Sleeves; Compressed-Air Bottles Inside Supply the Diver with Fresh Air, and He Has a Phone Cable to the Ship

DIVING FOR DIAMONDS HIDDEN IN DROWNED LINER

Where are the 10,000 diamonds, worth about \$6,250,000, said to have been sunk with the Belgian liner "Elisabethville," torpedoed in forty fathoms of water off Belle Ile, near the port of St. Nazaire, on the French Biscay coast? This is a mystery about which a band of puzzled deep-sea divers were asking themselves last August when they were hunting for the treasure of this drowned liner. The insurance company says that the jewels were put in the liner's strong room, while the owners are positive they were in a safe in the captain's cabin. The first diver dynamited a way into the mail room but found no treasure. Then the divers forced a way into the captain's cabin and brought

to the surface a safe which was placed under seals. For the work under the great sea pressure at forty fathoms, the salvage ship carried two of the latest diving suits of cast-steel cylinders with jointed iron legs. No outside air supply is needed, because these suits are equipped with compressed-air bottles, and are connected with the ship by cable and telephone. A week after it was brought to the surface, the safe was opened. It contained a few banknotes, but no diamonds. The salvage company still thinks the jewels lie somewhere in the wreck, but just where is not known. Salvage operations are to be continued, not so much to find the lost diamonds, as to practice for the attempt to salvage the "Lusitania."

RUBBER-TIRED DISK USED FOR HOME BOWLING GAME

1430 A bowling game that can be played in the home recently has been placed on the market by an eastern manufacturer. Instead of bowling balls, a light discus, covered with a rubber tread, is used, wood blocks mounted on rods taking place of pins. When the disk strikes a pin the latter revolves on its shaft, but,

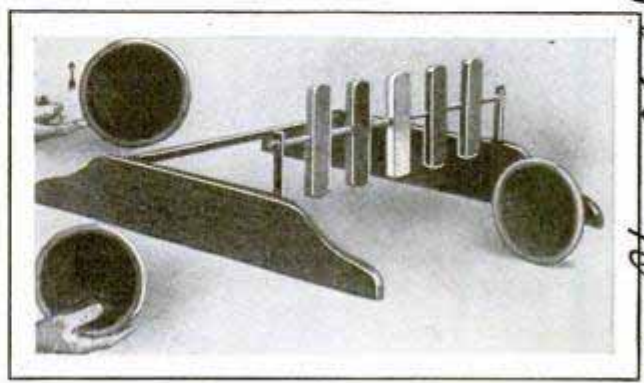

Bowling-Game Outfit That Uses Rubber-Tired Discus Instead of Balls; the Pins Are on Bar

Neufeldt + Kuhne
 Kiel Germany

The Discus Co.
 Box 42 Weymouth

Chicago at present

daily mail
9/11/28

creamland vanish

1395

as the mounting hole is slightly off the center, it always comes to rest again in a vertical position. A rod behind the targets checks the disk and throws it back, so that there is a chance of striking another pin on the rebound.

LIFE STORY OF BIG DIAMOND TO BE FILMED

1443

The life story of a diamond is to be filmed in England, with the consent and assistance of the king and queen. The diamond is the famous Kohinoor, which was presented to Queen Victoria by the East India company after it had come into the company's possession through the death of the Rajah of Lahore and the annexation of the Punjab. The film will trace the recorded history of the stone from 1304, when it came into the hands of Ala-ud-din, emperor of Delhi. Legend carries the history back much earlier, but from the time of the Delhi emperor its successive owners are more or less known. Two centuries after Ala-ud-din the stone belonged to the son of Barbar, the founder of the Mogul dynasty. It was probably this stone that Aurungzebe used as an eye in the peacock throne, though some authorities hold the eye stone was the Great Mogul, from the Golconda mines, and that the Kohinoor is only a fragment of it. In 1739, the diamond belonged to Nadir Shah, the Persian conqueror, from whose descendants it passed to Runjit Singh. At one time in its history it was sent to the laundry in the pocket of a pair of trousers and rescued by an Indian servant who thought it a pretty piece of glass. When it came to the English crown jewels, the stone weighed 186½ carats, but it was improved by recutting, which reduced the weight to 106½ carats. It is still the sixth biggest diamond in the world.

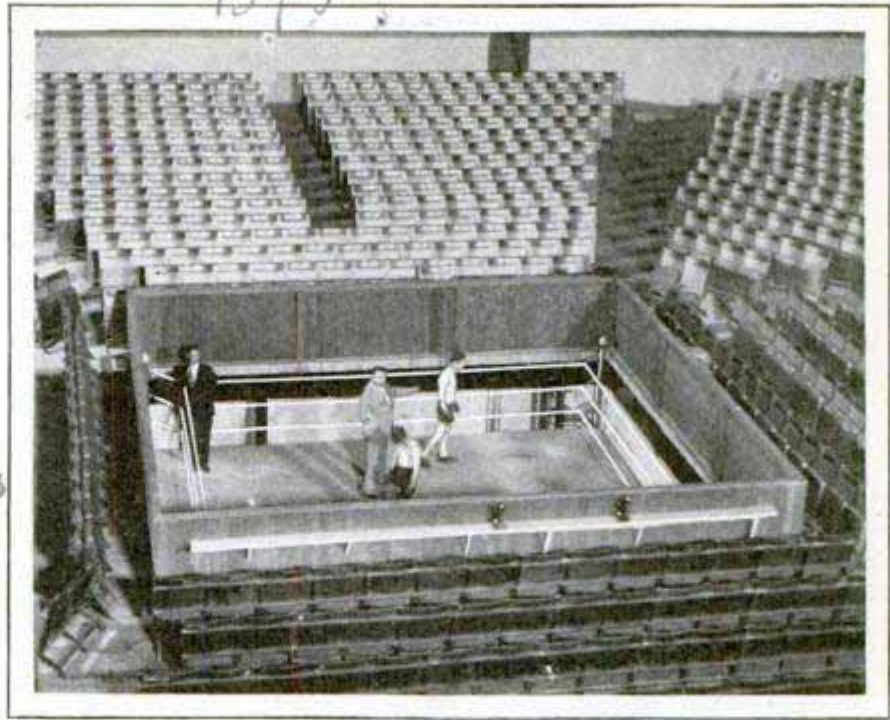

Boxing Arena with the Ring on Platform, Which Can Be Raised or Lowered with the Fighters and Referees

DISAPPEARING RING IS LATEST IN BOXING CIRCLES

The idea of the disappearing orchestra in movie theaters has been adapted to the prize-fight ring with a new installation in San Francisco. The ring is the platform of an elevator. It is lowered to the basement, the fighters and seconds, with the referee, step aboard, and then the ring rises into view, with the principals already seated in their corners. The arrangement saves the fighters the trouble of elbowing their way through the crowd going to and coming from the ring.

CHAIN LINKS EASILY PARTED THROUGH PATENT SLOT

1428

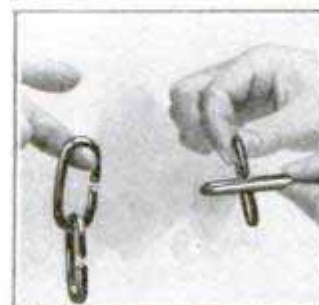

A new type of chain which can be lengthened or shortened at will, without the use of tools and without marring the finish, is being made, particularly for use in chandeliers. The

links have a small opening on one side, and when the openings of two links are brought together at right angles, they can be slipped apart or joined.

newark, n. j.

☐The largest existing bird is the ostrich.

Written by Sir E. A. Mison, G.C.S.I., director of

C. J. Williamson
Wire Novelty Co

10. Kay Electric Co

389 C 9/6/28

936

POPULAR MECHANICS

181 Chestnut
Newark N.J.

1383

Los Angeles, Calif.
A. O. Matz

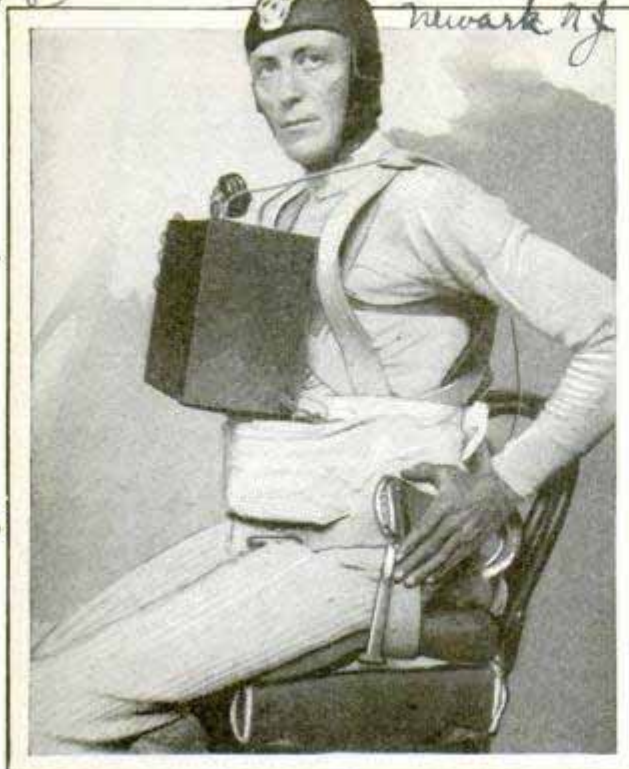

Parachute Jumper with Portable Broadcasting Outfit
Used to Describe the Thrills during the Descent

CHUTE JUMPER BROADCASTS DURING HIS DESCENT

Broadcasting a description of how it feels to be floating down to earth with a parachute was tried recently at Los Angeles, when a jumper leaped from a plane at 20,000 feet carrying a tiny portable transmitter which weighed less than twenty-five pounds. The messages were picked up by a local station and rebroadcast on a wavelength for home reception.

EIGHTEEN-CARAT RED DIAMOND FOUND IN SOUTH AFRICA

An eighteen-carat red diamond, the rarest tint of all, has been found in the Lichtenburg diamond field in the Transvaal, South Africa. It has been valued at \$20,000. Diamonds are found in all colors of the rainbow, including blue, green and yellow, but red is the rarest of all. The diamond is a curious case of fault being worth more than perfection, for the red tint is due to impurities within the stone. Blue stones rank next to red in value, the largest known one being the famous "Hope" diamond. The biggest known green stone is a forty-eight and a half carat one, slightly paler than an emerald which is now in the Dresden museum.

PLANTS SUBJECT TO SUNBURN SCIENTISTS FIND

The browning of plants under the hot rays of the sun is akin to human sunburn, according to reports made to the botany section of the British association for the advancement of science. Dr. E. M. Delf, secretary of the botany group, reported that exposure of plants to the ultraviolet rays from a quartz mercury-vapor arc caused the plants' skin to turn brown, and that microscopic examination showed a breakdown of the outer layer of cells.

STEREOPTICON IS COMBINED WITH PHONOGRAPH

A stereopticon which can be operated in synchronism with a talking machine to produce an illustrated lecture has been invented by an El Paso photographer. The two units can be placed in a single console cabinet, or operated separately, at any distance from each other. The stereopticon also can be used by lecturers to present slides without the aid of an assistant, as the lecturer can change the slides at any distance and without the audience being aware of the operation.

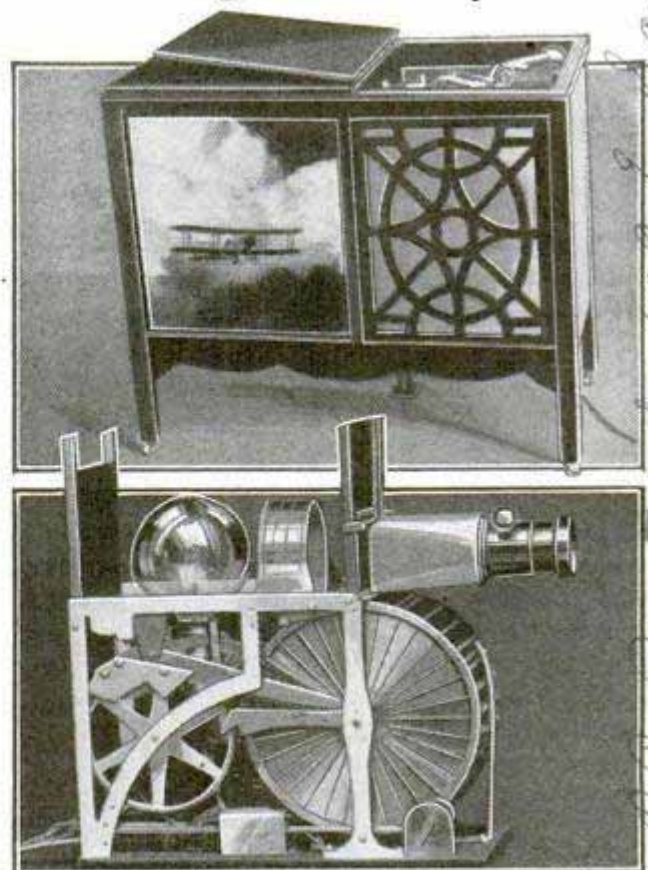

Combination of Phonograph and Stereopticon Which
Delivers an Illustrated Lecture without Human Aid

1404

Cont. George H. Holden Esq.
Highland Wood Jackson New York

C. C. Bernard 609 E. San Antonio St.
El Paso, Texas.

SPECIAL BOATS FOR AUTOS CARRY MANY CARS

Approximately 150,000 automobiles made in Detroit were delivered to distant dealers by water this year, according to reports from the steamship operators on the Great Lakes. Water delivery was first tried in 1918, during a railroad embargo, but has only come into general use since 1925. Several boats specially designed for the service carry nothing but automobiles, while other cars are shipped as deck loads on ore and grain boats bound up the lakes for their usual cargoes, and still more on ordinary package freighters. The special automobile boats carry from 500 to 650 cars, while from 150 to 175 cars can be loaded on the spar deck of the ore and grain boats. The deck loads are not lashed down or fastened in any way. When the cars are driven aboard, under their own power, the gears are put in low and the brakes set. As no blocking and bracing is necessary, and the ship freight rates are lower than the rates by rail, the automobile dealers save considerable money.

COLLAPSIBLE MAIL CASE GIVES ROOM FOR SORTERS

A collapsible mail case, providing space for the sorting of a large volume of mail, after which it can be folded into a small space and put away until needed again, has been invented by a North Dakota man. While intended primarily for rural-route post offices, it also can be used in large offices and factories.



Looking Toward the Pilot's Compartment in the Sikorsky Amphibian Yacht Built for a New York Millionaire

AIR YACHT HAS ALL COMFORTS OF A RAILROAD PULLMAN

An air yacht with all the comforts of a fine railroad car or seagoing pleasure craft has been built by the Sikorsky company for John Hay Whitney, son of the late Payne Whitney. The craft, a twin-motored amphibian, is similar to the airplane which carried Gene Tunney from his training camp to New York for his last fight. The pilot's compartment has dual controls for two pilots. Back of it is the passenger cabin, with a divan, pillows, chairs, table and lockers.

GERMAN AIR LINES OPERATE 40,000 MILES DAILY

Germany's air lines, grouped in the Luft Hansa organization, are doing the bulk of the civil flying in Europe. The summer schedule this year called for 160 big passenger planes flying daily, and covering routes aggregating 40,000 miles a day. Twenty thousand passengers were carried in one month, as well as 123 tons of freight, 163 tons of baggage and 102 tons of mail. During the same period the English lines flew but 112,750 miles in the entire month, and carried 6,531 passengers and 100 tons of freight. Subsidiaries of the company are operating throughout the continent.

and G. A. ...

... 80, 128

1337

W. Madison. Chicago
Story - Cedric E. Hart, 1911 *Veronica Blod*
Hollywood. Calif

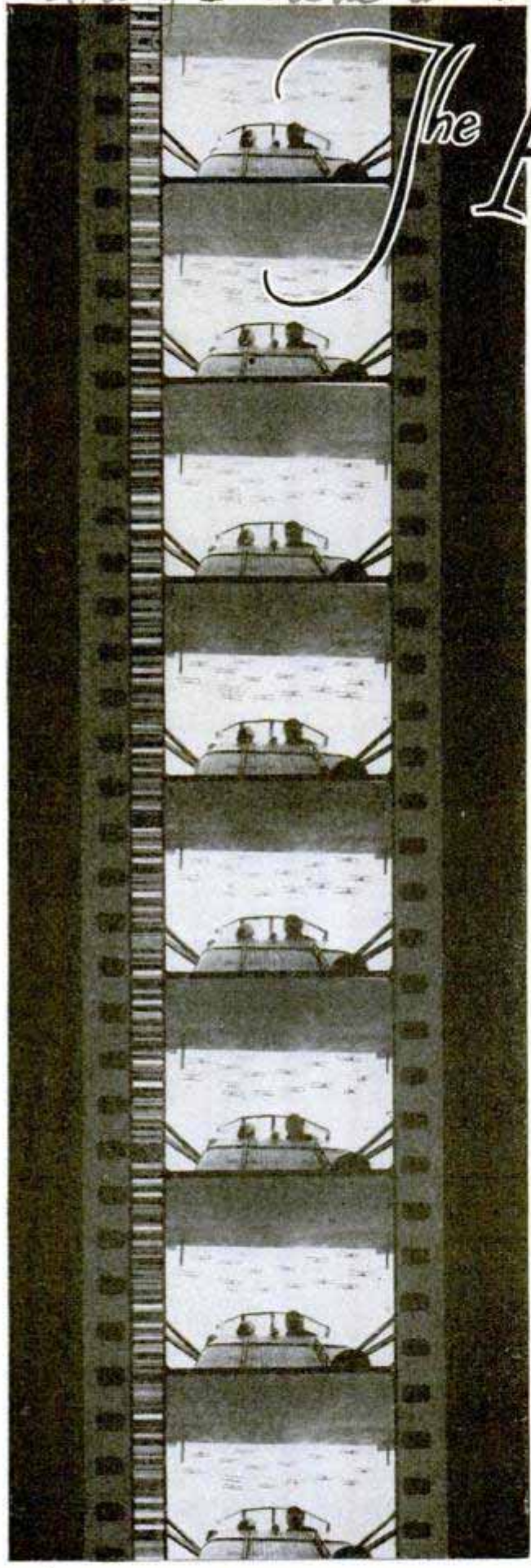

The Amazing

A BUCKET of water poured on the shoulders of a feminine film player, sounded, in the "talkies," like dropping popcorn. Then somebody discovered that a cymbal, borrowed from the orchestra and played at a distance, sounded just like falling water. Not important, in itself, but just one of the million and one new problems encountered in giving the silent drama a voice.

More startling still is the change in studio atmosphere. In the days when the celluloid drama was still silent, directors went around armed with megaphones to make themselves heard above the din, and a studio stage might be as noisy as a boiler shop, for the camera didn't care.

But now that the movies are being heard as well as seen, a talkie studio is the last word in silence. A sound not much louder than that of a dropping pin is enough to cause the perpetrator to be banished forever, for one extraneous noise may force the junking of thousands of dollars' worth of work.

Hollywood is embarked on the greatest experiment of its career. Voice-culture establishments are springing up in every street to teach actors and actresses the proper way to speak. Enterprising radio engineers are coining money with recording apparatus that enables every actress to carry along a talking-machine record of her speaking voice to demonstrate to the director just how she sounds when recorded. And the producers are staging a wild race to build the best and most soundproof studio stage first.

Where it all is going to end none can predict. Recording a musical accompaniment for a standard film is one thing. Fitting the characters out with dialogue and slowing the action down to a speaking rate is another. What the rest of the world thinks about the great speaking movie rush was summed up recently by G. A. Atkinson, movie critic of the London Express, when he wrote:

The Shaded Lines at the Left of the Picture Form the Sound Track, Recording the Roar of the Battle Planes in the Distance

Mr. Uare & Son,
1711 Winona Blvd.
Hollywood, Calif.

1337
Speaker

Story of the "Talkies"

"America's remarkable stampede over 'talkies' has practically made a present of the film-producing industry to Britain. It is no part of my purpose to inquire why Hollywood has suddenly decided to double-cross its own destiny. What is not so obvious, but is patent to a few clear-sighted men, is that Hollywood, as a film-producing center, may be rushing on commercial suicide."

The British critic points out that, while the silent drama can tell its story in any language, the foreign field for a talkie is limited to England and English-speaking dominions, and that neither the American-speaking voice nor American dialogue might be acceptable to English audiences.

The great stampede, as Mr. Atkinson so aptly names it, has been just that; as wild an upheaval as a Klondike gold rush.

On the technical side, an entirely new art has had to be learned, and it could be learned only by bitter experience. The problem of making falling water sound like itself was not an exception, but the rule. Practically every sound that had to be recorded was successfully registered only after painstaking experiment to determine which wrong sound would produce the right effect. What goes into the microphone and what comes out of the record or the light band on the film, depending on which of the two processes is used, sometimes differ entirely.

No one has yet solved the problem of taking outdoor scenes for the talkies. It is quite simple to make a news-reel shot of a parade or a cheering baseball crowd,

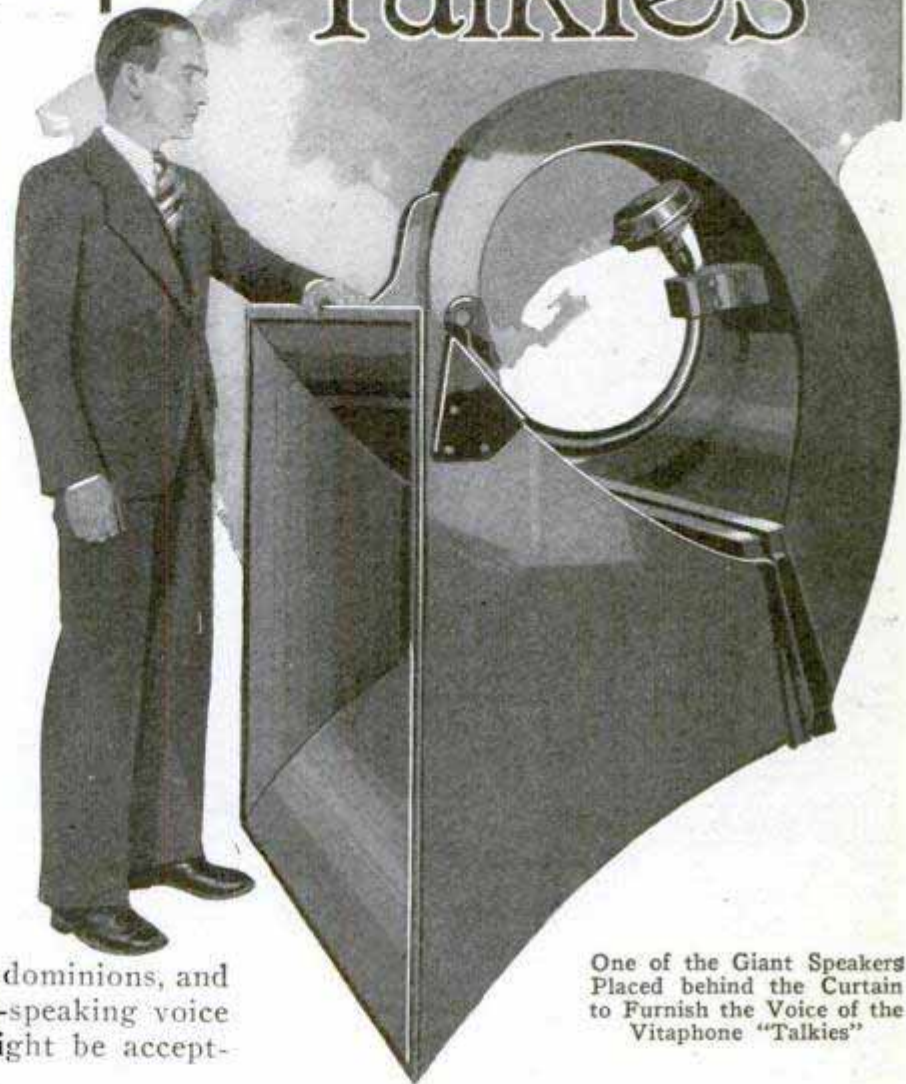

One of the Giant Speakers Placed behind the Curtain to Furnish the Voice of the Vitaphone "Talkies"

but try to record a dialogue between two actors, and every passing automobile, pedestrian or street car is going to be heard and distract the audience's attention.

Absolute quiet is so essential that directors who learned the game yelling through a megaphone now have to talk with their fingers. Soundproof studios, with eight-inch concrete walls, hermetically sealed doors, and deeply padded walls and ceilings are used. To eliminate the clicking of the camera, it is operated inside a padded chamber and shooting through double plate-glass windows. After the action has been rehearsed, a whistle blows and from then on absolute silence must reign.

In a padded lookout room, high up on the wall of one studio, an observer checks the action while listening to the voices coming through giant loud speakers, ex-

actly like those which will be used in the theaters. In the recording room, experts stand at mixing panels and blend the output of the various microphones, regulate the volume and pass the current on to the recording apparatus, where the master record is made.

When the other talkie process is used, recording the sounds on the film itself, the result is achieved in a somewhat dif-

crete walls are separate layers of acoustic plaster, with a dead-air space between the two. The roofs are six inches of concrete and steel, with inner ceilings of acoustic material. The doors weigh two tons each, run on ball-bearing tracks and are built of steel and acoustic material to make them soundproof. Ventilation is taken care of by ducts between the double walls, supplied with air from a distant fan house,

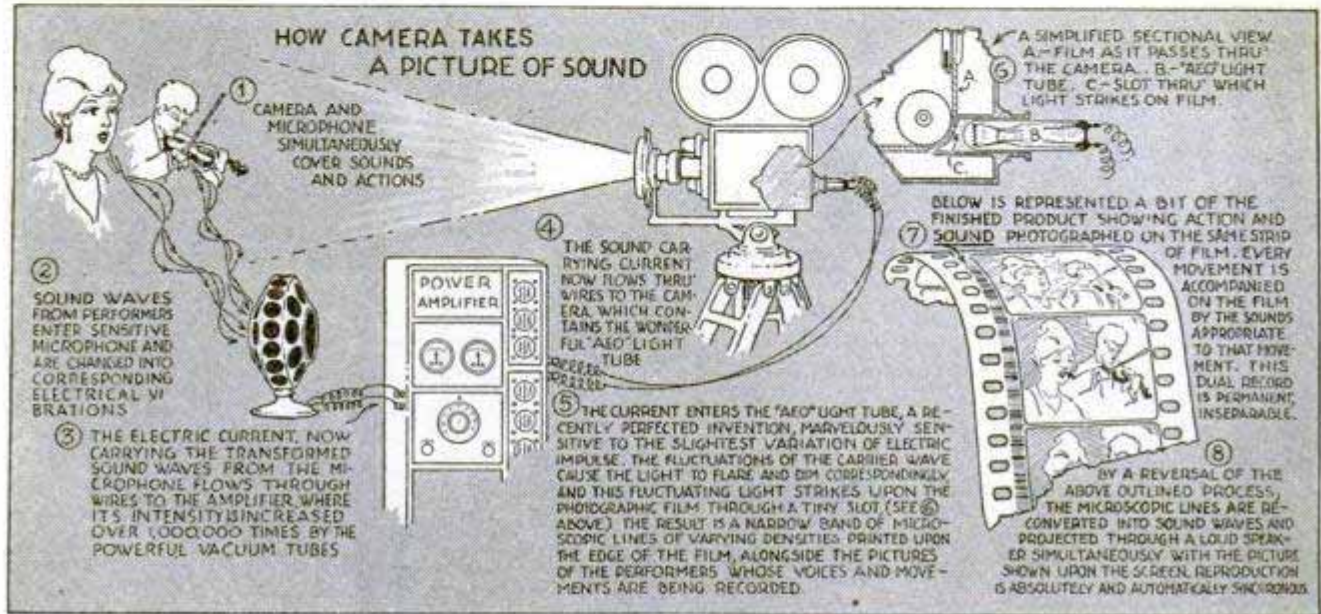

ferent way. The current from the microphones passes through the mixing and control stages and then back to the camera, which contains a sensitive light playing, through a narrow aperture, on a strip at the edge of the film. The variations of the current from the microphones cause the light to fluctuate, and when the film is developed it shows bands of shading. A light of constant strength in the projector will then fall on these, and that part of the light which passes through actuates a photo-electric cell, the output of which, amplified many times, is transmitted to the loud speakers.

At the Metro-Goldwyn-Mayer studios there is a main stage, 100 by seventy-four feet, a control room, fifty-four by fifty-eight, a second stage of the same size, and a two-story recording building to house the electrical apparatus. The recording building is almost as large as the main stage. All the buildings have thick concrete walls, going down to vibrationless piers, and floors sixteen inches thick, consisting of a six-inch sand cushion, four inches of concrete, four inches of cork, and a double wood floor. Within the con-

crete walls are separate layers of acoustic plaster, with a dead-air space between the two. The roofs are six inches of concrete and steel, with inner ceilings of acoustic material. The doors weigh two tons each, run on ball-bearing tracks and are built of steel and acoustic material to make them soundproof. Ventilation is taken care of by ducts between the double walls, supplied with air from a distant fan house,

the air passing through filters that remove all the fan hum. Such elaborate precautions are necessary because some of the microphones used are so delicate they can pick up the footfalls of a fly and amplify them until they sound like hammer blows.

Talking movies are not new, in fact they were demonstrated years ago, but it was not until the fall of 1926 that the industry became vitally interested. Curiously enough the father of all talkies—the telephone—is the parent of the speaking movies, for, in their present form, they are a by-product of the telephone laboratory. Engineers of the Bell Telephone company were hunting ways to improve the telephone. As a result of their experiments they developed various side issues, which included the public-address system of huge loud speakers used to carry a speaker's voice to 50,000 or 100,000 people in a single audience; the electrical method of registering phonograph records; the orthophonic phonograph horn, and, finally, the talking movie.

The latter was turned over to the Western Electric company, which builds all

1337



Fanny Brice, Above, Singing for the Movie Camera While the Voice Expert in the Foreground Regulates the Volume of Sound Passing to the Recording Apparatus, Located in Another Building; Inset, Operator in the Movie Booth Starting the Record, Which Is Synchronized with the Film; Unlike Home Talking Machines, the Movie Record Is Played from the Center Outward, Just the Reverse of the Usual Process; Below, Al Jolson, the Famous Jazz Singer, in One of the Scenes during the Making of the Film of That Name; the Orchestra Is Removed Some Distance from the Microphones So That It Will Not Drown Out the Singer's Voice.

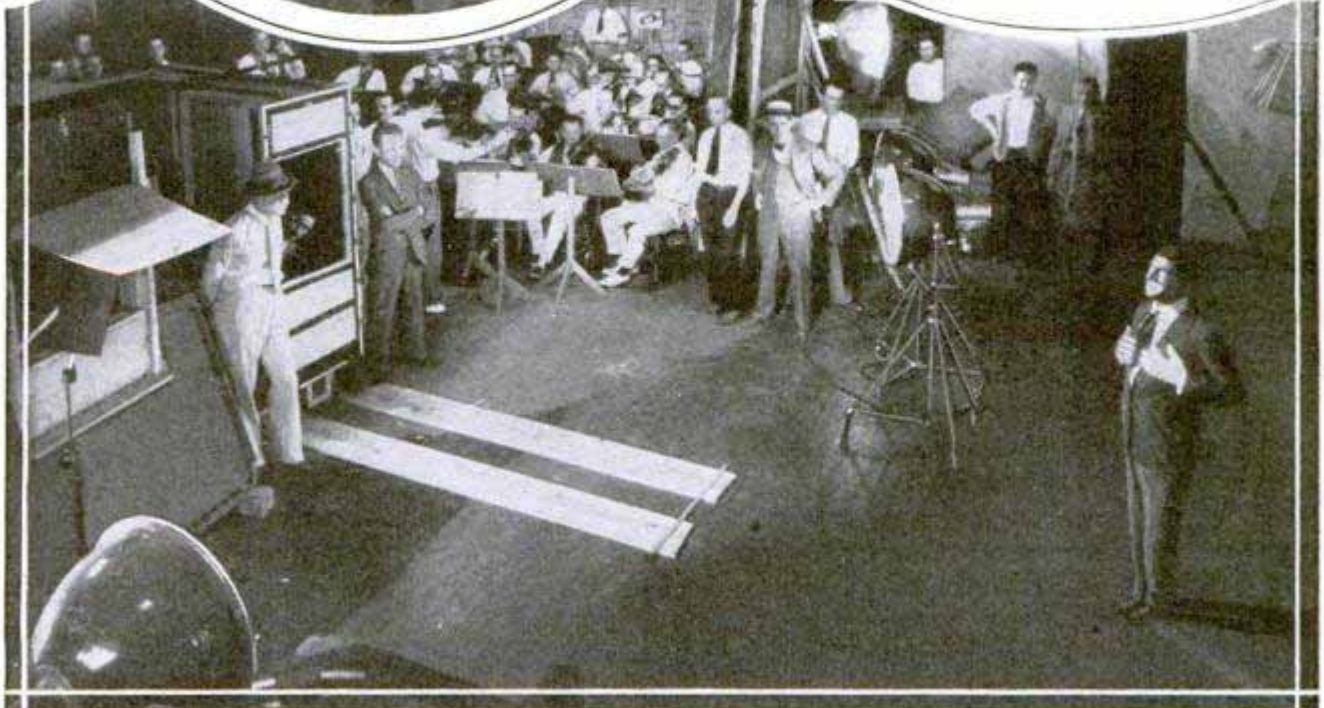

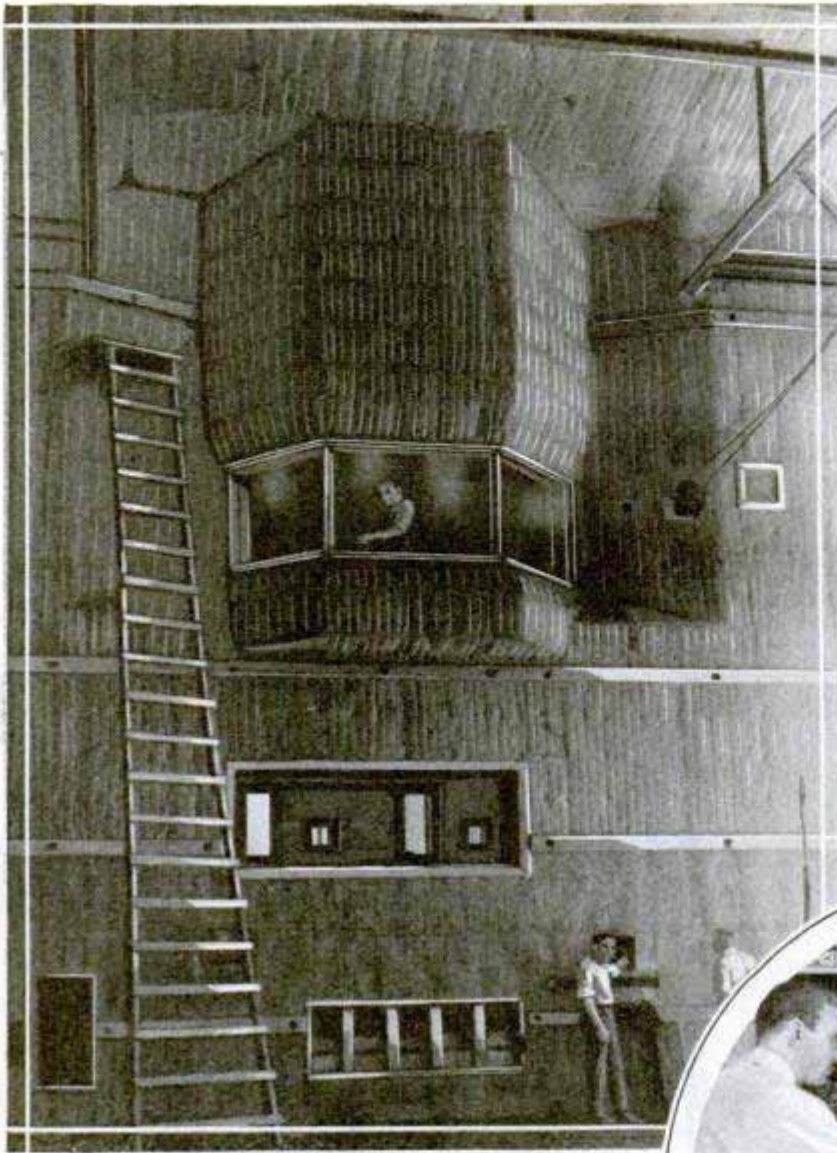

Interior of the New Soundproof Studio on the M-G-M Lot; the Monitor Room Is High Up on the Wall; the Inset Shows the Monitor at the Controls

The director calls for a rehearsal. The actors go through their scene, speak their lines distinctly, carefully omitting the hiss of sibilants and tongue notes. Assistant directors, who formerly bellowed out commands for lights and camera, now glide softly on rubber-soled shoes. So do the property men, the cameramen and the electricians. If the rehearsal is done to the director's satisfaction, he signals an assistant director, who blows a sharp blast on a whistle. Everything within sound of that whistle must maintain an absolute quiet until two blasts lift the spell, signaling the end of the scene. The director then

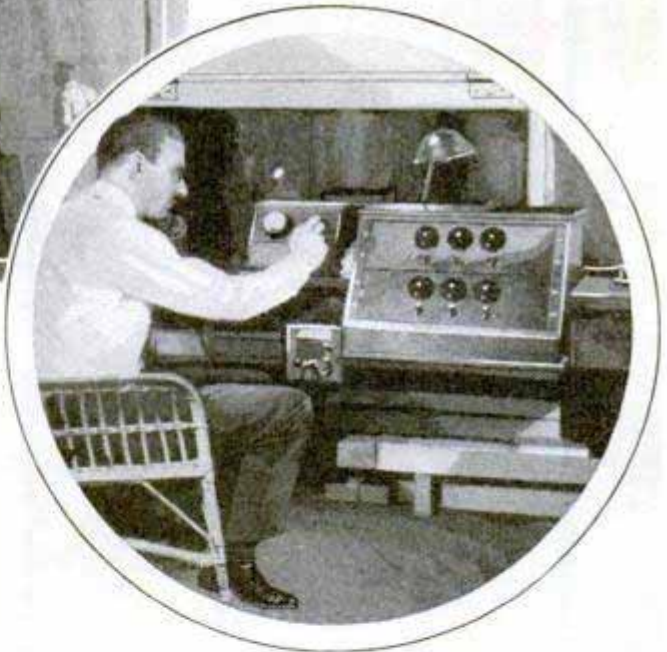

Bell telephone apparatus, and in 1925 motion-picture producers were invited to consider its possibilities. All passed the opportunity except the late Sam L. Warner, of Warner Brothers. He visioned the future of sound in films and, unable to obtain the exclusive use of the phonograph-disk method, obtained a license and the exclusive use of the name Vitaphone.

Fox followed with Movietone, the film-band process. Its development, however, dates back nineteen years, when Theodore Case, a Yale student, began experiments which led to its development. Needing money to carry on his work, he obtained a million from the Fox movies, and now the Fox-Case corporation controls a veritable gold mine.

How is a talking movie made?

Activity inside the stage is well-ordered.

talks through a hand telephone to the operator, who photographed the scene from inside the movable booth, and finds out whether a retake is required or the shots were all right. It is here that the monitor operator or mixer, a new figure in the film world, has his place. He has heard the voices of the players through a speaker just as they will register on the screen. He is an expert on voice culture. He tells the director, for instance:

"Miss Jones' voice was a bit shaky, and Mr. Smith's 'humph' wasn't very emphatic.

1334

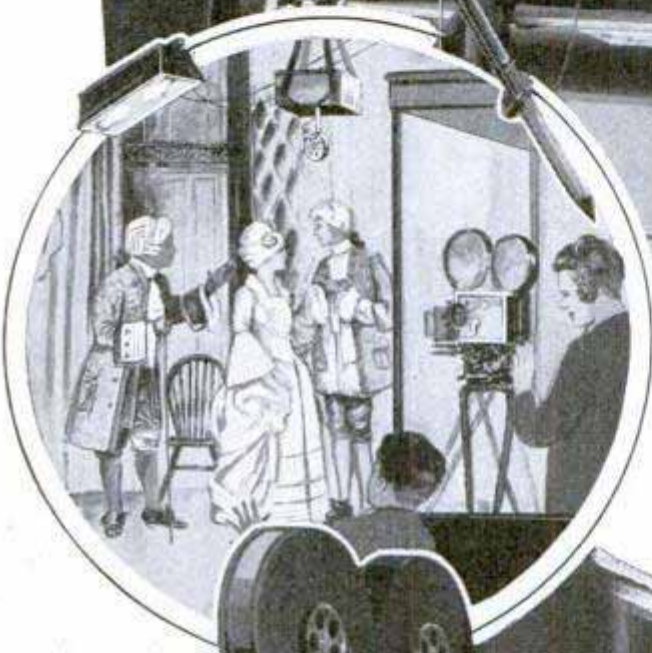

Making Movietone Film for the News Reels with a Portable Outfit Carried in a Motor Truck; from the Microphone the Voice Signals Pass to the Radio Amplifiers Mounted in the Truck, and the Amplified Current Then Returns to the Movie Camera to Operate the Light Which Shines on the Sound Track at the Edge of the Film; the Insert Shows a Studio Scene, with the Camera Operated inside a Glass Cabinet, in Order That the Microphone May Not Pick Up the Clicking of Its Mechanism; Keeping Out Unwanted Sounds Is the Hardest Job in the Making of a "Talkie"



Miss Madge Bellamy Impersonates Sir Harry Lauder for the Movietone; Hand Cranking Is Eliminated and the Camera Is Driven at Constant Speed



Sounded more like a record defect than anything else."

So the scene has to be shot again. And, remember; this recording is done under ideal conditions. Outdoor scenes with

sound aren't even being thought of as yet. Innumerable things may spoil recordings. A passing airplane, a loud-toned automobile horn on a neighboring street, the habit of people of yelling at passing picture folk, a twig snapping under the feet of one of the camera staff; all these, or any one of them, may ruin a scene. The microphone knows no distinction between a \$5,000-a-week voice and the bark of a mongrel dog.

Cost is indeed a decisive factor in the talkies. There is not only the terrific item of installing stages and equipment in studios, but the wiring of theaters as well. Variety, the theatrical magazine, estimates that one-third of a billion dollars will be invested by motion-picture companies in these two divisions. Of this amount, \$200,000,000 will go into the wiring of playhouses and \$100,000,000 into studio installation, it is reported.

Experiments are being made with double films, taking the picture on one and the sounds on another, the two films running through the camera side by side to keep them synchronized. One of the movie companies has been working on the process for some time. Its advantage lies in not reducing the size of the picture to make room for the sound track, and in providing a better recording of the sounds. When the sound track is used along the edge of the film, the density gathering left

along the outer edge of the film in developing extends into the sound path and produces a low-frequency hum in reproduction. In using two separate films, it is not only possible to record the sound in the center of the film, where development is best, but it is likewise possible to record several sound tracks, one for each microphone.

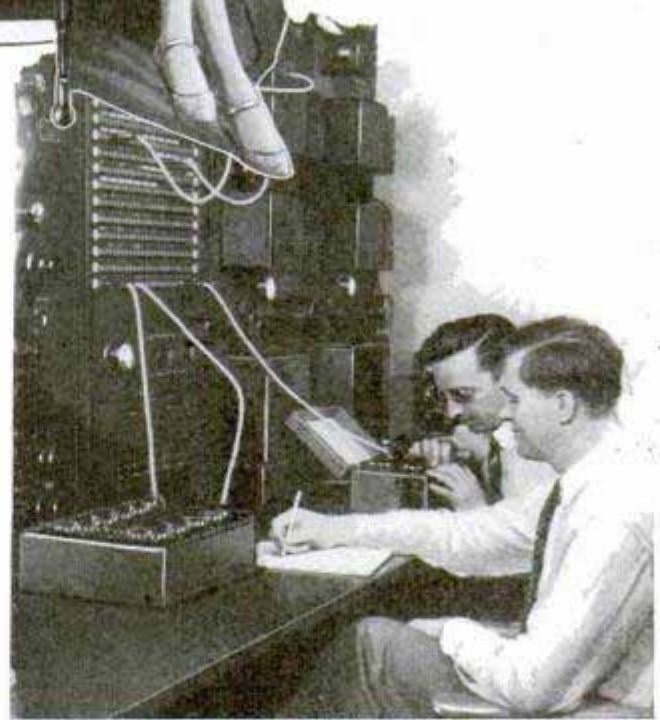

The Soundproof Camera Booth; an Actress Making a Record for a Voice Test, and, Bottom, the Mixing Panel in a Movietone Studio

1437 Peoria Star, Peoria, Ill. 945

When this is done, a series of separate photo-electric cells are used, each focused on one of the parallel tracks. In reproduction, the output of each sound track can be amplified separately and played separately in a loud speaker, so that the volume can be regulated. In this way, if the violins are too loud, they can be toned down, and if some other part of the orchestra is too weak, it can be amplified.

That problem of regulating sounds is one of the biggest facing the talkies. Whistles or high piping noises are never reproduced well by the microphone. Violins and flutes have to be kept at a distance. The sound of breaking glass is enough to ruin a record. Kettledrums are fairly easy to reproduce, but bassdrums have to be mounted on springs to prevent their vibrations being taken up by the building.

The human element offers as great difficulties for directors, scenario writers and actors all have to learn a new technique.

1459
TRAIN TO CONTROL WHEAT SMUT SAVES FARMERS MILLION

Pennsylvania farmers whose crops have been depleted by the ravages of wheat smut, have been saved over \$1,000,000 besides enjoying financial increases due to bigger yields, as a result of the smut-control train operated by the Pennsylvania state college and the Reading railway system. The train carries a treatment plant for the cleansing of seed wheat and makes one stop a day at stations designated by a previously announced schedule. Farmers who do not have access to other treatment plants, bring their wheat to the train, where it is handled and returned to them at the rate of 100 bushels an hour. About the only direct expense required of the grower is the purchase of a chemical dust with which the wheat is treated.

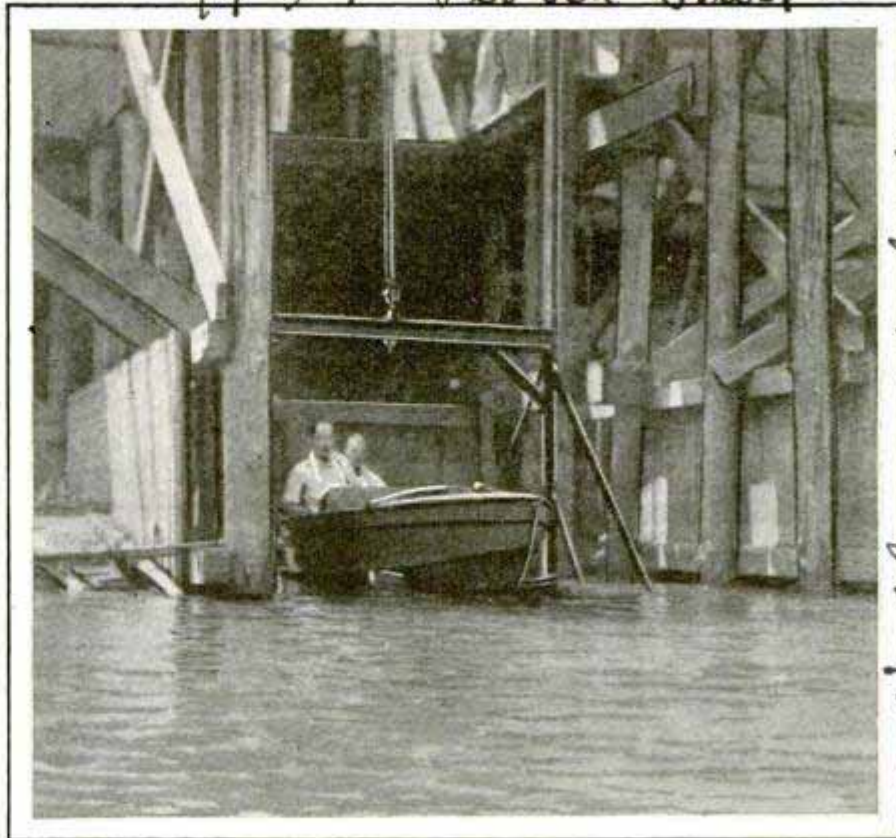

Electric Hoist for Elevating Boats from Illinois River to Docking Space on Bank; It Will Lift Two Tons

ELECTRIC ELEVATOR FOR BOATS SIMPLIFIES STORING

One of the chief objections to pleasure boating, the taking out and storing of the craft, has been solved by an Illinois yacht club with a lift constructed from an ordinary freight elevator. A small electric motor furnishes the power, and the hoist is capable of handling a load of two tons.

GEAR-SHIFT INDICATOR AIDS BEGINNERS IN DRIVING 1423

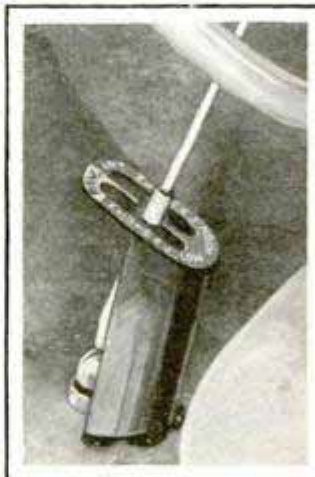

A gear-shift index that always shows the position in which the gear lever should be for any speed is a new aid to the beginner in learning to drive. The device consists of a slotted indicator, mounted several inches above the floor on a support-

ing bracket. The slots are the proper length for the gear in any position.

Gear Shift Guide Co. Arvada, Colo.

Illinois Valley Yacht Club, Peoria, Ill.

Mr. Gene Wachs
Washington etc

Corn Flour to

see Aug 1939
230.

Engineering & Experiment in
Agriculture

Corn meal

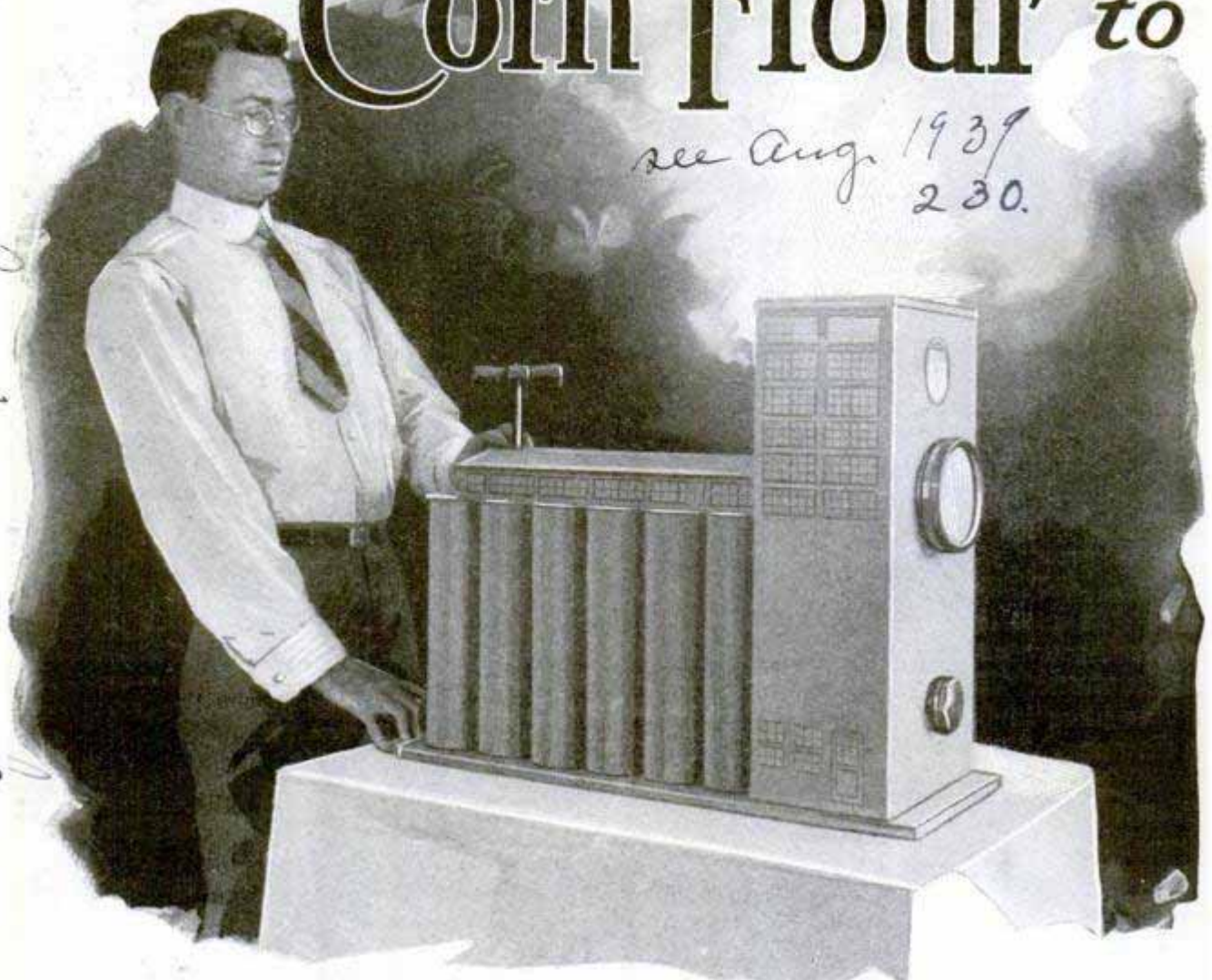

Miniature Grain Elevator Used to Demonstrate Dust Explosions; Such Blasts Have Wrecked Gigantic Concrete Storage Bins and Done Enormous Damage Before Their Cause Was Learned

GASOLINE being so high in price, why not drive the automobile engine with corn flour? As fuel, it costs only about one-third as much.

Already the thing is being done. At Arlington, across the Potomac from Washington, some remarkable experiments have been made in that line—feeding a mixture of corn flour and air to the engine, and thereby, with the electric spark, producing a series of explosions.

The idea was evolved in a rather curious way. For several years past, government scientists have been trying to find out all there was to know about the dust explosions which wreck so many flour mills, grain elevators and factories.

For experimental purposes they had built toy-size models of such structures, and had produced explosions by blowing flour or grain dust into them, the ignition

usually being furnished by a lighted candle placed inside.

A newly constructed model of this kind represents in miniature a first-class modern grain elevator, and an improved method of setting off the dust inside of it is to ignite it with an electric spark. The little elevator has a tower at one end, open at the top. A piece of strong paper is fastened tightly over the top, and the explosion bursts it outward, with a loud report and a cloud of smoke.

Until quite recently it was not imagined that dust of any kind could explode spontaneously. Even after the fact had been pretty well established, mill owners and others who had suffered from disastrous accidents of the kind refused to believe it. The most important usefulness of the experimental models has been to give convincing demonstration to the incredulous.

Run Autos?

It will presently be seen how direct is the bearing of this phenomenon upon the operation of an automobile engine by explosions of corn flour mixed with air, for this is, under suitable circumstances, an explosive, comparable in power to dynamite.

If a housewife were to go into her kitchen with a few pounds of corn flour, and scatter the stuff by throwing handfuls of it into the air, she would only have to light a match in order to blow up the house.

Under such conditions, the corn flour being suspended in a cloud of finely divided particles, every individual one of the latter in direct contact with the oxygen of the air, a flame spreads through the whole cloud so instantaneously that in a moment a great volume of gas is generated, the power of its expansion so great as to burst the walls.

The housewife of today keeps on her pantry shelves a variety of things which, though they seem to be the most innocent imaginable, are capable of acting as high explosives. Not even TNT can be more destructive than ordinary wheat flour, if the latter be set afloat in quantity in the air of a room and ignited. Rice flour, under like circumstances, is equally dangerous.

The same is true of oatmeal. One of the most frightful explosions was that of the Oliver oatmeal mill in Chicago, five years ago. Equally harmless, on the pantry shelf, is starch powder. Yet it may act as a high explosive. Not very long ago, at Pekin, Ill., a starch-powder factory blew up, with a loss of many lives. Five men in box cars, thirty feet away from one of the buildings, disappeared entirely, while nothing was left of the cars but splinters.

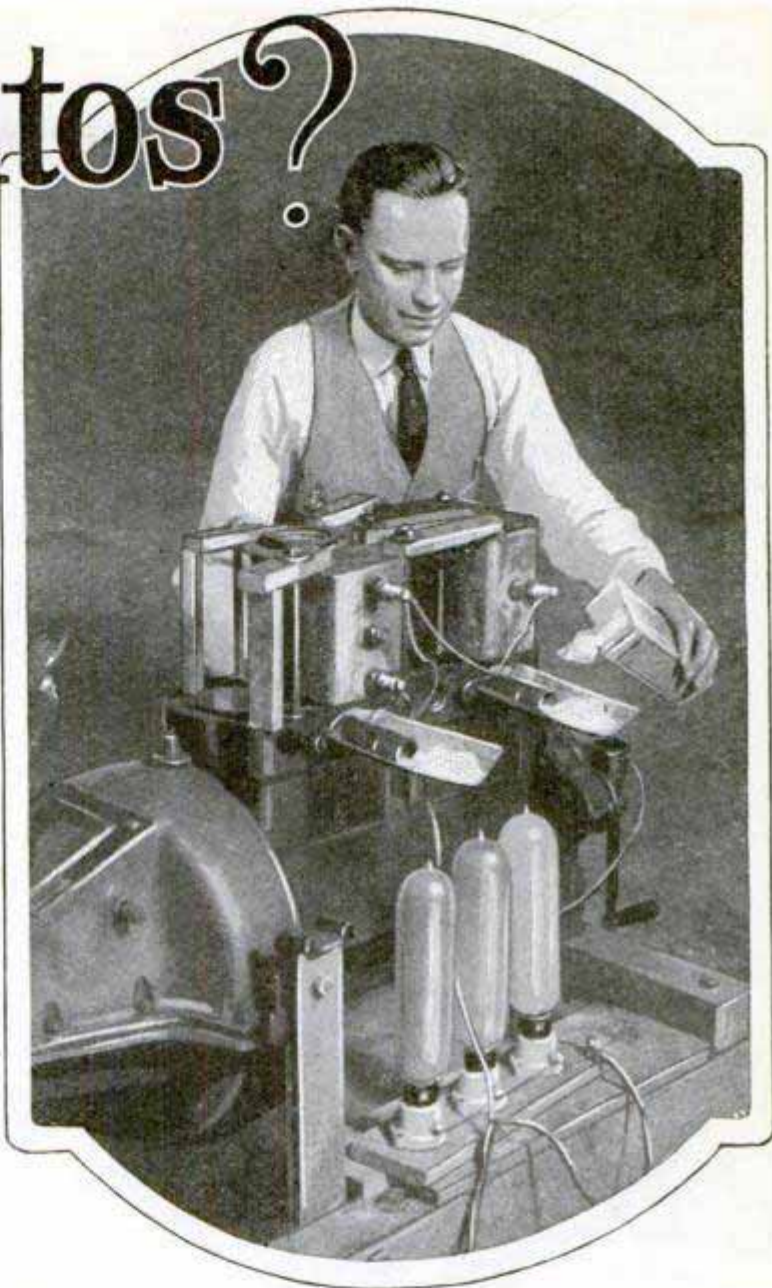

Running an Automobile Engine on Corn Flour, a Simple Demonstration of the Energy Contained in Vegetable Matter

Every now and then a candy factory is blown up; for powdered sugar is a high explosive even more dangerous than any of those mentioned above. In a Boston candy shop several girls were engaged in coating marshmallows with sugar. The air of the room was full of it. One girl lit a cigaret, and instantly there was a frightful explosion. The building was blown up.

What more harmless than a cake of soap? To make it burn, one would have to put it into the furnace. But the soap powder used by every housewife is capable of as tremendous destructiveness as any high explosive known. For soap is fat, and therefore combustible; and, if dry and distributed through the air of a room, the

powder invites ignition, and a mere spark will set it off.

Any combustible substance in powdered form, if so mixed with air as to be supplied with plenty of oxygen, will, in a confined space, explode if a match is lighted. There have been disastrous explosions of hard-rubber dust and of fish meal.

The method of using the electric spark to produce explosions in a miniature grain elevator suggested the experiment, at Arlington, of utilizing a mixture of corn

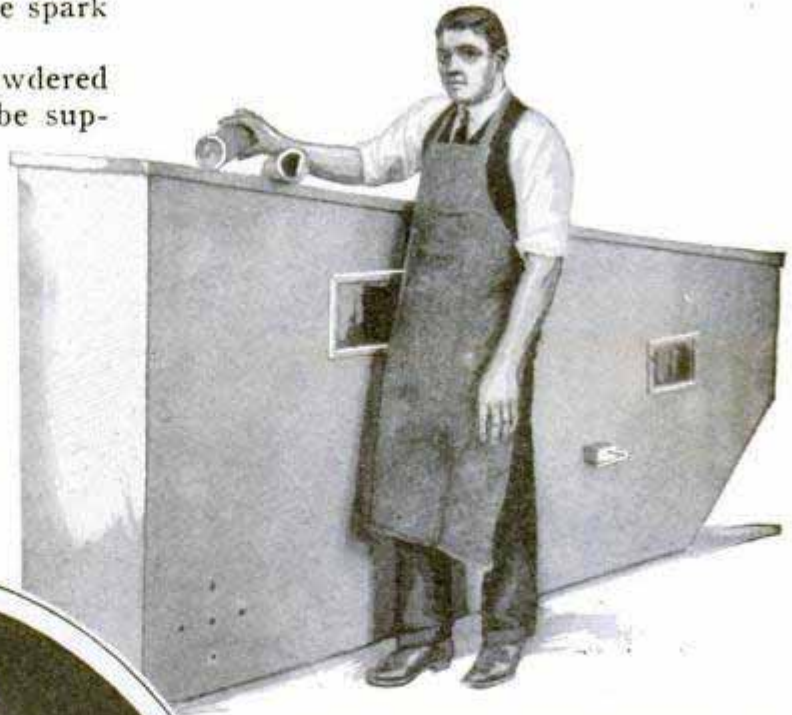

Sheet-Metal Box Used to Mix the Corn Flour and Air to Form an Explosive Product, and the Auto Engine, with Head Removed, Showing, at Right, the Pipe through Which the Mixture Is Sucked

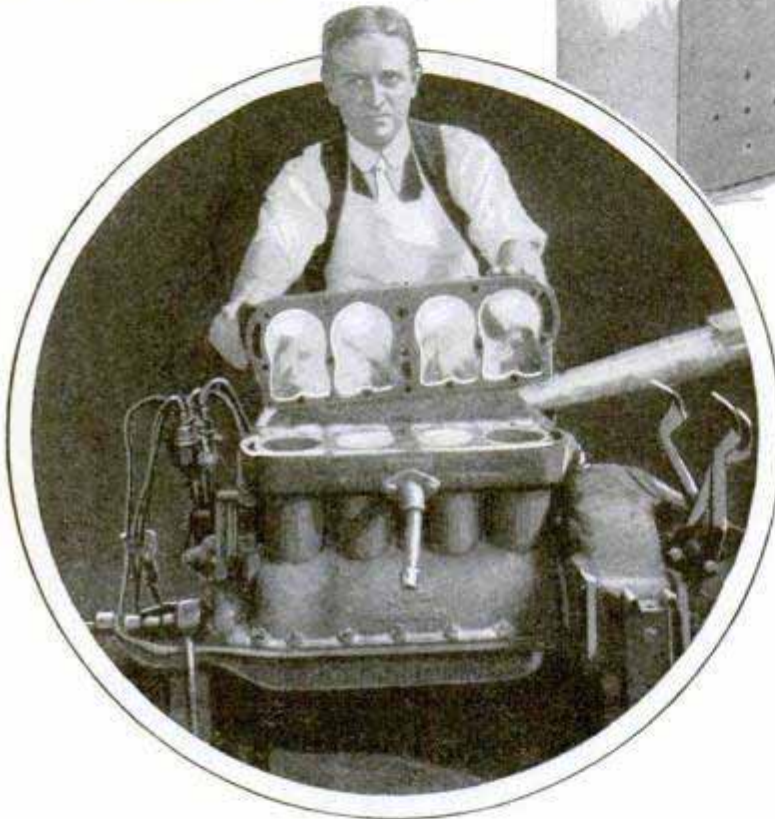

metal box, using for the purpose an electric fan inside the box. From the box a stream of the flour-laden air is drawn by suction through a pipe into the automobile engine, producing a series of small explosions as it is ignited by the electric spark.

How tremendous is the power developed by the explosion of cereal dust mixed with air may be judged from a statement by Prof. Charles E. Munroe, the government's chief expert in explosives,

flour and air as fuel for the automobile engine. In this way, by a series of small explosions, the engine is operated successfully, the corn flour required for the purpose being bought in cartons at a grocery store.

Rice flour, wheat flour, or powdered sugar might be used just as well instead. The problem, however, has been merely to determine how far it might be practicable to run an engine by dust explosions; and the idea in immediate view is to ascertain the practicability and cheapness of this method for application to stationary engines, rather than to those of motor cars.

The method adopted is to mix a quantity of corn flour with air in a large sheet-

who says that the contents of a twenty-four-pound sack of wheat flour, mixed with 4,000 cubic feet of air in a closed place, will, if ignited, generate in an instant enough power to throw a mass of iron weighing one ton to a height of five miles.

A phenomenon that has to do with spontaneous combustion has but newly attracted the attention of the chemical-engineering division, the experts of which are greatly puzzled by it. And no wonder, inasmuch as it relates to the starting of fires by water!

As a consequence of the recent floods in Vermont and Massachusetts, many barns were burned. Masses of stored hay, wetted by the water, underwent a fermentation that was productive of a heat so

high as to start fires. Even while the barns were surrounded by flood water to a depth of several feet, in some instances, the hay stored above took fire.

On one farm near Middlesex, Vt., located in a narrow valley where the flood waters rose exceptionally high, there was a barn that held about fifty tons of meadow hay and alfalfa. The crest of the flood arrived early Friday morning, Nov. 4. On the following Monday a charred odor was noticed; some hours later the barn burst into flame and was burned.

The flood waters in Vermont and Massachusetts reached the haymows of hundreds of barns. Excessive heating set in almost immediately after the flood receded, endangering the farm buildings. In many cases stores of hay steamed so alarmingly that the farmers hastened to remove them into the open. A large number of students of the University of Vermont, at Burling-

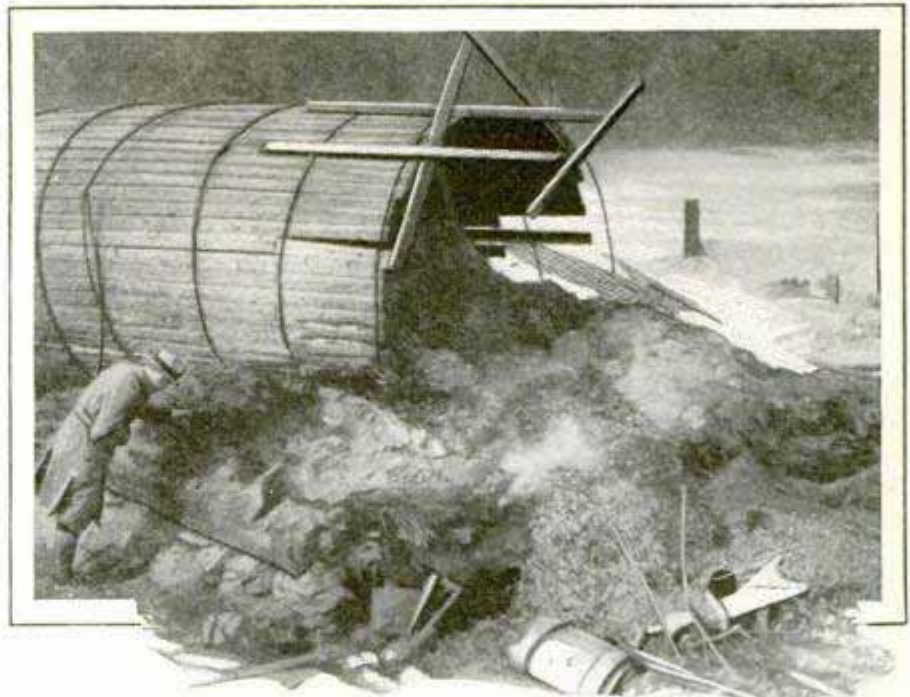

A Farm Silo near Middlesex, Vermont, Blown to Pieces as a Result of Spontaneous Combustion Igniting the Gases during Fermentation

ton, volunteered to help pitch the hot hay out of the barns.

The chemical-engineering division is at a loss for an explanation. It is easy to say "spontaneous combustion," but how account for it? Nobody knows. Apparently some chemical action in moistened hay is capable of generating a temperature high enough to start a fire.

FIRE FIGHTERS TO GET COFFEE FROM SERVICE CAR

A service car manned by a crew of five women will serve hot coffee and sandwiches, and render first aid to Pasadena

firemen. The car was donated to the department by the women's auxiliary, composed of wives, sisters and mothers of firemen. It has a complete kitchen on wheels, with its own water, light and fuel systems, an ice box, sink, table, cabinets, hot plate, serving dishes, staple food supplies and a five-gallon coffee urn, with room for a crew of four women, besides a fifth at the wheel. A thirty-gallon tank of fresh water is carried on the roof. One compartment is equipped with a complete first-aid kit and most of the women of the organization, who take turns in volunteering for duty at fires, have taken first-aid courses, so as to be able to attend injuries.

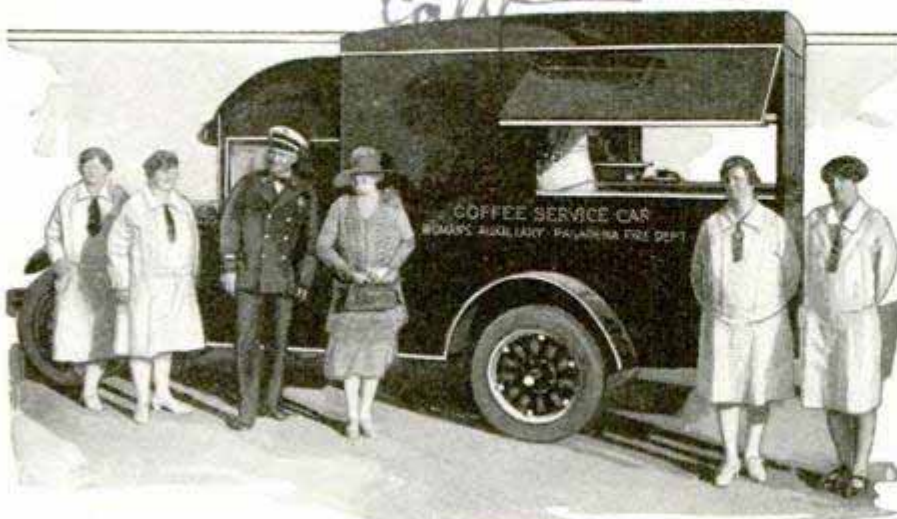

Coffee-Service Car and Crew of Relatives Who Provide Hot Drinks and Food for Fire Fighters

Cont. Lee, Inc. Crace.
1691 N. Hill Ave.

14
Cannot locate maker



Herbert
With His Boat Full of Water, This Oarsman Can Still Row Ashore, For the Rubber Tube Surrounding It Carries Enough Air to Keep the Craft from Going to the Bottom

LIFE RING FOR BOATS SAVES THEM FROM SINKING

A rubber life ring, like a greatly enlarged inner tube, is the latest safety device for the rowboat. The ring can be blown up and attached around the outside of the boat, following which the craft can be filled with water and still rowed ashore.

WIRE FENCE BAR TO INSECTS PLANT STUDY SHOWS

1368
How a barbed-wire fence acts indirectly as a barrier against grasshoppers and other insects, as well as against cattle, was one of the interesting observations made by Prof. A. O. Weese of the University of Oklahoma. Studying buffalo pastures in the Wichita national forest, he found that the associations of insects were as distinct on the two sides of the fence as were the associations of plants. The reason was the difference in the plant life. Where animals had been permitted to graze, there appeared grasses, and other growths

quite different from those found on the native prairie. Insects frequenting the pasture lands were seldom found on the other side of the fence.

OIL YIELDS FLAVOR OF PEACHES AND KIND OF SOAP

1369
Soap and an extract with a peach flavor can both be prepared from petroleum, chemists report. They do not anticipate that crude oil will be diverted from its present chief use as a source of fuels, but the experiments are considered especially important as showing a way to obtain a substitute for various vegetable acids and other materials that might be utilized for food instead of for making soap. Other interesting facts were brought out at a recent meeting of the Society of Chemical Industry—coal burns slowly all the time, even when it is stored in the basement, but the reaction is so slight as to be unimportant, and also that, by using a thin film of color in lacquer, it is possible to protect auto finishes from sunburn.

Journal 9/27/29
Kansas City

Norman, Okla.

Mr. Benjamin J Brooks
50 E 41st St. New York

9/18/21
420
**BIRDS SO STUPID THEY ARE
CAUGHT IN FISH NETS**

More than 100,000 little auks, birds so stupid they cannot tell the difference between a man standing still and a pile of stones, were observed on Hakluyt island in the Arctic ocean by Dr. R. M. Anderson, Canadian government zoologist, on an expedition into the far north last summer. Taking advantage of the birds' stupidity, the natives catch them by sweeping them up in the ordinary landing nets used by fishermen. The little auks stand upright, resembling the penguin, and, like their larger relative, form in lines of almost martial array. Dr. Anderson trapped two lemming voles, a rodent so rare that hardly a dozen specimens are known, and found four white-footed fieldmice near Port Burwell, on Hudson strait, in a land where it would seem almost impossible for them to find food to exist. He also watched the Eskimos capture white whales by beating on pans in the mouth of a little bay, so frightening the whales they floundered around until the tide went out and left them stranded.

**NEW SOLAR-HEAT MACHINE
GETS FIRE FROM SUN** 1398

A new solar-heat machine is being tried in the search of science for cheaper fuel sources than coal. The mirrors focus the sun's rays in one spot, concentrating the heat in a small area, and giving a much greater effect than a burning glass.

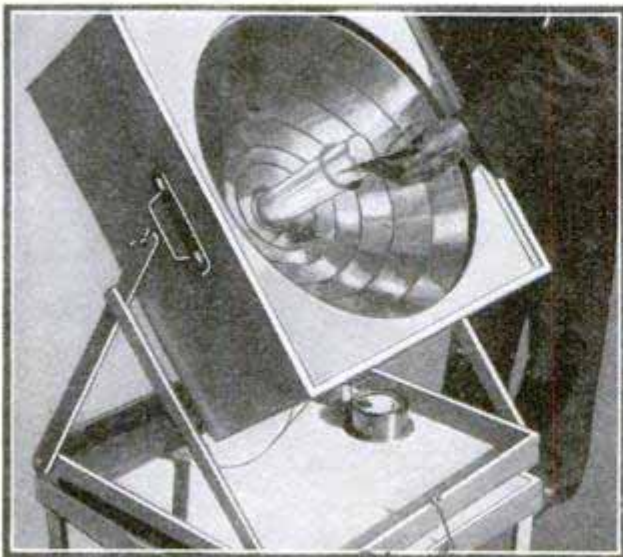

Solar-Heat Machine Which Collects the Sun's Rays over a Large Area and Concentrates Heat in One Spot

Dr. Pasteur, Paris

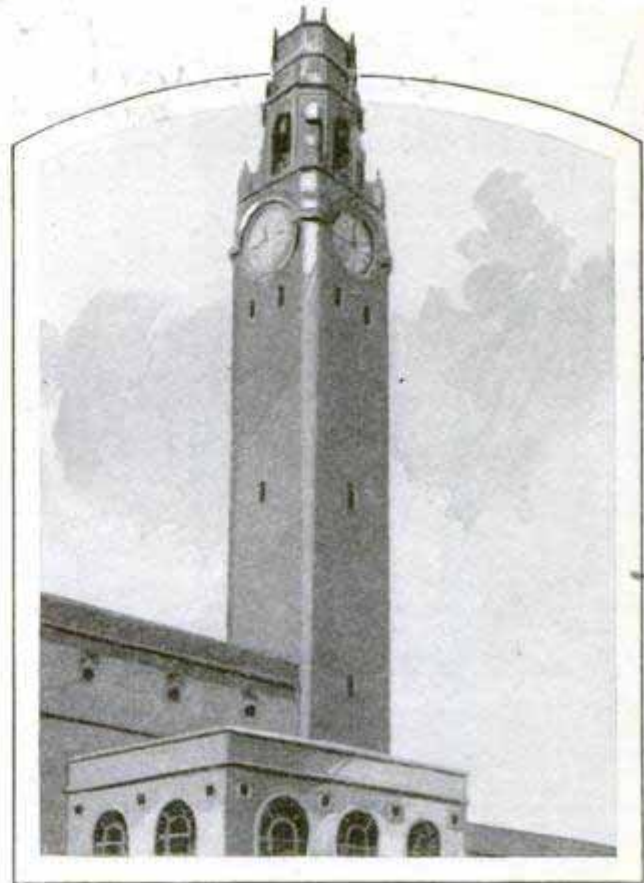

This Stately Clock Tower, Built as a War Memorial, Is Really the Chimney of a Heating Plant

**CHIMNEY USED AS CLOCK TOWER
AND WAR MEMORIAL**

Using the chimney of a heating plant as a war memorial, and at the same time making it a graceful addition to the campus instead of an unsightly obstruction, is the unique result achieved at the University of Detroit. A tall square tower, pierced with narrow slit windows and topped with a gothic design, below which is a four-faced clock, hides the smokestack of the new university power plant.

**MILK CAN BE SOLD BY YARD
IN NEW SHEET FORM** 1399

Milk may be sold by the square foot or the lineal yard if dairymen adopt a new process invented by a Copenhagen, Denmark, milk producer. His machine rolls dried milk into sheets like tissue paper, and in this form it is claimed the product will keep for several years without any change in quality.

ⓐ A total of 7,698 miles of airways have been marked for night flying, with 1,284 electric and acetylene beacons in use.

910 S. Michigan Ave
Chicago
Linh. Bell Co.
Dr. Proprietor
Prabak. Manichappi, Sr. Herkynongle.

MOTOR AIR CLEANER DRAWS SUPPLY INSIDE CAR

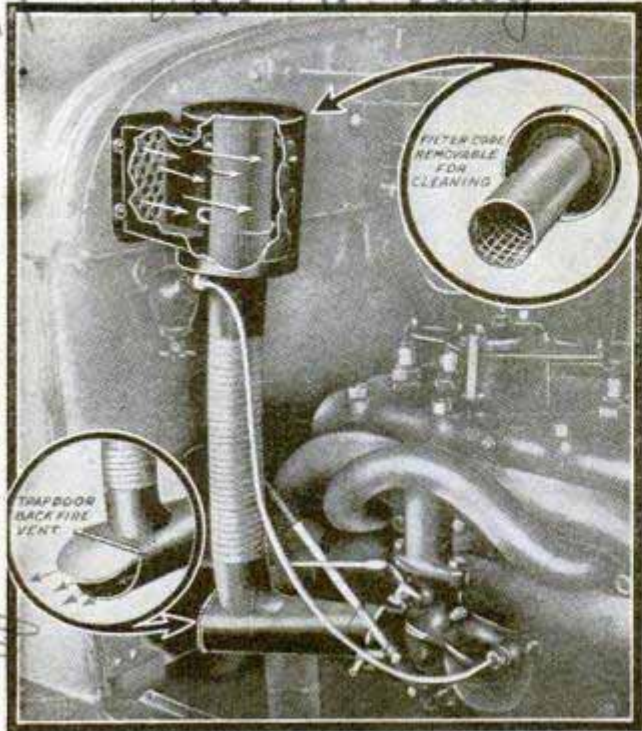

Carburetor Air Intake Which Draws Clean Supply from the Inside of the Automobile

A motor air cleaner that draws the air supply for the carburetor from within the car, where the air is practically free from the dirt sucked into the engine compartment through the radiator, is the latest accessory for the automobile. The cleaner is attached to the dash, and has a removable filter. A flexible connection leads down to a horizontal passage to the carburetor intake. A trapdoor, normally kept closed by the engine suction, blows open in event of a back fire.

TEST SHOWS FAMOUS BRIDGE STRONG AS NEW

Recent examination of the fifty-four-year-old Eads bridge across the Mississippi river, at St. Louis, shows the famous structure to be in as sound condition as when it was last inspected, in 1902, twenty-eight years after it was built. The bridge is noted not only because it was the first in America in which steel was used for main members, but because its huge 520-foot arches carry a double line of railway on one deck and a highway and interurban tracks on another, a total load that required special materials. The main members of the arches are eighteen inches in diameter and are unusual in that they are

made of six staves of chromium steel two and an eighth inches thick, fitted together like the staves of a barrel inside a sheath of quarter-inch steel boiler plate, riveted around them. The result is a hollow tube of thirteen and a quarter inches' inside diameter and eighteen inches' outside made up of six segments. In the recent examination, inch holes were drilled into these tubes to see whether water and rust had penetrated inside, but they were found to be perfectly dry. Capt. James B. Eads, who designed the bridge, was a versatile engineer, who achieved success in glass manufacture and gunboat building, and later in life supervised the flood-control work on the lower Mississippi. He had to surmount almost unconquerable obstacles to get the special steel for his bridge.

RAZOR-BLADE STROPPER USES TWO STEEL BALLS

Knife sharpeners which utilize the principle of drawing the blade between two hard-steel surfaces are more or less common, but now one manufacturer has brought out a razor stropper employing the same principle. Two steel balls are mounted in a handle so that they revolve easily in cups while their inner surfaces are in contact. Either an old-style blade

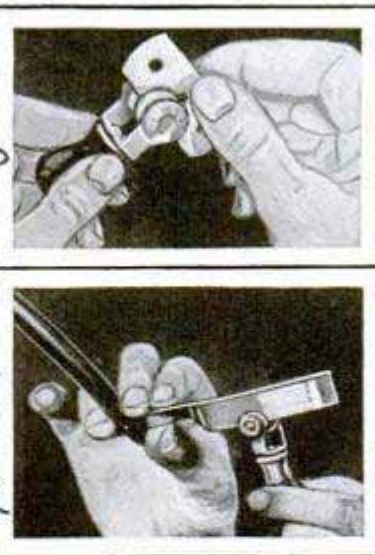

Razor-Blade Sharpener Uses Two Steel Balls to Strop Either Safety Blades or Old-Style Razors



or a safety-razor blade can be drawn back and forth between them to strop its cutting edge. Because of their shape, the balls are especially adapted to stropping hollow-ground blades.

Model 9 Ford or \$7.50
whipped for

The Clifton Age
9/20/28

be used

Chicago - 719 W. Monroe

Ace Hardware Supply Co.
445 N. 12th St. P.S.

*University Ave
The Bronx
New York*



Babies in a Hebrew Home in New York Entertain Themselves in This Spring-Operated Chair, Which Bounces Up and Down and Hops over the Floor at the Slightest Movement of the Occupant

Gimmie Jumper
SPRING-OPERATED SEESAW AMUSES THE BABY

A seesaw for one person, operated by a spring, is the latest device for amusing infants in the Hebrew infant asylum in New York. One end of the balanced board, which carries a seat and tray for the child, is held down by a spring. The slightest movement of the baby is sufficient to start it bobbing up and down and moving about in hops over the floor.

paris. After the material had set, the clusters of grain could be moved around at will. The job cost \$3,000, besides what was paid the farmer for the use of his grain and fields, but when it was done, the eye could not tell where the growing grain left off and the transplanted stalks began.

AUTOMATIC PANCAKE MACHINE COOKS AND TURNS THEM

An automatic pancake machine that measures out the batter, cooks the cake, turns it and delivers it ready to be served has been invented by a Portland, Oreg., man. Compressed air operating on a cylinder containing the batter, regulates, by its pressure, the quantity to be released for each cake. The batter is discharged

on a revolving hot plate, heated by electricity. One revolution of the plate requires ninety seconds. Halfway around, the cake slides onto a metal shelf, which is flipped over by power from the driving motor, and the other side is cooked the last half of the revolution, when a gate slides it off the plate.

MOVIES MOVE WHEAT FIELD TO GET PICTURE EFFECT

Filming a story in the eastern Oregon wheat country recently, a movie director discovered his script called for a miserly farmer who utilized every available inch of land by planting grain up to the very walls of his house. No such farmer or grain field could be found, so it became necessary to move two acres of wheat to fill in the vacant spaces. The technical department solved the problem by mounting clusters of wheat in plaster of



Automatic Pancake Machine; Batter Container at the Right, and the Cake-Turning Arm at the Left

Cont. H. E. Thomas, 911 Linnickley Ave. Corvallis, Oregon

*Wallace Co
551 - 5th Ave. New York*

*see Aug. 29, 1919 L. Halmeri
357 Alameda St. Los Angeles Calif*

S. W. Murnace

William T. ...

1400

The MYSTERY

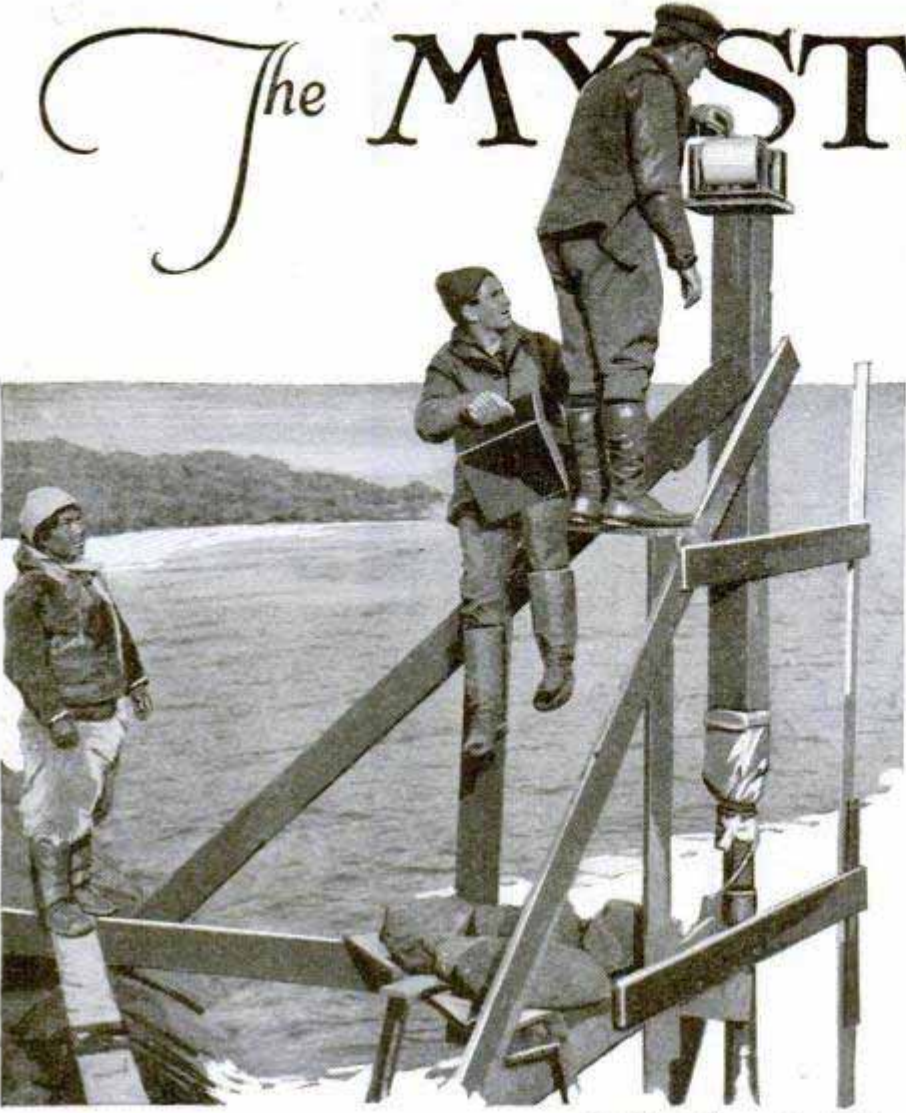

© National Geographic Society
 Taking Tidal Observations at Etah, Greenland, the Port Made Famous as
 the Base for Arctic Explorations

seas. More specifically, the cause is the difference between the pulls on the center of the earth and on the near and far sides.

When you playfully grasp a small child by the hands and swing it around in a circle, you cannot stand erect and pivot on a single heel. Instead you lean backward and take tiny steps in a very small circle in order to maintain your balance. The small circle which your feet follow represents the tidal pull due to the drag of the weight of the whirling youngster in his larger orbit.

The situation with regard to the earth and the moon is similar. The force which connects these two whirling globes is just as real as though it depended on a huge steel shaft, several hun-

dred miles in diameter, connecting the globes. When the earth swings the moon around it, the earth must back off, so to speak, in a little circle (or ellipse) of its own.

Theoretically, every star and planet in the universe raises its separate tide in our oceans. Actually, however, even Jupiter, the greatest of our sister planets, is so far away and relatively so small, that its influence cannot be detected. To all intents, therefore, it may be said that only the moon and the sun, respectively our nearest and our most powerful neighbor in space, have a share in making the earth's tides.

The evolution of maritime traffic from the shallow-draft sailing vessels of an earlier generation to the great fleets of speedy deep-draft steamers of today has revolutionized the needs of the mariner, making imperative the utilization of im-

WHAT science now knows about the tides constitutes as fascinating a story as anything ever devised by the versatile pen of Jules Verne, fanciful French romancer who several decades ago delighted the youth of the world.

Knowledge of the tides affects the safety of all the vessels in every ocean port in the world; it enables the deep-sea fisherman to plan his expeditions most profitably, the dock engineer to determine the level at which breakwaters and piers should be built, as well as how to salvage and lay large pipe lines; the expert on sewage disposal to know just how far out to deposit a city's sewage without endangering the health of thousands of people.

Why is a tide and what is it? The explanation starts with the fact that it is the periodical rise and fall of the ocean waters caused by the peculiar attraction of the moon and the sun on the earth's

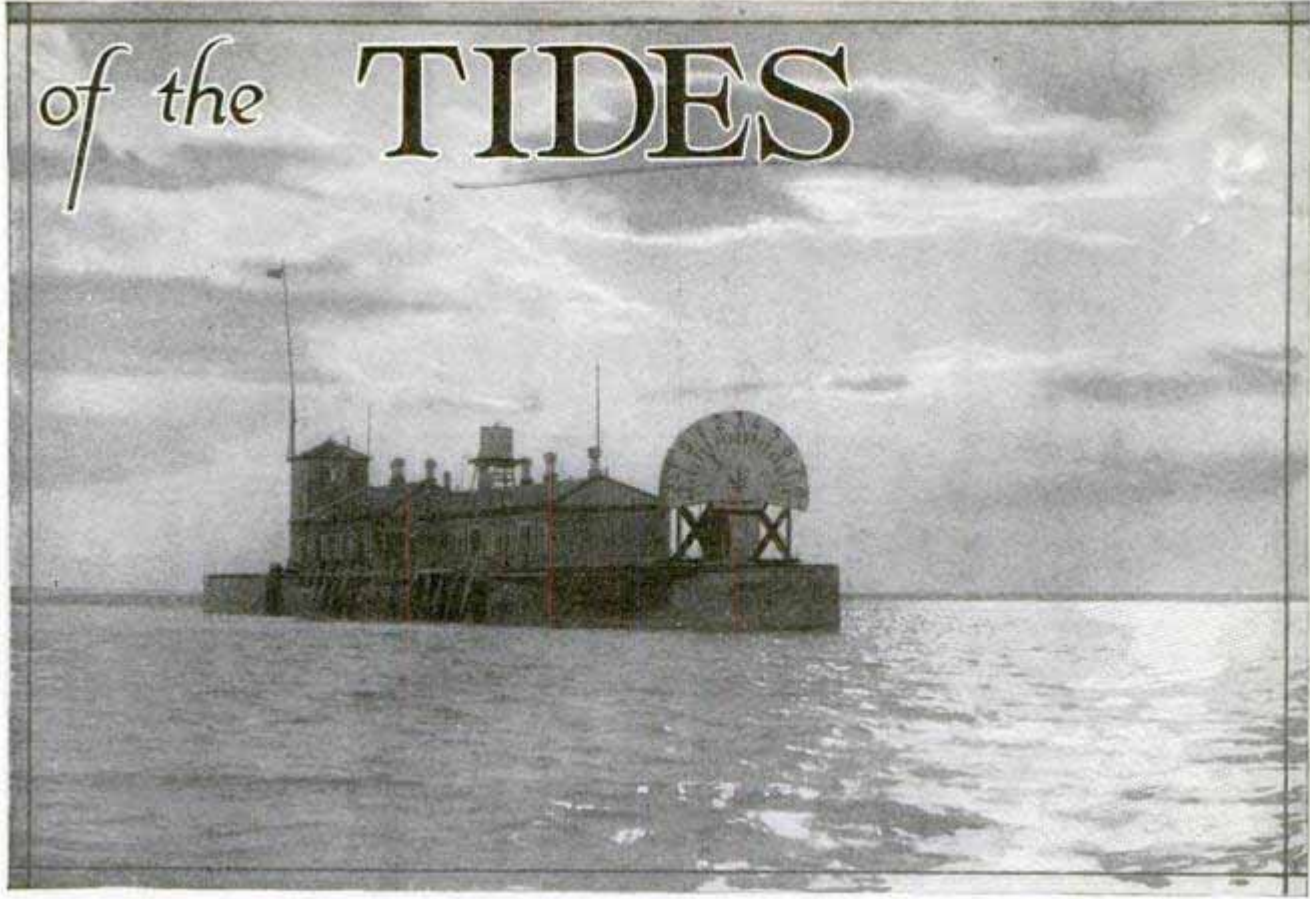

Courtesy U. S. Coast and Geodetic Survey

Reedy Island Pier and Tidal Indicator in Delaware Bay, as It Appears by Moonlight; Tidal Fluctuations Are, in the Main, Accurately Charted but Occasionally the Predictions Are Wrong

proved methods and instruments whose development has proceeded simultaneously. In the early days of light-draft vessels, advance knowledge of tidal conditions was of slight importance, but as the draft approached the depth of the water over bars and into harbors, such knowledge has become almost indispensable in the navigation of a modern vessel upon leaving and entering port.

Each of the leading nations issues tide tables. These now cover the entire maritime world. Of course, it would be impracticable to predict the times of the tides for each one of the eighty-eight principal ports of the world. A number of the main ones, therefore, having representative types of tides, have been selected as standard reference ports. Daily predictions are made for these, and all other localities are referred to them, allowing, of course, for differences of time. For instance, the tides at Poughkeepsie, N. Y., come four hours forty-five minutes later than the daily predictions for the tides off New York City.

These predictions are issued a year in advance, in handy booklet form for the

mariner. The booklet also contains tidal information for some 3,500 secondary ports, which, in connection with the daily predictions for the principal ports, gives the navigator all the necessary tidal data for any part of the world. The publication contains over a million figures and each must be absolutely correct so as to insure the safety of life and property.

The U. S. coast and geodetic survey maintains what are known as primary tide stations at the main cities along all our coasts. Working from these bases, the engineers make surveys from time to time so as to keep absolutely up to date the chart which guides the mariner. Such surveys involve many soundings, in order to make an accurate profile of the bottom and indicate on the chart a visualization of the bars, channels and shoals over the charted area, so that the mariner may readily avoid dangerous points.

Among the remarkable instruments used by the survey engineers, are the automatic tide gauge and the tide-predicting machine. The first consists of a clock that moves a sheet of paper forward automatically, and a float that rests on the water

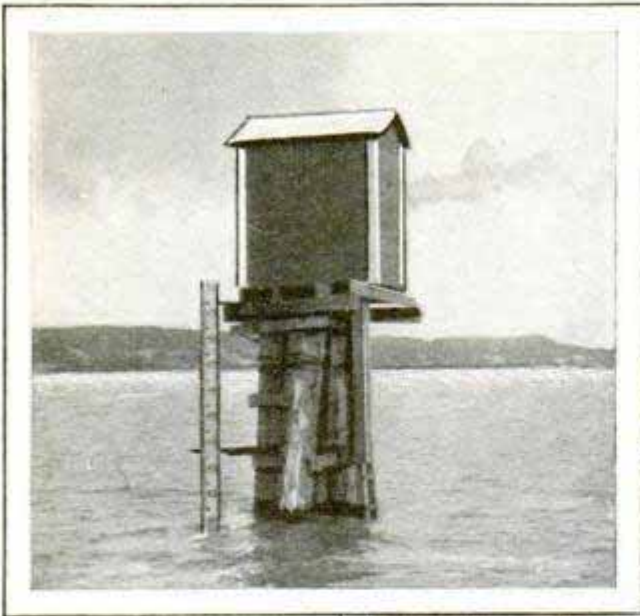

and rises and falls with the tide. This float causes a pencil to move up and down the paper so that the combined motions of the paper, due to the clock movement, and the pencil, due to the actuation of the float, automatically produce a curve from which the height of the tide at any desired instant may be obtained. In some gauges, the time is indicated by cross-section paper; in others, a second clock indicates the time on the curve at hourly intervals.

The float is inclosed in a long vertical cylinder, or well, that is water-tight except for a small opening in the bottom, allowing the water to rise and fall in unison with the slow tidal movements. In order to insure accuracy of the gauge record at all times, it is compared daily with readings taken directly from a staff placed near the gauge. The staff is a board with graduated markings showing the height of the tide.

Most of us have heard of the tide-predicting machine, described as a "mechanical prophet with brains of brass." The device, weighing about 2,500 pounds, is some eleven feet long, two feet wide and six feet high. It was conceived, designed

and constructed by government scientists back in 1910 and has been in continuous use ever since.

The prophet's operation is nothing short of marvelous. It was designed to calculate simultaneously the effect of thirty-seven factors which go to make up the tide, a feat that would require the services of from fifty to 100 expert mathematicians and the computation of more than a million figures. The factors depend on the

relative positions of the sun, moon and earth, and also on the shape and size of the harbor for which predictions are made. Its greatest error has been only six one-hundredths foot.

The machine will foretell the tides a hundred years in advance as easily as it will those of two or three years ahead, and will likewise prophesy the times of slack water of

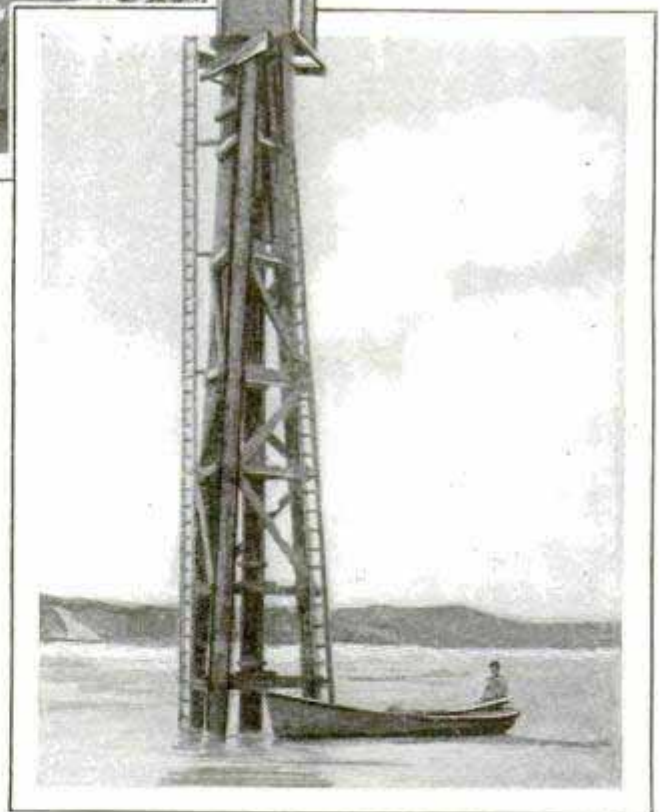
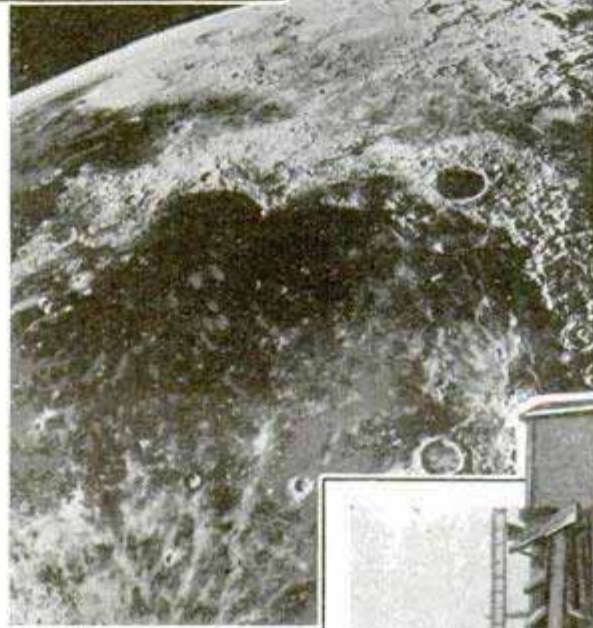

Tidal Gauge at Anchorage, Alaska, at High and Low Water, Difference Thirty-Three Feet, and, Center, Close-Up of the Moon, Which Causes Tides

1400

tidal currents and the velocities and strengths of these currents. Already a striking practical instance of its value in this connection has taken place. Even before the recent deepening of the Chesapeake and Delaware canal, the automatic prophet predicted what the times of slack water would be in the canal a hundred years hence.

Tests are now being made with a new device that promises to revolutionize the science of tide surveying. It is a current meter, not yet fully perfected, which is essentially an automatic motion-picture camera, recording current velocity and direction beneath the surface. When improved a little more, the device is expected to take the place of a complete observing unit composed of one boat, one officer and six men. It has the added advantage of operating continuously for a week without attention and works as follows: Inside the

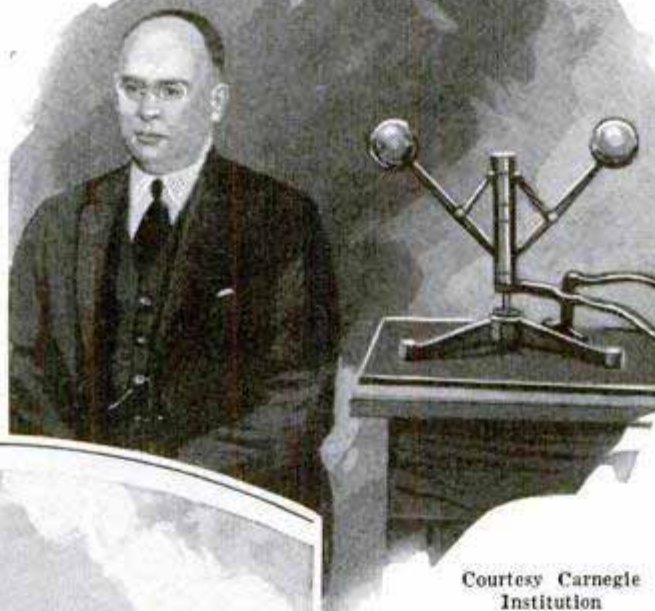

Courtesy Carnegie Institution

meter are a compass dial and revolution dial of which motion pictures are taken each half hour, thereby constituting a permanent record of current movement.

Many people wonder why the sun has so little tidal effect on the earth. It would take more than 26,000,000 moons to make a mass as heavy as the sun,

and yet there would be enough material left for something like 10,000 planets the size of the earth. One would naturally suppose, then, that the sun would exert a correspondingly greater attraction on our globe than does its far tinier neighbor. And so it does. But there is a vast difference between the total pull of a body on another and its tide-producing force. As was mentioned earlier, the tide on the earth results from the difference between the pulls on the center of the earth and those on the near and far sides.

Why do we have the greatest tides at the full moon? Because, whereas ordinarily the moon and sun are pulling in different directions, they now are pulling



Courtesy U. S. Coast and Geodetic Survey
Box Tide Gauge at Lynnhaven, Va.; Dr. Ralph E. Wilson, of the Carnegie Institution, with Device Illustrating Tides, and Workmen Erecting Gauge

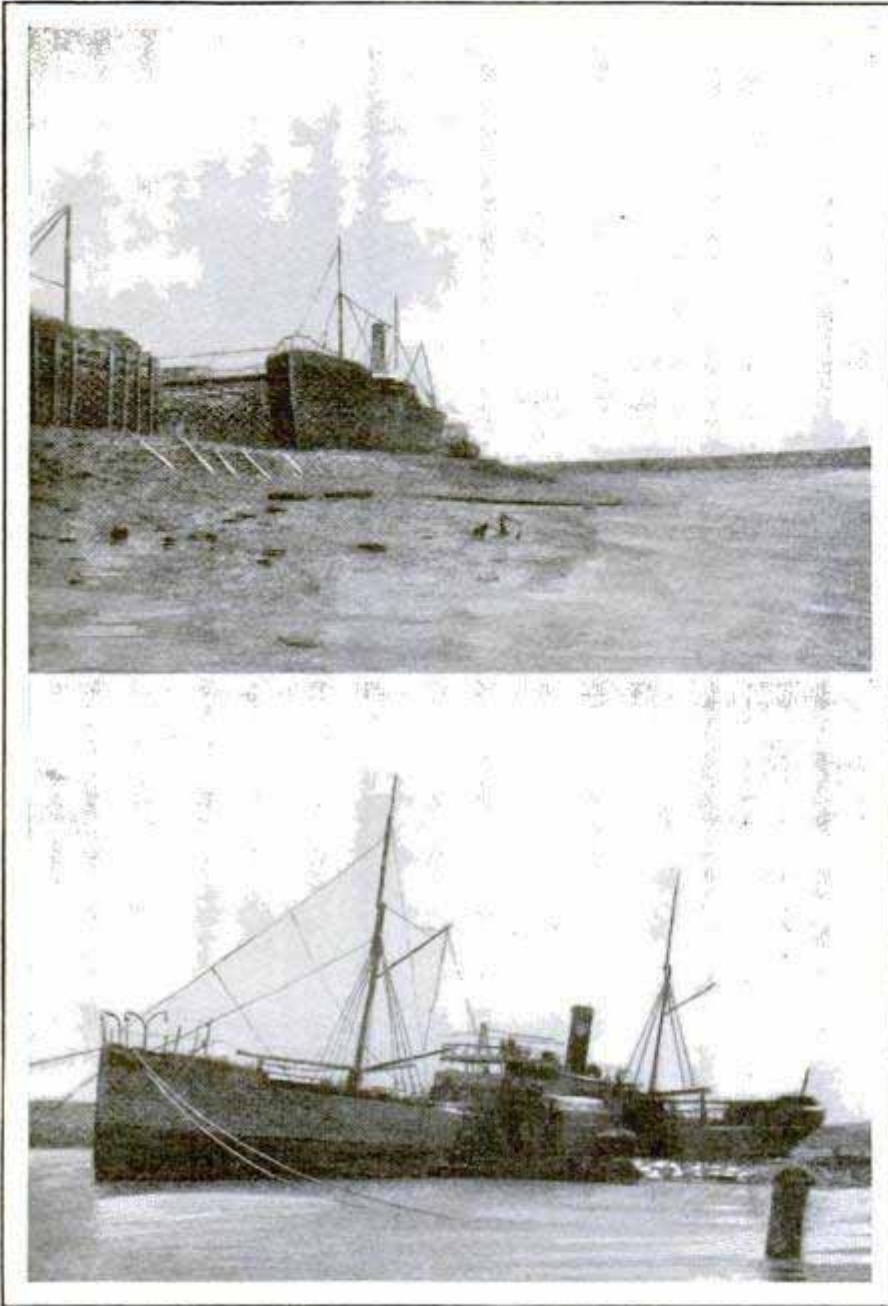

Courtesy U. S. Coast and Geodetic Survey
High and Low Tide in the Bay of Fundy, Showing a Ship on Dry Land at
the Low Stage and Afloat at High

together, in the same line. On the other hand, we have the smallest range of tides at the first and last quarters because then the moon and sun are pulling at right angles to each other, each force tending to neutralize the attraction of the other body.

It is interesting to note the wide range of differences between the average tidal heights at certain of our eastern seaport cities. Eastport, Me., has the highest tide, normally about twenty feet, while Galveston, Tex., has the lowest, about one foot. New York City has four and one-half feet at high tide, whereas there is scarcely any difference between the tidal waters at San Francisco and Los Angeles, the former

having three and nine-tenths feet, and the latter, three and eight-tenths. The highest tide in the world is about fifty feet, at Minas Basin, Bay of Fundy. The lowest tides occur in the Mediterranean and at the Virgin islands, averaging commonly less than a foot.

Contrary to popular belief, especially that long cherished by many seamen, tides exert no influence whatsoever on the weather, according to the U. S. weather bureau. As a matter of fact, close observers have discovered that extreme weather conditions affect the tides to some degree. Tides ebb and flow at every point on the coast with clocklike regularity. Nevertheless, the weather continues to be fair or foul, regardless of these tides. On the other hand, conditions of extremely low barometric pressure, and very strong winds from favorable directions, may cause either unusually low or unusually high tides as the case happens to be. Take a somewhat fantastic instance:

If it were possible to eliminate from this earth the Isthmus of Panama, an interesting speculation is whether or not the waters of the Pacific would start flowing into the Atlantic. The answer is that they would do so during high water. At low water the current would be reversed flowing from the Atlantic into the Pacific.

As a matter of fact, the average height today of ocean waters at the Pacific end of the Panama canal is about three-fourths of a foot higher than the average height at the Atlantic terminal. This point actually has been settled beyond all question by the precise leveling operations of the canal engineers. The cause of the differ-

115 S. Dearborn

ence in tidal height at the two extremities is thought to lie in meteorological conditions, principal among them the direction of prevailing winds.

Now and then we hear mention of land tides. Just what they are is explained thus by W. D. Lambert, eminent mathematician of the coast and geodetic survey: "The materials of the earth's surface are elastic. They can be disturbed by natural causes, but they will tend to go back to their original shape when the forces acting upon them have ceased or changed. The same forces of the moon and sun which cause the tides of the oceans cause the tides of the land. But the latter are smaller because land tides are due to the distortion of the earth rather than to the free-moving water along its surface. The maximum distortion or tide of the solid earth is not greater than one foot, and absolutely imperceptible to any of us. But the tides of the oceans would be slightly higher or lower if the earth's surface were so rigid as not to have land tides. In other words, the land moves upward just as does the water, but the difference between the extent of the two movements is what we call the water tide.

"The smallness of the land tides is a fact that in itself serves to indicate that the earth is virtually solid down to a depth of at least one-half of its total radius, and may even be solid clear through its center."

BOAT AND BOOTS COMBINED FOR THE HUNTER

1427

A combination of rubber boots and boat is the latest aid for the hunter. The legs are water-tight compartments secured to the wearer by straps. A seat in the compartment which the hunter occupies enables him to rest while in deep water, and he can propel his craft either by kicking his feet or use a paddle. Lightweight plates attached to the feet of the boots protect them when the user is walking.



Rubber Boots and Boat in One Unit for the Duck Hunter, Who Can Propel Himself by Kicking

C. C. Carmichael
4614 Helton St.

ELECTRIC COMB AND FUR IRON RENOVATES OLD COATS

1433

Chicago
\$12.50



Out of business

Renovating Fur with the Combination Electric Iron and Comb; Heat Kills Moth Larvæ

A combination of heated iron and comb for renovating fur coats takes the place of the old-style flatiron, and, it is claimed, does a better job in less time. Shaped like a large dagger, weighing sixteen ounces instead of the several pounds weight of an ordinary iron, the device is light, and easy to use. It is applied with a forward and backward motion, never being lifted from the fur, except to turn and use the comb to smooth out tangles. The heat is said to kill all moth larvæ.

☐ The life of an airplane may exceed that of an automobile; one plane flew 225,000 miles between 1920 and 1928.

14 19

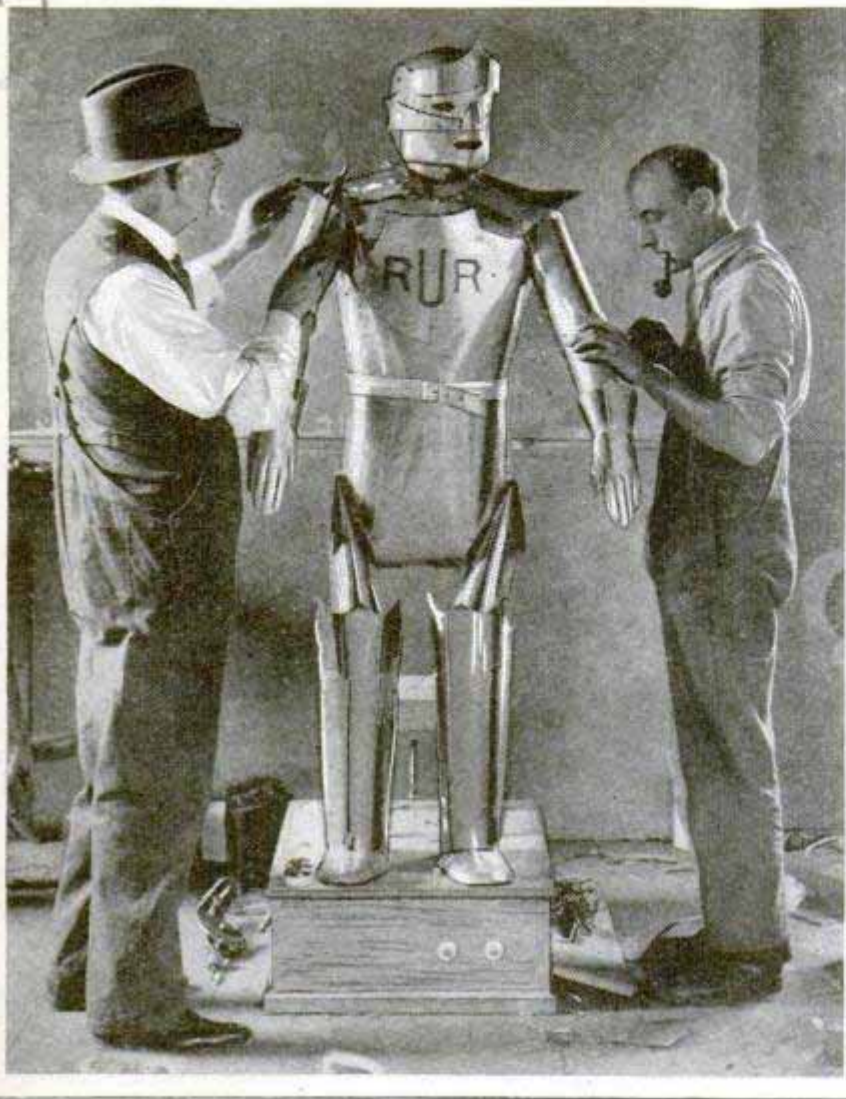

© P. & A.
Putting the Finishing Touches on "Eric," the Mechanical Man Who Delivered the Opening Speech at a London Exposition

storage batteries, two electric motors, and a system of belts, shafts and pulleys constitute the working mechanism.

OUNCE OF METAL SAVES PHONE MILLIONS

How slightly more than half an ounce of a comparatively rare metal is earning more than \$7,000,000 a year, is one of the romances of the telephone industry. The metal is barium, which is used as a mixture to coat the filaments of repeater tubes, important units in long-distance and other phone systems, to preserve the volume and clarity of the sounds. Its particular service is to greatly increase the number of electrons emitted at a given temperature thus improving the tubes efficiency. A barium-coated filament requires less than one-tenth of the power consumed by one of tungsten, effecting a

1401

Nov. Herald

ROBOT THAT MOVES AND TALKS OPENS EXPOSITION

"Eric," a man of tin who moves and talks, stood up, when asked to, on a platform in London recently and formally declared open the annual exhibition of the Model Engineer society. Looking like a suit of ancient armor borrowed from the London Tower, the mechanical man, in response to the invitation to address the audience, made a whirring noise and slowly arose until he stood more than six feet tall. He bowed stiffly from the waist; fire, furnished by concealed electric lamps, flashed from his eyes; a spark jumped across his teeth, and, turning his head from side to side, Eric began his speech. The words reached the robot's loud-speaker throat via wireless from a small broadcasting plant off stage. Twelve-volt

saving of \$120 for the life of each tube, which is approximately 10,000 hours. In the process of manufacture, a mixture of barium and strontium oxides is prepared as a paste with paraffin. It is then applied to the platinum filament base, and the paraffin is later burned off, leaving the oxides clinging to the filament. Barium is not classed among the precious metals, but since it performs such a great service in such small quantities, its working value reduces that of other metals—and even of the precious jewels—to that of dust by comparison.

Popular Mechanics Magazine does not publish the name of the maker or seller of any device described in its pages, but this information is kept on file and will be furnished, free, by addressing our Bureau of Information.

Wm. Capel W. H. Richards

Wm. J. Danison and J. C. Cooper

DENTAL PROBES WRAPPED BY MOTOR

1473
 A sanitary way to wrap cotton around the broaches, the sharp-pointed instruments used to cleanse and medicate cavities in the teeth, has been developed by a Chicago dentist. As a substitute for the fingers, he has devised a motor to wrap the tools, thus preventing dirt and germs from the hands and fingers from coming in contact with the material entering the patient's mouth. The cotton is wound evenly and in any quantity desired, and the operation takes but a few seconds. The motor is placed on a pedestal or within a cabinet, and the outfit includes units for thoroughly sterilizing both the cotton and the broaches.

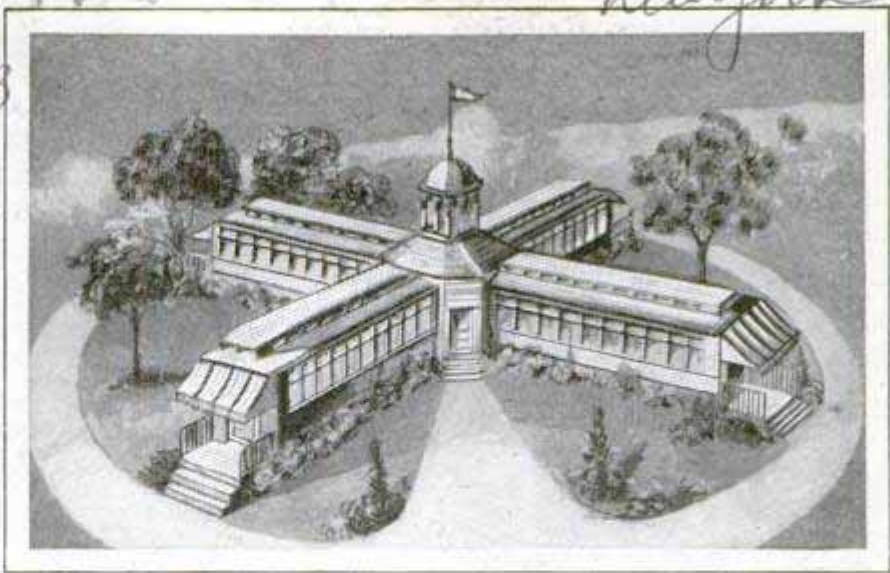

Sketch to Show How School Buildings and Shops from Old Street-Railway Cars Will Appear When Completed

St. Edmunds School
SHOP FROM OLD RAILWAY CARS TO AID SCHOOL BOYS

Estimable
 Four abandoned street cars are to be converted into a machine shop and industrial school for boys by the Kiwanis club of Cincinnati, as a tribute to one of their members. The cars are to be grouped in the form of a Maltese cross, mounted on concrete bases and will have woodworking, machine, clay-modeling and electric shops as well as a room in which general instruction is to be given.

SIDECAR BICYCLE FOR CHILDREN ADDS TO OUTDOOR FUN

146
 Patterned after a motorcycle, a child's bicycle, recently patented, has a sidecar for an extra passenger. Rubber tires insure comfort, and the unit is designed to afford even more healthful exercise for the operator, as well as to increase the children's fun.



Fun for the Rider and Tiny Passenger on Child's Bicycle That Has Sidecar Attached

NEW ALLOY-STEEL TOOLS NEAR DIAMOND IN HARDNESS

media
 1182
 An alloy steel manufactured by the Krupp works at Essen, and now being marketed in this country for use in tools and tool bits, is claimed to be only slightly inferior to the diamond in hardness, far surpassing usual tool steels. The material does not require heat treatment, and, as it has no temper to lose, can be operated even when the cutting edge has reached a bright red heat. Tips of the new metal can be brazed to carbon tool steel, but not to high-speed steel. Comparative cutting tests are claimed to indicate it is 200 per cent better than high-speed steel in cutting hard cast iron and 600 per cent better in cutting soft castings; 800 per cent better in cutting brass, and 500 per cent better in cutting hard rubber and similar materials. To maintain the necessary sharp edge, special grinding wheels are used for rough and finish grinding.

Dr. W. H. C. Bennie & Thomas
15 1/2 W. 15th St. New York

Mr. Wilson
Editor, Science Service
21st & B, Washington, D.C.

739

HAVE YOU A

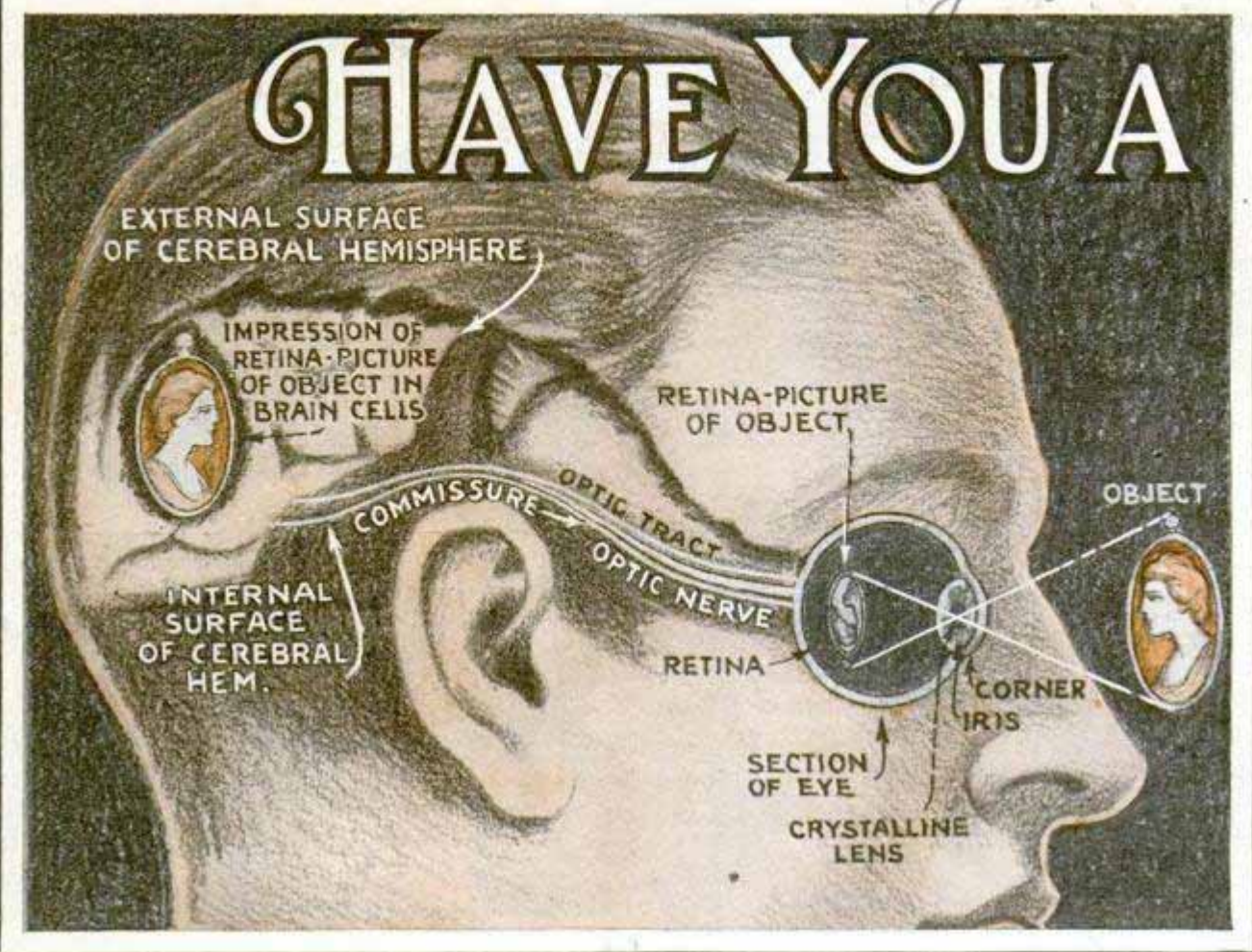

LIVING in a world that is revealed to us largely by our eyes, ears, fingers, tongues and noses; traveling over country that is well marked with roads, traffic signs or places to ask the way, we mere human beings have difficulty in approaching the problem that every bird, animal or fish must face and solve in order to exist.

Psychologists and laymen alike have realized that animals often differ from human beings in their keenness of senses and their development of instincts. A faint whiff will sensitize the nose of a dog; the eye of many birds is more observant than the keen sight of a marksman, while a wild animal starts at the mere crackle of a distant leaf. But the ordinary senses are not enough to explain to the entire satisfaction of many students some of the wonders of animal behavior and accomplishment.

What guides the migrating bird on its spring journey northward? How does the salmon with unerring accuracy find its way up branching rivers to the scene of its childhood? How does the banished dog or cat find its way over strange terrain to the home of its master? To ex-

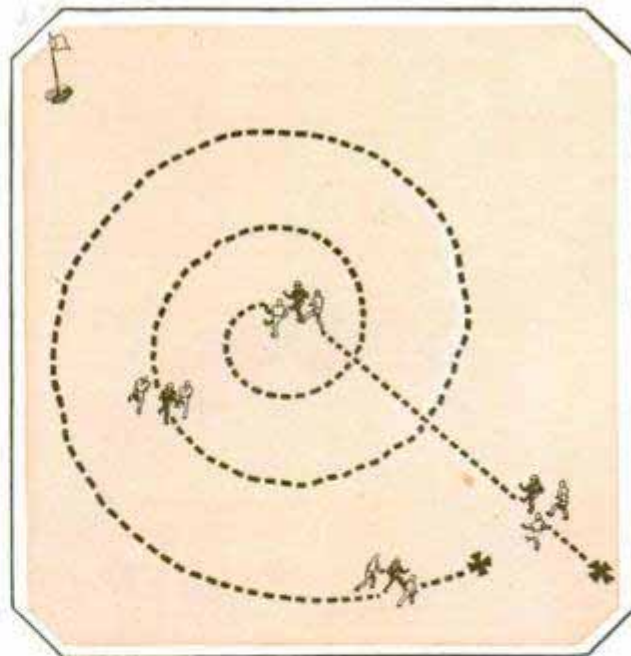

Diagram of the Eye and Brain, and Sketch Showing Course Followed by a Blindfolded Man Trying to Walk in a Straight Line to a Distant Flag

plain these mysteries of animal nature, scientists are tempted to explore the realms beyond the ordinary senses. The search for a new sense is under way.

The occult sense is one name suggested for this phenomenon. But this is a mis-

NINTH SENSE?

nomer. To the uninitiated, radio would seem to be mystic and supernatural. Experimenters feel sure that their researches will reveal that the new sense is as understandable as sight, hearing, smelling, tasting and feeling, once the tests tell what it is and how it operates.

The sense of direction, the magnetic sense, the homing sense, the orientation sense—such are some of the terms that have been applied to this possible addition to the recognized sensory equipment of the animal world.

In the laboratories of Columbia University, New York City, the search for the new sense is now being most actively prosecuted. Dr. Frederick Tilney is the director and stimulator of the research. Although experiments are difficult and arduous, the results inconclusive in many cases, and the whole project just begun, one interesting result has emerged.

Rats or mice are used on account of their intelligence and ability to find their way about in puzzling surroundings. The scientists have devised mazes, with blind alleys—enticing but false corridors that make their journeys to the food reward difficult and slow. This is a rat scale equivalent to the labyrinth of the amusement park in which pleasure seekers pay to become lost. But the rodent uses its brains and its memory and, after a period of trials, gradually learns the maze in all its ins and outs, dashing through it in quite an expert way if hunger urges and the food is tempting.

With such maze-running rodents, Dr. Tilney and his associates are doing their preliminary work on determining the nature of what Dr. Tilney calls the "ninth sense." The first clue to the nature of this sense is the fact that if the maze is moved, the rat or mouse, expert in its



Remarkable Photograph of a Golden Eagle, the American National Bird, as It Appears in Flight

knowledge of the maze, is forced to start at the beginning again and learn all over. This is true despite the fact that great care is taken not to change in any way the surroundings of the maze that are visible to the rodent.

This would seem to support the idea of earlier experimenters that the sense is bound up with geographical position, possibly through terrestrial magnetism, the same force that affects the compass needle. Certainly another and unknown sense, besides those commonly recognized, is possessed in high degree by certain birds if we are to explain and understand the remarkable flights that they make over oceans and lands totally strange to them. Even Lindbergh is a novice compared with the arctic tern which wings its way over trackless oceans some 11,000 miles from the antarctic to their nesting grounds near the North Pole. Even the tiny warbler, no bigger than a man's thumb, flies across the Gulf of Mexico, and the golden plover makes a marvelous non-stop flight of 2,400 miles over the Atlantic from Nova Scotia to the northeast coast of South America. Common and unappreciated are achievements of homing and carrier pigeons which can be liberated over a thousand miles from their home cote and still return wing-weary a few days later.

The birds fly high, so high that they can see their home cote or other objective, some persons contend. This explanation



"Cher Ami," Army Carrier Pigeon, Delivered Message from Verdun Though Its Leg Had Been Shot Away

was made before man first flew, and a few minutes of figuring upon the spherical shape of the earth will show that even the keenest of bird eyes in the clearest of weather cannot look below the earth's curve to the distances covered. Moreover, some birds are known to fly at night and in fogs with unerring accuracy.

Most inviting and most plausible is the theory that magnetic sensibility is the secret of the ninth sense. The French scientist, C. Viguier, many years ago maintained that the physical force that enables animals to direct their course must be everywhere present, "in the heights of the atmosphere as well as in the depths of the sea." Even Darwin gave attention to this idea and raised the objection that a compass without a chart avails but little. Viguier replied in the following analysis of the problem: "Is this objection insurmountable? I think not. The compass gives to our mariners a simple direction. They need to know the angle that this direction makes with their route in order to direct themselves. It is the chart which serves this purpose; and if one conceives of animals endowed with a sense which permits them to recognize only the direction of magnetic north, these animals would have a constant notion of north, but would not be capable of returning to their

point of departure unless they had maintained an exact memory of the length of the lines traversed in this or in that direction. The mariner, navigating by dead reckoning, has to write down the length as well as the direction of all his rhumb lines. Such a view demands at least a constant perception and a prodigious memory and does not correspond at all to the simplicity of the notion of which I spoke above. But terrestrial magnetism furnishes other indications. If we suppose that an animal is capable of perceiving influences which actuate the needle of the compass of inclination, and that the position of this animal remains always the same with respect to the vertical of the place, he will be able to recognize the differences in intensity which cause the variations in the angle

which we measure with this compass.

"Finally, there are other data which we may gather from the use of our instruments, and which one can suppose perceptible through an appropriate organ. We have in mind variations in magnetic intensity. If one disturbs the position of equilibrium of the needle of the compass



A Noddy Tern Come Home to Its Tagged Nest after a Trip over Unknown Seas

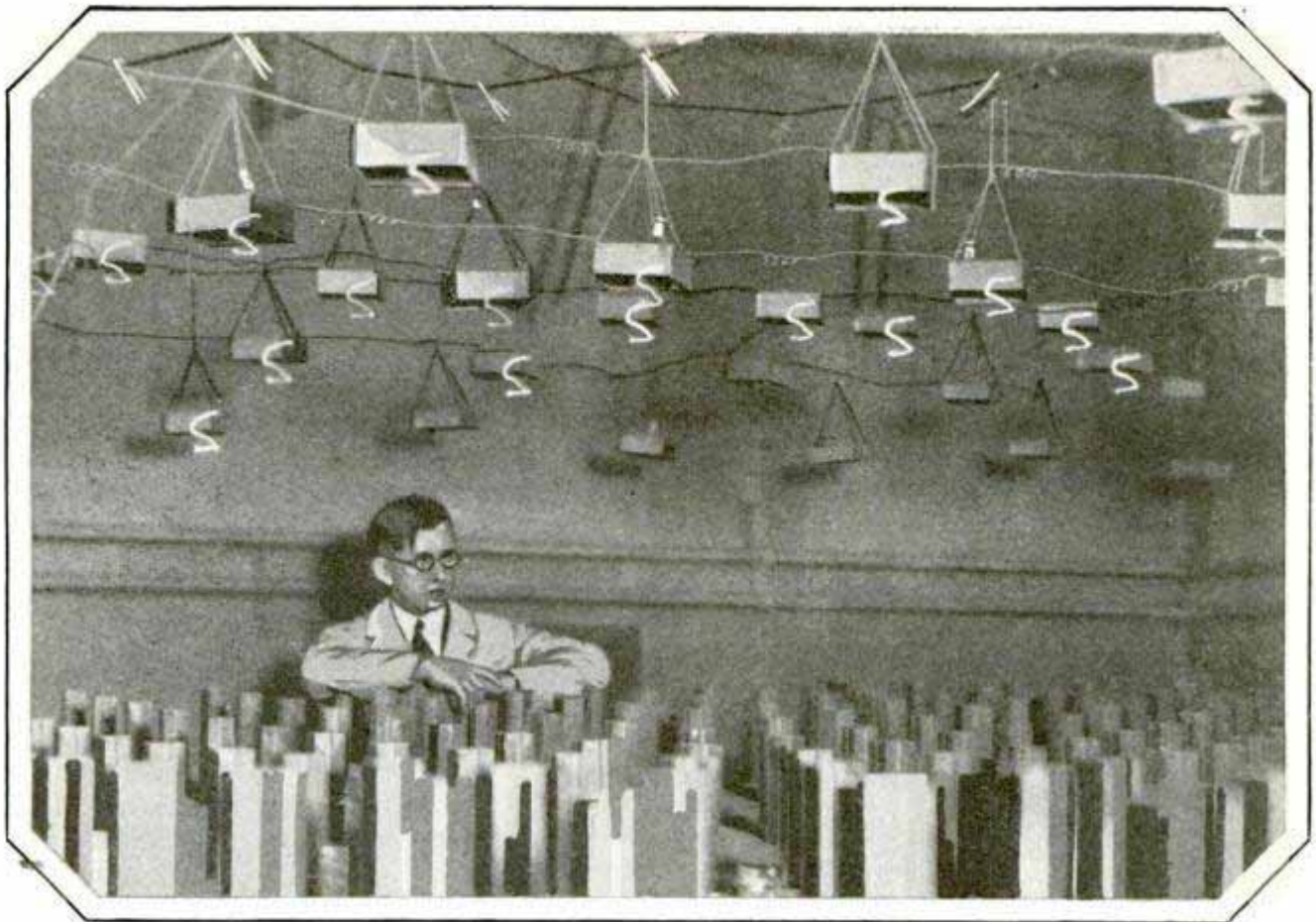

An Elaborate Maze Constructed at the University of Michigan to Test the Intelligence of Rats and Mice; Such Devices Are Used by Dr. Tilney in Studying the Ninth Sense

of declination, the needle comes back, by a series of oscillations, which show a variable force according to the place. By joining all the points where this force is equal we can trace on our maps a series of lines. One can then admit that a line can be determined for an animal, endowed with the magnetic sense as complete as we are assuming it to be, by the value of the magnetic actions in inclination and declination, just as fairly as it would be determined for us by the intersection of given magnetic lines. These magnetic conditions once known, the animal will be capable always of going directly to this point. Carry it to considerable distances, cause it to describe complicated circles, stop it even during transport, it will be able always to come back to its point of departure. This sense is supposed to give the animal general direction. It will suffice to bring it into a neighborhood where the five senses can be employed."

Pigeon fanciers and those who train the racing carrier pigeons have in some cases made observations that support the magnetic theory. On days and on routes that are beset by magnetic storms the

pigeons often go astray. Just as the telegraphic lines and the compass are affected by these invisible electrical storms, so the directional faculties of the birds seem to be paralyzed while the magnetism of the earth is affected.

Some of the most interesting and informing experiments upon the directional sense in birds were performed by Dr. J. B. Watson. Upon the Dry Tortuga islands, off the southwest coast of Florida, noddy and sooty terns make their nests, coming to these islands from the south each spring. These islands are the most northern breeding places of these birds, and they are not known to wander much farther north. In one of a series of tests, Dr. Watson captured twelve sooty and twelve noddy terns, decorated them with gaily colored paint as identification marks, and sent them by ship to Galveston, Tex., a thousand miles of unbroken water away from their homes. They were carried below deck where they could not see the sea. Some were released 400 miles away from the islands, others had to travel much farther. Thirteen of the birds returned to their nests. These tests, and other similar flights, are con-

vincing evidence that birds can fly long distances over a sea wholly unfamiliar to them and attain their desired objectives.

Everyone is familiar with the conventional five senses, sight, hearing, touch, taste and smell. To these five Dr. Tilney adds three others that are not so easily appreciated. We have a skeletal sense and a visceral sense, both of which originate within the body itself. As the eighth sense, Dr. Tilney lists what he calls the hurt or pain sense, which, unlike the other guiding senses, is protective in its function.

The directional, homing or magnetic sense, when it is authenticated, will be the ninth sense. In what organ of the body this sense is seated is at present unknown. Dr. Tilney has suggested tentatively that it is associated with the retina of the eye. Older theories have suggested that it is related to the fluid of the ear in which the earth's magnetism may induce currents like those in a magnetic needle.

Perhaps, when the ninth sense is better understood, it will be discovered to be one of the endowments of certain fortunate men and women. Aviators contend that there is a feel for flying with which some are gifted. Now that man is launched upon an aerial existence by machines of his own creation, his new environment may enable him to understand himself more thoroughly.

GATHERING ALOES BITTEREST JOB

The bitterest job in the world is gathering the sap of South Africa's aloe plants for American and English medicine manufacturers. Each year 250 tons of the sap is gathered by native collectors in the Albertinia region of Cape Province. Aloes comes from the leaves of the plant, which grows in isolated clusters along stony hillsides. The leaves are cut off with sickle-shaped knives, and piled in a hole, dug in the ground and lined with old

sacking. For hours the juice drips from the leaves. After they have run dry the leaves are removed and the congealed chemical poured into an old gasoline can to be boiled down over a fire. When the cans reach Cape Town the tin is cut away with shears and the dried product, looking like glue, packed for shipment. The collectors get \$5.50 a hundred pounds, but as a single plant only yields about eight cents worth of aloes, the pay is very small. While the ostrich-feather industry was at its height the Boer farmers would not allow their plants to be tapped, as they believed the ostrich feathers acquired an extra sheen when the birds were allowed to eat the aloe leaves.

SEVEN-FOOT STEAM PIPE MADE BY ARC WELDING

A steam pipe seven feet in diameter, claimed to be the largest ever built, has been completed at the Westinghouse factory for installation in a large power plant. The pipe will carry 1,600,000 pounds of steam per hour at a pressure of forty pounds. To make it, sections of rolled steel were welded together, producing the required strength without the great weight and expense of a casting.

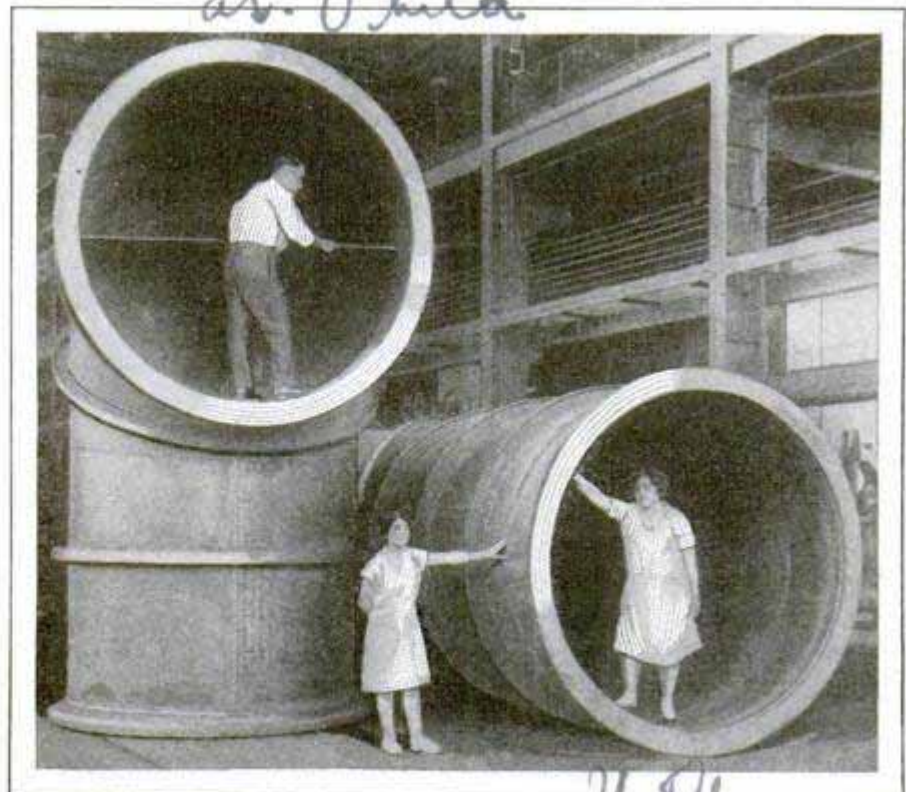

Giant Steam Pipe, Seven Feet in Diameter, Formed by Arc Welding of Steel Plates, a New Time and Money-Saving Method

1390

Cmd. Eric Rosenthal, Esq
Box 1696, Johannesburg, S.A.

ab. Phila

W. C.

COAST-GUARD PATROL TRACKS ICEBERGS TO LAIR



Gun of Coast-Guard Cutter "Marion," Used to Break Up Icebergs, and, Right, Deep-Sea Sample Taker

Back from an exploring trip to the lair of the North Atlantic icebergs, a little 125-foot coast-guard cutter recently reported the discovery of the spot from which a large majority of the towering ice mountains come down into the Atlantic steamship lanes each year. The Eskimos of the Greenland coast in the vicinity of Diske island have their own name for the annual movement of the ice into the open sea, a native word that means "catastrophe" when translated into English. The vast fields of glacial ice break off each year and fill a huge basin between the island and the mainland, until a tremendously fast current sweeps them out through a four-mile channel into the sea. From the heights above, it looks like a vast railroad yard, filled with moving monsters, and the grinding and crashing of giants whose weight runs into hundreds of thousands of tons can be heard for miles. The cutter "Marion," which spent six weeks between Labrador and Greenland studying the ocean currents and the iceberg formations, was commanded by Lieut. Comm. Edward H. Smith, who has been on the international ice patrol, established after the "Titanic" disaster, since 1920. As a result of deep-sea soundings and the collection of water samples from far beneath the ocean's surface, the expedition discovered a stream of cold water which flows up from the Antarctic ocean along the bottom of the sea, rises and flows back to the south again.

Its presence was established when thermometers disclosed a difference in water temperatures at great depths. The expedition also studied the salt content of the northern waters. One way of detecting icebergs is to measure the salinity of the water, as a near-by berg, melt-



ing in warmer waters, releases so much fresh water that the salt content of the ocean in its neighborhood is reduced. The "Marion" also carried a gun to blow up stray icebergs in its path.

RED ANT ENTERED IN FIGHT AGAINST BOLL WEEVIL 1375

A new entry in the fight against the cotton boll weevil has been found in Kaufman county, Texas, where a species of red ant has been discovered that attacks the weevil, and always wins. Experts from the state department of agriculture are studying the insect further to see whether it can be generally used in the war to save the cotton crop.

*William Allen Ward
Box 1614, Dallas*

1435 WATER "WATCH DOGS" GUARD LOGS FOR PAPER



© Factory Mutual Record

Streams from Monitor Nozzles around Big Pile of Logs for Paper Pulp Drench Every Portion of the Heap and Can Be Turned On Instantly to Extinguish a Blaze Before It Gains Headway

Modern methods of fire fighting aim at halting a blaze before it gets a good start, and this plan is well illustrated at some of the mills where large piles of logs for paper pulp are stored. Batteries of "monitor nozzles" have been installed so that as much as 1,000 gallons of water per minute could be directed from a single hose instantaneously at the discovery of the blaze, eliminating the delay that would occur if the fire department had to be summoned and hose lines laid. The nozzles are distributed so as to cover the entire pile and protect every part of the heap. Although such an installation is costly, owners consider the investment a wise one where as much as 20,000 cords, representing a value of \$300,000, may be included in one pile.

1452 **SHAPE OF EARTH UNDER THE SEA GAUGED FROM SUBMARINE**

What is the shape of the earth under the ocean? Scientists have made many charts on the basis of soundings, but more accurate maps are to be prepared of the

region off the Atlantic coast and about the Gulf of Mexico and the Caribbean sea, by means of special apparatus carried on the submarine "S-21." One of the most interesting instruments to be used is a pendulum arrangement which determines the force of gravity at any point on the earth's surface where it is set up and operated. It cannot be used satisfactorily from an ordinary vessel because of the swell of the water, but it is practical when applied from a submarine. Accompanying the expedition will be two "eagle" boats from the navy department. They will be employed as the surface headquarters for the submarine, which will also be used in taking accurate soundings by means of the sonic depth recorder. The pendulum apparatus is the invention of Dr. F. A. Vening Meinesz, of the Netherlands, who has come to this country as the guest of the Carnegie Institution at Washington to aid in the under-sea measurements. He designed the instrument for use on the comparatively shaky soils of certain parts of Holland, where ordi-

U.S. Steady 9/24/28

nary apparatus was not accurate. It proved so satisfactory that the application to sea measurements was immediately suggested. The submarine was therefore pressed into service and has become a great help to the scientists in the important task of charting the floor of the sea.

BIG SHIP AS FLOATING FACTORY HAULS WHALES ABOARD

With a novel landing grating in her queer-looking stern and with powerful winches aboard, the whaler "Antarctic" recently left Cardiff, Wales, for the waters off South Georgia in quest of the riches that come from blubber and other products of the big sea mammals. If the season proves favorable, the "Antarctic" is

Once harpooned and subdued, the whale is hauled into the steamer up the special slipway at the rear by winches. An iron-lattice door is dropped down to keep out the waves. The vessel has twenty-two big boilers for the manufacturing of oil. Experienced whalers say that it is useless to fish in the same waters two seasons in succession because attacked whales that succeed in making their escape shun those districts for at least three years.

PEARLS FOUND BY THE BUSHEL IN AMERICA'S EARLY DAYS

Prehistoric American Indians probably picked up pearls by the bushel along the Ohio valley, and diamonds were found in many localities, according to Dr. George F. Kunz, research curator of precious stones of the American Museum of Natural History. Tracing the use of the gems by the early inhabitants of North and South America, he has concluded that the Mayan aborigines were far behind those of Africa and Eurasia in the working of metals and precious stones. Although diamonds were available, the Indians did not employ them, he said. Jade was used by early settlers in Alaska, copper by Indians near Lake Superior, turquoise by pioneers in New Mexico, and in Chile there were quantities of lapis lazuli. Most of the gold and copper was picked up in the streams. Dr. Kunz points out that it is strange that the Indians evidently knew little of the rich stores of gold in California later developed by the white man.

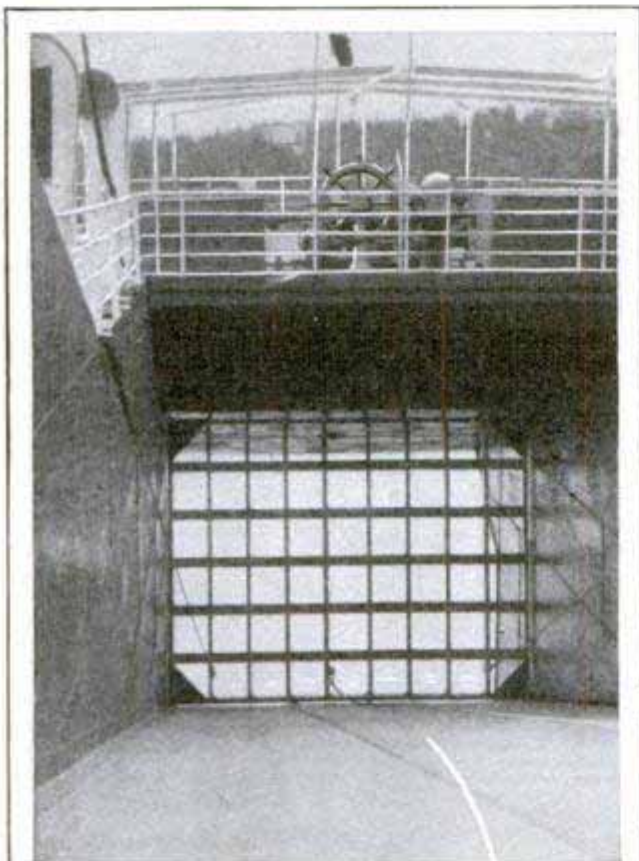

Courtesy M. Brun
View of the Big Whaling Vessel "Antarctic," and a Glance through the Lattice Door at the End of the Slipway up Which the Whales Are Hauled with Winches and Cut Up and Prepared for the Boilers



expected to capture 1,000 whales. They should yield about 60,000 barrels of oil, which alone would be worth some \$1,500,000.

*Owned by Norwegian firm
B. Bruen and J. Under Lippie*

*77th St. Central Park
West, New York*

456

1469

1275

International Bldg.
Washington D.C.

The Romance of

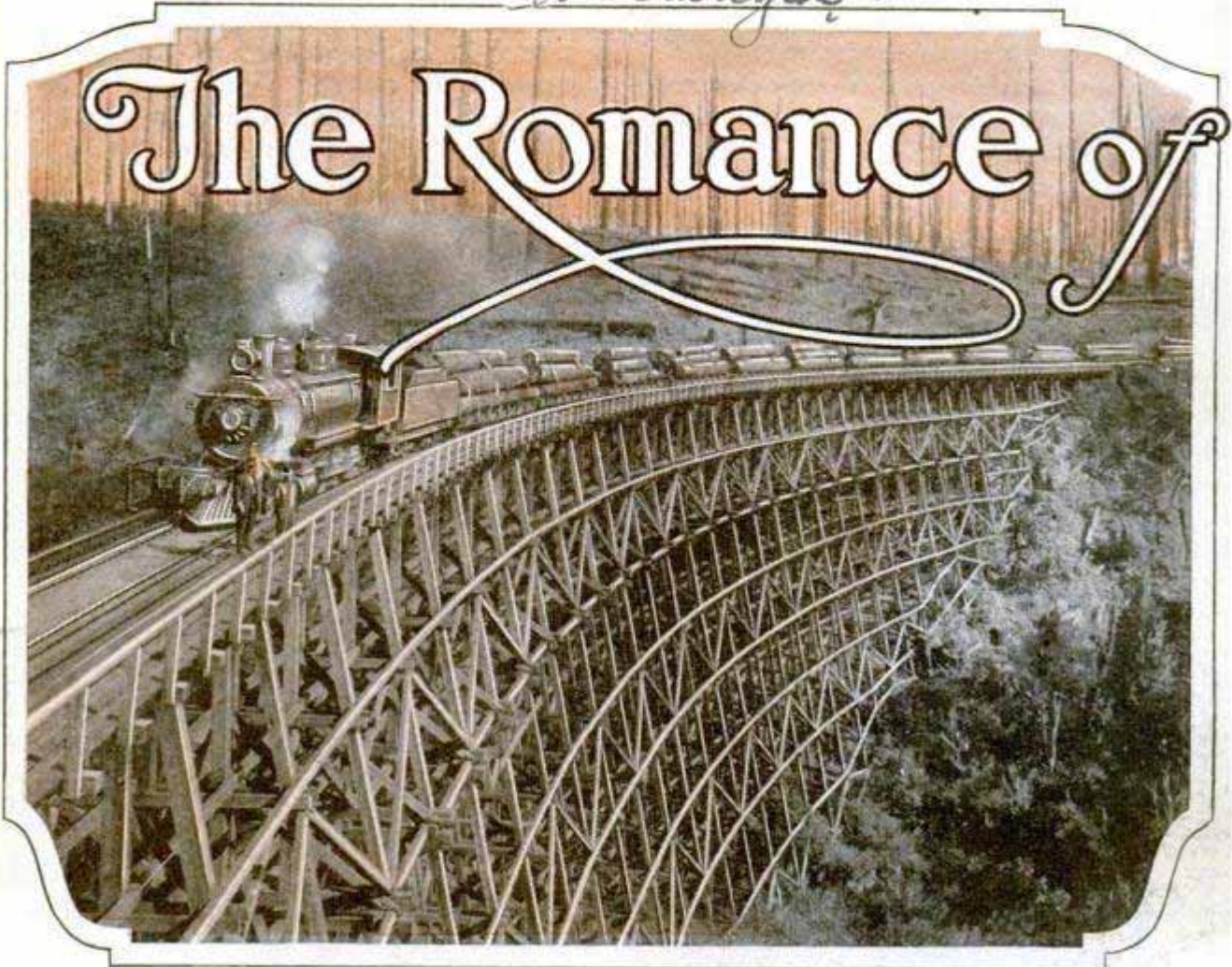

Huge Trestle of Squared Timbers Built to Carry a Logging Railroad over a Deep Ravine; the Investment in Equipment for Modern Logging Makes It an Enormous Industry

By WALTER RALEIGH,

THE LOGS that provide the mills with the lumber for your house, furniture and interior decorating are factory-produced these days. The great forests are merely the source of supply from which modern mechanical equipment develops the product demanded.

Gone are the days of the rough-looking lumberjacks living on baked beans, salt pork and molasses, whose ability rested chiefly in wielding a long snake whip over several teams of stubborn mules.

The modern logger is an efficient worker and uses the latest mechanical methods to accomplish his purpose. The present-day woodsman is a product of a new age and as such is satisfied with nothing but the best. Even his food and physical comforts must be first-rate, although he may live for weeks far from large cities. The logging camp has advanced from the salt-pork-and-molasses era to the diet obtained at the best hotels. The bunk houses are

electric-lighted, there are showers, laundry, library, radio, and all the essentials of city life.

The modern logger has progressed even as the farmer. The latter does not use a crooked stick to plow, the logger has ceased to demand muscle as the essential in getting out the timber. In the great western forests not an animal is found about the logging camps. Under the new mechanical methods employed, a mule or a horse would be as alien to the requirements as they would if placed in an automobile plant to help move the assembled cars about.

It takes skillful engineering and large capital to tackle the great wooded mountains of the western coast. As only large-scale methods are considered, railways of standard gauge must be built. Deep ravines must be bridged, and the rough ground made smooth for track laying. Roadbeds, as smooth as the ballasted lines

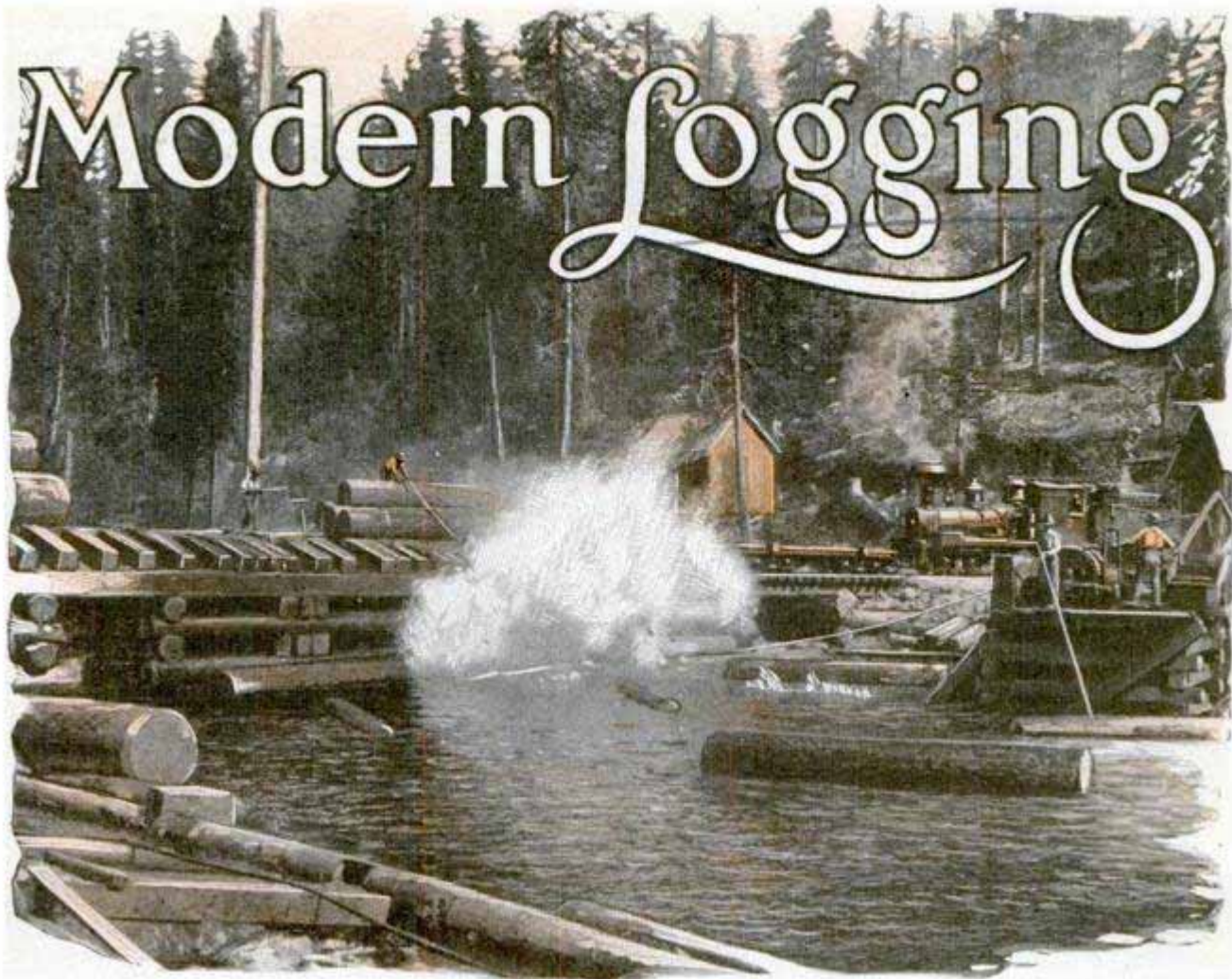

Carried Down from the Hills by Special Railroads, the Logs Are Dumped into Streams Where They Can Be Lashed Together in Great Seagoing Rafts for Distant Delivery

of the crack flyers of the eastern states, are provided for the strange engines that pull the timber trucks from the hills.

But before any logging can be carried on, much must be done, including the transporting of all the equipment to the chosen camp. Since the modern loggers want "every modern convenience," this means an investment of large sums of money before a single tree is cut.

With the railroad in operation to the very site of the logging camp, with the power car that will provide electricity ready, with shower car and drying car and commissary equipped, the next step is to put up a rig for collecting the logs.

The modern logger, in selecting his camp, first hunts a particularly tall and straight tree at least eight to twelve feet at its base. This is the spar tree chosen by the head rigger as the key to the work in that region. Early in the morning he will don his long spurs, and using a rope which he flips about the tree as he works himself

up, he begins his long climb toward the top. Sometimes the rope or the spurs will encounter loose bark and then there is the doubtful thrill of slipping back down the great trunk for ten to fifteen feet. Working slowly and carefully, he will, by noon, be up to the first great branches of the spar tree, a monarch of that forest region. Properly knotting the rope and securing his seat, he will signal for his lunch. His meal will be sent by a helper using a rope which he has carried tied to his back.

After lunch, the rigger will proceed to the sawing off of the lower branches of the tree. Working evenly, consistently, he will cut the limbs away for about 200 feet above the ground. Then he will drill for the placing of a dynamite charge. Fastening the electric wires, he is lowered to the ground by means of the donkey engine. A connection is made with the power car and the whole top or whip part of the tree is blown off.

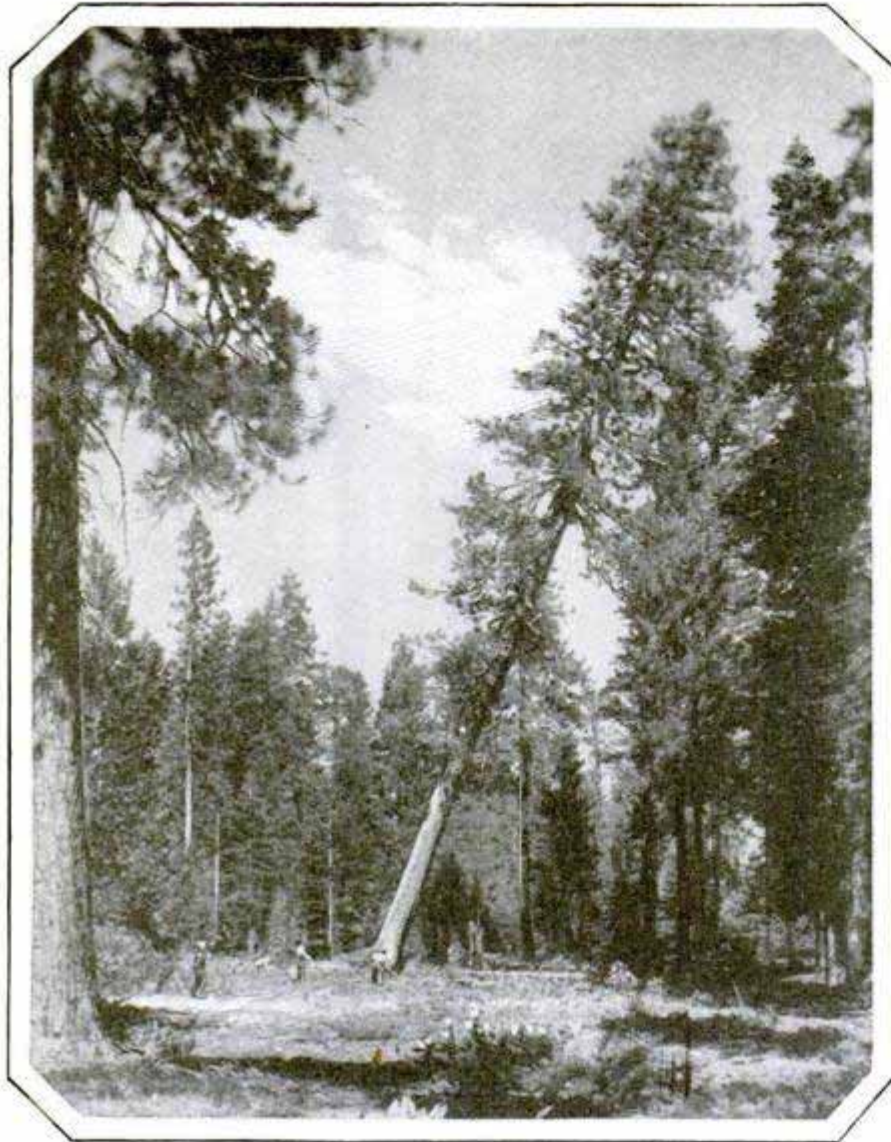

The Fall of a Forest Giant; the Pygmy Figures at Its Base Give an Idea of the Immense Height of the Tree

While working in the spar tree, the head rigger has prepared for the guy cables which stretch out to other trees in all directions till the giant looks like the center pole of an enormous tent. From well up on this tree, the overhead cable is strung out to a "tail" tree which may be 200 feet from the spar tree. If the contour of the ground is favorable, it may be as much as 5,000 feet away.

The logs to be brought in are lifted by power to this great cable stretched from spar to tail tree, and by means of a method which the loggers call "bicycling," are drawn into the "yard," which is the region about the base of the spar tree. By such methods the trees are cut out in the whole region within a radius of this center pole. After being cut, they are transported by means of the great cable. Oftentimes they go flying through the air on their overhead tramway. As the giant logs travel,

one end may strike a smaller tree below, and because of the speed of their flight and their great weight, the smaller trees may be completely knocked down. Frequently trees several feet around are thus uprooted.

In some cases where it is not possible to string the cable so that the logs travel high, one end of the log is allowed to drag along the ground. With one end free, the ground is hit and the stones and dirt fly with great violence. Stones as big as baseballs are hurled through the air when even the knot on the end of two cables drags through the woods. The winch doing the pulling has enormous power.

Generally the logs are next loaded on flat cars ready for transportation to the mills near some large cities. These cars have separate trucks and, spacing them apart as desired, it is possible to

send the logs around the curved tracks, using a spiked ridge along their top to keep them from pulling apart. The draw is thus through the logs themselves from railway truck to railway truck.

Logging trains, usually operating on a steep grade, have a special problem in providing efficient braking power. It is impracticable to use air brakes owing to the fact that the trucks must be spaced at irregular intervals according to the length of the logs. Thus the braking is done by hand, and it is the most dangerous of all the occupations connected with logging. If a log should roll from its place, there is likely to be a wreck. As the loads are very great, the engines are often built with several vertical pistons which drive a rotating horizontal shaft geared to the drivewheels. The speed of such an engine is small, but to make up for this, it has enormous driving power.

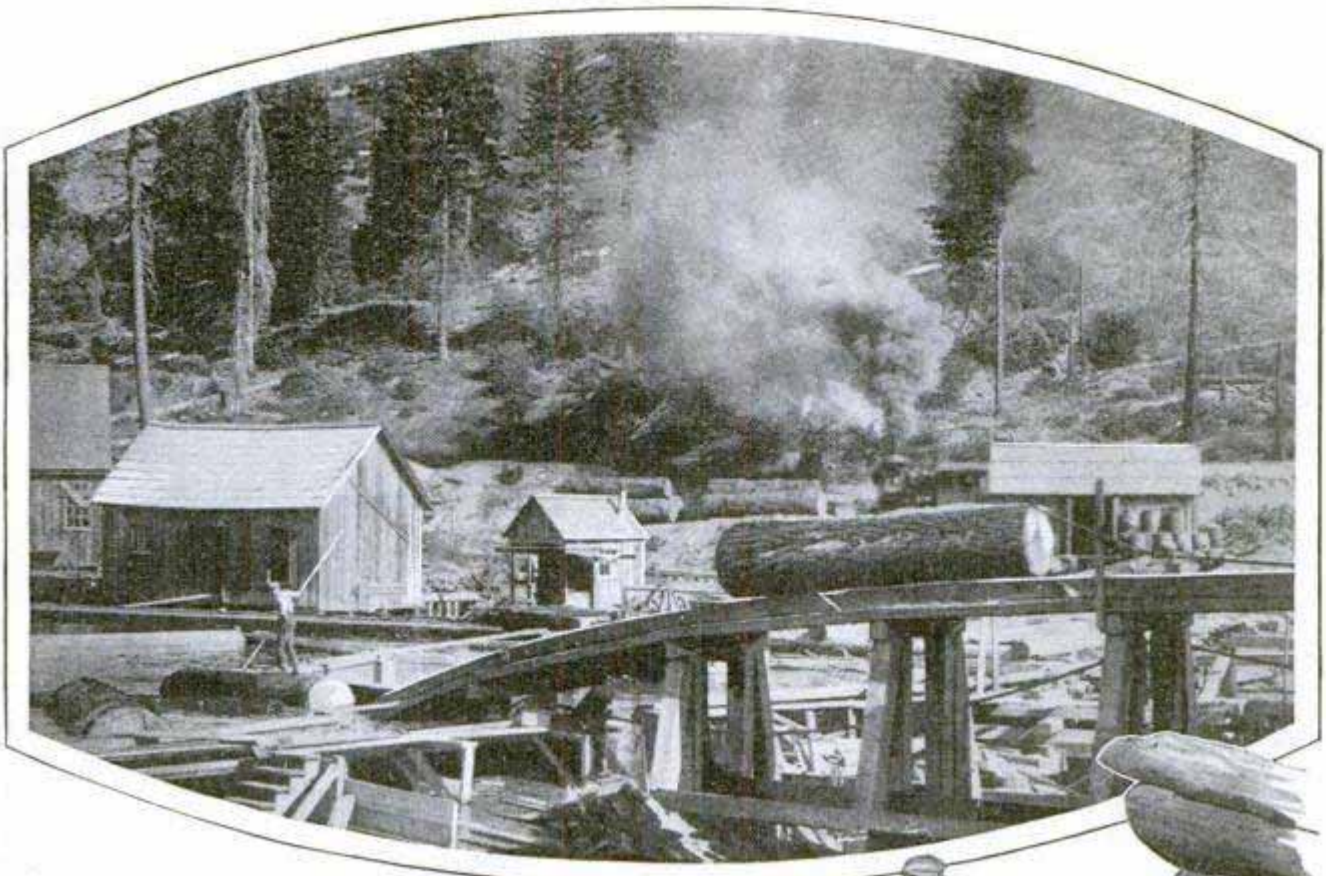

From the Mill Pond, a Runway Leads Up to the Waiting Saws and up It Log after Log Goes to Be Cut into Boards; Getting the Logs Out of the Forest Is No Longer a Job for Oxen and Horses; Instead, the Endless-Tread Tractor Hooks On to a Wood Sled and Yanks a Cargo Down to the Railway; Another Way of Carrying Logs in More Open and Level Country Is Shown Below; the High-Wheeled Carts Can Pick Up Two or Three Giant Sections, Swing Them Free of the Ground and Go Trundling Off to the Track Where the Loading Is Done

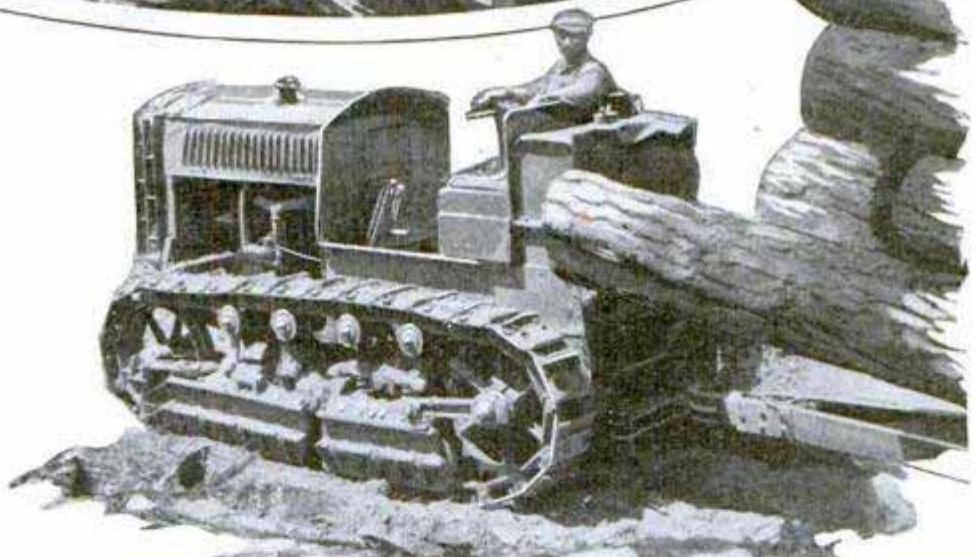

1275



Photos Courtesy U. S. Forest Service

Toppers and High Riggers Remove Branches and Top of a Tall Tree and Place the Rigging That Brings the Timber through the Air, Ready to Be Loaded from One Central Position

The railroad delivers the logs to the nearest waterway where they are stored in an inclosed quiet region known as the "boom." As rapidly as possible, they are made up into huge cigar-shaped rafts that rival an ocean liner in size, running up to lengths of as much as 1,000 feet and drawing thirty feet or more of water. The whole is held together by a cradlelike construction of timbers and lashed with chains. Towed by a tugboat, the rafts often make 1,000-mile journeys.

Using such modern production methods, logging is now a year-round industry. Instead of waiting for ice and snow for the purpose of making it easier to haul the logs out, the winter impedes the work of the men. Yet, with all the mechanical efficiency of wheel, steam power and electricity, there still survives the pride of the individual woodsman whose stout sinews can wield his ax so skillfully that only a stump as smooth and polished as a table, without a mark showing, will be left.

YIELD OF DIAMONDS INCREASING FROM BELGIAN CONGO

1466

Since the World War, the Belgian Congo has assumed increased importance as a diamond producer, the yield growing from about 15,000 carats in 1913 to more than 1,000,000 carats in 1926. These results have been attained largely by the installation of improved machinery and the adaptation of better methods of mining. Steam units have supplanted the pick and other hand implements, and the latest types of

washing machines have been acquired so that many more diamonds are found with scarcely any increase in the number of workers. The Congo fields, however, do not compete with those of South Africa in point of size of the stones discovered. Not long ago, a diamond weighing 412 carats was unearthed at the latter fields and sold for \$25,000. When it is ready for the market, it is expected to bring twice that sum. After the Congo stones are separated from the mud and soil, many of them are sent to Antwerp for cutting.

*Kansas City Journal
 Post 9/12/26*

American Benberg & Manufacturing Corp

**SILK IS MADE FROM COTTON
IN HUGE PLANT**

A plant costing \$55,000,000 is being completed in the hills of eastern Tennessee to make artificial silk from cotton. The product has no relation to rayon, the synthetic silk made from cellulose extracted from wood fiber. The new artificial silk is said to look like real silk, feel like it, and also to wear like it. The plant was located at Elizabethton, Tenn., because a mammoth spring of chemically pure water there furnished one of the necessary materials. The other is cotton linters, the short fibers which adhere to the seeds when they are extracted from the raw cotton in the gin. The linters are removed from the seeds before the latter are reduced to extract cotton-seed oil, and are more or less a drug on the market, as their uses in the past, at least in peace times, have been limited. In the new process, the invention of a German chemist, the cotton is put through a chemical treatment that breaks down the cotton cells. The material is then processed again to reconstruct new cells closely resembling real silk. From the new material, the silk thread is formed in much the same way as rayon thread is made by squirting the raw material through small holes.

1995
20018

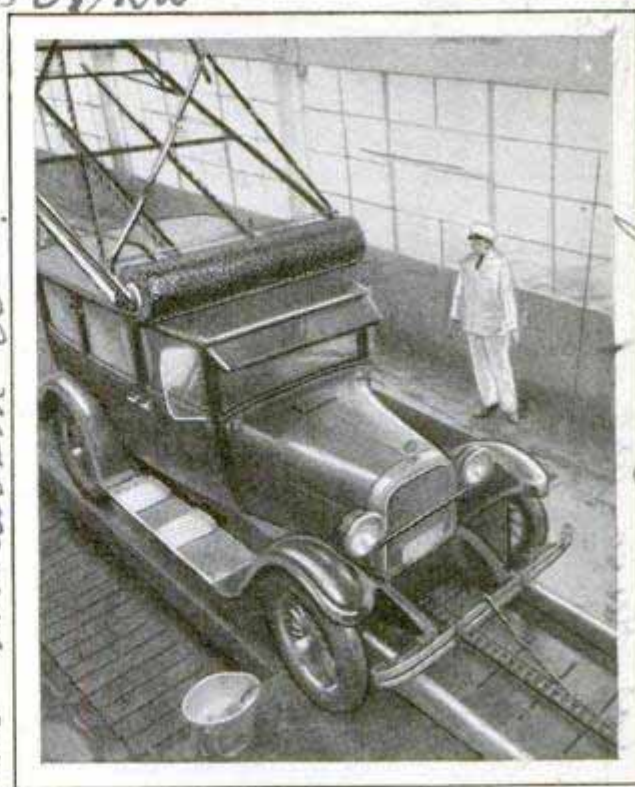

Motor-Driven Brush to Wash Auto Top Does Job Automatically as Car Passes through Laundry

**BRUSH TO WASH AUTO TOPS
SAVES HAND LABOR**

One of the serviceable units in a western automobile laundry is a motor-driven revolving brush that cleans the tops of the cars as they pass along on a moving runway. This does the work of one or more attendants, gives a thorough cleansing, as the bristles are adjusted to reach all parts, and helps maintain the output of the laundry on a regular basis, since no delay is necessary for washing the top.

**MIXER MOUNTED ON SPRINGS
CHURNS BUTTER AND FOODS**

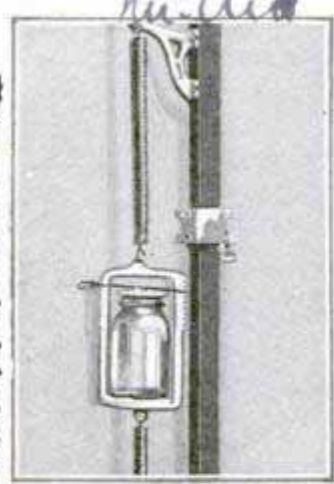

A spring mounted churn food and drink mixer now on the market produces butter, cake batter, whipped cream and meringues, and mixes all sorts of drinks. The food to be mixed is placed in a sealed glass container, mounted

between two vertical coil springs. The operator then grasps the top spring near the middle and forces it up and down until the container acquires a vertical movement of about five inches. Approximately one minute is required to produce butter.

**GOLF-STROKE METER CLOCKS
LENGTH OF DRIVE**

A new golf-stroke meter, recently placed on the market, measures the yardage of the heftiest drive. The ball is attached by a rod to the meter, and rests on a protecting support, which is wide enough to keep the golfer from striking the floor. After each drive, it returns automatically to its position.



15th St. Auto Laundry
Portland, Oregon
275. 00. F.O. Portland
Built by George
H. White of

Other addresses in date

Weisenborn Sales Co.
Box 598, Chicago

Mayfair Plaything
Store, 741 5th Ave

14 7 5.
976

slippy boat

Dr. Julius Goldman
Los Angeles Calif
5067 Los Feliz Blvd.

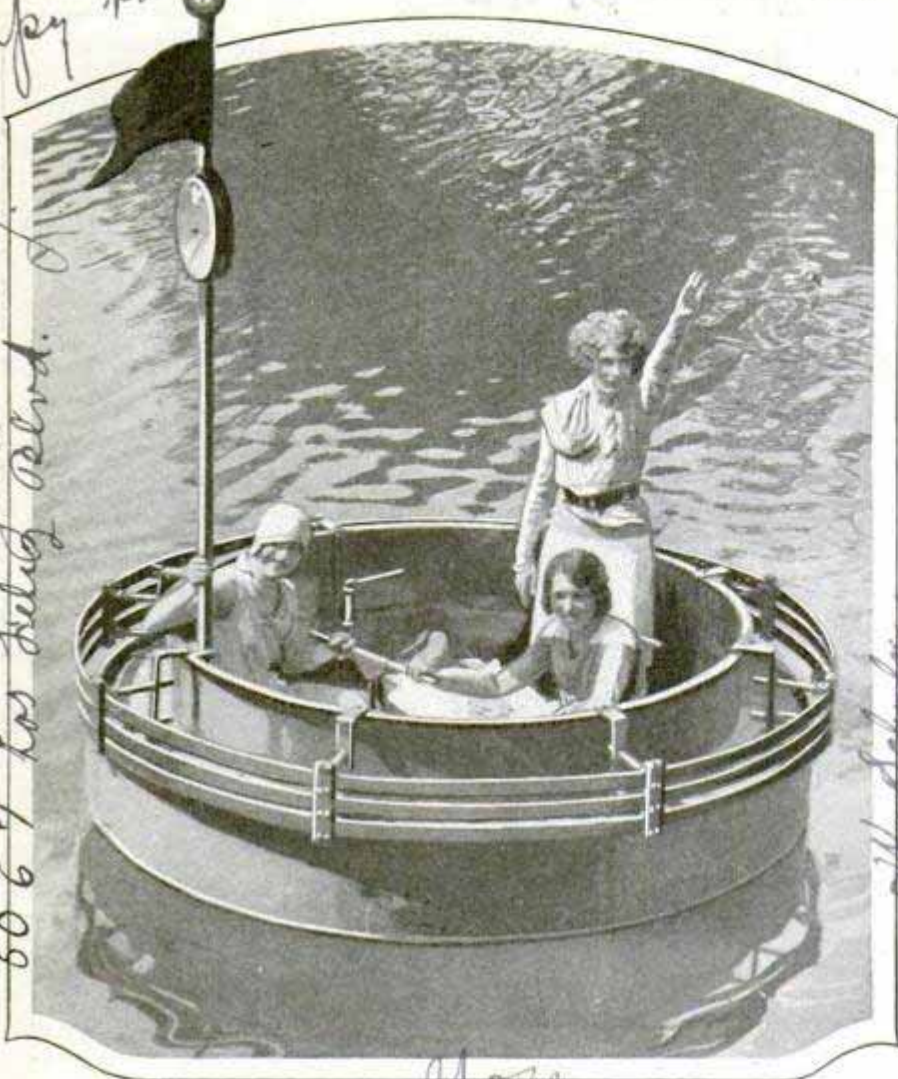

Metal Boat for Slow but Safe Travel and Water Sports; Note the Handles with Which the Paddles Are Operated

METAL BOAT IS CIRCLE-SHAPED AND WON'T TIP OVER

For water sports with a minimum of danger, a metal boat, of circular shape and holding eight persons, has been introduced. It is kept afloat by an air-filled pontoon as an additional aid to stability, and is propelled by paddles. Because of its shape and size, it can be rocked without hazard and is not likely to tip over.

MYSTERY OF WILL-O'-THE-WISP DUE TO PRESSURE?

That there may be a relation between the occurrence of the will-o'-the-wisp, the strange, luminous phenomenon sometimes observed in the woods and other places, with the pressure of the air, is the conclusion of a German scientist who has been studying the mystery. Not long ago, he observed four small bluish flames, about

the height of a candle's, on a swamp near an iron mine. Their light had no heat and was sufficiently intense to permit reading the face of a watch. They lasted about fifteen minutes. There are several radioactive springs in the vicinity. The next day, the scholar could find no source of the odd flames, but concluded that they were caused in some way by the atmospheric and other conditions, the air pressure being a special factor. The higher the pressure, the less the light. The lights appeared to be independent of air temperature. During the war, a German officer saw pale greenish and yellowish flames shooting up from both sides of a rough road through the woods over which heavy artillery had been passing shortly before. The flames, twelve to eighteen inches high, were produced by the great pressure caused by the passing guns, scientists believe; that factor, combined with the heat and the rain and the gases that streamed from the moist earth, producing the phenomenon.

SAFETY CHAINS FOR SHOE SOLES PREVENT WINTER ACCIDENTS

Chains attached to the underside of the shoe soles have been introduced for wear



on slippery walks and other places where falls are likely to happen. They are furnished for men, women and children and a more rugged type is made for hunters,

climbers and railroad men. The links are especially adapted to give a firm grip.

Science Service news 392. cc
9/27/28

H. H. Srenna

Bert Hobbette
Winchester

not slip on marble

**FLYERS FIND NEW SUGAR CANE -
IN HEAD HUNTERS' LAND** 1355

An airplane expedition into New Guinea, land of the head hunters, has yielded 171 distinct varieties of sugar cane for the U. S. department of agriculture, including twenty wild kinds and one species wholly new to science. The expedition, under the leadership of Dr. D. W. Brandes, was unusual as it marked the first use of the airplane by plant hunters to explore new territory. Fourteen lakes not on any map were located, and a number of other new geographical features discovered. The expedition spent seven weeks on the upper Fly river, three weeks in the Owen Stanley range, and two weeks on the upper Sepik river.

**CIRCULAR WALLS OF CONCRETE
BUILT BY MACHINE** 1370

A machine for building circular storage tanks, silos and similar structures of monolithic concrete, reinforced with steel, has been invented by a Cincinnati engineer. Adjustable to structures from ten to twenty-four feet in diameter, the machine includes a "spider" placed in the center, moving up a mast, and carrying extension arms which support the circular forms. Four men can operate the machine.

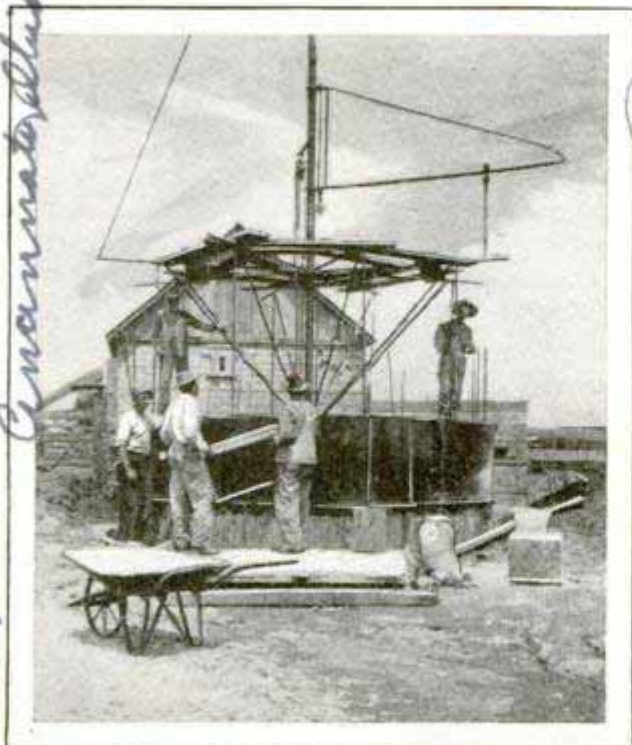

Mast and Movable Forms Which Speed Building of Circular Storage Bins of Reinforced Concrete



© Henry Miller News Picture Service
Dictating Machine Which Records Messages on a Fine Steel Wire Instead of a Wax Record

**WORDS ARE RECORDED ON WIRE
BY DICTATING MACHINE**

A new dictating machine which records the dictation on a fine steel wire has been introduced in Germany. Dr. Kurt Stille, the inventor, is shown demonstrating the apparatus to his stenographer. One use predicted for the machine is the recording of two-way wireless conversations.

**NEW METAL FOR AUTO USES
OUTLASTS IRON**

Most of the good qualities of cast iron and steel are claimed for a new metal being employed in automobile motors and for other purposes. It is lighter than iron and tougher, so that cylinders of it would not have to be rebored so often, it is said. The material is made by placing a certain substance into a ladle of cast iron. The normal qualities of the iron are changed, although it retains practically the same chemical nature.

Our Bureau of Information will answer all questions regarding articles appearing in this magazine.

1355
No information on
33 Victoriastrasse
Berlin W. 10, Germany

Alexander L. Nash
Cincinnati, Ohio
Engr.

3 Victoriastrasse, Berlin
W. 10, Germany
mechanite

Chicago Iron Works
9/14/28

Alexander L. Nash
Engr. Cincinnati, Ohio
According to Col. William
Wall Indianapolis, Ind.

1312

Uncle Sam to Show



Government Sculptor at Work on Plastic-Wood Model of Prairie Schooner, Our First Transcontinental Vehicle, for Exhibition in the Transportation Exhibit at Seville, Spain

By G. H. DACY

Ar. Bethesda, Md. 4639 Montgomery

A GIANT cow of cardboard, which talks with the fluency of a public lecturer, is the latest creation of the government exhibit builders at Washington.

Mechanized "Bossie" is taller than the average man and is twice as long as high. She resembles a normal cow which has been inflated like a rubber tube to thrice her normal size. By means of a projection lamp, the slide picture of a cow was focused on a large piece of wallboard. The outline of this image was then traced with crayon on the board. Subsequently, the figure of the cow was cut out with a scrollsaw and prepared for educational exhibition purposes.

Beginning with the 1929 season, this talking cow will be displayed at state and interstate fairs throughout this country, and will be heralded as a star attraction. Some 20,000,000 Americans will be entertained by her antics and lectures on how milk is produced. The talking cow is manipulated by a concealed attendant who operates four electrified switches, five

strings, a control lever with a universal joint and a talking machine with a dynamic power amplifier. The cow, as a four-legged actress, engages in an animated dialogue with her owner—a dummy dressed as a farmer. This conversation explains in popular language how the animal manufactures milk from the generous amounts of grass, grain and other forage which she consumes. This interesting exhibit explains a mystery which has long baffled the public. It removes the riddle from that old saying popular among stockmen: "There is nothing darker than the inside of a cow."

The inventor of Uncle Sam's first and only talking cow sits behind the scene and actuates "Bossie" in performing her set of tricks, such as switching her tail, moving her jaws as she talks, chewing her cud and bobbing her head. This "show" cow talks by radio although by near rather than remote control. Her power of speech is centered in a talking-machine attachment hidden behind her body. It is provided

model



Talking Cow

Building a Mechanical Man Who Will Talk by Radio, Gesture, Move Jaws and Turn Head Back and Forth; These Figures Are Used to Attract Attention to Government Exhibits

with an amplifier which steps the power up to 400 volts. A dynamic speaker, consisting of a large coil of wire in a steel case, provides the deep bass voice which "Bossie" uses in telling her story to the crowds, which stop, stare and study in puzzlement when they first see this scientific "sideshow."

Mechanical inserts and light boxes have been placed in the big cow as visual educators which will show to the audience at a glance how the food is handled and digested in the different stomachs. These "sight-of-eye" demonstrations, linked to the lecture facts which spout from the cow's mouth, tell a very technical tale in simple, condensed manner that all can understand.

There is a realistic appeal about lifelike manikins that gesture and gesticulate which draws the crowds. The office of exhibits of the U. S. department of agriculture reports that talking dummies that move their arms, heads and mouths are "wows" wherever shown. They fascinate young and old alike. Folks return several times to look at their antics and

to listen to their words. Such manikins hammer home scientific facts of importance which otherwise are spurned by the average farmer, stockman and layman.

That is why Uncle Sam and Aunt Sarah are employing the cut-out effigies of human beings as the newest assistants of scientific teaching. A case in point is that of a pair of talking manikins dressed in tailor-made suits, which will be shown on the 1929 fair circuit. They were made in the same way as the cow by projecting lantern-slide images on wallboard, marking the outlines and eventually cutting out the figures.

Each automaton gesticulates emphatically to stress his arguments concerning methods of dairy feeding, breeding and pure-milk production and marketing. One dummy holds a paper in his hand while the other grasps a short stick. A small electric motor, concealed behind the manikin in each case, operates the gesturing arm. This motor also actuates a mechanical plunger attached to the lower jaw of each effigy. The face of the imitation man is made of dental rubber tinted



A Corps of Sculptors and Artists Are Kept Busy Making Uncle Sam's Educational Exhibits Different from All Others

The designers and model makers are now engaged in the production of educational exhibits which will be displayed at the world's fair at Seville, Spain. This exposition will be open to the public for about six months. The long show period prevents Uncle Sam from displaying his most spectacular mechanized and motorized exhibits because of the difficulty of keeping them in perfect running order for months at a time. Neither the talking cow nor the manikins will voyage to the Old World on this account.

The ships of Columbus brought the first pure-bred live stock to the United States. These animals were the forebears of our current \$3,000,000,000 live-stock

with water colors of the proper hue. Oil paints were impractical as experiments showed that they caused the rubber to harden and deteriorate. The plunger and the rubber, which alternately is stretched and loosened, move the mouth of the dummy in accurate simulation of movements accompanying human speech.

One model stands in a comfortable pose with a foot resting on a box, while the other is close by. A government representative, hidden from view behind these manikins, operates the dummies like a "Punch and Judy" show by means of toggle switches. He shifts the records on the concealed talking machine, linked to a radio loud speaker hidden in a bushel basket, which rests on a box near the talkers. The words and gestures of these talking models are co-ordinated so that the manikins fool the more distant spectators, who imagine that a duo of federal farming experts are the actors in this educational show. The phonograph records which give speech to the manikins and automatic cow were made by a national manufacturer on government order.

business. One of the Seville exhibits is a remarkable group of models of an old Spanish sailing ship anchored near the Florida coast while cattle were being driven ashore. An electric fan supplies the breeze which flutters flags and sails and ripples the imitation salt water. Waves are produced in this chemically colored sea by means of a board which is moved up and down in the tank by machinery.

Uncle Sam at first schemed to use a rubber sheet as a sea and a special machine with many extendable arms which would bob up and stretch the rubber at regular intervals and then would fall so that the effect would resemble the action of waves. This plan was too costly, so, finally, experiments with various wave-making devices were conducted in a large laboratory tank at Washington. Eventually, a satisfactory wave maker was devised. The experimenters found, however, that it was necessary to provide a sand beach to produce the desired wave action in the imitation sea.

Charles III, king of Spain, presented George Washington with a champion jack

Dept. of Agriculture

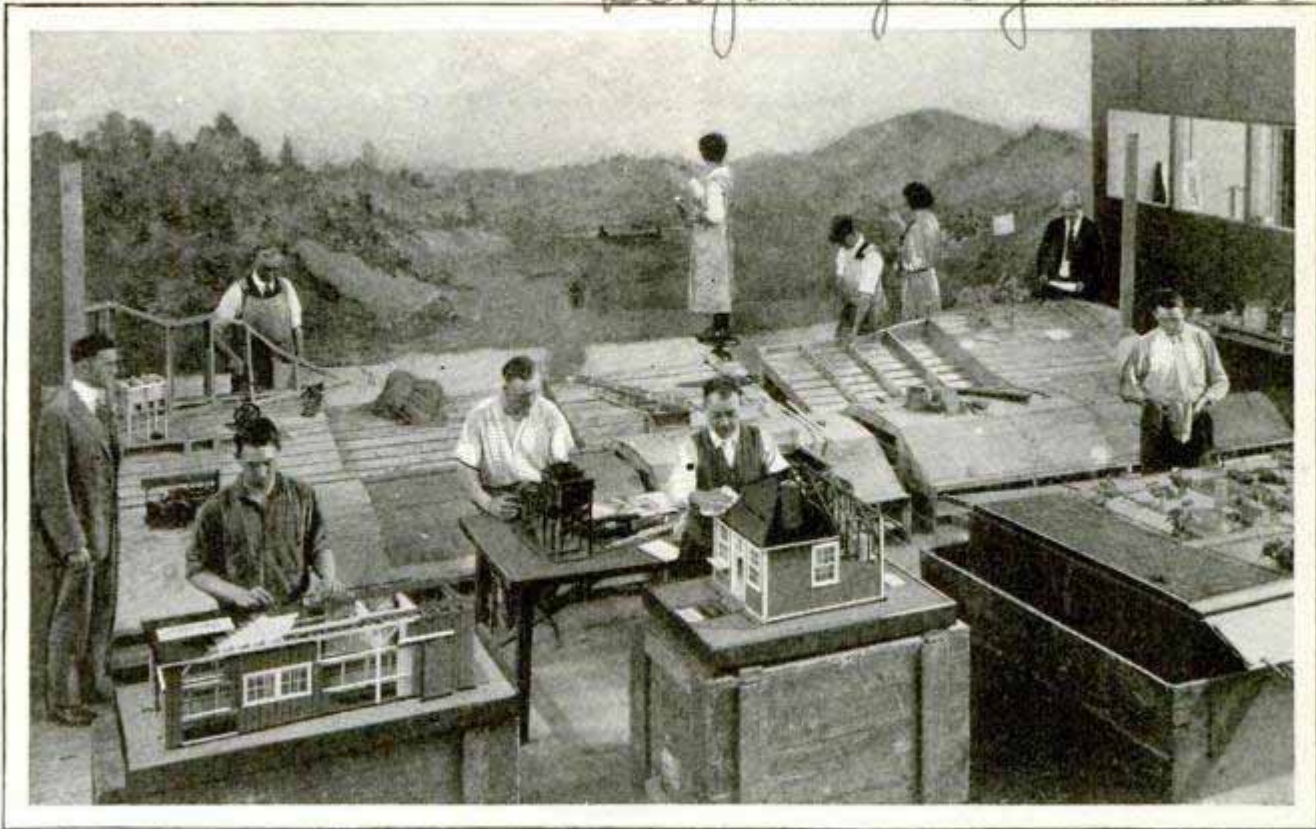

Making Educational Models of Farms and Farm Buildings at the Washington Exhibits Laboratory; the Models Will Be Sent Throughout the Country to Keep Farmers Posted

named "Royal Gift," in 1785. A plaster statuette of this animal, exhibited in a glass case, will be shipped to Seville. The jack is eulogized as the progenitor of the American mule-raising industry which now adds up to 5,000,000 animals.

The good-roads exhibit consists of remarkable models made of plastic wood which present the "then and now" picture of transportation in the United States. One group represents a prairie schooner, its double team of mules, hardy pioneers and their hunting dogs, who braved the dangers of hostile redskins, wild beasts and unexplored territory in extending civilization to western conquests.

Pioneering transportation, slow, laborious and hazardous, is balanced by a second group of models depicting an improved highway and the modern vehicles of cross-country travel. The tourists, a honeymooning pair, have stopped to make a picture. A motor truck loaded with freight is also parked temporarily by the roadside. The models in pantomime tell the story of how progress has fostered better transportation aided by good roads. The campaign has run the gamut from mule power to gasoline, from a speed of thirty miles a day to upward of 300.

Invaluable exhibits of corn, wheat, cotton and tobacco will also create international interest in American varieties. The tobacco exhibit is astonishing in that it features an automatic smoker, an original device which smokes four cigars simultaneously and ascertains the burning qualities of different kinds of tobacco. It operates by means of water displacement and air suction.

Over in Spain, the favorite amusement is watching matadors kill the wild bull. In the United States, one of the great ambitions of our government is to teach farmers how best to raise tame bulls that will aid in more and better milk production. One educational exhibit consists of a large number of model sires, the cut-out photographed figures of real bulls. Spectators are asked to pick the best animal in the group. On the opposite side of the display, each bull with five of his best daughters is shown by models. The exhibit shows the impossibility of selecting live stock merely by examination without consulting breeding or production records—"all that glitters is not gold," either in metal or bulls.

Another new exhibit consists of an effigy expert that moves his arms by machinery

1312

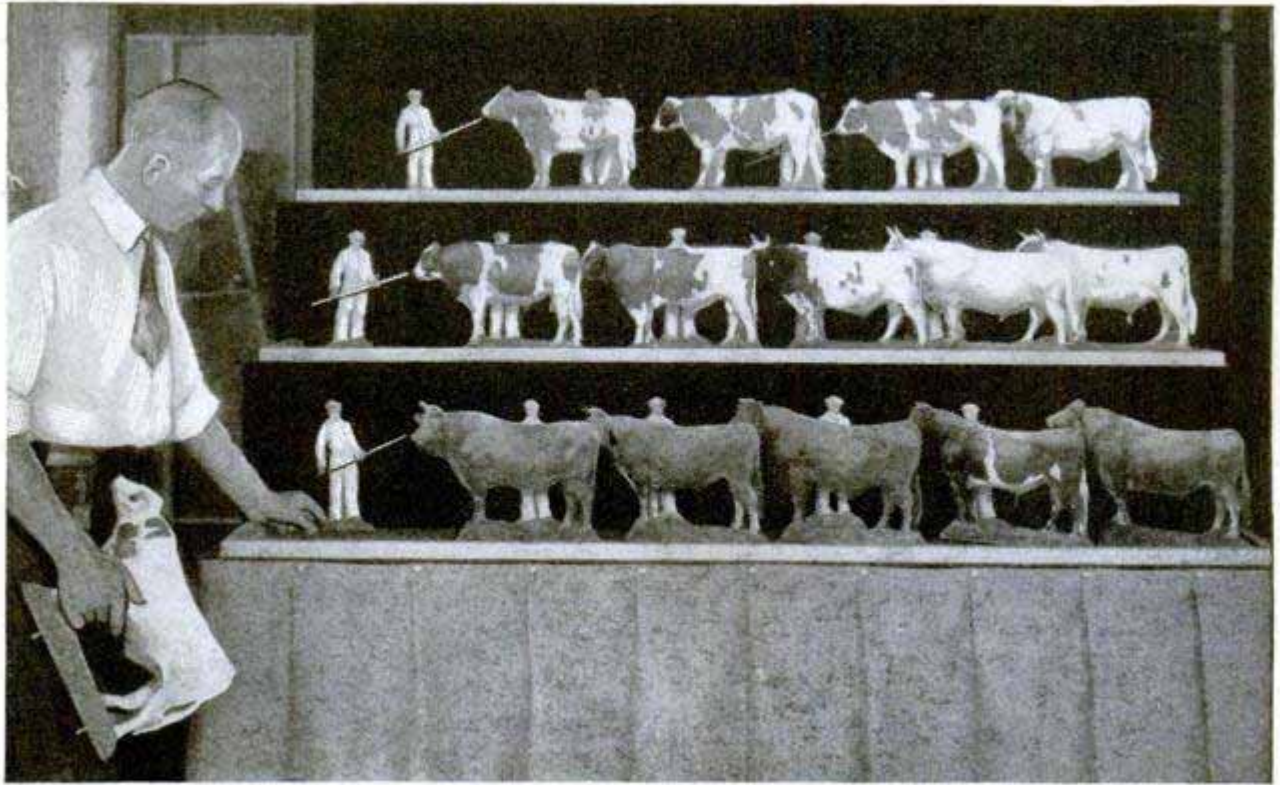

A Group of Model Cows Used by the Dairy Department to Illustrate to Farmers the Features of Good Cattle in the Best Sizes for Both Milk and Beef Production

and talks by use of a special machine which projects words sidewise from his mouth. He is shown dipping a chicken in a chemical solution to kill lice and mites. The surface of the imitation chemical is made of colored convex pyraline. The chicken's head protrudes through a hole

in this imitation glass. There is a "balloon" of finely woven cloth back of the manikin's mouth on which the words he speaks as he describes the dipping process are projected.

The multimillionaire losses wrought by rats is visualized by the use of cross-sec-

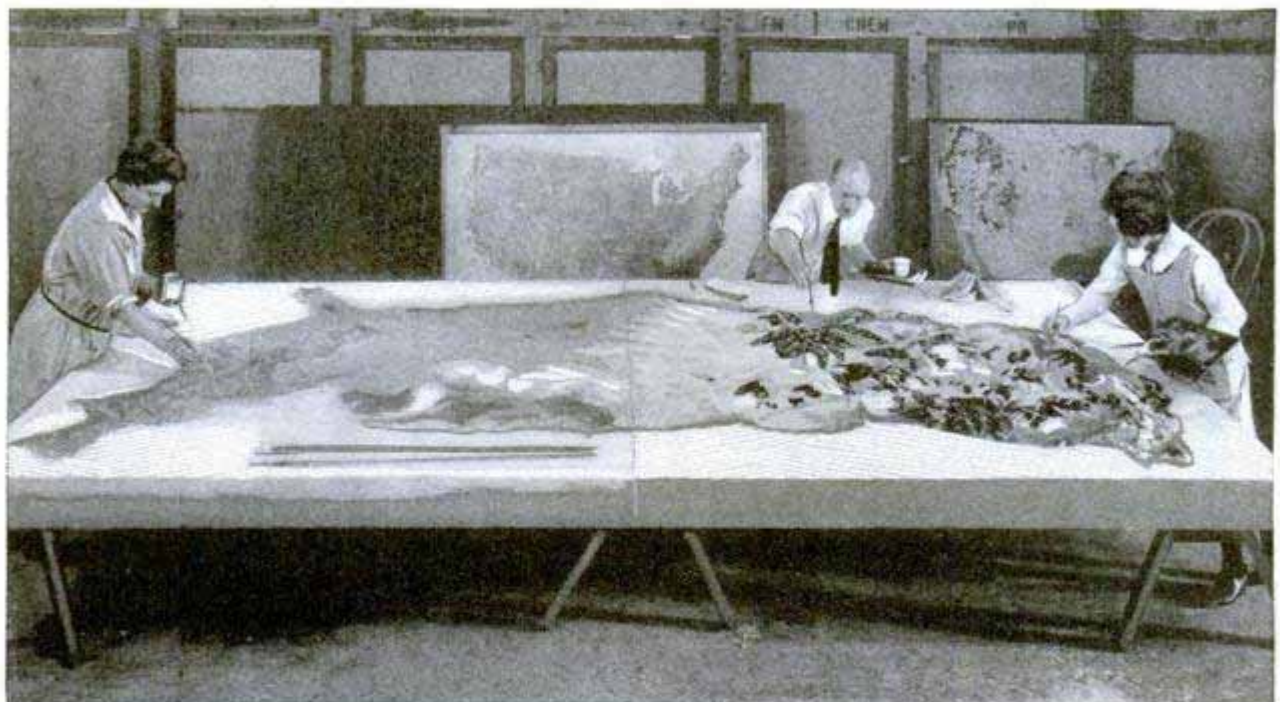

Making a Topographical or Relief Map of a Government Forest; These Huge Maps, Carefully Built to Scale, Show in Full Relief Every Feature of Immense Areas of Land

tion models of two Lilliputian houses, one rat-proofed and the other unprotected. Models of rats, mounted on endless belts and operated by motor, roam through the walls and under the floors of the exposed house and show exactly how they destroy foods, clothing and other articles.

By the use of different colored lights and a shadow machine, Uncle Sam has perfected a new system of simulating forest fires. This exhibit consists of an excellent oil painting of a virgin forest. Almost immediately, a red lurid light is centered on this picture while fans, operated at varying speeds, are employed to produce remarkable shadows. To the spectator, it appears as if the forest were burning to the ground. This exhibit serves to impress the public in general, and motor tourists, hunters and fishermen in particular, with the importance of camp-fire control in the national forests so that the stupendous annual fire losses may be reduced.

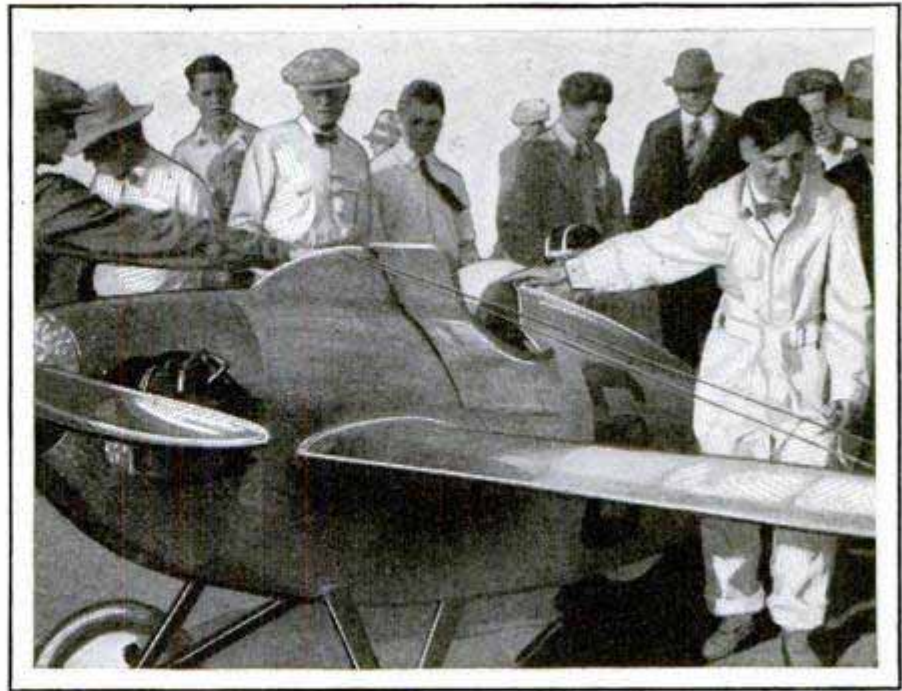

Getting 149 Miles an Hour Out of a Two-Cylinder Engine Was the Feat Which Won the Light-Plane Race for This Craft

"BABY BULLET" BREAKS SPEED MARKS IN AIR RACES

The smallest plane entered in the recent light-airplane races at Los Angeles took the prize, gaining eight miles on its nearest rival in a fifty-mile race on a closed course. The speed of the winner, "Baby Bullet," averaged 149 miles an hour. The tiny plane was designed and built in the E. J. Heath factory at Chicago and flown in the race by Mr. Heath. Only thirteen feet long, with a wing spread of eighteen feet, the little plane weighs but 250 pounds empty. It is powered with a two-cylinder motor, and the speed it made breaks all records for such a small power plant.

1927 Sedgwick
BIRDS VANISH FROM STRICKEN CITY IN GREECE *1442*

When an epidemic of dengue fever recently attacked Athens, Greece, all the birds of the capital city unaccountably disappeared. Previous to the appearance of the disease, which attacked more than 300,000 residents, the gardens of Athens had been filled with feathered songsters. Within a few days hardly one was left. Zoologists were puzzled to know whether the birds themselves had been attacked by the fever and flown away to die in seclusion, or whether their instinct had made them seek refuge elsewhere.

GREEN-DISK SHADE FITS BULB AND ENDS GLARE *1393*

A small green-glass disk, fitted with a wire holder that clamps over an electric-light bulb in any position, is being marketed to end the glare of unshaded lights in sick rooms, offices or shops. The disk, three and a half inches in diameter, kills the direct glare into the eyes or on the work, without cutting down the illumination in the rest of the room.



☐The United States air mail carried 1,654,165 pounds of mail in 1927, the companies receiving \$2,643,454 compensation.

George Johnson, 1243

mail 9/11/28
daily

1363
984

Detroit Mich



Shaking Table Which Gives an Automobile All Its Road Tests on One Platform, Taking the Place of Proving Grounds

SHAKING QUALITY INTO CARS ON TEST STAND

In this day of motor-car supremacy, manufacturers have gone to great lengths to obtain uniformly satisfactory service, long life and better performance in their product. The daily production of an automobile factory may range from 200 to perhaps 5,000 cars. Identical in design, style and mechanical details are these cars. One may go to China, the next to California's smooth roadways, a third to Africa's trackless jungles, and another to the frigid driving atmosphere of Russia. Considering these facts alone, it is small wonder that the engineering and testing divisions of the larger motor-car manufacturers resemble veritable laboratories with practically no limit to their extensive operations. For years, one of the older manufacturers has had access to the great Indianapolis speedway as a testing ground for his product. Some automobile makers have constructed special speed tracks and elaborate proving grounds and one devised and perfected a veritable tornado, whirlwind and "Rocky Road to Dublin," all in one. So strenuous is the hammering given a car on this device that the equivalent of a season's mileage and wear and tear is shaken into the machine within the space of a few hours. The huge frame was constructed of *cherry* steel and this was securely attached to a concrete base

in the ground. Four pairs of steel rollers, about two and one-half feet in diameter and eight inches wide, were mounted below the frame tracks so that their converging surfaces made a "V" in which rested the car's wheels. At irregular intervals on the roller surfaces were welded steel cleats of various sizes and shapes. The four rollers were geared to turn as a unit when operated by the car's motor and could thus be driven at any given speed simply by opening or closing the throttle. In operation, the cleats

transmitted shocks of varying intensity and at irregular intervals to the car itself. So terrific were these vibrations that employes could not endure staying in the driver's seat and stand the punishment. After starting the motor and shifting the car into gear, they were compelled to operate the throttle from the ground. The factory at once began to learn how to improve the car.

AUTOMATIC SIPHON STARTS AND STOPS ITSELF

An automatic siphon which starts without the necessity of sucking on the tube to exhaust the air is being manufactured by a California inventor. The lower end of the tube, which is immersed in the liquid, is corked, and the inlet is somewhat higher and in the side. When it is plunged into a liquid, the air in the lower end forces the liquid upward. As the siphon will only work until the level is lowered to the cut-out in the side, it can be used for such purposes as removing cream from milk.



Marvel Mfg Co

Mr. Chas. H. ...

*Co. H. Toll, 1097. H
American Air Line*

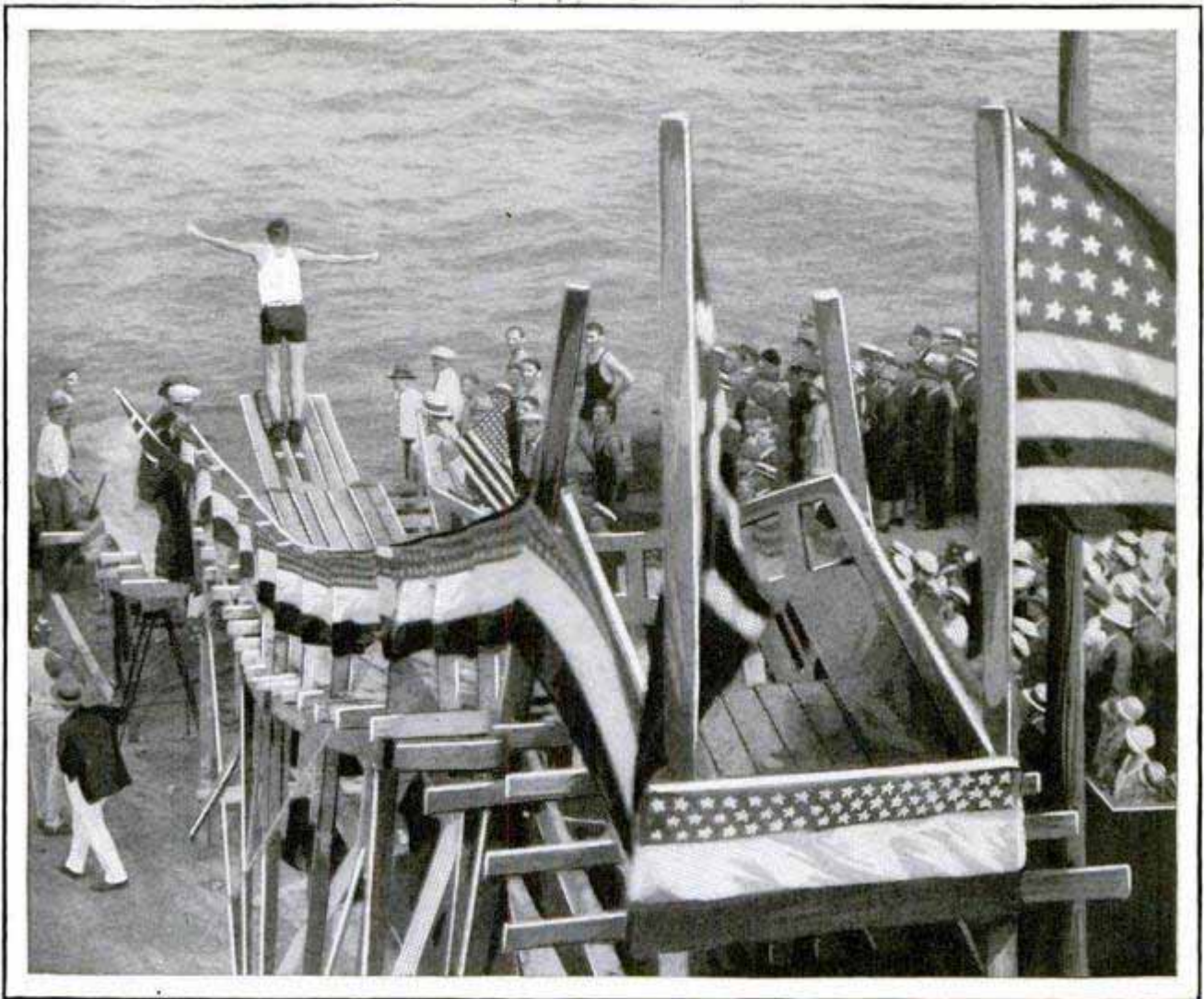

Ski Jumping as a Summer Sport Was Inaugurated When Norwegian Ski Experts Attired in Bathing Suits Sped down a Greased Slide at Chicago and Dipped into Lake Michigan

WATER SKIING MAKES NORSE SPORT YEAR-ROUND GAME

Skiing, formerly classed as a purely winter sport which required considerable snow or ice to be enjoyed, may become a year-round amusement as the result of the introduction of water skiing by the Norwegian national league in Chicago. A greased ski slide was built at the navy pier, and the skiers slid down it, wearing bathing suits, and plunged into the water.

FORT MADE FAMOUS BY KEY IS RESTORED BY ARMY 1364

Fort McHenry, facing Baltimore harbor, which was made famous when Francis Scott Key wrote the "Star Spangled Banner," after watching the British attempt to take the place in a night attack, has been fully restored by the army under a special appropriation by congress. Working from

the old plans found in the war-department files, the excavators and builders restored the fort as nearly as possible to its condition at the time of the War of 1812. They uncovered by accident the old guardhouse, with three small cells built into the massive brick walls leading to the sally port. The latter served as an entrance to the casemates, each an underground cave eight feet high and thirty feet long, primarily intended for the storage of powder and munitions, but used during the Civil war to confine prisoners taken at the battle of Gettysburg. The wooden gates of the sally port are of oak, four inches thick, and studded with massive iron bolts. In the old messroom, a fireplace was uncovered, in which hung a finely wrought iron crane, used more than a century ago to swing kettles over the fire.

Good fuel and illuminating gas has been produced from low-grade lignite coal.

*Chas. N. C. McLeod
 2720 Maryland Ave*

293

*Union League Club
San Francisco, Calif*

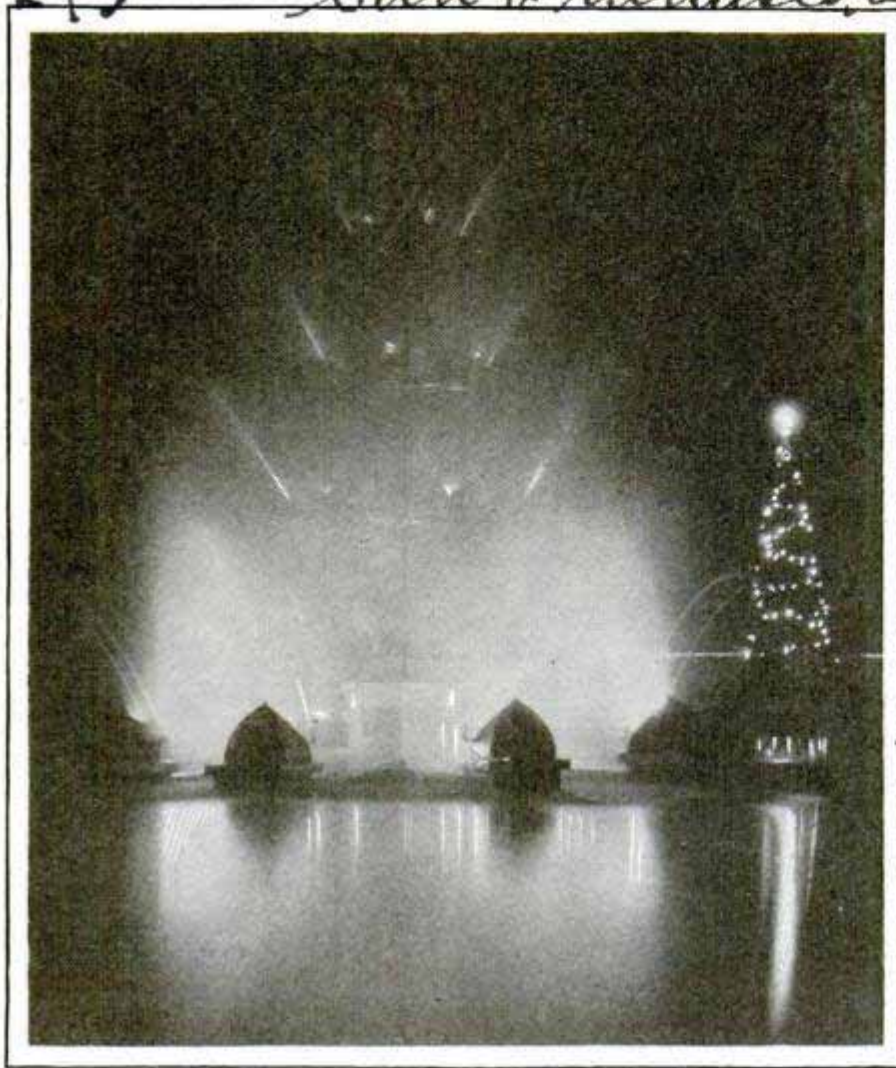

"Christmas Tree" of Water; Floodlights Illuminate the "Branches" of This California Fountain

FOUNTAIN AS CHRISTMAS TREE RIVALS EVERGREEN

Rocking Park
Lighted by flood lamps, a tree-shaped fountain was a feature of the Christmas display at Fresno, Calif. The jets were arranged to fall in such a way that they resembled the drooping branches of a fir tree, while the lights produced an effect of solidity when directed upon the water.

SIX-MILE-A-MINUTE PLANE BUILT IN ENGLAND

1386
In an effort to capture the world's air-speed record, now held by Italy at 318 miles an hour, England has produced a new secret airplane, expected to do six miles a minute, or 360 miles an hour. The machine has been constructed under close guard, and in preliminary tests has only been flown at dawn, when few people would be up to see it. It is described as smaller and more perfectly streamlined

than the plane which won the Schneider cup from Italy last year. Flight Lieut. D'Arcy Greig, assigned to fly the craft, was placed in training for several weeks to prepare him for the task. Some idea of what 360 miles an hour means is gained from the fact that a ship at that speed could fly from London to Paris in thirty-eight minutes, or would bring Chicago to within less than three hours from New York.

GARMENTS MADE OF CORK

405
Clothes made of sheets of cork are being tried in France, where a scientist has developed a method of treating the material to remove all the resinous matter, leaving the sheets of cork so soft and pliable they can be folded in the hand without damage. Light in weight, the cork suits are said to

be almost as warm as pure wool, to provide proper ventilation because they are porous yet shed rain, and be buoyant enough to support the wearer in water.

Cork Holder
MEAT CARVER HOLDS JOINT WHILE CHEF WORKS



A meat-carving attachment that holds the joint of beef while the cook slices it, was exhibited at the new inventions show in London recently. The device consists of a metal frame with sharp teeth on the

International
base, and a number of skewers to be stuck into the joint and hold it while the carving is done.

Espress 9/4/28

Supermarine 85. Sold by Lewis + Conger 6th Ave +

FLYING HOTEL BUILT TO CROSS THE ATLANTIC

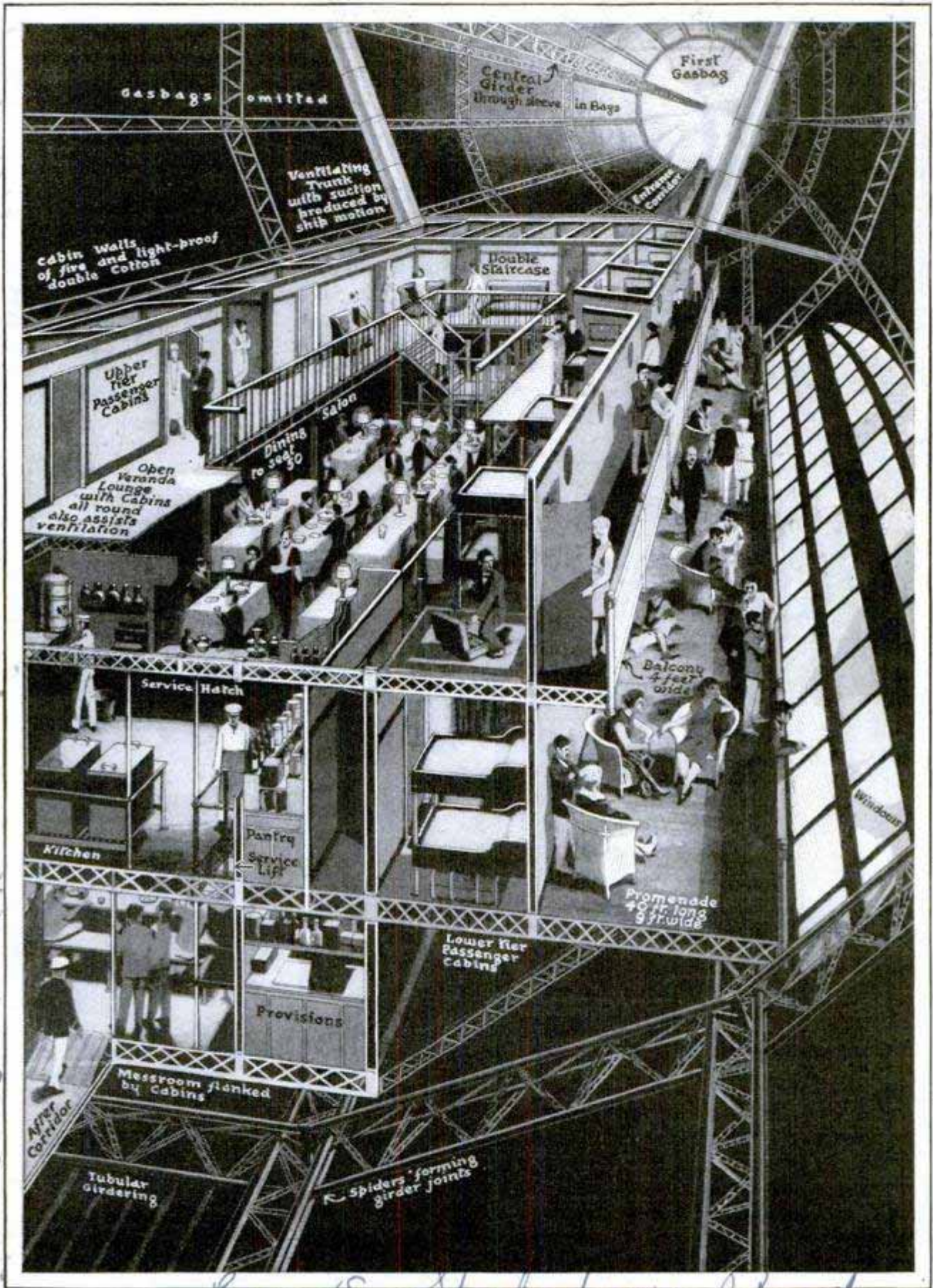

© S. W. Clatworthy, *Exp. 18, Shakespeare Road.*
 The New British Zeppelin "R-100," Built for Transatlantic Passenger Service, with Accommodations for Fifty Guests, Is About Ready for the Trial Trip; the Ship Is 709 Feet Long, 133 Feet in Diameter, and Has a Gas Capacity of 5,000,000 Cubic Feet

Herrn Hill, London. S.E. 24 Eng

220 Commercial to change Old

FLASHLIGHT WORN ON COAT LEAVES HANDS FREE

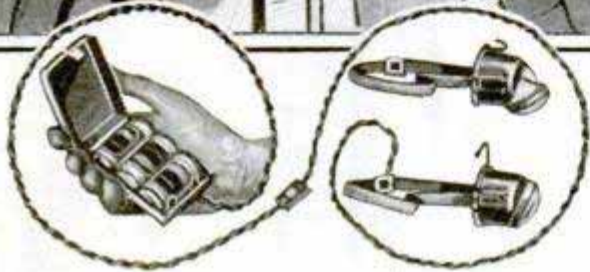

Flashlight with Extension Cord and Pocket Battery Case Leaves Hands Free to Do Their Work

Worn on the forehead, cap, coat, dress or in any other convenient place, an electric flashlight now on the market leaves both hands free and directs the rays where they are most needed. An adjustable bulb and reflector can be turned to any angle, and current is supplied from a compact battery case, carried in the pocket or attached to the belt. The lamp itself may be slipped into the pocket.

SOLID FUEL USED TO RUN DIESEL ENGINES 136 2

An internal-combustion engine working on a fuel composed of pulverized solids—an idea first suggested by Diesel—has been perfected by R. Pawlikowski, of Goerlitz, Germany. The engine will run on coal dust, lignite, or even sawdust or rice husks. The idea can be adapted to any existing heavy-oil engine by adding a special lock, which, during each suction stroke, is exhausted, then charged at low pressure with a pulverized-fuel emulsion and, after being closed, loaded with pressure, in or-

der finally to be discharged into the working cylinder. Whereas in the case of the original Diesel engine the fuel has to be heated and ignited within a fraction of a stroke, the new engine allows a full stroke for the same operation.

NEON LAMP SOLVES PROBLEMS OF HIGH-SPEED MACHINES

The neon lamp, familiar because of its widespread use in tubular electric signs and less well-known in television, is revolutionizing the study of machinery operating at high speeds. The neon globe is useful in television because it can be lit and extinguished, with no afterglow, in an interval measured in millionths of a second. The same property makes it useful in studying machinery, for a rotating object, illuminated by flashes of such brief duration and timed to occur exactly in step with its rotation, will appear to be standing still, or moving very slowly, if the rate is varied slightly. The phenomenon is often noticed in the movies when the wheels of an automobile appear to stop for an instant or even turn backward.

ELECTRIC VAPORIZER STOPS WHEN BOILED DRY 135-6

An electric vaporizer that automatically shuts off the current when it is boiled empty, has been placed on the market by a New York manufacturer. In use, the jar is filled with water, the medicine added, and the cord plugged into an electric-light outlet. Short and long nozzles, adjustable to any position, are provided. When the water boils out, it breaks the circuit.



Contracts are in operation or have been let for thirty-two air-mail lines, covering 14,502 miles and calling for 30,450 miles of flying daily.

Emb W. A. Bradenwity
Berlin - Friedenau
Germany
Leaslerstrasse 20.

Utility Corp
Central
Brown

776 Jamaica an

reference engineering

Cont. Page 988
Apr 80'9
537 Dearborn Chicago

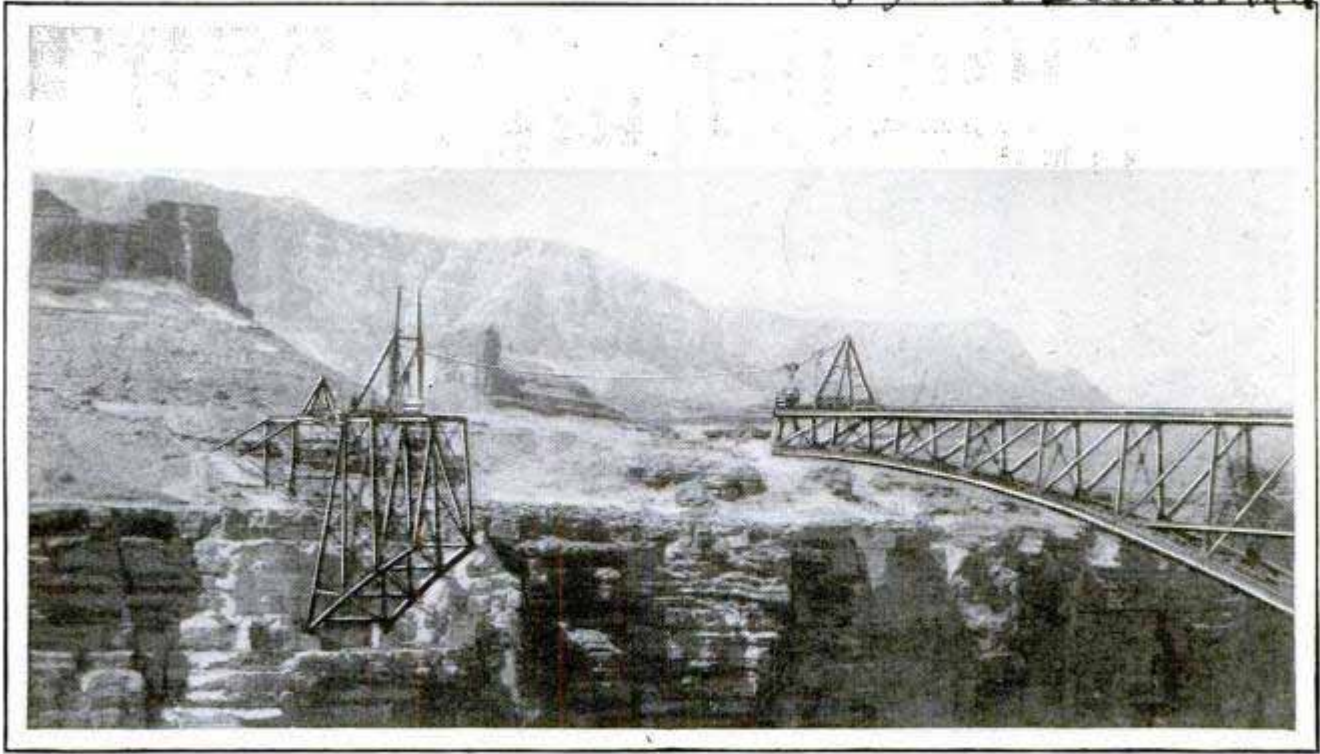

Erecting Steel Work for the New Bridge across the Grand Canyon; at Its Highest Point the Structure Is 467 Feet above the River, and the Span Has a Total Length of 835 Feet

BRIDGE ACROSS GRAND CANYON TO REPLACE FERRY

Opening to tourists a vast and little-known region, a great bridge is nearing completion over the northeasterly arm of the Grand Canyon, 130 miles north of Flagstaff, Ariz. From the precipitous walls of the chasm it appears to be a slender web of steel, stretched across the gulf, nearly 835 feet long, and, at its highest point, 467 feet above the river. It is said to be the highest highway bridge in the world and is scheduled for opening about January 1. The main span has an arch of 618 feet. The bridge will supplant the historic Lee's ferry, which has been in operation since 1872, six miles above the site of the bridge.

NEW HALF DOLLAR OF HAWAIIANS RARE PRIZE

If you have a 1928 Hawaiian half dollar, collectors advise you to keep it, for the coin is already worth \$2 as a collection specimen, and the value is expected to increase

greatly. Ten thousand of these half dollars were issued by the mint as part of the Captain Cook sesquicentennial, commemorating the discovery of the islands 150 years ago.

BAGGAGE CAR TO CARRY AUTOS HAS DOORS AT ENDS

Tourists can now conveniently take their automobiles with them on railroad journeys by means of special baggage cars with doors that open at the ends. This plan simplifies loading and unloading of the automobiles.

Southern Pacific R.R.

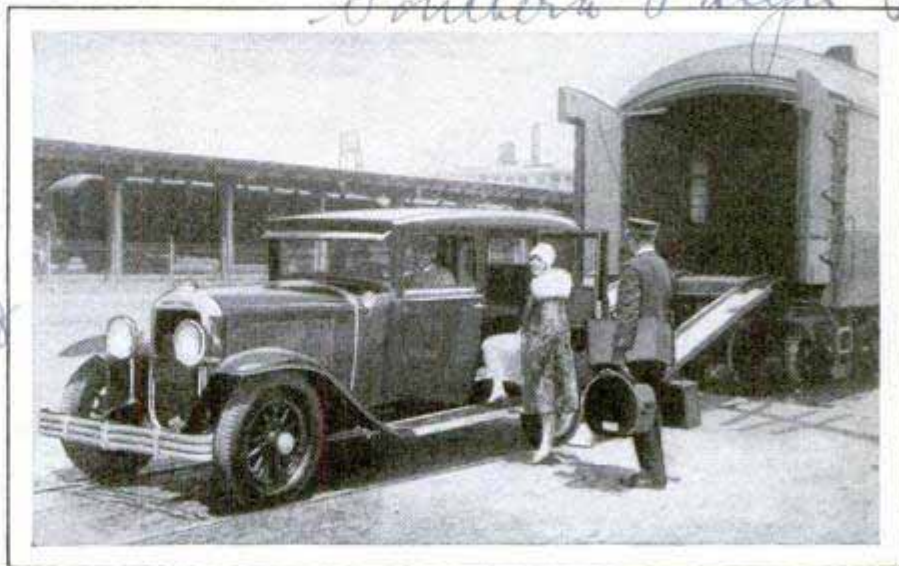

With New Baggage Cars Provided with End Doors, It Is Possible to Take the Automobile on a Railroad Journey

Cont. News Magazine
Puaa 206 Beach Walk

To Save Work

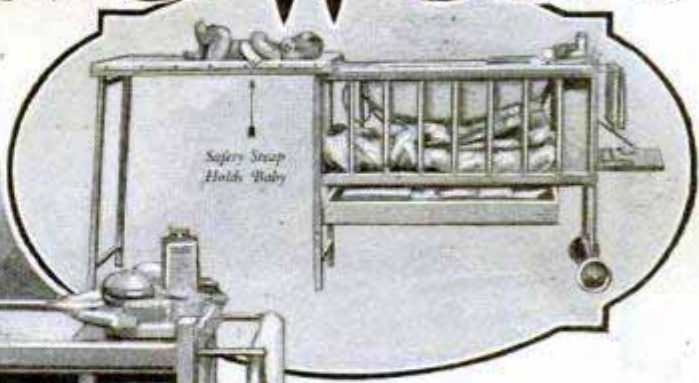
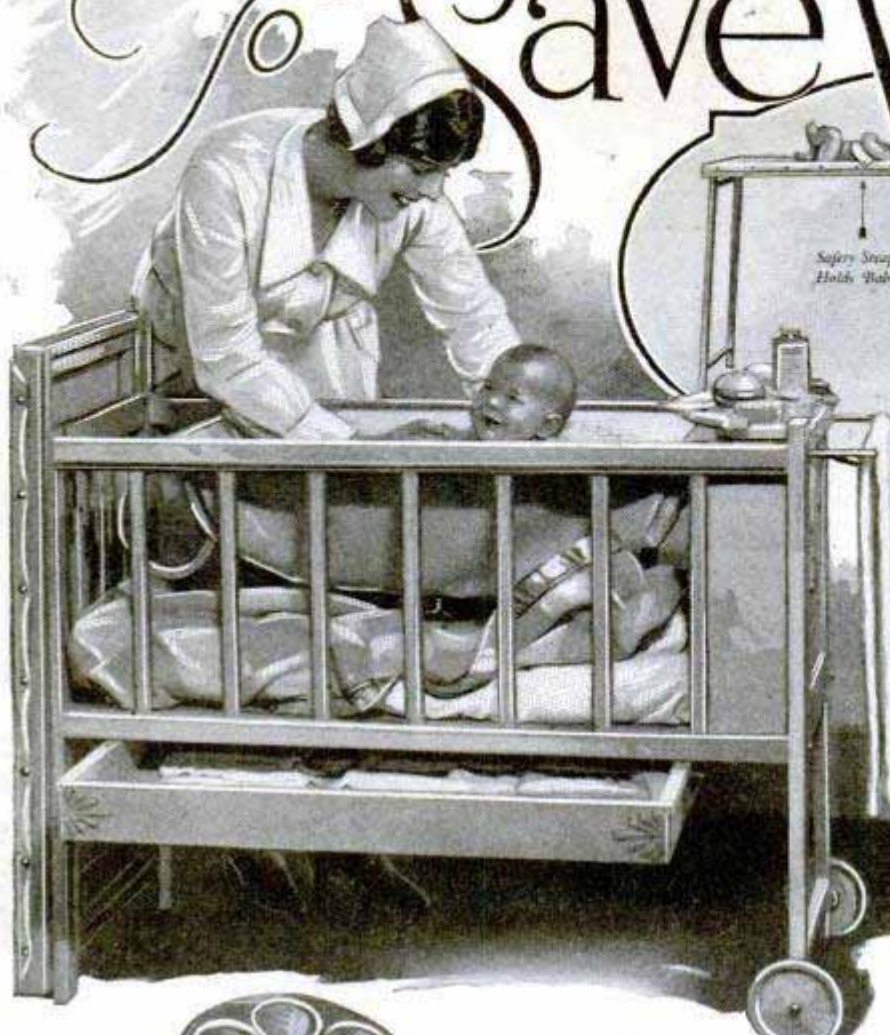

Nearly a Whole Nursery in One Unit, This Compact Outfit for the Baby Includes a Crib, Dressing Table, Clothes Drawer, Tub and Indoor Carriage with Rubber-Tired Wheels; It Saves the Mother or Nurse Many Steps



Cooker for Gas Stove That Saves Lighting the Oven; It Works over One Burner

One Holds Salt, the Other Pepper; This Combination Shaker Is Made of China in Gay Colors and Does Not Tip Over Easily

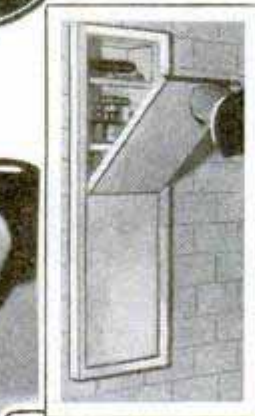
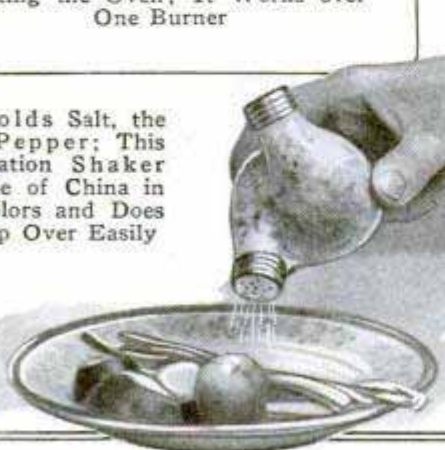

Home Shoe-Shining Cabinet Is Concealed in the Wall and Has a Handy Folding Foot Rest, Also Space for Storing Several Articles

in Your Home



Left, Checkerboard Cake and the Three Special Tins in Which It Is Prepared, Showing Color Arrangement; at Right, Wall Desk for the Telephone Also Has Room for Accommodating Writing Materials



Below Is a Set of Racks for Drying Small Articles; They May Be Folded Flush against the Wall When Not in Use



Lever Garment Hanger Fits in Door Frame without Use of Bolts or Screws; Ends Are Protected with Rubber to Prevent Marring Woodwork

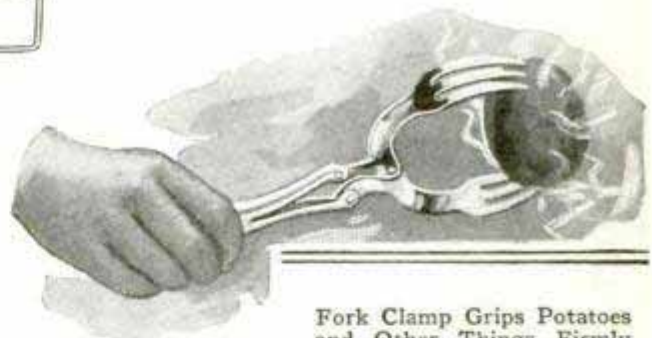

Fork Clamp Grips Potatoes and Other Things Firmly without Burning Fingers

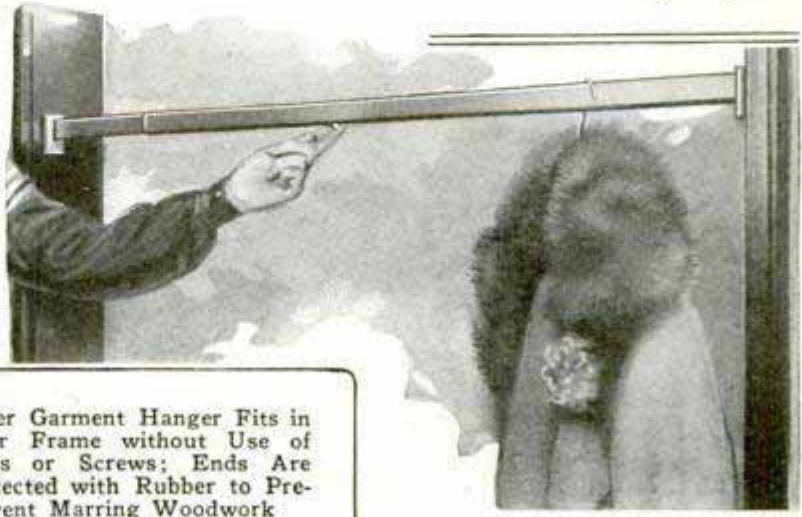

ments at the other end of the observation record the fact. Aerial photography also is being used with success to bring out outcroppings of rock and other surface indications of buried minerals.

GAS FROM GARBAGE TO HEAT HOUSES IN THE FUTURE

Gas manufactured from garbage and other household waste may be used to heat homes in the future, according to Dr. Gustavus J. Esselen, of Harvard. Fuel gas of about twice the heat content of ordinary artificial gas has been obtained from such wastes by fermentation of the cellulose they contain. Cellulose is the most abundant constituent of vegetable matter.

Cambridge, Mass

PORTABLE AIR CAMERA USES STANDARD-SIZE PLATES

A portable aerial camera for still pictures, using standard eight-by-ten-inch plates, has been developed by a Hollywood studio. The camera, which is of very light weight, has a twelve-inch lens and focal-plane shutter and carries a finder, which, with fixed focus, makes it possible to get high speed of operation.

*Paramount Motion Picture
5341 - Melrose Ave*

1358

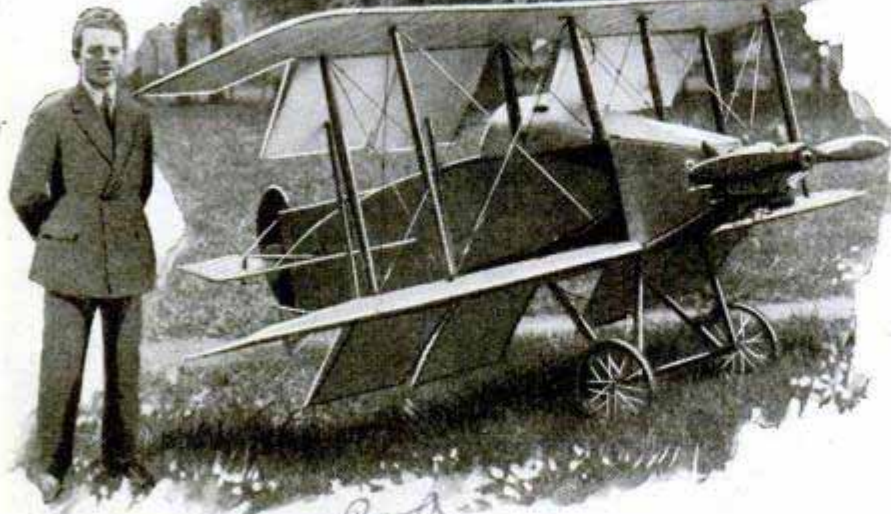

Belgian Inventor with His Plane, Which, It Is Claimed, Can Rise Almost Vertically: It Is Practically Tailless

MIDGET PLANE WITHOUT TAIL RISES VERTICALLY

A midget airplane, practically tailless, and with a new type of wing ailerons which, it is claimed, enable it to rise almost vertically, has been invented by a young Belgian. Instead of the usual ailerons used for banking the ship in a turn, the new airplane has a pair of large movable wing sections on either side. It is driven by a small two-cylinder engine.

ELECTRIC PROSPECTING HOLDS HOPE FOR NEW MINES

Electrical prospecting may speed up the location of hitherto undiscovered mineral deposits and help meet the increasing demands of industry, the American Institute of Mining and Metallurgical Engineers, in recent convention, was told. The electrical prospector depends on the same phenomenon that causes electric-light and traction and gas and water companies so much trouble in cities—the fact that a current passing through the ground seeks the easiest path. In the cities this path is often the gas and water mains, and electrolysis, which destroys their joints, results. In prospecting, however, the current introduced into the ground at one point will flow much more easily through an underlying mineral deposit than it will through the earth and measuring instru-



Inventor Demonstrating His New Aerial Camera, Which Is Portable and Uses Standard-Size Plates

Ernest Schenbaum

M. Rutters

1375

1376

Pod

90

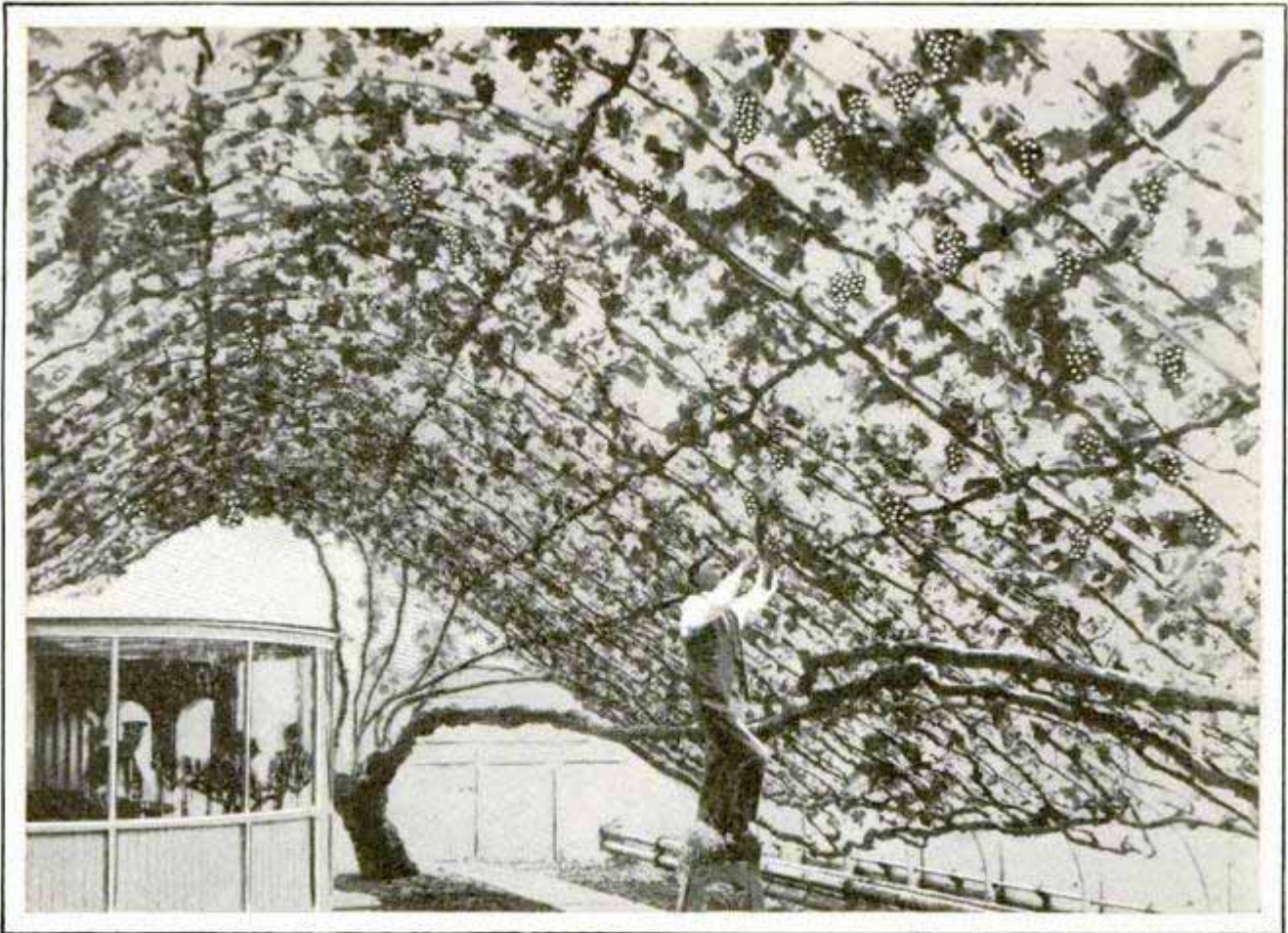

A Grape Vine, One Hundred and Sixty Years Old, at Hampton Court Palace, England, Is Still Producing, and Yielded Six Hundred Fine Clusters of Fruit This Year.

GRAPE VINE OVER CENTURY OLD PRODUCES MANY CLUSTERS

One of the most famous grape vines in the world is at Hampton Court palace in England, where it has been growing for 160 years. This season, 600 fine clusters ripened on the huge vine, which is given expert care from year to year and is supported by a large, specially constructed trellis that covers a wide area under glass.

REST HELPS RAZOR-BLADES REGAIN SHARP EDGE

Metals become fatigued as do other materials, and, for that reason, letting the safety-razor blade rest for a week or two will sometimes permit it to regain a fairly satisfactory edge even though it was so dull as to demand discarding. Keeping the blades in an anti-corrosive liquid, instead of wiping them off and putting them back in the razor or in a case, also prolongs their life, metal experts declare. Because of the rapidity with which the average man shaves with a safety and the

large number of hairs that are cut in that time, one engineer has estimated that a razor will maintain its most effective edge for only about fifty seconds.

ELECTRIC PAINT-SPRAY GUN IS EASY TO HANDLE

Ease of handling and the assurance of better results are advantages claimed for an improved electric spray gun for applying varnishes, paints, disinfectants and other liquids. It is operated on alternating or direct current from any convenient socket and has an air compressor that develops from twenty-five to thirty pounds' pressure, so that the liquid is said to be thoroughly atomized and will thus reach difficult places with a minimum of waste. Three widths of spray are obtained by changing nozzles. The gun weighs but five and one-half pounds and holds a full quart of liquid.



Kansas City Times 8/29/21

J. H. Anderson Kayseria

Presto Model 82 1345

1343

Prof. J. W. Kommers University of Michigan

metals specialties N.Y.C. 338 N

98

Easy Tricks *with* Fruit

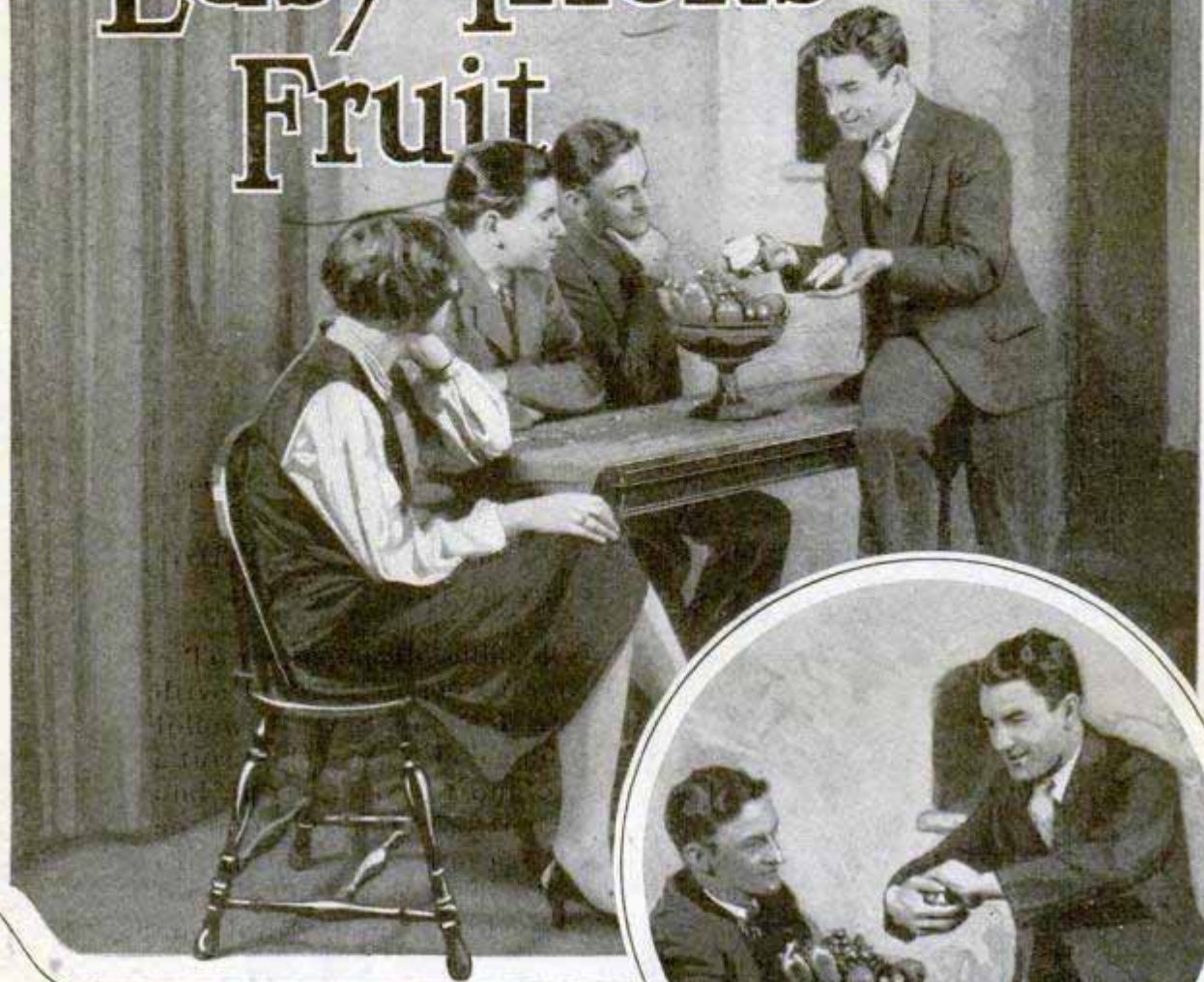

By SAM BROWN

St. Marion Ohio *151 Carhart*

ONCE upon a time there was a man. He never cut an apple in two. Instead, he tore it neatly in halves with his bare hands. He told me his secret. It was beautifully simple. He merely broke the skin of the apple by running his thumb nail in a circle around the outside. After that, it was a simple matter to twist the apple in two. And so I turned strong man. I tore apples in two. Of course, my audience was never allowed to see me casually running my thumb nail around the apple before the show proper commenced.

Listen to this one. A spectator is requested to tear off a number of grapes from a bunch and to arrange these single grapes in two rows, with the top row (farthest from the spectator) containing one more grape than the lower one. With-

Simple Way to Prove You Are a Strong Man by Tearing an Apple in Half with Your Hands

out looking at the grapes, the performer commands the spectator as follows:

"Take two grapes out of the bottom row.

"Take as many grapes out of the top row as are left in the bottom row.

"Clean out the bottom row.

"Make a mental note of how many grapes are left and then sweep all the grapes into one pile."

And then comes the grand denouement. The performer takes a banana from the fruit bowl, and on peeling it he discovers that it has been magically divided into three pieces—the exact number of grapes

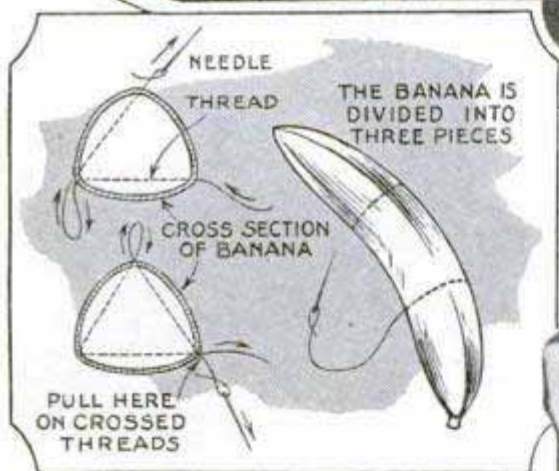

The Great Banana-and-Grape Mystery, in Which the Divided Banana Solves the Mathematical Problem of the Grapes



that had been left on the table!

How was it done? Take a good look at the picture. Do you see how the performer can, with needle and thread, previously cut the banana into three parts without removing the skin? Does that explain the banana part? And now you're asking, "but how do you know there will be three grapes left?" Well, that's easier yet. Go back a few paragraphs and look at the first command the performer gives: "Take two grapes out of the bottom row." That "take two" means that the answer will always be three. If you say "take three," the answer will be four; "take one," the answer will be two—always the answer is just one more than the number

of grapes removed at the start of the trick.

This one has to do with the balancing of a banana on the crown of a soft hat. The performer does it with a long needle which he has concealed in the lining of the hat. This needle is pushed up through the felt, into the banana, and there you are!

Did you ever see a banana peel itself. No? Listen!

Take a large, fully ripened banana and turn back about one inch of the skin. Light a bunch of oil-soaked paper or

waste and drop it into a milk bottle. Quick, then, the partially peeled banana. Set it in place as shown in the picture. That's all. Vacuum will then draw the banana completely into the bottle, minus its skin.

Briefly, the next one goes like this: The performer asks a spectator for an orange. From this unprepared orange, the magician removes two or three yards of brightly colored baby ribbon.

The whole trick hinges on the little apparatus shown in the illustration. This is a needle, just long enough to go completely through the orange, around the eye of which has been threaded and wound the length of ribbon. The loose end of the ribbon

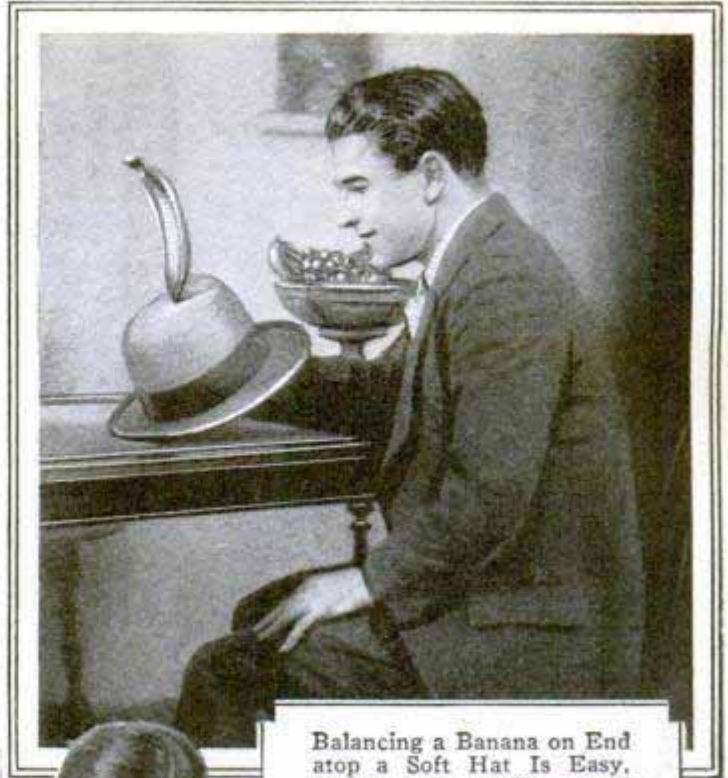

Balancing a Banana on End atop a Soft Hat Is Easy. If You Know How, and Making the Banana Then Peel Itself Is Just a Variation of the Hard-Boiled-Egg-in-a-Milk-Bottle Trick

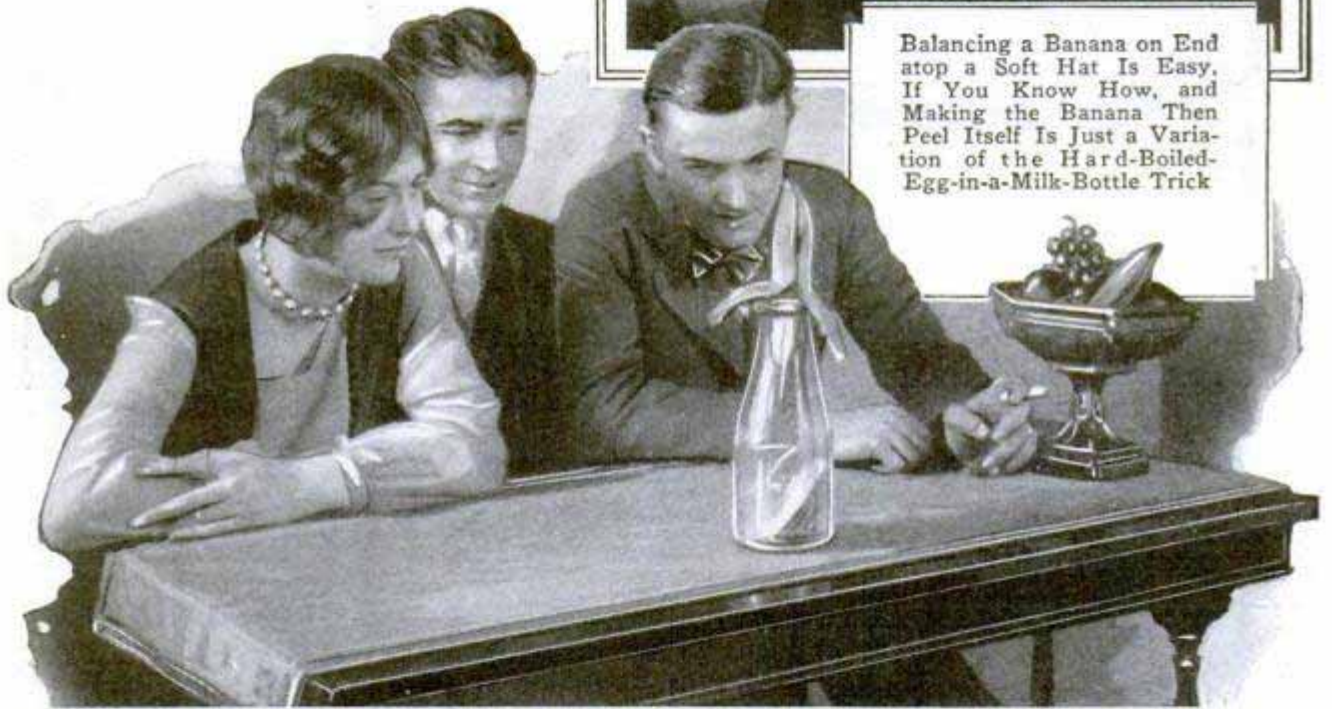

is fastened to the orange with a small pin.

It is an easy matter, when seated at a table, to secretly remove the ribbon-wound needle from your coat pocket. Hold it in your left hand. Remove the pin. After receiving the orange from a spectator, you immediately press the needle into it, as shown on the opposite page.

The next step is the removal of a small piece of peel so that you can get at the needle. Once located, the needle is pulled out, under cover of the left hand. After the needle is completely out and concealed in your right hand, you tilt the orange toward the audience and proceed with the

production. At the conclusion of the trick, it is a natural movement to wipe your hands on a handkerchief, and in that operation the needle is removed from your right hand and placed in your pocket.

Another mind-reading stunt: The performer asks a spectator to hold an orange in one hand and an apple in the other, and to think hard of one of them. To make the experiment less difficult, the performer asks the spectator to hold the hand containing the article he is thinking of close to his forehead. The performer turns away. After due "concentration," he asks the spectator to place both the orange and

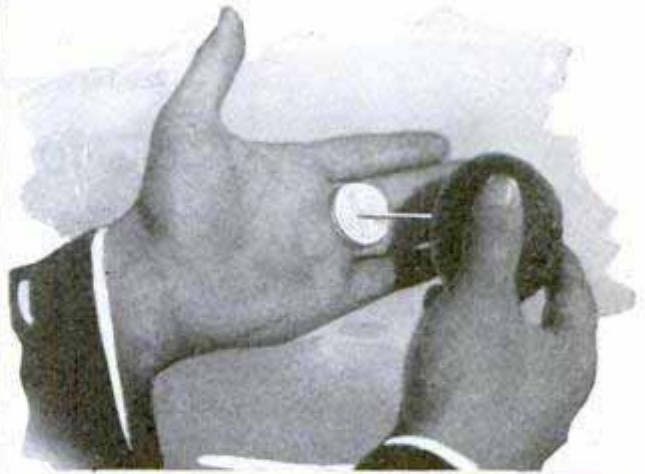
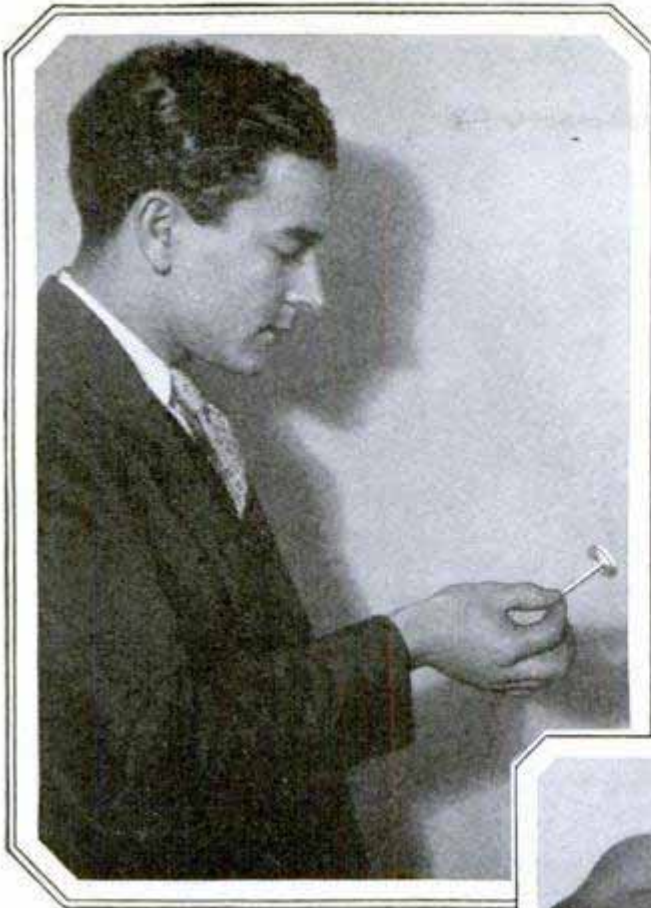

Around a Needle, Long Enough to Pass through an Orange, You Wind Several Yards of Narrow Ribbon as the First Preparation for This Trick; the Loose End of the Ribbon Is Held Down by a Pin until the Outfit Is Needed



This Is the Side the Audience Doesn't See; the Roll of Ribbon, Above, Is Concealed in the Palm beneath the Orange While You Pull the End through the Fruit

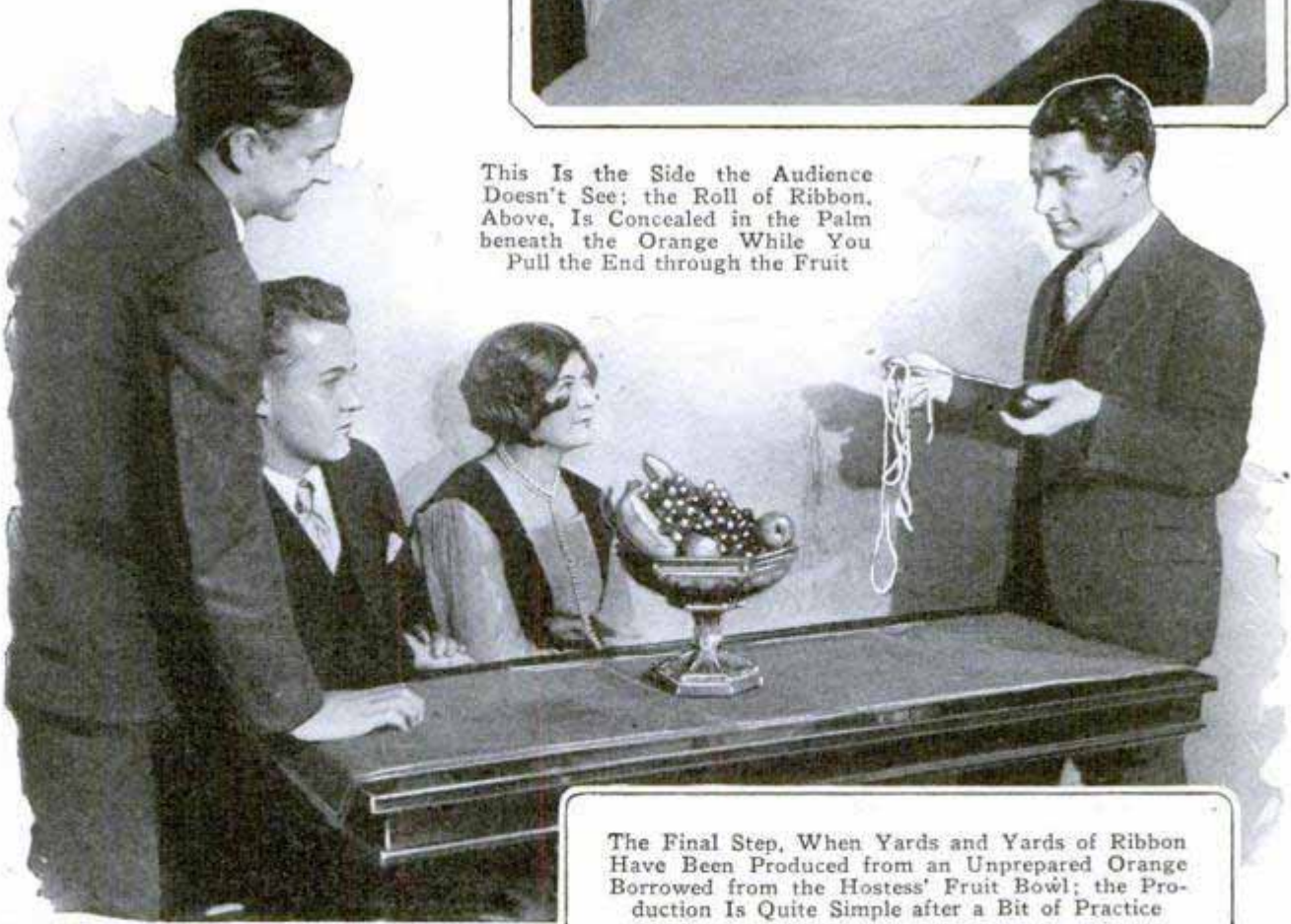

The Final Step, When Yards and Yards of Ribbon Have Been Produced from an Unprepared Orange Borrowed from the Hostess' Fruit Bowl; the Production Is Quite Simple after a Bit of Practice

apple on the table. The "mind reader" then takes the apple and orange, and by placing them to the spectator's forehead, he tells which one was selected.

The secret of this effect is absurdly simple. When the performer turns around, he glances quickly at the spectator's hands, and the whiter of the two he knows was the one which was held to the forehead. Notice the difference shown in the picture. You must secretly note which hand held the orange and which the apple before turning your back.

The beauty about all these fruit tricks is that nobody ever suspects an innocent-looking banana, orange or lemon of having been

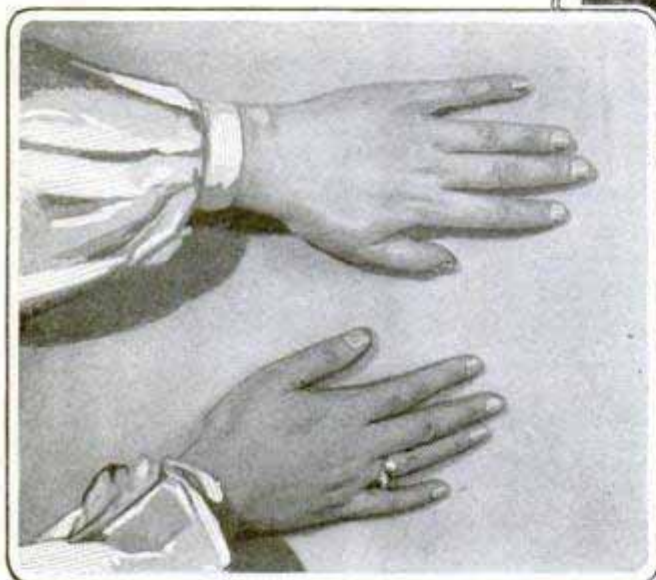

Notice the Difference in Color of the Hands? That Is the Solution of This Mind-Reading Stunt

prepared in advance. Its skin is guarantee for its purity, and who would expect to find a coin or a diamond ring or the important note concealed in a lemon? It can be done, though, as many a stage magician has proved. Such tricks as that, however, require elaborate preparation and special "gimmicks." A gimmick, you may remember, is any kind of device that helps the performer fool the eye.

Most of the tricks here described, however, require neither gimmicks nor preparation, and, best of all, you don't even have to furnish your own fruit. An apple borrowed from the hostess' fruit basket

always looks more innocent than one you brought with you—and borrowing the tools for entertainment cuts down the high overhead of being a parlor entertainer. It's even possible surreptitiously to extract a banana when no one is looking, operate on it with the needle to divide the contents in three parts, and then restore the fruit to the dish in such an artlessly artful way that when you ask some one to hand you one banana, he can't help but pick the prepared fruit. It's always best to let the audience render little helps like that, and do the picking, when you feel quite sure they can't avoid picking the right thing.

This concluding number is only a catch, but it has entertaining value nevertheless.

Tear a small hole in a sheet of paper, and then ask a spectator if he can push an orange through it. After everyone has given up, you perform the trick.

Just stick your pencil through the hole and begin pushing the orange. You can push it all around the table.

"But," says some one, "I thought you said push the orange through the hole?"

Exactly—and isn't that just what the pencil does?

Monday Mail 8/29/25

"SNIFFER" IN GAS-MASK PLANT HAS UNUSUAL POSITION

The job of "sniffer" in a gas-mask factory takes rank as one of the most unusual positions created since the war. Each mask is tried on one of the testers to insure that the chemicals contained in the purifying canister work properly. In an English mask factory in London five testers are employed. The masks are mounted so that the canisters are inclosed in a gas-tight chamber and the face pieces on the outside. The five testers don them and the chamber is then filled with gas. If the masks work perfectly the testers breathe pure air. If they get a whiff of the gas, which produces tears, coughing and sneezing, the mask is discarded.

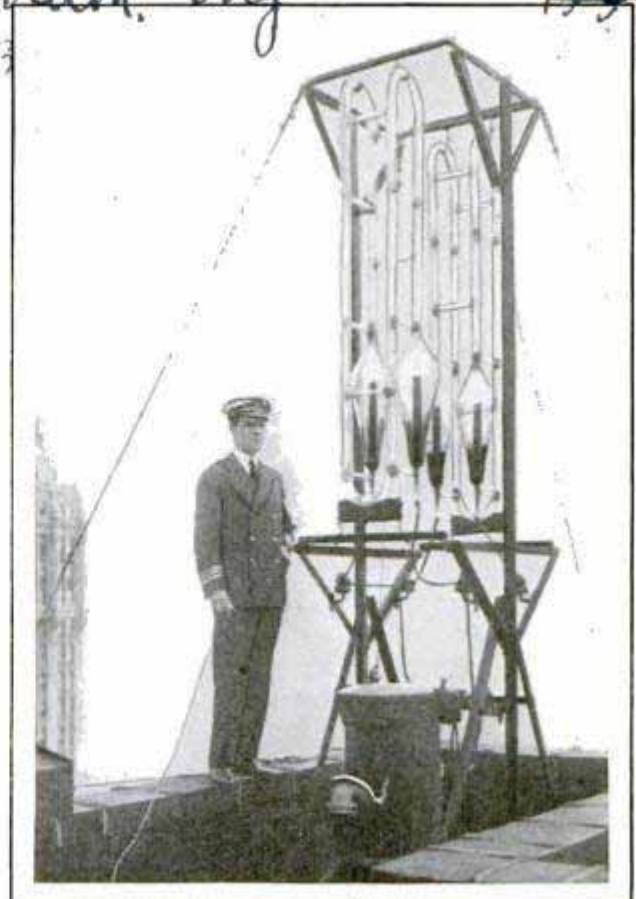

Comm. Richard E. Byrd Examining a Neon Aerial Beacon Atop a New York Hotel

COMBINATION DESK AND PIANO SAVES APARTMENT SPACE

The combination of a piano and a secretary desk in one piece of furniture has been effected by a New York piano manufacturer as one solution of the small-apartment problem. When the keyboard is closed with the desk arm over it, there is nothing to indicate the presence of a musical instrument, unless one looks for the pedals. The instrument is available either as a straight piano or as a player, and a radio set can be built in if desired.

Model 366



For the Small Apartment This Combination of Secretary Desk and Piano Offers a Space-Saving Idea

AIR BEACON ON SKYSCRAPER VISIBLE MANY MILES

One of the last public acts performed by Commander Byrd before sailing for the Antarctic was to pull a switch that sent current through the huge lamps of an aerial beacon on top of a New York hotel. This powerful battery of tubes can be seen from a distance of seventy-five miles and, because of its orange-red glow, will penetrate a fog for twenty-five miles.

Baltimore

EIGHT MORE LEPERS FREED BY U. S. AS CURED

Eight more lepers have been freed from the national leper home at Carville, La., as completely cured, bringing the total number released in the seven years the institution has been in operation to thirty-seven. Only one of those freed has had a relapse and been returned. At present there are about 400 lepers under treatment with chaulmoogra oil at Carville. The majority were born in Louisiana, Florida and Tennessee. Quite a number of the others are foreign-born, China, Greece and Mexico leading.

366

Piano Crayers Guild!

Janssen Piano Co.
82 Brown Place

1350

Eng. Inman L. M. Pfeiffer
Creese, Pa.

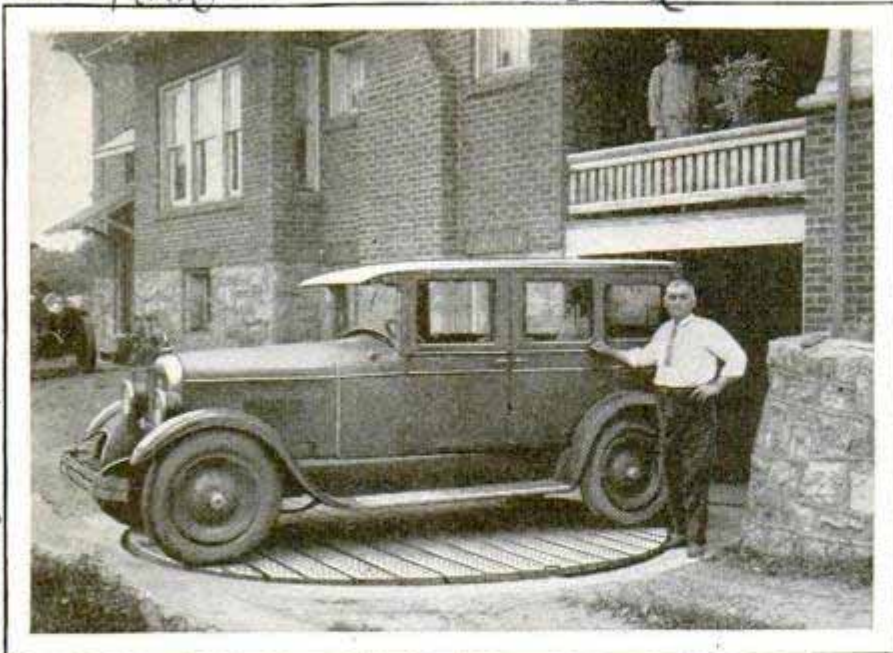

Turntable in Front of Garage Solves the Problem of Entering and Leaving by a Narrow Driveway

AUTO TURNTABLE FOR GARAGE SOLVES DRIVE PROBLEM

To overcome the difficulty of a narrow drive in front of his garage, an engineer followed a railroad plan and constructed a turntable so that he could run his car in and out with little trouble. The table is so smoothly adjusted that a child of six can turn it when the car is on the platform. The pit is twelve feet in diameter and fourteen inches deep, sidewalls and bottom being of reinforced concrete. The table runs on ball-bearing wheels.

VACUUM TUBES FOR ELEVATORS GIVE AUTOMATIC CONTROL

Three-element vacuum tubes, similar to those employed in radio sets, have been adapted to an automatic control for elevators to bring the cars to the correct floor level. The tube has been installed for some time on railroad locomotives to help transmit block signals into the engineer's cab in visible form, and its success as an elevator regulator lies in the fact that the plate current increases when the tube changes from an oscillating to a non-oscillating condition. A suitable number of the tubes are placed on each elevator car and are normally in oscillation. By an arrangement of coils and vanes, the motion of the car, as it approaches a floor level, is made to stop the oscillation of the

General Electric Co
Schenectady, N.Y.

tubes. This actuates relays which govern circuits that slow up the car and stop it at its correct position. The system operates whenever the car is running no matter in which direction.

Chicago - 432 S. Michigan

COAL IS TINTED BRIGHTLY TO TELL BRAND

1342

Spraying coal with a purple paint to distinguish its quality is the method adopted by an eastern company to "brand" its better grades.

A shade so light as to be almost pink is on the

markets and tests have shown that the paint rubs off only after repeated handling. Considerable research was necessary to obtain a coloring material that would be permanent and would not produce a mottled effect. According to the company, the paint does not affect the burning qualities of the coal.

Philadelphia - Reading

COVER SURF PLANE WITH METAL TO KEEP OUT WATER

1349

Speed of eighty-five miles an hour is claimed for a metal-covered surf plane an eastern inventor has constructed. It is made of oak, sheathed in metal to keep the water from penetrating the frame, and is run by a 220-horsepower motor. The plane weighs but 1,350 pounds.

Le Island

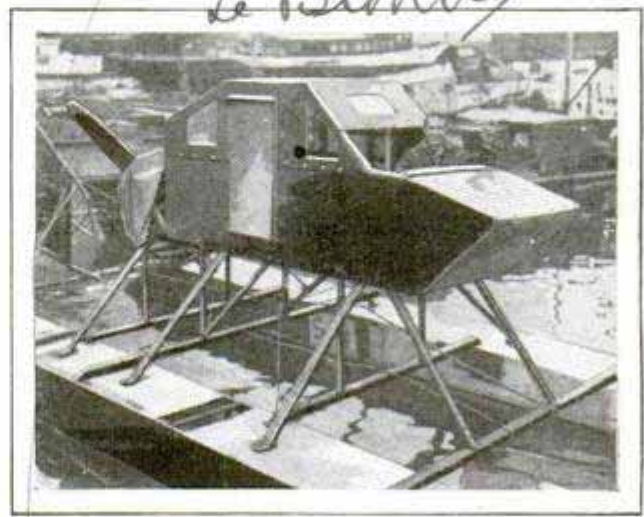

Speed Boat Built like Wingless Seaplane, for Which Eighty-Five Mile Speed Is Claimed

San Mesiana
New York

Los Angeles 1001
Calif

TWO-DECK FLYING YACHT TO CARRY THIRTY-FIVE

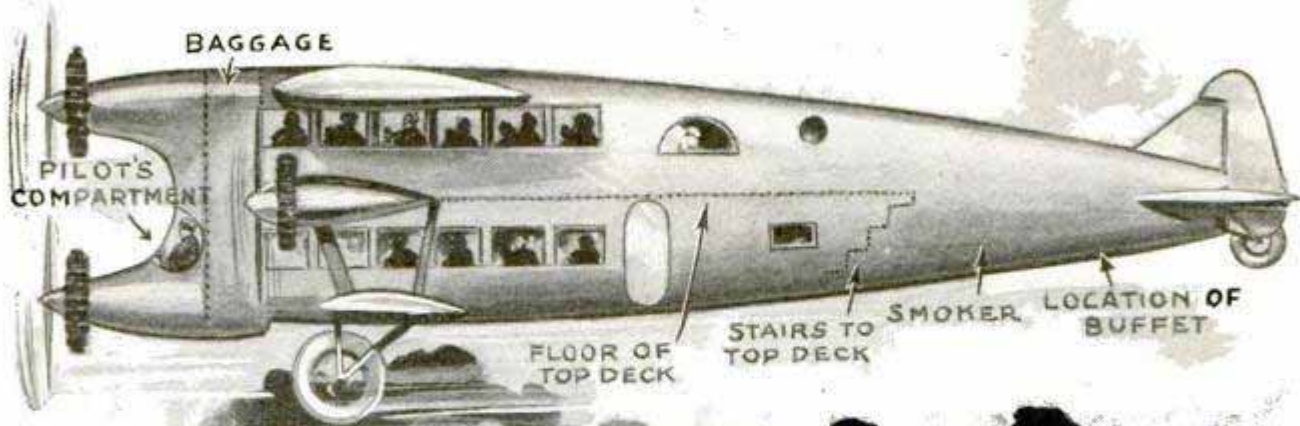

Double-Decked Airplane with Four Motors, Planned for a Western Air Line; It Will Have Accommodations for Thirty-Five Passengers

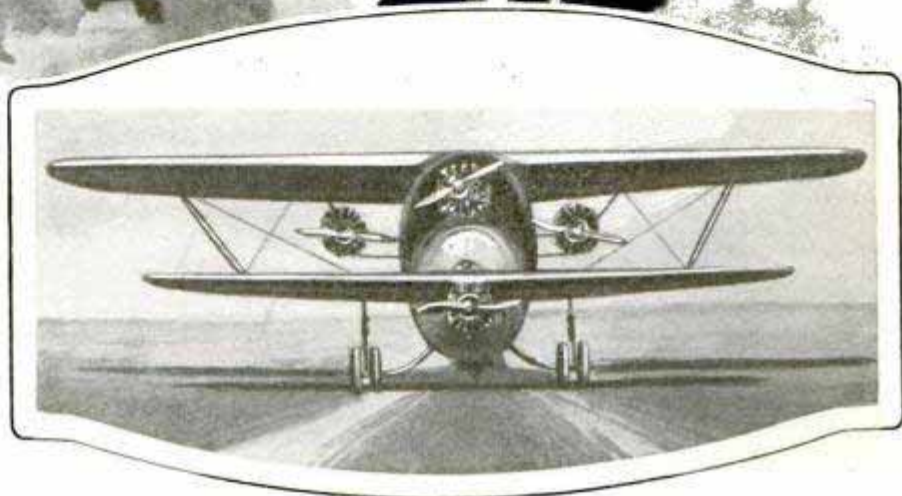

Two decks or passenger compartments, one above the other, compose the chief feature of a "liner of the skies" planned for a western aviation company. The flying yacht will carry thirty-five passengers; will have four motors with a combined horsepower of 1,620; the cruising radius will be 800 miles, and a speed of 120 to 152 miles an hour is anticipated. Smoking room, buffet, large baggage space and other comforts will be provided. Passengers will go from one deck to another by a short flight of stairs. There will be four wheels on the front landing gear. The ship is to have two wings, the upper with an eighty-five-foot spread and the lower, sixty-five feet. The gross weight of the ship will be eight tons.

dates 1778-1928 in black print just below. Some 2,000,000 of the stamps have been issued but they already are becoming scarce, and collectors in Hawaii were offering four cents for each canceled two-cent and eight cents for each five-cent stamp of the surcharged issue when this edition of Popular Mechanics Magazine went to press. An sale at ls P.C.

HAWAIIAN TWO-CENT STAMP IS PRIZED BY COLLECTORS

Collectors are cherishing the canceled surcharged Hawaiian two-cent stamps issued in connection with the celebration of the 150th anniversary of the discovery of the islands by Capt. James Cook. The stamp is a United States two-cent impression bearing the word "Hawaii" and the

GOLF SCORER WORN ON WRIST ALSO HOLDS MONEY

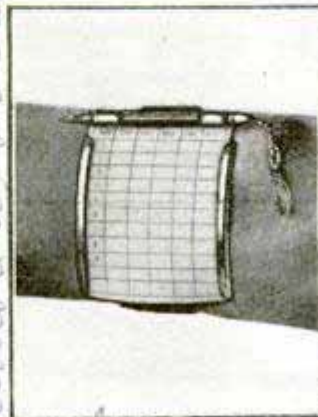

Designed especially for the convenience of women players, a silver holder, worn on the wrist, contains a golf-scoring card, a place for the pencil and, at the back, space for paper money. The device is chromium-plated.

1329
Chicago 298 Madison
1313
Cont. Keoni Elee ne
Puna 006 Beach Walk
theodore W. Master
1415

United Radio Corp
Rochester, N.Y.
1583 R

Magara Stamping Co,
237 90th St
Rochester, N.Y.

Radio Set

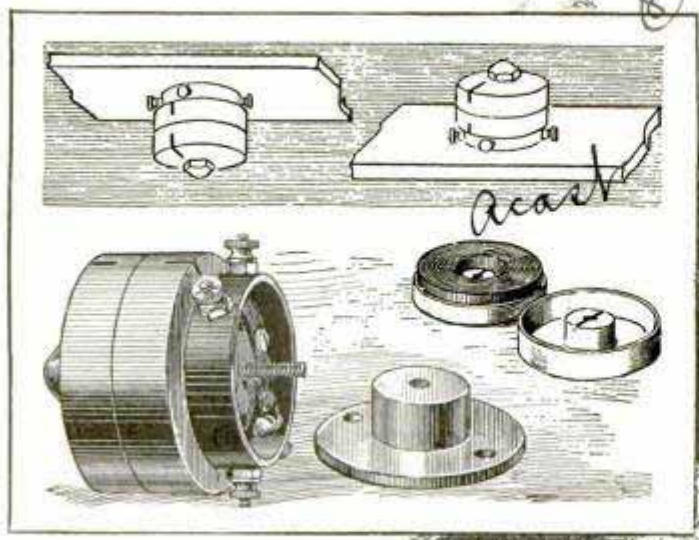

This Audio Transformer Is a New Design Using a Solid Core Instead of Laminations; the Core Is Cast from Special Metal in Two Pieces, Which Are Held by a Single Screw to Form a Cup for the Transformer Coil; Two Methods of Mounting Are Shown Above

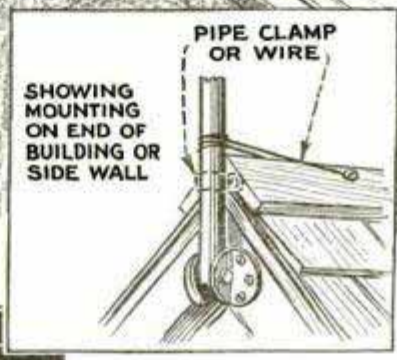
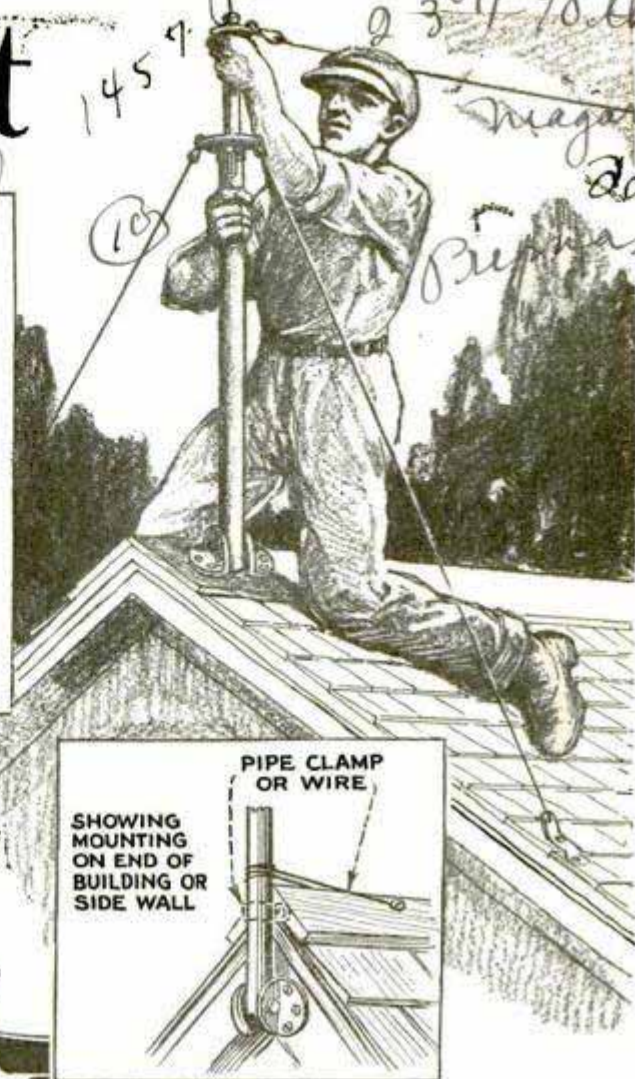

Collapsible Aerial Masts That Will Fit Any Roof Simplify Installation; These Masts Are Built of Tubular Steel and Are Available in Both Two and Three-Section Units That Telescope to 4-Ft. Lengths; a Simple Locking Device Clamps the Extension at Any Desired Height, and the Adjustable Base Is Easily Fastened Either to Flat or Sloping Roofs, or at the End of the Building as Shown

Subvational Radio Corp
145 Pacific
1391-a
9

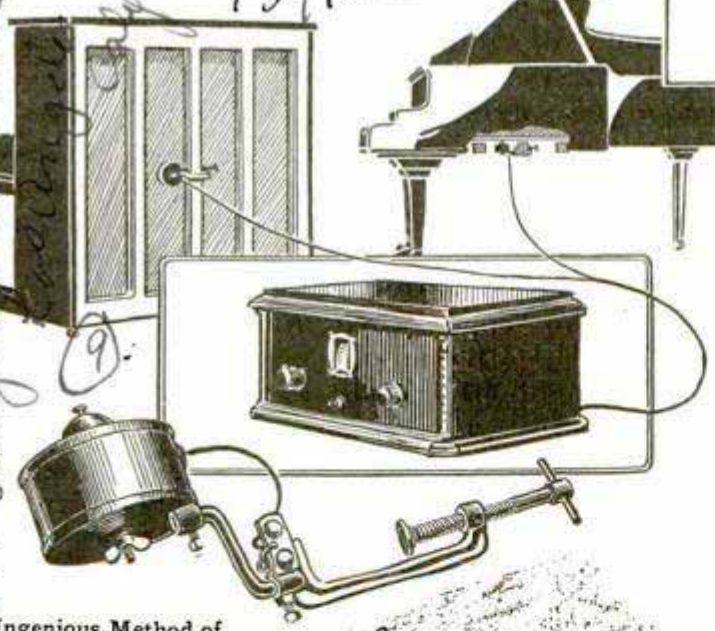

An Ingenious Method of Using the Well-Known Tone Quality of the Piano Sounding Board as a Radio Loud Speaker Is Shown Here; the Special Microphone, with Mounting Bracket, Is Supplied, and Piano Owners Need Look No Farther for a Good Loud Speaker; the Thrust Rod of the Unit Is Clamped So That It Touches the Sounding Board

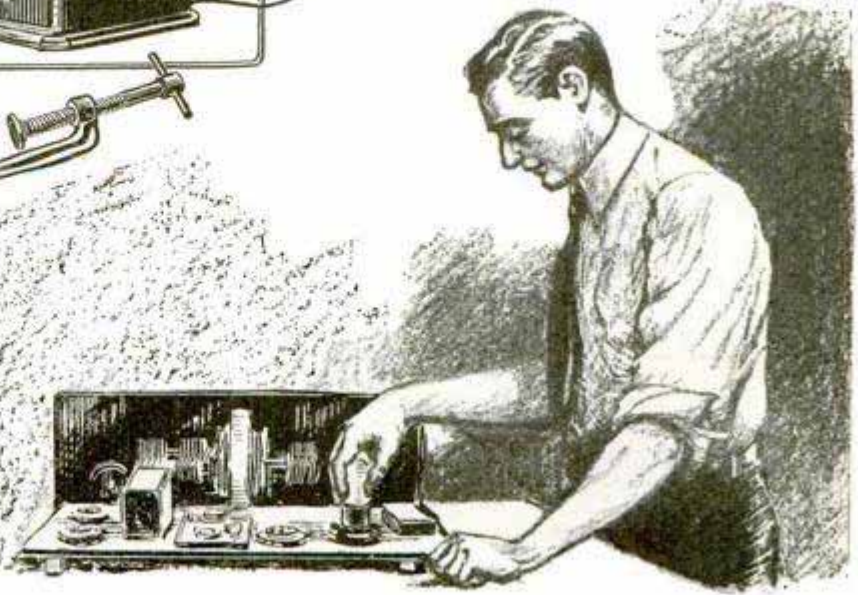



By Frank L. Brittin

simple tuning unit to be plugged into the detector, or sometimes the first r.f. socket of the set. A suitable adapter unit was described in the March, 1928, issue and may be used in combination with your present set or directly connected to the amplifier shown in the diagram on page 1006.

ALTHOUGH far from perfect, television signals and apparatus are in a sufficiently advanced state to provide an interesting field for the experimenter. Anyone having a radio receiver can easily add the necessary equipment for the new purpose. Experimental broadcasts are increasing in number and, by the time this article appears, they will probably be available in most parts of the country. DX-reception has not been very satisfactory up to the present time, although visual programs broadcast from Washington, D. C., have been received fairly well in Chicago. It is quite likely that most of these programs will be broadcast on short waves. Any radio receiver may be adapted for short-wave reception by means of a

The receiver must be selective enough to receive a clear audible signal with little distortion and good volume. Pictures of a sort may be received with transformer-coupled a.f. amplification, but the wide band of frequencies necessary for good picture definition make resistance-coupled amplifiers especially suitable for this work.

Before attempting to build a television receiver, the elementary principles involved should be understood. Seeing by radio is only slightly more complicated than sound reception. When broadcasting voice, as the reader knows, the person stands before a sensitive microphone, similar to a telephone transmitter, in which the sound waves are converted into varying electrical impulses; these are then amplified and broadcast through the ether and received in the home.

For television transmission, the person stands before four or more photo-electric or light-sensitive cells capable of responding to varying intensities of light or shadow and faithfully converting them into electrical impulses of corresponding strength. A rapidly revolving metal disk, perforated with a series of holes arranged in spiral form and known as the "scanner," is located behind the light-sensitive cells. A powerful arc light is employed behind the disk, and light is focused on the subject through the revolving disk, with very little discomfort to

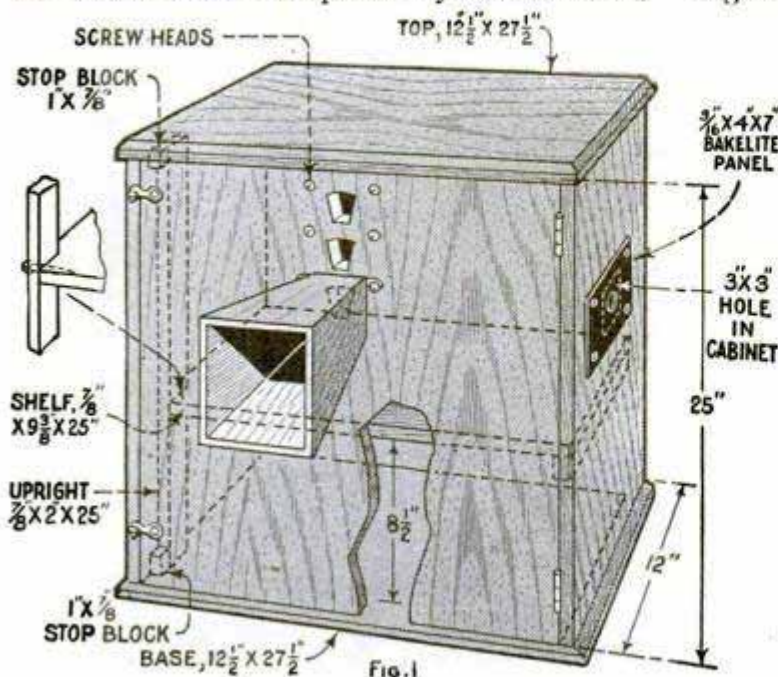

Television Receiver!



him. The pencils of light through the holes, play across the face of the subject, thus, in effect, dividing it into horizontal lines the number of which depends on the quality of the picture desired. The variation of light and shadow along these lines is received and converted by the light-sensitive cells, and the resulting electrical impulses are amplified and transmitted through the ether in exactly the same manner as for voice waves. The television signal has a very distinctive sound which may be tuned in at the receiving set and heard on the loud speaker or through the headphones.

When the signal has been tuned in to the loudest volume, a tube filled with neon gas is substituted for the phones or speaker. This tube has the property of responding instantly to the varying signal intensities and glows with a pinkish light, the brilliance of which depends on the strength of the signal. Immediately in front of this neon tube another scanning disk, identical with the one used at the broadcasting station and revolving at the same speed, permits the light from the tube to pass through the holes in the disk, where it reaches the eye of the observer. The revolving disk recreates the image, serving the eye, in a way, as the loud speaker serves the ear.

At present practically the same system is used at all stations broadcasting television, the only difference being in the number of holes in the revolving disk.

The aim of this article is to give the experimenter simple directions for assembling his own television receiver so that he may tune in on test programs. The cost for parts is about that for building a standard radio receiver and may be reduced by building up the amplifier stages instead of using the wired unit.

The metal disk used in the model is a

manufactured type employing three perforated spirals, a combination of 24, 36 and 48 holes. This permits the operator to tune in on any one of the three popular transmitting methods now in use. As the art develops, disks employing a larger number of perforations may come into use, and disks will be available to meet such

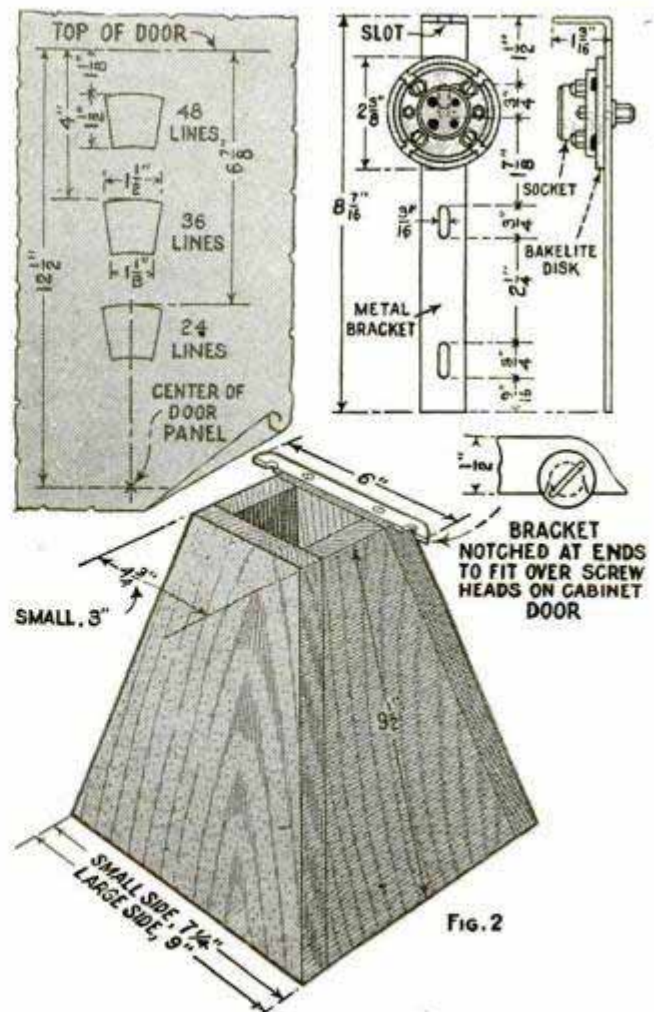

FIG. 2

the set is not in use. The output of the detector tube is fed directly into the amplifier. If there is no detector jack in the receiver, install one. Run a flexible insulated wire from the plate post on the detector-tube socket to the upper blade of the jack, then run a lead from the detector B-supply post in the set to the lower blade of the jack. Use a single open-circuit jack, and a standard horn plug for the input leads to the amplifier unit, as shown in Fig. 3.

In order to obtain greater illumination from the neon tube, two power tubes may be used in multiple as shown in the diagram. The power tubes may be MU-6 or any type desired. Battery-operated tubes of the MU-20, or similar, type are used for the first and second amplifier stages. Raw a.c. may be used on the filaments of the power tubes if desired, and this is advised for best results; but a.c. must not be employed for the first two stages.

When a resistance-coupled amplifier is employed, as in this case, it will be necessary to raise the detector B-voltage in the receiving set to an approximate value of 45 to 67½ volts.

In operation, as the disk approaches critical speed, flashes will be thrown across the window and finally strange figures will appear until the speed of the receiving disk matches or is synchronized with that of the disk at the transmitter. When synchronous speed is reached by adjusting the rheostat, the picture will make its appearance, and will remain as long as the disks are in step.

The push-button switch shunted across the rheostat is used only for the purpose of short-circuiting the resistance, thereby speeding up the motor momentarily in order to make it run at the same rate as the transmitter motor and keep in step with it, that is, to synchronize the two.

For testing purposes, the operator may employ a phonograph and magnetic pickup connected directly to the amplifier unit. The regular musical record will then throw a geometrical design on the revolving disk.

When receiving actual pictures, the operator may be puzzled to find his received picture upside down, but this may be easily corrected. It is only necessary to remove

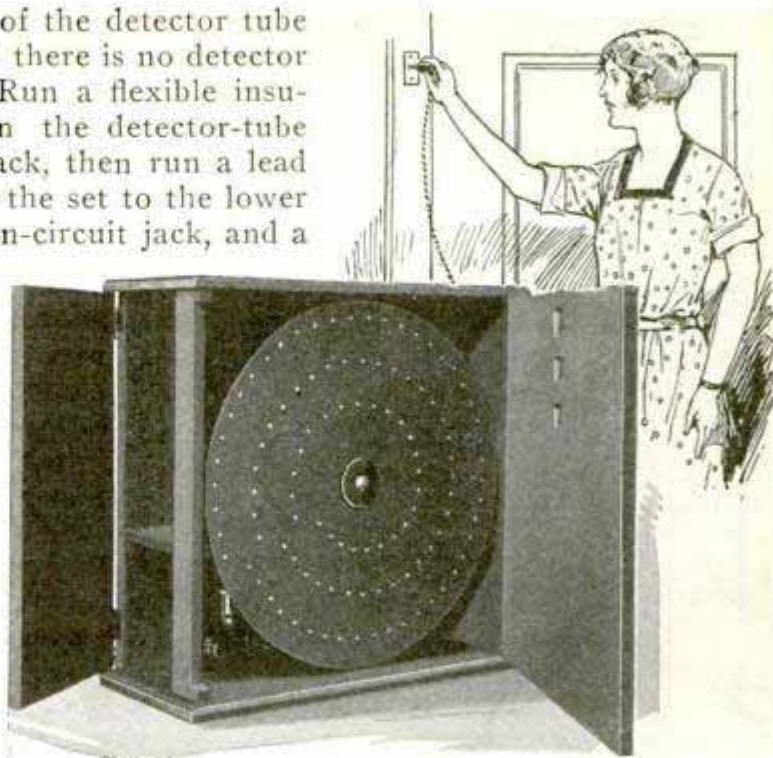

Completed Television Receiver Showing the Combination Disk in Position

the disk from the shaft of the motor and turn it around.

A large blueprint showing the cabinet construction and detailed wiring diagram for building up the amplifier unit, may be obtained from Popular Mechanics radio department for 15 cents to cover cost and packing. Specify blueprint No. 139. No charge is made for a list of the materials used in the model, and it will be mailed to any address upon request. Copies of the March, 1928, issue, in which the Short-Wave Adapter article appeared, are available for those who wish to adapt their present sets for short-wave reception.

Improving the Tone of Old Sets

Although there is nothing new about shunting the secondary of the a.f. transformer with a variable resistance to improve tone quality, very few take advantage of the idea. The best method is to place a proper resistance across the secondary of the second a.f. transformer and possibly across the secondary of the first as well, although it may cause a slight loss of volume. Just what value of resistance to use is difficult to state, as it depends on conditions in the circuit. The range may be anywhere from 50,000 to 200,000 ohms, and in some cases even higher.

*Mrs. Melba Goldberg,
Brighton Station
Brooklyn, N.Y.*

Increasing Range of Voltmeter

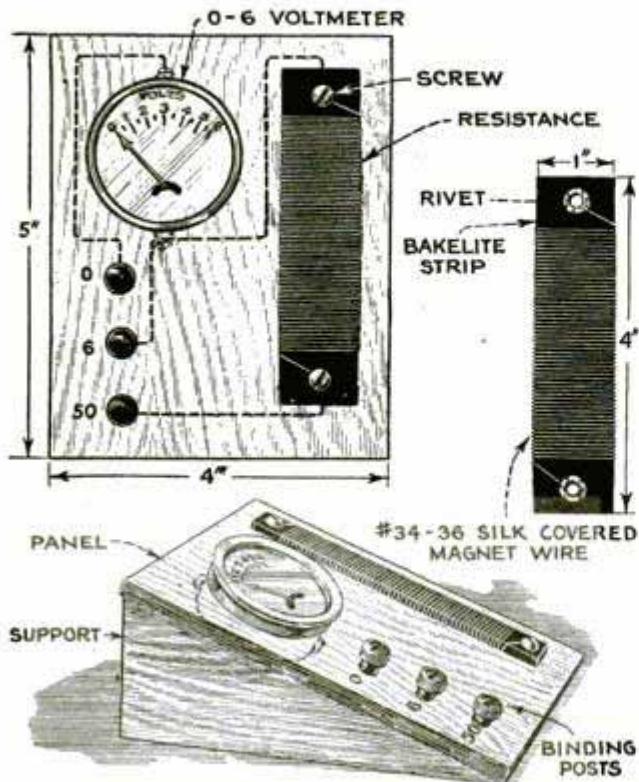

Panel Layout and Wiring Diagram; Right, Details of Resistor Strip; Below, Completed Voltmeter

The common inexpensive pocket voltmeter reading from 0 to 6 volts may be adapted for higher ranges by adding resistance in the circuit. The method employed is clearly shown in the sketch, and when so arranged, readings from 0 to 6 and from 0 to 50 volts are possible. The base consists of a board, 5 in. long and 4 in. wide, with a hole cut for the meter in the upper left-hand corner. Two triangular supports under the sides of the panel tip it up at a nice reading angle. A coat of shellac or stain and varnish will give the base a neat appearance. Arrange the three binding posts as shown and wire the negative post of the meter to the binding post marked 0. A wire is then run from the positive side of the meter to the center binding post marked 6. The resistance unit is wound on a strip of bakelite or fiber, 1 in. wide and 4 in. long. Drill a small hole in each end of the strip, and place a shoe eyelet or tubular rivet in each hole. A layer of either No. 34 or No. 36 s.c. copper magnet wire is then wound on the strip, the beginning end of the wire being soldered to one of the rivets. When the first layer is wound, reverse the direction of the winding and run the second layer back over the first, and so on until

the proper resistance is obtained. To check the resistance, bare a spot on the wire occasionally and test the value in the circuit with a 6-volt battery. When the needle reads approximately .7 of a volt from the 6-volt battery, the resistance will be about right. When the winding is done, solder the finishing end to the remaining rivet on the strip. Two wood screws are used to fasten the strip to the panel, one end of the strip is wired to the positive post of the meter and the other end to the lower binding post, marked 50. For 6-volt readings, connect wires to binding posts 0 and 6; for 45-volt readings, connect to 0 and 50. The 45-volt reading will come at approximately the 5½-volt marking on the meter dial and should be indicated by a red-ink line on the dial.

Screen-Grid Tube Requirements

Screen-grid tubes require somewhat different handling from tubes of the standard type. The r.f. transformers used with these new tubes must have a high primary impedance to obtain the amplification of which they are capable; therefore the transformer primary should have about the same inductance as the secondary. Impedance coupling, using a single coil common to both the plate circuit of one tube and the grid circuit of the next, will give the necessary amplification.

Kink for Starting Nuts

The radio builder who encounters difficulty in starting nuts on machine screws located in awkward positions, will find the simple method shown in the sketch to be a timesaver. Place the nut on a length of busbar wire, and, holding it to the upper end of the wire, place the other end on the machine screw, as shown. Then release the nut and it will slide down to a position where it may be started by

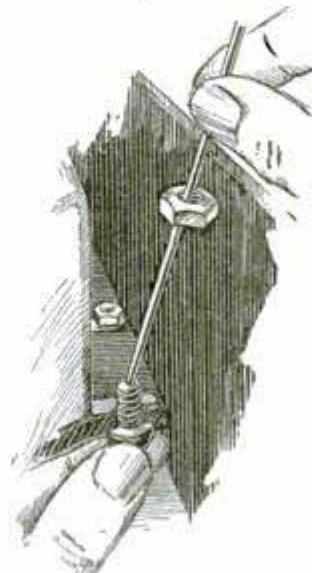

twirling it with another piece of wire, a long-shanked screwdriver or a nut driver.
—Henri T. Schultze, Kansas City, Mo.

Testing Batteries and Power Units

When testing batteries with the usual voltmeter, the battery should be connected to the set and tested while the set is in operation to obtain the true reading under load. Batteries will frequently test up to full voltage when not connected to the set, but, when connected under operating conditions, may show insufficient power. This also applies to socket-power units which should be tested under operating conditions, and in this case an accurate high-resistance B-eliminator voltmeter should be employed.

Wire Holder Simplifies Soldering

Many tedious soldering operations may be simplified by means of a wire holder consisting of a block of wood, two large corks and two thumbtacks. The corks are fastened to the wooden block with glue, and small nails are driven through the block. The thumbtacks hold the work in

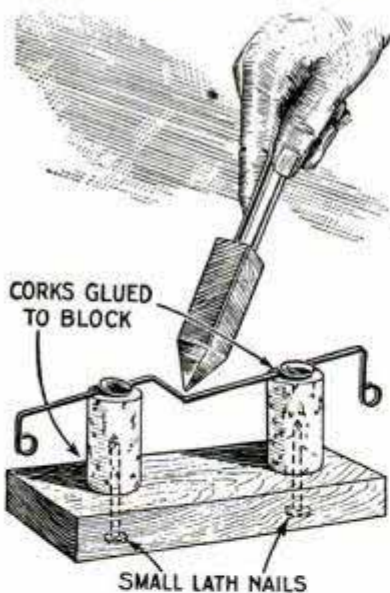

the desired position, leaving both hands free. This simple holder is also handy for soldering delicate instrument parts that must be hard-soldered by means of a small blow-pipe.—Jno. H. Schalek, Swissvale, Pa.

Homemade Line-Voltage Control

Very few a.c. receivers are provided with a means of limiting the line voltage applied to the tubes. Excessive line voltage is detrimental to a.c. tubes and step-down transformers, and the simple device described here, which will cut down excessive voltage, will be found worth while.



Making Resistance Unit for Limiting Line Voltage Supplied to Receivers Using A. C.

Obtain a small spool of No. 22 nichrome resistance wire; these spools may be obtained from any electrical-supply house. The wire is wound on a piece of broomstick, about 1 ft. long, the length of wire required depending on the amount the line voltage is to be reduced. A roll of electrical friction tape and an a.c. voltmeter scaled to read from 0 to 150 volts are also required. Wind a length of tape around the broomstick and fasten the starting end of the wire under a tack. Place the turns about $\frac{3}{32}$ in. apart and, when about three-fourths of the stick is filled, connect the resistance in one side of the supply line and test the voltage at the power-unit input. Now, either add or remove turns of wire until the reading is not in excess of 110 volts. When the correct length of wire is determined, clip it from the spool and secure the end with a tack as at the start. An inch or two should be left at each end for connecting in the line, and a turn or two around the tack will hold the coil in place. A layer of tape is now wound over the coil to prevent shorts, and the resistance unit is ready to connect in one side of the supply line; Fahnestock clips may be used for the connections. As the line voltages vary during the day and at night, before winding the resistance unit, determine with the voltmeter just when the peak is reached and wind the resistance when the line voltage is highest.—F. W. Luecker, Jr., 9BBX, Milwaukee, Wisconsin.



Helpful Radio

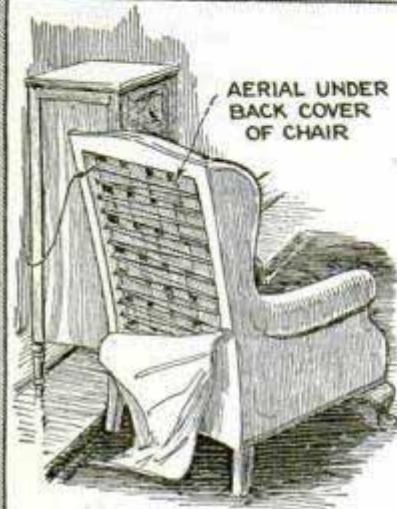

AERIAL UNDER BACK COVER OF CHAIR

Right, Useful as Well as Ornamental, This Odd-Appearing Trellis Is an Efficient Antenna Consisting of One Continuous Insulated Wire Formed in Loops on a Wooden Frame, and Located under the Window near Which the Receiver Is Installed

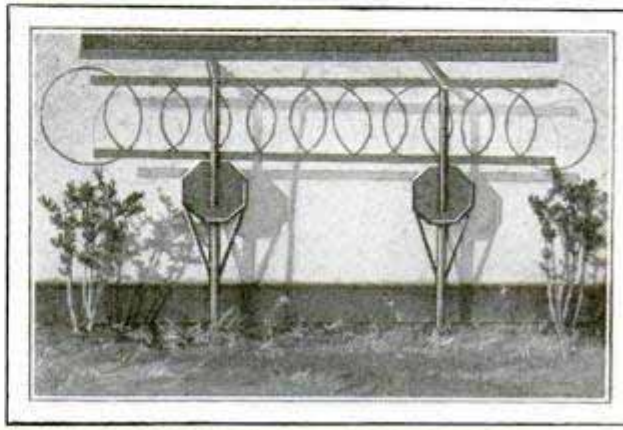

An Overstuffed Chair Affords a Good Hiding Place for an Indoor Antenna; the Cloth Cover Is Removed and the Wire Strung over Insulated Tacks; It Terminates in a Clip Connector

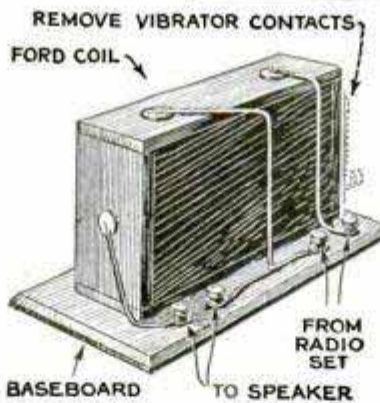

Left, an Output Filter Made from a Ford Coil Protects the Loud-Speaker Winding from High-Voltage Direct Current and Improves the Tone of the Set; the Vibrator Contacts Are Removed and the Coil Is Then Wired as Shown

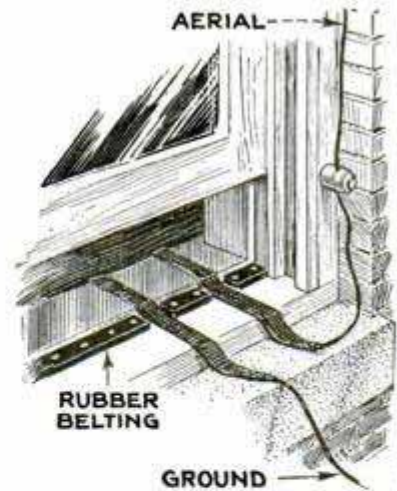
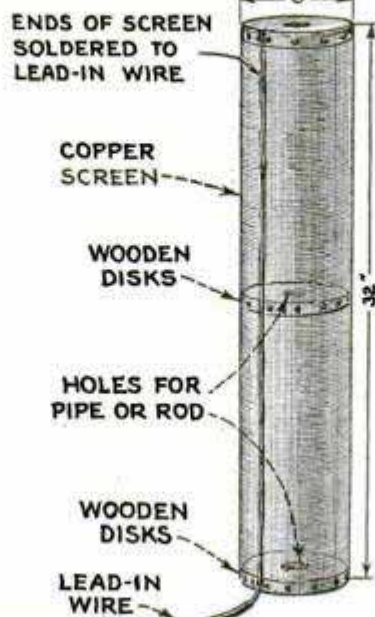

When Antenna and Ground Lead-In Strips Are Employed, the Sash Will Rarely Exclude Cold Air and Dust; a Tight Fit May Be Secured by the Use of Rubber Belting or Strips of Felt Tacked to the Sill as Shown



A Copper-Screen Antenna Installed, and, Right, Details of Its Construction

Hints Experts

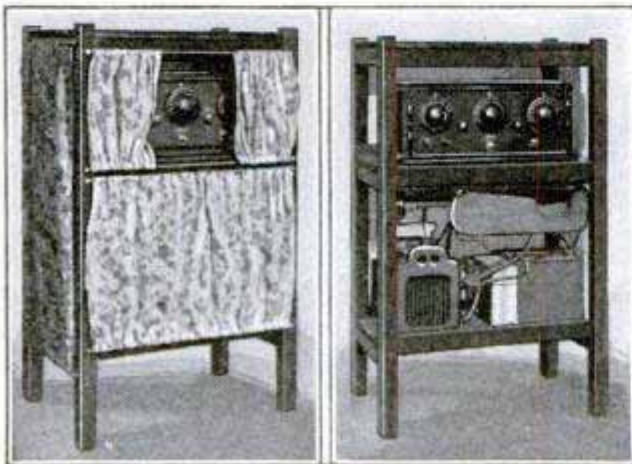
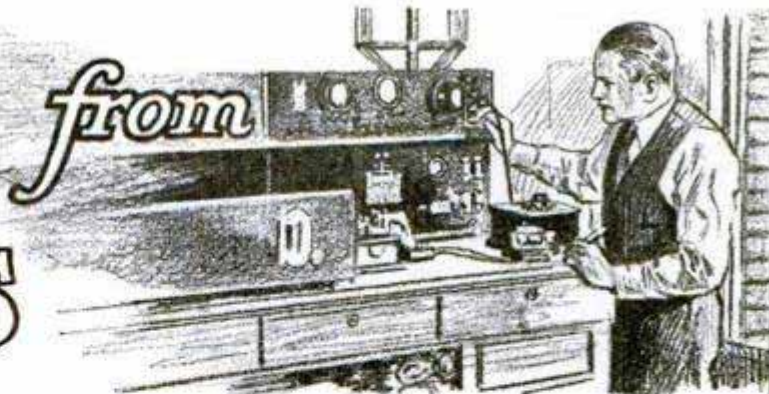

Left, an Inexpensive Means of Modernizing an Old Radio Installation; the Curtains Hide the Batteries and Protect the Set from Dust

Right, Home-made Remote-Control Box Consisting of a Variable High Resistance Provides a Handy Means for Regulating Volume



VOLUME CONTROL

A Single Phone Unit, Connected to an Old Tube Base Plugged into the Detector Socket, Makes a Simple Broadcasting Device; Connecting the Plug to the Speaker Terminals, Room Conversations Are Picked Up by the Speaker and May Be Heard in an Adjoining Room with Headphones Extended from the Speaker Jack in the Set

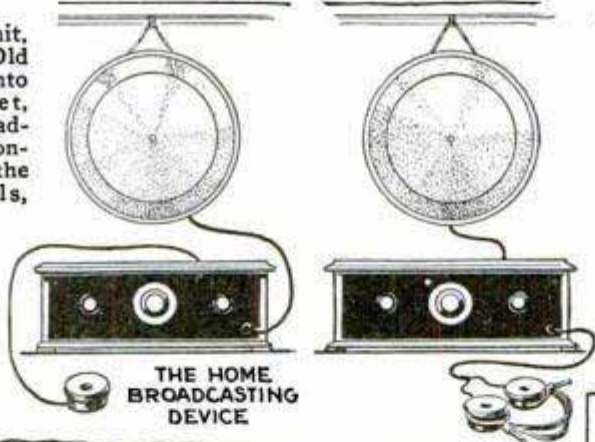

THE HOME BROADCASTING DEVICE

THE DETECTIVE ARRANGEMENT

Right, When Necessary to Remove the Diaphragm from a Phone Unit, Slip It Off as Shown, Don't Pull It; These Disks Are Thin and Must Be Handled Carefully

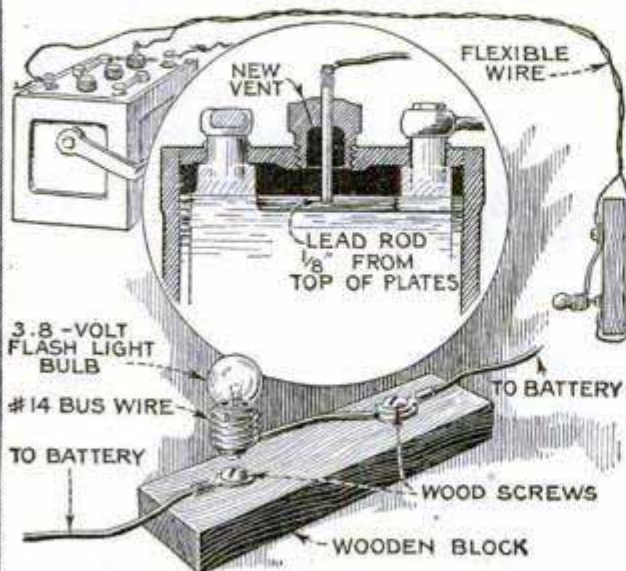

Left, a Simple Water-Level Indicator; When the Lamp Is Pushed Down to Make Contact with the Screw Head Below, It Will Light If the Electrolyte Is High Enough to Touch the Lead



TYPICAL ANGLE IRON



MOUNTING A CYLINDRICAL COIL HORIZONTALLY



MOUNTING COIL VERTICALLY

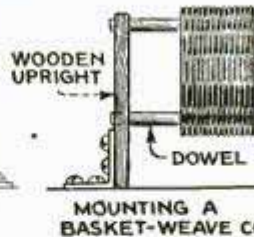

MOUNTING A BASKET-WEAVE COIL



VERTICAL MOUNTING FOR HONEYCOMB COIL



MOUNTING FOR ONE-HOLE TYPE RHEOSTAT



ONE-HOLE MOUNTING FOR VARIABLE COND.

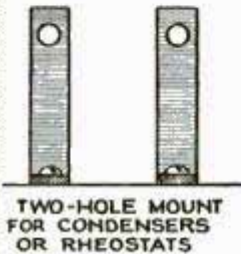

TWO-HOLE MOUNT FOR CONDENSERS OR RHEOSTATS

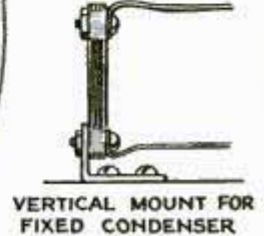

VERTICAL MOUNT FOR FIXED CONDENSER

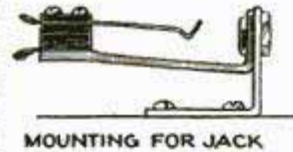

MOUNTING FOR JACK



MOUNTING FOR GRIDLEAK

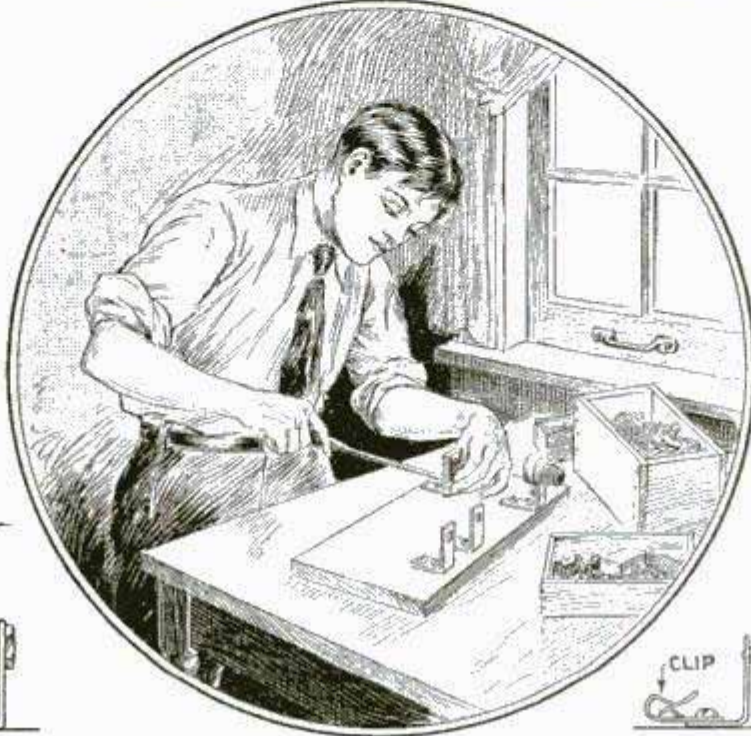

Inexpensive Angle Brackets, Preferably Made of Brass Strip, Provide the Experimenter with a Handy Mounting for Various Radio Instruments without the Use of Panels; These Angles May Be Purchased, or the Experimenter Can Make Them in Various Sizes to Suit the Work in Hand

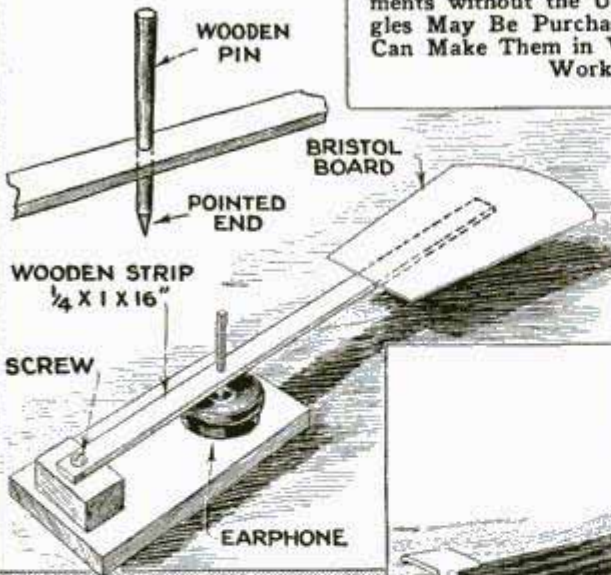

WOODEN PIN
BRISTOL BOARD
POINTED END
WOODEN STRIP 1/4 X 1 X 16"
SCREW
EARPHONE

An Improved Loud Speaker Built from Odds and Ends by a Canadian Camping Party, So That All Could Listen In without Passing around the One and Only Earphone

TO REGULAR RECEIVER

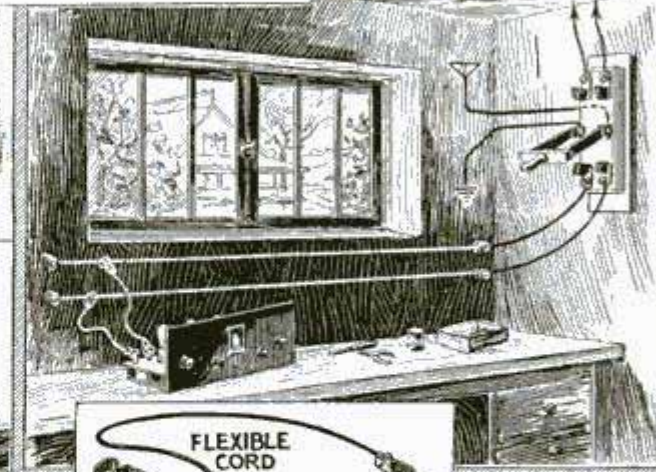

FLEXIBLE CORD
SPRING CLIPS

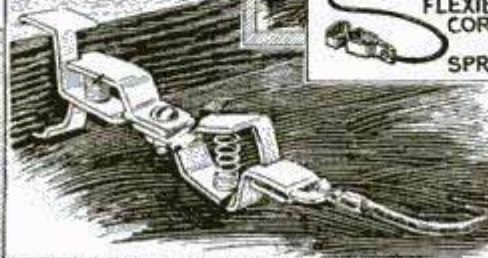

A Timesaving Method of Shifting Antenna and Ground Connections When Testing Sets; Left, Two Spring Clips Bolted Together as Shown Form a Handy Soldering Vise

The Latest in Television Apparatus

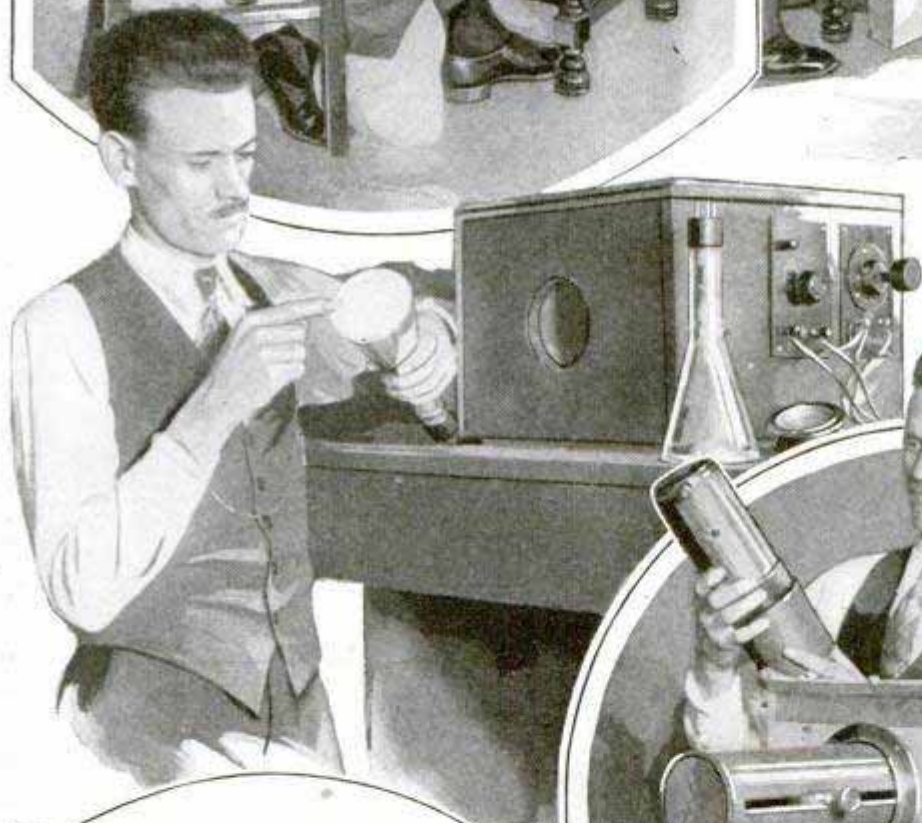
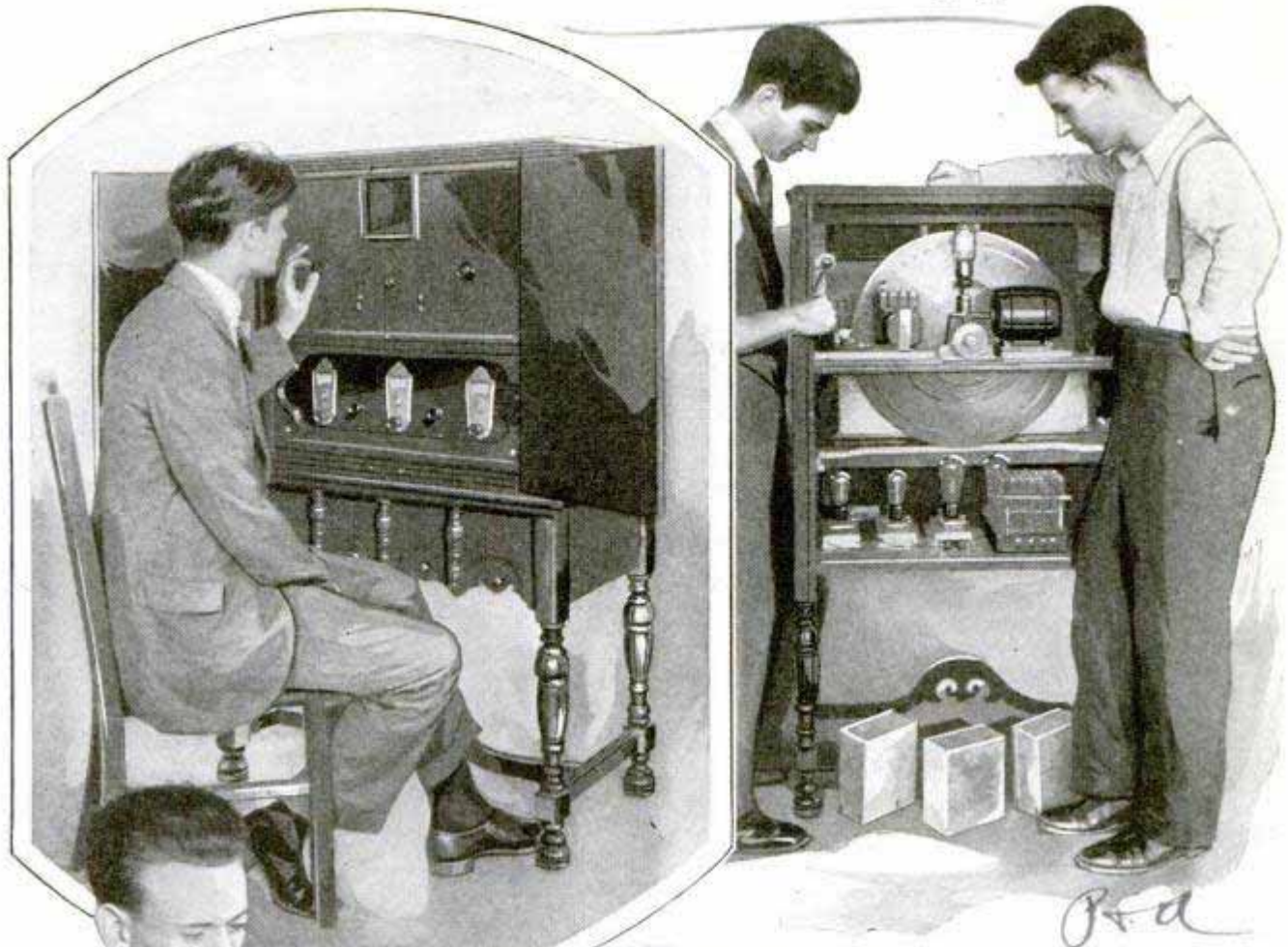

Above, Left, John Gelso, of the Pilot Electric Mfg. Co., Adjusting His Complete Television Receiver and Observing a Test Picture; Right, Rear View Showing the Arrangement of the Apparatus

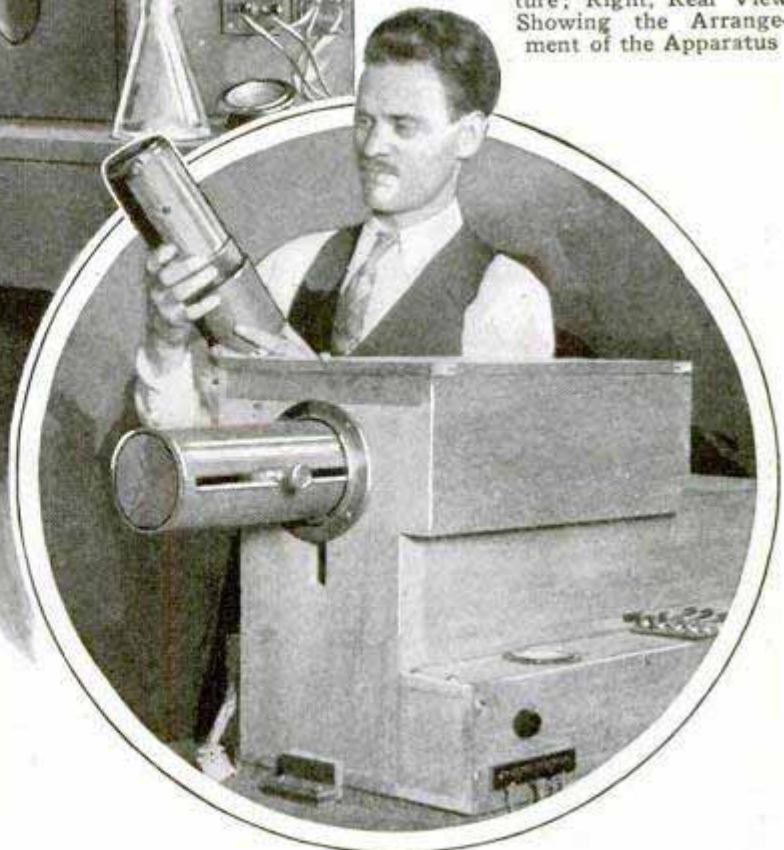

Philo T. Farnsworth, Young Utah Inventor, Who Has Been Working in a Laboratory at San Francisco, Demonstrating His Newly Developed Tube and System of Television, Involving Two Fundamentally New Principles; His Apparatus Is Unique in That There Are No Moving Parts and That It Requires Only Half the Wave-Band Length Used in Other Methods of Television

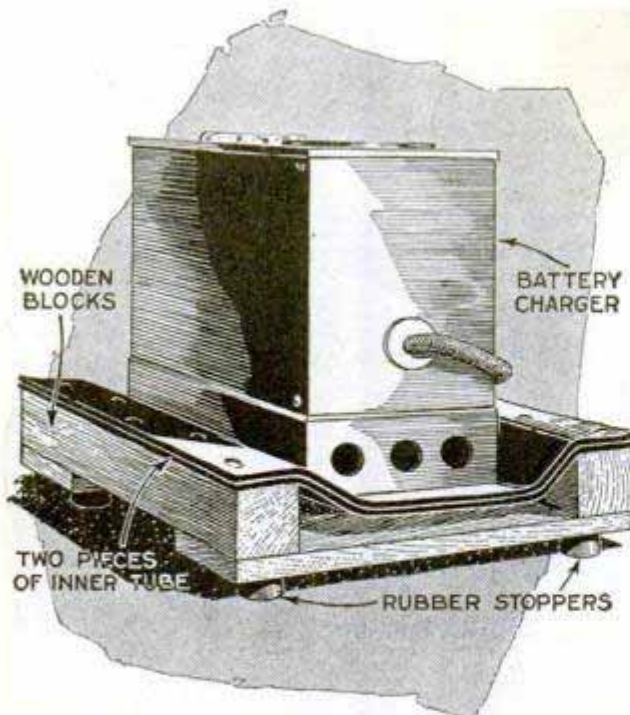

Details of Support for Reducing Noise of Operation, Showing Charger in Position

Reducing Charger Noises

Radio owners who have battery chargers of the older types, some of which are quite noisy, may reduce the noise and vibration to a minimum by means of the simple arrangement shown in the sketch. The charger is suspended on strips of rubber cut from an old auto inner tube, the strips being nailed one on top of the other between the two sidepieces of the simple wooden frame and forming an elastic sling or cradle. The frame itself is further insulated by means of rubber feet, which may be made from rubber stoppers. This device prevents the vibrations from reaching the floor or table on which the charger rests. A slight hum may still be heard, but the vibrations are not amplified. —Benjamin H. Hoopes, East Berlin, Pa.

Pin Jacks Simplify Connections

The ordinary binding posts used for battery, speaker, ground and antenna connections are often placed in awkward positions for making quick hookups. The holes in the binding posts through which the wire is to be threaded are out of sight and at right angles to the post, making connections very difficult. There are several types of small pin jacks on the market that make ideal substitutes for binding posts under such conditions. The wire ends may be provided either with cord tips

or special miniature plugs which are inserted in the small jacks. These jacks may also be mounted on the front panel and connected across points where current or voltage is to be checked.

R. F. Chokes Prevent Distortion

When properly used, a good r.f. choke-coil will prevent distortion resulting from the coupling of separate circuits, reduce undesirable regeneration or oscillation and prevent the entry of r.f. currents into a.f. circuits. The use of these chokes reduces the necessity for shielding and for the extreme care otherwise essential in placing parts to avoid coupling effects. Good r.f. chokes have very low values of distributed capacity; if improperly made they will act more as condensers than chokes and will permit the r.f. currents to pass freely, defeating the purpose intended. The extremely low capacity values of good chokes of the r.f. type are sufficient to block the path of the r.f. currents, and to divert them through the by-pass condensers as intended.

Mounting Loop on Portable Set

Mounting a loop on a portable receiver so that it will be held securely in an upright position and at the same time permit turning in any direction presents a problem for many experimenters. The sketch

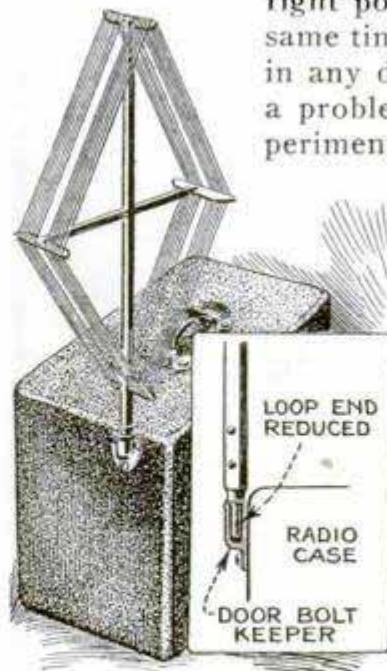

shows a simple means of doing this, and the secret lies in the use of an ordinary door-bolt keeper that is screwed to the side of the case. Keepers may be obtained from any hardware store for a few

cents. The inset diagram shows the method so clearly that little comment is necessary. The keeper is so shaped that no parts project above the case.

AMATEUR MECHANICS



Stage Scenes from Vacation Pictures

By PAUL PADDOCK

IF YOUR summer's outing has been normally successful, you probably have taken a picture or two that are worth preserving. An interesting and unusual way to do this is to make a scenic setting out of them, after the manner of a model stage grouping.

The main view (if it is an outdoor scene, all the better) will serve as the back drop. One showing good perspective is most satisfactory, as the effect of depth is one of the pleasing results of the setting. The picture should

mountains or diminishing groups of trees is favored, as it gives the impression of distance. A hazy sky in the far distance also will add much to the effectiveness of the finished group.

The actors in the scene, of course, are the persons who appear in the picture. The figures should be cut out in outline, also mounted on stiff board or wood, and anchored to a base of wood or cardboard so that they will not fall down. Do not attach them permanently to the bottom of your stage, as you will want to move them about from time to time. The figures may be enlarged or reduced as you need, to keep the proper perspective; placing them close to the front or nearer the back

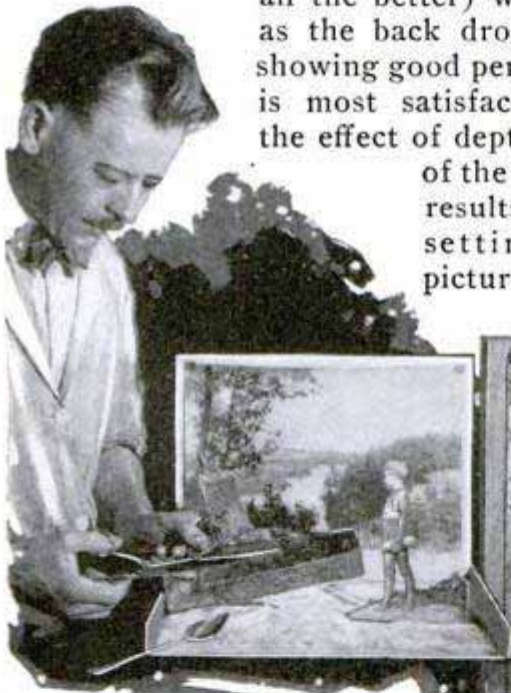

Above, Cutting Out the Prints for the Setting; Right, the Partly Completed Layout

be mounted on stiff cardboard and fastened to a substantial backing, so that it will stand erect and not easily become dislodged. Care should be taken that no wrinkles show. A background that includes a river, distant

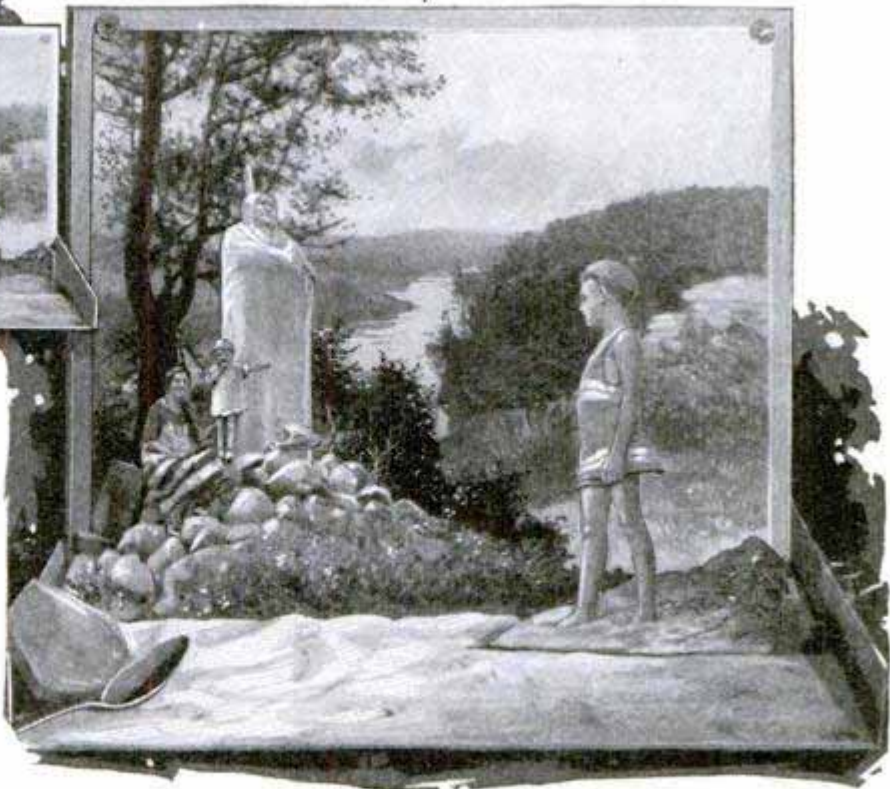

of your setting will sometimes give the right result. Attaining the proper proportions and perspective is a problem that must be worked out for each picture and will afford added interest.

The scene may be made from one photograph or from several, and if you have in mind the making of the setting when you take the picture, figures may be



Sand, a Bit of Looking Glass and a Few Small Pebbles Form a Realistic Foreground; Upper Right, the Permanent Setting

grouped properly at the time, and you can have as many prints made as are necessary for the cut-outs in the setting. It is also necessary, of course, to take one picture of the background with no figures appearing on it.

By coloring the pictures and adding realistic foregrounds of sand, bits of grass or other materials, the settings assume a much more lifelike appearance. When the scene is completed, it may be assembled in a box or booth, and interesting lighting effects produced by placing small bulbs back of the units or at the footlights, as is done in actual stage displays. Sun and moon effects may be attained by lights behind the back drop.

The group illustrated here was completed in less than an hour after the prints

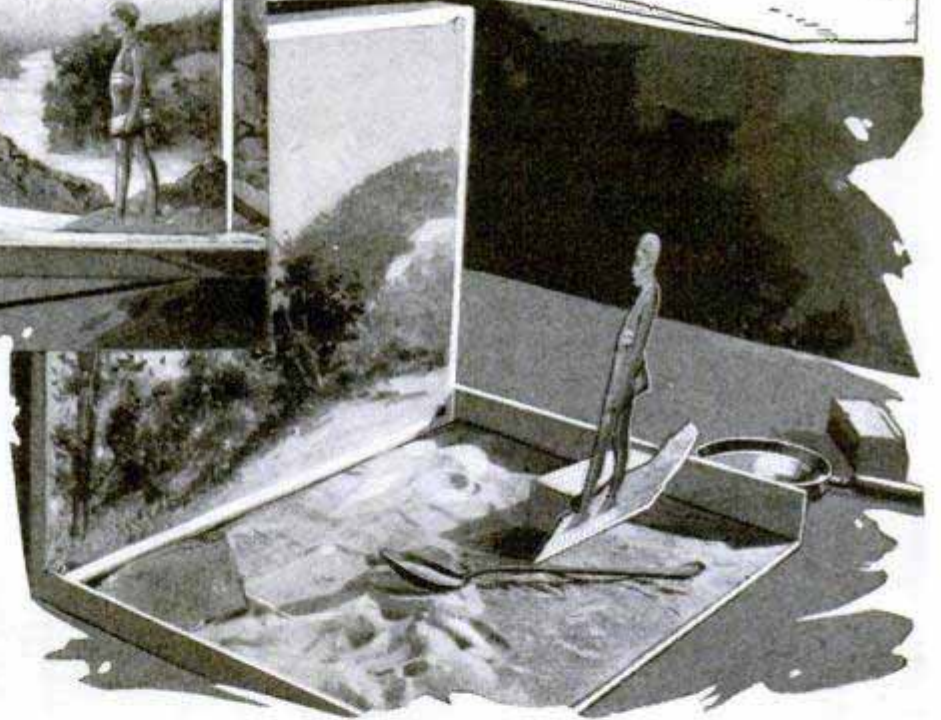
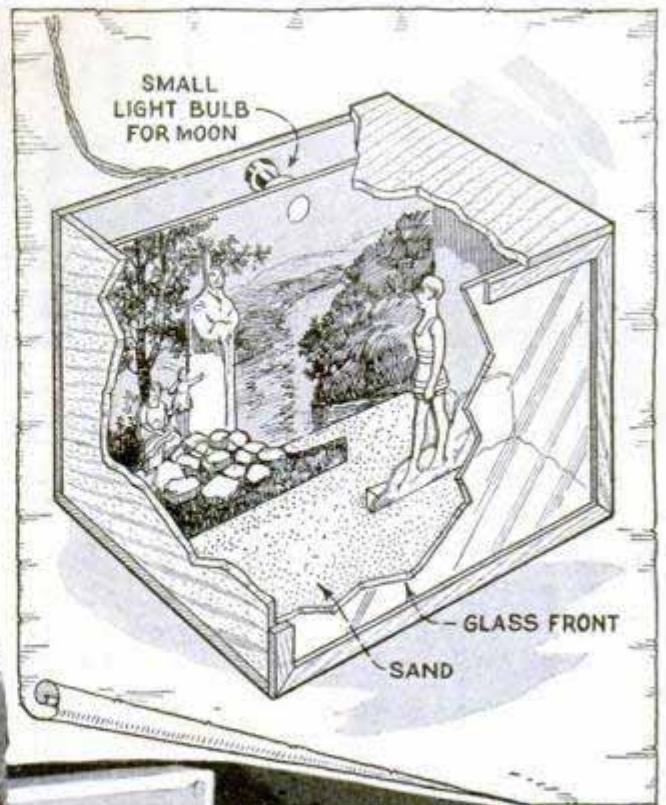

had been made, and three pictures were used in its arrangement.

Preheating Water for Gas Heater Reduces Gas Bill

In many homes one-half of the gas bill represents heat used for warming water. One type of heater is automatically turned on when the corresponding faucet is opened, thus providing hot water only in such quantities as desired. The water entering the heater is practically the same temperature as that in the outside main,

which is often many degrees lower than the air inside of the house. Even though the water passes through 50 ft. or more of pipe in the house on its way to the heater, it moves at such velocity that it does not have time to heat up appreciably before reaching the heater. Quite a bit of gas can be saved if the water is allowed to reach the temperature of the house before it enters the heater. This can be done by installing a tank in the line to the heater, or by using oversize pipe for the line in order to provide water-storage space. The tank should be large enough to hold the average amount of water required at any one time. The cold-water inlet should be located at the bottom of the tank and the outlet to the heater at the top. Supposing that water is required at 130° F., and during the winter time it enters the house at an average temperature of 40°. The cold water would then have to be heated 90°. By installing a tank as suggested, the water in the tank would gradually attain the house temperature of about 70°. Then the gas flame would have to heat the water only 60°. It is obvious that much more gas is required to heat the water 90° than 60°. In one case this method of preheating water reduced the average monthly bill from about \$9 to \$6.—C. C. Phelps, Montclair, N. J.

Measuring Half Capacity of Containers

It often happens that housewives and others who measure ingredients do not have half measures, and are then tempted to guess. The quantity of any container can be exactly halved by proceeding as shown in the drawing. Merely pour enough of the liquid or other contents out until the surface extends diagonally from one side of the bottom to the opposite side of the top. The quantity of liquid in the container is then exactly half of its full measure.—Stanley H. Phillips, Drummondville, Can.

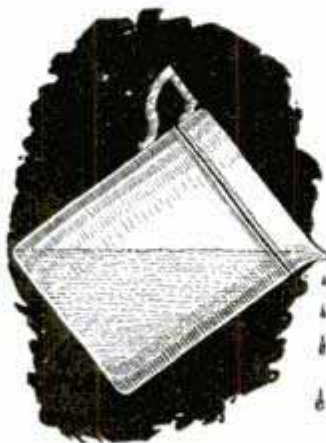

Convenient Arrangement for Hoisting Sagging Clotheslines Out of the Way

Hoist for the Clotheslines

In our backyard we had several clotheslines which sagged and were therefore more or less in the way, especially when mowing the lawn. To hoist them entirely out of the way, I provided a long center pole with an iron ring and pulley as shown. The ends of four clotheslines were attached to the ring, which could be raised or lowered at will by means of a length of rope attached to it and run over the pulley attached at the top of the pole. The other ends of the clotheslines were permanently fastened to posts or buildings. Besides clearing the backyard of sagging lines, this arrangement also eliminates props.—W. H. Snyder, Pocatello, Idaho.

Can You Do It?

In the article under the above title in the August issue of the magazine, an error appeared in the key numbers of the dice game. The proper key numbers are: 8, 15, 22, 29, 36, 43 and 50. These can easily be memorized if it is remembered that they are the number seven and its multiples, plus one.



Helical Spring Slipped over Wood Auger Prevents It from Running

Spring Prevents Auger from Running in Wet Wood

Wet and sappy wood, especially soft wood, tends to draw an auger into it much faster than the guide screw does ordinarily. This trouble, known as "running," can be prevented by slipping a helical spring over the auger as shown, the small end of the spring being of such size that it will not slip over the chuck. This exerts a back pressure on the auger, permitting it to feed slowly as it should. Helical springs for this purpose can be found in discarded auto seats.

Shields for Balloon or Oversize Tires

After changing to balloon or oversize tires, many auto owners find that the projecting nuts on fender supports cut the tires under certain circumstances. For instance, when the car is heavily loaded, the fenders are brought down close to the surface of the tires. Then, when traveling over a

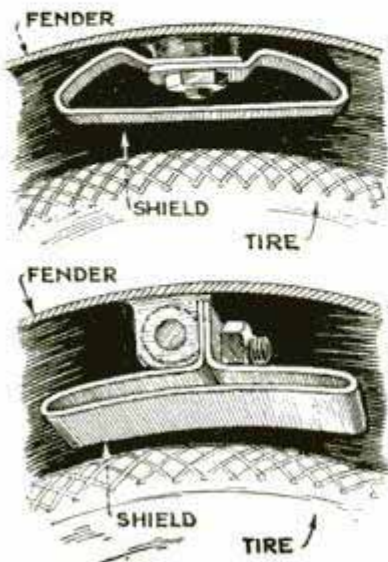

somewhat rough road, the supports occasionally touch the tires and slash them. To avoid this trouble, simple shields can be made to fit on the brackets. The illustration shows two types, both of which can be made from lengths of flat iron. The shield in the upper detail is attached to the underside of the fender bracket, while the lower detail shows a shield attached to the side of the bracket.

Splicing Ends of Short Wires

A quick and neat method of splicing an electric cord, especially at a point where it is rather short, as in motors and fans, is to cut a $\frac{3}{4}$ -in. length of No. 14 solid-copper wire, and wrap the cleaned strands of the cord around it, after which the three pieces are carefully soldered together. If the repaired part is subject to strain, the ends of the solid wire should be bent over with a pair of pliers just before soldering, then taped in the usual way.

Homemade Brush for Applying Tar

For tarring a roof, which was so small that I did not feel justified in purchasing a regular brush, I made one which answered the purpose just as well. It consisted of an old paintbrush, a garden hoe and a small C-clamp, the latter holding the brush securely to the hoe, as shown. This improvisation was assembled in a few moments.—Paul Kiefer, Hamilton, Ohio.



White Paint for Concrete

A durable white paint for concrete steps, walls and walks can be made from lime and cement. Take hydrated lime, two parts, and cement, one part; mix these together thoroughly and scald with boiling water. If a very white finish is desired, use white cement. It is applied with a large paintbrush and forms a coating that will not rub off.

Make Your Own CHRISTMAS DECORATIONS

by

Edwin M. Love



WHILE inexpensive Christmas-tree and table ornaments of almost infinite variety can be purchased during the holiday season, many folks like to give original and personal touches to the decorations. To such people these suggestions are addressed.

Eggshell ornaments are illustrated in Fig. 1. Make small openings in the eggs and blow out the contents. Draw a pencil line around a shell a little below the center, the large end being at the top, and gild the upper top, shaking Christmas "ice" powder over the paint while still wet. Paint the lower end with scarlet water color or lacquer. Cut a strip of gold or silver paper, 1 in. wide, long enough to go around the egg at the division line with a little lap, fold it into an accordion pleat, and cut the folds with scissors to make a fancy border. Glue

this band around the egg, paste narrow strips, 1½ in. long, on each point, and stick a 2-in. paper tassel to the egg point. Complete the trinket by pasting colored string to the upper end.

The other tailed-shell ornament is made by drawing four equal-sized oval ornaments on the surface, with the edges slightly overlapping. Paint the spaces above and below the ovals bright red, the ovals emerald green or light blue, and the small elliptical ovals within the others, gold. The paper pendant is also gilded.

The third shell is laid out by sketching six equidistant spirals from end to end, as in Fig. 1. This is fairly easy to do. If the colors used are transparent, erase the false lines. Paint in blue and gold.

A large variety of ornaments can be made with walnut shells, by gluing the halves to paper



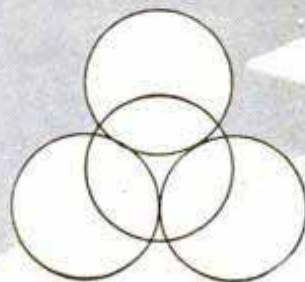
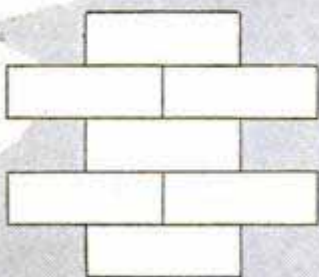
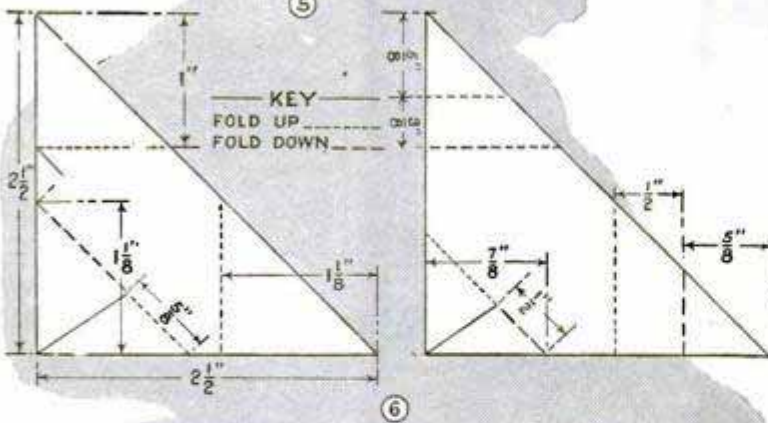
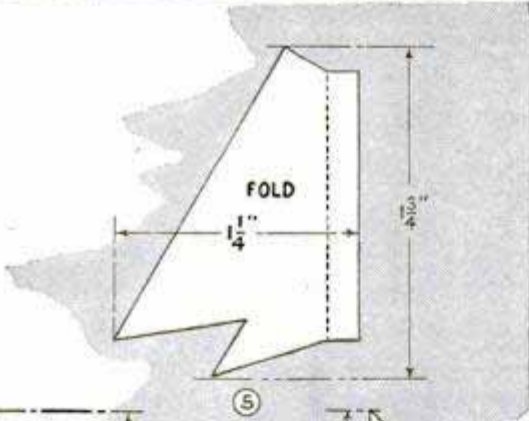
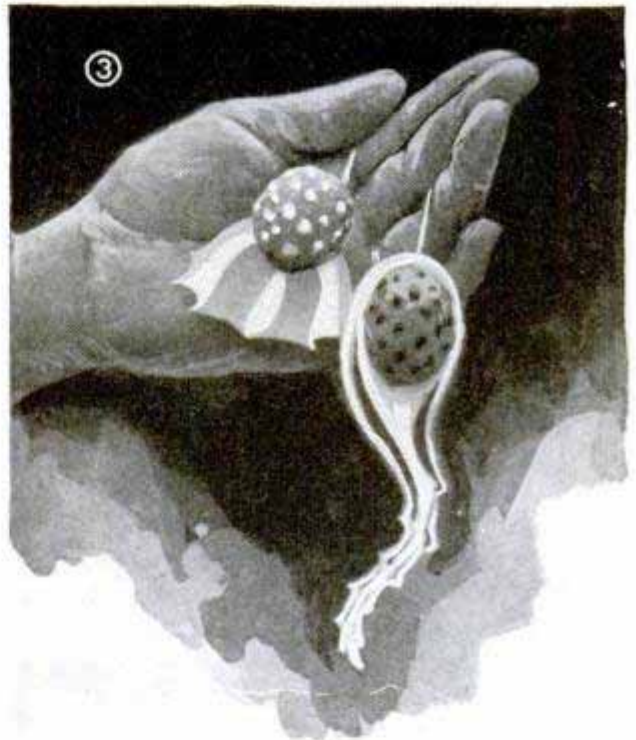
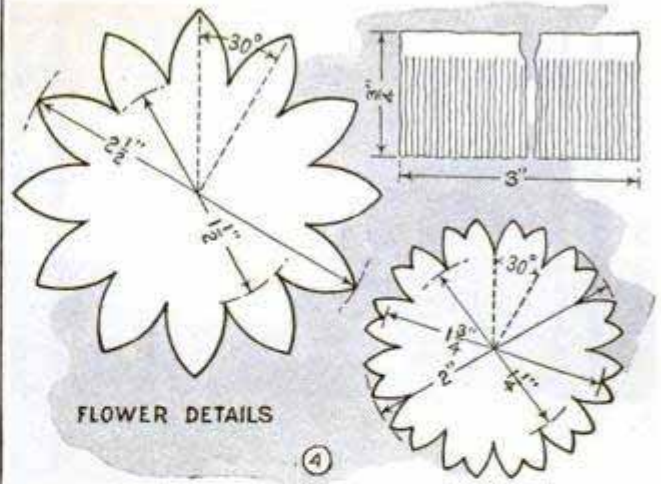

backings of various graceful shapes, as in Fig. 3.

Flower decorations are especially attractive for the Christmas tree. (See Figs. 4 to 9.) Cut two circles 2½ in. in diameter, from colored paper (Fig. 4) and divide them into twelve equal parts. Cut the petals ½ in. deep, as at the upper left. Make a third tier of petals 2 in. in diameter, cutting the petals ⅜ in. deep. Notch the petal ends ⅛ in. deep, and assemble the three papers by stitching the centers. Add the stamens in the form of a paper fringe, ¾ in. wide, rolled into a tassel. Bend the petals upward, and the flower is complete.

Figs. 5, 6, 7, and 10 illustrate ornaments in modern design. The center device in the photograph is made by pasting together four of the cardboard cut-outs dimensioned in Fig. 5. The other angular ornament is built up of the two triangles shown in Fig. 6. Cut as indicated, folding



the points upward on the dotted lines and downward on the dashes.

The circle ornament is built up of nine $\frac{3}{4}$ -in. circles made by lapping the ends of col-

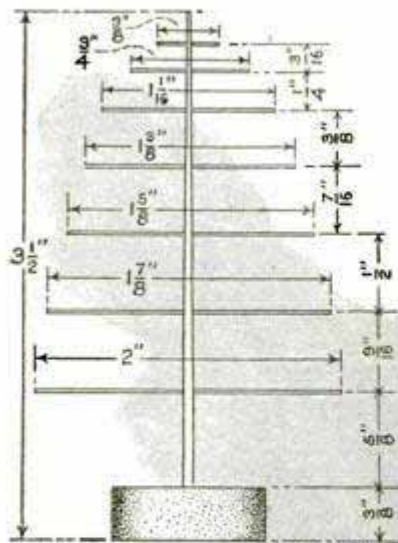
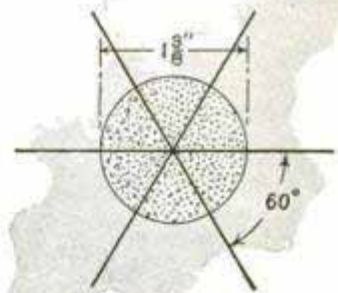
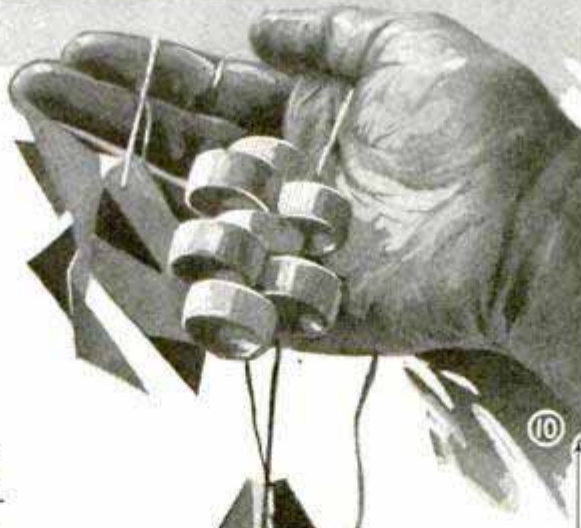

HORIZONTAL TYPE TREE PLACE CARDS

(12)

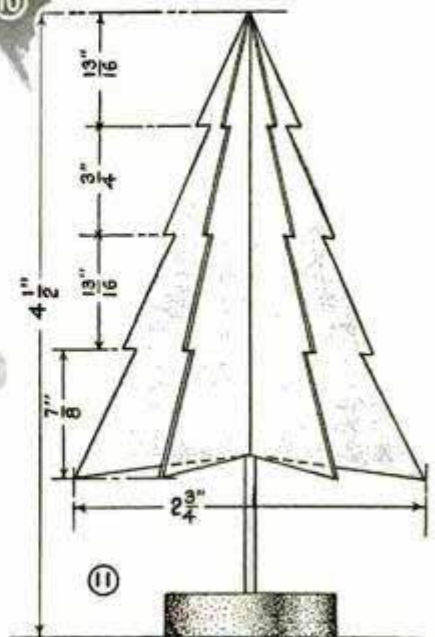

VERTICAL TYPE TREE PLACE CARD

ored paper strips, $\frac{1}{4}$ in. wide. Glue up two sets of three circles each, and join them with a circle glued in the center, as in Fig. 7. Paste the other two circles to the

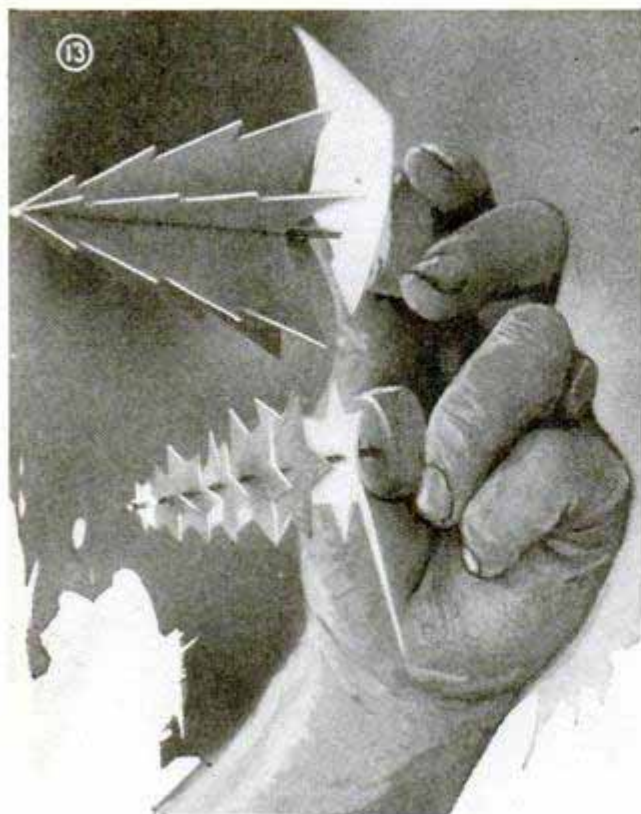

ends, and lay aside to dry before tying on the string.

Two interesting place-card favors for the Christmas table are pictured in Fig. 13. One miniature tree is made by threading six-pointed star forms over a splinter of wood, $3\frac{1}{2}$ in. long, as in Fig. 12. Observe the variation in diameter and spacing. A section of cork makes a good stand. Make the place cards themselves $\frac{3}{4}$ in. wide and 3 in. long, with the ends cut on an angle, one being slitted to clamp on the tree trunk. The other tree is a vertical type. Make three triangular forms, $2\frac{3}{4}$ by $3\frac{1}{4}$ in., and stitch them together up the center. Fold the layers radially outward, so as to form the six sets of leaves, glue or sew to a stick for a trunk, and add the base.

Repairing Small Cracks in Earthenware

Earthenware vessels that are cracked so that they will not hold water, but are otherwise in good condition, can readily be repaired in the following way: Get some black iron enamel and, after the vessel has been thoroughly dried so that no moisture remains in the cracks, apply some of the enamel with your finger, rubbing it well into these. After repeating this three or four times, remove the excess enamel with a rag dampened with gaso-

line. After the enamel has dried, the vessel will again be water-tight. For large cracks, it is better to apply the enamel with a brush, applying three coats and permitting each coat to dry thoroughly. When pottery becomes covered on the inside with a deposit that will not readily come off, such as the white residue of water glass, apply a few coats of the enamel.

Emergency Methods of Opening Bottles and Cans

When a corkscrew or can opener is not available, the illustrated methods of opening bottles and cans will be found convenient. To remove a stubborn cork, get a short length of wire, about $\frac{1}{16}$ in. thick, and bend it to the shape shown, wrapping one end around a short stick, which serves as a handle. Tin cans can be easily opened without any risk of cutting one's hands by means of the improvised cutter shown

in the lower detail. It consists of a short piece of flat wood with a nail driven through it at one end to serve as a pivot. A slot is cut in the wood so that a pocketknife can be inserted in the position shown. The nail is pressed down through the center of the top of the can, and the knife blade through the top near the edge. Then, by turning the device, the top will be slashed open.

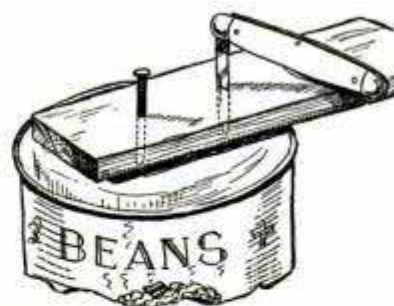

Homemade Stove Polish

Put into a bottle one-half cupful of pulverized graphite, 1 pt. of turpentine, one teaspoonful of sugar, and mix. Shake up well and apply with a cloth or brush, being sure to get plenty of the graphite on the cloth. Then polish with a clean cloth.

Spanish Windlass Pulls Auto Out of Mud

Although principally used for felling trees, a Spanish windlass, which exerts tremendous power, may be put to a variety of uses, among them to pull an auto out of a mud hole. Hitched to a convenient tree or deadman, one can easily pull the auto out single-handed, as shown in the drawing. All the equipment necessary consists of two lengths of

one $\frac{1}{2}$ -in. brass compression bib, one 1 by $\frac{1}{2}$ -in. galvanized reducing elbow, and the necessary $\frac{1}{2}$ -in. galvanized tees, elbows, nipples and pipe, according to the number of founts and their spacing. The drawing

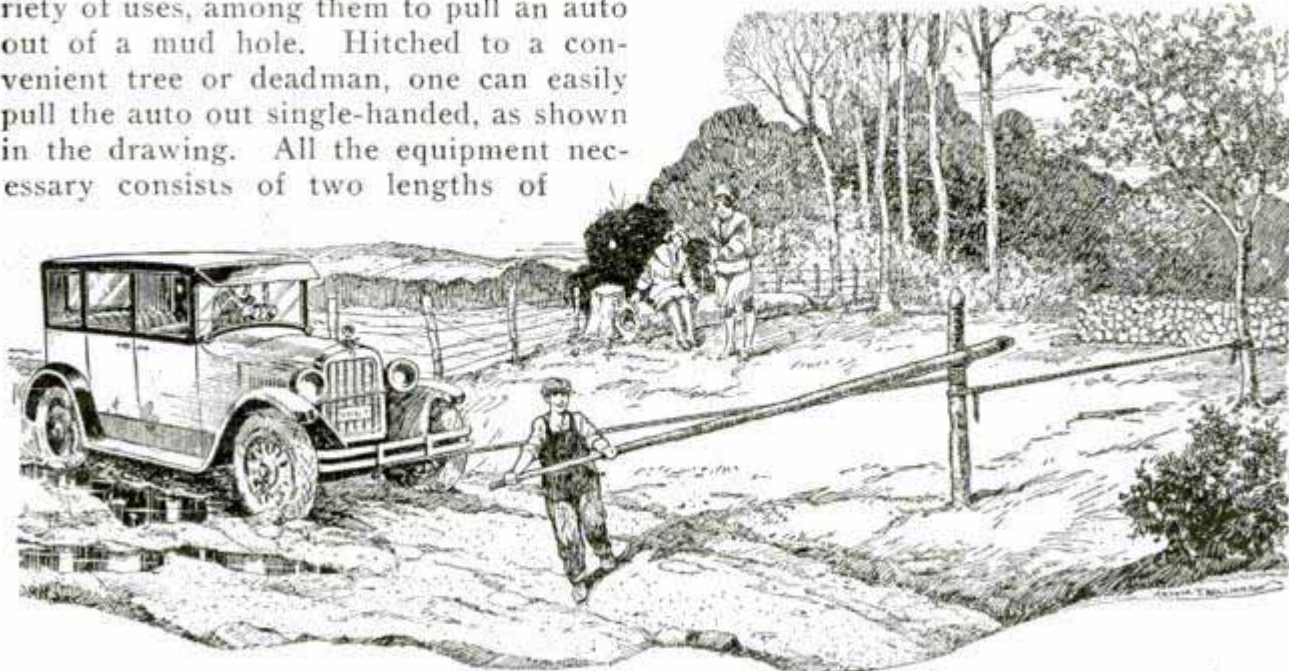

When Your Auto Is Stuck in the Mud and There Is No Help Available, You Can Pull It Out Single-Handed by the Use of This Spanish Windlass

heavy rope and two stout poles. One of the latter is set up vertically so that it is free to turn, and is braced by a length of rope tied to a near-by tree or stump as shown. The other rope is tied to the car and to the end of the second pole, which is used to wind the rope around the vertical pole as a fulcrum. As this is free to turn, there will be no appreciable friction of the rope on this pole and practically the whole force will be used in pulling the car.—P. A. Smith, Jennings Lodge, Oreg.

Convenient Poultry Fountain

Besides automatically supplying several drinking cups, the poultry fountain shown in the drawing has some advantages over those of the usual type. There is little chance of the cups running dry, which would cause suffering and loss of production, especially during hot weather, and baby chicks can use them without any danger of drowning. Owing to their size they cannot be contaminated easily, and can be cleaned with little trouble by opening and closing two valves. Get a 50-gal. barrel, made for holding liquid, and clean it out thoroughly. The pipe and fittings needed are three $\frac{1}{2}$ -in. brass valves,

shows the method of installing this fountain. A is the brass compression bib, while B, C and D are brass valves. The founts, no matter how many there are, must be at the same height so that the water level will be equal in all of them. To fill the barrel with water, close the valve C and open bib A, which allows the air in the barrel to rush out while water is replacing it. Open valves B and D. When the water starts flowing out of the bib, the barrel is full. Valve D and bib A are then closed. Drinking water is now available at all the founts.

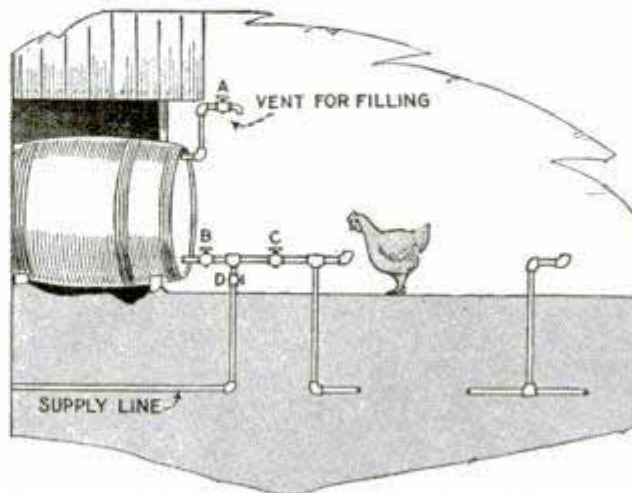

Automatic Poultry Fountain Which Has Advantages over Those of the Usual Type

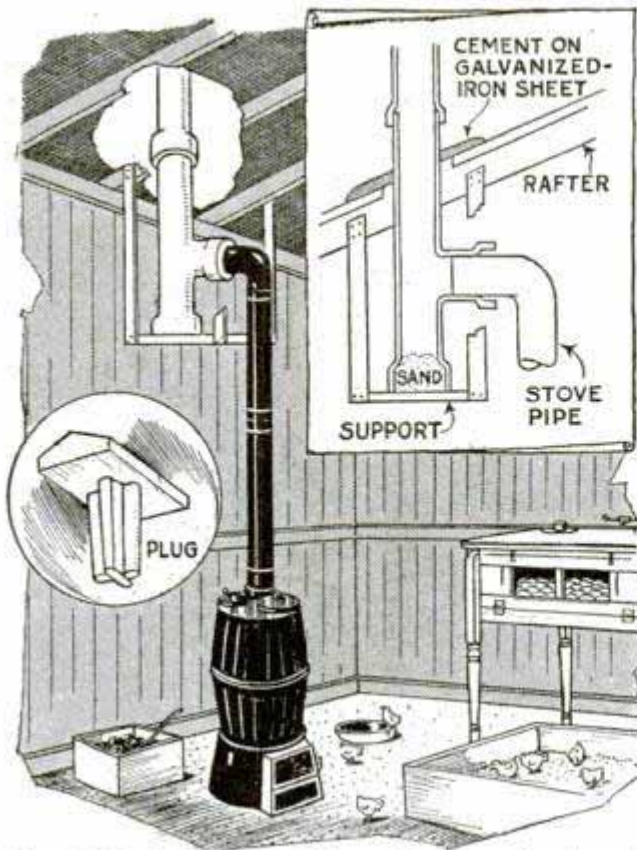

Use of Drain Tile for Chimney Prevents Rusting of Stovepipe

Tile Chimney through Roof Saves Stovepipe from Rusting

When a stovepipe chimney is run through the roof, the action of rain and of the gases of combustion soon causes the pipe to rust through, making it necessary to go to the trouble and expense of renewing it nearly every season. However, by substituting a tile chimney, as shown in the drawing, the trouble can be eliminated. A suitable shelf is first built to support the tile, which consist of a tee and one or more lengths of 4-in. drain. The tee rests on the supporting shelf as indicated in the detail, and a quantity of sand is thrown inside of it to form a 3 or 4-in. layer on the shelf. This serves the double purpose of protecting the board from fire, and absorbing rain water that may run down inside. The hole in the roof through which the chimney projects should be about 4 in. larger in diameter than the tile, and the clearance around the pipe is covered with a sheet of galvanized iron, cut to fit the tile. Iron lath, or even wire netting, will do, if it is well covered with cement, some pitch being poured over the top of the latter to make the joint leak-proof. Some sand or gravel may be sprinkled over the pitch while it is still soft.

One or more lengths of straight tile are cemented on top of the tee to raise the chimney to any desired height. The stovepipe is fitted to the tee, and when the stove is not in use, it is of advantage to plug the chimney.—D. F. McKinley, Bronte, Can.

Ridding Pets of Vermin

To effectively rid your pets of vermin, fix a draw string around the open end of a 25-lb. sugar sack for cats, or a 50-lb. sack for dogs, and put a handful of Dalmatian powder in the sack. Then put the animal inside with the head projecting outside, and draw the string up to close the bag around its neck. The animal will struggle to get out and in doing so will cause the powder to sift through the hair thoroughly, which is exactly what is desired. In this way the powder will be applied without wasting any of it and without getting it in the eyes of the animal, which would cause more or less discomfort.—H. A. Norrell, Augusta, Ga.

Oil Lamp Heats Soldering Iron

Where an electric soldering iron is not available or cannot be used, good results will be obtained with an ordinary round-neck, center-draft oil lamp for heating it. A tin chimney, about 4 in. long, is substituted for the regular glass chimney and the soldering iron is placed on it. Before using the iron, wipe it off on a rag as the flame will cover it with soot. This method is better than placing the iron in a stove, which heats it too much and burns off the tin on the surface. With two small irons heated alternately, one can get along very well with this outfit.—Sixten N. Swenson, Harris, Minn.



Shaping Sail of a Model Ship

The appearance of wind-filled sails has been variously obtained by ship-model builders, copper or soft-iron wire, sewed in the edges of the sail, frequently being used to retain the desired curves. Sometimes sheet metal, or even wood, has been used in place of cloth for the sails. However, all of these methods are rather unsatisfactory. I have found that excellent results can be attained in the following way: Cut the sails carefully to shape from lightweight unbleached cloth, allowing a $\frac{1}{8}$ -in. strip along each edge for hemming. Turn the edges twice and bind them with close short stitches. With a well-heated iron, press the sail until it is flat. Now bend the sail to its yard and suspend it horizontally as shown. A sheet of waxed paper is then placed smoothly on the surface of the sail. Upon this, pour sufficient fine sand to cause the sail to bulge as desired. The sail can be made to assume almost any shape by loading the most sand where the deepest bulge is required. Next, apply liberally to the underside of the sail a coat of good white shellac. After an hour or two, apply a second coat. The waxed paper

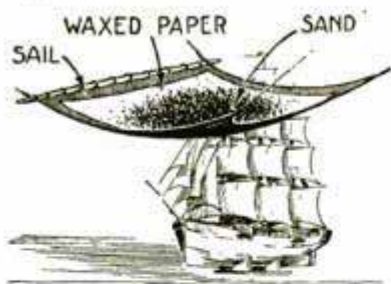

will prevent the sand from adhering to the upper surface of the sail. After the shellac has dried thoroughly, remove the sand and the waxed paper. Apply two coats of shellac on the inside of the sail. When the shellac has hardened, the sail will be found surprisingly stiff and smooth. The white shellac does not alter appreciably the color of the cloth. Sails, made in this way more than three years ago, have retained their shape exactly to this day.—Carleton Goff, East Providence, Rhode Island.

Many people use a little turpentine and warm water for cleaning varnished wood-work and furniture.



Frozen Water Pipes Thawed Out by Steam Admitted through Small Hole Drilled in Floor

Thawing Out Frozen Water Pipes

During a freezing spell some of the water pipes between the joists of my home were frozen and in order to thaw them out it seemed necessary to take up some of the flooring. In order to avoid this, I thought of the method illustrated and found it entirely successful. A hole was drilled in the floor over the pipes to admit a length of rubber tubing, which was in turn slipped over the spout of a kerosene can. After the can was half filled with water, it was set on two bricks, and the flame of a blowtorch directed against it to boil the water. The steam given off goes through the rubber tubing and strikes the pipes, which thaws them out in a very short time.—C. W. Hubert, Corry, Pa.

Remedy for Floors That Squeak

Squeaking floors are often rather annoying. A remedy is to drive wood screws between the adjoining ends of the boards



as shown. If no screws are at hand, use small wooden plugs. Either way will stop the squeak at once. Coat the plugs with glue before driving them in.

Protecting Lacquer Finish on Auto



Sheet-Metal Shield over Radiator Prevents Spilling Alcohol Solution on Lacquered Finish

Lacquer finishes are especially susceptible to alcohol spotting and therefore, when filling radiators with anti-freeze mixtures containing alcohol, one should prevent the splashing or dripping of the mixture on the finish. A simple guard, which will prevent such spotting is shown in the drawing. It consists of a flat, inclined metal shield, about 1 ft. square. The rear edge is bent to rest on the engine hood as indicated. A sheet-metal cone or cylinder is soldered to the shield below a hole cut in the center, the cone extending into the filler opening of the radiator. If any of the liquid is spilled or splashed it is caught by the guard and drips off the lower edge without touching the lacquered surface.—G. A. Luers, Washington, D. C.

Calculating Number of Studs Required in a Wall

To calculate the number of studs, rafters or joists required when spaced 16 in., center to center, divide the length of the wall by four and multiply by three. In case of joists add one to the result. With rafters for the common type of plain gable roof, multiply the result by two and add two, which gives twice as many rafters as joists,

as the former are used in pairs. For studs add two to the result, because two are used to make a corner with which to start. For example, if a wall is 20 ft. long there will have to be 17 studs, 16 joists and 32 rafters. A part less than 16 in. is always treated as a full space.—Con G. Goodwin, Oklahoma City, Okla.

How to Get More Wear from Women's Overshoes

Usually the first part of a woman's rubber overshoe to show wear is the heel, and this is caused almost entirely by the high, sharp shoe heels, which have a tendency to push a hole right through the overshoe. To prevent such wear, get a piece of sole leather, sheet fiber, or some other similar tough material, cut it to fit exactly inside of the overshoe heel and fasten it with rubber cement. This should be done when the galoshes are new, and will be found to reduce the wear considerably.—Newcomb Leonarde, Mystic, Conn.

Method of Bracing Guitar

As my Hawaiian guitar is almost in constant use, I keep the strings tight all the time. This practice, however, sprung the neck to some extent, completely ruining the tone of the instrument. To restore it, I made the repair shown in the drawing. This consisted in slipping a metal link, as shown in the detail, over the tailpiece plug of the guitar, and driving a small wood screw into the underside of the neck, and then running a screen-door brace, provided with a turnbuckle, from the metal brace to the wood screw. By turning the turnbuckle, the neck was

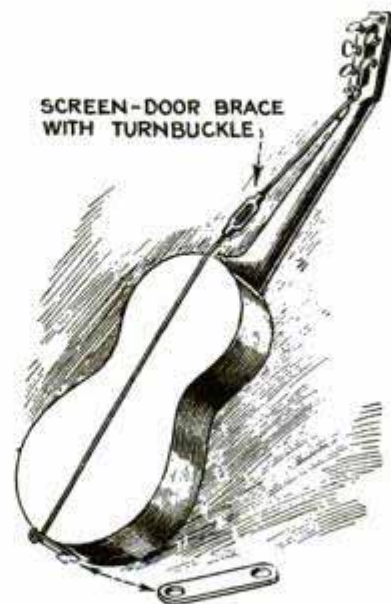

pulled back to its proper position.—Thos. F. Johnson, Schulenburg, Tex.

Water Glass as Wood Filler

Ordinary water glass, such as is used for "putting down" eggs, makes an excellent filler for soft wood and is particularly effective for covering knots in green wood. The water glass, under paint, will set up a hard finish through which no sap will penetrate. It is applied with a soft brush after the surface of the wood is reasonably clean and dry.

Easy Method of Cleaning Poultry Nests

Many backyard poultry keepers, having from 10 to 25 hens, find that the cleaning of the nests is more or less unpleasant and troublesome. To make this job an easy one, merely get some pieces of cardboard, and cut them down to a rectangular shape about 1 in. wider and longer than the bottom of the nest. Bend the edges as indicated and cut out the corners. This makes a false bottom on which the nest straw is placed. When it is necessary to clean the nest, the false bottom is removed. If an egg is broken in the nest, burn the paper board and replace it with a new one. The side flaps are turned up when placed in the nest, and thus offer handholds which permit one to lift them without difficulty.—W. E. Boyd, Visalia, Ky.



False Bottom in Poultry Nests Makes It Easy for the Owner to Clean Them

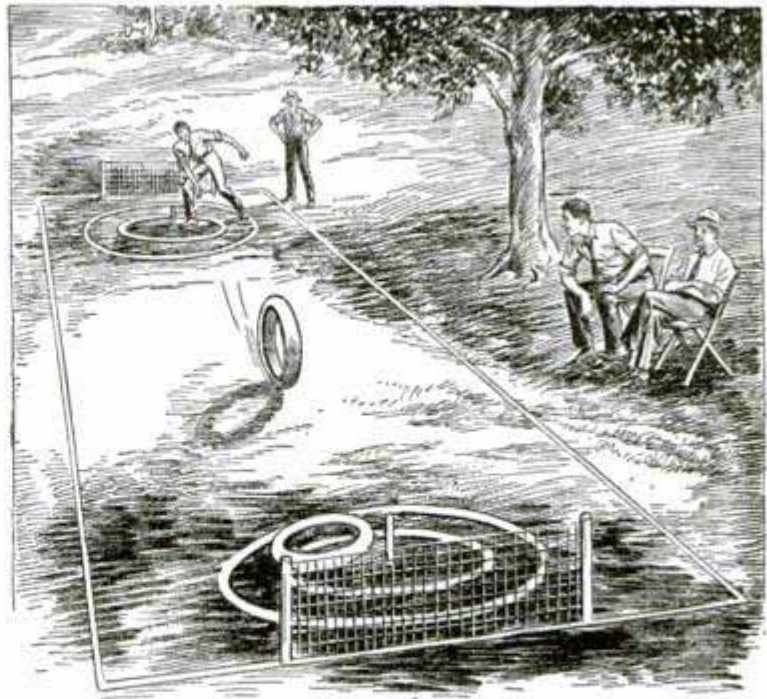

"Jitney Golf," an Interesting Outdoor Game in Which Tires Are Used to Ring Stakes

Jitney Golf Is Interesting

Last fall, during a family reunion on our farm, the men sought amusement by playing "barnyard golf," but my partner and I could not find any more horseshoes, so we originated a game played with old auto tires and called it "jitney golf." At first the others looked upon it as a joke, but were soon impressed with the fact that it was much more difficult than it seemed and, therefore, interesting. Two stakes are driven into the ground, 50 ft. apart, and are left projecting about 1 ft. above it. About 8 ft. behind each stake a wire-mesh backstop is set up. Two circles are laid off around the stakes as centers, the smaller circle having a diameter of 5 ft. and the larger one, 8 ft. If desired, a playing court can be marked off as shown. Two discarded 30 by 3½-in. tires, which are still in such condition that they can be rolled over the ground, are used, and two or four persons play the game, which consists in trying to ring the stakes. Each player or pair of players are stationed at one of the stakes. Two rolls are made by each side. A ringer on the stake counts for 25. When the tire leans on the stake, the points gained are 10, when it drops in the inner circle, 3, and in the outer circle, 2. If the tire rolls entirely outside of the playing yard, the player loses 10 points.—C. N. Harrington, Sioux Falls, S. Dak.

Barrel Hoop Holds Wood While Chopping



Setting a Number of Pieces of Wood on Edge in a Barrel Hoop Facilitates Chopping

Splitting wood piece by piece takes a long time as each piece has to be handled, put in place and cleared away for the next piece. A much quicker method is shown in the photo. Get an ordinary barrel hoop and set up a number of pieces to be chopped, with the hoop around them. The chopping is done on a small plank platform and the writer has used this method for years with entire satisfaction.—John S. Carnes, Red Wing, Minn.

Care of Your Auto Generator

As there is much more drain on an auto storage battery during the winter than in summer, due to starting difficulties and more use of light, a charging rate of 15 amp. has been found best for the cold season and 10 amp. for warm weather. When the car is driven all day it is often necessary to burn the lights in order to prevent overcharging the battery. Expensive repair bills are often caused by an owner's neglect in lubricating the generator bearings. Usually the front bearing gets its

lubrication from the motor, but the rear one must be oiled, a small hole being provided for that purpose. If you run the car about 100 miles a week, a few drops of oil once per month is sufficient. If the generator develops a grinding noise, get it repaired at once, as this is quite often an indication that one of the bearings has worn out, and delay in giving it attention may ruin the armature. Squeaks in the generator are usually caused by the smallest of the three brushes. The trouble can be determined by lifting this brush from the armature while the engine is running. By smearing a little vaseline on the contact end of the brush, or by altering its position slightly, the squeak can often be stopped, but, if not, a new brush is needed. Brushes can be replaced in most generators without taking them apart, but you should notice carefully how the connections to the brushes are made. A button hook is handy for lifting the brush spring so that the brush can be removed.—Glen F. Stillwell, Collinsville, Ill.

Celluloid on Windshield Prevents Steaming

During the winter months moisture usually collects on the inside of the windows and windshield of a car. A good remedy is as follows: Take a sheet of celluloid,

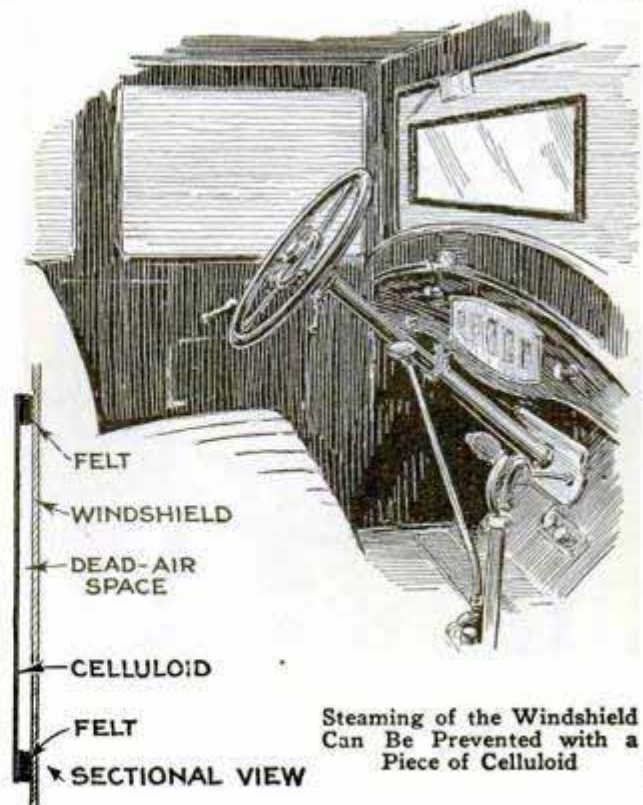

Steaming of the Windshield Can Be Prevented with a Piece of Celluloid

about 12 by 15 in. in dimensions, and along the edges paste strips of felt about $\frac{1}{2}$ in. in width. Place the celluloid on the windshield in front of the driver, inside of the car, with the felt against the shield and fasten it with friction tape as shown. This forms a dead-air space between the celluloid and the windshield, preventing either from steaming.

Electric Flatiron Thaws Frozen Water Pipes

Having been away for a few days during a cold spell, I found, upon my return home, that the water pipes behind the bathtub were frozen. Their position, which was hardly accessible, did not permit the use of a blowtorch to thaw them out. I therefore heated an electric flatiron and applied it to the frozen pipes. This method produced quick results for in less than 10 minutes the pipes were thawed out. I used an extension cord connected to the nearest light socket.—F. W. Read, Wooster, Ohio.

Luminous Paint on Keyhole



When coming home at night, I often had trouble in finding the keyhole, as the door was in a hall that was dark all the time. To eliminate the trouble I bordered the keyhole with luminous paint, as shown, and now it is an easy matter to find the keyhole in the dark.—Charles Latour, Jr., Plattsburg, N. Y.

Flashlight Used for Photographing

Beautiful light and shadow effects in photographs of still objects can be obtained by the use of a strong flashlight to illuminate them while taking a time exposure. Examples of this kind of work, done by an amateur photographer, are shown in the accompanying illustration.

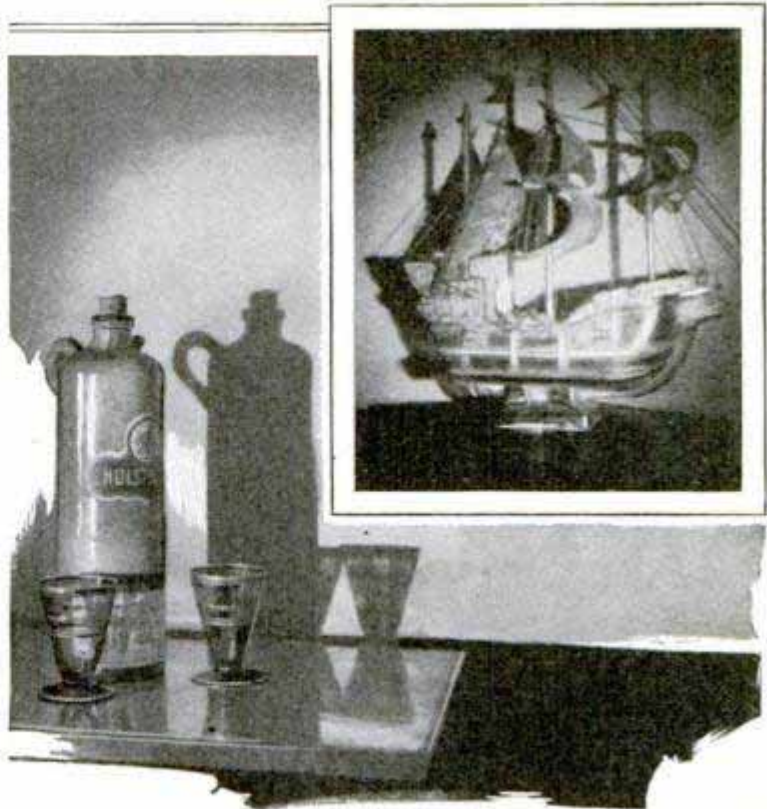

Beautiful Time Exposures Can Be Taken at Night with the Aid of a Strong Flashlight

The flashlight used for the purpose was a large, five-cell type, having a focusing cap and capable of throwing a powerful beam of light. The camera is set about $2\frac{1}{2}$ or 3 ft. from the object, and the light in a position on one side and somewhat behind the camera. Then the shutter is opened and an exposure varying from $1\frac{1}{2}$ to 2 minutes allowed. By moving the flashlight throughout the exposure, every portion of the object was well illuminated.

Lock for Loose Hinge Pin

Loose pins in hinges often work out of place and may be lost. If the pins are a fairly tight fit they will even work up and drop out of vertical hinges. This trouble can be prevented by driving a thin finishing nail or brad at an angle into the door or the frame. If driven at the right angle it will not stop the door and need be taken out only if the hinge pin is to be removed.

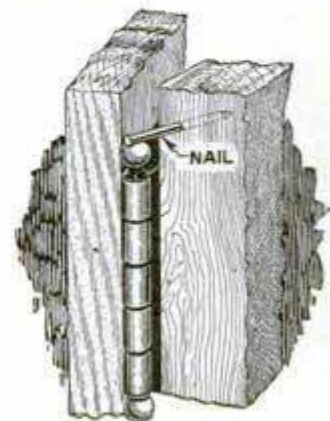

*N. W. Ayer & Son,
308 Chestnut St
P. 1*

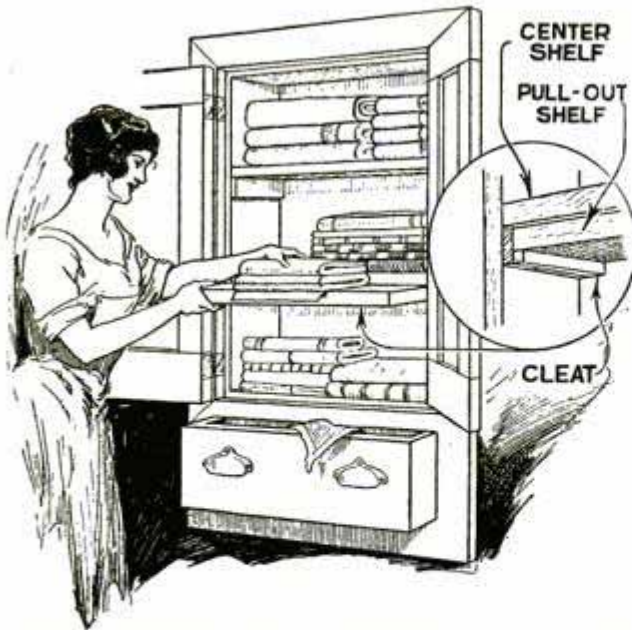

Pull-Out Shelf Facilitates Handling of Linen When Arranging or Removing It from Closet

Pull-Out Shelf for Linen Closet

When arranging or removing supplies from a linen closet, the pull-out shelf shown in the drawing will be convenient as a place to lay some of the linen down while both hands are occupied in getting a piece from the bottom of the pile. Two cleats are nailed under the shelf where the slide is to be located. The detail clearly shows how this is arranged. Although not necessary, a stop may be provided to prevent the movable shelf from sliding too far.—C. C. Brabant, Detroit, Mich.

Emergency Repair on Worn Brake Linings

When brake linings are badly worn and adjustment can no longer be made to make them hold, danger is involved at a time when the brakes are badly needed. In case it is impossible to have the brake bands relined at once, the following emergency repair will be found helpful: Get a number of wooden toothpicks and force them between the brake band and the worn-out lining at 1-in. intervals as shown. This serves as a

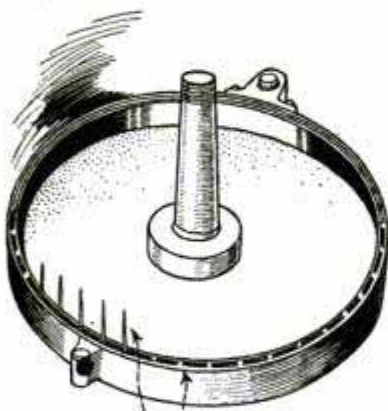

TOOTHPICKS INSERTED AND BROKEN OFF

found helpful: Get a number of wooden toothpicks and force them between the brake band and the worn-out lining at 1-in. intervals as shown. This serves as a

shim, temporarily increasing the effectiveness of the lining. An auto with brakes repaired in this way was run safely for a few hundred miles. It should be remembered, however, that the repair is only temporary and that the brake lining must be renewed at the earliest possible opportunity.

Fitting Brushes on Fan Commutators

Small electric fans equipped with carbon brushes often emit squeaking noises when new, which is caused by poor fitting of the brushes. To avoid this trouble, the brushes should be "run in" in the following way: Apply two or three drops of thin oil on the commutator of the new fan and connect it to run. Then set a second, and preferably larger, fan behind it so that the breeze of the latter will cause it to rotate faster than it would of its own accord. At this high speed, the brush tips, being slightly softened by the oil, will soon wear down to a good fit.—A. H. Klingbeil, Ash-tabula, Ohio.

Key Ring Serves as Picture-Frame Clamp

Some time ago I had a number of small picture frames to make. Having only one clamp, I used ordinary spring key rings, as shown in the illustration. They were cut to have an opening of about $\frac{1}{2}$ in., the ends being filed to a sharp bevel. I found these so effective on small frames that I have discarded the regular clamps.—Harry G. Tienken, Syracuse, N. Y.

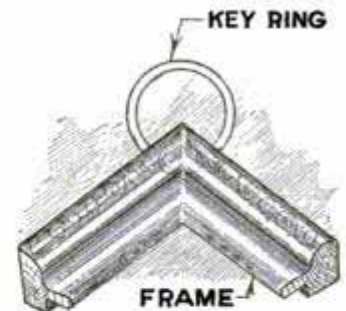

Whitewash for Various Purposes

Whitewash is an excellent preservative, brightens the cellar, the cottage, the shed, and the barn, and protects trees against worms and insect pests. It can be prepared easily and applied effectively by anyone. Two simple formulas are widely used for general-utility work, one for exterior, and the other for interior application. For sheds, tree trunks, stables, fences, etc., dissolve 15 lb. of common salt in about $7\frac{1}{2}$

gal. of water. To this solution add 50 lb. (1 sack) of hydrated lime, or the putty made by carefully slaking $\frac{1}{2}$ bu. of fresh quicklime. Mix thoroughly until a thick, smooth paste is formed. Thin to the desired consistency with fresh water, and apply. For interior work the following solution is popular: Dissolve 3 lb. of glue in about 2 gal. of water. Make a thick cream of 50 lb. (1 sack) of hydrated lime and about 7 gal. of water, or carefully slake to a soft putty $\frac{1}{2}$ bu. of quicklime. Add the glue solution to the lime, stirring constantly. As thin applications work best, make the mixture of such consistency, that the surface can be seen through the film while it is wet. The coating will dry opaque. Best results are obtained when the work is done in clear, dry weather. By adding 1 qt. of crude carbolic acid to either of the above mixtures, the whitewash becomes mildly disinfectant and insecticidal. Clean the surface to be treated of all dirt, etc., and dampen it before applying the fresh coat so that the wash will dry gradually.

How to Prevent Ink Blots When Ruling

When using an ordinary writing pen and a ruler for drawing lines, care must be taken to prevent ink from creeping under the ruler. A good method is to slip a paper clip over it at each end as shown. This will raise the ruler a trifle and if some of the ink should accidentally get on it, there will be no risk of getting a blot on the paper unless, of course, one is very careless. The use of the clips does not affect the accuracy of the work.

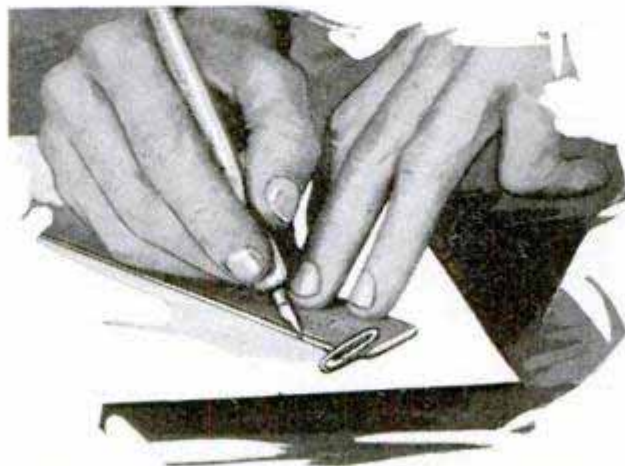

Clips on Ruler Prevent Ink from Smudging Paper

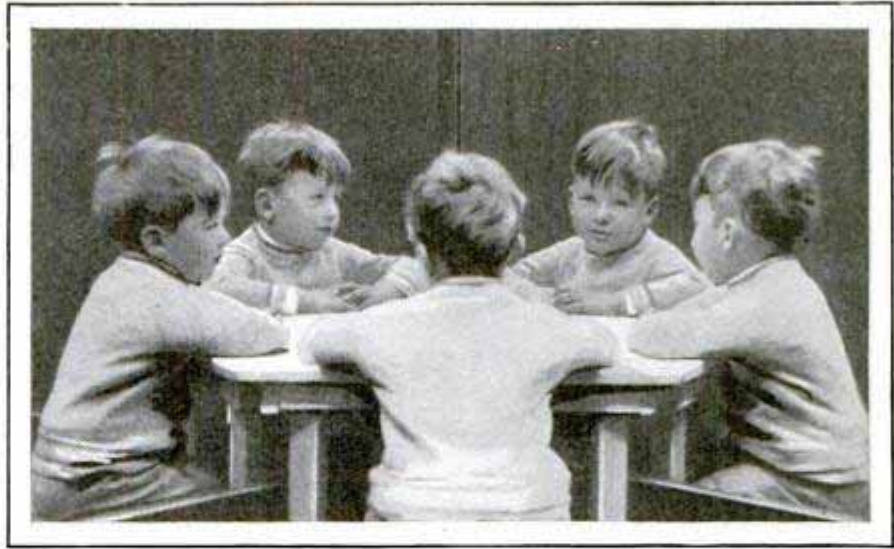

Photograph Showing Five Images of Same Subject Taken with One Exposure from a Point in Line with the Corner

Five Photos in One Exposure

On the Atlantic City boardwalk a photographer makes use of a clever device for simultaneously producing five different views of the same subject on the same photo with only one exposure. The method is simple: Two large mirrors are placed together like the covers of a half-open book, with their reflecting surfaces facing each other. The angle formed by the mirrors is about 40° . A small triangular table is fitted into the space between the mirrors, and the subject to be photographed sits at the table facing the mirrors, which produces four reflections at a point a few feet behind the subject.—Bennie Agron, Atlantic City, N. J.

How to Tighten Cane Seats

Cane-seated chairs have a tendency to sag after having been in use for some time, and reseating is usually considered necessary. However, the slack can be taken up by shrinking the cane as follows: Sponge the sides of the strips of cane with hot soapsuds and then let them dry. When nearly dry, cover the seat with a cloth and go over it with a hot flatiron.

Knots Should

SUPPOSE we are mountain climbers, and that one day, while strolling amongst the peaks, we have to negotiate a series of five 100-ft. terraces in order to reach the floor of a valley far below. We have but one 150-ft. length of rope, but, since one of us is an old hand, and well versed in the important element of knot making, we find the solution easy. We proceed to use our rope in descending the first drop, then, standing on the first terrace, we give the rope a few vigorous jerks and down it comes, tumbling in a pile at our feet. And so to the valley. Back up the cliff again means taking the longest way round, of course, but anyway, our immediate problem is solved. And where does the knot come in? Well, it solved the all-important problem of how to take our rope along with us. We used the "sheep-

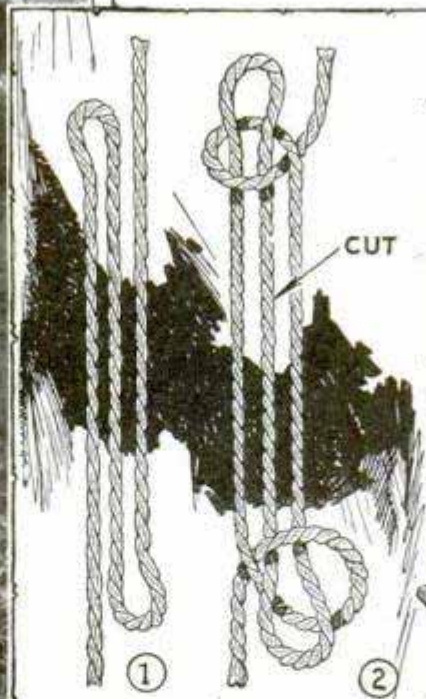
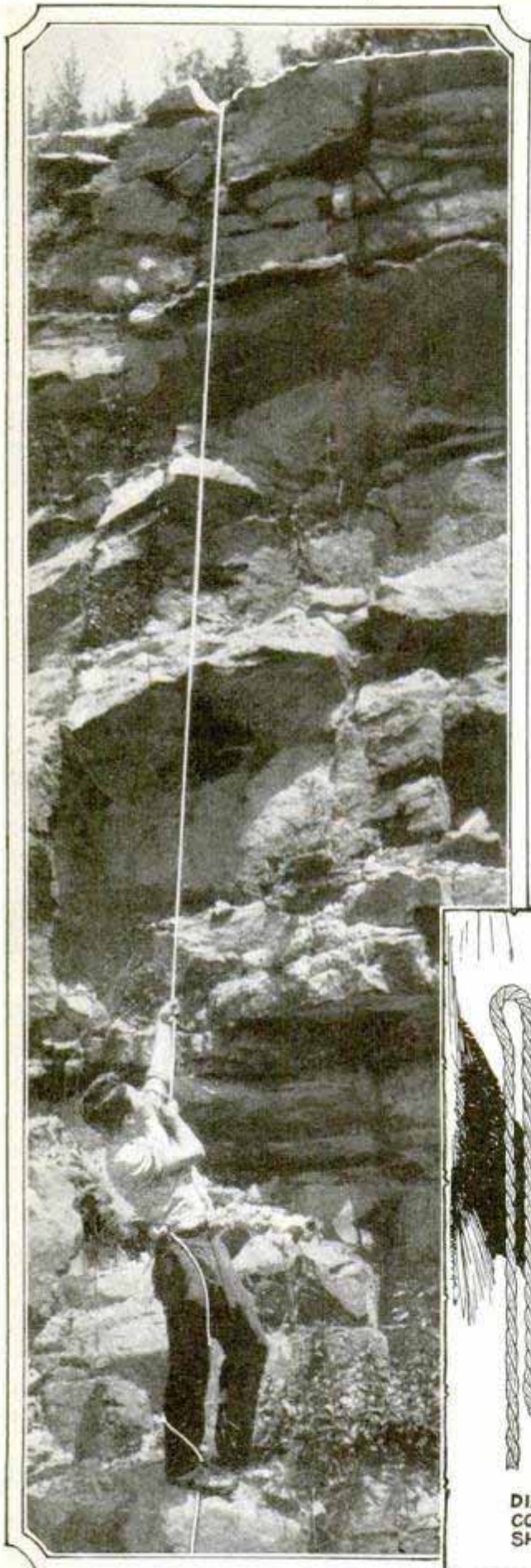

DIAGRAMS SHOWING CONSTRUCTION OF SHEEPSHANK



Dropping down the Face of a Hundred-Foot Cliff, and Taking His Rope with Him as He Goes, Is a Snap for the Man Who Knows His Knots

You Know

By Sam Brown

shank," which is illustrated in Figs. 1 and 2. First we lashed or tied one end of the rope to a solid support. Then, doubling the rope back on itself, as in Fig. 1, we made a half hitch around each end, as pictured in Fig. 2. Finally, we cut the one strand that passed through both of the half hitches.

Then we dropped down the first terrace. As long as our weight kept the rope taut, the knot held with the strength of Gibraltar. With the weight off the rope, however, the knot became slightly loosened, so that a few vigorous jerks was all that was necessary to free it and let the rope come tumbling down. Of course, we lost a couple of feet of rope at every terrace, but what of it?

This cutting of the sheepshank should be practiced only in the case of an emergency meriting the additional risk. In most cases, the sheepshank is used only as a handy and quick method of shortening a rope that is too long for a particular purpose, without cutting it. A practical use for the knot is illustrated in Fig. 3, where it has been used to shorten a temporarily installed electric-light cord, and used in this way, it is a great deal neater, as well as more practical, than the clumsy, untidy, tangled knots one usually sees employed for the purpose.

The knot as just described is but one of the many which everyone should know. Thousands of lives are risked yearly on this knot and others. Every day sailors, explorers, mechanics and painters risk their lives on the knots that they tie. Even you and I use a rope occasionally, and we usually muddle through the task in an unworkmanlike manner. The tying of a box, the proper lashing for a towrope, the right way to tie a string to a rope—these



**TWO HALF HITCHES
MAKE AN EXCELLENT
KNOT FOR THE TOW
ROPE**

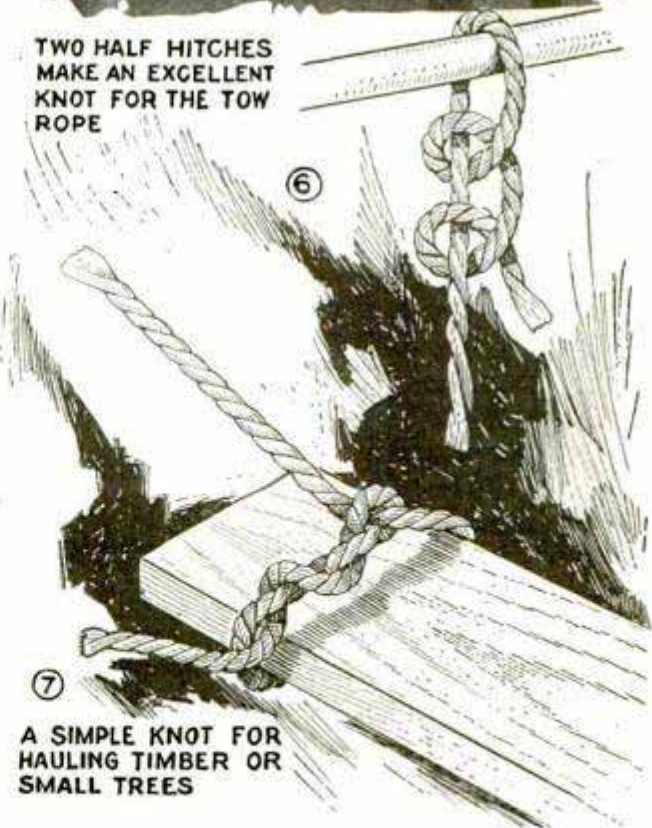

**A SIMPLE KNOT FOR
HAULING TIMBER OR
SMALL TREES**

Above, Tying a Package Alone Is a Simple Trick by the Use of the Knot Illustrated

are everyday knots which all should know.

Knots should not be complicated affairs of numerous twistings. They should be of a kind that can be tied rapidly; they should hold fast when pulled tight; they should be easily untied.

With these qualities in mind, we will talk a bit on a knot that you use every day—the one used in tying a package. You want a tight string and a good knot, so, generally, a second person is called, his duty being to hold his finger on the first knot while you get the twine or rope ready for the second knot. But why the second person? If you twist the one end

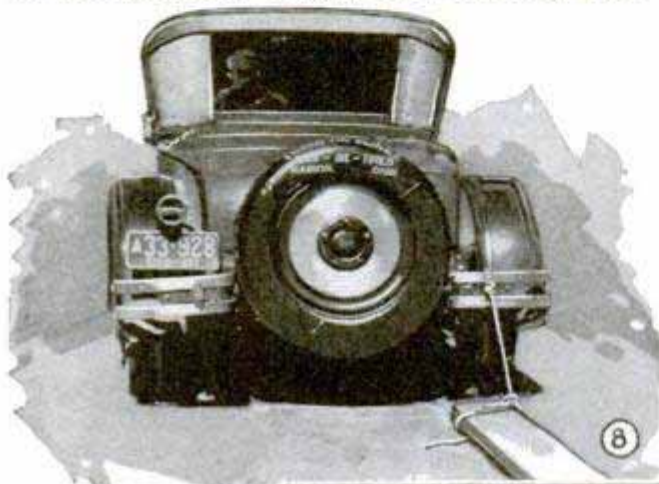

of the first knot once or twice around the string, as shown in Fig. 4, and then pull the free ends cross-wise as in Fig. 5, you will find that this single knot will hold fast until you get the second knot into place.

A simple knot which is constantly being used, or misused, by an automobile-riding American public, is the one used to attach a disabled car to one that is "up and going." For this purpose, nothing is better than two half hitches. Their formation is plainly shown in Fig. 6, and needs no other explanation. These two hitches will not slip under any strain, and they can be loosened far more readily than a haphazard knot where the average per-

son adds two or three unnecessary twists "just to make sure it'll hold."

Farmers and lumbermen are constantly called upon to fashion a knot around a small tree or a heavy plank so that it can be hauled to its destination. For this purpose, they merely pass the end of the rope around the timber, then lead it around the standing part and back for two or three twists around its own part, as shown in Fig. 7. The strain holds it quite securely, as illustrated in Fig. 8.

A common knot used quite frequently in everyday work, is the "Blackwall hitch," shown in Figs. 9 and 10. In a junk yard, where the illustrative photograph was taken, this knot was used to fasten one end of a rope to a derrick hook while the other end was fastened to the front end of a car with two half hitches. Both knots hold fast because of the resultant strain; both knots can be unloosened in the proverbial "jiffy" once the load has been released, of course.

Linemen, carpenters and painters often find it necessary to throw a rope to some one who is stationed a considerable height above. Generally, the weight of the rope

makes it unsuitable for throwing. The thing to do is to tie a light string to the heavier rope, and throw the ball of string to the "high-up fella." You will want a knot that is simple; something that can



be easily untied by the man at the other end. What you want is the becket hitch. This is illustrated in Fig. 11. It is absurdly simple to tie, equally simple to unfasten, and it



does away with much unnecessary guesswork. This knot is also an

rope, Fig. 16, and you have a noose at the end of the rope that

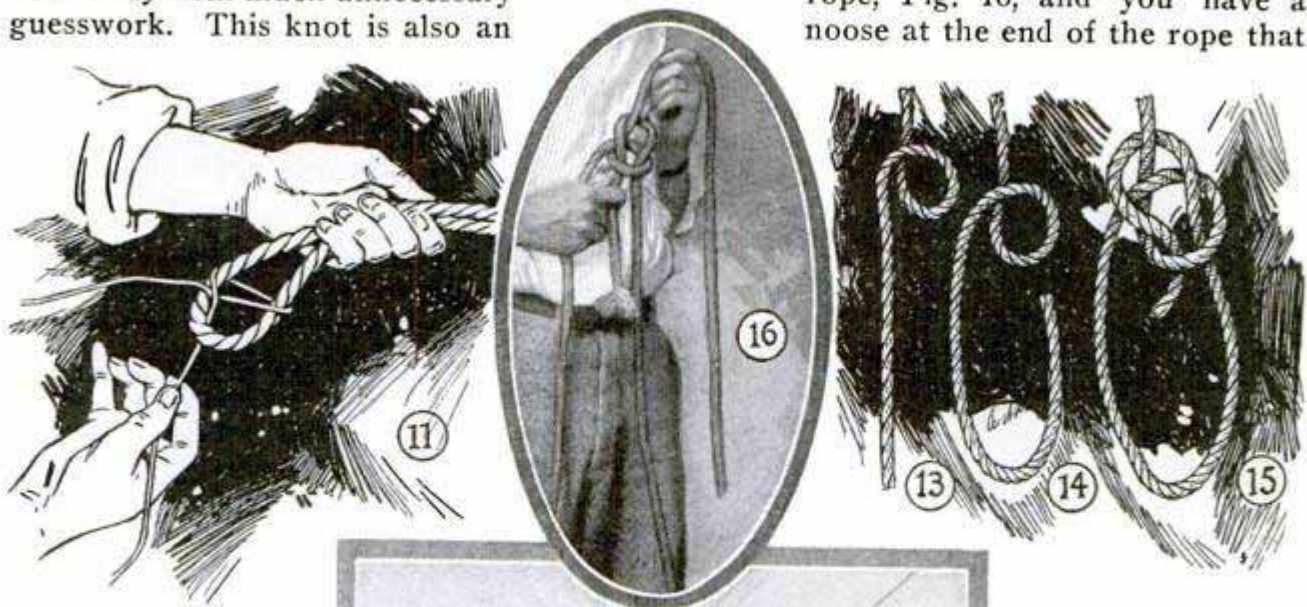

excellent non-slip method of tying two ropes together. It is sometimes called the weavers' knot because of its adaptability to the tying of fine weavers' threads in a knot that cannot possibly slip.

If you long for the "life of a fireman," then it becomes absolutely essential that you learn how to tie a bowline. It is the one and only knot for lowering a person from a burning building, for making a single-loop child's swing or for making a large loop at the end of any rope—a loop that can't slip under strain.

To make the bowline, form a small loop on the rope, as shown in Fig. 13. This loop should be made at some distance from the end of the rope so that you will have sufficient rope to form the large loop, Fig. 14. After the large loop has been formed, pass the rope up around the standing part and then down through the small loop again, as shown in Fig. 15. There! Tighten the knot by holding the noose in position and pulling the long part of the

will not slip and is easily untied.

Of course, your first attempts at making some of these knots, simple as they are (the bowline, for example), would probably bring a broad smile to the face of a deep-water sailor. In knot making, as in everything else, there is a technique that must be learned if one is to become an expert. But, no matter how awkwardly the knots are made, they will be just as good as the expert's if the drawings are followed closely. If

you want to learn the proper motions in tying knots, any rigger on a building-construction job will show you. Of course, the ideal instructor is the sailor, but there are not many of them in captivity. The lumberman also is a specialist on knots.

☞ Paper can be made transparent for tracing by saturating it with turpentine; as long as it is moist, the tracing can be carried on, but, when the turpentine has evaporated, the paper will again be opaque, and ink and colors will not run.



Improved Corn Popper Can Be Made from an Old Cooking Pan and a Piece of Wire

Improved Corn Popper

In the absence of a regular corn popper, it is an easy matter to improvise one that will serve the purpose fully as well as the commercial type. Take a cooking pot of about 2-qt. capacity, remove the knob from the cover and fit a tube or bushing, about 2 in. long, in its place. To a tin cover this bushing can be soldered, but if the cover is of aluminum, soldering is difficult unless special flux and solder are used, and it may be better to rivet it. A length of galvanized-iron wire, of a diameter to fit inside of the bushing, is then bent to the shape shown and a wooden knob attached. This stirring device is rotated when the corn is being popped to prevent it from burning.

Use Correct Type of Spark Plug

Not every automobile owner realizes the importance of the type of spark plug he uses with his car. His knowledge of its relation to the operating efficiency of the motor is confined generally to the bare fact that it furnishes a spark to ignite the gasoline charge. He should have the plug specified not only for his car in general but for his particular model, or he is likely to invite trouble. The correct spark plug

is of this importance, because engine-compression ratios differ, and the cooling coefficient and the r.p.m. of the motor usually vary with its make and model. With the development of higher compression ratios and higher speeds, it became necessary for manufacturers to design their spark plugs so that the heat in the motor did not affect their operation. Also, with a variation in cylinder-head design, the specified plug is necessary in order that the proper location of the sparking points may be had in relation to the combustion chamber. To perform efficiently, the electrodes must not become too hot. When too long a plug is used, the lower end extends too far into the firing chamber, where it is exposed to the full heat of the explosion, which causes the electrodes to become red-hot and results in pre-ignition, loss of power, missing and back-firing. If the plug is too short, it will be pocketed in the cylinder head, and a remnant of unburned gas in this pocket, left during the exhaust stroke, will foul the plug. The gases also will prevent proper firing of the fresh incoming charge. Thus, when the new spark occurs, there will be delayed burning, causing overheating of the motor just as a retarded spark would. This means loss of power and fuel, the motor becomes sluggish and difficult to start, and the acceleration slows up. At times the motor also may miss at high speeds.

Preventing Cast-Iron House Numbers from Discoloring Paint

Ordinary cast-iron house numbers, when placed on light or white-painted wood, usually cause rust marks below them. I found that by grinding or filing down the lower portion of the numbers, as shown in the photo, any rain water will drop free of the wood near the number in trickling down and will not discolor the paint.

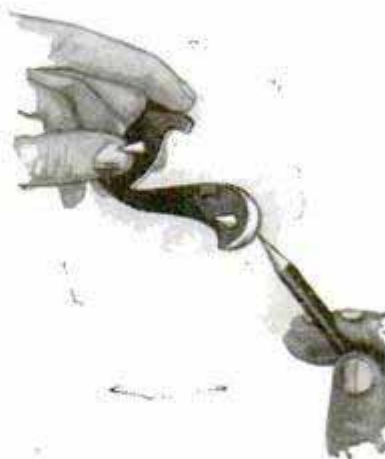

SHOP NOTES



All Shop Notes published in 1927, in book form—Fifty Cents—from our Book Department

Hints for Ship Modelers

By W. F. CROSBY

THE SHIP model builder who attempts to make his own blocks out of wood will probably find that he is up against a real problem, particularly if he tries to make these close to actual scale. In order to overcome the difficulty, the use of ordinary wire solder, as shown in Fig. 1, is about the best possible way of making non-splitting blocks. This solder may be obtained in several different diameters, it is soft enough to be drilled easily and may also be cut with a knife to the desired length. The groove for the strap is cut in easily and the hole for the running rigging cut at right angles to this.

Another method is to use small pellets of plastic wood slightly flattened out. A

thin wire strap may be worked around the pellet just before it is hard and a hole drilled without much difficulty for the line to pass through. This material will not split, and blocks may be made with great rapidity and with the utmost ease. The only thing to watch out for is that the

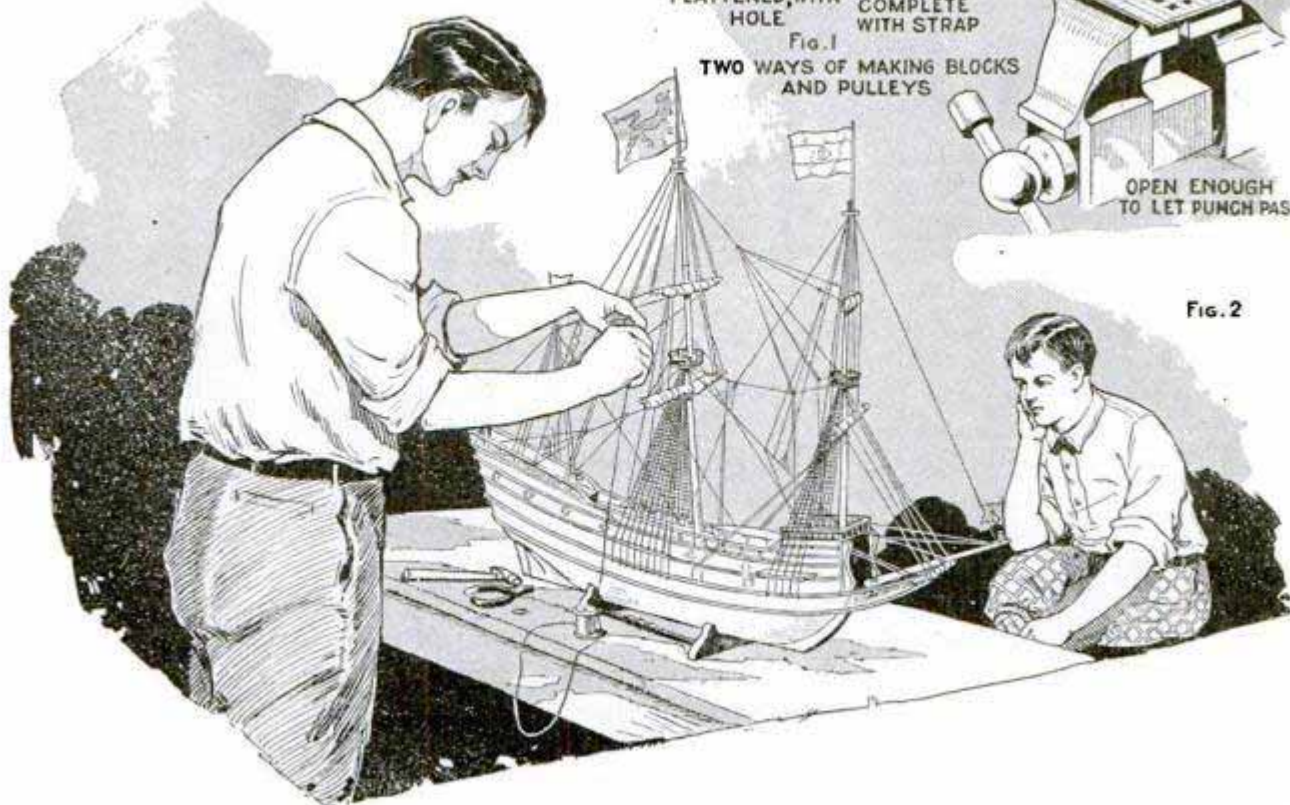
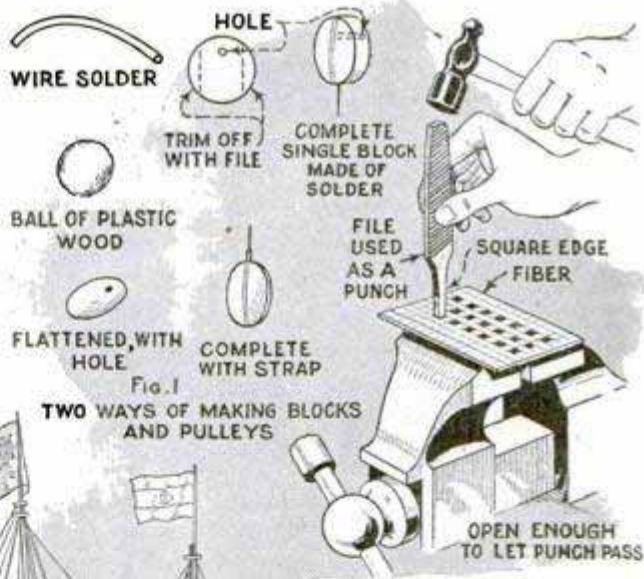
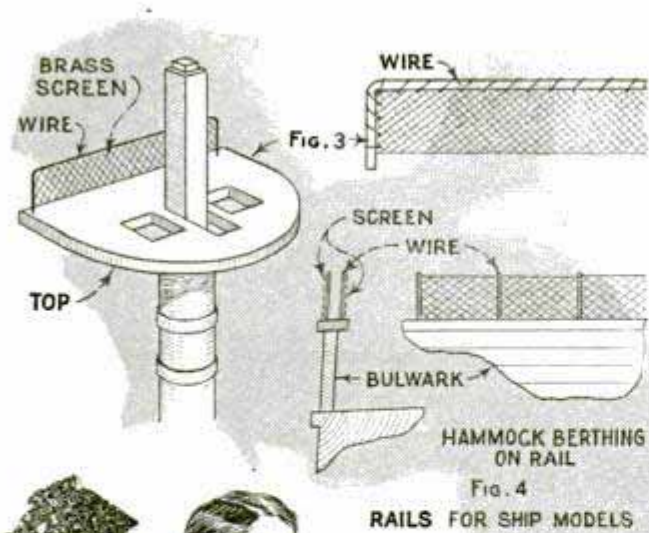
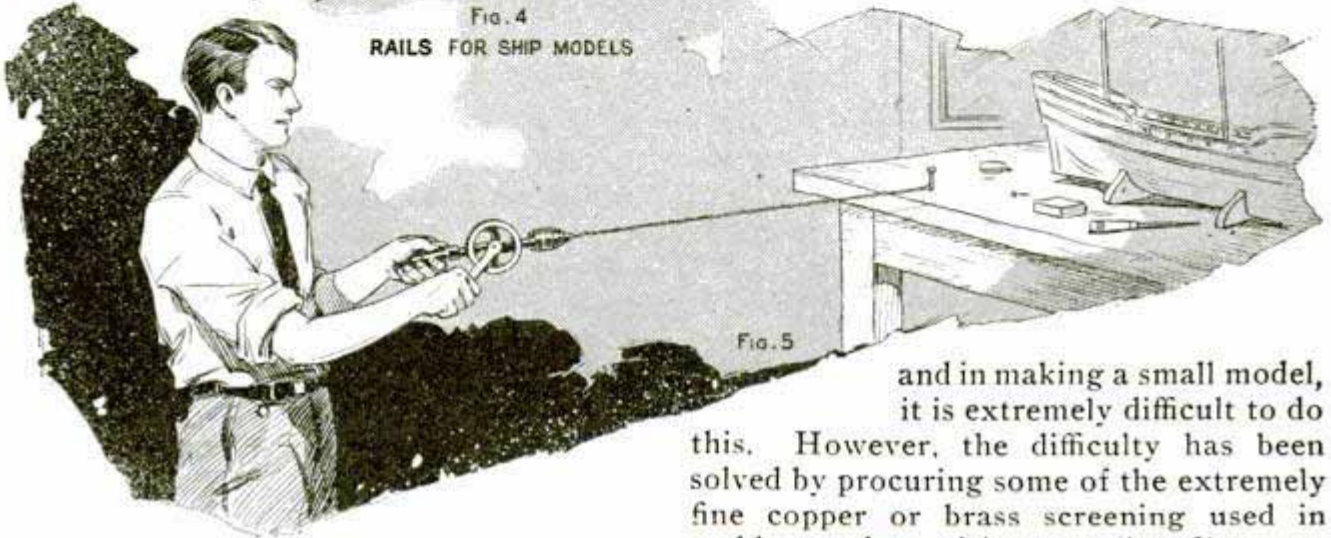

FIG. 2



RAILS FOR SHIP MODELS



blocks are all of exactly the same size.

The deck of the average sailing ship will be found to contain several gratings of fine "mesh" and also two or three skylights which may be extremely difficult to make of wood. Fiber of a thickness to suit the scale of the model will serve the purpose. This material will not split and may be worked and finished to look exactly like wood. For gratings, the size and shape should be secured and marked off into the desired mesh. The tang end of a small file should then be squared off and sharpened on a stone, and this may be used as a punch. The fiber is held over a narrow slot opening in the vise (Fig. 2) and the homemade punch driven through it by a quick blow of a light hammer. The entire surface may thus be worked into the desired number of square holes. If the fiber has a tendency to shred off on the underside, an old razor blade or sharp knife may be used for trimming off this excess material.

Fiber also may be used for rails and skylights, but in the heavier sizes it may be necessary to cut out the square holes

of a skylight with a small drill, later finishing it smooth with a file. Windows may be made from old camera film, washed clean of emulsion.

On many of the old-time frigates, line-of-battle ships and other war vessels, the after side of each top was arranged with a small rail which was put there to keep the sharpshooters from falling overboard or to the deck. (See Fig. 4.) These rails quite often had a fine-mesh rope screen woven into them,

and in making a small model, it is extremely difficult to do this. However, the difficulty has been solved by procuring some of the extremely fine copper or brass screening used in making and repairing gasoline filters on automobiles. A framework should be made of light copper wire and the screening fastened to it by sewing with fine thread or copper wire.

The same copper screening may be used for the hammock berthing along the main rail of most of these old naval-ship models, this screening also being supported by wire uprights set at appropriate distances.

More than half the charm of a ship model lies in the accuracy of the work, and in this respect it is essential that the rigging be of proper sizes. The stays of the various masts will usually be of the heaviest material, the lower shrouds of the next heaviest and the upper rigging somewhat lighter. The running rigging will be the lightest of all.

Since suitable cord is sometimes hard to get in the right sizes, it is somewhat easier to make up material which will be suitable by winding together several smaller cords to make one large "rope." This may be done by measuring the approximate distance that the line is to go and then allowing a few inches at each end for fastening. Take several such

pieces and tie them to the workbench or fasten them in a vise (see Fig. 5) and then place the other ends in the chuck of a small hand drill, turning the handle toward you and winding until the different cords are securely twisted together. However, do not wind too tightly or the cord will be greatly shortened.

Such rigging must be kept tight or it will untwist and small clamps may be secured to each end until it is time to use it. A better and much more satisfactory way is to make up the rigging only as needed and then keep it taut until it is securely in place on the model.

One of the tedious jobs in completing an old-fashioned ship model is in the making and finishing of the many guns necessary. The guns themselves may be cast of lead or solder or, better yet, turned from hardwood on a small lathe. In the latter case, the material should be finished smooth and then painted either with bronze or black paint, depending upon the period of the ship.

The average frigate had carronades on deck and the heavier guns below and, in nine out of ten such models, the deck guns will be made incorrectly or mounted improperly. Carronades were considerably smaller than the other guns and had carriages which consisted of a flat piece with three little rollers on the underside. The carronade itself was mounted on a

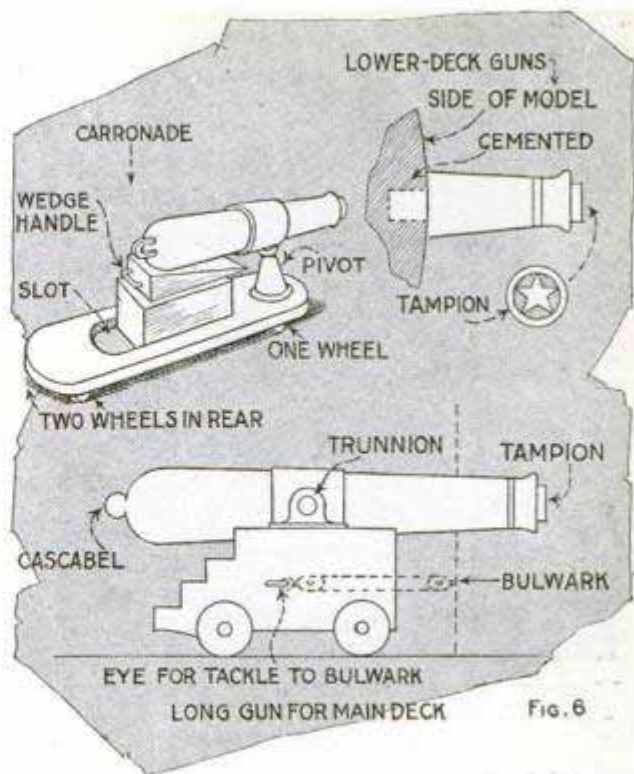

swivel at the end nearest the rail, with a wedge arranged under the inboard end to depress or elevate the muzzle.

On the average model of this sort, the guns on the lower decks will simply be short pieces cemented into holes in the hull. These guns should be slightly greater in diameter and also slightly longer than the ones above. If long guns are to be made for the main deck, Fig. 6 will furnish a guide to the proper proportions for gun and carriage.

Curtain Rod Holds Surgeon's Tape

Rolls of adhesive tape of varying sizes are always convenient in the office of a police surgeon at San Diego, Calif. The rolls are held on a small curtain rod. Just below the rod, a piece of plate glass is provided to permit attaching one end of the tape to it when it is necessary to pull a section of tape off the roll and cut it with the use of only one hand, as, for in-

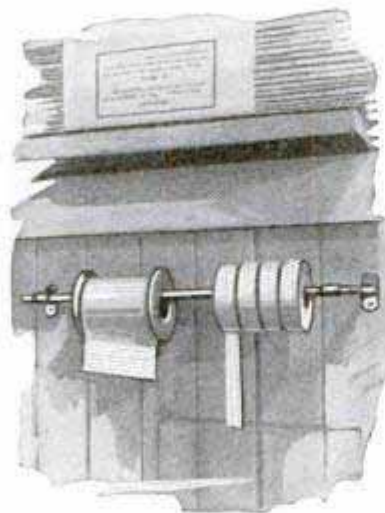

stance, in case the other hand is needed for holding the bandage on the patient.—Alpheus Lincoln, Los Angeles, Calif.

Acid Helps Remove Broken Tap

Mechanics often have trouble in removing a broken tap, especially if the tap is in tight and has broken below the surface. Before attempting to use any tools to remove it, fill the hole containing the broken part of the tap with muriatic acid or spirit of salt, taking care not to get it on the hands or clothing. Let the work stand for a few hours, which will give the acid time to dissolve some of the steel around the tap, so that the latter will be loosened sufficiently to be turned out. Sometimes the broken tap will become so loosened that it can even be lifted out.—James E. Noble, Toronto, Can.

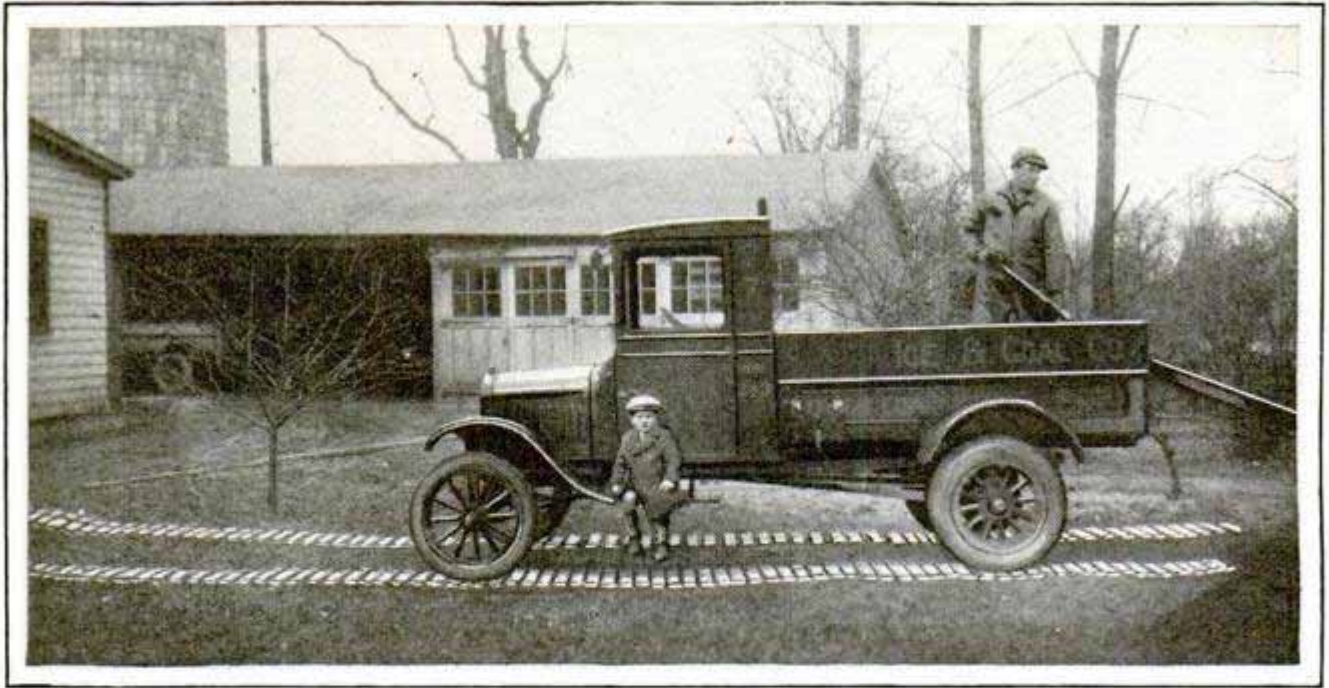

Portable Truck Tracks, Made of Hardwood Slats Connected by Means of Chain, Prevent the Risk of Running Deep Ruts in Soft Lawns, besides Saving Considerable Time

Portable Tracks Save Lawns from Injury by Delivery Trucks

Portable tracks made of hardwood slats and connected by means of light chains have been found very useful in driving over soft lawns, to prevent ruining them. One truck owner who handles coal found sections 14 ft. in length most convenient. Each of these weighs about 70 lb., can be rolled up into a compact bundle and readily put on top of the load. This track saves the customer the extra charge for carrying the coal in baskets or bags, and the coal man a lot of time.—S. Merritt, Nyack, N. Y.

Facing Pipe Fittings

In our machine shop a job came in which made it necessary to face off pipe elbows so that the two ends would be at perfect right angles. To do this we blocked up the lathe and the elbow with parallel blocks as shown. The cross slide was fastened to the faceplate, with the cutting tool arranged to turn down the face of the elbow. The handle of the cross slide was given part of

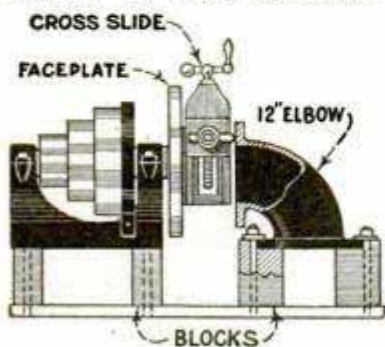

a turn at each revolution. After it was once set up, we made good time in this way.—C. Kugler, Philadelphia, Pa.

Repair for Broken Gear Tooth

It is occasionally necessary to replace a broken tooth of an iron gear, as this is not only much easier, but also less expensive than getting a new gear, especially if it is large. The repair described here is only intended for use on parts that are not subjected to heavy loads. The gear face is ground down on each side of the broken tooth, and a piece of sheet metal is then used to make the shell of a new tooth. The sheet metal should be as heavy as can be conveniently worked. It is bent to shape over an adjacent tooth, one side being bent first and the top section bent back so that the tooth will not be too wide. The shell is securely fastened to the gear as shown and filled with babbitt.

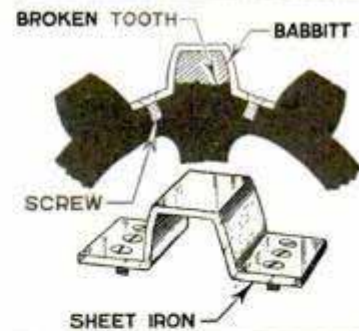

☛ Chalk rubbed on a file for use on steel prevents chips from sticking to the tool and scratching the work.

Home-made

A Simple Rack for Draftsmen

At different times a draftsman needs a large number of tracings and blueprints for reference, when working on a single job, and unless he has them arranged in a systematic way, he loses a good deal of time in picking out each sheet as needed. In addition, he has little room to work if his table is covered with a pile of drawings, and his difficulties are seriously increased if he is engaged on the kind of map work in which one job is continued from sheet to sheet. A handy rack which takes up little room can be made out of a 2-in. plank, about 1 ft. square. Plane and sandpaper it, and drill sixteen 1-in. holes—four to a row—which should be enough for most purposes. Sandpaper the inside of the holes, varnish or stain the block as desired, and mark numbers neatly against the holes. The rolled drawings can then be placed in the holes, so that they will take up little room, and will be easy to pick out. Drawings usually have numbers assigned to them for classification on the drafting-room records, but for this purpose it will cause no confusion if temporary numbers are given to the different sheets, corresponding to the holes. The numbers can be written lightly in pencil on the backs of the sheets.

Handy Drawer for Double Bench

When a double-bench drawer can be pulled out from one side only it is annoying for men working on the other side, as they either have to walk around or ask someone on the drawer side to get the tools they need. One shop solved this difficulty in a simple manner: A drawer was made the full width of the bench with a handle at each end, and the tool-holding compartment was arranged to slide inside the drawer, on two runways.

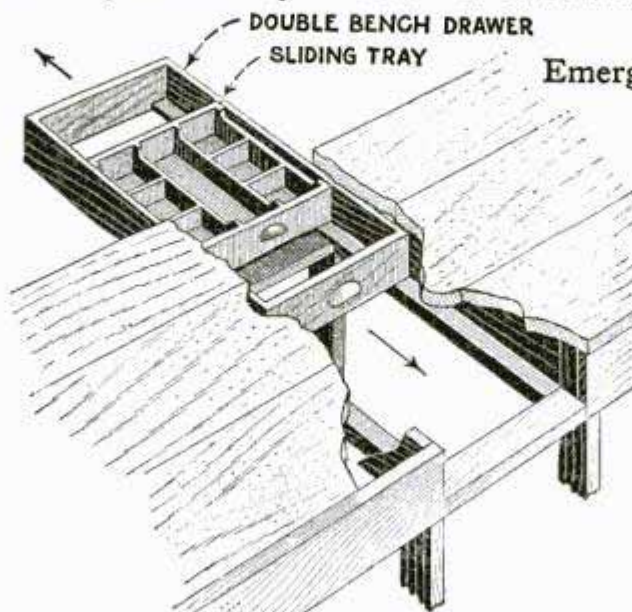

Handy Drawer for Double Workbench Can Be Pulled Out at Both Sides

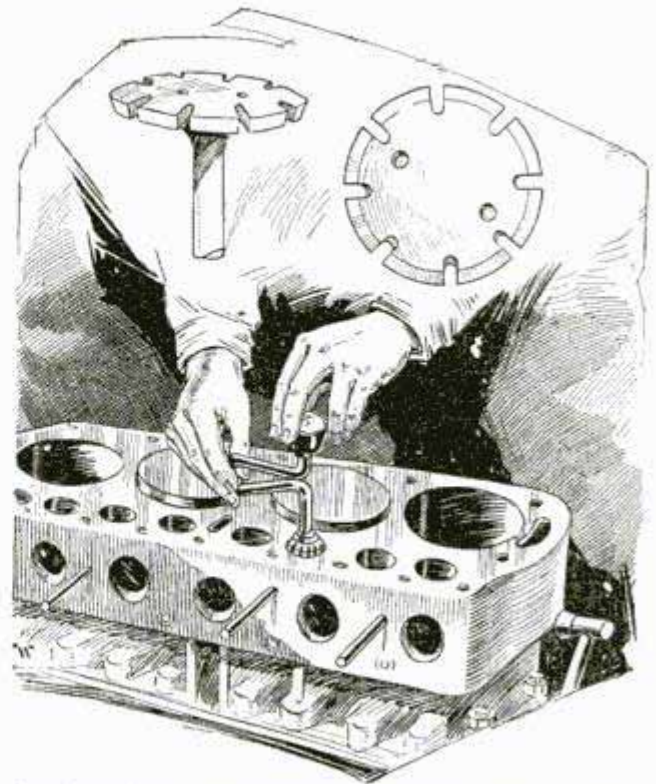

Cutting Lips on Edge of an Old Valve Make It a Good Valve-Seating Tool

Valve-Seating Tool Made from Old Valve

A tool for cutting valve seats can be made from an old valve. The edge of the head is slotted with a saw in about eight places, as shown in the illustration. One side of each slot is relieved by filing in order to leave one cutting edge. The valve head is then hardened. An ordinary valve-grinding tool is used to rotate this cutter. In ordinary cases, only a few turns are necessary to true up and smooth a rough seat.—G. A. Luers, Washington, D. C.

Emergency Lacing for Belts

Take a piece of electricians' tape, about 1 ft. long, twist it lengthwise to form a cord about the thickness of a match, and lace the belt the same way as you would with regular lacing. It is strong, lasting and lies flatter than ordinary belt lacing; also it will not cut.—Ben F. Imhof, Davenport, Iowa.

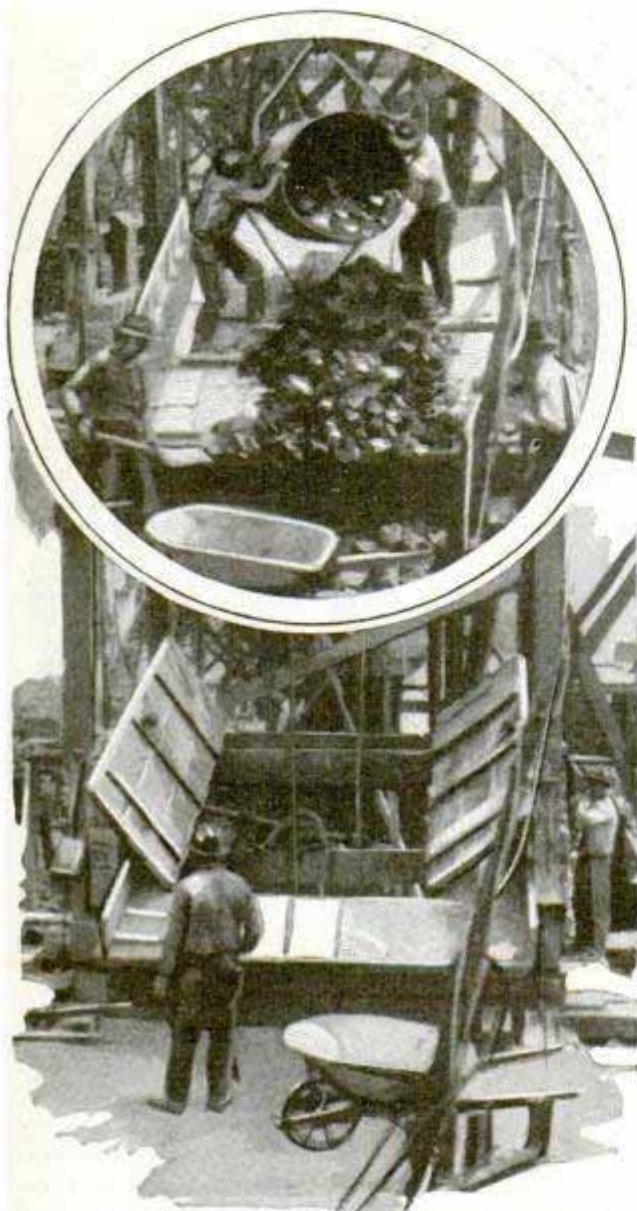

Cellar Doors Aid Work of Excavating Besides Protecting the Workers in the Pit

Cellar-Door Idea Employed in Foundation Digging

In sinking wells, 209 ft. deep, on the site of the Cleveland terminal, when the bucket carrying the excavated material came to the top, it was raised 6 or 7 ft. above the ground. Then the men slammed down two doors similar to cellar doors. As soon as they were down, the bucket was lowered onto them and dumped. Being on a sharp slant, the doors shot the excavated material onto a platform where it was picked up easily. The empty bucket was then lifted, the doors opened and the bucket lowered. The doors prevented any of the excavated material from dropping back into the well in the process of dumping. They were safety devices besides facilitating the work considerably.

To Prevent Radiator from Freezing

Autoists are often bothered in the winter by the freezing of the cold-water pipe leading from the bottom of the radiator to the lower part of the cylinder water jacket. If this pipe is frozen, and the engine is started, the water in the upper part of the radiator will soon boil, but as heat goes up, and not down, it will boil away before thawing out the frozen pipe. There is an easy method of remedying this, in a way that is entirely automatic. When the circulation is stopped, the boiling water is soon carried off in the small overflow pipe. If the lower end of this pipe is loosened from its fastening, and moved to a point directly at the base of the cold-water pipe, the heat of the steam will thaw out that pipe while the car is in motion. As soon as it has thawed out, the circulation, of course, will be resumed.

If the overflow pipe is so located that it cannot be moved, the autoist should carry a section of rubber tube to slip over the end of the pipe, and so direct steam to any cold part of the radiator he desires. The steam flow will cease as soon as circulation of the water through the piping is taking place again.

Fixture for Bending Structural Iron

For bending light structural iron of the kind often used in foundries for trolley tracks, the illustrated fixture has been found useful. It consists of two plates, A, bolted to a steel block, B, and to two spacing pieces at the ends. Two straps, E, are used to hold the device and the work together, and can be moved along the plates A to suit the work. Block B is threaded to receive a screw provided with a bar to turn it. The drawing shows an I-beam about to be bent, which is done by turning the screw against it.—C. Kugler, Philadelphia, Pa.

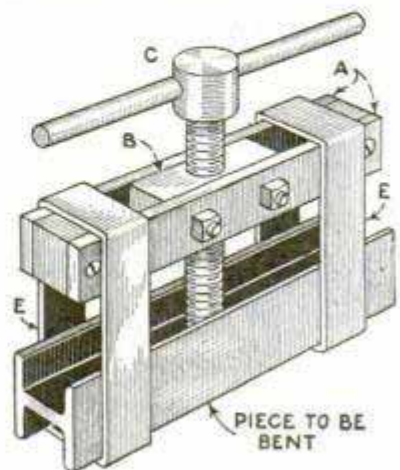

Combination Seat, Cabinet
and Workbench

The illustrated combination seat, cabinet and workbench was exhibited at an exposition of the Berlin housewives' association, and shows what can be done along space-saving lines. It can be used as a hall chair if desired, although rather massive for this purpose. Sewing material can be stored in it, and when it is necessary to

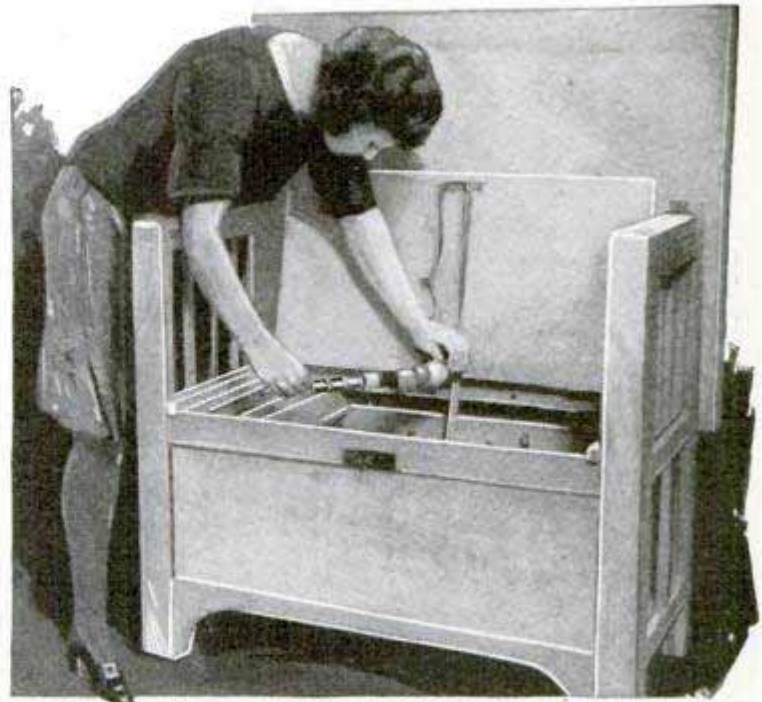

Copyright, Henry Miller

Space-Saving Combination of Seat, Cabinet and Workbench; the Upper Photo Shows It as a Cabinet and the Lower, as a Workbench

have a large bench for cutting material, it can be set up quickly and without trouble by unfolding the double endpieces and the large top.

Working Glass in Machines

At one time we had an order for a lot of glass tubes, inside diameter $\frac{1}{2}$ in., outside diameter $\frac{3}{4}$ in., and 10 in. long, to be threaded on each end with eight threads to the inch. The lathe was geared up for this thread, and a three-jaw universal chuck put on the spindle. The tubes were chucked with a piece of leather placed between the jaws and the glass. Near the other end of the glass tube the center rest was set, and a piece of leather

was folded over each end of the center-rest jaws and wired in place. The leather was used to prevent the glass surface from being scratched. Very little pressure was found needed to keep the work from turning. The tube was chucked and centered by running the tail center up and setting the jaws of the center rest. A 4-in. drum pulley was taken from the small tool grinder and put up over the lathe, and a tool-post

grinder, which was carrying a properly beveled emery wheel, was set in the tool post instead of the threading tool. The tool-post grinder was belted to the 4-in. drum pulley, and the emery wheel set with a center gauge, whereupon the thread was cut as usual. We found that by using hard wheels, dressed to suit the work, or by using a combination of wheels, glass can be worked as easily as cold-rolled steel. This would apply to planer work as well. Glass should be worked at high speeds, and a dull surface will be the result. The emery wheel must be kept wet, either by using a centrifugal pump or by means of a tin can with a hole punched in the bottom.—J. B. Murphy, Plainfield, New Jersey.

HOW TO YOUR OLD

The Popular Enamel Finish

off with clear water; the rinse-off being important, as any deposit of soap left on the surface is liable to prevent the new finish from drying or cause other trouble. Next wipe over the surface with a cloth dampened with gasoline, naphtha or benzine, to cut any greasy substance that may be present, from furniture polish or the handling a chair receives. Then sand-paper the surface lightly with No. 00 sand-paper, as in Fig. 1, to cut the gloss of the previous finish, and dust off all loose particles of sand.

That's all it is necessary to do in the way of preparatory work, unless there are digs, holes or cracks in the wood, in which event they should be filled with a plastic-wood

preparation, such as is now sold for the purpose, or with a mixture of fine sawdust, liquid glue and whiting; sawdust, shellac and whiting, or



FURNITURE finishing, formerly an art for the professional only, has, with the vogue for color and the popularity of enamel and lacquer finishes, become a fascinating hobby of thousands of amateur painters throughout the country. It affords an opportunity, second to none of the home crafts, for the practical and profitable use of spare time, and is quite as interesting as fashioning things from wood or metal, when one knows how to go about it. Say, you have one of the old-fashioned golden-oak chairs (Fig. 2) with high-gloss varnish finish; it can be converted into an odd chair of as smart and professional appearance as any you see in the stores. (See Fig. 4.)

First, determine the color scheme. The charm of the odd chair lies in its beauty of color, and the use of the right colors to fit in with the decoration and furnishings of the room in which it will be placed. Have a definite location for the chair, and select colors that will look well in this particular place as well as in combination with each other.

Next, prepare the surface for refinishing. It is not necessary to remove the old coatings. Ordinarily, you can enamel previously finished surfaces by preparing them as follows: Simply wash the piece thoroughly with soap and water, and rinse



REFINISH FURNITURE

By
Berton Elliot

sawdust, lacquer and whiting, any of which is satisfactory, knifed well into the indenture, and, when dry, sandpapered down absolutely even with the surface. In the event, also, that the piece has previously been finished in mahogany stain, a coat of pure shellac should be applied after the clean-up work, to seal in the powerful stain and keep it from "bleeding" through the new finish. Of course, for the finest possible finish, the old coatings should be stripped off with paint and varnish remover, or sanded down to the bare wood, and the new finish built up from the wood, but a strictly first-class job can be produced over old coatings.

We are now ready to build up the enamel finish. Enamel is transparent by nature, and with the light, delicate shades especially,

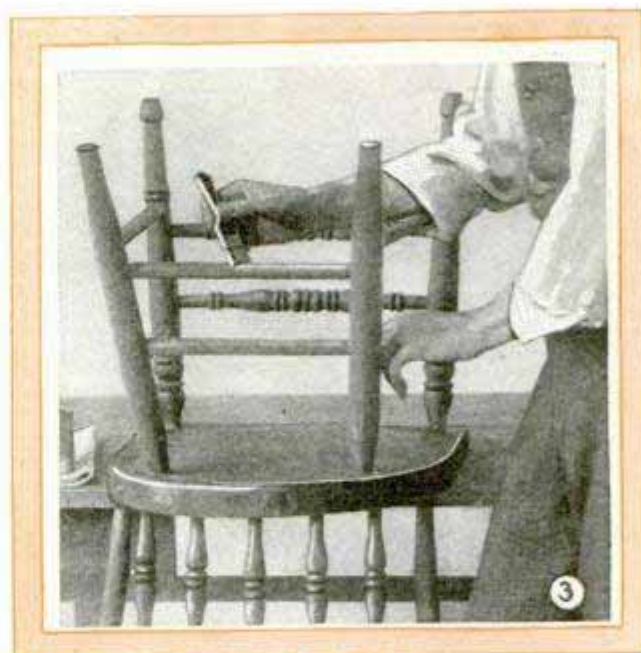

it is necessary to provide an even foundation of solid-covering flat paint, to hide

the wood and surface imperfections. Regular enamel under-

coater, sold by paint stores (usually in white only), is the simplest and most

convenient form of flat material to use for the very

light colors, but when enameling in the bright and strong colors, flat wall paint, in a color closely approximating the color of the finishing enamel coat, is usually a more satisfactory undercoater for the amateur.

When finishing in white or any of the light colors, such as ivory, cream, sand color, the delicate tones of blue, green, etc., a three-coat job will ordinarily produce a thoroughly satisfactory finish, when properly applied.

First, apply a coat of flat undercoater, in which a little varnish (about 10 to 15 per cent) has been incorporated, to help the coating adhere to the old varnished finish, without chipping off later on. Second, when dry, sandpaper lightly, to remove brush marks and level off the surface, dust clean, and apply a coat of half undercoater and half enamel mixed. Third, when dry, sandpaper lightly, dust off, and apply a finishing coat of full enamel.

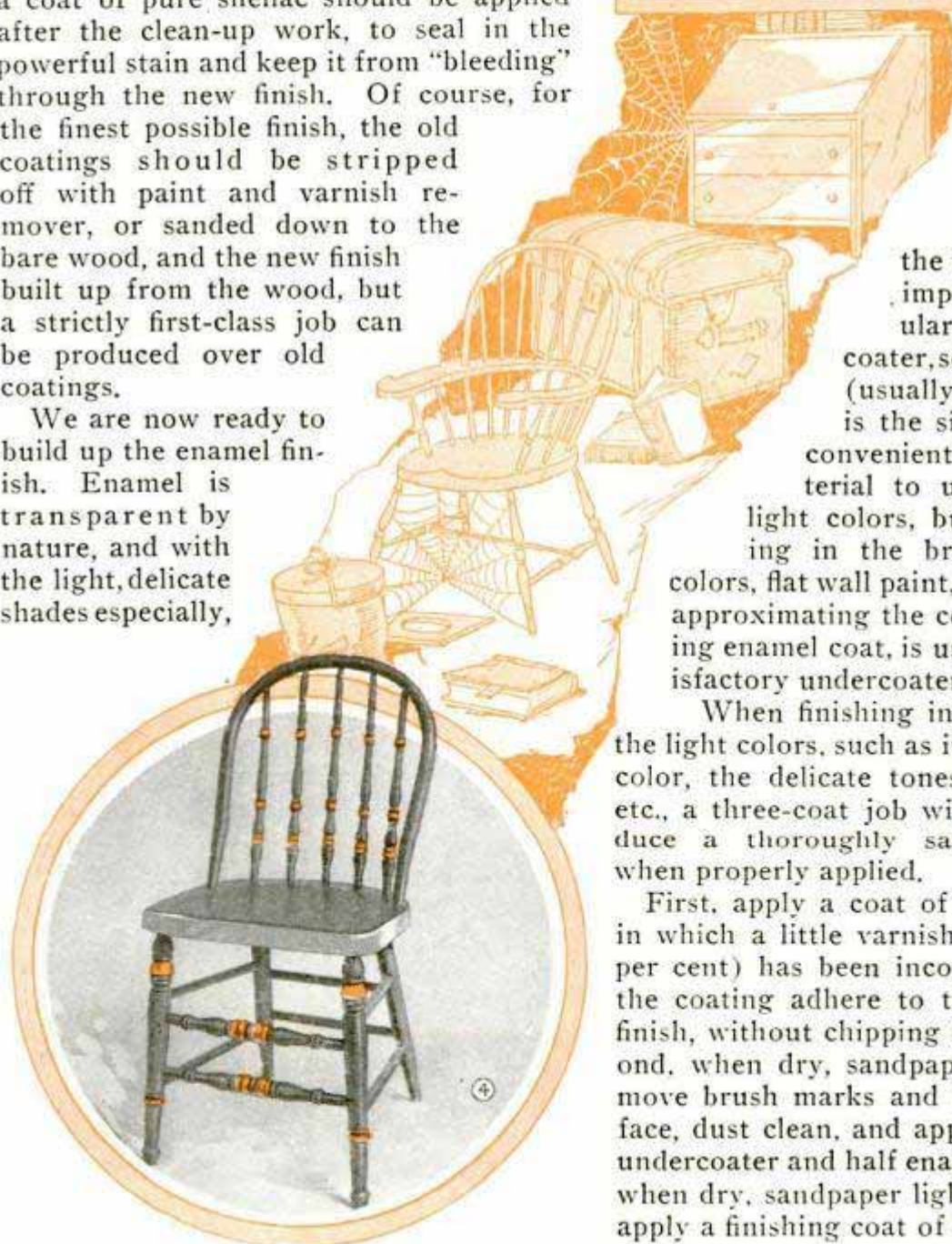



If, owing to the condition of the surface or lack of experience in painting, a thoroughly satisfactory finish is not obtained with three coats, especially on large and conspicuous surfaces, sandpaper lightly again and apply another coat of full enamel. On the other hand, with the bright or dark colors, it is often possible to produce a first-class finish with two coats of straight enamel, preferably, however, mixing a little flat undercoater (about 25 per cent) with the first coat to give it a little more body and make a more solid covering. Enamel coats should be allowed to stand at least 48 hours before sandpapering and recoating; undercoaters may be sanded and recoated the next day. Only fine sandpaper should be used, never coarser than No. 00, and preferably No. 0000 or very fine wet-or-dry sandpaper or garnet paper for the enamel coats.

In applying enamel, first brush it onto the surface freely and quickly, with the grain of the wood. Then "cross over," without refilling the brush. This drags the enamel over any spots that may have been missed in applying the material and spreads it out into a uniformly even film. Then, with light strokes, brush over the surface again with the grain, without refilling the brush. This process gives a smooth, even, porcelainlike surface.



The use of the right kind of brushes for enamel work is important. A soft-hair brush should be used, as it is next to impossible to lay on undercoaters and enamel with a stiff bristle brush, without leaving ridges or brush marks. It is also most important to keep dust from the surface. Particles from sandpapering should be dusted off, brushes should be perfectly clean, so that no dust or particles of

grit will get into the work from them, and care should be taken that no dust is raised in the room until the enamel has dried dust-free. Work should be done as quickly as possible, as any brushing of the surface after the en-



amel has commenced to set will result in a rough finish.

The final enamel coat can be left in full gloss, rubbed to a semi-dull finish, or polished to a highly brilliant "piano" finish. The rubbed effect is produced with pumicestone and oil in the following manner: Place some powdered pumicestone, which can be obtained at most paint stores or at a drug store, in a saucer or shallow dish. In another receptacle pour a little regular rubbing oil or good sewing-machine oil. Fold a soft cloth into a pad, or use a regular felt rubbing pad. Moisten the pad in the oil, then dip it into the powdered pumice, and rub over the surface, only about five or six times, and with not too heavy pressure, so as not to cut through.

Always rub with the grain, and as far as possible, rub the entire length of the surface with one stroke, to avoid a patchy appearance. Any carved or relief work can be reached by using a small vegetable brush, dipped into the oil and then into the pumicestone. When through, clean by wiping off the surface with a dry cloth, using a little cornstarch if necessary to help dry up the oil. Water is sometimes used instead of oil for rubbing. The rule is to use pumicestone and water wherever it is desired to rub undercoats, as oil rubbing leaves a greasy film on the surface which cannot be satisfactorily finished over. Oil is best for the finishing coat, as water rubbing cuts much faster and is likely to spoil the finish.

The high polish previously referred to is produced as follows: After the pumicestone rubbing and clean-up, wait until the following day, and rub the surface again, in a similar way, with powdered rottenstone and water, which imparts the hand-polished effect seen on the finest furniture. The rubbing of a fine enamel finish calls for carefulness and considerable good judgment, and the amateur should be very cautious when first doing this work.

Unpainted furniture and novelty wood-ware, now so popular, can be finished in the same way as previously finished



furniture, except that the first coat of flat undercoater should be thinned with turpentine to help penetrate into and satisfy the absorption demand of the wood; and, of course, the preliminary clean-up is unnecessary. The surface, however, should be sandpapered with fine sandpaper, with the grain, to plate smoothness, as ordinarily these pieces are only machine-sanded, and when examined will be found covered with tiny scratches which should be sanded out for a fine finish.

Auto Used as Tractor on Ice

Ice skating rinks throughout the country may profit from the experience of the skating pavilion in San Francisco, where

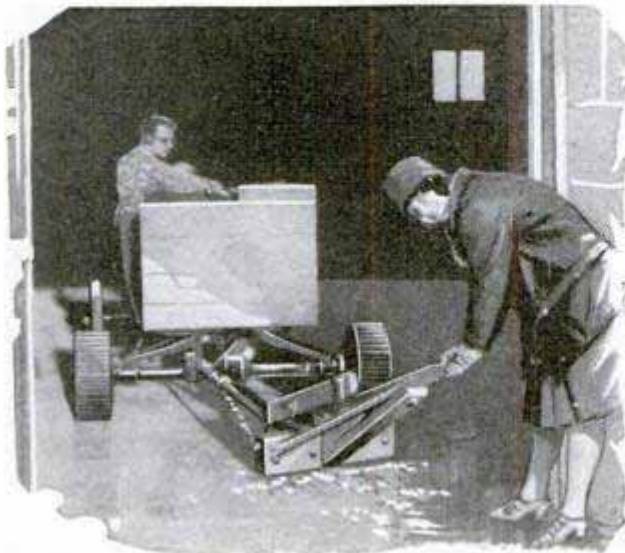

Old Auto Equipped with Grooved Cast-Iron Wheels Pulls Scraper over Ice

an old auto was fitted with grooved, cast-iron wheels so that it could be used as a tractor for pulling scrapers over the ice. This method is much better than the use of chains, which are not always effective and, besides, dig grooves in the ice, which cause extra labor.—C. W. Geiger, San Francisco, Calif.

Soldering Lead Joints

When making lead-to-lead joints, one of the main things to remember is to keep soldering acid or paste away from the cleaned lead surface, as any trace of this will make it very difficult to tin the lead. Finely powdered rosin mixed with alcohol makes a good non-tarnishing flux for lead. Neat's-foot oil is also good, this often being used in soldering the thin lead frames or "comes" on stained-glass windows.—James E. Noble, Toronto, Can.

Inclosure Prevents Frozen Pump

Although provided with drains below the surface for emptying the pipe above

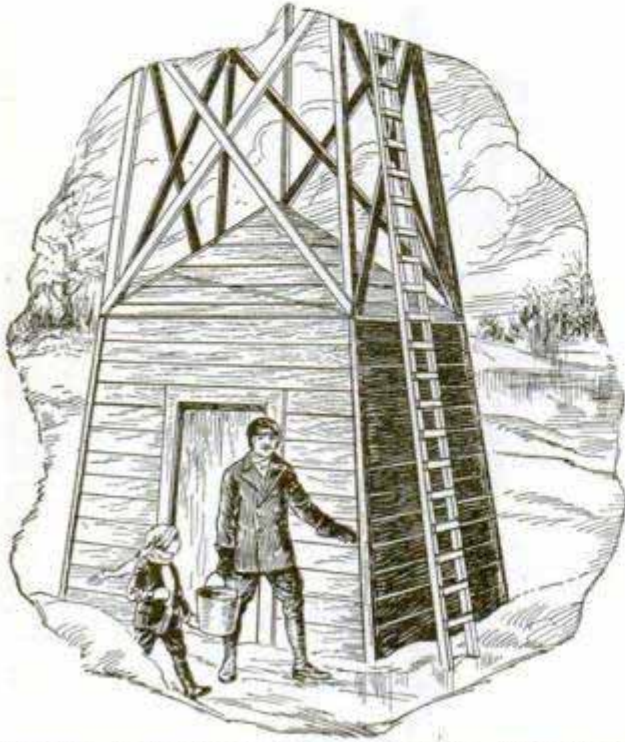

Wooden Inclosure Lined with a 12-In. Straw Wall Prevents Pump from Freezing

the cylinder, some pumps freeze in cold weather, often when the supply is low or there is an urgent need for water. The owner of a mill-operated pump built a simple inclosure between the four tower legs, as shown in the illustration. On the inside, a straw wall and roof, about 12 in. thick, was held in place by woven wire. This insulation maintains an even temperature, keeping out the frost during the winter, and the extreme heat during summer. The door is on the south.—Dale R. Van Horn, Lincoln, Nebr.

Using a Large Planer for a Press

Some time ago we had several steel tubes, about 5 in. in diameter and 4 ft. long, which had to be a press fit over the piston rods they were to cover. Not having a press large enough to handle the job, we were stuck until the following idea was hit upon. There was about .003 in. left for a force fit. Both ends of each tube were capped and live steam turned into them, which enlarged them about the amount mentioned. The rods were bolted upon the platen of a 36 by 36-in. planer, and a solid backstop was erected just far

enough away to allow for starting the tube. When all was ready, the steam was turned off, the caps removed, and the tube lifted in position and shoved on by hand for about 8 in., when it began to go hard; then the planer was started very slowly, which pushed the tube home without further trouble. The whole scheme worked out very nicely and without much outlay.—A. Dane, Pottstown, Pa.

Rough-and-Finish Calipers

When calipers are set to a certain dimension, care is required to prevent the work from being made too small. However, with the calipers changed as shown, one can work quicker because the tool shows when one is near to the correct size, leaving enough stock for finishing. The calipers are made in the ordinary way, but with an auxiliary leg as shown, which is riveted to the short leg and a vee cut out on the top. The short leg is then tapped for a fine-thread screw, which is put in tight. Next a knurled nut is made with a plain part, which fits the vee of the auxiliary leg. In use, the calipers are set to the finished size of the work with the nut tightened. To measure the work down to the finishing cut, the nut is loosened to clear the vee. This allows the leg to rock to the extent of the difference between the plain part of the nut and the diameter of the screw. The nut, of course, is again tightened to lock the leg for the finished size. With the auxiliary leg unlocked,

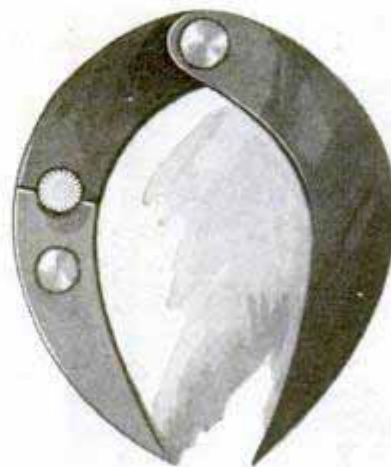

work can be done rapidly, and if it does happen that too big a cut is taken off the work, it will usually be found that there is still sufficient stock for finishing, due to the difference allowed by the two settings on the caliper.—Harry Moore, Montreal, Can.

☐ A stick wedged into the slot will sometimes aid in starting machine screws.

An Unusual Table Lamp

By H. F. WEATHERBY

THE TABLE lamp illustrated herewith is not only of a novel design, but it is in addition a most attractive and useful piece of furniture to add to one's living room or study. It gives a very restful and pleasing reading light and provides a space for one's favorite books, always at hand. If desired, the book shelf may be dispensed with, and a simple stretcher, as shown in one of the illustrations, may be substituted.

Most of the readers of Popular Mechanics have at least some small articles of shop equipment, and the construction of the lamp calls only for a coping or scroll saw, handsaw, brace and $\frac{3}{4}$ -in. bit, plane, half-round wood file, a hammer, and a vise in which to hold the work.

Go to the nearest cabinet shop or mill, where plywood can be bought, and get $\frac{1}{4}$ -in. material, from which the following pieces can be cut: Two pieces for shade, 6 by 14 in.; two pieces for ends, $7\frac{1}{2}$ by

$16\frac{1}{4}$ in.; one shelf piece, $3\frac{3}{8}$ by $12\frac{1}{2}$ in., and one 3 by $12\frac{1}{2}$ in. Plywood is recommended because of its strength, and the chances are that scraps can be found, at little or no cost, large enough to make the above parts.

A cardboard pattern is laid out for the ends, as indicated, using 1-in. squares. Exact dimensions are not given on the drawing and the design may be changed to express one's individuality. Using this pattern as a template, mark around the two endpieces and saw them out with a coping, jig or band saw, if available. Smooth the rough edges, being careful to keep the plywood from splitting. The straight edges should, of course, be planed carefully.

The top pieces may also be cut out with a coping saw, but great care must be taken to keep the inside edges straight. If a circular saw is at hand, and you exercise care, the glass openings may be cut and rabbeted on this machine, as indicated by the left-hand section detail of frame; otherwise, if the work is done by hand, rabbeted blocks, as at the right, will prove easier to make and much more satisfactory.

The shelf parts call for no explanation other than that they must be

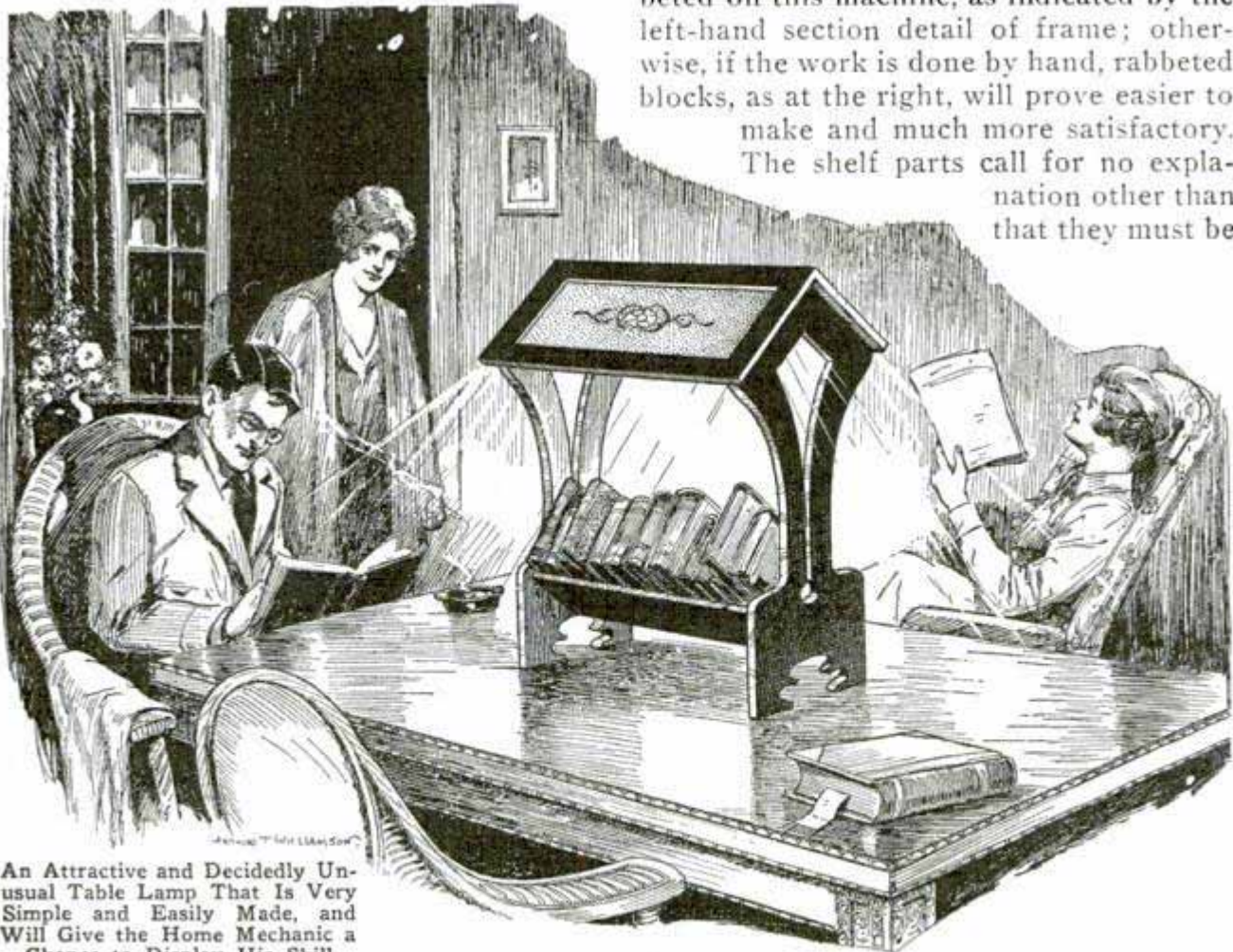

An Attractive and Decidedly Unusual Table Lamp That Is Very Simple and Easily Made, and Will Give the Home Mechanic a Chance to Display His Skill

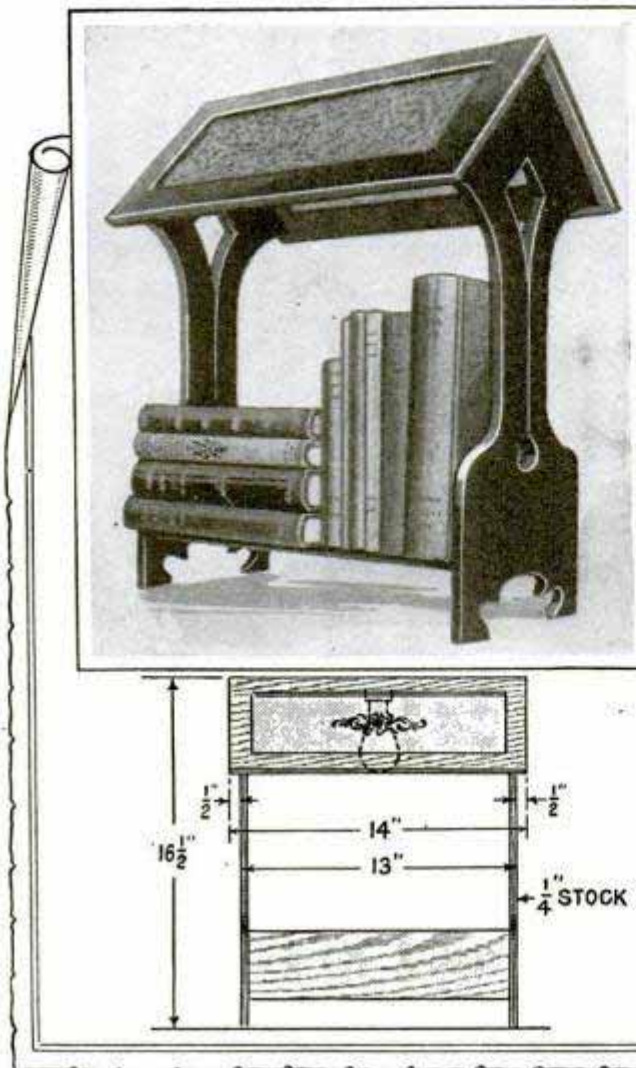

two-tone lacquer effects that are so popular nowadays and that set off small articles of furniture so well.

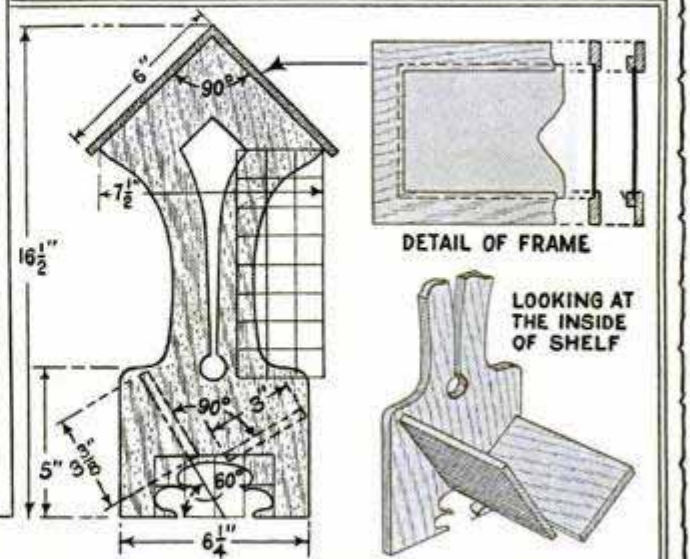

carefully squared to the exact dimensions desired.

A hole of $\frac{3}{8}$ -in. diameter, to accommodate a short length of $\frac{1}{8}$ -in. threaded pipe, is bored just above the opening on one of the endpieces. When the lamp is finished, a screw-thread socket is to be turned onto the inside end of this pipe and a nut on the outside end to hold the socket.

The pipe may be extended to the center of the frame, and an ell and nipple used to make the bulb hang vertically, if desired, or two bulbs, one at each end, can be used instead of the single bulb at end or center, to suit the maker's taste. If the latter system is employed, it is suggested that long bulbs of the candle type be used. The wiring, of course, is very simple.

After careful sanding, nail the different parts together, and place $\frac{1}{4}$ -in. square glue blocks on the underside of the shade, and under the shelf. None of these can be seen, but they will help greatly in adding sturdiness to the finished job. When these are dry, finish the lamp in any way desired. The writer suggests some of the



Colored art glass to match the finish is suggested for the shade, or simply a white ground or frosted glass which can be made most attractive by the addition of two of the transfers that are being used a great deal now. If the maker is sufficiently skilled, a design may be painted on the glass. The glass is held in place as indicated.

☞ To sharpen the knives of meat-cutting machines, first rough-grind them, then set them up under a drill press so that the machine turns them backward, with the cutting side of the knife face down on a piece of plate glass on which valve-grinding compound is applied.

An Inexpensive Universal Joint

In light and medium-heavy machinery, a very cheap, durable and efficient universal joint may be made from three straight chain links of round section. In connecting this form of a joint, one end of each shaft, the driving and driven, must be slotted to receive the end link, and a bolt put through the shaft to prevent the link from pulling out. A reinforcing collar is shrunk over the end of the shaft to strengthen the slotted part. Such a joint will drive at almost right angles with very little friction. It is especially recommended for experimental and similar classes of machinery.

Hose on Street Protected by Pipe

When a length of hose is run across a street, where passing traffic is likely to cut or crush the hose, an inexpensive and effective protector can be made of pipe and fittings, as shown in the drawing. Take a piece of 2-in. pipe, about 10 or 12 ft. long, fit a tee at each end and screw a 1-ft. length of pipe into each tee to project in opposite directions, in order to prevent the pipe from rolling. For garden hose, 2-in. pipe has been found satisfactory, but for larger hose larger pipe should be provided. Such a protector is practically indestructible and can be carried from one job to another without even removing the hose.—G. C. Douglas, Raleigh, N. C.

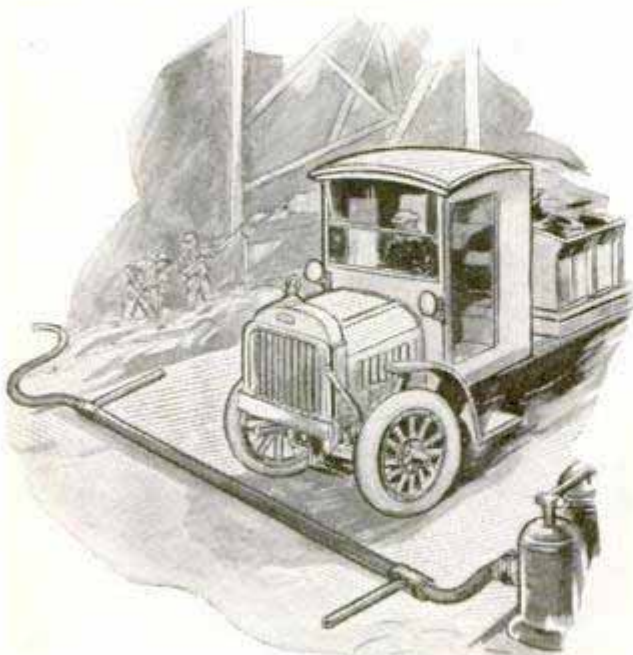

Length of Pipe Makes a Good Protector for Hose Laid over Busy Street

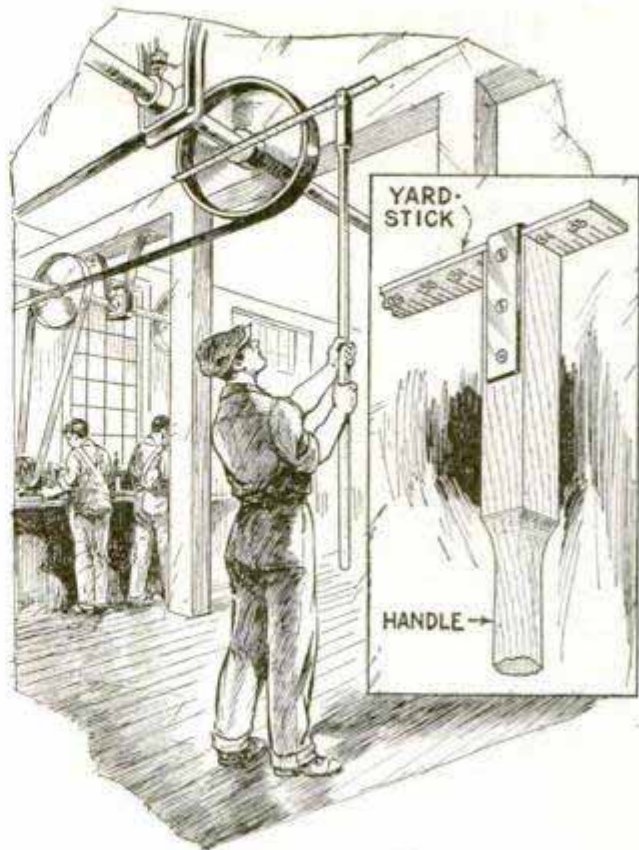

Yardstick Held at Right Angles to End of Pole for Taking Overhead Measurements

Measuring Overhead Pulleys

In making a survey of a large industrial plant, the writer found it necessary to measure a number of overhead pulleys, which were rather difficult to get at, so that a stepladder had to be carried along. To eliminate this encumbrance, I mounted a yardstick at the end of a long pole as shown. The end of the pole was planed square, and a strip of tin was bent to a U-shape permitting it to be screwed to the pole to hold the yardstick at right angles. Obviously, this device can be used for taking other overhead measurements.—L. G. Roller, Cedar Rapids, Iowa.

How to Make Wallpaper Washable

Ordinarily wallpaper cannot be washed but the following treatment will enable this: Dissolve borax, 2 parts, and shellac, 2 parts, in water, 24 parts. After mixing thoroughly strain through a fine cloth. With a brush or a sponge apply this to the surface of the paper, and when dry, polish it to a high gloss with a soft brush. Thus treated, the paper may be washed without fear of damaging the colors.—Edward Piranian, Philadelphia, Pa.

Useful Tire-Chain Repairing Tools

By G. A. LUERS

IN many garages and auto-service stations the repair of tire chains is an important task, especially during the winter months, when the streets and roads are icy and chains are frequently broken. However, as very few garages have proper equipment for removing, inserting and clinching the links, the tools described in this article will be of interest to owners of such establishments.

After mud and dirt are washed off the chains, prior to repairing them, they should be dipped in a bath of used crankcase oil and kerosene, in order to prevent rust. A steel drum is convenient for holding the mixture, and a number of hooks should be provided over the drum so that the chains can be hung up after the bath and the surplus oil drip back into the drum. A bench, about 10 ft. long, will provide plenty of room for extending the chains full length on the top and working on them. The bench also makes it easy to inspect the chains and avoids the inconvenience of laying them on the floor.

Close to the bench, a strip of wire mesh is tacked to the studs of the wall or to wooden cleats nailed there. This forms a simple holder for spare links for repairs. The links can be hooked to the wire mesh at almost any point, or, if desired, the links can be arranged in sections, according to their sizes, which may be marked on the wall above the mesh.

For opening or cutting out links there is a simple fixture at the left end of the bench. It is detailed at the top of the drawing and consists of a punch, held loosely in vertical position in a holder. This device is less tiresome to use than a pair of heavy pliers, tongs or hand cutters. Several chisel-shaped punches, of the same diameter, about $\frac{3}{4}$ in., so that they will all fit in the holder, are provided, some having sharp, hardened edges for cutting the links, and some with blunt, wedge-shaped ends for opening them. The holder is made of steel plate, cut, drilled and bent to shape and securely mounted on a steel base.

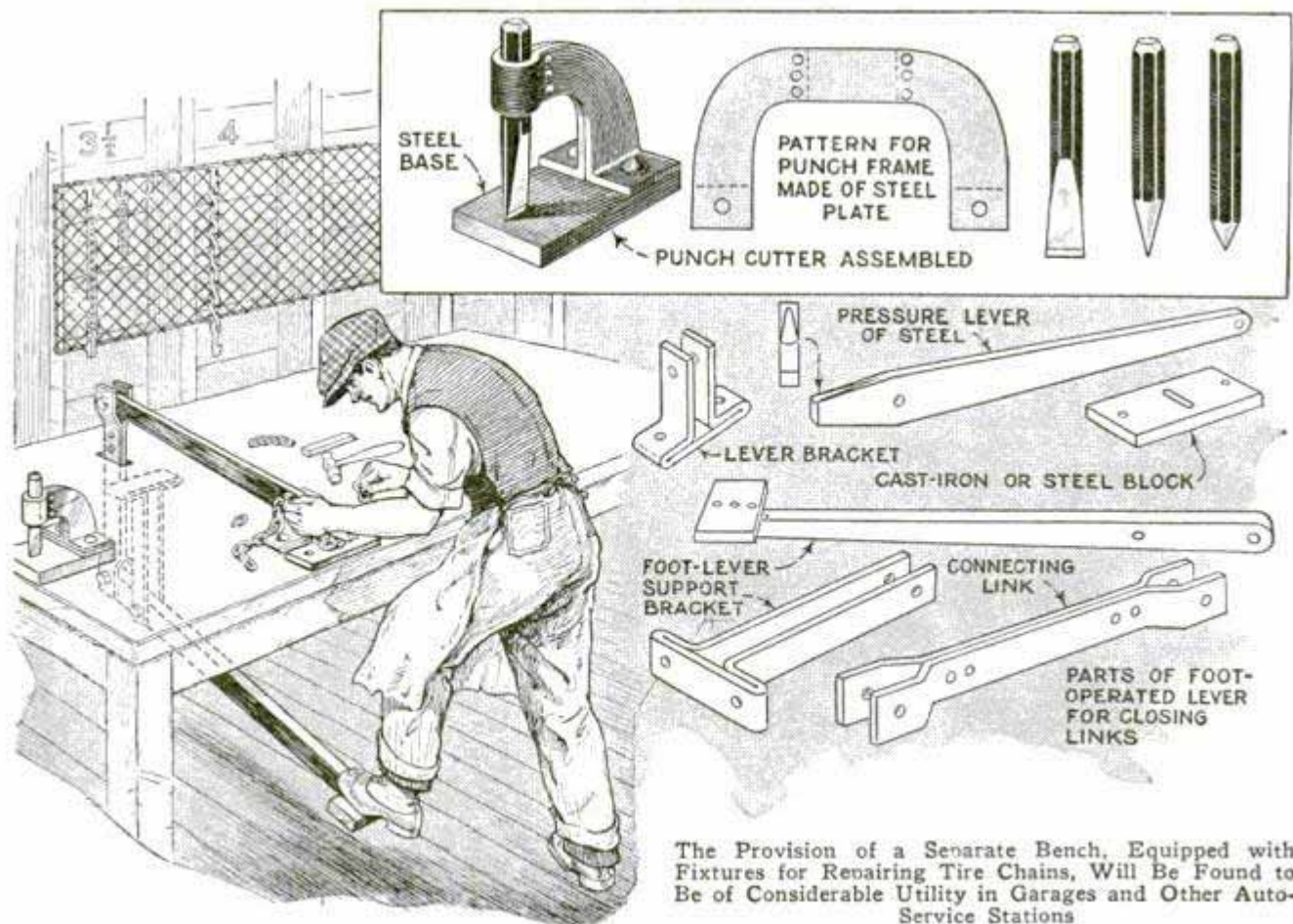

The Provision of a Separate Bench, Equipped with Fixtures for Repairing Tire Chains, Will Be Found to Be of Considerable Utility in Garages and Other Auto-Service Stations

For closing links, a foot-operated press, linked to exert heavy pressure when the foot is pushed down on the lower lever, permits the free use of both hands for assembling, setting and holding the links or chain sections under the jaw. It is mounted on the bench and consists of two levers, one forming the press jaw and the other the foot treadle. Two brackets support these levers, the rear ends being linked together to permit free movement of each, and a spring, not shown in the drawing, provided to hold the levers in an elevated position for working. A steel or cast-iron block is bolted to the bench under the jaw of the upper lever, which should be made of steel, while the lower one may be made of wood. The brackets are made of steel plate. With these tools and equipment, any shop is able to give quick service in the repair of tire chains.



Oilcloth Cover Pulled Down over Bunch of Bananas Protects Them from Frost

Screw Holder Made from Clock Spring

Difficulty is often experienced in getting screws started in places where one cannot hold them with the fingers. Many methods and devices are resorted to for doing this, but the one shown in the photo has been found to be effective. Take two lengths of clock spring, about 3 or 4 in. long,

put them together as indicated, insert the ends, which must be ground square, into the screw slot, and press the springs together at the other end. This will grip the screw securely so that it will not drop off, and can readily be inserted. Also, the curva-

ture and the stiffness of the springs enable the worker to give the screw a considerable twist.

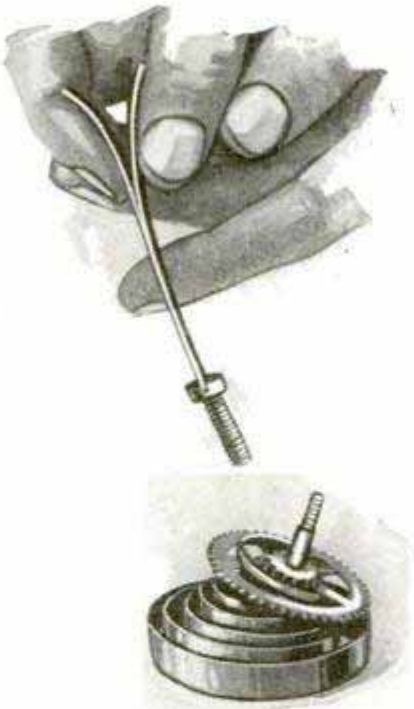

When bunches of bananas are left suspended in a store window overnight during cold weather, they may sometimes be frost-bitten. To guard against this a Wisconsin fruit dealer improvised the effective protector shown in the illustration. It consists of a cylindrical cover, made from small barrel hoops and white oilcloth. To the top edge two equal lengths of stout cord are fastened. An old window-shade roller having a good spring is attached to the ceiling just above the bunch, and the free ends of the cord are tacked to the roller as indicated. The cover can then be raised and lowered in the same way as a window shade, and does not spoil the appearance of the window.

Refacing Old Oilstones

When hollows begin to appear in oilstones, it is time to reface them. This can be done by grinding the surface down on a marble slab, on which coarse emery and some water are applied. Slate can be used instead of marble if desired, or a piece of coarse emery cloth, tacked to a smooth board. Rub the oilstone over the abrasive with a circular motion.

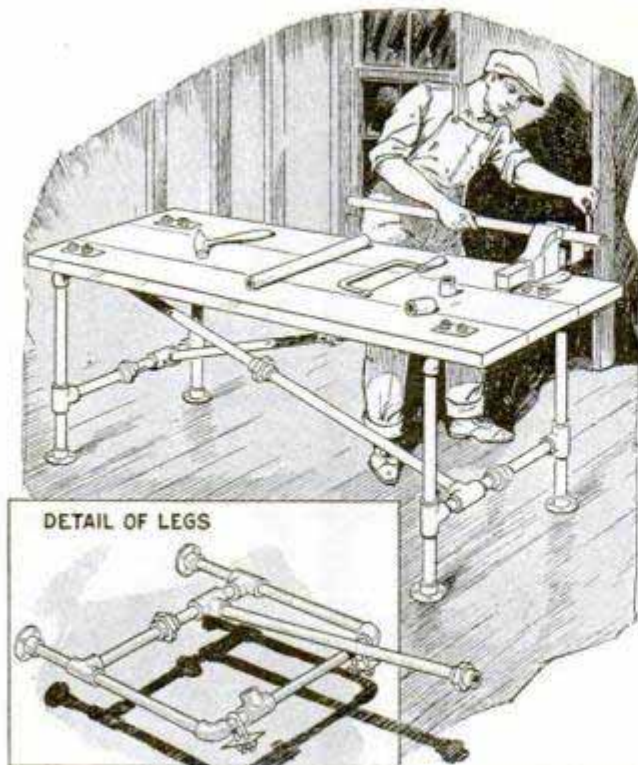

Collapsible Benches for Pipe Fitters Are Rigid and Take Very Little Space When Folded

Collapsible Workbench Made of Pipe and Fittings

While passing a plumbing and pipe-fitting shop one day, I noticed a number of collapsible benches made of pipe and fittings. They were arranged so that, when set up, they would be rigid, which is usually not the case with collapsible benches, and when folded, they would take very little space in the truck. The supporting framework consists of a number of lengths of pipe, tees, elbows, flanges and couplings, arranged as shown in the drawing. U-bolts are used to hold the bench top securely to the frame, as indicated.—Irwin Chesterfield, Chicago, Ill.

Cover Keeps Steering Wheels Clean

Garage mechanics may unintentionally soil the steering wheels of autos with greasy hands, when moving the cars about. To avoid this, one garage owner provided covers to fit tightly over the wheel, entirely inclosing it. They are made of circular pieces of canvas. A

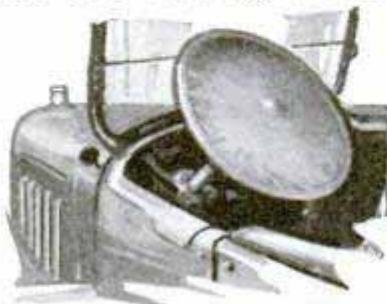

hem is sewed all around the edge to receive a length of elastic tape, which keeps the cover firmly in place. A large cloth is also placed over the driver's seat so that the mechanic will not soil it.

Burlap Used on Poultry-House Nests and Roosts

By covering the fronts of poultry nests with burlap curtains, the nests are made dark, and therefore more attractive to the hens. They are also a protection against egg-eating, since the hens will not eat eggs lying in darkened nests. If they already have the habit, they can be broken of it by providing the nests with the burlap curtains. These curtains should fall to within 3 in. of the bottom of the nests, and each should have a V-shaped piece, 4 by 5 in. in size, cut out for air and a small amount of light. For nests used by sitting hens, the curtain should be made to cover the whole nest, a diamond-shaped piece being cut out for air and light. The curtains should be fastened with hooks, so that the hen may be released twice a day for food, water and exercise.

Weighted File Handle Prevents Breakage

A ball-shaped handle is often the most convenient kind for small, light files, and if the handle is weighted it will serve the further purpose of preventing the file from being easily broken, especially on jobs where ordinary and comparatively heavy tools are used. If, in a moment of forgetfulness, a heavy tool is dropped on the file, it will probably be broken, but a weighted ball handle prevents this, as it holds the file in a vertical position as shown. No matter how it is laid down, it assumes this position automatically. The handle is made in two sections, one of metal and the other of wood, being joined by means of a screw, and afterward ground to an approximate ball shape. The file shank is stuck into the wooden part.—Harry Moore, Montreal, Que., Can.

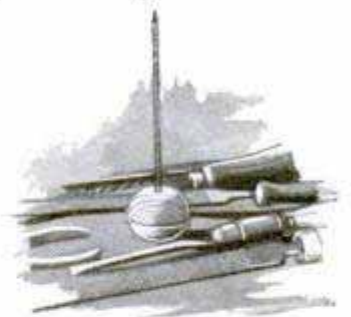

1028

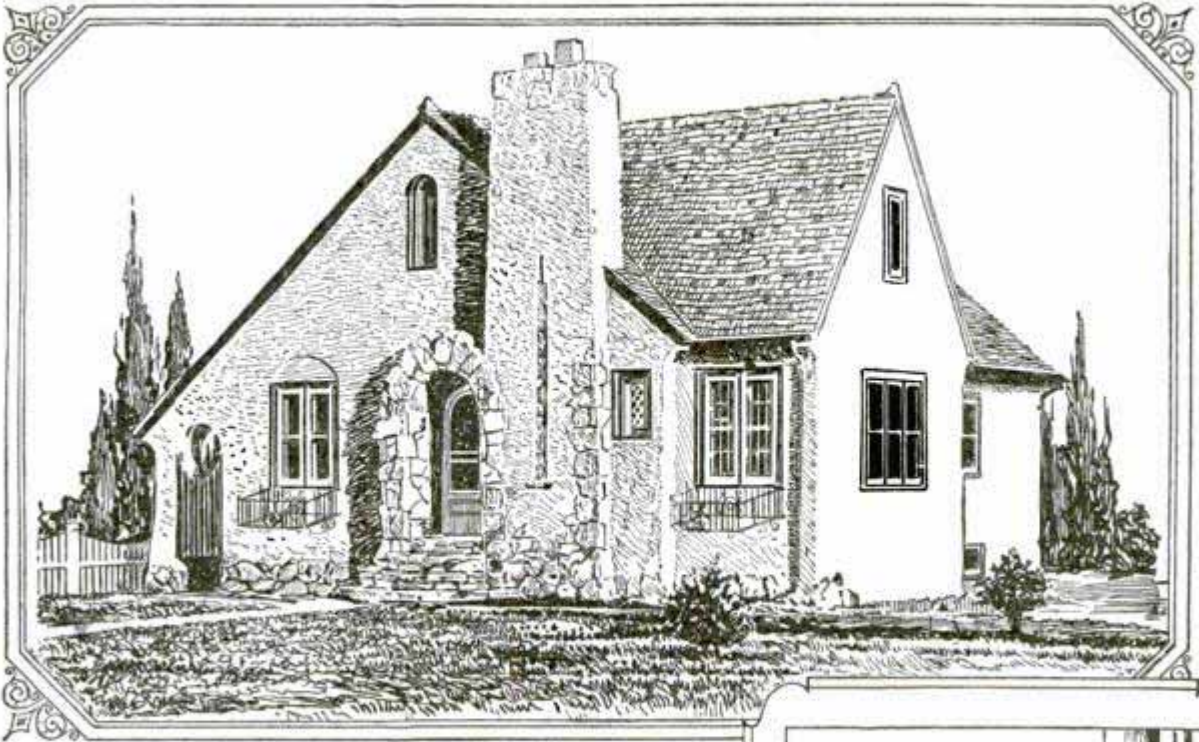

© POPULAR MECHANICS

PLAN 5-S-27

An Easy Way to Save \$1500⁰⁰

ARE you pinching pennies and waiting impatiently for the day to come when your bank account will be big enough to build and pay for the house of your dreams?

If so, the following story may suggest one way to keep down costs and thus enable you to begin now.

Here is the story: A young man and his wife, living in a rented house on the outskirts of a big city, had scraped and saved a tidy sum of money. They had skimmed on the necessities and prayed for the day when they could give a builder an O. K. to go ahead with the job. They couldn't wait longer. They wanted to get out from under the load of rent. They wanted their own home, yet they hadn't sufficient cash to make the beginning. They didn't care to go into debt and go ahead.

Like thousands of young couples get-



ting started in life, they studied plan books, shopped around for prices, talked with friends and builders. Time and again, they went over their plan. They cut and pruned and eliminated almost everything within reason. But they couldn't get the price of the house down to the amount of their savings.

And then the young man made a discovery. In studying the cost estimates, he found that labor represented about fifty per cent of the total expense. He saw that individually and collectively, the prices for building materials and equipment were

A NEW SERVICE

To help our readers get started on one of life's most glorious experiences—building and owning a home—Popular Mechanics Magazine will supply readers a one-sheet blueprint of the house here installed for \$2. This blueprint does away with the necessity of first purchasing a complete set of plans to find out whether you can afford to build. It contains floor plans, elevations, a section, detail, size of joists, studs, etc., and also a brief specification. Submit it to tradesmen and dealers for building estimates.

very reasonable. In fact, only a slight increase over pre-war days. For example: Insulation would cost him in round numbers about \$100; plumbing \$300 or about

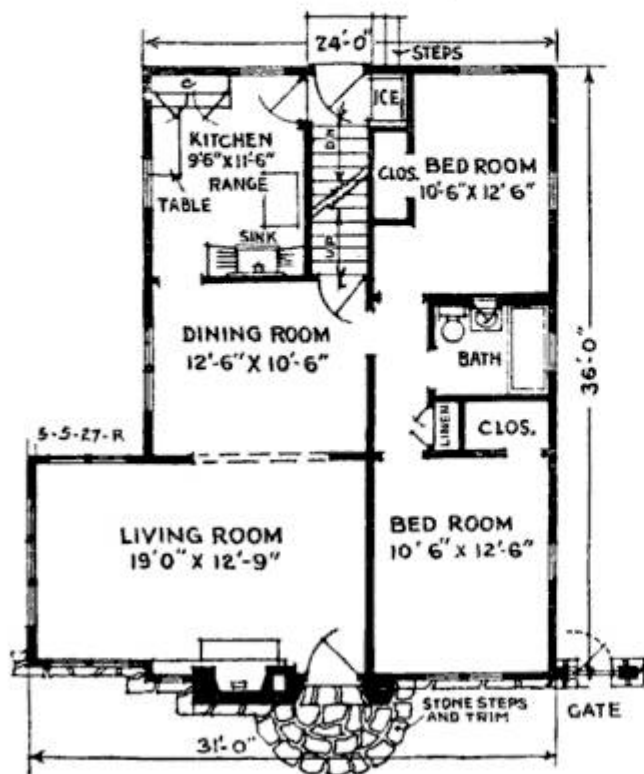

six per cent; heating about five per cent, etc. As he studied these percentages, he arrived at a decision. He saw that each item was in reality a small one as compared with the total cost. He further found that, if in some way he could cut the cost for labor, he might be able to build and pay for his home out of his savings and income.

And so he decided to pull on a pair of overalls and go to work on the job himself. He kept a careful record of everything, including his own time. There was much rough work he did himself. In other cases, he worked as helper to the experienced tradesmen whom he hired. With one good local carpenter and other specialized laborers when he needed them, he managed to stick it through. His hands were calloused. He picked up an occasional sliver in his fingers. But he saved a cool \$1,500 by his own labor and got his home at a price he could afford. The final cost was in the neighborhood of \$4,000. A very reasonable figure. And a proud and happy owner.

You may not be able to pull on overalls, swing a hammer and push a saw. If, however, you have the time and are located

where you can do some of the work yourself, there's no easier or quicker way of saving money. This is especially true in smaller communities, suburbs and urban localities where building ordinances are less exacting than in the big cities.

Finally, there is this to be said about building costs today. Labor is generally lower in smaller towns and on the outskirts of medium-sized cities. Workmen are reliable. They have to live with their work and meet their customers day after day. Their reputation is at stake. They are not fly-by-nights. And building materials, in some cases, are apt to be lower outside the larger centers of population.

Building-material costs are more favorable today than in many years. If you can do a little work yourself, if you have the courage and time to buckle down to the job of handyman and helper, you too may be able to pull the cost of your dream home down to the size of a tolerably lean pocketbook.

The house here illustrated is in many ways like the house built by the young man we opened this story with. It is a newer type of house that has come into favor in the past few years. Its ancestors, away back, may have been Spanish or Italian. It is only reminiscent of those styles. The plan provides complete living quarters on the first floor—bungalow equipment. There are two bedrooms on the second floor.

There is probably no more popular or satisfactory arrangement of living and dining rooms than the one offered here. By bringing the roof line down over the arched entrance at the right, the house is made to appear wider and thus larger than it is. The chimney of native field stone, while perhaps a bit theatrical, is nevertheless in line with modern tendencies, and, with the field-stone entrance arch adds an effective bit of decoration in contrast to the simplicity of the walls.

EDITOR'S NOTE: Popular Mechanics Magazine has prepared a new plan book, "Twenty Popular Low Cost Homes and Ten Commandments for Home Builders." These are selected homes and show labor, space and time-saving ideas. They are \$5,000 homes and less. Send 10 cents in stamps to cover postage. Address Building Editor.



To bore holes for screws, a man needs a "Yankee" Automatic Push Drill No. 41—with eight sizes of drill-points, $\frac{1}{8}$ " to $\frac{1}{4}$ ". Price, \$2.60.



"Yankee" No. 15—a ratchet driver, has thumb-turn on blade for starting wobbly little screws with thumb and forefinger. Price (4 in. blade), 80c.



No. 90 is a husky "Yankee" plain screw-driver that stands all sorts of use and abuse. Price (8 in. blade), 75c.



The finest tool on earth of its kind is "Yankee" Ratchet Bit Brace No. 2100. Price (10 in.), \$8.20. Lucky man, who gets a "Yankee" Bit Brace.

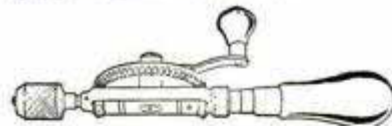

"Yankee" No. 1530 Ratchet Hand Drill (above), and No. 1555 Ratchet Breast Drill are fine gifts for motorists. These drills have five ratchet adjustments: they work where others can't. Price: No. 1530, \$5.25; No. 1555, \$11.00.

"Yankee" Tool Set No. 105—ratchet tool holder with nine attachments. For the man who works on radio and home electric appliances. Price, \$3.25.

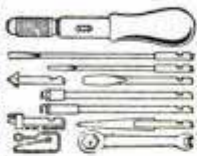

"Yankee" Tool Book
FREE

This tool book shows all the "Yankee" Tools, and tells how they help a man to make things by saving time and labor. Write us for the book.



"YANKEE" Tools

are fine gifts for man or boy . . . mechanic, handyman, motorist. Fine tools, they have all the ingenuity their name implies. Make work interesting. Save time, labor.

And, remember, your hardware store is a real gift shop. The dealer is expert in knowing what men and boys want. Let him tell you what tools to give a mechanic; what tools the handyman needs for making things for the home.

For driving screws quick and easy . . . simply by pushing on the handle . . . every man wants this "Yankee" Spiral Ratchet Screw-driver No. 30-A.

Price, \$3.00. Three bits included.



NORTH BROS. MFG. Co., Philadelphia, U. S. A.

"YANKEE" — *"That's the best there is!"* says the tool dealer.

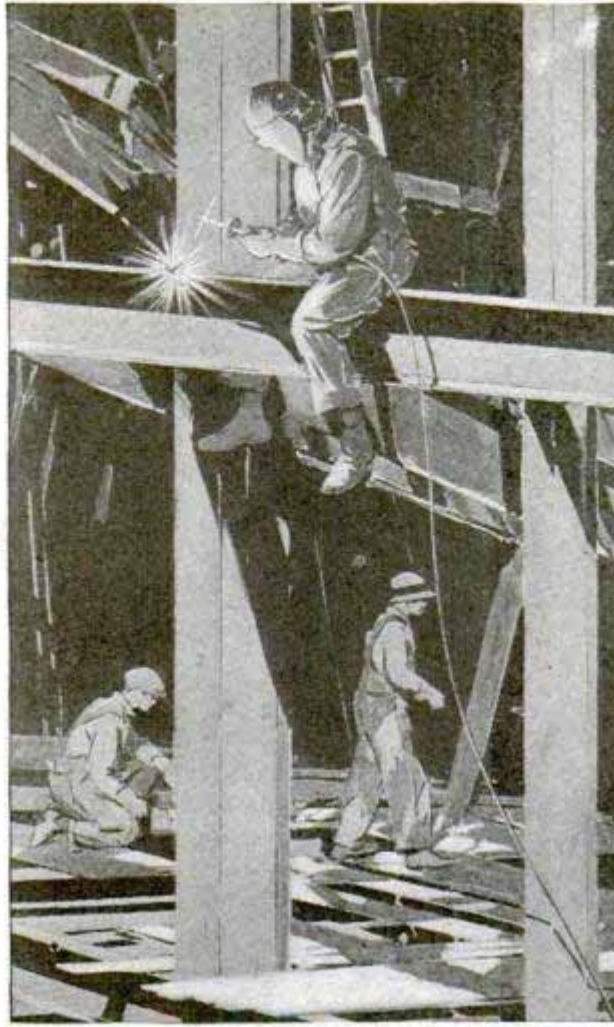

SILENCED!

YESTERDAY America's skyscrapers stormed into the air to the deafening clatter of the riveting hammer.

To-morrow, this ear-splitting racket will be silenced. Silently, swiftly, easily, and at a considerable saving in cost, our great new structures will

arise—welded by electricity.

Electric welding! An electric arc, guided by expert hands, knits metal together with joints as strong as the metal itself. Already it is written in the book of progress that construction's drums shall be silenced.



The G-E monogram is assurance that the products on which it appears are electrically correct and dependable.

GENERAL ELECTRIC ^{530-33C}

20 New Big Exclusive Features in the 1929 Model "Delta" Electric Handi-Shop

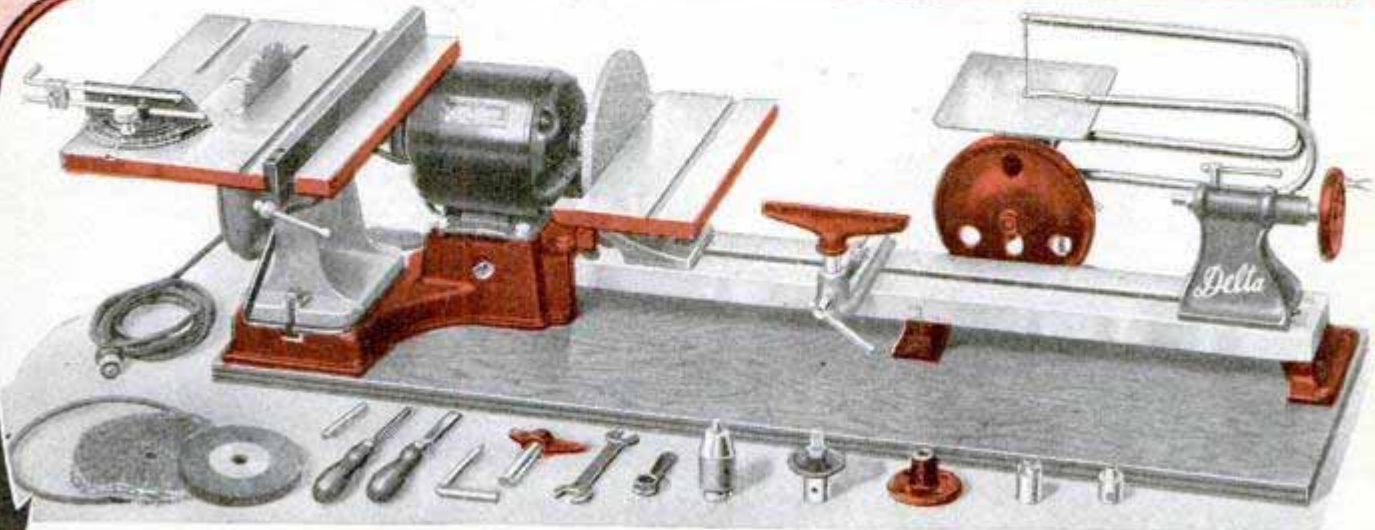

New Features of 1929 Model

found exclusively in the "Delta" Handi-Shop, in addition to the many regular advantages, include:

- New Delta Miter-Gauge (with many new features)
- New Circular Saw Adjusting Lever
- New Delta Adjustable Rip Gauge
- Larger Circular Saw Table
- One-third H. P. Motor
- Larger Triple Foundation Lathe Bed
- 1/2-in. Capacity Drill Chuck

For full details, send coupon below.

Many Exclusive Advantages In This Big Husky Home Workshop

The DELTA Handi-Shop is a man-sized motorized workshop, complete, efficient, and PRACTICAL IN DESIGN! Does everything from building full-sized furniture, turning table legs, to finishing delicate detail work. Note the two-shaft motor that permits two or three operations at one time—the heavy Triple Foundation U-Shaped Lathe Bed (no rods)—the practical arrangement of the Circular Saw that permits the cutting of large lumber without interference—the Improved Tilting Tables on the Circular Saw, Sanding Disc, and Jig Saw. Has automatically oiled bronze bearings and is completely assembled on heavy veneered wood base.

This combination of advantages, plus many more, IS FOUND EXCLUSIVELY IN THE "DELTA" HANDI-SHOP! No wonder even last year's Handi-Shop was an outstanding value. And now, with the many additional exclusive features of the new 1929 model, this shop is in a class by itself—above all comparison—at a new price that is surprisingly low.

10-DAY TRIAL IN YOUR OWN HOME

without obligation. See how PRACTICAL, how EFFICIENT is this sturdy, full-sized machinery under actual working conditions. Study its many exclusive advantages. You will find the Handi-Shop complete with all necessary equipment for Circular Sawing, Wood-turning, Jig Sawing, Sanding, Drilling, Grinding and Buffing.

Easy Terms

Then if you decide to keep the Handi-Shop, you can have your choice of three convenient methods of payment.

Send Coupon

at once for FREE beautifully illustrated literature giving complete description of the New 1929 Model "Delta" Handi-Shop, and full details of the 10-day Trial Offer and Convenient Payment Plans.

Delta Specialty Company
Dept. A. 128

1661-67 Holton St., Milwaukee, Wis.



The TWO-SHAFT motor is the practical motor for the workshop. Permits you to carry on two or three important operations at one time without continually dismantling set-up.



Heavy Triple Foundation U-Shaped Lathe Bed (not rods or rails) is guaranteed not to spring or chatter.

Write for Valuable Book

crammed with practical information on how to construct useful and decorative objects. Illustrated.

If you want this book, enclose 10c to cover mailing cost. See Coupon.



Delta Specialty Company, Dept. A. 128
1661-67 Holton St., Milwaukee, Wis.

Please send FREE illustrated literature on new Delta Handi-Shop. Also full details of 10 Day Trial Offer and Easy Payment Plans.

Please send me copy of "How to Make Things with a Workshop." I enclose 10c to cover cost of mailing.

Name.....

Address.....

Make the Things You Have Always Wanted to Make

It's so easy and so quick with the Handi-Shop. Save money on repair work. Earn money in your spare time. Complete instructions and Blue Prints furnished. A few of the hundreds of articles you can make with the "Handi-Shop" shown below.

Blue Prints Included



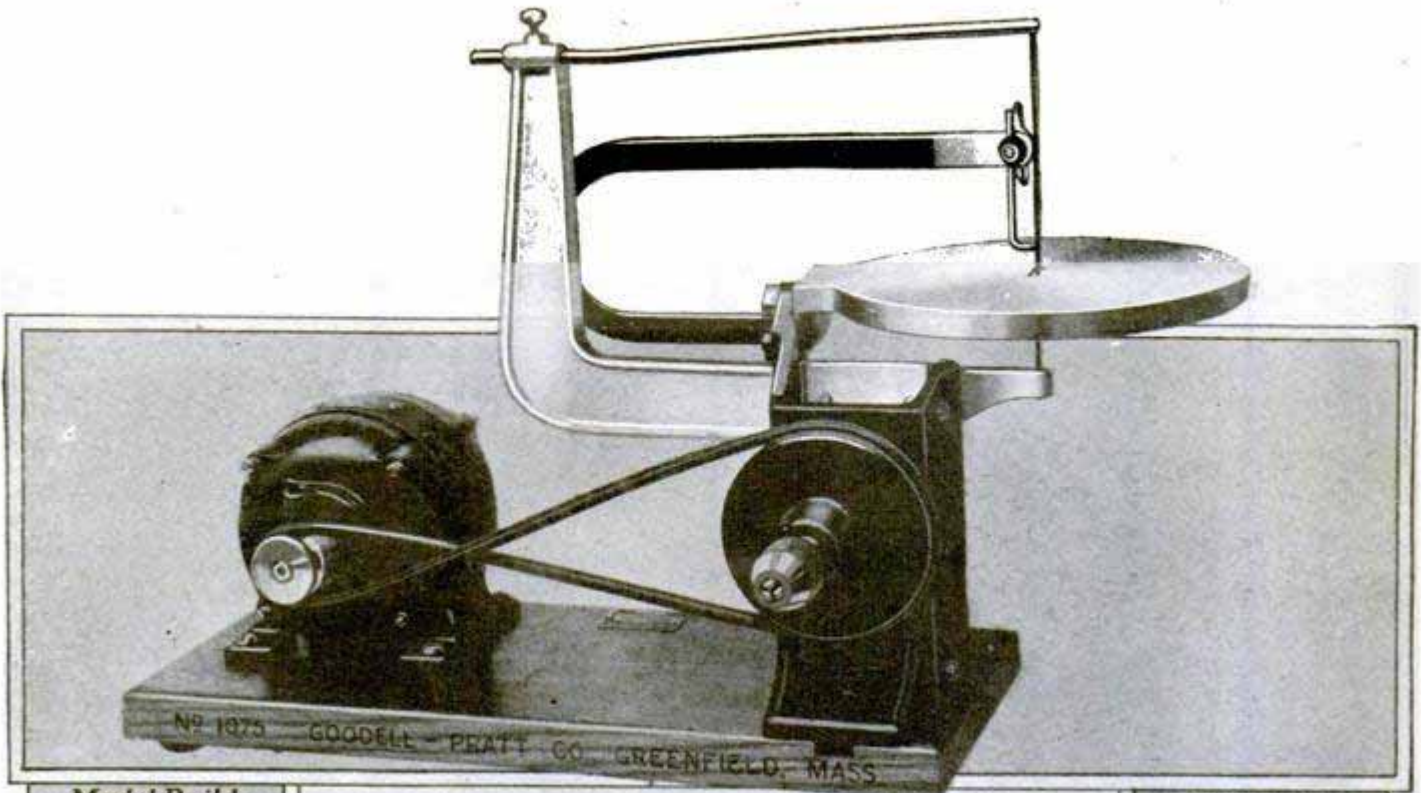

Model Building--For cutting out and shaping up innumerable small parts.

Pattern Making--For delicate work on patterns of intricate design.

Sign Making--For cutting out block letters.

Antique Furniture--For matching odd pieces and parts in restoration work.



The Mark of a Complete Line of Super-Performance Electric Drills

Make the long winter evenings shorter!

You can do it with one of these Motor Driven Scroll Saws. It's a real tool--a Goodell-Pratt Tool--and there are a thousand and one uses for it.

Increases range of work

You can do these jobs yourself which you'd otherwise have to have done for you, and save both time and money.

Stimulates pride of accomplishment

With this saw, you'll derive the satisfaction which can be had only when you have done *all* the work yourself... the pride of the creator and builder.

Saves you time

Think of how much more work you can do, and do it better... more accurately, and of the real pleasure you'll derive from working with a tool which is designed right, made right and priced right.

No. 1075 Motor Driven Scroll Saw \$36.00

If your dealer hasn't one of these in stock and cannot supply you, write us direct.

Jewelry--For roughing out shapes or ornaments of soft metal. A special attachment can be provided to take Jeweler's Saw Blades.

Inlaying--For the finest kind of inlay work in both wood and soft metals.

Wood Carving--For cutting out designs for applique wood work.

Cabinet Work--For a great variety of uses, such as cutting grills ornaments, toys, etc., etc.

GOODSELL-PRATT COMPANY *Toolsmiths*, GREENFIELD, MASS. U.S.A.

GOODSELL-PRATT

1500 GOOD TOOLS



Hello boys! Send for your free copy of **A.C. GILBERT'S SPORTS BOOK**
Tells all about the new 1928 **ERECTOR** world's sports and champions

Boys! Send today for my free Olympic Sports Book. It's all about world famous athletes and Erector. Erector gives you play days you will never forget. Build with your own hands wonderful mechanical inventions, and have your models operate under their own power. Everything necessary lies beneath the cover of the brass bound chest. Oh boy! What a thrill building models that whiz and hum along, just like the big ones engineers build. With its exclusive and feature patented parts, you can build and operate airplanes, automobiles, trains, steam shovels, locomotives, derricks, bridges, hoisting machinery, power plant and construction equipment of every description and kind. Engineers call it "The World's Greatest Toy."

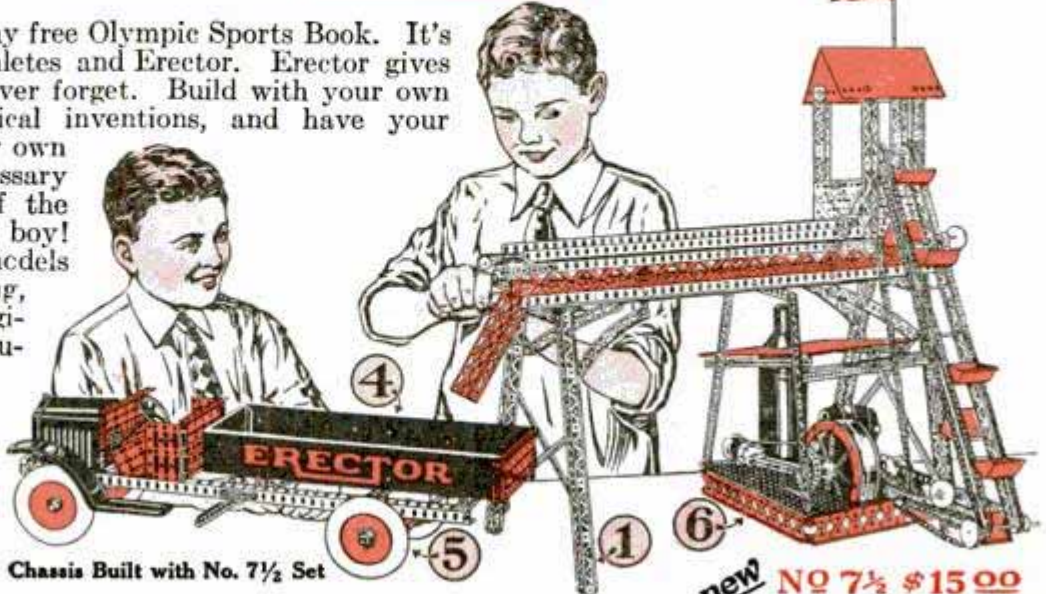

Chassis Built with No. 7½ Set

new No 7½ \$15.00 with Automobile Chassis

Why the New 1928 ERECTOR is the world's greatest toy

- 1 Patented Trumodel features. Erector Square Girder. Like real girders engineers use. Exclusive feature. Makes sturdy, strong models—all Erector Sets.
- 2 Erector Motors. Powerful battery motor in No. 4, No. 77 and 1 No. 7½. Famous 110 volt Universal Motor in No. 8 Trumodel Set and up.
- 3 Completely assembled gear box, adaptable to every possible gear combination, and reversing movements. Convertible into 3 drum hoisting engine. Standardized for use with battery or 110 volt motor. Assembled in No. 4 Set and up.
- 4 Heavy, solid, steel truck body. 14¾ inches long. Complete unit. Exclusive feature. In No. 7½ Set and up.
- 5 3¼ inch solid steel disk wheels. Balloon tires. Exclusive feature.
- 6 Big Giant Channel Girders. Straight and curved. Exclusive feature in No. 77 and up.
- 7 Large solid steel model building tray. Standard holes for model building. Exclusive patented feature. Many other exclusive and patented features.



Here's the greatest thrill you ever had. Fun, oh boy! It's the real thing. Great assortment of patented feature Erector parts. Builds 749 models — automotive models of every description. Big red brass bound chest, solid steel, 14¾ in. truck body, solid steel model building tray, 100 page manual, powerful motor, assembled gear box, steel disk wheels, balloon tires, every automotive accessory. 25 lbs. of scientific thrills for every day in the year.

A.C. Gilbert

A. C. GILBERT'S RADIO SPORTS TALKS

Get in on these big radio thrillers. Every Monday night at 6:30 Eastern Time, 5:30 Central Time. Pick out your station now:
WEAF — New York
WJAR — Providence
WFI — Philadelphia
WRC — Washington
WGR — Buffalo
WCAE — Pittsburgh
WTAM — Cleveland
WWJ — Detroit
WSAI — Cincinnati
KSD — St. Louis
WHO — Des Moines
WOW — Omaha
WTMJ — Milwaukee
KOA — Denver
WHAS — Louisville
WSB — Atlanta
KVOC — Tulsa
KPRC — Houston
KYW — Chicago
WOAI — San Antonio
WEEL — Boston
WDAS — Kansas City
and all stations on entire Red Network Circuit.

Sensational New 1928 Features

- 1—Multi-unit control. Gives realism. Insures successful operation.
- 2—Famous 110 volt Universal Motor.
- 3—Patented machine frame foundation. Exclusive Erector Control part. Adaptation makes possible genuine machinery models.
- 4—New Giant Channel Girder. Straight and curved. Adapted from patented Erector channel girder, embodying all its features.
- 5—Duplex Base Plate. Double standard holes, possible to use axles of two sizes and increase adjustment adaptability. Exclusive patented feature.
- 6—Cone Pulley, Helical Gear, Cams, Rack, etc.

Famous ERECTOR Sets

- No. 1—Dandy Beginner's Set. Builds 460 models. \$1.00.
- No. 3—Gears and Big Red Wheels. Builds 562 models. \$2.50
- THE BIG FOUR**
- Famous No. 4—Powerful electric motor, completely assembled gear box, builds 680 models. \$5.00.
- New Big No. 77—Builds the Steam Shovel. Steel model building tray. Motor and gear box. Builds 727 models. \$10.00.
- No. 7½—Motorized Erector. Builds the Chassis. Builds 747 models. \$15.00.
- No. 8—Trumodel Set. 110 volt Universal Motor. All features described above. More parts. Builds 827 models. \$25.00.
- No. 10—Giant Fly Wheel. Contains every feature. Over 2000 pieces. 110 volt motor. Builds unlimited models. \$50.00.
- ERECTOR ACCESSORY SETS**
- No. B Set—Big Girder Set. Builds the Ferris Wheel. Builds 57 models. \$8.50.
- No. 3005 Electrical Set—Electrifies and illuminates. \$5.00.
- No. C Set—Erector Airplane Set. \$10.00.

A. C. Gilbert's Olympic Sports Book

Know All About the Greater Erector

Get the whole story with a series of exciting sports talks by America's most famous athletes. Coupon brings this free to you. Mail it today.

FREE! Send for it!

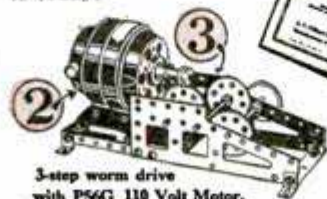
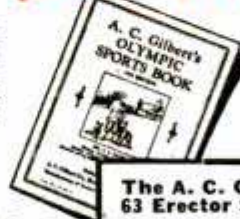

3-step worm drive with P56G 110 Volt Motor.

The A. C. Gilbert Co., New Haven, Conn. 63 Erector Square.

Please send free, copy of A. C. Gilbert's Olympic Sports Book and Gilbert toy catalog.

Name.....
Street.....
City..... State.....

IDEAL Model AIRPLANES

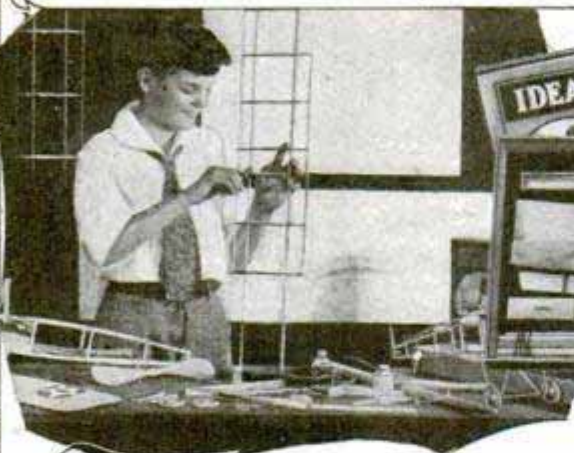

This Christmas — get a Flying Scale Model of a Real Airplane!

GET the thrill of Model Building and Flying with an IDEAL Model of a Real Airplane! IDEAL Models are the most perfect copies of large Airplanes it is possible to make in Models that will fly. They are miniature duplicates of real machines, and are guaranteed to fly when correctly constructed. IDEAL Complete Construction Outfits show how to build them and contain everything required; all parts and materials with Scaled Plans, full size Diagrams and Patterns and complete Building-Flying Instructions.

Here are the most popular Models; pick yours now and get it for Christmas!



WIN the IDEAL Silver Wings and Certificate of Award for Proficiency in Model Aviation. Given Free to those who build and fly Ideal Models. Full information in every Outfit.



**CECIL PEOLI
Racing Airplane**

A 36 in. Championship Racer. Flies far and fast. Very easy to construct. Complete Construction Outfit.....\$3.75



**3 ft. Flying Model of the
DeHAVILLAND Biplane**

An accurate Model, 1-14th actual size. The most popular machine of Biplane type, easy to build and will fly wonderfully when correctly constructed. Complete Construction Outfit.....\$7.50



**3 ft. Flying Model of the
"SPIRIT of ST. LOUIS"**

An exact model-reproduction of the most famous Airplane in the world. 36 in. wing span; weight 10 1/2 oz. A wonderful flier when correctly constructed. Complete Construction Outfit.....\$7.50

**3 ft. Flying Model of the
FOKKER Monoplane**

A perfect Model of the trimotored Monoplane which Commander Byrd flew over the North Pole. Has all the constructional features of the original and is guaranteed to fly when correctly constructed. Outfit contains everything required to build and fly the Model. Complete Construction Outfit.....\$8.50



**Every Boy's
IDEAL
Airplane**

A handsome 3 1/2 ft Monoplane made largely of Aluminum; can be assembled easily and quickly. Just the Model for younger boys. Complete Outfit..... 6.00

IDEAL Model Airplanes and Supplies for Model Builders are sold by Toy, Sporting Goods and Department Stores. Ask for them by name—IDEAL. If unobtainable, we will fill your order upon receipt of price. (West of Denver, Colo., and in Canada, add 50 cents to each price mentioned above.)

Plans for Model Airplanes

Complete Plans and Instructions for any one of the following Models, mailed for 25c: New York-Paris (Spirit of St. Louis); FOKKER; De Havilland; Curtiss; NC-4 Seaplane; Nieuport, Bleriot or Taube Monoplanes; Cecil Peoli Racer. Catalog of Models and Parts free with each Plan.

IDEAL AEROPLANE & SUPPLY COMPANY, Inc.

Largest Manufacturers of Model Airplanes
Established in 1911

26 W. 19th St., New York City

Big Catalog Models & Parts

Contains plans for building Gliders and Racers, full information about Scale Models, and the most complete catalog of Parts, Supplies, Fittings and Materials for building all kinds of Model Airplanes. No Model library complete without this book. Send 5c for your copy right away.

NEW

THE 50 BOX of Gillette Blades

**EVERY TIME HE
SHAVES IN 1929
HE'LL THANK YOU**

A SMART, masculine gift box that's bound to be appreciated all over again each morning! Generous measure for generous shaving comfort! Not a short-lived present, not a frivolous one, but a soundly sensible, month-after-month gift that appeals to a man's practical nature.

And the distinctive thing about it is its newness...it is presented by Gillette for the *first time* this Christmas. You can be sure, when you choose the Fifty Box for him, that he has never before received a similar gift for Christmas — or any other time.

P. S.—When empty, this strongly-built little chest makes an ideal cigarette box for your desk. Or use it for stamps. Or even on your dresser for collar buttons. Its usefulness is varied and its life is long.

Brand-new!

Fifty of the famous double edged Gillette Blades (one hundred shaving edges) tucked away in a sturdy, compact, colorful box. An original, personal way to carry your season's greetings far into the New Year.

\$5
everywhere
**The
perfect
gift**

GILLETTE SAFETY RAZOR CO., BOSTON, U. S. A.

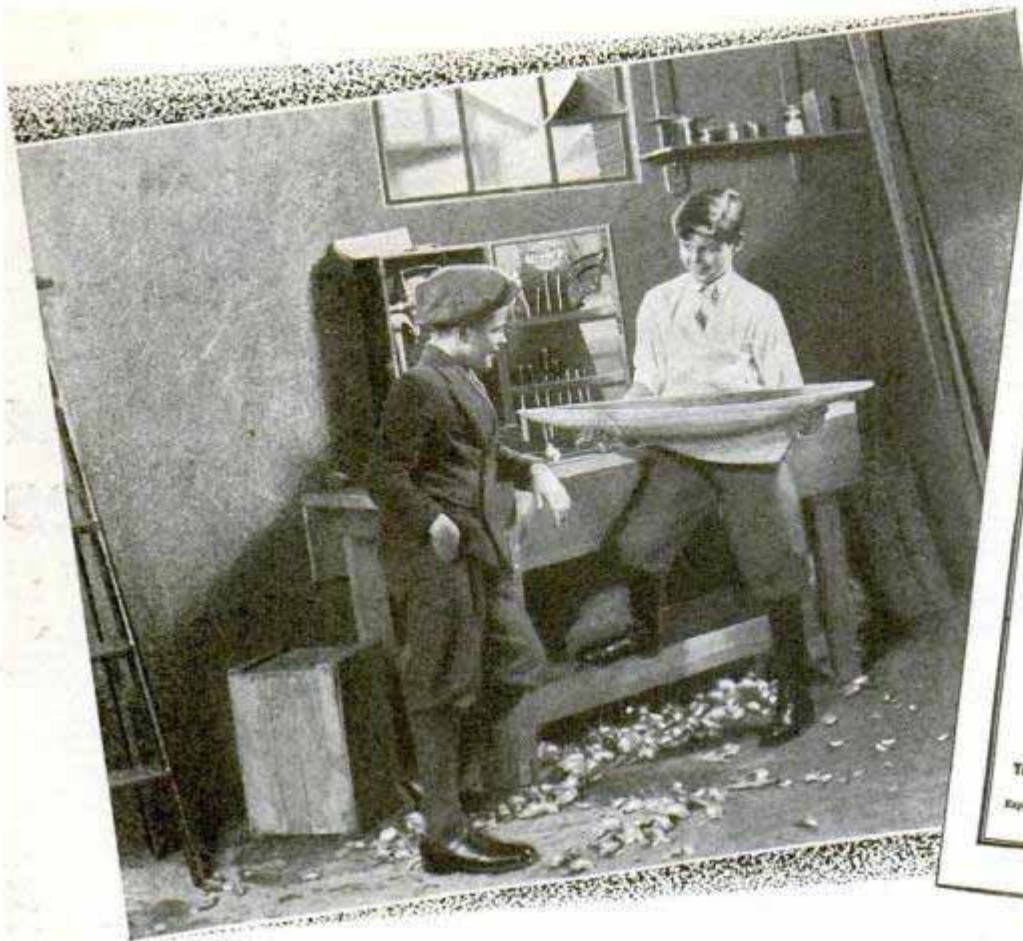

Your boy is safe when he is working with tools and wood



Set No. 904; 12 tools—
oak cabinet. Price \$15.



Set No. 907; 7 tools in cardboard
box. Price \$5. This set includes
plans for making a tool cabinet.



Set No. 902; 20 tools—oak
cabinet. Price \$25.

Fun for him—plus something more—this working with tools and wood.

A chest of tools will keep your boy's mind occupied profitably. Your boy's spare time deserves your thought—your guiding influence.

And—did you ever stop to think—how few toys make *lasting* gifts? Tools, with Stanley Plans to get him started right, will keep him interested all year 'round—and many years to come.

There are 25 Stanley Plans:

boats, dog houses, tables, chests, work benches, etc. They sell for 10c each at your hardware dealer's. There is, also, our new book "How to Work with Tools and Wood". Your hardware dealer has this, too. You can get it for \$1.

On the left are three typical Stanley Tool Chests. There are 16 altogether, ranging in price from \$5 to \$95. Ask your hardware dealer for catalog showing them all. Or write to us for a free copy of Catalog No. Sd35. The Stanley Works, Advertising Dept., New Britain, Conn.

STANLEY TOOL CHESTS

The all-year-'round Xmas gift

Lionel Trains with 100% "Distant-Control"

A movement of the switch at any distance from the track and your LIONEL will start, and stop, and reverse itself at any speed, with the precision of a real railroad train.

You don't have to touch the train! It's all done electrically by means of LIONEL'S marvelous 100% "Distant-Control", with you as the operator at the Switch Tower. Signals change, crossing gates raise and lower themselves, warning signals flash red and green as the semaphore arm goes up and down, controlling perfectly the movement of your train. With a LIONEL model railroad you learn the principles of electric railroad operation—so true to life is every detail. And remember that only LIONEL can produce such handsome, accurate copies of actual railroad locomotives and cars!

See the wonderful LIONEL demonstrations at all Toy, Hardware, Sporting Goods, Electric, Furniture, and Department Stores.

THE LIONEL CORPORATION Dept. 1 15-17-19 East 26th Street NEW YORK CITY

"STANDARD OF THE WORLD SINCE 1900"

LIONEL ELECTRIC TRAINS

MODEL RAILROAD ACCESSORIES

"MULTIVOLT" TRANSFORMERS

Lionel Electric Railroads Priced from \$6.75 to \$300.

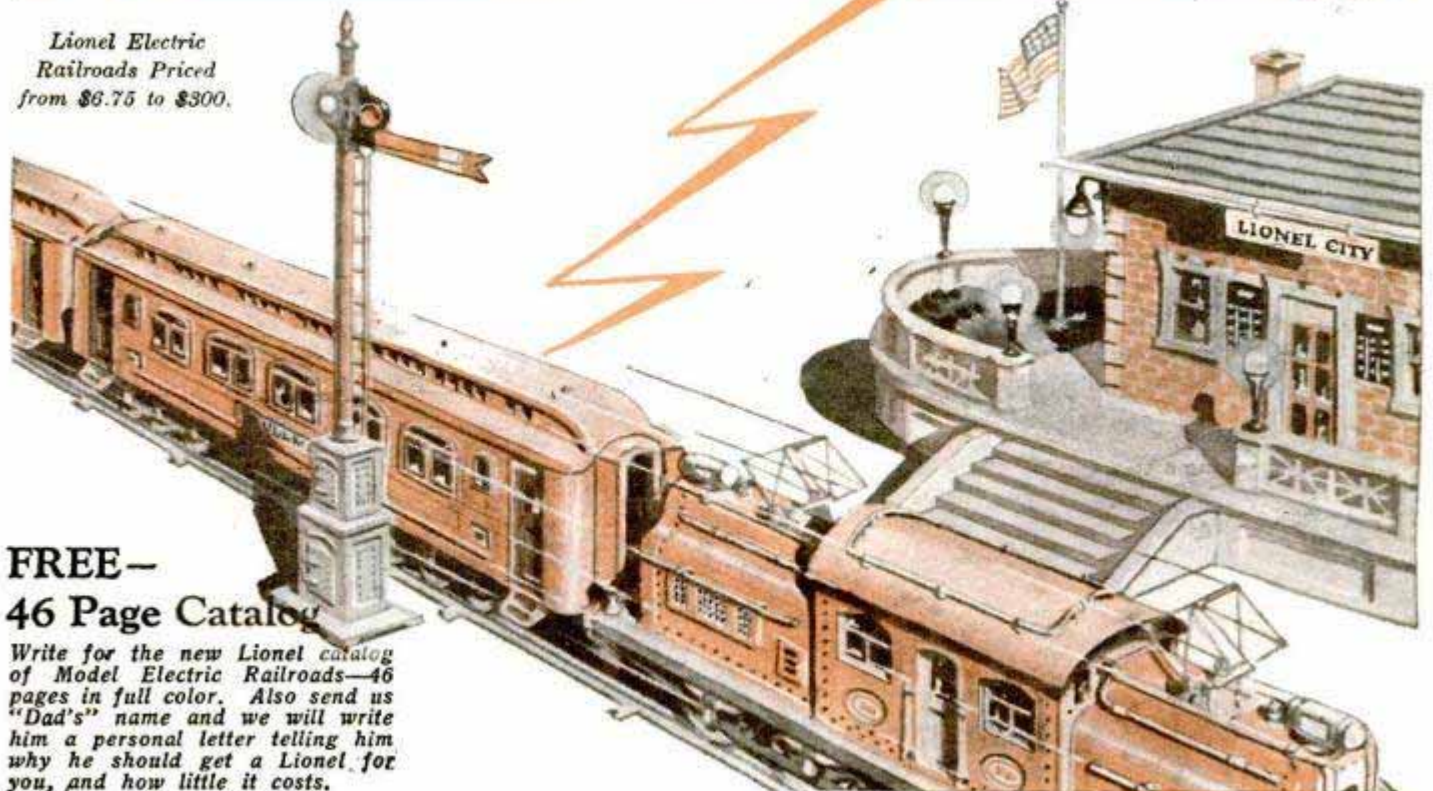

**FREE—
46 Page Catalog**

Write for the new Lionel catalog of Model Electric Railroads—46 pages in full color. Also send us "Dad's" name and we will write him a personal letter telling him why he should get a Lionel for you, and how little it costs.

By means of Lionel's 100% "Distant-Control" one or more trains can be operated on a series of tracks—quickly and positively controlled by any boy from his post at the New Lionel Power House No. 840 shown above.



C & L 158

This blow-torch is especially made and priced for the man who likes to do odd jobs around the house, or to tinker with mechanical things. It will last a lifetime if it is not abused. The usual retail price is about five dollars. Most hardware, electrical and automobile accessory stores have it—or can get it for you quickly. Look for the red handle.

Whatever you need in a blow-torch you'll find in the Clayton & Lambert line

PERHAPS you use a blow-torch only once in a while. In that case you don't need a torch built for hard use on every kind of a job, every day and all day. And you don't need to pay the higher price, either. Not when you can buy the new Clayton & Lambert 158.

It's a low-priced blow-torch, but we don't know where you can buy a better blow-torch at any price, outside of the Clayton & Lambert line. It's husky, with a strong, thick base that protects the tank. Everything in it is made to exacting precision standards, so that it works right—and keeps on working right as long as it is not abused. It holds its compression. And it gives you a hot flame in a jiffy.

On the other hand, if you do use a blow-torch in your daily work, we believe you'll find the Clayton & Lambert 32

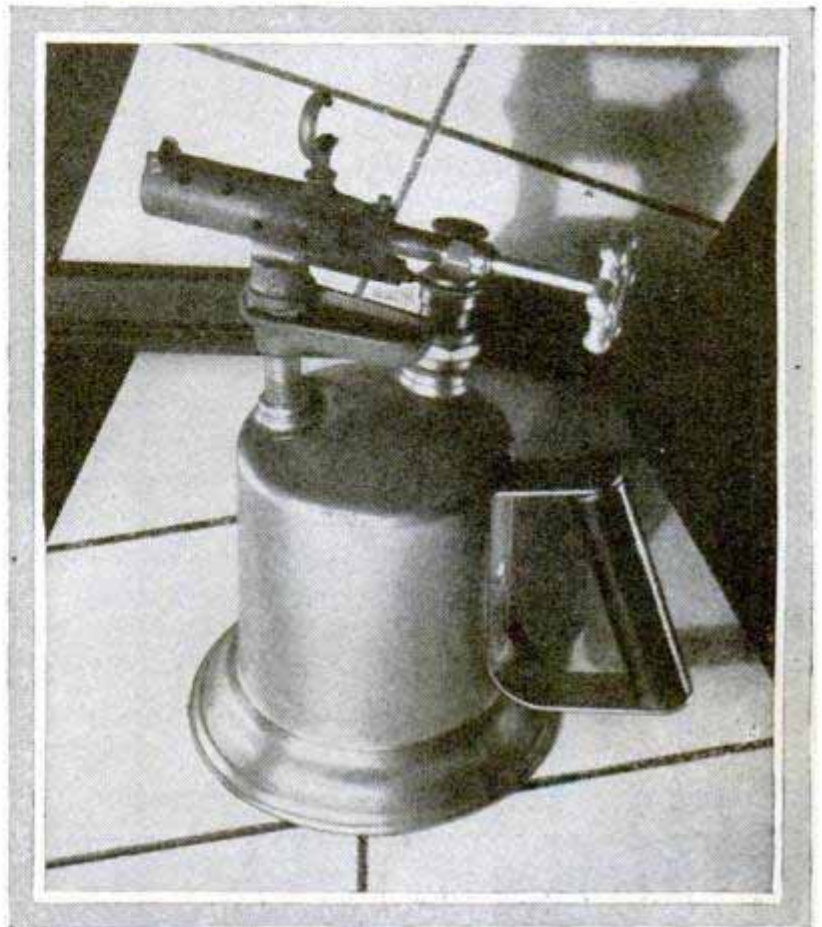

better suited to your needs. For in addition to the excellent qualities of the 158, it has the new, patented Clayton & Lambert gas orifice. That orifice is made to the exact size for perfect operation. And it cannot be spread and enlarged by the needle-valve. Nor can it clog; every time you turn the torch off, the needle-valve cleans the orifice.

Blow-torch users have made the Clayton & Lambert line the most popular in the world. Hardware, electrical and supply houses sell these Clayton & Lambert blow-torches — you can identify them easily by the *red handle*.

CLAYTON & LAMBERT

MANUFACTURING CO.

DETROIT, MICHIGAN

Ideal Christmas Gifts of Enduring Beauty!



Your Choice
SENT FOR \$1
FULL YEAR TO PAY



CA2 \$27⁵⁰
 Finest blue white diamond, lady's hand engraved 18K Solid White Gold mounting. \$2.21 a month.



CA3 \$48⁵⁰
 18K Solid White Gold engagement ring. "A. A. 1" diamond. \$3.96 a month.



CA6 \$29⁵⁰
 Handsomely engraved 18K Solid White Gold wedding ring, 5 genuine blue white diamonds. \$2.38 a month.



CA7 \$36⁷⁵
 New, lady's friendship ring, 18K Solid White Gold, 3 perfectly matched, blue white diamonds. \$2.98 a mo.



CA10 \$37⁵⁰
 Exquisitely hand engraved and pierced 18K Solid White Gold lady's ring. Finest quality, genuine blue white diamond. \$3.01 a month.



CA11 \$47⁵⁰
 Gents 14K solid Green Gold ring, 18K white gold top. "A. A. 1" blue white diamond. \$3.88 a month.



\$35

CA12-The "Madam Jenny"
 The latest from Paris, expressing the modern vogue. Guaranteed Elgin movement. As dependable as it is beautiful. Supplied in GREEN JADE, BLACK or RUBY ENAMEL. \$2.83 a month.

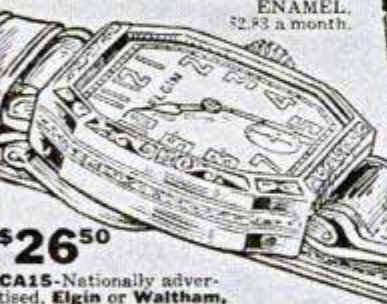

\$26⁵⁰

CA15-Nationally advertised, Elgin or Waltham, gentleman's strap watch. Handsomely engraved, Green or White Gold filled case. Warranted 20 years. Radium dial, accurate and dependable. Specially priced. \$2.12 a month.

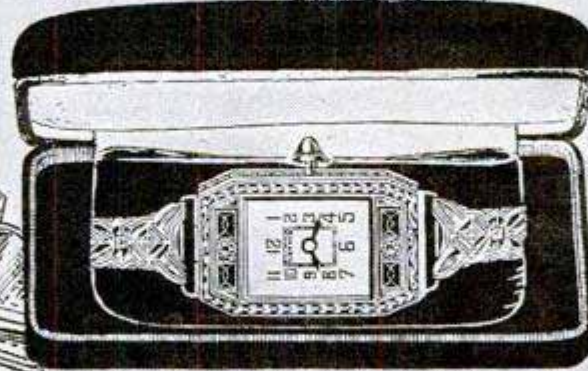

CA16-Ultra fashionable, diamond wrist watch, hand engraved 14-K SOLID WHITE GOLD case, 15 ruby and sapphire jewelled movement, 2 blue white diamonds, 4 French blue sapphires. Genuine "WRISTACRAT" bracelet; patented safety clasp. \$2.79 a month. **\$34⁵⁰**



CA1 \$42⁵⁰
 Lady's Dinner ring, beautifully hand engraved, lace work design, 18K Solid White Gold, 3 genuine blue white diamonds, 2 French blue triangular sapphires. \$3.46 a month.



CA4 \$48⁵⁰
 Dazzling cluster of 7 perfectly matched, finest quality blue white diamonds, 18K Solid White Gold mounting. \$3.96 a mo.



CA5 \$75⁰⁰
 The "Bordeaux" 18K Solid White Gold engagement ring, hand carved floral design. Finest grade, blue white diamond. \$6.18 a month.



CA8 \$57⁵⁰
 The "Mayfair" 18K Solid White Gold, beautifully hand pierced lady's mounting. Finest grade, genuine blue white diamond. \$4.71 a month.



CA9 \$75⁰⁰
 Artistically hand engraved 18K solid white gold, newest style lady's mounting, 3 fiery first quality, blue white diamonds. \$6.16 a month.

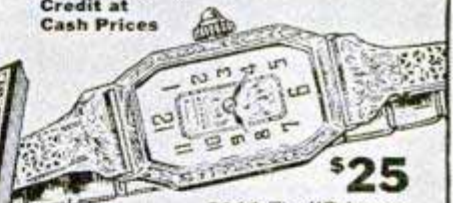

\$25

CA14-The "Princess Pat", 14-K SOLID WHITE GOLD, engraved case. Accurate, dependable, 15 jewel movement. Genuine "WRISTACRAT" flexible bracelet. \$2.09 a mo.



CA17-Gents combination, nationally advertised, Elgin or Waltham thin model movement, 12 size, engraved octagon design, green gold filled case. Guaranteed 20 years. Complete with knife and chain. \$22⁵⁰ \$1.79 a mo.

GUARANTEED SAVINGS

Direct Diamond Importations and volume sales, enable us to offer you genuine diamonds, standard watches and exquisite jewelry at saving prices with the added advantage and convenience of dignified credit.

HOW TO ORDER

Just send **\$1** with your order and your selection comes to you on **10 Days Free Trial**. No C. O. D. to pay on arrival. After free trial, pay balance in twelve equal monthly payments.

10 DAYS FREE TRIAL Satisfaction Guaranteed

If not satisfied after 10 days trial, return shipment at our expense and entire deposit will be refunded. Written guarantee bond with every purchase.

All Dealings Strictly Confidential

A Full Year To Pay! No extra charges. You take no risk-satisfaction absolutely guaranteed or money back.

Send for this Catalogue

FREE Completely illustrated catalogue of genuine diamonds; Bulova, Elgin, Waltham, Hamilton, Howard, Illinois watches; fine jewelry, silverware at bargain prices. Write now to get your **FREE** copy.



ESTABLISHED 1895

ROYAL DIAMOND AND WATCH CO.

ADDRESS DEPT. 11-M, 170 BROADWAY, NEW YORK, N.Y.

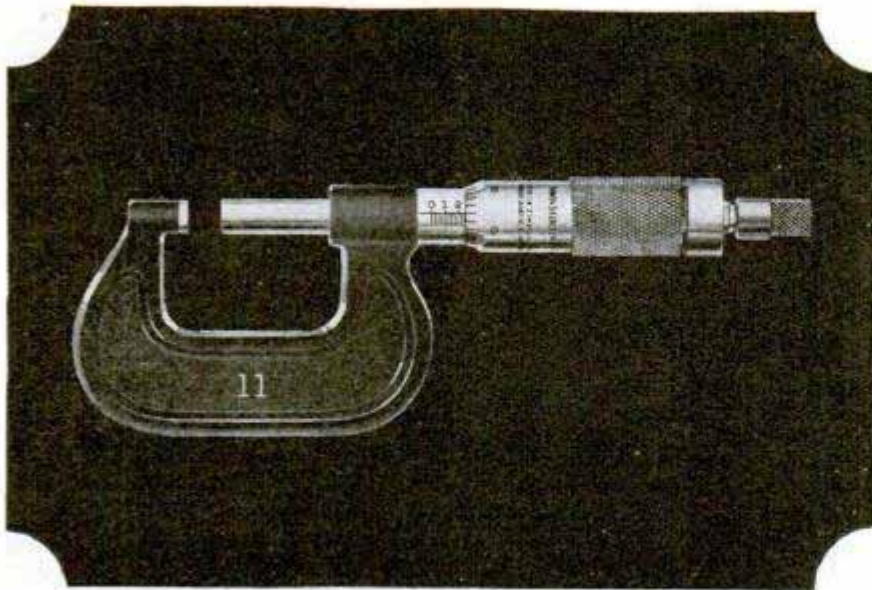

Micrometer No. 11, illustrated above is designed to have increased measuring capacity. The new shape of the frame at the anvil and spindle ends allows measurements not possible with ordinary micrometers.

Good Tools Keep Production On A Precision Basis

With American industry always aiming for faster production, there is the constant danger that speed will lead to carelessness—that haste will make waste.

Increased use of precision tools reduces the dangers of increased speed. Brown & Sharpe Tools are at work all over the world making possible rapid work on a precision basis. Brown & Sharpe tool equipment enables manufacturers and mechanics to keep pace with the increasing demands for production.

Ask your dealer for Catalog No. 30 listing over 5000 items. Or you may get a free copy from us. Dept. P. M., Brown & Sharpe Mfg. Co., Providence, R. I., U. S. A.

BROWN & SHARPE TOOLS



* PLANER AND SHAPER
GAUGE No. 625



* STAINLESS
STEEL RULE
No. 350



* THICKNESS
GAUGE
No. 648



* DIE MAKERS'
SQUARE
No. 552



* COMBINATION SET
No. 438

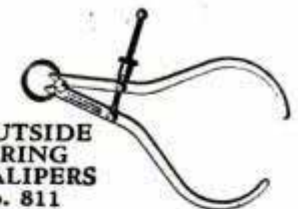

* OUTSIDE
SPRING
CALIPERS
No. 811



* SCREW PITCH GAUGE
No. 630



* ADJUSTABLE SQUARE
No. 554

* A description of this tool
appears in Catalog No. 30



"WORLD'S STANDARD OF ACCURACY"

**KINGSBURY
SUNBEAM RACER**

19 in. model of Major Segrave's famous "Mystery Sunbeam," first car to go over 200 miles per hour. Strongly built. Powerful spring racing motor. Brilliant red finish. Dunlop rubber tires. (West of Miss. \$3.30)



\$3⁰⁰

**KINGSBURY
COUPE**

13 1/2 in. model of up-to-date Sport Car. Spare wheel, bumpers, disc wheels, rubber tires. Speed motor. (West of Miss. \$3.30)

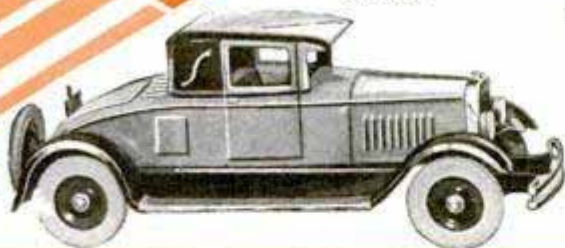

\$3⁰⁰

**KINGSBURY
"BLUEBIRD" RACER**

19 in. model of the famous Napier "Bluebird" in which Capt. Campbell travelled 207 miles per hour down in Florida. Bright blue finish. Powerful spring racing motor. Dunlop rubber tires.

(West of Miss. \$3.85)

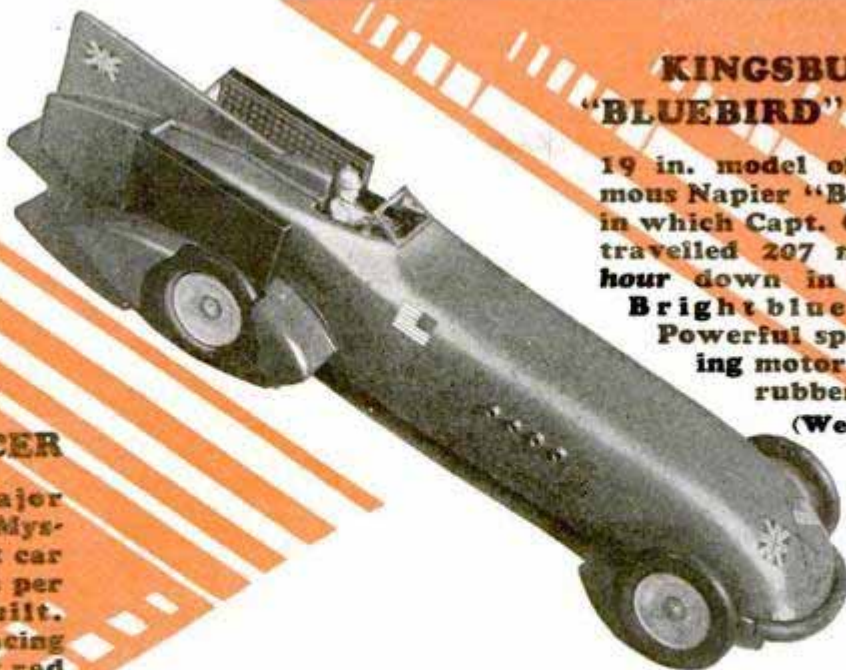

\$3⁵⁰

**KINGSBURY
TRI-MOTOR PLANE**

15 in. wing spread. Strongly built, all of steel. Finished in two-tone gold and blue bronze. Strong spring motor sends it spinning around floor, propellers whirring.

(West of Miss. \$2.20)



\$2⁰⁰

SPEED TOYS for CHRISTMAS!

Only 10c!

A fine eraser made from the disc wheel of a Kingsbury Toy, equipped with balloon size tire of eraser rubber. Set of four, 35c.



JUST a hint of the wide array of speed toys shown in the new Kingsbury Catalog. The most lifelike realistic toys you ever saw! Equipped with spring motors that give amazing speed and long service. If your dealer hasn't these Kingsbury Christmas novelties in stock, order direct from us.

Kingsbury Mfg. Company, 83-M Myrtle St., Keene, N. H.

KINGSBURY
MOTOR DRIVEN TOYS



FREE!
New Catalog

showing over forty of the most interesting speed toys. Free for the asking. Send for your copy today.

Only \$12⁴⁰ a Month

Price \$155

Weight
375 lbs.

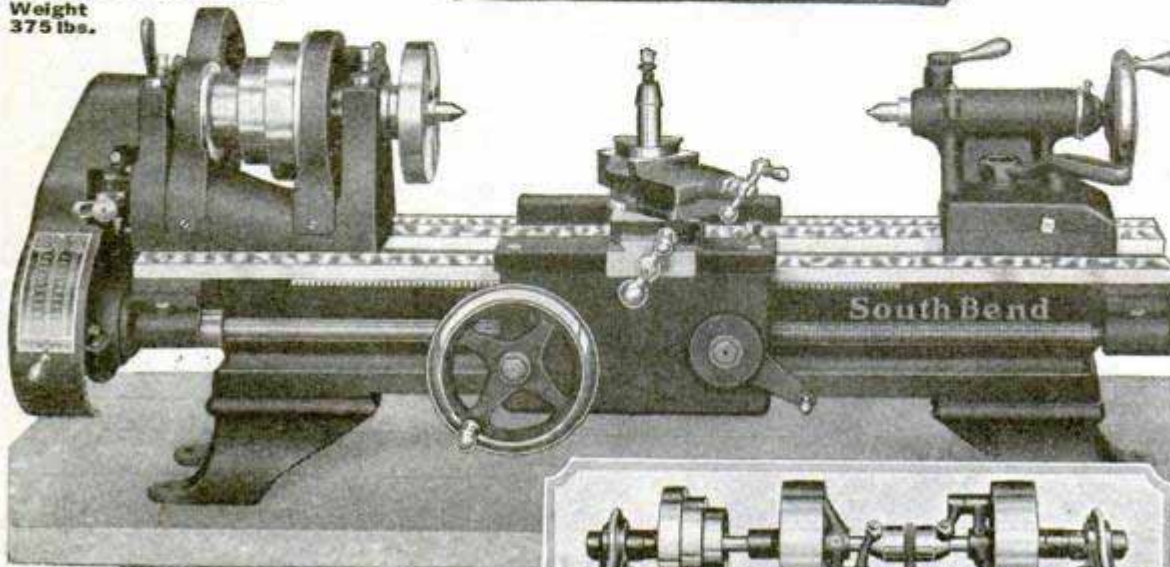

THIS LATHE WILL

- Do Turning
- Boring
- Chucking
- Grinding
- Cut Screw Threads
- Make Bushings
- Reface Valves
- Finish Pistons
- Bore Connecting Rods
- Undercut Mica
- True Commutators
- and do hundreds of other jobs in the Machine Shop, Manufacturing Plant, Repair Shop, Service Station, Laboratory, and Engineering Shop

9" x 3' New Model SOUTH BEND Jr. Back Geared Screw Cutting Precision LATHE

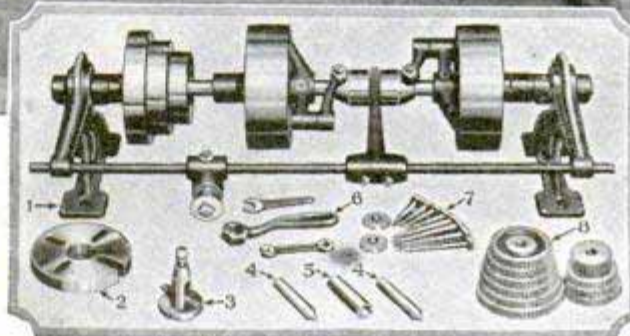

We ship Lathe immediately upon receipt of small down payment, and give you 10 months to pay balance in equal installments. With each Lathe we send free complete Instruction Book, "How to Run a Lathe."

Features and Specifications

Power Feed to Carriage
 Graduated Compound Rest
 Set-Over for Taper Turning
 Hole through Spindle— $\frac{3}{4}$ in.
 Spindle Speed—48 to 714 R.P.M.
 Width of Belt—1 in.

Also furnished with floor legs and in three types of Motor Drive, one of which is shown below

Prices and Terms of 9-inch Junior Lathes

Size Lathe	Between Centers	Weight	Down Payment	Monthly Payment	Price Lathe
9"x2½'	11 in.	350 lbs.	\$30.00	\$12.00	\$150.00
9"x3'	18 in.	375 lbs.	31.00	12.40	155.00
9"x3½'	23 in.	400 lbs.	32.00	12.80	160.00
9"x4'	29 in.	425 lbs.	33.00	13.20	165.00
9"x4½'	36 in.	450 lbs.	34.00	13.60	170.00

USE LATHE WHILE PAYING
 You can install any South Bend Lathe by making a small payment with your order and take care of the balance in small monthly payments over a period of ten months. We ship as soon as the down payment is received.

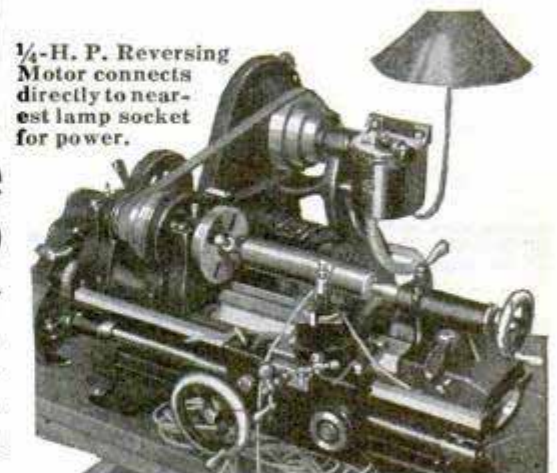

¼-H. P. Reversing Motor connects directly to nearest lamp socket for power.

Only \$18.64 per month
 9"x3' New Model Junior Self-Contained Motor Driven Bench Lathe, complete.

Write for FREE Time Payment Catalog 40

—showing 57 sizes and types of New Model South Bend Lathes with Prices, Down Payments and Monthly Payments on each size. Catalog also shows larger sizes of lathes from the 11" swing to the 24" swing. Fill out and mail coupon.

SOUTH BEND LATHE WORKS, South Bend, Ind.
 648 E. Madison St., South Bend, Ind.
 Gentlemen: I would like your net factory price on a Screw Cutting Lathe size: () Manufacturing () Machine Shop () Garage Work
 Please send Free Catalog.
 Name:
 Address:
 City:
 State:

SOUTH BEND LATHE WORKS
 648 E. Madison Street SOUTH BEND, IND., U. S. A.
 New York City: J. E. Beggs Co., 183 Centre St.



Hello boys!

Tell 'em you built it with
GILBERT "Big-Boy" Tools
"Constructed for Service"

Boys, here's your chance to give mother and dad a real surprise. Build furniture, airplanes, toys, bird houses, and hundreds of other practical things. Tell dad you will start right in, as soon as you get your Big Boy Set. Lift the lid of the big red brass-bound Tool Chest, and you open up a new world of exciting thrills. Call in your pals. Oh, Boy! How their eyes will pop! Boy Builder's Plan Book tells exactly how each job is done, and there is a tool for every purpose. Find out right away how smart you are with your hands. Look over my Big Boy Tool Chests and Machine Shop outfits at any good store. Pick out your Set and start right in building wonderful things.

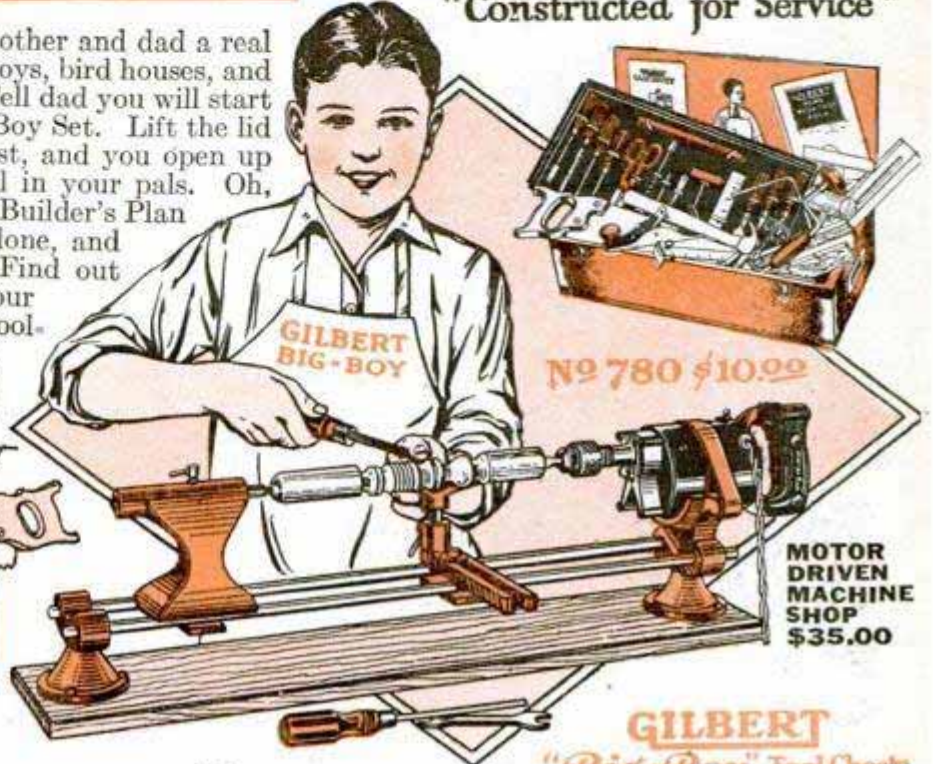

When You Buy Your Tool Chest
See that you get these
Feature Tools

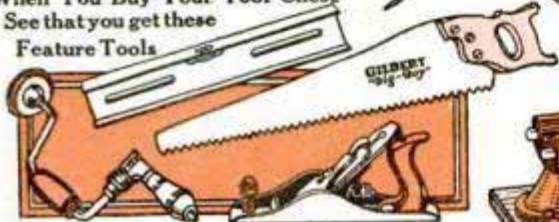

Let's Go

Boys, want to make things hum? My brand new Motor-Driven Machine Shop is the greatest thing I have made for boys since I invented Erector. A complete scientific work shop, combination portable lathe, demountable drill, emery wheel, scratch brush, buffing wheel, etc. And—Boy, here's news—this work shop's equipped with a 1/8 H.P. Universal Motor for A. C. or D. C., with toggle switch, cord and plug. Send the coupon, and get the booklet that tells you all in words and pictures.

Boys

The big No. 780 is the treasured possession of thousands of red-blooded boys. They wouldn't swap it for a million dollars. 26 pieces in all, 18 lbs. of scientific fun, the kind you'll never get tired of. Chuck-full of he-man tools for the boy builder. Two complete books show clearly and exactly how to build hundreds of wonderful useful things. See Big Boy at your favorite Toy Shop.

GILBERT
"Big-Boy" Tool Chests
Consist of

Boys' Size

- No. 701**—11 pieces with Plan Book, \$1.00.
- No. 701E**—13 pieces with Plan Book, \$1.50.
- No. 702**—16 pieces with Plan Book, \$2.50.
- No. 707**—19 pieces including Plan Book, \$3.50.
- No. 765**—23 pieces, real tools for practical service. Big red chest with Plan Book, \$5.00.

Dad's Size

- No. 780**—26 pieces, real he-man tools, big cross-cut saw, steel level, plane—a regular outfit. 2 Plan Books, brass bound chest, \$18.00.
- No. 785**—Practical high grade tools, 33 pieces, 2 Plan Books, steel level, plane, cross-cut and keyhole saws—brass bound chest, \$15.00.
- No. 790**—36 pieces, plane, ratchet brace, level, cross, rip and keyhole saws, 2 Plan Books—every needed tool for master builders—big red chest with lock, \$25.00.

The New 1928 Line Includes These Important Desirable Features

Be sure to get these big exclusive features in Dad size Chests:

- 1—BIG BOY TOOL CHESTS have more and better tools than any other chest of equal value.
- 2—All-metal spirit level. In No. 765 and up.
- 3—High quality, ground face Block Plane. In No. 765 and up.
- 4—Bench Plane. The kind that real carpenters use. In No. 785 and up.
- 5—LePage's Glue with Home Workshop Booklet. In all Dad Size Chests.
- 6—New 1928 Plan Book. In all sets.
- 7—Carpenter's apron. In all Dad Size Chests.
- 8—Drop forged hammers. In Dad Size Chests.
- 9—Big-Boy-Saws.
- 10—Metal Tray.
- 11—Big Red Brass-bound Chest.

A. C. Gilbert's Olympic Sports Book

You will want to know all about this greater 1928 Erector and Big Boy Tool Chests. Get the whole story, together with a series of exciting sports talks by America's most famous athletes. The little coupon brings this free book to you. Just write in your name and address and mail the coupon today.

A. C. Gilbert's Radio Sports Talks

Every Monday night, 6:30 Eastern Time, 5:30 Central Time, over WEAf and entire red network. See Station Listing Page 117.

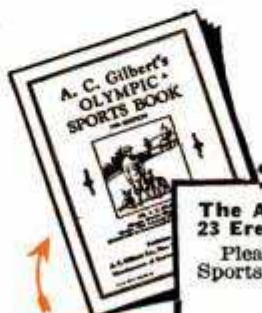

FREE:-
Send for it!

The A. C. Gilbert Co., New Haven, Conn.
23 Erector Square.

Please send free, copy of A. C. Gilbert's Olympic Sports Book and Gilbert toy catalog.

Name.....
Street.....
City..... State.....

There's no fun like Chemistry with

REGISTERED TRADE MARK
CHEMCRAFT
THE CHEMICAL OUTFIT



Be a Boy Chemist!

Work Wonderful Chemical Experiments in Your Own Laboratory—Start Your Own Chemistry Club—Astonish Your Friends with Marvelous Chemical Tricks!

CHEMCRAFT No. 8—a wonderful outfit in a wooden cabinet. Contains 80 chemicals and pieces of apparatus. Manual of Instruction explains 478 fine experiments, and practical work can be done with this outfit. **Price \$8.00.**

CHEMICAL experimenting is the finest sport you ever had; shows you the wonders of chemical science, gives you practical information you can use every day and introduces you to one of the most fascinating and valuable scientific subjects—the Science of Chemistry. You can make soap, dyes, ink and paint; test food, water, soil and metals; analyze lots of things and learn their chemical contents. Perform tricks of chemical magic, too, and surprise your friends; and experiment with chemical sorcery and produce wonderful changes. When you get your **CHEMCRAFT** you can join the Chemcraft Chemist Club and be the Chief Chemist of your own local Chapter—and that means more sport! These new outfits are the finest ever made; more chemicals and apparatus, more and better experiments, liberal quantities of chemicals and nicer boxes and wooden cabinets.

Seven Fine Outfits to Choose from!

Each is a complete chemical laboratory containing safe chemicals, all necessary apparatus and a Manual of Instruction. Here are five practical outfits; select yours now. Look for **CHEMCRAFT** in any store where toys are sold; be sure you see the name on the box and insist on having the best outfit. If unobtainable, we will send your set, fully prepaid, upon receipt of price as listed here.

The **PORTER CHEMICAL COMPANY**
113 Summit Ave., HAGERSTOWN, MARYLAND



CHEMCRAFT No. 1—just right for beginners. Contains 16 chemicals and pieces of apparatus. 100 experiments are explained in the Manual of Instruction, and each can be repeated many times. **Price \$1.00.**

CHEMCRAFT No. 2—contains 31 chemicals and pieces of apparatus, and 181 experiments are given in the Manual of Instruction. **Price \$2.25.**

CHEMCRAFT No. 3—there are 40 different chemicals and pieces of apparatus in this fine outfit. 264 experiments are explained in the Manual of Instruction. **Price \$3.50.**

CHEMCRAFT No. 5—the most popular outfit of all. 60 chemicals and pieces of apparatus, with more than 375 experiments explained in the Manual of Instruction. **Price \$5.00.**

Try Chemistry with this 25c Set!

Make ink, dye cloth, test water, do magic tricks and see if you like chemistry. Send for this **CHEMCRAFT JUNIOR** set now; try it out and then get a big one. Just send 25c in stamps or coin to address above.



FREE Magazine for Boys!

Full of stories, new ideas and Chemcraft Club News. It's a fine magazine for boys who want to know more about chemistry. It's **FREE**—just write for your copy right now!



\$1 Greatest Value Ever Offered **\$1**
MACOY'S 5 WINDOW PASS CASE



Genuine Gold Corners
Morocco Goatskin

Well made in every way. Edges turned and stitched; pocket for business cards; Shrine or Masonic Emblem **FREE**. Gold stamping, name and address, 35c per line extra. **Clip this adv. and enclose \$1 bill.**

5 Window Pass Case.....\$1.00
9 Window Pass Case.....\$1.50
13 Window Pass Case.....\$2.00

Enclose another dollar for beautiful solid gold O.E.S. or Masonic Pin (Reg. \$1.50) and ask for Catalog "8"—Jewelry, Novelties, Leather Goods, etc. for Xmas gifts.

MACOY PUB. & MASONIC SUPPLY CO.
35 W. 32nd St., (Est. 1849) New York

"You're there with a CROSLLEY"

Genuine neodymium battery type Bandbox \$55
AC Electric power speaker GEMBOX \$65
THE CROSLLEY RADIO CORPORATION
Cincinnati, O. Powell Crosley, Jr., Pres.



Collar and Cuff Links Given
1 Carat Elite Diamonds. Matchless for their dazzling rainbow brilliancy. You'll be delighted. **Elite Rings** surpass all others. Stand acid and other tests. Handsomely Engraved Ring, sterling **Guaranteed**. Looks like \$250.00. Proud owner offered **\$85.00** 5 minutes after buying one. With each ring order, we give free beautiful combination Set. Set with small **Elite Diamonds**. **SEND NO MONEY**. Just send name, address and finger size. On arrival pay postman \$3.89 and postage. Satisfaction Guaranteed. Write today. Cash with Canadian or foreign orders.
ELITE JEWELRY HOUSE, Dept. 1612, 6343 S. Ashland Ave., Chicago, Ill.

YOU CAN BUILD

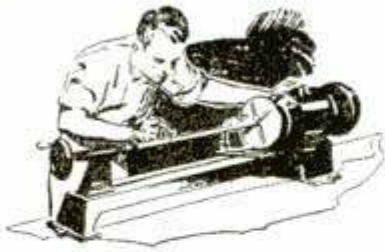

Worth While Things
ONLY WITH
Worth While Tools

AR-CON UTILITOOL

THE KING OF THEM ALL

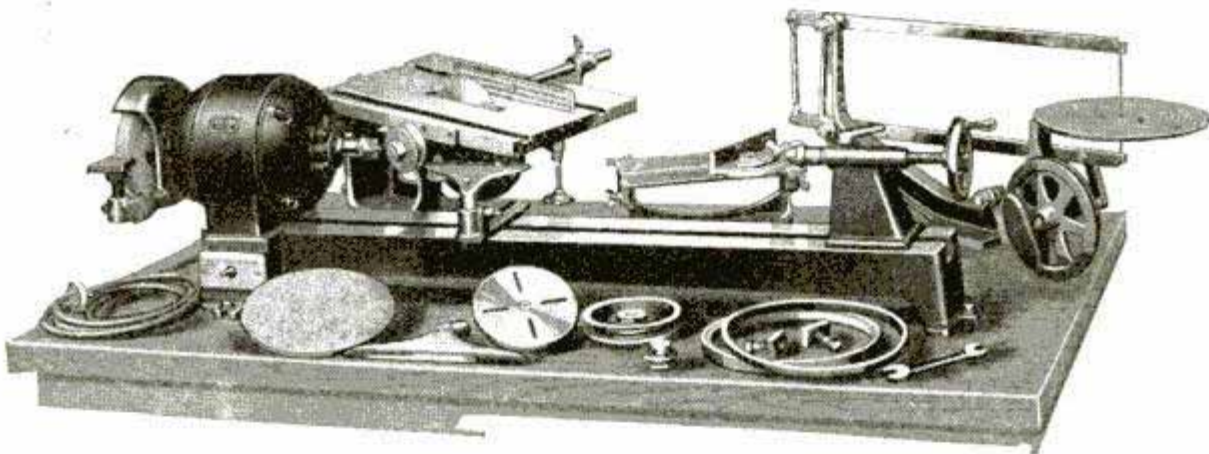

Whether your objective is profit, or merely the joy and satisfaction of "making things," the degree in which you realize your aim is dependent directly upon the quality of your workmanship and the ease and speed with which it is accomplished. And these in turn are dependent upon the quality and efficiency of the equipment you have to work with.

The Ar-Con Utilitool was designed to squarely meet the need for a home work-shop that could match the results of commercial equipment—a work-shop built for strength, and accuracy, and durability under constant hard usage. Its sturdy one-half horse power ball-bearing repulsion-induction type motor—the most efficient type built—provides abundant power for any work the outfit will be called upon to do.

The complete Ar-Con Utilitool consists of a rugged motor-driven lathe with full accessory equipment, including grinding wheel and cotton buffs; a circular saw table; jig and scroll saw; sanding disc and table, and all necessary accessories. Here is a work-shop that will do everything you ask it to do, in the way you want it done.

Easy Terms

Ar-Con Utilitool units may be purchased singly or in any combination of units if the complete outfit is not required at the start. Moreover, the purchase can be made by convenient time payments, if desired. Send for fully illustrated descriptive circular and complete price-list, with terms. The coupon is for your convenience.

THE AR-CON TOOL CO.
 500 Fassett St. Toledo, Ohio

The Ar-Con Tool Company,
 500 Fassett Street, Toledo, Ohio.

Mail descriptive circular on Ar-Con Utilitool, with prices and terms.

Name.....

Street Address.....

City and State.....

CHROME



The Watch Dog of Power

CHROME, a preservative, guards power when your Burgess "Super B" Batteries are not in use. Thus extra life and service are added. The valuable properties of Chrome in lengthening battery life were long known to scientists, but it remained for Burgess engineers to discover the secret of utilizing Chrome in battery construction.

The year's noteworthy achievement in radio enjoyment and economy is the Burgess "Super B" Batteries

"Super B" No. 22308

is a medium size heavy-duty 45-volt battery designed for general, all around use.

"Super B" No. 21308

is the largest size Burgess heavy-duty 45-volt battery—made especially for heavy-current consuming sets.

These two "Super B" Batteries answer practically all radio set requirements.

BURGESS BATTERY COMPANY
General Sales Offices: CHICAGO
In Canada: Niagara Falls & Winnipeg

BURGESS "SUPER B" BATTERIES



SAVE \$10000 ON WORLD'S FINEST CUSTOM-BUILT SETS!

This new 80-page Hi-Q Construction Manual is the most important radio book of the year—shows you how to save at least \$100.00 or how to make a big, steady income through the New CUSTOM-BUILT Hi-Q Receivers—Junior Hi-Q 29 at \$54.35; Junior A.C. Hi-Q 29 at \$103.95; Master Hi-Q 29 at \$99.50; Master A.C. Hi-Q 29 at \$151.80—4 wonderful completely shielded "coast-to-coast" instruments—acknowledged to be the last word in sensitivity and knife-like selectivity—unequaled in tone quality by any ready-made

Write for this Book



set selling for \$50.00 to \$100.00 more.

This greatest of all Hi-Q Manuals is complete with text, photos and diagrams. Covers every detail of Hi-Q building. Gives full information on power amplifiers, short wave adaptors, installation, antennae, house

wiring and a wealth of other data. Shows you how to save money on your own set and how to make money building for others.

Price 25 cents postpaid.

Write for your copy today before first edition is exhausted.

**Hammarlund
Roberts
Custom-Built
Radio**

Hammarlund-Roberts, Inc., 1182-X Broadway, New York City

FREE CHI-RAD'S NEW 1929 RADIO CATALOG

Includes complete parts for HFL ISOTONE, New TYRMAN "80," MADISON-MOORE "AC," New THOR-DARSON Power Amplifier. Also write for Special Circular on the World's Finest DYNAMIC SPEAKER. Discounts for Set Builders.

CHICAGO RADIO APPARATUS CO.

415 S. Dearborn Street

Dept. PM

CHICAGO, ILL.

COMPLETE RADIO

Just what millions of homes have been waiting for. 300,000 already sold. Write today for life size picture and folder number 18

LEON LAMBERT MFG. CO., Wichita, Kans.

\$10⁹⁰

\$75 to \$125 Weekly

5 Down Charging Batteries Starts You

Let me show you how to make big money right from the start. I've prepared a FREE book explaining all details. First week's profit pays for all equipment. You can get all the battery charging business in your community with my Service Station Charger—it's years ahead of ordinary chargers—handles 50% to 70% more batteries. I explain everything—start you in a business of your own and put you on the way to big money. Write for FREE Book.

C. F. HOLMES, Chief Engineer, Dept. PM
Independent Electric Works, 5116 Ravenswood Ave., Chicago

FREE BOOK—Just Out

Big Profits

7

The Meccano patented two-way electric motor is a remarkable piece of workmanship because it embodies all the rigid principles of construction of standard types.

This transmission gear assembly gives a splendid, clear idea just how these gears mesh. Several prominent automobile schools use this Meccano model in their classes.

The differential gear is a device which transmits the power evenly to the road wheels and at the same time compensates for difference in speed in turning corners.

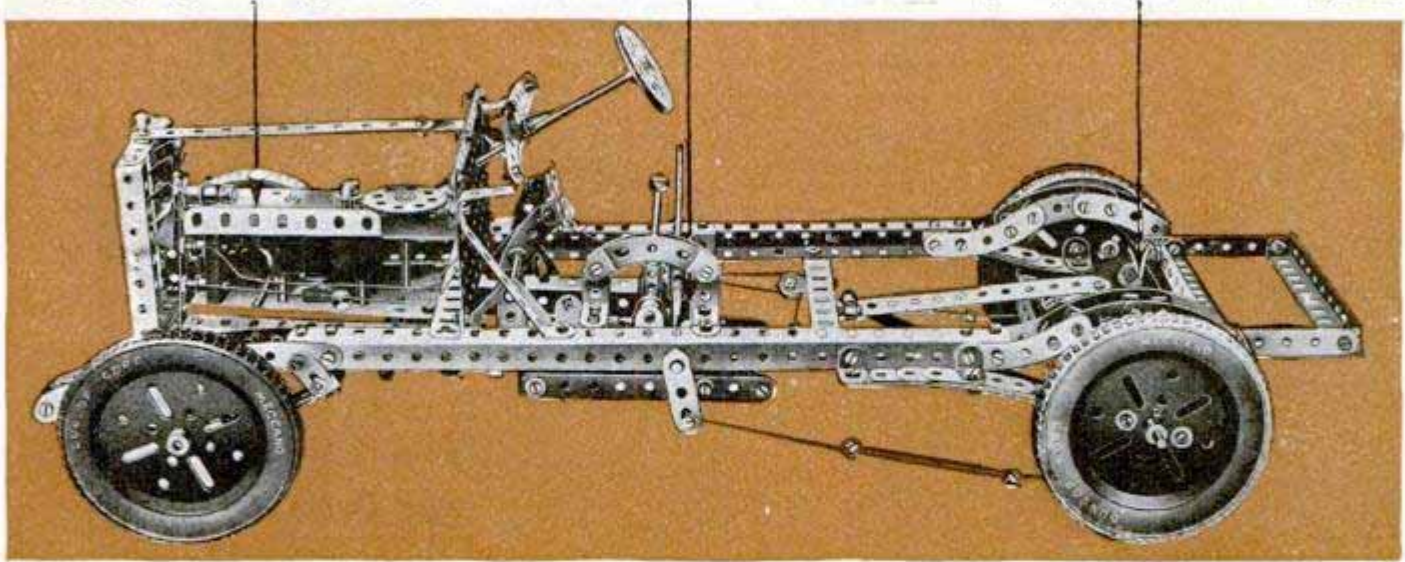

GIANT BLOCK SETTING CRANE

In harbor construction work great steel cranes are used to place 200-ton concrete blocks in position on the sea bed. All these operations are reproduced in miniature by this Meccano crane operated by the two-way electric motor.



686 Models and a Two-Way Electric Motor to Run Them for \$5.00

Shown above is the famous No. 1X Meccano outfit which contains hundreds of precision parts; four big swivel base wheels, braced girders, plates, trunnions and a complete book of instructions.

The magnificent 2X special Leader Set that all the boys are talking about builds 734 special models and has the exclusive Meccano reversing electric motor. It contains a set of four solid massive tread tires giving the last word in realism. This set costs \$10.00 and is packed in a fine wood cabinet.

Get Your Meccano Set Today and Join the Experts.

Makes MOST... BIGGEST... and BEST MODELS

Construction parts that satisfy the expert

THE U S. War Department would never have approved the construction of the New Perth Amboy (New Jersey) projected suspension bridge if they had not been able to examine a scale replica of it made with Meccano. Meccano is the equipment that graduate engineers and architects employ to make their scale models; it is the choice of the experts, and if you wish to build models for real fun, or for profit — as they do — you must join the experts.

Cast your expert eye over this automobile chassis shown above. Here are only a few of its specifications: geared transmission operating three speeds forward and reverse; positive differential gear; Ackerman improved steering; friction clutch; torque rods; foot brake on cardan shaft; internal expanding brakes; radiator fan; semi-elliptic laminated springs; disc wheels; Dunlop tires. Junior engineers the world over prefer Meccano in the ratio of

one thousand to one. Meccano's popularity is no accident, but founded on solid worth. Make this test yourself. Compare Meccano's flat steel strips and girders with any others on the market. Note particularly the equidistant holes set one half inch apart and micrometer tested to the 1/1000th part of an inch. Whether you purchase a small Meccano set for a dollar or a *de luxe* outfit for \$17.50 only one quality is used throughout — the best.



A new leaflet containing detailed instructions how to make the motor car illustrated above—easily understood diagrams and clear directions make it possible for you to build your own car from radiator to rear axle housing—as well as countless other models just as interesting, is free for the asking. Just drop a penny postcard with your own name and address to Meccano Co., Inc., Div. H, Elizabeth, N. J. In Canada: 45 Colborne St., Toronto.

Over 43,000 hours this famous clock made of Meccano parts has ticked away, varying not more than a few seconds a year. A booklet describing how any boy can build this clock will be sent free to all who write for it.

MECCANO

THE TOY THAT MADE ENGINEERING FAMOUS

75
LATEST
RADIO
CIRCUITS
500
ILLUSTRATIONS

WHOLESALE PRICES

NEW 1928-29
EDITION

FREE
This
148 Page
RADIO
CATALOG

BUY FROM
RADIO'S OLDEST
MAIL ORDER HOUSE

We are the oldest established, exclusive radio mail order house in the country. All orders are positively shipped within twenty-four hours; quick, prompt, courteous service. We carry a larger variety of radio parts, radio instruments, accessories and radio findings than any other radio house in the country.

You will find in Catalog No. 18 the largest assortment of radio merchandise in this country. Radio Specialty carries more radio parts and radio material than any other house in the country. You will find in this catalog positively the largest variety of radio merchandise.

If you are in need of certain small radio parts that other radio and mail order houses do not bother to carry get the Rasco Catalog and you will find the small parts there, anything from a screw to copper ribbon, telephone diaphragms, as well as thousands of the small radio findings.

If you possess this Book (No. 18) write for Television Catalogue or Supplement to No. 18

Be sure to get this great 148-page book with net prices.

Radio Specialty Company is radio's oldest radio parts mail order house in the country, and the new confidential prices on standard radio merchandise are the lowest of any radio house.

We are ready now to appoint additional agents in all parts of the country. If you are contemplating making big money in radio merchandise, be sure to get in touch with us at once.

We carry the Largest Variety of Small Radio Parts in the World BUT we also carry All Standard Radio Merchandise.

RADIO SPECIALTY CO., 244 Greenwich St., NEW YORK

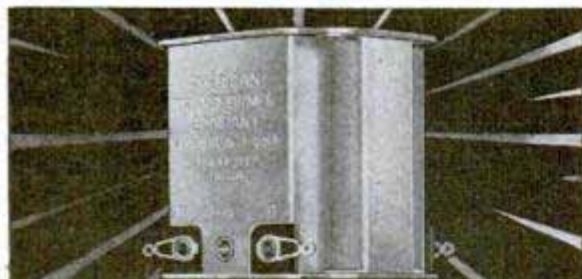
**AMERTRAN
DE LUXE**

First Stage turn ratio 3 } \$10.00
Second Stage turn ratio 4 } Each

Standard of Excellence in Audio Amplification

AmerTran De Luxe Transformers are but two of more than 30 quality Radio Products bearing the name AmerTran, including power transformers, choke coils, push-pull systems and allied products. Each AmerTran device is designed for a specific use. Full and authoritative information will be given on any audio or power problem.

AMERICAN TRANSFORMER COMPANY
Transformer Manufacturers for 28 Years
254 Emmet St., Newark, N. J.

Makers of High Quality
Condensers and
Resistors

AEROVOX
"Built Better"
TOM WASHINGTON ST. BROOKLYN N.Y.

Write for
THE RESEARCH
WORKER—A FREE
MONTHLY PUBLICATION.

**Set Builders!
Dealers!**



Big Catalogue FREE!

Hundreds of bargains in latest kits and parts at liberal discounts. See our new catalogue for

ELECTRIC PHONOGRAPHS—pickups, turn-tables, dynamic speakers.

TELEVISION kits and parts.

SHIELD GRID Kits, coupling impedances, shields and other parts.

SHORT WAVE Sets, kits, parts.

POWER PACKS—All kinds, including 250-tube and push pull circuits.

Van-Ashe has everything, at big discounts, ready for 12-hour shipment. Send post-card for new catalogue and discount sheet.

Dan-Ashe Radio Co.

206 N. 10th St.  St. Louis, Mo.

The 100 inch Hooker Telescope at Mt. Wilson Observatory which has increased the known universe by half a billion stars. The movable parts weigh 100 tons but can be regulated down to a minute fraction of an inch. The telescope is a symbol of supreme accuracy. It in turn is dependent upon a perfection of mechanical workmanship in which Starrett Tools play a vital part.

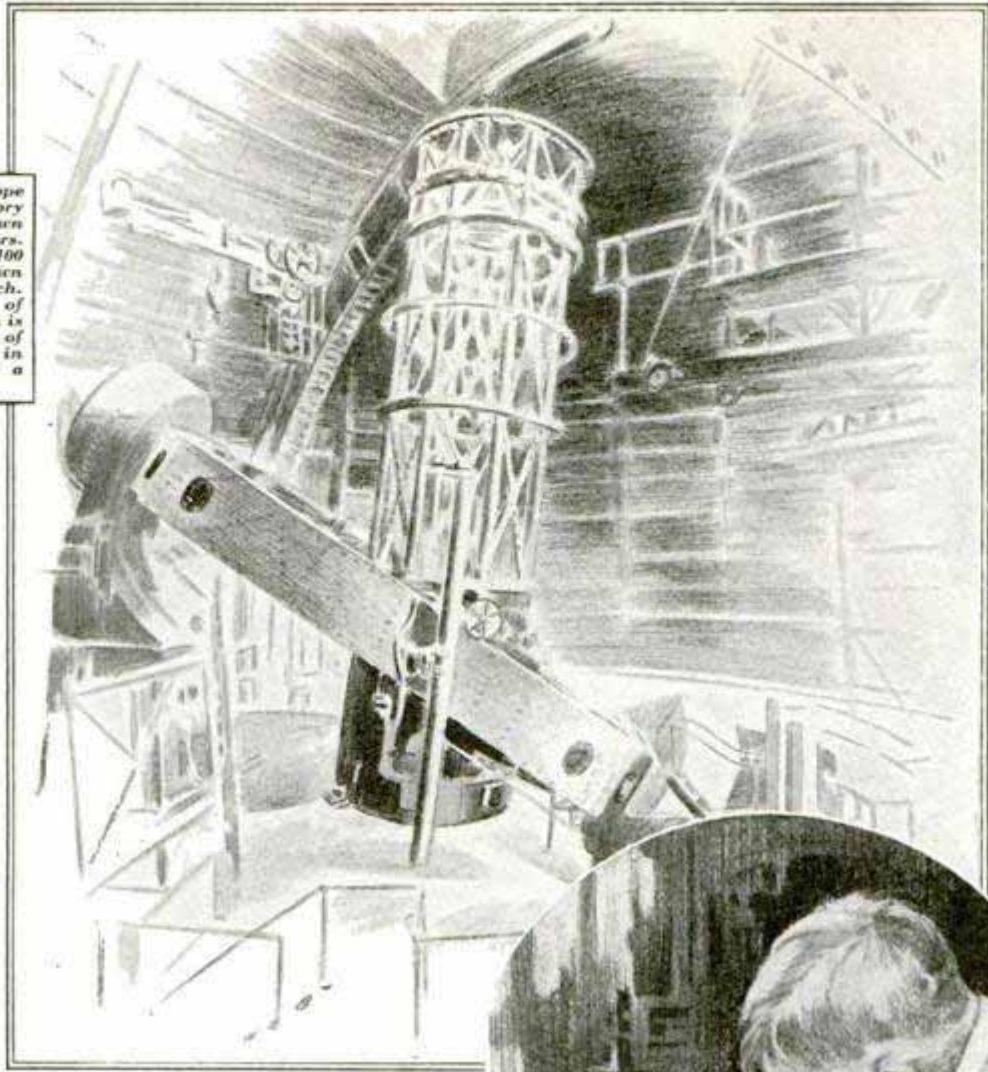

Wherever ACCURACY counts you'll find Starretts



Search for the underlying causes of the breath-taking mechanical achievements that have spurred human progress over the past three decades and you'll find principal among them the development of the art of precision workmanship on a grand scale.

The L. S. Starrett Company takes sincere and honest pride in the fact that it has given to industry and engineering the tools without

which such progress would have been materially impeded.

Tool dealers everywhere are glad to sell you genuine Starrett Tools.

There are over 2500 Starrett Tools, some of which you need to do better work more easily and with greater satisfaction. Your tool dealer has them. Ask him and write us to send you a free copy of the complete Starrett Catalog No. 24 "AP".

THE L. S. STARRETT CO.

*World's Greatest Toolmakers
Manufacturers of Hacksaws Unexcelled
Steel Tapes—Standard for Accuracy
ATHOL, MASS., U. S. A.*



Use Starrett Tools

RIGHT!

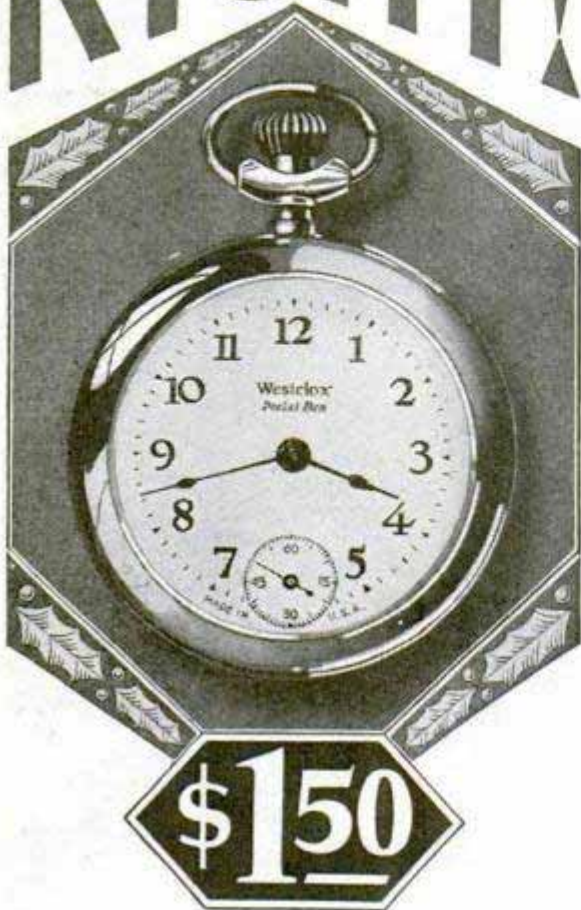

\$150

Pocket Ben

There, in one word you have the real reason why Pocket Ben is in high favor with millions of men. Right—on time! A thoroughly dependable, precision-built timepiece. Neatly designed. Handsomely finished. Attractive and trustworthy.

For that boy of yours—Pocket Ben is just the gift for Christmas. Boys like what men like.

Built by the makers of Big Ben and other Westclox

WESTERN CLOCK COMPANY
La Salle, Illinois



\$250

New Auto Clock
Good looking—convenient—reliable. Quickly attached to dash or above windshield of any car.

Do Away with Handsanding

TAKE-ABOUT Sander



Large or small surfaces easily sanded with this little machine. Handles like a plane, leaving a flat even finish, due to the smooth action of belt. Sands five times faster than by hand. Fine for refinishing furniture, woodwork, stairs, floors, etc. Works from any light socket. No experience required to operate.

PORTER-CABLE MACHINE CO.

1704-10 No. Salina St.
SYRACUSE, N. Y.

"Machine Tool Builders for 20 Years"

INKOGRAPH

10 DAY FREE TRIAL

Writes with ink smoothly, answering purpose of pen and pencil. Never blots, scratches, teaks or dries up. Makes 3 carbon copies at one time with original in ink.

THE PENCIL POINTED PEN
\$1.50

SAME SIZE AS \$7 AND \$875 FOUNTAIN PENS.

SEND NO MONEY. Pay postman \$1.50 plus postage, sent with order. Fed., within 10 days.

Money. Sent prepaid if cash is Money back if not satisfied.

INKOGRAPH COMPANY, INC.
199-649 Centre Street, New York

Send for Inkograph or write for free Sales plan booklet. Big value—sell on sight—no investment—no competition.

AGENTS

6 SHOT 22 Cal. Blank Automatic

WITH BOX CART RIDGES FREE!

You need no license or permit to own this 6 shot Automatic. Use for fun or self-defense. Keeps away ramps. Frightens thieves, scares away dogs—a real home protector. Fool your friends. Same as an expensive automatic in construction, finish, appearance, durability; automatic magazine loading and ejection of cartridges, instantly and powerful report. Guaranteed absolutely safe. Send no money. Pay expressman \$4.38 for automatic with box cartridges. JENKINS, 621 Broadway, N.Y., Dept. 23-M-12



\$4.38

GENUINE LEATHER HOLSTER FREE

PARKS

WOODWORKING MACHINES

Cabinet Shop Special No. 10

\$290

With Motor

You ought to have this handy Parks in your shop. Compact, complete machine designed like a big production outfit at 1/2 the cost. Floor space required only 42x72 in. Does any kind of cabinet and joinery work. Write for circular.



The Parks Woodworking Machine Co.

1500-40 Knowlton St.

Cincinnati, Ohio

Canadian Factory: 333 Notre Dame East, Montreal

FACTORY TO YOU—SAVE 50%—COMPARE WITH COSTLIEST OUTFITS BEFORE YOU BUY

Enjoy a powerful new **MIRACO** ^{set or complete outfit} **30 DAYS FREE**
AC Electric or Battery

Get Our
Send No
Money
9th
Anniversary
Offer!

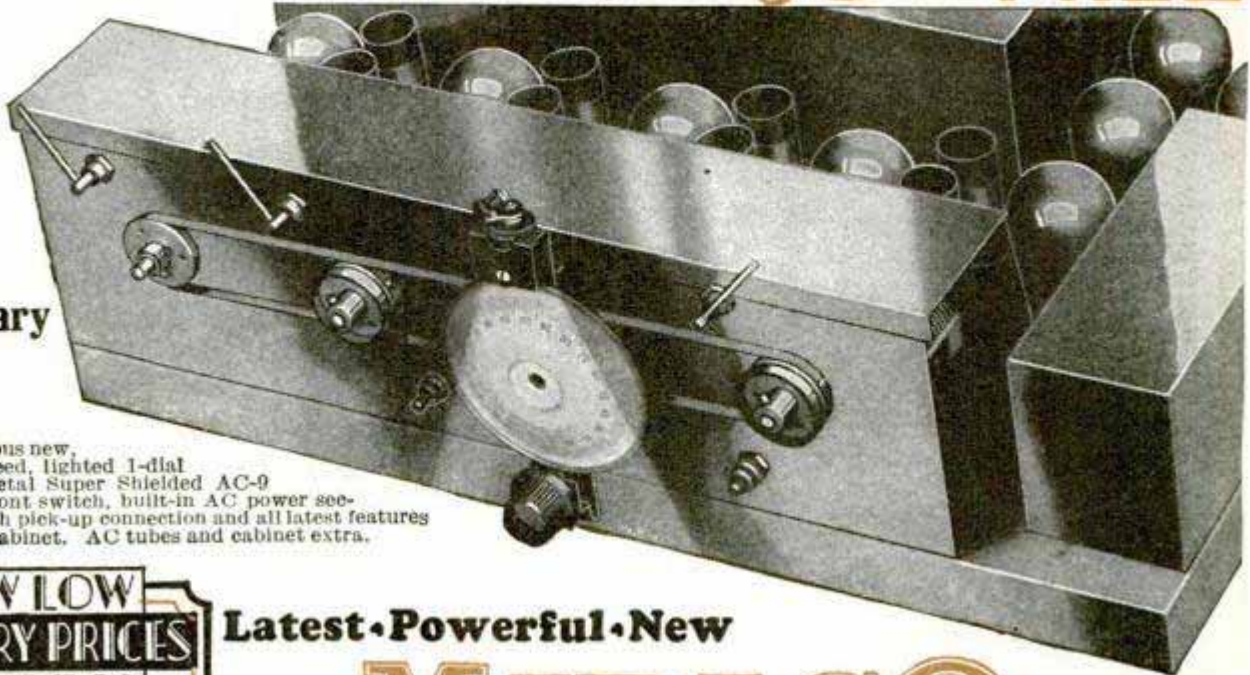

View of marvelous new, 3-year guaranteed, lighted 1-dial control, All Metal Super Shielded AC-9 chassis (with front switch), built-in AC power section, phonograph pick-up connection and all latest features removed from cabinet. AC tubes and cabinet extra.

NEW LOW FACTORY PRICES
SAVE 50%

Choice of Cabinets
AC or Battery Sets

30 Days' Trial



Richly designed genuine walnut console of finest type. Electro-dynamic or magnetic power speaker

Graceful Spinet console, genuine walnut. Choice of speakers. Also comes in Radio-Phonograph Comb'n.



A Le-Boy Console that costs little. Dynamic Power speaker.



Popular inexpensive combination. Set on table speaker.

New-type arm-chair console of genuine walnut—latest speakers.



Latest • Powerful • New

MIRACO
TRADE MARK REGISTERED

Cathedral Toned, Super Selective, Long Distance Getters

Battery or Electric AC Sets

Celebrating its 9th successful year, America's big, old, reliable Radio Corporation springs a genuine sensation in high-grade sets. With its latest, Super-powered, 1-dial Miracos—the All Electric wholly self-contained, hum-free, AC-8 and AC-9, using AC tubes or the new 8-tube Ultra for batteries or Eliminators—you are guaranteed the greatest values and savings in the fine set field.

Compare a Miraco with highest-priced radios, for 30 days in your home. Surprise and entertain your friends—get their opinions. Unless 100% delighted, *don't buy it!* Return everything—the complete outfit—at our expense. Your decision is final—absolutely!

Only exceptionally fine radios, of the very latest approved type, at rock-bottom prices, could possibly back up so liberally unconditional a guarantee. Send coupon now for *Amazing Special Factory Offer!*

Don't Confuse with Cheap Radios
With its rich, clear Cathedral tone, hum-free operation, tremendous "kick" on distant stations and razor-

edge selectivity—with its costly sturdy construction, latest features, including phonograph pick-up connection, ease of tuning, beauty, and economy—a Miraco will make you the envy of many whose radios cost 2 to 3 times as much!

Many thousands of Miracos—bought after 30 day home comparisons—are cutting through locals and getting coast to coast, Canada, Cuba, Mexico, with the tone and power of costly sets. Miracos are laboratory-built with finest parts, and embody 9 years' actual experience in constructing fine sets. Approved by Radio's highest authorities.

Deal Direct with Big Factory

Everything reaches you splendidly packed and rigidly tested to insure your instant enthusiasm. Enjoy the outfit 30 days—then decide. Liberal 3-year guarantee on each set. Play safe, save lots of money, and insure satisfaction by dealing direct with Radio's old, reliable builders of fine sets—9th successful year.

Ultra 8
\$49⁸⁸

Electric AC-8
\$71⁵⁰

Electric AC-9
\$83⁷⁵



Metal or wood compact style cabinets. Wood cabinets in walnut or new shaded silver-chrome finishes. Cathedral Electro-Dynamic or Magnetic-Power Speaker, to match!

MIDWEST RADIO CORP'N, 407-RD Miraco Bldg., Cincinnati, Ohio, U. S. A.
BEAUTIFULLY ILLUSTRATED CATALOG, AMAZING SPECIAL FACTORY OFFER
Testimony of Nearby Users—All the proof you want—of our honesty, fairness, size, financial integrity, radio experience and the performance of our sets—including Amazing Factory Offer—sent with catalog.

Free!

MIDWEST RADIO CORPORATION
Pioneer Builders of Sets—9th Successful Year
407-RD Miraco Bldg., Cincinnati, Ohio

THIS COUPON IS NOT AN ORDER

WITHOUT OBLIGATION, send free catalog, Amazing Special Factory Offer, testimony of nearby users, etc. User Agent Dealer
 Check here if interested in an **EXCLUSIVE TERRITORY PROPOSITION**
NAME ADDRESS

LUMINOUS PAINT

Make Your Watches, Clocks, Etc., Visible by Night

The very latest discovery in the scientific world. Hitherto, practically unobtainable except at an exorbitant price, we have at last succeeded in producing this remarkable LUMINOUS PAINT, which, applied to the surfaces of any article, emits rays of white light, rendering it perfectly visible in the dark. THE DARKER THE NIGHT, THE MORE BRILLIANT IT SHINES. Quite simple to use. Any one—you can do it. A little applied to the dial of your watch or clock will enable you to tell the time by night. You can coat the push buttons or switch plates of your electric lights, match boxes, and innumerable other articles; make your own Luminous Crucifixes, Luminous Rosaries, etc. Small bottle, price 25c. Larger sizes, 50c and \$1 postpaid. **JOHNSON SMITH & CO., Dept. 830 RACINE, WIS.**



CIGARETTE MAKER

Roll your own and save money. Better and quicker; saves more than half. Use your favorite brand of tobacco. Neat, useful, handy. Pocket size, weighs 1/2 oz. Made entirely of metal, nickel plated. 25c, 3 for 65c postpaid anywhere.



GOOD LUCK RING

Very striking, quaint and uncommon. Silver finish; skull and crossbones design, two brilliant, flashing gems sparkle out of the eyes. Said to bring good luck. Only 25c ppd.



Exploding Cigarettes

JUST LIKE ORDINARY CIGARETTES! BUT SUCH REAL STARTLERS! The box contains ten genuine cigarettes of excellent quality. They appear so real, but when each cigarette is about one-third smoked, the victim gets a very great surprise as it goes off with a loud BANG! A great mischief provoker yet entirely harmless. Price 25c box.

NOVELTY BADGES



Kissing Permit 10c. Garter Inspector 10c. Two very novel metal badges, nickel plated, that you can wear, giving you fun out of all proportion to their trifling cost. 10c, each badge, 3 for 25c, or 75c per doz. postpaid anywhere.

MIDGET BIBLE

GREAT CURIOSITY Smallest Bible in the World. Size of a postage stamp. 200 Pages. Said to bring good luck to the owner. A genuine work of art. Must be seen to be appreciated. Always good money selling them to friends, church acquaintances, etc. PRICE 15c each, 3 for 40c, 12 for \$1.35, 100 for \$7.50. Also obtainable in Leather Binding, with gold edges. Price 50c each, 3 for \$1.25, \$4.50 per doz. Magnifying Glass for use with Midget Bible, 15c.

STAGE MONEY



With a bunch of these bills, it is easy for each person of limited means to appear prosperous by flashing a roll of these bills at the proper time and peeling off a genuine bill or two from the outside of the roll, the effect created will be found to be all that can be desired. Prices, postpaid: 40 Bills 20c, 120 for 50c, or \$3.50 thousand postpaid.

MAGIC NOSE FLUTE



The Magic Nose Flute, or Humanozone, is a unique and novel musical instrument that is played with nose and mouth combined. There is just a little knack in playing it which, when once acquired after a little practice, will enable you to produce very sweet music—the tone somewhat resembles a flute. There is no fingering, and once you have mastered it you can play all kinds of music with facility and ease. When played as an accompaniment to a piano or any other musical instrument, the effect is as charming as it is surprising.

SURPRISE MATCHES

More fun than fighting with your wife. Look just like ordinary matches. Put up in boxes just like regular Safety Matches. As the victim tries to light one he gets quite a surprise. Price 10c per box, 3 boxes for 25c, 12 for 75 cents.

These clever locks cannot be opened unless you know the combination. No key necessary. For your locker, bicycle, tool chest, mail box, thousands of uses. Shackle and turn bolts nickel plated. Weighs trifle over one ounce. Small yet strong. Secret and full instructions with each lock. Price 25c or 3 for 65c postpaid.



Wonderful X-Ray Tube

A wonderful little instrument producing optical illusions both surprising and startling. With it you can see what is apparently the bones of your fingers, the lead in a lead pencil, the interior opening in a pipe stem, and many other similar illusions. A mystery that no one has been able to satisfactorily explain. Price 10c, 3 for 25c, 1 dozen 75c. Johnson Smith & Co.

Every Boy His Own Toy Maker

A great book for boys. It gives plain, practical instructions for making all manner of toys, machines and other articles, amusing and useful. Tells how to make a Steam Engine, a Photographic Camera, a Windmill, Microscope, Electrical Machine, Galvanic Battery, Electric Telegraph, Electrotyping Apparatus, Telephone, Kaleidoscope, Magic Lantern, Aeolian Harp; how to make Boats of all kinds, Kites, Balloons, Paper Toys, Masks, Card Racks, Wagons, Cars, Toy Houses, Bows and Arrows, Pop Guns, Slings, Fishing Tackle, Rabbit and Bird Traps, etc. 200 Illustrations. PRICE 25c Postpaid. Postage Stamps accepted.

Serpent's Eggs

Box contains 12 eggs. When lit with a match, each one gradually hatches itself into a snake several feet long, which curls and twists about in a most life-like manner. Price per box, 10c postpaid, 3 for 25c.

BLANK CARTRIDGE PISTOL

Protection against Burglars, Tramps, & Dogs. Special Offer 1 Blank Cartridge Pistol 100 Blank Cartridge 1 550-page Novelty Catalog **ONLY \$1.50**

Well made and effective, modeled on latest type of Revolver; appearance alone is enough to scare a burglar. When loaded it may be as effective as a real revolver without danger to life. It takes standard .22 Cal. Blank Cartridges—obtainable everywhere. Special cash with order offer: 1 Superior quality Blank Cartridge Pistol, 100 Blank Cartridges, and our new 550 page De Luxe Catalog of latest novelties; all for **ONLY \$1.50**. Shipped by Express only. Cannot go by parcel post. Extra Blank Cartridges 50c per 100. Special Holster (Cowboy Type) for pistol 50c. No C. O. D. shipments.

THROW YOUR VOICE

Into a trunk, under the bed or anywhere. Lots of fun fooling the teacher, policeman or friends.

THE VENTRILO a little instrument, fits in the mouth out of sight, used with above for Bird Calls, etc. Anyone can use it.

Never Fails. A 16 page course on ventriloquism, the Ventrilo, ALL FOR 10 CENTS



It is made in the shape of and looks like a regular Automatic Pistol. No one is likely to stop and ask you whether it is real or not. Thus it is likely to prove itself very handy in an emergency. On pressing the trigger it opens up as shown in the illustration at the right, revealing nine most useful articles—Opera and Field Glass, Telescope, Mirror, Magnifying Glass and Burning Lens, Reading Glass, Sun Dial, Sun Compass, etc. In the handle of the revolver there is a place for various pocket necessities, such as First Aid Articles, Buttons, Pins, etc. The Pistol is of sheet metal, blued finish, that can be carried comfortably in pocket. PRICE \$1.00 postpaid.

Watch Charm Pistol \$1.75



Exact reproduction of a real pistol; actually fits REAL BLANK CARTRIDGES of miniature size. Illustration is actual size. 1 1/4 inches long, with ring at end for attaching to watch chain. Loads like a regular pistol. Pull the trigger and it goes off with a loud bang. Pistol is break open type; illustration shows position for loading. Made entirely of high grade steel, nickel plated, octagon barrel, handsomely engraved handles, complete in box with cleaning rod. PRICE \$1.75. Also furnished with pearl handles, \$2.50. BLANK CARTRIDGES, 50c per box of 25. **JOHNSON SMITH & CO., Dept. 830, RACINE, WIS.**

MICROPHONE TRANSMITTER BUTTON



You can easily make a highly sensitive detector-telephone by using this Transmitter Button to collect the sound waves. You can build your own outfit without buying expensive equipment. It is simple and inexpensive. You can install an outfit in your home and hear conversations being held all over the house. You can connect up different rooms of a hotel. (This outfit was used by secret service operatives during the war. It is being used on the stage. It is ultra-sensitive and is the greatest invention in detector-phones. You can mount the button almost anywhere—card board boxes, stove pipes, stiff calendars, on the wall behind a picture frame, etc. Button is so light and small it cannot be detected. Persons can be overheard without suspecting it. You can listen in on conversations in another room. A deaf person in the audience can hear the speaker. Connected to phonograph, piano or other musical instrument, music can be transmitted; often makes an old line "talk up" when nothing else will. The ideal microphone for radio use; carries heavy current and is extremely sensitive. Amplifies radio signals. Countless other similar uses will suggest themselves. Experimenters find the button useful for hundreds of experiments along the lines of telephones, amplifiers, loud speakers, etc. Many fascinating stunts may be devised, such as holding the button against the throat or chest to reproduce speech without sound waves. PRICE \$1.00. **JOHNSON SMITH & CO., DEPT. 830, RACINE, WIS.**

JOHNSON SMITH & CO.

Dept. 830 RACINE, WIS. A De Luxe Edition of our new 1929 CATALOG mailed on receipt of 25c. Handsome binding. Bigger and better than ever. Only book of its kind in existence. Nearly 600 pages of all the latest tricks in magic, the newest novelties, puzzles, games, sporting goods, rubber stamps, unusual and interesting books, curiosities in seeds and plants, etc., unobtainable elsewhere. Remit by Stamps, Coin, Money Order, Check, etc. Unused U. S., Canadian and Foreign Stamps also accepted.

REMARKABLE VALUE IN WRIST WATCHES



CUSHION SHAPE
Unbeatable value in a man's Sport Model Wrist Watch. Case in nickel-plated, cushion shape, with silver metal dial, with radium figures and hands. Lever escapement movement. Fine quality leather strap with nickel buckle. A first-class timekeeper. An undoubted bargain at the price. Fully guaranteed. **Price Postpaid, \$3.95**

OCTAGON SHAPE
The always popular octagon shape, size 10 1/4 Lines, silver nickel case. Butler finish back. Fitted with a reliable 6 jewel lever movement. Fancy silvered dial with luminous figures and hands. Shows time clearly in the dark. Selected leather finely stitched strap, buckle to match. For men or boys, a gift that cannot fail to be appreciated. **Price Postpaid, \$9.95**

SQUARE SHAPE
One of the latest and most popular shapes, size 10 1/2 Lines, with **CURVED BACK**, shape of wrist. Case is genuine 14K Rolled Gold (choice of white or green gold), and can be had in 6 or 15 Jewels. The square dial is silvered and has luminous figures and hands showing time in dark. Best quality cowhide leather strap. **With 6 Jewels... \$12.50**
With 15 Jewels... \$16.50

JOHNSON SMITH & CO. Dept. 830 RACINE, WIS.

MAGICIAN'S BOX OF TRICKS

Apparatus and Directions for a Number of Mysterious Tricks, Enough for an Entire Evening's Entertainment..... **\$1.00**

ANYONE CAN DO THEM

It is great fun mystifying your friends. Get this Conjuror's Cabinet, and you will be the cleverest fellow in your district. It contains the apparatus for ten first-class tricks, including the **MAGIC BALL AND VASE TRICK** (a wooden ball is placed inside, and upon replacing the lid has disappeared and is found in someone else's pocket); the **INKLETT TRICK CARDS** (can be made to change completely no less than five times); **DISAPPEARING COIN BOX** (a coin, placed in the wooden box, vanishes entirely or changes into a coin of another denomination); the **GLASS GOBLET TRICK** (a coin is dropped into a glass of water and when the water is poured out the coin has vanished and is found somewhere else); the **RIBBON FACTORY FROM THE MOUTH TRICK** (a seemingly endless supply of colored paper ribbons comes out of your mouth); the **DISAPPEARING HANDKERCHIEF** (a handkerchief held in the hand mysteriously vanishes); the **WIZARD'S RING COIN TRICK**; the **ENCHANTED BOTTLE** (no one but yourself is able to make it lay down); the **GREAT HAT AND DICE TRICK** (a large dice is placed on top of a hat, disappears, and is found underneath yet no one has touched the hat), and last, but not least, the **GREAT PHANTOM CARD TRICK**, or two from five leaves nothing. Full instructions are sent for performing each trick. In addition to the above, a number of other feats and illusions are fully explained for which you can easily make or procure the necessary apparatus. **Price complete \$1.00 postpaid. JOHNSON SMITH & CO.**



U. S. BABY TANK



It goes with real Yankee Pep—by its own power. Most remarkable toy ever invented. By drawing the Tank backward, either with the hand or over the floor or table and then placing it down, it will crawl along, overcoming all obstacles, in the same life-like manner as the larger Tank that proved so deadly in the great war. What makes it go is somewhat of a mystery, for there is no mechanism to wind up as is usually understood with mechanical toys, yet this tank will keep plodding along ten times longer than the ordinary run for toys. It will perform dozens of the most wonderful stunts. **Price only 25c prepaid. Stamps accepted. JOHNSON SMITH & CO.**

It goes with real Yankee Pep—by its own power

Most remarkable toy ever invented. By drawing the Tank backward, either with the hand or over the floor or table and then placing it down, it will crawl along, overcoming all obstacles, in the same life-like manner as the larger Tank that proved so deadly in the great war. What makes it go is somewhat of a mystery, for there is no mechanism to wind up as is usually understood with mechanical toys, yet this tank will keep plodding along ten times longer than the ordinary run for toys. It will perform dozens of the most wonderful stunts. **Price only 25c prepaid. Stamps accepted. JOHNSON SMITH & CO.**

Rubber Chewing Gum



It is just like a regular package of chewing gum and looks so real that it fools everybody. Of course no one suspects it is not genuine until they start to chew it. There's a world of fun in this rubber chewing gum—5 sticks to the package. **Price, 10c Pkg., 3 for 25c; 12 for 75c postpaid. JOHNSON SMITH**

INVISIBLE INK

The most confidential messages can be written with this ink, for the writing makes no mark. Cannot be seen unless you know the secret. Invaluable for many reasons. Keep your postals and other private communications away from prying eyes. Great fun for playing practical jokes. **Only 15c a Bottle; 3 for 40c. JOHNSON SMITH & CO. Dept. 830 RACINE, WIS.**



POCKET CIGAR LIGHTERS

You may pay more, but these two Lighters will do the work as well as the most expensive. The **"SIMPLEX"** (Illustrated on the left) sells for 20c; lights merely by giving the wheel a turn with the thumb. The **"AUTOMATIC"** (on right) lights automatically; press the button, the lid flies open and lights wick at same time. Better, safer and cheaper than matches. A light instantly available whenever you want it. **Prices: Simplex Lighter 20c; Automatic Lighter \$1.00, extra flints for either 5c each. All postpaid.**

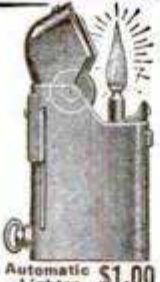

There is a great deal of wholesome fun and amusement to be derived from these handcuffs. Although merely a toy, they are well and strongly made, with extremely simple mechanism that can be slipped on and off in a moment. No key is required either to lock or unlock them. Just snap them over the wrists and you have your pal securely handcuffed. These Handcuffs stand for Law and Order and, in the hands of the boy, inspire him with respect for Clive Virtues. They are entirely nickel-plated all over. **Price only 65c pair postpaid.**

There is a great deal of wholesome fun and amusement to be derived from these handcuffs. Although merely a toy, they are well and strongly made, with extremely simple mechanism that can be slipped on and off in a moment. No key is required either to lock or unlock them. Just snap them over the wrists and you have your pal securely handcuffed. These Handcuffs stand for Law and Order and, in the hands of the boy, inspire him with respect for Clive Virtues. They are entirely nickel-plated all over. **Price only 65c pair postpaid.**

Lover's Knot or Friendship Ring

Made of 4 strands of genuine 14K gold filled wire, woven into the True Lover's Knot, symbolic of love or friendship. Very pretty, yet not showy. Each ring made by hand by gold wire expert. It looks good and it is good. **Price 50c postpaid**



Resurrection Plant

Great curiosity. Place in water, plant opens up and starts to grow in 20 minutes. Taken out it dries up and goes to sleep till put in water again. 10c, 5 for 25c, 75c doz. p. pd.



Great Fire Eater

A great trick by which you can apparently breathe fire from mouth, to the horror and consternation of all. Quite harmless. All apparatus necessary sent complete in box for **ONLY 30c, p. pd. JOHNSON SMITH**



SQUIRT ROSE

A REAL STARTLER. This is the most popular of all squirt tricks. The flower in your coat looks so fresh and sweet that everyone is tempted to inhale the delightful perfume. Then is the moment to press the bulb. Gee-whillikens. Don't they jump? There is a very long rubber tube that easily reaches to the pocket of your coat or trousers, and the bulb is large enough to make a dozen shots with one loading. **PRICE 25c each, or 3 for 65c postpaid.**



SEEBACKROSCOPE

Place this clever instrument to your eye, you see what is going on behind your back. Very interesting things sometimes occur when no one thinks you are looking. Just like having eyes at the back of your head. **PRICE 25c POSTPAID**

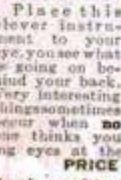

Female SEX Indicator

Hold the **MAGIC INDICATOR** over a man's hand—instantly it moves in a straight line, backward and forward. Hold it over a woman's hand and it describes a complete and continuous circle. The same action can be obtained over a letter written by a man or woman, etc. It is fascinating; baffling. We have never been able to figure out how it's done—but we've never seen it fail. Many novel and entertaining feats may be performed with the Sex Indicator. For example, similar results can be obtained with animals, cats, dogs, rabbits, over birds, chickens, canaries, etc. Also used to predetermine the sex of chickens and birds, etc. In fact it is sold as a patented egg tester in Europe. **Price 25c, or 3 for 65c, postpaid.**



DISSOLVING VIEWS

You may have a lot of fun with this little peep show. A regular startler. Made entirely of metal, having a microscopic lens fitted into one end. While the victim is absorbed in admiration of the pretty picture, and turns the button in the confident expectation of seeing something interesting, a spring syringe is brought into action, and the observer experiences a very great surprise. **50c p. pd. Johnson Smith & Co., Dept. 830, Racine, Wis.**



Comical Motto Rings

Lots of harmless fun and amusement wearing these rings. Made in platinum finish (to resemble platinum), with wording on enameloid, as illustrated. **Price only 25c Postpaid.**

The "Little Giant" Typewriter

A First Class Writing Machine For \$1.50

A perfect little typewriter for \$1.50. There are thousands of persons who would like to use a typewriter but whose needs and business do not warrant the expense attached to the purchase and use of a fifty or seventy-five dollar machine. To such persons we confidently recommend our Little Giant. It is strongly made, but simple in construction, so that anyone can quickly learn to operate it, and write as rapidly as they would with pen and ink. The letters of the alphabet most frequently used are so grouped as to enable one to write rapidly, the numerals 1 to 10, and the punctuation marks being together. With this machine you can send your best girl typewritten love letters, address envelopes, make out bills, and do almost any kind of work not requiring a large, expensive machine. With each typewriter we send a tube of ink and full printed instructions for using the machine. **Price complete \$1.50 by mail postpaid to any address in the world.**



SPRAYS



Model A
Compressing Unit Attached to Spray Gun
\$37.50

Paint, Whitewash,
Lacquer, Insecticide,
Varnish, Stain,
Disinfectant

The Atomister

THE EVEN PRESSURE SPRAYING MACHINE

For use in the home, factory, garage, shop, farm, etc. Plugs into any electric socket. At your dealer's—or direct from us.

The Atomister Corporation
32 Hamilton St., Rahway, N. J.

Model B
Compressing Unit Separated from Spray Gun
\$39.50



EDWARDS METAL ROOFING



BIGGEST VALUE · LOWEST COST

Buy your metal roofing, shingles, Spanish tile, sidings, etc., DIRECT from the world's largest manufacturer of sheet metal building materials, at BIG SAVINGS. Thousands of satisfied users.

We own our own rolling mills. Enormous output insures lowest production costs. Factory-to-consumer plan makes prices rock bottom. You get the benefit. Many varieties. Edwards metal roofs last longer, look better. Resist rust, fire and lightning. Roofing, shingles, etc., of COPPER BEARING STEEL at special prices. This steel stands the acid test. Outlasts the building to which applied.

Ready Made Garages and Buildings

Low in cost. Easily erected. Permanent. Good-looking. All types and sizes to suit your purse and purpose. Now's the time for action. Write for Roofing and Material Book No. 150 and for Garage Book.

— FREE —
SAMPLES
BOOKS
ESTIMATES

EDWARDS MFG. CO.
1200-1250 Butler St.,
Cincinnati, Ohio



Press the button and let the MOTROLA

wind your phonograph

The Motrola is a small electric motor that replaces the winding crank on your phonograph. Readily attached to outside without marring the woodwork or affecting the mechanism. Merely press the button and the Motrola winds your phonograph more quickly and evenly than you can crank it. Stops automatically when spring reaches proper tension. Your old phonograph with Motrola and electric pick up to your radio—gives the same results as the costly new machines.

QUICKLY, EASILY APPLIED

Anyone can apply or detach the Motrola in a few minutes, using only a screw driver. Winds any make or size of machine. No parts to wear out—costs only a cent a month for electricity. Attractively finished, equipped with light socket plug and 10 feet of cord. Sold with our unqualified guarantee. Thousands now giving dependable, labor saving service. Ask your dealer for demonstration.

[Write us today for
illustrated descriptive folder]

JONES-MOTROLA SALES CO.
Dept. 112, 370 Gerard Avenue
New York City

MEN WANTED

to become floor surfacing contractors—Pay averages \$30.00 per day—no lay offs—your own boss—work the year round—demand ever increasing—New "American" machines do the finest work and are easiest to handle. Complete information sent free without obligation. Write today.



AMERICAN FLOOR SURFACING MACHINE COMPANY
523 S. St. Clair Street
Toledo, Ohio

Match Your Coat and Vest With New Trousers. FREE SAMPLE

DON'T DISCARD YOUR OLD SUIT. Wear the coat and vest another year by getting new trousers to match. Tailored to your measure. With 90,000 patterns to select from we can match almost any pattern. Send vest or sample of cloth today, and we will submit FREE best match obtainable.

AMERICAN MATCH PANTS CO.,
Dept. C.O. 6 W. Randolph St., Chicago, Ill.

BUCHSTEIN'S FIBRE LIMB



Send for Catalog Today

is soothing to your stump—strong, cool, neat, light. Easy payments. Braces for all deformities. **D. BUCHSTEIN CO.** 610 3rd Ave., So. MINNEAPOLIS, MINN.

New Model Men's Strap Watch



CUT PRICE SALE

\$3.85

Two years written guarantee given with this full jeweled elegant Swiss watch. Your choice is square, tonneau or cushion shape—same price. Radiom dial, tells time in dark. Accurate timekeeper, tested and adjusted. Rush your order. Quantity limited. Send no money, pay postman \$3.85. **JENKINS**, 621 Broadway, New York, Dept. 23-F-12

THE AMAZING NEW 5000 HOUR ELKON RECTIFIER FOR "B" ELIMINATORS

NEW, UNIQUE!



SOLID, DRY!

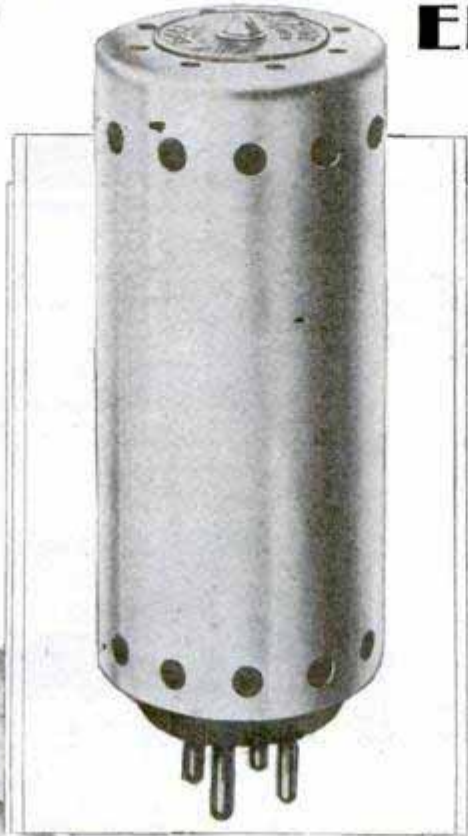

REVOLUTIONARY!



NOT A TUBE!

ONLY 200,000 AVAILABLE THIS SEASON

JUST as the Elkton dry, low-voltage rectifier revolutionized the design of chargers and "A" Eliminators, the new Elkton "B" type Rectifier will revolutionize the design of "B" Eliminators.

The Elkton EBH Rectifier plugs into any Eliminator using the former standard "B" rectifier tube. Simply take out the fragile 1,000 hour tube—plug in the husky Elkton EBH and the change is made. No changes in wiring—no adjustments.

It is sturdy, solid, dry—has none of the frailties of a tube—not affected by accidental overloads or line surges. It is self healing. The power is smoother, quieter.

From the orders already received from dealers and jobbers in all parts of the country, we know that we will be tremendously oversold this season—only 200,000 of these revolutionary rectifiers will be available.

The elaborate manufacturing, testing and aging equipment necessary to produce the Elkton EBH Rectifier precludes any greater production the first year.

Look for the Red and Yellow display carton on your dealer's shelves. The new EBH is packed in a metal can.

Buy one from your dealer today! Plug it into your "B" Eliminator—Trouble free for at least 5,000 hours!

ELKON, INC.

Division of
P. R. Mallory & Co., Inc.

350 Madison Ave., New York City



Hand and Eye must synchronize in testing the Elkton EBH Rectifier

ELKON, INC., Dept. E-5
350 Madison Ave., New York
Gentlemen:
Please send me complete information on Elkton
Quality Radio Products.
Name _____
Address _____

GAS HEAT 1 1/2¢ an hour

~NO MATTER WHERE YOU LIVE

No Smoke,
Soot or Ashes

38 Below Zero

is not too cold when you have a **SUNSHINE Radiant Heater**. Makes and burns its own gas. No piping or installation costs. Gives you clean, healthful, safe, modern gas heat. Floods the room with cheery warmth. Penetrates every corner. Easy to carry anywhere while in operation. A beauty in design and appearance.

Cheapest heat you ever had! Pays for itself first winter in fuel economy alone. Beats coal or wood heat. No back-breaking splitting of wood or carrying of coal. No soot, ashes or odor. Bringing cheery warmth to thousands of homes now! Guaranteed.

15-DAY TRIAL

To prove its astonishing value we'll send the **SUNSHINE** anywhere on 15-day trial. Use it in your home or store. Test it in every way. Prove to your own satisfaction how convenient and economical it is.



FREE STARTLING Money-Saving Offer

Get our world-beating offer on 1929 model. You'll be utterly astonished how low priced is the **SUNSHINE**—Also our new **FREE Trial Plan**. Write today!

AGENTS BIG MONEY



R. M. Spangler Made \$168.00 in Two Days!

You can easily make big money just like these two men. This sensational home gas heater is a whirlwind seller. Nationally advertised. Sells with demonstration. Just show it and pocket your money. No experience needed. All or part time pays astounding profit. Write for new easy selling plan.



L. Maloney made \$53.80 one day with SUNSHINE!

SUNSHINE PRODUCTS CO. 333 Factory Bldg. Kansas City, Mo.

\$35100 CLEARED IN ONE DAY

So writes **W. H. Adams** of Ohio. Letter from California man reports **\$11275** sales in three months; New Jersey **\$4000** profits in two months; Pa. **\$3000** profits in four months. **Ira Shook** **\$365** sales in one day. **Bram** bought one outfit April 5 and **7 more** by August. **Iwata** bought one outfit and **10 more** within a year.



J. R. Bert says "only thing I ever bought that equaled advertisement." **John Culp** says: "Everything going lovely. Crispette wrappers all over town. It's a good old world after all." **Kellog**, **\$700** ahead end of 2d week. Wholesale or retail. Big profits either way. No town too small. Business is pleasant, fascinating and dignified. You manufacture a food product.

WE START YOU IN BUSINESS

Furnish secret formulas, raw material and equipment. Little capital required; no experience needed.

Build a Business of Your Own

No limit to the sale of Crispettes. Everybody likes them. It's a delicious food confection. Write for facts about a business that will make you independent. Start now, in your own town.

PROFITS \$1000 MONTH EASILY POSSIBLE

Send postal for illustrated book of facts. It contains enthusiastic letters from others—shows their places of business, tells how and when to start, and all information needed. Free. Write now!

LONG-EAKINS COMPANY

1228 High Street

Springfield, Ohio

EXPERT SOLDERING

We are equipped to handle any amount of special soldering jobs for the trade or experimenter. Send us your soldering problems and we will submit estimate. Hard and Silver soldering and anything that demands careful and expert workmanship.

Write:

C. F. VERZIER, 278 Pearl St., New York, N. Y.

LIGHTING FIXTURES

Ready to hang

Direct from the manufacturer. Completely wired, including glassware. Send for new catalogue No. 29. Just Reduced Prices. *Special Proposition to Dealers.*

Erie Fixture Supply Company, Inc.
Station A
ERIE, PA.

30 Days' Free Trial

New Models now ready for delivery direct from our factory. *Astonishing low prices and terms. Do not buy until you get them.*

RIDER AGENTS WANTED to ride and exhibit sample. Make big money. Many models \$21.50 up. *Guaranteed \$1.50 each, wheels, lamps, horns, equipment at half usual prices. Send No Money. Write for our marvelous prices and terms on RANGER Bicycles.*

Mead **CYCLE CO. Dept. 8 109 CHICAGO**



Latest Model

Men's Strap Watch \$3.99



A REGULAR WATCH \$10.00

Our Price only \$3.99

A fully GUARANTEED, accurate timekeeper—tested and adjusted jewel-led Swiss movement—artistically engraved case as illustrated—radium dial—genuine leather strap. Order this bargain today. Pay on delivery only \$3.99. We pay postage. "FEDCO" U. S. Swiss Agents, 561 Broadway, New York, N. Y., Dept. W10

The New Home Craftsman's Wonder Shop

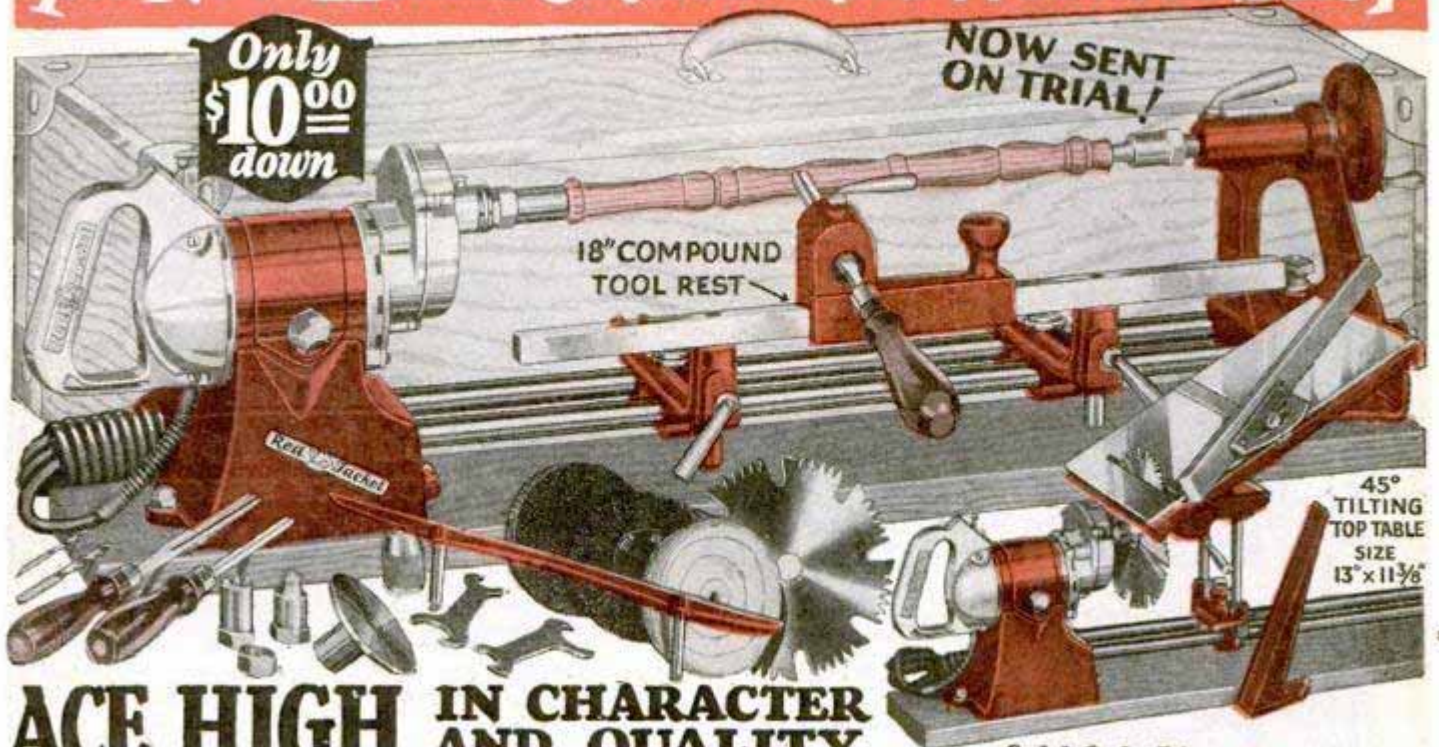

ACE HIGH IN CHARACTER AND QUALITY

Sold Only Direct from Factory

3 years of testing, experimenting and improvement is wrapped up in each new Red Jacket Home Work Shop. The finest tools and accessories that can be made go with each assembly order. Red Jacket equipment is designed, tested, approved and guaranteed by Wm. L. Aylward, a nationally known craftsman and manufacturer, who has developed his hobby into a co-operative association of thousands of craftsmen.

Portable — Interchangeable — Complete RED JACKET Home Work Shop

The new Red Jacket Combination of Electric tools brings you a Red Jacket Band Saw and in addition the powerful Red Jacket Master Drill Motor with direct drive to the Waco Craftsman's wood turning lathe (capacity 9"x36"), also compound and 18" rests, a tilting top mitre saw with both depth and side gauges, scroll and jig saw, and all accessories for both portable and stationary power drilling, buffing, grinding and cleaning. Attaches to light socket and converts your work bench into a complete private tool and machine shop. It is a complete chest full of electrically driven tools designed for the private use of tool lovers and men who create, repair and appreciate handy tools at home.

Make It Yourself!

Exclusive Features with WACO—

- All Aluminum Master Drill Motor
- Perfect Tilting Saw Table 13"x11 1/2" in.
- Patented Compound Tool Rests
- Finest Quality Hand Tools
- Unconditional Guarantee
- Unlimited Service
- Read Our Code of Business Ethics—

Ask 7000 Happy Waco Owners



NOW! Make Things at Home Electrically

Send coupon at once for information valuable to those interested in beautiful handiwork. It is FREE. It tells you how easy it is to operate a Red Jacket set of tools and lists the advantages and privileges that are free to member craftsmen. Don't miss knowing all about Waco. You are invited. **Look out for imitations.** There is only one Red Jacket—one Waco—you will not find WACO TOOLS sold by retailers. All sales made direct from factory.

The WACO Guarantee
If it is not what you want when you get it—send it back.

SPECIAL CRAFTS COURSE FREE
SPECIAL CRAFTS COURSE and blueprint service is free to Red Jacket Shop owners—all there is to know about handicraft methods, raw materials, woods, carving, sawing, turning, designing, carpentering, decorating, is taught by special correspondence.

BUY ON YOUR OWN TERMS Only \$10.00 down. Liberal discount for cash. Easy monthly payment plans. It is no hardship to own a Red Jacket.

SEND THE COUPON—Interesting Literature Free You will be surprised with all it contains. Beautiful, Instructive, Fascinating, Interesting. Fill in and MAIL TODAY.



Loving Cup Won by Waco Grand Prize of American Master Craftsmen's Assn.

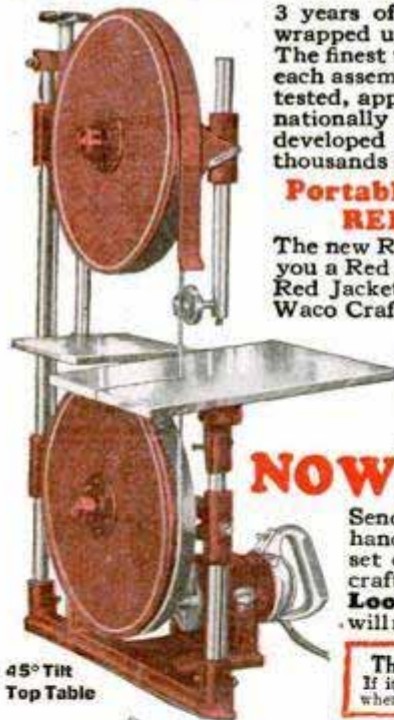

45° Tilt Top Table



The most elaborate and unusual drill motor ever designed for driving power.

free BLUE PRINTS



This Headstock furnished where no electricity is available.

Red Jacket MASTER DRILL

WACO TOOL WORKS, Inc.,
5216 W. Kinzie St., Chicago

Manager, Dept. 112. Please send me all free information and literature on Red Jacket Assemblies and FREE Services.

Name.....

Address.....

**the
Drill
of many
Uses**

C-O Utility Drill



The Makers of the famous C-O Garage Tools and Equipment, known the world over, offer you a Utility-Drill complete, ready for the job, for **ONLY \$34.00.**

Not an attachment nor a makeshift, but a real drilling machine designed by master engineers. Here's real drill value — just read these specifications: Vertical type motor, 110 volt, 60 cycle, single phase, AC, with cord and switch; belt drive; 3-law chuck; 11x6" bench space; 23" high; weight 62 pounds.

Bores holes up to 3/8"; works in 9" circle; 2 1/2" up and down spindle run; 7 1/2" range on column; 1100 to 2200 spindle speed.

Ideal for garages, repair and service plants, factories, all mechanics and farm and home craftsmen.

Also furnished in other voltages and cycles. Prices on request. Order today or if you need more information write for circular.

FULLY GUARANTEED
CANEDY-OTTO MFG. CO.
 Dept. PM. Chicago Heights, Ill.

**ONLY
\$34.00
COMPLETE
WITH
MOTOR**

1-3/16
Ct.
\$118



Ask Why

60% of Market Price

HERE (Every Quality)

Diamonds

Legitimate Offers of
a 3/4 Century House

Jos. DeRoy & Sons

See why this 1 less 3/16 ct. faultlessly cut blue-white diamond is just \$118. Try to match at 60% more, this, or other startling cash offers. Examination free, of course. A 3/4 century institution, now of 10 large loan companies rated financially over a million dollars, operating as the world's largest diamond banking house. Loans made over \$35,000,000.00 on Diamonds, Jewels, Watches, in sums of \$5.00 to \$5,000.00.

**All Details Free
With Latest List**

Jos. DeRoy & Sons, 1975 DeRoy Bldg. Opposite Post Office, Pittsburgh, Pa.

Yes, you can send me free, in plain envelope, detailed reasons, for startling diamond offers to individuals, dealers, wholesalers alike. Mail this coupon now!

Name _____

Address _____

Low as \$60 a Carat for Diamonds

DISTRIBUTORS



Men and Women to sell K.P.—The Aluminum Cleanser without a competitor. Not sold in stores. Priced right. Liberal commissions. Write now for details. If you mean business, this will interest you.

KEYSTONE PRODUCTS COMPANY
 800 Sarah Street Pittsburgh, Pa.

**Sport Bodies for Fords
AT FACTORY PRICES!**



This Model in Grey Prime **\$38.50**

Other Bodies of Rare Beauty \$18.75 and up.

**AURORA HI-COMPRESSION HEAD
Speed up Your Model T Like Model A Ford**

Price \$9.00



Send 10c for Booklet A-2 showing complete line of Sport Bodies and Equipment.

**SPORT FACTORIES, AURORA, ILL.
SALESMEN! \$100 WEEKLY
SELL COX HOLDFAST SCREW DRIVERS**



Also made to use in Yankee or Ratchet Handle. Sells on sight to Garages, Radio Men, etc. Self Holding. Self Releasing. Sample and Proposition, 50c. **S. J. COX, Dept. F, Franklin, Pa.**

CAN YOU SELL GAS at 5c PER GAL.?

If so write me quick. My Distributors make as high as \$3,000.00 per month. Let me show you how.

SEND FOR FREE TRIAL

Proof of astounding success and my \$15.00 a day Guarantee to Distributors.

Frank Andrews, Dept. 805-T. B., 154 E. Erie St., Chicago, Ill.



BASHFUL?

"Shame on you!" Are you nervous, embarrassed in company of the other sex? Stop being shy of strangers. Conquer the terrible fear of your superiors. Be cheerful and confident of your future! Your faults easily overcome so you can enjoy life to the fullest. Send 25c for for this amazing book.

RICHARD BLACKSTONE, 8-4712 FLATIRON BLDG., NEW YORK



A Good Profit—365 days in the year!

Rain or sunshine, hard times or good, summer or winter, is all the same to the man who owns a **JERRY O'MAHONY LUNCH CAR.**

These attractive, business-getting Dining Cars have all the conveniences of the modern restaurant and cost far less. They can be shipped anywhere by rail. Business good every day of the year. Many owners are making \$10,000 a year profit and over.

Only small cash payment down. We help you finance and tell you how to start. Write today for our big illustrated catalog showing profits others are making.

JERRY O'MAHONY, Inc.—Dining Car Manufacturers
 983 W. Grand St. Elizabeth, New Jersey

MY CHRISTMAS PRESENT TO YOU

A SPEEDWAY SHOP JUST TO PROVE YOU CAN MAKE THINGS LIKE THIS!



Yours for The Asking

Everyone who fills in and mails the coupon will receive free of all charge, illustrated plans and instructions for making this beautiful Priscilla Sewing Cabinet. Perhaps you read about it in a recent issue of Popular Mechanics, but I want to show you how to make it in one-fourth the time on my **MOTORIZED** work bench—the Speedway Shop!

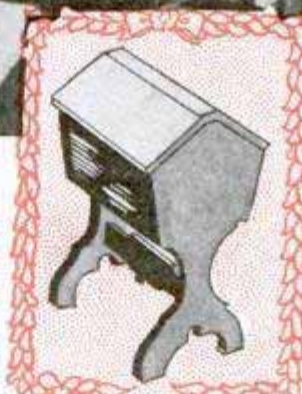

Free Trial and Instructions Free Plans and Materials

We are anxious that every owner of a Speedway Shop shall get the maximum pleasure and profit from it. That's why we have established the Speedway Personal Service Department.

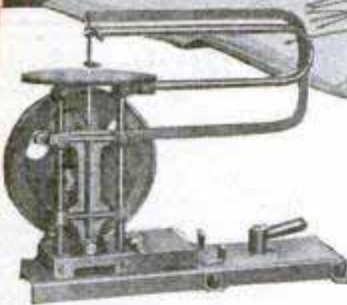

Jig Saw

This Pattern Makers Jig Saw is part of the Model "55" Shop. Follows a perfect line. Extra blades included free.

Bench Saw

Built heavy and strong. Set into place and operated in 5 seconds.rips, mitres, grooves, cross cuts.

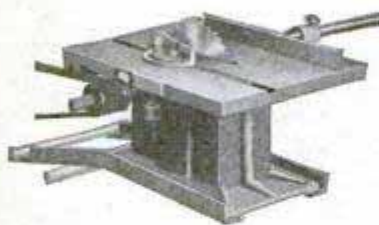

Discard Your Hand Tools

Don't let hand tools put a limit on your Craftsmanship. Let me show you how to start with this simple Priscilla Cabinet—go on into grooving, mitring, mortising, scroll work, wood turning—make Humidors. Fancy Gateleg Tables, etc. Why limit your ingenuity when it is so easy to own a Speedway Shop? Remember—Speedway is the Shop used by Manual Training instructors everywhere.

Motorize Your Work-Bench

You can be sure you're getting the right shop when you realize that Speedway alone has been serving the World's Industries with Portable Electric Tools for the last twenty years. I want you to examine the exclusive features of a Speedway Shop.

24 Blue Prints FREE

With each shop we include 24 Blue Prints of Furniture, Toys, etc., that anyone can make with the Speedway Shop. Mr. L. L. Hull in charge of our Personal Service Dept., will answer your special questions. Here is a real service department at your beck and call.

Free Crafts Books

When we receive your coupon we will send you a list of the best books on Craftsmanship from which to make your selection to be sent free with your shop.

Quick Action Needed!

We cannot continue Special Offers like this indefinitely. Use the coupon today and we will send the Priscilla Cabinet plans and Instructions at once.

Get Your Magazine Basket Quick!



While they last, we're giving away the lumber to make the beautiful magazine basket shown at the left. It is yours to keep even if you should decide to return the shop. Act at once before they are all gone. Instructions for making it are included, of course!

Trivial Down Payment

We'll show you how to earn or save the small down payments that come due just once a month. So simple, too, for any man who knows his ABC's about tools. Ask what Mr. Watts of Miami, Fla., did. Send in the coupon today!

ELECTRO MAGNETIC TOOL CO.
 Department 2D 1832 S. 52nd Avenue
CICERO (Adjoining Chicago) **ILLINOIS**

MAIL TODAY!

Electro Magnetic Tool Co., Dept. 2D, 1832 S. 52nd Ave., Cicero, Ill.

Gentlemen:
 Please send me free the complete plans and instructions for making the Priscilla Sewing Cabinet shown above. Also complete details about your Christmas Shop offer.

Name.....
 Street.....
 City.....State.....



“There’s the new Ned Tyson”

He’s making \$6500 a year now

“I USED to know him when he was a kid—we went to grammar school together. Then his father died and he had to go to work. Got a job with Brooks & Watson as a clerk, but couldn’t seem to get ahead.

“Then something seemed to wake him up. We could all see that he was doing better work.

“Then Old Man Brooks became interested—wanted to know how Ned happened to know so much about the business. Ned told him he’d been studying at home at nights through the International Correspondence Schools. ‘H’m,’ said Mr. Brooks, ‘I’ll remember that.’

“He did too. Put Ned out on the road as a salesman for a year or so and then brought him into the main office as sales manager.

“He’s getting \$6500 a year now and everybody calls him ‘the new Ned Tyson.’ I’ve never seen such a change in a man in my life.”

An International Correspondence Schools course will help you just as it helped Ned Tyson. It will help you to have the happy home—the bigger salary—the comforts you’d like to have. At least find out how.

Mail the Coupon for Free Booklet

INTERNATIONAL CORRESPONDENCE SCHOOLS
 “The Universal University”
 Box 5584-F, Scranton, Penna.

Without cost or obligation, please send me a copy of your booklet, “Who Wins and Why,” and full particulars about the subject before which I have marked X in the list below:

BUSINESS TRAINING COURSES

- | | |
|--|---|
| <input type="checkbox"/> Business Management | <input type="checkbox"/> Salesmanship |
| <input type="checkbox"/> Industrial Management | <input type="checkbox"/> Advertising |
| <input type="checkbox"/> Personnel Management | <input type="checkbox"/> Business Correspondence |
| <input type="checkbox"/> Traffic Management | <input type="checkbox"/> Show Card and Sign Lettering |
| <input type="checkbox"/> Accounting and C. P. A. Coaching | <input type="checkbox"/> Stenography and Typing |
| <input type="checkbox"/> Cost Accounting | <input type="checkbox"/> English <input type="checkbox"/> Civil Service |
| <input type="checkbox"/> Bookkeeping | <input type="checkbox"/> Railway Mail Clerk |
| <input type="checkbox"/> Secretarial Work | <input type="checkbox"/> Common School Subjects |
| <input type="checkbox"/> Spanish <input type="checkbox"/> French | <input type="checkbox"/> High School Subjects |
| | <input type="checkbox"/> Illustrating <input type="checkbox"/> Cartooning |

TECHNICAL AND INDUSTRIAL COURSES

- | | |
|---|--|
| <input type="checkbox"/> Electrical Engineering | <input type="checkbox"/> Architect |
| <input type="checkbox"/> Electric Lighting | <input type="checkbox"/> Architects’ Blueprints |
| <input type="checkbox"/> Mechanical Engineer | <input type="checkbox"/> Contractor and Builder |
| <input type="checkbox"/> Mechanical Draftsman | <input type="checkbox"/> Architectural Draftsman |
| <input type="checkbox"/> Machine Shop Practice | <input type="checkbox"/> Concrete Builder |
| <input type="checkbox"/> Railroad Positions | <input type="checkbox"/> Structural Engineer |
| <input type="checkbox"/> Gas Engine Operating | <input type="checkbox"/> Chemistry <input type="checkbox"/> Pharmacy |
| <input type="checkbox"/> Civil Engineer <input type="checkbox"/> Mining | <input type="checkbox"/> Automobile Work |
| <input type="checkbox"/> Surveying and Mapping | <input type="checkbox"/> Airplane Engines |
| <input type="checkbox"/> Plumbing and Heating | <input type="checkbox"/> Agriculture <input type="checkbox"/> Navigation |
| <input type="checkbox"/> Steam Engineering | <input type="checkbox"/> Mathematics <input type="checkbox"/> Radio |

Name.....

Street Address.....

City..... State.....

Occupation.....

Persons residing in Canada should send this coupon to the International Correspondence Schools Canadian, Limited, Montreal, Canada

No. 888—6”
\$1.75

No. 654—6”
\$1.30

PLIERS -for radio work

You’ll find there is a Crescent-Smith & Hemenway Plier for every phase of radio and electrical work. Long, slim noses for hard-to-reach places, keen diagonal cutters for skinning and cutting wire, and many others for general work—all with characteristic Crescent easy action, dependability and long life. See them at your hardware dealer’s.

No. 942—6”
\$1.50

No. 500—5”
\$1.10

CRESCENT TOOL COMPANY
210 Harrison Street
Jamestown, N. Y.

CRESCENT and Smith & Hemenway TOOLS

Catalog on request

Spinning Auto Light

SPINS WITH THE WIND NIGHT or DAY

The Flying Ace

Spinning airplane windmill rainbow auto light. Beautiful color combinations. The most beautiful light in the world. The Daddy of them all. Red, White & Blue—Blue, White & Orange—Red—Green—Yellow for Taxis—Special colors for colleges, etc. Anyone can install to any part of auto, truck, motorcycle, boat or air plane quickly. Ideal chromium plated radiator ornament—spins night or day. Just patented. Furnished complete. Order today. Pay mailman \$3 plus postage or prepaid on receipt of \$3. Money back guarantee. Go Light Co., 19 Liberty St., N. Y. C. Dept. 100. Agents Wanted.

An Ideal Gift

\$3.00 Complete

MOTORCYCLES

Price \$10 and up purchased through our Co-Operative Plan for as low as \$1.00 down and \$1.00 per week

Indians Harley-Davidsons Ace Henderson and Clevelands

Send ten cents for Bulletin A.

Motorcycles shipped to all parts of the world

WALKER-INDIAN CO., 78 Brookline Ave., BOSTON

New Aero Green Book for 1929

Contains 25 new circuits—Short wave and broadcast—information needed by every amateur and set builder. Send 25c for your copy.

Aero Products Corp., Dept. 498—4611 E. Ravenswood Ave., Chicago

MOTOR CYCLES CHEAPER THAN BICYCLES \$25 TO \$50

Easy terms. Tires \$2.50; belts, \$6; frames, \$3; forks, \$3; tanks, \$3; wheels, \$4; chains, \$2; saddles, \$5; engines, \$15; handle bars, \$5; engines for airplanes, \$15; used tires, 29-4-40, \$2.50; new, \$4.50; truck tires, 33x5, \$6; 36x4½, \$6; 30x3½, \$3; new bicycle tires, \$1.10; boat, airplane and ice sled propellers. Presto Lites, \$4.00. Send 50c for catalog.

PRICE CUTTER DENINGER Rochester, N. Y.

DIAMONDS WIN HEARTS

LOFTIS
BROS. & CO. 1218

**DIAMONDS, WATCHES,
CASH OR CREDIT**

No. 12
Beautiful blue white Diamond set in solid 18-k white gold. \$50
\$1.25 a week

No. 849
Gorgeous blue white Diamond; solid 18-k white gold ring. \$100
\$2.50 a wk.

Wedding Rings
No. 824—The "Elite" solid 18-k white gold. **\$7.50**
Set with 3 Diamonds, **\$22.50**; 5 Diamonds, **\$32.50**; 7 Diamonds, **\$42.50**; 9 Diamonds, **\$52.50**; 12 Diamonds, **\$67.50**. All platinum, \$25.
With 3 Diamonds, \$50; 5 Diamonds, \$70; 7 Diamonds, \$80; 9 Diamonds, \$100; circled by Diamonds, \$200.

17 Jewel Elgin No. 14, Thin Model
White gold filled, 20 year quality case; 12 size; silver dial; assorted patterns, \$23.50. \$2.35 down and \$2.35 a month.

All makes of Railroad Watches, guaranteed to pass inspection. Credit at Cash Prices.

CREDIT TERMS: Pay one-tenth down; balance weekly, semi-monthly, or monthly at your convenience. All goods delivered on first payment. On request we will send any article (NO MONEY DOWN) for your free examination.

LOFTIS BROS. & CO. National Jewelers
Dept. G-894, 108 N. State St., Chicago, Ill.
Stores in Leading Cities—Established 1853

Values Beyond Your Expectation in Worthwhile Christmas Gifts

A genuine Diamond ring, pin or bracelet, a watch, wrist watch, pearl necklace, onyx or emblem ring, mesh bag, silverware, etc., is sure to please. We have endless assortments of gifts appropriate for everyone. We invite comparisons. **SATISFACTION GUARANTEED OR YOUR MONEY BACK!**

SEND FOR FREE CATALOG
Big 132-page book illustrating our Diamonds, Watches, Jewelry, Silverware and gift articles for all occasions, sent absolutely free. **WRITE TODAY!**

No. 865
Man's ring, fine blue white Diamond; solid 18-k white gold. \$50
\$1.25 a wk.

No. 881
Blue white Diamond; exquisite solid 18-k white gold ring. \$150
\$3.75 a week

Rec-tangular Wrist Watch No. 868
Solid 14-k white gold, 15 Jewels, Gold filled bracelet to match. \$35. \$3.50 down
\$3.50 a month.

No. 872
Three blue white Diamonds, solid 18-k white gold ring. \$125
\$3.25 a wk.

AIRPLANE

12-inch scale model of Lindbergh's Spirit of St. Louis. Scientifically designed and very realistic. Rises from ground by own power and flies 30 ft. or more. Stays in air 8 to 10 seconds.

Easily built in 2 or 3 hours. No tools needed. Construction set, with all parts and full directions, postpaid in U.S., only 50c. (no stamps). Satisfaction or money back. Send today. **Mann & Benton, Box D, Chillicothe, O.**



AGENTS 500% PROFIT

GENUINE GOLD LEAF LETTERS

\$ guaranteed to never tarnish. Anyone can put them on stores and office windows. Enormous demand, large profits. Paul Clark says: Smallest day \$28.70. R. L. Reel made \$920 in two months. Write today for free sample and liberal offer to general agents. **METALLIC LETTER CO., 433-B N. Clark St., CHICAGO**

AGENTS—SALESMEN

ALL-IN-ONE patented Cigarette and Match Case. Holds a package of cigarettes and box of safety matches. Beautiful, grain finish Black or Brown Du Pont Fabricord. Keen and convenient.

A whirlwind seller for agents. Costs \$3.60 dozen, \$36.00 gross. Write today for complete details.

ALL-IN-ONE SALES CO.
Dept. A-12 4648 Grand Ave.
MINNEAPOLIS, MINN.

Sample, 50c



PLUMBING-HEATING

YOU SAVE HALF

Send for **FREE BOOK** of Guaranteed Plumbing and Heating. Everything cut-to-ft. 50 yrs. in business. Thousands of customers. "You saved me \$400.00," says Mr. Edw. Borkosky of N. J. Write today. **HARDIN-LAVIN CO., 107-17 C Pershing Rd., CHICAGO**



NEW VEST POCKET ADDING MACHINE

ADDS, SUBTRACTS, MULTIPLIES, DIVIDES

Does work of \$300 machine. Guaranteed 5 years. NOT A TOY. Made of steel and indestructible. Million dollar capacity. Fits in pocket. Will not make mistakes. So simple child can operate it. Instructions furnished. Everybody should carry one for figuring.

FREE TRIAL \$2.50 Total Cost

SEND NO MONEY—Just name and address. We will ship Calculator immediately. On delivery pay postman \$2.50 (Plus few cents Postage). (If outside U. S. send cash.) 10c additional in Leatherette Case. If not satisfied after 10 day trial you get your money back. **THOUSANDS OF SATISFIED USERS.**

Guaranteed This is lowest priced practical calculator made. "Why pay more for inferior imitations?" Order from this ad.

Mail Coupon Today

BABY CALCULATOR SALES CO., (MANUFACTURERS)
Dept. 41, P. O. Box 1118, CHICAGO, ILL., U. S. A.

I am enclosing \$2.50—send adding machine prepaid.

Send Adding Machine C. O. D. \$2.50 plus postage. (10c additional in Leatherette Case)

Name.....
Address.....
City.....State.....

AGENTS Write for big commission and territory proposition.





"Lava-clean"

**hands
are
clean!**



Men—you who love to tinker—here's just the soap you need. Cleans quickly and thoroughly the toughest-looking pair of hands that ever fussed around a work bench. Makes more lather in 15 seconds than ordinary soap in 60, and even hard or cold water won't discourage it. Millions use it. "Good old Lava," they call it. Gets hands *clean!* Not just "surface clean," but clean 'way down deep. As easy on your hands as fur-lined gloves—because it's made from the finest of vegetable oils. All grocers sell it.

Full size cake of Lava Soap FREE!

Mail this coupon

Procter & Gamble (Dept. W-1228)
Cincinnati, Ohio

Please send me, FREE, a full size cake of LAVA, the hand soap that removes *all* the dirt and grease.

Name.....
Street.....
City.....
State.....



**Do
You
Play
a
Uke?**

REGAL
OCTOFONE

\$15.00

"UKE" players, the Regal Octofone is made for you. This new, uniquely shaped instrument has the deep mellow tone of the Spanish Guitar, and can be tuned and played just the same as a "uke"! Nothing new to learn—no lessons. The same chords

on a brand new instrument.
**Can Be Tuned Like 8
Different Instruments**

By mere changes in tuning the Octofone can be tuned and played like 8 different instruments—the "uke," tenor guitar, tenor banjo, mandolin, mandola and other instruments played with a pick. FREE booklet of instructions accompanying each instrument tells you how to tune the OCTOFONE eight different ways.

Your dealer will be glad to give further information, or write us.

Regal Musical Instrument Co.
3207 Grand Ave., CHICAGO

FREE New Book
FACTORY PRICES

Save $\frac{1}{3}$ to $\frac{1}{2}$

New FREE book quotes **Reduced Factory Prices. Lower terms—year to pay.** Choice of 5 colors in New Porcelain Enamel Ranges.



Furnaces **\$54⁹⁵ up**



Ranges **\$37⁷⁵ up**

New Circulating Heaters—\$37.50 up. 200 styles and sizes. Cash or easy terms. 24-hour shipments. 30-day FREE trial. 360-day test. Satisfaction guaranteed. 27 years in business. 700,000 customers. Write today for FREE book.

KALAMAZOO STOVE CO.
391 Rochester Ave.
Kalamazoo, Mich.

"A Kalamazoo... Direct to You"
Trade Mark Registered



MYERS ELECTRIC IRON CORD HOLDER

A wonderful invention. Keeps cord out of way while ironing. Grips the ironing board. Tested and approved by Good Housekeeping Institute.

AGENTS WANTED

Sample 50 cents postpaid.

C. A. MYERS CO.

6339 Woodlawn Ave., CHICAGO, ILL., U.S.A.

Beautiful HOUSES \$900 and BUNGALOWS

CAN BE BUILT FOR AND UP

This and many others in my new book, Building Plans for Modern Homes, will save you hundreds of dollars. One of the most complete and comprehensive books of plans ever published by any architect. New edition just off the press. Nearly 600 floor plans and photographs of Colonial houses, bungalows, etc., costing from \$200 up; gives sizes and cost to build. Sent postpaid for \$3.00.



FREDERICK H. GOWING ARCHITECT
101 Tremont St., BOSTON, MASS.

PAYS BIG

Show Gibson tailoring and make \$100.00 a week and more. Real style, finest made-to-measure tailoring, all-wool fabrics. Remarkable values at \$23.50 and \$31.50. Sales come wonderfully easy and quick, even if you have no previous experience. **Your customer's satisfaction is always sure and repeat orders come fast for you.** Liberal commissions paid in advance. We handle deliveries, collections and give active co-operation in helping you build a big paying business. High grade sample outfit, with over 100 large wool samples, style book, supplies, etc., furnished you FREE. Don't delay—write for this handsome outfit that will put you in business for yourself.

SHOW \$23.50 Tailoring

W. Z. GIBSON, Inc.
500 Throop St.,
Dept. Z-516, Chicago



A Ring You Will Be Proud To Wear

Genuine Full Cut Diamonds [No Chips] **SEND NO MONEY**



No. 6132. Solid Gold Men's Initial or Emblem Ring. 2 Genuine Diamonds, 14-Kt. White Gold Top, Emblem (any lodge) or any initial (Old English) Yellow or White Gold inlaid in Genuine **Hope Ruby or Black Onyx**. Mention if desired in solid white gold or green gold, same price. Terms (6 Mos. to Pay)

No. 6746. Genuine Double Head Cameo (raised hand-carved heads); 1-piece stone. Heavy Shank in White Solid Gold or Green Gold. Genuine Stone—onyx, (nicely shaded). Send number of ring, size of finger, initial or emblem desired, and ring will be sent for inspection.



No. 6746 Exact size of **\$24** ring.

BUFFALO JEWELRY MFG. CO. "The Mail Order House"
Dept. P (or at your Jeweler's)
501 Washington St., Buffalo, N. Y.

\$25

This Reg. Trade Mark guarantees you genuine diamonds.

Ask for Keds by name

They are not Keds unless the name Keds is on the shoe



GIVE YOUR FILMS A CHANCE!
They deserve it. Send for Sample. See what good prints look like. Ask for prices.
FRANK SCOBIE, 43-D, SLEEPY EYE, MINN.

They're Shooting GENUINE AIR RIFLES Now.

Boys Everywhere Are Turning By The Thousands To The Gun of Guns - The **BENJAMIN**



Boys who hit the mark, the leaders and the leaders to be, in sports, in play, and the careers to come, sense the difference when they take hold of this real air gun. It's the gun that shoots regular air rifle shot with utmost efficiency, accurately, safely (only a trigger pull will release it). No springs to break or weaken, lasts a life time, giving all the magic power of compressed air under perfect control. A pump stroke and you can shoot—additional power depends on strength of boy. Guaranteed for one year. Price, postpaid, **\$5.00**, but see your dealer first and ask to see and feel and aim this gun. Right away, though, get your copy of "The Shooter's Art".

The BENJAMIN

Shoots Regular Air Rifle Shot Using Compressed Air As Shooting Force

SEND THIS COUPON IN TODAY!

Send this coupon at once to learn all details of this amazing gun and to get your copy of "The Shooter's Art". All your life you'll be glad you read it—how to aim, hold and handle your gun. Learn to hit moving targets and be an all-around crack shot. It's FREE—Send Now!

Parents say OK



FREE TO BOYS

Benjamin Air Rifle and Mfg. Co.
609 N. Broadway, St. Louis, Mo.

Gentlemen: Please send me FREE, without obligation, a copy of "The Shooter's Art."

Name

Address

Town State

Dealer's Name

Town



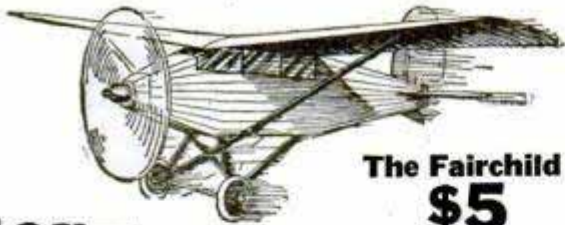

The Fairchild
\$5

**Boy—
She's a Wonderful Bus!**

Fly this genuine Clinton "scale model" plane and grab all the prizes! It has 22-inch, high-lift wing, all-metal motor mount and propeller, rubber-tired aluminum wheels. Will fly over 200 feet, dip, zoom, roll like a real plane. The Fairchild model shown above, the Fokker or the Spirit of St. Louis sent postpaid anywhere in the U. S. for \$5.

ARMY SCOUT
\$3.50

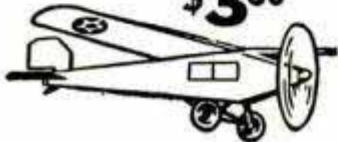

Army Scout Plane shown at left, or the Navy Scout, \$3.50. All planes sent ready to fly, and *guaranteed to do it!* Order now.

Catalog and free glider 10c

THE CLINTON TOY CORP., Dept. D12
North Haven, Conn.

DEALERS AND JOBBERS, WRITE

**CLINTON
AIRPLANES**

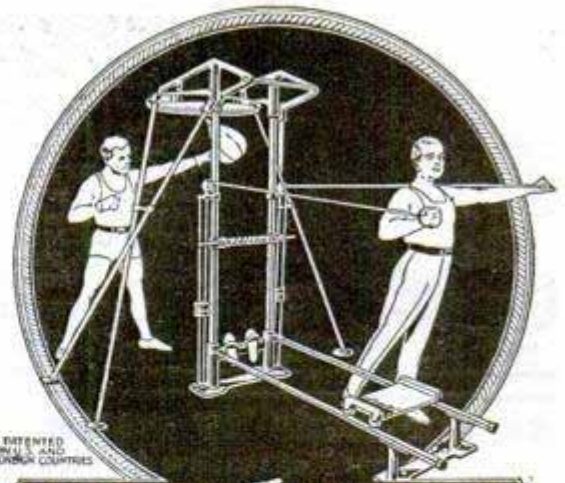

PATENTED
IN U. S. AND
FOREIGN COUNTRIES

GYM JUNIOR
The Home Gymnasium

**Play
Your Way
To
Strength**

A compact, malleable iron home gymnasium consisting of a Rowing Machine, Punching Bag, Chest Weights, Parallel Bars, Chinning Bar, Wrist Machine, Wall Ladder, Massage Roller, etc. Fits in any spare space, 7½x9 feet. Durable, attractively finished and easily erected.

Hundreds sold to indoor workers and others who want to enjoy daily gymnastics and to keep physically fit. An adult's equipment, priced reasonably and sold on easy terms. Write for Booklet.

GYM JUNIOR CO. 530 GREGORY AVENUE
WEEHAWKEN, N. J.



The Musical Sensation
ACCORDEON
Played by Music Rolls

Without any knowledge of Music or Notes you play in a few minutes, perfect like an Artist, latest hits, songs and dances. No study or practice. Nobody can see the arrangement. Three models. \$40.00, \$55.00, \$70.00. Every instrument guaranteed. Interesting circular No. 1 and Roll List mailed free.

TREASURE SALES COMPANY, 1690 Boston Road, New York

MOVIES AT HOME



Many models of genuine MOVIE MACHINES, some as low as \$3.75, all using standard size big theatre films. Our stock of films is the most complete and lowest in price—with an exchange service. Films of leading stars and religious subjects are available. **DON'T DELAY. WRITE FOR FREE INTERESTING CATALOGUE NOW!**

PARAMOUNT MFG. CO.
Dept. 1371-L BOSTON, MASS.

SANTA CLAUS

Finds it easy to
get a pair of

NORHLAND SKIS

down the chimney. Ask dad to tell him you want the kind of skis the experts use. Genuine Northlands bear the deerhead trademark. Free booklet on "How to Ski."



Northland Ski Mfg. Co.
95 Merriam Park, St. Paul, Minn.



New Free Catalog!

Send today for our new Catalog! Smashing bargains in **Plumbing, Heating, Hardware, Millwork, Roofing, Paint and Electrical Supplies.**

Absolutely Free!

STANLEY PLUMBING SUPPLY CO., Inc.
400 N. 12th St. Phila., Pa.



9:65 MEN'S ALL PURPOSE SUITS!

\$2.50 Commission in Advance! Workmanship, Fit, Guaranteed! For Semi-Work or Dress! Looks, Feels Like Wool! Wears Like Iron! **FREE Kit!** **FITZ-U-TAILORING CO., Dept. 172, South Whitley, Ind.**

DO YOU

WANT a new business profession of your own, with all the trade you can attend to? Then become a foot correctionist, and in a few weeks earn big income in service fees,—not medical nor chiropody—easy terms for home training, no further capital needed, no goods to buy, no agency. *Address*

Stephenson Laboratory, 1 Back Bay, Boston, Mass.

ATKINS



SILVER STEEL SAWS



ATKINS No. 400 HAND SAW SHIP POINT
Finest saw made. Silver Steel, Ship Point blade. Perfection handle.



ATKINS JUNIOR MECHANIC HAND SAW
Handy, high-grade saw for boys or men. 20 in. polished blade.



ATKINS No. 2 BACK SAW
Rigid Silver Steel blade. Apple wood handle. 8 to 18 in. lengths.



ATKINS No. 3 NEST OF SAWS
Adjustable handle with compass, keyhole and metal-cutting blades.

In Your Home Workshop

Men who have home workshops get great pleasure and profit in making things, with ATKINS Saws and Tools. They save time, work and material in cutting wood and metal—do the work far quicker, easier and better.

Only in ATKINS Saws do you get "SILVER STEEL," that takes a sharper cutting edge and holds it longer. You'll find that ATKINS Saws are "Taper Ground" to make sawing easier and prevent binding. And only ATKINS Saws have Perfection Handles to eliminate all wrist strain.

See ATKINS Saws and Tools for home workshops, at your hardware store.

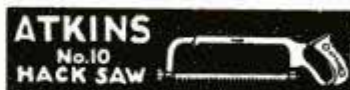

ATKINS No. 10 HACK SAW
Nickel steel adjustable frame. Non-Breakable or Silver Steel Blades.



ATKINS No. 0 SCRAPER
"Silver Steel." Makes the best Scraper you ever used. All sizes.

Saw Books FREE

Get these two helpful booklets—"Saws in the Home" and "Saw Sense." Both sent FREE—just mail us the coupon below.

E. C. ATKINS & CO., Est. 1857
426 S. Illinois St.
Indianapolis, Ind.

Please send me "Saws in the Home" and "Saw Sense," free.

E. C. ATKINS & CO. Est. 1857
426 S. Illinois St., INDIANAPOLIS, IND.

Leading Manufacturers of Highest Grade Saws for Every Use; Saw Tools, Saw Specialties, Plastering Trowels, Machine Knives, Grinding Wheels and Files.

Name.....
Address.....

\$25 To \$50 Per Day Drilling Wells!

Cash in on demand for good wells in every community! Any man with mechanical turn of mind can easily operate one of our drills, make big money, be independent, work the year 'round! A few hundred dollars starts you in this big paying business—pay balance out of earnings! Write for FREE CATALOG describing ARMSTRONG ALL STEEL WELL DRILLS—gasoline traction or non-traction models. Write now—today—Armstrong Mfg. Co., 810 Chestnut St., Waterloo, Iowa.



LE PAGE'S GLUE

HOW TO MAKE YOUR OWN ATTRACTIVE FURNITURE
Send 10 cents for LePage's New Third Home Work Shop Book, containing complete directions for making 20 different projects. LePage's Craft League, 617 Essex Ave., Gloucester, Mass.

WOODWORKERS ATTENTION!

This bandsaw-lathe combination fits in exactly with what you are doing. Bandsaw can be used to rip and cross cut. 3-speed lathe insures first class turning.



WRITE
KORNAU MACHINE COMPANY
Station A CINCINNATI, OHIO

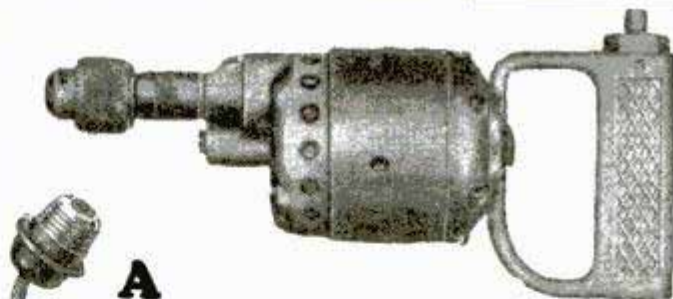

A New Lightweight Electric Drill

Only \$18.75

A sturdy, practical electric drill, fully guaranteed for one year. Specially designed for light and intermittent work. Weighs only 4 pounds. Built to use in even the tightest corners. Many of the large industrial plants are buying this drill by the dozen.

Weights Only 4 Pounds

Universal Motor

Write for our catalog showing complete line.

Uses direct or alternating current, and is supplied to you for 110 to 125 volts, 200 to 250 volts or 32 volts. Fitted with a special Jacobs Chuck. Bore up to 1/4". Stop and start switch in the handle. Comes complete with 10 feet of cord and socket. Price postpaid anywhere in the U.S.A.—\$18.75.

Send check or money order. If not satisfied return in 5 days and money will be gladly refunded. In ordering, be sure to specify voltage used.

Jones Motrola Sales Co.
Dept. 12, 370 Gerard Avenue,
New York.

DEVITT 8" COMBINATION SAW

8,000 IN USE!

A SHOPFUL OF TOOLS WITHIN ARMS REACH!

SAW TABLE RAISED SHOWING EMERY WHEEL, SAW GUARD AND DRILL ATTACHMENT



PLANER ATTACHMENT ON SAW TABLE

SHOWING SANDING DISC ATTACHED



DADO HEAD ATTACHED FOR GROOVING

TABLE TILTED FOR BEVELING

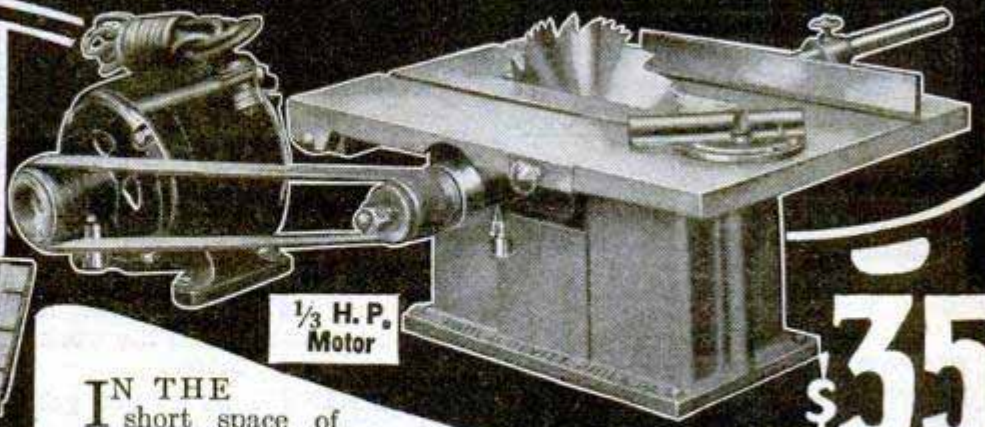

1/3 H.P. Motor

\$35

F.O.B. PHILA

In the short space of four years, the Devitt 8-Inch Combination Saw has become a practical necessity in thousands of shops, factories and households everywhere. Many imitators have sprung up, but Devitt leads them all. Think of the convenience and economy of this handy little machine that will rip, cross cut, bevel, miter, groove, mortise, tenon, drill, rabbet, grind, buff and polish. Attachments are easily and quickly adjusted. The saw and motor, when set up for work, occupy very little room. Saw is equipped with 1/3 H.P. 60 cycle, 1750 R. P. M. 110-volt A. C. Motor which can be attached to ordinary light socket, and provide power for other purposes when wanted. A cut up to 2 1/4" can be made without planing. Comes complete with following attachments—12"x16" table, 8" Combination Saw, iron pulley for saw table, 10" ripping fence, adjustable cut off miter gauge, motor-specifications as above, 1 1/4" endless leather belt, wood pulley, 8 ft. cord and plug, 6" buffing wheel, 3/8" 3 jaw drill chuck, 5" emery wheel, 6" sander, saw guard, and 2" dado insert. \$35.00 F. O. B. Phila. Height 7 1/2", shipping weight, 100 lbs.

(Only \$12 extra for Planer Attachment to fit on table top. Can smooth pieces up to 2 inches wide. Price, F. O. B. Phila.)

Send today for our attractively illustrated 4-page circular

PAUL J. DEVITT

Dept. N 1102 SOUTH 2ND ST. PHILA., PA.

"Interlox" MASTER SLIDE RULE Speeds up all measuring. Slides in and out—no folding. Direct-reading for instant inside measurements, as well as outside. Any length, 2 to 8 ft., 20c lineal ft. If not at dealers, sent postpaid.



MASTER RULE MFG. CO., 813 E. 136th Street, NEW YORK
Dealers and Agents: Write for attractive proposition.



You can get yourself no Better Christmas Gift than **A Gerstner Tool Chest** Ideal for Toolmakers and Machinists Write for free catalog

Gerstner & Sons

460 Columbia St., DAYTON, OHIO



Start a Welding & Battery Shop

- Lead Burning Outfits.....\$18.00 up
- Welding Outfits..... 25.00 up
- Soldering Outfits..... 8.00
- Lead Burning Torches..... 6.00
- Welding Torches..... 10.50 up
- Cutting Torches..... 30.00 up
- Regulators and Gauges..... 9.50 up
- Paint Sprayers..... 14.00

Welding Supplies

Superior Oxy-Acetylene Machine Co.
P. O. Box 285 Hamilton, Ohio

Makes Old Ford a Tractor

Now you can convert that old Ford car into a useful farm tractor without altering any Ford parts. We furnish the traction wheels, drive gears and auxiliary axle and mountings, ready to clamp on to the Ford frame. Pulls 16" plow.

We supply a Belt Pulley also



Write for Free Particulars.
Shaw Mfg. Co., Dept. 4512, Galesburg, Kan.



WADE AMATEUR MECHANICS, REPAIR SHOPS, INVENTORS, STUDENTS

BENCH LATHE A real machine tool for the home work bench—capacity 4" dia. x 12" length. For Metal—Wood—Composition materials. Turning—Facing—Boring—Drilling—Winding—Thread Cutting. Accurate—Strong—Quiet—Compact. Slide-rest has travel entire length of bed. Leadcrew inside bed. No. 1 Lathe, plain headstock, \$28.00. No. 2 Lathe, back-gear headstock, \$38.00. Extra for lathes with 18 inches between centers, \$7.00. Complete line of accessories at equally low prices. Write for free catalog.

THE GEROLD CO. Dept. P-49 120 Liberty St. New York

SIMONDS

SAWS FILES KNIVES STEEL

FILES

**CUT EASIER
WEAR LONGER**

In industrial plants, where every cost factor is vigilantly watched, Simonds files are always found at work. They save valuable hours of working time because their accurately cut teeth do their work faster. They save worthwhile dollars of tool expense because their tough teeth last longer in hard use. Send for copy of booklet, "File Facts," FREE.

Specify
Simonds for
Economy

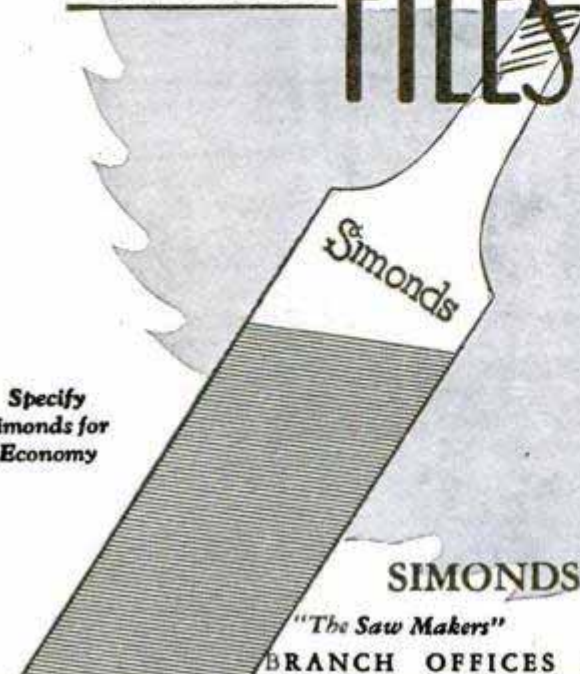

SIMONDS SAW AND STEEL COMPANY

"The Saw Makers"

Fitchburg, Mass.

Established 1832

BRANCH OFFICES AND SERVICE SHOPS IN PRINCIPAL CITIES

ONE HANDLE TAKES THE PLACE OF MANY
WITH THIS NEW FLEXIBLE HANDLE SOCKET SET

1/4" square connection. Six sockets 7-16", 1/2", 9-16", 5-8", 11-16", 3/4" hex openings. Chrome Vanadium steel. Speedy. Guaranteed. Money back if 10 days' trial doesn't satisfy. \$3.65, prepaid, cash with order; \$3.90, C. O. D. Handle only, \$1.75 cash, \$1.90 C.O.D. Acts. Writd. Tool Service Sales Co., Box 4605, Sellwood Sta., Portland, Oregon

Illustration clearly shows flexibility of handle.

BURN YOUR NAME ON TOOLS WITH THE ARKOGRAF

PROTECT YOUR TOOLS FROM THEFT
Write with electricity any name or design on the hardest and finest tools and instruments, or any metal, like writing on paper with pen or pencil. Complete outfit \$3.50—Prepaid Anywhere. Interesting illustrated circular free. Write today. Agents wanted. ARKOGRAF PEN CO., 1171 E. Stark St., Portland, Oregon

For the Handy Man!

TORIT TORCH No. 23
Uses acetylene only from a Presto auto tank. Finest thing you ever saw for Radiator and Battery Repairing, Soldering, Light Brazing, Heating, etc. Complete with 4 tips, soldering copper, hose, connections.

PRICE \$7.50
(Except tank)

TIP 24, MEDIUM FLAME
TIP 28, LARGE FLAME
TIP 23, FOR HEATING SOLDERING COPPER
TIP 20, FOR RADIATOR & BATTERY WORK
SOLDERING COPPER USE WITH TIP NO. 23
ADAPTER - C USE WITH TIPS 20 & 23

ST. PAUL WELDING & MFG. CO., 177 W. 3rd, St. Paul, Minn., U.S.A.

In the Far Corners of the Globe

CORNWELL TOOLS are Known

KNOWN throughout the world for their phenomenal strength and amazing performance, CORNWELL tools are prized by mechanics everywhere. They accomplish remarkable results under the most adverse conditions and do work that no other tools will do. They are made by our special CORNWELL processes, which insure their unvarying quality.

There Is No Substitute for Cornwell Quality

Mechanics are amazed at the startling tests which demonstrate the superior quality of CORNWELL tools. Your money back if any tools fail to do what we claim.

We Stand the Risk

You are fully protected by our guarantee that covers every tool. You take no risk. If tools are not exactly as represented send them back and we will refund your money.

CORNWELL CATALOG - FREE
Published in English and Spanish

The Cornwell Quality Tools Co., Dept. E, Mogadore, Ohio. (Formerly at Cuyahoga Falls, Ohio)

Send me new illustrated catalog with prices on full line of CORNWELL Handmade Tools.

..... Where Employed

Name.....

Address.....

City..... State.....

Among those presents

RIGHT up in the front rank of things to give for Christmas put Eveready Flashlights. Not only because that's one of the easiest and most successful ways out of the Christmas-gift dilemma, but because it's the *sensible* thing to do.

Everybody, from six to sixty, wants a genuine Eveready. Not just "a flashlight," but a genuine Eveready. Yes, it's important to insist on this point. Genuine Evereadys have ALL the newest and best features. There are models and types for every possible purpose.

This year, brighten the lives of all to whom you give. Start them *right* with the flashlight habit, that national movement to save skinned shins, banged heads and ripped clothes. Give them the world's best portable light-maker—a genuine Eveready Flashlight.



Palmolive Shaving Cream
"5 New Delights for Men"

TYPEWRITERS
ALL STANDARD
10 days FREE Trial at 1/2 PRICE
Underwood, Remington Royal, etc.
ONLY 14¢ A DAY
All late models, completely refinished brand new. GUARANTEED for ten years. Send no money—big free catalog shows actual machines in full colors. Get our direct-to-you easy payment plan and 10 days' trial offer. International Typewriter Ex., 186 W. Lake St., Dept. 1294, Chicago, Ill.

DEAFNESS IS MISERY

Multitudes of persons with defective hearing and Head Noises enjoy conversation, go to Theatre and Church because they use Leonard Invisible Antiseptic Ear Drums. Tiny Megaphones fitting in the Ear entirely out of sight. No wires, batteries or head piece. They are Unseen Comforts and inexpensive. Write for booklet and sworn statement of the inventor who was himself deaf.

A. O. LEONARD, Inc., Suite 699, 70 5th Ave., New York

WURLITZER

Trade Mark Reg. THE WORLD'S LARGEST MUSIC HOUSE



200 Years Ago in the little Saxon town of Schoeneck lived Hans Adam Wurlitzer, Master Violin Maker. His shop was a gathering place for musicians of the time, for he was a true craftsman.

When he died his shop passed into the hands of his eldest son, and for seven generations, down to the present day, the descendants of Hans Adam Wurlitzer have carried on his work.

Today in every Wurlitzer instrument you will find a quality, a character, that could not come from mere excellence of manufacture. It is the heritage of these seven generations of music craftsmanship.



Try any Wurlitzer Instrument in your Own Home

YOU may now have any Wurlitzer instrument for a generous free trial in your own home. Examine the instrument, show it to your friends, play it as much as you wish. No obligation to buy—no expense for the trial. We make this liberal offer because we want you to try for yourself these wonderful instruments, the result of 200 years' experience in musical instrument Building. Easy payments are arranged to suit your convenience. This is your opportunity to try a famous Wurlitzer instrument in your own home.



Send for New Catalog

The greatest musical catalog ever published. Over 3,000 articles—every known instrument described and illustrated; many of them shown in full colors. Gives you lowest prices and all details of Free Trial, Easy Payment plan. All sent FREE—no obligation.

Send this Coupon

THE RUDOLPH WURLITZER CO., Dept. 1779
117 E. 4th St., Cincinnati

Send me absolutely free, your new illustrated catalog, with prices and description of every known musical instrument. Also tell me how I may try any instrument in my own home and pay for it in small monthly sums. No obligation.

Name.....
Address.....
City..... State.....
Instrument..... (State instrument in which you are interested)

PATENT

Protect Your Ideas

Take the First Step Today

If you have a useful, practical, novel idea for any new article or for an improvement on an old one, you should communicate with a competent Registered Patent Attorney AT ONCE. Every year thousands of applications for patents are filed in the U. S. Patent Office. Frequently two or more applications are made for the same or substantially the same idea (even though the inventors may live in different sections of the country and be entirely unknown to one another). In such a case, the burden of proof rests upon the last application filed. Delays of even a few days in filing the application sometimes mean the loss of a patent. So lose no time. Get in touch with me at once by mailing the coupon on the opposite page.

Prompt, Careful, Efficient Service

This large, experienced organization devotes its entire time and attention to patent and trade mark cases. Our offices are directly across the street from the U. S. Patent Office. We understand the technicalities of patent law. We know the rules and requirements of the Patent Office. We can proceed in the quickest, safest and best ways in preparing an application for a patent covering your idea. Our success has been built on the strength of careful, efficient, satisfactory service to inventors and trademark owners located in every state in the Union.

NO CHARGE for Information On How to Proceed

The booklet shown here contains valuable information relating to patent procedure that every inventor should have. And with it I will also send you my "Record of Invention" form on which you can sketch your idea and establish its date before a witness. Such evidence may later prove valuable to you. Simply mail the coupon and I will send you the booklet, and the "Record of Invention" form, together with detailed information on how to proceed and the costs involved. Do this NOW. No need to lose a minute's time. The coupon will bring you complete information entirely without charge or obligation.

My Patent Law Offices
Just Across
Street From
U.S. Pat. Office



Above is a view of my drafting and specification offices where a large staff of experienced experts are in my constant employ. All drawings and specifications are prepared under my personal supervision.

NEWS

Inventors
Write for these **Free**
Books

Strict Secrecy Preserved

All communications, sketches, drawings, etc., are held in strictest confidence in strong, steel, fireproof files, which are accessible only to authorized members of my staff. Feel free to write me fully and frankly. Your case will have my personal attention. It is probable that I can help you. Highest references. But **FIRST**—clip the coupon and get my free book. Do **THAT** right now.

Clarence A. O'Brien

Registered Patent Attorney

Member of Bar of: Supreme Court of the United States; Court of Appeals, District of Columbia; Supreme Court, District of Columbia; United States Court of Claims. Practice confined exclusively to Patents, Trade marks and Copyrights

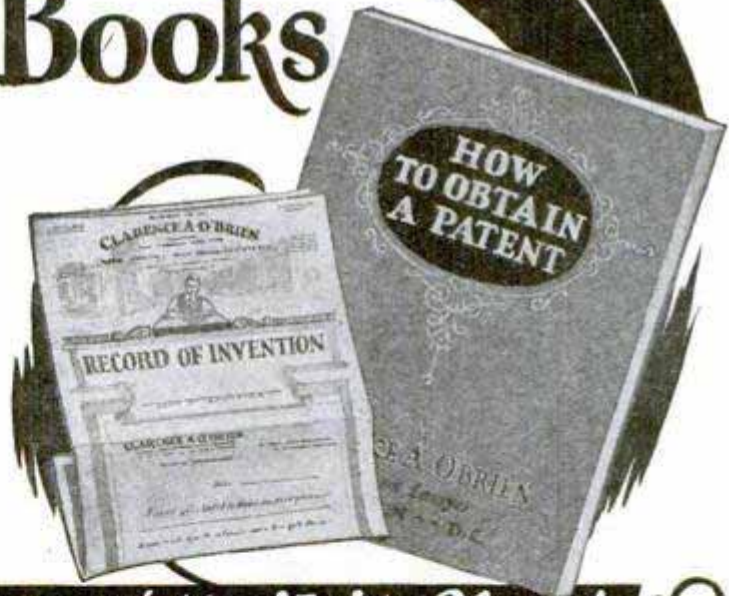

Clip this Coupon and Mail it Now!

CLARENCE A. O'BRIEN, Registered Patent Attorney

70-H Security Savings and Commercial Bank Bldg., Washington, D. C.

Please send me your free book, "How to Obtain a Patent," and your "Record of Invention" form without any cost or obligation on my part.

Name.....
(Important: Write or Print name clearly.)

Address.....

PATENTS TRADE MARKS COPYRIGHTS

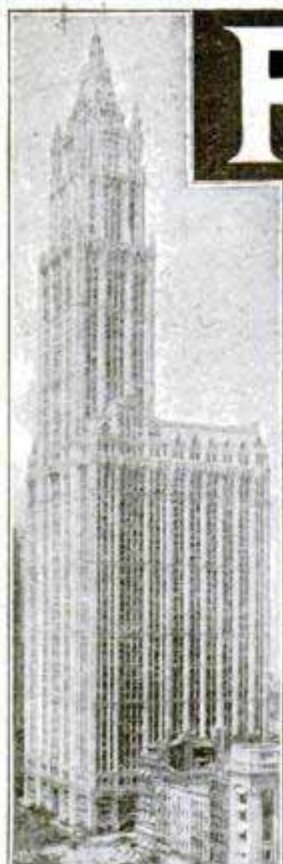

Our New York Office
Suite 1007 Woolworth Bldg.



Our Philadelphia Office
Suite 518-519 Liberty Bldg.



Our Washington Office, Victor Bldg.



Have You An Idea?

Our Offer: FOR THE PROTECTION OF YOUR INVENTION

YOUR FIRST STEP

The inventor should write for our blank form

"RECORD of INVENTION"

This should be signed and witnessed and returned to us together with model or sketch and description of the invention for

INSPECTION AND ADVICE

No Charge for the Above Information

**Our Five Books Mailed
Free to Inventors**

Our Illustrated Guide BOOK

How to Obtain a Patent

Contains full instructions regarding U. S. Patents, Our Methods, Terms, and 100 Mechanical Movements illustrated and described.

Our Trade Mark Book

Shows value and necessity of Trade Mark Protection. Information regarding *Trade Marks and unfair competition in trade.*

Our Foreign Book

We have Direct Agencies in Foreign Countries, and secure Foreign Patents in shortest time and lowest cost.

Progress of Invention

Description of World's Most Pressing Problems by Leading Scientists and Inventors.

We Regard a Satisfied Client as our best advertisement, and furnish anyone, upon request, lists of clients in any state for whom we have secured patents.

**Highest References—Prompt Service
—Reasonable Terms**

VICTOR J. EVANS & CO.

PATENT ATTORNEYS

Main Offices: 789 9th St., N. W., Washington, D. C.

Opposite U. S. Patent Office

DELAYS ARE DANGEROUS IN PATENT MATTERS

IMPORTANT! To Avoid Delay!

YOU SHOULD HAVE YOUR CASE MADE SPECIAL IN OUR OFFICE to save correspondence, secure protection and early filing date in the Patent Office. To secure special preparation of your case send \$25.00 on account with model or sketch and description of invention.



MAIN OFFICE, VICTOR J. EVANS & CO.—VICTOR BUILDING, WASHINGTON, D. C.

Our Lawyers Practice in all U. S. Courts and defend Clients in Suits involving Patents, Trademarks and Copyrights

All Communications and Data Strictly Confidential. Interference and Infringement Suits Prosecuted

OUR ORGANIZATION OFFERS PERSONAL SERVICE By Experienced Patent Lawyers, Solicitors and Draftsmen



Our Chicago Office Suite 1110 Tacoma Building



Our Pittsburgh Office Suite 514 Empire Building

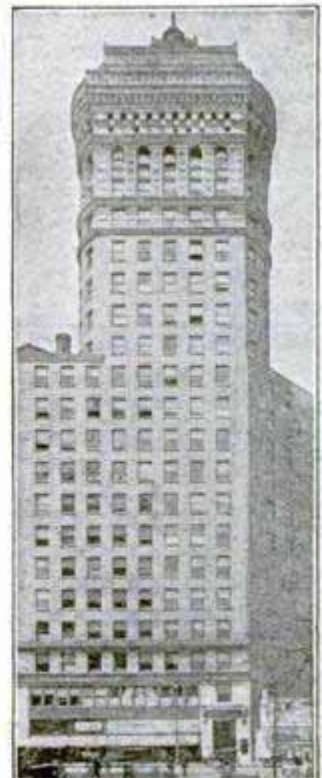

Our San Francisco Office Suite 1010 Hobart Building

**FREE
COUPON**

**VICTOR J. EVANS & CO.
PATENT ATTORNEYS**

NEW YORK OFFICES
1007 Woolworth Bldg.

CHICAGO OFFICES
1110 Tacoma Bldg.

PHILADELPHIA OFFICES
518-519 Liberty Bldg.

PITTSBURGH OFFICES
514 Empire Bldg.

SAN FRANCISCO OFFICES
1010 Hobart Bldg.

MAIN OFFICES: 789-9th Street, N. W., WASHINGTON, D. C.

Gentlemen: Please send me *Free of Charge* your books as described on preceding page.

Name

Address

PATENTS

TRADE-MARKS · DESIGNS
FOREIGN PATENTS

MUNN & CO.
PATENT ATTORNEYS

Associated since 1846 with the Scientific American

SCIENTIFIC AMERICAN BUILDING
24 W. 40th St., New York City

SCIENTIFIC AMERICAN BUILDING
Washington, D. C.

TOWER BUILDING
Chicago, Ill.

VAN NUYS BUILDING
Los Angeles, Cal.

HOBART BUILDING
San Francisco, Cal.



Books and Information on Patents and Trade-Marks by Request.
Associates in All Foreign Countries.

1000 NEEDED INVENTIONS!

Here is the most remarkable book ever offered to inventors. One thousand needed inventions listed and described. Arranged as follows: General Problems; Automotive; Mechanical; Electrical; Chemical; Radio; Marine. Separate chapter on the Ten Most Needed Inventions. This book may give you one idea that will win you a fortune. Nothing else like it has ever been published. Compiled at enormous expense. Edited by Raymond Francis Yates, formerly Managing Editor of a leading scientific magazine. Over 100 pages, durably bound. Price \$1.25.

SEND NO MONEY

Cut out this advertisement and send it to us with your name and address, plainly written, and your copy of this remarkable book will be sent immediately. Pay the postman only \$1.25, plus postage, on arrival. Money back, after 10 days' examination, if desired. Limited edition. Write NOW. (Outside U. S., \$1.45, cash with order.)

BUREAU OF INVENTIVE SCIENCE
Dept. 312 Rochester, New York



PATENTS

Send us sketch or model for advice and exact cost of patent. Our book "How to Obtain a Patent" sent free. It tells how to apply for Patents, Trade Marks, Foreign Patents, Copyrights, etc.; gives information on Patent Procedure; tells what every inventor should know. Thousands of Inventors, who are our clients, are our reference.

CHANDLEE & CHANDLEE, 25 Years' Experience
410 Seventh St. Washington, D. C.

PATENTS

Trade Marks, Copyrights, Patent Litigation Handbook with illustrations, 100 mechanical movements. Sent free on request.

ALBERT E. DIETERICH
formerly member Examining Corps U. S. Patent Office
REGISTERED
PATENT LAWYER and SOLICITOR
621-A, Ouray Bldg.
30 Years' Experience Washington, D. C.

PATENTS

Booklet Free Highest References
Promptness Assured Best Results

Send drawing or model for preliminary examination of Patent Office records.

ALL BUSINESS GIVEN PROMPT AND PROPER ATTENTION

Listed Patent Lawyer in the latest editions of the Rand-McNally Directory of Bankers and Bonded Attorneys, published by Rand-McNally & Co., Chicago, Ill.; The Baggott & Ryall Directory of Guaranteed Attorneys, published by the Ryall Legal Directory Company, New York City; Flugel's List, published by the Legal Directory Publishing Co. of St. Louis, Mo.; the American Lawyers Annual, published in Cleveland, Ohio; Eyre's Law List, Bush Terminal Building, New York City.

WATSON E. COLEMAN,
REGISTERED PATENT LAWYER

Victor Building, 724 Ninth Street, N. W.
WASHINGTON, D. C.

PATENTS

To the Man with an Idea

I offer a comprehensive, experienced, efficient service for his prompt, legal protection and the development of his proposition. Send sketch, or model and description, for advice as to cost. Preliminary advice gladly furnished without charge.

Booklet of valuable information and form for properly disclosing your idea free on request. Write Today.

IRVING L. McCATHRAN, Patent Lawyer

Formerly with and successor to Richard B. Owen

55 Owen Building
WASHINGTON, D. C.

41-B Park Row
NEW YORK CITY

TRADE-MARKS REGISTERED

INVENTORS PROTECT YOUR IDEAS

Send for our Guide Book, **HOW TO GET A PATENT**, and Evidence of Invention Blank, sent Free on request. Tells our terms, methods, etc. Send model or sketch and description of your invention for **INSTRUCTIONS**. No charge for the above information.

RANDOLPH & CO.
301 Victor Bldg., WASHINGTON, D. C.

NAME.....
STREET.....
CITY..... STATE.....

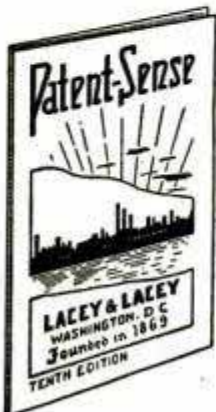

Patents

Inventors who derive largest deserved profits know and heed certain simple but vital facts **BEFORE** applying for patents. Our book **PATENT-SENSE** gives these facts. Sent **FREE**.

LACEY & LACEY

WASHINGTON, D. C.

ESTABLISHED 1869

Lacey & Lacey, 646 F St., N. W. Washington, D. C.
Please send me your **FREE** book **PATENT-SENSE**.
Name.....
Address.....
City.....
State.....

MODERN JEWELRY AT A MODERATE PRICE

\$100
brings your choice
10 months to pay

\$52.50
21-Cupid engagement ring with motif of arrows, hearts and cupids; set with three blue white diamonds. \$1.00 with order. \$5.15 a month.

\$65
22-Bird design engagement ring; 18K white gold; A A 1 blue white diamond. \$1.00 with order, pay \$4.00 to Postman; \$5.00 a month.

\$42.50
20 - Love Knot; 18K white gold set with A A 1 blue white diamond. \$1.00 with order. \$4.15 a month.

\$50
23-Roman scroll design; 18K white gold; large A A 1 blue white diamond. \$1.00 with order. \$4.90 a month.

\$39.50
27-Two blue white diamonds; four blue sapphires, 15 Jewels; 14K solid white gold wrist watch. Complete with flexible bracelet set with two triangular cut blue sapphires

26-New Bulova watch 15 Jewels; dust-tite cap; radium numerals and hands. Nationally advertised cash price \$29.75. \$1.00 with order \$2.87 a month.

New Friendship Ring — \$42.50
25-Beautiful design, 18K white gold, three blue white diamonds; four blue sapphires. \$1.00 with order, \$4.15 a month.

WHAT YOU DO—
Send \$1.00 with number of article desired, and brief note stating (1) how long at address, (2) age, (3) married or single, (4) name of employer, (5) nature of work, (6) how long in employ. Information will be held strictly confidential — no direct inquiries sent to employer.

WHAT WE DO—
We will immediately open a 10 month Charge Account and send selection for approval and 15 days trial. If satisfied you pay balance in 10 equal monthly payments. Otherwise, return and your dollar will be refunded.

No articles sold to persons under 20 years of age.

Sent to any Adult interested in the purchase of diamonds, watches or jewelry. Ten months to pay on everything.

L.W. SWEET
INCORPORATED
Dept 68-11660 BROADWAY
NEW YORK, NY

PATENTS
TRADE-MARKS
Don't Lose Your Rights To Patent Protection

Before disclosing your invention to anyone send for blank form "EVIDENCE OF CONCEPTION" to be signed and witnessed.

LANCASTER & ALLWINE
480 Ouray Bldg. WASHINGTON, D. C.
Originators of forms "Evidence of Conception."

GEARS ALL KINDS SMALL

The most accurate made and prices reasonable. We carry a complete line of gears in stock for immediate shipment. Can also quote on special gears of all kinds. Send us your inquiries.

WRITE FOR CATALOGUE 10
CHICAGO STOCK GEAR WORKS
105-109 S. Jefferson St., CHICAGO

BLUE BOOK ON PATENTS
AND PRIORITY RECORD BLANK GRATIS.
MONROE E. MILLER, PATENT LAWYER
411-2 Ouray Building, WASHINGTON, D. C.
ELECTRICAL AND MECHANICAL EXPERT

EDGAR M. KITCHIN
Attorney & Counsellor at Law
Patent and Trade Mark Specialist 805 O St. N. W., Washington, D. C.

PATENTS Write for FREE Instructions. Send Drawing or Model for Examination.
CARL MILLER, Patent Attorney
former member examining corps U. S. Patent Office
260 McGill Building Washington, D. C.

DIE-CASTING MACHINES
R. BYRD. R. D. 8 COR. BUFFALO & SALTSMAN ROADS **ERIE PA.**

6 Shot 22 Cal. BLANK Automatic  **\$4.99**

A real home protector. Shoots six loud-powerful shots—like expensive automatic in appearance. Construction, finish, durability—use for fun or self defence. Frightens thieves, tramps, dogs—fool your friends. Guaranteed absolutely safe. Automatically loads magazine and ejects cartridges. Send no money. Pay on arrival \$4.99. 100 cartridges given Free. Federal Mail Order Corp., 561 Broadway, N. Y. C., Dept. B119

NO PERMIT or LICENSE REQUIRED

Catch Fish! 

Eels, Mink, Muskrats with our new folding galvanized **STEEL WIRE TRAP.** Write for our **FREE TRAP OFFER** and Bargain Catalog. \$1 Box of our famous Fish Bait FREE to introduce our traps. **WALTON SUPPLY CO., 3502 JUNIATA AVE., ST. LOUIS, MO.**

MOTORCYCLES 

WE WILL TRUST YOU
Pay As Low As \$2.00 per Week
Hendersons, Harley-Davidsons, Indians

Slightly used and rebuilt. Hundreds to select from.
Send 10c for list today.
MYEROW BROS. CO., 15 Berkeley St., Boston, Mass., U. S. A.



A Conn for Christmas Means Year-Round Fun

OH, BOY! Can you think of any bigger thrill than to have a Conn for Christmas? It brings you chances for pleasure and profit that otherwise never would come—a life-long source of joy.

Get in the Band or Orchestra

In the band, you go places and see things, get the spotlight wherever interesting events are happening. Orchestras offer wonderful chances for part or whole time engagements at big pay!

You Play Tunes At Once on a Conn

Conn's famous easy-playing features and the new instruction methods enable anybody who can whistle to play tunes in the very first lessons. No more drudging exercises; it's fun right from the start.

FREE TRIAL

Easy Payments

With all their exclusive features Conns cost no more. You can have any instrument for the band or orchestra for free trial in your own home. Easy payments if you desire, gladly arranged.

Send the coupon now for free literature and details of trial offer. Mention instrument interested in.



CONN

BAND INSTRUMENTS

WORLD'S LARGEST MANUFACTURERS

C. G. CONN, Ltd., 1231 Conn Bldg., Elkhart, Indiana
Gentlemen: Please send free literature and details of trial offer on [Instrument].....

Name.....
St. or R.F.D.....
City, State.....
County.....

I Want to Send You a Santa Fe Special Watch

for You to see and examine

Our 21 Jewel Santa Fe Special Guaranteed for Life

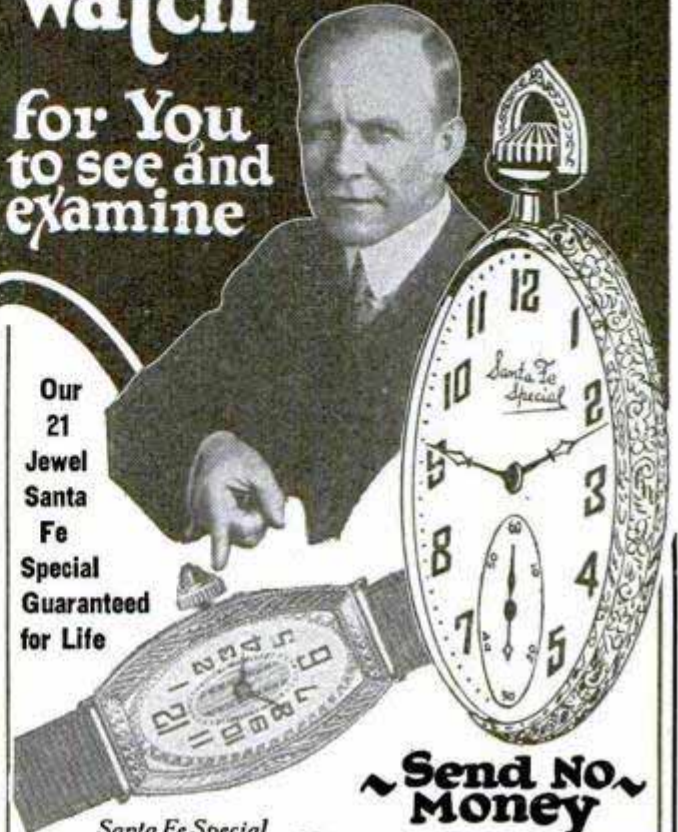

Send No Money

Watch Sent on 30 Day Free Trial

Santa Fe Special Watches are today being shipped to every civilized country in the world, and are probably the best and most favorably known watch in both Army and Navy.

In addition to our NEW LOW PRICE, I will send for your approval one of these Standard Watches, guaranteed for a lifetime of satisfactory service, not only by the Santa Fe Watch Company, but by the Great Illinois Watch Factory. So accurate, Government officials carry them; so perfect and beautiful, jewelers say they are worth 1-3 to 1-2 more than we ask for them. I will send you one to see WITHOUT ONE PENNY DOWN—allow you to wear it 30 days FREE—then sell it to you on easy payments.

WHY NOT OWN A 21 JEWEL SANTA FE SPECIAL WATCH?

You will never miss the few cents a day that will make you own one of these watches—SEND FOR WATCH BOOK—illustrating in beautiful colors hundreds of designs and combinations in cases in the POCKET WATCH, MEN'S STRAP WATCH and LADIES' WRIST WATCH. You can have your name or monogram and any emblem you may desire engraved in the Case to suit your own ideas. Write today for Free Watch Book, and make your selection at once, while this offer lasts.

FREE A limited offer! With every Santa Fe Special beautiful gold chain or strand of exquisite pearls. Write today. Mail coupon for both Watch and Diamond Catalog

SANTA FE WATCH COMPANY
Dept. C-6 Thomas Building Topeka, Kansas
(Home of the Great Santa Fe Railway)

Mail coupon to-day!

SANTA FE WATCH COMPANY
Dept. C-6, Thomas Bldg., Topeka, Kansas
Please send prepaid and without obligation your Watch Book Free, explaining your "No Money Down" Offer on the Santa Fe Special Watch.

Name.....

Address.....

City..... State.....

*A pound of cheer
to start the year*



WITH the Yule log burning brightly and a pound canister beside him of the mildest, most fragrant pipe mixture that ever came out of the South—what more could a man ask? Give him the pound can of Sir Walter Raleigh Smoking Tobacco for Christmas. It's protected inside by heavy gold foil and the canister comes in a handsome Christmas carton. Brown and Williamson Tobacco Corporation, Winston-Salem and Louisville.



**SIR WALTER
RALEIGH**

Who discovered how good a pipe can be

It's



milder



THE LUCKY BOYS
Will Get Them This
CHRISTMAS

How'd you like to have an air rifle that looks and feels like a real Remington .22 caliber repeater? Wouldn't any boy be crazy for one? Can you imagine a better Christmas present?

Remington has made just such an air rifle for you. It's a fifty-shot repeater built on the lines of a Remington .22 rifle. There are no levers sticking out to spoil the looks and pinch your fingers. The stock and fore-end are made of fine American walnut and it has a pistol grip.

And, oh boy! how it shoots! You'd never believe you could shoot so far and so straight with an air rifle. It's safer, too, because it has some special safety features to keep it from going off accidentally—just like a rifle that shoots cartridges.

We can't describe half the improvements in this short space, but you can see them for yourself at your hardware or sporting goods store. When you get your hands on this air rifle and throw it up to your shoulder, you'll know what you want this Christmas. We'll send you a circular telling all about it if you'll write us for one.

REMINGTON ARMS COMPANY, INC.

Originators of Kleanbore Ammunition
25 Broadway New York City

Remington
AIR RIFLES

CORONA

for Christmas

WHAT a wonderful Christmas gift! The newest and most modern of all the Coronas—the finest we have built in all our twenty-years' experience. No other portable has so many big machine features. None can equal Corona's record for durability.

Attractive Duco colors at no extra cost—and a gay Christmas gift carton. At typewriter stores everywhere. Write for latest catalog.

L C Smith & Corona Typewriters Inc

Established 1903

1212 Washington St., Syracuse, N. Y.
Sales offices in principal cities of the world



AMAZING NEW IDEA!

We Show How You Save Hundreds of Dollars Installing Your Own

PLUMBING and HEATING

Get wonderful **FREE BOOK** explaining how you can do your plumbing and heating. **4000 great bargain offers** including Sinks, Water Heaters, Laundry Tubs, Sewage Disposal Systems, Fencing, Tinning, Paints, etc. All Fittings, Tools and Supplies.

Wholesale Cut Prices

Rock-bottom, factory, wholesale prices. **No firm ever undersells us.** You make enormous savings here.

EVERYTHING SENT ON APPROVAL

Highest quality guaranteed. Your money sent back at once if you're not completely satisfied.



55¢
Complete Bathroom Outfit
Greatest variety of plumbing supplies at amazing prices.

Save 1/2 on Material • Save All Labor Cost

Startling Plan explains how you can be your own plumber—Plumbing and Heating Revolutionized

Our amazing plan is simple and easy. No experience necessary. Thousands of our customers do their own plumbing and heating work.

Small, Easy Payments

Many offers in our Big Catalog sold on small, easy payments. Goods shipped in 24 hours. **Largest stock in U. S.** All questions answered.



6-Room Bungalow Furnace

Get full details on marvelous furnace, steam and hot water bargains.



Automatic Electric Water System

Best water systems made. Our Bargain Catalog will astound you.

GET FREE BOOK—NOW

BURKE (4) BROS.
429 Liberty Ave., Pittsburgh, Pa.
Send your Big Free Catalog of 4000 Wholesale Bargains explaining how I can install my own plumbing and heating.

Name.....
Address.....
City..... State.....

\$100 a Week Showing Merchants It Pays to Advertise

R. O. Gooden of Michigan made \$321.05 in 9 days—sold 5 machines in 2 1/2 hours.

THE EUREKA ADVERTISER (Automatic Wrapping Paper Printer)

Automatically prints the merchants' "ADS" on his wrapping paper in one or two colors. Costs only what it costs to have "AD" printed on twenty rolls of paper. Flint of New York sold four machines in two hours. You collect and keep your commission. We deliver. Every merchant a prospect. Many buy five or more machines—one for each paper rack they use.

SALESMANAGER, Dept. A-12, 1201 Cortland Street, Chicago, Illinois



1929 RADIO BOOK

New Hook-ups. This book shows how to make Short Wave Receivers and Short Wave Adapters. How to use the new screen grid tube in D. C. and A. C. Circuits. How to build Power Amplifiers, and ABC Eliminators. Up to the minute information on all new radio developments. Set Builders, Fans, Dealers, send for it today.

KARAS ELECTRIC COMPANY
4028M N. Rockwell St., Chicago, Ill.

Please send me your free book
Name.....
Address.....
City..... State.....
4028M

FREE to You

Write for it!



ANNOUNCING



Three new construction sets for building a 19 1/2 inch model of the famous Mississippi River steamboat "Buckeye State," a 19 inch model of the square rig clipper ship "Lightning" and a 37 inch model racing power boat. The "Buckeye State" should be exceptionally interesting to the great number desiring blue prints and material for building this famous river craft. We can also supply special construction sets, semi-finished hulls and fittings such as anchors, blocks, dead-eyes, guns, capstans, forebush, ventilators, masts, davits, rigging line, blue prints, etc., for "Flying Cloud," "Constitution," "Sovereign of the Seas," "Half Moon," "Mayflower," Spanish Galleon, and many others. Also books, special tools for the model makers, model steam engines, boilers, blow-torch, propellers, etc. A new large 48-page photographically illustrated booklet has just been released. Contains valuable information and hints for building ship models in addition to prices and full description of the above articles. The finest ship model booklet published. A copy will be sent postpaid upon receipt of 15 cents.



At Last A real appropriate watch charm model makers or boat enthusiasts. This miniature steering wheel is made of heavily plated 14-Kt. gold spokes and hub. The rim is made from coco-bola (a Porto Rican hard red wood). Made in two styles. For the charm, one spoke has a small ring attached. The lapel style illustrated, has a threaded hub and nut for fastening. Can also be worn on yachtling caps. Packed in a handsome case. Price \$1.50 postpaid. Be sure to mention style when ordering.

Model Ship Supply Co., Dept. H Mineola, N. Y.



SQUAB BOOK FREE

Breed squabs and make money. Sold by millions for more than chickens. Write at once for free 48-page book beautifully printed in colors telling how to do it. *You will be surprised.*
PLYMOUTH ROCK SQUAB CO.
634 H Street Melrose Highlands, Mass.

AMAZING BURNER

Use Ordinary Kerosene

The most startling heat producing burner ever made. Indispensable on the farm, in factory, for boiling, cooking and heating. Ideal for butchers, dairies, repair shops, for stoves, boilers, ovens, cooking equipment and numerous other uses. Will boil any quantity desired in half the usual time.

BOILS 50 GALLONS IN LESS THAN HOUR

TERRIFIC HEAT!

SILENT BLUE FLAME
NO NOISE, NO SMELL, NO SMOKE, NO SOOT



Think of it! Improved oil burner produces twice the heat of city gas at half the cost. Regulate to any degree desired. So simple, easily installed and operated. Double generator assures continuous operation with shut-downs. Nothing to wear out. Starts in a jiffy. Will last a lifetime. Every burner guaranteed fully to give complete satisfaction. "I would not take \$500 for it if I could not get another," writes J. H. Cox, Mich. "It is worth its weight in gold and is the best on the market," J. B. Ashcraft, O. "Produces terrific heat and saves lots of kerosene," writes H. C. Kistler, Pa.

(Burns OUTDOORS as Well as Indoors)

Also Burners for Cook Stoves and Heaters
Let us send you our catalog of Improved THERM-O-GAS Burners.
HOME MFG. CO., Dept. 2613, 20 E. Kinzie St., Chicago, Ill.



Beautiful your NOSE

to shapely proportions—while you sleep!



ANITA NOSE ADJUSTER is SAFE, painless, comfortable. Speedy, permanent results guaranteed. Doctors praise it. No metal to harm you. Small cost. Write for FREE BOOKLET



ANITA INSTITUTE, 1212 Anita Bldg., NEWARK, N. J.

"Plug In!" start work

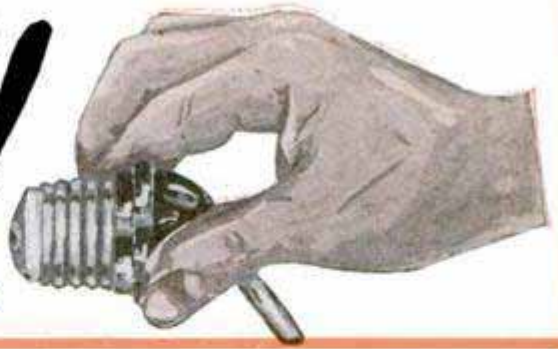

Up-to-Date Home Craftsman Shop

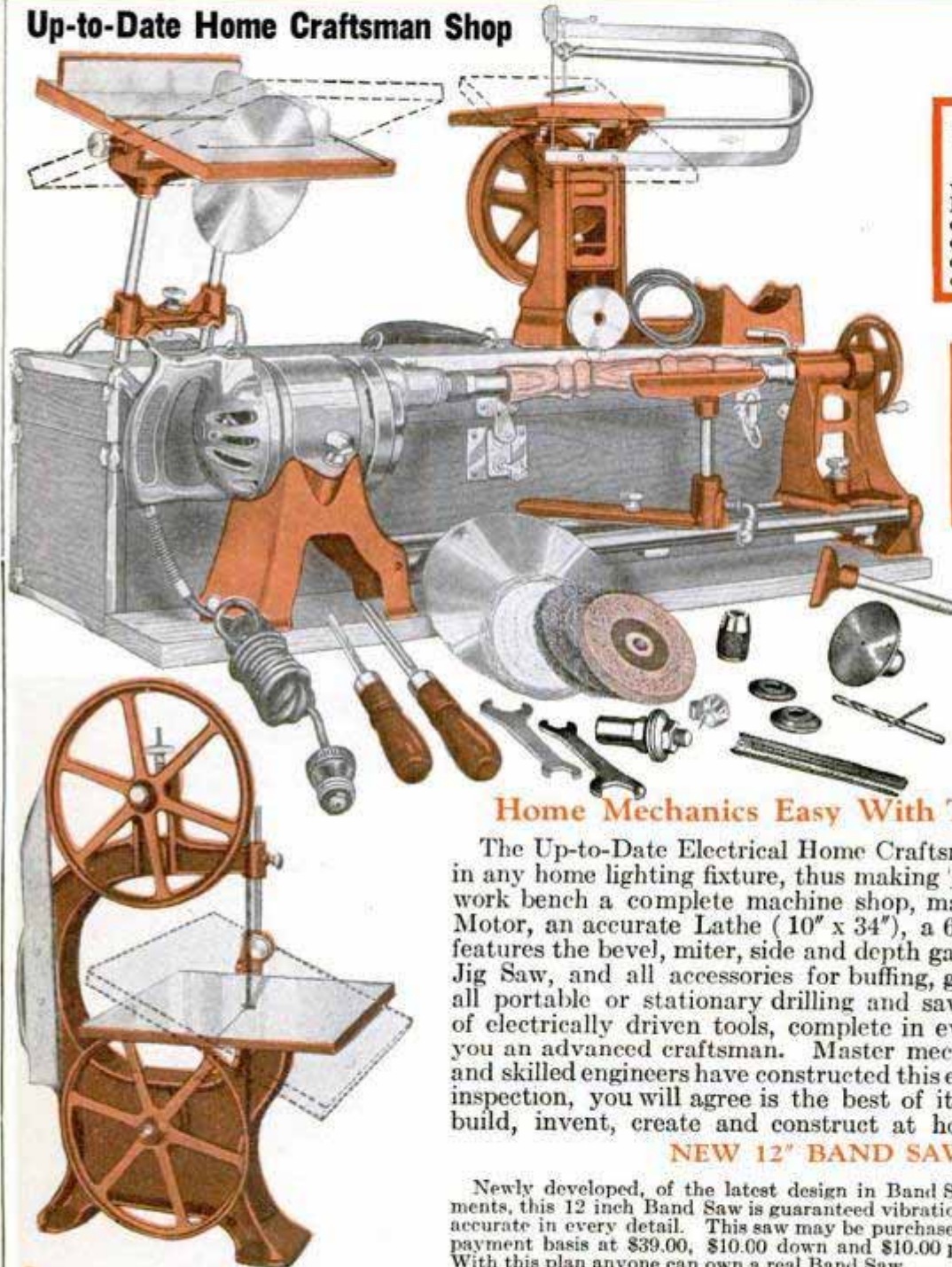

FREE CRAFTS COURSE

Under personal supervision of Master Craftsman Eugene E. Maurey, a special correspondence crafts course is given in simple detail with full information on wood handiwork.

FREE BLUE PRINTS

Blueprint service giving plans and details for making hundreds of pieces of wood handiwork included in this course FREE to our users.

Home Mechanics Easy With This Equipment

The Up-to-Date Electrical Home Craftsman Shop can be used in any home lighting fixture, thus making of your old-fashioned work bench a complete machine shop, made of a Super-power Motor, an accurate Lathe (10" x 34"), a 6" circular saw, which features the bevel, miter, side and depth gauges, a Tilting Table, Jig Saw, and all accessories for buffing, grinding, cleaning and all portable or stationary drilling and sawing. This collection of electrically driven tools, complete in every detail, will make you an advanced craftsman. Master mechanics have designed and skilled engineers have constructed this equipment which, after inspection, you will agree is the best of its kind. For those who build, invent, create and construct at home, it is unexcelled.

NEW 12" BAND SAW

Newly developed, of the latest design in Band Saw equipments, this 12 inch Band Saw is guaranteed vibrationless, and accurate in every detail. This saw may be purchased on time payment basis at \$39.00, \$10.00 down and \$10.00 per month. With this plan anyone can own a real Band Saw.

\$35⁰⁰
F. O. B.
Chicago, Ill.

**ONLY \$10.00 DOWN—10-DAY TRIAL
FREE CRAFTS COURSE BLUE PRINTS
USE COUPON—SEND FOR DETAILS**

MAIL THIS

for full particulars to

Up-to-Date Machine Works,
2915 S. Wabash Ave., Chicago, Ill.

Manager, Dept. 27. Without any obligation, please send me all particulars about your shop, 10-day free trial, free blue prints, free crafts course, also \$10.00 down payment offer.

NAME.....

ADDRESS.....

BOYS

\$2000.00 IN PRIZES

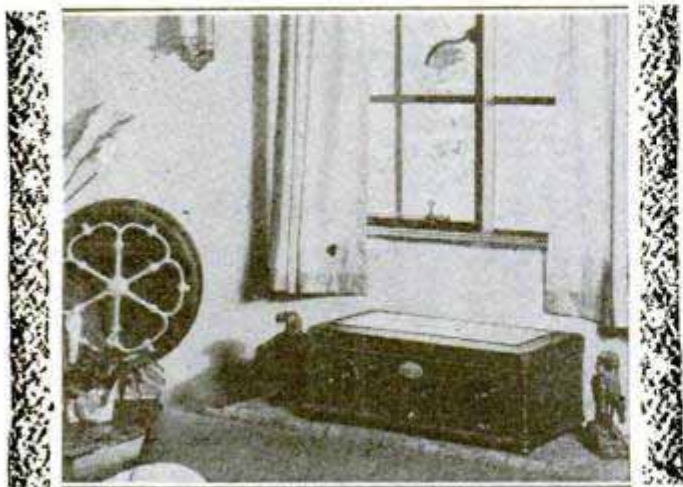

FIRST PRIZE. Atwater Kent Electric Radio

2D PRIZE. Complete Camping Outfit, Value \$115.

3D PRIZE. Pathex Motion Picture Camera and Projector, Value \$75.00. And 617 Other Wonderful Awards, Helbros Gold Watches, Athletic Goods, etc.

BOYS! Here's the snappiest contest ever staged. Two thousand dollars in prizes; 620 separate awards. All you have to do is answer five simple questions—and you can answer these easily when you read the Dorfan Official Contest Folder that you can get at any Dorfan dealer. This free folder tells you all about it. When you read the folder and the gripping page of "Marvelous Railroad Facts" you'll know how to make your short answers. Ask your dealer now for a free Dorfan Official Contest Folder.

Wouldn't you feel just "top of the world" to land that Model 44 Atwater Kent Electric Radio with the classy speaker and seven tubes and all accessories? You *can* do it! And what about the scores of other awards such as the Helbros 15-jewel, 14K. Wrist Watch worth \$40 and Ken-Wel Basket Balls and Footballs. And 2000 handsome Engineering Certificates given away besides to winners. That makes 5620 chances to win!

These prize awards are to show the appreciation of the Dorfan Company for the interest that millions of boys have shown in Dorfan Electric Trains. But you don't need to own a Dorfan to win a prize! All you do is write out the brief answers to five easy questions.

When you go to the dealer to get your free Official Contest Folder you'll probably notice the Dorfan Trains with the famous take-apart engine which you can take apart and put together yourself.

Because Dorfan engines are made of non-magnetic metal, no power is lost through induction as is the case with ordinary engines made of sheet steel. All the "juice" there is, hums into speed-power. Now, don't forget those prizes. If your dealer does not have the free Dorfan Official Contest Folders, send us his name and address and we will see that he is supplied. The Dorfan Company, 137 Jackson St. Newark, N. J.



The Year Around This Gift Brings Joy to Young and Old

S EARCH as you may through the endless list of possible gifts—you will find nothing that assures so much genuine, lasting pleasure, to everybody, as the modern harmonica.

It is easy to learn—simple to play—yet it is a real musical instrument. Its tonal accuracy and musical range satisfy completely the desire for self-expression which is equally natural to girls and boys, men and women.

At modest cost, the harmonica provides a gift that is welcomed with enthusiasm by old as well as young—that means months of joyous melody for the player.



HOHNER "MARINE BAND". The ideal instrument for the beginner, embodying almost two octaves in the diatonic scale. Ten single holes, 20 reeds, brass plates, heavy convex covers finely nickel-plated. In hinged box bearing photograph of the United States Marine Band. Price each 50c.

FREE INSTRUCTION

book will be mailed, postage paid, on request. Just use the coupon below, or send a penny post-card.



FREE

M. HOHNER, Inc.
114 E. 16th St., Dept. 508-M, N. Y.

Please send free Instruction Book

Name _____

Address _____

A GUARANTEED TOOL OF UNLIMITED UTILITY

As Finely Built As The Most Expensive Automobile Motor
Will Stand Years Of Hard Use!

COMPLETE

\$35

F. O. B.
PHILA.

NOT A TOY—MUST BE SEEN TO BE APPRECIATED

THE Wilbar 8" Combination Saw is used and endorsed by the most highly skilled craftsmen! It is a finely constructed machine that will be invaluable

around the shop, factory or home. Absolutely compact. Note base which makes it a real portable outfit.

This sturdy machine will make a cut up to 2 1/4" without planing. It will rip, cross-cut, bevel, mitre, groove, mortise, tenon, drill, rabbet, buff, grind, sand and polish. Attachments are quickly and easily adjusted. Bronze bushings on each end of mandril with grease cup is only one of the many points of superiority this saw has over others. This feature provides perfect lubrication at all times.

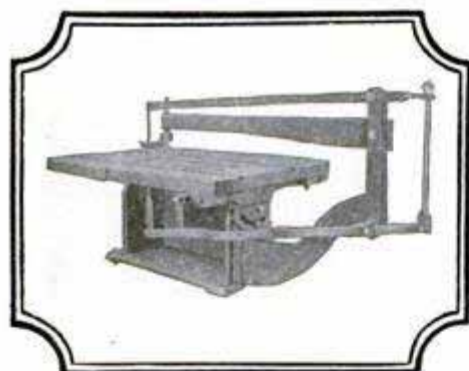

Wilbar Jig Attachment

Now you can put those elaborate finishing touches to your work. Wilbar Jig attachments cut swiftly and accurately true to the marks. Easily attached or detached. Only \$12.00 F. O. B. Philadelphia.

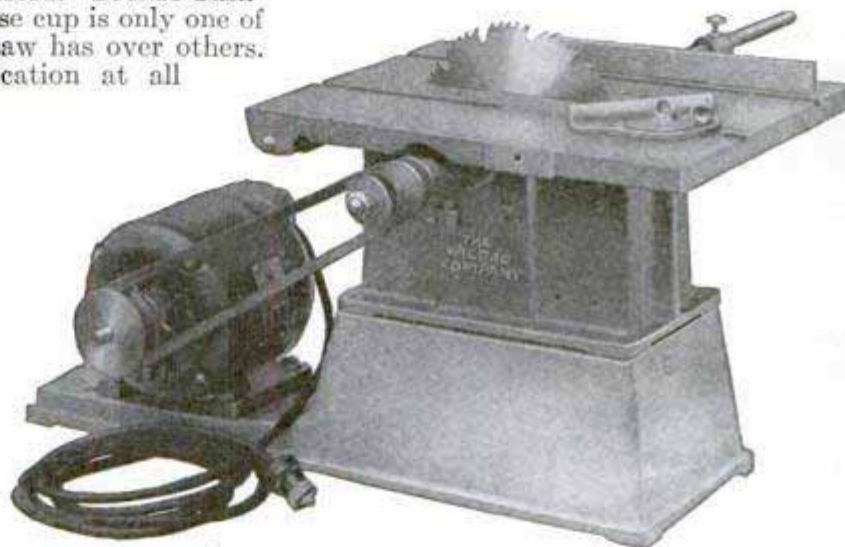

Complete With Motor and Attachments
Listed Below for \$35.00 F. O. B. Phila.

3/4 H.P. 60-cycle, 1750 R.P.M. 110-volt A. C. Motor	Specially constructed V-Belt
12" x 16" Table	Iron V-Pulley for Motor
8" Combination Saw	8 ft. Cord and Plug
Iron V-Pulley	6" Buffing Wheel
10" Ripping Fence	3/4" 3-jaw Drill Chuck
Adjustable Cut-off	5" Emery Wheel
Mitre Gauge	2" Dado Insert
6" Sander	Large Sub-base, 24" x 8"
Saw Guard	

Motor plugs into any light socket and you're ready for work. Planer attachment to smooth pieces up to 2" wide can be had for only \$10.00 extra. F. O. B. Phila.

Groover or Dado Heads extra.
Send for Free Folder of full saw details, also Wilbar Bench Lathes, Wilbar Combination Saw and Lathe (Wilbar Workshop), and other Hardware specialties.

THE WILBAR CO.

2012-14 E. ARIZONA ST., PHILA., PA.

New Food Idea Pays Big Profits!

Men! Women! Investigate the wonderful NEW Brown Bobby GREASELESS Doughnut. Sells like wildfire! You can easily make \$50 week spare time; \$5000 to \$8000 year full time. Investment small! No experience needed. Write today for big special offer. Food Display Machine Corp., Dept. 1359, 500-510 N. Dearborn St., Chicago

IRWIN AUGER BITS

DEMANDED BY ELECTRICIANS, CARPENTERS, PLUMBERS, HOME MECHANICS, INSTRUCTORS. THE IRWIN AUGER BIT CO., WILMINGTON, O.

DO ALL YOUR OWN PAINTING

New—Quick—Easy Way—By Air—No Brush

Electric Spray Outfit
Only \$49.50



Now anyone can own a spray outfit and apply lacquers, Duco, varnishes, paints, etc. Spray Guns make painting easy; gets into the most intricate corners where it would be impossible with a brush. A wonderful smooth-glass-like finish is applied as if by lightning. Your Automobile, Furniture, Wicker Ware, Screens, etc., or in fact anything around the house can be finished this 20th Century way. You do not have to learn to operate these outfits, as the KB Spray Gun itself is the skilled workman.

WRITE FOR FREE FOLDER

Vacuum Cleaner Attachment \$4.95

KOCH BROS. MFG. CO., Dept. 31, 2339 Nelson St., Chicago

Complete Outfit
\$9.75



Agents Wanted

GIFTS for XMAS

One Year

To Pay

No Red Tape

10 Days Trial



No. 312—\$48
\$4 Down—\$1 Weekly
 Here is an exceptional value. A fine quality, genuine blue-white diamond full of fiery brilliance is set in this magnificent lady's ring. The 18 Kt. solid white gold mounting is hand engraved in a fascinating bow-knot design. Your friends will think you paid at least \$75 for it. Makes a marvelous gift.

18 Kt.

SEND NO MONEY

Just fill out the coupon below—that's all. When article is delivered, pay the small deposit to the postman and the balance in small equal payments taking one year to pay.

MONEY BACK GUARANTEE

You assume no risk in buying from this old established reliable concern. You have 10 days free trial. If you are not satisfied that whatever article you buy is not the biggest bargain you ever saw, return it and we will refund every cent you paid. All credit dealings are kept strictly confidential. No red tape—no needless delay.

LOWEST PRICES EASIEST TERMS

Try as hard as you please, you cannot buy elsewhere and get as good value for your money. The terms are so easy that you'll never miss the money. Everything sold on written guarantee.

WRITE FOR FREE BARGAIN CATALOG

It brings our large Jewelry Store right into your home. Gives weights, grades and complete description so you can buy diamonds like an expert. Gives you information other jewelers dare not tell. Diamonds from \$197 per Carat up.



No. 298—\$69
\$6 Down—\$1.25 Wk
 Fine quality, blue-white genuine diamond set in man's massive 18 Kt. solid white gold engraved ring. \$110 Value.

18 Kt.



No. 310—\$69
\$6 Down—\$1.25 Wk
 7 fine quality, genuine diamonds set in solid platinum disk. 2 emeralds in sides of lady's, engraved 18 Kt. white gold mounting. \$110 value.

18 Kt.



No. 311

598: \$9 Down—\$1.80 a Week
 9 flashing, blue-white diamonds and 10 emeralds are set in this magnificent 18 Kt. solid white gold, engraved dinner ring. Equal to any \$150 ring.



4 Diamonds—4 Sapphires
 are set in the dainty, 14 Kt. solid white gold case. Finest 15 jewel movement guaranteed an accurate timekeeper. Equipped with silk grograin ribbon. Every woman is bound to like this small wrist watch. Free presentation case. Reduced from \$55. **\$39**
\$4 Down—\$1 Weekly.



15 Jewel BULOVA
 Here's the very latest style man's strap watch. Choice of white or green 14 Kt. gold filled case. It is fitted with a 15 jewel BULOVA movement guaranteed accurate timekeeper. Equipped with patented "DUST-TITE" cap which prevents dust and dirt from entering movement. Radium dial—removable straps. Sold on credit at nationally advertised cash price. **\$29⁷⁵**
\$3 Down—\$1 Weekly.

AGENTS WANTED—EARN \$100 WEEK. WRITE FOR DETAILS
STERLING DIAMOND & WATCH CO., INC.
 DIAMOND IMPORTERS—\$1,000,000 STOCK—ESTABLISHED 1879
 1540 BROADWAY DEPT. 2550 NEW YORK

STERLING DIAMOND & WATCH CO., Inc.
 1540 Broadway, Dept. 2550 N. Y.

Please send No. _____ price \$_____ on ten days free trial. I agree to pay for it according to your terms. (Deposit can be sent with order if you prefer.)
 Send me your FREE, beautifully illustrated catalog.)

Name _____
 Street Address _____
 City & State _____

NEW MAGIC FLUID

DOES AWAY WITH POLISH



A marvelous liquid called Nu-Rex—a new fluid of amazing properties which does away entirely with all polishes and waxes—has just been discovered.

MAKES OLD CARS LOOK NEW

Nu-Rex requires no rubbing, painting, cleaning or waxing. Just the sweep of the hand and the drab, dull surfaces vanish before your eyes, and the hidden color gleams forth with wondrous luster from under this marvelous protective covering—so easily. Anyone can apply Nu-Rex in a few minutes' time—it's easier than washing your car.

\$100 WEEKLY DEMONSTRATING NU-REX

This is a proposition that will make you big money. Every car owner wants a demonstration, every demonstration will make a sale, and every sale will bring you repeat business. In spare time you can easily make \$5.00 to \$10.00 per hour for yourself.

REFINISH YOUR OWN CAR FREE

Right now men are being appointed in various localities to take care of the big demand. Sample supply of Nu-Rex furnished free to workers. To get full particulars and free sample offer, send your name and address at once to

NU-REX PRODUCTS CO.

Sta. C. Dept. 100 Milwaukee, Wis.

A PRACTICAL COURSE IN MECHANICAL DRAWING

By WM. F. WILLARD

An ideal book for home study. Each exercise is clinched in the mind of the student by practical application to every day practice. 160 Pages. 157 Drawings. Cloth. Price \$1.00 Postpaid

POPULAR MECHANICS PRESS 200 E. Ontario St. CHICAGO

TRY THIS RAPID NEW EASY WAY TO PAINT!

\$9⁶⁵

Put aside slow, messy paint brushes and give everything around the place a new, handsome finish this quick, efficient way. Haywood improved Payntgun makes painting Autos, Furniture, Woodwork or any surface a joy! Try it yourself and see how surprisingly easy it is to get highly superior results.

Now Anyone Can Do Finished Work—NO Streaks

Smooth, even coverage—no streaks or brush marks. Beautiful blends and antique effects easily obtained. Old rundown furniture and car surfaces restored to original show-room beauty.

Send Only \$1.00

Simply pin a dollar bill to this coupon and mail today. Your Payntgun, complete with sprayer, hand pump, tank and hose will be shipped at once for \$8.65 C. O. D. plus postage, on 10 day guaranteed free trial. We trust you. If it does not please and satisfy you return it in good condition and purchase price will be refunded at once. Don't stand for shabby furnishings. Keep things brightened up easily and attractively. Mail coupon TODAY.

Send for Literature



10 DAY FREE TRIAL

MAIL THIS COUPON NOW!

Haywood Company,
 2330-T Ogden Ave.,
 Chicago, Illinois

() Attached find \$1.00. Send at once Haywood Payntgun for \$8.65 C. O. D. plus postage, on 10 Day Guaranteed Free Trial.
 () Send Literature.

Name _____
 Address _____
 City _____ State _____

New Discovery "No-Frost" Offers \$15 a Day PROFIT!



KEEPS AUTO WINDSHIELDS CLEAR

FOR MOTORMEN

KEEPS STEAM OFF MIRRORS

FOR SHOW WINDOWS

Here's an absolutely new money-making idea. Brings big profits—easy profits—quick profits. You can make \$50 a week in spare time—\$100 a week in full time—helping me handle orders in your territory for No-Frost. No-Frost is a new scientific preparation that is absolutely guaranteed to keep steam, frost, fog, rain, sleet, mist, and snow off auto windshields, windows, eyeglasses. Think of it! Keeps glass clean, bright and clear in all kinds of weather.

Anyone, Anywhere, Can Make Big Money

All you do is demonstrate to housewives, automobile owners, stores, garages, etc., and take the orders. We don't sell to dealers. All business from your locality must come through you. *You alone get the profit on every order.* Every demonstration brings you 2 to 4 orders. Just put a little

No-Frost on the glass. It doesn't show. It won't streak, smear, mar, or scratch. Yet keeps glass clean and clear as crystal. A necessity for every auto owner, storekeeper, street car conductor, locomotive engineer, housewife, and everyone who wears eyeglasses. Prevents accidents and takes the place of mechanical devices that don't work half the time.

VAUGHN CLEARS \$125 IN ONE WEEK

C. Vaughn, Ohio, cleared \$125 in one week and says he has more money and friends than ever before. Men and women everywhere are making amazing profits with No-Frost and my 350 other fast-selling products. H. Heintjes, N. J., cleared \$30 in 1 day. Mrs. K. R. Roof, S. C., made \$50 the first week in spare time. Mrs. B. L. Hodges, N. Y., averages \$18 to \$20 a day—day in and day out. H. C. Hanson jumped his pay from \$25 a week to \$75 a week—and he works only part time. You can make these big profits too.

do and say in this easy pleasant work. You don't risk a penny. Yet it's an opportunity to pocket hundreds—yes, thousands of dollars in clear cash profits. You can make \$10 to \$20 a day—right from the start.

JUST MAIL COUPON

Introduce No-Frost in your territory while it's new; before imitations are put on sale in the stores. Skim the rich cream off the profits. Clinch a big permanent, repeat business. Make more money than you've ever made in your life before. Get the facts and read the proof. Mail coupon today—*NOW!*

Albert Mills, Pres., American Products Co., 750 Monmouth Ave., Cincinnati, Ohio. Without cost or obligation, send me full details about the money-making possibilities of your amazing new product NO-FROST.

Name.....
 Address.....

 (Print or write plainly)

SEND NO MONEY

Just put your name and address on the coupon. Give me a chance to *prove* that you can make \$50 to \$100 a week. You don't need capital, training, or experience. I furnish everything and tell you just what to

Flying Cloud Model

Miniature model finishes 20" long. Complete in details. Set consists of Hull Block, 30-1 5" S. P. Blocks, Steering wheel, Anchor, Bell, Capstan, Bitts, Flag, Spar materials, Rigging Brass wire, Pins, etc., also all materials for Deck Houses and rails. Complete set with instructions, \$10.00 plus postage for 5 lbs. Hull shaped and sanded, \$1.00 extra. Figure head 50c.

Also Something Sensationally New!

A beautiful new line of Sailboats that really sail! Totally unlike anything you have ever seen before. They can't sink nor capsize. Have automatic rudder control. Beautifully finished in brilliant colors, authentic and carefully rigged. Our "Captain" model, a 25' racing sloop, ready to sail is only \$10.00. Order one today. Or send Dime for our big Ship Model Supply catalog.

ROY HANCOCK, 323 Douglas Ave., Portsmouth, Va.

NATIONALLY KNOWN MFR. WITH COUNTRY wide sales organization, splendid mfg. plant, ample capital, annual sales running into millions and investing half-million annually in advertising, desires to add and market new articles of merit. Patented household and mechanical specialties especially desired. Mfrs. and inventors, having worthy articles which have not developed successfully because of lack of capital, sales organization or other reasons, should get in connection with advertiser. Owners of newly patented household and mechanical devices, ready to market may find it extremely profitable to write, giving full information, for the advertiser is in position to develop big sales in a short time on any item that fits into his business. Address Charles G. Perry, 110 N. 7th St., St. Louis, Mo.

"SPIRIT of ZENITH"

TAKING OFF

DESCENDING IN PARACHUTE

Last Word in Aircraft

PATENTS PENDING

THIS HELICOPTER is a recent invention by a former U. S. expert aviation mechanic. Helicopters, the dream of inventors, may help solve the future problems of aviation. "Spirit of Zenith" rises vertically. Parachute releases automatically when it starts down, protecting the craft from the fall. Just what you have been waiting for. Made of expensive materials, including brass fittings and fine silk parachute. Assembled in two minutes and GUARANTEED TO FLY. Order now and get a real novelty for the holidays. Price, postpaid, insured mail, \$3.00. If real handy with tools, you can make one yourself. Plans and specifications, 25c. In ordering, print name and address to avoid mistakes. Do not send stamps.

UNIQUE MODEL AIRCRAFT CO. Dept. H, 5725 Oram St. Dallas, Texas



Clyde Doerr, Famous Buescher Saxophonist
You can hear him "on the air"
and on Victor and Cameo Records.

Big Money and a Barrel of Fun

First-Class Saxophonists make big money and the work is easy and pleasant. You might easily become a wizard like Tom Brown or a great record-maker like Clyde Doerr or Bennie Krueger or Joseph Smith. \$100 to \$500 weekly is not unusual for such musicians to earn.



True Tone Saxophone

It's the ideal instrument for social entertainment. It is a key to social popularity. At parties, everywhere, the Buescher Saxophone player is the center of attraction.

Easy to Play—Easy to Pay

The Buescher Saxophone is the easiest of all instruments to play. You don't have to be "talented." Besides being easy to play, we make it easy to pay for a Buescher Saxophone. Play and earn while you pay.

Only a Buescher gives you these extra features: Snap-on Pads, greatest improvement, easy to replace, no cementing—Patented Automatic Octave Key—perfect Scale Accuracy—convenient key arrangement.

6 Days' Trial on any Buescher Saxophone, Cornet, Trumpet, Trombone or other instrument. Fill out and mail coupon for full information. Mention instrument in which you are interested.

Buescher Band Instrument Co.

2617 Buescher Block Elkhart, Indiana

BUESCHER BAND INSTRUMENT CO. (485)	
2617 Buescher Block, Elkhart, Ind.	
Gentlemen: Without obligating me in any way please send me your free literature.	
I am interested in the following instrument.....	Age.....
Name.....	
Address.....	

Wholesale Prices on RADIO

Get our big new 1929 Radio Catalog—hot off the press. Contains thousands of amazing bargains. Latest, nationally advertised Radio equipment. Latest in Ham Transmission equipment. Everything at lowest wholesale prices.

NEW RADIO CLUB—Big Prizes

Get all the facts about "Ether Trappers" Club, now. No dues. Many advantages. Write for **FREE** Membership at once.

This Big Book of money-saving bargains is yours **FREE**. A regular Radio encyclopedia. Write today for your copy of this book.
AMERICAN RADIO & MERC. CO.
Dept. 26
American Radio Building
KANSAS CITY, MO.



SOLDERALL

METAL IN PASTE FORM

The only convenient metal solder



Every Electrical Connection needs Solderall for perfect reception
25¢
The SOLDERALL CO., NEWARK, N.J.



PRICE \$5.00

INTERESTED in TELEVISION?

Write for literature on Television Control. The new SPEED CONTROL CLAROSTAT solves problem of correct scanning disk operation. Brings in screen image and holds it. See this latest Clarostat; in metal case, amply ventilated, protected screw terminals; controls small motor from standstill to full speed; pushbutton for quick start and momentary acceleration; 25-500 ohm fixed or variable resistance.

CLAROSTAT MFG. CO., Dept. G.H., 285 N. 6th St., Brooklyn, N.Y.

SPEED CONTROL CLAROSTAT

REG. U. S.

PAT. OFF.

Send for WESTERN RADIO

New 1929 Catalog

THE NEW 1929 Catalog is crammed full of the FINEST, NEWEST, Nationally known A. C. sets, consoles, cabinets, dynamic speakers, kits, eliminators and accessories at **Lowest Prices**. Largest stock of radio parts. Prompt delivery. Write for our Free catalog.
WESTERN RADIO MFG. CO.
128 W. Lake St. Dept. PM-12 CHICAGO



The Big Friendly Radio House



A Complete Line of Volume Controls Exclusively Licensed by Technidyne Corporation under U.S. Patent Nos. 1593653, 1634102, 1634104.

Enjoying Fan Confidence! TONATROL

Trade-Mark

Concerts, sporting events, speeches, jazz—how much better they come in if your volume is just right! Tonatrol enables you to control volume smoothly and adapt it to each occasion. There are types designed expressly for your circuit whether it's battery or A. C. Can be had with filament switch or power switch attached \$1.50 to \$3.00.

TRUVOLT All Wire RESISTANCES

Reg. U. S. Pat. Off.

The ideal variable, fixed and tapped voltage controls Truvolt Variables simplify B-Eliminator construction by eliminating difficult calculation and making all adjustments easy. 22 stock types \$3.50 each.

Truvolt Fixed resistances are adjustable to different set values by the use of sliding clip taps—an exclusive Truvolt feature! Made in all desirable resistance values and current ratings.

Electrad specializes in a full line of Controls for all Radio Purposes, including Television. Mail coupon for full information.



Pats. Pending

Electrad, Inc., Dept. F-12, 175 Varick Street, New York. Please send me descriptive circulars on the following products and put me on your mailing list for similar literature.

- General Circular
 - Tonatrol Volume Controls
 - Phasatrols
 - Royalty Variable Resistors
 - Truvolt Divider
 - “Electrad Control Manual” (Enclose 10c for mailing)
 - “What I Build” (Enclose 10c for mailing)
- I am particularly interested in

Name.....
Address.....

ELECTRAD

Inc.

Pastor STOP-WATCH

\$9.95



Combination Watch and Stop-Watch. Invaluable to inventors and scientists; mechanics and machinists; engineers, etc. Keeps accurate time and gives fifth second timing independently. Made in U. S. A. and used by the Government after tests proved it the most durable stop-watch made. Unbreakable crystal, nickel finish case. Guaranteed.

STERLING STOP-WATCH CO., Dept. 15 East 26th Street, NEW YORK, N. Y.

\$3⁰⁰!
Hourly

CHRISTMAS SPECIALTY

Salesmen and Agents wanted everywhere to sell stores and homes our beautiful Christmas Window Display Cards; also Christmas Sales Cards, “Useful Holiday Gifts” and 20 other wordings. Sold day or evening alone or as a side line; ideal with Christmas Greeting Cards. Cash sales; no order taking. Write today for free literature.

Consolidated Co., 65A West Van Buren, CHICAGO

Recharge Your Dry “B” Batteries

With Amazing New Invention



Recharges RUN-DOWN OR WEAK “B” Batteries (dry) overnight. Makes them last three times as long. Uses less current than 25-watt lamp. For DC or AC any cycle. Don't throw away your “B” batteries—invest \$1.00 in this guaranteed charger, renew their life and save money. No extras to buy.

No Harmful Acids—No Tubes to Burn Out

Send \$1.00 currency, stamps, check or money order, plus 10c to cover mailing cost. Charger will be sent postpaid. If not satisfied, return within 5 days and your money will be refunded.

Only \$1.00 Complete

Order today—NOW! You can't lose—we guarantee you satisfaction or money back.

ROLL-O RADIO COMPANY

Dept. G-23, 3rd and Sycamore Sts., Cincinnati, Ohio

ENJOY the THRILL of ELECTRIFIED RADIO at SMALL COST

only \$6⁸⁵ complete
FREE TRIAL

Banish forever all the annoyance and expense of buying new “B” Batteries with a TOWNSEND “B” POWER UNIT. Hooked up in a few moments—and you have permanent

power from your light socket from



that time on. Use same tubes now in your set. No changes.

You'll be amazed at the way Townsends improve your reception and add to distance getting. More than 50,000 now in use. Send coupon today for full information and free trial offer.

Townsend Laboratories, Chicago, Ill.

-----COUPON-----

TOWNSEND LABORATORIES, Dept. 15, 713 Townsend St., Chicago, Ill.

12/28

Please send me full information on the Townsend “B” Power and Free Trial Offer.

Name.....

Address.....

Profitable-Useful-Interesting H & A HOME CRAFTSHOP

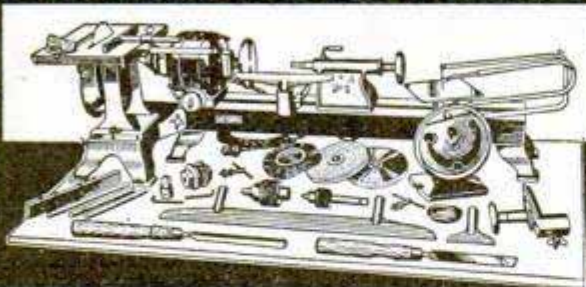

MAKE the things you've always wanted to make—at home—with this complete equipment of high grade motor-driven tools—useful, beautiful, salable things of wood for home, yard or garden. Handles every wood-working job from the simplest repair to fine cabinet work. Includes the famous H & A Wood Lathe, Rip Saw, Scroll Saw and complete accessories. The 1/4 H. P. motor drives the whole outfit; **JUST PLUG INTO THE NEAREST LIGHT SOCKET.**

Buy it on the H & A unit plan, if you choose—just the items you want or can afford now, and add others as you need them. Use it for your own pleasure and recreation, or turn your leisure hours into cash by making things to sell.

What a Wonderful Christmas Gift!

An outfit to delight the heart of any man or boy who loves good tools. All items priced separately, so you can make up your own assortment. All reasonably priced. **WRITE TODAY** for descriptive literature and price list.

HESTON & ANDERSON
612 Western Ave. Fairfield, Iowa



Never Before a Motor Like This!

4 cylinders bring new thrills to outboard motoring. The Super Elto Quad drives racers better than 35 miles per hour—comfortable runabouts at 25 miles—cabin cruisers at 15 miles. Brings

luxurious motor boating within reach of all. Send for catalog of Quad and other Super Elto models. Address, **ELTO OUTBOARD MOTOR CO.**, Ole Evinrude, President, Mason St., Department AA, Milwaukee.

The Super Elto
Quad

Establish a Good Future

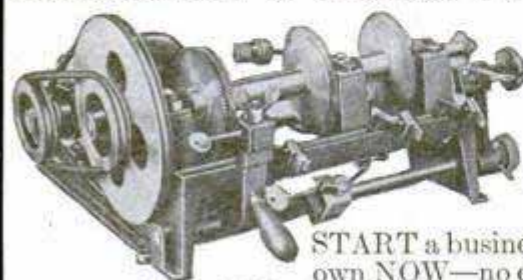

DON'T BE A SHOP WORKER

START a business of your own **NOW**—no experience necessary. The only key machine that cuts ALL kinds of keys. No hand-filing. Make first keys by number without taking locks apart. Instructions furnished free. **WRITE TODAY.**

BEISSER KEY MACHINE COMPANY
407 Fort St. East Detroit, Mich., U. S. A.

CONTROL

Prevent the ups and downs of your tubes. Install **AMPERITES**—the filament control that keeps voltage constant. **AMPERITES** insure long tube life and better reception. A type for every tube—battery or A. C.

\$1.10 with mounting (in U.S.A.)

Radiall Company
507 BRANKLIN ST., NEW YORK



FREE New "Amperite Blue Book"—brim full of useful radio pointers and circuit diagrams. Write Dept. P.M. 12

AMPERITE

REG. U.S. PAT. OFF.

The "SELF-ADJUSTING" Rheostat

only **\$1.00** DOWN

10 Day FREE Trial

You can have a genuine L. C. Smith (the world's only ball bearing typewriter) for \$1 down. Lowest price ever offered! Easiest terms. All the 1928 operating attachments. Re-newed. **GUARANTEED FOR FIVE YEARS.** \$1 down and we ship. No delay. No red tape. 10 day Free Trial. Free Typewriter Course. Tools, Waterproof Cover if you act now. Write for \$1 down offer and free manual.

Smith Typewriter Sales Corp., 11C-360 E. Grand Ave., Chicago, Ill.

\$10.00 DOWN

Brings this Lathe to You

Lathes \$6.00 to \$75.00. Largest line of small lathes in America. Send six cents for 32 page catalog of lathes, drill presses, bench saws, jig saws, band saws, etc.

SYRHER MANUFACTURING COMPANY
Dept. D Toledo, Ohio

HB PAINT SPRAY DOES THE WORK OF FIVE MEN

QUICK, EASY PROFITS!

Practically no investment. Small space required. Steady demand and **BIG PROFITS** refinishing autos, furniture—painting houses and barns with HB quick spray method. One man does the work of five with brushes. Pays for itself on easy monthly payments. **30 DAYS' TRIAL.** Write today for details.

EASY TERMS. 30 DAYS TRIAL. QUICKLY PAYS FOR ITSELF.

HOBART BROS. CO.
Box M1281, Troy, Ohio

5 TUBE SETS \$14.90

in beautiful walnut cabinets

THE MOST ASTOUNDING OFFER

Ever made in radio
Tuned radio frequency circuit
Guaranteed for Tone Quality and Selectivity

These are used sets and were taken in trade for A. C. sets. If after trying out one of these sets, you do not find that this is the most wonderful buy you ever saw in a radio set, we will cheerfully refund your money.

We are also offering to dealers and set builders the following accessories: Audio Transformers \$0.75. Crosley Cone Units \$2.50. UX250 B Eliminator Tubes \$1.75. 30 Henry Chokes \$1.00. 2 Mid. Condenser Blocks \$0.60. Sockets \$0.15. Rheostats \$0.25. Potentiometers \$0.35. Cables \$0.35. Glo-Dials \$0.85. Radiola Loop Antennae \$1.65. Crosley or Atwater-Kent walnut panels, size 9x26 inches \$0.85. Out put transformers for Dynamic speakers \$0.95. Panels 6x10 1/2 \$0.35. Vario couplers \$0.65. Deresnadyn walnut cabinets \$6.45. Peanut Tubes UV199 and UX199, 75 cents each. Send money order with order.

CHAS. HOODWIN CO. Dept. H, 4240 Lincoln Ave. CHICAGO, ILL.
DEALERS IN BANKRUPT STOCKS

LATHES *for the Tool Room- Manufacturing- Machine Shop-Repair Shop-Service Station*

New Model South Bend Back-Geared Screw Cutting Precision Lathes

Built in the same plant where 40,000 other fine South Bend Precision Lathes have been manufactured for the United States Government, Ford, Westinghouse, Bethlehem Steel Company, U. S. Steel Corporation, and hundreds of other large industries in the United States and 78 Foreign Countries.

Easy Payments if Desired

A small down payment brings you any Lathe to use while you are paying for it. We ship immediately upon receipt of the down payment.

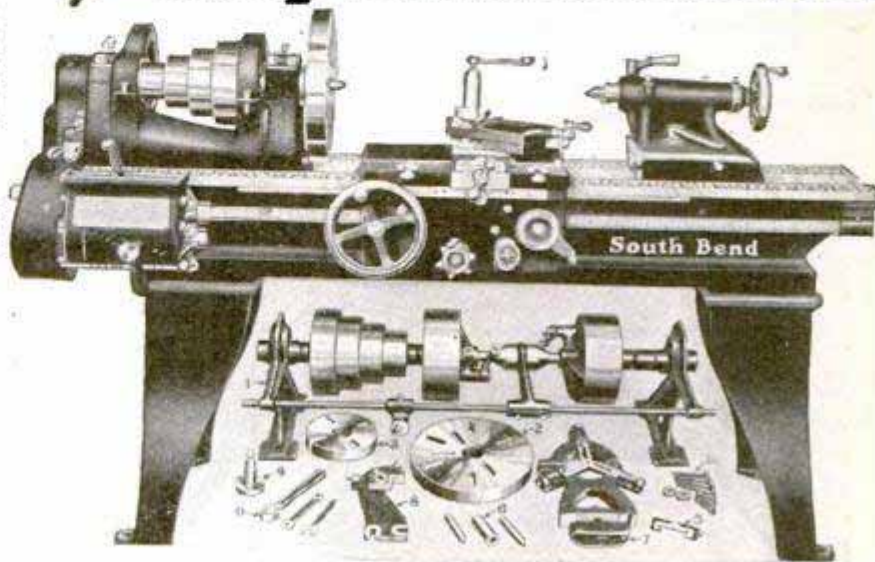

16" x 6' New Model South Bend Quick Change Gear, Back Geared Screw Cutting Lathe - **\$540**

Other Popular Selling Sizes

The Prices of Popular Selling Sizes with Countershaft and Equipment

Size of Lathe	Shipping Wt.	Standard Change Gear	Quick Change Gear
9" x 3'	490 lbs.	\$235.00	\$270.00
11" x 4'	725 lbs.	300.00	335.00
13" x 5'	1110 lbs.	352.00	402.00
15" x 6'	1550 lbs.	430.00	490.00
16" x 8'	2035 lbs.	510.00	570.00

Used by America's Largest Industrial Plants

The best proof of the quality and accuracy of South Bend Lathes is that they are used in production, tool room work and in general machine work by America's largest industrial plants. For example: General Electric Co., Western Electric Co., Packard Motor Co., Oldsmobile Co., Houdaille Engineering Co., Victor Talking Machine Co., Black & Decker Mfg. Co., International Harvester Co., and in many departments of the United States Government.

FREE — Write for No. 89-A Catalog describing 57 sizes and types of New Model South Bend Lathes. Check off in the squares of coupon below, indicating Lathes and Books in which you are interested.

SOUTH BEND LATHE WORKS

Main Office and Works
644 E. Madison St.

South Bend, Ind., U. S. A.

New York City, J. E. BEGGS CO.,
183 Centre Street

Carried in Stock by Machinery
Supply Dealers in Principal
Cities Throughout the
World.



9" x 2 1/2' Junior Back Geared Screw Cutting Bench Lathe **\$150**

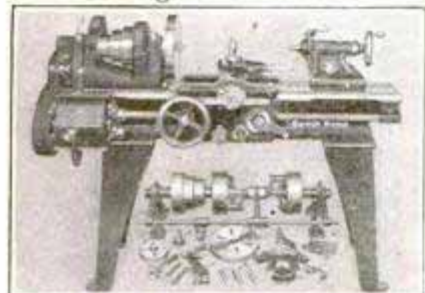

11" x 4' Quick Change Gear Lathe, Straight Bed - **\$335**

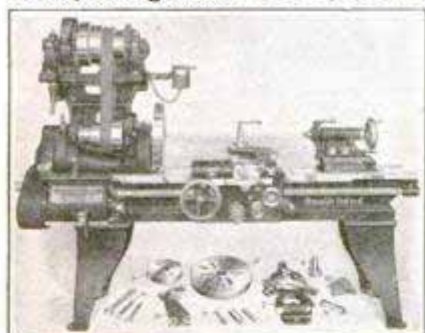

18" x 8' Quick Change Gear Motor Driven Lathe - **\$908**

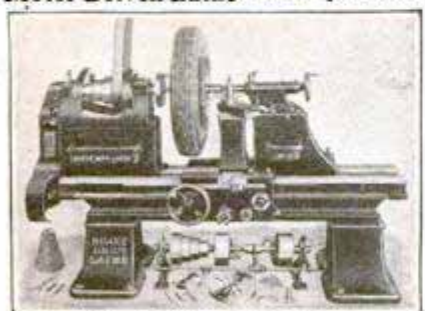

Brake Drum Lathe

Handles all Brake Drum work without removing tire.

No. 1 Lathe, Wheels to 32" diam. **\$475**

No. 2 Lathe, Wheels to 36" diam. - **650**

No. 3 Lathe, Wheels to 42" diam. **1400**

South Bend Lathe Works, U. S. A.
644 E. Madison St., South Bend, Ind., U. S. A.
Cutting Lathes: I would like your new factory price on a Screw Lathe: 9" 11" 13" 15" 16"
No. 89-A: How to Run a Lathe, 25c. New General Catalog Auto Me-
chanics: Service Book, 25c. Brake Drum Lathe

Name: _____
Address: _____
City: _____ State: _____

**New Low
Factory
to You
Offer**

**ONLY
\$25
DOWN**

**WITTE TREE AND
LOG SAW OUTFIT**

FULL YEAR TO PAY BALANCE

A Fast Cutter



**WICO
Magneto
Equipped**

*Built and
Guaranteed
by
WITTE*

Now you can get my latest improved tree and log sawing outfit for a small, factory-to-you, down payment of \$25.00.

MAKE MONEY THIS WINTER clearing land, sawing wood, cross ties, fence posts, shingle butts and other kinds of timber.

CUTS 15 TO 40 CORDS A DAY on a little cheap fuel. Easy to start in all kinds of weather. **Plenty of steady, low-cost power.** Use the engine for feed grinding, corn shelling and other power jobs.

Cash or Your Own Terms

A Full Year To Pay—No Interest. My Life-time Guarantee protects you. **Write for Special Tree and Log Saw Folder**, and new, low, factory-to-you price list. Save 25 to 40 per cent. Over 250,000 WITTE Sawing Outfits, Engines and Pumps in use.

ED. H. WITTE, Pres.

WITTE ENGINE WORKS

ENGINE BUILDERS SINCE 1870

7749 Oakland Avenue, Kansas City, Mo.
7749 Liberty Street, Pittsburgh, Pa.

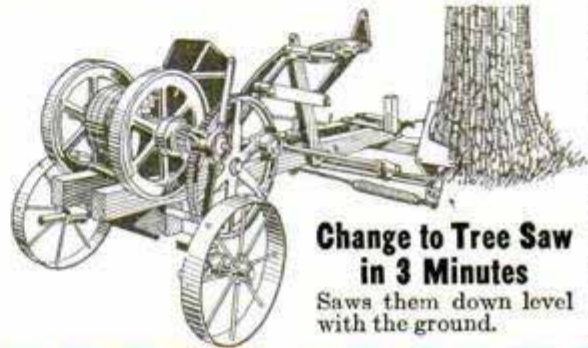

**Change to Tree Saw
in 3 Minutes**

Saws them down level with the ground.



New Outing Kit \$5.00

A Gift for every man and boy

Six Power Pocket Telescope to observe distant objects with ease and clearness.

Scout Knife with sturdy cutting blade, screw driver, reamer, bottle and can opener, is an outdoor necessity.

Reliable Compass, pocket size, is indispensable on land or sea.

Pocket Magnifier that is always useful.

At your dealer, or direct, postpaid, \$5.00.

WOLLENSAK OPTICAL CO.

854 Hudson Ave., Rochester, N. Y.

Cal. 30-40 Six Shot



KRAG CARBINE

All the qualities of a high price rifle. In fine used condition, all working parts guaranteed for one year. Send today for our Free 50-page illustrated catalog of money saving values: Guns, Ammunition, Cutlery, Sports and Gov't goods. Deposit required on all orders. Money refunded if not satisfactory.

W. Stokes Kirk, 1627-P. M. North 10th St., Philadelphia, Pa.

**Price
\$9.75**

METAL TURNING LATHE \$49.50



Also 7 in. swing
3 speed cone pulley

Speed Lathes

\$10.50

Goodwin Mfg. Co. 435 Keota St., OTTUMWA, IOWA

CHLORINE HOME TREATMENT

For those who suffer from Colds, Bronchitis, Catarrh, Whooping Cough and respiratory diseases is now available for home use. Pour the contents of ampoule into vessel and breathe the medicated air in your room for one hour. Treats one to six at a time. This simplified treatment, endorsed by thousands, produces the same results as treatments with elaborate apparatus has shown 94% cured and improved.

Special Offer Three Home Treatments

Mailed prepaid on receipt of \$1.00

Medical Products Corporation 153 E. Elizabeth Street
Detroit, Mich.

JUST OUT Spors No. 9 Combination Pen and Pencil

AGENT'S SAMPLE 66c Sells for \$1.35. Make \$15 daily easily. 8 different colors. **Ideal Xmas Gift.** Comes in Holly Box.

Guaranteed 2 years. Money back if not pleased.

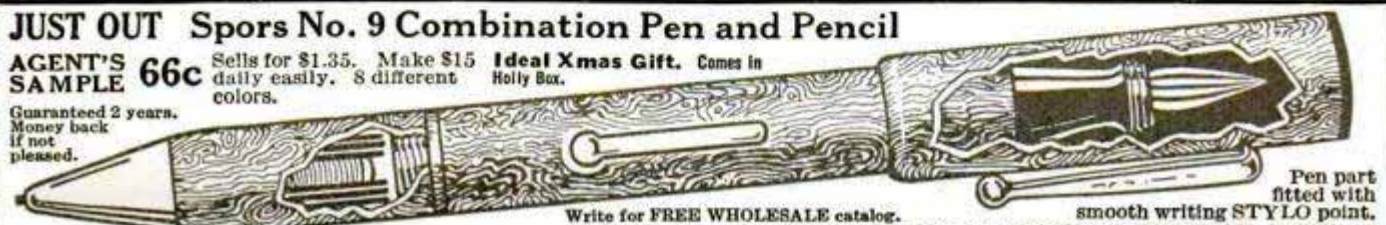

Write for FREE WHOLESALE catalog.

Pen part fitted with smooth writing **STYLO** point.

F. SPORS & CO., 1028 MAIN STREET, LESUEUR CENTER, MINNESOTA

Give Him a Masonic Gift!

\$100 Emblem Stamped on in Heavy Gold FREE!
For Choice



Gifts that he will appreciate

Latest style, genuine leather, 5 window pass case, with gold trimming. Masonic or Shrine emblem stamped on free. Name or other stamping 35c a line extra. Our leader: it's a dandy. 9 windows \$1.50, 13 windows \$2.



SOLID GOLD PIN

Just the right size. Latest style. A lasting remembrance and an appreciated present. Large variety — Masonic, Chapter, 32nd Degree, Shrine, Grotto, O. E. S., De Molay **\$1.00**
SEND FOR OUR CATALOGUE

REDDING MASONIC SUPPLY CO. INC. (Est. 1859)
Dept. P. M., 200 Fifth Ave., New York

A NOVEL CHARM



A most mysterious watch charm of heavy plated gold. Shows the Square and Compass when revolved. Something different. Packed in an attractive box. Catalogue suggests many other gifts. **\$1.00**

-----FOR YOUR CONVENIENCE-----

Name..... City..... Enclosed find
Street..... State..... \$.....



BOW LEGS?

THIS GARTER (Pat'd)
Makes Trousers Hang Straight
If Legs Bend In or Out
Free Booklet—Plain Sealed Envelope
THE T. GARTER CO., Dept. E
South Bend, Ind.



MODEL AIRPLANE MOTOR

Only motor of kind on market. Compressed air. Tanks, blueprints. The only motor for model aircraft builders. A powerful little job and a real beauty. **\$4.90**
IDEAL CHRISTMAS GIFT. Send for descriptive circular.
Amalgamated Sales & Service Corporation
542 West Jackson Boulevard Chicago, Illinois

Information on any book free. Write Popular Mechanics Press, Chicago, Ill.

Boice-Crane Workshops \$48 and Up!

Boice-Crane Workshops consist of individual machines as shown and are better for your shop because each machine is always ready for use—no attachments to change. Each machine is efficient, accurate, powerful and far superior in size and capacity. Should not be compared with flimsy attachments. Will do far heavier work and a wider variety of jobs. All machines can be used at one time without interference. You are not limited to a "one man shop." In all our 14 years experience as bench machine manufacturers, these new Boice-Crane machines are the greatest values we have ever offered at such low prices.

Boice-Crane specializes in workshops. Five are illustrated in our catalog. One of them is sure to meet your exact requirements. Send 10c for the new 1929 Boice-Crane 80-page catalog describing the five workshops, individual machines and Books of Designs.

W. B. & J. E. Boice
Dept. P. M. 12-D Toledo, Ohio

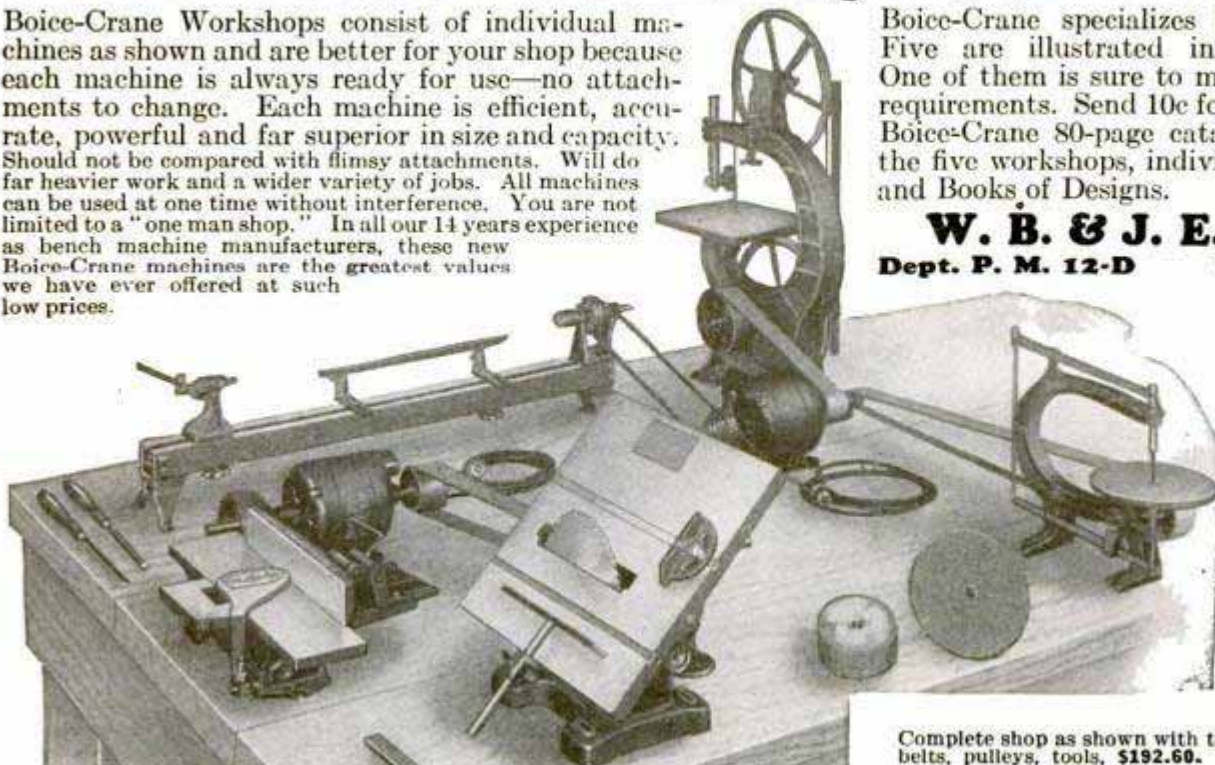

- As Illustrated
- Band Saw, 12" **\$35.00**
 - Universal Hand-saw **\$30.00**
 - Universal Jig Saw **\$12.00**
 - Handi Jointer, 4" **\$28.00**
 - Lathe 7"x41" C. to C., \$26.15. (Shorter length lathe, **\$13.50**).

Complete shop as shown with two ½ h. p. motors belts, pulleys, tools, **\$192.60**.

\$2 to \$4
an hour for
Spare Time

- A NEW Business

Here's a **BIG OPPORTUNITY** for men who want to get ahead in a **PERMANENT, WELL PAYING BUSINESS** for themselves. Hundreds of men all over the country are making **BIG MONEY** sharpening saws on the **Foley AUTOMATIC Saw Filer**. Nothing else like the **Foley**—it files saws automatically better than the most expert hand filer, and faster too!

No Competition with FOLEY AUTO-MATIC SAW FILER

Start in your spare time and work up a full-time business. You can get all kinds of saws to file—from carpenters, contractors, factories, schools, hardware stores, saw mills, woodworking plants and every kind of business that uses saws, because the **Foley** files them **AUTOMATICALLY** with such mechanical accuracy that they cut faster, cleaner and truer. When your customers see what good work you do for them on your **Foley**, they will give you all the business you can handle.

Chas. E. Fuller Made \$3.00 in 40 Minutes

Most **Foley** users get 50c for each saw filed and average 5 to 8 hand saws an hour easy.

Harry O'Brien says, "I had 7 saws waiting before I got my machine. Have already made \$130." * * * From Nels Emstad, "Have filed 225 saws, and it works absolutely perfect. Not bad for a side line."

"I am a carpenter working every day and file about 100 saws a month," says Oscar Porr. * * * "I have sharpened over 2000 saws with the filer—it's a wonder," says L. J. Frederick.

Money-Making Plan

FREE

No experience needed to operate the **Foley**. Our Free Plan has started hundreds on the road to success. Don't delay—get it now! **OTHERS MAKE BIG MONEY**—why don't you? Send the coupon today for complete information.



MAIL THIS COUPON TODAY

Foley Saw Tool Co., Inc. PM 12-28
234 Foley Bldg., 11 Main St. N. E.
Minneapolis, Minn.

Gentlemen: Please send me Free Plan to build a business filing saws on the **Foley**.

Name.....
Street.....
City..... State.....

Kills Glare of Bright Lights

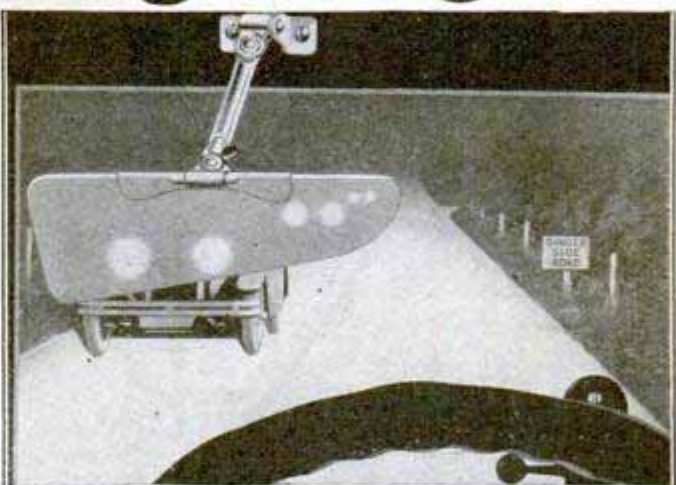

The amazing new Liberty Glare Shield actually dims the bright lights of approaching cars so perfectly that it is as safe to drive at night as in the day. It is adjustable to all angles and a touch of the finger operates it. Gives perfect protection against the sun as well as bright lights. When not in use it can be folded up against the roof of the car. It is scientifically shaped and placed. Statistics show that thousands have lost their lives in auto accidents due to glaring headlights. The Liberty Glare Shield banishes this danger and makes driving a safe pleasure.

\$5.00 AN HOUR TO MEN WHO WILL HELP INTRODUCE IT

Men are needed in every locality to take care of local business. The money making possibilities are tremendous. Every car owner is a prospect. Full time or part time workers will find this the biggest money maker they ever handled. Sales experience is absolutely unnecessary. The Liberty Glare Shield and our sales instructions do the selling for you.

FREE SAMPLE OFFER

Our workers are furnished with a Liberty Glare Shield for their own cars so that they will be able to make demonstrations. Send for full particulars of our sales proposition and free offer.

Liberty Manufacturing Company, Dept. 231
West Allis, Wisconsin

SPEEDSTER AIRPLANE



11-inch wing spread 9½ inches long, wood propeller accurately machined. A fast flyer that rises from the ground and speeds beautifully through the air. Comes to you all assembled. Only 25 cents postpaid.

Speedo-Plane Flyer

Rises from the ground. Soars to great heights and glides perfectly to ground. Has wing spread of 16 inches. Motor stick 14 inches. 7 inch accurately machined wood propeller. Match its performance against your \$5 plane. Fully assembled 50 cents postpaid. Positively guaranteed to fly or money refunded. **SPEEDO MANUFACTURING COMPANY** Dept. M, 253 Albany Ave. BROOKLYN, N. Y.

NOW! You Can AIRPAINT

It's easy to paint this NEW WAY—Brighten up the home, paint your Auto, etc. Beautiful results: smooth and even.

Home Outfit ONLY \$10.50

Paasche Airbrush Co., 1955 Diversey Parkway, CHICAGO



OXO-GAS Oil Burners

Will Heat Stoves, Ranges, Coffee Urns, Steam Tables, Tanks, Boilers, Vulcanizers, Water Coils, Rendering Kettles, Bake Ovens, Griddles, Lead Pots, Pressing Machines, etc.

No Noise—No Smoke—No Soot—No Ashes
Require No Mechanical Skill to Operate
Can be Installed in 30 Minutes
Last a Lifetime

Responsible Distributors Wanted
Write for illustrated catalog.

DORAN OIL BURNER CO.
111-12 No. May St. CHICAGO, ILL.

A Condenser That Has Made Radio History

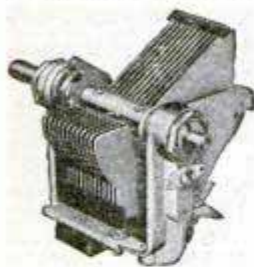

The Hammarlund "Midline" Condenser holds an enviable leadership in the radio world. Its super-quality of design and performance makes it the first choice of radio engineers and experienced fans.

Be safe—use Hammarlund Condensers in your receiver and enjoy radio at its best. Write for folder.

HAMMARLUND MANUFACTURING CO.
424-438 W. 33rd St., New York, N. Y.

For Better Radio
Hammarlund
PRECISION
PRODUCTS



DON'T INVEST Until You INVESTIGATE the MULTICRAFT

The greatest invention in time and labor saving machinery. The turret revolves. Any desired tool instantly ready for use. A postal will bring full particulars. Send for it NOW.

Tessmer Machine & Tool Co., 1425-1445 RIVARD ST., Detroit, Michigan

Be Your Own Broadcaster

WITH AMAZING NEW MICROPHONE ONLY \$1.00 COMPLETE



No "Extras" to Buy

Microphone comes to you all ready for use. Just attach to set and start having fun.

Thousands of laughs and tricks are hidden in this clever Microphone. You can actually do your own broadcasting with this remarkable invention and fool all your friends. Instructions tell you how you can hook this instrument up with your own loud speaker. Connections can easily be concealed. No

interference with your regular radio reception. This attachment is great for parties, your friends will never tire of it. Full instructions accompany instrument.

MONEY BACK GUARANTEE

Send only \$1.00 with order blank, and add 10c in stamps or coin for mailing cost. Keep ten days. If not actually tickled with results, return it to us in good condition and your money will be refunded. Order NOW!

R. B. SPECIALTY CO.

Dept. E-306 318 Sycamore St., Cincinnati, O.

Pretty Soft
\$6,000 to \$10,000 a year
and
His Own BOSS!

YOU CAN DO IT! No school—no tuition. Half an hour shows you how. One week's practice makes you an expert. Sounds too good to be true, but is.

Here are the facts.

There's a big demand for the work Clarke FlorKraftsmen are doing! The demand for fine smooth floors grows greater every day. Millions are spent

every year sanding old and new floors—in homes—in office buildings. \$25.00 to \$75.00 per day can be yours. And here's the point. No one can do this work so easily—so beautifully—as the Clarke FlorKraftsmen.

Your ambition to succeed, to have the things you want, the extra savings—the extra luxuries, can all be yours. There's no mystery—no magic about it. The facts we will send you show the way.

It's a sure big pay proposition. Over a thousand Popular Mechanics readers who have seen our announcement in the last six months, are now making from two to five times their previous earnings. Costs nothing to get the facts. Be sure to send the coupon NOW.

CLARKE SANDING MACHINE CO.

Dept. T-12

3831 Cortland Street
CHICAGO, ILL.

Originators and for 11 years Manufacturers of Portable Sanding Machines.



answers all calls

CLARKE SANDING MACHINE CO.,
Dept. T-12, 3831 Cortland St.,
Chicago, Ill.

Please send me the facts about Clarke FlorKraftsmanship. No obligation to me.

Name.....

Address.....

City..... State.....

New

21 Jewel

BURLINGTON

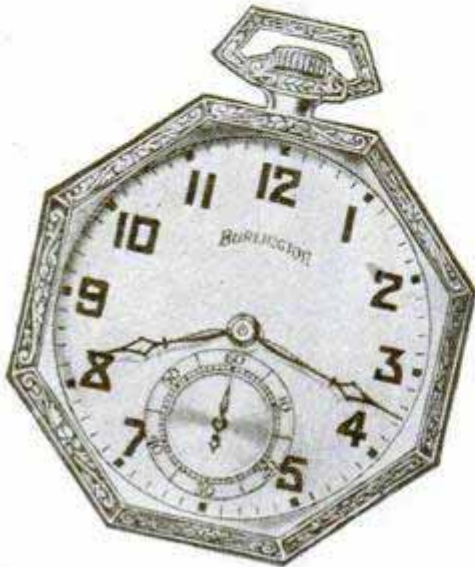

Write!—while this special offer lasts!—for the NEW Burlington Book, showing in colors the NEW 21 Jewel Burlington in all the latest designs—including the New Burlington Bulldog, the New Lady Burlington, new strap watches—in fact, a watch for everyone! Always a masterpiece, the New Burlington is now better than ever! 21 Ruby and Sapphire jewels; adjusted to the Second, to Temperature, to Isochronism, to Positions; 25 Year Gold Strata Case.

\$1⁰⁰ Down

-30 Days Trial

Yes! Carry this watch masterpiece for 30 days, with no obligation to buy unless delighted! Only \$1.00 down, the balance in small easy monthly payments at our rock-bottom, direct-to-you price, saving you from 25% to 40%! But don't delay! Take advantage of this offer NOW!

Write! While this Special Offer Lasts!

Find out about this special offer of 30 Days Trial and \$3.50 a month—made for a limited time only. And get our FREE New Burlington Book. It shows how to judge the real value of a watch and avoid purchasing watches that are overpriced. Just fill out the coupon and mail it TODAY.

Burlington Watch Co., Dept. 13-59
 19th St. and Marshall Blvd., Chicago
 Canadian Address: 118 Princess St., Winnipeg, Man.
 Please send me (without obligation and prepaid) your new free book on watches, also your special \$1.00 down, 30 day trial offer on the New Burlington Watch.
 Print name and address plainly.

Name.....
 Address.....

Genuine KEYSTONE MOVIEGRAPH

(PATENTED)

SHOWS BIG SIZE MOVING PICTURES

Safe for **\$6.95** Non-Inflammable Safety Films
 the Home 54 FT. FILM GIVEN FREE

The following reels are only a few in the film catalogue, and are genuine, posed by the actors themselves. The film is the same size as used in the theatre.

Charlie Chaplin in "Making Pies"
 Wm. S. Hart in "Western Train Robbery"
 Tom Mix in "The Battle on Horseback"

Also Slides, Drawing Slides, Theatre Tickets and PROFIT SHARING COUPONS included.

Every live boy should have at home or club a Keystone Moviegraph that shows pictures the same as in the movies with powerful French lenses and constructed along professional lines.

The electric cord is included for connecting to any lamp socket your electric bulb will fit. Can also be had for any Dry Cell Batteries for the home without electricity. Nothing to get out of order. No complicated parts. We have the largest comedy film service in the country for home machines. Size of machine all set up is 10" by 8". Weight complete 6 lbs. Send Money Order or check. No C. O. D. Guaranteed to give good big pictures or your money back. Reference American Trust Co., Boston, Mass.

Machine and 54 Ft. Film Complete for \$6.95

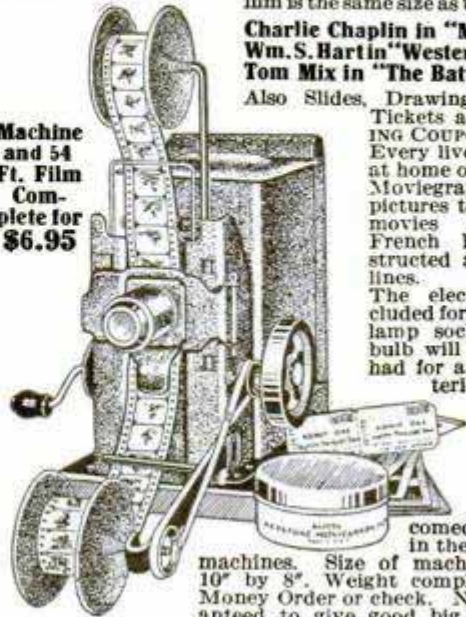

Price for Machine and 54 ft. Film \$6.95 complete, prepaid in U. S.

Order your machine today in time for Christmas
LIBBEY & NICHOLS
 P. O. Box 52, E. Milton, Mass.

FREE Wholesale Radio Catalog

Set Builders-Dealers! Save Money!

Send for the most complete book of nationally known Parts, Kits, Cabinets, Consoles, Speakers, Power Units, Sets, etc. All at lowest wholesale prices. Quick service on all your needs. Write now, it is FREE—

SETBUILDERS SUPPLY CO.

124 Romberg Bldg. Madison and Market Sts. CHICAGO, ILL.

Is Your Car..... A Gas Eater

New Invention Increases
 Mileage on Auto Gas
 Eater from 13½ to 34.6
 Miles on a Gallon

An astonishing new device has been perfected that is amazing car owners everywhere. Goerzen reports increase from 13½ to 34.6 miles on his Dodge. Thousands have been installed and users report 30-40 and more miles on a gallon of gas. In addition power is increased, instant starting and flashy pick-up is noticed and carbon formation disappears. Every car owner in the country needs this new invention. Its cost is so trivial it pays for itself in a few days' time, yet it will save hundreds of dollars for its owners in gasoline.

\$100 a Week Territory Open

\$5.00 an hour for spare time. Men are needed in every locality to take care of the tremendous local demand. Sales ability is not required. Every car owner will buy on sight. Ideal for spare time workers.

FREE Offer enables our workers to obtain this marvelous Whirlwind gas saver for their own cars without cost. Quick action is necessary. Be the one in your locality to cash in on this device which every auto owner will buy. Send today for full particulars and free sample offer.

Whirlwind Mfg. Co., 999 378-E Third Street MILWAUKEE, WISC.



A \$100 SHIP MODEL FOR \$4⁹⁸

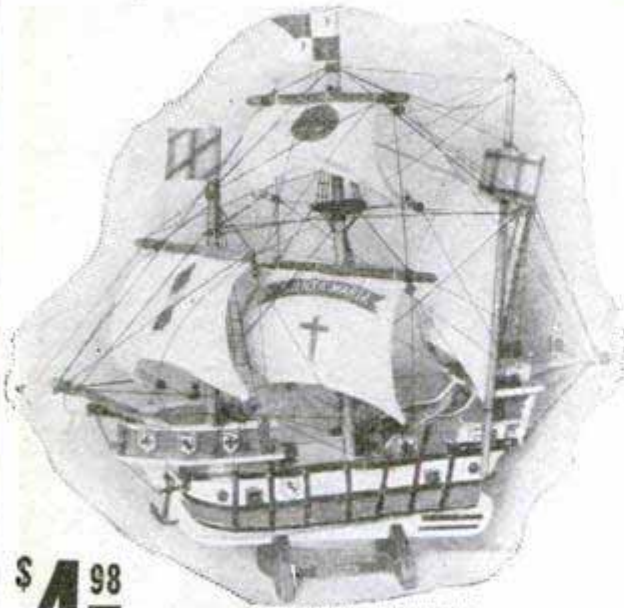

\$4⁹⁸

SANTA MARIA

25" High; 11" Wide; 27" Long

Write for our beautiful illustrated booklet containing photos and information on all of our models.

Miniature Ship Models, Inc.,

Dept. PP-2, 3818-24 BARING STREET
PHILADELPHIA, PA.

**You can put a beautiful
Ship Model together in a few
hours of pleasant pastime**

Let the World's Largest Builders of Ship Models supply you with all the necessary parts cut to fit and ready to put together for the models, Santa Maria, Mayflower, or LaPinta. You need not know anything about ship building to assemble one of these models. If you have never seen a ship model you can put one of these models together in a few hours by following our diagram and instruction sheets which explain and show you exactly what to do with each part. All you need is a small tack hammer to tap the parts in place. The diagram making it impossible for you to go wrong. These models when completed are exact in every detail of the famous old ships they represent, and when completed will add a distinctive touch to your home. We also have parts for the model for the Constitution at \$6.98; all other models listed at \$4.98 each.

MINIATURE SHIP MODELS, INC., Dept. PP-2,
3818-24 Baring Street, Philadelphia, Pa.

Please send me the complete parts cut to fit and ready to put together for the Model.....
I will pay postman..... plus a few cents postage.
Please print name and address plainly to avoid delay.

Name.....

Street or R. F. D.....

City.....

State.....

Will You Pay \$95⁰⁰
for a \$15,000⁰⁰ a Year
BUSINESS?



"From Nothing to \$15,000 a Year!"

No dream—but an actual fact! L. E. Berry, Barnesville, O., writes—"Have built a business up from nothing to \$15,000.00 a year. I owe my success to your Haywood plan." Haywood proved plan has made over 16,000 men independent. Free training. Write at once for free book, "Steps to Success."

J. A. Schreiber, Pres.
HAYWOOD TIRE EQUIPMENT CO., 2330-T Ogden Ave., Chicago



Cut the Family Barber Bills



Belle City Home Electric Hair Clipper

Anyone can trim or bob hair, shorten bangs, clip neck or underarms in a shape almost impossible with hand clippers or shears. Operates on direct and alternating current. Will not clog or cut the skin, and cuts as cleanly as a razor. Thousands in use. Rigidly guaranteed.

Fits Any Light Socket

TEN DAYS' FREE TRIAL

If your hardware or electrical dealer can't supply you, write for interesting booklet, or order from this ad. Send no money—pay postman \$8.75. Return it in ten days if not satisfactory. State whether 110, 220 or 32 volt current is used.

Dealers and Representatives Wanted
Belle City Appliance Co., 1022 12th St., Racine, Wis.

EASY \$100 a Week FUGO FIRE EXTINGUISHER



Unusual opening for live agents in every locality. Make \$5000 or more a year—easily. Fugo—the instantaneous automatic fire extinguisher—is needed and wanted in every home, store, theatre, garage, shop, school, automobile, etc. Cheapest fire protection available today. Within reach of all.

1 Qt. Size \$5.00 2 Qt. Size \$7.50

Recharged in a jiffy
Amazing 30-second demonstration clinches sale—each one sold sells others. Territory going fast. Write at once for wonderful proposition that will make you big money.

THE NATIONAL FORMETAL CO.
6535 Metta Ave., N. E. Cleveland, Ohio



A Genuine \$2 Knife for \$1.18 Postpaid

Handy shaped Blade makes this knife best for mechanics, sportsmen and farmers; light but strong; re-sharpened easily. Stag handle. German silver finish; blades file tested, hand forged from razor steel and warranted.

Direct at Factory Prices

Sample \$1.18 3 for \$3.00 Postpaid

Hand Forged Razor Steel Blades

Send for our 100-page FREE List and "HOW TO USE A RAZOR."

Maher & Grosh Co.
106 A St., Toledo, Ohio

—FREE—

\$5.00 Book of Blue Prints Showing 46 PRIZE PROJECTS with \$35. Outfits.

The only machine that you can tilt the table to 45° without removing insert. Big advantage on pattern work.

S&B 8" Combination Saw 18 Tools In One

Sent to You on 15 days approval

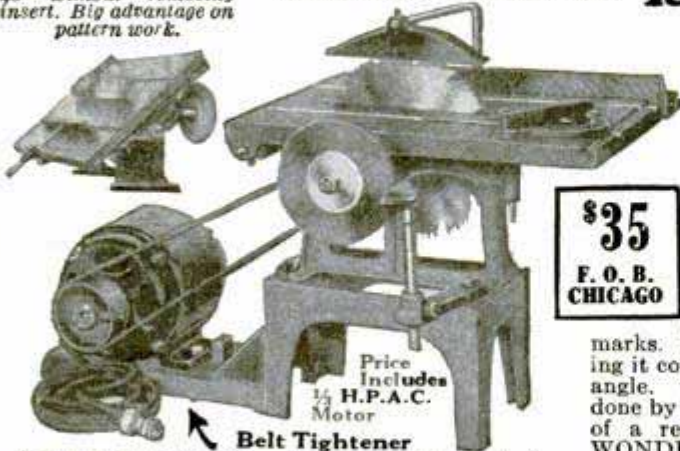

\$35
F. O. B. CHICAGO

Price includes 1/3 H.P.A.C. Motor

Belt Tightener

1/3 H. P. Motor-40°-100% overload Double Shaft Extension

18 Tools in One—Greatest Machine You Ever Saw

THE S&B 8-in. COMBINATION SAW (18 tools in one) is the ideal machine for the shop, factory or the home; will rip, cross cut, bevel, miter, mortise, groove, drill, tenon, grind, rabbet, buff and polish. Motor is mounted on a base that is a part of the machine proper. Run from any light socket, also provides power for other purposes when the saw is not in use. Complete with attachments and price includes 1-3 H. P. Motor, 60-cycle, 110-Volt A. C. Price \$35.00 F. O. B. Chicago. Shipping Weight 100 lbs.

(Planer attachment to fit on table top will smooth pieces up to 2 in. wide, \$10 extra.)

SCOTT-BANSBACH MACHINERY CO.
130 So. Clinton St., Dept. 97, CHICAGO, ILL.

Write for Complete Illustrated Folder—Dealers Wanted.

Money Back Guarantee

12" Band Saw

12" Band Saw

Positively a sensation and at this LOW PRICE you can NOW do the 1001 things you wanted quick and easy. This 12" BAND SAW has a tilting table, with Miter and sturdily built. Ideal for the shop or home.



S&B Scroll Saw

Here is the outfit of practical usefulness. Will cut wood and light metal true to marks. Table top tilts to 45 degrees, making it convenient and easy to cut at proper angle. Thousands of jobs can NOW be done by any man or boy with the accuracy of a real mechanic. This S&B WONDER SCROLL SAW is free from vibration.

\$35.00 F.O.B. Chicago without Motor
Scroll Saw



Delights Every Boy

\$15.00

F. O. B. CHICAGO
1/3 H. P. A. C. Motor \$15 extra

A Whole Winter's ENTERTAINMENT for \$5.25

COLUMBIA RECORDS

The world famous electric recorded records. None better — made to last a life time. No surface noise or scratch. These Old Time Tunes will fill your winter evenings with real entertainment.

- 15290—Two Little Girls in Blue
The Fatal Rose of Red75
Sung by Leo Boswell
- 15288—Home Sweet Home
Where the River Shannon Flows .75
Sung by McMichen's Melody Men.
- 15201—A Corn Licker Still in Georgia.
Parts 1 and 275
Sung by McMichen, Puckett, Tanner, Stokes, Norris, Nichols and Brown.
- 15140—A Fiddlers' Convention in Georgia.
Parts 1 and 275
Played by McMichen, Tanner, Puckett, Nichols, Norris and Lcyne.
- 15218—Little Marian Parker.
Where Is My Mama?75
Sung by Al Craver and Charlie Wells.
- 15074—Bully of the Town.
Pass Around the Bottle75
Gid Tanner and His Skillet Lickers With Riley Puckett.
- 15189—Wednesday Night Waltz.
Good Night Waltz75
Leake County Revelers.

SEND NO MONEY—Unless you wish. Records will be shipped C. O. D., 75c each or all for \$5.25 plus C. O. D. charges. Send only 75c each if you send cash. No extra charge on cash orders—postage paid.

GUARANTEE—If not entirely satisfied send records back to us and get your money back, including postage.

ST. LOUIS MUSIC CO., St. Louis, Mo., Dept. 829. Send records I have marked X. Send them C. O. D., or I am enclosing money order (state which you prefer).

Name.....
Town.....State.....
Street or R. F. D.....

42 Miles on 1 Gallon

Amazing New Vapor Gas Saver

For All Make Autos. Spare or full time Agencies Wanted. Big Profits.

1 SENT TO INTRODUCE

MOISTURE does it. Increases mileage 1/4 to 1/2. Faster getaway. More power. Higher top speed. Eliminates hard carbon from engine. **CRITCHLOW, Inventor, SA-805, WHEATON, ILL., U.S.A.**

AGENTS Make big earnings, taking orders for made-to-individual measure suits at less than ready-to-wear prices. Giant Chicago wholesale house makes world's greatest values at \$23.50 and \$29.50. Your profit \$4 and \$5 per sale in advance—we deliver and collect. No experience needed, work full or part time.

FREE OUTFIT Send no deposit. Write for details of our unique money-making plan. Nothing like it ever before offered. Act at once.

GENERAL TAILORING CO., DEPT. 12A, 529 South Franklin St., Chicago



BUILD YOUR OWN CLOCK WITH OUR HELP

Profitable spare time work for fall. Turn idle hours into welcome dollars by building clocks from our instructions. We furnish plans, instructions, blue prints, works, dials, and all materials at surprising low prices. You make a big profit building artistic clocks for your friends.

Banjo Clocks, Mantel Clocks, works as low as \$1.65. Beautiful Grandfather Clocks with chimes. All styles, all prices.

ASK FOR OUR ATTRACTIVE FREE BLUEPRINT PLAN AND CATALOG

AMERICAN CHIME CLOCK COMPANY
1670V Ruffner Street, Philadelphia

You Can Easily EARN \$150 to \$300 MONTHLY Profits

30 DAYS TRIAL

COSTS Only \$16 MONTHLY



Pays for itself—No Expenses to You

Bigger Profits for You Barnum cleared \$350 the first month. Wilson cut his electric bills in two and doubled his business. Start a money-making business of your own—Make Battery Charging the biggest Money-Maker in your shop.

Auto and Radio Battery Business Good Now You can do it with HB 8 Hour Battery Service. Pulls trade from other shops because you give a far better charge in one-third the time required by others—only costs you half as much for current as old slow methods. No expensive bulbs to burn out. Start Now.

30 DAYS' TRIAL AT OUR RISK

Pays for Itself and a Profit Besides

Silent Twin Air Compressor

Where they stop they buy. Bring 'em to your Shop with Air Service better than the other fellow's. HB Silent Twin Air Service will do it. Only \$11 for a few months. Increased business easily pays for it. Check No. 2 in coupon below.

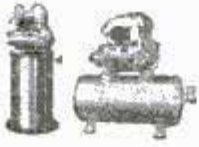

Electric Test Bench

The best paying Auto Electrical work is now available to small shops with this new low-priced HB Test Bench—that does better work and makes more tests than many benches costing \$100 to \$150 more. Costs only a small part of the extra profits it brings. \$20 monthly. Check No. 3 below for particulars.



Paint 'em for \$15 and sell 'em for \$100 more. That's why HB Paint Spray is going into hundreds of Garages. Does the work of five brush painters. Big profits in contracting painting—interior decorating—or production work. No experience necessary. Check No. 4 to get more details on this profit maker.



HB Equipment built in HB Factories does more and costs less. Any item can be had on 30 Days' Trial and easy monthly terms. It pays for itself with a handsome profit for you.

HOBART HB BROTHERS
Successful manufacturers ~ since 1893 ~

BOX M128 TROY, OHIO

Tear Off and Mail Today

Hobart Brothers, Box M128, Troy, Ohio.
Send me complete information on the items I've checked—your thirty day trial offer—easy payment terms—information on how HB equipment will increase my earnings.
No. 1 () HB 8 Hour Battery Charger.
No. 2 () HB Air Service.
No. 3 () HB Test Bench.
No. 4 () HB Paint Spray.

Name..... Address.....

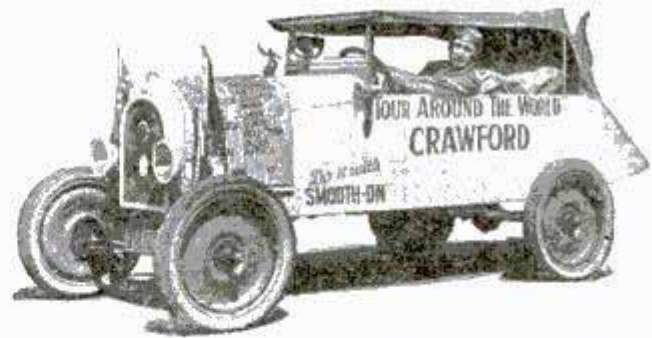

150,000 MILES IN 7 YEARS
—never without a 1-lb. can of

SMOOTH-ON No. 1

"CONTINUOUS TOURIST" CRAWFORD has driven this flivver since 1921—in Siberia, China, Indo-China, India, Africa and Australia—and has found Smooth-On No. 1 indispensable. In rattling over ice in Siberia, and elsewhere on rough stretches without roads, Smooth-On No. 1 was the only thing that would keep the nuts and grease cups tight, and stop radiator leaks. In Indo-China, when the circulating pump broke, a Smooth-On repair got the car back to civilization.

In Mr. Crawford's case, not one extra pound of weight can be carried, but he would never be without Smooth-On.

Get Smooth-On No. 1 in 7-oz., 1-lb. or 5-lb. tins at any hardware store or if necessary direct from us.

FREE

THIS booklet tells how to stop not only water leaks in radiators, cracked water jackets, and at loose hose connections, but also how to stop gas leaks from the tank, gasoline lines and exhaust system, and oil leaks at gaskets and at cracks in crank or gear case. It also tells how to make headlight posts, nuts, hub caps and bolts and grease cups stay tight, and shows dozens of simple money saving Smooth-On repair jobs. Sent free if you return the coupon.



Write for **FREE BOOK**



Do it with SMOOTH-ON

SMOOTH-ON MFG. CO., Dept. 37,
574 Communipaw Ave., Jersey City, N. J.

Please send the free Smooth-On Repair Book.

Name.....

Address.....

A Brand NEW INVENTION!

**OPENS NEW FIELD FOR AGENTS
PAYS \$90 TO \$125 WEEKLY
BIG PROFITS ON EVERY PHONE
AND ELECTRIC IRON**



Sell only device in existence that prevents kinking, snarling and tangling of telephone and electric iron cords.

Nothing in World Like NEVERKNOT

Housewives and business men buying 1 to 50. Large companies equipping all phones. Sales of 10 to 150 with immense profit to salesman not uncommon. Used on telephones of Federal Reserve Bank, General Electric Co., Mellon National Bank and many other big companies.

NEW KIND OF CORD SET FREE

This new kind of ironing cord automatically coils itself out of the way, yet every inch of its seven feet is available for use. A new kind of switch plug prevents scorching and saves electric bills. THIS SET IS A "GOLD MINE" FOR HOUSE-TO-HOUSE WORKERS FOR YOU HAVE NO COMPETITION. Ladies buy instantly as they see it saves its own cost. This complete Neverknot Switch Plug Cord Set and a Neverknot for your telephone cord are given to you free at once if you work for us. Agents without experience are making \$90 to \$125 weekly with these new and different inventions so don't delay. Send now for free proposition.



Neverknot Co., Dept. 12-V, 4503 Ravenswood, Chicago, Ill.

You Can Play a Pan-American Clarinet!



Everybody likes a Clarinet, the sweetest singer of them all. Clarinet players are in constant demand, at big salaries. The Pan-American Clarinet is a beautiful solo instrument for home, church, school, or private entertainment. Famous band leaders learned the Clarinet first! You can! They are so easy to blow—and to learn to play.

Remarkably LOW-PRICED

Pan-American Clarinets are called "the greatest value for the money on the market" by America's foremost band and orchestra leaders. Tested and found superior by the leading artists. Send coupon below today for our remarkably low price offer. Easy Payment Plan—and catalog of complete line of Pan-American Band and Orchestra instruments.

FREE TRIAL OFFER

SEND NO MONEY MAIL COUPON

The Pan-American Band Instrument & Case Co., Elkhart, Indiana Dept. G-23

YES—Send me complete information on PAN-AMERICAN Clarinets and other band instruments. I would like to learn to play.....(instrument)

Name.....
Address.....
My local Music Dealer is.....

"I would not part with it for \$10,000"

So writes an enthusiastic, grateful customer. In like manner testify over 100,000 people who have worn it.

The Natural Body Brace

Comfortable and Easy to Wear

Overcomes Weakness and Organic Ailments of women and men. Develops erect, graceful figure, brings restful relief, comfort, health and strength.

Not Sold in Stores—

Made to Measure—Makes work easy and walking a pleasure; replaces and supports misplaced internal organs; reduces enlarged abdomen; straightens and strengthens the back; corrects stooping shoulders; develops lungs, chest and bust; relieves backache, curvatures, nervousness, ruptures, constipation.

Get Well—Stay Well Write today for illustrated booklet, measurement blank, etc., and read our very liberal proposition.

HOWARD C. RASH, Pres., Natural Body Brace Co. 123 Rash Building - - SALINA, KANSAS



30 Days Free Trial

Photos ENLARGED

Size 16x20 inches Same price for full figure or bust, groups, landscapes, or pet animals etc., enlargements of any part of group picture. Safe return of your own original photo guaranteed.

98c

SEND NO MONEY Just mail photo or snapshot (any size) and within a week you will receive your beautiful life-like enlargement size 16x20 in. guaranteed fadeless. Pay postman 98c plus postage or send \$1.00 with order and we pay postage. **SPECIAL FREE OFFER** With each enlargement we will send FREE a hand-tinted miniature reproduction of photo sent. Take advantage now of this amazing offer—send your photo today.

UNITED PORTRAIT COMPANY 1652 Ogden Ave. Dept. 369 Chicago, Ill.



AGENTS! DEALERS! BIG MONEY IN RADIO

Demonstrate Metrodynes at home. Big profits. Demonstrating set on 30 days' free trial. Write for money making proposition.

METRO ELECTRIC CO 2161 N. California Ave. Dept. 23, Chicago, Ill.

MODEL AIRPLANES

FOR XMAS—BUY THIS \$5 "AIR-MAIL EXPRESS" Complete Construction Set

No. 211—(Illustrated)—Wing spread 33 in.; length over-all 22 in. Made a record flight of 53 seconds, flying over 850 feet. Body is balsa wood, lacquer finish; wings adjustable, releases when landing; special snap fasteners hold motor in place; 9 in. finished propeller, detachable. Set includes panels, ribs, landing gear, etc., cut to shape; wing covering; dope—everything needed, packed in box with full instructions and geared winder. **Price, \$5.00.**

No. 211A—Beautifully finished, with silk wings, ready to fly, \$10.00.

"SKY-HAWK" Model
No. 20—Flies fast and far. Made of balsa wood; main wing lacquer finish; yellow stabilizer; green rudder. Detachable metal hanger; wire landing gear, with celluloid wheels. Length \$ 19 in. Packed in box with flying instructions. Postpaid. Other models from 25c to \$25.

Clip this adv. and enclose 10c for big new catalog P.

BROADFIELD AEROPLANE CO. Hempstead, N. Y.



PUT THIS WORKSHOP IN YOUR HOME FREE For 10 Days-No Deposit!

A New and Improved Workshop

Here is a workshop built to a standard of perfection—accurate in operation—most durable in construction—easy to operate. It is absolutely dependable and will withstand severe constant service. Try it for ten days at our expense and you will be convinced of its superiority.

Suitable for Carpenters, Home Workers, Pattern Makers, Etc.

Furniture manufacturers use MAC—the Popular Mechanic Workshop—for making furniture models. Manual Art Schools use it for instruction. Home workers use it for pleasure and profit. Carpenters use it for making repair parts, spindles, chair legs, cabinets. It is ideal for making all kinds of furniture.

mac
THE POPULAR MECHANIC

URNS, RIPS,
CROSSCUTS, DRILLS,
SURFACES, POLISHES,
GRINDS, CUTS SCROLLS.

**A PERFECT
WORKSHOP**

The Lowest Price for Such a Sturdy, Complete Workshop

MAC, THE POPULAR MECHANIC, represents the utmost in value and dependability. Now you can have an accurate, practical workshop at a big saving. Once you use MAC you will be convinced of its superior qualities. That's why we want you to try it for 10 days at our expense.

- Model 70—As illustrated \$135.00
- Model 50—As illustrated—without Drill or Glue Pot 105.00
- Model 20—As illustrated—without Drill, Glue Pot, Circular and Jig Saws 75.00

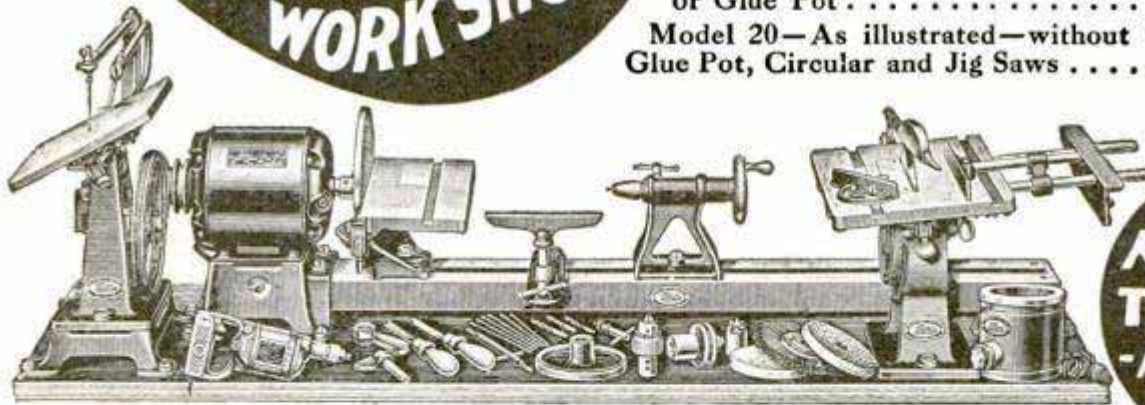

**12
MONTHS
TO PAY
-NO MONEY/
DOWN!**

MODEL NUMBER 70
Wagner 1/4 H. P. Motor, 8 1/2" Sander Disc, Circular Saw, Jig Saw, 30" Lathe with 9" swing, Black & Decker 3/4" Drill, Electric Glue Pot. Accessories include 5" Dia. Face Plate, Spur and Cup Type Wood turning Centers, 3/4" Three-jaw Geared Chuck, Arbor and Flange, 6" Cotton Buffs, 6" Wire Brushes, 5" Emery Wheel, Adjustable Tool Rest and Tool Supports with Bed Clamp, Two Turning Tools and Socket Wrenches.

A YEAR TO PAY!

MAC, THE POPULAR MECHANIC WORKSHOP, may be purchased as low as \$5.40 per month—within the reach of anyone. You use it as you pay. **Send No Money** We will send this equipment to you on ten days free trial. If you decide to keep MAC—send a small deposit—if not—send it back. There will be no obligation on your part. Could any offer be more liberal? **Send the Coupon Now** Right now, before it slips your mind, send the coupon for Ten Day Free Trial or for MAC literature. You take no chances whatsoever in sending for MAC—for MAC is guaranteed to please or you may send it back to us. **Send Coupon Now!** Dealers: Write for our Proposition!
Midland Appliance Corporation
Dept. R10 219 N. Michigan Ave., Chicago

MIDLAND APPLIANCE CORPORATION
Dept. R10, 219 N. Michigan Ave.,
Chicago, Illinois.

Kindly send literature with full particulars of your unusual No-Deposit Trial Offer. Also tell me about your low prices and easy payment plan.

Send Model No. I will try it for 10 Days and if I decide to keep it, agree to remit in accordance with your terms.

Name.....

Address.....

City..... State.....

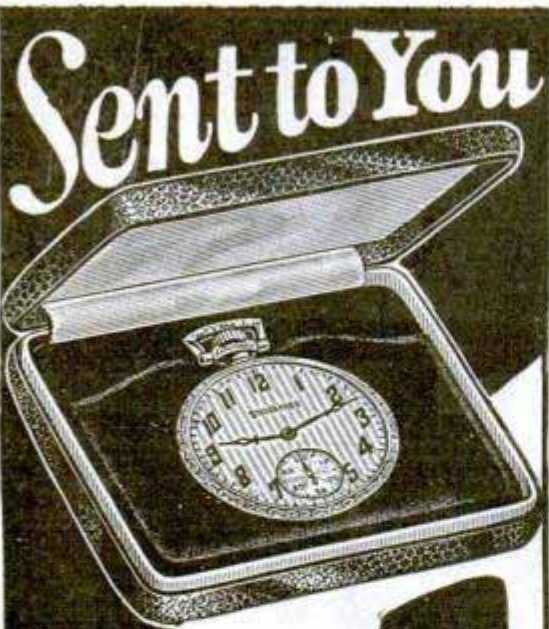

Sent to You

for Only \$1

A Sensational Offer!
 Only \$1.00 and you get the famous 21-Jewel Studebaker Watch direct from factory. Balance in easy monthly payments!
 Lowest prices ever named on similar quality. You save 30% to 50%.

DOWN

21 JEWEL-Extra Thin
STUDEBAKER
The Insured Watch

Ladies' Bracelet Watches, Men's Strap Watches. Diamonds and Jewelry also sold on easy payments. This company is directed by the Studebaker Family of South Bend, known throughout the world for three-quarters of a century of fair dealing. 100,000 satisfied customers. Send coupon at once for full particulars of our amazing offer. Studebaker 21-Jewel Watches have 8 adjustments—heat, cold, isochronism and 5 positions. An insurance policy is given free—insuring the watch for your lifetime!

WRITE FOR FREE CATALOG!

A copy of our beautiful, new, six-color catalog will be sent free to anyone sending the coupon below. Shows 80 magnificent, new Art Beauty cases and dials. Latest designs in yellow gold, green gold and white gold effects. Exquisite thin models. Masterpieces of the watchmaker's craft.

Special Offer: Watch Chain FREE

To those who write at once for free Catalog we will include particulars of our special offer of an exquisite Watch Chain free. This offer is for a limited time only. Send coupon at once—before it expires.

Studebaker Watch Co.
 Directed by the Studebaker Family—three-quarters of a century of fair dealing
WATCHES—DIAMONDS—JEWELRY

Dept. N907 South Bend, Ind.
 Canadian Address: Windsor, Ont.

SPECIAL OFFER COUPON

STUDEBAKER WATCH COMPANY
 Dept. N907 South Bend, Indiana

Please send me your free Catalog of Advance Watch Styles and particulars of your \$1 down offer

Please send me Jewelry Catalog free.

Name.....

Street or R. F. D.....

City or Post Office.....

State.....

The New Victoreen "B" Power Supply

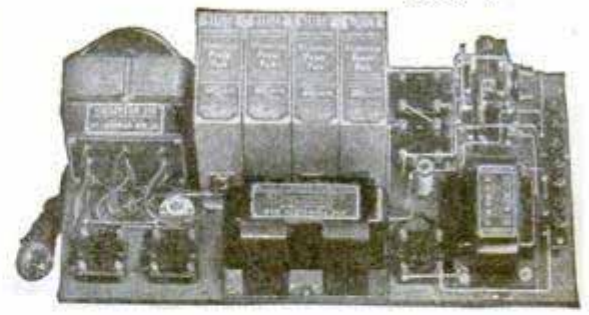

A super radio achievement embodying vital improvements which make it the most remarkable power supply on the market. Makes any good set better—produces marvelous tone quality.

Uses the new U. X. 250 Tube. Two voltage regulator tubes assure a constant voltage potential of 90 and 180 volts, thus making possible the use of definite known values of "C" voltage. As a result, fluctuation in the output circuit cannot affect the first audio and thus cause distortion.

Four voltages are supplied—0-90 variable, 90, 180 and 450 volts constant potential.

FREE BLUE PRINTS

and full constructional data on the new Power Supply, and the new Victoreen A. C. and D. C. Circuits are yours for the asking. Write for the ones you want.

GEO. W. WALKER CO.
 Merchandisers of Victoreen Radio Products
 2825 Chester Ave., Cleveland, Ohio

Victoreen

Quality Radio Parts

STARTLING ADDING PENCIL

INVENTION Adds-Calculates. Absolutely accurate, Guaranteed

MONEY MAKER Turn spare time into money just showing it to friends. Get sample and literature now

ADD-O-GRAPH CO., Dept. 24, SALTILLO, MISS.

MASON, FENWICK & LAWRENCE
PATENT LAWYERS

600 F St., N. W., Washington, D. C.

Estb. over sixty years. Send sketches.
 Electrical and Chemical Inventions carefully handled. Practice before the U. S. Courts and the Patent Office. Prompt and careful service.

TRADE MARKS REGISTERED

THREAD CUTTING LATHE

A REAL Lathe. 9' swing; 30' between centers. Speedy and accurate. Special attachments and tools available.

12' Band Saw
 Powerful, practical. Not a toy. Has tilting table. **Price \$30**
 Bronze bearings, only

Rossbacher Machine Co., 1516 Fernwood Ave. TOLEDO, OHIO

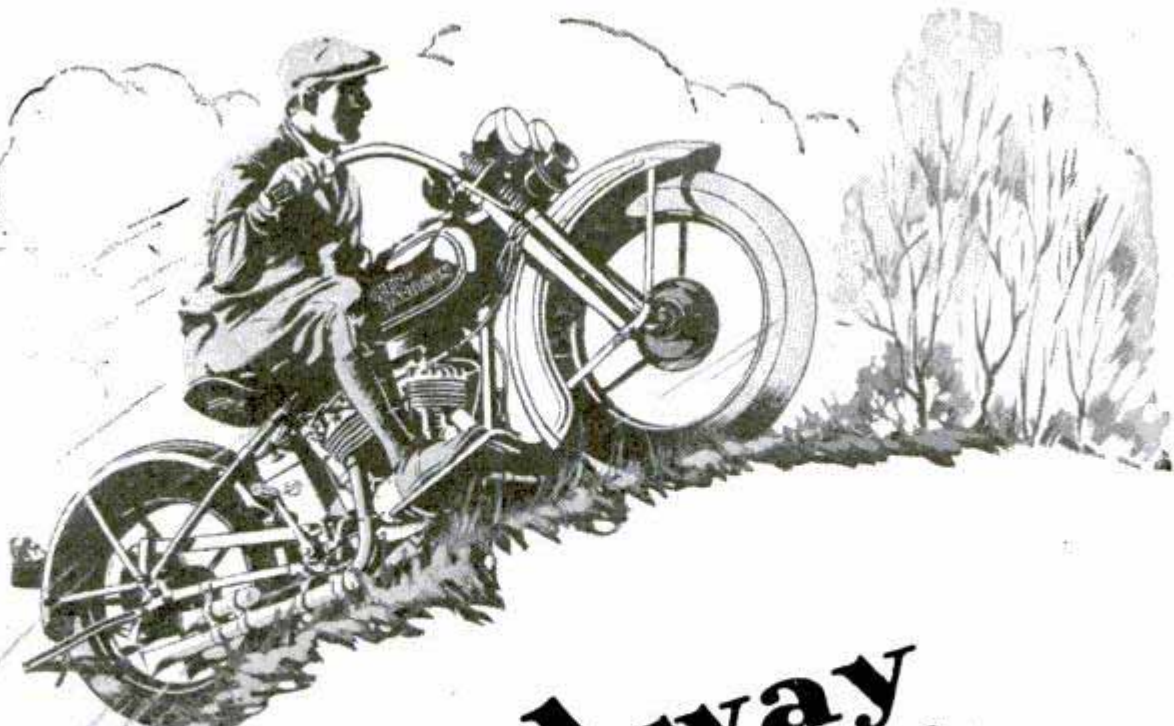

Soar Away over the hills!

BREEZE up the longest grades, shoot down the straightaways on this the new Harley-Davidson "45" Twin!

Note its wonderful balance—the surging power of its motor—its silent speed—the velvety sureness of its front and rear brakes. And it sells at only \$290, f. o. b. factory!

Here is the ideal solo mount—the Harley-Davidson that the motorcycle world was waiting for! See it at your dealer's today. Ask about his Pay-As-You-Ride Plan.

Mail the Coupon for
illustrated literature.

HARLEY-DAVIDSON Motorcycles

HARLEY-DAVIDSON MOTOR CO.
Dept. P, Milwaukee, Wis.

Interested in "45" Twin, Big Twins,
 Single. Send literature.

Name.....

Address.....

SILVER ACE Models fly

800 feet!

CONVERTIBLE [Monoplane • Biplane • Seaplane

Biplane Seaplane

The perfect Xmas Gift

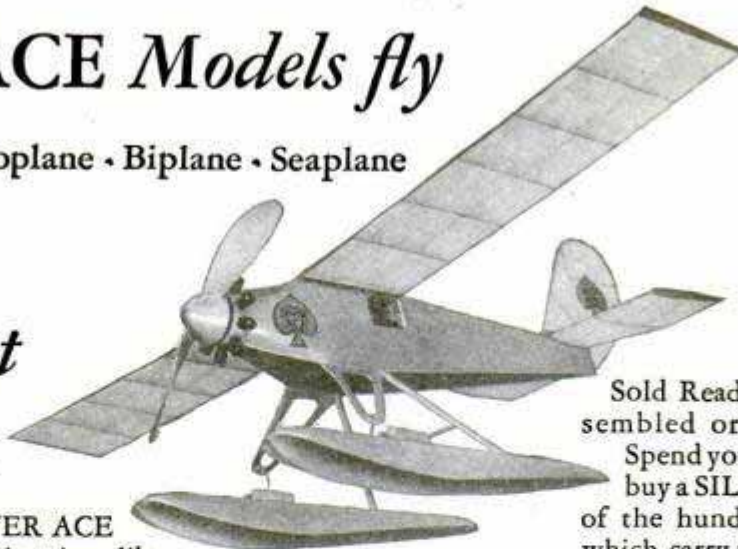

The vast superiority of SILVER ACE MODELS is due to the fact that they, like the big planes today, represent a great advance in expert engineering.

Their beauty will thrill you, and they have the *design, power* and very *light weight* to outfly any scale model you ever owned.

Yet SILVER ACES are simple to construct and amazingly strong for their feather weight. The 30-inch wing span monoplane weighs only 3 3/4 ounces. Its silk covered demountable wings, semiflexible propeller and landing gear resist shock.

You can build a cabin monoplane of the Ryan-Stinson-Fairchild type, or of the Spirit of St. Louis, as you prefer, with a day or two of fascinating work. Add an extra pair of wings or SILVER ACE pontoons and you can still fly your model over snow and ice, for it is waterproof.

Sold Ready-to-Fly, Partly Assembled or Knocked Down.

Spend your money wisely and buy a SILVER ACE from one of the hundreds of best stores which carry them. If your dealer does not sell them, remit to us with 50c extra for shipping.

PRICES:

Specify Spirit of St. Louis or Cabin Type

Ready-to-Fly Monoplane	\$12.50
Partly Assembled	9.00
Knocked Down	8.00
Contest Kit	5.00
Extra Pair of Wings	3.50
Pair of Pontoons	4.00
Catalogue10

C. O. D. orders not accepted

THE AERO MODEL COMPANY, 329 Plymouth Court, Chicago

CANARIES GOLD FISH, CAGES AND SUPPLIES

Big bargains in guaranteed singing Canaries, Parrots and Fancy Birds. Complete stock of cages, supplies and remedies. Write today for FREE instructive booklet and catalog. CHICAGO BIRD & CAGE CO., 422 S. State Street, Dept. 192, Chicago, Ill.

FOR HIS CHRISTMAS

Bartlett DROP-FORGED Compound Lever Snips \$2.70 to \$9.50

Made of high-grade Crucible Tool Steel, accurately tempered. Cuts metal up to 18 gauge easily. 7-in. size just right for household use. 7-in. stamped, \$2.70
8-in. forged, \$4.00 10-in. forged, \$6.00
12-in., \$8.00 14-in., \$9.50
Your dealer has them or can get them from his jobber. If he will not we will ship prepaid in U. S. at above prices.



FOLDER ON REQUEST

Bartlett Mfg. Co., 420 E. Lafayette Ave., Detroit, Mich.

WRIST ADDING MACHINE



Size of a Dollar, Hang it on Watch Fob, etc. Capacity Ten Thousand. Push keys with pencil. Agents sell hundreds per day and make 50%, it sells to every body. Sample \$1.00 prepaid to first Agents. 10 days money back guarantee.

E. R. HANSON CO.
REDSTONE, MONT.

\$244.00 PROFIT One day!

R. W. Helmer reports this from Minnesota on **Trippe Auto Reflectors**. Wonderful device—100% more light and no glare! Pocket big money waiting for you now. Whirlwind seller, makes astounding demonstration—low cost—agents cleaning up—300% profit—big repeater—sells on sight. Over 300 sets sold in one town of 2,000 people. GET YOUR FREE SAMPLE OFFER TODAY—Wire or write.

38,000 CANDLEPOWER NO GLARE!

AERIAL ELECTRIC CO.
327 W. Ohio St.
CHICAGO

CRESCENT WOOD WORKING MACHINES

Portable Bench Machines for the small shop; operate from any light socket; are sturdily built for accurate, efficient work. Take them out on the job and cut labor costs.

Heavy Equipment for factories,—large line of modern, highly efficient machines for quality-quantity production. THE CRESCENT MACHINE CO., 93 Columbia St., LEETONIA, O.

Send for FREE BULLETINS

CHARMING UNUSUAL

Santa Maria
Size—26" x 12" x 26"

Make them for your friends. Cash in on **BIG PROFITS**. It's easy to make a SANTA MARIA or MAYFLOWER model sailing ship to ornament Living Room, Den or Vacant Corner.

Hull is completely assembled, ready to rig and paint—all sails, shields and flags fully picture decorated in beautiful colors.

Complete instructions and colored picture furnished to enable you to finish correctly. Only one of its kind made: No carpenter work necessary: Nothing to cut out: Everything complete and can be finished in a few hours: Excellent pastime.

Plus a small parcel post charge. Send check or money order and mention ship desired. Satisfaction is guaranteed.

\$4.45

GIFT CRAFTERS

1639 Mascher & Turner Sts.
PHILADELPHIA, PA.

WORKACE Electric WOODWORKER

Complete Outfit Including Planer, Saw, Lathe and Electric Motor and Many Useful Attachments

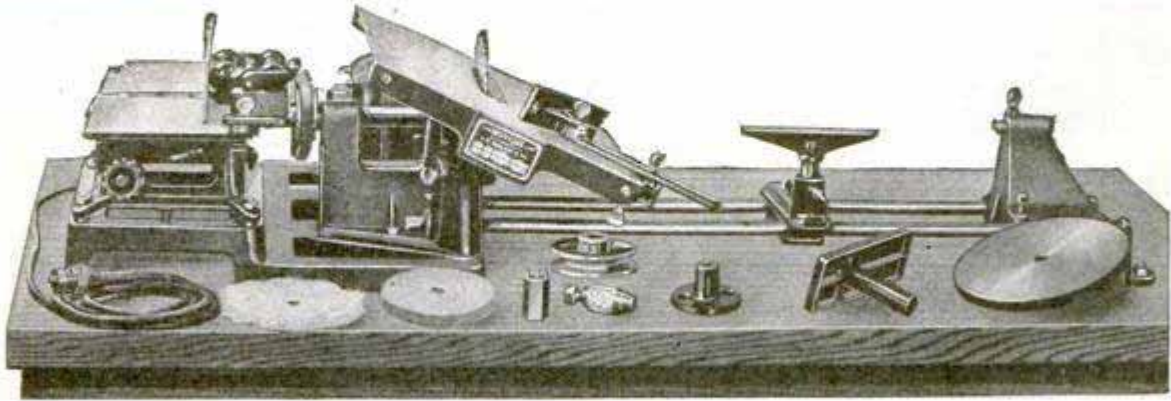

Fast-Accurate-Complete *For every kind of woodworking operation*

A COMPLETE all-electric shop to use at home or in business. Costs a lot less than most other outfits. Fast and accurate for every kind of

woodworking operation: Planing, sawing, turning, drilling, grinding, sanding, buffing, etc. Saves time, does better and cleaner work, too.

Amazing low price **\$89** Easy Terms—

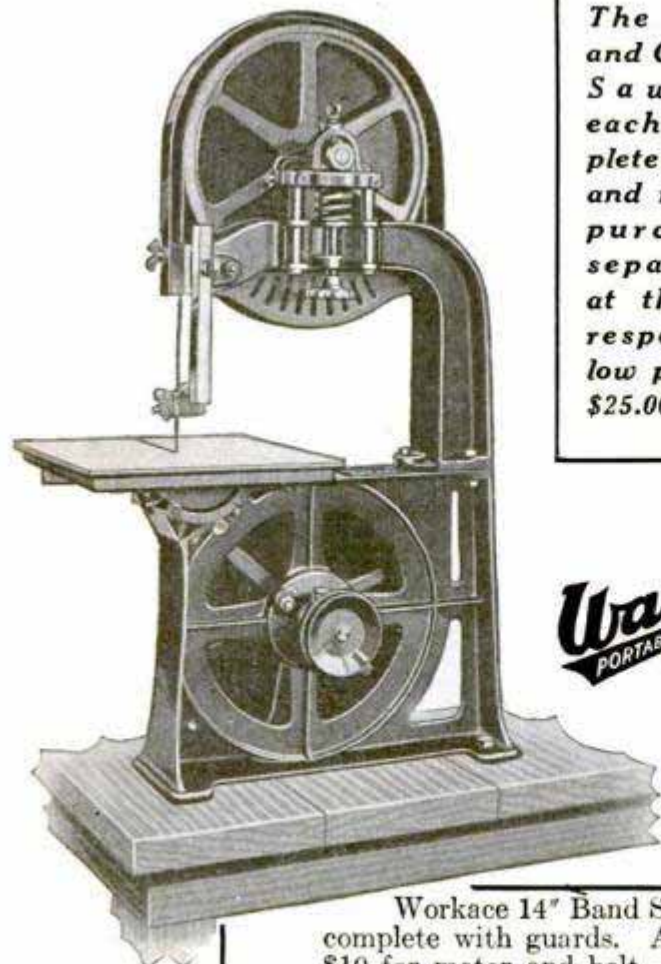

The Planer and Circular Saw are each complete units and may be purchased separately at the corresponding low price of \$25.00 each.

Wallace
PORTABLE MACHINES

Workace 14" Band Saw complete with guards. Add \$19 for motor and belt. **\$75**

The Workace Woodworker has power, strength, and capacity to handle any job quickly and economically—mitering, tapering, rabbeting, beveling, slotting, turning, cross-cutting, ripping. Every unit works from motor—parts are sturdy and well fashioned. The WALLACE GUARANTEE assures replacement of defective parts for one year.

Become an expert woodworker—make tables, chairs, stools, screens, lamps, lattices, fences, cabinets, doll houses, book cases, chests—make woodworking your hobby and turn it to profit, as hundreds do.

Terms are all in your favor. Small down payment brings the Workace COMPLETE. Monthly payments so small you'll never miss the money. Many pay for their Workace out of profits it makes—so can you.... Send the coupon now and we'll see that you get full details immediately.

J. D. Wallace & Co.,
Adams Street and California Ave.,
Chicago, Ill.

That Workace Electric Woodworker sure looks good to me. I want to know all about it, including your easy terms, right away.

Name..... City.....

Address..... State.....

Am interested in the band saw, too.



“What would I do if I lost my job?”

SUPPOSE your employer notified you tomorrow that he didn't need you any longer? Have you any idea where you could get another position?

Don't have this spectre of unemployment hanging over your head forever. Train yourself to do some one thing so well that your services will be in demand. Employers don't discharge such men. They promote them!

Decide today that you are going to get the specialized training you must have if you are ever going to get—and keep—a real job at a real salary. It is easy if you really try.

Right at home, in the odds and ends of spare time that now go to waste, you can prepare for the position you want in the work you like best. For the International Correspondence Schools will train you just as they are training thousands of other men—no matter where you live—no matter what your circumstances or your needs.

Mail the Coupon for Free Booklet

INTERNATIONAL CORRESPONDENCE SCHOOLS

“The Universal University”

Box 5581-F, Scranton, Penna.

Without cost or obligation, please send me a copy of your booklet, “Who Wins and Why,” and full particulars about the subject before which I have marked X in the list below:

BUSINESS TRAINING COURSES

- | | |
|--|--|
| <input type="checkbox"/> Business Management | <input type="checkbox"/> Business Correspondence |
| <input type="checkbox"/> Industrial Management | <input type="checkbox"/> Show Card Lettering |
| <input type="checkbox"/> Personnel Management | <input type="checkbox"/> Stenography and Typing |
| <input type="checkbox"/> Traffic Management | <input type="checkbox"/> English |
| <input type="checkbox"/> Accounting and C.P.A. Coaching | <input type="checkbox"/> Civil Service |
| <input type="checkbox"/> Cost Accounting | <input type="checkbox"/> Railway Mail Clerk |
| <input type="checkbox"/> Bookkeeping | <input type="checkbox"/> Mail Carrier |
| <input type="checkbox"/> Secretarial Work | <input type="checkbox"/> Common School Subjects |
| <input type="checkbox"/> Spanish <input type="checkbox"/> French | <input type="checkbox"/> High School Subjects |
| <input type="checkbox"/> Salesmanship | <input type="checkbox"/> Cartooning |
| <input type="checkbox"/> Advertising | <input type="checkbox"/> Illustrating |
| | <input type="checkbox"/> Lumber Dealer |

TECHNICAL AND INDUSTRIAL COURSES

- | | |
|--|---|
| <input type="checkbox"/> Architect | <input type="checkbox"/> Automobile Work |
| <input type="checkbox"/> Architectural Draftsman | <input type="checkbox"/> Airplane Engines |
| <input type="checkbox"/> Building Foreman | <input type="checkbox"/> Plumber and Steam Fitter |
| <input type="checkbox"/> Concrete Builder | <input type="checkbox"/> Plumbing Inspector |
| <input type="checkbox"/> Contractor and Builder | <input type="checkbox"/> Foreman Plumber |
| <input type="checkbox"/> Structural Draftsman | <input type="checkbox"/> Heating and Ventilation |
| <input type="checkbox"/> Structural Engineer | <input type="checkbox"/> Sheet-Metal Worker |
| <input type="checkbox"/> Electrical Engineer | <input type="checkbox"/> Steam Engineer |
| <input type="checkbox"/> Electrical Contractor | <input type="checkbox"/> Marine Engineer |
| <input type="checkbox"/> Electric Wiring | <input type="checkbox"/> Refrigeration Engineer |
| <input type="checkbox"/> Electric Lighting | <input type="checkbox"/> R. R. Positions |
| <input type="checkbox"/> Electric Car Running | <input type="checkbox"/> Highway Engineer |
| <input type="checkbox"/> Telegraph Engineer | <input type="checkbox"/> Chemistry |
| <input type="checkbox"/> Telephone Work | <input type="checkbox"/> Pharmacy |
| <input type="checkbox"/> Mechanical Engineer | <input type="checkbox"/> Mining Engineer |
| <input type="checkbox"/> Mechanical Draftsman | <input type="checkbox"/> Navigation <input type="checkbox"/> Assayer |
| <input type="checkbox"/> Machine Shop Practice | <input type="checkbox"/> Iron and Steel Worker |
| <input type="checkbox"/> Toolmaker | <input type="checkbox"/> Textile Overseer or Supt. |
| <input type="checkbox"/> Patternmaker | <input type="checkbox"/> Cotton Manufacturing |
| <input type="checkbox"/> Civil Engineer | <input type="checkbox"/> Woolen Manufacturing |
| <input type="checkbox"/> Surveying and Mapping | <input type="checkbox"/> Agriculture <input type="checkbox"/> Fruit Growing |
| <input type="checkbox"/> Bridge Engineer | <input type="checkbox"/> Poultry Farming |
| <input type="checkbox"/> Gas Engine Operating | <input type="checkbox"/> Mathematics <input type="checkbox"/> Radio |

Name.....

Address.....

City..... State.....

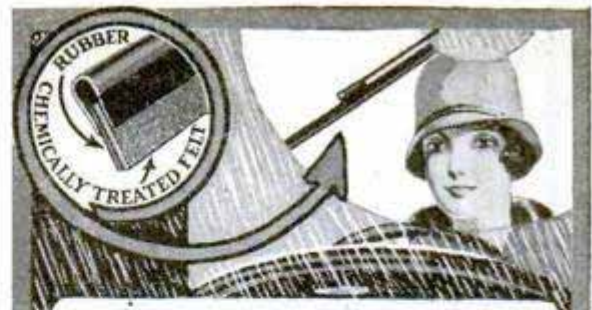

Ends continuous wiping. RUBBER takes off dirt, FELT puts on chemical that keeps vision area clear for hours, in rain, fog, mist or snow.

CHRISTEN'S SAFETY WINDSHIELD BLADE WIPER

Fits any style windshield wiper—just take out old blade—insert Christen blade. Once “broken in”—after two or three hard rains—a few strokes clear glass—and it stays clear. Guaranteed for 1 year. Protects glass from ugly scratches—adds to driving safety and pleasure. Over 1 1/2 million in use. Standard 7 1/4-in. size. Special 9 in. size, 60c. Wherever auto accessories are sold.

35¢

V. H. CHRISTEN MFG. CO.
321 Orleans St., Detroit, Mich.

NEW AUTOMATIC WINDOW WASHER

Washes-Cleans-Dries-Polishes in ONE Quick Operation.



Amazing new invention completely revolutionizes window washing. Carries its own water supply! It eliminates all the drudgery and unpleasantness. Five times as fast as old methods! No pail. No brush. No sponge. No chamols. Your hands never touch water with the NEW AUTOMATIC. Can be used with or without pole. Every housewife, auto-owner, storekeeper and factory owner a live prospect. Sensational demonstration. Sells at sight. Big repeat business. Year 'round seller.

MAKE \$90 TO \$150 A WEEK!

Agents coin tremendous profits. Going like wildfire. Sells for only \$1.95. Liberal profits for agents. \$10 to \$25 a day easy; \$200 to \$300 a week possible.

WRITE FOR OUR FREE SAMPLE OFFER

You risk nothing. Don't delay. Write for money making proposition today.

NATIONAL INDUSTRIES, Wrigley Bldg., Dept. 1512, CHICAGO

RADIO FREE

LATEST CATALOG OF NEWEST SETS AND KITS
Fresh from the press. Shows all the newest standard parts, sets, kits at big savings. Most complete line in America.

Big discounts to set builders. Send name and address at once.
BARAWIK COMPANY 1012B Canal Sta., CHICAGO, ILL.

Play Tune in 10 Minutes

ON THESE New Amazing INSTRUMENTS

New Kind of E-Z Playing Tenor Banjo, Ukulele, Mandolin and Guitar

equipped with exclusive patented invention that enables you to play tunes in a few minutes. Simple as A. B. C. Press keys and play tunes at once. No knowledge of music required. No long months of tiresome practice. No expensive lessons. Play by numbers at first—learn to play by note automatically while playing tunes.

Popularity! Big Money

Astonish your friends. Be center of attraction at all parties. Produce rich harmony, syncopated jazz. Loads of fun! Money-making chances.

10 DAY TRIAL—EASY TERMS Choose favorite instrument on Special 10-Day Free Trial Offer. Play tunes at once or trial costs you nothing. If satisfied, pay at rate of few cents a day. Send for

Free Catalog of E-Z Playing Instruments. Contains big money-saving values. (If you have instrument, you can secure E-Z Playing Method separately.) You risk nothing. No obligation. Send today!

FERRY & CO., Dept. 1779 Chicago, U. S. A.



10 DAY TRIAL

Now-AVOID STATIC Enjoy Real Radio Pleasure

Amazing New Aerial Invention Makes Any Radio Clear as a Bell

At last science has found a way to avoid static and other maddening outside noises with the newest improvement in radio—SUB-AERIAL. Experts say your unsightly, haphazard roof aerial is the weak link in your radio reception. The air is full of static and your overhead aerial picks it up and delivers it to your speaker. SUB-AERIAL comes down out of the air and takes the radio wave from the ground, where it is pure, clear and practically static-free. You can't imagine the difference in reception with this amazing invention!

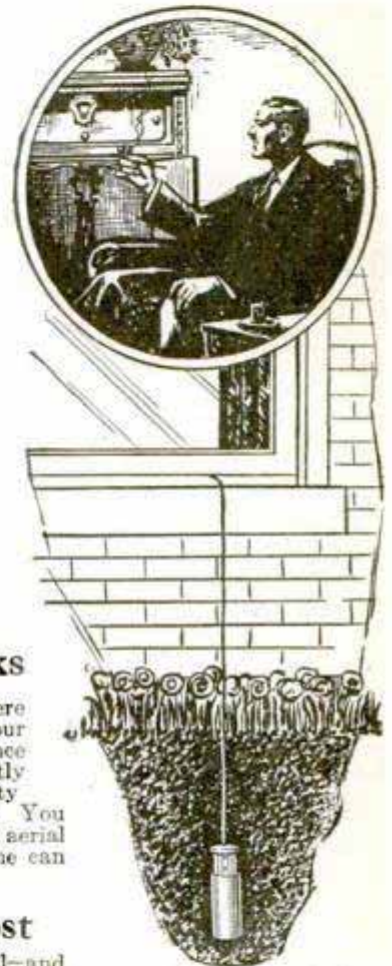

Can be installed
in a few minutes

SUB-AERIAL Endorsed by Experts

SUB-AERIAL has been subjected to the severest tests and has convinced many radio experts and fans of its remarkable performance. Radio engineers and magazines will tell you that SUB-AERIAL is the reliable system of avoiding static and interference and improving the tone, volume, selectivity, sensitivity and distance getting ability of a radio. Read the endorsements reproduced below then send for Free Trial of SUB-AERIAL and prove its merits at our risk.

May 8th, 1928.

"I am very glad to state that after testing many Aerials in my Laboratory I find your Sub-Aerial is the best for clarity of tone and elimination of static, also for greater volume and selectivity. Your Sub-Aerial will fill a long-felt want among the Radio Fans."

A. B. Johnson,
Radio Engineer.

Aug. 31, 1928.

"I received my Underground Aerial all O. K. It has any aerial beat I have ever seen. I have used every aerial on the market since I have been a radio fan. The first day I installed it I got distant stations that my set had never touched before. It wasn't good radio weather either. I got stations in the East that I had never dreamed of getting and with absolute clearness and without static or interference. I heartily recommend your instrument to any lover of good radio reception."

A. N. Whitaeue, Box 565, El Reno, Okla.

Volume—Distance—Selectivity

Now a new joy in radio reception awaits you! Don't put up with shrieks, howls, fading and other annoyances. You don't have to! Get reception—music, singing, speaking—as clear and pure as if the artists were "in the next room." Get increased volume and better long distance reception. Get sweeter tone and finer selectivity without distortion. Use the whole earth as a static and noise filter with SUB-AERIAL!

How This New Ground Aerial Works

SUB-AERIAL takes the radio waves from the ground, where they are filtered practically static-free, delivering to your radio all the notes in their true, natural form. Interference from other radios or stations is either eliminated or greatly reduced. Cut through and enjoy remarkable selectivity. Your radio is more sensitive in picking up distant signals. You are free from lightning risk and have a permanent ground aerial guaranteed for 25 years. And the cost is so small no one can afford to be without this great new invention.

Low Original Cost—No Upkeep Cost

SUB-AERIAL costs no more than an overhead or loop aerial—and less than many. Its first cost is the only one. SUB-AERIAL is permanent. No trouble—no hard work, or risking your neck on roofs.

TRY IT FREE

We know so well the surprising results you'll get that we'll let you put in a SUB-AERIAL entirely at our risk. You be the judge. Don't take down your overhead aerial. Pick a night when there is a lot of static. If Sub-Aerial doesn't sell itself to you right then on performance—you needn't pay us a cent. Send for "all the dope on SUB-AERIAL." You'll be surprised. Do it NOW.



Underground Aerial Systems

St. Clair Bldg., Dept. 805-T. S.
Cor. St. Clair & Erie Sts., Chicago, Ill.

Replace Your Old Noisy Aerial with

SUB-AERIAL

MAIL THIS COUPON TODAY

Underground Aerial Systems, Dept. 805-T. S., Chicago, Ill.
St. Clair Bldg., cor. St. Clair & Erie Sts., Chicago, Ill.

Send me complete information on Sub-Aerial, Proof and Free Trial Offer. No obligation.

Name.....
Address.....
City.....
State.....

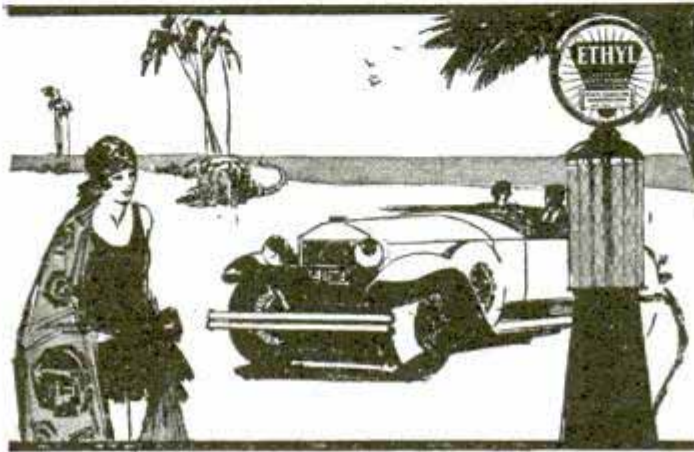
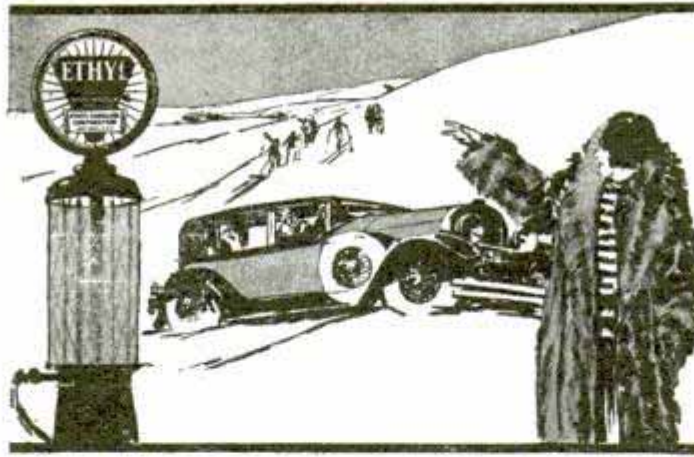

ETHYL

Knocks out that "knock"

north . east . south . west

WHETHER you live in Canada or Florida, Maine or California—or anywhere in between—you will find Ethyl pumps, at which a superior motor fuel suitable to your climatic conditions is on sale.

Ethyl Gasoline knocks out that "knock." Makes carbon an asset. Increases the performance of any type of car—whether of low or of high compression. Try Ethyl in your car today.

ETHYL GASOLINE CORPORATION

25 Broadway, N. Y. 56 Church St., Toronto, Can. 36, Queen Anne's Gate, London, Eng.

Radio's
greatest
value!

7
SUPERPHONIC

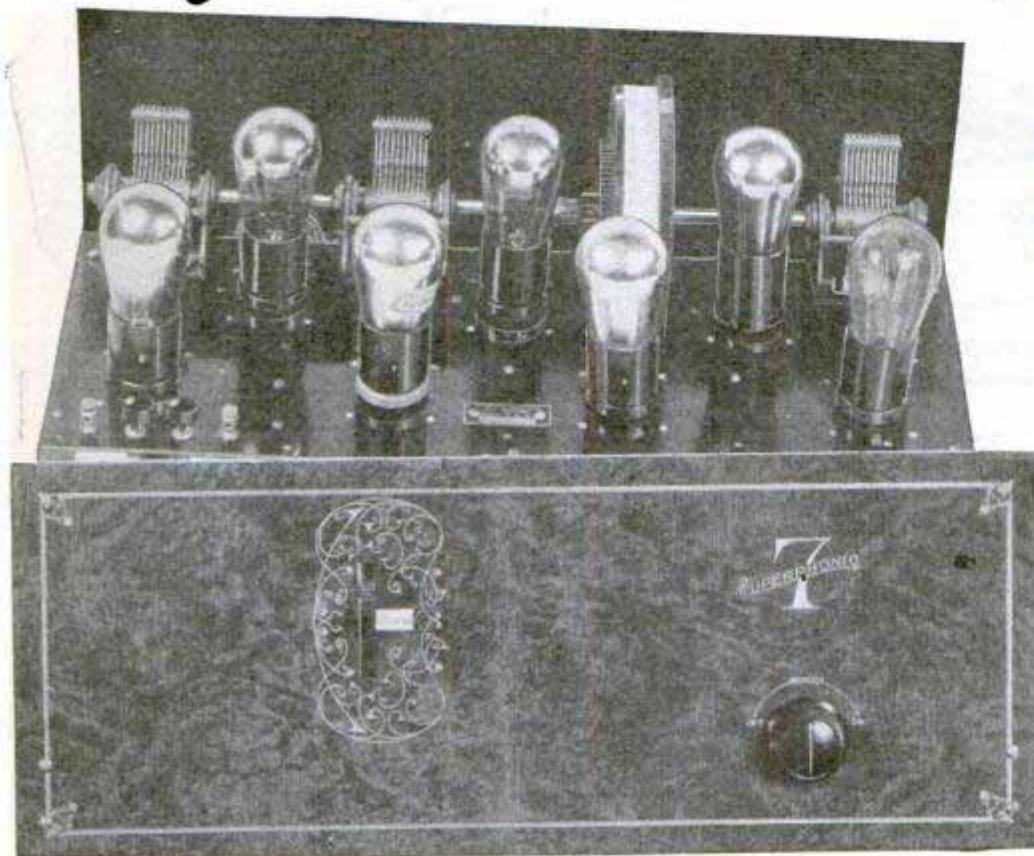

Only
\$**16.95**

COAST
to COAST
RECEP-
TION

7
TUBES
SINGLE
DIAL

Superphonic 7 is a world beater! An exceptionally high grade receiver that is amazing the Radio World. Latest 7 tube tuned radio frequency circuit, using 4 radio frequency amplifiers, detector and 2 stages of audio. Power tube can be used in last audio stage. Extremely selective, marvelous sensitivity. Single drum dial control. Straight line wave length condensers permit accurate, equally spaced tuning over entire wave band. All sockets spring cushioned to eliminate microphonic noises. Bakelite subpanel [8 1/2 in. deep] insures minimum dielectric losses. Clear and realistic reception guaranteed. An exceptionally beautiful, walnut finish, metal front panel 7 in. x 18 in. Complete chassis. No extra parts to buy. All parts mounted ready to wire. No special tools needed. All hook-up wire and colored battery cable included. Value \$60.00; our price **\$16.95.**

SIMPLE WIRING DIRECTIONS

Very easy to wire this set with the instruction we furnish. Just connect a few wires. **All you have to do is to follow numbers. Simple as adding 2 and 2.** Can be wired in a few minutes by anyone. No radio knowledge needed. Make money by wiring these sets in your spare time and selling them to your friends.

COMPLETELY WIRED

If you would rather receive Superphonic 7 completely wired, we will be glad to have it wired for you at an additional charge of only \$2.00. Please indicate on your order whether or not you want Superphonic 7 wired.

RADIO EQUIPMENT COMPANY
Dept. 10-M, 551 S. Wells St., Chicago, Ill.

TESTED AND APPROVED

Severe laboratory tests have proved the remarkable efficiency of this set. Owners everywhere are sending us letters praising its wonderful receptive qualities. E. Richmond, Detroit, Michigan, writes: "Tried out my Superphonic first night with weak batteries. Was surprised to get all local and 7 other long distance stations loud and clear. This is some record. I expect to get even better results tonight with full power. A friend heard it and wants one too. Please ship me another outfit immediately." B. J. Gillis, Denver, Colorado, says: "Wired set in short order. Getting stations all over the country. Plenty of volume. The set is a dandy." M. A., Syracuse, N. Y., sends telegram: "Rush at once 2 more Superphonics." M. Madsen, Chicago, Ill.: "Don't know anything about radio. Got it wired up in a little while and it works great." C. Drysch, Chicago: "First night set was up got 12 out of town stations. Everything came in clear as a bell and nice and loud."

SEND NO MONEY

Fill in the coupon and mail it today. We will ship you this great outfit immediately. Upon arrival pay only \$16.95 (ready to wire) or \$18.95 (completely wired) plus a small delivery charge. Foreign countries send \$19.50 (ready to wire) or \$21.50 (completely wired) with order. We pay shipping charges.

RADIO EQUIPMENT CO.,
551 S. Wells St.,
Dept. 10-M, Chicago, Ill.

Gentlemen:

Please send me at once Superphonic 7.

Check set desired.

(ready to wire) \$16.95

(completely wired) \$18.95.

Upon arrival I will pay the above price plus a small delivery charge.

Name.....

Address.....

City..... State.....

SAY FELLOWS — LEARN ELECTRICITY.

Let me tell you in my big free book how I can train you quickly for jobs leading to salaries of 60.00 to 200.00 a week. NOT BY CORRESPONDENCE
NOT BY BOOKS. you learn



H. C. LEWIS —
President

by doing, on real electrical machinery IN 90 DAYS. you don't need advanced education or former experience. EARN WHILE LEARNING. FREE employment service for life after you graduate. Clip coupon TODAY fill in and mail for my BIG FREE BOOK. It tells you the whole story.

FILL OUT - MAIL TODAY!

Mr. H. C. Lewis, Pres.
COYNE ELECTRICAL SCHOOL, Dept. 98-75
500 So. Paulina Street, Chicago, Ill.

Dear Mr. Lewis: Without obligation send me your big free catalog and all details of Free Employment Service, Radio and Automotive Electrical Courses that are included and how many "earn while learning." I understand I will not be bothered by any salesman.

Name.....
Address.....
City..... State.....

COYNE
ELECTRICAL SCHOOL

H. C. LEWIS, Pres., Dept. 98-75 Est. 1899
500 So. Paulina St., Chicago

Start to Play Very First Day

This Year Give Yourself
Lifelong Fun
Profit and
Popularity



PARENTS!

What greater gift can you confer on your children this year than lifelong fun and entertainment?

Love of music means love of home, an appreciation of the finer things in life. Here is a chance to give your boy or girl that love without the tedious practice that most instruments require. The Xylorimba is easy to play. No teacher is needed. Practice is actually a joy.

Remember, the Xylorimba is the guaranteed product of a company established nearly half a century ago—a company that stands back of every promise it makes.

THINK of the best Christmas gift you have ever received. Multiply the pleasure it gave you by ten, and still you have only an idea of the joy you can give yourself this Christmas if you act at once!

Start to Play the Very First Day!

Haven't you, like millions of others, envied the fellows who "bring down the house" with snappy xylophone or xylorimba numbers? Haven't you longed to create your own music, to be looked up to wherever you go, to be able to make real money in spare time? If you have, this ad spells O-p-p-o-r-t-u-n-i-t-y. The xylorimba—wonderful for home, in demand at dances and gatherings—is nevertheless *the easiest of all instruments to play*. In fact, on the very day you get yours you play simple melodies, even if you can't read a note of music right now. In a few weeks you astonish your friends and family. *All your life* you have the joy that comes to those who can entertain.

Plays 20 Minutes; Gets \$20!

Ralph Smith, Chicago, played twenty minutes at wedding; his "pay" was \$20. Altho only 12, Turk McBee, Jr., plays big-time vaudeville exclusively. Harry Breuer, New York, has

made thousands of friends thru his xylophone selections on the radio. L. E. Hallman, Reading, Pa., writes: "Made \$300 in 5 weeks—spare time."

And now J. C. Deagan, Inc., (world's largest manufacturer of xylophonic instruments) has made it so easy to own a xylorimba that nothing stands in your way. Sizes and styles to fit every age and pocketbook. A five-day free trial that eliminates risk. Free, easy lessons that make teacher unnecessary—and, best of all, such easy payments that they are hardly noticed.

Will You Investigate?

Everyone wants to be popular. Everyone wants to make extra money. Everyone wants to be *center of attraction* at gatherings. But these advantages don't come by themselves. Opportunities must be seized. This is *your* opportunity—will you pass it up without investigation? The accompanying coupon will bring our big FREE book to your door. It tells all about the Deagan line, the free trial, the easy payments. Remember, no cost or obligation! Simply fill in and mail the coupon—but do it before it slips your mind. Today is as good a day as any. Do it NOW!

J. C. DEAGAN, Inc.
Dept. 1459, 1770 Bertosa Avenue, Chicago

Please send me full details on the Free Trial offer and easy payment plan of the Deagan Xylorimba.

Name _____
Address _____
City _____ State _____

YOUR
MAGIC
KEY

to Popularity

Mail
Now!

Send for
BIG FREE
Book!

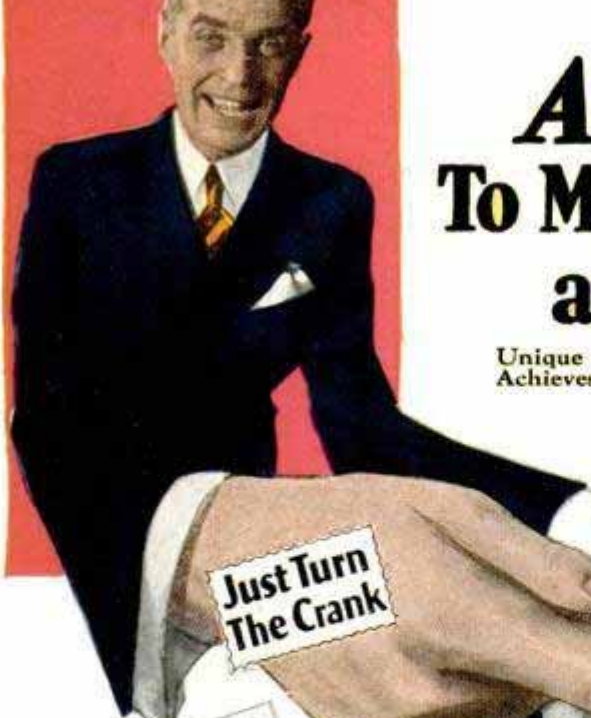

And Now
A MACHINE
 To Make Shaving 50% Easier
 and 100% Cheaper!

Unique Invention Arouses a Whirlwind of National Interest! ...
 Achieves Amazing Records of Unbelievably KEEN, Cool Shaves ...
 Special Introductory Offer in Force Right Now!

Just Turn
 The Crank



MAKES ONE BLADE LAST 365 DAYS!

THIS is the age of amazing scientific discoveries. And now comes the most surprising invention of all;— a machine that absolutely revolutionizes shaving!

Just think of a device that can take any ordinary razor blade on the market and multiply its sharpness 50% to 100% in exactly 11 seconds! And just imagine what a slick, painless shave you can get when your blade is just about twice as keen as any you have ever tried before!

No More Blades to Buy

But that isn't all. KRISS-KROSS not only stops blades to unbelievable sharpness—but it makes them last almost indefinitely! Day after day—week after week—you can keep using the same old blade and still get smoother, better shaves than you now get from a blade right out of a fresh package! Any number of cases are on record where one blade has lasted over a year and is still going strong. And M. T. Main of Kenosha, Wisconsin, has used one single blade for more than five solid years of the coolest shaves he ever got in his life!

**Rejuvenates All
 Makes of
 Razor Blades**

KRISS-KROSS is so remarkable that it is more a blade-rejuvenator than a stropper. It embodies 7 mechanical features that have long baffled inventors.

Works on all brands of blades except Durham. Reproduces the magic diagonal stropping-stroke of the master barber. Reverses blade automatically, first one side and then the other. Starts with strong pressure and finishes light. Nickel jig flies up to notify you when blade is ready with the keenest cutting edge steel can take!

Generous Introductory Offer

KRISS-KROSS is never sold in stores—but only through authorized representatives in each locality. Right now, we are making a generous offer and are giving a new kind of 3-way, adjustable razor FREE to introduce KRISS-KROSS. Use the coupon below to get details of this unusual invention and offer. See for yourself how ingenious KRISS-KROSS is and what undreamed of shaving comfort it holds in store for you. No obligation. Clip the coupon now. Mail it to-day!

Agents!
\$30 a Day And More

KRISS-KROSS is an astonishing money maker and brings excellent profits to men who are willing to act as our representatives in their home territories. Many earn \$30—\$60 a day and others are making \$5000 and \$7500 a year clear profit. Spare-time agents often take in \$6—\$12 an evening and up to \$200 a month. We give you an extremely generous proposition and show you just how to get started the easiest way. Write for information and see just exactly what we offer. It will pay you to investigate. Check bottom line of coupon below and mail it to-day!

Rhodes **KRISS KROSS**
STROPPER

RHODES MFG. CO., Dept. W-373
 1418 Pendleton Ave. ST. LOUIS, MO.

Wonderful Xmas Gift!

KRISS-KROSS makes a novel and unique Xmas gift that will be remembered for years to come. Attractively boxed in holly wrapper for holiday season. Inexpensive. Also ideal remembrance for business houses to give employees or special customers.

Rhodes Mfg. Co., Dept. W-373,
 1418 Pendleton Ave., St. Louis, Mo.
 Without obligation, please send me complete illustrated explanation showing how KRISS-KROSS rejuvenates all types of razor blades (except Durham). Also give me details of your special introductory offer and the Free 3-way razor you are giving away at present.

Name.....
 Address.....
 Town..... State.....
 Check here if interested in becoming a representative.

SEPTEMBER

25 CENTS

POPULAR MECHANICS

MAGAZINE

TEN SO YOU CAN UNDERSTAND IT

REG. D. TRADE MARK GREAT BRITAIN No. 40426

REG. U. S. PAT. OFF.



SEE PAGE 415

ATKINS SILVER STEEL SAWS

3

SAVINGS IN SAWING

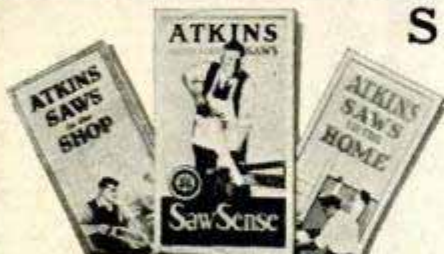

Saw Books FREE

Write today for our FREE books, "Saw Sense," "Saws in the Home," and "Saws in the Shop." Valuable to every saw user.

E. C. ATKINS & COMPANY, Est. 1857
426 S. Illinois Street, Indianapolis, Ind.

Leading Manufacturers of Highest Grade Saws for Every Use; Saw Tools, Saw Specialties, Plastering Trowels, Machine Knives, Grinding Wheels and Files



1 Silver-Steel

THIS special Saw Steel, found only in Atkins Saws, guarantees added years of use—outlasts two or three "cheap" saws—and makes your saw hold its cutting edge longer.

Taper Ground?

Note the wide edge of the cutting tooth tapering to the back. The blade also tapers from tip to handle. Taper Grinding prevents binding and makes sawing easy.



3 Perfection Handle

Glad muscles testify to the relief from strain of this different saw handle. Another feature found only in Atkins Saws; (also made with old-style handles). Atkins makes "A Perfect Saw for Every Purpose." You'll find savings in Atkins Saws, at your Hardware Dealer's.