

# POPULAR MECHANICS

## MAGAZINE

WRITTEN SO YOU CAN UNDERSTAND IT

REGD. TRADE MARK GREAT BRITAIN NO. 41051E

REG. U. S. PAT. OFF.



SEE PAGE 717



# Make an Electric A.C. Set of your Present Radio!

**NO CHANGES IN WIRING  
NO HARNESS OR ADAPTERS  
USE YOUR OLD TUBES**

OF course you want electric operation of your radio. Everybody does! Radio was never so convenient, never so carefree as now when its only demand on you is the snap of an electric switch.

But if you have a good radio now, don't discard it. A good time-tried circuit, using efficient time-tried tubes is naturally better than new untried circuits and tubes. There isn't a better A. C. set made than your present radio converted to use A. C. power.

And Kuprox has made conversion so easy! You don't have to change a single wire or alter the set in any way. No harnesses or adapters . . . no tricky wiring . . . not even new tubes are necessary. Just connect the Kuprox A. C. Power Pack to the battery terminals of your set, plug it into the nearest lamp socket, and your radio operates entirely from A. C.

Then compare your radio with the best A. C. set you ever heard. Compare the tone, the power, the dis-

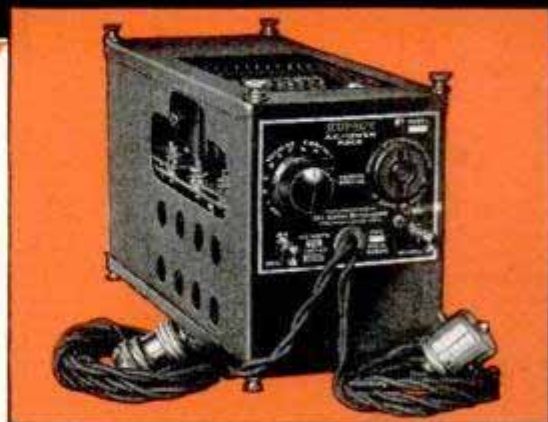

tance getting ability, the selectivity and ease of control! In your set there's not the slightest hum, no distortion or crackling because of faulty tubes, none of the failings that variations in electric current can cause in A. C. sets. A good battery set, Kuprox equipped, is A. C. reception at its finest!

The Kuprox A. C. Power Pack contains no moving parts, nothing to wear out or break down. It is a permanent addition to your radio that does away with all attention. Several models are offered, some supplying filament (A) current only for those who already have a "B" eliminator, some supplying plate (B) current only, and several compact units that supply all current (A, B, and C) and make the entire set A. C. They are priced from \$32.50 up, and any good radio dealer can show you the various models.

In case you first desire more information, or specific information about your own set, fill in the coupon, tell us exactly what set you have and the number of tubes. We'll recommend the proper model Power Pack you need, and send you literature giving a full description.



**Kuprox Multi-rate Rectifier,**  
for trickle charging, dynamic  
speaker operation, etc. Ad-  
justable rate up to 1-ampere.  
Price \$11.50



**Kuprox Replacement Unit,**  
eliminates acids, liquids,  
bulbs on all standard trickle  
chargers.  
Price \$5.00

**THE KODEL ELECTRIC & MFG. CO.**

Formerly the Kodel Radio Corporation

517 E. Pearl Street - - Cincinnati, Ohio

**USE THIS COUPON**

Please give me full information on Kuprox A. C. Power Pack

Name.....

Address.....

City.....

Make of Set..... State.....

No. of Tubes.....

# KUPROX

## A.C. POWER PACK



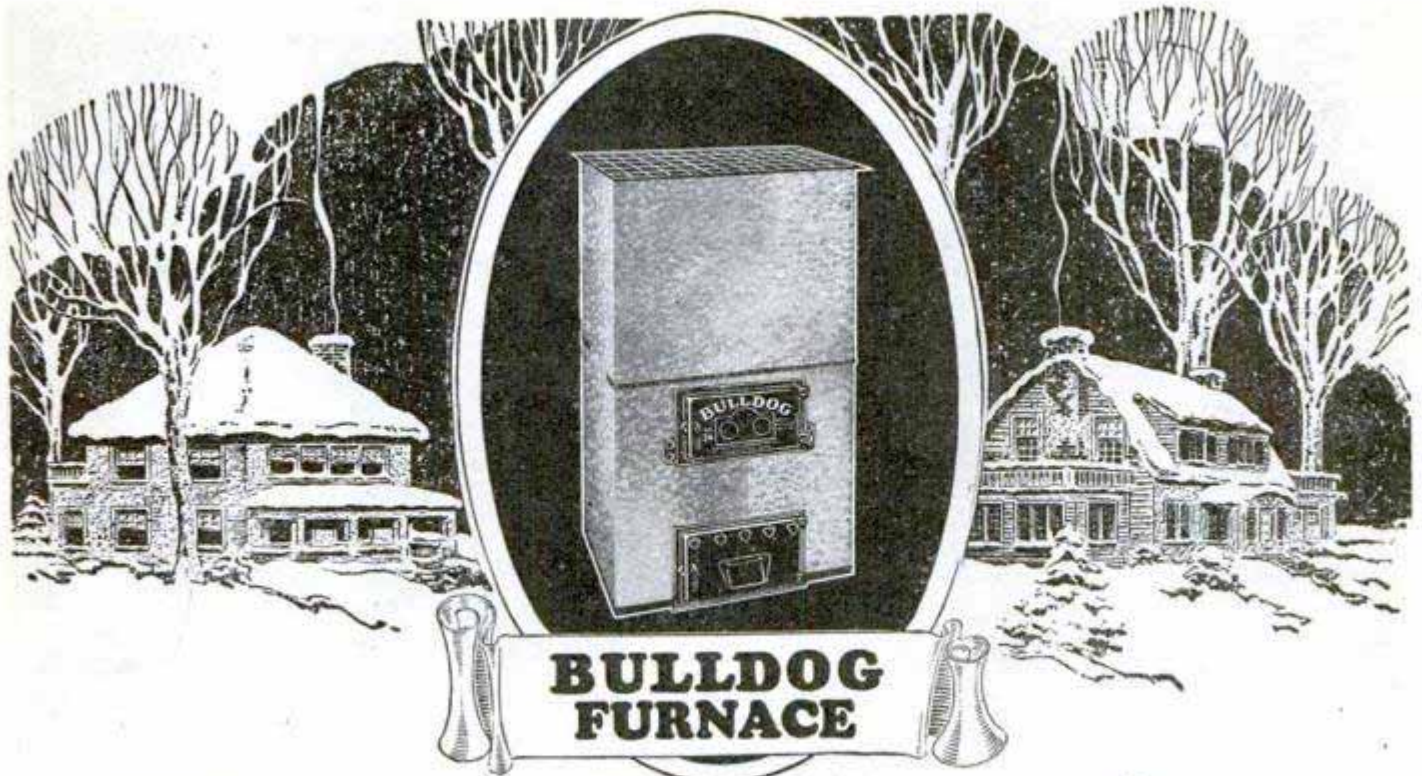

# Heats Home for 25¢ a Week!

"I can run my Bulldog furnace steady for fourteen days in normal weather conditions on the actual cost of fifty cents." So writes F. R. Redetzke, of Cleveland, North Dakota, and he adds: "Hard to believe is it? That's what some of my neighbors thought until I showed them! We have an unlimited amount of grain screenings in this country. That's the fuel I am using."

That's what the Bulldog does with about the lowest grade fuel you can think of! Here's what it does with coal:

**After 6 Years—"Heats as Good as Ever"**

"Our furnace has been in use 6 years and heats as good as ever."

—Arthur Cloepfil, R. F. D. No. 1, Rockport, Mo.

**"Does the Work of 3 Stoves"**

"This is my third winter with the Bulldog. It does the work of 3 coal stoves that I used, which only warmed up part of the house and not very well at that. My Bulldog not only does that, but 3 rooms upstairs, with great satisfaction. My house is located in a very cold place, with no protection at all. It is the easiest furnace to handle I have yet seen." E. C. Diplock, 105 Elm St., Camden, Me.

**Cuts Coal Bill in Half**

"I had a hot air furnace in our 7-room house before I got the Bulldog and our house was always cold. With the Bulldog it only takes *half as much coal* and we had weather below zero, and the house was nice and warm in the morning when we got up. We never have the draft on more than half an hour at a time, and it has the place red hot. It keeps the fire all day in mild weather."

—Jess T. Conrad, 1211 W. Arch St., Shamokin, Pa.

## No Money Down!

**Small Monthly Payments—Installed Almost as Easily as a Cook Stove!**

The Bulldog is sent to you for *free inspection*. Then, if satisfied, you make only small monthly payments at our remarkably low price. Write today! *Don't miss this chance to cut down your fuel bills! Install a Bulldog Furnace.* It comes to you completely erected—goes through any door—fits any height of basement—and you install it yourself in less than two hours! In fact, you can install the Bulldog just about as easily as you

would a kitchen stove. *Don't* put up with the old fashioned stove heat or some outworn furnace—when you can so easily get the greatest advance in scientific heating at an astonishingly low price. The Bulldog burns almost *any kind of fuel*, from hard coal to cheap screenings. Keeps a wood fire over night. **We have factory connections in both east and west and ship from the nearest point.**

## Send for Free Book

Learn how to have all the heat you want—where you want it—and save money! Remember the Bulldog is *differer-t*—and *better!* Complete combustion of gases save 25% of your fuel bill. Exclusive Gable-Top Radiator receives *all* the direct rays of the fire. Exclusive oblong fire-pot is not only ideal for coal, but enables you to keep a wood fire over night. Remember—the Bulldog is sent for *free inspection*—then small monthly payments at an amazingly low price! **Send for Free Book TODAY!**

**BULLDOG FURNACE CO.—Babson Bros. Sole Distributors**  
19th Street and California Ave. Dept. 13-58 Chicago, Ill.

**Bulldog Furnace Co.,** Babson Bros. Sole Distributors

19th St. and California Ave., Dept. 13-58 Chicago, Ill.

Canadian Address: 110 Princess St., Winnipeg, Man.

Without obligating me in any way, please send me your free catalog and special offer on the Bulldog Furnace.

Have you a basement? Yes   
No

Name .....

Address .....



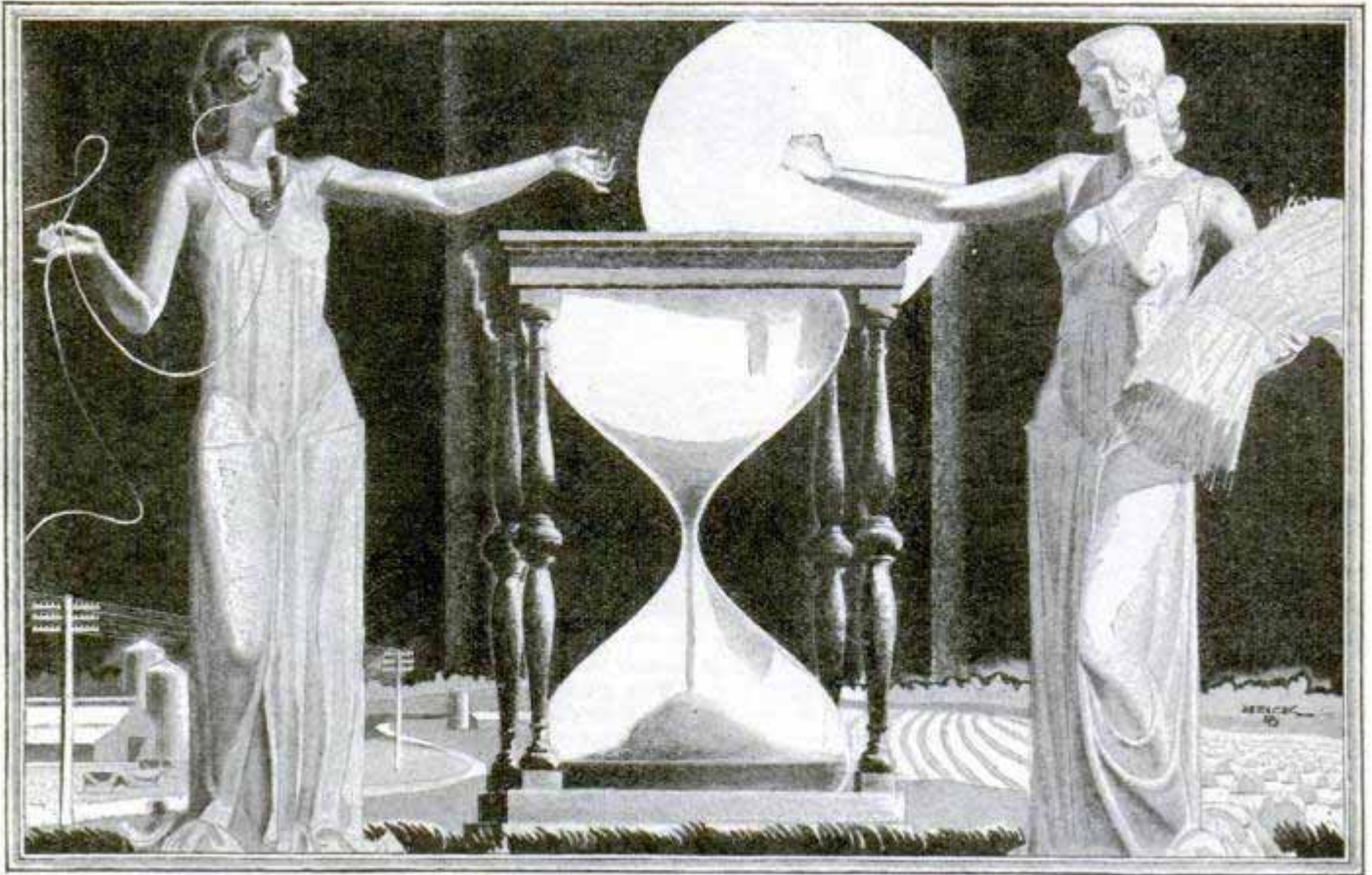

## Kansas saves Twenty Years

*An Advertisement of  
the American Telephone and Telegraph Company*

MORE than three hundred studies are being carried on constantly by the research, engineering and business staffs of the American Telephone and Telegraph Company and the associated companies of the Bell System to accomplish definite improvements in telephone service.

In 1927 the number of local calls not completed on the first attempt was reduced by 5 per cent. This means the better handling of 200,000,000 calls a year.

In 1926 the average time of handling toll and long distance calls was 2 minutes. In 1927 this average was reduced to 1½ minutes, with further improvements in voice transmission.

On 6,820,000 long distance and toll



calls made in Kansas in 1927 an average reduction of a minute and a half was made on each call—a total of twenty years saved. These more than three hundred special studies have as their goal definite improvements in local, toll and long distance service. It is the policy of the Bell System to furnish the best possible service at the least cost to the user.

The American Telephone and Telegraph Company accepts its responsibility for a nation-wide telephone service as a public trust. It is fundamental in the policy of the company that all earnings after regular dividends and a surplus for financial security be used to give more and better service to the public.



# Popular Mechanics Magazine

200 E. Ontario Street, Chicago, U. S. A.

H. H. WINDSOR, Founder

H. H. WINDSOR, Jr., Editor and Publisher

London: Hachette & Cie.,  
7 King William Street, Charing Cross, W. C. 2

Paris: Hachette & Cie.,  
111 Rue Reaumur

Melbourne: Gordon & Gotch  
509-513 Little Collins St.

ISSUED MONTHLY

SUBSCRIPTION:

SINGLE COPY, 25 CENTS

In United States and its possessions, also Canada, Cuba, and Mexico, per year, postpaid - \$2.50

To all other countries in the Postal Union - 3.00

All subscriptions are discontinued at expiration. Please examine the date printed on your wrapper.

Entered as Second Class Matter Sept. 15, 1903, at the Post Office at Chicago, Illinois, under Act of March 3rd, 1879.

Entered as Second Class Matter at the Post Office Department, Canada.

Published monthly by POPULAR MECHANICS CO.

Copyright, 1928, by Popular Mechanics Co.

Copyright in Australia. Copyright in France

Vol. 50

Contents for November, 1928

No. 5

## Special Features

Inventors of Circus Laughs.....	722
The New Age of Electric Heat.....	730
Twenty-Five Years of Flying.....	739
Air-Picked Gold Fields.....	754
Easy Tricks with Thimbles.....	765
Cheating the Sea.....	770
The Master of Light.....	778
The Champion of the Fleet.....	786
What Are the Northern Lights?.....	792
Crashes Made to Order.....	804
What Television Offers You.....	820
Acoustics—sound velocity in helium twice that in air.....	752
Agriculture—berry patch grown on cars.....	768
Airplanes	
flying fort lifts 5½ ton load.....	785
modeled after "Blimp".....	818
to transport rubies from Burma mines.....	797
world's biggest seaplane.....	728
Aluminum—plating on metals by electricity.....	811
Ants	
African, secret water supply.....	813
man-eating.....	759
Apples—stored in gas to prevent decay.....	791
Archæology	
famous Biblical rock in Horeb.....	761
find stables of King Solomon.....	810
Architecture—late styles in.....	813
Automobile Bus—for road or rail.....	758
Automobiles	
carved Chinese for bridal parties.....	707
chassis oiling system operated by engine heat.....	726
clerk's office on wheels.....	764
magnets on bumper clear road of nails.....	801
Automobiles—Accessories	
fan on auto heater.....	784
gas tank cap prevents spilling.....	799
spring greasing clamp.....	819
Automobiles—Tires—pop valve for.....	784
Aviation	
arrow on roof guides airplanes.....	817
beacon on border honors Mexican flyer.....	775
flying police for airport traffic.....	752
Grand Canyon air trip latest thrill.....	789
mask for aerial camera man.....	759
model airplane as wind vane.....	810
naval flyers get weather data.....	763
plane flies without pilot.....	802
Aviation—continued	
uniform markers for airways.....	737
will rocket planes reach the stars?.....	717
Awning—inside control for.....	769
Barbecue—electric, for stores.....	802
Bird Houses—model village for birds.....	764
Blueprints—drawings produced direct from positive.....	721
Book—concealed in ring.....	813
Building Construction—apartment houses of Biblical	
days rebuilt.....	762
new, eliminates plastering.....	737
Buildings	
"health hotel" shaped like a steel ball.....	783
house in form of big globe.....	729
Clipper, Lawn—cuts tall weeds.....	816
Clothing—women's winter apparel more healthful than	
men's.....	784
Crane—carries house over sea.....	736
Disease—radio transmitter helps treat.....	801
Door—peep glass in.....	801
Electric Iron—without cord.....	726
Electric Power—Diesel engines may displace super-	
power.....	802
Engines—oval cylinders reduce friction.....	791
Engines, Marine—new type of magneto.....	727
Fires, Forest—destroy fertilizer.....	729
Floods—chain of bonfires warn of expected.....	753
Frogs—lids move upward when blinking.....	729
Garage—basement used as.....	777
Gauge—for bevel cutting also serves as compass.....	797
Geysers—new in Yellowstone National Park.....	817
Golf—putter, mechanical, tests grasses best for greens	
Guns.....	753
army mortar lays smoke screens.....	763
gas, like fountain pen.....	736
Hammer—nail holder on.....	776

*Electric office  
on wheels 764*

*Diabetes tank for 783*

[Continued on Page 4]

*Cathedral St. Paul*

*Durmon Papers into for 801*



*Health*  
*Life*  
*Submarine 706*  
*Hospital 783*  
*769*  
*Paper & repair 801*  
*Shoals & Calhoun*

*Stars, Will*  
*Plano Beach 717*  
*Tobacco pipes Wood for 913*  
*Votes Clerk office on wheels 769*  
*Chair seats rush or fibre 915*  
*atomic hydrogen 730*

[4] [Contents—Continued]

Hedge Trimmer—electric, prolongs life of vines	799
House Plan	879
Household Devices	814
Insects	
have larger wings than birds proportionately	727
that devour insects, protect plants	735
trap attached to casters	729
Lamp—clamps on book	729
Lifeboat—launched by tractor	721
Lightning—measure speed of with two-lens camera	785
Logging—safety brake for saves time	788
Lubrication—oil can seal prevents waste	790
Magnet—rids road of nails	810
Measuring—depth of sea	784
Metals—mystery of rusting	782
Models—cathedral carved with jackknife	816
Mosquitoes—spray tank on motorcycle helps kill	752
Motorboat—racing, speeds seventy miles an hour	811
Motor Bus—Pullman of road includes berths and diner	799
Moving Pictures—lenses on screen give depth to Navy, U. S.—makes amends	761
Oil—study of spots on the sun aids search for	705
Pearls—fake, revealed by camera	758
Phonograph—record folds up in cigar case	738
Pins—office, holder saves time and fingers	817
Pipe—cat helps clean	710
Pipes, Smokers'—self-adjusting cleaner	803
Plant Ills—spies to detect, to protect home crops	783
Playground—Ferris wheel for, boy's invention	790
Police—use thumb cuffs instead of handcuffs	790
Psychology	789
do faces reveal fortune?	777
intelligence tests for babies	764
Radio	
device reduces motor interference	840
guides ship without crew	707
Radio—Apparatus—r.f. transformers for screen-grid tubes	840
Radio—B—Eliminators—voltage divider for	840
Radio—Batteries—trickle charger, homemade	826
Radio—Cabinets—a Spanish desk	828
Radio—Coils—homemade r.f. choke	834
Radio—Condensers	
reducing line interference	827
variable, drilling templates for	840
Radio—Construction	
hints for set builders	827
panel saw, homemade	827
Radio—Loud Speaker—employs double diaphragm	834
Radio—Receivers	
amplifier for crystal set	826
expert discovers tone purity by ear	738
new perfect-tone six	835
regenerate, keeping detector tube from spilling over	826
Radio—Reception—tone filter for magnetic pick-up	825
Radio—Repairing—by-pass condensers	827
Radio—Television	
condensing lenses aid	797
in natural colors	750
Radio—Tubes—r.f. transformers for screen-grid	840
Railroads	
boiler inspection hottest job on	760
elephant wrecks railway in India	819
rubber pads for	729
Rays	
cosmic, linked with creation of matter	714
invisible, pierce fog to guard ocean liners	799
lamp for health treatment	769
ultraviolet, crystal mine yields lenses for	813
Safety Devices and Measures	
auto rings warning bell at grade crossing	760
portable electric alarm warns section gangs	796
Sawdust Burner—installed with furnace	761
Sculpture	
circus display in butter	818
fisherman modeled in sand	783
Ships and Shipping	
automatic SOS receiver	760
false stacks used as storage rooms	763
four day liners launched in Germany	751
quest for faster liners	769
service station for	776
Shoes—shining stand has screen for women	710
Skating—skate with jointed blade	753
Skis—water, for soldiers, substitute for boats	791
Slate—Indians used as mirrors	817
Sled—foot propelled ice, develops high speed	785

Snow—rollers clear roads of	782
Sprinkler, Lawn—underground	811
Steel—secret of Damascus, known by Romans	752
Street Cars—mirror on door causes women to alight forward	720
Table	
Combination table-top and picture panel	819
folding, for picnics	809
with concealed ironing board	815
Telegraph—telegrams sent in Chinese	818
Theater—outdoor, water curtain hides stage	811
Trees	
dead, felled with dynamite	727
examine trunk with X-rays for defects	759
Tricycle—operated by rowing	803
Tunnel—eight-mile railroad breaks record	710
Vending Machines—stamp dispenser gives correct change	761
Ventilation—headaches caused by poor circulation	816
Vibrations—"death whispers" from quartz kills small animals	738
Violin—vibrations break crystal goblets	818
Water—purified with tablet	775
Water Power—water speed in plant exceeds fastest auto	790
Weather—dust from volcanoes affects	802
Welding—arc to replace casting of machine parts	788
Window—portable, false electrically lighted	803

AMATEUR MECHANICS

Advertising—turntable facilitates window decorations	845
Automobiles—Repairing—removing broken lamp	860
Bird Houses—made from flowerpots	847
Boats and Boating	
carrying a canoe on a sedan	846
quick hitch for a rowboat	854
Clock, Alarm—opens hen-house door	843
Clothesline—safe and handy hanging of	846
Cot, Folding—equipped with casters	860
Cream Whipper—electric, homemade	861
Cushions—leather, improvised	861
Drill Press—small hand, treadle feed for	858
Games—two homemade ball	862
Gymnasium—how to make, for home	849
Incubator—thermometer lighted by small lamp	847
Keys—making a key impression	845
Musical Instrument—how to make a Chinese fiddle	848
Nails—holding small securely	854
Paints and Painting	
getting ivory color	858
keeping paint cans sealed	857
moisture resisting paint	844
Partitions—retrieving articles lost in	858
Piston Rings—keep edges sharp	854
Polishing—use kerosene on stove before	857
Pot-Cover—wire holder	844
Pottery—decorative, made from paper scraps	859
Scissors—handy in the kitchen	856
Screen Doors—removable sash for	857
Shadow Pictures—a fascinating pastime	841
Steel—punching small hole in thin	844
Stockkeeping—"want tags" for hardware store	847
Toys—walking duck, how to make	855
Trailer—support for trailer tongue	844
Transformers—cutting core strips for	860
Trapping—handy trap placer	857
Wardrobe—curtain and shelf form space for	862

SHOP NOTES

Auger—post, marking handle to test depth	878
Batteries—removing terminals	878
Chuck—grinding, quick-tightening	878
Clay—modeling, use for in workshop	874
Concrete Forms—method for cutting the wire for	878
Door—securing with loose-pin hinges	873
Fence—barbed-wire, stringing tightly	874
Furniture	
how to make rush or fiber seats	875
two tables of modern art	863
Gate—for the farm	872
Greenhouse—back porch used as	874
Mechanical Drawing—paper clip holds triangle	877
Shaper, Bench—how to make a 6-in.	869
Sports, Winter—snowshoes made from tennis rackets	873
Tamper—made of concrete	877



# DRAKE'S PRACTICAL MECHANICAL BOOKS

## THEY WILL RAISE YOUR PAY— ORDER ON 5-DAY TRIAL

The books listed below will perfect you in your chosen trade—pave the way to the big positions. Written in non-technical language—easy to read and understand. Every book covers its subject completely. An entire course of instruction condensed into one volume. Your choice sent postpaid—you benefit 5 days—money refunded in full if not entirely satisfactory. Order direct from this page.



### Automobile Books

- Automobile Starting, Lighting and Ignition, by Manly... 700 pp. \$3.00
- Brookes' Automobile Handbook... \$2.00
- Ford Motor Car, Truck and Tractor, by Manly... Cloth \$1.50
- Auto and Radio Battery, Care and Repair, by Manly... Leatherette \$2.00
- Motorcycle Handbook, by Manly... \$1.50

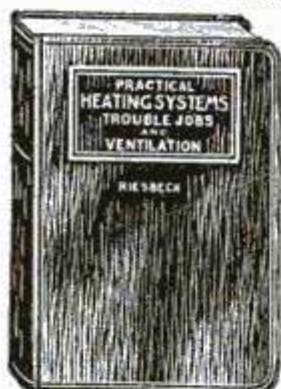

### Shop Practice Books

- Practical Heating Systems, Trouble Jobs and Ventilation... \$4.00
- Sheet Metal Workers' Manual... \$2.00
- Oxy-Acetylene Welding and Cutting... Cloth \$1.25
- Slide Rule and Logarithmic Tables... \$2.00
- Handbook for Millwrights... Cloth \$2.00
- Mechanical Shop Practice... Cloth \$2.00
- Mechanical Drawing and Machine Design... Cloth \$2.00

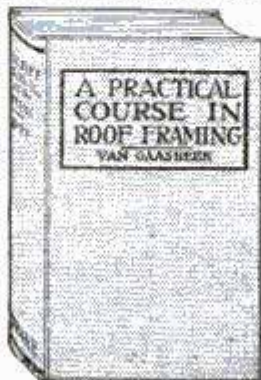

### Carpentry Books

Cloth Binding

- Modern Carpentry, 2 vols... \$3.00
- The Steel Square, 2 vols... \$3.00
- Modern Estimator... \$1.50
- Timber Framing... \$2.00
- Builders' Architectural Drawing... \$2.00
- Concrete... \$1.50
- Practical Bungalows... \$1.00
- Roof Framing, by Van Gaasbeek... \$1.50

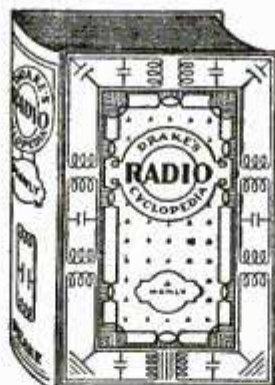

### Drake's Radio Cyclopaedia

June, 1928 Edition  
By H. P. Manly

920 Pages, 1025 Illustrations, 1700 Subjects, arranged alphabetically. For Service and Repair Men, Dealers, Salesmen, Experimenters and Designers. Bound in Art Buckram. Price... \$6.00



### Painting and Decorating

- Practical Estimating for Painters and Decorators... Cloth \$2.00
- How to Draw Funny Pictures—a Complete Course in Cartooning... Cloth \$3.00
- Layouts for Advertising... Lea. \$3.00
- Furniture, Furniture Finishing, Decoration and Patching... \$5.00
- Ross Crane Book of Home Furnishing and Decoration... Cloth \$3.00
- House Painting Methods with the Brush and Spray Gun, by Vanderwalker... Cloth \$2.00
- Interior Wall Decoration, by Vanderwalker... Leatherette \$4.00
- The Mixing of Colors and Paints, by Vanderwalker... Cloth \$2.00
- Studio Handbook—Letter and Design... \$3.00
- A Show at Sho' Cards... Cloth \$4.00
- Sign Painting, by Atkinson... Cloth \$4.00
- Strong's Book of Designs, Leatherette \$4.00
- Modern Painters' Cyclopaedia... Cloth \$2.00
- Automobile Painting... Cloth \$1.50
- New Hardwood Finishing... Cloth \$1.50
- Wood Finishing, Plain and Decorative... Cloth \$2.00
- Owen's Paint Guide... Cloth \$1.00
- Steam Engineering**
- Swingle's Handbook for Steam Engineers and Electricians... Leatherette \$4.00
- Examination Questions and Answers for Marine and Stationary Engineers... Leatherette \$2.00
- Steam Boilers... Leatherette \$2.00
- Swingle's Catechism of Steam, Gas and Electrical Engineering... Leatherette \$1.50
- Modern Languages**
- By Prof. P. S. Allen, U. of Chicago
- French without a Teacher... Cloth \$1.25
- Spanish without a Teacher... Cloth \$1.25
- German without a Teacher... Cloth \$1.25
- Everyday French... \$1.25
- Everyday Spanish... \$1.25

## ORDER DIRECT FROM THIS PAGE—ON OUR MONEY-BACK PLAN

The books listed above are only a few of the many in our catalogue, which you will receive promptly after filling out and mailing us the attached coupon. For quick action order direct from this page—cross name of each book wanted and send in with price quoted. We prepay postage and send the books on our money-back plan.

## FREDERICK J. DRAKE & CO.

Publishers

R508—179 No. Michigan Ave. CHICAGO

Drake Books Are For Sale at All Book Stores

Mail Coupon For Free Catalogue  
Your Guide to Home Study

FREDERICK J. DRAKE & CO.  
R508—179 No. Michigan Avenue  
Chicago, Ill.

GENTLEMEN:—Please send me free, postage paid, your illustrated catalogue which lists and describes 200 Practical Mechanical Books for Home Study.

My name

This One

and my



43EK-LQ3-L9HW



# Neglect of Home-Study Training Cost This Man \$47,424!

*How much are you paying to stay untrained?*

Some time ago we received a letter which every man working for a living ought to read—whether he's making \$20 a week or \$200. Here it is:

"During the forty years that I have been working, my salary has averaged less than twenty-four dollars per week with the exception of the last two years while I have been acting as foreman. I made good in this position and saw, through the failings of others, what would happen to me unless I found a way to train for larger responsibilities.

"I had read of correspondence courses and began searching for one I thought would benefit me. I found it in the LaSalle Modern Foremanship course, and benefited by it, my salary being nearly doubled, and I was promoted from foreman to factory superintendent.

"This happened in a period of about ten months, and by devoting only about four or five hours per week to the studies.

"I am now enrolled as a member of the Industrial Management course, and find the work very interesting and beneficial. It can be applied every day in the factory, and brings results.

"I regret that I put it off to so late a day in life to reap the benefits I am now enjoying, and can truthfully say to younger men that if they would only profit by the experience of others they can gain more knowledge through one year's training by LaSalle methods than can be obtained in ten years' practical experience by hard work."

We quote the above letter not because the man who wrote it is making a staggering salary as a result of his training, but because it illustrates so clearly the principle behind LaSalle training.

Here is a man who all his life had accepted the thought that he was compelled to work for little or nothing.

For one thousand, nine hundred and seventy-six weeks the writer of this letter *paid at least \$24 a week for the doubtful privilege of staying in the ranks of untrained men.*

Can anyone doubt that training would have doubled his salary just as easily when he was thirty-eight years younger—when he could attack his work with the abundant energy of a younger man?

Yet his neglect of this main avenue of progress cost him—leaving simple and compound interest out of the reckoning—the appalling sum of \$47,424—a fortune in itself.



## If You Could Use \$47,424, Pause Before You Turn This Page

Perhaps you are already making quite as much as the writer of that letter—perhaps more. Perhaps, on that account, you may think that his experience does not apply to YOU.

But if training in Higher Accountancy—or Modern Salesmanship—or Business Management—or Law—or Business Correspondence—or any of a dozen other branches of business could change your forty-eight dollars into no more than \$72 a week (which is easily possible) and if you now NEGLECT to advance yourself—will you not find it difficult, thirty-eight years from now, to explain to those who are dear to you why you threw away \$47,424?

We're not going to moralize. We're not even going to cite any of the thousands of letters from men who have not merely increased but doubled and tripled their incomes through home-study training under the LaSalle Problem Method. We have the letters. We will show them to you, if you like. But understand, please, that they would not

alter the facts—they would merely *emphasize* them. Below this text there's a coupon. It will bring you not only full details of the training that appeals to you, but also a copy of that most inspiring book, "Ten Years' Promotion in One."

If you are sincere in your desire for advancement, you will not turn this page until you have clipped the coupon, filled it in, and by placing it in the nearest mail box placed *yourself* on the road to real success.

— — — Find Yourself Through LaSalle! — — —

## LaSalle Extension University

The World's Largest Business Training Institution

Dept. 1164-R

Chicago

I would welcome an outline of the LaSalle plan, together with a copy of "Ten Years' Promotion in One," all without obligation.

- |   |   |
|---|---|
| <input type="checkbox"/> Business Management            | <input type="checkbox"/> Law—Degree of LL.B.                  |
| <input type="checkbox"/> Modern Salesmanship            | <input type="checkbox"/> Commercial Law                       |
| <input type="checkbox"/> Higher Accountancy             | <input type="checkbox"/> Credit and Collection Correspondence |
| <input type="checkbox"/> Traffic Management             | <input type="checkbox"/> Industrial Management                |
| <input type="checkbox"/> Railway Station Management     | <input type="checkbox"/> Modern Foremanship                   |
| <input type="checkbox"/> Banking and Finance            | <input type="checkbox"/> Personnel Management                 |
| <input type="checkbox"/> Modern Business Correspondence | <input type="checkbox"/> Expert Bookkeeping                   |
| <input type="checkbox"/> Business English               | <input type="checkbox"/> Commercial Spanish                   |
| <input type="checkbox"/> Effective Speaking             | <input type="checkbox"/> C. P. A. Coaching                    |
| <input type="checkbox"/> Telegraphy                     | <input type="checkbox"/> Stenography—Stenotypy                |

Name .....

Present Position .....

Address .....



# AUDELS ENGINEERS & MECHANICS GUIDES

EXAMINE FREE!

For Every

Engineer  
Mechanic

Machinist  
Electrician

Fireman; Oiler  
Engineer Student



\$12  
Complete  
Set  
8  
Guides

**T** HIS Master Set is a gold mine of daily, practical helps for workers in every branch of engineering. A self-educating study course for the student; the standard reference work for the chief. Thousands of rules, tables, calculations and diagrams make it easy to read and learn. Latest inside information on theory and practice of modern engineering for reference study and review. Thousands of new short-cuts that make the job easier. Examine free! Pay \$1 a month (less than 4c a day) if satisfied that this set will help you to a better job—or make your present job easier.

## AUDELS STANDARD LIBRARY

With Questions and Answers That Solve Your Problems

EASY  
TERMS

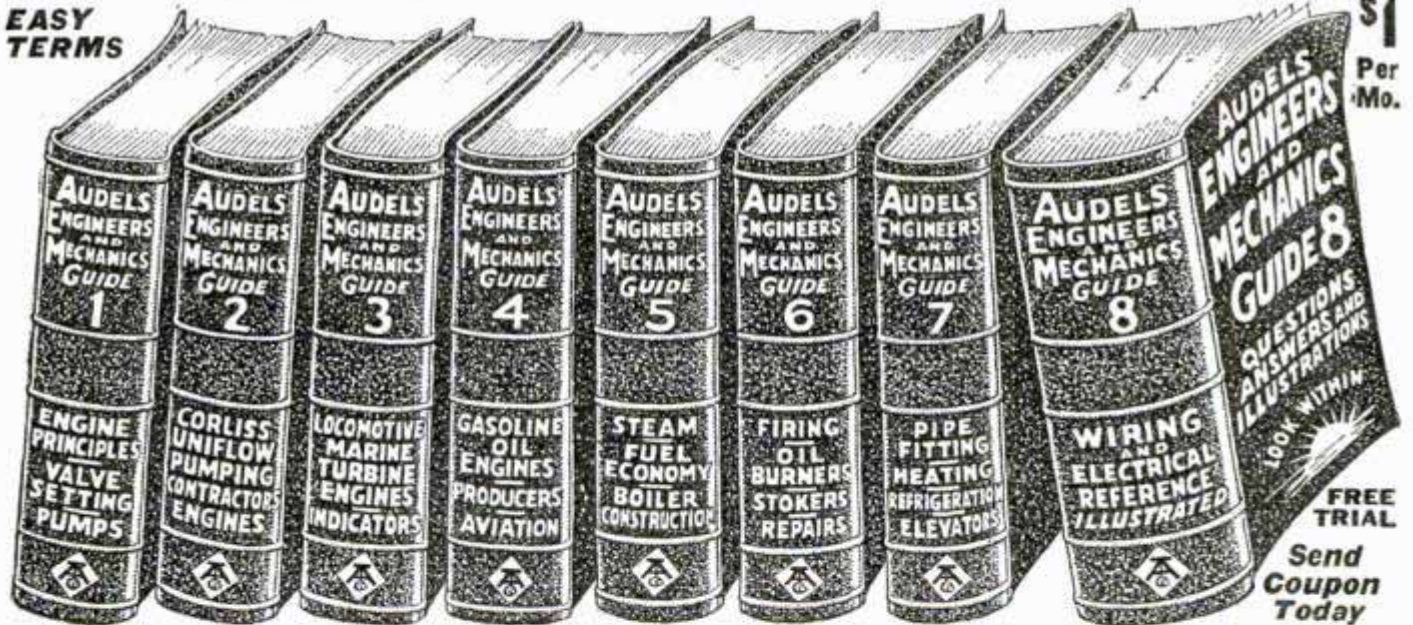

### 8 GUIDES 8754 PAGES—4750 ILLUSTRATIONS—POCKET SIZE

8 pocket numbers with Ready Reference Index. 8754 pages. 4750 illustrations. Easy to read. Highly endorsed. A good help in securing Engineer's License. Price \$12; terms, \$1 per month. Free Trial.

**INFORMATION: — In A Handy Form.** Answers to Your Questions and Problems. Here is a partial list of the subjects covered:—**Engine Principles, Valve Setting, Pumps, Corliss Engines, Uniflow Engines, Pumping Engines, Contractors Engines, Locomotives, Marine Engines, Turbine Engines, Gas Engines, Oil Engines, Indicators, Producers, Aviation, Steam, Fuel Economy, Boiler Construction, Firing, Oil Burners, Stokers, Boiler Repairs, Pipe Fitting, Heating, Refrigeration, Elevators, Dynamos, Motors, Lighting, Wiring, Electrical Diagrams, Radio, Electrical Reference and Calculations.**

FREE BOOK—FOR LIMITED TIME.



While the edition lasts, "Audels Answers" will be included with each set of Audels Guides. Contains special information for those who want to go before the board to get a license. Makes Engineers exams. easy. Send this coupon at once.

**THEO. AUDEL & CO., 65 West 23rd St., New York City**  
Send me AUDELS ENGINEERS AND MECHANICS GUIDES, 8 numbers, \$12 and "Audels Answers" for free examination. If satisfactory, I will send you \$1 in 7 days, then \$1 monthly until \$12 is paid.

Name.....

Address.....

Occupation.....

Employed by.....



# Make Money Quick!

## Like Tucker Did

### LEARN AUTOS AT HOME

\$215 in a Single Week—only 3 months after enrolling and in his third week in business! That's what "Job-Way" Training did for Ernest E. Tucker of Cotton, Minn. He says, "After the first day, work started rolling in—the following week I put on one man—the next week another—I am busy night and day."

### Earn Up to \$100 a Week!

You want to make big money quick, too. Then get into the Auto Business—where really big money is being made. Why, look here—every year \$5,000,000,000—not millions, but BILLIONS—is spent on auto upkeep alone. Get your share. Stop slaving your life away at dull, tiresome work. Quit selling your time for barely enough to live on. You don't have to. Start right now to prepare for a big money job. Get my FREE AUTO BOOK. Learn how quickly and easily you can learn all about autos—at home—in spare time. I've trained thousands of men and I'll train you, too, no matter where you live or what you are doing now.

#### Trained Men Needed

The auto business needs you—Never before was the demand for trained men—real Auto Experts—greater than right now. Never before were there so many splendid opportunities. And no wonder—there are over 25,000,000 autos and they all need service. That's why I say to you—take "Job-Way" Training and get in line for an expert's job at an expert's pay.

#### "Job-Way" Is Easy

Common schooling is all you need—if you're between 15 and 55 and you like autos—get my free book. Read how both old and young—many with very little education have been lifted out of poorly paid jobs—boosted to \$50, \$75 and even \$100 a week—and they all say it was due to "Job-Way" Training. That's what you can expect, too. Make the start today!

#### Earn While Training

Clip coupon for Free Auto Book and learn how scores of "Job-Way" students start right in getting raises and earning big, extra spare time money—while training—without giving up their regular jobs—and later go into business and make real money—like Tucker. And, you should be able to do as well as any of them.

#### Only One "Job-Way"

Nowhere else on earth can you get this wonderful "Job-Way" Training that is showing such wonderfully quick results. There is only one "Job-Way" and that is B. W. Cooke "Job-Way"—the training that has prepared thousands of men for brilliant futures in the World's Biggest Business—AUTOS! Get all the facts, today!

#### Get Details of My Big Offer

Find out about the 3 big outfits, my special Aviation Course, my Employment Department that helps you get a good job, my Consultation Service, my Automotive Magazine, and many other valuable features you can get right now without any additional charge, if you will act quick. Clip the coupon and let me tell you all about them.

**B. W. COOKE, Directing Engineer**  
**Chicago Motor Training Corp.**  
1916 Sunnyside Ave. Dept. 11-68  
CHICAGO

### Mail Coupon for Free Book!

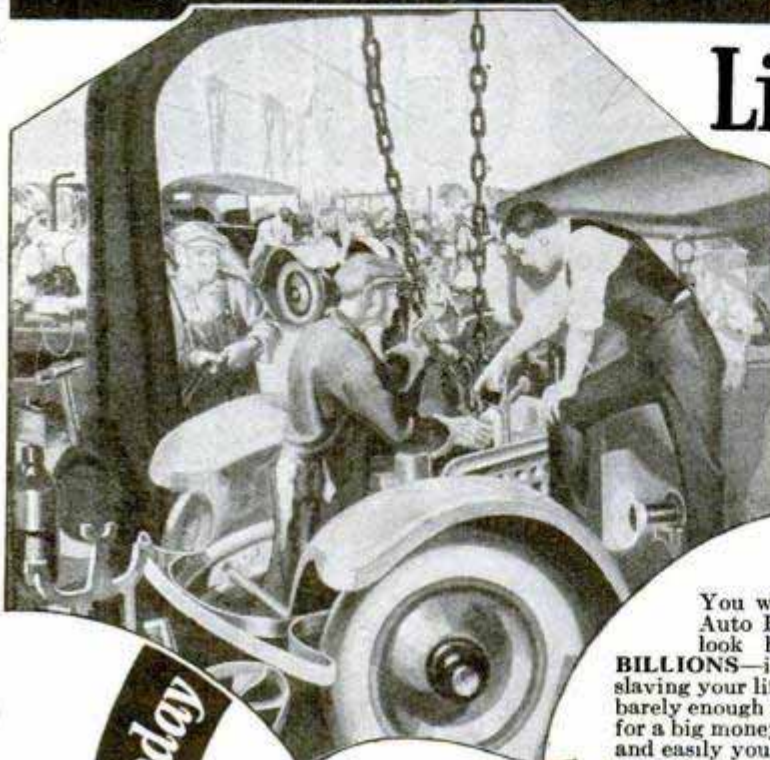

Send Today

**AVIATION COURSE**  
also included  
**FREE** of any  
extra cost  
if you act  
quick!

#### Money-Back Agreement

Remember, I agree that you must be absolutely satisfied when you finish or your "Job-Way" Training costs you nothing. I make this agreement with you in writing when you start.



B. W. Cooke, Directing Engineer,  
CHICAGO MOTOR TRAINING CORP.  
1916 Sunnyside Ave., Dept. 11-68, Chicago.  
I want to make money quick. Send me proof of quick results, also your Free Auto Book and full information about your big offer. No obligation to me.

Name.....  
Address.....  
Town..... State.....  
Age..... Occupation.....



# Only 28 years old and earning \$15,000 a year

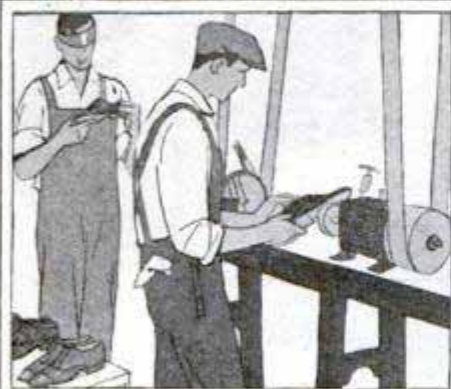

### Works in Shoe Factory

W. T. Carson was forced to leave school at an early age. His help was needed at home. He took a "job" in a shoe factory in Huntington, W. Va., at \$12 a week.

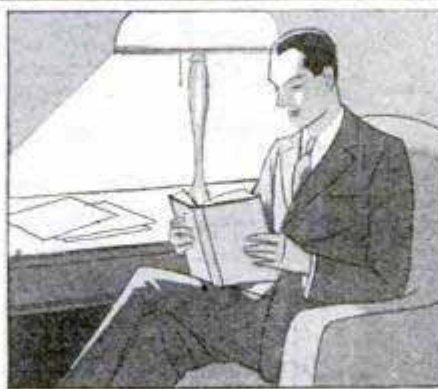

### Starts Studying at Home

Carson determined to make something of himself before it was too late, so he took up a course with the International Correspondence Schools and studied in spare time.



### Now Owns Big Business

Today W. T. Carson is the owner of one of the largest battery service stations in West Virginia, with an income of \$15,000 a year. And he is only 28 years old!



### Lectures at College

Just a few months ago a large college asked Carson to lecture before a class in electricity. That shows the practical value of his I. C. S. course.



### How to Earn More Money

If the I. C. S. can smooth the path to success for men like W. T. Carson it can help you. If it can help other men to earn more money it can help you too.



### The Boss is Watching You

Show him you are ambitious and are really trying to get ahead. Decide today that you are at least going to find out all about the I. C. S. and what it can do for you.

INTERNATIONAL CORRESPONDENCE SCHOOLS, Box 5571-F, Scranton, Penna.

"The Universal University"

Without cost or obligation, please send me a copy of your booklet, "Who Wins and Why," and full particulars about the subject before which I have marked X in the list below:

- Business Management
- Industrial Management
- Personnel Management
- Traffic Management
- Accounting and C. P. A. Coaching
- Cost Accounting

#### BUSINESS TRAINING COURSES

- Bookkeeping
- Secretarial Work
- Spanish  French
- Salesmanship  Advertising
- Business Correspondence
- Show Card and Sign Lettering

- Stenography and Typing
- English  Civil Service
- Railway Mail Clerk
- Common School Subjects
- High School Subjects
- Illustrating  Cartooning

#### TECHNICAL AND INDUSTRIAL COURSES

- Electrical Engineering
- Electric Lighting
- Mechanical Engineer
- Mechanical Draftsman
- Machine Shop Practice
- Railroad Positions
- Gas Engine Operating

- Civil Engineer
- Surveying and Mapping
- Plumbing and Heating  Mining
- Steam Engineering  Architect
- Architects' Blueprints
- Contractor and Builder
- Architectural Draftsman

- Concrete Builder
- Structural Engineer
- Chemistry  Pharmacy
- Automobile Work
- Airplane Engines
- Agriculture  Navigation
- Mathematics  Radio

Name.....Street Address.....

City.....State.....Occupation.....

Persons residing in Canada should send this coupon to the International Correspondence Schools Canadian, Limited, Montreal, Canada



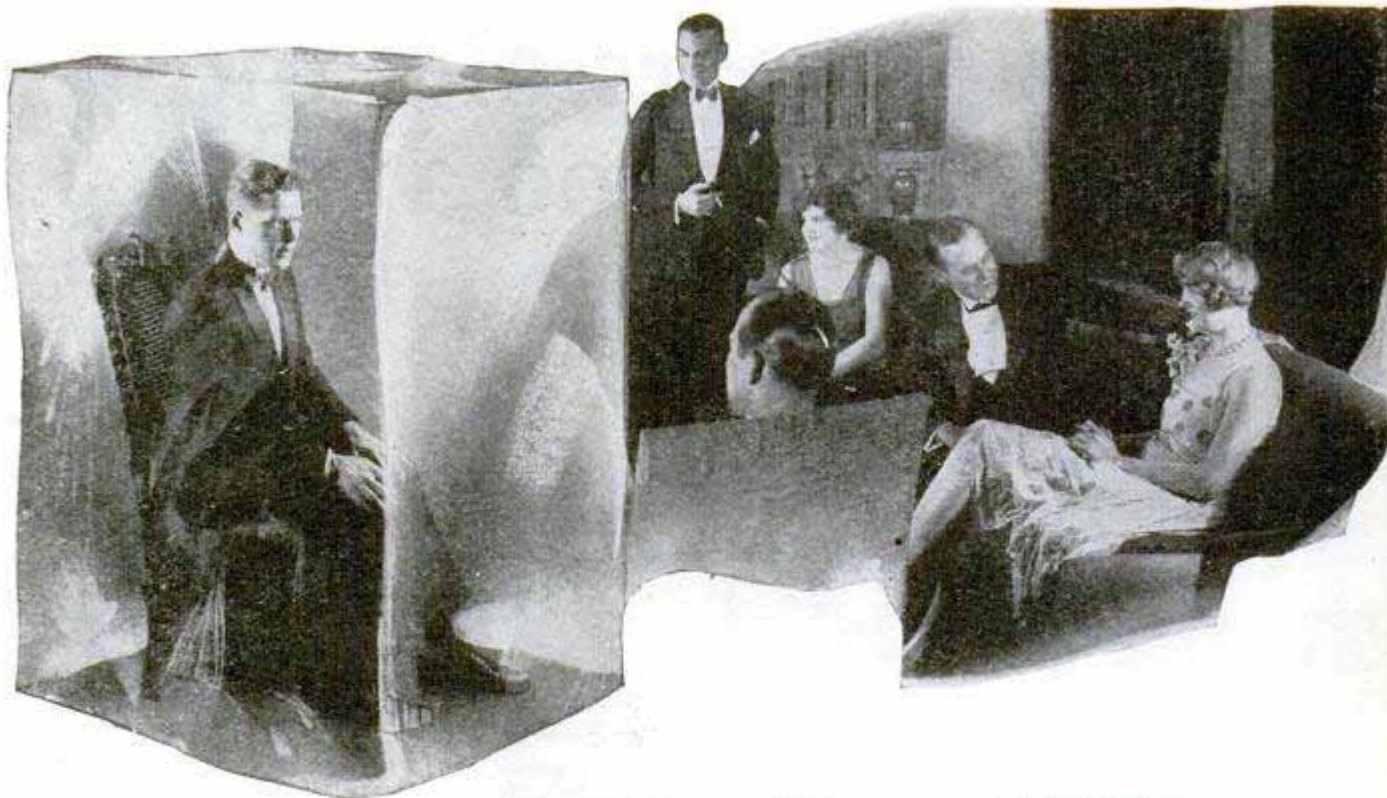

# I Turned To Ice When I Tried To Talk

## -But Now I Can Sway An Audience of Thousands!

I HAD always been painfully bashful. When trying to carry on even the most commonplace conversation my voice would sound unnatural and my hands and knees would tremble. Often I would listen to an argument among a group and become so keenly interested that I would want to voice my own opinion—yet timidity would keep me silent. I never had the courage to stand up for what I knew to be my rights—I was always afraid of "what people would say," ridicule. Since my childhood I had had a secret desire to appear in public—to be active in politics—but my shyness was so great that I turned to ice when I tried to talk—in even the smallest gathering!

My inability to talk was also affecting my business success. I dreaded going in and asking for a raise—I was afraid of any situation that meant using my voice—having to express myself. I didn't know how to present the ideas which I was sure the firm could use. I was just a plodder—a truck horse, capable of doing a lot of heavy work but of no use where brilliant performance was required. Often I would see men who were not half so thorough nor so hard working as I, promoted to positions where they made a brilliant showing—not through hard work, but through their ability to talk cleverly and convincingly—to give the appearance of being efficient and skillful.

### 20 Minutes a Day Will Show You—

How to talk before your club or lodge  
 How to propose and respond to toasts  
 How to address board meetings  
 How to tell entertaining stories  
 How to make a political speech  
 How to make after-dinner speeches  
 How to converse interestingly  
 How to write letters  
 How to sell more goods  
 How to train your memory  
 How to enlarge your vocabulary  
 How to develop self-confidence  
 How to acquire a winning personality  
 How to strengthen your will-power and ambition  
 How to become a clear, accurate thinker  
 How to develop your power of concentration  
 How to become master of any situation

### In Twenty Minutes a Day

And then suddenly I discovered a new easy method which made me a forceful speaker almost overnight. I learned how to dominate one man or an audience of thousands—how to say just the right words at the right time, how to win and hold the attention of those around me, how to express my thoughts simply and clearly, yet in a pleasing, interesting and amusing way. In just a few months I was able to make campaign speeches for a

local candidate—I who a short time before had turned to ice when I tried to carry on an ordinary conversation!

Soon I had won salary increases, promotion, popularity, power. Today I always have a ready flow of speech at my command. I am able to rise to any occasion, to meet any emergency with just the right words, to approach all types of people with ease and fearlessness. And I accomplished all this by developing the natural power of speech possessed by everyone, but cultivated by so few—by simply spending 20 minutes a day in my own home on this most fascinating subject.

### Send for This Amazing Book

This new method of training is fully described in a very interesting and informative booklet which is now being sent to everyone mailing the coupon below. This book is called **How To Work Wonders With Words**. In it you are shown how to conquer stage fright, self-consciousness, timidity, bashfulness and fear—those things that keep you silent while men of lesser ability get what they want by the sheer power of convincing speech. Not only men who have made millions, but thousands have sent for this book—and are unstinting in their praise of it. You are told how to bring out and develop your priceless "hidden knack"—the natural gift within you—which will win for you advancement in position and salary, popularity, social standing, power and real success. You can obtain your copy absolutely free by sending the coupon.

Now Sent FREE



**NORTH AMERICAN INSTITUTE**

3601 Michigan Ave. Dept. 1358  
 Chicago, Illinois

North American Institute,  
 3601 Michigan Ave., Dept. 1358,  
 Chicago, Illinois.

Please send me FREE and without obligation my copy of your inspiring booklet, *How To Work Wonders With Words*, and full information regarding your Course in Effective Speaking.

Name.....

Address.....

City..... State.....



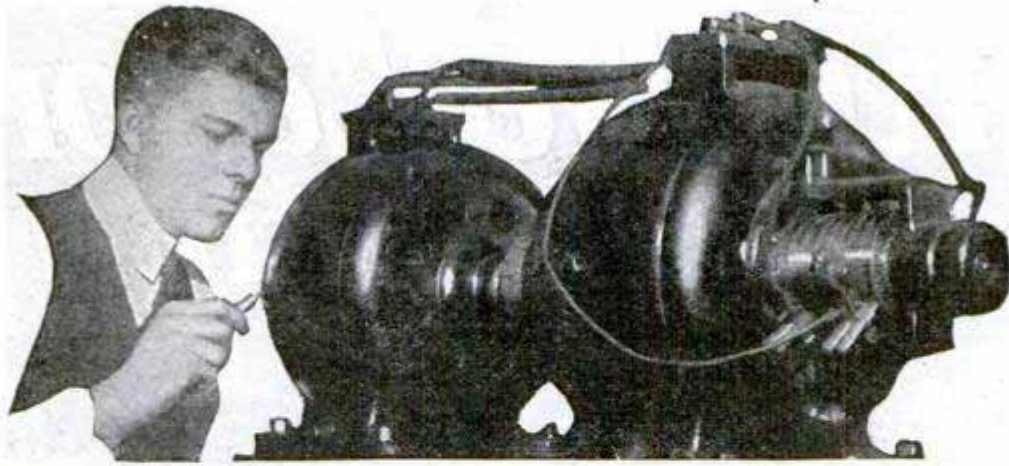

# Amazingly Easy Way to get into ELECTRICITY

Don't spend your life waiting for \$5 raises in a dull, hopeless job. Now . . . and . . . forever . . . say good-bye to 25 and 35 dollars a week. Let me teach you how to prepare for positions that lead to \$50, \$60 and up a week in Electricity—NOT by correspondence, but by an amazing way to teach that makes you a practical electrician in 90 days! Getting into electricity is far easier than you imagine!

## Learn on Actual Electrical Machinery in 90 Days

LACK of experience — age, or advanced education bars no one. I don't care if you don't know an armature from an air brake—I don't expect you to! It makes no difference! Don't let lack of money stop you. Most of the men at Coyne have no more money than you have. That's why I have worked out my astonishing offers.

### FREE Employment Service

Many of my students earn a good part or all of their living expenses and should you need this assistance we will help you. Then, in 12 brief weeks, in the great roaring shops of Coyne, I train you as you never dreamed you could be trained . . . on one of the greatest outlays of electrical apparatus ever assembled . . . real dynamos, engines, power plants, autos, switchboards, transmitting stations . . . everything from door bells to farm power and lighting . . . full-sized . . . in full operation every day!



### Prepare For Jobs Like This

Here are a few of hundreds of positions open to Coyne-trained men. Our free employment bureau gives you lifetime employment service.

Armature Expert	\$58 a Week and up
Substation Operator	\$65 a Week
Auto Electrician	\$60 a Week and up
Inventor	Unlimited
Maintenance Engineer	\$60 a Week and up
Service Station Owner	\$60 a Week and up
Radio Expert	\$60 a Week and up

houses, etc. That's a glimpse of how we help to make you a practical electrician, and fitting you to hold big jobs after graduation.

### Jobs, Pay, Future

Don't worry about a job. Coyne training settles the job question for life. Big demand for Coyne-trained men. Our employment department gives you lifetime service. Two weeks after graduation, Clyde F. Hart got a position as electrician with the Great Western Railroad at over \$100 a week. That's not unusual. We can point to many Coyne men making up to \$600 a month. \$60 a week is only the beginning of your opportunity. You can go into radio, battery or automotive electrical business for yourself and make \$3000 a year and up.

### Get the Facts

Coyne is your one great chance to get into electricity. Every obstacle is removed. This school is 29 years old — Coyne training is tested — proven beyond all doubt — endorsed by many large electrical concerns. You can find out everything absolutely free. Simply mail the coupon and let me send you the big, free Coyne book of 150 photographs . . . facts . . . jobs . . . salaries . . . opportunities. Tells you how many earn expenses while training and how we assist our graduates in the field. This does not obligate you. So act at once. Just mail coupon.

Get this FREE Book



### Not a Correspondence School

Learn by doing . . . all real actual work . . . building real batteries . . . winding real armatures, operating real motors, dynamos and generators, wiring



### Now in Our New Home

This is our new fireproof, modern home wherein is installed thousands of dollars worth of the newest and most modern Electrical equipment of all kinds. We now have a larger amount of floor space devoted to the exclusive teaching of practical electricity. Every comfort and convenience has been arranged to make you happy and contented during your training.

Mr. H. C. Lewis, Pres. COYNE ELECTRICAL SCHOOL, Dept. 88-72, 500 S. Paulina St., Chicago, Ill.

Dear Mr. Lewis: Without obligations send me your big free catalog and all details of Free Employment service, Radio and Automotive Courses without extra cost, and how many "earn while learning." I understand I will not be bothered by any salesman.

Name . . . . .  
 Address . . . . .  
 City . . . . . State . . . . .

**COYNE ELECTRICAL SCHOOL**  
 H. C. LEWIS, Pres., Dept. 88-72  
 500 S. PAULINA ST. Founded 1899 CHICAGO, ILL.



# Here's 3 Free Lessons! in Auto Painting

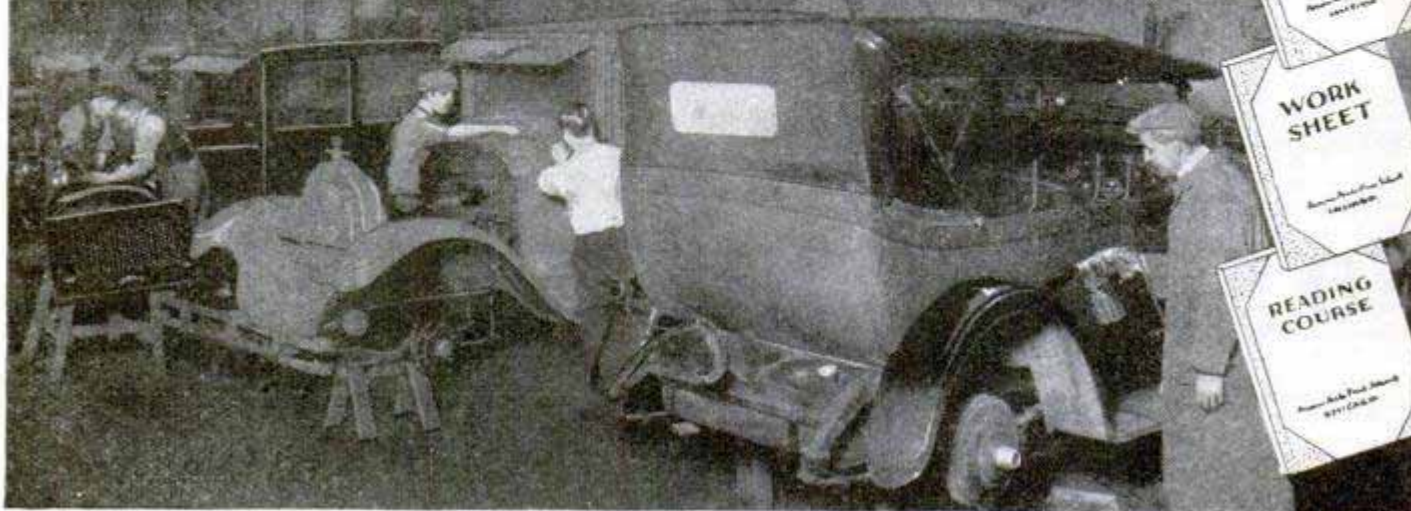

## We Furnish All Equipment!

Cars everywhere need painting! Painters' incomes running into thousands. That's the situation all over the United States today. Doesn't that move you to fill out and mail the coupon below to get the proof? The 3 free lessons are yours and you won't owe me a cent.

Are you making \$60.00 to \$125.00 a week now? Is your work so easy? **CAN YOU EVER BE YOUR OWN BOSS?**

Just your name and address brings full details—and the 3 free lessons to prove that you too can learn to be a real Auto Painter through my simple, easy shop-type method of home training.



## You can practice at Home

You don't have to give up your present job. You can get ready in your spare time—in the evenings. It's fascinating. I furnish 13 big outfits with the course so you get actual experience on wood and metal panels as you go along—right at home. I'll soon have you fully prepared for a job anywhere. Places waiting for first class men at high pay.

You can tackle anything in the auto painting line with the utmost confidence after you've had my training. I'm "right at your elbow" to help you anytime you need me. I'm right here for lifetime consultation. All this for only a few pennies a day. Mail coupon! This may be the turning point of your life. Men like yourself now making \$5000 to \$10,000 a year!

## I help you go into business

**BOSS YOUR OWN BUSINESS!** Get others to do the work for you. That's the way the **BIGGEST MONEY** is made. It is so easy to start an auto painting business of your own that you'll wonder why you never thought of it! I don't care whether you have a cent in the bank or not. *I'll show you the way.* And how this trade does grow! Set your stakes for the biggest Auto-painting business. By my plan you can have it some day and not so far in the future either. This business is here to stay—and now is the time to get into it.



G. King Franklin  
Superintendent

## GET THE PROOF

G. King Franklin, Supt.  
American Auto Painting School  
Dept. 2001, 425 S. Ashland Ave., Chicago

Send sample shop-tickets free and information on how I may learn auto painting and Duco at home in spare time.

Name.....

Street No.....

City..... State.....

**LEARN**

## BIG PAY EVERYWHERE

Just get this—these opportunities are waiting for you NOW. And a few months puts you in line to go right up and grab one off. No long tedious course—nothing technical. I don't care what schooling you've had or have not had. If you are a normal red-blooded man with ambition I can give you just as fine an opportunity as any man in the business. The point is will you act now? Sign and mail the coupon—3 free lessons. No obligation.

**G. KING FRANKLIN, Supt.**  
**AMERICAN AUTO PAINTING SCHOOL**  
Dept. 2001, 425 South Ashland Avenue, CHICAGO



# AUTO

## 5 AUTO BOOKS SENT FREE!

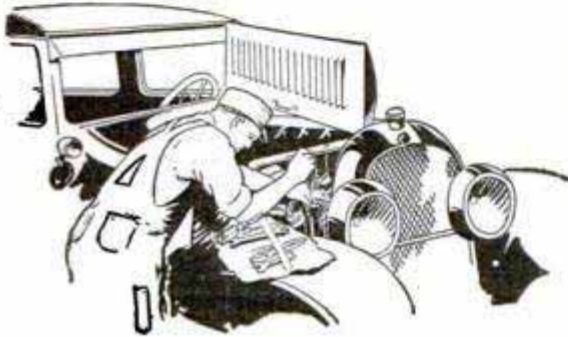

Mail the coupon and we'll send you a set of these remarkable auto books, just off the press. Whether you are mechanic or helper, expert or student, auto owner or driver, if you're interested in autos, by all means take advantage of this opportunity to see the latest and most complete work on autos we have ever published. Built by eighteen of America's greatest automotive engineers. Simple enough for men with little schooling to understand, yet in daily use by hundreds of engineers, service-station superintendents and foremen as an authoritative REFERENCE Cyclopedic. This new edition includes straight-eights, 4-wheel brakes of all types and other features of the 1928 models.

### Put the JIFFY INDEX

*to work for you!*

## Can You FIX IT?

Can you take out "play" in differential? Can you kill the "Shimmy" in steering? Can you reset TIMING? Can you put your finger on engine trouble without guessing or tinkering? Can you pull the starter off and fix it? Can you adjust and repair transmission, engine, rear axle, bearing?

### These Books Tell How!

They bring the answer to any auto problem instantly. And they show the best, quick, professional way to do EVERY repair and replacement job you will ever need. Auto owners say the cost is saved over and over again by showing how to make adjustments and emergency repairs on the road.

### 5 Big DeLuxe Volumes just off the press!

2400 pages, over 2000 illustrations, wiring diagrams, equipment charts, etc. De Luxe edition with gold-stamped flexible binding. Sent FREE for 15 days' use. If not wanted return express collect. If kept, send only \$2 after 15 days, then \$3 a month until special advertising price, \$24.80, is paid.

### A Year's Consulting Membership FREE!

Privilege of consulting engineers of million-dollar American Technical Society on any automotive problem for one year without charge, if you mail coupon immediately.

## American Technical Society



Dept. A-819, Drexel Ave. & 58th St.,  
CHICAGO, ILL.

The billion-dollar auto industry offers rich prizes to men with gumption enough to really learn all branches of automotive mechanics. A better job, bigger pay—a chance to go into business and get a share of the huge profits, are waiting for any man who even half tries to improve his ability to deliver service. And here's the shortest, easiest way: No tedious studying, no memorizing, no lessons or examinations. Just LOOK UP the fact you seek. You'll find the answer to any auto problem literally at your finger-tips, in the famous JIFFY INDEX. No need to "carry it in your head," at all.



"Was garage hand—now have Shop of my own," writes W. Sidle of Toboso, O.

J. H. Geise of Detroit says: "I received \$50 worth of information out of them the first 5 days."

"I got a raise," says P. Ervin of Yarmouth, N. S., shortly after getting his books.

And D. S. Reid of Siluria, Ala., was offered \$4000 for invention worked out with these Auto Books.

## Don't Send a Penny!

AMERICAN TECHNICAL SOCIETY,  
Dept. A-819, Drexel Ave. and 58th St., Chicago, Ill.

I would like to see the new 5-volume edition of your AUTO BOOKS, but without obligating me to buy them. I will pay the few cents delivery charges only, but if I choose to, I will return them express collect and owe you nothing. If after 15 days' use I prefer to keep them, I will send you \$2 and pay the balance at the rate of only \$3 a month, until \$24.80 is paid. Please include free membership.

Your Name .....

Your Address .....

Reference Name .....

Reference Address .....



# Hawaiian Guitar

## GIVEN

Worth \$20

to our Students

This Hawaiian Guitar expert and professor wants the opportunity to welcome you as a student so you will quickly learn how to play a Hawaiian Guitar—yes, you will be able to play just like the native Hawaiians. To get you started and help your musical success, which will bring you popularity, you will receive a beautiful Hawaiian Guitar, the same as the one pictured, when you enroll. Our short cut method of instruction will enable you to play a piece almost from the first lesson. Rush coupon for full particulars today and we will reserve a Hawaiian Guitar for you.



### Learn to Play Quickly

With our short cut method of instruction you will quickly learn how to play Hawaiian Guitar, which will bring you popularity and social success. You learn to play from notes. If you never had any musical training, you will quickly get on, because our experts have perfected a course of home instruction which is as simple as learning A, B, C's.



**PICTURE and PHONOGRAPH RECORD METHOD EASY** We don't depend upon printed lessons only for your success, but we furnish pictures of our professors playing, diagrams, charts and phonograph records for each lesson. This practically brings our professors from our studio to your home and enables you to listen to their playing just as if they were actually in front of you. To prove this is easy, we will send you your first lesson free.

### RUSH COUPON—Send No Money

So positive are we that you will become one of our students, we will send free, without obligation, our first lesson. Also receive our free big book which gives particulars about our course. Write for your free book and your free lesson today.

HAWAIIAN STUDIO No. 52118 of New York Academy of Music 100 Fifth Avenue, New York, N. Y.

Please rush your free book, "How to Learn Hawaiian Guitar," and my first free lesson. Also reserve a Hawaiian Guitar for me. This obligates me in no way whatever.

Name.....

Address.....

## BE A RAILWAY TRAFFIC INSPECTOR

**PAYS UP TO \$250 per month SALARY plus expenses**



**No Hunting for a Position after Completing your Training**



Read what R. H. Kruger says: "Having completed your course in Traffic Inspection, I find that it is very interesting work; also it is one of the most interesting studies of today. The work is very fascinating, and I would be glad to advise anyone wishing to take up this course, as it is sure wonderful work, with a splendid future."

If you are a normal man over 19— You can earn as high as \$250 per month salary with expenses paid, in the fascinating, uncrowded profession of Railway Traffic Inspection. You'll be out in the open, away from dingy shop or monotonous desk, meeting new people, seeing new places. You'll be practically your own boss—dressed in good clothes—reporting only to high railway officials. Promotions are rapid—your future is as big as you care to make it.

We'll train you for Traffic Inspection and upon completion assist you to a position at a definite salary, or refund your tuition. There's no gamble—no hard selling—no hunting for a job. Traffic Inspectors start after completion of 3 months' spare time home study, at \$120 or more per month salary. During the last nine years, we have placed hundreds of men in this profitable profession. Don't chase a rainbow—learn a profession that will pay you a salary, as soon as you start, and will quickly increase to \$185 to \$250 a month.

**SEND FOR FREE BOOKLET** Send for our booklet "A Profession of Protection" now! Read our employment agreement which shows how we are able to assist our graduates to salaried positions.

Standard Business Training Institute, Div. 2, Buffalo, N. Y.

## Electrical Engineering

Course for men of ambition and limited time. Over 5000 men trained. Condensed course in Theoretical and Practical Electrical Engineering including the closely related subjects of Mathematics and Mechanical Drawing.

Students construct motors, install wiring, test electrical machinery. Course designed to be completed in one college year. Prepare for your profession in the most interesting city in the world. Est. 1893. Catalog on request.



## Bliss Electrical School

121 Takoma Ave., Washington, D. C.

## Pathfinder

EVERY WEEK 13 WEEKS TRIAL \$1 A YEAR 15 CENTS

Your neighbors know the Pathfinder and you will like it—the every week news digest from the Nation's Center. Bright, interesting, dependable, different—nothing else like it. Washington gossip, politics, science, travel, fun, lots of pictures, instruction, entertainment. Trial 13 weeks—13 big issues—only 15c or \$1 for full year—52 issues. Send now. Address Pathfinder, Dept. 25, Washington, D. C.

## LEARN WATCHMAKING

and become independent. We help you secure a position. Easy to learn. Send for FREE CATALOG. ST. LOUIS WATCHMAKING SCHOOL, Dept. 5, ST. LOUIS, MO.

## Learn Furcraft

Learn by mail, evenings at home, to Renew, Repair and Make-up all kinds of fur garments. Learn glazing, ironing and storage. Big demand, big need for your service in every neighborhood. \$3 an hour in your spare time or a real business now and a fur shop later. We teach you secret processes. Earnings start in 30 days. Uncrowded field for men and women. FREE BOOK—send now for free book giving details. No obligation. Northwestern Fur Co. 3378 Sunderland Bldg. OMAHA, NEBRASKA





# The Man I Pity Most

**P**OOOR OLD JONES. I see him now, standing there, dejected, cringing, afraid of the world. No one had any use for him. No one respected him. Across his face I read one harsh word—FAILURE. He just lived on. A poor worn out imitation of a man, doing his sorry best to get on in the world. If he had realized just one thing, he could have made good. He might have been a brilliant success.

There are thousands and thousands of men like Jones. They, too, could be happy, successful, respected and loved. But they can't seem to realize the one big fact—that practically everything worth while living for depends upon STRENGTH—upon live, red-blooded, he-man muscle.

Everything you do depends upon strength. No matter what your occupation, you need the health, vitality and clear thinking only big, strong virile muscles can give you. When you are ill the strength in those big muscles pulls you through. At the office, in the farm fields, or on the tennis courts, you'll find your success generally depends upon your muscular development.

## Here's a Short-Cut to Strength and Success

But, you say, "It takes years to build my body up to the point where it will equal those of athletic champions." It does if you go about it without any system, but there's a scientific short-cut. And that's where I come in.

### 30 Days Is All I Need

People call me the Muscle-Builder. In just 30 days I can do things with your body you never thought possible. With just a few minutes work every morning, I will add one full inch of real, live muscle to each of your arms, and two whole inches across your chest. Many of my pupils have gained more than that, but I GUARANTEE to do at least that much for you in one short month. Your neck will grow shapely, your shoulders begin to broaden. Before you know it, you'll find people turning around when you pass. Women will want to know you. Your boss will treat you with a new respect. Your friends will wonder what has come over you. You'll look ten years younger, and you'll feel like it, too. Work will be easy. As for play, why, you'll realize then that you never knew what play really means.

### I Strengthen Those Inner Organs Too

But I'm not through with you. I want ninety days in all to do the job right, and then all I ask is that you stand in front of your mirror and look yourself over.

What a marvelous change! Those great squared shoulders! That pair of huge, lithe arms! Those firm, shapely legs! Yes, sir. They are yours, and they are there to stay. You'll be just as fit inside as you are out, too, because I work on your heart, your liver—all of your inner organs, strengthening and exercising them. Yes indeed, life can give you a greater thrill than you ever dreamed. But, remember, the only sure road to health, strength and happiness always demands action. Fill out the coupon below and mail it today. Write now!

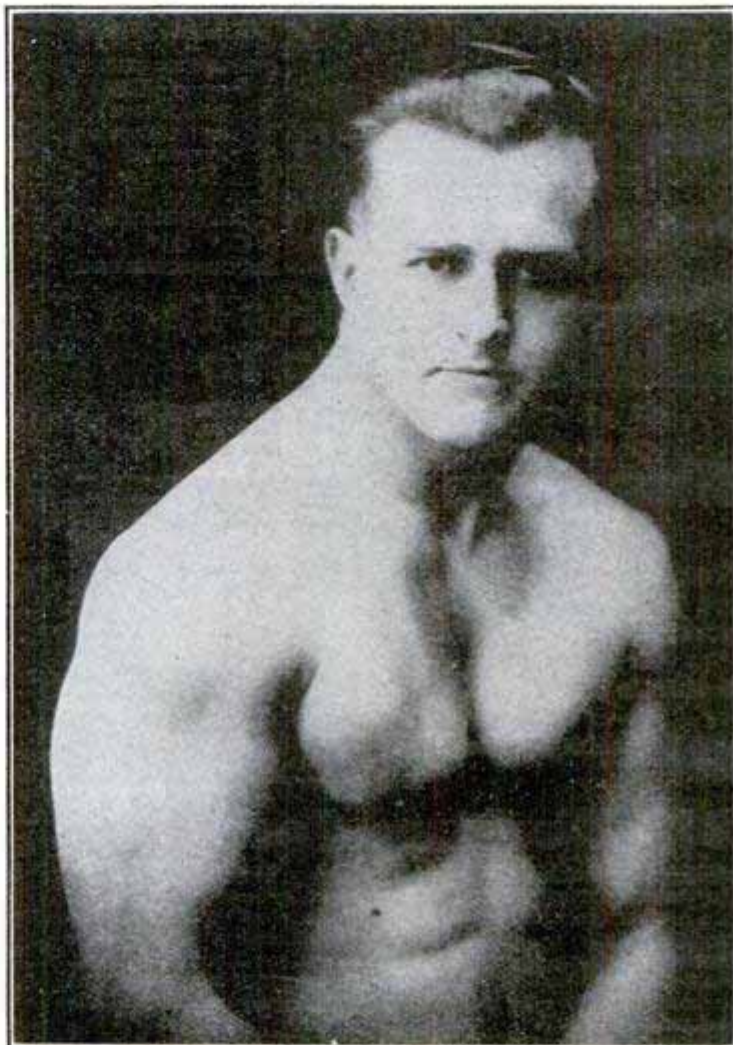

**EARLE LIEDERMAN, The Muscle Builder**

Author of "Science of Wrestling," "Muscle Building," "Secrets of Strength," "Here's Health," "Endurance," Etc.

Send For My New  
64 Page Book  
**"Muscular Development"**  
IT'S FREE

It contains forty-eight full-page photographs of myself and some of the many prize-winning pupils I have trained. Some of these came to me as pitiful weaklings, imploring me to help them. Look them over now and you will marvel at their present physiques. This book will prove an impetus and a real inspiration to you. It will thrill you through and through. This will not obligate you at all, but for the sake of your future health and happiness do not put it off. Send today—right now before you turn this page.

**EARLE LIEDERMAN**

Dept. 2011 305 Broadway, New York City

**DON'T  
SEND ONE  
PENNY**

**YOUR  
NAME  
AND  
ADDRESS  
ON A  
POSTAL  
WILL DO**

**EARLE LIEDERMAN,  
Dept. 2011, 305 Broadway,  
New York City.**

Dear Sir: Without any obligation on my part whatever please send me a copy of your latest book, "Muscular Development."

Name.....

Street.....

City..... State.....

(Please write or print plainly.)



# We Will Train You in a Few Months



Day and Night Schools in Chicago, Detroit, Cleveland, Boston, Phila.

Tune in WBBM (389.4 Meters) for McCarrie hour each Monday at 8:30 P. M. Central Standard Time

Experts Earn Up To **\$125 A WEEK**

## as MECHANICAL DENTISTS

We teach you to make rubber plates, crowns, bridge work, metal base dentures, etc., for dentists. After graduating you are ready for a job or can open your own laboratory. We assist you.



## Big Demand for Men!

Mechanical Dentistry is the laboratory bench work which the dentist turns over to the laboratory worker. Master this profession and help meet the demand of 64,000 dentists for laboratory work. Every city and every town where dentists are located offers work to the mechanical dentist. We train you in a few months in day or night school for this uncrowded field—no classes—no books—no mechanical experience necessary.

## Work Your Way Thru School

We will help you find a job to meet your expenses while taking our training. And we will help you find satisfactory living quarters when you arrive.

Schools located in Chicago, Detroit, Cleveland, Boston, Philadelphia. Day and night schools.

## INTERESTING FREE BOOK

Our illustrated free book on Mechanical Dentistry will acquaint you with some surprisingly interesting facts. It tells about the thriving profession of Mechanical Dentistry—the way to swift and certain success. And it tells about the progress of many of our graduates—men who have succeeded beyond their expectations, also full details of our liberal offers. Mail the coupon and find out more about this fascinating opportunity.

**McCarrie School of Mechanical Dentistry**  
1338 S. Michigan Ave., Dept. 189, Chicago, Ill.

McCARRIE SCHOOL OF MECHANICAL DENTISTRY  
1338 S. Michigan Ave., Dept. 189, Chicago.

Without cost or obligation, send me your illustrated book on Mechanical Dentistry, and complete information as to my opportunities in dental laboratory work.

Name.....

Address.....



# Young outdoor men wanted

Interesting, vigorous outdoor work in a growing organization where merit wins advancement. Good starting wages. Permanent positions and a real future for men who make good. Our present field force of Davey Tree Experts cannot meet the increasing demand. So we are selecting now, to enter our employ, a few sturdy, clean young men, thorough Americans, single, between 20 and 30 years old, free to travel, industrious, with good practical education, and able to give good references. Write for qualification blank to serve in place of personal interview.

The Davey Tree Expert Co., Inc.,  
126 Federal Bldg., Kent, Ohio

# LAW

**STUDY AT HOME**  
Become a lawyer. Legally trained men win high positions and big success in business and public life. Be independent. Greater opportunities now than ever before. Big corporations are headed by men with legal training. Earn **\$5,000 to \$10,000 Annually**. We guide you step by step. You can train at home during spare time. Degree of LL.B. conferred. LaSalle students found among practicing attorneys of every state. We furnish all text material, including fourteen-volume Law Library. Low cost, easy terms. Get our valuable 64-page "Law Guide" and "Evidence" books FREE. Send for them NOW. LaSalle Extension University, Dept. 1164-L Chicago. The World's Largest Business Training Institution

## MUSIC LESSONS IN YOUR HOME



You can read music like this quickly  
Write today for our FREE booklet. It tells how to learn to play Piano, Organ, Violin, Mandolin, Guitar, Banjo, etc. Beginners or advanced players. Your only expense about 3c per day for music and postage used. American School of Music, 51 Manhattan Bldg., Chicago.

# STAMMER

IF YOU Write for my free book "Millard's Advanced Natural Corrective Course" and a free copy of my speech magazine. 10,000 cases successfully treated. Est. 24 years. Largest school for stammerers in world. Millard Inst. of Normal Speech, 2317 Millard Bldg., Milwaukee, Wis.

# BE AN ARTIST

WE CAN TEACH YOU DRAWING in your own home during your spare time. Twenty-five years of successful teaching proves our ability. Artists receive large salaries.

Write Today for Art Year Book

SCHOOL OF APPLIED ART  
ROOM NO. 2 BATTLE CREEK MICH.





**Success in 1 month  
for Leshner!**

**\$85 a week  
for McCarty!**

**Over \$278 in Spare  
Time for McGriff!**

"Before starting your course, I did not know a thing about the Tenor Banjo but within one month after I received the first lesson, I was playing with a very good dance orchestra. The course was so easy to understand that my progress was very rapid."—L. V. Leshner, Braddock, N. Dak.

"Before taking up your course, I was making \$18 weekly as a clerk and knew nothing about music, but I made my first 'paid' performance in less than eight weeks after starting. Today I owe my salary of \$85 a week as a professional Tenor Banjoist to your excellent training."—Kenneth McCarty, Parkview Hotel, South Haven, Mich.

"When I ordered your Tenor Banjo course I had never had my hands on a Banjo. I now have a \$278 Banjo bought with extra money made by playing. Now also play weekly at the picture show and for dances at our country club, too."—J. P. McGriff, Hawkinsville, Ga.



R. J. Smith, 522 N. Mich. Ave., Big Rapids, Mich., makes \$22 extra a week for three evenings' play with a dance orchestra.



James J. Delnero, 1407 Westfield St., Springfield, Mass., makes \$32 extra a week for playing with a dance orchestra.



# The Book that started Leshner, McGriff and McCarty is Now Ready for YOU!

PROBABLY you've never really considered the proposition I have to offer you. Probably like thousands of others whom I have helped find themselves, you have thought of the Tenor Banjo as just a pastime—just a remarkable, melodious instrument for those who have "talent." . . . But then think of earning \$15, \$20 or \$25 a week EXTRA SPARE-TIME MONEY for two, three or four nights' fun! Look at the men pictured above. None of them had ever touched a string—ever read a single note.

**Ready for YOU!**

**I'll train you right at home to play the Tenor Banjo in 1 to 3 short months**

If you can whistle a tune, read a printed page, understand a picture and hear a phonograph record—then YOU CAN DO what Leshner, McGriff and McCarty have done! Many of my students get off their first tune within half an hour after they receive the big Tenor Banjo you see pictured here. It isn't hard or tedious; instead the Play-Way is interesting all the way through. It's like learning a game. Not one thing stands between you and popularity, good times, scores of new friends—and big EXTRA PAY.

**LOOK! My course even includes Phonograph Records**

Everything you see here—and MORE—comes to you as a part of the Play-Way course. The outfit includes this full professional size Tenor Banjo; Phonograph Records demonstrating every selection in the course; Banjo Pick, Tuner, Extra Strings—copyrighted Gain-Time Chart to help you quickly learn notes. Everything you need to learn—everything you need AFTER you learn. Mail the coupon TODAY.

A. F. Bloch, President  
New York Academy of Music,  
Studio 1118,  
100 Fifth Avenue,  
New York City



"The Play-Way to Popularity and Big Pay"—that's the FREE book I want you to have. It will open YOUR eyes—just as it did for Leshner, McGriff and McCarty. Whatever you've thought about your opportunities, your advantages, your future as a Tenor Banjoist before—you'll want to think again the minute you lift the cover of this remarkable FREE book. It has been the stepping stone, the start, for hundreds who today are enjoying more fun, popularity and prosperity than they ever dreamed could be possible. It costs nothing. It may count for much. Don't pass this page until the coupon's ready to mail.

**Big Outfit Comes with Very First Lesson**



**Get Your FREE Copy Quick**

A. F. BLOCH, President,  
New York Academy of Music,  
Studio 1118, 100 Fifth Ave., New York City.

I'd like to know more about The Play-Way and about my opportunities as a Tenor Banjoist. I'm ready NOW for my copy of your FREE book.

Name.....

Address.....

**A raise of \$50 a month for just two evenings a week!**





# BOYS

Make Big Spare Time Money Surprise your chums

# ELECTRICITY

*This Quick Easy Way*

Electricity is great fun! And it pays. Lots of my boys still in school are making \$10 to \$15 a week in spare-time—and getting a real training besides for a regular he-man's Big-Pay job in Electricity when school days are over. You can, too! I'll show you how. Begin right now to prepare for a big future in this fascinating field of great opportunity. Your chances of success are simply wonderful!

## Learn Right at Home

With my easily-learned, spare-time Electrical Course I will train you at home like I trained hundreds of other boys who are now big successful men. It won't interfere with your school work. And you'll find it so enjoyable it will be more like play than study. It's just the thing for you fellows who are ambitious to get somewhere and be somebody after you have finished school.

## I Train You RIGHT!

My training is practical—you learn along work-shop lines by doing. I furnish you with all necessary equipment to work with. And it doesn't cost you a penny extra! Six Big Outfits of tools, material and apparatus, including a real electric motor—not toys, but the real thing. And they're yours to keep—to learn right with, and to help you do the spare-time work I tell you how to get and how to do.

## Mail Coupon for Book

If you want lots of spending money—if you want to be ready to jump into a Big-Pay Electrical Job when you're through school—my Big Book will show you how. Get it—you'll like it—it's full of "dope" data and pictures that will thrill you. And it's FREE—won't cost you a penny—mail coupon for it right now!

## L. L. COOKE

Chief Instruction Engineer  
Dept. 018, CHICAGO, ILL.

## RADIO COURSE NO EXTRA CHARGE

Every fellow wants to learn radio. And this Course is a dandy. It's simple—it's thorough. You'll be surprised what it will teach you about Radio. And it's yours without a penny of extra cost!

## 6 BIG OUTFITS given, including a REAL MOTOR

What a thrill you'll get from these Six Big Outfits of tools and apparatus! There's enough equipment in this fine layout for you to tackle any kind of spare-time work. Imagine having all this for "keeps."



## Use this SPECIAL OFFER Coupon

L. L. COOKE, Chief Instruction Engineer,  
L. L. Cooke School of Electricity,  
Dept. 018, 2150 Lawrence Ave., Chicago, Ill.

Send me free and fully prepaid your Big Book about Electricity, and full particulars about your Electrical Course and extra Radio Course. This does not obligate me.

Name.....

Address.....

City..... State.....

(This coupon only for use of boys 15 years old or more)

## PREPARE FOR AN ART CAREER

—thru the only art school operated as a department of a large art organization, who have actually produced over a quarter million drawings for leading advertisers. Where else can you get so wide an experience? Home study instruction. Write for illustrated book telling of our successful students.

**MEYER BOTH COMPANY**  
Michigan Ave. at 20th St. Dept. 16, Chicago, Ill.

### LEARN A TRADE Be Independent



Easy to Learn Watchmaking and watch and clock repairing by our practical method of individual training.

**Earn Up to \$100 A WEEK**

**FREE BOOK** Learn in few months to fill big pay job or start your own business. Big shortage of trained watchmakers. Day or evening school. No books or classes. You can earn part of your tuition on actual repair work you do in school. **Write for Free Book Today!**

**NATIONAL SCHOOL OF WATCHMAKING**  
1340 S. Michigan Ave. Dept. 41 CHICAGO, ILL.

## YMCA TRADE SCHOOL

Learn Auto Mechanic, Auto Electrical, Battery, Machine Shop, Electrical, Radio Mechanic, Aviation Mechanics, Tiling, Brick-laying, Plastering, Plumbing, Electric Acetylene and Airplane Welding, Drawing, Estimating, Show Card, Sign Painting, Window Dressing, Fine and Commercial Art.

Write for Catalog 50.

**BROOKLYN ENGINEERING INSTITUTE**  
(Operated by Bedford Br. Y. M. C. A.)  
1125 Bedford Ave., Brooklyn, New York City.

## CHIROPODY

**MAKE \$5,000 TO \$15,000 A YEAR**

In dignified profession. Doctors of Surgical Chiropody needed everywhere. Best known College in America gives you full course, prepares you for practice in 2 years. Largest foot clinic in the world. Faculty of leading physicians, chiropodists. Finest equipment. 15th year. Study in Chicago. Varied interests of city life—opportunities all around. Earn while you learn. Write for catalog. No obligation. Dept. 811.

**Illinois College of Chiropody, 1327 N. Clark St., Chicago**

## ILLINOIS COLLEGE of PHOTOGRAPHY

Prepares you in from 6 to 8 months to earn \$200 to \$500 a month as a photographer or photo-engraver. Thorough practical training. Expenses low. Constant demand for our graduates. 35th year. Enroll immediately. Free catalog. **Box 4118, Effingham, Illinois.**

## "STAMMERING

### Its Cause and Cure"

You can be quickly cured if you stammer. Send 10 cents coin, or stamps, for 288 page cloth bound book on Stammering and Stuttering. It tells how I cured myself after Stammering and Stuttering for 20 years. **BENJAMIN N. BOGUE**  
11111 Bogue Building, 1147 N. Ill. St. Indianapolis



Wonderful, new device, guides your hand; correct your writing in few days. Big improvement in three hours. No failures. Complete outline FREE. Perfect Penmanship Inst. D-34, St. Louis, Mo.



# This Singular Book Wields a Strange Power Over Its Readers

*Giving them a MAGNETIC PERSONALITY almost instantly!*

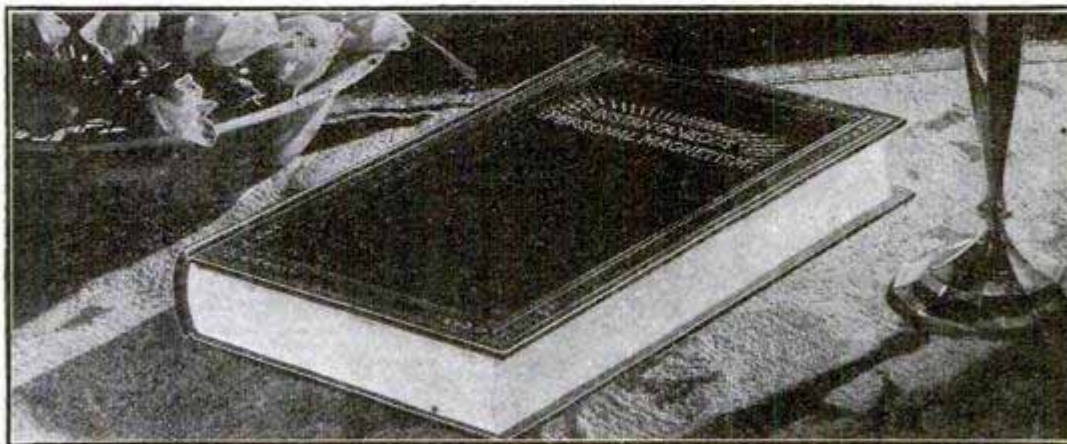

## Will You Read It 5 Days FREE—to Prove It Can Multiply Your Present Income?

**A** STRANGE book! A book that seems to cast a spell over every person who turns its pages!

A copy of this book was left lying on a hotel table for a few weeks. Nearly 400 people saw the book—read a few pages—and then sent for a copy!

In another case a physician placed a copy in his waiting-room. More than 200 patients saw the book—read part of it—and then ordered copies for themselves!

Why are people so profoundly affected by this book?—so anxious to get a copy? The answer is simple. The book reveals to them for the first time how any one can develop a Magnetic Personality *instantly!* It explains how to gain *overnight* the personal charm that attracts countless friends—the self-confidence that insures quick success in any business.

It tells how to draw people to you at once, irresistibly—how to be popular in any society—how to overcome almost at once any timidity you may have—how to be a magnet of hu-

man attraction, well-liked wherever you go.

Best of all it tells you how to accomplish these results *instantaneously!*

### Whence Comes This Uncanny Volume?

Forty years ago, Edmund Shaftesbury, student of the human mind, set out to discover the secret of Personal Magnetism. He applied his discoveries to his friends. Results were astonishing! His methods seemed to transform people into *entirely new beings!* Shaftesbury's fame spread. Great men came to him. His students and friends embraced such names as Gladstone, Queen Victoria, Edwin Booth, Henry Ward Beecher, and Cardinal Gibbons.

Until recently Shaftesbury's teachings have been available only to people who could pay \$25 or \$50 each for instruction books. Now, his wonderful teachings have been collected into a single volume, at a price *within the reach of all!* And furthermore, Shaftesbury has consented to reveal hundreds of new discoveries never before put into print.

### Strange Effect on Readers

Readers of this book quickly become masters of a singular power to influence men and women around them. Not by force—not by loud argument. But rather by some subtle, insinuating power that sways men's emotions. They are able to play on people's feelings just as a skilled violinist plays upon a violin.

Is it any wonder that thousands of men and women say that they are overjoyed with the results they have received? One enthusiast said of this volume, "Things I have read there I would never have dreamed of." Another wrote, "I would not give up what Shaftesbury has taught me for \$100,000!"

In your everyday life—in social life—you will find this book of immense value. You will learn to fascinate people you meet—to attract new friends—to gain speedy promotion in business.

### Read This Book 5 Days Free

Merely mail coupon below and this remarkable volume, with cover in handsome dark burgundy cloth, gold embossed, will be sent you for free examination. If you aren't stirred and inspired in the 5-day free period, return it and it costs you nothing. Otherwise keep it as your own and remit the Special Price of only \$3 in full payment. This volume was originally published to sell at \$5—but in order to reach many readers—it is being offered at reduced price. You risk nothing—so clip and mail this coupon NOW. Ralston University Press, Dept. 13-T, Meriden, Conn.

RALSTON UNIVERSITY PRESS  
Dept. 13-T, Meriden, Conn.

All right—I'll be the judge. You may send me the volume "Instantaneous Personal Magnetism" for 5 days' FREE EXAMINATION in my home. Within the 5 days I will either remit the special low price of only \$3.00, in full payment, or return it without cost or obligation.

Name.....

Address.....

City.....State.....

### Book Tells You

- How to develop a Magnetic Personality
- How to use certain Oriental Secrets
- How to gain perfect nerve control
- How to read people's feelings by watching their mouths
- How to read people's thoughts by watching their eyes
- How to develop a magnetic eye
- How to make your face appear 20 years younger
- How to control others by a glance
- How to use Magnetic Healing
- How to end awkwardness and timidity
- How to attract the opposite sex
- How to get ahead in your business or profession
- How to make your subconscious mind work wonders
- And dozens of other vital topics





# "How we saved our first \$500"

"MARY and I had been married four years, but we couldn't save a cent. Fact is, we were constantly in debt and I was always worried for fear I would lose my position.

"Then one night I saw that something must be done, so I told Mary I was going to take up a course with the International Correspondence Schools. 'I've been hoping you would do that,' she said. 'I know you can earn more money if you really try.'

"So I started studying after supper at night, in the spare time that used to go to waste. It wasn't hard and pretty soon I began to see it was helping me in my work. In three months a new position was open and the Boss said he'd give me a chance at it because he'd heard I was studying with the I. C. S.

"Well, that was the start. Before the end of the year I received another raise in salary and we began to save a little each week. We've got \$500 in the bank now and we're going to have a lot more soon. The Boss says he's going to give me a still better position if I keep on studying with the I. C. S."

For thirty-five years the International Correspondence Schools have been helping men to win promotion, to earn more money, to get ahead in business and in life.

You, too, can have the position you want in the work you like best. Yes, you can.

At least, find out how, by marking and mailing the coupon printed below. It doesn't cost you a penny or obligate you in any way to do this, but it may be the means of changing your entire life. Do it now.

### Mail This Coupon for Free Booklet

INTERNATIONAL CORRESPONDENCE SCHOOLS

"The Universal University"  
Box 5574-F, Scranton, Penna.

Without cost or obligation, please send me a copy of your booklet, "Who Wins and Why," and full particulars about the subject before which I have marked X in the list below:

#### BUSINESS TRAINING COURSES

- |  |   |
|--|---|
| <input type="checkbox"/> Business Management                     | <input type="checkbox"/> Salesmanship                                     |
| <input type="checkbox"/> Industrial Management                   | <input type="checkbox"/> Advertising                                      |
| <input type="checkbox"/> Personnel Management                    | <input type="checkbox"/> Business Correspondence                          |
| <input type="checkbox"/> Traffic Management                      | <input type="checkbox"/> Show Card and Sign Lettering                     |
| <input type="checkbox"/> Accounting and C. P. A.                 | <input type="checkbox"/> Stenography and Typing                           |
| Coaching   | <input type="checkbox"/> English <input type="checkbox"/> Civil Service   |
| <input type="checkbox"/> Cost Accounting                         | <input type="checkbox"/> Railway Mail Clerk                               |
| <input type="checkbox"/> Bookkeeping                             | <input type="checkbox"/> Common School Subjects                           |
| <input type="checkbox"/> Secretarial Work                        | <input type="checkbox"/> High School Subjects                             |
| <input type="checkbox"/> Spanish <input type="checkbox"/> French | <input type="checkbox"/> Illustrating <input type="checkbox"/> Cartooning |

#### TECHNICAL AND INDUSTRIAL COURSES

- |   |  |
|---|--|
| <input type="checkbox"/> Electrical Engineering                         | <input type="checkbox"/> Architect                                       |
| <input type="checkbox"/> Electric Lighting                              | <input type="checkbox"/> Architects' Blueprints                          |
| <input type="checkbox"/> Mechanical Engineer                            | <input type="checkbox"/> Contractor and Builder                          |
| <input type="checkbox"/> Mechanical Draftsman                           | <input type="checkbox"/> Architectural Draftsman                         |
| <input type="checkbox"/> Machine Shop Practice                          | <input type="checkbox"/> Concrete Builder                                |
| <input type="checkbox"/> Railroad Positions                             | <input type="checkbox"/> Structural Engineer                             |
| <input type="checkbox"/> Gas Engine Operating                           | <input type="checkbox"/> Chemistry <input type="checkbox"/> Pharmacy     |
| <input type="checkbox"/> Civil Engineer <input type="checkbox"/> Mining | <input type="checkbox"/> Automobile Work                                 |
| <input type="checkbox"/> Surveying and Mapping                          | <input type="checkbox"/> Airplane Engines                                |
| <input type="checkbox"/> Plumbing and Heating                           | <input type="checkbox"/> Agriculture <input type="checkbox"/> Navigation |
| <input type="checkbox"/> Steam Engineering                              | <input type="checkbox"/> Mathematics <input type="checkbox"/> Radio      |

Name.....

Street Address.....

City..... State.....

Occupation.....

Persons residing in Canada should send this coupon to the International Correspondence Schools Canadian, Limited, Montreal, Canada

# FOR YOUR FUTURE



**INVESTIGATE THIS VOCATIONAL TRADE OPEN TO ALL WHETHER 18 OR 80**

The opportunity of a lifetime to become financially independent. Earn up to \$5,000 a year. Great demand and always will be because it is a human necessity. Easily learned in three to six months by actual practice with the regular tools of the trade. No previous training required. Business of your own if desired. Oldest establishment in this field is now ready to train an additional number of men for this work. Remarkably low cost—starting fees as low as \$15. R. R. Fare to nearest school included. Earn while you learn if necessary—regular arrangement for part time positions. Investigate this opportunity. The facts are convincing. Write today for Bulletin No. 2 which gives complete information.

## BODEE INSTITUTE

New York 1755 Broadway Philadelphia 1305 North Broad Street Brooklyn 85 Court Street

# Learn to Dance

## This New Easy Way

You can learn all the modern dances—Charleston, Black Bottom, Valencia, Canter, French Tango, St. Louis Hop, Latest Waltzes, Fox Trots, etc., at home easily and quickly. New chart method makes dancing as simple as A-B-C. No music or partner required. Learn anywhere, anytime. Win new popularity. Be in demand at parties. Same course of lessons would cost \$20 if taken privately.



### Send No Money

Just send your name and address. We'll ship the complete course—323 pages, 49 illustrations—without one cent in advance. When package arrives, send postman only \$1.98, plus delivery charges, and this wonderful course is yours. Try for 5 days. Money back if not delighted. Send your name NOW.

FRANKLIN PUB. CO., 800 N. Clark St., Dept. 9418, CHICAGO



## "BECOME A LIGHTNING TRICK CARTOONIST"

Send \$1.00 for Laugh Producing Program of 23 Trick Drawings with Instructions, Catalog of Chalk Talk Supplies Free. BALDA ART SERVICE, Dept. 1, Oshkosh, Wis.

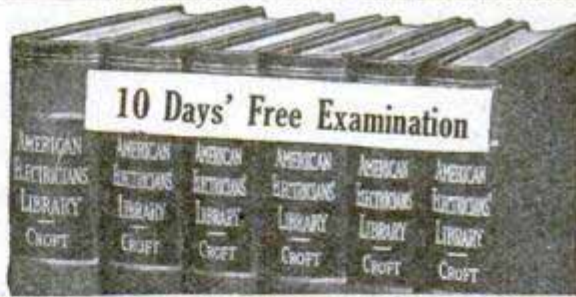

## Get into the electric wiring field—big demand—big money!

THE whole wiring field covered. Kinks; helps; short cuts; practical, on-the-job electrical data, written particularly to help wiremen, trouble shooters, maintenance men, armature winders, electrical contractors and students.

**American Electricians' Library**  
6 volumes, 2000 pages, illustrated, \$17.50 payable \$1.50 in ten days and \$2.00 a month

The books tell you all you must know about conduit wiring, armature winding, wiring for lighting circuits and switches, wiring for machinery, circuit troubles, circuit testing, or electrical machinery erection. Through a study of this great set you can push yourself into a big-pay job for life.

**See it FREE—Send no money—ACT**

### FREE EXAMINATION COUPON

McGraw-Hill Book Co., Inc.  
370 Seventh Avenue, New York

Send me the American Electricians' Library for 10 days' free examination. If satisfactory, I will send you \$1.50 in 10 days and \$2 monthly until the full price, \$17.50, is paid. If not wanted, I will return the books at your expense.

Name.....

Address.....

City and State.....

Position.....

Company..... P. M. 11-28



# Easy as A-B-C!

You Can Play Any Instrument  
In a Few Months  
This Delightful  
New Easy Way!

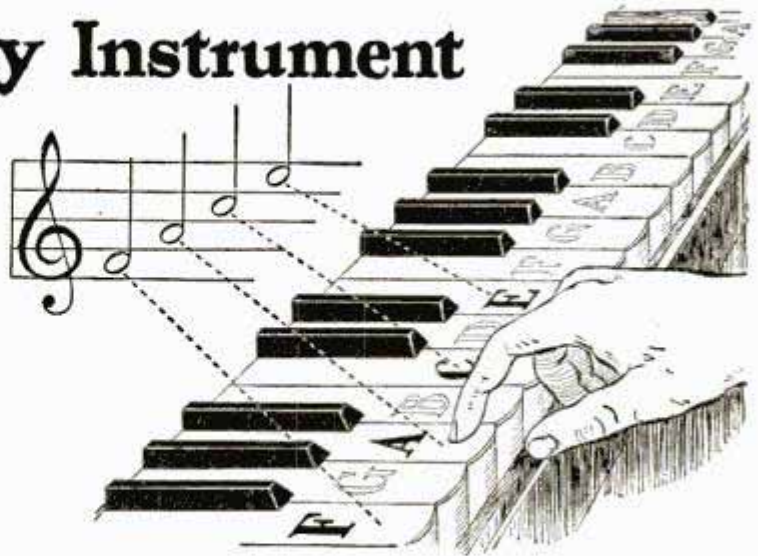

Quickest because natural and pleasant. Grateful students say they learn in a fraction of the time old dull methods required. You play direct from the notes. And the cost averages only a few cents a lesson!

**L**EARNING music is no longer a difficult task. If you can read the alphabet, you can now quickly learn to play your favorite instrument! A delightful new method has made it positively easy to become a capable performer within just a few months. And the cost is only a *fraction* of what people used to spend on the old, slow methods! You don't need a private teacher, this new way. You study entirely at home, in the privacy of your own room, with no one to interrupt or embarrass you. And, strange as it may seem, you'll enjoy every minute of it—because the new method is *agreeable* as well as *rapid*!

## No Tricks or Stunts—You Learn from "Regular" Music

You don't have to know the first thing about music in order to begin. You learn to play from actual notes, just like the best musicians do. And almost before you realize your progress, you begin playing real tunes and melodies instead of just scales. There are no trick "numbers," no "memory stunts." When you finish the U. S. School of Music course, you can pick up any piece of regular printed music and understand it! You'll be able to read music, popular and classic, and play it from the notes. You'll acquire a life-long ability to please your friends, amuse yourself, and, if you like, make money (musicians are highly paid for their pleasant work).

Whether you like the piano, violin, 'cello, organ, saxophone, or any other instrument, you can now learn to play it in an amazingly short time. By means of this wonderful newly perfected method reading and playing music is made almost as simple as reading aloud from a book. You simply can't go wrong. First, you are *told* how a thing is done, then a picture *shows* you how, then you do it yourself and *hear* it. No private teacher could make it any clearer. The lessons come to you by mail at regular intervals. They consist of complete printed instructions, diagrams, all the music you need, and music paper for writing out test exercises. And if anything comes up which is not *entirely plain*, you can write to your instructor and get a full, prompt, personal reply!

## The Surest Way to be Popular and Have a Good Time

Do you sit "on the sidelines" at a party? Are you out of it because you can't play? Many, many people are! It's the musician who claims attention. If you play, you are always in demand. Many invitations come to you. Amateur orchestras offer you wonderful afternoons and evenings. And you meet the kind of people you have always wanted to know. So don't miss this exceptional opportunity.

### Learn to Play by Note

Piano	Saxophone
Organ	'Cello
Violin	Sight Singing
Drums and Traps	Guitar
Banjo	Ukulele
(Plectrum, 5-String, or Tenor)	Hawaiian Steel Guitar
Mandolin	Harp
Clarinet	Cornet
Flute	Piccolo
Voice and Speech	Trombone
Automatic Finger Control	
Piano Accordion	

Also for advanced Pianists a special Course including 24 famous classics . . . a distinctive addition to any pianist's repertoire.

## Free Book and Demonstration Lesson

The whole interesting story about the U. S. School course can not be told on this page. So a booklet has been printed—"Music Lessons in Your Own Home." You can have a copy absolutely free by mailing the coupon below. In the booklet you will find an offer that makes the U. S. course available to you at a very low price. With it will be sent a free demonstration lesson which shows better than words how delightfully quick and easy this wonderful Method is. If you are really anxious to become a good player on your favorite instrument, mail the coupon now—today. Instruments supplied when needed, cash or credit. U. S. School of Music, 711 Brunswick Bldg., New York City.

U. S. School of Music,  
711 Brunswick Bldg., New York City.

Please send me your free book, "Music Lessons in Your Own Home," with introduction by Dr. Frank Crane, Free Demonstration Lesson, and particulars of your easy payment plan. I am interested in the following course:

.....  
(Name of Instrument or Course)

Name.....

Address.....

City..... State.....



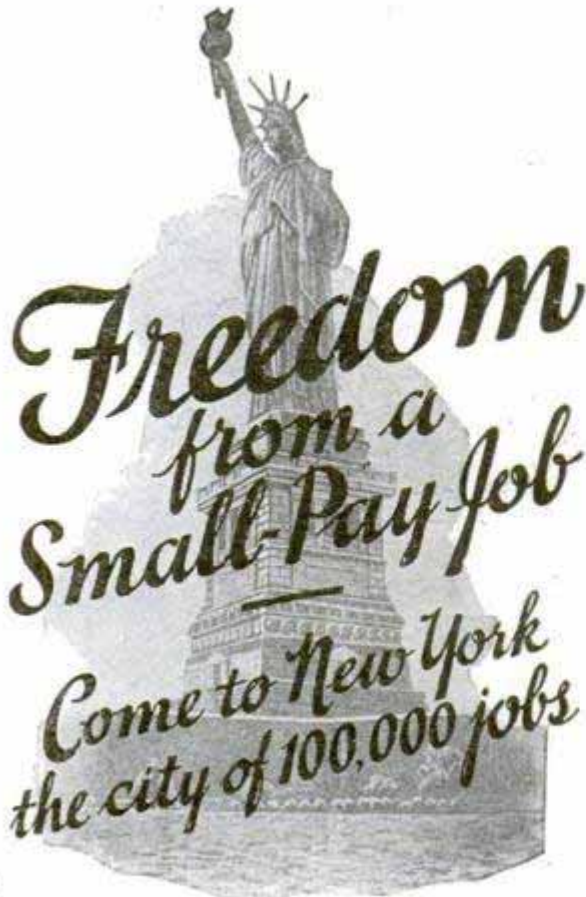

**A**NY MAN who can read and write and use a pair of pliers can become an electrical expert and free himself forever from the long hours and drudgery of a small pay job.

And you can learn the BIG PAY profession of electricity right in New York City—the heart of the electrical world—the city of 100,000 jobs. At the same time you are learning the BIG PAY profession you can be enjoying the sights and wonders of New York, the modern Bagdad.

### Be An Electrical Expert

Graduates of the NEW YORK ELECTRICAL SCHOOL are in demand by all the big electrical companies. Or, if you prefer the independence of a business of your own, there are thousands of opportunities for efficient, dependable men to become electrical contractors. When you are your own boss the money you can make is limited only by your own energy and ability.

### Personal Instruction

The NEW YORK ELECTRICAL SCHOOL is not a correspondence school. You learn by doing—by personal instruction on full size standard electrical equipment under the personal supervision of trained instructors.

At N. Y. E. S. you train your hands and mind at the same time. You learn the theories of electricity—and then you are shown how to put the theories into actual practice by solving the problems with your own hands.

The man who has learned electricity by actually doing electrical work under intelligent personal instructors can go to any part of the world and be sure of a good living. There are N. Y. E. S. graduates in all the countries of the world.

Write today for the 48-page booklet giving full information about the N. Y. E. S. Course and showing pictures of the equipment available for your personal use in our two seven-story buildings. Mail coupon *now!* The New York Electrical School, 44 W. 17th Street, New York.

The New York Electrical School  
44 W. 17th Street, New York

Please send me FREE your 48-page booklet. It is understood that this request puts me under no obligation.

Name.....

Address.....

## THE CHICAGO DAILY NEWS School and College Bureau

### Offers You Its Specialized Services in Choosing a School

Last year the School and College Bureau of The Chicago Daily News saved many busy parents and questioning boys and girls both time and worry by sending them prompt, reliable information about just the kind of school they wanted—personal requirements as to location and tuition charges being considered in each individual case.

Again this year many young people will be perplexed by the problem of finding the right school. Why not let us help you?

The Chicago Daily News maintains this service absolutely free of charge to you. No need to hurriedly select a school on mere hearsay when expert advice can be obtained by telephoning Dearborn 1111, writing or calling for a personal interview at

## THE CHICAGO DAILY NEWS

School and College Bureau

Dept. K, 15 N. Wells St., Chicago, Illinois

Learn to **PAINT**  
**SIGNS and SHOW CARDS**

We quickly teach you by mail, or at school, in spare time. Enormous demand. Big future. Interesting work. Oldest, foremost school.

**EARN \$50 TO \$200 WEEKLY**

John Vassos, N. Y., gets \$25 for single show card.

Crawford, B. C., says: "Earned \$200 while taking course." Send today for free information samples and guarantee.

**DETROIT SCHOOL OF LETTERING**  
154 Stimson Ave. Est. 1899 Detroit, Mich.



## Learn Photography at HOME

Make money taking pictures. Prepare quickly during spare time. Also earn while you learn. No experience necessary. New easy method. Nothing else like it. Send at once for free book, OPPORTUNITIES IN MODERN PHOTOGRAPHY and full particulars

**AMERICAN SCHOOL OF PHOTOGRAPHY**  
Dept. 1358 3601 Michigan Ave. Chicago, U. S. A.

### ALWAYS Ask For DENISON'S—53 Years of Hits

Comedy-Dramas, Farces, Musical Vaudeville Acts, Monologs, Dialogs, Comedies, Revues, Entertainments, Musical Readings, Comedy Songs, Chalk Talk Books, Minstrels, Blackface Skits, Make-up Good: Catalog FREE.

**T. S. DENISON & CO., 623 S. Wabash. Dept. 9, CHICAGO**

### Learn Watchwork, Jewelrywork and Engraving

A fine trade commanding a good salary, and your services always in demand. Address **Horological**, Dept. P, Bradley Institute, PEORIA, ILLINOIS, for our latest catalog.

MEN TO LEARN

## MOTION PICTURE PROJECTION

A BIG-MONEY PROFESSION—\$2,000 TO \$4,000  
We Assist Students to Earn While Learning

**MOVIE OPERATORS SCHOOL**  
61 Sprout Street Detroit, Michigan



# These Real Blue Prints **and two Books** Sent **FREE**



**Just mail the coupon below! Send no money!**

Every builder can get these real blue print plans and our book "How to Read Blue Prints" without sending us a penny. Just send the coupon. Lots of valuable and interesting information—all *free*. Yes, and we'll send along another book on building; it tells why "the big money goes to the man who *knows*." It explains the practical Chicago Tech. easy method of home training for men in the building trades. Learn how to get the jobs that pay most money or how to get into your own business as a building contractor.

## **Plan Reading — Estimating — Superintending, etc.**

**Train at Home to MAKE MORE MONEY No Schooling Necessary**

Learn how to read plans, lay out work and run jobs. Your spare time is enough. Wherever you may be—whatever your job—we can help you quickly to fill a higher place and have a bigger income. Age does not matter. Previous school

training is not needed. This is a practical course for practical men, prepared by practical instructors who have been through every branch of the building game themselves. You owe it to yourself to find out how to make more money.

### **To Builders Living in or Near Chicago**

Visit our Day or Evening School for builders and see with your own eyes the work we do. 1000 builders attend each year. You can get the same training *at home*. Same lessons—same blue prints—same practical instructors—same successful results.

**Get the Facts** Find out how little time it takes to make more money—much more money—in building. Write today. The coupon brings all *Free*.

**Chicago Technical SCHOOL for BUILDERS**

Dept. P-141, 118 East 26th St., Chicago, Ill.

### **Mail the Coupon—NOW**

**Chicago Technical SCHOOL for BUILDERS**

Dept. P-141, 118 East 26th St., Chicago, Ill.

Please send me without obligation, Free and Postpaid, your two Books and Blue Prints for Builders. It is understood that no salesman will call on me.

**[Please Write or Print Name Plainly]**

Name .....

Address .....

City ..... State .....

Age ..... Occupation .....



# At Last

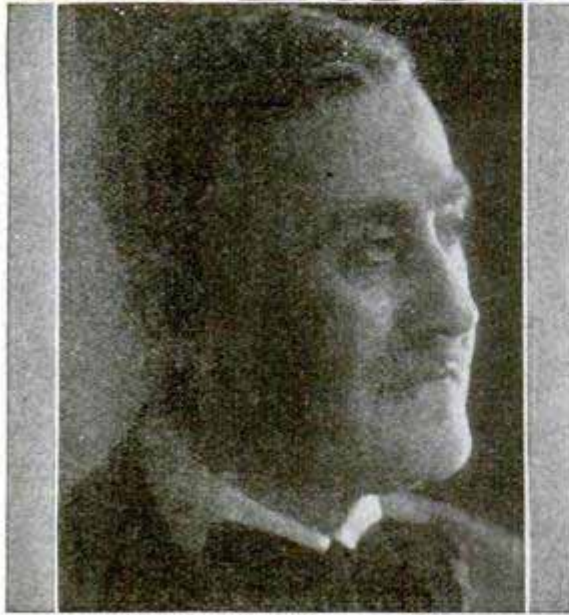

Eugene Feuchtinger, A. M.

## Voice Teacher Who Actually Guarantees Results!

NOW!—YOU can be *sure* of possessing a rich, strong, beautiful, magnetic voice! Prof. Feuchtinger, descendant of a long line of European musicians, *guarantees* to improve *any* normal voice at *least 100%* or refund every penny.

Eugene Feuchtinger does not merely teach you how to sing. He actually develops the voice! No monotonous, tiresome scale work. He teaches you to build up the strength and elasticity of your vocal organ by scientific muscular exercise—*silent exercises!*—which you may practice in the privacy of your home. Thousands of men and women have been astonished to see how their voices have been *marvelously* improved—even when other methods have failed.

### Physical Voice Culture Book

**FREE** Your voice has marvelous possibilities that you may not even suspect. "Physical Voice Culture" will reveal them to you. Send for this great book. Read the astounding *true stories* of what others have done. Learn how to build up a rich, strong, beautiful, magnetic voice and all about Prof. Feuchtinger's wonderful guarantee offer.

#### Perfect Voice Institute

1922 Sunnyside Avenue, Studio 13-58, Chicago

#### MAIL COUPON NOW!

Perfect Voice Institute, Studio 13-58  
1922 Sunnyside Ave., Chicago, Ill.

Please send me, FREE and without any obligation, Prof. Feuchtinger's new book, "Physical Voice Culture." I have checked the subject in which I am most interested.

- Weak Voice
- Singing
- Stammering
- Speaking

Name.....

Address.....

City..... State.....



## Learn to Write

### I Teach by Mail

Begin Today—Write for My FREE Book. I can make a good penman of you at home during sparetime. Write for my **FREEBOOK**, "How to Become a Good Penman." It contains specimens and tells how others mastered penmanship by the Tamblin System. Your name will be elegantly written on a card if you enclose stamp to pay postage. Write today for book.

F.W. Tamblin, 418 Ridge Bldg., Kansas City, U.S.A.

## BE AN OIL EXPERT!

Trained men needed! Geologists, Drillers, Refiners (Chemists and Still Men), Oil Salesmen, earn 2 to 10 times more than in other fields. Write today! FREE Booklet! Petroleum Engineering University, Dept. 231, Fort Wayne, Ind.

# THE RED BOMBER COMBAT PLANE

## FREE!



Positively a sensational offer. Here's the Red Bomber Combat Model Plane, a twin propeller model that flies amazingly. And you can have it free! Boys everywhere are flying model planes. Now is the time to get yours. This sensational plane will fly 600 feet easily, often further. Wings made of special fibre, two powerful rubber motors, two cleverly fashioned propellers. Not a glider—a real model plane.

### Assembled in two minutes

Best of all no tedious hours of toil constructing. This plane can be put together ready to fly by any boy in less than two minutes—positively! Two minutes after the postman delivers your plane, you can send it into the air diving and dipping, zooming, banking, then soaring to greater heights. Every boy will envy you. Order your plane right now!

### THRILLING BOY'S MAGAZINE

**12 Fat Issues** THE OPEN ROAD for BOYS has 50 pages crammed with stories of aviation, mechanics, sport, high adventure, great serials, jokes and humor. Correspondence club. Contests galore for all. "Golden Medallion," mystery serial smash now starting—breathless reading! We will send you the Red Bomber Combat Plane and a subscription to The Open Road for Boys Magazine—12 fat issues—both for \$1. Send the coupon now.

**BOTH FOR ONLY \$1**

Pursuit Pilot,  
Open Road for Boys Magazine,  
130 Newbury Street, Boston, Mass.

Friend:

By all means I will grab this offer. Enclosed is \$1. Please rush me the Red Bomber Combat Model Plane. Enter my name to receive a year's subscription—12 issues—to The Open Road for Boys Magazine beginning with the very next number.

Name.....

Street.....

Town or City.....

State.....

You'll Get a pleasant Surprise



# A Challenge Made Me Popular!

**"A** BOX of cigars says you don't dare dance with her—Wallflower!" That was the challenge they flung at me!

My sporting blood boiled! "All right, I accept!" I responded. And I started across the floor.

**I** NEVER was much of a dancer. But when our club gave this affair I couldn't stay away. Even now, I should have been sitting safely on the "sidelines"—if only the fellows hadn't made that sarcastic remark.

"Show them you can do it! Show them you can dance as well as they!" my pride whispered. And I would!

But halfway across the hall my courage died. I was nearly paralyzed with fright. There she was, waiting expectantly—Marion Blake, an exquisite dancer—graceful, poised, at ease. Suppose she should refuse? Suppose she should leave me in the center of the floor? Oh, wouldn't the fellows chuckle then!

## The Unexpected Happens

"I'm—I'm sorry"—I stammered. "I guess——"

"Why, of course, I'll be glad to dance!" she interrupted. And before I realized it we were swallowed up in the dancing throng.

What a terrible ordeal it was for me! And twice as bad for her. I stumbled through the steps. I trod on her toes. I tried desperately to keep in time with the music. Yes, my dancing was inexcusable—hopelessly out-of-date!

Suddenly she suggested that we sit out the rest of the number. I blushed furiously "Now, it's coming!" I thought. "Now, she is going to tell me what she thinks of my nerve!"

But I was in for the surprise of my life. "Jim," she began softly. "I'll be frank. You're not the best dancer in the world. But you're certainly not the worst. What you need is 'brushing up' on the latest steps. Why don't you get in touch with Arthur Murray?"

"Arthur Murray! Arthur Murray!" I repeated. "He teaches dancing by mail. You can't learn that way!"

"No?" and Marion arched her eyebrows. "The truth is, that's *exactly* the way I learned—even though no one *does* suspect it!"

Naturally I was astounded, but the next evening I found one of Arthur Murray's ads and clipped the coupon. Then I mailed it, asking for his free booklet and five free lessons. If Marion could become a wonderful dancer that way it was certainly worth investigation—especially since I didn't risk a penny.

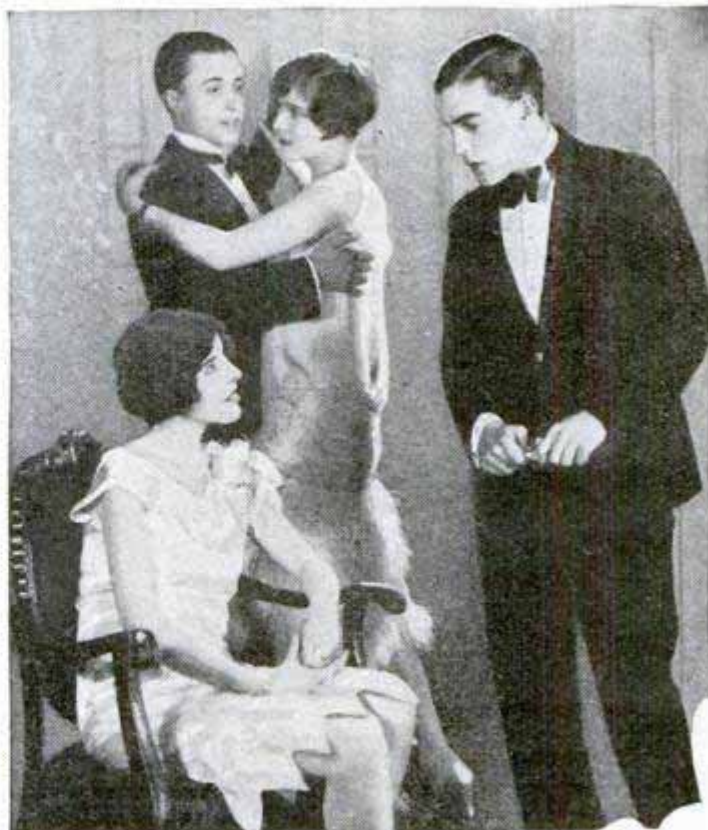

*I was nearly paralyzed with fright. There she was, waiting expectantly—Marion Blake, an exquisite dancer—graceful, poised, at ease. Suppose she should refuse? Suppose she should leave me in the center of the floor?*

## I Find the Secret!

The booklet and free lessons came promptly. What a revelation! They showed me how many mistakes I had been making—how *utterly ignorant* I was of the modern style of dancing. In a few evenings I had learned the modern Waltz—the modern Fox Trot and many delightful variations of the *very latest* steps—without music, partner or teacher!

## I Turn the Tables

A week later I attended a dance. The old crowd was there. "Here he is again!" they chorused. "Give him the cigars! He earned them!" Imagine how surprised they were when I asked Marion to dance! They stood open-mouthed as I glided around the floor like an expert! Now girls are always delighted to dance with me. I laugh when I think how scared I was that terrible evening—for everywhere I go I am welcomed as an accomplished dancer!

## Will YOU Accept These 5 FREE Lessons?

No matter how poorly you dance now—no matter if you've never even been on a dance floor in your life—Arthur Murray's method makes you a finished dancer in 10 days, or you don't have to pay a penny. To prove it he is willing to send you five lessons from his remarkable course *absolutely free!* Just mail coupon (with 10c to cover cost of printing and mailing) and these valuable lessons will be forwarded at once. Also a free copy of his new book, "The Short Cut to Popularity." Mail coupon *NOW!*

Arthur Murray, Studio 838, 7 East 43rd Street, New York City.

Arthur Murray, Studio 838,  
7 East 43rd Street, New York City

To prove that I can learn to dance at home in ten days you may send the FIVE FREE LESSONS. I enclose 10c (stamps or coin) to pay for the postage, printing, etc. You are to include free "The Short Cut to Popularity."

Name.....

Address.....

City.....State.....

See how easy it is to learn the Arthur Murray way!



# Learn Electricity IN LOS ANGELES

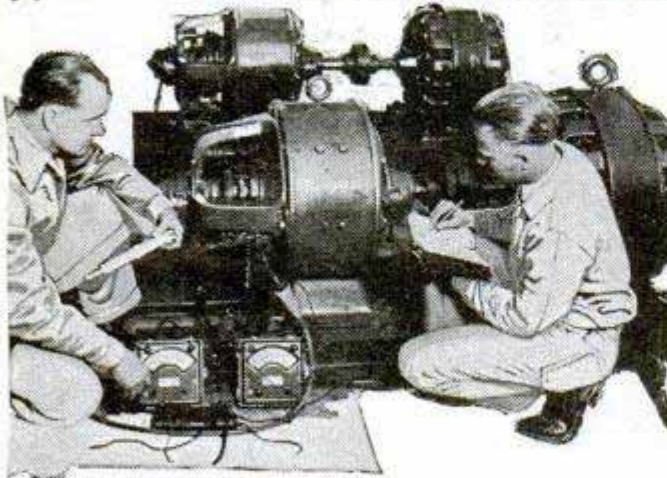

## FREE Employment Service!

There are more calls for "National-Trained-Electrical-Men" than we can supply. Jobs are open now paying \$50 and up a week—but you must first get the right training. Get it at National—a world-famous institution with a quarter century record of success in training big pay men.

### All These Advantages:

1. Unlimited Training Until Competent.
2. Free Employment and Welfare Service.
3. Million Dollar Training Shops.
4. Personal, Individual Training Guaranteed.
5. You actually perform work that employers pay big money for.

6. Official Diploma and certified record of work performed.
7. Unexcelled training; 32 instructors.

## FREE!

Read how National insures your success. Send for this free Electrical catalog—illustrated by actual photos of students training under instructors on a half million dollars' worth of new electrical equipment. Mail coupon now.



# National Electrical School

Dept. 524, 4006 Figueroa St., Los Angeles, California.

Send me your big free illustrated catalog of Electrical Opportunities.

Name.....  
 Address.....  
 Age..... City..... State.....

**\$100 a Week** for TAKING PICTURES

Working in spare time, J. H. WADE made \$200 in 2 weeks. A. G. MASON earned \$617 for a few days' work.

You, too, can soon qualify for the wonderful opportunities in this fascinating, big pay profession. **CAMERA FREE BOOK GIVEN** teaches you money-making secrets of photography, in your spare time at home, or in our great New York Studios—how we help you get a fine position or start your own business—how we give you a professional camera.

Write today for Book and Job Chart  
 N. Y. INSTITUTE OF PHOTOGRAPHY, 10 W. 33rd St.

## BE A MOVIE OPERATOR

We give projector and teach you at home. Big demand by movie and vaudeville theatres. Write for folder.

NEW YORK, Dept. 49

# DEVELOP POWER

## AT HOME

to initiate, persevere, achieve; carry on through life your education; earn credit toward a Bachelor degree, by using the 450 courses

## The University of Chicago Gives by Correspondence

Inquire, or check the advertisement to show desire and mail to 527 Ellis Hall, University of Chicago, Chicago, Illinois.

## Anyone CAN LEARN

No talent or experience necessary. Fascinating work. Pays big money. Complete instruction book tells about: Alphabets, Colors, How to Mix Paints, Show Cards, Window Board and Wall Signs, Ready made letters, Gilding, Tricks of the Trade, also gives 100 Alphabets and Designs. Book bound in flexible imt. leather-gold edges, and four ball bearing Show Card Pens. Sent postpaid \$3.00, C. O. D. 110c ex. Ogilvie Pub. Co., 57 Rose St. Dept. 29, N. Y. City

**EARN MONEY IMMEDIATELY— WE FURNISH EQUIPMENT TO START!!**

## LEARN WATCHMAKING AND ENGRAVING

BY OUR PROFIT-SHARING PLAN OUR GRADUATES SUCCEED

One of our Iowa students started in a very small way—now doing over \$30,000 a year. Another in Wisconsin, over \$10,000 the first year. Day or night classes. Call or write for FREE BOOK.

Chicago School of Watchmaking, Dept. 4801, 549 W. Randolph St., CHICAGO

## Learn Advertising at HOME

Send your name and address for free booklet giving interesting information and vital facts about Advertising. Find out how we prepare you at home, in your spare time, for the opportunities open in this fascinating business. Practical work. No text books. Old established school. Successful graduates everywhere. Just the plan you have always wanted. Write today. No obligation.

**PAGE-DAVIS SCHOOL OF ADVERTISING**  
 Dept. 1358 3601 Michigan Ave. Chicago, U. S. A.

# GOV'T. POSITIONS \$35 TO \$75 WEEKLY

**MEN - WOMEN**

( ) Ry. Mail Clerk	( ) Steno-Typist
( ) Prohibition Inv.	( ) Immigrant Inspector
( ) R. F. D. Carrier	( ) Seamstress
( ) Special Agent (investigator)	( ) Auditor
( ) City Mail Carrier	( ) Steno-Secretary
( ) Meat Inspector	( ) U. S. Border Patrol
( ) P. O. Clerk	( ) Chauffeur-Carrier
( ) File Clerk	( ) Watchman
( ) General Clerk	( ) Skilled Laborer
( ) Mstron	( ) Postmaster
	( ) Typist

OSZMENT INSTRUCTION BUREAU, 111 Arcade Bldg., St. Louis, Mo. Send me FREE particulars How To Qualify for positions marked "X". Salaries, locations, opportunities, etc. ALL SENT FREE.

NAME.....  
 ADDRESS.....

**AGE 18 to 55**



**"Possessed  
of the  
Devil?"**

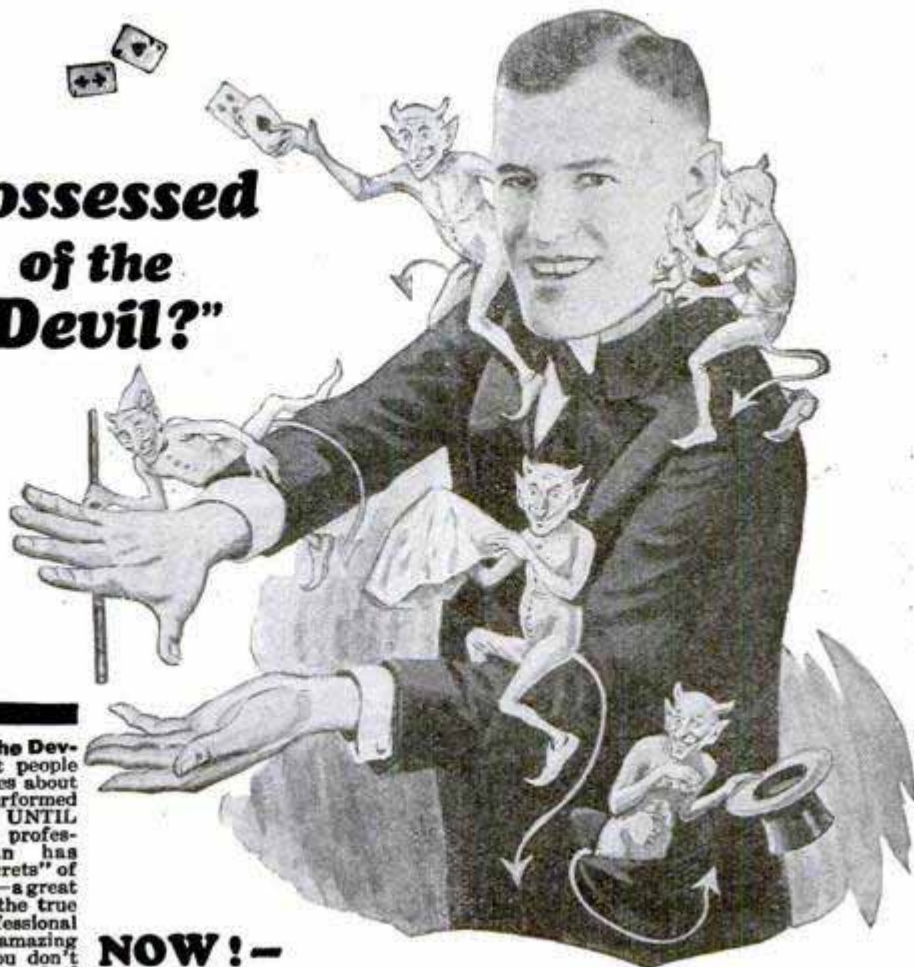

**"Possessed of the Devil?"**—that's what people said in olden times about the man who performed tricks of Magic. UNTIL NOW—only the professional magician has KNOWN the "Secrets" of Magic. BUT NOW—a great Magician reveals the true long-guarded professional "Secrets" in an amazing NEW Course. You don't need to be "possessed of the devil" to perform these seemingly impossible feats.

**NOW!—  
YOU CAN—**

# Learn MAGIC

## At Home—by Mail

Mail coupon below and learn how the great Magician, Dr. Harlan Tarbell, NOW makes it possible for you to learn Magic—real professional Magic—quickly and easily—**AT HOME—BY MAIL—**and at a very nominal cost!

If you will pledge yourself to secrecy, Dr. Tarbell, internationally known magician and teacher of some of the world's greatest magicians, will reveal to you the long-guarded secrets of the magic profession. He reveals these secrets in an amazing NEW and elaborately illustrated

Course. Never before disclosed Secrets of the Orient, Mysteries from Europe, India, China and Japan—as well as a massive array of card tricks, parlor tricks, and sleight-of-hand feats—**ARE NOW YOURS** to learn easily and quickly—**BY MAIL—AT HOME—**during your spare time.

Mail coupon now for free Magic Book telling all about this amazing NEW Magic course that makes even the most super-human feats of the skilled magician as simple as "abc"!

## Earn \$250 to \$1000 a Month

The NEW Tarbell Course in Magic will give YOU that magnetic popularity that will make you the center of any crowd. Business and social success is assured when you can perform Magic Feats. Without even giving up your present position, you can earn big money on the

side. Clubs, Lodges, Charity and Social Affairs—all pay high fees to the man who knows Magic. Magicians make from \$250.00 to \$1000.00 a month. You have everything to gain. You can't lose. Mail the coupon NOW—before you forget it—and learn all that is in store for YOU.

## Write for Free Magic Book and Our Low Prices

**Money-Back Guarantee Protects You**  
The great NEW Tarbell Course in Magic is backed by an Iron Clad Money-back GUARANTEE. You get your money back if YOU are not entirely satisfied. You risk nothing. You GAIN EVERYTHING! Send today for YOUR free copy of this great unparalleled GUARANTEE.

Mail this coupon NOW—and without cost or obligation on your part—we will send you an elaborate book telling all about this marvelous NEW Tarbell Course in Magic that—for the first time in the history of Magic—gives you the opportunity to LEARN MAGIC—AT HOME—BY MAIL! Not just card or parlor tricks—BUT—REAL PROFESSIONAL MAGIC. Write at once so that you'll be sure to get in on our present low prices. Be sure to mail that coupon RIGHT NOW!

### Mail This NOW!

TARBELL SYSTEM, Inc. Studio 13-58  
1926 Sunnyside Ave., Chicago

Tell me all about Dr. Tarbell's new and simple system by which I can learn the secrets of MAGIC. Also tell me about your Low Prices and Easy Payment Plan. No obligation on my part.

Name.....

Address.....



# You can play the HAWAIIAN GUITAR just like the Hawaiians!

Play all the latest hits just as the Hawaiians do. Be the most popular member of your set, a happy crowd always around you, everybody enjoying and admiring your playing. Get in on all the good times. Entertain your friends—or play professionally. We will help you.



## Native Hawaiian expert directs you

You get expert instruction, directed by a world-famous player and teacher, Prof. Walter Kolomo-ku. He quickly reveals to you the secrets of this fascinating instrument.

## Complete Conservatory Course

You get 52 complete printed lessons. Nothing is omitted. Pictures explain every move. And no matter how

little you know about music when you begin, no matter if you have never touched a musical instrument, you can positively learn to play by our plain, easy picture method. You are sure to learn! What we can do for others we can do for you. 51,000 successful students. This record assures your success.

## Learn at home in spare time

Study in spare time—in absolute privacy—when you like—as long as you like. Even if you don't know one note from another, our method is so simple you begin a piece your first lesson. In half an hour you can play it!

## Only 4 motions to learn

Then you can play any music—popular songs, classical, old-time melodies, native Hawaiian airs—or real jazz—separately or with accompaniment. You'll never be lonesome after you learn to play on this beautiful Hawaiian Guitar.

# GIVEN when you enroll— \$18 to \$20 Hawaiian Guitar

With Genuine Seal Grain Fabrikoid Cover and Complete Playing Outfit

Reliable retailers ask \$18 to \$20 for a similar instrument and outfit without the fine Fabrikoid Case, which alone is valued at \$3.50. Yet you receive this sweet-toned splendidly built Hawaiian Guitar, case and entire playing outfit, including picks, steel playing bar, tuning pipe, etc., without one penny of expense, as soon as you enroll.

## Pay as you play

We make it easy for you. Start any time with a small first payment—then pay while learning. It comes to only a few cents per lesson. And bear in mind: Your only investment is the cost of the course—we furnish everything else.

**FREE** Our new illustrated book, "The Romance and Enchantment of Hawaii—Its Music and Its People." A book you will want to keep. You won't lay it down until you have read it from cover to cover. Send for your copy today.

**OTHER COURSES** Tenor Banjo, Violin, Tiple, Tenor Guitar, Ukulele, Banjo Ukulele—well-known instructors.

**FIRST HAWAIIAN CONSERVATORY OF MUSIC, Inc.**

9th Floor Woolworth Bldg., Dept. 548, New York, N. Y. Approved as a Correspondence School Under the Laws of the State of New York.

Member of National Home Study Council

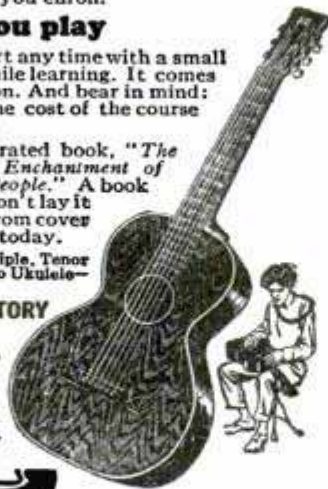

## Send This Coupon for Liberal Offer!

**FIRST HAWAIIAN CONSERVATORY OF MUSIC, Inc.**  
9th Fl., Woolworth Bldg., Dept. 548, New York, N. Y.

Please send full information about your 52-lesson Hawaiian Guitar Course. I am not obligated to enroll unless I want to.

Name \_\_\_\_\_  
Address \_\_\_\_\_  
City \_\_\_\_\_ State \_\_\_\_\_

# ELECTRICITY

**Finlay Men are in Demand. There is a Reason.** Promising Future for Practical Trained Electricians and Engineers at Big Salaries. Fascinating work, rapid advancement, opportunities unlimited.

**12 Weeks Intensive Courses in Practical Electricity and Power Plant Operation** covering Wiring, Motors, Generators, Armature Winding, Radio, Farm Lighting, Switchboards, Electric Refrigeration, Automotive Electricity, etc. **These Courses Open To You Now.** ONE and TWO YEAR COURSES in Electrical Engineering leading to degrees. Registration for these courses open Sept. 18 to Oct. 18. Laboratories extensively equipped with modern machinery and apparatus. Faculty of recognized experts. 27th year. Free employment service for graduates. Part-time work secured during training. Catalog free.

**FINLAY ENGINEERING COLLEGE**  
1001 A Indiana Ave. Kansas City, Missouri

# LEARN WATCH REPAIRING



You can learn by our modern and original system of instruction every part of the **Watch Repairing Trade** at home as good or better than at a shop. You can earn money while learning and secure a well paying position or start in business after completing our course of instruction. Good watch repairers are always in demand and earn from \$50 to \$75 per week. For particulars apply to the **Wisconsin School of Watch Repairing** 166 Mason St., MILWAUKEE, WIS.

# STAMMERING

easily, permanently corrected. Win happiness and success. Ask for full information and special phonograph record. Send dime for postage 60 Massachusetts Av., LEWIS INSTITUTE, Detroit



**LUCKY POCKET PIECE**, triple horse shoe puzzle, always keep one with you—10c, 4 sets 25c pp., with secret solution. Western Puzzle Works, St. Paul, Minn.



# DRAFTING

BOOKS SENT FREE!

## For Beginners

Written so you can understand every word, by 18 famous Engineers and Architects. Deluxe, flexible binding. 1750 pages, 1050 blue prints, charts and diagrams. Prepare you for a good Drafting job in mechanical or architectural lines. Sent for 15 days' free use, if you mail coupon immediately.

Only fifteen minutes a day with these WONDER BOOKS will prepare you for a good Drafting job in less than a year! Mechanical and Architectural Drafting from simple straight lines to important, complex plans, a step at a time! Built especially for beginners, for men with only grammar schooling. Drafting room practice plus engineering made easy and clear!

## Big Field—Big Demand—Big Pay!

Competent Draftsmen are urgently needed right now in all building and manufacturing lines at \$50 to \$100 a week. That's just the beginning—for draftsmen have the best chance for advancement! Pleasant, fascinating work, easy to learn and do. Learn quick with these books—send coupon for a set FREE, and see for yourself!

A year's Consulting Membership in the American Technical Society now given free to all readers of this famous Cyclopedia of Drafting. Many say that's worth more than cost of books.

American Technical Society  
Dept. D-819, 58th & Drexel Ave., Chicago

# Modern American Homes FREE!

American Technical Society  
Dept. D-819, 58th & Drexel Ave., Chicago

Send for 15 days' free use 4-volume set of **DRAFTING**. In return for mailing this coupon promptly send absolutely FREE "Modern American Homes," 112 plates, exteriors, interiors and plans. I will pay the few cents delivery charges. If I wish I may return books in 15 days and owe you nothing. But if I prefer to keep them I will send \$1.80 after 15 days, then \$2.00 a month until \$14.80 (special reduced price) is paid.

Name \_\_\_\_\_  
Address \_\_\_\_\_  
Employed by \_\_\_\_\_  
Address \_\_\_\_\_



# Earn \$75 to \$100 a Week as AUTO MECHANIC—

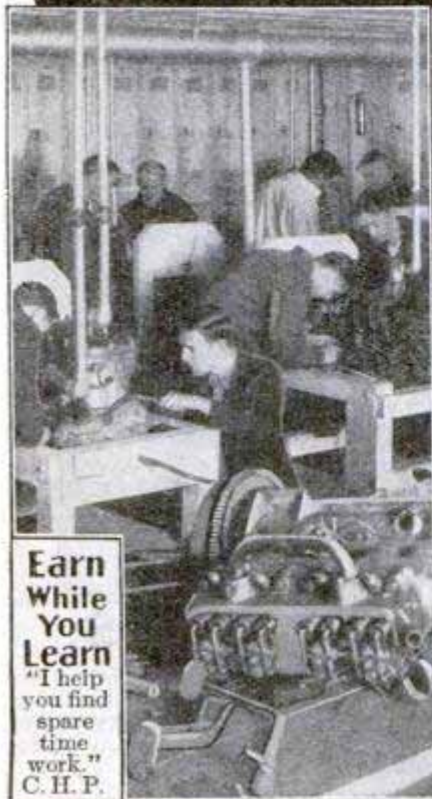

## Learn Easily in 8 Weeks on Real Machinery—

No Dry Books  
No Lectures

Eight short weeks of pleasant, fascinating, practical auto work in my big shops—and then a real job paying \$75.00 to \$100.00 a week! You can step right out of low pay, long hours, and no future into the job of a high-salaried auto mechanic. Everywhere jobs are waiting for men trained as I train them. Change the whole course of your life in 8 weeks!



I'll Pay Your R. R. Fare  
Clyde H. Pratt  
President

### Employment Dept. Helps My Graduates

Come to my shops. I will make you a mechanic able to handle the hardest auto jobs quickly and easily. I'll teach you to know autos inside out. You don't need education. You don't need previous experience. All you need is ambition. You learn by doing—by working on actual cars with real tools. This is not a correspondence course.

### Short Cut to Big Pay

Learn how easy it is to get a steady, big-pay job in the great auto field. Learn what other fellows like you have done with CLEVELAND Auto Training.

### Mail Coupon for Book

# CLEVELAND

AUTO SCHOOLS

1815 E. 24th St.,  
Cleveland, Ohio

Clyde C. Pratt, Pres.,  
CLEVELAND AUTO SCHOOLS,  
1815 E. 24th St., Dept. C-11, Cleveland, O.

Please send me FREE BOOK on Auto Mechanics, and details of spare-time work and Employment Help.

Name.....

Address.....

City.....State.....

Earn While You Learn "I help you find spare time work." C. H. P.

# Step INTO A BIG-PAY HOTEL JOB



### THESE LEWIS STUDENTS "MADE GOOD"

Jos. T. Freed, Phila., Pa.—“Without the training of the Lewis Schools I could never have secured the position of Assistant Superintendent of Service.”

Editha Thompson—“Am Manager of a Chicago Apartment Hotel. My work with you enabled me to secure this fine position.”

Julius M. Winslow—“Now Assistant Manager of a 15-story hotel in New York City. I knew nothing of hotel work until I began your course 6 months ago.”

Mrs. Ida Hartman—Stamford, Conn. “I am Housekeeper in the Hospital where your Employment Bureau placed me, and am very pleased with my new home.”

BE A HOTEL HOSTESS

## Earn \$2,500 to \$10,000 a Year

IN America's 3rd Largest Industry, Hotels, Clubs, Restaurants, Institutions, Schools, Colleges, Hospitals, etc., are daily calling for Lewis Trained Men and Women. Over 70,000 high-class positions paying \$2,500 to \$10,000 a year open annually in hotels alone. Salaries up to \$3,500 to start.

### We Put You in Touch with Positions

Without cost let us show you how big pay, fascinating work, quick advancement can be yours in the great hotel industry. Age is no obstacle—young and old alike have equal chance for success. A common school education is all you need with the amazing Lewis System of Training in Hotel Operation.

### Previous Experience Unnecessary

Hundreds of Lewis students are winning success. Totally unacquainted with hotel work before taking the Lewis Course, N. Frank Hills is now Assistant Manager of a \$250,000 Apartment House in Los Angeles, Cal. Lena Blair became Manager of a Tulsa, Okla., Apartment House even before she completed the Lewis Course! YOU can do as well. Low cost—easy terms—money back agreement. Write today for Free Book, “Your Big Opportunity,” and complete details, mailed without obligation.

MANAGE AN APARTMENT HOTEL



LEWIS HOTEL TRAINING SCHOOLS,  
Room BC-339, Washington, D. C.

Send me the Free Book, “Your Big Opportunity,” without obligation.

Name.....

Address.....

City.....State.....

OPPORTUNITY COUPON





## Become an Expert Accountant

*The Profession That Pays*

The demand for skilled accountants—men who really know their business—is unceasing. Big corporations are in constant need of expert counsel in matters relating to Auditing, Cost Accounting, Business Law, Organization, Management, Finance. Men who prove their qualifications in this important branch of business are rapidly promoted to responsible executive positions—given an opportunity to earn real salaries. The range is from \$3,000 to \$15,000 a year—even to higher income-figures.

**Send for Free Book—**  
 “Accountancy, the Profession that Pays”

Why let the other fellow walk away with the better job, when right in your own home you can equip yourself for a splendid future in this profitable profession?

Preliminary knowledge of bookkeeping is unnecessary. Our free book on accountancy fully explains how we train you from the ground up, according to your individual needs. Low cost; easy terms.

The facts about LaSalle training in Accountancy and the opportunities in this highly profitable field are clearly outlined in a 64-page book which LaSalle will send you free.

The man in earnest to get ahead will find this coupon a most profitable aid to progress. If you have the urge and the will to increase your income, clip and mail the coupon NOW.

— Find Yourself Through LaSalle! —

### LaSalle Extension University

*The World's Largest Business Training Institution*

Dept. 1164-HR Chicago

I would welcome details of your salary-increasing plan, together with copy of “Accountancy, the Profession that Pays,” also a copy of “Ten Years’ Promotion in One,” all without obligation.

**Higher Accountancy**

Training for position as Auditor, Comptroller, Certified Public Accountant, Cost Accountant, etc.

**Other LaSalle Opportunities:**

LaSalle opens the way to success in every important field of business. If more interested in one of the fields indicated below, check and mail now.

- |   |   |
|---|---|
| <input type="checkbox"/> Business Management                  | <input type="checkbox"/> Law—Degree of LL.B.            |
| <input type="checkbox"/> Modern Salesmanship                  | <input type="checkbox"/> Modern Business Correspondence |
| <input type="checkbox"/> Traffic Management                   | <input type="checkbox"/> Stenography—Stenotypy          |
| <input type="checkbox"/> Railway Station Management           | <input type="checkbox"/> Expert Bookkeeping             |
| <input type="checkbox"/> Banking and Finance                  | <input type="checkbox"/> C. P. A. Coaching              |
| <input type="checkbox"/> Commercial Law                       | <input type="checkbox"/> Business English               |
| <input type="checkbox"/> Industrial Management                | <input type="checkbox"/> Commercial Spanish             |
| <input type="checkbox"/> Modern Foremanship                   | <input type="checkbox"/> Effective Speaking             |
| <input type="checkbox"/> Personnel Management                 | <input type="checkbox"/> Telegraphy                     |
| <input type="checkbox"/> Credit and Collection Correspondence |   |

Name.....  
 Present Position.....  
 Address.....



## CHICAGO TECHNICAL COLLEGE

25th Year  
**Engineering**  
**Architecture**  
**Electricity**  
**Drafting**

Intensely practical training. 2 year Diploma; 3 year B. S. Degree; special 3 and 4 months' short courses. Courses adapted to your needs. No time wasted. Expert instructors. Graduates in constant demand. Opportunities for self-support while studying. Day and evening classes. Athletics. Enter any time. Low tuition—easy terms. Write today for your copy of 80-page illustrated “Blue Book,” mailed free.

Dept. P-76  
 118 E. 26th St  
 Chicago  
**Chicago Technical College**

## LANGUAGE POWER

Mastery English wins friends, increases chances for success. Sherwin Cody's wonderful new invention gives you language power in only 15 minutes a day (fascinating spare-time study at home. No rules to memorize. Learn correct English this new, easy way. Write for free book “How to Speak and Write Masterly English” today. SHERWIN CODY SCHOOL OF ENGLISH, 511 Searle Bldg., Rochester, N. Y.



## HAIR GROWS!

when our Vacuum Cap is used a few minutes daily. Sent on 60 days' FREE trial at our expense. No drugs or electricity. Stops falling hair, cures dandruff. A postal brings illustrated booklet.



**MODERN VACUUM CAP CO.**  
 557 Quincy Denver, Colorado

## LEARN ELECTRICAL TRADES

Practical Training on Massive Lay-Out of Expensive Electrical Equipment. Armature Winding, House Wiring, Electric Welding, Electric Refrigeration, Power Plants, Switchboards, Transformers, Motors, Generators, Radio Batteries. Automobile Course included without extra cost. Write Today for Free Catalog.

COLEMAN ELECTRICAL SCHOOL, 1628U Main St., Kansas City, Missouri

## CHEMISTRY



Complete, practical home-study courses prepared by some of the best-known chemists in this country, including ALLEN ROGERS, B.S., M.S., Ph.D.—Head of Department of Industrial Chemistry, Pratt Institute; L. M. TOLMAN, Ph.D.—Formerly Chief Chemist, Wilson & Co. Now Vice-president, United Chemical and Organic Products Co.; BRADLEY STOUGHTON, B.S.—Head of the Department of Metallurgy, Lehigh University, and OWEN L. SHINN, Ph.D.—Professor of Applied Chemistry, University of Pennsylvania.

Mail Coupon for Free Booklet

**INTERNATIONAL SCHOOL OF CHEMISTRY**  
 Associated with the International Correspondence Schools  
 Box 5578-F, Scranton, Penna.

Without cost or obligation, please send me full details of your home-study course in

<input type="checkbox"/> Analytical Chemistry	<input type="checkbox"/> Metallurgical Chemistry
<input type="checkbox"/> Chemical Engineering	<input type="checkbox"/> Short Chemistry Course
<input type="checkbox"/> Industrial Chemistry	<input type="checkbox"/> Pharmacy

Name.....  
 Address.....



# Wanted - men who seek BIGGER pay - Learn Autos in Los Angeles

## \$40 to \$75 per week easily earned

A few months' intensified training at National Automotive School qualifies you to obtain the automobile job you seek. \$40 to \$75 per week is being earned by N. A. S. graduates immediately upon leaving the school. Thousands are earning more, depending upon individual ability. National graduates in greatest demand.

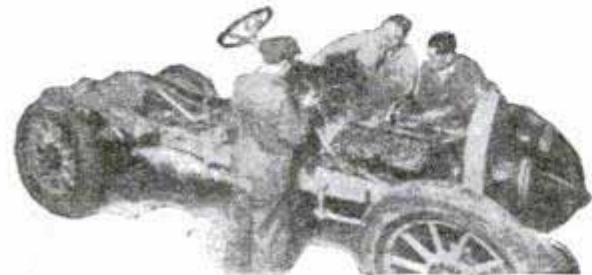

### Jobs Waiting

Big auto boom in California has caused shortage of trained auto men. Big-pay jobs waiting for N. A. S. graduates. Hundreds of our graduates now own garages and service stations, earning large yearly incomes. Many have become financially independent within a short time after graduating. Most of our boys start at \$40 per week and soon earn about double this amount. You can do the same.

### Costs Less to Live in Sunny California

Winter is approaching. Why not learn the auto business where it is perpetual summer? Enjoy life while learning. No snow, sleet or rush to endure. Trips to beaches, mountains and famous California resorts can be enjoyed while learning.

### SPECIAL Autumn Offer—Ask About It. Send No Money

For the next 90 days National is making a generous offer in addition to the regular enrollment, that will interest you. Fill in your name and address on bottom coupon and get full details.

### 74-Page De Luxe Book of Auto Facts Now Free

The most instructive book we ever published on auto training. Now available without cost to Popular Mechanics readers. 74 pages brimful of facts about the most advanced auto instruction. Yours for the asking! Only 865 copies available for immediate distribution—so hurry your request for a copy.

**Enrollment cost returned if you are not satisfied 100%**

Acres of departments filled with latest equipment occupying our magnificent Class A fireproof building in Los Angeles. Complete up to date equipment. Large, light, airy workrooms, scores of expert instructors, outdoor gymnasium, reading rooms, free evening entertainment. Everything you need.

### Complete Auto, Electrical, Aviation Courses

Nominal enrollment fee pays for complete auto instruction including repair of all types of motors, trouble shooting, ignition systems, chassis, transmissions, differentials and instruction in everything that the skilled auto mechanic should know. Nothing omitted. Also special electrical and aviation courses. The most practical training in the finest technical school on the West coast.

**17,874 successful graduates in world-wide demand**

### Life Scholarship

Unlimited scholarship is offered. You can take a few weeks' training now and come back any time later for additional training without one cent extra cost. The most liberal scholarship we ever offered.

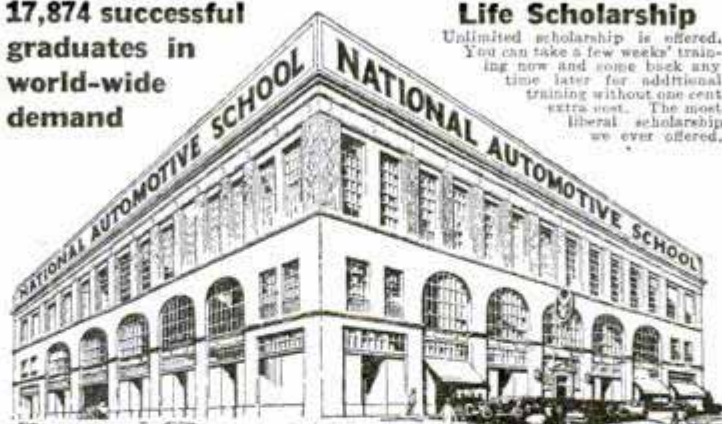

**You earn while learning. National's big Employment Dept. helps get you a job when you enroll—if needed.**

If you need financial assistance while enrolled we will help obtain a job for you to earn your room and board. Right now we have more jobs waiting than applicants. We also have constant call for trained mechanics and electricians. When you complete your course at National we help you secure a big-pay position. No age limit. Any man can learn quickly. Big opportunities await you.

### Biggest Auto School on Entire West Coast

### Earns \$4,000

Paul Briggs of Portland was earning \$100 per month. He came to National, took complete course and now earns \$4,000 per year. He considers National training worth five years of ordinary shop experience and attributes his success entirely to National.

### Gets \$65 Week Job

Wm. Becker of Flint, Michigan, says, "Because of National training I have increased my wages to \$1.00 per hour, twice what I was getting. Now I earn \$250.00 per month." Not so bad for a 20-year-old boy.

### Wins 50% Increase

Lloyd Knapp, a rehabilitated sailor, after taking the National course of training, increased his income approximately 50% immediately upon leaving the school. Now earning double his previous wages. Sam Garvin entered the school at 22 years of age; was a ranch-hand, \$40.00 per month and now earns \$170.00 per month in a garage.

### N. A. S. Graduate Goes into Business

Cecil Nichols, since graduating from N. A. S., accepted a position in a Tucson, Ariz., garage and had his salary raised several times within 2 years. He is now earning better than \$200.00 per month.

### Chosen from 140 Men for Big-pay Job

E. C. Hall, a N. A. S. graduate, took a civil service examination in competition with 140 men immediately upon graduating and scored a grade of 95%, far higher than other men who had been in the business for years. He won a big-pay job in competition with men of many years' experience.

### Jimmie Dunn Gets 450% Pay Increase

He is the highest salaried man in the Nadeau Ford organization in Los Angeles. Dunn declares, "I owe my success to N. A. S. training. It has increased my pay 450%. I certainly advise any man entering the auto industry to get National training." We can refer you to thousands of graduates, many in your locality.

### N. A. S. Endorsed by Biggest Auto Companies

The leading auto distributors in California, and many elsewhere, choose their men from N. A. S. and highly endorse National training because all graduates are well-grounded in auto fundamentals. A diploma from N. A. S. wins a job almost anywhere.

# National Automotive

LOS ANGELES J. A. ROSENKRANZ, ESTABLISHED 1905  
President

Dept. 716

4006 South Figueroa Street

(Corner of Santa Barbara)

Sign your name below, tear off and mail, for big free Book.

YOUR NAME \_\_\_\_\_

YOUR ADDRESS \_\_\_\_\_





# High School Course in Two Years!

## You Want to Earn Big Money!

And you will not be satisfied unless you earn steady promotion. But are you prepared for the job ahead of you? Do you measure up to the standard that insures success? For a more responsible position a fairly good education is necessary. To write a sensible business letter, to prepare estimates, to figure cost and to compute interest, you must have a certain amount of preparation. All this you must be able to do before you will earn promotion. Many business houses hire no men whose general knowledge is not equal to a high school course. Why? Because big business refuses to burden itself with men who are barred from promotion by the lack of elementary education.

### Can You Qualify for a Better Position

We have a plan whereby you can. We can give you a complete but simplified high school course in two years, giving you all the essentials that form the foundation of practical business. It will prepare you to hold your own where competition is keen and exacting. Do not doubt your ability, but make up your mind to it and you will soon have the requirements that will bring you success and big money. YOU CAN DO IT.

Let us show you how to get on the road to success. It will not cost you a single working hour. Write today. It costs you nothing but a stamp.

### American School

Dept. H-874, Drexel Ave. and 58th St., Chicago

### American School

Dept. H-874, Drexel Ave. and 58th St., Chicago

Send me full information on the subject checked and how you will help me win success.

- |                              |                            |
|------------------------------|----------------------------|
| .... Architect               | .... Business Law          |
| .... Building Contractor     | .... Lawyer                |
| .... Automobile Engineer     | .... Machine Shop Practice |
| .... Automobile Repairman    | .... Mechanical Engineer   |
| .... Civil Engineer          | .... Shop Superintendent   |
| .... Structural Engineer     | .... Employment Manager    |
| .... Business Manager        | .... Steam Engineer        |
| .... Cert. Public Accountant | .... Foremanship           |
| .... Accountant and Auditor  | .... Sanitary Engineer     |
| .... Bookkeeper              | .... Surveyor (& Mapping)  |
| .... Draftsman and Designer  | .... Telephone Engineer    |
| .... Electrical Engineer     | .... Telegraph Engineer    |
| .... Electric Light & Power  | .... High School Graduate  |
| .... General Education       | .... Wireless Radio        |
| .... Vocational Guidance     | .... Undecided             |

Name.....

Address.....

## Recharge Your Dry "B" Batteries With Amazing New Invention



Only **\$1.00** Complete

Recharges RUN-DOWN OR WEAK "B" Batteries (dry) overnight. Makes them last three times as long. Uses less current than 25-watt lamp. For DC or AC any cycle. Don't throw away your "B" batteries—invest \$1.00 in this guaranteed charger, renew their life and save money. No extras to buy.

### No Harmful Acids—No Tubes to Burn Out

Send \$1.00 currency, stamps, check or money order, plus 10c to cover mailing cost. Charger will be sent postpaid. If not satisfied, return within 5 days and your money will be refunded.

Order today—NOW! You can't lose—we guarantee you satisfaction or money back.

### ROLL-O RADIO COMPANY

Dept. D-4, 3rd and Sycamore Sts., Cincinnati, Ohio

# I'll Pay You

## \$30 a Day



### To Show My Rain Proof FITS-U Caps to Men

I'll pay you \$30 a day to show my marvelous line of rain-proof Fits-U Caps. More for active workers. With my liberal commission of \$1.00 on every sale—it's a cinch to clean up \$5.00 or more an hour in spare time. "In two hours," writes one successful salesman, "I made \$15.70. It's the rain-proof and made-to-measure features that get the orders so quick."

**FREE Outfit**

By a secret process, every Fits-U Cap is made absolutely rain-proof! Rain has no effect on the Fits-U Cap. You collect big commissions in advance. EVERY CAP MADE TO INDIVIDUAL MEASURE! Many other fast selling numbers: Men's Felt Hats, Ladies' Hats, Mufflers, Ties, etc. Don't Wait—Act Now. I'll send elaborate selling outfit to you FREE. Get started immediately. Just send name and address. Postal will do. Write today!

FITS-U CAP CO., Dept. A-75, CINCINNATI, OHIO



## ZIP-ZIP SHOOTER

THOUSANDS of boys are made happy with this wonderful Zip-Zip shooter, something every boy wants and never gets tired of. Zip-Zip shooter is scientifically and practically

made; if you like hunting and outdoor sports, get a Zip-Zip shooter with plenty of pep and force. If your dealer happens not to have them, order from us. Zip-Zip shooter 35c or three for \$1.00; send stamps, coin or money order.



AUTOMATIC RUBBER CO., Dept. B. B., COLUMBIA, S. C.

## 10c NEW SCIENTIFIC WONDER

### "X-RAY" CURIO

3 for 25c SILVER ONLY

**BOYS** You apparently see thru Clothes, Wood, Stone, any object. See Bones in Flesh. FREE—PKG. RADIO PICTURE FILMS. Takes pictures without camera. "You'll like 'em." 1 pkg. with each 25c order.



MARVEL MFG. CO. Dept. 31 NEW HAVEN, CONN.

## PAINT SIGNS and SHOW CARDS

We quickly teach you by mail, or at school, in spare time. Enormous demand. Big future. Interesting work. Oldest and foremost school.

**EARN \$50 TO \$200 WEEKLY**  
John Vassos, N. Y., gets \$25 for single show card. Crawford, B. C., writes: "Earned \$200 while taking course." Don't delay. Send today for complete information, samples and guarantee.

**DETROIT SCHOOL OF LETTERING**  
150 Stimson Ave. Est. 1897 DETROIT, MICH.





# *At Last! Real College Instruction in Drafting At One-Third the Cost!*

## *Right at Home!*

Unquestionably, hundreds of the readers of this magazine have waited and hoped to run across just such a message as this. For an old-established and recognized engineering school now makes an important announcement about Drafting. At last, you can get real college training right at home, inexpensively, in this big-pay profession. The trial lesson and other material offered below bear convincing proof and may now be obtained without cost simply by mailing the coupon.

LOOK here, men. It is true that this message is addressed to men who would like to have the very highest type of college training in drafting. But let's understand one another right at the start. Just because some of the most successful business and professional men in America are Chicago Tech graduates is no sign that anybody is going to try to get "high-brow." And because students come to Chicago from all over the world—often spending many hundreds of dollars—doesn't mean that you have to pay a lot of money for this practical, simplified, easily mastered training. Far from it! For now as part of the Chicago Tech new plan you may obtain complete home training in Drafting at a mere fraction of the usual cost of a college course.

### Experience Is the Best Teacher

Nearly everyone has heard of Chicago Technical College. Over 1,000 men each year attend this well-known school. Here they quickly learn engineering and architecture, including Drafting. Not out of dry, hard-to-master text books. Not by a lot of tedious "study." But by the wonderful "practice" system developed by Chicago Tech. By this method everything is far easier to learn because it is more interesting. In fact man after man will tell you that learning any subject the Chicago Tech way is more like playing a fascinating new game than anything else. It is almost as different from the drudgery that you will find in ordinary "schooling" as night is from day. And now this easily mastered, pay-raising training is yours quickly, right at home, in spare time, at nominal cost.

### Earn \$50 to \$100 a Week

This is the type of training that really leads to the big-pay positions in Drafting, where many earn from \$5,000 to \$7,500 a year and up. The largest employers of skilled draftsmen recognize the value of College-Training-in-Drafting, and con-



stantly apply to Chicago Tech for Draftsmen. Hundreds of Chicago Tech graduates who are now in top-notch positions of authority or in business for themselves do the same. The Chicago Tech employment department makes no charge either to student or employer if you accept one of these jobs. The entire success of this College-Training-in-Drafting has been proved so thoroughly that the "at-home" training is covered by a binding money-back agreement. With the Chicago Tech course you are supplied a full set of high-grade drawing instruments in pocket case. A special drawing table for home use. And a valuable drawing outfit. These are the same as used in the College. You get them without any extra cost whatever.

### Learn the Facts—Now!

Where else on earth can you get real college training in Drafting like this? Yet now it is offered to you as part of the new Chicago Tech Home-Study plan on amazingly liberal terms. So if you want to learn Drafting the successful, approved and easy way—get the Free Trial Lesson and other valuable information. Simply mail the coupon without obligation.

**Get Free  
Proof**



## CHICAGO TECHNICAL COLLEGE

Dept. P-201, Home Study Division,  
Chicago Tech. Building, 118 E. 26th St., Chicago, Ill.  
"College-Training-At-Home"

**COLLEGE-TRAINING-AT-HOME COUPON**  
Chicago Technical College, Dept. P-201, Home Study  
Division  
118 E. 26th Street, Chicago, Ill.

Please send me the facts about your new system that enables men to master professional Drafting at home just as you teach it at the college in Chicago. Include your FREE TRIAL LESSON. This does not obligate me in any way.

Name.....

Address.....

Town..... State.....

( ) Check here only in case you prefer coming to Chicago to take our short course in Drafting at Chicago Tech.



**O. C. MILLER**

Director  
Extension  
Work

American  
School



## The American School

A two million Dollar *No-Profit* Educational Institution, now offers men a *double* service—training for a specific job, then help in finding the job. For one small price, on terms of only \$6.00 a month, you are now assured of definite benefits, both in position and salary. Write for complete information—*today!*

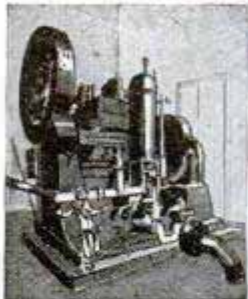

No machine can be built until the Draftsman first builds it on PAPER. This training prepares you for this work.



Never has the world seen anything like the building boom of today. This has created enormous demand for real Draftsmen.

# 3 Drafting

to prove you can

We have invented a new, simplified way to teach Drafting—the first real improvement in Drafting home instruction in history. We want you to see a few of these new Job-lessons, try them, test your own ability to master them—without one penny of cost or obligation. For instance, you will see how we get away from the “copying” methods used in the past, so you develop into a DRAFTSMAN, instead of a “tracer.” See for yourself the ingenious new method which compels you to think, to solve problems, to do actual Drafting-room jobs from the very first lesson!

## A New, Rapid, Simplified Training

Copying drafting lessons prepares you to be only a “tracer.” This new “Job-Method” gives you actual drafting-room jobs in a new one-step-at-a-time way. With pictures which you can understand almost without reading the “lessons.” And that is why the American School-trained Draftsmen can qualify for a good job at big pay when they graduate.

## 5 BIG-PAY Branches

The big money in Drafting goes to men who specialize in Machine Design, or Electrical Drafting, or Architectural Drafting, or Structural, or Automotive. It is not enough merely to know *general* Drafting practice. You must know how to calculate and design and plan original work. You need many Engineering subjects to fill the kind of a Drafting position that pays \$40 to \$100.00 a week. The American School now includes this specialized training in its Drafting course.

## Win Success Thru Drafting

Drafting is easy, fascinating work. Short hours. Big pay. And the Draftsman is always in line for promotion to executive positions. This training is *complete*. It includes high school subjects (if you need them) and all the Engineering and Mathematics Drafting experts require.

## FREE Job Service!

The American School now offers its students and graduates, without cost, the services of an efficient employment department keeping in constant touch with employers of Draftsmen all over the U. S. We have placed hundreds of men in good, big-pay Drafting positions. We've made this training so complete, so practical, so easy to master, that our students are bound to **make good**. And so, because the demand for real Draftsmen continues to exceed the supply and because this training actually prepares men for good Drafting positions we back it with a **Free Employment Service**.

The American School

Dept. D-874  
Drexel Avenue and  
58th St., CHICAGO



# Lessons *Actually* FREE

learn at home in spare time!  
**Draftsmen Wanted!**  
**\$40 to \$100 a Week!**

yourself. Plan your future in Drafting. Even if you have only common schooling, even if you know nothing of Drafting, we guarantee to make you a real Draftsman or to refund your money!  
 Coupon brings complete information.

70,000 fine jobs advertised last year. Get ready to fill one. Get out of the rut. Make something of

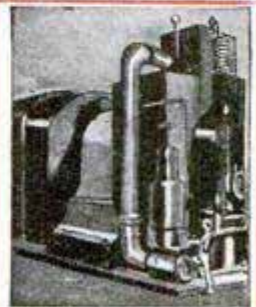

Electricity needs draftsmen who know Electrical principles as well as general Drafting practice. I give you this training.



The demand for Draftsmen experienced in concrete and structural steel work is enormous. Many big-pay positions open.



Every great Auto factory employs Draftsmen who specialize in Automotive work—men who design bodies, plan engines, etc.

**I Will Make This Contract With You**  
 WHEN you enroll for our home-training in Drafting, we agree to give you:

1. Complete Drafting training, by the new Practice-Method.
2. We will help you get a good Drafting position at a substantial increase in pay,
3. or we'll refund every cent of your money.



**American School**  
 —the two Million Dollar Educational Institution



*O. C. Miller*  
 Director Extension Work

**Coupon Brings 3 Lessons FREE!**

Get them. Test your own ability to learn Drafting and get ready for a fine job and big pay. Coupon also brings complete information about your opportunities for success in Drafting. *Mail It Today!*

**Read These Letters!**

**City of Chicago**  
**Department of Buildings**  
 Gentlemen: The same day I received my diploma I got word that I was one of the two candidates who had successfully passed the examination for Deputy Commissioner of Buildings of the City of Chicago, a position paying \$3600 per year.

There were eight applicants examined besides myself, all men well known to the architectural and engineering profession. Seven of these failed to obtain a passing grade of 70%. My grade was 84.6%.

Inasmuch as I failed to pass this same examination three years before, my present success is mainly due to the knowledge gained through your School.

Yours very truly,  
**ROBERT KNIGHT**

**Got His Draftsman's Job**

"I wanted to let you know how I came out in getting that job at the Brownell Co., Dayton, Ohio. I was to start and have a trial at Drawing, and I am still in the Drawing room. The engineer seems to like the work I make, and also the other draftsmen. I thank the school very much for getting me in at this place, because your letter of recommendation helped me a whole lot to get the job."

**BERNARD WEBER,**  
 730 St. Nicholas Ave., Dayton, O.

**Liberty High School**  
**Bethlehem, Pa.**

Dear Sirs:—This is to thank the American School for all that you have done for me since I signed up for the Drafting and Design Course.

In the eight years since then, I have gradually climbed from the position of tracer to that of Head of the Department of Machine Drawing and Design in our magnificent new \$2,000,000 High School here, at many times the salary which I received at that time.

The officials of the Pennsylvania State Department, and Dr. Wm. C. Ash of the University of Pennsylvania, all claim that our Course in Drafting and Design is the best now being taught in this state. Every drafting graduate that we have turned out has proved successful, and one is now Chief Draftsman in a local steel concern. Yours sincerely,  
**J. S. LEAR**

**Has Charge of Large Jobs**

"Even before I had finished my course, I was put in charge of large construction jobs in different cities. I have been doing that ever since, and the jobs are getting larger all the time. I owe my success to the American School because of the knowledge I gained in mathematics and calculations."

**ELMER L. LAMB,**  
 1306 Smith St., Peoria, Ill.

## 3 Drafting Lessons *Actually* FREE

**O. C. MILLER, Director Extension Work**  
**AMERICAN SCHOOL**

**Dept. D-874, Drexel Ave. and 58th St., Chicago.**

Rush 3 Free Drafting Lessons, Job and Raise Offer, complete information, money-back guarantee, etc., to prove I can become a real Draftsman at home in spare time.

Name.....

Street No.....

City..... State.....

Age..... Occupation.....



# Automobile Mechanics are needed!

**Prepare yourself now for  
a big-pay auto job!**

THE demand for trained men in the automobile field is far greater than the supply.

More than 20,000,000 automobiles are in use in this country now, and every week the figures grow larger.

There are not enough trained automobile service and repair men to keep up with this steady growth.

If you are not satisfied with your present earnings, look into this proposition NOW.

Recently Published

## PRACTICAL AUTOMOBILE LIBRARY



Four Books—\$1.50 in 10 days and \$2  
monthly for 6 months—only \$13.50 in all!

These four practical books, written by five well known teachers of automobile practice, will teach you, right in your own home during your leisure time, just what you need to know about automobile troubles and repair. They will teach you automobile construction, maintenance and repair as practiced by experts and will help you to earn an expert's pay.

### Your Big Chance—Get Ready for it!

Hundreds of question-answering diagrams—hundreds of clearly-marked illustrations—make the books plain and readily understandable to any man with the mechanical instinct. All the explanations and descriptions are clear, simple, direct. Every chapter is packed with definite, step-by-step, how-to-do-it information.

### Examine This New Library Free No money down Small monthly payments

These books were written specially for self-instruction by men who have trained thousands of automobile operators and garage men. Examine the library for 10 days free. Just fill in and mail the attached coupon.

If you find the books what we say they are, send us \$1.50 in ten days and \$2 monthly for only six months. If you do not want the books, send them back at our expense. Act now and send the coupon.



### FREE EXAMINATION COUPON

McGraw-Hill Book Co., Inc., 370 Seventh Ave., New York

Send me for 10 days' free examination the New Practical Automobile Library. If satisfactory I will send you \$1.50 in 10 days and \$2.00 monthly until the special price of \$13.50 is paid. If not wanted, I will return the books at your expense.

Signed.....  
Address.....  
City and State.....  
Position.....  
Company..... P31-11-28

## \$2500 DRAWING \$298 COURSE for



Haven't you often wished that you could draw cartoons, illustrate some idea, sketch some pretty face, etc.? You can do all of these things. One of America's most famous Cartoonists and illustrators has developed a great, simple system for success in all branches of Commercial Art. This system has revolutionized the entire theory of drawing. It means that drawing can be as easy for you as

writing—much simpler than learning shorthand, bookkeeping or typewriting.

We are now placing this original system for learning Drawing, Art and Cartooning, consisting of 34 lessons with over 500 illustrations, within reach of every one. If you will devote a few hours each week to the Course WE ABSOLUTELY GUARANTEE that you will learn to draw and draw well before you have half finished the Course. If we fail to make this claim good, we will refund every cent paid us. By eliminating a large office force for answering correspondence, expensive catalogs, etc., we are enabled to make a price of \$2.98, the cheapest price ever known for a high-grade, home study course. Many have sent us letters similar to that of Rob't P. Davis of Detroit, who wrote: "I can't see how you ask so little. It is more than I expected." Learn to draw. It is a big asset, no matter what field you are in.

### Send No Money

Just order the course and \$2.98 on arrival pay postman plus a few cents postage, payment in full for the entire Course and Drawing Outfit. If not entirely satisfied, return within five days and we will Refund Money. Address:

If you order the course at once, we will include a drawing outfit, consisting of artist's pencils, pens, paper, erasers, thumb tacks, etc., enabling you to go to work without any additional cost.

LEDERER SCHOOL OF DRAWING, Dept. 210-P, Chattanooga, Tenn. Orders from outside the U. S. A. are payable \$3.28 cash with order.



### BIG VALUE FOR 10 Cts.

6 songs, words and music; 25 Pictures Pretty Girls; 40 Ways to Make Money; 1 Joke Book; 1 Book on Love; 1 Magic Book; 1 Book Letter Writing; 1 Dream Book and Fortune Teller; 1 Cook Book; 1 Base Ball Book, gives rules for games; 1 Toy Maker Book; Language of Flowers; 1 Morse Telegraph Alphabet; 12 Chemical Experiments; Magic Age Table; Great North Pole Game; 100 Conundrums; 3 Puzzles; 12 Games; 30 Verses for Autograph Albums. All the above by mail for 10 cents, and 2 cents postage.

ROYAL SALES CO., Desk 316, Norwalk, Conn.

## Daring Young Men!

Heed the  
Call to...

## Aviation.

### Quickly Train at Home for BIG PAY

If you want thrills, adventure, fame, popularity—get into Aviation. Now—a complete practical, EASY-TO-GRASP Course in Aviation fundamentals offered at a low price. We teach you—by Home Study—in the quickest possible time every step necessary to qualify for position as a Pilot, Instructor, Designer, Motor Expert, Inspector, Mechanic, etc.

You are taught every branch of Aviation: Motors, Wings, Assembly, Construction, Design, Nomenclature, Flight Principles, Air Rules, Meteorology, Navigation, How to Handle Ship in Air and on ground and 100 other fascinating subjects. Profusely illustrated with all necessary diagrams, charts, plans, etc. Endorsed by Aviation experts. Accredited Diploma, on graduation.

All over America manufacturing, transport, air-port service and sales organizations are springing up—with valuable openings for high priced, skilled men. FREE Employment Service.

Write today for your FREE copy of new book, "Aviation."

### FREE Book Coupon

National Aviation Training,  
Dept. 17, 1031 So. Broadway, Los Angeles, Calif.  
Send me, without obligation, the Free Book "Aviation."

Name.....  
Address.....  
City..... State.....





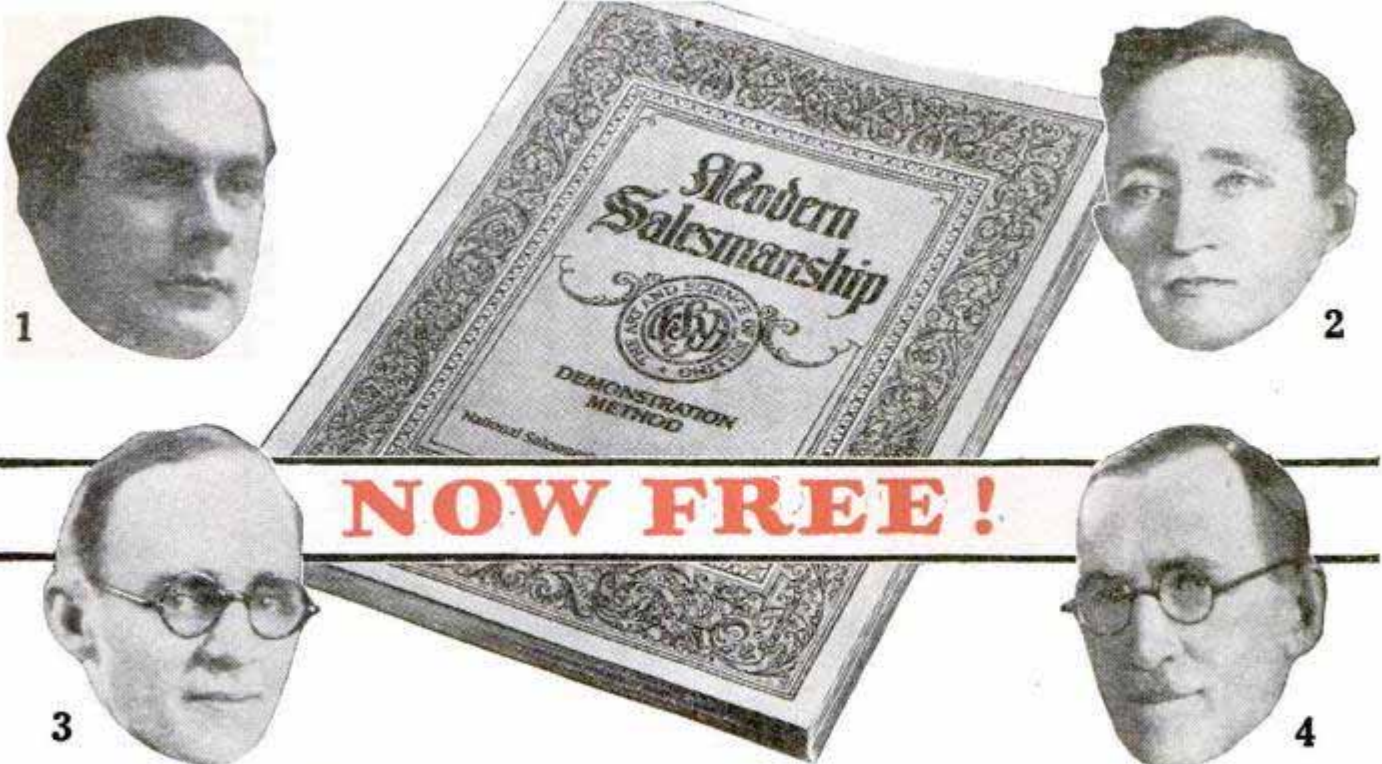

**NOW FREE!**

**They Found This Book Was Worth a Year's Pay! -and so Have Thousands of Others**

**A** BOOK? Worth a year's pay? Worth from \$1,000 to \$5,000 to most any man? Ridiculous, you may say. All right, doubt it if you will, but remember one thing. The men whose pictures you see above, and thousands of others whose success records have been equally startling, perhaps doubted it too. But that didn't stop them investigating, sometimes even in the face of ridicule from "wise-cracking" friends. They sent for "Modern Salesmanship." They read the vivid, inspiring message contained within its sixty-four fascinating pages. They learned of a new easy way to enter the highest-paid profession in the world on an even footing with men of five and ten years' experience. And the direct result was the same in each case—increased salaries, broader vision, new luxuries! No wonder a year's pay now seems a modest valuation for the book that opened their eyes to such amazing opportunities!

**The Secret of Earning Big Money**  
Figure it out for yourself. Most jobs are worth just so much and no more. No matter how hard a man works, he just can't get his salary past the limit set for certain classes of routine labor. The salaries of clerks, bookkeepers, mechanics, laborers, etc., are limited, because there are always plenty to fill the ranks. The opportunity for advancement is practically negligible. But how different with Salesmanship! Master Salesmen are the very life-blood of any business. Upon their efforts depend the profits which any concern makes. No company can exist without them—and there is almost no limit to the importance which a good salesman can achieve in the eyes of the firm employing him.

**Proof That You Can Become a Master Salesman**  
Yet despite all the wonderful advantages

enjoyed by the Master Salesman, proficiency in this fascinating field is surprisingly easy for any average man to attain—without losing a day or a dollar from his present position. During the past twenty years, the National Salesmen's Training Association has developed thousands of every-day, ordinary men into Master Salesmen, able to earn incomes ranging from \$5,000 to \$10,000 a year and even more. No matter what your present occupation is, there is no reason why you cannot make good as a salesman. There is no reason why you cannot quickly learn the simple principles that have guided others to just such success as you have often dreamed of for yourself. "Modern Salesmanship" will point the way.

**A Gold Mine of Valuable Information—FREE!**  
If we were asking several dollars a copy for this remarkable book, you might hesitate. But it is now FREE. And since the information which it contains may be worth so much to you, it is surely worth while to fill in and mail the coupon below. This coupon will bring a copy to you without cost or obligation of any sort. Take this opportunity now to find out exactly what your chances in the selling profession are—what membership in this Association means—and why our Free Employment Bureau received calls for more than 50,000 salesmen last year! Mail the coupon to-day!

**NATIONAL SALESMEN'S TRAINING ASSOCIATION**  
Dept. S-101  
N. S. T. A. Bldg. Chicago, Ill.

- \$10,000 A Year**  
1 "N. S. T. A. training has enabled me to learn more, earn more, and BE more. My earnings this year will exceed the 5-figure mark."  
C. V. Champion, Danville, Ill.
- \$1,000 In A Week**  
2 "Before joining the N. S. T. A. I was making \$200 a month. Last week my earnings amounted to over \$1,000."  
O. D. Oliver, Norman, Okla.
- \$7,500 A Year**  
3 "Three years ago I was working in a shop for \$15 a week. To-day I am making \$7,500 a year. N. S. T. A. training has put me where I am to-day."  
C. W. Birmingham, Dayton, Ohio
- \$7,286 Last Year**  
4 "I was working as a clerk earning \$1,000 a year when I enrolled with N. S. T. A. Last year my income tax showed earnings of \$7,286."  
Frank J. Walsh, Springfield, Mass.

**National Salesmen's Training Association,**  
Dept. S-101, N. S. T. A. Bldg., Chicago, Ill.  
Please mail me Free your illustrated book, "Modern Salesmanship" and particulars of membership in your Association.

Name.....  
Address.....  
City..... State.....  
Age..... Occupation.....





# “Another \$10 Raise!”

“Why, that's the third increase I've had in a year! It shows what special training will do for a man.”

Every mail brings letters from some of the thousands of students of the International Correspondence Schools, telling of advancements won through spare-time study.

How much longer are you going to wait before taking the step that is bound to bring you more money? Isn't it better to start *now* than to wait for years and then realize what the delay has cost you?

One hour after supper each night spent with the I. C. S. in your own home will prepare you for the position you want in the work you like best.

Without cost, without obligation, mark and mail this coupon. *Do it right now!*

## INTERNATIONAL CORRESPONDENCE SCHOOLS “The Universal University” Box 5573-F, Scranton, Penna.

Without cost or obligation, please send me a copy of your booklet, “Who Wins and Why,” and full particulars about the subject before which I have marked X in the list below:

### BUSINESS TRAINING COURSES

- |  |   |
|--|---|
| <input type="checkbox"/> Business Management                     | <input type="checkbox"/> Salesmanship                                     |
| <input type="checkbox"/> Industrial Management                   | <input type="checkbox"/> Advertising                                      |
| <input type="checkbox"/> Personnel Management                    | <input type="checkbox"/> Business Correspondence                          |
| <input type="checkbox"/> Traffic Management                      | <input type="checkbox"/> Show Card and Sign Lettering                     |
| <input type="checkbox"/> Accounting and C. P. A.                 | <input type="checkbox"/> Stenography and Typing                           |
| Coaching   | English <input type="checkbox"/> Civil Service                            |
| <input type="checkbox"/> Cost Accounting                         | <input type="checkbox"/> Railway Mail Clerk                               |
| <input type="checkbox"/> Bookkeeping                             | <input type="checkbox"/> Common School Subjects                           |
| <input type="checkbox"/> Secretarial Work                        | <input type="checkbox"/> High School Subjects                             |
| <input type="checkbox"/> Spanish <input type="checkbox"/> French | <input type="checkbox"/> Illustrating <input type="checkbox"/> Cartooning |

### TECHNICAL AND INDUSTRIAL COURSES

- |   |  |
|---|--|
| <input type="checkbox"/> Electrical Engineering                         | <input type="checkbox"/> Architect                                       |
| <input type="checkbox"/> Electric Lighting                              | <input type="checkbox"/> Architects' Blueprints                          |
| <input type="checkbox"/> Mechanical Engineer                            | <input type="checkbox"/> Contractor and Builder                          |
| <input type="checkbox"/> Mechanical Draftsman                           | <input type="checkbox"/> Architectural Draftsman                         |
| <input type="checkbox"/> Machine Shop Practice                          | <input type="checkbox"/> Concrete Builder                                |
| <input type="checkbox"/> Railroad Positions                             | <input type="checkbox"/> Structural Engineer                             |
| <input type="checkbox"/> Gas Engine Operating                           | Chemistry <input type="checkbox"/> Pharmacy                              |
| <input type="checkbox"/> Civil Engineer <input type="checkbox"/> Mining | <input type="checkbox"/> Automobile Work                                 |
| <input type="checkbox"/> Surveying and Mapping                          | <input type="checkbox"/> Airplane Engines                                |
| <input type="checkbox"/> Plumbing and Heating                           | <input type="checkbox"/> Agriculture <input type="checkbox"/> Navigation |
| <input type="checkbox"/> Steam Engineering                              | <input type="checkbox"/> Mathematics <input type="checkbox"/> Radio      |

Name.....

Street Address.....

City..... State.....

Occupation.....  
Persons residing in Canada should send this coupon to the International Correspondence School Canadian, Limited, Montreal, Canada

## The MOCAR

### Model Airplanes that FLY!

Only \$1.50 Complete

All Aluminum Construction

**BOYS**—at last, here is a genuine aluminum model airplane that really flies. And at a small price. The “Mocar” monoplane—Set No. 1—is a copy of the famous Spirit of St. Louis. Wing spread 18 inches, fuselage 12 inches, powerful motor, ball bearing propeller, rubber tired disc wheels. Weight complete only about 2½ oz. This is a practical, simple, real model plane that gives you a whole lot of fun for the moderate cost. The all metal construction makes a sturdy plane that will stand a lot of abuse. The outfit is mounted on cardboard with all parts plainly marked and full instruction for assembly. Pliers only tool necessary. Complete with rivets, bolts, nuts, wheels, wing and fuselage covering material, only \$1.50 post paid (3 for \$4.00).

*Great fun, learn how to make and fly airplanes. Order now. Jobbers, dealers and schools write for discounts.*

**THE MOUNT CARMEL MFG.CO.**

Dept. M

Mount Carmel, Conn.

# Play “JAZZ” ~ on the Saxophone

Become a musician so quickly as to astound everyone. Learn by playing *real music*—instead of tiresome “exercises.” You'll soon become the most popular person in your “set.”

## New Easy Method

is a revelation. Nothing else like it for thoroughness and rapidity. So simple that young and old find it easy to play with amazing skill. No “trick music”—but actual notes, learned quickly right in your own home.

**Choose Your Course**

Mandolin	Saxophone
Piano	Cello
Organ	Ukulele
Violin	Cornet
Banjo	Trombone

or any other instrument

Also for advanced pianists a special course including 24 famous classics—a distinctive addition to any pianist's repertoire.

**FREE BOOK and Demonstration Lesson**

offer this wonderful musical opportunity. Send for them today before copies are exhausted. You'll be astounded, thrilled, fascinated, at this easy, rapid way to become a veritable master of your favorite instrument. Instruments supplied when needed, cash or credit.

**U. S. SCHOOL OF MUSIC, 711-A Brunswick Bldg., New York City**

Send me your amazing free book, “Music Lessons in Your Own Home,” with introduction by Dr. Frank Crane, also FREE DEMONSTRATION LESSON. This does not put me under any obligation. (Please Write Plainly.)

NAME.....

ADDRESS.....

INSTRUMENT..... Have you this inst.?



**Read what BIG money these fellows have made in the RADIO BUSINESS**

**\$375 One Month Spare Time**



"Recently I made \$375 in one month in my spare time installing, servicing, selling Radio sets. And, not so long ago, I earned enough in one week to pay for my course."  
EARLE CUMMINGS,  
18 Webster St., Haverhill, Mass.

**\$1597 in Five Months**



"The N. R. I. is the best Radio school in the U. S. A. I have made \$1597 in five months. I shall always tell my friends that I owe my success to you."  
HENRY J. NICKS, JR.,  
302 Safford Ave.,  
Tarpon Springs, Fla.

**\$1164 Spare Time Profits**



"Look at what I have made since I enrolled, \$1,164—money I would not have had otherwise. I am certainly glad I took up Radio with N. R. I. I am more than satisfied."  
HENRY R. HEIKKINEN,  
123 W. Erie St., Chicago, Ill.

**Over \$1000 in Four Months**



"My opinion of the N. R. I. course is that it is the best to be had at any price. When I enrolled I didn't know a condenser from a transformer, but from December to April I made well over \$1000 and I only worked in the mornings."  
AL JOHNSON,  
1409 Shelby St., Sandusky, Ohio.

# I will show you too how to start a spare time or full time Radio Business of Your Own without capital



J.E. SMITH Pres.

Radio's amazing growth is making many big jobs. The world wide use of receiving sets and the lack of trained men to sell, install and service them has opened many splendid chances for spare time and full time businesses.

Ever so often a new business is started in this country. We have seen how the growth of the automobile industry, electricity and others made men rich. Now Radio is doing the same thing. Its growth has already made many men rich and will make more wealthy in the future. Surely you are not going to pass up this wonderful chance for success.

**More Trained Radio Men Needed**

A famous Radio expert says there are four good jobs for every man trained to hold them. Radio has grown so fast that it simply has not got the number of trained men it needs. Every year there are hundreds of fine jobs among its many branches such as broadcasting stations, Radio factories, jobbers, dealers, on board ship, commercial land stations, and many others. Many of the six to ten million receiving sets now in use are only 25% to 40% efficient. This has made your big chance for a spare time or full time business of your own selling, installing, repairing sets.

**So Many Opportunities You Can Make Extra Money While Learning**

Many of our students make \$10, \$20, \$30 a week extra while learning. I'll show you the plans and ideas that have proved successful for them—show you how to begin making extra money shortly after you enroll. G. W. Page, 1307-21st Ave., S., Nashville, Tenn., made \$935 in his spare time while taking my course.

how to begin making extra money shortly after you enroll. G. W. Page, 1307-21st Ave., S., Nashville, Tenn., made \$935 in his spare time while taking my course.

**I Give You Practical Radio Experience With My Course**

My course is not just theory. My method gives you practical Radio experience—you learn the "how" and "why" of practically every type of Radio set made. This gives you confidence to tackle any Radio problems and shows up in your pay envelope too.

You can build 100 circuits with the Six Big Outfits of Radio parts I give you. The pictures here show only three of them. My book explains my method of giving practical training at home. Get your copy!

**I Will Train You At Home In Your Spare Time**

I bring my training to you. Hold your job. Give me only part of your spare time. You don't have to be a college or high school graduate. Many of my graduates now making big money in Radio didn't even finish the grades. Boys 14, 15 years old and men up to 60 have finished my course successfully.

**You Must Be Satisfied**

I will give you a written agreement the day you enroll to refund your money if you are not satisfied with the lessons and instruction service when you complete the course. You are the only judge. The resources of the N. R. I. Pioneer and Largest Home-Study Radio school in the world stand back of this agreement.

**Get My Book**

Find out what Radio offers you. My 64-page book, "Rich Rewards in Radio" points out the money making opportunities the growth of Radio has made for you. Clip the coupon. Send it to me. You won't be obligated in the least.

**Address**

J. E. Smith, Pres.

Dept. 33HH

National Radio Institute

Washington, D. C.

*This Book points out what Radio offers you Get a copy!*



**This coupon is good for a FREE copy of my Valuable Book, Mail it NOW!**

J. E. Smith,  
President,  
Dept. 33HH  
National Radio Institute, Washington, D. C.

Dear Mr. Smith: Send me your book. I want to know more about the opportunities in Radio and your practical method of teaching at home in spare time. This request does not obligate me to enroll and I understand no agent will call on me.

Name.....Age.....  
Address.....  
City.....State.....

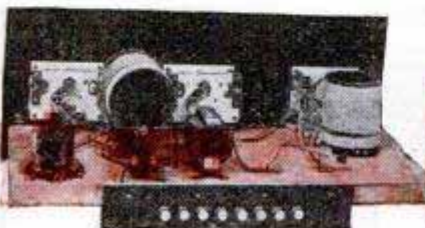



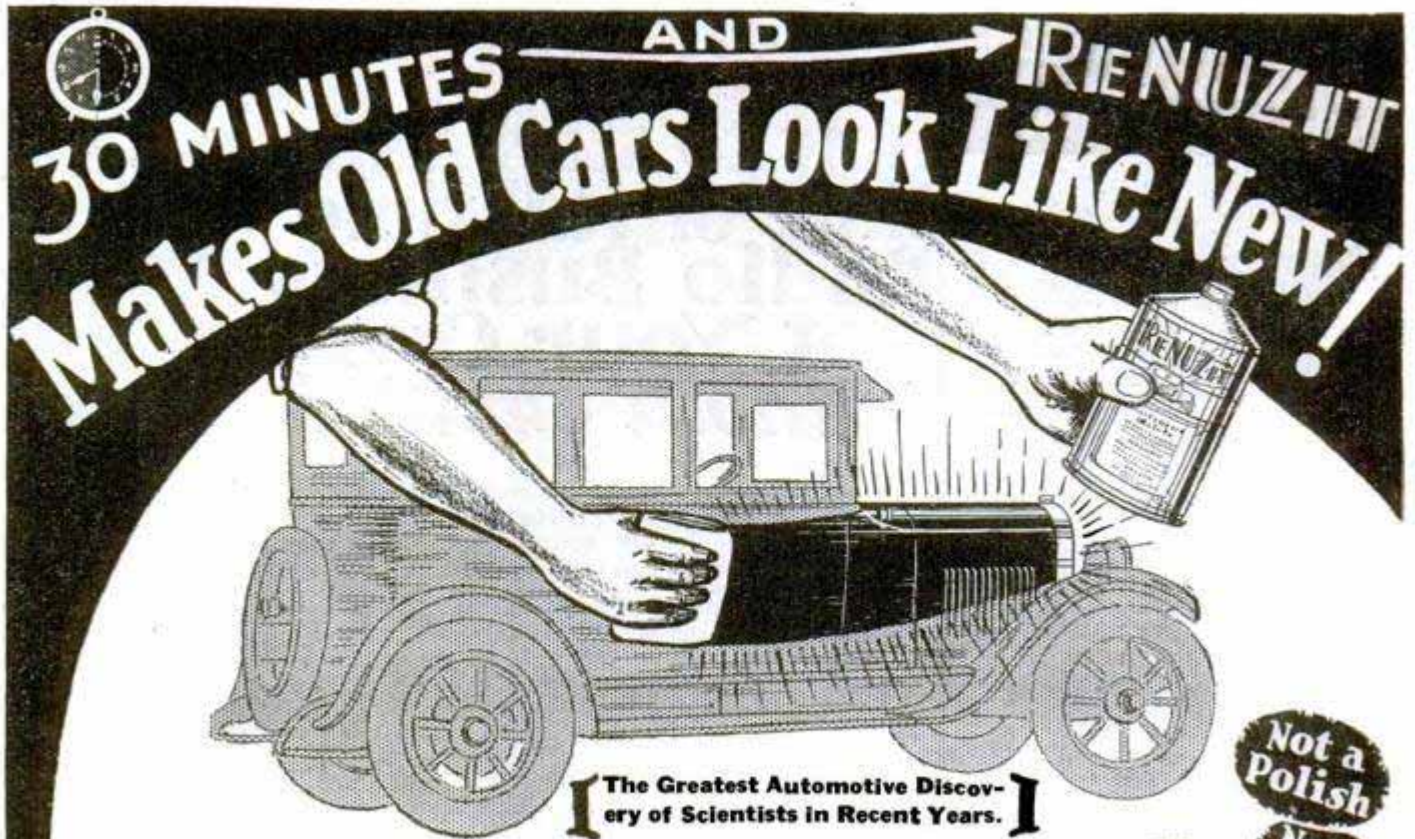

The Motor World is astounded at this marvelous scientific Fluid that transforms old, run-down looking cars into smartly gleaming new ones in the time it takes the minute hand of your watch to travel from "12" to "6"—not more than 30 minutes. Try it yourself without risking a cent. You'll get a thrill you won't forget!

Not a Polish  
Not a Paint  
Not a Cleaner  
Not a Wax

## AGENTS NEW PLAN—MAKE \$50. A DAY

Millions are waiting to buy ReNUZit. For every one of the thousands of new cars on the streets today there are at least 20 OLD ones—and more are losing the bloom of youth every day. What a whale of an opportunity for the man who thinks quick enough to seize a good thing when it's new! That is why

ReNUZit Agents all over the country can make almost unbelievable profits. ReNUZit is the big sensation they are all talking about and eager to try. And our proposition is so GOOD that you should have no trouble making \$50.00 a day and up. It costs nothing to investigate. You can't afford not to.

## How This New Miracle Fluid Works

You just flow ReNUZit onto any automobile with a piece of cheesecloth and instantly the ORIGINAL color and lustre of that car is like new again! Not a polish, cleaner, wax or paint, but a marvelous chemical discovery that restores the sparkling beauty of any automobile or any painted, lacquered or enameled surface in the twinkling of an eye. No tiresome rubbing or polishing. Harmless—Lasting—Sure. Simple to apply as "A B C"—Dries almost immediately. No trouble—No bother—No mess.

MAIL THIS COUPON

Curtan Mfg. Co.,  
154 E. Erie St.,  
Dept. 805-P.R.  
Chicago, Ill.

Rush full details of ReNUZit, with Free Trial Offer, and Agent's New Plan on how I can make \$50.00 a day. No obligation.

Name.....  
Address.....  
City..... State.....

## Car Stays Like New!

ReNUZit not only restores the faded, dull or worn surface of any car to its original showroom beauty but **KEEPS IT THAT WAY.** Just mail coupon for free trial and see for yourself.

## Test ReNUZit Free!

You have the privilege of trying ReNUZit yourself right now without risk or obligation. Prove to yourself what miracles it accomplishes. See your own car being transformed to a thing of glistening beauty! Send coupon TODAY for full details and Free Test Offer.

**CURTAN MFG. CO.**

154 E. Erie St.

Dept. 805-P. R., Chicago, Ill.

## ReNUZit Service Stations Bring \$1,000 a Month

It is easy to see why so many men can get into the big money class operating ReNUZit Service Stations. By this we mean real money—\$10,000 to \$12,000 a year!

They can make big incomes transforming Auto-Owners' old cars into New ones in 30 minutes! This is the sensational new business that is taking the motor world by storm. Think of the millions of cars in use that need refinishing. Car owners are crying for just such a LASTING finish as ReNUZit. The need is far greater than the number of service stations. This is YOUR chance to get into a fine big-paying business, without risking any capital. Send coupon for the thrilling story of ReNUZit and Your wonderful opportunity to make \$12,000.00 a year. Do it Now!





# RAILWAY POSTAL CLERKS

## \$158 Month First Year

### Raise to Maximum of \$225 Month

Many other U. S. Government Jobs Open to Men and Boys 18 up

**POST OFFICE CLERKS**  
**RURAL MAIL CARRIERS**

**CITY MAIL CARRIERS**  
**PROHIBITION AGENTS—INVESTIGATORS**

These are steady positions. Strikes, poor business conditions, lockouts or politics do not affect them. U. S. Government employees get their pay for full twelve months every year. There is no such thing as "HARD TIMES" in the U. S. Government Service.

### A STEADY BIG PAY JOB

Railway Postal Clerks now get \$1900 the first year regular, being paid on the first and fifteenth of each month. \$79.16 each pay day. Their pay is increased \$100 and \$150 a year. The maximum is \$2700 a year. \$112.50 each pay day. They get extra allowance for hotel expenses when away from home.

### PAID VACATIONS

Railway Postal Clerks, like all Government employees, are given a yearly vacation of 15 working days (about 18 days). When on runs they usually work 3 days and have 3 days off duty or in the same proportion. During this off duty and vacation, their pay continues just as though they were working. When they grow old, they are retired with a pension. As Railway Postal Clerks are continually traveling, they have an excellent chance to see the country.



### City Mail Carriers—Post Office Clerks

Clerks and Carriers get \$1700 the first year regular and automatically increase \$100 a year to \$2100 with further special increase to \$2300. They also have 15 days' vacation. City residence is unnecessary.

### What Will You Earn 5 Years from Now?

Compare these conditions with your present or your prospective condition, perhaps changing positions frequently, kicking around from post to pillar, no chance insight for PERMANENT employment; frequently out of a position and the year's average salary very low. **DO YOU EARN \$1900 EVERY YEAR? HAVE YOU ANY ASSURANCE THAT A FEW YEARS FROM NOW YOU WILL GET \$2700 OR MORE A YEAR, EVERY YEAR?**



### Get Free List of Positions

Fill out the coupon. Tear it off and mail it to-day—now, at once. **DO IT NOW**—This investment of two cents for a postage stamp may result in you getting a U. S. Government Job.

**FRANKLIN INSTITUTE,**  
Dept. J-173,  
ROCHESTER,  
N. Y.

(Not connected with U. S. Government)

Rush to me entirely free of charge 32 page book with (1) a full description of the position checked below; (2) a list of U. S. Government jobs now obtainable; (3) tell me how to get the position checked.

- Railway Postal Clerk.. (\$1900-\$2700)
- Post Office Clerk..... (\$1700-\$2300)
- City Mail Carrier..... (\$1700-\$2100)
- Rural Mail Carrier..... (\$2100-\$3300)
- Clerk in Government Offices... (\$1260-\$2100)
- Prohibition Agent—Investigator.. (\$2300-\$3400)

Name.....

Address.....

Use This Coupon Before You Mislays It—Write or Print Plainly.

MAIL COUPON TODAY



# "He is a Failure," They Said— but in 9 Weeks He Was Holding Down a \$90-a-Week Job



ANY man—YOU—can do what Frank did. I have trained 50,000 men in my famous auto shops. You need no education to start. You don't learn by reading books or listening to lectures. You work shoulder to shoulder with expert instruc-

"Oh, Frank will never amount to anything," is what everybody said. But he fooled them. He disappeared from his home town for 8 weeks. No one knew where he went. One day he suddenly returned—interviewed the big local auto accessory manufacturer—and walked out with a foreman's job at \$90 a week! He surprised everybody by becoming a TRAINED auto man. And he's making good!

**Be a Success—Learn Auto Mechanics in My Shops—8 Weeks—then Big Pay!**

tors. You work on actual cars and learn autos inside out. Ignition, etc., etc., all taught you in 8 weeks. Then a big pay job as trained auto mechanic or in business of your own is easy.

**Employment Help FREE!**

After you complete course, my Employment Department will assist you in finding the job you want. If necessary, you will also be assisted in finding spare time work to pay tuition.

**Big Auto Book—FREE!**

Why wait? Why not plan to make big money soon? Rush coupon for BIG FREE ILLUSTRATED Auto Book—and get details of my amazing tuition and Free Railroad Fare offer. Do it now.

Mr. J. H. McSweeney, Pres.,  
McSweeney Auto Schools,  
Dept. 11-S, Cincinnati, O.  
Dear Mac: Send on, without obligation, BIG ILLUSTRATED AUTO BOOK and amazing tuition and Free Railroad Fare Offer.

Name .....

Address .....

Town ..... State .....



## SPORTSMEN

**Read This Offer!**

Send the COUPON and receive a magnificent Sportsmen's Book telling you how to learn to MOUNT GAME-HEADS, BIRDS and ANIMALS. You can NOW be your own Taxidermist. Our school has over 100,000 graduates throughout the world. You can now learn AT HOME in SPARE TIME.

**Mount Your Own Trophies!**

Hunting and Fishing have entered a new era. All true sportsmen now kill fewer specimens, but DOUBLE their interest by mounting their trophies. The secrets of Taxidermy (mounting birds and animals) are now revealed. YOU CAN NOW LEARN TAXIDERMY FOR YOURSELF. Be a Taxidermy artist. Mount birds, animals, game-heads, fishes, tan skins and make beautiful rugs and robes. Easily and quickly learned in your own home. Adorn your home and den with nature's finest ART. If you enjoy hunting—you will enjoy Taxidermy MORE.

**Big Profits** Do you want to MAKE MORE MONEY? Then give your SPARE TIME to Taxidermy. Make \$50 to \$250 a month by mounting for others or selling your mounted specimens, or go into business—open a Taxidermy shop of your own, and earn \$3,000 to \$6,000 a year.



**This Book FREE**



Every Sportsman should have this marvelous book. You can right now, while this edition lasts, get a copy Free and prepaid by mailing the coupon NOW. Only limited number free—Send Today. Nothing like it. Just off the press. Contains 48 large pages and cover in brilliant colors. More than 100 photos of splendid game specimens and masterpieces of the National Museum at Washington. Brim full of interest to every sportsman. And think of it, this valuable unique and artistic book can be had now, by Sportsmen for the asking.

**Mail the Coupon!**

If you want to preserve your trophies; if you desire to make money from your spare time, if you are a nature lover—send the coupon and receive your copy by return mail.

N.W. School of Taxidermy, 3378 Elwood Bldg., Omaha, Neb.

**N. W. School of Taxidermy**  
3378 Elwood Bldg., Omaha, Neb.

Send me your free illustrated book "Sportsmen and Their Trophies." Also tell me how I may learn this fascinating art easily and quickly by mail. No obligation.

Name .....

Address .....



# FREE

**This Genuine  
Ivory Pocket  
Rule**



Get out your pencil and copy the Jack right now

← You get this rule for copying this Jack →

Can you copy it? Try it. How you copy it may give me some idea of what kind of a draftsman you would be. If you are 16 years old or older and will mail me your sketch at once, I will send you, free, and prepaid, a draftsman's Ivory Pocket rule, shown here.

This will go to you entirely with my compliments.

In addition I will send you my book on Successful Draftsmanship. Don't wait. Copy the sketch now and mail it to me.



Copy me and get Ivorys Rule Free. — Jack

## Draftsmen Needed In

### Auto Work

The automobile industry is one of the greatest in America. Thousands of draftsmen needed. I'll train you for the work.

### Electricity

Electricity is the coming motive force of the world. Draftsmen are needed in every department of this fascinating work. I'll train you at home.

### Aviation

Aviation is just in its infancy. It is bound to expand to enormous proportions. Draftsmen are essential to it. I'll train you quick at home for drafting position.

### Motor Bus Work

Motor bus building and motor bus transportation have become leading world industries. Hundreds of draftsmen engaged in this work. I'll show you the way.

### Building Work

There will always be building. No structure can be erected without plans drawn by draftsmen. I'll train you for an architectural draftsman's job at home.

## Get My Free Pay-Raising Plan



Write to me. I will send you this new book. Not a catalog. My Pay Raising Plan and Money Making Advice. I can prove that John Savadge, trained by me, makes \$300 a month. Earl J. Dupree, trained by me, refused \$600 a month because he makes more in his own business. A. H. Bernier, trained by me, earns \$7000 to \$9000 a year. Arthur Dewalt, trained by me, makes more than \$400 a month. D. C. Stroop, trained by me, makes \$475 a month. L.V. Broughten, trained by me, makes \$300 a month.

I can give you many more names of Dobe trained draftsman who are making big salaries. They wrote to me just as I am asking you to write. They asked for my Free Book. They saw that opportunities in all of the great industries were tremendous for draftsman. Through drafting you can get into almost into any industry you want.

### Money Back if Not Satisfied

What could be fairer than that? I don't ask you to take any chances. I train you under a positive Money Back Agreement. If my training does not satisfy you after you have finished you get every penny back.

### Earn While You Learn

You can start earning extra money a few weeks after beginning my training. I give you special work and tell you how to make money.

### Age or Lack of Education No Drawback

You do not need previous experience. You do not need to be a high school graduate. My practical, home study course gives you just the kind of training you need to become successful. Your spare time is all that is necessary.



"I will train you at home." — Engineer Dobe

**If You Earn  
Less Than  
\$70 a Week**

**Write Me Today!**

**ACT NOW** Before You Put this Magazine Down. Let me send you my books "Successful Draftsmanship" and "My Pay Raising Plan". Remember Draftsmen are needed everywhere. That's the kind of profession to get into. Get started now. Get into a better position, paying a good straight salary the year around.

**Engineer Dobe** 1951 Lawrence Avenue Div. 13-58, Chicago, Ill.

### Employment Service

After training you I help you to get a job without charging you a cent for this service. Employers of draftsmen come to me for men because they know that men I train make good.

### I Train You at Home, New, Quick, Sure Way

My practical working method makes every step in learning drafting, as clear as a moving picture. That's why I train you so fast to be a draftsman.

You GET THESE FINE QUALITY, GENUINE, IMPORTED DRAFTSMAN'S TOOLS, just as soon as you become my student. No finer tools can be made for practical drafting work.



You get these tools as my student

## FREE RULE COUPON!

### ENGINEER DOBE

1951 Lawrence Ave., Div. 13-58, Chicago

Here's the sketch. Send me free rule; also send me free of all cost books "Successful Draftsmanship" and "My Pay-Raising Plan" — how to earn money while learning and proof of big money paying positions.

Name.....Age.....

Address.....

Post Office.....State.....



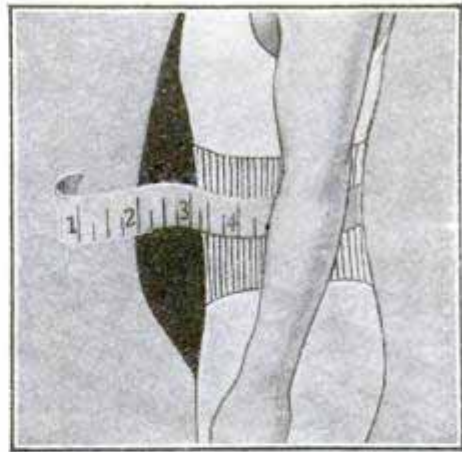
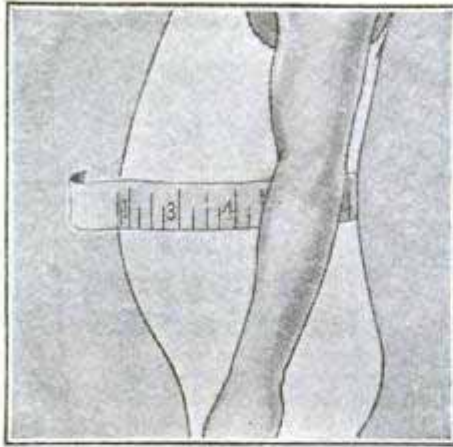

# Free Proof That WAISTLINE FAT Can Be Quickly Reduced —without drugs, diets or exercises

**I**NSTEAD of wasting your time—instead of risking your health by weakening diets, exhausting exercises and pill-taking, in an effort to get rid of bulging waistline fat—try the popular Weil Reducing Belt for 10 days—at our expense. Made of scientifically treated rubber it causes a gentle, un-noticed massage action as it comes in contact with flabby flesh.

So that with every move you make unwanted fat is being moulded away—and kept away for good—and at a fraction of the price charged by expert masseurs.

### Look Thinner Instantly!

Take your waist measurement before and after this Free 10-Day Trial. Note the difference in inches. Feel the improvement in your general condition. According to the terms of our absolute guarantee, you must be thoroughly satisfied with the results secured—or you pay nothing.

### Coupon Brings Free Details

Write us at once and you will receive our Special 10-Day Trial Offer—a detailed description of this most successful reducing method, the principles of which are highly endorsed by leading physicians and professional athletes everywhere. For the sake of your health and appearance take advantage of this offer at once. Send no money. Write now. The Weil Company, 911 Hill Street, New Haven, Conn.

THE WEIL COMPANY,  
911 Hill Street, New Haven, Conn.

Gentlemen: Please send me complete description of the Weil Scientific Reducing Belt and also your Special 10-Day Trial Offer.

Name.....  
Address.....  
City.....State.....

**Study LAW AT HOME** Lincoln did it! Also thousands of other great lawyers, politicians and business men. YOU, too, can become a lawyer or law trained business man through home study guided by the successful practicing lawyers of our faculty. Write today for free book.  
**AMERICAN CORR. SCHOOL OF LAW**  
3601 Michigan Ave., Dept. 1358, Chicago

**Learn Watchwork, Jewelrywork and Engraving** A fine trade commanding a good salary, and your services always in demand. Address **Horological**, Dept. P, Bradley Institute, PEORIA, ILLINOIS, for our latest catalog.

# BOYS

# Learn ELECTRICITY



Study right at home in spare time to get a good position in this fascinating profession or have a business of your own. Complete, practical, well-illustrated electrical courses of International Correspondence Schools make every step easy. Cost \$200,000 to prepare. Written by well-known electrical engineers. Endorsed by Edison and Steinmetz.

**INTERNATIONAL CORRESPONDENCE SCHOOLS, Box 5576-F, Scranton, Pa.**  
Without cost or obligation, please send me booklets describing your courses in  
 ELECTRICITY     RADIO     AIRPLANE ENGINES  
 Drafting     Civil Engineer     Chemistry     Automobiles

Name.....  
Address.....

Mail Coupon for Free Booklet



# No More Razor Blades To Buy!



365 KEEN SHAVES

A Year With One Single Blade

"I want to say that KRISS-KROSS Stropper is the best thing I ever saw. I have been using one blade continuously for one year and nine months and have no idea how much longer it will last."  
C. S. Stephenson, Okla.

# Inventor Discovers Amazing New Way to Shave! -Without Buying Blades!

**K** EEN, velvety shaves forever and no more blades to buy! That's what this astonishing invention offers the great army of American shavers today!

KRISS-KROSS is destined to revolutionize all existing traditions of shaving! Its performance is so sensational that it seems hardly fair to call it a stropper. Rather it is a super-stropper or blade-rejuvenator! No longer do you find that your blades "die" after five or six shaves. KRISS-KROSS "brings 'em to life" a surprising way! Actually—you can take a blade right out of a fresh package and improve it as much as 100% in eleven seconds with KRISS-KROSS.

## MAGIC DIAGONAL STROKE

KRISS-KROSS employs the famous diagonal stroke, same as a master barber uses. Never before has anyone captured the secret of reproducing it automatically. Eight "lucky leather grooves" do the trick in 11 seconds with a precision it takes a master barber years to attain. Stropps from heavy to light. Adjustable, automatic jig flies up and notifies you that your blade is ready—ready with the keenest cutting-edge that steel can take!

KRISS-KROSS produces unbelievable sharpness and prolongs the life of any razor blade for months and even years. Fits all brands and makes except Durham. Eliminates 83% of shaving costs and solves your blade problem for all time!

## SENSATIONAL OFFER

And now for my surprising offer. To introduce KRISS-KROSS, I am giving with it Free a new kind of razor. Possesses remarkable features. Instantly adjustable to any shaving position. A flip of

*Rhodes* **KRISS KROSS**

**STROPPER**

**RHODES MFG. CO.**

Dept. S-373 1418 Pendleton Ave. ST. LOUIS, MO.

Largest Manufacturers of Mechanical Stroppers in the World.

the finger makes it (1) T-Shape; (2) straight (old style); (3) or diagonal (new way). Also adjustable for light, medium or heavy shaves. Gives a sliding instead of pulling stroke. Simply zips right through the toughest crop of whiskers. Made of rustless metal. Comes with 5 special-process blades and is entirely unlike anything you ever saw before!

## GET FREE OFFER

Send for full information on these surprising new inventions today. KRISS-KROSS products are never sold in stores. You deal direct with me or my authorized representative. Write for illustrated description and full details of free razor offer. It's even more remarkable than I can tell you in this short space. Clip the coupon now. Mail it today.

## Agents \$30 a Day and Up

Make big money with KRISS-KROSS. Giving away FREE razors boosts your profits amazingly. H. King made \$66 in one day. N. C. Paige made \$104 in 3 days! Others average \$350 and up to \$750 a month! Spare-time workers, Office and Factory men make \$6-\$12 extra a day showing KRISS-KROSS to friends and fellow employees. S. Kantala made \$154 extra just working evenings 3 weeks. Get details at once. Check bottom of coupon and mail it tonight!

**RHODES MFG. CO., Dept. S-373,  
1418 Pendleton Ave., St. Louis, Mo.**

Without obligation, please send me illustrated description and full details of your special introductory offer on KRISS-KROSS super-stropper and FREE 3-way razor.

Name.....

Address.....

Town..... State.....

( ) Check here if interested in making money as authorized KRISS-KROSS representative.



# THIS IS YOUR CHANCE AT BIG MONEY

**\$3500**  
a year  
and up  
IN ELECTRICITY



**\$100 A Week**

"Dear Chief:  
I had only a grammar school education and knew nothing about Electricity. But your lessons were easy and am now making \$100 a week."  
R. M. HINES,  
Dellview Resort,  
Mirror Lake, Wis.



**Big Increase**

"Dear Mr. Cooke:  
With only a country school education, was a truck driver at 42c an hour. Today am Electrician at 3 times more pay. With your help a fellow is sure to win."  
A. R. GROLL,  
255 Uhler Ave.,  
Marion, Ohio



**\$100 A Week**

"Dear Mr. Cooke:  
I am now manager of the Regina Electric Cleaner Co. in this district and make on an average of \$100 a week—very nice money compared with my wages when I was mining coal."  
JOHN WRIGHT,  
Smith-Mill, Pa.

**Triples Pay in 7 Months**

"Dear Mr. Cooke:  
I was in the common labor class getting \$18 a week, but now I've jumped to \$50 a week and over, all in 7 mos. You have the greatest Course in the world."  
W. H. STEPHENS  
44 Mechanic Street  
Ft. Edward, N. Y.



**Now Gets \$90 A Week**

"Dear Mr. Cooke:  
I am well pleased. Am only 20 years old and was making \$16 a week in a small company. Now make \$90 a week and have a share in the business."  
A. J. CURTIS,  
875 West End Avenue,  
Atlanta, Georgia



**Stop Right Here!**

This is YOUR Opportunity! Electricity needs you, wants you, offers Big Pay to get you. \$12 to \$30 a day — that's the pay of the Electrical Expert. And thousands of "Cooke" Trained Men are making \$3,500 to \$10,000 a year in this biggest-paying field. Get in line for one of these Big Jobs. You can do it. I'll show you how.

**The Job For You**

Why stick to work that offers no chance, no promotion, no big income. It's a shame for you to earn only a mere \$4, \$5 or \$6 a day, when you could make \$12 to \$30 in the same 8 hours in Electricity? That's the kind of a job for you — that's the kind of money you ought to be making. And you can do it. It's easy when you know how, and —

**I'll Train You At Home**

Give me a little of your spare time and I'll get you ready for Big Pay almost before you realize it! And my Training is practical. It is simple, thorough, easily learned and quickly mastered. With my now famous "Work Sheets" and "Job Tickets" you learn by **doing**—and you learn RIGHT. I teach you Electricity from A to Z — right in your own home.

**Earn While Learning**

That's the way I teach Electricity — so you can make it pay as you learn! Yes, sir! I show you how to get work and how to do it. Lots of my "boys" make \$10 to \$30 a week extra money this way. You can, too. You can pay for my Course many times over this way, and bank real money besides!

**Six Outfits Given**

—at no extra cost—you get Six Big Outfits of Tools and Apparatus — everything you need to learn Electricity right, and to make real spare-time money while learning. They're not toys, but the real thing — and yours to keep — to help you get "on-the-job" experience for the Big-Pay Job that's to come later on.



The "Cooke" Trained Man Is The



# There is Always a BIG DEMAND for ELECTRICAL EXPERTS and "COOKE" TRAINED MEN are getting the BIG MONEY in ELECTRICITY everywhere

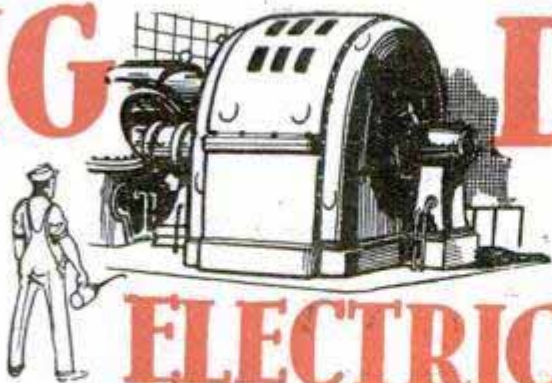

**Electrical Men Needed Everywhere** Electricity, the world's greatest profession offers you countless opportunities. Even ordinary electricians — the "screw driver" kind — are making big money. \$40 a week is only ordinary pay in Electricity. \$70 to \$200 a week is what thousands of my "boys" are making. Yet none of them were any smarter than you. Think of that! Picture yourself in such a job! Here is your opportunity — here is your chance for Big Money! Get into this great field. You can do it with "Cooke" Training — yes, you can do it easily!

**Nothing Like "Cooke" Training** Don't confuse my Training with "book learning"—don't confuse it with anything else you've ever heard of. "Cooke" Training is different—it's practical—it's successful. Don't be satisfied with anything else. It stands alone in the field — there's nothing like it anywhere. It's the Training that Electrical Men are praising—the Training that great Electrical Companies recommend to their employees—the Training that has jumped thousands of other men into work paying \$3,500 to \$10,000 a year. It's the Training for you!

**Lack Of Schooling No Drawback** Don't think you need "education to make good with "Cooke" Training. Don't hesitate because you didn't get very far in school. That makes no difference to me. Many of my "boys" never finished the grade school. But look at them now — Big Pay Men! They learned — and so can you — because "Cooke" Training is simple as A-B-C — there's nothing like it under the sun for putting men into the Big Money class!

**L. L. COOKE**  
Chief  
Instruction  
Engineer

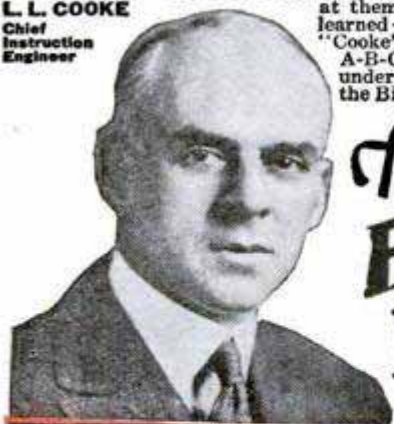

This  
**FREE  
BOOK**  
TELLS YOU  
HOW!

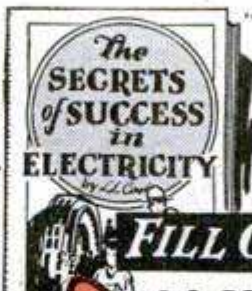

L. L. COOKE, Chief Instruction Engineer

**L. L. COOKE SCHOOL  
OF ELECTRICITY**

Dept. 18

2150 Lawrence Avenue  
Chicago, Illinois

**FILL OUT & MAIL AT ONCE**

**L. L. COOKE, Chief Instruction Engineer,**  
Dept. 18, 2150 Lawrence Avenue, Chicago, Illinois

Please send copy of your Big FREE book — "Secrets of Success in Electricity," and full particulars about your home study Course in Electricity.

Name

Address

City  State

(Residents of Canada send coupon to R. A. Farrow, Special Representative, 7 Medbury Lane, East, Windsor, Ontario, Canada.)

**MAIL THE COUPON NOW!**

**6 BIG OUTFITS**  
to work with - no extra cost

**"Big Pay" Man**



# PAIN and DISEASE

Quickly Conquered by

## VIOLET RAY



Let us tell you how thousands of men and women suffering from rheumatism, neuritis, paralysis, nervousness, skin diseases, headaches, constipation, sprains, prostate trouble, goitre and many other ailments, even hay fever and asthma, have found quick relief—new health and vitality with this marvelous, scientific invention. Pains vanish almost instantly.

# Violetta

Ten Days FREE Trial

For Health—Beauty—Vigor

Endorsed and used by hospitals, sanitariums and physicians. Every home can now have one. Saves hours, days, months of suffering. No medicine. Painless, pleasant treatment. Only the violet ray can penetrate to every nerve affected. Simple, safe, painless—anyone can use VIOLETTA. Why suffer pain and poor health when you can try VIOLETTA 10 days FREE.

## This Book FREE

Tells all about violet rays—how this marvelous discovery by Nikola Tesla, the electrical wizard, now brings this mysterious curative power to all. Contains many astounding testimonials from our thousands of satisfied users. Send for the facts and our liberal trial offer today. Mail the coupon now.



VI-REX CO., Dept. 1131  
2304 Warren Avenue, Chicago

VI-REX CO., 2304 Warren Ave., Dept. 1131 Chicago

Please send me your free book on Violet Rays and details of your 10 days' free trial offer.

Name.....

Address.....

City..... State.....

Ailment.....

# How To Secure A Government Position

Why worry about strikes, layoffs, hard times? Get a Government job! Increased Salaries, steady work, travel, good pay. I'll help you become a Custom House Clerk, Railway Postal Clerk, Post Office Clerk, City Mail Carrier, Rural Carrier—or any other Government job you want. I was a Secretary-Examiner of Civil Service Commission for 8 years. Have helped thousands.



## Now FREE

My 32-page book tells about the jobs open—and how I can help you get one. Write TODAY  
ARTHUR R. PATTERSON, Civil Service Expert, PATTERSON SCHOOL, 811 Wisner Building, Rochester, N. Y.

# GIVEN TO YOU

A Brand New High Grade Fine Tone

VIOLIN, TENOR BANJO, HAWAIIAN GUITAR, BANJO, CORNET, UKULELE, BANJO UKULELE, GUITAR OR MANDOLIN

We will give you without extra charge when you enroll, any instrument you select and teach you to play it by our NEW copyrighted easy to learn home-study course. Over 500,000 men, women, boys and girls have learned to play by our simplified method. Cost is only a few cents a day for lessons. No other charge. You pay while you learn. Instrument and first lessons sent on FREE trial. Write today.  
CHICAGO CORRESPONDENCE SCHOOL OF MUSIC, INC.  
1632 No. Halsted St., Dept. 727 Chicago, Ill.

# Give a Magic Show at Home



Complete Apparatus for Ten Startling Tricks

## FREE!

A marvelous magic chest with complete apparatus for ten startling tricks including: disappearing spots, great card trick; multiplying billiard balls, fool all; jumping peg, vanishing disk, pencil and loop, beads on a string, magic ball and vase and the amazing billiard ball, defies gravitation, etc. No skill required. Give shows at home, at sociables. Fool your friends at school. Mystify all. Guaranteed to please you 100%. Get yours today. Hurry.

## Breathless Reading

The Open Road for Boys Magazine has 50 pages every month crammed with thrilling stories of high adventure on land, on sea and in the air—great serials, absorbing departments; big mechanics department; stamp department; clubs; contests galore, prizes for all. Read "Golden Medallion" mystery serial smash. Regular subscription price \$1 per year. We will send you the great magic chest and a whole year's subscription to The Open Road for Boys Magazine both for \$1. Rush your order.

Master Magician  
Open Road for Boys Magazine  
130 Newbury Street  
Boston, Mass.

Gentlemen:  
I will grab that offer. Here's my dollar. Rush me the great magic chest and put me down for a year's subscription to The Open Road for Boys Magazine.

Name.....

Street.....

Town or City.....

State.....



# MOVIES teach YOU ELECTRICITY

## Actual Motion Pictures Prepare You at Home for Bigger Pay

**EASIEST**, surest of all ways to learn electricity is this amazing new method of *teaching with movies!* Actual motion pictures, in your own home, with projector and films we furnish, prepare you in spare time for big pay rewards in this ever-growing field.

You know how easy it is to look at movies! In no other course can you get the big advantages of this fascinating instruction method. No dry text book matter! Live, fascinating pictures of *electrical machinery in operation!* Animated diagrams show you exactly how electricity operates, how you can control it. *Projector we furnish, at no extra cost, is so simple anyone can operate it at once, without experience.*

### Drafting Instruction and Equipment; No Extra Cost

Our complete course gives you thorough and practical preparation for electrical work of all kinds. Our employment department helps you locate a Big Pay Job in Aviation Electricity, Radio, Switchboard Work, Sub-Station and Power Plant Operation, Automotive Electricity, Wiring, Contracting, Merchandising, etc.

You are personally guided and helped by practical engineers and educators, including: Bruce Rogers, M. S., Western Electric Company; J. A. Shimek, M. E., DeVry Corporation; A. P. Hollis, formerly Director Visual Education, University of North Dakota; W. N. Littlewood, formerly instructor University of Wisconsin, and others.

### You Get This DeVry Projector



Standard Model DeVry motion picture Projector, value \$75.00, and thousands of feet of film, supplied to every student for use during the course at no extra cost. So simple anyone can operate it, immediately. Uses ordinary light connection, farm lighting equipment, or automobile battery. Gives clear, brilliant, flickerless movies right in your own home.

etc. Everything that is necessary for this complete course in electricity with drafting, at no added cost.

### Drafting Set Given



Complete professional outfit, including the set of fine instruments in plush lined case shown here, and in addition drawing board, rules, T-square, scale, paper,

etc. Everything that is necessary for this complete course in electricity with drafting, at no added cost.

### What a Practicing Engineer Says:

Charles E. Fitz, M. E., E. E., formerly associated with Steinmetz, says: "I am amazed at how clearly and simply you explain the facts about electricity. The points are *so much easier to grasp* than by the usual methods of instruction that *the student must make quicker, surer progress.*"

### We Pledge to Help You Earn More or You Don't Pay a Cent!

You receive this pledge in writing immediately upon enrollment. "When you graduate from your complete course in Electricity you must be convinced that you have received the training and employment service necessary to obtain a better position than you now have, *or we will refund your tuition*, provided you give notice within 30 days after forwarding final examination papers."

### FREE THREE LESSONS AND OUR NEW BOOK "The Film Way to Bigger Pay in Electricity"

Send coupon now for full information about this new easier way to a better job. No obligation. Act today!

The NATIONAL SCHOOL of VISUAL EDUCATION

"The Film Way to Bigger Pay"



Electricity driving rollers in sugar mill



Twin Tandem electric unit in steel mill



Electric furnace used in refining metals



Section of test room in telephone plant

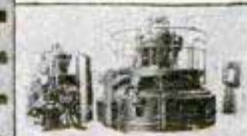

Hydro-electric plant making current from waterfall



Telephone "line finder" of Bell Company



Electricity is brain and nerve of huge plane



**Chicago, Ill.**

**Dearborn St. Chicago, Ill.**

**THE FILM WAY TO BIGGER PAY**

Name \_\_\_\_\_

St. or R.F.D. \_\_\_\_\_

City \_\_\_\_\_

State \_\_\_\_\_

County \_\_\_\_\_

Age \_\_\_\_\_

**Mail this Coupon At Once!**





# 400,000 miles of flight are behind the training Hinton gives You



**WHAT'S** more, Hinton's hundreds of thousands of miles in the air is only one side of his remarkable experience. The thing that so many other star performers lack—the thing that makes Hinton what he is today, a real Maker of Men—is his ability to share his knowledge with others in a clear, simple, interesting manner. As proof of that, consider Hinton's record during the war. He was one of the crack pilots singled out by the U. S. Navy to instruct recruits. Under his capable, seasoned eye, hundreds of newcomers learned their P's and Q's of Aviation; made their first excursions into the clouds.

## Now's the Ideal Time to Get Into Aviation

**WALTER HINTON**  
First—to pilot a plane across the Atlantic (the famous NC-4)—to fly from North to South America—to explore the wild regions of the Upper Amazon by air.

**There's Your First Step—That BOOK**  
Many, when they first wrote to Hinton, were skeptical. They didn't realize that Aviation is MORE than a pilot's pastime. But they changed their minds in a hurry—and have been glad ever since—the moment they met up with Hinton in the interesting pages of his big, FREE book. Are you, too, willing to listen? Can you stand a great surprise? Will you pause for fifteen minutes to look into Aviation's future—YOUR FUTURE—through Walter Hinton's eyes? If your answer is YES!—use the coupon.

The business world has taken to the air in earnest. Letters fly from coast to coast. During the past eighteen months, Ford-Stout planes, operating between half a dozen cities have already carried more than 20,000 people. There's a daily passenger schedule from Chicago to San Francisco and between scores of other important centers. Yet our growth in the air has just begun. The things you see today will be nothing within five years. See Aviation's future ahead of the crowd. Get your training; get BUSY—while the industry is young. Get ahead in Aviation before Aviation gets ahead of you.

## Get Your Ground Work Where You Are—AT HOME

Right at home, in spare time, Hinton will fit you for a job while your chance to grow fast is greatest. Hinton's course takes you over a plane inch by inch; shows you all about construction, rigging, motors, instruments, theory of flight, air navigation—EVERYTHING. It's the foundation for any one of Aviation's fifty highly paid branches. Beyond that, Hinton will help you get a job. If it's actual flying you seek, he'll even see that your rates are specially reduced. Don't pass this page until you've called for the book below.

## Aviation Institute of U. S. A.

Walter Hinton, President  
1115 Connecticut Avenue  
Washington, D. C.

**Send to Washington Quick**

AVIATION INSTITUTE OF U. S. A. 11  
Walter Hinton, President  
1115 Connecticut Avenue  
Washington, D. C.

Send at once your big FREE book telling about the opportunities in Aviation and about your method of giving me my "ground work" right at home.

Name.....Age.....

Street.....

City.....State.....

# NEW INDUSTRY NEEDS MEN

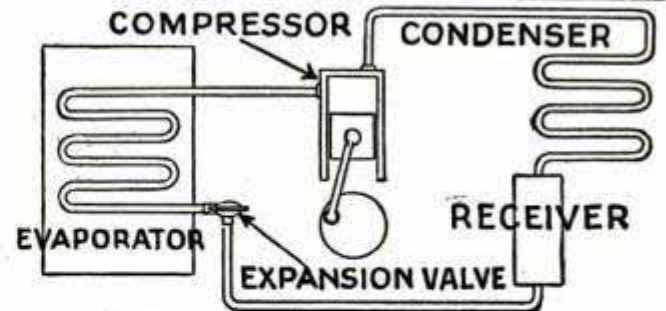

## ELECTRIC REFRIGERATION

**Calls You!** Newest American industry needs men for \$200 to \$1,000 a month jobs in production, service, installation and sales. Fastest growing money-making field—backed by General Motors, General Electric, etc. New easy home training qualifies you for big pay job. This training is endorsed by Servel, Kelvinator and other large manufacturers.

### FREE BOOK

"Opportunities in Electric Refrigeration" reveals amazing plan to ambitious men. Sent free. No obligation. Be the first in your neighborhood to get into this new magic industry. Write today.

Utilities Engineering Institute,  
Dept. 611, 3120 N. Clark St., Chicago, Ill.



## Learn Watchwork, Jewelrywork and Engraving

A fine trade commanding a good salary, and your services always in demand. Address **Horological**, Dept. P, Bradley Institute, PEORIA, ILLINOIS, for our latest catalog.

# AVIATION Information FREE

Send us your name and address for full information regarding the Aviation and Airplane business. Find out about the many great opportunities now open and how we prepare you at home, during spare time, to qualify. Our new book *Opportunities in the Airplane Industry* also sent free if you answer at once.  
AMERICAN SCHOOL OF AVIATION, Dept. 1358, 3601 Michigan Av., CHICAGO

The U.S. Government Job is a Good Job,

\$1260 to \$3400 a year

STEADY WORK  
Vacation with full pay

MEN — WOMEN  
18 to 55

VALUABLE COUPON  
Mail it today  
SURE



FRANKLIN INSTITUTE, Dept. J175, Rochester, N. Y.  
(Not connected with U. S. Government)  
Rush to me FREE OF CHARGE, list of U. S. Government BIG PAY JOBS now obtainable. Send FREE 32-page book telling salaries, duties, hours, etc. with sample coaching. Tell me how I can get a position.  
Name.....Address.....



## EARNED \$500 SPARE TIME WITH RADIO

Coplay, Pa., June 4—(RA)—During the few months that Frank J. Deutsch has been a member of the Radio Association of America, he has made over \$500 out of Radio in his spare time.

"Four super-heterodyne sets of my own construction brought me a profit of \$60.00 each, and the other profit was from sales of supplies purchased through the Wholesale Department of the Association," he said. "The Association certainly has a great plan for ambitious men."

In a neighboring state, Werner Eichler, Rochester, N. Y., another member of the Association, has been making \$50 a week during his spare time.

They are only two of the hundreds of Radio Association members who are making money out of Radio in their spare time.

## Becomes Radio Engineer in One Year

Toronto, Canada, May 20—(RA)—One of the newly admitted associate members of the Institute of Radio Engineers is Claude DeGrave, a member of the engineering staff of the DeForest Company of this city. "I knew nothing about Radio and started from the ground up," Mr. DeGrave stated, "when I enrolled a year ago in the Radio Association. Its easy lessons and superb training made it possible for me to become a Radio Expert in less than a year's time. My income is now about 225% more than at the time I joined the Association."

The Institute of Radio Engineers is a well known organization, so that Mr. DeGrave has reason to be proud of his election.

## Clerk Doubles Income in Six Months Through Radio

Chicago, Ill., May 9—Even though his membership in the Radio Association has resulted in W. E. Thon securing the managership of a Radio Department in a large Chicago store, his ambition was not satisfied. Six months later, he started his own store.

"The Radio Association has an excellent plan for the man who wants to get out of the rut and succeed," says this man who quickly rose from clerkdom to the proprietorship of a profitable radio store. "I attribute my success entirely to the Radio Association of America. Six months after I had enrolled, I had doubled my income through its help."

# 5 Easy Ways to make \$3<sup>00</sup> an hour in Your Spare Time in RADIO

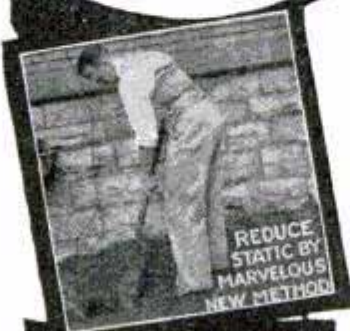

EACH of these plans, developed by the Radio Association of America, is a big money-maker. Set owners everywhere want to get rid of static, to have their sets operate from the electric light socket, the tone improved, and the volume increased, and transformed into single-dial controls. Phonograph owners want their machines electrified and radiofied. If you learn to render these services, you can easily make \$3.00 an hour for your spare time, to say nothing of the money you can make installing, servicing, repairing, building radio sets, and selling supplies.

Over \$600,000,000 is being spent yearly for sets, supplies, service. You can get your share of this business and, at the same time, fit yourself for the big-pay opportunities in Radio by joining the Association.

## Join the Radio Association of America

A membership in the Association offers you the easiest way into Radio. It will enable you to earn \$3.00 an hour upwards in your spare time—train you to install, repair, and build all kinds of sets—start you in business without capital or finance an invention—train you for the \$3,000 to \$10,000 big-pay radio positions—help secure a better position at bigger pay for you. *A membership need not cost you a cent!*

The Association will give you a comprehensive, practical, and theoretical training and the benefit of our Employment Service. You earn while you learn. Our cooperative plan will make it possible for you to establish a radio store. You have the privilege of buying radio supplies at wholesale from the very first.

## ACT NOW—If you wish No-Cost Membership Plan

To a limited number of ambitious men, we will give Special Memberships that may not—need not—cost you a cent. To secure one, write today. We will send you details and also our book, "Your Opportunity in the Radio Industry." It will open your eyes to the money-making possibilities of Radio.

### Mail This Coupon NOW

RADIO ASSOCIATION OF AMERICA  
Dept. PM-11, 4513 Ravenswood Ave.  
Chicago, Ill.

Gentlemen: Please send me by return mail full details of your Special Membership Plan, and also copy of your book, "Your Opportunity in the Radio Industry."

Name.....  
Address.....  
City..... State.....





# Happy Because They Make \$60 a Day



## With This New and Novel MASTER Suction CIGARETTE HOLDER and ASH TRAY

Yes, you can make \$60.00 a day with the handiest specialty created in recent years—the PATENTED MASTER SUCTION GRIP ASH RECEIVER. Holds to any surface by its suction grip. No screws, no holes to bore, just press it on and it stays put. Comes off in a jiffy for emptying. A wonderful convenience and protection—complying with automobile fire laws. Ideal for autos, homes and offices as Cigarette Holder or Ash Tray. Made of beautiful Bakelite in Black, Brown, Green, Mottled—a color to harmonize with every interior.

### With Owner's Monogram You Sell Every Prospect

As Suction CIGARETTE HOLDER

Slicks Tight Instantly to Any Surface by Suction Grip

Master Ash Receivers monogrammed in gold with owner's initials, gives them added richness and beauty. Everybody takes to this attractive novelty and buy two or more on sight.

**Retails for Only 75c—You Make 100% to 200% Profit Even on Dealer Sales—**

**Selling to Dealer Plan Starts You in a Big Paying Repeat Business**

Our proven successful plans outline a sure way of making big money selling consumers and getting orders by mail, distributing patented self-selling envelope circulars. Our Dealer Plan shows you how to make \$60.00 a day, and build a steady repeat business, placing Master Automatic Salesmen on store counters.

### Send for Sample or a Dozen Now

Send 50c (Stamps if you like) for sample. Or better still, get started immediately. Send \$4.50 or \$1.00 deposit—balance C. O. D.—for a dozen Master Ash Receivers in assorted colors packed in display carton. **YOU MAKE \$4.50 PROFIT ON THE DOZEN** selling to consumer or use sample dozen to take orders from dealers.

**YOU TAKE NO RISK.** They must sell or we refund your money. Five Amazing Selling Plans sent at once with dozen of sample. **EXCLUSIVE TERRITORY.** Reap the many advantages of getting in on the ground floor of this whirlwind seller. **ORDER NOW** and get in line for territory.



As Suction Ash Tray



Place This Self-Selling Display Carton on 20 Store Counters and Make \$60 a Day Profit!

**Gordon Mfg. Co.**  
NL-9, 110 E. 23rd St.  
New York, N. Y.

# RUSH COUPON

**GORDON MFG. CO., Dept. NL-9, 110 East 23rd St., New York**

I enclose \$..... for which please send me order checked below: ( ) One dozen Master Ash Receivers, in self-selling counter display carton. Price \$4.50. (If \$1.00 is enclosed, send one dozen for the balance C. O. D.) ( ) Sample Master Ash Receiver. Price, 50c. (Stamps will do.) Please include full details of all your sure-fire selling plans which guarantee that I will make sales.

NAME.....  
ADDRESS.....  
TOWN..... STATE.....

**Complete Course in BOXING**  
Jiu-Jitsu & Wrestling

Complete Course \$1.97 Plus Postage

Complete course in Boxing, for only \$1.97. Our scientific methods cut time of learning in half. Teaches the blows used by professionals—Dempey's Triple, Fitzsimmons' Shift, etc. Every blow illustrated. Also Wrestling, Jiu-Jitsu and History of Boxers. Six big books—hundreds of pages. Send no money—see coupon.

Marshall Stillman Association, Dept. 18-M, 247 Park Avenue, New York. Send on 10 day approval complete Self-Defense course. I will deposit \$1.97 plus postage, with postman. I will return course in 10 days if not satisfactory and money will be refunded. (Outside U. S. A.—Cash with order.)

Name.....  
Street and City.....

**HERE IS THE WAY to more pay**

If you are a mechanic, woodworker, carpenter, sheet metal worker, millwright, etc. **This Short, Practical Course Will Put More Pay Into Your Envelope**

Learn blueprint reading and elements of drafting. Put yourself in line for promotion. Turn your spare hours into profitable investment. Our course is easy, pleasant and interesting. No complicated problems, no dreary book reading. **Practical men teach you.** No theory. Just matter-of-fact instruction. Endorsed by employers.

**WRITE FOR THIS LOW PRICED OFFER**

Get our wonderful proposition. Our low price and easy terms make it possible for you to learn in a few weeks what many men have spent years to learn. Full drawing equipment sent the minute you enroll.

**BLUE PRINT READING SCHOOL, Inc.**  
1721 Nicholas Bldg. TOLEDO, OHIO

**FLY** The Finest Opportunity to Get Into Aviation

Through the combined efforts of one of Chicago's leading AIRCRAFT factories and airplane sales agency we can offer you a course in flying and ground work that is complete in every detail. You learn to build real airplanes. You fly in modern and government licensed ships piloted by licensed pilots. Employment assistance given to students who must earn while they learn. A reasonable amount will start you.

**Commercial Aircraft Sales, Dept. P. M., 400 No. Michigan Avenue, Chicago**

**TELEGRAPHY**

(Morse and Wireless) and RAILWAY ACCOUNTING, taught thoroughly. Big salaries; great opportunities. Oldest, largest school. Endorsed by Telegraph, Railway, Radio, and Government officials. Expenses low—opportunities to earn large portion. Catalog free. **DODGE INSTITUTE, Jones St., Valparaiso, Ind.**

**6 FT. LONG GIVEN** Boys! Here's the great navy model Airship—Large 6-foot air bag with inflators, parachute with automatic release and complete instructions for flying. Will fly for miles at height of 1000 feet. Great chance to study aerial navigation. Send name and we'll send 6 of our new art pictures to dispose of on special 25c offer. Send the \$1.50 you collect and as a reward for this service we will send this wonderful Airship with full instructions free.

**C. M. THOMAS, 337 W. Madison St., 11-K-91 CHICAGO**

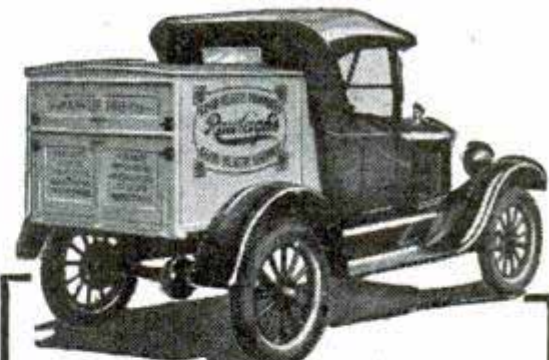

**WANTED!**

**500 Dissatisfied Farmers and Sons to Stop Renting**

And begin retailing Rawleigh's Good Health Products to Consumers. Start your own business. Make from \$100 to \$400 a month or more clear profit. Be your own boss. No selling experience required. We supply everything—Products, Outfit, Sales and Service Methods. Profits increase every month. No lay off. Steady year-round. Lowest prices. Best values. Most complete Service. Rawleigh Methods get the most business everywhere. For particulars write

**THE W. T. RAWLEIGH CO.**  
DEPT. K-18PPM FREEPORT, ILL.



DO YOU  
LIKE TO  
DRAW?

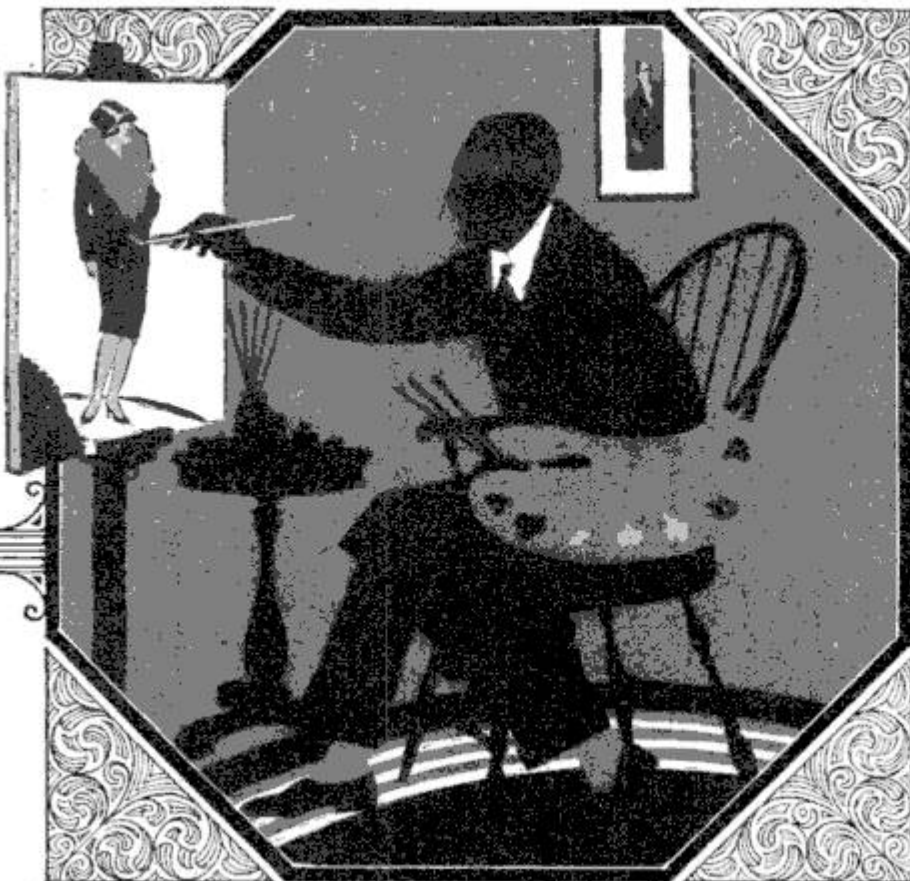

### Results Count!

Byron C. Robertson says:

"The reason why I enrolled with the Federal Schools was that they had many students to point to who had made good. Today I am on the art staff of one of the largest illustrating concerns in America, receiving a salary of \$3,900.00 a year."

From Mr. W. A. Sowell:

"I am Art Director with a salary and commission which has made it possible for me to earn more than at any time in my life, for example last month ran over \$400.00 and for the last four months it has averaged \$300.00. I know this all came about from the excellent instructions I received from the Federal Schools."

Mr. Edwin McTeer says:

"I suppose you remember I opened my own independent commercial art studio, and to make a long story short, my earnings are now at the rate of over \$10,000.00 a year."

## TRAINED ARTISTS HIGHLY PAID

**T**HIS is indeed the age of opportunity for the young man or woman who likes to draw. Every age and race understands pictures. Literally millions of dollars are spent annually for magazine and newspaper illustrations, cover designs, pictures in ads, posters, etc. Modern business offers rich rewards to the trained artist who can produce *good* work.

### FEDERAL TRAINING GETS RESULTS!

Invest your spare time in your ability to draw. Federal Training, based on 25 years of actual experience in producing illustrations and designs, will give you practical knowledge, and bring you to the earning point in the shortest possible time. You receive illustrated lessons by many leading artists and illustrators, and *individual personal* criticism of your work. Many Federal Students are earning \$2,000, \$4,000, \$5,000 and \$6,000 yearly,—some much more.

### YOUR ART ABILITY ANALYZED FREE

If you like to draw, here is your opportunity to find out if it will pay to develop your talent. This fascinating free test has been an eye-opener to many. It tests your sense of design, proportion, color, perspective, etc., you will be frankly told what your score is.

**Free Book, "Your Future,"** tells all about the Federal Course in Commercial Designing and how commercial artists all over the world are succeeding with its help. It's an inspiration to anyone interested in drawing. Fill out and mail the coupon today and get this book and art ability questionnaire.

**Federal Schools Inc.**

638 Federal Schools Bldg.  
MINNEAPOLIS, MINNESOTA

### Men Who Know

"We recommend your course highly to anyone contemplating art work as a livelihood, and shall certainly call upon you when in need of more artists."  
**SUFFOLK ENGRAVING & ELECTROTYPE CO.**  
Boston, Mass.

"You certainly have a galaxy of the best known and most capable artists in the country contributing to this course. I can well understand how and why the Federal Art Course has become so successful."

**JAHN & OLLIER**  
ENGRAVING CO.,  
Chicago, Illinois



**Federal Schools of Commercial Designing,**  
638 Federal Schools Building,  
Minneapolis, Minn.

Please send me Art questionnaire, and book "Your Future."

COUPON

Name.....  
Age..... Occupation.....  
Address.....

THE SCHOOL FAMOUS FOR SUCCESSFUL STUDENTS



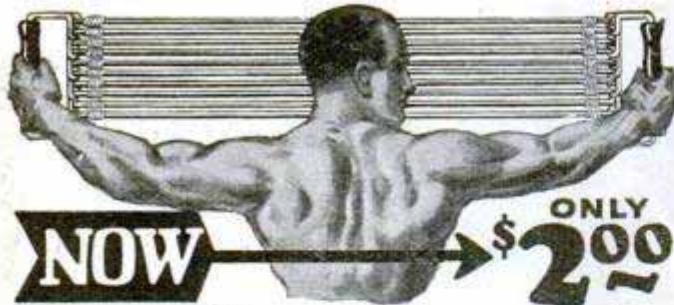

**NOW** → **ONLY \$2.00**

# Giant Chest Expander

and

## Progressive Exerciser

Be a muscular marvel. Have the muscles of a superman. Become strong for your health's sake or to astound your friends with extraordinary feats which only men of giant strength can do. In a few short weeks you will easily do stunts which now seem difficult—then real muscles and strength will be yours—and yours to keep. If you want exercise to just keep in good shape you can reduce the strength of the Progressive Exerciser by eliminating as many cables as you wish. If you want great resistance so as to build up big solid muscles then use the full strength.

**Send No Money Use This Money Saving Coupon**

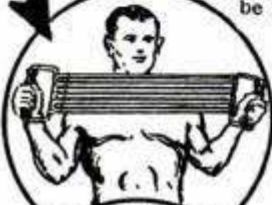

### How the Giant Chest Expander and Progressive Exerciser is Made

The Giant Chest Expander and Progressive Exerciser is made with new live, springy rubber so as to give it long wearing and great resisting qualities. Do not pay more for an exerciser that has forty or less rubber strands to each cable. Get the best and most durable. The Giant Progressive Exerciser has 50 strands of the finest rubber procurable to each cable.

### Free Instructions

We do not think it enough to send you an exerciser worth double what we ask, so for a limited time, we will also include instructions absolutely free. These instructions are interesting and simple to follow—they show you the short cut to health and strength. Order today before this wonderful offer is withdrawn.

### Your Guarantee

The Giant Chest Expander is sold with a guarantee that you will say it is the finest you ever saw or your money back.

**\$2 FOR 5 CABLES**  
**\$4 FOR 10 CABLES**  
**\$6 FOR 15 CABLES**  
**\$8 FOR 20 CABLES**

**How to Order—Send No Money**  
 Sign your name and address to coupon below and get your Giant Exerciser at the present low introductory price by return mail. The price is made low because we want everyone to enjoy muscles and strength at the lowest possible cost. Don't pay more—order from us—get the most for your money. Use coupon now.

**PROGRESSIVE EXERCISER CO.,**  
 4011 Langdon Bldg.,  
 Broadway and Duane Street, New York

Please send  Your 10 Cable  Your 15 Cable  Progressive Exerciser  
 Your 5 Cable  Your 20 Cable  Exerciser

Check the Exerciser you want, and it will be sent you by return mail. Pay postman introductory price, plus few cents postage on arrival. It is understood that if you are not entirely satisfied with your exerciser you may return it within 5 days and get your money back.

Name.....

Street.....

City.....State.....

If you live outside the United States, send cash with order.

# Learn How to BOX

## JIMMY DeFOREST BOXING COURSE

Teaches by mail the Same System he taught Champion JACK DEMPSEY

In 20 weeks, under the System of Jimmy DeForest, WORLD'S GREATEST TRAINER AND MAKER OF CHAMPIONS, you will master the priceless knowledge that made Jack Dempsey his millions, and fortunes for a host of other Jimmy DeForest-trained ring stars. Boys who were once rank amateurs are today earning big money; weaklings have been made strong, courageous; men have learned the art of self-defense. Send today for the now famous book, "THE GOLDEN AGE OF BOXING," greatest book of its kind ever written; full of valuable information, photos of great fighters and pupils who became successes over night. Enclose 10c to cover cost of mailing, etc. WRITE NOW.

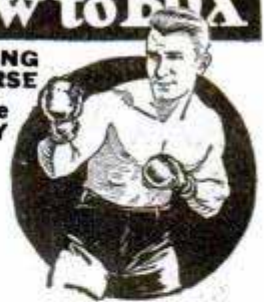

## JIMMY DeFOREST BOXING COURSE

347 Madison Avenue, Box 136, New York City

## NO JOKE TO BE DEAF

—EVERY DEAF PERSON KNOWS THAT



I make myself hear, after being deaf for 25 years, with these Artificial Ear Drums. I wear them day and night. They stop head noises and ringing ears. They are perfectly comfortable. No one sees them. Write me and I will tell you a true story how I got deaf and how I make you hear. Address



**GEO. P. WAY, Artificial Ear Drum Co. (Inc.)**  
 80 Hoffman Bldg., Detroit, Mich.

# Save Your Feet

When all else fails, end your suffering with the

## Heefner Arch Support No Metal



Fully patented. It re-adjusts the entire foot. Write for free book and statements from doctors and users.

Heefner Arch Support Co. 666 M. E. Taylor Bldg. Louisville, Ky.

# FREE TRIAL

# Grows Hair



## AMAZING NEW ELECTRICAL DISCOVERY

A noted surgeon has discovered an amazing way to grow hair, called Dermo-Ray. In 30 days no more dandruff. Scalp tissues are given new life. Then within a few weeks, luxuriant new hair! The startling discovery of the almost magic effect of Infra-Red Rays on the hair-growing tissues was made by a leading surgeon. Two years ago he was himself bald. Today his hair is full and thick.

## FAMOUS SURGEON'S DISCOVERY

Here is his own personal, home treatment, called Dermo-Ray. At last a home method endorsed by science. Guaranteed to bring you these same results in 30 days—or you pay nothing. You can use Dermo-Ray in any home with electricity. The warm, soothing Infra-Red Rays vitalize the scalp while you rest—a few minutes each day is all the time required.

**SEND NO MONEY** Complete facts about this astounding new scientific discovery, opinions of authorities, incontrovertible evidence, and details of special trial offer sent free, if you mail the coupon below. To end your scalp and hair troubles, act at once. Print your name and address plainly—and mail the coupon NOW!

### FREE TRIAL OFFER

The Larson Institute  
 216 N. Wabash Ave., Dept. 358, Chicago, Ill.

Send me at once, without obligation, full particulars—in plain envelope—of your 30-day Free Trial of DERMORAY.

Name.....

Address.....

City.....State.....



# ELECTRICITY

**PAYS BIG!**

## LEARN IN 90 DAYS ON ACTUAL MACHINERY—NO BOOKS

**I'LL PAY YOUR R·R· FARE TO CLEVELAND**

Don't let the world bluff you. Get into electricity—earn \$50.00 to \$150.00 a week—and hold your head as high as the next man. You can do it easily by coming to my famous electrical school. In 12 short weeks you'll pack in many years of practical knowledge. You work shoulder to shoulder with expert instructors on full-sized, moving, whirling motors, generators, batteries, switchboards, telephone and telegraph systems, etc., etc. McSweeney trained men get the biggest paying jobs. Every day I receive requests for graduates.

### No Education or Experience Needed

No books to read. No dry lectures to listen to. You learn by doing. I don't care if you can't tell a motor from a horse-and-

buggy now. When you graduate I guarantee that you'll know electricity from "A" to "Z." If you're not fitted to fill a big-pay job I'll refund every penny of your tuition.

### Employment Department Helps You!

I help my students find spare time jobs while they attend schools—and my Employ-

ment Department assists my graduates to locate good positions after graduation. McSweeney trained men are in demand.



### Big Illustrated Book Sent FREE

Today, right now, take the first step out of that low pay rut. Mail the coupon to me for big, illustrated book on ELECTRICITY. Act to-day. Get my special Railroad Fare offer and Remarkable Tuition offer.

### Just Mail Coupon!

J. H. McSweeney, Pres.  
McSweeney Electrical Schools,  
Dept. 51-S, Cleveland, O.

Dear Mac: Without obligation send me a copy of your big book on ELECTRICITY; also Railroad Fare offer, and details of Employment Service.

Name.....  
Address.....  
Town..... State.....



### IT'S EASY THIS WAY

Fascinating, practical shop work in my big school fits you. Not a correspondence course.



**Earn While You Learn!**

## McSWEENY ELECTRICAL SCHOOL

Dept. 51-S Cleveland, Ohio

## YOU CAN OIL PAINT

Amazing new method teaches men or women to earn after first lesson. OIL PAINT photos—portraits, landscapes or art subjects. Earn \$18 to \$50 and more a week. OIL PAINT OUTFIT GIVEN. Send now for free illustrated book. PICTORIAL ART STUDIOS Inc. Dept. MP, 2926 Broadway, Chicago, Ill.

## MINSTRELS

complete show with special songs, opening choruses, etc. Full line of plays, stage songs, crossfire, monologues, afterpieces, vaudeville acts and make-up. CATALOGUE FREE.

T.S. DENISON & CO., 623 So. Wabash, Dept. 19, Chicago

Musical Comedies and Revues. Unique Minstrel First - Parts for

## Ultra-modern HOT PIANO

Piano Jazz taught by mail. Note or ear. Easy rapid lessons for adult beginners. Also Self-instruction system for advanced pianists. Learn 358 Bass Styles, 976 Jazz Breaks, hundreds of Trick Endings, Hot Rhythms, Soek, Stomp and Dirt Effects; Symphonic and Wicked Harmony in latest Radio and Record Style. Write for FREE booklet.



WATERMAN PIANO SCHOOL, 1828 W. Adams St., Los Angeles, Calif.

# LEARN CARTOONING

AT HOME DURING SPARE TIME

with the course that has trained HUNDREDS of beginners successfully. The Landon Picture Chart Method of teaching ORIGINAL drawing by mail makes cartooning easy to learn. This school is a Member of The National Home Study Council. Write today for sample picture chart to TEST YOUR ABILITY and examples of the work of successful students now earning from \$50 to \$200 and more per week.

Enclose 6c in stamps and STATE YOUR AGE.

THE LANDON SCHOOL, 2838 National Bldg., Cleveland, Ohio



# EARN \$150 A WEEK HIS OWN BOSS!

## BIG OPPORTUNITIES FOR YOU IN MECHANICAL DENTISTRY

Why waste the best years of your life at uncertain jobs at small pay? Learn this modern money making business and become YOUR OWN BOSS. Big demand. Age no barrier and no previous experience required. You learn by doing actual work in rubber and gold. Easy terms. Individual instruction. Day and night school. Write NOW for Catalog P. Railroad fare allowed—no extra cost.

NEW YORK SCHOOL OF MECHANICAL DENTISTRY  
147 West 33rd Street NEW YORK



Kern's Dental Lab.

## MAIL COUPON NOW

N. Y. School of Mechanical Dentistry  
147 West 33rd Street, New York.

YES, send me without obligation, your big free Catalog P on Mechanical Dentistry, and its wonderful opportunities.

Name.....  
Address.....  
City..... State.....



Grad. Kern writes

"—My success is due to your excellent training and I appreciate what you have done for me."

(Signed)  
Geo. KERN.

SEND FOR FREE BOOK







**AVIATION  
has a Place  
for YOU**

*Get  
the right training  
and win Your Success*

Choose the position you want—pilot, mechanic, designer, aircraft business man, field superintendent, airport manager, aircraft manufacturer—countless big positions are open for the trained man in every line of aviation. Take the training that will equip you for any one of those positions—get the newest features of aeronautical training at the College of the Air.

The "jack of all trades" has no place in aviation—masters are wanted. You need a specialized training. Marshall Flying School has new courses, new equipment and new methods of instruction to give you the help you need; all courses are offered now.

**It's Easy to Start with Straight Flying Course at \$75.00**

For the low cost of \$75.00 you can enter aviation and take all the fundamentals. This course, teaching you regular flying, will be a stepping stone for you—a means of entrance in the greatest of careers.

This Straight Flying Course is but one of the many new courses which the College of the Air has introduced after four years of experience in giving aeronautical training to young men.



One class of the Marshall fall term students.

- Straight Flying Course. Price (without ground course), \$75.00
- Primary Flying Course. Advances students to crosswind landings and take-offs. Including Mechanic's and Engineer's Ground Course.....\$150.00
- Intermediate Flying Course. Student can be soloed if ability is shown. Price, including Mechanic's and Engineer's Ground Course.....\$200.00
- Complete Aviation Course. Everything needed to make you a successful flyer. Solo guaranteed. No bond required. Price, including Mechanic's and Engineer's Ground Course.....\$245.00
- Private Pilot's License Course. Price, after solo.....\$150.00
- Limited Commercial Course. Qualifies you under the Department of Commerce for the Government Limited Commercial Pilot's License.....\$700.00
- Mechanic's and Engineer's Ground Course. 300 hours of training. Price.....\$75.00



Former Marshall student, now holding big job.

This course is given free with all our flying courses with the exception of the Straight Flying Course.

**Get This Book FREE!**

Mail the coupon and receive this catalog. It shows you the equipment, buildings and the large number of planes used at this school—explains about the new courses—tells you how you can make your start and win your way.

**MARSHALL FLYING SCHOOL, Inc.**

630 North English Street MARSHALL, MISSOURI

Gentlemen:—Please send me without obligation your new catalog.

Check the instruction you want.

- Pilot
- Mechanic
- Designer
- Aircraft Business

Name.....

Address.....

A New Standard in Oil Burners

**The LACO OIL BURNER Does Every Heating Job Better—Cheaper**

You have wanted to get away from dirt and ashes in heating your home, but have thought that a satisfactory oil burner was only for the rich. Now that is changed. The New LACO Oil Burner satisfies every requirement.

**Very Low in Price—Extra High in Performance**  
No other oil burner combines to such an unusual degree the highest mechanical perfections with extremely low price. It is fully automatic, practically noiseless in operation, will not interfere with Radio and is absolutely SAFE.

**Economical—Durable—Safe—Attractive**  
The LACO is economical to buy and to operate. It has a patented, indestructible mineral wick—the only one of its kind. The firepot never becomes overheated nor burns out for the flames are on top, not in the bottom. Finished in Pyroxylin lacquer—red, blue, green or black—your choice.

**A Size to Meet Every Need—Write Today for Full Details**  
Don't bother with dirty fuel any more. Investigate the LACO Oil Burner. You will be delighted with its superior performance and the price will suit you—from \$125 up—depending on size. Write today. A postal will do.

**LACO GAS BURNER CO.**  
113 Union Street, Griswold, Iowa

**I POSITIVELY GUARANTEE**

to increase your arms one-half inch in size, chest one full inch, strength 25%, health 100% in one week's time, by following my instructions and using my exerciser 10 minutes mornings and at night. Send \$1 for complete course and exercisers. Satisfaction guaranteed or \$1 refunded. Prof. J. A. DRYER, Box 1850-P, Chicago, Ill.

**This is the BANJO**

YOU have been wanting—brilliant, powerful, musical tone, easy-playing qualities, expert craftsmanship, handsome appearance. Beginners and professionals choose the Gibson Mastertone.

Payment plan makes it easy to own a Gibson. Send the coupon for details.

Gibson stringed instruments are today's most popular instruments. Mention which interests you: Banjo; Mandolin; Guitar; Ukulele.

**Gibson**

GIBSON, Inc. 1103 Parsons St. Kalamazoo, Mich.  
Gentlemen: Send Free Book and details of payment plan on

[Instrument]

Name.....  
St. or R.F.D.....  
City..... State.....



# WANTED- for murder!

## \$1,000 Reward

In a dirty, forlorn shack by the river's edge they found the mutilated body of Genevieve Martin. Her pretty face was swollen and distorted. Marks on the slender throat showed that the girl had been brutally choked to death. Who had committed this ghastly crime? No one had seen the girl and her assailant enter the cottage. No one had seen the murderer depart. How could he be brought to justice?

Crimes like this have been solved—are being solved every day by Finger Print Experts. Every day we read in the papers of their exploits, hear of the mysteries they solve, the criminals they identify, the rewards they win. Finger Print Experts are always in the thick of the excitement, the heroes of the hour.

### Not Experienced Detectives Just Ordinary men

Within the past few years, scores of men, men with no police experience, men with just ordinary grade school educations, have become Finger Print Experts. You can become a Finger Print Expert, too. Can you imagine a more fascinating line of work than this? More trained men are needed. Here is a real opportunity for you.

### Learn the Secrets of Identification

More and more the detection of crime resolves itself into a problem of identification. You can learn the methods of famous identification experts. You can learn the science of finger print identification—right at home in your spare time.

Send for the free book which tells how famous Finger Print Experts got their start in this fascinating work. Tells the stories of thirteen actual cases solved by Finger Print Experts. Tells how you can become a Finger Print Expert in an amazingly short time.

## Rewards and How to Win Them!

### This Coupon Brings Full Details

Also Confidential Report Operator No. 38 Made to His Chief  
Men just like you have climbed to big success through Finger Print knowledge, gained at home in spare time. Get the thrilling book, telling in stories and pictures of the famous crimes solved by Finger Print Experts. This book is now FREE. Sent prepaid if you just mail the coupon AT ONCE!

**University of Applied Science**  
Dept. 13-58 1920 Sunnyside Ave., Chicago, Ill.

### Mail This NOW for Free Book

University of Applied Science,  
1920 Sunnyside Avenue, Dept. 13-58, Chicago, Ill.

Without any obligation whatever, send me your new, fully illustrated, FREE book of authentic detective tales, "Finger Prints"; also Confidential Report Operator No. 38 Made to His Chief.

Name .....

Address .....

City and State ..... Age .....





## With Violet Ray Vibration Ozone Medical Electricity

The Four Greatest Curative Powers Generated by This

### Great New Invention!



Elco Health Generators at last are ready for you! If you want more health—greater power to enjoy the pleasures and delights about you, or if more beauty is your desire—write! Ask for the book on these inventions which has just been prepared. It will be sent to you without cost. It tells you how Elco Health Generators aid you in leaving the lethargy and hopelessness of bad health and weakness behind forever. Re-vitalize yourself. Bring back energy. Be wholly alive. Write today!

Here's What Elco Users Say—

"Wouldn't take \$1000 for my Elco. It has done me more good in 2 weeks than doctors did in three years."



"Cured my Rheumatism." "My Eczema gone." "Cured my stomach trouble." "Cured my weakness." "Now I sleep soundly all night." "Thanks to Elco my strength and vigor are back." "No more pain." "Colds never bother me now." "Chronic Constipation banished."

These great new inventions generate Violet Ray, Vibration, Electricity and Ozone—combined or separate. They operate on the electric light in your home or on their own motive power at less than 50 cents per year. Elco Health Generators are positively the only instruments which can give you in one outfit Electricity, Violet Ray—Vibration and Ozone—the four greatest curative agents. Send the coupon below. Get the Free Book NOW!

### MAIL COUPON for FREE BOOK

Do not put this paper down without sending the coupon. Don't go on as you are with pains and with almost no life and energy. You owe it to yourself to be a better man or woman. You were put here to enjoy life—not just to drag through it. So do not rest another day until you have put your name on the coupon here. That will bring the whole story of these great new inventions. Do it today—now.



**Lindstrom & Company**  
 2322 Indiana Ave. Dept. 13-58 Chicago  
 Please send me your free book, "Health—Power—Beauty" and full information of your 10-day Free Trial Offer.  
 Name.....  
 Address.....

## QUIT TOBACCO



No man or woman can escape the harmful effects of tobacco. Don't try to banish unaided the hold tobacco has upon you. Join the thousands of inveterate tobacco users that have found it easy to quit with the aid of the Keeley Treatment.

## KEELEY TREATMENT STOPS Tobacco Habit

Quickly banishes all craving for tobacco. Write today for Free Book telling how to quickly Free yourself from the tobacco habit and our Money Back Guarantee.

THE KEELEY INSTITUTE  
 Dept. A 915 Dwight, Illinois



## RESHAPE your NOSE

to beautiful proportions—while you sleep!



### ANITA NOSE ADJUSTER

is SAFE, painless, comfortable. Speedy, permanent results guaranteed. Doctors praise it. No metal to harm you. Small cost.



Gold Medal Won 1923 Write for FREE BOOKLET  
 ANITA INSTITUTE, 1112 Anita Bldg., Newark, N. J.

### How to Straighten Bow and Knock-kneed Legs!

Improve your personal appearance by using the new patent "Lim-Straitner," Model 18. Corrects now Bow and Knock-kneed legs safely, quickly and permanently at home. No costly operation or discomfort. Is worn at night. Easy to adjust; its result will save you soon from further humiliation and will improve your personal appearance 100 per cent. Write today for copyrighted Physiological and Anatomical book and experience of others without obligation. Enclose a dime for postage.

M. TRILETY, Specialist Dept. 1642L BINGHAMTON, N. Y.

### BUCHSTEIN'S FIBRE LIMB

is soothing to your stump—strong, cool, neat, light. Easy payments. Braces for all deformities.

D. BUCHSTEIN CO.  
 610 3rd Ave., So. MINNEAPOLIS, MINN.

Send for Catalog Today

## Stop Using a Truss

STUART'S ADHESIF PLAPAO-PADS are entirely different from trusses—being mechano-chemico applicators made self-adhesive purposely to keep the muscle-ionic "PLAPAO" continuously applied to the affected parts, and to minimize painful friction and danger of slipping.

No straps, buckles or springs attached



Soft as velvet—easy to apply— inexpensive

For almost a quarter of a century satisfied thousands report success without delay from work. Stacks of sworn statements on file. Process of recovery natural, so no subsequent use for a truss. Awarded Gold Medal and Grand Prix. Trial of "PLAPAO" will be sent you absolutely FREE No charge for it now or ever. Write name on coupon and send TODAY.

PLAPAO CO., 588 Stuart Bldg., St. Louis, Mo.

Name .....

Address .....

FREE—Trial Plapao—FREE



# Master Others!



*Win Admiration  
...Popularity...Success...  
BIG MONEY!*

## I'll Teach You the Secrets of **HYPNOTISM**...or No Cost!

Quit being just one of the crowd—stand out—dominate—make others admire and obey you! Learn how to sway others, to develop a strong, magnetic personality, to gain popularity, success, big money—by the USE OF HYPNOTISM!

In just a few hours, I'll show you how to use the strange, mysterious power of Hypnotism to help you master every situation or the **Five Days' Trial is FREE!** There is nothing uncanny, weird or malign about the amazing power of Hypnotism! Every one has concealed in his or her make-up the germ of this mysterious power. All you need do is to train it properly. Then when this mighty power is released, it will help you to overcome obstacles, achieve your fondest ambitions—become a master of yourself. Hypnotism will strengthen your will power—banish fear and worry—improve your memory—overcome bad habits—increase your earnings.

In a startling NEW book, "The Science of Hypnotism," written by a world famous hypnotist, Prof. M. Young, you are told exactly how the great operators handle their subjects—you are given all the facts and methods necessary for a full knowledge of Hypnotism. You see how easy it is to sway others—how to make them follow your suggestions, adopt your plans—how to be perfectly at your ease before an audience or among strangers. Through this wonderful book you can, if you have an active and intelligent mind, quickly develop yourself into a cultured, magnetic person who will be admired and envied by everyone.

Prof. Young reveals the methods used by all the noted Hypnotists. This NEW Book is really an encyclopedia on Hypnotism. In simple, clear, forceful terms it tells all about the theory and practice of Hypnotism—the nine degrees of Hypnotism, different stages of Hypnotism, the Hypnotic Mirror, Telepathic suggestion, auto-suggestion, how to select your subjects, mesmerism vs. hypnotism, magnetic healing, various methods of hypnotizing, how to waken the subject, how to make money out of hypnotism. Prepared especially for self instruction, this is the only Practical Course in Hypnotism that starts the student out on a plain, common sense basis.

### Mysteries of Hypnotism Revealed

Different Methods  
How to Hypnotize at a Glance  
Susceptible Subjects  
Duration of Hypnotic Sleep  
How to Waken a Subject  
Making Others Obey You  
Overcoming Bad Habits  
Use of Hypnotism in Operations  
How to Give an Entertainment

### Try Five Days FREE—Send No Money

Thousands have learned the secrets of Hypnotism from Prof. Young. So confident are we that his great book will teach you the amazing science of Hypnotism, that we will send you a copy without one cent in advance. Simply clip and mail the coupon. When the package arrives, pay the postman only \$2.50 plus the delivery charges. Test the powers of Hypnotism for five days. Then if you are not

delighted, simply return the book and your money will be refunded immediately. Get the coupon in the mail this instant—we have only a limited edition at this low price. **Franklin Publishing Co., 800 N. Clark St., Dept. P-70, Chicago.**

**Franklin Publishing Co.,  
800 N. Clark St., Dept. P-70, Chicago.**

Please send me your amazing New Book—"The Science of Hypnotism"—by Prof. Young. When the book arrives I'll pay the postman only \$2.50 plus delivery charges. If I'm not satisfied after five days' trial, I may return the book and you are to refund my money.

Name.....

Street and No.....

City.....State.....

If you may be out when the postman calls, send \$2.50 with the coupon and we'll pay all delivery charges. Customers outside of U. S. must send cash with order.



# Swear Off Tobacco



Tobacco Tells on Nervous System



Tobacco Ruins Digestion



Tobacco Stunts Boy's Growth



Tobacco Robs Man of Vitality



Tobacco Steals from You the Pleasures, Comforts, Luxuries of Life

## Tobacco Habit Banished Let Us Help You

### Quick Results

Trying to quit the tobacco habit unaided is often a losing fight against heavy odds, and may mean a serious shock to your nervous system. So don't try it! Make the tobacco habit quit you. It will quit you if you will just take **Tobacco Redeemer** according to directions.

It doesn't make a particle of difference whether you've been a user of tobacco for a single month or 50 years, or how much you use, or in what form you use it. Whether you smoke cigars, cigarettes, pipe, chew plug or fine cut or use snuff—**Tobacco Redeemer** will positively remove all craving for tobacco in any form in a few days. Your tobacco craving will usually begin to decrease after the very first dose—there's no long waiting for results.

**Tobacco Redeemer** contains no habit-forming drugs of any kind and is marvelously quick, scientific and thoroughly reliable.

### Not a Substitute

**Tobacco Redeemer** is in no sense a substitute for tobacco, but is a radical, efficient treatment. After finishing the treatment you have absolutely no desire to use tobacco again or to continue the use of the remedy. It helps to quiet the nerves, and will make you feel better in every way. If you really want to quit the tobacco habit—get rid of it so completely that when you see others using it, it will not awaken the slightest desire in you—you should at once begin a course of **Tobacco Redeemer** treatment for the habit.

### Results Absolutely Guaranteed

A single trial will convince the most skeptical. Our legal, binding, money-back guarantee goes with each full treatment. If **Tobacco Redeemer** fails to banish the tobacco habit when taken according to the plain and easy directions, your money will be cheerfully refunded upon demand.

### Let Us Send You Convincing Proof

If you are a slave of the tobacco habit and want to find a sure, quick way of quitting "for keeps" you owe it to yourself and to your family to mail the coupon below or send your name and address on a postal and receive our free booklet on the deadly effect of tobacco on the human system, and positive proof that **Tobacco Redeemer** will quickly free you from the habit.

**Newell Pharmacal Company**  
Dept. 300, Clayton Station, St. Louis, Mo.



### Free Book Coupon

**NEWELL PHARMACAL CO.,**  
Dept. 300, Clayton Station, St. Louis, Mo.

Please send, without obligating me in any way, your free booklet regarding the tobacco habit and proof that **Tobacco Redeemer** will positively free me from the tobacco habit or my money will be refunded.

Name.....

Street and No.....

Town..... State.....



# Strongfort—Man Builder tells you how to be powerful



**STRONGFORT—Builder of Men**

*Dr. Sargent, of Harvard University, U. S. A., declared Lionel Strongfort to be unquestionably the finest specimen of physical development he had ever seen.*

book, "Promotion and Conservation of Health, Strength and Mental Energy." It will tell you frankly how you can make yourself over into a vigorous specimen of vital manhood. It will teach you how to fit yourself to be a credit to your social and business associates. Just mark the subjects on the free consultation coupon on which you want special confidential information and send to me. It's a man-builder and a lifesaver. Send for my FREE BOOK—Right Now. **TO-DAY!**

**Y**OU—like every other man worthy the name of "man"—have a burning desire to be strong—to be dynamic—to be vigorous—to be capable of defense—to be an outstanding figure—admired and respected by men and women. You know the penalty of weakness. You know that the skinny fellow with hollow chest and sallow face—like the flabby fellow with too much stomach and too little wind—is a ridiculous object, laughed at and despised—undesirable in company, unsought as a companion.

You don't have to be one of this kind. *You can be a real 100 per cent. man.* You can be just such a man as any one of the splendid fellows I have instructed. The world holds no parallel for the work I have accomplished in upbuilding weak men. And what I have done for others I can do for you through **STRONGFORTISM**—my world famed Course of health and strength building.

## STRONGFORTISM

### Will Do Wonders For You

I have made powerful men out of mere weaklings and many have become nationally famous. You may not seek tremendous strength. You may not want to become a professional strong man. But you do want good health and manly strength—*every man wants that!* You want energy and vitality. You want a clear, unflinching eye and a steady nerve. You want courage, "sand" and pep! And you can get all these by following in the paths in which I have directed thousands—you can be a real man. Above all, you can rid yourself of disheartening weaknesses and blighting ailments such as constipation, indigestion, rheumatism, high blood pressure, nervousness, lassitude, insomnia, catarrh, chronic colds, etc., if you are so afflicted.

### Vibrant Life Awaits You

Many young men write me the most pathetic letters about their sorry plight and their hopeless state of mind. What I reveal to them, what I do for them, transforms their lives, makes them happy, joyous souls, with an entirely new outlook on life. My methods give to them speedily a bodily feeling so new, so different, so vigorous that they are like men reborn—vibrant with life, bubbling with energy, eager for contact with others, full of ambition and pep. Results are truly marvelous. Thousands testify to this fact. They tell a story of rejuvenation, restoration and rebuilding of the human body that is beyond dispute.

### My Scientific Methods Are Beyond Physical Culture

Do not confuse the *Science of STRONGFORTISM* with gymnastic or ordinary physical culture courses. I am not merely a muscle developer. I am far more than that, for I have devised a system that restores sick, ailing, hopeless men to the Glory of Powerful Manhood—to the Summit of Health, Strength, Happiness and Success—without the use of dope and drugs, lifting and stretching-machines, unnatural deep breathing, starvation diets, nerve-racking routines or other foolish fads and fancies. What I have done for thousands of others I can do for you.

### SEND FOR MY Free Book

The experience and research of a lifetime are contained in my wonderfully instructive

### Send this FREE Consultation Coupon ABSOLUTELY CONFIDENTIAL

Mr. Lionel Strongfort, Strongfort Institute, Dept. 628, Newark, N. J.—Please send me absolutely free my copy of your book, "PROMOTION AND CONSERVATION OF HEALTH, STRENGTH AND MENTAL ENERGY." I have marked (x) before the subjects in which I am most interested.

- .. Catarrh
- .. Colds
- .. Asthma
- .. Headache
- .. Rupture
- .. Thinness
- .. Pimples
- .. Insomnia
- .. Overweight
- .. Constipation
- .. Weak Back
- .. Weak Eyes
- .. Rheumatism
- .. Nervousness
- .. Short Breath
- .. Weak Heart
- .. Great Strength
- .. Lung Troubles
- .. Round Shoulders
- .. Manhood Restored
- .. Stomach Disorders
- .. Increased Height
- .. Muscular Development

Other Ailments.....

Name.....

Age..... Occupation.....

Street.....

City..... State.....

## STRONGFORT INSTITUTE

LIONEL STRONGFORT, DIRECTOR,

Physical and Health Specialist

DEPT. 628

NEWARK, NEW JERSEY, U. S. A.

NOTE: Lionel Strongfort Institute is owned solely by Lionel Strongfort, its founder,—not by any advertising or publishing house.



# Reading Architects' BLUEPRINTS

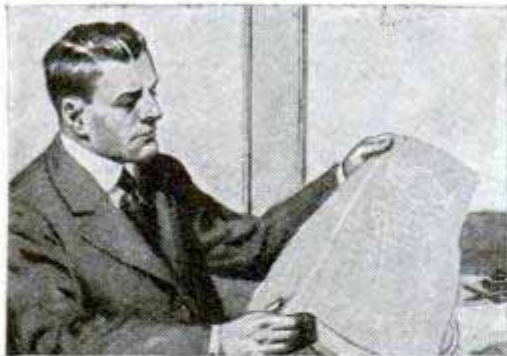

## Learn at Home!

THE building trades are booming. Employers everywhere are looking for men who can read architects' blueprints. Splendid salaries and rapid advancement are offered men who have this special training.

There is an easy, delightful way to learn. The International Correspondence Schools will teach you right at home in an hour a day of the spare time that now goes to waste.

You will like the course because it is so PRACTICAL. You work on actual blueprints—the same blueprints a contractor would use if asked for an estimate, or a foreman would receive from a contractor.

In a surprisingly short time you can acquire a knowledge of blueprints that will be of great value to you in a salary way the rest of your life.

*Mail the Coupon for Free Booklet*

INTERNATIONAL CORRESPONDENCE SCHOOLS  
"The Universal University"  
Box 5572-F, Scranton, Penna.

Without cost or obligation on my part, please tell me how I can qualify for the position or in the subject before which I have marked an X:

**READING ARCHITECTS' BLUEPRINTS**

- |  |   |
|--|---|
| <input type="checkbox"/> Architect                                   | <input type="checkbox"/> Electrical Engineering |
| <input type="checkbox"/> Contractor and Builder                      | <input type="checkbox"/> Electric Lighting      |
| <input type="checkbox"/> Architectural Draftsman                     | <input type="checkbox"/> Mechanical Engineer    |
| <input type="checkbox"/> Concrete Builder                            | <input type="checkbox"/> Mechanical Draftsman   |
| <input type="checkbox"/> Structural Engineer                         | <input type="checkbox"/> Machine Shop Practice  |
| <input type="checkbox"/> Chemistry <input type="checkbox"/> Pharmacy | <input type="checkbox"/> Railroad Positions     |
| <input type="checkbox"/> Airplane Engines                            | <input type="checkbox"/> Gas Engine Operating   |
| <input type="checkbox"/> Automobile Work                             | <input type="checkbox"/> Civil Engineer         |
| <input type="checkbox"/> Agriculture                                 | <input type="checkbox"/> Surveying and Mapping  |
| <input type="checkbox"/> Mathematics                                 | <input type="checkbox"/> Mining                 |
| <input type="checkbox"/> Radio <input type="checkbox"/> Navigation   | <input type="checkbox"/> Steam Engineering      |

**BUSINESS TRAINING DEPARTMENT**

- |   |   |
|---|---|
| <input type="checkbox"/> Salesmanship                 | <input type="checkbox"/> Business Management                              |
| <input type="checkbox"/> Advertising                  | <input type="checkbox"/> Industrial Management                            |
| <input type="checkbox"/> Business Correspondence      | <input type="checkbox"/> Personnel Management                             |
| <input type="checkbox"/> Show Card and Sign Lettering | <input type="checkbox"/> Traffic Management                               |
| <input type="checkbox"/> Stenography and Typing       | <input type="checkbox"/> Accounting and C.P.A. Coaching                   |
| <input type="checkbox"/> English                      | <input type="checkbox"/> Cost Accounting                                  |
| <input type="checkbox"/> Civil Service                | <input type="checkbox"/> Bookkeeping                                      |
| <input type="checkbox"/> Railway Mail Clerk           | <input type="checkbox"/> Secretarial Work                                 |
| <input type="checkbox"/> Common School Subjects       | <input type="checkbox"/> Spanish <input type="checkbox"/> French          |
| <input type="checkbox"/> High School Subjects         | <input type="checkbox"/> Illustrating <input type="checkbox"/> Cartooning |

Name.....

Address.....

City..... State.....

Occupation.....

Persons residing in Canada should send this coupon to the International Correspondence Schools Canadian, Limited, Montreal, Canada

## A WHIRLWIND SELLER

Nothing Like It!



## MIRACLE INVENTION

Pays Salesmen \$29 A Day

MEN, there's a clean-up—a real honest-to-goodness gold mine awaiting YOU in ADDOMETER, my revolutionary portable adding machine! Positively most ingenious invention in years. Different! Startling! Does every kind of figuring as speedily and accurately as costliest \$300 machines—yet fits easily in the coat pocket and SELLS FOR ONLY \$10 COMPLETE! What's more you can make

**BIG PROFITS ON EVERY SALE!**

ADDOMETER astounds and fascinates. Adds, subtracts, multiplies—quickly and correctly. Entirely automatic. All metal. Weighs but 14 ounces. Fully guaranteed. Unheard-of low price made possible only by chance discovery of amazing new operating principle that eliminates keys and levers. Unequaled value at five times its low \$10 cost! That's why storekeepers, business men and all who use figures buy on sight. 3 minute demonstration clinches sale—every time!

**FREE \$15.00 Demonstrating Kit!**

YOUR territory is jammed with red-hot, ready-to-buy prospects. No experience required to close them. Men now selling are averaging \$29 a day! Bridge (Mich.) made \$35 **FIRST DAY!** Same opportunity open to YOU. Write quick for details of my sure-fire Money-Making Plan and FREE \$15 Demonstrating Kit we will give you to start. Do it right now!

**W. C. EDWARDS, Dept. 48**  
173 W. Madison Street • • • CHICAGO, ILL.

# LAW Free Book

Write today for FREE 128-page book, "THE LAW-TRAINED MAN," which shows how to learn law in spare time through the Blackstone home-study course prepared by 80 prominent legal authorities, including law school deans, lawyers, and U. S. Supreme Court justices. Combination text and case method of instruction used. All material necessary furnished with the course, including elaborate 25-volume law library, which is delivered immediately upon enrollment. Many successful attorneys among our graduates. LL. B. degree conferred. Moderate tuition, low monthly terms. Money-Back Agreement.

Write for free book today

**BLACKSTONE INSTITUTE,** 307 N. Michigan Ave. Dept. 58 Chicago

## Don't Envy The Plumber—BE ONE!

\$11.00-\$16.00 PER DAY and work EVERY day, is the Plumber's wage.

**LEARN IN 8 to 12 WEEKS** without previous experience.

If you are making less than \$60.00 a week you owe it to yourself to investigate. Get FREE catalog that tells in pictures and words how we teach this trade. Special rates now.

UNIVERSAL PLUMBING SCHOOL, 2030 Troost Avenue, KANSAS CITY, MO.

# BASHFUL?

"Shame on you!" Are you nervous, embarrassed in company of the other sex? Stop being shy of strangers. Conquer the terrible fear of your superiors. Be cheerful and confident of your future! Your faults easily overcome as you can enjoy life to the fullest. Send 25c for this amazing book. **RICHARD BLACKSTONE, 88-4711, FLATIRON BLDG., NEW YORK**



# Worth Money to Ruptured!

Send New **FREE BOOK** and  
Amazing **FREE SAMPLE**  
of **AIRTEX**  
Without Obligation

Name.....

Address.....

City..... State.....

Mail this coupon to  
New Science Institute,  
2154 Clay Street,  
Steubenville, Ohio

Here is an amazing offer to victims of rupture—an offer that has proved to be worth hundreds of dollars to many who have accepted it. Yet it costs you nothing.

A famous rupture specialist with a record of more than 20,000 cases will send you free of cost a newly-

edited book that contains amazing new discoveries about rupture relief . . . case histories galore . . . illustrated in detail. A few of the facts contained in this free book are given below. But do this right now. Tear out the coupon at the right and send for this unusual book!

## Can Rupture Be Exercised Away? Get Newest Book Now **FREE** to Ruptured

"IT was twenty years ago when I first got ruptured. Today I consider myself entirely cured. Your system is nothing short of marvelous." John Miller, Jr. "Some months ago I ordered your outfit for the treatment of rupture of my son. Our doctor fitted it on him and he was skeptical it would help cure the condition, for it was one of the worst ruptures he had ever seen. Five months later I took the boy back to the doctor. He examined him and pronounced the rupture completely healed." D. E. Lytle, Orrville, Ohio.

These are but two of many astounding letters received from people, many of whom had despaired of obtaining relief from the torture and agony of rupture.

and more unhampered. Thus nature is allowed to knit new tissues together so that rupture often disappears completely without a trace remaining—in unbelievable time. Incredible? Yet the facts are ready now!

### Now or Never

Be fair to yourself. Get the complete facts about Magic Dot and the offer that permits you to feel this marvelous relief, before you decide to buy. Don't go through life in constant pain. Relief from rupture is certainly worth the 2c stamp it costs you to send the coupon above. Send it—not tomorrow or next week—but NOW!

**NEW SCIENCE  
INSTITUTE  
2154 Clay Street  
Steubenville, Ohio**

Never Before a  
**FREE  
SAMPLE**  
Like This

### Not a Truss

What is this wonderful device that has made thousands feel again the joy of living a full life? It is not a truss like men wore in the days of Lincoln. It has no steel springs, no leg straps, no bulky cushions. It can never slip off the rupture. Wearing it, you can still cough, run, jump, bend or sleep in any position. In fact, many are able to work every day—exercise as much as they desire—probably we should say truthfully actually **EXERCISING RUPTURE AWAY!**

Imagine a simple little device weighing less than a feather—little larger than a quarter—that rests firmly against the rupture without the need of strapping tightly. Think of a flesh-soft pad that yields with the slightest movement of your body—filled with millions of air-cells that breathe fresh, cool air into the spot around the rupture. And all the while blood circulation is more free

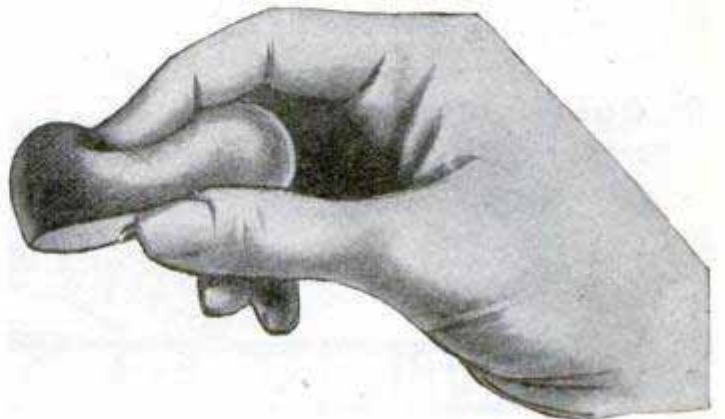



# The "MOVIE WAY" Replaces Old-Fashioned Methods

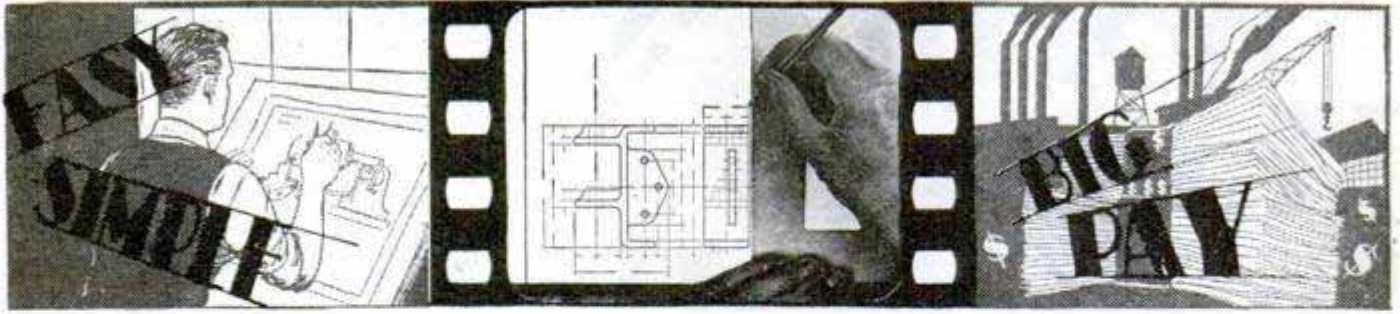

## NOW ~ a simpler, easier way to Big Pay in **DRAFTING** Learn with MOVIES ~ every step a picture!

At last—a quick, complete, fascinating way to learn Drafting, and learn it right! Experts acknowledge my new, simple, easy "Movie Method" to be the first new idea in teaching Drafting in 30 years. It's the most easily-grasped, sound and sensible plan ever devised for Home Study instruction—so clear, so interesting, so practical that almost before you know it, you're through—have finished—and are ready to go to work on a Big Pay Job.

### Learn to Earn—\$60 to \$100 a Week

That's what the expert draftsman gets. And he's never out of work the year 'round—for he's the King-Pin of Industry—the man they've got to have. Not a wheel can turn, not a brick can be laid, not a wire can be strung, until the job has first been planned and drawn on paper by a draftsman. Why don't you get into work like that? Why don't you be a man they can't get along without—a Big Pay Man with a year 'round Big Pay Job? You can—it's easy—I'll show you how.

### I'll Quickly Prepare You for a Big Pay Drafting Job

With my new copyrighted "Movie Method," I'll help you

get ready for a Big Pay Draftsman's job so quickly you will be astonished. Spare time only needed. With my method—just like "slow motion movies" you see how it's done in pictures and you do it yourself almost automatically. It's amazingly simple—yet so thorough and complete you learn Drafting from A to Z—learn it so you can sit in with the best of them on the Jobs that pay Big Money.

### Professional Instruments and Outfit Included—Nothing to Buy

You start out with a complete professional outfit sent to you with your very first Job Sheet. Everything is included without extra cost of any kind. You learn by using these instruments and continue to use them on the job when you get into Drafting Work.

### INVESTIGATE—See These Things First

Don't sign up for any Drafting Course until you've investigated my amazing new "Movie Method." Mail coupon for Big FREE Book. See my great Earn-while-Learning Plan—see the big Professional Drafting Outfit you get at no extra cost—learn about my Nation-wide Job Service—my positive Money Back Agreement. Mail coupon NOW!

K. M. Boyd, Director.



### MAIL COUPON FOR FREE BOOK

K. M. Boyd, Director,  
Practical Drafting Institute of America,  
Dept. 18, 2154 Lawrence Ave., Chicago, Ill.

Send me your book "Draw Big Pay in Drafting" and tell me more about your "Movie Method." This does not obligate me in any way.

Name.....

Address.....

City.....State.....

**The BOYD "MOVIE WAY" is the BIG PAY WAY**



# Classified Advertisements

## WORLD'S BEST WANT AD MEDIUM

Advertisements in this section, 30 cents per word, each insertion, minimum 10 words, payable in advance. To be inserted under proper classification in December issue, copy should be in our office October 18th

### ADVERTISING AGENCIES

**FRANK W. LENHOFF** Advertising Agency, 66 East Lake St., Chicago, Ill. (Established 1897). Chicago's most progressive agency, will mail free on request their new 60 page Advertiser's Rate Book, with United States map in colors. Gives complete information of best paying newspapers and magazines in the United States and Canada. Our copy department has seasoned advice to give on advertising and selling. No obligation.

**ADVERTISE** in 24 Big Sunday Newspapers, 24 words \$15.00. Excellent for securing agents, salesmen and business opportunities. Catalog listing 1,000 leading dailies, weeklies, mail order magazines. Everything. Free. Wade Advertising, Baltimore Bldg., Chicago.

**ADVERTISERS:** 24 words, 38 magazines, \$6.50; 198,420 guaranteed circulation. Checking proof. Ad-Service, 367 E. Maplehurst, Ferndale, Mich.

**ADVERTISE** 50 Magazines 5c word; \$4.00 inch; 5,000 country weeklies 1c line, per paper; lists free. Evans King Co., 672P. Wilmington, Del.

**TIME** Counts in applying for patents. See pages 138 and 139. Clarence A. O'Brien, Registered Patent Attorney, Washington, D. C.

**BEFORE** Advertising get our catalogue. No charge. 25 years in business. The largest classified agency in the world. Ankrum Advertising Agency, 20 W. Jackson Blvd., Chicago Ill.

**FREE—New 1928 Advertisers Rate Guide.** 36 pages. Includes everything. Lowest rates. E. H. Brown Advertising Agency, 140 S. Dearborn, Chicago.

**INCH** Display 50 Monthlies Thrice \$8.00. Meyer Agency, 4112M Hartford, St. Louis, Mo.

### FOR ADVERTISERS

**ADVERTISE** in weekly papers. Lists free. Keator, Hartford Bldg., Chicago.

**ADVERTISE—28** Words in 277 rural newspapers \$10; lists free. Roberts' Agency, Forreston, Ill.

**ADVERTISER'S** Manual, 1929 edition. Postpaid 25c. Owl, Times Bldg., New York.

**40 WORDS** Insert 50 magazines \$2.00. Empire Agency, Shawano, Wis.

### SALES PROMOTION

**\$50 TO \$50,000** Daily Sales Developed during 28 years for clients by our direct mail plans, copy, campaigns. One product, 1923, an idea; this year \$100,000 orders booked. Fifty year old concern desired 50 national representatives in 1925; we produced 40 in three months. 700 dealers in 10 months at \$3 each, for another. Ten years Sales Promotion Manager Larkin Co. Submit sales problems for free diagnosis. James C. Johnson, 118A Woodbridge Ave., Buffalo.

### LETTER SPECIALISTS

**"ELECTRIFIED** Advertising!" Letters and literature that shatters objections—coaxes inquiries, checks, orders. Interesting! Convincing! Profitable! Rates reasonable. Consultation free. Finkel—Advertising, 131-P Glenwood, Jersey City, N. J.

### BUSINESS ADDRESSES

**BROADWAY 200**—Best address in New York. Two blocks from Wall street. Desk room or mail privileges. Rates exceedingly reasonable. We forward your mail daily. Christean Iverson, Room 404.

**IN** The heart of New York—New York mail address \$2.00 month; forwarded daily, \$3.00 month. Edward Armour, M-1, 136 East 28th.

**HAVE A** New York mail address \$1.00 monthly. Mail forwarded to you daily. New York Mail Service, 15 Park Row, New York.

### BUSINESS SERVICE

**M. B. OLIVER,** Lawyer, 203 Lawyers' Bldg., Raleigh, N. C. Phone 3008.

### AUTOMOBILE SUPPLIES

**DODGE** 16 Valve racing head, new, \$60.00. Geo. Laatch, 706 Madison St., Chicago.

**RADIATORS** At wholesale prices. All standard makes. Satisfaction guaranteed. Send for prices, stating make and model. Independent Radiator Co., 1119 S. Wabash Ave., Chicago.

**TOOL** Salesmen and mechanics with some sales ability sell our line electrical tools to auto mechanics and garages. Easy sales, and very liberal commissions. Barker Specialty Co., Girard, Pa.

### AUTOMOBILES

**TIME** Counts in applying for patents. See pages 138 and 139. Clarence A. O'Brien, Registered Patent Attorney, Washington, D. C.

### AUTOMOBILE SERVICE EQUIPMENT

**SAVE** Money—Garage equipment reconditioned and guaranteed like new. Unusual bargains in test stands, car washers, battery chargers, air compressors, etc. Shipped on trial—easy terms. What do you need to complete your equipment? E. C. Galbreath, Box M1184, Troy, Ohio.

**MORE** Profits! With a Scito battery charger. We carry a complete line of battery shop equipment. Send for free dealer's catalog Number 29. Adams Barr, Columbus, Ohio.

**BIG** Profits in automotive service with our new 8 hour battery charging equipment. Low in price—small down payment brings it; pays for itself with handsome profit besides. Write for details. No obligation. E. M. Connor, Box M1183, Troy, Ohio.

**YOU** Are wanted to resilver mirrors at home. Immense profits plating autoparts, tableware, etc. Write for information. Sprinkle, Plater, 77, Marlon, Ind.

**BARGAINS** in reprocessed battery chargers, rectifiers of all kinds and a few Constant Potential 8 Hour Chargers, two of them practically new. Lowest prices; terms if wanted; 30 days' trial. Write today to I. C. Helmick, Box M1182, Troy, Ohio.

### FOR FORD OWNERS

**UNDERSLUNG** With "RKO" Swing Lo Irons. See "Red-I-Cut" ad page 132.

**AURORA** Underslung parts and 3.1 racing gears, speedster bodies, headlights. See Sport Factories ad, page 152.

### MOTORCYCLES, BICYCLES AND SUPPLIES

**MOTORCYCLES** Cheaper than bicycles. \$25 to \$50. Easy terms. Tires \$2.50; Frames \$3; Forks \$3; Tanks \$5; Wheels \$4; Chains \$2; Saddles \$5; Handle Bars \$5; Engines \$15; Motorcycle Tires \$2.50; Truck Tires \$7; Airplane Engines \$15; Bicycle Tires \$1.25. Send 50c for catalog. Price Cutter Deninger, Rochester, N. Y.

**NEW** And used motor cycle parts. Tower Cycle Co., 3528 Maywood Ave., Pine Lawn, Mo.

**SLASHING** Price Reduction! Fine Harley-Davidson motorcycle bargains. New, used and rebuilt motorcycles, \$50.00 and up. Send for our new free bargain bulletin just off the press. Knuth's Harley-Davidson Agency, 2525 Fond du Lac Ave., Milwaukee, Wis. Exclusive Harley-Davidson Distributors.

**USED** Motorcycle bargains. All makes. Lowest prices. Guaranteed. Shipped on approval. New easy payment plan. Motorcycle parts—supplies. Catalog free. Floyd Clymer, "Largest Motorcycle Dealer in the West," Denver, Colo.

**BARGAINS** in used motorcycle parts for all makes. No Catalogs. J. B. Dahl, 3661 Archer Ave., Chicago, Ill.

**USED** Motorcycles, all makes, lowest prices; price list free; used parts half price and less. Rochester Harley Davidson Corp., 129 West Main St., Rochester, N. Y.

**USED** Indian motorcycle parts half price and less, engines \$15. Parts list 25c. Hurek Indian Motorcycle Co., 2127 Locust, St. Louis, Mo.

### AVIATION

**NEW** Book "Making Good in Aviation" tells you how to fit yourself for marvelous opportunities open to flyers and mechanics. Contains stirring story of Col. Lindbergh as our chief air mail pilot and instructor. Rise of "Bud" Gurney from barnstormer to chief pilot. Published by well known Robertson School of Aviation, 9½ years old, hundreds of graduates, no accidents. Army school system of flying taught by active air mail pilots. Government licensed and inspected training ships. No bond, no breakage charges. 700-acre field. "Ryan" and "Robin" factories on site. Send 25c for book, "Making Good in Aviation." Robertson Flying Services, Inc., Dept. O, Lambert-St. Louis Airport, Anglum, St. Louis Co., Mo.

**SKILLED** Airplane mechanics find opportunities everywhere now. Our new extension course in practical aviation, prepared and directed by airplane manufacturer, trains you quickly for this interesting, highly-profitable career. Send your name on a postal at once for free book giving full details of our course and easy payment plan. Ohio Aero School, 1460 South Ave., Youngstown, Ohio.

**HOME** Study course in aviation by pioneer school at new low price. Complete, including motors, wings, nomenclature, meteorology, navigation, flying and 100 other fascinating subjects. Endorsed by experts. Diploma given. Free employment service. Complete details sent free. National Aviation Training, Dept. 18, 1031 So. Broadway, Los Angeles, Calif.

**BUILD** And fly your own monoplane—20-foot wing spread, 72 mph with only 12 hp. motor. Plans and working drawings complete, \$10.00. Descriptive folder ten cents. Warner Co., 311 Edwards Bldg., Cincinnati, Ohio.

**AIRPLANE** Propellers and motors, 28 to 200 hp. Smith, Box 1343, Houston, Tex.

**SCALE** Model airplanes ready to fly—all types. Send dime (3 for 25c) for flying glider and catalog. The Clinton Toy Co., Box 141, North Haven, Conn.

**PROPELLERS.** For small airplanes, snow and ice sleds. Blueprints for sleds one dollar. Crawford Airport, Seal Beach, Calif.

**BUILD** Your own glider. Complete plans \$7.50. Special price list 25c. J. P. Schroeter, 445 Milwaukee St., Milwaukee, Wis.

**BUILD** Our wonderful one piece monoplane. Adapted to motorcycle or other air-cooled motors to 35 h.p. Detailed blueprints \$2.00. Hawley Aircraft, 3366 Grinn, San Diego, Calif.

**SIMPLEX** Air Model Co., Auburn, Mass. Send five cents for supply booklet.

**BUILD** Model airplanes that fly. Our 52 page catalog illustrates 26 flying and exhibition models. Most complete line of accessories and supplies. Send 10 cents for our big catalog. U. S. Model Aircraft Corporation, 341 Monroe St., Brooklyn, N. Y.

**BIG** Bundle various sizes wood, reeds, 26" long, bamboo, rubber band, wheels, 6" propeller, onion skin paper. About 40 pieces in all. Also circulars on free three foot model. All for 25c, no stamps. Aero Shop, 3050 Huribut Ave., Detroit, Mich.

**BLUEPRINTS** For building carefully designed sportplanes that really fly; monoplane, \$2.50; biplane, \$5; circular 20c. Allison Airplane Co., Lawrence, Kans.



**PROPELLERS:** 3', \$5.50; 4', \$8.75; 5', \$13.25; 6', \$16.50; others proportionately. Aerodrive boat and sled blueprints 50c each. \$8.25 value aviator's helmet and resistal goggles only \$5.00 set. Ostergaard Aircraft, 1309 N. Narragansett, Chicago.

**"SKYWARD Ho!"** New book by Derek White on your future in aviation. Opens road to career, fame, fortune. Sent free. Write at once. Parks Air College, 213 Missouri Theatre Bldg., St. Louis, Mo.

**THE American School of Aviation** announces a new correspondence course in Mechanics of Aviation. A thorough training in Practical Aeronautics. American School of Aviation, Dept. 1871, 3601 Michigan Ave., Chicago, Ill.

**JUST Out**—book and blue prints on design, construction of small sport plane. Dependable information on motors to use, etc. Includes flying lessons and weather map reading. All for one dollar. Chas. Russell, 545 Stadium Drive, Ft. Wayne, Ind.

**TIME Counts** in applying for patents. See pages 138 and 139. Clarence A. O'Brien, Registered Patent Attorney, Washington, D. C.

**NEW Aircraft magnetos**, 6 or 8 cylinders, cost government \$75.00, sacrificed \$7.50. Real airplane propellers, 8 foot long, given away, \$5.00. Air Transport Co., Carle Place, N. Y.

**BIGGEST**, Best Catalog Model Airplanes, Parts, Supplies; 5c postpaid. Ideal Company, 19 West 18th Street, New York.

**PARACHUTES.** Specify weight. Thompson Bros. Balloon Co., Aurora, Ill. Established 1903.

**THE Super Parasol**, America's most popular sport plane. Wonderful detailed shop blue prints \$5.00 per set. 10c for large illustrated folder. Heath Airplane Co., Chicago, Ill.

**THREE-IN-ONE** Model airplane. Catalog for stamp. Stewart Marshall, Rome, Ga.

**FLY!** With motorcycle engine. Build your own airplane at small cost. Booklet with five drawings tells how to build fuselage, wings, controls, etc. Price one dollar. Hodgdon, 324 Bay St., Springfield, Mass.

**IT'S New!** The modern airpans, 125 pages, 40 illustrations, tells everything you want to know about flying. Recommended by leading pilots and flying schools. Sent postpaid for \$1.00 or write for free descriptive circular. Roth Downs Airways, 2502 University, St. Paul, Minn.

#### BOOKS AND PERIODICALS

**4TH EDITION** Just off press, "Radio Theory and Operating," by Mary Texanna Loomis. The standard radio text and reference book of America. Nearly 900 pages, over 700 illustrations, flexible binding. Price \$3.50 postage paid. For sale by hundreds of bookdealers throughout America and many foreign countries. Or may be purchased direct from the publishers. Send check or money order to Loomis Publishing Company, Dept. 18, Washington, D. C.

**BOOKS**, 6th and 7th Book of Moses, 50c; Albertus Magnus, 50c; Pow-Wow, 50c; Silent Friend, \$1.00; Book of Luck, 25c. The F. & R. Co., 87 Fourth Ave., Dept. "L," New York.

**"THE Personal Liberty Course"**—A clever combination of mirth, information and instruction for quickly overcoming fear, bashfulness and physical complexes in men. No drugs, no gymnastics. Full particulars free, sealed. Harry J. Gardener, P. O. Box 607, Station C, Los Angeles, Calif.

**FREE To you**—Interesting catalog of unique books and novelties. Address S. Mustal & Co., 10-12 Lincoln St., Yonkers, N. Y.

**HYPNOTISM** Easily learned. Lessons guaranteed. Postpaid, \$1.10. Smith Pub. Co., Dept. 3, Springfield, Mass.

**CURIOUS Books**, Unique Novelties, Stunning Pictures. Samples, 10 cents prepaid. Linds, 214 W. 34th St., New York.

**BOOKS**, Magazines, art publications in French, Spanish, English. Photo novelties, etc., samples. Lists, 20 cents stamps. Villaverde Co., Dept. 207, Box 1329, Havana, Cuba.

**INDUSTRIAL Alcohol**. Wright's book. Full directions for making, fully illustrated. \$2.50. Spon & Chamberlain, 120 P.M. Liberty Street, New York, N. Y.

#### PICTURES AND POSTCARDS

**WONDERFUL African jungle photos**, size 5x7, ten postpaid \$1.00. Two samples and list subjects, quarter. Holt, 47 Rue Emile Banning, Ixelles-Brux, Belgium.

**SEE New York at home**. Large book 80 pages, over 150 photographs, descriptions points greatest interest. \$1.00; 25 colored New York souvenir post cards, 25 cents. J. Zmora, 321 Avenue "A," New York City.

**FREE Book**—"What men know about women?" Humorous and interesting. Kind men like, 10 snappy cards. Red hot pocket novelty. Copy America's greatest illustrated cartoon book. All for 25c. White Mule, Beaver Dam, Wis.

**ART Pictures**—300 all different. Particulars 10c. Howard Sales Co., Dept. 15, Box 529, San Francisco, Calif.

#### MAGIC TRICKS, BOOKS AND JOKER NOVELTIES

**"THE Book of 1,000 Wonders"** will be sent postpaid for 10c. Explains many mystifying tricks with coins, cards, handkerchiefs, etc., you can do. Also, contains complete catalog of magic tricks, jokes, puzzles, books, escapes, mindreading acts, spiritualistic effects, illusion plans, curios and imported novelties from many foreign lands. Large assortment, lowest prices. You will amaze and mystify your friends! Send 10c today. Lyle Douglas, Station A-5, Dallas, Tex.

**MAGIC—Tricks, Books and Supplies**. For amateurs as well as the great professionals. Anyone can learn through our instructions. Picture Acts in Mind-Reading, Spiritualism, Rope Ties, etc. Large illustrated professional catalog, 20c. Chicago Magic Co., 140 So. Dearborn St., Dept. B, Chicago, Ill.

**SEVEN Magical Delusions and catalogs**—25c. Gilmaglio, Morgan Park, Ill.

**MAGICAL Tricks, puzzles, novelties**. Catalog 5c. Matz Novelties, Reading, Pa.

**FREE Magic catalog**. New pocket tricks 50c; three for \$1.00. Wholesale, retail. Eagle Magic, Minneapolis, Minn.

**SIX Mystifying card tricks**, done with ordinary pack cards. Easily learned. 25c including large catalog. Wizard Magic Co., Dept. 15A, Box 1935, Station C, Los Angeles, Calif.

**UNIQUE Novelties**, magical mysteries, perplexing puzzles. Catalog free. Hellwig, 2050 West Davison, Detroit.

**"THE Naked Truth"**, a real hot novelty. 20c postpaid. W. E. Coffin, Berlin, Md.

**153 TRICKS**, Fully explained, and catalog 10c. American Specialty Co., Swampscott, Mass.

**BOOKS**, Magic, herbs, incenses, perfumes, novelties, catalog, sample 10c. Marelle Company, 55 E. Washington, Chicago.

**MAGIC Set** 35c coin. Wondar, 1509 Wenhonah Ave., Berwyn, Ill.

**LATEST French model pocket mirror** and set of transparent art cards all for \$1.00. World Service Co., 336 Marcy Ave., Brooklyn, N. Y.

**FREE** with \$25 order die box. Send 20c for our large catalogue of tricks, wigs, sensational escapes. Oaks Magical Co., Dept. 548, Oshkosh, Wis.

**ELECTRIC Fun!** Seventy stunts, 110 volts, \$1. Cooper Sons, Campbell, Calif.

#### GAMES, ENTERTAINMENTS AND PLAYS

**PLAYS**, Musical comedies and revues, minstrels, comedy and talking songs, black-face skits, vaudeville acts monologs, dialogues, recitations, entertainments, juvenile plays and songs, musical readings, make-up goods. Catalog free. T. S. Denison & Co., 623 So. Wabash, Dept. 11, Chicago.

**LEARN Ventriloquism** by mail—small cost. 2c stamp brings particulars. Geo. W. Smith, Room S-303, 125 N. Jefferson St., Peoria, Ill.

#### NOVELTIES, CURIOS, ETC.

**"THE Book of 1,000 Wonders"** will be sent postpaid for 10c. Explains many mystifying tricks with coins, cards, handkerchiefs, etc., you can do. Also, contains complete catalog of magic tricks, jokes, puzzles, books, escapes, mindreading acts, spiritualistic effects, illusion plans, curios and imported novelties from many foreign lands. Large assortment, lowest prices. You will amaze and mystify your friends! Send 10c today. Lyle Douglas, Station A-5, Dallas, Tex.

**INDIAN Flint arrow heads**. Colorado perfects 50c. Flint drills \$1.00. A. W. Brockett, 842 South Pearl St., Denver, Colo.

#### STAMP COLLECTING

**READY November 1st, 1929 (83th) edition**. Scott's standard postage stamp catalog. In one volume; every stamp ever issued by any stamp issuing country, illustrated, numbered, and described by date of issue, color, perforation, paper, watermark denomination, type of printing, surcharge, etc., and priced, used and unused. Watermarks illustrated by special photographic process. Cloth cover \$2.00, with thumb index \$2.50. For sale at stamp department, book and stationery stores. If ordered from the publisher forwarding extra, shipping wt. 3 lbs. Scott Stamp & Coin Co., 1 West 47th St., New York, N. Y.

**500 DIFFERENT Stamps for 25c!** Big collection 500 different stamps from Bosnia-Herzegovina, Crete, Epirus, Hong Kong, Iceland, Kenya and Uganda, Liberia, Malta, Nyassa, North Borneo, Orange River Colony, Siam, Wallis and Futana, and other "hard" countries. Catalog value \$10.00. Price only 25c to approval applicants! Special bargains, 1,000 different 79c; 15 triangle stamps 49c; 100 Africa 45c; 100 Asia 50c; 100 Balkan States 35c; 100 British Colonies 25c; 100 French Colonies 30c; 100 Portuguese Colonies 50c. All 8 packets for \$3.00! Illustrated lists free. Loma Stamp Co., 3925 32nd St., San Diego, Calif.

**MYSTIC "Queer Country" Packet!** Contains scarce stamps from the following strange lands: San Marino, Antioquia, Congo, Cyprus, Fiji Islands, Gwallor Hyderabad, Iceland, Jhind, Kenya, Uganda, Lebanon, Monaco, North Borneo, Nyassa, St. Thomas Prince, Eastern Roumelia, Siam, Sierra Leone, Tanganyika, Trinidad Tobago, Ubangi, Upper Volta, Wallis Futuna, Alauites. Get this wonderful packet of "freak countries" and make your friends envious! Price only 10c to approval applicants! Write today. Mystic Stamp Company (Dept. 8), Camden, N. Y.

**ANCHERS \$\$\$ Outfit—only 12c!** Fine triangle stamp; set German stamps with (pre-war) value forty million dollars (interesting!); perforation gauge, mm scale; airmail set; scarce stamp from smallest republic on earth; newspaper set; packet good stamps and Travancore, Malay, Dutch Indies, etc. Entire outfit for 12c to approval applicants! (Nice pocket stock book, value 25c, with every order!) Ancher Stamp Co., Ramsey, N. J.

**78 FAR-OFF Countries** only 10c. Angola, Dahomey, Travancore, Jamaica, St. Pierre, Schleswig, Martinique, Ivory Coast, Esthonia, Luxemburg, Peru, Newfoundland, South Africa. Marvelous packet 78 different stamps from 78 different countries, including all above and 65 more. Bargain price 10c. Big lists and approvals with each order. C. D. Reimers Company, 7 Flatiron Bldg., Fort Worth, Tex.

**100 DIFFERENT Foreign stamps** from 100 different foreign countries, including Africa, Asia, Australia, Europe, West Indies, etc., for only 20c. Free with each order, our pamphlet which tells "How to Make a Stamp Collection Properly," together with our price lists of albums, supplies, and hundreds of bargains in sets, packets, etc. Queen City Stamp & Coin Co., Room 36, 604 Race St., Cincinnati, Ohio.

**WHOLESALE!** Large 52-page illustrated stamp catalog free, containing hundreds of money-making bargains. Grossman, 108 W. 42d St., New York.

**ANNIVERSARY OFFER!** 15c six beautiful sets: "Occupation," "Commemorative," "Airmail," "Charity," "Pictorial," "War." Also three packets: (International), (British) French, Portuguese Colonies), (Bulgaria). Approvals, lists, discounts. Deering, Fairmount, Marlborough, Mass.

**200-200-200-200 ALL Different stamps;** 200 hinges; approval sheet to hold 200 stamps; perforation gauge, millimeter scale and ruler; duplicate stamp container—all for only 15c to approval applicants. Edgewood Stamp Company, Milford, Conn.

**STAMP Stock sacrificed**. Confederates, dime. Big-Treasure-Boxes delight boys: \$1.25, \$5.00. Mission, Santa Rosa, Calif.

**FREE**—Set worth three dollars to approval applicants. 1,000 unused stamps 50c. 1 pound mission mixture \$1.00, postage extra. Importer, Box 156, Needham, Mass.



**\$1.00 FREE.** Black U. S. Postage. Given away with each order. Pioneer Stamp Album with 500 illustrations. 150 different stamps from 40 countries, Syria, Lebanon, Hejaz, Liberia, New French Colonies, British, Portuguese Colonies, South Africa, Australia, 500 hinges, 36 page illustrated catalogue. All for 15c. Big Commission to Agents for the Best approval sheets of stamps ever offered. Write for sample outfit. Hussman Stamp Co., Dept. M, 620 Olive St., St. Louis, Mo.

YOUR Government has nearly 100 different stamps to sell collectors at face value. Pamphlet describing Government Philatelic Agency, list of stamps, and sample of "Washington Stamp News," all for 10c. A. L. Nickles, 213 Seaton, Washington, D. C.

**SEND** For approvals and receive free 50 different stamps. Postage 2c. Mueller Stamp Co., 22775 Grand River, Detroit, Mich.

**SWEDEN.** No. 131. Mint. catalog \$1.25, 35c. 100 different stamps, catalog value \$3.00 to approval customers, 20c. References please. List free. J. Johnson, 618 W. 52nd Place, Los Angeles, Calif.

150 **GOOD** Mixed foreign stamps 3 cents. Stanton, Niantic, Conn.

**UPPER** Silesia—7 varieties 10c. Lists free. Allison, Angola, Ind.

**FREE.** 6 Different Luxemburg to approval applicants. E. D. Stamp Co., 3905 Forest Park Ave., Baltimore, Md.

**FREE:** Stamp collection from eleven foreign countries for sending 4c postage for price list. Argonaut Stamp Co., Dept. 113, New Canaan, Conn.

**EXTRAORDINARY** Packet! 60 different stamps from Nyasaland, Persia, Natal, Transvaal, Rhodesia, Montenegro, Nigeria, etc. Only 5c! with excellent approvals. Viking Stamp Co., P. O. Box 18, Sheephead Bay Station, Brooklyn, N. Y.

**SOUTH** Central America, 40 different 10 cents. Croston, Box 25, Haverhill, Mass.

1,000 **MIXED** Foreign stamps 25c. Phil Lundstedt, Cape Cottage, Me.

250 **STAMPS** China, Siam, Persia, India, Australia, etc., over 100 different 10c. Stevens Stamp Co., Walden, N. Y.

**SURPRISE** Packet with U. S., high values 9c. Approvals. Golden Rule Stamp Co., Box 1248, Chicago.

100 **FOREIGN** Stamps 3 cents. Lufbery Stamp Co., North Branford, Conn.

**COLLECTION** Business is your opportunity. Free particulars. Ramos Renfrow, Canon City, Colo.

**EXCHANGE** Duplicates. Packets, approvals. Albums. Postage. Pop. GPO, Box 471, New York.

**OUR** Booklet, How to Collect Stamps, and 1,000 all different fine stamps for \$1.00, 1928 price list free on request. The Hoffman Stamp Co., Inc., 18-20 West 34th St., New York.

**BIG** Bargains. 1/4c up. Babcock, 407 E. Fort, Detroit, Mich.

**FREE**—Genuine Mexican \$5 bill with purchase of 100 different foreign stamps for a dime. B. Nagle, 1101 Marion, Reading, Pa.

**BEGINNER'S** Big surprise packet. 2c postage. Superior Stamps, Midland, Ontario, Can.

111 **DIFFERENT** Stamps, including French colonies, free with approvals. Postage 2c. Leader Stamp Co., 2056 East 24th St., Brooklyn, N. Y.

**FREE!** Loose leaf postage stamp album at rate of 8 pages each month given with subscription to monthly journal. Send 2c stamp for prospectus. United Stamp Co., Marquette Bldg., Chicago, Ill.

**DANZIG** Stamps free—Interesting packet from Danzig with big catalogs free for 2c. Midland Stamp Company, Toronto, Can.

**SURPRISE** Packet—Borneo, Australia, Malay, U. S. Commemoratives, etc., and illustrated lists for 6c. Moseley, 4321 Parkview, St. Louis, Mo.

**FREE**—100 Different stamps to applicants for our fine approvals. State Stamp Co., New Kensington, Pa.

1/4c **APPROVALS**—5,000 Borneo, Liberia, etc. References. Philatelic Exchange, Huntington, W. Va.

25 **DIFFERENT.** Including Cuba, Lindbergh, Belgium Olympics, Roumania, Coronation, Samoa, Carinthia 25c. C. Lacombe, 1800 W. Fayette, Syracuse, N. Y.

100 **DIFFERENT** Stamps from 60 countries for 10c. Lists and approvals sent with each order. P. R. Lincoln, 217 Summit St., Norristown, Pa.

500 **UNPICKED** U. S. before 1921, only 25c. Arrow Stamp Co., Box 433, Meriden, Conn.

5 **ICELAND** Free to approval applicants. Edward Hammond, Auburndale, Mass.

**CONGO** Stanley commemoratives, just out, 5 varieties unused only 15c. Skillman, Titusville, N. J.

1,000 **VARIETIES** For 69c! Approvals. Kenmore Stamp Co., 703 Kenmore Place, Brooklyn, N. Y.

**UNITED STATES**—Send on approval. Send me your want list. Ref. please. M. Hanna, New Kensington, Pa.

**ONLY** 5c! 10 Airmail stamps, including scarce Esthonia triangle; Azores, Red Cross set; packet fifty different stamps—all unused—from Guyane, Ubangi, etc. All for 5c! Approvals and free lists with each order. Curhan Stamp Company, Gloucester, Mass.

200 **DIFFERENT** Stamps, Zanzibar; Album, 12c. Liberty, 3974 Arsenal, St. Louis, Mo.

**PHILATELIC** Gossip—large 32-page weekly, three months with premium 25c. Gossip Print, Horton, Kans.

100 **DIFFERENT** Epirus, etc., hinges, case, gauge, all for 10c to approval applicants. Maitland Milliken, Fostoria Bldg., Denver, Colo.

**HEADHUNTER.** Sphinx, tiger, elephants, packet of 105 varieties, nickel, plus postage, to approval applicants. Universal Shop, 91 Gelston Ave., Brooklyn, N. Y.

250 **DIFFERENT** Foreign postage stamps only 10c. Skillman, Titusville, N. J.

**FREE**—True-Blue book. Exchange stamps, postcards. Erlson, Elroy, Wis.

**FREE** Ten airmails to approval applicants. Prall, Somerville, N. J.

**FREE** Ceylon stamps cataloging 35c, to approval applicants sending 2 references, ordering 11 beauties (Barbados, Ceylon, Iraq, Malta, Mauritius, Palestine, Transjordanian only; catalog \$2.19) price 48c. Reuter, Fullerton, Calif.

**FREE!** 12 Scarce Azerbaijan, bargain lists of sets, packets, 2c postage. Penna Stamp Co., Greensburg, Pa.

100 **ALL** Different stamps free to each subscriber to The Stamp Collector. Twenty-five cents six months. The Stamp Collector, 719 Lodi St., Syracuse, N. Y.

**FAMOUS "A"** packet—38 varieties stamps. Countries beginning with "A." Aitutaki, Azores, Azerbaijan, Angola, etc., only 25c. Net approval books. R. Bovard, Fort Benton, Mont.

200 **DIFFERENT** 8c, 100 U. S. 25c, U. S. stamps; foreign packets. Lists free. Midwest Stamp Co., Keaper Bldg., Kansas City, Mo.

**LINDBERGH** Air mail and 25 different other air mail only 15c to approval applicants. Special bargains: 100 Africa, 45c; 100 British Colonies, 25c; 100 French Colonies, 30c; 1,000 different from all over world, 75c. All 4 packets for \$1.50. L. W. Hudson, 1439 East 7th, Plainfield, N. J.

**STAMPS.** Wonderful \$1.00. Dealers stock over \$18.00. Catalog. Lindsey, Norwich, N. Y.

200 **FINE** Foreign stamps. American eagle cent, 2 crisp notes and catalog 10c. George Best, Cedar Rapids, Iowa.

1,000 **HINGES** Free with 25 Persia 25c or 25 Guatamala 25c. Weber, 1377 Park, Plainfield, N. J.

**SELLING** Out, 100 Barbados 40c, 100 British Guiana 35c, 100 Africa 35c. Craven Stamp Co., Thompsonville, Conn.

**WORLD'S** Greatest values: 215 diff. Congo, airmails, Nigeria, high value U. S., 10c to approval applicants, 100 diff. U. S., 30c; 1,000 hinges 9c. Lists. Hawkeye Stamp Co., Cedar Rapids, Iowa.

100 **EUROPEAN** Stamps, 38c. No duplicates. Wischmann, 1604 Austin Blvd., Cicero, Ill.

**BEGINNERS**—Kober, 1959 Oakdale, Detroit, sells good stamps cheap. 1-3, 8c; 1/2—1-6 cat. Pays the postage.

**FINE** Grade fall approvals now ready. Napp, 413 Oak Grove, Beloit, Wis.

6 **DIFFERENT** Crete with approvals 3c. Iowa Stamp Co., Cedar Rapids, Iowa.

100 **BRITISH** Colonials, all different, including some of the older varieties, for 25 cents. Approvals of the better grade stamps for advanced and medium collectors. Also beginner's selection. Lists free. Your name on our mailing list guarantees you satisfaction. Humber Stamp Co., 401 Quebec Ave., Toronto 9, Canada.

**AMATEURS** Attention! Low priced sets on approval. Wickham Stamp Co., Secaucus, N. J.

**FREE**—Sample copy of Stamp Collector's Magazine, world's largest monthly. Philatelic Publishing Co., 15 John St., New York.

**LIBERIA** Snake Triangle and two other triangles in our packet of 53 genuine foreign stamps for five cents. Crowder Company, Waverly, Baltimore, Md.

**ALBUM** 1,000 Hinges, 200 foreign, 25 Cuba, 25 Japan, 35c. Burtiss Company, Saratoga, N. Y.

50 **DIFF.** Soviet Russia 25c. Approvals if you wish. Glenn R. Knight, Box 3, Sausalito, Calif.

40 **DIFFERENT** United States 10c. 60% approvals. Seidenberg, Baroda, Mich.

5,000 **FINE** Stamps \$1.00. Longacre Hobby Shop, 106 W. 42d St., New York.

**CANADIAN** And American commemoratives, five cents to approval applicants only. The Stamp Chest, 84 Jane St., Toronto 9, Canada.

**BIG** Circus packet 10c—Worth much more; gigantic bargain; animals of the jungle, birds of prey, natives, elephants, giraffes, lions, ant eaters, caribou, camels, mule from Iraq, Liberian jungle and big lot of fine stamps only 10c to applicants of our low-priced approvals. E. P. Johnson, Box 692, San Jose, Calif.

**LINDBERGH** Panama issue complete, 40c. Wirth, 139 Shepherd Ave., Brooklyn, N. Y.

100 **DIFFERENT.** Arabia, Azerbaijan, Zanzibar, etc. 10c to approval applicants. Floyd Marsh, 524 Hamilton Ave., Indianapolis, Ind.

300 **DIFFERENT.** 20c; 600, 50c; 1,100, \$1 2,000, \$3.50. Fred Onken, 639 79th St., Brooklyn.

**BEAUTIFUL** Picture stamps sent free. Paul Cornish, Schenectady, N. Y.

500 **STAMPS** 17c, 3,000 Hinges 25c. Ask about special approval discount. Elmer, 61 Court St., Boston.

105 **CHINA, Etc.,** 2c. Album (500 illustrations) 3c. Bullard, Sta. BB, Boston.

110 **DIFFERENT** Stamps, many unused, high values, free to collectors requesting our Net Approvals. Postage 2 cents. Christensen, Milwaukee, Wis.

**STAMPS,** 100 all different. Postage 2c. Lists free. P. M. Quaker Stamp Co., Toledo, Ohio.

**REVENUES**—Telegraphs—Every country. Pretty—Intriguing—Cheap. Mint \$5.00 revenue free to applicants with references. Vanderhoof, 1114 Logan, Denver, Colo.

**HIGH-CLASS** Approvals. References Required. Pikes Peak Stamp Co., Colorado Springs, Colo.

110 **NEW** Europe All Different, a wonderful collection cataloging several dollars, free to collectors requesting our Net Approvals. Postage 2 cents. Badger Stamp Co., Milwaukee, Wis.

**BEST** One cent approvals in America. F. P. Hand, 1117 So. 60th St., Philadelphia, Pa.

**DANDY** Mint stamps 2c to those requesting approvals. Harvey Teeple, Decatur, Ind.

1,000 **ALL** Different stamps \$1.00. New price list of all United States stamps free. Voorhees, 7 South Dearborn St., Chicago.

**STAMPS** sent on approval at 70% discount. Reference required. Emory Renoll, Hanover, Pa.

**TRIANGLES**—Ten different for 15c to approval applicants. Fenway Stamp Co., 161 Massachusetts Ave., Boston.

101 **DIFFERENT** Free with 50% Approvals, 2c postage. Noemus Stamp Co., 312 East 23rd St., New York.

**UNITED** States and Canadian 32-page price list free. Stamps bought. Stanley Gibbons, Inc., 38p Park Row, New York City.

**THOUSAND** Foreign stamps 50c; twenty foreign coins \$1. Prof. McCreery, Chatham, Ontario.

**PENNY** Approvals that Satisfy. Neil Gronberg, Box 5441, Philadelphia, Pa.

500 **MIXED** U. S., old and new, 10c. Weatherby, Lakewood, Ohio.



**FREE** Germany air mail (5 var.) for new applicant of my 1, 2c and 3c approvals and also my 50% discount. Chas. W. Schmidt, P. O. Box 4832, Frankford Sta., Philadelphia, Pa.

**FREE!** 115 Different stamps to approval applicants, 2c postage. Paige Stamp Co., Oak Park, Ill.

**STAMPS**, 100 varieties, Africa, Brazil, Peru, Cuba, Mexico, etc., 10c; 25 different U. S. 25c; 1,000 mixed, 40c; 1,000 hinges, 15c. List free. C. Stegman, 5941 Cote Brillante, St. Louis, Mo.

24 **VARIETIES** Cuban stamps, 10 cents. List of 6,000 low-priced stamps free. Address Chambers Stamp Co., 111P, Nassau St., New York City, N. Y.

200 **DIFFERENT** stamps 10c; 1,000 Hinges 10c. R. H. Carlton, 380 W. So. Temple, Salt Lake, Utah.

**COVERTCO** Packet, 100 different stamps 10 cents, with 60% discount approvals. Covert Stamp, 39 State, Rochester, N. Y.

#### RARE COINS

**COMMEMORATIVE** Half dollars, all un-circulated. Lincoln, Pilgrim, Grant, Monroe, Lexington, Oregon Trail and Bennington. \$1.20 each. Maine, Alabama, Huguenot and Philadelphia, \$1.50 each. Stone Mountain, 80c each. Norse American medals, \$1.15. Postage extra. Ambrose Brown, Box 203, Marblehead, Mass.

**OLD Money** wanted—Will pay fifty dollars for nickel of 1913 with Liberty head (no buffalo). We pay cash premiums for all rare coins. Send 4c for large coin folder. May mean much profit to you. Numismatic Co., Dept. H, Ft. Worth, Tex.

**UNITED States**. Large cent, two-cent bronze, three-cent nickel and bargain list, 25c. Thirteen dates large cents, \$1.00. George Coffin, Greenwood Mountain, Me.

40 **OLD Coins** all different \$1.00; 100 different coins, \$3.00; 100 mixed foreign coins, \$1.00; Monroe half-dollar Unc, \$1.00; Grant half-dollar Unc, \$1.00; Stone Mountain half-dollar Unc, 75c; 100 different civil-war tokens, \$7.50. Claud Denney, Box 315, Dallas, Tex.

**RARE Coin** book, 65c. 700 illustrations. Money refunded if not satisfactory. Coin Bulletin \$1.00 per year. Coins appraised for estates. Guttag Bros., 16 Exchange Place, New York.

**GET Profit** and pleasure in collecting old coins. Send 10c for large illustrated coin catalogue. You'll be delighted with it. Send for it right now. B. Max Mehl, Numismatist, Mehl Bldg., Dept. P, Forth Worth, Tex. Largest Rare Coin Firm in the U. S.

**OLD Coins**, large Fall selling catalog of coins for sale free to collectors only. Catalog quoting prices paid for coins, ten cents. William Hesselein, 101A Tremont St., Boston, Mass.

**CALIFORNIA** Gold quarter 27c, half 52c; cents: 1814, 40c; eagle, 20c; Washington, 2c; 1863 encased stamps. A. Wylie, 365, Wheaton, Ill.

20 **ASSORTED** Foreign coins, postpaid 25c. Oddehon, Box 681, Kansas City, Mo.

\$2 TO \$500 Each paid for hundreds of old coins. Keep all old money, it may be very valuable. Send 10 cents for illustrated coin value book, 4x6. Prices guaranteed. Get posted. We buy and sell. Clarke's Coin Office, Box 5, Le Roy, N. Y.

**RARE** United States and foreign coins, war medals and decorations, Chinese coin and catalog 10c. Alexis Mengelle, Colorado Springs, Colo.

**CALIFORNIA** Gold—Quarter size, 27c; 3/4 size, 53c; 3c piece and catalog, 10c. Norman Shultz, Box 746, Salt Lake, Utah.

**AMERICAN** Eagle cent, large cent, French 10c piece, 2 crisp notes and catalog 20c. George Best, Cedar Rapids, Iowa.

**EMERGENCY** Coin, six emergency bills, catalog, 10c. Wacker, Minster, Ohio.

#### FOR BOYS

"THE Book of 1,000 Wonders" will be sent postpaid for 10c. Explains many mystifying tricks with coins, cards, handkerchiefs, etc., you can do. Also, contains complete catalog of magic tricks, jokes, puzzles, books, escapes, mindreading acts, spiritualistic effects, illusion plans, curios and imported novelties from many foreign lands. Large assortment, lowest prices. You will amaze and mystify your friends! Send 10c today. Lyle Douglas, Station A-5, Dallas, Tex.

**LOOK—Boys, girls** earn money for Christmas. Make \$2.00-\$3.00 easily every day after school. You will never be a success unless you try things while you are young. Costs nothing to find out. Don't pass this up. Write Johnson-Wagner Co., 1219B Grace St., Chicago, Ill.

**EARN** Christmas money. Order 50 sets Christmas Seals. Sell for 10c set. When sold return \$3.00, you keeping \$2.00. No work—just fun. St. Nicholas Seal Co., Dept. 43PM, Brooklyn, N. Y.

**BOYS!** Look! Supplies for model airplanes. Price list on request. Smash, Stapleton, N. Y.

#### CAMERAS AND PHOTO SUPPLIES

**PHOTOGRAPHIC** Equipment and accessories of every description are listed and illustrated in our 228-page catalog. It will pay you to secure a copy which is issued free, as our prices are low. We also deal in used goods which are sold under the same guarantee as new goods. Ask for our Bargain Book. Central Camera Co., Dept. E135, 112 S. Wabash Ave., Chicago, Ill.

**PUT** your camera to work; \$5 and even \$10 often paid for small snap-shots. 611 pictures from \$4 camera brought \$2,126.84 with our plan. Send \$2.00 at once for this big-profit, play-work proposition. Dale Van Horn, 420 Federal Trust, Lincoln, Nebr.

**EARN** Big money with your camera in your spare time, using Halldorson Home Portrait Lamp. Write for booklet "Home Portrait Photography" and catalog—both free. The Halldorson Company, 4747 N. Western Ave., Chicago.

**SALES** Inceaser—Sheasgreen's "Location Analysis Guide," \$1.00. Standard Cost, PM1427 North Penn, Minneapolis, Minn.

**SNAPSHOTS** Enlarged from your negatives. Two 8x10 for \$1.00. Send money with order or write for particulars. Wesley Studios, Box 30, East Orange, N. J.

**GERMAN** Cameras, lenses. Bartro, 6438 La Riba Way, Los Angeles, Calif.

**BIG** Money in photography. Catalog 49A free. New York Institute of Photography, 10 West 33rd St., New York.

**TIME** Counts in applying for patents. See pages 138 and 139. Clarence A. O'Brien, Registered Patent Attorney, Washington, D. C.

**MAKE** money in photography. Learn quickly at home. Spare or full time. New Plan. Nothing like it. Experience unnecessary. American School of Photography, Dept. 3431, 3601 Michigan Avenue, Chicago.

**ROLL** Developed—Six prints, one beautifully tinted, 25c. 8x10 enlargement, 30c. Falls Foto Finishers, Dept. A, Glens Falls, N. Y.

**HAVE** You a Camera? Write for Free sample of our big magazine, showing how to make better pictures and earn money. American Photography, 116 Camera House, Boston, 17, Mass.

**FILMS** Developed. Special Trial Offer. Any Size Kodak film developed 5c, prints 3c each. Trial 6x10 Enlargement in handsome folder 40c. Overnight Service. Roanoke Photo Finishing Co., 209 Bell Ave., Roanoke, Va.

#### MOTION PICTURES

**NEW** \$150 Spring movie camera, \$29.50; 35mm film, 2 1/2 foot; Filmo Camera \$100; Cine Kodak 16mm camera, \$50; 16mm, 100 ft. negative film \$4.50 postpaid; 100 ft. complete 16mm comedy, western travel, or war reel, \$4.50. Cameras, projectors and films bought and exchanged. New twin arc movie lamps \$40. 3 1/2 x 5 1/2 Kodak, \$9; Remington typewriter, \$16, Ray, 296 Fifth Ave., New York.

**ASTONISHING** Small capital starts you into moving picture exhibitional business. \$35.00 upward profit nightly. Openings everywhere. Experience not essential. Teach you, furnish everything. Address, Box 481, General Postoffice, New York.

**STARTLING** Bargains in motion-picture cameras, projectors, apparatus. Send stamp for the 192nd issue of the Bass Bargain-gram. Never in history has such startling bargains been offered in guaranteed apparatus. Write for your copy now. Remarkable motion-picture exposure meter, \$2.00. Sixty-six page catalogue. Send stamp. Bass Camera Company, 179 W. Madison St., Chicago, Ill.

**BARGAINS:** Projectors and films sold and loaned. Allowance on old machines. Richters, 756 East 155th St., New York.

**\$1,250.00 FOR** A photoplay story by an unknown writer and sold through our sales department. We revise, copyright and market. Located in the heart of the motion picture industry. We know the demand. Established 1917. Postal brings free booklet with full particulars. Universal Scenario Company, 206 Western and Santa Monica Bldg., Hollywood, Calif.

**JUST** Out! Fourth edition Motion Picture Projection by Cameron, 1,248 pages. Largest work ever published. Includes 150 pages on talking movies. Covers all known makes of projectors, including amateur. A liberal education. Yours for \$6.00 postpaid anywhere in the United States. Foreign, \$6.25. Circular on request. Bass Camera Company, 179 West Madison St., Chicago.

**MOTION** Picture lenses for sale. 32 mm., 40 mm., 50 mm. and 75 mm., F 2.5, F 3.5, F 4.5. Some in Bell Howel mounts. Make us offer. Universal Pictures Corporation, Purchasing Dept., Universal City, Calif.

**FOR** Sale: Moving picture films, features, comedies, serials, one dollar per reel and up. Progressive Pictures, 3320 Lindell, St. Louis, Mo.

**SWAP** 16mm Films. Standard films \$2.50 reel. Stewart Marshall, Rome, Ga.

**WANTED** To buy—Second-hand Power's, Simplex and Motiograph machines. Also extra mechanisms and stands. Must be bargains. P. O. Box 202, Birmingham, Ala.

**BE** A movie exhibitor—Big opportunity—Only moderate capital required—Complete equipment at remarkably low prices. Write. Atlas Moving Picture Co., 624 South Michigan Ave., Chicago, Ill.

**NEW** and Rebuilt Projectors for Theaters, Schools, Churches, Traveling Shows. Supplies and Complete Theater Equipments. Bargain Prices. Free Catalog. Monarch Theatre Supply Co., Memphis, Tenn.

**MOVIE** Films, 1,000 ft. reels, \$2.50 each; shipped anywhere on receipt of remittance. Particulars on request. Independent Films, 177 Golden Gate Ave., San Francisco, Calif.

**TIME** Counts in applying for patents. See pages 138 and 139. Clarence A. O'Brien, Registered Patent Attorney, Washington, D. C.

**BIG** Money in photography. Catalog 49A free. New York Institute of Photography, 10 West 33rd St., New York.

**FILMS** 1/2 Foot. Searles, 130 Fisk St., Providence, R. I.

**LEARN** Theatre management at home. Write for catalog M. Moving Picture Theatre Managers Institute, Elmira, N. Y.

**FILMS** For toy machines. New bargain list. Alton Films, 205 Brush Creek, Kansas City, Mo.

1,000 **FEET** Of comedy, \$2.00. No lists. Sunset Film Exchange, 298 Turk St., San Francisco, Calif.

250 **FEET** Film \$1.00. Eastin Films, Box 424, Galesburg, Ill.

**FILMS**, 200 Feet full of action \$1.00. J. Brink, 43 Winchester St., Boston, Mass.

#### SCENERY TO RENT

**WORLD'S** Most Beautiful Settings for operas, plays, minstrels, Amelita Grain, Philadelphia.

#### EDUCATIONAL AND INSTRUCTION

**STUDY** Law at home. Lawyers earn \$5,000 to \$10,000 yearly. Send for catalog. Chicago School of Law, Reaper Block, Chicago, Ill.

**SHORTHAND** In 30 days. Big field. \$35-\$45 week. Send for catalog. Chicago Home Study Schools, 801 Reaper Block, Chicago, Ill.

**BECOME** Watchmaker, jeweler, diamond setter; own business; paying job. Watchmakers Institute, 111 West 111th, New York.

**BE** A Landscape Architect—Splendid earnings, real success awaits you in this uncrowded profession. We train you by correspondence. Personal guidance by noted authorities, helping you get started. Immediate income possible. Catalog free. Write today. National School of Landscape Design, 518 Equitable Bldg., Des Moines, Iowa.

**DANCING**—Full instructions, 50c. Stewart's, 3446 North Third St., Philadelphia, Penna.

**WANTED**—Boys—men. Become auto mechanics. Sample training free. Franklin Institute, Dept. J400, Rochester, N. Y.

**SHORTHAND** 20 Lessons. Gregg system, taught by correspondence. Write W. Wise, 519 W. 12th St., Grand Island, Nebr.



**MEN—Women, 18-50.** Get U. S. government life jobs. Commence \$105.00 to \$158.00 month. Steady work. Paid vacations. Common education. 32-page book with list positions, sample coaching and full particulars free. Write immediately. Franklin Institute, Dept. J-14, Rochester, N. Y.

**MAIL Carriers, clerks, railway postal clerks.** \$158.00 to \$225.00. Steady jobs. Men, 18-45. Sample coaching free. Write immediately. Franklin Institute, Dept. J-3, Rochester, N. Y.

**FIREMEN, Brakemen, baggagemen (white or colored), sleeping car, train porters (colored),** \$150-\$250 monthly. Experience unnecessary. 810 Railway Bureau, East St. Louis, Ill.

**WANTED Immediately, men to qualify for railway mail clerk, P. O. clerk, carrier;** \$141-\$225 mo. Write, Ozment Inst., 101, St. Louis, Mo.

**STAMMERING, Stuttering, other speech troubles, corrected.** Wilson Schools, Dayton, Ohio.

**BIG Demand for photoplay and magazine stories.** We revise, develop and copyright. Sell on commission. Established 1917. Booklet free. Universal Scenario Company, 406 Western and Santa Monica Bldg., Hollywood, Calif.

**U. S. GOVERNMENT wants men.** \$1,700-\$1,900 and up at start. Railway Mail clerk examination coming. Let our expert (former Government examiner) prepare you for this and also Rural Carrier, Post Office, Customs, Internal Revenue, and other branches. Write today for free booklet. Dept. 8, Patterson School, Rochester, N. Y.

**STUDY A Scientific Profession. Sanitation—Bacteriology—Microbiology. Extension—Residential courses. Diplomas—Degrees granted. Urinalysis outfit and prospectus free.** Int. College of Microbiology, 722 Calumet Ave., Hammond, Ind.

**DON'T Prepare for any civil service examination without seeing our catalog.** Free. Columbian Correspondence College, Washington, D. C.

**BIG Money in photography.** Catalog 49A free. New York Institute of Photography, 10 West 33rd St., New York.

**DOUBLE Entry Bookkeeping mastered in 60 hours with 8 keys; guaranteed; diploma.** International Bookkeeping Institute, Dept. 8, Springfield, Mo.

#### RADIO OUTFITS AND SUPPLIES

**QUALITY A. C. Filament Transformers.** Input 110 volts, 60 cycles. No. 101 supplies six 226s, two 227s, and two 171s. No. 115 supplies nine or less Arcturus 15 volt tubes. Either type, list price, \$8.00. Factory to you price, \$3.90 prepaid. Wholesale price circular on transformers and chokes sent free. Quality Transformer Company, Box 135, Oak Park, Ill.

**RADIOLA No. 16—sets \$30.00; 6 tube 1 dial control Crosley Super Musicone speakers.** \$2.95; require cone paper only. Saal speaker units, \$2.00; transformers, 75c; Henry chokes, 90c; UX280 full wave tubes, \$1.75; 2 microfarad condensers, 60c; battery cables, 35c; condensers, 50c. Send money order with order. Charles Hoodwin Co., 4240 Lincoln Ave., Chicago. Dealers in Bankrupt Stocks.

**TRANSFORMERS 1,000v, 1,500v, 2,000v, \$8.00, 650v, \$5.50; 5-0v, \$4.00; chokes, 250ma, \$7.50; 160ma, \$5.00; 100ma, \$2.00.** Write for specifications. Radio Parts Co., Orange, N. J.

**300-MILE "Pocket" radio, \$2.00.** No tubes nor batteries required. Useful and practical. Loud-speaker volume. Order direct today. Spencer Laboratories, 116 Atlas, Akron, Ohio.

**DUBILIER Wave trap, best yet, \$1.00.** Durso, 25 Mulberry, New York City.

**TINY Cheap inside extra aerial will make your radio perform wonderfully.** Easy to make. Instructions, drawings, 25c coin. Berg, A-430 Davidson, Bridgeport, Conn.

**BARGAINS In used radios.** These receivers were taken in trade. All guaranteed perfect working order. Blue Ribbon 5 tube, 2 dial, console model \$19.95. Freshman 5 tube table model \$14.95. Atwater Kent \$19.50. Tubes included with sets. Many other makes. Send money order with order. Complete list of bargains on request. Surplus Radio Co., 549 S. Wells St., Chicago.

**WORLD'S Smallest receiving set, 25c.** Robert Berryman, 1611 Park Drive, Raleigh, N. C.

**FREE Radio catalog and text book.** Guaranty Radio Goods Company, 145 West 45th St., New York City.

**WANTED: Men to work with National Radio Service organization.** No selling scheme. Radio Doctors, Inc., Dept. M, Essex St., Salem, Mass.

**TIME Counts in applying for patents.** See pages 138 and 139. Clarence A. O'Brien, Registered Patent Attorney, Washington, D. C.

#### TRADE AND TECHNICAL SCHOOLS

**OUR Commercial radio operating and junior engineering course pays our graduates \$150 to \$300 monthly from start.** Rapid advancement. Fall term begins in September. Write for catalog of course including Extension Course. Loomis Radio College, Dept. 5-E, Washington, D. C.

**WANT A foreman's job? You may be a good mechanic but if you can't read blueprints you haven't a chance.** I train you quickly. Write me your trade. Carroll Rumsey, 266 Drexel Building, Philadelphia.

**TELEGRAPHY—Both Morse and wireless—taught thoroughly.** Big salaries. Wonderful opportunities. Expenses low; chance to earn part. School established fifty-four years. Catalog free. Dodge's Institute, Fern St., Valparaiso, Ind.

**LICENSED Radio doctors earn \$75.00-\$100.00 per week.** Big demand; investigate at once. Free booklet. Radio Doctors, Inc., Dept. A, Essex St., Salem, Mass.

**YOUNG Men—No experience.** Become R. R. station agents or telegraphers. Earn \$150 to \$300 monthly; no layoffs; rapid advancement. For free information write Illinois Telegraph, 1608 W. Madison St., or Room 711, 117 N. Dearborn St., Chicago, Ill.

**LEARN Decorating, sign painting, paper-hanging, card writing.** Practical training, oldest school in United States. Chicago Painting School, 448 North Clark St., Chicago, Ill.

**MEN—Boys learn auto mechanics and electricity.** Big pay. Big demand. Free catalog. Stevenson School, 2008 A Main St., Kansas City, Mo.

#### BUSINESS OPPORTUNITIES

**ARE Your profits correct? Accounting records supervised; taxes, audits and consultation services; systems installed by expert public accountant, \$5.00 month and up.** Limited number of ambitious persons trained under own personal supervision to handle clientele in their districts. Thomas S. Curley, 15 Homesite, Lynn, Mass.

**LOID-LAC—Make this new, wonderful, amazing discovery; restores color, new finish to old cars in sixty minutes!** Not a polish, cleaner, paint or wax. With my simple guaranteed formula you can easily manufacture Loid-Lac, clearing \$13.00 gallon profit! Clean up thousands with this guaranteed instant refinish. Miller, Chemist, 706 Miller Chemical Bldg., Tampa, Fla.

**NEW Specialized business—yet you can make \$1,000 per month.** Start an auto glass shop, replace broken glass in cars. Accidents increasing—garages send you work. I'll tell you how to start, but reserve Milwaukee territory. Write Auto Glass Shops, 752, 53 National, Milwaukee, Wis.

**MIRRORS Resilvered at home.** Costs less 5 cents per square foot; you charge 75 cents. Immense profits plating like new, brassy worn-off autoparts, reflectors, tableware, stoves, etc. Outfits furnished. Details free. Sorinkle, Plater, 127, Marion, Ind.

**KING System mail order business.** It's New! Different! Honest! Big profits! Details 25c. Satisfaction guaranteed. Evans King Co., Box 672PC, Wilmington, Del.

**MAKE Money selling my beautiful sea shell watch charms.** Sample by mail 20c. Dozen \$1.25. Box 2868, Miami, Fla.

**NO Peddling. Start own business.** Home, office. Free folder describes 27 money-making opportunities. No outfits. Elite Co., 38 Elizabeth St., New York.

**ARTIFICIAL Stone houses: You can have steady work all the year round.** Learn to build artificial stone-houses. Stronger than concrete and cost only one-fifth the price of frame houses. No experience needed. Complete instructions \$2.00. P. Swendsen, Box 60, Juneau, Alaska.

**UNIQUE Novelties, magical mysteries, perplexing puzzles.** Catalog free. Novelty, 2050 West Davison, Detroit.

**MILLIONS—Waiting to buy the wonder patented-combination auto tool-wrench-pry-clawhammer; indispensable to every autoist, no springs, no screws, quick ratchet adjustment, drop forged, steel, indestructible.** Salesmanship unnecessary; just show it. It's sold. Agents, big money. Territory free. Write Auto Tool Company, 12 South Canal St., Chicago, Ill.

**GOOD Positions are easy to get, anywhere.** Write for free advice P22. A. Allard, Mont-Joli, Que., Can.

**HONEST Money making plan; establish permanent repeat business, employ others and double profits; mail \$1.00 for instructions.** Masco Sales Co., 341 Lincoln Hotel Bldg., Rochester, N. Y.

**NEED Xtra money? Weave rugs at home.** Loom book free. Union Looms, Boonville, N. Y.

**CAPITAL Seekers—Put your project before 260 live wire brokers—cost trifling.** Details free. Amster Leonard, East Orange, N. J.

**\$1.00 BRINGS You 20 profitable business opportunities.** Each one a proven success. Cassidy, 1497 Heien, Detroit, Mich.

**START A Crispette shop.** Delightful confections. Everybody likes them. Make a lot of money. Adams reports \$364 profits in two days. We start you. Write, Long Eskins, 1962 High St., Springfield, Ohio. (Samples 10c.)

**BUSINESS Profession of your own and earn big income in service fees.** See Stephenson Laboratories, display ad page 134.

**100 MAIL Order sales plans \$1.00.** Wright service, 820 Garland Bldg., Chicago.

**LIVE in California—Thousands of miles of beautiful paved highways being constructed, making fine location for garages, service stations and other business.** Send for free information. B. Nisbet Co., 832 So. Vermont, Los Angeles, Calif.

**"12 EASY Money making plans" \$1.00.** Good anywhere. Cecil E. Hoover, 266 Los-Flores Dr., Altadena, Calif.

**\$100 STARTS Profitable route of peanut and chewing gum machines.** Particulars free. Chewit Corp., Dodworth St., Brooklyn, N. Y.

**IF You want expert information or formulas, any line at small cost, write H. Newman, Box 343, Madison Square Sta., New York, N. Y.**

**WANT More money? See what "The Silver Eagle" has for you!** Send ten cents stamps. L'hernault, 3170 Broadway, New York.

**SHOE Shiners and tailors—Learn how to clean hats and make more money.** Something new. Write Scientific American Hat Renovator, 432 Tenth St., New Kensington, Pa. Enclose stamp.

**ATTENTION! Establish for yourself new system real estate, brokerage and insurance agency; office at home; earn \$5,000 year.** Stamp free booklet. Hayes Realty Association, Cincinnati, Ohio.

**AN Opportunity. Exclusive sale rights for Intol in your town.** Spare time to start. County proposition to follow if you measure up. Steady repeat business, all year round. Intol, Inc., Keyport, N. J.

**"SCHEMER" Subscribers surely succeed.** One reports \$50,000 from one tip; another \$25,000 from three Schemes; another \$10,000 from one formula. Try your luck! Year, \$1.00; three months, 30c. Patterson, Publisher, Alliance, Ohio.

**IF You are interested in saving 30 to 35% on your postage bill, mail me 5c for usable samples of my covered envelopes and cards; none free.** Edward Armour, M2, 136 East 28th St., New York.

**FREE Book.** Start your own little business anywhere, selling novelties by mail. My beginner's outfit contains everything required, novelties, circulars, instructions, etc. Descriptive book free. Hadwil, 2H-74, Cortlandt St., New York.

**BUSINESS Opportunities: Men and women—something new. Big profits.** E. A. Barr Co., Desk 1, Shamokin, Pa.

**MAKE Toys, novelties, children's furniture.** Instructions patterns, including scroll saw \$1.00. Wm. Bogren, 2264 Hermany Ave., New York.

**EXTRA Money and a chance to establish your own independence can be made with well chosen spare-time occupation.** We help you find it. Write Vocational Service, 7417 Lantona Ave., Seattle, Wash.



**MAKE Big Profits with a Fur Farm** in your backyard. Chinchilla Rabbits, Muskrat, Mink. Write for facts, 252 Conrad's Ranch, Denver, Colo.

**EARN More money**—We show you how. Catalog free. Herman Service, 706 Calhoun, Fort Wayne, Ind.

**SIGNS** And showcards easily painted with letter patterns. Large variety of styles and sizes. Samples for stamp. John Rahn, a2120 Neva Ave., Chicago.

**BUSINESS** Information of every character. We divulge actual supply source of American-made goods, how to sell locally, by mail or through agents. Chemical analysis, formulas, money-saving business information, opportunities. Write for catalog. Business Information Syndicate, Box 1071, Knoxville, Tenn.

**SELL** Latest imported novelties. French model pocket mirror and transparent art cards. Samples of all postpaid \$1.00. World Service Co., 336 Marcy Ave., Brooklyn, N. Y.

**15c BRINGS** Big bunch mail year. Kentucky Agency, Covington, Ky.

**INCOME** Increaser—Newly enlarged 36-page monthly magazine of best, latest ideas, plans, schemes, tips, pointers, starters. One year, \$1; sample, 10c. Income Increaser, 88 Pearl, Boston, Mass.

**YOU** Want to buy profitably established mail order business, or do you wish to sell? Write with name. Eastern Exchange-1, 112-Smith, Millville, N. J.

**10c BRINGS** YOU mail from everywhere and our opportunity information by return mail free. Witham, Box 153, Cathlamet, Wash.

**TIME** Counts in applying for patents. See pages 138 and 139. Clarence A. O'Brien, Registered Patent Attorney, Washington, D. C.

**SIXTY** Successful mail order propositions. K. Home, 3949 Metropolitan, Chicago.

**SELL** by Mail! Books, novelties, bargains! Large profits! Particulars Free! B-Elfco, 525 South Dearborn, Chicago.

**I MADE \$30 a Week** Home. French Breadmaking, 15 years' experience; Free Booklet tells. Ashbrook 67, Marengo, Ohio.

**CHEMICAL** Expert will furnish formulas and trade secrets. All lines. Lists free. W. L. Cummings, Ph. D., 228 Gordon Ave., Syracuse, N. Y.

**DON'T** Sell for others. Employ agents yourself. Make your own products. Toilet articles, household specialties, etc. 500% profit. Valuable booklet free. National Scientific Laboratories, 1984W Broad, Richmond, Va.

**CHARTERS:** Delaware; best, cheapest; free forms. Colonial Charter Co., Wilmington, Del.

**UNPATENTED** Ideas can be sold. I tell you how and help you make the sale. Free particulars (Copyrighted). Write W. T. Greene, 810 Baltic Building, Washington, D. C.

**A BUSINESS** of Your Own Making—Sparkling Glass Name and Number plates. Checkerboards. Signs. Big book and sample free. E. Palmer, 540, Wooster, Ohio.

**MECHANICS.** Painters, carpenters, start furniture refinishing, painting, handyman shop on nearly nothing; winning plan brings customers quickly. John Braceland, 1439 So. Ninth, Philadelphia, Pa.

**ARTIFICIAL** Marble sanitary flooring instructions, covering wood or cement flooring 1/2 inch thick, fireproof, waterproof, all colors, low cost. Ornamental castings, concrete, plaster, papier-mache decorations, garden furniture, statuary, flexible molds. 18 years instructing the public; particulars and illustrations free. Chris. Mahler, Huntington, N. Y.

**WE** Start you in business, furnishing everything; men and women, \$30.00 to \$100,000 weekly operating our "New System Specialty Candy Factories" anywhere. Opportunity lifetime; booklet free. W. Hillyer Ragsdale, Drawer 4, East Orange, N. J.

**SUCCEED** With Your Own Products. Make them yourself. Formulas, Processes, Trade-Secrets. All lines. Catalog, circulars free. B. Thaxly Co., Washington, D. C.

**LEARN** the collection business. Good income, quick results. Interesting booklet, "Skillful Collecting" free. National Collectors Assn., Long St., Newark, Ohio.

**MAIL** Order business your opportunity. Brenner's famous hand books by expert 28 years' experience show how to start selling articles you make or buy—all or part time—small capital. Fascinating, profitable. Set eleven books, \$3.25. Brenner Company, 1607 P. Sansom, Philadelphia. Sample book, 25c, pay \$3 for other ten if satisfied.

**SUPPLIES** For making chipped glass house numbers and signs. Tinfoils, glass and frames. Osborne Sims, 13580 Tuller, Detroit, Mich.

**DELAWARE** Incorporator. Charters; fees small; forms. Chas. G. Guyer, 901 Market St., Wilmington, Del.

#### TELEGRAPHY

**TELEGRAPHY**—Both Morse and wireless—taught thoroughly. Big salaries. Wonderful opportunities. Expenses low; chance to earn part. School established fifty-four years. Catalog free. Dodge's Institute, H St., Valparaiso, Ind.

#### CHEMISTRY

**YOUR** Chemical problems solved and working formula or process furnished for \$5.00. Write me. W. Stedman Richard, Industrial Chemist, Box 2402, Boston, Mass.

**CHEMICAL** Analysis, processes, technical information. Robert Henderson, Laboratory, Madison, Me.

#### FORMULAS AND TRADE SECRETS

**MAKE** Honey without bees. Good as the bees make four cents pound. Formula one dollar. Frame, Rockland, Ohio.

**CHEMICAL** Consultation and analysis. Manufacturing ideas made practical. Money-making formulas. Charges moderate. Write Associated Chemists, Indianapolis, Ind.

**FINE** Merchandise bought at bankrupt auction sales easily sold at 1/4 to 1/2 usual cost. Wonderful opportunity for agents. Ray, 296 5th Ave., New York.

**FREE** Formula catalog, latest money makers. Western Chemical, Salem, Ore.

**ENORMOUS** Profits manufacturing specialties at home. Youman's Guide tells how. \$2. Catalog free. Bernard Wells, 852 George, Chicago.

**MAKE** Your own products. Specific formulas \$1.00 each. Chemical consultation and analysis of your sample, \$5.00. Stenton Laboratories, 2122 Griffith St., Philadelphia, Penna.

**DON'T** Sell for others. Employ agents yourself. Make your own products. Toilet articles, household specialties, etc. 500% profit. Valuable booklet free. National Scientific Laboratories, 1984W Broad, Richmond, Va.

**SUCCEED** With Your Own Products. Make them yourself. Formulas, Processes, Trade-Secrets. All lines. Catalog, circulars free. B. Thaxly Co., Washington, D. C.

**FORMULAS**—170 Money makers and big illustrated catalog 20c. Ideal Book Shop, (K) Park Ridge, Ill.

**3,000 VALUABLE** Formulas prepaid \$1.00. National Service, 3937 Marburg, Cincinnati, Ohio.

**FORMULAS**—High grade trustworthy processes for producing popular guaranteed best selling specialties; all lines. Don't buy formulas till you've received my literature. Miller, Chemist, 706 E. Jetton, Tampa, Fla.

**SAWDUST.** Chemicals make sanitary flooring. Directions, \$1.00. Universal Supply Co., Auburn, N. Y.

**ANY** Desired formula \$1.00. Mark Twain Laboratory, Hannibal, Mo.

**TRAPPERS** Earn \$1,000 to \$5,000 each season with home made bait. Guaranteed to take fox and mink. Formula originally cost \$5.00, will sell to limited number for \$1.00. Raymond V. Parker, Trapper, 2 Clark St., Newport, Vt.

#### AGENTS WANTED

**AGENTS**—I'll pay your bills, give you steady income for rest of your life if you will take care of my business in your locality, full or part time. You be my partner, make \$15 a day. Ride in Chrysler sedan. Distribute teas, coffees, spices, extracts, things people eat. I furnish everything, world's finest super sales outfit containing 30 full sized packages low prices, big repeat business; \$25,000 guarantee on quality. I go 50-50 with you. Get my amazing offer. C. W. Van de Mark, 117 Duane St., Dept. 102-M, Cincinnati, Ohio.

**NO** Dull times in the food business. Selling Federal Pure Food Products is the greatest, surest and safest business in the world today, and here is your opportunity to get into it. You can make \$3,000, \$5,000, \$10,000 or more per year—the only limit is your ability to take care of the business. You will need no experience or money to get into this business. We teach you everything you need to know. We furnish you with license. No dull times, for the people must eat, and our food products are the fastest selling, surest and quickest repeat order goods in the world. Sell on sight in every home where food is used—repeat orders immediately and every week thereafter. A real big business all your own. Every new customer adds a great deal to your weekly income. Your business once established, has a market value just like a store and can be easily sold. The greatest money-making opportunity of your lifetime because you risk absolutely nothing. Remember! Guaranteed! Best products, biggest sellers, surest repeat orders. No capital or experience is required. We furnish capital and everything necessary for you to become a Federal distributor. Exclusive territory will be given honest men or women who write at once. Federal Pure Food Company, A2307 Archer Ave., Chicago, Ill. Largest packers of pure food specialties in the world. Reference, any bank, Dun or Bradstreet Rating Agency, Express or Railway Company in America.

**PRIVATE** Brand toilet articles, household specialties, perfumes, soaps, extracts, etc. We pack these goods for you under your private label. With your name on the goods you get all the repeat business. Don't sell for others but build up a profitable business for yourself. Highest quality merchandise. Extremely low prices. Quick shipments on both large and small orders. Write immediately for lowest wholesale prices and complete information regarding our amazing offer. Address Supply Department, National Scientific Laboratories, 1904W Broad, Richmond, Va.

**MAKE** Money with Christmas Greeting Cards in box assortments. \$2.00 to \$4.00 per hour easily made. Nothing ever sold compares with the sale of Christmas greeting cards; sell on sight. Our magnificent assortment contains 21 high-grade Christmas greeting cards and folders, each with envelopes, steel engraving. French water coloring, sparkling metallic old and silver effects, panelling and bordering. Sells for only \$1.00, costs you 50c. Write immediately for full particulars and free samples. Waltham Art Publishers, 7 Water St., Dept. TN, Boston, Mass.

**MAKE** These guaranteed biggest selling products yourself. Have others selling them. Investment small; profits immense! Loid-Lac Instant Automobile Refinish. Tuf-Nit prevents hosiery runs. Kazok automobile dry wash cloth. My "Eye Opening" literature of these and many other automobile, food, household, cleaners, soaps, polishes free. Make your own goods for one-fourth what "Private Brand" and other goods cost you. Miller, Chemist, 706-A Chemical Bldg., Tampa, Fla.

**AGENTS,** \$20 A day. Sell finest new line up-to-the-minute hosiery you ever saw. Every pair strictly guaranteed. Also appoint sub-agents and receive extra big commission daily. Exclusive territory. Producers earn Ford car. Premium to customers and new selling plan brings enormous sales and profits. Extra fine silk hose for your own use. Write quick for territory and samples. Wilkmit Hosiery Co., Dept. 5831, Greenfield, Ohio.

**AGENTS**—\$13.80 Daily in advance, introducing new insured hosiery for men, women, children. Must wear or replaced free. 57 styles, 39 colors including latest "Silk to the Top" ladies' hose. Nyland made \$395 in one month. Edwards, \$460.60. Mrs. Bone, \$425.45. Why not you? Even spare time should pay you \$3.00 an hour. No experience needed. We furnish samples. New plan. Write quick. Maccohee Company, Park 25611, Cincinnati, Ohio.

**TAKE** Orders for Orthophonola phonographs and make \$126 weekly. Part time brings \$3 hour. Write quick for samples. Orthophonola Mfg. Co., 757-F Broadway, New York.

**ENGRAVED** Nameplates, signs, numbers, initial, desk, city nameplates. Big profits. Hilton Specialty, 90 Stewart, Providence, R. I.



**AT LAST!** Amazing new patented automatic window washer cleans, washes, dries, polishes in one operation. Two sizes—homes, stores. Sells instantly on demonstration! Greatest knockout in all specialty selling history! Any man or woman who has sold the housewife can clean up on this! Write quick! Wonder Specialty Co., Dept. 23, Forest Hills, N. Y.

**AGENTS—**Big money selling most useful household articles and novelties. All "quick sellers." Special combination offer, four dozen articles for \$5.00. Your profit \$9.00. Exclusive territory. Ideal Utensil Co., Otis Bldg., Chicago.

**\$100 WEEKLY** Easily earned selling new patented electric water heater. Sells for \$6.50. You pay us \$3.00. Jiffy Electric Water Heater Co., 842 Maxlow, Detroit, Mich.

**BIG** Pay distributing cigar lighter sales boards. Burdick, 1223 Milw. Ave., Racine, Wis.

**SELLING** Like blazes! 11 piece toilet goods assortment at \$2.25 with 2 piece carrying set free to your customers. 100% profit. E. M. Davis, Dept. 511, 234 W. North Ave., Chicago.

**AMAZING** Profits showing new Polly wrench. 10 wrenches in one. Guaranteed seller at sight. Agents making \$10-\$25 daily! Get yours free! Gellman Mfg. Co., Dept. 6C, Rock Island, Ill.

**AGENTS:** Stop ringing door bells, place carded "Gitsnifes" on store counters; establish steady big repeat business. Write Gits Co., P5419 W. Chicago Ave., Chicago.

**LUSTREBAC** Transforms dull faded cars to glossy show room finish in 60 minutes. Not paint or polish but a permanent new finish. No rubbing. Just flow it on. Representatives making real money. If you want a live proposition write at once. Shenango Specialty Co., Box 413, Sharon, Pa.

**LARGE** Concern has opening for men and women to sell guaranteed hosiery. Make \$50.00 weekly. Samples furnished. Write today. Gold Bond Hosiery, Dept. 1911, 1011 Chestnut, Philadelphia.

**WANT** Distributing Agent for Handslick, powdered hand soap; removes anything from hands; everybody a customer; sample free. Solar Products Co., J-2142 S. Troy, Chicago.

**GENUINE** Gold Leaf Letters anyone can put on store windows. Guaranteed to never tarnish. Large Profits. Enormous Demand. Free Samples. Write today. Metallic Letter Co., 438-D North Clark, Chicago.

**DON'T** Sell for others. Employ agents yourself. Make your own products. Toilet articles, household specialties, etc. 500% profit. Valuable booklet free. National Scientific Laboratories, 1984W Broad, Richmond, Va.

**MORE** Than a million customers are waiting you to show and sell them this remarkable new auto accessory. Tested, proved seller that appeals. Not sold in stores. Write quick for free sample offer. H. H. Brown, Sales Mgr., 16017 Welland, Detroit, Mich.

**AGENTS,** Distributors, make \$75.00 to \$200.00 weekly, selling Surety Powdered Hand Soap to garages, factories, hotels, mechanics, jobbers, etc. Many uses; 150% profit. Exclusive territory. Investigate today. Surety Mfg. Co., 236 W. Huron, Chicago.

**THE** Easiest thing you ever sold in your life. Fine car owners buy on sight. Write Sponge Nozzle Auto Washer Co., 3780 Clairmount, Detroit, Mich.

**IF** You want to establish independent cash, repeat life income, in a brand new, sensational, high-class business, demonstrating mysterious, scientifically approved, secret invention that is without competition, write Cedarwood Fumi-Teurs Corp., Throver Bldg., Atlanta, Ga.

**AGENTS—**Watches, all kinds. Biggest profits. Best opportunity you ever had. Monarch Watch & Jewelry Co., 115 E. Holman St., Paterson, N. J.

**PATENTED** Window lock. Every home needs several. Send 10c for sample and proposition. H. C. Sales Co., 114 Roosevelt Dr., Springfield, Ohio.

**INVESTIGATE** Our unique sales plan—250 household favorites; quick sales. 100% profit; steady business. Davis Household Products, Dept. 510, 234 W. North Ave., Chicago.

**\$75 WEEKLY.** Man or woman wanted with ambition and industry, to distribute Rawleigh's Household Products to steady users. Fine openings near you. We train and help you so you can make up to \$100 a week or more. No experience necessary. Pleasant, profitable, dignified work. Write today. W. T. Rawleigh Co., Dept. K-53PPM, Freeport, Ill.

**DOUBLE** Your income. Duo Quality Products call for more. Wonder cleaner, double strength extracts, toilet preparations, many household specialties. We co-operate fully. Beautiful premiums for customers. Splendid car for you. Write today. Duoform Co., C-1 Attica, N. Y.

**\$50 UP** Each week, full or part time, introducing new household necessity. No competition; just out; all women buy. Sample \$1.00. Particulars free. Woodson Mfg. Co., 1361 S. Flower St., Los Angeles, Calif.

**THE** Christensen Oval Double Cone Mop Wringer, rubs and scrubs and cleans the mop. H. K. Christensen, Fort Atkinson, Wis.

**SELL** Eureka Patching Paste, the substitute for needle and thread, will wash and iron. Particulars and sample dozen \$1.25 prepaid. Eureka Cement Co., 128 So. Canal St., Chicago.

**MEN—**Make money. Sell Fifth avenue fabrics, dress trimmings, pattern service, semi-made dresses that almost make themselves. No experience needed—we show you how. Reserve your samples. Write today. Dept. P-11, Princess Silk Mills, 244 5th Ave., New York.

**SPEEDEE** Cleaner. Astonishing repeat sales, unusual profits. Send 35c for two big 35c packages. Speedee Products Co., Cedarburg, Wis.

**\$95 WEEKLY** Selling Fifth avenue tailored suits, overcoats, \$13.75; commissions \$3.50; 100% virgin wool, worsted suits, overcoats, \$19.75, commission \$4.00. Satisfaction or money back. Handsome outfit free. Dept. M11, Avenue Tailors, 140 Fifth Ave., New York.

**\$5,000 A YEAR—**Selling Perry Photo Medallions. Big demand. Ready sales. 400% to 600% profit. Any photo copied perfectly on medallions, mirrors, compacts, jewelry, etc. Guaranteed likeness. Investigate. Free catalog, full details on request. Write today. P.M. Perry Photo Novelty Corp., 1793 Jerome Ave., New York.

**\$25.00-\$100.00 EXTRA** Every month distributing samples and filling orders on New Wonder Product. Excellent side line. Write for complete particulars, or better yet, send 50c for sample outfit. Dalrymple Co., Benton Harbor, Mich. Dept. J-284.

**LADY** Made \$8.25 in few hours selling New Discovery. Prevents "runs" in silk hosiery. Fast seller. Particulars free. M. W. Smith-1, Millville, N. J.

**QUICK** Sales—big profits with Sta-Lit cigar lighter. Sample dozen \$1.50. Sample 25c. Martin Company, 52-A East Ninth St., New York.

**BIG** Three moneymakers. Here's a combination of tested sellers that have made good. Special sample outfit includes colored signs, flashing plug and pocket cigar lighter, \$1.00 postpaid. Catalog free. EverReady, 52-A East Ninth St., New York.

**AGENTS:** Liberal commissions and bonuses selling high quality hosiery, handkerchiefs, scarfs, men's ties, curtains, bedspreads, linens. Also a big line of dress goods, silks, etc. 1,000 samples furnished. Write quickly. The National Importing Co., 573 Broadway, Dept. L190, New York, N. Y.

**MYSTERIOUS** Fluid mends hosiery and fabrics instantly. Make \$100 weekly introducing it. Free outfit to workers. New Way Laboratories, Dept. 126, Mt. Healthy, Ohio.

**GOLD** Leaf Window Letters and script signs; no experience; 500% profit. Samples free. Our letters made Hazelhurst \$200 week. Consolidated, 69T West VanBuren, Chicago.

**MAKE** \$10.00 To \$25.00 a day selling our fine quality food products, full line of groceries, motor oils, paints, family remedies, toilet preparations. Over 500 necessities. Everybody a customer. No capital or experience necessary. Selling outfit free. Write Loverin & Browne, K 1602 So. State, Chicago.

**SELL** Beautiful "Style Tailored" shirts, pajamas, lumber jackets and neckties direct to wearer at factory prices. Many beginners earn \$50 first week in spare time. \$100 weekly full time easy. Selling outfit free. Howard Shirts, 1213 VanBuren, Factory 26, Chicago.

**AGENTS—**90c An hour to advertise our goods and distribute free samples to consumers. Write quick for territory and particulars. American Products Co., 2192 Monmouth, Cincinnati, Ohio.

**NEW** Invention—100% profit. Liquid quick mend for fabric and hosiery. Stops runs. Every woman buys. 100 other fast sellers. J. E. Johnson Co., Dept. 471, 6129 Wentworth, Chicago.

**BE** Independent. Make, sell your own goods. Immense profits. Catalog dependable formulas, special selected agents' best sellers free. R. Lusto, 526 Reaper Block, Chicago.

**AGENTS—**Make a dollar an hour. Sell new kind of sharpeners. Sharpens all knives and tools quickly. Demonstrating sample 10c. Premier Mfg. Company, Dept. 85, Detroit, Mich.

**NEW** Fall and winter line is complete with men's, women's and children's underwear, hosiery, raincoats, sweaters, dress and flannel shirts. Overcoats, sheeplined coats, leather vests. Big commission, outfit free. The May Co., 103 So. Wells, Chicago.

**AGENTS:** Fall and winter line ready. Men's and boys' overcoats, sheeplined coats, leather vests; ladies', men's and children's underwear, sweaters, raincoats and hosiery. Outfit free. Northern Sales Co., 101 So. Wells, Chicago.

**\$100 WEEKLY** Appointing agents Mother Hubbard Foods. No canvassing, delivering or investment. Mother Hubbard Products, 554F Congress, Chicago.

**STOP:** 300 Fast selling specialties from many parts of world. Proposition hard to beat. Write for free wholesale catalog. Spors Co., Lesueur Center, Minn.

**MY** Agents make \$90 a week wearing and showing my beautiful new free raincoat and giving away free hats. Write today for yours. Robt. King, 230 So. Wells, Dept. AB-11, Chicago.

**AGENTS,** \$240 Month. Dri-Klean-It makes any car look like new. Removes mud, grease, tar, road oil all in one operation. No soap or water used. Cleans any car for 10c. Exclusive territory. Make \$5,000 year. Write for free sample. American Accessories Co., Desk 3631, Cincinnati, Ohio.

**\$25 DAILY** Selling \$2.85 colored raincoats. Hat free. 3 dresses \$4.73. Beats all competition. Outfit of 50 numbers free. American Waterproof, N 724 Roosevelt, Chicago.

**CHRISTMAS** Greeting cards—Biggest, finest line. 72 subjects from \$5 per 100 up. Prices greatly reduced, lowest in field. Sales easily made. Liberal commissions paid daily. Get our proposition at once. Buckeye Plateless Engraving Co., 404 Jackson, Toledo, Ohio.

**STRANGE** Invention! Pays \$25 daily. Keeps telephone and iron cords from tangling and kinking. Prevents iron scorching. Saves electricity. Samples free. Neverknot, Dept. 11-A, 4503 Ravenswood, Chicago.

**AGENTS—**Highest commission-bonus selling dress goods at wholesale prices. Full-spate time. Sample outfit furnished. North American Importing Co., 1123A Broadway, New York.

**MAKE** \$15-\$25 Daily. Sell personal Christmas cards and \$1 box assortments. Highest commissions. Big sample outfit free. Doehla Co., Dept. 3R, Fitchburg, Mass.

**WELLS** Cleared \$620.00 in one month with "Business Guide" and free legal service. Write for free outfit. Prof. Nichols, Dept. 29, Naperville, Ill.

**COMPLETE** Fall line fascinating raincoats. Newest trench models. Factory prices. Biggest commissions advanced. Large outfit free. Jeffrey Mfg., 716 Madison, Chicago.

**MAKE** Big money selling hair straightener to colored people. Write for free samples and terms to agents. Marcellene Chemical Co., 1906W Broad, Richmond, Va.

**AGENTS,** Distributors; whirlwind seller; gas stations, dealers, drivers "Miracle" windshield cloth; one wiping defies rain 24 hours; amazing results; retails 50c. Celco Chemical Co., 2225 Lawrence Ave., Toledo, Ohio.



**WOMEN: \$2** An hour spare time; 100% commission; new idea sanitary necessity; sells on sight; every woman buys; new feature never before used; designed by physician; revolutionizes old uncomfortable methods; pay every day; no deliveries; no collections; no experience or capital required. Write Mary P. Coleman, Meriden, Conn.

**MAKE \$100** Every week! New magic interchangeable signs. \$1.00 seller. All merchants buy. 300% profit. Write quick. Modern Sign Works, B-818 No. Wells, Chicago.

**RAINCOATS.** Full line, including latest trench coats. Sheeplined coats, leather jackets, shirts; popular prices. Outfit free. Commission 25% with bonus. Hydro Raincoat Co., Dept. 45, 718 Independence, Chicago.

**NEW:** Just Invented: Comb fastens anywhere. Send 10c for a 20c value. Comb Co., Lesueur Center, Minn.

**AGENTS—100% Profit** selling our low-priced, beautiful and attractive felt rugs. Perfect color combinations win instant admiration, insuring quick sales. Excellent opportunity to build substantial business. Eastern Mills, Everett, Mass.

**HEAT** Homes with oil for few dollars. Make big money on coldest days; \$100.00 a week or return sample. Write for proposition today. Otto Buder, Inventor, 3808 Park Ave., St. Louis, Mo.

**\$20 TO \$50** A week easy selling Parmode guaranteed shirts, nightwear, underwear direct to user. 24 hour delivery. Outfits free. Parmode, Inc., St. Louis.

**\$18 TO \$25 Daily;** biggest selling line of 2-piece suits, \$9.95 and \$12.50; 3-piece wool suit, \$17.95 (regular \$28.00 value). All-wool overcoats, \$18.50. Splendid raincoats, slickers and boys' suits. Biggest commissions. Free outfits. "Jim" Foster, Inc., Dept. 211, 2250 S. Spaulding Ave., Chicago, Ill.

**AGENTS—Just out!** \$8.88 for men's suits! Anyone can sell. Big commission in advance! Free sales kit. SSS Company, Dept. CL-7, Fort Wayne, Ind.

**AGENTS.** Portraits, photo-pillow tops, frames, sheet pictures, medallions, photo-jewelry, soaps, perfumes, laundry tablets, food products, toilet preparations, luminous crucifixes. Catalog 200 specialties free. 30-days' credit. Jas. C. Bailey Co., Station C-11, Chicago.

**EARN \$48.00** A week and expenses introducing our soap and washing powder. Auto earned by producers. Buss-Beach Company, Dept. A42, Chippewa Falls, Wis.

**350% PROFIT.** Samples free. Brighton Chem. Co., 3624 No. Western Ave., Chicago, Ill.

**AGENTS** Make \$100.00 weekly selling artograph (protected) marvelous new Swiss discovery \$1.00 prepaid, worth \$10.00 to watchowners. Artograph Co., 128 Octavia, San Francisco.

**MARVELOUS Seller—War** souvenir memorial. 273 Columbia, Portland, Oreg. Samples 25c.

**BARGAIN** Lots of chemical specialties for less than production cost. List free. People's Chemical Laboratory, 2519 South Crawford Ave., Chicago, Ill.

**1,000 REPRESENTATIVES** Wanted at once. Cass Service, 1497 Helen Ave., Detroit, Mich.

**ARE** You old at 40? See our advertisement on page 88 of this issue. The Electro Thermal Company, 2111 Morris Ave., Steubenville, Ohio.

**MAKE \$2.00** Every hour. Sell every home wonderful preparation; mends hosiery and clothing without sewing. Invisible. Results guaranteed. Send for free sample of work. Queen City Laboratories, PM-11, Cincinnati, Ohio.

**MAKE \$50 To \$75** a week. Everyone needs shoes. Sell Mason's all-leather shoes, amazingly low prices, 85 styles—Men's, women's, children's. No experience needed. Big outfit free. Mason Shoe Mfg. Co., Dept. 2211, Chippewa Falls, Wis.

**\$800.00** Before Xmas taking orders for Rhinestone Initial buckles, other fast sellers. Experience unnecessary. Pay daily. No investment. Outfit free. Chaton, 600C, Blue Island, Chicago.

**SELL** Absolute necessities. Cost 2c, sells 25c. Prices lowest. Seven different samples 30c. Catalog free. Mills Sales Co., 13 East 16th St., New York.

**AGENTS—Best seller;** Jem Rubber Repair for tires and tubes; supersedes vulcanization at a saving of over 800 per cent; put it on cold, it vulcanizes itself in two minutes, and is guaranteed to last the life of the tire or tube; sells to every auto owner and accessory dealer. For particulars how to make big money and free sample, address Amazon Rubber Co., Philadelphia, Pa., Dept. 505.

**NO Selling** pays \$22 daily. Place boxed "Neverun" on store counters everywhere. Enormous demand. Establish steady income. Quincey Co., Dept. 861, 185 N. Wabash, Chicago.

**PENNANTS—City or school.** American Pennant Co., 53 Hanover St., Boston, Mass.

**AGENTS** Wanted for fast selling big profit articles. Particulars free. Box 590, Westport, La.

**WONDER Wrench.** Handiest kitchen tool ever invented. Over 100% profit. Sales guaranteed. Sample and details free. National Fibre Broom Co., St. Louis, Mo.

**AGENTS** Make money selling No Spark enclosed cigarette holder. Circular free. Star Metal Works, Dept. 11, McKinney, Tex.

**NEW** Chemically treated auto mitten duster. Cost 25c, sells for 60c. Sales guaranteed. Sample and details free. National Fibre Broom Co., St. Louis, Mo.

**AGENTS: \$20 Daily!** Latest patented ironing board pad and cover combination. Guaranteed. Low price. Sample for yourself free. American Braiding, 329-AE, West Monroe, Chicago.

**SELL** Holiday poultry banners to meat markets until Thanksgiving. Big profits. Great for crews of canvassers. Write today. Consolidated, 67-A West Van Buren, Chicago.

**"HAVALITE"** Cigarette lighter, like fountain pen; big holiday item. Sample 60c. Act now. Stevenson & Co., 161 Champlain St., Rochester, N. Y.

**AGENTS.** Get ready for Christmas trade! Beautiful hand-decorated cards. Natural feathers. Mexican curios for dens, Indian rooms. Send 25 cents stamps, samples. G. Medina Rosa, 78 Mexico City, Mex.

**GOOD** Profit selling wholesale and retail nationally known brand Swedish steel imported razor blades. Sharpest blades made; repeat orders guaranteed. Sample 5c. Felts Cutlery Shop, Huntington, N. Y.

**NO Peddling.** Start own business. Home, office. Free folder describes 27 money-making opportunities. No outfits. Elite Co., 38 Elizabeth St., New York.

**DON'T** Sell for others. Employ agents yourself. Make your own products. Toilet articles, household specialties, etc. 500% profit. Valuable booklet free. National Scientific Laboratories, 1984W Broad, Richmond, Va.

**\$60-\$200 A WEEK.** Genuine Gold Letters for store windows. Easily applied. Free samples. Liberal offer to general agents. Metallic Letter Co., 438-B North Clark, Chicago.

**AGENTS—Men's all-purpose suits!** \$9.55! Looks, feels like wool! Resists snags, sparks, water! Workmanship, fit guaranteed, \$2.50 commission in advance. Free kit. Act at once. Fitz-U-Tailoring Co., Dept. 171C, South Whitley, Ind.

**BIG** Profits selling useful holders. Capital unnecessary. Particulars free. Dow Mfg. Co., W. Lebanon, N. H.

**SACRIFICING** Showroom samples, expensive Fall dresses. Peddlers, storekeepers, home dress parlor people, write Hirschler Dress Jobbers, 249 West 34th, New York.

**AGENTS:** Get this now; earn \$10 daily; new fast seller; no competition; you can put out subagents; double your income; 15c brings 35c sample; money back; free folder explains. Excel Products Co., Bridgeport, Conn., Box 3034.

**POTATO** Parer, steel plated, new, fast seller, sample 10c. Edward, 694 Evergreen Ave., Brooklyn, N. Y.

**WRITE** For plan—\$2.50 rug free. Globe Center, Altoona, Penna.

**AGENTS—Buy** direct, hosiery, lingerie, neckwear at lowest mill prices and make 100% profit. Write today. Superior Knitting Co., Dept. 12, New Haven, Conn.

**YOUR** Favorite Products: Manufacture them yourself. Guaranteed manufacturer's formulas supplied. All lines. Latest specialties. Romig, Box 103-X, Station W, New York.

**MIRRORS** Resilvered at home. Costs less 5 cents per square foot; you charge 75 cents. Immense profits plating autoparts, reflectors, tableware, stoves, refinishing metal, etc. Outfits furnished. Details free. Write Sprinkle, Plater, 128, Marion, Ind.

**AGENTS—Make \$3.00** an hour taking orders for our 40 fascinating kitchen specialties. No competition. Write quick. General Products Co., Dept. L-207, Newark, N. J.

**AGENTS, \$240 Month.** Take orders for finest line guaranteed pocket knives you ever saw. Name and address on handle or emblem of any society or fraternal order. Big demand. Territory given. Write quick. Novelty Cutlery Co., Desk 2831, Canton, Ohio.

**NEW** Kind of mop washes floors, cleans walls, ceilings, wrings itself. Waxes and polishes floors. You make \$1.00 on every \$2.45 sale. We deliver. Sample mailed on approval without deposit. Kleanezy, Dept. G-25, Delphos, Ohio.

**ATTENTION!!** Collect and keep \$6.00 every order. Make from \$60 to \$180 every week. Two suits or suit and overcoat \$27.95. Satisfaction guaranteed. Big swatch outfit free. LaSalle Gold Seal Clothes, 527 Broadway, Dept. 66, New York.

**\$50,000 PICTURE** Man Friedman made canvassing. Beginners can make \$100.00 weekly with my sales talk. Experienced men make more. Free book. "Profits in Portraits" explains. Sample free. Picture Man Friedman, Dept. 8-A, 541 W. Lake, Chicago.

**FLAVORING** Extracts—Bottle yourself; concentrated, add water. Free labels, whirlwind sellers. 500% profit. Money-making opportunity. Write Thomas Manufacturing Company, Indianapolis, Ind.

**REPRESENT** Factory. \$20.00 daily selling changeable letter signs. Every merchant wants. 300% profit. for \$9.00 day guarantee offer. Maze Co., 542 Washington, Chicago.

**AGENTS:** Buy for one cent a package 50-cent size; extracts, pie-fillings, toilet articles. Russell, Harvey, Ill.

**MAKE \$1,000** Before Christmas selling exclusive personal Christmas cards, steel engraved designs. Expensive sample book free. Wetmore, Janes and Sugden, Rochester, N. Y.

**32 SECONDS** Complete tire change by Detmer, Ohio, with Morey Quick Action Rim Tool. Sold, singly, 49 three days, cleared \$100. Anderson, Mont., sold 1,400 in 14 weeks. Get details for good territory. Harvest time now. M. Morey Rim Tool, Buffalo, N. Y.

**NO** Experience necessary. You'll sell Wonder Changeable Signs fast. We show you how. Write Currier Mfg. Co., 31 Northwestern Terminal, Minneapolis, Minn.

**LATEST** Portrait frames. Specialty foreign shipping. Write catalog. Victor Portrait Co., 2223 Brush St., Oakland, Calif.

**SHOW** Us the housekeeper who likes to clean stair-corners; earn big money selling Corner Dust Shields. Write today. Ideal Stairway Equipment Co., Dept. PM, Canton, Ohio.

**BIG** Fall seller! Merchants need colored embossed signs. Everyone buys. Extra large profit. Dime brings fifty cents worth of samples. Franklin, 3322 Third Ave., New York.

**TOOT** Sweet keeps the feet sweet. Toot Sweet Co., Mason City, Iowa.

**AGENTS—If** you need money write for free sample So Easy Mystery Polishing Cloth. Mohler, Box 453-C, Chicago.

**AGENTS—Big** profits showing new ironing board pad and cover. Every housewife buys. Write for outfit offer! Burlington Blanket Co., Dept. F, Burlington, Wis.

**MAIL** Order business is your opportunity. Free particulars. Pruett System, Brookfield, Ill.

**NO** Peddling. Start own business. Home, office. Free folder describes 27 money-making opportunities. No outfits. Elite Co., 38 Elizabeth St., New York.

**AN** Opportunity. Promotion rapid. Five million dollar company entering direct selling field with product every woman wants. One sale brings another. Openings for district managers. Rapid advancement, crew managers, canvassers. The Strong Manufacturing Co., Sebring, Ohio.

**GREATEST** Specialty for rural agents. Write Hawbaker Co., Elmore, Minn.



**AGENTS—Crew managers.** Part time workers, men and women, sell 2 greeting card box assortments. One box contains 22 assorted Christmas cards. Other box contains 22 cards for everyday occasions, birthdays, congratulations, condolences, anniversaries, etc. Boxes sell on sight \$1.00 each. You double your money. Every person a prospect. Write for particulars today. Amity Greeting Cards, 1100 South Wabash, Chicago.

**AGENTS:** Would you like to make \$12.00 extra each week supplying our famous food products to your neighbors? Write now. Blair Laboratories, Lynchburg, Va.

**DON'T Sell for others.** Employ agents yourself. Make your own products. Toilet articles, household specialties, etc. 500% profit. Valuable booklet free. National Scientific Laboratories, 1984W Broad, Richmond, Va.

**AMSCO Magnetic health belts** \$15.00. Guaranteed. Ionacos, old style, \$25.50. Amasco Manufacturers, 721 18th St., Oakland, Calif.

**PORTRAIT Agents** make more money than any other class of agents. Write for our new catalog—Portrait enlargements, medallions, etc. Adam J. Kroll & Co., 2343 South State St., Chicago, Ill.

**MAKE More money** selling exclusive line of steel die engraved personal Xmas cards. Largest commission paid. Art Craft Engraving Co., 117 No. Wells St., Dept. M, Chicago, Ill.

**FOR Autos and trucks "The Amber Eye,"** a new safety reflector, prevents night accidents, reflects light from approaching car. Very efficient. Penetrates fog. Great demand, big profits for you. Sells \$2.50. Send \$1.00 for sample. Write Hunt & Moore, New Haven, Conn.

**AGENTS—Mosco Corn and Callous Remover** will build you a steady repeat business. Fend today for pocket-size trial outfit. The Moss Company, 418 Searle Bldg., Rochester, N. Y.

**GOLD-LEAF Sign Letters;** copyrighted Manufacturing Instructions; profits 1,000%. Johnston Co., Quincy, Ill.

**TIME Counts** in applying for patents. See pages 138 and 139. Clarence A. O'Brien, Registered Patent Attorney, Washington, D. C.

**AGENTS Wanted—To sell Electric Hair Clippers.** Retail at \$8.75. Guaranteed. Useful in every home. The Master Appliance Co., Box 33, Racine Junction, Wis.

**ARVEO Polishing cloths—they produce results.** Be our local representative—big profits for you. Testing sample free. Arveo Industries, Dept. F, Grosse Ile, Mich.

**AUTO Owner tire agent** wanted each locality to use free demonstrating tires and take orders for new heavy duty Mellinger tires, guaranteed 15 months against all road trouble. Shipped on free trial. Get your own tires and earn \$300 monthly—no capital or experience needed. Write Mellinger Tire Co., Dept. 282, Kansas City, Mo., Warren, Ohio, Oakland, Calif.

**MAN** in each town to plate auto parts, reflectors, bathroom fixtures, refinishing beds, mirrors, chandeliers; by new method. No capital or experience required. Simple plan of manufacturing at home starts you in big money-making business. Outfit furnished. Free particulars and proofs. Gun Metal Co., Ave. H, Decatur, Ill.

**AGENTS—Here's a New One.** "Bestever Powdered Hand Soap." Sells like wildfire. Marvelous Discovery. Removes grease, paint, ink, oil, in fact anything from hands. Cannot harm skin. 150% Profit. Great Repeater. Agents simply coin money. "Free Samples Get the Business." Write immediately. Bestever Products Co., 4315W Irving Park, Chicago.

**LOWER Prices** on gold-eyed needle cases. Finest agent's article; sell fast, immense profits, \$50 to \$300 weekly. Proof free. Sample 10c. Paty Needle Co., College Ave., Somerville, Mass.

**ELECTRIC Cigar lighters.** Make \$100 week. Brilliant flashing advertisements. Three beautiful models. Used by dealers everywhere. Write Drake Mfg. Company, Dept. M, Milwaukee, Wis.

**AGENTS—We start you in business** and help you succeed. No capital or experience needed. Spare or full time. You can easily earn \$50-\$100 weekly. Write Madison Company, 566 Broadway, New York.

**DON'T Sell for others.** Employ agents yourself. Make your own products. Toilet articles, household specialties, etc. 500% profit. Valuable booklet free. National Scientific Laboratories, 1984W Broad, Richmond, Va.

**AUTOMOBILE Specialties.** Guaranteed formulas for all latest money makers. Lowest prices. Write for free lists. Murphy, Chemist, Tujunga, Calif.

**AGENTS.** Our cigar lighters and sales-boards sell quick. Large wholesale catalog free. Joseph Sales Company, 223 Madison St., Chicago.

**\$1,000.00 REWARD** If this is not the greatest money-making house to house proposition ever known. N. R. G. tablets wash clothes in 10 minutes without rubbing. Free samples. N. R. G. Co., H 500 W. Division, Chicago.

**AGENTS Wanted—Sell Xmas cards.** Big profits. Great demand. Finest assortment. Deal with manufacturer. C. M. Kightlinger, Millburn, N. J.

**TWO Money makers** for agents. "Francis" Pocket Adding Machine retails \$1.85. To you \$1.00. "Excelligraph" Rotary Stencil Duplicator \$37.50 retail. Write Type-writer Supply, 102 Hersch Bldg., Pittsburgh, Pa.

**MAKE And sell your own goods.** No machinery. Guaranteed formulas. Catalog free. Clover Laboratories, (E) Park Ridge, Ill.

**AGENTS—Sell stores 5c canny Specialties.** Lorrac Products, Albany, N. Y.

**AGENTS Wanted to sell Men's Hats** direct from factory. Write for catalog. Model Hat Mfg. Co., Dept. M-14, East Orange, N. J.

**BIG Money and Fast Sales.** Every owner buys Gold Initials for his auto. You charge \$1.50; make \$1.35. Ten orders a day easy. Write for particulars and free samples. American Monogram Co., Dept. 40, East Orange, N. J.

**MONOGRAM Automobiles.** \$1.35 Profit ten minutes' work; every owner wants them; millions without; particulars free. Motorists Accessories Co., Mansfield, Ohio.

**AGENTS—Clever Invention!** Inkapoon makes every pen a fountain pen. Fast office seller; big profit, demand increasing everywhere. Exclusive territory offered. Sample free. H. Marul Company, Tribune Bldg., New York, N. Y.

**WE Start You Without a Dollar.** Soaps, Extracts, Perfumes, Toilet Goods, Experience Unnecessary. Carnation Co., 2480, St. Louis, Mo.

**AGENTS: Stamping names** on pocket-key protectors. Sample check with your name and address, 25c. Stamping outfits. Emblem checks, check-fobs, name plates. Hart Mfg. Co., Desk 2, 303 Degraw St., Brooklyn, N. Y.

**\$12.00 DAILY** Showing new table cloth. Looks like linen. Wash like oilcloth. No laundering. You just take orders. We deliver. Pay daily. Sample free, "Besco," 4217-NW Irving Park, Chicago.

**BIG Pay every day,** showing Nimrod's all-year sellers! Dress, work and flannel shirts, overalls, pants, sweaters, underwear, pajamas, leather coats, lumberjacks, playsuits, etc. Experience unnecessary. Big outfit free. Nimrod Co., Dept. 8, 4922-28 Lincoln Ave., Chicago.

**REPLATE** brass worn-off Automobile Parts, Reflectors, Bath Room Fixtures, Worn Spoons, Forks, etc., with pure silver. Looks like new. Use U-Kan-Plate Polish. Positively no mercury. \$1.00 half pints. Post Paid. Satisfaction Guaranteed. Agents wanted. Dept. A, U-Kan-Plate Co., Philadelphia.

**\$50.00 WEEKLY** easy, Applying Gold initials on Automobiles. No experience needed. \$1.45 profit every \$1.50 job. Free samples. "Ralco Monograms," X1043 Washington, Boston, Mass.

**"HOW To Secure Agents,"** a specially prepared booklet, tells of one of the most inexpensive methods in which to secure good live producing agents. It is free; write for your copy today! M. L. Rund, Mgr. Classified Advertising, Popular Mechanics Magazine, 200 E. Ontario St., Chicago, Ill.

**A BUSINESS of your own—Making sparkling glass name and number plates, check-boards signs.** Big book and sample free. E. Palmer, 512, Wooster, Ohio.

**MAKE Big money.** Be the electrical dealer in your town. Sell a big line of low priced, quality appliances. Write for our selling plan. Dandyline Products, 4420 N. Western Ave., Chicago, Ill.

**CAN You sell a washing machine** for \$9.75? Agents are making \$75.00 to \$300.00 weekly showing new automatic washer to housewives. Thoroughly cleans and sterilizes. No rubbing necessary. Write for protected territory. Storm Royalty Co., Inc., 3601 Enright, St. Louis, Mo.

**AGENTS—Steady income.** Large manufacturer of handkerchiefs and linens, wishes representative in each locality. Factory to consumer. Big profits, honest goods. Credit given. Send for particulars. Freeport Mfg. Co., 59 Main St., Brooklyn, N. Y.

**SUCCEED With Your Own Products.** Make them yourself. Formulas, Processes, Trade-Secrets. All lines. Catalog, circulars free. B. Thaxly Co., Washington, D. C.

**FIBRE Brooms—detachable handles, fine finish.** Good profits, repeat sales. The Fibre Broom People, 147-C New Jersey Ave., Brooklyn, N. Y.

**REMNANT Store, Bethel, Ohio.** Greatest Dry Goods Bargains on Earth. Agents and Dealers.

**NEW Unusual necessities** paying phenomenal profits. Make money as you've never made it. Unequaled, amazing detailed offer, free. Concentrated Products Co., Box 3772-P, Tampa, Fla.

**GET Our Free Sample Case—Toilet articles, perfumes and specialties.** Wonderfully profitable. La Derma Co., Dept. A, St. Louis, Mo.

**POLMET Polishing Cloth** removes tarnish from metals without the use of liquid, paste or powder. Our agents say it sells like "hot cakes." Retail 25c; sample free. Gale & Co., Inc., 15 Edinboro St., Boston, Mass.

**OUR Luminous Crucifix** shines in the dark. Every one amazed at the wonderful effect. Easily demonstrated—easily sold. W. G. Hannan Co., 2543 So. State St., Chicago.

**AGENTS—Engraved name plates, signs, numbers, etc.,** easily sold, profits large. Bratt Bros., Roxbury Crossing, Boston, Mass.

**SOMETHING New.** Every motorist a buyer of our electro-magnetic-emergency Wenderlamp; takes only one minute to demonstrate and make a sale; no experience necessary; \$5.00 an hour easily made; full time or evenings. Write for sample. Wenderlamp Co., 926 Fisk Bldg., Dept. 10-A, New York.

**CALIFORNIA Perfumed beads** selling like hot cakes. Agents coin money. Big profits. Catalog Free. Mission Factory P, 2328 W. Pico, Los Angeles, Calif.

**PHOTO Medallion Men and Women,** the largest line of Photo Novelties in the world. Lowest prices, quickest service. Send for catalogue showing over 200 money makers. Photo medallions, photo medallion clocks, photo mirrors, photo fountain pens, photo powder compacts, photo jewelry and photo buttons. Gibson Photo Jewelry Co., 608-614 Grand Ave., Brooklyn, N. Y.

**AGENTS** Are making \$75.00 to \$300.00 weekly selling new brake lining machine. Every garage, accessory store, car dealer, service station a prospect. Big profit. Write quick for open territory. Linley Brothers Co., 577 Fairfield Ave., Bridgeport, Conn.

**BE A printing broker.** Run your own business selling salesbooks, manifold books, stationery, restaurant checks, register printing, fanfold, tags. Shelby Salesbook Co., Shelby, Ohio.

#### HIGH-GRADE SALESMEN WANTED

**I'LL Put money in your pocket** and make your income grow continuously if you will use all or part of your time looking after my business. I'll put you in a business where every man, woman, and child is your customer—for everybody must have shoes and hosiery. I'll supply all you need to start in at once making \$15 per day and increase your pay every month. Complete sample outfit of actual shoes and hosiery. Million dollar stock to deal in. Free book "Getting Ahead" will surprise and delight you. Write for it today. Wm. J. Mishel, Tanners Shoe Mfg. Co., S 10310 C St., Boston, Mass.

**FEW \$1,000 Monthly earnings** ads are truthful. Our men actually earn \$300 to \$500 regularly selling our lines. Adelitte, the newcomer in electric window salesmen, is making a big hit. More for the money than anybody gives. Business posters for every line. Changeable letter system too. Permanent business for you working with us. Territory protected and repeats credited. Fat commissions. Full details will prove very interesting. Display Products, Ltd., 409-A East 31st St., Kansas City, Mo.



**WALKER** Made \$165.00 first day selling our collection systems to doctors and merchants. He says it's the easiest selling line he ever handled and he is now making more money than he ever dreamed was possible. The system retails for \$7.50. Collects at least \$75.00 and costs only \$2.50. \$5.00 profit on each one sold. Write at once for complete details to Adjustment P. Service, Mobile, Ala.

**SALESMAN:** Neat, progressive, initiative and ability to put over cleancut proposition, establish agencies and become state representative. Two established lines to select from—industrial—mercantile. Goods guaranteed. House of 40 years' standing. Repeaters. Large returns. Ensign Co., 10703 Quebec Ave., Cleveland.

**AUTOMOBILE** Tool salesmen—If you know how to sell tools to the garage trade we have over 300 tools, many of them specialties. If you really want to make this your business permanently there are steady profits for you representing one of the largest manufacturers. Kent-Moore Organization, General Motors Bldg., Detroit.

**AUTO** Seat covers. Lower priced than anywhere else for same quality. Shop coats, coveralls, work shirts. Spot commissions. Outfit free. Coverall, 11621 Detroit, Cleveland, Ohio.

**EVERY** Home a prospect. Make big money. Take orders trees, shrubbery. Experience unnecessary. No dull season. Commissions paid weekly. We deliver, collect. Write Perry Nurseries, Dept. R-11, Rochester, N. Y.

**WONDERFUL** Invention. Seals fifty envelopes minute. Sells on sight at \$3.50. Attractive proposition. Square deal. Bank references. Kendall Sealer Co., C5, East Jeffrey, N. H.

**BE** Your own boss, increase your income, build permanent future as district manager for Durham Method of Floor Waxing. Modern home necessity, patented, nothing like it. No get-rich-quick rainbow, but a sound, common-sense road to success. Get the facts. Write Donald Durham, Mfr., 804 24th St., Des Moines, Iowa.

**SPLENDID** Sideline. Excellent profits selling to trade finest complete line vending machines, etc. No samples, sell from catalog. Specialty Mfg. Co., B724 N. Racine, Chicago.

**A WINNER.** 100% profit. New pocket size check protector. Can't be forged. Sells only \$5. Millions need it. Banks endorse it. Safety Check Protector Corp., Dept. 35, North Chicago, Ill.

**SELL** Advertising lead pencils; lowest prices, highest quality, liberal commission. Dandy sideline; new Christmas numbers ready. F. S. Pencil Works, Quincy, Ill.

**CHRISTMAS** Cards—Start early. \$2.00 hourly, spare time. 87 samples free. Windermere Press (Established 1909), 6702 Dorchester, Chicago.

**\$50 TO \$75** Weekly selling new improved coveralls and service coats with customer's name embroidered on back to garages, oil stations, etc. Advertising value and unusual construction gets the big orders. We pay biggest commission. Free outfit. Am. B. Co., 329 West Monroe, Chicago.

**\$10-\$20 DAILY** Selling printed stationery and new advertising specialties, blotters and envelopes. Good sideline. Liberal commission. Free sample outfit. Embograp, 4538-62 Elston, Chicago.

**WANTED** Salesmen with stock, bond, car, washing machine and other selling experience. A new, clean, sound and popular proposition. Above the average profits for salesmen. Box 785, Minneapolis, Minn.

**EXPERIENCED** Magazine, book, newspaper, insurance salesmen. Two-year subscription \$7.50 accident policy \$7.80. Commission \$3.00. Free outfit. Burns Company, Johnstown, Pa.

**SELL** Letterheads, statements, business cards, etc., at \$2.95 per thousand delivered and make \$1 per thousand commission; we pay the postage; orders for 500 accepted; free cut service; sample outfit of 27 items free. Retailers Association Press, 420 N. Broadway, Oklahoma City, Okla.

**PROVEN** Money-maker: New electric hot dog machine; sells \$18.50; commission \$6.50; buyers buy on sight. Leonard E. Dickerson, Dept. E-5, Springfield, Mo.

**SELL** Printing. Biggest line. 33 items. 600 free cuts defy competition. Largest commissions advanced. Pocket outfit free. Kaeser & Blair, Dept. 13, Cincinnati, Ohio.

**AMERICA'S** Greatest tailoring line free. 175 large samples; all wool; tailored to order; union made; sensational low price. Big commissions paid daily. Cash bonus besides. Exclusive territory to producers. Hustlers making \$100 a week and up. Get outfit at once. Address Dept. 734, Goodwear, 844 Adams, Chicago.

**STATE** Mgr. Marvelous invention seals 3,000 envelopes hourly! Sells \$1.50 only; equals work expensive electric machines. Offices buy 1-100. Exclusive territory. Opportunity earn \$7,000 yearly. Free trial offer. Write quick! Rede, 25 Winthrop Bldg., Boston.

**ATTENTION!** Collect and keep \$6.00 every order. Make from \$60 to \$180 every week. Two suits or suit and overcoat \$27.95. Satisfaction guaranteed. Big swatch outfit free. LaSalle Gold Seal Clothes, 527 Broadway, Dept. 67, New York.

**SELL** Union label printing—Brand new proposition. Copyright cuts and elaborate outfit free. 40% commissions advanced. Beats all competition. Myerson, G 1132 So. Racine, Chicago.

**PUNCHBOARD** Salesman—\$250.00 per week easy. 90 complete deals. Slot machines of all kinds. The most gigantic line ever featured. Repeat commissions. Big beautiful 4-color catalog free. Lion Mfg. Co., 398 W. Erie, Chicago.

**\$1 TO \$7** Commission and big cash bonuses. Fastest selling line today direct to wearer. Real quality men's suits or overcoats only \$18.50. Dept. 2A, Preston Tailoring Co., Denver, Colo.

**EARN** \$20 A day. Establish income for life selling for \$1 a year, \$1,000 accident policy. Write W. C. Stone, 11 So. LaSalle, Chicago.

**LET** Us help you build up a big, permanent, repeat order business handling groceries, auto oil, paint, poultry and stock supplies. No rent, no investment in goods. Big pay. Write Hitchcock Hill Co., Wholesale Grocers, 38 W. Kinzie, Dept. 1, Chicago.

**SALESMEN**—Sell shirts direct to consumers; four shirts for \$5 made to measure, 2 for \$5.40; liberal commission; experience unnecessary. Menzin Shirt Co., Inc., 481 East Tremont Ave., New York.

**NEW** Profit sharing plan—150% profit. \$75 to \$200 weekly. Soaps, extracts, toilet articles, food products, etc. Free sample case. Experience unnecessary. Carnation Co., Dept. 2500, St. Louis, Mo.

**SELL** 365 Electric signs 7c apiece. \$8.50 profit every sale. Brilliant, blinking colors. Gilco, 217-CA N. Desplaines, Chicago.

**SALESMEN**—Earn \$100 weekly taking orders for Dazzler and Rainbow Glow electric signs. Big commissions. Exclusive territory. High grade proposition. Write Chicago Sign Sales Co., Dept. 42, Charlotte, N. C.

**SALESMEN:** Earn 20% selling dealers our line newly patented "Sta-tite" hammers. This new, thoroughly practical idea eliminates competition, and low price makes sales easy. Nicholls Tool Co., Lemont, Ill.

**SALESMAN** Handling hardware, paint, sporting goods and automatic accessory dealers, for fast selling sideline specialty; commission basis. Manufacturer, 1186 Grove St., Irvington, N. J.

**GOLD** Leaf Window Letters and script signs; no experience; 500% profit. Samples free. Our letters made Hazelhurst \$209 week. Consolidated, 69-V West Van Buren, Chicago.

**SALESMAN** For unique combination of Webster's New International Dictionary with reference history and atlas of world. Well-known high-grade specialty. G. & C. Merriam Co., Springfield, Mass.

**\$60-\$200 A WEEK.** Genuine Gold Letters for store windows. Easily applied. Free samples. Liberal offer to general agents. Metallic Letter Co., 438-A North Clark, Chicago.

**ALL-YEAR-ROUND** Profitable business selling wonderful new water softener and cleaner. Removes grease, oil, ink and dirt quickly. Every home and business place a live prospect. 100% profit. Big repeat orders. Exclusive territory. Write for free sample. Seacoast Laboratories, Sea Bright, N. J.

**PUNCHBOARD** Salesmen. 2 hours daily. \$100 every week. New line. Lowest prices. Full commission on repeat business. Catalog free. Puritan Novelty Co., 1409 Jackson, Chicago.

**PUNCHBOARD** Salesmen: It's easy to earn repeat commissions with the "Lincoln Line." Merchants everywhere use punchboards. Someone sells them! Why not you? Big pay every day. Catalog free. Lincoln Sales Co., 9 South Clinton, Chicago, Dept. D.

**DON'T** Sell for others. Employ agents yourself. Make your own products. Toilet articles, household specialties, etc. 500% profit. Valuable booklet free. National Scientific Laboratories, 1984W Broad, Richmond, Va.

**PUNCHBOARD** Salesmen. New fascinating game. Excitement; legal all states; \$200 weekly easy; one minute sales talk; pay daily. Cigar Stores Novelty Co., Dept. A, Peoria, Ill.

**SALESMEN**—Become Independent. Own your business; experience unnecessary, selling our \$7,500 Accidental Death; \$50 Accident; \$25 Sick Weekly Benefits—\$10.00 yearly. Other amounts proportionate. Guaranteed steady income from renewals. \$250,000 deposited Insurance Department, Universal Policy, Dept. A, 40 Clinton Street, Newark, N. J.

**40% COMMISSION** Selling printed business stationery at knockout prices. Part or full time. Free outfit. L Process Service, Minneapolis, Minn.

**SALESMEN** Selling to stores. Opportunity to handle unusual specialty line, main or side; commissions immediate, connection permanent, with large old-established manufacturer. Union Specialty Works, Dept. 222, Booneville, N. Y.

**BANG-UP** Good new sideline! Sells everywhere, all merchants, banks, mfrs. Big comms. advanced daily. Pocket outfit free. Carroll, 319 N. Albany, Dept. YA-322, Chicago.

**TO** Market 3A garage door holders, simple automatic action, quickly installed, instantly attracts garage owners, builders, dealers. Write for exclusive territory proposition. Knowlson-Stevenson Co., 1113 Packard, Ann Arbor, Mich.

**AGENTS!** Sell shirts and build a permanent successful business of your own. No capital or experience required. Liberal cash commission. Bostonian guaranteed shirts sold direct from factory to wearer will give you a good steady income. Write today for a complete selling outfit free. Bostonian Mfg. Co., Dept. M4, 72 Summer St., Boston, Mass.

**\$5 SALE**—\$5 Commission with lifetime renewals. New combination life-accident policy. Write immediately. United Underwriters, PM-2, Willow Hill, Ill.

**"TRY IT"**—"Punch Ball"—2 brand new machines that's startling country. \$125-\$200 weekly. Every store prospect. Pocket outfit free. Ad-Lee 827 Wabash, Chicago.

**PUNCHBOARD** Salesmen. \$150 weekly, selling new double profit deals from catalog. 100% prospects. 90% sales. Exclusive territory. Repeat commissions. Rudy Sales, 339 W. Madison, Chicago.

**GALLOPING** Ivorys. New game that's thrilling America. Absolutely legal. Every cigar counter waiting for you. \$125-\$200 weekly. Hurry. K&S, 4395 Ravenswood, Chicago.

**SELL** Printing; 40% commission daily. Lowest prices, with or without deposit. Copyright cuts free. Inquiry brings pocket outfit. Salesmanager, 1522 Wells, VanBuren Bldg., Chicago.

**BIG** Pay every day, showing Nimrod's all-year sellers! Dress, work and flannel shirts, overalls, pants, sweaters, underwear, pajamas, leather coats, lumberjacks, playsuits, etc. Experience unnecessary. Big outfit free. Nimrod Co., Dept. 65, 4922-28 Lincoln Ave., Chicago.

**FURNACE** Carburetor for any heating furnace or boiler. Eliminate 80% of smoke and soot. Reduces coal bill one-third. Easily installed and operated. We offer you a permanent business with a big profit. Give sales experience, reference and territory covered when answering. The Campbell-Hausfeld Company, Box 9, Harrison, Ohio.

**TRANSPARENT** Mirror flashing sign—the smartest novelty conceived in a century. Clear crystal mirror—similar to any other looking-glass—flashes into life in half a second—amazing, tempting. Large earnings on liberal commission basis to real salesmen calling on national and local advertisers. Write me today—right now. Phil. W. Duke, Sales Manager, 2642 South Michigan Ave., Chicago, Ill.



**MANUFACTURER** Wants salesmen to sell tires and auto accessories to tire stores, garages, etc., on a liberal commission basis; no objection to sideline. Economy Rubber Products Co., 420 Master St., Dayton, Ohio.

**PUNCHBOARD** Salesmen. \$200 weekly. Liberal plan assures sales. Latest assortments. Nothing to carry. Full commissions on repeats. M&L Sales Co., 301 W. Adams, Chicago.

**SALESMEN**—Four \$15.00 sales to merchants net you \$40.00 daily. Sayers Systems, 2813 Sheffield, Chicago, Ill.

#### HELP WANTED

**WHY** Not sell us your spare time, \$2.00 an hour, \$19.70 daily easy full time. Introduce 12 months guaranteed hosiery—47 styles, 39 colors for men, women, children, including latest "Silk to the Top" ladies' hose and men's fancies. No capital or experience needed. We furnish samples. New plan. Macohee Hosiery Company, Park 26011, Cincinnati, Ohio.

**DO** You need more money? Let me add \$30 a week to your pay without interfering with your present occupation. Interesting, pleasant work. Particulars free. Albert Mills, 2193 Monmouth, Cincinnati, Ohio.

**YOU** Are invited to resilver mirrors at home. Immense profits plating autoparts, tableware, etc. Write for information. Sprinkle, Plater, 287, Marion, Ind.

**SILVERING** Mirrors, French plate. Patented process, easily learned. Immense profits. Plans free. Wear, Excelsior Springs, Mo.

**PERMANENT** Business your own; men and women, earn \$35 to \$100 weekly operating our original "Specialty Candy Factories." Few dollars starts you home spare time; we instruct and furnish everything. Booklet free. W. Hillyer Ragsdale, Drawer 350, East Orange, N. J.

**OBTAIN** Employment! Get positions you want, quickly, anywhere. Use clever "Ways That Win." One person was offered 70 jobs! Complete methods, 50 cents. Money promptly returned if wanted. New Idea Service, Box 39-1, Station K, New York.

**ARE** You old at 40? See our advertisement on page 88 of this issue. The Electro Thermal Company, 2111 Morris Ave., Steubenville, Ohio.

**BECOME** A landscape architect. Uncrowded profession; wonderful opportunity for money-making. Easily mastered by mail. Earn while you learn. Est. 1916. Write for details. American Landscape School, 56, Newark, N. Y.

#### INFORMATON

**MISSING** Heirs—Send \$1.00 and four printed or typewritten family names. Index advertisement files searched and report made at once. American Claim Agency, Masonic Temple, Francesville, Ind.

**TRACING.** Make secret investigations. Work home or travel. Experience unnecessary. Write American System, 2188 Broadway, New York.

#### MAILING LISTS

**99% GUARANTEED** Mailing lists. Accurate. Reliable. Guaranteed. The kind that produces business; compiled for every possible business or individual. Lists of every kind of any business or individuals compiled for your individual needs anywhere. Catalog and information on request. National List, 847 Broad, Newark, N. J.

**FOR** Sale: Live mailing list compiled in August from fan mail from the United States and Canada. Twenty-five dollars per thousand addresses or three cents each for less. Room 218, Outpost Bldg., Hollywood, Calif.

**1,000 1928 RURAL** Women names, \$1.00. Sheasgreen, PM1427 North Penn, Minneapolis, Minn.

**LATE** Names—Opportunity seekers. Live, fresh, active. Guaranteed correct. Priced right. De Muth Company, Englewood, N. J.

**1,500 WOMEN** Buyers 1928 Penna addresses \$2.00. Crane Agency, 649 Wabash Bldg., Pittsburgh, Pa.

#### TYPEWRITERS AND SUPPLIES

**TYPEWRITERS**, all standard makes, \$10 up. Fully guaranteed. Free trial. Write for complete illustrated lists. Northwestern Typewriter Exchange, 121 N. Francisco Ave., Chicago.

**TYPEWRITERS**—Factory Rebuilt Royals, Remingtons, Underwoods, New Royal, Remington and Corona Portables. New "Excelsior" Rotary Stencil Duplicator \$37.50. Terms. Catalog Free. Pittsburgh Typewriter Supply, 945—339 Fifth Ave., Pittsburgh, Pa.

**TYPEWRITERS**—All makes, \$5 to \$19. Fully guaranteed. Dee Typewriter Exchange, Ada, Okla.

**TYPEWRITERS**, Motorcycles, radios, \$3.00 to best \$30.00. Knights, 1512 Locust, St. Louis, Mo.

#### PRINTING, ENGRAVING AND MULTIGRAPHING

**CHEAPEST** Line in America. 14x17 in. De Luxe calendars, 6c; 12x14 in., 5c; 8x14 in., 4c; advertising needle books, 1c. Samples sent. Leh & Co., E. Greenville, Pa.

**FINE** Printing—Low prices. Large modern plant (thirty employees) in small town, low operation cost. Special prices on stationery, circulars, pamphlets, ruled forms, catalogs, large or small orders. Write for samples and prices. Shenandoah Publishing House, Inc., Strasburg, Va.

**5,000 LETTERHEADS**, 8½x11, 20lb. bond paper, \$10.00; 5,000, 6½, XXX, W. W. envelopes, \$7.50. Sample on request. Low Cost Printers, 121-P West 21st St., New York City.

**\$2.95, 1,000 BOND** Letterheads. Ewan, 49 Pearsall, Jersey City, N. J.

**250 BUSINESS** Cards \$2; 500, \$3; 5 lines. Adroit Press, 5057 N. Robey, Chicago.

**1,000 6½** Envelopes printed \$1.85. Free samples. Spors Printery, Lesueur Center, Minn.

**500 BUSINESS** Cards 98c. Other printing reasonable. Samples free. Hanzler's, 1039 S. Cleveland, Philadelphia, Pa.

**100 LETTERHEADS**, 100 Envelopes, in two colors, \$1.25. Ozark Company, Heber Springs, Ark.

**5,000 ELEGANT** Envelope slips, \$5.00; 5½x8½ circulars, \$10.00. Folders, booklets, catalogs lowest prices. Samples. Goodprint, Harrisonburg, Va.

**500 BOND** Letterheads, envelopes, cards, \$2.35 each. Quality, satisfaction, samples. H. Curtis, 811 Harrigan, Kalamazoo, Mich.

**200 LETTERHEADS** And 100 envelopes, \$1.10, postpaid. Oberman Company, Box 1268, Chicago.

**50 EACH**, Letterheads, envelopes, cards, \$1.00. Sherman, Printer, Merriam, Kans.

**WE** Print stationery, booklets, catalogs, circulars. Samples. Commercial Press, Batavia, Ohio.

**SAMPLES** Raised letter printing with special prices free. LaClyde Service, Westfield, Mass.

**BOND** Envelopes, letterheads, \$2.95 1,000. Cuts used. Samples free. Williams Printing Co., Reed, Ky.

**5,000 ENVELOPES**, White (printed) 6½, 24lb., \$8.50. We print anything. Lawrence Envelope Co., 700 So. Kedzie, Chicago.

**250 BOND** Letterheads, Envelopes, Billheads, Cards, \$1.35 each. Economic Press, Leonia, N. J.

**QUALITY** Printing! Reasonable Prices! Send for Free Standardized samples and prices. Folders. Circulars. Catalogs our specialty. Earnest Fantus, 525 South Dearborn, Chicago.

**MULTIGRAPHING** Business correspondence two dollars thousand. Hammermill letterheads, four dollars; inexpensive quality, three dollars. Miscellaneous printing. Mayera Corporation, Monmouth, Ill.

#### GUMMED LABELS

**1,000 PRINTED:** Name, business address 50c. JBS Company, Box 93, Holyoke, Mass.

**GUMMED** Labels, 500 2 lines, 35c; 3, 55c, cash. Label catalog, Eastern Label Co., C. Clintonville, Conn.

#### RUBBER STAMPS

**RUBBER** Stamps! Name, address, two lines 25c; three lines, 35c. DeLuxe Stamp Works, B572M, Auburn, Nebr.

#### PRINTING, OUTFITS AND SUPPLIES

**PRINT** Your own cards, stationery, circulars, advertising, etc. Complete outfits, \$8.85; job presses, \$11, \$29; rotary, \$149. Print for others; big profit. Easy rules furnished. Write for catalog presses, type, paper, etc. Kelsey Company, J-11, Meriden, Conn.

**PRE-USED** Printing presses. Type supplies. List for 2c stamp. Popular Bargains, Richland, Pa.

**PRINTING** Outfits—Presses, type supplies, type novelties. Send stamp for catalogue. Model Press, York, Penna.

#### DUPLICATORS AND DEVICES

**YOU** can make 50 to 100 copies of a letter, notice, etc., at a cost of three cents on a Heyer Quality Duplicator. Write for free trial offer. The Heyer Duplicator Co., 909 Jackson Blvd., Chicago, Ill.

#### ADDING MACHINES

**NEW** \$3.50 Automatic adding machine. Adds, subtracts, multiplies, absolutely accurate. Capacity \$999,999.99. Fully guaranteed. 75,000 pleased users. Makes adding easy, positive, quick. Eliminates mistakes. Saves time. Postpaid \$3.50. Bassett Co., 1458-N, Hollywood Ave., Chicago.

#### FOR THE HOME

**GRANDFATHER'S** Clock Works, \$5.00. Build your own case; instructions free; make good profits selling your friends. Clock works with chimes for old or new cases. Write for full particulars. Clock Co., Ruffner St., Philadelphia.

**CEGAR** chests only \$11.65—"Red-i-Kut" complete with rich copper trim—you assemble and save half—send for pictures. Kuempel Furniture Company, Guttenberg, Iowa.

**COMBINATION** Ironing table—stepladder, \$4.50. C. R. Smith, Freeport, Ohio.

**ROCKFORD** Furnaces—Pipe and pipeless \$50 and upward. Write for price list. Rockford Furnace Co. Rockford, Ill.

**NEED** Xtra money? Weave rugs at home. Loom book free. Union Looms, Boonville, N. Y.

#### BOATS AND LAUNCHES

**BOATS** More popular than ever; be up to date, build your own boat during your spare time this winter using our knockdown materials and save money. 55 new designs. Send 25c for 1929 catalog. Brooks Boat Co., Inc., Rust Ave., Saginaw, Mich.

**PROPELLERS**, Pumps, stuffing boxes, bearings, etc. Wm. H. Baker, Pond St., Quincy, Mass.

**ICE** Yacht, 158 square foot sail; complete plans 35 cents. Free boatbuilding catalog. The Rudder, 15 Murray St., New York City.

**MAKE** 16' Rowboat; blueprint 30c. Weesho-Uco, 31st Office, Detroit, Mich.

#### GUNS, SPORTING GOODS, ETC.

**HUNTERS** And trappers: See and try the "Screw-Bug," a mechanical ferret for routing rabbits, skunk and other burrowing animals. Sold direct by mail, allowing five days' trial with an absolute money back guarantee. Price \$4.00 each with order, or collect plus postage. Free circulars. The Grabow Co., Dept. A, Franklin Square, New York.

**FIELD** Glasses 5X, \$7.95; Luger carbine stocks, \$1.50; Krag rifles, \$10.50; genuine Springfield, \$27.00; exercisers, \$1.20. Write for catalog. Hudson Sporting Goods, W54 Warren St., New York.

**SHOTGUNS** On monthly payments; all gauges; double barrel hammerless; full price \$25; single barrel hammer guns \$10; American manufacture known for 50 years. Write for catalog. Franklin Sporting Goods, Ampere, N. J.

**ARE** You a rotten shot? Hunting season now open. Our shotgun peep-sight makes you a good shot, \$2.50 postpaid. Booklet "Wing Shooting Made Easy," 10 cents. Wilbur Gun Sight, Box 185, Times Square, New York City.

#### ARCHERY

**BOWS**—Arrows, and all raw materials. Send for complete catalog. Stemmler Co., Queens Village, N. Y.

#### FIELD GLASSES, TELESCOPES AND MICROSCOPES

**C-FAR** Field Glasses \$2. Consists of two rimmed lenses in neat leather case, slips into vest pocket, weighs only 1½ ounces. Gives 6 diameters magnification. Money back if not satisfied. Send \$2 today to Buffalo Optical Co., Dept. PM-6, 574 Main St., Buffalo, N. Y.

**USED** Fieldglasses; \$2 to \$75. J. Alden Loring, Dept. J, O-we-go, N. Y.



## FOR SMOKERS

**CAN'T** Beat this bargain. Box, fifty Bankers' Bouquet cigars, Sumatra wrapper, fine flavor, full size, 10c value, postpaid, \$2.45. Trial package, three, 20c. Allied Jobbers, 74 West Washington St., R811, Chicago.

**PIPE** Smokers—We have specialized in pipe tobaccos for 23 years. Factory to smoker. Wonderful blends and flavors. Write for free catalog. The Planters Tobacco Co., Henderson, Ky.

**USE A No-Spark** enclosed cigarette holder. Smoke in home or office. No ashes or fire. Regular price \$2.50; advertising price only \$1.15 postpaid. Star Metal Works, Dept. 14, McKinney, Tex.

**TOBACCO:** 5c Cigars 50, \$1.50; twist 30, \$1.80; plugs 30, \$1.80; bag smoking 30, \$1.80. 10c sizes. Sweetleaf smoking 10 lbs. \$1.40; chewing, \$1.75. Farmers League, Watervalley, Ky.

## ANTIQUES, WAR RELICS AND INDIAN GOODS

**OLD** Arms, Indian relics, miscellaneous curios. Illustrated lists, ten cents. N. Carter, Elkhorn, Wis.

**FOR** Dens. Relics and medals from Europe's battlefields. Illustrated catalog, 25c. International, 885 Flatbush Ave., Brooklyn, N. Y.

## PHONOGRAPHS AND RECORDS

**BUILD** Your own phonograph. Catalog and instructions to build new type horn model for 10c. American Phonograph Co., 4116 West 24th Place, Chicago.

## MUSIC AND MUSICAL INSTRUMENTS

**MAKING** Violins new way. Complete plans. We sell wood and tools for construction. For particulars write Rodell Music House, 468 Pleasant, New Bedford, Mass.

**WHY** Pay \$150.00 or more for a high-class professional model Tenor or Plectrum banjo? Three styles offered at \$30.00, \$36.00 or \$45.00. Made by the originators of the "Regal" Tenor guitar and octofone. Ask your dealer or write us. Regal Musical Instrument Co., 3211 Grand Ave., Chicago.

**SONGWRITERS.** Substantial Advance royalties are paid on publishable work. Anyone having original ideas for songs may submit poems for examination and free advice. Walter Newcomer, 1674 Broadway, New York.

**SONGWRITERS.** Submit poems; prompt preliminary publication services. Brennon, Dept. L, 1652 Broadway, New York.

**SONGWRITERS:** Submit your song or poem. Same returned immediately if not accepted. Chester Escher, 1547 Broadway, New York City.

**SONG** Poem or melody writers—Have "real" proposition. Hibbeler, D1, 2104 No. Keystone, Chicago.

**POEMS** Wanted, 50-50 plan. Great Eastern Song Bureau, Dept. 27, Thomaston, Me.

**SONG-POEM** Writers: Address Monarch, 236 W. 53th, Dept. 201, New York.

**SONG** Writers: Send for our "Publishing Agreement." McKinley Music Printers, 1501 E. 55th St., Chicago.

**SONG** Poems solicited. A different proposition. Richard Broughton, Sioux Falls, S. Dak.

**VIOLINS.** Deep, mellow, soulful—on credit. Easy terms for wonderful instrument. Get details today. Gustav F. Henning, 302 University Building, Seattle, Wash.

**CORNETISTS**—Trombonists—Saxophonists—Clarinetists. Get "Free Pointers." Name instrument. Virtuosi School, Buffalo, N. Y.

**PLAY** Piano by Ear. A Sound System. Booklet free. Boucher's Harmony Studio, Ottawa, Can.

**SONG** Poem Writers, Write Sequoia Songwriters' Service, Sherman Branch, Los Angeles, Calif.

**"BANJOS"** Should interest all musicians on account of the popularity of the Banjo, as it easily increases a Player's income. Illus. Catalog of 48 pages free. The Bacon Banjo Co., Inc., Groton, Conn., U. S. A.

**I WANT** Song Poems. Casper Nathan, 3544 N. Racine, Chicago.

**"MUSIC** Composed" to words. Bauer Bros. (formerly of Sousa's Band), Oshkosh, Wis.

**WRITE** Songs. Big money and reputation. Write for information, J. Gordon Pub. Co., 201 N. Hoyne Ave., Chicago.

**FREE**—"Song Writers Guide," Beaver, 1257 Elm, Green Bay, Wis.

**SONGWRITERS:** Get in touch with Bell at once. Address D-6, 4718 So. Broadway, St. Louis, Mo.

## PATENT ATTORNEYS

**PATENTS** Procured, prompt service, personal careful and efficient service. Highest references. Moderate fees. Send sketch or model for actual search and advice. George P. Kimmel, Master of Patent Law, 54-K, Legal Bldg., Washington, D. C.

**INVENTORS:** Send for booklet telling how to patent and sell your inventions at lowest cost. Ralph Burch, Patent Lawyer, 900 F St., Washington, D. C.

**SELL** Your patent to reliable manufacturers. No advance fees. Inventors' Service, 15 Park Row, New York.

**INVENTORS**—Why pay more? H. M. Plaisted, registered patent attorney, 30 years' experience patents and trade-marks, 4413 Page, St. Louis, Mo.

**JOHN PATTEN DUFFIE,** Registered patent attorney, Victor Bldg., Washington, D. C. Reasonable rates. Advice free. Booklet.

**FREE** Instructions. Registered attorney. Former patent office examiner. Booklet. Albert Jacobs, 727 Barrister Bldg., Washington.

**PATENTS,** Trade marks and designs secured through Parker & Snyder, 5 Barrister Bldg., Washington, D. C. Send sketch or model of invention for consideration.

**PATENTS.** Prompt personal service. Write for information. Albert E. Dieterich, Registered Patent Lawyer, 621½ Ouray Bldg., Washington, D. C.

**PATENTS**—Write for our free book, "How to Obtain a Patent" and Record of Invention Blank. Send model or sketch of inventions for inspection and instructions free. Terms reasonable. See advertisements on pages 110 and 141. Victor J. Evans & Co., 934 Ninth, Washington, D. C.

**LACEY'S** Patent Sense. Valuable book free. See ad page 143.

**PATENTS**—Write for free instructions. Send drawing or model for examination. Carl Miller, Registered Patent Attorney (former Patent Office examiner), 259 McGill Bldg., Washington, D. C.

**INVENTORS:** Send sketch or model for advice and exact cost of patent. Ask for our Free book: "How to Obtain a Patent." Tells what every inventor should know. Established twenty-eight years. Highest references. Prompt service. Reasonable charges. Chandee & Chandee, 414 Seventh, Washington, D. C.

**PATENTS** Procured: Trade Marks Registered—A Comprehensive, experienced, prompt service for the protection and development of your ideas. Preliminary advice gladly furnished without charge. Booklet of information and form for disclosing idea free on request. Irving L. McCathran, 200 Owen Bldg., Washington, D. C., or 41-R Park Row, New York.

**"INVENTOR'S** Guide" sent free; contains valuable information. Frank Ledermann, Registered Attorney-Engineer, Woolworth Building, 1712, New York.

**MONROE E. MILLER,** Ouray Bldg., Washington, D. C., Patent Lawyer; Mechanical, Electrical Expert. Booklet and Priority Record blank gratis.

**SELL** Your invention before patenting. Write for free particulars. W. T. Green, 801 Baltic Bldg., Washington, D. C.

**ESTABLISHED** 1864. Milo D. Stevens Company. Free Booklet. Patents, Trade-Marks, Copyrights. Offices, Monadnock Block, Chicago; Barrister Building, Washington, D. C.

**INVENTORS**—Write for our Guide Book, "How to Get Your Patent," and Evidence of Invention Blank. Send model or sketch of your invention for our prompt examination and instructions free. Randolph & Co., Dept. 430, Washington, D. C.

**UNPATENTED** Ideas can be sold. I tell you how and help you make the sale. Free particulars (Copyrighted). Write W. T. Greene, 806 Baltic Building, Washington D. C.

**LANCASTER** and Allwine, 221 Ouray Bldg., Washington, D. C. "Originators of the Form Evidence of Conception." Before disclosing your invention to anyone send for blank form to be signed and witnessed. Form and patent information bulletin free.

**PATENTS, Trade-Marks, Designs.** This firm has 27 years' experience and gives expert personal service at reasonable rates. We properly protect your invention. Write for free information and exact cost of procuring patent before proceeding. John B. Thomas & Co., 902 F St., N. W., Washington, D. C.

**ADVICE** Free! Patents procured—Reasonable—efficient Service. 25 years' experience. Chester W. Brown, Registered Patent Attorney, 510 Van Buren Street, Chicago.

**PATENTS.** Booklet free. Highest references. Best results. Promptness assured. Send model or drawing for preliminary examination. Watson E. Coleman, Patent Lawyer, 724 Ninth St., Washington, D. C.

**PATENTS** Procured at reasonable rates with time to pay. Sales negotiated. Staff of registered attorneys and engineers. A complete service for inventors. Write for particulars. Inventors Service Bureau, Box 1648, Washington, D. C.

**PATENTS, Trade-marks, Copyrights.** Reliable services by an experienced practitioner devoting personal attention to each case. Inquiries invited. References furnished. B. P. Fishburne, Patent Lawyer, 525-A McGill Bldg., Washington, D. C.

**TIME** Counts in applying for patents. See pages 138 and 139. Clarence A. O'Brien, Registered Patent Attorney, Washington, D. C.

## FOR INVENTORS

**PATENTS.** If you have an invention which you wish to patent you can write fully and freely to Munn & Co., for advice in regard to the best way of obtaining protection. Please send sketches, or a model of your invention and a description of the device, explaining its operation. All communications are strictly confidential. Our Hand-Book on Patents is sent free on request. This explains our methods, terms, etc., in regard to Patents, Trade Marks, Foreign Patents, etc. "Scientific American" contains Patent Office Notes, Decisions of interest to inventors and particulars of recently patented inventions. Munn & Company, Solicitors of Patents, 1523 Scientific American Building, 24 W. 40th St., New York City; 524 Scientific American Bldg., Washington, D. C.; 1313 Tower Bldg., Chicago, Ill.; 666 Hobart Bldg., San Francisco, Calif.; 521 Van Nuys Bldg., Los Angeles, Calif.

**AUTOMOBILE** inventions wanted—to sell to the largest automobile companies. This is a straight, above-board proposition. No fees or money wanted from you. No charge if invention is not sold. If I sell your invention, you pay me a commission which we shall agree upon in advance. Only sound, practical inventions considered. Address P. O. Box 377, Providence, R. I.

**PROFIT** On your patent. 250 page book \$2 on approval. Tells how to profitably sell patents, new ideas. Patent Enterprises, California Bldg., Los Angeles, Calif.

**I SELL** patents. A service that will sell your patent, or give you evidence as to why not. Charles A. Scott, 773PM Garson Ave., Rochester, N. Y.

**INVENTORS**—Sell your patent yourself. Copyrighted sales plan and list of real buyers. Leroy Brown, 2519 Barclay St., Baltimore, Md.

**MAKE** Money with patents; circular free. Floyd Clymer Co., Denver, Colo.

**INVENTORS**—We sell inventions. Royalties, outright sales. Inventors' Sales Bureau, Box 544, Seattle, Wash.

**WANTED**—Patented medical or health device to manufacture on royalty basis. Cincinnati Automatic Machine Co., Cincinnati, Ohio.

**INVENTORS** Universal - Educator—contains 900 mechanical movements; 50 perpetual motions. Tells how to obtain and sell patents. Suggests new ideas. Explains how to select your attorney and avoid patent sharks. Price (revised edition) \$1.00 postpaid. Albert E. Dieterich, 621 Ouray Bldg., Washington, D. C.

**PATENTS**—Write to B. P. Fishburne (a South Carolinian), Registered Patent Lawyer, 525-E McGill Bldg., Washington, D. C.

**TIME** Counts in applying for patents. See pages 138 and 139. Clarence A. O'Brien, Registered Patent Attorney, Washington, D. C.

**SELL** Your invention before patenting. Write for free particulars. W. T. Green, 802 Baltic Bldg., Washington, D. C.

**LACEY'S** Patent Sense. Valuable book free. See ad page 143.



**INVENTIONS**—Write for our free book, "How to Obtain a Patent" and Record of Invention Blank. Send model or sketch of inventions for inspection and instructions free. Terms reasonable. See advertisements on pages 140 and 141. Victor J. Evans & Co., 157 Ninth, Washington, D. C.

**INVENTIONS** Commercialized and industrial research conducted for inventors. Frank G. Buffum Mfg. Co., Louisiana, Mo.

**GET** your own patents. Legal blanks, complete instructions \$1. Cutting Sons, Campbell, Calif.

**UNPATENTED** Ideas can be sold. I tell you how and help you make the sale. Free particulars (Copyrighted). Write W. T. Greene, 807 Baltic Bldg., Washington, D. C.

#### PATENTS FOR SALE

**FOR** Sale—Patent on dirigible head lights for automobiles and trucks, very simple and efficient, also cheap to manufacture, a system everybody will want. Sell for cash and royalty. Arnold E. Daly, Mather, Manitoba.

**PERFECT** Hair weaver, bids received on manufacturing, royalty or outright. Patent 1,652,356. S. Hammerly, Marshall, Ill.

**OUTRIGHT** Or royalty basis, simple device that positively muffles engine explosions. Leonard Swan, 1019 Pike St., Seattle, Wash.

**TOY** "Scampcar." Wide range of possibilities. Lloyd Gerrish, Kittery, Me.

**HAND** Planter consists of can holding about a tea cup of seed. J. H. Hart, Box 132, Route 5, Tacoma, Wash.

**FOR** Sale, United States patent letters No. 1,574,967, pat'd March 2, '26. Plant thinning and topping machine to thin out plants, cotton and sugar beets in rows; have sample of machine, for sale very reasonable; copy on request. Joseph Hajos, 5259 Emerson Ave., St. Louis, Mo.

**VAGINAL** Syringe; provides a whirling, cleansing spray; comparatively inexpensive to manufacture, durable and positive. Sell outright or on royalty. Louis Novak, 140 Carlton Ave., Jersey City, N. J.

**OUTRIGHT** Or royalty basis, scrub brush with hand operated valve for water flow. Joseph Matta, 637 S. Radmacher, Detroit, Mich.

**OUTRIGHT** Or royalty—U. S. 1,513,455, R. R. Crosbie; specifications sent upon request. Only buyers need reply. Invest and resell. Kohler Greenfield, Owner, Kernersville, N. C.

**FOUNTAIN** Shaving brush; brush is attached to shaving cream tube. L. Forslund, 3206 Wilton Ave., Box 44, Chicago.

**OUTRIGHT**—Portable revolving vise for splicing wire rope. C. A. Lind, 1255 Center St., Honolulu, T. H.

**ATTRACTIVE**, Compact, electrically operated automobile turn signal. Patent pending. F. L. Glaze, 175 Harding, San Jose, Calif.

**NEWLY** Patented invention—iron safety device on autos for sale event, partner to finance manufacturing. John Tuba, 500 Alexander Ave., E. Chicago, Ind.

**OUTRIGHT** Or royalty, patent 1,595,896 for dial telephone. Ike Levine, 101 Watson Ave., Newark, N. J.

**ADVERTISING** Specialty: A combination ruler and scale for stenographers and typists. Easily manufactured. M. Rose, 3324 Fernside Blvd., Alameda, Calif.

**ARTIFICIAL** Fish aquatic toy patent for sale, outright or royalty; one pill makes fish move one hour; they actually swim. Philip Theo. Asary, Cor. Almaden and Hillsdale, Valley View, San Jose, Calif.

**GREATEST** Improvement known in ignition systems. Charge in combustion chamber ignited by large hot gas flame produced by double electric spark-gas device. Surprising results. Wonderfully simple. Adaptable to any automobile engine. American patent for sale. Fernando M. Espinosa, San Salvador, Central America.

**FORM** Front, ladies' garment hanger attachment, manufactured for half cent. Holds garment natural form, no wrinkling. Necessary for cleaners, laundries, merchants and manufacturers ladies' wear. H. E. Belt, El Rey Hotel, Los Angeles.

**INVENTOR** Of new famous table game wants earnest partner or co-operation for commercializing his invention. S. K. Hahn, 826 Oakdale Ave., Chicago, Ill.

**FOLDING** Boat patent for sale or royalty. Ecco Langen, 76 Ash St., Gardner, Mass.

**OUTRIGHT** Or royalty—Door holder for garage, hotel, office, stores; cheap to manufacture. Chas. Mitchell, 3905 S. Vermont, Los Angeles, Calif.

**OUTRIGHT**—Simple mechanical dandelion remover, destroys plant permanently with one pull. Louis Mausch, 846 Corona St., Denver, Colo.

**NEW** Invention: Children's plaything. Want partner to finance patent. Half interest. R. E. Cox, Box 72, Sweet Water, Tex.

**FOR** Sale—U. S. and Canada patent on automatic water gauge. John Rhodes, LeGrand, Iowa.

**PATENT**—For sale. Stop that hum in your disk wheels—use my patented wheel and rim; also make the easiest shift of tires. J. L. Greenwood, N. E. Harbor, Nova Scotia, Canada.

**OUTRIGHT** Or royalty. New patent, automatic cigarette cases, takes the whole pack, hands them to you "one at a time." For pocket, car and table use. A. Sidebotham, 109 Brown St., S. W., Grand Rapids, Mich.

**OUTRIGHT**: Auto bumper; costs less than \$3.00 to manufacture. Albert Weiss, 161 W. 21st St., New York City.

**LEATHER** Purses, shapes: "Apple," "peach," "grapes." Outright or royalty. Write Masse, 4271 Delanauere, Montreal, Canada.

**OUTRIGHT**—Reasonable pipe joint for toilets, bathtubs, basins, sinks. Patented United States and Canada. Robert Dawson, Skillman, N. J.

**COMBINATION** Motor truck, concrete and mortar mixer; establishing a new mixing principle and will prove a big money maker to manufacturer. Chas. Payne, 27 Fulton Ave., Waukegan, Ill.

**TIME** Counts in applying for patents. See pages 138 and 139. Clarence A. O'Brien, Registered Patent Attorney, Washington, D. C.

#### SURVEYING INSTRUMENTS

**SAVE** On transits and tools. Rebuilt instruments. All kinds and makes. Cash or terms. Write today for descriptive list M-11. Warren-Knight Co. (Manufacturers of "Sterling" Transits and Levels) 136 N. 12th St., Philadelphia.

**LARGEST** Stock of new and used surveying instruments in the country direct from factory. Satisfaction guaranteed or money refunded. Also farm levels. Wissler, 619 N. Broadway, St. Louis, Mo.

#### MODELS AND MODEL SUPPLIES

**PRACTICAL** Working models, inventors' ideas developed, improved, manufactured. Tools, dies, for economic production. Aid in marketing patents. Lowest prices. Stanford Metal Products, 306 Hanover St., Baltimore, Md.

**MODEL** And experimental work at lowest cost. Wagar Model & Machine Works, 115 So. Clinton St., Chicago.

**WORK** With master machinist; 15 years experimental experience, well equipped shop. Albert Weiss, 161 W. 21st St., New York City.

**MODEL** Steam engines and boilers for miniature boats. Six cylinder radial engines for model airplanes. New catalog 15c. Model Machine Shop, 212 Price St., Rahway, N. J.

**SPECIAL** Machine builders, tool and die makers, inventors' models production work of all kinds. Dept. L. Quality Hardware & Machine Corporation, Ravenswood and Thorndale Aves., Chicago, Ill.

**TIME** Counts in applying for patents. See pages 138 and 139. Clarence A. O'Brien, Registered Patent Attorney, Washington, D. C.

**LET** Our experience be your guide. Models that are models; tools and equipment for economic manufg. Patterns of all types; manufacturing in all branches. Satisfaction guaranteed. United Machinery Company, Cincinnati, U. S. A.

**WE** make working models for inventors and do experimental work and carry a complete stock of brass gears and model supplies. Send for catalogue. The Pierce Model Works, Tinley Park, Ill.

**DEADEYES**— $\frac{3}{4}$ " 3-18" \$3.50 hundred, belaying pins 18c dozen. C. Libby, Tuckahoe, N. Y.

**SHIP** Model Fittings: Send Dime for booklet. A. J. Fisher, 1002 Etowah Ave., Royal Oak, Mich.

**ACME** Model Works, 200 North Jefferson St., Chicago, Ill.—Working models, mechanical, electrical and optical apparatus designed and built. Screw-machine work. Stamping.

**WE** Make models, tools, dies, special parts, stamping and general manufacturing. Badger Tool & Mfg. Co., 134 So. Clinton St., Chicago, Ill.

**THE** Modelmaker, a magazine for all interested in making working models, boats, etc. Sample 10c. Modelmaker, 122 Liberty St., New York.

#### FOR MANUFACTURERS

**MANUFACTURERS**: Job lots of anything bought for cash. What have you? E. Foote, Westerly, R. I.

**SPECIAL** Machine builders, tools, dies, inventors' models, production work all kinds. Chicago Metal Novelty Co., 7821 Yates Ave., Chicago.

#### MANUFACTURING

**MANUFACTURING** Models, dies, stampings, brass work, one or thousands, Circular free. Baum's Metal Specialties, Kansas City, Mo.

**SPECIAL** Machinery or parts, dies, tools, metal specialties, models, special gears, stock gears and model supplies. Send for Catalogue. The Pierce Model Works, Tinley Park, Ill.

**ECONOMICAL** Manufacturing from sheet, bar, wire or tubing. Models, dies, special machinery. Swanberg, 5124 N. Kildare Ave., Chicago.

**WIRE** goods made to order. Cooley Mfg. Co., 530 N. Western Ave., Chicago.

**WIRE** Or sheet metal goods made to order. Chicago Metal Novelty Company, 7821 Yates Ave., Chicago.

#### MACHINERY, TOOLS AND SUPPLIES

**NO. 1** Brown & Sharpe universal miller with dividing head, \$175.00; 12"x5" Barnes engine lathe, \$95.00; No. 60 Health grinder, \$275.00; 24" Barker back geared crank shaper, \$400.00; 16" Walcott shaper, \$145.00; 20"x10" Flather quick change lathe, \$375.00; 24" Hamilton drill press, complete, \$135.00; Quincy air compressor with tank and hose, \$65.00; 10" bench drill press, \$19.00. Terms to suit. Write for catalog. Cincinnati Machinery & Supply Co., 28 West Second St., Cincinnati, Ohio.

**COMBINATION** Bench saw only \$9.80. Runs with  $\frac{1}{4}$  horse power motor. Will rip and crosscut. Consists of 6 inch saw, grinding, drilling, polishing, sanding attachments. 100 other bargains. Washing machine motors, \$5.50,  $\frac{1}{2}$  H. P. \$15.75. Electric drills \$13.95, electric grinders \$7.55, etc. Send for bargain bulletin No. 633. Acme Tool Co., 627 Washington St., Chicago, Ill.

**HEAVY** Duty portable electric drills, cannot be stalled by two men;  $\frac{1}{4}$ " \$22.00;  $\frac{1}{2}$ " \$48.00;  $\frac{3}{8}$ " \$84.00;  $\frac{1}{2}$ " \$78.00. Ten dollars down, balance easy terms. Here is something new, just out. Refillable pencil and spark plug testers combined. Send \$1.00 for sample today. General Distributing Company, Duluth, Minn.

**9 IN.** Barnes Screw cutting lathe. Price \$70. Many other bargains in lathes, milling machines, woodworking machinery. Write us. Machinery Dealers Incorporated, New Haven, Conn.

**COMPRESSORS**, Twin cylinder, for small tire shops. Duco spraying. J. Trockman & Sons, Inc., 110-112 Lincoln Ave., Evansville, Ind.

**START** business of your own, small investment required, doing nickel, copper and silver plating. This work in big demand. Information free. Electro Platers Supply Co., 547 Considine Ave., Cincinnati, Ohio.

#### ENGINES, MOTORS AND DYNAMOS

**BARGAINS**—Motors, machinery, wash, machine motors \$5.55  $\frac{1}{2}$ hp., \$17.50; electric drills, \$14.75; electric grinders, \$7.45; farm plant motors, \$3.45; generators, \$15.95; electric vacuum cleaners, \$8.95. 100 other bargains. Send for bargain bulletin No. 636. Acme Tool Co., 627 Washington St., Chicago.

**NEW** 750 Watt, ball bearing generators, \$28.00; 1250 watt, 32 volt lighting plants with engine, \$169.75;  $\frac{1}{2}$ hp. 32 volt motors, \$9.75;  $\frac{1}{2}$ hp. General Electric, repulsion, a.c. motors, \$27.00. All brand new. Write for bargain catalog. Do not buy, consult us first. General Distributing Company, Duluth, Minn.

**STEAM** Engines—One H. P. \$18.00;  $\frac{3}{4}$ , \$12.00. James Chambless, Bessemer, Ala.



**NEW 1/4 Hp.** Westinghouse motors \$26.00; 1/2 hp. \$8.50; for direct current \$11.50. 110 volt or 32 volt motors with emery, buffer and drill chuck \$7.50. American time switches \$7.00. Many other bargains, also generators. Queen City Electric Co., 1736 Grand Ave., Chicago, Ill.

**EDISON** Phonograph electric universal motors with speed governor, finest small motor made. \$5.00 plus postage, 9 pounds. Geo. Shulz, Calumet, Mich.

**NEW Motors:** General Electric 1/4 hp., \$9.50; 1/2 hp., \$26; 1 hp., \$38.50. Mail \$3, will ship C. O. D. anywhere. Motor Specialties Co., Crafton, Penna.

**ONLY A few left:** new 1/4 horse, 110 volt, 60 cycle, 1,750 speed, alternating motors with cord, plug, flat pulley and two-year factory guarantee, \$7.00 each; \$6.50 each lots of six. 3/4 kw. 32 volt, new General Electric, 1,750 speed generators for battery charging or lighting \$29.00 each. Also other sizes of motors and generators. Alternating and direct current. Electrical Surplus Company, 1911 West Chicago Ave., Chicago.

**FOR Sale:** 1-8 hp. motors, 110 volt, 1,750 R.P.M., 60 cycle, alternating current. Slightly used. Good running condition. \$1.50 each, while they last. Cash with order. The Maytag-Chicago Co., 337 W. Madison St., Chicago, Ill.

**MAKE your own—half and one horse-power electric motors.** A. C. Induction motor model shows winding connections plain sight. Quick easy way. Gaines Bros., Box 481, Gainesville, Texas.

**ELECTRIC Motors—Reconditioned equal to new.** Money back guarantee. A.C. or D.C. 1/2 H.P. \$16.00, 1 H.P. \$26.00, 2 H.P. \$35.00, 3 H.P. \$40.00. Others to 10 H.P. Tell us your motor problems. Temps Brothers Motor Co., One Martin Ave., Glendale, Long Island, N. Y.

**AUTO Engines** make excellent power plants in the shop, mine, mill or farm, but they need governing. We make the governors for \$10 up. Fit any make of engine. See advertisement below.

**GOVERNORS** For auto engines when used for power plants. Sent on 30 day free trial. Circulars. Candee-Smith Governor Co., 215 W. Manchester Ave., Los Angeles, or St. Catharines, Ont.

**TIME Counts** in applying for patents. See pages 138 and 139. Clarence A. O'Brien, Registered Patent Attorney, Washington, D. C.

#### BENDING MACHINES

**THE Famous Hossfeld "Wrenchless"** Universal Iron Bender is the last word in bending machines. Bends metal, cold or hot, into most any conceivable shape, including Eye Bolts and Automobile Spring Eyes. Bends up to 1" bars or 1 1/2" pipe cold. Thousands in use by all classes of trade, from the smallest shops to the largest railway systems. Write for circular and prices. Hossfeld Mfg. Co., Winona, Minn.

#### BLACKSMITHS

**BE a Master Mechanic Blacksmith and Expert Tool Maker and Dresser** with colored tempering charts. Price \$1.00. Valuable samples free. W. M. Toy, Sidney, Ohio.

#### WANTED—MISCELLANEOUS

**WHY** Not gather up and mail me your broken and discarded jewelry, dental work, etc. Turn them into cash. Highest prices paid for old gold, silver, platinum, etc. Satisfaction guaranteed or goods returned. F. Polcer, 2408 South Cicero Ave., Cicero, Ill.

**MAIL Us** your discarded jewelry, gold, crowns and bridges, watches, diamonds, silver, platinum. Money promptly mailed. Goods returned if offer refused. United States Smelting Works (The Old Reliable), Dept. 71, Chicago.

#### FOR SALE—MISCELLANEOUS

**WATCHMAKERS' Lathe** for sale at a bargain. R. Jaegermann, 5815 Easton Ave., St. Louis, Mo.

**ADDRESSOGRAPHS.** Letter folders, multigraphs, envelope sealers, duplicators, less than half price. Guaranteed. Pruitt Co., 117 No. Market, Chicago.

#### FARMS AND FARM LANDS

**PECAN-Orange-Fig groves "On the Gulf"** Monthly payments. Guaranteed care. Big, quick returns. Suburban Orchards, Dept. M. Ocean Springs, Miss.

**5 ACRE Orange grove.** C. Sauers, Fort Pierce, Fla.

**LAND Free** if planted to bananas. Bananas bear a full crop the second year. \$5.00 monthly will plant a five acre orchard, which should pay \$1,500.00 profit annually. As bananas ripen every day, you get your check every 90 days. Reliable companies will cultivate and market your bananas for one-third. For particulars address Jantha Plantation Company, 410 Empire Bldg., Block No. 30, Pittsburgh, Pa.

**CALIFORNIA.** 2 Acre income homesites on paved streets adjoining town of 40,000 people, east of Los Angeles, with 4-room bungalows built to order with bath, gas, electricity and water; 1,000 bird poultry house and 2-car garage all for \$4,800. Terms \$1,200 down, balance like rent. Send for free illustrated booklets. J. B. Roof, Incorporated, Owners, 708 Quinby Bldg., Los Angeles, Calif.

**ATTENTION!** Get acquainted, cash for your property, farm, hotel or retail store, no matter where located, confidential service. Hayes Business Agency, Cincinnati, Ohio.

**80 ACRES** Nearly level; good buildings; modern house; near school, \$7,500.00 and give terms; many other northern Illinois offerings five acres up; residence or small income accepted on some. Raymond D. Hart, DeKalb, Ill.

**240 ACRES** Well improved. 2 teams, 7 cattle, 6 sows, 150 hens; furniture, implements; everything. 3 miles railroad. Valley farm, hog fences, springs, fruits. Priced \$7,250. Terms. Healthful climate. Other bargains. Ray Wilks, Mountain Home, Ark.

**\$3,500** STROUT Farm pays \$3,150. See page 16 Strout's big illus. catalog of 100 pages, covering 20 states. Many splendid bargain offerings. Write today for your free copy. Strout Agency, 255-P 4th Ave., New York City.

**SMALL Fruit and poultry farms** near Los Angeles. Ten years to pay. Send for free illustrated booklets. Fontana Farms Co., owners, Room 617, 631 S. Spring St., Los Angeles, Calif.

**FARMS** in Mississippi highlands, year round crops, healthy, good water, ideal climate, low price, easy terms. Write for pictures, etc. Dana P. Smith, Paw Paw, Mich.

**SELL** your property quickly for cash, no matter where located. Don't pay big commission. Particulars free. Real Estate Salesmen Co., Desk B, Lincoln, Nebr.

**MONEY** made in Mich. potatoes. \$10 down now and easy terms buys land near markets, lakes, streams. Write today. Swigart & Co., P-1276, 1st Nat'l Bank Bldg., Chicago.

**OZARKS—10 acres** near White River and proposed power dam, \$100, \$5 monthly. Alvin Zimmerman, 1802 N. 5th, Kansas City, Kans.

#### ROOTS AND HERBS

**MEDICINAL Herbs and roots** for all ailments. Over 1,000 varieties. Catalog free! Botanics, 145 West 112th St., Chicago.

#### SEEDS, PLANTS AND TREES

**IMPORTED** Bulbs from Little Holland Farm. Mixed Darwin tulips, \$2.50—100. Also 15 specified colors \$3.00—100 and up. Single early and double tulips, hyacinth and crocus. Ask for price list. Wm. & C. Van Schalk, Delmar, N. Y.

#### MUSKRATS

**MAKE Money** from Muskrat Fur—Raise Muskrats in dry land pens or hutches. Get the facts. 652, Conrad's Ranch, Denver, Colo.

#### RABBITS

**MAKE big profits** with Chinchilla Rabbits. Real Money-makers. Write for facts. 852 Conrad's Ranch, Denver, Colo.

#### SWINE

**OHIO Improved Chester White** boars, sows (pigs no kin. \$10 each), vaccinated, pedigreed. Fred Ruebush, Sciota, Ill.

#### DOGS AND PETS

**HUNTING Hounds.** Descriptive price list free. J. E. Adams, New Florence, Mo.

**RAISE Guinea pigs;** easy to raise; little space required; very profitable. Particulars and booklet how to raise free. Cavies Distributing Co., 3102 C. C. Station, Kansas City, Mo.

**GOLD Fish—Imported Japanese fish.** Artistic aquariums, aquatic plants; interesting circulars free. Pioneer Aquarium Shop, Racine, Wis.

**HUNTING Hounds cheap;** trial. Literature free. A7, Dixie Kennels, Herrick, Ill.

**ST. BERNARDS,** Registered thoroughbred Puppies from Championed parents. Prices reasonable, duty free, photos submitted. Helvetia Kennels, 181-P McKenna, Montreal, Que.

**FOR Sale.** Minks, squirrels, raccoons, foxes, ferrets, muskrats, ginseng, rabbits, skunks, wolf pups, opossums. B. Tippman, Caledonia, Minn.

#### PERSONAL

**RECEIVE Mail** free from firms everywhere. Mailorder agency, homework propositions. Listing 20c. Larson, E-3410 North Ave., Chicago.

**YOGA Development course,** Hindu spiritual books, magic incense. Catalog 10c. Hindu Publishers, Garrick Bldg., Chicago.

**I TEACH men** to become interesting. Complete instructions \$1. Beth Barrett, 6526 W. Blvd., Los Angeles.

**INGROWING Nails** corrected without knife or pain; information free. Eugene Eaton, D106, Brandon, Ore.

**HIGH Blood pressure** inexpensively overcome, without drugs. Send address. Franklin Stokes, Mohawk, Fla.

**TOBACCO Or snuff habit** cured or no pay! \$1.50 if cured. Sent on trial. Frances Willard, 5724 1/2 Lemon Grove, Hollywood, Calif.

**TOBACCO Or snuff habit** cured or no pay. \$1.50 if cured. Remedy sent on trial. Superba Co., N3, Baltimore, Md.

**STOP** Fingernail biting habit. Copyrighted recipe \$3.00, guaranteed cure or money refunded. No trick dope or chemicals. M. W. McIntire, Wilmington, N. C.

**ADVICE,** Information, any subject, 25c coin. References. Fred Klotz, Reading, Pa.

#### PRECIOUS STONES

**AUSTRALIAN Opals,** black opals, fire opals, cabinet specimens. List free. Norman Seward, Optician, Melbourne, Australia.

#### MISCELLANEOUS

**EMBOSS** Your stationery with hand embosser. Circular free. Midwest, Box 47, Springfield, Ill.

**AGATE Opal cut stones** and cabinet specimens. Cutting, mounting. E. W. Birch, The Stone Man, Salem, Ore., Box 34.

**AUTOMATIC Cigarette making machines.** Rolls and glues 50 cigarettes for 10 cents. Ask illustrated folder. Postpaid \$2.50. For home use. Automatic Cigarette Machine Maker, 6247-51 Broadway, Chicago, Ill.

**TENT Bargains—All kinds,** all sizes. For sale or rent. Kerr Co., 1954 Grand Ave., Chicago, Ill.

**MIRRORS** Resilvered at home. Costs less 5 cents per square foot; you charge 75 cents. Immense profits plating autoparts, reflectors, tableware, stoves, refinishing metalware, etc. Outfits furnished. Details free. Write Sprinkle, Plater, 288, Marion, Ind.

**BUILD** Your toys and furniture from our blueprints. Send stamp for list. Woodcraft, Box 436, Troy, N. Y.

**MEXICAN Made** holsters, lariats, horsehair articles; rattlesnake belts. Send four cents for illustrated list. Tex-Mex Leather Co., 309 Esperson Bldg., Houston, Tex.

**I CATCH** from 45 to 60 foxes in from 4 to 5 weeks' time. Can teach any reader of this magazine how to get them. Write for particulars. W. A. Hadley, Stanstead, Que.

**AMATEUR Cartoonists—Sell your work.** Write Smith's Art Service, Wenatchee, Wash.

**TIME Counts** in applying for patents. See pages 138 and 139. Clarence A. O'Brien, Registered Patent Attorney, Washington, D. C.

**ARTISTS** And art students are printing 250 signs or pictures an hour without machinery. Sample and particulars 10c. Straco, 1013 Mulberry, Springfield, Ohio.

**TATTOOING** Outfits, supplies. Illustrated list free. "Waters," 965 Puttnam, Detroit.

**HOMEOPATHIC** And Biochemic preparations sent postpaid to all parts of the world. Manual and booklet free. Halsey Bros. Co., 5547 Ravenswood Ave., Chicago, Ill. Established 1855.

**WEEDS—Cut them** with cutter bar on Shaw Garden Tractor. Also plows, cultivates and runs belt machinery. Low prices. Immediate delivery. Shaw Manufacturing Company, Department C, Galesburg, Kans.

**CUTS** anybody can make. Simple, cheap process. \$1. Specimens, particulars. 2c stamp. M. Day, Windfall, Ind.



# How \$5 Grew to \$100,000 In This Amazing Business

Let me send you my free book. It tells how, starting with a \$5 bill, I made \$100,000 in less than 5 years as a real estate specialist. I had no experience, little education, was in poor health, and had no influence. But I did have a system of my own which worked! And it is working today for many others who are making more money than they ever dreamed they would! My book tells their stories, too. Mail the coupon for your free copy

I STARTED with \$5—and an idea. My friends laughed and said, "it's a fool idea."

But I was doing work I was not fitted for and which I thoroughly disliked, so I decided to "take a chance," especially since I had nothing to lose.

I was living in a gloomy boarding house, wearing cheap clothes, striving to keep out of debt, and getting mighty few of the good things of life.

In less than two years after I started to specialize in real estate, I was making nearly *one thousand dollars a month*. And in less than five years I cleaned up a net profit of *over one hundred thousand dollars*.

You, too, can make big money MY WAY. You can start in your own home, in your spare time. I don't care how old or how young you are or how discouraged you may be. I don't care how little education or influence you may have. I don't care how little business experience you may have had. You can make big money if you follow my methods—and when I say big money I MEAN it.

## Amazing Earnings

The first step is for you to write for my free book.

Read my own story. Then read how W. E. Shoop, a former weaver, made \$6,000 on his first sale; how Mrs. Evalynn Balster, a widowed schoolteacher, made \$5,500 com-



mission on her first sale; how Eugene Walrath, formerly in the clothing business, cleared \$17,000 on one deal; how Thomas E. Mone, Jr., a former insurance man, made \$40,000 in 2 years, using my method. How Chas. F. Worthen, formerly a salesman, made \$8,500 in 17 weeks by following my method. How H. G. Stewart earned \$14,400 in commissions in 6 months. How Earl Beam earned \$910 in spare time after supper in a few months with my system. How Anthony C. Maurell made \$4,000 in 3 months. How Al West made \$3,200 in 15 days. How A. D. Perkins, formerly in the furniture business, made \$2,556 in 2½ months. How F. B. Bennett made \$435 on his first day. They all did it in this amazing business, using my methods.

My free book tells all about these wonderful successes. It tells how when I started in real estate I thrust overboard all the hit-or-miss, haphazard, rule-of-thumb methods of the past and put into operation my system which is as superior to the old way as the modern ocean liner is superior to the old sailing vessel.

## A Wonderful Business

Real estate—conducted my way—is a great business. It is as permanent as the earth itself. It is getting bigger and bigger as the country grows. It doesn't require years of study to learn like most other businesses and professions. It offers enormous earnings to ambitious men and women. Users of my system report earnings of \$1,000—\$5,000—\$10,000—on single deals—as much as the average man gets for months and years of hard work. And the business is practically unlimited. Ten million properties are now on the market for rent, sale or exchange. And you can start without capital or experience—right at home—in your spare time. I did. So did others. So can you. My free book tells you how.

## Get Free Book Now

My big, new illustrated book is filled with fascinating facts about my kind of a real estate business—what I did—what others are doing—what you can do.

Mail coupon right now and get this valuable, money-making information free. It doesn't cost you a nickel to find out what this book can do for you. So, act at once. You will never forgive yourself if you turn your back on this unusual chance to win big business success. Address PRESIDENT, American Business Builders, Inc., Dept. 44-11, 18 East 18 Street, New York.

## \$1,000 Reward

We do not claim that all who follow our instructions make such amazing profits so quickly and so easily. But we do say that the fact that so many have done so is proof that the average person can make more money in less time OUR WAY than in any other way we know of. And we back up this statement with an offer of ONE THOUSAND DOLLARS in gold, to anyone furnishing proof of any other course of any kind that is helping as MANY men and women make as MUCH money in as SHORT a time as our Real Estate Course.

AMERICAN BUSINESS BUILDERS, INC.

President, American Business Builders, Inc.

(Authorized Capital, \$500,000.00)

Dept. 44-11, 18 East 18 St., New York, N.Y.

Mail me your free book telling how you made \$100,000 in a new kind of real estate business—how others are making big money and how I can do the same.

Name..... Please print or write plainly

Address.....

City..... State.....





# ANY BOY CAN WIN THESE PRIZES

Here are just a few of the attractive prizes selected from our Prize Book containing over 300 articles. You can easily have these and many more prizes . . . and besides earn your own spending money. Thousands of boys who are members of The Crowell Club of Junior Salesmen are doing this regularly. You are missing the time of your life if you don't get in with these fellows who spend part of their spare time delivering The American Magazine, Woman's Home Companion and Collier's The National Weekly to regular customers.



Here's smiling Bernard Korn, Ohio, with a few of the prizes he has won. How would you like to be as lucky as Bernard to have a good looking bicycle . . . a full chest of tools . . . a football . . . baseball glove . . . and a handsome set of silverware for Mother? Bernard will tell you that it's as easy as fun winning these prizes.

## You Need No Experience to Start

If you want to win worth-while prizes, such as these shown, hurry and send your name and address on the coupon below. We will then start you as a Crowell Junior Salesman and tell you about the methods hundreds of boys are using to earn money and prizes.

## SEND THIS COUPON NOW!

Mr Jim Thayer, Dept. 77,  
THE CROWELL PUBLISHING CO.,  
Springfield, Ohio.

Dear Jim: I want to earn money and prizes. Please start me off as a salesman.

My Name \_\_\_\_\_

Address \_\_\_\_\_

Town \_\_\_\_\_

State \_\_\_\_\_



# Test This Amazing Money Making Invention **FREE**



Men, here's the most remarkable money maker of the age! A little automatic machine that makes old style can openers obsolete! Now, just a twist of the wrist makes the dollars hum for you! So mail the coupon today for liberal **FREE TEST OFFER.**

## \$7 to \$10 In An Hour Just Showing This \$1,000,000 Can Opening Machine

**NO MORE** awkward stabbing and hacking with old-style can openers! No more danger of blood poisoning from gashed and lacerated fingers! For now a remarkable new invention banishes every old-style can opener to the scrap heap. Now a simple twist of the wrist opens any can in a couple of seconds. No wonder they all simply go wild over it! No wonder salesmen often sell to every house in the block and make from \$7 to \$10 in an hour!

### Works Like a Charm

This queer little device doesn't just chop a ragged hole in the top of the can. It cuts the entire top completely out, clean as a whistle! The machine takes hold of the can—opens it—flips up the lid so you can grab it—and gives it back without any sharp edges to snag your fingers. You just put the can in the machine—turn the handle—and almost instantly the job is done!

### Sells Itself in 10 Seconds

Everyone knows how women detest the dangerous old-style can opener. Imagine, then, how

#### Opens Any Can in a Jiffy



any can, square, round or oval, in a few seconds. And, men, **IT'S PATENTED**, so there is no competition.

they welcome this startling new method—this automatic way of doing their most distasteful kitchen task. Men, honestly, I'm not exaggerating one bit when I tell you that not ten words are necessary to sell any of them! All you do is hand your demonstrator to your prospect and let her try it! She sells herself in ten seconds by the clock—and you pocket a nice, fat profit! Yes really, it's just that simple and easy! That's why \$75 to \$150 a week is easy anywhere.

### Act Quick for Free Trial Offer

I don't care whether you're an old timer or just breaking in—the quickest, easiest money of your life is waiting for you now, right here! That's a mighty strong statement. But all I ask is a chance to prove it at my risk. I know this proposition will coin money for you so fast that it will make your head swim! Territories are closing fast. The Free Test costs you nothing. Just mail me the coupon and I'll shoot you the most sensational dollar making plan you ever heard of. Mail it today! Right now!

## AGENTS!



**Full Time \$265 in a Week**

"Here is my record for first 30 days with Speedo: June 13, 60 Speedos; June 20, 84 Speedos; June 30, 192 Speedos; July 6, 288 Speedos. Speedo sells to 9 out of 10 prospects."

M. Orloff, Va.  
**SPARE TIME—\$9 First Half Day**  
"The first afternoon I received my Speedo outfit I made \$9."

Mrs. R. Spain, Kans.  
**PART TIME—\$20 in 3 Hours**  
"I worked about three hours and took 25 orders. This is certainly a money-maker."  
O. C. Gregg, Wyo.

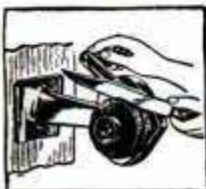

### Revolutionary New Sharpener

Works like magic. Puts a razor edge on any knife or tool in a few seconds. Anyone can use it. Sharpens scissors, too. The coupon brings full details.

## Central States Manufacturing Company

Dept. P-702, 4500 Mary Ave. St. Louis, Mo.

Central States Manufacturing Co., Dept. P-702, 4500 Mary Ave., St. Louis, Mo.

Tell me how I can make \$75 to \$150 a week through your Free Test Offer.

Name.....  
Address.....  
Town..... State.....





## Get Into AVIATION!

**MEN** wanted at every airport and factory. Big pay jobs await trained Airplane Mechanics. Our recognized Extension Course in Practical Aviation—prepared and directed by prominent airplane manufacturer—trains you quickly for this thrilling, profitable career.

### EARN RIGHT AT HOME

Tear out this coupon—sign and mail it *at once* for our FREE Book which tells all about opportunities in aviation, describing our practical Diploma Course of simple lessons, free employment service and *easy payment plan*.

### Now Sent Free

Use Coupon to Receive Book Without Cost

#### OHIO AERO SCHOOL

1453 South Avenue

YOUNGSTOWN, OHIO

Send me your Free Book entitled "The Call of Aviation," and full particulars concerning your Extension Course and easy payment plan.

Name.....

Address.....

City..... State.....

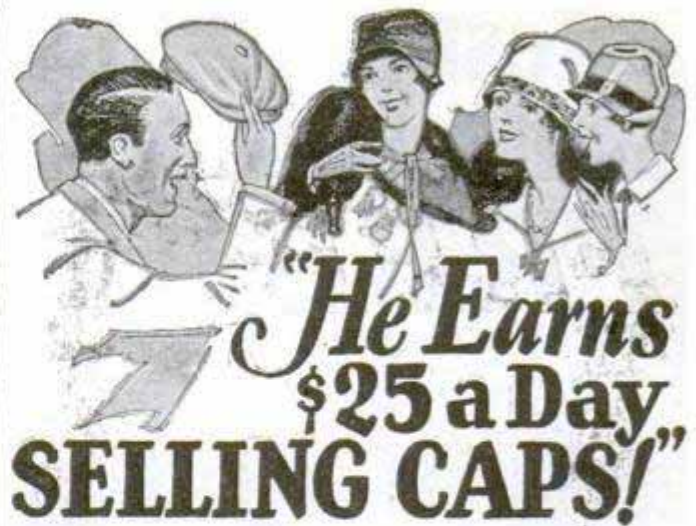

"Yes—I can remember the time he clerked at the bank for \$25.00 a week. But now he makes big money, now he is his own boss, keeps his own hours, has a fine business. And he does all that by taking orders for amazing new cap—The Taylor Rainproof Made-to-Measure Cap. Last Saturday he took 53 orders in a box factory."



#### Amazing Rainproof Test Convinces All

We're talking about R. M. Lander of Michigan. But he's only one of hundreds who are making the biggest, easiest money of their lives with this fast selling line of Taylor Caps. Every man orders. All you do is pour water on the cap. Men gasp with amazement when they see the water roll off the surface, without wetting it. Absolutely rainproof. Wear the Taylor cap in rainstorms—it keeps perfectly dry, and keeps its smart new appearance. Positively the sensation of America.

**SELLING OUTFIT NOW FREE**—Taylor caps are sold direct from maker to wearer at low factory price. Agents wanted in your community. You collect big commission in advance. Made-to-measure. Perfect fit guaranteed. 20 beautiful fabrics. Many new styles. Big new outfit just ready. We will send it to you absolutely FREE, if you rush your name and address to

Taylor Cap Manufacturers, Dept. 22-L, Cincinnati, Ohio



### MEN NEEDED FOR RAILROADS

Nearest their homes—everywhere—to train for Firemen, Brakemen; beginners \$150-\$250 monthly. Promoted to Conductor or Engineer—\$3,000-\$4,000 yearly—highest wages on railroads. Also clerks. Railway Educational Association, Dept. D-1-II Brooklyn, N. Y.

**earn money AT HOME**  
Men or women earn \$25 to \$50 a week at home. All or part time. Fascinating work. Nothing to sell. We teach you at home. Furnish all tools and materials. ARTCRAFT STUDIOS, Dept. 50, 427 Diversey Parkway, Chicago



### PAINT SHOW CARDS

and SIGNS. LEARN AT HOME IN SPARE TIME. DEMAND INCREASING. \$75 WEEKLY. PREPARE NOW. FUTURE UNLIMITED. CIRCULAR FREE. Universal School of Lettering WATERBURY, CONN.



## DRAW CARTOONS

**TURN YOUR TALENT INTO MONEY**

Cartoonists earn from \$50 to \$250 per week—some even more. Remarkable *Circle System of Drawing* teaches you in half the usual time. Students from all parts of the world are enrolling for this exceptional instruction. *Personal* criticism service and up-to-the-minute instruction make it easy for National students to attain success. Send for interesting **BOOKLET** and **SAMPLE LESSON PLATE** explaining full details of the Course and what National students are accomplishing. No salesman will call.

The National School of Cartooning, 623 Penton Bldg., Cleveland, Ohio



# PATENTS

Booklet Free Highest References  
Promptness Assured Best Results

Send drawing or model for preliminary examination of Patent Office records.

## ALL BUSINESS GIVEN PROMPT AND PROPER ATTENTION

Listed Patent Lawyer in the latest editions of the Rand-McNally Directory of Bankers and Bonded Attorneys, published by Rand-McNally & Co., Chicago, Ill.; The Baggott & Ryall Directory of Guaranteed Attorneys, published by the Ryall Legal Directory Company, New York City; Flugel's List, published by the Legal Directory Publishing Co. of St. Louis, Mo.; the American Lawyers Annual, published in Cleveland, Ohio; Eyre's Law List, Bush Terminal Building, New York City.

**WATSON E. COLEMAN,**  
REGISTERED PATENT LAWYER

Victor Building, 724 Ninth Street, N. W.  
**WASHINGTON, D.C.**



# FREE!

# MEN! Here's the dope you've been looking for

## HOW TO GET INTO THE RADIO BUSINESS

J.E.S.

Many Earn \$50 to \$250 a Week in Work That is Almost Romance

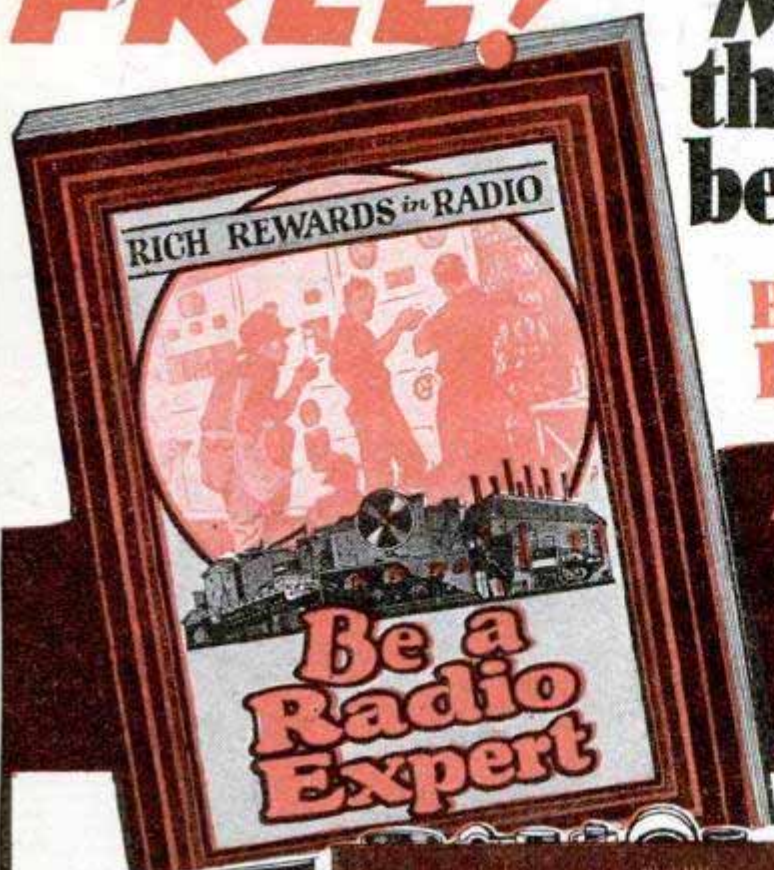

## I Give You 6 Big Outfits of Radio Parts

If you're earning a penny less than \$50 a week, clip coupon now for FREE BOOK! New 64-page book pictures and tells all about the Radio business, hundreds of opportunities—in work that is almost romance! YOU can learn quickly and easily at home, through my tested, proved methods to take advantage of these great opportunities! Why go along at \$25, \$35, or \$45 a week when you can pleasantly and in a short time learn how to hold the big-pay jobs?

### Clip Coupon for Free Book

Don't envy the other fellow who's pulling down the big cash! My proven home-study training methods make it possible for you, too, to get ready for better jobs, to earn enough money so you can enjoy the good things of life. One of the most valuable books ever written on Radio tells how—interesting facts about this great field, and how I can prepare you in your spare time at home, to step into a big-pay Radio job. GET THIS BOOK. SEND COUPON TODAY.



J. E. SMITH, Pres.  
National Radio Institute  
Dept. 33H, Washington, D. C.

I Have Trained Hundreds of Men at Home for Big Radio Jobs. My Book Proves I Can Do the Same for You.



J. E. SMITH, President  
NATIONAL RADIO INSTITUTE  
Dept. 33H  
WASHINGTON, D. C.

With them you can build 100 different circuits—learn the "how" and "why" of practically every type of Radio set. This kind of training fits you to step into the good jobs—sends you out an experienced Radio expert. When you complete, my Employment Department will help you get a big Radio job like Graduate Edward Stanko, Chief Operator of Station WGR, or Frank M. Jones, 922 Guadalupe St., San Angelo, Tex., builder and operator of Station KGFI and Manager of the best equipped Radio shop in the Southwest, or help you start a Radio business of your own like Richard Butler, 1419 No. 17th St., Phila., Pa., who made around \$500 a month compared with a job as motorman when he enrolled.

### The Famous "Course That Pays for Itself"

Spare time earnings are easy in Radio almost from the time you enroll. G. W. Page, 1807 21st Ave., S., Nashville, Tenn., made \$935 in his spare time while taking this course. Al Johnson, 1409 Shelby St., Sandusky, O., \$1,000 in four months, and he didn't know the difference between a condenser and a transformer when he enrolled. I'll give you a contract, backed by N. R. I. pioneer and largest home-study Radio school in the world, to refund every penny of your money if you are not satisfied, upon completing, with the lessons and instructions received. Find out what Radio offers you. Mail coupon.

Dear Mr. Smith:  
Without obligating me in any way, send me your big FREE BOOK, "Rich Rewards in Radio," and all information about your practical home-study, Radio Course.

Name..... Age.....  
Address.....  
Town..... State.....

ACT NOW~COUPON BRINGS MY

FREE BOOK





# Everyone Can Write Shorthand

## This New Way

### USED BY

- Executives
- Sales
- Managers
- Salesmen
- Reporters
- Engineers
- Physicians
- Writers
- Clergymen
- Teachers
- Students
- Stenographers
- Clerks.

At last—a really scientific way to write shorthand! No drudgery! No tedious memory work! No unfamiliar signs and symbols! Just your ABC's, written with pencil or on the typewriter. After your first hour's study you can begin to use this system. The most accurate and rapid shorthand ever known.

### Only 3 Weeks Required to Complete the Course

Contrast this short time (three to eight weeks) with the months of study and years of practice necessary to attain proficiency in the use of any other system. (Government statistics show that 88% of those who study other systems fail to make use of them!)

years of practice necessary to attain proficiency in the use of any other system. (Government statistics show that 88% of those who study other systems fail to make use of them!)

### Amazing Speed Quickly Developed

No one ever fails to master this new, easy method. Students and graduates make speed records never attained before. Notes made by one person can be transcribed by another.

# Speedwriting

The NATURAL SHORTHAND

—was originated by Miss Emma B. Dearborn, a nationally recognized authority, who for eighteen years trained teachers, students and speed contestants, in practically every kind of conventional shorthand, in such notable educational institutions as Columbia University, University of California, Rochester Business Institute and Simmons College, Boston. Throughout the United States and in foreign lands Speedwriting has been welcomed enthusiastically by business and the public. Everywhere this new, natural shorthand is hailed as the perfect system that will eventually supplant all others.

### Mail Coupon for FREE Book

Illustrated book tells you what Speedwriting and Speed-TYPING are like, how they will save your time, money and strength and make you more valuable in your work, whether you are an executive, professional or business man or woman, experienced stenographer or beginner.

### Mail the Coupon NOW!

**Brief English Systems, Inc. Dept. L73**  
**200 Madison Avenue, New York City.**

Without cost or obligation on my part, please send me your new illustrated booklet on Speedwriting, the natural shorthand.

Name.....

Address.....

City.....State.....

Be a Time Study Engineer!

# BIG PAY

Learn at Home in Spare Time



awaits ambitious time study men who have had practical training. Learn at home in spare time under guidance of practical engineers with 5 to 25 years' experience teaching men for National Cash Register, Delco-Remy, Frigidaire and Delco-Light. Complete home study courses in Time Study Engineering, Mathematics, Mechanical Drawing, Tool Designing, Blue Print Reading. Easy payments. Special rates to students enrolling now. Write for full details.

**MICHAEL'S SCHOOL, INC.**  
 Dept. 10, Miami Savings Bldg.  
 DAYTON, OHIO

Earn \$3,000.00 to \$10,000.00 a Year!

## \$50 Every Saturday



### MAKING AMAZING DEMONSTRATION

I mail pay-checks every Saturday to men I appoint in every territory. Work full or spare time making amazing demonstration that will save prospects thousands of dollars.

### Demonstrator Furnished

We will furnish outfit for sensational demonstration. No investment for stock—no deliveries or collections. Every one a prospect. Show in homes, stores, garages, schools, offices, and to farmers, etc. Many of our men now making \$300 to \$600 a month. Write at once to

### FYR-FYTER COMPANY

90-L Fyr-Fyter Bldg., Dayton, Ohio

## Books on 31 Subjects

Popular Mechanics Press specializes in supplying books on any subject. Look over this list. Check the books you want, and mail this advertisement as your order blank. Catalog with lists on 2,000 subjects free.

- AEROPLANE**  
Construction and Operation.....\$2.50
- AUTOMOBILE ELECTRICITY**  
Wiring Diagrams New Ford and Other 1928 Models.....\$5.00
- BLUE PRINT READING**  
Machine.....\$2.00
- BOYS**  
How to Put on an Amateur Circus.....\$1.75
- BUILDING TRADES**  
Building Trades Handbook.....\$1.00
- CHALK TALKER**  
Chalk Talk and Crayon Presentation.....\$1.25
- DICTIONARY**  
Simplified, 1500 Pages, 3000 Illus.....\$5.00
- DOGS**  
Training.....\$1.50
- ELECTRICITY**  
Practical Applied Electricity.....\$2.00
- FLIGHT**  
A B C of.....\$1.50
- FURNITURE**  
Finishing, Decoration and Patching.....\$5.00
- GARDENING**  
Garden Guide All Kinds.....\$1.50
- LETTERING AND DESIGN**  
For Artists and Advertisers.....\$3.00
- MILLWRIGHT**  
Erecting and Operating Machinery.....\$2.00
- MIRRORS**  
Silvering.....\$1.00
- OUTDOOR OCCUPATIONS**  
Outdoor Opportunities.....\$2.00
- PHOTOGRAPHY**  
Making the Camera Pay \$3.50
- PLUMBING**  
Plumber's and Fitter's Handbook.....\$1.00
- PUBLIC SPEAKING**  
For Business Men.....\$2.50
- PUZZLES**  
Mathematical.....\$1.50
- RADIO**  
Theory and Operating.. \$3.50
- RUSTIC WORK**  
Rustic Carpentry.....\$1.00
- SHEET METAL WORKER**  
1000 Aids For.....\$5.00
- SLIDE RULE**  
How to Use.....\$3.00
- SPEECH**  
18,000 Words Often Mispronounced.. \$2.00
- STEAM ENGINEER**  
Steam Engineer's Handbook.....\$1.00
- STEEL SQUARE**  
A B C of the Steel Square.....\$1.00
- THEATRE PATRONAGE**  
Building.....\$5.00
- THINGS TO MAKE**  
Make It Yourself.....\$3.00
- TOOLS (Using)**  
Tinkering with Tools... \$2.00
- WINDOW TRIMMER**  
Handbook of Window Display.....\$5.00
- WOOD WORKING**  
For Amateur Craftsmen.....\$1.00

### SEND NO MONEY

Just check the books you want, and mail the whole advertisement. It is your order blank. When postman hands you books, pay him the price and the postal charges. If outside the U. S. remit when ordering and include 10 cents per book extra for postage. **POPULAR MECHANICS PRESS, Room P11, 200 East Ontario St., Chicago, Ill.**



# Great Industrial Concerns Unite With School of Engineering!

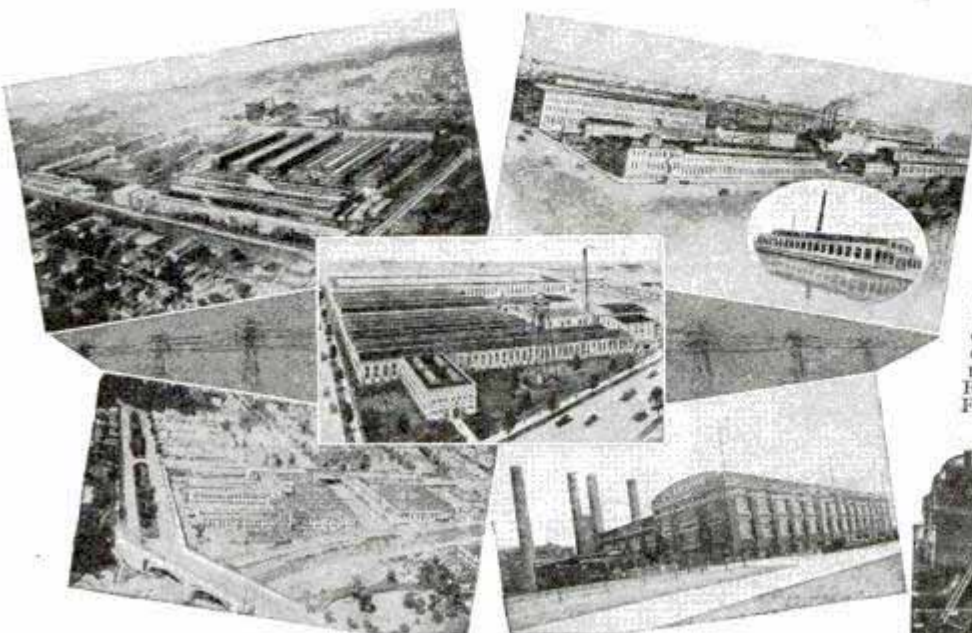

To meet the tremendous demand for men trained in electricity—Milwaukee's leading electrical concerns have united with the School of Engineering in a gigantic program of Industrial Cooperation. This program, unlike anything ever attempted by any Engineering School in the country, insures every student at the School of Engineering a practical training to fit the needs of the country's largest industrial concerns. More than that—this plan offers possibilities for actual employment both while attending the School of Engineering, and after graduation—even financial assistance for worthy students—that makes it one of the finest opportunities available for the young man who wants to FORGE AHEAD! Read below—then send coupon for FREE details.

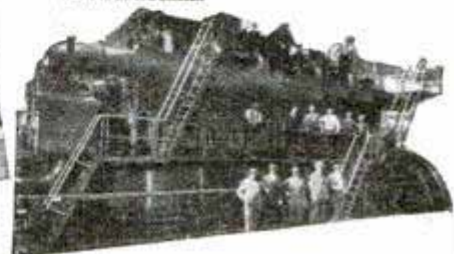

U. S. Govt. requests S. of E. Students to assist in acceptance tests of 3 Diesel Engines for Panama Canal.

## MEN WANTED FOR Commercial Electrical Engineering

Over a score of leading industrial concerns of the type of the Allis-Chalmers Co., Milwaukee Elec. Ry. & Light Co., Nordberg Mfg. Co., Allen Bradley Co., Harnischfeger Corp., have placed their seal of approval on the School of Engineering of Milwaukee, joined hands in an Industrial co-operative program, established a special School of Engineering Loan Fund to assist deserving students. Here is the opportunity of a life time to get into ELECTRICITY through this large, splendidly equipped, 24 year old Engineering School. Get out of the overcrowded, low-paid laborer class. Become a Master Electrician, Junior Electrical Engineer, or Commercial Electrical Engineer in 12 short months. Get into the field where manufacturers are actually pleading for practically trained men—where they are glad to pay big salaries ranging from \$2,000 a year and up. Not a dream—A DEAD SURE FACT! For 24 years we have trained men for the electrical profession and Our Graduates Have Succeeded in All Parts of the World. Our 12 months' intensive training is the boiled down essence of what We Know fits men for big paying positions. It is work you'll love. No limit to advancement. Practical engineers teach you. They know What to teach and How to teach it, so you can earn money with it. Hundreds of thousands of dollars' worth of actual commercial electrical equipment to work on in this school.



Electric Engineering B. S. Degree in 3 years!

practically trained men—where they are glad to pay big salaries ranging from \$2,000 a year and up. Not a dream—A DEAD SURE FACT! For 24 years we have trained men for the electrical profession and Our Graduates Have Succeeded in All Parts of the World. Our 12 months' intensive training is the boiled down essence of what We Know fits men for big paying positions. It is work you'll love. No limit to advancement. Practical engineers teach you. They know What to teach and How to teach it, so you can earn money with it. Hundreds of thousands of dollars' worth of actual commercial electrical equipment to work on in this school.

### Earn While You Learn

By our special system you may earn part of your way while learning. Exceptional opportunities now available thru co-operation with large industrial concerns. Our Employment Department will help you secure a position to which you may devote a part of each day, spending the remainder at the school. This plan both solves the students' financial problems and provides splendid experience at the same time. Low tuition fee, Board and room reasonable. Daily Broadcasting WISN (formerly WSOE). School Orchestra. Fraternities.

### Photo Story Just Off Press FREE!

Write today for our FREE illustrated Photo Story and catalog. Contains over 136 colored actual photographs. Read about this wonderful institution and the great opportunities that lie before you. Find out about our specialized method of training and the details of our "Earn While You Learn" plan.



### Radio and Electrical Refrigeration

Learn in three months—just 90 days and you can be one of the new group of trained men who will guide and develop the newest and best paying of America's gigantic industries. Radio and Electric Refrigeration are tremendous money makers for the trained man who gets into the game early. Experts are needed for big, responsible, well-paying jobs. We train you quick and help place you in a good position. ACT NOW!

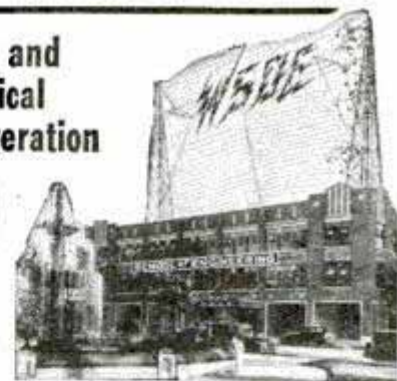

### FALL TERM OPENS NOW!

School of Engineering of Milwaukee, Dept. P. M. 1128, Milwaukee, Wis.

Without obligating me in any way please mail free Photo Story book, "Rise to Success Through Electricity" (just off the press), and NEW Bulletin regarding the course I have marked with an X.

- |  |   |
|--|---|
| <input type="checkbox"/> Commercial Elec. Eng. for High School Grad. 1 year. | <input type="checkbox"/> Elec. Refrigeration.   |
| <input type="checkbox"/> Commercial Elec. Eng. others 1 to 2 years.          | <input type="checkbox"/> Radio.                 |
| <input type="checkbox"/> Elec. Eng., B. S. Degree 3 yrs.                     | <input type="checkbox"/> Armature Winding.      |
| <input type="checkbox"/> Automotive Elec.                                    | <input type="checkbox"/> Light, Heat & Power.   |
| <input type="checkbox"/> I am interested in your Earn While You Learn Plan.  | <input type="checkbox"/> Practical Electricity. |
|  | <input type="checkbox"/> Home Lab. Service.     |

Name..... Age.....  
 Address.....  
 City..... State.....  
 Education.....





# AUTOMATIC DRAFTING TABLES

*The only ones on which you can make a neat and accurate drawing quickly*

Used by government engineering departments, engineers, architects, etc. They sell for much less than ordinary tables on cast iron stands. Guaranteed for ten years. Easy terms. It is an ideal drafting table for beginners. If you want to learn mechanical, architectural or structural drafting quickly, we will give you one of the best and most complete **DRAFTING COURSES FREE** with each table. Write for details.

**JEROME W. HURYCH MFG. CO.**

24-31 Kindred St.

Astoria, Long Island, New York



from A Practical School with Modern Equipment

All Instructors and Airplanes Licensed by U. S. Govt.

There is money for you in Aviation, if—you get thorough training now! Our courses will give you this training—they are taught under the direction of U. S. Licensed Transport Pilots and Mechanics and cover everything about planes, motors, their maintenance and construction. Everything a pilot or mechanic must know to secure a good paying position. Our equipment is new and of modern design, subject to daily U. S. Gov't Inspection.

## TRAINED MEN ARE NEEDED

The training which the Von Hoffmann student receives is the exact training which he must have to qualify for immediate positions on the ground or in the air. Our courses have been laid out with a single object in view—to give thorough training in all branches of aviation. Commercial aviation needs men and there is an ever increasing demand **ONLY** for those who have been properly trained—Von Hoffmann gives you this training.

### Thorough Instruction at Low Cost

We teach you by actual flying and practical instruction; no long course needed. We guarantee sufficient hours in the air to make each student master of his ship; pilot it safely and efficiently by himself. No student bond required. Our ground course gives thorough instruction in ground work and qualifies you for a position as motor and plane mechanic, rigger, electrician, welder and any other ground position, or you can take the course combining ground instruction and flying which will qualify you for an industrial, limited commercial or transport pilot. The cost is low considering daily flying and thoroughness of theoretical and ground instruction on latest modern type planes. Wright Whirlwind and other standard motors. Our big new book "Aviation and You" tells all the facts.



Fill out the coupon and mail it at once—no obligation. **DO IT NOW!**

**VON HOFFMANN AIRCRAFT SCHOOL**  
112 Lambert—Saint Louis Flying Field, ANGLUM, MO.

**VON HOFFMANN AIRCRAFT SCHOOL**  
112 Lambert—Saint Louis Flying Field  
(Lindbergh's Own Field), Anglum, Missouri

Send me your big, new book, "AVIATION AND YOU," giving all the facts about your ground and flying courses. I assume no obligation.

Check ... I am interested in GROUND COURSE  
Here ... I am interested in FLYING COURSES

Name.....  
Address..... Age.....  
Town..... State.....

## BIG NOVELTY BARGAIN! 10c

**Throw Your VOICE**  
Into a trunk, under the bed or anywhere. Lots of Fun fooling the Teacher, Policeman or Friends. **Barrels of Fun.**

**THE VENTRILO —**  
a little instrument, fits in the mouth out of sight, used with above for Bird Calls, etc. Sent with full instructions; anyone can use it. **NEVER FAILS.**

Also a **32 PAGE BOOK ON VENTRILOQUISM.** Formula for Secret Writing, 12 Money Making Secrets and the marvelous

**NOVELTY X-RAY WONDER**  
With it you can apparently see the bones in your fingers, lead in pencil, etc.; lots of fun with this outfit. Also 10 Big Magic Tricks Free with every order. All the above Novelties by prepaid mail for **10c**

Ventrilo Company, Dept. 608, Norwalk, Conn.  
LARGEST and OLDEST Mail Order House in Connecticut

# YOU'RE NEXT

## Now Watch YOUR Muscles GROW!



### BEFORE and AFTER

Transformed from a weakling into a perfect specimen of **MANHOOD!** All in 30 short days! That's what a few minutes a day of Titus Training did. Do YOU want **MUSCLE? HEALTH? STRENGTH? VITALITY?**

**YOU see what I did for this man!** I've done that for thousands. Let me do it for YOU. I don't care what your present condition may be. Or whether you're 20 or 50.

**In 30 Days I'll Increase** Just give me a few minutes a day! Watch your muscles **Your Muscles by INCHES** **GROW!** I'll broaden your shoulders, fill out your chest, cover your body with brawny layers of **LIVE muscle.**

**FREE Amazing New Book** "Miracles in Muscle" Titus, Dept. M-132 105 East 13th Street, New York City.

Tear off that coupon! Mail it today! It brings you **FREE** the greatest physical culture book you've ever seen—filled with astounding photographs of men rebuilt—Don't miss it!

Dear Titus: Send Along your big new book, "Miracles in Muscle"—**FREE!**

The One and Only **TITUS** Name.....  
105 East 13th Street Address.....  
New York, N. Y. Town..... State.....



# GENUINE MODEL T CORONA

## 1/3 OFF REGULAR PRICE



**H**ERE'S your chance to own that genuine Model T Corona you've wanted—on the easiest terms ever offered — at **ONE-THIRD OFF** regular price! Complete in every detail; back spacer, etc., **NEW MACHINE GUARANTEE**. Recognized the world over as the finest, strongest, sturdiest, portable built.

**\$2<sup>00</sup> DOWN**  
**BALANCE EASY TERMS**

**Yours for 10 Days FREE**  
*Send No Money*

Only a limited number of these splendid machines available. To get one, you must act now! Experience the joy this personal writing portable typewriter can give you! Use it 10 days free! See how easy it is to run and the splendidly typed letters it turns out. Ideal for the office desk, home, traveling. Small, compact, light, convenient. Don't send out letters, manuscripts, reports, bills in poor handwriting when you can have this Corona at such a low price or on such easy terms.

**Carrying CASE**

**Included—If You Act Now**

Leatheroid carrying case, oiler, instructions free on this offer. Send no money—just the coupon. Without delay or red tape we will send you the Corona. Try it 10 days. If you decide to keep it, send us only \$2—then \$3 a month until our special price of \$39.90 is paid (cash price \$36.40). Now is the time to buy. This offer may never be repeated. Mail coupon now.

**Smith Typewriter Sales Corp.**

Dept. 3-B, 360 E. Grand Ave.

Chicago, Ill.

**\$15.10 SAVED  
BY USING THIS COUPON**

**Smith Typewriter Sales Corp.**  
**[Corona Division]**  
**360 E. Grand Ave., Chicago, Dept. 3-B**

Ship me the Corona, F. O. B. Chicago. On arrival I'll deposit \$2 with express agent. If I keep machine, I'll send you \$3 a month until the \$37.90 balance of \$39.90 price is paid; the title to remain with you until then. I am to have 10 days to try the typewriter. If I decide not to keep it, I will repack and return to express agent, who will return my \$2. You are to give your standard guarantee.

Name.....

Address.....

Employed by.....





# ADVANCE WITH AVIATION

Get into this great expanding field. This large commercial Transport and Training Company offers the highest type of training. Lowest rates consistent with safety. Specialized courses for Business Men. Aerial photography Home Study course in theory leading to practical course in Ground Mechanics and flying.

Finest equipped shops. Latest type planes with seasoned pilots. Modern Brick Hangar at the country's busiest airport. Employment Department to help pay living expenses while learning. Return this ad with age, name and address and full information will be sent you.

**AVIATION SERVICE AND TRANSPORT, INC.** Dept. P.M. 11  
203 No. Wabash Avenue

**STEEL BLUE Elite Diamond**  
IF YOU CAN TELL IT FROM A DIAMOND  
**SEND IT BACK!**

**\$389 C.O.D.**

**1 Carat Elite Diamonds.** Matchless for their dazzling rainbow brilliancy. You'll be delighted. **Elite Rings** surpass all others. Stand acid and other tests. Handsomely Engraved Rings, sterling **Guaranteed.** Looks like **\$250.00.** Proud owner offered **\$85.00** 5 minutes after buying one. With each ring order, we give free beautiful combination Set. Set with small **Elite Diamonds.** **SEND NO MONEY.** Just send name, address and finger size. On arrival pay postman \$3.89 and postage. Satisfaction Guaranteed. Write today. Cash with Canadian or foreign orders.  
**ELITE JEWELRY HOUSE, Dept. 1611, 6343 S. Ashland Ave., Chicago, Ill.**

*Ingersoll*  
**WATCHES & ALARM CLOCKS**



## BOW LEGS?

THIS GARTER (Pat'd)  
Makes Trousers Hang Straight  
If Legs Bend In or Out

Free Booklet—Plain Sealed Envelope  
**THE T. GARTER CO., Dept. E**  
South Bend, Ind.

# This Discovery for Men

## Brings New Meaning to the Years that Follow 40!

### NOW... In Your Own Home You Can Use This Great Natural Drugless Gland Stimulant

**T**HE long sought method of drugless gland stimulation has been found. Already it is used by more than 50,000 men—victims of prostate gland disorder—men past 40, men who have found themselves suddenly on the down grade. Quietly, without the noisy publicity which has attended the work of certain European gland surgeons this great discovery has almost over night spread from coast to coast, from nation to nation. Absolutely harmless, including nothing of medicine, drugs, violet ray or quackery, this type of treatment has been accepted by many physicians and specialists.

America's foremost sanitarium has advised this great discovery for home treatment.

This "treatment-discovery" is the work of a pioneer scientist in the field that has recently made discoveries recognized as the most momentous by medical science the world over. It can be used by any man in the privacy of his own home. Men 90 years old have used it successfully.

Are you aging too soon—getting up 5 to 10 times at night? Is vitality ebbing... are you half-living... blue, depressed, subject to chronic fatigue, constipation, backache, foot and leg pains? Then you should know at once about the vital prostate gland, how it sends its warning to every part of the body, slowing up mental as well as physical functions. Do not make the mistake of confusing your trouble with bladder or kidney ailments as so many thousands of men do.



Users are telling how this method worked when all others had failed. Many say they were on the verge of a painful gland operation when relief was found at last. Others tell of beneficial results which seem almost miraculous. Thousands say they felt years younger.

So wonderful are the marvelous results this treatment often brings that it is sent to your home with the understanding that unless its benefits are positive and immediate—within 6 days—it costs you nothing.

Mail the coupon below for full details. An interesting illustrated book will be sent you free, in plain wrapper. No obligation. But act now. It may mean the saving of years of a painful and torturous condition.

**W. J. Kirk, President, 2111 Morris Ave., Steubenville, Ohio**

If you live West of the Rockies, mail your inquiry to  
**The Electro Thermal Co.**  
303 Van Nuys Building, Dept. 21-L  
**LOS ANGELES, CAL.**

**W. J. Kirk, President**  
2111 Morris Ave., Steubenville, Ohio.  
Please mail at once a FREE copy of the booklet, "Why Many Men Are Old at 40", and all details about the new treatment. I'm not obligated in any way.

Name.....  
Address.....  
City..... State.....  
In Canada address: The Electro Thermal Co., Desk 21-L,  
44 Young St., Toronto, Ontario, Can.



I'll Pay Your Railroad Fare to Chicago Without Extra Cost

UP TO \$15,000 a year for GREER GRADUATES

ELECTRICITY, AUTOS, AVIATION now pay hundreds of trained men up to \$200 A WEEK. Here are THE 3 WORLD'S GREATEST BUSINESSES. BILLIONS—not millions, but BILLIONS of dollars are spent in them every year. CHOOSE ONE OF THESE THREE, HERE and NOW.

GREER trained men are NEEDED. I HAVE MADE hundreds of \$10,000 A YEAR MEN. 90,000 in the last 26 years have come to GREER. THOUSANDS MORE in the future will likely come here. BE ONE OF THEM. Send coupon to me for openings.

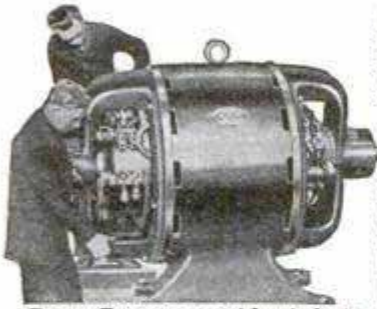

Rotary Converter, used by students for testing

Amazing Opportunities for you in one of World's 3 Biggest Businesses

MEN WANTED

I will help you get a position while learning, also after graduation. Never before such unusual opportunities. GET MY FREE BOOK NOW. LEARN ABOUT THE BIG PAY. ELECTRICITY. AUTOS. AVIATION. I lead WORLD'S BUSINESS. That's why GREER. Collect selected these fields and ONLY THESE.



Learn to Boss the Job

AVIATION



ELECTRICITY

AUTOS

Learn in Only 3 Months in GREAT GREER SHOPS ON LARGE LIVE EQUIPMENT

Mine is NOT A CORRESPONDENCE COURSE. You can start any day or any evening. It is PRACTICAL, EASY, QUICK, FASCINATING training. You learn on Great, running, live Equipment in tremendous GREER SHOPS. AUTO BUSINESS is a BIGGEST BUSINESS in the world. ELECTRICITY is FASTEST GROWING, and yet in its Infancy. AVIATION, most fascinating, alluring business today, is already a Billion Dollar Industry.

full of HARD THEORY—NO HEADACHES in GREER PRACTICAL SHOPS TRAINING. You learn to DO BY DOING. You learn to Fly—by Flying.

Choose one of these 3 wonderful professions today. Trained men are needed by scores, for positions up to \$200 a week and up. Find out now, about my great Shops training.

You Get Real Help to BIG JOBS!

TWELVE PEOPLE are in my Big EMPLOYMENT DEPARTMENT getting jobs for Greer men. You get their help AS OFTEN AS YOU NEED IT, both BEFORE and AFTER Graduation.

Quickest, Easiest of Ways to Become Expert

I'LL PAY YOUR FARE HERE FREE of extra cost, then help you to a JOB WHILE LEARNING. Then I not only FIT YOU to get BIG PAY JOB, but I'll help YOU HOLD IT. Young and Old, Educated and Uneducated, Inexperienced and Experienced have found GREER SHOPS training EASY, FASCINATING and VALUABLE. Coupon below brings details.

Not Correspondence Course

Here at GREER SHOPS you learn on BIG, ACTUAL FULL SIZE Machinery, like you will work on out on the Big Pay Job. You get close personal supervision. NO Guess work—NO books

Erwin Greer



Get My FREE BOOK NOW

Don't let money hold you back. Get my Free Book. Find out NOW, how I PAY YOUR FARE HERE, let YOU ATTEND EITHER DAYS or EVENINGS and help you find DAY or EVENING WORK to PAY YOUR EXPENSES while learning. Then when ready we help you find the real BIG PAY JOB. LEARN how I get you ready so Employers WANT YOU, and GLADLY pay you what you are worth.

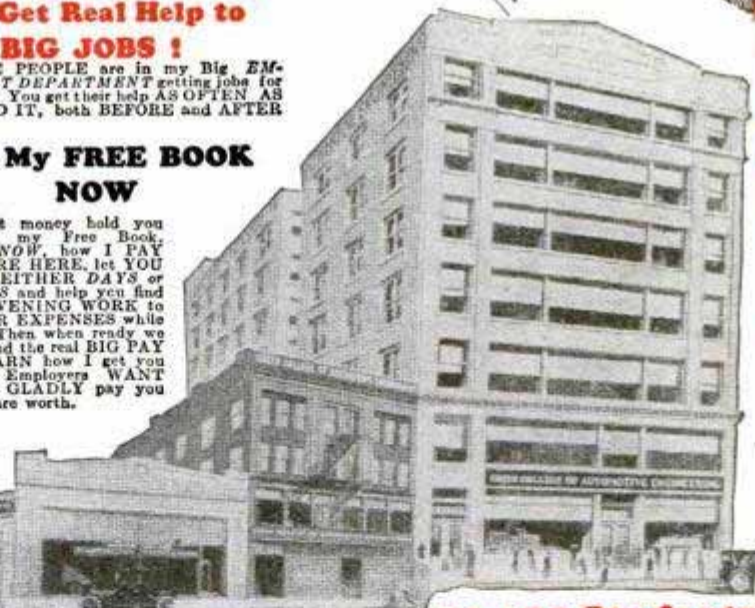

90,000 Students

26 Years Tremendous Success

Above is the important history of GREER COLLEGE. Note the steady 26-years growth, thru genuine SERVICE, from the tiny Shops on the left to the tremendous Building on the right, filled with GREAT TRAINING Equipment. These

moves to always greater quarters mean GROWTH—PROGRESS and SERVICE. What is it you like—ELECTRICITY—AUTOS—or fascinating AVIATION? GREER will train you in EITHER, as YOU SHOULD BE TRAINED.

GREER COLLEGE

Electricity—Autos—Aviation  
Dept. 801  
2024 So. Wabash Ave.  
CHICAGO, ILL.

Get My Big Offer Now!

Would an offer of \$100 a week be OPPORTUNITY or DISAPPOINTMENT for you? If you could HOLD THE JOB it would truly be OPPORTUNITY. If you can't hold the \$100 a week job, PREPARE. Be ready. Don't invite disappointment. Learn about GREER SHOPS. Right now if you act quick, I can make you a most unusual short time offer. Clip coupon NOW and find out. Address me personally

ERWIN GREER, President

SCISSORS FOR FREE BOOK

ERWIN GREER, President

Dept. 801  
2024 So. Wabash Avenue,  
Chicago, Illinois

Send Free Book indicated below and details of Special offer, without obligation to me.

Autos  Electricity  Aviation

Name.....

Address.....





# Electric Motor FREE

A wonderful, powerful electric motor equipped with driving pulley, and two-blade fan, mounted on polished wooden base, binding posts, control switch. Runs mechanical toys beautifully. A little gem, you may have it free.

The Open Road for Boys Magazine has 50 pages a month crammed with thrilling fiction and articles. It is the hit of the year. Regular subscription price \$1.00 a year. We will send you 12 issues—a year's subscription—and this great electric motor all for \$1. Order now.

## A Whole Year of Breathless Reading



## Both for \$1 for

Open Road for Boys Magazine, Dept. H. E.  
130 Newbury Street,  
Boston, Mass.

Friends:  
Here's my \$1. Rush me the electric motor and put me down for one year for The Open Road for Boys Magazine.

Name.....  
Street.....  
Town or City.....  
State.....



## SQUAB BOOK FREE

Breed squabs and make money. Sold by millions for more than chickens. Write at once for free 40-page book beautifully printed in colors telling how to do it. *You will be surprised.*

**PLYMOUTH ROCK SQUAB CO.**  
634 H Street Melrose Highlands, Mass.



## INCREASE YOUR POULTRY PROFITS!

By proper Breeding, Feeding, Housing, Culling and Marketing **AMERICAN POULTRY JOURNAL** tells how to do it, and in addition a series of **Colored Pictures** with explanatory text tell and show many things you should know. They are not just colored pictures of birds but pictures of an educational nature, something never before shown by a poultry paper. **12 issues of American Poultry Journal contain about 1000 pages—Price 25c a year—5 years for \$1.**

**AMERICAN POULTRY JOURNAL, 14-536 S. Clark St., CHICAGO**

# Wrestling Book FREE

Learn at Home



Be an expert wrestler. Learn at home by mail. The greatest wrestlers of all, **Frank Gotch** and **Farmer Burns**, both world's champions have prepared the most wonderful course of lessons ever written on Physical Culture and Expert Wrestling. Be strong and healthy! Handle big men with ease. This great free book tells you how. Don't delay. Write now. State your age. **Farmer Burns School, 3378 Ry. Exchange Bldg., Omaha, Neb.**

# WANTED!

Ornamental Iron and Bronze Draftsmen. \$50.00 to \$65 a week to trained men — up to \$500.00 a month to experienced men. We train you at home and help place you when ready. Demand greater than supply. Get out of the rut — write today for full information and booklet "Knowledge—Your Greatest Asset."

**American Institute of Ornamental Iron & Bronze**  
3074 Hennepin Avenue, Minneapolis, Minn.

## Miller's American Poultry Guide FREE

Tells all about chick's-care, feeding and raising for profit. Also describes Hot Water & Electric **"Ideal" Incubators \$11.50 Up** With Original Patented EGG TURNING TRAYS **"Ideal" Brooders -- \$6.90 Up** Coal, Oil, and Electric Brooders, Poultry Supplies, Baby Chicks. Special LOW PRICES! Write Today!



**J. W. MILLER CO., Box 12, Rockford, Ill.**



## FOY'S BIG BOOK, in Colors

A complete guide to successful Poultry and Squab Raising. Low prices on CHICKS, Breeding Stock and PIGEONS. Write Today! FREE!

**FRANK FOY, Box 18, Clinton, Iowa**



# GIVEN

## BIG MOVIE MACHINE

**THIS Large Size Movie Machine operates on same principles as expensive professional models, uses standard size films same as big theatres. Imported double Convex Lenses show large, clear pictures. Complete outfit furnished—enough for a full hour's show, including Tem Mix film, etc. Easy to operate, guaranteed for life. Just send for 12 large Bottles *Salut D'Amour* Perfume that sells at 25cents each. *This is a real bottle size 3 1/2 inches.* We also send 12 Perfume Novelties which you give away free of charge and Easy Plans for obtaining MOVIE Machine. Send no money. We trust you.**

**TREVAUX Perfume Co. Dept. 7C78 CHICAGO**



# Show Card Lettering

HERE is the very course you need if you want to get a good paying position as a Show Card Letterer or Sign Letterer, or have a business of your own. This course is complete and practical and especially arranged to meet the needs of the student who studies at home. It was written by E. L. Koller, Principal of the International School of Art, member of the American Federation of Arts, and The National Society of Craftsmen.



H. L. Wood, a clerk, made more than \$700 "on the side" before he had completed this course. Harry Lord writes that he has more than doubled his salary. William Whitman is earning three times as much as he did before enrolling with the International School of Art.

**INTERNATIONAL SCHOOL OF ART**  
Division of the International Correspondence Schools  
Dept. 5577-F, Scranton, Penna.

**Learn at Home**

**Mail Coupon for Free Booklet**

Without cost or obligation, please send me full details of your home-study course in

SHOW CARD LETTERING  
 ILLUSTRATING       CARTOONING

Name.....  
Address.....



# "Every 3 Months"

*This Little Auto Device Meets The Payment On My Car!*

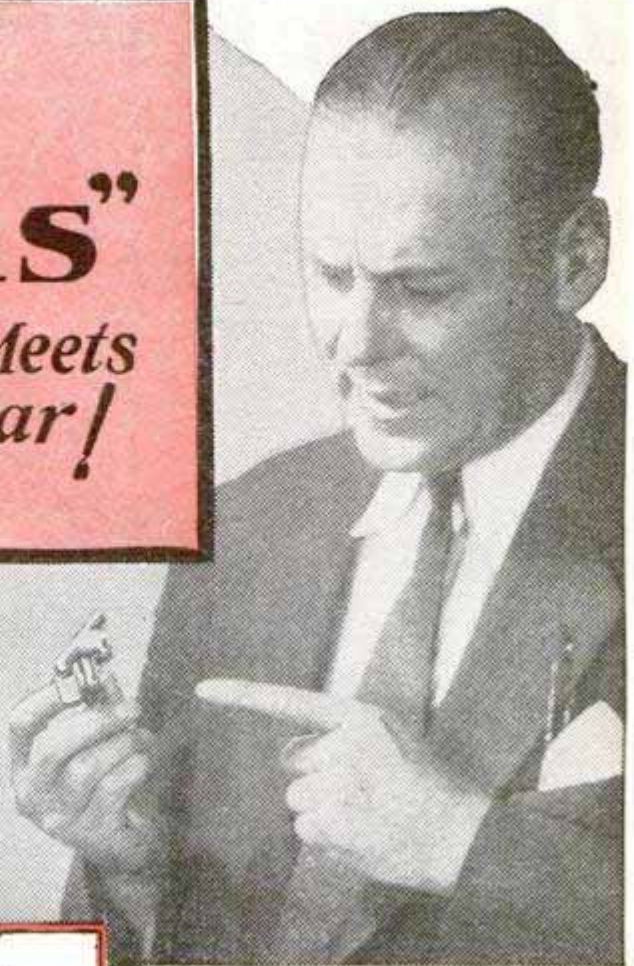

"YES sir,—I began to save money on my car from the first day I installed this little invention. I figure it's already earned enough to take care of one-third of my investment in the car."

"How do you figure that?"

"Simply this. Before I heard of this device I was getting only 12 miles per gallon of gas. But since installing it a year and a half ago I've been averaging 25 miles per gallon. I've driven 20,000 miles since then. That means a saving of 866 gallons of gasoline, or \$173.20—which is equal to seven payments within a year and a half. Isn't that enough to make a car owner happy?"

"Pretty good, all right. But darned if I can see how a little thing like that can save gasoline."

"Neither could I. But a friend of mine tipped me off to it. He came back from a long trip and said that it saved him \$40.00 on this one tour. And do you realize that about three million car owners have installed it? They can't all be wrong."

"What's the principle of the thing?"

"Why, it's very simple. In the first place, the average motorist uses too rich a mixture. Official tests have revealed that the average man wastes two or three gallons for every ten he buys. What he needs is some sort of automatic control that will keep the car running on the thinnest mixture of gasoline. Carburetors help, but not enough."

"This invention acts after the gasoline leaves the carburetor. Its principle is to vaporize the gasoline more completely, without interfering in any way with power or speed. And by controlling the gasoline flow, many car owners say that it checks the evil of unconsumed gasoline, thus reducing to a minimum carbon deposits, fouled spark plugs, from over-rich mixture, etc."

"How do you install it?"

"Oh, it's easy to install. You can put it on as quick as a fan

belt. There's a special model made for every type of car, truck or tractor. And complete instructions come with every model, so the owner can put it on himself in five minutes."

"Well, I'd like to save gasoline, of course. But I'd hate to buy it and then not have it bring results."

"You don't take any chances at all. The inventors will send you samples to test at their risk. If you don't get at least fifty per cent more miles per gallon, the samples don't cost you a penny."

"Fair enough—I can't lose on that offer. I'll send for samples today."

## AGENTS

G. F. Fuller made \$114 in five days. Foster made \$357 in two weeks! Eberlein sold 23 vaporizers in 35 minutes. Our offer gives demonstrators one vaporizer free. Wonderful spare time money-making plan. No experience required—I show you easy plan. Mail coupon below quickly!

## Make This Free Test

Test this device on your car—and expect results that will amaze you. Double your mileage—get flashing pickup and power—forget carbon troubles, sluggish motor and fouled spark plugs from over-rich mixture—and save enough on your gasoline to more than keep you in tires. These results are guaranteed or the test costs you nothing.

Mail coupon below for full details, guarantee, and free sample offer, which is even more remarkable than we can tell you here. No obligation whatsoever. Do it now. J. A. Stransky Mfg. Co., Dept. P-10, Stransky Block, Pukwana, S. D.

J. A. Stransky Mfg. Co.,  
Dept. P-10, Stransky Block,  
Pukwana, S. D.

Without obligation send me full details of your free trial offer.

Name.....

Address.....

City..... State.....

( ) Check here if you want to become a Stransky Distributor.



# Decorate these Giftwares and Make Money



Earn money at home,  
this fascinating new way,  
in spare time

We Show You How

THIS is the most delightful work you could imagine; you will enjoy every minute you devote to it. Many people do it solely for the artistic pleasure they get in creating beautiful things. But it also pays surprisingly well, for there is an enormous demand for giftwares. Many of our members make \$10 to \$25 a week, and have built up profitable businesses from small beginnings. Think of decorating a Hanging Shelf, for example, requiring only 3 hours work, and realizing a profit of \$10.50. What other work could be so interesting, and pay so well?

## No Special Ability Needed

The national association of homeworkers known as Fireside Industries now has openings for new members. This is your opportunity. Find out how you can secure a membership. The work is easily learned, and easy to do. You have only to follow the simple directions given by Gabriel Andre Petit, the Art Director, and you can easily learn the latest methods of decorating wooden toys, parchment lamp shades, painted furniture, book-ends, greeting cards, batik and other objects of art. You are furnished a complete outfit of materials, worth \$10.00 without extra cost. You can start making money almost at once.

## Money-Back Offer

What thousands of others are doing in Fireside Industries, you also can do. So sure are we of your success in this fascinating work that we refund your money in full if, after completing your instructions, you are not entirely pleased. You take no risk whatever.

## Beautiful Book FREE

The beautiful Book of Fireside Industries, illustrated in color, explains all about this new way to earn money at home. It will be sent you, absolutely FREE and without obligation. Just mail the coupon, or write, enclosing 2c stamp for postage. But do this at once, while openings for new members are being offered.

**FIRESIDE INDUSTRIES**  
Dept. 66-S, Adrian, Mich.

Fireside Industries, Dept. 66-S  
Adrian, Michigan

Please send me, Free, the book on Fireside Industries, which explains how I may earn money at home. I enclose 2c stamp.

Name.....

Address.....

City..... State.....

(Write in pencil—ink will blot)



## Be a drummer!

Trap Drumming made easy in a short time. Our free instruction course furnished with genuine Ludwig Trap-Drum Outfit. Develop your natural sense of rhythm. Go to your nearest dealer or write for full details.

LUDWIG & LUDWIG, 1611 North Lincoln Street, Chicago



## BE AN OFFICER in the U. S. Coast Guard \$1700 Up to \$7,500 Yearly

\$780 yearly at the U. S. Academy while training. You rank Ensign to Captain in service. Age requirements 18 to 22. Write Dept. PM for information.

COAST GUARD PREPARATORY SCHOOL  
4000 Ga. Ave., N. W. Washington, D. C.

## BART'S NEW CHALK TALK BOOK

"Their Best Stunts" from 25 chalk experienced talk artists. \$1.25 prepaid, 5-day trial. Also catalog "A", Art Supplies, or "S", Show Card Supplies.

BART SUPPLIES, 512 Eustis Bldg., Minneapolis, Minn.

## KNOTTING AND SPLICING

A new book for every man who ever uses ropes. "Knotting and Splicing" tells how to tie and splice all kinds of knots—from simple and useful to more fancy and intricate. Illustrated with 208 Engravings and Diagrams. Your money refunded if after examination you find that it is not what you want. Price 75c. Write for Free Catalog. DAVID McKAY CO., 604 So. Washington Square, Dept. 211, Philadelphia, Pa.

## REAL ESTATE EDUCATOR

A most comprehensive yet concise arrangement of useful facts about buying, selling, leasing and sub-letting of Real Estate, contracting, for erection or repairs, mortgaging, transferring, insuring, etc. New revised edition. 288 pp. Price \$2.00, postpaid. POPULAR MECHANICS PRESS, 200 E. Ontario St., CHICAGO



## There's Quicker, Bigger MONEY for YOU—in POULTRY

No Matter Where You Live—You Can  
Make \$1000 to \$5000 a Year—EXTRA!



A Big money-making opportunity is waiting for YOU right NOW—in your own back yard! Thousands of my students are cashing in BIG, the way you can—in part or full time. Start with a small flock—small investment, and make a good profit. Eggs and poultry meat are in big demand at high prices. I'll PROVE that I can put YOU among the big money-makers QUICK!

Spare Time or Full Time  
YOU Can Cash-in BIG

No matter where you live—city, town or country—or what you do now, my proved methods will assure your success right from the start. I give you all the "secrets"—all the "short cuts." You'll be your own boss and I'll show you how to make from \$1000 to \$5000 a year—and UP!—and how to make your tiny investment multiply itself automatically. What I've done for thousands of others—I can do for you.

FREE Book Shows Way to  
Success and BIG Profits

Mail coupon below TODAY—for my Big NEW FREE Book, "How to Raise Poultry for Profit." My forty years of experience are yours. The Poultry Industry needs YOU. You need my book. Get it—and get in line for the BIG Money that's waiting for you in POULTRY.

## Mail NOW for FREE Book

National Poultry Institute, Dept. 411-C,  
Washington, D. C., Att'n: Harry M. Lamon, Pres.

Dear Mr. Lamon: Send me your FREE Book, "How to Raise Poultry for Profit." I want to know more about my opportunity to make \$1000 to \$5000 a year, spare or full time.

Name.....

Address.....





# Scientist's Amazing Discovery Makes Old Cars Like New!

Goodbye, Shabby Old Cars! New and Amazing Discovery Brings Back Original Finish Like Magic! Easy to Apply—Just Flow It On! Lasts Indefinitely! Sells Like

Wildfire, Netting Agents as High as \$25 a Day and Better! Right Now the Inventor Will Send You FULL-SIZE Sample at His Own Risk! See Coupon Below.

## MAKE \$150 A WEEK...AND MORE!

HERE is an astonishing new liquid discovery that restores show-room lustre and color to old cars—and adds 100% to their appearance in a single hour, yet actually costs less than a good inner tube! Nothing like it has ever been known before. It is not a wax—not a polish—not a paint—not a cleaner! It is simply a transparent liquid that possesses the mysterious power of rejuvenating original color and producing a mirror-like gloss at the same time. It LASTS, TOO—for month after month!

So surprising and amazingly successful is this remarkable discovery (called NAVON) that salesmen all over the country are piling up big, liberal commissions for just a few hours work. J. Porter (Wis.) took in \$98 in a single day. And H. Geiss (Ill.) made \$300 in one week just showing it to motorists and friends.

### Easy To Apply!

NAVON comes in a handy container ready for instant use. Just put it on the car as it comes out of the can, guiding its flow with a piece of cheese cloth. No fussing with brushes or tiresome rubbing. It flows smooth and dries without streaks. No experience necessary to get perfect results. Dozens of enthusiastic

users write that it is "easy as washing a car"—and "not half the trouble of waxing."

And not only that, NAVON is guaranteed harmless and safe. Contains no acids, alcohol, benzol, or other injurious substance. Acts both as a protection and preservative. Fine for metal, leather and wood.

### Sensational Money-Getter!

Nothing offered to the auto public has ever made such an instant hit as NAVON. 9 out of 10 motorists want it on sight. Agents and demonstrators are pocketing surprising profits—up to \$150 and \$300 a week. Even spare-time workers are making \$10 to \$15 an evening or Sat. afternoon just showing NAVON to friends, neighbors, etc.

Be the NAVON representative in your locality—and get your share of the profits that are awaiting. Wonderful money, too, in operating a Service Station—from \$5000 to \$10,000 a year. NAVON-izing cars for people in your town. You can start right away in your own garage—or rent one, clearing as high as \$65 a day!

SEND FOR DETAILS and our 14 Tested Money-Making plans—together with a TRIAL OFFER that allows you to test NAVON on your own car without a penny's risk! No obligation. Mail the coupon today!

## READ

what users say of this amazing discovery.

"SURPRISED!"

"I refinished my 1925 Ford with NAVON and it looks as good as the day I bought it. I am surprised at the results and so is everybody else." W. A. Burge, Mass.

"GREAT!"

"NAVON certainly exceeded my expectations. I think it is great and so do my friends. I am going to start a NAVON Service Station and have already secured a garage." Geo. Kelley, Pa.

Consolidated Specialties Corp., Dept. 56-S  
21 W. Elm St., Chicago, Ill.

Without obligation, send me your No-Risk TRIAL OFFER, together with special Money-Making proposition on NAVON.

Name.....

Address.....

Town..... State.....

# NAVON

INSTANT REFINISH  
FOR ALL SURFACES

CONSOLIDATED SPECIALTIES CORP., Dept. 56-S  
21 W. ELM ST. CHICAGO, ILL.



# The Gambler

He gambles that a "lucky break" will come to him in the course of time



**M**OST men live in the HOPE that their "Lucky Break" will come TOMORROW or NEXT WEEK or NEXT YEAR. They risk their whole lives on what may COME to them in TIME.

Gambling on what TIME and FATE have in store for you is more costly than any gambling known. You lose MORE than money. You lose your SELF-RESPECT. You lose the self-respect of those about you.

And as each year passes your CHANCE to amount to anything becomes slimmer and slimmer.

But there's ONE SURE WAY—yes, and ONLY one—to get what you want out of life. Scientists and psychologists tell us we use only about TEN PER CENT of our brain power. The mind is like a muscle. It grows in power through exercise and use. It weakens and deteriorates with idleness. Increase your own BRAIN power and you will increase your EARNING power.

Spend 2c for a postage stamp. Send the coupon below for a FREE copy of "Scientific Mind Training."

This little book will tell you how Pelmanism has shown over 650,000 people the secret of developing more effective brain power. How self-confidence—a strong will—a powerful memory—and a keen imagination can be yours by the application of a few proven scientific principles. How Pelmanism will help you to banish such qualities as forgetfulness, brain fog, inertia, indecision, self-consciousness, lack of ideas, mind wandering, lack of system and timidity.

Men like Judge Ben B. Lindsey, Sir Harry Lauder, Prince Charles of Sweden, Jerome K. Jerome and hundreds of others equally famous praise the simple method of increasing brain power described in this free book.

You have only TWO CENTS to lose by writing for your copy. Yet you may gain thousands of dollars, peace of mind, happiness and independence.

The thousands who are open minded will ACT on their impulse to send the coupon—will YOU? For your own sake—and for the sake of your loved ones, don't continue to GAMBLE. Send for this FREE book TODAY. Don't wait. ACT NOW.

## THE PELMAN INSTITUTE OF AMERICA

71 West 45th St. Suite 611 New York City

The Pelman Institute of America, Suite 611, 71 West 45th St., New York City.

Please send me without obligation your free booklet "Scientific Mind Training." This does not place me under any obligation and no salesman is to call on me.

Name .....

Address .....

City ..... State .....



# Learn AVIATION

Money — fame — adventure! They all await you in Aviation. Experts who can fly—who can design, build and repair airplanes and motors, are in big demand everywhere. You can make from \$75.00 to \$500.00 a week after thorough training. You may be internationally famous in a year!

## Prepare for Big Pay Jobs

We give you complete and thorough flying and ground instructions on modern equipment such as Travel Air and other new-production ships, and on Whirlwind, Caminez and other new engines. You'll be taught Air Navigation, Meteorology, Aerodynamics, Airplane Construction and Maintenance, Motor Overhaul, Airport Management—and you'll learn to fly by flying with expert transport pilots. You'll find yourself in a hotbed of aviation activity. You'll see all the latest planes zooming and roaring, coming and going at our field. Parks is not a correspondence school.



234-H Mo. Theatre Bldg. ST. LOUIS, MO.

**FREE**  
This  
**Inspiring Book!**

Send at once for "Skyward Ho!" the free aviation book that gives facts about opportunities—shows how you can get into this great industry that is making fortunes for many almost over night. Special offer for this month saves you half the cost—if you write at once.



# A few cents a day brings you THOUSANDS OF DOLLARS

Sponsored by RCA, G-E and Westinghouse, this radio course qualifies you for big earnings and SUCCESS.

**T**HE Radio Institute of America, conducted by RCA and sponsored by General Electric and Westinghouse offers you at low cost the training you need for success in radio.

Nothing so clear, comprehensive and up-to-date, nothing so generous in apparatus furnished has ever before been offered in radio training by any organization.

This is basically the same course that has enabled our thousands of graduates to advance to positions of importance and high remuneration in the respected profession of radio. But new and revolutionary changes make the instruction clearer and easier, permitting faster progress—and the course now embraces television, airplane radio equipment and photoradiograms.

You can study at home—when you please and as long as you please. Your rate of progress is limited only by your own ability.

MAIL THE COUPON BELOW. It brings you—free—an interesting illustrated booklet that shows the tremendous opportunities in the radio industry and outlines the Radio Institute of America's course of home study.



RADIO INSTITUTE OF AMERICA  
Dept. P-11, 326 Broadway, New York City  
Please send me your new booklet with full information about your Home Study Course of Radio Instruction.  
Name .....  
Address .....  
City .....



# for just a few cents more The EVEREADY LAYERBILT

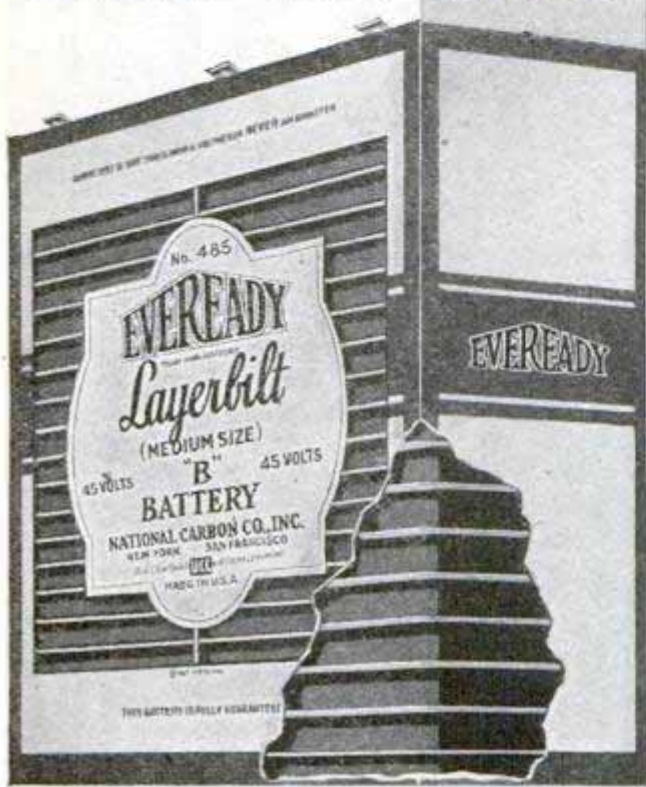

Now \$2.95 Eveready Layerbilt Medium Size "B" Battery No. 485, 45 volts. The longest-lasting Eveready of its size.

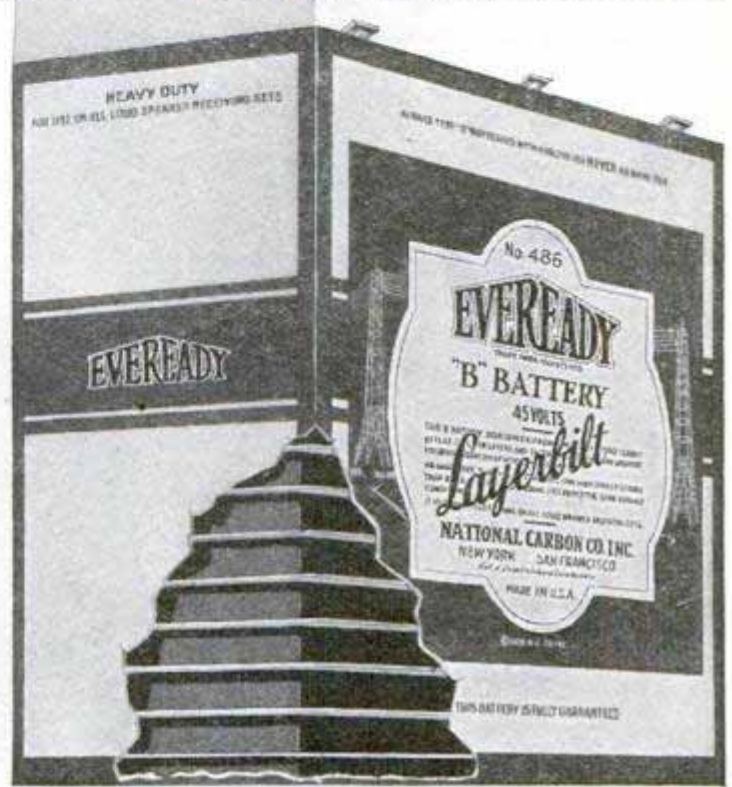

Now \$4.25 The original Layerbilt "B" Battery No. 486, 45 volts. For heavy duty. The longest lasting of all Evereadys.

## lasts weeks and months longer

TO GET a genuine Eveready Layerbilt "B" Battery you need pay only a few cents more than you would for a cylindrical cell Eveready of the same size. The longer life built into the Eveready Layerbilt is worth much more to you than its cost. Every Eveready Layerbilt "B" Battery is built of flat cells, which occupy all available space within the battery case, avoid waste spaces between the cylindrical cells in the older type of battery, and produce much more current.

That is why the Eveready

Layerbilt lasts much longer than the cylindrical cell type of battery. The added life is far greater than you might suppose.

There are two Eveready Layerbilts. One is the original No. 486, built for heavy duty, the longest lasting of all Evereadys and the most economical. It costs 25 cents more than a cylindrical cell Eveready of the same size. The other is the newer Medium Size Eveready Layerbilt No. 485, which has the same dimensions as the cylindrical cell Eveready

No. 772, but which lasts much longer, though costing only 20 cents more.

When you buy "B" batteries, add a few cents to the price of a cylindrical cell Eveready, and get Eveready Layerbilts.

NATIONAL CARBON CO., INC.  
New York San Francisco

Unit of Union Carbide  and Carbon Corporation

Tuesday night is Eveready  
Hour Night

East of the Rockies

9 P. M. Eastern Standard Time  
Through WEAJ and associated N. B. C.  
stations

On the Pacific Coast

8 P. M. Pacific Standard Time  
Through N. B. C. Pacific Coast network  
Layerbilt construction is a patented  
Eveready feature. Only Eveready makes  
Layerbilt Batteries.



1200

# CHAINING THE DOME OF ST. PAUL'S TO SAVE IT

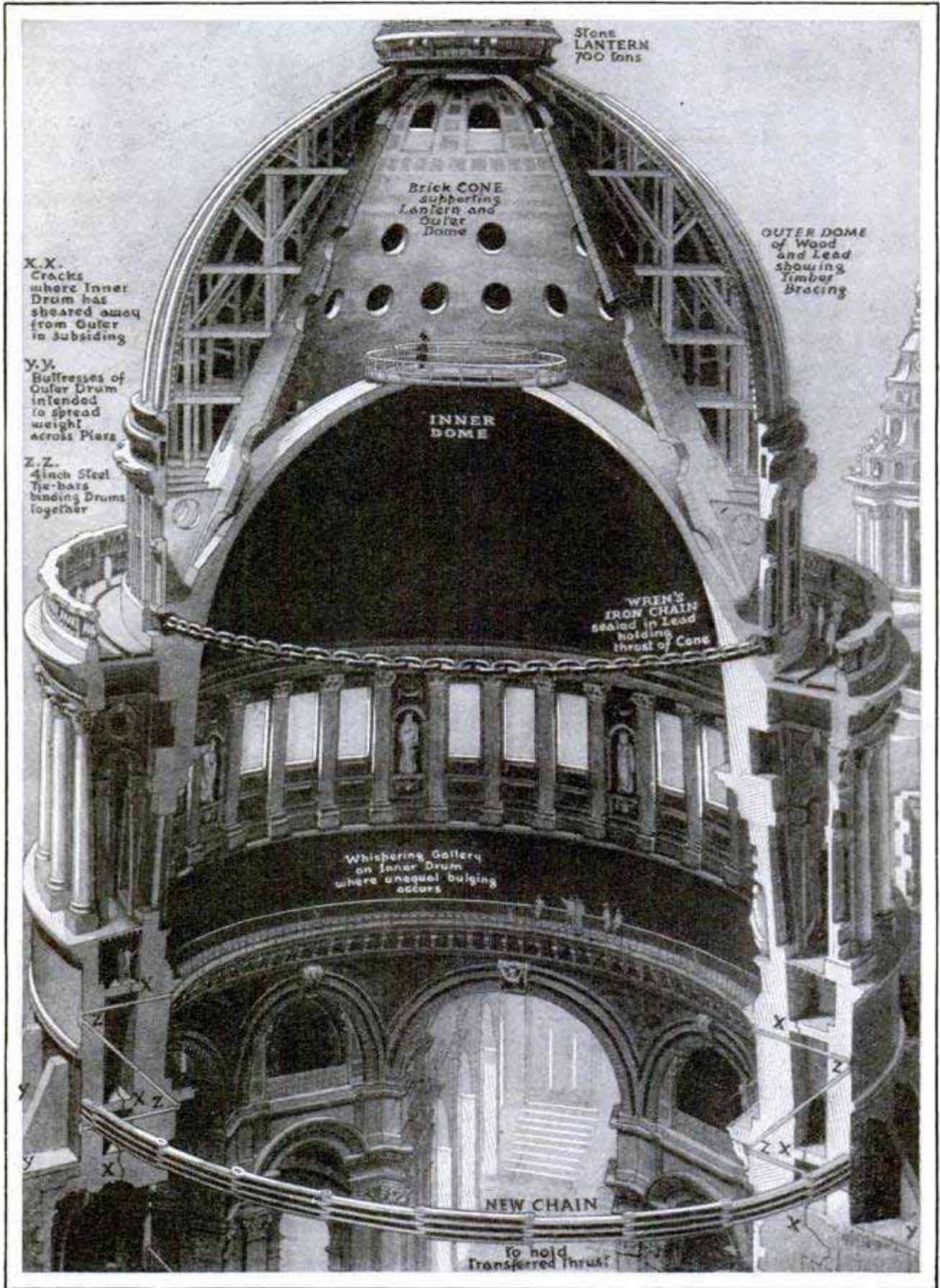

© S. W. Clatworthy

To Save the Dome of St. Paul's Cathedral, London, a New Chain of Special Steel Alloy Eye Bars Is Being Fitted; Sir Christopher Wren, the Architect, Expected Eight Main Pillars to Carry the 23,000-Ton Load of the Dome, but Their Rubble Filling Has Disintegrated under the Enormous Thrust, Threatening Destruction

18 Shakespeare  
Road, Herne Hill



# Popular Mechanics Magazine

REGISTERED IN U. S. PATENT OFFICE

WRITTEN SO YOU CAN UNDERSTAND IT

Vol. 50

NOVEMBER, 1928

No. 5

1286

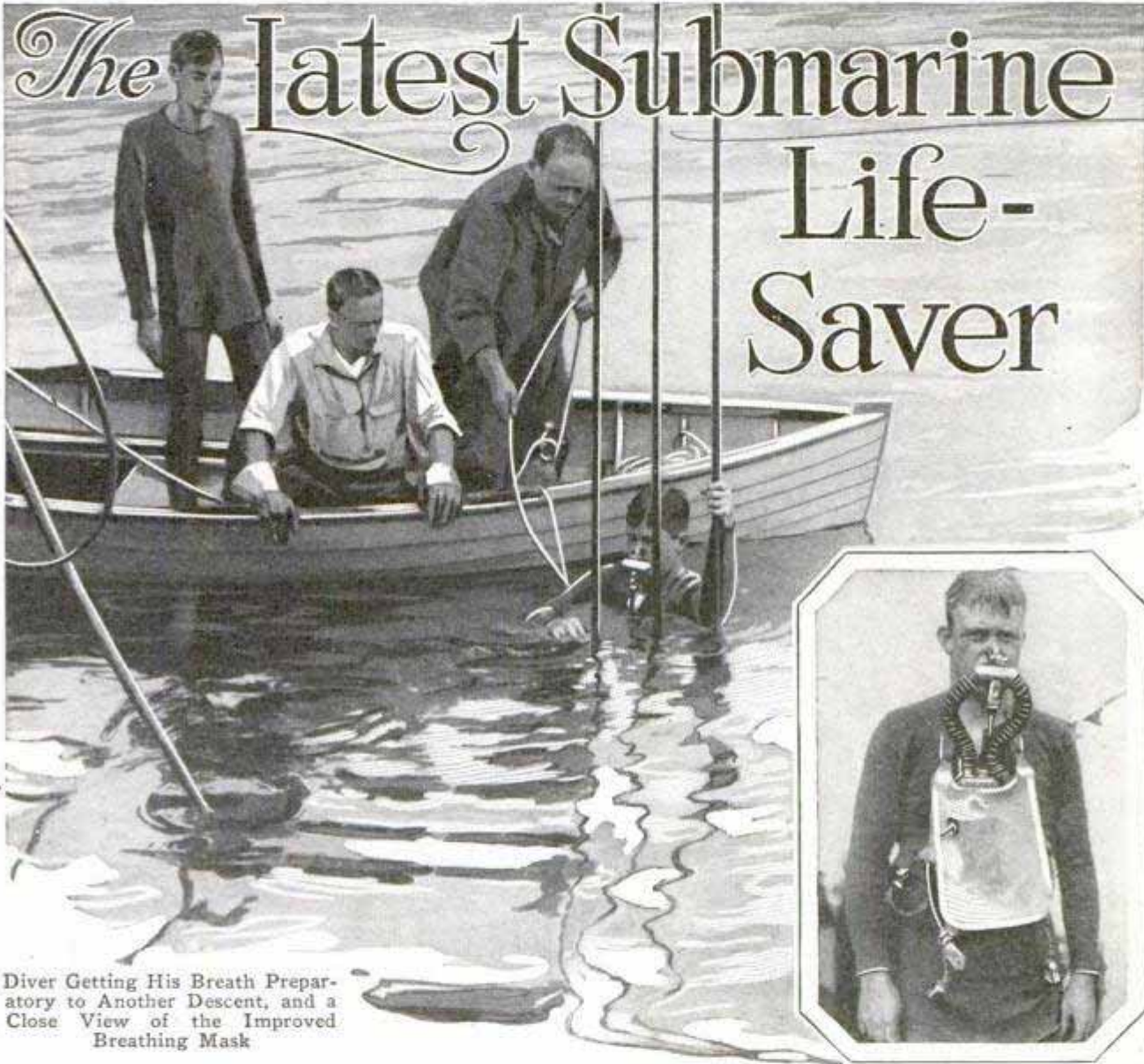

Diver Getting His Breath Preparatory to Another Descent, and a Close View of the Improved Breathing Mask

**T**WO men recently spent a quiet afternoon diving into a great tank at the navy yard, Washington. They wore bathing suits and on their heads was a curious-looking device not unlike an ordinary gunny sack with a rubber tube attached to the wearer's mouth.

First one man would disappear slowly beneath the surface. His every move was visible to the few spectators above, for the water was absolutely clear. Treading water, he would find the bottom and then, by means of some magic powers attached to the head device, he would re-

main down there, may be half an hour, possibly longer. Safe on the surface once more, he would watch similar maneuvers of his companion diver.

Since the apparatus is so built as to work efficiently only from the bottom up, rather than from the surface down, it was necessary to inclose the diver's head into a device looking like an inverted half of a barrel. It served the purpose of entrapping a substantial quantity of air, thus permitting quick descent.

Extremely simple as those diving operations appeared to be, they meant much to

Cont. James Nevill Miller  
1906 H. St. 2 (11) Washington, D.C.  
705



1286  
706



First Stage in Descent with the Diving Bell; Diver Climbing Inside for Lowering

system meantime becoming gradually accustomed to the steadily increasing pressure until he reached the bottom, 110 feet below the surface.

Fundamentally, the apparatus has all the essential characteristics of standard European life-saving apparatus, but the new navy device weighs only two pounds—many times lighter than others of its kind, which range around twenty-one pounds. Then, too, the re-breather is small, about eight by ten inches.

Lieutenant Momsen, one of the inventors of the newcomer, gives a graphic description of its operation on the scene of actual disaster. "There are two ways," he explains, "whereby it may be used to advantage. First of all, when no help seems to be at hand and the crew of

humanity—the possibility of avoiding loss of life in submarine disasters.

The two divers are counted among America's best-known experts on submarine life-saving devices—Lieut. C. B. Momsen and Chief Gunner C. L. Tibbals. For six months they had been working night and day on the breathing device they had invented in conjunction with F. M. Hobson, civilian engineer in the naval bureau of construction.

Following the tank tests in sixty feet of water, the experts took their apparatus a few miles down the historic Potomac, recently choked with mud through flood. Instead of the inverted barrel, an especially rigged up diving bell, weighing about 1,500 pounds, was employed to convey the diver to the bottom. During the descent, he was located within the bell in such fashion that, while standing on a platform, his head was inside a bubble of air. Slowly he was lowered, his

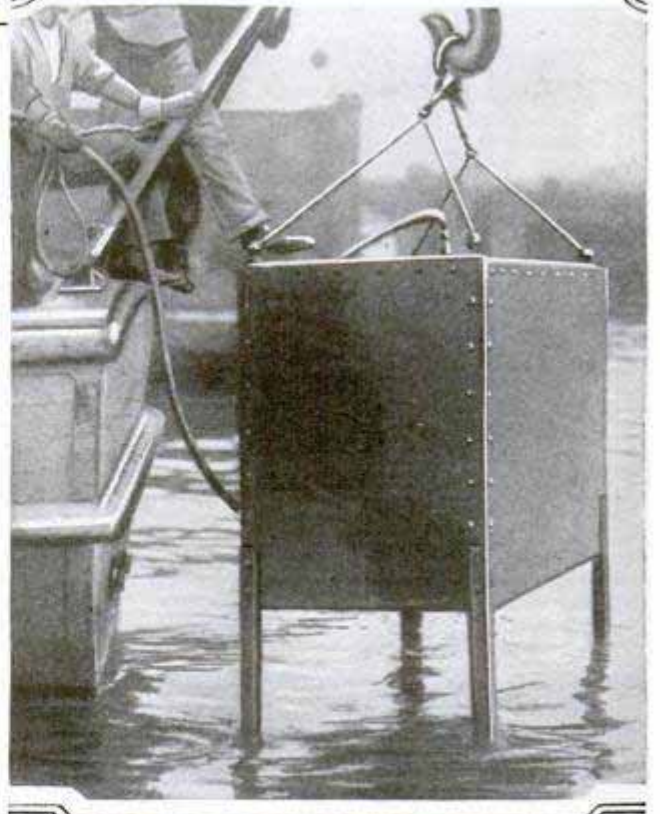

Close View of the Bell That Aided in Rapid Descents during Breathing-Mask Tests by the Navy; Note Air Hose and Connection



the wrecked submarine must brave the treacherous depths alone; and secondly, when a diver has descended, ready to give aid. In the first case, it will take the men only a few seconds to don the apparatus.

"At this point one might well inquire, how in the world the men will be able to withstand the terrific pressure that prevails at 200 to 300 feet. Here is the answer: Under normal atmospheric conditions we all are under a pressure something like 14.7 pounds. Down around 200 feet the pressure jumps to 88 pounds. Certainly that is a terrific force to beat against a man's body. But after all, it is a relative matter, since pressure conditions become equalized all over the body.

"Nor should we forget that nature has equipped us all with a remarkably devised pressure resistor, the Eustachian tube, a tiny structure running from the mouth to the ears. So, with the aid of that and the new device, the men in a sunken submarine should be able to gain the surface without experiencing that terrific pull on the eardrums which sometimes spells death to a diver. All the while, of course, there is no heavy weight to hold the men down and, when they have stepped outside the wrecked craft, the buoyancy of their bodies will hurtle them to the top. Once there, granted that other human beings are fairly close by, their lives should be saved.

"Of course, a somewhat different situation exists when the crew of the submarine happens to have an expert diver from above come to their aid. In such case, the submarine's commander may send the men out of the wrecked craft one at a time. Thereupon the diver, being attached to a strong rope, need merely signal to his helpers up above, and the two men will reach the top quickly. Another diver will then go down and the procedure be continued until every man is saved.

"However, the chief point to emphasize in the new instrument lies in the fact that it enables life-saving operations to be conducted and completed without the slightest interference with salvage maneuvers. Once the crew has reached the surface, the submarine commander may aid materially in salvaging his craft."

## EAST AND WEST MEET IN AUTO CARVED FOR BRIDAL USE

1804  
Oriental splendor and tradition ride on a modern motor car in an elaborate chassis carved for bridal processions in Shanghai.

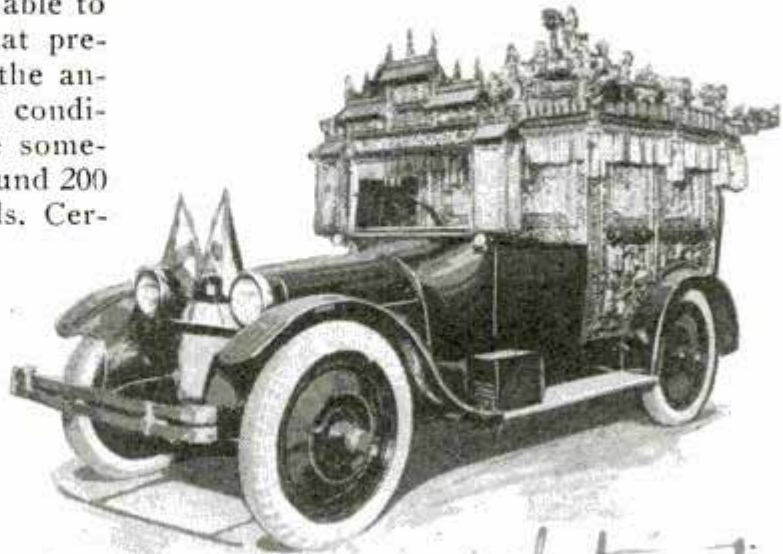

Elaborate Motor Car Designed for Chinese Bridal Processions; Its Ornate Carvings Conform to Old Oriental Traditions

Rich decorations, an ornate chair, hangings and tassels of silk, with other trinkets, feature the vehicle, which is a motorized duplicate of carriages used in China when the bridal party parades abroad.

## RADIO GUIDES "PHANTOM" SHIP SAILING WITHOUT CREW

1300  
Radio control of ships has been further demonstrated in Germany with the directing of the "Zaehringen," an 11,000-ton vessel, through complicated maneuvers without the aid of a single person on board. The ship's only point of contact with the outside world is its antennæ, the wireless orders being sent from a mother ship some distance away. The "Zaehringen" started, stopped, slowed up and changed its course wholly by radio control. Besides these performances, an interesting series of other functions can be executed by wireless direction, for instance, if the oil burners should cause a fire. By radio, automatically governed extinguishers can be put into action and, should the oil-feeding apparatus break down and the ship stop, rockets are automatically fired off to signal the operators on the mother ship that something has gone wrong.

Chicago Daily News,  
8/10/28



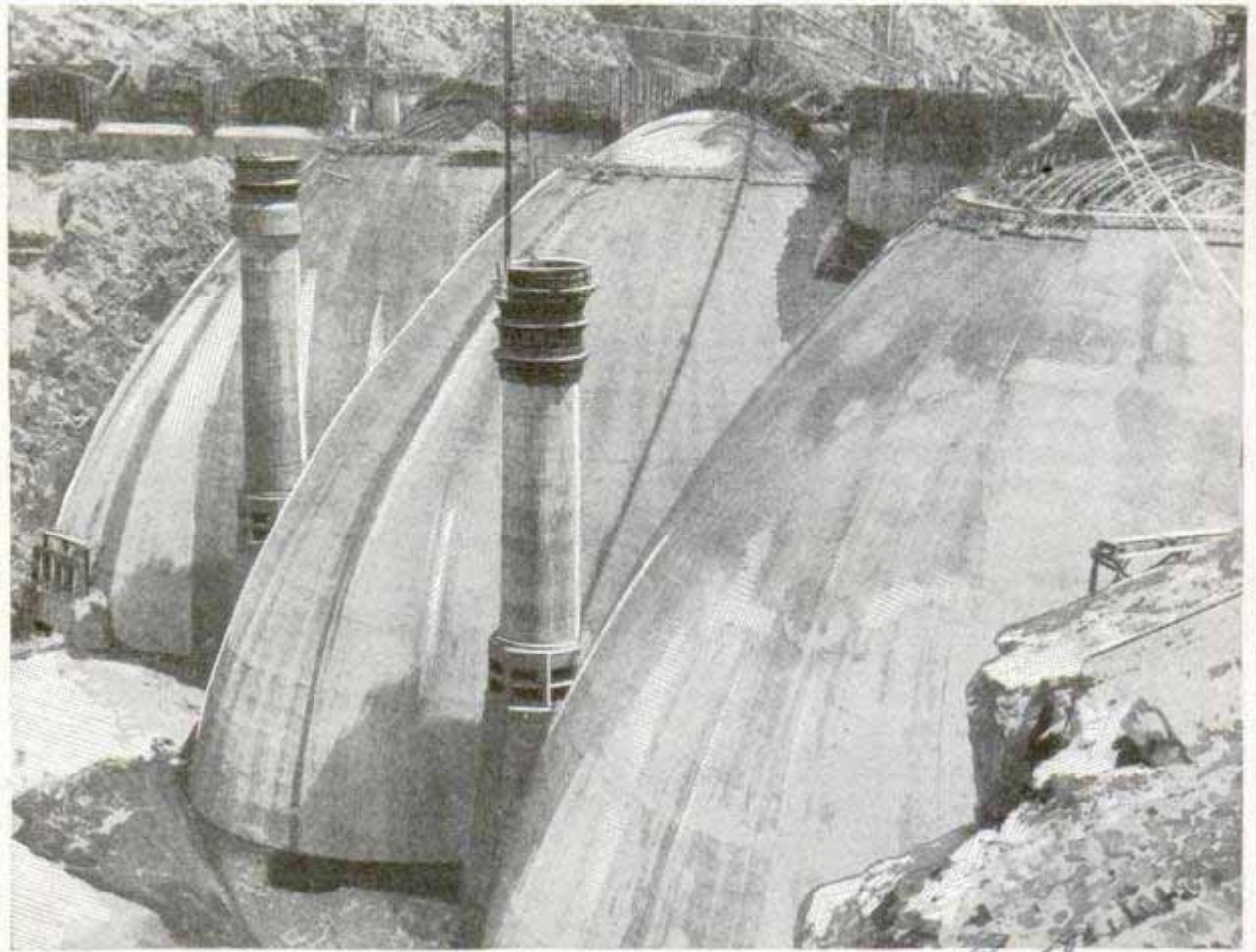

Constructed to Withstand Severe Strains; the Multiple-Dome Coolidge Dam across the Gila River, near Phoenix, Ariz.; It Has Been Built at a Cost of Almost \$3,500,000

### THREE-MILLION-DOLLAR DAM TO RECLAIM DESERT

Work on the Coolidge dam across the Gila river not far from Phoenix, Ariz., is rapidly nearing completion and engineers are studying it with special interest because of its form of construction. It is of what is known as the multiple-dome type and is said to be the largest of this kind in the world. The buttresslike form is intended to give greater strength. The dam has been built by the United States reclamation service and the Indian department at a cost of approximately \$3,500,000.

### TELEVISION INVENTOR PLANS FULL-SIZE PROJECTION

Projection of television images on a large screen, in the same manner in which movies are shown, is planned by C. Francis Jenkins, television and radio-movie inventor. If the method on which he is working succeeds, the chief problem of

television reception—the smallness of the image possible with all existing systems—will be solved. In the old Jenkins process, as in all others, a scanner is used to reproduce the picture. The Jenkins scanner had forty-eight holes, drawing forty-eight successive lines of light, and, as the picture is square, the effect is of forty-eight times forty-eight dots, or a total of 2,304 separate units. Behind the scanner disk is a neon light, the intensity of which is controlled by the received signal, and the illusion of a picture depends on the persistence of vision in the eye, the light of each line lingering until all of them have painted a complete picture. In his new system Jenkins is using 2,304 small incandescent flashlight lamps, mounted closely together in a square bank. A revolving switch or commutator connects the lamps successively to the radio set to receive the incoming signals. But, unlike the neon light, the filament of the incandescent lamps continues to glow for an instant after the current is turned off.

Science Service  
Bulletin 388 21-389a  
9/1/28

115 miles East



Thus the background does not merely appear to be bright, but actually is bright, though the glow from the lamps which have been turned off is not bright enough to detract from the light of those that are in circuit to form the picture. The net effect, however, is a much larger picture with infinitely more light than a neon lamp can produce, so it is possible to place a condensing lens in front of the lamp bank and project the picture on a screen. Jenkins is trying a similar system at the transmitting end, with 2,304 small photo-electric cells on which the image, focused by a lens, will fall.

**HOW CROCODILES ARE HATCHED REVEALED BY PHOTOS**

Interesting stages in the hatching of crocodiles have been obtained by photography by training a camera on a number of eggs that were taken from a Java river bank and hatched in a laboratory under favorable conditions. One of the remarkable features of the young reptiles is their great development as they leave the shell, one specimen showing the naturally savage

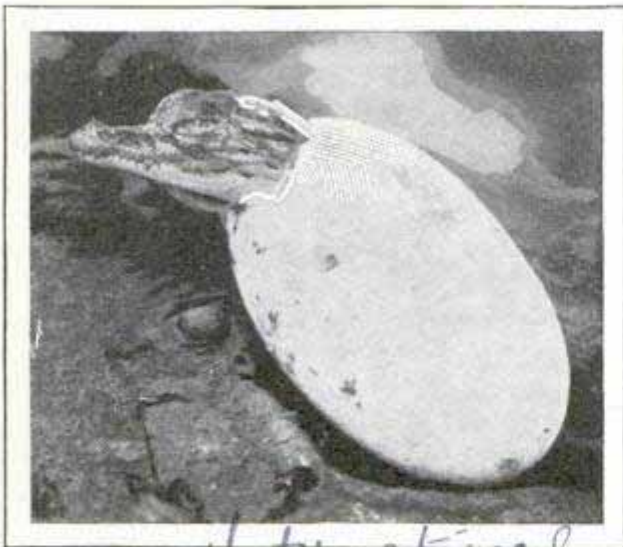

Just Emerging from the Shell, a Baby Crocodile Surveys the World and the Camera

tendencies of the species by opening its jaws when a finger was moved close to it.



Puncture Trap That Can Be Quickly Extended across the Road to Halt Cars; Pressing a Button Releases the Rack

**PUNCTURE MAT TO STOP CARS HELPS FOIL BANDITS**

Stop your car or puncture your tires, is the forcible warning behind a mat of sharp spikes that can be spread across the road at a moment's notice to halt bandits traveling in automobiles or drivers of stolen cars. A press of a button expels the mat from its holder at the side of the street.

**VESUVIUS ON VERGE OF NEW OUTBREAK OF LAVA**

Mount Vesuvius, the world's most famous volcano, is approaching a new eruption, according to Professor Malladra, who operates the observatory on the mountain slope. The mountain's outbreaks occur from twenty to thirty years apart, and, as the last one of any size was in 1906, another is just about due. The conditions which give warning of an approaching eruption are the failure of springs around the mountain, a series of earthquake shocks, and the filling of the volcano crater with lava. The crater has been practically full since 1926, but the other two manifestations of approaching activity have not yet appeared. In each major eruption the stored-up energy in the mountain blows out the lava which clogs the crater and clears the volcano's throat, so it can "breathe" easier. Then the crater clogs up again and the process continues until the collected lava closes most of the vent and backs up pressure enough to cause another outbreak.

*Daily Mail 8/21/28*





Using the Electric Shoe-Shining Stand with Protecting Shield for Women

pins, is attractively finished and does not spill the pins, as they come in special refill tubes ready for insertion in the holder.

**EIGHT-MILE RAILROAD TUNNEL BREAKS RECORDS**

An eight-mile tunnel through the Cascade mountains, the longest bore in America and fifth longest in all the world, is nearing completion in the northwest. When trains start through it, probably about the first of the new year, the Great Northern's route to the coast will be shortened by many miles, the climb over the mountains reduced 505 feet, a two-and-a-half-mile tunnel abandoned, and six miles of costly snowsheds eliminated. The new tunnel is to cost \$10,000,000, but the saving on upkeep of snow and avalanche sheds alone is expected to pay for it. When President Coolidge, on May 1, pressed a telegraph key in Washington and set off the blast that holed through the pioneer bore alongside the big tunnel, he marked the beginning of the end; after two and a half years of labor. The pioneer bore is a smaller shaft, parallel to and sixty feet distant from the big one. It cost several millions to drive the preliminary tunnel, but the savings it made possible made the outlay worth while. Only two gangs, one starting at each end, can work at one time in a single tunnel, but by rushing the smaller bore through the mountains for eight miles, the engineers were enabled to drive short connecting shafts sidewise to the line of the big bore, and then start additional crews from each shaft, working in either direction. In this way the main tunnel was attacked from eight different places, the two outer portals and six in the mountain, with two crews working in each direction from the six, or a total of fourteen crews working at one time. Seventeen and a half miles of the present railroad line will be eliminated, along with the old tunnel and the 505-foot climb to its level. The new bore eliminates also track curves that are equivalent to nearly seven complete circles.

**ELECTRIC SHOE-SHINING STAND HAS SCREEN FOR WOMEN**

Equipped with a shield in front and a motor-driven brush, a shoe-shining stand now on the market is especially designed for women patrons. The operator's stool is a separate unit and carries the motor underneath. The customer's chair is easily mounted, has a comfortable seat and back, and as entrance is gained from the side, there is no danger of catching the clothing on protruding parts. The electric brush, it is said, produces a higher degree of polish than can ordinarily be obtained with the usual hand tools and, of course, also saves time.

**OFFICE-PIN HOLDER SAVES TIME AND PROTECTS FINGERS**

Waste of time, pricked fingers, and other unpleasant features, are avoided in a special holder for office pins. It has a top so arranged that when it is pressed, a pin emerges head first from a little opening where it can be grasped with the thumb and forefinger, ready for immediate use. The container holds 200



Write our Bureau of Information, if you wish to know who makes or sells any article described in this magazine. Send no postage; the service is free.

*King Shoe Shiner Corp  
119 W. 28th St  
New York  
9/12/24  
Shoe Shiner  
S. Carter  
263  
Chicago, Ill.  
Washington*

*and refill \$1.00  
" Carlson 45c*



1212 Mr. R. Williams, Great Northern Ry.  
Assistant, Great Northern Ry.  
St. Paul, Minn.  
POPULAR MECHANICS 711

# AMERICA'S LONGEST TUNNEL NEARING COMPLETION

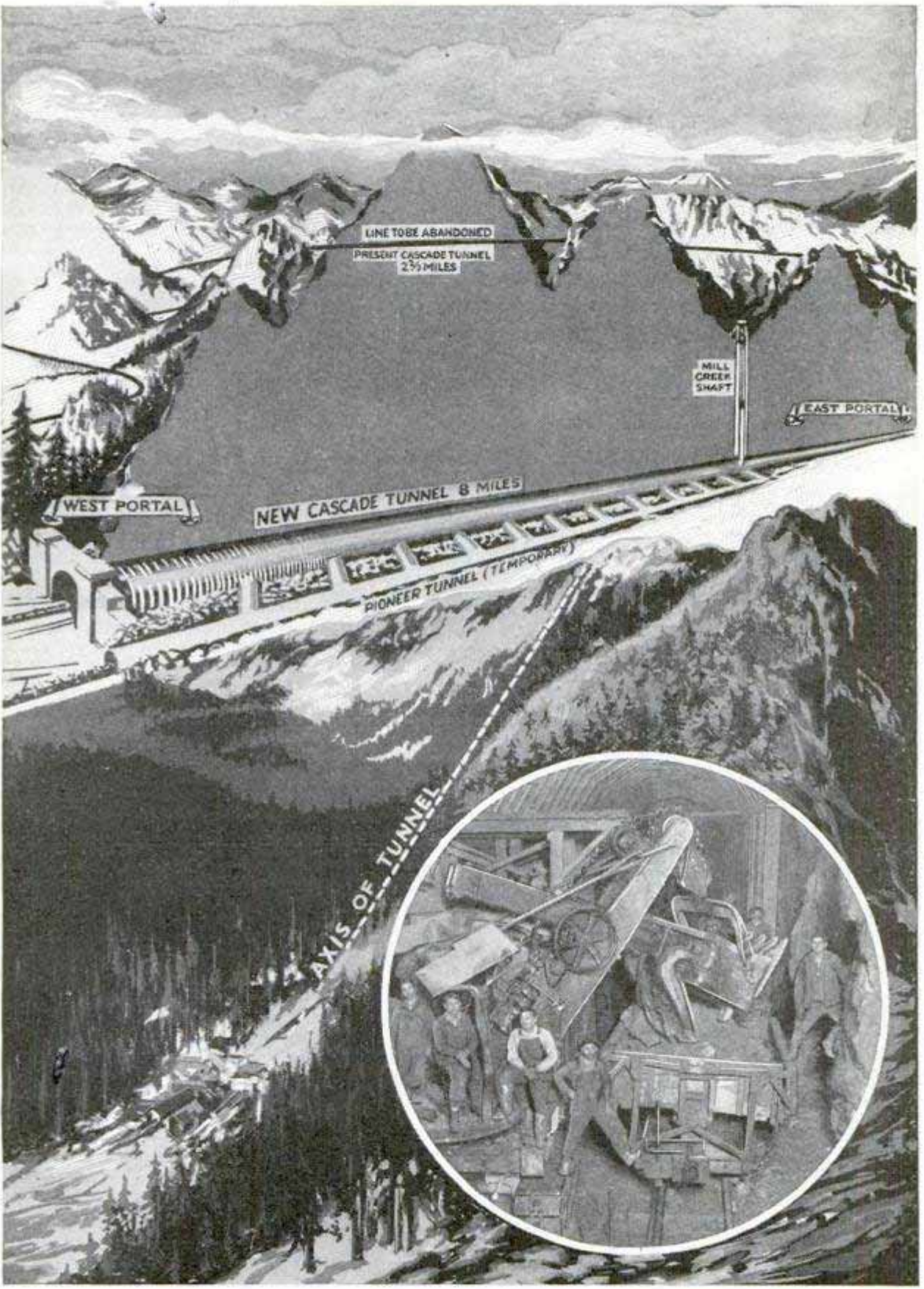

Cross Section of the Cascades, Showing the New Tunnel 500 Feet Below the Present Railroad Line; Photograph of the Range under Which the Big Bore Passes, and, in Circle, One of the Compressed-Air Shovels That Works in Limited Quarters to Clear Away the Rock



*at Lakehurst*

*Pratt and Whitney Aircraft Co  
1324  
Meritor, Inc.*



Examining Big Bomb on the Fighting Plane, Which Also Carries Four Machine Guns and a Crew of Two

### DIVING PLANE FOR BOMBING CARRIES FOUR GUNS

Tests with one of the fastest fighters of the skies were conducted at Mitchell field recently when pilots rode a diving bombing plane through varied maneuvers. This ship, which is equipped with a "Wasp" motor, is capable of a speed of 170 miles an hour and can dive at a rate of 300 miles an hour. Besides four machine guns, it carries a big bomb under the motor and is manned by a crew of two.

### CAMERA RECORDS ITS LOCATION ANYWHERE ON EARTH

Accurately recording its position on the earth at the point where the picture was snapped, a sextant camera that has been included in Commander Byrd's equipment for the South Pole adventure, is expected to prove of great service to all navigators by sea, land or air. With one motion, the user can determine his position, whereas, for centuries, a number of instruments and more or less elaborate calculations have been required. It will function even when no ground markings are in sight, and the picture will also show the exact time at which it was taken, the day of the month and the angle at which the exposure was made. This remarkable camera was developed by Comm. M. R. Pierce

of the United States navy in co-operation with the Eastman Kodak company. It takes pictures of the sun, and one of the secrets of its operation lies in its ability to "fold and wrap light into a small package." The finished photo is smaller than the hand, 100 pictures can be made on one roll of film, and as each exposure is made, it is cut out and deposited in a dark box. The various recording instruments are housed inside the camera, and the light beams are brought into focus on the film, where they record the data essential for determining the exact position of the camera at the time.

### PHONOGRAPH IN WATCH CASE PROVES ACTRESS' VOICE

Practical use is claimed for a tiny phonograph that fits into a watch case and is operated by a small spring. Its records will hold about fifteen spoken words, and these can be reproduced by the owner to show the quality of her voice as reproduced for the talking films. The entire outfit can be carried in a vanity bag.



Gwen Lee Demonstrating the Watch-Case Phonograph, Which Plays a Record of Her Voice

*Carl M. P. Clute  
2227 8 1/2th Ave. Wash*

*Metro. & oldways. nager*



133

The Popular Mechanics, 713  
Karnival Corp.  
Columbia Ala

# CIRCUS STAGED WITH PUPPETS ATTRACTS CROWDS



Where Puppet Clowns and Actors Present an Eight-Ring Circus; Views of the Elaborate Motor-Driven Arena and the Entrance

*Playland at Rye, Westchester Co. New York.*

One of the most attractive features of an eastern amusement park is a miniature eight-ring circus, in which all the performers are puppets that go through realistic movements by the action of electricity. A tiny band wagon furnishes the music, while midget animals, jugglers and acrobats perform, roller coasters, merry-go-rounds and aeroplane swings operate, and practically all the lively thrills of a real circus are duplicated in miniature. The elaborate installation is the result of a country merchant's plan to attract customers to his show windows. Trade was dull, so he exhibited a few manikins, dressed in the latest fashion and operated by clockwork mechanisms. The device grew so popular that it was gradually enlarged until it became a complete circus.

lage claimed is that the roots grow to three or four times the size of the briar's so that more pipes can be cut from them.

## DETACHABLE MOTOR FOR BARGE HAS SAFETY PROPELLER

To speed canal traffic, an English inventor has introduced a motor which may be removed or attached in a few minutes and has power enough to tow three fully loaded barges. Its chief feature is that the propeller is so adjusted that, should it strike an obstacle, it automatically rises above the obstruction to prevent damage. This is an important point when running in shallow waters.

## NEW WOOD FOR TOBACCO PIPES SEASONS MORE QUICKLY

Due to the shortage of genuine briar, a substitute wood has been grown by grafting the gnarled, knotted roots of the bruyere to ordinary red and white hawthorn and with satisfactory results, according to reports. Pipes made from this hybrid wood are said to be light in weight, to absorb nicotine readily, give a cool, sweet smoke, and can be seasoned in about three months as against the three years necessary for the real briar. Another advan-

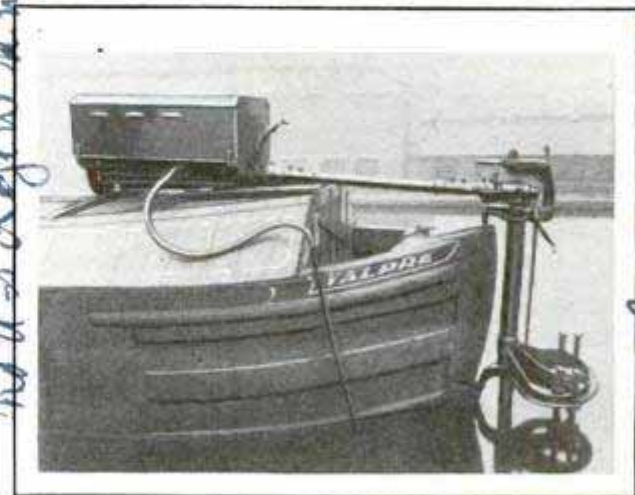

Propeller of This Detachable Motor Rises When It Meets an Obstruction, to Prevent Damage

*Sold by the Secretary  
Viscra Alphonse*

*George H. Holden, Esq. Windy Hill  
Highfield New Tipton New Road*

*Coggin Harrington & Co. Wharf. Lechfield Birmingham Eng*



1249 COSMIC RAYS LINKED WITH CREATION OF MATTER

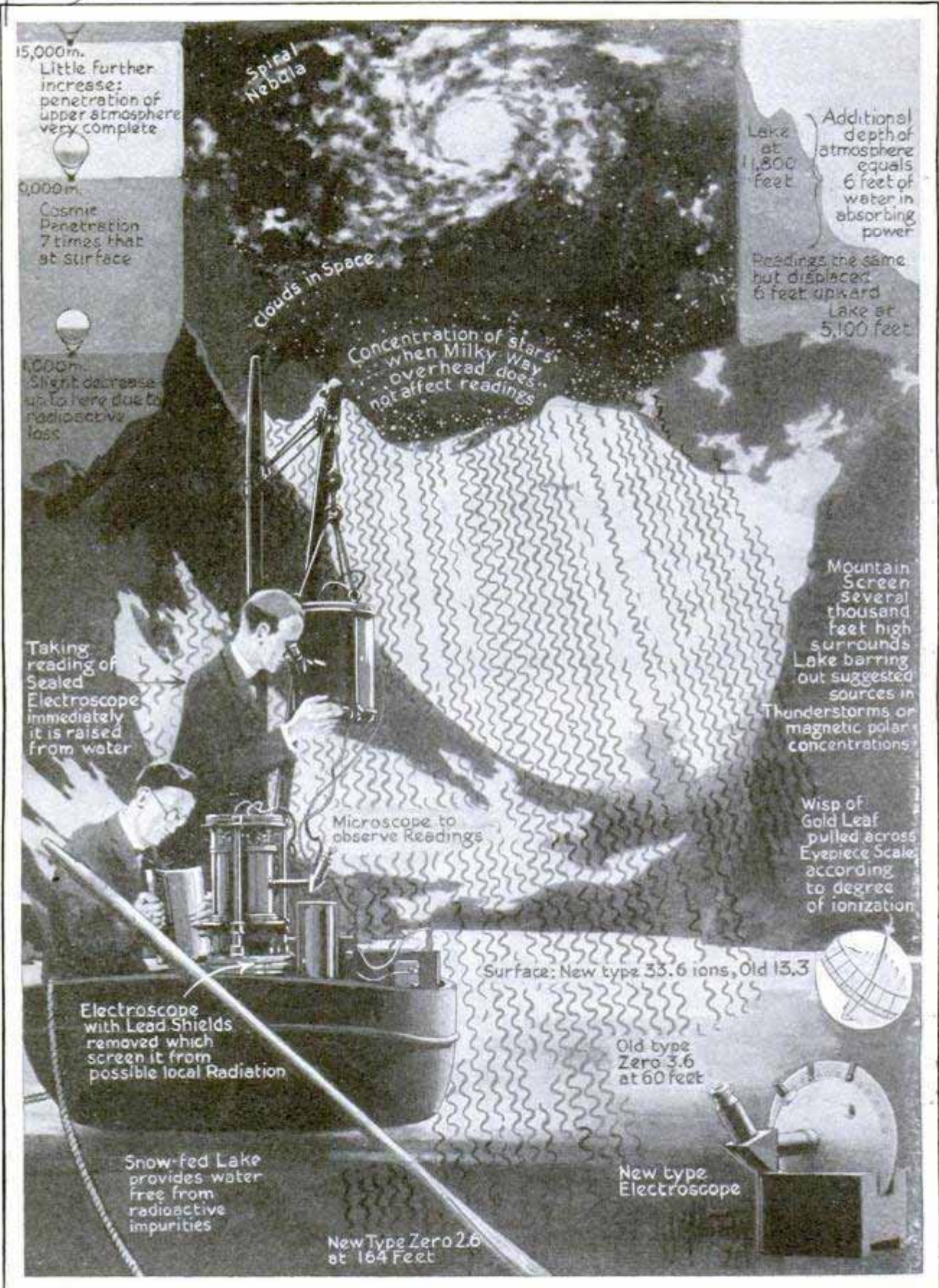

© S. W. Clatworthy

Artist's Diagrams Showing, Center, How Cosmic Rays Were Measured in a Mountain Lake; and, in Inserts at Left, Earlier Experiments with Electroscopes Sent Up in Sounding Balloons

*S. W. Clatworthy Esq.  
18 Shakespeare Road  
New York*



1323

### CREATION OF MATTER IN STAR SPACE EXPLAINS RAYS

The cosmic rays discovered a few years ago by Prof. R. A. Millikan, the famous California scientist, are the waste energy generated by the creation of oxygen, magnesium, silicon and iron in the vast laboratories of outer space, according to a recent announcement by their discoverer. The cosmic rays are the most minute, yet most powerful radiations ever detected, with wavelengths less than one-hundredth of those of radium, and yet requiring the enormous electrical potential of 59,000,000 volts to generate them. Their initial discovery was made by sending electroscopes into the upper atmosphere, attached to sounding balloons, and then studying their recorded findings when the gas bags came back to earth. In his latest experiments, Professor Millikan measured their penetration in the clear waters of a high mountain lake. The presence or absence of the billions of stars which compose the Milky Way had no effect on their intensity, so they apparently come from more distant realms of space. Professor Millikan found that the rays were able to penetrate 16.7 feet of lead or 190 feet of water.



West Point Football Players Refreshing Themselves at the Nozzles of the Gridiron Water Wagon

### SPRAY WAGON FOR FOOTBALL SUBSTITUTE FOR SPONGE

Football men at West Point have discarded the old unsanitary sponge in favor of a water spray wagon from which eight men may refresh themselves at the same time and with much less trouble. A fine spray is forced through the nozzles in such a way that it reaches the face and neck with cooling effect and without spilling so much water on the suits. The wheels are equipped with heavy rubber tires so that the wagon can be trundled over almost any ground with little difficulty.

### SEEK CAUSE OF PAINT SCALING TO PROTECT WOODS

1321

Paint adheres to wood chiefly by gaining mechanical grip in minute openings on the surface of the wood, forest products laboratory experts have concluded after an investigation into the causes of paint scaling and other factors connected with paints. What is needed, they declare, is an improvement in painting practice, a method that will cause the paint to cling more firmly rather than scale off. The effect of the grain of the wood on the durability of a coat of paint can be seen on wood that has wide annual rings. The part that grew rapidly in the spring contains more openings than the summer part, which is denser. Paint scales off this summer band much more quickly than it does from the spring wood, the investigators found.

U.S. Daily 9/1/28

Every hour, fires destroy two human lives and approximately \$60,000 worth of property in the United States.

### AIR-MAIL STAMPER PRINTS TWO COLORS AT ONCE

Ordinary envelopes are quickly identified for delivery to the air mail with a stamping outfit that prints the words "via air mail" in red and blue, conforming to the postal regulations. The contrivance is fitted with a self-contained pad, the rubber die being adjusted for automatic self-inking, in the same manner as most other similar stampers for quick and efficient work.



stamping outfit that prints the words "via air mail" in red and blue, conforming to the postal regulations. The contrivance is fitted with a self-contained pad, the rubber die being adjusted for automatic self-inking, in the same manner as most other similar stampers for quick and efficient work.

Bankers + Merchants Stamp Works

Chicago  
322 25 - Sheffield



322 W 15th St.

New York

1315

U.W. Fred G. Lord



Apparently Holding an Ordinary Club, But Actually Taking Picture with Camera Hidden in Baton

**CAMERA IN POLICEMAN'S CLUB TAKES TWENTY PICTURES**

Concealed in the policeman's club, a miniature camera takes from ten to twenty pictures at one loading, and the negatives, although but an inch square, are so sharp that they will stand enlargement up to four inches square or more, it is said. To make an exposure, all that is necessary is to press a button, then turn an unexposed film into place. Time or instantaneous pictures may be made as readily as with an ordinary camera.

**TELEVISION TO CONDUCT MUSIC OF HIDDEN ORCHESTRA**

Practical use for television has been proposed by an orchestra leader in directing a group of musicians who play off stage during a symphony. Heretofore, it has been the custom to have an assistant leader, who peered through a hole in a wall, took his cues from the conductor and then directed the hidden players as he looked through the opening. By television, the leader's movements will be projected on a screen so that all the second-orchestra members can see them and the need for an assistant conductor will be rendered unnecessary.

Herald Examiner  
9/4/28

Wrestling Gleim's Concinnate Symphony Orchestra

210 gal. size with motor \$70.00 each to factory

**LILACS BLOSSOM AT CHRISTMAS WITH AID OF CHEMICAL**

Lilacs, flowering almonds and other blossoms may be had for Christmas decorations by exposing the potted plants to the vapor of a special chemical, Dr. F. E. Denny, of the Boyce Thompson institute for plant research, recently reported. The trick is an easy one, the chemicals are obtainable on the market and about the only precaution to be taken is that the gas treatment should be done in a tightly closed room. Ethylene dichloride or ethylene chlorhydrine is used and almost any florist can arrange a treatment room without great expense. Dr. Denny recently demonstrated the effectiveness of the method with two twigs on the same branch, as much alike as possible. The treated twig responded quickly while the other remained dormant. He has also applied chemical "awakeners" to various other plants and has succeeded in getting seed potatoes to grow soon after harvesting. This is expected to be of considerable commercial importance.

**WATER SYSTEM FOR THE HOME WORKS AUTOMATICALLY**

Advantages of a city water-supply system may be enjoyed in farm and country homes through an electric pumping and pressure outfit that starts and stops itself, is economical to operate and is furnished in two sizes to give either 210 or 420 gallons per hour. The unit is compactly constructed and housed under a hood that can easily be lifted off for oiling or inspection; only two pipe connections are required, and, if desired, the unit may be employed in connection with a big storage tank. The outfit can be installed in two hours. Users do not have to press any buttons or operate any switches and the pump is self-oiling, so that the apparatus requires practically no attention.



see data file for agent

Hairbanks Morse Co.  
900 S. Wabash



1250 The Sphere July 1, 1928 Vol. 25  
also New York Times

# WILL ROCKET PLANES REACH THE STARS?



The Perfect Streamlining of the Lockheed "Vega" Plane, Which Sir George Wilkins Flew across the Arctic, and Art Goebel Flew Non-Stop across the Continent, Shows How Great Speed Can Be Obtained by Proper Design, One of the Problems the Rocket-Plane Makers of Germany Are Attempting to Solve; the "Vega" Fuselage Is Pressed from Wood Veneer

**C**ONSTRUCTION of man-carrying rockets capable of crossing the millions of miles of outer space and reaching the planets is scientifically possible and may eventually come, according to Fritz von Opel, the German automobile builder who, within a few months, has produced a rocket automobile and a rocket airplane.

But such ideas, he adds, are still far off, and have nothing to do with the practical work of introducing the rocket age, which he visions as an era of almost unbelievably fast transportation over the face of the earth. Rocket planes, he says, will span the Atlantic in an hour and a half, rising miles above the earth's protective envelope of air into a realm where there is neither air resistance nor the vagaries of weather to be reckoned with.

What such speed, 2,000 miles an hour, would mean can be conceived by comparing it with the non-stop flight across the continent, made by Col. Arthur Goebel, winner of the Dole race, who landed in New York just eighteen hours and fifty-eight minutes after leaving Los Angeles. His average speed for the trip, which

broke all existing records, was 142 miles an hour. At that speed he clipped two hours and fifty minutes off the fastest previous crossing of the continent, Lieut. Russell L. Maughan's famous "dawn to dusk" flight. But, more interesting still, the latter was made in a specially prepared racing ship, an army pursuit type, and in a series of hops, as the plane could not carry more than a few hours' gas supply. The flight of Goebel's Lockheed "Vega" plane was non-stop, carrying a full load of gasoline, and the ship itself was a stock model commercial plane, with cabin room for five passengers. The difference between Lieutenant Maughan's record and Colonel Goebel's achievement represented just four years' progress in airplane and engine building.

Only one plane had ever crossed the country non-stop before, piloted by Lieutenants MacReady and Kelley, and Goebel cut nearly eight hours off their record, besides making the flight in the opposite direction, so that he had to lift his entire load of gas over the Rocky mountains in the first hours of the flight, instead of



1250  
reaching the high mountains near the end of the journey, when his ship had been lightened by the consumption of most of its fuel.

Opel's rocket-car and rocket-plane experiments are important because the rocket offers the one method yet discovered for navigating space at high altitudes, above the earth's envelope of air. All existing motors depend on air for their operation, and all existing types of propellers screw their way through the selfsame air. The rocket, on the other hand, can be shot out into space and attain tremendous speed by escaping the resistance of the air.

The rocket idea is not new. Prof. R. H. Goddard, at Clark University, Worcester, Mass., made some experiments and calculations as long ago as 1912 and 1913, to prove that it was technically feasible to shoot a rocket to the moon and explode a giant charge of magnesium powder, producing a flash big enough to be observed by telescopes on the earth.

Three German engineers, H. Oberth, W. Hohmann and Max Valier, and the work

of the latter largely inspired Herr Opel's rocket car and plane. Valier has calculated that a rocket plane could be shot from Berlin to New York in ninety-three minutes, dividing the journey in three stages. He would start from the German capital and come down at Vigo, Spain, take off there for an island in the Atlantic, and make the third hop to New York. He would shoot his rocket into the air at the steep angle of seventy degrees in order to reach the region of rarefied air in the shortest possible time. A minute and five seconds after the take-off, the plane would be thirty miles above the earth and nearly forty-five miles from the starting point, and would have attained a speed of more than 4,500 miles an hour. Allowing 100 seconds to get under way and reach full speed and 1,500 seconds for gliding, Vigo would be reached in twenty-seven minutes from Berlin.

The only objection he sees to rocketing across the ocean is the weight of the explosives required. Fully sixty-nine per cent of the entire weight of the ship on the

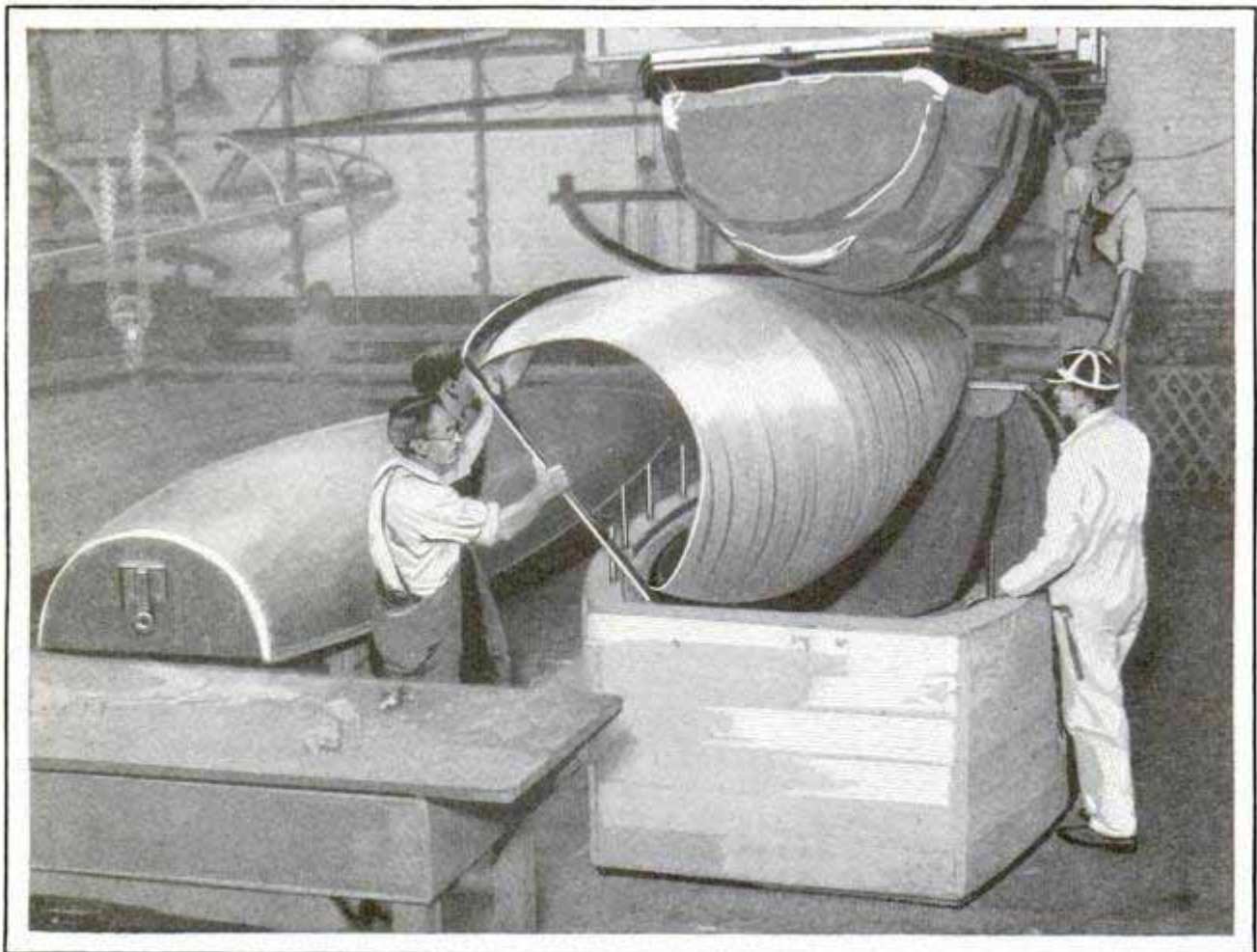

Sheets of Vincer Are Glued Together, Then Placed in This Concrete Mold and Formed into Fuselage Halves under a Pressure of Fifty Tons; Two Halves Are Then Joined



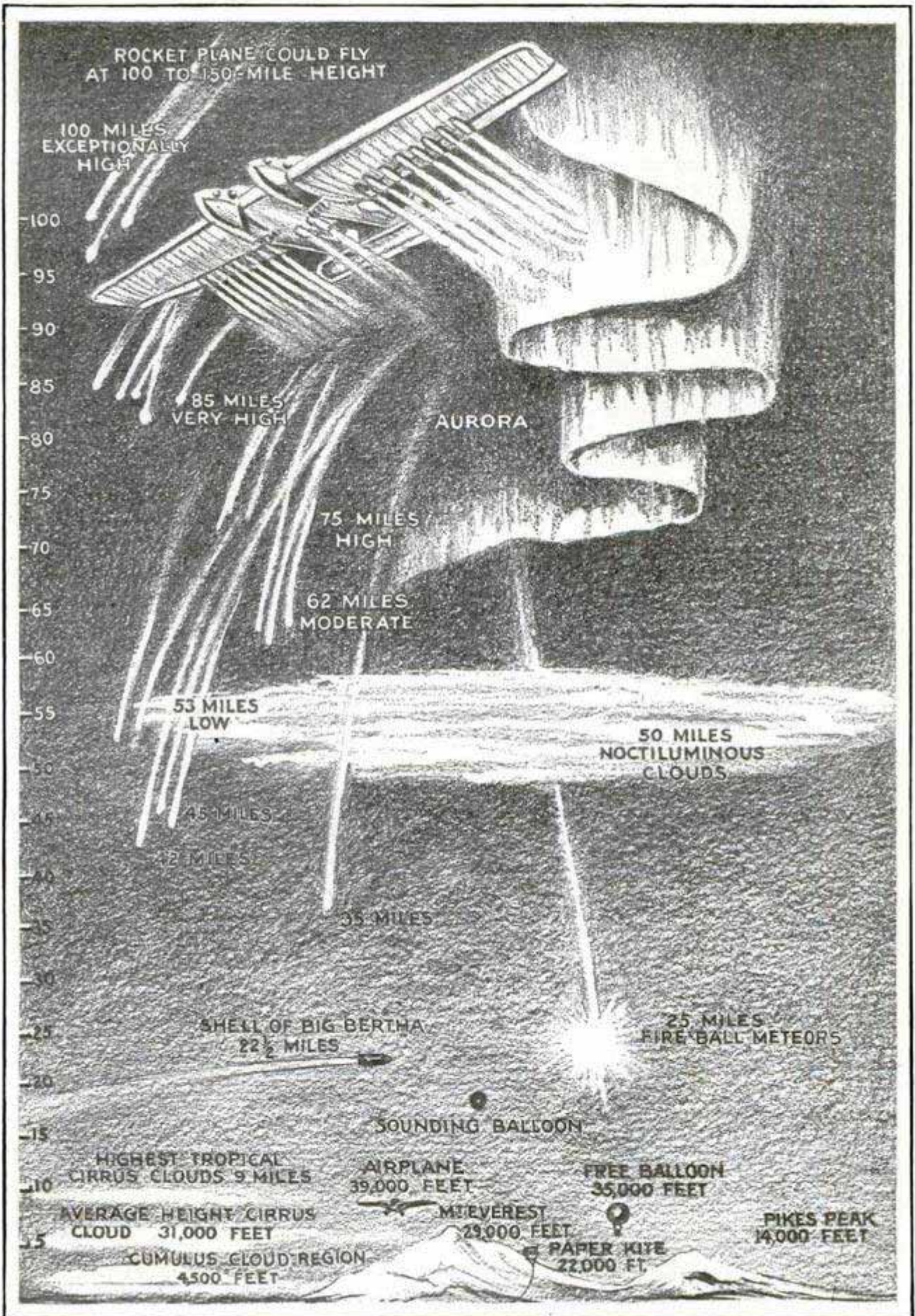

Courtesy New York Times

An Artist's Conception of a Rocket Plane in Flight Out in Space beyond the Earth's Envelope of Air, Where It Would Have for Neighbors the Northern Lights and Occasional Meteors



*Morgan Worcester Mass*

250 720

first leg of the journey would have to be given over to fuel, and seventy-six per cent for each of the ocean stages. To transport a ton of pay load from Berlin to New York thus would require about fifty-two tons of fuel.

If the speed of the gases could be increased, the amount of fuel could be cut down. Valier estimated that if, instead of the technically possible 7,200-feet-a-second velocity, the gases could be made to move at 13,000 feet a second, the fuel would be cut from fifty-two to sixteen tons.

In Professor Goddard's experiments, using smokeless powder, he obtained gas velocities of 8,000 feet a second. The fastest rifle bullet has a muzzle velocity of not over 2,500 feet per second. As every marksman knows, increasing the muzzle velocity of a bullet increases the kick-back of the gun, so Professor Goddard's 8,000-foot-a-second gases should produce an enormous recoil to propel the rocket on its way.

One problem that remains to be solved is whether the human body could withstand the terrific strains involved in being shot into space at such speeds. In experiments with a rocket car mounted on railway wheels and operated on a track, Opel placed a cat in the seat to see how it would withstand the strain. The car, however, blew up and the cat was killed, so nothing was learned.

**TWO SHIFTS GIVE MORE DAYLIGHT**

1303 Employees of an eastern mill enjoy nearly half a day of daylight out of the shop each working day, and the company has been benefited, officials report, as the result of a two-shift, eighty-eight-hour week schedule that

has been in effect several years. The first shift goes on at 6:30 o'clock in the morning and works until 2:30 p. m., when it is replaced by the second shift which is on until 11:42 p. m. On Saturdays, the first shift works until 12:30 p. m. Lunch time deducted each has a forty-four-hour week. Younger men prefer the second shift, for it gives them a long week end, from Friday night until Monday afternoon, and the older men favor the first shift with its shorter day. From the company's standpoint, the plan reduces overhead costs and machinery gives a maximum return before it becomes obsolete. The three-shift program is necessary in some establishments, but in this particular business, the two-shift schedule has been practiced as a happy medium. Elimination of the third shift, from midnight on, has not meant a serious loss, for studies have shown that this is the least productive period.

**MIRROR ON STREET-CAR DOOR HELPS PROTECT WOMEN**

1309 Street cars in Germany are being equipped with mirrors on the exit doors to induce women to face forward just before

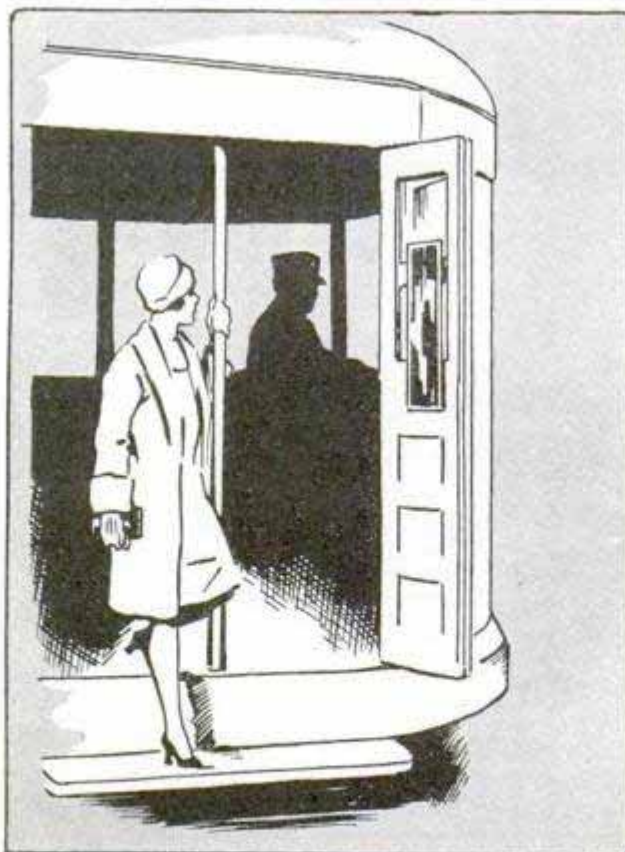

Mirror on Street-Car Exit Door Induces Women to Face Forward When Alighting

1309 before alighting and thus prevent a possible fall. Such accidents are common among women, an explanation being that, due to centuries of experience in carrying children on the left arm and working with the right, she naturally uses the right hand to grasp a support when leaving a street car or train. This causes her to face to the rear, the wrong position. Since the mirrors have been installed, accidents have decreased in number, it is reported, and women passengers appreciate the additional mirror.

*drawn by 8/30/23*

*Safety News*



LIFEBOAT LAUNCHED BY TRACTOR SPEEDS RESCUES

W. J. Sagal & Co.

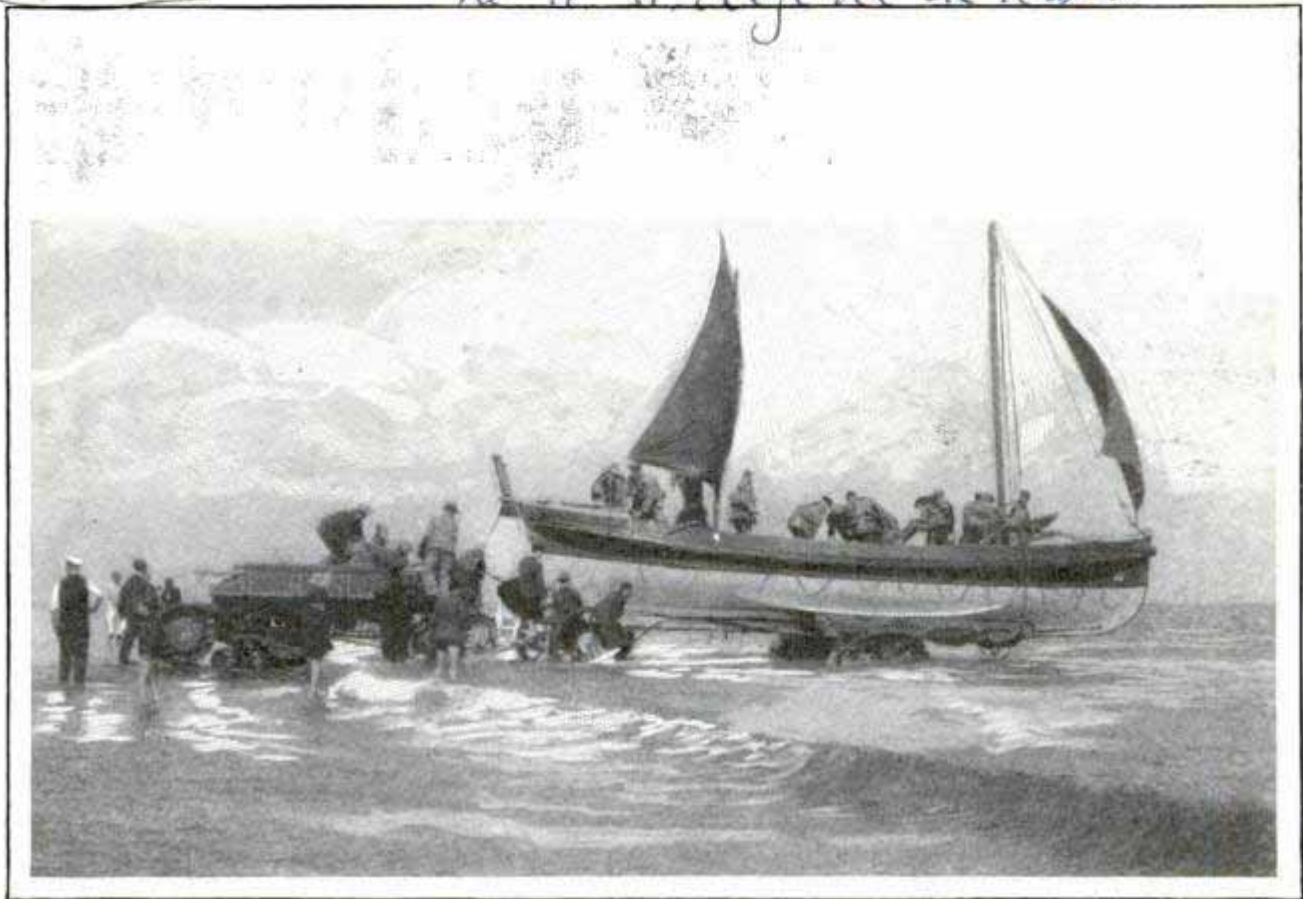

Launching the Big Lifeboat with Aid of Tractor That Hauls It across Sands and Rough Shore, Pushes It into the Water and Hauls It Out Again

To speed up the launching of lifeboats rushed to the rescue of sinking or distressed ships off the English coast, the British royal national lifeboat institution recently tested a tractor and auto trailer that hauled a lifeboat and crew to the aid of a ship off the dangerous shore of Dungeness, on the English Channel. The tractor, named the "F. W. D. Roadless," brought the lifeboat over a rough shingle road to the shore and then launched it by pushing the boat and its carriage into the

sea. The tractor then backed, and by an ingenious device, pulling on a cable which travels around a pulley at the rear end of the boat and passes to the bow, pulled the lifeboat off the carriage and sent it in a seaward direction. When the launching had been accomplished, the auto tractor hauled the carriage to the shore, while the seven-ton lifeboat rowed out to the distressed ship. On loose shingle and sea-soaked sandy shores, the new auto tractor has operated successfully.

DRAWINGS REPRODUCED DIRECT FROM POSITIVE

Positive prints of drawings and other subjects, that are said not to fade and that can be made as easily and as economically as blueprints, are prepared from a positive under a patented process. Dark lines are revealed on light tinted paper as in the original and are not reversed. No liquid or water is used; the undeveloped print, after exposure, is merely inclosed in

a box containing a dish of ammonia water or any compound which gives off ammonia fumes. These act upon the paper to produce the picture. The print can be removed in five or ten minutes and needs no further attention.

Popular Mechanics Magazine does not publish the name of the maker or seller of any device described in its pages, but this information will be furnished free upon application to our Bureau of Information.

Dr. W. J. Sagal & Co.?  
 New York  
 121

Sold by Eugene Stetzgen, Co. 166 W. Monroe Chicago  
 1218 E 23rd St





Camouflaged Stilts and a Balloon Are Parts of This Grotesque Costume Worn by a Balancing Artist

By PAUL PADDOCK

ONE of the most valuable automobiles in the world is an old car likely to fall apart any instant; it back-fires unexpectedly, often chases anyone who gets in front of it, and, without warning, rears on its hind wheels and may spill its occupants backward. The average driver would refuse it as a gift, but its owner and designer, Myron "Buck" Baker, chief of the automobile clowns in Ringling Bros., Barnum and Bailey's circus, wouldn't part with it for a small fortune. It has made

him famous, has moved millions of persons to laughter and has brought thousands of dollars into the coffers of the show.

The chief reason is that this old car and the stunts it does, furnish the chief ingredients for laughter, a priceless phenomenon for which the circus, and other institutions devoted to entertaining the public, spend millions yearly. Say "circus" to anyone and the first word that pops into his mind is likely to be "clown." The two are synonymous in the minds of almost everyone, and that explains why the shows carry hundreds of these entertainers and why the performers themselves are constantly looking for new stunts, rehearsing and improving old ones and seeking new ideas. The clown department of a circus is similar in some respects to a separate show in itself. It



"Trained" to Break Down with a Loud Explosion, the Bridal Taxicab Has Inspired Millions of Laughs



# Circus Laughs

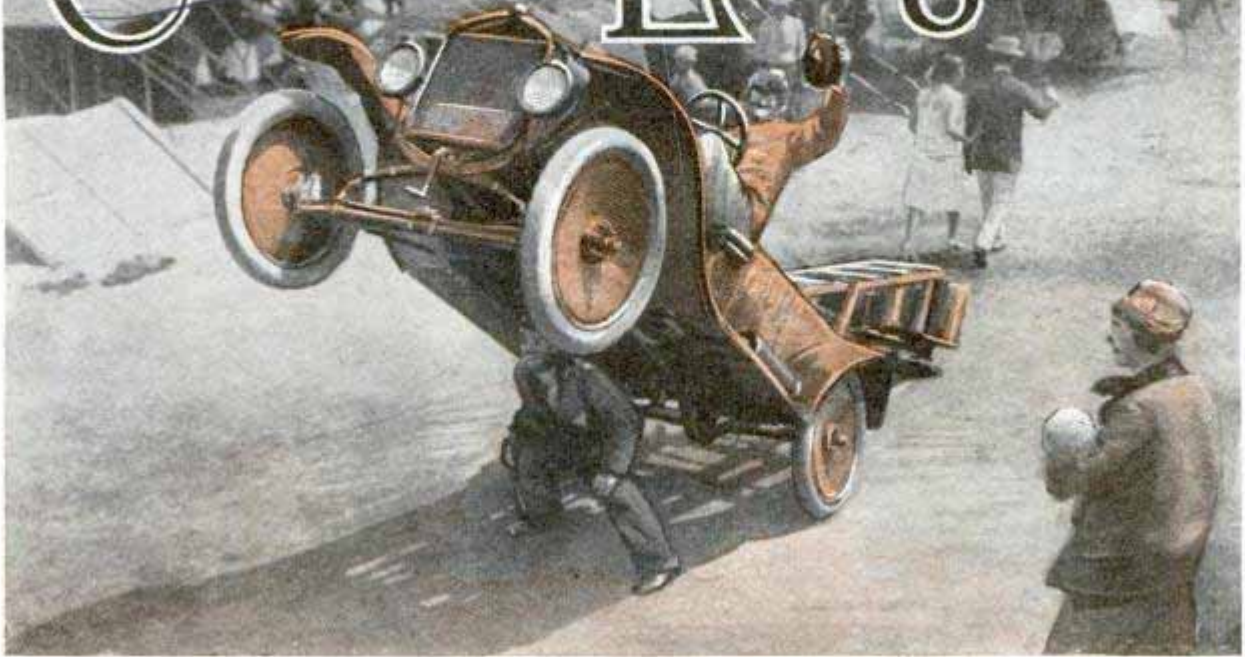

Myron "Buck" Baker at the Wheel of His Famous Flivver That Runs on Its Hind Wheels, Chases Him and Performs Other Tricks Developed from a Thorough Knowledge of Auto Mechanics

has its producing clowns—the idea men—trainers and critics who pass on the merits of an act before it is offered to the public.

Long before he joined the circus, Baker was a trick bicycle rider. He discovered that unexpected mechanical feats brought thrills as well as laughs. When the automobile came along, he seized upon it, altered its normal working parts, disguised it and otherwise changed it until he had developed it into a star circus performer, one of the most effective on the entire lists, not excepting the trained animals and the acrobats. Henry Ford once told him that he "was the only man he knew who could get more out of a Ford car than was put into it."

Baker stages seven acts with his trick autos. They fall apart, explode, apparently obey commands without a human driver as well as with one, and do other amazing stunts, but everyone of them is based on mechanical processes that Baker has carefully worked out, tested and improved in his "laugh laboratory" at Sarasota, Fla., where the circus has its winter quarters. While animal trainers are rehearsing and caring for their pets, Baker

looks after his squad of trick automobiles. He has invented more than a score of special attachments and several devices for general use, not associated with the circus. One of these is a lifting rack for garages, an idea he worked out from his experiments with automobile tricks.

"Why do people laugh at the cars?" Baker replied while tuning up for a recent performance. "I've wondered about that myself sometimes and I'm not sure I know."

"Laughter is a mystery, I guess. I sometimes work out an elaborate stunt that I think is funny, but it doesn't go across half as well, may be, as a simple little thing like an unexpected back fire. I figure this is because the more complex stunts are hard to follow, people are busy watching other things, and then a lot of them have had experience with balky cars. When they see me in trouble with mine, it tickles them. They laugh at me and not at the car. Of course, they know that I am making the car back-fire on purpose, but the stunt seems to recall unpleasant experiences of their own and they're glad they don't have to worry about the car that won't run."



1685



A Favorite Fire Brigade of Circus Fans Everywhere; the Midget Engines and Their Crew; Baker, the Inventor, Is the First Standing Figure at the Left

According to psychologists, Baker's explanation is a logical one. It is human nature to laugh at the other fellow, they say. We chuckle because we're glad we are not in his position. Laughter of this sort is a kind of self-congratulation. We don't stop to make the analysis at the time; laughter just happens naturally, as does all the other emotional and nervous processes that are still mysterious to us. Surprise, suspense, incongruity and various other elements are mixed up in the complex cause of a chuckle, and Baker's trick automobiles are such successful laugh getters, because they furnish all these requirements with a good measure of mystery on the side.

One of the most amazing of his cars this season was a tiny racer, "Sarasota," carrying "Tip," a small monkey, in the driver's seat. It tore around the arena at high speed, mystifying everyone because monkeys have not yet been trained to manage gear-shift cars, but this one has all the attachments and speeds of a full-size racer. Some persons say that a human driver is concealed in the car. But it is little more than six feet long and has been driven within five feet of the front rows, yet no one has been able to see a hidden pilot, if he is there. Mechanics told Baker that he couldn't build such a

car. He did it, and the secret of its operation is known only to a few.

Months of planning and experimenting were devoted to the construction of the chief auto trickster, the old paint car that breaks in two, chases a man and rears on its hind wheels. The balking is accomplished by a feat of balancing. Three 300-pound weights, disguised as paint pails, are hung on the rear of the body. To make the front wheels leave the ground, the occupants of the car have but to tip back slightly. An amazing thing about the car is that it will rear up even if a heavy man stands on the front axle, and Baker says that his weight apparently has no effect on the tipping. Getting the car on its rear wheels was not so difficult, but Baker found that he had a number of unexpected problems to solve after he had done so. For instance, the gasoline wouldn't run into the carburetor at such a steep angle. He had to install an auxiliary tank under the hood back of the radiator and also control the oil so that it wouldn't run out of the engine. Then, the two rear tires had to be inflated at the same pressure or the machine would start going in circles and possibly run into a ring or the grandstand.

Another difficulty appeared. When the front wheels are in the air, Baker is unable



to see them. It is highly important that they be straight ahead when he comes down or the car will plunge off to one side of the track. He therefore made a compass out of his steering wheel by bending and twisting it in such a manner that he could tell by the irregularities, when the wheels were properly turned for the descent. He has never had an accident in the ring. The car is locked so that it cannot be thrown into high speed.

The loud back fires are made in various ways. One is to fire off blank cartridges in a big spring affair like a large rat or mousetrap. Holes are punched in the top of the radiator so that water can be forced through to simulate a violent boil-



Like a Goldberg Cartoon and It Works—Sometimes; the "Trick" Cigar Lighter and Its Inventor



One Reason Why the Circus Tent Has to Be High; But Is a Log Chain Necessary to Hold a Pup?

ing over, while the "shimmying" effect is attained by cams on the rear wheels. One of the most baffling stunts the car performs is to chase the driver, apparently obey his whistle or a wave of the hand while he stands several feet away, and back up without any evident shift of gears. Again, persons have said that this is done by a hidden pilot, but that is not the fact. Baker has worked out an ingenious method of remote gear control whereby he can operate the car at a distance of fifty feet or more, about as well as if he were in the seat. Concealed wires, a reel hidden in his sleeve, and one or two other items, are required to operate the distant-control system, which is being kept secret in order that circus-goers may not be robbed of the pleasure of seeing the mysterious performance.

Long after other memories of the circus have faded, children and adults, too, recall the tiny fire engines, almost perfect replicas of the full-size apparatus. These were also designed by Baker, who supervised the construction of special parts and adapted odd pieces to the cars to make them realistic imitations of the larger engines. When he had nearly finished one, he discovered that there was no room



*Large Automobile Products, Inc. Detroit, Mich*

*1185-*

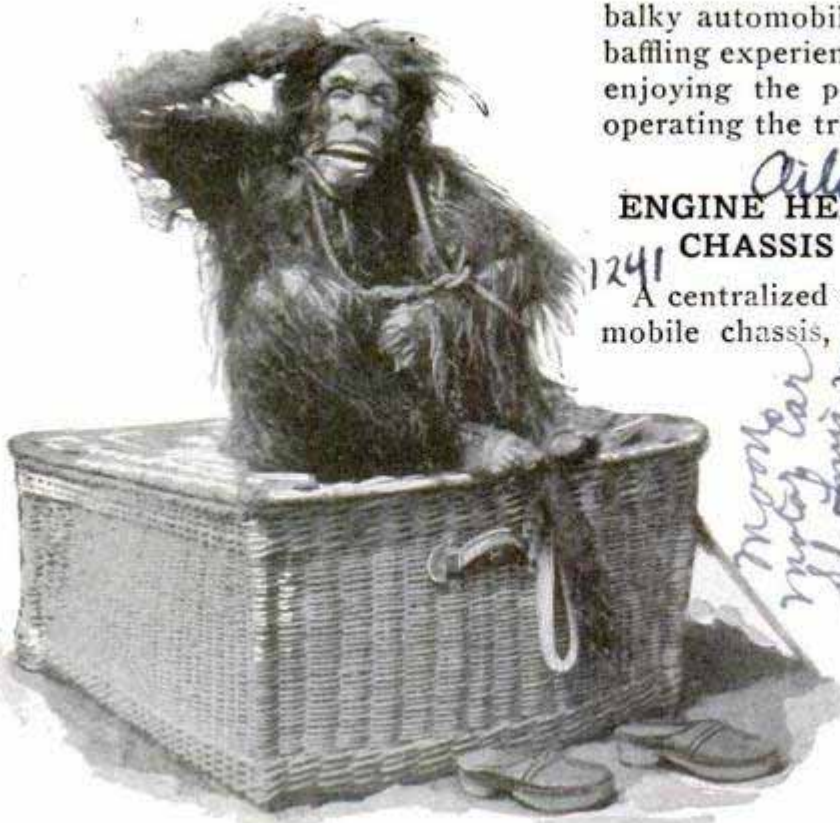

When Man Imitates the Monkey; Clown Actor in Realistic Costume That Never Fails to Puzzle the Circus Crowd

balky automobile, many of them had had baffling experiences with lighters and were enjoying the predicament of the clown operating the trick lighter.

*Oilometer*  
**ENGINE HEAT OPERATES NEW CHASSIS OILING SYSTEM**

*1241*  
A centralized oiling system for the automobile chassis, operated by the heating of the engine, has been adopted by one American manufacturer, and foreign rights sold in Germany, France, Italy and England for use on cars of those countries. A sealed tank, holding a quart of oil, is attached to the exhaust manifold, with piping leading to all of the chassis parts that are to be oiled. The short tubes connecting to the bearings contain wicks. In operation, as soon as the engine is

*motor car St. Louis, Mo*

for a gasoline tank. This proved a puzzler for a moment, but since the engine was air-cooled and had no use for the ordinary type of radiator, this unit was converted into the gasoline tank. The famous wedding taxicab that empties its load at an unexpected moment, is a real cab, the body literally sawed in two and hinged so that it tips back. It is kept from falling off entirely by means of chains and is held upright by buckle supports which can be unfastened from the inside.

According to circus managers, laughs are increasingly difficult to produce as the public is indifferent to many things that inspired response a few years ago. Clowns and cartoonists unconsciously work hand in hand, borrowing and exchanging ideas, although Baker prefers to leave the "funny papers" alone in order that he may give the audience something that they have not seen before.

One of the effective acts in this season's circus was the demonstration of a trick cigar lighter which functioned with the elaborate detail of a Goldberg cartoon and proved a taking burlesque. When it failed, the audience was as pleased as when it worked, because, as in the case of the

started, the oil tank begins to warm up, the heated oil building up pressure which forces it through the pipe system to the bearings. When the engine is stopped, the oil reservoir cools and a vacuum is created which draws the oil back from the bearings, preventing waste through dripping. The quart reservoir holds enough oil to last for from 3,000 to 5,000 miles, the manufacturer claims. Ordinary crankcase oil is used.

*1198*  
**ELECTRIC IRON WITHOUT CORD REDUCES FIRE HAZARD**

Instead of having its cord directly attached, an electric iron now on the market,



is heated through a contact in a metal holder which is connected to a lighting socket. Two irons are employed with

the outfit, one being used while the other is left in the cabinet to be heated. The arrangement eliminates the bothersome cord that often becomes entangled or frayed, prevents fire and supports the irons safely.

*Mrs. O. E. Allen 503 Angel St. P. O.*



1239

Am. Crown Co. Chicago  
412 W. 29th St.  
Vancouver 727 Wash

POPULAR MECHANICS

# TREES FELLED WITH DYNAMITE TO CHECK FIRES

Trees Falling at Blast; Partial View of the Portable Electric Power Plant, Showing Switch being Thrown to Set Off Explosion, and Drilling a Hole for Explosive with a Motor-Driven Auger



*in Pacific Northwest*

To remove dead trees in burned-over areas, a portable electric power plant, drills and dynamite are being used successfully by forest rangers. Charges of the explosive, placed in holes drilled by electricity in the dead trunks, fell the tree much more rapidly than could be done by other methods and several can be destroyed at once. The dead trunk in a section that has been swept by fire, is considered one of the most dangerous menaces to other trees when a new fire occurs.

## NEW TYPE OF MAGNETO HAS NO REVOLVING ARMATURE <sup>1276</sup>

A new type of magneto, which has neither revolving armature, slip ring or distributor, is being marketed in England for marine engines. The magnetic field

is produced by permanent bar magnets to which are attached pole pieces carrying the primary and secondary windings. An armature is at one end of the poles, and high-tension current is produced by pulling the armature away from the coils and breaking the primary circuit. The return of the armature closes the circuit and completes the cycle of operations. The intensity of the spark is entirely independent of the speed at which the engine is running. The mechanism for moving the armature is shaft-driven so the magneto can be fitted to existing engines without alteration.

☐ In proportion to the size of their bodies, insects have larger wings than birds.

*W. H. S. Agent National Supply Corp. 165, Queen Victoria St. London, E.C. 2, England*

*National Supply Corp. 165, Queen Victoria St. London, E.C. 2, England*



1236

# WORLD'S BIGGEST SEAPLANE FLOWN SUCCESSFULLY

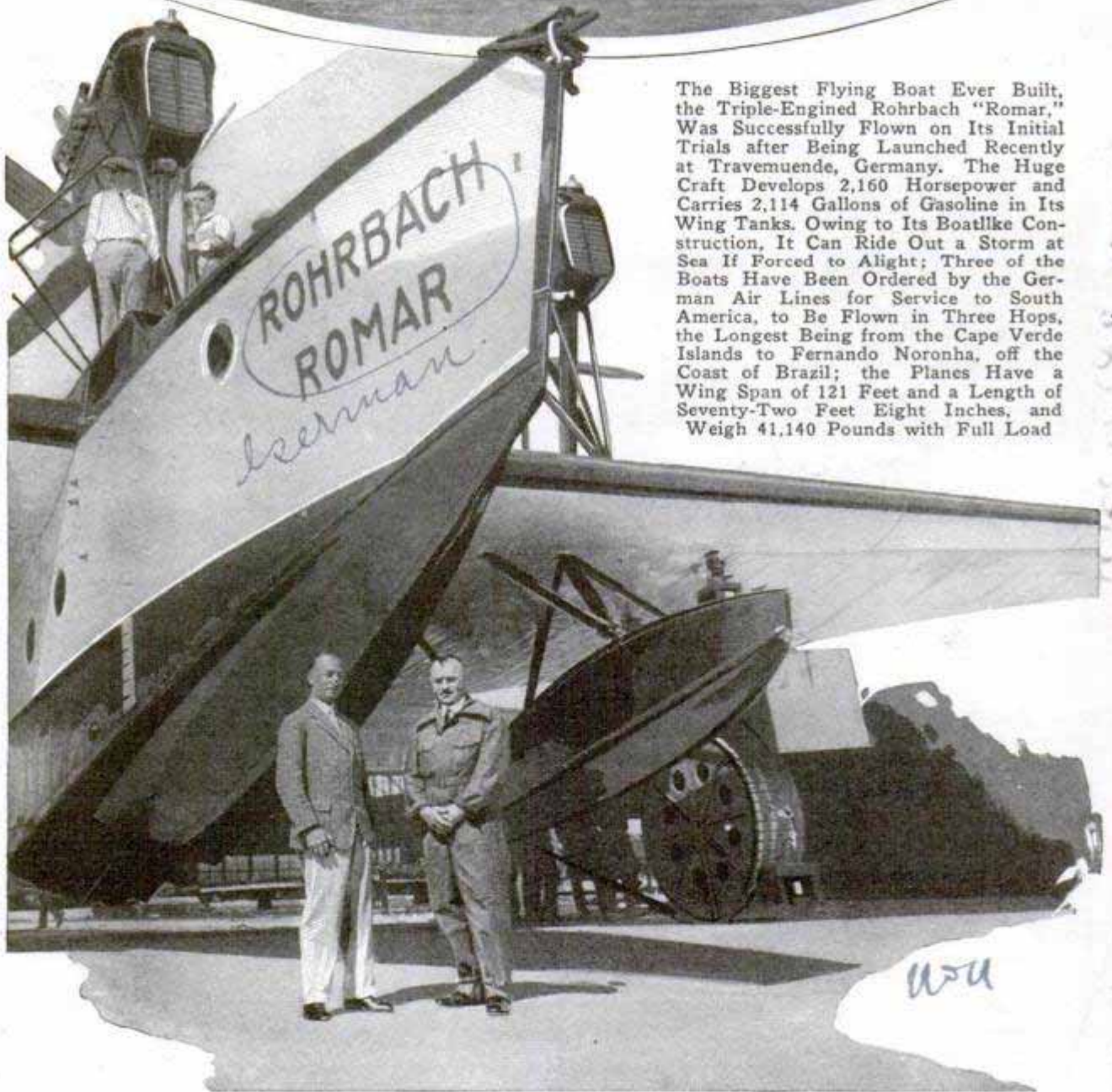

The Biggest Flying Boat Ever Built, the Triple-Engine Rohrbach "Romar," Was Successfully Flown on Its Initial Trials after Being Launched Recently at Travemuende, Germany. The Huge Craft Develops 2,160 Horsepower and Carries 2,114 Gallons of Gasoline in Its Wing Tanks. Owing to Its Boatlike Construction, It Can Ride Out a Storm at Sea If Forced to Alight; Three of the Boats Have Been Ordered by the German Air Lines for Service to South America, to Be Flown in Three Hops, the Longest Being from the Cape Verde Islands to Fernando Noronha, off the Coast of Brazil; the Planes Have a Wing Span of 121 Feet and a Length of Seventy-Two Feet Eight Inches, and Weigh 41,140 Pounds with Full Load

USA



*As a result  
Service*

12 39

**DESTROYED FERTILIZER  
INCREASES TOLL OF  
FOREST FIRES**

1280

Besides the enormous quantities of timber and game they destroy, forest fires do great damage by burning natural supplies of fertilizer on the ground of wooded areas. For instance, in a pine forest, where the fall of needles insures a rich supply of nourishing materials for the plant growth of the future, this abundant fertilizer is converted into ashes by a fire, driving off the beneficial oxygen in the form of a gas that is lost to the soil and otherwise impoverishing the ground. Experts have estimated that to replace the helpful materials on one acre of pine forest, after it has been swept by a fire, it would require the addition of seventy pounds of sodium-nitrate fertilizer at a cost of about \$3, and a blaze may do \$10 to \$15 per acre damage by this destruction alone.

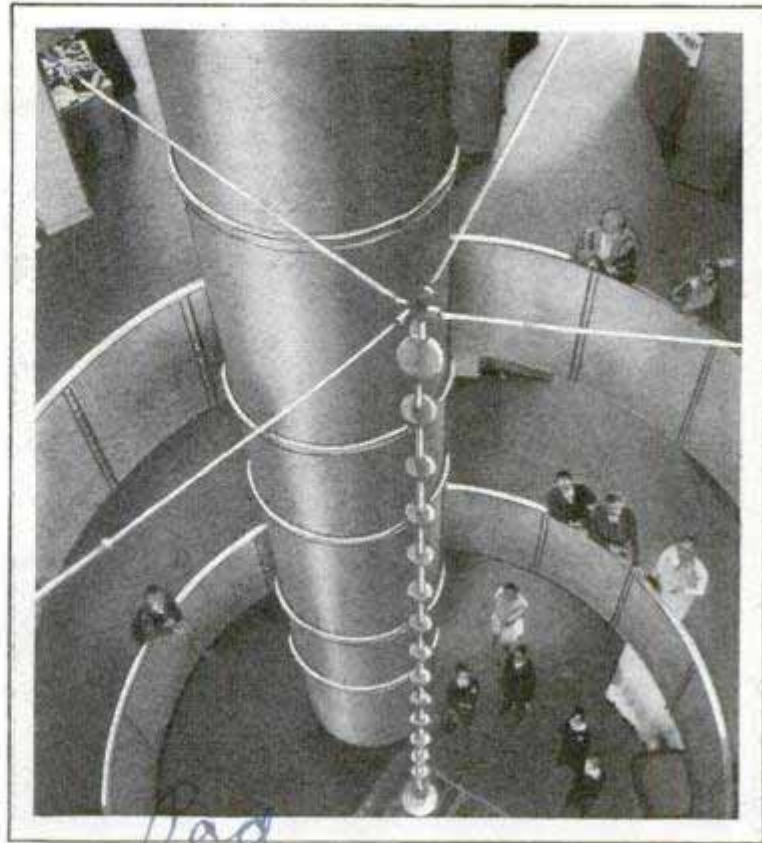

Central Court of the Spherical House Built for Exposition in Germany, Showing the Wide Space for Light and Air

**HOUSE IN FORM OF BIG GLOBE  
WELL LIGHTED INSIDE**

One of the chief features of the huge, ball-shaped house constructed for the "Technical City" show in Dresden, is the central court or passageway from the top to the bottom. This admits light to the hallways that radiate from the center of the building and also affords ample means for effective ventilation.

**TRAP ATTACHED TO CASTERS  
FOILS INSECT PESTS**

1256

To keep ants and other insects from entering cabinets, refrigerators and other pieces of furniture, a felt trap, saturated with kerosene or other anti-bug liquid, is attached to the casters. The felt holds a liberal supply of liquid, is easily put on and seldom needs renewal.

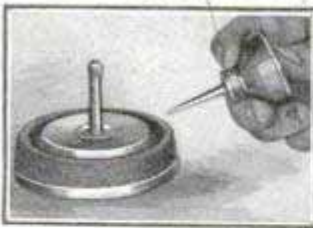

**LAMP THAT CLAMPS ON BOOK  
HELPS PROTECT EYES**

122

Clamped on the edge of the book and having a wide shade that keeps all glare from the eyes, a reading lamp is of special convenience for persons who like to read late or for use in the sick room.

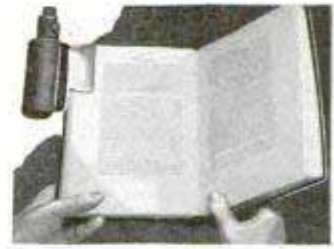

Since the light is directed entirely upon the pages, it does not disturb others.

When frogs wink their eyes, the lids are moving upward.

*U.S. Study of 8/28 to Chicago*

**RUBBER PADS FOR RAILROADS  
GIVE SMOOTHER RIDE**

1278

Specially processed rubber pads are being installed along the right of way of railroads in the Federal Malay states to deaden the sound of the engines and cars and to absorb unpleasant vibrations. According to reports, they have worked successfully on a trial mile of track. The pads also help protect the ties.

*Donald Plenshaw,  
American Trade*

*130 W. 42 nd  
Melodelite Corp  
132 Nassau St*

*Similar. Portlight-Book Section  
Marshall Field*



1187  
General Electric Co, Schenectady  
NY  
see April 1928 625



The Latest Thing in Electric Welding, the Atomic-Hydrogen Process; Hydrogen Fed to the Arc Has Its Molecules Broken into Atoms, Which, in Recombining, Produce Intense Heat

*Pictogram Co, Box 840, Washington, D.C.*  
By CALVIN FRAZER

WHEN you tell the average person that electrical heating has made revolutionary progress within the past few years, he thinks of his domestic furnace, now burning coal, oil or natural gas, and asks whether the time has come to discard these fuels for something better. Let us therefore explain that the new era of electric heat does not yet affect to any marked extent the problem of keeping your house warm in winter.

The "house without a chimney" flourishes on certain reclamation projects in the west, where cheap electricity is a by-product of irrigation under the auspices of a paternal government. It prevails to some extent in Europe, where water-power electricity is equally cheap. Electric "heat reservoirs" have been installed in many Swiss and German houses. These are huge tile-incased stoves, of ancient

pattern but with electric heating elements placed inside instead of the usual coal or wood fires, to heat the heavy slabs of slate or soapstone that compose the walls. Current is supplied to these devices during the off-peak hours of the night at low rates, and they store enough heat to last all day. A few "all-electric" houses in England are heated on a similar basis, hot water being used to retain the heat.

Generally speaking, however, the heating of entire houses by electricity does not yet loom on the horizon, though small portable electric heaters for single rooms—especially bathrooms and bedrooms—are common. Even as applied to ordinary household cooking, electric heat is still unable to compete with coal and gas in most communities. Its uses in the home are mainly in small appliances that consume but little current, including toasters,



# of Electric Heat

grills, chafing dishes, percolators, flatirons, curling irons, bed warmers, hair driers, and so on. These domestic conveniences are steadily increasing in number, and their advent may be said to mark a new epoch in housekeeping, but it is in the industrial field that the amount of electric energy used as heat has lately become truly enormous. A well-known engineer has recently predicted that before the year 1935 we shall see as much electricity used industrially in this country for heating as is used in turning the wheels of machinery.

This development was undreamed of a generation ago. Look back to the year 1882, and you find Edison establishing in New York city the first public plant for supplying electricity. A 200-kilowatt generator sufficed for its needs and the output was devoted entirely to lighting. A few years later the motor load began to figure in central-station operations, with the advent of desk fans in offices. Electric elevators and other applications of the motor followed. By the early nineties of the last century, electricity was driving a large variety of machines, electric railways were rapidly multiplying, and the business of producing and selling electric current had come to be known as the electric-light and power industry, a name that it still retains. In the statistics of the industry, the part of the output used for lighting is usually segregated, while that used for driving motors, for heating and for electrochemical purposes is lumped together under the head of power. Not until the second decade of the present century did the central stations begin to supply more energy for power than for lighting, and only within the past six or eight years did the portion of the former applied to industrial heating begin to bulk large.

Let us now see how this new electrical giant is serving the needs of industry.

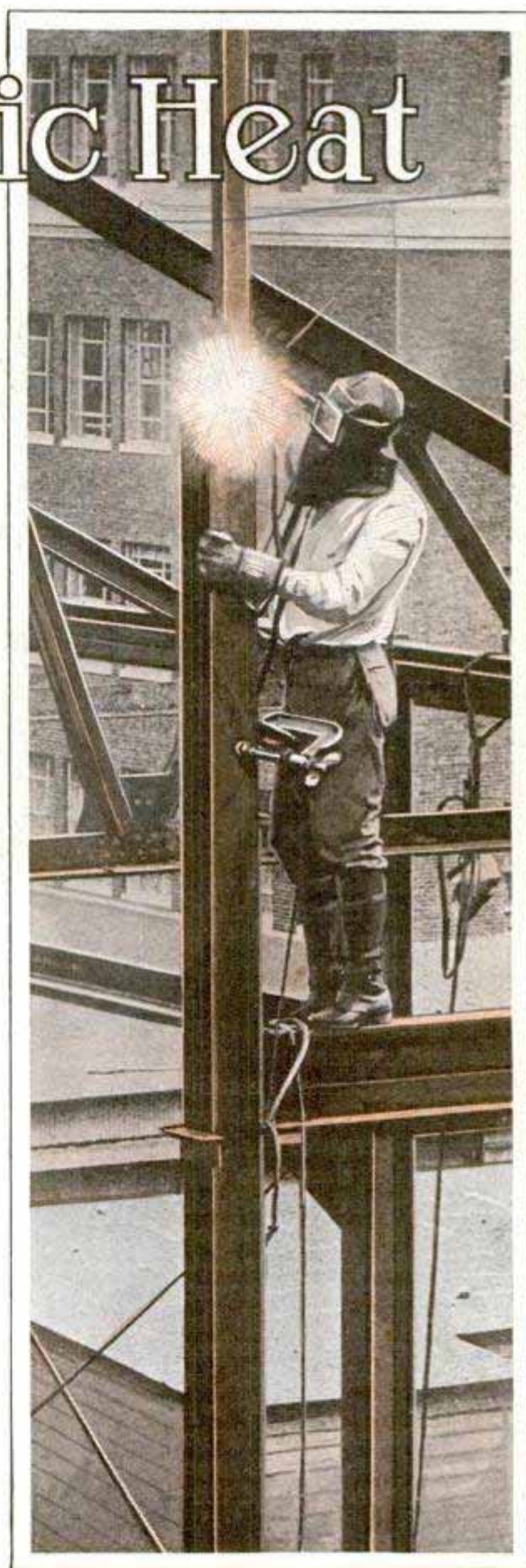

Putting Together a Steel Building by the New Process That Promises to Banish the Rat-a-Tat-Tat of Pneumatic Riveting Hammers



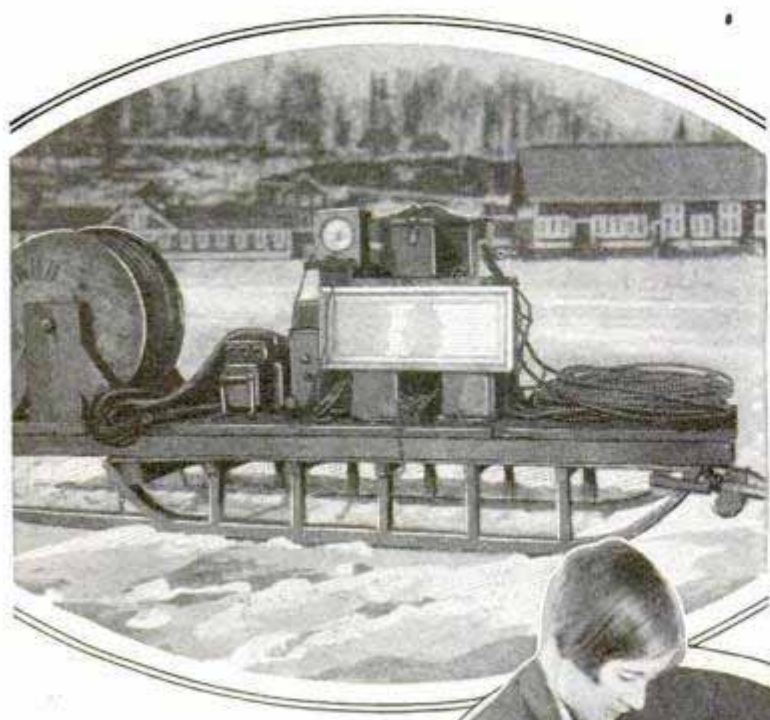

the latter process, and it is also in many cases much cheaper in the long run on account of incidental economies realized in its use. Heating with fuel means combustion, and combustion means that a great amount of air must be heated, much of this heat escaping up the chimney; that undesirable fumes and soot are produced, and that exact regulation of temperature is difficult or impossible. Electric heating is not a combustion process; it requires no air; produces no soot or fuel gases, and can be regulated as perfectly and easily in ordinary industrial work as under the conditions of

the electrical laboratory. One of the many incidental advantages of electric heat is that it can generally be used without raising the temperature of the air in workrooms, and thus it is not, like combustion heating, a source of discomfort to the workmen.  
No type of equip-

There are two ways in which electricity can be used for heating: the arc method and the resistance method. The arc is, of course, a special case of electric resistance (the air or other gas between the electrodes being the resistant medium) but it always produces intense heat, while the resistance of a solid conductor can be adapted to producing any temperature desired. The arc method is therefore confined to the melting of metals, including iron, steel, brass, etc., and to welding. In using the resistance method, the electric current may be sent directly through the material to be heated, produced by induction in this material, or sent through a heating unit separate from the material to be heated. The last of these three processes is the most versatile and the most widely used.

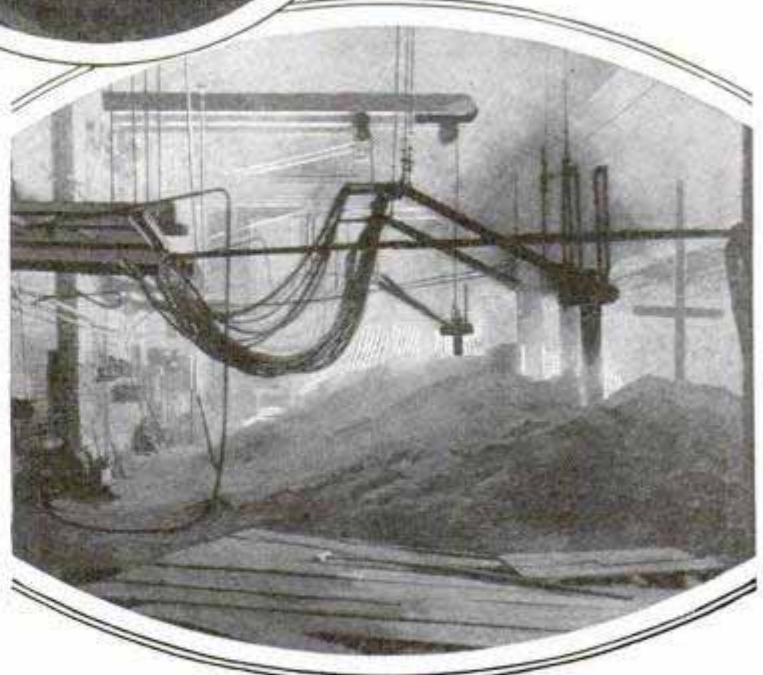

Thawing Machine on the Alaska Railroad; a Small Electric Furnace Used to Glaze the Porcelain on Artificial Teeth at a Temperature of 1,945 Degrees, and Furnaces Making Abrasives

X Columbus Dental Mfg Co,  
Columbus, Ohio.



1787

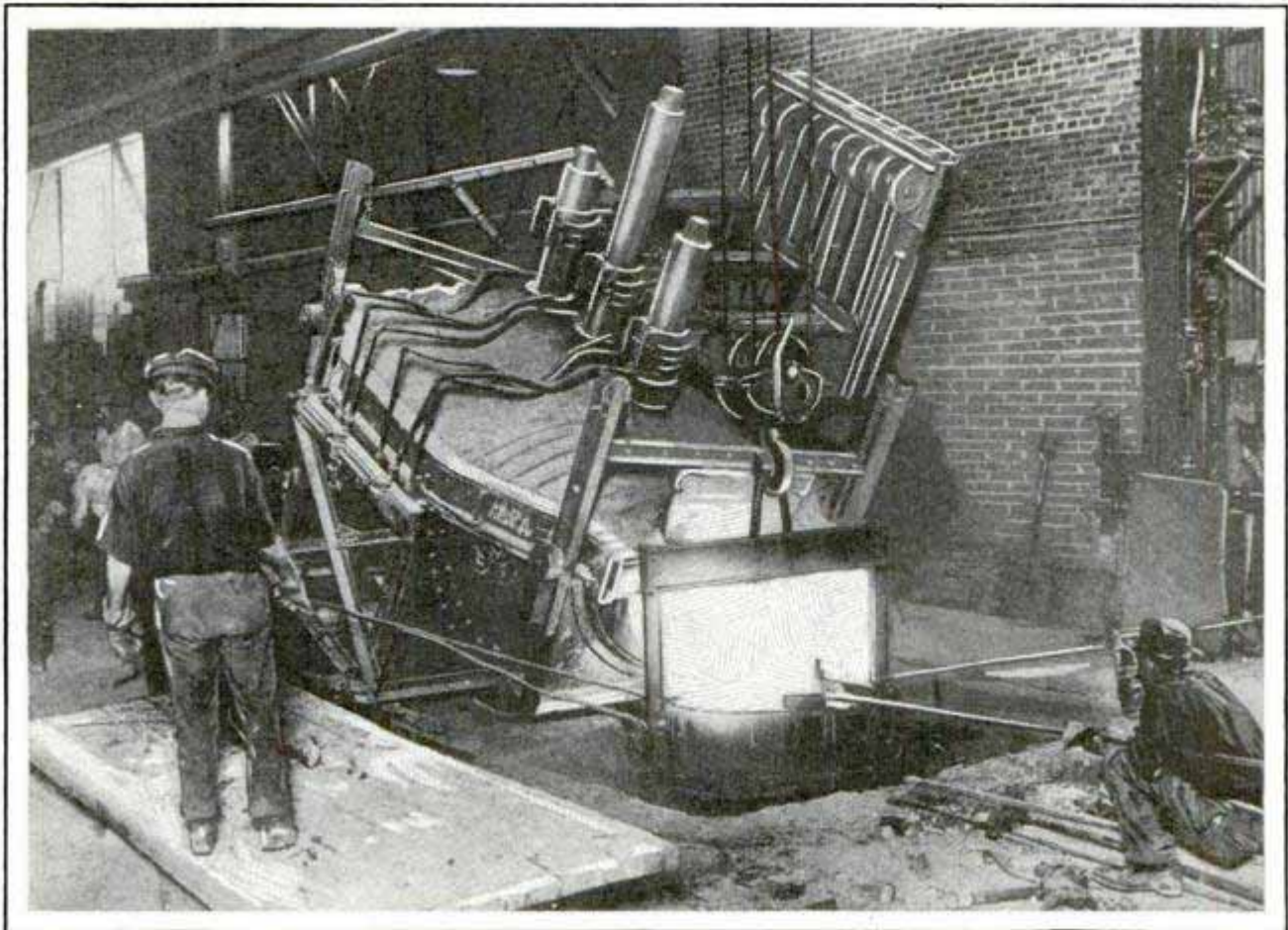

Pouring the Molten Charge from an Electric Steel Furnace; a Large Percentage of All the Energy Generated at Niagara Falls Is Used as Heat in Various Manufacturing Processes

ment for applying electric heat has had a more spectacular success in the industrial world than the electric furnace, of which there are several varieties, some working on the arc principle and some on the resistance principle. Among the main uses of the electric furnace are the melting and the heat-treatment of metals. In the iron and steel industry, for example, a high grade of pig iron is produced by the use of the electric furnace in place of the blast furnace. A much more important application, however, is in the making of steel. In the electric furnace, the charge is melted in a closed chamber. There is no oxidation, no contamination from fuel gases, and the temperature can always be perfectly controlled. Thus, steel of crucible quality can be made much more rapidly than by the crucible process. The electric furnace is used especially for making the various alloy steels, and for super-refining steel made by the open-hearth and Bessemer processes. It is also widely used in melting steel for castings. Lastly the electric-heat-treatment furnace provides a far more perfect control of temperatures

than any fuel-heated furnace, and is therefore the ideal means of annealing, hardening and tempering metal.

The triumph of electric steel dates essentially from the year 1915, when the demand for high-grade steel was greatly stimulated by the requirements of warfare. Since that time, electric heat has come into extensive use for the melting and heat treatment of brass and other non-ferrous metals. In a long list of metallurgical operations, electricity introduces the exactness of laboratory practice into the workshop and at the same time minimizes the need of skilled labor.

The most romantic feats of the electric furnace are those achieved by the use of temperatures unattainable by fuel-heated furnaces, as, for example, in the manufacture of artificial abrasives and in the fixation of atmospheric nitrogen. Carborundum, of which thousands of tons are produced annually at Niagara, owes its existence entirely to electric heat. All the aluminum made in the world is produced in electric furnaces. The same is true of calcium carbide, calcium cyanamide, alu-



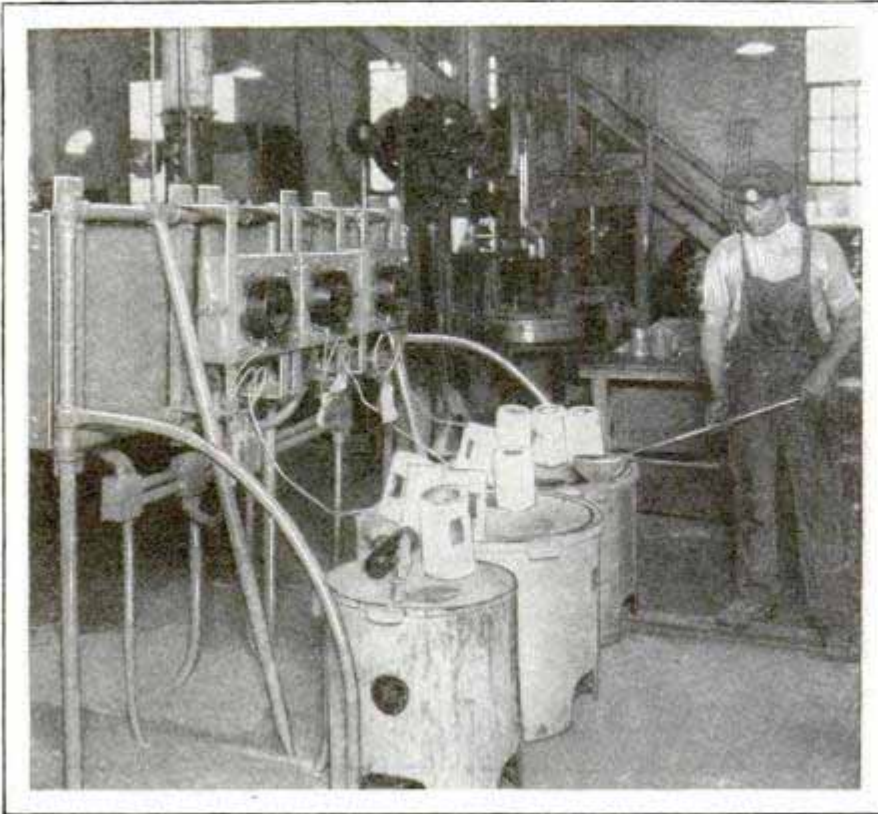

Battery of Electric Babbitt Pots Used by a Street-Railway Company to Melt Metal to Be Poured into Car Bearings

mina and a large number of other highly useful compounds.

The electric oven, used for baking, drying, etc., at temperatures lower than those of the electric furnace, offers similar advantages of accurate temperature control, facility of operation and freedom from the contaminating effects of combustion. These ovens are now used in the preparation of hundreds of important products, ranging from pies and doughnuts to glassware, enamel ware, motor armatures, piano keys and watch dials. Chinaware is fired more easily and successfully in the electric oven than in combustion ovens, as the former provides a perfectly uniform temperature in all parts of the heating chamber, and any desired temperature can be exactly reproduced for each batch fired.

The electric "lehr" or annealing oven has recently come to the front in the glass industry. The quality of the glass annealed in it has proved so superior that many large users of glassware now specify in their orders, "must be annealed by electric lehr." One nationally known maker of ginger ale, after experiencing an average bottle breakage of two per cent in his filling machines, made the astonishing record of filling and capping 720,000 elec-

trically annealed bottles with the loss of only four from the entire lot!

To describe, even briefly, all the applications of electric heat in industry would require a large book—which would be out of date by the time it was published, as interesting new developments are cropping up every day. The following are a few random details of the story:

Electric heat is used to stimulate oil wells that are running dry. Heating coils are lowered into the well to melt the heavy-oil accumulation and permit it to flow freely.

The evenness of heat essential to the correct curing and vulcanizing of rubber is automatically

obtained by the use of electric apparatus to produce steam. In this process, the operation is confined to a single self-contained unit and does away with all piping.

Power and light companies find it profitable to use electric heat in purifying transformer oil. The oil is placed in a rotating apparatus which separates the suspended carbonized particles. The application of heat then vaporizes the contained water and other impurities, leaving the oil in proper condition to be used again.

In the preparation of effervescent salts, electric heat is found to be the most effective means of expelling moisture. It is now widely applied to drugs that must be packed in a perfectly dry condition.

Electric melting pots attached to typesetting machines are a boon to the printing industry. With the even temperature thus secured, the operator's attention is no longer diverted at frequent intervals to watching the thermometer, and production is said to be increased from fifteen to twenty-five per cent. Moreover, the appearance of the typography is much improved, as a sharp, clear type face results from maintaining exactly the right casting temperature.

Electric heat is used with great ad-



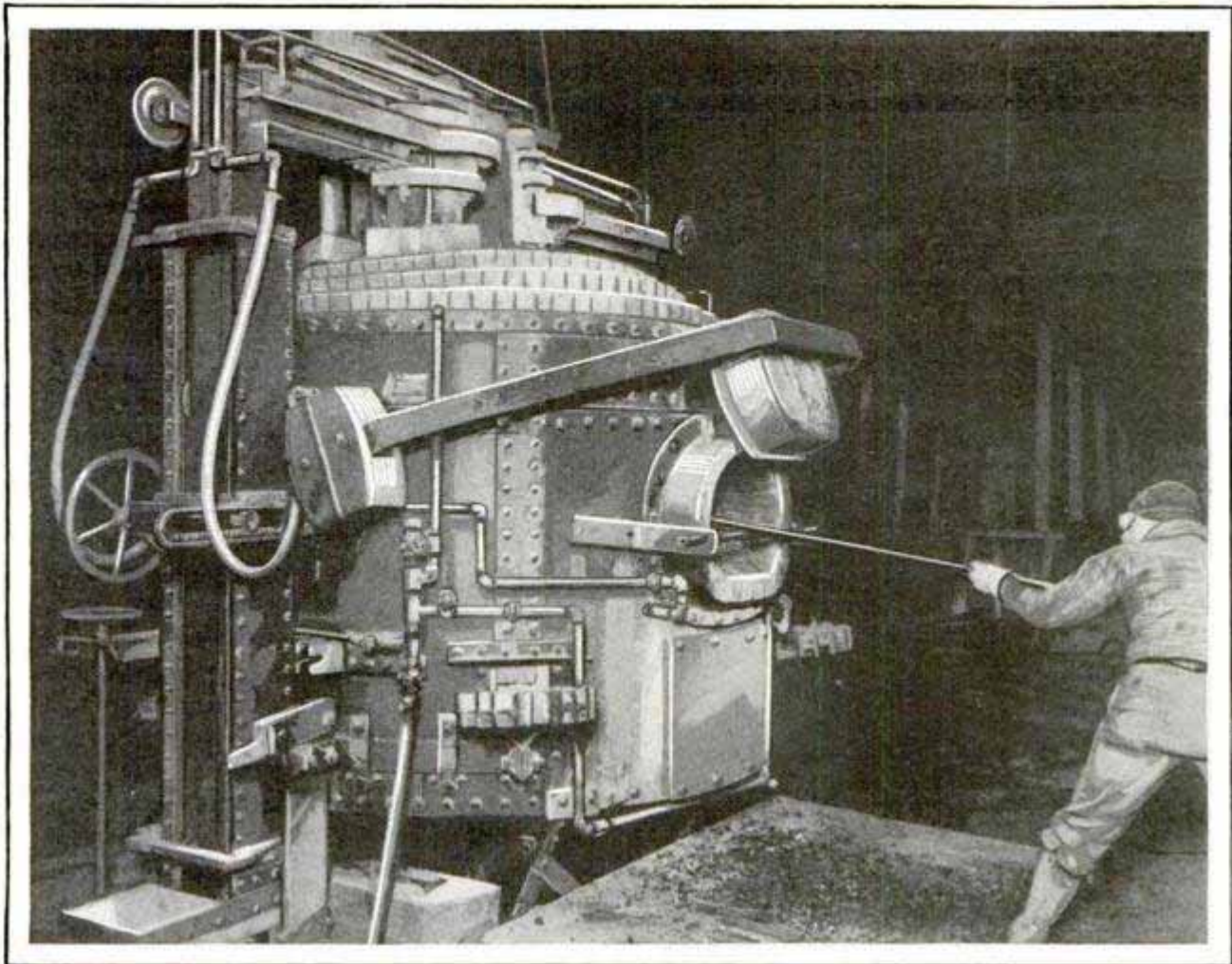

Courtesy Iron Trade Review

Goggled to Protect His Eyes against the Glare of Molten Steel, the Attendant Tests the Charge to See If It Is Ready for Pouring; Electric Steel Is Expensive but Best

vantage to melt glue in the manufacture of paper boxes, shoes, furniture, books, pianos and automobiles. It is also the ideal means of melting lead and tin, as well as solder, babbitt and similar alloys. The electric melting pot maintains the correct temperature automatically, without the danger of burning and without slag.

The electric welding of steel and other metals began half a century ago, but it has lately assumed many new forms and has been applied to a great variety of purposes. One of its newer feats is to add metal to rails where they are worn at the joints without removing them from the track. Various automatic welding machines have come into use, especially for welding the seams of tubes and pipes. Electric arc welding has had sensational success during the last two or three years as a substitute for riveting in the construction of steel-frame buildings, and also in shipbuilding.

Another important application of welding is in the construction of airplane fuselages. Metal has practically displaced wood in American-built commercial planes because of the superior strength of special alloy tubing, with no appreciable difference in the weight of the completed machine. Tests of properly welded joints invariably show that the weld is stronger than the rest of the material.

"Heat it electrically," is the new watchword of industry.

## INSECTS THAT DEVOUR INSECTS TO PROTECT PLANTS

Orchardists in South Africa have been calling upon California for supplies of a certain species of beetle that devours the troublesome mealy bugs attacking trees in Africa. Growers are attempting to cultivate the beetles and raise a large army of them against the mealy bugs.

*Science Service  
Bulletin 384-8  
8/24/22*



736

565 Howard St.

POPULAR MECHANICS

GAS GUN LIKE FOUNTAIN PEN TO AID BANK CLERKS

also at Los Angeles



Pen-Shaped Gas Holder for Repulsing Bandits; It Shoots Fumes Twelve Feet and More

Shaped like a fountain pen, a small container for gas fumes, to foil bandits, has a lever that shoots the vapors a distance of twelve feet and more. It is intended for the use of bank tellers, clerks and others, and is deceptive to an intruder as its appearance gives no indication of its purpose. The "pen" unscrews in the middle for the insertion of a gas cartridge.

IRON WIRE ACTS AS NERVE ACID TEST SHOWS

The expression, "he is a man of iron nerves," may be more true literally than has been supposed, an interesting series of tests just concluded by Prof. Ralph S. Lillie, of the University of Chicago, indicates. His experiments have revealed a striking similarity between nervous action, particularly heart action, and the behavior of iron wire in a nitric-acid bath.

A pure iron wire, one to five centimeters long, was immersed in a nitric-acid solution of sixty to eighty per cent. A colorless film immediately formed over the wire and, if one end was scratched, a wave traveled rapidly along the wire. When a glass tube was placed in the acid, around one end of the wire, rhythmical waves passed the length of the piece at the rate of fourteen to 120 times a minute, depending upon the strength of the solution; the temperature and the length of the wire. Dr. Lillie concluded that a sort of battery was formed. The film, only one molecule in thickness, acquired an electrical charge negative to that of the wire. When the film was scratched, a current was set up which dissolved the film next to the bare spot. This continued until the bare spot, which was seen as a wave, had passed the length of the wire. The film forms again after the wave has passed. The influence of temperature, electrical polarization, concentration of acid and length of the wire, have been shown to be the same as their influence on living nerves.

HOUSE TRAVELS OVER THE SEA ON POWERFUL CRANE

A sturdy crane picked up a house and floated it several miles across the water to a new location in Rotterdam recently. The crane was part of the equipment of a powerful harbor vessel, used in wrecking, dredging and other heavy tasks.

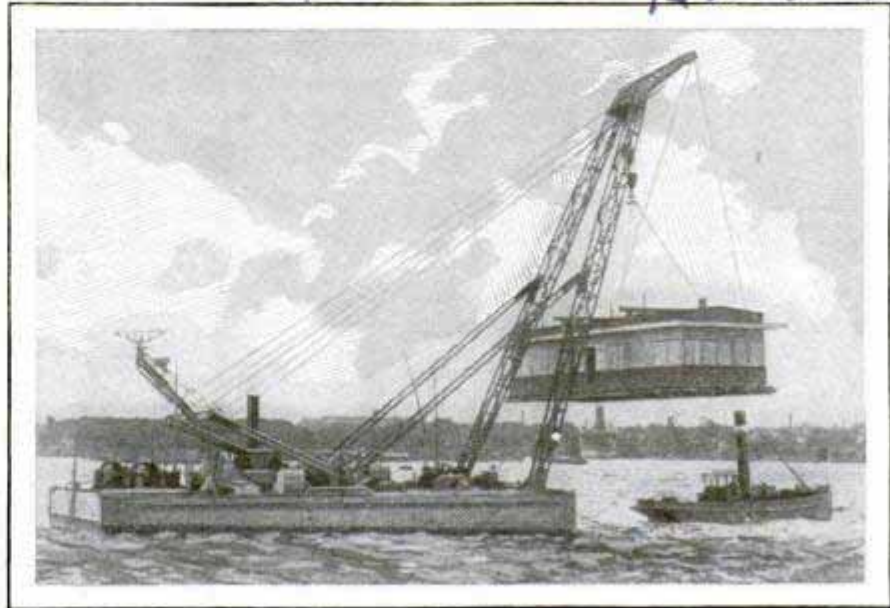

Giving a House a Ride; Powerful Crane Carrying Dwelling across Stretch of Water to New Location at Rotterdam

Bullard - Davis Co. 565 Howard St. San Francisco

1225

1231

Science Service Bulletin

Com. Isegg J. Paul. 537 S. Dearborn





© U. & U.

Assistant Secretary of Commerce William P. MacCracken, Jr., and Art Goebel Examining Sample Markers Proposed for Use on the Airways of the Country to Guide Flyers

### UNIFORM AIRWAY MARKERS TO AID FLYING

Department of commerce officials are endeavoring to induce the adoption of a uniform style of markers to guide flyers along the airways of the nation. Different colors will be used for different cross-country routes, and other distinguishing details will be employed, according to present plans, to make it easy for the pilots to tell where they are. When the proper form of markings has been decided upon, it is intended to have them widely displayed to make them known.

### NEW WAY OF BUILDING WALL ELIMINATES PLASTERING

Greater economy, a saving of time, and other advantages, are claimed for a patented form of wall construction which leaves the interior in such a finished state that it is not necessary to use plaster. The essential feature of the method is its interlocking units which may be made of metal, concrete, fiber, gypsum or other materials

suitable for wall construction. These units are molded in long channel shape and are set on end instead of being built up as the ordinary wall of blocks or of brick. The length of the channel depends upon the height of the story, it is two feet or more wide and has an interlocking flange that holds it to the channel placed next to it. The depth of the channel depends upon what thickness of wall is desired, and the interior of the unit forms a dead-air space

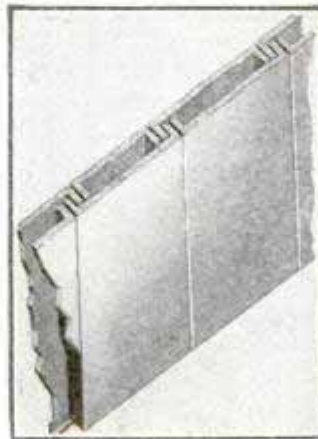

which affords insulation or may be used for wires, pipes or other conduits. Where a column is desired for support, the space may be filled with concrete. When finished, the wall requires no stone or other covering on the inside, while the

joints on the outside may be concealed beneath any appropriate form of finish.

*Inv. & maker. J. C. Fitzpatrick. 418 Church St. Worcester, Mass.*



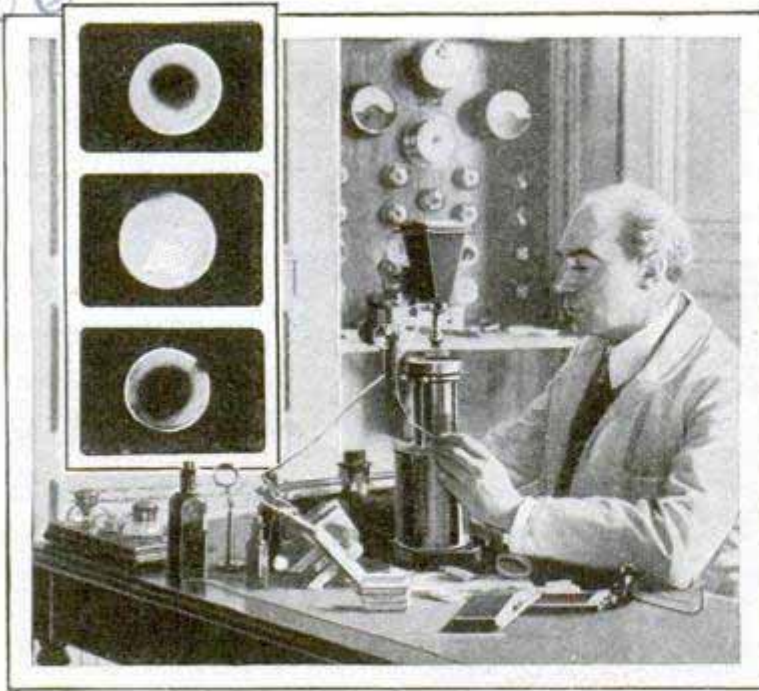

Using the Pearl-Inspecting Camera, and a Close View of Three Genuine Pearls Showing the Internal Structure

### FAKE PEARLS ARE REVEALED BY SPECIAL CAMERA

French experts have recently introduced a camera that takes pictures of the inside of pearls so that the genuine may be told from the imitation. Detailed views of the interior structure, and other points that are impossible to detect with the unaided eye, are said to be clearly revealed so that successful passing of the false for the genuine is not likely to occur after an examination with the instrument.

### DEATH WHISPERS FROM QUARTZ KILL SMALL ANIMALS

Further interesting experiments with inaudible sound waves have been performed recently by Alfred L. Loomis, who causes a quartz crystal to produce vibrations at the rate of two and one-half million per second, called "death whispers," because they kill small organisms in water. In earlier experiments, he produced vibrations at the rate of three-quarters of a million per second. The more recent effects have been obtained with a tiny slab of quartz, less than an inch long, about three-eighths of an inch wide and one-sixteenth of an inch thick. Its high rate of vibration is partly due to its smaller size as compared with the other crystal, and to the more rapidly oscillating electric current to which it is submitted to cause

vibrations. Plant and animal cells were killed by the violent stirring of their contents. The cell walls of the plants were not broken, as they were evidently too tough and strong, but the contents were seen to be swirled into a disorganized mass by the action of the weird whispers of death.

### TONE TESTER LOCATES RADIO TROUBLES BY KEEN HEARING

Listening to radio programs through loud speakers, as many as 250 of them a day, is the task of Martin T. Olsen, a veteran in one of the most highly specialized activities in the world. He is a tone tester. Just as the tea-taster's sense of taste has been

developed to a point where he can detect the slightest difference in blends, so Olsen's ears can distinguish the least variation in pitch. The average person can tell the difference in tones or notes up to about 5,000 or 6,000 frequencies per second, scientists say, but Olsen, in a competitive test, demonstrated that he was able to distinguish notes at frequencies of over 10,000 cycles per second. During a broadcast program, he can usually tell if distortion or extraneous noise is the fault of the microphone, is in the station studio, or if the interfering noise or faulty tone is caused by the set itself, and if so, where the trouble lies. His chief business is to listen to the loud speakers manufactured by a radio company to determine if they are up to the standard of the master model in tone and pitch. If they are not, Olsen's keen sense of hearing aids in locating the difficulty.

Martin T. Olsen, Testing Tone of Loud Speaker



*Chief Tester Jensen  
Radio Mfg. Co. Inc. Chicago*

*1306  
Lurido Park, N.Y.  
Lurido Park, N.Y.*

*Science & Service  
Bulletin 388-8*



# Twenty Five Years of Flying



*al Wilson*

*Maddux Air Lines  
International*

A Wright Pusher Type of 1910 alongside a Modern Twelve-Passenger Tri-Motored Cabin Plane; the Old Wright Machine, Still in Flying Condition, Escorted the New Ship on Its First Trip

**T**WENTY-FIVE years ago, the seventeenth of December, a crude structure of bamboo and silk, powered with a homemade motor, shot down a wooden rail in the lonely sand dunes at Kitty Hawk, N. C., and took to the air. It flew along for 260 yards and settled gently to earth.

A feat that had intrigued the minds of men since the dawn of recorded history had been accomplished. Two bicycle builders from Dayton, Ohio, Wilbur and Orville Wright, had flown a power machine through the air.

Less than a quarter of a century later the descendants of that first crude flying machine had flown the Atlantic and the Pacific, remained in the air more than sixty hours, traveled more than 4,200 miles without a stop, had been to the North pole, played a vital part in the greatest war in all history, were carrying mail and passengers day and night on regular schedules, and were performing a thousand useful tasks. All that happened within the lifetime of youths who cast their first votes this year, for, while the initial flight was made in 1903 it was not until 1908 that public flights were made.

The pilot on that first flight was Orville, while his brother, the late Wilbur Wright, supervised the take-off. To launch the ship into the air, they mounted it on a rail and used a weight, dropped from a derrick, to give it the initial starting impulse. The motor, built in their Dayton bicycle shop, turned a pair of propellers, through bicycle chain gearing, at the slow speed of 400 revolutions a minute, as compared to the speeds of 1,500 to 1,900 revolutions common in modern airplanes.

The first flight of the motor-powered plane had been preceded by years of experimentation with gliders, in which they had made several thousand flights. Before they tried power, both brothers had learned to fly their gliders in winds with a force up to thirty-five miles an hour, to maneuver them in the air and land safely. In all their glider experiments they had but one accident, when Orville fell thirty-five feet and escaped without a scratch. By the time they were ready to build the power machine for the famous flight of 1903, they knew more than anyone living about the problems of flying



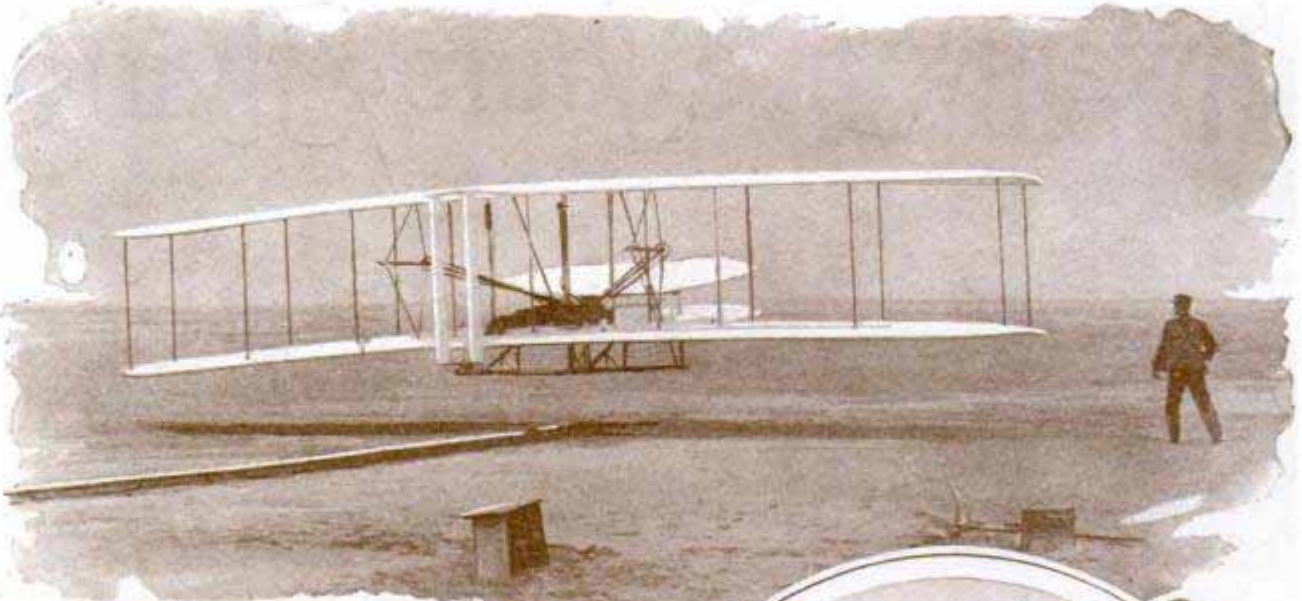

Above Is the First Airplane Flight Made by Man, at Kitty Hawk, N. C., on December 17, 1903; Wilbur Wright Is Running alongside the Plane, Which Has Just Left the Catapult Track, and Orville Wright Is at the Controls; at Right, Herring Flying One of Octave Chanute's Gliders over the Sand Dunes of Indiana, just Outside Chicago; Chanute's Experiments Were the Connecting Link between Lilienthal and the Wrights

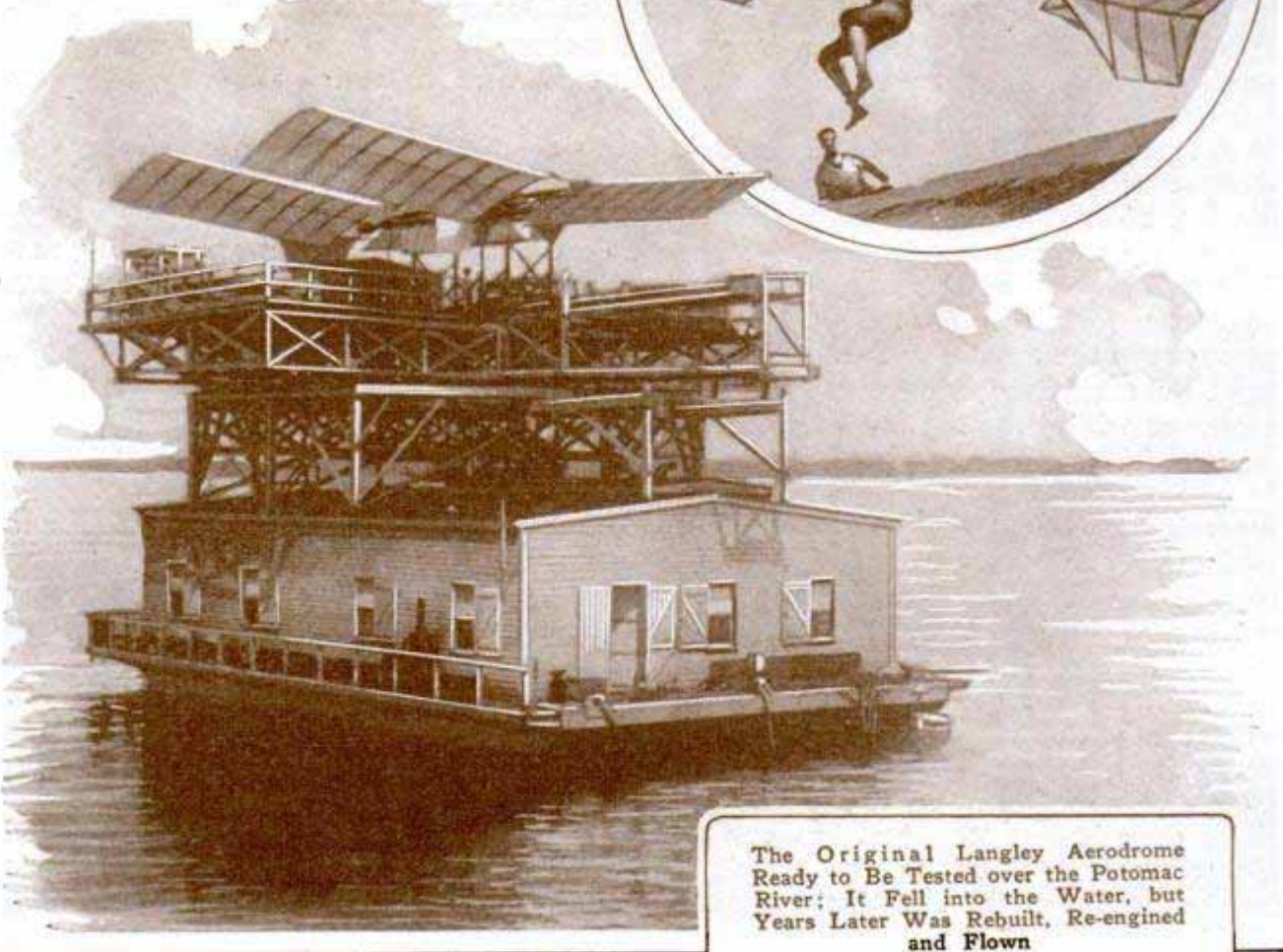

The Original Langley Aerodrome Ready to Be Tested over the Potomac River; It Fell into the Water, but Years Later Was Rebuilt, Re-engined and Flown



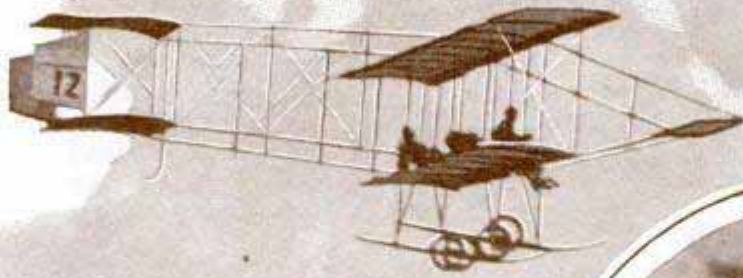

Right, Chinese Military Attache at Washington Learning to Fly; Note the Aileron Controls Strapped to the Shoulders

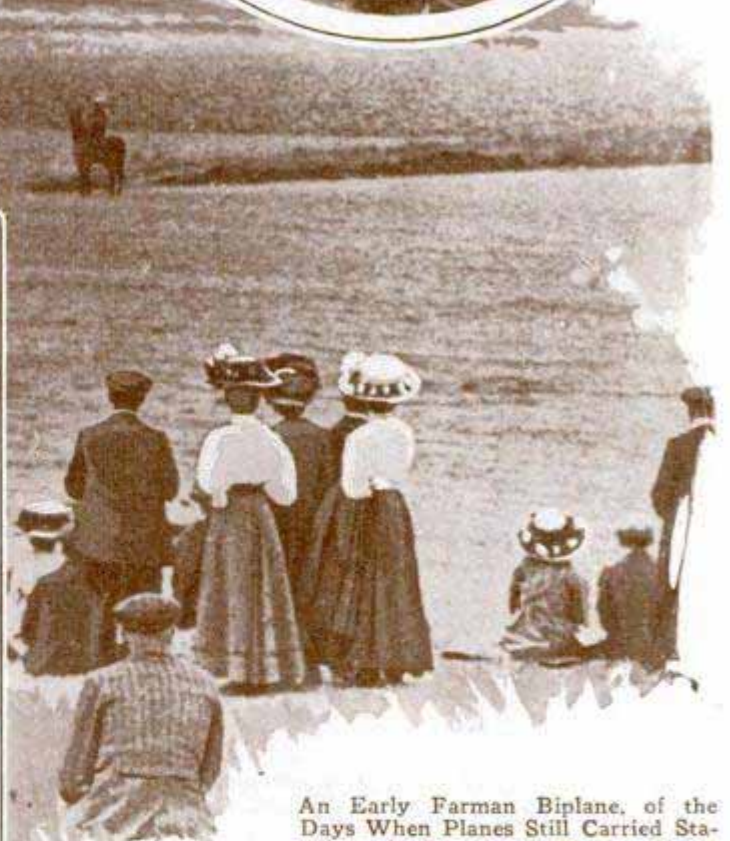

An Early Farman Biplane, of the Days When Planes Still Carried Stabilizers in Front; the Clothes of the Spectators in the Foreground Give a Hint as to the Year; at the Left Is the First Aerial Bomb in All History; Its Inventor, Riley Scott, a West Point Graduate, Is Attaching the Device to His Plane; the Place Is Rockwell Field, San Diego, and the Year Is 1913; the Bomb Weighed Six Pounds, in Contrast to the 4,000-Pound Monsters Carried by the Huge Bombing Planes of Today; the Plane Has a Steering-Wheel Control, a Device That Is Coming Back into Use for Some of the Bigger Ships Today



670

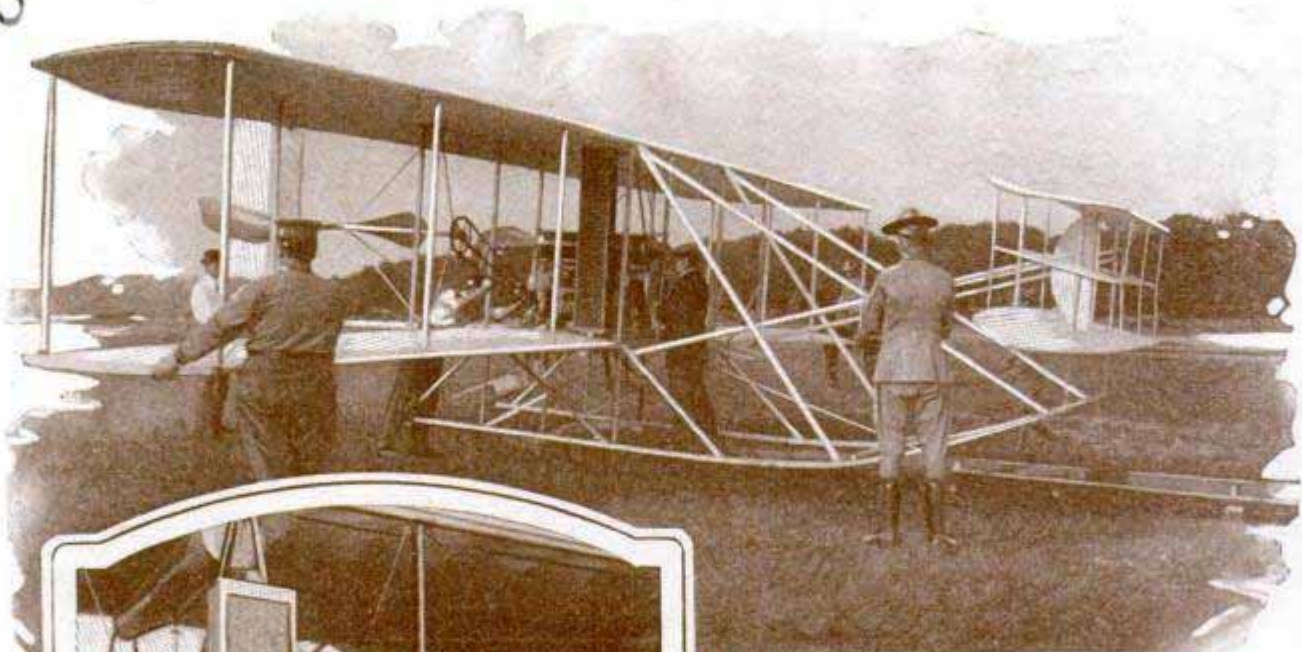

It Was Just Twenty Years Ago That the Army Bought Its First Plane, the Wright Machine Shown Above, at Ft. Myer, Va., in 1908; in the First Demonstration Lieut. Selfridge, the Army's First Flyer, for Whom Selfridge Field, Mich., Is Named, Was Killed and Orville Wright Badly Injured; at Left Is Capt. Holden Richardson, U. S. N., in a Sixteen-Year-Old Curtiss Seaplane, Recently Resurrected from the Navy Store House, Assembled and Flown; the Old Machine Is a Pusher Type with the Propellers behind the Wings

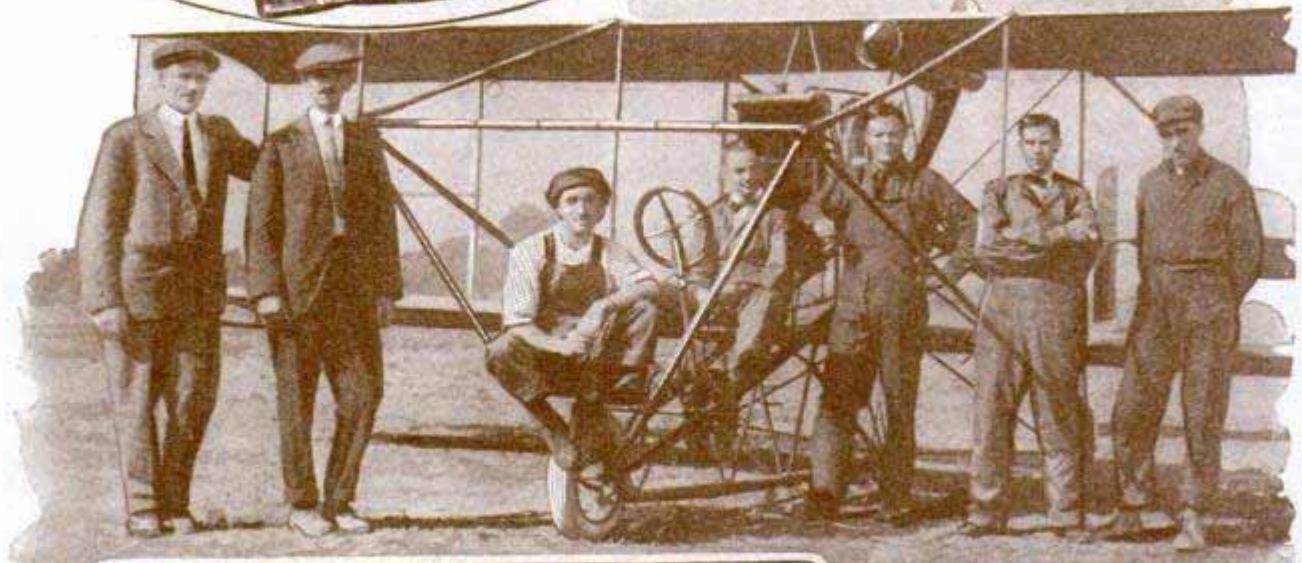

The First Curtiss School of Aviation at North Island, San Diego, Calif.; Glenn Curtiss Himself Is the Man with Cap and Mustache, Second from the Left



670

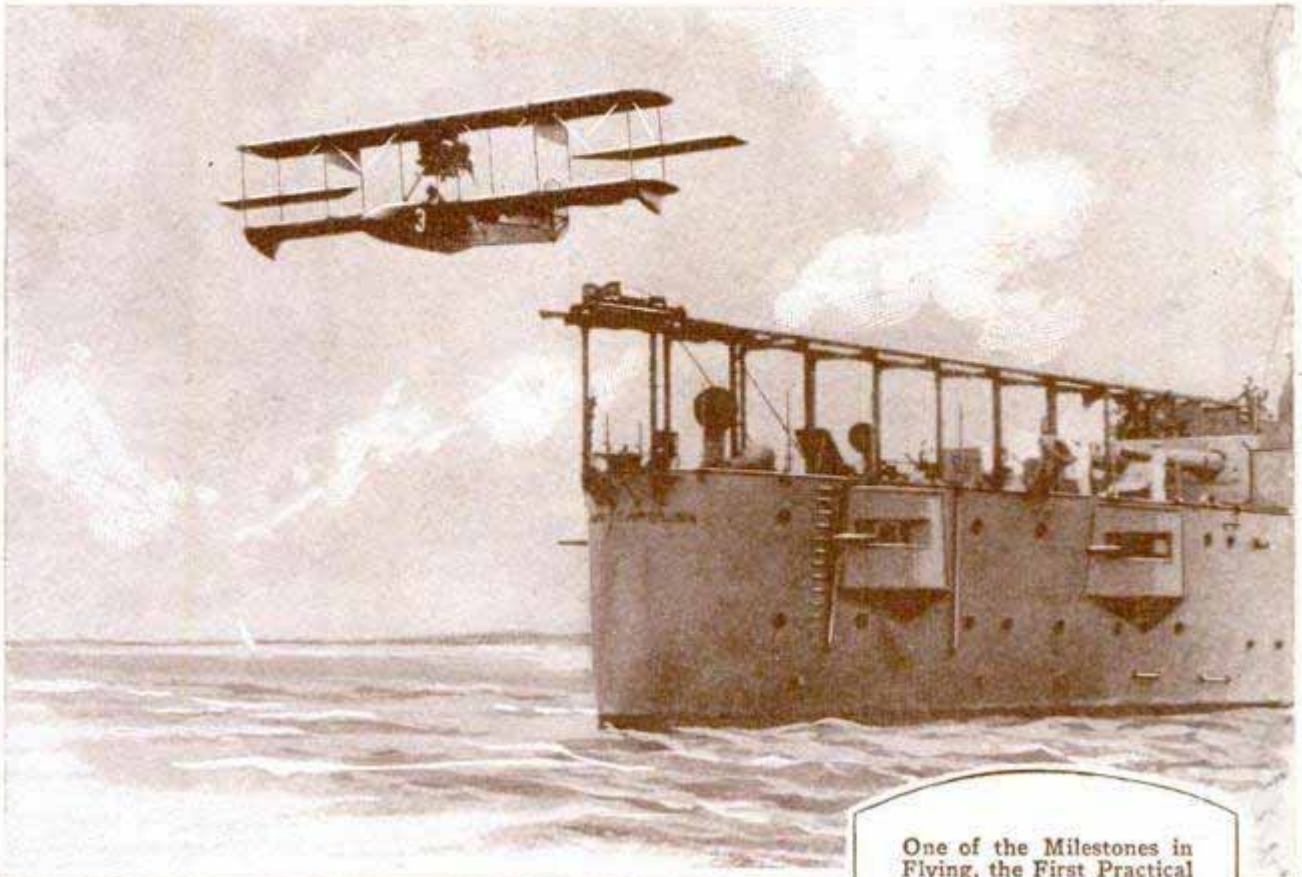

One of the Milestones in Flying, the First Practical Airplane Catapult on the Old Battleship "North Carolina," Now Scrapped; the Modern Catapult, a Small Revolving Platform, with a Gunpowder Mechanism to Shoot the Planes into the Air; Below, the Modern Seagoing Aerial Taxicab, a Junkers Seaplane Carried by the German Liner "Columbus" for the Use of Passengers during Visits to West Indian Ports

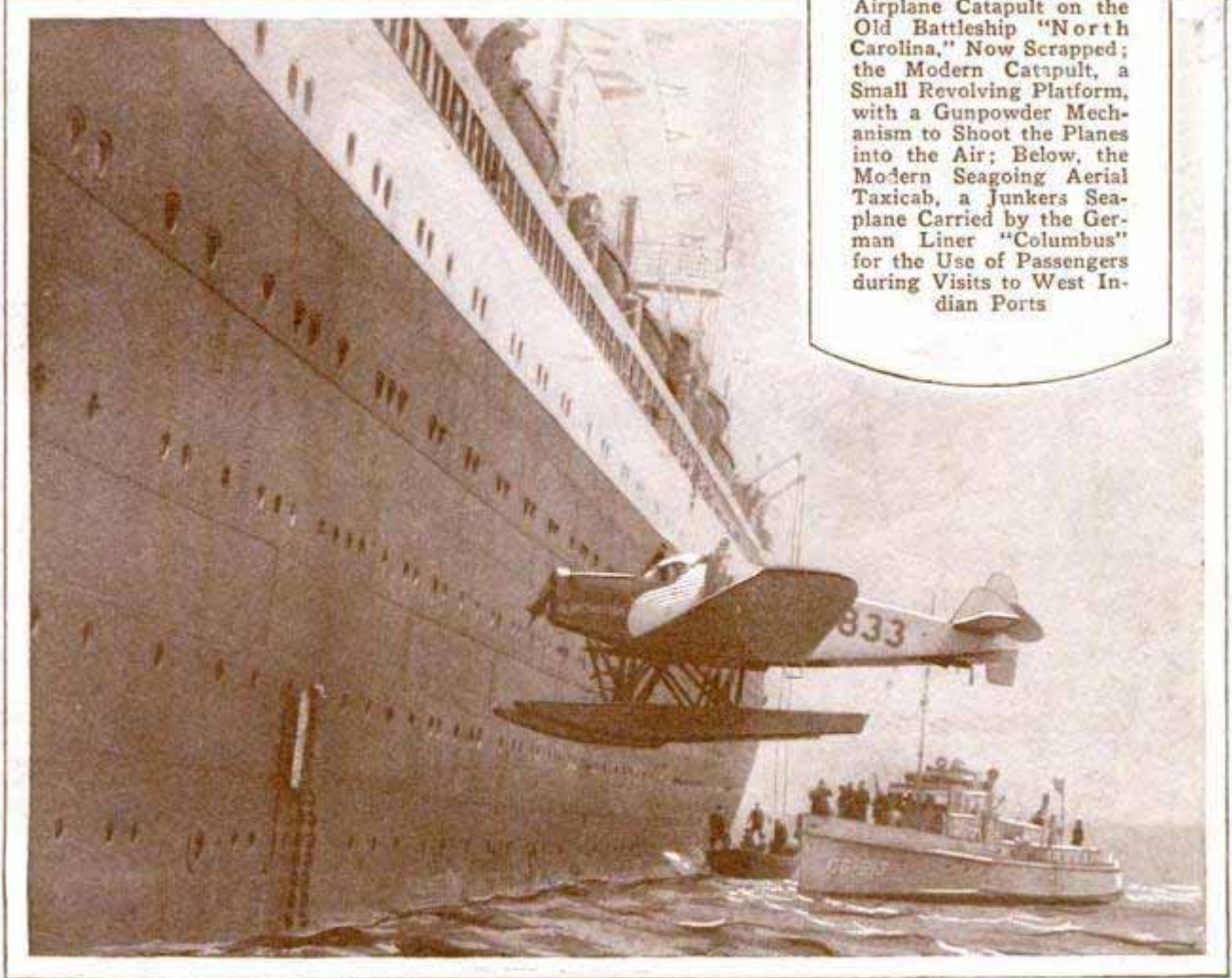

1911  
 1912  
 1913  
 1914  
 1915  
 1916  
 1917  
 1918  
 1919  
 1920  
 1921  
 1922  
 1923  
 1924  
 1925  
 1926  
 1927  
 1928  
 1929  
 1930  
 1931  
 1932  
 1933  
 1934  
 1935  
 1936  
 1937  
 1938  
 1939  
 1940  
 1941  
 1942  
 1943  
 1944  
 1945  
 1946  
 1947  
 1948  
 1949  
 1950  
 1951  
 1952  
 1953  
 1954  
 1955  
 1956  
 1957  
 1958  
 1959  
 1960  
 1961  
 1962  
 1963  
 1964  
 1965  
 1966  
 1967  
 1968  
 1969  
 1970  
 1971  
 1972  
 1973  
 1974  
 1975  
 1976  
 1977  
 1978  
 1979  
 1980  
 1981  
 1982  
 1983  
 1984  
 1985  
 1986  
 1987  
 1988  
 1989  
 1990  
 1991  
 1992  
 1993  
 1994  
 1995  
 1996  
 1997  
 1998  
 1999  
 2000  
 2001  
 2002  
 2003  
 2004  
 2005  
 2006  
 2007  
 2008  
 2009  
 2010  
 2011  
 2012  
 2013  
 2014  
 2015  
 2016  
 2017  
 2018  
 2019  
 2020  
 2021  
 2022  
 2023  
 2024  
 2025



Probably made by  
Bristol Aeroplane Co. 62  
Bristol, Eng  
C. A. Guerin  
Bristol  
Bromie

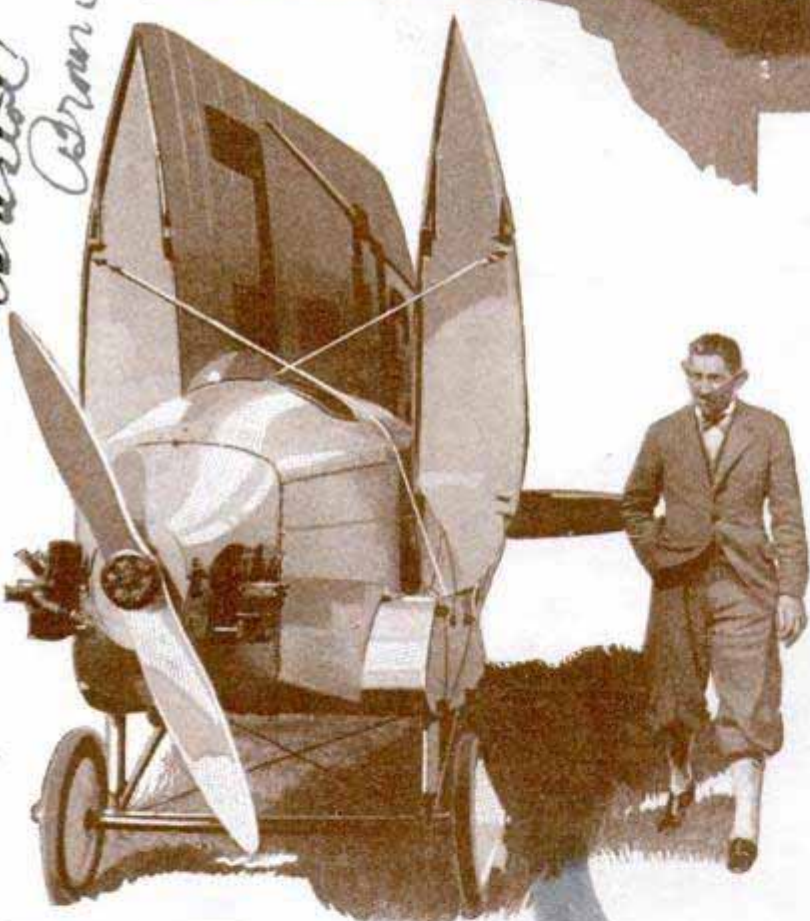
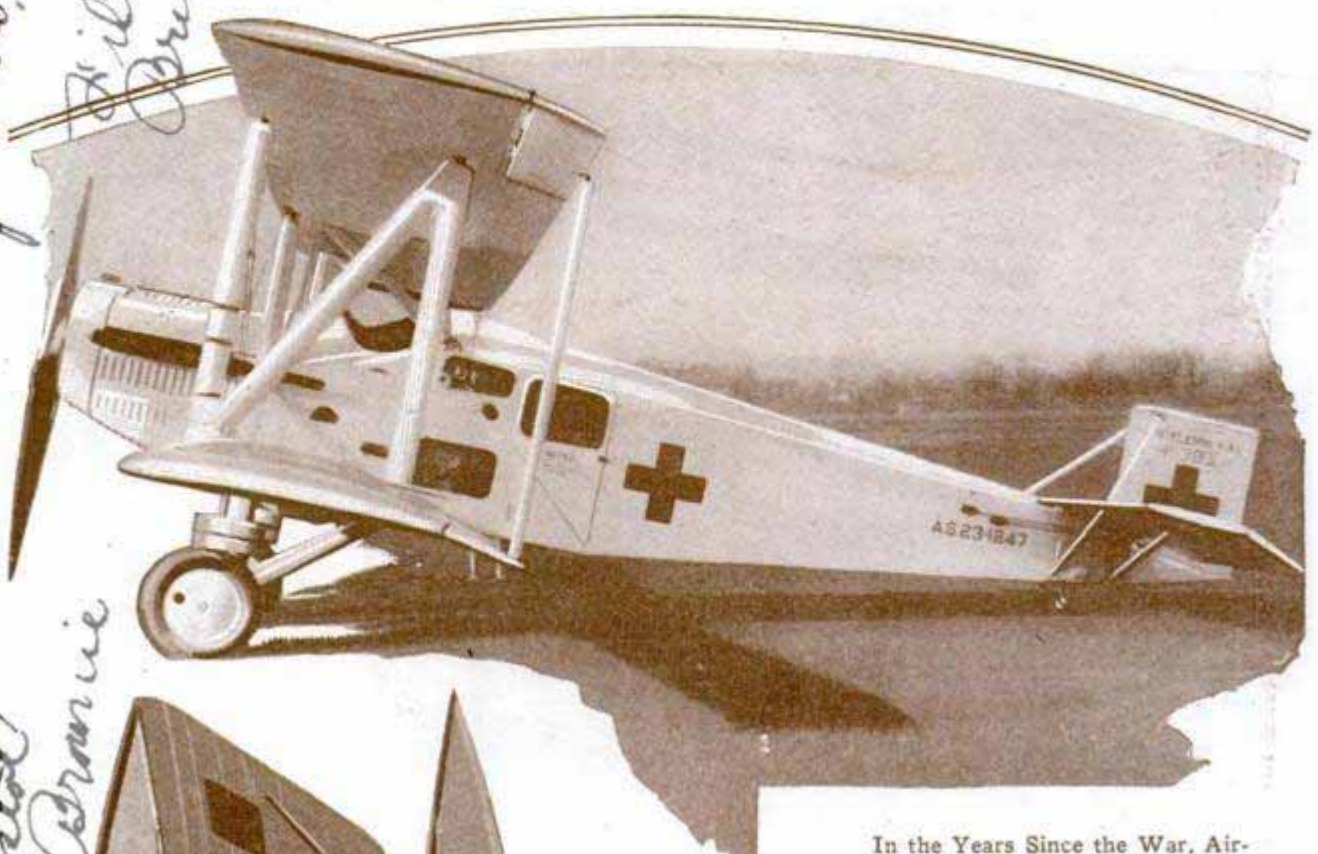

In the Years Since the War, Airplanes Have Developed Rapidly, Both for Military and Commercial Purposes; Above Is a Modern Flying Ambulance; the Army and Navy Use Airplanes Fitted with Stretchers and First-Aid Equipment to Carry Patients to Hospitals, and They Have Proved Especially Useful in Rescuing Victims of Aerial Accidents, Frequently Getting the Injured to the Hospital in Time to Save Their Lives, Whereas Normal Transportation, Often from Isolated Districts, Might Have Been Fatal; at the Left Is a British Monoplane with Folding Wings, Which Can Be Kept in a One-Car Garage; Its Spread of Wings Has Been One Drawback to the Airplane, but with the Advent of Folding Wings, Especially Adaptable to Monoplane Construction, the Ship Is Easily Stored, or Can Be Hauled through a City's Streets behind an Auto Truck, without Obstructing Traffic

At the Right Is One of the First of the Amphibians, Capable of Landing or Taking Off Either from Water or Land; Comm. Richard Byrd Used Loening Amphibians in the Arctic with the MacMillan Expedition, and the Army Flew Them around South America

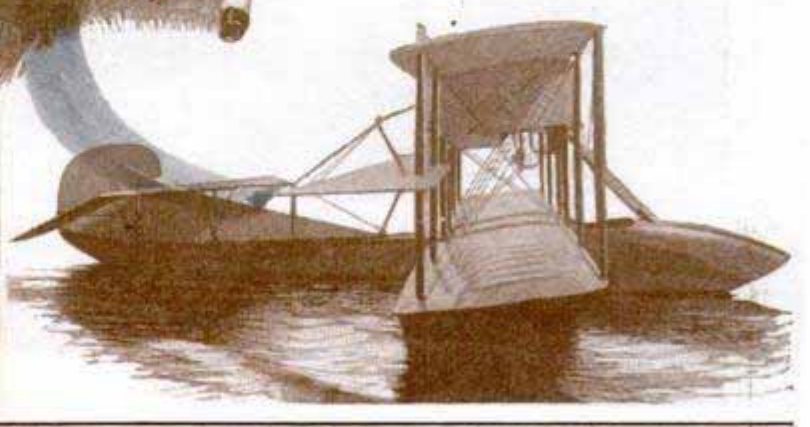



690

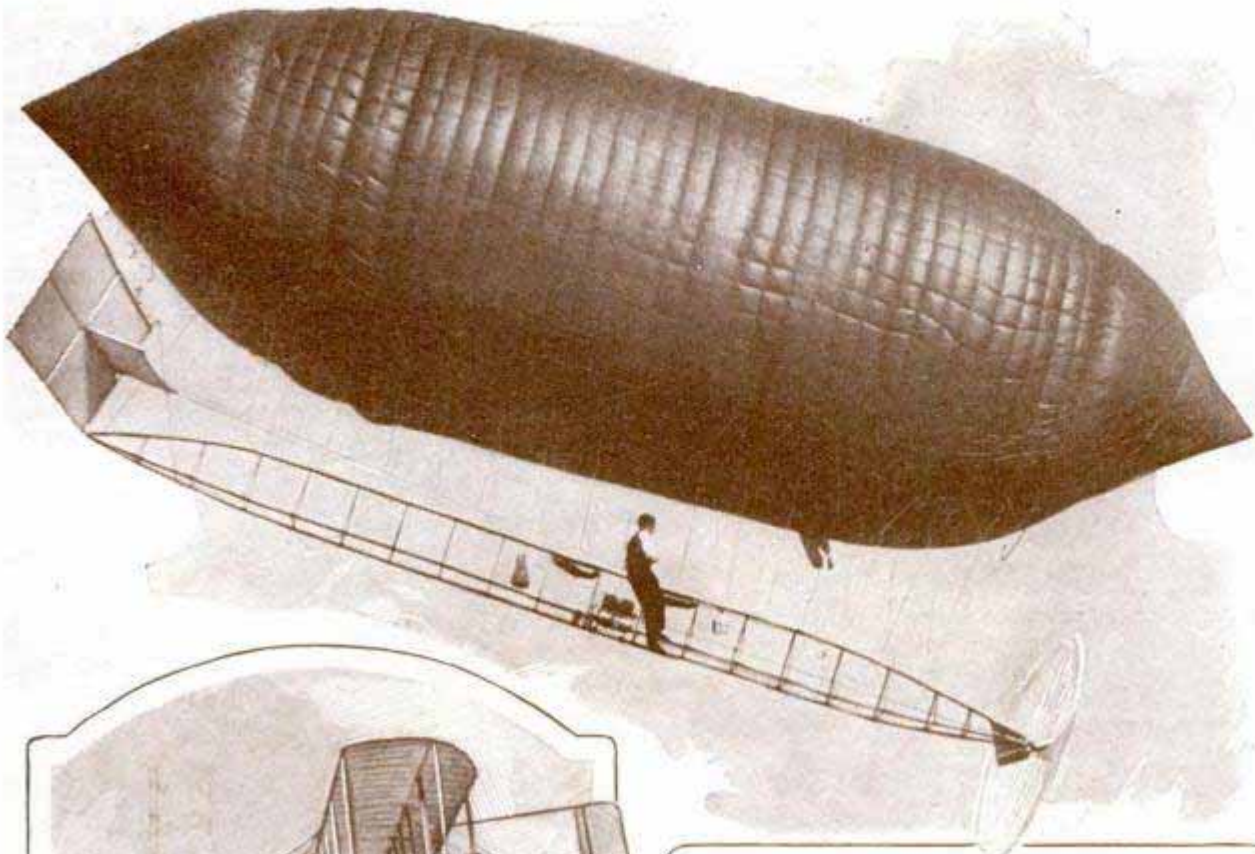

Lincoln Beachey, Later a Famous Airplane Pilot, Got His Start with This Crude Little Dirigible; the Pilot, Straddling a Triangular Frame, Ran Back and Forth along the Keel to Point the Ship Up or Down, as the Bag Itself Had No Elevator Planes; at Left, Wilbur Wright Flying at Le Mans, France; This Is the Plane with Which He Electrified Europe by His Sensational Flights in 1908 and 1909



Drexel Taking Off in His Bleriot Monoplane; It Was in a Mate to This Ship That the Designer Wrote His Name into Aviation History When He Flew across the English Channel in 1909; Nineteen Years Later the "Southern Cross" Was Spanning the Pacific





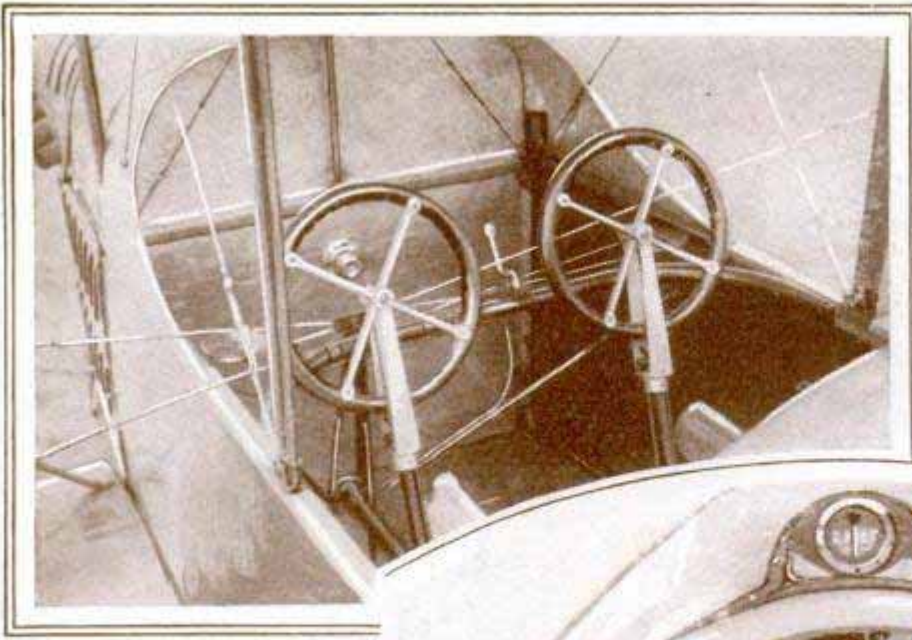

An Early Airplane Cockpit Fitted with Dual Control for Training, but with a Dash Bare of Instruments, Whereas Even a Student Ship Nowadays Is Fitted with Oil-Pressure Gauge, Water Thermometer, Altimeter and Engine Tachometer; the Early Controls Were Varied, the First Wright Ships Having Two Hand Levers, One for the Elevators and the Other Operating both Rudders and Wing-Warping Controls, While There Was No Rudder Bar; the Curtiss Ships for a Time Used a Shoulder Harness to Work the Ailerons as the Pilot's Body Swayed

At the Right Is a Modern Cockpit, with So Many Instruments They Have Overflowed from the Board; Compass, Bank and Turn Indicators, Drift Indicators, Dual Ignition Switches, Lights, Altimeter, Tachometer, and a Multitude of Gauges Are Among Those Included

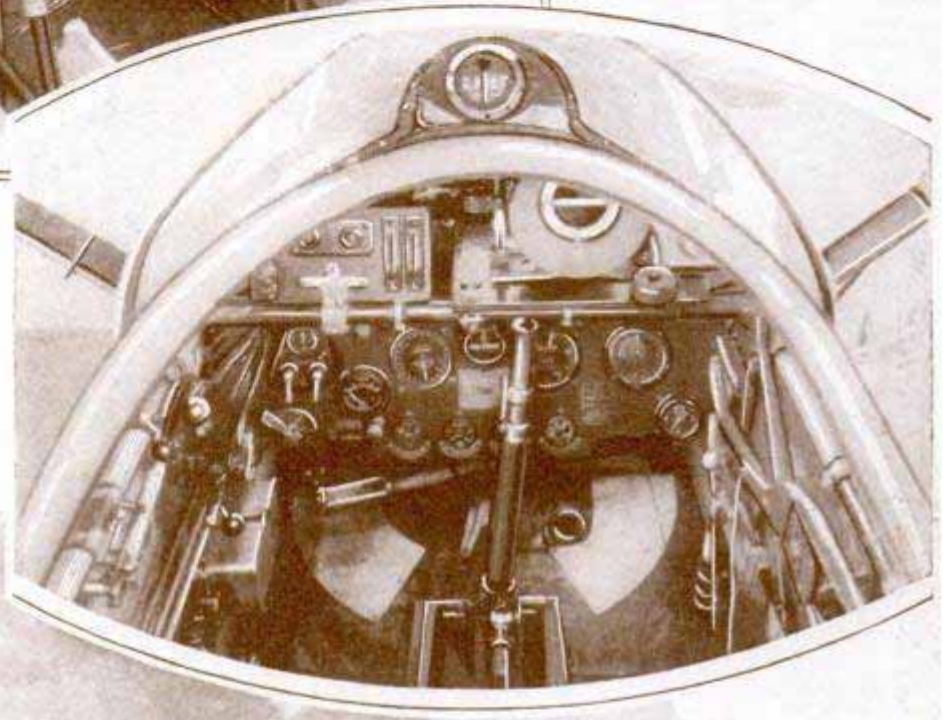

*Dornier - Jupiter - hull of metal  
4 Bristol Jupiter engines 2,000 hp  
Golden Eagle service  
Bel. Brazil  
Palermo*

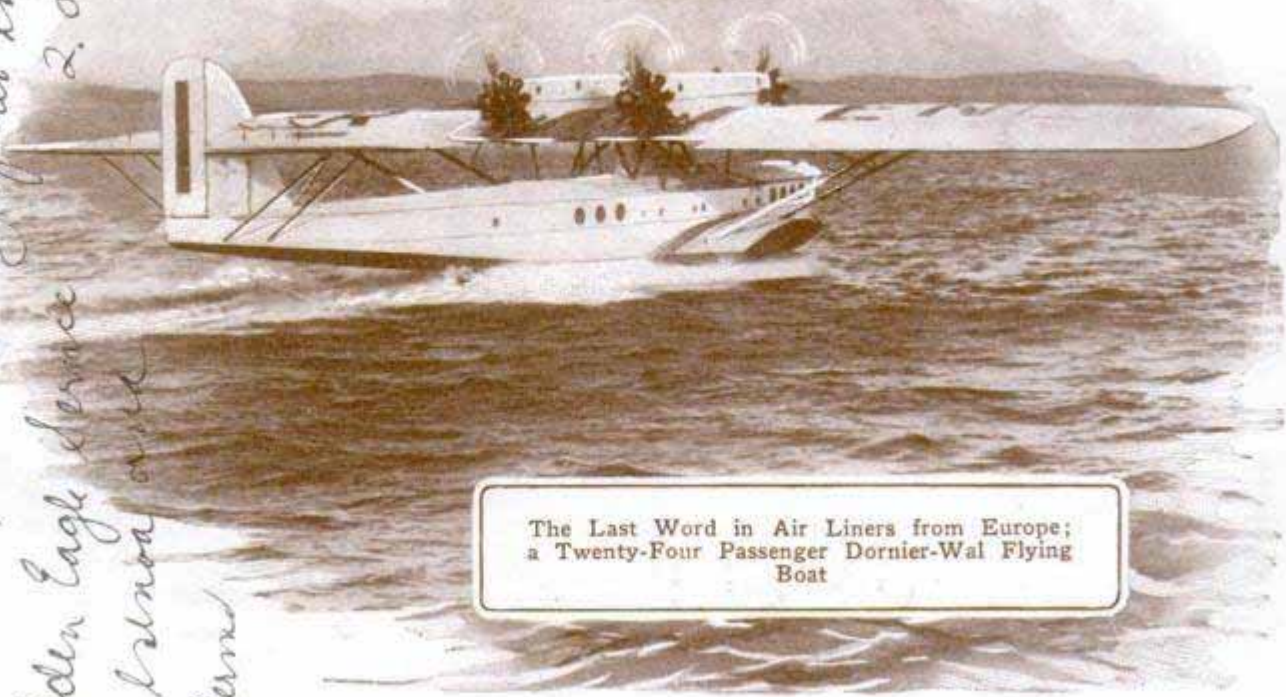

The Last Word in Air Liners from Europe; a Twenty-Four Passenger Dornier-Wal Flying Boat



670



Loening Amphibian, with Three-Bladed Propeller; the Same Type Ship Is Being Produced as an Air Yacht, with Comfortable Cabin

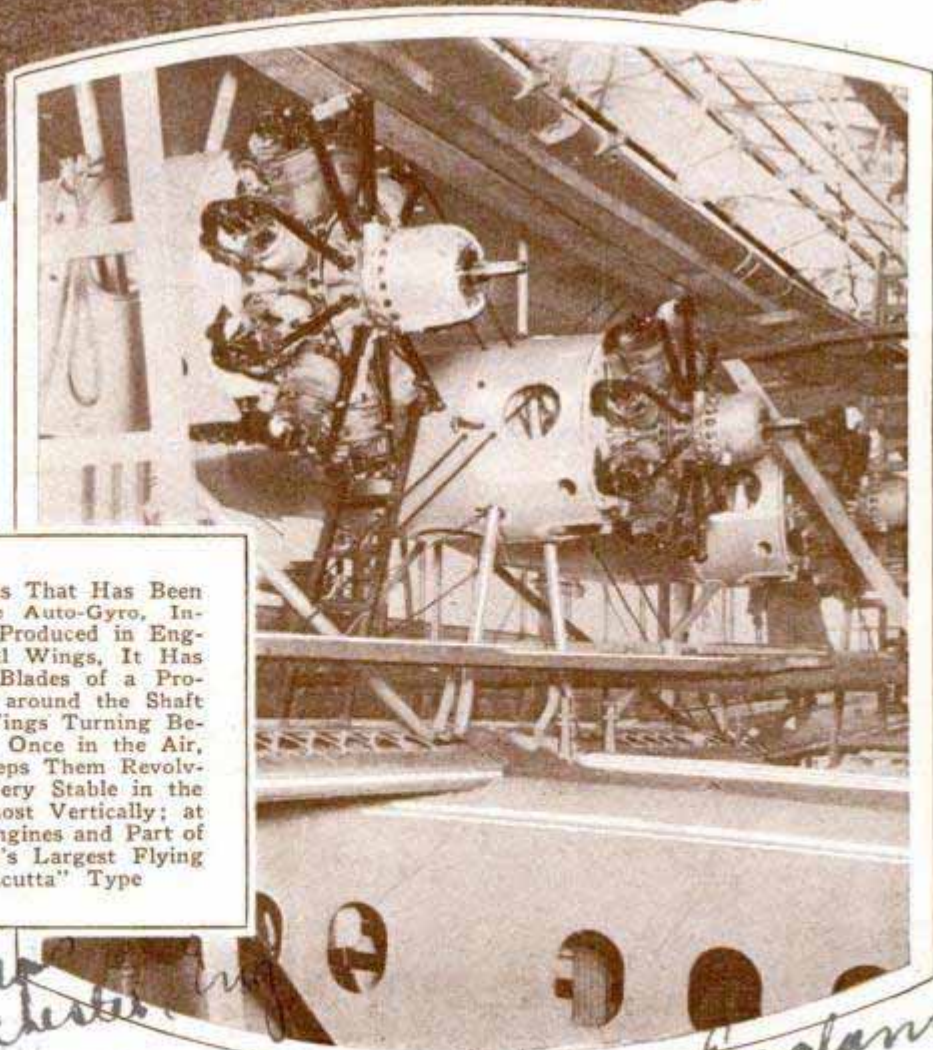

One of the Strangest Planes That Has Been Successfully Flown Is the Auto-Gyro, Invented by a Spaniard and Produced in England; Instead of the Usual Wings, It Has Four, Revolving like the Blades of a Propeller; a Rope Is Wound around the Shaft and Pulled, to Start the Wings Turning Before the Plane Takes Off; Once in the Air, the Speed of the Plane Keeps Them Revolving; the Queer Ship Is Very Stable in the Air, and Can Descend Almost Vertically; at the Right Are the Three Engines and Part of the Metal Hull of England's Largest Flying Boat, the Short "Calcutta" Type

Shorts Bros  
 Rochester, N.Y.  
 Empire Airway - between England  
 and Australia



670

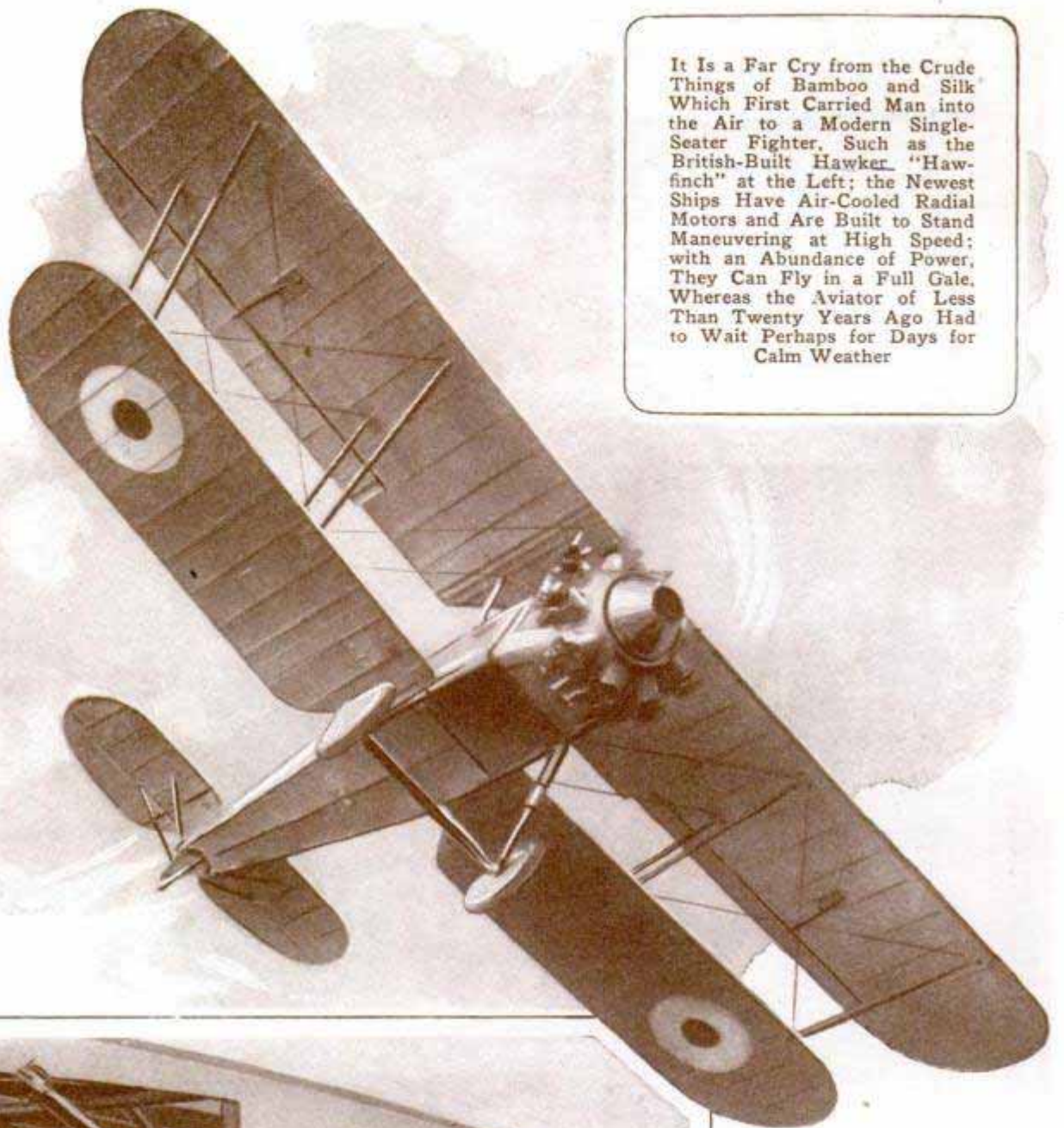

It is a Far Cry from the Crude Things of Bamboo and Silk Which First Carried Man into the Air to a Modern Single-Seater Fighter, Such as the British-Built Hawker "Hawfinch" at the Left; the Newest Ships Have Air-Cooled Radial Motors and Are Built to Stand Maneuvering at High Speed; with an Abundance of Power, They Can Fly in a Full Gale, Whereas the Aviator of Less Than Twenty Years Ago Had to Wait Perhaps for Days for Calm Weather

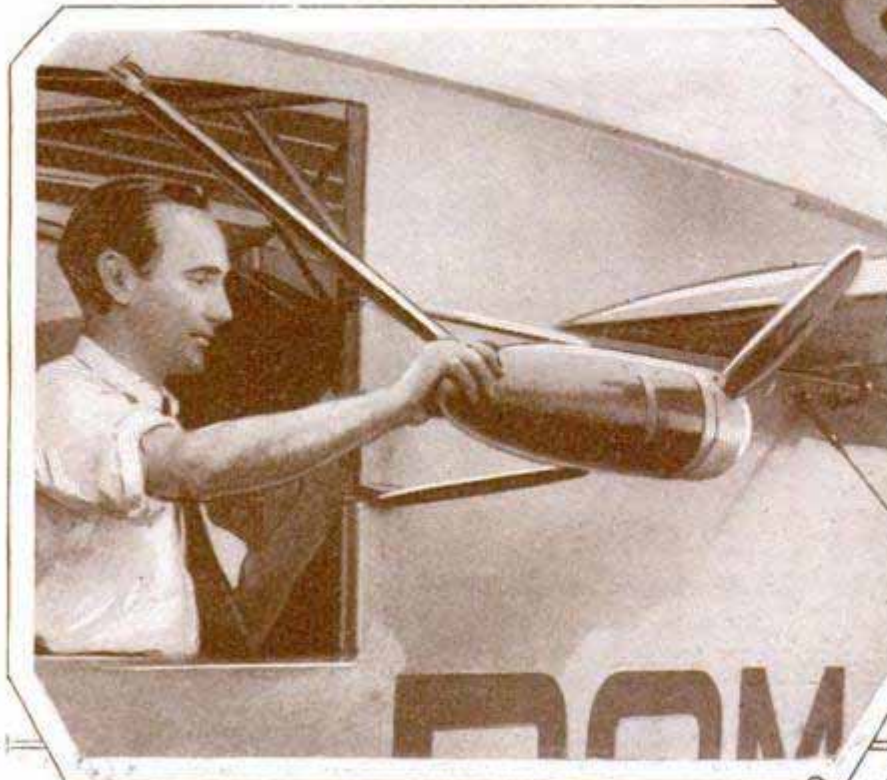

One of the Queerest Inventions to Aid Aircraft Is the Propeller of the Constant-Speed Generator Used to Operate the Wireless Transmitter; the Propeller Has Only One Blade, with an Ingenious Arrangement That Keeps It Turning at a Fixed Speed despite Variations in the Speed of the Plane through the Air; the Photograph at the Left Shows Capt. Pietro Bonelli, Navigator and Radio Operator of the Sesqui-Plane "Roma," Built for Captain Sabelli's New York to Rome Flight; a Sesqui-Plane, as the Name Indicates, Has One and a Half Wings, the Lower Wing Really Being Merely a Broadening Out of the Struts Which Otherwise Would Brace the Wing of a Normal Monoplane

*Radio  
Radio Corp  
of America*



*Monogram* *Memo. Aircraft 670*  
*line.*  
POPULAR MECHANICS

*Mohrle d. H.*

I at  
speak of  
The Fliv  
flew an  
Nation  
practi  
the f  
Ameri  
so

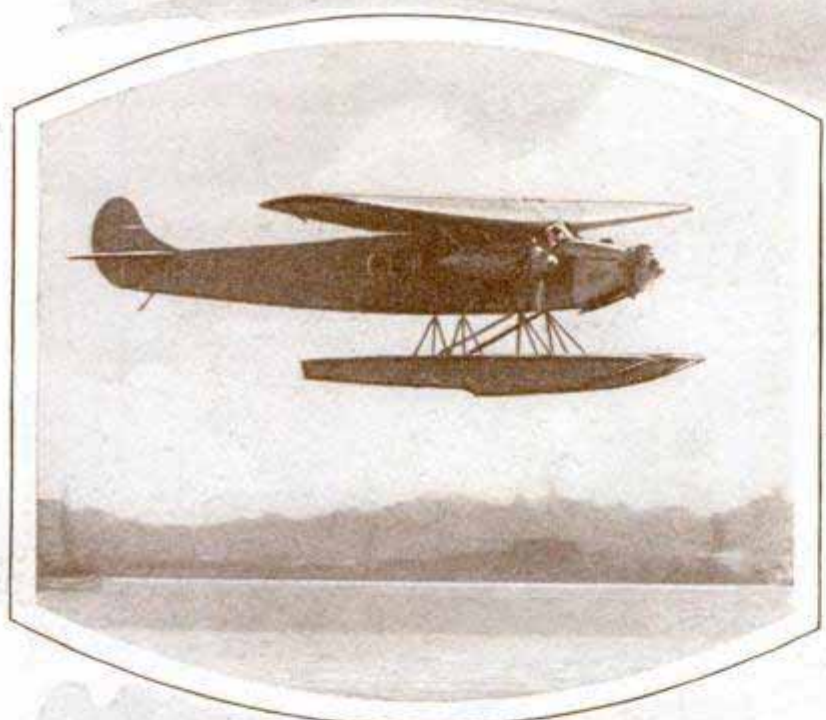
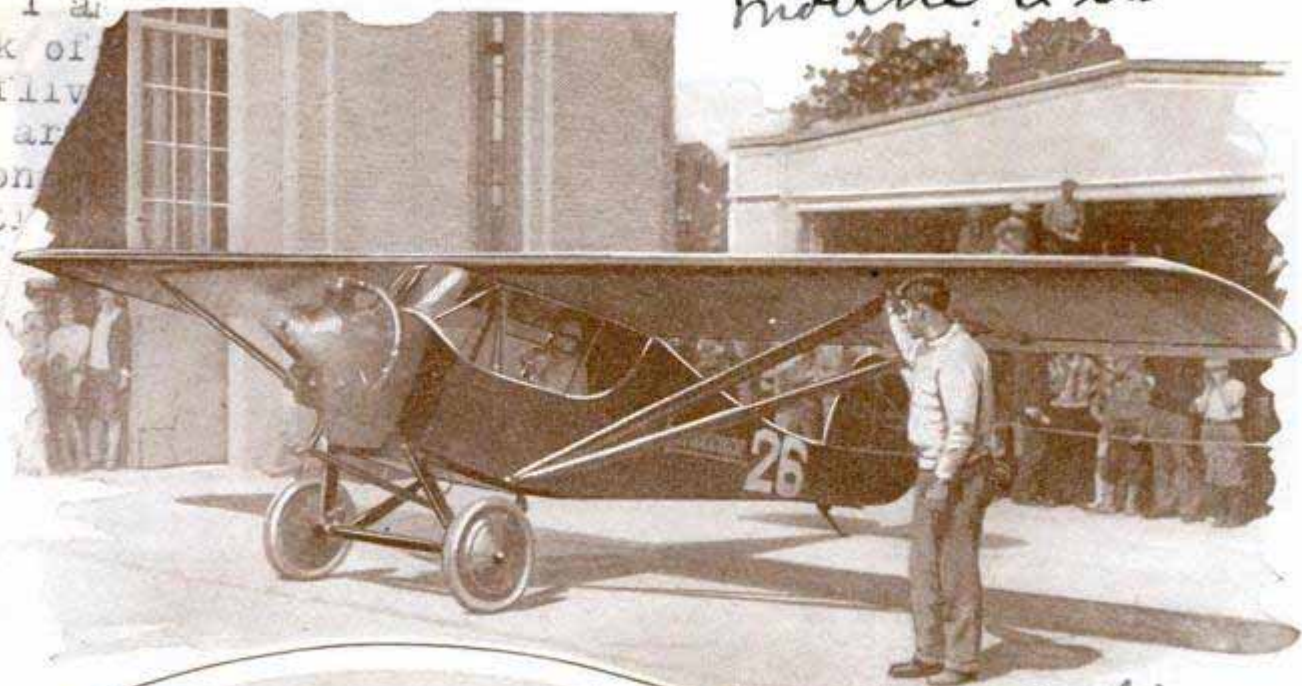

*Mrs. Emilie*  
*Memphis,*  
*Tenn.*

Above is a Flivver Monoplane Piloted by a Woman in This Year's Ford Reliability Tour; Powered with an Air-Cooled Engine and Fitted with a Luxurious Cabin for Two People. It Costs Less Than \$2,700; at the Left is the First Plane with Sea Pontoons to Fly the Atlantic, Miss Amelia Earhart's "Friendship"; Hers Was the First Seaplane to Make the Trip, and the First Plane Capable of Landing on Water Since the Initial Flight of the Navy's "NC-4" Flying Boat; All the Other Crossings Were Made by Land Planes without a Chance to Survive at Sea.

*Tri-motor Fokker*



Modern Cabin Plane with Folding Wings; the Fairchild Monoplane John Henry Mears Used in Round-the-World Trip



1285  
12750  
Mr. N. J. Wilkins, Esq.  
Barnhurst Road, Beverly Hill,  
near London Eng.  
POPULAR MECHANICS  
PICTURES IN COLORS ARE SENT BY TELEVISION

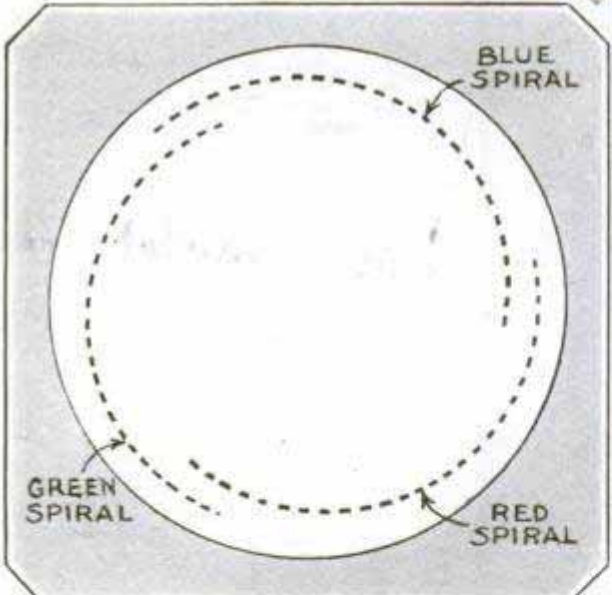

Transmitting a Daylight Television Picture; Drawing to Show the Perforated Transmitter Disk That Helps Produce Color Effects, and Demonstrating Receiver

**T**HE PROBLEM of perfect television has been brought a stage nearer solution by the recently successful tests of two devices invented by John L. Baird, English expert. Mr. Baird has succeeded in transmitting by his radio televisior in daylight, with the sun hidden by clouds, the images of the head and shoulders of a man, whose living picture appeared clearly on a screen in the interior of a darkened room. He next attacked the problem of

transmitting by radio television the living pictures of objects in their natural colors. In this successful transmission, the receiver showed a small image about as large as a visiting card, but in perfect detail. For radio-television in this process, the English inventor uses a three-color device, in which the three primary shades of blue, red and green are made to transmit successive images of a live or still object. In rapid succession, a green, a blue and a red

22 Frith St. London, W.1. Eng



1285

image are presented to the eye watching the receiving screen. They are seen as one white image. The new device consists of a transmitter disk perforated with three sets of holes set around the edge of the disk in spirals. One spiral is covered with a red filter, one with a blue and the third with a green filter. Light is projected through these holes so that, as the disk rotates, the object televised is traversed first by a red spot of light, then by a blue, then by a green. At the receiving station, a similar disk revolves at the same speed and its holes are also covered with red, green and blue filters. Behind the disk, and in a line with the observer's eye, are two lamps, one of them a neon-filled glow lamp, and the other filled with mercury vapor and helium. These lamps are the source of the colored rays, and are operated by

current from the transmitter. A commutator arranges that the neon lamp, the red-ray source, is alight during the time in which the radio eye views the image of the object through perforations covered by the red filters. When the blue and green images of the object are being transmitted, and the radio eye is viewing the image through the blue and green filters, the mercury and helium lamp, emitting blue and green rays, is in operation.

Another advance in the Baird television processes, is the reproduction of living images in stereoscopic relief. Here a similarly perforated disk is used. Pencils of rays from a spotlight lamp scan the object to be transmitted through lenses, so that it is explored from two points, one to the right and the other to the left. On the receiving disk, the two images are viewed through two prisms, making the observer see an apparently solid object.

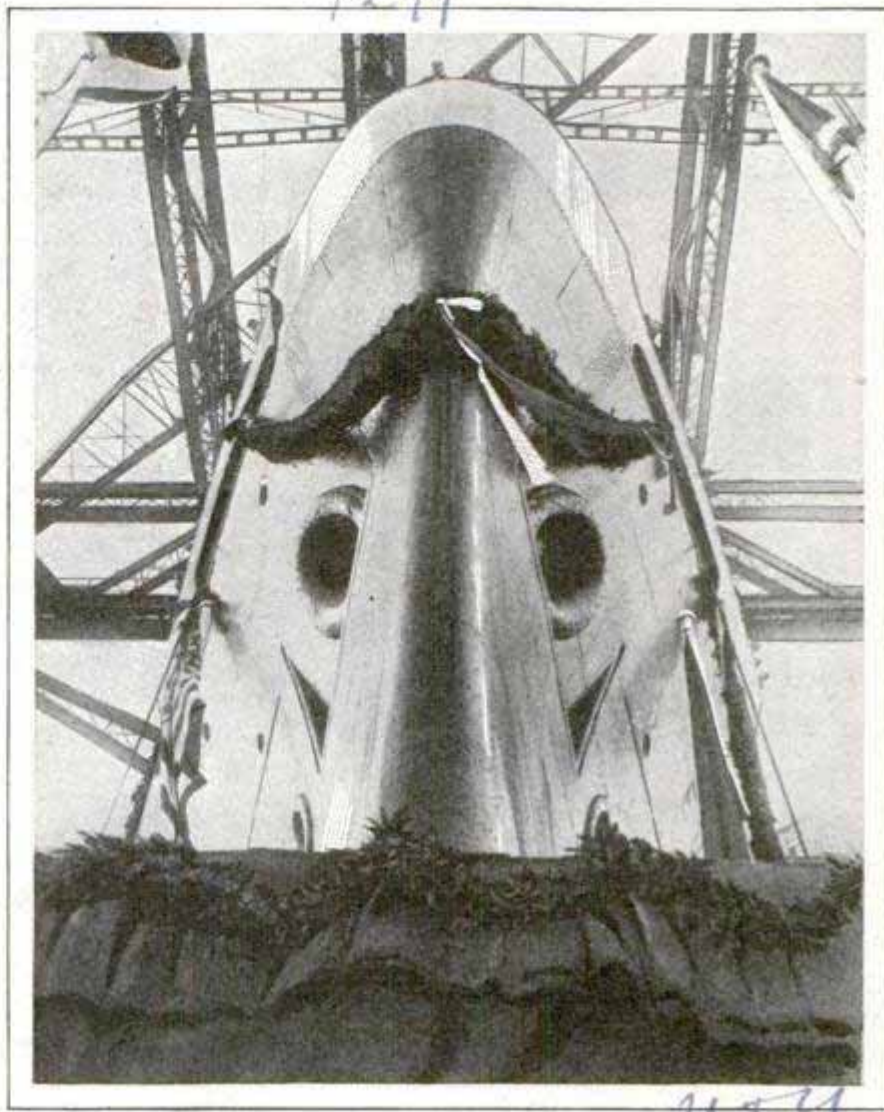

454

Bow View of the "Europa," Taken from the Launching Stand Just Before the New German Liner Slipped Down the Ways

#### FOUR-DAY SHIPS LAUNCHED IN GERMANY

A battle for ownership of the speed honors of the North Atlantic, held for many years by the now aging "Mauretania," is in prospect with both England and Germany building larger and faster ships. The German yards have launched two 46,000-ton liners, to be named the "Bremen" and "Europa," and both the White Star and Cunard lines are preparing to build 60,000-ton ships which will equal the ill-fated "Titanic" in size, being longer than either the American-owned "Leviathan" or the British "Majestic," both of which, incidentally, were built by German yards just before the war to make a bid for the Atlantic de-luxe passenger business, but fell into the hands of the allies. The two new liners recently launched are expected to cross the Atlantic in four days.



1299



Police Plane That Keeps Order in the Air; the Command, "Land at Once," Requires Immediate Notice

### FLYING POLICE FOR AIRPORT PROTECT PLANE TRAFFIC

When flyers skim too low over the city of San Diego, Calif., perform dangerous stunts against the air regulations, or otherwise jeopardize traffic, a police plane takes off, flies alongside the offender and informs the pilot by the message written on the side of the ship to stop his acrobatics and "Land at Once." The force has been organized by the San Diego board of air control and is expected to prove a valuable aid to aviation at this port, where traffic of the skies is almost daily becoming more congested. The written order was decided upon to make identification of the police plane easy and to save the patrolmen's voices as it would be almost impossible to yell the orders loud enough to make them heard above the roar of the motors.

### SECRET OF DAMASCUS STEEL KNOWN TO OLD ROMANS

That some of the Roman blades which conquered the world of their time was of a workmanship that later became known by the name of Damascus, is the interesting conclusion of Prof. B. Neumann, of the Institute of Technology at Breslau. He has just completed an extensive research in metallurgy based on fragments of a number of Roman swords which were found buried in a German peat bed where they had lain for more than 1,600 years. Since they were preserved from the action

of the air by the damp earth, they were in far better condition than other specimens of Roman steel. Apparently, the bars from which these swords were made, were prepared by sandwiching alternate thin layers of high and low-carbon steel and then "sweating" the whole together. Left straight, the bar could be forged into a blade with a striped or ribboned effect. Twisted and then forged, it produced a blade with a vee-damascening. Two twisted bars sweated together and then forged into a blade gave a W-pattern on the finished sword. Some of the Roman blades also show a curled or "rose" pattern, but how the smiths achieved this is not yet known. Professor Neumann's examination of the steel samples shows that the Romans tempered only the outside of the blade so that it would give a hard edge and point backed up by a tough body.

### SPRAY TANK ON MOTORCYCLE HELPS KILL MOSQUITOES

Motorcycles have been enlisted in the warfare against mosquitoes in suburbs of Chicago. A thirty-five-gallon tank of an acid tar oil is carried on the machine and the liquid is sprayed over small pools of water where the insects breed. The rider operates the spray hose without leaving

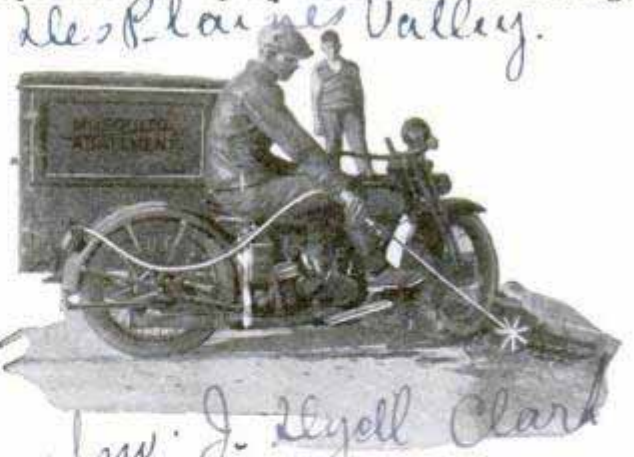

Spraying a Small Pool from the Anti-Mosquito Motorcycle with Its Tank of Tar and Oil

his seat and, in a single day, can cover a wide territory. A district comprising more than seventy-five square miles, has been visited by the cycle throughout the season, and a marked reduction in the number of mosquitoes has been noticed.

Sound passes through helium almost twice as fast as it does through air.

Article in Forschung in  
a Fortschritt

Germany  
8/25/28



**BONFIRE CHAIN PLANNED BEFOREHAND TO WARN OF EXPECTED FLOOD**

The greatest bonfire chain since the news of the approach of the Spanish Armada was "telegraphed" by that means around the coast of England, was organized this past summer in Kashmir, India, to send the news should an ice barrier break in remote Tibet and send an avalanche of water down the valley of the Indus. Several years ago a glacier slid across the river Shyok, one of the tributaries of the Indus, and formed a lake 17,000 feet above sea level. Behind the ice barrier, 120,000,000 tons of water collected, the lake finally growing so great that it became apparent its waters probably would break through when the level reached the top of the barrier and the sun this summer began softening the ice. The government of Kashmir prepared by laying a chain of bonfires 140 miles long, each in sight of the next, and stationing a sentinel to touch off the pile when the waters started. In charge at the lake end, Col. E. B. Howell, British resident attached to the Kashmir government, established a camp on the glacier itself, more than three miles above sea level and fourteen days' march from civilization. All the villagers in the lowlands were moved out by troops and preparations made to abandon a great part of the famous Vale of Kashmir if the flood came. Colonel Howell's post, on the "roof of the world," was one of the most lonely spots that could be found, with no one but a small escort of Tibetan mountaineers to keep him company.

**PUTTER TESTS KINDS OF GRASS BEST FOR GOLF GREENS**

By actual tests with a mechanical putter, experts at the turf garden of the United States golf association near Washington, D. C., decide what varieties of grass are best for the greens. The device is essentially a pendulum arrangement which simulates the stroke of a player in putting, and the force of the stroke can be regulated by means of a spring. Tests have been made

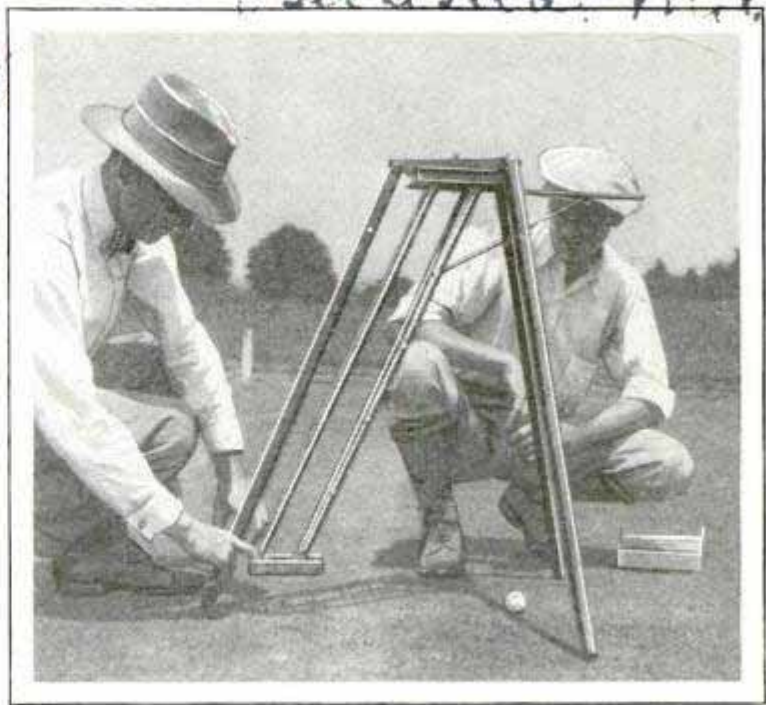

Applying Science to the Game of Golf, to Test Varieties of Grass; the Mechanical Putter in Operation

on some 500 plots and with many different kinds of grass. The trials have revealed that certain varieties are not successful, as they impede the progress of the ball unnecessarily or deflect it from a straight course. The advantage of the mechanical putter is that strokes of exactly the same force can be made and the ball always struck in the same way.

**SKATE WITH JOINTED BLADE REDUCES FOOT STRAIN**

Greater ease in skating is claimed with a jointed-blade skate now on the market. It adapts itself more readily to the movements of the feet without interfering with forward progress, and is said to enable the wearer to easily keep his balance.



Jointed Skate That Is Said to Reduce Foot Strain without Impairing Speed

1108 42nd St  
New York

maker unknown  
11/1/18

cont. George J. Paul.



1186 754

*Fairchild Airplane Mfg Co  
Farmington, S.D., Supt.*

*Chicago 332 St. Michigan*

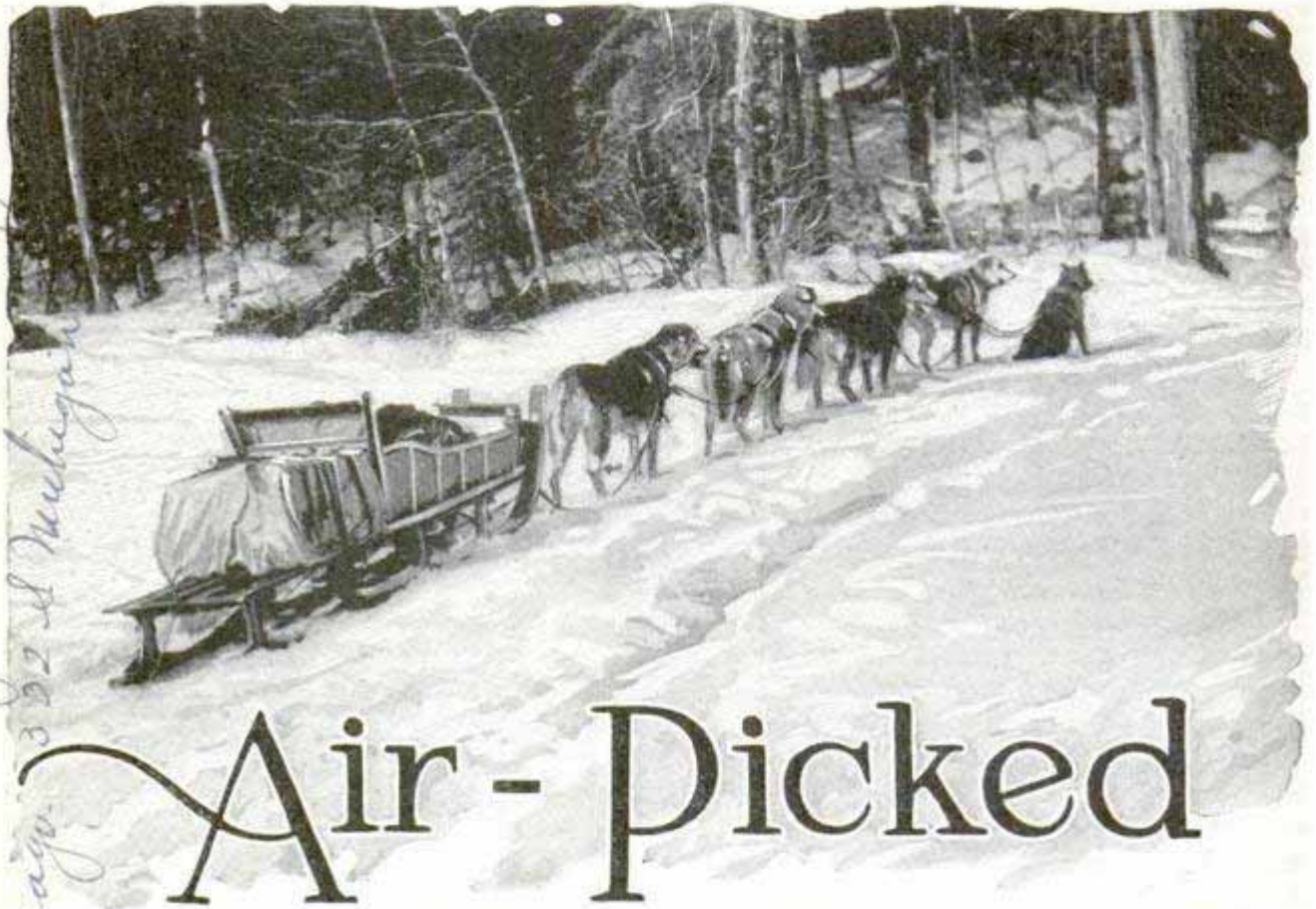

# Air - Picked

Transportation in the North, as It Has Been from the Beginning Down to the Advent of the Airplane; Because of Limited Carrying Capacity and Speed the Dogs Are Being Displaced.

By JAMES MONTAGNES

*365 Bay St. Toronto, Ont. Can. R 304*

"THEY'RE off!" That phrase signifies a race. Make it an airplane race. Make its starting point New York. Watch two pontoon-equipped cabin monoplanes wing their way upward from the waters of Long Island sound. See them head for Montreal and then disappear in the distance.

They stop at the biggest city in the Dominion. Their arrival is a few hours apart, since they did not start together. They refuel, are custom-inspected, stand the gaze of hard financiers, and then they taxi over the waters of the St. Lawrence in their hop for Shirley air station near Ottawa. Another rest, the pilots are but beginning their race. Those first 700 miles were the easiest. Now they head for Winnipeg, 1,600 miles westward. It's a big hop, but it is also a big race—for gold.

Winnipeg finds the two pilots a little fagged out. Stewart J. Cheeseman is at the stick of one plane, while Capt. Charles Sutton flies the other.

Then they set their compass for The Pas, 500 miles northwest. That is the last place of civilization they will see. Here

Cheeseman will pick up some prospectors. From now on the race really becomes a race. It is the sprint. The last lap. A jump of 1,200 miles until Chesterfield Inlet, at the top of the western shore of Hudson Bay, comes into sight. And it is Chesterfield Inlet and the surrounding millions of acres of rock-strewn country that are the final goal of these two modern marathons. There they will meet their supply ships, the "Morso" and the "Michael and Patrick."

Gold and diamonds are what those prospectors, being rushed to the subarctic by sea and air, expect to find in that lonely land. Adventurers all, from the financiers in the big city, who are backing them with millions of dollars, to the newest of the mining engineers in the rival parties, they have started on one of the biggest commercial adventures of recent years. For two years they will fly over that land which is unexplored as yet, and will bring out of the earth minerals in quantities as yet entirely unknown.

One concern felt so certain about the



1186



# Gold Fields

Unloading Supplies Brought by Air to the Jackson-Manion Mines in Ontario; with a Vast Network of Frozen Lakes and Rivers on Which to Land in Winter, the Planes Can Go Anywhere in the North

value of those unknown mineral deposits, that they asked the Dominion government for exclusive exploration rights for three years in that district, in return for which they would map and photograph a large part of it from the air.

Why this sudden rush to the far north in search of precious gold? Why this adventurous use of the airplane in unexplored and lake-studded, rock-strewn wilderness?

After an impatient rail journey of 1,000 miles, a young man from Hamilton, Ont., stepped off the transcontinental train at Sioux Lookout in northern Ontario. He was in a hurry. He had never been to Sioux Lookout before, yet he seemed to know the way, as if by intuition. The airplane hangar was the goal of his quick search. Within a few minutes he had made arrangements for a plane to take him north that day.

He set out to buy some supplies, food, clothing and mining tools. At the hangar at the appointed time, the airplane was ready for him. He hopped in, the plane took off and set its course northward, over

a rough, desolate and lake-covered country. For more than one hundred miles the journey continued, when a larger lake hove in sight. Another twenty miles and the seaplane began to descend, at last alighting at a mining camp.

Here the passenger stepped out, strapped his kit on his back and set off to an office to get directions. Then on the trail, which quickly led into the bush. Here and there men were busy examining the ground. Notes on the trees told him that others before him had made their stakes. But he continued. Then, after a few days, an airplane took him out again, this time to the recorder's office at Gold Pines.

"I want to stake these claims, and register them," he told the representative of the government. "My father came out here thirty years ago and staked these claims, but we have never worked them. Now I am staking them anew."

Thirty years ago this young chap's father had invaded the virgin bush of northern Ontario around Red Lake in search of gold. He had found what looked like possible locations, had recorded them



and gone away. At that time there was no railway within a few hundred miles, as now, nor was the airplane a means of transportation. A trail which led over hills, portages and lakes, through heavy bush in a black-fly-infested country, there was little likelihood of those claims being worked. The cost of getting materials in would have been far in excess of the output. So the claims were unworked.

Then, in 1926, came news of a gold strike in the Red Lake country. Prospectors from every part of the continent and even from other continents left home and set out for the frozen north. They arrived at Hudson and Sioux Lookout on the railway in thousands, old-timers and newcomers. Dogs were at a premium, and food sold at unheard of prices, eggs bringing \$1 apiece. This in the latter part of the winter.

Airplanes soon made their appearance, as several companies decided to make a profit, if possible, from these men who were so anxious to get into the rich unearthed gold fields. There was rivalry in the air as to which plane could cover that trip, which took twelve days by land, in the fastest time. They did a thriving business, \$200 for each passenger and \$1 a pound for baggage.

The prospector is not the only one who uses the plane to get into rough inaccessible territory in Canada's north. Two young New York stockbrokers flew into Quebec early in July for the purpose of

looking over some claims. They flew their own plane, making their way over a rather wild section of Quebec. They were forced down by engine trouble on Lake David, some 200 miles northeast of Quebec city. A Canadian plane came to their rescue, and they continued their work.

As a means of fast freight transportation, the airplane is unequalled in the northland. There came one day a letter to the office of the Western Canada airways at Winnipeg. Would the company make an offer to transport thirty-five tons of machinery, diamond drills, food, gasoline and similar material as well as forty men? Yes, the company would, and so started one of the most remarkable feats of modern airplane transportation into the forbidding wilds.

The mine was located at Cold Lake, northern Manitoba, 400 miles northwest from Winnipeg as the crow flies, near The Pas, well-known jumping-off point and winter-resort center, famous for its dog races. By air, it is a matter of 150 miles from The Pas to Cold Lake. One Fokker Wright - Whirlwind - equipped universal was allotted to the job. It made its trips between The Pas and Cold Lake with regularity of the Twentieth Century. In record time that order which had seemed so big to the mining people, was safely delivered, enabling one of the largest camps of Manitoba to get under way.

Patricia Airways and Exploration limited is another concern which flies from Sioux Lookout, Ont., about 1,000 miles north of Chicago, to the Red Lake mining country. They have operated there since early in 1926. Capt. D. S. Bondurant, a native of Cairo, Ill., and now one of the best-known of the Canadian transport pilots, states that flying in that north country is by no means child's play.

Last winter he was en route with a load of supplies for one of the camps at Red Lake. The thermometer hovered around forty-eight degrees below

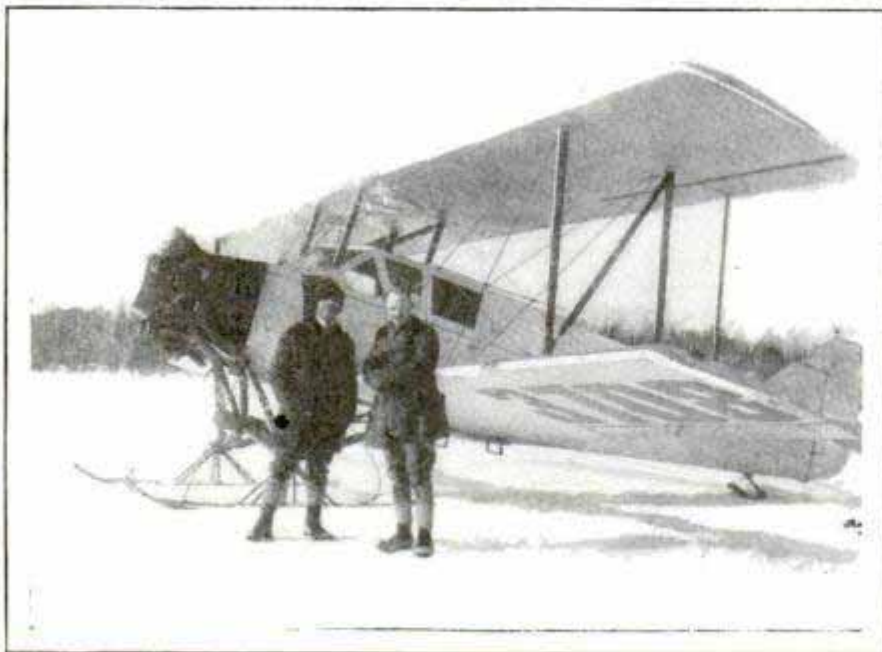

Capt. D. S. Bondurant with His Cabin Plane in the Red Lake Country; Scene of a Gold Rush Two Years Ago





In Summer, Pontoons Replace the Winter Skis; This Is an American-Built Cabin Monoplane with Folding Wings; Wheels Are Never Used in the North as There Are No Landing Fields

zero, when he left. Gone about halfway, his motor froze, and he brought his machine down in a ten-foot snowdrift. A biting wind was sweeping over the desolate white landscape. It was cold, and the thought of facing a mush on snowshoes to the nearest camp, some twelve miles distant, was still more chilling. But Bondurant determined to set out to get assistance.

"When I reached the camp I was black," he tells us. "My nose and ears were frozen early in the trip. Then, when I took snow to rub over my ears and nose, my hands froze. The whole of the underside of my face was stiff and black, frozen. My feet froze, and I reached my destination more like a solid icicle than a human being. I was stiff for a week."

But he got a crew together and the ten of them went out with tents and a small stove and all the necessary tools to bring the big ship out of the snowdrift. The weather had become warmer. It was now only thirty-five degrees below zero. After several days of digging and warming the engine, Bondurant flew his ship on to its destination.

At another time he was flying over a

number of small lakes in a hydroairplane, which had a wing spread of seventy-four feet. The gears meshed, and he glided down to a small lake. Getting in was quite a feat, but it was accomplished by means of sliding and slipping. Repairs were quickly made, and the situation looked over. It was a small lake, blind at one end and at the other end a big cliff hid a curve where the water flowed over a narrow route into another lake, a little bigger than that where he now was floating.

Paddling the plane to the farthest shore from the gully connecting the two lakes, Bondurant started the motor. She roared in that still wilderness, and her echo rolled between the cliffs. Then, giving her the gun, she taxied for the opening, but would not rise. Again and again the attempt was made with the full load the machine was carrying. At last, when it looked as if he would be stranded through lack of gasoline, she rose, and with one wing in the water as he banked into the curve, the heavy plane made the passage, landing on the lake on the other side, from where it was easier to take off and sail to the nearest gasoline cache.



1186



The Howey Mining Camp at Red Lake, Showing Typical Country over Which Prospectors and Supplies Are Regularly Transported; Practically All the Planes Are Built in the U. S.

The small lakes, uncharted and unnamed, that abound in Canada's northland make incidents such as this fairly frequent. To get out of such places requires a skilled pilot—the reason why all Canadian air companies operating in that northern country are so particular about employing only the most experienced flyers.

Passengers and tools for mining camps are not the only loads carried by the airplane transports of the north. Everything in this mining game, whether it be the transportation of a mining engineer or a case of dynamite, requires speed.

**AUTO BUS FOR ROAD OR RAIL TO EXTEND MOTOR TRAVEL**

Wider use of the motor bus is promised through the introduction of a vehicle that

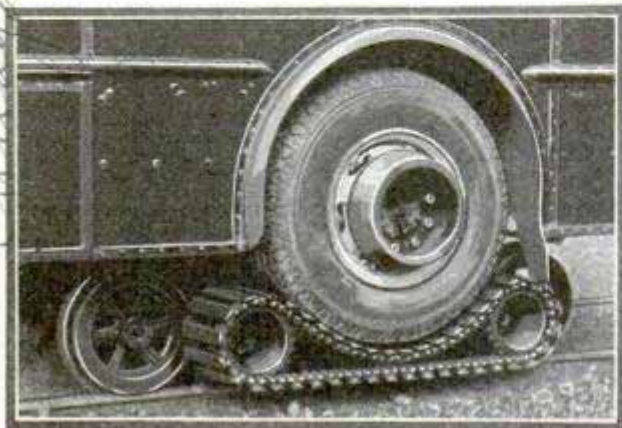

Motor Bus with Flanged Wheels Adjusted to Travel on Rails; Traction Is Afforded by the Endless Tread

can be run on rails or on an ordinary road without undergoing any changes in its body design or arrangement. This is made possible by flanges on the wheels and a series of special sockets and lugs. Traction on the rails is furnished by gearing and an endless-tread arrangement operated by the pneumatic-tired wheels.

**STUDY OF SPOTS ON THE SUN AIDS SEARCH FOR OIL**

There seems to be little connection between the occurrence of spots on the sun and a prospector's success in finding oil or minerals, but scientists believe there is a definite relation and are making further study to establish their theories. The effects of the sunspots on the earth are not known for a certainty, but the phenomena are believed to be associated with magnetic storms here, from time to time, disturbances that cannot be perceived by the senses but that are detected by the action of delicately suspended magnets. When there is such a storm, the magnet behaves strangely, its needle often deviating from the true north to a far greater degree than normally. Oil prospectors who are using the magnetic system, keep in touch with coast and geodetic survey observatories where records are kept of the magnetic storms, and are thus guided in their activities and findings.

*U. S. Daily 8/17/28*

*12/10  
Twin Coach Caravan  
231 S. La Salle  
Chicago*



**MAN-EATING ANTS  
PROVE TERROR  
AT NIGHT**

In parts of Africa and other tropical regions, a species of ant that marches as an army, destroying animals and insects as it goes and even attacking human beings, has given more than one traveler an exciting adventure. Dr. Hanns Lwiers relates one experience he had with the marauders. They entered his cottage one night, killed mice, spread over the carpet and slowly came toward him. He took refuge on a chair, then on a table and finally mounted a washstand and stood in a pitcher of water. He was horrified to see that the ants made a living bridge to the and and would have reached him had he jumped to the bed, which was standing in pots of kerosene, one to each leg. These insects will not pass through the lid, and he was safe. Naturalists report that these ants have been known to devour alive horses, leopards, apes and other large animals. They work with incredible swiftness, march only at night and apparently the sole obstacle that diverts them from their path is a pool of kerosene or some such liquid. As in other ant colonies, the division of labor is highly developed. Besides the warriors with their huge "jaws," the tribe has workers of various types, sorters that decide what things are to be brought into the nest or be discarded. One of the few effective enemies of the ants is a kind of beetle which secretes an intoxicating substance on its hairy body. When the ants are stupefied by this, they are killed by ant lice.

Greater Comfort for the Flying Camera Man; Face Mask for Winter Picture Work



**MASK FOR AERIAL CAMERA MAN  
AIDS IN WINTER FLYING**

Storms and cold weather are difficult for almost all aviators, but work particular hardships with the aerial camera man who must expose his face to the wind over the side or above the cockpit as the plane speeds along. To protect himself from this discomfort, an eastern photographer has devised a special mask which covers practically all his face and fits tight without stopping the circulation.

**EXAMINE TREES WITH X-RAYS  
TO FIND TRUNK DEFECTS**

Hidden defects and diseases in tree trunks are revealed by means of an X-ray outfit which shows conditions that cannot be detected by ordinary examination. The outfit illustrated herewith is one of the first to be developed and has since been improved into a more compact form. The apparatus is also useful in inspecting poles that carry power or other wires, to determine if any of them are dangerously decayed inside.



Courtesy Eastman Kodak Co.  
Taking X-Ray Photo of Tree Interior

*Used by John U. Rockefeller  
in his news aerial  
Camera man*

*1247*

*207*

*1212*

*Roberts*

*Cont. h. e. Maryland line*

*2720*



1226

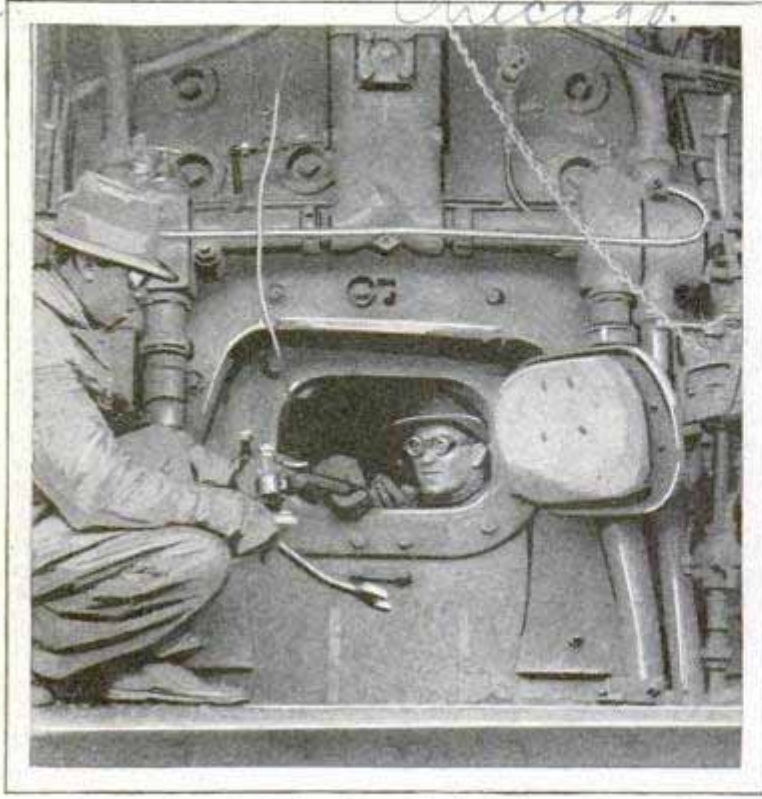

Into the Fire Box of the Broadway Limited after a Run, to Inspect Boiler While Engine Is Still Hot

### HOTTEST JOB ON RAILROAD INSPECTING BOILERS

Soon after the fire has been dumped in a locomotive at the end of a run, an inspector climbs into the fire box to make a thorough examination of flues and other parts. His job is one of the hottest in the entire work of railroading, yet, after training, the inspector can remain inside the torrid chamber for twenty or thirty minutes and longer without harmful results at all seasons of the year. The chief reason that he must enter the box when he does, is that there is not time to allow the engine to cool off before it is again needed for service. Inspecting boilers is just one of the unusual jobs around the railroad, where scores of different occupations are included in the diversified operation of a large system. A big railroad's roster will include farmers, Y. M. C. A. secretaries and aviators, besides the expected

quotas of firemen, engineers, conductors and the like. The Pennsylvania railroad, for instance, hires a number of deep-sea divers in connection with the operation of its ferries and other craft.

### AUTOMATIC SOS RECEIVER RELIEVES SHIP CREW

Distress signals are now registered on automatic receivers installed on several British boats so that operators do not have to sit constantly on the watch with earphones on their heads, awaiting a possible SOS. The automatic alarm has changed the method of sending the signal. Before a steamer gives the distress call, twelve four-second dashes are tapped off the transmitter with a one-second space between each dash. The automatic receiver revolves a selector apparatus on the receipt of these dashes, which causes three bells to sound, two in the wireless rooms and the third on the bridge. Thus aroused, the operator listens for the familiar SOS call and the position of the ship sending it.

### AUTO RINGS WARNING BELL AT GRADE CROSSING

To further protect grade crossings and prevent automobile accidents at such places, an Illinois inventor has introduced a simple device whereby cars sound an alarm bell at the side of the road as they approach the railroad tracks. This is accomplished by striking a small bar which projects partly across the pavement or road where it is sure to be run over by an approaching car. The alarm can be placed sufficiently far from the crossing to provide an adequate warning, and is expected to be of special service at night and when there is a fog.

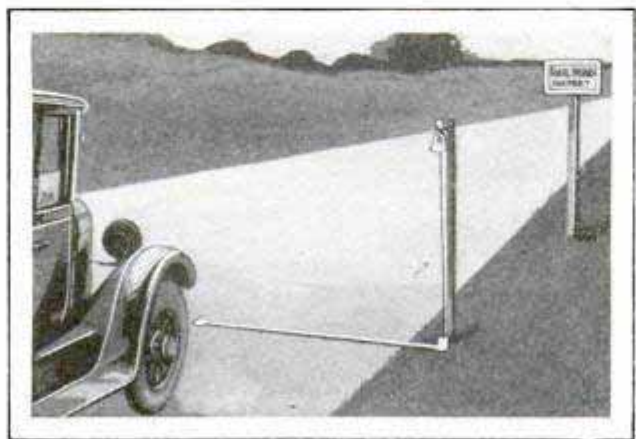

Warning Bell at Crossing and Trap Bar by Which It Is Rung as Auto Passes

N. J. Cornerford, 822 Western  
Ave. Joliet Ill.

1242  
1204  
R 17  
C. J. B. Broadway, N.Y.  
C. J. B. Broadway, N.Y.  
C. J. B. Broadway, N.Y.  
C. J. B. Broadway, N.Y.



exp. 07/1/20

Carnal locate map

*Do not answer letter*  
**LENSES ON SCREEN GIVE DEPTH  
125 TO MOVIES**

Movies in three dimensions, a problem on which several fortunes have been spent in recent years, is achieved in an entirely new way by an English inventor who has developed a movie screen which has for its surface 900,000 tiny glass lenses, each barely a quarter of an inch across. The screen is made by first coating the usual surface with a thick layer of white lead and then affixing the glass globules by hand to this coating. The stereoscopic effect is then obtained with ordinary film and a standard projector, for the myriad tiny lenses split up the light into hundreds of thousands of minute beams which are individually magnified on the screen so that each lens gives depth in relief and produces the illusion that the spectator is looking around the object photographed. The lenses themselves are not visible to the spectator unless he is seated almost directly under the screen, looking upward along its surface.

**SAWDUST BURNER FOR HOMES  
REDUCES FUEL EXPENSE**

Sawdust and other mill waste are used for fuel to heat the home in a burner that

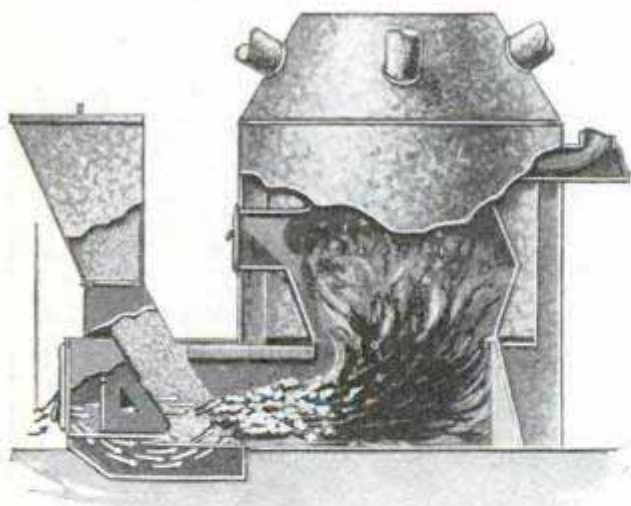

Sawdust Burner Installed with Furnace; the Hopper Holds a Generous Supply of the Fuel

can be installed in a short time and is said to be simple to operate. The grates are removable so that free access may be had to the interior, a large hopper holds sufficient fuel for several hours and, if desired, an automatic control may be employed. It is made in various sizes.

*Morris Burner and  
Boiler Co., 2314 Fourth Ave.*



It Functions as a Clerk; Machine That Sells Stamps and Returns the Correct Change

**MACHINE THAT SELLS STAMPS  
ALSO MAKES CHANGE**

Dispensing stamps and making the correct change at the same time, a coin-in-the-slot machine recently introduced takes the place of a clerk and saves the customer a trip to the post office. The outfit was demonstrated a short time ago in Los Angeles where it is being used successfully.

**BIG ROCK THAT MOSES SMOTE  
STILL GIVES WATER**

Explorers from the Field Museum of Natural History have come across the famous rock in Horeb, which, legend states, was struck by Moses and yielded water for the thirsty Israelites crossing the desert. A stream still trickles forth and forms a creek, the Wady Musa or stream of Moses. The rock is a large one, and the discoverers were unable to determine what part of it Moses struck. To find the apparent source of the water, the travelers had to peer into a small cave in the center of a mass of stone. The water spot is now surrounded by a series of wells stretching to the north, toward Damascus, and another to the east, toward Bagdad.

□ We want all our readers to write us freely and often whenever they wish additional information on articles published in this magazine. Address Bureau of Information, Popular Mechanics, Chicago.

1189

*Similar. made by  
Consolidated Automobile  
Merchandising Corp. 70th  
St. New York*

245-54

254  
*By way of notation*



# 1018 APARTMENT HOUSES OF BIBLICAL DAYS REBUILT

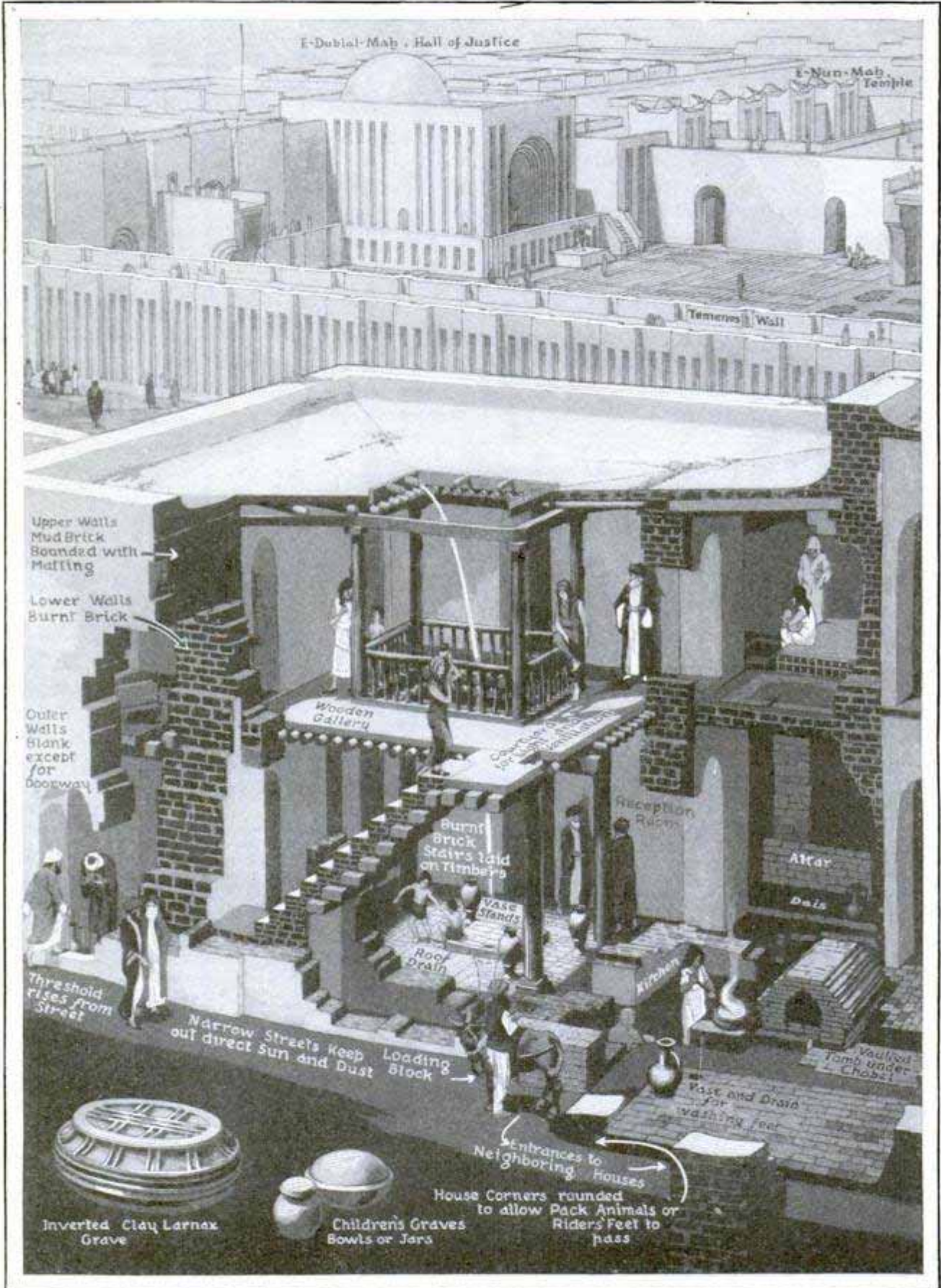

Reconstruction Drawing of One of the Homes of Ur, the Famous City of the Chaldees; They Were Built Much Like Modern Spanish Architecture, the Roof Draining into a Central Patio; Walls Were of Sun-Dried Brick and Interiors of Timber

Copyright S. W. Clatworthy

*18, Shakespeare Road,  
Herne Hill, London*



**HOME LIFE IN ABRAHAM'S DAY RECONSTRUCTED FROM RUINS**

How people lived in Abraham's time is now more clearly understood as a result of the discovery of a well-preserved town-site at Ur by the joint expedition of the British museum and the University of Pennsylvania. The accompanying drawing shows one of the houses as fully restored. The lower rooms were for the public; the upper, for private use. If the owner left for some time, he merely bricked up the entrance doorway, probably the only opening in the outer walls. Burial places were found under the chapel walls, where present; in their absence, under any floor. Vaulted tombs were used again and again, the previous remains being merely thrust aside, one having as many as ten.

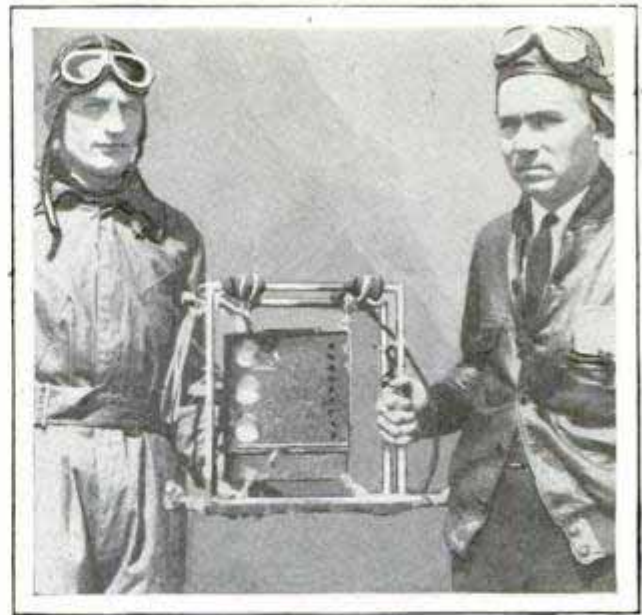

Naval Flyers with One of the Weather-Recording Instruments Used in Observations above the Clouds

**FLYERS GET WEATHER FACTS ABOVE THE CLOUDS**

In San Diego, Calif., a naval flyer goes aloft every day to obtain data about weather and flying conditions. One of the instruments useful in securing the information is a special registering device attached to one of the wings of the plane. It automatically records facts which enable a more accurate estimate and prediction of weather conditions for next day.

**FALSE STACKS ON BIG LINERS USED AS STORAGE ROOMS**

With the change to oil-burning equipment, not all of the stacks on some of the big ocean liners are now used for smoke, but have been converted into storage space for tarpaulins, rope and other supplies. Even new steamers built for oil burners and needing but one funnel, are commonly provided with two or more, for the public are used to seeing them and like them.

**LIGHTWEIGHT ARMY MORTAR LAYS SMOKE SCREENS**

Especially suited for service in rough country, a lightweight portable mortar can be fired at the rate of ten to twenty shots per minute. It is intended for laying down smoke screens, spreading gas or throwing explosives. It has an effective range over 2,500 yards. In firing, a shell is slid from the muzzle to the breech where a firing pin strikes its priming cap. This ignites the propelling material which is placed in rings at the base of the shell.

The range of the projectiles may be altered by changing the elevation of the barrel or by increasing or decreasing the number of rings of explosive used. The mortar can be carried on the back of a pack animal or on a special cart which has space for a supply of ammunition. This unit was first designed by the British but later adopted by the United States army after some minor modifications.

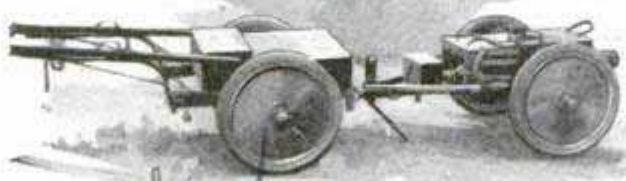
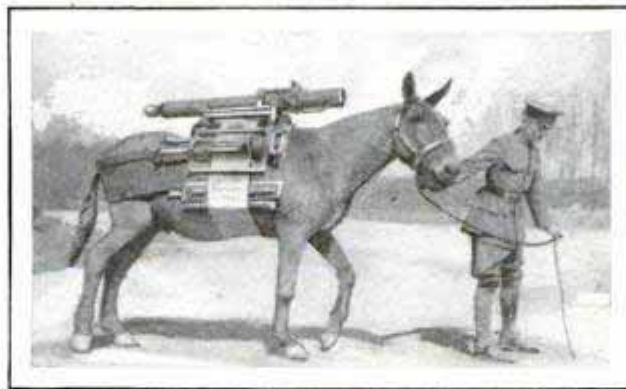

Light Mortar as It Is Packed on Mule Back, and the Truck Outfit Which Also Carries Ammunition

Pa  
 1096  
 3. Sactler  
 2. Sactler  
 1. Sactler  
 Robert  
 Emb. Leant.

*Stokes*

*Kansas City  
 James 8/24/28*



1099  
764

*Science Service News Bulletin*  
3847: 8/323

*Pacific Highway near Mount Angel, Ore.*

Bird Village of Tiny Homes with Its Community Bath and Flagpole

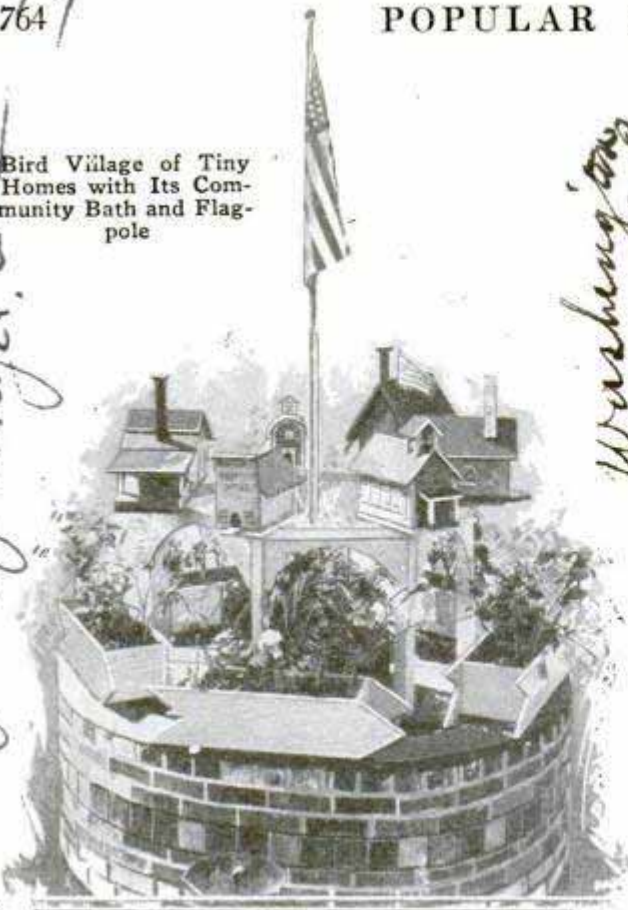

*Washington*

### MODEL VILLAGE FOR WILD BIRDS HAS COMMUNITY BATH

Birdhouses have been arranged as a model village near a western tourist camp. The tiny town has a bungalow, a schoolhouse, an apartment building, a church and lodge hall besides a community bathing pool. A flagpole is the feature of the commons at the center of the village, which attracts many birds.

*1193  
143*

### INTELLIGENCE TEST FOR BABIES SHOWS MENTAL GROWTH

Tests intended to measure the mental development of babies, from one month up

to one year of age, have been devised to show how rapidly the infant's mind progresses and whether it is up to the normal standards. H. E. Linfert and H. M. Hierholtzer, of the Catholic University of America, after many experiments, found that, at one month of age, the majority of babies will grasp a pink ring placed at their finger tips. At the age of four months, ninety-eight per cent of them responded to the test in this way, but none of the one-month-old babies tried to put the ring in its mouth. This was done when the infant had reached the age of two months, but only two per cent of them did so, and, at four months, thirty per cent of those tested placed the ring in the mouth. Because of the rapid mental progress of the subjects, two sets of tests had to be devised. One was for babies up to four months and the other for those from six months to a year old. The investigators declare that the difference between a baby one month old and one twelve months of age, is probably as great as that between a pupil in the first-grade of the public schools and a university student.

### CLERK'S OFFICE ON WHEELS HELPS COLLECT VOTE

Determined to arouse the eligible voters of Centralia, Wash., to their civic duty, City Clerk Jessie J. Ward, fitted up a temporary office in a motor outfit disguised as a railway caboose and toured the town to urge the voters to come out and to haul them to their registration places. The office was in a trailer chassis towed by a car fitted to resemble an engine. The campaign was continued for fifteen days.

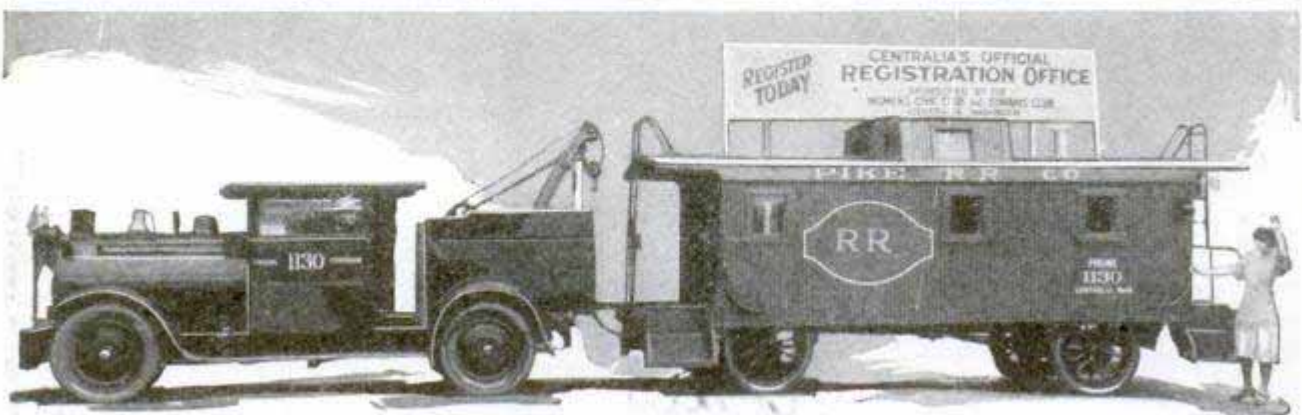

Registration Special at Centralia, Wash.; It Was Driven about the City to Haul Persons to the Booths and to Stimulate Civic Interest in the Coming Election

*cont. H. Quilley Wilcox  
328 W. Union St. Centralia*



# Easy Tricks

## with Thimbles



**I**N the good old days a thimble was used mostly by dressmakers, but today it is a valued magical property which has more than usual possibilities.

How's this? The performer exhibits three thimbles, colored gold, white and silver. He drops the three thimbles into a hat. He takes out the gold thimble and places it in his pocket. He takes out the silver thimble. And, now, what thimble is left in the hat? The answer is, of course, an emphatic "the white one," but it is the silver thimble and not the white one which is found in the hat, while the white thimble and the gold one are removed from the performer's pocket!

Here's the equipment: One gold thimble, one white thimble, one silver thimble, all No. 7. You will also need an additional silver thimble, No. 8. This is concealed in the lining of the hat. And now for the trick. The three thimbles are dropped into the hat. The gold one is taken out, and placed in the pocket. Then, apparently, the silver thimble is taken out, but it is not the original silver one at all; it is the concealed silver thimble nested over the white one, in the manner shown in the illustration. Nested in this fashion,

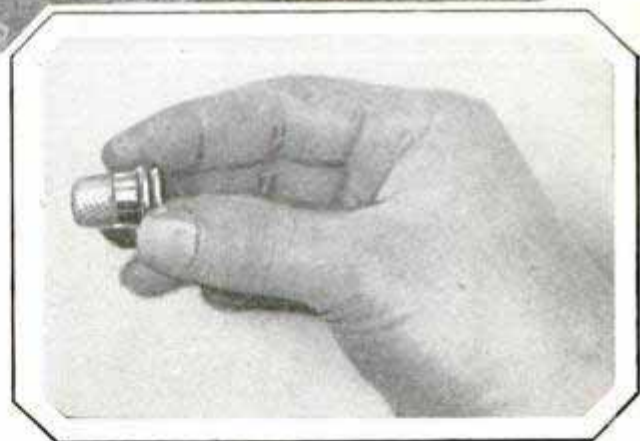

One Spare Thimble, Slightly Larger Than the Others, Forms the Nest for a Feat of Legerdemain

the double thimble is apparently the silver thimble only.

And so the trick is finished. Although you have openly taken the silver thimble from the hat, it is still there, while the gold and white thimbles are removed from your pocket, leaving the extra silver thimble behind.

Did you ever see a pair of thimbles smoke? No? Well, try this. Place a few drops of hydrochloric acid (spirit of salt) into one of the thimbles. Treat the second thimble to a few drops of ammonia. When the two thimbles are placed together, a heavy vapor resembling tobacco smoke will pour forth.

In the next effect, the performer ex-



hibits three large thimbles and a dime, which he places on the table. When he turns his back, someone is asked to cover the dime with one of the thimbles. The performer, on turning around, points out the thimble under which the dime is.

The secret of this trick is absurdly sim-

ple. The dime used is prepared by having a short length of hair fastened by beeswax to one of its sides. The hair projects beyond the rim of the thimble, and, although quite invisible to everyone else, it serves as an index to the performer in making his mystic divination.

And now comes a bit of manipulation. It's really quite easy. Don't skip it!

The performer exhibits a thimble on the forefinger of his right hand. He places his forefinger in the palm of his left hand. He closes his left hand and carries away the thimble. But no, the magician shows his left hand empty, while the right hand reproduces the thimble from the air!

Here's the how: The illustration shows the starting point; the right forefinger with the thimble on it is placed in the left palm. Now, both hands swing in slightly to the position indicated. In this position, the thimble is carried back and clipped at the crotch of the thumb. The empty forefinger now resumes its original position, as pictured. The left hand then surrounds

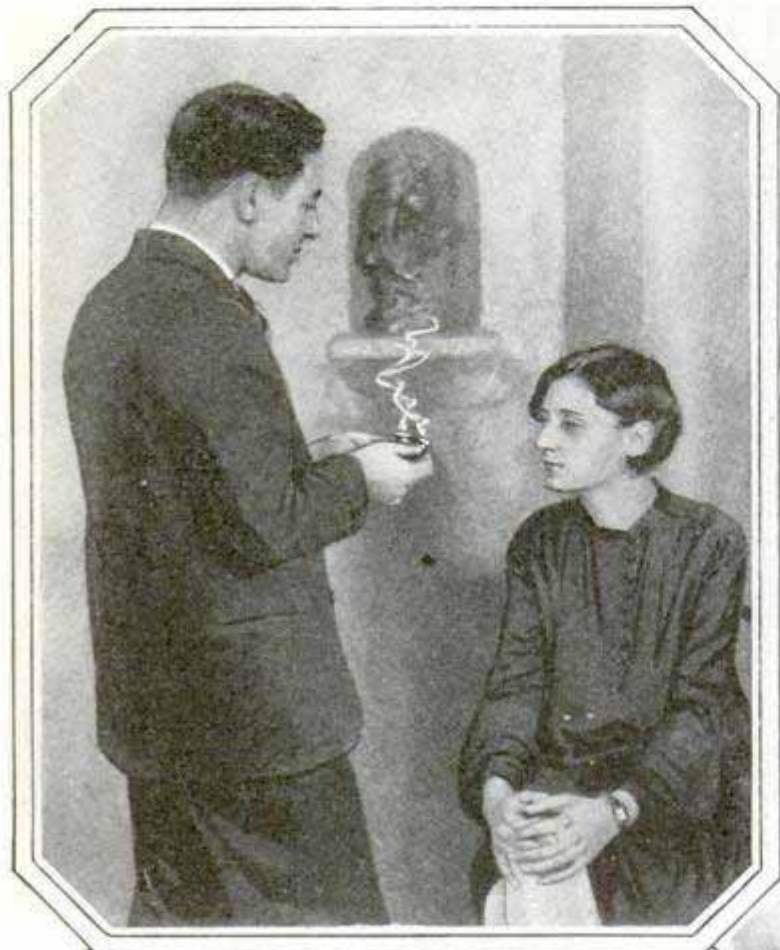

Ever See a Pair of Thimbles Smoke? Here Is a Chemical Illusion That Is Very Easy to Perform, When You Know How



Picking the Thimble That Conceals the Dime, a Variation of the Old Shell Game, Is Made Easy by Attaching an Almost Invisible Hair to the Coin with a Bit of Wax



the right forefinger. The left hand apparently takes the thimble away, while the right-hand forefinger subtly serves to misdirect by pointing to it. And then the left hand is opened. The thimble is gone! It is reproduced by simply inserting the right forefinger into it and bringing it to view. Try it! In the language of the street: "It's slick!"

The following effect is one which can be worked equally well with a ball, coin, or other small object, but since this is an article on thimble magic, we'll do it with a thimble. The thimble in question is placed in a spectator's hand. She is instructed to close her hand as quickly as possible on the count of one, two, three. All right, one, two, three, close!

But, the thimble is in the performer's hand, while the fair young spectator finds herself holding a fistful of nothing more nor less than nothing! Of course, it's a trick! On the count of three, the performer hits the side of the spectator's hand a sharp rap,



and as a result the thimble is transferred to the performer's hand, although the spectator may be quite unaware of the change.

Here's another manipulative effect; the thimble this time, being apparently swallowed.

Like this: Start, as shown, with the thimble on your right forefinger. A quick flourish is

made and the thimble is apparently placed in the mouth. In reality, however, it is thumb-palmed while doing the preliminary flourish, and the empty forefinger is then carried to the mouth. The right hand follows the imaginary course of the thimble as it is being swallowed, and then reproduces it from the region of the waist line.

And now comes a little juggling conceit. The performer takes two thimbles and, after some difficulty, succeeds in balancing them, one on top of the other, although the rounded ends would apparently make this impossible.

And, of course, it is impossible to anyone but the magician. He, however, has previously stuck a minute portion of chewing gum on the tip of his thumb nail, and during the preliminaries he casually

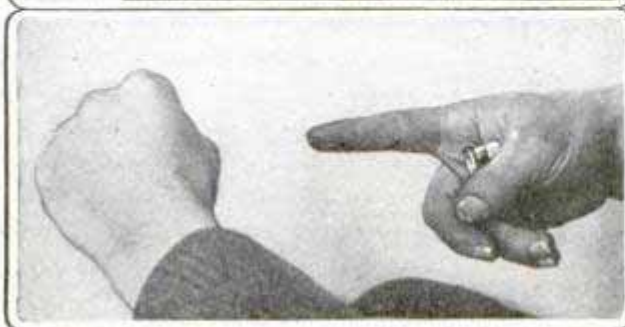
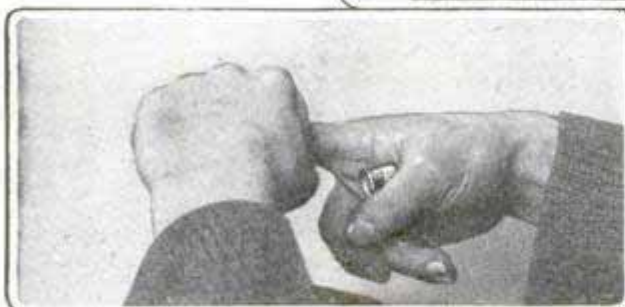

Six Stages in the Popular and Mystifying Disappearing-Thimble Trick; a Clever Performer Can Make the Sewing Implement Vanish at Will



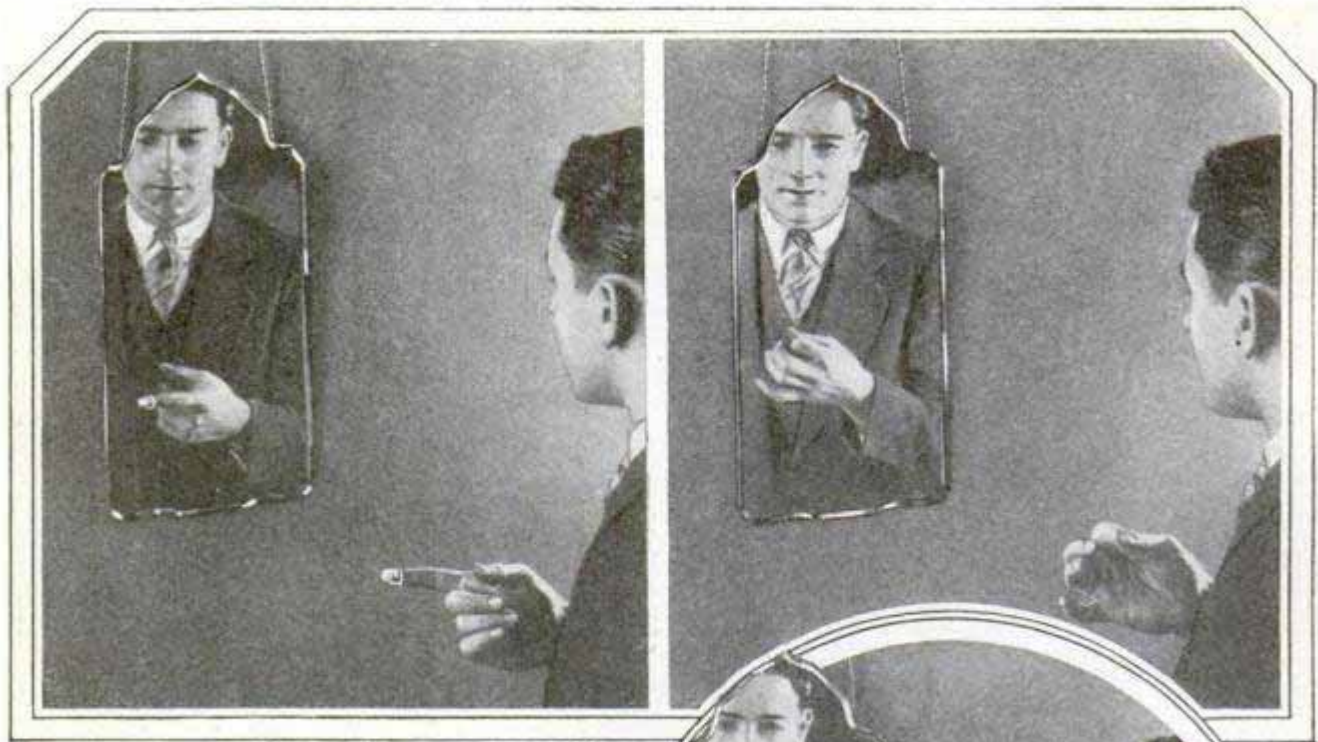

Do You Know How to Swallow a Thimble, and Then Extract It from the Region of Your Lower Vest Button? The Implement, of Course, Is Palmed, as at the Upper Right, and Concealed in the Hand as the Finger Traces Its Course.



the mountains of Sierra county, California, one planter there enjoys a crop each year, for he has a portable patch. It is in boxes, about six feet long, three feet wide and a foot deep, which are placed on the trucks of old mining cars.

gets this onto the end of one of the thimbles where it furnishes sufficient foundation for the second thimble to stand erect.

When the nights are cool, the entire patch is simply wheeled into an old mining tunnel where it is protected from frost. As the tracks of the mine still remain undisturbed, this involves but little work.

**BERRY PATCH GROWS ON CARS TO AVOID FROSTS**

Although the climate is ordinarily too cold for the growing of strawberries up in

Whenever you find that you wish to know more about any article in this magazine, write our Bureau of Information.

*Carl K. E. Chute*  
*Box 407, Route 4, Calif*



*Chas. Francis Leitch*  
*100 Canadian*  
**POPULAR MECHANICS**  
*Blue Francis Premier*

**QUEST FOR FASTER LINERS  
 REVIVES CLIPPER SPIRIT**

Something of the spirit of the clipper days when speed on the seas was the keenest quest of the nations, has appeared again in the five-party race for faster liners. The shipyards of England, Germany, France and Italy, together with those of the United States, are active and plans have already been announced for several vessels to reduce the passage time across the Atlantic and to provide greater comfort for passengers. According to reports, Germany contemplates, early next year, the first voyages of the "Bremen" and the "Europa," which have been designed to lower the present speed record held by the "Mauretania." The 1,000-foot, 60,000-ton "Britannic" of the White Star line, is scheduled for launching before many months, and six 1,000-foot vessels are planned by the Transoceanic corporation for four-day service from Montauk Point, Long Island, or New London, Conn., to Plymouth or Le Havre. The very latest ideas in ocean transportation will be incorporated in these ships and while present liners make fourteen trips a year, some of the new vessels, it is expected, will make at least twenty-five.

*1265 Paris*

*1229*  
*87.50*



Two Practical Applications of the Health Lamp, Which Is Designed to Exclude Harmful Rays

**LAMP FOR HEALTH TREATMENT  
 REMOVES HARMFUL RAYS**

Several interesting features are claimed for a health lamp now on the market, and one of the most important is that rays which would be harmful to the body are filtered out before they can reach the skin.

A saving is also effected by the method of adjusting and feeding the carbon electrodes to reduce waste. The entire electrode is used up before a new one is needed and this is loaded by the simple turn of a thumbscrew. The lamp can be set to give either the infra-red (heat rays) or the ultra-violet rays and is operated from any electric-light socket.

**INSIDE CONTROL FOR AWNINGS  
 SAVES OPENING WINDOWS**

Awnings may be lowered or raised from inside the house with a patented automatic spring control that operates simply by pulling a single cord hanging from a pulley on the interior wall. This arrangement saves going out in the rain, raising windows or screens and eliminates unsightly rods and crank boxes. The pulley and the cord, which are the only inside fixtures, are both designed to form decorative features.

*1224*

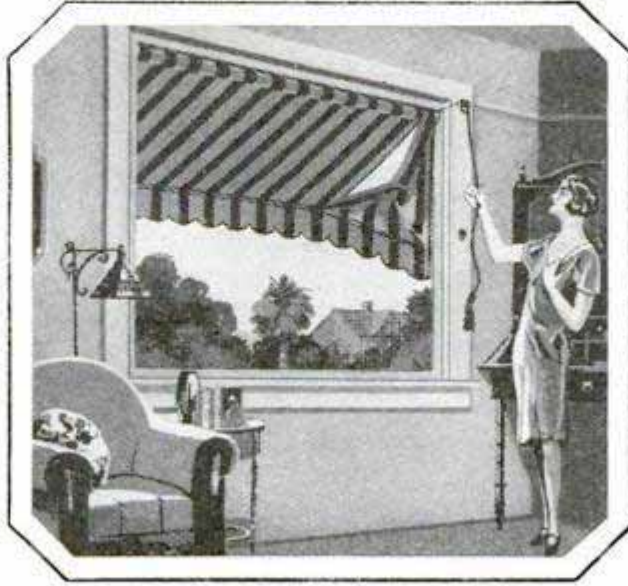

Lowering Awning by Manipulating Cord Inside

*Chicago*  
*W. H. Jackson*  
*2438 W. W. Co.*  
*Wm. W. Co.*

*Boadwin & Burns*  
*100 Canadian*



910

Cont. H. H. Clunne, 2/22  
Prince St, Berkeley, Calif.

# Cheating

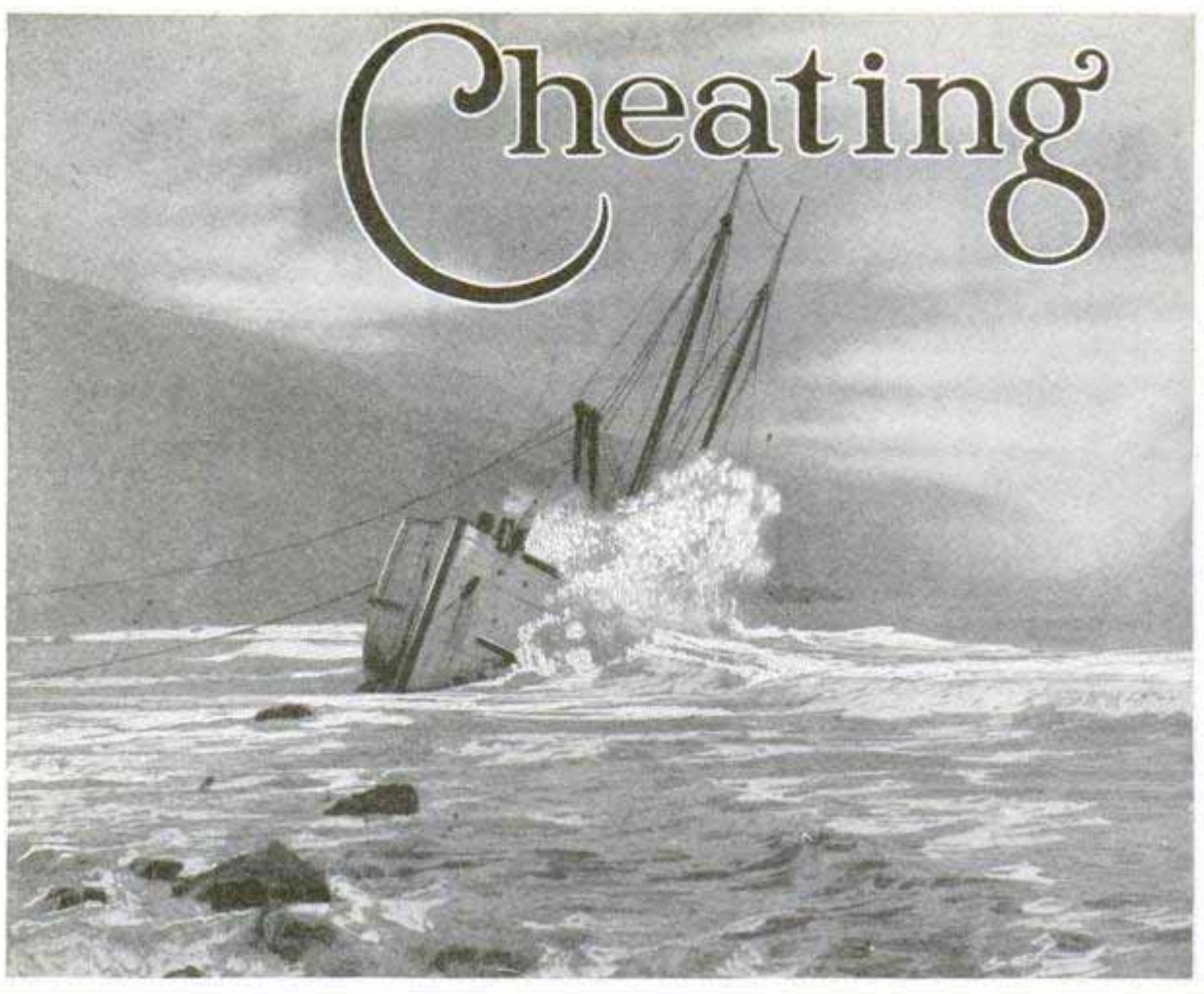

"A Terrible, Always Hungry Monster, with Long White Teeth, Is the Sea," Says Captain Whitelaw, and Here Is the Sailing Ship "Majestic" Slowly Being Crunched to Death

By CAPT. T. P. H. WHITELOW

THE SEA is a smiling witch one day—a terrible monster the next. With strength incomprehensible to the man who has not fought it, the combined force of winds, waves, currents and tides make piles of splintered wood and steel from the best of man's sea-riding constructions. But, though we cannot hold the wind-jammer or the liner out of the grip of the sea, mechanical developments in the art of salvaging have brought us to the point at which, like surgeons, we are able to save life after an accident. For ships, let me say, have individuality, each leading its own life, sometimes against the will of man. Some ships survive almost incredible disasters, as do some men, while others leave their wood and steel bones on the first reef against which they are thrown.

Yet few ships, unless they are sunk in deep water through collision with other

ships or with icebergs, need be listed as losses, provided the salvager is equipped with proper tools, adequate barges and tugs, and trained divers. A tug recently completed a 4,600-mile voyage to pull an American steamer off a rock in the South seas, and succeeded in saving ship, crew and the greater part of the cargo. Many years ago, a steamer from San Francisco went to the northeastern coast of Siberia, released a lumber schooner frozen in a huge ice floe, and both vessels returned in safety.

More than a third of a century ago, I sat on the hatch of a 220-foot freighter as she lay fast on the rocks off Point Montara, on the California coast. All of my men had gone ashore. There came a rending crash, and the after half of the hull, on which I was sitting, fell away from the forward half as cleanly as if cut by a



# the Sea

knife. I leaped to my feet, ran up the deck, already slanting stiffly in its slide into deep water on the seaward side of the ledge. As the crack between the halves widened, I put all my strength into a jump—and made it, across rather better than fifteen feet of gaping space.

The second I caught my feet on the steadier half of the wreck, still hanging to the rocks, the forward mast, with all its rigging, came crashing down. Then the mizzenmast fell on top of it. Half of the hull, released by the parting of the after section, swung suddenly

to port, pivoting on the pinnacle of rock which bound it to the shore. As it rolled, the great weight hurled the masts and rigging overside, and I stood free, unharmed by so much as a splinter. This was the "Respigerdo," and not much of that ship was saved. That escape gave me my first idea of the dangers which beset the salvor of ships, the man who goes down to the sea after the sailors have done their best, and puts them and their vessel back on the water again.

The underlying principle of all victories won over the sea is to compel the wrecked vessel to float. The hull cannot be lifted from the sands or the rocks, because the wrecking ships cannot get sufficient "purchase" on the surface of the sea to give their cranes enough leverage to raise several thousand tons of water-filled hulk. Therefore, the ship salvager must do the same thing that the shipbuilder does—he must create an artificial buoyancy within

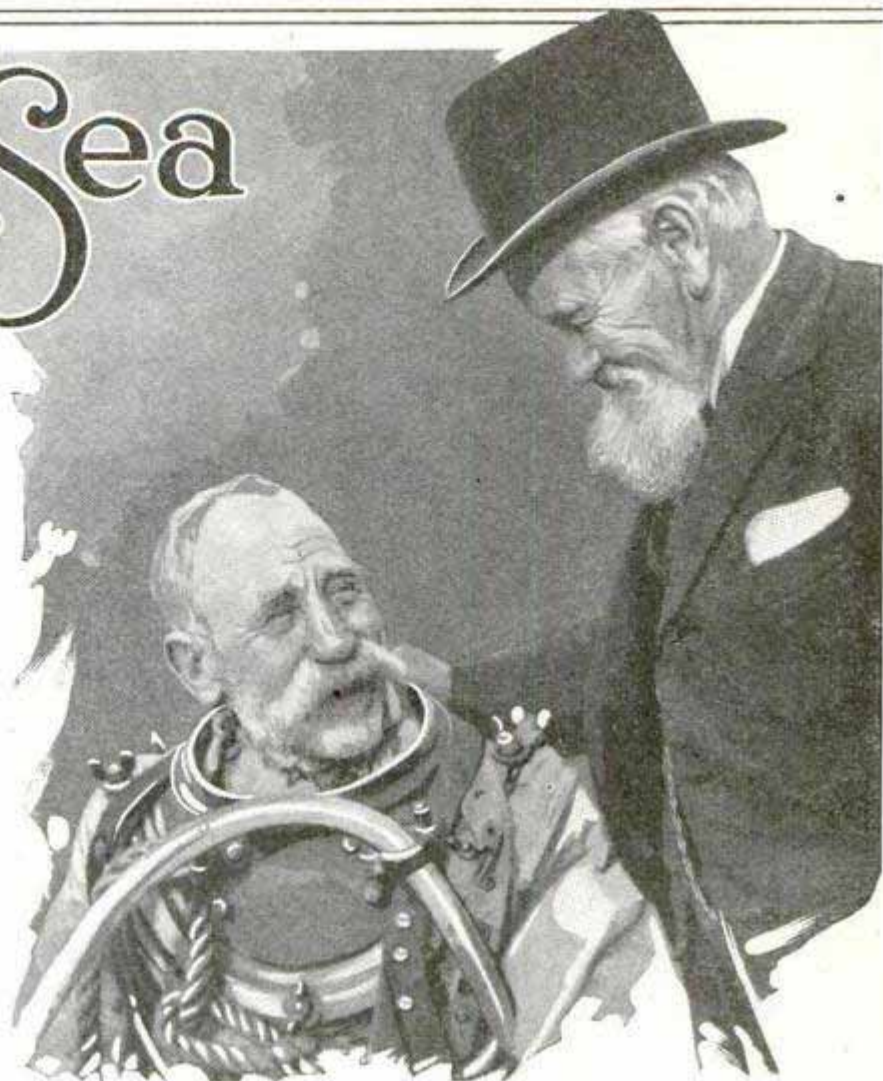

Capt. T. P. H. Whitelaw, Eighty Years Old, for Sixty Years a Ship Saver, Giving Instructions to One of His Divers

the hull great enough to make the vessel lighter than the water she displaces, and he must do it under conditions far more difficult than those confronting the shipbuilder. In accomplishing this result, the salvager is constantly confronted by new conditions, for no two wrecks are alike.

Take the oil tanker "Rosecrans," which went on a reef on the Oregon coast, with the loss of twenty-three men. They told me I could not save the "Rosecrans," but I did. Though the distance from her topmast to her keel was 140 feet, the white-lipped waves rolled their spray so completely over her that sometimes she was hidden entirely from the view. About six feet of rock, some ten feet wide at the base, projected into the hull of the tanker. This could be reached only from the inside, but the opening into this section of the hull was so small that a diver, fully dressed, could not pass through it. The only way to save the ship was to remove



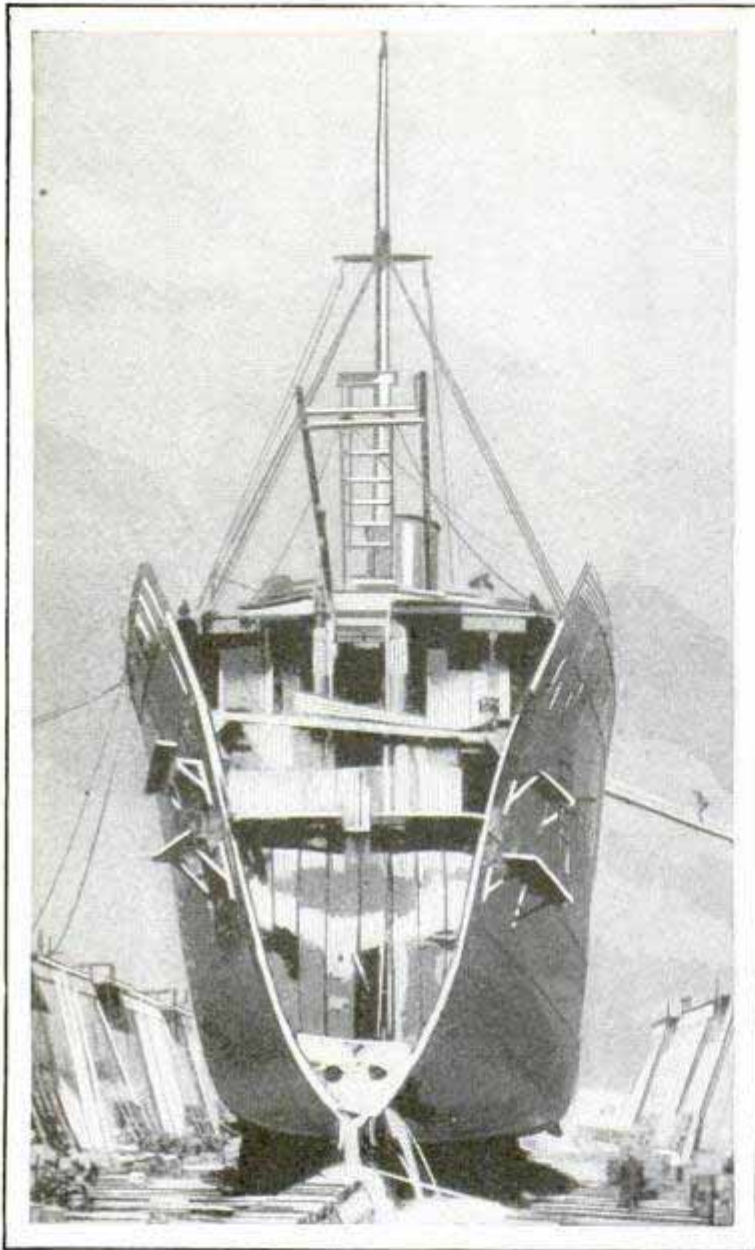

With Her Bow Torn Off, This Ship Was Saved, Floated and Towed to Port, with a Wooden Bulkhead in Place

this rock. So I put a small charge of dynamite under one of the deck plates, blew it up enough so that the men could remove the bolts and take off the entire plate. The divers went down through this hole and placed a tiny blast in the rock, blowing it up gently, inside the hull, yet without damaging the ship. Then steel plates were bolted across the hole.

These plates did not fit tight, owing to the jagged shape of the hole, so we filled the crevices with cement. The tide, of course, was moving in and out of that hole all the time, while the surf, pounding against the bottom of the ship, added to the difficulty of getting both plates and cement in place. To enable the divers to work, we installed pumps, forcing water

into the hull while the tide went out, and sucking it out as the tide came in. This equalized the pressure until we got the plates down and the cement set.

When virtually all the leakage was stopped, we passed chains and hawsers to the hull from the salvage ship, "Greenwood," and started to pull the "Rosecrans" off the rocks. We had been working on her for nearly twenty days, and, quite naturally, the tanker had settled somewhat. With the spring in the hawsers, the power of the salvage tug, and the force of heavy waves which struck her just as the tug started to pull, the tanker leaped from her bed like some living monster of the sea and dashed straight at the little "Greenwood."

Instantly, we cut the lines, turned the tug hard aport, and the great tanker dashed past, not twenty-five feet from the salvage vessel. A moment's delay would have seen us all in the water, with our tug smashed to toothpicks. Then we had to overtake the "Rosecrans," which dashed out to sea, and "rope" her, much as a cowboy ropes a runaway steer. She was towed to drydock and thus a \$250,000 ship was saved for the owners.

In marked contrast to the method of salvaging that vessel, is that with the "Umatilla," which went on the rocks at Cape Flattery. After being pulled off successfully, she was patched sufficiently to permit her being towed to the harbor at Esquimault. No sooner did she arrive, however, than she sank in about sixty feet of water. We then built a cofferdam completely around the hull, rising from the sides of the deck to about two feet above the surface of the water. This cofferdam not only had to be water-tight, but it had to be so braced from within that it would withstand the external pressure when the water was removed, or it would have crumpled like so much cardboard.

Large tanks, filled with water, were sunk alongside the "Umatilla" and lashed



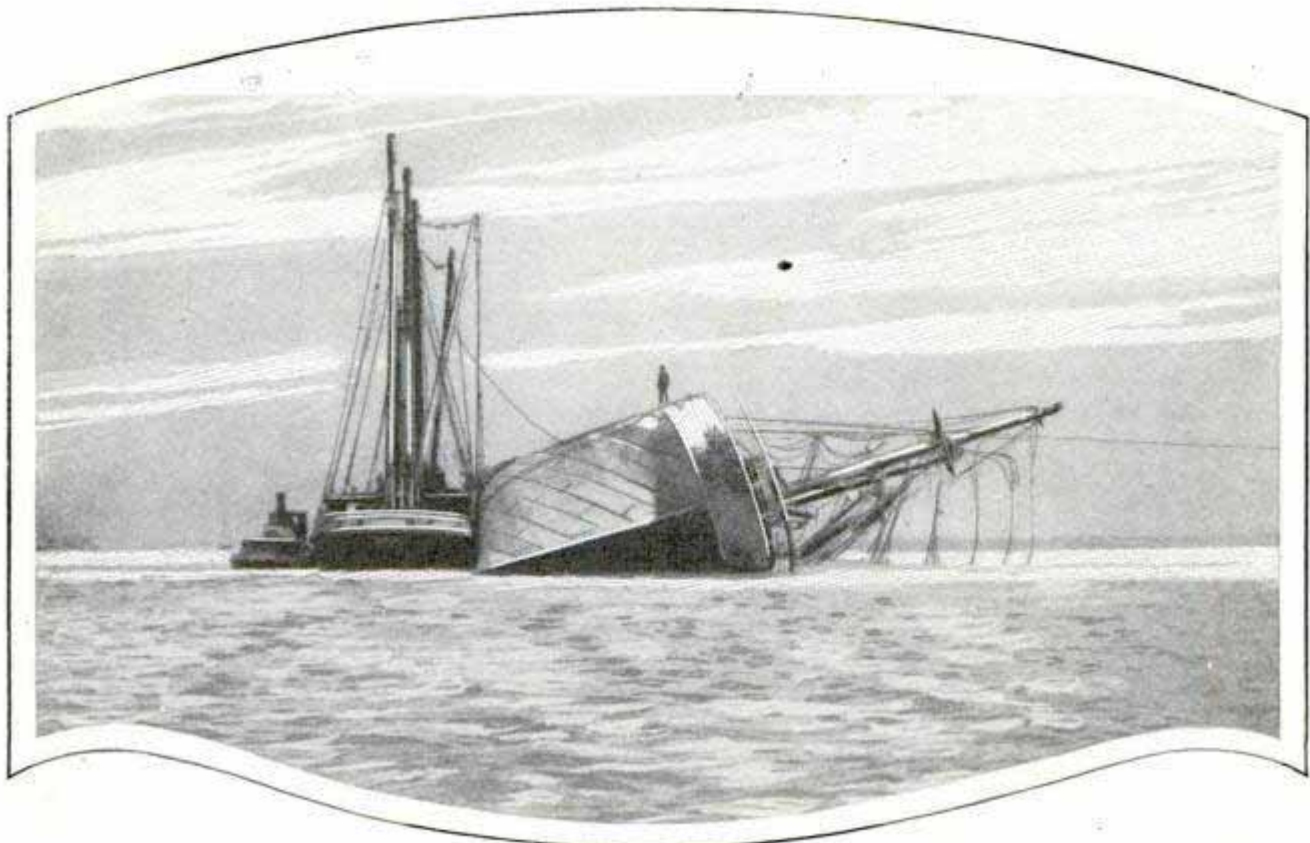

The "Blairmore" Turned Over in San Francisco Harbor; Captain Whitelaw Is Shown Standing on Her Hull, Directing His Rescue Crew While They Prepare to Right the Steamer

to her with chains, passed by divers from pontoon to pontoon, beneath the hull. Then we sucked the water out of the cofferdam, the hull, and the pontoons. This made the ship lighter and caused the pontoons to lift her from the bed of the sea. As soon as the water was all pumped out, she came to the surface like a cork. It took us 160 days to prepare for raising this ship, and twenty minutes to get her to the surface.

Occasionally a ship is in collision in comparatively shallow water, with either her bow or her stern stove in as a result. In these days of ship construction, watertight bulkheads confine the damage to one compartment, but in the older ships, it is necessary to send divers into the dark and dangerous hold to put in a wall of planks, two to four inches thick and a foot wide, set on end, to keep out the water. Then again, by applying pumps to the interior, behind this wall of planking, the water which the ship has "swallowed" is sucked out, her buoyancy restored, and she floats. But without the divers, the ship salvor would be almost powerless. And the diver in this work is a highly specialized man. He must be not only a competent diver, thoroughly familiar with all underwater

work, but he must be a carpenter, a steel worker, a riveter and, to some extent, a shipwright. He also must have at least an elementary knowledge of hydrostatics, and be able to estimate the strength he must build into his bulkheads, patches and cofferdams, while working in the dark.

Indeed, it was as an impromptu and untrained diver that I started this work of sixty years, which has taken me into almost every port in the world, and given me salvage work on many oceans. When I was twenty, I was nearing the end of my apprenticeship as a ship carpenter at San Francisco, working on a drydock. The diver at the dock became ill, and I, though I never had put on a diver's suit, applied for his place. I was permitted to try it, and found the hardest part of the job was driving nails under water. I mastered this, and in three weeks had the position permanently.

Then the schooner "Golden Rule" was hit by a steamer in San Francisco bay. The drydock owner took the job of repairing her as she rested on the bottom, and I was sent down to patch several holes in her hull. I did the job in six hours, though I was supposed to remain under water only four, and my employer gave



910 me a \$200 bonus in addition to my regular pay. This was the turning point in my life, and with the \$200 I purchased a diver's suit and became what was then known as a "wrecker," afterward converted to the higher-sounding term of "ship salvor."

Not all the disasters to ships are at sea. The "Blairmore," a full-rigged ship of British registry, once turned completely over while in her berth at San Francisco. The stevedores, in unloading her, took out all the cargo, without putting in any ballast, and her heavy masts, coupled with an unusually strong tidal current, tipped her upside down as neatly as if she had been dropped into the bay on her rigging instead of her keel. Her deck was completely under water, and only a section of the bottom, near the keel, was visible.

Here appeared still another problem in salvaging: This vessel had to be righted before she could be pumped out, and again we made the ship save herself, as must be done in all ship-rescue operations. On the exposed part of the hull, we built a platform lengthwise of the ship, extending over the keel at an angle of about forty-five degrees, a kind of huge lever, with which, if weight enough could be placed on the outer end, we could right the ship. At the outer end of this platform, we built four large water-tight tanks.

Divers then attached lines to the "Blair-

more's" masts, on the bed of the bay. These lines were carried to wrecking tugs, and, as these tugs pulled upward on the masts, water was pumped into the tanks on the platform. Between the lift and the lever, the ship slowly turned on her longitudinal axis, and soon the tanks on the platform were touching the surface of the bay. Then it became necessary for the tugs to hold up the ship, by the masts, while the platform and the tanks, emptied of their water, were moved farther up the side of the hull, so as to repeat the leverage from a higher point.

This was accomplished, and, when she was upright, part of the water was pumped out of her hold, leaving enough to counterbalance the lofty masts, and she was towed to shallower water. There we completed the pumping out, stored her with ballast, and towed the ship back to her berth, where she was filled with cargo and sent on her way. Probably more than half of the ships rescued during my sixty years of this work are still in service, some of them being sailing ships, out on remote trade routes, and others iron and steel steamers, which, apparently, are just as good as they ever were.

There are times, however, when the powerful hand of the sea reaches right into the work of the salvor and wrenches an almost saved vessel from his grip. So

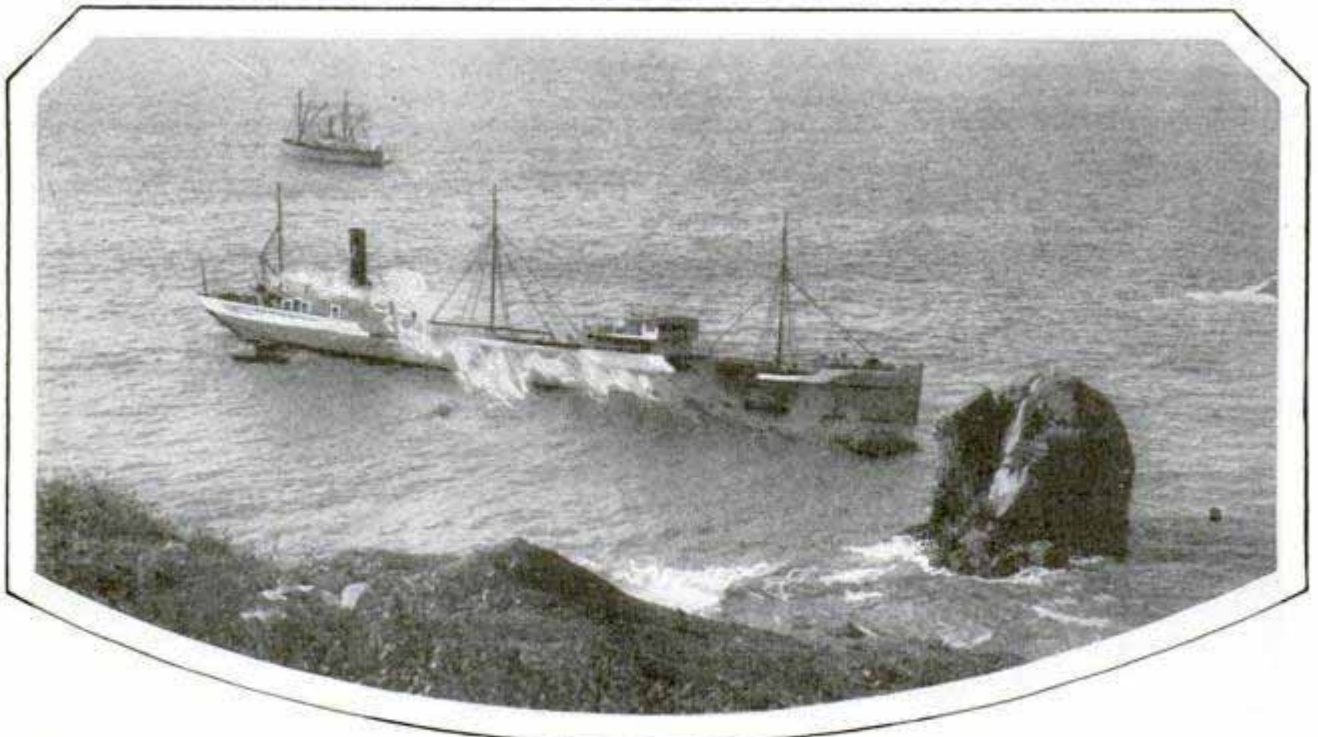

Many Vessels Are Lost during Fog Almost within Sight of Port; Here Is the Tanker "Lyman Stewart" on the Rocks of Golden Gate, Only a Few Miles from Her Berth



terrific is the pounding of tides and currents that a ship driven on exposed rocks will be aged twenty years in a week or ten days. Take the "Drum-barton," wrecked some fifteen years ago on Point Pedro, on the California coast. We were certain we could save her, with tugs and barges standing off shore and a number of men working on board. All at once, there came a series of grinding crashes. The men leaped overside into their boats and pulled to the barges. In less than half an hour there was not even a splinter of wood or a steel plate remaining on the rocks to indicate that a ship ever had been there. An hour before, she had seemed perfectly solid, except for a hole in her hull, which, we believed, could be patched with comparative ease at low tide, and the vessel lifted off at high tide.



Bell Tower at Tia Juana, on Top of Which a Brilliant Beacon Will Be Placed in Memory of the Late Capt. Emilio Carranza

Thus, such inanimate enemies, tides, winds, currents, rocks, reefs, hard sands and quicksands, are more dangerous to the diver than all the supposedly threatening life beneath the waters. It has been my experience, and that of my divers, that sharks are afraid of a man in a diving suit, whatever they may do to the undressed swimmer. The octopus, however, is a real menace, though, fortunately for the ship-salvaging business, these great devilish seldom appear near a vessel unless it has been in the water for months.

**AVIATION BEACON ON BORDER HONORS MEXICAN FLYER**

In honor of the late Capt. Emilio Carranza, Mexican flyer, a powerful aviation beacon is to be erected on top of a building in Tia Juana. Its rays will be visible for twenty-five miles on both sides of the border, and it is intended to serve as a re-

minder of the friendly feelings inspired by Captain Carranza's flight to this country. He was killed in attempting a non-stop flight back to Mexico City.

**PURIFY WATER WITH TABLET INSTEAD OF BOILING**

Army chemists report the successful use of a chemical to purify water when boiling is not practical. It is prepared in the form of a small tube about the size of a cigaret, and one tablet is sufficient to treat thirty-six gallons of water. Chemicals have been used for some time to purify water, but the chief advantage of this preparation is that it is said not to deteriorate and affects the taste of the water but little.

Our Bureau of Information will answer all questions regarding articles appearing in this magazine.

*International*

*Department of Chemistry  
American Chemical Society*

*Major C. B. Wood  
U.S. Army Medical Dept.*



1255

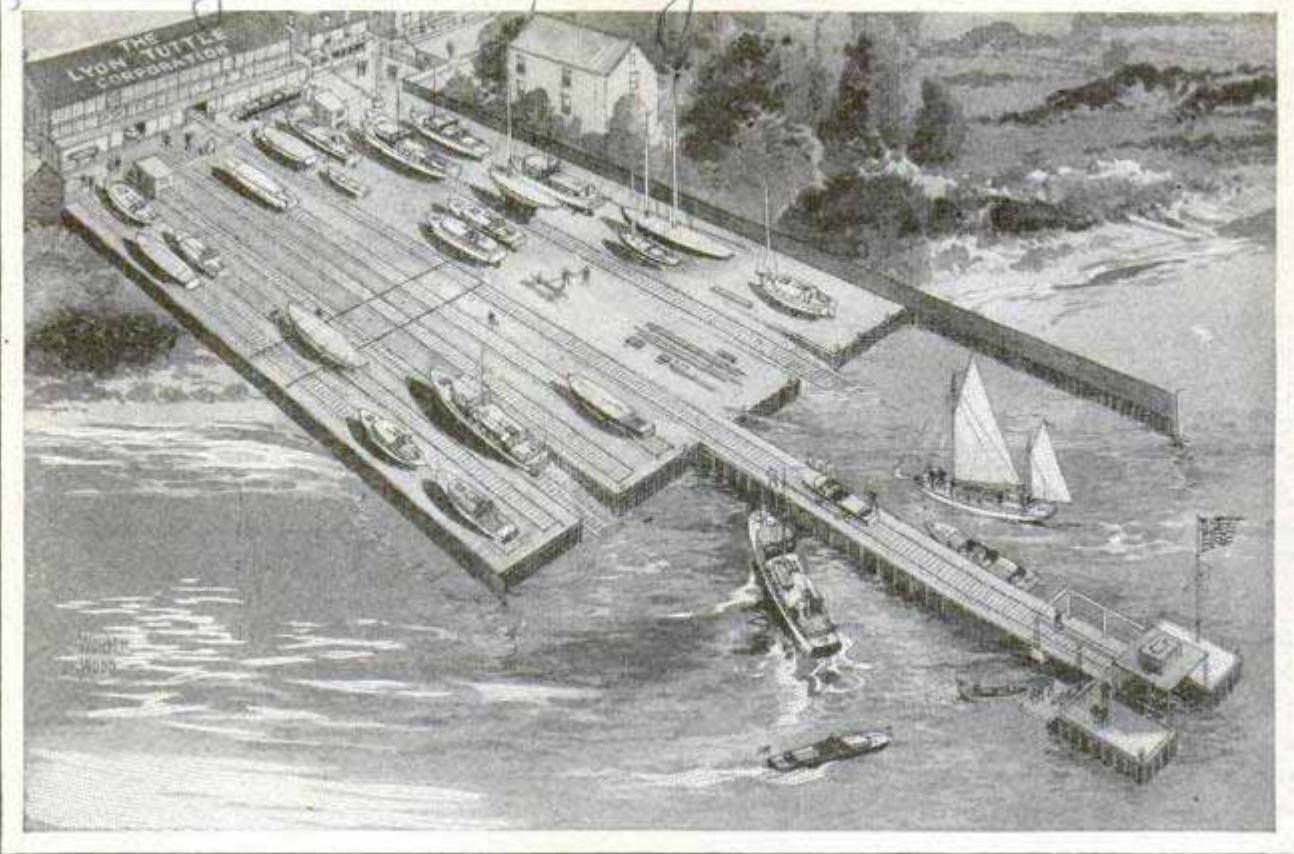

Drawing of the Big Service Station for Boats, Showing the Rail Lines on Which the Craft Are Hauled from the Water and Launched, and the Repair Building in the Background

### SERVICE STATION FOR SHIPS PROLONGS LIFE OF CRAFT

Not far from New York city, a completely equipped service station for repairing and storing boats has been established, along somewhat the same lines as an automobile shop. Craft of various kinds can be quickly hauled from the water up trackways that lead to the main building, where repairs and servicing are done. The beaching and launching apparatus is so convenient that boats are taken from the water at the end of each trip. They are thus subjected to less wear and tear when in dry storage. The station has accommodations for 100 large cruisers and yachts and under-cover storage for at least 150 runabouts. There are 300 feet of waterfront, and the marine railways are capable of handling yachts up to 150 feet in length. At low tide, the water in front of the station is twenty feet deep, so that even the largest yachts can be accommodated. Boat owners patronizing this dock can step ashore immediately after the trip, and when they wish to go out, they can telephone to have their craft launched and meeting them at some certain point and

time, if they desire. At this yard ten 110-foot submarine chasers and ten 150-foot ice-breaking steel tugs were produced during the war.

### NAIL HOLDER ON HAMMER HEAD LEAVES ONE HAND FREE

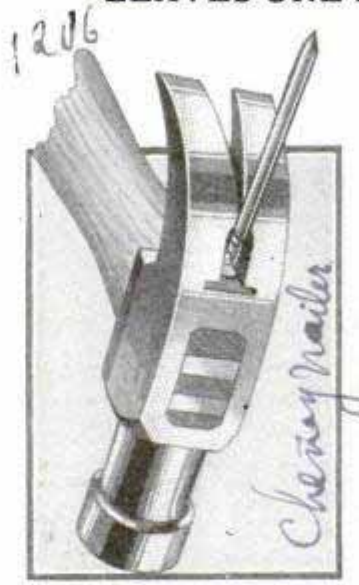

Especially adapted for overhead work, or for other places where it is difficult to hold the nail with one hand and the tool with the other, a special driving hammer has been introduced. It has a holder for the nail on the back side just above the claw. The nail is inserted between

two metal points that are pushed back and return to position through the action of springs. The nail is driven in with the back side of the hammer, released and then driven home in the usual manner.

Prentiss, Vise Co,  
108 Lafayette N.Y.



Science Service Bulletin 387c 8/22/21

Wesleyan University

DO FACES REVEAL FORTUNES? NO SAYS SCIENCE

Telling fortunes from faces is an unreliable method for practical purposes, psychologists of Wesleyan University have decided. Persons destined to become famous as lawyers, surgeons, or in other fields of enterprise, carry no shining mark upon their countenances—at least, none that an employer could safely rely upon. The findings were derived from an interesting test. Forty photographs of men graduated twenty-five years ago were shown to psychology students who were asked to judge as to the success or failure of each and the line of work for which each subject appeared to be best fitted. "In practically every case, the observers disagreed and the same person might be assigned from ten to fifteen different vocations," declared Dr. Carney Landis and L. W. Phelps, who conducted the experiment. The photographs were of lawyers, physicians, teachers and engineers. The five most successful individuals in each profession as well as the five who had achieved the least success were shown. Ten of the twenty students who studied the portraits decided that one of the successful engineers was a clergyman. Six voted that he had succeeded in that line, while four concluded that he was a failure. A man in a minor teaching post, was rated as a successful banker by six of the judges. One of the main conclusions was that an applicant's photograph should not be the basis of employment.



Typical Arrangement for the Basement Garage Which Insures a Warm Place for the Car and Saves Lots of Space

BASEMENT USED AS GARAGE SAVES SPACE AND COST

Utilizing the basement as a garage is becoming increasingly popular with home owners who have small lots and do not wish to go to the expense and trouble of building a separate building. The first floors of the homes are of concrete, the plan utilizes space that often would not be occupied, and entrance to the basement garage is gained by way of a ramp.

RHINOCEROS PICTURE ON ROCK SHOWS DAWN OF ART

A glimpse of the days when artists worked on rock instead of canvas, and when crude cutting tools served as brushes,

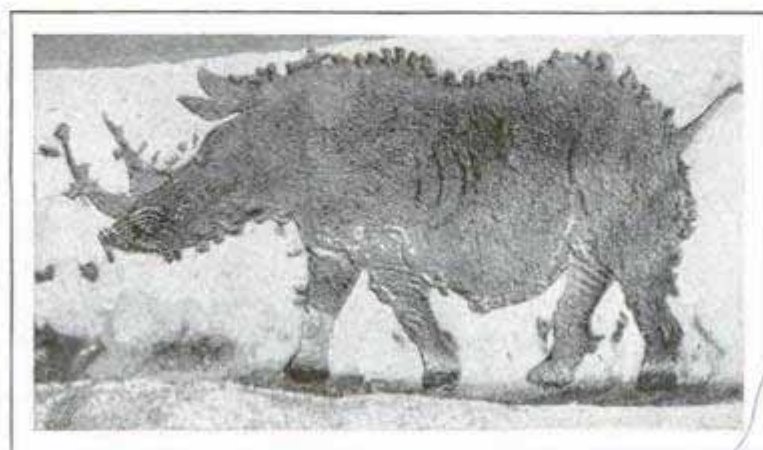

An Artist's Masterpiece of Centuries Ago; Rock Carving of a Rhinoceros Recently Found in Africa

has been revealed by the discovery of a picture of a white rhinoceros on basalt rock in southern Africa. It is believed to have been carved by an artist from 25,000 to 50,000 years ago and is in excellent preservation.

Buff. The Pembroke Chicago Ar. Evanston, Ill.

Carl Carle 1406

Southwestern Transvaal



1219

# THE MASTER OF

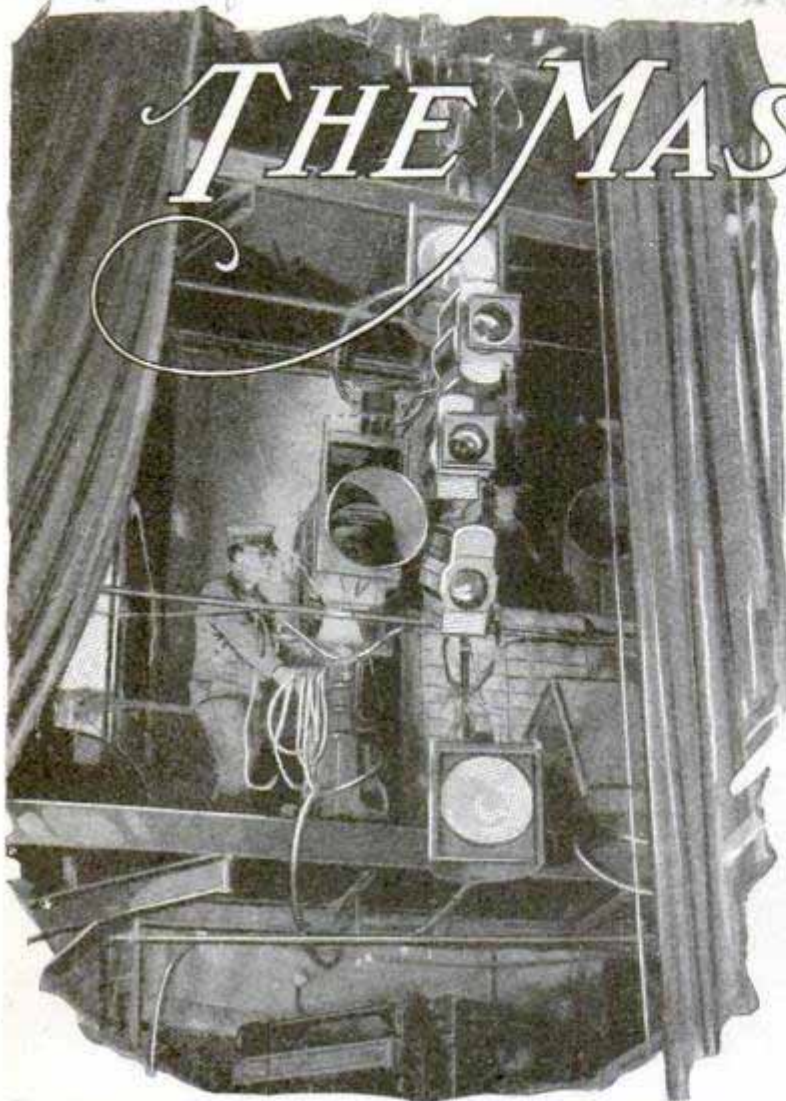

One of the Floodlight Bridges in Roxy's Theater, with the Battery That Produces Light Effects for Stage Spectacles

By FAIRFAX DOWNEY

*114 6  
70 to St. newspaper*

**T**WO pictures: Then and Now.  
A green light flashes on the board beside the music rack. The piano player speeds up. On the motion-picture screen before him, the villain and his followers are in full flight with the hero and his cowboys in hot pursuit.

Isolated up in the clatter of the projection booth, the operator-manager of the little coal-town, one-reeler theater, S. L. Rothafel, presses his green-light button again. More headlong music answers from below, until the villain is caught and duly baffled.

Then a yellow and a blue beacon shine on the board. Music, soft and sweet and low, for the sentimental conclusion.

The other picture, twenty years later: On the screen, the hero still pursues, the villain flees. The leader of a one-hundred-

and-ten-piece orchestra presses a button on his music rack. The electrical impulse travels the length of almost a city block up to the projection booth of the largest theater in the world. A red light glows. The projectionist retards the speed of his film a trifle. The music ends with a triumphant burst exactly as the hero triumphs.

But in this picture the operator is not the same man. Roxy, known as such to the nation by radio, is up in his office on the sixth floor of his Roxy theater, New York City. Follow him up to the projection booth, which is equipped with three projection machines. By automatic shutter-control shifts, one machine follows another, projecting a second picture as soon as the first has been completed, without the loss of a second's time. An asbestos safe holds the films until required. A ventilating system supplies cool air. A radio microphone and loud speaker insure communication with the stage manager.

Watch with Roxy the feature film as it runs its length. The theater house lights are turned up at its conclusion and you find your eyes are minus much of that weary, smarting feeling which can be recalled from the earlier days. For that you have to thank Roxy's invention of a new shutter for the projection machine.

As the film strip passes before the lens at the average rate of twenty pictures a second, it is cut off one-half of the time by the opaque half of the shutter. For the open half, Roxy substituted a translucent shutter of the three primary colors, red, green and blue, overlaid, giving the white light which those colors make in combination, but a beam which showed on the screen in a far softer and more natural tone than the unfiltered ray. Luminosity





**Roxy Himself Conducting His Broadcasting Orchestra, Which Has Made the Famous Theater Owner's Name Familiar throughout the Land among People Who Have Never Seen His Shows**

was not impaired, and much of the ultra-violet light, which was so hard on the eyes of the early movie goers, was eliminated. Further softness he achieved by blue edges to the shutter, which, at the cut-off point of the opaque half, eased the "pull-down" or passage before the light ray. This shutter device is now universally used.

Say that you have not been to a movie in recent years, and a Roxy theater usher shows you to a seat well on the side. Past experience would draw a demand for center or nothing, for you would expect a distortion of the figures on the screen; some of them would look as broad as they are long. But the side seat will do nicely. At Roxy's instance, manufacturers developed for him the first lens of increased diameter whereby the pictures keep their sharpness and the optical illusion of their depth without the necessity of an increase of light. By collaboration with the screen manufacturers, he obtained a screen which the pictures fitted exactly, with a diffusion

of light so nearly even that the images retain approximately the same brilliance from all angles.

Also you will note the novelty of the projection booth, inclosed in the center of the balcony directly facing the screen, not set in the back wall or shoved off to one side. With the angles removed, the more parallel projection further does away with distortion. That innovation cost space for 400 choice seats. But the Roxy reasoning was: What's the use of 400 seats, if customers who like to see things on the screen as they ought to look, won't come in and fill the other seats?

If you are grateful for the fact that you enter the theater while the picture is running, not through the inky blackness of yore, but rather through a mellow twilight with colored lights glowing in the proscenium balconies, accompany Rothafel back several years to a night stroll along the Hudson river. The powerful searchlights of a fleet of battleships are playing about the sky. The inventive spark burns,



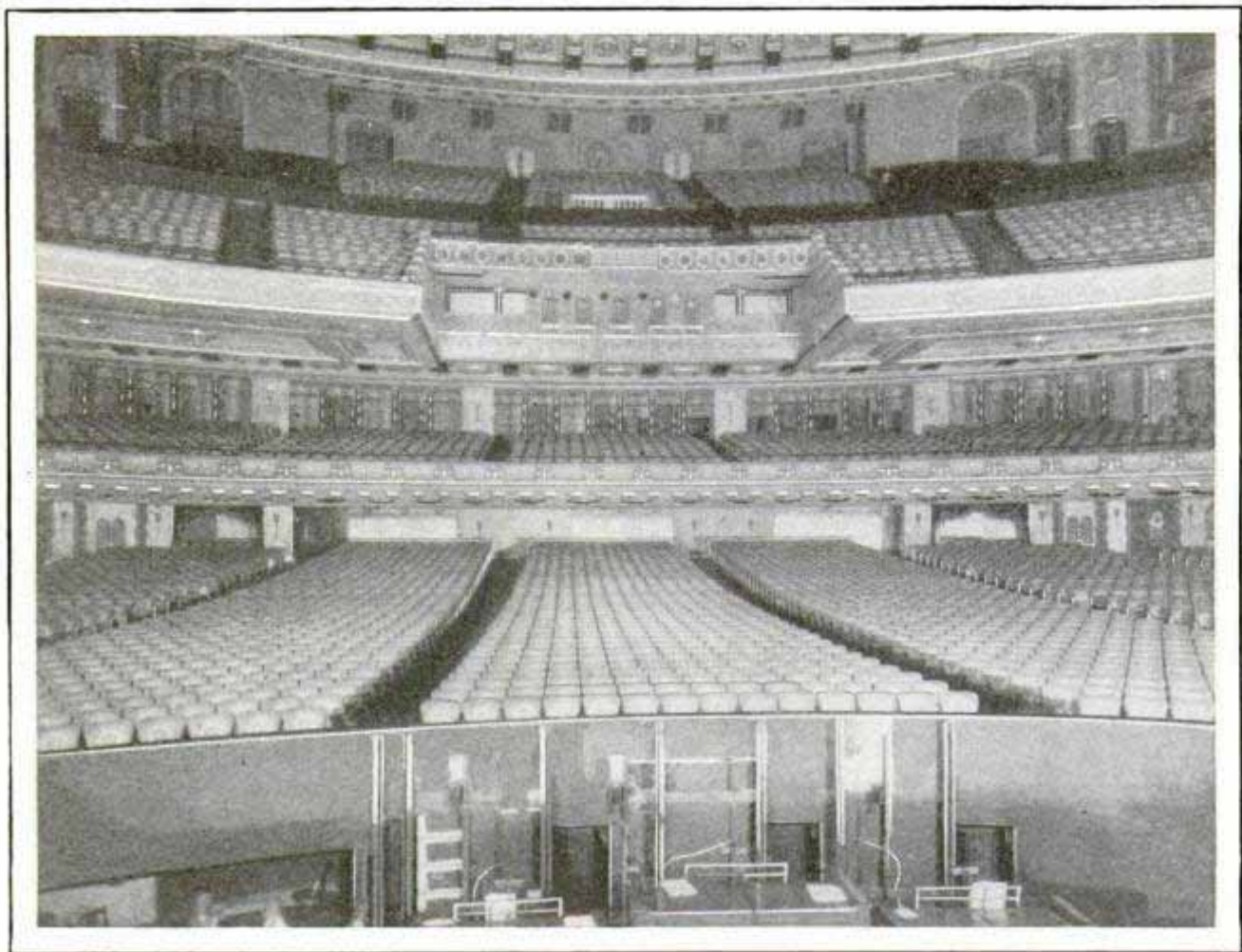

How a Huge Theater Looks from the Wings; the Orchestra Pit Has Been Lowered to the Basement; the Cut-Away Section of the Upper Balcony Shows Spotlights and the Movie Booths

too, and the stroller asks himself why these searchlight beams would not work in a theater. They would. The idea grew into the first employment of high-tension arc lights, now generally used for projecting motion pictures with a fifty-percent increase in luminosity, as well as for stage-lighting effects.

Once a week Roxy and his staff stand by while the next week's show is jointly conceived in the conference room of the theater. Ideas all in, they are plotted on a blackboard. The show is born. Part of the raising of the young hopeful you may witness if you sit with Roxy in the trial projection room of the theater of a Friday evening. There he has already seen and selected the feature picture and the bits for the news reel.

Now the music. Roxy swears he cannot read a note, but his musical memory is a regular encyclopedia. A shot of Italian aviators—that draws the "March Reale." For a boat dive, a march with a sudden silence during the actual plunge.

President Coolidge is awarded an echo of his college days, "Lord Geoffrey Amherst." An American horse winning the Grand Prix—that is given a gallop with "Yankee Doodle" at the finish. The music librarian hurries with the list to the long steel files where music is indexed and cross-indexed by title, type, tempo, composer and nationality. He comes back with the scores, and a pianist plays the selections as the reels are run again, and each piece is fitted exactly to the film it accompanies. Then a third musician receives the amended scores, for which he will orchestrate parts for every instrument. Monday morning the orchestra will be rehearsed and ready for the news-reel magazine when it flashes on the screen for the first show.

Ready, too, are uniformed ushers trained by marines, in which corps Roxy has served. They are equipped with flashlights, answers to any question and small phials of spirits of ammonia for emergency treatments. In a lounge on a lower floor,



a shoemaker is ready to reattach any high heels which may be lost.

The audience moves through a magnificent marble rotunda over a floor covered with a huge \$35,000 rug. An organ in the foyer balcony plays people briskly into the 6,186 seats. This organ is operated automatically and plays rolls. In the pit another organ rises on an elevator. It has three separate consoles played by three organists at the same time.

Those who enter the theater sit comfortably in cool, fresh air produced by the ventilating and refrigerating plants which are noteworthy parts of the equipment.

In summer the refrigerating machines, with a capacity of 500 tons of ice, cool and wash air sucked in through a duct in the roof of the building at the rate of 275,000 cubic feet a minute. The heating plant is located beside the refrigerating apparatus. It uses the same outlets and is equipped with a filter from which sometimes

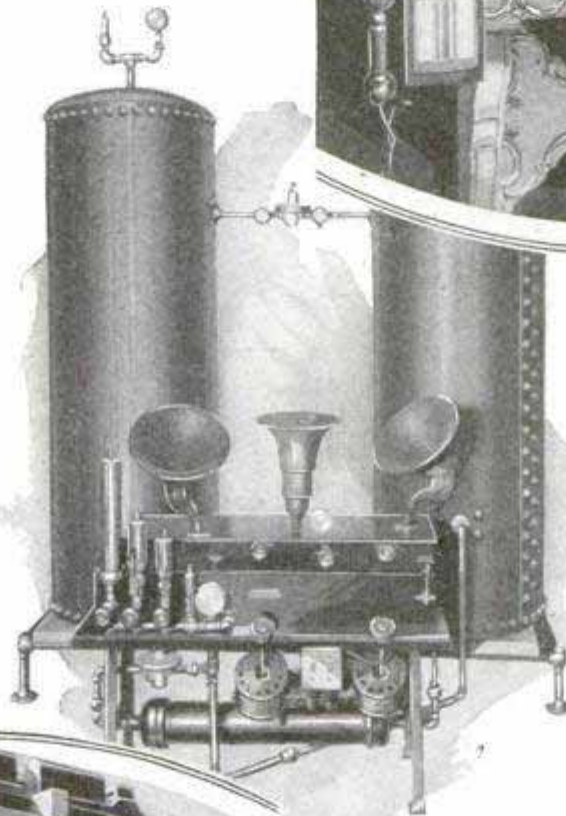
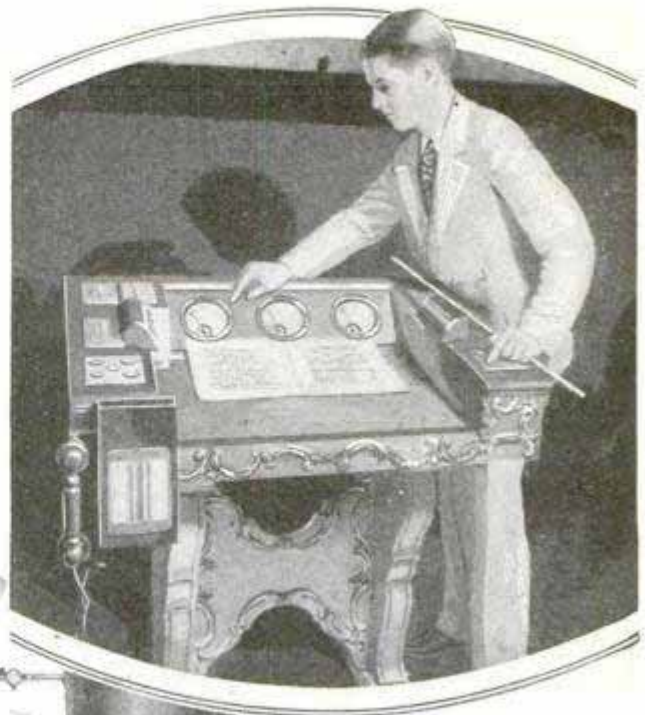

as much as an inch of mud, as the result of air impurities, is removed at weekly cleanings.

The audience, safe from distraction by stuffy air, heat or cold, the show may proceed. The gorgeous lighting fades a stage day into a stage night with the finesse of Mother Nature. The acts and ballets, Roxy was a pioneer in

adding to the movies, go on and off with pace and verve and time-table exactitude. The amplifier system picks up the tenors and sopranos of the chorus in boxes on one side of the house, blends their voices with those of the altos and basses on the other side and carries the harmony distinctly to the most distant seat.

Into its making have gone musical rehearsals, first and dress rehearsals, lighting rehearsals with Roxy presiding at his light board, a most intricate contrivance, until long past midnight. Marvelous mechanical devices have joined their forces to human ingenuity which created them. At the huge power switchboard and the radio control board, men swiftly achieve the effects. Art conceals the art.

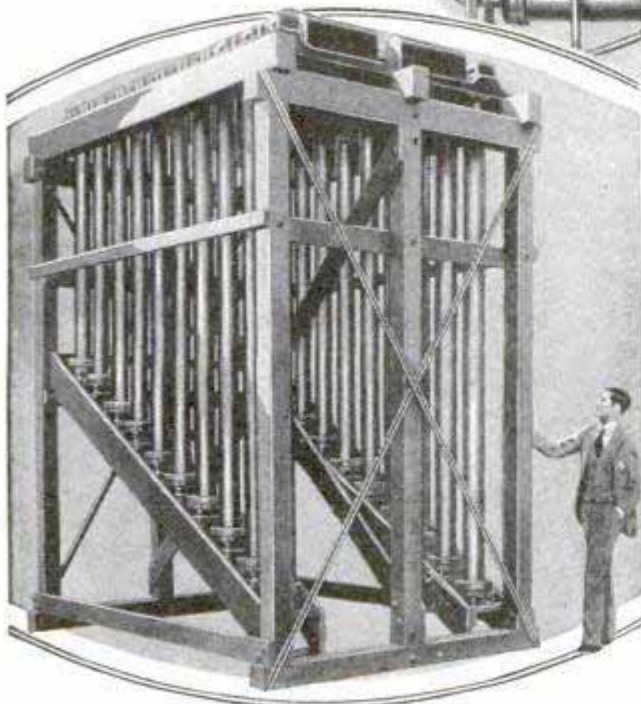

The Orchestra Leader's Film Controls; Compressed-Air Effects to Reproduce Noises, and Section of Pipes



Cont. George A. Paul.  
R. 809. 537 S Dearborn

POPULAR MECHANICS

1233 Chicago

Mr. R. H. Gray 20  
Isrange Road  
Leves. Mass., Inc

works so well that, last year, some of the roads were open during the winter for the first time in history.

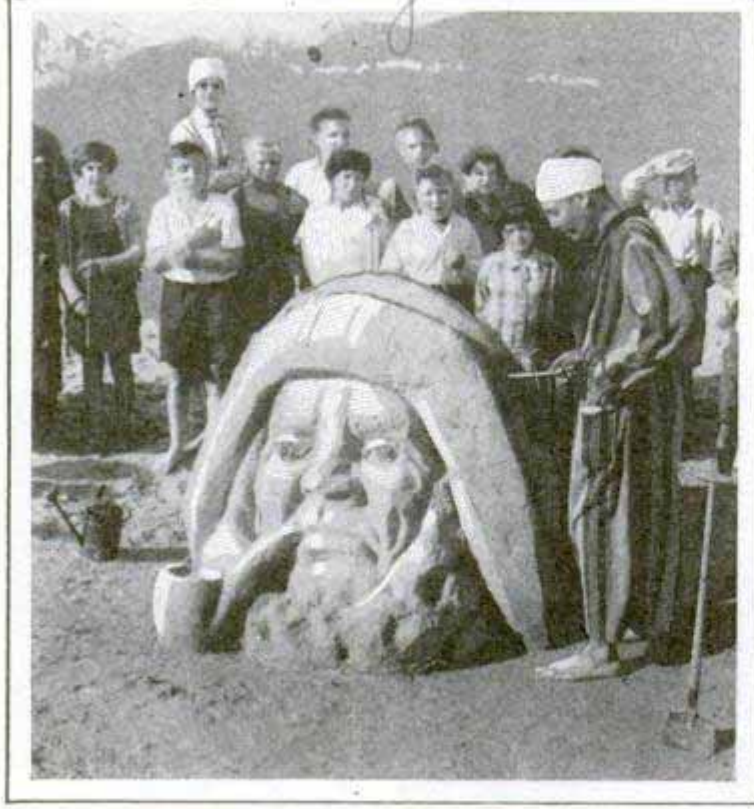

Sand Sculpture from Life; a Fisherman's Head in Graphic Detail, the Work of a Skillful Beach Artisan

### FISHERMAN MODELED IN SAND SHOWS SCULPTOR'S SKILL

Sand serves as clay for a sculptor at one of the ports along the Baltic sea, and he demonstrates his skill by modeling the heads of fishermen and of other human subjects. Considerable ingenuity is required in fashioning a base or armature for the pieces, as the sand lacks the consistency of customary modeling materials.

### SNOW ROLLER CLEARS ROADS WITHOUT SHOVELING

To open the snow-clogged roads of a Colorado town to traffic, huge rollers, seven feet in diameter, are run over the drifts, packing the snow so hard that horses and automobiles can pass over the surface with little difficulty. The outfit is pulled by a four-horse team and

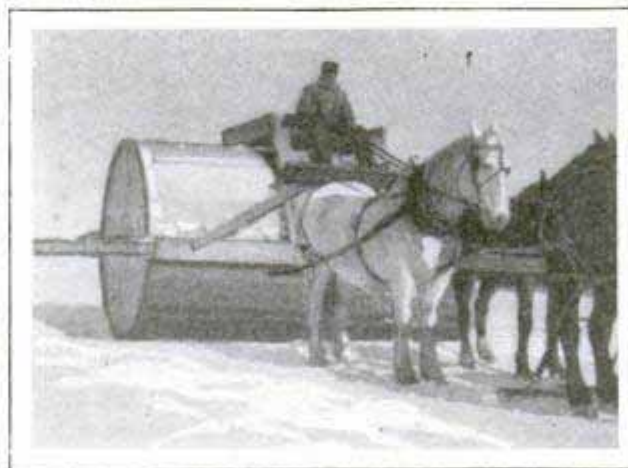

Packing the Snow with Big Roller Instead of Shoveling It Away; How Roads Are Kept Clear in Colorado

### MYSTERY OF RUSTING METALS PERPLEXES ENGINEERS

While rust or corrosion is a familiar phenomenon, in iron and other metals, the exact causes of its formation are not fully understood, although oxidation is commonly accepted as a basis of the process. It causes enormous damage in iron, but, in some instances, it may form a tough protecting coating over aluminum in temperate regions, while in tropical climates, the film is porous and accounts for the unpleasant taste often felt when drinking from aluminum receptacles in those countries. Zinc is also protected by the thin white film that

forms in the presence of moist air and carbonic acid, and that is the chief reason why galvanizing—coating with zinc—prolongs the life of the metal beneath. When plates of metal are cut by shearing or are punched, engineers have noticed that the edges are more likely to become corroded than the rest of the area. This is due to the fact that the shearing and punching slightly alter the physical properties of the metal, including the electrical potential. Hence, in the presence of moisture, the slightly dissimilar parts of the same piece of metal, act like the two dissimilar metals

in a voltaic cell, and rusting is accelerated by electrolysis. In alloys, the same process is often noticed. Duralumin, an alloy of aluminum, is an example. It contains numerous hard particles, imbedded in a softer mass. Here again, electrolytic action contributes to corrosion, and starts with minute pits.

L. W. Gray  
S. Dearborn  
Colo.  
335









© U. & U.

Part of the Echo-Measuring Apparatus, and the Bomb Which Is Exploded to Help Gauge Depths

### ECHO OF EXPLODING BOMB TELLS DEPTH OF SEA

One of the methods employed for measuring the depth of the sea while a ship is in motion is to explode a bomb of T N T and note the time consumed by the echo of the explosion in returning from the ocean's bottom. A microphone on the underside of the vessel picks up this echo and, with the speed of sound in water known, the depth can be determined.

### FAN ON AUTO HEATER HELPS WARM CAR QUICKLY

Installed under the dash, an odorless heater for the automobile utilizes hot water from the motor and is fitted with an electric fan that blows the warm air to all parts of the interior. The unit is compact, easily attached, requires but little room and no more current than a tail light.



### WOMEN'S WINTER DRESS MORE HEALTHFUL THAN MEN'S

Man lives in a tropical climate while women enjoy a cool, dry atmosphere like that of the Alps, and all because of a difference in clothing, the odds being entirely in favor of the women, a German professor declares. He has made a careful study of the wearing apparel of both sexes and finds that the dress of women, in winter especially, is far more conducive to health than that worn by men. In the first place, the weight of man's clothing averages about four times that of a woman's, the temperature inside is nearly eighty-eight degrees Fahrenheit with a relative humidity of seventy, while the temperature under woman's clothing is slightly more than eighty degrees and the humidity is but fifty-five. But the worst feature for the man is that his clothing is so closely woven and lined that the healthful rays of the sun cannot reach his skin while women's light and porous garb provides comparatively free access for the beneficial radiations. The professor recommends seeking protection from the cold with heavier outer garments to be removed when coming into heated houses rather than wearing thicker underwear.

### POP VALVE FOR AUTO TIRES PREVENTS OVERINFLATION

Tires can be inflated to the proper pressure in the dark, or without using a gauge, with the aid of a special pop valve, lately introduced. It is so arranged that, when enough air has been let into the tire, a signal sounds and any further air is by-passed and runs outside instead of into the tube.



Popular Mechanics Magazine does not publish the name of the maker or seller of any device described in its pages, but this information is kept on file and will be furnished free upon application to our Bureau of Information.

*Liberty Drapery Co., 227 W. Randolph, Chicago*

*547 W. Wabasha St. Chicago Sales of...*

*1262*

*1213*



FLYING FORT LIFTS FIVE-AND-A-HALF-TON LOAD



Courtesy L'Aeronautique

All Three Engines in This Huge Army Plane of French Design Are Started at Once and, If One Stops in Flight, the Controls Are Automatically Corrected to Compensate for the Difference

A starter for three-engined airplanes which starts all three motors at the same time has been developed by a French inventor and tried successfully on a five-and-a-half-ton military plane, virtually a flying armored fort. The inventor also has perfected means of automatically correcting the controls if one of the wing engines stops. After being flown successfully in a number of tests with three 180-horsepower engines, the center motor was removed and a 600-horsepower engine substituted. The ship made one successful test flight, but on the second it crashed and the pilot, Maurice Drouhin, one of the most famous flyers in France, and his mechanic were both killed.

settled. Actually it does both. It starts from the cloud and the ground at nearly the same instant, and about one seven-thousandth of a second later, the two ends unite in mid-air. These interesting observations have been made by Prof. C. V. Boys, a British physicist, who has been measuring lightning flashes for twenty-six years. His camera is equipped with two lenses, mounted on a disk that whirls rapidly while the instrument is pointed at a cloud that promises good lightning flashes. When one occurs, the camera is closed and the plate developed. Two pictures are obtained through the double lens, the image in one being slightly displaced in a direction opposite to the other. By careful comparison of these two pictures and accurate measurements, the rate of travel of the flash can be determined.

MEASURE SPEED OF LIGHTNING WITH TWO-LENS CAMERA

Science has put the stop watch on a lightning flash in the form of a camera with two whirling lenses and reports that it takes about a seven-thousandth of a second for a flash to complete itself and no part of it lasts more than approximately one-thirty-five-hundredth of a second. In addition, the old dispute as to whether lightning strikes downward from the clouds or jumps upward from the ground has been

FOOT-PROPELLED ICE SLED DEVELOPS HIGH SPEED



Foot and Hand-Propelled Sled with the "Pusher" Arm at the Rear; Note the Lightweight Construction

Healthful exercise and sport are obtained with a foot-propelled ice sled that is said to develop a speed of twenty miles an hour under favorable conditions. It is suitable for adults or children and collapses into a small bundle, easily carried by anyone, when not in use.

Cond. Harold J. Wilkins by Columbia Broadcasting Co. Mr. London

M. Cougnet

American Automatic Accessory Corp. 4th St. Church, d. U.

Science & Service Bulletin 387-11

Mr. American Automobile Accessory Corp. Oak



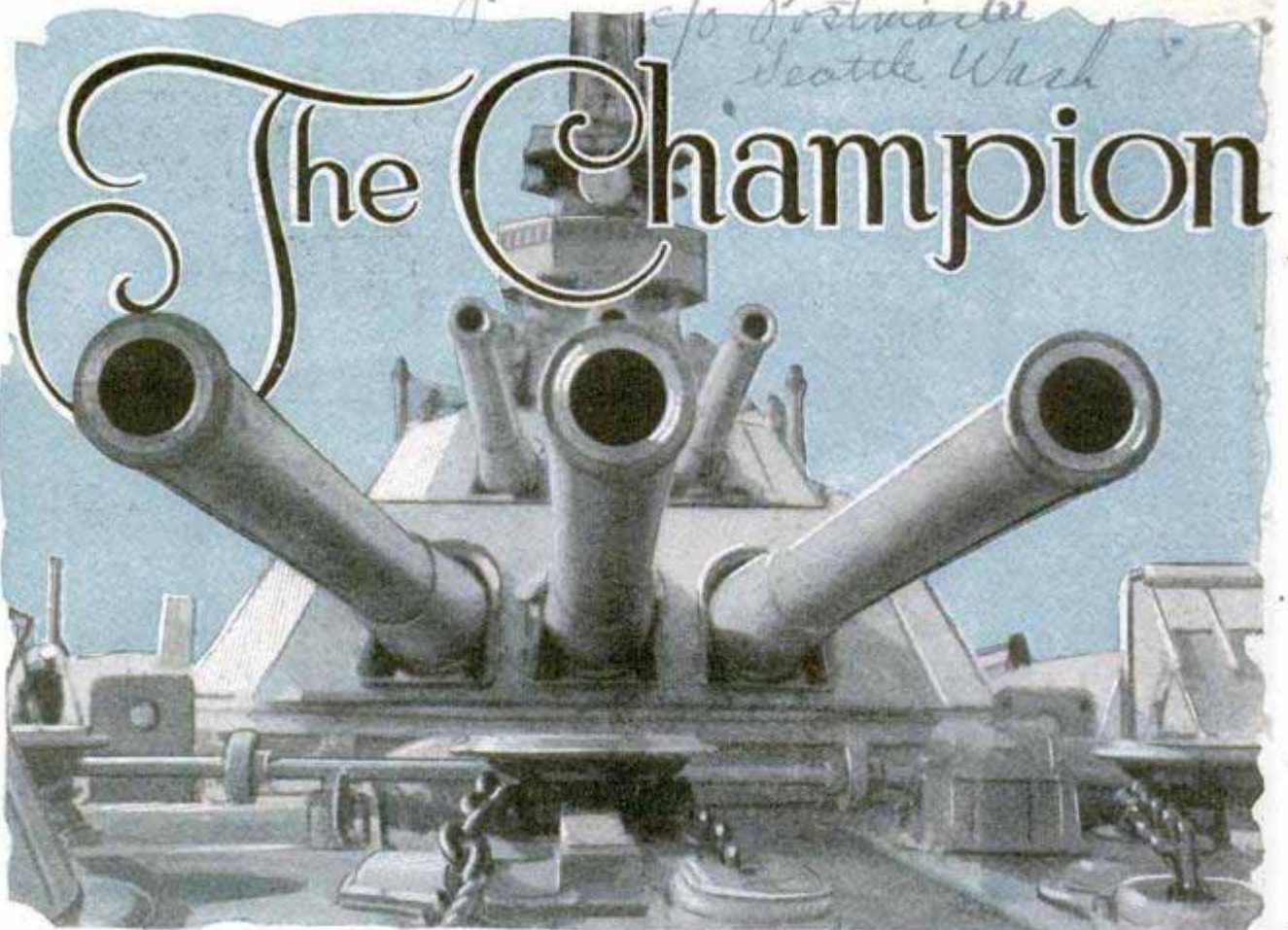

The "Loud Speakers" of the "New Mexico"; the Six Big Guns in These Two Turrets Are to Be Elevated When the Ship Is Modernized, to Bring Their Range Up to Its Limit

By THOMAS W. KUNE

OUT in the Pacific, where the battle fleet of the American navy maneuvers, steams and shoots throughout the year in preparation for any emergency, an unusual event has taken place.

One ship has captured all of the naval efficiency trophies in the battleship class. She is the only battleship in the navy that ever has accomplished this feat. She is the first electrically driven battleship our navy placed in commission. She is one of the older vessels, having been commissioned in 1918. The ship that wears all these honors is the "New Mexico."

Every year there is keen competition in the navy for three trophies: the gunnery trophy, awarded to that ship which excels all other ships in her class in the various target practices; the engineering trophy, presented to the ship which steams more efficiently than other ships of her type, and the communications trophy, given to that ship which stands first in visual signals and radio. And to the ship which has the highest average in gunnery and

engineering goes the kingpin of all—the battle-efficiency pennant, known throughout the navy as the "meat ball."

For winning the gunnery trophy, the "New Mexico" now possesses a beautiful bronze plaque, which has been the navy's prize for the best-shooting battleship since 1902, in the days of the famous old "Oregon." A large white "E," standing for excellence in gunnery, adorns the ship's conning tower, where her guns were so effectively controlled during the past competitive year. "E's" also decorate various guns about the ship, significant of scores made at target practices which measured up to the navy department's standard for excellence. There also are "E's" on the sleeves of many of the men who manned these guns and prize money has been paid to the men who helped win the gunnery trophy for the ship.

The honor, however, that the ship as a whole prizes most of all, is that in the most difficult practice of the year—long-range battle practice—her four three-gun,



# of the Fleet

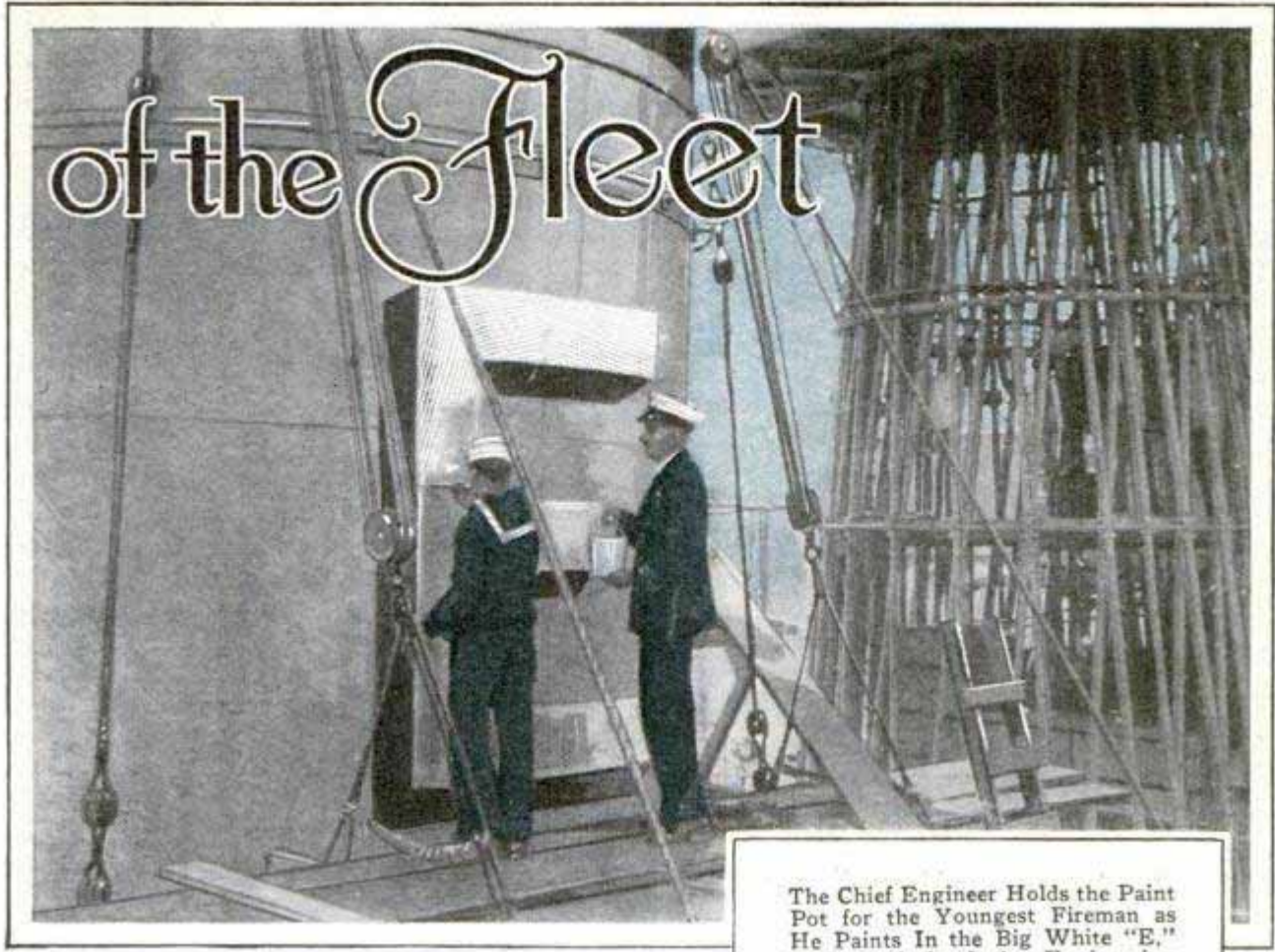

The Chief Engineer Holds the Paint Pot for the Youngest Fireman as He Paints In the Big White "E," Emblematical of the Engineering Championship of the Fleet for the Current Year

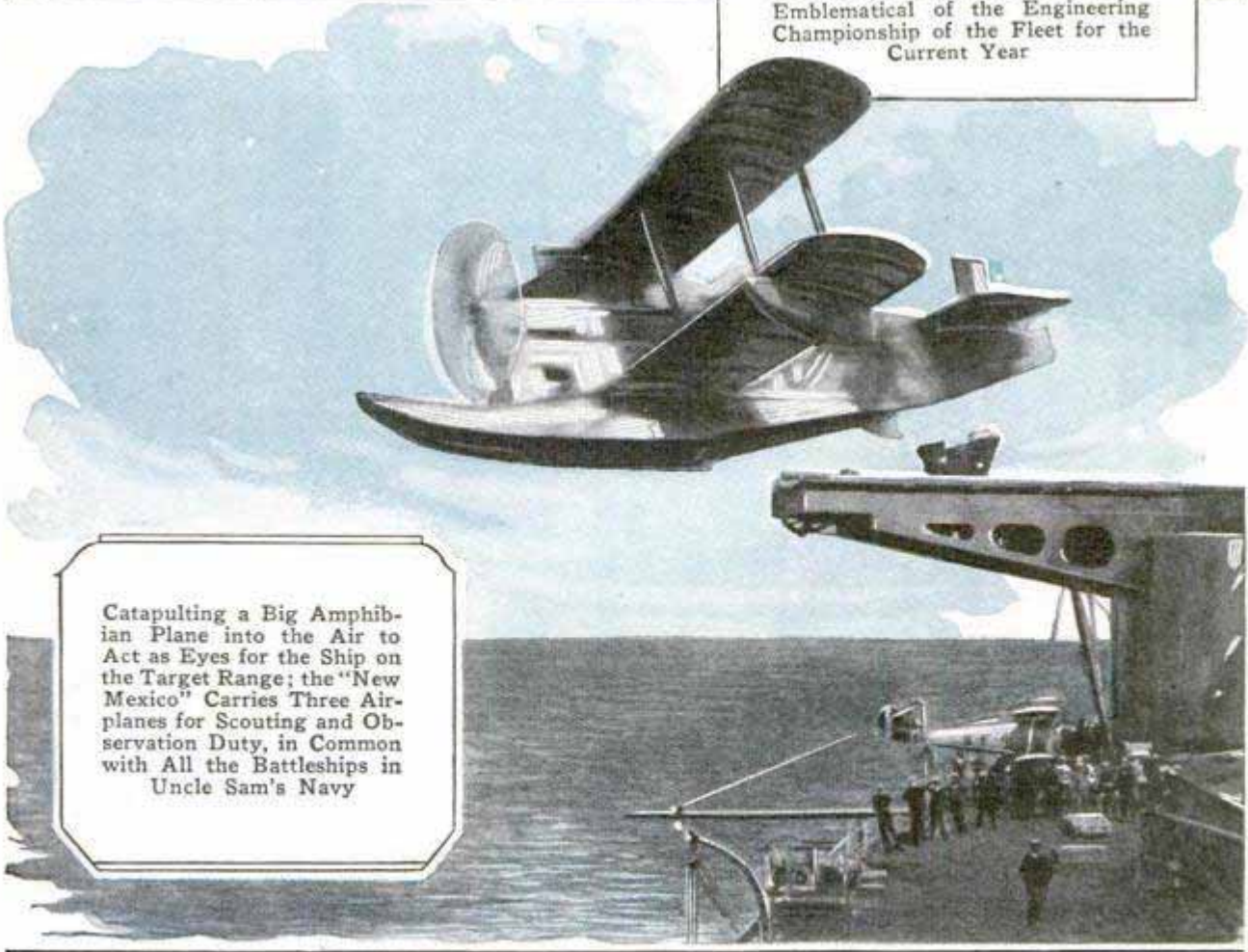

Catapulting a Big Amphibian Plane into the Air to Act as Eyes for the Ship on the Target Range; the "New Mexico" Carries Three Airplanes for Scouting and Observation Duty, in Common with All the Battleships in Uncle Sam's Navy



1166

fourteen-inch turrets established a world's record, and one which will last for many years to come. Steaming at full speed on a course convergent to a target representing an enemy battleship, the "New Mexico" straddled the enemy with salvo after salvo of 1,400-pound projectiles, registering enough hits to put her antagonist out of commission in less than five minutes.

For winning the engineering trophy, the "New Mexico" was given a bronze tablet of magnificent design which has been the navy's prize for the best-steaming battleship since 1910. A block letter "E," six feet in height, standing for excellence in engineering, is painted on each side of her smokestack. "E's" decorate the sleeves of the 300 men constituting her engineering force. The black gang also has been awarded prize money. It is significant that the present engineering force has

raised the "New Mexico" from last place to first in the fleet engineering race in exactly eighteen months.

The highest honor, the battle-efficiency pennant, is a bit of red bunting with a black ball in its center. It resembles the red pennant flown on navy ships at the yardarm during meal hours, and received its sobriquet of meat ball from a bluejacket in the early days of naval competition because it resembled the meal pennant so closely and because, at meals in those days, the favorite meat dish was a sort of hash made up in the form of a cannon ball.

The navy has established these trophies in an effort to progress along scientific lines. The spirit of striving to excel has been built into the fleet. Progress along scientific lines has followed research and experiment. The race for the meat ball has been responsible.

**SAFETY BRAKE SET FOR LOGGING SAVES WORK AND COST**

<sup>103</sup> For handling loads of logs downgrade, a brake set anchored at the top of the hill and controlled by a hand lever has been found efficient. It permits working areas at a comparatively low cost, as fewer expensive roads have to be built and the work of sanding hills is also saved. The

speed of the load is under perfect control of the operator and the line can be marked to show the exact location of the load.

**ARC WELDING TO DISPLACE CAST MACHINERY PARTS**

1292

The electric arc welder will soon displace the foundry as a source of machine parts, according to a recent announcement by the Westinghouse manufacturing company, in opening what is said to be the largest arc-welding laboratory in the world. The company has been experimenting for some time with welded steel buildings, replacing rivets, and has completed ten such structures, as well as two large welded bridges. The new laboratory will turn out turbine-generator frames, locomotive frames, electric-motor frames and spiders, machinery bases, floor plates and tanks, industrial heating apparatus, steel pipes and shop furniture, all welded instead of being cast.



Controlling the Speed of Logs' Descent down Steep Grade with Braking Appliance at the Top of the Hill

*Ryther & Brunck Co.  
Carthage N.Y.*

*Power P's & S's*



1257 Scenic Airways,

*between Grand View and  
Desert View*

# GRAND CANYON AIR TRIP LATEST TRAVEL THRILL



Seeing the Grand Canyon from the Air; Train Passengers May Enjoy This Thrill without Interrupting Their Schedule, as They Are Returned to Their Train at the Next Station after Flight

Travelers in the west may leave their train, take a huge three-motored airplane and enjoy a ride over and down into the Grand Canyon of the Colorado. The ship then flies to the railroad and lets them out at a point where they catch the same train they left, thus not interrupting their journey and providing a delightful side trip by which they can see more of the canyon in an hour or so than they would in days by the usual methods of travel. Contrary to expectations, the flyers have found that the air over the canyon is remarkably smooth instead of bumpy, and the trips are accomplished with complete comfort to passengers in the large planes, which have room for several persons, toilet facilities and ample space for baggage. Besides the special trip for train passengers, other journeys are made, from fifty to 240 miles long, over the scenic district of the canyon. One of the popular shorter trips is over the "north rim" country. Occupants of the plane can see the mysterious Navajo mountain, the painted desert and many other scenes of interest. This hop

takes but thirty minutes. A ride of nearly three hours' duration leads to Phoenix by way of Sunset peak, the lava beds, Oak Creek canyon, Roosevelt lake and the Apache trail from the terminal at the Grand canyon. The flying time for the train and back to train trip is less than two hours.

## THUMB CUFFS FOR PRISONERS PREVENT ESCAPES

As a substitute for the usual handcuffs, the Evanston, Ill., police department has been testing thumb cuffs to shackle prisoners. They are clamped tightly over each thumb and are said to offer greater security, for the wearer cannot try to get them off without suffering greater pain than when the bonds are on the wrists.

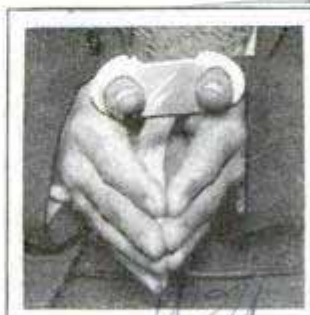

*W.A. Lilly  
6900 Kensington*



1273

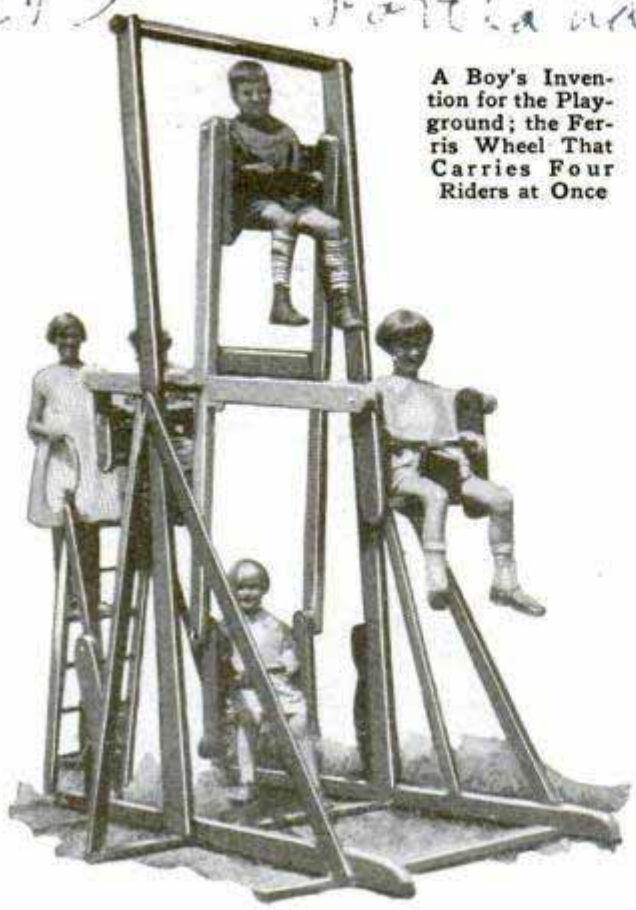

A Boy's Invention for the Playground; the Ferris Wheel That Carries Four Riders at Once

**BOY INVENTS FERRIS WHEEL FOR CHILD'S PLAYGROUND**

A seventeen-year-old boy is credited with the invention of a revolving wheel for the playground. It operates on somewhat the same principle as the famous Ferris wheel, the "cars" being supports for the riders who cause the entire frame to make a revolution by "pumping" as they would in a swing. While it is intended chiefly for children, larger models may be made for adults, and it is said to afford helpful exercise as well as amusement.

**WATER SPEED IN HYDRO PLANT EXCEEDS FASTEST AUTO**

The fastest man has ever traveled on land, slightly better than 200 miles an hour, is far exceeded by the speed of the water jet that drives the waterwheels in the new Big Creek plant of the Southern California Edison company. Falling 2,300 feet down the mountainside through a big conduit, the water jet, passing through an eight-and-a-half-inch pipe, strikes each bucket of the wheels with a velocity of 255 miles an hour, exerting an impact force of 90,000 pounds. The waterwheels, the

largest pair ever built, are rated at 56,000 horsepower. The two bearings on each unit are said to be the largest oil-ring bearings ever built. They are seven feet long and have a thirty-two-inch bore. The total load carried on the bearings is about 700,000 pounds.

**SPIES TO DETECT PLANT ILLS TO PROTECT HOME CROPS**

In order to detect the presence of injurious diseases in plants of foreign countries before domestic growths are exposed to them through importation, the national plant board has planned to send "spies" into lands abroad to make a study of plant ills. It is pointed out that most of our worst plant pests and diseases are of foreign origin and there are potential ills abroad that have not yet been brought to America. It is therefore considered an economical move to determine what these diseases are, what plants are infected and so prevent their being sent to this country. An initial move in the campaign has been proposed with reference to a citrus black fly that is now troublesome in parts of Central America. It is planned to search Asia for a natural enemy of this insect, so that its inroads may be curbed before it crosses our borders.

**OILCAN SEAL PREVENTS WASTE AND AIDS LUBRICATION**

Attached to the tip of the oilcan spout, a soft-nosed sealing unit keeps the oil from running out the sides and directs it into the bearings and other places, where but little usually penetrates with the ordinary oiler. It fits any oilcan, is especially useful with pressure oilers and is adaptable to cups of practically every kind. The seal can be put on in a second or two and is

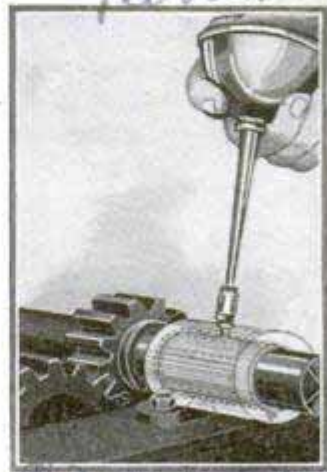

popular among mechanics, as it eliminates the spilled oil that generally has to be wiped up.

1293

Boyer 1/28/28

Auto. Mfg. Co. 145/5

Science Service, Bulletin 127-8



DECAY OF APPLES IS RETARDED BY GAS STORAGE

By keeping them in an atmosphere containing about eleven per cent oxygen and ten per cent carbon dioxide, apples have been stored for longer periods without decay, English investigators report. The treatment is said to be especially effective with apples "sick" with a disease called "brown heart." The malady spreads to other apples in storage because those afflicted as well as the others, continue to live and breathe after they have been picked and the air soon becomes contaminated from those that have the "brown heart."



Foot Pontoons for the Soldiers Who Patrol the Danube River; Waterproof Sacks Inside Keep Their Feet Dry

WATER SKIS FOR SOLDIERS SUBSTITUTE FOR BOATS

Austrian soldiers who patrol along the Danube river, have been equipped with foot pontoons with which they can walk on the water or propel themselves along with a double paddle while seated. Inside the "skis" are waterproof sacks to keep the feet dry.

MODEL PLANE AS BILLBOARD TURNS TO SHOW SIGNS

Interest in aviation has been turned to advertising purposes in a California city where a full-size model of a plane has been mounted on a tall standard and is turned by a concealed motor. The sides of the fuselage are used to bear legends of the various products advertised.

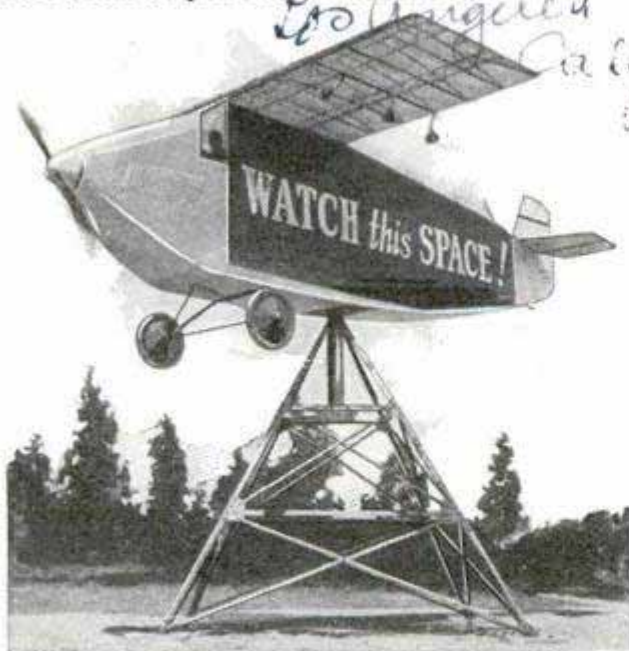

Advertisers Capitalize the Public's Interest in Aviation; the Model Plane That Serves as Billboard

OVAL CYLINDERS FOR ENGINES TO REDUCE VIBRATION

Several advantages are claimed for engine cylinders of oval cross section instead of round, according to experts who have been testing them—a development that was first suggested during the World War by an English engineer. In practice, it is said they work quietly with considerably greater clearance than must be observed in motors of the conventional types, and that the piston rings, which, in round cylinders, often tend to creep until their slots line up and permit the escape of compression, are bound to remain stationary in the oval pistons. They also occupy less longitudinal space, a distinct advantage, especially in the case of rotary airplane motors in which all the pistons work on a single crankshaft throw. This means that thirteen oval cylinders will take no more space than nine round ones, with gain in power, less whipping and vibration and larger valves, allowing more complete filling and quicker exhaust of the cylinders.

*later developed by Germans.*  
*63 radshaw,*

*Mr. C. West ... and Mrs. J. ...  
Low Temperature Research Station  
Cambridge ...*

*1293*

*1230*

*1252*

*127*

*Los Angeles  
Calif*

*Com. ...  
Pilot ...*



1152

# WHAT ARE THE

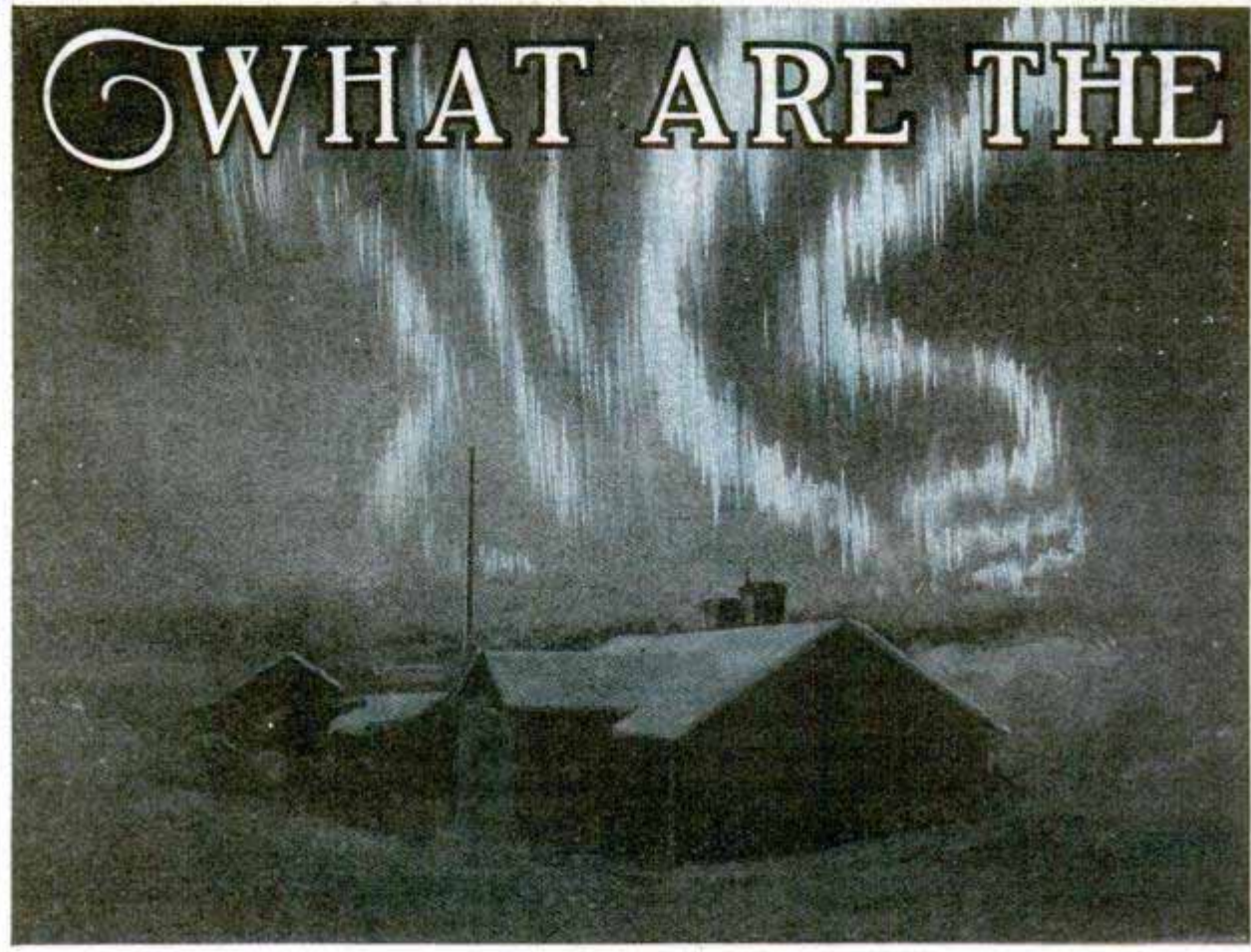

The Aurora Borealis, or Northern Lights, from a Photograph by Prof. Carl Stormer; the Electrical Display Apparently Has Some Connection with Storms on the Sun

By JAMES NEVIN MILLER *1906 N 21 NW Washington D.C.*

**W**ILL science ever solve the mystery of the earth's magnetic attraction, which is closely bound up with the steering problems of the mariner and aviator, and is related with those strange and marvelous manifestations of nature known as the Northern Lights, or Aurora Borealis?

This great earth of ours, with its more than 80,000,000 square miles of land, and something like 120,000,000 miles of water, is in effect a giant magnet possessed of imaginary poles that have a tremendous drawing power. The fact was discovered 'way back in 1600, and since that time the world of science has sent explorers to the most remote corners of the globe to probe new theories on the subject.

To William Gilbert, famed Englishman, goes credit for the original discovery. He pointed out that there is a marked parallel between the action of an ordinary magnet and the widely separated poles of the earth. It will be found by trial that there are two places in a magnet, near each end,

at which the attraction is greatest, and that there is a neutral line near the middle where the effect of the attraction dwindles to zero.

Of course there are no actual magnetic poles within the earth's confines, but the imaginary poles, mentioned by Gilbert, have been computed on the basis of expeditions conducted throughout the world, so that authorities now agree that the north magnetic pole is about a thousand miles from the north geographic pole, just inside the arctic circle and a little distance north of Hudson bay; whereas the south magnetic pole is down on the south polar continent, below Australia.

Fairly recent exhaustive tests have indicated that the sun likewise has a magnetic field, substantially like that of Mother Earth. Daniel L. Hazard, expert on magnetism of the geodetic survey, even goes so far as to say that it is probable that all celestial bodies are surrounded by such fields. Indeed, it has been suggested that



# NORTHERN LIGHTS?

every large rotating mass, such as the earth, in a manner not yet determined is an electromagnet endowed with stupendous magnetic force.

Ever since it was first observed that a magnetized piece of iron would assume an approximately north-and-south position if permitted to move freely, navigators have experienced difficulty in shaping their courses. The trouble has been that at certain times and in different places the compass points considerably away from an exact north-and-south direction. This variation is due to the fact, as observed above, that the magnetic poles do

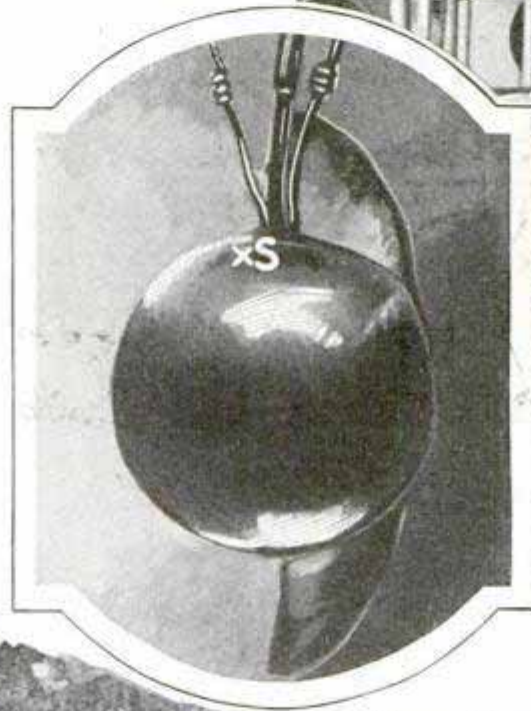
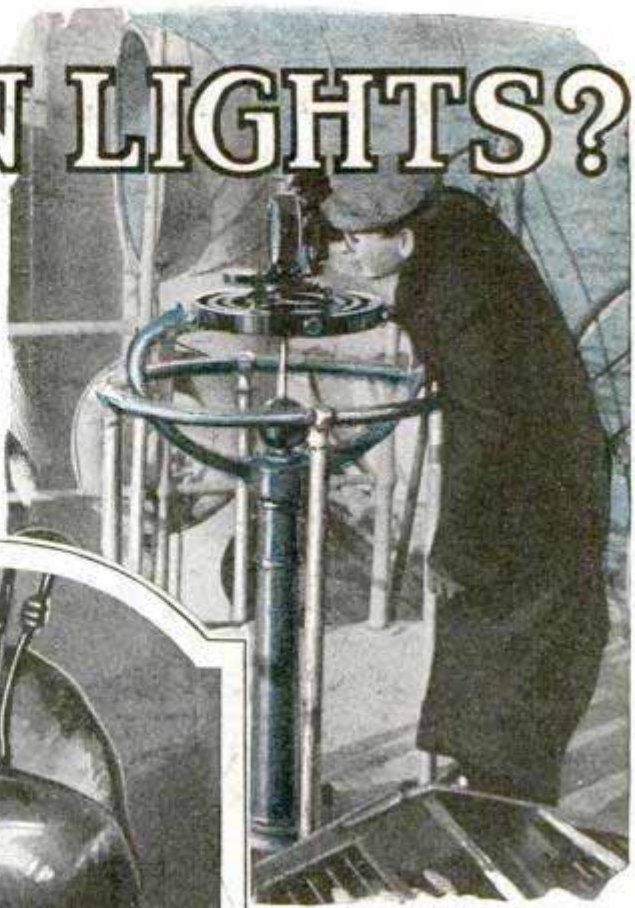

not coincide with the geographic poles.

This discovery was made by none other than Christopher Columbus. Today, the fact is borne out even more strikingly. At points along a line run-

ning through eastern Kentucky and Tennessee and thence through South Carolina, the compass points directly north. At all localities in the United States east of this line, the compass points west of north; at all places west of the line, it points east of north. The extremes of compass variation in this country are found in Maine and in the state of Washington, ranging from twenty degrees west of north in the one locality to twenty-five degrees east of north in the other.

Not only does the north magnetic pole lie about a thousand miles from the north geographic pole, but it seems to lie far beneath the earth's surface. Consequently in the northern hemisphere the compass does not come to rest in a horizontal position but dips downward. Along a line running near Washington, D. C., and St. Louis, thence northwest to a point near



Courtesy Carnegie Institution

Observing Magnetic Dip at Sea; a Magnetized Iron Sphere Demonstrating Possible Cause of Northern Lights, and Scientists Burying Electrodes



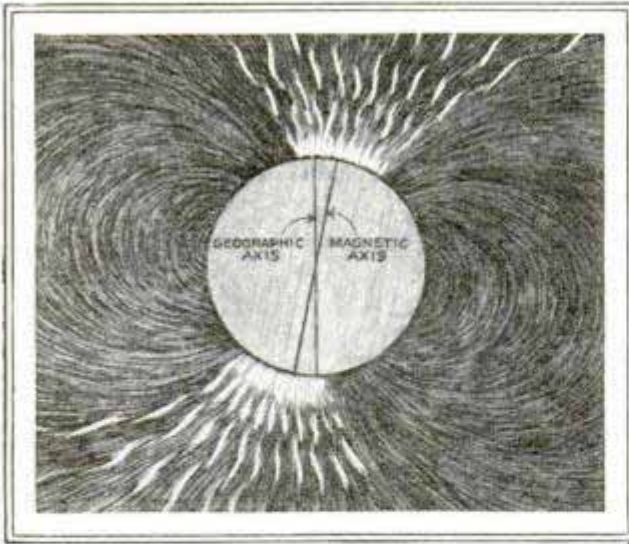

Seattle, it dips seventy degrees. In general, as one goes northward, the dip, or angular distance from Mother Earth, increases until it becomes ninety degrees over the magnetic pole.

Besides this curious fact, it is known that magnetic conditions are slowly changing throughout the world. At the present time the dip is increasing slowly in most parts of the United States, while the north end of the compass needle is ever moving slowly westward.

In an endeavor to map completely the earth's magnetic field, the Carnegie Institution has sent out no less than 170 land expeditions. Observations covering more than a million miles have been made at 5,700 points. The experts have penetrated remote portions of the globe, oftentimes amid great difficulties and dangers. Among the most notable of these expeditions may be mentioned: the complete crossing of the Sahara from Algeria to Nigeria; a caravan trip from Peking to Turkestan and across the Himalayas to India; the crossing of central Australia; the crossing of Africa in the equatorial and southern regions; hazardous journeys in Central

and South America; difficult trips into the interior of Asia Minor and Persia, and extensive expeditions by canoe into the little explored regions of British America.

In 1899, a systematic magnetic survey of the entire country was begun by the government. It has now been completed. To meet the needs of local surveyors, the work was based largely on the county subdivision of states, with a magnetic station at every county seat. Most of the stations were marked in a permanent manner, so that they would be available for future use. At intervals of about five years,

observations have been repeated at selected stations distributed over the whole country, to keep track of changes.

Closely allied to the consideration of the earth as a great magnet is the study of the peculiar electrical situation in the space surrounding the globe. Magnetic storms, which mysteriously cripple our telegraph and telephone systems, arise from unknown electrical causes and scientists are working overtime these days in an effort to shed light on the subject. Instruments have been devised which work on the

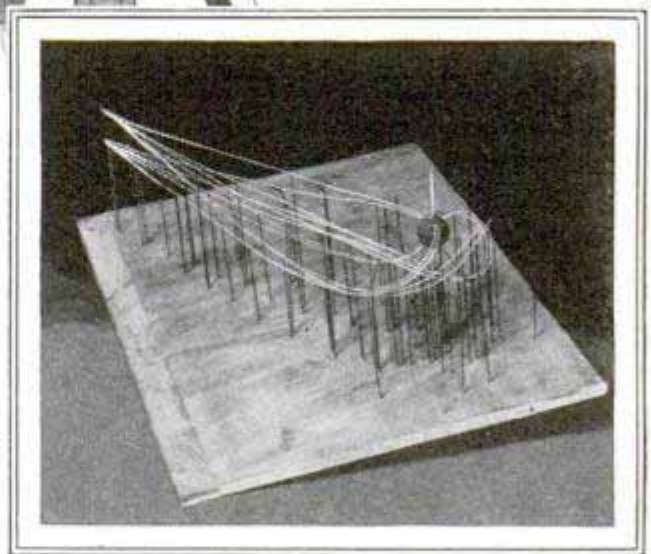

At Top, Model Showing Earth's Lines of Magnetic Force; Center, Scientist Studying Atmospheric Conditions, and, at Bottom, Model Explaining the Aurora



automatic principle, continuously recording the strength of the atmosphere's electrical discharges at different points.

While the origin of the electrical currents on and around the earth is not known, there is abundant evidence that from some source or other the charge is constantly replenished. Certain investigators have made tests which they claim indicate that the sun is the cause of the renewal, while others say lightning discharges may be the cause. However, one point meets rather general approval—that somewhere high above the earth's crust there exists a layer of air possessed of an electrical conductivity enormously greater than that of the air we breathe. Observations from balloons and high mountains back this theory, which is further substantiated by thorough investigations of the behavior of radio waves many miles above the earth.

Then again, it is well known that transatlantic radio transmission is better in winter than in summer and that distant stations can be picked up more readily at night than during the day. In their attempts to discover the why of these conditions as well as the reasons

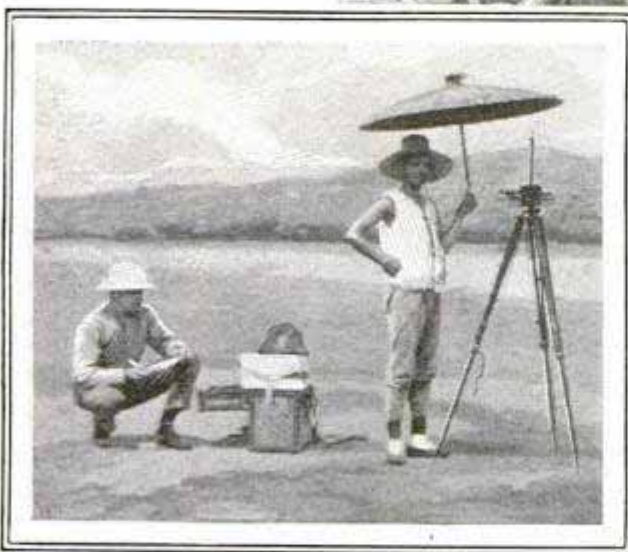
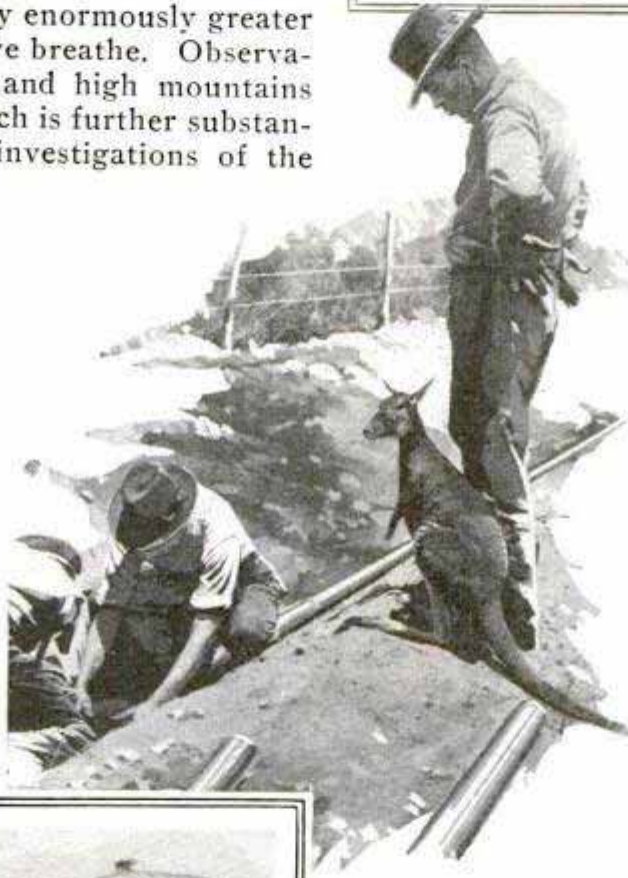
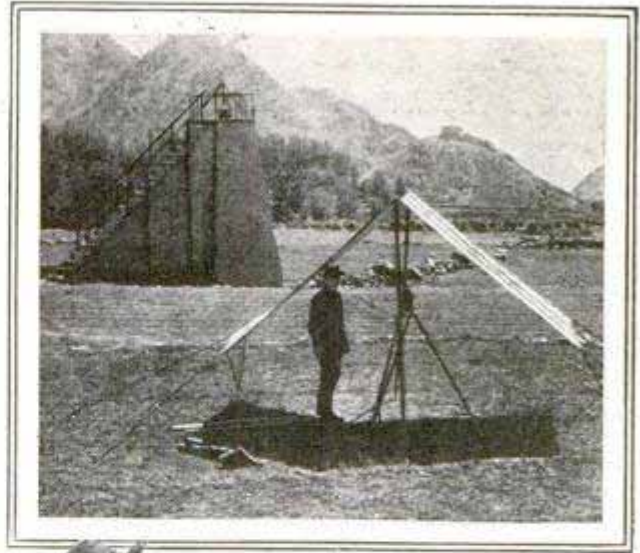

Top, an Eclipse Station in Far-Away Tibet; Center, Magnetic Study in Australia, and, at Bottom, Workers under the Burning Desert Sun

for the fading of radio messages, investigators likewise have endorsed the theory claiming the existence in the upper air of a belt in which electrical conductivity is much greater even than has been found in the highest balloon observations. Various theories have been offered to explain the existence of the earth's great magnetic field. Certain scientists believe that magnetism arises from the earth's habit of continuous rotation. They point out that tests have

shown that a piece of iron may be magnetized by rotation.

As for the Northern Lights, the highest visible natural phenomena in the earth's atmosphere, their study, in the words of Charles F. Talman, of the U. S. weather bureau, constitutes the most romantic chapter in the history of upper-air research. Certainly their characteristic manifestation is so colorful and luminous as to hold the imagination spellbound for long moments. Most of us tend to think of the auroral displays as being characteristic only of the northern United States and sections of Canada. But Mr. Talman



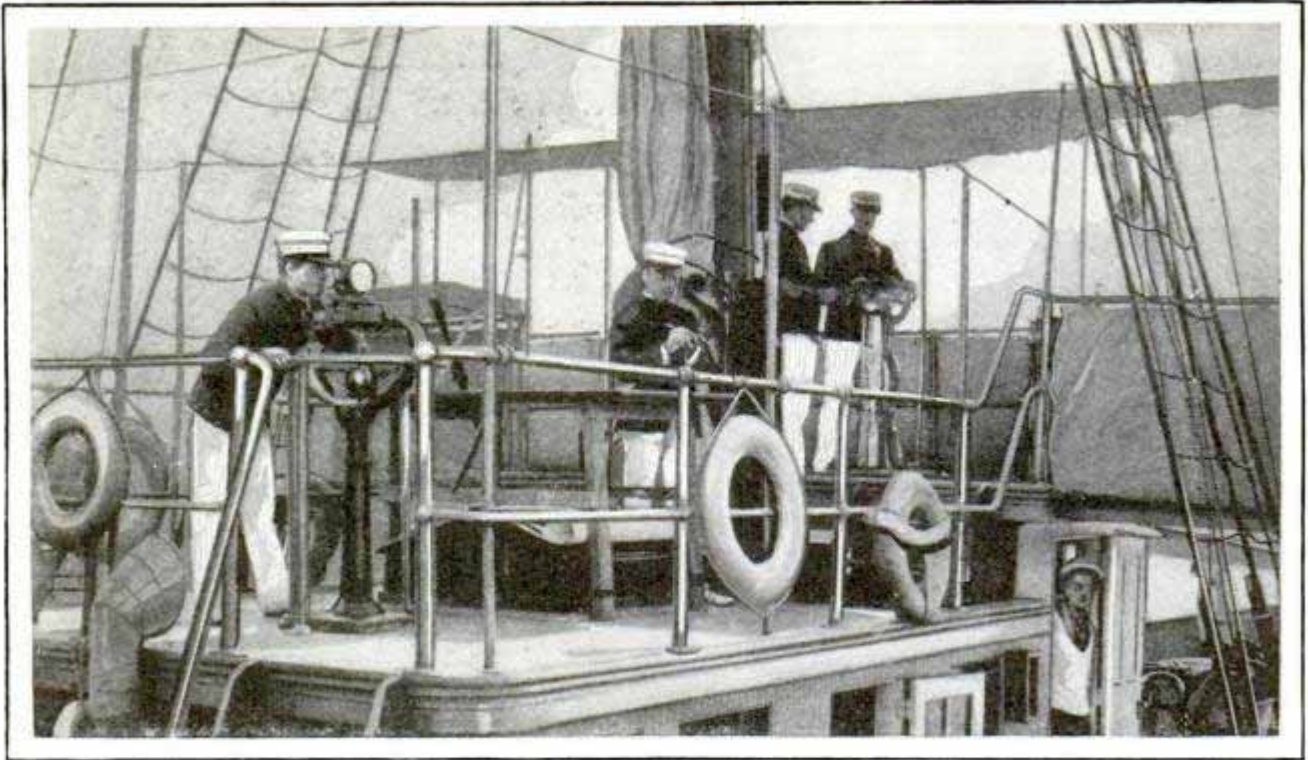

Courtesy Coast and Geodetic Survey

Scientists of the Carnegie Institution Making Magnetic Observations Aboard the Famous Ship "Carnegie," Which, Because of Its Construction, Is the Only Non-Magnetic Vessel Afloat

explains that the Northern Lights are actually more common in Europe than in America. Often they take a distinct arch shape, but then, too, they are liable to light up almost the entire sky with their varicolored beams and massive curtains.

Well up in the arctic regions there is more or less of an irregular belt in which the displays occur with some frequency, sometimes being visible south, rather than north, of the observer. People in the torrid belts occasionally see the aurora, notably the East Indians and the northern Africans. The southern hemisphere offers similar displays, occurring with like frequency, and known commonly as Aurora Australis.

Notable among the scientists who have made careful probes of the magnificent Northern Lights have been the Norwegians, particularly Professor Birkeland of the University of Christiania, and Prof. Carl Stormer. As a result of their investigations, they have agreed on at least one substantial point—that "an auroral display is an electrical discharge in the rarefied gases of the upper atmosphere, probably produced by the absorption of cathode rays in the upper air that were attracted to the earth's magnetic poles." Professor Birkeland goes on to explain

that cathode rays from the sun are at the root of the aurora, setting up electric currents in the atmosphere which in turn give rise to more cathode rays. Not long ago he supported his theory by the feat of producing artificial auroras within his own laboratory.

Using a magnetized steel ball to represent the earth, he suspended it in a tube almost entirely exhausted of air and exposed to cathode rays. Professor Birkeland's colleagues were highly pleased with the results of the tests, particularly since they resembled so closely the conditions under which the genuine auroras probably are produced by nature, master magician. The steel ball was given a phosphorescent coating so that the sphere glowed in realistic fashion in two zones located in miniature relation to the earth's auroral belts.

#### PORTABLE ALARM ON RAILWAYS PROTECTS SECTION GANGS

1291 Portability is the essential feature of an alarm bell for railways to warn section gangs of an approaching train. It is electrically operated and consists of a switch, which is clamped to the flange of the rail, is closed when the train runs over a cam, projecting slightly above the rail head.

*Illustrated Technik*  
8/17/28



1261

and is opened again by coil springs after the wheels of the cars have passed the cam. Electrical connection, to a bell alarm at the place where work is going on, is thus established and broken, causing the bell to ring intermittently as long as the train is running over the switch. By arranging the switch at a suitable distance from the section gang, in either direction from the crew on a single track and on both tracks of a double-tracked road, the workers receive warning of a train's approach in ample time to seek safety. The switch is sturdily constructed to stand shocks, and all parts are protected against the weather. Instead of a bell, a light can be installed or both may be used to make the device more effective.

### BEVEL GAUGE AND RULE IN ONE ALSO SERVES AS COMPASS

Several useful tools are combined in a single pocket unit for the carpenter, mechanic or other worker. It consists of a ruler attached to an angular frame, the sides of which are shaped to align the rule at different angles to the right or left for making bevel cuts. By placing a pin through a hole in the point of the frame, the unit can be swung about as a compass, and under the ruler is a spirit level. Almost any rule, two feet long or so and not too wide, can be used with the holder, which has a socket and screw for keeping the rule in proper position. The meas-

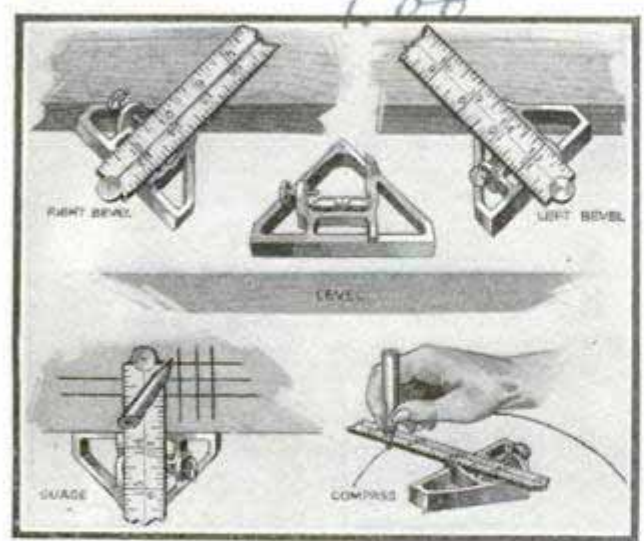

Typical Uses of the Combination Bevel, Gauge and Level Showing Ease of Adjustment

ure is quickly removed when the gauge is to be placed in the pocket.

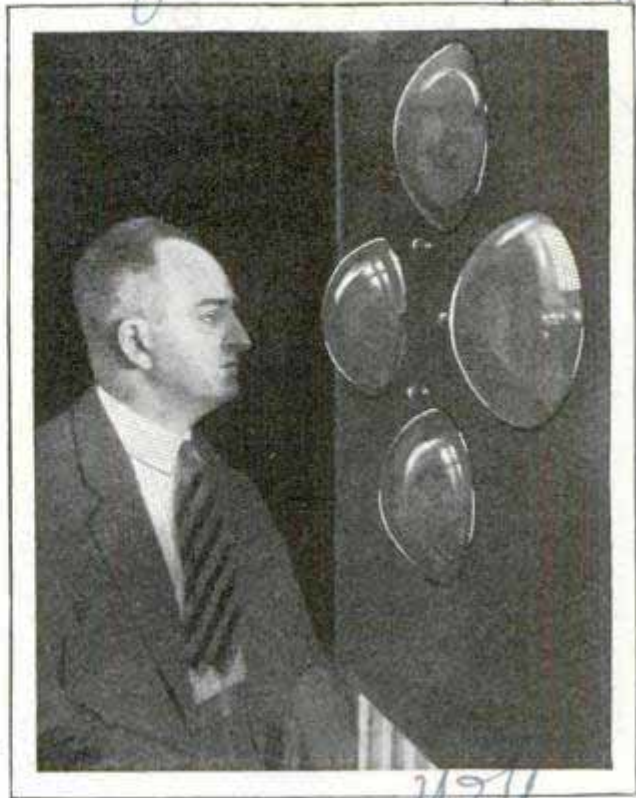

Behind Four Large Lenses Are the Photo-Electric Cells That Change an Image into Electrical Impulses

### FOUR LIGHT CELLS ARE USED TO BROADCAST FACE

Four photo-electric cells, receiving light from huge condensing lenses, were used in a public demonstration of television at the recent New York radio show. By dividing the burden among four light-sensitive tubes and then combining their output, a more sensitive television is obtained.

### RUBIES CARRIED BY AIRPLANE — TO FOIL JUNGLE THIEVES (130)

To avoid the animals and robbers that have menaced convoys through the jungles from the ruby mines of Burma, still rich although worked for many centuries, engineers are planning to transport the gems by airplane. Strong guards have to be sent with the porters as the rubies are of the famous and exceedingly valuable pigeon-blood variety, and although the journey is not a long one, it continually presents difficulties to the mine owners. Should the plan be executed, the use of the planes would seem a curious fulfillment of a native legendary superstition which holds that sometimes in the dead of night, a mysterious white bird swoops down on the mines and carries away a priceless gem in its beak.

*Have a specialty*  
*Mrs. C. 240*

*Chicago Daily News*  
*8/30/28*



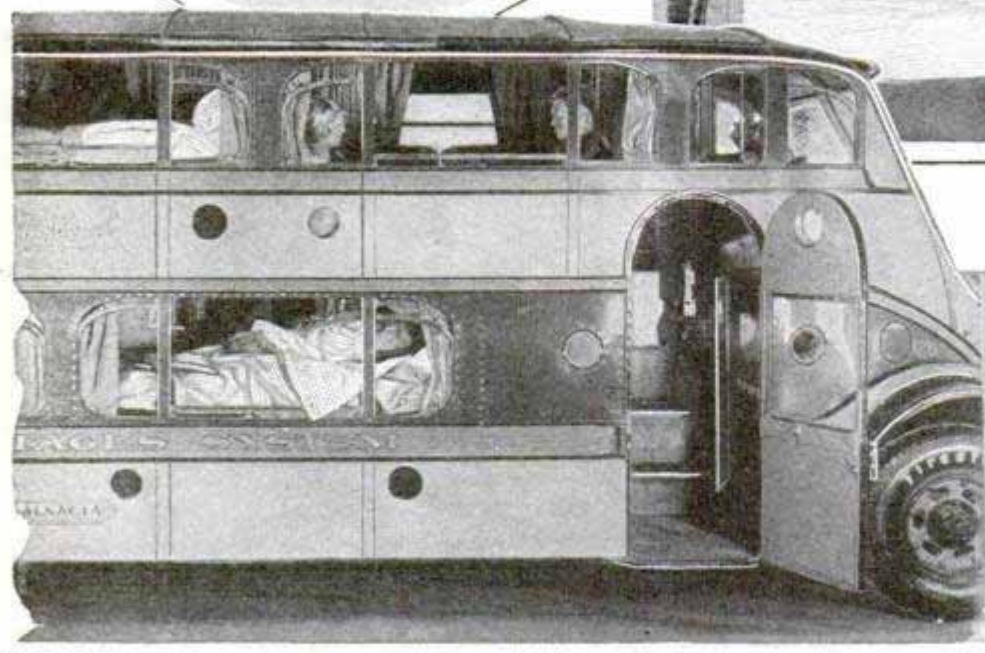
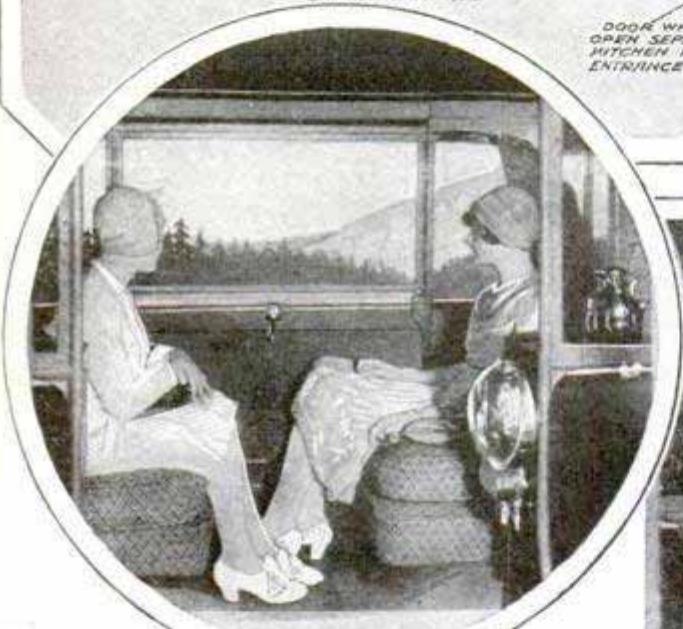
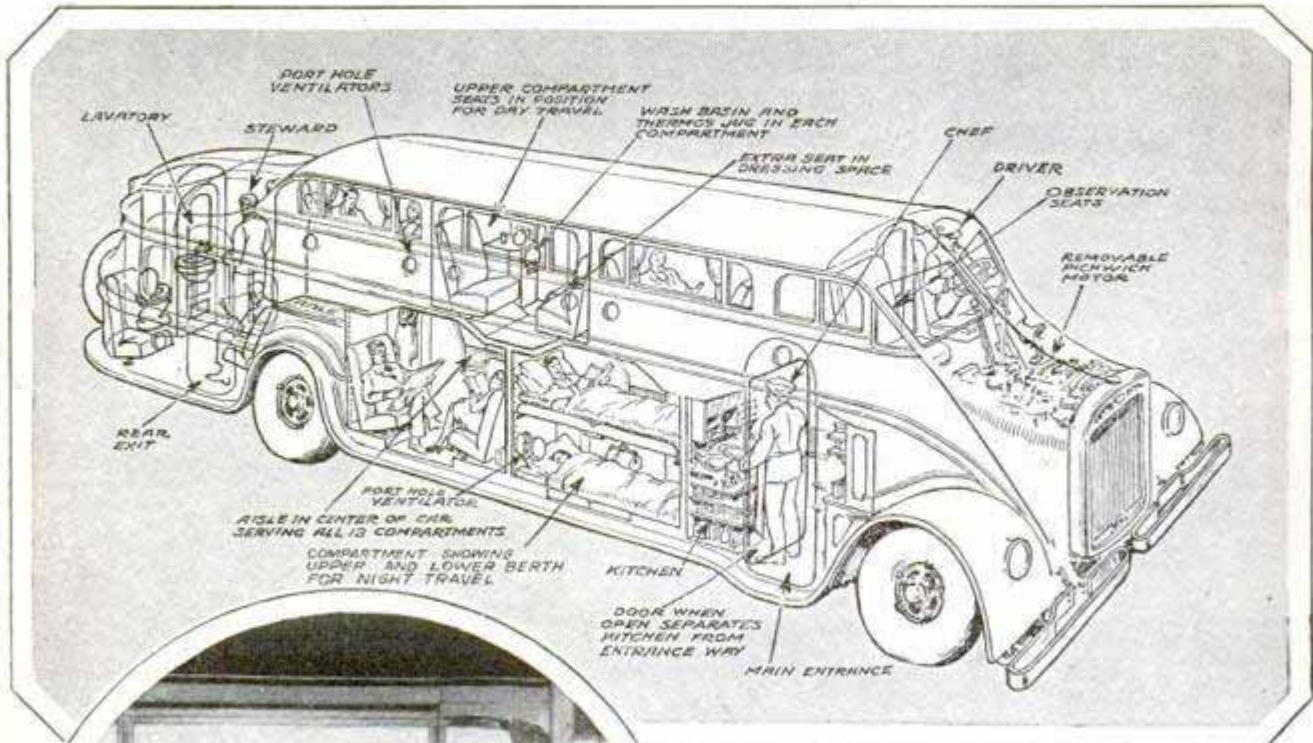

The Motor-Coach Sleeper, Showing the Arrangement of Berths at Night and Seats by Day, and, at Top, a Diagram Illustrating the Positions of the Driver, Chef, Steward and Passengers; the Car Is First of a Line Which Will Run from Los Angeles to Vancouver, and Later May Extend across the Continent



*Pickering Page 4 me.*  
*717th Los Angeles St*  
**POPULAR MECHANICS**  
*Los Angeles, Calif.*

1238

**PULLMAN OF ROADS INCLUDES BERTHS AND DINER**

1176

A Pullman of the highways, with berths for twenty-six passengers, kitchen and dining facilities, and all the other features of a de-luxe railroad train, has been completed in California as first link in a coach line that will reach from Vancouver, B. C., to Los Angeles, and later may be extended across the continent. The motor sleeper-diner is thirty-four and a half feet long, eight feet wide and stands ten feet three inches high, being exceptionally low for a double-deck coach, because of its unique construction. The car, which weighs 14,000 pounds and cost \$30,000 to build, has no chassis in the ordinary sense. Instead, a heavy steel I-beam around the car just beneath the lower-berth windows provides means for carrying the under-slung body and also furnishes protection for the passengers in event of accident. The driver sits above the engine instead of behind it, and the engine itself, a special 110-horsepower motor, is so mounted that it can be removed and a new one installed in twelve minutes. Complete engine assemblies are to be carried at the terminals for change in event of trouble. The thirteen two-passenger compartments, which, like Pullman berths, become seats by day, are reached by a step down or a step up from the central aisle. Each berth is six feet four inches long.

*amt: 1201*

**GAS-TANK CAP FOR NEW FORDS PROTECTS COWL IN FILLING**

To keep gasoline from spilling over, when one is filling the tank of the new Ford cars, a combination tank cap and drip pan has been devised. It is attached in place of the standard cap, with a large collar nut, and, in appearance, is similar to the cowl ventilators on many cars. It also prevents splashing fuel on the windshield.

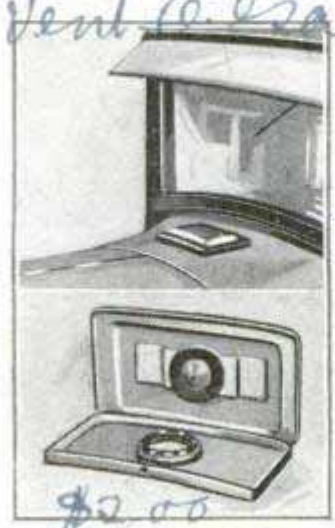

*\$2.00*

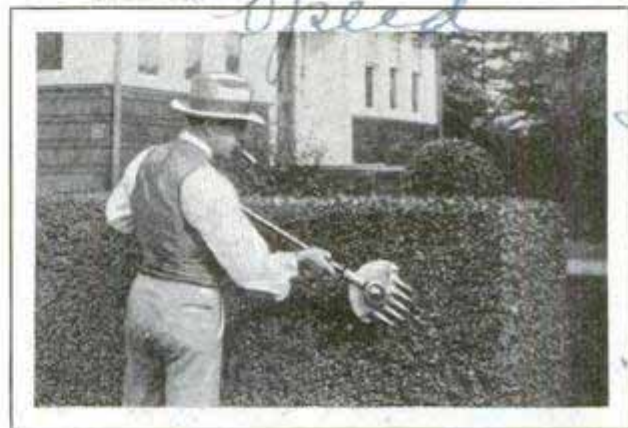
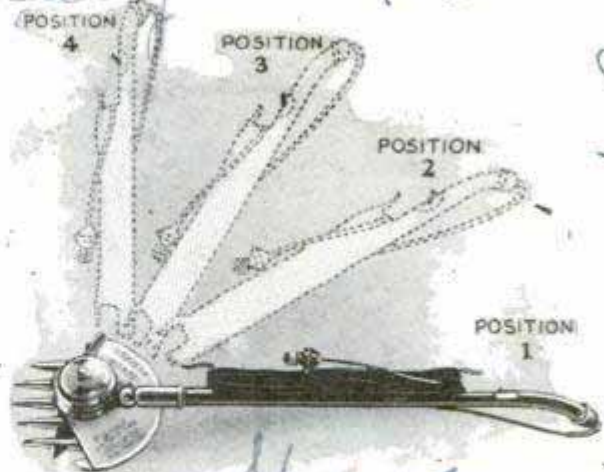

*Speed*

Using the Electric Hedge Trimmer, and Drawings to Show Positions to Which It May Be Adjusted

**ELECTRIC TRIMMER FOR HEDGE PROLONGS LIFE OF VINES**

Besides saving time and work, an electric hedge trimmer, recently introduced, is said to leave the plants in better condition than when using a hand cutter, as it produces a smoother surface and cuts with a natural drawing stroke. The unit is operated on either alternating or direct current from any convenient lighting socket, has 100 feet of cord and a blade that revolves past slotted points that draw the vines to cutting position.

*Letter recd 10/14/32*  
*45.00*  
*newark N.J.*

**INVISIBLE RAY TO PIERCE FOG GUARDS OCEAN LINERS**

1277

Among the equipment on two German liners recently launched, is an apparatus for projecting an invisible ray that penetrates fogs. The beam is said to increase by twenty times the distance through which the human eye can see, is as efficient by night as it is by day and retains its power even in fogs. It is expected to play an important part in promoting greater safety at sea.

*The Commercial Ind Co*  
*817*

*Herald Examiner*  
*8, 27, 28*



Cont. - George M. S. Inc.  
R. 809, 537 S.

Auto Notes. 8/11/28

800

1246 *Dearborn, Chicago*



Placing Pigeon in Its Berth for a Trip on Dog Back to Soldiers at Distant Point

### PIGEONS CARRIED BY DOGS TO HELP IN TRAINING

Carrier pigeons acquire the ability to return home largely through training, and one of the methods used in the army is to send the pigeon to soldiers stationed at distant points where the birds are released and allowed to fly back. Dogs have been taught to carry the pigeons in one army unit. A harness with side pockets is strapped about the dog, the pigeon placed in one of the pockets and taken safely and comfortably to its destination.

### RADIO PHONES ON WHALERS KEEP FLEET TOGETHER

Science has been changing many of the time-honored methods followed by the whaling fleets. Harpoons are no longer hurled by hand but by guns, improved ways have been developed for lifting and cutting the whales when they are caught.

1246 *Chicago Daily News 8/11/28*

and now the fleets are installing wireless telephones to help keep the boats from losing their mother ship. This reduces anxiety and saves wasted time while enabling a more efficient movement of the fleet when on the hunt. Radio direction finders are employed with the telephones to help guide the vessels.

### WIRE WHEELS DISPLACE DISKS IN AUTOISTS' FAVOR

1246

The steel-disk wheel, which a few years ago threatened to eclipse the old-style wooden artillery type, has in turn been displaced by wire wheels, according to production figures for the first half of 1928. The output of wire wheels, on the basis of figures for the first six months of the year, will exceed one million for the first time, while the disk wheel output will drop below the million mark for the year. The preliminary figures show an increase in wire-wheel manufacture of more than 800 per cent since 1925, while, in the same period, the disk-wheel output has dropped to one-third of what it was at the peak. The changing fashion in wheels is attributed partly to the general introduction, on high-priced cars, of the practice of carrying two spares mounted on either fender, as practically all cars coming equipped with six wheels use the wire-spoke type. Another contributing factor has been the reduction in cost of wire wheels through improvements in manufacturing processes.

### PISTON SETTER SAVES TIME AND FITS ALL SIZES

1197



To simplify the task of setting pistons in the cylinders, a spring frame holder keeps the rings in place and enables the operator to use both hands. The holder accommodates all sizes.

Whenever you find that you wish to know more about any article in this magazine, write our Bureau of Information.

*Chicago 2019 S. Memphis Ave*  
*Ken. Moore Organ. General Motors*



**POCKET RADIO TRANSMITTER HELPS TREAT DISEASE**

By treating them with ultra-short radio waves, a German investigator reports that he has successfully kept mice from dying of tuberculosis. Thirty of the animals were inoculated with the germs of the disease. Fifteen of them were subjected to the radio waves and the others left untreated. After a month, the former group were alive and well, but all the rest died within a short time. There is considerable danger in using the rays, the experimenter reports, as they increase the temperature of the human body one degree centigrade per second and also cause the disintegration of some of the cells of the body. In connection with his tests, he has developed a radio transmitter, smaller than a cigar box, and has used it in sending wireless messages a considerable distance even with a small amount of energy. He is able to send telephone messages with ultra-short waves of but three meters length.



Every Car a Road Sweeper with This Set of Magnets That Gather Nails and Other Metal Hazards

**MAGNETS ON AUTO BUMPER CLEAR ROAD OF NAILS**

Automobiles are being fitted with magnets attached to the front bumper a few inches above the pavement, to gather nails and other bits of metal that might puncture the tires. Current is supplied from the car's generator, and the magnets are placed sufficiently high to prevent damage over bumpy roads. With this arrangement, individual cars perform much the same function as the special road-sweeper magnet trucks that have been used by automobile clubs and other associations.

**PEEP GLASS IN HOUSE DOOR HELPS FOIL INTRUDERS**

So that the housewife may see who is knocking, a glass lens, set in a metal frame in the door, has proved an effective means of preventing the entrance of tramps or other undesirables. It is placed so that the person inside can see the one outside clearly without opening the door.



Making Sure Who Is on the Other Side of the Door; the Peephole Helps Bar Intruders

**PAPER SUITS FOR FIREMEN SEEN IN NEW PROCESS**

As a result of the process he has developed for fireproofing paper, a German chemical engineer predicts that firemen will be equipped with paper suits when entering burning buildings, that safes can be made of the material in compressed form which will resist blazes, books can be made which will not burn, and many other uses will be found for the substance. In a recent test, he wrapped a newspaper in a covering of the fireproof paper and held the ball over a flame that would have melted glass or burned a hole in a plaster wall. The wrapping was not damaged, and the paper inside was not even scorched after a few minutes' exposure to the blaze, according to reports.

*Sechenheim & Necher Germany*

*1207 Cykoauto mag*  
*Chicago Cant locate*  
*The Bill. O. Bernie Co.*  
*Cali. 0945, Belar rd 72 E 14th St. Chicago*

*\$15.00 per set.*

*1244*

*28, Holsteinische Strasse, Berlin, Wilmersdorf.*

*Ant. Karl, 2442, Kapitänleutnant, der*

*H. Rang (Frank) Berlin Germany*



*Ans. W. I. Varky*

*10th Ave 36th  
New York*

*211 Portland Ave.*

*2/1 Acme Commercial Photographers, 5th & Clark Sts.*



Electric Barbecue for the Lunch-Room Counter; the Knife Sharpener Is at Extreme Left

### MEAT ROASTER TOASTS BREAD AND SHARPENS KNIVES

For drug stores, lunch rooms and other places serving meals, an electric barbecue occupies little space on the counter and can be used for frying or toasting. It also has attachments for sharpening knives or polishing silver.

### PLANE RUN BY REVOLVING WING FLIES WITHOUT PILOT

Foreign aviation experts have been interested in experiments with an airplane that is propelled by a "hub screw" revolving wing, twenty-three feet long, which turns horizontally. Tests have been made without a pilot and the ship is reported to have risen from the ground successfully.

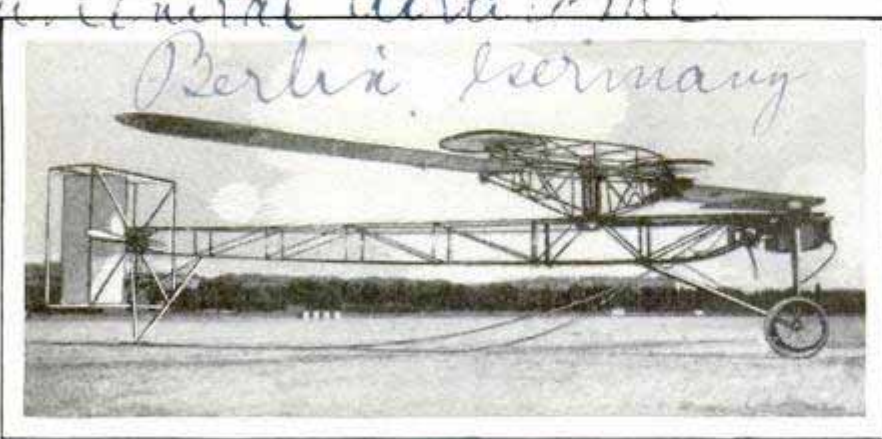

Odd Plane Which Is Reported to Have Flown Successfully in Tests without a Pilot; the Long Wing Revolves Horizontally

### DIESEL ENGINES MAY DISPLACE SUPER-POWER PLANTS

Super-power, the hooking together of electric generating plants throughout the country with long transmission lines, a development that seemed assured as late as two years ago, may be abandoned as a result of the latest developments in the electrical industry. For small Diesel-engine-driven generators are proving so efficient that they are rapidly being installed, particularly in the southwest. The reason for super-power was that the efficiency of a steam-boiler plant and the efficiency of a steam turbine increase with their size. It was cheaper, therefore, to build one giant plant and then transport the output for long distances over high-tension wires than to build a number of smaller plants. For the first time in power history, however, the small Diesel engine offers a prime mover as efficient as a large one. Hence, in communities where the power load is not strung out along miles of line, a small Diesel plant is cheaper than one large generator station, with transmission lines to widely separated communities.

### FINE DUST FROM VOLCANOES AFFECTS WEATHER?

Does a big volcanic eruption have a direct effect upon the weather? Studies made by Prof. W. J. Humphries, of the weather bureau, and by other scientists indicate that there probably is a connection between these phenomena and the weather conditions over a wide area, perhaps over the entire world. The reason is believed to be that the volcanoes, shooting enormous quantities of dust high into the air, thereby form a veil which has a marked effect on the degree of heat that reaches the earth from the sun's rays. In 1816, the "year without a summer," there was a marked change in weather conditions the world over. Just the year before, a terrific explosive eruption of the Tomboro volcano had occurred. Again in 1883,

*Cont. George H. Paul  
1. 8. 19. 5. 3  
215  
a. General Aerodrome  
Berlin, Germany*

*Ans. Engineer Paschka,*

*Service Bureau  
Bulletin 285 71*



*Schweitzer, Chief*

the East Indian volcano Krakatoa shattered the island on which it stood and killed 35,000 persons. Three years later, Alaskan and New Zealand volcanoes were active, and the low-temperature period that followed this group of volcanic explosions was second only to that of 1816. Four eruptions of note have occurred this year, although none of them compares with the disturbances already mentioned. Scientists point out that there is no way of telling whether they may be merely the preliminary bouts of a really huge outburst which may again bring us a year without a summer.

**CAT SERVES AS LIVING BRUSH TO HELP CLEAN PIPE** *12 14*

Until recently, the pet cat in a western factory lived a life of ease and indolence, but the animal is now hard at work helping to clean the interiors of long pieces of pipe and apparently enjoys its occupation, the shop managers report. It had been the custom to roll a small bowling ball, with a string attached, through the seventy-foot pipe which was ten inches in diameter, but this proved a slow and often hard task even for the shop's best bowler. After the string was passed through, it was attached to a small rope and when this was hauled through the pipe, a cable was connected and a plunger pulled back and forth to clean the pipe. One day, the pipe man saw the cat dozing near by. He was struck with an idea. He seized the animal, tied a string about its neck then placed the cat in the pipe. The outside was pounded gently with a hammer and the cat scurried through to the other end, emerging with the string, which was quickly attached to the rope and the cleaning accomplished in a fraction of the time formerly required. The cat now does its pipe dash several times daily.

*For class and individual management*

**ELECTRIC WINDOWS FOR INSIDE GIVE OUTDOOR EFFECTS** *1184*

To brighten gloomy interiors, a false window, electrically lighted and showing

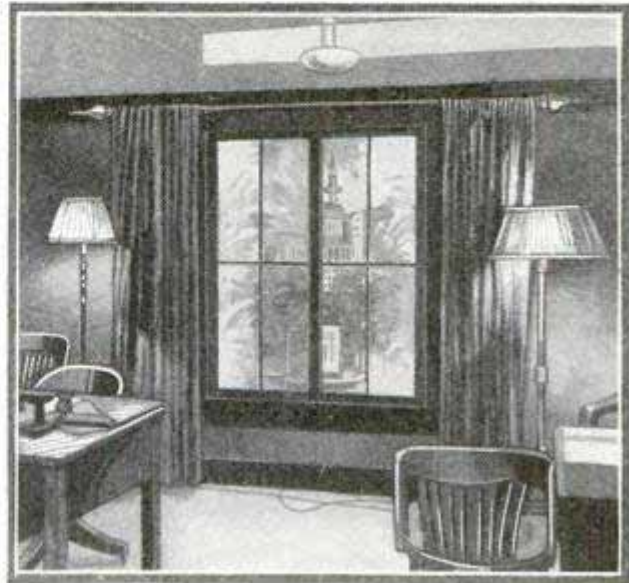

False Window with Electrically Lighted Background, to Give Outdoor Appearance to Basement Room

what appears to be an outdoor scene, has been introduced. It is portable, can be set up in a few moments and electricity is obtained from a wall socket. The window is intended especially for basement restaurants, sales rooms and other places where a natural view is lacking. Where these installations have been made, it is said the depression felt by workers in such surroundings has been greatly alleviated.

**TRICYCLE OPERATED BY ROWING AFFORDS GOOD EXERCISE** *1106*



Tricycle Propelled by Rowing; It Develops Considerable Speed

Rowing on dry land is the healthful exercise derived from a tricycle unit introduced in France. *ins.* The main wheels are operated by two "oars" or handles, which in turn work a chain and sprocket gear. A small guide wheel in front facilitates steering, done by pulling harder on one handle than on the other. Coil springs attached to the oars facilitate the strokes.

*cannot locate Wide World*

*Electrical Engineer, Commercial Bldg. 92 W. Adams, Chicago*



923

# Crashes

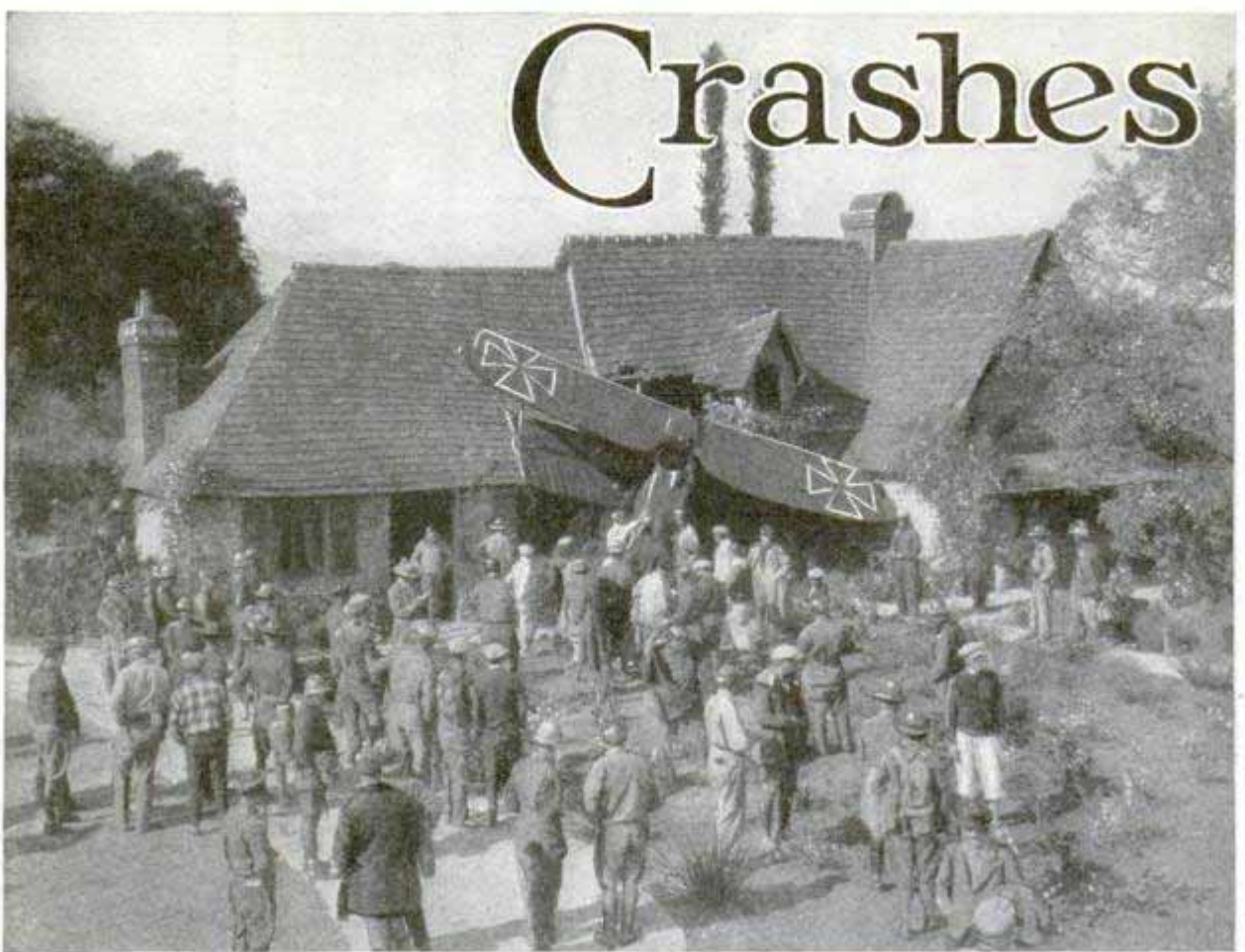

Movie Players Inspecting the Wreck of a German Fokker, Which Was Crashed into the Roof of a House during the Filming of a War-Time Aerial-Thrill Picture in Texas

By LELAND S. JAMIESON

A SMALL group of movie actors were crowded around a camouflaged Spad airplane. The pilot was talking with the director of the picture. From time to time he looked up and examined the ground in "no man's land" appraisingly.

"Just take it easy," the director was saying. "If you can't get free of the cockpit and down into the shell hole right after you crash, just take it easy and don't spoil the shot. I'll have plenty of men out there to help you after the scene is made. You don't need to be afraid of fire; I'll have a whole fire department right there."

"But, Bill, you've got your camera men in such a position that I'll have to fly over no man's land down wind. I'll have ninety-miles-an-hour speed when I hit the wire, can't you put them on the other side of where you want me to crash?"

"No," said the director, "the light's bad that way; you'll have to do it this way."

The pilot shrugged his shoulders. "All right, but you be ready to pull me out."

"We will. Well, good luck, Dick." They gripped hands for a brief second and the pilot clambered into the plane. The group of movie people scurried back to safety from the whirling propeller as the plane swung around and into the wind. The ship thundered into the air, leaving a cloud of drifting dust and a group of apprehensive men and women.

The Spad climbed and spiraled up in wide, graceful circles. It disappeared into a fluffy white cloud. Then it reappeared, but this time there was a plane "on its tail," a plane which bore black crosses on each wing—a "German." The German ship was persistent, it could not be shaken by the Spad; it banked and turned and whipped through the maneuvers of the dog fight with deadly precision. The Spad rolled over on its back and started earthward in a sickening vertical dive. The Fokker rolled over likewise and started down. Both ships dived 2,000 feet and leveled out. The Spad was still in front;



# Made to Order

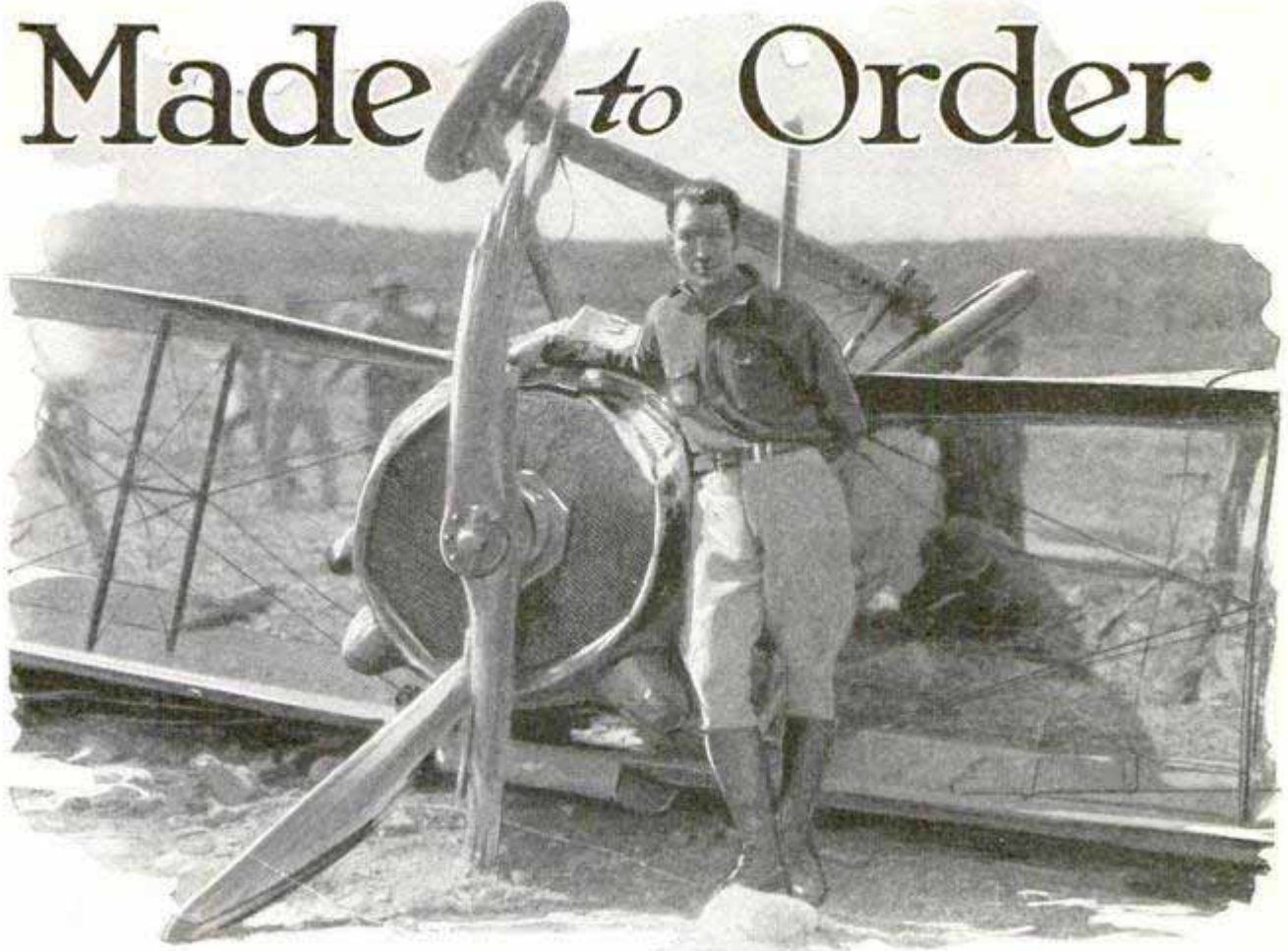

Dick Grace, Movie Dare-Devil and Stunt Flyer, Standing beside a Plane Which He Crashed into the Ground at a Speed of Ninety Miles an Hour

the German ship still maintained its position of advantage.

A thin gray wisp of smoke spurted from the Spad. The ship seemed to pause for a moment, then headed directly toward the battery of cameras. The camera men stood with hands on their cranks, waiting for the director's order to start grinding. The plane came on, lower and lower; it skimmed the wire of the "German Lines" and started across no man's land.

"Camera!" the director shouted through his megaphone. A dozen men commenced their slow grinding.

The plane floated out its speed. Suddenly it dipped, the landing gear hooked over a rugged cedar post, the nose smashed into the ground with violent force. There was a crunching of wood and a ripping of fabric. The nose of the plane buried itself in a fury of dust. The tail rose like a whip, careened over the buried nose and fell onto the ground with an ominous crash.

A figure scrambled out of the wreckage and paused a moment at the side of the

plane, apparently undecided as to where to take refuge from the spray of "bullets" from the German Fokker. The figure dived into a shell hole and lay still. The Fokker dived at the wreck again and again; then, with a flaunting zoom, it sped away toward its own lines. Thus one of the greatest crash scenes in motion-picture history was made.

It is placing a great strain on the layman's credulity to expect him to believe that the crash shots of the moving picture "Wings" are not "faked." Never before had such crash scenes been attempted; even the producers were doubtful whether they could be consummated successfully. Yet they were, and with only one exception, and that on account of the unavoidable destruction of one of the crash planes by a windstorm, and the scenes were real—in all essentials actually performed as shown in the finished picture.

How these things were accomplished has baffled the public. "How," many have asked, "can a pilot intentionally completely wreck an airplane and escape being hurt?"



In one scene, the scenario called for the shooting down of a German plane just as it took off in pursuit of an American pilot who had stolen a Fokker plane from a German airdrome. It was impossible to use a model airplane on this shot because of the evolutions the craft must perform just prior to the crash. Besides, a model does not possess the speed and the inertia to simulate an actual crash with realism, unless it dives straight into the ground. So it was necessary to use a real airplane, flown by a real, live pilot.

The stunt pilot who crashed the Spad earlier in the picture, volunteered for the job. It looked easy, compared with the first crash, for the ship would not yet have attained great speed and, in all probability, would not turn over when it struck the ground. But the pilot went about his preparations with the thoroughness which had marked his previous crashes. He padded the inside of the cockpit thickly with cotton and leather; he removed all sharp instruments and parts of the plane which would be a menace to his safety, and he built a special belt which could be placed around his shoulders to prevent his body from being snapped forward by the

suddenness of the impact when he rammed the ship into the ground.

The batteries of cameras were placed in the proper position and the scenes preceding the take-off were shot. The pilot, Dick Grace, cranked the plane and took off as nonchalantly as if he had been going on a hundred-mile cross-country flight. He jockeyed the plane into the air; then, when about ten feet above the ground and directly in front of the cameras, he shoved the control stick forward and slammed the nose of the plane into the ground. The landing gear collapsed, the plane ricocheted a few feet and skidded to a stop.

To those of us on the ground watching, it seemed a very ordinary and undramatic crash. But Grace did not climb out of the cockpit with his usual celerity, and after the cameras had stopped their grinding, he was lifted out. His entire right side was paralyzed. A subsequent X-ray showed that the fifth vertebra of his backbone had been dislocated and that one vertebra in his neck was broken. For



Grace, in Center, before the Wreck of a German Fokker, Which He Crashed; After He Was Lifted Out of the Cockpit, It Was Discovered His Neck Was Broken



three months he wore a plaster cast.

Grace was injured in a crash which was "mild" in comparison with a great many others he had performed for moving pictures. The fault was in the material of the belt; it had broken under the strain and his head and shoulders had been snapped forward with sufficient force to break his neck.

One of the great difficulties encountered in crashing airplanes for the movies is that the exact results of the crash can never be known until after it is all over. A crash which to the eye appears to contain all the essential thrills for the scene, may be, when reproduced upon the screen, a complete "flop." The cameras may have been taking the scene from a bad angle; the light may have been poor because of a passing cloud; the pilot may have inadvertently let the ship get too far away from the cameras before crashing it—any one of an unbelievable number of things may ruin the shot. And when a crash has been completed, the equipment has been destroyed and there may be no more to take its place. Hence directors must use utmost care in preparing the scenes.

In one picture it was necessary to have a German Fokker crash into the side of a stone house while in full flight. Naturally the plane and the house both would be wrecked. If the shot turned out badly, and a retake was necessary, it would require days to rebuild the house and procure another plane. Also, it was a foregone conclusion that the pilot of the plane would have only a remote chance of escaping the crash with his life. Therefore it was necessary to have the plane fly pilotless, into the side of the house.

After much calculation and discussion

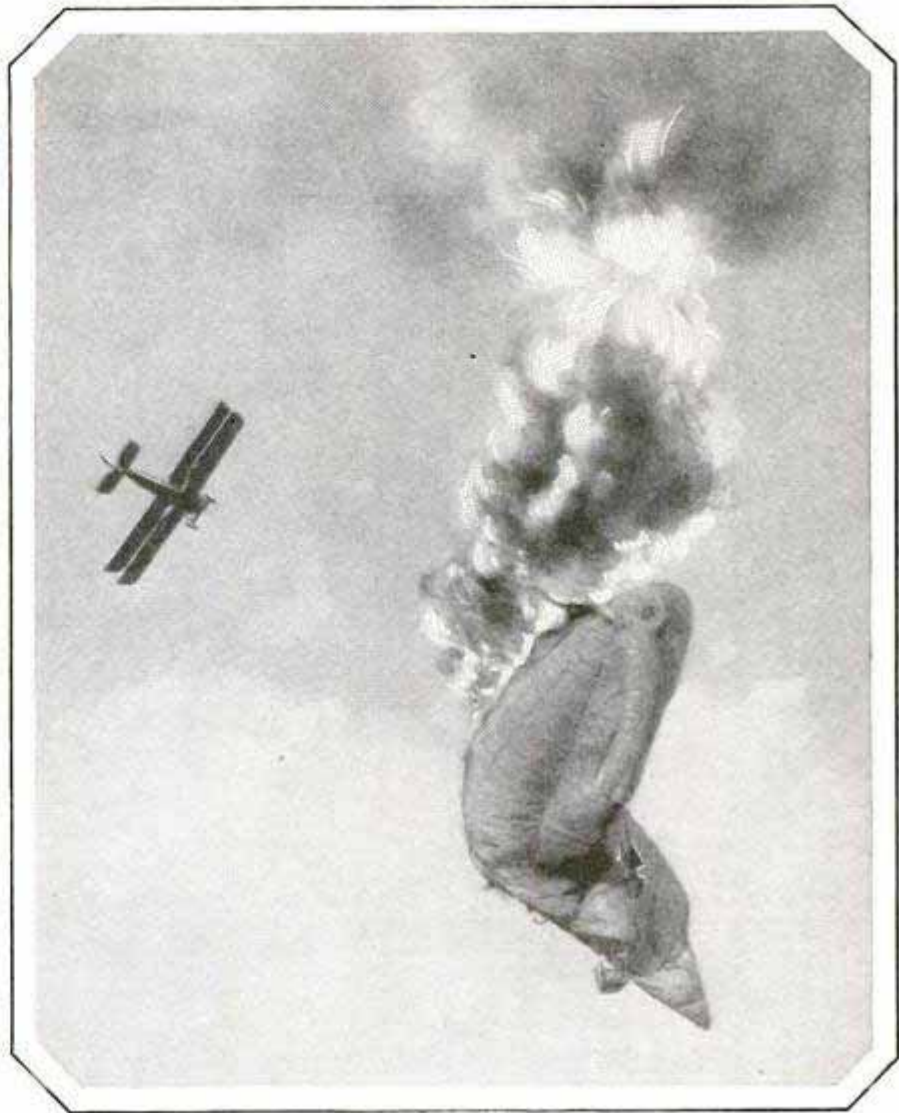

An American Plane Shoots Down a German Sausage Balloon in Flames as One Thrill for the Film

with his staff, the director hit upon the idea of constructing a high runway, from which the ship could be flown. Experiments were conducted with the plane, to determine exactly how long a run would be necessary to get it into the air, and the plane was rigged so that it would fly straight ahead rather than to either side. With all the available information at hand, the runway was constructed at a distance of about 300 feet from the house. Grooves were built which would hold the wheels and tailskid in place until the ship got into the air.

The plane was then dragged to the top of the runway and the controls lashed in a position to maintain normal flight. Chocks were placed in front of the wheels, the motor started and tested. A dozen camera men were stationed on the ground at various positions and, at a word from the director, began to crank. A mechanic





One of the Most Spectacular Shots Ever Made; the Camera Caught the Plane Just as It Was Turning Over on Its Back

by the side of the plane opened the throttle wide and stepped back; another mechanic jerked the chocks from in front of the wheels. The plane leaped forward and down the runway.

It gained speed so quickly that it rose into the air before it reached the bottom of the runway. Headed directly toward the house, it seemed about to climb over the building. If it should miss the house, it would go on into space, a wandering, pilotless juggernaut of the air. Just before it reached the house, a gust of wind threw the ship down a few feet. It plunged into the house at terrific speed, half burying itself in the roof. Bits of the plane and slivers of wood from the house flew high in the air. Skill and calculation, plus a whim of nature, had done the trick.

One scene in the same movie depicted a German Fokker falling in flames behind a hill. The burning ship dropped from several thousand feet in a tailspin and, just before it struck the ground, a hill hid it from the view of the cameras. Immediately after it had disappeared, a great cloud of black smoke and a sheet of flame flared up over the brow of the hill. To those in the audience who had seen an ac-

tual crash, this shot was just as realistic as the real thing. They could almost hear the crunching of the plane as it ground itself into the earth; they waited for the muffled explosion before the flames appeared; they could see the mass of twisted metal and wires.

This shot was obtained by placing the cameras on one side of a high hill and having the plane crash on the other. Just over the crest of the hill, away from the cameras, was placed a pile of wood and brush, which had been heavily soaked with gasoline. An electric detonator was hooked up to be operated from one of the camera stands. The burning-plane effect was obtained by releasing a

stream of lampblack from a hopper on the ship as it fell in a spin toward a point back of the hill which was directly in line with the brush pile and the cameras. Just before reaching the ground, and when well out of sight of the cameras, the pilot kicked the plane out of the spin and dived away. As soon as it was out of sight, the detonator was set off and the fire started, apparently just where the plane fell.

In another scene of the finished film, a huge German Gotha was shot down by an American pursuit ship. The Gotha spun down to the ground and crashed into flames. French peasants and American soldiers ran up to the burning wreck and looked on while the victorious American pilot made repeated dives and pumped it full of machine-gun "bullets."

For the purposes of the picture, a German Gotha plane was actually built at the flying field. It was not to be flown, but in all respects it exactly duplicated the famous German ships. The directors planned to crash it from a runway in a manner similar to the Fokker, but a day or two before, a windstorm came up during the night and blew the Gotha away, thoroughly wrecking it.



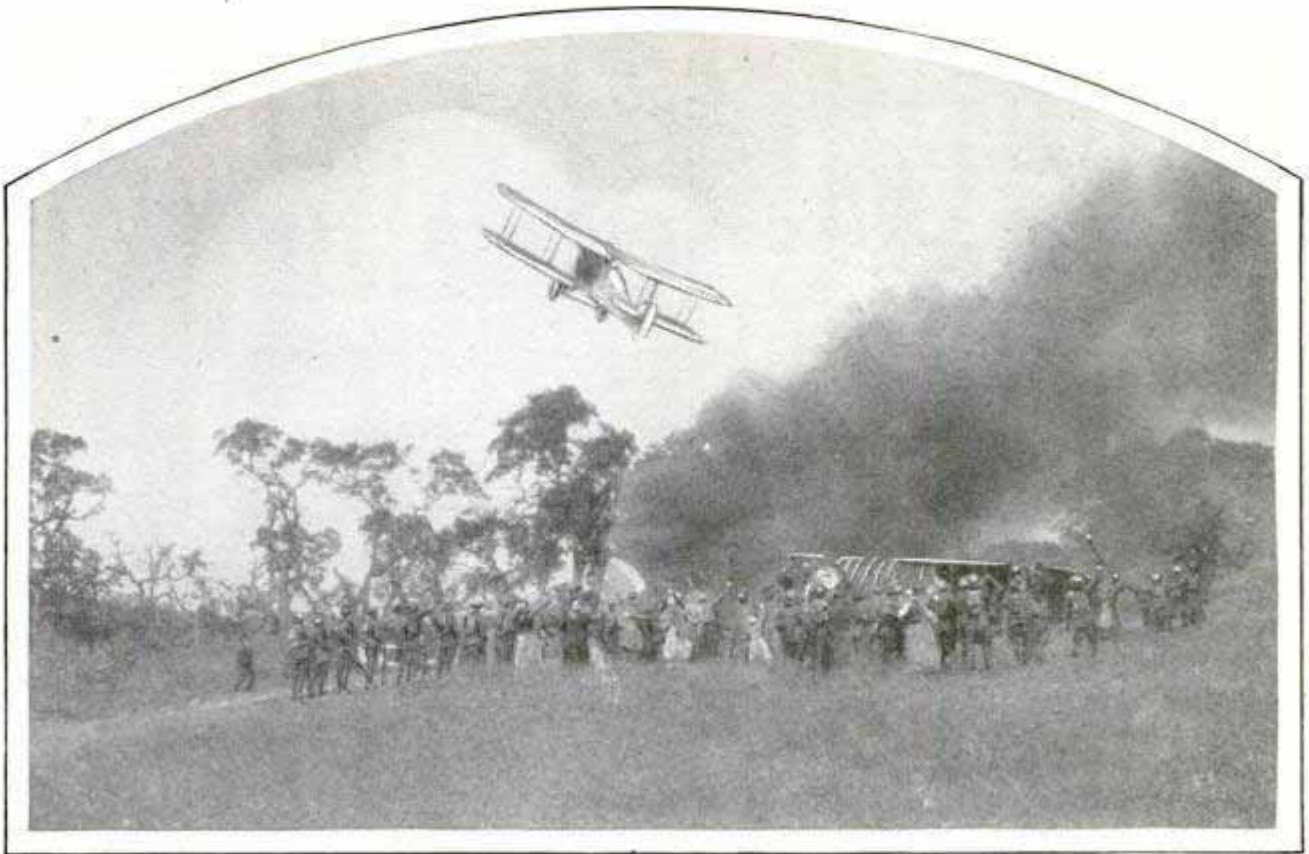

Flying Low to Inspect the Damage; an American Plane Swoops Down to Look Over the Burning Wreck of a German Gotha, Shot Down But a Moment Before in an Aerial Dog Fight

With weeks of work ahead of them unless they could in some way utilize the wrecked plane, the directors hit upon the scheme of using a model airplane for that particular scene. They constructed one, and built a miniature landscape duplicating the spot where the Gotha was to have been crashed. Very ingeniously they "spun" the model down from a height of six or seven feet into the miniature set, and when it struck the ground a dynamite cap exploded, setting off a small charge of powder, thus simulating the effect of a real crash.

By trick photography the camera men were able to make the miniature scene look exactly like the real one would have, had the Gotha been crashed from flight. The wreckage of the full-sized Gotha was soaked with gasoline and ignited, and while the American plane dived furiously at the blazing mass, and French peasants and American soldiers ran frantically toward the wreck, cameras ground out their film and preserved the continuity.

In man-made crashes, as one pilot expressed it, "You won't get hurt if you know just what you are trying to do. You've got to crash your plane the way

you want to crash it; you've got to fly the plane from the minute you hit the ground until the last bounce is over and the ship has stopped."

**FOLDING TABLE FOR PICNICS HELPS CURB INSECTS**

For the convenience of motorists and campers, a folding table rolls up into a small bundle when not in use. The top comes off and fits about the legs. The table will support considerable weight.

Folding Table of Convenient Height for Picnic Use; the Top Is Detachable and Rolls into Small Bundle



*Wide World*

*no information 11/3/28*



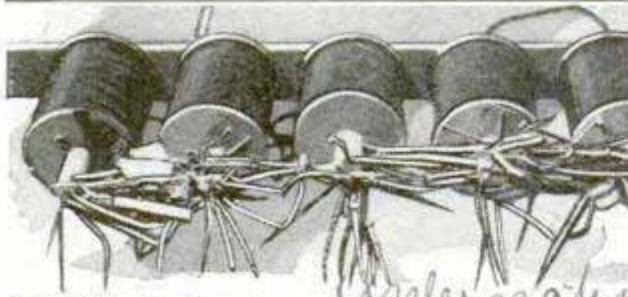
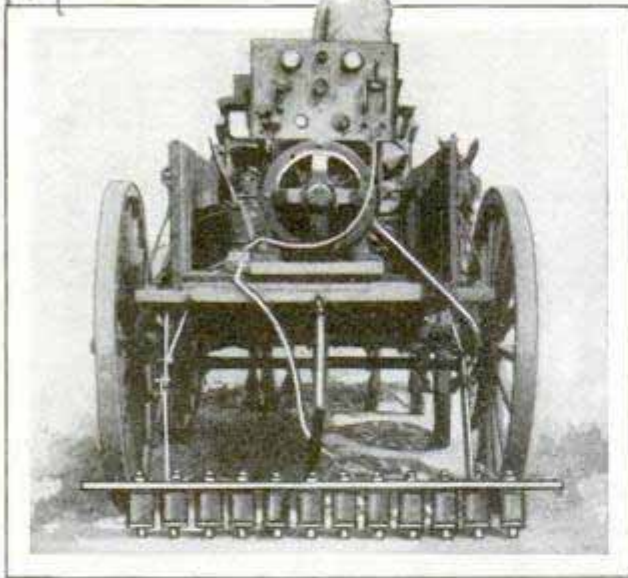

Nail Picker in Operation, and a Close View of Some of the Magnets, Showing Objects Gathered from Road

### MAGNET RIDS ROADS OF NAILS TO PROTECT AUTO TIRES

Nails, pins, bits of steel and other metal objects that might cause punctures, are removed from roads with the aid of a magnet comb the army signal corps has been using. The teeth of the comb consist of a series of individual magnets energized from apparatus carried in the truck which draws the comb over the road.

### SOLOMON A DEALER IN HORSES STABLE DISCOVERY SHOWS

119 d That King Solomon was a lover of fine horses and a successful dealer in them has been further proved by the discovery of the ruins of his famous stables at Armageddon, in Palestine, where an expedition of scientists from the Oriental institute of the University of Chicago has been at work for more than two years, exploring the debris of this historic spot. According to a report of the find from P. L. O. Guy, field director of the expedition, the stables were laid out systematically, the stalls being arranged in double rows. The horses, about twelve to the row, stood facing each other with a passage between the

two rows for the grooms to feed and control them. In front of each horse was a manger and the rows of mangers were divided by massive stone hitching posts, which still contain the original tie holes for the insertion of the halter ropes. Dr. James Henry Breasted, director of the institute, believes that the discovery is of great historical importance and reveals an interesting side of Solomon's life which is suggested in the First Book of Kings as follows: "And the horses which Solomon had were brought out of Egypt and the king's merchants received them in droves, each drove at a price." Solomon's marriage to the daughter of the Pharaoh of Egypt gave him close connection with the Egyptian court, and he therefore enjoyed opportunities for securing the best horses on the markets, Dr. Breasted points out.

### MODEL AIRPLANE AS WIND VANE HELPS FLYERS LAND

To show pilots which way the wind blows, a vane in the shape of a monoplane, twenty feet long and with a wing spread of twelve feet, has been mounted in a conspicuous place at the Oakland, Calif., airport. At night, it is lighted with neon lamps which can be seen at an altitude of 5,000 feet, flyers report.



Dummy Airplane That Serves as Wind Vane; It Is Brilliantly Lighted at Night



1174

**ALUMINUM PLATING ON METALS WILL SAVE MILLIONS**

1195

A process for plating aluminum on metal by electricity has at last been developed, Prof. D. B. Keyes of the University of Illinois announced recently to the American chemical society institute, and scientists are predicting that the discovery will prove beneficial in many lines of industry and will help in the saving of millions of dollars. Housewives, for instance, can now have aluminum-plated utensils with the strength of steel, but at a price cheaper than the pure aluminum, Professor Keyes pointed out. The plating can also be applied to machinery parts in the manufacture of fuel, in generating power in locomotives and in many other places. Professor Keyes said that the new plating process may have universal application to all metals. Among them he named boron, the hardest metal known, tungsten, which would greatly lengthen the life of electrical equipment, and titanium.

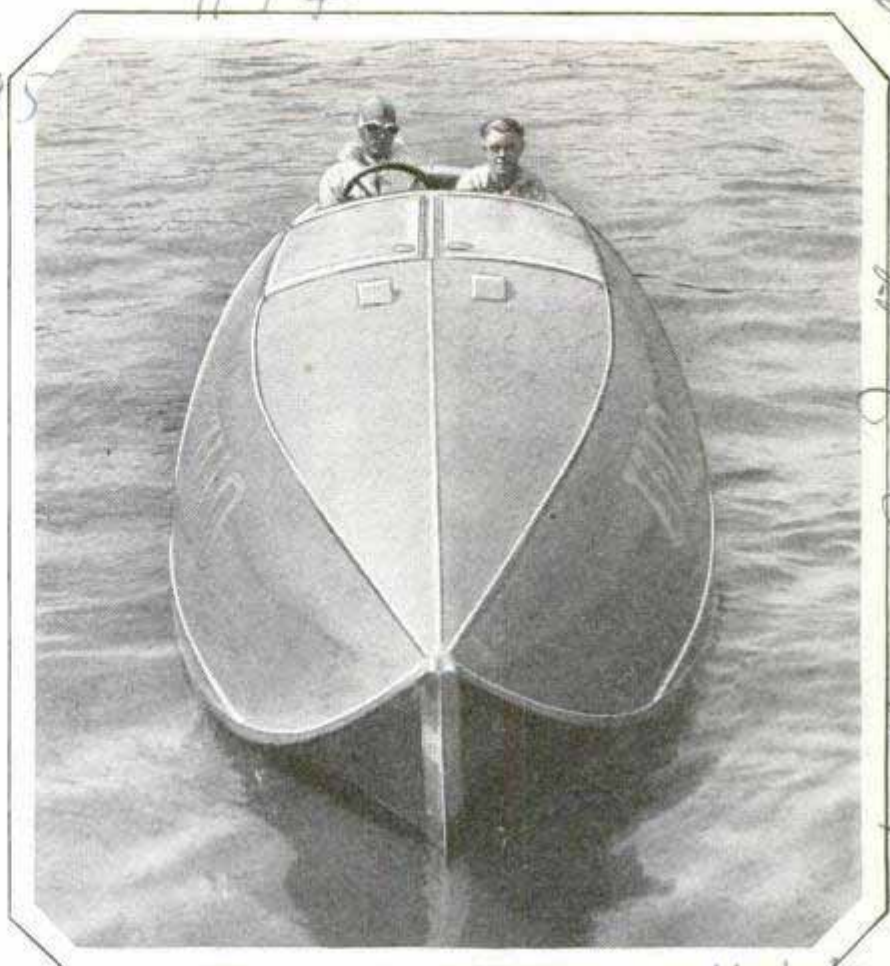

Streamline Design of Fast Motorboat That Has Made Seventy-Five Miles an Hour and Is Expected to Exceed That Mark

Built by Harry A. Miller  
 Eng. - Miller Works 2559 Long Beach Ave Los Angeles

**SPRINKLERS ARE SET IN GROUND TO ELIMINATE HOSE**

1188

Watering the lawn is a simple task with the aid of a system of sprinklers set underground, and where the nozzles will not interfere with the lawn mower. Simply turning a valve sends a number of sprays into action, insuring a thorough watering without dragging the hose about. A special nozzle gives a whirling motion and falls back when the water is turned off.



**RACING MOTORBOAT SPEEDS SEVENTY MILES AN HOUR**

During a recent test run, the "Miss Los Angeles," a sixteen-cylinder 750-horsepower motorboat made a dash at the rate of nearly seventy-five miles an hour in Long Beach harbor, California. This approaches the world's record for craft of this kind, the high mark, at the time the test was made, being slightly more than eighty miles an hour.

**WATER CURTAIN HIDES STAGE IN OUTDOOR THEATER**

1245

As a substitute for the usual curtain, an outdoor theater in Philadelphia has been using one of falling water, illuminated with colored lights. The water pours in a concealing sheet from an overhead pipe and falls into a trough at the bottom where it runs off. When the curtain is to be "poured" or "raised," all the operator has to do is to turn the valve of the water supply on or off.

Isordes Specialty Co,  
 48 N. LaSalle Ave  
 Chicago

For Bits 2/4/28



SECRET OF AFRICAN ANTS' WATER SUPPLY SOLVED

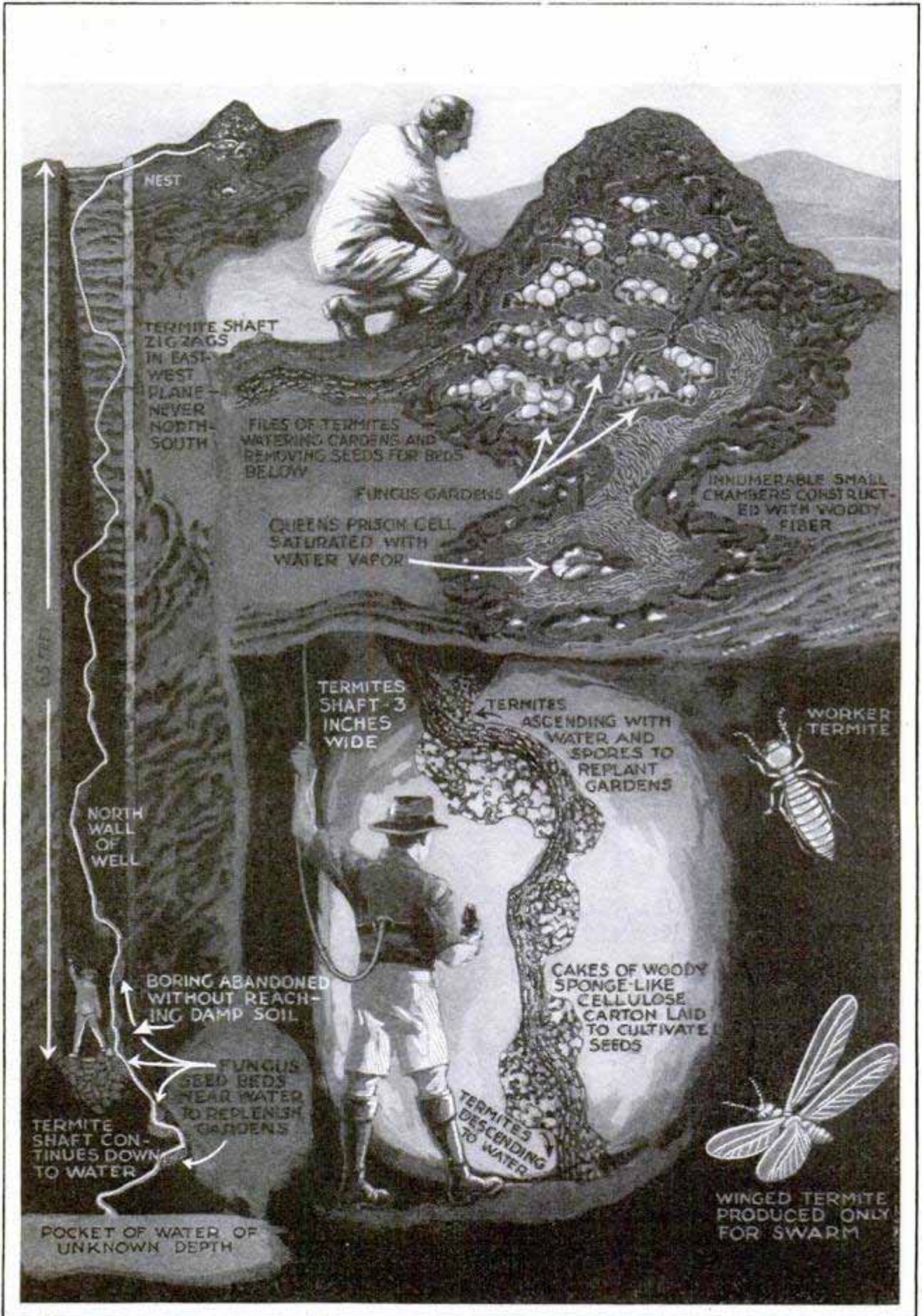

18, Shakespeare Road, 828  
 Heron Road London S.E. 24



SCIENCE DISCOVERS TERMITES DIG THEIR OWN WELLS

The mystery of how the termite ants of Africa keep up their water supply during years of drouth, a problem that has perplexed science since Dr. Livingstone first suggested the little insects must extract water from the atmosphere, has been solved by accident. Exploring a sixty-five foot dry well, a naturalist discovered a termite shaft which went on down to water some distance below. The ant nest, which is frequently built up for many feet above the plain, rose alongside the well. In digging the shaft, the workers had uncovered the ants' well. The ants had closed up the breaks, but by reopening them, the naturalist could watch continuous files of workers going down for water and coming back up. He colored occasional ones with dye, and found they averaged one round trip every half an hour. The termites live mainly on fungus, and maintain fungus seed-beds far underground, near the water supply, bringing up fresh seed daily to replace that destroyed by heat in the nest gardens. The artist's sketch on the opposite page shows, at the left, the termite well in relation to the dug shaft, while the larger drawings at the right give a section of the nest.

BOOK CONCEALED IN RING CONTAINS LONG POEM

So small that it can be carried under the setting of a ring, a tiny book contains the complete Rubaiyat of Omar Khayyam with pictures. While this is said to be one of the smallest books in the world, there are thousands of midget volumes in existence, and a collectors' society has been organized to gather and study them. During the war, the British government had half a million copies of the Koran printed in a size so small that Mohammedan soldiers could wear them over the breast as an amulet.

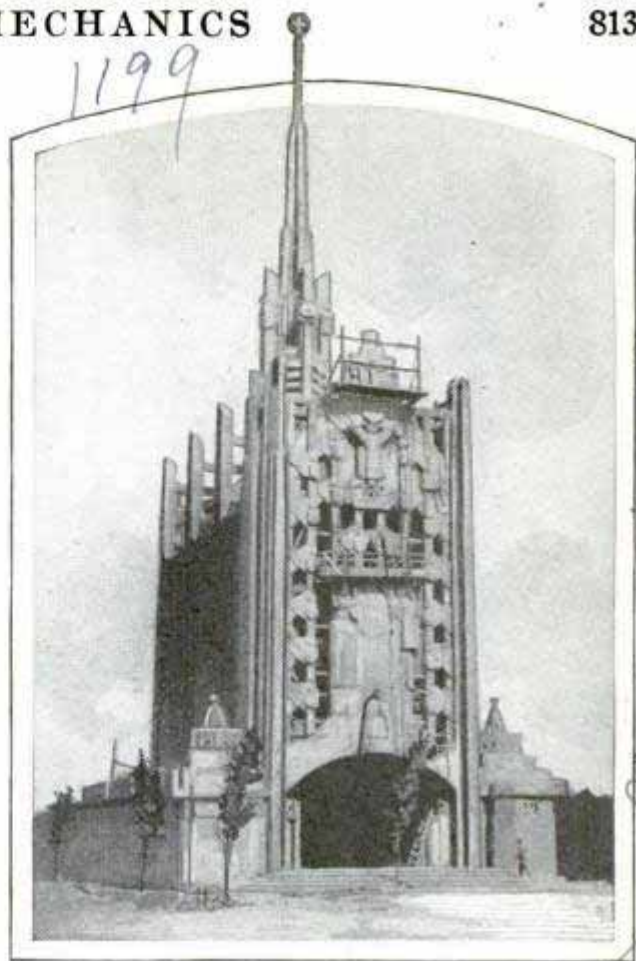

Where Modern Architectural Ideas Have Been Given Full Sway; the Church of New City near Paris

LATE STYLES IN ARCHITECTURE FEATURE FRENCH CITY

Examples of modern architecture are seen in many places, but near Paris, the French are building an entire city to exemplify the latest ideas in ornament and design. Its church illustrates how radically the modern architect has departed from some of the older ideas. The main entrance is behind a single arch that spans almost the entire width of the structure. Figures used for decorations on the exterior are unusually large, and the steeple is a tapering "shaft of angles."

CRYSTAL MINE YIELDS LENSES FOR ULTRAVIOLET RAYS

Cast aside during the gold rush of '49, large crystals taken from a California mine are now sought for the making of lenses and fused quartz for ultraviolet-ray instruments. Several years ago, a single crystal, weighing 2,200 pounds, was dug out of gravels, where, it is said, more than \$2,000,000 in gold was taken during the famous rush period. Many of the crystals weigh 100 pounds and more.

Owner - James Henderson, Brookline, Mass.

Com. A. L. Donnell, 2 Ludlow St.

Elizabethville on River side  
also owner and operator  
Com. Fred J. Smith, 1287 Chynoweth Blvd.

in Colveras County, Calif.



935

# Time and Money



Candle-Shaped Bulbs for Wall Brackets Glow with an Even, Mellow Light throughout Their Entire Length; They Are Made in Different Sizes and Colors and Produce Interesting Effects in Various Styles of Fixtures.

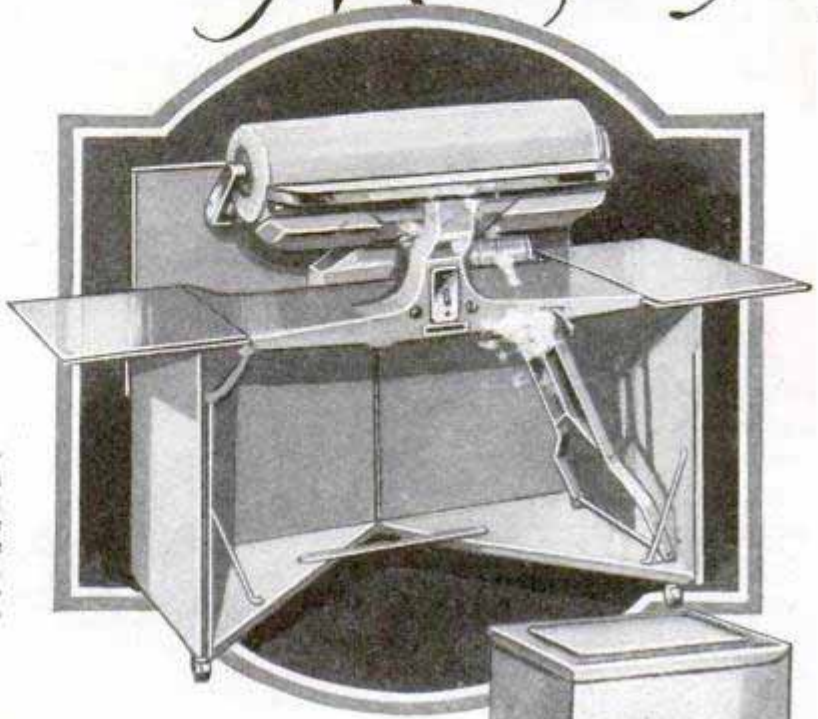

Operated from a 110-Volt Lighting Socket, an Electric Ironing Outfit Folds Up into a Handy Table on Casters When Not in Use; It May Be Rolled under Kitchen Sink or Table When It Is Collapsed

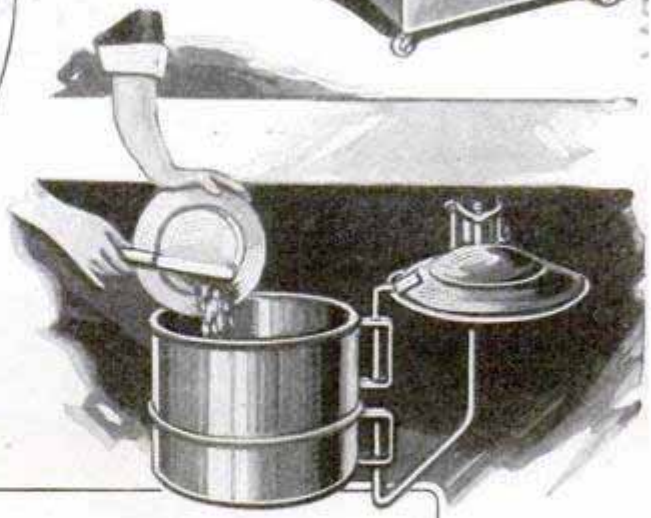

Long Handle for the Scrubbing Brush Saves Getting Down on the Knees, and Brush Clamps On with Setscrew That Permits Quick Renewal; at Right, Sanitary Container for Scrapings Swung under Table



nm

935

# Saving Things for your Home

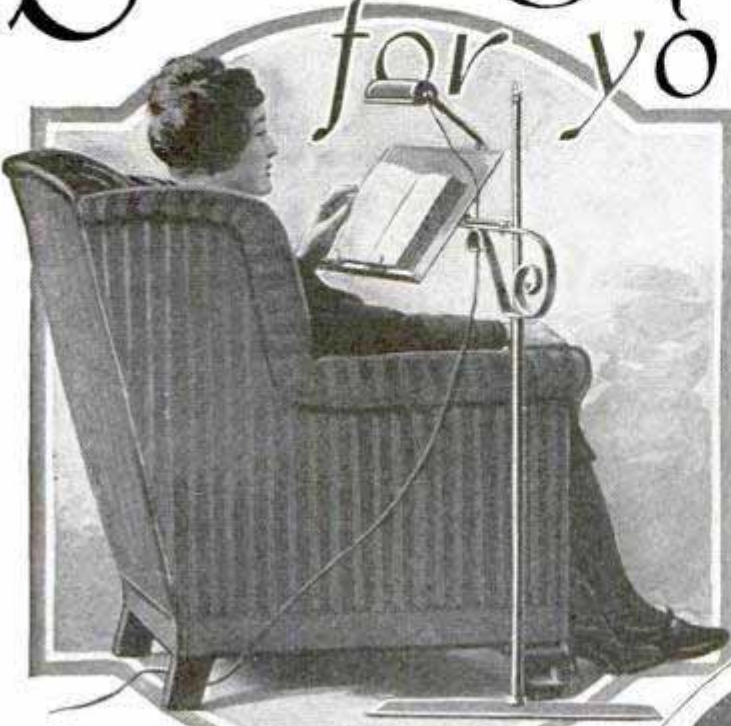

To Hold It in Position, This Hot-Water Bag Has Vacuum Cups That Keep the Bottle on the Body without the Use of Straps or Ties



For the Convenience of the Reader, This Combination Book Holder and Lamp Protects the Eyes, Is Adjustable to Many Positions and Leaves the Hands Free; Especially Useful When One Wishes to Read While Reclining

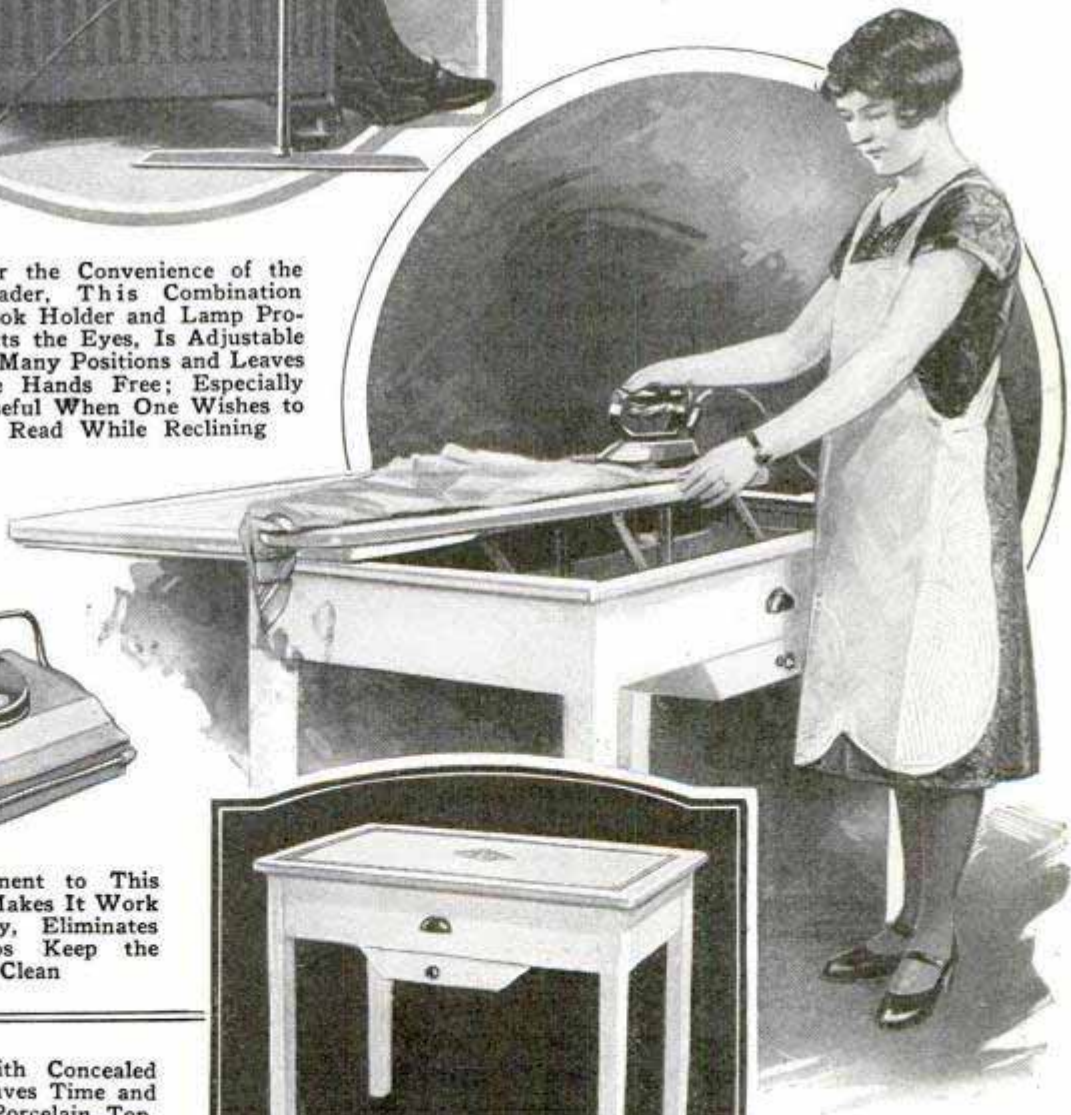

Vacuum Attachment to This Carpet Sweeper Makes It Work More Thoroughly, Eliminates Dust and Helps Keep the Brushes Clean

Handy Table with Concealed Ironing Board Saves Time and Space; It Has Porcelain Top, Drop Leaf and a Drawer





624

Completing the Model of the Cathedral of Ulm; Carver Fashioned the Replica in Wood with a Jackknife and a Few Other Tools

Model by Michael T. ...



**NINE-FOOT CATHEDRAL MODEL CARVED WITH JACKKNIFE**

Using a jackknife as his only carving tool, a Los Angeles craftsman has completed an accurate model of the cathedral of Ulm. It is nine feet high, eight feet long and more than three feet wide. The small wooden pieces were put together after being carved separate. About two years were devoted to the work.

**SCIENCE TO WEIGH HEADACHES FOR BETTER VENTILATION**

In connection with tests being made on different methods of heating and ventilating, experts are seeking a way whereby a reliable measure can be taken as to the severity of headaches. These troubles occur in stuffy, poorly ventilated rooms. Persons complain that the headaches become worse or better, as the case may be, but so far, science has devised no way of actually measuring the pain. If this effect on the human system could be more accurately gauged than the sufferer's opinion of it allows, engineers might be able to regulate ventilating conditions more efficiently, it is believed. "We want a comfort measure or discomfort indicator of

some sort," said Prof. J. E. Emswiler, of the University of Michigan, who has been conducting some of the tests. "We want to go behind what the subjects say. We must discount their temperament and substitute the findings of an instrument as a basis for a statistical headache report." The relation between stagnant air and discomfort was established by a series of experiments in 1902. Persons became nervous and developed headaches when shut up in rooms where there was no air stirring. When circulation was resumed, the unpleasant effects disappeared shortly, although the temperature of the rooms was unchanged. By these, and other experiments, engineers have proved that an essential requirement of adequate ventilation and heating for health is to have the air in motion.

**CLIPPER TO CUT TALL WEEDS 847 IMPROVES LAWN**

Weeds that spring up rapidly and mar the looks of the lawn between regular mowings are easily cut down with a special clipper now on the market. It is not meant to replace the mower, but to do work that the usual cutter will not do, topping the taller growth and snipping off long stems that the mower passes over.

40 in cutters \$40.00

Clipper That Cuts Wide Swath and Mows the Taller Grasses and Weeds. Difficult to Reach with the Regular Lawn Mower

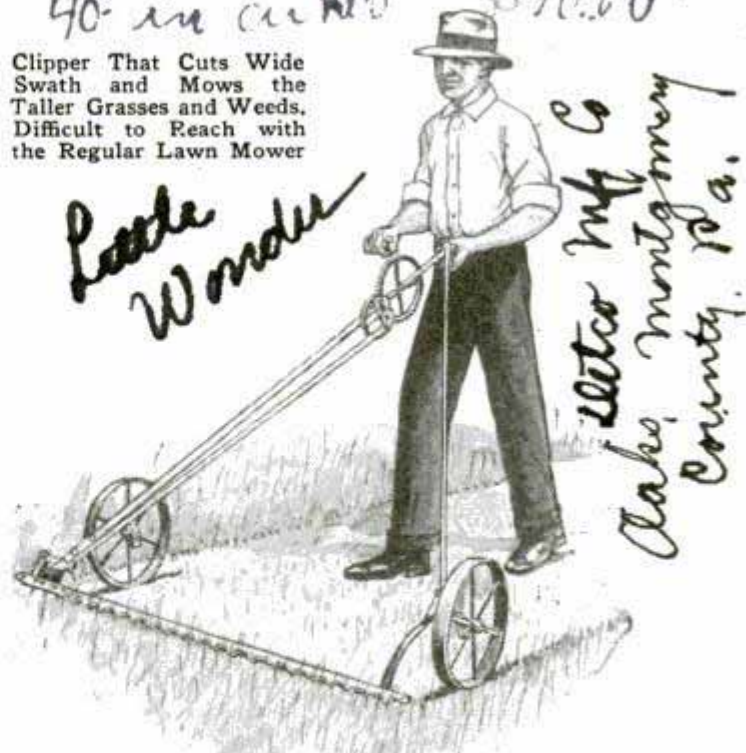

110

... ..

~~Lester Mfg Co~~  
~~301 ...~~



**NEW GEYSER IN YELLOWSTONE  
 SPURTS HUNDRED FEET**

1196  
 Eclipsing all other known geysers as to violence and size, a huge volume of hot water and steam broke out in Yellowstone national park recently, and because of its regularity of eruption and its spectacular performance, it bids fair to become one of the chief points of interest in the park. It reaches an average height of sixty to seventy-five feet with occasional spurts to 100 feet, and rises from a great crater, elliptical in shape, 100 by 120 feet in its two diameters, and eight feet deep. The eruptions last three hours or more, coming in intervals of fifteen or twenty seconds. Two of these long eruptive periods are staged every twenty-four hours. The volume of water ejected is enormous. The end of a "play" comes as suddenly as the beginning and the last of the violent steam explosions seem as energetic as the first.

**INDIANS USED SLATE AS MIRROR  
 RARE RELICS SHOW**

1178  
 Although they knew nothing of glass making, some of the Tsimshian Indians who lived on the extreme west coast of British Columbia and in the valleys of the Nass and Skeena rivers, enjoyed a crude form of mirror when they wished to make their toilets. These articles were fashioned from a dark-gray slate and only eleven specimens of them are known to exist. Evidently women of the higher families wore them around their necks from cords of twisted fiber or strips of bark, and the slate was made to reflect an image by wetting it or covering it with a thin coat of oil or grease. Some of the mirrors had two polished sides, but most were smoothed on the face only and the back carved with simple conventional designs.



It Served the Indians, but Would Hardly Suit a Modern Miss; Slate Mirror Used by Tsimshian Women

Carl Douglas Leechman,  
 Natl. Museum, Wash.

**HUNDRED-FOOT ARROW ON ROOF  
 GUIDES AIRPLANES**

3412  
 So that aviators may find their way to Lowry field, in Denver, Colo., Van Schaack & Co. have erected a huge wooden arrow on top of a downtown roof. It is sixteen

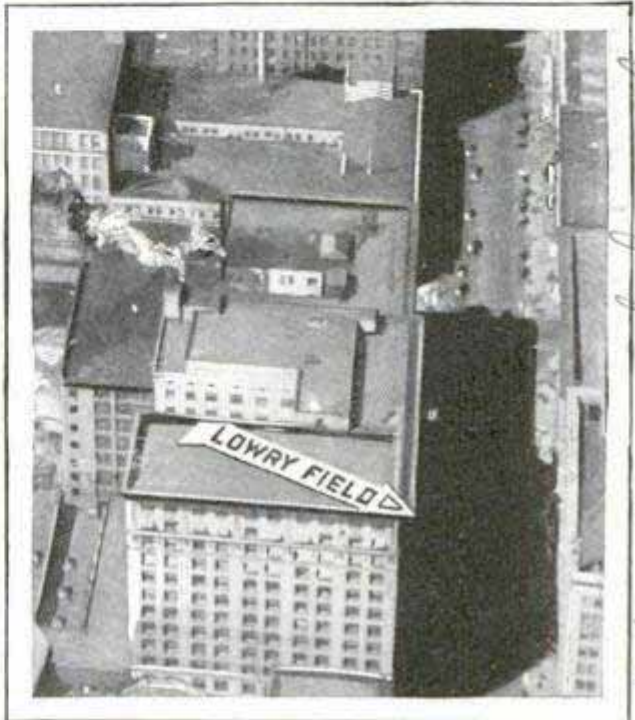

To Point Airplanes to Landing Field; Arrow on Roof of Denver Store Is Visible at Altitude of 5,000 Feet

feet wide and 100 feet long, painted white and visible at an altitude of 5,000 feet.

Built by Van Schaack & Co., Denver, Colo.

**PHONOGRAPH RECORD FOLDS UP  
 IN CIGARET CASE**

1193  
 Phonograph records that can be burned, jumped on or folded up in a cigaret case without injuring their playing qualities have appeared in England. They are of filmlike thickness, but so durable that the needle can be drawn across them without ill effects, it is said. According to one report, a record was played repeatedly for twenty-six hours and was still good.

World Echo Co.

London Daily Express 7/10/28



*Cont. L. M. Taylor.  
3440 72nd  
New York*

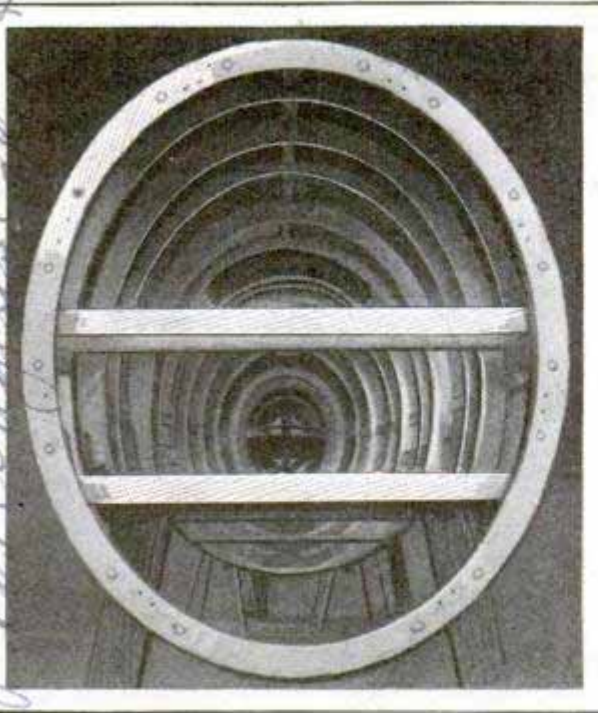

Looking into the Fuselage Framework of the Airplane Constructed for Wilkins' Proposed South Pole Flight

**PLANE FOR SOUTH POLE FLIGHT MODELED AFTER "BLIMP"**

A special airplane is being constructed for Sir George Hubert Wilkins' proposed flight over the south pole next summer and one of its chief characteristics is the development of the streamline effect to decrease wind resistance. The fuselage is patterned after the body of a dirigible, being of a tapered cigarlike shape.

**TELEGRAMS SENT IN CHINESE WITH RAISED LETTERS**

For the first time in history, Chinese writing is being sent by telegraph. Service was recently started between Peiping and Mukden with the system operating successfully. It is a form of picture telegraph.

raphy. The messages are written with a thick ink which, when it dries, leaves the characters in relief. The message is then relayed through a special transmitter to a receiver where a photographic reproduction of the writing is made. Before this method was devised, telegrams were sent in Chinese with the aid of a numerical code which had to be deciphered and the right characters substituted for the numbers sent by wire.

**MYSTERY OF BROKEN GOBLET TRACED TO VIOLIN**

One after another, four choice crystal goblets in the home of Zlato Balokovic developed long, disfiguring cracks although no one touched them. The mystery was finally explained by the vibrations of the musician's violin on which he practiced in a near-by room. The impulses set up sympathetic vibrations in the glasses and, being too fragile to withstand the strain, they cracked. The phenomenon has been known for some time, but scientists expressed surprise that the violin tones should cause the effect at such a distance from the instrument. Caruso could break goblets by singing a certain tone that would cause them to shatter under the vibrations set up in the glass.

**CIRCUS DISPLAY IN BUTTER SHOWS MOLDER'S SKILL**

An almost life-size reproduction of a circus camel palanquin in butter was an interesting exhibit at a recent Florida fair. The butter was molded upon forms of wood which were built from sketches of the original display.

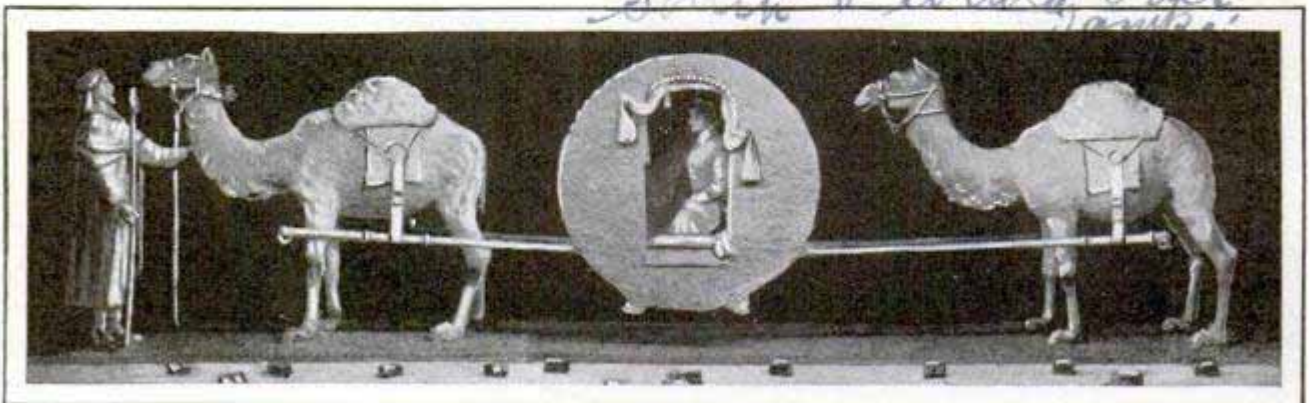

A Bit of the Circus in Butter; Realistic Model Prepared from Camel Group and Exhibited at Florida Fair; in the Foreground Are Pound Packages to Show Comparative Size.

*Lockheed Aircraft Co.  
Pacific Mutual Bldg.  
San Francisco  
Cont. L. M. Taylor*

*Molded by E. Wallace from  
Wooden Packages to Show Comparative Size*



*Colombier, Barnehurst Road, Besley, Seattle nr London*

**ELEPHANT WRECKS RAILWAY IN INDIA**

How a solitary "rogue" elephant wrecked part of new railroad line constructed to a mine in Mysore, India, was told recently by an engineer who had returned from the jungles. The line was being built through dense wilderness where animals were numerous. Natives reported that a solitary elephant was lurking about but none of the construction crew encountered it. One night after the workers had gone back to their camp, the elephant strode out of the jungle and started down the newly built right of way. Ties were ripped up, rails bent and twisted and other equipment destroyed. When the builders arrived the next morning, they found a wreck like that left by a tornado, they reported. Operations were not halted, however; the damage was repaired, and the railroad was finally completed.

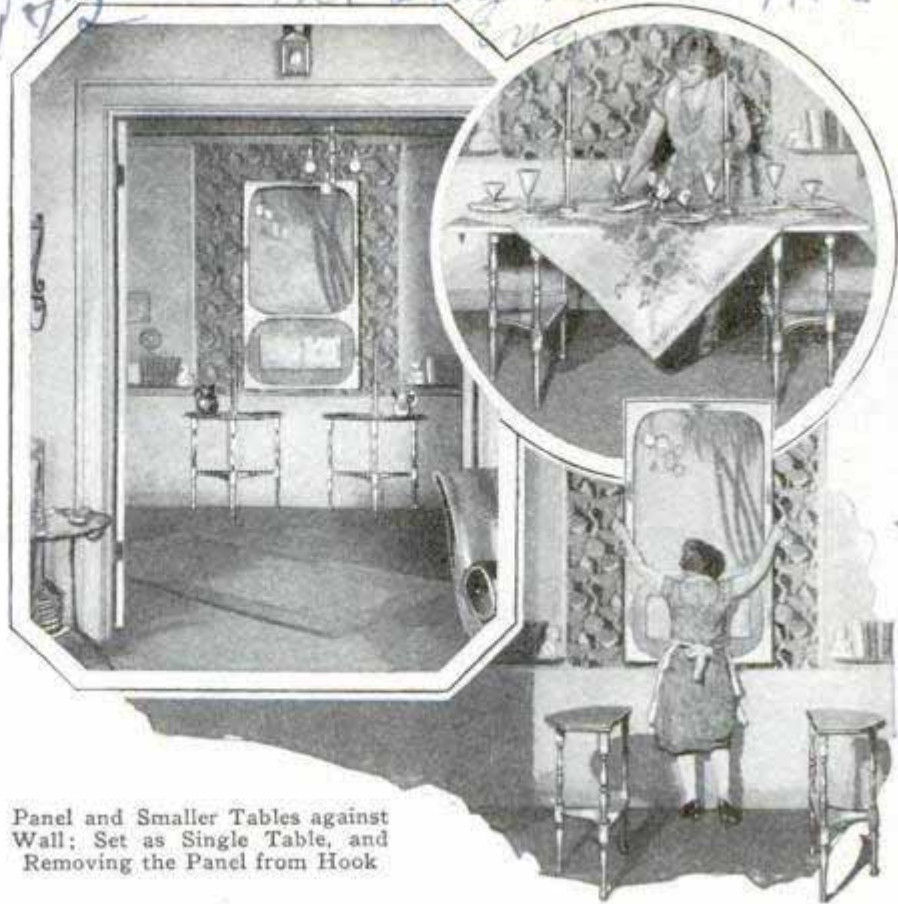

Panel and Smaller Tables against Wall; Set as Single Table, and Removing the Panel from Hook

**TABLE THAT HANGS ON WALL SERVES AS PICTURE PANEL**

To save space in small rooms and apartments, a combination table top and decorative panel has been introduced. It is made of plywood, ornamented to form an attractive wall piece, and is hung from a concealed hook when not in use as a table. Small handles on the sides afford a convenient grip when the panel is to be taken down and placed with the decorated side down, upon two smaller end tables. In this position, there is ample space for six persons. The panel and two smaller tables form an attractive group for the room. The change from wall panel to large table may be made in a few seconds, and the plywood board can be decorated in a wide variety of designs. The accompanying illustrations show one ornamented with a special clay composition which does not chip or mar and forms an attractive frame for a gaily colored picture.

*Made in studio of Miss Doroth by Margaret Lander 1,000 Indiana Ave Chicago*

**AUTO-SPRING GREASING VISE SAVES TIME AND WORK**

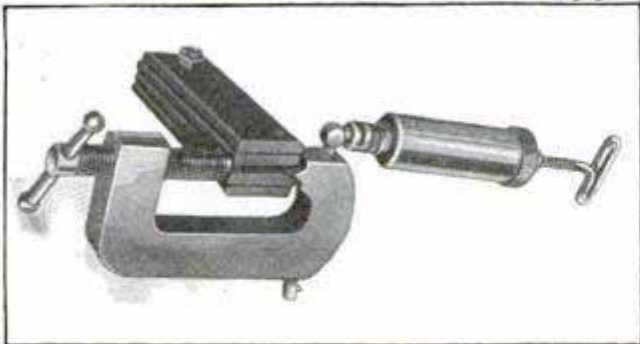

Auto Spring-Greasing Clamp in Position, Showing How It Pries the Leaves Apart

Automobile springs are given a thorough greasing in one operation, with a viselike apparatus introduced by a western inventor. It has small wedges that force the leaves of the spring apart and these are drilled to permit the flow of grease, forced from cups on the body of the clamp part of the vise.

☐ We want all our readers to write us freely and often whenever they wish additional information on articles published in this magazine. Address Bureau of Information, Popular Mechanics, Chicago.

*Eric H. Johnson, 900 ... are Portland*



# What

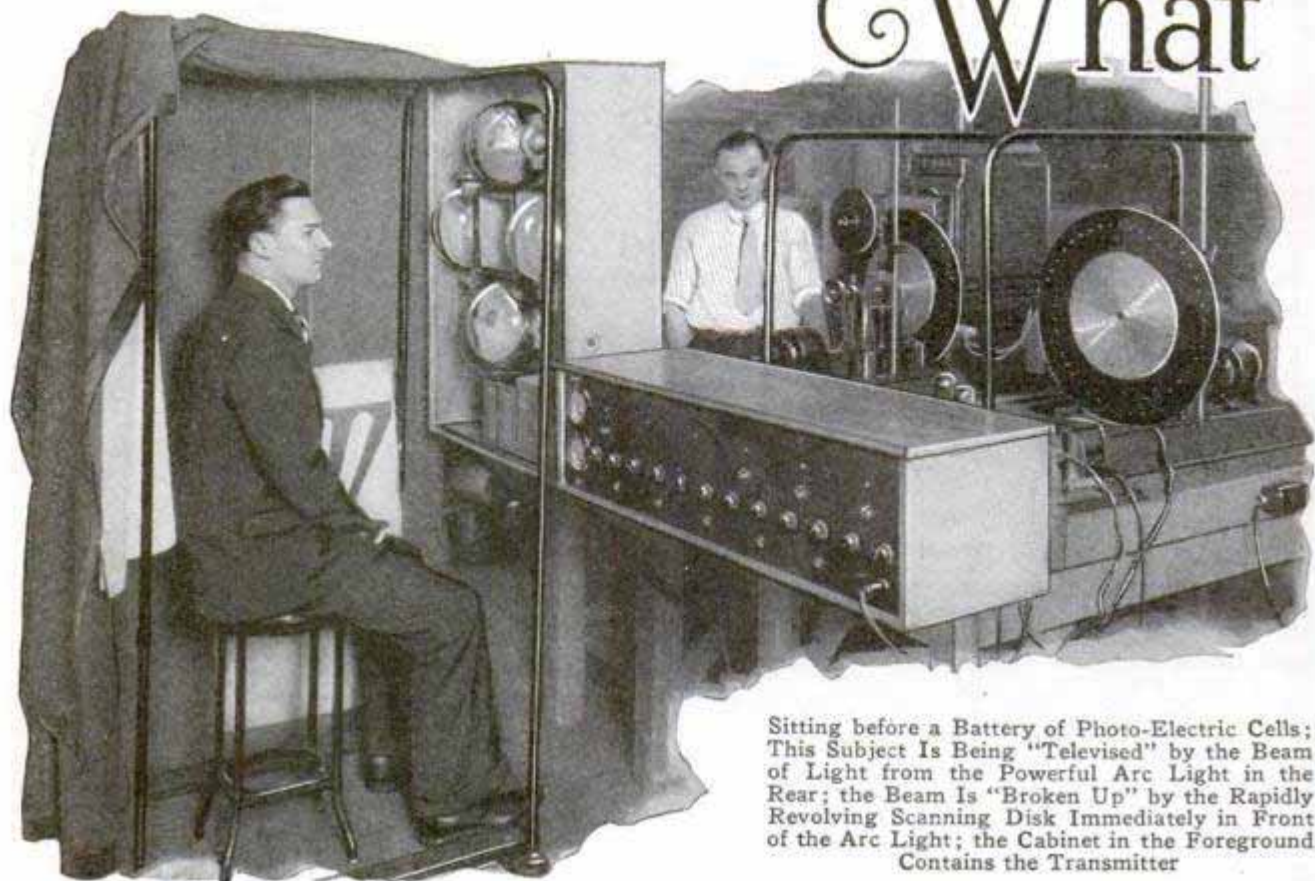

Sitting before a Battery of Photo-Electric Cells; This Subject Is Being "Televised" by the Beam of Light from the Powerful Arc Light in the Rear; the Beam Is "Broken Up" by the Rapidly Revolving Scanning Disk Immediately in Front of the Arc Light; the Cabinet in the Foreground Contains the Transmitter

**W**HEN will radio television and radio movies be available to the average radio fan for home reception?

That question, asked by untold millions, has provoked more and a wider variety of answers than has been evoked by any single phase of the radio industry's development.

Dr. Lee De Forest, inventor of the radio tube, says, "this development may be a matter of ten years or more."

Dr. C. Francis Jenkins, famous movie and television inventor, says "radiovisor receivers will be available for Christmas presents this year," and, "we expect to be broadcasting baseball and like entertainment by this time next summer."

David Sarnoff, vice-president and general manager of the Radio Corporation of America, estimates four or five years are yet needed for perfection.

H. P. Davis, vice-president of the Westinghouse Electric and Manufacturing company, declares, "anything so far demonstrated in television in my opinion would be premature if offered to the public as a service."

And the manufacturers of television kits say television has already arrived.

There are five different views, ranging from right now up to ten years—and probably every one of them is absolutely correct—a paradox that arises not through disagreement, but through different interpretations.

Messrs. Sarnoff, De Forest and Davis see television as something that should not be offered to the public until it is as complete, as simple, as perfect and as fool-proof as radio broadcasting is today—after years of experimental development.

Dr. Jenkins and the various manufacturers of television kits and parts believe there is a host of radio fans who got a lot of joy out of tinkering with crystal sets, coherers, fancy home-wound coils, and all the other accessories on which radio was raised from a pup, and who will get equal, if not greater, pleasure through a vicarious association with the development of television.

Anybody with an average acquaintance with the insides of a radio set, with fair mechanical ability, and \$45 to invest, can buy one manufacturer's kit, including an electric motor, scanning disk, neon lamp and other parts, fit a television receiver together, hook on some batteries



# Television Offers You

and his existing radio receiver, insert a few tubes and start receiving pictures.

They may be, in the words of Dr. De Forest, "small, poorly illuminated, coarse-grained, unclear silhouette and half-tone effects." But they will be pictures, either mirrored images direct from life, if you tune in on some stations, or radio movies, if you are in range of others. They will be pictures, and they will come through the air to you, and if you got a thrill a few years ago out of a jumble of DX-squeals, there is a bigger thrill in seeing an image in the frame of a homemade television receiver.

It is true that the image may be a tiny, black silhouette, about as clear and exciting as watching the fat gentleman across the street doing his setting-up exercises in a lighted room behind a drawn blind—in other words, it's a shadow picture, but it does move and live. Or it may be a rather sketchy half-tone effect requiring considerable exercise of the imagination to smooth out the blobs of dark and light into a mental picture of the face. But the first photographs transmitted by wire and radio were not perfect, either.

The companies that see millions in television as a regularly established commercial product are not interested, naturally, in the fan who wants to tinker with a homemade piece of apparatus. When they do go on the market, it will be with complete outfits in fine cabinets—press a button, turn a dial and the set does the rest. Popular Mechanics asked seven men who have been intimately associated with television and broadcasting for their opinions. Those seven included four who have been active in developing television and radio movies, one famous radio engi-

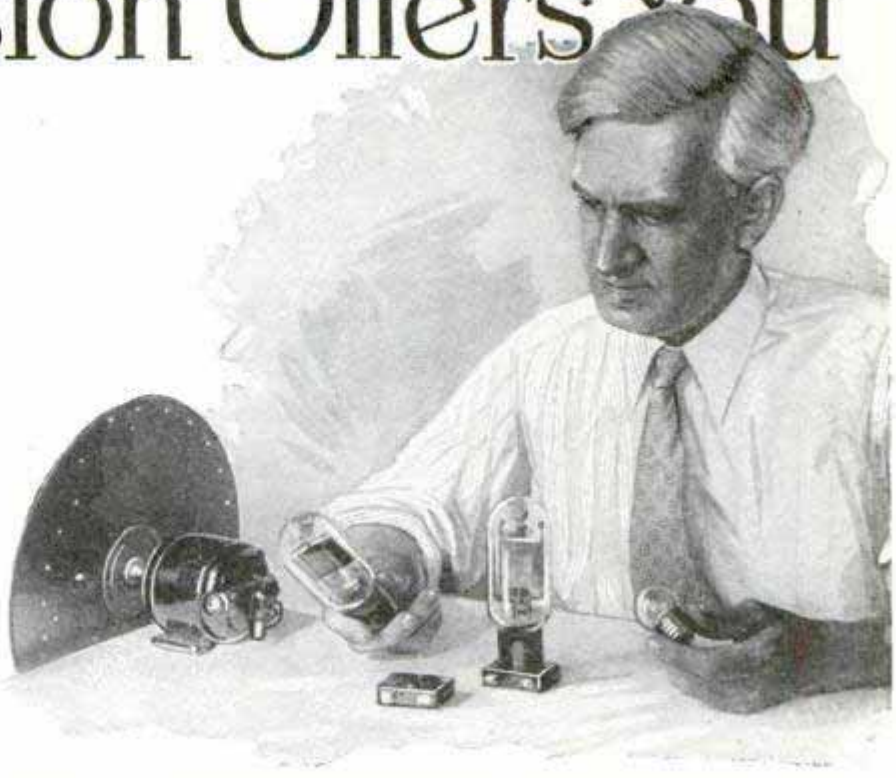

Some of the Apparatus Now Available to the Amateur; Scanning Disks, Special Motors, Photo-Electric Cells and Neon Lamps Are All on the Market

neer, and two who are leaders in radio manufacture and broadcasting. The four inventors of television and radio movies are Dr. Herbert E. Ives, who perfected the apparatus demonstrated by the Bell Telephone laboratories; Dr. E. F. Alexanderson, inventor of the General Electric company's television set; H. P. Davis, vice-president of the Westinghouse company and interested in the radio-movie outfit created in their laboratories; and Dr. C. Francis Jenkins, of Washington. The other three were David Sarnoff, of the Radio Corporation of America; Merlin Hall Aylesworth, president of the National Broadcasting company, and Dr. De Forest, the inventor of the radio tube.

From their replies listen to the following extracts. H. P. Davis of Westinghouse is speaking:

"Both television and radio movies are accomplished facts in electrical engineering laboratories, and, so far as laboratory research is concerned, there are no fundamental principles involved which today have not been solved. However, before these developments leave our laboratories and are offered the public in the manner in which radio broadcasting now offers public service or as adjuncts to broadcast



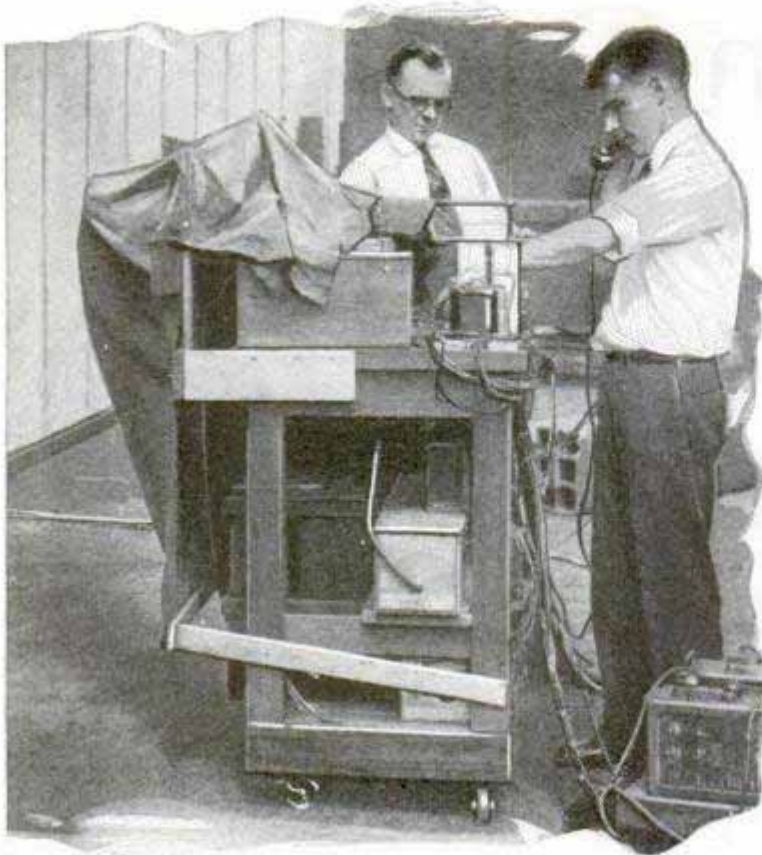

This Apparatus Transmits, by Means of Recently Developed Photo-Electric Cells, Pictures "Taken" in Daylight

programs, a considerable period will ensue, during which various elements entering into television and radio movies must be perfected and co-ordinated.

"Leading scientists and engineers all over the world are now working on the problem. There is an overwhelming public interest in its solution. Thus we have a supply of engineering talent and a public demand which should hasten practical development. I do not hesitate to state that the day is coming when television and radio movies will be at the service of the radio public.

"Since radio broadcasting is on such a high plane, serving a public which expects only the best from those organizations involved, I cannot believe that, in good faith, we should offer anything which, as yet, is in an experimental condition. It is my belief that the development period in television should be passed in the laboratories and that, when it is offered to the public, it should be a finished product. Anything so far demonstrated in television in my opinion would be premature if offered to the public as a service."

Now for the views of Francis Jenkins, an inventor himself and one who believes in letting all the amateur inventors in:

"Radio movies on forty-six meters are broadcast Monday, Wednesday and Friday evenings from our station and regularly received in many homes already. Our transmitters will soon be attached to stations now broadcasting music and radiovisor receivers will be available for Christmas presents this year. From this beginning the art will grow rapidly. We expect to be broadcasting baseball and like entertainment by this time next summer."

Lee De Forest has frequently voiced warnings against being overoptimistic about television, repeatedly pointing out that, when it comes, it will always be better over telephone wires, because free from static interferences. He repeats them now:

"Satisfactory television in the home is a very long way off. For the next few years radio fans will, however, derive much interest and

amusement from receiving small, poorly illuminated, coarse-grained, unclear silhouette and half-tone effects. All this talk about motion pictures by radio in the home and color by television, etc., as being just around the corner is the veriest bunk, and, in the interest of fact, common sense and on behalf of theater owners and sincere purveyors of motion-picture entertainment, some of whom are actually panicky concerning the future, such pipe dreams should be conscientiously discouraged.

"Real television will some time arrive, but will always be much more satisfactory over the wire than by radio. I consider this development may be a matter of ten years or even more."

Dr. De Forest's opinion on the effect of radio movies on the present motion-picture industry raises an interesting point. Harry M. Warner, president of Warner Brothers Pictures, Inc., first to produce satisfactory talking movies when he brought out the Vitaphone process, and Carl Laemmle, of Universal Pictures, who is going in for talkies on a large scale, were asked their opinions. Says Mr. Warner:

"Dr. De Forest is absolutely correct in



his statement that theater owners have nothing to fear from television. Television will no doubt be an advancement in transmitting photography, but to affect an industry which supplies entertainment is out of the question. On the contrary, should this invention be successful, it will be the greatest help to places of entertainment by stimulating interest direct in the home."

Mr. Laemmle is equally emphatic in his views, for, he says, "in the twenty-two years I have devoted to motion pictures I have never seen the time when science and invention damaged the industry. On the other hand, I have seen the business elevated to an art largely through the help of inventive genius. Therefore, whether television and radio movies are years away or just around the corner, I predict that, when they do come, they will prove a blessing and not a curse, and I sincerely urge those who may be panicky to remember that progress cannot possibly harm them. The very thought that these new wonders may at some time be perfected gives me a thrill of pride and greater confidence in the moving-picture industry."

So much for the great argument about the location of the corner which television must turn to enter the public's street. But what is the situation today?

Francis Jenkins, as he has stated, is broadcasting radio movies three times a week from his station in Washington on a wavelength of forty-six meters. He uses a system of forty-eight lines to a picture—

more will be said about that a little later.

The General Electric station at Schenectady, N. Y.—WGY—is broadcasting television images of twenty-four lines to the picture on several days each week.

In New York city WRNY is broadcasting television on a system employing thirty-six lines to the picture.

Before this article can appear in type, it is probable that several other broadcasters will be on the air.

Each broadcaster so far, regardless of the number of lines to the picture, is producing pictures one and one-half inches square. If you look directly into the picture frame in front of the revolving scanner disk, that is the size image you see. Obviously the amount of action and detail that can be crowded into a picture only an inch and a half square is limited. One human figure, or at most two, may be produced with fair results, but to attempt to crowd a baseball diamond, a prize-fight ring, or a political convention into that space would mean complete loss of detail.

Jenkins has improved on other systems by installing a large magnifying glass in front of the picture frame, giving the illusion of a picture some four inches square. Enlargement beyond that size, at least by any means known today, is impossible.

The reason lies in the scanner disk and the number of "lines" employed by it in transmitting the scene. The great difference between ordinary radio broadcast of music or voice and the broadcast of television is that the first is a one-dimensional, straight-line affair, and the second

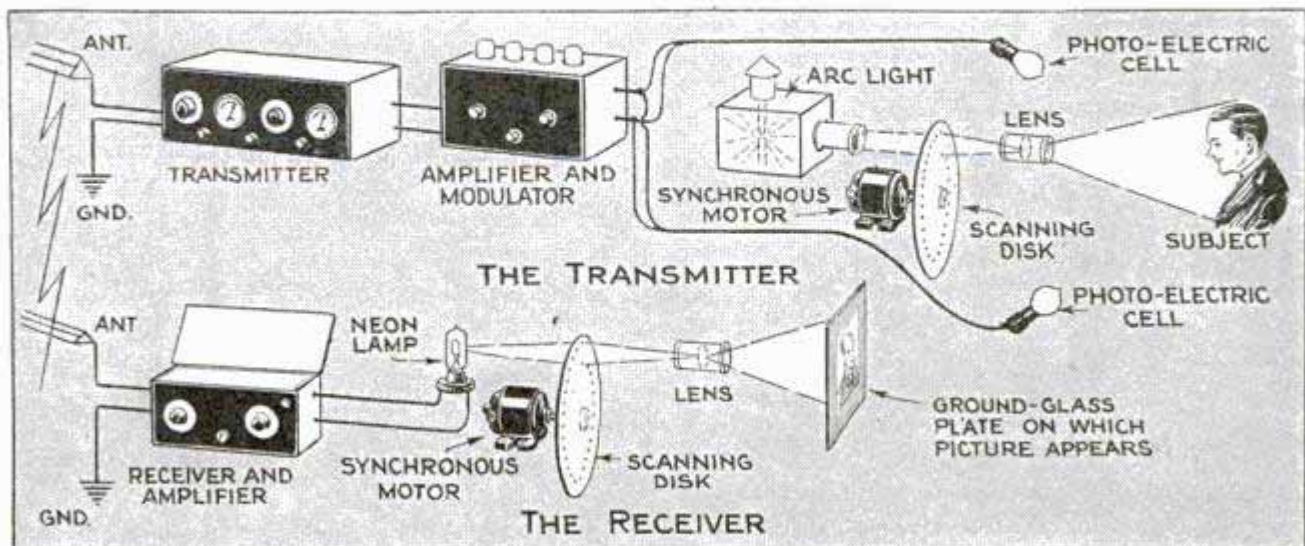

This Diagram Shows, in the Simplest Form, How the Light Waves from the Subject Are Transmitted by Radio and Converted Back into a Picture at the Receiver



is two-dimensional, having both width and length. The music is a series of successive signals, transmitted one after the other. The picture must be a complete square.

No one has ever found a means of transmitting an entire picture as an entity. Instead an optical illusion is utilized, the same optical illusion which makes the movies possible. It is called the retentivity of vision. When the eye sees a thing and telegraphs the intelligence to the brain, the image lingers for a fraction of a second. Because of this lingering, if approximately sixteen pictures are shown the eye each second, and each picture is slightly different from its predecessor, the eye is fooled with an illusion of movement.

In television the radio engineer goes farther than that. He cuts each picture up into a number of sections, transmits each section through the air as a straight-line radio signal, and then pieces the sections together before the eye so rapidly that the images of all linger as one picture.

The cutting process is done with a scanner, a large metal disk, revolving at high speed and containing a series of holes, arranged in a spiral. In all disks so far used, the distance between the outer hole of the spiral and the inner hole is one and a half inches, and the result is a picture one and a half inches square.

The number of holes that can be used and the number of pictures which can be transmitted each second—in other words, the speed at which the disk can be revolved, for each revolution transmits one complete picture—depend entirely on the sensitivity of the photo-electric cell, which receives the light passing through the holes in the disk and transforms its varying strength into electric impulses of corresponding intensity.

Photo-electric cells are improving rap-

idly. Hardly a year ago the best cells would not respond rapidly enough for a disk of more than twenty-four lines. A better cell made the thirty-six-hole disk possible; still better brought the forty-eight-hole disk, and lately the Westinghouse company has demonstrated radio-movies using sixty lines to the picture.

What does such a picture look like? The average newspaper half-tone illustration has sixty-five lines to the inch; in other words, sixty-five dots each way in its screen. That rating is to the inch, and all television images to date have been an inch and a half square, so the best transmission yet, with sixty lines, has been spread over an area fifty per cent greater each way than the newspaper illustration.

The illustrations in Popular Mechanics have 110 lines to the inch, against forty to the inch for the best television experiment, with the new Westinghouse apparatus. Engravings for reproduction on fine calendered paper may be made with 120 lines, 133 or even 150 lines to the inch. From these

figures it is easy to estimate the relative clearness of a television image.

Remember that each television picture consists of a series of lines—twenty-four, thirty-six, forty-eight or sixty, as the case may be. Put an enlarging glass in front of the image and you get the same result as when you hold a magnifying glass in front of a newspaper illustration. Enlarge it a little bit, and you see the dots quite plainly. Keep on enlarging it, and the dots spread so far apart they cease to form a picture. That's the reason why television, as yet, can't be thrown life-size on a screen, like movies.

Scientists expect to solve this problem, and all the other problems of television. The experimenter who wants to get in on the fun can buy a kit and build a set, but finished television has not yet arrived.

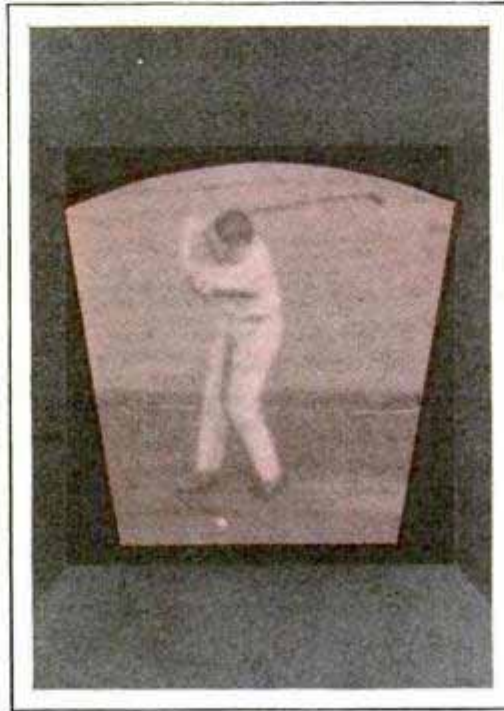

The Above Illustration Shows the Exact Size of the Received Image with Approximately the Same Color and Definition





### Tone Filter for Magnetic Pick-Up That Anyone Can Arrange

The magnetic phonograph reproducer offers the radio owner an opportunity to listen to music perfectly, through the radio amplifier and loud speaker. All that is necessary, having the radio set and speaker, is some form of phonograph turntable and the magnetic reproducer or pick-up, which rides the record instead of the old reproducer. The pick-up is connected with the a.f. amplifier in the radio set by means of an adapter placed in the detector socket. Such a unit usually includes a volume-control resistance, and sometimes a "scratch filter" to eliminate the needle noise. The magnetic pick-up changes the vibrations of the record into electrical impulses, corresponding to the sound waves ordinarily reproduced. It is a simple matter to play tricks with these impulses, one of which uses the tone filter illustrated in the diagram.

This simple filter permits the operator to obtain any desired balance between the bass and high notes; the unit may be assembled in a small box and placed where it can be changed at will. The choke coil consists of the primary winding of an old a.f. transformer. The secondary of the transformer is not used and the ends are left open. Any type of a.f. transformer may be employed. An 0 to 200,000-ohm variable resistance is connected across the primary winding as shown in the diagram. The choke acts as a retard coil for the a.f.

currents passing through the unit. With the maximum resistance in, this tone filter will offer an impedance at 5,000 cycles—a very high note—or about fifty times more than at 100 cycles—a very low note. Thus, with this resistance, the bass parts of a record will be much more prominent than the high notes. With only half the resistance in, the bass notes are still favored, and when entirely out, the music is reproduced faithfully without favoring either bass or treble. As the resistance is increased the volume must also be increased by means of the control for the

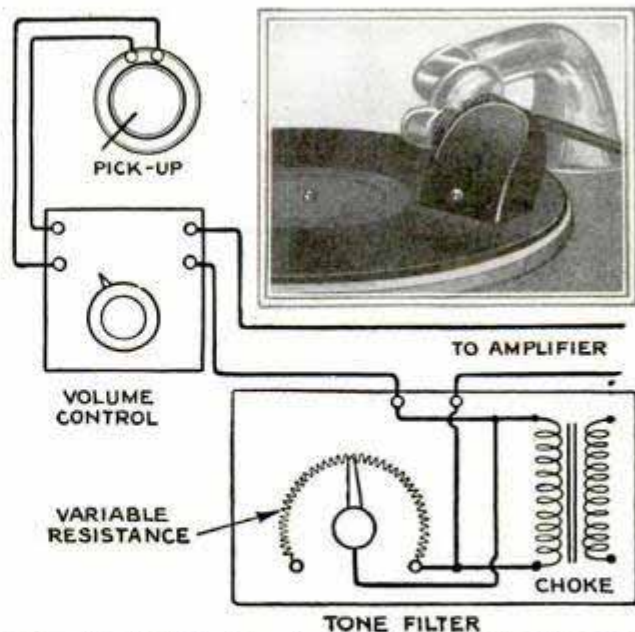

Magnetic Pick-Up Mounted on Phonograph Tonearm; —Connections for Volume Control, and Filter

latter feature.—H. R. Rawson, chief engineer, Station WOS, Jefferson City, Mo.

*Sylvia Radio Co. 825  
312 S. Wells.*



### Homemade Trickle Charger

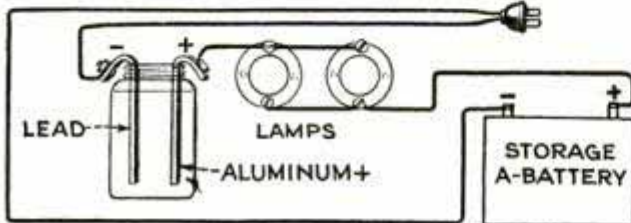
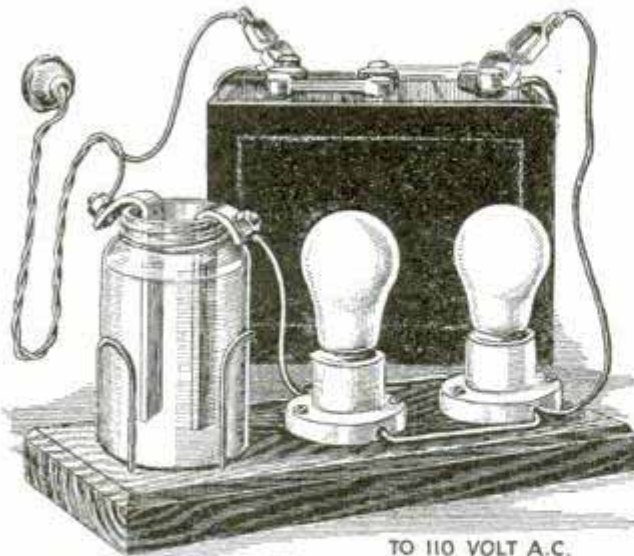

Completed Trickle Charger Mounted on Wood Base, and Wiring Diagram Showing Connections

All that is necessary to make an efficient trickle charger for your storage A-battery, is a plain fruit jar, a strip of aluminum, a strip of lead, a socket or two for ordinary electric lights and a little borax and water. Take a piece of aluminum, as pure as you can get it, drill a hole through one end in which mount a battery binding post or a brass machine screw and nut. Bend the aluminum strip over so that it will hang on the edge of the jar. Do the same with the lead strip, hanging it on the other side of the jar so that the two strips will not make direct contact with each other. These two strips should be about 1 in. wide, and any thickness between  $\frac{1}{8}$  and  $\frac{1}{4}$  in. The aluminum strip is the positive electrode and should be connected to the positive terminal of the storage A-battery through a pair of ordinary electric lamps, connected as shown in the diagram and sketch. The negative terminal of the battery is connected to the other side of the 110-volt a.c. lighting circuit. This device will not work on d.c. lines; therefore be sure to check the type of current you are using before attempting to build the device. The pint or quart fruit jar should be filled with a saturated solution of borax and water, the two strips placed in

position and the connections made to the battery and the lighting circuit. Adding more lamps or lamps of higher wattage will increase the current flow and cause the battery to charge at a faster rate. However, if this rate is too fast, the solution will heat and crack the jar, or cause sparking. A charger of this type will not be suitable for a battery that is completely discharged, but will keep the battery up if used continuously when the set is not in operation.—W. F. Crosby, engineer, Wireless Radio Corporation, Brooklyn, New York.

### Amplifier for Crystal Set

Crystal reception on a loud speaker without distortion appeals to the home experimenter and a number of sets of this type are now in use in this locality. The diagram shows a simple circuit that costs very little to operate and will work a speaker on stations several hundred miles away if a long outside antenna is used. For locals, a short aerial will do, but the longer the aerial, the better the volume and distance. A diamond-weave vario-coupler with seven taps, a variable condenser provided with a vernier dial and fixed condensers of the mica type are used. Make all leads as short as possible and use two a.f. transformers of either three-to-one or three-and-one-half-to-one ratio.

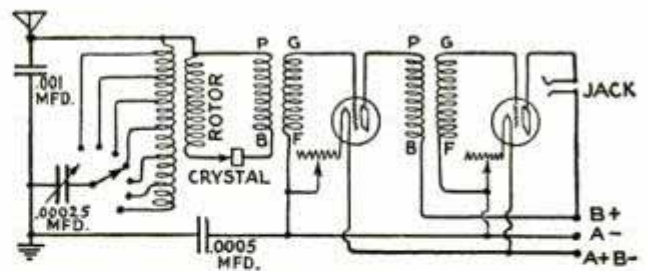

Diagram Showing a Simple Method of Amplifying the Crystal Detector

Two 45-volt B-batteries supply the necessary plate voltage and the connected series, according to whether 201A or 199 tubes are used. The 201A tubes will give the greater volume, and are preferable.—Collins Pentz, designing engineer, Minneapolis, Minn.

When operating receivers of the regenerative type, the detector tube may be kept below the spilling-over point by turning back the filament rheostat.



### Hints for Set Builders

Annoying situations frequently crop up to try the patience of the amateur builder of a radio receiver. The following hints may help those of little experience. One common annoyance is the dropping of a nut or screw in some awkward place where it cannot be reached with the fingers or pliers. A simple way to recover the part is to place a strip of tape over the end of a screwdriver and press it against the nut or screw. This will make it stick to the tape and it can easily be removed. The same idea may be applied to starting small bolts, screws or nuts in difficult positions. Never use a metal tool, such as a screwdriver, in a set unless the tubes and batteries have been removed. If a repair must be made after the set is installed, use a wood spudger or insulate the shaft of the screwdriver with tape or rubber tubing so as to prevent short circuits. Frequently a builder will discover that he has not a drill of the right size for the work in hand; in cases of this kind, a tapered reamer is an excellent substitute. Long round-hole lugs may be bent together to form short soldered connections where wired connections are difficult. Always complete all wiring possible on the sub-panel before screwing on the front. This will greatly speed up the assembly.—E. H. Sieg, service engineer, Red Wing, Minn.

### Reducing Line Interference

Electrically operated household devices are an increasing source of radio interference. The simplest method of reducing or eliminating this is shown in the sketch and merely consists in placing a suitable

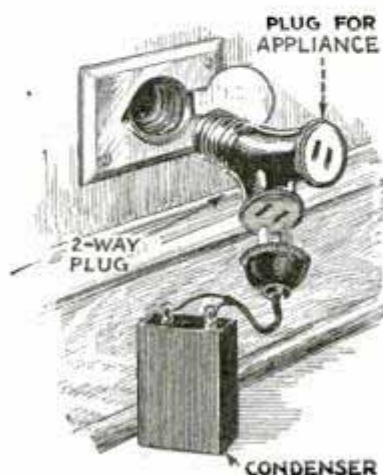

condenser across the 110-volt line from which the appliance takes its current. It is, of course, necessary to use a heavy-duty filter condenser of either 2 or 4-mfd. capacity. Noises caused

by small motors may also be corrected in this manner. The condenser is wired to an ordinary plug for insertion in a two-way socket as shown, making a handy arrangement that may be moved from one appliance to another.—E. S. Capron, consulting engineer, Buffalo, N. Y.

### Homemade Panel Saw

Cutting holes in radio panels is a rather difficult task unless special cutter and tools are used. For large round or irregular holes for meters, bezels, drum dials or similar apparatus the small saw shown will do very well. A hacksaw blade

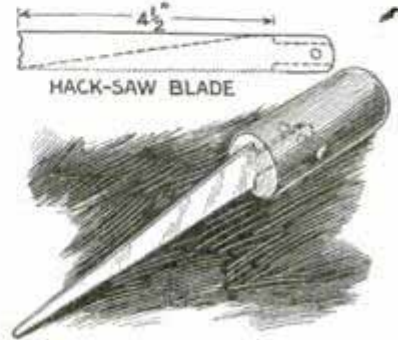

is cut down to the shape indicated by grinding on an emery wheel. The blade may be made of any size, but one 4½ in. long is about right. A small hole is drilled in the blade at the wide end, a piece of dowel being used for a handle. A screw or rivet is driven through the handle and filed flush with it. To cut a large hole, first scribe the outline with a pointed tool, then drill a series of ¼-in. holes around the inside of the circle; the solid portions between the small holes are then cut away with the saw and the rough places around the inner edge of the large hole smoothed off.—Herman R. Wallin, commercial operator, Brooklyn, N. Y.

### Repairing By-Pass Condensers

The service man frequently encounters by-pass condensers that cannot be replaced without considerable trouble or loss of time. In such cases, disconnect the condenser from the set and connect it across the 110-volt a.c. line for a second or two, after first making sure that there are fuses in the line. Nine condensers out of ten, burned open in this manner, will stand up indefinitely on battery voltages of 135 volts or less; the idea is not practical, however, if much higher plate voltages are used.—Chas. Middleton, chief engineer, Station WRAF, La Porte, Ind.





## PART II

**T**HE BOX consists of a framework sheathed on the ends and top with  $\frac{1}{4}$ -in. three-ply figured walnut. (See Fig. 5.) Build each end of three stiles and two rails halved together, made from 1 by 2-in. pine. When the glue is dry, rabbet the front stiles  $\frac{1}{4}$  by  $\frac{1}{4}$  in., and smooth the joints.

The bottom is preferably made from  $\frac{3}{4}$ -in. five-ply pine, but two widths of 1 by 10-in. solid stock, doweled together, may be used. It is dimensioned in Fig. 8. Assemble with the ends, bracing them at right angles with diagonal strips tacked on the edges. Reinforce the joints with two  $\frac{3}{8}$ -in. dowels in the back stiles and one in the middle and front.

Cut a back upper rail from 1 by 2-in.

pine, getting the length from the bottom between the stiles. Size the ends with glue so that they can dry while the front stile is being made. The latter is of walnut, dimensioned in Fig. 5.

Glue the back rail in place, laying a clamp lengthwise to hold it while a couple of dowel holes are bored in the corners. In the same way place the front rail, putting one dowel into the thick part.

Two walnut door stiles are cut from rough stock to sizes given in Fig. 5, rabbeted  $\frac{1}{4}$  by  $1\frac{1}{16}$  in. on one side and  $\frac{1}{4}$  by  $\frac{1}{4}$  in. on the other, and notched on the upper ends to fit around the upper rail. Size the ends.

The shelf, of three-ply pine, is dimensioned in Fig. 5. The ends are marked by contact with the box end stiles and are notched around them. The front edges of the ends are flush with the  $\frac{1}{4}$ -in. rabbets, but the front edge of the shelf is notched back  $2\frac{3}{8}$  in. farther for the center section, terminating  $7\frac{1}{8}$  in. from the ends.

Force the shelf into place with the underside  $7\frac{1}{2}$  in. above the box bottom. Support the ends with  $\frac{3}{8}$  by 1-in. cleats, glued and brass-screwed to the box stiles. A couple of screws through the shelf into each cleat will suffice to hold it in place.

Joint the door-stile edges to allow for the end panel veneer to be glued in front. Set them with the inner rabbets  $7\frac{1}{8}$  in. from the corner-stile rabbets. Put a dowel into each end. Glue a shelf-support cleat to the back edge of each stile, a stop strip







along the bottom, flush with the rabbets in the panel spaces, and a walnut stop,  $\frac{1}{4}$  by  $1\frac{1}{16}$  in., to the bottom, flush with the backs of the rabbets.

To complete the tone chamber, fit three-ply partitions between the shelf and the top, the back edges coming flush with the shelf and the front ones being  $\frac{1}{2}$  in. back from the shelf edge, forming backing for the grill. The outer faces are  $7\frac{3}{4}$  in. from the insides of the box-end frames. Temporarily nail the lower edges through the shelf, and the upper back corners with nails through the rail.

The front of the door desk and the two end panels are made from the same piece of walnut veneer, so that the grain will match straight through. Fit the panels tightly to their rabbets, making them a full  $7\frac{1}{8}$  in. wide. Rabbet the stile edge on the back face of each, paring away the inner veneer and core until the front veneer is stripped. Glue in place, laying the box on its back, so that the panels can be weighted. The veneer must be held tightly to the stile edges with strips of wood well clamped. When dry, the projecting ve-

ner from the veneer projecting, cut the end-pieces, and glue them on, making sure that the veneer joins perfectly with the upper ends.

Glue triangular cleats inside the four corners of the tone chamber, and square cleats at the tops of the compartments against the partitions.

Make the arched upper section of the speaker grill of walnut plywood. (See Fig. 6.) The arches are centered  $\frac{1}{4}$  in. above the lower edge. Make two end posts of  $\frac{1}{4}$ -in. walnut,  $\frac{7}{8}$  in. wide by  $7\frac{1}{4}$  in. long, and a lower rail  $\frac{1}{4}$  by  $1\frac{1}{16}$  in. by 1 ft.  $6\frac{3}{8}$  in. A front rail,  $1\frac{1}{2}$  in. wide and 1 ft.  $8\frac{1}{2}$  in. long, an upper rail,  $1\frac{3}{4}$  in. wide and 1 ft.  $6\frac{5}{8}$  in. long, and a pair of stiles,  $\frac{3}{4}$  in. wide by  $12\frac{1}{2}$  in. long, are glued over the others, as shown, to make the assembly. The front lower rail shows a  $\frac{1}{16}$ -in. margin on the one behind, while the stiles give a margin of  $\frac{1}{8}$  in. on the posts. Fit caps,  $\frac{7}{16}$  in. wide, over the stiles, letting them project  $\frac{1}{16}$  in., to correspond to the caps of the turned pilaster.

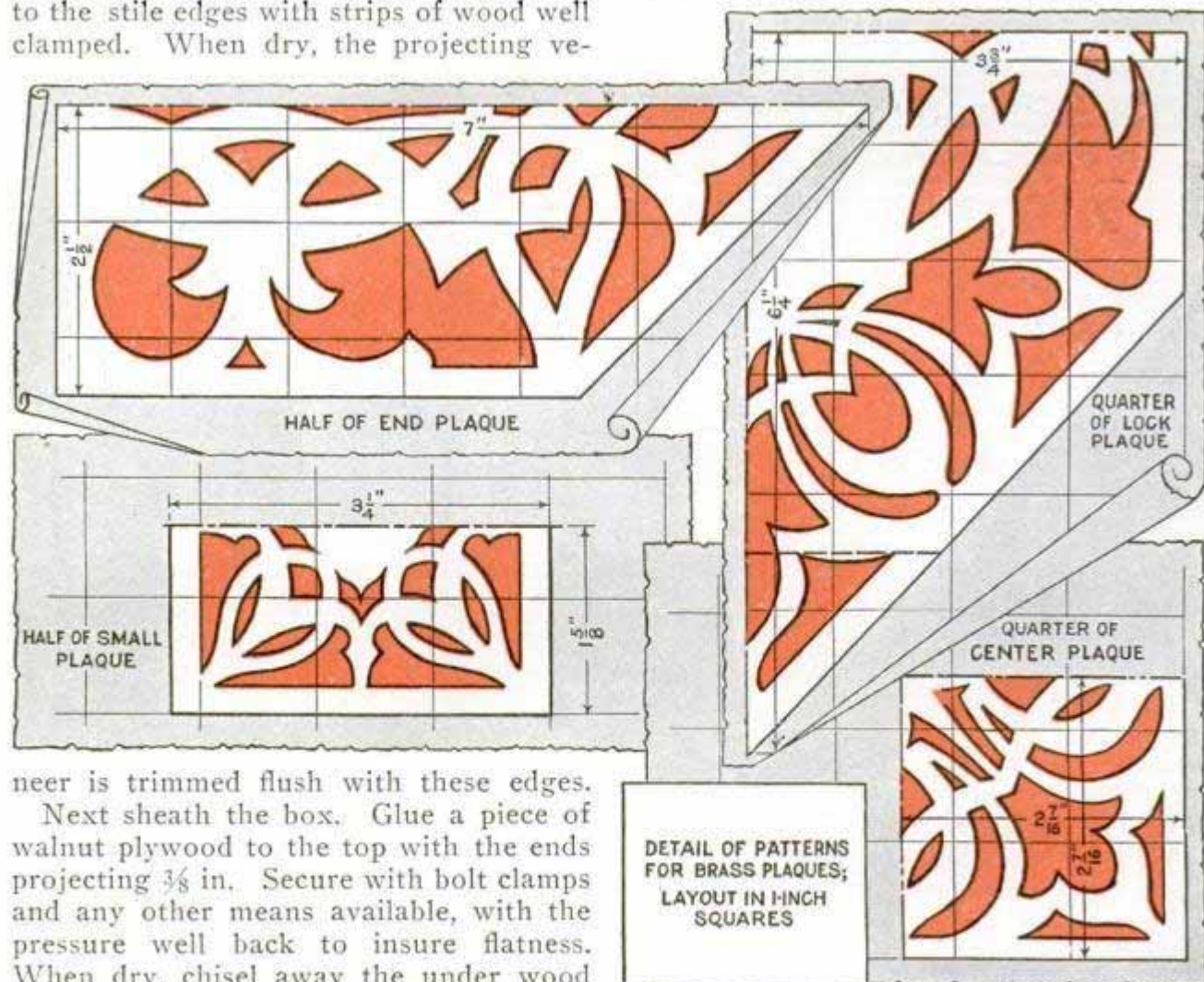

ner is trimmed flush with these edges.

Next sheath the box. Glue a piece of walnut plywood to the top with the ends projecting  $\frac{3}{8}$  in. Secure with bolt clamps and any other means available, with the pressure well back to insure flatness. When dry, chisel away the under wood



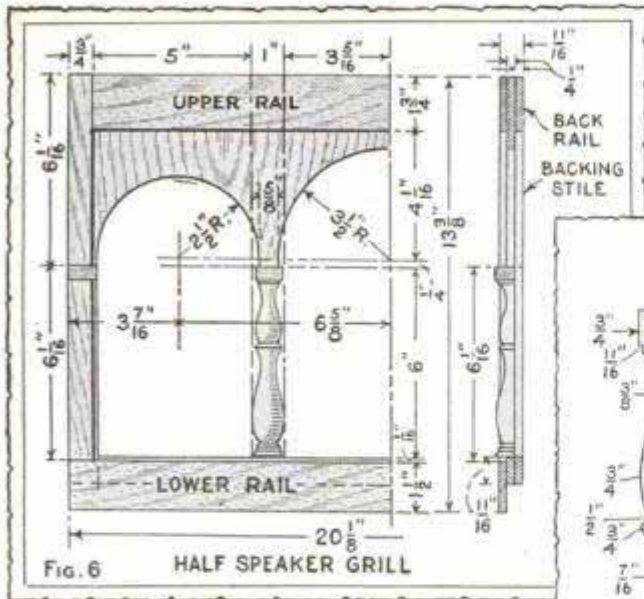

pletes this. Joint the front edges of the box and glue a 1/16-in. veneer over them, mitering the corners.

Glue up the door, using walnut plywood outside and in, with a center core of three-

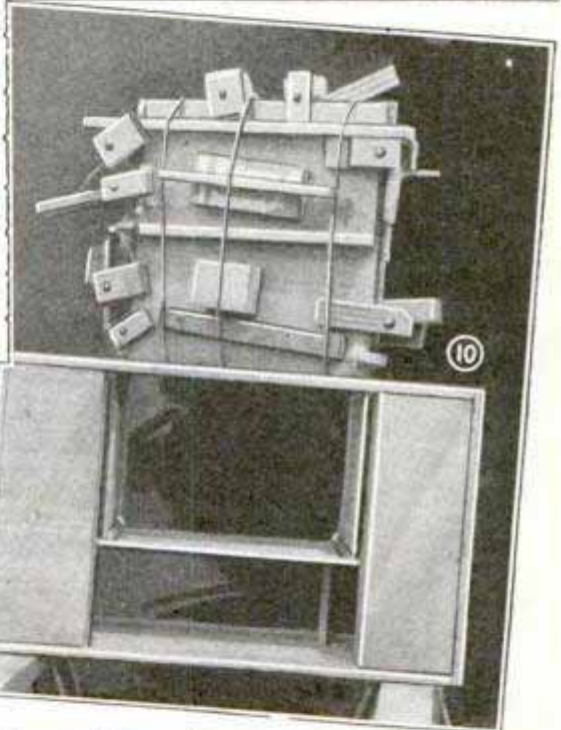
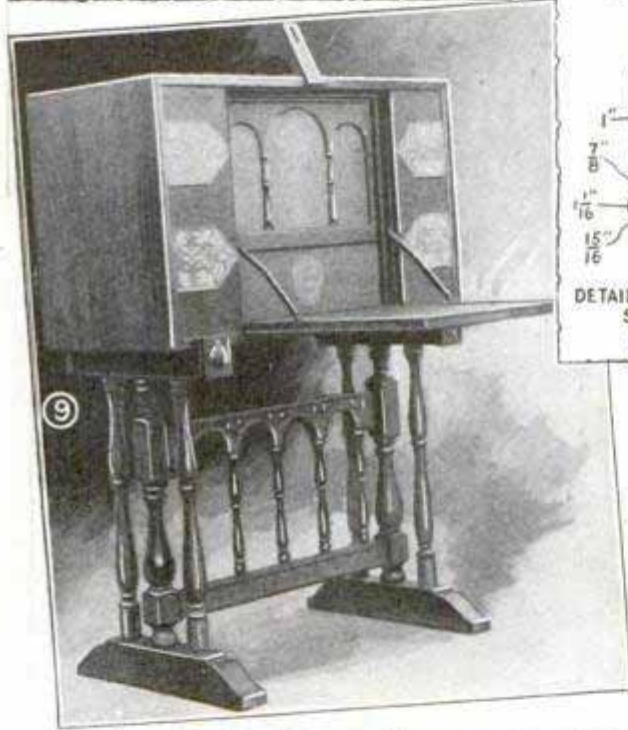
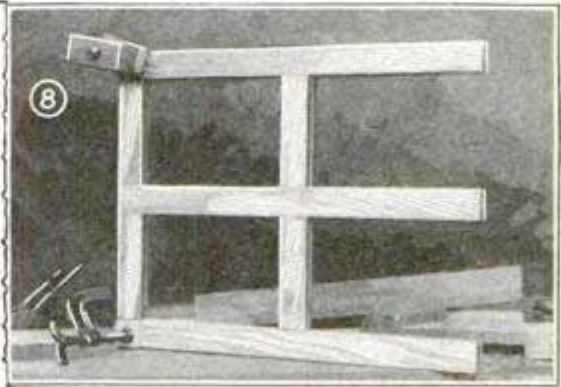
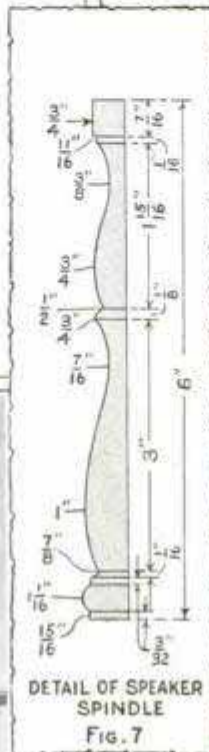

Fig. 8, Box End Frame; Fig. 9, the Desk Open; Fig. 10, Veneered Box with Glued-Up Desk Door

Turn the latter as a single spindle, to be ripped down the center.

Stretch brocaded silk over the back of the grill, placing the design with respect to the arches and holding it in place with backing stiles and rails, 1/4 in. thick. Two 3/4-in.-wide stiles are added between the arches to carry the pilasters, which are nailed from the back with brads.

Install the grill in front of the tone chamber, with the lower front rail bearing against the shelf. Make two walnut side stops, 3/8 by 3/4 in., notch them to fit against the grill, so that the back edges line with the back of the grill rail and the bottom stop, and tack in place with three brads each. A stop at the top, 1/2 in. wide, com-

ply pine. Bind with wire, force wedges underneath, and add clamps to the edges. When dry, fit it snugly, screw on the piano hinge, and scribe the edges with a clearance at sides and top of 1/16 in. Glue veneers on these, to hide the plies, and surface with sandpaper.

The back of the case is closed with a cane panel, the frame being built of 1 by 2-in. pine, halved together at the corners. (See Fig. 5.) Wet the cane webbing before tacking on. Trim the edges and tack a flat molding in the rabbets. When dry, the cane will be stretched as tight as a drumhead, and the panel can be fitted into the box. Put a stop along the top, and secure the panel with four brass screws,



so that it can be quickly removed to get at the set.

Cut down the hasp hinge as required, mortising it into the upper door rabbet, and mortise the staple into the door. Have them plated to match the plaques.

Half and quarter patterns for the brass plaques are given on page 830. Cut the plaques out and paint one side of each with asphalt varnish. Heat them to the smoking point, and allow to cool. Coat the reverse sides with wax. Trace the patterns onto the asphalt, afterward scratching through the paint with a sharp metal point. Build a dike around the edges with wax, to hold dilute nitric acid in the proportion of one to five,  $\frac{1}{4}$  in. deep. Some parts may be eaten through ahead of others, spilling out the acid; but the others will be so thin that they can be easily knocked out. Clean off the paint and smooth the rough edges. Give them an antique finish, or etch the surface lightly with acid, and coat with clear lacquer.

The old Spaniards were fond of red-velvet backing under the plaques, but velvet is a dust

catcher, and a coat of magenta lacquer will be found much more satisfactory, or the finished wood itself will give a good effect. Use small round-headed escutcheon nails to attach the plaques.

Sandpaper the cabinet carefully before filling. The amateur will find oiling and waxing the easiest finish to apply, and it is much to be recommended. Repeated oiling, from time to time, combined with "elbow grease," will result in a fine finish,

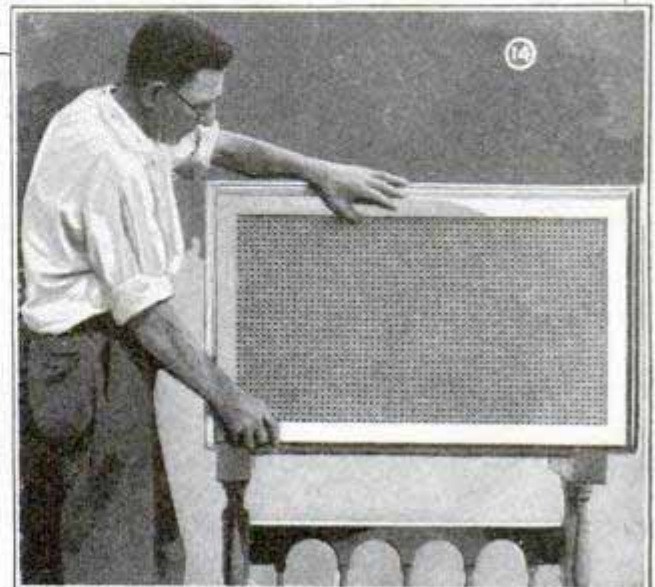
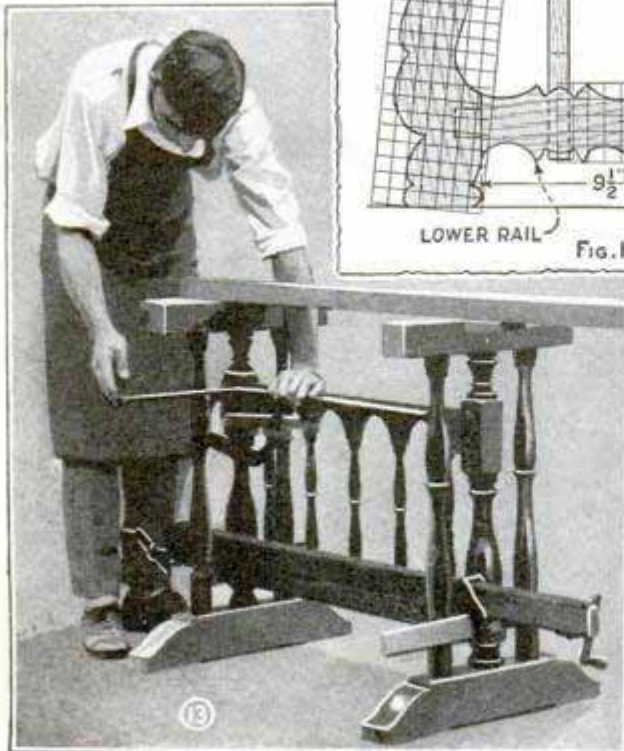
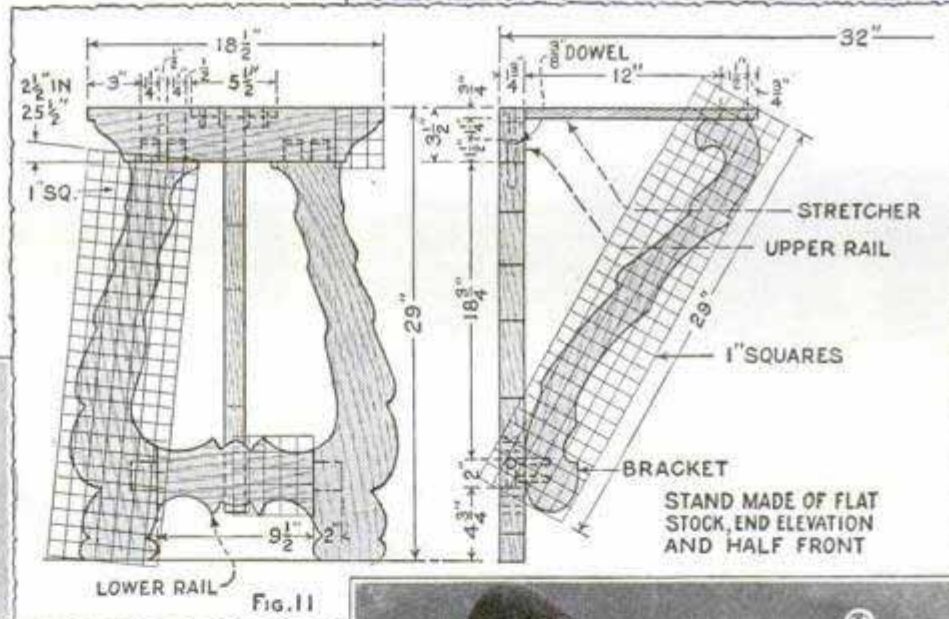

Fig. 12, Measuring Acid for Etching; Fig. 13, Squaring the Stand; Fig. 14, Trying the Back Panel



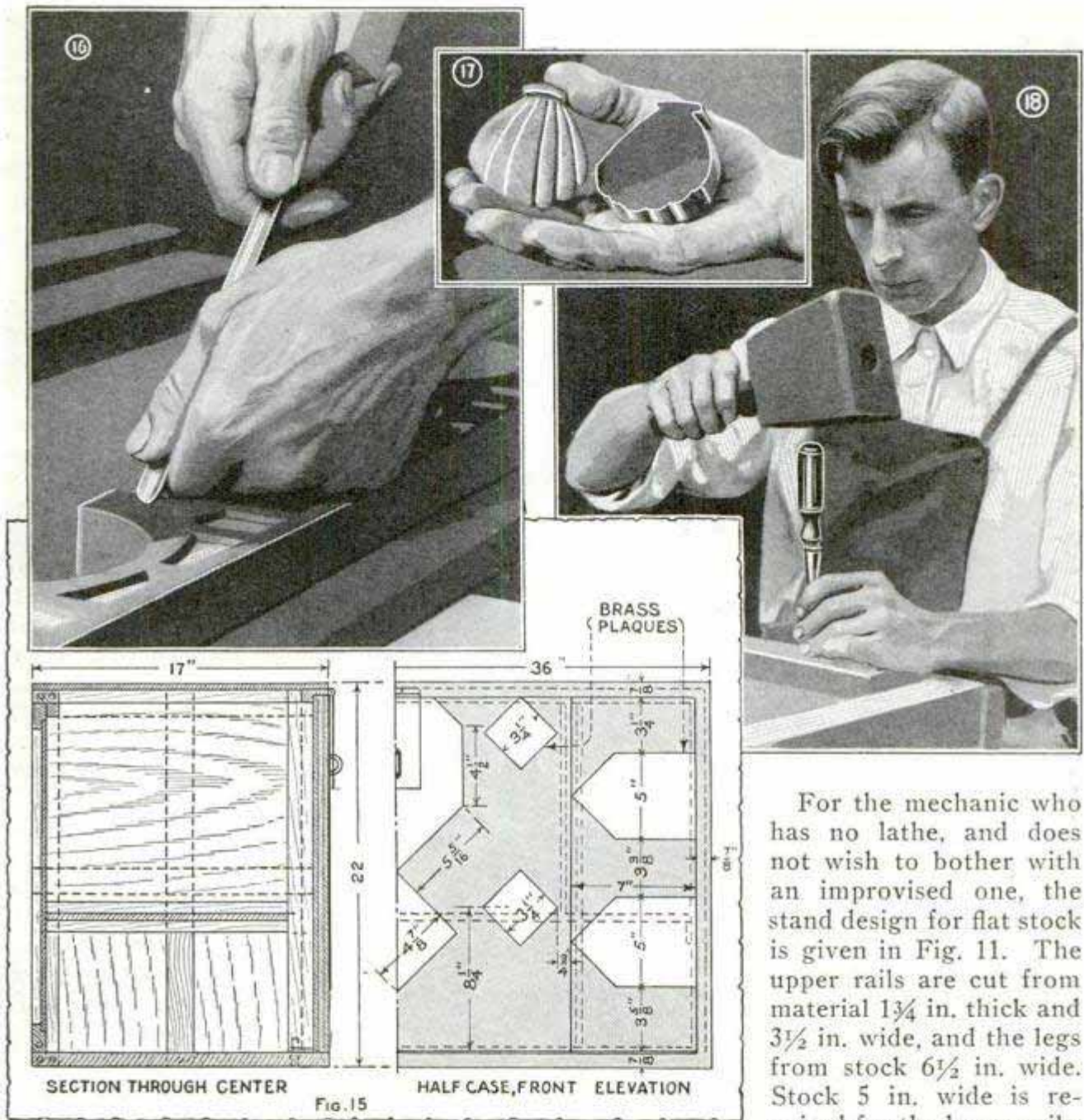

Fig. 16, Carving the Flower Ornaments; Fig. 17, Shell Ornaments in Process of Carving; Fig. 18, Outlining the Carving

For the mechanic who has no lathe, and does not wish to bother with an improvised one, the stand design for flat stock is given in Fig. 11. The upper rails are cut from material  $1\frac{3}{4}$  in. thick and  $3\frac{1}{2}$  in. wide, and the legs from stock  $6\frac{1}{2}$  in. wide. Stock 5 in. wide is required for the lower rails, and  $5\frac{1}{2}$  in. wide for the brackets. The upper rails

more beautiful from an artistic standpoint than the gloss of polished varnish.

are attached to the legs with double tenons. Saw the parts roughly to profile.

**MATERIAL LIST**

**For Cabinet**

- 2 pieces,  $\frac{3}{4}$ -in. three-ply figured walnut panel veneer, good one side, 18 in. by 6 ft.
- 1 piece,  $\frac{3}{4}$ -in. three-ply figured walnut panel veneer, good one side 24 in. by 4 ft.
- 1 piece,  $\frac{3}{8}$ -in. three-ply pine panel veneer, good one side, 36 in. by 5 ft.
- 1 piece,  $\frac{3}{4}$ -in. five-ply pine panel veneer, good one side, 17 by 36 in.
- 1 piece, 3 by 3 in. by 5 ft., rough walnut.
- 1 piece, 2 by 2 in. by 9 ft., rough walnut.
- 1 piece, 1 by 6 in. by 10 ft., rough walnut.
- 1 piece, 3 by 3 in. by 3 ft., pine or fir, S4S.
- 1 piece, 3 by 4 in. by 4 ft., pine or fir, S4S.
- 5 pieces, 1 by 2 in. by 8 ft., pine or fir, S4S.

- 1 piece, cane webbing, 18 by 34 in.
- 1 qt. liquid glue.
- 4 ft.  $\frac{1}{2}$ -in. hardwood dowel.
- 6 ft.  $\frac{3}{8}$ -in. hardwood dowel.
- 1 pt. light oak filler.
- 2 ft. piano hinge.
- 1 heavy iron hasp and staple.
- $2\frac{1}{2}$  sq. ft. No. 21 gauge, sheet brass.

**For Flat-Stock Stand**

- 1 piece, 2 by 7 in. by 10 ft., rough walnut.
- 1 piece, 2 by 4 in. by 3 ft., rough walnut.
- 1 piece, 2 by 5 in. by  $2\frac{1}{2}$  ft., rough walnut.
- 1 piece, 2 by 6 in. by 5 ft., walnut, S4S.
- 1 piece, 1 by 6 in. by 3 ft., pine, S4S.



smoothing them when they are assembled. A 1 by 6-in. pine stretcher joins the upper rails, being housed in and further secured with  $\frac{3}{8}$ -in. dowels. The lower ends of the brackets are doweled to the lower rails, while tenons on the upper ends fit into through mortises in the stretcher.

The radio installation is made entirely

from the back, but the grill must be removed from the front.

Full-sized blueprints of the half and quarter patterns for the brass plaques may be obtained from Popular Mechanics radio department, 200 E. Ontario St., Chicago, for 25 cents to cover cost and packing. Specify blueprint No. 137.

**New Speaker Employs Double Diaphragm**

The speaker shown in the illustration consists of two vibrating diaphragms,

the tubing and allow it to dry thoroughly, then place it in a warm oven for half an hour. Two holes are punched in the tubing,  $\frac{3}{4}$  in. from the starting end of the coil;

then the wire is threaded through these holes to anchor it, leaving an end about 6 in. long. For standard broadcast wavelengths wind about 250 turns of No. 32 d.c.c. wire on the tube and secure the finishing end through two small holes as at the start. Both ends of the coil are then connected to two small binding posts or Fahnestock clips at the finishing end, the starting end being brought up inside the tube. The mounting block consists of a piece of  $\frac{1}{2}$  by  $\frac{1}{2}$ -in. wood rounded at the ends to fit into the bottom of the

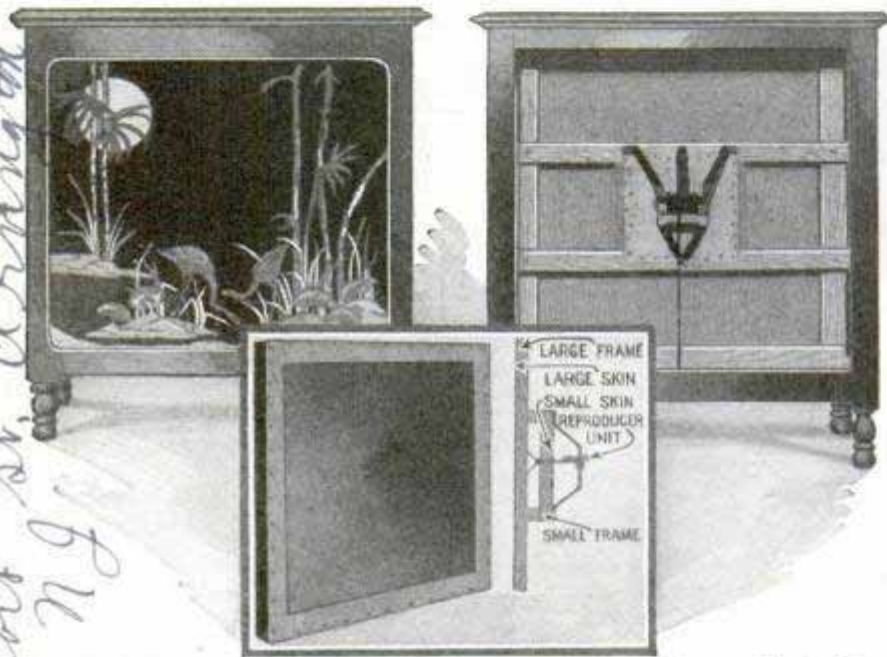

Top, Left, Speaker Installed in Cabinet with Tapestry Front; Right, Rear View; Below, Construction Details and Front View of Large Diaphragm

tightly stretched upon two frames, the center point of each diaphragm being connected to the other. The pin of the reproducer unit is fastened to the balanced center point. The speaker may be used with all 210 and 171 power amplifiers and is suitable for all types of amplifiers including the 50-watt power type. It is said to give a uniform response from 50 to 10,000 cycles, reproducing with practically equal facility all notes from that of the bass viol to the highest note of the piccolo.

tube. This wood strip is drilled at the center to take either a wood or machine screw for mounting the coil upright on the subpanel or baseboard. Choke coils of this type may be used also in short-wave transmitters, but in that case the wire should be No. 26. The number of turns

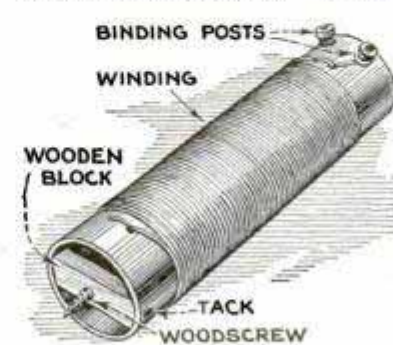

necessary for wavelengths below 100 meters should be about 130. No. 26 wire is of sufficient size to carry the plate current of a 500-watt transmitter, yet small enough so that the necessary number of turns may be wound on the tube.

**Homemade R.F. Choke Coils**

Radio-frequency choke coils are a necessary part of most modern receivers. These coils are not costly, but if you prefer to make your own, cardboard tubing from tissue rolls is about the right size. Shellac

*Chicago. 549 W  
Washington  
168 Chambers  
of West Hallington  
The Air Chrome Studios. due  
1899-1900  
St. Crumpton  
N.Y.*



# New Perfect-Tone Six Employs Screen-Grid Tubes

THE PREVIOUS perfect-tone six receivers have proved to be among the most popular instruments ever designed in Popular Mechanics radio laboratory, and resistance-coupled a.f. amplification owes some of its present popularity to these particular sets. The advent of the new screen-grid tube with its remarkable r.f. amplifying qualities, together with improved coils and tuning units offered possibility for further improvement. Laboratory experiments show that the tonal quality cannot be improved without going into expensive power amplification; therefore we have retained the original resistance-coupled a.f. unit and have taken advantage of the latest electrical and mechanical devices to improve the circuit. Wider range, owing to greater amplification of weak distant signals; better selectivity, due to improved shielding methods; simplified tuning and regenerative detector under control, to provide greater sensitivity, make this new set interesting to the critical circuit fan. The tone is all that the name implies, when used with any good modern speaker.

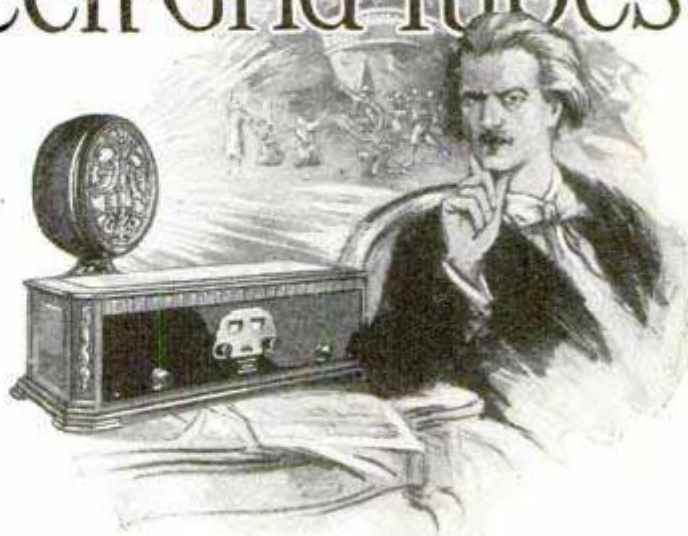

The rear views of the completed instrument, together with the simplified diagrams, tell the story of construction so plainly that little comment is necessary. To prevent confusion in the limited space available in the large diagram for the detector and r.f. stages, an additional diagram of these stages, showing the wiring in detail, will be found on page 839. The wires are numbered on both diagrams, so that no difficulty will be encountered in tracing the circuit, and a large blueprint of the entire wiring in one unit and

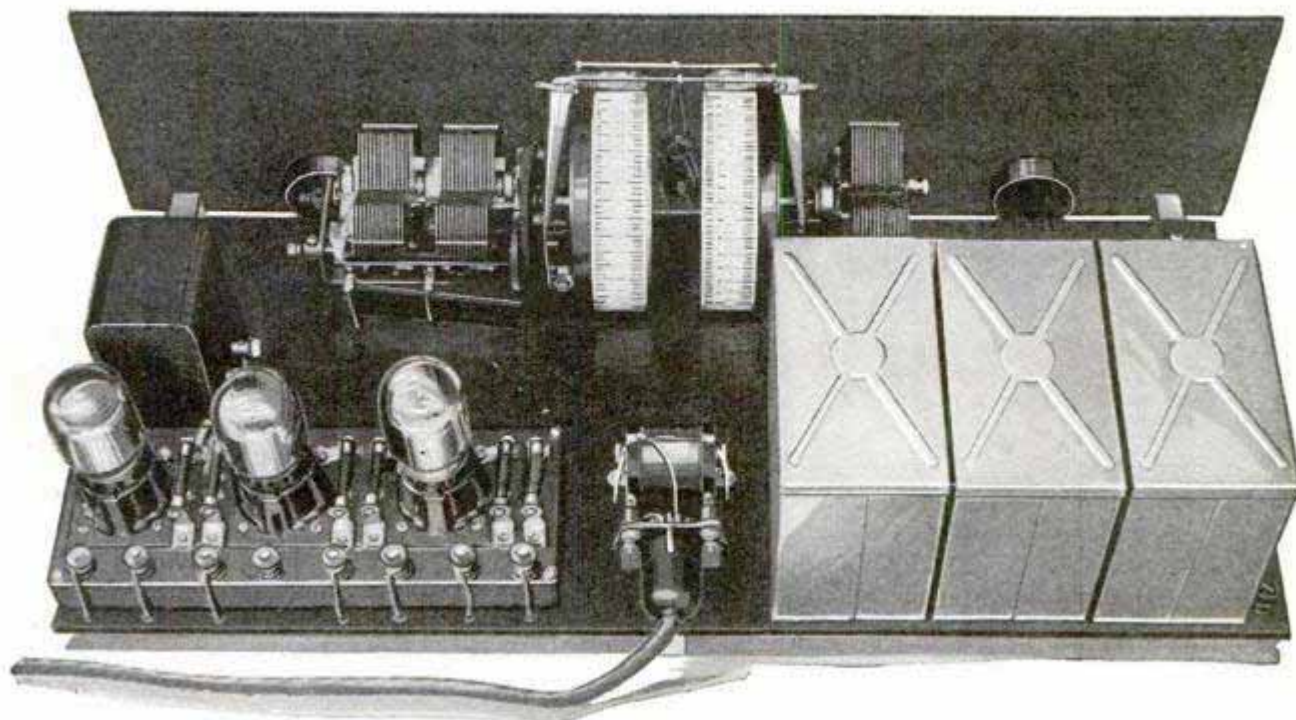







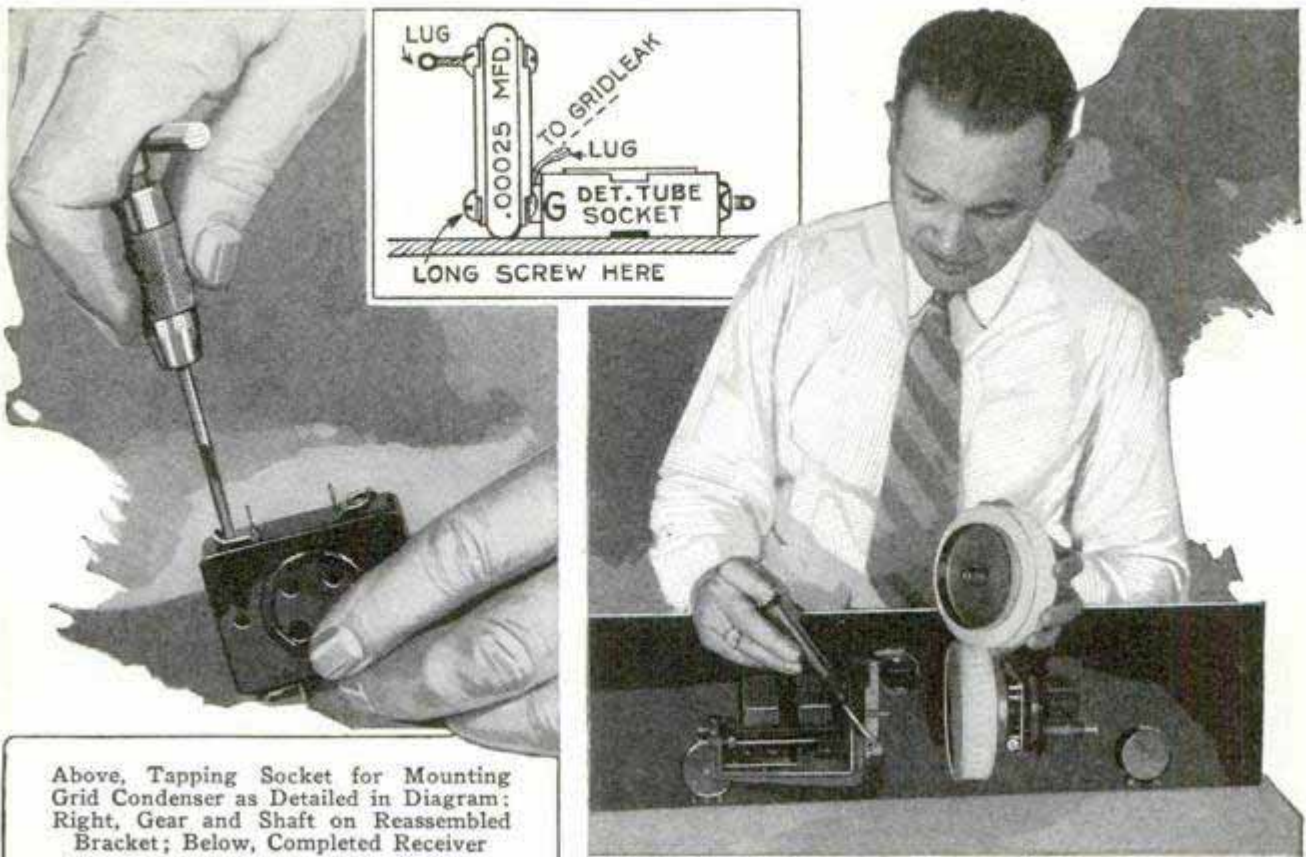

Above, Tapping Socket for Mounting Grid Condenser as Detailed in Diagram; Right, Gear and Shaft on Reassembled Bracket; Below, Completed Receiver

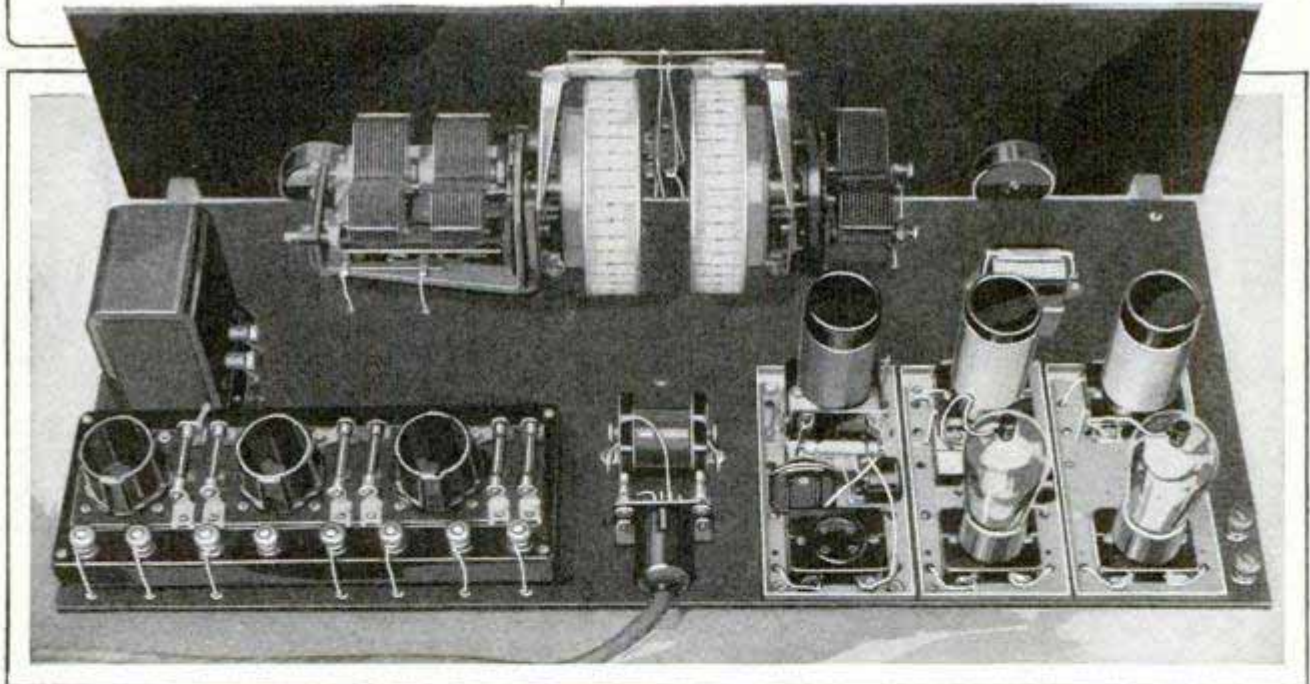

a built-up assembly of the a.f. amplifier are available. Drilled and engraved panels may be had if desired, greatly simplifying the work of assembly.

The instruments on the front panel are mounted first, and the photos on pages 837 and 838 clearly illustrate the method of mounting the variable condensers and drum dials. The single variable condenser is screwed to the bracket shown at the right on this page, and the drum dial is

then mounted on the shaft. No change is necessary in this bracket; it is mounted just as it comes from the carton. The bracket at the left, for the gang condenser, however, must be reversed and reassembled. Remove the shaft and take off the small brass gear, replace it with the extra gear provided with the unit and remount the shaft in the lower slot on the bracket. This makes the condenser dials rotate in the same direction with similar rotation of











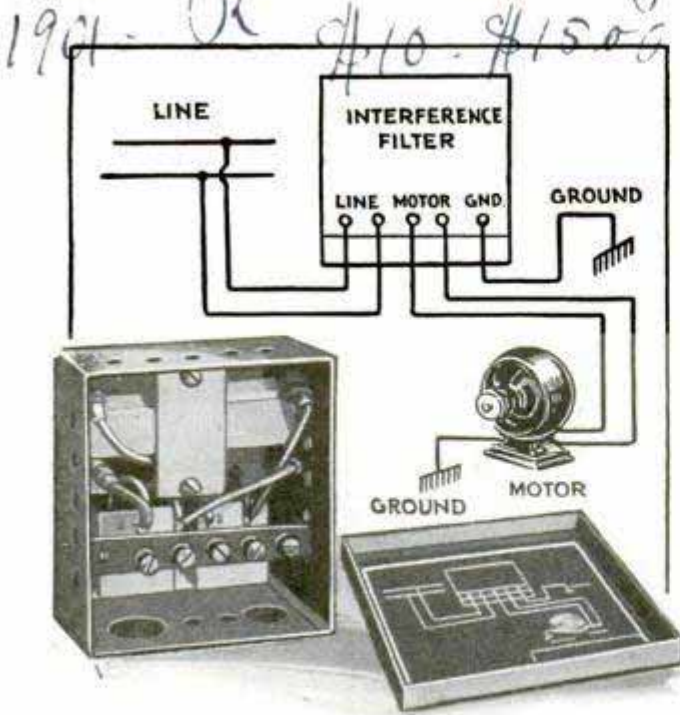

Above, Simple Diagram of Connections; Below, Interference Filter with Cover Removed

### Device Reduces Motor Interference

A new device for reducing interference from motors up to 5 hp. at 220 volts is now available; this type is shown in the photo and a similar device has been designed for smaller motors of the household type. The unit is built, in accordance with code requirements, in a ventilated metal box, for attachment to wall or machinery. The terminals are brought out to a bakelite strip with heavy screw posts and knockouts are provided in the bottom of the box for attachment to standard BX or conduit. The type shown is specially designed for elevator motors, motor-generator sets and other types of interfering electrical apparatus employing large motors. The smaller type referred to is designed for use with motors on oil burners, under-grate blowers, electric refrigerators, and for small motors on vibrators, fans and sewing machines.

In many cases the interference is such that it can only be reduced and cannot be entirely eliminated; however in a majority of cases the filter device is claimed to reduce the interference to a point where it is no longer noticeable.

Popular Mechanics' radio department offers its information service free to all readers of our magazine. We will be glad to help you with your problems, and will promptly answer all inquiries.

### Drilling Template for Variable Condensers

When mounting variable condensers, or similar apparatus requiring accurately located holes in the panel, a template of some type is necessary for good work. If that supplied with the part is lost, one may be made from a sheet of paper. Cut a small round hole in the proper place for the condenser shaft, making this hole a trifle small to insure a tight fit. Place the paper over the shaft and force it down over the mounting holes in the condenser, pressing it firmly over the holes so as to leave a good impression on the paper. Remove the paper and place it on the panel, centering the shaft hole in the proper position; then, with an ice pick or other sharp tool, locate the centers of the remaining holes.—R. J. Plaisted, Cleveland.

### R.F. Transformers for Screen-Grid Tubes

Radio-frequency transformers for use with screen-grid tubes should have a high primary impedance in order to give the amplification of which the tubes are capable. This means that the inductance of the primary winding should be about the same as that of the secondary.

1904-R

### Voltage Divider for B-Supply

The voltage divider shown in the illustration provides a complete resistance unit so constructed that, by simply connecting



it to the output terminals of the filter, proper plate and grid voltages for the radio receiver are obtained. This device simplifies the construction of

B-power units both for the professional and amateur builder. Wire-wound resistors are used, each being provided with five adjustable contacts. The unit is not only flexible enough to meet all receiver current conditions, but, owing to the design, it is possible to calibrate the adjustable contacts. It is also possible, by use of the tables and graphs supplied with the device, to adjust the output to the proper voltages without the use of an expensive high-resistance voltmeter.

Electrad, Inc.  
175 North Street



# AMATEUR MECHANICS



## Shadow Pictures—a Fascinating Pastime

By R. GREGG

**O**F COURSE you're not an artist. But, if someone sketched a dark shadow on a piece of paper, you could, artist or no artist, take a pen and draw a line around it? Certainly you could! Then you can make shadow pictures. Besides being a lot of fun, these shadow pictures are a

any photographer can enlarge your snapshot negatives to the required dimensions.

Fig. 1 is the photograph "in the raw." Take a pen and with black ink outline all of the dark portions in the picture. Paint in these dark portions with a black, opaque water color or black ink, as shown in Fig. 2. In a profile view like this, all of the smaller black portions, such as the ear, the mouth, the eye and eyebrow must be connected to one of the two main black areas, either to the hair or the black background which surrounds the picture.

This is done so that, when you cut out the white portions, which is the next step, your black areas will form a continuous mass. (See Fig. 3.) In cutting out the whites, use a very sharp penknife or a pair of small scissors. The penknife is the best for detail, while the scissors are especially

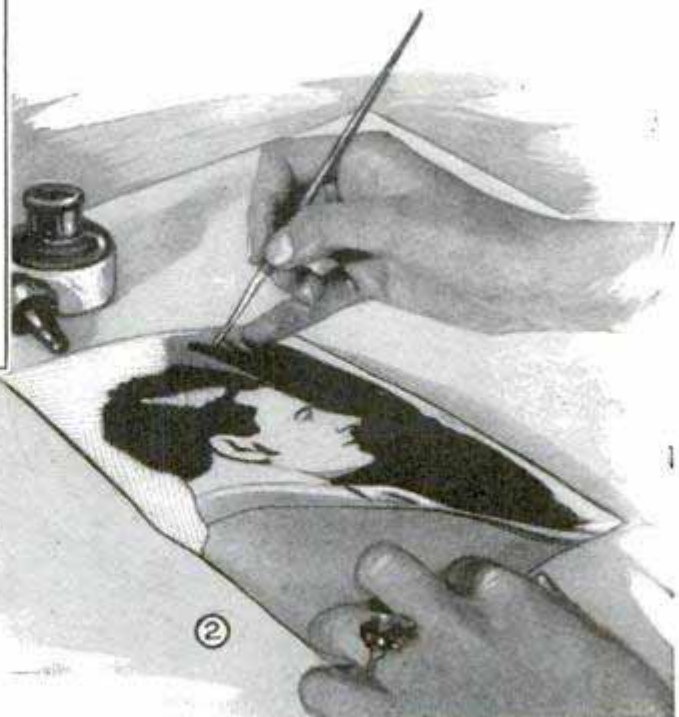
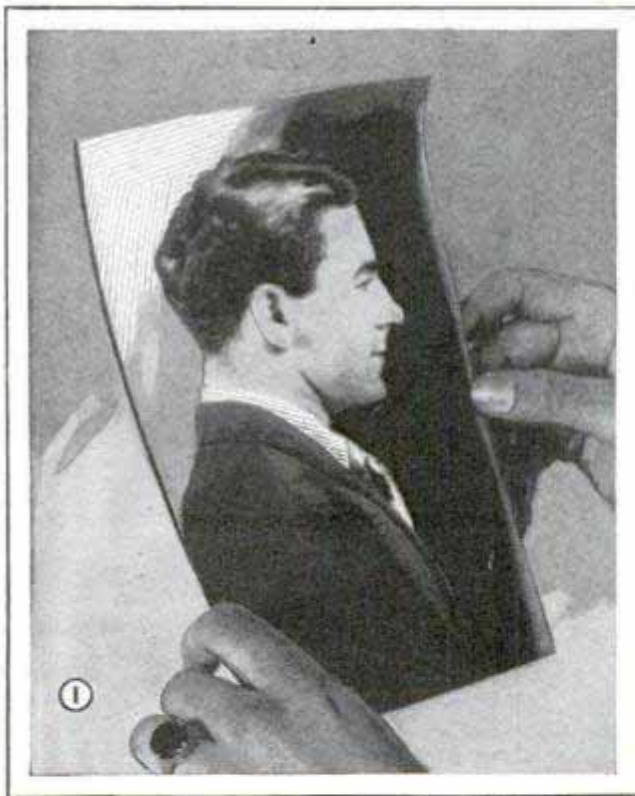

distinct ornamental unit which can be used to good advantage in decorating lampshades, sidelights and window panes.

First of all, get a photograph of yourself. This should be at least 3 by 5 in. in size. If you have none on hand of this size,



suitied for larger areas. If the hair of your picture is dark, it will be necessary to cut a white line entirely around it in order to keep it distinct from the background. Care must be taken, of course, not to cut this line so far that any piece of the picture will drop out.

After the white portions of the picture have been cut out, cover the reverse side lightly with paste, as shown in Fig. 4, and then mount it on a thin sheet of white paper, the same size as the photograph. Paste another sheet of white paper in place on the front side and press the whole thing out flat. The finished picture, when held to the light, will appear somewhat like the one shown in Fig. 5. In this form, it makes a rather attractive novelty—something a little different from the ordinary photograph.

If you wish to preserve these shadow pictures, you can do so by mounting them

on a lampshade. The type of shade to use is that of undecorated parchment, which can be purchased at any department store. They come in a variety of sizes and shapes, and in selecting one, you should get it of a size in proportion to the picture to be mounted on it.

In the mounting, no paper backing is needed. The picture is coated with paste on either side and pasted directly to the inside of the shade. After the paste is dry, the lampshade can be placed over the bulb and the light switched on. The result will be something like those shown in Figs. 6, 7 and 8. In making full-face shadow pictures, like the one in Fig. 7, where the eyes, nose and mouth are unconnected to the main shadows, the simplest method for the amateur is to have two prints made of the same size, and use one as a sort of template. Black in and cut out one only, cutting the eyes, etc., out





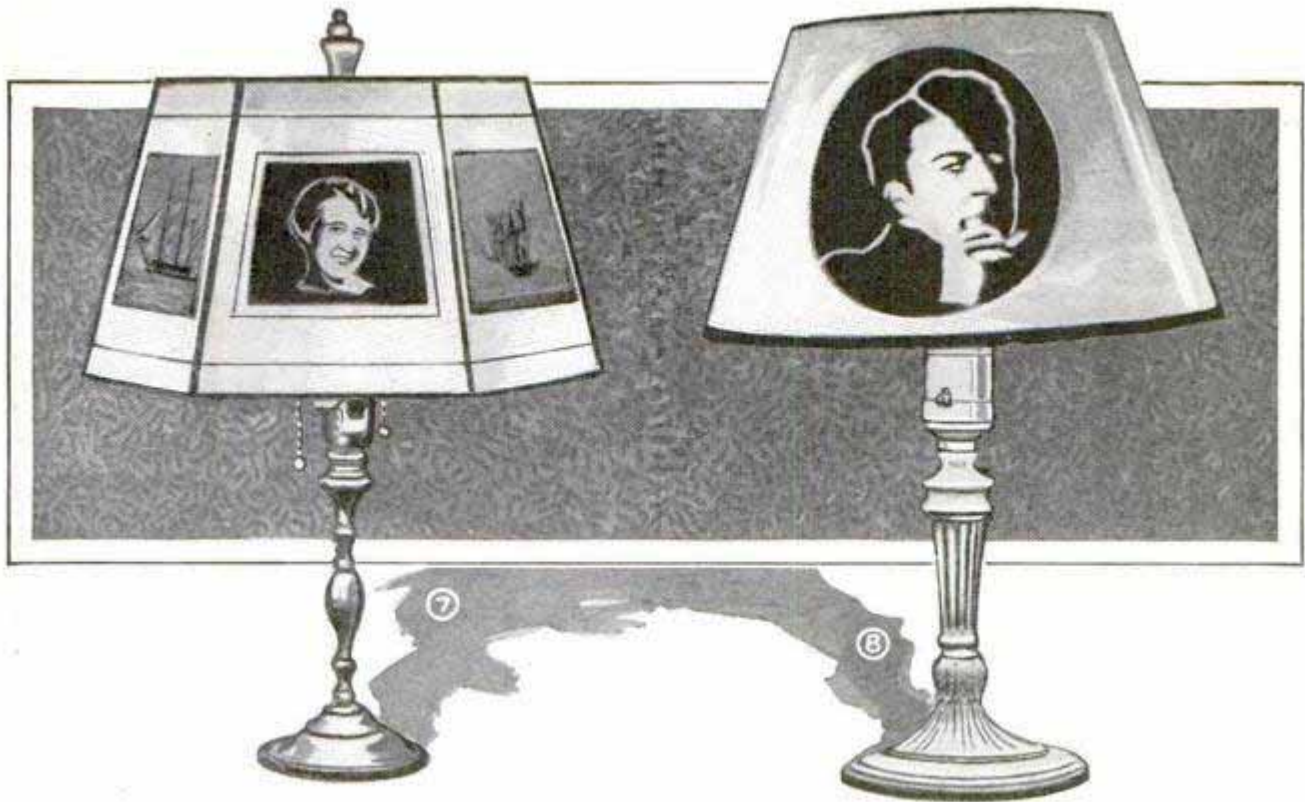

separately; then stretch a sheet of thin tissue or tracing paper over the untreated photo, coat the parts of the shadow picture and paste them in place on the tissue paper, registering the parts with reference to the full photo below. The shadow picture, with its paper backing, can then be mounted as before.

Actual photographs are only one medium in making these shadow pictures. Any of the thousands of printed photographs found in newspapers and magazines, as well as paintings and drawings, can be treated in the same manner. It is simply a matter of selecting the dark shadows and then painting them in. It takes a little knack to get really good shadow pictures, and you will probably spoil a picture or two before you get something which brings you real satisfaction. Once the simple technique of the thing has been mastered, you will find shadow pictures easy.

#### Alarm Clock Opens Hen-House Door

Poultry owners often close the hen-house trapdoor during the night in order to keep rodents out and prevent drafts. The door must be opened early in the morning and this is sometimes rather inconvenient. One poultry owner overcame this objection by fixing the trapdoor so

that it opened automatically at a predetermined time. The installation consists of an old alarm clock, set on a small shelf above the door, a couple of hinges with which the door is pivoted at the bottom, a latch and hinged trigger to hold the door shut, a stout cord attached to the trigger and to a short piece of wire which is in turn attached to the alarm-winding key of the clock. When the alarm rings at the time for which it is set, the winding key jerks the cord so that the latter pulls the trigger loose and the door consequently drops.

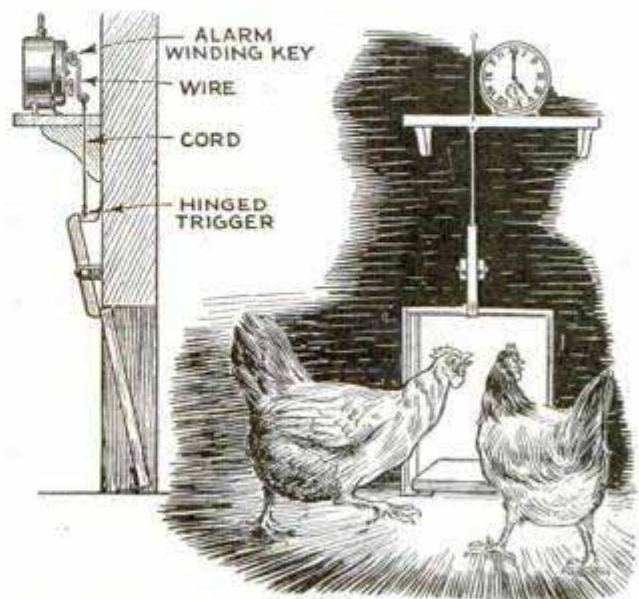

Alarm Clock Opens Poultry Trapdoor Automatically in the Morning



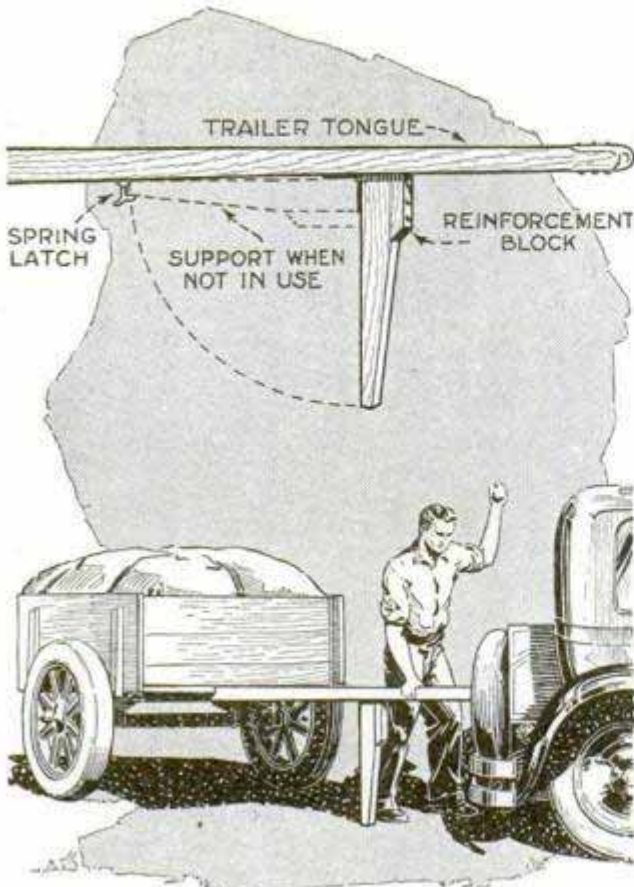

Hardwood Support for the Trailer Tongue Is a Help to the Motorist

**Support for the Trailer Tongue**

Any motorist who occasionally makes use of a two-wheeled trailer has undoubtedly experienced difficulty in handling it, owing to the necessity of dropping the trailer tongue on the ground, or finding some support for it, which is not always available. Here is a good solution for the difficulty. Simply make a support from a length of 2 by 4-in. hardwood and a small reinforcement block of the same stock. Hinge the support to the tongue with a strap hinge placed on the side toward the trailer, as shown, so that, when not in use, the support can be swung back and held in place by a spring latch. There is little or no danger of the support falling down when the trailer is towed, but even if it should, no damage would be done, as it would swing back and drag.

**Moisture-Resisting Paint**

Moisture-resisting paint for wood or stone can be made by mixing 12 oz. of rosin in 6 gal. of fish oil and 1 lb. of melted sulphur. Rub up some ocher, or any coloring substance, with a little linseed oil and mix this with the prepared solution.

*linseed oil can be used*

Apply several coats, the first of them rather thin. This paint has been found satisfactory by an experienced painter.—Charles Latour, Jr., Plattsburg, N. Y.

**Punching Small Hole in Thin Steel**

I wanted to drill a tiny hole through a steel strap  $\frac{1}{16}$  in. thick, but unfortunately broke the drill. After some thought, I took a centerpunch and, holding it over the spot where the hole was wanted, struck it with the hammer, which raised a "pimple" on the opposite side of the piece to be drilled. I filed this point off smooth, then punched the opposite side, again filing off the raised metal. After a few repetitions of this process I was able to run a small wire clear through.—G. H. Mansfield, Cuyahoga Falls, Ohio.

**Wire Pot-Cover Holder**

Pot covers can be conveniently kept in the simple wire holder shown in the drawing. Take a 46-in. length of No. 9 galvanized-iron wire and bend it to the shape shown, the dimensions of the straight parts from bend to bend being indicated in the detail. It only takes a few moments to make a holder, which can be hung on a nail in a suitable location near the stove or in the pantry.—C. Newkirk, Chicago, Ill.



A Length of Galvanized-Iron Wire Makes a Good Pot-Cover Holder for the Kitchen

*243 0 is hold enough*



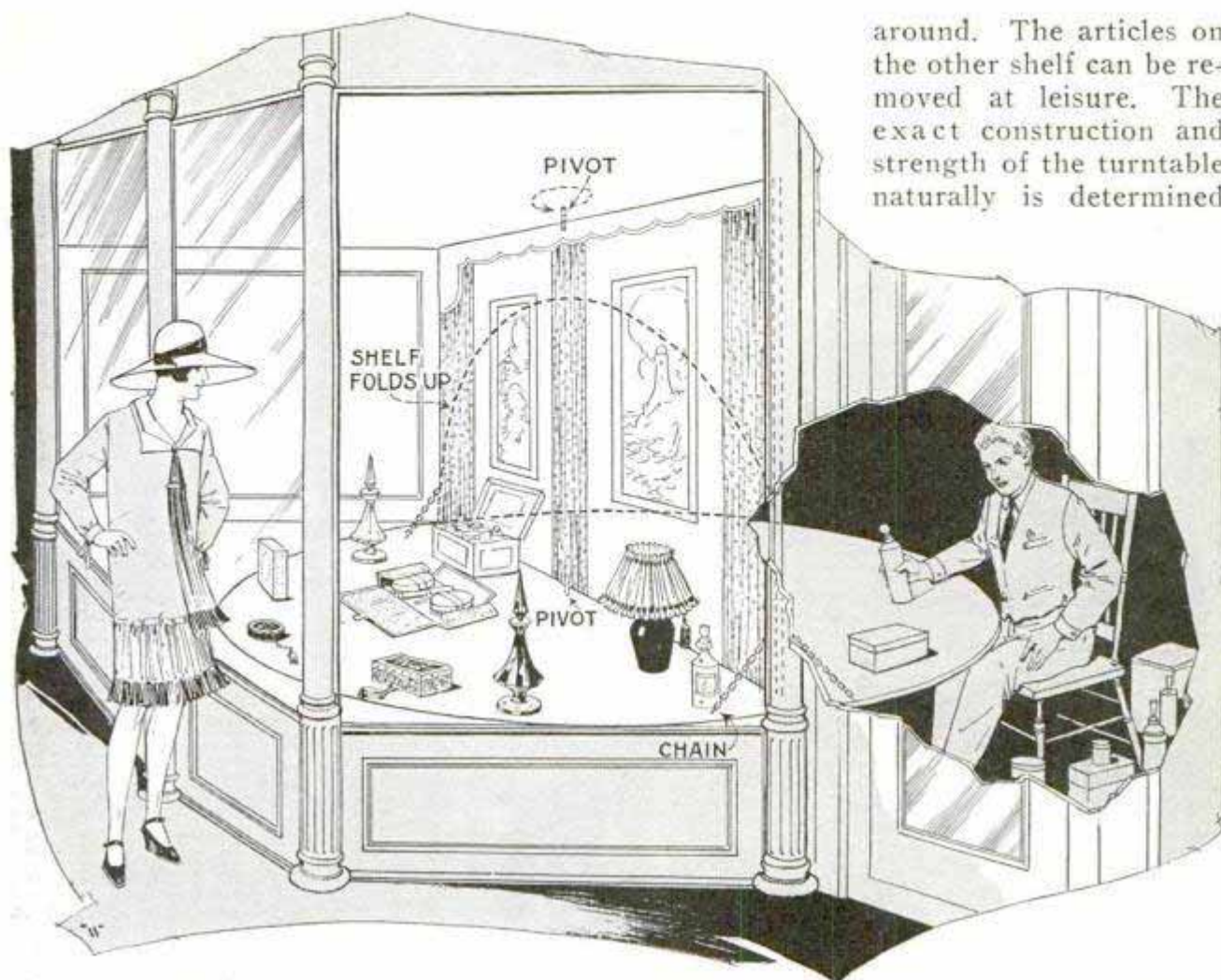

Large Turntable Consisting of a Pivoted Wallboard Partition and Two Hinged Shelves Facilitates the Arrangement of Displays in Store Window

### Turntable Facilitates Window Decoration

Frequent changing of a window display allows the passer-by to see more of a merchant's wares, but is usually delayed because of the work connected with it. One enterprising merchant devised the novel turntable shown in the drawing, which enables him to arrange the new goods to be displayed inside of the store, while the old goods are still in the window. The turntable consists of a pivoted partition, made of wallboard, suitably braced with 2 by 4-in. wood. On each side of this partition a shelf is hinged as indicated. These shelves can be folded up against the partition, catches being provided to hold them there when they are not in use, or they can be lowered to a horizontal position where they are securely held with chains. When the window scene is to be changed, the decorator merely unhooks and drops down the rear shelf and proceeds to arrange the articles to be displayed, after which the turntable is swung

around. The articles on the other shelf can be removed at leisure. The exact construction and strength of the turntable naturally is determined

by the kind and the weight of the wares that it is to hold. It should also be remembered that the window ledge should be built circular to conform to the curve of the turntable shelves. The upper and lower pivots, which support the turntable, must be in a true vertical line so that the shelves will always be in a horizontal position.—E. R. Smith, Walla Walla, Wash.

### Making a Key Impression

There are many methods of getting key impressions where the original key cannot be left for comparison. An accurate method of matching is to make an impression as follows: Fold tinfoil from a cigaret package several times to form a rectangular pad, slightly longer and wider than the blade of the key. Lay the key and pad over some hard flat surface and tap the tinfoil down on the key. A clean, accurate impression will be made, which is useful for comparison when filing a new key.—F. W. Bentley, Jr., Missouri Valley, Iowa.



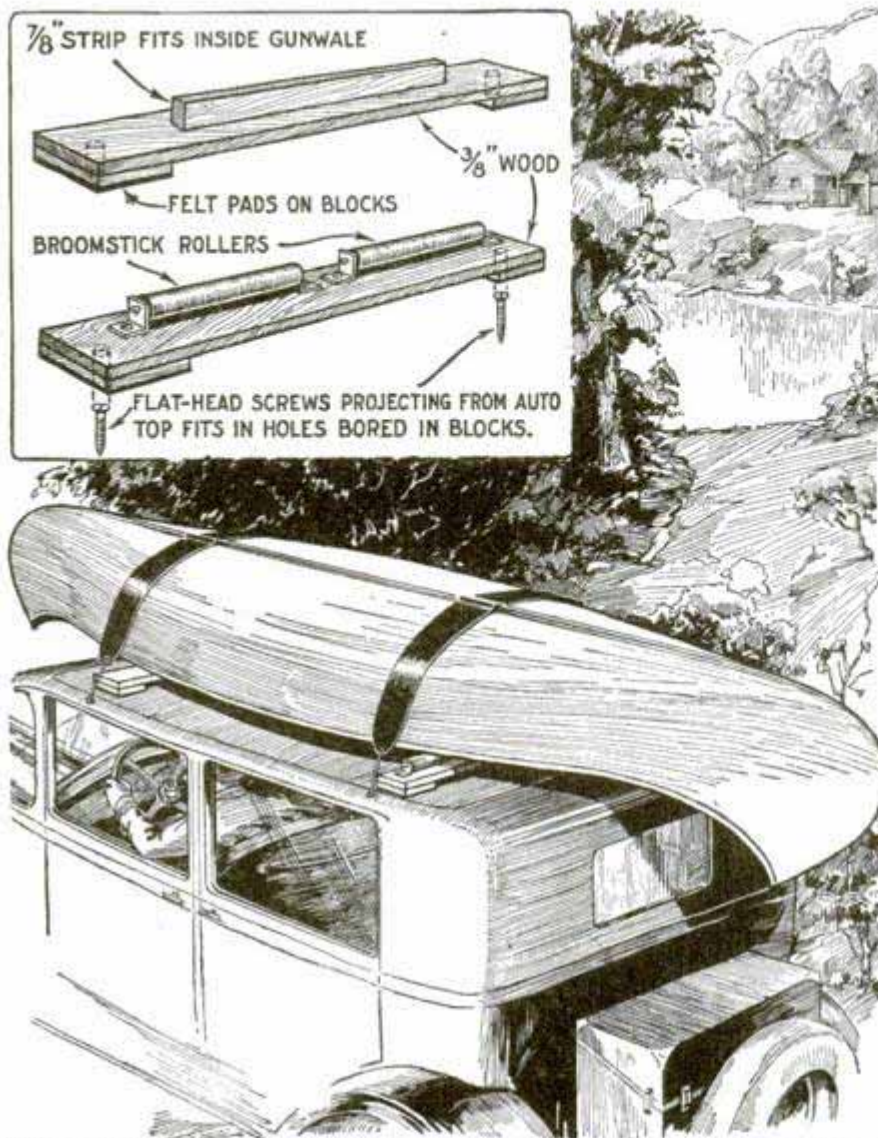

This Easily Made Canoe-Carrying Rig Will Not Spoil the Appearance of Your Sedan; Insert, Details of Holding Blocks

### Carrying a Canoe on a Sedan

City residents who like canoeing are restricted in their choice of summer resorts because that type of boat, in most cases, cannot be had for hire. But if you have your own canoe, you can take it anywhere by providing a carrying rig on your sedan as shown. The permanent fittings on the car are only four wood screws and four screweyes. The screws are driven into two cross braces of the top and serve as dowels to hold padded blocks in place, holes being drilled in the latter to fit over the screws. The screweyes also are driven into solid parts of the roof frame, at the edge and near the blocks, and their purpose is to provide means of attaching rubber straps, which are slipped over the canoe to hold it down on the blocks. The construction of the blocks is shown in the insert. The rear one is provided with

wooden rollers made from broomsticks, and must be located close to the back end of the auto top so that one man can raise a canoe until it rests on the rollers without marring the edge of the top. It is then comparatively easy to push the canoe, upside down, on the rollers until the other end of it is over the front block. A  $\frac{7}{8}$ -in. strip of wood of suitable length to fit inside of the gunwale is screwed onto the front block. The blocks bear the weight of the canoe and the rubber bands, which may be cut from old inner tubes, simply hold the canoe and prevent it from being dislodged. It was found convenient to attach spring clips to the ends of the rubber bands for quick attachment to the screweyes. A canoe supported in this way will ride nicely at any speed and can be as easily removed as it is put in place.

The rig itself may also be taken from the car with little trouble.—R. L. Brehmer, Circleville, Ohio.

### Safe and Handy Hanging of Clothesline

My clothesline is arranged so that it can be taken down in an instant if necessary. The ends of the line are tied to ordinary spring snaps of the kind shown in the drawing, and screweyes are driven into the posts. A large spring snap, attached

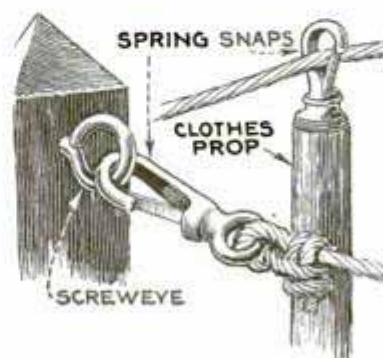

to the top of the clothes prop, is also useful. It will hold the line securely so that



there is little danger of having it come down, leaving the clothes dragging on the ground.—Mrs. C. D. Haddaway, South Park, Ky.

### “Want Tags” for the Hardware Store

In most retail stores a “want book” is used to list the materials which are out of stock and must be ordered. A Wisconsin dealer, finding that this sometimes was neglected in the press of other duties, substituted a more convenient method, which practically prevented neglect. Into each drawer section containing the smaller articles, he put a red tag on which was printed the kind of merchandise in that drawer. The clerks were instructed to leave these tags in their respective places until the stock represented became low, when the tags were to be removed and placed in a convenient file. The order clerk could then make a circuit of the departments at regular periods, gather up the tags and place orders for the goods needed. When the new goods arrived and were placed in the drawers, the tags were likewise returned. This method, the hardware man claims, has worked successfully, mainly because the sales clerks need not do any writing.—G. E. Hendrickson, Argyle, Wis.

### Bird Houses Made from Flowerpots

Flowerpots that are no longer used make good bird houses if the bottom is knocked out and they are held against the house or barn wall by means of four wooden brackets. The brackets are cut from 1-in. material, to fit the pot snugly. In mounting the house three brackets are first screwed on; then the pot is inserted between them and the fourth bracket attached. The best location is just under the gable. —Wm. C. Thomas, Chicago, Ill.

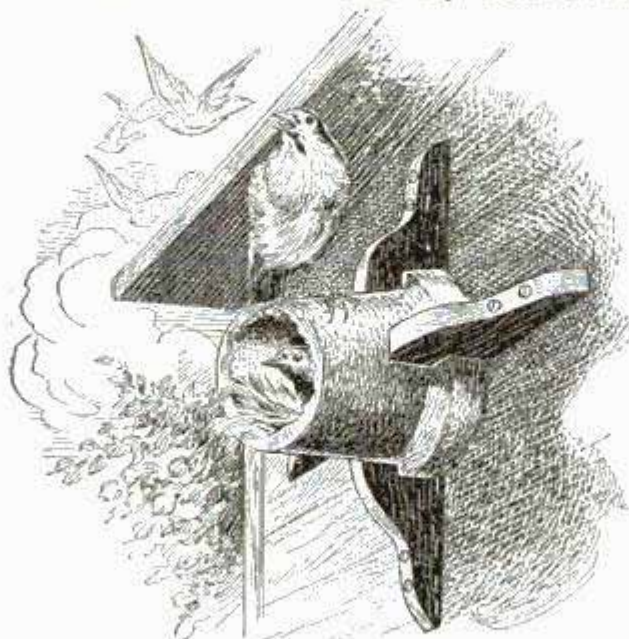

Old Flowerpots with the Bottom Broken Out Make Good Bird Houses

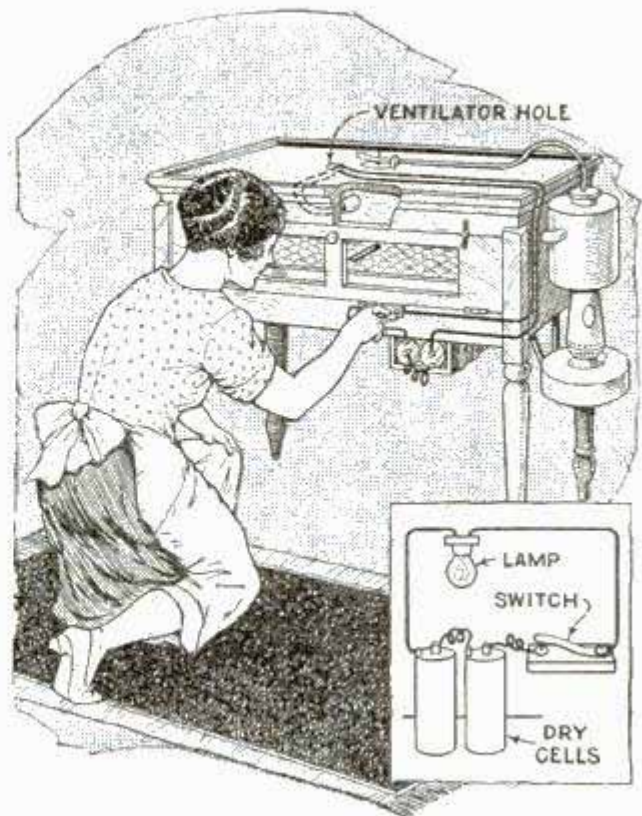

Small Lamp Installed Inside of an Incubator Facilitates Reading the Thermometer

### Incubator Thermometer Lighted by Small Lamp

Lighting the inside of an incubator to facilitate reading the thermometer can be accomplished by installing a small 3.8-volt flashlight lamp, held by a miniature screw socket, in a position just in front and toward one side of the thermometer, so that the latter will be illuminated. Only two dry cells are needed to furnish current for the lamp,

and these can be held on a small shelf attached to the underside of the incubator, as shown. An ordinary door-bell switch is mounted on the outside, and as the lamp lights only when the switch is depressed, it cannot be left on by mistake. The wiring of the circuit is given in the insert. As the incubator need not be opened, cooling of the eggs is avoided.



### Make This Mellow-Toned Chinese Fiddle



Homemade Chinese Fiddle Which Gives a Surprisingly Soft and Pleasing Tone

Although a one-string fiddle does not seem to be much of a musical instrument when compared with a regular violin, yet a surprisingly mellow tone may be obtained from a Chinese fiddle. With a little care and patience anyone can make it. The body consists of a pasteboard tube, 7 or 8 in. long and 4 in. in diameter. It is shellacked inside and out to prevent absorption of moisture. The neck is a 27-in. length of  $\frac{3}{4}$ -in. hardwood, 1 in. wide, which is braced by means of a piece of  $\frac{3}{4}$ -in. hardwood, 12 in. long, curved at one end to fit the tube. The brace is fastened to the neck with wood screws, and the curved part is glued to the tube. Care must be taken that no parts are loose as they would then rattle from the vibration when the instrument is played. The prong, or floor rest, is a length of  $\frac{1}{8}$ -in. brass rod, about 12 in. long, threaded about 2 in. at one end. It is held on the tube securely by means of two wooden blocks, two washers and two nuts, assembled as shown in the upper-left detail. Heavy-pasteboard disks are cut to fit snugly in the end of the tube, shellacked on both sides, and carefully glued in place. One of the disks is perforated to accommodate a child's toy trumpet, which is inserted in the hole after the glue holding

the disk in place has dried thoroughly, the reed being first removed from the mouth-piece. Either a curved or a straight horn may be used for this purpose. The bridge is cut out of hardwood or bone, and is about  $\frac{1}{8}$  in. thick, 1 in. long and  $\frac{1}{2}$  in. wide. Some experimenting will show the position to place the bridge in order to elevate the string so that it is parallel to the face of the neck, for easy fingering. The peg at the head of the neck is an ordinary violin peg and it is fitted into a tapered hole of corresponding size, which is drilled about 2 in. from the end. The string used is an ordinary gut violin E-string. To improve the appearance of the instrument stain the neck ebony or walnut and paint the body and horn with bright-colored lacquer, such as "mandarin red," allowing sufficient time for the lacquer to dry thoroughly before handling. The instrument is played in the manner of a cello, as shown in the illustration, or as a violin. In both cases, an ordinary violin bow is used.—Truman R. Hart, Ashtabula, Ohio.

### Holder for Gasoline-Lamp Mantles Prolongs Life

Gasoline-lamp mantles often chafe and break at the point of contact with the supporting tube. The reason for this is that the mantle itself is usually rather loose on the tube even though the asbestos cord holding it may have been drawn up tightly when the mantle was attached. An effective method of holding the mantle to the tube securely at all times is to use a coil spring made of 36 to 40-gauge nichrome resistance wire, obtainable at most radio and electric stores. The spring is made by wrapping the wire around a nail. The ends are bent so that they can be hooked together. Held by such a spring, the mantle will not chafe.

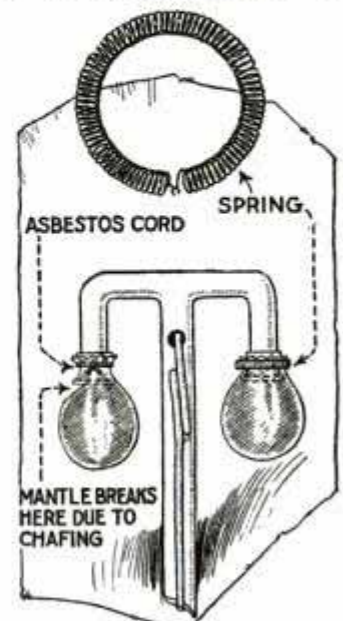



# YOUR HOME GYMNASIUM

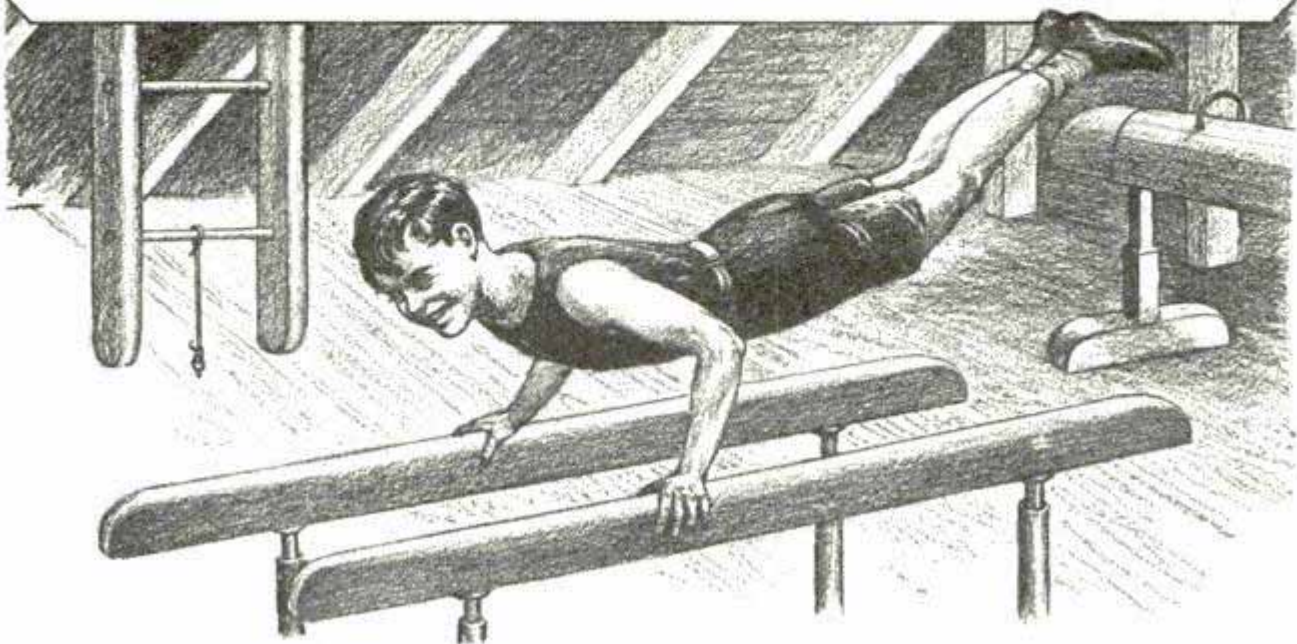

WITH a little outlay of time and money an attic or basement can easily be fitted up with homemade apparatus as a gymnasium, where the "daily dozen" can be taken with more zest and interest than is usual with the light movements of calisthenics. Lacking sufficient headroom, rings and the flying trapeze are pretty much out of the question, but a well-selected group of other devices is possible.

A trapeze bar is useful, even when the ceiling height is not sufficient to allow of much work above it. Obtain two pieces of 2 by 4-in. pine, or other wood not likely to splinter, mill-dressed on all sides, and cut them  $\frac{1}{4}$  in. shorter than the distance from ceiling plaster or joists to the floor. Round off both edges to semicircular profiles by gauging lines on the faces  $\frac{3}{4}$  in. from the edges, jointing off the corners to octagon shape, and ending by removing the new corners formed, until the pieces can be finished with scraper and sandpaper. Centering on each end, work a tenon,  $1\frac{1}{2}$  in. square and  $1\frac{3}{8}$  in. long, by notching in from the edges 1 in. These form the uprights for carrying the bar.

For secure fastening to floor and ceiling, cut a piece of 2 by 4, 8 in. long, and one 1 ft. 6 in., working mortises in each,  $1\frac{1}{2}$  in. square, through the thickness of the stock

and centering on the faces, by boring a  $1\frac{1}{2}$ -in. hole and chiseling out the corners. Bore  $\frac{1}{4}$ -in. holes for lag screws 1 in. from each end, and chamfer the edges of the faces back to the point of joining with the uprights.

To erect the uprights, note the direction of the ceiling joists, so that the ceiling cleats may be turned lengthwise or crosswise of the joists as the case may require, and slip the cleats on the tenons. Place the ceiling cleat of an upright so that the screws will enter the joists, and slide the lower end with its cleat to its place. Plumb in both directions, using a straightedge with the level in case the upright is sprung, and drill  $\frac{1}{8}$ -in. holes in floor and ceiling to receive the lag screws. Use a washer under the head of each screw, and turn down as tightly as possible. Preferably, the uprights should be 5 to 6 ft. apart, but this distance, of course, will be determined by the space at hand.

A length of  $1\frac{1}{4}$ -in. pipe forms the bar. Determine the height of one end and level across the other upright, and bore holes large enough to allow the bar to be forced through. When it is in place, screw over each end a plate, about  $\frac{1}{8}$  in. thick, 2 in. wide and  $2\frac{1}{2}$  in. long, drilled and countersunk for No. 10 screws. To prevent turn-



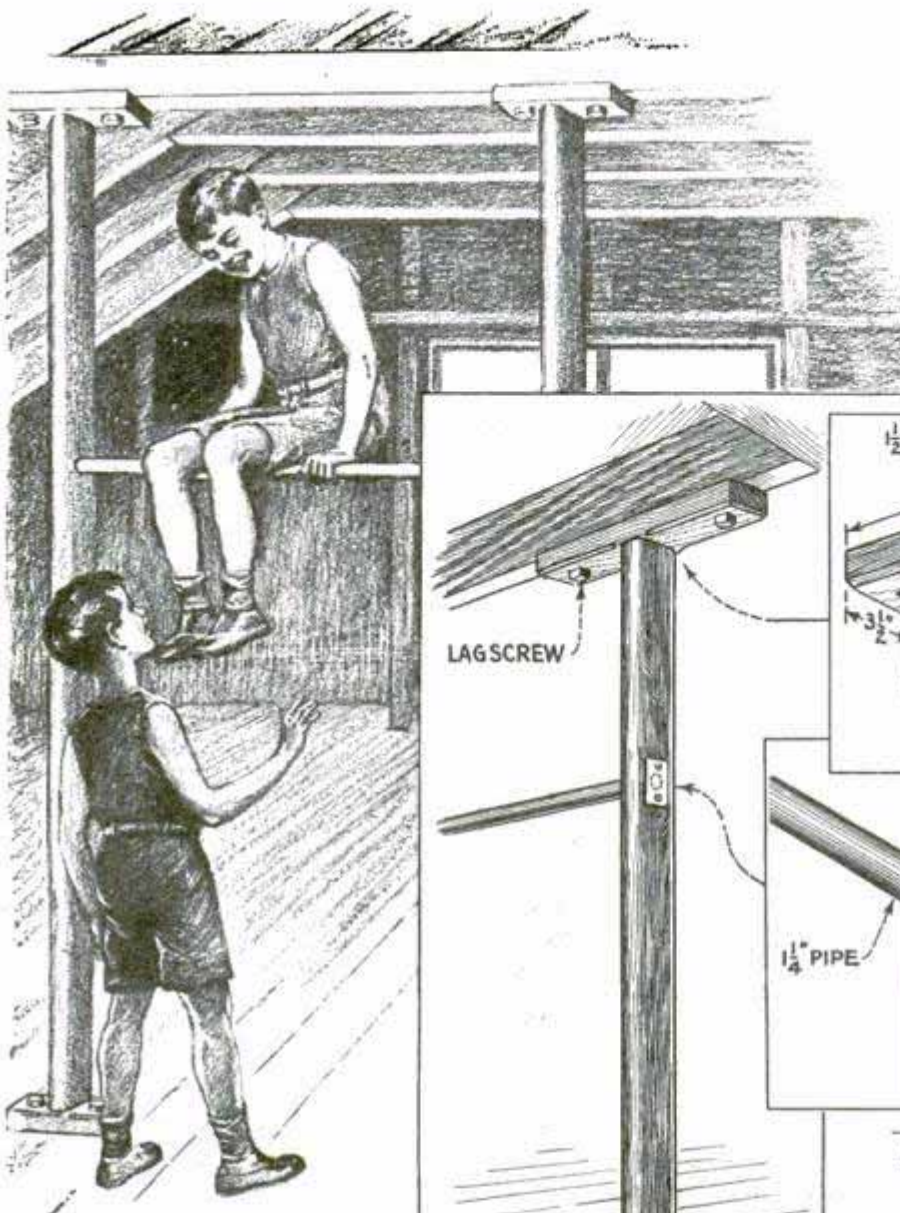

ing, drill a  $\frac{1}{4}$ -in. hole through each upright from edge to edge, passing through the bar, to receive a cotter pin made

of a 16-penny common nail. Two coats of boiled linseed oil are a sufficient finish for the wood, although a coat of shellac followed by two of varnish lessen the chance of splintering.

The parallel bars are so simple of construction as to hardly require a description. The bars are 5 ft. long, of 2 by 3-in. stock, surfaced four sides, with upper edges and ends rounded as described for the trapeze uprights.

The post sockets are made by screwing into one end of a tee-fitting a 1-in. pipe, cut 2 ft. 3 in. long and threaded at one end, and into the other end a  $3\frac{1}{2}$ -in. length of pipe. A piece of 3 by 4-in. pine, 16 in.

long and rounded at the corners, is bored through from edge to edge, centering, to fit over the short pipe of each socket. Unite the sockets of each bar with a 1-in. pipe stretcher, 3 ft. 2 in. long, threaded at both

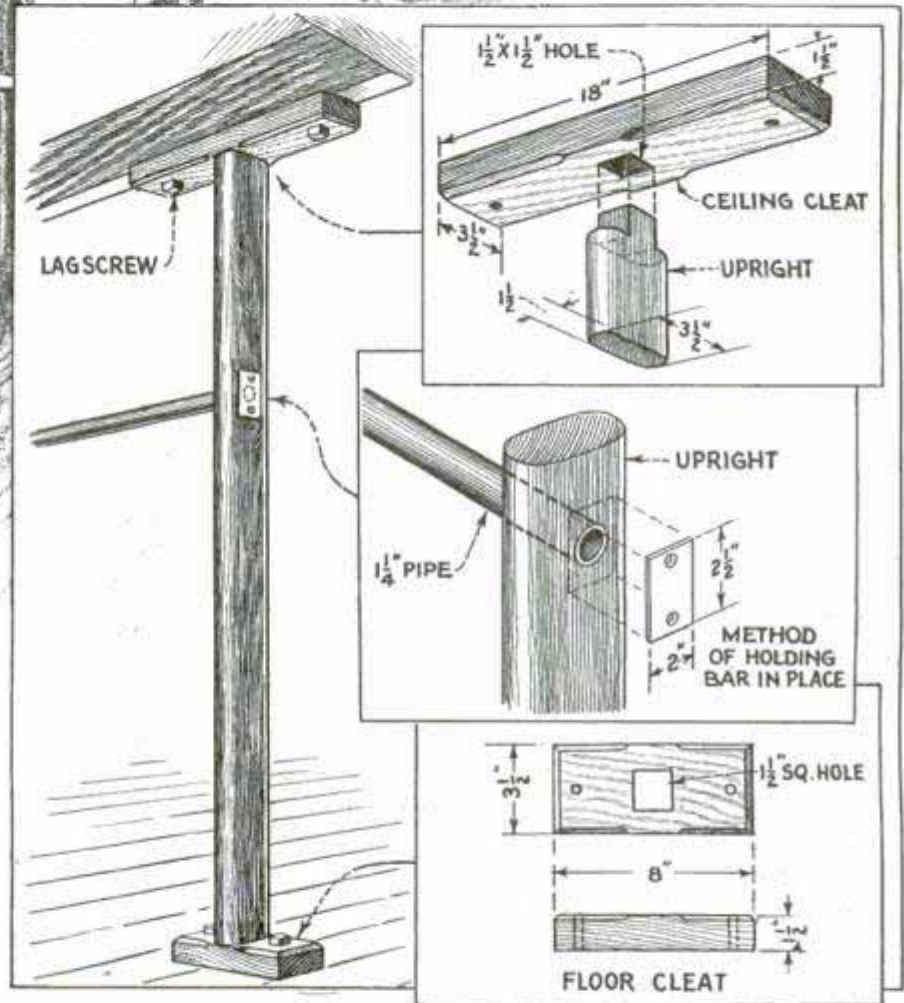

ends and screwed into the tee branches. Turn the bases at right angle to the stretcher, and  $\frac{1}{2}$  in. above the lower edge of each, drill a  $\frac{1}{4}$ -in. cotter hole passing through the short pipe.

The posts are of  $\frac{1}{2}$ -in. pipe, cut 2 ft.  $9\frac{3}{4}$  in. long. Starting 4 in. below the upper ends, drill  $\frac{1}{4}$ -in. holes through the posts every 2 in. to within about 8 in. of the lower ends. Locate the holes in the bars for the sockets by comparison with the assembled stands. Sixteen-penny nails serve as pins to adjust the height of the bars. Put the posts in the bars, slip a washer over each, and mark for a  $\frac{1}{4}$ -in. cotter hole.



For the body of the buck or "horse," make from 2 by 8-in. stock four bulkheads, 10 in. long, as shown in the detail. The semicircular edges, 5 in. in radius, are most easily cut by repeatedly sawing off corners, and finishing with a chisel and spokeshave. Two of these, forming the ends of the main body, are drilled 1 in. and 5 in. above the lower edges for  $\frac{1}{4}$ -in. bolts, and counterbored on the face to sink the bolt heads flush. The other two are notched  $\frac{3}{4}$  in. wide and  $2\frac{1}{2}$  in. deep,  $3\frac{3}{8}$  in. from each end. Just above these notches, on one side of each, nail a  $\frac{3}{4}$  by  $1\frac{1}{2}$ -in. strip, and 1 in. above it bore two pairs of  $\frac{1}{4}$ -in. holes, as shown, to receive the legs of the U-bolts that secure the handles.

Each post is of 3 by 3-in. stock, sized to  $2\frac{1}{2}$  in. square, and cut 2 ft. 11 in. long. Five inches below the upper end cut notches  $2\frac{1}{2}$  in. wide on opposite sides and  $\frac{3}{8}$  in. deep. Centering on these sides, bore  $\frac{1}{2}$ -in. holes every 2 in. below the notches to within 8 in. of the lower end. Centering on the other sides, bore two  $\frac{1}{4}$ -in. holes, one  $2\frac{1}{2}$  in. from the upper end and the other  $3\frac{3}{4}$  in. below it.

Bolt the posts to the end bulkheads with  $\frac{1}{4}$ -in. machine bolts,  $\frac{1}{4}$  in. long. Cut two pieces of 1 by 3 in., sized to  $\frac{3}{4}$  by  $2\frac{1}{2}$  in., 2 ft. 9 in. long.

and unite the two posts by gluing the ends of the strips into the post notches and holding them with two No. 10 wood flat-head screws. Slip the other bulkheads

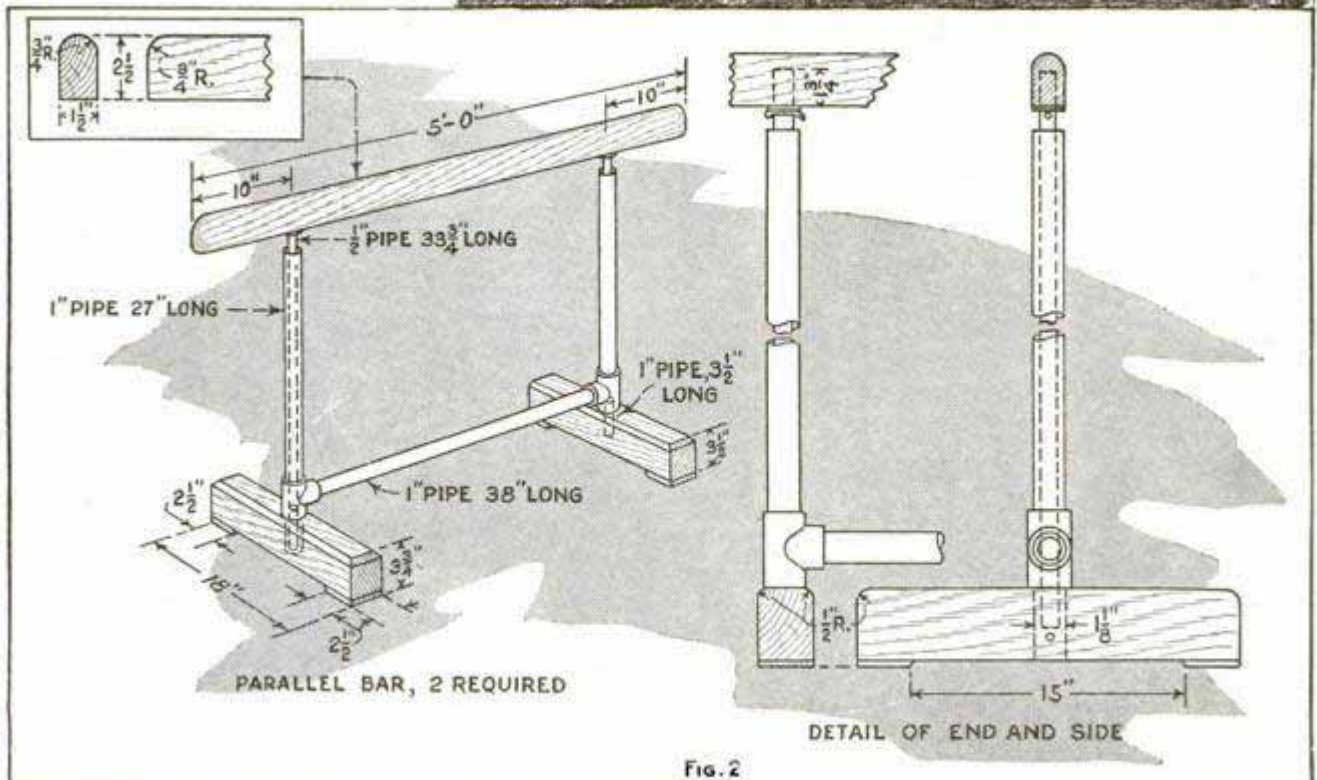
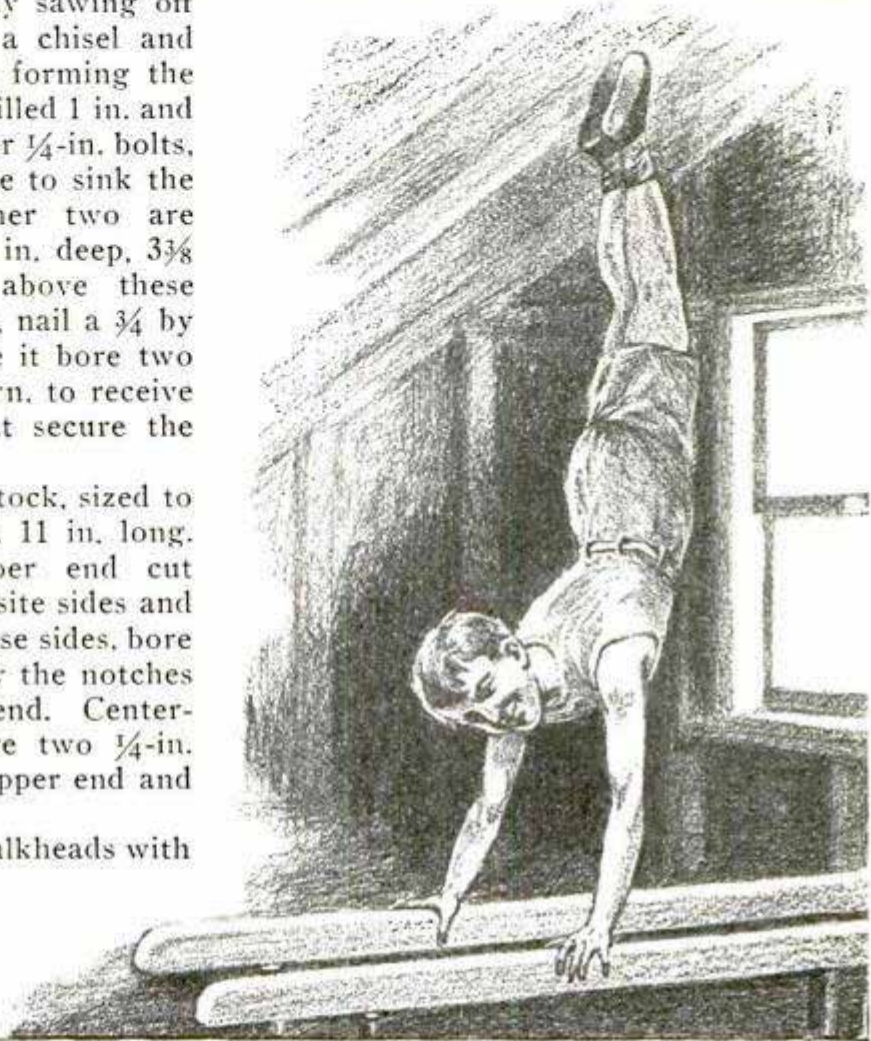
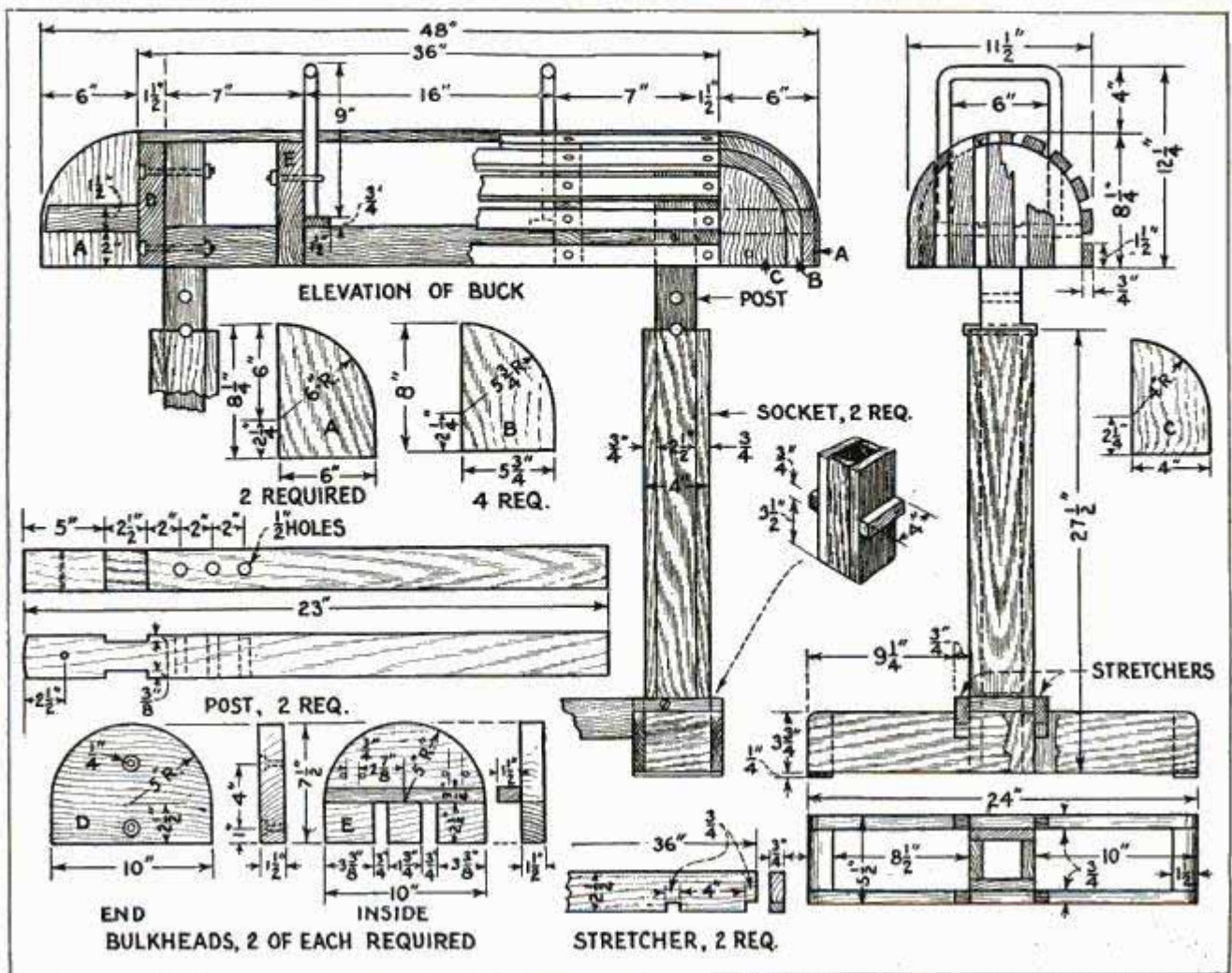

Fig. 2





over the strips, cleats toward the center, with 7 in. between end bulkhead and the inner. Nail the cleats to the strips.

Make two handles by bending pieces of 1/2-in. round iron, 2 ft. long, into "U's" as illustrated, with 6 in. between the legs. Bolt these to the inner bulkheads with 1/4-in. U-bolts, resting the legs on cleats.

Now cut eleven 3-ft. strips of 3/4 by 2-in. pine and tack to the bulkheads as shown, with equal spaces between. Bore and countersink for No. 10 flat-head wood screws at each bulkhead.

The rounding ends are made by cutting the three sizes of 2-in. stock illustrated. Make the large sizes and nail to the centers of the end bulkheads, and nail on each side a spacing strip 1 in. thick. Nail in place the four next smaller segments, nail on other spacing strips, and lastly nail up the sidepieces. Chisel off the corners to the desired roundness.

The sockets are square tubes made by gluing and nailing a pair of strips, 3/4 by 2 1/2 in. by 2 ft. 3 1/2 in., between two pieces of the same thickness and length, 4 in. wide.

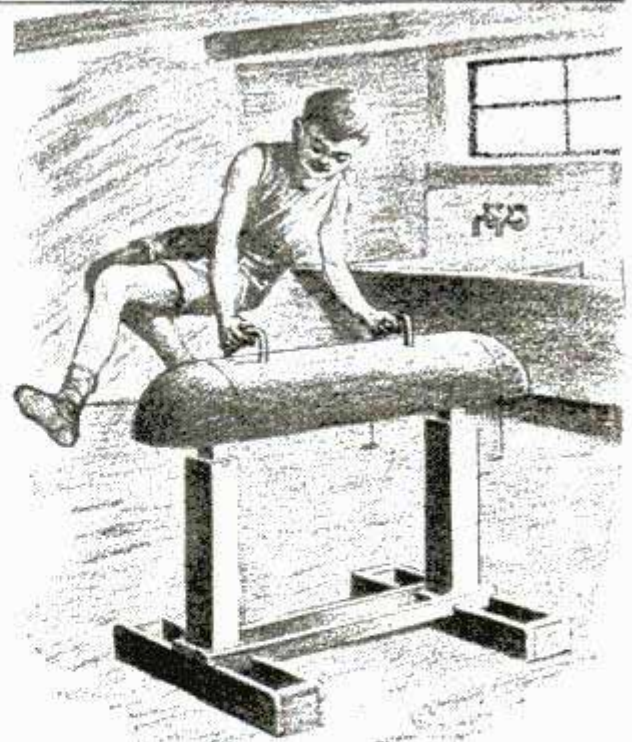

Glue and screw across each wide board side a 3/4 by 3/4-in. cleat 3 1/2 in. from the lower end. For the feet, cut four 2-ft. lengths of 1 by 4-in. stock, finished to 3/4



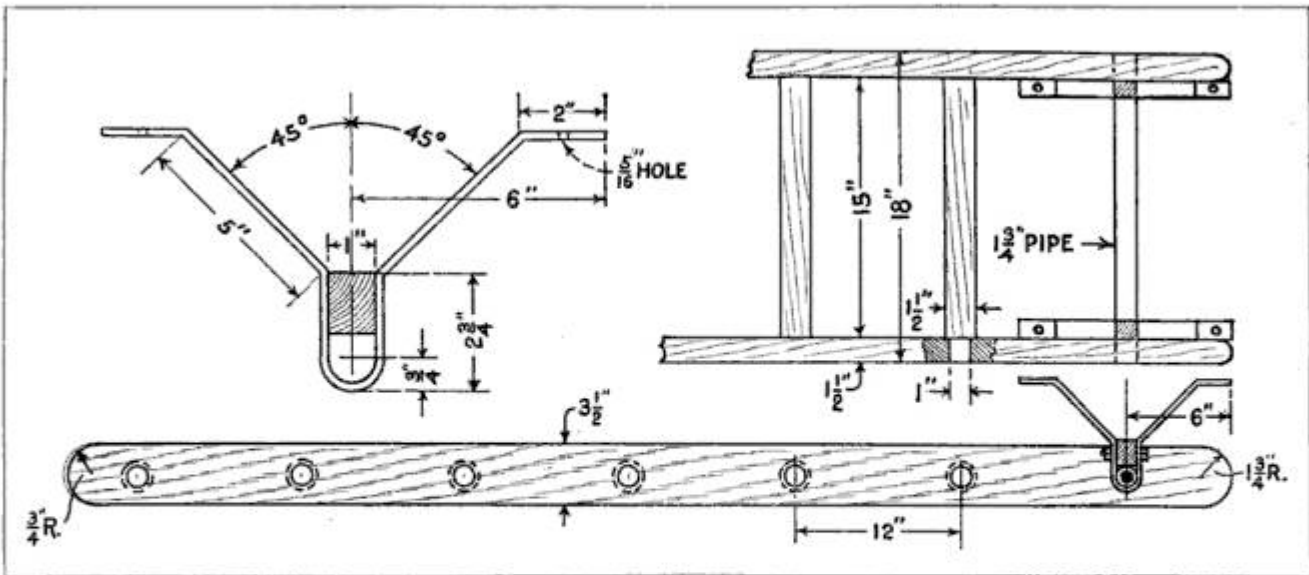

by  $3\frac{1}{2}$  in. Glue and secure with two screws, butting the upper edges against the cleats as shown; or if it is desired to make them removable, use four screws without glue. Give an equal projection at each end, and be sure they line with each other and are square with the sockets. Cut a 2 by 4-in. block between each end, nailing solidly, and put across the bottom a  $\frac{1}{4}$ -in. strip,  $1\frac{1}{2}$  in. wide, to prevent rocking of the buck in case of twisting of the material. Flush with the socket sides, cut  $\frac{3}{4}$ -in. notches,  $\frac{3}{4}$  in. deep, to receive the stretchers.

The stretchers are of 1 by 3-in. stock, cut 3 ft. long, with the longer corners notched  $\frac{3}{4}$ -in. square, and similar notches cut 4 in. behind them. Slip these into the foot notches and put two screws in each end into the sockets. Put the posts into the sockets, and hold them at any desired height between 3 ft. and 5 ft. with hardwood pins passed through holes in the posts. Make a semicircular hole in the top of each socket to bed the pins.

Pad the body with rags and cover with burlap, folding the edges neatly underneath and nailing with upholsterers' tacks.

The ladder, shown in the last illustration, is an excellent exerciser. Like the uprights of the trapeze, the ladder slides are rounded on both edges, but their length is 2 in. less than the height of the room, and the ends, instead of being tenoned, are rounded off. Starting 6 in. from one end, bore 1-in. holes every 12 in., centering on the sticks, until the last round, which is also placed 6 in. from the end. The upper round is a piece of  $\frac{3}{4}$ -in. pipe.

Make the necessary number of rounds  $1\frac{1}{2}$  ft. long from  $1\frac{1}{2}$ -in. full round. Taper the ends and assemble with the sides as these lie on a pair of sawhorses. With the frame squared, set a pair of dividers to  $1\frac{1}{2}$  in., less the distance the round ends are entered, and scribe the tenon shoulders. Remove the rounds, saw in carefully  $\frac{1}{4}$  in., and pare the tenons true.



Reassemble the rounds and the sides, applying glue to both mortises and tenons, and clamp solidly together. Wipe off excess glue while it is soft. When the glue has set, smooth the wood very carefully, since the ladder is used for heavy hand work, and splinters or rough places will mean injury.

The two hangers are bent from  $\frac{1}{4}$  by 1-in. strap iron, cut 21 in. long and bent at the middle with a 1-in. pipe as a mandrel. Bend back the sides  $2\frac{3}{4}$  in. above the bottom of the curve to angles of  $45^\circ$ , and bend the ends back 2 in. until they line with each other. Drill  $\frac{5}{16}$ -in. holes in the ends to receive  $\frac{1}{4}$ -in. lag screws, and drill simi-

lar holes through the loops, where bolts, passing through wooden blocks, can clamp the pipe round at the upper end of the ladder to prevent bounding when in use.

Screw the hangers to 2 by 4-in. cleats, similar to the ceiling cleats for the trapeze uprights, and screw the latter to the ceiling joists. To support the other end, when the ladder is up from the floor, put up a ceiling cleat with a stout screweye, and loop a rope under the round. A like device near the floor on the wall or a screweye in the floor holds the ladder vertical.

For use in conjunction with the ladder in abdominal exercises, build a stout little bench for a seat.

### Quick Hitch for a Rowboat

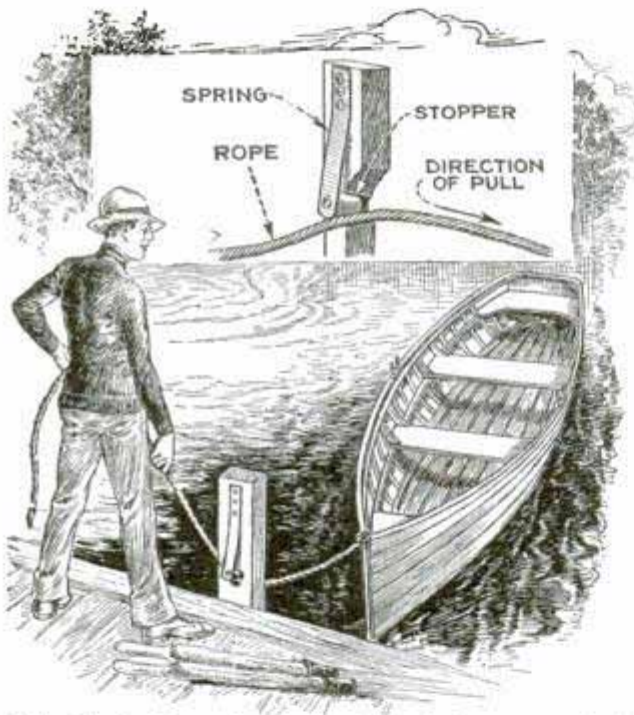

This Simple Fastening Device Permits Anyone to Dock a Rowboat Securely

Many persons who like to row are not familiar with the proper method of fastening a rowboat to the dock. Some knots will slip and others may come untied. By providing the simple arrangement shown in the drawing, anyone can quickly fasten the boat so that it will not come loose and drift away. A short plank is spiked vertically to the edge of the dock, and a hole, somewhat larger than the tie rope or painter, is drilled through it about 4 in. above the floor. The hole should be tapered with a sharp knife so that the opening facing the water is at least  $\frac{1}{4}$  in. less

in diameter than the opposite one. A hardwood stopper, about half as large across as the hole, is made and fastened securely with a wood screw to a strip of spring steel, which is bolted or screwed to the plank above the hole so that it forces the stopper into the hole. The spring should rest flat against the plank. When the boat is docked it is only necessary to push the rope through the hole for a short distance. The pressure of the spring forces the stopper against the rope, and any pull by the boat will jam the stopper even tighter.

### Holding Small Nails Securely

It is often difficult to hold and start small brads and nails. Here is a method which enables you to hold the brads securely. Cut a fairly deep slit in the rubber eraser on the end of a lead pencil and slip the brad into the slit. Hold the pencil so that the brad is set in the proper position and drive it down with the hammer. —Frank W. Bentley, Jr., Missouri Valley, Iowa.

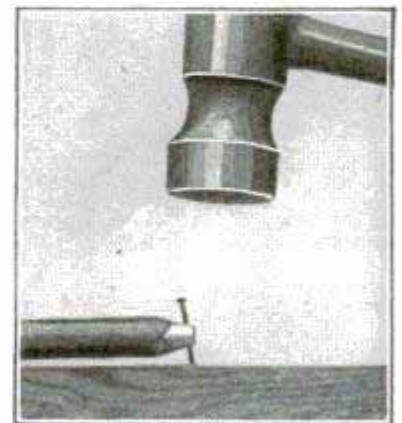

☐ Piston-ring edges should be left sharp, and only a slight burr removed.



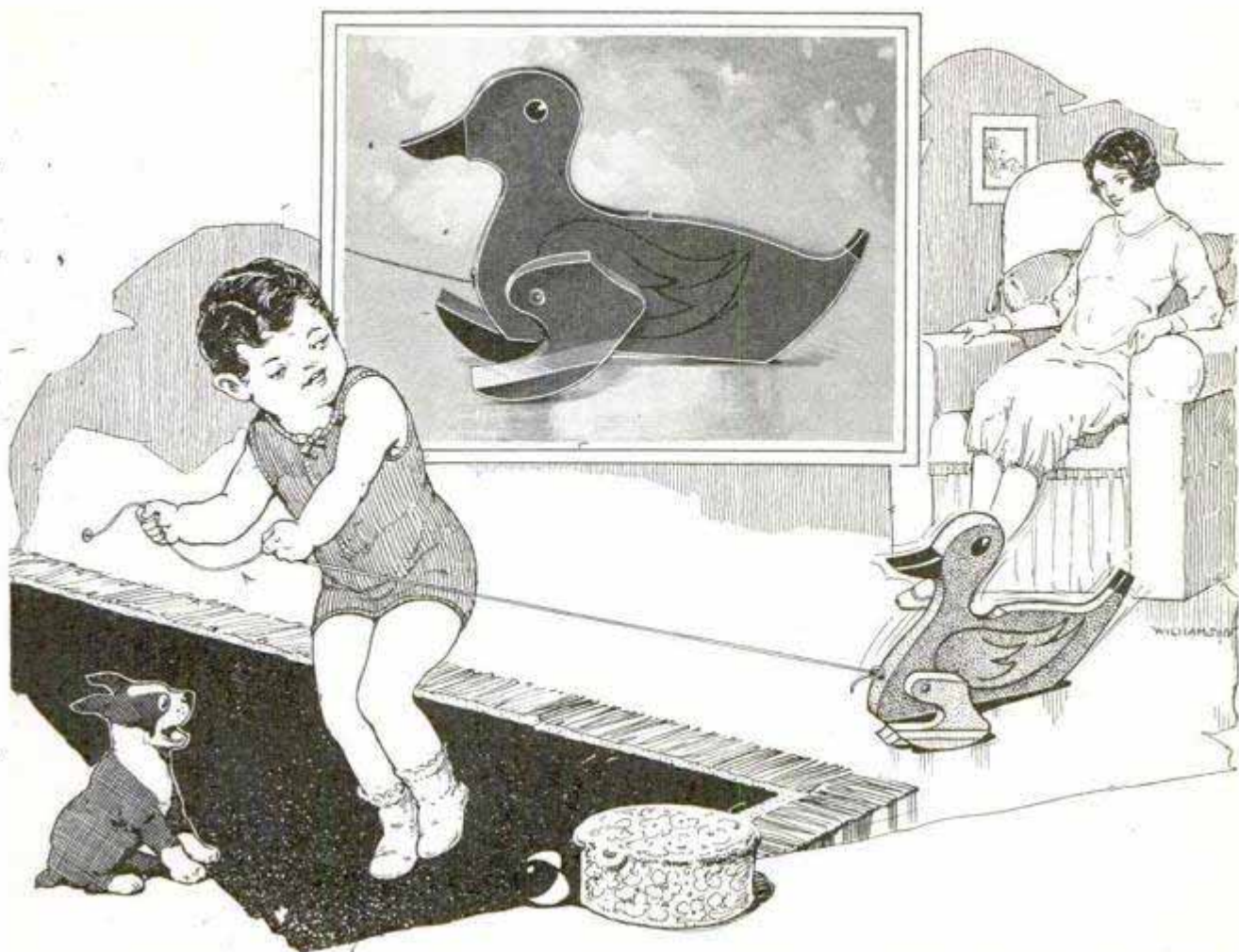

This Realistic and Amusing Walking-Duck Toy Offers an Opportunity for the Home Craftsman to Display His Talents and Amuse the Youngsters at the Same Time

## The Walking Duck

By H. C. McKAY

**W**ALKING toys are always popular with children, and, in fact, many adults like to watch their antics. Toy builders are familiar with many mechanical devices for imparting the walking motion, such as joints, cranks, interrupted or eccentric wheels, but the least complicated and most effective is the form that operates through the forces of gravity and momentum. One of the simplest toys incorporating this principle is the walking duck, although, as will be seen, the same principle may be applied to any toy whose shape allows it to rest in equilibrium.

The toy is cut from  $\frac{1}{2}$ -in. wood. Fig. 1 is the layout for the body. The feet are shown dotted in order that the proper relationship between them and the body may be seen, although, of course, the body is cut out without feet. It is drilled for the foot pivot as shown. This hole should

be at the exact point indicated for best results. The eyes and wings are next painted. In fact, the entire body should be fully enameled and the details added before assembly. When this is done, the feet are made.

Two feet are cut out of  $\frac{1}{2}$ -in. wood as shown in Fig. 2, following the heavy line. These are placed together in a vise and carefully shaped so that they will be exactly alike, and exactly like the pattern, and the pivot hole is bored while both are clamped together. Take care to get this hole straight through and do not let it run at an angle.

The construction of the actual foot will be more easily understood by referring to Fig. 4. The cut-out piece (Fig. 2) has a piece of wood fastened to the bottom edge with small screws and glue. This piece is shaped to conform to the lower curve in



Fig. 2. When this assembly is complete, the foot will have the "leg" portion rising from one side, and will be supported upon a "rocker,"  $1\frac{1}{2}$  in. wide, since the squares in the diagram represent  $\frac{1}{2}$  in. This rocker form should be true, so that there will be

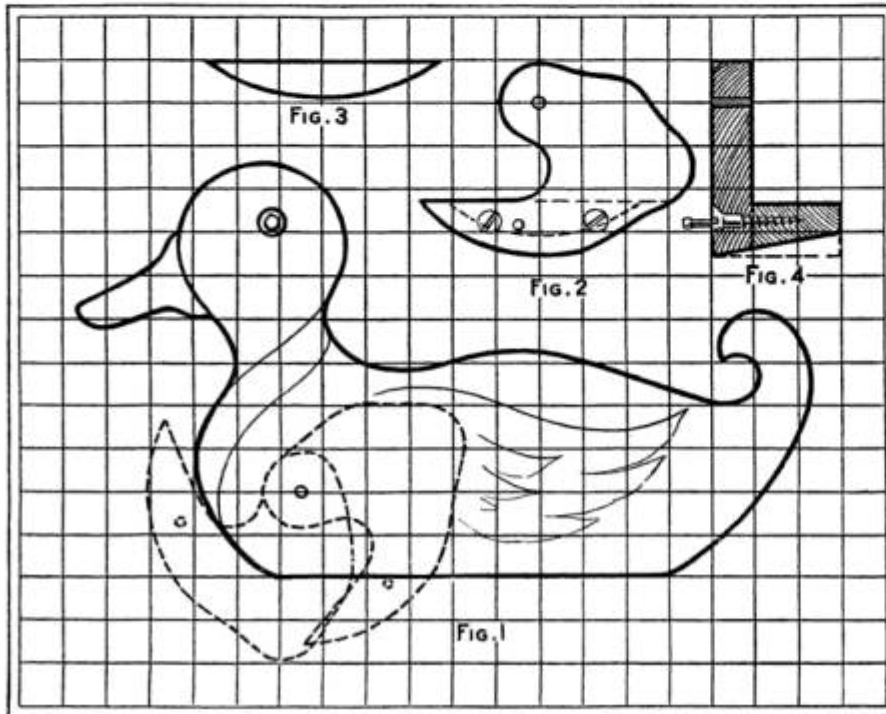

a uniform forward motion to the walk.

The next step is the most important one in the construction, and the most difficult. Clamp the foot in a vise with the bottom of the rocker uppermost. With a fine file bevel the outside edge of the rocker, removing the portion shown by the dotted lines in Fig. 4. This removal is uniform on all surfaces of the bottom of the rocker, making its outer edge concentric with, but smaller than, the inside curve.

The dotted lines in Fig. 2 show the effect viewed from the side, while Fig. 3 shows the relative size and shape of the outer edge of the rocker. When this is complete and the assembly stood upright, the leg will no longer stand perpendicular but will lean toward the outside. The other leg is made to correspond, the bevel being in the opposite direction, of course.

The legs are now attached to the body of the duck with a pin of such size that they will swing freely. To prevent any binding, a washer should be placed between each leg and the body. The ends of the pin also receive washers and are then upset or flattened to prevent the legs from coming off.

The duck is now placed upon the table and pushed forward until the extreme front portion of the rockers lie upon the table surface. Mark the place where the legs strike the body. Into the inside of each leg drive a brad at this mark, leaving about  $\frac{3}{8}$  in. projecting. This brad serves as a stop to prevent the foot from swinging too far back.

A cord is now attached to the front curve of the duck's breast. This completes the toy. If it is placed upon the floor and pulled by the string, the pull will throw the body to one side or the other. If it goes to the left, the surface of the left foot acts as a balance, and the duck moves forward upon the left rocker. Gravity swings the right foot forward, and the reaction throws the body to the right and it topples over, only to be stopped by the

surface of the right rocker coming into contact with the floor. It moves forward upon this while the left foot swings forward. This motion is continuous, the body of the duck swaying from side to side, the feet alternately advancing and retreating. The result is a very amusing simulation of the duck's waddle.

The decoration of this toy is left to the builder. A full-size blueprint of the toy is available for those who find it difficult to lay out by the square method. Send 25 cents to the Amateur Mechanics department, specifying the "Walking-Duck" blueprint.

### Scissors Handy in the Kitchen

A pair of sharp scissors will cut meat for curries, pies, etc., in about one-half the time required to do it with a knife. They can also be used for cutting up oranges, dates, figs, grapefruit, etc., and are handy for trimming fins from fish. For stoning large cherries I have found nothing better and for cutting string beans scissors are hard to beat.—Mrs. James E. Noble, Toronto, Can.



### Keeping Paint Cans Sealed

I had a quart of screen paint, part of which I wanted to use, but upon trying to pry the cover off with a screwdriver, I found that it had been pressed in firmly and that some paint, previously smeared along the edges, had dried and cemented the cover in place. The lid did not budge, so I punched two holes in it with the screwdriver, one near the edge and the other in the center. The paint could then be poured out easily. After using the paint, a film formed over the holes, which, when dry, made the can air-tight and kept the contents in perfectly good condition.—Joseph Pauly, South Chicago, Ill.

### This Trap Placer Is Handy

I do quite a bit of trapping for muskrats and have found it rather difficult to place the traps in the proper position without getting into the water. Of course, I have boots, but found that I could accomplish the work much more quickly and easily by using a simple homemade pair of tongs, as shown in the illustration. This tool can be made from two old hayrake teeth, bent and flattened near the center where they are pivoted by means of a rivet. The handles are shaped by bending the ends to form rings, about  $2\frac{1}{2}$  in. in diameter. A trap held by this tool can be set where it is wanted without any risk of snapping it shut.—Luther Strosnider, Onaga, Kans.

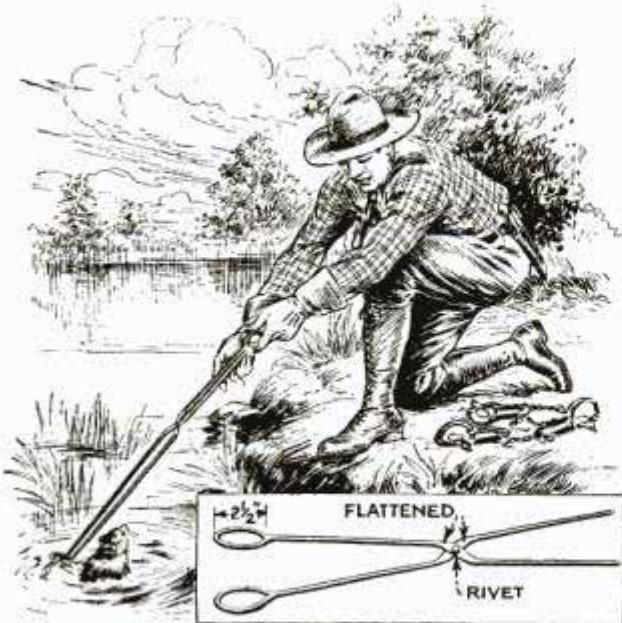

Pair of Tongs Made from Old Hayrake Teeth Useful for Setting Muskrat Traps

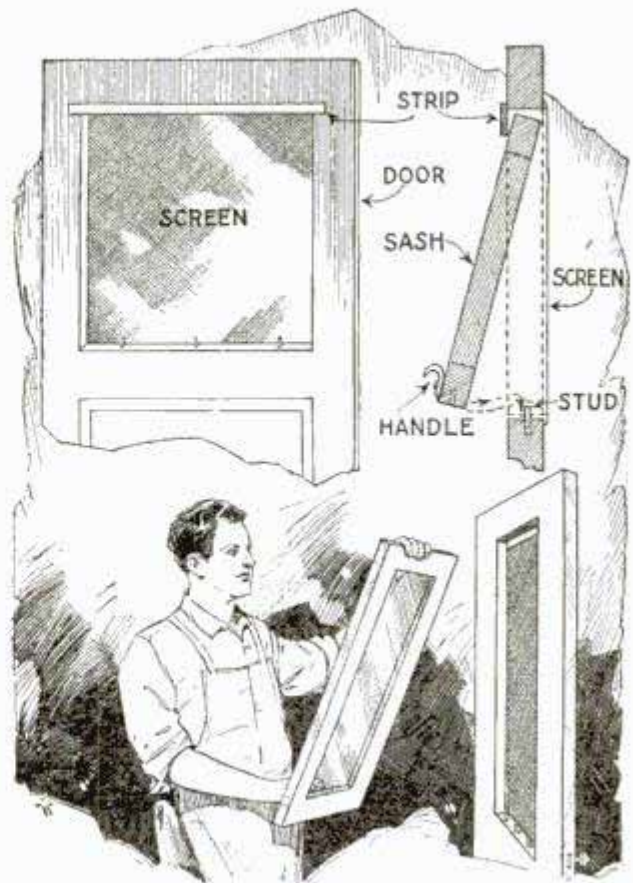

Ordinary Screen Door Fitted with Window Sash Saves Cost of Storm Door

### Removable Sash for Screen Doors

Instead of having separate screen and storm doors I have found it much more convenient to make a sash to fit in the screen door so that it can be removed or inserted in a moment. This saves the cost of a storm door and the trouble of hanging it each season. To fit a sash to a screen door, nail a 1-in. strip of wood across the top of the screen opening as shown, and drive three finishing nails, or nails with the heads cut off, at the bottom, letting them project about  $\frac{1}{2}$  in. above the surface of the wood. The sash for the glass is then made to fit the opening but should be  $\frac{5}{8}$  in. shorter. Three holes are drilled in the bottom edge of the sash to fit over the nails in the door frame. The method of inserting the sash is clearly shown in the upper right-hand detail.—A. Stenson, Gardena, Calif.

Just before polishing a stove with blacking, it is well to rub the surface to be polished with a rag dipped in kerosene; this seems to increase the life of the polish after it has been applied. Another advantage is that kerosene will prevent rust.



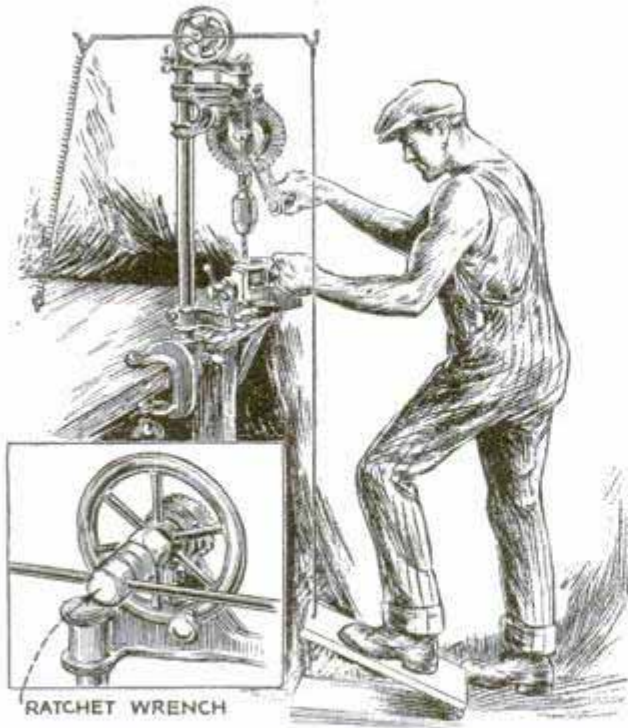

The Treadle Feed for This Drill Press Permits Workman to Use Both Hands Freely

### Treadle Feed for Small Hand Drill Press

Many small workshops are equipped with a drill similar to that shown in the drawing. As one hand is needed to turn the feed wheel, there are many jobs that are quite difficult. A simple and inexpensive attachment, which can be fastened to the feed-wheel shaft, and is operated with one foot, leaving the hands free to hold the work and to turn the crank on the drill, will, therefore, be found convenient. It consists of a ratchet device, such as found in many automobile wrench sets, a fairly strong hinge, a screen-door spring, an iron rod, about 18 in. long, and two pieces of 1-in. wood, about 4 by 12 in. in dimensions. The ratchet device is attached to the shaft by means of a setscrew, which has previously been placed in such a position that it passes through the bushing in the hexagon end of the ratchet. An excellent bushing for this purpose may be made by using a hexagon nut. In some drills, it may be necessary to remove the feed wheel. A hole of the same diameter as that of the iron rod is drilled through the top of another socket wrench, which fits the ratchet. Through this hole, the iron rod is passed for half of its length and is fastened by burring. If desired, the rod may be halved and then inserted in tapped holes. One end of the rod is fastened to the spring, and this is in turn fastened to

the bench, as indicated. To the other end of the rod a stout cord is attached and this is run to a treadle made by fastening the two boards together with the hinge.—Myron L. Harmon, Chicago, Ill.

### Retrieving Articles Lost in Partitions

While I was talking to an electrician friend of mine who was wiring in the attic of an old house, his pair of pliers fell out of his hand and dropped three stories down a partition. The problem of recovering the pliers did not seem to worry him much, and he soon had them fished up with the aid of a clothesline, an old flatiron, some coarse wire mesh and about a pound of putty. He put a few layers of wrapping paper on the bottom of the flatiron to keep it clean. On this he put a  $\frac{3}{4}$ -in. layer of putty and then placed the wire mesh over the putty, bending the mesh in over the top of the iron, after which a 2-in. layer of putty was spread over the mesh. He tied the end of a sufficiently long piece

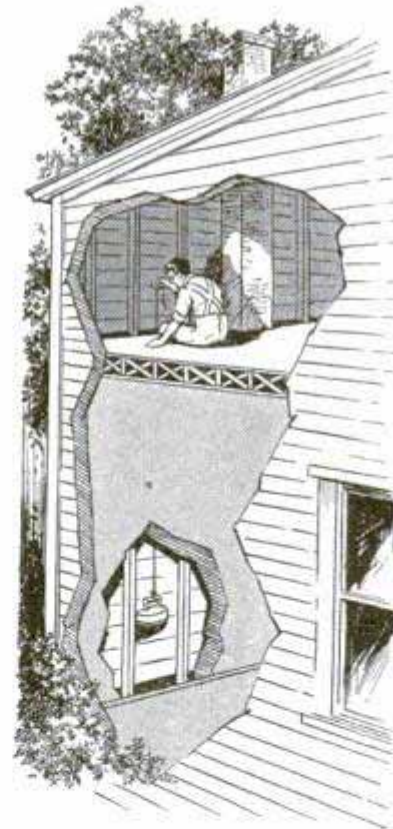

of clothesline to the handle of the flatiron and then lowered the latter into the partition as shown. In a very short time he pulled up the flatiron with the pliers clinging to the putty. The purpose of using the wire mesh, he explained, was to make all the putty share in lifting the pliers. He said that he had, on other occasions, lifted things weighing several pounds in this way.—Herbert A. Freeman, Willimantic, Conn.

☛ Ivory color is made by tinting white with medium yellow; a touch of black gives old ivory.



# Paper Scraps Make Decorative Pottery

By HAROLD JACKSON

**M**AKING something ornamental and useful out of waste material is not always an easy matter. However, by the simple method described here very pretty and bizarre vases can be made from old pickle jars or similar bottles. Clay flower-pots can be made much more attractive by this interesting process. It can also be successfully applied to bowls and dishes used on the table, the only requirement being that the vessel to be decorated has a smooth surface, free from raised designs. When treated in this manner, the articles will have the appearance of being made up of numerous irregular pieces of brightly colored glass and china. The surface is not easily marred, is waterproof and can be washed when necessary. The work is very interesting and pleasing effects are easily obtained.

The materials required are a bottle of glue and a few bright-colored advertising pictures from a high-class magazine. These pictures are cut up into irregular pieces, regardless of outline. The pieces

are then glued to the outer surface of the jar without system or order, except that the adjacent edges of the paper pieces are trimmed to fit together, and in applying the pieces, care must be taken not to place together colors that "swear" at each other.

When the vessel is completely covered and the glue has dried, all the seams are painted with a small brush or pen that makes a stripe about  $\frac{1}{8}$  in. wide. This stripe must go around each separate piece of paper. Black or colored lacquer can be used for this purpose. The top of the jar is painted with the same color. Gold paint can be used with good effect in some cases. When the paint is thoroughly dry, the entire vessel is given a coat of white shellac or linoleum varnish, which brightens the surface and renders it waterproof. If the object is to be set on a varnished surface, glue a piece of felt on the base.

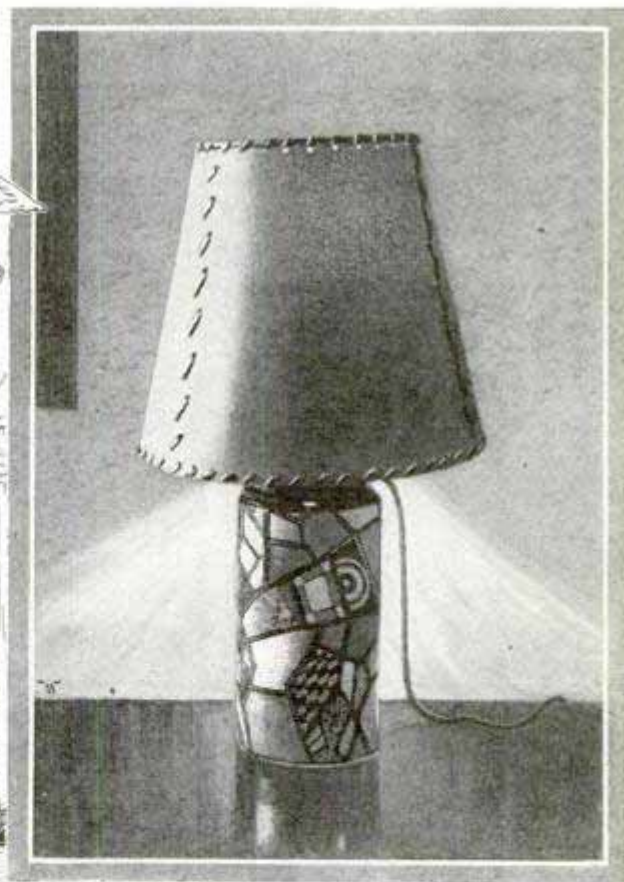

The Photo Shows a Lamp Base Made from a Pickle Jar by the Simple Method Described in This Article: Very Pretty, as Well as Novel, Effects Are Easily Attained in This Work





Folding Cot Equipped with Casters Is Stored Out of Sight under the Bed

### Equipping Folding Cot with Casters

In small homes and apartments, where the available bedroom space is limited, a folding cot is useful, but, when collapsed, it is usually too large to set in a clothes closet, and, if kept in the bedroom, it is unsightly. Besides, the mattress is a bulky piece to store during the day, if the cot is in use every night. To overcome these difficulties, one home owner fastened casters to the end posts of the cot, as shown, so that, when these are folded, the cot can be wheeled around easily. The best place to store it, with the mattress left on it, is under the regular bed, where it is entirely out of sight.—L. A. Zaun, San Bernardino, California.

### Removing Broken Auto Lamp from the Socket

It is difficult to remove a broken auto lamp from the socket and there is considerable danger of cutting one's hands in attempting to do this without the use of any tool. A good method, which avoids this trouble, is to use an ordinary clothespin. It is pinched together, inserted into

the lamp base and then allowed to spring tight. Press down on the clothespin and turn it the same way as you would to remove a lamp.—J. W. Baush, Springfield, Massachusetts.

### Cutting Core Strips for Transformers

Those who have built transformers know how difficult it is to cut the strips of silicon steel of which the core is built up. Here is a method, however, that is comparatively easy. After a large sheet has been cut into long strips of the required width, take a tinners' snips and clamp one handle in a vise, as shown, keeping the cutting edge horizontal. Put a board under the clamped blade. To this board, on each side of the snips, nail small wooden blocks sufficiently high to be level with the cutting edge, and just so far apart that the free arm can swing. A guide for the strips is nailed to the block on the side of the movable blade, and a stop on the other side. The strip of steel to be cut is placed flat on the block, pushed against the guide, and slid between the blades of the snips until it hits the stop. Then the free arm is pressed down to cut the strip. Two persons can do this work better than one, one to feed and the other to press down the handle. Three hundred pieces were cut in fifteen minutes with

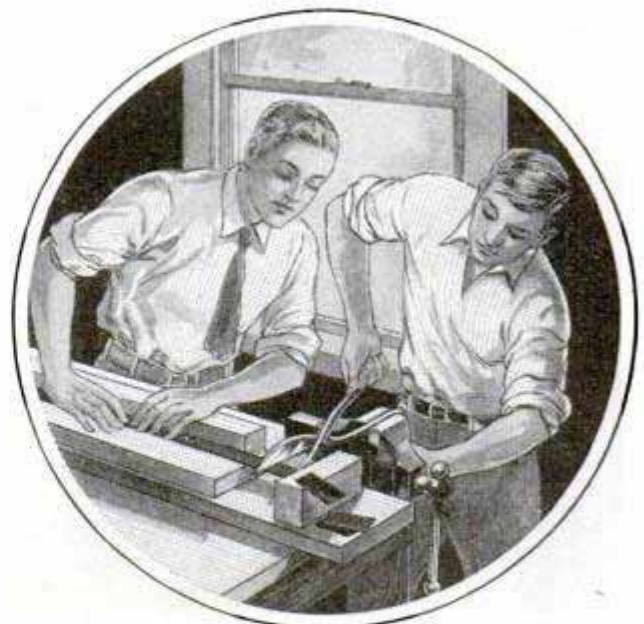

Easy Method of Cutting Transformer Core Strips of Equal Length

this improvised device—ordinarily a job of a couple of hours.



### Homemade Electric Cream Whipper

You can make the electric cream whipper illustrated with very little trouble. It consists of an old auto-horn motor, in good condition, a toy-train or a bell-ringing transformer, a wooden stand to hold the motor and a coffee can for the cream to be whipped. A  $\frac{1}{8}$ -in. rod, about 6 in. long, is welded or brazed to the end of the motor shaft and a small nut or propeller is securely attached to the other end of the rod. The stand is made of two 12-in. lengths of  $\frac{1}{2}$ -in. wood, 4 in. wide, and one 6-in. length of the same stock. The drawing clearly shows how the stand is made and how the motor is mounted on it. Two nails are driven into the vertical section of the stand as indicated, to hold the can. The upper nail is bent downward to hook over the edge of the can, while the lower nail extends straight and serves as a rest. The wiring is also shown so that no mistake need be made. One terminal of the transformer is connected to the lower nail, while one terminal of the motor is connected to the upper nail. The remaining open terminals of the motor and transformer are then wired together. Afterward the cord from the transformer is connected to a light socket or wall plug. If desired, the transformer can be attached to the stand permanently. The can, making contact between the two nails, serves as a switch so that when it is set in place the motor is turned on, and as soon as it is removed, the motor stops. In case no light current is available, the motor can be run on three dry cells or a storage battery. Besides whipping cream, this device will churn butter and can be used for many other purposes.—William Coulbourn, Suffolk, Va.

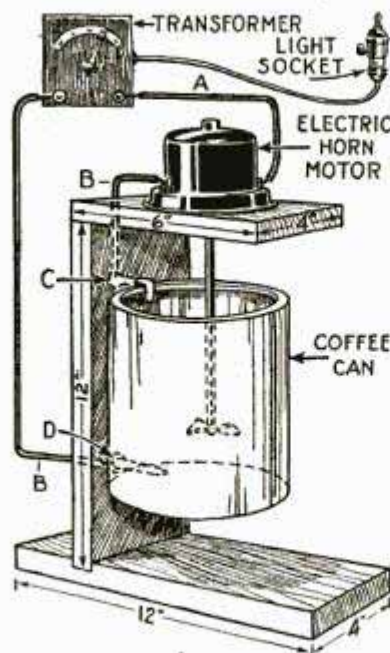

—William Coulbourn, Suffolk, Va.



Handy Folding Camp-Fire Grate for the Tourist-Camper Takes Up Little Space in the Car

### Simple Folding Camp Grate

To save space in the car, tourist-campers require collapsible equipment, and for this reason the folding grate shown in the drawing is of interest. It consists of six lengths of  $\frac{1}{2}$ -in. iron rod, four of which are 12 in. and two, 24 in. long. Both ends of the long rods and one end of each short rod are flattened and drilled to receive a pin, permitting them to be folded as indicated in the upper detail. The ends of the short pieces should be ground or hammered to a point so that they can be pushed into the ground easily. In use, the two members are placed about 6 in. apart so that pots and other utensils will stand securely across them.—E. L. MacFarlane, Nashwaaksis, Can.

### Improvised Leather Cushions

Desiring some leather cushions for his auto, but not being able to purchase them, a farmer substituted a few imitation-leather shopping bags. He placed an old sofa pillow in each one, cut off the tops of the bags, punched holes along the edges and laced them with a shoestring. The pillows make good backrests and serve the purpose just as well as any ordinary leather cushions offered in the market.—Chas. Latour, Plattsburg, N. Y.



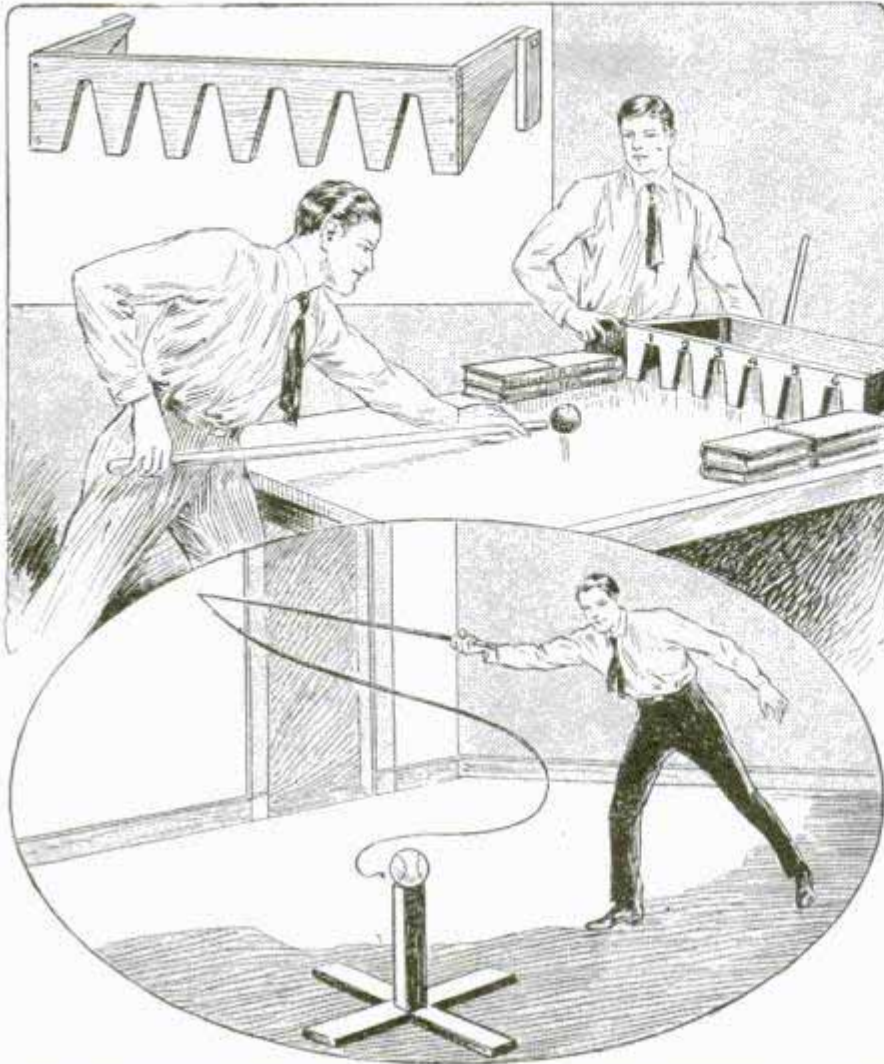

Two Homemade Games of Skill Which Afford Endless Amusement for Young and Old; Both Are Easy to Make

### Two Homemade Ball Games

Two games, which will afford endless amusement to adults as well as to the younger folks, are shown in the drawing. One is similar to the well-known game played with marbles. A length of 1-in. board, nailed to two end supports so that it can be set on edge, a pair of cues made from old broomsticks and a couple of balls about the size of baseballs are all the equipment required. A number of notches, just a trifle larger than the balls to be used, are cut in the board. This makes it necessary to shoot the ball through the holes squarely, which requires skill. The game is begun by shooting the ball, from a starting point, toward one of the holes. If the hole is missed, the next player takes his turn. If desired, the size of the notches may be graduated so that the smallest hole counts for the greatest number of points. The lower illustration is a game, also novel, in which the player lashes a

baseball from a pedestal with a whip. Considerable skill and a sure eye are necessary to strike the ball, but one man has become so expert that he can curl the lash around the ball and, with a quick jerk, pull the ball forward and catch it. In this game each player is given a number of chances to dislocate the ball. The whip used consists of a strong wooden stick to which a length of rawhide is tied.—James E. Noble, Toronto, Can.

### Curtain and Shelf Form Neat Wardrobe Space

When building a shelf in a bedroom, which was not provided with a clothes closet, it was desired to hang the clothes under the shelf and this made it necessary to hang a curtain to cover the wardrobe, keeping the clothes out of sight and

protecting them from dust. Instead of the usual method of attaching the curtain so that it could be slid back on a cord, I had a wide hem sewed at the top edge so that two  $\frac{1}{2}$  by  $\frac{7}{8}$ -in. sticks, 18 in. long, could be inserted. These sticks were pivoted with wood screws to the underside

of the shelf so that they could be swung out as shown. Metal clips were provided to support the ends of the sticks at the center of the shelf when the curtain was closed. On the sides and front, the curtain was tacked to the edge of the shelf and to the pivoted sticks.—A. J. Call, Hartsville, Mass.





# SHOP NOTES



All Shop Notes published in 1927, in book form—Fifty Cents—from our Book Department

## Two Tables in Art Moderne

By E. R. HAAN

**I**NTERESTING, attractive furniture in ultra-modern style is the latest fad. Lamps, tables, stands, etc., in fantastic, bizarre color combinations, which make

these items truly novel, can be seen and purchased at most art and many of the larger department stores. Although generally of simple construction, this type of

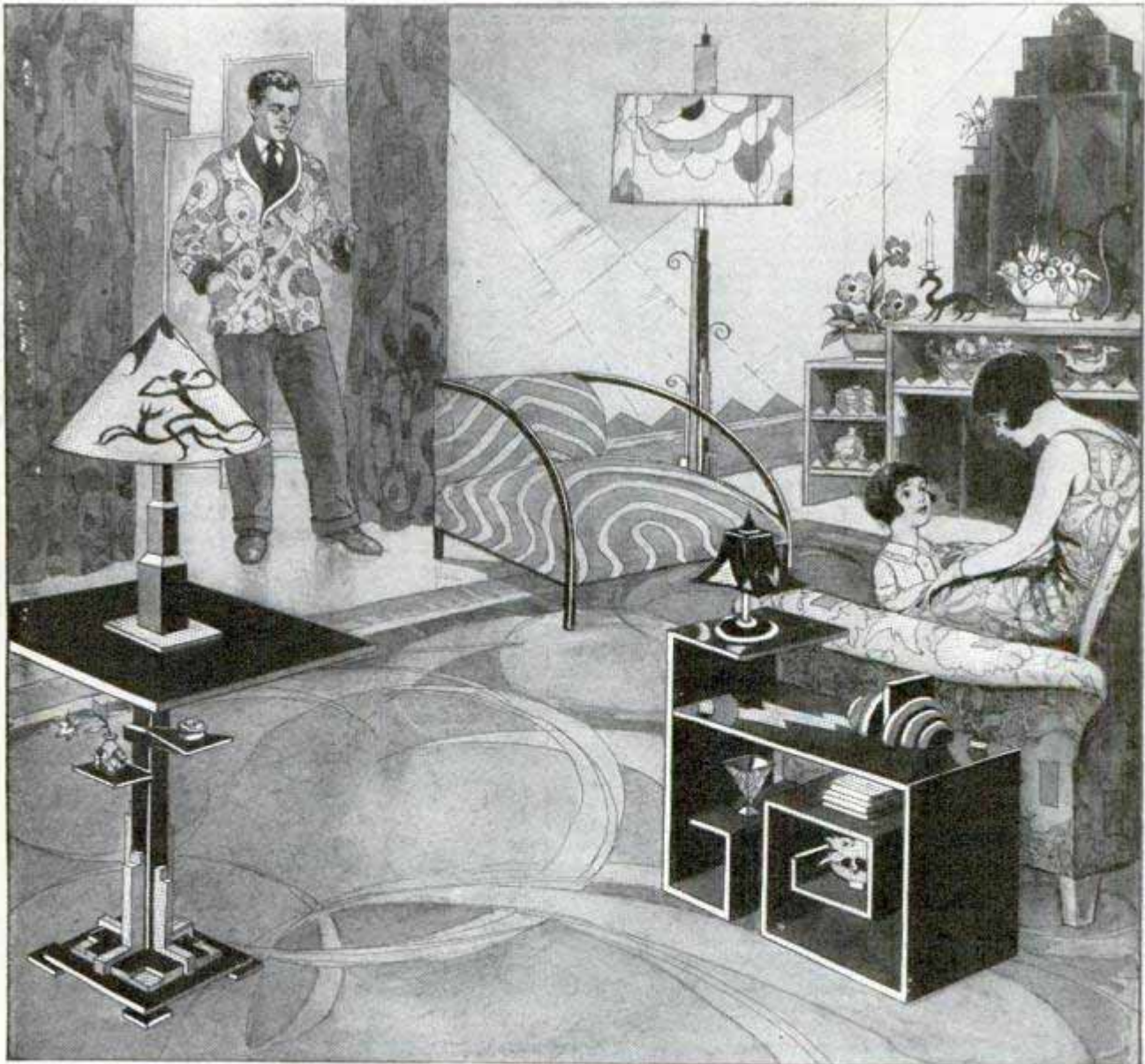

Bizarre, Colorful and Attractive Furniture, Executed in Art Moderne, Has Become Extremely Popular, Entire Rooms Being Furnished and Decorated in This Style



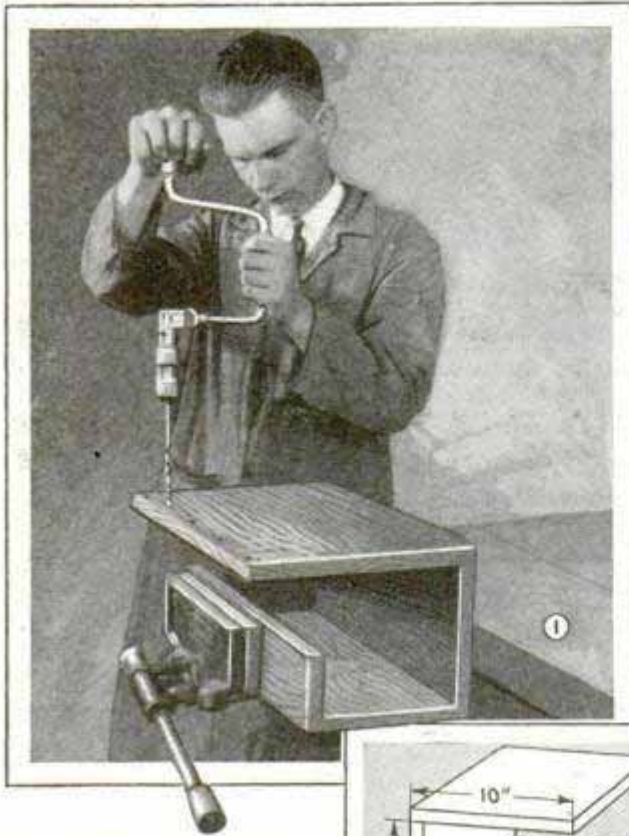

furniture is, at present, rather costly. Many admirers of the work, therefore, do not feel justified in purchasing it, but they may, with very little trouble and care, make it themselves at a fraction of the cost by following the instructions contained in this article. As small tables and stands undoubtedly have the widest range of usefulness and popular appeal, an occasional table and a davenport end table are herewith described and illustrated. Although the exact size, arrangement and color scheme of these items are given, it is permissible to construct them either smaller or larger, and the details may also be varied to suit the ideas of the builder.

The davenport end table is made of  $\frac{7}{8}$ -in. five-ply veneer, which is more expensive than ordinary wood, but has the advantage of being much stronger, and will not warp or crack through atmospheric changes. You can purchase the veneer already cut to specified sizes at most mills that handle this stock. The very cheapest

kind of veneer is satisfactory for making the table, as the surface is to be painted and beauty of the grain therefore need not be taken into account. Thirteen pieces of veneer, 16 in. wide, are used for making the end table. The dimensions of the various pieces are given in Fig. 2. As the method of joining these pieces together must not show on the finished product, 2-in. wood screws are used for this purpose, five of them being driven through adjoining sections, and spaced at equal intervals so that the strain will be well distributed. It is absolutely necessary to drill holes in both adjoining pieces to accommodate the screws. To drill these holes accurately, prick-punch a spot for the center hole,  $\frac{7}{16}$  in. from the edge. Then prick-punch the centers of the two end holes and finally

the remaining two, which must be located halfway between the center and the end holes. Drill the holes a trifle larger than the largest part of the screw shank, as in Fig. 1. Counterbore these holes in order to permit sinking the screw heads below the surface. After this has been

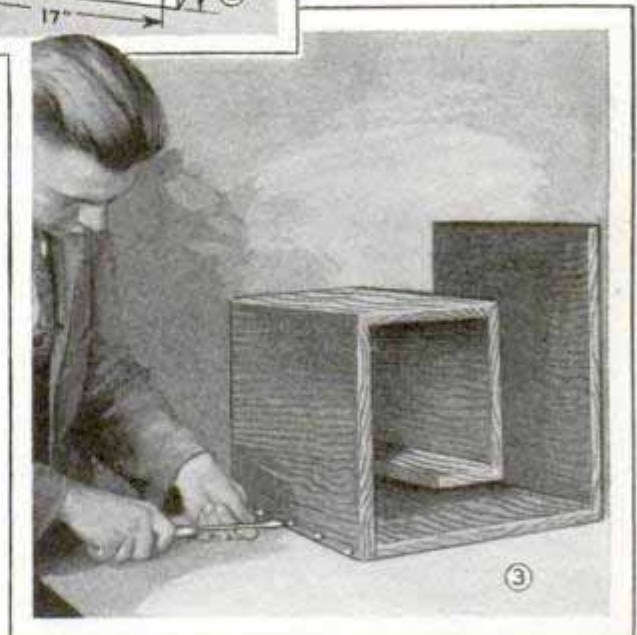
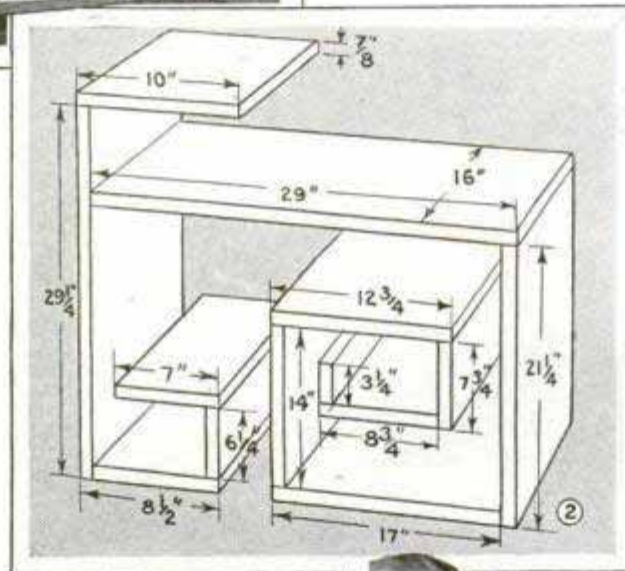

done, the drilled piece is placed on the piece to which it is to be attached, and



holes, smaller than the threaded section of the screw, are drilled in the end of the second piece. These holes enable you to drive the screws into the wood easily, and without risk of cracking the wood. To reduce the friction of the screws entering the wood, smear soap or beeswax over the threads. When driving in the screws, care should be taken to avoid slipping of the screwdriver, as this may mar the surface and such marks are very difficult to cover when the table is being finished. The use of a screwdriver bit in a carpenter's brace is recommended for driving the screws, although any ordinary screwdriver can be used. Fig. 3 shows part of the table joined in this way. When each piece is fitted to its neighbor, the outside edges must be perfectly flush and smooth. As the stock will not always fit exactly, it

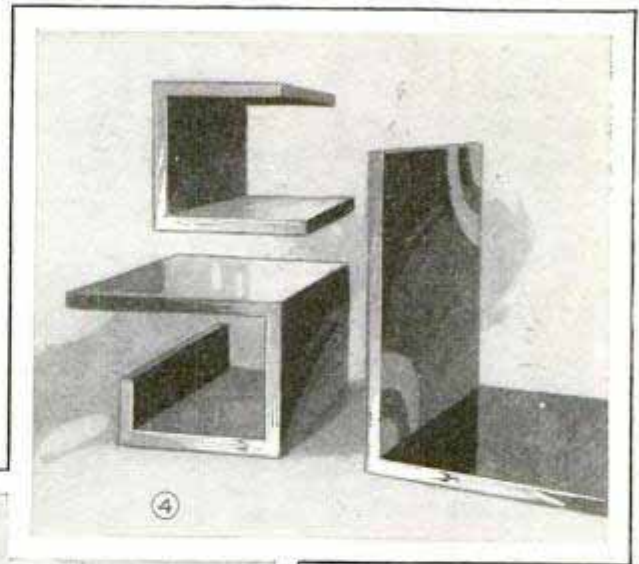
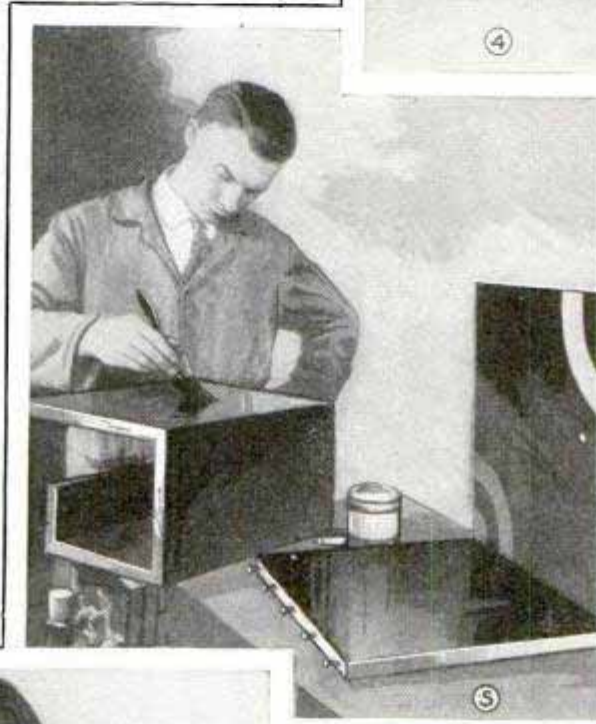

surface is smoothed with fine sandpaper.

It must be remembered, however, that it is nearly impossible to apply the design, and to finish the surface properly after the table is completely assembled. Therefore, it has been found convenient to assemble the pieces into four separate sections, three of which are shown in Fig. 4. The remain-

ing section consists of the top, the sides and the upper shelf. The four sections are finished on all sides, but not on the edges, before they are assembled. The finishing of the edges is done when the table is completely assembled, as they have to be planed down and sandpapered smooth to match each other; the table is therefore assembled temporarily, the edges carefully fitted, and the sections taken apart again for finishing.

Water putty or "plastic wood" is used to fill the counterbored holes into which the screw heads are sunk. Force the filler in firmly, allowing a small quantity to project above the surrounding surface. When it has thoroughly dried, which takes from 24 to 48 hours, use a sharp chisel to cut off the surplus neatly. Having done this, apply a coat of shellac all over. This application should be quite



may be necessary to use a small plane to get the edges true, after which their



liberal on the edges where the crossgrain of the core of the veneer is exposed. Allow the first coat of shellac to dry overnight and then apply a second coat. When this is dried, rub the surface down with sandpaper held on a smooth block of wood. Steel wool can be used to remove particles of dust, which may have collected on the surface of the shellac while this was drying. The surface is cleaned thoroughly and a first coat of one of the new quick-drying enamels, or lacquer, is then applied. The entire surface of all the pieces is enameled or lacquered black.

At this point you may become rather anxious to hasten the process of applying successive coats of paint, but each coat must be allowed to dry thoroughly before it can be rubbed down and the next one applied. The enamel or lacquer may dry to the touch within a few moments and may seem hard after a few hours, but do not misjudge the true condition by these appearances. Wait at least 48 hours before you attempt rubbing down the ridges and removing the dust specks that are sure to be found on the dried surface. When painting, which can be done either with a brush or by means of a spray gun, the utmost care should be observed. First, the shop or room where the work is done should be clean, and the air should be as free from dust as possible. Therefore, do not sweep the floor, use a circular saw or a sander, or any other machinery, which is likely to raise dust, just before you apply the paint. Also, it is preferable to keep the windows and doors shut, especially on a windy day, when dust flies about everywhere. Your brush should be thoroughly clean. This is impossible if it is stirred in some old, exposed turpentine, or thinner, and then slapped against a wood surface. This is a dust-collecting rather than a dust-removing process. If the condition of a brush is doubtful, it should first be cleaned thoroughly in the solvent of the paint used, which is turpentine in case of ordinary paints and enamels, and thinner in case of lacquers. Thereafter, give it a thorough washing in clean, soapy water, rinse it well and set it away to dry. Dry brushes should be wrapped up in paper to keep out the dust. Before actually opening the lid of the paint can, raise it all around about  $\frac{1}{8}$  in., and blow the dust

away from the edge of the cover, for paint cans are often packed in sawdust, and some of the dust gets under the edge of the cover, dropping into the paint the moment the cover is removed. When the paint can is not in constant use, keep the cover on. Use a piece of cloth that leaves no lint, or a wide brush, to wipe off the surface just previous to applying the paint.

The precautions just mentioned may seem absurdly "fussy" but these seemingly insignificant details are really the things that count in doing good work, which, under ordinary slovenly methods, is entirely impossible. This is the secret of the beautiful finish which is usually credited only to experienced, capable painters. Brush the paint over the surface evenly, flowing on a moderate quantity, so that brush marks will even out. However, do not apply too much for this may take weeks or months to dry hard. Quick work is necessary when lacquer is used, as it cannot be brushed over a second time, but this must be done immediately after it is applied.

Rubbing down each coat, after it has dried thoroughly, is another trick for obtaining a flawless finish. Fine sandpaper, held on a block, may be used conservatively, that is, it should not be used too vigorously and should not be rubbed on one spot too long. It is much better to use the finest grade of garnet paper on a block, as shown in Fig. 6, keeping the surface well covered with water to prevent the accumulation of loose paint on the paper, which would ruin its effectiveness as an abrasive. After the surface has been cleaned and dried, the second coat of paint or lacquer may be applied. Three or four coats are necessary to permit a good rub-down to a perfect finish. Be sure to use the same kind of paint for each coat. The last coat is rubbed down with greater care than the preceding ones. After the garnet-paper rubdown with water, the surface is dried, and powdered rottenstone is used with rubbing oil to eliminate all the small scratches. A small piece of cloth, tightly wadded, is used to do this rubbing, which will result in a smooth, glasslike finish, rewarding you for your painstaking efforts. In the absence of rubbing oil, use ordinary sweet oil or crude oil.

The design is then applied. Modern-



istic furniture designs consist mainly of straight lines and arcs, combined to make simple geometrical forms. Fig. 7 shows a neat, attractive design, which may be followed. Overwrought, intricate designs in many colors are to be avoided for this is contrary to the

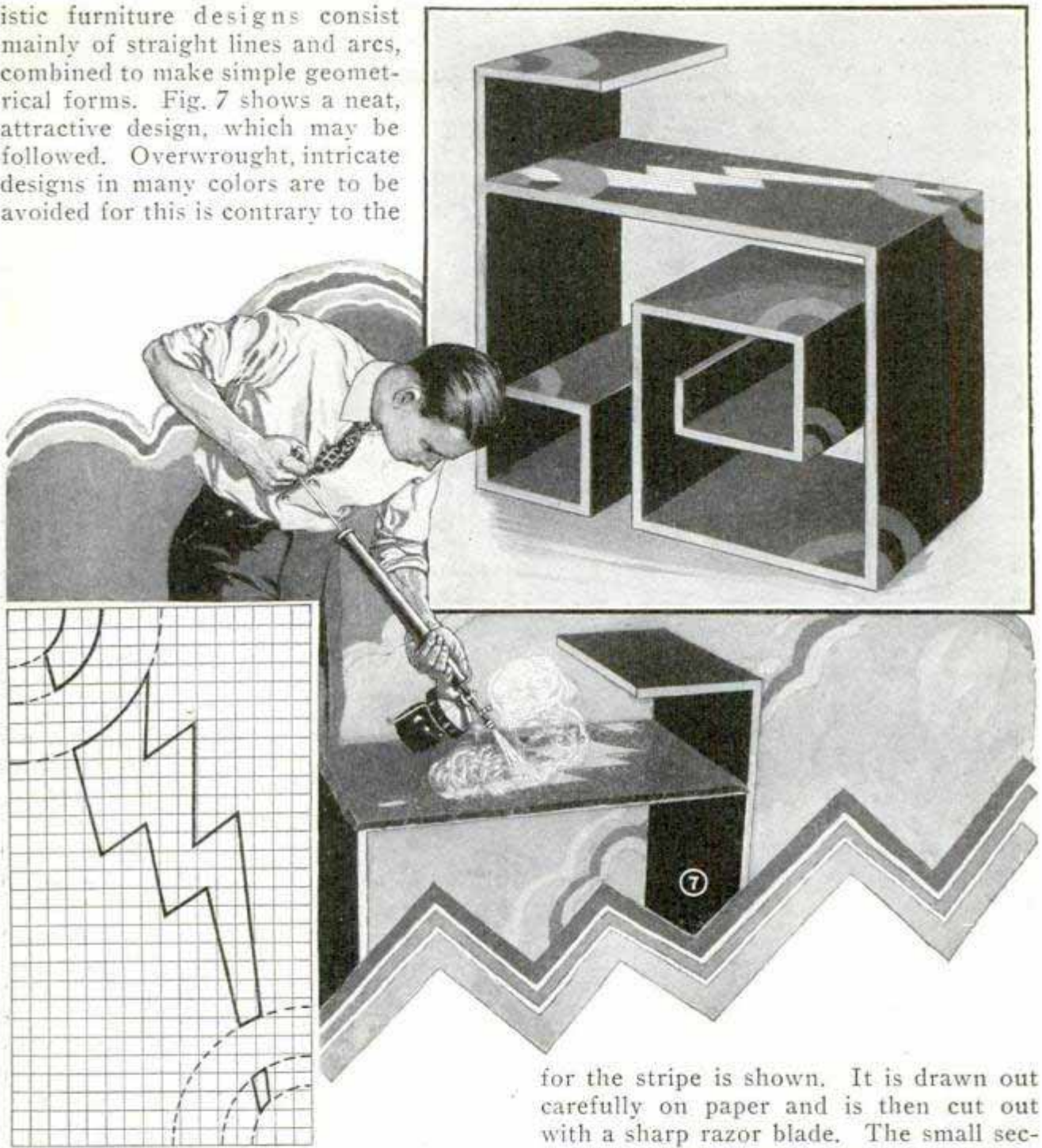

idea of simplicity, which modern art seeks to express. The design illustrated rendered in two colors, such as Chinese, mandarin or oriental red, with aluminum or silver, or a light gray on a black background, stands out in bold relief and is very distinctive. In this case the double quadrants were painted red, the irregular stripe or "lightning flash" aluminum, and all the edges aluminum. The designs can best be applied by means of stencils. This is comparatively easy and accurate results can be obtained. In the lower left-hand corner of Fig. 7, the template

for the stripe is shown. It is drawn out carefully on paper and is then cut out with a sharp razor blade. The small sections fit between the two bands of the quadrants. It is a good idea to cut the stencil for the quadrants at the same time, to be sure that the stencils fit together well. When the stencils are ready, get some rubber cement and apply a thin coat to the underside of the stencil, just around the edge of the cut-outs. Allow the cement to become apparently dry before pressing the stencil down on the surface on which the design is to be applied. The edges of the cut-outs must adhere to the surface securely, or the paint, upon being applied, will run under the stencil and ruin the work. A small hand spray gun of the



kind shown in Fig. 7 has been found handy for applying the design, care being taken to thin the paint to the consistency most suitable for spraying and adjust the gun to the same end.

After the sections of the table have been completely finished, they are assembled and screwed together securely as described above. The remaining counter-bored holes are filled, and several coats of paint are applied over the putty spots, each coat being rubbed down to match with the surrounding surface. The photo in the upper right-hand corner of Fig. 7 shows the davenport end table finished. Parts of the design are repeated at several corners.

Fig. 8 shows a useful occasional table,

top. Veneer, however, is necessary for the top, as it is of quite large size, and ordinary stock would have a tendency to warp, besides being more easily cracked and broken. All the other parts of this table consist of scrap pieces which anyone can find around the house or shop. They are cut carefully, planed and sandpapered smooth, and assembled as indicated. The color scheme in this case was jade green and oriental red on a black background, which was found very effective. The center-post braces are painted red, the post itself being black. The small square notches in the corners of the base are green, and the edges of the shelves may be painted either red or green, and similarly the edge of the top, although this does not show in the photo. The method of fastening the top to the center post is shown in the lower right-hand detail. The top may carry any suitable design.

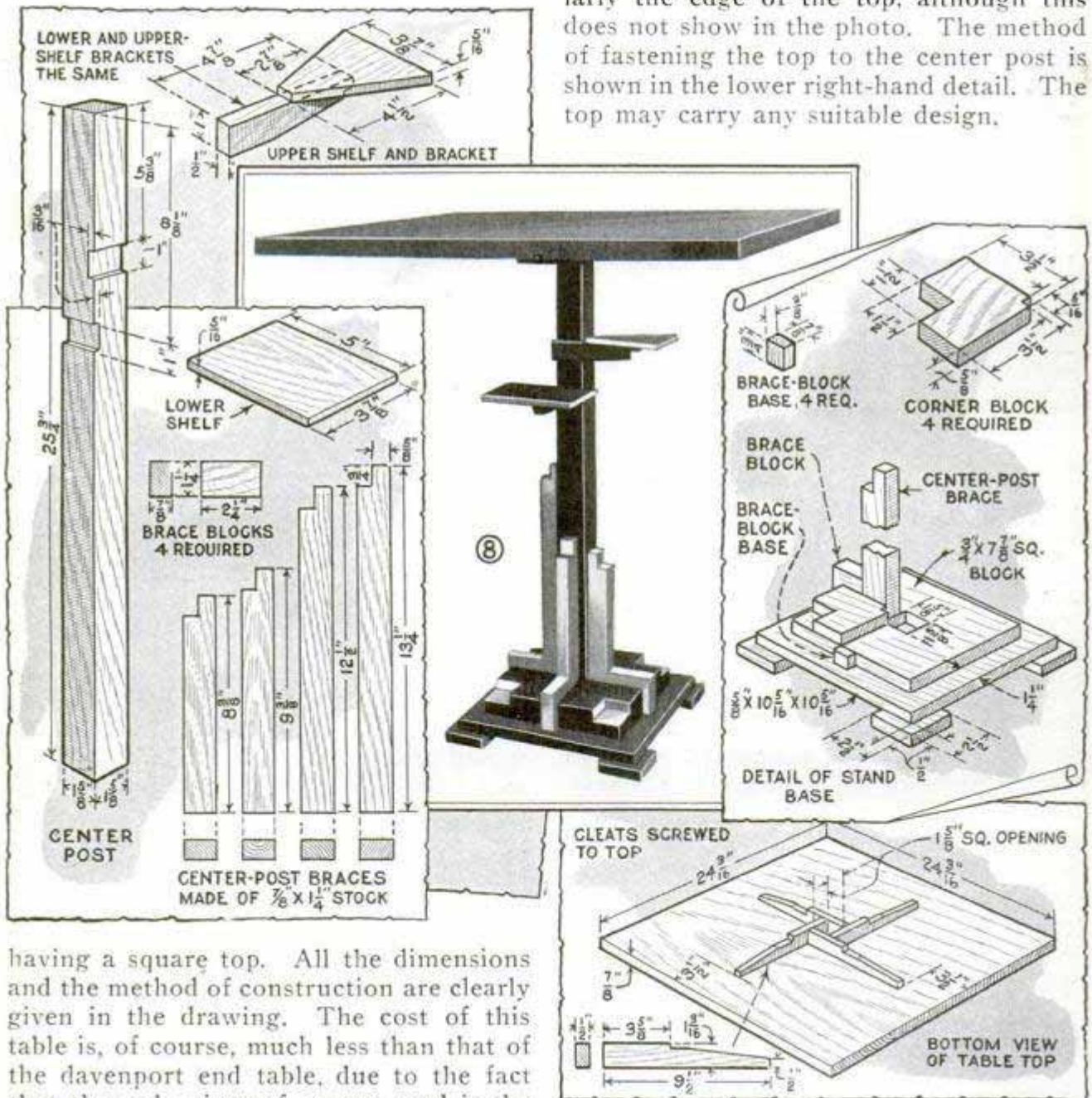

having a square top. All the dimensions and the method of construction are clearly given in the drawing. The cost of this table is, of course, much less than that of the davenport end table, due to the fact that the only piece of veneer used is the



*Crab. 6" in shaper + 3 1/2 in slotted*

# A 6-in Bench Shaper

by J. V. Romig

THE VALUE of the shaper as a machine tool is appreciated by every mechanic, but the man in the small shop, much as he may appreciate the advantage of such a tool, is not always in a position to purchase it. Here, however, is a shaper that can be made in any small shop at a reasonable cost, and which, on work within its capacity, will rapidly pay for the labor and slight expense of building.

There are two types of shaper in general use, the push-cut and the draw-cut. Each has its advantages; the draw-cut shaper, for example, is the better for tool work, where profiling to a layout line is to be done, since the layout line faces the operator, and the tool, cutting on the back or draw stroke, cuts clean to the line. On work of this kind the push-cut shaper, cutting on the forward stroke, breaks off the edge of the work, and makes it much more difficult to work close to the line. In addition to this, the draw-cut type takes heavier cuts with less vibration, as the pressure on the slides and the work is toward the main frame. On the other hand, the push-cut type is better for work in which the tool must be carried at an angle, and it permits the use of gooseneck tools. The advantages of both types are combined in this shaper, by the simple expedient of employing two clapper boxes, one of the push-cut and the other of the draw-cut type, either of which can be used to suit the work in hand.

In addition, and by eliminating a

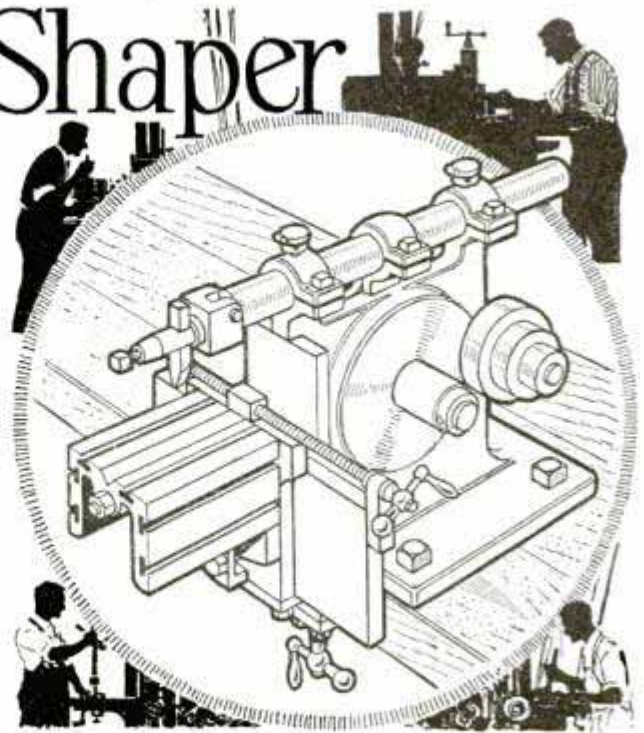

few of the usual components of shaper construction, such as the slide on the ram, a more powerful and rigid tool is obtained. Vertical feed is secured by raising the cross-rail assembly, and angular work is machined by tilting the table. Horizontal movements are obtained in the usual manner, by sliding the table saddle on the cross rail by means of the feed screw.

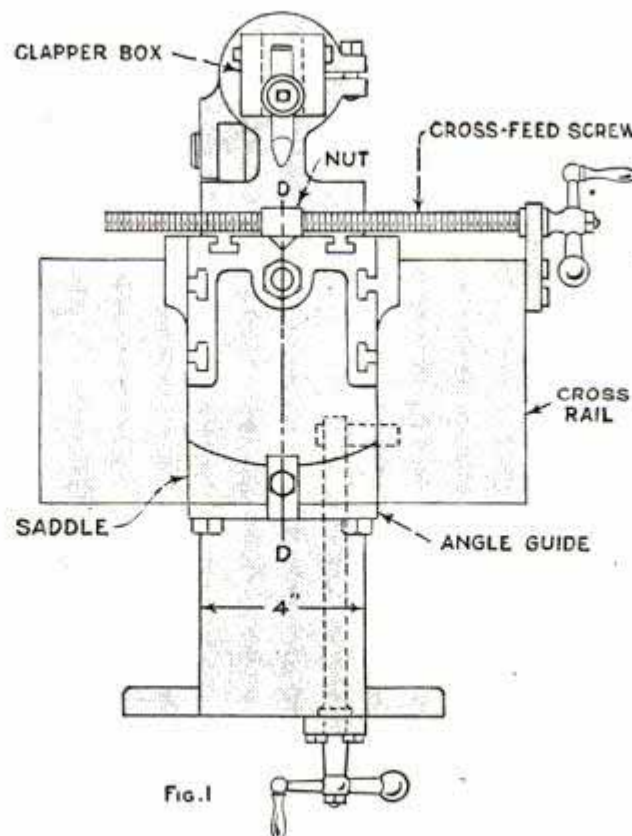

The main frame of this little shaper is a gray-iron casting, machined to the sizes given in the accompanying drawings. The pattern for the casting is made of white pine, and is quite easy to fashion, even for the amateur patternmaker. All the parts to the right of the frame are cast integral with it, while the parts to the left are separate, and positioned with pins. These portions are the part of the front slide and the base that overhang the center web of the



machine, and the portion of the ram bearings at the top. The housings for the gear mechanism do not need any cores, as the shaft holes can be drilled from the solid. Patterns for the remainder of the parts should be made with sufficient allowance for the machining operations.

The ram is made from a length of cold-rolled steel, machined only on its front end for the clapper boxes. The bar should be tested with an indicator, in the lathe, and straightened. It may seem, at first glance, to be rather long, but this is an advantage, as many jobs that would take a longer stroke than 6 in. can still be done by taking two "hitches" of the ram; also, work that is too far from the front slide to be reached by the tool in normal position can be finished by moving the ram forward. The ram slides in two bearings in the main frame, and is kept from turn-

ing by the clapper boxes, of course, kept in a vertical position.

The clapper boxes are made of machine steel, to the drawings, and fastened to the ram with taper pins. The draw-cut box is held with two pins, and has an auxiliary toolholder swiveling on a taper pin. The setscrew that holds the tool tight is reached through the hole in the front of the box. The toolholder for the push-cut box is turned from a length of steel, and is held in the box by its lower flange, which fits in the counterbore in the rear of the box. A serrated tool-steel washer is used between the tool and the front. The tools are 1/2 in. square, or 1/2 by 3/4 in.

When machining the main frame, care must be taken to get the ram-bearing holes square with the front slide, both vertically and horizontally. It is therefore best to machine the front slides first, to get a working surface for the subsequent operations.

The ram bearings can be fitted with bronze bushings, although this is not essential. Compensation for wear is secured by splitting the bearings and adjusting with the clamping screws. Use oil cups or sight-feed lubricators on the bearings.

The ram is reciprocated by a crankpin on the main gear, the pin carrying a slide which fits the slot in the rocker arm. The crank may be clamped in any position on the gear, permitting

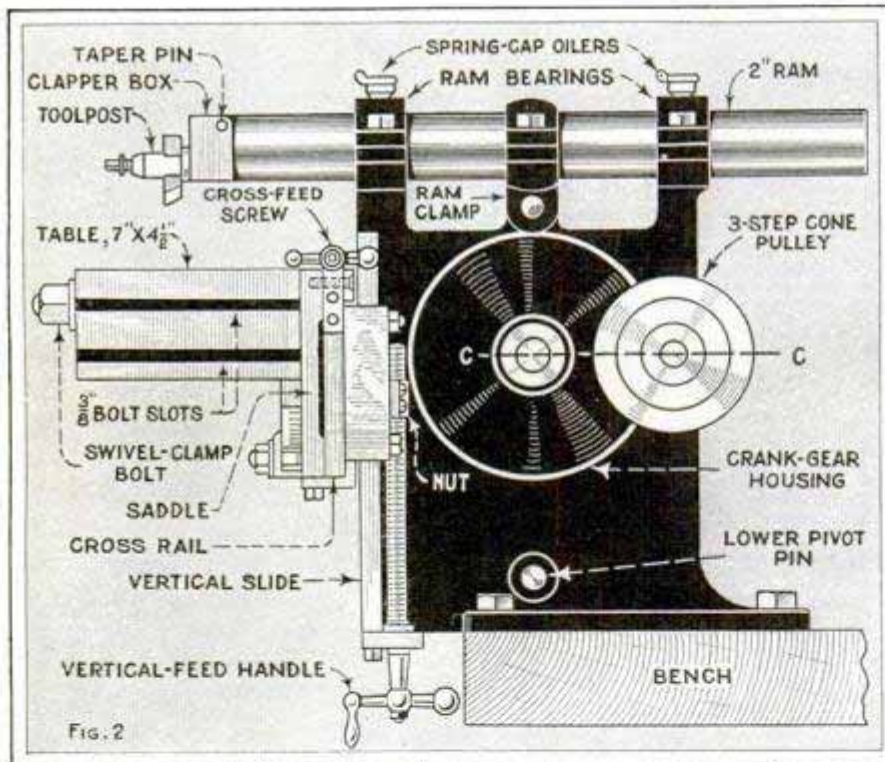

FIG. 2

ing by the clamping member, which is also connected to the rocker arm below. On angular work, clearance for the tool on the return stroke is effected by turning the ram in the clamp the requisite amount. For all straight shaping or slotting work, the clapper

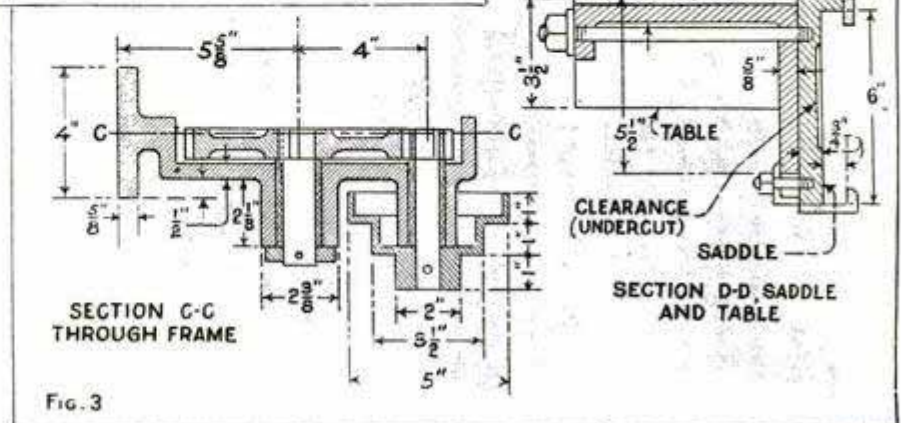

FIG. 3







are  $\frac{1}{2}$  in., 20 threads per in., fitted with ball-crank handles. All feed-screw nuts are of bronze, the one for the elevating screw being fitted to the rear right-hand slide plate, and the bearing for the cross-feed to the right-hand side of the rail.

The saddle is a casting, machined as in Fig. 3. It will be noted that the casting is wider at the top than at the bottom; this provision is made because there is greater wear and strain on the top slide than on the bottom one. The worktable

is also a casting, with the bolt slots cored in. It is machined square on all faces, and swiveled to the saddle on a  $\frac{1}{2}$ -in. bolt near the top face, and clamped near the bottom. The lower edge of the table can be laid off in degrees to facilitate setting up angular work. The three faces of the table enable work of almost any shape to be handled from any angle.

When using the draw-cut clapper box, reverse the belt, so as to obtain slow motion on the return stroke.

### Tool Carrier with Hingeless Cover Made from Common Wood Box

Any ordinary wooden box can be made into a serviceable tool box by using a length of rope for a handle. By arranging the rope as shown in the drawing, it

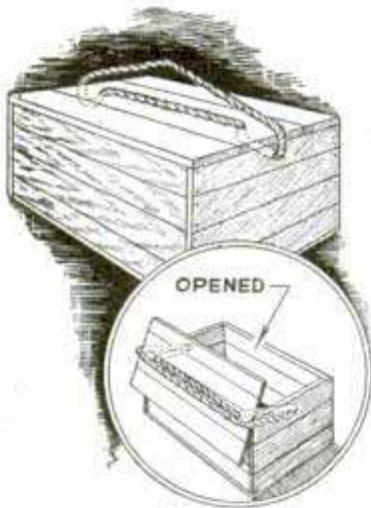

acts not only as a handle but also as a substitute for hinges, and enables one to press the lid on tightly while the box is carried from place to place. Drill a hole in each end of the box, in the center and near the

top edge and two holes in the lid, all four being alined as shown. Pass the rope through the holes and splice or knot it. The length of the rope is determined by the size of the box and should be sufficient to allow the lid to be lifted and swung back out of the way when the box is opened. When carrying the box, the top part of the rope is held in the hand, and the weight of the contents causes the lower part of the rope to press down tightly on the top, so as to keep the lid securely in place.—Harry Moore, Hamilton, Can.

### Handy Gate for the Farm

Always open to pedestrians but closed to stock, the gate shown in the drawing has been found both practical and con-

venient. The trouble of opening and closing the gate is eliminated and it cannot easily be left open by mistake. It consists of four posts set into the earth, about 3 ft. apart. The gate is hinged to one so that it swings between the two side posts as indicated by the dotted line. It is a good idea to arrange one of the side posts so that the gate will just clear it, but then it is necessary to hinge an extra piece of 2-in. stock to this post as shown. Unless it is swung back, this piece prevents the gate from being opened entirely. A hook and screw-eye are used to hold it in place securely. In this way the gate can be opened, when desired, to permit the passage of objects that are too bulky to get through the narrow opening, as, for instance, a wheelbarrow, or the live stock.—I. M. Wilson, Kansas City, Mo.

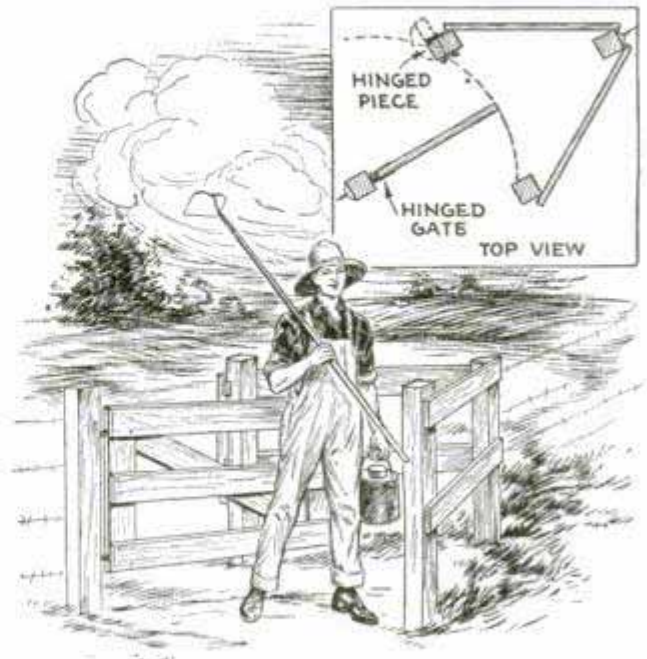

Hinged Gate for the Farm Is Convenient and Cannot Be Left Open by Mistake



### Snowshoes of "Beaver" Pattern Made from Tennis Rackets

You can make a pair of "beaver" design snowshoes from a pair of old tennis

awl about the edges of the leather footrest and the straps. Fasten the footrest into place with waxed thread or leather strips stitched through the holes around the

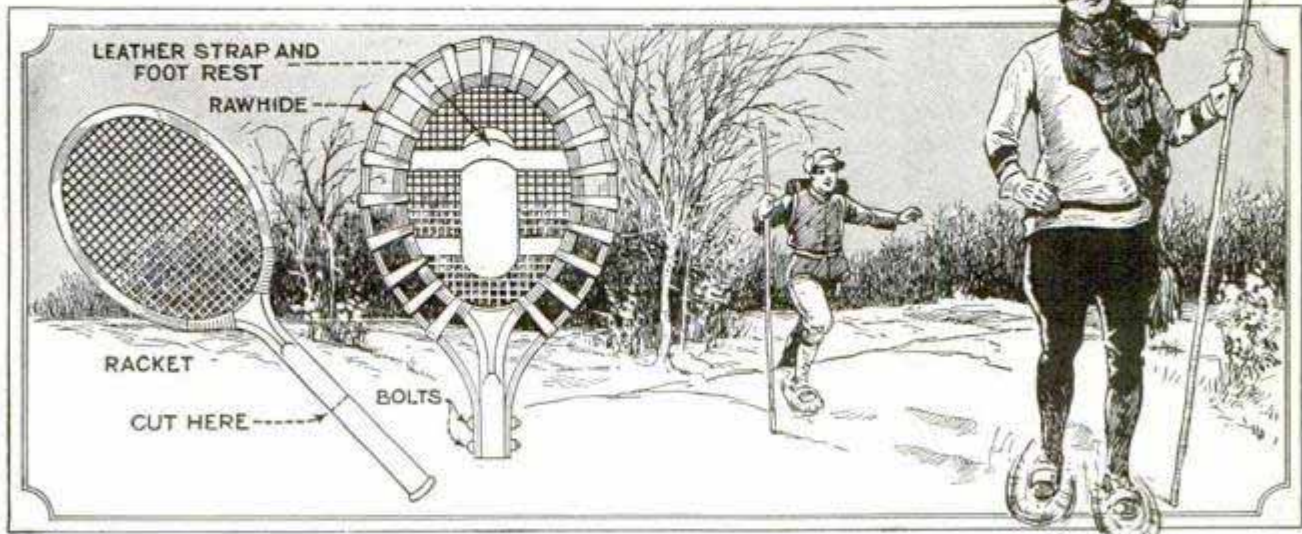

Tramping over Loose Snow Is Great Sport. These Snowshoes Were Made from Old Tennis Rackets and Anyone Handy in the Home Workshop Can Duplicate Them

rackets and two ash whips, bolted at the tail of the shoe and bound to the racket with rawhide strips. It doesn't matter if the tennis rackets are warped badly and have a few broken strings, for they can be replaced with strips of rawhide. Saw off the ends of the racket handles at a point 5 in. from the end. Whittle down two ash poles, each about  $\frac{3}{4}$  in. in thickness, and dry them in the sun or by the fire. Each pole should be long enough to form a space about 3 in. wide about the tennis-racket rim. Then soak them in water until they can be bent into a loop without cracking. Whittle down the ends of each pole and drill two  $\frac{1}{4}$ -in. holes at each end, with a distance of about 4 in. between them. Drill two  $\frac{1}{4}$ -in. holes in the handle of the racket to correspond to the holes in the ash pole, and fasten the pole in place with a pair of small bolts through the handle. Replace any missing gut strings with lengths of leather. Cut a number of long strips from the side of a boot, each  $\frac{1}{2}$  in. wide, and bind the ash rim to the edge of the racket with an over-and-over stitch. Small and shallow notches should be made at intervals in the ash rim to keep the rawhide from slipping out. Cut out a leather footrest and a pair of straps long enough to stretch across the tennis racket. Make rows of holes with an

edge. The rear strap should be fastened in the same way, save that a loop is formed over the footrest so that the toe of the boot can be slipped under it snugly. Give each snowshoe a generous coating of tallow or oil, to keep it from becoming water-soaked. You will have to practice to get on to the "gait." Every time you take a step you must swing the shoe around the other one before setting it down, and the first few steps will probably result in a spill or two. However, you will soon catch on to the step, and after a few trial tramps you will be able to cover considerable distances at good speed and without discomfort or weariness.—G. Everett Van Horn, Milton, Wis.

### Securing Door with Loose-Pin Hinges

Loose-pin hinges on doors of cabinets and other similar constructions often permit intruders to gain entrance by removing the pins and lifting the hinge edge of the door outward. This may be overcome by fixing pins cut from a wire nail into the edge of the casing above the upper and below the lower hinges. Holes drilled into the edge of the door to fit the pins prevent the withdrawal of the door even after the pins are removed from the hinges.—George Niederhoff, St. Louis, Mo.





Cambridge School-Teacher Who Glazed In the Space under His Back Porch to Make a Greenhouse

### Back Porch Used as Small Greenhouse

Even in a city, where you have a very limited space, it is possible to provide a small greenhouse for pleasure or for extra earnings. A school-teacher of Cambridge, Mass., built the one shown in the photo, right under his back porch. It consists merely of a number of sash held in position securely on a suitable frame. Some of the sash are arranged to swing open to permit ventilation. The position of the porch is such that it receives considerable sunshine, and that is, of course, partly the reason why the porch could be used for this purpose.

### Use for Modeling Clay in the Workshop

Modeling clay will often be found handy in the shop. A small quantity—25 or 50 cents' worth—is enough for any ordinary job, and pays for itself many times over in saving of time. If a small screw or nut is lost in a maze of machinery, it can be quickly recovered by molding a ball of

clay on the end of a stick or wire and lowering it to make contact with the lost object, which will stick to the clay and can then be lifted up without any trouble. The clay also helps to insert a screw in a tapped hole which is located in a recess of a machine so that one cannot get at it by hand. Fill the slot in the screw head with clay and then push the screwdriver blade into the slot. The screw will stick to the end of the screwdriver and thus be started in the thread. If a drawing is to be made of a casting having an irregularly shaped groove, its contour can be transferred to the drawing as follows: Fill a short space of the groove with clay, carefully remove it without distorting it and shave

down a thin slice. This can be laid on the drawing and its profile traced. Imperfections in a model can be temporarily filled with clay while a casting is made in plaster of paris, and the clay can be reclaimed later.—L. B. Robbins, Harwich, Mass.

### Stringing Barbed Wire Tightly

When stringing barbed-wire fences, many farmers use one-horse sleds of the kind shown in the drawing. If a fence is long, a reel often pays out so loosely that it is necessary to use a wire stretcher several times before the wire can be stapled to the posts. To overcome this trouble, one farmer fitted his sled with a simple brake. It consists of a long hook made of tire iron and is attached to the sled as indicated.

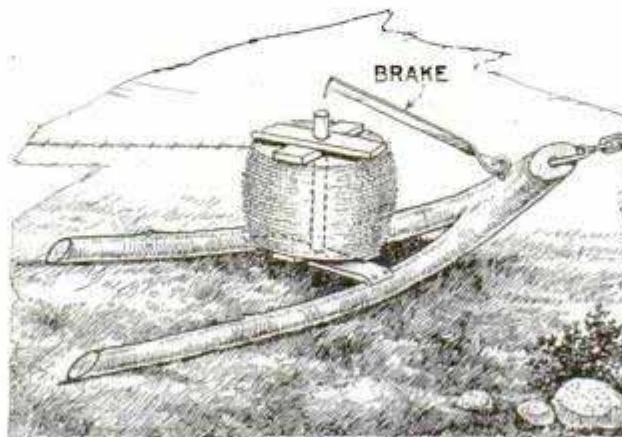

Simple Iron Brake on Sled Holds Reel from Revolving and Takes Up the Slack in the Wire

When not in use, the barb of the hook rests in the end of the pipe axle of the reel, but when it is desired to brake the spool, to take up the slack in the wire, the hook is made to engage with the wire so that the reel cannot revolve.—G. E. Hendrickson, Argyle, Wis.



225 Salmaire Ave  
Chicago

Shurston Manual  
Training Supply Co  
Amherst, Mass  
American Fibre Corp  
Hardner Mass

# How to Make Rush or Fiber Seats

By L. DAY PERRY

WHILE the making or repairing of rush seating appears to be a very complicated process, it is in reality very simple and easy. The seat described here may be made by any careful boy in the home workshop. If well made, the finished piece of furniture will be very interesting, comfortable and serviceable. A working drawing of the seat which may be made by the amateur worker is shown in Figs. 1 and 2. The general dimensions as given are about right, it is well proportioned and may be easily transferred from place to place. However, the seat may be made square and either larger or smaller to suit the owner. The instructions for weaving the seat apply equally well, of course, either to new work or to the repair of old seats.

There are two kinds of serviceable ma-

terial to use for wrapping the seat. One is the natural rush and the other is manufactured fiber. Both may be purchased from dealers in such supplies. If you wish to gather and prepare the rush you may readily do so. The ordinary swamp cat-tail is the plant, the leaves of which are used for rush seating. These leaves are cut in the fall, about the time the tips begin to turn brown, and dried slowly in the shade in basement, shed or loft. Before they are used, they should be soaked for several hours in water, and just before wrapping run through an ordinary clothes wringer to remove excess water.

Fiber is firmly twisted kraft paper procurable by the pound in indefinite length. For seating, it should be about  $\frac{1}{8}$  to  $\frac{3}{16}$  in. in diameter and preferably of natural-brown color. In every way fiber is easier to handle and quite as serviceable as rush.

Oak is probably the best wood for the construction of the frame, for it finishes well, tones in satisfactorily with the fiber, and will stand severe usage. Yellow poplar is also a wood that works well, takes stain beautifully, and is susceptible of fine polish. The worker need not hesitate to use this wood if he likes it.

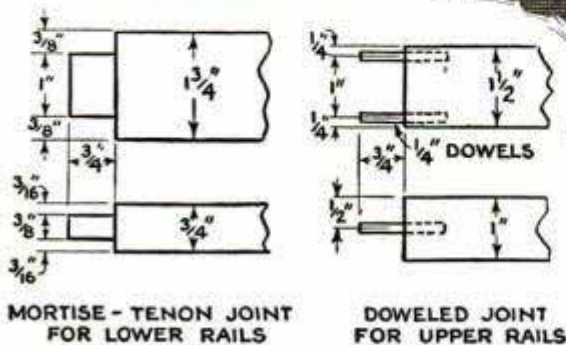
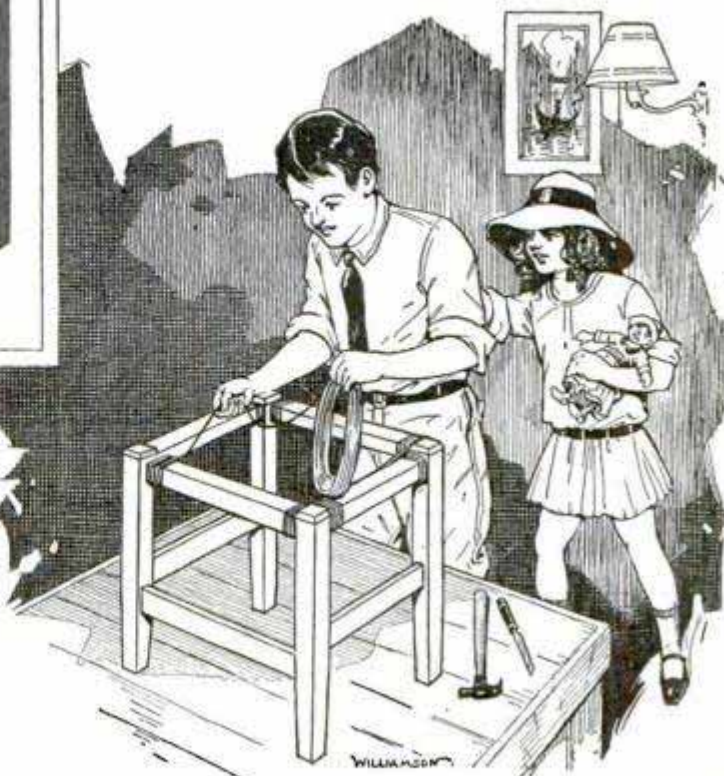
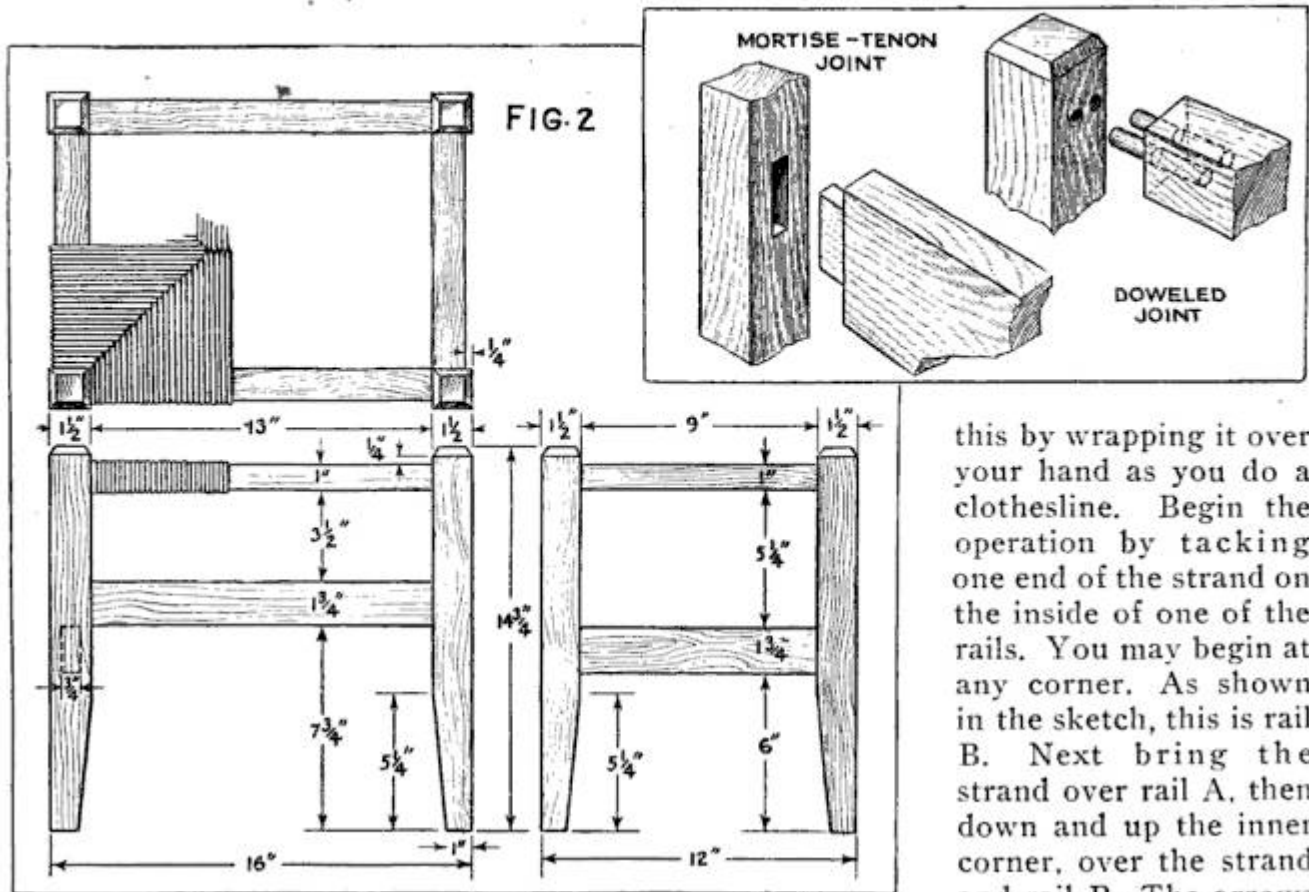

Fig. 1



Levin & Tinghton  
Brookline, 34 Everett St.  
Boston Mass  
34, Boston Mass





In Fig. 2 are shown two kinds of joints commonly used in furniture construction. One is the mortise-and-tenon joint and the other the doweled joint. Either may be used. Both are used here. The size of each is given in Fig. 1. The doweled joint is used on the upper rails and the mortise-and-tenon on the lower ones. Certain trimming will need to be done where the dowels fit at right angles at the posts.

The holes for the dowel pins must be bored straight and accurate. A doweling jig is an excellent tool to use in centering and boring the holes. This tool is inexpensive and is a very fine one to have in the kit. A dowel bit should be used for boring, as it is a shade less in diameter than the regular bit and assures a tight fit and satisfactory joint. Be sure that each tenon fits into the mortise with a "driving" fit. Put the whole frame together to see that all points fit snugly, then finally assemble it with glue.

The method of wrapping the seat rails is shown in Fig. 3. This general scheme applies to any material which one may use for seating. The description to follow applies particularly to fiber, or fiber cord as it is commercially known. First wind about 25 ft. of the fiber into a coil. Do

this by wrapping it over your hand as you do a clothesline. Begin the operation by tacking one end of the strand on the inside of one of the rails. As shown in the sketch, this is rail B. Next bring the strand over rail A, then down and up the inner corner, over the strand and rail B. The arrows

on the sketch point the way. Continue down and under rail B, directly across the inner space to rail C. Wrap over and down rail C, up at the inner corner, then over the strand and rail A. Wrap the strand over and down rail A, then directly across the inner space to the top of rail D. This process is repeated at all corners. The sketch will make the process very clear, as the turns are numbered in the order in which they are made.

The strand of fiber should be pulled firm and tight at all times, and particular care should be taken at the corners, where the strands cross and the turns are made. Add

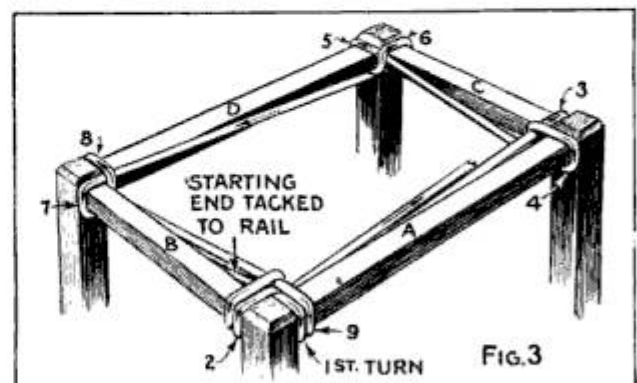

each new length of fiber by tying a square knot underneath the seat, or tacking the



end of the old strand and the beginning of the new underneath one of the rails. The wrapping is continued until the two short rails are covered. Be sure that the strands are kept close together over the rails. A little tap with a block of wood and hammer will do the trick. When the short rails are filled, the wrapping is not yet complete, for there is an unfilled space on the two longer rails. Continue to wrap the fiber cord over and under these rails until the entire space is filled. Finally tack the end of the last strand under the proper rail. On a square seat, like the one in the photo, all rails are filled at about the same time, but on all rectangular seats the shorter rails fill first.

As the wrapping progresses, there are formed open spaces between the upper and lower strands. This space must be packed firmly with kraft paper such as may be purchased from the local store. Packing is necessary to build up the seat, to prevent sagging with use and to keep the fiber from breaking down at the inner corners of the rails.

If cat-tail leaves are used for the seating, first cut off the butt ends of the leaves as these are too coarse. Twist two or three leaves together to make a strand. Make a long twist and always in one direction. Add another leaf as the strand thins out, for there must be uniformity in thickness if the seat is to look neat and workmanlike. The butt ends are used for stuffing the seat. Aside from making the strand as the wrapping is done, the process for rush is the same as for the fiber cord.

The seat frame may be stained any desired color, and then filled with a paste wood filler. After thorough rubbing and drying, apply a coat of thin white shellac. Sand down the shellac with a fine grade of sandpaper. Apply several coats of good varnish to the fiber. Do not rub the varnish. Wax the frame or give it a coat of varnish and rub it down to a dull finish with pumicestone and water.

### Tamper Made of Concrete

A tamper for use in the garden or in home concrete construction may be made as follows: Get a tomato can, about  $4\frac{1}{2}$  in. in diameter, and remove the top. Drive nails part way into the end of a broom-

stick, or other round wooden rod, so as to form radiating projections. Insert the broomstick into the can and pour concrete around it. Care should be taken that the handle comes in the center of the can, and that its lower end does not touch the bottom while the concrete is being poured into place. Permit the mixture to harden, and a substantial tamper will result.—W. W. Baldwin, Washington, D. C.

### Drawing Parallel Diagonal Lines

When a number of parallel lines have to be drawn at other angles than the ordinary

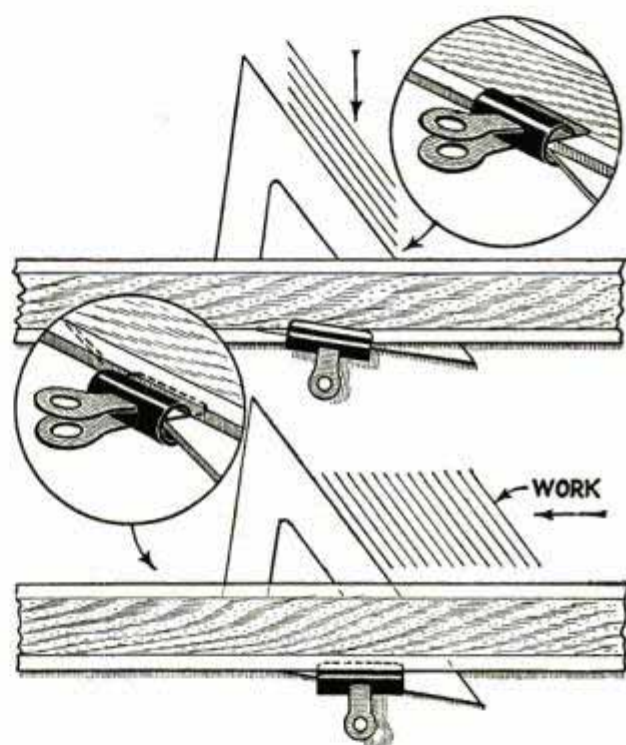

Using a Paper Clip to Hold a Triangle in Position for Drawing Parallel Diagonal Lines

triangles provide for, as in shading certain sections, the draftsman will find the use of a paper clip to be of considerable help in holding the triangles in the correct position. If the section to be shaded runs from top to bottom of the paper, the triangle is clipped to the T-square as indicated in the upper detail, and the square, carrying the triangle, is moved down the board as the lines are drawn. If, on the contrary, the shaded section runs horizontally, the clip is attached to the triangle as shown in the lower detail, and the triangle is then slid along under the T-square, with the clip bearing against the lower edge of the square.—W. G. Partin, Cleveland, Ohio.





Simple Jig Which Facilitates Cutting Tie Wires for Concrete Forms

### Handy Jig for Cutting Tie Wire for Concrete Forms

A large number of tie wires, to hold concrete forms together, can be cut to the required length quickly and easily with the improvised device shown in the drawing. It consists of a plank laid across two ordinary sawhorses; a reel pivoted at one end of the plank to hold a roll of wire from which the tie wires are cut, and a tie-wire shaper, which is pivoted at the other end of the plank. The latter is made from a length of 2 by 4 or 2 by 6-in. stock, and a spike driven in at each end to hold the wire in the form of a flat coil, as indicated. The distance between the spikes must be equal to the length of one tie wire. After as much wire has been wound on the shaper as it will hold, or as much as desired, wrap the loose end around one end spike and then, with a large pair of wire cutters, cut through the coil of wire at the exact center between the end spikes. The number of U-shaped lengths of wire thus formed are then of the correct length and ready for use.—A. W. Burg, Lake View, Iowa.

### Removing Battery Terminals

Battery terminals should always be tight. However, a terminal frequently becomes so tight that it is difficult to remove it when necessary. Strong-arm methods may injure the battery by loosening the post, allowing leakage and loss of the acid solution. Sometimes the post is even torn from the battery-plate assembly necessitating an expensive repair. For this reason, when detaching terminals from the posts, care should be observed to put as little strain on the post as possible. Special tools can be had for removing the different types of terminals.—Elmer Whittaker, Segregansett, Mass.

### Quick-Tightening Grinding Chuck

A chuck with a novel method of tightening was made to hold some flanges while grinding out the taper hole. The flanges had four bolt holes, but instead of using bolts and nuts in the ordinary way, we threaded the chuck at the back and made a tightening sleeve that acted on four plain pins and secured the work by one movement of the sleeve. The pins have a groove cut in them a little wider than the thickness of the sleeve, and the face of the chuck and the sleeve are drilled to match the four bolt holes. The sleeve is also slotted at one side of each hole to suit the diameter at the bottom of the groove in the pins. In use, the four pins are pushed in place through the flange, chuck and sleeve. A bar is then inserted in the hole in the sleeve and this is turned, which causes the grooves in the pins to enter the slots and thus tightens all four pins equally and securely at the same time.—Harry Moore, Hamilton, Can.

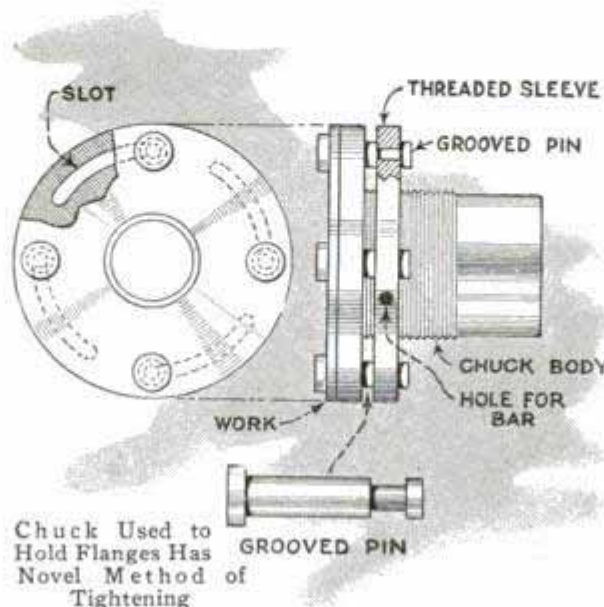

☐ Marks at intervals of 6 in. on the handle of a post auger will aid in determining the depth of the hole.



# BUILD A HOME THAT RUNS ITSELF

*Popular Mechanics  
Low Cost Homes*



Copyright, Popular Mechanics

Plan No. 6-S-27

A MAN'S chances of getting an ideal wife, a homemaker, are three out of ten, according to Mrs. G. G. Goodwin, past president of the Illinois federation of women's clubs.

There's hope ahead, however. Mrs. Goodwin believes, that most women would turn out better homemakers if they were given the equipment to make better homes with. What does she mean? Just this: Labor-saving and timesaving machinery; anything that will take the drudgery out of housekeeping and save time for other things. What things?

Here is one answer by 100,000 housewives from all sections of the United States. Eighty-five per cent said recently in reply to a letter by a large manufacturer that they used prepared foods in their homes in order to save time. To save time for what?

For the call of the great out-of-doors, week-end excursions in the new

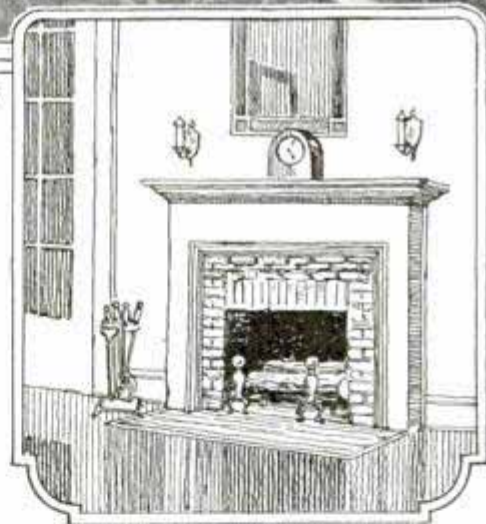

car, camping, picnics, recreation, club work, community service and a long list of privileges which women are entitled to just as much as men.

That brings us to the story of the little

house illustrated above: "A Home That Runs Itself." What a fascinating title! And a very practical idea that will appeal to both men and women who do not want to be overloaded with so large a house and

## A NEW SERVICE

To help our readers get started on one of life's most glorious experiences—building and owning a home—Popular Mechanics Magazine will supply readers a one-sheet blueprint of the house here illustrated for \$2. This blueprint does away with the necessity of first purchasing a complete set of plans to find out whether you can afford to build. It contains floor plans, elevations, a section, detail, size of joists, studs, etc., and also a brief specification. Submit it to tradesmen and dealers for building estimates.



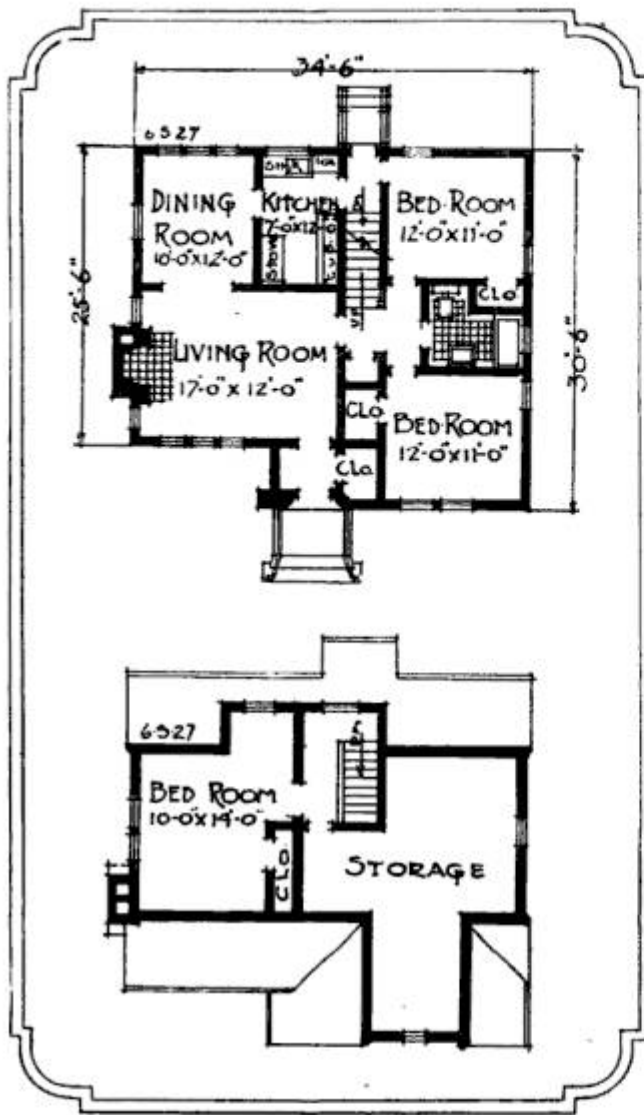

so many responsibilities that little or no time is left for outside interests.

First and foremost, the modern house, in order to save the housewife's time, must be small, compact, in fact almost self-operating. This does not mean that a family must be fitted into a house with the exactitude of sardines in a can. It means only scientific planning. It means that you must put into small houses the same efficiency, comforts and conveniences as you expect in the modern city flat. It can be done at reasonable cost.

This house illustrates the modern time-saving and efficiency idea. Let's investigate it in detail.

First note the compact plan. There is no unused space. Living quarters are all on one floor as in a bungalow or apartment. The kitchenette is small to be sure, but it saves many miles of needless walking each year. There are five good rooms and bath on the ground floor; a third bedroom and large storage space on the sec-

ond floor. It would be easy to convert the storage space into another bedroom.

If you are watching every penny on initial expense, you can save some money by finishing the second floor later.

Now consider the time and labor-saving equipment that women want. If you install an oil burner, thermostatic control, electric refrigeration, washing machine, dishwashing machine, vacuum cleaner and other mechanical devices, you would in truth have a house that almost runs itself. You can close it up for a day or week and return to find it as ready-to-use as a well-kept flat.

You may not be able to install all these things to begin with. But plan for them. And by economizing on construction you may have sufficient cash on hand for several timesavers to start with. Building practices have progressed so far in recent years both in the utilization of entirely new materials for new effects and the adoption of worth-while substitutes for older practices, that the building of a new home is a revelation. Labor costs still remain the big item in building, and the whole trend of development has been toward the reduction of this item through materials that are quicker and cheaper to apply, such as wallboard, metal lath and other large-surface materials. When you plan your home it is possible to work many of them in, and save not only money, but obtain artistic effects.

The house is economical to build. There is no trick roof or complicated construction to pile up costs; fully insulated side-walls, roof and ceilings; stucco exterior; frame construction; either wood-shingle or composition roof. It is what may be called a \$5,500 house, exclusive of lot.

Timesaving plans—houses that are self-operating to a large extent—take the drudgery out of housekeeping, promote happiness for all the family and can be built at moderate cost.

**EDITOR'S NOTE:** Popular Mechanics Magazine has prepared a new plan book, "Twenty Popular Low Cost Homes and Ten Commandments for Home Builders." These are selected homes and show labor, space and time-saving ideas. They are \$5,000 homes and less. Send 10 cents in stamps to cover postage. Address Building Editor.



# Won't Loosen on any bit

Unbreakable  
hard rubber  
handle.  
Steel clad.  
Ball Bearing.

## "YANKEE" No. 2100 Ratchet Brace

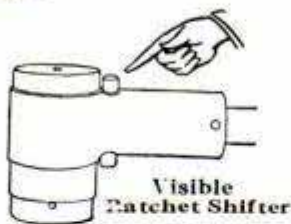

Visible  
Ratchet Shifter

"YANKEE"  
Tool Book, Free  
Write us for this book  
illustrating the uses of  
many ingenious tools.



"YANKEE" Chuck. — New, patented, quick centering. Ball bearing. Holds any bit accurately. Round, square, taper. Won't loosen; bit can't pull out in work. Two-jaw. Capacity up to  $\frac{1}{2}$ -inch round and  $\frac{5}{8}$ -inch square.

"YANKEE" Handles. — Hard rubber. Unbreakable. Won't warp, shrink, crack, or bind. Top handle steel clad, ball bearing. Sweep handle held by patented "Yankee" method: keeps caps in place; prevents excessive handle play.

"YANKEE" Famous Ratchet. — Smooth as the stem wind of a watch. Yet unbreakable! No need to hold chuck on ratchet movement. Dust-proof. Moisture-proof. Quick, positive, easy-acting and *visible* Ratchet Shifter.

"YANKEE" Finish. — Strictly in keeping with the precision of its construction: one of the finest tools of any kind ever made. No matter what bit-braces you have, you will want this "Yankee" Brace. See it at your hardware dealer's. Made in four sizes: 8-, 10-, 12- and 14-inch. Price, 10-inch sweep, \$8.20.

### "YANKEE" Bit Extension No. 2150

Holds bit in socket. — No jaws to break. No loosening and pulling out of bit in work. Can't jam. Fits any brace. Follows through. Stands abuse. Lengths, 15, 18, 21, 24 in. Prices, \$2.25 to \$2.40.



NORTH BROS. MFG. CO., Philadelphia, U. S. A.

# "YANKEE" TOOLS

*Make Better mechanics*



# Use Good Tools For Every Job

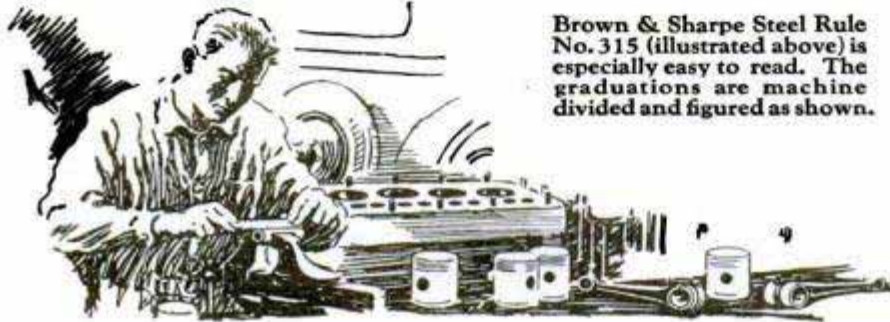
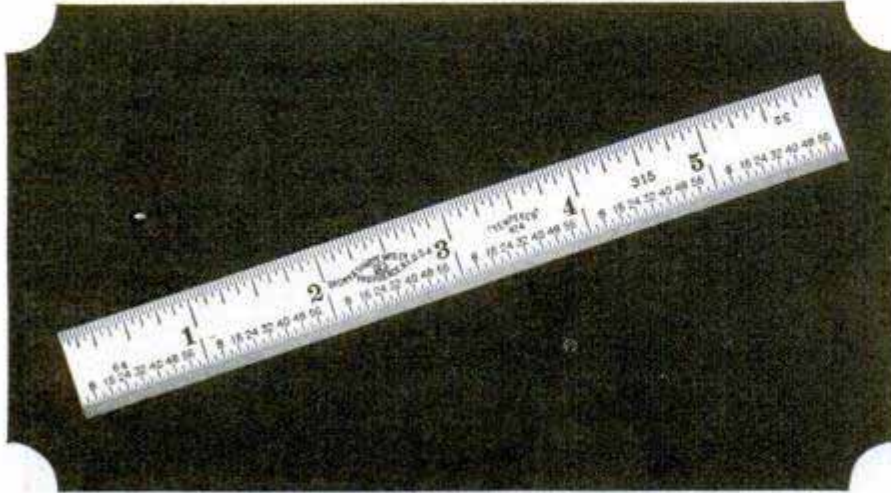

Brown & Sharpe Steel Rule No. 315 (illustrated above) is especially easy to read. The graduations are machine divided and figured as shown.

For the commonplace measuring jobs as well as those requiring extremely fine measurements, use good tools. The Brown & Sharpe line includes not only precision tools for the most exacting work, but many such general tools as the rule shown above, excellently made and handy for many mechanical jobs.

Consistent use of these high grade, well made tools will serve to keep up the quality of your work. Complete Brown & Sharpe tool equipment is a stimulus to do all your work well.

Ask your hardware dealer for Brown & Sharpe Catalog No. 30 listing over 5,000 items. If he cannot supply you, write direct to us. Dept. P. M., Brown & Sharpe Mfg. Co., Providence, R. I., U.S.A.

## BROWN & SHARPE TOOLS



\* MICROMETER CALIPER  
No. 11 RS



\* VEST POCKET SPEED  
INDICATOR  
No. 746



\* DIAL TEST INDICATOR  
No. 733



\* TWIST DRILL AND  
STEEL WIRE GAUGE  
No. 705



\* RULE DEPTH GAUGE  
No. 615



\* AUTOMATIC CENTER  
PUNCH  
No. 771

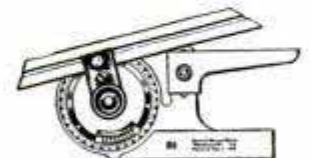

\* UNIVERSAL  
BEVEL PROTRACTOR  
No. 496

\* A description of this tool appears in Catalog No. 30



"WORLD'S STANDARD OF ACCURACY"



# Use This Useful Workshop in Your Home for **TEN DAYS FREE**

## -No Deposit!

*Mac*  
THE POPULAR MECHANIC

**ELEC-  
TRIC  
WORK-  
SHOP**

Free Instruc-  
tion and Plans

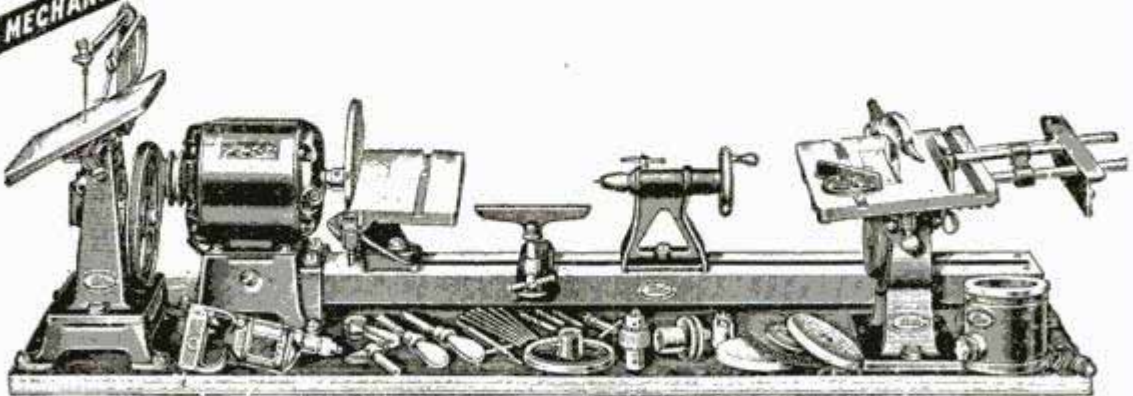

## Quick and Easy to Make Furniture, Cabinets, Patterns,—Do Repair Work, Etc.

You can do the job easier, better and quicker, for "Mac" is an accurate, substantial outfit. Will do the work in one-tenth the time required by hand labor. It is used and recommended by carpenters, pattern makers and home owners everywhere.

### Turns Spindles, Rips, Crosscuts, Surfaces, Drills, Grinds, Polishes, Cuts Scrolls, Etc. A Mechanically Perfect Workshop

Mac, THE POPULAR MECHANIC, contains everything necessary to convert raw lumber into graceful, artistic chairs, tables, benches, cabinets, or to do work about the home. Wagner  $\frac{1}{4}$  H.P. motor; 8 inch Sander Disc; Circular Saw; Jig Saw; 30 in. Lathe with 9 in. swing; Black & Decker  $\frac{1}{4}$  in. Drill; Electric Glue Pot. Accessories include 5 in. Dia. Face Plate; Spur and Cup Type Wood turning Centers; Arbor and Flange; 6 in. Cotton Buffs; 6 in. Wire Brushes; 5 in. Emery Wheel; Adjustable Tool Rest and Tool Supports with Bed Clamp; Two Turning Tools and Socket Wrenches. Ready for use by plugging into light circuit.

**Priced from \$75 to \$135. NO MONEY DOWN**

You will be amazed at the wonderful equipment we furnish at the price. It is substantially built and mechanically accurate. Just try it for ten days in your shop and if you decide to keep "Mac" you merely send a small deposit and pay the balance in twelve small monthly installments.

**12 Months  
to Pay**  
Terms as Low as  
\$5.40 a Month

### GET IT NOW—SEND COUPON Enables You to Do More and Earn More

"Mac" owners are earning big money making furniture novelties, etc., for "Mac" is a complete motorized workshop. You will enjoy using "Mac." Just send your name and address for literature and terms or order a machine on approval right now. Send coupon.

*Satisfaction Guaranteed*

**MIDLAND APPLIANCE CORPORATION**  
Dept. P-10 219 N. Michigan Ave. Chicago

Midland Appliance Corporation,  
Dept. P-10, 219 N. Michigan Ave.,  
Chicago, Illinois.

- Kindly send literature and details of low monthly payments.
- Send machine. I will try it ten days and remit according to your terms if I decide to keep it.

Name.....

Address.....

City.....State.....



MAKE THEM YOURSELF



Plan No. 15d



Plan No. 5d

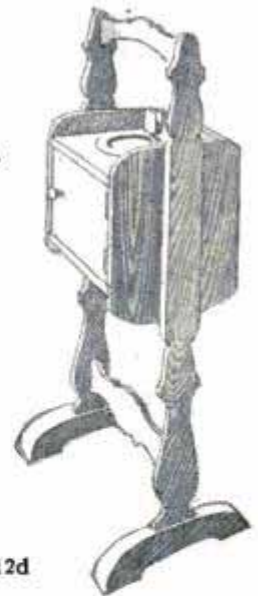

Plan No. 12d

## New skill for amateur hands

through Stanley Plans — only 10¢ each

**Y**OU have a mechanical “turn” or you wouldn’t be reading this magazine. But have you ever really experienced the pleasure of making things with tools and wood? You can make articles like the above at little cost. Thousands are now using Stanley Plans and are enjoying a useful hobby as well as the pleasantest one of them all!

There are 25 different Stanley Plans. The list is shown in the center of this page. Each plan, covering every step, tells you just how to make the object—how to

Here is the complete list of Stanley Plans No.

- 1d—Book Rack
- 2d—Candle Stick
- 3d—Pipe Rack
- 4d—Flower Box
- 5d—Table Lamp
- 6d—Toy Automobile
- 7d—Sconce
- 8d—Dinner Gong
- 9d—Bird Houses
- 10d—Dog House
- 11d—Book Stand
- 12d—Smoking Cabinet
- 13d—Kitchen Cabinet
- 14d—Sewing Cabinet
- 15d—Cedar Chest
- 16d—End Table
- 17d—Tea Wagon
- 18d—Model Sailboat
- 19d—Flat Bottom Row-boat
- 20d—Combination Kitchen Seat and Step Ladder.
- 21d—Garden Seat
- 22d—Garden Trellises
- 70d—Small Tool Chest
- 71d—Large Tool Chest
- 72d—Work Bench

select and cut the wood, how to assemble the job, how to sandpaper, paint and finish it.

To do your best work you need good tools—of course! Practically every carpenter uses Stanley Tools. Manual training classes, too. Stanley makes the most complete line.

Buy your Stanley Plans from your hardware dealer. If he cannot supply you, write to us. Send 10c for each plan and ask for a free catalog of Stanley Tools. Address Advertising Department, The Stanley Works, New Britain, Conn.

The best tools are the cheapest to use



Ask your hardware dealer

# STANLEY TOOLS

The choice of most carpenters



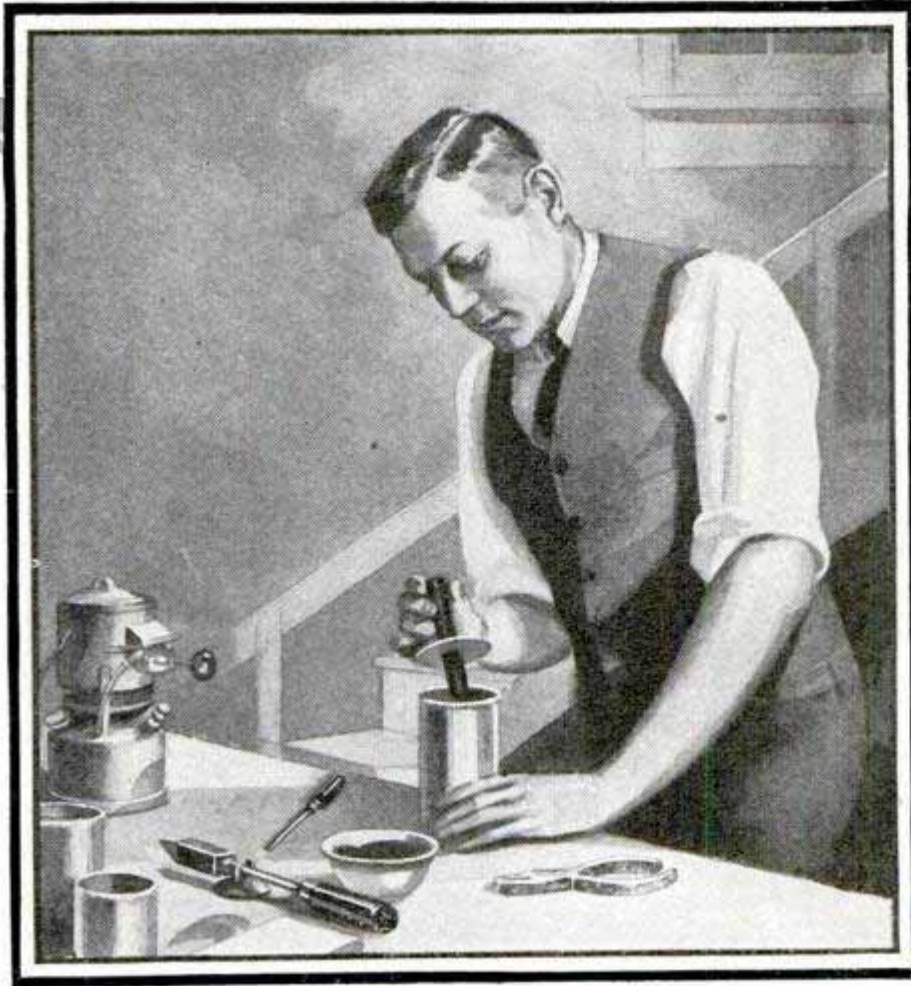

## Lots of people know how to make a dry cell— but not the Eveready Columbia

PROBABLY you know how to make a dry cell. No secret about it. The principal ingredients are zinc, sal ammoniac, manganese, carbon. With just those four things you could make a dry cell that would work—for a time. But we add tiny quantities of other things, too, measure them with great exactness, add them just so, control every process by laboratory tests, and turn out a product that is scientifically exact. Some of the ingredients we mine in our own mines, refine in our own mills, and thus govern quality completely. There's no secret about the Eveready Columbia except this: We know how to make it. Thirty-three years of scientific investigation and

controlled manufacture have developed it until today it is the greatest dry cell made. Available in single cells, and in batteries of 4, 5 and 6 cells, 6, 7½ and 9 volts, ready-connected in a water-proof steel case and sold as the Eveready Columbia Hot Shot.

NATIONAL CARBON CO., Inc.  
New York                      San Francisco



Unit of Union Carbide  
and Carbon Corporation

# EVEREADY COLUMBIA Dry Batteries

*-they last longer*

FOR RADIO: Insist on the No. 7111 dry cell, six inches of battery goodness, scientifically designed to give its best results on radio sets using tubes of the WD-11 and WX-11, and UV-199 and UX-199 types.



# wanted

## 100,000 CARPENTERS and Home Mechanics to Try this IRWIN AUGER Bit



A sincere trial is all that is needed to convince you of the speed, toughness and superior cutting qualities of the Irwin Mainbor Bit No. 62-T, specially designed and manufactured for carpenters, cabinet makers, home mechanics and handy men.

Made to cut quick and clean. Made to save time. Made to save effort.

Just try this Irwin Bit—you're sure to like it.

### Special Offer

To those who have never used the Irwin Mainbor Bit we will send postpaid, for 25c, one Mainbor No. 62-T in the one-half inch size, that lists at 65c.

This is well below the cost of production. In fact we make the price of 25c just to cover the cost of handling and mailing, and to eliminate the idle inquiry.

We want to receive requests for this sample bit from sincere workers—interested in learning of a better tool. Just mail the coupon, with 25c and we will send the sample bit postpaid. Only the one size will be sent, and only one will be sent to an individual.

If you don't feel, after buying the bit, that it is the best you have ever used—send it back, tell us why and we will refund your money by return mail. Send the coupon today.



**The Irwin Auger Bit Co.**  
Wilmington, Ohio

"Largest Makers of Wood Boring  
Tools in the World"

The Irwin Auger Bit Co.  
Wilmington, O.

Enclosed find 25c for which please mail postpaid, one of  
your Mainbor No. 62-T bits.

Name.....

St. Address.....

City and State.....

**CLIP THIS COUPON**

**The IRWIN Bit**

REG. U.S. PAT OFF





**SUNDAY**  
*Plenty of time*



**MONDAY**  
*Hurry up*



**TUESDAY**  
*Feeling fine*



**WEDNESDAY**  
*Out of sorts*

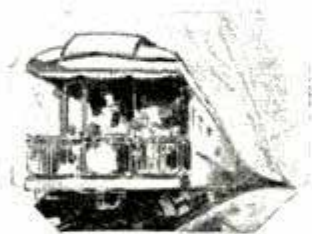

**THURSDAY**  
*On the train*



**FRIDAY**  
*Hot Water*



**SATURDAY**  
*Cold Water*

# Every Day

you give your razor a different job to do  
*but your Gillette Blade will do every job smoothly and surely*



**I**T takes all kinds of days to make a week. This morning you can take your time. Tomorrow you have to rush. One day you're feeling fit; the very next morning you may be ragged from lack of sleep. Hot water, cold water, soft water, hard water, a slap-dash lather, or a careful thorough preparation of the beard which may take a full three minutes.

You never give your Gillette Blade the same job twice.

Yet you can always get a smooth, comfortable shave from your Gillette Blade; the blade, at least, doesn't change, and its swift, sure

job is the same under any conditions.

Eight out of ten American men count on the Gillette Blade to start the day right—seven days a week. And Gillette takes extraordinary precautions not to disappoint them.

The steel is the finest in the world. It comes in long gleaming ribbons, and we test every ribbon with crucible and micrometer be-

fore we even pay the import duty.

During the last ten years Gillette has spent millions of dollars on steady blade improvements alone. Four out of every nine Gillette employees are inspectors and do nothing else. They get double pay for every blade they discard. They make certain that every package of Gillette Blades contains its full quota of smooth, comfortable shaves for you.

GILLETTE SAFETY RAZOR CO., BOSTON, U.S.A.

To be sure of a smooth, comfortable shave under any conditions, slip a fresh Gillette Blade in your razor.

# Gillette





*This blow-torch is especially made and priced for the man who likes to do odd jobs around the house, or to tinker with mechanical things. It will last a lifetime if it is not abused. The usual retail price is about five dollars. Most hardware, electrical and automobile accessory stores have it—or can get it for you quickly. Look for the red handle.*

## Time tells the better value of Clayton & Lambert torches

NEARLY any piano sounds good when it's new. Nearly any automobile runs well when it's new. Nearly any blow-torch performs right when it's new. Time . . . use . . . these bring out the enduring, built-in "class" in a product, show the true worth of it.

The ability of Clayton & Lambert blow-torches to prove their "class" in the test of time and use has made them the largest selling blow-torches in the world. This is not the result of mere honest manufacture. It is caused by our ceaseless seeking for improved performance, improved design, improved materials—shown by a string of blow-torch patents as long as your arm.

Why is the brass tank given a satin finish, instead of shiny? Because buffing the metal weakens it in some spots—and these would "give," in time. Why a lead washer in the filler plug, instead of leather? Because it wears longer. Why a double spring on the pump valve? Just one reason—satisfaction year after year.

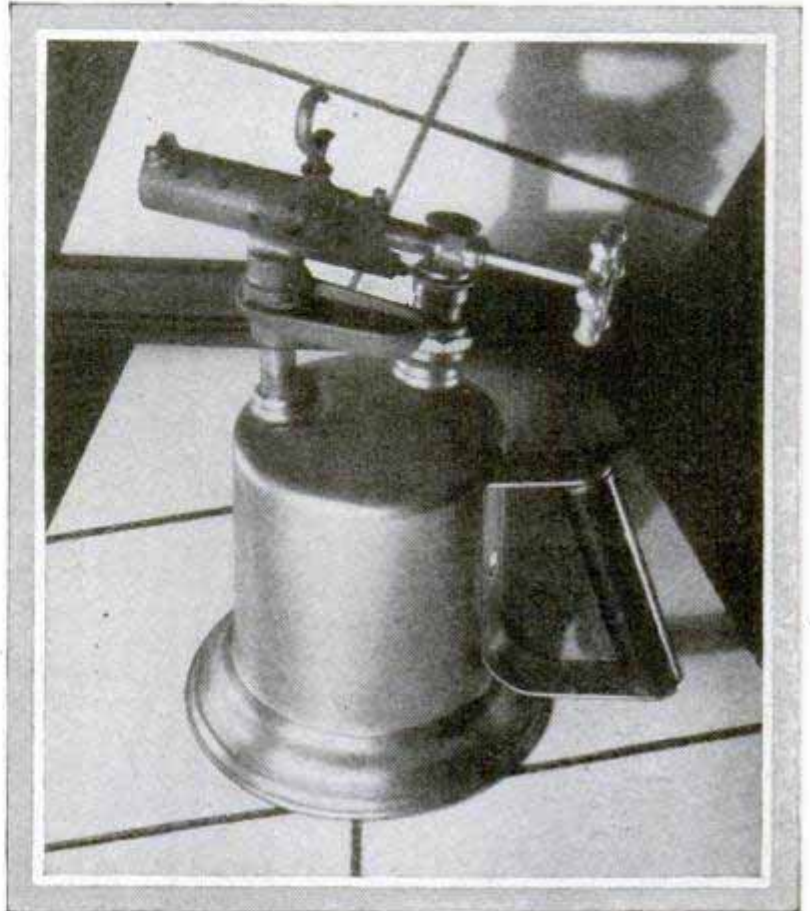

Handles so attached that bending or breaking them can't make the tank leak, protection for the base of the tanks, to guard against rough handling. Only one reason—longer service for you.

The patented burner orifice on No. 32 can't be spread, no matter how careless a man is in shutting the valve too tight—again, longer service for you.

About the only thing on Clayton & Lambert blow-torches not placed there for the special purpose of giving you better performance over a longer period, is the red paint on the handles. And that's put there so you can identify these torches, and get their greater value.

# CLAYTON & LAMBERT

MANUFACTURING CO.

DETROIT, MICHIGAN



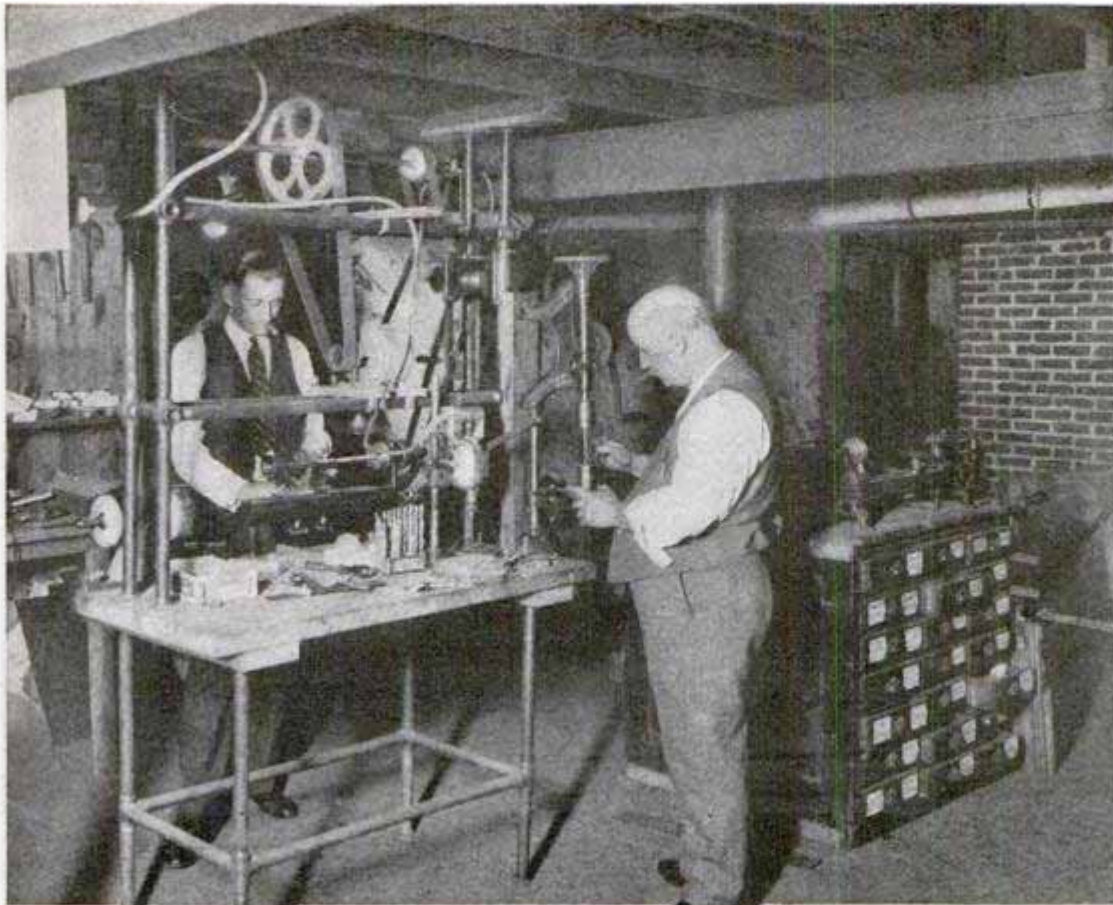

Actual photograph of the home workshop of Mr. Fred Bailey

Lexington, Mass. Mr Bailey uses these and other Starrett Tools.



No. 436



No. 22-C

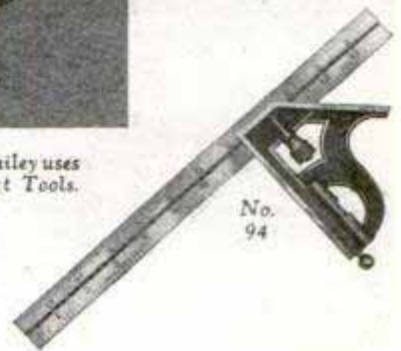

No. 94

# Starretts for the home shop

The first thing every man or boy who owns, or plans to own, a home workshop needs is the big, new Starrett Catalog fully describing and illustrating all of the fine precision tools for workers in wood or metal, whether professional or amateur.

Experts will tell you that Starrett Tools, Hacksaws and Tapes are the accepted standard for quality, accuracy and honest value.

Your tool dealer sells and recommends the genuine Starrett's. Ask him to show you.

Write now for free copy of Starrett Catalog No. 24 "AP"



No. 153



No. 588

No. 320-K

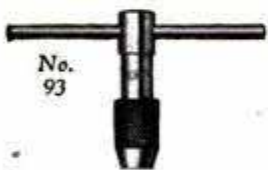

No. 93

**THE L. S. STARRETT CO.**

World's Greatest Toolmakers  
Manufacturers of Hacksaws Unexcelled  
Steel Tapes—Standard for Accuracy  
ATHOL, MASS., U. S. A.



# Use Starrett Tools





#### "BILD-A-LOCO"

An extraordinary new Lionel locomotive with the motor that you can take apart and rebuild. Its powerful three-speed reversible motor may also be used separately to operate other mechanical toys!



#### FREE

This new 46 page full-color Lionel Railroad Planning Book, describing every Lionel Model Railroad and accessory in detail. Also send us "Dad's" name and we will write him a personal letter telling him why he should get a Lionel Electric Railroad for you, and how little it costs.

### Swift! Powerful! Handsome!

You know, of course, that no other electric trains in the world compare with LIONEL for perfection of mechanical detail, for power and speed, and beauty of construction. LIONEL alone produces trains that are life-like copies of real trains. And, because of Lionels 100% "Distant-Control" you can operate your model railroad at any distance from the track, without touching the train, controlling its forward and backward movement, or switching it from one track to another by a series of levers ingeniously arranged in the LIONEL Switch Tower. Lionel also offers every boy the greatest variety of engines, cars, work trains and accessories that it is possible to conceive. See the Lionel display at your local dealer's today! Send for the magnificent new LIONEL 46 page full-color Railroad Planning Book today!

THE LIONEL CORPORATION

Dept. 1

15-17-19 East 26th St., New York City

"STANDARD OF THE WORLD SINCE 1900"

# LIONEL ELECTRIC TRAINS

MODEL RAILROAD ACCESSORIES

"MULTIVOLT" TRANSFORMERS



# WHIRL AWAY

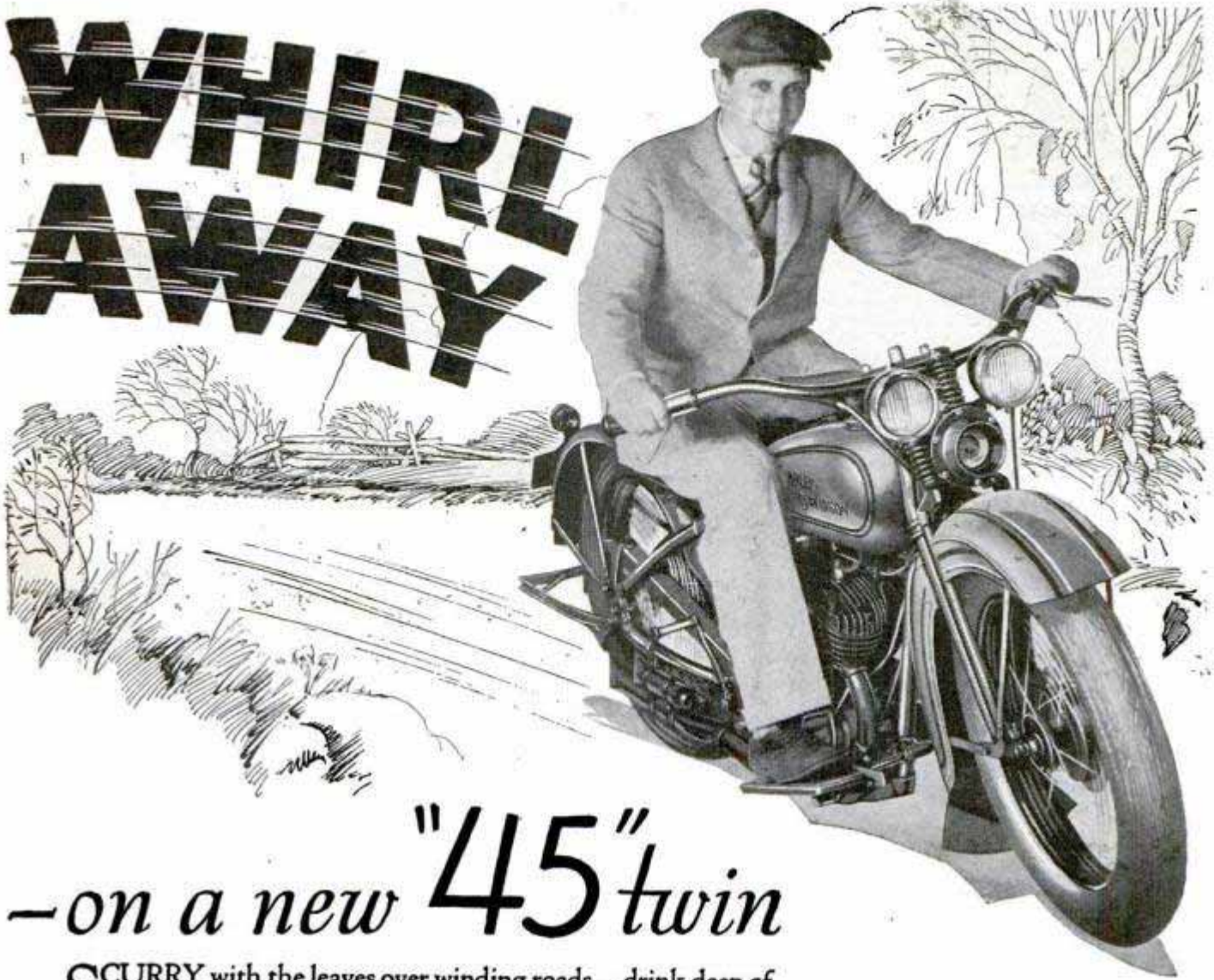

—on a new "45" twin

**S**CURRY with the leaves over winding roads—drink deep of the keen Autumn air—feel the thrill of motorcycling at its best, in the saddle of Harley-Davidson's latest Twin—the "45". Here is surging, silent power — lightning getaway — speed enough to pass any mile-a-minute car. Perfect balance, handy controls, and brakes front and rear make the "45" delightfully easy to ride and safe to handle. Upkeep cost is almost nothing — and the price of the "45", f. o. b. factory, is only \$290. Ask your Dealer about his Pay-As-You-Ride Plan. Go out for a trial spin — he'll gladly teach you to ride, free, in a few minutes.

*Mail the Coupon for illustrated literature.*

**HARLEY-DAVIDSON MOTOR COMPANY**  
Department P Milwaukee, Wisconsin

## HARLEY-DAVIDSON

### Motorcycles

HARLEY-DAVIDSON MOTOR COMPANY

Dept. P., Milwaukee, Wis.

Interested in the "45" Twin—send literature.

Name.....

Address.....

City.....





# LATHES

*for the Tool Room-  
Manufacturing-  
Machine Shop-Repair  
Shop-Service Station*

## New Model South Bend Back-Geared Screw Cutting Precision Lathes

Built in the same plant where 40,000 other fine South Bend Precision Lathes have been manufactured for the United States Government, Ford, Westinghouse, Bethlehem Steel Company, U. S. Steel Corporation, and hundreds of other large industries in the United States and 78 Foreign Countries.

### Easy Payments if Desired

A small down payment brings you any Lathe to use while you are paying for it. We ship immediately upon receipt of the down payment.

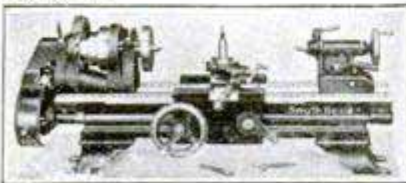

9" x 2 1/2' Junior Back Geared  
Screw Cutting Bench Lathe **\$150**

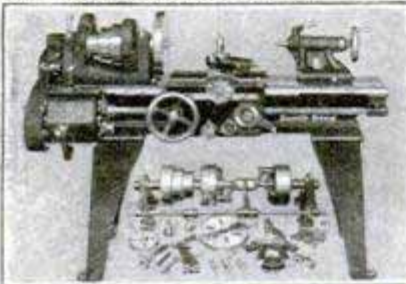

11" x 4' Quick Change Gear  
Lathe, Straight Bed - **\$335**

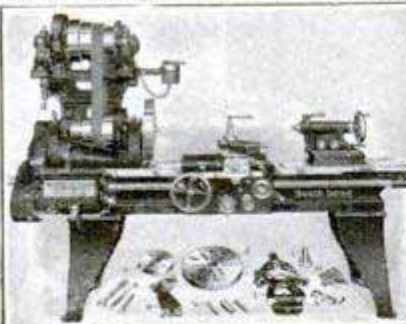

18" x 8' Quick Change Gear  
Motor Driven Lathe - **\$908**

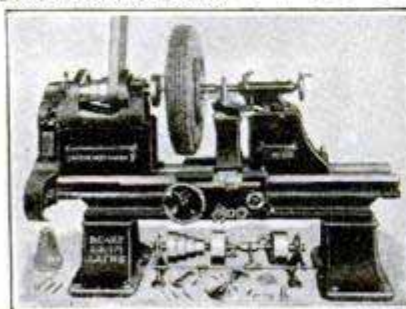

### Brake Drum Lathe

Handles all Brake Drum work without removing tire.

No. 1 Lathe, Wheels to 32" diam. **\$475**  
No. 2 Lathe, Wheels to 36" diam. - **650**  
No. 3 Lathe, Wheels to 42" diam. **1400**

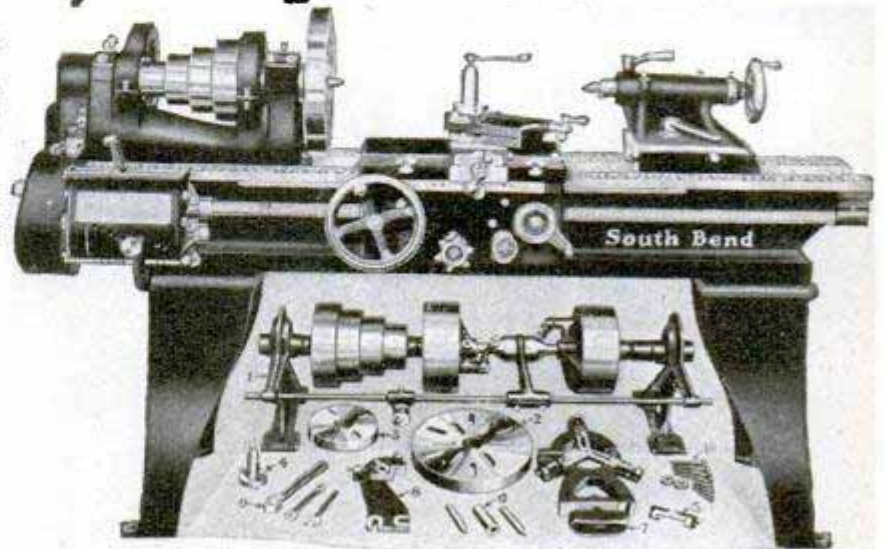

16" x 6' New Model South Bend Quick Change  
Gear, Back Geared Screw Cutting Lathe - **\$540**

## Other Popular Selling Sizes

The Prices of Popular Selling Sizes with Countershaft and Equipment

Size of Lathe	Shipping Wt.	Standard Change Gear	Quick Change Gear
9" x 3'	490 lbs.	\$235.00	\$270.00
11" x 4'	725 lbs.	300.00	335.00
13" x 5'	1110 lbs.	352.00	402.00
15" x 6'	1550 lbs.	430.00	490.00
16" x 8'	2035 lbs.	510.00	570.00

### Used by America's Largest Industrial Plants

The best proof of the quality and accuracy of South Bend Lathes is that they are used in production, tool room work and in general machine work by America's largest industrial plants. For example: General Electric Co., Western Electric Co., Packard Motor Co., Oldsmobile Co., Houdaille Engineering Co., Victor Talking Machine Co., Black & Decker Mfg. Co., International Harvester Co., and in many departments of the United States Government.

### FREE—Write for No. 89-A Catalog

describing 210 sizes and types of New Model South Bend Lathes. Check off in the squares below, indicating Lathes in which you are interested.

- |  |  |
|--|--|
| <input type="checkbox"/> 9" Junior Lathe | <input type="checkbox"/> New General Catalog No. 89-A      |
| <input type="checkbox"/> 11" Lathe       | <input type="checkbox"/> "How to Run a Lathe," 25c         |
| <input type="checkbox"/> 13" Lathe       | <input type="checkbox"/> Auto Mechanics' Service Book, 25c |
| <input type="checkbox"/> 16" Lathe       | <input type="checkbox"/> Brake Drum Lathe Circular         |
| <input type="checkbox"/> 18" Lathe       |  |

## SOUTH BEND LATHE WORKS

Main Office and Works

**643 E. Madison St., South Bend, Ind., U.S.A.**

New York City, J. E. BEGGS CO., 183 Centre Street  
Carried In Stock by Machinery Supply Dealers in Principal Cities  
Throughout the World.





I'll loan you a  
SpeedWay Shop—just  
to prove you can make  
things like this!

**Yours for  
The Asking**

Everyone who fills in and mails the coupon will receive free of all charge, illustrated plans and instructions for making this beautiful Priscilla Sewing Cabinet. Perhaps you read about it in the October Popular Mechanics but I want to show you how to make it in one-fourth the time on my **MOTORIZED** work bench—the SpeedWay Shop!

**Discard Your Hand  
Tools**

Don't let hand tools put a limit on your Craftsmanship. Let me show you how to start with this simple Priscilla Cabinet—go on into grooving, mitring, mortising, scroll work, wood turning—make Humidors. Fancy Gateleg Tables, etc. Why limit your ingenuity when it is so easy to own a SpeedWay Shop? Remember—SpeedWay is the Shop used by Manual Training instructors everywhere.

**Motorize Your Work-  
Bench**

You can be sure you're getting the right shop when you realize that SpeedWay alone has been serving the World's Industries with Portable Electric Tools for the last twenty years. I want you to examine the exclusive features of a SpeedWay Shop.

**Trivial Down Payment**

We'll show you how to earn or save the small down payments that come due just once a month. So simple, too, for any man who knows his ABC's about tools. Ask what Mr. Watts of Miami, Fla., did. Send in the coupon today!

**ELECTRO MAGNETIC TOOL CO.**  
Department 2N 1832 S. 52nd Avenue  
**CICERO (Adjoining Chicago) ILLINOIS**

**Free Trial and  
Instructions  
Free Plans and  
Materials**

We are anxious that every owner of a SpeedWay Shop shall get the maximum pleasure and profit from it. That's why we have established the SpeedWay Personal Service Department.

**24 Blue Prints FREE**

With each shop we include 24 Blue Prints of Furniture, Toys, etc., that anyone can make with the SpeedWay Shop. Mr. L. L. Hull in charge of our Personal Service Dept., will answer your special questions. Here is a real service department at your beck and call.

**Free Crafts Books**

When we receive your coupon we will send you a list of the best books on Craftsmanship from which to make your selection to be sent free with your shop.

**Quick Action Needed!**

We cannot continue Special Offers like this indefinitely. Use the coupon today and we will send the Priscilla Cabinet plans and Instructions at once.

**Jig Saw Bench Saw**

This Pattern Makers Jig Saw is part of the Model "SS" Shop. Follows a perfect line. Extra blades included free.

Built heavy and strong. Set into place and operated in 5 seconds. Rips, mitres, grooves, cross cuts.



**Get Your Magazine Basket  
Quick!**



While they last, we're giving away the lumber to make the beautiful magazine basket shown at the left. It is yours to keep even if you should decide to return the shop. Act at once before they are all gone. Instructions for making it are included, of course!



**MAIL TODAY**

**Electro Magnetic Tool Co.,**  
Dept. 2N, 1832 S. 52nd Ave.,  
**Cicero, Ill.**

Gentlemen:  
Please send me free the complete plans and instructions for making the Priscilla Sewing Cabinet shown above. Also complete details about your Shop and free offers.

Name.....  
Street.....  
City..... State.....  
My age is..... Occupation is.....  
I will use Shop for fun [ ] or profit [ ]



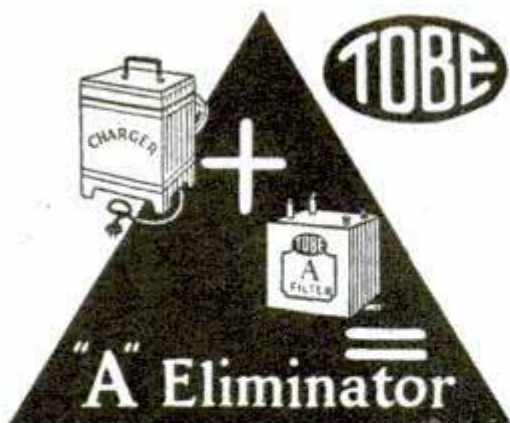

ANY standard charger such as a Tun-gar, Rectagon, bulb or electrolytic, etc., can be converted in less than a minute to a four or six volt A eliminator by using a **TOBE A FILTER**.

Tobe A filter is a development consisting of 8000 Mfd. of dry condenser and two chokes mounted in a container.

This combination, a charger and a Tobe A filter, does away with your messy A battery forever.

## Convert charger into "A" Eliminator in less than a minute

Tobe A filter list price \$18.00

If unable to obtain this unit at your dealer's send direct.

Also ask for latest complete cata'og

### TOBE DEUTSCHMANN CO.

NEW YORK

CANTON, MASSACHUSETTS

CHICAGO

## MOVIES AT HOME



Many models of genuine MOVIE MACHINES, some as low as \$3.75, all using standard size big theatre films. Our stock of films is the most complete and lowest in price—with an exchange service. Films of leading stars and religious subjects are available. **DON'T DELAY. WRITE FOR FREE INTERESTING CATALOGUE NOW!**

**PARAMOUNT MFG. CO.**

Dept. 1371-K

BOSTON, MASS.



(ACTUAL SIZE)

500 to 5,000,000 ohms

distributed capacity and inductance practically negligible. The most accurate and efficient resistance unit known to radio. Write for booklet E.

**DAVEN CORPORATION**

NEWARK, N. J.



"UKE" players, the Regal Octofone is made for you. This new, uniquely shaped instrument has the deep mellow tone of the Spanish Guitar, and can be tuned and played just the same as a "uke"! Nothing new to learn—no lessons. The same chords

on a brand new instrument.

### Can Be Tuned Like 8 Different Instruments

By mere changes in tuning the Octofone can be tuned and played like 8 different instruments—the "uke," tenor guitar, tenor banjo, mandolin, mandola and other instruments played with a pick. FREE booklet of instructions accompanying each instrument tells you how to tune the OCTOFONE eight different ways.

Your dealer will be glad to give further information, or write us.

**Regal Musical Instrument Co.**  
3207 Grand Ave., CHICAGO

REGAL  
OCTOFONE

\$15.00

## SILVER ACE Flying Models

SILVER ACE airplane models are designed by aeronautical engineers for study in actual flight.

They represent a tremendous advance in the art of building real little planes capable of flying 800 feet and more.

They are beautiful miniature types of the famous big ships like the Ryan, Cessna, Fairchild and Stinson, convertible into monoplanes, biplanes and seaplanes if you wish. The reputation of SILVER ACES for appearance, construction, performance and amazing strength is well established all over the world.

They are for sale by hundreds of dealers, Ready to Fly, Partly Assembled, Knocked Down or in a Contest Kit where you do all the work. Also a new flying Fokker which will thrill you to build.

Buy or build a SILVER ACE with the knowledge that you will own the last word in model airplanes which perform.

Catalog—10 cents

**THE AERO MODEL COMPANY**  
329 Plymouth Court Chicago, Illinois



# Over 900,000 Balkite Chargers Need this Authorized Replacement Rectifier



(A)  
Type *BNK* for  
Models *N* and  
*K* Balkite Trickle  
Chargers.

(B)  
Type *BJ* for  
Model *J* Balkite  
Charger.

## **ELKON** *the only authorized Replacement* **Unit for Balkite Chargers**

The Elkon Replacement Units and those made by the Fansteel Products Co. containing the Elkon Dry Rectifier are the only ones authorized for replacing the acid jars in Balkite Power Units.

No trouble in making the change—anyone can do it. And the difference! No fussing and messing with water and dangerous acids, with the Elkon Rectifier in place all trouble, attention and adjustment is eliminated for 5000 hours!

Increased efficiency, too. With the Elkon Replacement Units, the charging rate of Model *K* is increased from 4/10 of an ampere to 8/10; The Model *N* is increased from 8/10 to 1 ampere; and all of the charging rates of the Model *J* are increased 20%!

Solid, dry, self-healing, not affected by line surges, noiseless—truly the trouble-free rectifier.

### **ELKON, INC.**

PORT CHESTER, N. Y.

*Division of*

**P. R. MALLORY & CO., INC.**

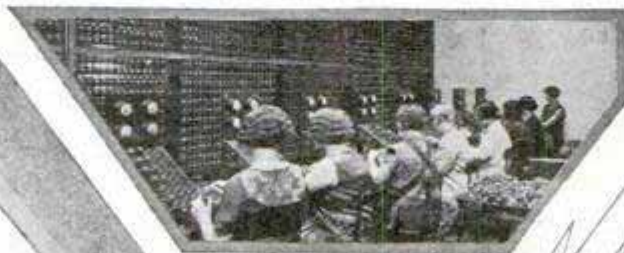

Not a telephone switchboard—operators testing Elkon rectifiers and the seasoning boards in the background.

**ASK  
ABOUT  
THE  
OTHER  
ELKON  
RECTIFIERS,  
TOO**

M-16 for "A" Eliminators and 3 ampere chargers. V-4 for tricklechargers—and this new EBH for replacing BH tubes in "B" Eliminators.

Radio Department, ELKON, Inc.  
231 Fox Island Road, Port Chester, N. Y.  
Radio Products  
Send me full information on Elkon  
Name \_\_\_\_\_  
Address \_\_\_\_\_



# Pocket Ben

**\$1.50**



You are always sure of the right time when you carry Pocket Ben, the famous Westclox watch. It's the kind of time-piece any man can be proud of . . . long life, good looks, reliability—real value at \$1.50.

*Built by the makers of  
Big Ben and other Westclox.  
Sold everywhere*

WESTERN CLOCK COMPANY  
La Salle, Illinois

## New Westclox Auto Clock

Attractive, Convenient, reliable. Fits any car. Quickly attached on dash or above wind-shield

**\$2.50**



**10 DAYS FREE TRIAL**

Writes with ink freely, smoothly and easily answering purpose of both pen and pencil. Never blots, balks, dries up, scratches, leaks or soils hands. Draws lines to ruler; no smear or smudge. **MAKES 3 CARBON COPIES** at one time with original in ink. **SEND NO MONEY.** Pay post-man \$1.50 plus postage, or sent prepaid if remittance accompanies order. Your money back if not satisfied, within 10 days.

**INKOGRAPH COMPANY, INC.,**  
199-803 Centre Street, New York.

**AGENTS**

—Send for Inkograph or write for Free Sales plan booklet. Big value sells on sight—no investment. No competition—immediate commissions.



**GAS HEAT ANYWHERE**  
*1 1/2 an hour*



38 Below Zero is not too cold when you have a **Sunshine Radiant Heater**. Makes and burns its own gas. Gives you clean, safe, healthful heat in 60 seconds from cold start. No piping, no installation costs. Easy to carry from room to room while in operation.

**15-Day Trial**  
We'll send you the **SUNSHINE** on 15-day trial. Use it in your own home or store. Prove to yourself how easy it does away with dirt, ashes, smoke and odor. **Sunshine** is bringing cheery comfort to thousands of homes, now.

**FREE** Startling low offer on new, beautiful 1929 Model—and book, how new heater brings comfort and ease. Get your copy. Write today. **SUNSHINE SAFETY LAMP CO.**  
332 Factory Bldg., Kansas City, Mo.

**AGENTS**  
**BIG MONEY**—easy sales on part or full time. **WRITE!**

## Good Mixing Pays!

Sell the Niagara Mixer. Banish the old tiresome way of hand beating. All kinds of drinks, desserts, mayonnaise, etc., mixed by water power. Simply attach Niagara Mixer to the faucet. Demonstration convinces anyone. You make \$10 to \$20 a day. Responsible agents only need apply. **THE NIAGARA MIXER CO., 215 The Arcade, Cleveland, Ohio**

## Sport Bodies for Fords AT FACTORY PRICES!



This Model in Grey Prime **\$38.50**  
Send 10c for Booklet A-2 Showing This and Other Models

**SPORT FACTORIES, AURORA, ILL.**

## 965 MEN'S ALL PURPOSE SUITS!

**\$2.50 Commission in Advance!** Workmanship, Fit, Guaranteed! For Semi-Work or Dress! Looks, Feels Like Wool! Wears Like Iron! **FREE KIT!** **FITZ-U-TAILORING CO., Dept. 171, South Whitley, Ind.**

## MOTORCYCLES



Price \$10 and up purchased through our Co-Operative Plan for as low as \$1.00 down and \$1.00 per week **Indians Harley-Davidsons Ace Henderson and Cleverlands**  
Send ten cents for Bulletin A.  
Motorcycles shipped to all parts of the world

**WALKER-INDIAN CO., 78 Brookline Ave., BOSTON**



# AR-CON UTILITOOL

THE KING OF THEM ALL

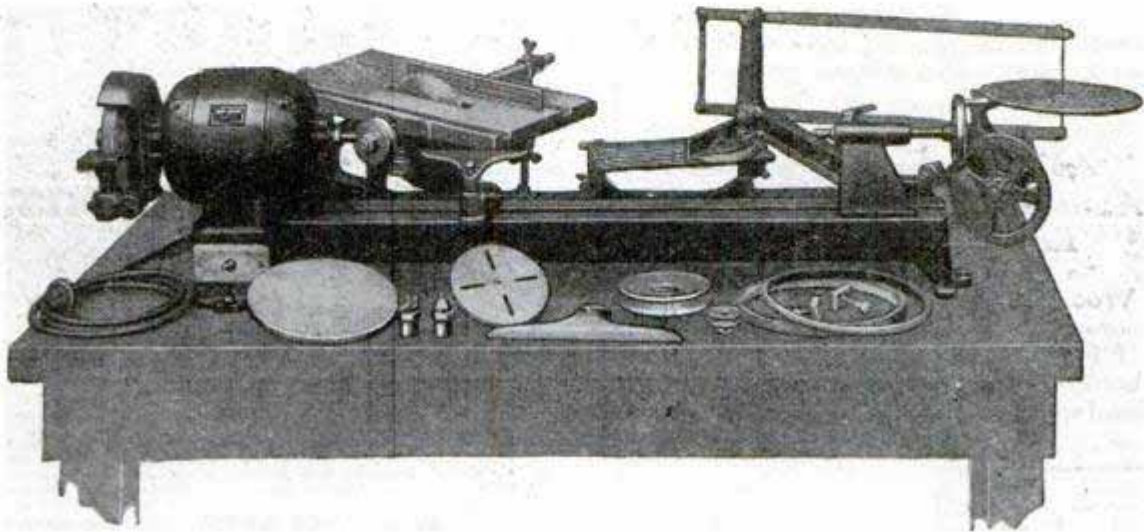

## You Don't Need to Pamper THIS Home Work Shop

Whether you're sawing off a 2x6, or executing a delicate scroll-saw design, the rugged strength of the Ar-Con Utilitool is a decided advantage to you. For the sturdy construction which enables it to handle heavy loads without vibration or chatter **also** insures the accuracy essential in working to close dimensions.

From the powerful  $\frac{1}{2}$  H.P., ball-bearing, repulsion-induction type motor, to the wing lock screws and units of drop-forged steel, every part and every detail of the Ar-Con Utilitool is designed and built for a life-time of efficient service. Lathe, circular-saw table, jig and scroll saw, sanding disc and table, and grinding and buffing

**THE AR-CON TOOL COMPANY**  
500 FASSETT STREET TOLEDO, OHIO

wheels, with their various accessories, provide a complete home work shop that will prove a source of lasting satisfaction to the man or boy—professional or amateur—who takes pride in the quality of his work.

A fully illustrated descriptive circular, with prices and terms, is yours for the asking. Just fill in and mail the coupon below.

**THE AR-CON TOOL COMPANY,**  
500 Fassett Street, Toledo, Ohio.

Please mail complete description and prices of Ar-Con Utilitool.

Name.....

Street Address.....

City and State.....

M.



# PLASTIC WOOD

[Reg. U. S. Pat. Off.]

*Handles Like Putty - Hardens Into Wood*



## Furniture Repairs

Plastic Wood will hold drawer pulls permanently; tighten loose joints; fill in gouges; hold casters. It takes paint, varnish and lacquer perfectly.



## Automobile Repairs

Plastic Wood will fix rotted or split top bows; fill in body dents; hold loose screws, bolts or locks. It becomes hard wood—waterproof and greaseproof.



## Loose Tiles

Plastic Wood is the ideal preparation for home repair of loose or broken tiles, cracked porcelain. Use it for holding pulled out fixtures and filling cracks.

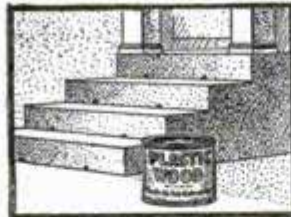

## Plugs in Concrete

Plastic Wood completely fills holes bored in concrete to give a hard wood base for affixing carpets or fixtures to floors or walls with nails or screws.



## Electrical Insulation

Plastic Wood has a volume resistivity of  $10^{12}$  ohmcentimeters, 100 times greater than mica. Use it to insulate tool handles and fill holes around wiring.

1 lb. can \$1.00    ¼ lb. can 35 cts.  
At Hardware and Paint Stores

ADDISON-LESLIE CO., 4 Bolivar St., Canton, Mass.

**CHEMCRAFT**  
The ORIGINAL CHEMICAL OUTFIT

## BE A BOY CHEMIST!

GET a CHEMCRAFT outfit; that's all you need for a real fun! Work hundreds of fascinating and useful chemical experiments; make soap, dyes and ink; test foods, water and soil; perform tricks of chemical magic and surprise your friends. CHEMCRAFT is the original and best chemistry set; contains more chemicals; more and better experiments—the most for the money! Seven fine outfits:

**Sold in all Toy Stores**

No. 1—\$1.00	No. 3—\$3.50	No. 6—\$ 8.00
No. 2—\$2.25	No. 5—\$5.00	No. 12—\$12.00

Every set complete with chemicals, apparatus and Manual of Instruction. Ask for yours by name—CHEMCRAFT—and get the best outfit!

**Try Chemistry for 25c**  
Get CHEMCRAFT JUNIOR; just right for boys who want to try chemistry. Performs lots of fine experiments. Sent postpaid for only 25 cents.

**Free Magazine for Boys**  
CHEMCRAFT Chemist Club Magazine; full of fine ideas, stories; chemical stunts and information about the best Chemistry outfits. Ask for your Free copy right away.

**The PORTER CHEMICAL COMPANY**  
113 Summit Avenue Hagerstown, Md.



## AGENTS—SALESMEN

ALL-IN-ONE patented Cigarette and Match Case. Holds a package of cigarettes and box of safety matches. Beautiful, grain finish Black or Brown Du Pont Fabricord. Keen and convenient.

A whirlwind seller for agents. Costs \$3.00 dozen, \$36.00 gross. Write today for complete details.

## ALL-IN-ONE SALES CO.

Dept. A-11 4648 Grand Ave.  
MINNEAPOLIS, MINN.

Sample, 50c

## Ask for Keds by name

*They are not Keds unless the name Keds is on the shoe*



## CORONA IN COLORS!

Beautiful Duco finishes. Write for new illustrated folder.

L. C. Smith & Corona Typewriters Inc 1112 E. Washington St., Syracuse, N. Y.

**BOYS! VALUABLE GIFTS FREE**

Sell White's Christmas Cards. Get White's Gift Certificates, or make your selection from over 150 different articles, knives, sporting goods, cameras, pens, jewelry, tools, etc.—given to you for White's Gift Certificates. Send today for free catalogue and details how you can get these gifts without cost to you.

White's Quaint Shop, Dept. C, Westfield, Mass.





**Modernistic Folding Screen**  
See *LePage's Book*, page 12

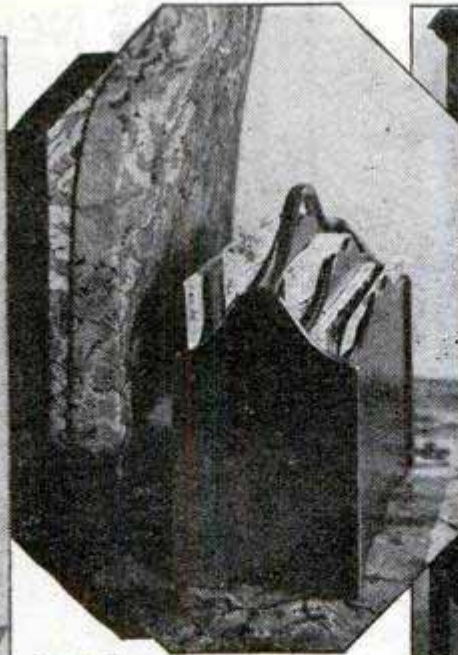

**Book Trough and Magazine Stand**  
See *LePage's Book*, page 19



**Old Salem Ship's Cupboard**  
See *LePage's Book*, page 5

# How to make your own Household Furniture

**LePage's Latest Book Shows How —for Yourself; for Christmas Gifts**

## 12 NEW Job Plans, Too!

There is, of course, a limit to what we can give in *LePage's New Third Home Work Shop Book* for only a dime. But we realize many men want additional projects. Hence our 12 new Job Plans. These also were made by Mr. Klenke. They are projects that require more elaborate presentation than we can give in our book. Each Job Plan presents one project on a single large sheet of paper. Each is well worth its price, one dime. Look over these projects and order those you want by number (see coupon), enclosing 10 cents for each.

- 16 Sheraton Writing Desk
- 17 Sheraton Desk Chair
- 18 Colonial Hanging Book Shelves
- 19 Smoking and Reading Cabinet
- 20 Colonial Mirror
- 21 Tea Wagon
- 22 Telephone Cabinet
- 23 Stool for Telephone Cabinet
- 24 Manual Training Work Bench
- 25 Home Worker's Tool Cabinet
- 26 Spanish Galleon
- 27 Vanity Table



*LePage's* latest book, the new "Third Home Work Shop Book," contains complete, easy-to-follow directions for making 20 attractive pieces of household furniture, of which, 17 are entirely new and never offered before.

This year the designs are divided into three groups. One group is based on famous old colonial pieces. Another group follows the furniture in popular demand for American homes of today. The third group is known as modernistic furniture, showing the influence of the modern skyscraper set-back architecture of New York City. To buy 20 such pieces would cost about \$1,000. You can make them for a fraction of that, yet be the owner of truly fine furniture.

### Designed by Expert

All the designs, dimension drawings, actual pieces and photographs were made by William W. Klenke, Instructor in Wood-working, Central Commercial and Manual Training High School, Newark, New Jersey. Also the designer of the first two *LePage's* Books. Each project and the directions for making it are perfectly practical.

Each project is presented in three parts—a photographic illustration of the finished project, a complete dimension drawing of its parts, and simple easy-to-follow, step-by-step directions.

In addition to the three pieces shown above, the book includes the following: Cape Cod Chest of Drawers, Alexandria Nest of Tables, Lady Washington Sewing Cabinet, Modernistic Book Shelves, Desk, Table, and Fire Screen, Smoking Table, Caned Side Chair, China or Book Cabinet, Magazine Carrier, Vanity Case, Book Stand, Fernery Stand, Folding Sewing Screen, Plymouth Built-In China Closet, and Chess and Checkers Table. Where else could you get complete directions for making all these for only 10 cents?

**Send 10 cents for this NEW *LePage's Home Work Shop Book***

Simply use the coupon below, sending it to us with 10 cents in coin or stamps, and we will at once send you a copy of this latest *LePage's Book*, postage paid.

**MAIL THIS COUPON**

**LEPAGE'S CRAFT LEAGUE**  
616 Essex Ave., Gloucester, Mass.  
Gentlemen: Enclosed please find 10 cents (coin or stamps) in payment for *LePage's New Third Home Work Shop Book*. Please send a copy of this book to:

Name .....

Street .....

City.....State.....

Please also send the following Job Plans.....(indicate by number those you want. See column at left), for each of which I enclose an additional 10 cents.

# LE PAGE'S GLUE

HANDIEST TOOL IN YOUR WORK SHOP



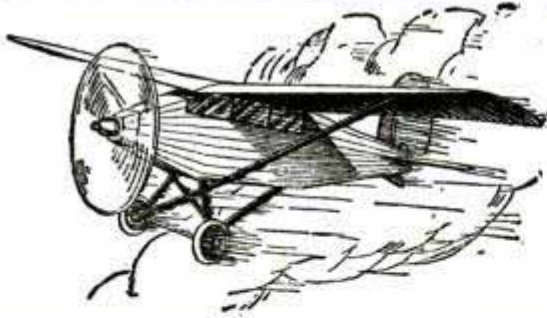

# CLINTON AIRPLANES

*The Most Wonderful Models on the Market*

Boys, fly a genuine Clinton "scale model" and win all the prizes. Has 22 in. high-lift wing, all-metal motor mount and propeller, rubber-tired aluminum wheels. Every model guaranteed. They fly over 200 feet, dip, zoom, roll the same as large airplanes. Order now.

Army or Navy Scout Plane sent ready to fly postpaid, \$3.50. Spirit of St. Louis, Fokker or the Fairchild model illustrated above, your choice, postpaid U. S. only, \$5.00.

Catalog and Free Glider, 10c

Dealers and Jobbers, Write

**The Clinton Toy Corp.**

Dept. D, North Haven, Conn.

# FREE New Book FACTORY PRICES

Save  $\frac{1}{3}$  to  $\frac{1}{2}$

New FREE book quotes **Reduced Factory Prices. Lower terms—year to pay.** Choice of 5 colors in New Porcelain Enamel Ranges.



Furnaces \$54<sup>95</sup> up



Ranges \$37<sup>75</sup> up

New Circulating Heaters—\$37.50 up. 200 styles and sizes. Cash or easy terms. 24-hour shipments. 30-day FREE trial. 360-day test. Satisfaction guaranteed. 27 years in business. 700,000 customers. Write today for FREE book.

**KALAMAZOO STOVE CO.**  
391 Rochester Ave.  
Kalamazoo, Mich.

**"A Kalamazoo Direct to You"**  
Trade Mark Registered

**DENINGER WILL TRUST YOU**  
SEND 50c IN STAMPS FOR CATALOGUES  
BIG MONEY SAVING FOR YOU  
Used and rebuilt motorcycles \$25 to \$100, used bicycles \$2.50, tandems \$20. All machines fully guaranteed. New bicycles and motorcycles at factory prices, save dealers' profits. Motorcycle and automobile tires \$3. Complete line frames, engines, supplies.  
DENINGER PRICE CUTTER, ROCHESTER, N. Y.  
**PAY AS YOU RIDE**

**MOTORCYCLES**  
**WE WILL TRUST YOU**  
Pay As Low As \$2.00 per Week  
Hendersons, Harley-Davidsons, Indians  
Slightly used and rebuilt. Hundreds to select from.  
Send 10c for list today.  
**MYEROW BROS. CO., 15 Berkeley St., Boston, Mass., U. S. A.**

**MAKE YOUR FORD Into The "LARK"**  
\$5.00 Red-i-Kut life size patterns Class-Snap  
Famous sure-fit RED-I-KUT life-size patterns and picture instructions show how you can easily convert your Ford into this Fast, Saucy, Sport-Car as thousands have done with easily obtained materials. No need to lay up the car. Rear seat folds, making 4-passenger car. Send 10c coin for actual body photo and new manual of other distinctive sport body patterns from \$3.00 up—"RKO" Steel "Swing-Lo" irons, Tops and Windshields. ORDER RIGHT NOW  
**KUEMPEL COMPANY, 102 Kuempel Bldg., GUTTENBERG, IOWA**

**PLUMBING-HEATING**  
**YOU SAVE HALF**  
Send for BIG FREE BOOK of Guaranteed Plumbing and Heating. Everything cut-to-fit. 50 yrs. in business. Thousands of customers. "You saved me \$400.00," says Mr. Edw. Borkosky of N. J. Write today.  
**HARDIN-LAVIN CO., 107-17 C Pershing Rd., CHICAGO**

**Catch Fish!**  
Eels, Mink, Muskrats with our new folding galvanized **STEEL WIRE TRAP.** Write for our **FREE TRAP OFFER** and Bargain Catalog. \$1 Box of our famous Fish Bait FREE to introduce our traps.  
**WALTON SUPPLY CO., 3502 JUNIATA AVE., ST. LOUIS, MO.**

**\$75 to \$125 Weekly**  
**Charging Batteries Starts You**  
5 DOWN  
Let me show you how to make big money right from the start. I've prepared a FREE book explaining all details. First week's profit pays for all equipment. You can get all the battery charging business in your community with my Service Station Charger—it's years ahead of ordinary chargers—handles 50% to 70% more batteries. I explain everything—start you in a business of your own and put you on the way to big money. Write for FREE Book.  
**C. F. HOLMES, Chief Engineer, Dept. PM**  
Independent Electric Works, 5116 Ravenswood Ave., Chicago  
**FREE BOOK—Just Out**  
Big Profits



# WORKACE Electric WOODWORKER

Complete Outfit Including Planer, Saw, Lathe and Electric Motor and Many Useful Attachments

**Wallace**  
PORTABLE MACHINES

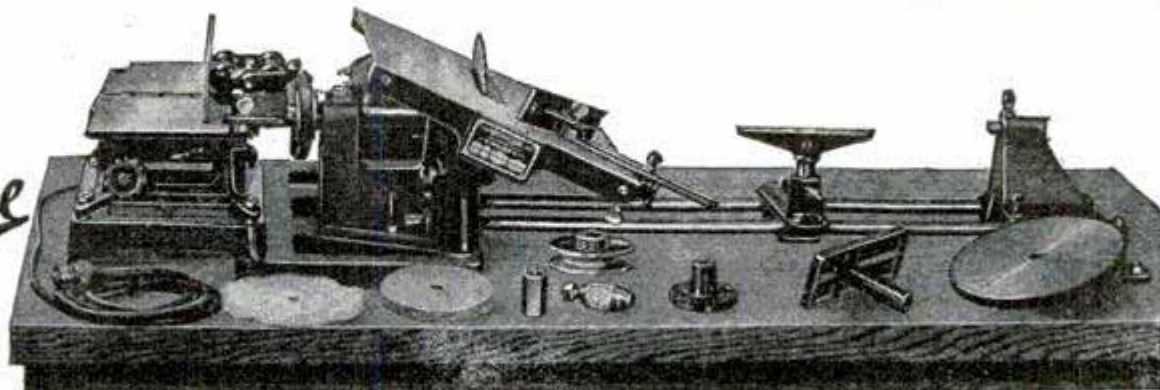

## Fast-Accurate-Complete *For every kind of woodworking operation*

A COMPLETE all-electric shop to use at home or in business. Costs a lot less than most other outfits. Fast and accurate for every kind of

woodworking operation: Planing, sawing, turning, drilling, grinding, sanding, buffing, etc. Saves time, does better and cleaner work, too.

**Amazing low price \$89 . . . . Easy Terms—**

The Workace Woodworker has power, strength, and capacity to handle any job quickly and economically—mitering, tapering, rabbeting, beveling, slotting, turning, cross-cutting, ripping. Every unit works from motor—parts are sturdy and well fashioned. The WALLACE GUARANTEE assures replacement of defective parts for one year.

Become an expert woodworker—make tables, chairs, stools, screens, lamps, lattices, fences, cabinets, doll houses, book cases, chests—make woodworking your hobby and turn it to profit, as hundreds do.

**The Planer and Circular Saw are each complete units and may be purchased separately at the corresponding low price of \$25.00 each.**

Terms are all in your favor. Small down payment brings the Workace COMPLETE. Monthly payments so small you'll never miss the money. Many pay for their Workace out of profits it makes—so can you.... Send the coupon now and we'll see that you get full details immediately.

J. D. Wallace & Co.,  
Adams Street and California Ave.,  
Chicago, Ill.

That Workace Electric Woodworker sure looks good to me. I want to know all about it, including your easy terms, right away.

Name.....City.....

Address.....State.....

## AGENTS 500% PROFIT GENUINE GOLD LEAF LETTERS

**S** guaranteed to never tarnish. Anyone can put them on stores and office windows. Enormous demand, large profits. Paul Clark says: Smallest day \$28.70. R. L. Reel made \$920 in two months. Write today for free sample and liberal offer to general agents. METALLIC LETTER CO., 433-B N. Clark St., CHICAGO

**Cut Price Sale!**

Two years' written guarantee given with this fully jeweled improved Swiss pocket watch with pen-knife and chain and pistol-shaped cigarette lighter. High-grade thin model watch combination white and green gold effect case, artistically engraved, rich, elegant. Accurate timekeeper, tested, adjusted. **Send no money.** Pay postman \$3.59 plus postage. Jenkins, 621 Broadway, Dept. 23-M-11 New York, N. Y.

## PIN A DOLLAR BILL TO THIS

and get this genuine leather 5-window gold corner pass case. Holds Railroad Passes, Auto License, Lodge Cards, etc. Masonic or Shrine Emblem stamped on in gold free. Your name or other stamping 35c extra per line. Cash must accompany order.



We carry **EVERYTHING MASONIC**

Send for free catalogue No. 10 P. M. of Books, Monitors, Jewelry; No. 11 P. M. of Lodge Supplies.

*We Have Been in Business 67 Years!*

**REDDING MASONIC SUPPLY CO.**  
200 Fifth Ave., Desk P. M. NEW YORK



Fastest Cutting

Saws Fifteen Cords a Day!



Men—  
Let Me Send You My  
Greatest LOG SAW Offer!



It's easier now than ever before to own this fastest-cutting, easiest-moved, most powerful Log Saw. Now, you can make big money sawing firewood, stove-bolts, ice, shingle timber, etc. Write today for full details of this most wonderful offer. Know how easy it is to make big money sawing fifteen cords of wood a day with no hard work.

350 Saw Cuts a Minute—

nearly six each second. Just think of it—now you have a log—in a few seconds it's all sawed up into lengths you can use—without any hard work! The OTTAWA has balanced crank shaft, power force feed, friction clutch.

Make BIG MONEY—

Wood selling at \$3 a cord brings owner \$45 a day. Saw your own wood—go into the wood business. Don't let the lack of ready money stop you. Remember, we sell on very easy terms. More in use than all others combined.

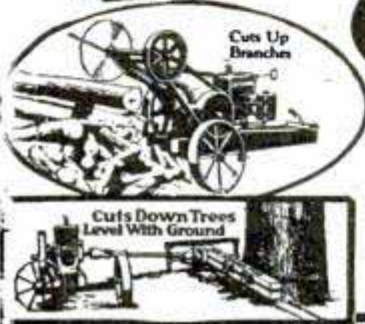

# OTTAWA 4 H.P. LOG SAW

30 Days to Try—one whole month to use the OTTAWA at your own sawing. Shipped on trial only—backed by 10-year guarantee. Prove to yourself how easy you can saw 15 cords or more a day—at a cost of 1 1/2¢ a cord.

To Save You Freight—and get your machine to you a few days after you order, I ship from: Ottawa, Kan.; Pittsburgh, Pa.; St. Paul, Minn.; Albany, N. Y.; Memphis, Tenn.; Indianapolis, Ind.; Pueblo, Colo.; Ft. Worth, Texas; Portland, Ore.; San Francisco, Cal.

**FREE**

Send me your name and address on postcard today, so I can send you my wonderful new edition of the "Wood Sawing Encyclopedia." Educational, instructive. Be sure to investigate—will help you to make big money.

**C. E. WARNER, Pres. OTTAWA MFG. CO.**  
1742-P Wood St., OTTAWA, KANS.

**ONLY \$39**

**Puts the OTTAWA Working for YOU!**

"I average \$20 profit a day with my OTTAWA."—J. Schill, New York. "My OTTAWA has earned \$700 for me."—S. Graham, Wisconsin. "I can make more money with the OTTAWA than by farming."—D. Goff, Missouri.



## Shoot the Best Gun

The NEW BENJAMIN is the finest air rifle ever made. Unlike all others. Has amazing accuracy—shoots hard and far. It's the original American genuine AIR operated rifle. One to six pump strokes compress air to any desired degree of power. Same force as in air drills and air hammers except you control the shooting force. Never loses force—no springs or levers to get out of order. Makes crack shots quickly, inexpensively. Gives years of delightful recreation with utmost safety. At your dealer's, or sent postpaid for \$5.00.

**Shoot 5 Days FREE**

We give you five days, ammunition supplied, to test the NEW BENJAMIN. If in this time you don't believe it to be the finest air rifle you've ever seen or used, and if you don't believe it is the one and only air rifle for you, return it, postpaid, and your money will be refunded at once.

## The NEW BENJAMIN AIR RIFLE

America's Original Air Rifle

**\$5** at your dealer's or sent postpaid direct from factory on FREE Trial as above if dealer does not handle it—write for our wonderful offer.

**Get This Book and Details FREE**

BENJAMIN AIR RIFLE & MFG. CO.  
645 N. Broadway, St. Louis, Mo.

Please send your amazing offer and free copy of "The Shooter's Art," telling how to become a crack shot, how to hold, aim, and handle guns and guide others in use of guns.



Name \_\_\_\_\_  
Address \_\_\_\_\_



The Musical Sensation  
**ACCORDEON**  
Played by Music Rolls

Without any knowledge of Music or Notes you play in a few minutes, perfect like an Artist, latest hits, songs and dances. No study or practice. Nobody can see the arrangement. Three models. \$40.00, \$55.00, \$70.00. Every instrument guaranteed. Interesting circular No. 1 and Roll List mailed free.

TREASURE SALES COMPANY, 1690 Boston Road, New York

**DO YOU** WANT a new business profession of your own, with all the trade you can attend to? Then become a foot correctionist, and in a few weeks earn big income in service fees,—not medical nor chiropody—easy terms for home training, no further capital needed, no goods to buy, no agency. Address Stephenson Laboratory, 1 Back Bay, Boston, Mass.

## TYPewriter PRICES CUT

All Standard Makes your choice of the World's best typewriters—Underwood, Remington, Oliver—full size, late model, completely rebuilt and refinished brand new. Prices smashed down to half. Act quick.



**\$2 and it's yours** Free Trial

Just send your name and address and we will mail you our complete FREE CATALOG prepaid, fully describing and showing actual photographs of each beautiful machine in full colors. Tell every detail of our direct-to-you small-payment plan. Write now for tremendous saving. No obligation whatever. Still time if you act now.

International Typewriter Exchange  
184 W. Lake St. Department 1194 Chicago, Illinois



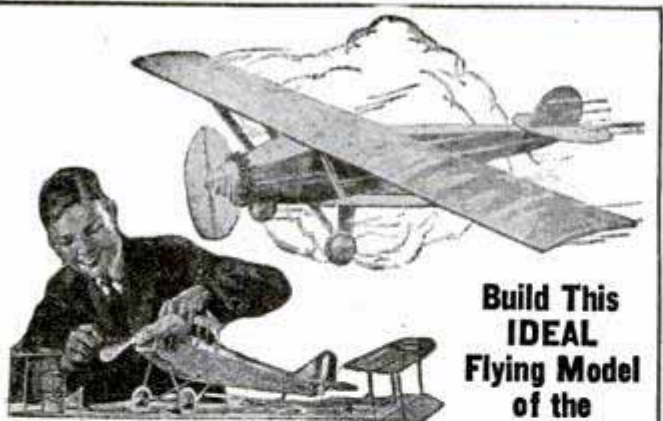

Build This  
IDEAL  
Flying Model  
of the

**"Spirit of St. Louis"**

A perfect 3-foot miniature of the most famous Airplane in the world! Anybody can build and fly it. The IDEAL Complete Construction Outfit contains everything needed; all parts, fittings and materials, full plans, diagrams and instructions. The Model is guaranteed to fly when correctly built. Complete Construction Outfit..... **\$7.50**

(West of Denver, Colo., and in Canada \$8.00)  
Ask Your Dealer or Order Direct.

**Plans for Model Airplanes**

Complete, accurate, 1/4-size Plans, with Building-Flying Instructions, for any one of the following: New York-Paris FOKKER; Curtiss; DeHAVILLAND; NC-4 Siplase; Blériot Taube or Nieuport; Gull Post-25c Model Book Free with each plan. Each

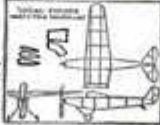

**64-pg. Book for Model Builders**

Contains plans for building Gliders and Racers, full information about Scale Models; and most complete catalog of Parts, Supplies, Materials and Fittings for all kinds of Models. Postpaid for..... **5c**

**Ideal Aeroplane & Supply Co., Inc.**  
26 West 19th Street, New York City



**I'll Pay YOU  
\$100 a Week**

Sell tailored-to-measure all wool suits and overcoats at **\$23.50** and **\$31.50**. Liberal commissions paid in advance. They sell on sight—steady income from repeat orders—extra bonus money. Complete sales outfit FREE including big cloth samples. All you do is sell. We deliver and collect. Great opportunity—write NOW. **W. Z. GIBSON, Inc., 500 Throop St., Dept. Y-516, Chicago**

**RAISE BELGIAN HARES**

**NEW ZEALAND REDS—Chinchillas—Flemish Giants**  
MAKE BIG MONEY—We supply stock and pay you following prices for all you raise: Belgian Hares \$2 each—New Zealands \$3 each—Chinchillas \$4 each—Flemish Giants \$5 each. 32-page illustrated book, catalog and contract, also copy of Fur Farming magazine, tells how to raise skunk, mink, fox, etc., for big profits, all for 10c. Address

**OUTDOOR ENTERPRISE CO., Box 25, Holmes Park, Mo.**



**On your feet—  
In a good Paying Business**

We start you in the shoe and hosiery business. Inexperienced workers earn \$5000 yearly with our Direct-to-Wearer plan. Just show Tanners Famous Line of Footwear. We tell how and where to sell. Perfect fit through Patented System. Collect your pay daily. We furnish \$40.00 Sample Outfit of actual shoes and hosiery. 72 styles. Send for free book "Getting Ahead" and full particulars. No obligation. **TANNERS SHOE MFG. CO.**  
50110 South C Street, Boston, Mass.

The Old Reliable Credit Jewelers  
**LOFTIS BROS. & CO.** EST'D 1858  
Dept. F-894  
108 N. State St.  
Chicago Ill.

**DIAMONDS AS LOW AS \$100 A WEEK**

**Genuine Diamonds Guaranteed CASH OR CREDIT**

Beautiful Diamonds for Christmas! Diamonds for Christmas at a great saving! Dazzling gems of fine blue-white color—all special importations—exquisitely set in mountings of solid 18-k white gold. Buy direct from Loftis, the importer, and save what others pay to middlemen. Order now—direct from this ad!

Satisfaction guaranteed, or money back. Goods sent for your free examination on request. Credit Terms: Pay one-tenth down; balance weekly, semi-monthly, or monthly at your convenience. All goods delivered on first payment.

**Christmas Catalog Free!**  
Big 132-page book, illustrating our Diamonds, Watches, Jewelry, Silverware, and gift articles for all occasions, sent absolutely free. Write today.

No. 877 \$50 \$1.25 a wk.  
No. 878 \$100 \$2.50 a wk.  
No. 879 \$150 \$3.75 a wk.  
No. 880 \$75 \$1.75 a wk.  
No. 864 \$37.50 \$1 a wk.  
No. 867 \$100 \$2.50 a wk.

**Rectangular Wrist Watch No. 868**  
Solid 14-k white gold, 15 Jewels, Gold filled bracelet to match. \$35. \$3.50 down, \$3.50 a month.

**Cushion Nickel, 6 Jewels—high Strap Watch grade Leather strap, Special \$8.50**

**"To Be Successful, Look Successful—Wear a Genuine Diamond"**

**No. 860**  
HANDSOME RING FOR MEN—An unusual value. Solid 18-k White Gold set with a Brilliant Blue White Diamond. \$17.50 a week

**No. 884**  
STUNNING DINER RING, priced especially low. Solid 18-k White Gold set with 5 dazzling Blue White Diamonds. \$2.25 a week

**RAILROAD WATCHES**  
GUARANTEED TO PASS INSPECTION

**HAMILTON NO. 992.** 21 Jewels. Adjusted to 5 Positions. Gold filled 25-Year Quality Case..... **\$55**  
\$2.95 Down and \$2.95 a Month.

**ELGIN'S LATEST RAYMOND.** 21 Jewels, 8 adjustments. Runs 40 hours one winding. Gold filled 20-Year Quality Case..... **\$55**

**ILLINOIS "BUNN SPECIAL."** 21 Jewels, Adjusted to 5 Positions. Gold filled 25-Year Quality Case. 60 hours, 1 winding..... **\$50**

**HOWARD RAILROAD WATCH.** 21 Jewels, 8 Adjustments. 25-Year Quality Gold filled Case..... **\$80**

Railroad Watches sold on our regular credit terms.

**BEAUTIFUL WEDDING RINGS**  
SPECIAL LOW PRICES

**No. 824—The "Elite"** solid 18-k white gold..... **\$7.50**

Set with 8 Diamonds, \$22.50;  
6 Diamonds, \$32.50; 7 Diamonds, \$42.50; 9 Diamonds, \$52.50; 12 Diamonds, \$67.50

**Send for Free Catalog!**





## Accept 10 Days' Proof

*To prove the claims men make for this unique shaving cream are justified*

### GENTLEMEN:

We make no claims for Palmolive Shaving Cream other than the fact that millions of men, once wedded to rival preparations, have shifted to this new creation.

Hence—that it is worth a trial. So we send 10-day tubes for that purpose. Will you accept one as a courtesy to us?

### 5 new factors

1. Multiplies itself in lather 250 times.
2. Softens the beard in one minute.
3. Maintains its creamy fullness for 10 minutes on the face.
4. Strong bubbles hold the hairs erect for cutting.
5. Fine after-effects due to palm and olive oil content.

### Just send coupon

Your present method may suit you well. But still there may be a better one. This test may mean much to you in comfort. Send the coupon before you forget.

**PALMOLIVE RADIO HOUR**—Broadcast every Wednesday night from 9:30 to 10:30 P. M., eastern time; 8:30 to 9:30 P. M., central time over station WEAJ and 32 stations associated with The National Broadcasting Company.

With the new unbreakable Bakelite top

## 10 SHAVES FREE

and a can of Palmolive  
After Shaving Talc

3978

Simply insert your name and address and mail to Dept. B-1562, Palmolive, 3702 Iron St., Chicago, Ill.

Residents of Wisconsin should address Palmolive, Milwaukee, Wis.

(Please print your name and address)

## If I had a workshop

OUT in the garage, in the attic or downstairs somewhere, I'd have a couple flashlights handy there. Ready for the times when you need an extra-bright eye of light to help out. I'd have them, too, as a fire-prevention measure. Oil, waste and those odds and ends that always collect don't need much encouragement to cause a serious fire. Give me Eveready Flashlights and safety.

The flashlight habit will see you safely through many a dark situation. You can't begin too early, either. Get an Eveready today and promise yourself to use none but the very best of batteries in it. They're Eveready Batteries, of course. The kind that lasts so long. *Extra-good*. Packed with a BIG load of light. Always dependable, never-fail Evereadys. Remember them when you reload a flashlight.

## FREE Wholesale Radio Catalog

### Set Builders-Dealers! Save Money!

Send for the most complete book of nationally known Parts, Kits, Cabinets, Consoles, Speakers, Power Units, Sets, etc. All at lowest wholesale prices. Quick service on all your needs. Write now, it is FREE—

**SETBUILDERS SUPPLY CO., Dept. 12-3**  
Romberg Bldg. Madison and Market Sts. CHICAGO, ILL.

## Wholesale Prices on RADIO

Get our big new 1929 Radio Catalog—hot off the press. Contains thousands of amazing bargains. Latest, nationally advertised Radio equipment. Latest in Ham Transmission equipment. Everything at lowest wholesale prices.

### NEW RADIO CLUB—Big Prizes

Get all the facts about "Ether Trappers" Club, now. No dues. Many advantages. Write for **FREE** Membership at once.

This Big Book of money-saving bargains is yours **FREE**. A regular Radio encyclopedia. Write today for your copy of this book.  
**AMERICAN RADIO & MERC. CO.**  
Dept. 26  
American Radio Building  
KANSAS CITY, MO.







Licensed by Rider Radio Corporation. Patented 5/3/16, 7/27/26. Pats. Pending.

## Controls That Meet Every Test

Electrad Resistances are the product of one of the oldest and largest parts manufacturers. They are the choice of leading radio authorities and circuit designers—the standard by which others are judged. Ask for and be sure you get genuine Electrad controls. Electrad specializes in a complete line of Resistances for all Radio Purposes.



Exclusively Licensed by Technidyne Corporation. Under U. S. Patent No. 1593658, 1034103, 1034104.

### PHASATROL

Reg. U.S. Pat. Off.  
**A True Balancing Device for Radio Frequency Amplifier**

An unusually efficient device for controlling radio frequency oscillations and thus eliminating disturbances to reception. A wonderful improvement for the new A. C. circuits where the elimination of oscillation is a problem. Price \$2.75 each.

### TONATROL

**Complete Line of Volume Controls**

Smooth, gradual control of intensity under all conditions will be your reward if you incorporate the Tonatrol Volume Control in your receiver. Furnished in standard types, or with filament switch or power switch attached. From \$1.50 to \$3.00.

Tear out and mail coupon for complete FREE circulars and information

Electrad, Inc., Dept. 7-11, 175 Varick Street, New York.  
Please send me descriptive circulars on the following products and put me on your mailing list for similar literature.

- General Circular
- Tonatrol Volume Controls
- Phasatrols
- Royalty Variable Resistors
- Trovolt Divider Manual (Enclose 10c for mailing)
- "Electrad Control Manual" (Enclose 10c for mailing)
- "What B Eliminators Shall I Build?" (Enclose 10c for mailing)

I am particularly interested in  
Name.....  
Address.....

# ELECTRAD

Inc.

## Beautiful HOUSES \$900 and BUNGALOWS

**CAN BE BUILT FOR AND UP**  
This and many others in my new book, **Building Plans for Modern Homes**, will save you hundreds of dollars. One of the most complete and comprehensive books of plans ever published by any architect. New edition just off the press. Nearly 600 floor plans and photographs of Colonial houses, bungalows, etc., costing from \$200 up; gives sizes and cost to build. Sent postpaid for \$3.00.



**FREDERICK H. GOWING ARCHITECT**  
101 Tremont St., BOSTON, MASS.

## Set Builders! Dealers!



### FREE — Big Catalogue

Hundreds of bargains in latest kits and parts at liberal discounts. See our new catalogue for

**TELEVISION** kits and parts.  
**SHORT WAVE** Sets, kits, parts.

**POWER PACKS**—All kinds; including 250-tube and push pull circuits.

**ELECTRIC PHONOGRAPHS**—pickups, turn-tables, dynamic speakers.

**SHIELD GRID** Kits, coupling impedances, shields and other parts.

Van-Ashe has everything, at big discounts, ready for 12-hour shipment. Send post-card for new catalogue and discount sheet.

## Hotter than Coal ~ and no dirt



*A New Invention*

Do away forever with the drudgery of wood or coal. The most simple and economical invention on the market is now giving perfect satisfaction to enthusiastic users everywhere.

### Burns 96% Air—4% Cheap Oil

The Okay Oil Burner fits in the fire box of your furnace or stove. Installed in a few minutes. No noisy motors or complicated parts.

### Costs only a Few Dollars

Heats any stove or furnace just as well as a \$400 or \$500 oil burner without electricity or gas. Simply turn one valve and have all the heat you want. Cleaner and better for heating and cooking. Approved by engineers everywhere. Over 100,000 in use.

### 30 Days FREE Trial Offer

Try this wonderful Okay Oil Burner right in your own home at our risk. Act quickly and get our special low introductory price. Sold under absolute money-back guarantee. Write at once for our free booklet on home heating and free burner offer.

**AGENTS**—Our men are making big money introducing Okay Oil Burners. The demand is enormous. We want spare or full time workers immediately. If \$500 a month and more interests you, write or wire us for our protected territory offer.

----- Clip This Coupon -----

Okay Mfg. Co., 1501 South Spring Ave., St. Louis, Mo., Dept. N-201  
Send your free booklet and free details on home heating for stove. } Also free burner offer.  
furnace. }  
Name.....

Address.....  
 Check if interested in making money as an Okay representative with protected territory.



## Van-Ashe Radio Co.

206 N. 10th St. St. Louis, Mo.



# PATENT

## Protect Your Ideas

### Take the First Step Today

If you have a useful, practical, novel idea for any new article or for an improvement on an old one, you should communicate with a competent Registered Patent Attorney AT ONCE. Every year thousands of applications for patents are filed in the U. S. Patent Office. Frequently two or more applications are made for the same or substantially the same idea (even though the inventors may live in different sections of the country and be entirely unknown to one another). In such a case, the burden of proof rests upon the last application filed. Delays of even a few days in filing the application sometimes mean the loss of a patent. So lose no time. Get in touch with me at once by mailing the coupon on the opposite page.

### Prompt, Careful, Efficient Service

This large, experienced organization devotes its entire time and attention to patent and trade mark cases. Our offices are directly across the street from the U. S. Patent Office. We understand the technicalities of patent law. We know the rules and requirements of the Patent Office. We can proceed in the quickest, safest and best ways in preparing an application for a patent covering your idea. Our success has been built on the strength of careful, efficient, satisfactory service to inventors and trademark owners located in every state in the Union.

### NO CHARGE for Information On How to Proceed

The booklet shown here contains valuable information relating to patent procedure that every inventor should have. And with it I will also send you my "Record of Invention" form on which you can sketch your idea and establish its date before a witness. Such evidence may later prove valuable to you. Simply mail the coupon and I will send you the booklet, and the "Record of Invention" form, together with detailed information on how to proceed and the costs involved. Do this NOW. No need to lose a minute's time. The coupon will bring you complete information entirely without charge or obligation.



My Patent Law Offices  
Just Across  
Street From  
U.S. Pat. Office



Above is a view of my drafting and specification offices where a large staff of experienced experts are in my constant employ. All drawings and specifications are prepared under my personal supervision.

# NEWS

## Inventors Write for these Free Books

### Strict Secrecy Preserved

All communications, sketches, drawings, etc., are held in strictest confidence in strong, steel, fireproof files, which are accessible only to authorized members of my staff. Feel free to write me fully and frankly. Your case will have my personal attention. It is probable that I can help you. Highest references. But **FIRST**—clip the coupon and get my free book. Do **THAT** right now.

### Clarence A. O'Brien

*Registered Patent Attorney*

Member of Bar of: Supreme Court of the United States; Court of Appeals, District of Columbia; Supreme Court, District of Columbia; United States Court of Claims. Practice confined exclusively to Patents, Trade marks and Copyrights

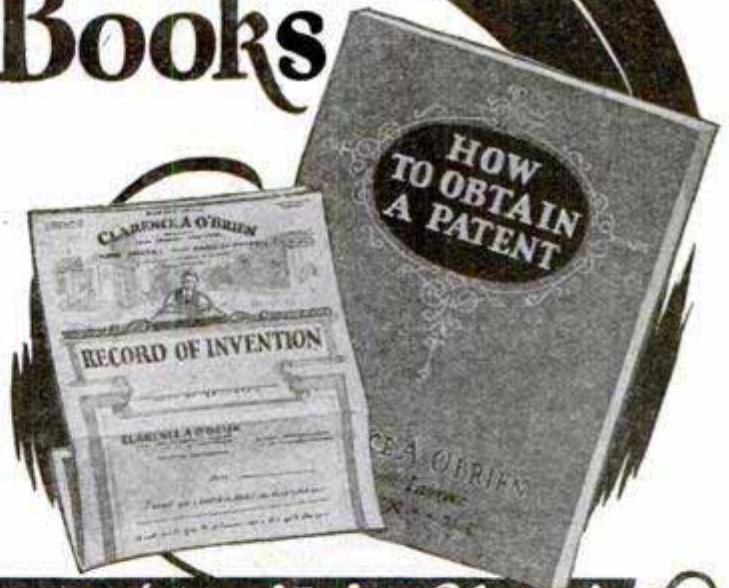

**Clip this Coupon and Mail it Now!**

**CLARENCE A. O'BRIEN, Registered Patent Attorney**

70-G Security Savings and Commercial Bank Bldg., Washington, D. C.

Please send me your free book, "How to Obtain a Patent," and your "Record of Invention" form without any cost or obligation on my part.

Name.....  
(Important: Write or Print name clearly.)

Address.....



# PATENTS TRADE MARKS COPYRIGHTS

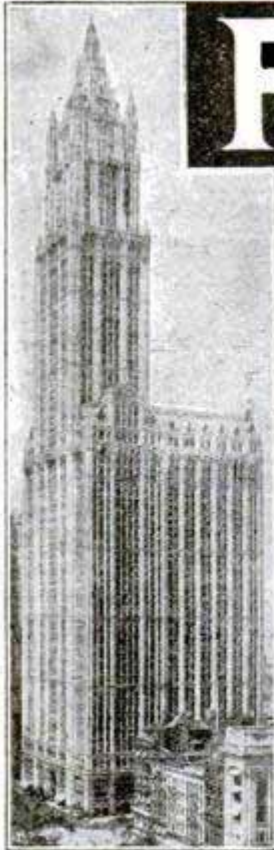

Our New York Office  
Suits 1007 Woolworth Bldg.



Our Philadelphia Office  
Suits 518-519 Liberty Bldg.



Our Washington Office, Victor Bldg.



**Have You An Idea?**

**Our Offer:** FOR THE PROTECTION  
OF YOUR INVENTION

## YOUR FIRST STEP

The inventor should write for our blank  
form

### “RECORD of INVENTION”

This should be signed and witnessed and  
returned to us together with model or  
sketch and description of the invention for

### INSPECTION AND ADVICE

*No Charge for the Above Information.*

### Our Five Books Mailed

**Free to Inventors**

*Our Illustrated Guide BOOK*

### How to Obtain a Patent

Contains full instructions regarding U. S. Patents.  
Our Methods, Terms, and 100 Mechanical Move-  
ments illustrated and described.

### Our Trade Mark Book

Shows value and necessity of Trade Mark Protec-  
tion. Information regarding *Trade Marks and un-  
fair competition in trade.*

### Our Foreign Book

We have Direct Agencies in Foreign Countries, and se-  
cure Foreign Patents in shortest time and lowest cost.

### Progress of Invention

Description of World's Most Pressing Prob-  
lems by Leading Scientists and Inventors.

*We Regard a Satisfied Client* as our best advertise-  
ment, and furnish anyone, upon request, lists of clients  
in any state for whom we have secured patents.

**Highest References—Prompt Service**  
**—Reasonable Terms**

## VICTOR J. EVANS & CO.

**PATENT ATTORNEYS**

Main Offices: 789 9th St., N. W., Washington, D. C.

*Opposite U. S. Patent Office*



# DELAYS ARE DANGEROUS IN PATENT MATTERS

## IMPORTANT! To Avoid Delay!

YOU SHOULD HAVE YOUR CASE MADE SPECIAL IN OUR OFFICE to save correspondence, secure protection and early filing date in the Patent Office. To secure special preparation of your case send \$25.00 on account with model or sketch and description of invention.



MAIN OFFICE, VICTOR J. EVANS & CO.—VICTOR BUILDING, WASHINGTON, D. C.

*Our Lawyers Practice in all U. S. Courts and defend Clients in Suits involving Patents, Trademarks and Copyrights*

All Communications and Data Strictly Confidential. Interference and Infringement Suits Prosecuted

OUR ORGANIZATION OFFERS PERSONAL SERVICE By Experienced Patent Lawyers, Solicitors and Draftsmen

### FREE VICTOR J. EVANS & CO. PATENT ATTORNEYS

NEW YORK OFFICES 1007 Woolworth Bldg. CHICAGO OFFICES 1110 Tacoma Bldg.  
 PHILADELPHIA OFFICES 518-519 Liberty Bldg. PITTSBURGH OFFICES 514 Empire Bldg. SAN FRANCISCO OFFICES 1010 Hobart Bldg.

MAIN OFFICES: 789-9th Street, N. W., WASHINGTON, D. C.

Gentlemen: Please send me *Free of Charge* your books as described on preceding page.

Name .....

Address .....



Our Chicago Office Suite 1110 Tacoma Building



Our Pittsburgh Office Suite 514 Empire Building



Our San Francisco Office Suite 1010 Hobart Building



# PATENTS

TRADE-MARKS · DESIGNS  
FOREIGN PATENTS

**MUNN & CO.**  
PATENT ATTORNEYS

*Associated since 1846 with the Scientific American*

SCIENTIFIC AMERICAN BUILDING  
24 W. 40th St., New York City

SCIENTIFIC AMERICAN BUILDING  
Washington, D. C.

TOWER BUILDING  
Chicago, Ill.

VAN NUYS BUILDING  
Los Angeles, Cal.

HOBART BUILDING  
San Francisco, Cal.



Books and Information on Patents and Trade-Marks by Request.  
Associates in All Foreign Countries.

## PATENTS

**Don't Lose Your Rights  
To Patent Protection**

Before disclosing your invention to anyone send for blank form "EVIDENCE OF CONCEPTION" to be signed and witnessed. As registered patent attorneys we represent hundreds of inventors all over the United States and Canada in the advancement of inventions. The form "Evidence of Conception," sample, instructions relating to obtaining of patents and schedule of fees sent upon request.

**LANCASTER & ALLWINE**

480 Ouray Bldg. WASHINGTON, D. C.  
*Originators of forms "Evidence of Conception."*

## PATENTS

Trade Marks, Copyrights, Patent Litigation Handbook with illustrations, 100 mechanical movements. *Sent free on request.*

**ALBERT E. DIETERICH**  
formerly member Examining Corps U. S. Patent Office

REGISTERED

**PATENT LAWYER and SOLICITOR**  
621-A, Ouray Bldg.

30 Years' Experience Washington, D. C.



## PATENTS

Send us sketch or model for advice and exact cost of patent. Our book "How to Obtain a Patent" sent free. It tells how to apply for Patents, Trade Marks, Foreign Patents, Copyrights, etc.; gives information on Patent Procedure; tells what every inventor should know. Thousands of Inventors, who are our clients, are our reference.

**CHANDLEE & CHANDLEE, 25 Years' Experience**  
410 Seventh St. Washington, D. C.

## PATENTS

**Booklet Free Highest References  
Promptness Assured Best Results**

Send drawing or model for preliminary examination of Patent Office records.

**ALL BUSINESS GIVEN PROMPT AND PROPER ATTENTION**

Listed Patent Lawyer in the latest editions of the Rand-McNally Directory of Bankers and Bonded Attorneys, published by Rand-McNally & Co., Chicago, Ill.; The Baggott & Ryall Directory of Guaranteed Attorneys, published by the Ryall Legal Directory Company, New York City; Flugel's List, published by the Legal Directory Publishing Co. of St. Louis, Mo.; the American Lawyers Annual, published in Cleveland, Ohio; Eyre's Law List, Bush Terminal Building, New York City.

**WATSON E. COLEMAN,**  
REGISTERED PATENT LAWYER

Victor Building, 724 Ninth Street, N. W.  
**WASHINGTON, D. C.**



# PATENTS

## To the Man with an Idea

I offer a comprehensive, experienced, efficient service for his prompt, legal protection and the development of his proposition.

Send sketch, or model and description, for advice as to cost. Preliminary advice gladly furnished without charge.

Booklet of valuable information and form for properly disclosing your idea free on request. Write Today.

**IRVING L. McCATHRAN, Patent Lawyer**

*Formerly with and successor to Richard B. Owen*

200 Owen Building  
WASHINGTON, D. C.

41-E Park Row  
NEW YORK CITY

# TRADE-MARKS REGISTERED

## INVENTORS PROTECT YOUR IDEAS

Send for our Guide Book, **HOW TO GET A PATENT**, and Evidence of Invention Blank, sent Free on request. Tells our terms, methods, etc. Send model or sketch and description of your invention for INSTRUCTIONS. No charge for the above information.

**RANDOLPH & CO.**  
301 Victor Bldg., WASHINGTON, D. C.

NAME.....  
STREET.....  
CITY..... STATE.....



# Patents

Inventors who derive largest deserved profits know and heed certain simple but vital facts **BEFORE** applying for patents. Our book **PATENT-SENSE** gives these facts. Sent **FREE**.

**LACEY & LACEY**  
WASHINGTON, D. C.  
ESTABLISHED 1869

**Lacey & Lacey, 646 F St., N. W. Washington, D. C.**  
Please send me your **FREE** book **PATENT-SENSE**.  
Name.....  
Address.....  
City..... State.....



# \$351<sup>00</sup> CLEARED IN ONE DAY

So writes W. H. Adams of Ohio. Letter from California man reports \$11275 sales in three months; New Jersey \$4000 profits in two months; Pa. \$3000 profits in four months. Ira Shook \$365 sales in one day. Bram bought one outfit April 5 and 7 more by August. Iwata bought one outfit and 10 more within a year.



J. R. Bert says "only thing I ever bought that equaled advertisement." John Culp says: "Everything going lovely. Crispette wrappers all over

town. It's a good old world after all." Kellog, \$700 ahead end of 2d week. Wholesale or retail. Big profits either way. No town too small. Business is pleasant, fascinating and dignified. You manufacture a food product.

## WE START YOU IN BUSINESS

Furnish secret formulas, raw material and equipment. Little capital required; no experience needed.

## Build a Business of Your Own

No limit to the sale of Crispettes. Everybody likes them. It's a delicious food confection. Write for facts about a business that will make you independent. Start now, in your own town.

## PROFITS \$1000 MONTH EASILY POSSIBLE

Send postal for illustrated book of facts. It contains enthusiastic letters from others—shows their places of business, tells how and when to start, and all information needed. Free. Write now!

**LONG-EAKINS COMPANY**

1128 High Street

Springfield, Ohio

# Build a ... Real Model AUTOMOBILE

This is a real model motor car in every way; with a real three speed forward and reverse gear shift, friction clutch, differential, steering mechanism, internal-expanding brakes, etc. You can build it yourself with your own hands.

Or, if you prefer, you can make a scale model of a High Speed Ship Cooler that will actually load coal, or of a trimotored, mail AIRPLANE that works.

We will send you an easily understood instruction booklet for any one of these models you prefer, free. These booklets usually cost 10c each. If you want all three, send 20c. All you have to do is to send us your name and address and that of three of your friends, telling us which booklet you prefer. This is a wonderful chance. Act now!

**Meccano Company, Inc., Div. H-1 Elizabeth, N.J.**

## THIS OFFER WORTH 10¢

### Big commission - MEN'S SUITS

**\$8.88** Any one can earn \$2,000 extra money yearly in view of low price. Up to date styles, workmanship. Variety of beautiful patterns. **FREE SALESKIT** 888Co., Dept. L-7, Fort Wayne, Ind.

# AGENTS

*Sell Genuine Diamonds on Cash or Credit*

Everyone is always thinking of buying real jewelry for themselves or as a gift for some dear one. Show them our plan of CASH OR CREDIT. Show them how they can have a beautiful genuine diamond ring, high grade watch, standard-make silverware or any solid gold jewelry they desire, CASH OR CREDIT with 12 months to pay. You will find customers everywhere ready to order Sterling merchandise. We put you in the diamond and jewelry business for yourself without a single cent of investment. We have a line that beats anything seen—yet is lower in price! Guaranteed.

**OVER \$85 Weekly! Easy!**

No matter what you are selling you have the opportunity to make extra profits with this new remarkable line. The genuine diamond and jewelry business is not seasonal. Every day people have occasion to buy for an anniversary, wedding, birthday, etc. Show our nationally advertised line and get these sales that mean big profits for you.

**SEND FOR FREE OUTFIT**  
Write for complete free outfit which contains illustrated catalog in colors, order blanks and full instructions. We send by return mail everything to start you earning without delay—no investment—write today—NOW. Please state if white or colored. **STERLING DIAMOND & WATCH CO., Inc.**  
1540 Broadway Dept. A-216 New York, N. Y.

# \$300,000 For This Invention

That's what Eastman Kodak paid for the Autographic idea. Thousands of other inventions are needed and offer enormous opportunities for earning fortunes. If you are of an inventive turn of mind why not concentrate on things that are really NEEDED. Get Raymond Yates's new book.

## "1000 NEEDED INVENTIONS"

Costs only \$1.25 and may start you thinking along the right lines. You'll get nowhere just fussing around. Concentrate on what the industries need, and on what the public wants. Mr. Yates's book tells you what these things are. Send no money. Just write postal. Pay mail man \$1.25 plus postage when book arrives. Your money back if you want it. This offer limited. Write now and get on the right track. (Outside U. S. \$1.45, cash with order.)

**BUREAU OF INVENTIVE SCIENCE**  
Dept. 311, Wisner Building, Rochester, N. Y.

**CLASS PINS 35¢**  
FREE CATALOG SHOWING 200 DESIGNS  
EITHER DESIGN SHOWN, SILVER PLATE 35¢ EA. 12 OR MORE \$3.50 DOZ. STERLING SILVER OR GOLD PLATE, 50¢ EA. 12 OR MORE, \$5.00 DOZ. 1 OR 2 COLORS ENAMEL, ANY 3 LETTERS AND DATE.  
**BASTIAN BROS. CO. 893 BASTIAN BLDG. ROCHESTER, N. Y.**

**PATENTS** Write for FREE Instructions. Send Drawing or Model for Examination.  
**CARL MILLER, Patent Attorney**  
former member examining corps U. S. Patent Office  
260 McGill Building Washington, D. C.

**EDGAR M. KITCHIN**  
**Attorney & Counsellor at Law**  
Patent and Trade Mark Specialist 805 O St. N. W., Washington, D. C.

**BLUE BOOK ON PATENTS**  
AND PRIORITY RECORD BLANK GRATIS.  
**MONROE E. MILLER, PATENT LAWYER**  
411-2 Ouray Building, WASHINGTON, D. C.  
ELECTRICAL AND MECHANICAL EXPERT

**ALL GIVEN**  
10 year guar. Watch with chain and ring, large Eastman Roll Film Camera or 22 cal. Hamilton Rifle, yours for introducing finest assorted liquid perfume at 15c a bottle. Send for 20 bottles and choose gifts as per offer in our catalog. We trust you—just write to **BELL PERFUME CO., Dep. B153, Chicago, Ill.**

**22 CAL. RIFLE**



### Build a Daven Television Receiver

Complete Essential Kit, \$60.00

THE first complete Kit. Furnished with either T-24, T-36 or T-48 Scanning Disk, Motor, Bushing, Rheostat, Daven Television Tube, 3 Complete Stages of Daven Television Amplification and Instructions for Building.

Daven Television Receiver, Complete, including Television Tube—\$100.00 (Less amplifier Tubes.)

#### DAVEN TELEVISION APPARATUS

Daven Television Scanning Disks	Each	
24 T-24	.....	\$ 5.00
36 T-36	.....	7.50
48 T-48	.....	10.00
Comb. Disc with 24, 36 and 48 Apertures T-468	.....	15.00
Daven Tele. Amp. T-3	.....	12.50
Daven Spec. Telev. Amp. T-4 for 2 Hi Mu Tubes and 2 power Tubes	.....	17.50
Daven Telev. Neon Lamp, 20 to 80 Milliamperes Striking Voltage 100 Plate 1 1/2" x 1 1/2"	.....	12.50
Daven Telev. Motor	.....	27.50
Daven Bushing to fit 1/2", 3/4" and 5/8" Motor Shafts	.....	1.00
Daven Bushing for 48 Aperture disc	.....	3.50
Daven Rheostat	.....	3.50
Daven Telev. Photo Elect. Cell 1 1/4" Bulb	.....	20.00
Daven Telev. Photo Elect. Cell 3" Bulb	.....	37.50
Daven Television Couplers		
1st Stage No. 421x D-421xx		
2nd Stage No. 422x D-422xx		
3rd Stage No. 423x D-423xx		
x Glastors are used for Grid and Plate resistors	.....	2.15
xx Super Davohms in Plate and Glastors in Grid	.....	4.65
Daven AC 71 for output tubes in series with Television Lamp	.....	3.50
Daven AC 10 (for brighter illumination)	.....	9.00
Daven Mu 20 Hi Mu Tubes for Amp. Stages	.....	2.25
Daven Mu 6 Power Tube	.....	3.50



**THE DAVEN CORPORATION**  
Amplification Specialists  
161 Summit Street Newark, N. J.

### FREE CHI-RAD'S NEW 1929 RADIO CATALOG

Includes complete parts for HFL ISOTONE, New TYRMAN "80", MADISON-MOORE "AC", NATIONAL B. D. "AC", New THORDARSON Power Amplifier and others. Latest Parts and accessories. Discounts for Set Builders

CHICAGO RADIO APPARATUS CO.  
415 S. Dearborn Street Dept. PM CHICAGO, ILL.

### SOLDERALL

METAL IN PASTE FORM

The only convenient metal solder

Every Electrical Connection needs Solderall for perfect reception

**25¢**

The SOLDERALL CO., NEWARK, N.J.

only **\$1.00** DOWN

10 Day FREE Trial

You can have a genuine L. C. Smith (the world's only ball bearing typewriter) for \$1 down. Lowest price ever offered! Easiest terms. All the 1928 operating attachments. Re-noved. GUARANTEED FOR FIVE YEARS. \$1 down and we ship. No delay. No real tape. 10 day Free Trial. Free Typewriter Course, Tools, Waterproof Cover if you act now. Write for \$1 down offer and free manual.

Smith Typewriter Sales Corp., 11B-360 E. Grand Ave., Chicago, Ill.

## THE MIRACLE OF THE RADIO WORLD!

Newest Guaranteed 7-Tube 1-Dial Console Set—Worth \$200

BUY DIRECT 1929 MODEL



**ALL ELECTRIC RADIO**  
**30 DAYS' FREE TRIAL!**

A Wonder Bargain!

Buy direct from factory. \$200 VALUE

Outperforms sets selling at 2 and 3 times our low price. Includes console shown, made of combination walnut; A. C. electric set, all tubes, built-in magnetic speaker and aerial equipment,



**COMPLETE Nothing Else to Buy**

**Powerful Reception—Amazing Tone!**

Remember—30 days free trial. You be the judge! Worth \$200 and looks it! Only one dial to tune—illuminated! Marvelous mellow tone. Selective and gets distance easily. The radio sensation for quality, price and performance. Mail coupon today for our big, money-saving Free Catalog, before you buy any radio or accessories!

**Battery Sets** Our low factory prices on the complete line of Diamond Electric and battery operated radios shown in catalog will amaze you!

**Our New FREE Catalog—Just Published—Shows You How To SAVE HALF!**

**Diamond Radio Company**  
Dept. 234 820 S. Clinton St., Chicago, Ill.

**MAIL THIS COUPON TODAY!**

Diamond Radio Company, Dept. 234  
820 S. Clinton St., Chicago, Ill.

Please send me your Free Catalog of Diamond radios and details of your 30 Day FREE Trial offer

Name.....

Address.....

City.....State.....

**WADE AMATEUR MECHANICS, REPAIR SHOPS, INVENTORS, STUDENTS**

**BENCH LATHE**

A real machine tool for the home work bench—capacity 4" dia. x 12" length. For Metal—Wood—Composition materials. Turning—Facing—Boring—Drilling—Winding—Thread Cutting. Accurate—Strong—Quiet—Compact. Slide-rest has travel entire length of bed. Leadcrew inside bed. No. 1 Lathe, plain headstock, \$28.00. No. 2 Lathe, back-gear headstock, \$58.00. Extra for lathes with 18 inches between centers, \$7.00. Complete line of accessories at equally low prices. Write for free catalog.

**THE GEROLD CO.** Dept. P-48 120 Liberty St. New York



# Get a Grip of - - S T E E L



## Send Only 25c for My Double Strength Krusher Grip

INCREASE the size and strength of your arm overnight. A strong grip is the barometer of your personality. With each *KRUSHER GRIP* I will give

# FREE

a beautiful illustrated booklet filled with handsome pictures. It tells you how you can possess a manly figure packed with energy and power. How to put inches on your chest, neck, arms, and legs and get a body as shapely as Sandow.

Fill in the coupon, mail it with 25c and get this *FREE BOOKLET* and my Double Strength *KRUSHER GRIP*—the finest thing you've ever seen for building up the hands, wrists and forearms.

This *KRUSHER GRIP* will give you a grip of steel. I guarantee it. Your money back if it fails.

### THE JOWETT INSTITUTE OF PHYSICAL CULTURE

422 Poplar St.

Scranton, Pa.

Dear Mr. Jowett:

4-LL

Enclosed is 25 cents for your double strength Krusher Grip, with which I am to receive your illustrated booklet FREE.

Name.....

Address.....

## EDWARDS METAL ROOFING



### BIGGEST VALUE · LOWEST COST

Buy your metal roofing, shingles, Spanish tile, sidings, etc., DIRECT from the world's largest manufacturer of sheet metal building materials, at BIG SAVINGS. Thousands of satisfied users.

We own our own rolling mills. Enormous output insures lowest production costs. Factory-to-consumer plan makes prices **rock bottom**. You get the benefit. Many varieties. Edwards metal roofs last longer, look better. Resist rust, fire and lightning. Roofing, shingles, etc., of COPPER BEARING STEEL at special prices. This steel stands the acid test. Outlasts the building to which applied.

### Ready Made Garages and Buildings

Low in cost. Easily erected. Permanent. Good-looking. All types and sizes to suit your purse and purpose. Now's the time for action. Write for Roofing and Material Book No. 150 and for Garage Book.

— FREE —  
SAMPLES  
BOOKS  
ESTIMATES

### EDWARDS MFG. CO.

1100-1150 Butler St.,  
Cincinnati, Ohio



### New Free Catalog!

Send today for our new Catalog! Smashing bargains in **Plumbing, Heating, Hardware, Millwork, Roofing, Paint and Electrical Supplies.**

Absolutely Free!

STANLEY PLUMBING SUPPLY CO., Inc.  
400 N. 12th St. Phila., Pa.



### HB PAINT

SPRAY  
DOES THE  
WORK OF  
FIVE  
MEN

### QUICK, EASY PROFITS!

Practically no investment. Small space required. Steady demand and **BIG PROFITS** refinishing autos, furniture—painting houses and barns with HB quick spray method. One man does the work of five with brushes. Pays for itself on easy monthly payments, **30 DAYS' TRIAL**. Write today for details.

EASY TERMS.  
30 DAYS TRIAL  
QUICKLY PAYS  
FOR ITSELF.

HOBART BROS. CO.  
Box M1181, Troy, Ohio

# muscular aches

quickly relieved by Absorbine, Jr.

It brings ease and comfort to sore, aching muscles. Absorbine, Jr. is economical—only a few drops required for an application. It does not stain the skin. Keep it handy.

At all druggists', \$1.25. Send for free trial bottle  
W. F. YOUNG, Inc. - SPRINGFIELD, MASS.

# Absorbine Jr.



# The New Home Craftsman's Wonder Shop



## ACE HIGH IN CHARACTER AND QUALITY

Sold Only Direct from Factory

3 years of testing, experimenting and improvement is wrapped up in each new Red Jacket Home Work Shop. The finest tools and accessories that can be made go with each assembly order. Red Jacket equipment is designed, tested, approved and guaranteed by Wm. L. Aylward, a nationally known craftsman and manufacturer, who has developed his hobby into a co-operative association of thousands of craftsmen.

### Portable — Interchangeable — Complete RED JACKET Home Work Shop

The new Red Jacket Combination of Electric tools brings you a Red Jacket Band Saw and in addition the powerful Red Jacket Master Drill Motor with direct drive to the Waco Craftsman's wood turning lathe (capacity 9"x36"), also compound and 18" rests, a tilting top mitre saw with both depth and side gauges, scroll and jig saw, and all accessories for both portable and stationary power drilling, buffing, grinding and cleaning. Attaches to light socket and converts your work bench into a complete private tool and machine shop. It is a complete chest full of electrically driven tools designed for the private use of tool lovers and men who create, repair and appreciate handy tools at home.

### Make It Yourself!

Exclusive Features with WACO—

- All Aluminum Master Drill Motor
  - Perfect Tilting Saw Table 13 x 11 1/2 in.
  - Patented Compound Tool Rests
  - Finest Quality Hand Tools
  - Unconditional Guarantee
  - Unlimited Service
- Read Our Code of Business Ethics—  
Ask 7000 Happy Waco Owners



## NOW! Make Things at Home Electrically

Send coupon at once for information valuable to those interested in beautiful handwork. It is FREE. It tells you now easy it is to operate a Red Jacket set of tools and lists the advantages and privileges that are free to member craftsmen. Don't miss knowing all about Waco. You are invited. **Look out for imitations.** There is only one Red Jacket—one Waco—you will not find WACO TOOLS sold by retailers. All sales made direct from factory.

**The WACO Guarantee**  
If it is not what you want when you get it—send it back.

**SPECIAL CRAFTS COURSE FREE**  
SPECIAL CRAFTS COURSE and blueprint service is free to Red Jacket Shop owners—all there is to know about handicraft methods, raw materials, woods, carving, sawing, turning, designing, carpentering, decorating, is taught by special correspondence.

**BUY ON YOUR OWN TERMS** Only \$10.00 down. Liberal discount for cash. Easy monthly payment plans. It is no hardship to own a Red Jacket.

**SEND THE COUPON—Interesting Literature Free** You will be surprised with all it contains. Beautiful, Instructive, Fascinating, Interesting. Fill in and MAIL TODAY.



45° Tilt Top Table



The most elaborate and unusual drill motor ever designed for driving power.

free BLUE PRINTS



This Headstock furnished where no electricity is available.

Red Jacket MASTER DRILL

**WACO TOOL WORKS, Inc.,**  
5216 W. Kinzie St., Chicago  
Manager, Dept. 111. Please send me all free information and literature on Red Jacket Assemblies and FREE Services.

Name.....  
Address.....





**"Lava-clean"  
hands  
are  
clean!**



Men—you who love to tinker—here's just the soap you need. Cleans quickly and thoroughly the toughest-looking pair of hands that ever fussed around a work bench. Makes more lather in 15 seconds than ordinary soap in 60, and even hard or cold water won't discourage it. Millions use it. "Good old Lava," they call it. Gets hands *clean!* Not just "surface clean," but clean 'way down deep. As easy on your hands as fur-lined gloves—because it's made from the finest of vegetable oils. All grocers sell it.

Full size cake of Lava Soap FREE!

Mail this coupon

Procter & Gamble (Dept. W-1128)  
Cincinnati, Ohio

Please send me, FREE, a full size cake of LAVA, the hand soap that removes *all* the dirt and grease.

Name.....  
Street.....  
City.....  
State.....

**250 POWER  
MICROSCOPE**  
MADE IN - U.S.A.

\$16<sup>50</sup>

Educational, entertaining, this fine microscope helps all to know life that can't be seen with unaided eye. Tiny insects look like monsters. Plant and mineral life reveal new wonders in form and color. Used by students, dentists, physicians, scientists — in home, office, school and laboratory. Precise optical qualities.

Magnifies 100 to 250 times. Tilting stand, fine finish, nickel trim, plush-lined case, prepared slide, instructions. At your dealer or direct postpaid. Money back guarantee. Other models \$2.50 and \$8.50.

Catalog Free.



**Wollensak Optical Company,**  
853 Hudson Ave. Rochester, N. Y.

**An  
Amazing  
Offer!**

only  
**\$1<sup>00</sup>**  
DOWN



Brings You This  
**21 JEWEL-Extra Thin  
STUDEBAKER**

Just \$1.00! The balance in easy monthly payments. You get a famous Studebaker 21-Jewel Watch direct from factory at a saving of thirty to fifty per cent.

Your choice of 80 new Art Beauty cases and dials. Latest designs in white gold, yellow gold and green gold effects. 8 adjustments, including heat, cold, isochronism and 5 positions. Insured for lifetime. Ladies' Bracelet Watches, Men's Strap Watches, Diamonds and Jewelry, too. All sold on easy monthly payments. Your credit is good! Write today for free book of Advance Watch Styles or Jewelry Catalog.

**Watch Chain FREE!** For a limited time we are offering a beautiful Watch Chain free. This special offer will be sent to everyone who writes at once. Don't delay! Get this free chain offer today—while it lasts.

**STUDEBAKER WATCH COMPANY**

Directed by the Studebaker Family—known for three-quarters of a century of fair dealing

Dept. P907 South Bend, Indiana

Canadian Address: Windsor, Ont.

**AGENTS AND SIGN MEN**

Now Making \$50.00 to \$100.00 and Up Per Week Selling Our **GOLD LEAF SIGN LETTERS**



For store and office windows, board signs, trucks and glass signs. We also make to order script signs and business emblems singly or by the thousands. A permanent business. No capital or experience required. Big demand in every city. Samples and Literature Free.

CONSOLIDATED SIGN LETTER CO. 71-X W. Van Buren CHICAGO, ILL.

**22 Cal. Blank Automatic**

WITH 100 permit to own this 6-shot Automatic. Use for **CART**—fun or self-defence. keeps away tramps, RIDGES Frightens thieves, scares away dogs—a real home protector. Fool your friends. Same as an expensive automatic in construction, finish, appearance, durability; automatic magazine loading and ejection of cartridges. Instantly and powerful report. Guaranteed absolutely safe. Send no money. Pay expressman \$4.99 for automatic with 100 cartridges. JENKINS, 621 Broadway, New York, Dept. 2-3-111



**CAN YOU SELL GAS at 5c PER GAL.?**

If so write me quick. My Distributors make as high as \$3,000.00 per month. Let me show you how.

**SEND FOR FREE TRIAL**

Proof of astounding success and my \$15.00 a day Guarantee to Distributors.

Frank Andrews, Dept. 805-P. B., 154 E. Erie St., Chicago, Ill.



**I Offer You  
\$8<sup>00</sup> a Day**

and a Write quick for new proposition. We offer \$8.00 a day and a new Chevrolet Coach, for demonstrating and taking orders for Comer All-Weather Top-coats and Raincoats. Spare time. No Experience required. Sample outfit free. Write now.

COMER MFG. CO., Dept. W-5136, Dayton, O.





*only*  
**\$99** for **PACKARD**  
**this** **SUPER 8—\$250 A. C.**  
**ELECTRIC RADIO**

**Direct From Our Factory**

Today's greatest radio!  
 A truly sensational offer!  
 The 8-tube PACKARD  
 A. C. Electric Radio set  
 —a regular \$250 radio—  
 shipped to any home in  
 the U. S. at direct from  
 factory price of only \$99.

And to prove our claims we will ship this  
 set to your home on

**\$5,000.00**  
**CASH BOND**  
 to Back Our  
**GUARANTEE**



**The PACKARD Engineers**

have invented this most unusual, powerful SUPER-Eight Tube Radio. Astonishing volume and tone quality. Remarkable selectivity and long-distance reception. Leading radio engineers unanimously agree that there is no better radio made—regardless of price.

Let us prove this by shipping a set to your home on 30 days' trial. Examine the set from A to Z. Let the most exacting critics pass on its merits. And if, after the 30 day trial period, you are convinced that the Packard Eight-tube Electric is fully the equal of any console radio set selling up to \$250—then, and only then, need you decide to keep it at our factory price of only \$99—otherwise, return it.

This marvelous set combines every new scientific development in receiving sets—possessing beauty, refinement, durability. Gets everything on the air from coast to coast—from Mexico into Canada, loudly, clearly, and distinctly. Only one dial to tune in all stations.

**You Save the Jobbers', Dealers' and Salesmen's Profits**

The PACKARD Radio is shipped direct from our factory. All the in-between profits are deducted from the price of the set and instead of paying \$250 you pay only \$99. Quantity production, economy in selling, and only a small profit for the manufacturer make this astounding offer possible.

**MAIL COUPON NOW FOR  
 30 Days' Free Trial Offer**

Don't miss this opportunity. Mail coupon at once for complete information about the PACKARD A. C.—8 TUBE ELECTRIC RADIO and our liberal 30 days' free trial offer. No obligation on your part. Our \$5,000.00 cash bond backs up our guarantee.

**MAIL COUPON NOW**  
**PACKARD RADIO CO.**  
 2323 Milwaukee Ave., Dept. 307, Chicago, Ill.



**WORLD'S GREATEST RADIO**  
**Genuine Walnut Console Cabinet**

Eight powerful A. C. tubes and one genuine full-wave rectifying tube—nine tubes in all. Supreme quality throughout. Simple to operate. Connect the plug to electric socket and turn switch. Only one dial to tune. One hundred per cent electric. Handsome walnut cabinet—two-tone genuine DUCO finish. Metal trimming finished in old gold. Marvelous built-in, powerful speaker. Size of cabinet is 54 inches high, 27 inches wide.

**Packard Radios are also  
 made for BATTERY OPERATION  
 PRICED AS LOW AS \$53**

**Packard Radio Company**

2323 Milwaukee Ave., Dept. 307, Chicago, Ill.

I am interested in Packard Radios and your \$5,000.00 Bonded 30 days' free trial offer and guarantee. Send full details.

Name.....

Address.....

City..... State.....



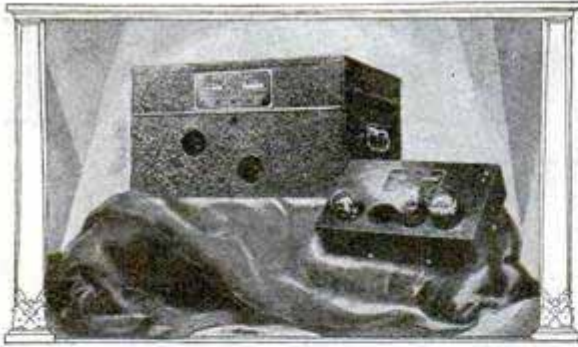

## Is Your Set a 60 Percenter?

TOO many sets are delivering only 60% of the tones broadcast by the studio. Most of the audio systems choke off or distort the very tones which give that fullness and roundness which makes the difference between ordinary and Natural Reproduction.

Link up your Tuner to Natural Reproduction with the companion units, The AmerTran Push-Pull Power Amplifier and the AmerTran ABC Hi-Power Box.

You must hear it to appreciate it. Even your imagination will not exaggerate the difference. Write for full information or ask us to arrange a demonstration at your dealer's store, no obligation of course.

**AMERICAN TRANSFORMER CO.**  
253 Emmet St., Newark, N. J.  
*Transformer Manufacturers for 28 years*

**AMERTRAN**  
TRADE MARK REG. U.S. PAT. OFF.

## BROWNING-DRAKE A. C. SHIELD GRID KIT FOR EXTREME DISTANCE

BROWNING-DRAKE has been the largest selling Kit in the world since 1924. The 1929 model, just out September 15th, is designed for A. C. Shield Grid operation, and is described by Prof. Browning as the best Browning-Drake Kit ever offered.

*Full scale constructional data free on request.*

**BROWNING-DRAKE CORPORATION**  
CAMBRIDGE, MASS.

Get Out of Doors  
this winter on  
a pair of speedy

## NORTHLAND SKIS

You can't buy finer skis. That's why most champions use them. Look for the famous deerhead trademark. Send for free booklet "How to Ski."



Northland Ski Mfg. Co.  
95 Merriam Park, St. Paul, Minn.

**"From Nothing  
to \$15,000.00  
a Year!"**



*"My success has been all that a man could desire as I have built a business up from nothing to \$15,000.00 a year. I owe my success to your Haywood Plant."*  
L. E. Berry, Barnesville, Ohio

**Let Me Put You into a  
\$15,000.00 a Year Business!**

This is not a dream. It is an actual fact. My proved, successful, workable plan has made over 16,000 men independent for life. Berry is only one example. We furnish everything. You put up only \$95.00—and you are immediately backed by a 19 year old internationally known firm. Quick action is important.

### FREE TRAINING

Over 16,000 other men have become Haywood experts through my Free course. You, too, will find this course easy to master, whether you decide to learn at home with my simple diagrams and instructions, or come up here to my factory, with expenses paid while you are here.

### WRITE FOR MY FREE BIG BOOK "HAYWOOD STEPS TO SUCCESS"

It's so easy to start. Our big book explains everything, and tells you of scores of Haywood Successes. We want good men to join us. The need for Tire Repair Stations is far greater than our present staff can handle. If you are ambitious, write me today!

J. A. Schreiber, President.

**Haywood Tire Equipment Company**  
2330-P Ogden Ave., Chicago  
Cable Address—FANBRO

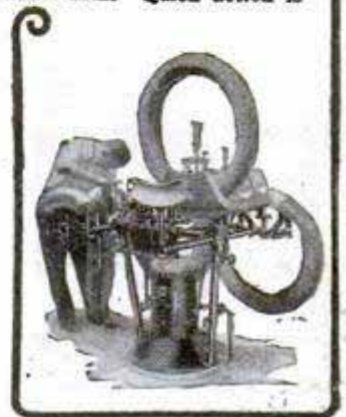

## A SHIP MODEL FOR \$4 98



3818 Baring St.

The World's Largest Builders of Ship Models will supply you with all necessary parts, cut to fit and ready to assemble and you can build a beautiful model of the historic Santa Maria, La Pinta or Mayflower for \$4.98 plus a few cents postage. No tools are needed except a small hammer. Full directions with each kit. Parts for the Constitution (Old Ironsides) may be had for \$6.98 plus postage. Send for our beautifully illustrated catalog. No obligation.

**MINIATURE SHIP MODELS, Inc.**  
Dept. P. P., PHILADELPHIA, PA.

## LIGHTING FIXTURES

*Ready to hang*



Direct from the manufacturer. Completely wired, including glassware. Send for new catalogue No. 29. Just Reduced Prices. *Special Proposition to Dealers.*

**Erie Fixture Supply Company, Inc.**  
Station A, ERIE, PA.

## Do your own Printing!



Cards, stationery, circulars, tags, labels, advertising, book, menus, etc. Save money and time, cut cost in half. Easy rules furnished with every outfit.

### Print for Others BIG PROFITS

A big opportunity to turn your spare time into cash, or develop a full time business of your own at small cost.

**Now and popular Raised Printing like**

Engraving done with any of our presses. Complete Outfits \$8.85 up; Job presses \$11.29.; Rotary \$149.

Write for catalog No. 537 of presses, type, cards, paper, supplies and full information.

**The Kelsey Co., Meriden, Conn.**



# Do Away with Handsanding



## TAKE-ABOUT Sander

Large or small surfaces easily sanded with this little machine. Handles like a plane, leaving a flat even finish, due to the smooth action of belt. Sands five times faster than by hand. Fine for refinishing furniture, woodwork, stairs, floors, etc. Works from any light socket. No experience required to operate.

**PORTER-CABLE MACHINE CO.**  
1704-10 No. Salina St.  
SYRACUSE, N. Y.

*pin this ad to your inquiry*

**THREAD CUTTING LATHE**  
A REAL Lathe. 9" swing; 30" between centers. Speedy and accurate. Special attachments and tools available.  
12" Band Saw  
Powerful, practical. Not a toy. Has tilting table. Price **\$30**. Bronze bearings. **only \$30**.  
Write today for Circular and Prices on these and other machines.  
1516 Fernwood Ave. TOLEDO, OHIO

### SALESMEN! \$100 WEEKLY SELL COX HOLDFAST SCREW DRIVERS

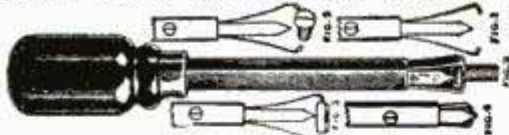

Also made to use in Yankee or Ratchet Handle. Sells on sight to

Garages, Radio Men, etc. Self Holding, Self Releasing. Sample and Proposition, 50c. S. J. COX, Dept. F, Franklin, Pa.

### Boils 50 Gallons In Less Than Hour

#### No Other Compares With This Improved Oil Burner

Use Ordinary Kerosene or Coal Oil  
**(Burns Outdoors as Well as Indoors)**  
THE most remarkable Kerosene Burner ever built. Boils down apple cider, maple syrup, molasses, etc., in half the ordinary time. Ideal burner for dairies, butchers, indispensable on the farm.  
**PRODUCES TERRIFIC HEAT WITH SILENT BLUE FLAME**

**NO NOISE  
SMELL  
SMOKE  
SOOT**



So efficient it produces twice the amount of heat of City gas at half the cost. So simple anyone can install and operate. Double generator assures continuous operation without shut-downs. Nothing to wear out, starts in a jiffy, will last a life time. Every burner guaranteed fully. Write for special introductory price and free catalog of outdoor utility and kitchen stove oil burners.  
**HOME MFG. CO., Dept. 2513, 18 E. Kinzie St., CHICAGO**

## Suppose You Were Offered Diamonds at 60% of Market Price



Suppose a reason you rarely think of makes possible here radically low prices, even for finest quality diamonds. Thousands of representative people, bankers, lawyers, merchants, others—continually reap this real advantage. Everything sent for Free Examination. This 3/4 century, oldest, largest diamond banking institution in the world, rated over \$1,000,000.00,—converts into cash the diamonds on which money was loaned and not repaid. Loan values, a fraction of market values, are the price basis. Diamonds too from big cash deals direct with European cutters. Must sell now

### Why Pay Full Prices

When Much Less Buys the Same  
See this 3/4 less 1/16 ct., snappy solitaire for \$69.50. Try to match at \$115.00. Examine free any bargain at our risk. Startling, legitimate offers here of diamonds at 60% of market price. Send now for full details. Diamonds of unusual qualities (also watches) from unpaid loans, offered at radically low prices based on mere loan values. Then, too, we have hundreds of diamonds from big, cash, European deals with diamond cutters, who sacrificed these gems away under the market. Send now for our latest offers of this internationally known cash headquarters.

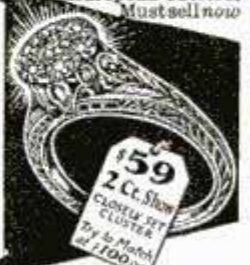

### Unpaid Loan Listings Ready

### As low as \$60 a Carat

Radically different from a catalog. List accurately describes every diamond in full detail with guaranteed exact weight, color, quality, etc. Explains Guaranteed Cash—like Insurance Policy Loan guarantee. Also Unlimited Exchange privilege at price paid us. Gives full details of free examination offers. Don't wait, the very diamond you want may be in this very list at a price that will amaze you. Costs nothing to see. Write today. A postal envelope, or—**Mail Coupon NOW!**



Command Recognition  
a DIAMOND Does It!

**JOS. DE ROY & SONS**  
Only Opposite Postoffice  
1974 De Roy Bldg., Pittsburgh, Pa.

Without obligation to buy, send me free, in plain envelope, your Latest Bargain List of Diamonds, Watches, and other Jewels.

Name \_\_\_\_\_  
Address \_\_\_\_\_  
City \_\_\_\_\_ State \_\_\_\_\_  
References by Permission:—Bank of Pittsburgh, N. A. S. Marine National Bank; Union Trust Co., Pittsburgh, Pa. Your bank can look us up in the mercantile agencies.

## NEW VEST POCKET ADDING MACHINE

**ADDS, SUBTRACTS, MULTIPLIES, DIVIDES**  
Does work of \$300 machine. Guaranteed 5 years. NOT A TOY.  
Made of steel and indestructible. Million dollar capacity. Fits in pocket. Will not make mistakes. So simple child can operate it. Instructions furnished. Everybody should carry one for figuring.

**FREE \$2.50 TRIAL** Total Cost

SEND NO MONEY—Just name and address. We will ship Calculator immediately. On delivery, pay postman \$2.50 (Plus few cents Postage). (If outside U. S. send each) 10c additional in Leatherette Case. If not satisfied after 10 days trial you get your money back. THOUSANDS OF SATISFIED USERS.

Guaranteed This is lowest priced practical calculator made. "Why pay more for inferior imitation?" Order from this ad.

Mail Coupon Today

**BABY CALCULATOR SALES CO., (MANUFACTURERS)**  
Dept. 41, P. O. Box 1118, CHICAGO, ILL., U. S. A.  
 I am enclosing \$2.50—send adding machine prepaid.  
 Send Adding Machine C. O. D. \$2.50 plus postage. (10c additional in Leatherette Case)

Name \_\_\_\_\_  
Address \_\_\_\_\_  
City \_\_\_\_\_ State \_\_\_\_\_

**AGENTS** Write for big commission and territory proposition.



**WITTE FARM and RANCH ENGINES**  
at New Low Prices - Cash or Easy Terms

ONLY  
**\$5<sup>00</sup>**

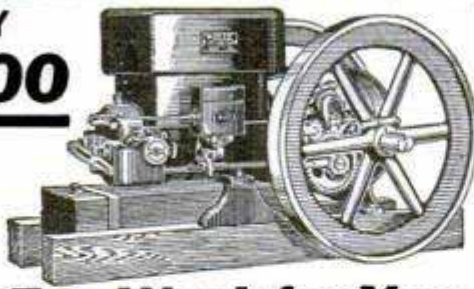

**Puts This WITTE to Work for You**

**BURNS CHEAP FUELS**

**WITTE Type "F" on Wood Skids, 2 to 6 H. P.**—Runs milking machines, feed grinders, cream separators, washing machines, pumps water for home and stock, irrigating, etc. Smooth even flow of power—no jerks—no vibration. Easily and quickly taken wherever power is needed. **Lifetime Guarantee for your protection.**

**Cash or Your Own Terms**

**FREE! Catalog!**

**NO INTEREST To Pay.** Yes, I will give you a full year to pay for your WITTE Engine or Outfit. I want it to pay its own way while you pay me. It's so much cheaper to have your work done with a WITTE than it is to hire help.

describing WITTE Throttling Governor Types "F" and "H" and Heavy Duty Engines, 2-30 H. P. and all improvements, also labor saving power outfits — log and buzz saws, pumper cut-fits, etc. — all at direct factory-to-you new low cash or easy term prices. Send today for your copy.

**ED. H. WITTE, President**  
**WITTE ENGINE WORKS**

1748 Oakland Ave.,  
1748 Liberty Street.

Engine Builders Since 1870  
**KANSAS CITY, MO.**  
**PITTSBURGH, PA.**

**NEW! "Wienie Mint" Red Hot Cooker!**



**\$5000<sup>00</sup> to \$15000<sup>00</sup> a year profits**

**Amazing New Invention!**

Men! Women! Here's your chance to go in business for yourself! Investment SMALL! Profits ENORMOUS! \$50.00 a week spare time—\$5,000.00 to \$15,000.00 a year full time! The NEW "Wienie MINT" cooks Red Hots by amazing NEW method—and OH! What a new and deliciously different flavor. Light. Portable. Write Quick!

**Adams, Inc., Dept. 13-58 500-510 N. Dearborn St., Chicago**

**SPRAYIT ELECTRICALLY**  
**New Superior Model**



Rotary compressor type. For fine professional work such as one-coat enamel on fixtures, or in automobile and cabinet work where job is rubbed between coats. Price, \$39.50. Write for complete details on this and other models.

**THE ELECTRIC SPRAYIT CO.**  
211 E. Colfax South Bend, Ind.

**JUST OUT Spors No. 9 Combination Pen and Pencil**

**AGENT'S SAMPLE 66c** Sells for \$1.35. Make 8 different colors. \$15 daily easily.

Guaranteed 2 years. Money back if not pleased.

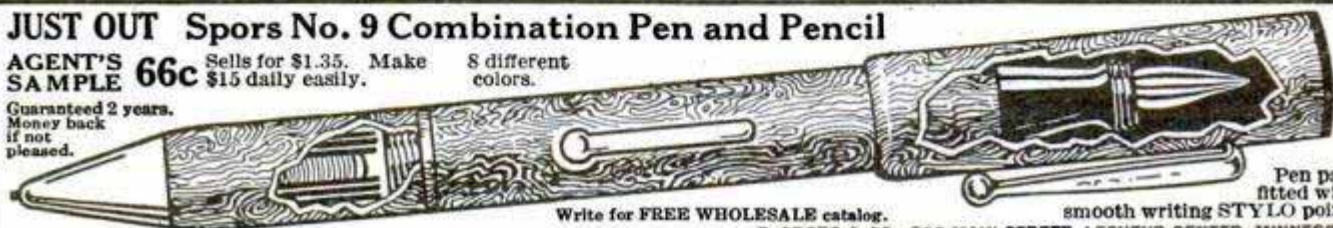

Write for **FREE WHOLESALE** catalog.

Pen part fitted with smooth writing **STYLO** point.  
**F. SPORS & CO., 926 MAIN STREET, LESUEUR CENTER, MINNESOTA**

**Is Your Car..... A Gas Eater**

**New Invention Increases Mileage on Auto Gas Eater from 13 1/2 to 34.6 Miles on a Gallon**



An astonishing new device has been perfected that is amazing car owners everywhere. Goerzen reports increase from 13 1/2 to 34.6 miles on his Dodge. Thousands have been installed and users report 30-40 and more miles on a gallon of gas. In addition power is increased, instant starting and flashy pick-up is noticed and carbon formation disappears. Every car owner in the country needs this new invention. Its cost is so trivial it pays for itself in a few days' time, yet it will save hundreds of dollars for its owners in gasoline.

**\$100 a Week Territory Open**

\$5.00 an hour for spare time. Men are needed in every locality to take care of the tremendous local demand. Sales ability is not required. Every car owner will buy on sight. **Ideal for spare time workers.**

**FREE** To help our workers we furnish them with this marvelous Whirlwind gas saver free for their own cars. Quick action is necessary. Be the one in your locality to cash in on this device which every auto owner will buy. Send today for full particulars and free sample offer.

**Whirlwind Mfg. Co. 999 352-E Third Street MILWAUKEE, WISC.**



Best in the world. 10-year guarantee, lowest prices. **FREE** instruction, ask for **FREE** catalog. RUATTA, SERENELLI & CO., 1014 Blue Island Ave. Dept M Chicago, Ill.

**6 Shot 22 Cal. BLANK Automatic**



A real home protector. Shoots six loud—powerful shots—like expensive automatic in appearance. Construction, finish, durability—use for fun or self defence. Frightens thieves, tramps, dogs—fool your friends. Guaranteed absolutely safe. Automatically loads magazine and ejects cartridges. Send no money. Pay on arrival \$4.99. 100 cartridges given Free. Federal Mail Order Corp., 561 Broadway, N. Y. C., Dept. B119

**NO PERMIT or LICENSE REQUIRED**



**MODEL SHIPS**

Build a beautiful scale model of Flying Cloud, Constitution, Half Moon, Mayflower, Spanish Galleon and other types. Photographically illustrated booklet with prices for construction sets, hulls, blocks, deadeyes, guns, anchors, special tools, blue prints, etc. Sent postpaid upon receipt of 10 cents.

**Model Ship Supply Co., Dept. C, Mineola, N. Y.**

**BASHFUL?**

"Shame on you!" Are you nervous, embarrassed in company of the other sex? Stop being shy of strangers. Conquer the terrible fear of your superiors. Be cheerful and confident of your future! Your faults easily overcome so you can enjoy life to the fullest. Send 25c for this amazing book, **RICHARD BLACKSTONE, B-4711 FLATIRON BLDG., NEW YORK**



## WOODWORKERS ATTENTION!

This bandsaw-lathe combination fits in exactly with what you are doing. Bandsaw can be used to rip and cross cut. 3-speed lathe insures first class turning.

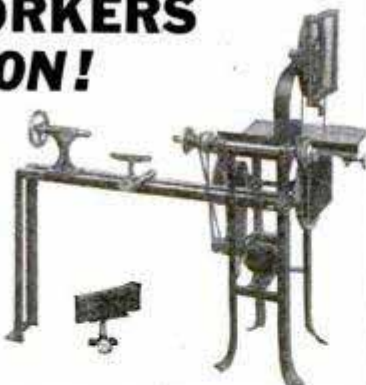

WRITE

**KORNAU MACHINE COMPANY**  
Station A CINCINNATI, OHIO

## \$25 To \$50 Make \$25 to \$50 per day and be Your Own Boss! Per Day Drilling Wells!

Cash in on demand for good wells in every community! Any man with mechanical turn of mind can easily operate one of our drills, make big money, be independent, work the year 'round! A few hundred dollars starts you in this big paying business—pay balance out of earnings! Write for FREE CATALOG describing ARMSTRONG ALL STEEL WELL DRILLS—gasoline traction or non-traction models. Write now—today—Armstrong Mfg. Co., 810 Chestnut St., Waterloo, Iowa.



**"Interlox" MASTER SLIDE RULE** Speeds up all measuring. Slides in and out—no folding. Direct-reading for instant inside measurements, as well as outside. Any length, 2 to 8 ft., 20c lineal ft. If not at dealers, sent postpaid.



**MASTER RULE MFG. CO., 813 E. 136th Street, NEW YORK**  
Dealers and Agents: Write for attractive proposition.

## \$1500 WITHOUT MOTOR SCHROETERS No. 15 Motor Driven SCROLL SAW for Home or Small Shop

The saw is mounted on a neat wood base and has a 7 1/2-inch nickel plated tilting table which is essential for inlay work. The work which can be accomplished is marvelous. Has a range of work from the finest inlay up to 7/8-inch white pine. A practical machine for sawing Radio panels such as bakelite, sheet brass, hard rubber, bone, fibre, etc. Has 10-inch swing. Weight only 21 pounds without motor. We supply a catalog of 250 miniature scroll saw designs with each machine.

Add \$5.00 when boring attachment is wanted

For More Information Write for Our Scroll Saw and Tool Catalog  
**SCHROETER BROS. HARDWARE CO.**  
810 Washington Ave., ST. LOUIS, MO.

## Add \$3000 to your income

In spare time making collections and checking up on sales of "NEVERUN" which prevents runs and triples the wear of silk hose. No canvassing. Write immediately for full information.  
**QUINCY CO., Quincy Bldg., Dept. 855, CHICAGO**



## AIRPLANE

12 inch scale model of Lindbergh's Spirit of St. Louis. Scientifically designed and very realistic. Rises from ground by own power and flies 30 ft. or more. Stays in air 8 to 10 seconds.

Easily built in 2 or 3 hours. No tools needed. Construction set, with all parts and full directions, postpaid in U.S., only 50c. (no stamps). Satisfaction or money back. Send today. **Mann & Benton, Box D, Chillicothe, O.**



## Because—

You buy a hammer or any other tool for a lifetime of use, be sure and get the type of tool that will live up to your expectations—that will stand up under all kinds of usage. In other words, look for the Pexto trademark when you buy.

A few of the popular items in the Pexto line are Braces, Bits, Chisels, Hatchets, Pliers, Pruning Shears, Screw Drivers, Snips, Squares, Wrenches and Hammers.

Write us for a booklet

**THE PECK, STOW & WILCOX CO.**  
Southington, Connecticut



# ATKINS SILVER STEEL SAWS

for Your HOME Workshop



A well equipped home workshop like this is a source of great pleasure and profit. Have you a workshop, or set of good tools in YOUR home?

## GOOD Saws for Men Who Make Things

YOU'LL get far more fun and satisfaction in making things in your home workshop, if you use ATKINS Saws. They help you to do any job of cutting wood or metal faster, easier and better; save you time, effort and material!

To see "ATKINS" on a saw is to know that it is the best you can buy. For, only ATKINS Saws have "Silver Steel" to hold a sharp cutting edge longer. Only an ATKINS is "Segment Ground" to make your saw cut easily without binding. And only ATKINS Saws are fitted with "Perfection Handles" to eliminate all wrist strain.

### ATKINS "Workshop" Assortment

Here is a list of ATKINS Saws and Tools needed in every home workshop. Ask your hardware dealer about them.

ATKINS No. 53 Hand Saw . . . No. 53 or No. 51 Rip Saw . . . Coping Saw . . . Compass Saw . . . No. 2 Back Saw . . . Nest of Saws . . . Hack Saw Frame and "Silver Steel" Hack Saw Blades . . . Handy Saw . . . Scraper Blades . . . Slim Taper Files . . . Mill B. Files . . . Saw Set.



## Saw Books FREE.

Write today for our FREE books, "Saw Sense," "Saws in the Home," and "Saws in the Shop." Valuable to every saw user.

E. C. ATKINS & COMPANY, Est. 1857  
426 S. Illinois Street, Indianapolis, Ind.

Leading Manufacturers of Highest Grade Saws for Every Use; Saw Tools, Saw Specialties, Plastering Trowels, Machine Knives, Grinding Wheels and Files

# PARKS

WOODWORKING MACHINES

Cabinet Shop Special No. 10

\$290

With Motor

You ought to have this handy Parks in your shop. Compact, complete machine designed like a big production outfit at 1/4 the cost. Fits in a corner of your basement. Does any kind of cabinet and joinery work. Write for circular.



The Parks Woodworking Machine Co.

1500-40 Knowlton St.

Cincinnati, Ohio

Canadian Factory: 208 Notre Dame East, Montreal

## MEN WANTED



to become floor surfacing contractors—Pay averages \$30.00 per day—no lay offs—your own boss—work the year round—demand ever increasing—New "American" machines do the finest work and are easiest to handle. Complete information sent free without obligation. Write today.

AMERICAN FLOOR SURFACING MACHINE COMPANY

523 S. St. Clair Street

Toledo, Ohio



High Quality. Long Life. Right Prices.

These are found in all Gerstner TOOL CASES AND CHESTS for Machinists and Toolmakers. A postal brings free catalog

*Gerstner & Sons*

459 Columbia St., DAYTON, OHIO



### Start a Welding & Battery Shop

- Lead Burning Outfits..... \$18.00 up
- Welding Outfits..... 25.00 up
- Soldering Outfits..... 8.00
- Lead Burning Torches..... 6.00
- Welding Torches..... 10.50 up
- Cutting Torches..... 30.00 up
- Regulators and Gauges.... 9.50 up
- Paint Sprayers..... 14.00

Welding Supplies

Superior Oxy-Acetylene Machine Co.  
P. O. Box 285 Hamilton, Ohio

### ONE HANDLE TAKES THE PLACE OF MANY

WITH THIS NEW FLEXIBLE HANDLE SOCKET SET

1/4" square connection. Six sockets 7-16", 1/2", 9-16", 5-8", 11-16", 1/2" hex openings. Chrome Vanadium steel. Sturdy. Guaranteed. Money back if 10 days' trial doesn't satisfy. \$3.65, prepaid, cash with order; \$3.90, C. O. D. Handle only \$1.75 cash, \$1.90 C. O. D. A-to-z. Wm. Tool Service Sales Co., Box 4905, Sellwood Sta., Portland, Oregon



Illustration clearly shows flexibility of handle.



### The International Motor Saw

does every sawing job from straight cutting to intricate scroll and design work; crosscuts, rips, miters, bevels, inside and outside jig sawing and scroll cutting. One saw instead of several. Write for full description. Dept. S, The International Stamping Co., 400 N. Leavitt St., Chicago, Ill.



# SIMONDS

**SAWS FILES KNIVES STEEL  
CROSS-CUT SAWS  
THAT LESSEN LABOR**



**N**O cross-cut saw, so far developed, cuts faster or holds its sharpness longer than a Simonds. Simonds Crescent-Ground Cross-Cut Saws built their reputation for excellence on the foundation of the highest grade of specially treated steel followed by the finest craftsmanship. The result is a saw that does its work faster, easier and more economically than other saws that often cost more.

Specify  
Simonds for  
Economy!

**SIMONDS SAW AND STEEL COMPANY**  
"The Saw Makers" Fitchburg, Mass. Established 1872  
BRANCH OFFICES AND SERVICE SHOPS IN PRINCIPAL CITIES

**BURN YOUR NAME ON TOOLS**

**WITH THE  
ARKOGRAF**

**PROTECT YOUR TOOLS FROM THEFT**  
Write with electricity any name or design on the hardest and finest tools and instruments, or any metal, like writing on paper with pen or pencil.  
**Complete Outfit \$3.50**—Prepaid Anywhere interesting illustrated circular free. Write today. Agents wanted.  
ARKOGRAF PEN CO., 1171 E. Stark St., Portland, Oregon

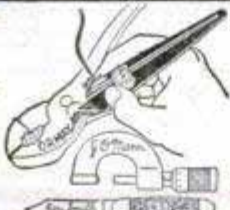

**Makes Old Ford a Tractor**

Now you can convert that old Ford car into a useful farm tractor without altering any Ford parts. We furnish the traction wheels, drive gears and auxiliary axle and mountings, ready to clamp on to the Ford frame. Pulls 16" plow.

We supply a Belt Pulley also



Write for Free Particulars.  
Shaw Mfg. Co., Dept. 4511, Galesburg, Kan.

**For the Handy Man!**

**TORIT TORCH No. 23**  
Uses acetylene only from a Presto auto tank. Finest thing you ever saw for Radiator and Battery Repairing, Soldering, Light Brazing, Heating, etc. Complete with 4 tips, soldering copper, hose, connections.



**PRICE  
\$7.50**

(Except tank)

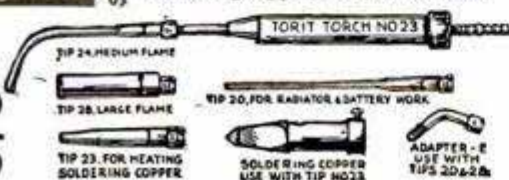

**ST. PAUL WELDING & MFG. CO., 177 W. 3rd, St. Paul, Minn., U.S.A.**

**CORNWELL**  
*forged*  
**Socket  
Wrenches**

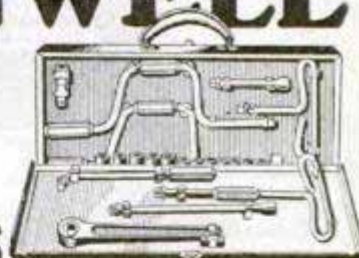

**T**HE only wrenches of their kind now being made and sold. They are forged from our special formula Chrome Molybdenum Alloy, individually hardened and heat treated. Walls are very thin, permitting use in very close places. They are of amazing strength and durability. Sold in convenient kits or separately as required.

**There Is No Substitute  
for Cornwell Quality**

The long record of CORNWELL tools for strength and durability, for utility and practicability, and for amazing performance under the severest difficulties has convinced tool users of their absolute quality. No other tools are like them. A trial order will convince you.



*This Catalog Sent-FREE*

The Cornwell Quality Tools Co.,  
Dept. D, Mogadore, Ohio.  
(Formerly at Cuyahoga Falls, Ohio)

Send me new illustrated catalog with prices on full line of CORNWELL Handmade Tools.

..... Where Employed  
Name.....  
Address.....  
City..... State.....



# DEVITT 8" COMBINATION SAW

8,000 IN USE!

**A SHOPFUL OF TOOLS WITHIN ARMS REACH!**

SAW TABLE RAISED SHOWING EMERY WHEEL, SAW GUARD AND DRILL ATTACHMENT

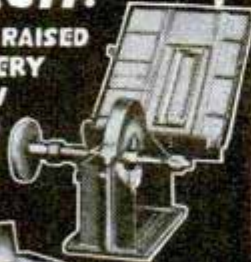

SHOWING SANDING DISC ATTACHED



TABLE TILTED FOR BEVELING



DADO HEAD ATTACHED FOR GROOVING

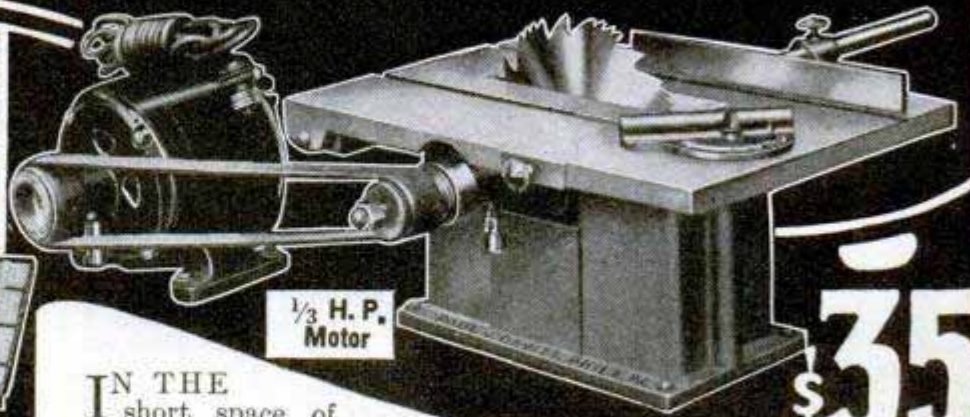

1/3 H.P. Motor

**\$35**

F.O.B. PHILA

**I**N THE short space of four years, the Devitt 8-Inch Combination Saw has become a practical necessity in thousands of shops, factories and households everywhere. Many imitators have sprung up, but Devitt leads them all. Think of the convenience and economy of this handy little machine that will rip, cross cut, bevel, miter, groove, mortise, tenon, drill, rabbet, grind, buff and polish. Attachments are easily and quickly adjusted. The saw and motor, when set up for work, occupy very little room. Saw is equipped with 1/3 H.P. 60 cycle, 1750 R. P. M. 110-volt A. C. Motor which can be attached to ordinary light socket, and provide power for other purposes when wanted. A cut up to 2 1/4" can be made without planing. Comes complete with following attachments—12"x16" table, 8" Combination Saw, iron pulley for saw table, 10" ripping fence, adjustable cut off miter gauge, motor-specifications as above, 1 1/4" endless leather belt, wood pulley, 8 ft. cord and plug, 6" buffing wheel, 3/8" 3 jaw drill chuck, 5" emery wheel, 6" sander, saw guard, and 2" dado insert. \$35.00 F. O. B. Phila. Height 7 1/2", shipping weight, 100 lbs.

(Only \$12 extra for Planer Attachment to fit on table top. Can smooth pieces up to 2 inches wide. Price, F. O. B. Phila.)

Send today for our attractively illustrated 4-page circular

## PAUL J. DEVITT

Dept. M 1102 SOUTH 2ND ST. PHILA., PA.



### HOLLAND PRINTS

Wonderful new way of binding kodak pictures. Keep a photographic record. Sample Holland print from your negative for 10c.

FRANK SCOBIE, 43-H, SLEEPY EYE, MINN.



### WRIST WATCH GIVEN

Sell my Grape Gum, Gumlets, Candy Mints, etc., at 6c pack. Everybody will buy from you. I give wrist watch and other dandy presents FREE and besides you make money every day. Write today for agent's package. Chas. David, Sta. V, Cincinnati, O., Dept. 388

*the*  
**Drill**  
*of many*  
**Uses**

## C-O Utility Drill



The Makers of the famous C-O Garage Tools and Equipment, known the world over, offer you a Utility-Drill complete, ready for the job, for ONLY \$34.00.

Not an attachment nor a makeshift, but a real drilling machine designed by master engineers. Here's real drill value — just read these specifications: Vertical type motor, 110 volt, 60

cycle, single phase, AC, with cord and switch; belt drive; 3-jaw chuck; 11x6" bench space; 23" high; weight 62 pounds.

Bores holes up to 3/8"; works in 9" circle; 2 1/2" up and down spindle run; 7 1/2" range on column; 1100 to 2200 spindle speed.

Ideal for garages, repair and service plants, factories, all mechanics and farm and home craftsmen.

Also furnished in other voltages and cycles. Prices on request. Order today or if you need more information write for circular

FULLY GUARANTEED

CANEDY-OTTO MFG. CO.

Dept. PM.

Chicago Heights, Ill.

**ONLY**  
**\$34.00**  
**COMPLETE WITH MOTOR**



# New!

**WONDERFUL RADIO!**  
**Super-Eight—100% Electric**  
**8 TUBES — SINGLE DIAL**

*Coast-to-Coast*

Shipped Direct from our Factory on

**30 Days Free Trial**

**{Battery or Electric}**

Metro's latest achievement—the world's greatest electric radio set. Powerful long distance 8 tube receiver—clearness of tone that is astounding—ultra-selective. Radio engineers pronounced it the ultimate for all-around perfection. To prove our claims, we will send this marvelous set to you direct from our factory on **30 days' free trial**. Compare its quality, beauty and price with any other radio on the market, and decide to keep it only after you are satisfied that the new 1929 Metrodyne Super-Eight is the peer of them all.

# Metrodyne

**SUPER-EIGHT ELECTRIC**

**Save 1/2—Low Price a Big Feature**

Amazingly low price! Console or table cabinet. Low cost of distribution direct from our factory enables us to save you about half regular value. Never before have you been offered such sets at such low prices. We are so sure of their quality, beauty and performance pleasing you that we will let you **try one for 30 days** before deciding to keep or return it.

**SUPER QUALITY THROUGHOUT**

Eight powerful tubes. Highest quality low loss parts. Illuminated single dial. Positive switch control—simply turn a knob and it's on. Select your stations with accuracy at any desired volume. Beauty of tone unsurpassed. Console and table cabinets are handsomely grained genuine walnut, hand rubbed, in two-tone effect—artistically carved trimmings. All metal parts finished in two-tone gold. Seeing is believing. **YOU WILL BE THE JUDGE.**

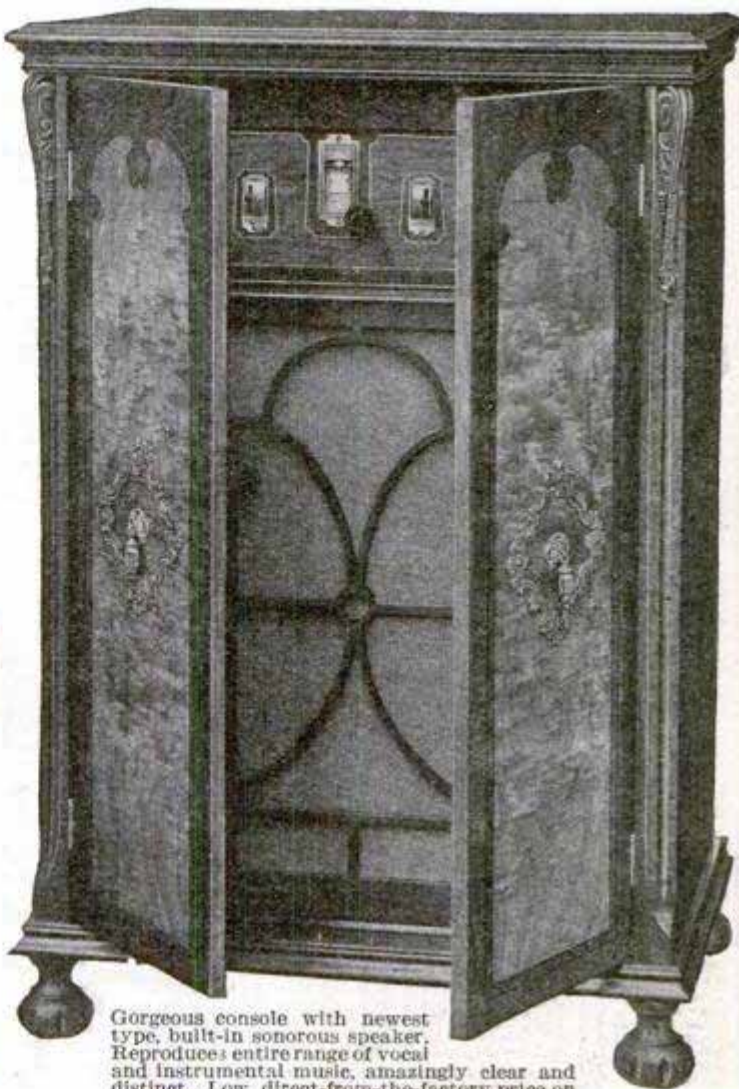

Gorgeous console with newest type, built-in sonorous speaker. Reproduces entire range of vocal and instrumental music, amazingly clear and distinct. Low, direct-from-the-factory price on **30 DAYS' FREE TRIAL.**

**METRODYNE  
 RADIO SETS**

*Are Equipped For*

**BATTERY or  
 ELECTRIC  
 OPERATION**

**Agents and Dealers**

The 1929 Super-Eight line offers great money making opportunities. Nothing like them for high quality—nothing near them in price. Let us prove this by shipping you a **DEMONSTRATION SET** on

**30 Days' Free Trial**

Test it—compare it—demonstrate it to prospective radio buyers. Get our liberal discounts—exclusive territory—newspaper and billboard advertising offer that will help sell Metrodyne radios quickly.



Send Coupon Today for Our **30 Days' Free Trial Offer** →

We are one of the pioneers of radio. The success of Metrodyne sets is due to our liberal **30 days' free trial offer**, which gives you the opportunity of trying before buying. Thousands of Metrodynes have been bought on our liberal free trial basis. We will send you hundreds of letters from owners who acclaim the Metrodyne as the greatest radio set in the world. A postal letter or the coupon brings complete information, testimonials, wholesale prices and our liberal **30 days' free trial offer**—**WRITE TODAY!**

**METRO ELECTRIC COMPANY**  
 2161-71 N. California Avenue, Dept. 22  
 Chicago, Illinois

Gentlemen:

Send me full particulars about Metrodyne Super-Eight sets and your **30 days' free trial offer.**

Name.....

Address.....

If you are interested in *AGENT'S* proposition, place an "X" in the square

**Metro Electric Company**

2161-71 North California Avenue  
 Dept. 22 CHICAGO, ILLINOIS



# LUMINOUS PAINT

**Make Your Watches, Clocks, Etc., Visible by Night**

The very latest discovery in the scientific world—hitherto practically unobtainable except at an exorbitant price, we have at last succeeded in producing this remarkable LUMINOUS PAINT, which, applied to the surface of any article, emits rays of white light, rendering it perfectly visible in the dark. **THE DARKER THE NIGHT, THE MORE BRILLIANT IT SHINES.** Quite simple to use. Anyone—you can do it. A little applied to the dial of your watch or clock will enable you to tell the time by night. You can coat the push buttons or switch plates of your electric lights, match boxes, and innumerable other articles; make your own Luminous Crazettes, Luminous Rosettes, etc. Small bottle, price 25c. Larger size, 50c and \$1 postpaid. **JOHNSON SMITH & CO., Dept. 829 RACINE, WIS.**



## CIGARETTE MAKER

Roll your own and save money. Better and quicker; saves more than half. Use your favorite brand of tobacco. Neat, useful, handy. Pocket size, weighs 15 oz. Made entirely of metal, nickel plated. 25c, 3 for 65c postpaid anywhere.



## GOOD LUCK RING

Very striking, quaint and uncommon. Silver finish; skull and crossbones design, two brilliant, flashing gems sparkle out of the eyes. Said to bring good luck. Only 25c p.p.d.



## Exploding Cigarettes

JUST LIKE ORDINARY CIGARETTES. BUT SUCH REAL STARTLERS! The box contains ten genuine cigarettes of excellent quality. They appear so real, that when each cigarette is about one-third smoked, the victim gets a very great surprise as it goes off with a loud BANG! A great mirth provoker yet entirely harmless. Price 25c box.

## NOVELTY BADGES



Kissing Permit 10c. Garter Inspector 10c. Two very novel metal badges, nickel plated, that you can wear, giving you fun out of all proportion to their trifling cost. 10c, each badge, 3 for 25c, or 75c per doz. postpaid anywhere.

## MIDGET BIBLE

**GREAT CURIOSITY** Smallest Bible in the World. Size of a postage stamp. 200 Pages. Said to bring good luck to the owner. A genuine work of art. Must be seen to be appreciated. Make good money selling them to friends, church acquaintances, etc. PRICE 15c each, 3 for 40c, 12 for \$1.35, 100 for \$7.50. Also obtainable in Leather Binding, with gold edges. Price 50c each, 3 for \$1.25, \$4.50 per doz. Magnifying Glass for use with Midget Bible, 15c.



## STAGE MONEY

With a bunch of these bills, it is easy for each person of limited means to appear prosperous by flashing a roll of these bills at the proper time and peeling off a genuine bill or two from the outside of the roll, the effect created will be found to be all that can be desired. Prices, postpaid: 40 Bills 20c, 120 for 50c, or \$3.50 thousand postpaid.

## MAGIC NOSE FLUTE

The Magic Nose Flute, or Humantone, is a unique and novel musical instrument that is played with nose and mouth combined. There is just a little knack in playing it which, when once acquired after a little practice, will enable you to produce very sweet music that somewhat resembles a flute. There is no fingering, and once you have mastered it you can play all kinds of music with facility and ease. When played as an accompaniment to a piano or any other musical instrument, the effect is as charming as it is surprising.

Post Paid 10c

## SURPRISE MATCHES

More fun than fighting with your wife. Look just like ordinary matches. Put up in boxes just like regular Safety Matches. As the victim tries to light one he gets quite a surprise. Price 10c per box, 3 boxes for 25c, 12 for 75 cents.

These clever locks cannot be opened unless you know the combination. No key necessary. For your locker, bicycle, tool chest, mail box, thousands of uses. Shackle and tumbler nickel plated. Weighs a trifle over one ounce. Small yet strong. Secret and full instructions with each lock. Price 25c or 3 for 65c postpaid.



## Keyless Lock

## Wonderful X-Ray Tube

A wonderful little instrument producing optical illusions both surprising and startling. With it you can see what is apparently the bones of your fingers, the lead in a lead pencil, the interior opening in a pipe stem, and many other similar illusions. A mystery that no one has been able to satisfactorily explain. Price 10c, 3 for 25c, 1 dozen 75c. Johnson Smith & Co.

## Every Boy His Own Toy Maker

A great book for boys. It gives plain, practical instructions for making all manner of toys, machines and other articles, amusing and useful. Tells how to make a Steam Engine, a Photographic Camera, a Windmill, Microscope, Electrical Machine, Galvanic Battery, Electric Telegraph, Electrotyping Apparatus, Telephone, Kaleidoscope, Magic Lantern, Aeolian Harp; how to make Boats of all kinds, Kites, Balloons, Paper Toys, Masks, Card Banks, Wagons, Cars, Toy Houses, Bows and Arrows, Pop Guns, Slings, Fishing Tackle, Rabbit and Bird Traps, etc. 200 Illustrations. PRICE 25c Postpaid. Postage Stamps accepted.

## Serpent's Eggs

Box contains 12 eggs. When lit with a match, each one gradually hatches itself into a snake several feet long, which curls and twists about in a most life-like manner. Price per box, 10c postpaid, 3 for 25c.

## BLANK CARTRIDGE PISTOL

Protection against Burglars, Tramps, & Dogs. Special Offer 1 Blank Cartridge Pistol 100 Blank Cartridges 1 650-page Novelty Catalog **ONLY \$1.50** The Lot Shipped by Express Only Cash With Order Only

Well made and effective, modelled on latest type of Revolver; appearance alone is enough to scare a burglar. When loaded it may be as effective as a real revolver without danger to life. It takes standard .22 Cal. Blank Cartridge—obtainable everywhere. Special cash with order offer: 1 Superior quality Blank Cartridge Pistol, 100 Blank Cartridges, and our new 650 page De Luxe Catalog of latest novelties; all for **ONLY \$1.50**. Shipped by Express only. Cannot go by parcel post. Extra Blank Cartridges 50c per 100. Special Holster (Cowboy Type) for pistol 50c. No C. O. D. shipments.

## THROW YOUR VOICE

Into a trunk, under the bed or anywhere. Lots of fun fooling the teacher, policeman or friends.

## THE VENTRILO

a little instrument, fits in the mouth out of sight, used with above for Bird Calls, etc. Anyone can use it. Never Fails. A 16 page course on ventriloquism, the Ventrilo, **ALL FOR 10 CENTS**

**PISTOL, OPERA AND FIELD GLASS** In One

It is made in the shape of and looks like a regular Automatic Pistol. No one is likely to stop and ask you whether it is real or not. Thus it is likely to prove itself very handy in an emergency. On pressing the trigger it opens up as shown in the illustration at the right, revealing nine most useful articles—Opera and Field Glass, Telescope, Mirror, Magnifying Glass and Burning Lens, Reading Glass, Sun Dial, Sun Compass, etc. In the handle of the revolver there is a place for various pocket necessities, such as First Aid Articles, Buttons, Pins, etc. The Pistol is of sheet metal, blond finish, that can be carried comfortably in pocket. **PRICE \$1.00 postpaid.**

**Watch Charm \$1.75** Exact reproduction of a real pistol; actually first REAL BLANK CARTRIDGE of miniature size. Illustration is actual size. 1 1/4 inches long, with ring at end for attaching to watch chain.

**Pistol** Loads like a regular pistol. Pull the trigger and it goes off with a loud bang. Pistol is break open type; illustration shows position for loading. Made entirely of high grade steel, nickel plated, octagon barrel, handomely engraved handles, complete in box with cleaning rod. **PRICE \$1.75.** Also furnished with pearl handles, \$2.50. **BLANK CARTRIDGES, 50c per box of 25.** **JOHNSON SMITH & CO., Dept. 829, RACINE, WIS.**

## MICROPHONE TRANSMITTER BUTTON

You can easily make a highly sensitive telephone by using this Transmitter Button to collect the sound waves. You can build your own outfit without buying expensive equipment. It is simple and inexpensive. You can install an outfit in your home and hear conversations being held all over the house. You can connect up different rooms of a hotel. This outfit was used by secret service operatives during the war. It is being used on the stage. It is ultra-sensitive and in the greatest invention in micro-phones. You can mount the button almost anywhere—card board boxes, stove pipes, stiff calendars, on the wall behind a picture frame, etc. Button is so light and small it cannot be detected. Persons can be overheard without suspecting it. You can listen in on conversations in another room. A deaf person in the audience can hear the speaker. Connected to phonograph, piano or other musical instrument, music can be heard hundreds of feet away. Button may be used to renew telephone transmitters; often makes an old line "talk up" when nothing else will. The ideal microphone for radio use; carries heavy current and is extremely sensitive. Amplifies radio signals. Countless other similar uses will suggest themselves. Experimenters find the button useful for hundreds of experiments along the lines of telephones, amplifiers, loud speakers, etc. Many fascinating stunts may be devised, such as holding the button against the throat or chest to reproduce speech without sound waves. **PRICE \$1.00.** **JOHNSON SMITH & CO., DEPT. 829, RACINE, WIS.**



# JOHNSON SMITH & CO.

Dept. 829 RACINE, WIS.

A De Luxe Edition of our new 1929 CATALOG mailed on receipt of 25c. Handsome binding. Bigger and better than ever. Only book of its kind in existence. Nearly 600 pages of all the latest tricks in magic, the newest novelties, puzzles, games, sporting goods, rubber stamps, unusual and interesting books, curiosities in seeds and plants, etc., unobtainable elsewhere. Remit by Stamps, Coin, Money Order, Check, etc. Unused U. S., Canadian and Foreign Stamps also accepted.



**REMARKABLE VALUE IN WRIST WATCHES**



**CUSHION SHAPE**  
Unbeatable value in a man's Sport Model Wrist Watch. Case is nickel-plated, cushion shape, with silver metal dial, with radium figures and hands. Lever escapement movement. Fine quality leather strap with nickel buckle. A first-class timekeeper. An undoubted bargain at the price. Fully guaranteed.

**OCTAGON SHAPE**  
The always popular octagon shape, size 10 1/2 Ligne, silver nickel case, Butler finish back. Fitted with a reliable 6 jewel lever movement. Fancy silvered dial with luminous figures and hands. Shows time clearly in the dark. Selected leather or finely stitched strap, buckle to match. For men or boys, a gift that cannot fail to be appreciated.

**SQUARE SHAPE**  
One of the latest and most popular shapes, size 10 1/4 Ligne, with **CURVED BACK**, shape of wrist. Case is genuine 14K Rolled Gold (choice of white or green gold), and can be had in 6 or 15 Jewels. The square dial is silvered and has luminous figures and hands showing time in dark. Best quality cowhide leather strap.

Price Postpaid. **\$3.95** Price Postpaid. **\$9.95** With 6 Jewels **\$12.50** With 15 Jewels **\$16.50**  
**JOHNSON SMITH & CO. Dept. 829 RACINE, WIS.**

**Rubber Chewing Gum**

It is just like a regular package of chewing gum and looks so real that it feels everybody. Of course no one suspects it is not genuine until they start to chew it. There's a world of fun in this rubber chewing gum—5 sticks to the package. Price, 10c Pkg.; 3 for 25c; 12 for 75c postpaid. **JOHNSON SMITH**

**INVISIBLE INK**

The most confidential messages can be written with this ink, for the writing makes no mark. Cannot be seen unless you know the secret. Invaluable for many reasons. Keep your postals and other private memorandums away from prying eyes. Great fun for playing practical jokes. **Only 15c a Bottle; 3 for 40c.** **JOHNSON SMITH & CO. Dept. 829 RACINE, WIS.**

**POCKET CIGAR LIGHTERS**

You may pay more, but these two Lighters will do the work as well as the most expensive. The "SIMPLEX" (illustrated on the left) sells for 20c; lights merely by giving the wheel a turn with the thumb. The "AUTOMATIC" (on right) lights automatically; press the button, the lid flies open and lights wick at same time. Better, safer and cheaper than matches. A light instantly available whenever you want it. Prices: Simplex Lighter 20c; Automatic Lighter \$1.00; extra flints for either 5c each. All postpaid.

**Lover's Knot or Friendship Ring**

Made of 4 strands of genuine 14K gold filled wire, woven into the True Lover's Knot, symbolic of love or friendship. Very pretty, yet not showy. Each ring made by hand by gold wire expert. It looks good and it is good. Price 50c postpaid

**Resurrection Plant**

Great curiosity. Place in water, plant opens up and starts to grow in 20 minutes. Taken out it dries up and goes to sleep till put in water again. 10c, 5 for 45c, 75c box p. pd.

**Great Fire Eater**

A great trick by which you can apparently breathe fire from mouth, to the horror and consternation of all. Quite harmless. All apparatus necessary sent complete in box for **ONLY 30c. p. pd.** **JOHNSON SMITH**

**SQUIRT ROSE**

25c

A REAL STARTLER. This is the most popular of all squirt tricks. The flower in your coat looks so fresh and sweet that everyone is tempted to inhale the delightful perfume. Then is the moment to press the bulb. Gee-whizzers. Don't they jump! There is a very long rubber tube that easily reaches to the pocket of your coat or trousers, and the bulb is large enough to make a dozen snorts with one loading. **PRICE 25c each, or 3 for 65c postpaid.**

**SEEBACKROSCOPE**

Place this clever instrument to your eye, you see what is going on behind your back. Very interesting things sometimes occur when no one thinks you are looking. Just like having eyes at the back of your head. **PRICE 25c POSTPAID**

**WONDER OF THE 20th CENTURY**

Send remittance (Postage Stamps accepted) for all articles listed on above and previous page to

**MAGICIAN'S BOX OF TRICKS**

Apparatus and Directions for a Number of Mysterious Tricks, Enough for an Entire Evening's Entertainment. **\$1.00**

**IF ANYONE CAN DO THEM**

It is great fun mystifying your friends. Get this Conjuror's Cabinet, and you will be the cleverest fellow in your district. It contains the apparatus for ten first-class tricks, including THE MAGIC BALL AND VASE TRICK (a wooden ball is placed inside, and upon replacing the lid has disappeared and is found in someone else's pocket); THE HINDOO TRICK CARDS (can be made to change completely no less than five times); DISAPPEARING COIN BOX (a coin, placed in the wooden box, vanishes entirely or changes into a coin of another denomination); THE GLASS GOBLET TRICK (a coin is dropped into a glass of water and when the water is poured out the coin has vanished and is found somewhere else); THE RIBBON FACTORY FROM THE MOUTH TRICK (a seemingly endless supply of colored paper ribbons comes out of your mouth); the DISAPPEARING HANDKERCHIEF (a handkerchief held in the hand mysteriously vanishes); the WIZARD'S RING COIN TRICK; the ENCHANTED BOTTLE (no one but yourself is able to make it lay down); the GREAT HAT AND DICE TRICK (a large dice is placed on top of a hat, disappears, and is found underneath yet no one has touched the hat), and last, but not least, the GREAT PHANTOM CARD TRICK, or two from five leaves nothing. Full instructions are sent for performing each trick. In addition to the above, a number of other feats and illusions are fully explained for which you can easily make or procure the necessary apparatus. **Price complete \$1.00 postpaid. JOHNSON SMITH & CO.**

**U. S. BABY TANK**

It goes with real Yankee Pep—by its own power. Most remarkable toy ever invented. By drawing the Tank backward, either with the hand or over the floor or table and then placing it down, it will crawl along, overcoming all obstacles, in the same life-like manner as the larger Tank that proved so deadly in the great war. What makes it go is somewhat of a mystery, for there is no mechanism to wind up as is usually understood with mechanical toys, yet this tank will keep plodding along ten times longer than the ordinary run for toys. It will perform dozens of the most wonderful stunts; 2 1/2 inches long. **Price only 25c prepaidd. Stamps accepted. JOHNSON SMITH & CO.**

**BOYS' HAND CUFFS**

65c

There is a great deal of wholesome fun and amusement to be derived from these handcuffs. Although merely a toy, they are well and strongly made, with extremely simple mechanism that can be slipped on and off in a moment. No key is required either to lock or unlock them. Just snap them over the wrists and you have your pal securely handcuffed. These Handcuffs stand for Law and Order and, in the hands of the boy, inspire him with respect for Civic Virtues. They are entirely nickel-plated all over. **Price only 65c pair postpaid.**

**Female SEX Indicator**

25c

Hold the **MAGIC INDICATOR** over a man's hand—instantly it moves in a straight line, backward and forward. Hold it over a woman's hand and it describes a complete and continuous circle. The same action can be obtained over a letter written by a man or woman, etc. It is fascinating; baffling. We have never been able to figure out how it is done—but we've never seen it fail. Many novel and entertaining feats may be performed with the Sex Indicator. For example, similar results can be obtained with animals, cats, dogs, rabbits, over birds, chickens, canaries, etc. Also used to predetermine the sex of chickens and birds, etc. In fact it is sold as a patented egg tester in Europe. **Price 25c, or 3 for 65c, postpaid.**

**DISSOLVING VIEWS**

50c

You may have a lot of fun with this little peep show. A regular startler. Made entirely of metal, having a microscopic lens fitted into one end. While the victim is absorbed in admiration of the pretty picture, and turns the button in the confident expectation of seeing something interesting, a spring syringe is brought into action, and the observer experiences a very great surprise. **50c p. pd. Johnson Smith & Co., Dept. 829, Racine, Wis.**

**Comical Motto Rings**

Lots of harmless fun and amusement wearing these rings. Made in platinum finish (to resemble platinum), with wording on enameloid, as illustrated. **Price only 25c Postpaid.**

**The "Little Giant" Typewriter**

A First Class Writing Machine For \$1.50

A perfect little typewriter for \$1.50. There are thousands of persons who would like to use a typewriter but whose needs and business do not warrant the expense attached to the purchase and use of a fifty or seventy-five dollar machine. To such persons we confidently recommend our Little Giant. It is strongly made, but simple in construction, so that anyone can quickly learn to operate it, and write as rapidly as they would with pen and ink. The letters of the alphabet 1 to 10, and the punctuation marks being together. With this machine you can send your best girl typewritten love letters, address envelopes, make out bills, and do almost any kind of work not requiring a large, expensive machine. With each typewriter we send a tube of ink and full printed instructions for using the machine. **Price complete \$1.50 by mail postpaid to any address in the world.**





# How's Your Radio?

## The Radio Clearatuner

Tunes Your Aerial and Helps You Get Those Distant Stations

**"Coast to Coast"**

**The Radio Clearatuner**

Tunes your aerial. Simply hook it up between your aerial and radio.

We guarantee it will give you greater distance, greater volume, greater selectivity, less static, less interference and better tone quality.

New improved model \$2.00. Sent postpaid anywhere Money back if not satisfied.

**RADIO CLEARATUNER COMPANY**

341 GARDNER BLDG.

TOLEDO, OHIO



## Here's Happiness With a Pan-American Saxophone

Pleasure, Pride, Popularity, Profit—all these wonderful advantages and more are yours when you've learned to play a PAN-AMERICAN Saxophone. Here's an instrument you'll treasure highly for the real pleasure it will bring. Made as only PAN-AMERICAN knows how to make really fine saxophones, with clear, sweet, beautiful tones—handsomely finished, mechanically perfect.

**AS EASY TO OWN AS IT IS TO PLAY**

No other saxophone—not one—can possibly give you such fine quality—such real satisfaction, plus an iron-clad factory guarantee, at a cost so surprisingly low. And it's easy to learn how to play this splendid instrument. Decide now to get full particulars about our free trial offer and easy payment plan on Saxophones and the full line of better PAN-AMERICAN band and orchestra instruments. You'll be glad you did.

**FREE TRIAL**

**Send No Money Just Mail Coupon**

The Pan-American Band Instrument & Case Co., Dept. G-22 Elkhart, Indiana

Send Along full information and low prices on Pan-American Saxophones and other band instruments. I want to learn to play..... (instrument).

Name.....

Address.....City.....State.....

My local music dealer is.....

## Send for WESTERN RADIO

# New 1929 Catalog

THE NEW 1929 Catalog is Terammed full of the FINEST, NEWEST, Nationally known A. C. sets, consoles, cabinets, dynamic speakers, kits, eliminators and accessories at Lowest Prices. Largest stock of radio parts. Prompt delivery. Write for our Free catalog.

**WESTERN RADIO MFG. CO.**  
128 W. Lake St. Dept. PM-11 CHICAGO



**The Big Friendly Radio House**

## Authorities Agree

that the best choice for television reception is the type of amplifier that can be built from the

**Lynch Television Amplifier Kit**

Send for free book

**ARTHUR H. LYNCH, INC.**

1775 Broadway

New York City

## 30 Days' Free Trial

New Models now ready for delivery direct from our factory. Astonishing low prices and terms. Do not buy until you get them.

**RIDER AGENTS WANTED** to ride and exhibit sample. Make big money. Many models \$21.50 up.

Guaranteed \$1.50 each, wheels, lamps, horns, equipment at half

usual prices. **Send No Money.** Write for our marvelous prices and terms on RANGER Bicycles.

**Mead CYCLE CO. Dept. A 109 CHICAGO**



# NOW! You Can Do Your Own NICKEL-PLATING

For Plating Nickel, Brass, Copper, Silver, Gold, etc.

**Make \$150 to \$500 a Week**

**New Scientific Invention Enables Anyone To Nickel-Plate Anywhere with Aladdin Portable Outfit**

This marvelous Invention enables anyone to NICKEL-PLATE anything—anywhere; in the Home, Garage, Office, Store or Shop—in fact, you can do all the NICKEL-PLATING on any automobile with the ALADDIN ELECTRO PORTABLE OUTFIT

in a very short time—without removing any of the parts. This interests every auto owner (and others) because you can **SEE THE NICKEL FLOW** NOW take the Plater to the job instead of taking the job to the Plater. This offers wonderful ECONOMY to users and BIG MONEY-MAKING possibilities to AGENTS. Positively guaranteed to do as we claim. **WRITE FOR FREE BOOKLET.**

Introductory Offer

**\$6.50**

Plus Postage

P. J. F. BATENBURG

Dept. 43

RACINE, WISCONSIN

—AGENTS— WANTED EVERYWHERE







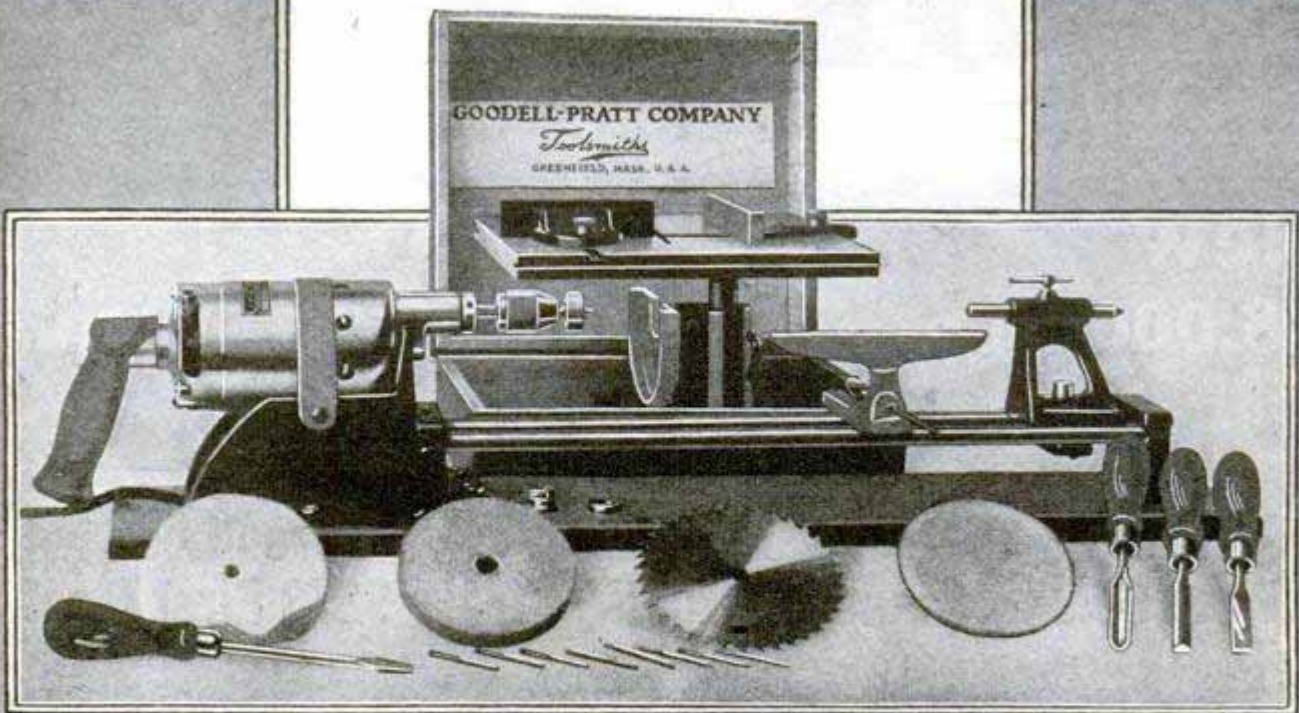

*You can SEE this  
BEFORE you Buy it!*

Ask your local dealer to show it to you. He probably has it in stock. Examine it. Its quality stands out. Made by a maker of good tools since 1888, you take no chances. Your dealer will guarantee it. We'll back him up. Note these features:

*Power Unit*

A No. 1040 1/4 inch Electric Drill: easily removable for use as a portable drill.

*Lathe Unit*

Practical and sturdy. Used for years on our foot power lathes. Adjustable Tee Rest and Tail Stock can be locked at any desired points. Capacity, 12 inches between centers; 5 inch swing.

*Saw Table*

Adjustable to cut from 0 to 1 inch. Made of wood, 9x10 inches, with steel inset and guard. Two Saw Guides--for ripping and for cross-cutting or mitering.

*Polishing and Grinding*

A 4 inch Grinding Wheel with 1/2 inch face and a 4 inch Buffing Wheel. Can be used either in lathe or portably.

*Disc Sanding*

Sanded Disc, with 4 inch face. Emery Cloth may be substituted for polishing or grinding.

*Accessories*

Three Wood Turning Chisels. Screw Driver, eight Drill Points--1/16 to 11/64 inch.

*LIST PRICES*

No. 1070	110V, complete	\$50.00
No. 2070	220V, complete	\$52.00
No. 3070	32V, complete	\$52.00

*If your local dealer hasn't one of these in stock, write us.*

*For*  
Sawing  
Drilling  
Polishing  
Buffing  
Grinding  
Wood Turning  
Model Making  
Cabinet Making



*The Mark of a  
Complete Line of  
Super-Performance  
Electric Drills*

GOODELL-PRATT COMPANY *Toolsmiths* GREENFIELD, MASS. U.S.A.

**GOODELL-PRATT**  
1500 GOOD TOOLS





I Want to send you a  
**Santa Fe Special**  
 Watch  
 for your  
 Examination-  
 Approval  
 21  
 Jewels

**Send No Money**  
 Watch Sent on 30 Days Free Trial

In addition to our New Low Price, I will send for your approval one of these Standard Watches, guaranteed for a lifetime of satisfactory service, not only by the Santa Fe Watch Company, but by the Great Illinois Watch Factory. They are found in the pockets of men in the service on every railroad in this country. Senators, Congressmen and Governors keep their official appointments by "Santa Fe Special" time. Army officers and privates carried them all through the Greatest War in history—thousands of these splendid watches are in use all over the World. If you want one on my liberal new **LOW PRICE PLAN**, you had better write for my Free Watch Book today and make your selection without delay. I will send the Watch for you to see **WITHOUT ONE PENNY DOWN**—I will even allow you to wear the Watch 30 days **FREE**—then sell it to you on a binding money-back guarantee.

**Why Not Own A 21 Jewel Watch**

You will never miss the few cents a day that will make you own one of these watches—**SEND FOR WATCH BOOK**—illustrating in beautiful colors hundreds of designs and combinations in cases in the **POCKET WATCH, MEN'S STRAP WATCH and LADIES' WRIST WATCH.** You can have your name or monogram and any emblem you may desire engraved in the Case to suit your own ideas.

**New Case Designs** I want you to see the new models and wonderful case design in the Santa Fe Special, the Santa Fe Mogul, the Santa Fe Strap Watch and the Petite Santa Fe Princess Watch. No matter what your choice of a watch may be there is a Santa Fe Watch to please you. Send coupon for our beautiful **FREE** catalogue showing hundreds of designs and models in watches and newest creations in Diamond Rings and Jewelry.

**WRITE FOR SPECIAL CASH OFFER — GOOD FOR 30 DAYS**

Mail **SANTA FE WATCH COMPANY**  
 Dept. B, 6 **THOMAS BUILDING, TOPEKA, KANSAS**  
 Coupon

for Beautiful  
**FREE Watch**  
 and  
**Diamond Book**

Santa Fe Watch Company,  
 Dept. B, 6, Thomas Building, Topeka, Kansas.  
 Please send prepaid and without obligation your Watch Book Free, explaining your "No Money Down" Offer on the Santa Fe Special Watch.

Name.....  
 Address.....  
 City..... State.....



**FREE** A limited offer!  
 With every Santa Fe Special, a beautiful gold chain or strand of exquisite pearls. Write today.



**RUSH—Absolutely FREE**

"The World's Most Useful Small Tool" and the 125-Picture **PLIERENCH Circular**.

Name.....  
 R. F. D. No., St.....  
 P. O. City, Stt.....

Intrstd. in Big Factory Repr. Proposition

**CLIP HERE**

Mail today to **THE FLASH SALES CORP'N**  
 PK-4809 N. Ashland Ave. CHICAGO, ILL.

**FREE ON COUPON—an E-F ANGLE SCREWDRIVER—**



Of tempered crucible Spring steel, it has 7 powerful driving edges for large and small screws and 101 other uses—works under obstructions where others won't. Carries like small pocket knife—often more valuable.

Also **FREE**—the "55,000" Circular giving amazing 125-Picture story of

**The Pocket Machine Shop!**



with its **1-TON POWER-GEAR** it Outrips a 40-LB. Visel!

The "hand-crip" of a tiny Rubber band holds a Bearing Ball—the Hardest-to-hold thing known—against a 300-lb. Pull!

IT IS AN AUTOMATIC LOCK-GRIP RATCHET WRENCH



**All In One**

No. 3—for all Wire chain, spring-making, fence work, etc.  
 No. 2—for all Pipe work, "chewed" nuts in tight places, etc.  
 No. 1—Universal—for ALL Pliers, Nut Wrench, Vise and clamp, Spring-making Work, etc.

**EIPEL-FLASH PLIERENCH KIT**

(Say "Eye-fel-Flash") "The T. N. T. of Tools"

You get the amazingly Quicker, Better, Easier, Universal Tool Service of Nos. 1, 2 & 3—Convertible in 1-5 second—in the new 24-Ounce Master Tool Kit—for the Price of One Good Tool; yet it Does the Work of the best other tools Weighing 60 Pounds and Costing \$50.00! It is Incomparably Superior!

Hundreds of Thousands of Men and Women are using these wonder Kits to make their Homes and Estates more comfortable—Farms, Shops, etc., more profitable; to get more and better service from Automobiles and all mechanical devices; with an enormous saving in money, time and energy! Used by the U. S. Army and Navy. Just try a Plierench Kit Once, and you would no more go back to other tools than to the ancient Ox-Cart.

With each Kit is a 64-page Manual of Mechanics

**A GUARANTEED SUPER-QUALITY PRODUCT**

**\$97.50 IN SEVENTEEN AND A HALF MINUTES**

is the report of a Georgia representative. L. M. E. earned the price of a good sedan in one month. Every man a prospect. Sells at sight! If interested in permanent income of \$75 to \$200 weekly—as factory representative, full or part time—mark coupon!

**MAIL the Valuable Coupon above—NOW!** Especially appreciated as a holiday gift. Means extra fall sales and profits for distributors.

... Before You Buy ...  
**PLUMBING**

or Heating equipment—such as Bathtubs, Lavatories, Closets, Sinks, Water Supply and Sewerage Disposal Systems—Furnaces, Steam and Hot Water Heating Plants—or Pipe and Parts, Fittings, Accessories, Tools, Supplies—or Paint, Varnishes—you should

**Send for FREE Catalog** 60 pages, 4,000 offers and sizes—also on hand Fencing, Tinning, Roofing—largest variety and stock in U.S.—over 1,000,000 items. Some articles on Easy Payments—anything on Open Account if in business and rated. Satisfaction Guaranteed.

**Cut Prices** You save one-third to one-half on highest grade, perfect goods—no "seconds." We ask you less than many plumbers pay their jobber. You can "Be Your Own Plumber"—easy to do your own installing—our Free Book tells how. Get it—compare our quality and prices with others'—see for yourself.

**WRITE TODAY—NOW!**—while you are thinking about it! You need it. You will like it. And at the same time you will be so kind as to add the name of one or more persons who soon will want goods in our line? Thank you. But be sure to write NOW!

**BURKE @ BROS.**

Dept. 1639 E 433 Liberty Ave., Pittsburgh, Pa.

**NOW! You Can AIRPAINT**

It's easy to paint this NEW WAY—Brighten up the home, paint your Auto, etc. Beautiful results; smooth and even.

Home Outfit ONLY \$10.50

Paasche Airbrush Co., 1954 Diversey Parkway, CHICAGO

**FREE RADIO CATALOG**

Since the dawn of Radio, Barawik has been known the world over as headquarters for radio set builders and fans. Here, under one roof, is everything you need—sets, parts, supplies—thousands of products—ready to ship to you the same day your order arrives. Barawik prices save you money. Barawik service saves you time. Barawik merchandise always please. A quarter million satisfied customers say, "Barawik is Best." Let us send you the Big Barawik Book free and prove it to yourself.

**BARAWIK CO., 1011A Canal Sta., CHICAGO, U. S. A.**



**\$100 a Week Showing Merchants It Pays to Advertise**

R. O. Gordon of Michigan made \$321.05 in 9 days—sold 5 machines in 2 1/2 hours.

**THE EUREKA ADVERTISER (Automatic Wrapping Paper Printer)**

Automatically prints the merchants' "ADS" on his wrapping paper in one or two colors. Costs only what it costs to have "AD" printed on twenty rolls of paper. Flint of New York sold four machines in two hours. You collect and keep your commission. We deliver. Every merchant a prospect. Many buy five or more machines—one for each paper rack they use.

**SALESMANAGER, Dept. A-11, 1201 Cortland Street, Chicago, Illinois**



**FUGO FIRE EXTINGUISHER**

**EASY \$100 a Week**

Unusual opening for live agents in every locality. Make \$5000 or more a year—easily. Fugo—the instantaneous automatic fire extinguisher—is needed and wanted in every home, store, theatre, garage, shop, school, automobile, etc. Cheapest fire protection available today. Within reach of all.

**1 Qt. Size \$5.00 2 Qt. Size \$7.50**

Recharged in a jiffy

Amazing 30-second demonstration clinches sale—each one sold sells others. Territory going fast. Write at once for wonderful proposition that will make you big money.

**THE NATIONAL FORMETAL CO.**

6535 Metta Ave., N. E. Cleveland, Ohio





# Only \$150

## -and Easy Payments If Desired

**With This Lathe**

- You Can**
- Machine Armatures
  - Make Bushings
  - Reface Valves
  - Machine Pistons
  - Undercut Mica
  - Cut Threads
  - Bore, File, Drill, Turn, Face, Grind, Polish and do hundreds of other jobs.

Here is the greatest Lathe Value ever offered. A Universal Tool of highest quality and accuracy—one that will work metals of all kinds—cast iron, wrought iron, steel, aluminum, brass, bronze, copper, monometal—also fibre, hard rubber, and wood in pattern making. Note the many kinds of work it will do.

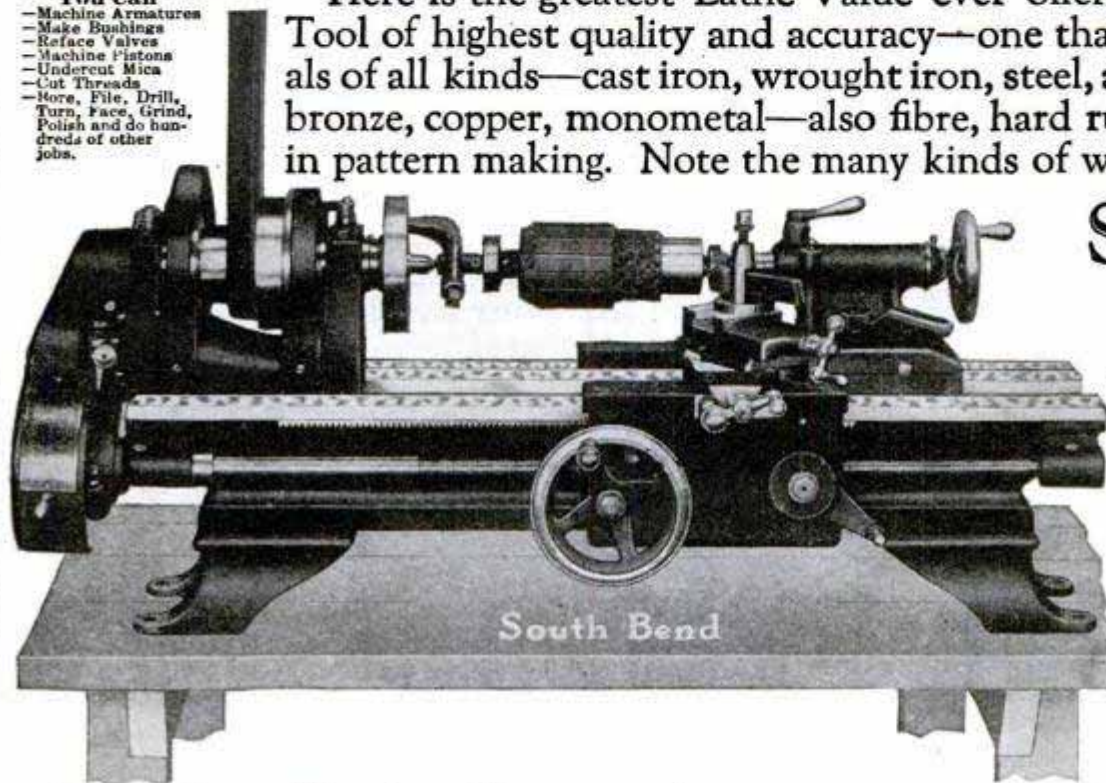

### SOUTH BEND LATHE No. 22

**Specifications:**  
 9 1/4" x 3' Back-Geared Screw Cutting, swing over bed, 9 1/4"; distance between centers 16 1/2"; width of belt cone drive, 1"; length of bed, 3 ft. Power required, 1/4 H. P.; shipping weight, 350 lbs.

### Complete Book of Instructions Sent Free with Each Lathe

It is as easy to learn how to run a Lathe as to learn to run a car. The operator soon becomes proficient, especially if mechanically inclined. With each South Bend Lathe, we send most complete book of instructions telling just how to do all kinds of work on the Lathe.



### Easy Payments!

If you prefer, you can order any South Bend Lathe and pay for it out of income instead of capital. Write for free Catalog and Bulletin No. 23, which tells all about this unusual South Bend Lathe now priced at only \$150. South Bend Lathes are also made in larger sizes from the 11" swing to the 24" swing.

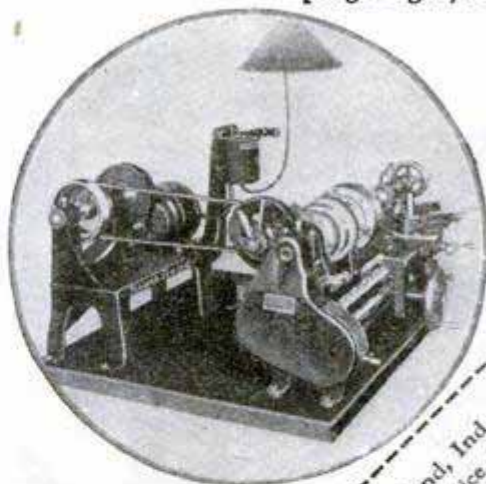

Illustration above shows South Bend Lathe No. 22 complete with Unit Drive, very compact Bench Outfit. Plugs in a light socket for Power.

**SOUTH BEND LATHE WORKS**  
 647 E. Madison Street South Bend, Ind., U. S. A.  
 New York City: J. E. Beggs Co., 183 Centre Street  
 Carried in stock by Machinery Supply Dealers in Principal Cities throughout the World



Electrical Work



Piston Work



Cutting Threads

**SOUTH BEND LATHE WORKS**, South Bend, Ind., U. S. A.  
 647 E. Madison Street  
 Gentlemen: I would like your net factory price on a Screw Cutting Lathe, size \_\_\_\_\_  
 Manufacturing  Machine Shop (check kind of work)  
 Please send Free Catalog No. 23.  
 Name \_\_\_\_\_  
 Address \_\_\_\_\_  
 City \_\_\_\_\_  
 State \_\_\_\_\_



## Make \$2 to \$3 an Hour in a Clean, Dignified Business of Your Own!

BE your own boss . . . . make more than you ever made working for others. You can start in spare time, evenings, making \$2 to \$3 an hour, while building up a business that will make you independent. Start a saw-filing business with the Foley Automatic Saw Filer. No experience or skill as a filer needed, no canvassing necessary (our Free Plan starts you right), very little capital required. Listen to these reports, typical of many in our files:

"I am kept quite busy filing saws. To tell the truth I get more saws than I can handle. Everybody who uses a saw that is sharpened on the Foley says how well it works."—*William G. Diederich, Mendota, Ill.*

"I have had all the work I could handle in my spare time and did not advertise in any way."—*Joseph P. Nolan, Marquette, Mich.*

Think of the steady business you can get from carpenters, contractors, schools, factories, woodworking shops, farmers and homes.

## FOLEY Auto-matic Saw Filer

files all kinds of hand saws, band saws  $\frac{1}{8}$  in. to  $4\frac{1}{2}$  in. wide, and cross-cut circular saws 3 in. to 24 in. in diameter. Teeth, bevels and pitches are all made uniform and mechanically accurate. Saws cut cleaner, truer and faster. No eye-strain. More than twice as fast as hand filing. Easy work.

### FREE

complete plan for starting a saw-filing business. It's easy. You can do it. Write today.

### Foley Saw Tool Co., Inc.

233 Foley Bldg.

11 Main Street N. E.

MINNEAPOLIS, MINN.

Foley Saw Tool Co., Inc.,

233 Foley Bldg., 11 Main St. N. E., Minneapolis, Minn.

Send plan for starting saw-filing business.

Name.....

Address.....

## CRESCENT SCREW DRIVERS *Stand this test!*

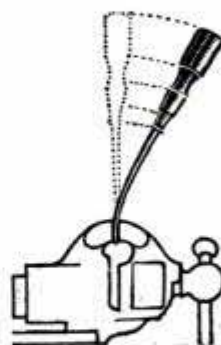

The new Crescent Screwdrivers will stand the abuse which this tool usually gets. Spring tempered shanks of forged alloy steel spring back into shape and the rigid handles will not turn. Crescent blades have a gently tapered point which "hangs" to screw slot and increases the turning power. At your hardware dealers.

Crescent Tool Company  
210 Harrison St.,  
Jamestown, N. Y.

No. 214  
2 to 12 inch  
\$.20 to \$.65

## CRESCENT and Smith & Hemenway TOOLS

Catalog on Request.

Karoway

## A Two-Handed Board Game of Compelling Fascination

The only worth while game of a generation. Decidedly superior to any other yet produced. Destined to become America's most popular game. Entertaining for both children and adults alike. Intensely interesting and decidedly different. Easy to learn. Difficult to master. Order today.

Postpaid U. S. \$1.50.

Dealers Wanted.

THE KAROWAY COMPANY, Box 206, MORENCI, ARIZONA

## BIGGER Radio Guide

LATEST  
RADIO  
GUIDE

Elections have brought back Custom Set building. Business is booming. Thousands of old-timers are cleaning up. Let Barawik show you the way to bigger profits, more sales. Send today for Barawik's Big Bargain Book—the radio man's bible.

FREE BARAWIK CO. 1011-B Canal Sta., CHICAGO, U. S. A.

## CHLORINE HOME TREATMENT

For those who suffer from Colds, Bronchitis, Catarrh, Whooping Cough and respiratory diseases is now available for home use. Pour the contents of ampoule into vessel and breathe the medicated air in your room for one hour. Treats one to six at a time. This simplified treatment, endorsed by thousands, produces the same results as treatments with elaborate apparatus has shown 94% cured and improved.

Special Offer Three Home Treatments

Mailed prepaid on receipt of \$1.00

Medical Products Corporation

153 E. Elizabeth Street  
Detroit, Mich.



## GEARS ALL KINDS SMALL

The most accurate made and prices reasonable. We carry a complete line of gears in stock for immediate shipment. Can also quote on special gears of all kinds. Send us your inquiries.

WRITE FOR CATALOGUE 10

CHICAGO STOCK GEAR WORKS  
105-109 S. Jefferson St., CHICAGO



# The Up-to-Date Home Craftsman Shop

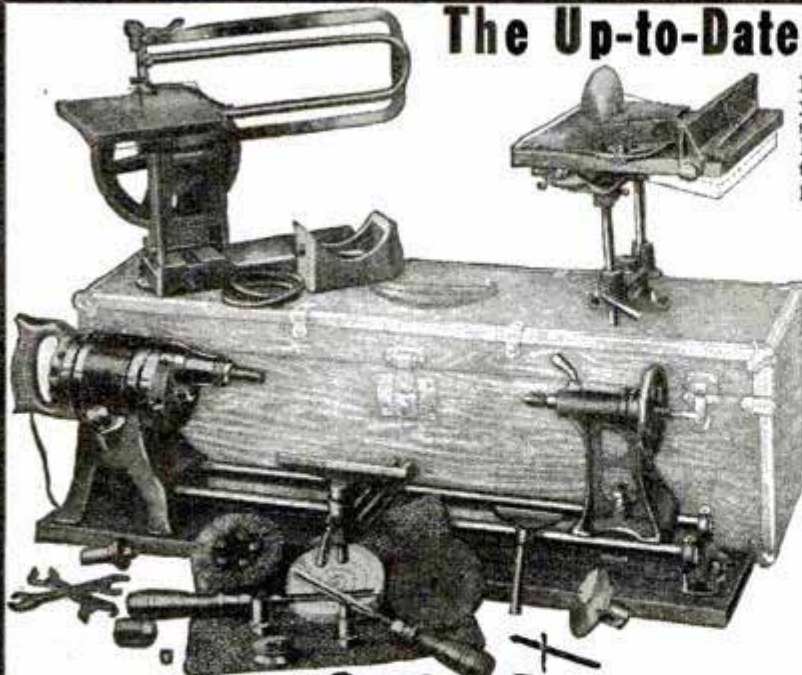

Plug in on any light socket and go to work. Make your old work bench a modern Up-to-Date workshop. Convenient, portable and simple to operate. Now! You can build, or repair furniture, cabinets, toys, boats, novelties and hundreds of other wood projects. Send for Free literature today.

**ONLY \$10 DOWN**

**GUARANTEE**

If upon receipt of the Up-to-Date Home Craftsman Shop you are not satisfied, without question every cent refunded and return express charges paid.

## NEW 12" BAND SAW

Newly developed, of the latest design in Band Saw equipments, this 12 inch Band Saw is guaranteed vibrationless, and accurate in every detail. It is supplied with a tilting table, miter and side gauge.

**\$35.00**  
Without Motor  
**F. O. B. CHICAGO**



May be purchased on time payment basis at \$39.00, \$10.00 down and \$10.00 per month. With this plan anyone can own a real Band Saw.

## Home Mechanics Easy With This Equipment

**The Shop Complete** consists of a Super-power Motor, an accurate Lathe (10" x 34"), a 6" circular saw which features the bevel, miter, side and depth gauges, a Tilting Table, Jig Saw, and all accessories for buffing, grinding, cleaning and all portable or stationary drilling and sawing. **Blueprints and Craftcourse Free to Users.** Under supervision of Master Craftsman Eugene Maurey, blueprints and craftcourse giving complete information on home handicraft and details for making hundreds of pieces of woodwork. This service **Free to Up-to-Date Home Craftsman Shop users.** Your own terms on purchase \$10.00 down. Liberal discount for cash.

**Our Literature Gives All Details**

**SENT ON TRIAL**

Use our shop for 10 days at our expense. If not satisfied — return — express charges collect.

**Mail This**

for full particulars to  
**Up-to-Date Machine Works**  
2015 S. Wabash Ave., Chicago, Ill.  
MANAGER, Dept. 24. Without any obligation, please send me all particulars about your shop, 10-day free trial, free blue prints, free craftcourse, also \$10 downpayment offer.

NAME.....  
ADDRESS.....

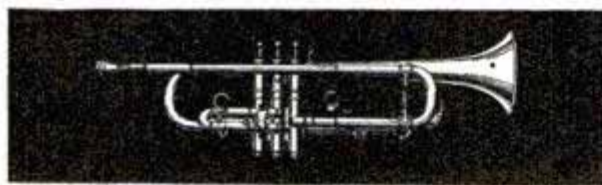

**FREE TRIAL**  
**on**  
**any Conn**

**SELECT** any instrument for S band or orchestra; we will permit you to try a Conn in your own home free, without obligation. Conn easy-to-play features enable you to play tunes from the start. With all their exclusive features, Conn cost no more.

Send Coupon Now for free literature and details of trial offer.



Sousa uses and endorses Conn instruments

C. G. Conn, Ltd.  
1131 Conn Bldg.  
Elkhart, Ind.

**CONN** Mail This Coupon  
BAND INSTRUMENTS  
MUSICIANS' LABORATORY

Please send literature and details of free trial offer on

(Instrument).....  
Name.....  
St. or R. F. D.....  
City.....  
State, County.....

**HFL** This amazing new receiver

Has started the entire country with its reception of far distant stations



## The Model 10 ISOTONE

**THIS** new screened grid, custom built radio phonograph is the finest instrument on the American market. Units assembled and wired at the factory. Complete construction in one hour. A.C. or D.C. operation. Beautiful appearance. Thirty radically new features. Fully guaranteed. All circuits and information **FREE.** Send for booklet.

**-MAIL TODAY-**  
**High Frequency Laboratories,**  
Office C., 28 N. Sheldon St., Chicago, Ill.  
Gentlemen:  
Without obligation please send your new Isotone booklet.

Name.....  
Address.....  
City..... State.....

PLEASE PRINT PLAINLY



# SUPREME

*In Life  
and Power*

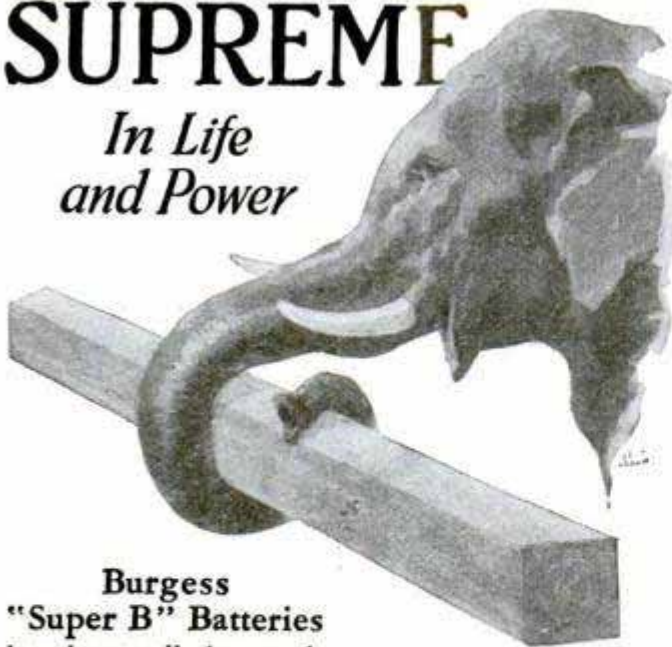

**Burgess**  
"Super B" Batteries have larger cells than standard batteries. Extra power and life are thus provided. Uniformity is insured by scientific precision in manufacture. Radio's cost is lowered appreciably by the use of "Super B" No. 22308, a medium size heavy-duty 45-volt battery, designed for general, all around use . . . or "Super B" No. 21308, the largest size Burgess heavy-duty 45-volt battery, made especially for heavy-current consuming sets.

BURGESS BATTERY CO.  
General Sales Offices: CHICAGO  
In Canada: Niagara Falls & Winnipeg

## Chrome

CHROME is a preservative that guards power when your Burgess "Super B" Battery is not in use. Extra life and service are thus added. It is a patented feature of the two Burgess "Super B" Batteries, which answer practically all radio set requirements.

# BURGESS "SUPER B" BATTERIES



## BUILD YOUR OWN EXPONENTIAL HORN



This marvelous 17x21" exponential horn with a 96" air column can be easily built by any amateur of 1/4" soft wood which produces the most wonderful tone quality. We furnish you with a set of

**Full-Sized Patterns** which have been accurately and scientifically worked out according to the exponential principle. Simply saw out the wood to the size and shape of the patterns and nail and glue together and you have the latest and

**Most Efficient Tone Producer** Send \$2.00 for a set of these full-sized patterns and complete instructions.

Or we can furnish you the COMPLETE KIT which includes the wood cut to fit, the nails, the glue, our large sized CONCERT UNIT and full instructions. All complete with postage prepaid for \$11.75. Ask your dealer.

## RADIO PRODUCER CO.

1244 Jefferson Bldg. Dept. 6 Peoria, Ill.

## KI-LOWAVE NOW! EVERYBODY CAN HEAR THE SHORT WAVE PROGRAMS



KI-Lowave Adapter instantly converts any set into a Short Wave Set by simply inserting adapter plug in place of a tube. No extra tubes, batteries, etc., required, no changes in wiring necessary. Amazing Results. Many users report hearing England, Holland and others, as well as the U.S. short wave stations. Bring your set up to date with a short wave adapter. Order Now, direct price \$19.50 prepaid anywhere, or write for literature.

ADAPTER \$19.50 prepaid anywhere, or write for literature.  
14 to 96 Meters KILO RADIO CO., 1722 PALLISTER, DETROIT, MICH.

# FREE Radio Handbook

Write today for your copy of the new Radio Association handbook. Shows you easy ways to make money in Radio. Tells you how our members are cleaning up \$3.00 an hour spare time. Write for Membership Plan which need not cost you a cent and FREE RADIO HANDBOOK.

RADIO ASSOCIATION OF AMERICA  
Dept. PM-11A, 4513 Ravenswood Ave., Chicago

## Build Your Own B Eliminator

Makes no difference whether you have AC or DC at your disposal—"The Gateway to Better Radio" gives you the practical dope on the construction of simple, inexpensive and practical radio power units. And this big manual of 20,000 words and 88 illustrations contains many other subjects of vital importance to you. Order your copy from your dealer or direct from us. It's yours for a quarter.

Clarostat Mfg. Co., Inc. 285 N. 6th St. Brooklyn, N. Y.

## ENJOY the THRILL of ELECTRIFIED RADIO at SMALL COST

only \$6.85 complete  
**FREE TRIAL**

Banish forever all the annoyance and expense of buying new "B" Batteries with a TOWNSEND "B" POWER UNIT. Hooked up in a few moments—and you have permanent power from your light socket from that time on. Use same tubes now in your set. No changes. You'll be amazed at the way Townsends improve your reception and add to distance getting. More than 50,000 now in use. Send coupon today for full information and free trial offer.

Townsend Laboratories, Chicago, Ill.

-----COUPON-----  
TOWNSEND LABORATORIES, Dept. 15, 713 Townsend St., Chicago, Ill. 11/28  
Please send me full information on the Townsend "B" Power and Free Trial Offer.  
Name.....  
Address.....



## OIL HEAT



INCANDESCENT  
ROTATING FLAME →

**THE  
VAPO-GAS  
OIL BURNER**

in your heating plant (Hot Water, Steam or Hot Air) will automatically and economically maintain the desired temperature under all weather conditions. The simplest, most efficient yet lowest priced Oil Burner in the field.



### OXO-GAS Oil Burners

**Will Heat** Stoves, Ranges, Coffee Urns, Steam Tables, Tanks, Boilers, Vulcanizers, Water Coils, Rendering Kettles, Bake Ovens, Griddles, Lead Pots, Pressing Machines, etc.

**No Noise—No Smoke—No Soot—No Ashes  
Require No Mechanical Skill to Operate  
Can be Installed in 30 Minutes  
Last a Lifetime**

Responsible Distributors Wanted  
Write for illustrated catalog.

**GLORIA LIGHT COMPANY**  
111-11 No. May St. CHICAGO, ILL.

# The NEW Indian 4



**Give It Your Own "ROAD TEST"**  
Smooth, silent, quick on the pick-up  
and quickly stopped. Here's an en-  
tirely new motorcycling sensation.

Go to your dealer's—he'll let you take the new Indian 4 for a spin. Give it your own "Road Test."

Take one of the old familiar runs and just compare the performance and pleasure with any motor you have ever ridden. Give it a little more gas on the last fifty feet of that long hill and the surge of power that sends you over the top will make your sporting blood tingle.

See how smoothly you take the sharpest curves.—Low saddle position and weight close to the ground.

Braking power will be a revelation. You can stop quickly and smoothly. Added safety.

Try traffic for a few minutes. Easy to "lock-out" the clutch when you stop. Spring clutch foot pedal. Sound the horn. That's a real horn, too. Pierces the air with a clear vibrating note.

Stop by the roadside and look at the improved construction. Strong—compact, and every part that should be accessible is accessible.

We'll be glad to send you by mail a handsome folder showing the new Indian 4—every improvement is pictured and every feature is fully described.

*Indian Motorcycle Company*

SPRINGFIELD, Massachusetts

Name..... Age.....

Address .....

City..... State.....

Send folder on the new Indian 4, please. Also give name of nearest Indian dealer. .... (Check only if unknown to you.)

P. M. 11-28

## Flying Cloud Model



Miniature model finishes 20" long. Complete in details. Set consists of Hull Block, 30-1/8" S. P. Blocks, Steering wheel, Anchor, Bell, Capstan, Bitts, Flag, Spar material, Rigging Brass wire, Pins, etc., also all materials for Deck Houses and rails. Complete set with instructions, \$10.00 plus postage for 5 lbs. Hull shaped and sanded, \$1.00 extra. Figure head 50c.

### Also Something Sensationally New!

A beautiful new line of Sailboats that really sail! Totally unlike anything you have ever seen before. They can't sink nor capsize. Have automatic rudder control. Beautifully finished in brilliant colors, authentic and carefully rigged. Our "Captain" model, a 25" racing sloop, ready to sail is only \$10.00. Order one today. Or send Dime for our big Ship Model Supply catalog.

ROY HANCOCK, 323 Douglas Ave., Portsmouth, Va.

**Cut Your Costs on Millwork  
by Making Your Own With the**

## H&A Ball SHAPER

Bearing



Make your own mouldings, beading, matching, etc., at a fraction of the usual cost. A sturdy, high grade precision tool; portable; electric. Take it right to the job. Write for catalog and prices.

**HESTON & ANDERSON,** 611 Western Ave., Fairfield, Iowa



**SPEED LATHE \$10.50**

complete as shown. 7 in. swing, 24 in. metal bed, 3 speed cone pulley.  
Longer bed \$1.00 per additional foot.

**GOODWIN MFG. CO.** 435 Keota St. Ottumwa, Iowa

## Match Your Coat and Vest With New Trousers. Free Sample

**DON'T DISCARD YOUR OLD SUIT.** Wear the coat and vest another year by getting new trousers to match. Tailored to your measure. With 90,000 patterns to select from we can match almost any pattern. Send vest or sample of cloth today, and we will submit FREE best match obtainable.

**AMERICAN MATCH PANTS CO.,**  
Dept. B.S., 6 W. Randolph St., Chicago, Ill.





**FREE!**

*That Musical Gal of Mine*

**How to Play the HARMONICA**

INSPIRING everyone to play a musical instrument means laying the foundation for much happiness and contentment. No instrument is better adapted to universal use than the Harmonica. May the time soon come when every man, woman and child will feel it is an important part of their equipment.

PETER W. DYKEMA,  
Professor of Music Education at  
Columbia University,  
New York City

Instruction Book for the HARMONICA

*Just Read It and PLAY!*

TO PLAY a harmonica is the greatest fun in the world. This free book tells you how and shows you how. In no time at all, you'll be reeling off all your favorites—and amazing those who listen to you!

Use the coupon—or just a penny postcard—to send for it. There's no cost of any kind. Do it NOW, before you forget!

M. HOHNER, Inc.  
114 E. 16th St., Dept. 508-L New York

Please send free Instruction Book

Name \_\_\_\_\_

Address \_\_\_\_\_

**Photos ENLARGED**

Size 16x20 inches  
Same price for full figure or bust, cups, landscapes, or pet animals, enlargements of any part of picture. Safe return of your original photo guaranteed.

**98c**

**SEND NO MONEY** Just mail photo or snapshot (any size) and within a week you will receive your beautiful life-like enlargement size 16x20 in. guaranteed fadeless. Pay postman \$1c plus postage or send \$1.00 with order and we pay postage. **SPECIAL** With each enlargement we will send FREE a hand-tinted miniature reproduction of photo sent. Take advantage now of this amazing offer—send your photo today.

**UNITED PORTRAIT COMPANY**  
652 Ogden Ave. Dept. 388 Chicago, Ill.



# Old Cars Made NEW

## in 30 Magic Minutes

**KOTAL gives the BEAUTY and LUSTRE of an Expert Paint Job at 1/20th the Cost!**

**NOT A POLISH—NOT A PAINT**  
This Amazing New Liquid, discovered in a famous industrial research laboratory, has started the Motor World. Just flow KoTal on with a cheesecloth pad as easy as wiping a car with a chamomile. **NO Rubbing—NO Hard Work. Results are Amazing**—with one sweep of your hand you restore BOTH the COLOR and Original Mirror-like FINISH to Dull—Drab—Faded Cars. Gives a glass hard protective coat that does not hold dust and the Lustre Lasts for months. Makes shabby OLD cars look like the day they were driven NEW off the dealer's floor. Words cannot describe the startling transformation. Warranted harmless to any finish. Manufactured by a long established highly rated, financially responsible concern and sold under the **STRONGEST GUARANTEE** ever put on any product.

**AGENTS**  
EARN  
**\$5 to \$10**  
Every Hour You Work  
**\$200 a Week**  
is Easy Money  
**\$1000 Would Not Buy the Start We Give You FREE. Get the Facts**

We Furnish FREE every sales help conceivable. We back you to the limit. *Man Alive!* Here is the *Biggest* thing in the motor industry today—it's going over like a house afire. Everybody claims big money—KoTal men actually make it. Hustlers laugh at \$100 per week. Millions of cars need this Quick—Economic—Magic finish which adds 25 to 40% to resale value. Demonstrates itself instantly. No Talking Needed. Men who have tried to sell everything on earth and failed are making good with KoTal. Even inexperienced country boys make money hand over fist. Strike while the Iron is Hot. Get the facts and get them now. We will send you our Big FREE BOOK illustrated in colors, and Agents' FREE TRIAL OFFER. Good territory is going fast. Act NOW—Act at once. **Send TODAY.**

**E. RICHWINE & CO., 17 W. Jackson Blvd., Dept. 130, Chicago**

# AGENTS

Make big earnings, taking orders for made-to-individual measure suits at less than ready-to-wear prices. Giant Chicago wholesale house makes world's greatest values at \$23.50 and \$29.50. Your profit \$4 and \$5 per sale in advance—we deliver and collect. No experience needed, work full or part time.

**FREE OUTFIT** Send no deposit. Write for details of our unique money-making plan. Nothing like it ever before offered. Act at once.

**GENERAL TAILORING CO., DEPT. 11A, 529 South Franklin St., Chicago**

# Cut the Family Barber Bills

**Belle City Home Electric Hair Clipper**

Anyone can trim or bob hair, shorten bangs, clip neck or underarms in a shape almost impossible with hand clippers or shears. Operates on direct and alternating current. Will not clog or cut the skin, and cuts as cleanly as a razor. Thousands in use. Rigidly guaranteed.

**TEN DAYS' FREE TRIAL**

If your hardware or electrical dealer can't supply you, write for interesting booklet, or order from this ad. Send no money—pay postman \$8.75. Return it in ten days if not satisfactory. State whether 110, 220 or 32 volt current is used.

*Dealers and Representatives Wanted*  
**Belle City Appliance Co., 1022 12th St., Racine, Wis.**

**Fits Any Light Socket**



# CAMPBELL'S INFRA-RED RAY LAMP



## Have You Some Troublesome Ailment?

You will be greatly surprised when you learn how Infra-Red Rays relieve congestion or troubles causing aches and pains in the body. The Campbell Infra-Red Ray Lamp concentrates a mild beam of Infra-Red Rays upon any part of the body.

These rays penetrate deeply into the tissues. As they penetrate they create an active circulation of the blood. Most ailments are due to congestion—relieve the congestion and you relieve the ailment. Nature herself does the healing by active, normal blood circulation.

## Why Suffer Needless Pain?

If you or some one in your home have a troublesome ailment, a lamp like this is a blessing. May be used safely by anyone. Entirely unlike ultra-violet or X-Ray. Positively cannot sunburn or blister.

Relieve bronchial trouble, Neuralgia, Neuritis, Sinus trouble, Catarrh, head noises, Asthma, Ear trouble, Rheumatism, Hemorrhoids, Prostatitis, Gall-Bladder, Tonsillitis, Lumbago and many other ailments with soothing Infra-Red Rays.

## Let Us Send You Our Book on Infra-Red Rays

We have an interesting book on the use of Infra-Red Rays which we shall be glad to send free to any reader upon request. Our book quotes leading authorities as well as users of our lamp. Full directions for use, how to order, our home trial offer, etc., are also explained.

Infra-Red Rays have brought such wonderful results for others you are sure to be interested. Write today for our book telling more about it.

**THE WILLIAM CAMPBELL COMPANY**  
1040 Union Avenue - Alliance, Ohio

**New Model  
Men's  
Strap  
Watch**

**CUT PRICE  
SALE**

**\$3.85**



Two years written guarantee given with this full jeweled elegant Swiss watch. Your choice in square, tonneau or cushion shape—same price. Radium dial, tells time in dark. Accurate timekeeper, tested and adjusted. Rush your order. Quantity limited. Send no money, pay postman \$3.85. JENKINS, 621 Broadway, New York, Dept. 23-F-11

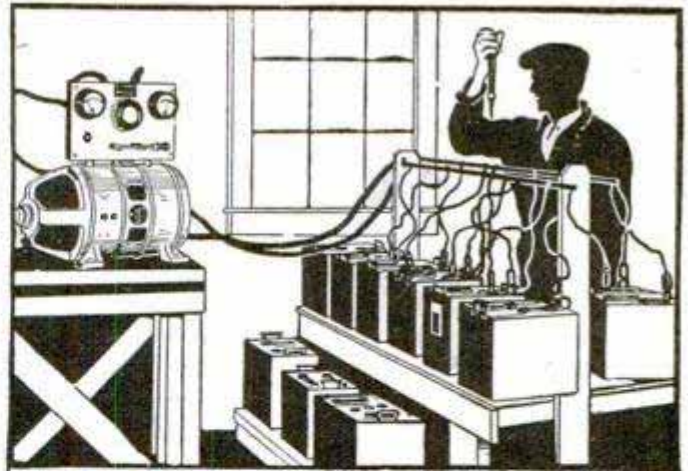

## You Can EARN \$150 to \$300 MONTHLY

### Charging Batteries in 8 Hours

Start a Money Making Business of your own. Mechanics, Filling Stations, Repair Shops, Garages and Battery Stations are all making BIG MONEY with HB 8 Hour Battery Service. Recommended by the leading car and battery makers. Constant Potential lets you give a better charge than the other fellow in one-third the time, and at a saving of 30% to 50% on current. Anyone can operate. Check coupon below for full information on how to get started in this money making work.

Shouldn't Cost You a Cent  
Pays for Itself—Brings a Big Profit Besides

## Only \$16 Monthly

30 DAYS TRIAL AT OUR RISK



Test Bench

## Largest Profits

Starting, Lighting and Ignition work comes in volume—with the largest profits in Auto Repair—to the shop equipped with HB Test Bench. Priced at least \$100 lower than others of similar quality because we build it—not assemble. Check Coupon for more information.

## Earn 5 Men's Wages

Portable Paint Spray does the work of five brush painters. You get four men's wages as profit. Paints Cars, Houses, Garages, Barns, Furniture. No experience necessary to operate. Check coupon for trial offer and terms.



Paint Spray

## Air Service

## Only \$12 Monthly



Free Air Service costs you only \$12 monthly for a few months. Fully Automatic day and night service will draw customers to your shop as well as operate your air tools. Check coupon for full details without obligation.

**HOBART**  **BROTHERS**  
Successful manufacturers ~ since 1893 ~

BOX M118

TROY, OHIO

## Tear off and Mail Today

Hobart Brothers, Box M118, Troy, Ohio.

Send me complete information on the items I've checked—your thirty day trial offer—easy payment terms—information on how HB equipment will increase my earnings.

- HB 8 HOUR BATTERY CHARGER
- HB TEST BENCH
- HB PAINT SPRAY
- HB AIR SERVICE

Name.....Address.....



## ROBIN HOOD

Or any member of your family would appreciate the gift of

## BOWS—ARROWS

Archery Outfits—Accessories

Splendidly finished; or everything needed, with instructions, to make your own. Write for FREE Catalog No. 12. L. E. STEMLER CO., QUEENS VILLAGE, N. Y.

(Established 1912)



# TOBE

## Now Offers THE 4 PURPOSE LIGHT SOCKET AERIAL

AT LAST!

A better and  
more practical  
aerial.

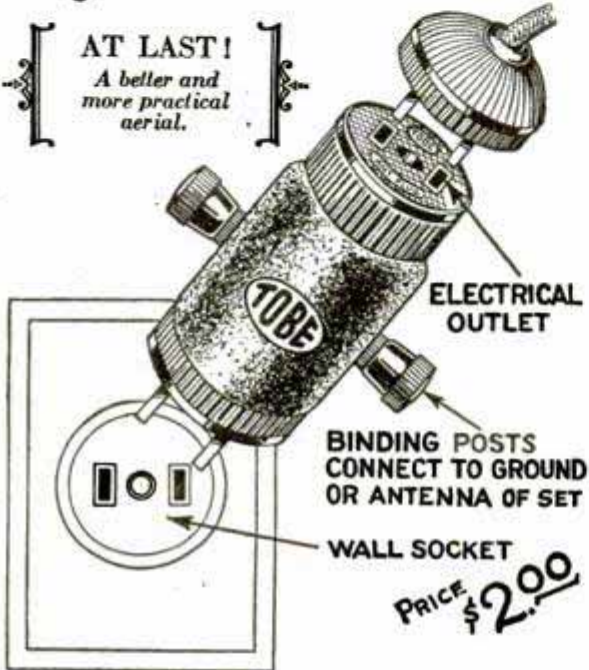

### A Better Aerial or Tobe Would Never Build It

This Tobe product is GOOD and does the work for which it was designed. The device combines—a perfect antenna or ground, a through way power outlet, and eliminates the necessity for lightning arrester. Uses no current.

### Reduces Static Pick-Up to a Minimum

Compare this light socket aerial with others—if you have never used one you are in for a pleasant surprise. The quiet receptive qualities of this new TOBE product will amaze you.

This light socket aerial is TRUTHFULLY better and is sold by all good dealers with a trial money-back offer, because we have faith in its performance.

Individually packed, 12 Socket  
Aerials in one display Carton.

## Tobe Deutschmann Co.

CANTON, MASS.

NEW YORK

CHICAGO

Single dial control

# 7 TUBE

SUPERPHONIC RADIO

All parts mounted

Only \$16.95

COAST to COAST RECEPTION

Superphonic 7 is a world beater! An exceptionally high grade receiver that is amazing the Radio World. Latest 7 tube tuned-radio frequency circuit, using 4 radio frequency amplifiers, detector and 2 stages of audio. Power tube can be used in last audio stage. Extremely selective, marvelous sensitivity. Single drum dial control. Straight line wave length condensers permit accurate, equally spaced tuning over entire wave band. All sockets spring cushioned to eliminate microphonic noises. Bakelite subpanel (8½" deep) insures minimum dielectric losses. Clear and realistic reception guaranteed. An exceptionally beautiful, walnut finish, metal front panel 7" x 18". Complete chassis. No extra parts to buy. All parts mounted ready to wire. No special tools needed. All hook-up wire and colored battery cable included. Value \$60.00; our price \$16.95.

#### TESTED AND APPROVED

Severe laboratory tests have proved the remarkable efficiency of this set. Owners everywhere are sending us letters praising its wonderful receptive qualities.

#### Simple Wiring Directions

Very easy to wire this set with the instructions we furnish. Just connect a few wires. All you have to do is to follow numbers. Simple as adding 2 and 2. Can be wired in a few minutes by anyone. No radio knowledge needed. Make money by wiring these sets in your spare time and selling them to your friends.

NO RADIO  
KNOWLEDGE  
NEEDED!

## SEND NO MONEY

Just write your name and address on a post card and ask us to send you this wonderful outfit. We ship right away. Upon arrival pay only \$16.95 plus a small delivery charge. (Foreign countries send \$19.50 with order. We pay shipping charges.)  
Radio Equipment Co., Dept. 10-L, 649 South Wells Street, Chicago, Ill.

Makers of High Quality  
Condensers and  
Resistors

**AEROVOX**  
TOM WASHINGTON ST. BROOKLYN N.Y.

Write for  
THE RESEARCH  
WORKER—A FREE  
MONTHLY PUBLICATION.

## EXPERT SOLDERING

We are equipped to handle any amount of special soldering jobs for the trade or experimenter. Send us your soldering problems and we will submit estimate. Hard and Silver soldering and anything that demands careful and expert workmanship.

Write:

C. F. VERZIER, 278 Pearl St., New York, N. Y.

## Discarded Tires Run 20,000 Miles

SALESMEN make big money demonstrating TIRE ARMOR, the amazing new tire protector. It is a powerful tire re-inforcement preventing punctures, blowouts, stone bruises, etc. Guaranteed for 3 years. Discarded tires if equipped with TIRE ARMOR give as high as 20,000 additional miles of use and good tires often as high as 40,000 miles of service.

Write today for particulars and  
FREE Sample

MOTOR PRODUCTS CO.,  
Dept. P  
1760 Lunt Ave., Chicago, Ill.





# FREE BOOK

**For You—Just what you want. Get it before you buy. Crammed full of up-to-date offers at Bargain Prices.**

—Lowest anywhere. Everything is high grade, perfect.

**No "Seconds"!** Our goods are of the kind that last and please all the while.

Get it—compare our quality and prices with others—**We save you 10 to 15**—you pay as little as many plumbers pay their jobbers. **"Be Your Own Plumber"**—it's easy—Book tells how. **60 pages—4000 offers and sizes—everything in Plumbing—Heating—Tinning—Paint**

Such as Bathtubs, Lavatories, Closets, Sinks, Laundry Tubs, Water Heaters, Range Boilers, Water Supply Systems, Pumps, Tanks, Pipe, Sewage Disposal Systems—Furnaces, Steam and Hot Water Heating Plants—Parts, Fittings, Tools, Accessories, Supplies—Paint, Varnishes—and on hand also Fencing, Roofing, Tinning—**anything you want—all at cut prices—over 1,000,000 items—largest stock and variety in U.S. Some articles on Easy Payments—anything on Open Account if in business and rated. Write for Free Book Today—NOW.**

**BURKE & BROS.** Dept. 1639D, 433 Liberty Ave. PITTSBURGH, PA.

**60 Pages 4000 Offers—Everything you could think of Send TODAY**

**→ YOU Need It**

# New 21 Jewel BURLINGTON



Write!—while this special offer lasts!—for the NEW Burlington Book, showing in colors the NEW 21 Jewel Burlington in all the latest designs—including the New Burlington Bulldog, the New Lady Burlington, new strap watches—in fact, a watch for everyone! Always a masterpiece, the New Burlington is now better than ever! 21 Ruby and Sapphire jewels; adjusted to the Second, to Temperature, to Isochronism, to Positions; 25 Year Gold Strata Case.

## \$100 Down \$1-30 Days Trial

Yes! Carry this watch masterpiece for 30 days, with no obligation to buy unless delighted! Only \$1.00 down, the balance in small easy monthly payments at our rock-bottom, direct-to-you price, saving you from 25% to 40%! But don't delay! Take advantage of this offer NOW!

## Write! While this Special Offer Lasts!

Find out about this special offer of 30 Days Trial and \$3.50 a month—made for a limited time only. And get our FREE New Burlington Book. It shows how to judge the real value of a watch and avoid purchasing watches that are overpriced. Just fill out the coupon and mail it TODAY.

**Burlington Watch Co., Dept. 13-58**  
 19th St. and Marshall Blvd., Chicago  
 Canadian Address: 118 Princess St., Winnipeg, Man.  
 Please send me (without obligation and prepaid) your new free book on watches, also your special \$1.00 down, 30 day trial offer on the New Burlington Watch.  
 Print name and address plainly.

Name.....  
 Address.....

## LATHES! \$6 to \$75!

Largest line and best quality small lathes in America. Send six cents for 32 page catalog of lathes, drill presses, bench, jig and hand saws, etc. Deferred payments if desired. A Sypher lathe is the best money can buy and prices right.

**SYPHER MFG. CO., Dept. D, Toledo, O.**

**NEW ELECTRIC BENCH LATHE**  
 Length over all 40 inches

Cal. 30-40 Six Shot

**KRAG CARBINE** Price \$9.75

All the qualities of a high price rifle. In fine used condition, all working parts guaranteed for one year. Send today for our Free 50-page illustrated catalog of money saving values: Guns, Ammunition, Cutlery, Sports and Gov't goods. Deposit required on all orders. Money refunded if not satisfactory.

**W. Stokes Kirk, 1627-P. M. North 10th St., Philadelphia, Pa.**

## NEW AUTOMATIC WINDOW WASHER

*Washes-Cleans-Dries-Polishes in ONE Quick Operation.*

Amazing new invention completely revolutionizes window washing. Carries its own water supply! It eliminates all the drudgery and unpleasantness. Five times as fast as old methods! No pail. No brush. No sponge. No chamolis. Your hands never touch water with the NEW AUTOMATIC. Can be used with or without pole. Every housewife, auto-owner, storekeeper and factory owner a live prospect. Sensational demonstration. Sells at sight. Big repeat business. Year 'round seller.

**MAKE \$90 TO \$150 A WEEK!**  
 Agents coin tremendous profits. Going like wildfire. Sells for only \$1.95. Liberal profits for agents. \$10 to \$25 a day easy; \$200 to \$300 a week possible.

**WRITE FOR OUR FREE SAMPLE OFFER**  
 You risk nothing. Don't delay. Write for money making proposition today.  
**NATIONAL INDUSTRIES, Wrigley Bldg., Dept. 1511, CHICAGO**





## “I’m going to raise his salary”

“I’ve had my eye on him for some time and I know he can handle bigger work.

“He studies those I. C. S. textbooks every chance he gets, and I want to tell you it has made him a valuable man for this business.

“I’m going to raise his salary and give him that new job we were talking about. I wish we had more men like him.”

How do you stand when your employer checks up his men for promotion? Does he pass you by as just a routine worker, or does he think of you as a man who is ambitious to get ahead? Won't you be far more likely to get the promotion if he knows you are studying at home and are really preparing yourself to handle bigger work?

Think it over. Then act. It takes only a moment to mark and mail the coupon and find what the International Correspondence Schools can do for you, yet that one simple little step may be the means of changing your whole life.

### Mail the Coupon for Free Booklet

#### INTERNATIONAL CORRESPONDENCE SCHOOLS

“The Universal University”

Box 5575-F, Scranton, Penna.

Without cost or obligation, please send me a copy of your booklet, “Who Wins and Why,” and full particulars about the subject before which I have marked X in the list below:

#### BUSINESS TRAINING COURSES

- |  |   |
|--|---|
| <input type="checkbox"/> Industrial Management                   | <input type="checkbox"/> Advertising                                      |
| <input type="checkbox"/> Personnel Management                    | <input type="checkbox"/> Business Correspondence                          |
| <input type="checkbox"/> Traffic Management                      | <input type="checkbox"/> Show Card and Sign Lettering                     |
| <input type="checkbox"/> Accounting and C. P. A. Coaching        | <input type="checkbox"/> Stenography and Typing                           |
| <input type="checkbox"/> Cost Accounting                         | <input type="checkbox"/> English  |
| <input type="checkbox"/> Bookkeeping                             | <input type="checkbox"/> Civil Service                                    |
| <input type="checkbox"/> Secretarial Work                        | <input type="checkbox"/> Railway Mail Clerk                               |
| <input type="checkbox"/> Spanish <input type="checkbox"/> French | <input type="checkbox"/> Common School Subjects                           |
| <input type="checkbox"/> Salesmanship                            | <input type="checkbox"/> High School Subjects                             |
|  | <input type="checkbox"/> Illustrating <input type="checkbox"/> Cartooning |

#### TECHNICAL AND INDUSTRIAL COURSES

- |   |  |
|---|--|
| <input type="checkbox"/> Electrical Engineering | <input type="checkbox"/> Architect                                       |
| <input type="checkbox"/> Electric Lighting      | <input type="checkbox"/> Architects' Blueprints                          |
| <input type="checkbox"/> Mechanical Engineer    | <input type="checkbox"/> Contractor and Builder                          |
| <input type="checkbox"/> Mechanical Draftsman   | <input type="checkbox"/> Architectural Draftsman                         |
| <input type="checkbox"/> Machine Shop Practice  | <input type="checkbox"/> Concrete Builder                                |
| <input type="checkbox"/> Railroad Positions     | <input type="checkbox"/> Structural Engineer                             |
| <input type="checkbox"/> Gas Engine Operating   | <input type="checkbox"/> Chemistry <input type="checkbox"/> Pharmacy     |
| <input type="checkbox"/> Civil Engineer         | <input type="checkbox"/> Automobile Work                                 |
| <input type="checkbox"/> Surveying and Mapping  | <input type="checkbox"/> Airplane Engines                                |
| <input type="checkbox"/> Metallurgy and Mining  | <input type="checkbox"/> Agriculture <input type="checkbox"/> Navigation |
| <input type="checkbox"/> Steam Engineering      | <input type="checkbox"/> Mathematics <input type="checkbox"/> Radio      |

Name.....

Street Address.....

City..... State.....

Occupation.....

Persons residing in Canada should send this coupon to the International Correspondence Schools Canadian, Limited, Montreal, Canada

# THIS BOOK SAVES YOU \$100.00 ON WORLD'S FINEST CUSTOM-BUILT SETS!

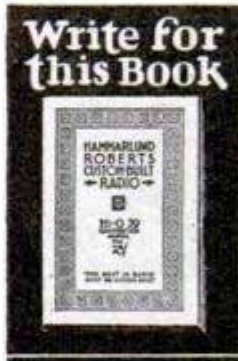

This new 80-page Hi-Q Construction Manual is the most important radio book of the year—shows you how to save at least \$100.00 or how to make a big, steady income through the new CUSTOM-BUILT Hi-Q Receivers—Junior Hi-Q 29 at \$54.35; Junior A.C. Hi-Q 29 at \$103.95; Master Hi-Q 29 at \$99.50; Master A.C. Hi-Q 29 at \$151.80—4 wonder-

ful completely shielded “coast-to-coast” instruments—acknowledged to be the last word in sensitivity and knife-like selectivity—unequalled in tone quality by any ready-made set selling for \$50.00 to \$100.00 more.

This greatest of all Hi-Q Manuals is complete with text, photos and diagrams. Covers every detail of Hi-Q building. Gives full information on power amplifiers, short wave adapters, installation, antennae, house wiring and a wealth of other data. Shows you how to save money on your own set and how to make money building for others.

Price 25 cents postpaid. Write for your copy today before first edition is exhausted.



Hammarlund-Roberts, Inc., 1182-X Broadway, New York City

## SUBANTENNA—Try it FREE

Write at once for full particulars on the first satisfactory device to pick up clear ground waves—Improved SUBANTENNA. Get loud, sharp distance reception, like local. Free trial guarantee offer. Write today.

CLOVERLEAF MFG. CO., 2711-G Canal St., Chicago, Illinois

### 6-TUBE RADIO COMPLETE

\$34.75 to \$66.66

Licensed R. C. A. Circuits. Shielded. One Dial

Write for catalog. Big discounts to agents

Consumers Radio Co., Dept. 171, 4721 Lincoln Ave., Chicago

## WITTE LOG & TREE SAW with ALL PURPOSE ALL FUEL ENGINE

Easy Terms



New Low Factory to You Prices

Cuts up 15 to 40 cords of wood a day on just a few cents' worth of cheap fuel, also cross ties, fence posts, etc.—safe, easy to operate.

### USE THE ENGINE 365 DAYS A YEAR

All-purpose engine can be used for all other power jobs around the farm or ranch, such as pumping water—grinding feed—running milking machine—cream separator, etc.

### Send for Big Free Catalog

of log and tree saws, portable saw rigs, pumper outfits, and engines for the farm and ranch. A WITTE Outfit or Engine will save the expense of hired help. New, low prices—new, easy terms—lifetime guarantee for your protection.

ED. H. WITTE, President,

### WITTE ENGINE WORKS

7748 Oakland Ave.,  
7748 Liberty Street,

KANSAS CITY, MO.  
PITTSBURGH, PA.



# Make big money from repair work



Practically every householder spends at least \$10.00 to \$50.00 each year and many spend several times that much on simple repairs that can be made *quickly, easily and well* with

## Smooth-On No. 1

With a can of Smooth-On, you can save this money in your own home — and by doing similar repair work for others, you can make money.

No skill is required to make repairs and the amount of Smooth-On used on any one job seldom costs more than a few cents.

*Typical repairs that can be made perfectly with Smooth-On:*—Stopping leaks in steam, water, gas, oil or stove pipes, mending cracks, breaks or leaks in furnaces and boilers, radiators, tanks, sinks,

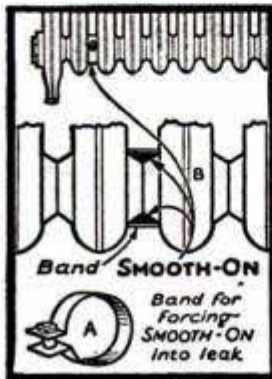

Leak at radiator joint stopped with Smooth-On

pots and pails, making loose handles tight on umbrellas, knives, hammers, brushes, drawers, etc., tightening loose screws, hooks, locks, door knobs, etc.

*On the Automobile:*—Making bursted water jackets and pumps good as new, stopping leaks in radiators, hose connections, gas tank and gas, oil and exhaust lines, making a fume-proof joint between exhaust pipe and tonneau heater, tightening loose headlight posts, keeping grease cups, hub caps, and nuts from loosening and falling off, etc.

To get perfect results, write to us for and use the Smooth-On Repair Book. Free if you return the coupon.

Get Smooth-On No. 1 in 7 oz., 1-lb. or 5-lb. tins at any hardware store or if necessary direct from us.



Write for **FREE BOOK**



# Do it with SMOOTH-ON

SMOOTH-ON MFG. CO., Dept. 37,  
574 Communipaw Ave., Jersey City, N. J.  
Please send the free Smooth-On Repair Book.

Name.....  
Address.....  
11-28.....



each evening  
**10**  
evenings

A few simple exercises, practiced quietly for an hour or so each evening, and before you know it you're playing popular tunes on your easy fingering

## BUESCHER

### True Tone Saxophone

The perfected Buescher Saxophone is a marvelous instrument. It is one of the most beautiful of all musical instruments. By the range and wealth of its tones it may take the place of almost any other instrument. Yet it is so perfected and simplified that it is the easiest of all instruments to play.

### Only a Buescher Gives You All These Features

Snap-on Pads, greatest improvement, easy to replace, no cementing—Patented Automatic Octave Key—perfect Scale Accuracy—convenient key arrangement.

### Always Welcome Everywhere

You are always welcome with a sweet-toned Buescher Saxophone. Thousands of men and women, of all ages, have found it an infallible key to social popularity. For home entertainment, for church, school or lodge affairs, the Saxophone is the most popular and adaptable instrument. Saxophone players enjoy, also, many opportunities of earning money. They are always in demand for dance orchestras.

**6 Days' Trial** You may have in your own home for 6 days one of these latest Buescher Saxophones, without obligation to keep it.

Fill out and mail coupon for full information. Mention instrument in which you are interested.

**Buescher Band Instrument Co.**  
2611 Buescher Block Elkhart, Indiana

BUESCHER BAND INSTRUMENT CO. (481)  
2611 Buescher Block, Elkhart, Ind.  
Gentlemen: Without obligating me in any way please send me your free literature. Mention instrument interested in.  
Age?..... Name instrument.....  
Name.....  
Address.....

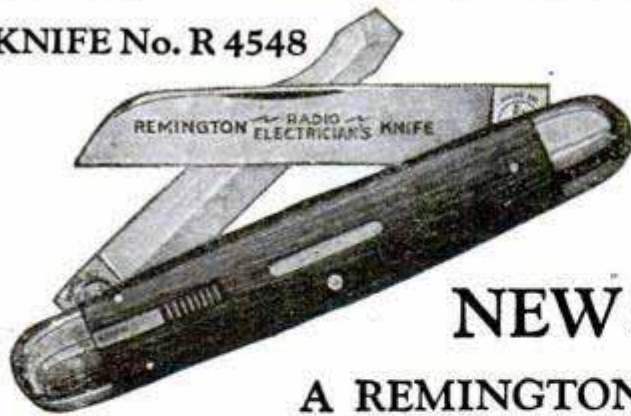

KNIFE No. R 4548

**NEW!**

A REMINGTON  
KNIFE FOR ELECTRICIANS  
AND RADIO FANS . . .

**T**HIS new Remington knife is just what electricians and radio tinkers have been waiting for. Can't be beat for scraping insulation from wires, making connections, tightening up, doing odd jobs. Has one 3-inch sheep-foot blade, and a 2½-inch screw-driver. The blade is forged from high carbon steel, razor sharp, and holds its edge a long time. One side of the screw-driver is ground to a cutting edge. Safety catch prevents screw-driver from closing when in use. Nickel silver bolsters, brass linings.

Ask your dealer to show you the Remington Radio Electrician's Knife. Note its hard, handsome, cocobolo handle. Test its razor-sharp blade. Note the screw-driver... see how strong it is. Knife No. R 4548 is a wonderful value for \$2.00. If your dealer hasn't it in stock, send us his name and the price. The knife will be forwarded at once, postpaid.

REMINGTON ARMS COMPANY, Inc.  
*Originators of Kleanbore Ammunition*  
25 Broadway New York City

# Remington

KNIVES THAT BITE

© 1928 R. A. Co.

R 4548

**One Year To Pay**

**No Red Tape 10 Days Trial**

**No. A295 - \$59**  
**\$5 Deposit - \$1 Weekly**

You've never seen a more exquisite ring than this. The fine quality, full cut, genuine blue-white diamond is full of fiery brilliance. Two smaller, blue-white diamonds are set in the sides of this handsomely hand engraved, 18 Kt. solid white gold, lady's mounting. Makes a wonderful engagement or friendship ring. Your friends are bound to admire this magnificent ring. Handsome gift case free.

**18 KT.**

**SEND NO MONEY** When you get the ring, pay only \$5.00 to the postman. If you keep it, pay only \$1.00 a week for one whole year. All credit dealings kept strictly confidential—no unnecessary delay. State if white or colored.

We are an old **Money Back** firm of diamond importers. You take no risk. If you are not satisfied that the ring is the biggest bargain you ever got, return it within 10 days and we will refund every cent you paid.

**PRICE CUT TO \$59.00 - WORTH \$100.00**

You can now buy this gorgeous ring at the wholesale price. Compare it with similar rings at \$100. We guarantee it to stand any test or comparison. Greatest bargain offered by any Diamond Importer. We allow 8% annual increase in exchange for a larger diamond ring.

**Write for FREE Illustrated Catalog**

It brings our large Jewelry Store right into your home. Gives weights, grades and complete description so you can buy diamonds like an expert. Gives information other jewelers dare not tell. Write today!

**AGENTS WANTED - EFRN \$200 WEEK. WRITE FOR DETAILS**

**STERLING DIAMOND & WATCH CO. INC.**  
DIAMOND IMPORTERS - \$1,000,000 STOCK - ESTABLISHED 1879  
1540 BROADWAY DEPT. 2530 NEW YORK

**ENGINEITE**  
THE WONDER FLUID FOR  
YOUR MOTOR COOLING SYSTEM

ENGINEITE prolongs the life of your motor, by giving free circulation to water in the radiator, preventing and removing rust, scale and corrosion. Surest remedy for overheating motors. Gives more pep and power. ENGINEITE is as important as gas and oil. Guaranteed satisfactory or money refunded. \$1. (West of Rockies 25c extra.) Dealers write.

Manufactured by  
**INDUSTRIAL REFINING CO. Inc.**  
120 W. 42nd Street  
NEW YORK CITY

**\$1**

**Ford Owner** Stop that ruinous chatter on your car. **MAKE THIS TEST**—take out your floor boards, pull your emergency brake back and forth. If you notice play at the ball joint, you need Bredar's Ball Shim. Price \$50. Ask your Dealer or order direct. Demand Bredar's Shim.

**NIC BREDAR'S SON MFG. CO., Rock Island, Ill.**

**Never Before a Motor Like This!**

4 cylinders bring new thrills to outboard motoring. The Super Elto Quad drives racers better than 35 miles per hour—comfortable runabouts at 25 miles—cabin cruisers at 15 miles. Brings luxurious motor boating within reach of all. Send for catalog of Quad and other Super Elto models. Address, **ELTO OUTBOARD MOTOR CO., Ole Evinrude, President, Mason St., Department AA, Milwaukee.**

*The Super Elto*  
**Quad**



# POSITIVELY NEW! SENSATIONAL INVENTION PIERCE VAPO VALVE OILER

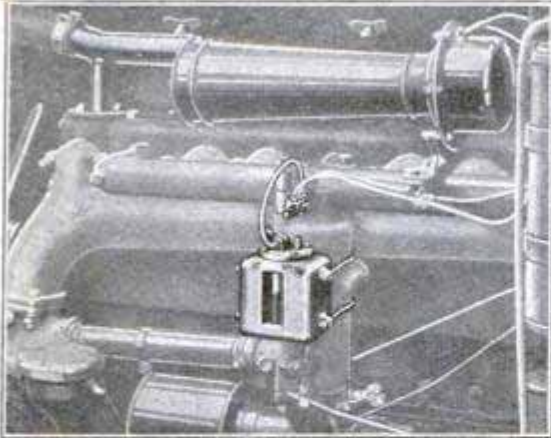

Eliminate your valve troubles—Get Better Compression. New and old cars alike need it. No more sticky valves. Complete Top Cylinder Lubrication; efficiently distributed with the fuel mixture to each cylinder. Perfect control under all speeds and lubricates instantly when engine starts in Summer or Winter. Engineers speak highly of its efficiency.

## Motor Runs Better—More Power—More Miles

The PIERCE VAPO VALVE OILER overcomes the present deficiencies in motor lubrication and avoids wear and damage to the valves. Makes any motor run better, smoother and quieter, actually giving you More Power and More Miles out of your fuel.

## EVERYONE IS ENTHUSIASTIC

Motorists are pleased over the marvelous improvement it adds to their car and the repair bills it saves in valve trouble. Mr. Pierce the Inventor also developed an oil to dissolve carbon and rust known as Pimovaol (Pierce Motor Valve Oil) which has a world-wide reputation.

## Keeps Spark Plugs Clean—Full Compression

This Marvelous Invention keeps your spark plugs clean and maintains full compression by properly lubricating the valves so that they work efficiently. Adds many thousands of miles to the life of your car.

## 30 Days' Trial on Your Car MONEY BACK GUARANTEE

So sure are we of your satisfaction that we guarantee to please you or refund your money during 30 DAYS TRIAL.

## \$15-\$35 a Day EASY—Better Hurry!

Put one on your car and soon you will have everyone in the neighborhood talking about it. Easy to install and every one in use sells a dozen more. Wonderful Money-Making Opportunity. Write us TODAY!

## THE W. C. PIERCE COMPANY

2431 Prairie Ave.

CHICAGO, ILL.

## MAIL TODAY

The W. C. Pierce Company,  
2431 Prairie Ave.,  
CHICAGO, ILL.

**FITS  
EVERY  
CAR**

Gentlemen:

I am interested in your SPECIAL OFFER. Please mail me FREE PARTICULARS.

Name .....

Address .....

## "You're there with a CROSLLEY"

Genuine neodyne battery type Bandbox \$55  
AC Electric power speaker GEMBOX \$65

THE CROSLLEY RADIO CORPORATION

Cincinnati, O.

Powel Crosley, Jr., Pres.



## MODEL AIRPLANE MOTOR

Only motor of kind on market. Compressed air. Tanks, blueprints. The only motor for model aircraft builders. A powerful little job and a real beauty. **\$4.90**

IDEAL CHRISTMAS GIFT. Send for descriptive circular.

Amalgamated Sales & Service Corporation  
542 West Jackson Boulevard  
Chicago, Illinois

## Individual Machines Workshop!

You can do heavier work and a larger variety of jobs with individual machines in your workshop. Boice-Crane machines are each designed to give maximum efficiency and are superior in size, capacity and ability.

You can start your shop with any one of the units in the Boice-Crane Workshop illustrated, and enlarge it as desired.

Send 10c for the Boice-Crane catalog illustrating and describing these extraordinary machines.

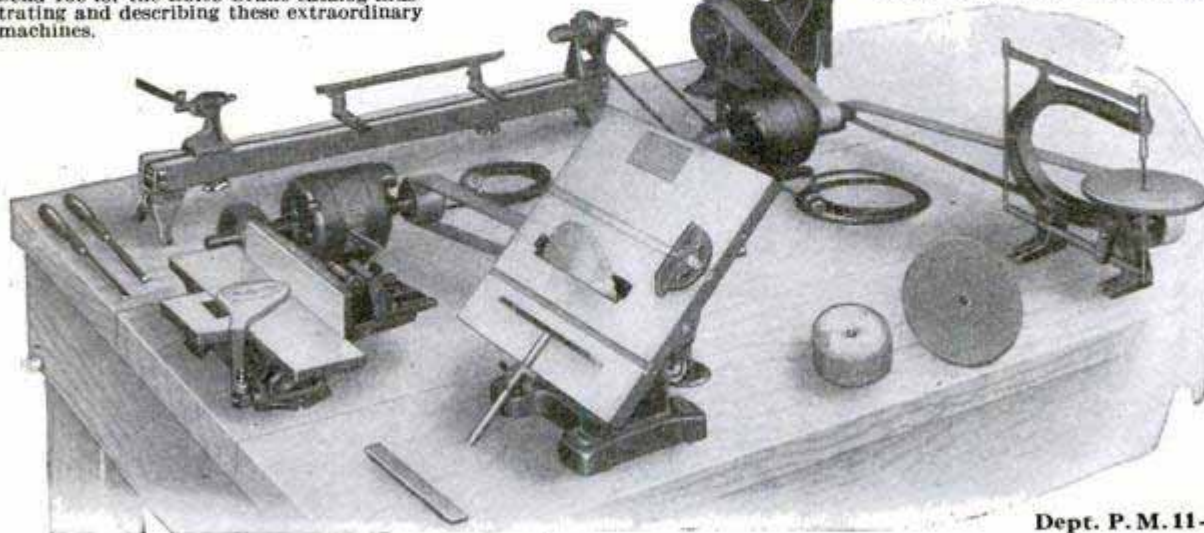

## Make the Best

**Band Saw, 12-in., NEW,** like our successful 14 in. machine. A high-grade Boice-Crane product. Price..... **\$35.00**

**Lathe, 7 in. x 41 in., as shown..... \$26.15**

**Universal Handisaw.** A whole workshop in itself. Will do more heavy and difficult jobs than any other you can buy. Why not make it the nucleus of your shop? With 8 in. saw..... **\$30.75**

**Handjointer, 4 in., NEW!** Perhaps greatest Boice-Crane value ever offered. Built similar to

our **\$84.00** precision machine. Has features never before offered in a machine of such low cost. Price..... **\$28.00**

## UNIVERSAL JIG SAW

Cuts 1/16 in. fret blades or heavy power blades 1/8 in. to 3/8 in. wide. Cuts cardboard or 1 1/2 in. stock. Price..... **\$12.00**

## Complete Shop As Illustrated

with two 1-3 h. p. motors. Price..... **\$192.60**

Hardware and Machinery Dealers Wanted. Write for attractive proposition.

**W. B. & J. E. BOICE,**

Dept. P. M. 11-D, Toledo, Ohio



**MODERN JEWELRY AT A MODERATE PRICE**

**\$100**  
brings your choice  
10 months to pay

**\$52.50**  
21-Cupid engagement ring with motif of arrows, hearts and cupids; set with three blue white diamonds. \$1.00 with order. \$5.15 a month.

**\$65**  
22-Bird design engagement ring; 18K white gold; AA 1 blue white diamond. \$1.00 with order, pay \$4.00 to Postman; \$5.00 a month.

**\$42.50**  
20-Love Knot; 18K white gold set with AA 1 blue white diamond. \$1.00 with order. \$4.15 a month.

**\$50**  
23-Roman scroll design; 18K white gold; large AA 1 blue white diamond. \$1.00 with order. \$4.90 a month.

**\$39.50**  
27-Two blue white diamonds; four blue sapphires, 15 Jewels; 14K solid white gold wrist watch. Complete with flexible bracelet set with two triangular cut blue sapphires

**26-New Bulova watch 15 Jewels; dust-tite cap; radium numerals and hands. Nationally advertised cash price \$29.75. \$1.00 with order. \$2.87 a month.**

**New Friendship Ring — \$42.50**  
25-Beautiful design, 18K white gold, three blue white diamonds; four blue sapphires. \$1.00 with order, \$4.15 a month.

**WHAT YOU DO—**  
Send \$1.00 with number of article desired, and brief note stating (1) how long at address, (2) age, (3) married or single, (4) name of employer, (5) nature of work, (6) how long in employ. Information will be held strictly confidential — no direct inquiries sent to employer.

**WHAT WE DO—**  
We will immediately open a 10 month Charge Account and send selection for approval and 15 days trial. If satisfied you pay balance in 10 equal monthly payments. Otherwise, return and your dollar will be refunded. No articles sold to persons under 20 years of age.

Sent to any Adult interested in the purchase of diamonds, watches or jewelry. Ten months to pay on everything.

**It's a Bulova**

**L.W. SWEET INCORPORATED**  
Dept 68-S 1660 BROADWAY  
NEW YORK, N.Y.

**A New Victoreen A. C. Circuit**

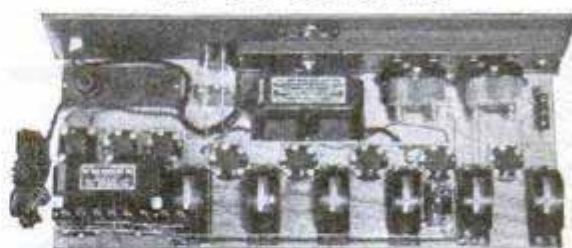

Vital changes in Victoreen R. F. Transformers, together with radical improvements in the A. C. circuit itself, have still further perfected and simplified a "Super" which for years has had no superior.

The new Victoreen is simply marvelous. Here you have A. C. operation at its best. Tone quality such as you have never heard before—selectivity such as you never dreamed to be possible—greater simplicity of assembly.

The heart of the new Victoreen circuit is of course the world famous Victoreen R. F. Transformer—greatly improved in efficiency. Each transformer is individually tuned to a precision of less than 1-3 of one per cent by the Victoreen patented method.

To get the results which only Victoreen gives, either build, or have built for you, a Victoreen Super.

**BLUE PRINT FREE**, together with full constructional details. Write for it today.

**The Geo. W. Walker Company**  
Merchandisers of Victoreen Radio Parts  
2825 Chester Ave., Cleveland, Ohio

**Victoreen**  
Quality Radio Parts

**PANTS MATCHED**  
**WHY THROW AWAY THAT COAT AND VEST?**



Save \$25 or more! Let us match your coat and vest with new trousers, and save the price of a new suit. Hundreds satisfactorily matched every day. Each pair tailored to your measure. Over 100,000 patterns. We submit sample of cloth for your approval. No obligations. Just mail sample of the suit, or your vest.

Originals and largest pants matchers

**MATCH PANTS COMPANY**  
Dept. 25, 20 W. Jackson Blvd., Chicago

**See Miles Away!** 5 Sections 8-Power

**5 DAY TRIAL**

with Big 3 Ft. Telescope

Brings distant people and objects close to your eyes. Wonder telescope opens over 3 ft. long. 5 big sections, brass bound. 8 power lenses. Ideal for sports, camping, travel.

Read numbers on freight car mile away.—A. C. Palmer.

**FREE CARRYING CASE and SHOULDER STRAP**

**SEND NO MONEY** On arrival pay postman \$1.95 plus postage (2 for \$3.75). Or send \$1.95 and we pay postage. Try 5 days. Money refunded if not delighted. Send today.

FERRY & CO., DEPT. 1778 CHICAGO, U. S. A.

**42 MILES ON 1 GALLON OF GAS**

Walter Critchlow, 805-R2 Street, Wheaton, Ill., has patented a Vapor Moisture Gas Saver and Carbon Eliminator for all Autos and Engines that beats any ever got out. Old Fords report as high as 42 miles on 1 gallon. New Fords 40. Other makes report amazing increases of 1/4 to 1/2 more. Mr. Critchlow offers to send 1 to introduce. Write him today. He also wants County and State Agencies everywhere to make \$250 to \$1000 per month.



# Made \$517 Profit in 3 Weeks



W. V. JONES

W. V. Jones, Texas, made this money. Shedrick of Ohio, earned \$177 in 4 days. Fauley, W. Va., made \$257 in 18 days. Good territory still open for ambitious men.

**\$18<sup>50</sup> to \$22<sup>50</sup> Profit Per Order!**

Every cash or time payment order gives salesmen \$18.50 to \$22.50 commission. Easy to earn \$100 every week. No experience needed. Store owners, cafes, theatres, hotels—all are prospects for

## Dazzler and Rainbow Glow Electric Signs

Write today for beautifully illustrated literature showing Dazzler and Rainbow Glow Electric Signs in full color, also money making proposition and exclusive territory arrangement. Don't wait! Get in the big money class as our representative. Write at once.

**CHICAGO SIGN SALES CO.**  
Dept. 33  
Charlotte, N. Carolina

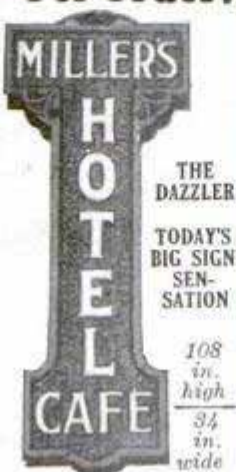

# \$1<sup>50</sup> Makes An Efficient Workshop of Your Electric Motor Fastens Directly on Shaft

Without Chuck  
**\$1<sup>85</sup>**

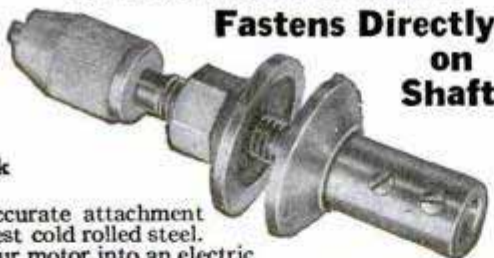

With Chuck

A handy, accurate attachment made of finest cold rolled steel. Converts your motor into an electric Polishing, Grinding, Drilling and Sawing outfit. Sizes to fit 3/8, 1/2 and 5/8 inch shafts. State size. Postage prepaid on receipt of remittance.

**EVRY USE PRODUCTS CO., 178 C-11 Centre St., New York**

## SEND FOR NEW RADIO BOOK—IT'S FREE!

New hook-ups. This book shows how to make short-wave receivers and short-wave adapters. How to use the new screen grid tube in D. C. and A. C. circuits. How to build power amplifiers, ABC eliminators. Up-to-the-minute information on all new radio developments. It's free. Send for copy today.

**KARAS ELECTRIC COMPANY**  
4028L2 North Rockwell St., Chicago, Ill.

Name.....  
St. and No.....  
City and State.....  
4028L2

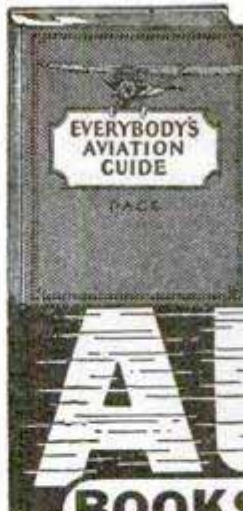

## "AVIATION" GUIDE FREE With Auto Books!

For a limited time only we will give absolutely free Major PAGE'S sensational "best seller" among aviation books, 256 pages crammed full of the latest dope on modern aircraft, airplane motors, control systems, lessons on flying, etc. Written in simple, non-technical language, especially for beginners planning to go into aviation. Mail coupon, send no money.



## Can You FIX IT?

Can you take the "play" out of differentials? Can you kill the SHIMMY in steering? Can you reset TIMING? Can you put your finger on engine-trouble without guessing or tinkering? Can you pull the STARTER off and fix it? Can you adjust and repair transmission, rear-axles, engines and electrical systems?

## These Books Tell HOW!



Whether you are a mechanic or helper, expert or student, auto owner or driver, by all means take advantage of this opportunity to see and use the latest and most complete library on AUTOS every published! Built by eighteen of America's greatest automotive engineers. Simple enough for men with little schooling to understand, yet in daily use by thousands of engineers, service station superintendents and foremen. Tells you how to do any auto job RIGHT the first time.

## 5 BIG VOLUMES

2400 pages, over 2000 illustrations, wiring diagrams, equipment charts, etc. DeLuxe edition with gold-stamped flexible binding. Sent FREE for 15 days' use. If not wanted return express collect. If kept, send only \$2. after 15 days, then \$3. a month until special advertising price, \$24.80 is paid.

## Don't "Study"—LOOK IT UP!

The ten-billion dollar auto industry offers rich prizes to men with gumption enough to really learn all branches of automotive mechanics. A better job—bigger pay—the chance to go into business for yourself and get a share of the huge profits are waiting for any man who even half tries to improve his ability to deliver service. And here's the quickest, easiest way—no tedious memorizing or lessons. JUST LOOK UP the facts you seek. You'll find the answer to any auto problem literally at your finger-tips in the famous JIFFY INDEX.

**American Technical Society**  
Dept. A-819B Drexel Ave. & 58th St., Chicago, Ill.

## DON'T SEND A PENNY!

**American Technical Society**  
Dept. A-819B Drexel Ave. & 58th St., Chicago, Ill.

I would like to see the new 5-volume edition of your AUTO BOOKS, but without obligating me to buy them. I will pay the few cents delivery charges only, and if I choose to, I will return them express collect. If after 15 days' use I prefer to keep them I will send you \$2 and pay the balance at the rate of only \$3 a month, until \$24.80 is paid. Please include a year's consulting membership free, and send "AVIATION GUIDE" without cost after I notify you I will keep the books.

## AVIATION BOOK FREE

Name.....  
Address.....  
Employer's Name.....  
Employer's Address.....



**—FREE—**

\$5.00 Book of Blue Prints Showing 46 PRIZE PROJECTS with \$35. Outfits.

# S&B 8" Combination Saw 18 Tools In One

*Money Back Guarantee*

# 12" Band Saw

The only machine that you can tilt the table to 45° without removing insert. Big advantage on pattern work.

Sent to You on *15 days approval*

## 12" Band Saw

Positively a sensation and at this LOW PRICE you can NOW do the 1001 things you wanted quick and easy. This 12" BAND SAW has a tilting table, with Miter and sturdily built. Ideal for the shop or home.

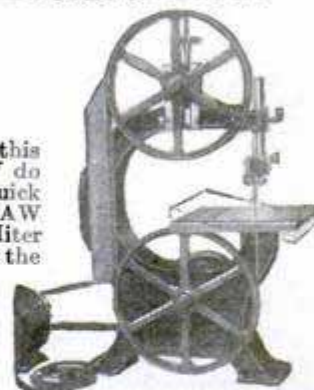

## S&B Scroll Saw

Here is the outfit of practical usefulness. Will cut wood and light metal true to marks. Table top tilts to 45 degrees, making it convenient and easy to cut at proper angle. Thousands of jobs can NOW be done by any man or boy with the accuracy of a real mechanic. This S&B WONDER SCROLL SAW is free from vibration.

**\$35<sup>00</sup>** F.O.B. Chicago without Motor  
**Scroll Saw**

Delights Every Boy



**\$15<sup>00</sup>**

F. O. B. CHICAGO  
1/2 H. P. A. C. Motor \$15 extra

**\$35**  
F. O. B. CHICAGO

Price Includes 1/2 H.P.A.C. Motor

## Belt Tightener

{ 1/2 H. P. Motor-40°-100% overload Double Shaft Extension }

## 18 Tools in One—Greatest Machine You Ever Saw

THE S&B 8-in. COMBINATION SAW (18 tools in one) is the ideal machine for the shop, factory or the home; will rip, cross cut, bevel, miter, mortise, groove, drill, tenon, grind, rabbet, buff and polish. Motor is mounted on a base that is a part of the machine proper. Run from any light socket, also provides power for other purposes when the saw is not in use. Complete with attachments and price includes 1-3 H. P. Motor, 60-cycle, 110-Volt A. C. Price \$35.00 F. O. B. Chicago. Shipping Weight 100 lbs.

(Planer attachment to fit on table top will smooth pieces up to 2 in. wide, \$10 extra.)

**SCOTT-BANSBACH MACHINERY CO.**  
130 So. Clinton St., Dept. 95, CHICAGO, ILL.

Write for Complete Illustrated Folder—Dealers Wanted.

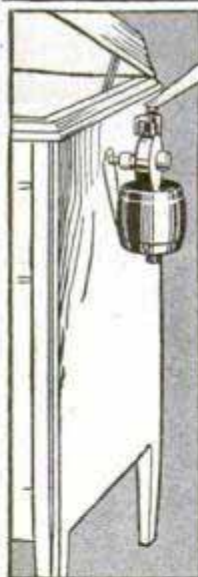

# Press the button and let the **MOTROLA**

## wind your phonograph

The Motrola is a small electric motor that replaces the winding crank on your phonograph. Readily attached to outside without marring the woodwork or affecting the mechanism. Merely press the button and the Motrola winds your phonograph more quickly and evenly than you can crank it. Stops automatically when spring reaches proper tension. Your old phonograph with Motrola and electric pick up to your radio—gives the same results as the costly new machines.

### QUICKLY, EASILY APPLIED

Anyone can apply or detach the Motrola in a few minutes, using only a screw driver. Winds any make or size of machine. No parts to wear out—costs only a cent a month for electricity. Attractively finished, equipped with light socket plug and 10 feet of cord. Sold with our unequalled guarantee. Thousands now giving dependable, labor saving service. Ask your dealer for demonstration.

If you prefer to buy direct, we will ship postpaid anywhere in the U. S. A. Just forward check or money order with your name and address. **\$25** Special Price.

Write us today for illustrated descriptive folder

**JONES-MOTROLA SALES CO.**

Dept. 111, 370 Gerard Avenue

New York City

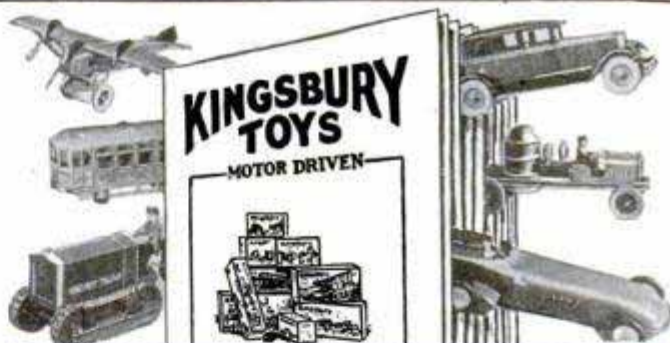

## FREE — This Book of Christmas Inspiration

SEND for your copy today! A book of Toys—wonderful toys—lifelike toys—exciting toys! Automobiles, Racing Cars, Aeroplanes, Fire Engines, Ladder Trucks, Busses, Tractors, Trolleys, Dump Trucks, Sedans, Coupes, etc., etc. Toys that will bring days and days of happiness to any boy or girl. Sturdy, lasting toys, built all of steel, with strong, speedy clock-spring motors. And finished so handsomely—bright durable colors, smart trims. A book filled full of Christmas inspirations. Send for a copy today—it's free—and save hours of tiresome shopping at the last crowded minute.

**Kingsbury Mfg. Co., 83 L Myrtle St., Keene, N. H.**

P. S. Enclose 10¢ and we'll include also a novel Eraser—a disc wheel from a Kingsbury Toy with a big, fat, balloon size tire of eraser rubber. Set of four, 35¢.

**KINGSBURY MOTOR DRIVEN TOYS**



# A Thousand Popular Mechanics Readers Now Making \$500 to \$1000 a Month as CLARKE FlorKraftsmen

Yes—a few over a thousand and more every day. Think of it! Men—young men and older men too—men just out of school—men on small salaries just a few months ago are now making \$25 to \$75 a day.

That's just the opportunity we have been offering to Popular Mechanics readers for the last few months. Many readers have grasped the opportunity and are now in the \$6000 to \$12,000 a year class.

Many others have read the offer but have held back. If you are one of them, at least get the facts.

The plan is so simple, anyone can follow it, and earnings are sure.

## Pleasant, Easy Work

The Clarke is light—easily carried with one hand anywhere. Operates off any light socket, and is as dustless and almost as easy to operate as a vacuum cleaner. You simply guide the Clarke.

It does the work of many men hand scraping, does a better job too, and you get all the pay.

Think of surfacing new floors at the rate of 800 to 2000 sq. ft. per day and refinishing 300 to 1000 sq. ft. of old varnished floor in the same time. The Clarke cuts right through the varnish, without using varnish remover too. It's fascinating work and profitable work. Everywhere people want their floor surfaced. You get from 2 to 5c for new floors, 8 to 15c for old varnished floor. And the Clarke does the hard work for you—quicker, better and more economically than anyone else can do it.

Remember not only floor contractors but men like you are making the big money as FlorKraftsmen.

*Don't wish for the money you want.* Get it. Other Popular Mechanics readers have. They did just what we ask you to do. They got the facts. It costs you nothing to find out. Fill out and send the coupon in *NOW*.

## CLARKE SANDING MACHINE CO.

Dept. T-11

3831 Cortland St., CHICAGO, ILL.

Originators, and for over 11 years, Manufacturers of  
Portable Sanding Machines



**NO TUITION  
—Start Earning  
at Once**

Simply become a Clarke FlorKraftsman, surfacing new floors and old floors. You don't have to learn a trade. You don't have any tuition to pay. You can start right in making the money. We show you how in 15 minutes. A day's practice makes you expert with the Clarke, for the skill and power is built in the Clarke.



POWERFUL - FAST CUTTING  
**CLARKE**  
VACUUM PORTABLE SANDER

CLARKE SANDING MACHINE CO.,  
Dept. T-11, 3831 Cortland St.,  
Chicago, Ill.

Please give me the facts about Clarke FlorKraftsmanship. No obligation to me.

Name.....

Address.....

City.....State.....





*I was just a poor laborer*



**One day I picked up a magazine out of the street - that was my start in AVIATION!**

**Y**OUR training opened up to me a new life. You took me out of the labor ranks and gave me a real opportunity. It happened like this:

"One day while I was fixing a tire, I noticed an old magazine lying in the street. I picked it up and glancing through its pages, I saw Lieut. Hinton's picture. I read what he said about opportunities in Aviation and how he was training men at home. Finally I sent for your free book; but more for fun than anything else. Then sure enough, I 'fell for it.' Then came the first instructions—and I want to tell you that right there, I took on new life. I went through the whole course and when I finished, I could talk Aviation like an authority.

"About that time, they opened up an aero club here and I went over to talk with the flight instructor. He asked me a few questions about a plane and I answered him like an old timer. Then he tried to fool me with some catch questions, but I answered them all—told him how to start the motor, take

off, make a landing against the wind with the motor idling and a whole lot more. He wanted to know where I had piloted and believe me he was some surprised when I told him I had never flown.

"Well the upshot of it was that I was made an assistant instructor, teaching the students about a plane and its controls. So now I'm getting my hours in the air and at the same time getting paid to teach others some of the things that you taught me. My advice to anyone who is interested in getting into Aviation is to train under you first of all, for then he will be ready for ANY opportunity, whether it's on the ground or in the air."

**ALBERT SHUKOFF,**  
Hamilton, Ont., Canada

**get HINTON'S free book**

Albert Shukoff is but one of many men who owe their present profitable place in Commercial Aviation to Lieutenant Walter Hinton. Get the facts—find out how he trained them and how he is ready to train you—right at home. Learn how he can arrange Flight instruction for you, if you want to fly, at *specially reduced rates*. This big book is FREE to men over 16 years of age. The eye opening, interesting facts will be in your hands in no time, if you'll mail that coupon NOW.



**Walter Hinton**

First to pilot a plane across the Atlantic; the famous NC-4; first to fly from North to South America; former crack flying instructor for the U. S. Navy. Today he's training ambitious men right at home—for big futures in the best paying, fastest growing field of all—Commercial Aviation.

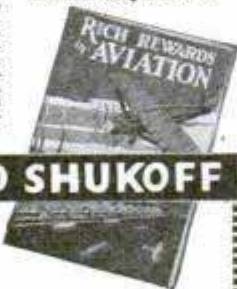

**THIS BOOK STARTED SHUKOFF**

Lieut. Walter Hinton, President,  
24-L Aviation Institute of U. S. A.,  
1115 Connecticut Avenue,  
Washington, D. C.

Dear Lieutenant Hinton: Please send me your interesting FREE book, called "Rich Rewards in Aviation."

Name .....

Street .....

City .....

**Charge It!**

**Princess Pat Combination** \$25

**BP1-14K Solid White Gold engraved case, 15J guaranteed movement, complete with silk grosgrain ribbon & Wristocrat bracelet, \$2. a month, \$25**

**SENT FOR \$1 NO C. O. D. TO PAY**

Only the finest, and a full year to pay—Send \$1 with order and your choice comes to you prepaid—no C. O. D. to pay on arrival.

**10 DAYS FREE TRIAL**

**A FULL YEAR TO PAY**

After examination and 10 day free trial, pay balance in 12 equal monthly payments. No interest. No extras. All transactions strictly confidential. You take no risk—satisfaction absolutely guaranteed or money back.

**BP2-Hand engraved 18K solid white gold mounting; genuine blue-white diamond, \$3.95 a mo. \$48.50**

**BP3-Elgin or Waltham movement, hand engraved 20 year guaranteed gold filled case. \$2.12 a month. \$26.50**

**FREE** New catalog of genuine diamonds; Bulova, Elgin, Waltham, Hamilton, Howard, Illinois watches; fine jewelry. Write for your copy now.

Wear an American Watch

Estab. 1895

**ROYAL DIAMOND & WATCH CO.**  
ADDRESS DEPT. 11-L 170 BROADWAY, N.Y.

**Play At Once!**

Play latest hits. So easy—pictures show everything. Romance! Friends! Fun! Popularity!

**Free TRIAL OFFER**

Free New method, 200 songs and pick free with beautiful jumbo size Uke. Patent pegs—regular \$5.00 value. Rich, sweet tone.

**Send No Money** Pay Postman \$2.98 plus postage. (Or send price and we pay postage.) Play 6 days, money back if not satisfied.

Ferry & Co., Dept. 3778, Chicago

**BUILD YOUR OWN CLOCK WITH OUR HELP**

Profitable spare time work for fall. Turn idle hours into welcome dollars by building clocks from our instructions. We furnish plans, instructions, blue prints, works, dials, and all materials at surprising low prices. You make a big profit building artistic clocks for your friends.

**Banjo Clocks, Mantel Clocks, works as low as \$1.65. Beautiful Grandfather Clocks with chimes. All styles, all prices.**

**ASK FOR OUR ATTRACTIVE FREE BLUEPRINT PLAN AND CATALOG**

**AMERICAN CHIME CLOCK COMPANY**  
1679 Ruffner Street, Philadelphia



# Send for This Electric "Delta" Handi-Shop

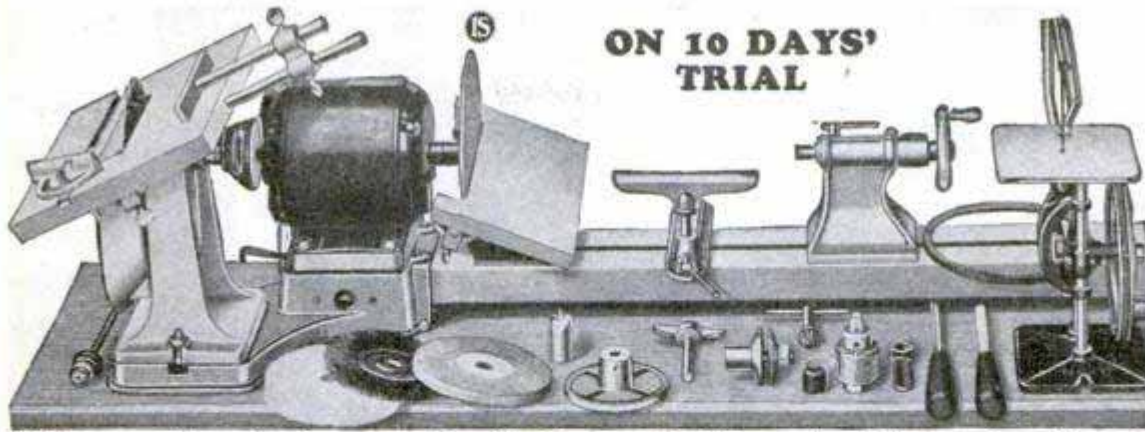

**ON 10 DAYS' TRIAL**

**Blue Prints Free!**

With each Handi-Shop comes a complete set of working drawings. Below are pictured a few of the hundreds of articles that can be made quickly and easily!

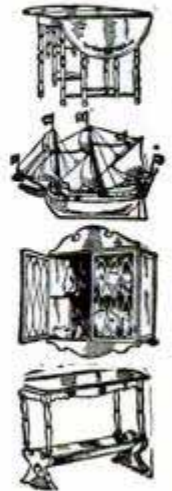

Mail the coupon below—learn how you can have this big complete Delta Handi-Shop for 10 Days' Trial right in your own home. Test it to your heart's content! Note its many exclusive features. See how this sturdy man-size machinery stands up under actual working conditions. Note how convenient is the two-shaft motor that enables

you to handle two or three jobs at one time without dismantling set-up. See what wonders in craftsmanship, woodturning, carpentry are possible with this efficiently designed outfit. Make the things you've always wanted to make. Save money on repair work. Earn money in your spare time.

### Husky Practical Machine

With the Delta Handi-Shop you can do anything from building full-sized furniture, turning table legs, to carving delicate little wood decorations. You will find the Handi-Shop a real worker's shop. COMPLETE, FULL-SIZED, including all necessary equipment for woodturning, face turning, circular sawing, scroll-saw work, sanding, drilling, dado and joining work, grinding, buffing, tool-sharpening, and carving. And you'll be surprised at the low cost.

### Easy Payments

Mail coupon NOW for beautifully illustrated literature giving complete description of Delta Handi-Shop and pictures of its many exclusive features. Also full details of 10-Day Trial Offer and your choice of 3 convenient methods of payment.

### Many Exclusive "Delta" Features!

A few of them are: 1. Powerful, two-shaft motor—handles two or three operations at same time. 2. Heavy U-shaped lathe bed guaranteed not to spring or chatter. 3. Improved circular saw with exclusive tilting table features and extension guides. 4. Improved sanding disc with special tilting table (can be operated without detaching saw). 5. Improved scroll saw with special tilting table. 6. Completely assembled on heavy veneered wood base.

**Delta Specialty Co. Dept. MP-1128**

1661-1667 Holton St.

Milwaukee, Wis.

Delta Specialty Company, Dept. MP-1128, 1661-67 Holton St., Milwaukee, Wis.

Please send me, without obligation, illustrated literature describing Delta Handi-Shop. Also full details of 10-Day Trial Offer and Easy Payment Plans.

Name.....  
Address.....  
.....

## GO IN BUSINESS FOR YOURSELF

**Make \$50 to \$100 a Week**

Stop building fortunes for others and build one for yourself. Clean suits, coats, dresses, etc., at amazing speed. Big demand—everybody has clothes cleaned! Public spent \$168,000,000 for cleaning in 1918; estimated \$350,000,000 this year.

### The BABY GRAND Dry Cleaning System

has made thousands of dollars for others and will do the same for you. Clean, easy work! No experience necessary! Small investment. We teach you business! Tailor shops, barber shops, pressing shops, etc., can add big profits. Write today!

GRAND MFG. CO.

304 S. State St., Indianapolis, Ind.

# BIG PROFITS!

### New Aero Green Book for 1929

Contains 25 new circuits—Short wave and broadcast—information needed by every amateur and set builder. Send 25c for your copy.

Aero Products Corp., Dept. 488—4611 E. Ravenswood Ave., Chicago

GENUINE HARTZ MOUNTAIN  
**HENRY BARTELS**  
**Canaries**  
GUARANTEED TO SING

Enjoy the sweet, golden song of a Henry Bartels "Bred-To-Sing" Canary. Every bird is perfectly healthy, thoroughly acclimated; bred from famous singers. If no dealer near you has genuine Henry Bartels Canaries, we will ship a selected, fine young singing male direct on receipt of price; satisfaction and safe delivery guaranteed.

**\$8** for fine, young, healthy singing Hartz Mountain ROLLER. **\$12** for Hartz Mountain CHOPPER, famous for beauty of song.

Enameled cage (white, blue, green or red) \$3.50 additional. Complete Descriptive Price List of various cage birds FREE.

**HENRY P. BARTELS** Leading Importers of Canaries and Parrots  
206 Fulton Street New York City

**\$10<sup>98</sup> WILKINSON Improved SAFETY RAZOR**

PREPAID in real solid leather case, complete with three foil

HOLLOW GROUND BLADES

"Lasting like ordinary razors." Improved Automatic Honing and Stropping Machine, Badger Shaving Brush, made by Wilkinson Sword Co., England.

**THE LINCO SUPPLY CO. HAMILTON, BERMUDA**

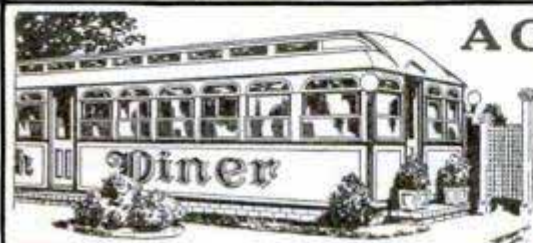

## A Good Profit—365 days in the year!

Rain or sunshine, hard times or good, summer or winter, is all the same to the man who owns a JERRY O'MAHONY LUNCH CAR. These attractive, business-getting Dining Cars have all the conveniences of the modern restaurant and cost far less. They can be shipped anywhere by rail. Business good every day of the year. Many owners are making \$10,000 a year profit and over.

Only small cash payment down. We help you finance and tell you how to start. Write today for our big illustrated catalog showing profits others are making.

**JERRY O'MAHONY, Inc.—Dining Car Manufacturers**  
983 W. Grand St. Elizabeth, New Jersey



# WHOLESALE PRICES

## New 1928-29 EDITION

# FREE

## This 148 Page RADIO CATALOG

**75 LATEST RADIO CIRCUITS 500 ILLUSTRATIONS**

**BUY FROM RADIO'S OLDEST MAIL ORDER HOUSE**

We are the oldest established, exclusive radio mail order house in the country. All orders are positively shipped within twenty-four hours; quick, prompt, courteous service. We carry a larger variety of radio parts, radio instruments, accessories and radio findings than any other radio house in the country.

You will find in Catalog No. 18 the largest assortment of radio merchandise in this country. Radio Specialty carries more radio parts and radio material than any other house in the country. You will find in this catalog positively the largest variety of radio merchandise.

If you are in need of certain small radio parts that other radio and mail order houses do not bother to carry get the Raseo Catalog and you will find the small parts there, anything from a screw to copper ribbon, telephone diaphragms, as well as thousands of the small radio findings.

If you possess this Book (No. 18) write for Television Catalogue or Supplement to No. 18

Be sure to get this great 148-page book with net prices.

Radio Specialty Company is radio's oldest radio parts mail order house in the country, and the new confidential prices on standard radio merchandise are the lowest of any radio house.

We are ready now to appoint additional agents in all parts of the country. If you are contemplating making big money in radio merchandise, be sure to get in touch with us at once.

*We carry the Largest Variety of Small Radio Parts in the World BUT we also carry All Standard Radio Merchandise.*

**RADIO SPECIALTY CO.,** 244 Greenwich St., NEW YORK

## On Every Parts List

AMPERITE automatic filament control is officially specified for all of the popular new circuits. Engineers have used and praised it for seven years. Put AMPERITE on your parts list. Entirely unlike fixed resistors. A type for every tube—battery or A. C. At all dealers.

FREE—"Amperite Blue Book" gives latest construction data and circuit diagrams. Write Dept. P. M. 11.



**RADIALL CO.**  
50 Franklin St.,  
New York

# AMPERITE

REG. U.S. PAT. OFF.

The "SELF-ADJUSTING" Rheostat

## New Karas Short Wave Kit Reaches Around the World

New radio thrills await you. Listen to Australia, Europe, Asia. Tune in on the world's airplane flyers, ships at sea; in fact, the whole world. You can do it easily with the remarkable Karas Short-Wave Receiver. You can't know the fascinations of radio until you experience this new sensation. Karas engineers have developed short wave to new peaks of perfection. Easy to build. Easy to tune with Karas Micrometric dials, 63 to 1 ratio. Uses famous Karas condensers, built like a fine watch. Karas coils and audios—the world's standard. Send now for full information and construction drawing—free.

### Karas Electric Company

4028LI N. Rockwell St. Chicago, U. S. A.

Name .....

St. and No. ....

City and State .....

4028LI

**Send for FREE BULLETINS**

### CRESCENT WOOD WORKING MACHINES

**Portable**—for the small shop and for use out on the job. Power from any light socket.

**Heavy Equipment**—for planing mills, furniture factories, etc. All are efficient, easily adjusted and operated, accurate, durable, moderately priced.

**The Crescent Machine Co., 93 Columbia St., Leetonia, O.**

### SIMPLIFIED RADIO BLUEPRINTS

Blueprints for the most popular sets described in Popular Mechanics Magazine can be obtained for a charge just sufficient to cover the cost of production and mailing. The sets for which blueprints are available are:

<b>Three-Tube, Loud Speaker, Loop Set</b> .....	Dec. 1926	— 25c
<b>Three-Tube, 15 to 550 Meter Set</b> .....	Nov. 1926	— 25c
<b>Four-Tube, Loop Set, for Car or Home</b> .....	Aug. 1926	— 25c
<b>Six-Tube, Portable, Loop Set</b> .....	June 1926	— 25c
<b>Electrolytic B-Eliminator</b> .....	Feb. 1927	— 25c
<b>Non-Radiating Unit</b> .....	May 1926	— 25c
<b>Simple Tube Tester and Chart</b> .....	July 1926	— 25c
<b>Two-Tube Loud Speaker Set</b> .....	Oct. 1927	— 25c
<b>Economy Nine Superheterodyne; Sixty dollars builds this Super. Complete drilling templates and blueprint diagrams</b> .....	Nov. 1927	— 50c
<b>Loop Set for Cabinet Speaker</b> .....	Dec. 1927	— 25c
<b>Aero-Dyne Six Receiver</b> .....	Jan. 1928	— 25c
<b>Homemade A-Battery and Charger</b> .....	Jan. 1928	— 25c
<b>B-Eliminator for Direct Current</b> .....	Feb. 1928	— 25c
<b>Fifteen Dollar B-Eliminator</b> .....	Mar. 1928	— 25c
<b>Short-Wave Converter</b> .....	Mar. 1928	— 25c
<b>All-Electric Five</b> .....	April 1928	— 25c
<b>Three-Tube All-Wave Set</b> .....	May 1928	— 25c
<b>Push-Pull Power Amplifier and Power Supply Unit</b> .....	June 1928	— 25c
<b>Edison Type Storage B-Battery</b> .....	July 1928	— 25c
<b>Browning-Drake Screen-Grid Tube Receiver</b> .....	Sept. 1928	— 25c
<b>A Compact B-Eliminator</b> .....	Oct. 1928	— 25c
<b>New Screen-Grid Perfect-Tone Six</b> .....	Nov. 1928	— 15c

**Address the RADIO DEPT.**

Popular Mechanics Magazine, 200 E. Ontario St., Chicago

Back numbers of the magazines describing the construction of the sets can be obtained from our Circulation Department, price 25 cents each.



# Invents Amazing New Way To Wring Mops!

Young Ohio Inventor Discovers Remarkable New Wringing Principle That Ends All Mopping And Scrubbing\* Drudgery For Women Everywhere! Wrings Mop Bone Dry Under Water In Amazing Test Demonstration! Mops, Scrubs, Squee-Gees Utterly Different and Better. Housewives Go Wild Over RING-RITE As Agents Clean Up Sensational Profits—\$6—\$12 An Hour! Get Details And Limited FREE OUTFIT Offer Quick!

## Salesmen Make \$1.00 Profit Every 10 Minutes

HERE is that fast-selling, money-making proposition that you have wished for a thousand times, men. A brand-new, patented device that replaces old-fashioned mops and scrub-brushes and turns housework into a positive joy! Just hand RING-RITE to any woman. Show her it's a real rope mop—the kind everyone knows is best. Then show her how it mops, scrubs, and wrings utterly dry just by pulling up and turning a simple crank. Let her see how it ends stooping and going down on hands and knees forever—how she need never again plunge her hands into dirty, soapy water, or wring out a slimy old mop by hand! Then tell her the price. "I'll take it." And no wonder—

## Mops Floors in Her Best Dress

RING-RITE is so light and handy, so amazingly clean and easy to use, that one woman writes she has no use for aprons, as she can now mop and scrub in her best dress without fear of slopping or soiling! Such an amazing seller that Braddock made \$58 in a day, while even spare-time workers clean up \$6-\$12 rewards for every hour they spend showing women how to use this fascinating device to end household drudgery! RING-RITE is absolutely unique—it sweeps aside all competition. Astonishing under-water demonstration guarantees automatic orders by the score. Enthusiastic owners hand you dozens of red-hot prospects to boost your sales and profits sky-high. Why not join us and get your share of this quick, easy money?

## FREE OUTFIT Offer—Mail Coupon

Right now we offer you a chance to get started 3 surprisingly profitable ways, one of which includes a complete selling outfit with mops, brush attachment; etc. absolutely FREE. Also a special plan that gives you TWO commissions in every home instead of one. This offer is absolutely unique and can hand you easily \$75-\$150 a week, so mail the coupon for full details at once. No obligation. No risk now or ever. Act right NOW for the biggest money of your life.

## Just-Rite Products Co.

Dept. P-10

Delphos, Ohio

Just-Rite Products Co.,  
Dept. P-10, Delphos, O.

Send at once full information on RING-RITE with your limited FREE OUTFIT offer and Double-Commission Plan. I am not obligated.

Name.....

Address.....

City..... State.....



### How It Works

Large illustration shows crank pulled up and locked in wringing position. Note how mop lies flat along handle, making slopping impossible. After wringing, slide crank to bottom and use as ordinary mop. For scrubbing, lock in wringing position and attach squee-gee brush shown below.







GEORGE F. JOWETT, *Champion of Champions*

## Do You Want Pep, Punch and Power and shapely muscles as strong as steel?

WITHIN every man are oceans of power floating aimlessly around. Tons of energy lying asleep. This should not be, and you know it. Then **HARNESS YOURSELF** to do things. Gather these forces together and utilize them. I will show you how. I will convert those inert muscles into fighting machines.

### *I Will Make You a Miracle of Muscle*

I will give you nerves of iron and husky shapely muscles as strong as steel and as pliant as a whip. You must realize that nowadays men win their jobs by the spread of their shoulders and the trimness of their waistline. Those are the vital men. Let me show you how it is done. I guarantee to put inches on your chest and give you a man-sized arm.

### *A Purely Personal Course*

My course is a purely personal one. Every pupil is separately and confidentially taken care of. **YOUR COURSE IS LAID OUT TO SUIT YOUR SPECIFIC REQUIREMENTS AND YOURS ONLY.** You are trained on the basis of

### *The Twelve Principles of Life*

No other course teaches them. That is why there are thousands of dissatisfied, discouraged men who have sought a healthy body and have not gotten it. You cannot build up your body to its limit on one principle, merely doing a few exercises. There are other things to be considered. With each enrolment is given

### *Patented Jowett Disk Dumbbells*

They are an unequalled form of apparatus for body building. Can be used by anyone. The strong and the weak alike. I stand behind them with my guarantee that they are the best in the world for **CREATING HEALTH and BUILDING MUSCLE.**

### *Send for My Free Booklet*

This booklet explains all about the **JOWETT SYSTEM OF HEALTH AND MUSCLE BUILDING.** Beautifully illustrated, it is an example of my course which is the finest and most elaborate ever produced.

**DON'T WAIT FOR TOMORROW. FILL IN THE COUPON AND MAIL IMMEDIATELY.**

**THE JOWETT INSTITUTE 4-L  
OF PHYSICAL CULTURE**

**422 Poplar St. Scranton, Pa.**

Dear Mr. Jowett:

Please send me your Free Booklet explaining the Jowett System of Health and Muscle Building.

Name.....  
Street.....  
City..... State.....

# BARGAIN! ONLY 39¢

## GUARANTEED RADIO TUBES

For clear reception on election news, market news, etc., your radio set should have new tubes. Why pay \$2.00? Here's the chance to get guaranteed high quality 201A type radio tubes for only 39¢ each. Send check, money order, or sent C. O. D.

**Send for Free Radio Guide.** These bargain tubes and other bargains are shown in Barawik's Big Radio Guide. Send for free copy today—now! Thousands of other radio bargains—newest coast-to-coast sets, speakers, parts, supplies—all at lowest prices.

*Send Now for Free Radio Guide*

**BARAWIK CO., 1011 Canal Sta., Chicago, U. S. A.**

**25% MORE LIGHT** A simple way to reduce your electric bill 25%, or to get 25-90% more light for the same money in your Store, Factory, Office, and Home without any extra expense. The book explaining this new improvement will be sent you upon receipt of \$1.00.

**S. GLASKO 740 Belden Ave., Chicago, Ill.**

## Be the Life of the Party



### Play a Tune in 10 Minutes

**Popularity—new friends—money-making opportunities come to those who can play!**

Now you can pick up your favorite stringed instrument and play a tune almost instantly. **NO** knowledge of music is needed. **NO** expensive lessons. **NO** weeks of tiresome practice. Play tunes from the start. Play by numbers. Surprise and astonish your friends. **Amazing new invention** makes it easy to play Ukulele, Banjo Ukulele, Tenor Banjo, Guitar, Mandolin. Just press the keys and play.

Trixie Frigans, famous Vaudeville Star, wrote: "I played in 3 minutes and never touched a stringed instrument before." John A. Cruser: "I was skeptical about anyone playing tunes instantly but, have changed my ideas completely." W. B. Matthias: "Your advertisement didn't tell the half of it." Mrs. A. Kasen: "My friends and I play wonderful tunes. The more we play the better it gets."

### ASTONISH Your Friends

You have always wanted to play. Do not delay—it is so easy --so wonderfully easy that we guarantee success or it costs you nothing.

## SEND FOR FREE BOOK!

More popularity—more fun from life—new friends—money-making opportunities. If you want to play tunes at once—send today for a free book about **Ferry E-Z Playing Stringed Instruments.** Soon, you, too, can know the joy of making your own music. "No play, no pay." E-Z Playing Instruments are sold complete or the E-Z Player can be attached to your own stringed instrument in a jiffy.

Mail Coupon Today!  
**FERRY & CO., Dept. 9778, Chicago, U. S. A.**

Send free book telling how I can get more fun out of life, make more friends, have greater opportunities for getting ahead by learning to play my favorite stringed instrument in 10 minutes. No obligation.

Name.....  
Address.....  
City..... State.....



# Just Count the Doors And Windows in Any Home!

**—and Let Owners  
Pay You \$18  
to \$36 a Day!**



Yes, Just Counting Outside Doors and Windows In Homes All Around Them Is Now Paying Men The Quickest, Easiest Money They Ever Made In Their Lives! The Invention of Red-D-Ply, An Amazing New and Inexpensive Type of Metal Weatherstrip, Has Opened Up An Astonishing New Selling Field Where Profits Are Absolutely Unlimited! Fits All Openings. Installed by Anyone In A Jiffy. Saves \$30—\$60 A Year In Fuel Bills Alone! Clinch Your Territory For This Whirlwind Seller At Once!

**New Kind of Lifetime Bronze Weatherstrip Brings Amazing Comfort and Economy at Small Cost!**

Now—an epoch-making invention that offers boundless opportunities to ambitious men! Now salesmen can get their share of the millions spent for weatherstripping! Red-D-Ply offers you \$5000 a year in quick, easy, cash profits—and another \$5000 from automatic repeat business! Red-

D-Ply, sold in convenient unit packages, a package for any door or window made, makes it possible for the humblest homes to know real comfort, freedom from dirt, dust, soot, cold air and draughts! And not only that—this amazing product is guaranteed to outlast any building and to repay its trifling cost in fuel savings alone in two years! Do you wonder that sales of \$20 to \$50 are easy in every home—that salesmen clean up \$25 a day and more with such clock-like regularity? Such a quick seller that Walter Vernohm of Missouri made \$142 in one single day!

## Remarkable New Principle

Red-D-Ply is made of pure spring bronze, "hemmed" on both edges, holes for tacks punched clear through. One edge is tacked flat against door or window frame. The other floats free, maintaining constant spring pressure that closes clearance crack up tight. Automatically adjusts itself to swelling and shrinking of sashes. So simple that anyone who never saw it before can install Red-D-Ply on any opening with no tools but a hammer and ordinary scissors.

# Red-D-Ply

Trade Mark Registered

**Red-D-Manufacturing Co., Dept. S-10**  
3711-15 Parnell Ave. St. Louis, Mo.

Nothing is removed during application. Every year it saves \$30 to \$60 in fuel alone, not to mention cleaning and doctor bills. Keeps warm air in—cold air out. Ends window rattles, makes them slide easier, and stops dust, soot and rain that leaks in around every ordinary opening.

**GUARANTEED**  
To repay its cost in  
fuel saving alone  
in 2 years!

## Make Free Test— Mail Coupon

As the Red-D-Ply distributor in your territory you are on the way to amazing profits. You can sell at least one or two packages to every man or woman who owns a home. You can sell complete installations for homes, offices, apartments, schools, hospitals, factories, and institutions of all sorts. Repeat business boosts your profits 100% every year. The longer you work, the easier it is. Write to-day for complete information about this remarkable new money-making opportunity. We'll send a FREE sample of Red-D-Ply and details of our plan that enables hundreds to earn a day's pay in an hour a day. Complete selling outfit furnished. No capital required to build up a \$10,000 business in a short time. Let us show you how you can test this plan without risk or obligation. Simply mail the coupon. It will bring you one of the greatest opportunities ever offered to salesmen.

Red-D Mfg. Co., Dept. S-10  
3711-15 Parnell Ave., St. Louis, Mo.

Send without obligating me full information about Red-D-Ply and your special Test Offer to salesmen.

Name.....

Address.....

City..... State.....





# 3 Food Experts Invent a New Business That Pays Up To \$1,000 a Month

Now Anyone Can Own a Big Food Business and Pocket Steady Profits of \$50 to \$250 a Week! Investment SMALL! Profits ENORMOUS! Mail the Coupon for the Amazing Details.

**C**HICAGO food experts have discovered a remarkable new food! A crispy, delicious new kind of *Greaseless* doughnut! Easily digested! More captivating than old-style doughnuts ever were! Yet cooked at the rate of 1 dozen every three minutes by an *inexpensive* electrical device that operates from any ordinary light socket!

## THE SECRET OF BIG MONEY

These experts knew that millions of old-style doughnuts are sold every day—hundreds of people are making fortunes in the doughnut business. No wonder they were surprised, yes, literally astounded at the possibilities! And now they have devised a unique co-operative plan. They agree to start every honest, ambitious man or woman in this big-money business. They supply complete manufacturing equipment—free advertising material—sure-fire sales plans—prepared doughnut mix, etc.



**\$1,000 a Month**  
"My business was successful from the first day. I made over \$3,000 my first 3 months—more money than ever before in my whole life!"—Thos. Minch, Fla.

F. Costopolis, Ill., says, "The first machine paid for itself in a few days—it is not unusual for me to take in \$15 in a couple of hours and my trade is growing constantly."

**WRITE QUICK FOR  
DETAILS!**

Food Display Machine Corp., Dept. 13-58,  
500-510 N. Dearborn St., Chicago, Ill.

I want to make \$50 to \$250 a week in a business of my own. Without obligation to me, send details of your new co-operative plan.

Name.....

Address.....

Town..... State.....

## A New Lightweight Electric Drill

**Only \$18.75**

Weights Only 4 Pounds  
—  
Universal Motor  
—  
Write for our catalog showing complete line.

A sturdy, practical electric drill, fully guaranteed for one year. Specially designed for light and intermittent work. Weighs only 4 pounds. Built to use in even the tightest corners. Many of the large industrial plants are buying this drill by the dozen.

Uses direct or alternating current, and is supplied to you for 110 to 125 volts, 200 to 250 volts or 32 volts. Fitted with a special Jacobs Chuck. Bore up to 1/4". Stop and start switch in the handle. Comes complete with 10 feet of cord and socket. Price post-paid anywhere in the U.S.A.—\$18.75.

Send check or money order. If not satisfied return in 5 days and money will be gladly refunded. In ordering, be sure to specify voltage used.

**Jones Motrola Sales Co.**  
Dept. 11, 370 Gerard Avenue,  
New York.

## Establish a Good Future

**DON'T BE A SHOP WORKER**

**START** a business of your own **NOW**—no experience necessary. The only key machine that cuts ALL kinds of keys. No hand-filing. Make first keys by number without taking locks apart. Instructions furnished free. **WRITE TODAY.**

**BEISSER KEY MACHINE COMPANY**  
407 Fort St. East Detroit, Mich., U. S. A.

## AGENTS \$6 A DAY

taking orders for No-Frost—the amazing new preparation that keeps rain, snow, frost, mist and steam off auto windshields, show, windows, mirrors, etc. A sensation everywhere. No hunting for prospects. Auto owners, bus drivers, store keepers, housewives buy on sight. Steady Repeat business. Big income every day.

**\$83 First 5 Days**  
Victor Baumann made \$83 first 5 days. Mrs. Roof averages \$50 a week *spare time*. You can do as well. No capital or experience needed. We furnish everything. Don't miss this chance. You risk nothing. Earnings start at once. Wonderful opportunity for men and women everywhere. Write quick for Profit-Sharing Offer.

**AMERICAN PRODUCTS CO.**  
749 MONMOUTH AVE.,  
CINCINNATI, OHIO.

EVERY AUTO OWNER A PROSPECT



# Now-Make Your Radio Clear as a Bell~ with Marvelous New GROUND AERIAL!



## SUB-AERIAL Endorsed by Experts

May 8th, 1928.

"I am very glad to state that after testing many Aerials in my Laboratory I find your Sub-Aerial is the best for clarity of tone and elimination of static, also for greater volume and selectivity. Your Sub-Aerial will fill a long-felt want among the Radio Fans."  
A. B. Johnson, Radio Engineer.

Aug. 31, 1928.

"I received my Underground Aerial all O. K. It has any aerial beat I have ever seen. I have used every aerial on the market since I have been a radio fan. The first day I installed it I got distant stations that my set had never touched before. It wasn't good radio weather either. I got stations in the East that I had never dreamed of getting and with absolute clearness and without static or interference. I heartily recommend your instrument to any lover of good radio reception."  
A. N. Whitson, Box 565, El Reno, Okla.

## Get Amazing Distance, Greater Volume and Finer Selectivity without Distortion

Why go on listening to terrible static and other maddening outside noises? Now you can get the real music your present Radio is capable of giving, by hooking your set onto the clear, practically static-free ground waves with Sub-Aerial. The air is always full of static and your overhead aerial picks it up and brings it to your speaker. So why stay in the air—when you can use the whole earth as a static and noise filter with Sub-Aerial?



Can be installed in a few minutes

## Low Original Cost—No Upkeep Cost

SUB-AERIAL costs no more than an overhead or loop aerial and less than many. Its first cost is the only one. SUB-AERIAL is permanent. No trouble—no hard work, or risking your neck on roofs.

## Try It FREE!

your overhead Aerial. Pick a summer night when static and noise interference on your old Aerial are "Just Terrible." If Sub-Aerial doesn't Sell Itself to You Right Then on Performance—you needn't pay us a cent. Send for "all the Dope on Sub-Aerial." You'll be surprised. Do it NOW.

## 25-YEAR GUARANTEE

Underground Aerial Systems

St. Clair Bldg., Dept. 805-P.S.  
Corner St. Clair and Erie Sts., Chicago, Ill.

# Ground Out Static with SUB-AERIAL

Underground Aerial Systems, Dept. 805-P. S.,

St. Clair Bldg., cor. St. Clair and Erie Sts., Chicago, Ill.

Send me complete information on Sub-Aerial, Proof and Free Trial Offer. No obligation.

Name.....

Address.....

City.....State.....





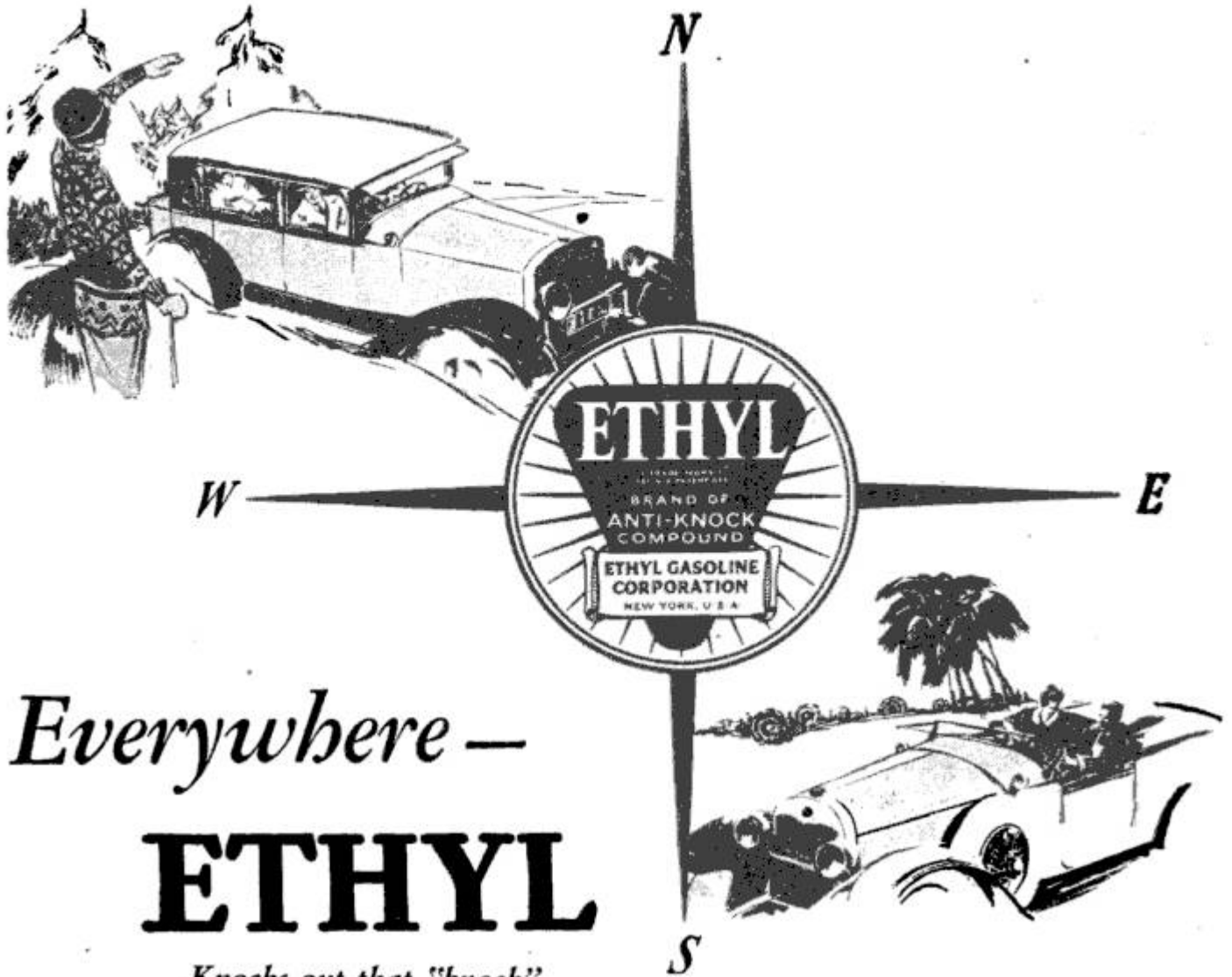

*Everywhere —*  
**ETHYL**

*Knocks out that "knock"*

**W**HEREVER you live, whatever the climate, you will find one or more oil companies putting ETHYL fluid in gasoline suited to your driving conditions.

What is responsible for this widespread distribution?

Appreciation by thirty-six of the leading oil companies of the merit of ETHYL, which was developed by the General Motors Research Laboratories in its years of search for something that would eliminate the "knock" inherent in gasoline.

These major companies have found ETHYL fluid so effective

that they are mixing it with their already good gasoline to provide a still better fuel — *Ethyl Gasoline*. They are meeting the demands of the motoring public in making this fuel available in every community—through their own stations, hundreds of resellers and thousands of dealers.

Ethyl Gasoline improves the performance of any car. It turns the higher compression created by carbon into extra power

It gives a special thrill in the high compression motors now being manufactured.

**ETHYL GASOLINE CORPORATION**

25 Broadway, New York 56 Church Street, Toronto, Can. 32, Queen Anne's Gate, London, Eng.



# Start to Play Very First Day!



**How'd you like to play this instrument? Free easy lessons show you how... 5 days' trial in your own home... a year to pay!**

## A LIFETIME of Popularity . . . . A LIFETIME of Extra-time Money A LIFETIME of Musical Happiness

**T**O YOU who have so often remarked, "If only I could be as popular as some fellows," this is an opportunity. To you who a thousand times have said, "If only I could play some musical instrument," we now say, "There is no reason why you shouldn't."

Even if you can't read a note of music right now, you can, by following the free easy lessons furnished with each instrument, play a simple melody on the day you get your Xylorimba! Before you realize it, you will be playing well enough to amaze friends and relatives. Then a new life opens to you. Long, happy evenings of joy; not only invited to parties but the center of attraction—the pride of every girl and the envy of every fellow present. The thrill of having your friends listen to you over the radio! Last but not least, the same chance to earn \$5 to \$25 a night as Ralph Smith, Chicago, who says: "I played twenty minutes at a wedding—received \$20." Or the Hallmann family, Reading, Pa.—"Made \$300 in five weeks, spare time. Had never played instrument before."

We don't ask you to take our word for this. We offer to send you the

Xylorimba of your choice for five days' trial in your own home, so you can judge for yourself. See how easy it is to play. Look over the simple lessons, prepared by experts, which make a teacher unnecessary.

Keep the instrument only if you are satisfied—and then take an entire year to pay!

Was a fairer offer ever made? We make it because we want you to know the joy of creating your own music, the pleasure of being looked up to wherever you go, the profit of big extra money. Remember, this is the most fascinating of all instruments—the same make as used by national stage, radio and phonograph artists. Remember, too, you begin to play at once—no finger

or lip exercises; no teacher; no tiresome practice.

Hundreds will take advantage of this chance. Will you be one of them? The coupon will bring, without obligation, our big FREE book which tells more about this amazing offer. Send it in today!

### MAIL COUPON TODAY!

**J. C. Deagan, Inc., Dept. 1458, 1770 Berteau Ave., Chicago**

Send me, without obligation, full details of Free Trial offer and easy payment plan on the Deagan Xylorimba.

Name.....

Address.....

**Start  
to Play  
Very  
First  
Day!**



Fame and Money  
Broadcasting



Center of Attraction  
at Gatherings



Big Money at  
Dances



**LEARN**

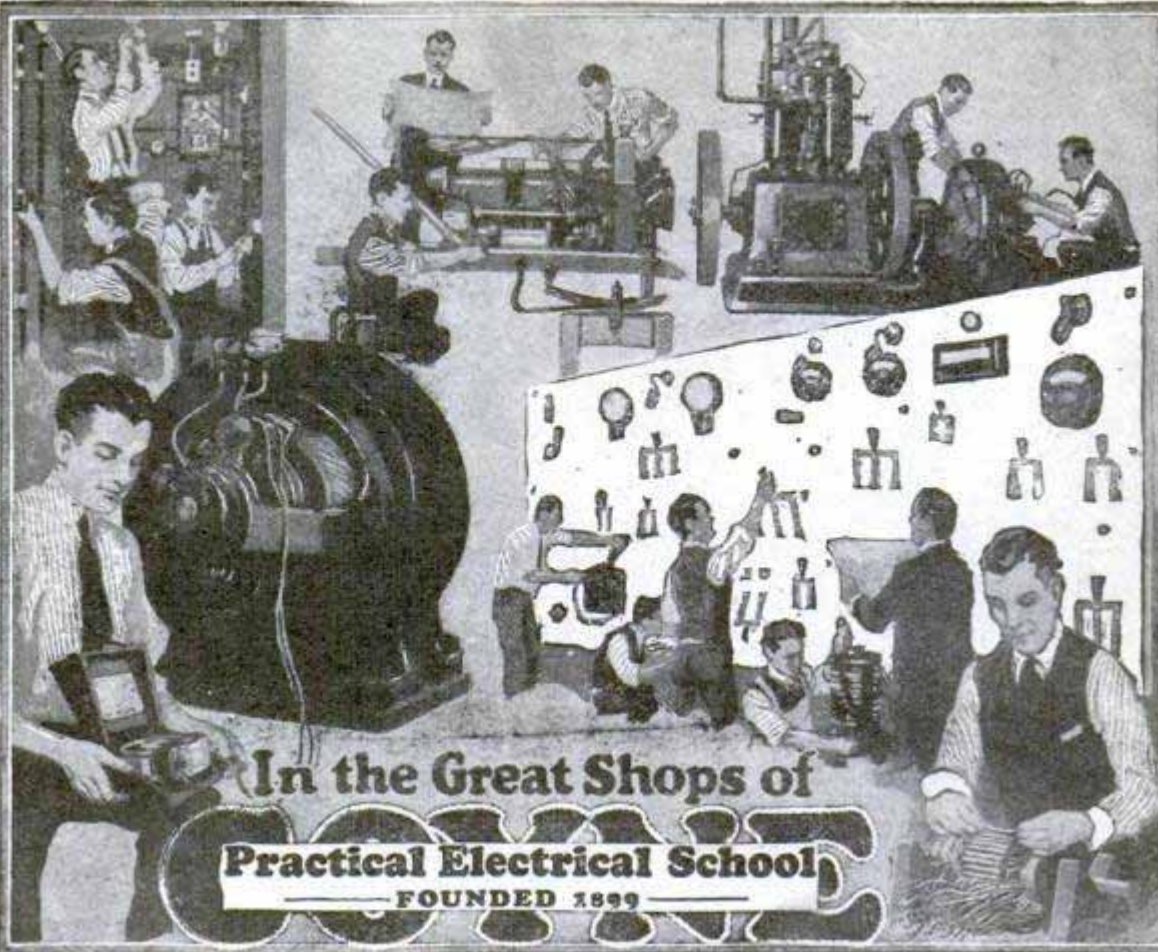

**ELECTRICITY**

In the Great Shops of  
**COYNE**  
 FOUNDED 1899

**MAKE  
 \$200  
 to  
 \$800  
 A  
 MONTH**

**EARN BIG PAY!  
 LEARN TO EARN \$200 TO \$800 A MONTH**

Why work for small pay? Why be satisfied to make \$25.00 or \$30.00 or even \$40.00 a week in a disagreeable job where you never know when you might

get fired. Do pleasant work. ELECTRICAL EXPERTS earn \$200 to \$800 a month or go in business for themselves and earn up to \$10,000 a year.

**PRACTICAL WORK... Not Books**

I train you on real Electrical Machinery. I don't teach you a lot of useless theory. My training gives you useable

knowledge on the same kind of machinery you will find in Power Houses, Plants and in industrial businesses.

**EARN WHILE YOU LEARN**

Don't let lack of money stop you. Many of my students earn most of

their expenses while learning. You can do the same.

**My Free Big Book Tells Complete Story**

I haven't space here to tell you the advantages of my training but I'll send ABSOLUTELY FREE my big new book with over 150 actual photographs and success stories of my graduates. It tells you all about my employment service after graduation and

how many earn their expenses while attending my school. *Fill out the COUPON Now and Mail it at once.* You owe it to yourself to get the facts.

H. C. Lewis, Pres.  
**Coyne Electrical School**  
 500 S. Paulina Street  
 Dept. 88-75 Chicago, Ill.  
 Dear H. C.—I sure want to get all the facts. Send me that big handsome 12x16 inch book. Of course I'm under no obligations and it doesn't cost me a cent.

**COYNE** Founded 1899 H. C. Lewis, Pres.  
**ELECTRICAL SCHOOL**  
 Dept. 88-75  
 Chicago, Illinois  
 500 S. Paulina Street

Name.....  
 Address.....  
 Town.....  
 State.....



**9th Anniversary Offer!**

**ENJOY ANY MIRACO 30 DAYS - RETURN EVERYTHING AT OUR EXPENSE UNLESS DELIGHTED**



View of marvelous new, 3-year guaranteed, lighted 1-dial control. All Metal Super Shielded AC-9 chassis (with front switch, built-in AC power section, phonograph pick-up connection and all latest features) removed from cabinet. AC tubes and cabinet extra.

**NEW LOW FACTORY PRICES SAVE 50%**

**Choice of Cabinets AC or Battery Sets**

30 Days' Trial



Richly designed genuine walnut console of finest type. Electro-dynamic or magnetic power speaker.

Graceful Spinet console, genuine walnut. Choice of speakers. Also comes in Radio-Photograph Combination.

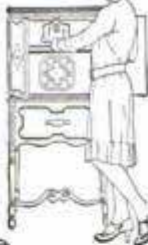

A Lo-Boy Console that costs little. Dynamic Power speaker.



Popular inexpensive combination. Set on table speaker.



New-type arm-chair console of genuine walnut—latest speakers.



**MIRACO Radio gets you Coast to Coast**

**Latest • Powerful • New**

**MIRACO**  
TRADE MARK REGISTERED

**Cathedral Toned, Super Selective, Long Distance Getters**

**Battery or Electric AC Sets**

Celebrating its 9th successful year, America's big, old, reliable Radio Corporation springs a genuine sensation in high-grade sets. With its latest, Super-powered, 1-dial Miracos—the All Electric wholly self-contained, hum-free, AC-8 and AC-9, using AC tubes or the new 8-tube Ultra for batteries or Eliminators—you are guaranteed the greatest values and savings in the fine set field.

Compare a Miraco with highest-priced radios, for 30 days in your home. Surprise and entertain your friends—get their opinions. Unless 100% delighted, don't buy it! Return everything—the complete outfit—at our expense. Your decision is final—absolutely!

Only exceptionally fine radios, of the very latest approved type, at rock-bottom prices, could possibly back up so liberally unconditional a guarantee. Send coupon now for *Amazing Special Factory Offer!*

**Don't Confuse with Cheap Radios**

With its rich, clear Cathedral tone, hum-free operation, tremendous "kick" on distant stations and razor-

edge selectivity—with its costly sturdy construction, latest features, including phonograph pick-up connection, ease of tuning, beauty, and economy—a Miraco will make you the envy of many whose radios cost 2 to 3 times as much!

Many thousands of Miracos—bought after 30 day home comparisons—are cutting through locals and getting coast to coast, Canada, Cuba, Mexico, with the tone and power of costly sets. Miracos are laboratory-built with finest parts, and embody 9 years' actual experience in constructing fine sets. Approved by Radio's highest authorities.

**Deal Direct with Big Factory**

Everything reaches you splendidly packed and rigidly tested to insure your instant enthusiasm. Enjoy the outfit 30 days—then decide. Liberal 3-year guarantee on each set. Play safe, save lots of money, and insure satisfaction by dealing direct with Radio's old, reliable builders of fine sets—9th successful year.

**MIDWEST RADIO CORP'N, 407-AN Miraco Bldg., Cincinnati, Ohio, U. S. A.**

**BEAUTIFULLY ILLUSTRATED CATALOG, AMAZING SPECIAL FACTORY OFFER**

**Testimony of Nearby Users**—All the proof you want—of our honesty, fairness, size, financial integrity, radio experience and the performance of our sets—including *Amazing Factory Offer*—sent with catalog.

**BIG DISCOUNTS**

**Exclusive Territory to User-Agents on BATTERY OR AC ELECTRIC Outfits**

**Ultra 8 \$49.88**

**Electric AC-8 \$71.50**

**Electric AC-9 \$83.75**



Metal or wood compact style cabinets. Wood cabinets in walnut or new shaded silver-grain. Builders: Cathedral Electro-Dynamic or Magnetic-Power Speaker to match!

**Free!**

**MIDWEST RADIO CORPORATION**  
Pioneer Builders of Sets—9th Successful Year  
407-AN Miraco Bldg., Cincinnati, Ohio

**THIS COUPON IS NOT AN ORDER**

WITHOUT OBLIGATION, send free catalog, *Amazing Special Factory Offer*, testimony of nearby users, etc.  User  Agent  Dealer  
 Check here if interested in an **EXCLUSIVE TERRITORY PROPOSITION**  
NAME ADDRESS



# WURLITZER

TRADE MARK REGISTERED

THE WORLD'S LARGEST MUSIC HOUSE



## Try Any Wurlitzer Instrument in Your Own Home

EXAMINE it, show it to your friends, play it as much as you wish. An ample free trial—no obligation to buy. We make this liberal offer because we want you to see for yourself this superior quality of Wurlitzer instruments, the result of 200 years' experience. Noted musicians praise them for unusual tone quality, artistic workmanship and ease of playing. They are used in the finest bands and orchestras throughout the country.

### Easy Payments

If you decide to buy, payments are arranged in small monthly sums. A few cents a day pays for your instrument. Special offers on complete musical outfits. Buy direct from Wurlitzer and save money.

## SEND FOR New Catalog

The greatest musical catalog ever published! Over 3,000 articles—every known instrument described and illustrated; many of them shown in full colors. Gives you lowest prices and all details of Free Trial, Easy Payment plan. All sent FREE—no obligation. Just clip coupon and mail today.

Clip and Mail

THE RUDOLPH WURLITZER CO.,

Dept. 1778

117 E. 4th St., Cincinnati

Send me, absolutely free, new instrument catalog, with price and details of Free Trial, Easy Payment plan. No obligation.

Name.....

Address.....

City..... State.....

Instrument.....  
(State instrument in which you are interested)