

OCTOBER

25 CENTS

POPULAR MECHANICS

MAGAZINE

WRITTEN SO YOU CAN UNDERSTAND IT

REG'D TRADE MARK GREAT BRITAIN NO. 410426

REG. U.S. PAT. OFF.

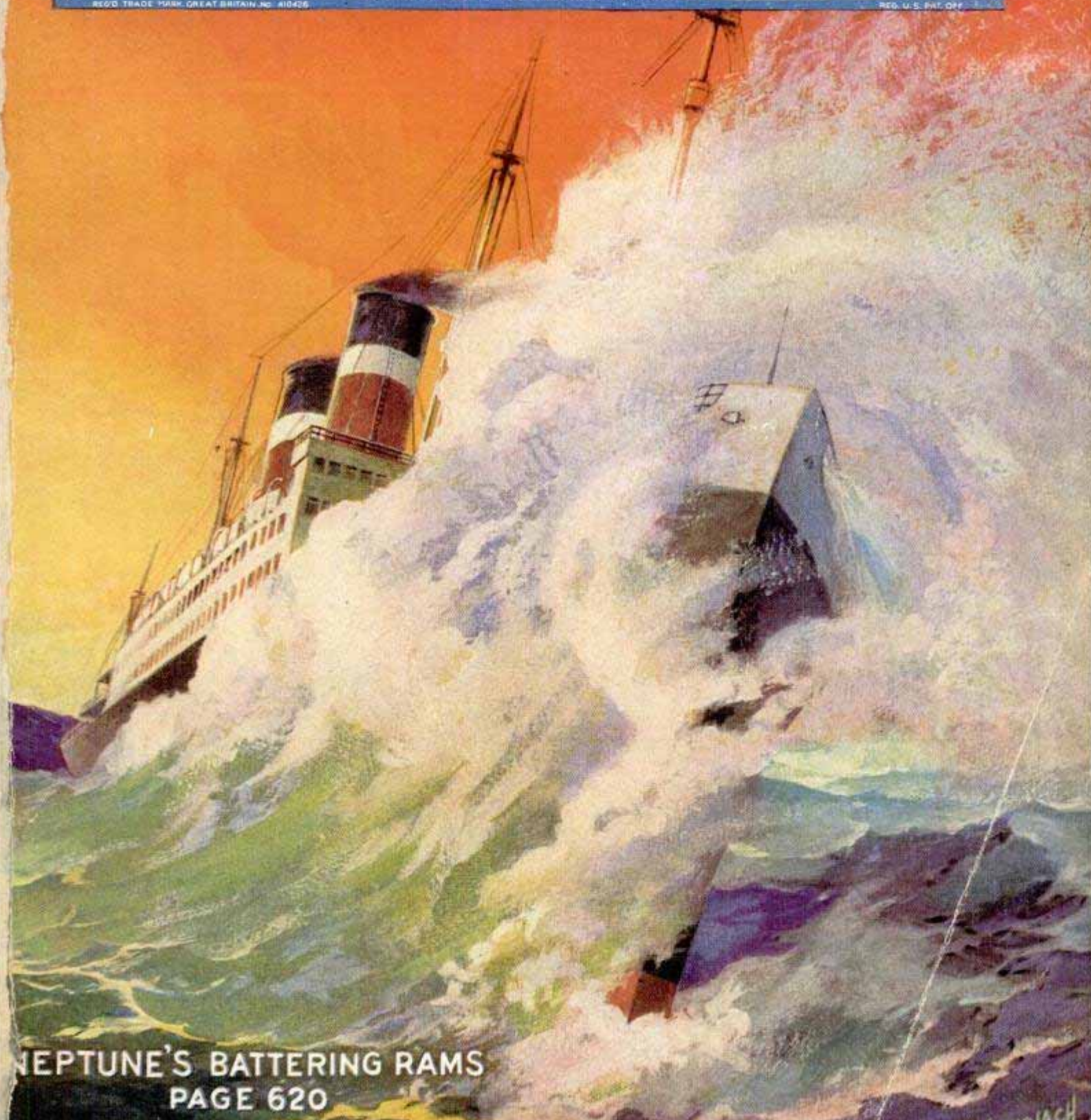

NEPTUNE'S BATTERING RAMS
PAGE 620

Make an Electric A.C. Set of your Present Radio!

**NO CHANGES IN WIRING
NO HARNESS OR ADAPTERS
USE YOUR OLD TUBES**

OF course you want electric operation of your radio. Everybody does! Radio was never so convenient, never so carefree as now when its only demand on you is the snap of an electric switch.

But if you have a good radio now, don't discard it. A good time-tried circuit, using efficient time-tried tubes is naturally better than new untried circuits and tubes. There isn't a better A. C. set made than your present radio converted to use A. C. power.

And Kuprox has made conversion so easy! You don't have to change a single wire or alter the set in any way. No harnesses or adapters . . . no tricky wiring . . . not even new tubes are necessary. Just connect the Kuprox A. C. Power Pack to the battery terminals of your set, plug it into the nearest lamp socket, and your radio operates entirely from A. C.

Then compare your radio with the best A. C. set you ever heard. Compare the tone, the power, the dis-



tance getting ability, the selectivity and ease of control! In your set there's not the slightest hum, no distortion or crackling because of faulty tubes, none of the failings that variations in electric current can cause in A. C. sets. A good battery set, Kuprox equipped, is A. C. reception at its finest!

The Kuprox A. C. Power Pack contains no moving parts, nothing to wear out or break down. It is a permanent addition to your radio that does away with all attention. Several models are offered, some supplying filament (A) current only for those who already have a "B" eliminator, some supplying plate (B) current only, and several compact units that supply all current (A, B, and C) and make the entire set A. C. They are priced from \$32.50 up, and any good radio dealer can show you the various models.

In case you first desire more information, or specific information about your own set, fill in the coupon, tell us exactly what set you have and the number of tubes. We'll recommend the proper model Power Pack you need, and send you literature giving a full description.



Kuprox Multi-rate Rectifier, for trickle charging, dynamic speaker operation, etc. Adjustable rate up to 1-ampere. Price \$11.50



Kuprox Replacement Unit, eliminates acids, liquids, bulbs on all standard trickle chargers. Price \$5.00

THE KODEL ELECTRIC & MFG. CO.
Formerly the Kodel Radio Corporation
517 E. Pearl Street - - Cincinnati, Ohio

USE THIS COUPON
Please give me full information on Kuprox A.C. Power Pack

Name _____
Address _____
City _____ State _____
Make of Set _____
No. of Tubes _____

KUPROX

A.C. POWER PACK

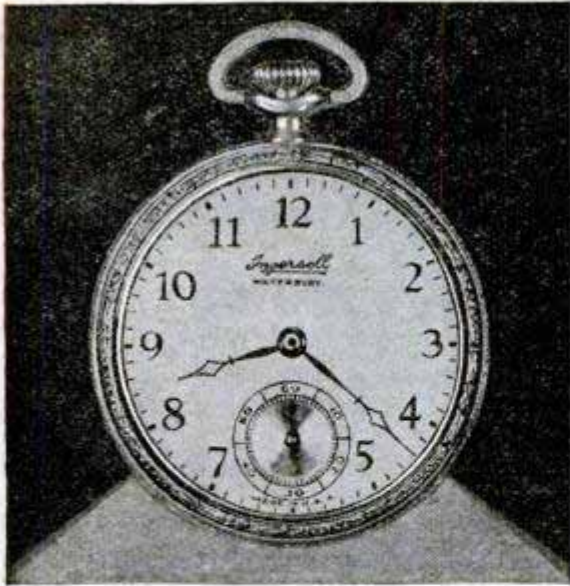

The Best Watch

\$ 5⁰⁰

Will Buy

Platinum-like in blue-white brilliance; diamond-like in hardness; amazingly resistant to rust and corrosion!

Such are the qualities of chromium—qualities that make chromium plating an ideal finish for a watch case.

Ingersoll

WATERBURY

with **CHROMIUM FINISH CASE**

This brilliant and enduring finish at once gives the new Waterbury greater beauty and more endurance. But in other ways, too, new beauty is added. The tasteful artistry of the engraved design... the Butler finish metal dial with sunk second circle and graceful hands and figures... the Butler finish back—all will appeal to you.

A new pull-out set makes it delightfully easy to set with nice precision.

These improvements and refinements are built on the solid foundations of jeweled accuracy and remark-

able sturdiness that have made the Waterbury one of America's most famous and most popular watches.

The price is just \$5. It is easily "the best watch \$5 will buy," and looks the part of a very much higher priced watch. With radium-luminous dial \$6. If not at your dealer's, sent postpaid.

A Dependable Alarm Clock

for \$1⁵⁰

Strikingly good-looking, really dependable, able to stand the gaff of everyday use. Guaranteed. Now in four striking colors, as well as nickel finish.

Ingersoll
TYPE - T



INGERSOLL WATCH CO., Inc.
New York Chicago San Francisco

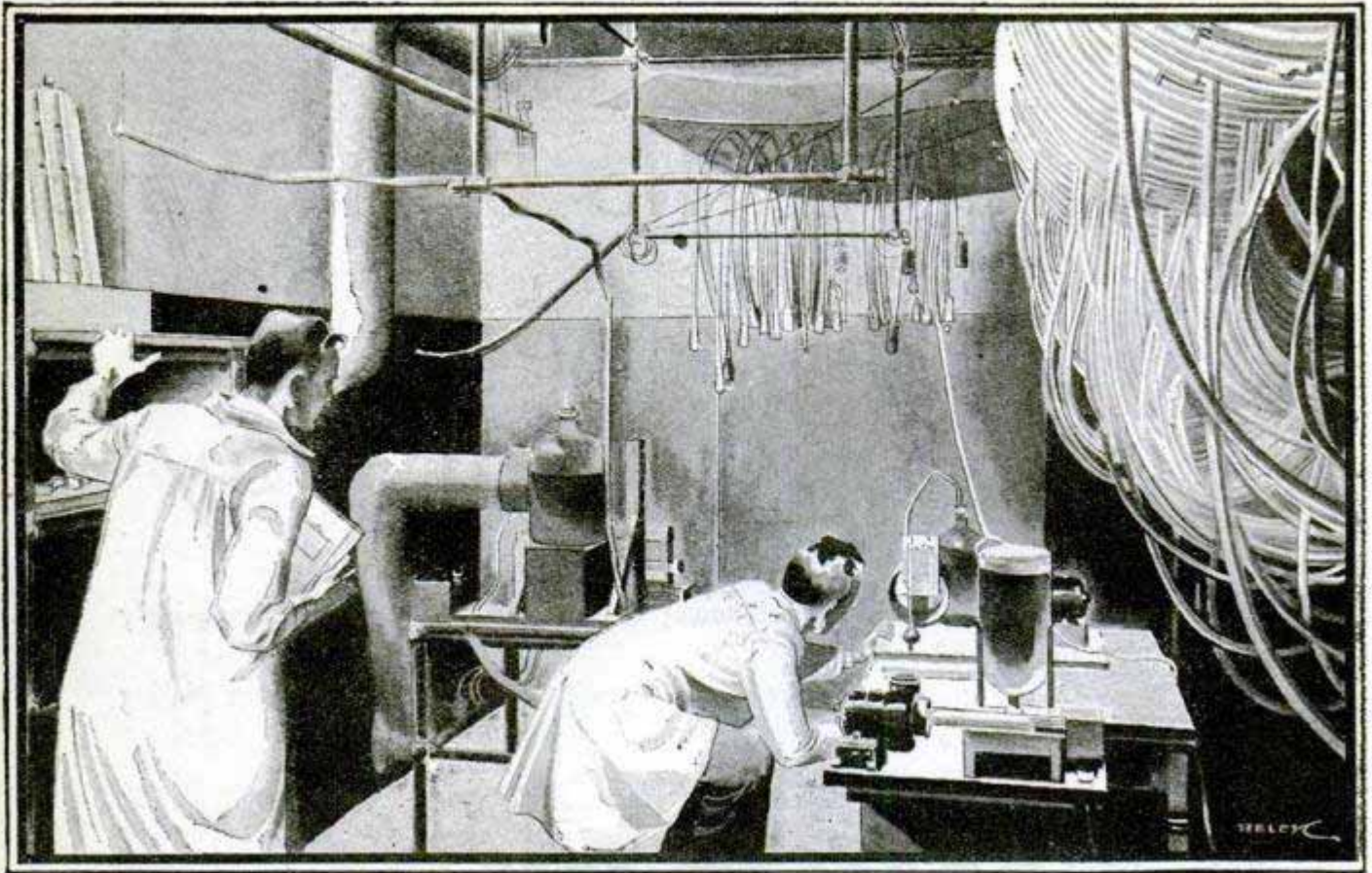

5000 people whose sole job is bettering your service

*An Advertisement of the
American Telephone and Telegraph Company*

THE very nature of the telephone business necessitates a single inter-connected system. The American Telephone and Telegraph Company accepts its responsibility for a nation-wide telephone service as a public trust.

It also accepts responsibility for the safety of the funds invested in it by more than 420,000 persons in every walk of life. From the time of its organization it has never missed paying a regular dividend, so that investors rightly feel assurance in providing money for the growth of the business.

It is the policy of the company to use all income, beyond that necessary



to pay regular dividends and maintain a surplus for financial stability, to improve and extend the service. Because of

the nature of the business, speculative profits have no place in it.

The Bell System maintains in its research, engineering and business staffs and in the Bell Laboratories 5000 workers—in a total of 350,000 employees—whose sole occupation is to improve the telephone art and to make these improvements instantly available throughout the nation. These workers are a guaranty of continued progress in furnishing the public a constantly improving telephone service at the lowest possible cost.

Popular Mechanics Magazine

200 E. Ontario Street, Chicago, U. S. A.

H. H. WINDSOR, Founder

H. H. WINDSOR, Jr., Editor and Publisher

London: Hachette & Co.,
16-17 King William Street, Charing Cross, W. C. 2

Paris: Hachette & Co.,
111 Rue Reaumur

Melbourne: Gordon & Gotch
509-513 Little Collins St.

ISSUED MONTHLY

SUBSCRIPTION:

SINGLE COPY, 25 CENTS

In United States and its possessions, also Canada, Cuba, and Mexico, per year, postpaid - \$2.50

To all other countries in the Postal Union - 3.00

All subscriptions are discontinued at expiration. Please examine the date printed on your wrapper.

Entered as Second Class Matter Sept. 15, 1909, at the Post Office at Chicago, Illinois, under Act of March 3rd, 1879.

Entered as Second Class Matter at the Post Office Department, Canada.

Published monthly by POPULAR MECHANICS CO.

Copyright, 1928, by Popular Mechanics Co.

Copyright in Australia. Copyright in France

Vol. 50

Contents for October, 1928

No. 4

Special Features

Can Flyers Conquer Thunderbolts	536
Guardians of the Sea	546
Trapping Wild Elephants	557
Solving the Secrets of Life	563
Fighting Fire with Fire	570
Making Aircraft Airworthy	580
Sunspots Forecast Better Radio	594
Teaching Bees New Tricks	603
Learning to Fly, concluded	611
Neptune's Battering Rams	620
A New Highway for an Old Empire	627
Growing Wings for the Army	642
Advertising <i>non. Electric Signs 594</i>	
flying billboard has lights underneath wings	552
plane as flying billboard shows signs by flags	579
tank in form of pineapple for canning plant	560
Agricultural Implements—cultivator saws the soil for better planting	552
Airplanes	
fly from ocean liner with aid of catapult	545
queer new, tailless, with movable wings	632
Archaeology—Ur tombs reveal ancient sacrificial customs	630
Architecture—new ideals of beauty shown in European cities	588
Astronomy—world's biggest lens to solve Mars riddle	636
Automobile—combined with bike for deliveries	593
Automobile—Accessories	
bed concealed in top simplifies touring	617
folding armrest adds comfort in driving	576
safety seat for baby	568
top over rumble seat quickly taken off	569
Automobiles—Batteries—oilier for storage prevents corrosion	561
Automobiles—Driving	
"cat's eye" traffic lights guide motorists	602
four-wheel brake tester aids safer	609
Automobiles—Equipment and Supplies	
gasoline vaporizer replaces carburetor	592
roof top rolls back at pull of tab	619
Automobiles—Repairing	
trouble lights worn on head aid	553
vacuum cleaner to paint car and oil springs	630
Automobiles—Tires—twin, decrease jars	555
Automobiles—Touring—washing cabinet contains first-aid kit	601
Aviation	
aided by old fire engine as cleaner for motors	578
airplane loaded in flight from metal chute	591
air sickness prevented by pungent vapor	609
air sign boards aid flyers win endurance record	574
glider sails four hours on American flight	592
road sign for air travelers shows wind direction	600
Baby Carriage—fly screen guards infant's sleep	625
Bath Attachment—fountain for soapsuds and other toilet preparations	602
Boats and Boating	
boat inflated like tire, fits in knapsack	555
boat propelled by pumps develops high speed	647
electric lifeboat launched in three seconds	592
folding boat fits on auto running board	598
outboard hull like plane gives high speed	607
sailing boats with big kites is latest water sport	591
Borax—to kill mosquitoes	562
Building Construction	
hoist run by truck is latest aid	617
houses built flat on the ground and raised to position	635
Corks—easily removed without turning	636
Cotton—gas mask protects driver of duster for boll weevil	637
Digestion—human body portrayed as a factory	626
Doors	
folding partition is substitute for	608
rubber cushion silences slamming	553
Door Snubber—ends slamming and helps fight fires	577
Electricity	
power from a new kind of perpetual motion	554
power tapped from wire without stopping cars	577
Electric Plug—with safety light to help prevent fires	636

[Continued on Page 4]

Chart of Body
Cigar Lighter without wire

Mr. Mastener for June 6 8

Weed Kill Mosquitoes

520
543
532
544

Fire Fighting—rubber suits for dock firemen keep wearers afloat 633
Floors—block, without nails, deaden sound 636
Furnace—air moistener promotes health 609
Gas, Poison—carrier on motorcycle is latest army unit 591
Highway—super, proposed for autos to cross the nation 561
Hoe—with adjustable head saves extra tools 633
Household Devices 638
House Plan 703
Humidifier—air in homes is "washed" to guard health 578
Incinerator—in form of tree improves looks of yard 575
Keys, Automobile—case prevents rattling and loss 616
Lathe—to true brake drums for servicing 625
Light Waves—easily bent around ball 574
Milk Can—cooler for, simplifies handling 641
Mines and Mining—Edison's miners' safety lamp to prevent explosions 586
Motorcycle—center rest aids flying start 575
Moving Pictures—camera in phone box helps trap crooks 555
Music Lessons—on multiple keyboard aided by lights 619
Newsstand—portable, helps patrons catch cars 587
Nuremberg Castle—magic beauty revealed by floodlights 601
Police
motor tricycle carries five men 608
walking faults revealed by treadmill test 618
Pump—three-way spout eliminates adjustments 630
Radio
headgear for airmen to aid communication 587
headphones on loud-speaker lines 663
identification of aerial and ground connections 664
neutralizing r.f. stages 664
Radio—Aerial
handy kink 662
misused antenna insulation 663
Radio—Applications—new tests for radio waves as disease cure 560
Radio—Broadcasting—tower on mountain reached by cable cars 568
Radio—Eliminator
build this compact B 649
direct A-supply from charger 660
Radio—Installation—better reproduction 653
Radio—Loud Speaker
dynamic, is operated from light socket 651
novel unit 651
Radio—Pictorial 659
Radio—Receiver
a Spanish-desk cabinet 654
keeping the set dry 662
modernizing old installations 660
portable, is equipped with screen-grid tube 653
Radio—Reception
fading signals in a.c. sets 661
razor blades make headphone diaphragms 661
Radio—Repairing
A. F. transformers 664
safety insulation for screwdriver 663
Radio—Television—new parts for experimenters 652
Railroad—two-deck sleeping car has hotel comforts 569
Razor, Safety—sharpeners whets both edges 633
Reflection—of sun and moon upon ice-crystal clouds 599
Rifle—fired with one hand, wins British prize 632
Roadster—electric, seats two and goes anywhere 640
Roller Skate—quick clamp prevents accidents 553
Safety Device and Measures
escaping gas sounds alarm to prevent accidents 545
fog lamp for traffic police 637
Sand, Beach—screened for lost valuables 640
Saws and Sawing—portable electric in kit carried like baggage 641
Senses—tested by looking at world upside down 562
Ships and Shipping
illuminated flagship in fleet display 629
stainless-steel propellers reduce shipping costs 551
Shoes—wheel to assemble speeds production 607
Siphon—automatic, also filters 648
Smokers Accessories—cigar lighter without wire latest auto convenience 545
Submarine—Uncle Sam's biggest mine-laying 634
Swimming
portable camp bathing pool serves auto tourists 577
rubber tube harness helps beginners 593
Swing—flying, like airplane adds to child's sport 551
Target Practice—bullets trace lines of fire to aid marksmen 586
Taxicab—with radio to attract passengers 600
Tear-Gas—club for policemen to help conquer crooks 599
Telephone
directory in outdoor booth serves public 641
wires in plant form show cable structure 576

Tires—gauge and deflator helps protect valves 598
Tool, Metal Worker—three-in-one latest shop aid 551
Traffic—danger bell traps autos running past lights 562
Window Cleaning—safety brush to be used from the inside 648

Windmill

AMATEUR MECHANICS

Advertising—novel window manikins from pipe cleaners 682
Automobiles—guard for the starter keeps children from meddling 680
Automobiles—Repairing—anti-rattlers for hood clips 686
Automobiles—Tires—trough for testing those that leak slowly 676
Belt—expansion buckle 679
Boats and Boating
handholds facilitate carrying rowboat 683
more speed from the outboard boat 665
Bookplate—how to make a color stamp 669
Boomerang—throwing is great sport 671
Camping
large, folding grate for campfire 684
old auto chain holds pots over campfire 675
salt and pepper shaker 676
Clothesline—preventing double from slipping on pulleys 676
Cockroach—sure-catch trap 685
Corks—to remove from bottles 674
Dents—removing from metal ware 680
Door, Basement
holder for 683
simple base prevents sagging 680
Fish and Fishing
holder for the fishing rod 668
loosening stiff fishing-rod joints 666
two handy tools for the fisherman 679
Flashlight—carried on boot 678
House Numbers—made from old auto license plates 667
Lantern—medieval easy to make 681
Locks—for windows 666
Motor, Automobile—governor for stationary 670
Motor, Outboard—preventing loss of propeller 675
Razor—using carborundum stone for sharpening 676
Rings—cleaning large set 685
Shoestring—splicing broken 683
Sink—clean-out plug for drain 684
Stirring Rod—heavy, for chemists 679
Stove—substitute for broken oven-door spring 686
Stumps—pulled with help of a keg 678
Tennis—a solo game 668
Tents—elastic stay ropes for 667
Tools—porch cabinet for garden 677
Trap—unusual for rats 677
Trap, Bow—how to make 679
Windows, Porch—hinging to avoid trouble 678
Wire—unrolling, single-handed 685

SHOP NOTES

Angles—laying out accurately 694
Automobiles—Repairing—device helps to reline brake bands 694
Blueprints—holder prevents soiling 694
Boats, Toy—your boy will like this liner 691
Cabinet Work—attractive wooden trim for 687
Clamp, Spring—for leather workers 695
Corn, Seed—storage shed for 696
Drilling—kinks for accurate 702
Furniture—designing, to cover radiators 697
Gauge—for duplicating diameters takes place of caliper 690
Incubator—reading the thermometer 690
Lathe—to turn a large pulley 698
Linoleum—fitting snugly against raised concrete border 698
Machine Parts—accurate measuring of keyways and grooves 699
Milk Can
rack for auto truck 696
rack for draining 699
Photography—holding small steel articles for photographing 701
Pipe, Brass—how to handle 700
Reaming—with drill press 696
Saws and Sawing
handy pocket saw 695
how to cut duplicate pieces on a bandsaw 699
Steel—prevention of scale when hardening 695
Tools—cementing tangs in handles 701
Tractor—inexpensive, for light farm work 689
Wall Studs—spotting 702
Washers—counterboring 695

DRAKE'S PRACTICAL MECHANICAL BOOKS

THEY WILL RAISE YOUR PAY—

ORDER ON 5-DAY TRIAL

The books listed below will perfect you in your chosen trade—pave the way to the big positions. Written in non-technical language—easy to read and understand. Every book covers its subject completely. An entire course of instruction condensed into one volume. Your choice sent postpaid—you benefit 5 days—money refunded in full if not entirely satisfactory. Order direct from this page.



Automobile Books

Automobile Starting, Lighting and Ignition, by Manly... 700 pp.	\$3.00
Brookes' Automobile Handbook...	\$2.00
Ford Motor Car, Truck and Tractor, by Manly... Cloth	\$1.50
Auto and Radio Battery, Care and Repair, by Manly... Leatherette	\$2.00
Motorcycle Handbook, by Manly...	\$1.50



Shop Practice Books

Practical Heating Systems, Trouble Jobs and Ventilation...	\$4.00
Sheet Metal Workers' Manual...	\$2.00
Oxy-Acetylene Welding and Cutting... Cloth	\$1.25
Slide Rule and Logarithmic Tables...	\$2.00
Handbook for Millwrights... Cloth	\$2.00
Machine Shop Practice... Cloth	\$2.00
Mechanical Drawing and Machine Design... Cloth	\$2.00

ORDER DIRECT FROM THIS PAGE—ON OUR MONEY-BACK PLAN

The books listed above are only a few of the many in our catalogue, which you will receive promptly after filing out and mailing us the attached coupon. For quick action order direct from this page—cross name of each book wanted and send in with price quoted. We prepay postage and send the books on our money-back plan.

FREDERICK J. DRAKE & CO.
Publishers

R508—179 No. Michigan Ave. CHICAGO
Drake Books Are For Sale at All Book Stores

Mail Coupon For Free Catalogue
Your Guide to Home Study

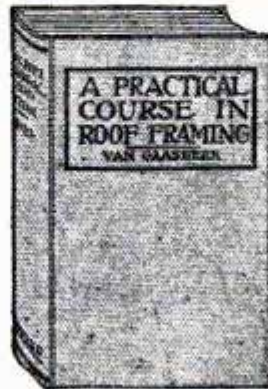

Carpentry Books

Cloth Binding

Modern Carpentry, 2 vols.....	\$3.00
The Steel Square, 2 vols.....	\$3.00
Modern Estimator.....	\$1.50
Timber Framing.....	\$2.00
Builders' Architectural Drawing...	\$2.00
Concretes.....	\$1.50
Practical Bungalows.....	\$1.00
Roof Framing, by Van Gaasbeek..	\$1.50

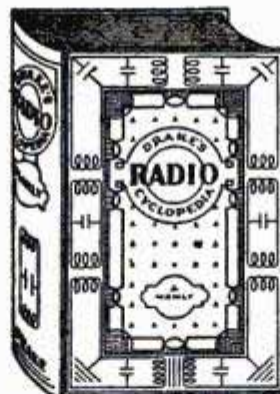

Drake's Radio Cyclopeda

June, 1928 Edition
By H. P. Manly

920 Pages, 1025 Illustrations, 1700 Subjects, arranged alphabetically. For Service and Repair Men, Dealers, Salesmen, Experimenters and Designers. Bound in Art Buckram. Price.....\$6.00



Painting and Decorating

Practical Estimating for Painters and Decorators..... Cloth	\$2.00
How to Draw Funny Pictures—a Complete Course in Cartooning... Cloth	\$3.00
Layouts for Advertising..... Lea.	\$3.00
Furniture, Furniture Finishing, Decoration and Patching.....	\$5.00
Ross Crane Book of Home Furnishing and Decoration..... Cloth	\$3.00
House Painting Methods with the Brush and Spray Gun, by Vanderwalker..... Cloth	\$2.00
Interior Wall Decoration, by Vanderwalker..... Leatherette	\$4.00
The Mixing of Colors and Paints, by Vanderwalker..... Cloth	\$2.00
Studio Handbook—Letter and Design.....	\$3.00
A Show at Sho' Cards..... Cloth	\$4.00
Sign Painting, by Atkinson... Cloth	\$4.00
Strong's Book of Designs, Leatherette	\$4.00
Modern Painters' Cyclopeda, Cloth	\$2.00
Automobile Painting..... Cloth	\$1.50
New Hardwood Finishing... Cloth	\$1.50
Wood Finishing, Plain and Decorative..... Cloth	\$2.00
Owen's Paint Guide..... Cloth	\$1.00

Steam Engineering

Swingle's Handbook for Steam Engineers and Electricians... Leatherette	\$4.00
Examination Questions and Answers for Marine and Stationary Engineers..... Leatherette	\$2.00
Steam Boilers..... Leatherette	\$2.00
Swingle's Catechism of Steam, Gas and Electrical Engineering..... Leatherette	\$1.50

Modern Languages

By Prof. P. S. Allen, U. of Chicago	
French without a Teacher... Cloth	\$1.25
Spanish without a Teacher... Cloth	\$1.25
German without a Teacher... Cloth	\$1.25
Everyday French.....	\$1.25
Everyday Spanish.....	\$1.25

FREDERICK J. DRAKE & CO.
R508—179 No. Michigan Avenue
Chicago, Ill.

GENTLEMEN:—Please send me free, postage paid, your illustrated catalogue which lists and describes 200 Practical Mechanical Books for Home Study.

My name

This One

and my



SBTT-N3G-QE9C

When they cut the pay roll

—will you be hunting for another job?

It usually comes like a bolt from the blue—
You are called into the manager's office—he looks troubled, worried—reluctantly he explains that business isn't holding up, he has more men than he needs. *And what can he do?*

Suddenly it dawns on you that you're being politely told you're through!

You're cut off—and you've got to start selling your ability in competition with thousands of other men in the same fix!

Make Sure of Your Future Now through Practical Home-Study Training

WHAT assurance is yours that when the "axe" falls, it will not hit you?

What assurance is yours that if you are suddenly thrown out of employment—through no fault of yours—you can always get back in, at an attractive salary?

Thousands of men—in every large city in America—are face to face with that problem now.

Upon some the "axe" has already fallen. They are trying as best they can to sell their services, yet they find themselves faced with the fact that the market is flooded with men who can offer just as much as they.

Men Who Are Never Fired —Steadily Promoted

For thousands of others, however, the "axe" has not the slightest terror. Regardless of how drastically their employers chop the pay roll, they know they will steadily advance—either with the companies they now are serving or with others which need precisely what they have to offer.

For how can it be otherwise?

Suppose, for example, you could point to some twenty-seven suggestions you had already made to your company, representing savings from \$20 to \$75 daily—as did J. R. Hollingsworth, in charge of a shift of men at one of the big factories in Akron...

Or suppose, as a trained salesman, you could increase the sales in your territory 50 per cent—as did I. A. Gould, district manager for Michigan for the Smith Agricultural Chemical Company, Columbus, Ohio.

Or suppose that the balance sheet of your employer showed that—through your knowledge, as accountant, of the various factors that determine the success of a business enterprise—you had turned a loss into a profit—as did E. W. Neir, manager of the Hotel Rowe, Grand Rapids.

Or suppose you could demonstrate specialized ability in Personnel Management, say, or Business Correspondence, or any one of a dozen other attractive fields of business where good men are always in demand and where proved ability quickly finds its reward in increased responsibility and increased pay.

EMPLOYMENT
MANAGER



How could any business man who was blessed with sense be persuaded to part with your services—when very clearly those services were showing him a handsome profit!

Are you one of those men who wake up to their needs only when unemployment stares them in the face?

Can you afford to side-step so important a matter any longer—when at home, without losing an hour from work or a dollar of pay, you can *make your position sure, can steadily equip yourself for greater earning power?*

The Secret of Success —Preparedness!

On the coupon indicate the training that most clearly meets your need—fill in your name, address and present position, and place the coupon in the mail.

It will bring you—free—an attractive book clearly outlining the opportunities in the business field of your choice, together with a free copy of "Ten Years' Promotion in One," the book that has started thousands of men on the shorter path to a bigger income.

Do you mean what you say when you say that you want to get ahead?

Prove it by what you do with this coupon—NOW!

— — — Find Yourself Through LaSalle! — — —

LaSalle Extension University

The World's Largest Business Training Institution

Dept. 1064-R

Chicago

I would welcome an outline of the LaSalle plan, together with a copy of "Ten Years' Promotion in One," all without obligation.

- | | |
|---|---|
| <input type="checkbox"/> Business Management | <input type="checkbox"/> Law—Degree of LL.B. |
| <input type="checkbox"/> Modern Salesmanship | <input type="checkbox"/> Commercial Law |
| <input type="checkbox"/> Higher Accountancy | <input type="checkbox"/> Credit and Collection Correspondence |
| <input type="checkbox"/> Traffic Management | <input type="checkbox"/> Industrial Management |
| <input type="checkbox"/> Railway Station Management | <input type="checkbox"/> Modern Foremanship |
| <input type="checkbox"/> Banking and Finance | <input type="checkbox"/> Personnel Management |
| <input type="checkbox"/> Modern Business Correspondence | <input type="checkbox"/> Expert Bookkeeping |
| <input type="checkbox"/> Business English | <input type="checkbox"/> Commercial Spanish |
| <input type="checkbox"/> Effective Speaking | <input type="checkbox"/> C. P. A. Coaching |
| <input type="checkbox"/> Telegraphy | <input type="checkbox"/> Stenotypy—Stenography |

Name.....

Present Position.....

Address.....

POCKET EDUCATORS

For all
BUILDERS AND MECHANICS



Read Audels Pocket Educators for advancement and profit in your work. Every mechanic in the building trades should have this inside trade information at his fingers' ends. Learn the scope and possibilities of your profession. Any job can be done better if you are well informed. To earn more, learn more.



AUDELS CARPENTERS AND BUILDERS GUIDES—4 VOLS. \$6



\$1 PER MO.

Inside Information for Carpenters, Builders, Joiners, Building Mechanics—all Woodworkers. 1600 pages; 3700 diagrams; flexible; pocket size. Short-cut instructions, new methods, ideas, solutions, plans, systems—money saving suggestions. An easy progressive course for the apprentice. A practical daily helper and Quick Reference for the master worker. A Helping Hand to Easier and Better Work and Better Pay. To get this aid for yourself, simply fill in and mail the FREE COUPON below.

INSIDE TRADE INFORMATION ON:

How to use steel square; How to file and set saws; How to build furniture; How to use mitre box; How to use chalk line; How to use rules; How to make joints; Carpenters' arithmetic; Mensuration problems; Estimating strength of timbers; How to set girders and sills; How to frame houses and roofs; How to estimate costs; How to build houses, barns, garages, bungalows, etc.; How to read and draw plans; Drawing up specifications; How to excavate; How to use settings 12, 13 and 17 on the steel square; How to build hoists and scaffolds—skylights; How to build stairs; How to put on interior trim; How to hang doors; How to lath—lay floors; How to paint.

"Audels Guides worth four times their price—handy too as I carry them in pocket for reference." W. J. Bates, Knoxville, Pa.

AUDELS PLUMBERS AND STEAMFITTERS GUIDES—4 VOLS. \$6



\$1 PER MO.

A new set—just out! A practical, illustrated, Reference Library and Study-Course for Master Plumbers, Journeymen and Apprentice Steamfitters, Gas Fitters and Helpers, Sheet Metal Workers, Draughtsmen, Master Builders, Engineers and all Building Trade Students. 1670 pages; 3642 diagrams; flexible; pocket size. Guides explain all the principles, advances and short cuts of the Plumbing and Heating trade. Contains instructions on how to figure and estimate jobs. Use FREE COUPON below to examine, without obligation, this valuable work.

INSIDE TRADE INFORMATION ON:

Soldering, tinning. Joint wiping, bending, beating. Pipe—iron—steel, threading. Mathematics, tables, physics. Materials—iron, steel, copper, brass, lead, tin, antimony. Sheet metal—galvanized—plate. Sanitation, syphonage, tanks. Drainage, sewage, purification. Fixtures—bath—kitchen. Pipe fittings, soil pipe, tools. Laying out work. Roughing. Screwed fittings, flanges, joints. Pipe bending, examples. Elbows. Heating, ventilation, refrigeration. Water supply, mains, wells, tanks. Gas-fittings. Underwriters. Sheet metal work, problems, methods, brazing, heating, lead burning. Welding, various welds, methods. Blacksmithing, forges, tools.

"Audels Guides are practical, easy to understand, reliable. Cover the field in plain language." W.F. Arringer, Annapolis, Md.

AUDELS MASONS AND BUILDERS GUIDES—4 VOLS. \$6



\$1 PER MO.

A new, complete, illustrated trade reference library, for Bricklayers, Cement Workers, Plasterers, Tile Setters and Stone Masons, including a practical outline of Steel Construction. 1100 pages; 2867 diagrams; flexible; pocket size. A practical Trade Assistant explaining modern methods of masonry construction. Easy to understand and apply. A reliable and authentic reference work and study-course for Master Journeyman and Young Mechanic. Use FREE COUPON below and find out for yourself, without obligation, whether this set will benefit you.

INSIDE TRADE INFORMATION ON:

Bricklaying, tools, materials; Brick designs, patterns, bonds; Setting frames and foundations; Mortars, scaffolds, estimating; Mortars and mortar mixing; Tile setting, mosaic, hollow tile; Straight edge test, troweling; How to figure brick work; Safe loads, piers, chimneys; Boiler settings, anchors, fire stops; Labor tables; Concrete, forms; How to figure concrete work; Stucco—on old and new buildings; Plastering—wood lath—metal; Plasterers agreement; Plastering on various surfaces; Stonemasonry; Cutting, finishing, estimating stone; Derricks, rigging; Steel construction; Fire proof; How to read blue prints.

"Audels Masons Guides are the best books on the subject. Have laid brick 12 years and am able to judge." H.A. Bonnett, Cortice, Pa.

PRACTICAL ELECTRICITY — 1 VOL. \$4

Audels Handy Book of Practical Electricity is a simplified Ready Reference and Study Course in one pocket size, leather bound volume—for Engineers, Professional Electricians and Students. 1040 pages; 2600 diagrams; flexible red leather bound. A reliable authority and handy helper for every electrical worker. Contains important and valuable wiring diagrams, calculations, machine sketches, helps on maintenance and repair. Use this FREE COUPON today and find out, without obligation, how this handy book will help you in your daily work.

Complete in one handy, red leather bound volume



INSIDE TRADE INFORMATION ON:

Electro-Therapeutics, X-Rays, Shocks, Welding, Brazing, Radio Hook-ups, Motion Pictures, Telephone, Telegraph, Cranes, Bells, Elevators, Pumps, Tools, Ship Drive, Railways, Vehicles, Automobile Electric Systems, Ignition, Generation, Lighting, Plant Management, Power Plans, Armature Winding, Repairing, A. C. Motors and Apparatus, D. C. Motors and Apparatus, Alternator Construction, Dynamos, Wiring Diagrams, Sign Flashers, Cable Splicing, Power Wiring, Outside Wiring, Switches, Lighting, Rectifiers, Converters, Transformers, Fuses, Circuit Breakers, Rheostats, Electro Plating, Electrolysis, Storage Batteries, Magnetism, Electrical Energy, Conductors, Insulators, Static, Dynamic, Radio Electricity, Applications, Ready Reference and Index Covering the entire field of Modern Electricity.

Learn More and You Will Earn More!

Know your job and you'll never be without one. The skilled man is always in demand. Knowledge is power. Learn your trade thoroughly by easy reading. This coupon is your opportunity for advancement and better pay. You risk nothing in sending for Audels Guides for free examination. Send it NOW!

FREE EXAMINATION COUPON

THEO. AUDEL & CO.,
65 W. 23 ST., NEW YORK CITY

Please mail me for free examination the books marked (x) below. If I find them satisfactory, I agree to mail \$1 in 4 days, on each set ordered, and to further mail \$1 monthly on each set until I have paid the purchase price.

4 CARPENTERS GUIDES \$6 | 4 PLUMBERS GUIDES \$6

4 MASONS GUIDES \$6 | 1 ELECTRICIANS HANDY BOOK \$4

NAME

ADDRESS

OCCUPATION

EMPLOYED BY..... 10T30

LEARN AUTO

New Easy Way to

Earn UP TO \$100 a Week

AT HOME!

Say goodbye to low pay. Get into the Auto Business, where big pay—extramoney—raises come quick! A brilliant future awaits you in the World's Biggest Business. If you're earning a cent less than \$60 a week, clip that coupon. Learn how \$50—\$75—even \$100 a week is possible for you now! Find out about this training which boosted Yancy of Perla, Ark., from \$30 a week up to \$90!

Open Your Own Auto Shop

My Free Book tells how men make extra money while training, and then go into business with no further Capital. It's the training that counts, and it is complete training that I give you.

Common Schooling All You Need

Men between 15 and 60, with very little education, are becoming Garage Owners, Superintendents, Foremen. Whether you have had years of Auto Experience, or never touched a car before, send for this Free Book Now. I'll show you the quick way to get in line for real success in the Auto Business.

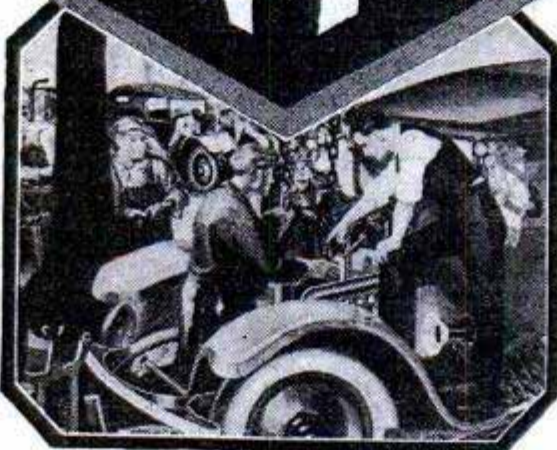

Send coupon for Free Auto Book. See how I train you right at home, in every branch of Auto work—Learn how I prepare you, quickly and easily, for the Big Jobs, paying up to \$100 a week, and more. "Job-Way" Training includes all Mechanical and Electrical work—Starting, Lighting, Ignition—also Welding, Brazing, Vulcanizing—everything you need to get in line for a big pay Job as an Electrical and Mechanical Auto Expert.

AVIATION COURSE

and many other valuable features included FREE of any extra charge to you NOW, if you act QUICK! Mail coupon below today!

Money-Back Agreement

My Money-Back Agreement gives you absolute protection. You must be satisfied or "Job-Way" Training costs you nothing.

I'll Help You Get a Good Job

My Employment Department will help you get a good Job whenever you want one. You don't have to wait until you have graduated to use this service. No sir, as soon as you have shown that you know enough about Autos to hold the Job I'll give you this help whenever you ask for it! What is more, you can use it as long as you live!

Get All the Facts!

Send for my new Free Book now! See what "Job-Way" has done for hundreds. See what it can do for you. Learn all about my legal money-back agreement—and the many added features. Clip coupon now!

MAIL THIS COUPON

FREE Auto Book!

B. W. COOKE, Directing Engineer, Chicago Motor Training Corporation, Dept. 11-67 1916 Sunnyside Ave., Chicago, Ill. Send me your Book, "Auto Facts", Free of charge. Also full particulars of your Aviation Course offer and of "JOB-WAY" Training. This obligates me in no way whatever.

Name.....
 Address.....
 Town..... State.....
 Age..... Occupation.....

B. W. COOKE Directing Engineer
 Dept. 11-67
 Chicago Motor Training Corp.
 1916 Sunnyside Ave., CHICAGO

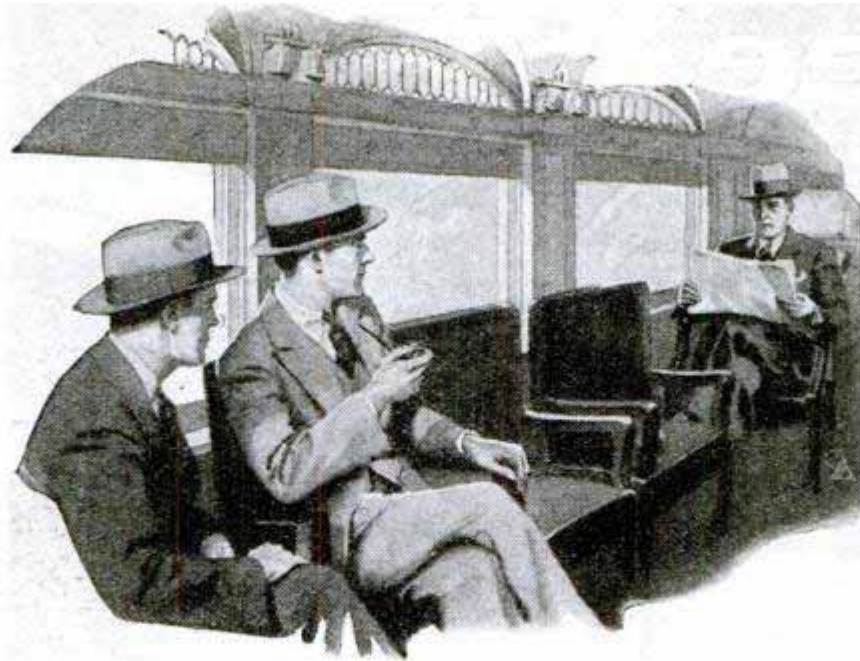

“What’s Andy Blair doing now?”

Bill—“Haven’t you heard? He’s the new sales-manager for Hess & Schoble and they say his salary is \$7500 a year.”

Tom—“He certainly has come up fast. He wasn’t getting over \$50 a week the last time I saw him. How’d he do it?”

Bill—“Took up a course with the I. C. S. and studied at night. That’s why the old crowd hasn’t seen so much of him in the last few years. I wish I’d had the sense to do it too. I’d be making more money right now if I had.”

Why don’t *you* study and get ready for promotion too? We’ll be glad to help you if you will only make the start.

Thousands of men have happy, prosperous

homes because they had the foresight to prepare themselves for advancement through the home-study courses of the International Correspondence Schools. Hundreds of them report salary increases of \$10, \$15 and \$25 a week. Many are earning \$75, \$100 and \$150 a week. Some have doubled and even tripled their salaries. Some are earning \$10,000 and \$15,000 a year. Others have become owners of businesses of their own.

If the I. C. S. can help other men to raise their salaries, it can help you. At least find out how. It won’t obligate you to ask for our Free Booklets, but that one simple act may change your entire life. Do it now. Do it for HER!

INTERNATIONAL CORRESPONDENCE SCHOOLS, Box 5564-F, Scranton, Penna.

“The Universal University”

Without cost or obligation, please send me a copy of your booklet, “Who Wins and Why,” and full particulars about the subject before which I have marked X in the list below:

- | | | | | |
|--|---|--|---|---|
| <input type="checkbox"/> Business Management | <input type="checkbox"/> Cost Accounting | <input type="checkbox"/> Secretarial Work | <input type="checkbox"/> Business Correspondence | <input type="checkbox"/> Railway Mail Clerk |
| <input type="checkbox"/> Industrial Management | <input type="checkbox"/> Accounting and C.P.A. Coaching | <input type="checkbox"/> Spanish <input type="checkbox"/> French | <input type="checkbox"/> Show Card and Sign Lettering | <input type="checkbox"/> Common School Subjects |
| <input type="checkbox"/> Personnel Management | <input type="checkbox"/> Bookkeeping | <input type="checkbox"/> Salesmanship | <input type="checkbox"/> Stenography and Typing | <input type="checkbox"/> High School Subjects |
| <input type="checkbox"/> Traffic Management | | <input type="checkbox"/> Advertising | <input type="checkbox"/> English <input type="checkbox"/> Civil Service | <input type="checkbox"/> Illustrating <input type="checkbox"/> Cartooning |
- BUSINESS TRAINING COURSES**
- | | | | | |
|---|---|--|--|---|
| <input type="checkbox"/> Electrical Engineering | <input type="checkbox"/> Railroad Positions | <input type="checkbox"/> Steam Engineering | <input type="checkbox"/> Concrete Builder | <input type="checkbox"/> Airplane Engines |
| <input type="checkbox"/> Electric Lighting | <input type="checkbox"/> Gas Engine Operating | <input type="checkbox"/> Architect | <input type="checkbox"/> Structural Engineer | <input type="checkbox"/> Agriculture |
| <input type="checkbox"/> Mechanical Engineer | <input type="checkbox"/> Civil Engineer <input type="checkbox"/> Mining | <input type="checkbox"/> Architects’ Blueprints | <input type="checkbox"/> Chemistry | <input type="checkbox"/> Mathematics |
| <input type="checkbox"/> Mechanical Draftsman | <input type="checkbox"/> Surveying and Mapping | <input type="checkbox"/> Contractor and Builder | <input type="checkbox"/> Pharmacy | <input type="checkbox"/> Navigation |
| <input type="checkbox"/> Machine Shop Practice | <input type="checkbox"/> Plumbing and Heating | <input type="checkbox"/> Architectural Draftsman | <input type="checkbox"/> Automobile Work | <input type="checkbox"/> Radio |
- TECHNICAL AND INDUSTRIAL COURSES**

Name..... Street Address.....

City..... State..... Occupation.....

Persons residing in Canada should send this coupon to the International Correspondence Schools Canadian, Limited, Montreal, Canada

See Life
Win Applause...Thrills
Big Money

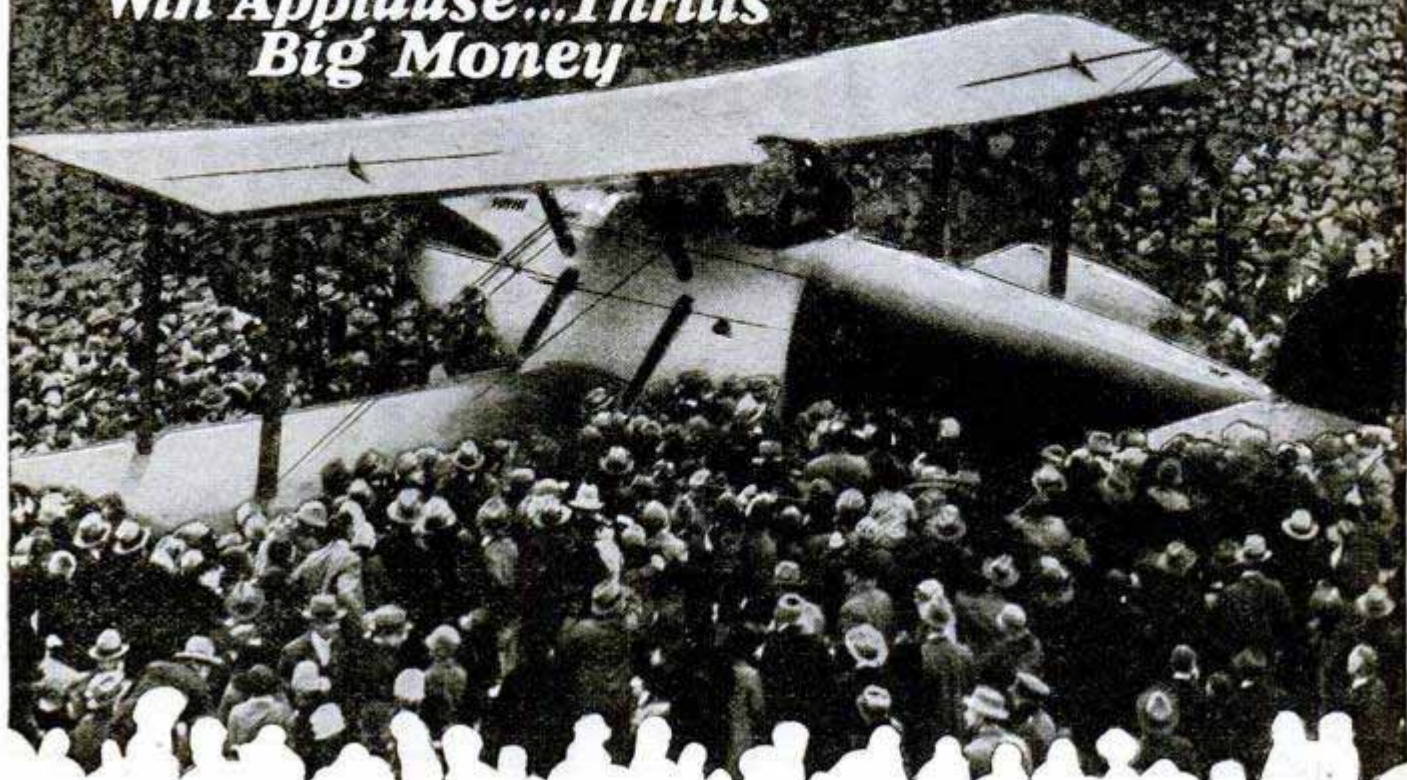

Get Into Aviation!

SEIZE the biggest thrill ever offered to man—the biggest adventure since time began—smash into Aviation—the game for men with sporting blood! Step into a life of excitement, daring and big money—away from a tame, narrow, humdrum existence.

Think what Aviation offers you. Thrills such as you never had before! The praise and plaudits of the multitude. And a chance to get in on the ground floor where rewards will be unlimited!

Amazing Opportunities

Aviation is growing so swiftly that one can hardly keep track of all the astonishing new developments. Air mail routes have just been extended to form a vast aerial network over the entire U. S. Airlines and airplane factories are springing up all over the country. Men like Henry Ford are investing millions in the future of commercial aviation in America! The possibilities are so tremendous that they stagger imagination!

Everything is set for the greatest boom in history. Big fortunes came out of the automobile industry and out of motion pictures. Big fortunes will also come out of Aviation. The development of Aviation as an industry is bringing with it a call for trained men. The opportunities open cannot be overestimated. Those who qualify quickly should find themselves on the road to undreamed of money—success—popularity—and prominence.

Easy to Get Into Aviation By This Home Study Method

Get into this thrilling business at once while the field is new and uncrowded. Now—by a unique new plan—you can quickly secure at home, during spare time, the preliminary training necessary to get a start in the Aviation Industry. Experts will teach you the secrets—give you the inside facts that are essential to your success. And the study of Aviation

by our method is almost as fascinating as the actual work itself. Every lesson is chock-full of interest—and so absorbing that you actually forget you are studying. But best of all are the ultimate rewards you are fitting yourself to gain.

PICK YOUR JOB!

Get Ready Now for One
 of These Positions

Flying
 Airplane Repairman
 Airplane Mechanician
 Airplane Inspector
 Airplane Salesman
 Airplane Assembler
 Airplane Builder
 Airplane Pilot
 Airplane Instructor
 Airplane Contractor
 Airplane Engineer
 Aerial Photography
 Aerial Advertising

Send for FREE Book

Send the coupon for our new, free book, just out—*Opportunities in the Airplane Industry*. It is unusually interesting, reads like a romance, and gives vital facts about Aviation you never even dreamed of. You owe it to yourself to at least read it. We offer you a free copy now. No obligation. Mail the coupon for yours today.

FREE
AMERICAN
SCHOOL OF
AVIATION

Dept. 1357
 3601 Michigan Ave.
 Chicago, Ill.



American School of Aviation,
 Dept. 1357, 3601 Michigan Ave.,
 Chicago, Ill.

Without obligation, please send me your FREE Book, *Opportunities in the Airplane Industry*. Also information about your Home Study Course in Practical Aviation.

Name..... Age.....
 Address.....
 City..... State.....

I'll Pay Your Railroad Fare to Chicago Without Extra Cost

UP TO \$15,000 a year for **GREER GRADUATES**

ELECTRICITY, AUTOS, AVIATION now pay hundreds of trained men up to \$200 A WEEK. Here are THE 3 WORLD'S GREATEST BUSINESSES. BILLIONS—not millions, but BILLIONS of dollars are spent in them every year. CHOOSE ONE OF THESE THREE, HERE and NOW.

GREER trained men are NEEDED. I HAVE MADE hundreds of \$10,000 A YEAR MEN. 90,000 in the last 26 years have come to GREER. THOUSANDS MORE in the future will likely come here. BE ONE OF THEM. Send coupon to me for openings.

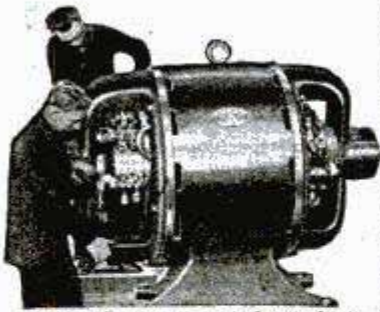

Rotary Converter, used by students for testing

Amazing Opportunities for you in one of World's 3 Biggest Businesses

MEN WANTED

I will help you get a position while learning; also after graduation. Never before such unusual opportunities. GET MY FREE BOOK NOW. LEARN ABOUT THE BIG PAY. ELECTRICITY, AUTOS, AVIATION lead WORLD'S BUSINESS. That's why GREER College selected these fields and ONLY THESE.



Learn to Boss the Job

ELECTRICITY AVIATION AUTOS

Learn in Only 3 Months in GREAT GREER SHOPS ON LARGE LIVE EQUIPMENT

Mine is NOT A CORRESPONDENCE COURSE. You can start any day or any evening. It is PRACTICAL, EASY, QUICK, FASCINATING training. You learn on Great, running live Equipment in tremendous GREER SHOPS. AUTO Business is BIGGEST BUSINESS in the world. ELECTRICITY is FASTEST GROWING, and yet in its Infancy. AVIATION, most fascinating, alluring business today, is already a Billion Dollar Industry.

Choose one of these 3 wonderful professions today. Trained men are needed by scores, for positions up to \$200 a week and up. Find out now, about my great Shops training.

full of HARD THEORY—NO HEADACHES in GREER PRACTICAL SHOPS TRAINING. You learn to DO BY DOING. You learn to fly by flying.

You Get Real Help to BIG JOBS!

TWELVE PEOPLE are in my Big EMPLOYMENT DEPARTMENT getting jobs for Greer men. You get their help AS OFTEN AS YOU NEED IT, both BEFORE and AFTER Graduation.

Get My FREE BOOK NOW

Don't let money hold you back. Get my Free Book. Find out NOW how I PAY YOUR FARE HERE, let YOU ATTEND EITHER DAYS or EVENINGS and help you find DAY or EVENING WORK to PAY YOUR EXPENSES while learning. Then when ready we help you find the real BIG PAY JOB. LEARN how I get you ready so Employers WANT YOU, and GLADLY pay you what you are worth.

Quickest, Easiest of Ways to Become Expert

I'LL PAY YOUR FARE HERE FREE of extra cost, then help you to a JOB WHILE LEARNING. Then I not only FIT YOU to get BIG PAY JOB, but I'll help YOU HOLD IT. Young and Old, Educated and Uneducated, Inexperienced and Experienced have found GREER SHOPS training EASY, FASCINATING and VALUABLE. Coupon below brings details.

Not Correspondence Course

Here at GREER SHOPS you learn on BIG, ACTUAL FULL SIZE Machinery, like you will work on out on the Big Pay Job. You get close personal supervision. NO Guess work—NO books

Erwin Greer



GREER COLLEGE

Electricity—Autos—Aviation
Dept. C-01
2024 So. Wabash Ave.
CHICAGO, ILL.

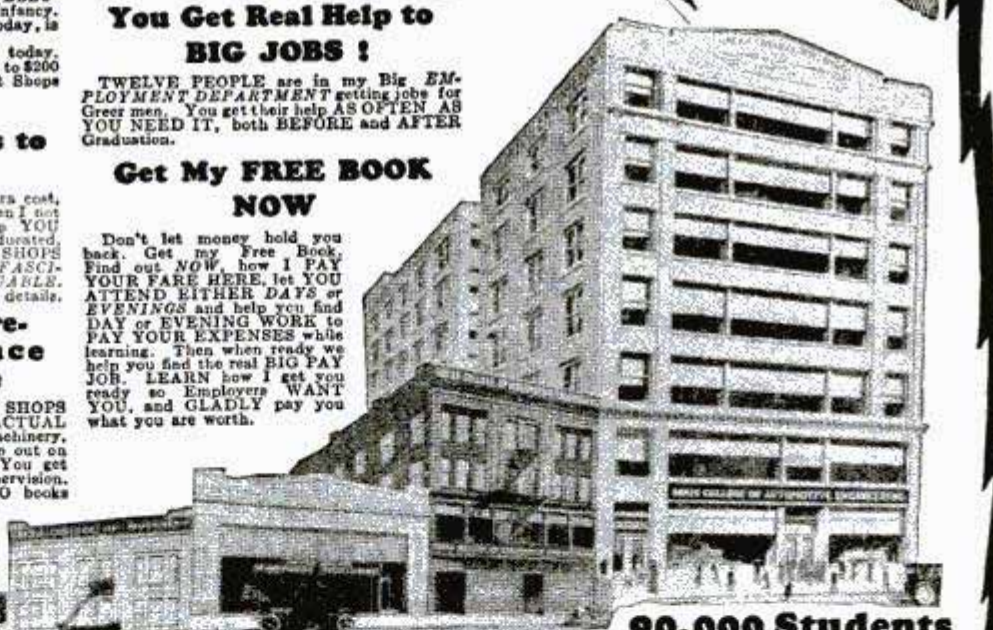

90,000 Students

26 Years Tremendous Success

Above is the important history of GREER COLLEGE. Note the steady 26-years growth, thru genuine SERVICE, from the tiny Shops on the left to the tremendous Building on the right, filled with GREAT TRAINING Equipment. These

moves to always greater quarters mean GROWTH—PROGRESS and SERVICE. What is it you like—ELECTRICITY—AUTOS—or fascinating AVIATION? GREER will train you in EITHER, as YOU SHOULD BE TRAINED.

Get My Big Offer Now!

Would an offer of \$100 a week be OPPORTUNITY or DISAPPOINTMENT for you? If you could HOLD the JOB it would truly be OPPORTUNITY. If you can't hold the \$100 a week job, PREPARE. Be ready. Don't invite disappointment. Learn about GREER SHOPS. Right now if you act quick, I can make you a most unusual short time offer. Clip coupon NOW and find out. Address me personally
ERWIN GREER, President

SCISSORS FOR FREE BOOK

ERWIN GREER, President
Dept. C-01
2024 So. Wabash Avenue,
Chicago, Illinois

Send Free Book indicated below and details of Special offer, without obligation to me.
 Autos Electricity Aviation

Name.....
Address.....

Here's 3 Free Lessons! in Auto Painting



We Furnish All Equipment!

Cars everywhere need painting! Painters' incomes running into thousands. That's the situation all over the United States today. Doesn't that move you to fill out and mail the coupon below to get the proof? The 3 free lessons are yours and you won't owe me a cent.

Are you making \$60.00 to \$125.00 a week now? Is your work so easy? **CAN YOU EVER BE YOUR OWN BOSS?**

Just your name and address brings full details—and the 3 free lessons to prove that you too can learn to be a real Auto Painter through my simple, easy shop-type method of home training.



You can practice at Home

You don't have to give up your present job. You can get ready in your spare time—in the evenings. It's fascinating. I furnish 13 big outfits with the course so you get actual experience on wood and metal panels as you go along—right at home. I'll soon have you fully prepared for a job anywhere. Places waiting for first class men at high pay.

You can tackle anything in the auto painting line with the utmost confidence after you've had my training. I'm "right at your elbow" to help you anytime you need me. I'm right here for lifetime consultation. All this for only a few pennies a day. Mail coupon! This may be the turning point of your life. Men like yourself now making \$5000 to \$10,000 a year!

I help you go into business

BOSS YOUR OWN BUSINESS! Get others to do the work for you. That's the way the **BIGGEST MONEY** is made. It is so easy to start an auto painting business of your own that you'll wonder why you never thought of it! I don't care whether you have a cent in the bank or not. *I'll show you the way.* And how this trade does grow! Set your stakes for the biggest Auto-painting business. By my plan you can have it some day and not so far in the future either. This business is here to stay—and now is the time to get into it.



G. King Franklin
Superintendent

GET THE PROOF

G. King Franklin, Supt.
American Auto Painting School
Dept. 1901, 425 S. Ashland Ave., Chicago

Send sample shop-tickets free and information on how I may learn auto painting and Duco at home in spare time.

Name.....
Street No.....
City..... State.....

FREE

BIG PAY EVERYWHERE

Just get this—these opportunities are waiting for you NOW. And a few months puts you in line to go right up and grab one off. No long tedious course—nothing technical. I don't care what schooling you've had or have not had. If you are a normal red-blooded man with ambition I can give you just as fine an opportunity as any man in the business. The point is will you act now? Sign and mail the coupon—3 free lessons. No obligation.

G. KING FRANKLIN, Supt.
AMERICAN AUTO PAINTING SCHOOL
Dept. 1901, 425 South Ashland Avenue, CHICAGO

AUTO

5 AUTO BOOKS SENT FREE!



Mail the coupon and we'll send you a set of these remarkable auto books, just off the press. Whether you are mechanic or helper, expert or student, auto owner or driver, if you're interested in autos, by all means take advantage of this opportunity to see the latest and most complete work on autos we have ever published. Built by eighteen of America's greatest automotive engineers. Simple enough for men with little schooling to understand, yet in daily use by hundreds of engineers, service-station superintendents and foremen as an authoritative REFERENCE Cyclopedic. This new edition includes straight-eights, 4-wheel brakes of all types and other features of the 1928 models.

Put the JIFFY INDEX
to work for you!

Can You FIX IT?

Can you take out "play" in differential? Can you kill the "Shimmy" in steering? Can you reset TIMING? Can you put your finger on engine trouble without guessing or tinkering? Can you pull the starter off and fix it? Can you adjust and repair transmission, engine, rear axle, bearing?

These Books Tell How!

They bring the answer to any auto problem instantly. And they show the best, quick, professional way to do EVERY repair and replacement job you will ever need. Auto owners say the cost is saved over and over again by showing how to make adjustments and emergency repairs on the road.

5 Big DeLuxe Volumes just off the press!

2400 pages, over 2000 illustrations, wiring diagrams, equipment charts, etc. De Luxe edition with gold-stamped flexible binding. Sent FREE for 15 days' use. If not wanted return express collect. If kept, send only \$2 after 15 days, then \$3 a month until special advertising price, \$24.80, is paid.

A Year's Consulting Membership FREE!

Privilege of consulting engineers of million-dollar American Technical Society on any automotive problem for one year without charge, if you mail coupon immediately.

American Technical Society

Dept. A-719, Drexel Ave. & 58th St.,
CHICAGO, ILL.



The billion-dollar auto industry offers rich prizes to men with gumption enough to really learn all branches of automotive mechanics. A better job, bigger pay—a chance to go into business and get a share of the huge profits, are waiting for any man who even half tries to improve his ability to deliver service. And here's the shortest, easiest way: No tedious studying, no memorizing, no lessons or examinations. Just LOOK UP the fact you seek. You'll



find the answer to any auto problem literally at your finger-tips, in the famous JIFFY INDEX. No need to "carry it in your head," at all.

"Was garage hand—now have Shop of my own," writes W. Sidle of Toboso, O.

J. H. Geise of Detroit says: "I received \$50 worth of information out of them the first 5 days."

"I got a raise," says P. Ervin of Yarmouth, N. S., shortly after getting his books.

And D. S. Reid of Siluria, Ala., was offered \$4000 for invention worked out with these Auto Books.

Don't Send a Penny!

AMERICAN TECHNICAL SOCIETY,

Dept. A-719, Drexel Ave. and 58th St., Chicago, Ill.

I would like to see the new 5-volume edition of your AUTO BOOKS, but without obligating me to buy them. I will pay the few cents delivery charges only, but if I choose to, I will return them express collect and owe you nothing. If after 15 days' use I prefer to keep them, I will send you \$2 and pay the balance at the rate of only \$3 a month, until \$24.80 is paid. Please include free membership.

Your Name

Your Address

Reference Name

Reference Address

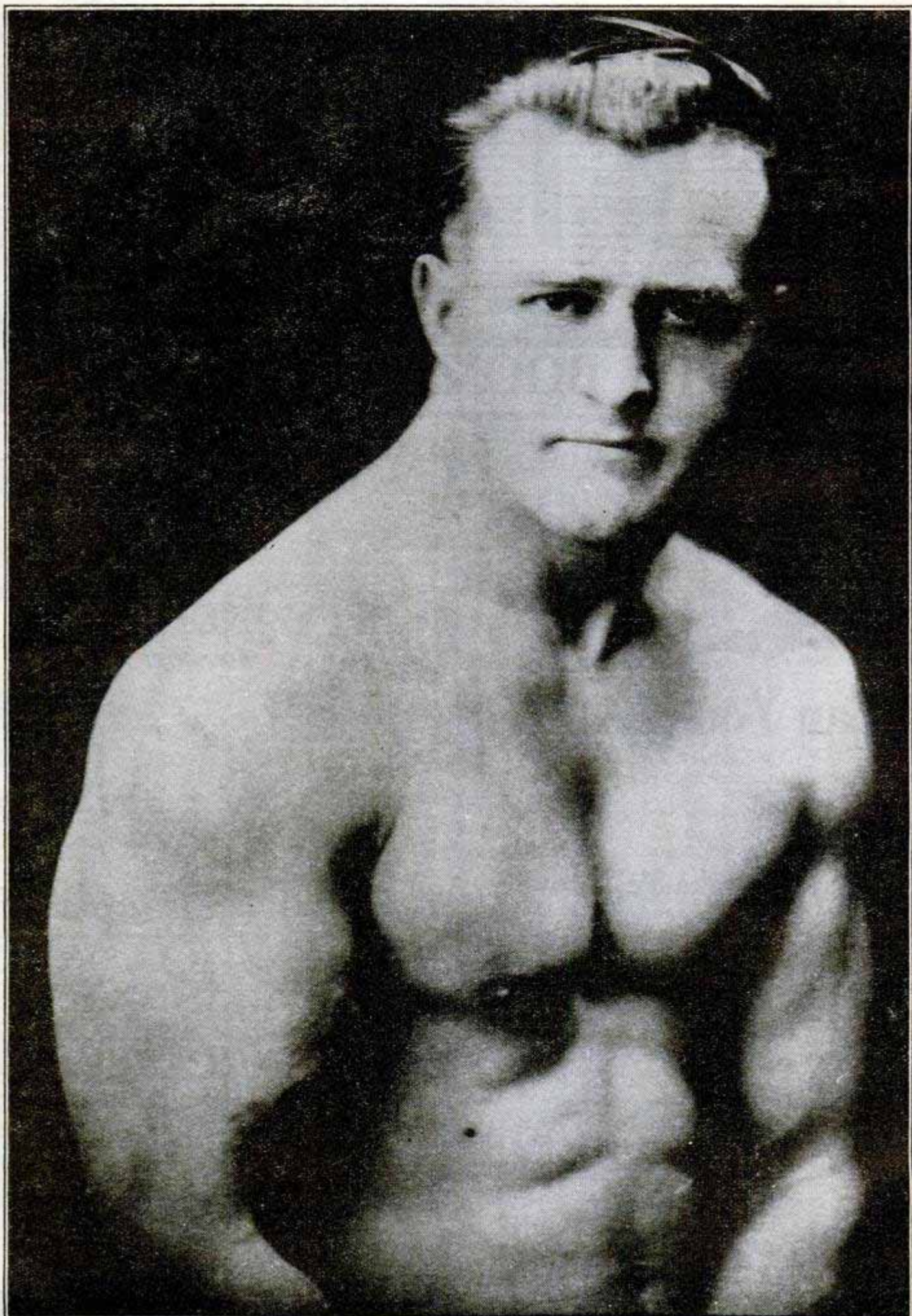

EARLE E. LIEDERMAN, *The Muscle Builder*

Author of "Science of Wrestling," "Muscle Building," "Secrets of Strength," "Here's Health," "Endurance," etc.

NEW BODIES *in 24 hours*

HAVE you ever watched a magician pick wriggling rabbits out of a high hat? A wonderful trick, you say. Well, I'm a magician of a different sort—a magician that builds health and strength into your body in just 24 hours. And it is no trick. It took me 19 years of tireless planning and experimenting to be able to do it.

People call me the Muscle-BUILDER, because I take weak, run-down bodies and transform them into strong, virile, handsome bodies in double-quick time. *And I actually do it in 24 hours.*

In the Privacy of Your Own Room

By this I do not mean that you must exercise 24 hours continuously. My scientific short-cut to healthy, handsome, broad-shouldered bodies must be taken in short 15 minute doses. Because, if you exercise more than that in my high-pressure, quick development way, you would tear down more than I can build up. So all I ask of you is 15 minutes of your spare time each day for 90 days (actually only 22½ hours time) doing simple, easy exercises under my guidance. You can do them in the privacy of your room, if you wish, but you must do them every day to get the best results.

And What Results!

In the first 30 days I guarantee to add one whole inch of real, live muscle on each of your arms, and two whole inches of the same revitalizing strength across your chest. I'll take the kinks out of your back, strengthen and broaden your shoulders, give you a wrist of steel, and a fighting, peppy personality that just yells youth, vigor and vitality all over.

I Work Inside As Well As Out

Your heart, your liver, your kidneys, your lungs—all your internal organs get the jolt of their young lives when I start to work on them. And they settle down to an orderly, well-mannered existence that means a new kind of happiness for you—the joy of living that only a healthy, virile body can give you. And the headaches, constipation troubles, aches and pains that are always caused by weakened, flabby bodies somehow miraculously disappear.

You'll See It in Her Eyes

And will your friends notice the difference! Just watch that girl you love so dearly open her eyes, and *fight* to hold your attention! And the men in your crowd—they'll look up to you as a real leader. Instinctively they worship strength and leadership that must go with it. But let me tell you all about it. All you have to do is

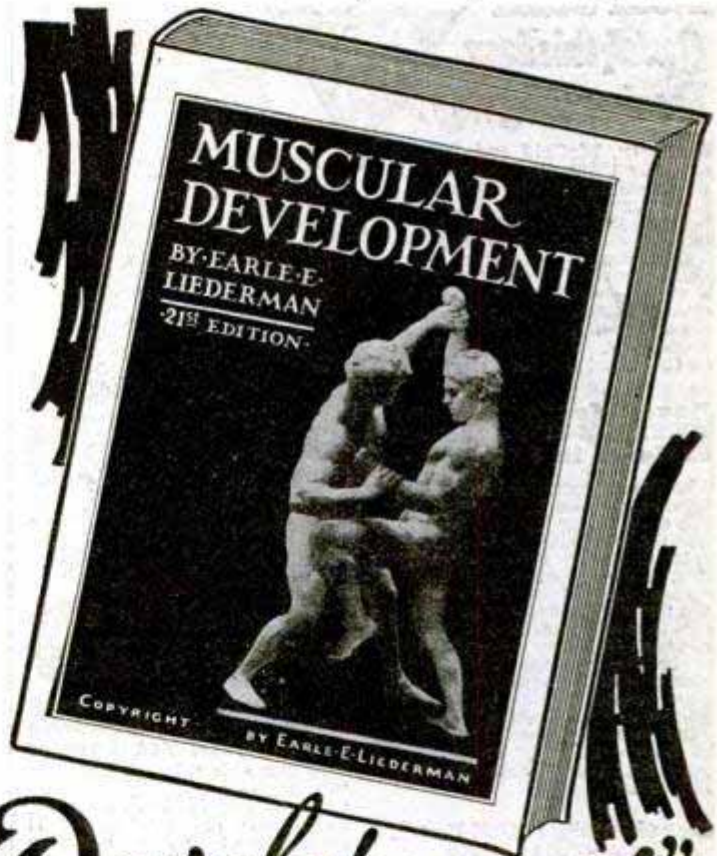

Send For My New
64 Page Book

"Muscular Development"

IT IS FREE

What do you think of that? I don't ask one cent. And it's the peppiest piece of reading you ever laid your eyes on. I swear you'll never blink an eyelash till you've turned the last cover. And there's 48 full-page photos of myself and some of my prize-winning pupils. This is the finest art gallery of strong men ever assembled. And every last one of them is shouting my praises. Look them over. If you don't get a kick out of this book, you had better roll over—you're dead. Come on, then. Take out the old pen or pencil and sign your name and address to the coupon. If you haven't a stamp, a postal will do. But snap into it. Do it *now*. Tomorrow you may forget. Remember, it's something for nothing and no strings attached, no obligation. *Grab it!*

EARLE E. LIEDERMAN

Dept. 2010, 309 Broadway, New York City

It Is FREE
DON'T SEND ONE PENNY — YOUR NAME AND ADDRESS ON A POSTAL WILL DO

EARLE E. LIEDERMAN

Dept. 2010, 305 Broadway, New York City

Dear Sir: Please send me, absolutely FREE and without any obligation on my part whatever, a copy of your latest book, "Muscular Development."

Name.....

Street.....

City..... State.....

(Please write or print plainly.)

\$85

**a Week for
McCarty**

Kenneth McCartney, South Haven, Mich.—former \$18 week clerk—now orchestra Tenor Banjoist earning \$85 weekly.



\$278

**Extra for
McGriff**

J. P. McGriff, Hawkinsville, Ga., playing for dances and movies, has already earned \$278 in spare-time.



\$100

**a month extra
for Abbott**

L. G. Abbott, Williston, N. D., "happiest fellow in town," cashing-in BIG every month.



You Can Make Real Cash Quick this Easy Fascinating Way

TENOR BANJO Pays Big!

McCarty, McGriff and Abbott are only three out of thousands of my students who have made more money and friends through my amazingly simple, rapid method of learning to play the Tenor Banjo. Most of them had never read a note or touched a string—but my clear, interesting instruction has made them *top-notchers* socially and financially. Now I'm ready to do the same thing for YOU!

Have Friends, Fun and EXTRA MONEY—Learn at Home in 1 to 3 Mos.

The Tenor Banjoist has all the friends, all the invitations, all the good times he wants. And he makes **BIG MONEY**—spare-time or full-time. Parties, dances, entertainments, orchestras—all of them want the melodious, snappy music of this favorite instrument. YOU can cash-in on such popularity; make yourself the most popular one in town; put plenty of good round dollars into your pocket too! And you can do it in 1 to 3 months' spare-time study at home—actually be playing your first tune within the first *half hour!*

Get this Big FREE Book Now—Tells How

"The Play-Way to Popularity and Big Pay" is the book that has started thousands toward popular, prosperous *Success!* It brings all the proof and facts about my astounding course—describes the wonderful Tenor Banjo and Outfit I send you—shows how you too can have more friends, fun and **EXTRA CASH** this easy way. Get this big book quick; no obligation. Don't put it off, don't delay. Mail the coupon at once!



This TENOR BANJO \$20

Complete Outfit and Phonograph Records Come with 1st Lesson

The same day I receive your "O. K."—telling me that you want to get in line quick for good times and good pay—I'll send you at no extra cost this splendid, professional size, full-tone Tenor Banjo worth \$20; Complete Outfit of pick, tuner, strings; Gain-time Chart; rapid progress lessons and instructions—and *Demonstration Phonograph Records* of every selection in the course, showing you exactly how to play each note, each tune. No long, tedious practicing or "scales." Instead, real fun—easy, fascinating! Get the FREE Book first—get the facts! Send coupon now!

Clip-Sign-Send!

A. F. Bloch, President
NEW YORK ACADEMY OF MUSIC
Studio 1105, 100 Fifth Avenue,
New York City,

Please send me FREE Book on Tenor Banjo Success—"The Play-Way to Popularity and Big Pay."

Name.....

Address.....



CHICAGO TECHNICAL COLLEGE

25th Year
**Engineering
Architecture
Electricity
Drafting**

Intensely practical training. 2 year Diploma; 3 year B. S. Degree; special 3 and 4 months' short courses. Courses adapted to your needs. No time wasted. Expert instructors. Graduates in constant demand. Opportunities for self-support while studying. Day and evening classes. Athletics. Enter any time. Low tuition—easy terms. Write today for your copy of 50-page illustrated "Blue Book," mailed free.

Dept. N-76
178 E. 28th St.
Chicago Technical College
Chicago

Learn to PAINT SIGNS and SHOW CARDS

We quickly teach you by mail, or at school, in spare time. Enormous demand. Big future. Interesting work. Oldest and foremost school.

EARN \$50 TO \$200 WEEKLY

John Vassos, N. Y., gets \$25 for single show card. Crawford, B. C., writes: "Earned \$200 while taking course." Don't delay. Send today for complete information, samples and guarantee.



DETROIT SCHOOL OF LETTERING
150 Stimson Ave. Est. 1899. DETROIT, MICH.

Learn Watchwork, Jewelrywork and Engraving A fine trade commanding a good salary, and your services always in demand. Address **Horological**, Dept. P, Bradley Institute, PEORIA, ILLINOIS, for our latest catalog.

MUSIC LESSONS IN YOUR HOME

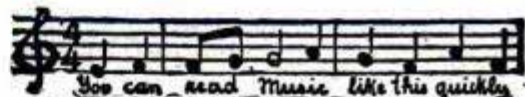

Write today for our **FREE** booklet. It tells how to learn to play Piano, Organ, Violin, Mandolin, Guitar, Banjo, etc. Beginners or advanced players. Your only expense about 2c per day for music and postage used. **American School of Music, 51 Manhattan Bldg., Chicago.**

LUCKY POCKET PIECE, triple horse shoe puzzle, always keep one with you—10c, 4 sets 25c pp., with secret solution. **Western Puzzle Works, St. Paul, Minn.**

LEARN ELECTRICAL TRADES

Practical Training on Massive Lay-Out of Expensive Electrical Equipment. Armature Winding, House Wiring, Electric Welding, Electric Refrigeration, Power Plants, Switchboards, Transformers, Motors, Generators, Radio Batteries. Automobile Course included without extra cost. Write Today for Free Catalog.
COLEMANELECTRICALSCHOOL, 1628T Main St., Kansas City, Missouri

QUIT TOBACCO

No man or woman can escape the harmful effects of tobacco. Don't try to banish unaided the hold tobacco has upon you. Join the thousands of inveterate tobacco users that have found it easy to quit with the aid of the Keeley Treatment.

KEELEY TREATMENT STOPS Tobacco Habit

Quickly banishes all craving for tobacco. Write today for Free Book telling how to quickly free yourself from the tobacco habit and our Money Back Guarantee.

THE KEELEY INSTITUTE
Dept. A 914
Dwight, Illinois

From \$160 a Month to \$10,000 A Year!

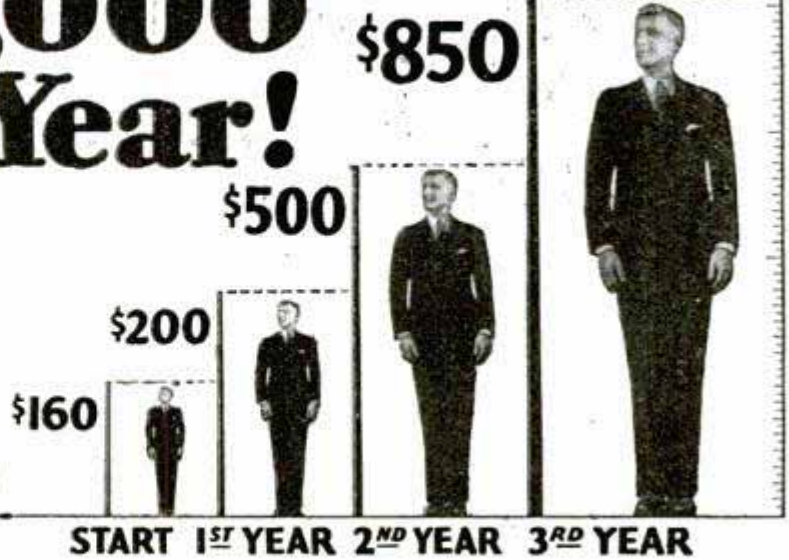
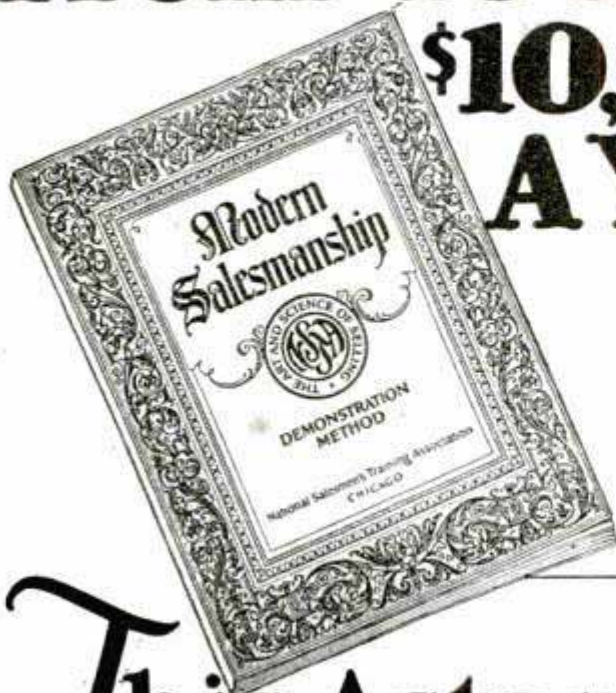

This Astonishing Book Showed Him How

How One Man Uncovered Hidden Possibilities He Never Suspected Within Himself and Raised His Yearly Income \$8,080! An Illuminating Message of Vital Interest to Every Man Who Ever Aspires to Earn \$10,000—\$20,000—or More a Year! SEE FOR YOURSELF This Remarkable Volume That Has Led So Many Men Into the Five-Figure Salary Class!

Where Shall We Send Your Copy FREE ?

TRUTH is stranger than fiction! And the true story that happened to R. B. Hansen proves it! His experience is not only intensely INTERESTING—but it will prove a revelation and positive inspiration to every ambitious man who reads this page.

Not long ago Hansen was working as a foreman in a rubber plant. His salary was \$160 a month. That meant skimping and petty economies that are bound to irk ANY ambitious man. Naturally he was keenly dissatisfied—but like so many other men caught in blind-alley jobs, he didn't know how to get out!

And then one day something happened! A certain book fell into his hands. Between its covers he discovered a certain force that eventually led him to rewards beyond his fondest expectations. Inspired to action and with his feet firmly guided to the first rungs of the ladder to Success, Hansen went into business for himself. And within a short time he had boosted his earnings to \$10,000 a year!

Salary Increases—200% to 900%!

A lucky accident? Not a bit of it! Hansen is not alone in his achievement of success after reading this remarkable book. OTHER men who have increased their salaries amazingly after reading these vital facts are numbered in the thousands! For example, C. W. Birmingham of Ohio read it and his salary raised from \$15 a week to \$7,500 a year. Wm. Shore of California made \$3,000 his first 5 months. And O. D. Oliver of Oklahoma, who used to earn \$200 a month, now makes as much as \$1,000 in a single week!

How did they do it? What did the book show them? Just this:—Every one of these men realized that Salesmanship offers BIGGER rewards and delivers them QUICKER than any other line of work under the sun. This vital book, "Modern Salesmanship," introduced them to hundreds of surprising and little-known facts about the highest paid of all professions,—SALESMANSHIP. It blasted dozens of old theories, explained the science of selling in simple terms and told them exactly how the great sales records of nationally-known star salesmen have been achieved. And not only that, it outlined a simple

plan that will enable almost any man to master scientific salesmanship without spending years on the road—without losing a day or dollar from his present position.

Free to Every Man

If we were asking two or three dollars a copy for "Modern Salesmanship" you might hesitate. But it is now FREE. We cannot urge you too strongly to take advantage of this opportunity to see for yourself what salesmanship has done for others—and what the National Salesmen's Training Association stands ready and willing to do for you. Find out exactly what the underlying principles of salesmanship are—and how you can put them to work for you. No matter what your opinion is now, "Modern Salesmanship" will give you a new insight into this fascinating and highly-paid profession.

Mail the coupon now!



Dept. R-101 N. S. T. A. Bldg. Chicago, Ill.

National Salesmen's Training Ass'n.
Dept. R-101, N. S. T. A. Bldg.,
Chicago, Ill.

Without cost or obligation you may send me your book, "Modern Salesmanship," with details of your system of training and FREE employment service.

Name

Address

City State

Age Occupation

*There's Always
in*

**Learn by
Doing!**

**You Learn on Actual Elec-
trical Machinery in 90 Days**

This new, quick, sure, easy method enables you to learn electricity without having had advanced education or previous experience. You start out with door bells and buzzers, actually working with complete circuit apparatus. Instructors are constantly available to show you step by step each little move. After you have been thoroughly trained in this department, you pass on to the next. You wire real houses — wind real armatures, operate giant switchboards and vast power machinery. Everything is real. There are no classes. Everyone gets individual instruction. No reciting before classes. The most highly fascinating training. You'll enjoy every minute of it. And it leads you to

**Big Pay in the world's greatest
and fastest growing industry.**

**It Stands
to Reason:**

**There is no substitute for personal,
practical training
in great shops.**

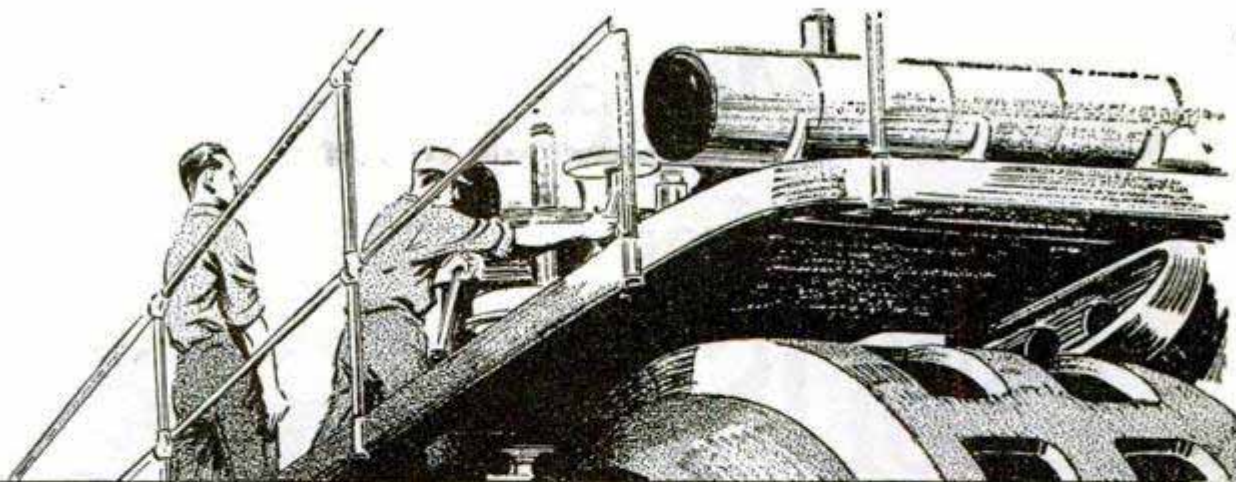

Work ~ Always Big Pay! ELECTRICITY!

Here is the short cut to big salaries. You don't need to envy the successful fellow anymore. You can get into the big pay class and do it in 90 days. All you have to do is DECIDE — make up your mind that YOU WANT BIG PAY. There are two things which control your future — TRAINING AND A DECISION TO MAKE A BIG INCOME.

Learn to Earn \$60⁰⁰ to \$200⁰⁰ a Week

How does \$60 to \$200 a week sound to you? Plenty of Coyne graduates making up to \$200 a week—fellows who had no previous experience—fellows who didn't even have advanced education. BUT — they had one thing that counts — DECISION. They made up their minds that they COULD MAKE BIG MONEY. They got into Electricity. You can do the same. In 90 days you can get a big job, and join the ranks of the big money makers.

You Can Qualify for a Big Job in 90 Days

Where else could you learn to earn \$60 to \$200 a week in just 90 days of training. Where else could you be taken from an ordinary clerk, laborer, truck driver or untrained free for all, and in 90 days land in the big pay class. When you graduate from Coyne, you can qualify for a big job. And just look at the future. The entire Electrical world is crying for trained men. The Electrical industry is growing so fast that oftentimes the demand for trained men is greater than there are practical electricians.

I Train You—Then Back You for Life

I have a real employment department that assists you to a part time job, if you need this extra help. Many fellows earn all or part of their expenses while training. Then when you graduate, we give you lifetime employment service. But that's not all. Once you belong to the Great Coyne fraternity, you are a member for life. You can always get employment and free consultation service for life.

My Big Dollar Book — FREE to You

This is the book for you. 56 pages! Contains over 150 photographs taken in the great roaring Coyne shops. It cost me a dollar to print—I'll send it to you—absolutely free. Clip the coupon NOW and mail today. It gives you the complete story of Coyne and tells the success story of many of my graduates and how they learned to earn \$60 to \$200 a week. ACT QUICK!

Fill in and Mail Coupon Today



H. C. LEWIS, President



COYNE

Electrical School

Founded 1899—H. C. Lewis, Pres.

Dept. 78-72

500 S. Paulina Street—Chicago

Mr. H. C. Lewis, Pres., Coyne Electrical School
Dept. 78-72 500 So. Paulina St., Chicago, Ill.

Dear Mr. Lewis: Without obligation send me your big free catalog and all details of Employment Service, Radio and Automotive Courses and how many "earn while learning."

Name.....

Address.....

State.....

City.....

Do You Make these Mistakes in ENGLISH?

MANY persons say "Did you hear from him today?" They should say "Have you heard from him today?" Some spell calendar "calender" or "calander." Still others say "between you and I" instead of "between you and me." It is astonishing how often "who" is used for "whom," and how frequently the simplest words are mispronounced. Few know whether to spell certain words with one or two "c's" or "m's" or "r's," or with "ie" or "ei." Most persons use only common words—colorless, flat, ordinary. Their speech and their letters are lifeless, monotonous, humdrum.



Sherwin Cody

Every time you talk, every time you write, you show what you are. When you use the wrong word, when you mispronounce a word, when you punctuate incorrectly, when you use flat, ordinary words, you handicap yourself enormously. A striking command of English enables you to present your ideas clearly, forcefully, convincingly. If your language is incorrect it hurts you more than you will ever know, for people are too polite to tell you about your mistakes.

Wonderful New Invention

For many years Mr. Cody studied the problem of creating instinctive habits of using good English. After countless experiments he finally invented a simple method by which you can acquire a better command of the English language in only 15 minutes a day. Now you can stop making the mistakes which have been hurting you. Mr. Cody's students have secured more improvement in five weeks than previously had been obtained by other pupils in two years!

Under old methods rules are memorized, but correct habits are not formed. Finally the rules themselves are forgotten. The new Sherwin Cody method provides for the formation of correct habits by calling to your attention constantly only the mistakes you make—and then showing you the right way without asking you to memorize any rules.

One of the wonderful things about Mr. Cody's course is the speed with which these habit-forming practice drills can be carried out. You can write the answers to fifty questions in 15 minutes and correct your work in 5 minutes more. The drudgery and work of copying have been ended by Mr. Cody! You concentrate always on your own mistakes until it becomes "second nature" to speak and write correctly.

FREE—Book on English

A command of polished and effective English denotes education and culture. It wins friends and makes a favorable impression upon those with whom you come in contact. In business as well as in social life correct English gives you added advantages and better opportunities, while poor English handicaps you more than you now realize.

A new book explaining Mr. Cody's remarkable method is ready. If you are ever embarrassed by mistakes in grammar, spelling, punctuation, pronunciation, or if you cannot instantly command the exact words with which to express your ideas, this new free book, "How to Speak and Write Masterly English," will prove a revelation to you. Send the coupon or a letter or postal card for it now. SHERWIN CODY SCHOOL OF ENGLISH, 510 Searle Building, Rochester, N. Y.

SHERWIN CODY SCHOOL OF ENGLISH
510 Searle Building, Rochester, N. Y.

Please send me your free book, "How to Speak and Write Masterly English."

Name.....
Address.....

Address.....

In Demand Oh, Boy!



They Want Me for Every Dance—and They Are Willing to Pay My Price, Too

I learned right at home—in odd half hours—that used to hang heavily on my hands. Easy? You bet. Right from the start I began to practice tunes. It was wonderful, playing catchy tunes—I liked learning better every lesson. Just some amazingly clear instructions and illustrations—real child's play. Why, I was playing like an old-timer before I realized it.

Pick Your Course!

- Piano
- Violin
- Banjo
- Flute
- Cornet
- Guitar
- Voice and Speech Culture
- Automatic Finger Control
- and many others
- Drums
- Mandolin
- Singing
- Ukulele
- Trombone
- Saxophone

Free Book and Demonstration Lesson

—Tells all about this marvelous new method, learned at home, that started thousands of skilled musicians. Ask about offer on tenor banjo course, now so popular. Or any instrument you prefer. See at once how to get popularity. Enjoy music and make money. Booklet absolutely free. Write at once.

U. S. School of Music
710-A Brunswick Bldg., NEW YORK CITY

BIG MONEY and BIG DEMAND for AUTOMOBILE MECHANICS

HERE is your opportunity to enter a big-pay field. These four practical books, written by five well known teachers of automobile practice, will teach you right in your own home during your leisure time just what you need to know about automobile troubles and repair. They will teach you automobile construction, maintenance and repair as practiced by experts and will help you to earn an expert's pay.



McGraw-Hill Practical Automobile Library: Four Big Books—\$1.50 in 10 days and \$2 monthly for 6 months—only \$13.50 in all!

Hundreds of question-answering diagrams—hundreds of clearly-marked illustrations—make the books plain and readily understandable. All the explanations and descriptions are clear, simple, direct. Every chapter is packed with definite, step-by-step, how-to-do-it information. The books bring you the best repair shop methods. They tell you exactly what to do and how to do it. The sections devoted to automobile troubles and their remedy are alone worth the price of the entire library. You cannot secure in any other way so valuable a collection of automobile information at so low a price.

FREE TRIAL — Just Send the Coupon

FREE EXAMINATION COUPON

McGraw-Hill Book Co., 370 Seventh Ave., New York
Send me for 10 days' free examination the New Practical Automobile Library. If satisfactory, I will send you \$1.50 in 10 days and \$2.00 monthly until the special price of \$13.50 is paid. If not wanted, I will return the books at your expense.

Signed.....
Address.....
City and State.....
Position.....
Employer..... P. M. 10-28



They Jeered at Me - But I Made Them Applaud Me Three Weeks Later!

I HAD never been called on to speak before. But the chairman had said: "Oh, it's easy, you won't have a bit of trouble. Just talk naturally." The minute I was on my feet I began to realize that speaking was a lot more difficult than I had expected. Everyone appeared to be bored and hostile. Suddenly I noticed two of the members whispering and laughing. For an instant I almost lost control of myself and wanted to slink out of that room like a whipped cur. But I pulled myself together and made a fresh attempt to get started when someone in the audience said, "Louder and funnier!" Everyone laughed. I stammered a few words and sat down!

And that was the way it always was—I was always trying to impress others with my ability—in business, in social life, in club work—and always failing miserably. Why couldn't I talk easily and fluently like other men talked? Often I saw men who were not half so thorough nor so hard working promoted to positions where they made a brilliant showing—not through hard work, but through their ability to talk cleverly and convinc-

ingly—to give the appearance of being efficient and skillful.

In 20 Minutes a Day

And then suddenly I discovered a new easy method which made me a forceful speaker almost over night. I learned how to dominate one man or an audience of thousands.

What 20 Minutes a Day Will Show You

- How to talk before your club or lodge.
- How to propose and respond to toasts.
- How to address board meetings.
- How to make a political speech.
- How to tell entertaining stories.
- How to make after-dinner speeches.
- How to converse interestingly.
- How to write letters.
- How to sell more goods.
- How to train your memory.
- How to enlarge your vocabulary.
- How to develop self-confidence.
- How to acquire a winning personality.

At the next meeting, just three weeks later, I got up and made the same speech I had tried to make before—but presented so forcefully, so convincingly that when I had finished they actually applauded me!

Soon I had won salary increases, promotion, popularity, power. Today I always have a ready flow of speech at my command. I am able to rise to any occasion, to meet any emergency with just the right words. And I accomplished all this

by developing the natural power of speech possessed by everyone, but cultivated by so few—by simply spending 20 minutes a day in the privacy of my own home, on this most fascinating subject.

There is no magic, no trick, no mystery about becoming a powerful and convinc-

ing talker. You, too, can conquer timidity, stage fright, self-consciousness and bashfulness. Today business demands for the big, important high-salaried jobs, men who can dominate others—men who can make others do as they wish.

Send for This Amazing Book

This new method of training is fully described in a very informative free booklet called, *How to Work Wonders with Words*. You are told how to bring out and develop your priceless natural gift—which will win for you advancement in position and salary, popularity, social standing, power and real success. Absolutely free. Mail this coupon.

Now Sent Free



NORTH AMERICAN INSTITUTE
3601 Michigan Ave., Dept. 1357, Chicago, Ill.

North American Institute,
3601 Michigan Ave., Dept. 1357,
Chicago, Ill.

Please send me FREE and without obligation my copy of your inspiring booklet, *How to Work Wonders with Words*, and full information regarding your course in Effective Speaking.

Name.....
Address.....
City.....State.....

See the World FREE!



Taste Romance and Adventure In the Far Lands of the Earth.

How often you've longed to see for yourself the awe of Egypt's pyramids—the beauties of the gorgeous Mediterranean sunset—the squalor of China's ancient cities!

Spend a few years, or the rest of your life, tasting high adventure on the seven seas and in all the world's great ports—roving the earth's highways and byways! You can do it FREE—all your expenses paid—and earn a good salary besides!

Only one profession will carry you around the world at will, travelling like a gentleman, but that's the most interesting and pleasant work there is—Radio Operating! Easily and quickly learned, there's no other profession like it for the man who wants the experiences and pleasures of world-travel. Radio operators are needed—all sea-going ships like the one shown here must carry from one to half a dozen or more.



Take a Look Beyond the Skyline Without a Penny's Expense

Radio operators aboard ocean liners live luxuriously—they rank as officers of the ship. Meals, a private cabin, all other living needs are furnished free, and besides the operator draws a good salary. You can learn quickly and easily at home in your spare time to be a Radio operator through our practical training methods. Take a look at the FREE BOOK which tells how—mail coupon below.

This U. S. Government-recognized school has been training successful operators since 1914. Our graduates are all over the world. We maintain an Employment Department to help put you on your own ship. The world-famous NACOMETER, a patented home code teacher given our students is recognized as the best and easiest way to learn the Radio code at home. A few short months, with the aid of the famous Nacometer and our quick home training, and you too can be a fully qualified Radio operator, sitting in your cabin like the one shown above, bound out for Liverpool or Nagasaki!

Read the Free Book that tells all about this fascinating profession and our practical Government-recognized methods of training you for it. Send coupon TODAY—no obligation. Special tuition offer now on, includes the Nacometer, famous code teaching machine. Find out what Radio offers you. Act at once. Dept. 22 HH.

NATIONAL RADIO INSTITUTE WASHINGTON, D. C.

SPECIAL OFFER COUPON

National Radio Institute,
Dept. 22 HH, Washington, D. C.

Gentlemen: Without obligating me in any way send me your free book and information about your offer of Nacometer with course.

Name.....

Address.....

Occupation.....

THE CHICAGO DAILY NEWS School and College Bureau

Offers You Its Specialized Services in Choosing a School

Last year the School and College Bureau of The Chicago Daily News saved many busy parents and questioning boys and girls both time and worry by sending them prompt, reliable information about just the kind of school they wanted—personal requirements as to location and tuition charges being considered in each individual case.

Again this year many young people will be perplexed by the problem of finding the right school. Why not let us help you?

The Chicago Daily News maintains this service absolutely free of charge to you. No need to hurriedly select a school on mere hearsay when expert advice can be obtained by telephoning Dearborn 1111, writing or calling for a personal interview at

THE CHICAGO DAILY NEWS

School and College Bureau

Dept. K, 15 N. Wells St., Chicago, Illinois



"BECOME A LIGHTNING TRICK CARTOONIST"

Send \$1.00 for Laugh Producing Program of 23 Trick Drawings with Instructions. Catalog of Chalk Talk Supplies Free. BALDA ART SERVICE, Dept. 1, Oshkosh, Wis.

PIANO JAZZ

By Note or Ear. With or without music. Short Course. Adult beginners taught by mail. No teacher required. Self-instruction Course for Advanced Pianists. Learn 259 styles of Bass, 684 Syncopated Effects, Blue Harmony, Oriental, Chime, Movie and Café Jazz, Trick Endings, Clever Breaks, Space Fillers, Sax Slurs, Triple Bass, Wicked Harmony, Blue Obligato, and 247 other Subjects, including Ear Playing. 133 pages of REAL Jazz, 25,000 words. A Postal brings our FREE Special Offer.

Waterman Piano School, 1826 W. Adams St. Los Angeles, Cal.



WHY NOT spend Spring, Summer and Fall gathering butterflies and insects? I buy hundreds of kinds for collections. Some worth \$1 to \$7 each. Simple outdoor work with my instructions, pictures, price-list. Send 10 cents (not stamps) for my illustrated Prospectus before sending butterflies.
MR. SINCLAIR, DEALER IN INSECTS,
Dept. 6, Box 1424, San Diego, Calif.

STAMMERING

easily, permanently corrected. Win happiness and success. Ask for full information and special phonograph record. Send dime for postage
153 Stinson Ave., The LEWIS INSTITUTE, Detroit

Learn Watchwork, Jewelrywork and Engraving

A fine trade commanding a good salary, and your services always in demand. Address **Horological**, Dept. P, Bradley Institute, PEORIA, ILLINOIS, for our latest catalog.

Learn Photography at HOME

Make money taking pictures. Prepare quickly during spare time. Also earn while you learn. No experience necessary. New easy method. Nothing else like it. Send at once for free book, OPPORTUNITIES IN MODERN PHOTOGRAPHY and full particulars

AMERICAN SCHOOL OF PHOTOGRAPHY
Dept. 1357 3601 Michigan Ave. Chicago, U. S. A.



*"And now I watched—
moodily, yet entranced!"*

How a sailor taught me the secret of *popularity*

YOU should have seen that sailor! Talk about popularity! He seemed to be more in demand than a "movie" star at a Broadway night club. Every dance saw him whirling over the floor with one of the best looking girls there. And the music no sooner finished than excited whispering could be heard from little groups of dancers. "Who is he?"—"Introduce me, please!"—"He's giving me the next!" *"How he does dance!"*

Phew! It was too much for me! Earlier in the evening I had slunk away to a corner. I wasn't going to give any girl a chance to turn me down again *that night!* And now I watched—moodily, yet entranced!

I Was a Wallflower

What was it about this sailor that made the girls so "crazy over him"? Was it his dancing? Well, I'd find out!

So, later in the evening, I cornered him in the smoking room. Dejectedly, I approached. "After seeing you dance," I began, "I think I understand why the girls can't see me. But they don't have dancing teachers on warships, do they? Then how—"

Laughingly, he overlooked my gentle sarcasm. "No, Buddy, you're right. They don't! But you can go to Arthur Murray. And if you can't go to Arthur Murray, he will come to you!"

The Sailor's Tale

Before I could interrupt to ask what he meant he continued. "You know even a sailor sometimes goes ashore, and when my ship used to hit port I liked to have a good time with the rest of the boys. But somehow I was always out of it. Every time I got in a party there was dancing—and every time there was dancing I was left alone. For, no doubt about it, I was as clumsy and awkward as they make 'em."

"Finally I decided I must do something—but what? And just about that time the Fleet lifted anchor and away we went for the Gulf."

"What with work aboard ship and keeping in trim there was no time to think about dancing then. But one night I was reading a magazine, and there it was, plain as day: An ad on dancing by this Arthur Murray. 'Let Me Prove I Can Teach You to Dance at Home,' it said. If that were possible, it would be fine, I thought, but I was a skeptic. Then it suddenly dawned on me—this Arthur Murray was the self-same Murray who had given personal lessons to the dancing instructors of the Naval Academy. That sounded promising. And it certainly was worth investigation—since I risked nothing."

"So I sent all the way to New York for the five free lessons offered. In a short time they came. I was amazed at the ease of this method. For I learned, right on the old ship, how to lead—how to have confidence while dancing—how to handle myself gracefully at all times."

"Buddy, it was a cinch—that's the word all right. And I did it all—right on the boat—without music or partner."

"Now whenever I'm on shore leave I have a whale of a time. Take my tip, Buddy, if you want good fun, real enjoyment and lots of friends, do what I did—and don't delay about it!"

And to all who are now in the same fix with me, I'll say just this: I'm following that sailor's advice.

Will You Accept These 5 FREE Lessons?

No matter how poorly you dance now—no matter if you've never been on a dance floor in your life—Arthur Murray's method makes you a finished dancer in 10 days, or you don't have to pay a penny. To prove it he is willing to send you five lessons from his remarkable course absolutely free! Just send the coupon (with 10 cents to cover cost of printing and mailing) and these valuable lessons will be forwarded at once. Also a free copy of his new book, "The Short Cut to Popularity." Don't wait. Mail coupon NOW! Arthur Murray, Studio 833, 7 East 43rd Street, New York City.

**ARTHUR MURRAY, Studio 833,
7 East 43rd Street, New York City.**

To prove that I can learn to dance at home in ten days you may send the FIVE FREE LESSONS. I enclose 10c (stamps or coin) to pay for the postage, printing, etc. You are to include free "The Short Cut to Popularity."

Name.....

Address.....

City.....State.....

You can play the HAWAIIAN GUITAR just like the Hawaiians!

Play all the latest hits just as the Hawaiians do. Be the most popular member of your set, a happy crowd always around you, everybody enjoying and admiring your playing. Get in on all the good times. Entertain your friends—or play professionally. We will help you.



Native Hawaiian expert directs you

You get expert instruction, directed by a world-famous player and teacher, Prof. Walter Kolomo-ku. He quickly reveals to you the secrets of this fascinating instrument.

Complete Conservatory Course

You get 52 complete printed lessons. Nothing is omitted. Pictures explain every move. And no matter how

little you know about music when you begin, no matter if you have never touched a musical instrument, you can positively learn to play by our plain, easy picture method. You are sure to learn! What we can do for others we can do for you. 51,000 successful students. This record assures your success.

Learn at home in spare time

Study in spare time—in absolute privacy—when you like—as long as you like. Even if you don't know one note from another, our method is so simple you begin a piece your first lesson. In half an hour you can play it!

Only 4 motions to learn

Then you can play any music—popular songs, classical, old-time melodies, native Hawaiian airs—or real jazz—separately or with accompaniment. You'll never be lonesome after you learn to play on this beautiful Hawaiian Guitar.

GIVEN when you enroll—
\$18 to \$20
Hawaiian Guitar

With Genuine Seal Grain Fabrikoid Cover and Complete Playing Outfit

Reliable retailers ask \$18 to \$20 for a similar instrument and outfit without the fine Fabrikoid Case, which alone is valued at \$3.50. Yet you receive this sweet-toned splendidly built Hawaiian Guitar, case and entire playing outfit, including picks, steel playing bar, tuning pipe, etc., without one penny of expense, as soon as you enroll.

Pay as you play

We make it easy for you. Start any time with a small first payment—then pay while learning. It comes to only a few cents per lesson. And bear in mind: Your only investment is the cost of the course—we furnish everything else.

FREE Our new illustrated book, "The Romance and Enchantment of Hawaii—Its Music and Its People." A book you will want to keep. You won't lay it down until you have read it from cover to cover. Send for your copy today.

OTHER COURSES Tenor Banjo, Violin, Tiple, Tenor Guitar, Ukulele, Banjo Ukulele—well-known instructors.

FIRST HAWAIIAN CONSERVATORY of MUSIC, Inc.
9th Floor Woolworth Bldg.
Dept. 548, New York, N. Y.
Approved as a Correspondence School Under the Laws of the State of New York.
Member of National Home Study Council.

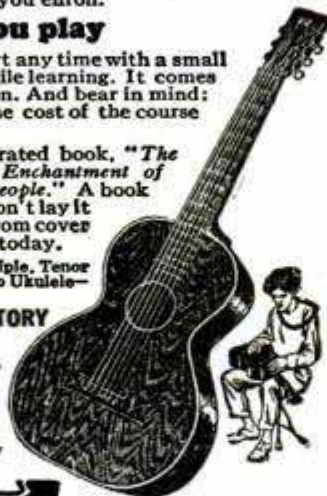

Send This Coupon for Liberal Offer!

FIRST HAWAIIAN CONSERVATORY OF MUSIC, Inc.
9th Fl., Woolworth Bldg., Dept. 548, New York, N. Y.
Please send full information about your 52-lesson Hawaiian Guitar Course. I am not obligated to enroll unless I want to.

Name _____
Address _____
City _____ State _____

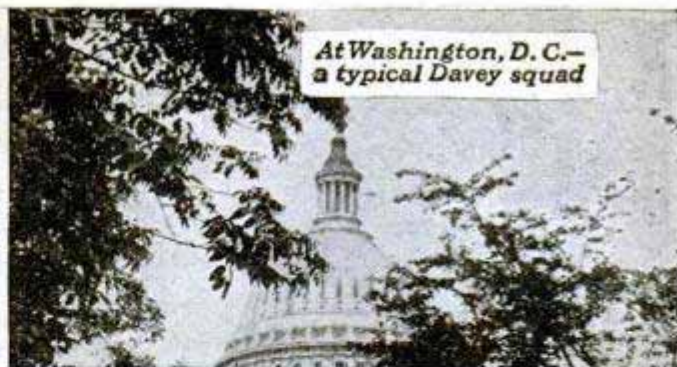

At Washington, D. C.—a typical Davey squad

Young outdoor men wanted



Interesting, vigorous outdoor work in a growing organization where merit wins advancement. Good starting wages. Permanent positions and a real future for men who make good. Our present field force of Davey Tree Experts cannot meet the increasing demand. So we are selecting now, to enter our employ, a few sturdy, clean young men, thorough Americans, single, between 20 and 30 years old, free to travel, industrious, with good practical education, and able to give good references. Write for qualification blank to serve in place of personal interview. The Davey Tree Expert Co., Inc., 125 Federal Bldg., Kent, Ohio.

YMCA TRADE SCHOOL

Learn Auto Mechanic, Auto Electrical, Battery, Machine, Electrical, Radio Mechanic, Tiling, Bricklaying, Plastering, Plumbing, Welding, Drawing, Estimating, Show Card, Sign Painting, Window Dressing, Fine And Commercial Art.

Write for Catalog 50.
BROOKLYN ENGINEERING INSTITUTE
(Operated by Bedford Br. Y. M. C. A.)
1125 Bedford Ave., Brooklyn, New York City.

YOU CAN OIL PAINT

Amazing new method teaches men or women to earn after first lesson. OIL PAINT photos—portraits, landscapes art subjects. Earn \$18 to \$50 and more a week. OIL PAINT OUTFIT GIVEN. Send now for free illustrated book. PICTORIAL ART STUDIOS Inc. Dept. MP. 2926 Broadway, Chicago, Ill.

GOV'T. POSITIONS

\$35 TO \$75 WEEKLY

MEN-WOMEN	() Ry. Mail Clerk	() Steno-Typist
	() Prohibition Inv.	() Immigrant Inspector
	() R. F. D. Carrier	() Seamstress
	() Special Agent (investigator)	() Auditor
	() City Mail Carrier	() Steno-Secretary
	() Meat Inspector	() U. S. Border Patrol
	() P. O. Clerk	() Chauffeur-Carrier
	() File Clerk	() Watchman
	() General Clerk	() Skilled Laborer
	() Matron	() Postmaster
	() Typist	

AGE 18 to 55

MENTAL INSTRUCTION BUREAU, 111 Arcade Bldg., St. Louis, Mo. Send me FREE particulars How To Qualify for positions marked "X". Salaries, locations, opportunities, etc. ALL SENT FREE.

NAME.....
ADDRESS.....



Now MOVIES Train YOU at Home for Bigger Pay in ELECTRICITY

A New, Easier Way to a Better Job

NOW, for the first time, an easier, quicker, surer way to make more money, by learning Electricity *at home!* Actual motion pictures—thousands of feet of film which we send you—explain every vital point in this complete course—show you how to do the work, train you for a better job and bigger pay.

By this amazing new method you learn easily and thoroughly. Motion picture close-ups, of all kinds of electrical machinery in operation, remarkable animated diagrams show you in detail the action of electrical energy. For years educators have planned to use this method, but were blocked by mechanical difficulties.

Our films bring the great laboratories to your home. You get *better than classroom instruction*. You can stop the film at any point—examine any picture or diagram as a "still." It's just like having one of our engineers at your side, to make everything plain. You can go over and over any point at will.

Motion Pictures Make Everything Clear

"One picture is worth 10,000 words," says an Oriental proverb. Electricity is a constantly moving force; it travels thousands of miles a second. *Here, in animated slow motion diagrams and pictures, you see how it works and is controlled.*

Our instruction is real, live, fascinating. No need to fear dry text-book matter. You prepare yourself for the big pay jobs electricity offers those who know how to control its force.

With the help of such practical engineers and educators as Bruce A. Rogers, M. S., Western Electric Co., J. A. Shimek, M. E., E. E. Engineer DeVry Corporation; A. P. Hollis, formerly Director Visual Education University of North Dakota; F. S. Wythe, Director Neighborhood Motion Picture School Film Service, and W. N. Littlewood, formerly instructor University of Wisconsin, who will have personal charge of your training, *you will soon be ready for big pay jobs in Aviation Electricity, Radio, Switchboard Work, Sub-Station and Power Plant Operation, Automotive Electricity, Wiring, Contracting, Merchandising, Etc.*

What a Practicing Engineer Says of Our Training

Charles L. Fitz, M. E., E. E., a practicing engineer, formerly associated with Steinmetz of General Electric, says:

"I am amazed at how clearly and simply you explain the facts about electricity and electrical work. *You show the principles in these motion pictures and animated diagrams better than we can even in the laboratory.*

"The points are so much easier to grasp than by the usual methods of instruction that the student must make *quicker, surer progress.* Your whole course seems to me by far the best method of getting thorough preparation for practical electrical work."

The NATIONAL SCHOOL of
VISUAL EDUCATION

"The Film Way to Bigger Pay"

DeVry Motion Picture Projector Furnished

No Extra Cost

A Standard Model DeVry School Projector for motion pictures is supplied for use in the course at **no additional cost.** The manufacturer prices these machines singly at \$75.

The DeVry projector is used in more schools, colleges and universities than all other makes combined. Simple and easy to operate in the home, with ordinary light connection; with farm lighting equipment or auto battery.



For the first time in any home study course, you get the advantage of methods rapidly being adopted by leading resident schools, *training YOU for the Better Job with Bigger Pay.*

Here's Our Promise to Help You Get a Better Job

This **NEW METHOD OF TRAINING** by motion pictures is practical, easy, complete and fits you to hold down a better job. Our **EMPLOYMENT DEPARTMENT** will help you locate one of these better jobs—you receive this pledge *in writing* immediately upon enrollment:

"When you graduate from your complete Course in Electricity, you must be convinced that you have received the training and employment service necessary to obtain a better position than you now have.

Or, we will refund your tuition, provided you give notice within 30 days after forwarding final examination papers."

Notice, we do not say, "take a chance with our new method of training." *There is no chance.* We have to give you what we say we will, or refund your money.

DRAFTING SET GIVEN. We supply our students as a part of their course, not only with instruction in drafting, but also with a complete professional drafting outfit consisting of 18 pieces.

Three Lessons and Our New Book FREE

Send the coupon now and we will give you, absolutely free, three lessons, showing exactly how motion pictures are used in this training. **Get our new book, "The Film Way to Bigger Pay in Electricity."** Fully illustrated. Shows how we train you for the bigger pay jobs. Sent Free.

Remember, action means advancement. Dreamers never arrive. **Be a doer, and get what you want.** Send the coupon now.

NATIONAL SCHOOL OF VISUAL EDUCATION
Dept. 10 H. 537 S. Dearborn St., Chicago, Ill.

Gentlemen: Without obligation to me, please send the free lessons and your book, "The Film Way to Bigger Pay in Electricity."

Name.....

St. or R. F. D.....

City, State.....



DRAFTING

BOOKS SENT FREE!

For Beginners
Written so you can understand every word, by 18 famous Engineers and Architects. Deluxe, flexible binding. 1750 pages, 1050 blue prints, charts and diagrams. Prepares you for a good Drafting job in mechanical or architectural lines. Sent for 15 days' free use, if you mail coupon immediately.

Only fifteen minutes a day with these WONDER BOOKS will prepare you for a good Drafting job in less than a year! Mechanical and Architectural Drafting from simple straight lines to important, complex plans, a step at a time! Built especially for beginners, for men with only grammar schooling. Drafting room practice plus engineering made easy and clear!

Big Field—Big Demand—Big Pay!

Competent Draftsmen are urgently needed right now in all building and manufacturing lines at \$50 to \$100 a week. That's just the beginning—for draftsmen have the best chances for advancement! Pleasant, fascinating work, easy to learn and do. Learn quick with these books—send coupon for a set FREE, and see for yourself!

A year's Consulting Membership in the American Technical Society now given free to all readers of this famous Cyclo-pedia of Drafting. Many say that's worth more than cost of books.

American Technical Society
Dept. D-719, 58th & Drexel Ave., Chicago



Modern American Homes FREE!

American Technical Society
Dept. D-719, 58th & Drexel Ave., Chicago

Send for 15 days' free use 4-volume set of DRAFTING. In return for mailing this coupon promptly send absolutely FREE "Modern American Homes," 112 plates, exteriors, interiors and plans. I will pay the few cents delivery charges. If I wish I may return books in 15 days and owe you nothing. But if I prefer to keep them I will send \$1.50 after 15 days, then \$2.00 a month until \$14.80 (special reduced price) is paid.

Name

Address

Employed by

Address

Electrical Engineering

Course for men of ambition and limited time. Over 5000 men trained. Condensed course in Theoretical and Practical Electrical Engineering including the closely related subjects of Mathematics and Mechanical Drawing.

Students construct motors, install wiring, test electrical machinery. Course designed to be completed in one college year. Prepare for your profession in the most interesting city in the world. Est. 1893. Catalog on request.



Bliss Electrical School

120 Takoma Ave., Washington, D. C.

LEARN WATCH REPAIRING



You can learn by our modern and original system of instruction every part of the Watch Repairing Trade at home as good or better than at a shop. You can earn money while learning and secure a well paying position or start in business after completing our course of instruction. Good watch repairers are always in demand and earn from \$50 to \$75 per week. For particulars apply to the Wisconsin School of Watch Repairing 166 Mason St., MILWAUKEE, WIS.

Be a Doctor of Surgical CHIROPODY

Dignified professional field. Call for doctors everywhere. Make \$5000 to \$15,000 a year. Course only 2 years at best known College of Chiroprody in America equips you for practice, 15th year. You are ready to enter with 4 years high school or equivalent. Largest foot clinic in world—large faculty physicians, surgeons, chiroprodists—study in Chicago—you can earn while you learn. Write for catalog. No obligation. Dept. 711.



ILLINOIS COLLEGE OF CHIROPODY
1327 North Clark Street Chicago

Earn \$75 to \$100 a Week as AUTO MECHANIC—

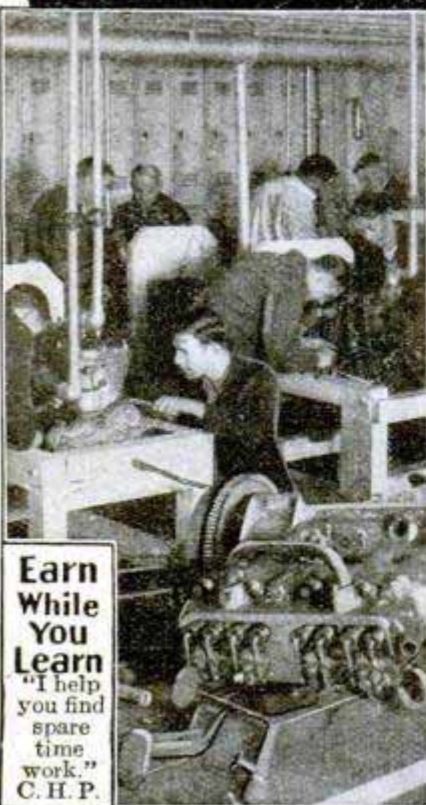

Earn While You Learn
"I help you find spare time work."
C. H. P.

Learn Easily in 8 Weeks on Real Machinery— No Dry Books No Lectures

Eight short weeks of pleasant, fascinating, practical auto work in my big shops—and then a real job paying \$75.00 to \$100.00 a week! You can step right out of low pay, long hours, and no future into the job of a high-salaried auto mechanic. Everywhere jobs are waiting for men trained as I train them. Change the whole course of your life in 8 weeks!

Employment Dept. Helps My Graduates

Come to my shops. I will make you a mechanic able to handle the hardest auto jobs quickly and easily. I'll teach you to know autos inside out. You don't need education. You don't need previous experience. All you need is ambition. You learn by doing—by working on actual cars with real tools. This is not a correspondence course.



I'll Pay Your
R. R. Fare
Clyde H. Pratt
President

Short Cut to Big Pay

Learn how easy it is to get a steady, big-pay job in the great auto field. Learn what other fellows like you have done with CLEVELAND Auto Training.

Mail Coupon for Book

CLEVELAND
AUTO SCHOOLS

1815 E. 24th St.,
Cleveland, Ohio

Clyde H. Pratt, Pres.,
CLEVELAND AUTO SCHOOLS,
1815 E. 24th St., Dept. B-11, Cleveland, O.

Please send me FREE BOOK on Auto Mechanics, and details of spare-time work and Employment Help.

Name

Address

City State

Half a Million People have learned music this easy way

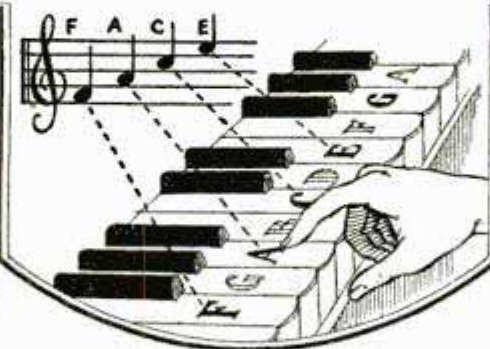

You, Too, Can Learn to
Play Your Favorite Instrument
Without a Teacher

Easy as A-B-C

YES, half a million delighted men and women all over the world have learned music this quick, easy way.

Half a million — 500,000 — what a gigantic orchestra they would make! Some are playing on the stage, others in orchestras, and many thousands are daily enjoying the pleasure and popularity of being able to play some instrument.

Surely this is convincing proof of the success of the *new, modern method* perfected by the U. S. School of Music! And what these people have done, YOU, too, can do!

Many of this half million didn't know one note from another—others had never touched an instrument—yet in half the usual time they learned to play their favorite instrument. Best of all, they found learning music *amazingly easy*. No monotonous hours of exercises—no tedious scales—no expensive teachers. This simplified method made learning music as easy as A-B-C!

Little theory—plenty of accomplishment. That's why students of the U. S. School of Music get ahead *twice as fast—three times as fast* as those who study old-fashioned, plodding methods.

You don't need any special "talent". Many of the half million who have already become accomplished players never dreamed they possessed musical ability. They only wanted to play some instrument—just like you—and they found they could quickly learn how this easy way. Just a little of your spare time each day is needed—and you enjoy every minute of it. The cost is surprisingly low—averaging only a few cents a day—and the price is the same for whatever instrument you choose. And remember you are studying right in your own home—without paying big fees to private teachers.

Don't miss any more good times! Learn now to play your favorite instrument and surprise all your friends. Change from a wallflower to the center of attraction. Music is the best thing to offer at a party—musicians are invited everywhere. Enjoy the popularity you have been missing. Get your share of the musician's pleasure and profit! Start now!

Free Booklet and Demonstration Lesson

If you are in earnest about wanting to join the crowd of entertainers and be a "big hit" at any party—if you really *do* want to play your favorite instrument, to become a performer whose services will be in demand—fill out and mail the convenient coupon asking for our Free Booklet and Free Demonstration Lesson. These explain our wonderful method fully and show you how easily and quickly you can learn to play at little expense. Instruments are supplied when needed—cash or credit, U. S. School of Music, 710 Brunswick Bldg., New York City.

U. S. School of Music,
710 Brunswick Bldg., New York City

Please send me your free book, "Music Lessons in Your Own Home," with introduction by Dr. Frank Crane, Free Demonstration Lesson, and particulars of your easy payment plan. I am interested in the following course:—

.....

Have you above instrument?

Name.....
(Please Write Plainly)

Address.....

City..... State.....

What Instrument for You?

- | | |
|-------------------------------------|-----------|
| Piano | Hawaiian |
| Organ | Steel |
| Violin | Guitar |
| Clarinet | Drums and |
| Flute | Traps |
| Harp | Mandolin |
| Cornet | Sight |
| Cello | Singing |
| Guitar | Trombone |
| Ukulele | Piano |
| Saxophone | Accordion |
| Piccolo | |
| Banjo (Plectrum, 5-String or Tenor) | |
| Voice and Speech Culture | |
| Automatic Finger Control | |

Also for Advanced Pianists a special Course including 24 famous classics . . . a distinctive addition to any pianist's repertoire.

It is like a fascinating game. From the very start you are playing *real* tunes perfectly by *note*. You simply can't go wrong, for every step, from beginning to end, is right before your eyes in print and picture. First you are *told* how to do a thing, then a picture *shows* you how, then you do it yourself and *hear* it. And almost before you know it, you are playing your favorite pieces—jazz, ballads, classics. No private teacher could make it clearer.

Learn Electricity IN LOS ANGELES

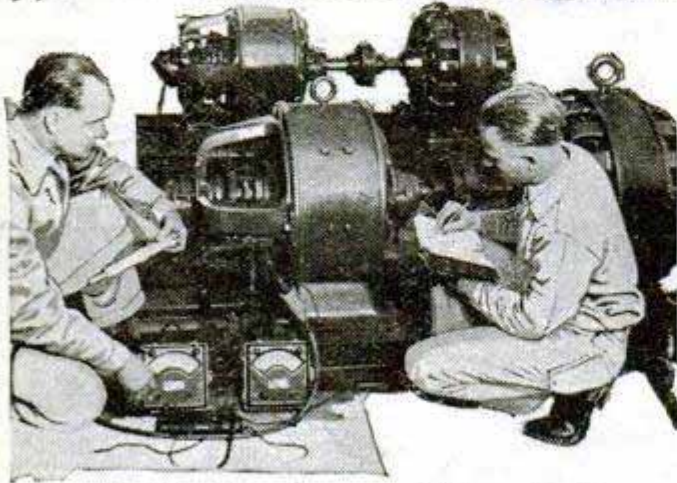

FREE Employment Service!

There are more calls for "National-Trained-Electrical-Men" than we can supply. Jobs are open now paying \$50 and up a week—but you must first get the right training. Get it at National—a world-famous institution with a quarter century record of success in training big pay men.

All These Advantages:

1. Unlimited Training Until Competent.
2. Free Employment and Welfare Service.
3. Million Dollar Training Shops.
4. Personal, Individual Training Guaranteed.
5. You actually perform work that employers pay big money for.

6. Official Diploma and certified record of work performed.
7. Unexcelled training; 32 instructors.

FREE!

Read how National insures your success. Send for this free Electrical catalog—illustrated by actual photos of students training under instructors on a half million dollars' worth of new electrical equipment. Mail coupon now.



Electricity - YOUR Opportunity!

This Big, Free Book Shows You How to Quickly Make BIG PAY

National Electrical School

Dept. 523, 4006 Figueroa St., Los Angeles, California.

Send me your big free illustrated catalog of Electrical Opportunities.

Name.....
 Address.....
 Age..... City..... State.....

PREPARE FOR AN ART CAREER

—thru the only art school operated as a department of a large art organization, who have actually produced over a quarter million drawings for leading advertisers. Where else can you get so wide an experience? Home study instruction. Write for illustrated book telling of our successful students.

MEYER BOTH COMPANY
 Michigan Ave. at 20th St. Dept. 16, Chicago, Ill.



Wonderful, new device; guides your hand; correct your writing in few days. Big improvement in three hours. No failures. Complete outline FREE. Perfect Penmanship Inst. D-34, St. Louis, Mo.

ILLINOIS COLLEGE of PHOTOGRAPHY

Prepares you in from 6 to 8 months to earn \$200 to \$500 a month as a photographer or photo-engraver. Thorough practical training. Expenses low. Constant demand for our graduates. 35th year. Enroll immediately. Free catalog. Box 4108, Effingham, Illinois.

"STAMMERING Its Cause and Cure"

You can be quickly cured if you stammer. Send 10 cents coin, or stamps, for 288 page cloth bound book on Stammering and Stuttering. It tells how I cured myself after Stammering and Stuttering for 20 years. BENJAMIN N. BOGUE
 11110 Bogue Building, 1147 N. Ill. St. Indianapolis



1,000 Hotel Positions Open!

HOTELS, restaurants, clubs, apartments, hospitals, institutions, schools and colleges everywhere need trained men and women. Over 70,000 high-class positions paying \$2,500 to \$10,000 a year open annually in the hotels of the United States. Nearly one and three-quarter billions of dollars' worth of NEW HOTELS, CLUBS AND INSTITUTIONS being built this year will need over 200,000 trained men and women. Hotels start you at salaries up to \$3,500 a year, with living usually included. At any time there are over 1,000 hotel positions open.

Previous Experience Unnecessary

You can have one of these fascinating, big-pay positions. Thru our Simplified Study Plan we give you the valuable knowledge that it has taken some of the most successful hotel men years to obtain. Age is no obstacle—young and old alike have equal chance for success. Past experience absolutely unnecessary. A common school education is all you need.

We train you in your spare time and put you in touch with big opportunities. All of your training under the personal supervision of Clifford Lewis, Managing Consultant for over 225 hotels throught the United States. Our students employed by leading hotels everywhere.

Send coupon today for Free Book, "Your Big Opportunity," showing how we can train you for one of these splendid positions and explaining our Money-Back Agreement.

FREE BOOK COUPON

LEWIS HOTEL TRAINING SCHOOLS,
 Room BA-385, Washington, D. C.

Send me without obligation the Free Book "Your Big Opportunity."

Name.....

Address.....

City..... State.....

"How can I get into Aviation?"



Read this Answer from

A World Famous Trans-Atlantic Pilot

AVIATION is waiting for no one! Too many millions of capital are already invested—the demand for air service of every kind is increasing too fast. Aviation demands men who KNOW. Men who can DO. Men who can step into the real jobs and command the real salaries. Plane production today is ten times what it was a year ago. And a year from now it will be twenty times what it is today! Landing fields, municipal airports, plane and equipment factories, air mail and passenger lines, service and sales organizations—all are leaping ahead in the fastest, most amazing development that any industry has ever known. In such racing, feverish activity, where is there any room for a man who has nothing to offer? An empty pocketbook is no drawback—but Aviation has no place, no patience, no time for empty hands or empty heads! Aviation is taking off for the greatest non-stop flight in history—and the men who will go along and climb to the top are the men with a foundation of FACTS under them.

Walter Hinton

The man who is ready to help YOU get into Aviation is the man who has four times been one of the world's outstanding flyers. Walter Hinton was pilot of the famous NC-4, first plane to fly the Atlantic; he piloted the first plane from North to South America; he was first to fly to the headwaters of the Amazon; he was the hero of the runaway Navy balloon that was swept halfway to the North Pole. But in addition to being an explorer, pioneer and aviator, Hinton also has the rare ability to teach others the knowledge he has gained. During the War he was a crack flying instructor for the Navy. Today—with a course that experts agree is the most complete and practical ever produced—Hinton is training keen-sighted men for the Big-Pay jobs in Aviation. The FREE Book below is YOUR first step to Success. Take this step—send for this book—NOW!

Get his
FREE Book
Tells YOU How to Start

You Don't Have to Fly; 40 Different Jobs On the Ground PAY BIG TOO!

To succeed in Aviation—make BIG MONEY—you need not necessarily be a pilot. There must be many thousands of pilots, certainly. But for every plane that flies, there's an immediate need for trained men in more than forty different important jobs on the ground. Construction, motor and instrument experts—airport managers, service foremen, salesmen—all make real money. Some of them even bigger pay than pilots earn. But every last one of them must have the FACTS. Today's problem—YOUR problem—is to LEARN Aviation quick. And right there is where Walter Hinton is achieving the biggest success of his career.

Get Your Ground Work NOW Right at Home—Hinton Is Ready to Train You

YOU can train at home in spare-time for the best paid jobs in the Industry. Hinton's proved course starts you at the beginning, trains you fast. You get all the facts about construction, rigging, motors, repairs, instruments, theory of flight, navigation, commercial Aviation—facts that every man must have to intelligently and profitably fill ANY job in the Industry. With this Institute's training you'll have your foundation, your start, for real accomplishment. Serious-minded — air-minded — men are reading and acting on the Free Book shown below. YOU should have a copy too! Send the coupon NOW.

Aviation Institute of U. S. A.
Walter Hinton, President
1115 Connecticut Ave., Washington, D. C.



Rush back to Washington Quick!

Walter Hinton, Pres. I-K
Aviation Institute of U. S. A.
1115 Connecticut Ave., Washington, D. C.

Please send me at once your FREE Book "Rich Rewards in Aviation" showing how I can get into this tremendous field.

Name.....
Street..... Age.....
City..... State.....

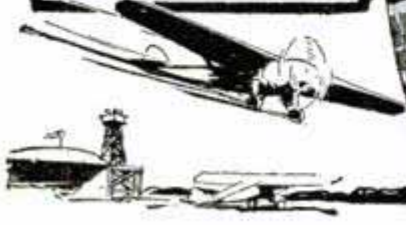

Quickly Learn to Play Hawaiian Guitar

Play Like This Native

Bring the romantic, enchanting, entrancing and melodious strains of the great instrument of the Hawaiian Islands into your soul. Become popular and successful. This **short cut method** of home instruction enables you to quickly master Hawaiian Guitar so you will **play as well as Native Hawaiians.**

Our staff of Hawaiian instructors have perfected a method of teaching, so **simple**, that without musical knowledge, you quickly learn to play real music from notes. **Simple as learning your A B C's** and it will not be long before you will play latest Broadway hits.

Only four simple motions to learn. You will then play any music, whether it be popular, dance or classical. Almost from first lesson, you play love songs like Aloha Oe.

To help you get started, we furnish without extra charge when you enroll as a student, a beautiful, full tone, genuine \$18.00 Hawaiian Guitar. Only 1,000 free instruments given away; if you want to get in on this offer, write for particulars at once—you must **act quickly.**



New Invention—Kno-All-Chart
QUICKLY TEACHES YOU HOW TO PLAY
 The newest invention of our Hawaiian instructor, which is exclusively used by us and which we call the "Kno - All - Chart,"

quickly teaches you how to play and read notes. So simple is this device that anyone can understand it and begin to **play immediately.**

Picture Method Easy

We do not depend upon our printed instructions alone for your success as a student, but we also supply you with many pictures of our professors' playing. This enables you to imitate the pictures. **Isn't this easy?**



Phonograph Records Given

As an additional guide, we also furnish you with **phonograph records** of our Hawaiian instructor's own playing of the piece you are learning. This practically brings our professors from your studio to your own home and enables you to listen to their playing just as if they were actually in front of you.

Genuine \$18.00 Hawaiian Guitar Given

Enroll as a student, and secure a beautiful full tone, genuine \$18.00 Hawaiian Guitar. We also furnish every bit of equipment so it is never necessary for you to spend an extra penny. When you graduate, you get a **beautifully engraved diploma** and after graduation, we also give you **six months' free service and consultation.** Send for free particulars now.

JAZZ
 Your Way to Popularity and Success

No forming class to wait for. Start at once and join hand wagon of success and popularity. Do it through Hawaiian Guitar.

Send for free **First Lesson and Book.** So positive are we you will become one of our students, that if you write at once, we will send you **free**, our first lesson which will enable you to see just what you can expect when you enroll. You will also receive our **big book** of full particulars. Write for your copy and **free lesson** today.

Write at **Hawaiian Studio No. 52108** of New York Academy of Music, 100 Fifth Ave., New York, N. Y.

HAWAIIAN STUDIO No. 52108 of New York Academy of Music, 100 Fifth Avenue, New York, N. Y.

Please rush your book, "How to Learn Hawaiian Guitar," and my first free lesson. Also reserve a Hawaiian Guitar for me without extra charge. This obligates me in no way whatever.

Name.....
 Address.....
 City..... State.....

\$25.00 DRAWING COURSE for \$2.98



Haven't you often wished that you could draw cartoons; illustrate some idea, sketch some pretty face, etc.? You can do all of these things. One of America's most famous Cartoonists and Illustrators has developed a great, simple system for success in all branches of Commercial Art. This system has revolutionized the entire theory of drawing. It means that drawing can be as easy for you as writing—much simpler than learning shorthand, bookkeeping or typewriting. We are now placing this original system for learning Drawing, Art and Cartooning, consisting of 34 lessons with over 500 illustrations, within reach of every one. If you will devote a few hours each week to the Course **WE ABSOLUTELY GUARANTEE** that you will learn to draw and draw well before you have half finished the Course. If we fail to make this claim good, we will refund every cent paid us. By eliminating a large office force for answering correspondence, expensive catalogs, etc., we are enabled to make a price of \$2.98, the cheapest price ever known for a high-grade, home study course. Many have sent us letters similar to that of Rob't P. Davis of Detroit, who wrote: "I can't see how you ask so little. It is more than I expected." Learn to draw. It is a big asset, no matter what field you are in.

Send No Money

Just order the course and **\$2.98** on arrival pay postman **\$2.98** plus a few cents postage, payment in full for the entire Course and Drawing Outfit. If not entirely satisfied, return within five days and we will Refund Money. Address:

If you order the course at once, we will include a drawing outfit, consisting of artist's pencils, pens, paper, erasers, thumb tacks, etc., enabling you to go to work without any additional cost.

LEDERER SCHOOL OF DRAWING, Dept. 124-6, Chattanooga, Tenn. Orders from outside the U. S. A. are payable \$3.28 cash with order.

Learn Advertising at HOME

Send your name and address for free booklet giving interesting information and vital facts about Advertising. Find out how we prepare you at home, in your spare time, for the opportunities open in this fascinating business. Practical work. No text books. Old established school. Successful graduates everywhere. Just the plan you have always wanted. Write today. No obligation.

PAGE-DAVIS SCHOOL OF ADVERTISING
 Dept. B57 3601 Michigan Ave. Chicago, U. S. A.

LEARN WATCHMAKING AND ENGRAVING

BY OUR PROFIT-SHARING PLAN OUR GRADUATES SUCCEED



One of our Iowa students started in a very small way—now doing over \$30,000 a year. Another in Wisconsin, over \$10,000 the first year. Day or night classes. Call or write for **FREE BOOK.**

Chicago School of Watchmaking, Dept. 4501, 549 W. Randolph St., CHICAGO

STAMMER

Write for my free book "Millard's Advanced Natural Corrective Course" and a free copy of my speech magazine. 10,000 cases successfully treated. Est. 24 years. Largest school for stammerers in world. Millard Inst. of Normal Speech, 2317 Millard Bldg., Milwaukee, Wis.

Study **LAW AT HOME** Lincoln did it! Also thousands of other great lawyers, politicians and business men. YOU, too, can become a lawyer or law trained businessman through home study guided by the successful practicing lawyers of our faculty. Write today for free book. **AMERICAN CORR. SCHOOL OF LAW** 3601 Michigan Ave., Dept. 1357, Chicago

I'll Pay You \$30 a Day



To Show My Rain Proof **FITS-U Caps to Men**

I'll pay you \$30 a day to show my marvelous line of rain-proof Fits-U Caps. More for active workers. With my liberal commission of \$1.00 on every sale—it's a cinch to clean up \$5.00 or more an hour in spare time. "In two hours," writes one successful salesman, "I made \$15.70. It's the rain-proof and made-to-measure features that get the orders so quick."

FREE Outfit

By a secret process, every Fits-U Cap is made absolutely rain-proof! Rain has no effect on the Fits-U Cap. You collect big commissions in advance. **EVERY CAP MADE TO INDIVIDUAL MEASURE!** Many other fast selling numbers: Men's Felt Hats, Ladies' Hats, Mufflers, Ties, etc. Don't Wait—Act Now. I'll send elaborate selling outfit to you **FREE.** Get started immediately. Just send name and address. Postal will do. Write today!

FITS-U CAP CO., Dept. P-75, CINCINNATI, OHIO

ELECTRICITY

PAYS BIG!

LEARN IN 90 DAYS ON ACTUAL MACHINERY—NO BOOKS

I'LL PAY YOUR R-R FARE TO CLEVELAND

Don't let the world bluff you. Get into electricity—earn \$50.00 to \$150.00 a week—and hold your head as high as the next man. You can do it easily by coming to my famous electrical school. In 12 short weeks you'll pack in many years of practical knowledge. You work shoulder to shoulder with expert instructors on full-sized, moving, whirling motors, generators, batteries,



Big Illustrated Book Sent FREE

Today, right now, take the first step out of that low pay rut. Mail the coupon to me for big, illustrated book on ELECTRICITY. Act to-day. Get my special Railroad Fare offer and Remarkable Tuition offer.

Just Mail Coupon!



IT'S EASY THIS WAY
Fascinating, practical shop work in my big school fits you. Not a correspondence course.



No Education or Experience Needed

No books to read. No dry lectures to listen to. You learn by doing. I don't care if you can't tell a motor from a horse-and-

buggy now. When you graduate I guarantee that you'll know electricity from "A" to "Z." If you're not fitted to fill a big-pay job I'll refund every penny of your tuition.

switchboards, telephone and telegraph systems, etc., etc. McSweeney trained men get the biggest paying jobs. Every day I receive requests for graduates.

Employment Department Helps You!

I help my students find spare time jobs while they attend schools—and my Employ-

ment Department assists my graduates to locate good positions after graduation. McSweeney trained men are in demand.



Earn While You Learn!

McSWEENEY ELECTRICAL SCHOOL

Dept. 51-R Cleveland, Ohio

Raise Poultry **MAKE BIG MONEY**

Results Quick—Part or Full Time

Take up poultry raising. It's interesting, healthful, PROFITABLE. Easy to sell all you can produce at big prices. Our new course by Henry M. Lamon, former gov't expert, gives short cuts to success. Write for free book, "How to Raise Poultry for Profit."

NATIONAL POULTRY INSTITUTE, Dept. 411-B, Washington, D. C.

Learn to PAINT SIGNS and SHOW CARDS

We quickly teach you by mail, or at school, in spare time. Enormous demand. Big future. Interesting work. Oldest, foremost school.

EARN \$50 TO \$200 WEEKLY

John Vassos, N. Y., gets \$25 for single show card. Crawford, B. C., says: "Earned \$200 while taking course." Send today for free information, samples and guarantee.

DETROIT SCHOOL OF LETTERING
154 Stinson Ave. Est. 1899 Detroit, Mich.

LEARN CARTOONING AT HOME DURING SPARE TIME

with the course that has trained HUNDREDS of beginners successfully. The Landon Picture Chart Method of teaching ORIGINAL drawing by mail makes cartooning easy to learn. This school is a Member of The National Home Study Council. Write today for sample picture chart to TEST YOUR ABILITY and examples of the work of successful students now earning from \$50 to \$200 and more per week. Enclose 6c in stamps and STATE YOUR AGE.

THE LANDON SCHOOL, 2838 National Bldg., Cleveland, Ohio



EARN \$150 A WEEK HIS OWN BOSS!

BIG OPPORTUNITIES FOR YOU IN MECHANICAL DENTISTRY

Why waste the best years of your life at uncertain jobs at small pay? Learn this modern money making business and become YOUR OWN BOSS. Big demand. Age no barrier and no previous experience required. You learn by doing actual work in rubber and gold. Easy terms. Individual instruction. Day and night school sessions. Write NOW for Catalog P. Railroad fare allowed—no extra charge.

NEW YORK SCHOOL OF MECHANICAL DENTISTRY
147 W. 33rd Street NEW YORK

MAIL COUPON NOW

N. Y. School of Mechanical Dentistry
147 West 33rd Street, New York.

Yes, send me without obligation, your big free Catalog P on mechanical dentistry, and its wonderful opportunities.

Name

Address

City.....State.....

SEND FOR FREE BOOK



Grad. Kern writes

"—My success is due to your excellent training and I appreciate what you have done for me."

(Signed)
GEO. KERN.



Kern's Dental Lab.



High School Course in Two Years!

You Want to Earn Big Money!

And you will not be satisfied unless you earn steady promotion. But are you prepared for the job ahead of you? Do you measure up to the standard that insures success? For a more responsible position a fairly good education is necessary. To write a sensible business letter, to prepare estimates, to figure cost and to compute interest, you must have a certain amount of preparation. All this you must be able to do before you will earn promotion. Many business houses hire no men whose general knowledge is not equal to a high school course. Why? Because big business refuses to burden itself with men who are barred from promotion by the lack of elementary education.

Can You Qualify for a Better Position

We have a plan whereby you can. We can give you a complete but simplified high school course in two years, giving you all the essentials that form the foundation of practical business. It will prepare you to hold your own where competition is keen and exacting. Do not doubt your ability, but make up your mind to it and you will soon have the requirements that will bring you success and big money. **YOU CAN DO IT.**

Let us show you how to get on the road to success. It will not cost you a single working hour. Write today. It costs you nothing but a stamp.

American School

Dept. H-774, Drexel Ave. and 58th St., Chicago

American School

Dept. H-774 Drexel Ave. and 58th St., Chicago

Send me full information on the subject checked and how you will help me win success.

- | | |
|-----------------------------|---------------------------|
|Architect |Business Law |
|Building Contractor |Lawyer |
|Automobile Engineer |Machine Shop Practice |
|Automobile Repairman |Mechanical Engineer |
|Civil Engineer |Shop Superintendent |
|Structural Engineer |Employment Manager |
|Business Manager |Steam Engineer |
|Cert. Public Accountant |Foremanship |
|Accountant and Auditor |Sanitary Engineer |
|Bookkeeper |Surveyor (& Mapping) |
|Draftsman and Designer |Telephone Engineer |
|Electrical Engineer |Telegraph Engineer |
|Electric Light & Power |High School Graduate |
|General Education |Wireless Radio |
|Vocational Guidance |Undecided |

Name.....

Address.....

BE A JAZZ MUSIC MASTER



Play Piano By Ear

Play popular song hits perfectly. Hum the tune, play it by ear. No teacher—self-instruction. No tedious ding-dong daily practice—just 20 brief, entertaining lessons, easily mastered.

At Home in Your Spare Time

Send for FREE BOOK. Learn many styles of bass and syncopation—trick endings. If 10c. (coin or stamps) is enclosed, you also receive wonderful booklet "How to Entertain at Piano"—and many new tricks, stunts, etc.

Niagara School of Music
Dept. 295, Niagara Falls, N. Y.

Send for this Free Book

DEVELOP POWER

AT HOME

to initiate, persevere, achieve; carry on through life your education; earn credit toward a Bachelor degree, by using the 450 courses

The University of Chicago Gives by Correspondence

Inquire, or check the advertisement to show desire and mail to 327 Ellis Hall, University of Chicago, Chicago, Illinois.



I Teach by Mail

Begin Today—Write for My FREE Book. I can make a good penman of you at home during spare time. Write for my FREEBOOK: "How to Become a Good Penman." It contains specimens and tells how others mastered penmanship by the Tamblin System. Your name will be elegantly written on a card if you enclose stamp to pay postage. Write today for book.

F.W. Tamblin, 418 Ridge Bldg., Kansas City, U.S.A.

BE AN ARTIST

WE CAN TEACH YOU DRAWING in your own home during your spare time. Twenty-five years of successful teaching proves our ability. Artists receive large salaries.

Write Today for Art Year Book

SCHOOL OF APPLIED ART
ROOM NO. 2 BATTLE CREEK MICH.



MEN TO LEARN

MOTION PICTURE PROJECTION

A BIG-MONEY PROFESSION—\$2,000 TO \$4,000
We Assist Students to Earn While Learning

MOVIE OPERATORS SCHOOL

61 Sproat Street

Detroit, Michigan

TELEGRAPHY

(Morse and Wireless) and RAILWAY ACCOUNTING, taught thoroughly. Big salaries; great opportunities. Oldest, largest school. Endorsed by Telegraph, Railway, Radio, and Government officials. Expenses low—opportunities to earn large portion. Catalog free. DODGE INSTITUTE, Jones St., Valparaiso, Ind.

LEARN WATCHMAKING

and become independent. We help you secure a position. Easy to learn. Send for FREE CATALOG.

ST. LOUIS WATCHMAKING SCHOOL,

Dept. 5.

ST. LOUIS, MO.

Pathfinder

TRIAL EVERY WEEK 13 WEEKS \$1 A YEAR 15 CENTS

Your neighbors know the Pathfinder and you will like it—the every-week news digest from the Nation's Center. Bright, interesting, dependable, different—nothing else like it. Washington gossip, politics, science, travel, fun, lots of pictures, instruction, entertainment. Trial 13 weeks—13 big issues—only 15 CENTS or \$1 for full year. Send now. Address:



Pathfinder, Dept. 25 Washington, D.C.



At Last... Real College Instruction In Drafting At One Third the Cost!

Unquestionably, hundreds of the readers of this magazine have waited and hoped to run across just such a message as this. For the Drafting opportunity outlined here is altogether unique and without parallel in the educational world. The trial lesson and other material offered below bear convincing proof and may now be obtained without cost simply by mailing the coupon.

RIGHT AT HOME!

LOOK here, men. Let's understand, one another. Just because some of the biggest business and professional men in America are Chicago Tech graduates is no sign that anybody is going to try to get "high-brow." And just because this school is over a quarter of a century old and so well known that students actually come here from all over the world—sometimes spending thousands of dollars to learn the things that Chicago Tech alone teaches in a plain, simple, understandable way—that doesn't mean you have to pay a lot of money for this practical training. Far from it! For now as a part of the Chicago Tech new plan you may obtain complete home training in drafting at a purely nominal cost.

Nearly everyone has heard of Chicago Technical College. Here over 1,000 men each year attend day and evening classes. They learn such subjects as practical engineering, construction, estimating, designing, and above all Drafting. Not out of dry hard-to-master text books. Not by a lot of tedious "study." But by the wonderful "practice" system developed by Chicago Tech. By this method everything is far easier to learn because it is interesting. In fact, man after man will tell you that learning drafting the quick, sure Chicago Tech way is more like playing a fascinating game than anything else. It is as different from the mental drudgery that you will find in

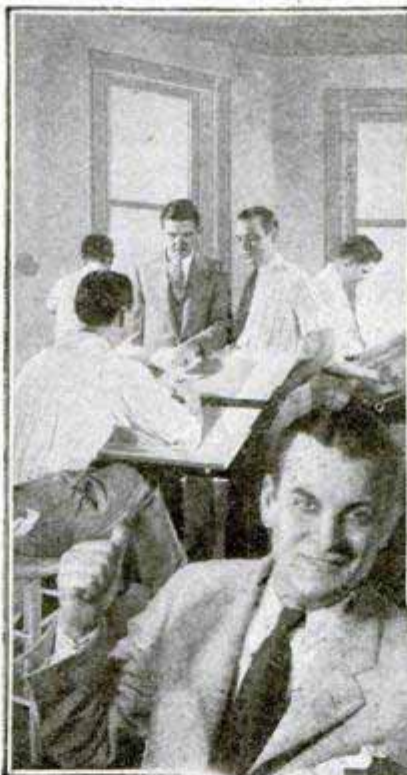

ordinary "schooling" as night is from day. And now this great training is yours right at home, in spare time.

It is not anticipated that every man who would like to be a draftsman will respond to this message. Probably not even every man who expects some day to study drafting will have the ambition and imagination to understand what the facts announced here can mean to him. But the thinking men, the men who are open minded and are willing to examine the proofs of a greater success in drafting than was ever possible for them before, these are the men to whom we earnestly desire to submit the plain, unexaggerated facts. Among other advantages to men who select this training Chicago Tech offers employment service for life. A complete professional drawing outfit is also supplied.

If you want to learn drafting the proved easiest way . . . if you have your eyes on the real big jobs paying \$5,000, \$7,500, \$10,000 and more a year . . . you should have these free lessons and all the other material that the coupon will bring. There is no obligation, so you should mail the coupon today.

Get Free Proof



Chicago Technical College

Dept. M-201

Extension Department of Drafting, Chicago Tech. Building
118 E. 26th Street Chicago, Ill.

"College-Training-At-Home"

Chicago Technical College, Dept. M-201
Extension Department of Drafting, Chicago Tech Bldg.,
118 East 26th Street, Chicago, Ill.

Please send me the facts about your new system that enables men to master Drafting at home just as you teach it in your regular College. Include your Free Trial Lesson in Drafting. This does not obligate me in any way.

Name

Address

Town State

() If you prefer coming to Chicago for our resident short course in Drafting, check here. We will be glad to send you our "Blue Book" No. 401, which gives full details.

We Will Train You in a Few Months



Day and Night Schools in Chicago, Detroit, Cleveland, Boston, Phila.

Tune in WBBM (389.4 Meters) for McCarrie hour each Monday at 7:30 P. M. Central Standard Time

Experts Earn Up To **\$125 A WEEK**

as MECHANICAL DENTISTS

We teach you to make rubber plates, crowns, bridge work, metal base dentures, etc., for dentists. After graduating you are ready for a job or can open your own laboratory. We assist you.



Big Demand for Men!

Mechanical Dentistry is the laboratory bench work which the dentist turns over to the laboratory worker. Master this profession and help meet the demand of 64,000 dentists for laboratory work. Every city and every town where dentists are located offers work to the mechanical dentist. We train you in a few months in day or night school for this uncrowded field—no classes—no books—no mechanical experience necessary.

Work Your Way Thru School

We will help you find a job to meet your expenses while taking our training. And we will help you find satisfactory living quarters when you arrive.

Schools located in Chicago, Detroit, Cleveland, Boston, Philadelphia. Day and night schools.

INTERESTING FREE BOOK

Our illustrated free book on Mechanical Dentistry will acquaint you with some surprisingly interesting facts. It tells about the thriving profession of Mechanical Dentistry—the way to swift and certain success. And it tells about the progress of many of our graduates—men who have succeeded beyond their expectations, also full details of our liberal offers. Mail the coupon and find out more about this fascinating opportunity.

McCarrie School of Mechanical Dentistry
1338 S. Michigan Ave., Dept. 184, Chicago, Ill.

McCARRIE SCHOOL OF MECHANICAL DENTISTRY
1338 S. Michigan Ave., Dept. 184, Chicago.

Without cost or obligation, send me your illustrated book on Mechanical Dentistry, and complete information as to my opportunities in dental laboratory work.

Name.....

Address.....



Learn AVIATION!

Money — fame — adventure! They all await you in Aviation. Experts who can fly—who can design, build and repair airplanes and motors, are in big demand everywhere. You can make from \$75.00 to \$500.00 a week after thorough training. You may be internationally famous in a year!

FREE This Inspiring Book!

Send at once for "Skyward Ho!" the free aviation book that gives facts about opportunities—shows how you can get into this great industry that is making fortunes for many almost overnight. Special offer for this month saves you half the cost—if you write at once.

Prepare for Big Pay Jobs

We give you complete and thorough flying and ground instructions on modern equipment such as Travel Air and other new-production ships, and on Whirlwind, Caminez and other new engines. You'll be taught Air Navigation, Meteorology, Aerodynamics, Airplane Construction and Maintenance, Motor Overhaul, Airport Management—and you'll learn to fly by flying with expert transport pilots. You'll find yourself in a hotbed of aviation activity. You'll see all the latest planes zooming and roaring, coming and going at our field. Parks is not a correspondence school.



234-G Mo. Theatre Bldg.

ST. LOUIS, MO.



BE AN OIL EXPERT!

Trained men needed! Geologists, Drillers, Refiners (Chemists and Still Men), Oil Salesmen, earn 2 to 10 times more than in other fields. Write today! FREE Booklet! Petroleum Engineering University, Dept. 230, Fort Wayne, Ind.

GIVEN TO YOU



A Brand New High Grade Fine Tone

VIOLIN, TENOR BANJO, HAWAIIAN GUITAR, BANJO, CORNET, UKULELE, BANJO UKULELE, GUITAR OR MANDOLIN

We will give you without extra charge when you enroll, any instrument you select and teach you to play it by our NEW copyrighted easy to learn home-study course. Over 500,000 men, women, boys and girls have learned to play by our simplified method. Cost is only a few cents a day for lessons. No other charge. You pay while you learn. Instrument and first lessons sent on FREE trial. Write today. CHICAGO CORRESPONDENCE SCHOOL OF MUSIC, INC. 1632 No. Halsted St., Dept. 712 Chicago, Ill.

Learn How to BOX

JIMMY DeFOREST BOXING COURSE

Teaches by mail the Same System he taught Champion JACK DEMPSEY

In 20 weeks, under the System of Jimmy DeForest, WORLD'S GREATEST TRAINER AND MAKER OF CHAMPIONS, you will master the priceless knowledge that made Jack Dempsey his millions, and fortunes for a host of other Jimmy DeForest-trained ring stars. Boys who were once rank amateurs are today earning big money; weaklings have been made strong, courageous; men have learned the art of self-defense. Send today for the now famous book, "THE GOLDEN AGE OF BOXING," greatest book of its kind ever written; full of valuable information, photos of great fighters and pupils who became successes overnight. Enclose 10c to cover cost of mailing, etc. WRITE NOW.



JIMMY DeFOREST BOXING COURSE
347 Madison Avenue, Box 135, New York City

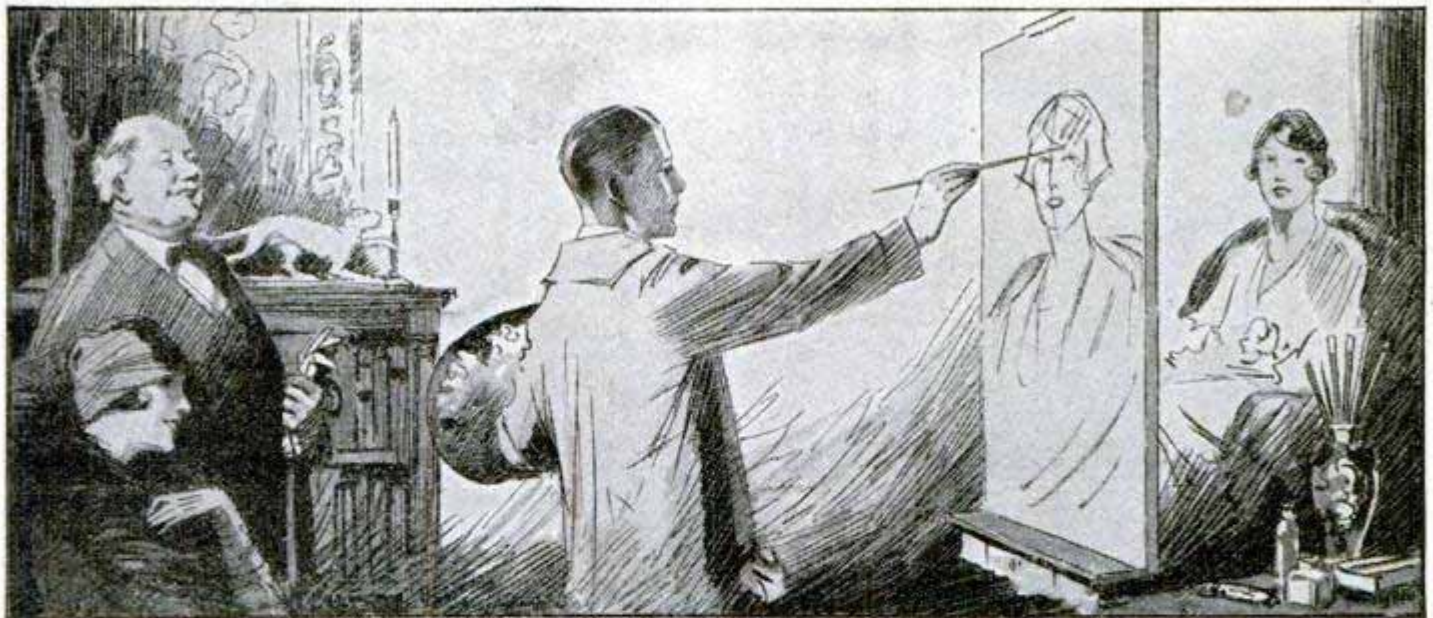

Simple Lines Earn Fame and Fortune

A Few Famous Federal Authors



SIDNEY SMITH



HERB JOHNSON



CLARE BRIGGS



NORM ROCKWELL



FONTAINE FOX



BART



NEYBA MCMEIN



FAY KING



CHARLES L. BULL



FRANK KING



CHAS. M. RUSSELL



W.J. WILWERDING

"YOU certainly make your money easily," remarked the heavy-set publisher. "My, such speed," interrupted his lady business associate. "How do you get such a true likeness in so few lines?" They had dropped in to purchase illustrations from the young artist whose masterful drawings in magazines and newspapers had started him on the road to fame.

"I never thought it was possible myself," he replied as he added a few telling strokes with his brush. "But I liked to draw. I knew it was fascinating and that it offered opportunities. So I decided to study. Through proper training I have learned to form simple lines into finished illustrations."

It was only a short time ago that this young artist filled out a coupon like the one below and mailed it to the Federal School of Illustrating. "And now," he continued, "each time I make a simple stroke with my brush it means money in my pocket."

This story illustrates the success of hundreds of Federal School graduates. Careful, conscientious training by members of our faculty has put thousands of students on the "Road to Bigger Things."

Over fifty famous artists have contributed lessons and drawings exclusively to the Federal Course of Illustrating. You are undoubtedly acquainted with the work of many of these masters. A few of their pictures appear on this page. They teach you their "tricks of the trade" about illustrating, cartooning, lettering, poster designing, window card illustrating, etc. Every subject is covered thoroughly. No one is competent to give instructions in all these branches. For this reason each subject in the course is covered

prepare you for any problem or emergency that may arise. If you like to draw, why plod along at some tedious work? Opportunities for artists have never been better. Thousands are wanted every year by magazines and newspapers that spend millions of dollars for illustrations. Drawing is easy to learn the "Federal Way." Study at home in your spare time. Earn while you learn if you wish. Many students find a market for their work after a comparatively short time of study. Others earn the price of the course several times before they finish.

Every mail brings news of the success of students. Charles Phil Hexom of Decorah, Iowa, writes, "My cover work brings from \$50.00 to \$150.00 per painting." A letter from Sam Nash reads, "I sometimes make as high as \$30.00 a day doing bulletins and have averaged \$150.00 a month outside of school hours." These are only two typical examples of the success that hundreds of young people are enjoying because of Federal training.

If you like to draw, opportunity lies no further away than the lower corner of this page. Write your name and address on the coupon and get our free book, "A Road to Bigger Things," which is illustrated below. With this book we will send our free Vocational Art Test to find out your ability. Hundreds of successful artists got their start by sending for these. This is your opportunity—grasp it. Mail the coupon now.



Federal School of Illustrating

FEDERAL SCHOOL OF ILLUSTRATING,
10138 Federal School Bldg., Minneapolis, Minn.
Gentlemen: Please send your free book, "A Road to Bigger Things," together with Vocational Art Test.

Name Age.....
Occupation.....
Address.....
.....

by a famous artist who has made a success in his particular field. You profit by their experience. Their instructions



The only man who could talk to the Superintendent

"SOON after I began studying," a student wrote to us the other day, "we had a change in management at our plant. I certainly was glad then that I had decided to study in my spare time. For, thanks to my I. C. S. course, I was the only man in the organization who could talk to the Superintendent in his own language. As a result, I was promoted over men who had been here from ten to twenty years. My salary has been increased 90% in the last ten months."

THAT'S a true story of what just one I. C. S. student has done. There are thousands of others. Every mail brings letters from men and women telling of promotions and increases in salary due directly to spare-time study.

One hour a day, spent with the I. C. S. in the quiet of your own home, will prepare you for success in the work you like best. *Yes, it will!* Put it up to us to prove it.

Mail the Coupon for Free Booklet

INTERNATIONAL CORRESPONDENCE SCHOOLS
"The Universal University"
Box 5568-F, Scranton, Penna.

Without cost or obligation, please send me a copy of your booklet, "Who Wins and Why," and full particulars about the subject before which I have marked X in the list below:

BUSINESS TRAINING COURSES

- | | |
|--|---|
| <input type="checkbox"/> Business Management | <input type="checkbox"/> Salesmanship |
| <input type="checkbox"/> Industrial Management | <input type="checkbox"/> Advertising |
| <input type="checkbox"/> Personnel Management | <input type="checkbox"/> Business Correspondence |
| <input type="checkbox"/> Traffic Management | <input type="checkbox"/> Show Card and Sign Lettering |
| <input type="checkbox"/> Accounting and C. P. A. Coaching | <input type="checkbox"/> Stenography and Typing |
| <input type="checkbox"/> Cost Accounting | <input type="checkbox"/> English <input type="checkbox"/> Civil Service |
| <input type="checkbox"/> Bookkeeping | <input type="checkbox"/> Railway Mail Clerk |
| <input type="checkbox"/> Secretarial Work | <input type="checkbox"/> Common School Subjects |
| <input type="checkbox"/> Spanish <input type="checkbox"/> French | <input type="checkbox"/> High School Subjects |
| | <input type="checkbox"/> Illustrating <input type="checkbox"/> Cartooning |

TECHNICAL AND INDUSTRIAL COURSES

- | | |
|---|--|
| <input type="checkbox"/> Electrical Engineering | <input type="checkbox"/> Architect |
| <input type="checkbox"/> Electric Lighting | <input type="checkbox"/> Architects' Blueprints |
| <input type="checkbox"/> Mechanical Engineer | <input type="checkbox"/> Contractor and Builder |
| <input type="checkbox"/> Mechanical Draftsman | <input type="checkbox"/> Architectural Draftsman |
| <input type="checkbox"/> Machine Shop Practice | <input type="checkbox"/> Concrete Builder |
| <input type="checkbox"/> Railroad Positions | <input type="checkbox"/> Structural Engineer |
| <input type="checkbox"/> Gas Engine Operating | <input type="checkbox"/> Chemistry <input type="checkbox"/> Pharmacy |
| <input type="checkbox"/> Civil Engineer <input type="checkbox"/> Mining | <input type="checkbox"/> Automobile Work |
| <input type="checkbox"/> Surveying and Mapping | <input type="checkbox"/> Airplane Engines |
| <input type="checkbox"/> Plumbing and Heating | <input type="checkbox"/> Agriculture <input type="checkbox"/> Navigation |
| <input type="checkbox"/> Steam Engineering | <input type="checkbox"/> Mathematics <input type="checkbox"/> Radio |

Name.....

Street Address.....

City..... State.....

Occupation.....

Persons residing in Canada should send this coupon to the International Correspondence Schools Canadian, Limited, Montreal, Canada

Read This
Inspiring
Book



Col. Lindbergh visits "Bud" Gurney, his successor as our Chief Air Mail Pilot & Instructor.

Making Good in Aviation

Get this vitally interesting new book—full of valuable suggestions—your opportunities in aviation—your first step—how pilots and mechanics train for big-paying positions. Read the thrilling story of the days when Col. Lindbergh flew the mails—how "Bud" Gurney rose from barn-stormer to Chief Air Mail Pilot.

"MAKING GOOD IN AVIATION"—containing full page photo of Col. Lindbergh and other interesting illustrations—sent postpaid for 25c, stamps or coin.

Air Mail Pilots Teach Flying

to advanced students at Robertson School of Aviation—an exclusive feature of this institution, one of the oldest, largest, best equipped schools in the country. Over 9½ years—550 graduates—no accidents. Army School system. Ten Licensed Transport Pilots on teaching staff. Modern training ships, "Ryan" and "Curtiss-Robin" factories on field. Write today. Dept. P.

ROBERTSON FLYING SERVICES, Inc.

Affiliated with Robertson Aircraft Corporation
Lambert-St. Louis Airport, Anglum, St. Louis County, Mo.

\$4,500 in ONE Sale



That's what L. C. Clarke made. Formerly a brakeman, earning an average of \$638.40 a year. Got started in real estate. Used my successful system. Now has large real estate business of his own. Do as he did. Be a Real Estate Specialist. Use my money-making system. Start in spare time, without capital or experience. Send for free book now.

Address President, American Business Builders, Inc., Dept. 44-10, 18 East 18 Street, New York, N.Y.

"Height Increasing"

Is Report of Hundreds

Results have been remarkable. Letters from all over tell of decided height increase gained in a few months. They tell of improved health, more pep and life, greater efficiency, more joy in living because of better physical condition. Nothing like our course. Based on sound, proven, scientific principles.

No Drugs — No Dope

We have no magic medicine to sell. Only a system of simple exercises and special diet, assisted by a simple apparatus. Takes but a few minutes each day. The Glover system helps overcome the flattening of the vertebrae and the sagging of the supporting muscles. Permits cartilage cushions in spinal column to expand. Strengthens muscles. Stimulates nerves. Results have been permanent because based on true physiology. Unusually successful in under-developed young men and women.



Stimulates nerves. Results have been permanent because based on true physiology. Unusually successful in under-developed young men and women.

EASY—INEXPENSIVE—CERTAIN
Write today for FREE information

GLOVER INSTITUTE — Dept. D3

508 S. Dearborn St.

Chicago, Illinois

LEARN AUTOS IN LOS ANGELES

Many N. A. S. Graduates earn up to \$5000 per year
Thousands easily earning \$40 or more per week

When you complete your course of training at National Automotive School you can handle a job paying \$40 per week or more. Our records prove that during the first year after completing N. A. S. training most students earn \$40 or more per week. Pay increases according to ability of student. Many N. A. S. graduates earning as high as \$5,000 per year. YOU can increase your present pay by learning autos in this magnificent Los Angeles institution.

A few months' Training increases your Wages for Life!

Los Angeles is the place to learn Autos right!

Now is the time to come to California where you can learn the auto trade under ideal circumstances. N. A. S. occupies one of the most magnificent buildings in California; reinforced concrete construction; scores of departments involving an investment of several hundred thousand dollars. Situated across from beautiful Exposition Park. No other school in America has such a perfect setting for automotive-minded men who are ambitious to earn more pay.

Jobs plentiful for N. A. S. Trained Men

Right now we have a waiting list for N. A. S. graduates. This condition will probably exist for years to come. The biggest garages and auto companies are anxious to obtain N. A. S. graduates and willing to pay \$40 or more per week for men qualified according to N. A. S. standards. We help graduates secure positions. We have aided many students in starting up business. Thousands now own their own garages, service stations and electrical businesses.

Jimmie Dunn gets big Pay increase

Jimmie Dunn is not an exception. He is a N. A. S. graduate who is employed by J. A. Nadeau, owner of one of the biggest Los Angeles Ford agencies. Nadeau says, "Jimmie Dunn is my best man." Jimmie Dunn says, "I owe my success to N. A. S. training. It increased my pay 450%. I certainly advise any man entering the auto industry to enroll at N. A. S." Thousands of N. A. S. graduates recommend this school without restriction.

Special Training— Practical Instruction by master mechanics

It has always been the N. A. S. policy to offer the most complete equipment for the training of students. Every year thousands of dollars worth of new chassis, motors, and machinery are installed to replace equipment that might be considered out of date. N. A. S. instructors are high priced men with years of experience in giving individualized training. One nominal enrollment fee gives you unlimited life scholarship in auto courses including care and repair of every type of motor, trouble shooting, complete instruction on chassis, transmissions, differentials, ignition systems, generators, brakes—in fact all training required by the most experienced auto man. Nothing lacking. Training also includes lectures, shop management, machine shop work, garage experience, cost finding, short cuts to profits, how to charge for work—all the necessary knowledge required.

Biggest School On Entire West Coast

National Automotive School covers four acres, filled with complete equipment. It is conceded to be the largest school on the West Coast. Automotive authorities look upon National as one of the finest technical training schools to be found anywhere in the World. Profits earned during the past 24 years have been turned back into the school to be reinvested in equipment, constantly increasing the standard of training so that every student shares in the profits by obtaining advanced training. More than 17,000 successful graduates guarantee your success.

Special Offer

For the next 90 days a special inducement will be offered you—an opportunity that you cannot afford to overlook. When you request the catalog full details will be given. We reserve the right to withdraw the offer prior to 90 days.

YOU EARN WHILE LEARNING

If you feel that you are not able to finance your expenses while taking the complete course our Employment Department can make arrangements whereby you EARN while learning. We help get you a job that will pay for your room and board so that it is unnecessary for you to worry about living expenses. Right now we have more jobs waiting than applicants and this condition will probably exist for some time. Hundreds of students, during the past year, have taken advantage of this wonderful opportunity to earn while learning. Request more information about the jobs available.

We Qualify You to Master ANY Auto Job—big or little

It has never been the policy of National Automotive to "rush" a student through training. The high standing of the school will not permit this. Every student can enroll for as long as he desires, without extra cost. Graduates are given diplomas that assure their qualifications and help land big-pay jobs anywhere. You tackle the most complicated auto repair job without fear of "falling down." You can earn approximately \$40 immediately upon graduating and can earn frequent increases in pay according to your ability and ambition. No age limit. Enroll at any time.

24 Years of Auto Training Service

N. A. S. is one of the oldest schools in America. Special day and night classes organized every fortnight.

Note—In addition to offering complete training in auto work, we offer special courses in electricity and aviation training. If you desire information regarding electricity and aviation, please indicate on your request for literature.

SEND NO MONEY Parents Attention for De Luxe Auto Book

At a cost of over \$10,000 we have prepared an elaborate and instructive book on automotive instruction. It is in great demand. Only a limited supply remains. Your copy will be sent without charge if you fill in the coupon below and mail immediately. This book tells all about the school, what you will learn, how long it takes to obtain the training, etc.

If your boy floundering from job to job without the foundation of experience, or disinterested in school work? If so why not have him enroll in National Automotive School amidst congenial surroundings, amongst students of high moral standing, where he will learn one of the most profitable trades and be equipped for life with a dependable trade experience. Special information regarding student body activities and personnel of school will be furnished upon request.

NATIONAL AUTOMOTIVE SCHOOL
 Dept. 715, 4004 So. Figueroa, LOS ANGELES, CAL.

FREE Catalog—Mail Coupon

J. A. ROSENKRANZ, President,
 National Automotive School,
 Dept. 715, 4004 S. Figueroa, Los Angeles,
 Cal.

Please send me, absolutely free, your big, 84-page illustrated auto catalog.

Name.....

Address.....

City.....State.....

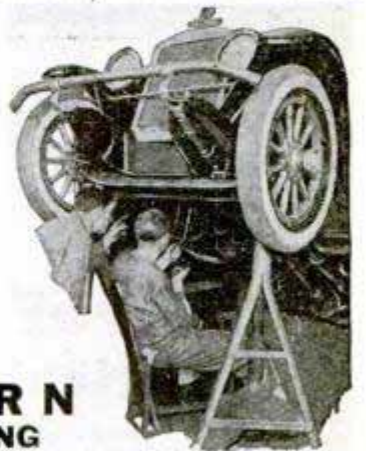

At N. A. S. you perform actual repair work on late model machines under supervision of master instructors who give personal attention just as if you were hiring them individually.





THIS is the electrical age, with unlimited opportunities for the man who has educated himself in the finer points of electrical practice.

Fit yourself for a big-pay job by knowing electrical practice complete, including inside and outside work, central stations, and the whole subject. With the aid of the Croft books you can know electricity as experts know it and put yourself in line for an expert's pay.

The Croft Library of Practical Electricity

A reference library and self-training course in eight volumes. 3000 pages—2100 illustrations

In these volumes Croft teaches you electrical practice complete. He takes you in quick, easy steps from the simplest principles to the complete and economical operation of a great central station. He tells you all that he has learned in twenty years of shirt-sleeve practice. With these books at his elbow a man can learn as much about electricity in six months—good practical "bread and butter" stuff—as he would ordinarily learn in a lifetime of practice.



Flexible binding for easy handling



The Standard in Practical Electrical Training

The Croft Library is a complete electrical educator. It is founded on practice—on work as it is actually done. It is jammed from cover to cover with the kind of hard-headed facts you want. Written so that the beginner can easily understand it, yet so sound, so thorough, that it is the daily guide of 59,000 highly paid electrical workers and engineers.

Croft tells you the things you need to know about motors, generators, armatures, commutators, transformers, circuits, switchboards, distribution systems—electrical machinery of every type—wiring for light and power—wiring of finished buildings—underwriters and municipal requirements—illumination in its every phase—the latest and most improved methods of lighting—lamps and lighting effects, etc.—how to do a complete job, from estimating it, to completion.

NO MONEY DOWN SMALL MONTHLY PAYMENTS

Fill in and mail the coupon attached and we will send you the entire set of eight volumes for ten days' Free Examination. We take all the risk—pay all charges. You assume no obligation—you pay nothing unless you decide to keep the books. Then \$1.50 in ten days and the balance at the rate of \$2.00 a month. Send the coupon NOW and see the books for yourself.



FREE EXAMINATION COUPON

McGraw-Hill Book Co., Inc., 370 Seventh Ave., New York

Send me for 10 days' free examination the Croft Library of Practical Electricity. If satisfactory I will send you \$1.50 in 10 days and \$2.00 monthly until the special price of \$19.50 is paid. If not wanted, I will return the books at your expense. To insure prompt shipment write plainly and fill in all lines.

Name.....

Address.....

City and State.....

Position.....

Company.....P. M. 10-28

Books on 65 Practical Subjects

Popular Mechanics Press specializes in supplying the outstanding best book on any subject. Check the books you want, and mail this advertisement as your order blank.

- | | |
|--|--|
| AIRCRAFT
Modern (Just Out).....\$5.00 | GARAGE
Management and Control.....\$5.00 |
| AIRCRAFT ENGINES
Dyke's New Instructor (Just Out).....\$5.00 | HAND FORGING
Hand Forging and Wrought Iron Ornamental Work.....\$2.00 |
| ARCHITECT
Design and Lettering.....\$2.00 | HOME REPAIRS
Practical Book of Home Repairs.....\$2.50 |
| ARTIFICIAL FLOWERS
How to Make for All Purposes.....\$2.50 | HOUSEHOLD CONVENIENCES
Built-In Furniture.....\$2.50 |
| AUTOMOBILE
Dyke's Encyclopedia.....\$6.00 | INTERIOR DECORATOR
Interior Wall Decoration.....\$4.00 |
| AVIATION
Popular Guide.....\$2.00 | INVENTOR
Inventions and Patents.....\$2.50 |
| BOAT BUILDING
and Outdoor Sports.....\$2.00 | JOINT WIPING
and Lead Work.....\$1.00 |
| BOOKKEEPER
Bookkeepers' Handbook.....\$1.00 | LANDSCAPE GARDENING
Practical.....\$2.50 |
| BOYS' BOOKS
The Boy Mechanic (4 vols.).....\$7.00 | LATHE WORK
and Drilling and Thread Cutting.....\$1.00 |
| BRICKLAYER
Plain and Fancy Brickwork.....\$1.50 | LEATHER WORKER
Leather Work.....\$1.50 |
| BUILDER'S BLUEPRINTS
How to Read.....\$2.00 | LETTER WRITING
Effective.....\$3.00 |
| CABINET MAKER
Furniture Making.....\$3.50 | LIFE WORK
Choosing.....\$2.50 |
| CALCULATOR
Ropp's Calculator.....\$1.00 | LOOM FIXER
Practical Loom Fixing.....\$1.50 |
| CARBURETORS
Everything About All Makes.....\$2.00 | MACHINIST
419 Machinists Kinks.....\$1.50 |
| CARPENTER
366 Carpentry Kinks.....\$1.50 | MAGIC
200 Tricks You Can Do.....\$1.00 |
| CARTOONING
How to Draw Cartoons.....\$3.00 | MAIL-ORDER AND DIRECT-MAIL
Selling.....\$5.00 |
| CIVIL SERVICE
Course in Civil Service.....\$1.50 | MATHEMATICS
Mathematics for the Practical Man.....\$1.50 |
| CONCRETE
173 Ways of Using and Home Mechanics.....\$1.00 | MECHANICAL DRAFTSMAN
Practical Course in Mechanical Drawing.....\$1.00 |
| COOKING
Settlement Cook Book.....\$2.50 | MODEL AIRPLANES
Building and Flying.....\$2.50 |
| DIESEL ENGINES
Diesel Engines, Marine, Locomotive, Stationary.....\$5.00 | MOVIE MAKING
For Amateurs.....\$3.00 |
| DOG FANCIER
Dog Encyclopedia.....\$2.00 | OUTDOOR OPPORTUNITIES
Fur Farming.....\$4.00 |
| DRAWING
Freehand and Perspective.....\$1.50 | PAINTING
House Painting Methods.....\$2.00 |
| ELECTRICIAN
214 Electrical Kinks.....\$1.50 | PLASTERING
and Stucco Work.....\$1.25 |
| ELECTROPLATER
Electroplating.....\$1.00 | PLUMBING
Repair Your Own.....\$1.50 |
| ENGINEER
Bailey's Handbook for Stationary, Marine, Diesel.....\$2.00 | RADIO
Trouble Shooting.....\$3.00 |
| ENGLISH
Self-Improvement in English.....\$2.50 | REAL ESTATE
Making Money In.....\$5.00 |
| ENTERTAINMENTS
Producing Amateur Entertainments.....\$2.00 | SHIP MODELS
Ship Model Making.....\$2.50 |
| ETIQUETTE
Book of Etiquette (2 vols.).....\$2.00 | SHOP NOTES
and Auto Repairman.....\$1.00 |
| FARMERS' HANDBOOK
and Handbook for Farmers' Wives.....\$1.00 | TAXIDERMIST
Methods in Taxidermy.....\$3.50 |
| FORD (New)
Treated in Modern Gasoline Auto.....\$5.00 | TOURING KINKS
and Atlas.....\$1.00 |
| FORMULAS
10,000 Formulas.....\$4.00 | TOY MAKER
Toy Manufacture.....\$1.50 |
| FURNITURE MAKING
Mission Style.....\$3.00 | TREE REPAIR
Practical.....\$2.50 |
| | WELDER
Welding Encyclopedia.....\$5.00 |
| | WIRING
House Wiring.....\$2.50 |
| | WOOD FINISHING
Plain and Decorative.....\$2.00 |

Books sent C. O. D. anywhere in U. S.

Just check the ones you want, write your name and address below, and mail the whole advertisement. It is your order blank. When postman hands you books, pay him the price and the postal charges. If outside the U. S. remit when ordering and include 10 cents per book extra for postage. We have many other books on these and 2,000 other subjects. Catalog free.

Name.....

City.....State.....

Address.....

Mail to Popular Mechanics Press, Room P10—200 East Ontario St., Chicago, Ill.

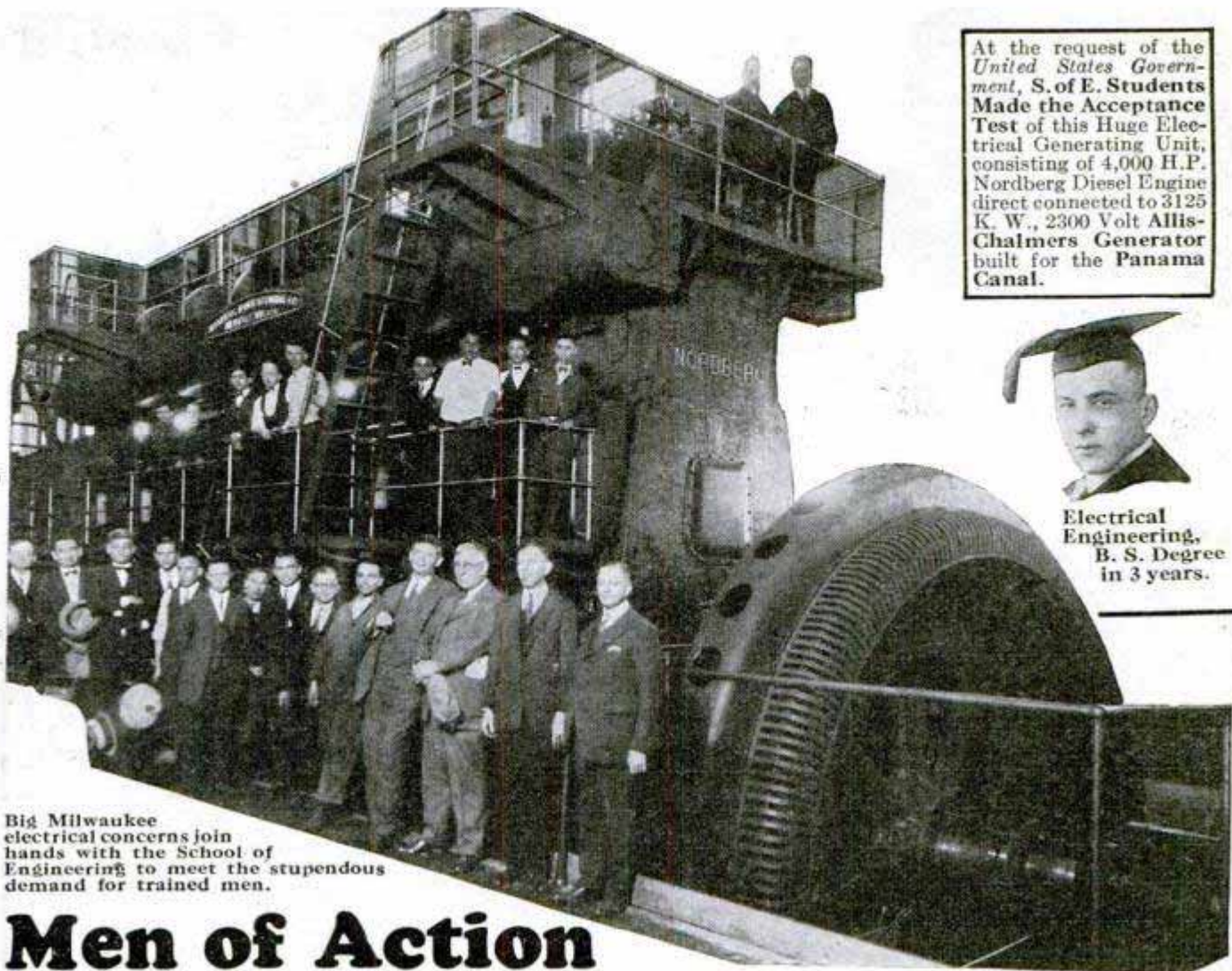

At the request of the United States Government, S. of E. Students Made the Acceptance Test of this Huge Electrical Generating Unit, consisting of 4,000 H.P. Nordberg Diesel Engine direct connected to 3125 K. W., 2300 Volt Allis-Chalmers Generator built for the Panama Canal.

Electrical Engineering, B. S. Degree in 3 years.

Big Milwaukee electrical concerns join hands with the School of Engineering to meet the stupendous demand for trained men.

Men of Action

WANTED FOR

Commercial Electrical Engineering

Takes you out of the class of the common laborer of which there is always an over plentiful supply at cheap rates of pay. Makes you a Graduate Electrician, Junior Electrical Engineer, or Commercial Electrical Engineer in 12 short months. Puts you in line for a job where big manufacturers are actually pleading for trained men and glad to pay Big Salaries ranging from \$2,000 to \$10,000 a year. Not a dream—A DEAD SURE FACT! For 24 years we have trained men for the electrical profession and Our Graduates Have Succeeded in All Parts of the World. Our 12 months' intensive training is the boiled down essence of what We Know fits men for big paying positions. It is work you'll love. No limit to advancement. Practical engineers teach you. They know What to teach and How to teach it, so you can earn money with it. Hundreds of thousands of dollars' worth of actual commercial machinery to work on in this school.

Uncle Sam Asks S. of E. OK!

Think of the opportunity to test plants such as this. The Nordberg Manufacturing Company is only one of many large concerns that is co-operating with School of Engineering students. This type of practical work, while in school, insures your future when you graduate. That's why our men are always in demand and always command big salaries. You can be one of these men if you ACT!

Earn While You Learn

By our special system you may earn part of your way while learning. Our Employment Department will help you secure a position to which you may devote a part of each day, spending the remainder at the school. This plan both solves the students' financial problems and provides splendid experience at the same time. Low tuition fee. Board and room reasonable. Daily Broadcasting WISN (formerly WSOE). School Orchestra. Fraternities.

Write for FREE Catalog

Write today for our free, illustrated catalog. Read about this wonderful institution and the great opportunities that lie before you. Find out about our specialized method of training and the details of our "Earn While You Learn" plan.

Radio and Electrical Refrigeration

Learn in three months—just 90 days and you can be one of the new group of trained men who will guide and develop the newest and best paying of America's gigantic industries. Radio and Electric Refrigeration are tremendous money makers for the trained man who gets into the game early. Experts are needed for big, responsible, well-paying jobs. We train you quick and help place you in a good position. ACT NOW!

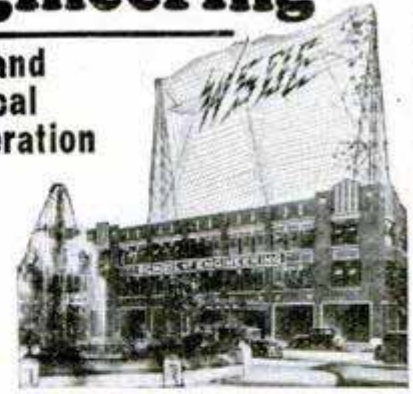

FALL TERM OPENS NOW

School of Engineering of Milwaukee, Dept. P. M. 1028, Milwaukee, Wis.

Without obligating me in any way please mail free Photo Story book, "Rise to Success Through Electricity" (just off the press), and NEW Bulletin regarding the course I have marked with an X.

- | | |
|--|---|
| <input type="checkbox"/> Commercial Elec. Eng. for High School Grad. 1 year. | <input type="checkbox"/> Elec. Refrigeration, Radio. |
| <input type="checkbox"/> Commercial Elec. Eng. others 1 to 2 years. | <input type="checkbox"/> Armature Winding, Light, Heat & Power. |
| <input type="checkbox"/> Elec. Eng., B.S. Degree 3 yrs. | <input type="checkbox"/> Practical Electricity. |
| <input type="checkbox"/> Automotive Elec. | <input type="checkbox"/> Home Lab. Service. |
| <input type="checkbox"/> I am interested in your Earn While You Learn Plan. | |

Name.....Age.....
 Address.....
 City.....State.....
 Education.....

SCHOOL of ENGINEERING
 of Milwaukee
 Founded 1905 PM 1028 Milwaukee, Wis.



"I Won't Be Clerk Any Longer!"

—so said P. S. Blessing, and through Higher Accountancy increased his salary 250 per cent.

For four years Philip S. Blessing worked hard as a clerk and got nowhere. He saw opportunities for promotion and salary increase, but they went to other men because he wasn't ready for them. He learned what every successful man knows—opportunity without trained ability means nothing. He decided to get that trained ability!

Within fifteen months after he started with LaSalle in Higher Accountancy, Mr. Blessing was made Assistant Treasurer of the Lancaster Brick Company, Lancaster, Pa., and his salary was increased 137 per cent. Since then it has increased even more, until now it is 250 per cent larger than when he enrolled. His employer, Clarence B. Horning, General Manager, adds the vital point: "We believe he has many successful years ahead of him. His business progress has only begun."

Send for Free Book—

"Accountancy, the Profession that Pays"

Is Mr. Blessing's swift promotion exceptional among LaSalle-trained men? Not at all. His record is typical of what hundreds of others have accomplished. Harry J. Williams, for example, was clerk with the Lehigh Valley Railroad. Through Higher Accountancy he won the position of Accounting Engineer, with a salary-increase of better than 60 per cent. John H. Lansing—now Public Accountant and Income Tax Specialist at Amsterdam, N. Y.—was 43 when he took up Higher Accountancy training. It increased his income more than 500 per cent.

Higher Accountancy training will not interfere with your present work; nor do you need bookkeeping experience in order to make your start. Our free book, "Accountancy, the Profession that Pays," will tell you everything you want to know about LaSalle training and the opportunities in the Accounting field. The coupon will bring it without cost or obligation.

— — — Find Yourself Through LaSalle! — — —

LaSalle Extension University

The World's Largest Business Training Institution

Dept. 1064-HR Chicago

I would welcome details of your salary-increasing plan, together with copy of "Accountancy, the Profession that Pays," also a copy of "Ten Years' Promotion in One," all without obligation.

Higher Accountancy

Training for positions as Auditor, Comptroller, Certified Public Accountant, Cost Accountant, etc.



Other LaSalle Opportunities

LaSalle opens the way to success in every important field of business. If more interested in one of the fields indicated below, check and mail now.

- | | |
|---|---|
| <input type="checkbox"/> Business Management | <input type="checkbox"/> Banking and Finance |
| <input type="checkbox"/> Modern Salesmanship | <input type="checkbox"/> Modern Business Correspondence |
| <input type="checkbox"/> Traffic Management | <input type="checkbox"/> Telegraphy |
| <input type="checkbox"/> Railway Station Management | <input type="checkbox"/> Expert Bookkeeping |
| <input type="checkbox"/> Law: Degree of LL. B. | <input type="checkbox"/> C. P. A. Coaching |
| <input type="checkbox"/> Commercial Law | <input type="checkbox"/> Business English |
| <input type="checkbox"/> Industrial Management | <input type="checkbox"/> Commercial Spanish |
| <input type="checkbox"/> Modern Foremanship | <input type="checkbox"/> Effective Speaking |
| <input type="checkbox"/> Personnel Management | <input type="checkbox"/> Stenotypy—Stenography |
| <input type="checkbox"/> Credit and Collection Correspondence | |

Name.....

Present Position.....

Address.....

Play Piano BY EAR

—IN 90 DAYS!



Play anything—jazz to classical! Even if you know nothing about piano music—I'll have your fingers dancing over the keyboard with confidence in 90 days. If you can hum or whistle a tune you can play it! My students are broadcasting—making money. MAKE ME PROVE IT! Without puzzling notes! Without practicing tedious scales! I've found the way to bring out your musical instinct. New and original system done away with years of work. YOU WANT THE PROOF? I'll send it. Write me now.

D. M. SUTTLE, Director
ILLINOIS SCHOOL OF MUSIC
615 Hunter Bldg., Chicago, Ill.

Send NOW for PROOF!

THE RED BOMBER COMBAT PLANE



FREE!

Positively a sensational offer. Here's the Red Bomber Combat Model Plane, a twin propeller model that flies amazingly. And you can have it free! Boys everywhere are flying model planes. Now is the time to get yours. This sensational plane will fly 600 feet easily, often further. Wings made of special fibre, two powerful rubber motors, two cleverly fashioned propellers. Not a glider—a real model plane.

two powerful rubber motors, two cleverly fashioned propellers. Not a glider—a real model plane.

Assembled in two minutes

Best of all no tedious hours of toil constructing. This plane can be put together ready to fly by any boy in less than two minutes—positively! Two minutes after the postman delivers your plane, you can send it into the air diving and dipping, zooming, banking, then soaring to greater heights. Every boy will envy you. Order your plane right now!

THRILLING BOY'S MAGAZINE

12 Fat Issues

THE OPEN ROAD for BOYS has 50 pages crammed with stories of aviation, mechanics, sport, high adventure, great serials, jokes and humor. Correspondence club. Contests galore for all. "Golden Medallion," mystery serial smash now starting—breathless reading!

We will send you the Red Bomber Combat Plane and a subscription to The Open Road for Boys Magazine—12 fat issues—both for \$1. Send the coupon now.



BOTH FOR ONLY \$1

Pilot McWalter,
Open Road for Boys Magazine,
130 Newbury Street, Boston, Mass.
Friend:

By all means I will grab this offer. Enclosed is \$1. Please rush me the Red Bomber Combat Model Plane. Enter my name to receive a year's subscription—12 issues—to The Open Road for Boys Magazine beginning with the very next number.

Name.....
Street.....
Town or City.....
State.....

You'll Get a pleasant Surprise



Big Money In MAGIC

*Read What These Men Are Making
In Their Spare Time!*

\$225 Extra

**—and hasn't yet
finished his course!**

"So far I have had a return
of \$225.00 from the Tarbell
Course in Magic."

GEORGE BROWN,
Detroit, Michigan

(Get that—not yet through with
his course and makes \$225.00—
spare time—evenings!)

\$200 Extra

**—only about half
through his course!**

"I have made the Tarbell
course pay for itself nearly
three times over to date."

THOMAS DUNCAN,
New York, N. Y.

(Mr. Duncan has already
earned nearly \$200.00 evenings
—spare time—and is only a
little more than half way
through his course.)

\$10 for ½ hour

**—after only 22
lessons!**

"I am being booked in
local shows, receiving more
money than ever before.
Just yesterday I performed
before a club of business
men at \$10.00 for a half
hour act."

FRANK FUNK,
Youngstown, Ohio

(Think of it!—about one-third
through the course and getting
\$10.00 for a half hour's EASY
Work.)

These men probably never dreamed that they could learn real professional Magic—so easily and quickly, at home, by mail. Men and women everywhere find that they—in an amazing short period—before they finish the course—are able to make big money performing Magic in the evenings during their spare time.

YOU Learn Easily—Quickly— At Home—By Mail

You, too, will soon find it easy to make from \$350.00 to \$1000.00 a month performing Magic. Even though you don't think you possess the slightest magic skill you will be amazed to see how quickly and easily the great Magic Wizard, Dr. Harlan Tarbell will have you mastering and performing real professional Magic. Baffling secrets of the world's greatest magicians—mysteries of the orient, wierd magic illusions as well as a massive array of card tricks and parlor magic effects. Mail coupon now and learn ALL that Dr. Tarbell will do for YOU. And remember you learn by mail—at home—during your spare time.

Astonish Your Friends

Your friends will be astonished at your amazing magic powers. You will be the life of every party—the center of every crowd. Business and social success come easy when you learn Magic the Tarbell Way. And it is EASY with the Tarbell Course. A great future lies right ahead of you—if you act quick—mail coupon NOW.



Dr. Harlan Tarbell, internationally known magician and teacher of some of the world's greatest magicians.

Magic Book Free

Write Don't delay—mail coupon now for the big free Tarbell Magic Book. Endorsed by the world's greatest magicians.

Learn what the great Magic Wizard, Dr. Harlan Tarbell will do for YOU. Get all the astonishing news. Get our low prices and easy terms. But—act quickly! No obligation. Hurry. Mail coupon NOW!

Tarbell System, Inc., Studio 13-57
1926 Sunnyside Ave. Chicago, Ill.

Mail for Free Magic Book!

Tarbell System, Inc., Studio 13-57
1926 Sunnyside Ave., Chicago, Ill.

Gentlemen: Without any obligation send me your free literature and information all about your wonderful "Tarbell Course in Magic." Also tell me about your Low Prices and Easy Payment Plan.

Name

Address

Age

One Little Ounce of Magic Dots Will Hold 25 Ruptures!!

Free!

Amazing new book explains new discoveries on rupture relief. Now sent free to rupture sufferers. Also get free sample of Airtex, the new way to hold rupture without pressing. Not a penny to pay, now or future. Simply tear out coupon below!

NO wonder over 20,000 rupture sufferers have switched to this new way to relieve rupture!

Magic Dot is so light in weight, so small and inconspicuous, that twenty-five of them weigh only one ounce! It would take fully three hundred of them to equal the weight of one truss that consists of steel springs, leg straps and hard cushions!

Think what this invention means to rupture sufferers in convenience alone! Yet convenience is only one of Magic Dot's many benefits in the correction of rupture and the end of constant pain, discomfort and embarrassment!

How it works

If you could always hold your rupture together with your thumb and forefinger, your rupture would probably disappear

in time. That is all the pressure it needs. And that is exactly the way Magic Dot operates. It weighs less than a feather, measures little larger than a quarter. Once fixed in place, it stays in place until you take it off.

But how does it stay always fixed against the rupture despite any movement of the body? The answer is Airtex—the most radical improvement in rupture appliances yet discovered. It is a flesh-soft pad about the size of your palm—filled with myriad air cells that sweep a constant flow of fresh cool air in, through and around the rupture.

You be the judge

You cannot fully appreciate the radical difference and marvelous improvement of Magic Dot until you see it fully described in the book now being sent free to rupture sufferers . . . until you feel the velvet-like softness of Airtex. Read the case histories below. Probably these cases and many others relieved by Magic Dot were worse

than yours. Why suffer needless pain, discomfort and embarrassment? Mail the coupon below now! New Science Institute, 2153 Clay St., Steubenville, Ohio.

Mail This NOW!

New Science Institute, 2153 Clay St., Steubenville, Ohio.
Yes, send me your interesting free book describing the wonders of the New Science System of rupture relief. This request does not obligate me.

Name
Address
City
State

Were These Rupture Cases Worse Than Yours?

"I am 80 years of age and have been ruptured 32 years. In that time I tried many trusses, but never have I found anything as easy and comfortable as the New Science Support. Have been trimming the lawn, working on my knees most of the day and Magic Dot and Airtex Pad stay right in place." — Henry C. Atwood, Los Angeles, Calif.

"My rupture is entirely cured. I believe the cure was complete within sixty days after I put on the appliance. However, I kept wearing it for six months, but now I use nothing of the appliance. I have been ruptured 20 years and my rupture dropped clear down into the scrotum." — M. P. Brumbaugh, Juniata, Penn.

"I am writing to let you know that my rupture does not trouble me any more and I think in a little while it will be gone. Your appliance has all you claim for it. Before I got it I could work only part of the time. Now I can do almost anything." — Mrs. C. W. DeLong, Gilboa, N.Y.



* HUNDREDS OF MEN ARE \$60 a Day!



**DEALERS BUY
ON SIGHT!**

Selling this Newly Invented
**MASTER Suction
ASH RECEIVER**
for Autos, Homes,
and Offices

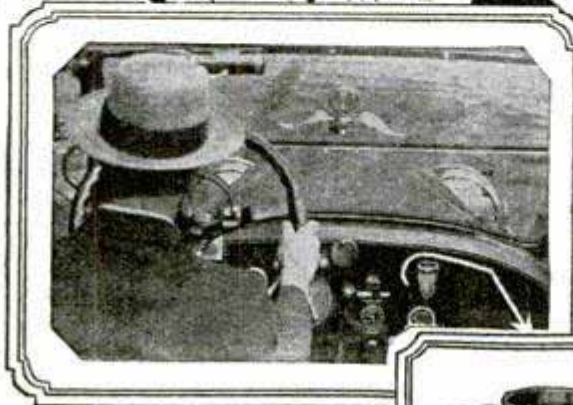

*We can show you names of hundreds of men in our files who are making that much and more right now. You can do the same. We will show you how.

You Make 100% Profit — Selling-to-Dealer Plan Starts You in a Big Paying Repeat Business

In selling to dealers, it is your job to distribute Master (Suction) Ash Receivers to dealers in your community. Sell to GARAGES, HARDWARE STORES, CIGAR STORES, DRUG STORES, AUTO ACCESSORY STORES, FILLING STATIONS and NOVELTY SHOPS; in fact, every store along the street is a good prospect. Every dozen Ash Receivers in assorted colors is packed in a handsome self-selling counter display box, a powerful silent salesman which catches the attention of everyone who comes into the store and makes sales automatically without any attention from the clerk. Keen merchants are always on the look-out for fast selling specialties and they realize at a glance that this product is a self-seller. Any dealer will be glad to place an order with you, and you both make a handsome profit.

This Whirlwind Seller and 4 Tested Selling Plans Lead You to Big Money!

Regardless of what your past experience has been, your earnings will be \$60.00 a day and more by following any one or more of our successful sales plans, selling patented Master Suction Ash Receiver—absolutely new and practical—a marvelous invention which holds to any surface by means of a SUCTION GRIP. No screws, no holes to bore—just press it on and it stays on. Comes off in a jiffy for emptying. Just what auto owners need. Keeps cars clean. A wonderful convenience and protection, complying with automobile fire laws. Ideal for autos, homes and offices as Cigarette Holder or Ash Tray. Made of durable Bakelite in Black, Brown, Red, Green and Mottled. A color to harmonize with every interior.

With Individually Engraved Gold Initials You Sell Every Prospect. Retail for Only 75c—You Make Up to 200% Selling to Consumers

Master Ash Receivers individually monogrammed with the owner's initials in gold gives them an added touch of richness and beauty and has a powerful personal appeal that no one can resist. You don't miss one sale in a hundred. Priced so ridiculously low you sell two or more at a glance.

Start Your Own Mail Order Business — Overnight! The Most Sensational Plan in Direct Selling

This plan is entirely new and different. The mailman brings you orders with cash enclosed in every envelope. We have originated a new, self-selling mailing envelope which is marvelous for getting orders by mail. These circulars offer the Master Ash Receiver to auto owners with a surprise FREE PREMIUM—the combination for \$1.00. We furnish these circulars at cost and imprint your name and address. These clever auto circulars do all your selling. They are distributed in empty cars, parked in streets or in garages, or they are mailed out to prospective customers. Full details of this amazing plan will come to you with your order for sample or dozen.

SEND FOR A SAMPLE OR A DOZEN NOW! Make \$4.50 Profit on Dozen in Less Than Half Hour

Send 50c (stamps if you like) for sample Master Ash Receiver, or better still, get started immediately. Order a dozen Master (Suction) Ash Receivers at our dozen price of \$4.50. They will come to you in assorted colors, packed in the "Self-Selling" display carton illustrated here. You make \$4.50 profit on the dozen selling to consumers or use sample dozen to take orders from dealers. They must sell or we refund your money. On bigger orders your profit is greater. Send \$4.50 with coupon, or attach a dollar bill (\$1.00) and we'll ship the dozen promptly C. O. D. for the balance. With your order for sample or dozen you will receive complete selling instructions and full details of all selling plans. You take no risk. We guarantee to refund your money for the dozen absolutely.

Exclusive Territory to Producers

Now is the time for you to get into this Master Ash Receiver business, because as soon as you show us that you mean business, we will protect you in as much territory as you can handle. You can still reap the many advantages of getting in on the ground floor of this whirlwind seller. Act Now!

GORDON MFG. CO.
DEPT. K-9
110 E. 23rd St., NEW YORK

We show you how to place this Self-Selling Display Carton on 20 store counters and make \$60.00 a day Profit!



**Rush
Coupon**

Gordon Mfg. Co. (Dept. K-9), 110 E. 23rd Street, New York.

I enclose \$.....for which please send me order checked below:
 One dozen Master Ash Receivers, in self-selling counter display carton. Price \$4.50. (If \$1.00 is enclosed, send one dozen for the balance C. O. D.)
 Sample Master Ash Receiver. Price, 50c. (Stamps will do)
 Please include full details of all your sure-fire, selling plans which guarantee that I will make sales.

Name.....
 Address.....
 Town..... State.....

Learn to Mount Specimens like These

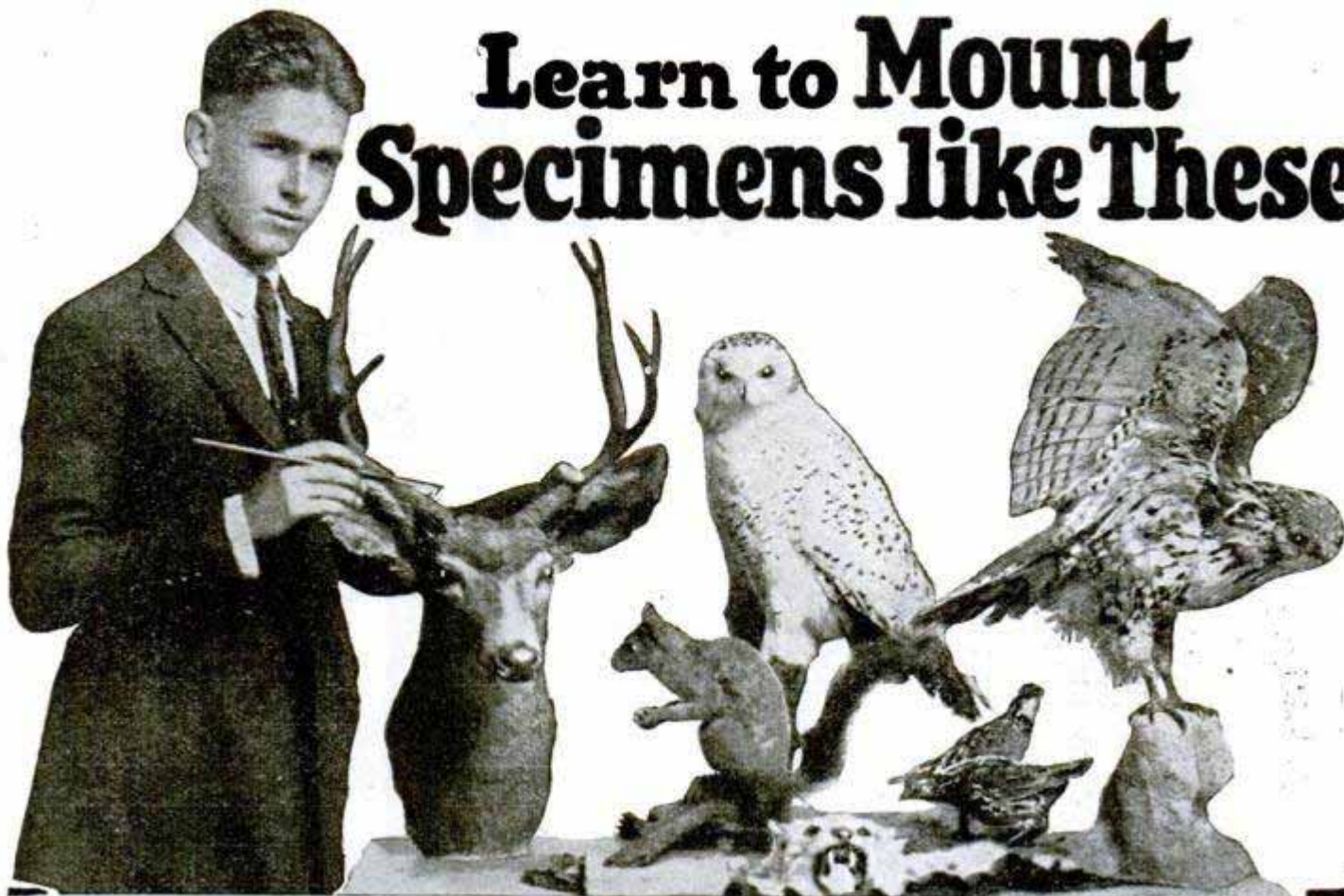

Make Big Money—

Taxidermy is the most profitable OF ALL spare time work. Sell your mounted specimens. Mount trophies for your friends, hunters, trappers and fishermen. Have a side business of your own. Be independent. Have plenty of spending money—for athletic goods, radio, books, traps, and for vacations. Here is your opportunity. Don't delay. Send the coupon right NOW.

Free Book Coupon

Northwestern School of Taxidermy
3377 Elwood Bldg., Omaha, Nebr.
Send me, absolutely free, your illustrated book "How to Mount Game." Also tell me how I may learn to be an expert taxidermist easily and quickly by mail. No obligation.



"Be Wise"

Name _____

Address _____

LEARN to mount and stuff all kinds of game, animals, birds, fish—tan furs and skins, make beautiful rugs, robes, etc. You can learn *easily and quickly* during your spare time by mail. *Great sport and lots of fun.* Lessons are easy and intensely interesting. Latest museum methods. This school is 20 years old, high class and reliable, and has 75,000 graduates. *Success guaranteed.* Don't delay, but start to learn this extremely fascinating art NOW.

FREE

Beautifully illustrated book, "How to Mount Game." Explains the secrets of taxidermy. Dozens of photos of mounted specimens. Tells how you can learn this great art, no longer a secret, right in your own home during *spare time*. Tells how to

become a taxidermy artist, how to save your own splendid trophies, how to beautify and decorate your room and home with nature's choicest art.

Tells how young men and boys can make the BIGGEST MONEY from their spare time. Don't delay. Clip coupon now. Send TODAY for this Free Book.

TELEGRAPH-RADIO

Operators earn \$150 to \$350 month and up. Learn in Chicago or at home. Chance to work while training. We furnish operators to U. S. Govt., Railroads, Com'l Cos., Broadcasting Stations and Ships.

CHICAGO TELEGRAPH INSTITUTE, Dept. 1-10-8, 1338 So. Michigan Ave., CHICAGO, ILL.

\$2 each for names of new customers who wear an artificial eye. Send names of any you know and earn commission. Nothing to buy or sell.
DENVER OPTIC CO., 319 Quincy, Denver, Colo.



DRAW CARTOONS

TURN YOUR TALENT INTO MONEY

Cartoonists earn from \$50 to \$250 per week—some even more. Remarkable *Circle System of Drawing* teaches you in half the usual time. Students from all parts of the world are enrolling for this exceptional instruction. *Personal criticism* service and up-to-the-minute instruction make it easy for National students to attain success. Send for interesting **BOOKLET** and **SAMPLE LESSON PLATE** explaining full details of the Course and what National students are accomplishing. No salesman will call.

The National School of Cartooning, 623 Penton Bldg., Cleveland, Ohio



Get Into Practical Aviation

This large commercial transport-training Company will accept and train a limited number of additional men intensively or in spare time or by home study for good pay positions as pilots or ground mechanics. Only U. S. licensed, latest type planes, pilots and instructors. Complete shops; modern hangar on country's busiest air mail field. Employment service to help pay training and living expenses. Write your name, age and address and state experience on margin of this page; then tear out and mail at once. Full details and copy of Airway, valuable book, will be sent to you.

AVIATION SERVICE & TRANSPORT, Inc.
Dept. P. M. 10, 203 N. Wabash Ave. Chicago



You Can Be Strong and Healthy *STRONGFORTISM Will Make You So*



STRONGFORT

Dr. Sargent of Harvard declared that Strongfort is unquestionably the finest specimen of physical development ever seen.

SEND FOR MY FREE BOOK

This book of many pages and dozens of pictures tells of my wonderful experience—how I became the outstanding athlete of the world, performing feats others dared not attempt; how I turned the knowledge gained through developing my own body to the benefit of others, and then how STRONGFORTISM was evolved. It tells what I have done for others, what I can do for you. It doesn't mince words. It tells plain truths. "Promotion and Conservation of Health, Strength and Mental Energy," points the way from disease and weakness to health and strength. It is priceless. I'll send it to you on request—FREE. Write for your copy today.

STRONGFORT INSTITUTE
LIONEL STRONGFORT, DIRECTOR.

Physical and Health Specialist
DEPT. 614 NEWARK, NEW JERSEY, U. S. A.

You have no apology for being a weakling—a make-believe man—one who is laughed at, gossiped about, despised. You are to be pitied if you are discouraged and despondent and down with the blues, but don't go on suffering. You want to be a manly man—a strong, healthy chap it is a pleasure to meet and associate with—a fellow that men like to call by his first name—one whose company is craved—a regular fellow. And you can be just such a man, no matter how far down the ladder you've slipped, no matter how you've neglected yourself, no matter what your excesses or your dissipations. YOU CAN BE REVITALIZED, regenerated restored to the full flower of manhood—

STRONGFORTISM Will Make a Man of You

Men who were afflicted with all sorts of ailments—annoying, destroying, weaknesses—men who were ashamed of their lack of stamina and muscular power—men who had well-nigh given up hope of ever being strong again—these men—thousands of them—in this country, in South America, in Europe, in Australia, in Cuba, in India even—came to me and they were put on their feet, restored to health and strength and became men who were proud of their physique and who feared no one—respected by men.

Our Pupils Praise Strongfort Methods

If you will take the time to read some of the fine testimonial letters that come from pupils everywhere you will realize the extent of the good that STRONGFORTISM has done. You will have no doubt of its value. You won't hesitate to apply it to yourself if you want robust health, vitality and muscular strength.

My Record in Body Building is Unparalleled

You can get rid of Constipation, Catarrh, Nervousness, Rheumatism, Indigestion, Dyspepsia, Weak Back, Insomnia, Palpitation and a whole string of other ailments if you will take up Strongfortism in dead earnest. I want to help you—and I can help you if you will give me a chance—if you will write and tell me what troubles you.

For over 27 years I have devoted myself to the development of men's bodies into fine specimens of manhood—not that they all wanted to be athletes, but because they wanted to possess full physical powers and feel like real men. No one in history has done more in the way of body building and restoration.

Send this FREE Consultation Coupon ABSOLUTELY CONFIDENTIAL

Mr. Lionel Strongfort, Strongfort Institute, Dept. 614, Newark, N. J.—Please send me absolutely free my copy of your book, "PROMOTION AND CONSERVATION OF HEALTH, STRENGTH AND MENTAL ENERGY." I am enclosing 10c (one dime) to help cover mailing expense, etc., and have marked (X) before the subjects in which I am most interested.

- | | | |
|-------------|-----------------|-------------------------|
| .. Catarrh | .. Overweight | .. Weak Heart |
| .. Colds | .. Constipation | .. Great Strength |
| .. Asthma | .. Weak Back | .. Lung Troubles |
| .. Headache | .. Weak Knees | .. Round Shoulders |
| .. Rupture | .. Rheumatism | .. Stomach Disorders |
| .. Thinness | .. Nervousness | .. Increased Height |
| .. Pimples | .. Short Breath | .. Muscular Development |
| .. Insomnia | | |

Other Allments.....
 Name.....
 Age..... Occupation.....
 Street.....
 City..... State.....

Caruso's



A post-mortem of Caruso's throat showed a superb development of his Hyo-Glossus muscle — the basic reason for his tremendous vocal power.

Strengthen your Hyo-Glossus

**-and YOUR Voice
will be Powerful,
Rich, Compelling**

YOU have a Hyo-Glossus muscle in your throat. But you never use it because the nerve center in the brain controlling this muscle is dormant.

The great secret of isolating this great vocal muscle was discovered by Eugene Feuchtinger, A.M., famous European musician-scientist, who has now made his simple scientific method of voice development available to everyone. It is ideally adapted to correspondence instruction. The exercises are silent. You can practice them in the privacy of your own home. The results are sure.

100% Improvement Guaranteed

The Perfect Voice Institute guarantees that Physical Voice Culture will improve your Voice 100%. You are to be your own judge—take this training—if your voice is not improved 100% in your own opinion, your entire tuition will be refunded.

Inspiring Book FREE Send the coupon below and we'll send you FREE this valuable work, "Physical Voice Culture." You assume no obligation. It may be the first step in your career. Do not delay.

Perfect Voice Institute

1922 Sunnyside Ave., Studio 13-57 Chicago

Perfect Voice Institute 1922 Sunnyside Ave. Studio 13-57 Chicago

Please send me a copy of your new book, "Physical Voice Culture," FREE. I understand that it is mine to keep and there is no obligation on my part. I am interested in

Singing Speaking Stammering Weak Voice

Name.....

Address.....

Age.....

Increase Your Earning Power

Apply time and labor-saving kinks to your work. Your efficiency will soon be recognized and you will be in line for advancement.

If you do machine shop work of any kind, sheet-metal work, painting, carpentry, auto repairing, farming, concrete work, plumbing, electrical work, welding, building glass work, general repairing, tool-making, poultry raising, masonry or home repair work, get this

LIBRARY OF 6000 TIME AND LABOR SAVING IDEAS FOR SHOPMEN AND HANDYMEN

15
B
I
G
V
O
L
S.

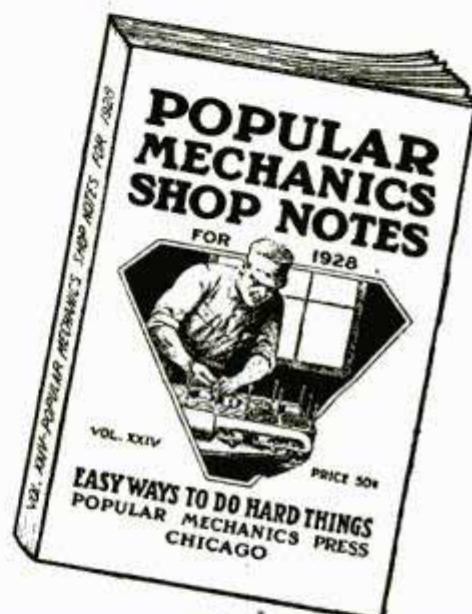

L
I
K
E
T
H
I
S

Think what it would mean to you to have the 15-volume Shop Notes Library of 6,000 easily understood short cuts to every-day jobs. Here are some of the subjects taken from just one of the volumes as an illustration:

Sheet Metal Working	Electrical Kinks	Cutting Glass
Painting Kinks	Battery Charging	Flagstone Walks
Carpentry	Cutvert Work	Hints for the Builder
Automobile Repairing	Automobile Repainting	Refinishing Soft-Wood Floors
Machine Shop Work	Hot-Flame Blowpipe	Setting Window Glass
Farm Mechanics	Lawn Mower Repairing	Etching Brass and Copper
Tool Repairing	Beautifying Your Home	Glue and Its Use
Lock Repairing	Portable Air Compressor	Proper Hot-Water Heater Installation
Key Making	Gasoline Pump Extension	
Concrete Work	Log Cabin Construction	
Poultry Appliances	Folding Bed for Roadster	
Plumbing Kinks		

Each volume contains approximately 500 articles and 400 illustrations and has 224 Pages. At the regular price of 50 cents per single volume this library costs you \$7.50 but for a limited period we will supply the 15 vols. when ordered at one time at the special reduced price of only \$4.50.

SEND NO MONEY

SPECIAL OFFER COUPON

POPULAR MECHANICS PRESS,
200 E. Ontario St., Room P10, Chicago, Ill.

Send me, as per your special offer the following books. I will pay postage and the price of books when they arrive. My money will be refunded if I am not satisfied. (Check what you want.)

1928 Shop Notes and Lathe Handbook, 98¢ Complete Shop Notes Library (15 vols.) \$4.50

Name.....

Street and No.....

City..... State.....

Double Your Strength Almost Overnight!

GET this, men! It's the greatest of all discoveries in physical culture! It's the secret that makes CHAMPIONS!

You don't know your own strength! There are hidden forces in your muscles that will amaze you. Learn how to use them and you'll be doing feats of strength you never thought possible. You'll be ALIVE with dynamic vitality. You'll have the SPEED of greased lightning—the deadly, crashing POWER of a tiger's spring. And oh man, what a PUNCH you'll pack. Just let some big bully start something with you—he'll think a Kansas cyclone hit him!

Throw away the old-fashioned dumb-bells and all the rest of those moth-eaten exercisers. Quit working your heart out to raise a couple of bumps of lead-like muscles. Let Science do for you almost overnight what years of ordinary exercising will never do.

Muscles Grow Like Magic

Muscle Concentration—that's the secret of SUPER-strength. Develop the power of Muscle Concentration and YOU will be in the CHAMPIONSHIP class. You will be able to concentrate into any single muscle the entire strength and nervous energy of your whole body. You will have more strength in your little finger than most men have in their arms!

You don't want BEEF. You don't want the clumsy, useless hulk of an

elephant. Let me build you the body of a CHAMPION. Almost before you know it you'll have one of the prettiest developments you ever laid eyes on. Your whole body will be wrapped in beautiful, long, rippling muscles. Take a look at the pictures on this page. They show how Titus Training makes muscles GROW! And boy, they grow FAST! Titus Training is SCIENTIFIC—it develops EVERY muscle in your body. It makes you over from head to foot, inside and out.



BEFORE Here's the way this lad looked before he wrote to Titus—pale-faced, soft, undeveloped. He had no more muscle than a snow-man. No strength, no energy. He certainly needed help.



AFTER And this picture shows what a few weeks of Titus Training did for him. He's as hard as nails now, and look at those big powerful muscles. Note how all his muscles are developed—arms, chest, stomach, etc.

Don't Miss This Amazing Book—Mail Coupon NOW



Wear This Medal
Strong men all over the world wear it. Made of solid statuary bronze and given to you free. Mail Coupon for full details.

Find out about the amazing discovery of Muscle Concentration. Read why Titus Training accomplishes such astounding results. See what it has done for thousands of others. This wonderful book is yours FREE if you send your name and address AT ONCE. Just shoot along a nickel to pay postage. Do it now—you can't afford to miss THIS book.

The One **TITUS** 105 E. 13th St. and Only New York City

Titus, Dept. M-1211
105 East 13th St., New York City.

Dear Titus: Send me a copy of your big new Book, "Miracles in Muscle." Here's a nickel for postage.

Name.....

Address.....

City.....State.....



What They Write Me:

"My last pay check was \$83.97. I learned battery work with you."
—Clarence Mitchell, Michigan.

Learn Auto Mechanics

In 8 Short Weeks

Regular Shop Work—No Books

STEP RIGHT INTO A BIG PAY JOB

I'll Pay Your R·R· Fare to Cincinnati

Why go on begging for a raise? Why growl and complain because you don't get it? Why, when every city, town, and farming community is pleading for more auto and tractor mechanics—trained as McSweeney students are trained, to know cars of every make and to know them "inside out"?

McSweeney Men Make Good

Every month my men are taking fine jobs formerly filled by half-trained students or half-baked, self-trained mechanical tinkerers. Let me send you the "proof," letters from former McSweeney students now earning up to \$10,000 a year, and few earning less than \$50.00 a week. "Mac's SHOP WAY Means Bigger Pay."

Employment Department Helps You

My employment department aids students to find spare time work while they study, and also helps graduates locate good-paying positions. Mac doesn't forget about his graduates after they finish his course.

No Experience or Education Necessary

Think of it! Working with real tools on real equipment you become in only EIGHT WEEKS a better auto mechanic than men who have "fiddled" around an

ordinary garage for years trying to learn. No previous experience or education necessary. You learn by doing practical jobs on real equipment with real tools.

Your Money Back Guaranteed

If, when you have finished your training, you are not perfectly satisfied; if you are not qualified to fill a big pay job, I will refund every cent

of your tuition. Save one-third by writing now for fascinating, illustrated book on AUTO AND TRACTOR MECHANICS. Your copy is free. Write now for remarkable tuition offer.



McSWEENEY Auto and Tractor School,
654 McMillan St., Cincinnati, Ohio., Dept. 11-R.
Please send your Big Illustrated Book, and FREE Railroad Fare and Employment Offer.

Name.....
Address.....
City..... State.....

BIG BOOK FREE
Just Mail Coupon

McSWEENEY SCHOOLS
AUTO AND TRACTOR DEPARTMENT
Cincinnati, Ohio

Brush DOLLARS INTO YOUR POCKET

Learn SHOWCARD WRITING; it pays big. Steady positions; countless side jobs. BEGINNER'S OUTFIT with DAILY'S SHOWCARD WRITING COURSE without extra charge—complete in 34 lessons—\$3. Best investment you ever made. Master this course; earn real money right off the reel. Get started—write today—every day you delay costs you plenty. I have out hundreds on the ladder to steady jobs at big pay. Can do it for you.

BERT L. DAILY
122 East Third St., Dayton, Ohio
Dept. O

CALCULATOR and BOOK

Kalqlex. Quick, Accurate, Durable. For Addition, Subtraction, Multiplication and Division to 6 places. \$1.00. Money back if not satisfied. Supersedes slide rule. Easily operated with 4 fingers at a time. Flat for pocket. Very helpful for quick figuring.

Dr. WETHERILL'S SPECIALTIES
AUDUBON, PA.

Don't Envy The Plumber—BE ONE!

\$11.00-\$16.00 PER DAY and work EVERY day, is the Plumber's wage.

LEARN IN 8 to 12 WEEKS without previous experience.

If you are making less than \$60.00 a week you owe it to yourself to investigate. Get FREE catalog that tells in pictures and words how we teach this trade. Special rates now.

UNIVERSAL PLUMBING SCHOOL, 2030 Troost Avenue, KANSAS CITY, MO.

CHEMISTRY—Learn at home

The Chemical Industry now ranks fourth among the industries of the United States and it offers a splendid opportunity for ambitious men.

One of the best ways to prepare for a good position in this fascinating field is through the home-study courses in Chemistry offered by the International School of Chemistry.

These courses are complete and practical because they were prepared by some of the best-known chemists in this country, including ALLEN ROGERS, B.S., M.S., Ph.D.

- Head of Department of Industrial Chemistry, Pratt Institute;
- L. M. TOLMAN, Ph.D.—Formerly Chief Chemist, Wilson & Co. Now Vice-president, United Chemical and Organic Products Co.;
- BRADLEY STOUGHTON, B.S.—Head of the Department of Metallurgy, Lehigh University, and OWEN L. SHINN, Ph.D.—Professor of Applied Chemistry, University of Pennsylvania.

INTERNATIONAL SCHOOL OF CHEMISTRY

DIVISION OF THE International Correspondence Schools
Dept. 5568-F, Scranton, Penna.

Without cost or obligation, please send me full details of your home-study course in CHEMISTRY



Mail coupon for Free Booklet

Name.....
Address.....



FREE BLUE PRINTS

AND FREE BOOK "HOW TO READ BLUE PRINTS"

SHOW YOU THE WAY TO

9 BIG PAY JOBS

- | | |
|--|---|
| 1 Building Superintendent — \$5,000 to \$12,000 | 6 Building Estimator — \$6,000 to \$10,000 |
| 2 Building Inspector—\$4,800 to \$8,000 | 7 Real Estate Expert—\$5,500 to \$12,000 |
| 3 Appraiser — \$6,000 to \$10,000 | 8 Construction Foreman—\$4,500 to \$8,500 |
| 4 Material Buyer—\$5,000 to \$7,500 | 9 CONTRACTOR AND BUILDER IN A BUSINESS OF YOUR OWN—\$5,000 to \$12,000 |
| 5 Material Salesman—\$5,000 to \$12,000 | |

FIND OUT HOW

Easy it is to Make \$4,500 to \$12,000 a Year

Learn to read Blue Prints this amazing new way! Get into the world's richest industry—Building! See how quickly and easily you can train to make \$4,500 to \$12,000 a year! My FREE Book "How to Read Blue Prints" discloses all the so-called "mysteries" of Blue Print Reading—also gives some startling facts about the nine best jobs in America. Don't send one penny—just mail the coupon!

NO longer need you spend years trying to pick up the "mysteries" of Blue Print Plan Reading. For now a quick, sure practical method has been perfected that has made thousands of men Blue Print Experts in a surprisingly short time.

This is no ordinary "school course." It is practical from start to finish. It is based on many sets of real Blue Prints—plans that would cost thousands of dollars if purchased from architects. Twenty famous experts in all lines of construction work talk over these Blue Prints with you in plain simple language. Show you every detail. Explain every short cut. Tell you the "secrets" of quick, accurate estimating. Explain Superintending. Give you for the first time many inside facts and money-making methods used by the "Giants" of the Building Industry. This is the kind of training that quickly puts men into \$4,500 to \$12,000 a year jobs—or into profitable contracting businesses of their own. Yet now you get it right at home in only 2 or 3 months. It requires no extensive education. If you can read and understand what is written here you can easily master it.

See what this training has done for others: Bartholomew, Calif., became a contractor at an in-

crease of over 300% his first year; Blair, Okla., stepped up to Superintendent at 100% increase; Dickerson, R. I., increased his salary 700% in 12 months; Marchand, La., says: "My income has increased 200% and I now have more contracting work than I can do."

Over seven billion dollars will be spent this year in new construction! No wonder then, such tremendous opportunities are open to you when you have this "head-work" training in Blue Prints.

If you want more money—real big money! Then choose a "Blue Print" job in Building, Clerk or Salesman, Carpenter or Bricklayer, here is the one field where there are unlimited opportunities for advancement.

So accept my FREE gift of a complete set of real working Blue Prints, and my fascinating Book, "How to Read Blue Prints" that tells all the interesting and instructive facts about Blue Print Plans. Don't send one penny—pay no C. O. D.—It's all FREE. Just fill out and mail the coupon today—NOW!

TWO BOOKS also FREE



IF YOU LIVE NEARBY

Visit our big day or evening school attended by over 1000 Builders. You can get the same training at home by mail—same plans, lessons and instructors. Your spare time is enough.

Chicago Technical School for Builders—Dept. N-141, Chicago Tech. Building, 118 East 26th Street, Chicago, Ill.

Please send me your free book, "How to Read Blue Prints," and complete set of real Blue Prints. I understand these are mine to keep without obligation. It is also understood that no salesman will call on me.

Name.....
 Address.....
 City..... State.....
 Age..... Occupation.....

Chicago Technical SCHOOL for BUILDERS



Dept. N-141, 118 East 26th St., Chicago, Ill.

You can have one of these fine

Power Plants

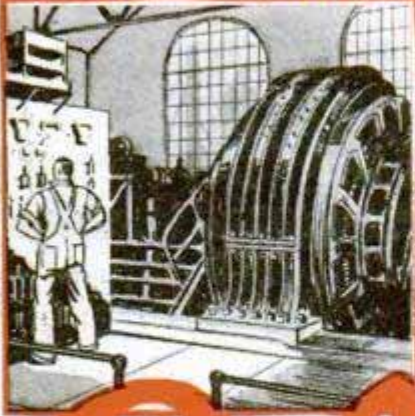

Transmission



Installation

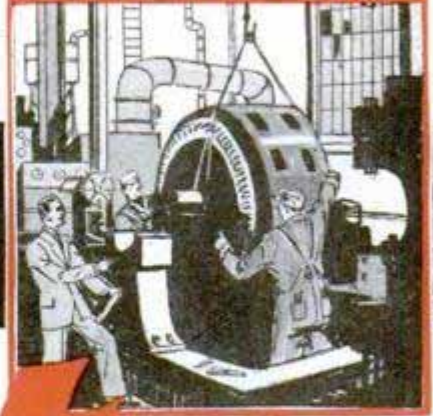

Electricity

**Chief
Engineer
DUNLAP**



and 29 Noted Engineers

have built a remarkable home-training in Electricity, using job-tickets and eight outfits of standard tools and materials, including the \$10 motor pictured below, all supplied without extra cost to the men we train. Theory and practice combined in a new, efficient way. Prepared by men from:

General Electric Co.
Commonwealth Edison Co.
Westinghouse Electric & Mfg. Co.
Western Electric Co.
Cutler-Hammer Co.
Allis Chalmers Co.
Mass. Institute of Tech.
Columbia University
and other leading corporations and universities



IF you are looking for the way out of small pay, hard monotonous work, frequent unemployment and lack of future—come into **ELECTRICITY**, the biggest, fastest-growing industry on earth. Here is a place and a chance for you.

This is the Electrical Age. Electricity turns our machinery, lights our homes and factories and offices and farms—gives us swift, clean transportation, carries our messages by telephone, telegraph and radio, thousands of miles—provides us with luxury and necessity at every turn. And the business has become as solid and prosperous as the nation itself.

That's the line to get into. **You can.** Get in touch with me and I'll tell you how.

Big Pay—Fine Jobs—Plenty of Them!

Thousands of giant Power plants, endless miles of transmission lines, huge installation projects, the manufacture of Electrical machinery and equipment, the operation and maintenance of billions of dollars' worth of Electrical properties, enormous building operations—these and a hundred other great branches of the Electrical industry provide more jobs, bigger salaries, and better chances for advancement than you can find in any other line. Work as interesting as an adventure. Security and a real future. A chance to make money anywhere in the wide world. A business of your own, or a permanent position. **All these now within your reach.**

Manufacturing

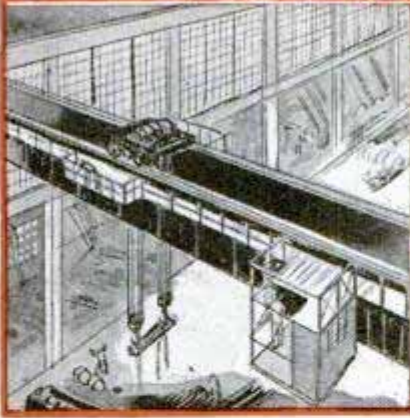

Building

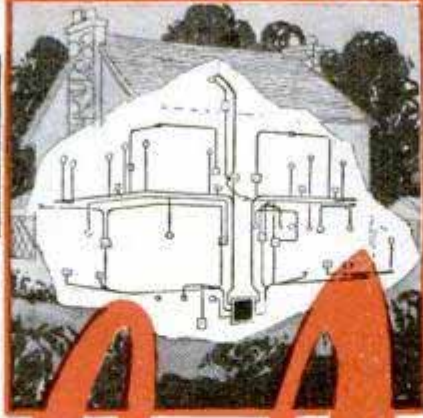

Thousand Uses



Electrical Jobs

The Way is easier than you think!

I AM looking for more ambitious young fellows to prepare for these fine Electrical positions. We are ready to make an agreement with you to quickly fit you for this interesting, well-paid work, then help you get placed at a substantial increase in pay or the entire service will not cost you a penny. We know the amazing opportunities open in Electricity, and we know exactly what training a man must have to take advantage of them. So we feel justified in putting our entire resources of over two million dollars back of this contract.

You can qualify for this life-time chance. If you are genuinely interested in Electricity, if you are willing to devote a part of your spare time to getting ready—you need neither money in the bank, nor a high-school diploma to get the training and employment service we offer.

If you are earning less than \$40 a week now, here is your opportunity to prepare for a position paying at least 50% more, at a cost you can afford, and **without cost**, if you don't.

Write me, or mail coupon, and I'll prove it.

Chief Engineer Dunlap

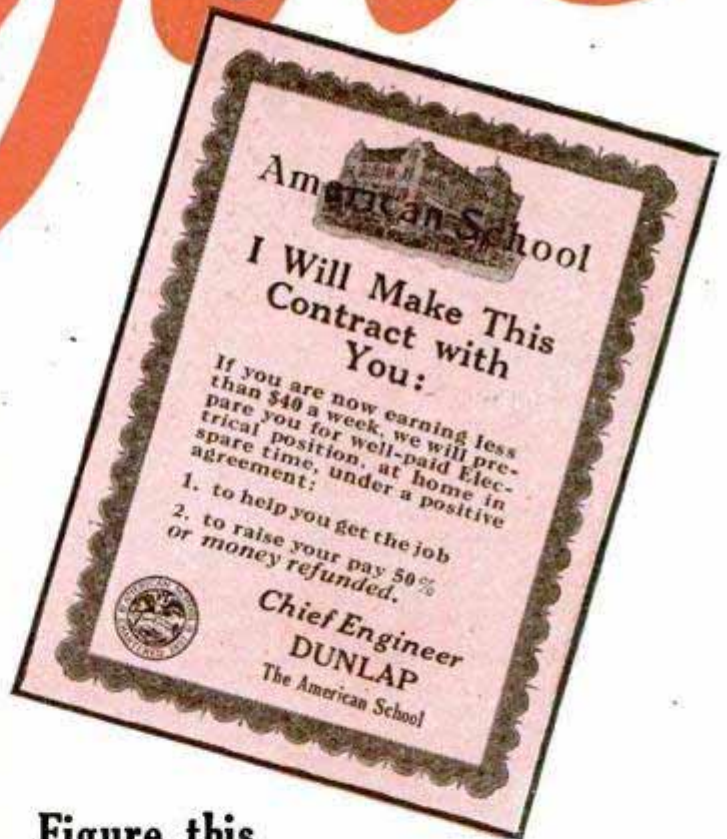

Figure this Agreement in Dollars and Cents!

If you are earning \$30 a week now, here is your chance to get \$45 a week and the \$15 raise will only cost you \$1.50 a week for a short time. That's better than a 10 to 1 "bet". Look into it.

The American School
Dept. E-774, Drexel Ave. & 58th St., Chicago, Ill.
Please send me complete information about your job and raise offer and facts about the opportunities in Electricity.

Name

Address

Age Occupation



Dept. E-774, Drexel Ave. and 58th St., Chicago, Ill.

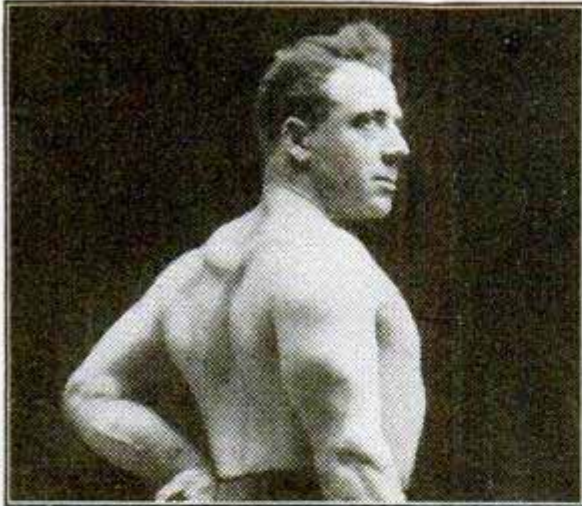

**"Rough? You
bet your life
I'm rough!"**

George F. Jowett.
CHAMPION OF
CHAMPIONS

Don't read another word if you think I've got any time to waste on MAMMA'S BOYS. And don't read another word if you think my system of body building is any pink-tea affair for drug store sheiks or lounge lizards with a YELLOW STREAK a yard wide. I'll treat you ROUGH when you take my course and I'll tell you where you get off, doggoned quick, if you don't do what I tell you.

I'll Make You Strong

But when I get through with you, you'll say that George F. Jowett is the BEST FRIEND you ever had.

You will have muscles of iron and nerves of steel and every fibre of your being will be athrob with HEALTH and ENERGY and VITAL FORCE. The virile red blood of a conqueror will flow through your veins. Mentally and physically I will give you the POWER that is the foundation of SUCCESS!

Patented Dumbbells Free

To every person who takes my course I will give a pair of my patented Jowett Progressive Disk Dumbbells. They cannot be equalled for workmanship and muscle building.

Here's another important point—my course is laid out personally for each pupil. Every week you receive a new set of exercises in order of progression. You get Twelve Courses covering the Twelve Principles of Life. On conclusion of your course you receive an emblem showing you are a graduate of the Jowett Institute of Physical Culture.

Get My Big Free Book

All I ask is this. Send for my big free book, "The Thrill of Being Strong." You'll get a real kick out of it because of the photographs and because it shows how easily you, too, can have nerves of steel and muscles of iron. Remember—I GUARANTEE to build you up or refund every penny.

**JOWETT INSTITUTE OF PHYSICAL
CULTURE**

Dept. 4-K
326 Poplar St., Scranton, Pa.

Dear Mr. Jowett:

Without cost or obligation, please send me a copy of your illustrated booklet, "The Thrill of Being Strong."

Name.....

Address.....

How To Secure A Government Position

Why worry about strikes, layoffs, hard times? Get a Government job! Increased Salaries, steady work, travel, good pay. I'll help you become a Custom House Clerk, Railway Postal Clerk, Post Office Clerk, City Mail Carrier, Rural Carrier—or any other Government job you want. I was a Secretary-Examiner of Civil Service Commission for 8 years. Have helped thousands.

Now FREE

My 32-page book tells about the jobs open—and how I can help you get one. Write TODAY.
ARTHUR R. PATTERSON, Civil Service Expert, PATTERSON SCHOOL, 810 Wisner Building, Rochester, N. Y.



Learn AVIATION

WHERE LINDBERGH STARTED!

GET TRAINING THAT ASSURES SUCCESS!

COME to the Lincoln Airplane School—where Lindbergh started. Get the same thorough, complete instruction—now under greatly increased facilities. Here you get practical Ground and Flying Training. You work on real planes and motors supplied by the Lincoln Aircraft factory. You go right up into the sky in our famous Lincoln Page planes. Competent, experienced instructors. Write at once for full information!

LINCOLN AIRPLANE SCHOOL

Successors to the Lincoln Standard Aircraft School
2417 O Street, Lincoln, Nebraska

FREE to BOYS!



Sample Copy of OPEN ROAD for BOYS Magazine . . . 50 pages thrilling stories, pictures, sports, mystery, etc. Free membership in WINNIT CLUB, badge-button, big outfit, catalog and new plan for getting easy money and swell prizes. Big surprise too. ALL FREE! No obligation. Write today to

WINNIT CLUB, 43,
130 Newbury St.

Open Road for Boys
BOSTON, MASS.

LAW STUDY AT HOME

Become a lawyer. Legally trained men win high positions and big success in business and public life. Be independent. Greater opportunities now than ever before. Big corporations are headed by men with legal training. Earn \$5,000 to \$10,000 Annually

We guide you step by step. You can train at home during spare time. Degrees of LL. B. conferred. LaSalle students found among practicing attorneys of every state. We furnish all text material, including fourteen-volume Law Library, Low cost, easy terms. Get our valuable 64-page "Law Guide" and "Evidence" books FREE. Send for them NOW. LaSalle Extension University, Dept. 1064-L Chicago The World's Largest Business Training Institution

Sell this Amazing Belt to Men!

"HOOK-FAST" pays you \$12 a day—Remarkable Sideline

Sell the marvelous "Hook-Fast" belt from actual sample that I furnish. Every belt beautifully made with personal initials and popular emblems. Astounding special device prevents belt from slipping yet gives absolute comfort. Men buy everywhere. Take quantity orders from clubs, associations, etc. Write today sure. Ask for Amazing Success Plan, Free Belt Offer and everything needed to get you started. Give full personal initials. Address John Dawson, Pres. NATIONAL CRAFTS COMPANY 41 John St., Dept. K-26, New York

I Will Train You at Home to Fill a Big-Pay Radio Job



If you are earning a penny less than \$50 a week, send for my book of information on the opportunities in Radio. It's FREE. Clip the coupon NOW. A flood of gold is pouring into Radio creating hundreds of big pay jobs. Why go along at \$25, \$30 or \$45 a week when the good jobs in Radio pay \$50, \$75 and up to \$250 a week? "Rich Rewards in Radio" gives full information on these big jobs and explains how you can quickly learn Radio through my easy, practical home-study training.

Salaries of \$50 to \$250 a Week Not Unusual

The amazing growth of Radio has astounded the world. In a few short years three hundred thousand jobs have been created. And the biggest growth is still to come. That's why salaries of \$50 to \$250 a week are not unusual. Radio simply hasn't got nearly the number of thoroughly trained men it needs.

You Can Learn Quickly and Easily in Spare Time

Hundreds of N. R. I. trained men are today making big money—holding down big jobs—in the Radio field. You, too, should get into Radio. You can stay home, hold your job, and learn in your spare time. Lack of high school education or Radio experience are no drawbacks.

Many Earn \$15, \$20, \$30 Weekly On the Side While Learning

I teach you to begin making money shortly after you enroll. My new practical method makes this possible. I give you SIX BIG OUTFITS of Radio parts and teach you to build practically every type of receiving set known. M. E. Sullivan, 412-73rd St., Brooklyn, N. Y., writes, "I made \$720 while studying." G. W. Page, 1807-21st Ave., S., Nashville, Tenn., "I picked up \$935 in my spare time while studying."

Your Money Back If Not Satisfied

My course fits you for all lines—manufacturing, selling, servicing sets, in business for yourself, operating on board ship or in a broadcasting station—and many others. I back up my training with a signed agreement to refund every penny of your money if, after completion you are not satisfied with the lessons and instructions I give you.

Act NOW—64-Page Book is FREE

Send for this big book of Radio information. It has put hundreds of fellows on the road to bigger pay and success. Get it. See what Radio offers you, and how my Employment Department helps you get into Radio after you graduate. Clip or tear out the coupon and mail it RIGHT NOW.

J. E. SMITH, President, Dept. 22H
National Radio Institute
Washington, D. C.

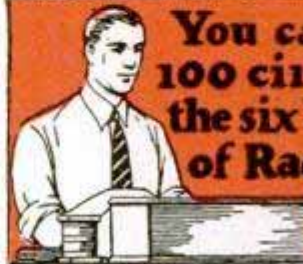
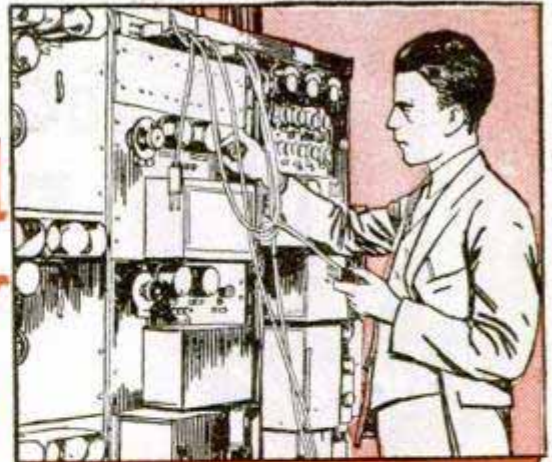

You can build
100 circuits with
the six big outfits
of Radio parts
I give you

3 of the 100 you
can build

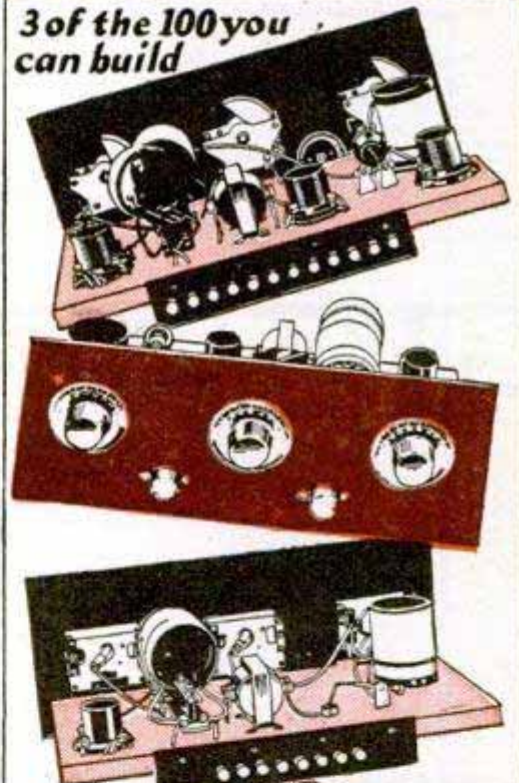

Find out quick
about this
practical way
to big pay



Mail This FREE COUPON Today

J. E. Smith, President,
Dept. 22H, National Radio Institute,
Washington, D. C.

Dear Mr. Smith: Send me your Free book "Rich Rewards in Radio" giving information on the big-money opportunities in Radio and your practical method of teaching with six Radio Outfits. I understand this places me under no obligation.

Name..... Age.....
Address.....
City..... State.....
Occupation.....

Here's the PROOF



\$375 One Month in Spare Time

"Recently I made \$375 in one month in my spare time installing, servicing, selling, Radio Sets."

Earle Cummings,
18 Webster St.,
Haverhill, Mass.



\$450 a Month

"I work in what I believe to be the largest and best equipped Radio shop in the Southwest and also operate KGFI. I am averaging \$450 a month."

Frank M. Jones,
922GuadalupeSt.,
San Angelo, Tex.

Employment Service to all Graduates

Originators of Radio Home Study Training

\$100

a Week

for TAKING PICTURES



What Others Are Doing
 "I earn more money now than I ever did." Alfred Jaques
 "It gives me great pleasure to thank you for placing me. I expect to make great headway." C. A. Harrison
 "I have made a connection as Cameraman with the Universal Pictures Corporation. \$75.00 a week isn't so bad for a starter, is it?" W. B. Holcombe

Working on the side in his spare time, J. H. Wade made \$200 in 2 weeks. He writes: "I find work only waiting for someone capable of doing it, and the possibilities are beyond my fondest hopes."

All over the world men and women are earning splendid incomes in Photography. Big opportunities everywhere. Find out how you can quickly qualify to make real money in Motion Picture Photography, Portraiture, Commercial and News Photography. Turn your spare hours into profit; or step into a good paying position; or open your own studio. The field is unlimited.

CAMERA GIVEN You can start making money at once with the real PROFESSIONAL MODEL CAMERA we give you. Your Camera. Mail the coupon for full details of this unusual offer. See how easily you can get started in this fascinating work.

N. Y. Institute of Photography, Dept. 49
 10 West 33rd St., New York, N. Y.
 Please send me illustrated book on Professional Photography, Job chart, and Free Camera Offer.

NO PREVIOUS EXPERIENCE NEEDED
 Our staff of famous experts will teach you everything. And you can learn in your own home or in our great New York studios.

BE A MOVIE OPERATOR
 Motion Picture Operating and Projection taught at home. Get a good pay job with Movie or Vaudeville Theatre. Projector given with course. Write for Folder.

Name

Address

City State

FREE BOOK—Send the coupon or write for handsome, illustrated book explaining the many opportunities in Professional Photography and how you can take advantage of them. Job chart and details of Free Employment Service included.

N. Y. INSTITUTE OF PHOTOGRAPHY
 Dept. 49, 10 West 33rd Street, New York, N. Y.

ELECTRICITY

Finlay Men are in Demand. There is a Reason. Promising Future for Practical Trained Electricians and Engineers at Big Salaries. Fascinating work, rapid advancement, opportunities unlimited.

12 Weeks Intensive Courses in Practical Electricity and Power Plant Operation covering Wiring, Motors, Generators, Armature Winding, Radio, Farm Lighting, Switchboards, Electric Refrigeration, Automotive Electricity, etc. **These Courses Open To You Now.** ONE and TWO YEAR COURSES in Electrical Engineering leading to degrees. Registration for these courses open Sept. 18 to Oct. 18. Laboratories extensively equipped with modern machinery and apparatus. Faculty of recognized experts. 27th year. Free employment service for graduates. Part-time work secured during training. Catalog free.

FINLAY ENGINEERING COLLEGE
 1001 A Indiana Ave. Kansas City, Missouri

Earn money AT HOME

Men or women earn \$25 to \$50 a week at home. All or part time. Fascinating work. Nothing to sell. We teach you at home. Furnish all tools and materials. **ARTCRAFT STUDIOS, Dept. 50, 427 Diversey Parkway, Chicago.**



ZIP-ZIP SHOOTER

THOUSANDS of boys are made happy with this wonderful Zip-Zip shooter, something every boy wants and never gets tired of. Zip-Zip shooter is scientifically and practically made; if you like hunting and outdoor sports, get a Zip-Zip shooter with plenty of pep and force. If your dealer happens not to have them, order from us. Zip-Zip shooter 35c or three for \$1.00; send stamps, coin or money order.



AUTOMATIC RUBBER CO., Dept. B. B., COLUMBIA, S. C.

Show Card Lettering

HERE is the very course you need if you want to get a good paying position as a Show Card Letterer or Sign Letterer, or have a business of your own. This course is complete and practical and especially arranged to meet the needs of the student who studies at home. It was written by E. L. Koller, Principal of the International School of Art, member of the American Federation of Arts, and The National Society of Craftsmen.



Learn at Home

H. L. Wood, a clerk, made more than \$700 "on the side" before he had completed this course. Harry Lord writes that he has more than doubled his salary. William Whitman is earning three times as much as he did before enrolling with the International School of Art.

Mail Coupon for Free Booklet

INTERNATIONAL SCHOOL OF ART

Division of the International Correspondence Schools
 Dept. 5570-F, Scranton, Penna.

Without cost or obligation, please send me full details of your home-study course in

SHOW CARD LETTERING
 ILLUSTRATING CARTOONING

Name.....

Address.....

FREE

Get two wonderful books by mailing coupon below.

You get these Genuine High Quality, Imported Drawing Instruments, 14 Other Tools and a Drafting Table—all included in my Home Training Course.



These Two Books—
Mail Coupon!
Yes, Absolutely
FREE

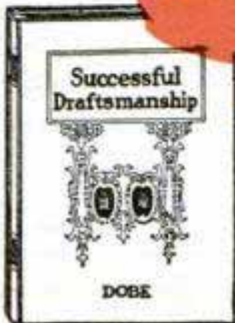

2 Books FREE



Just Send the Coupon Below!

Money-Back Agreement

I train you at home under a positive Money-Back Agreement. If my training does not satisfy you after you have finished, you get every penny back.

Age or Lack of Education, No Drawback

Previous experience is not necessary. You do not need to be a college man or high school graduate.

Help As Long As You Need It

As my student you can write to me any time you want to and as often as you like and I will give you help on any subject pertaining to draftsmanship. I will advise you about jobs, extra work, fees and how to make extra money.

Jobs for Draftsmen in Great Industries—Learn At Home

Automobiles—Electricity—Motor Busses—Aviation—Building Construction.

There are jobs for Draftsmen in all of these industries and in hundreds of others.

Aviation is expanding to enormous proportions. Electricity is getting bigger every day.

Motor Bus building is becoming a leading world industry.

Building of stores, homes, factories and office buildings is going on all the time.

No structure can be erected without plans drawn by a draftsman. No machinery can be built without plans drawn by a draftsman.

I train you at home, in Drafting. Keep the job you have now while learning drafting.

I will train you in drafting right where you are in your spare time. I have trained men

who are making from \$3,500.00 to \$9,000.00 a year. There is a big future for draftsmen because you plan and supervise the work of others, or you go into business for yourself. Get started now toward a better position, paying a good, straight salary, the year around. Comfortable surroundings. Inside work.

Earn As You Learn

I tell you how to start earning extra money a few weeks after beginning my training.

Employment Service

After training you I help you to get a job without charging you a cent for this service. Employers of Draftsmen come to me for men because they know that Dobe Trained Men make good as they have learned drafting by actually doing the work themselves, in a practical way. Employers know they are not taking chances on men trained by me.

If You Earn Less Than \$70.00 a Week Ask for My 2 FREE Books



Mail this coupon, at once. Get "My Pay Raising Plan" and "Successful Draftsmanship". Both of them point the way to Success. You owe it to yourself to find out what a big opportunity there is in practically all industries, for Draftsmen. These two books are Free. They come to you post paid. Mail the Coupon for them TODAY.

ENGINEER DOBE

1951 Lawrence Ave., Div. 13-57 Chicago

FREE BOOK COUPON

ENGINEER DOBE

1951 Lawrence Ave., Div. 13-57 Chicago

Send me free of all cost your book, "Successful Draftsmanship", also plan to earn money while learning and proof of big money paying positions. Also your new book "My Pay-Raising Plan."

Name.....Age.....

Address.....

Post Office.....State.....

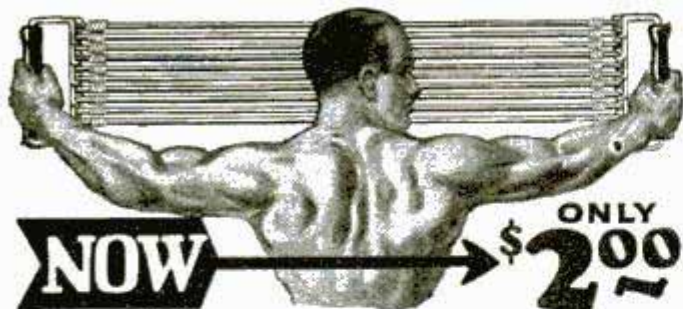

NOW → **ONLY \$2.00**

Giant Chest Expander

and

Progressive Exerciser

Be a muscular marvel. Have the muscles of a superman. Become strong for your health's sake or to astound your friends with extraordinary feats which only men of giant strength can do. In a few short weeks you will easily do stunts which now seem difficult—then real muscles and strength will be yours—and yours to keep.

Send No Money Use This Money Saving Coupon



If you want exercise to just keep in good shape you can reduce the strength of the Progressive Exerciser by eliminating as many cables as you wish. If you want great resistance so as to build up big solid muscles then use the full strength.

How the Giant Chest Expander and Progressive Exerciser is Made

The Giant Chest Expander and Progressive Exerciser is made with new live, springy rubber so as to give it long wearing and great resisting qualities. Do not pay more for an exerciser that has forty or less rubber strands to each cable. Get the best and most durable. The Giant Progressive Exerciser has 50 strands of the finest rubber procurable to each cable.

Free Instructions

We do not think it enough to send you an exerciser worth double what we ask, so for a limited time, we will also include instructions, absolutely free. These instructions are interesting and simple to follow—they show you the short cut to health and strength. Order today before this wonderful offer is withdrawn.

Your Guarantee

The Giant Chest Expander is sold with a guarantee that you will say it is the finest you ever saw or your money back.

\$2 FOR 5 CABLES
\$4 FOR 10 CABLES
\$6 FOR 15 CABLES
\$8 FOR 20 CABLES

How to Order—Send No Money

Sign your name and address to coupon below and get your Giant Exerciser at the present low introductory price by return mail. The price is made low because we want everyone to enjoy muscles and strength at the lowest possible cost. Don't pay more—order from us—get the most for your money. Use coupon now.

PROGRESSIVE EXERCISER CO.,
 4010 Langdon Bldg.,
 Broadway and Duane Street, New York

Please send { } Your 10 Cable { } Your 15 Cable { } Progressive
 Your 5 Cable { } Your 20 Cable { } Exerciser

Check the Exerciser you want, and it will be sent you by return mail. Pay postman introductory price, plus few cents postage on arrival. It is understood that if you are not entirely satisfied with your exerciser you may return it within 5 days and get your money back.

Name.....

Street.....

City..... State.....

If you live outside the United States, send cash with order.

FOR YOUR FUTURE



INVESTIGATE THIS VOCATIONAL TRADE OPEN TO ALL WHETHER 18 OR 50

The opportunity of a lifetime to become financially independent. Earn up to \$5,000 a year. Great demand and always will be because it is a human necessity. Easily learned in three to six months by actual practice with the regular tools of the trade. No previous training required. Business of your own if desired. Oldest establishment in this field is now ready to train an additional number of men for this work. Remarkably low cost—starting fees as low as \$15. R. R. Fare to nearest school included. Earn while you learn if necessary—regular arrangement for part time positions. Investigate this opportunity. The facts are convincing. Write today for Bulletin No. 2 which gives complete information.

BODEE INSTITUTE

New York
1755 Broadway

Philadelphia
1305 North Broad Street

Brooklyn
85 Court Street

LEARN A TRADE Be Independent

Easy to Learn Watchmaking and watch and clock repairing by our practical method of individual training.

Earn Up to \$100 A WEEK

FREE BOOK Learn in few months to fill big pay job or start your own business. Big shortage of trained watchmakers. Day or evening school. No books or classes. You can earn part of your tuition on actual repair work you do in school. **Write for Free Book Today!**

NATIONAL SCHOOL OF WATCHMAKING
 1340 S. Michigan Ave. Dept. 40 CHICAGO, ILL.

Learn How to WRESTLE

In Your Own Home By Mail

Yes, learn to become an expert wrestler right in your own home, by mail, from the greatest wrestlers the world has ever known. Be an athlete, be strong, be healthy. Learn how to throw and handle big men with ease. Learn to defend yourself. All taught in our course of lessons, and illustrated with hundreds of charts and actual photographs by

Farmer Burns and Frank Gotch

Farmer Burns, "the grand old man of the mat," taught Frank Gotch, the World's Champion, all he knew about wrestling, so Gotch said. He will now teach you Scientific Wrestling—Physical Culture—Jiu-Jitsu—Self Defense. Every man and boy in America, no difference what age, needs this wonderful course of lessons. Write today—your name, age and address on a postcard or letter brings you our fine book absolutely free, no obligation of any kind. A splendid book on wrestling and physical culture. Write today stating your age.

Farmer Burns School of Wrestling 3377 Range Bldg., Omaha

This Wrestling Book FREE

Learn Watchwork, Jewelrywork and Engraving

A fine trade commanding a good salary, and your services always in demand. Address **HOROLOGICAL**, Dept. P, Bradley Institute, PEORIA, ILLINOIS, for our latest catalog.

Poor English!

How much is it costing you in wasted opportunity?

Every day your associates are judging you — by what you say and how you say it! Hazy ideas, ill-chosen words, halting sentences, crude, slovenly speech—these mark a man as loose in thinking. Thoughts clear-cut, words that give true shape and color, sentences aflame with power and originality—these are the things that proclaim ability, that win for their users swift advancement. Stop apologizing for poor English—it's inexcusable! In the quiet of your home—with LaSalle's help—you can learn to speak and write with real distinction, learn to make the words you utter and the letters you compose stamp you as educated, cultured, a power to reckon with in the business world. Complete details in an attractive 32-page book, "Effective Business English," sent you free upon request. Ask for it TODAY.

LaSalle Extension University, Dept. 1064-BE, Chicago

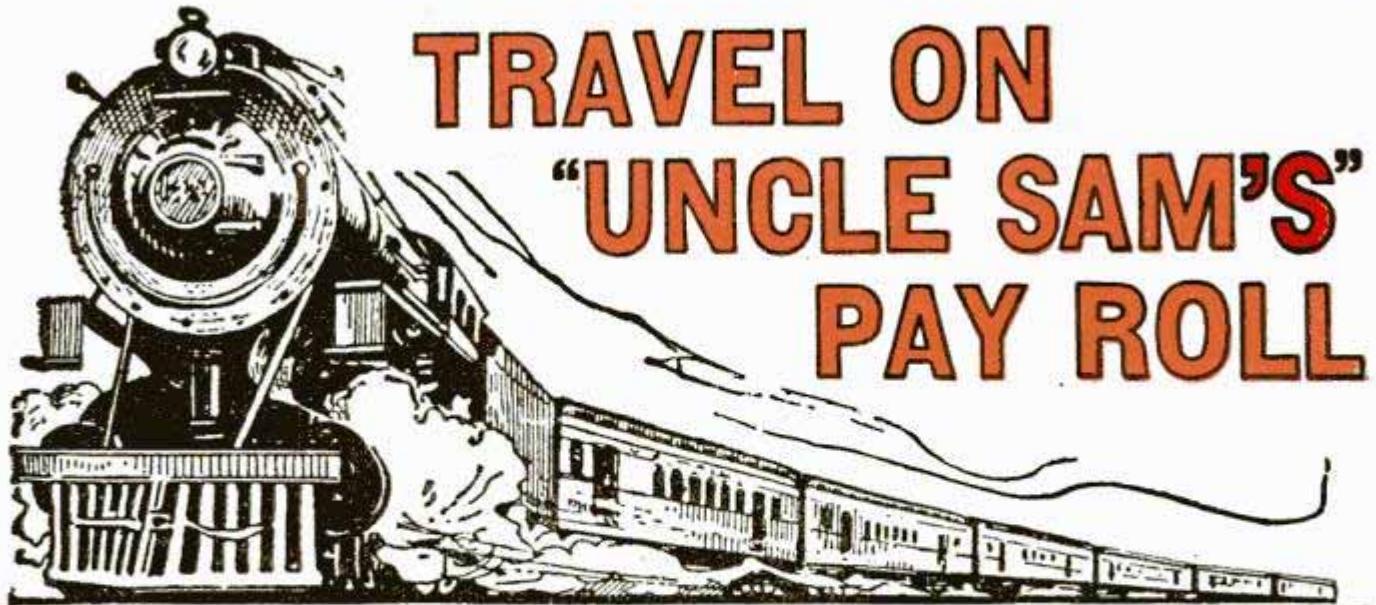

TRAVEL ON "UNCLE SAM'S" PAY ROLL

RAILWAY POSTAL CLERKS

\$158 Month First Year

Raise to Maximum \$225 Month

Many other U. S. Government Jobs Open to Men and Boys 18 up

Post Office Clerks
Rural Mail Carriers

City Mail Carriers
Clerks in Customs and Internal Revenue Service
Prohibition Agents—Investigators

These are steady positions. Strikes, poor business conditions, lockouts or politics do not affect them. U. S. Government employees get their pay for full twelve months every year. There is no such thing as "HARD TIMES" in the U. S. Government Service.

BIG—STEADY PAY

Railway Postal Clerks now get \$1900 the first year regular, being paid on the first and fifteenth of each month. \$79.16 each pay day. Their pay is increased \$100 and \$150 a year. The maximum is \$2700 a year. \$112.50 each pay day. They get extra allowance for hotel expenses when away from home.

PAID VACATIONS

Railway Postal Clerks, like all Government employees, are given a yearly vacation of 15 working days (about 18 days). When on runs they usually work 3 days and have 3 days off duty or in the same proportion. During this off duty and vacation, their pay continues just as though they were working. When they grow old, they are retired with a pension. As Railway Postal Clerks are continually traveling, they have an excellent chance to see the country.

City Mail Carriers—Post Office Clerks

Clerks and Carriers get \$1700 the first year regular and automatically increase \$100 a year to \$2100 with further special increase to \$2300. They also have 15 days vacation. Examinations are frequently held in the larger cities. City residence is unnecessary.

What Will You Earn 5 Years from Now?

Compare these conditions with your present or your prospective condition, perhaps changing positions frequently, kicking around from post to pillar, no chance in sight for PERMANENT employment; frequently out of a position and the year's average salary very low. **DO YOU EARN \$1900 EVERY YEAR? HAVE YOU ANY ASSURANCE THAT A FEW YEARS FROM NOW YOU WILL GET \$2700 OR MORE A YEAR, EVERY YEAR?**



Get Free List of Positions

Fill out the coupon. Tear it off and mail it today—now, at once. **DO IT NOW**—This investment of two cents for a postage stamp may result in you getting a U. S. Government Job.

FRANKLIN
INSTITUTE,
Dept. H-173,
ROCHESTER,
N. Y.

(Not connected with
U. S. Government)

Rush to me entirely free of charge 32 page book with (1) a full description of the position checked below; (2) a list of U. S. Government jobs now obtainable; (3) full particulars telling how to get them.

- Railway Postal Clerk . . . (\$1900-\$2700)
- Post Office Clerk (\$1700-\$2300)
- City Mail Carrier (\$1700-\$2100)
- Rural Mail Carrier (\$2100-\$3300)
- Clerk in Government Offices . . . (\$1260-\$2100)
- Prohibition Investigator (\$2300-\$3000)

Name.....

Address

Use This Coupon Before You Mislays It—Write or Print Plainly.

MAIL COUPON TODAY

This Amazing
 will show You **WHY** Thousands of
COOKE TRAINED
ELECTRICAL EXPERTS
EARN \$ **70** \$ **to** **100**
a Week Steadily

GET INTO THIS BIG PAY FIELD
the **COOKE** *WAY* -investigate

THE whole world has become an electrical paradise. The most mysterious power on the earth—the force that man once worshipped is now harnessed to be the slave of the universe and break the shackles of drudgery for every human being.

Electricity has made this the wonder age of all time! Look about you on all sides. You see people turning to electricity for the common comforts of life, for relief in their work, for education, for pleasure. It is the salvation of the age!



DR. CHARLES P. STEINMETZ, Chief Consulting Engineer of the General Electric Company, says:

"There is an enormous field for the Electrical Engineer. The world needs men who know something of electricity, of the operation and control of electrical power. It needs men more and more every year. Its very existence depends on the electrician."

ELECTRICAL EXPERTS
ARE THE REAL MAS-
TERS OF THE WORLD

Realize this! That electricity affects every man, woman and child on the face of the globe. **THE MEN WHO HOLD THE SECRET OF CONTROL OVER THIS GREAT FORCE ARE AMONG THE FAVORED FEW WHEREVER THEY GO!**

The electrical expert can pick the place he chooses to live and work. He is always sure that every community has a growing need for men with electrical training expertness. As proof of this, Cooke Trained Men can be found in highly paid jobs wherever electricity is used.

In the past twenty-five years this great field has developed beyond the dreams of pioneers. In the next ten years you will see electrical progress that would startle your imagination today.

It is easy to see that the thousands of young men who take the right steps now and learn electricity will be the ones to step into the big pay jobs just ahead.

2 minute test

The test that will open your eyes to a new world of opportunity at your very finger tips!

(1) How many homes using electricity are there in your community?

There are nearly eighteen million electrically wired homes in the U. S. and ten million more to be wired. The average cost of wiring a five-room house is \$150 to \$200. Multiply \$150 by these millions and you will get a forceful idea of the money-making possibilities in this single branch of electricity.

HUNDREDS OF COOKE TRAINED MEN ARE READY FOR THIS KIND OF WORK WITHIN A FEW WEEKS.

(2) How many automobiles are there in your community?

There are more than twenty million passenger cars alone in the U. S. Every one is equipped with complicated electrical devices, which cause 65% of the troubles which bring cars into shops.

Thousands of Cooke Trained Men are making big money in this work.

(3) How many radios in your community?

The surface hasn't been scratched. Still, there are eight million radios in the U. S. alone. Radio is one of the most interesting and highest paid fields for electrical experts. **Cooke Trained Men are holding down many fine jobs in this big pay industry.**

(4) Have you ever visited the power plant in your community?

There are more than four thousand power plants in this country. Each one manned by trained electrical men. Over 15,000 new

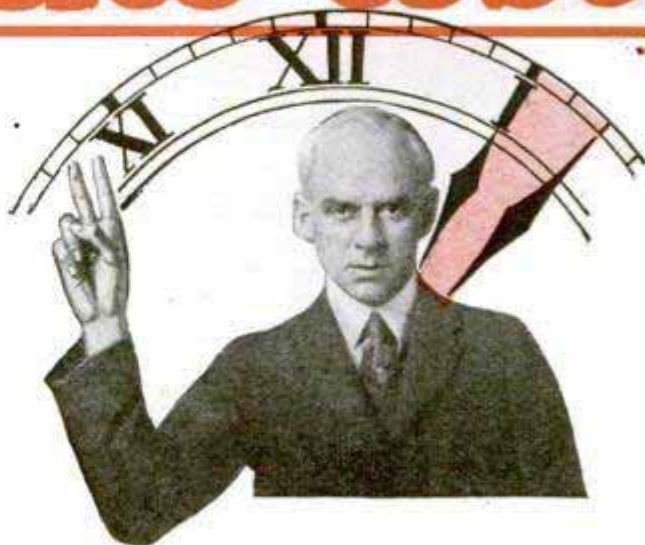

jobs have been opened up in power plants alone, last year. **Cooke Trained Men have found the big power companies ready to pay them big for their training in this field.**

THE LIST OF INDUSTRIES THAT ARE USING AND ADOPTING ELECTRICITY IS ALMOST ENDLESS. The instances above, however, should be enough for you to make electricity your choice for a life work. **Cooke Trained Men are making big money working with electricity in over 300 different ways.**

Can you be satisfied with humdrum work and small pay after knowing this?

Electricity is the ONE profession that you can be absolutely certain will continue to expand daily, constantly creating more openings for electrical experts, and more opportunities for earning a real he-man's salary. This 2-minute test only gives you a peek into the truth of this statement! The field is marvelous—wonderful—and needs thousands more of alert, ambitious young men.

ELECTRICITY NEEDS YOU

If you want to make more money—if you want a real honest-to-goodness job, where people will look up to you—get into electricity.

Lack of education does not bar you. L. L. Cooke's work sheet and job ticket methods are practical—simple—interesting. They are so easily understood that during your spare time you can learn to become a trained electrician in an amazingly short time—learn and earn \$70 to \$100 per week. Cooke training is a sure, quick and easy route to the best paying electrical jobs.

You Learn at Home and Earn While You Learn

You keep right on with your regular job giving only a little of your spare time each day. After a few weeks you are ready to do odd electrical jobs in your own neighborhood that ought to pay you up to \$30 a week. Hundreds of Cooke's "boys" are doing this now.

YOU ARE FURNISHED SIX BIG OUTFITS OF TOOLS AND APPARATUS TO WORK WITH FREE OF EXTRA COST.

Endorsed by Engineering Society Recommended by Employers

L. L. Cooke training is well known wherever electricity is used. It has been officially endorsed by a great engineering society and employers all over the U. S. come direct to the school's employment department for the electrical men they hire.

Money Back if Not Satisfied

You must be satisfied with the results you get from Cooke Training, or every penny of your money will be returned to you under a money-back agreement which you get when you enroll. A \$2,000,000 corporation stands back of this agreement to the limit.

Investigate if you earn Less Than \$70 a Week

Your name and address will bring you a big free book telling all about the great electrical industry and complete details of Cooke Training and the small monthly payment plan. You'll enjoy reading this book—send for it now.

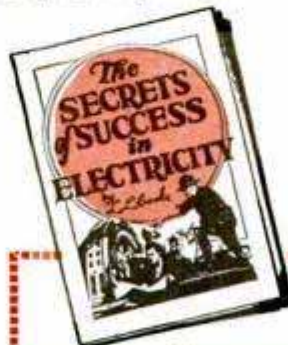

Mail Coupon NOW for Free Copy of this Book

L. L. Cooke, Chief Engineer,
L. L. Cooke School of Electricity,
Dept. 517
2150 Lawrence Avenue,
Chicago.

I would like to know more about electricity. Without obligating me in any way, send me "Secrets of Success" and details of your training.

Name.....
Address.....
City.....State.....



FREE!

This Nerve Chart

If you will mail the coupon below, this nerve center and vertebrae chart, showing how the nerves radiate from your spinal column to all organs of the body, will be mailed to you without one cent of expense. It is a chart which should be in every home.

Where is that PAIN?

It may be in the neck, back, hips, stomach, liver, legs or arms—wherever it is the chart will help to show you the location and cause of your ailment.

Stop that Pain

By Relieving the Cause with

**Violet Ray – Vibration
Ozone – Medical Electricity**

The Four Greatest Curative Powers Generated by This
Great New Invention!

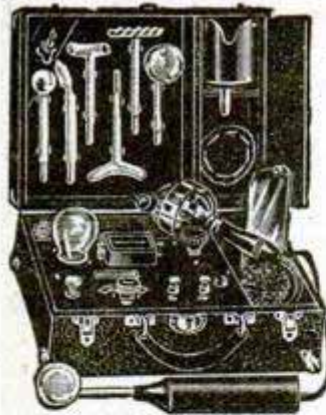

Elco Health Generators at last are ready for you! If you want more health—greater power to enjoy the pleasures and delights about you, or if more beauty is your desire—write! Ask for the book on these inventions which has just been prepared. It will be sent to you without cost. It tells you how Elco Health Generators aid you in leaving the lethargy and hopelessness of bad health and weakness behind forever. Re-vitalize yourself. Bring back energy. Be wholly alive. Write today!

Here's What Elco Users Say—

"Wouldn't take \$1000 for my Elco."
"Has done me more good in 2 weeks than doctors did in three years."



"Cured my Rheumatism." "My Eczema gone." "Cured my stomach trouble." "Cured my weakness." "Now I sleep soundly all night." "Thanks to Elco my strength and vigor are back." "No more pain." "Colds never bother me now." "Chronic Constipation banished."
These great new inventions generate Violet Ray, Vibration, Electricity and Ozone—combined or separate. They operate on the electric light in your home or on their own motive power at less than 50 cents per year. Elco Health Generators are positively the only instruments which can give you in one outfit Electricity, Violet Ray—Vibration and Ozone—the four greatest curative agents. Send the coupon below. Get the Free Book NOW!

MAIL COUPON for FREE BOOK

Do not put this paper down without sending the coupon. Don't go on as you are with pains and with almost no life and energy. You owe it to yourself to be a better man or woman. You were put here to enjoy life—not just to drag through it. So do not rest another day until you have put your name on the coupon here. That will bring the whole story of these great new inventions. Do it today—now.

Lindstrom & Co. [Makers of Therapeutic Apparatus since 1895.]
2322 Indiana Avenue Dept. 13-57 Chicago
Please send me your free book, "Health—Power—Beauty" and full information of your 10-day Free Trial Offer.
Name.....
Address.....



Become a Convincing SPEAKER!

Why sit sphinx-like while other men—with less knowledge, less ability than you—are springing to their feet and presenting their ideas in a way that immediately inspires confidence, fits them in the minds of listeners for positions of responsibility and power? Learn to speak powerfully, convincingly—to address audiences of business men with poise and self-possession. Learn to organize your thoughts—capture the interest of your listeners—drive home the arguments that win. Be a power to reckon with in your company and in your community!

Win Greater Success in Business

At home, with LaSalle's help, you can quickly develop your ability as a public speaker. "Have made wonderful progress in speaking to assemblies of salesmen"—"Your course has helped me beyond measure"—"Gave me power I never possessed before or dreamed of possessing"—these are but a few of the tributes paid to LaSalle home-study training in Effective Public Speaking by those who have enjoyed its benefits. Low cost; easy terms. Complete details in attractive 32-page book, "The Power that Brought Success," sent you free upon request. Ask for it TODAY.

LaSalle Extension University, Dept. 1064-ES, Chicago



GET ON "UNCLE SAM'S" Pay Roll

\$1700 to \$2300 a Year

MAIL CARRIERS — POSTAL CLERKS

Men 18 to 45

Steady Work

Paid Vacation

Write immediately for FREE list of positions and full particulars telling how to get a position.

FRANKLIN INSTITUTE

(Not connected with U. S. Government)

Dept. H311

Rochester, N. Y.



BOW LEGS?

THIS GARTER (Pat'd)

Makes Trousers Hang Straight
If Legs Bend In or Out

Free Booklet—Plain Sealed Envelope

THE T. GARTER CO., Dept. E
South Bend, Ind.

NOW! Complete Home Study Course

Aviation

..at New Low Price

Quickly Train at Home for BIG PAY

If you want thrills, adventure, fame, popularity—get into Aviation. Now—for first time—a complete, practical, EASY-TO-GRASP Course in Aviation fundamentals offered at a low price. We teach you—by Home Study—in the quickest possible time every step necessary to qualify for position as a Pilot, Instructor, Designer, Motor Expert, Inspector, Mechanic, etc.



You are taught every branch of Aviation: Motors, Wings, Assembly, Construction, Design, Nomenclature, Flight Principles, Air Rules, Meteorology, Navigation, How to Handle Ship in Air and on ground and 100 other fascinating subjects. Profusely illustrated with all necessary diagrams, charts, plans, etc. Endorsed by Aviation experts. Accredited Diploma, on graduation.

All over America manufacturing, transport, air-port service and sales organizations are springing up—with valuable openings for high priced, skilled men. FREE Employment Service.

Write today for your FREE copy of new book, "Aviation," telling quick, economical way to get into Aviation.

FREE Book Coupon

National Aviation Training,
Dept. 15, 1031 So. Broadway, Los Angeles, Calif.
Send me, without obligation, the Free Book "Aviation."

Name.....

Address.....

City..... State.....

Bald Men Look!

FREE



One Full Ampoule of my amazing hair fluid which I discovered myself and which grew hair on my head.

Here is How I Used to Look

I was just as bald as this picture. It is a true photograph without any tampering or retouching. It is exactly like I used to look. Then look at the full head of hair I have in the picture on the left!

As I have stated so often, I don't know whether I am the first man who discovered this great secret, but I do know I have it, that I grew my own hair and that I am growing hair on the heads of other men all the time.



This Ampoule is absolutely free. Don't send any money. There is no C. O. D. No charge whatsoever. All I want is an opportunity to show you how easily I grew hair on my own and hundreds of other men's heads. Merely mail the coupon below for Free Ampoule.

Bald Men Grow Hair Quick!

I grew my own hair just as it shows here.

I will prove to you FREE that I can grow hair, quick.



Here is Brennan
Brennan while he was bald.



And Brennan after Vreeland grew his hair. Write and I will tell you Brennan's story and give you his address.

Here is Wiseman
Wiseman was bald like this.



But Wiseman grew this head of hair with my wonderful hair growing fluid. All about Wiseman and how he did it, if you write. You'll get his address too.



What I accomplished on my own head and on other heads I can do for you, provided you are under 45 years of age and loss of hair was not caused by burns or scars. Anyhow, I must succeed or you pay nothing. No apparatus. My home treatment is simple, quick, inexpensive.

Mail this FREE Coupon

Mail the coupon today—Right Now—I will send you, immediately, one full Ampoule of my marvelous fluid which I discovered, of which I hold the secret and which grew my own hair on my own bald head. Besides the Free Ampoule of Fluid, I will send photographs, names and addresses of men and women who successfully used my Wonder Fluid for Dandruff, Falling Hair and particularly for Baldness.

VREELAND 1357 Euclid-Windsor Bldg. CLEVELAND, OHIO

FREE COUPON
 1357 Euclid-Windsor Bldg. CLEVELAND, O.
 Please send me, entirely free, one full Ampoule of the same Wonder Hair Fluid which grew your hair.
 My Name
 My Address
 State

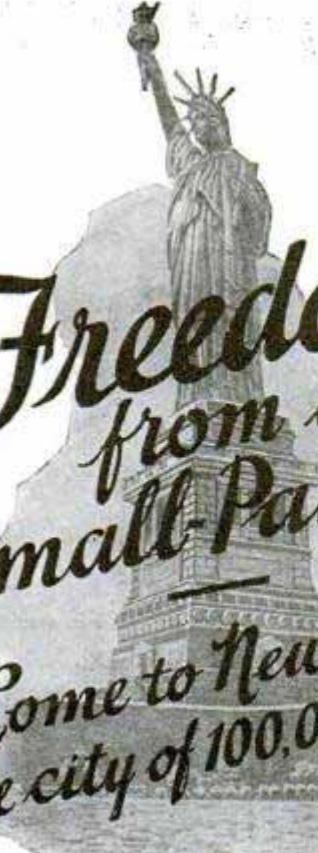

Freedom
from a
Small-Pay Job

Come to New York
the city of 100,000 jobs

ANY MAN who can read and write and use a pair of pliers can become an electrical expert and free himself forever from the long hours and drudgery of a small pay job.

And you can learn the **BIG PAY** profession of electricity right in New York City—the heart of the electrical world—the city of 100,000 jobs. At the same time you are learning the **BIG PAY** profession you can be enjoying the sights and wonders of New York, the modern Bagdad.

Be An Electrical Expert

Graduates of the **NEW YORK ELECTRICAL SCHOOL** are in demand by all the big electrical companies. Or, if you prefer the independence of a business of your own, there are thousands of opportunities for efficient, **dependable** men to become electrical contractors. When you are your own boss the money you can make is limited only by your own energy and ability.

Personal Instruction

The **NEW YORK ELECTRICAL SCHOOL** is not a correspondence school. You learn by doing—by personal instruction on full size standard electrical equipment under the personal supervision of trained instructors.

At **N. Y. E. S.** you train your hands and mind at the same time. You learn the theories of electricity—and then you are shown how to put the theories into actual practice by solving the problems with **your own hands**.

The man who has learned electricity by actually doing electrical work under intelligent personal instructors can go to any part of the world and be sure of a good living. There are **N. Y. E. S.** graduates in all the countries of the world.

Write today for the 48-page booklet giving full information about the **N. Y. E. S.** Course and showing pictures of the equipment available for your personal use in our two seven-story buildings. Mail coupon *now!* The New York Electrical School, 44 W. 17th Street, New York.

The New York Electrical School
44 W. 17th Street, New York

Please send me **FREE** your 48-page booklet. It is understood that this request puts me under no obligation.

Name.....

Address.....

The MOCAR

Model Airplanes

THAT
FLY!



Set No. 1
Only \$1.50

All
Aluminum
Construction

BOYS—at last, here is a genuine aluminum model airplane that really flies. And at a small price.

The "Mocar" monoplane—Set No. 1—is a copy of the famous Spirit of St. Louis. Wing spread 18 inches, fuselage 12 inches, powerful motor, ball bearing propeller, rubber tired disc wheels. Weight complete only about 2½ oz.

This is a practical, simple, real model plane that gives you a whole lot of fun for the moderate cost. The all metal construction makes a sturdy plane that will stand a lot of abuse. The outfit is mounted on cardboard with all parts plainly marked and full instruction for assembly. Pliers only tool necessary. Complete with rivets, bolts, nuts, wheels, wing and fuselage covering material, only \$1.50 post paid (3 for \$4.00).

Great fun, learn how to make and fly airplanes. Order now. Jobbers, dealers and schools write for discounts.

THE
MOUNT
CARMEL
MFG. CO.

Dept. M

Mount
Carmel,
Conn.



Be a
Civil
Engineer!

Learn
at
Home!



Cyclopedia of Civil Engineering

9 great volumes.
4000 pages.
3000 illustrations.
New edition just
off the press, by
twelve of America's
greatest engineers.
Includes: Surveying,
bridges, railroads,
steel structures, municipal
engineering, water supply, road
building, etc.

Earn
\$5000

a Year—and Up!

"**CIVIL ENGINEERING**"—in plain English written so you can understand it, even if you have only a limited education. Prepares you for a well-paid railroad structural or public works position. Covers every branch of Civil Engineering practice. At once a reading course for the ambitious student and an authoritative reference work for the experienced engineer. Borrow a set—free. Look over the test questions which help you master each subject quickly. Mail the coupon without obligation today!

American Technical Society
Dept. C-719 Chicago

American Technical Society,
Dept. C-719, Chicago

I want to **BORROW** the **CIVIL ENGINEERING Cyclopedia** for 15 days **FREE**. I will gladly pay the few cents express, but I am to pay nothing for the loan of the 9 big volumes if I return them within 15 days. If I wish to keep them I will send you \$2 after the 15 days, then \$3 a month until special advertising price, \$34.80, is paid.

Name.....

Address.....

(Attach letter stating age, occupation, employer's and references' names and addresses.)

Loaned Free!

To prove you can learn Civil Engineering at home in your spare time. And because no description here could do it justice, to let you see for yourself the scope and simplicity, the authority and quality of this great home reading course. Cost and terms are within your reach. Send no money—just mail the coupon.



JIMMIE, THIS THING WILL SELL! LET ME BORROW IT FOR THIS AFTERNOON

THAT'S WHAT THEY CALL A KRISS-KROSS STROPPER—IT GIVES THE SLICKEST SHAVES EVER INVENTED



JIMMIE, THAT KRISS-KROSS STROPPER YOU LOANED ME A YEAR AGO—WAS THE START OF A \$15,000 BUSINESS

I SHOULD HAVE KEPT IT AND GONE INTO THE KRISS-KROSS BUSINESS MYSELF

How I Started Making \$5300 A Year

With a Borrowed Kriss-Kross Stropper

BY B. G. LOUGHREN



\$200 the first week! \$1000 in a single month! And over \$5300 cash profits in a year! When I sit down and look at those figures in my bank book, I can't help marveling at the strangeness of fate. It was Chance—and Chance alone—that thrust this money-making opportunity into my path at the very moment I needed it most! I had been in the real estate business in Florida, when suddenly the "boom" collapsed. The immediate future looked gloomy, until one day when I dropped in to talk things over with a friend.

When I went into his office, he was at the wash bowl just finishing shaving, so I sat down at his desk where my eye fell on a little nickel-plated contrivance about half the size of my hand. There was something about it that aroused my curiosity.

NEW, REVOLUTIONARY INVENTION

"What's this thing?" I asked.

"That's one of those KRISS-KROSS razor stropers," said Jimmy. "You've read about it in the magazines. I've only been using it a month but I'm getting the keenest shaves of my life, all from the same blade. Look here, I'll show you how it works."

Well, it certainly was a mechanical marvel. I hadn't seen anything as ingenious in years!

"I wish I could invent something like that," I said. "I'll bet the company that puts it out is coining money hand over fist."

"They are," said Jimmy. "Furthermore, they only sell through agents and demonstrators,—and those agents are making plenty, too! I sent for their proposition the other day just out of curiosity."

He handed me a letter with some sample order blanks attached. I read it through and then read it all over again.

"Jimmy," I said at last, "this thing sure will SELL—and they certainly give their men a generous split! Let me borrow your stropper this afternoon and see how many orders I can take!"

ASTONISHING PROFITS

That afternoon I got the surprise of my life. The first man I walked up to had read all about KRISS-KROSS in the Saturday Evening Post and

said "Send me one" before I got half-way through my demonstration. By 4:30 I had 9 orders—and the next morning I got 11 more!

That sure convinced me—and I wrote the company that although they were not aware I was working for them, the only way they could stop me was by wire! . . . They wrote back—"Good work. Go to it." . . . Needless to say, I "went to it" in earnest and the end of the week found me with exactly \$200 cash profit in my pocket!

A \$15,000 BUSINESS ALMOST OVERNIGHT

The money I made that first week came easily enough—but after I got well started it became easier and easier. And then, before I knew it, I found that I was actually clearing as high as \$1000 in the single month!

Today I figure that I did a \$15,000 gross business that first year—with profit of over \$5000. And it all came from getting started with the right kind of a proposition. Success comes from giving the public what it wants and they surely have shown that they WANT KRISS-KROSS! Personally, I believe that it is the greatest direct-selling item of all time!

Mr. Loughren's experience is typical of the surprising successes of KRISS-KROSS representatives in all parts of the country. Practically every man finds himself making money faster and easier than he ever dreamed possible. Right now, due to our heavy Fall advertising program in Liberty, The Saturday Evening Post, Co'lier's, etc., there is room for more KRISS-KROSS representatives—to earn \$30 a day and up. Find out about this opportunity today. No obligation. Just clip the coupon and mail it at once!

RHODES MANUFACTURING CO.
Makers of KRISS-KROSS

Dept. P-373, 1418 Pendleton Ave., St. Louis, Mo.



Why KRISS-KROSS Pays Agents Such Astonishing Profits

KRISS-KROSS actually reproduces with mechanical precision the intricate diagonal stropping stroke of a master barber. Strops any make blade (except Durham Duplex), giving the keenest cutting edge that steel can take! Just insert blade and turn the crank for 11 seconds.

How can anyone help but be interested in such an amazing device, especially since it means cool, smooth shaves forever with no more blades to buy!

Rhodes Mfg. Co., Dept. P-373,
1418 Pendleton Ave., St. Louis, Mo.

Please send me details of KRISS-KROSS Stropper with generous commission proposition you offer to representatives and agents, working full or spare time.

Name.....
Address.....
Town..... State.....

The "MOVIE WAY" Replaces Old-Fashioned Methods

**DRAFTSMEN
PAID
\$60 to \$100 a week**

**Get Into This
WORK**

BIG PAY *with my
amazing, new, simple*
MOVIE-METHOD

At last—a quick, complete, fascinating way to learn Drafting, and learn it **right!** Experts acknowledge my new, simple, easy "Movie Method" to be the first new idea in teaching Drafting in 30 years. It's the most easily-grasped, sound and sensible plan ever devised for Home Study instruction—so clear, so interesting, so practical that almost before you know it, you're through—have finished—and are ready to go to work on a Big Pay Job.

Learn to Earn—\$60 to \$100 a Week

That's what the expert draftsman gets. And he's never out of work the year 'round—for he's the King-Pin of Industry—the man they've got to have. Not a wheel can turn, not a brick can be laid, not a wire can be strung, until the job has first been planned and drawn on paper by a draftsman. Why don't you get into work like that? Why don't you be a man they can't get along without—a Big Pay Man with a year 'round Big Pay Job? You can—it's easy—I'll show you how!

I'll Quickly Prepare You for Drafting

With my new copyrighted "Movie Method," I'll help you get ready for a Big Pay Draftsman's job so quickly you will be astonished. Spare time only needed. With my method—just like "slow motion movies"—you see how it's done, and you do it yourself almost **automatically.** It's amazingly simple—yet so thorough and complete you learn Drafting from A to Z—learn it so you can sit in with the best of them on the Jobs that pay Big Money. Don't sign up for any Drafting Course until you've investigated my amazing new "Movie Method." Mail coupon for Big FREE Book. See my great Earn-while-Learning Plan—see the big Professional Drafting Outfit you get at no extra cost—learn about my Nation-wide Job Service—my positive Money Back Agreement. Mail coupon NOW!

K. M. BOYD, Director

MAIL COUPON FOR FREE BOOK

K. M. Boyd, Director
Practical Drafting Institute of America,
Dept. 17, 2132 Lawrence Ave., Chicago, Illinois.

Send me your book "Draw Big Pay in Drafting" and tell me more about your "Movie Method." This does not obligate me in any way.

Name.....
Address.....
City..... State.....



This professional outfit **Free!**



The BOYD "MOVIE WAY" is the BIG PAY WAY

Classified Advertisements

WORLD'S BEST WANT AD MEDIUM

Advertisements in this section, 30 cents per word, each insertion, minimum 10 words, payable in advance. To be inserted under proper classification in November issue, copy should be in our office September 18th

ADVERTISING AGENCIES

ADVERTISERS—If you intend advertising, don't fail to write for our new 60 page improved Rate Book with United States map in colors, just off the press. Gives complete information best paying daily, weekly and monthly newspapers and magazines. Your 24 word advertisement inserted in the following 10 leading Sunday papers for \$10.00. (1,500,000 circulation). Constitution, Atlanta; Journal-Transcript, Peoria; Times Picayune, New Orleans; Pioneer Press, St. Paul; Courier, Buffalo; News and Observer, Raleigh; Enquirer, Cincinnati; World, Tulsa; Commercial Appeal, Memphis. 31 years of advertising experience at your command. Frank W. Lenhoff Advertising Agency, 66 East Lake St., Chicago. Chicago's Most Progressive Agency.

ADVERTISE in 24 Big Sunday Newspapers, 24 words \$15.00. Excellent for securing agents, salesmen and business opportunities. Catalog listing 1,000 leading dailies, weeklies, mail order magazines. Everything. Free. Wade Advertising, Baltimore Bldg., Chicago.

GET into advertising. Learn quickly at home. Experience unnecessary. New easy plan. No text books used. Practical work. Old established school. Send name and address for interesting free booklet. Page-Davis School of Advertising, Dept. 343-B, 3691 Michigan, Chicago.

LOWEST Classified rates in any medium. Send for free catalog just off press. 18 years' experience. Brinckerhoff, Inc., 37 W. VanBuren St., Chicago.

ADVERTISE 50 Magazines three months 10c word; old, reliable and result producing. King Advertising, Box 672PA, Wilmington, Del.

ADVERTISERS: Your "Ad" in 277 rural newspapers; 28 words, \$10. Other bargains. Lists free. Roberts' Agency, Forrester, Ill.

TIME Counts in applying for patents. See pages 138 and 139. Clarence A. O'Brien, Registered Patent Attorney, Washington, D. C.

BEFORE Advertising get our catalogue. No charge. 25 years in business. The largest classified agency in the world. Ankrum Advertising Agency, 20 W. Jackson Blvd., Chicago Ill.

LOWEST Rates. Catalog free. Owl Agency, Times Bldg., New York.

FREE—New 1928 Advertisers Rate Guide. 36 pages. Includes everything. Lowest rates. E. H. Brown Advertising Agency, 140 S. Dearborn, Chicago.

INCH Display 50 Monthlies Thrice \$8.00. Meyer Agency, 4112M Hartford, St. Louis, Mo.

FOR ADVERTISERS

ADVERTISE—28 Words in 72 country, town newspapers \$3.40. Lists free. Miller, 309-M Rich St., Syracuse, N. Y.

ADVERTISE in weekly papers. Lists free. Keator, Hartford Bldg., Chicago.

SALES PROMOTION

\$50 TO \$50,000 Daily Sales Developed during 28 years for clients by our direct mail plans, copy, campaigns. One product, 1923, an idea; this year \$100,000 orders booked. Fifty year old concern desired 50 national representatives in 1925; we produced 40 in three months. 700 dealers in 10 months at \$3 each, for another. Ten years Sales Promotion Manager Larkin Co. Submit sales problems for free diagnosis. James C. Johnson, 118A Woodbridge Ave., Buffalo.

TYPING SERVICE

EXPERT Typing with carbon copy. 5c hundred words. Julius Goldin, 926 Southern Boulevard, New York.

BUSINESS ADDRESSES

BROADWAY 200—Best address in New York. Two blocks from Wall street. Desk room or mail privileges. Rates exceedingly reasonable. We forward your mail daily. Christean Iverson, Room 401.

IN The heart of New York—New York mail address \$2.00 month; forwarded daily, \$3.00 month. Edward Armour, M-1, 136 East 28th.

AUTOMOBILE SUPPLIES

ATTENTION! Auto owners! Poor ignition, spark plug trouble located immediately with combination tester and mechanical pencil. Tells you at a glance if motor runs O. K. Tester with instructions \$1.00 C. O. D. L. Guenther, 1122 Diversey Parkway, Chicago, Ill.

AUTO Parts new and used. Lowest prices. Bankrupt supplies, motors, wheels, radiators, transmissions, generators, gears, carburetors, touring tops complete \$15. Brakelining 50% off. Brightman, 2065 Main St., Hartford, Conn.

SPECIAL Machine builders, tools, dies, inventors' models, production work all kinds. Chicago Metal Novelty Co., 7821 Yates Ave., Chicago.

SENSATIONAL New invention, sponge holding hose nozzle auto washer. Works like play; don't get wet. Retail \$2.00. Write how to get yours free. Sponge Nozzle Co., 909 Ford Bldg., Detroit, Mich.

RADIATORS At wholesale prices. All standard makes. Satisfaction guaranteed. Send for prices, stating make and model. Independent Radiator Co., 1119 S. Wabash Ave., Chicago.

BRAND New Basco Ignition switches, can be used for cars or motor boats, special 20c each; retail for \$3.00. Brand new \$15.00 Jewel volt and ammeters, 4" diameter, at \$4.00 each. Satisfaction guaranteed. General Distributing Company, Duluth, Minn.

TOOL Salesmen and mechanics with some sales ability sell our line electrical tools to auto mechanics and garages. Easy sales, and very liberal commissions. Barker Specialty Co., Girard, Pa.

BEST Auto polish formula. \$1.00 brings full instructions. Stenton Laboratories, 2122 Griffith St., Philadelphia, Pa.

AUTOMOBILES

TIME Counts in applying for patents. See pages 138 and 139. Clarence A. O'Brien, Registered Patent Attorney, Washington, D. C.

AUTOMOBILE SERVICE EQUIPMENT

BARGAINS in reprocessed battery chargers, rectifiers of all kinds and a few Constant Potential 8 Hour Chargers, two of them practically new. Lowest prices; terms if wanted; 30 days' trial. Write today to I. C. Helmick, Box M1085, Troy, Ohio.

YOU Are wanted to resilver mirrors at home. Immense profits plating autoparts, tableware, etc. Write for information. Sprinkle, Plater, 77, Marion, Ind.

OWN Your business! More profits with the Scoto Battery Charger. Wholesale only. Send for latest price list now. Adams-Barr, Columbus, Ohio.

BIG Profits in automotive service with our of new 8 hour battery charging equipment. Low in price—small down payment brings it; pays for itself with handsome profit besides. Write for details. No obligation. E. M. Connor, Box M1083, Troy, Ohio.

SAVE Money—Garage equipment reconditioned and guaranteed like new. Unusual bargains in test stands, car washers, battery chargers, air compressors, etc. Shipped on trial—easy terms. What do you need to complete your equipment? E. C. Galbreath, Box M1084, Troy, Ohio.

VULCANIZING Tires and converting old tires into salable mdse. Is a money-making business with our equipment. We have plants near you \$100 up; also paint spraying outfit, \$63, delivered. Catalog free. Equipment Exchange, 108 East 11th, Los Angeles, Calif.

BATTERY Chargers: Heaviest and cheapest on the market. 16 battery capacity \$50 complete. Lifetime guarantee. Very convenient terms. Satisfaction absolutely guaranteed or money refunded. We manufacture chargers exclusively—hence the price. For description write Ace Electric Products Co., 855 E. 78th St., Los Angeles, Calif.

FOR FORD OWNERS

UNDERSLUNG With "RKO" Swing Lo Irons. See "Red-I-Cut" ad page 144.

AURORA Underslung parts and 3.1 racing gears, speedster bodies, headlights. See Sport Factories ad, page 124.

MOTORCYCLES, BICYCLES AND SUPPLIES

MOTORCYCLES Cheaper than bicycles, \$25 to \$50. Easy terms. Tires \$2.50; Frames \$3; Forks \$3; Tanks \$5; Wheels \$4; Chains \$2; Saddles \$5; Handle Bars \$5; Engines \$15; Motorcycle Tires \$2.50; Truck Tires \$7; Airplane Engines \$15; Bicycle Tires \$1.25. Send 50c for catalog. Price Cutter Deninger, Rochester, N. Y.

SLASHING Price Reduction! Fine Harley-Davidson motorcycle bargains. New, used and rebuilt motorcycles, \$50.00 and up. Send for our new free bargain bulletin just off the press. Knuth's Harley-Davidson Agency, 2525 Fond du Lac Ave., Milwaukee, Wis. Exclusive Harley-Davidson Distributors.

USED Motorcycle bargains. All makes. Lowest prices. Guaranteed. Shipped on approval. New easy payment plan. Motorcycle parts—supplies. Catalog free. Floyd Clymer, "Largest Motorcycle Dealer in the West," Denver, Colo.

USED Motorcycles, all makes, lowest prices; price list free; used parts half price and less. Rochester Harley Davidson Corp., 129 West Main St., Rochester, N. Y.

BARGAINS in used motorcycle parts for all makes. No Catalogs. J. B. Dahl, 3661 Archer Ave., Chicago, Ill.

AVIATION

HOME Study course in aviation by pioneer school at new low price. Complete, including motors, wings, nomenclature, meteorology, navigation, flying and 100 other fascinating subjects. Endorsed by experts. Diploma given. Free employment service. Complete details sent free. National Aviation Training, Dept. 16, 1031 So. Broadway, Los Angeles, Calif.

BIG Bundle various sizes wood, reeds, 26" long, bamboo, rubber band, wheels, 6" propeller, onion skin paper. About 40 pieces in all. Also circulars on free three foot model. All for 25c, no stamps. Aero Shop, 3050 Hurlbut Ave., Detroit, Mich.

STUDY Where you can learn the most. Aeronautical training—all branches. Nine years of successful operations. Airplanes, parts, supplies. Southern Airways, Incorporated, Texas Bank Bldg., San Antonio, Tex.

TWO Ice-sled engines complete with propellers. George Heine, Orwigsburg, Pa.

AIRPLANE Motor boat engines. Ships, fuselages; ice sleds, propellers. Free Aircraft Works, Richmond, Ind.

PROPELLERS: 3', \$5.50; 4', \$8.75; 5', \$13.25; 6', \$16.50; others proportionately. Aerodrive boat and sled blueprints 50c each. \$3.25 value aviator's helmet and resistal goggles only \$5.00 set. Ostergaard Aircraft, 4309 N. Narragansett, Chicago.

THE Super Parasol, America's most popular sport plane. Wonderful detailed shop blue prints \$5.00 per set. 10c for large illustrated folder. Heath Airplane Co., Chicago, Ill.

CONSTRUCTION Blue print for 1 ounce, 3 cylinder compressed air motor \$1.00, tank to match 7 ounce, 3"x2"x40", 75c. Amalgamated Sales & Service Corp., 546 W. Jackson Blvd., Chicago, Ill.

PROPELLERS, For small airplanes. Get our price list on tooth pick, high speed propellers and have success. Eighteen years' experience. Crawford's Airport, Seal Beach, Calif.

BECOME An expert glider. The most fascinating sport. Send quarter for details. P. Schroeter, 445 Milwaukee St., Milwaukee, Wis.

THREE-IN-ONE Model airplane. Catalog for stamp. Stewart Marshall, Rome, Ga.

FLY! With motorcycle engine. Build your own airplane at small cost. Booklet with five drawings tells how to build fuselage, wings, controls, etc. Price one dollar. Hodgdon, 324 Bay St., Springfield, Mass.

WHICH Will you build, our Alco Sport monoplane or biplane? Our blueprints at \$2.50 and \$5.00 tell how. Sketches with price list 10c each. Allison Airplane Co., Lawrence, Kans.

IT'S New! The modern airplane, 128 pages, 49 illustrations, tells everything you want to know about flying. Recommended by leading pilots and flying schools. Sent postpaid for \$1.00 or write for free descriptive circular. Roth Downs Airways, 2502 University, St. Paul, Minn.

BUILD Model airplanes that fly. Our 52 page catalog illustrates 26 flying and exhibition models. Most complete line of accessories and supplies. Send 10 cents for our big catalog. U. S. Model Aircraft Corporation, 341 Monroe St., Brooklyn, N. Y.

"SKYWARD Ho!" New book by Derek White on your future in aviation. Opens road to career, fame, fortune. Sent free. Write at once. Parks Air College, 213 Missouri Theatre Bldg., St. Louis, Mo.

THE American School of Aviation announces a new correspondence course in Mechanics of Aviation. A thorough training in Practical Aeronautics. American School of Aviation, Dept. 1871, 3601 Michigan Ave., Chicago, Ill.

JUST Out—Book and blue prints on design, construction of small sport plane. Dependable information on motors to use, etc. Includes flying lessons and weather map reading. All for one dollar. Chas. Russell, 545 Stadium Drive, Ft. Wayne, Ind.

TIME Counts in applying for patents. See pages 138 and 139. Clarence A. O'Brien, Registered Patent Attorney, Washington, D. C.

NEW Aircraft magnetos, 6 or 8 cylinders, cost government \$75.00, sacrificed \$7.50. Real airplane propellers, 8 foot long, given away, \$5.00. Air Transport Co., Carle Place, N. Y.

BIGGEST, Best Catalog Model Airplanes, Parts, Supplies; 5c postpaid. Ideal Company, 19 West 18th Street, New York.

BOOKS AND PERIODICALS

4TH EDITION Just off press. "Radio Theory and Operating," by Mary Texanna Loomis. The standard radio text and reference book of America. Nearly 900 pages, over 700 illustrations, flexible binding. Price \$3.50 postage paid. For sale by hundreds of bookdealers throughout America and many foreign countries. Or may be purchased direct from the publishers. Send check or money order to Loomis Publishing Company, Dept. 18, Washington, D. C.

BOOKS, 6th and 7th Book of Moses, 50c; Albertus Magnus, 50c; Pow-Wow, 50c; Silent Friend, \$1.00; Book of Luck, 2c. The F. & R. Co., 87 Fourth Ave., Dept. "L," New York.

HYPNOTISM Easily learned. Lessons guaranteed. Postpaid, \$1.10. Smith Pub. Co., Dept. 3, Springfield, Mass.

CURIOUS Books, Unique Novelties, Stunning Pictures. Samples, 10 cents prepaid. Linds, 214 W. 34th St., New York.

BOOKS, Magazines, art publications in French, Spanish, English. Photo novelties, etc., samples, lists, 20 cents stamps. Villaverde Co., Dept. 207, Box 1329, Havana, Cuba.

AVIATION: A. B. C. of Flight, \$1.50; Automobile Engineering, Am. Tech., 5 vols., \$10.00; Physical Culture Classics, illustrated, \$4.00; Complete Radio Cyclopaedia, 1928 edition, \$6.00; Modern Guide to Permanent Health, send 25c stamps. For any kind of books. Goldman's Book Store, 424 S. Dearborn St., Chicago, Ill.

INDUSTRIAL Alcohol. Wright's book. Full directions for making, fully illustrated. \$2.50. Spon & Chamberlain, 120 P.M. Liberty Street, New York, N. Y.

PICTURES AND POSTCARDS

LIVING Pictures! Oh La La! Pretty European Girls Wiggle-wink. Something sensationally new. Only 50c. Tip Top Sales, East Dedham, Mass.

FREE Book—"What men know about women?" Humorous and interesting. Kind men like. 10 snappy cards. Red hot pocket novelty. Copy America's greatest illustrated cartoon book. All for 25c. White Mule, Beaver Dam, Wis.

MOST interesting photograph; source of Mississippi. 10c postpaid. Pape, Park Rapids, Minn.

PRETTY Girls, pictures and novelties. Samples and list 25c. Carr-Novelty Co., Box 196, West Haven, Conn. Dept. 14.

ART Pictures—300 all different. Particulars 10c. Howard Sales Co., Dept. 15, Box 529, San Francisco, Calif.

MAGIC TRICKS, BOOKS AND JOKER NOVELTIES

"THE Book of 1,000 Wonders" will be sent postpaid for 10c. Explains many mystifying tricks with coins, cards, handkerchiefs, etc., you can do. Also, contains complete catalog of magic tricks, jokes, puzzles, books, escapes, mindreading acts, spiritualistic effects, illusion plans, curios and imported novelties from many foreign lands. Large assortment, lowest prices. You will amaze and mystify your friends! Send 10c today. Lyle Douglas, Station A-5, Dallas, Tex.

MAGIC—Tricks, Books and Supplies. For amateurs as well as the great professionals. Anyone can learn through our instructions. Feature Acts in Mind-Reading, Spiritualism, Rope Ties, etc. Large illustrated professional catalog, 20c. Chicago Magic Co., 140 So. Dearborn St., Dept. B, Chicago, Ill.

SEVEN Magical Delusions and catalogs—25c. Gilmaglio, Morgan Park, Ill.

THE Flapper—A snappy joke novelty with a real shock, including novelty catalog, 10c. Bowman Novelty Co., Racine, Wis.

UNIQUE Novelties—Magical mysteries; perplexing puzzles. Catalog free. Hellwig, 2050 W. Davison, Detroit.

LATEST French model pocket mirror and set of transparent art cards all for \$1.00. World Service Co., 336 Marcy Ave., Brooklyn, N. Y.

CAMPAIGN Puzzle—Hoover wins or Smith goes to White House. Whirlwind sellers. Sample 25c. Agents wanted. Rebusse Co., Cohoes, N. Y.

153 TRICKS Fully explained and catalog 10c. American Specialty Company, Swampscott, Mass.

SIX Mystifying card tricks, done with ordinary pack cards. Easily learned. 25c, including large catalog. Wizard Magic Co., Dept. 15, Box 1033, Station C, Los Angeles, Calif.

FREE with \$25 order die box. Send 20c for our large catalogue of tricks, wigs, sensational escapes. Oaks Magical Co., Dept. 548, Oshkosh, Wis.

MAGIC Catalog 20c. Free trick. Lynn's, 105 Beach, Jersey City, N. J.

ELECTRIC Fun! Seventy stunts, 110 volts. \$1. Cooper Sons, Campbell, Calif.

GAMES, ENTERTAINMENTS AND PLAYS

PLAYS, Musical comedies and revues, minstrels, comedy and talking songs, black-face skits, vaudeville acts monologs, dialogues, recitations, entertainments, juvenile plays and songs, musical readings, make-up goods. Catalog free. T. S. Denison & Co., 623 So. Wabash, Dept. 11, Chicago.

LEARN Ventriloquism by mail—small cost, 2c stamp brings particulars. Geo. W. Smith, Room 8-302, 125 N. Jefferson St., Peoria, Ill.

"TAKE-ALL"—Lots of fun, and how? The game of eights. Fascinating, exciting, latest craze; sells on sight, ladies and gentlemen, if you want to be the life of the parties, start now, introduce this new game to your friends and their friends; you can learn in 5 minutes; make yourself \$5 and up every evening. Send 25c for games, booklet and price list. Take-All, Box 551, Vancouver, B. C., Canada.

NOVELTIES, CURIOS, ETC.

"THE Book of 1,000 Wonders" will be sent postpaid for 10c. Explains many mystifying tricks with coins, cards, handkerchiefs, etc., you can do. Also, contains complete catalog of magic tricks, jokes, puzzles, books, escapes, mindreading acts, spiritualistic effects, illusion plans, curios and imported novelties from many foreign lands. Large assortment, lowest prices. You will amaze and mystify your friends! Send 10c today. Lyle Douglas, Station A-5, Dallas, Tex.

STAMP COLLECTING

A DOZEN New Scott seal packets. Here are a dozen bargains in guaranteed genuine stamps just added to our Scott Seal Packet list. No. 401, 10 diff. Irish Free State, 15c; No. 405, 10 diff. Ecuador, 10c; No. 406, 25 diff., Ecuador, 25c; No. 407, 10 diff. Siam, 10c; No. 408, 20 diff. French Morocco, 25c; No. 409, 10 diff. Newfoundland, 10c; No. 410, 20 diff. Irish Free State, 35c; No. 411, 20 diff. Indo China, 25c; No. 412, 10 diff. Barbados, 20c; No. 413, 10 diff. Jamaica, 10c; No. 414, 10 diff. Salvador, 10c; No. 415, 12 diff. Latvia, 10c. When you order ask us to send you free our 80-page price list of more than 1,100 stamp packets and sets. Scott Stamp and Coin Co., 1 West 47th St., New York, N. Y.

500 DIFFERENT Stamps for 25c! Big collection 500 different stamps from Bosnia-Herzegovina, Crete, Epirus, Hong Kong, Iceland, Kenya and Uganda, Liberia, Malta, Nyassa, North Borneo, Orange River Colony, Siam, Wallis and Futana, and other "hard" countries. Catalog value \$10.00. Price only 25c to approval applicants! Special bargains, 1,000 different 79c; 15 triangle stamps 49c; 100 Africa 45c; 100 Asia 50c; 100 Balkan States 35c; 100 British Colonies 25c; 100 French Colonies 30c; 100 Portuguese Colonies 50c. All 8 packets for \$3.00! Illustrated lists free. Loma Stamp Co., 3926 32nd St., San Diego, Calif.

MYSTIC "Queer Country" Packet! Contains scarce stamps from the following strange lands: San Marino, Antioquia, Congo, Cyprus, Fii Islands, Gwallor Hyderabad, Iceland, Jhind, Kenya, Uganda, Lebanon, Monaco, North Borneo, Nyassa, St. Thomas Prince, Eastern Roumelia, Siam, Sierra Leone, Tanganyika, Trinidad Tobago, Ubangi, Upper Volta, Wallis Futana, Alaouties. Get this wonderful packet of "freak countries" and make your friends envious! Price only 10c to approval applicants! Write today. Mystic Stamp Company (Dept. 8), Camden, N. Y.

BOYS Here's real value. Just to make you acquainted with our wonderful packets we make this combination offer to hold good until October 1. Pocket A 28, 15 Moroccan post office (G. Brit., French and German surcharges) 25c. Packet A 38, 20 diff. Algeria 25c. Packet A 41, 10 Portugal-Azores Independence issue 15c; total 65c. You can have all three packets for 50c and receive triangle stamp premium free. If you are not satisfied on receipt, return them and get your money back. Price list free. Argonaut Stamp Co., New Canaan, Conn.

A SNAP—300 different foreign and 60 different U. S. stamps, including \$1 and \$2 revenues, all for only 25c. Free, with each order, our pamphlet which tells "How to Make a Stamp Collection Properly," together with our price lists of albums, supplies and hundreds of bargains in sets, packets, etc. Queen City Stamp & Coin Co., Room 36, 604 Race St., Cincinnati, Ohio.

AIRMAIL First flight and first day covers. Stamps. Howard M. Weaver, Waynesboro, Pa.

FREE. Two United States dollar stamps with order 123 different for 10c. Includes obsolete United States, French Colonials, etc. Also approvals. The Stamp Mart, New York Bldg., St. Paul, Minn.

PRETTY Set of 20 Liechtenstein and 500 all different stamps which catalog \$10.00 for only 20c. We send pretty approvals and lists. Special bargains: 200 different 7c, 1,000 different 69c, 100 United States 38c, 25 airmail 10c, 25 birds and beasts 20c, 25 portraits 15c, 10 triangles 25c, 25 different scenes 20c, 15 fair women 10c, 20 famous men 10c, 10 architecture 10c, 10 statuary 10c, 15 scenery 10c, 10 ships 10c, 10 wild animals 10c, 25 Canada 10c, 25 Denmark 10c, 25 Norway 10c, 25 Sweden 10c. V. W. Rotnem Stamp Co., 545 McKnight Bldg., Minneapolis, Minn.

ANCHERS \$\$\$ Outfit—only 12c! Fine triangle stamp; set German stamps with (pre-war) value forty million dollars (interesting!); perforation gauge, mm scale; small album; airmail set; scarce stamp from smallest republic on earth; newspaper set; packet good stamps from Travancore, Malay, Dutch Indies, etc. Entire outfit for 12c to approval applicants! (Nice pocket stock book, value 25c, with every order!) Ancher Stamp Co., 148½ Clerk St., Jersey City, N. J.

\$1.00 FREE Black U. S. Postage. Given Away with each order. Pioneer Stamp Album with 500 illustrations, 150 different stamps from 40 countries, Syria, Lebanon, Hejaz, Liberia, New French Colonies, British, Portuguese Colonies, South Africa, Australia, 500 hinges, 36 page illustrated catalogue. All for 15c. Big Commission to Agents for the Best approval sheets of stamps ever offered. Write for sample outfit. Hussman Stamp Co., Dept. M, 620 Olive St., St. Louis, Mo.

ANNIVERSARY Offer! 15c six beautiful sets: "Occupation," "Commemorative," "Airmail," "Charity," "Pictorial," "War." Also three packets: (International), (British) French, Portuguese Colonies), (Bulgaria). Approvals, lists, discounts. Deering Fairmount, Marlborough, Mass.

BABCOCK'S Bargain Broadides build collections. Babcock, 407 E. Fort, Detroit, Mich. Approvals only.

LIBERIA Snake Triangle and two other triangles in our packet of 53 genuine foreign stamps for five cents. Crowder Company, Waverly, Baltimore, Md.

100 BRITISH Colonials, all different, including some of the older varieties, for 25 cents. Approvals of the better grade stamps for advanced and medium collectors. Also beginner's selection. Lists free. Your name on our mailing list guarantees you satisfaction. Humber Stamp Co., 401 Quebec Ave., Toronto 9, Canada.

ALBUM 1,000 Hinges, 200 foreign, 25 Cuba, 25 Japan, 35c. Burtiss Company, Saratoga, N. Y.

FREE—Beautiful complete mint set 18 stamps to approval applicants. September applicants 100 different mint stamps extra. Postage 4c. Iron Spring Stamp Co., Iron Springs, Pa.

UNITED STATES high values, blocks, covers, sets, packets Lists free. Nagy, 8P South 18th, Philadelphia, Penna.

200 DIFFERENT Stamps and wonderful stamp magazine, 12c. Stamp Echo, 503A, Fifth Ave., New York.

50 DIFFERENT U. S. postage 5c to applicants for our U. S. and foreign approvals. 100 British colonies 25c; 1,000 mixed foreign 35c; 1,000 hinges 10c, 3,000 25c. Glendale Stamp Co., 1341 Linden, Glendale, Calif.

STAMP Collecting hints. This booklet free to beginners. T. Bottome, 2934 Shriver, Indianapolis, Ind.

50 DIFF. Soviet Russia 25c. Approvals if you wish. Glenn R. Knight, Box 3, Sausalito, Calif.

40 DIFFERENT United States 10c. 60% approvals. Seidenberg, Baroda, Mich.

5,000 FINE Stamps \$1.00. Longacre Hobby Shop, 106 W. 42d St., New York.

FREE! Large 52-page illustrated wholesale catalog to those dealing in stamps. Grossman, 108 West 42nd St., New York.

100 FOREIGN Stamps 3 cents. Lufbery Stamp Co., No. Branford, Conn.

CANADIAN And American commemoratives, five cents to approval applicants only. The Stamp Chest, 84 Jane St., Toronto 9, Canada.

500 MIXED U. S., old and new, 10c. Weatherby, Lakewood, Ohio.

78 FAR-OFF Countries, only 10c. Angola, Dahomey, Travancore, Jamaica, St. Pierre, Schleswig, Martinique, Ivory Coast, Esthonia, Luxemburg, Peru, Newfoundland, South Africa. Marvelous packet 78 different stamps from 78 different countries, including all above and 65 more. Bargain price 10c. Big lists and approvals with each order. C. D. Reimers Company, 8 Flatiron Bldg., Fort Worth, Tex.

BIG Circus packet 10c—Worth much more; gigantic bargain; animals of the jungle, birds of prey, natives, elephants, giraffes, lions, ant eaters, caribou, camels, mule from Iraq, Liberian jungle and big lot of fine stamps only 10c to applicants of our low-priced approvals. E. P. Johnson, Box 692, San Jose, Calif.

MAGNICAROCIOUS Packet foreign stamps, beauties from distant lands. (Many richly colored, unusual designs), free for 2c. Gray Stamp Company, Toronto, Can.

FREE—Early Bermuda, Canada listing 15c, to approval applicants sending two references, \$1.47 (no checks) for Barbados, Palestine, Malta, Mauritius cataloging \$5. Satisfaction or refund. Reuter, Fullerton, Calif.

TRIANGLES—Ten different for 15c to approval applicants. Fenway Stamp Co., 161 Massachusetts Ave., Boston.

FINLAND: 30 Different 15c postpaid. Lists free. Allion, Angola, Ind.

DANDY Honduras set cataloging 48c with approvals 8c. Atlas, 5044 Drake, Chicago.

FREE—Surprise packet to approval applicants. McEwen, 755 Wilson, Columbus, Ohio.

50 FRENCH Colonies 5c to all approval applicants. Prall, Somerville, N. J.

FREE—10 Unused and catalog of 300 packets arranged by countries. Bell Stamp Co., Box 455, Washington, D. C.

LINDBERGH Panama issue complete, 40c. Wirth, 139 Shepherd Ave., Brooklyn, N. Y.

FREE—Sample copy of stamp collector's magazine. World's largest monthly. Philatelic Publishing Co., 15 Johns St., New York.

AMATEURS! Low priced sets on approval. Wickham Stamp Co., Secaucus, N. J.
109 DIFFERENT, Arabia, Azerbaijan, Zanzibar, etc, 10c to approval applicants. Floyd Marsh, 524 Hamilton Ave., Indianapolis, Ind.

300 DIFFERENT, 20c; 600, 50c; 1,100, \$1 2.00, \$3.50. Fred Onken, 630 79th St., Brooklyn.

BEAUTIFUL Picture stamps sent free. Paul Cornish, Schenectady, N. Y.

FREE Packet Azerbaijan, Canada, Dutch Indies, etc., upon request for our 50% sheets. Enclose 2c. George Flagg, 165 Tremont St., Boston, Mass.

FRENCH Colonies free—Jungles, Tigers, Native Chiefs. 2c postage. Empire Stamp Co., Toronto, Canada.

HAWAIIAN Stamp free to approval applicants. Postage 2c. Lists free. Eastern Stamp Co., 1809 Kilbourne Place N. W., Washington, D. C.

500 STAMPS 17c, 3,000 Hinges 25c. Ask about special approval discount. Elmer, 61 Court St., Boston.

FREE! 12 Scarce Azerbaijan to approval applicants. Penna Stamp Co., Greensburg Pa.

105 CHINA, Etc., 2c. Album (500 illustrations) 3c. Bullard, Sta. BB, Boston.

110 DIFFERENT Stamps, many unused, high values, free to collectors requesting our Net Approvals. Postage 2 cents. Christensen, Milwaukee, Wis.

ONLY 5c! 10 Airmail stamps, including scarce Esthonia triangle; Greece Red Cross set; packet fifty different stamps—all unused—from Guyane, Ubangi, etc. All for 5c! Approvals and free lists with each order. Curhan Stamp Company, Gloucester, Mass.

STAMPS, 100 all different, Postage 2c. Lists free. P. M. Quaker Stamp Co., Toledo, Ohio.

REVENUES—Telegraphs—Every country. Pretty—Intriguing—Cheap. Mint \$5.00 revenue free to applicants with references. Vanderhoof, 1114 Logan, Denver, Colo.

HIGH-CLASS Approvals. References Required. Pikes Peak Stamp Co., Colorado Springs, Colo.

1,000 DIFFERENT Genuine stamps, catalog value around \$25.00, for only 79c. Guaranteed satisfactory. If you don't like the collection, just send it back and we will refund your money, plus your postage. A. K. Nickles, 213 Seaton, Washington, D. C.

110 NEW Europe All Different, a wonderful collection cataloging several dollars, free to collectors requesting our Net Approvals. Postage 2 cents. Badger Stamp Co., Milwaukee, Wis.

BEST One cent approvals in America. F. P. Hand, 1117 So. 60th St., Philadelphia, Pa.

DANDY Mint stamps 2c to those requesting approvals. Harvey Teeple, Decatur, Ind.

1,000 ALL Different stamps \$1.00. New price list of all United States stamps free. Voorhees, 7 South Dearborn St., Chicago.

GREECE—Bought, sold, exchanged. Approvals. \$1.00 deposit. Pop-Gpo, Bx471, New York.

ONE-CENT Approvals. Fine fillers, big bargains. State countries desired. George Ludlum, Box 123, Seattle, Wash.

FREE 50 British Colonials, if approvals requested. Postage 4c. Berkeley Stamp Co., South Berkeley, Calif.

FINEST Approvals 50% discount. Reference required. Premium with every purchase. Ioor, 802 State Life Bldg., Indianapolis.

MOST Sensational values; over 140 diff. Algeria, Airplanes, Azerbaijan, Barbados, Cameroon, Babon, Guyane, Irish set, large French Colony packet, largest stamp, 40 year old U. S., gauge, etc., for 10c to approval applicants. List free. 100 diff. U. S. 30c—1,000 hinges 9c—50 Bavaria 9c. Hawkeye Stamp Co., Cedar Rapids, 39, Iowa.

STAMPS sent on approval at 70% discount. Reference required. Emory Renoll, Hanover, Pa.

101 DIFFERENT Free with 50% Approvals, 2c postage. Noemus Stamp Co., 312 East 23rd St., New York.

UNITED STATES and Canadian 32-page price list free. Stamps bought. Stanley Gibbons, Inc., 38p Park Row, New York City.

FINEST One Cent Approvals in the United States. Stanton, Niantic, Conn.

THOUSAND Foreign stamps 50c; twenty foreign coins \$1. Prof. McCreery, Chatham, Ontario.

PENNY Approvals that Satisfy. Neil Gronberg, Box 5441, Philadelphia, Pa.

FREE Germany air mail (5 var.) for new applicant of my 1, 2c and 3c approvals and also my 50% discount. Chas. W. Schmidt, P. O. Box 4832, Frankford Sta., Philadelphia, Pa.

FREE! 115 Different stamps to approval applicants, 2c postage. Paige Stamp Co., Oak Park, Ill.

STAMPS, 100 varieties, Africa, Brazil, Peru, Cuba, Mexico, etc., 10c; 25 different U. S. 25c; 1,000 mixed, 40c; 1,000 hinges, 15c. List free. C. Stegman, 5941 Cote Brillante, St. Louis, Mo.

24 VARIETIES Cuban stamps, 10 cents. List of 6,000 low-priced stamps free. Address Chambers Stamp Co., 111P, Nassau St., New York City, N. Y.

200 DIFFERENT stamps 10c; 1,000 Hinges 10c. R. H. Carlton, 380 W. So. Temple, Salt Lake, Utah.

COVERTCO Packet, 100 different stamps 10 cents, with 60% discount approvals. Covert Stamp, 39 State, Rochester, N. Y.

FREE! 5 Rare Siam to approval applicants. Winthrop Smith, 3611 N. Cedardale Rd., Baltimore, Md.

9 ALGERIA 10c, 8 Malay States 10c, 1,000 hinges 10c. All for 25c. Elwood Weber, Plainfield, N. J.

RARE COINS

\$2 TO \$500 Each paid for hundreds of old coins. Keep all old money, it may be very valuable. Send 10 cents for illustrated coin value book, 4x6. Prices guaranteed. Get posted. We buy and sell. Clarke's Coin Office, Box 5, Le Roy, N. Y.

40 OLD Coins all different \$1.00; 100 different coins, \$3.00; 200 different copper and nickel coins, \$7.00; 100 different Germany war-coins, \$2.00; 100 mixed foreign coins, \$1.00. Claud Denney, Box 315, Dallas, Tex.

10 CIVIL War cents 50c, 10 confederate bills 50c, 10 handsome bills 50c, Roosevelt medal 15c, large Lindbergh bronze medal \$1.50, Washington medal 50c, 5 historical medals 35c, 20 cent piece 60c, trade dollar \$1.25, Franklin bronze medal 35c, Sesqui Centennial gilt medal, handsome 35c, 1857-1858 flying eagle cents 25c, 5 different dates 2 cent pieces 35c, 10 large cents 75, United States half cent 25c, Revolutionary war 1776 bill 40c, 10 Indian arrowheads 60c. Retail catalog free. Nagy, 8P, South 18th, Philadelphia, Penna.

OLD Money wanted. Will pay \$100.00 for 1894 dime, S. Mint., \$50.00 for 1913 Liberty head nickel (not Buffalo). Big premiums paid for all rare coins. Send 4c for large coin folder. May mean much profit to you. Numismatic Co., Dept. H-3, Fort Worth, Tex.

LINDBERGH Medals from sculptors' models, work of art, guaranteed bronze, \$1.50 each. Also artistic large campaign medals and small campaign buttons. Write Metallic Art Co., 210 East 51st St., New York.

AMERICAN Eagle cent, large cent, French 10c piece, 2 crisp notes and catalog 20c. George Best, Cedar Rapids, Iowa.

CALIFORNIA Gold quarter, 27c; half, 52c; 1787 cent, 50c; 1835, 25c; confederate \$100, 20c. A. Wylie, No. 365, Wheaton, Ill.

25 DIFFERENT Foreign coins 50c Oddehon, Box 681, Kansas City, Mo.

RARE United States and foreign coins, war medals and decorations, Chinese coin and catalog 10c. Alexis Mengelle, Colorado Springs, Colo.

CALIFORNIA Gold—Quarter size, 27c; 3/4 size, 53c; 3c piece and catalog, 10c. Norman Shultz, Box 746, Salt Lake, Utah.

UNITED STATES. Large cent, two-cent bronze, three-cent nickel and Bargain List. 25c. Fifteen dates large cents, \$1.00. George Coffin, Greenwood Mountain, Me.

GET Profit and pleasure in collecting old coins. Send 10c for large illustrated coin catalogue. You'll be delighted with it. Send for it right now. B. Max Mehl, Numismatist, Mehl Bldg., Dept. P, Forth Worth, Tex. Largest Rare Coin Firm in the U. S.

OLD Coins, large Fall selling catalog of coins for sale free to collectors only. Catalog quoting prices paid for coins, ten cents. William Hesslein, 101A Tremont St., Boston, Mass.

FOR BOYS

EARN Christmas money. Order 50 sets Christmas Seals. Sell for 10c set. When sold return \$3.00, you keeping \$2.00. No work—just fun. St. Nicholas Seal Co., Dept. 43PM, Brooklyn, N. Y.

SPECIAL—White 500 last. One dollar buys 33 beautifully embossed Xmas cards. Martin Huet, Box 245, Chicago.

"THE Book of 1,000 Wonders" will be sent postpaid for 10c. Explains many mystifying tricks with coins, cards, handkerchiefs, etc., you can do. Also, contains complete catalog of magic tricks, jokes, puzzles, books, escapes, mindreading acts, spiritualistic effects, illusion plans, curios and imported novelties from many foreign lands. Large assortment, lowest prices. You will amaze and mystify your friends! Send 10c today. Lyle Douglas, Station A-5, Dallas, Tex.

"THE Boy Electrician," pocket size, 75 illustrations, 30c. J. Tillbergh, Proctor, Vt.

CAMERAS AND PHOTO SUPPLIES

PHOTOGRAPHIC Equipment and accessories of every description are listed and illustrated in our 228-page catalog. It will pay you to secure a copy which is issued free, as our prices are low. We also deal in used goods which are sold under the same guarantee as new goods. Ask for our Bargain Book. Central Camera Co., Dept. E134, 112 S. Wabash Ave., Chicago, Ill.

KRUXO Photographic post cards, semi matt and glossy, three grades of contrast, soft, normal and ex-hard. Write us for samples and prices. Kilborn Photo-Paper Co., Cedar Rapids, Iowa.

SALES Increaser—Sheasgreen's "Location Analysis Guide," \$1.00. Standard Cost, PM1427 North Penn, Minneapolis, Minn.

BIG Money saved on photographic lenses and apparatus—goods exchanged; repairing done. Ralph J. Golsen, 1128 Argyle St., Chicago, Dept. P.

GERMAN Cameras, lenses. Bartro, 6436 La Riba Way, Los Angeles, Calif.

BIG Money in photography. Catalog 49A free. New York Institute of Photography, 10 West 33rd St., New York.

TIME Counts in applying for patents. See pages 138 and 139. Clarence A. O'Brien, Registered Patent Attorney, Washington, D. C.

MAKE money in photography. Learn quickly at home. Spare or full time. New Plan. Nothing like it. Experience unnecessary. American School of Photography, Dept. 3431, 3601 Michigan Avenue, Chicago.

ROLL Developed—Six prints, one beautifully tinted, 25c. 8x10 enlargement, 30c. Falls Foto Finishers, Dept. A, Glens Falls, N. Y.

HAVE You a Camera? Write for Free sample of our big magazine, showing how to make better pictures and earn money. American Photography, 116 Camera House, Boston, 17, Mass.

FILMS Developed. Special Trial Offer. Any Size Kodak film developed 5c, prints 3c each. Trial 6x10 Enlargement in handsome folder 40c. Overnight Service. Roanoke Photo Finishing Co., 209 Bell Ave., Roanoke, Va.

SAMPLE Enlargement—dime, and negative (returned). Trial roll, glossy prints, 25c silver. Brown, Warsaw, N. C.

MOTION PICTURES

NEW \$150 Spring movie camera, \$29.50; 35mm film, 2 1/2c foot; Filmo Camera \$100; Cine Kodak 16mm camera, \$50; 16mm, 100 ft. negative film, \$4.50 postpaid; 100 ft. complete 16mm comedy, western travel, or war reel, \$4.50. Cameras, projectors and films bought and exchanged. New twin arc movie lamps \$40. 3 1/4x5 1/2 Kodak, \$9; Remington typewriter, \$16. Ray, 296, Fifth Ave., New York.

JUST Out! Fourth edition Motion Picture Projection by Cameron, 1,248 pages. Largest work ever published. Includes 150 pages on talking movies. Covers all known makes of projectors, including amateur. A liberal education. Yours for \$6.00 postpaid anywhere in the United States. Foreign, \$8.25. Circular on request. Bass Camera Company, 179 West Madison St., Chicago.

FOR Sale: Moving picture films, features, comedies, serials, one dollar per reel and up. Progressive Pictures, 3320 Lindell, St. Louis, Mo.

FILMS For toy machines. Bargain clearance sale. Free list. Alton Films, 205 Brush Creek, Kansas City, Mo.

FEATURES And short subjects \$2.00 reel and up. Standard machines and suitcase projectors at bargain prices. Stamp for lists. Homer Shimp, 4547 Adams St., Kansas City, Kans.

WANTED To buy—Second-hand Power's, Simplex and Motograph machines. Also extra mechanisms and stands. Must be bargains. P. O. Box 202, Birmingham, Ala.

BE A movie exhibitor—Big opportunity—Only moderate capital required—Complete equipment at remarkably low prices. Write, Atlas Moving Picture Co., 624 South Michigan Ave., Chicago, Ill.

NEW and Rebuilt Projectors for Theaters, Schools, Churches, Traveling Shows. Supplies and Complete Theater Equipments. Bargain Prices. Free Catalog. Monarch Theatre Supply Co., Memphis, Tenn.

MOVIE Films, 1,000 ft. reels, \$2.50 each; shipped anywhere on receipt of remittance. Particulars on request. Independent Films, 177 Golden Gate Ave., San Francisco, Calif.

TIME Counts in applying for patents. See pages 138 and 139. Clarence A. O'Brien, Registered Patent Attorney, Washington, D. C.

FILMS: Our new catalog on movie machines and films now ready. Our low prices will surprise you. Exclusive Film Service, Dept. P, 732 So. Wabash, Chicago.

BIG Money in photography. Catalog 49A free. New York Institute of Photography, 10 West 33rd St., New York.

STARTLING Bargains in motion-picture cameras, projectors, apparatus. Send stamp for the 192nd issue of the Bass Bargain-gram. Never in history has such startling bargains been offered in guaranteed apparatus. Write for your copy now. Remarkable motion-picture exposure meter, \$2.00. Sixty-six page catalogue. Send stamp. Bass Camera Company, 179 W. Madison St., Chicago, Ill.

\$1,250.00 FOR A photoplay story by an unknown writer and sold through our sales department. We revise, copyright and market. Located in the heart of the motion picture industry. We know the demand. Established 1917. Postal brings free booklet with full particulars. Universal Scenario Company, 206 Western and Santa Monica Bldg., Hollywood, Calif.

MACHINES, Films, stereopticons, slides. National Equipment Co., Duluth, Minn. Bargains.

FILMS, 100 Feet 50c postpaid, listed. W. E. Temple, Dept. A, 13 Chester Ave., Somerville, Mass.

SCENERY TO RENT

WORLD'S Most Beautiful Settings for operas, plays, minstrels. Amelia Grain, Philadelphia.

EDUCATIONAL AND INSTRUCTION

U. S. GOVERNMENT Jobs—\$1,260-\$3,300 year. Men—boys, 18-50. Steady jobs. No "layoffs." Pleasant work. Paid vacation. Short hours. Experience unnecessary. Thousands appointments yearly. Full particulars with sample coaching, free. Write today sure. Franklin Institute, Dept. H14, Rochester, N. Y.

ARE You willing to qualify for government positions. \$120-\$250 month? Write Instruction Bureau, Dept. 101, St. Louis, Mo.

BIG Demand for photoplay and magazine stories. We revise, develop and copyright. Sell on commission. Established 1917. Booklet free. Universal Scenario Company, 406 Western and Santa Monica Bldg., Hollywood, Calif.

TRACE Missing people. Excellent paying work. Open to all. Write National Headquarters, 169 East 83rd, New York.

FIREMEN, Brakemen, baggagemen (white or colored), sleeping car, train porters (colored), \$150-\$250 monthly. Experience unnecessary. 810 Railway Bureau, East St. Louis, Ill.

BOYS—Men 16 up. Become auto mechanics. Particulars free. Franklin Institute, Dept. H400, Rochester, N. Y.

WORK For "Uncle Sam." Postoffice clerks, carriers, railway postal clerks, \$1,700-\$2,700 year. Men 18-45. Sample free. Write immediately. Franklin Institute, Dept. H3, Rochester, N. Y.

8 KEYS On bookkeeping. Booklet 50c. Mrs. Alice Anderson, 210 Vine, Poplar Bluff, Mo.

CARTOONISTS: Names and addresses of 50 syndicates and magazines which want art work. 50c. Write "Haines," Box 244, Greenfield, Ohio.

BE A Landscape Architect—Splendid earnings, real success awaits you in this uncrowded profession. We train you by correspondence. Personal guidance by noted authorities, helping you get started. Immediate income possible. Catalog free. Write today. National School of Landscape Design, 518 Equitable Bldg., Des Moines, Iowa.

U. S. GOVERNMENT wants men. \$1,700-\$1,900 and up at start. Railway Mail clerk examination coming. Let our expert (former Government examiner) prepare you for this and also Rural Carrier, Post Office, Customs, Internal Revenue, and other branches. Write today for free booklet. Dept. S, Patterson School, Rochester, N. Y.

STUDY A Scientific Profession. Sanitation—Bacteriology—Microbiology. Extension—Residential courses. Diplomas—Degrees granted. Urinalysis outfit and prospectus free. Int. College of Microbiology, 723 Calumet Ave., Hammond, Ind.

DON'T Prepare for any civil service examination without seeing our catalog. Free. Columbian Correspondence College, Washington, D. C.

BIG Money in photography. Catalog 49A free. New York Institute of Photography, 10 West 33rd St., New York.

DOUBLE Entry Bookkeeping mastered in 60 hours with 8 keys; guaranteed; diplomas. International Bookkeeping Institute, Dept. 8, Springfield, Mo.

SELF-INSTRUCTIVE Books, 50 subjects. Best Stenography, 25c. Circulars. Will Marr, B695, Nashville, Tenn.

RADIO OUTFITS AND SUPPLIES

CROSLY Super musicones speakers \$2.75. Require cone paper only. Atwater Kent 5 tube sets \$18.00. Saal Speaker units \$2.00. Transformers 75c, output 90c, 30 henry chokes \$1.00, 2 microfarad condensers 60c, full wave UX280 tubes \$1.75. Send money order with order. Charles Hoodwin Co., 4240 Lincoln Ave., Chicago, Ill., Dealers in bankrupt stocks.

BARGAINS in used radios. These receivers were taken in trade. All guaranteed perfect working order. Blue Ribbon 5 tube, 2 dial, console model \$19.95. Freshman 5 tube table model \$14.95. Atwater Kent \$19.50. Tubes included with sets. Many other makes. Send money order with order. Complete list of bargains on request. Surplus Radio Co., 549 S. Wells St., Chicago.

OVER 9,000 Radio bargains. Write American Radio Club, St. Paul, Minn.

PHENOMENAL! New short wave adapter, attaches to any set. Amazing results! Hear the US and foreign short wave broadcasts. \$16.50 prepaid. Literature free. Kilo Radio Co., 1722 Pallister, Detroit, Mich.

WANTED: Men to work with National Radio Service organization. No selling scheme. Radio Doctors, Inc., Dept. M, Essex St., Salem, Mass.

RADIO Power transformers, chokes, meters and miscellaneous material for sale. Write for lists and specifications. Radio Parts Co., Orange, N. J.

TIME Counts in applying for patents. See pages 138 and 139. Clarence A. O'Brien, Registered Patent Attorney, Washington, D. C.

DEATH To static. Send one dollar. P. O. Box 621, Ottawa, Can.

TRADE AND TECHNICAL SCHOOLS

OUR Commercial radio operating and junior engineering course pays our graduates \$150 to \$300 monthly from start. Rapid advancement. Fall term begins in September. Write for catalog of course including Extension Course. Loomis Radio College, Dept. 5-E, Washington, D. C.

WANT A foreman's job? You may be a good mechanic but if you can't read blueprints you haven't a chance. I train you quickly. Write me your trade. Carroll Rumsey, 266 Drexel Building, Philadelphia.

TELEGRAPHY—Both Morse and wireless—taught thoroughly. Big salaries. Wonderful opportunities. Expenses low; chance to earn part. School established fifty-four years. Catalog free. Dodge's Institute, Fern St., Valparaiso, Ind.

LICENSED Radio doctors earn \$75.00-\$100.00 per week. Big demand; investigate at once. Free booklet. Radio Doctors, Inc., Dept. A, Essex St., Salem, Mass.

BUSINESS OPPORTUNITIES

LOCAL Managers Wanted for Phelps power and light plants. A great industry is developing. The potential market in some counties is estimated in the neighborhood of 1,000. One county would make a good business and a permanent income. Experience is necessary. Only men who know how to sell electrical goods and install them are wanted. If you want to get into a permanent business this is your opportunity. Particulars free. Phelps Power and Light Corp., Rock Island, Ill.

MARVEL. The instant battery charger, charges radio and automobile batteries instantly. Start a service station of your own or a mail order business; sell under your own label. Write at once for territory and get started making money. Eastern Supply House, 11 15th St., Bangor, Me.

BUSINESS Opportunities: Men and women—something new. Big profits. E. A. Barr Co., Desk 1, Shamokin, Pa.

LOID-LAC—Make this new, wonderful, amazing discovery; restores color, new finish to old cars in sixty minutes! Not a polish, cleaner, paint or wax. With my simple guaranteed formula you can easily manufacture Loid-Lac, clearing \$14.00 gallon profit! Clean up thousands with this guaranteed instant refinishing. Miller, Chemist, 706 Miller Chemical Bldg., Tampa, Fla.

MANUFACTURING Business for sale: Completely equipped machine shop manufacturing two newly perfected articles, market unlimited. Write P. O. Box 392, Green Bay, Wis.

"SCHEMER" Subscribers surely succeed. One reports \$50,000 from one tip; another \$25,000 from three Schemes; another \$10,000 from one formula. Try your luck! Year, \$1.00; three months, 30c. Patterson, Publisher, Alliance, Ohio.

MIRRORS Resilvered at home. Costs less 5 cents per square foot; you charge 75 cents. Immense profits plating like new, brassy worn-off autopaarts, reflectors, tableware, stoves, etc. Outfits furnished. Details free. Sprinkle, Plater, 127, Marion, Ind.

If you are interested in saving 30 to 35% on your postage bill, mail me 5c for usable samples of my covered envelopes and cards; none free. Edward Armour, M2, 136 East 28th St., New York.

FREE Book. Start your own little business anywhere, selling novelties by mail. My beginner's outfit contains everything required, novelties, circulars, instructions, etc. Descriptive book free. Hadwilt, 2H-74, Cortlandt St., New York.

200 LETTERHEADS. 100 Envelopes, printed free with every fifth order sent us. Opportunity to make money. Christianson, Box 183, So. Omaha, Nebr.

MAKE Toys, novelties, children's furniture. Instructions patterns, including scroll saw \$1.00. Wm. Bogren, 2264 Hermany Ave., New York.

SMALL Capital starts profitable route of money making vending machines. Information free. Chewit Co., Dodworth St., Brooklyn, N. Y.

NO Peddling. Start own business. Home, office. Free folder describes 27 money-making opportunities. No outfits. Elite Co., 38 Elizabeth St., New York.

EXTRA Money and a chance to establish your own independence can be made with well chosen spare-time occupation. We help you find it. Write Vocational Service, 7417 Latona Ave., Seattle, Wash.

22 MONEY Making plans \$1.00. Globe Centre, Altoona, Penna.

REPAIR Watches. Learn in an evening. Instructions and drawings for cleaning and adjusting 25 cents. Phillips Watch Repair, 5131 Kenmore, Chicago, Ill.

MAKE \$6.00 Daily with potato Maid-on Flakes; send 2 dimes for sample. General Sales Co., Muncie, Ind.

EARN More money—We show you how. Catalog free. Herman Service, 706 Calhoun, Fort Wayne, Ind.

LEARN Theatre management at home. Write for catalog M. Moving Picture Theatre Managers Institute, Elmira, N. Y.

LEARN The real estate business; lucrative; no capital required. Free details. Cole, Tower Bldg., Syracuse, N. Y.

SIGNS And showcards easily painted with letter patterns. Large variety of styles and sizes. Samples for stamp. John Bahn, a2120 Nava Ave., Chicago.

FOUNDRY For lease. Write Box No. 287, Liberty, Ind.

BECOME Watchmaker, jeweler, diamond setter; own business; paying job. Standard Watchmakers, 111 West 111th, New York.

BUSINESS Profession of your own and earn big income in service fees. See Stephenson Laboratories, display ad page 148.

CONDUCT A name and address brokerage business. No capital, either sex, ideal for students. 9 pages typewritten instruction complete one dollar. Carolina Mailing Bureau, Box 76, Durham, N. C.

MAKE Big Profits with a Fur Farm in your backyard. Chinchilla Rabbits, Muskrat, Mink. Write for facts. 252 Conrad's Ranch, Denver, Colo.

BUSINESS Information of every character. We divulge actual supply source of American-made goods, how to sell locally, by mail or through agents. Chemical analysis, formulas, money-saving business information, opportunities. Write for catalog. Business Information Syndicate, Box 1071, Knoxville, Tenn.

SELL Latest imported novelties. French model pocket mirror and transparent art cards. Samples of all postpaid \$1.00. World Service Co., 336 Marry Ave., Brooklyn, N. Y.

BURNED-OUT Electric lamps repaired one cent. I teach you. West Coast Lamp Co., 1342 Shrader, San Francisco, Calif.

BUSINESS Opportunities. Also trade secrets. Free facts. R. Harvey, 511 West 9th St., Cincinnati, Ohio.

15c BRINGS Big bunch mail year. Kentucky Agency, Covington, Ky.

KING System mail order business, co-operation idea. It's new! Different! Honest! Big profits assured. Complete details 25c. Satisfaction guaranteed. King Company, Box 672P, Wilmington, Del.

INCOME Increaser—Newly enlarged 36-page monthly magazine of best, latest ideas, plans, schemes, tips, pointers, starters. One year, \$1; sample, 10c. Income Increaser, 88 Pearl, Boston, Mass.

COMPOSITION Floor Making earns industrious men \$12 and more daily if used as trade. Or make business of it with profits up to \$10,000 yearly. Openings everywhere. Semi-Tile, Box-43, Hollis, N. Y.

YOU Want to buy profitably established mail order business, or do you wish to sell? Write wants. Eastern Exchange-1, 112-Smith, Millville, N. J.

10c BRINGS You mail from everywhere and our opportunity information by return mail free. Witham, Box 153, Cathlamet, Wash.

TIME Counts in applying for patents. See pages 138 and 139. Clarence A. O'Brien, Registered Patent Attorney, Washington, D. C.

SIXTY Successful mail order propositions. K. Home, 3949 Metropolitan, Chicago.

SUPPLIES For making chipped glass house numbers and signs. Tinfoils, glass and frames. Osborne Sims, 13580 Tuller, Detroit, Mich.

START A Crispette shop. Delightful confections. Everybody likes them. Make a lot of money. Adams reports \$364 profits in two days. We start you. Write, Long Eakins, 1962 High St., Springfield, Ohio. (Samples 10c.)

MONEY For working capital; incorporate and sell shares in your business. 27 years organizing and raising money for businesses of merit. Terms reasonable. Prompt and confidential service. W. Harrison Cole, 507 5th Ave., Suite 510, New York.

SELL by Mail! Books, novelties, bargains! Large profits! Particulars Free! B-Elfec, 525 South Dearborn, Chicago.

I MADE \$30 a Week Home. French Breadmaking. 15 years' experience; Free Booklet tells. Ashbrook 67, Marengo, Ohio.

CHEMICAL Expert will furnish formulas and trade secrets. All lines. Lists free. W. L. Cummings, Ph. D., 228 Gordon Ave., Syracuse, N. Y.

DON'T Sell for others. Employ agents yourself. Make your own products. Toilet articles, household specialties, etc. 500% profit. Valuable booklet free. National Scientific Laboratories, 1984W Broad, Richmond, Va.

CHARTERS: Delaware; best, cheapest; free forms. Colonial Charter Co., Wilmington, Del.

UNPATENTED Ideas can be sold. I tell you how and help you make the sale. Free particulars (Copyrighted). Write W. T. Greene, 810 Baltic Building, Washington, D. C.

A BUSINESS of Your Own Making—Sparkling Glass Name and Number plates. Checkboards, Signs. Big book and sample free. E. Palmer, 540, Wooster, Ohio.

MECHANICS. Painters, carpenters, start furniture refinishing, painting, handyman shop on nearly nothing; winning plan brings customers quickly. John Braceland, 1439 So. Ninth, Philadelphia, Pa.

MAIL Order business your opportunity. Breniser's famous hand books by expert 28 years' experience show how to start selling articles you make or buy—all or part time—small capital. Fascinating, profitable. Set eleven books, \$3.25. Breniser Company, 1607 P. Sansom, Philadelphia. Sample book, 25c, pay \$3 for other ten if satisfied.

ARTIFICIAL Marble sanitary flooring instructions, covering wood or cement flooring 1/2 inch thick, fireproof, waterproof, all colors, low cost. Ornamental casting, concrete, plaster, papier-mache decorations, garden furniture, statuary, flexible molds. 18 years instructing the public; particulars and illustrations free. Chris. Mahler, Huntington, N. Y.

WE Start you in business, furnishing everything; men and women, \$30.00 to \$100,000 weekly operating our "New System Specialty Candy Factories" anywhere. Opportunity lifetime; booklet free. W. Hillyer Ragsdale, Drawer 4, East Orange, N. J.

SUCCEED With Your Own Products. Make them yourself. Formulas, Processes, Trade-Secrets. All lines. Catalog, circulars free. B. Thaxly Co., Washington, D. C.

LEARN the collection business. Good income, quick results. Interesting booklet, "Skillful Collecting" free. National Collectors Assn., Long St., Newark, Ohio.

THE Latest, most amazing products! 200% to 500% profit! Make them yourself. Write for free, valuable literature. Scheid, Chemist, Box 1199, New Haven, Conn.

DELAWARE Incorporator. Charters; fees small; forms. Chas. G. Guyer, 901 Market St., Wilmington, Del.

TELEGRAPHY

TELEGRAPHY—Both Morse and wireless—taught thoroughly. Big salaries. Wonderful opportunities. Expenses low; chance to earn part. School established fifty-four years. Catalog free. Dodge's Institute, H St., Valparaiso, Ind.

CHEMISTRY

YOUR Chemical problems solved and working formula or process furnished for \$5.00. Write me. W. Stedman Richard, Industrial Chemist, Box 2402, Boston, Mass.

BOOKLET Of experiments and chemical catalog 10c. George Ott, 1218 Chestnut, Reading, Penna.

FORMULAS AND TRADE SECRETS

INDUSTRIAL Chemist furnishes formulas, plans, trade secrets. All lines. Work guaranteed. Lists free. J. F. Mazur, 941 20th, Lorain, Ohio.

DON'T Sell for others. Employ agents yourself. Make your own products. Toilet articles, household specialties, etc. 500% profit. Valuable booklet free. National Scientific Laboratories, 1984W Broad, Richmond, Va.

SUCCEED With Your Own Products. Make them yourself. Formulas, Processes, Trade-Secrets. All lines. Catalog, circulars free. B. Thaxly Co., Washington, D. C.

FORMULAS—170 Money makers and big illustrated catalog 20c. Ideal Book Shop, (K) Park Ridge, Ill.

3,000 VALUABLE Formulas prepaid \$1.00. National Service, 3937 Marburg, Cincinnati, Ohio.

FORMULAS—High grade trustworthy processes for producing popular guaranteed best selling specialties; all lines. Don't buy formulas till you've received my literature. Miller, Chemist, 706 E. Jetton, Tampa, Fla.

GUARANTEED Formulas \$1.00 each. Chemical analysis, your sample, \$5.00. Stenton Laboratories, 2122 Griffith St., Philadelphia, Pa.

MANUFACTURING Ideas made practical. Chemical consultation and analysis. Money-making formulas. Charges moderate. Write Associated Chemists, Indianapolis, Ind.

AGENTS WANTED

NO Experience necessary. You'll sell Wonder Changeable Signs fast. We show you how. Write Currier Mfg. Co., 31 Northwestern Terminal, Minneapolis, Minn.

LATEST Portrait frames. Specialty foreign shipping. Write catalog. Victor Portrait Co., 2223 Brush St., Oakland, Calif.

WANTED At once: More good men to introduce and retail Rawleigh's Good Health Products. Town and country. Wonderful opportunity. Get into business with backing of largest manufacturer its kind. Capital over 15 million dollars. Quick freight, express, parcels post service from 10 great factories and branches—one near you. Nothing new—no experimenting. No experience required. You simply follow the same old time-tested Rawleigh Methods which secure the most business everywhere and have given consumers best values and satisfaction for 40 years. 170 necessities frequently needed every home. Enormous demand. Annual sales now over 35 million products. Big free trial inducements. Quick easy sales. Repeat every 30-60 days. Enormous profits—\$200-\$400 month and more clear profits. Steady year around; no layoff. No boss—you become sole owner and manager. Practically no capital required. We supply everything—stocks, outfit, sales and service methods. Big pay every day. Profits increase every month. "First come first served." For full particulars write W. T. Rawleigh Co., Dept. A10PPM, Freeport, Ill.

\$273 PROFIT One day. That's what A. L. Bradley made without experience, just showing the most amazing automobile light you ever saw; 38,000 candle power without glare; fits inside regular reflector, easy to install; wonderful patented device; 100% more light; eliminates glare without dimming or tilting; pocket big money, waiting for you now; whirlwind seller makes astounding demonstration; low cost; agents cleaning up 300% profit; big repeater; sells on sight. Finch sold 1,398 sets in six months and will sell over 20,000 sets this year; 24,000,000 prospects want this light; write today. Aerial Electric Co., 348 West Ohio St., Chicago.

MAKE Money with Christmas Greeting Cards in box assortments. \$2.00 to \$4.00 per hour easily made. Nothing ever sold compares with the sale of Christmas greeting cards; sell on sight. Our magnificent assortment contains 21 high-grade Christmas greeting cards and folders, each with envelopes, steel engraving. French water coloring, sparkling metallic gold and silver effects, panelling and bordering. Sells for only \$1.00, costs you 50c. Write immediately for full particulars and free samples. Waltham Art Publishers, 7 Water St., Dept. TO, Boston, Mass.

AGENTS—I'll pay your bills, give you steady income for rest of your life if you will take of my business in your locality, full or part time. You be my partner, make \$15 a day. Ride in Chrysler sedan. Distribute teas, coffees, spices, extracts, things people eat. I furnish everything, world's finest super sales outfit containing 30 full sized packages low prices, big repeat business; \$25,000 guarantee on quality. I go 50-50 with you. Get my amazing offer. C. W. Van de Mark, 117 Duane St., Dept. 102-K, Cincinnati, Ohio.

MAKE These guaranteed biggest selling products yourself. Have others selling them. Investment small; profits immense! Loid-Lac Instant Automobile Refinish. Tuf-Nit prevents hosiery runs. Kazok automobile dry wash cloth. My "Eye Opening" literature of these and many other automobile, food, household, cleaners, soaps, polishes free. Make your own goods for one-fourth what "Private Brand" and other goods cost you. Miller, Chemist, 706-A Chemical Bldg., Tampa, Fla.

AGENTS—\$13.80 Daily in advance, introducing new insured hosiery for men, women, children. Must wear or replaced free. 57 styles, 39 colors including latest "Silk to the Top" ladies' hose. Hyland made \$595 in one month. Edwards, \$450.60. Mrs. Bone, \$425.45. Why not you? Even spare time should pay you \$3.00 an hour. No experience needed. We furnish samples. New plan. Write quick. Macochee Company, Park 25610, Cincinnati, Ohio.

AGENTS—Best seller; Jem Rubber Repair for tires and tubes; supersedes vulcanization at a saving of over 800 per cent; put it on cold. It vulcanizes itself in two minutes, and is guaranteed to last the life of the tire or tube; sells to every auto owner and accessory dealer. For particulars how to make big money and free sample, address Amazon Rubber Co., Philadelphia, Pa., Dept. 505.

AGENTS: \$300 Month. We feed the world. Groceries, teas, coffees, food-specialties, soaps, perfumes, family medicines. Over 400 daily necessities. Steady, profitable repeat business. \$3.00 hour part time. Samples furnished. Harley Company, Desk M-2014, Dayton, Ohio.

MEN Make \$15.00 daily. Men's fancy first quality hose, \$1.08 dozen pairs. Send \$5.40 for 5 dozen assorted. No less sold. Lewis Hosiery Co., 12 N. 3rd St., Philadelphia, Pa.

IF I send you a suit made in latest style from finest goods, will you wear it and show it to your friends as a sample of my sensational values? Could you use \$3.00 an hour for a little spare time? If so, write at once for my wonderful new proposition. Address Sales Manager, Peoria and Adams, Dept. 954, Chicago.

PATENTED Invention—5 tools in one. Used by carpenters, machinists, trade schools amateurs. Everyone using tools wants it. Sample \$1.00. Hall Specialty Mfg. Co., 249 Market St., Newark, N. J.

AGENTS Are making \$75.00 to \$300.00 weekly selling new brake lining machine. Every garage, accessory store, car dealer, service station a prospect. Big profit. Write quick for open territory. Linley Brothers Co., 577 Fairfield Ave., Bridgeport, Conn.

FREE "Guide to full pocketbook." New ideas, original business plans, money-making secrets; other valuable information. Elite Co., 38 Elizabeth St., New York.

BETTER Than bootlegging! 400% profit taking orders liquid quick mend for fabrics and hosiery. Stops runs. Every woman buys. 100 other fast sellers. Johnson Co., Dept. 470, 6129 Wentworth, Chicago.

MEN And women make artificial fruit at home. Complete instructions \$1.00. This secret is worth more to you. Big profits. Every house a customer. Van Dyke Screen Co., 1963 Frederick, Detroit, Mich.

FREE To agents—Mail-order men and beginners in the mail order business, valuable tips and inside information. Enormous profits, clean and legitimate. Particulars. Nite Mail Order Supply Co., 609 27th St., Denver, Colo.

AUTOS Washed without water at practically no cost; no liquids, sponges, chamis; Marvo Wonder Cloth removes mud like magic; won't scratch; 100% profit. Security Mfg. Co., Dept. 35, Toledo, Ohio.

PATENTED Window lock. Every home needs several. Send 10c for sample and proposition. H. C. Sales Co., 114 E. Fourth St., Springfield, Ohio.

MAKE \$50.00 Weekly selling nationally known line of guaranteed hosiery. Experience unnecessary. Whole or part time. Exclusive territory and sample outfit furnished. Write at once. Gold Bond Hosiery Co., Dept. PM-10, 1011 Chestnut St., Philadelphia, Pa.

\$1.00 WILL Start you selling Aviation puzzle of the century; terms and sample 15c; \$100.00 cash name prize. Schwed, 118 East 28th, New York.

SECURE Your biggest income quickly selling new presidential candidates' photos and automobile plates. Automobile specialties. Federal Factory, 273 Columbia, Portland, Oreg.

WANT Distributing Agent for Handslick, powdered hand soap; removes anything from hands; everybody a customer; sample free. Solar Products Co., J-2142 S. Troy, Chicago.

AMERICA'S Greatest tailoring line free. 175 large samples; all wool; tailored to order; union made; sensational low price. Big commissions paid daily. Cash bonus besides. Exclusive territory to producers. Hustlers making \$100 a week and up. Get outfit at once. Address Dept. 710, Goodwear, 844 Adams, Chicago.

STATE Distributors. Patented smoking pipe reamer. Handy, necessary. No competition. Big profits. Rosentour, Main Ave., Passaic, N. J.

EVERY Merchant wants embossed show-cards; changeable signs; electric flashers. Two sample changeable signs (Retail \$1.50 each) sent postpaid \$1.00. Free catalog. Changeable Sign Works, 379 Logan St., Brooklyn, N. Y.

PRIVATE Brand toilet articles, household specialties, perfumes, soaps, extracts, etc. We pack these goods for you under your private label. With your name on the goods you get all the repeat business. Don't sell for others but build up a profitable business for yourself. Highest quality merchandise. Extremely low prices. Quick shipments on both large and small orders. Write immediately for lowest wholesale prices and complete information regarding our amazing offer. Address Supply Department, National Scientific Laboratories, 1904W Broad, Richmond, Va.

AGENTS—\$300 month. Bonus besides. Sell most attractive, highest quality hosiery you ever saw. Positively guaranteed 6 months or replaced free. 126 styles, colors. All fancy combinations of silk, rayon, lisle, novelty and sport numbers, full fashioned, chiffon, wool, etc. Sensational new sales plan gets big orders. Producers earn auto. We give you extra fine silk hosiery for your own use. Write quick for samples. Wilk-nit Hosiery Co., Dept. 5631, Greenfield, Ohio.

SHOW Us the housekeeper who likes to clean stair-corners; earn big money selling Corner Dust Shields. Write today. Ideal Stairway Equipment Co., Dept. PM, Canton, Ohio.

CHRISTMAS Boxes greeting cards; 21 cards sell for \$1.00; 16 for 50c. Samples both boxes \$1. Also stamps, tags, booklets. Klees Company, 1710 Undercliff Ave., New York.

AGENTS—Men's all-purpose suits! \$9.65! Looks, feels like wool! Resists snags, sparks, water! Workmanship, fit guaranteed. \$2.50 commission in advance. Free kit. Act at once. Filtz-U-Tailoring Co., Dept. 170C, South Whitley, Ind.

TOOT Sweet keeps the feet sweet. Toot Sweet Co., Mason City, Iowa.

AGENTS. Portraits, photo-pillow tops, frames, sheet pictures, medallions, photo-jewelry, soaps, perfumes, laundry tablets, food products, toilet preparations, luminous crucifixes. Catalog 200 specialties free. 30-days' credit. Jas. C. Bailey Co., Station C-10, Chicago.

AGENTS—Just out! \$8.88 for men's suits! Anyone can sell. Big commission in advance! Free sales kit. 888 Company, Dept. CK-7, Fort Wayne, Ind.

SELL Beautiful "Style Tailored" shirts and neckties direct to wearer at factory prices! Many beginners earn \$50 first week in spare time. \$100 weekly full time easy. Selling outfit free. Howard Shirts, 1213 VanBuren, Factory 16, Chicago.

\$50,000 PICTURE Man Friedman made canvassing. Beginners can make \$100.00 weekly with my sales talk. Experienced men make more. Free book. "Profits in Portraits" explains. Sample free. Picture Man Friedman, Dept. SM, 541 W. Lake, Chicago.

DON'T Sell for others. Employ agents yourself. Make your own products. Toilet articles, household specialties, etc. 500% profit. Valuable booklet free. National Scientific Laboratories, 1984W Broad, Richmond, Va.

BIG Fall seller! Merchants need colored embossed signs. Everyone buys. Extra large profit. Dinec brings fifty cents worth of samples. Franklin, 3322 Third Ave., New York.

\$100 WEEKLY Appointing agents Mother Hubbard Foods. No canvassing, delivering or investment. Mother Hubbard Products, 554F Congress, Chicago.

AGENTS—If you need money write for free sample So Easy Mystery Polishing Cloth. Mohler, Box 453-C, Chicago.

GENUINE Gold Leaf Letters anyone can put on store windows. Guaranteed to never tarnish. Large Profits. Enormous Demand. Free Samples. Write today. Metallic Letter Co., 428-D North Clark, Chicago.

NO Peddling. Start own business. Home, office. Free folder describes 27 money-making opportunities. No outfits. Elite Co., 38 Elizabeth St., New York.

AN Opportunity. Promotion rapid. Five million dollar company entering direct selling field with product every woman wants. One sale brings another. Openings for district managers. Rapid advancement, crew managers, canvassers. The Strong Manufacturing Co., Sebring, Ohio.

NEW Idea campaign buttons, solid bronze, real work of art, attractive quarter gross display cards, both candidates, retail 15c each, agents' price 10c each, jobbers prices furnished on request. First test shows great market, excellent possibilities for distributors, also high school boys. Send 30c for sample of each or \$3.50 for quarter gross trial card. Medallie Art Co., 210 East 51st St., New York.

MORE Than a million customers are waiting you to show and sell them this remarkable new auto accessory. Tested, proved seller that appeals. Not sold in stores. Write quick for free sample offer. H. H. Brown, Sales Mgr., 16017 Welland, Detroit, Mich.

AMAZING Profits showing new Polly wrench. 10 wrenches in one. Guaranteed seller at sight. Agents making \$10-\$25 daily! Get yours free! Gellman Mfg. Co., Dept. 6C, Rock Island, Ill.

SELLING Like blazes! Eleven piece toilet goods assortment at \$2.25 with two piece carving set free to your customers. 100% profit. E. M. Davis, Dept. 511, 234 W. North Ave., Chicago.

SELL Eureka Patching Paste, the substitute for needle and thread, will wash and iron. Particulars and sample dozen \$1.25 prepaid. Eureka Cement Co., 520 S. State St., Chicago.

AGENTS: Stop ringing door bells, place carded "Gitsnifes" on store counters; establish steady big pay repeat business. Write Gits Co., M5419 W. Chicago, Ave., Chicago.

INVESTIGATE Our unique sales plan—250 household favorites—quick sales. 100% profit; steady business. Davis Household Products, Dept. 510, 234 W. North Ave., Chicago.

START A business of your own. Every automobile owner needs a Magnetic Base Trouble Light. Sells on sight. Big money for state and county agents. Also direct salesmen wanted. Keller Magnetic Auto Lite Company, 1028 Market St., San Francisco, Calif.

ARE You old at 40? See our advertisement on page 161 of this issue. The Electro Thermal Company, 2110 Morris Ave., Steubenville, Ohio.

WONDERFUL invention; big profits. Non-slip auto brake renewer makes your brakes act like new, no competition; sell oil stations, garages, access, stores, etc. Repeats. Sample 25c. Write for territory. Conservative Chemical Co., 1818 S. Millard Av., Chicago.

MAIL Order business is your opportunity. Free particulars. Pruett System, Brookfield, Ill.

MAKE \$2.00 Every hour. Sell every home wonderful preparation; mends hosiery and clothing without sewing. Invisible. Results guaranteed. Send for free sample of work. Queen City Laboratories, PM-10, Cincinnati, Ohio.

MAKE \$50 To \$75 a week. Everyone needs shoes. Sell Mason's all-leather shoes, amazingly low prices. 85 styles—Men's, women's, children's. No experience needed. Big outfit free. Mason Shoe Mfg. Co., Dept. 2210, Chippewa Falls, Wis.

\$15 A DAY Sure. Sell guaranteed solid leather shoes. Unequaled low prices. 85 styles; men's, women's, children's. Free outfit offers complete line shoes, raincoats, leather coats, puttees. Consolidated Shoe System, Dept. 1015, Eau Claire, Wis.

NOW Free to agents! Amazing new self-wringing mop loaned free for ten day test. Women buy on sight. Turn handle—make \$75 weekly. Sample sent on receipt of name. No deposit. Write Delphos Mop Co., M-40 Oak St., Delphos, Ohio.

CHICAGO Diamond expert overvalued our Mexican Blu-Flash Gem 3,000%! The diamond's only guaranteed rival! Greatest spare-time, side-line agent's money-maker known! Amazing profits! \$5 pocket sample case free. Write quick! Mexican Gem Company, Box P7, Monterey, Calif.

NEW Kind of mop washes floors, cleans walls, ceilings; wrings itself. Waxes and polishes floors. You make \$1.00 on every \$2.45 sale. We deliver. Sample mailed on approval without previous deposit. Our salesmen average \$1.50 per hour. Kleenzy, Dept. G-24, Delphos, Ohio.

STRANGE Invention! Pays \$25 daily. Keeps telephone and iron cords from tangling and kinking. Prevents iron scorching. Saves electricity. Samples free. Never-knot, Dept. 10-A, 4503 Ravenswood, Chicago.

SELL Personal Christmas cards, names embossed in gold. \$1 dozen up. 50% commission. Samples free. Also box assortments. Dunbar Corp., New Brunswick, N. J.

AGENTS—Highest commission—bonus selling dress goods at wholesale prices. Full-spate time. Sample outfit furnished. North American Importing Co., 1123-A Broadway, New York.

AGENTS—Big profits showing new ironing board pad and cover. Every housewife buys. Write for outfit offer! Burlington Blanket Co., Dept. F, Burlington, Wis.

TIES Pay big! Write for big free outfit showing ties styled on Fifth avenue. Beautiful patterns at factory prices. \$60 weekly easy. Berck, 4947-PP Hudson Boulevard, North Bergen, N. J.

WELLS Cleared \$620.00 in one month with "Business Guide" and free legal service. Write for free outfit Prof. Nichols, Dept. 24, Naperville, Ill.

COMPLETE Fall line fascinating raincoats. Newest trench models. Factory prices. Biggest commissions advanced. Large outfit free. Jeffrey Mfg., 716 Madison, Chicago.

SIGN Agents—Free catalog. Koehler, Fourth and Morgan, St. Louis, Mo.

CASH Paid for Butterflies, Insects. See Sinclair Display Advertisement on page 22.

"HAVALITE" The new cigaret lighter—like fountain pen. A fast seller specialty or sideline. Sample 60c. Dozen \$3.60. A. G. Stevenson & Co., 161 Champlain St., Rochester, N. Y.

ENGRAVED Nameplates, signs, numbers, initial, desk, city nameplates. Big profits. Hilton Specialty, 90 Stewart, Providence, R. I.

SELL Cigars, wholesale, retail. Immense profits. Write Valles, 68 E. 110th, New York.

BARGAIN Lots of chemical specialties for less than production cost. List free. People's Chemical Laboratory, 2519 South Crawford Ave., Chicago, Ill.

AGENTS: Liberal commissions and bonuses selling high quality hosiery, handkerchiefs, scarfs, men's ties, curtains, bedspreads, linens. Also a big line of dress goods, silks, etc. 1,000 samples furnished. Write quickly. The National Importing Co., 573 Broadway, Dept. K-100, New York, N. Y.

HAVE A New York mail address \$1.00 monthly. Mail reforwarded to you daily. New York Mail Service, 15 Park Row, New York.

AMSCO Magnetic health belts \$15.00. Guaranteed. Ionacos, old style, \$22.50. AmSCO Manufacturers, 721 18th St., Oakland, Calif.

SILVER Plated identification tag, beautiful novelty, tubular-shaped, rolled card inside for name, address, for key rings, hand bags, dog collars, etc. Retailers for 25c, costs you 10c each, hundred lots prepaid; every one buys; now selling through agents; send 25c for sample and particulars. Satisfaction guaranteed. W. J. Donaldson, 305 West 119th St., Los Angeles, Calif.

PORTRAIT Agents make more money than any other class of agents. Write for our new catalog—Portrait enlargements, medallions, etc. Adam J. Kroil & Co., 2543 South State St., Chicago, Ill.

GREATEST Specialty for rural agents. Write Hawbaker Co., Elmore, Minn.

AGENTS—Make a dollar an hour. Sell new kind of sharpeners. Sharpens all knives and tools quickly. Demonstrating sample 10c. Premier Mfg. Company, Dept. 84, Detroit, Mich.

AGENTS: \$20 Daily! Latest patented ironing board pad and cover combination. Guaranteed. Low price. Sample for yourself free. American Braiding, 329-F West Monroe, Chicago.

\$90.00 WEEKLY Wearing and showing my beautiful new free raincoat and giving away free hats. Write today for yours. Robert King, 230 S. Wells, Dept. AB-10, Chicago.

AGENTS—Crew managers. Part time workers, men and women, sell 2 greeting card box assortments. One box contains 22 assorted Christmas cards. Other box contains 22 cards for everyday occasions, birthdays, congratulations, condolences, anniversaries, etc. Boxes sell on sight \$1.00 each. You double your money. Every person a prospect. Write for particulars today. Amity Greeting Cards, 1100 South Wabash, Chicago.

DON'T Sell for others. Employ agents yourself. Make your own products. Toilet articles, household specialties, etc. 500% profit. Valuable booklet free. National Scientific Laboratories, 1984W Broad, Richmond, Va.

NOVELTIES—194 Cuts, 6c. Black Studio, 1249 S. Grand, Los Angeles.

SACRIFICING Showroom samples, expensive fall dresses. Peddlers, storekeepers, home dress parlor people, write Hirschlar Dress Jobbers, 249 West 34th, New York.

WOMEN: \$2 An hour spare time; 100% commission; new idea sanitary necessity; sells on sight; every woman buys; new feature never before used; designed by physician; revolutionizes old uncomfortable methods; pay every day; no deliveries; no collections; no experience or capital required. Write Mary P. Coleman, Meriden, Conn.

CHRISTMAS Greeting cards—Biggest, finest line. 72 subjects from \$5 per 100 up. Prices greatly reduced, lowest in field. Sales easily made. Liberal commissions paid daily. Get our proposition at once. Buckeye Plateless Engraving Co., 404 Jackson, Toledo, Ohio.

AGENTS \$240 Month. Take orders for finest line guaranteed pocket knives you ever saw. Name and address on handle or emblem of any society or fraternal order. Big demand. Territory given. Write quick. Novelty Cutlery Co., Desk 2631, Canton, Ohio.

MAKE More money selling exclusive line of steel die engraved personal Xmas cards. Largest commission paid. Art Craft Engraving Co., 117 No. Wells St., Dept. M, Chicago, Ill.

FOR Autos and trucks "The Amber Eye," a new safety reflector, prevents night accidents, reflects light from approaching car. Very efficient. Penetrates fog. Great demand, big profits for you. Sells \$2.50. Send \$1.00 for sample. Write Hunt & Moore, New Haven, Conn.

BE Independent. Make, sell your own goods. Immense profits. Catalog dependable formulas, special selected agents' best sellers free. R. Lustru, 626 Reaper Block, Chicago.

MAKE \$10.00 To \$25.00 a day selling our fine quality food products, full line of groceries, motor oils, paints, family remedies, toilet preparations. Over 500 necessities. Everybody a customer. No capital or experience necessary. Selling outfit free. Write Loverin & Browne, J1602 So. State, Chicago.

WANTED: He-men to install shock absorbers between spring leaves. Easy work. Hammer only tool needed. Ford takes 5 minutes. Set costs you 75c. Your profit 233%. Autoists eagerly buy. Over 2,000,000 sold. Write for absolutely free sample and details of biggest money maker. Hamilton, Dept. 15-M, 528 W. 27th St., Los Angeles, Calif.

AGENTS, \$240 Month. Sell finest line silk hosiery you ever saw. Producers earn auto. Free silk hosiery for your own use. Write today for samples and state size of hose worn. Betterknit Hosiery Co., Silk 3431, Greenfield, Ohio.

DOUBLE Daily earnings with new, sensational wind-proof cigar lighter. Greatest agent proposition. Costs only \$1.50 dozen. Sample 25c. Martin, 52-A East Ninth St., New York.

\$25 DAILY Selling \$2.85 colored raincoats. Hat free. 3 dresses \$4.73. Beats all competition. Outfit of 50 numbers free. American Waterproof, G724 Roosevelt, Chicago.

MAKE \$100 Every week! New magic interchangeable signs. \$1.00 seller. All merchants buy. 300% profit! Write quick. Modern Sign Works, B818 N. Wells, Chicago.

HOW Would you like to own a store? I'll put you in business for yourself without a single cent investment. Prove you are energetic and ambitious and I'll do the rest. Send for my free outfit containing latest lingerie, men's shirts and underwear. Samples all manufactured by our own mills and sold direct. Take orders. Prove you mean to work and I will furnish a store for you on a main street in your town. You get paid liberally each day when selling to convince me of your qualifications. Write for free outfit and full particulars about my store plan today. Telson Mills, Dept. 1910, 1107 Broadway, New York.

AGENTS. Get vanilla extract at one-cent a bottle. Also new black walnut flavor. Welcome Foods, Harvey, Ill.

CAN You sell razor blades at half price? Send for free sample today. Clinton Holden, 45 Robert, Attleboro, Mass.

SELL The Christensen Oval Double Cone Mop Wringer. Easy seller. H. K. Christensen, Fort Atkinson, Wis.

AGENTS: Would you like to make \$12.00 extra each week supplying our famous food products to your neighbors? Write now. Blair Laboratories, Lynchburg, Va.

AGENTS, \$240 Month, Dri-Klean-It makes any car look like new. Removes mud, grease, tar, road oil all in one operation. No soap or water used. Cleans any car for 10c. Exclusive territory. Make \$5,000 year. Write for free sample. American Accessories Co., Desk 3431, Cincinnati, Ohio.

IF Selling the house wife direct a postal to O'Connell Mfg. Co., 3757 Wentworth, Chicago, will bring you the best money-making offer you ever received.

SALESMEN To sell new Superior Safety Razor; direct selling; a fast seller, liberal commission; reliable organization. Call or write. Madden Safety Razor Corporation, Room 914, 26 Cortlandt St., New York.

\$2.00 AN Hour for pleasant introductory work among local families. Pay starts immediately. Write American Products Co., 2190 Monmouth, Cincinnati, Ohio.

RADIO Agents: Add our line of amateur transmitting material. Write for sales sheet. No investment. Radio Parts Sales Co., Orange, N. J.

MIRRORS Resilvered at home. Costs less 5 cents per square foot; you charge 75 cents. Immense profits plating autoparts, reflectors, tableware, stoves, refinishing metalware, etc. Outfits furnished. Details free. Write Sprinkle, Plater, 128, Marion, Ind.

AGENTS—Make \$3.00 an hour taking orders for our 40 fascinating kitchen specialties. No competition. Write quick. General Products Co., Dept. K-207, Newark, N. J.

MAKE \$12 A day and liberal bonus selling Pioneer \$23.50 and \$33.50 all-wool tailoring. Commissions paid daily. 100 extra large cloth samples furnished. We train the inexperienced. Write Pioneer Tailoring Co., Congress and Throop, Dept. X1117, Chicago.

AGENTS—Mosco Corn and Callous Remover will build you a steady repeat business. Send today for pocket-size trial outfit. The Moss Company, 418 Searle Bldg., Rochester, N. Y.

GOLD-LEAF Sign Letters; copyrighted Manufacturing Instructions; profits 1,000%. Johnston Co., Quincy, Ill.

TIME Counts in applying for patents. See pages 138 and 139. Clarence A. O'Brien, Registered Patent Attorney, Washington, D. C.

FLAVORING Extracts—Bottle yourself! Concentrated, add water! Free labels, whirlwind sellers! 500% profit. Money-making opportunity. Write Thomas Manufacturing Company, Indianapolis, Ind.

AGENTS—Sell \$1 Christmas card assortments. Also beautiful personal greetings. Unequaled values. Highest commissions. Daily pay. Samples free. Harry Doehla, Dept. 2R, Fitchburg, Mass.

RAINCOATS, Full line, including latest trench coats, sheeplined coats, leather jackets, shirts; popular prices. Outfit free. Commission 25% with bonus. Hydro Raincoat Co., Dept. 45, 718 Independence, Chicago.

ARVEO Polishing cloths—they produce results. Be our local representative—big profits for you. Testing sample free. Arveo Industries, Dept. F, Grosse Ile, Mich.

AGENTS—\$65.00 Week selling guaranteed can opener. Latest patent device proves big seller. Sample furnished. Territory open. General Mfg. Co., Box 244, Dept. CC, Oak Park, Ill.

\$15 A DAY Easy! Write for big free outfit showing men's made-to-measure rain-proof caps. Also hats. Experience unnecessary. Free cap given. Fits-U Cap Co., Dept. PC-75, Cincinnati, Ohio.

DON'T Sell for others. Employ agents yourself. Make your own products. Toilet articles, household specialties, etc. 500% profit. Valuable booklet free. National Scientific Laboratories, 1984W Broad, Richmond, Va.

MAN In each town to plate auto parts, reflectors, bathroom fixtures, refinish beds, mirrors, chandeliers; by new method. No capital or experience required. Simple plan of manufacturing at home starts you in big money-making business. Outfit furnished. Free particulars and proofs. Gun Metal Co., Ave. H, Decatur, Ill.

AGENTS—Here's a New One. "Bestever Powdered Hand Soap." Sells like wildfire. Marvelous Discovery. Removes grease, paint, ink, oil, in fact anything from hands. Cannot harm skin. 150% Profit. Great Repeater. Agents simply coining money. "Free Samples Get the Business." Write immediately. Bestever Products Co., 4315W Irving Park, Chicago.

LOWER Prices on gold-eyed needle cases. Finest agent's article; sell fast, immense profits, \$50 to \$300 weekly. Proof free. Sample 10c. Paty Needle Co., College Ave., Somerville, Mass.

PROFITS In advance—low priced, quick selling gas (self-making) radiant heater—on installments or cash. No investment. We collect and deliver. Exclusive territory. Write quick. Sunshine Co., 410 Factory Bldg., Kansas City, Mo.

TAKE Orders newly patented valveless water bowl. Absolutely prevents backflow, pipe clogging, overflow. Low priced. Dairy-men eager buyers. Big profit. Free particulars. G. A. Hatton, Box 426, New Castle, Penna.

AGENTS—We start you in business and help you succeed. No capital or experience needed. Spare or full time. You can easily earn \$50-\$100 weekly. Write Madison Company, 566 Broadway, New York.

AGENTS, Sell stores 5c candy specialties; big profits. Colonial Co., 314 East 33d, New York.

ELECTRIC Cigar lighters. Make \$100 week. Brilliant flashing advertisements. Three beautiful models. Used by dealers everywhere. Write Drake Mfg. Company, Dept. M, Milwaukee, Wis.

FREE Sample! Latest novelty signs, biggest 1928 moneymakers. Sell on sight. 500% profit. Ever-Ready, 52-A East Ninth St., New York.

AGENTS Wanted—To sell Electric Hair Clippers. Retail at \$8.75. Guaranteed. Useful in every home. The Master Appliance Co., Box 33, Racine Junction, Wis.

AUTO Owner tire agent wanted each locality to use free demonstrating tires and take orders for new heavy duty Mellinger tires, guaranteed 15 months against all road trouble. Shipped on free trial. Get your own tires and earn \$300 monthly—no capital or experience needed. Write Mellinger Tire Co., Dept. 282, Kansas City, Mo., Warren, Ohio, Oakland, Calif.

BRAND New plan—Free suit to each agent. \$45 and up weekly, paid in advance. Take orders for our high-grade tailoring. Handsome carrying case outfit of large real cloth samples furnished free. Spencer Mead Company, Harrison and Throop, Dept. X816, Chicago.

DON'T Sell for others. Employ agents yourself. Make your own products. Toilet articles, household specialties, etc. 500% profit. Valuable booklet free. National Scientific Laboratories, 1984W Broad, Richmond, Va.

AGENTS—Steady income. Large manufacturer of handkerchiefs and linens, wishes representative in each locality. Factory to consumer. Big profits, honest goods. Credit given. Send for particulars. Freeport Mfg. Co., 59 Main St., Brooklyn, N. Y.

\$60-\$200 A WEEK. Genuine Gold Letters for store windows. Easily applied. Free samples. Liberal offer to general agents. Metallic Letter Co., 438-B North Clark, Chicago.

AUTOMOBILE Specialties. Guaranteed formulas for all latest money makers. Lowest prices. Write for free lists. Murphy, Chemist, Tujunga, Calif.

AGENTS. Our cigar lighters and salesboards sell quick. Large wholesale catalog free. Joseph Sales Company, 223 Madison St., Chicago.

\$1,000.00 REWARD If this is not the greatest money-making house to house proposition ever known. N. R. G. tablets wash clothes in 10 minutes without rubbing. Free samples. N. R. G. Co., H 500 W. Division, Chicago.

AGENTS Wanted—Sell Xmas cards. Big profits. Great demand. Finest assortment. Deal with manufacturer. C. M. Kightlinger, Millburn, N. J.

TWO Money makers for agents. "Francia" Pocket Adding Machine retails \$4.85. To you \$1.00. "Excelligraph" Rotary Stencil Duplicator \$37.50 retail. Write Typewriter Supply, 102 Hersch Bldg., Pittsburgh, Pa.

MAKE And sell your own goods. No machinery. Guaranteed formulas. Catalog free. Clover Laboratories, (E) Park Ridge, Ill.

AGENTS—Sell stores 5c candy Specialties. Lorrac Products, Albany, N. Y.

AGENTS Wanted to sell Men's Hats direct from factory. Write for catalog. Model Hat Mfg. Co., Dept. M-14, East Orange, N. J.

BIG Money and Fast Sales. Every owner buys Gold Initials for his auto. You charge \$1.50; make \$1.35. Ten orders a day easy. Write for particulars and free samples. American Monogram Co., Dept. 40, East Orange, N. J.

MONOGRAM Automobiles. \$1.35 Profit ten minutes' work; every owner wants them; millions without; particulars free. Motorists Accessories Co., Mansfield, Ohio.

AGENTS—Clever Invention! Inkspoon makes every pen a fountain pen. Fast office seller; big profit, demand increasing everywhere. Exclusive territory offered. Sample free. H. Marul Company, Tribune Bldg., New York, N. Y.

WRITE Atlas Sign Works for free working equipment. Beautiful window sign letters. Penny each! Any size. Wonderful offer to general agents. K1032 E. 55th St., Chicago.

WE Start You Without a Dollar. Soaps, Extracts, Perfumes, Toilet Goods, Experience Unnecessary. Carnation Co., 2480, St. Louis, Mo.

AGENTS: Stamping names on pocket-key protectors. Sample check with your name and address, 25c. Stamping outfits. Emblem checks, check-fobs, name plates. Hart Mfg. Co. Desk 2, 303 Degraw St., Brooklyn, N. Y.

\$12.00 DAILY Showing new table cloth. Looks like linen. Wash like oilcloth. No laundering. You just take orders. We deliver. Pay daily. Sample free. "Bestco," 4517-NW Irving Park, Chicago.

BIG Pay every day, showing Nimrod's all-year sellers! Dress, work and flannel shirts, overalls, pants, sweaters, underwear, pajamas, leather coats, lumberjacks, playsuits, etc. Experience unnecessary. Big outfit free. Nimrod Co., Dept. 8, 4922-28 Lincoln Ave., Chicago.

HOUSEHOLD Brushes, complete line; sample outfit and credit furnished to responsible men. National Fibre Broom Co., St. Louis, Mo.

200% PROFIT—Demonstration gives you immediate sale. A 25c item that to every housewife is an absolute necessity. C. Seed Manufacturing Co., 73 Franklin St., New York City.

MAKE \$1,000 Before Christmas selling exclusive personal Christmas cards, steel engraved designs. Expensive sample book free. Wetmore, Janes and Sugden, Rochester, N. Y.

32 SECONDS Complete tire change by Detmer, Ohio, with Morey Quick Action Rim Tool. Sold, singly, 49 three days, cleared \$100. Anderson, Mont., sold 1,400 in 14 weeks. Get details for good territory. Harvest time now. M. Morey Rim Tool, Buffalo, N. Y.

"HOW To Secure Agents," a specially prepared booklet, tells of one of the most inexpensive methods in which to secure good live producing agents. It is free; write for your copy today! M. L. Rund, Mgr. Classified Advertising, Popular Mechanics Magazine, 200 E. Ontario St., Chicago, Ill.

HANDSOME Profits supplying leading self-repeating auto necessity; no competition; pay daily; write today; best season. Topco Mfg., Dept. X, Sta. H, Cleveland, Ohio.

A BUSINESS of your own—Making sparkling glass name and number plates, check-boards signs. Big book and sample free. E. Palmer, 512, Wooster, Ohio.

MAKE Big money. Be the electrical dealer in your town. Sell a big line of low priced, quality appliances. Write for our selling plan. Dandyline Products, 4420 N. Western Ave., Chicago, Ill.

GOLD-LEAF Window letters and script signs. No experience; 500% profit. Samples free. Meyer writes 5 days profits \$141.36. Consolidated, 69-T West Van Buren, Chicago.

CAN You sell a washing machine for \$9.75? Agents are making \$75.00 to \$300.00 weekly showing new automatic washer to housewives. Thoroughly cleans and sterilizes. No rubbing necessary. Write for protected territory. Storm Royalty Co., Inc., 3601 Enright, St. Louis, Mo.

AGENTS—Sell Trousers' Friend. Keeps trousers spick and span. Sells easily. 100% profit. Trousers Friend, Dept. 1, Box 521, San Francisco, Calif.

NO Dull times selling food. People must eat. Federal distributors make big money; \$3,000 yearly and up. No capital or experience needed; guaranteed sales; unsold goods may be returned. We furnish you with sample case, license and free samples for customers—Sure repeat orders. Exclusive territory. Ask now! Federal Pure Food Co., A2307 Archer, Chicago.

SUCCEED With Your Own Products. Make them yourself. Formulas, Processes, Trade-Secrets. All lines. Catalog, circulars free. B. Thaxly Co., Washington, D. C.

FIBRE Brooms—detachable handles, fine finish. Good profits, repeat sales. The Fibre Broom People, 147-C New Jersey Ave., Brooklyn, N. Y.

REMNANT Store, Bethel, Ohio. Greatest Dry Goods Bargains on Earth. Agents and Dealers.

NEW Unusual necessities paying phenomenal profits. Make money as you've never made it. Unequaled, amazing detailed offer, free. Concentrated Products Co., Box 3772-P, Tampa, Fla.

GET Our Free Sample Case—Toilet articles, perfumes and specialties. Wonderfully profitable. La Derma Co., Dept. A, St. Louis, Mo.

POLMET Polishing Cloth removes tarnish from metals without the use of liquid, paste or powder. Our agents say it sells like "hot cakes." Retails 25c; sample free. Gale & Co., Inc., 15 Edinboro St., Boston, Mass.

OUR Luminous Crucifix Shines in the Dark. Every one amazed at the wonderful effect. Easily demonstrated—easily sold. W. G. Hannan Co., 2543 So. State St., Chicago.

AGENTS—Engraved name plates, signs, numbers, etc., easily sold, profits large. Brett Bros., Roxbury Crossing, Boston, Mass.

SOMETHING New. Every motorist a buyer of our electro-magnetic-emergency Wenderlamp; takes only one minute to demonstrate and make a sale; no experience necessary; \$5.00 an hour easily made; full time or evenings. Write for sample. Wenderlamp Co., 926 Fisk Bldg., Dept. 10-A, New York.

SELL men's neckwear; wonderful proposition. Astor, 318-M Broadway, New York.

CALIFORNIA Perfumed heads selling like hot cakes. Agents coining money. Big profits. Catalog Free. Mission Factory P. 2328 W. Pico, Los Angeles, Calif.

PHOTO Medallion Men and Women, the largest line of Photo Novelties in the world. Lowest prices, quickest service. Send for catalogue showing over 200 money makers. Photo medallions, photo medallion clocks, photo mirrors, photo fountain pens, photo powder compact, photo jewelry and photo buttons. Gibson Photo Jewelry Co., 608-614 Gravesend Ave., Brooklyn, N. Y.

15c PROFIT On every 25c sale. Box 500, Shreveport, La.

REPLATE brassy worn-off Automobile Parts, Reflectors, Bath Room Fixtures, Worn Spoons, Forks, etc., with pure silver. Looks like new. Use U-Kan-Plate Polish. Positively no mercury. \$1.00 half pints. Post Paid. Satisfaction Guaranteed. Agents wanted. Dept. A, U-Kan-Plate Co., Philadelphia.

\$50.00 WEEKLY easy. Applying Gold initials on Automobiles. No experience needed. \$1.45 profit every \$1.50 job. Free samples. "Ralco Monograms," X1043 Washington, Boston, Mass.

HIGH-GRADE SALESMEN WANTED

OUR Shop aprons sell for less than half the price of overalls. We undersell largest Chicago mail order firms. Full size samples at following prices: 36" blue, white or grey aprons 25c, retails up to 50c; 42" Ford rubber aprons 35c, retails up to \$1.00; 44" blue denim aprons 35c, retails up to 75c; 42" 38 oz. rubber aprons 45c, retails up to \$1.25; 44" 8 oz., white duck aprons, 35c retails up to 75c; 18" sateen or blue sleeves 20c, retails up to 35c. Wholesale prices less than samples. Jaxon Co., 8311 Epworth Blvd., Detroit, Mich.

AGENTS! Sell shirts and build a permanent successful business of your own. No capital or experience required. Liberal cash commission. Bostonian guaranteed shirts sold direct from factory to wearer will give you a good steady income. Write today for a complete selling outfit free. Bostonian Mfg. Co., Dept. M4, 72 Summer St., Boston, Mass.

SELL Advertising pencils, lowest prices, highest quality, liberal commission. Dandy side-line, new Christmas numbers ready. U. S. Adv. Pencil Works, Quincy, Ill.

SPECIALTY Salesmen, part or full time, calling on mills, factories, automotive shops, users of vices. To sell the fastest and easiest selling tool known. Regular or side line. Sample on consignment. Write for information. United Hardware & Tool Corp., 50 Howard St., New York City.

BIG Season just ahead. Advertising pencils most popular every day—every business prospect. Our line repeats. Big commissions. Established in 1902. North American Pencil Works, 126 So. Clinton, Dept. 55R, Chicago.

TAILORING Salesmen: Sell Simpson's new \$23.50 pure virgin-wool, union made-to-measure suits and overcoats; commissions in advance; exclusive territory; big outfit, 175 samples free. J. B. Simpson, 843 Adams, Dept. 1509, Chicago.

SALESMEN Wanted to sell advertising novelties to banks and rated concerns. Write for samples. Liberal commission. Bankers Thrift Corporation, 2240 No. Racine Ave., Chicago.

WONDERFUL Invention. Seals fifty envelopes minute. Sells on sight at \$3.50. Attractive proposition. Square deal. Bank references. Kendall Sealer Co., C4, East Jeffrey, N. H.

\$5 SALE—\$5 Commission with lifetime renewals. New combination life-accident policy. Write immediately. United Underwriters, PM-2, Willow Hill, Ill.

SELL Flints and wicks for cigar lighters displayed on attractive card. Big demand. Dealers buy quick. Big money all or part time. Fuller Co., Dept. 25, 605 Sycamore, Cincinnati, Ohio.

TAILORING Salesmen. Amazing line. All wool suits \$27.50. Extra pants free. Union made, \$6.00 commission. Free outfit. Garfield Tailoring, 3113 Armitage, Dept. A, 33, Chicago.

AMAZING Money maker! \$21.00 Daily. Men's suits, overcoats only \$12.50. Your commission \$3.00. Biggest values ever shown. Wonderful variety fall, winter patterns. Worthmore Tailors, 195 Greene St., New York.

SPLENDID Sideline. Excellent profits selling to trade finest complete line vending machines, etc. No samples, sell from catalog. Specialty Mfg. Co., B724 N. Racine, Chicago.

SELL Union label printing. Brand new proposition. Copyright cuts and elaborate outfit free. 40% commissions advanced. Beats all competition. Meyerson, U1132 So. Racine, Chicago.

INTRODUCE In your city pat. typewriter erasing shield; protects both carbon paper and all copies; sells 50c; write for sample; send 10c to cover cost of packing and mailing; also full information on Ruff-it typewriter stone; sells \$1.50; one hour in any office building will net you \$4.00. Typewriter Erasing Shield Corp., 837 Howard, San Francisco, Calif.

BIG Profits easy. \$100,000,000 Christmas cards sold last year. Our \$1 box 24 beautiful hand engraved cards and folders beats competition. 40 to 50% profit to agents. Also big demand for greeting cards with personal or business names. 40% commission. Write for sample box and instructions. Helen Acree Studio, 35 E. 30th St., New York, N. Y.

\$18 TO \$25 Daily; biggest selling line of 2-piece suits, \$9.95 and \$12.50; 3-piece wool suit, \$17.95 (regular \$28.00 value). All-wool overcoats, \$18.50. Splendid raincoats, slickers and boys' suits. Biggest commissions. Free outfits. "Jim" Foster, Inc., Dept. 210, 2250 S. Spaulding Ave., Chicago, Ill.

THE Greatest opportunity in selling field. Here are simple facts: A tailoring line. All wool goods. Made-to-measure. Sensational low price. Money-back guarantee. \$25.00 sales outfit showing quarter-yard samples free. Also greatest book of selling helps ever put out. Write at once to Dept. 547, Madison Brothers, 131 South Peoria, Chicago.

OUR Harvest season starts now and ends December tenth, on our new novelties and finest pencil line. State experience. Advertising Novelty Company, Newton, Iowa.

LET Us tell you how you can building up a big permanent repeat order business handling groceries, auto oil, paint, poultry and stock supplies. No rent, no investment in goods. Big pay. Write Hitchcock Hill Co., Wholesale Grocers, 30 Kinzie, Dept. 1, Chicago.

I'LL Put you in the shoe and hosiery business. Permanent income, protected territory, full commission on repeats. Experience not necessary. Handsome sample outfit, literature—everything you need to become a successful shoe merchant. Send for free booklet "Getting Ahead." Wm. J. Mishel, Tanners Shoe Mfg. Co., M1039 C St., Boston, Mass.

"TRY It"—"Punch Ball"—2 brand new machines that's startling country. \$125-\$200 weekly. Every store prospect. Pocket outfit free. Ad-Lee 827 Wabash, Chicago.

\$50.00 DAILY. 400% Profit. Money-getter. Business, professional men buy instantly. Newly-patented method for collecting bad debts. Sells \$5.00—costs \$1.00. Brooks, Texas, sold 20 first day, profit \$80.00. Experience unnecessary. Send \$1.00 today for \$5.00 complete outfit. Territorial rights. Federal Association, 6th St., Hartford, Conn.

DISTRIBUTORS Or salesmen to sell patented auto hat rack and our section ash receiver to dealers or user. Money maker for hustlers. Free details. Y. & M. Manufacturing Co., Box M, Warren, Penn.

GET Into raincoats—a profitable business without investment. Repeat orders. Big commission. Full line of rain and sport coats for men, women and children. Complete selling outfit free. Experience unnecessary. Associated Factories, 125 Staniford St., Boston, Mass.

SALESMEN—Sell men's Rayon Swiss and Jacquard ties—new startling features; highest commissions. Wonder outfit free. National Service Mills, 2054 83rd St., Brooklyn, N. Y.

EARN \$20 A day. Establish income for life selling for \$1.00 a year, \$1,500 policy. Write W. C. Stone, 11 So. LaSalle, Chicago.

\$4 to \$7 Commission and big bonuses. Fastest selling line today direct to wearer. Real quality men's suits or overcoats only \$18.50. Dept. 2A, Preston Tailoring Co., Denver, Colo.

\$10-\$20 CASH Daily selling printed stationery and new advertising specialties, blotters and envelopes. Good sideline. Liberal commission. Free sample outfit. Embograp, 4558-62 Elston, Chicago.

TWO Suits or one suit and overcoat \$39.50. Commission \$7.00-\$9.00. Union made. Free outfit. Square Merchant Tailors, 3115 Armitage Ave., Dept. A-47, Chicago.

\$50 TO \$75 Weekly selling new improved coveralls and service coats with customer's name embroidered on back to garages, oil stations, etc. Advertising value and unusual construction gets the big orders. We pay biggest commission. Free outfit. Am. B. Co., 329 West Monroe, Chicago.

CHRISTMAS Cards—Start early. \$2.00 hourly, spare time. 87 samples free. Windermere Press (Established 1900), 6702 Dorchester, Chicago.

DON'T Waste time on specialties. We can show you bigger profits, better values and permanent repeat business. \$750 a month is one man's income. No capital or experience needed. Write quick. American Products Co., 2191 Monmouth, Cincinnati, Ohio.

A PROVEN Money-maker—New electric hot dog machine; sells \$18.50; commission \$6.50; buyers buy on sight. Leonard E. Dickerson, Dept. E-4, Springfield, Mo.

PUNCHBOARD Salesmen. \$150 weekly, selling new double profit deals from catalog. 100% prospects. 90% sales. Exclusive territory. Repeat commissions. Rudy Sales, 339 W. Madison, Chicago.

GALLOPING Ivories. New game that's thrilling America. Absolutely legal. Every cigar counter waiting for you. \$125-\$200 weekly. Hurry. K&S, 4295 Ravenswood, Chicago.

EVERY Home a prospect. Make big money. Take orders trees, shrubbery. Experience unnecessary. No dull season. Commissions paid weekly. We deliver, collect. Write Perry Nurseries, Dept. R-10, Rochester, N. Y.

IT'S New—IT's great. Sells everywhere and how? Meta polish in tubes. An opportunity you can't afford to miss. Trial tube free. P. M. Reid, 1619 Clark, St. Louis.

SALESMEN: \$18 Daily. Big national concern wants men to sell guaranteed line oils, paints and roofing to all users. Long time credit terms. New free advertising plan makes sales easy. Pay weekly. Selling outfit free. Solar Products Co., Dept. A, Cleveland, Ohio.

NEW! Fast seller! Make \$8.00 an hour daily. Sell "Advertising Work Suits." Every workman, business a prospect. High-grade low-priced coveralls, shop-coats, 2-piece overalls. Firm name and advertisement woven on back. Outfit free. John Leeding Co., Dept. PM10, 70 E. 18th, Chicago, Ill.

SELL Printing at half prices. 40% commission daily. Free outfit. National Printers, 14 Troy, Dayton, Ohio.

BIG Pay every day, showing Nimrod's all-year sellers! Dress, work and flannel shirts, overalls, pants, sweaters, underwear, pajamas, leather coats, lumberjacks, playsuits, etc. Experience unnecessary. Big outfit free. Nimrod Co., Dept. 65, 4922-23 Lincoln Ave., Chicago.

FURNACE Carburetor for any heating furnace or boiler. Eliminate 80% of smoke and soot. Reduces coal bill one-third. Easily installed and operated. We offer you a permanent business with a big profit. Give sales experience, reference and territory covered when answering. The Campbell-Hausfeld Company, Box 9, Harrison, Ohio.

UNEMPLOYMENT, Elections, make slow collections for all merchants. Give them what they need. Not just collection system. Complete automatic credit and collection plan. Gets cash and keeps customer for merchant and for you. You get half cash on repeat orders for supplies without call-backs. Automatic income for you. 250% on original sale. Full or spare time. Judge by results! Commonwealth J Publishing Co., 508 So. Dearborn, Chicago.

SELL Printing—Biggest line, 27 items, 600 free cuts defy competition. Largest commissions advanced. Pocket outfit free. Kaeser & Blair, Dept. 13, Cincinnati, Ohio.

MANUFACTURER Wants salesmen to sell tires and auto accessories to tire stores, garages, etc., on a liberal commission basis; no objection to sideline. Economy Rubber Products Co., 420 Master St., Dayton, Ohio.

REPRESENT Auto seat cover manufacturer. Direct to automobile owners. High quality, low prices. Make \$125 weekly. Elaborate samples free. Marvelo, 2302 Wabansia, Chicago.

THOUSANDS Of men and women have wanted something for pressing neckties at home that does a real job. Here it is—an electric presser. No labor attached. New. Nothing like it on the market. Makes an impressive demonstration. Sells for \$2.00 and \$3.00. Saves many times its cost. Good commission. Hare Mfg. Co., Suite 701-02 Lewis Bldg., Philadelphia.

SALESMEN—Earn \$100 weekly taking orders for Dazzler and Rainbow Glow electric signs. Big commissions. Exclusive territory. High grade proposition. Write Chicago Sign Sales Co., Dept. 28, Charlotte, N. C.

\$60-\$200 A WEEK. Genuine Gold Letters for store windows. Easily applied. Free samples. Liberal offer to general agents. Metallic Letter Co., 438-A North Clark, Chicago.

ALL-YEAR-ROUND Profitable business selling wonderful new water softener and cleaner. Removes grease, oil, ink and dirt quickly. Every home and business place a live prospect. 100% profit. Big repeat orders. Exclusive territory. Write for free sample. Seacoast Laboratories, Sea Bright, N. J.

PUNCHBOARD Salesmen. 2 hours daily. \$100 every week. New line. Lowest prices. Full commission on repeat business. Catalog free. Puritan Novelty Co., 1409 Jackson, Chicago.

SALESMEN—Four \$15.00 sales to merchants net you \$40.00 daily. Sayers Systems, 2813 Sheffield, Chicago, Ill.

PUNCHBOARD Salesmen: It's easy to earn repeat commissions with the "Lincoln Line." Merchants everywhere use punchboards. Someone sells them! Why not you? Big pay every day. Catalog free. Lincoln Sales Co., 9 South Clinton, Chicago, Dept. D.

DON'T Sell for others. Employ agents yourself. Make your own products. Toilet articles, household specialties, etc. 500% profit. Valuable booklet free. National Scientific Laboratories, 1984W Broad, Richmond, Va.

PUNCHBOARD Salesmen. New fascinating game. Excitement; legal all states; \$200 weekly easy; one minute sales talk; pay daily. Cigar Stores Novelty Co., Dept. A, Peoria, Ill.

SALESMEN—Become Independent. Own your business; experience unnecessary, selling our \$7,500 Accidental Death; \$50 Accident; \$25 Sick Weekly Benefits—\$10.00 yearly. Other amounts proportionate. Guaranteed steady income from renewals. \$250.00 deposited Insurance Department, Universal Policy, Dept. A, 40 Clinton Street, Newark, N. J.

40% COMMISSION Selling printed business stationery at knockout prices. Part or full time. Free outfit. L Process Service, Minneapolis, Minn.

GOLD-LEAF Window letters and script signs. No experience; 500% profit. Samples free. Meyer writes 5 days profits \$141.36. Consolidated, 69-V, West Van Buren, Chicago.

SALESMEN Selling to stores. Opportunity to handle unusual specialty line, main or side; commissions immediate, connection permanent, with large old-established manufacturer. Union Specialty Works, Dept. 222, Roonville, N. Y.

BANG-UP Good new sideline! Sells everywhere, all merchants, banks, mfgs. Big comms. advanced daily. Pocket outfit free. Carroll, 319 N. Albany, Dept. YA-322, Chicago.

TO Market 3A garage door holders, simple automatic action, quickly installed, instantly attracts garage owners, builders, dealers. Write for exclusive territory proposition. Knowlson-Stevenson Co., 1118 Packard, Ann Arbor, Mich.

HIGHEST Commission, tailoring field. One suit or overcoat \$22.50. Union made. \$5.00-\$6.00 commission. Free outfit. Armitage System Tailors, 3111 Armitage, Dept. A-40, Chicago.

SELL Printing: 40% commission daily. Lowest prices, with or without deposit. Copyright cuts free. Inquiry brings pocket outfit. Salesmanager, 1522 Wells, VanBuren Bldg., Chicago.

SALESMEN—Main or sideline: Sell tires and auto accessories to tire stores, garages, etc. Protected territory. Liberal commission. U. S. Auto Supply Co., Dept. 118, Dayton, Ohio.

PUNCHBOARD Salesmen. \$200 weekly. Liberal plan assures sales. Latest assortments. Nothing to carry. Full commissions on repeats. M&L Sales Co., 301 W. Adams, Chicago.

HELP WANTED

PICK Your own job—Set your own pay. Our original complete plan and service helps you to secure the position you want anywhere in the world. A gold mine of information that will boost you into a steady, big pay job. Hundreds of our men have increased their income 500%. Start today. Send \$2.00 registration fee. Pick your job and get it. The Open Door, Box 179, South Norwalk, Conn.

WHY Be out of work. 10 successful ways of making money without capital or experience. No mail order bunk. Guaranteed 50 cents. Victor Mills, 3768 Second Blvd., Detroit, Mich.

ADVERTISING Work—\$5 to \$20 weekly. Everything furnished. Write now. W. M. Runion, New Market, Va.

WHY Not sell your spare time, \$2.00 an hour, \$19.70 daily easy full time. Introduce 12 months guaranteed hosiery—47 styles, 39 colors for men, women, children, including latest "Silk to the Top" ladies hose and men's fancies. No capital or experience needed. We furnish samples. New plan. Maceoche Hosiery Company, Park 26010, Cincinnati, Ohio.

CASH Paid for Butterflies, Insects. See Sinclair Display Advertisement on page 22.

SILVERING Mirrors, French plate. Patented process, easily learned. Immense profits. Plans free. Wear, Excelsior Springs, Mo.

PERMANENT Business your own; men and women, earn \$35 to \$100 weekly operating our original "Specialty Candy Factories." Few dollars starts you home spare time; we instruct and furnish everything. Booklet free. W. Hillyer Ragsdale, Drawer 350, East Orange, N. J.

OBTAIN Employment! Get positions you want, quickly, anywhere. Use clever "Ways That Win." One person was offered 70 jobs! Complete methods, 50 cents. Money promptly returned if wanted. New Idea Service, Box 39-1, Station K, New York.

INFORMATION

INVESTIGATING And tracing. Work home or travel. Experience unnecessary. Write American System, 2188 Broadway, New York.

YOUR Question answered—Technical information on any subject, \$1.00. Send remittance with question—money returned if we cannot answer. Commercial Service Co., 702 Dekum Bldg., Portland, Oreg.

MAILING LISTS

FOR Sale, mailing lists of Catholics, \$8 per thousand. 100,000 on file, full postage refund. Rev. F. Seifert, Daggett, Mich.

1,000 1928 WOMEN Buyers names, \$1.00. Sheasgreen, PM1427 North Penn, Minneapolis, Minn.

LATE Names—Opportunity seekers. Live, fresh, active. Guaranteed correct. Priced right. De Muth Company, Englewood, N. J.

TYPEWRITERS AND SUPPLIES

TYPEWRITERS, all standard makes. \$10 up. Fully guaranteed. Free trial. Write for complete illustrated lists. Northwestern Typewriter Exchange, 121 N. Francisco Ave., Chicago.

TYPEWRITERS—All makes, \$6 to \$29. Fully guaranteed. Dee Typewriter Exchange, Ada, Okla.

TYPEWRITERS—Factory Rebuilt Royals, Remingtons, Underwoods, New Royal, Remington and Corona Portables. New "Excellograph" Rotary Stencil Duplicator \$37.50. Terms. Catalog Free. Pittsburgh Typewriter Supply, 945-339 Fifth Ave., Pittsburgh, Pa.

TYPEWRITERS, Motorcycles, \$4.99 to \$34.99. Knights, 1512 Locust, St. Louis, Mo.

PRINTING, ENGRAVING AND MULTIGRAPHING

LOOK! Big bargain. 250 fine 5½x8½ letterheads and 150 envelopes, both, printed, postpaid, only \$1.00. L. T. Norton, 45 Richton Ave., Detroit, Mich.

WE Print stationery, booklets, catalogs, circulars. Samples. Commercial Press, Batavia, Ohio.

SAMPLES Raised letter printing with special prices free. LaClyde Service, Westfield, Mass.

200 BOND Letterheads, 8½x11, 150 envelopes, \$2.00; 250 cards \$1.00. Catalog. Dept. E, Hoosier Print Shop, Portland, Ind.

BOND Envelopes, letterheads, \$2.95 1,000. Cuts used. Samples free. Williams Printing Co., Reed, Ky.

PRINTED Personal stationery—200 sheets, 100 envelopes, \$1.00. Linc Mizner, Specialty Printing, Liberty, Ky.

5,000 ELEGANT Envelope slips, \$4.75; 5½x8½ circulars, \$9.50. Folders, booklets, small catalogs lowest prices. Samples free. Good's Printery, Harrisonburg, Va.

CIRCULARS, Colored bond \$3.00 thousand; letterheads \$3.50; envelopes \$2.50. Guaranteed finest work. Battlefield Press, Gettysburg, Penna.

100 LETTERHEADS 50c. Thiacomas, Martinsburg, W. Va.

5,000 ENVELOPES, White (printed) 6½x9, \$8.50. We print anything. Lawrence Envelope Co., 700 So. Kedzie, Chicago.

BEAUTIFUL Stationery, 125 letterheads, 100 envelopes, Hammermill bond, neatly printed to order, \$1.25, postpaid. (Samples-stamp). Star Printery, Uniondale, Ind.

200 HAMMERMILL Letterheads \$1.10. Samples; other prices. 9CKA, Corinth, Iowa.

200 LETTERHEADS And 100 envelopes, \$1.10, postpaid. Oberman Company, Box 989, Los Angeles.

"NEARGRAVURE" Processes business stationery. "Nuf sed. Samples (stamp appreciated). Solldays, Knox, Ind.

500 BOND Letterheads 8½x11, 250 envelopes, \$3.00 delivered. Neatness, quality. Samples. H. Curtis, 811 Harrigan, Kalamazoo, Mich.

250 BOND Letterheads, Envelopes, Billheads, Cards, \$1.35 each. Economic Press, Leonia, N. J.

QUALITY Printing! Reasonable Prices! Send for Free Standardized samples and prices. Folders. Circulars. Catalogs our specialty. Earnest Fantus, 525 South Dearborn, Chicago.

MULTIGRAPHING Business correspondence two dollars thousand. Hammermill letterheads, four dollars; inexpensive quality, three dollars. Miscellaneous printing. Mayera Corporation, Monmouth, Ill.

BUSINESS Stationery. Lowest prices. Excellent workmanship. Modern type faces. Moulton Printing Company, 1410-P East 8th, Kansas City, Mo.

RUBBER STAMPS

NEED Rubber stamps? Illinois Rubber Stamp Works, 2913 N. Rockwell, Chicago, Ill. Send for circular.

NAME And address, two lines, 25c. Self-inking pad 20c. Catalog. Rubber Stamp Shop, Muncie, Ind.

PRINTING, OUTFITS AND SUPPLIES

COMPLETE Printing outfits, presses, type, ink, paper, supplies. Write for catalog. Kelsey Company, G-11, Meriden, Conn.

PRINTING Outfits—Presses, type supplies; type novelties. Send stamp for catalogue. Model Press, York, Penna.

DUPLICATORS AND DEVICES

YOU can make 50 to 100 copies of a letter, notice, etc., at a cost of three cents on a Heyer Quality Duplicator. Write for free trial offer. The Heyer Duplicator Co., 909 Jackson Blvd., Chicago, Ill.

ADDING MACHINES

NEW \$3.50 Automatic adding machine. Adds, subtracts, multiples, absolutely accurate. Capacity \$999,999.99. Fully guaranteed. 75,000 pleased users. Makes adding easy, positive, quick. Eliminates mistakes. Saves time. Postpaid \$3.50. Bassett Co., 1458-N. Hollywood Ave., Chicago.

FOR THE HOME

GRANDFATHER'S Clock Works. \$5.00. Build your own case; instructions free; make good profits selling your friends. Clock works with chimes for old or new cases. Write for full particulars. Clock Co., Ruffner St., Philadelphia.

CEDAR chests only \$11.65—"Red-i-Kut" complete with rich copper trim—you assemble and save half—send for pictures. Kuempel Furniture Company, Guttenberg, Iowa.

KITCHEN Daylight unit with enameled ceiling fixture opal glass, ready to install, \$1.48. Will ship C. O. D. General Distributing Co., Duluth, Minn.

SILVERWARE, Cleaned our way, sparkles. Lasting. No pastes, no rubbing. Quick. Materials in every kitchen. Instructions 25c. "Sparkle-Way," Bloomfield, N. J.

BOATS AND LAUNCHES

BOATS More popular than ever; be up to date, build your own boat during your spare time this winter using our knockdown materials and save money. 55 new designs. Send 25c for 1929 catalog. Brooks Boat Co., Inc., Rust Ave., Saginaw, Mich.

PROPELLERS, Pumps, stuffing boxes, bearings; also used reverse gears. Wm. H. Baker, Pond St., Quincy, Mass.

HUBBELL Marine Coolers convert Ford engines into marine motors. Booklet free. Ford speedboat, easily built, large blueprint and directions one dollar. C. C. Hubbell, Perry Ave., Norwalk, Conn.

MAKE 16' Rowboat; blueprint 30c. Weesho-Uco, 31st Office, Detroit, Mich.

GUNS, SPORTING GOODS, ETC.

FIELD Glasses 5X, \$7.95; Luger carbine stocks, \$1.50; Krag rifles, \$10.50; genuine Springfield, \$27.00; exercisers, \$1.20. Write for catalog. Hudson Sporting Goods, W54 Warren St., New York.

FOR SMOKERS

WE, The manufacturers, have scientifically constructed a smoking pipe that you can take apart; the only really cleanable pipe made of genuine briar and bakelite. We want to introduce a limited number. Send \$1.00 and receive a \$2.00 Ajay pipe postpaid; satisfaction or money back. A worthy pipe to smoke, a worthy gift to make. Ajay Pipe Corp., Box 75, Varick St., Sta., New York.

FIELD GLASSES, TELESCOPES AND MICROSCOPES

C-FAR Field Glasses \$2. Consists of two rimmed lenses in neat leather case, slips into vest pocket, weighs only 1½ ounces. Gives 6 diameters magnification. Money back if not satisfied. Send \$2 today to Buffalo Optical Co., Dept. PM-1, 574 Main St., Buffalo, N. Y.

USED Fieldglasses; \$2 to \$75. J. Alden Loring, Dept. J, O-we-go, N. Y.

ANTIQUES, WAR RELICS AND INDIAN GOODS

ANTIQUES, Firearms, swords, daggers, china, pewter, glass, engravings. New catalog 4c stamp. Antique Shop, 8 South 18th, Philadelphia.

LARGE Illustrated list curios, Indian relics, old arms, ten cents. N. Carter, Elkhorn, Wis.

SEND 5c for fine new list Indian relics, antique firearms. F. E. Ellis, Webster Groves, Missouri.

WAR Relics—Indian pottery, helmets, medals. Catalog 25c. Dare, 440 55th, Brooklyn, N. Y.

PHONOGRAPHS AND RECORDS

BUILD Your own phonograph. Catalog and instructions to build new type horn mailed for 10c. American Phonograph Co., 4116 West 24th Place, Chicago.

MUSIC AND MUSICAL INSTRUMENTS

RELIABLE Firm wants good songs to contract for publication. Mail in your manuscripts at once for examination. Mayer & Mayer Music Publishing Co., Box 2403, Boston, Mass.

SONGWRITERS: Submit poems. Prompt preliminary publications services. Brennon, Dept. L, 1652 Broadway, New York.

SONG-POEM Writers: Address Monarch, 236 W. 57th, Dept. 204, New York.

SONGWRITERS, Substantial Advance royalties are paid on publishable work. Anyone having original ideas for songs may submit poems for examination and free advice. Walter Newcomer, 1674 Broadway, New York.

MAKING Violins new easy way. Complete plans. We sell wood and tools for construction; also imported old violins on credit. For particulars write **Rodell Music House**, 468 Pleasant, New Bedford, Mass.

SONG Poem writers, "Real" proposition. **Hibbeler**, D1, 2104 N. Keystone, Chicago.

SONG Writers: Send for our "Publishing Agreement." **McKinley Music Printers**, 1501 E. 55th St., Chicago.

SONG Poems solicited. A different proposition. **Richard Broughton**, Sioux Falls, S. Dak.

VIOLINS, Deep, mellow, soulful—on credit. Easy terms for wonderful instrument. Get details today. **Gustav F. Henning**, 302 University Building, Seattle, Wash.

CORNETISTS—Trombonists—Saxophonists—Clarinetists. Get "Free Pointers." Name instrument. **Virtuosi School**, Buffalo, N. Y.

PLAY Piano by Ear. A Sound System. Booklet free. **Boucher's Harmony Studio**, Ottawa, Can.

SONG Poem Writers, Write **Sequoia Songwriters' Service**, Sherman Branch, Los Angeles, Calif.

"**BANJOS**" Should interest all musicians on account of the popularity of the Banjo, as it easily increases a Player's income. Illus. Catalog of 48 pages free. **The Bacon Banjo Co., Inc.**, Groton, Conn., U. S. A.

I WANT Song Poems. **Casper Nathan**, 3544 N. Racine, Chicago.

"**MUSIC Composed**" to words. **Bauer Bros.** (formerly of Sousa's Band), Oshkosh, Wis.

WRITE Songs. Big money and reputation. Write for information. **J. Gordon Pub. Co.**, 201 N. Hoyne Ave., Chicago.

FREE—"Song Writers Guide," Beaver, 1257 Elm, Green Bay, Wis.

SONGWRITERS: Get in touch with **Bell** at once. Address D-6, 4718 So. Broadway, St. Louis, Mo.

PATENT ATTORNEYS

PATENTS Procured, prompt service, personal, careful and efficient service. Highest references. Moderate fees. Send sketch or model for actual search and advice. **George P. Kimmel**, Master of Patent Law, 543 Legal Bldg., Washington, D. C.

PATENTS. Prompt personal service. Write for information. **Albert E. Dieterich**, Registered Patent Lawyer, 621½ Ouray Bldg., Washington, D. C.

PATENTS—Write for our free book, "How to Obtain a Patent" and Record of Invention Blank. Send model or sketch of inventions for inspection and instructions free. Terms reasonable. See advertisements on pages 140 and 141. **Victor J. Evans & Co.**, 934 Ninth, Washington, D. C.

LACEY'S Patent Sense. Valuable book free. See ad page 143.

PATENTS—Write for free instructions. Send drawing or model for examination. **Carl Miller**, Registered Patent Attorney (former Patent Office examiner), 259 McGill Bldg., Washington, D. C.

PATENTS—Free instructions. Former patent office examiner. Moderate terms. Booklet. **Albert Jacobs**, 727 Barrister Bldg., Washington, D. C.

INVENTORS: Send sketch or model for advice and exact cost of patent. Ask for our Free book: "How to Obtain a Patent." Tells what every inventor should know. Established twenty-eight years. Highest references. Prompt service. Reasonable charges. **Chandlee & Chandlee**, 414 Seventh, Washington, D. C.

PATENTS Procured: Trade Marks Registered—A Comprehensive, experienced, prompt service for the protection and development of your ideas. Preliminary advice gladly furnished without charge. Booklet of information and form for disclosing idea free on request. **Irving L. McCathran**, 200 Owen Bldg., Washington, D. C., or 41-R Park Row, New York.

"**INVENTOR'S Guide**" sent free: contains valuable information. **Frank Ledermann**, Registered Attorney-Engineer, Woolworth Building, 1712, New York.

MONROE E. MILLER, Ouray Bldg., Washington, D. C., Patent Lawyer; Mechanical, Electrical Expert. Booklet and Priority Record blank gratis.

SELL Your invention before patenting. Write for free particulars. **W. T. Green**, 801 Baltic Bldg., Washington, D. C.

ESTABLISHED 1864. **Milo D. Stevens** Company. Free Booklet, Patents, Trade-Marks, Copyrights. Offices, **Monadnock Block**, Chicago; **Barrister Building**, Washington, D. C.

INVENTORS—Write for our Guide Book, "How to Get Your Patent," and Evidence of Invention Blank. Send model or sketch of your invention for our prompt examination and instructions free. **Randolph & Co.**, Dept. 130, Washington, D. C.

INVENTORS Having ideas to patent: Write for booklet explaining co-operative plan for handling your applications. Tells how to sell and safeguard inventions at lowest cost. **Ralph Burch**, Patent Lawyer, 900 F St., Washington, D. C.

UNPATENTED Ideas can be sold. I tell you how and help you make the sale. Free particulars (Copyrighted). Write **W. T. Greene**, 806 Baltic Building, Washington D. C.

PATENTS, Trade-marks, designs and copyrights. **Parker & Snyder**, Barrister Bldg., Washington, D. C.

LANCASTER and Allwine, 221 Ouray Bldg., Washington, D. C. "Originators of the Form Evidence of Conception." Before disclosing your invention to anyone send for blank form to be signed and witnessed. Form and patent information bulletin free.

PATENTS, Trade-marks, Designs. This firm has 27 years' experience and gives expert personal service at reasonable rates. We properly protect your invention. Write for free information and exact cost of procuring patent before proceeding. **John B. Thomas & Co.**, 902 F St., N. W., Washington, D. C.

ADVICE Free! Patents procured—Reasonable—efficient service. 25 years' experience. **Chester W. Brown**, Registered Patent Attorney, 510 Van Buren Street, Chicago.

PATENTS, Booklet free. Highest references. Best results. Promptness assured. Send model or drawing for preliminary examination. **Watson E. Coleman**, Patent Lawyer, 724 Ninth St., Washington, D. C.

PATENTS Procured at reasonable rates with time to pay. Sales negotiated. Staff of registered attorneys and engineers. A complete service for inventors. Write for particulars. **Inventors Service Bureau**, Box 1648, Washington, D. C.

PATENTS, Trade-marks, Copyrights. Reliable services by an experienced practitioner devoting personal attention to each case. Inquiries invited. References furnished. **B. P. Fishburne**, Patent Lawyer, 525-A McGill Bldg., Washington, D. C.

TIME Counts in applying for patents. See pages 138 and 139. **Clarence A. O'Brien**, Registered Patent Attorney, Washington, D. C.

PERCY S. WEBSTER, 203 Saving and Loan Building, Stockton, Calif. Patent booklet free.

FOR INVENTORS

I AM in touch with hundreds of moneyed men and manufacturers who wish to buy good inventions. Write **Hartley**, 25 Mercantile St., Bangor, Me.

I SELL patents. At it since 1900. Your patent may be worthy of experienced handling, rather than "puttering." **Charles A. Scott**, 773PM Garson Ave., Rochester, N. Y.

INVENTIONS Commercialized and industrial research conducted for inventors. **Frank G. Buffum Mfg. Co.**, Louisiana, Mo.

LACEY'S Patent Sense. Valuable book free. See ad page 143.

INVENTORS' Patent model exhibit and sales service. Free literature. **C. J. Williams**, Pacific Bldg., San Francisco, Calif.

GET your own patents. Legal blanks, complete instructions \$1. **Cutting Sons**, Cambell, Calif.

UNPATENTED Ideas can be sold. I tell you how and help you make the sale. Free particulars (Copyrighted). Write **W. T. Greene**, 807 Baltic Bldg., Washington, D. C.

WANTED To manufacture on royalty basis, appliances pertaining to health or surgery. Send full details. **Cincinnati Automatic Machine Co.**, Cincinnati, Ohio.

INVENTIONS—Write for our free book, "How to Obtain a Patent" and Record of Invention Blank. Send model or sketch of inventions for inspection and instructions free. Terms reasonable. See advertisements on pages 140 and 141. **Victor J. Evans & Co.**, 157 Ninth, Washington, D. C.

PATENTS. If you have an invention which you wish to patent you can write fully and freely to **Munn & Co.**, for advice in regard to the best way of obtaining protection. Please send sketches, or a model of your invention and a description of the device, explaining its operation. All communications are strictly confidential. Our **Hand-Book on Patents** is sent free on request. This explains our methods, terms, etc., in regard to Patents, Trade Marks, Foreign Patents, etc. "Scientific American" contains Patent Office Notes. Decisions of interest to inventors and particulars of recently patented inventions. **Munn & Company, Solicitors of Patents**, 1523 Scientific American Building, 24 W. 40th St., New York City; 524 Scientific American Bldg., Washington, D. C.; 1313 Tower Bldg., Chicago, Ill.; 666 Hobart Bldg., San Francisco, Calif.; 521 Van Nuys Bldg., Los Angeles, Calif.

WANTED—Patented medical or health device to manufacture on royalty basis. **Cincinnati Automatic Machine Co.**, Cincinnati, Ohio.

INVENTORS Universal - Educator—contains 900 mechanical movements; 50 perpetual motions. Tells how to obtain and sell patents. Suggests new ideas. Explains how to select your attorney and avoid patent sharks. Price (revised edition) \$1.00 postpaid. **Albert E. Dieterich**, 621 Ouray Bldg., Washington, D. C.

PATENTS—Write to **B. P. Fishburne** (a South Carolinian), Registered Patent Lawyer, 525-E McGill Bldg., Washington, D. C.

TIME Counts in applying for patents. See pages 138 and 139. **Clarence A. O'Brien**, Registered Patent Attorney, Washington, D. C.

SELL Your invention before patenting. Write for free particulars. **W. T. Greene**, 802 Baltic Bldg., Washington, D. C.

PATENTS FOR SALE

PORTABLE Irrigation headgate. Lightest weight headgate in the world. Controls, regulates, divides complete head of water. Designed especially for use with temporary checks, contours and newly made ditches and laterals, in tractor cultivated orchards and fields. Metal, wood, canvas. Simple, efficient, inexpensive. Universal demand today. Over twenty million acre market (part seasonal, part all-year). Parts can be shipped by parcel post. Patent pending. Western manufacturers investigate. **H. A. Ballard**, Clarksburg, Calif.

OUTRIGHT Or royalty—the Economy Pitt generator. **H. Prillwitz**, Weyauwega, Wis.

UNITED States 1,592,397 and Canadian 265,657 patented trap door type; animal trap. Into which animals can easily be trapped without least injury to captive or interrupting other animals from entering same. Has been thoroughly and successfully tested. Cheap to manufacture. Make offer. **John Wesley Vail**, 284 E. Exchange St., Akron, Ohio.

KIDNAPPING And theft preventing device for automobiles. Will prevent a thief from stealing your car after kidnapping you and throwing you out. Deranges ignition system secretly to stop car at a predetermined distance from holdup. Royalty or sale. **George Wettengel**, 5352 Queens Ave., St. Louis, Mo.

OUTRIGHT Or royalty. Die cast boat construction. No 1,667,561. **Medlavilla**, 446 W. 164th St., New York.

OUTRIGHT. Morning Dew Hair Grower. **Morning Dew Manufacturing Co.**, Guthrie, Okla.

PATENT For orange and grapefruit, fancy basket carver for use in restaurants, hotels, private homes; for sale or royalty. **Ben Lempek**, 509 E. 11th St., New York City, N. Y.

FISHING And retrieving otter: A device for all kinds of sport-fishing. Far superior to any fishingrod and cheaper to manufacture. Also useful as a retrieving device for duck-hunting. Made of small wooden pieces. No experiment. Have working models. An invention of real merit and wide marketability. Two U. S. patents. **Outright or royalty.** **John Hansen**, Box 304, Missoula, Mont.

OUTRIGHT Or royalty—new water gauge for locomotives. **Warren Meyers**, 605 Court St., Saginaw, West Side, Mich.

OUTRIGHT—Cartridge magazine and clip holder. Chas. Cook, 3857 Michigan Ave., Detroit, Mich.

OUTRIGHT—Automatic oiling device for overhead shaftings, bearings and tight places. A. Litzner, Sherman, 857 W. 33rd St., Baltimore, Md.

OUTRIGHT—Steel animal trap, approved by trappers. Pending. Drawing on request. George Kortum, Keller Stage, Wilbur, Wash.

OUTRIGHT Or royalty—Practical engine lathe device. Milan Bozsin, 1577 E. 36th St., Cleveland, Ohio.

PATENT 1,487,924 Chain belt puller. Best offer. D. Doyle, Box 1231 Sacramento, Calif.

OUTRIGHT Or royalty—Patented slide suspender and garter buckle. Attached without sewing. Albert Leighton, 525 W. 23rd St., New York.

TWO Sickle bars on a hay mower. Archie McKellar, Wausau, Wis.

SHUTTERLESS Moving picture machine attachment. Outright or royalty. Reasonable. John Le Roy, 126 West 99th St., New York City.

FOR Sale—Patent plant protector, low cost protection from frost for young plants. Chas. M. Armstrong, LaGrange, Ill.

OUTRIGHT—Blow-off valve, 1,540,954. Best offer. Rockwell, 2654 Geyer, St. Louis.

AIR Cooler for homes, sickrooms, hospitals; inexpensive manufacturing. D. J. Besse, 60 Broadway, Denver, Colo.

QUICK Action door bolt—something new to sell cheap. Easy to manufacture. Lefkowitz, 2160 7th Ave., New York City.

CHANGEABLE Picture frame, patent 1,626,150. Stanley Parda, Box 314, Middletown, Conn.

OUTRIGHT—Clothes pressing device. Crease guaranteed oversight. Best \$1.00 seller. G. R. Tierney, 3516 W. Adams St., Chicago, Ill.

OUTRIGHT Or royalty basis, new calf weaner and self-feeder; eliminates finger feeding. Henry Knutson, Wheatland, N. Dak.

FOR Sale—Combined sink and ice-cream freezer; also wonderful hair grower. Alberta Campbell, 1010 Davis, Aliquippa, Pa.

OUTRIGHT—Scalp-treatment hot-water cap. A proven success. Ralph Mauriell, Oceanport, N. J.

OUTRIGHT Or royalty—Multiple metal cabinet. No rivets, angle iron or bolts. Easily and cheaply manufactured. J. Lachaine, St. Martin, Que., Canada.

MEDICAL Patent recently issued and movable flynet, ready to issue. Sell outright. Simons & Smith, 229 C Ave., Lawton, Okla.

PATENTED Gasoline saver. Sale or royalty. Ben Potter, Ashland, Ky.

GREASELESS Doughnuts, Canadian patent 250,802. Process and apparatus inexpensive. Tremendous success United States. Ernest Kratzer, Los Angeles, Calif.

OUTRIGHT—Reasonable pipe joint for toilets, bathtubs, basins, sinks. Patented United States and Canada. Robert Dawson, Skillman, N. J.

ELECTRIC Water heater for kitchen and bath or home heating system. Economic. Efficient. Patent pending. Box 328, Ellwood City, Pa.

ATTENTION Mfrs. Electric, automatic garage door control. Royalty or outright sale. Mrs. Bliss, 712 Walnut, Royal Oak, Mich.

OUTRIGHT—Automobile fender trouble lamps for aid in replacing tires. Torrence Seiple, 60 Mary St., Ashley, Pa.

OUTRIGHT Or royalty—Three way water conductor for farms. No changing after setting up. Simple. John Train, Pipestone, Minn.

THREE Patents pending—Combination wrench, folding umbrella, bottle carrier. All practical. Cash or royalty. Sam Campbell, Pryor, Okla.

RADIO Gang condenser. First patent allowed, second pending. Simple, sturdy, smooth positive drum control. Any type tuning curve without irregular shaped plates. Tuning curves of all sections identical. M. Frederickson, 6240 Herzog St., Oakland, Calif.

OUTRIGHT—New amusement novelty. A fanciful figure appears and disappears in upper coat pocket. Roy Sherman, 1125 Capitol St., Vallejo, Calif.

OUTRIGHT—Royalty. Radiator cap. Patent pending. Toys, pneumatic tire. Song, W. Jones, 41 Manly St., Portsmouth, Va.

OUTRIGHT—Camphor holder for pianos. Easily attached; no screws. John De Carlo, 331 Court St., Brooklyn, N. Y.

COMBINATION Motor truck, concrete and mortar mixer; establishing a new mixing principle and will prove a big money maker to manufacturer. Chas. Payne, 27 Fulton Ave., Waukegan, Ill.

TIME Counts in applying for patents. See pages 138 and 139. Clarence A. O'Brien, Registered Patent Attorney, Washington, D. C.

BATHROOM And water heater patent and business for sale. Louis A. Faust, Comfort, Tex.

INVENTORS—Cash in on your invention now! Don't delay the sale any longer! Send for a free copy of our specially prepared booklet, "Turn Your Patent Into Money" today! It contains helpful information for all inventors. M. L. Rund, Mgr. Classified Advertising, Popular Mechanics Magazine, 200 E. Ontario St., Chicago, Ill.

SURVEYING INSTRUMENTS

GOOD-AS-NEW Guarantee goes with our rebuilt transits and levels. Bargain prices on all kinds and makes. Write today for descriptive list, M-10. Warren-Knight Co., 136 N. 12th St., Philadelphia, Pa., makers of "Sterling" Precision Instruments.

LARGEST Stock of new and used surveying instruments in the country direct from factory. Satisfaction guaranteed or money refunded. Also farm levels. Wissler, 619 N. Broadway, St. Louis, Mo.

MODELS AND MODEL SUPPLIES

WORKING Models built. Drawings prepared free. Let our designing and engineering department and 27 years' experience assist you with your invention. Lowest prices. Hohmeier Mfg. Co., 1385 E. 17th St., Cleveland, Ohio.

SPECIAL Machine builders, tool and die makers, inventors' models production work of all kinds. Dept. L. Quality Hardware & Machine Corporation, Ravenswood and Thorndale Aves., Chicago, Ill.

TIME Counts in applying for patents. See pages 138 and 139. Clarence A. O'Brien, Registered Patent Attorney, Washington, D. C.

LET Our experience be your guide. Models that are models; tools and equipment for economic manufg. Patterns of all types; manufacturing in all branches. Satisfaction guaranteed. United Machinery Company, Cincinnati, U. S. A.

MODEL Steam engines and boilers for miniature boats. Compressed air plants for model airplanes. New catalog 15c. Model Machine Shop, 212 Price St., Rahway, N. J.

WE make working models for inventors and do experimental work and carry a complete stock of brass gears and model supplies. Send for catalogue. The Pierce Model Works, Tinley Park, Ill.

DEADEYES— $\frac{1}{4}$ " 3-16" \$3.50 hundred, belaying pins 18c dozen. C. Libby, Tuckahoe, N. Y.

ACME Model Works, 200 North Jefferson St., Chicago, Ill.—Working models, mechanical, electrical and optical apparatus designed and built. Screw-machine work. Stamping.

WE Make models, tools, dies, special parts, stamping and general manufacturing. Badger Tool & Mfg. Co., 134 So. Clinton St., Chicago, Ill.

AUTO Chassis: complete working model. Gear shift, differential, brakes, etc.; fully illustrated instructions, 10c. Meccano Company, Inc., Dept. L, Elizabeth, N. J.

MODELS, TOOLS, DIES and General manufacturing. Logan Machine Co., 652 W. Lake, Chicago, Ill.

THE Modelmaker, a magazine for all interested in making working models, boats, etc. Sample 10c. Modelmaker, 122 Liberty St., New York.

SHIP Model Fittings: Send Dime for booklet. A. J. Fisher, 1002 Etowah Ave., Royal Oak, Mich.

ELECTRICAL

AUTOMATIC Burglar and fire alarms. Ed. F. Daly, 2328 May St., Cincinnati, Ohio.

FOR MANUFACTURERS

MANUFACTURERS About to launch a new product; I will design and tool your article and perfect it for marketable serviceability, sales advantage and quantity production. M. Alva Zook, Industrial Engineer, Glen Ellyn, Ill. (Suburb of Chicago.)

MANUFACTURING

MANUFACTURING Models, dies, stampings, brass work, one or thousands. Circular free. Baum's Metal Specialties, Kansas City, Mo.

SPECIAL Machinery or parts, dies, tools, metal specialties, models, special gears, stock gears and model supplies. Send for Catalogue. The Pierce Model Works, Tinley Park, Ill.

ECONOMICAL Manufacturing from sheet, bar, wire or tubing. Models, dies, special machinery. Swanberg, 5124 N. Kildare Ave., Chicago.

WIRE goods made to order. Conley Mfg. Co., 530 N. Western Ave., Chicago.

MACHINERY, TOOLS AND SUPPLIES

18"x10" LODGE & BARKER Engine lathe, \$125; No. 1 Brown & Sharpe milling machine, \$135; 12"x5" Barnes engine lathe, \$95; No. 60 Heald cylinder grinder, complete, \$275; 21" Barker shaper, back geared, \$400; 10" drill press, \$19; 24" Fay & Egan wood planer, \$150; 20" Hendy metal shaper, \$225; Quincy air compressor and tank, complete, \$65; $\frac{1}{4}$ hp. electric motors, \$12.50. Terms if desired. Write for catalog. Cincinnati Machinery & Supply Co., 27 West Second St., Cincinnati, Ohio.

SPECIAL Heavy duty portable electric drills that cannot be stalled by two men on each side. Quarter inch heavy duty, \$22.00; $\frac{1}{2}$ "", \$45.00; $\frac{3}{4}$ "", \$58.00; $\frac{1}{2}$ "", \$68.00. Five dollars down, balance easy terms. Money back if you want it. Over 20,000 sold last year. General Distributing Company, Security Building, Duluth, Minn.

NEW 16" Bench power drills complete with chucks. $\frac{3}{8}$ " capacity. Price \$22.00 each. f. o. b. New Haven. Rotwink Bros., Inc., 67 Water St., New Haven, Conn.

9 IN. Barnes Screw cutting lathe. Price \$70. Many other bargains in lathes, milling machines, woodworking machinery. Write us. Machinery Dealers Incorporated, New Haven, Conn.

COMPRESSORS, Twin cylinder, for small tire shops. Duco spraying. J. Trackman & Sons, Inc., 110-112 Lincoln Ave., Evansville, Ind.

WATCHMAKERS Lathe for sale at a bargain. R. Jaegermann, 5815 Easton Ave., St. Louis, Mo.

FOR Sale cheap. Davis-Bourneville No. 1 Oxygraph Oxy-Acetylene cutting machine. Shepherd Engineering Co., Williamsport, Pa.

START business of your own, small investment required, doing nickel, copper and silver plating. This work in big demand. Information free. Electro Platers Supply Co., 547 Considine Ave., Cincinnati, Ohio.

CONCRETE Building Block Machines and Molds. Catalog free. Concrete Machine Co., 5 North Main St., St. Louis, Mo.

ENGINES, MOTORS AND DYNAMOS

NEW Motors: General Electric $\frac{1}{4}$ hp., \$9.50; $\frac{1}{2}$ hp., \$26; 1 hp., \$38.50. Mail \$3, will ship C. O. D. anywhere. Motor Specialties Co., Crafton, Penna.

WRITE for bargain catalogs on electric motors, generators, electric drills, etc. Do not buy, consult us first. General Distributing Co., Security Bldg., Duluth, Minn.

ONLY A few left: new $\frac{1}{4}$ horse, 110 volt, 60 cycle, 1,750 speed, alternating motors with cord, plug, flat pulley and two-year factory guarantee, \$7.00 each; \$6.50 each lots of six. $\frac{3}{4}$ kw. 32 volt, new General Electric, 1,750 speed generators for battery charging or lighting \$29.00 each. Also other sizes of motors and generators. Alternating and direct current. Electrical Surplus Company, 1911 West Chicago Ave., Chicago.

EDISON Phonograph electric universal motors with speed governor, finest small motor made. \$5.00 plus postage, 9 pounds. Geo. Schulz, Calumet, Mich.

AUTO Engines make excellent power plants in the shop, mine, mill or farm, but they need governing. We make the governors for \$10 up. Fit any make of engine. See advertisement below.

GOVERNORS For auto engines when used for power plants. Sent on 30 day free trial. Circulars. Candee-Smith Governor Co., 215 W. Manchester Ave., Los Angeles, or St. Catharines, Ont.

NEW 1/2 Hp. Westinghouse motors, \$27.50; 3/4 hp., \$6.50; for direct current, \$6.50, 110 volt or 32 volt motors with emery, buffer and drill chuck, \$7.50. American time switches, \$6.75. Many other bargains in larger motors and generators. Queen City Electric Co., 1736 Grand Ave., Chicago, Ill.

FOR Sale: 1-6 hp. motors, 110 volt, 1,750 R.P.M., 60 cycle, alternating current. Slightly used. Good running condition. \$4.50 each, while they last. Cash with order. The Maytag-Chicago Co., 337 W. Madison St., Chicago, Ill.

MAKE your own—half and one horsepower electric motors. A. C. Induction motor model shows winding connections plain sight. Quick easy way. Gaines Bros., Box 481, Gainesville, Texas.

STEAM Engines—One II. P. \$18.00; 1/2, \$12.00. James Chambliss, Bessemer, Ala.

TIME Counts in applying for patents. See pages 138 and 139. Clarence A. O'Brien, Registered Patent Attorney, Washington, D. C.

BENDING MACHINES

THE Famous Hossfeld "Wrenchless" Universal Iron Bender is the last word in bending machines. Bends metal, cold or hot, into most any conceivable shape, including Eye Bolts and Automobile Spring Eyes. Bends up to 1" bars or 1 1/2" pipe cold. Thousands in use by all classes of trade, from the smallest shops to the largest railway systems. Write for circular and prices. Hossfeld Mfg. Co., Winona, Minn.

BLACKSMITHS

BE a Master Mechanic Blacksmith and Expert Tool Maker and Dresser with colored tempering charts. Price \$1.00. Valuable samples free. W. M. Toy, Sidney, Ohio.

WANTED—MISCELLANEOUS

WHY Not gather up and mail me your broken and discarded jewelry, dental work, etc. Turn them into cash. Highest prices paid for old gold, silver, platinum, etc. Satisfaction guaranteed or goods returned. F. Polcer, 2408 South Cicero Ave., Cicero, Ill.

MAIL Us your discarded jewelry, gold, crowns and bridges, watches, diamonds, silver, platinum. Money promptly mailed. Goods returned if offer refused. United States Smelting Works (The Old Reliable), Dept. 71, Chicago.

FOR SALE—MISCELLANEOUS

SLIDE-RULE. Full-size, accurate, \$3. Instructions. Moores, 38 Rounds, New Bedford, Mass.

"NEVER Mind Tomorrow." Raging radio (WMCA) popular song. Today postpaid 25c. Constance Howard, 33-C, Woodruff Ave., Brooklyn, N. Y.

ADDRESSGRAPHS. Letter folders, multi-graphs, envelope sealers, duplicators, less than half price. Guaranteed. Pruitt Co., 117 No. Market, Chicago.

FARMS AND FARM LANDS

SMALL Fruit and poultry farms near Los Angeles. Ten years to pay. Send for free illustrated booklets. Fontana Farms Co., owners, Room 617, 631 S. Spring St., Los Angeles, Calif.

LAND Opening—A new line under construction in Montana opens a million acres of good wheat and stock country. Send for New Line book. Minnesota, North Dakota and Montana offer best opportunity in two decades to secure good improved farms from banks. Insurance and mortgage companies at a fraction of their real value. Send for lists. Improved farms for rent. Washington, Oregon and Idaho have exceptional opportunities in fruit and poultry raising and dairying with mild climate and excellent scenic surroundings. Write for free book on state you prefer. Low homeseekers rates. E. C. Leedy, Dept. 857, Great Northern Railway, St. Paul, Minn.

CALIFORNIA Poultry and fruit farms. One acre up; on paved roads at Muscoy, adjoining city limits of San Bernardino. Population, 40,000. Heart of the orange empire. Water, gas, electricity. Long time to pay. Send for free illustrated booklets. J. B. Roof, Incorporated, Owners, 708 Quinby Bldg., 650 South Grand, Los Angeles, Calif.

\$100 GETS 224 Acre farm, brick house, 200 fruit trees. Productive soil, ready markets, handy advantages; 9-room brick residence, barn, garage, etc.; only \$1,600, fourth cash. Details pg. 20 big illus., catalog, bargains in 20 states. Copy free. Strout Agency, 255-P Fourth Ave., New York City, N. Y.

LAND Free if planted to bananas. Bananas bear a full crop the second year. \$5.00 monthly will plant a five acre orchard, which should pay \$1,500.00 profit annually. As bananas ripen every day, you get your check every 90 days. Reliable companies will cultivate and market your bananas for one-third. For particulars address Jantha Plantation Company, 410 Empire Bldg., Block No. 30, Pittsburgh, Pa.

160 ACRES Choicest northern Minnesota unimproved farm land. Beautiful Rainy Lake district of Arrowhead country. Gilt-edged title. No encumbrances. Possible big mineral value. Forced to sell. Will accept \$2.50 per acre cash. Attractive investment. E. J. Gjesdahl, International Falls, Minn.

5 ACRES, Lot fruit, poultry, near city, lakes, oil field, \$285; only \$5 monthly. Topping, Muskegon, Mich.

SELL your property quickly for cash, no matter where located. Don't pay big commission. Particulars free. Real Estate Salesmen Co., Desk B, Lincoln, Nebr.

MONEY made in Mich. potatoes. \$10 down now and easy terms buys land near markets, lakes, streams. Write today. Swigart & Co., P-1276, 1st Nat'l Bank Bldg., Chicago.

OZARKS—10 acres near White River and proposed power dam, \$100, \$5 monthly. Alvin Zimmerman, 1802 N. 5th, Kansas City, Kans.

TREE KILLERS

TIMBER. Weed killer, easily made. Particulars free. Miller P. Agency, Kensett, Ark.

ROOTS AND HERBS

MEDICINAL Herbs and roots for all ailments. Over 1,000 varieties. Catalog free! Botanic, 145 West 112th St., Chicago.

MUSKRATS

MAKE Money From Muskrat Fur—Raise Muskrats in dry land pens or hutches. Get the facts. 652, Conrad's Ranch, Denver, Colo.

RABBITS

MAKE big profits with Chinchilla Rabbits. Real Money-makers. Write for facts, 852 Conrad's Ranch, Denver, Colo.

SWINE

OHIO Improved Chester White boars, sows (pigs no kin, \$10 each), vaccinated, pedigreed. Fred Ruebush, Sciota, Ill.

DOGS AND PETS

HUNTING Hounds for sale. V. Langdon, Dresser, Ill.

FOR Sale. Minks, squirrels, raccoons, foxes, ferrets, muskrats, ginseng, rabbits, skunks, wolf pups, opossums. B. Tippman, Caledonia, Minn.

FOX Terriers, Collies, English, German Shepherds. Barnes Farm, Fairfield, Nebr.

GOLD Fish—Imported Japanese fish. Artistic aquariums, aquatic plants; interesting circulars free. Pioneer Aquarium Shop, Racine, Wis.

HUNTING Hounds cheap; trial. Literature free. A7, Dixie Kennels, Herrick, Ill.

ST. BERNARDS, Registered thoroughbred Puppies from Championbred parents. Prices reasonable, duty free, photos submitted. Helvetia Kennels, 181-P McKenna, Montreal, Que.

FOR Sale. Minks, squirrels, raccoons, foxes, ferrets, muskrats, ginseng, rabbits, skunks, wolf pups, opossums. B. Tippman, Caledonia, Minn.

PERSONAL

MOORE'S Method permanently relieves chronic constipation. No drugs, no dieting, no appliances, simple, easy, effective. Full price \$3. Particulars free. G. Moore, B-161 Newport Beach, Calif.

QUESTIONS Answered, information, reading \$1.00. Grace Callison, R. R. 8, Hamillon, Ohio.

THE "Sanatory Physician," an 80 page book teaching natural laws of health, also suggests reliable self-treatment of disease. Appreciated by every reader. Mrs. S. Denver, Colo., says: "I owe my regained health to that dear little book." Postpaid 20c. Address, Author, 320 James St., Seattle, Wash.

ARE You old at 40? See our advertisement on page 161 of this issue. The Electro Thermal Company, 2110 Morris Ave., Steubenville, Ohio.

YOUR Ingrowing nail corrected or no cost. Information free. Write Eugene Eaton, D106, Bandon, Ore.

RECEIVE Opportunity mail from everywhere. Listing 20c. Larson, N-3410 North Ave., Chicago.

TOBACCO Or Snuff habit cured or no pay! \$1.50 if cured. Sent on trial. Frances Willard, Box 796, Los Angeles, Calif.

ADVICE, information, any subject, 25c coin. Fred Klotz, Reading, Pa.

DRY Clean your brain. Results amazing. Money back if not satisfied. Morris, 3608 Warren St., Philadelphia.

MISCELLANEOUS

\$1 VALUE Novelties for 30c. Liberty Sporting Goods, 2343 So. Kedzie Ave., Chicago, Ill.

TOYS And furniture easy to build from our blueprints. Send stamp for list. Address Woodcraft, Box 436, Troy, N. Y.

MEXICAN Made holsters, lariats, horse-hair articles; rattlesnake belts. Send four cents for illustrated list. Tex-Mex Leather Co., 309 Esperson Bldg., Houston, Tex.

MIRRORS Resilvering at home. Costs less 5 cents per square foot; you charge 75 cents. Immense profits plating autoparts, reflectors, tableware, stoves, refinishing metalware, etc. Outfits furnished. Details free. Write Sprinkle, Plater, 288, Marion, Ind.

I CATCH from 45 to 60 foxes in from 4 to 5 weeks' time. Can teach any reader of this magazine how to get them. Write for particulars. W. A. Hadley, Stanstead, Que.

CASH Paid for Butterflies, Insects. See Sinclair Display Advertisement on page 22.

MUSIC Stamps, printing toys, rubber type. Firemen and police badge. Catalog 25c. Walt, Karstaedt, Dayton, Ohio.

ARE You old at 40? See our advertisement on page 161 of this issue. The Electro Thermal Company, 2110 Morris Ave., Steubenville, Ohio.

CHRISTMAS Greeting card assortment 21 beautiful cards and folders with envelopes postpaid \$1.00. Clifford Hoffman, 57 Broad St., Albany, N. Y.

AMATEUR Cartoonists—Sell your work. Write Smith's Art Service, Wenatchee, Wash.

TIME Counts in applying for patents. See pages 138 and 139. Clarence A. O'Brien, Registered Patent Attorney, Washington, D. C.

ARTISTS And art students are printing 250 signs or pictures an hour without machinery. Sample and particulars 10c. Straco, 1013 Mulberry, Springfield, Ohio.

TATTOOING Outfits, supplies. Illustrated list free. "Waters," 965 Putnam, Detroit.

HOMEOPATHIC And Biochemie preparations sent postpaid to all parts of the world. Manual and booklet free. Halsey Bros. Co., 5547 Ravenswood Ave., Chicago, Ill. Established 1855.

WEEDS—Cut them with cutter bar on Shaw Garden Tractor. Also plows, cultivates and runs belt machinery. Low prices. Immediate delivery. Shaw Manufacturing Company, Department C, Galesburg, Kans.

CUTS anybody can make. Simple, cheap process. \$1. Specimens, particulars. 2c stamp. M. Dav. Windfall, Ind.

AMATEUR Cartoonists: Make money in spare time with new cartoon selling plan. Write Smith's Service, PM1194, Wenatchee, Wash.

MICHIGAN STATE AUTO SCHOOL AND GREER COLLEGE AMERICA'S GREATEST TRAINING SHOPS NOW UNDER MANAGEMENT OF ERWIN GREER



LEARN AUTOS

Seven Billion Dollars are spent each year to repair Twenty-four Million Autos, Trucks and Tractors. Tinkering Mechanics are losing out. EXPERTS, trained on Big Equipment, by EXPERT TEACHERS are demanded at Big Pay. Thousands of Garage owners make up to \$15,000 a year.

New Purchase of Big School Gives Me Big Advantage

I recently bought the famous Michigan State Auto School, formerly of Detroit. The equipment I bought has all been installed at Greer College at Chicago. NOWHERE ELSE I know of, is there NOW such Auto TRAINING SHOPS as GREER COLLEGE, where you get practical training on a world of equipment.

Up To \$15,000 a Year

Clip coupon below for Free Auto Book. Learn how I fit you for Big Jobs. I have trained thousands to earn over \$100 a week. Ninety Thousand men, in 26 years, have started their Auto careers at Greer College. Welding, Ignition, Starting, Lighting—EVERYTHING—I teach you. MY TRAINING IS COMPLETE—no dull books or deep theory.

A Job for You While Learning

My Free Book shows how you DON'T NEED a lot of MONEY or EDUCATION, and how I PAY YOUR FARE HERE—how I HELP GET YOU A JOB WHILE LEARNING, to help pay your living expenses and tuition—also another one at graduation. Send for this great book today.

Only 3 Months—Then Big Pay

It takes me ONLY THREE MONTHS to fit you for big pay. In this great seven story building (shown above) which is filled with machinery and training equipment, I fit you for every branch of the auto business. There are AMAZING OPPORTUNITIES for Foremen, Garage Owners, Auto Specialists the country over. Let my Free Book show you.

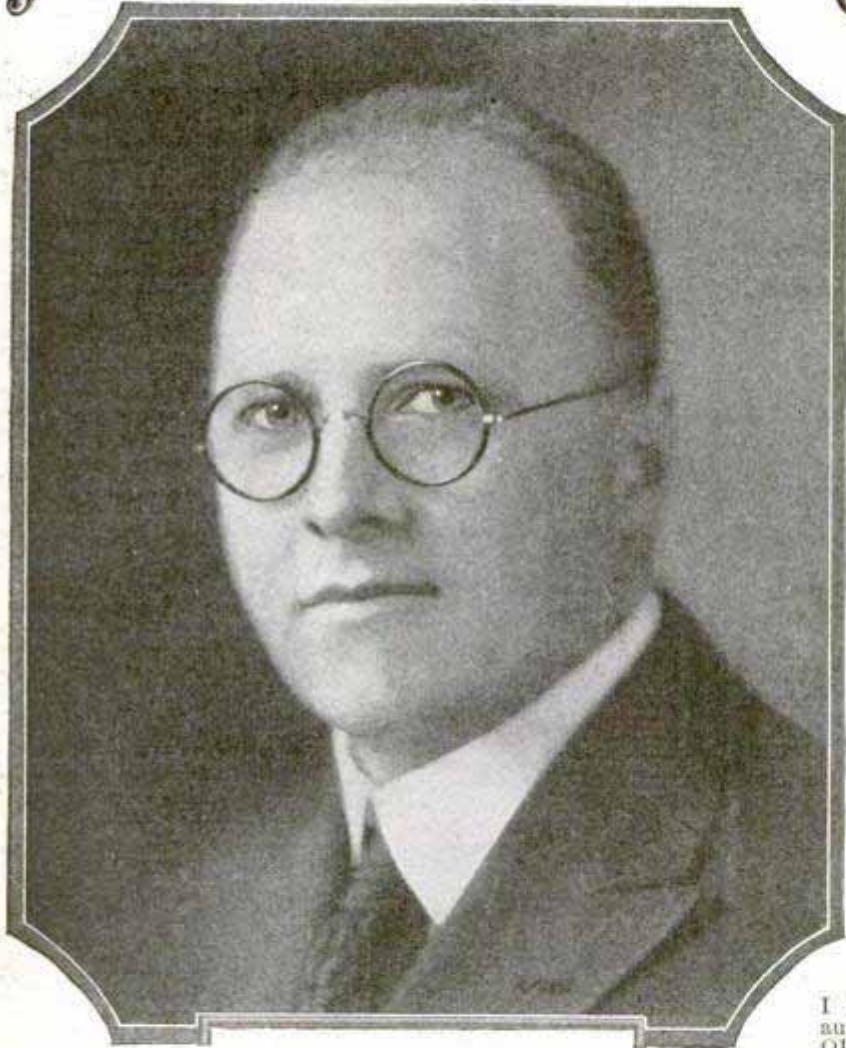

ERWIN GREER, President

LET ME HELP You To the Sunnyside of Life

My Free Auto Book will tell you about these remarkable GREER COLLEGE FEATURES; *Railroad Fare Paid—Easy Terms—Big Equipment—A Job while learning—Man's size income and YOUR FUTURE* as a trained AUTO EXPERT. I will and can solve your life's money-making problem. While your fine ambition is urging you on—ACT—SEND FOR MY FREE AUTO BOOK.

**ERWIN GREER, President
GREER COLLEGE,**

Dept. C-01X, 2024 Wabash Ave., CHICAGO, ILLINOIS

SCISSORS FOR SUCCESS BOOK

**ERWIN
GREER, Pres.
GREER COLLEGE,
2024 Wabash Avenue,
Dept. C-01X, Chicago, Ill.**

Dear Sir:
Send me your Big Auto Book—Free of Charge and without obligation to me.

Name.....

Street and No.....

City.....State.....



\$2⁰⁰ DOWN
BALANCE EASY TERMS

HERE'S your chance to own that Corona you've wanted—on the easiest terms ever offered—**at ONE-THIRD OFF** regular price! Complete in every detail; two color ribbon, back spacer, beautifully finished, **NEW MACHINE GUARANTEE**. Recognized the world over as the finest, strongest, sturdiest, portable built.

Only a limited number of these splendid machines available. To get one, you must act now!

Yours for 10 Days FREE—Send No Money

Experience the joy this personal writing portable typewriter can give you! Use it 10 days free! See how easy it is to run and the splendidly typed letters it turns out. Ideal for the office desk, home, traveling. Small, compact, light, convenient. Don't send out letters, reports, bills in poor handwriting when you can have this Corona at such a low price or on such easy terms.

Carrying Case Included—If You Act Now

Leatheroid carrying case, offer, instructions free on this offer. Send no money—just the coupon. Without delay or red tape we will send you the Corona. Try it 10 days. If you decide to keep it, send us only \$2—then \$3 a month until our special price of \$39.90 is paid (cash price \$36.40). Now is the time to buy. This offer may never be repeated. Mail coupon now.

\$15.10 Saved
By Using This Coupon

Smith Typewriter Sales Corp.
 [Corona Division]
 360 E. Grand Ave., Chicago, Dept. 3-A

Ship me the Corona, F. O. B. Chicago. On arrival I'll deposit \$2 with express agent. If I keep machine, I'll send you \$3 a month until the \$37.90 balance of \$39.90 price is paid; the title to remain with you until then. I am to have 10 days to try the typewriter. If I decide not to keep it, I will repack and return to express agent, who will return my \$2. You are to give your standard guarantee

Name _____
 Address _____
 Employed by _____

New Invention Brings Good Fortune While You Sleep

Grateful users report amazing benefits from

The PSYCHO-PHONE

HERE is what they say: "I find myself getting favors and preferences that I never got before." "I have increased my bank account \$500." "I have doubled my practice." "I was healed from an injury which had incapacitated me for several years." "I now have \$— in the bank." "I married the girl I wanted." "I look much younger." "I have overcome all my fears." "I consider the Psycho-Phone the biggest thing in the world today." "The Psycho-Phone is all you claim for it and more." "I would not part with it for any price if I could not get another," etc., etc.

Such is the startling testimony to the remarkable results obtained by users of the Psycho-Phone. Every day this great invention is helping men and women in every walk of life to achieve **SUCCESS, HEALTH and HAPPINESS.**

It works on the principle of impressing on your unconscious mind, while you sleep, the specifications of what you want of life. In this way you are attuned to the great creative intelligence of the universe and become possessed of Superman powers.

Find out how it can help YOU get the thing you want. Tell us in confidence your particular desire or need and let us send you our interesting free literature.

The Psycho-Phone Co.

153 Lafayette Street

New York City

FLY The Finest Opportunity to Get Into the Airplane Game

Through the combined efforts of one of Chicago's leading AIRCRAFT factories and airplane sales agency we can offer you a course in flying and ground work that is complete in every detail. You learn to build real airplanes. You fly in modern and government licensed ships piloted by licensed pilots. Employment assistance given to students who must earn while they learn. A reasonable amount will start you.

Commercial Aircraft Sales., 400 No. Michigan Avenue, Chicago

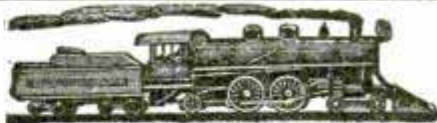

MEN NEEDED FOR RAILROADS

Nearest their homes—everywhere—to train for Firemen, Brakemen; beginners \$150-\$250 monthly. Promoted to Conductor or Engineer—\$3,000-\$4,000 yearly—highest wages on railroads. Also clerks.
 Railway Educational Association, Dept. D-1-10 Brooklyn, N. Y.

\$10.00 PER MONTH BUYS Fibre-Life Limbs



NEXT TO NATURE. BRACES MADE TO ORDER. AGENTS WANTED. FREE FIBRE SAMPLE **WORMAN CO.** 252-P HENNEPIN AVE. MINNEAPOLIS, MINN.

Learn to Dance

This New Easy Way

You can learn all the modern dances—Charleston, Black Bottom, Valencia, Canter, French Tango, St. Louis Hop, Latest Waltzes, Fox Trot, etc.—at home easily and quickly. New chart method makes dancing as simple as A-B-C. No music or partner required. Learn anywhere, anytime. Win new popularity. Be in demand at parties. Same course of lessons would cost \$20 if taken privately.

Send No Money

Just send your name and address. We'll ship the complete course—323 pages, 49 illustrations—without one cent in advance. When package arrives, hand postman only \$1.98, plus delivery charges, and this wonderful course is yours. Try for 5 days. Money back if not delighted. Send your name NOW.

FRANKLIN PUB. CO., 800 N. Clark St., Dept. 9417, CHICAGO



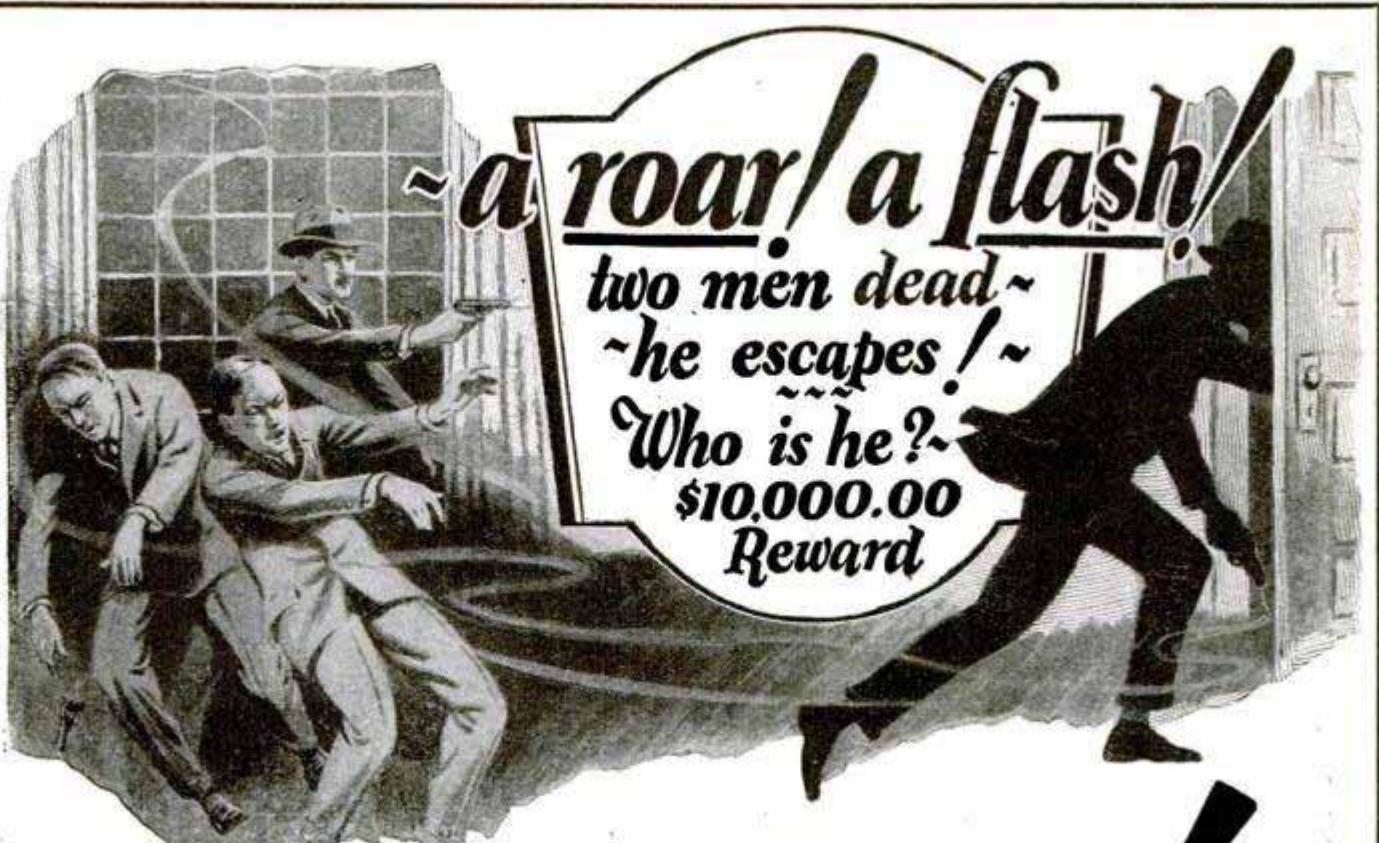

~ a roar! a flash!

*two men dead ~
~ he escapes! ~*

*Who is he? ~
\$10,000.00
Reward*

Follow Him!

IMAGINE the keen thrill that would be yours following some case like this: The escaping desperado is a notorious international character with a long record. He's wanted in five countries. Rewards range from \$5000 to \$25000 for his capture. He loots a palatial mansion. Kills two men. Escapes. Disappears. Changes his entire appearance. Pulls a clever "dead" fake and is recorded as "Dead" on all police records. Dead to all records except ONE—the Inevitable Finger Print.

For ten years he deceives the world. Prospers. Becomes a social lion. And then—Bang!—the Finger Print Expert nabs him. Society is shocked. They can't believe that this social Prince is the famous Mr. "X" of criminal

fame 10 years ago. But finger prints do not lie. Never! The Finger Print Expert always wins. Glory, fame, rewards are always his.

Thrills! Rewards! Await YOU!

Imagine the thrill, mystery, glory, fame and reward that would be yours if you were this Finger Print Expert. You can make them yours if you will. You can learn the secrets of this great science at home in your spare time. Any man of ordinary ability who can read and write can become a Finger Print Expert in a short time at a small cost.

A brilliant career and a handsome income with world-wide opportunities awaits you. Act Now. Don't let the other fellow enjoy what is rightfully yours. Mail that coupon now and learn the great things that are in store for you.

FREE

The Confidential Reports No. 38 Made to His Chief

Mail coupon now for free copy of confidential report Secret Service Operator No. 38 made to his chief. Get our big free book telling how you can become a real Finger Print Expert. Get our low prices and Easy Terms. But don't delay! Mail Coupon NOW!

UNIVERSITY OF APPLIED SCIENCE
1920 Sunnyside Ave., Dept. 13-57 Chicago, Ill.
Gentlemen:—Without any obligation whatever, send me free copy of Operator No. 38's confidential report, also your new, fully illustrated Free book on Finger Prints. Tell me all about your low prices and Easy Terms!

- PARTIAL LIST**
Graduates U. of A. S.
Recently appointed
Finger Print Experts
of these
States, Cities and
Institutions.
- State of Iowa
 - State of Idaho
 - State of Colorado
 - State of Washington
 - State of Michigan
 - Duluth, Minn.
 - Detroit, Mich.
 - St. Paul, Minn.
 - Pittsburgh, Pa.
 - Lincoln, Nebr.
 - Birmingham, Ala.
 - Columbus, Ohio
 - Havana, Cuba
 - Calgary, Ala. Canada
 - Pensacola, Fla.
 - Houston, Texas
 - New Haven, Conn.
 - Great Falls, Mont.
 - Galveston, Texas
 - Albany County Penitentiary
 - Albany, N. Y. (City)
 - Waterloo, Iowa
 - Wilkes Barre, Pa.
 - El Paso, Texas
 - Everett, Wash.
 - Schenectady, N. Y.
 - Alhambra, Calif.
 - Livingston, Mont.
 - Saginaw, Mich.
 - Tampa, Fla.
 - Fort Collins, Colo.
 - Windsor, Ont., Can.
 - Tulsa, Okla.
 - Pueblo, Colo.
 - Idaho Falls, Idaho
 - Lorain County, Ohio
 - Ogden, Utah
 - Lansing, Mich.
 - Gainesville, Texas
 - Walla Walla, Wash.
 - Indiana Reformatory
 - Jeffersonville, Ind.
 - St. Joseph, Mo.
 - Mingo Junction, Ohio
 - Oklmulgee, Okla.
 - Hazleton, Pa.

University of Applied Science
1920 Sunnyside Avenue, Dept. 13-57 Chicago

Name

Address

Age



ELECTRICAL EXPERTS IN DEMAND

Good positions await trained men. Salaries of \$12 to \$30 a day are paid many experts in this field.

THE Electrical field needs men. It needs them badly. Hardly a month or a year passes but what some new use for electricity is discovered. Each new use means new positions—*better positions*—for men who have trained themselves as experts in this wonderfully fascinating work.

Why don't you study electricity and prepare for a good position at a good salary?

You can do it right at home in spare time through the International Correspondence Schools. Home-study courses endorsed by Edison and Steinmetz. Successful students everywhere.

Mark and mail the coupon today for Free Booklet

INTERNATIONAL CORRESPONDENCE SCHOOLS
 "The Universal University"
 Box 5567-F, Scranton, Penna.

Without cost or obligation, please tell me how I can qualify for the position, or in the subject, before which I am marking X:

- | | |
|--|---|
| <input type="checkbox"/> Electrical Engineer | <input type="checkbox"/> Salesmanship |
| <input type="checkbox"/> Electrician | <input type="checkbox"/> Show Card and Sign Lettering |
| <input type="checkbox"/> Electric Wiring | <input type="checkbox"/> Railroad Positions |
| <input type="checkbox"/> Electric Lighting | <input type="checkbox"/> Illustrator |
| <input type="checkbox"/> Telegraph Expert | <input type="checkbox"/> Industrial Management |
| <input type="checkbox"/> Practical Telephony | <input type="checkbox"/> Secretarial Work |
| <input type="checkbox"/> Mechanical Engineer | <input type="checkbox"/> Business Correspondence |
| <input type="checkbox"/> Mechanical Draftsman | <input type="checkbox"/> Accounting and C.P.A. Coaching |
| <input type="checkbox"/> Toolmaker | <input type="checkbox"/> Bookkeeper |
| <input type="checkbox"/> Machine Shop Practice | <input type="checkbox"/> Stenographer and Typist |
| <input type="checkbox"/> Gas Engineer | <input type="checkbox"/> Traffic Management |
| <input type="checkbox"/> Civil Engineer | <input type="checkbox"/> English |
| <input type="checkbox"/> Surveying and Mapping | <input type="checkbox"/> Common School Subjects |
| <input type="checkbox"/> Reading Architects' Blueprints | <input type="checkbox"/> Civil Service |
| <input type="checkbox"/> Metallurgy <input type="checkbox"/> Architect | <input type="checkbox"/> Railway Mail Clerk |
| <input type="checkbox"/> Architectural Draftsman | <input type="checkbox"/> Textile Overseer or Supt. |
| <input type="checkbox"/> Plumbing and Heating | <input type="checkbox"/> Agriculture |
| <input type="checkbox"/> Sheet Metal Worker | <input type="checkbox"/> Spanish |
| <input type="checkbox"/> Automobiles | <input type="checkbox"/> Navigator |
| <input type="checkbox"/> Airplane Engines | <input type="checkbox"/> Mathematics |
| <input type="checkbox"/> Chemical Engineer | <input type="checkbox"/> Poultry Raising |
| <input type="checkbox"/> Pharmacy | <input type="checkbox"/> Radio |

Name.....

Street Address.....

City..... State.....

Occupation.....

Canadians should send this coupon to International Correspondence Schools Canadian, Limited, Montreal, Canada

BE A RAILWAY TRAFFIC INSPECTOR



DO YOU WANT TO EARN A REAL SALARY

in a pleasant profession where you are practically your own boss, see new faces and places each minute, are rapidly promoted? Would you like to be out in the open, away from dirty shop or monotonous desk—dressed in good clothes—a credit to yourself and your firm?

POSITION OPEN—WAITING FOR YOU
 All over the country—perhaps in your own town—men are needed in Railway Traffic Inspection. You can take one of these positions after a few months' spare-time home study. And upon completion of your studies, we'll assist you to a position paying at least \$120 per month to start, or refund your tuition. Lessons are easily understood—no previous training required—and you are equipped to accept a position as soon as you complete your training.

During the last nine years we have offered positions to 99.5% of our graduates, or refunded their money.

Read What Joe Ertle says—

I am earning \$192.00 per month and I have the knowledge and satisfaction that my work is highly satisfactory to my superiors.

I am far more than satisfied and received far more than I expected when I first subscribed for your course.

Considering you the greatest benefactor that has come into my life, I am,

(Signed) JOE ERTL.

Send for Free Booklet

Learn today about this great, uncrowded profession—and our refund and employment agreement. Free booklet tells all about Traffic Inspection—how we have been able to place our graduates in positions at \$120 or more per month—why they are so soon promoted to positions paying \$175 to \$250 per month—and what we can do for you.

STANDARD BUSINESS TRAINING INSTITUTE
 Div. 2, Buffalo, New York

No Hunting For a Position After Completing Your Training

EARN UP TO \$250 PER MO.



I POSITIVELY GUARANTEE

to increase your arms one-half inch in size, chest one full inch, strength 25%, health 100% in one week's time, by following my instructions and using my exerciser 10 minutes mornings and at night. Send \$1 for complete course and exerciser. Satisfaction guaranteed or \$1 refunded. Prof. J. A. DRYER, Box 1850-P, Chicago, Ill.

Be a drummer!



Trap Drumming made easy in a short time. Our free instruction course furnished with genuine Ludwig Trap-Drum Outfit. Develop your natural sense of rhythm. Go to your nearest dealer or write for full details.

LUDWIG & LUDWIG, 1611 North Lincoln Street, Chicago

BASHFUL?

"Shame on you!" Are you nervous, embarrassed in company of the other sex? Stop being shy of strangers. Conquer the terrible fear of your superiors. Be cheerful and confident of your future. Your faults easily overcome so you can enjoy life to the fullest. Send 25c for this amazing book. RICHARD BLACKSTONE, B-4710 FLATIRON BLDG., NEW YORK

WANTED!

Ornamental Iron and Bronze Draftsmen. \$50.00 to \$65 a week to trained men—up to \$500.00 a month to experienced men. We train you at home and help place you when ready. Demand greater than supply. Get out of the rut—write today for full information and booklet "Knowledge—Your Greatest Asset."

American Institute of Ornamental Iron & Bronze
 3073 Hennepin Avenue, Minneapolis, Minn.

A Fascinating New Way To Make Money Through The Arts!

free of extra cost

Our amazing new plan tells how you can get every one of the beautiful gift-wares illustrated here with all instructions for decorating. Mail coupon for Free Book and Offer.

Want Some Money? Here's a wonderful way to get it. Our beautifully illustrated book tells how. It tells all about our new methods of art decoration, art treatment, and how anybody can learn without previous experience. It tells how you can get the full assortment of giftwares and objects d'art shown on this page without one cent of extra cost, how we start you with this assortment and set you up in business. Contains page after page of color illustrations of what you can make and sell. You can make good money and this book is—

FREE Our system is amazingly easy to learn and the profits are larger than in almost any other business. You can produce beautiful objects almost from the start. Best of all you don't have to know how to draw for we show you the famous "3-Step Method." Begin making money now! All supplies are sent by us with instructions and many have made from \$10 to \$25 a week. Many society women do this work for their own amusement. But either way—pleasure or profit—it's the most delightful home work you can imagine. Don't miss this opportunity to get all these giftwares free of extra charge. Send now for your copy of this valuable book. It's FREE.

FIRESIDE INDUSTRIES
Dept. 66-P ADRIAN, MICH.

**GOOD
for
OFFER**

Fireside
Industries

Dept. 66-P
Adrian, Mich.

Gentlemen: Send me free book
and complete plan for making
money.

Name.....

Address.....

City.....State.....



Aviators now trained a newer easier cheaper way



The College of Air Introduces a Method of Training Found After Four Years of Teaching Experience

Now Everyone Can Learn to Fly!

For four years Marshall students have graduated from our courses to find profitable, responsible positions in every branch of the great aviation industry. Our rigid training and specialized equipment have carried them to success. Now, after four years of specialization, our pilots have found a newer, better system of teaching. Under the new plan you may take just as much training as you want, or can afford. If you lack the larger sums formerly required for training, you need not pass up the great opportunities awaiting you in aviation. The Straight Flying course at \$75.00 is within the reach of everyone who is physically fit. Other courses are available to fit your pocketbook—you pay for just what you get—and under the new plan you receive far more for your money than has heretofore been possible. **FALL TERM OPENS SEPTEMBER 15th**—plan now to enter with the many other students.

Take Your Choice of These Courses—

1. Straight Flying Course: Regular flying, banking, turning, climbing, diving, landings, takeoff—includes all the fundamentals. A good course to determine your ability. Price \$75.00.
2. Intermediate Flying Course: In addition to Straight Flying Course includes cross wind landings, takeoffs and flying under difficult conditions. Advanced work in all types of flying. Price \$150.00.
3. Ten Hour Flying Course: Includes everything in Courses 1 and 2, with ten full hours flying time. Price \$200.00.
4. Complete Flying Course: All the principles and practice to make you a successful flier—includes forced landings, cross country, all-weather, and solo flights. No bond required. Price \$245.00.
5. Private Pilots License Course: Completely qualifies you for license eligibility—ten hours solo—examination at our field. No bond required. Price \$150.00 after solo.
6. Limited Commercial Course: Qualifies you for Government Limited Commercial Pilot's License. Sixty Hours \$700.00.
7. Mechanics and Engineers Ground Course: All phases of construction, repair, maintenance, mapping, meteorology, navigation—finest ground course ever offered—300 hours training. Price \$75.00. Free with all courses except No. 1.

FREE BOOK

Opens the way to your future success—tells what others have done through training received at Marshall. Write for it today.



Get in touch with us immediately and learn of your opportunity before the Fall Term Opens.

MAIL THIS COUPON

MARSHALL FLYING SCHOOL

INC.

630 No. English St. Marshall, Mo.

Please send me complete information on new method of training aviators and special offer. I am interested in

Course No.

Name

Address

Get Up Into the Sky!



Styled-On-Fifth-Ave. TIES PAY BIG

You Can Make \$90.00 a Week with this great line—the best paying full time or spare time proposition in the country!

Beautiful patterns, sturdy long-wearing fabrics at factory prices sell on sight to men and women. Ideal to work with any other line you handle. Collect liberal commissions in advance. Write for big new FREE selling outfit today. Start earning big money immediately.

PUBLIC SERVICE MILLS, INC.
4947-P Hudson Blvd., North Bergen, N. J.

Canadian Office
110 Dundas St., London, Ontario, Canada



GIVEN Boys! Here's the great navy model Airship. Large 6-foot air bag with inflators, parachute with automatic release and complete instructions for flying. Will fly for miles at height of 1000 feet. Great chance to study aerial navigation. Send name and we'll send 6 of our new art pictures to dispose of on special 25c offer. Send the \$1.50 you collect and as a reward for this service we will send this wonderful Airship with full instructions free.

C. M. THOMAS, 337 W. Madison St., 10-K-91 CHICAGO

BREAKFAST NOOK and 26 other splendid articles of Built-In Furniture in our new book on this subject. 198 pages. Illustrated. Price \$2.50 Postpaid.
POPULAR MECHANICS PRESS, 200 E. Ontario St., Chicago

BIG MONEY IN ELECTRIC REFRIGERATION

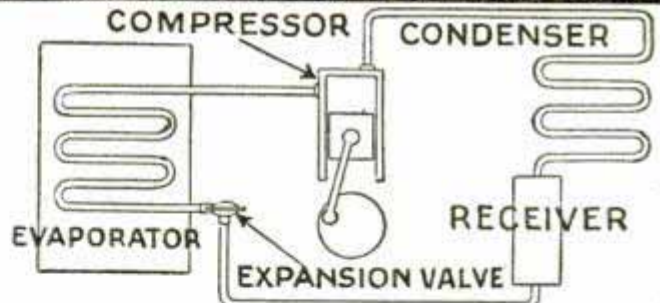

AMERICA'S biggest new industry—electric refrigeration—needs men to fill jobs paying \$200 to \$1,000 a month. The "cream" jobs are going begging while the field grows by leaps and bounds. The money powers of the country—General Motors, General Electric, and others—are investing billions. Millions of machines are being sold to homes, theaters, factories, stores, etc. Thousands of jobs are open in production, installation, service and sales which ordinary mechanics can't fill without special training in electric refrigeration.

EASY TO LEARN AT HOME

Learning electric refrigeration is now amazingly simple thru a new easy home training endorsed by authorities. Highly praised by Servel, Kelvinator, and other leading refrigerator manufacturers. **GET FREE BOOK.** See how easy you can become a highly paid refrigeration expert. Mail coupon to Utilities Engineering Institute, 3120 N. Clark St., Dept. 110, Chicago. **The only exclusive electric refrigeration school in America.**



Utilities Engineering Institute, 3120 North Clark St., Dept. 110, Chicago, Ill. **FREE!**

Without obligation, send me free information book.

Name

Address

City State

Men Who Work With Their Hands Make the Best DRAFTSMEN



We have placed machinists, carpenters, masons, plumbers, railroad men, farmers, office clerks and even laborers in fine Drafting jobs under this plan. Mail coupon for details of our remarkable offer.

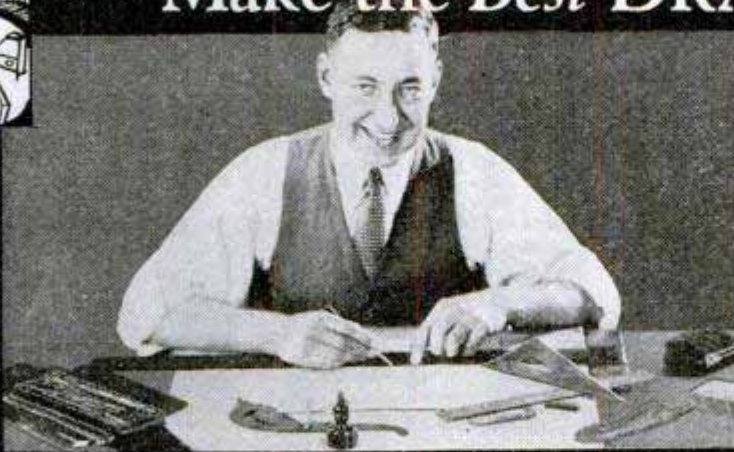

and we'll back them with this Contract
of a **DRAFTING JOB** and **RAISE**

We are looking for ambitious young fellows with factory, machine-shop, building trade or other kind of mechanical experience, to prepare for well-paid Drafting positions.

Such men, we find, are unusually successful as Draftsmen, because they know how things are done, and that's a priceless asset to the man who draws the plans. For Drafting is more than "mechanical drawing"—more than reading blue prints. The good Drafting jobs paying \$50 to \$100 a week, give you a chance to cash in on your entire past mechanical experience. Get in touch with me and I'll tell you how.



All manufacturing lines—such as the Electrical, Automotive, and Mechanical industries, depend on the Draftsman for the plans which keep the wheels turning and the workmen busy. The tiny watch on a girl's wrist and giant machinery and everything between must be built on paper before they can be fabricated of steel and iron.

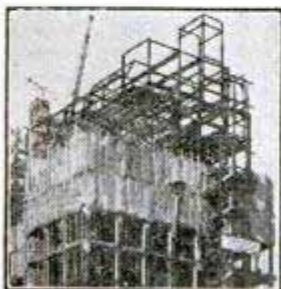

Billions of dollars worth of skyscrapers, hotels, factories, homes, apartments, bridges and public buildings are built each year. And not a stick or a stone can be placed in position until the Draftsman has calculated and designed it. Thousands of fine positions are open today for Draftsmen in building construction and structural steel lines.

Fine Jobs—Big Salaries Wonderful Opportunities!

Drafting reaches out into Electrical, Structural, Manufacturing, Building, Automotive and every other branch of industry. The work is fascinating, varied, original. Draftsmen are a fine bunch of fellows, well-paid, and they get the first call on promotions. **Go into Drafting, and your future is secure, whether times are good or bad.**

Easy to Learn in Spare Time at Home!

You need no "artistic talent," no high school diploma, no money in the bank to become a successful Draftsman. **The way is easier than you think.** Mail the coupon, and I'll tell you how quickly and easily you can learn Drafting by our remarkable Drafting Room Practice method. And how we can help you get a job and a raise, or money refunded. At a cost you can afford, on terms as low as 20 cents a day.

The American School

Dept. D-774, Drexel Ave. & 58th St., Chicago

American School

We will make this
Contract with you:

If you are now earning less than \$40 a week, we will prepare you to fill a drafting position paying 50% more, help you get it or refund every cent of your money.



R. T. Miller, Jr.,
Pres. (Signature)

Training Without Risk!

A two million dollar institution is prepared to get you ready for one of these fine Drafting jobs, help you get it and raise your pay, or the small amount charged will be refunded. Get a copy of this agreement—the most remarkable in the history of home-training. Mail the coupon and we'll tell you how you can take advantage of this life-time opportunity.

3

**Drafting Lessons
Actually FREE
to prove you can
get ready—Quick!**

Coupon also brings 3 of the first lessons, to show you how simple we have made the learning of drafting. Send for them and do them. Then you will know that a career in Drafting is now within your reach.

O. C. Miller, Director
Extension Work

The American School
Department D-774

Drexel Ave. & 58th St., Chicago

Please send at once without cost or obligation:

3 Drafting Lessons
Contract of Training, Job Service and a Raise
Facts about the Opportunities in Drafting

Name.....

Address.....

Age..... Occupation.....

Amazing New Can Opening Works Like

THINK of it! You just put the can in this amazing little machine! Turn the crank! And in five seconds—actually before you realize it—the trick is done! It's all automatic. Anyone can do it. Yet it's so astonishing that men and women everywhere can hardly believe their own eyes till they get it in their hands and try it. Actual tests show that four out of five people are then so enthusiastic that they insist on buying instantly. No wonder agents are making such surprising sums . . . \$200, \$300, sometimes even \$400 in a single week has been reported just introducing this new magic-maker. Even spare time workers write of earning as much as \$20 and \$25 in the space of a single hour.

NEW—REVOLUTIONARY—AMAZING

This queer new device does not look anything at all like the old-style can opener. And it is utterly different. As different as night from day. This invention is indeed far, far more than a mere can opener. It is a unique, simplified can opening machine that comes as close to deserving the name *revolutionary* as any invention of the last 25 years.

And now for the details! This uncanny little machine doesn't just cut a ragged hole around the rim of the can.

It lifts the entire lid completely out, clean as a whistle! Leaves the inside of the rim absolutely slick and smooth. You actually can drink out of the can without danger of cutting your lips!

Faster than you can read this print this great invention does four big things: 1—Holds the can like a vise (you don't have to touch the can while it is being opened). 2—Cuts the entire top out (not off, juices can't spill). 3—Flips up the lid so you can grab it. 4—Hands you back the can without any jagged edges to snag your fingers, and without muss, mess or fuss. Yes! You just put any shape can, round, square or oval in the machine, turn the handle, and almost instantly the job is done! Can you imagine anything so simple and yet so truly startling?

A Million Dollar Selling Opportunity

To any man with plain common sense there must be little need to point out that women everywhere hate the

A GREAT 20-YEAR OLD COMPANY

This proposition is backed by an old, well-known responsible company—this is your additional guarantee of fair-square dealings at all times.



*A Mere Twist of the
Wrist Opens Round,
Square or Oval Cans
In Five Seconds
—Automatically!*



Dickinson Wood Graff Neighbors

4 MEN MAKE \$1,365 IN A WEEK

Can a record like this be classed as "fool luck"? There *must* be some basic reason for the overwhelming success of Speedo when four average salesmen like Dickinson, Wood, Graff and Neighbors can clear such amazing profits! Think! Here are four men, located in Ohio, Wyoming, New York, and Indiana. One is what you'd call an "old timer." One is a youngster. But get this: the man who had the least experience of the lot made exactly \$348 in a single week, a short time ago. That same week the combined profits of the three others amounted to \$1017. That makes a total of \$1365 for the four—or an average income of exactly \$341.25 per week per man! Think that over, you fellows to whom \$100 a week looks like big money! It's small change with a proposition like Speedo.

Kind of Machine Magic!

old-style can opener. And no wonder! Every day fingers are cut and torn—often followed by infections and sometimes blood poisoning that results in expensive doctor bills. Meanwhile food is spilled, time is wasted. Yet every day millions of women have to go through the same old laborious hacking and stabbing with the old-fashioned can opener. If you wonder what most men think about it, ask any one of them how he feels when wife or mother calls him out to the kitchen and says, "There's a can over there by the sink, Bill, that I wish you would open—I can't seem to manage it." Men have just as tough a time as women with the old-style can opener, although they sometimes hate to admit it. But that's just why they all buy this new invention so quick. In fact this wonderful machine is already proved to be an amazing seller everywhere to both men and women. This naturally opens up unequalled selling opportunities and explains why this new invention is already on



No Jagged Edges

Speedo cuts the top out smooth, slick and absolutely clean. Ends forever the danger of infection from fingers cut on jagged tin edges. Banishes waste and bother. Yes, Speedo truly is Revolutionary.

as tough a time as women with the old-style can opener, although they sometimes hate to admit it. But that's just why they all buy this new invention so quick. In fact this wonderful machine is already proved to be an amazing seller everywhere to both men and women. This naturally opens up unequalled selling opportunities and explains why this new invention is already on



Food Pours Out

No more scraping or spooning food out of the can when you use Speedo. There is no ragged rim left to catch food. No fuss or muss. Even food frozen in the can pours right out.



Are Double Profits Now Possible Overnight?

Amazing as it may sound Speedo can opener now has a twin invention. A startling new method of sharpening everything used around the home—knives, tools, even scissors. It works with the can opener—sells with it—gives you \$1.50 to \$2.00 profit in every home. The coupon brings full details.



Banish This Danger and Make \$6 to \$16 Any Hour

its way to setting an all-time record as a quick, steady, easy money-maker. Yet what more could you expect when you just consider all the facts?

FREE TRIAL—ACT QUICKLY

This invention has been approved by Good House-keeping Institute and many other famous experts. It is beautiful as a piece of fine cutlery. Also covered by a written guarantee of 5 years perfect service. Recent experience has convinced the manufacturer that no one can resist this invention when they actually see and use it. So he now offered it on an absolutely Free Trial to anyone interested in making more money. Exclusive territories and complete sales training are offered. You also get door-opener ideas, quantity plans, club selling plans, a remarkable profit sharing plan that triples income, selling literature, in fact everything. Only a bare outline of the unusual money-making features can be given here. The time to find out about these things is now. Every day you put off making this absolutely Free Test you are losing money. Other live wires are reading this message also. Tomorrow, even, you may be too late. Make sure by simply mailing the coupon without obligation right now.

CENTRAL STATES MFG. CO.
Dept. M-702, 4500 Mary Ave., St. Louis, Mo.

—SPEEDO—

Central States Mfg. Co., Dept. M-702,
4500 Mary Ave., St. Louis, Mo.

Send me your Free Test Offer and I will agree to devote one hour of my time to making my own test of Speedo profits.

Name.....

Address.....

Town..... State.....



I Will Teach You the Secrets of HYPNOTISM —or no cost

I'll show you in a few hours how to use the strange, mysterious power of hypnotism to help you to master every situation, or the 5-Days' Trial is FREE!

THERE is nothing uncanny, weird or malign about the amazing power of hypnotism! Everyone has concealed in his or her make-up the germ of this mysterious power. All you need to do is to train it properly. Then, when this mighty power is released, it will help you to overcome obstacles, and to gain popularity, success, big money.

When you have this marvelous power at your command, you can work wonders. You can strengthen your own will-power; develop a magnetic personality; banish fear and worry; improve your memory; overcome bad habits; realize ambitions; increase your earnings. If you have an average active and intelligent mind, you should easily learn the secrets of Hypnotism.

All is now revealed in a wonderful book, *Practical Lessons in Hypnotism*, by L. W. de Laurence, a world famous hypnotist. In simple, easy-to-understand language, de Laurence explains the theory and practice of Hypnotism—how to master this power, how to select your subjects, how to hypnotize your subject, how to hypnotize by telephone, mesmerism vs. hypnotism, magnetic healing, various methods of hypnotizing, how to wake up the subject, how to make money out of hypnotism, and scores of other secrets. Prepared especially for self-instruction. This course should give you new power, confidence, and a more dominating personality.

**Try 5 Days Free
Send No Money**

Thousands of people have learned the secrets of Hypnotism from de Laurence. So confident are we that his great book will teach you the amazing science of Hypnotism, that we will send you a copy without one cent in advance. Simply clip and mail the coupon. When the package arrives, pay the postman only \$2.50, plus the delivery charges. Inspect this revealing volume. Test the powers of hypnotism for five days. Then if you are not delighted, return the book and your money will be refunded immediately. Mail the coupon now as we have but a limited edition at this low price. Franklin Publishing Company, 800 North Clark Street, Dept. M-70, Chicago, Ill.

Mysteries of Hypnotism Revealed

- How to hypnotize at a glance.
- How to gain confidence.
- How to wake a subject.
- How to hypnotize by telephone.
- How sickness is cured by hypnotism.
- How surgeons use hypnotism in operations.
- How to cure bad habits.
- How to induce hypnosis.
- How to use thought transference or telepathy.
- Duration of Hypnotic Sleep.
- Susceptible subjects.
- Methods of Fascination.
- How to give an entertainment.



Franklin Publishing Company,
800 N. Clark St., Dept. M-70,
Chicago, Ill.

Please send me your amazing course, *Practical Lessons in Hypnotism*, by L. W. de Laurence. When the book arrives, I'll pay the postman only \$2.50 plus delivery charges. If I'm not satisfied after 5 days' trial, I may return the book and you are to refund my money.

Name.....

Street & No.....

City..... State.....

If you may be out when postman calls, send \$2.50 with coupon and we'll pay the postage. Customers outside of U. S. must send cash with order.

Learn AVIATION!

WE TEACH YOU BY PRACTICAL INSTRUCTION
Our School Registered, All Instructors and Airplanes
Licensed by U. S. Government

There is money for you in Aviation, if—you get thorough training NOW! Our courses will give you this training—they are taught under the direction of U. S. Licensed Transport Pilots and Mechanics, and cover everything about planes, motors, their maintenance and construction. Everything a pilot or mechanic must know to secure a good paying position. Our equipment is new and of modern design, subject to daily U. S. Gov't Inspection.

TRAINED MEN ARE NEEDED

Our courses have been laid out with a single object in view—to give thorough training in all branches of aviation—training which will qualify the student to secure a good paying position immediately upon completion of his course. Commercial aviation needs men and there is an ever increasing demand ONLY for those who have been properly trained—Von Hoffmann gives you this training.



THOROUGH INSTRUCTION at LOW COST

We teach you by actual flying and practical instruction; no long course needed. We guarantee sufficient hours in the air to make each student master of his ship; pilot it safely and efficiently without assistance. No student bond required. Our ground course gives thorough instruction in ground work and will qualify you for any ground position or you can take the course combining ground instruction and flying which will qualify you for a private, industrial or limited commercial pilot's license. The cost is low considering daily flying and thoroughness of theoretical and ground instruction on latest modern type planes, Wright Whirlwind and other standard motors. Our big new book "AVIATION and YOU" tells all the facts—it is FREE. Write for it at once!

VON HOFFMANN AIRCRAFT SCHOOL
111 Lambert—St. Louis Flying Field, ANGLUM, MO.



Lincoln got his education chiefly by home-study. So can YOU.

HIGH SCHOOL EDUCATION AT HOME

Fascinating Question and Answer method. Used in High Schools. Certificate awarded. Write for FREE BOOKLET, "New Way to Get a High School Education at Home." HIGH SCHOOL HOME-STUDY BUREAU, Dept. X-2510, 31 Union Sq., New York **\$19.85**

BART'S NEW CHALK TALK BOOK

"Their Best Stunts" from 25 chalk experienced talk artists. \$1.25 prepaid, 5-day trial. Also catalog "A", Art Supplies, or "S", Show Card Supplies.

BART SUPPLIES, 511 Eustis Bldg., Minneapolis, Minn.

25% MORE LIGHT

A simple way to reduce your electric bill 25%, or to get 25-90% more light for the same money in your Store, Factory, Office, and Home without any extra expense. The book explaining this new improvement will be sent you upon receipt of \$1.00.

S. GLASKO 740 Belden Ave., Chicago, Ill.

BE AN OFFICER in the U. S. Coast Guard

\$1700 Up to \$7,500 Yearly



\$780 yearly at the U. S. Academy while training. You rank Ensign to Captain in service. Age requirements 18 to 22. Write Dept. PM for information.

COAST GUARD PREPARATORY SCHOOL
4000 Ga. Ave., N. W. Washington, D. C.



FREE!

The rare, valuable secret book which has astounded the world. Reveals the secrets of hypnotism, telepathy, personal magnetism, mesmerism, clairvoyance, mind reading, etc. This book—called the wonder of the 20th Century—worth \$3 but sent Free to you if you order our remarkable course in *Practical Hypnotism*—teaches you how to control others—make everybody obey your every wish and desire—conquer bad habits, enemies, win success in life and Love, obtain power, wealth, social position. Explains the greatest force in the history of man. The most perfect, complete and easily learned system. Pay only \$2.45 on arrival, including the "Hypnotic Eye," greatest aid to beginners.

EDUCATOR PRESS, 19 Park Row, New York, Dept. H-24

Are You Kidding Yourself Out of \$100 A YEAR?



By Refusing to Save Gasoline This Easy Way!

MANY car owners today report that they are saving gasoline at the rate of \$100 a year. You'll agree that \$100 is worth while saving on your car this year. This is your opportunity to save it. You may save less—you may save more. I'll let you test my amazing gas device on your car at my risk. Read the remarkable facts revealed below. Then mail coupon for complete description. Also learn how you can own a sample free of cost.

Over three million car owners have now installed this remarkable little device after this free test offer.

No matter what make of car you drive, I guarantee unconditionally that it will save you gasoline or you don't pay a penny.

Note the records listed on this page. These are but a few of thousands of reports from car owners all over the world, driving every make of car, under every conceivable driving condition. Forty-three miles per gallon from a Chevrolet, says F. S. Carroll. Forty miles on one gallon, says J. T. Jackson. Forty miles a gallon in a Dodge from Brownville, Texas, to Tampico, Mexico, says T. L. Brown.

What It Is

Fifteen years ago my father created what is now internationally famous as the Stransky Vaporizer. Since then it has been perfected to a remarkable point of efficiency. It is based on facts about potential gasoline power that few car owners know about. For example, official tests made by automotive authorities indicate that the average car owner wastes at least two or three gallons of gasoline for every ten he buys. This is because in most cases the driver does not have auto-

matic control over the mixture of gasoline and air.

How It Works

The Stransky Vaporizer is no bigger than a dollar coin—nor more expensive than a good wrench—no more trouble to attach than a fan belt. Anyone can install it on the intake manifold of any car in five minutes. Its principle is to assist the vaporization of the gasoline, thus creating a sharper explosion of power. Starting is not interfered with as the device shuts itself off automatically when the motor is idle.

AGENTS

G. F. Fuller made \$114 in five days. Foster made \$357 in two weeks. Eberlein sold 23 vaporizers in 35 minutes. Our offer gives demonstrators one vaporizer free. Wonderful spare time money-making plan. No experience required—I show you easy plan. Mail coupon below quickly!

Make This Free Test

Test the Stransky Vaporizer on your car—and expect results that will amaze you. See if you do not get exactly what many car owners have reported . . . doubled gas mileage, flashing pickup

and power, no more carbon trouble, sluggish motor or fouled spark plugs. These results are guaranteed or the test costs you nothing.

H. C. Cummings mailed the coupon below. Since then he reports savings in gasoline of approximately \$385.00 cash value. Mail it now, and get full description and amazing trial offer which is even more remarkable than we can tell you here. There is no obligation whatsoever.

J. A. Stransky Mfg. Company

M-10 Stransky Block
PUKWANA, S. D.

TEAR OUT AND MAIL

J. A. Stransky Mfg. Co.,
M-10 Stransky Block,
Pukwana, S. D.

Without obligation to me, send full description of Stransky Vaporizer, details of free test offer, and free sample proposition.

Name

Address

City State

Check here for money-making plan for representatives.



FORD

H. H. Cummings, Electric and Radio Engineer, California: "I have used one on my 1922 Ford, which I have driven over 50,000 miles myself. I am getting 30 miles on a gallon of gas, where before I got only 12 to 14 miles on a gallon."

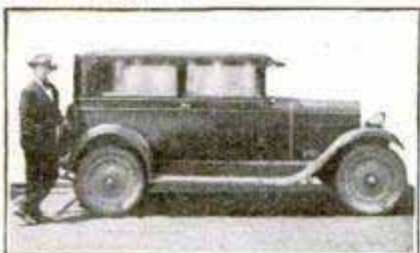

CHEVROLET

Mr. M. E. Miller, Kansas City, Mo., writes: "You people claim a saving of 25 to 50% of gasoline. I have subjected the Vaporizer to a severe and thorough test. After installing one on a Chevrolet, I found I was obtaining 43.8 miles to a gallon, whereas formerly, I had been getting only 19.5. That is not a saving of 25 to 50%, but 124%, so you see that the actual test surpasses your claim."



BUICK

E. Henderson, Auburn, Washington, writes: "I put one of your vaporizers on my friend's Buick. We tested it out by running seventy-five miles without the vaporizer. The best the car could make was 15 miles to the gallon. With the vaporizer, we make a little better than 31 miles to the gallon."

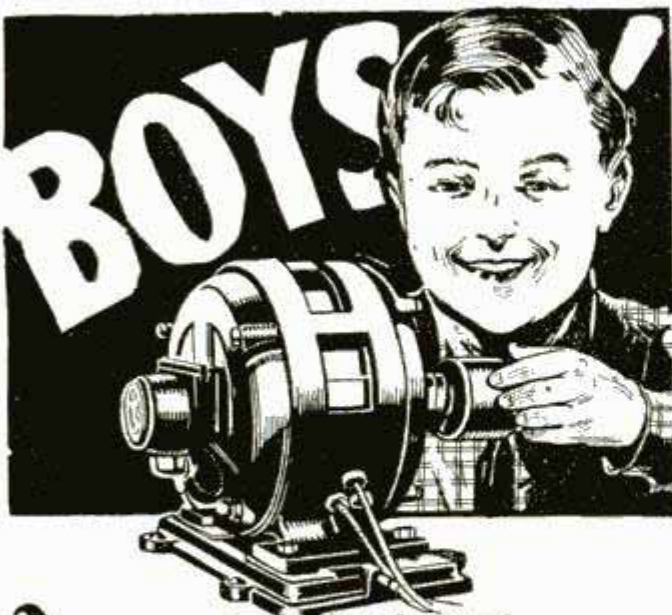

Here's FUN and SPENDING MONEY

How'd you like to have a pocketful of spending money all the time—\$5 or \$10 or even \$15 every week—all your own—and a lot of real fun at the same time! It would be great, wouldn't it? Well, you can have it! Hundreds of boys still in school are getting it! And they're no different from you except that they are "Cooke" Trained—they know how to do little electrical jobs in their spare time, after school hours, for which they get real money. I showed them how. And I'll show you, too, just as easily!

I Will Train You at Home

With my easily learned, fascinating Electrical Course, I'll train you at home like I've trained hundreds of other boys who are now successful men with jobs paying \$70 to \$200 a week! It's all done after school hours, without interfering with your school work or with your regular job if you're working. And it's more like play than study. But it's practical. It's sound. It's up-to-the-minute. It fits you thoroughly to land a Big-Pay job when school days are over. And it pays for itself as you learn and gives you plenty spending money besides, through the spare-time work I tell you how to get, how to do and what to charge for.

Tools—Apparatus and Radio Course—Given Without Extra Charge

You'll need tools to do Electrical work with, so I give them to you—sit big outfits of instruments and apparatus, and a real electric motor—a dandy layout that you can do any kind of spare-time work with—and it's all yours for "keeps." And not only that, but I also give you a brand new Course in Radio! All without extra cost!

Makes \$200 a Month

"Dear Mr. Cooke: When I began with you I was a sophomore in High School. Was making \$40 a month as grocery clerk. Now I am a \$200 a month electrician. Not so bad for a 17 year old boy, eh?"
Oliver P. Cooper
1131 Middle St.
Ashland, Pa.

Mail Coupon Now!

You want lots of spending money! You want a Big-Pay job when you're through school! Sure, you do! Then don't wait a minute—don't hesitate a second—act right this instant to get into this Big-Pay field where you can make \$2 or \$3 or more spare-time money every day while learning. Mail coupon at once and I'll send you my big 72-page book and a sample lesson: too—All FREE. See for yourself how easy it is. Fill in and mail coupon this minute!

6 BIG WORKING OUTFITS NO EXTRA CHARGE

Use this FREE BOOK COUPON

L. L. COOKE, Chief Instruction Engineer.
L. L. COOKE School of Electricity,
Dept. O17, 2150 Lawrence Ave., Chicago, Ill.
Send me your big Electrical Book, Sample Lesson and particulars about your Electrical Course and extra Radio Course. This does not obligate me in any way.

Name.....

Address.....

(This Coupon only for boys 15 years old or more)

FREE! New Way to Make SHOWCARDS

Here is a new, quick, easy way to make attractive window display signs and show cards. You can create striking, colorful cards for your own store, or the store where you work, or you can make money taking orders from merchants in your community. No drawing ability necessary, because by this new plan you use designs from Dennison's Decorated Crepe Paper. Send at once for complete directions, including 24 reproductions of actual cards you can copy. Just send a letter or postal and say "Send me FREE your new way to make show cards."

Dennison's Window Display Studio
Dept. 120-X
FRAMINGHAM, MASS.

LAW Free Book

Write today for FREE 128-page book, "THE LAW-TRAINED MAN," which shows how to learn law in spare time through the Blackstone home-study course prepared by 80 prominent legal authorities, including law school deans, lawyers, and U. S. Supreme Court justices. Combination text and case method of instruction used. All material necessary furnished with the course, including elaborate 25-volume law library, which is delivered immediately upon enrollment. Many successful attorneys among our graduates. LL. B. degree conferred. Moderate tuition, low monthly terms. Money-Back Agreement.

Write for free book today

BLACKSTONE INSTITUTE, 307 N. Michigan Ave.
Dept. 57 Chicago



FREE BOOK ON MIND TRAINING

An instructive book which explains an amazing system of mind training already used by more than 650,000 people.

Let us send you a free copy of "Scientific Mind Training." It will show you how and why Pelmanism is the only system of teaching for developing all the mental powers at the same time. Endorsed by such distinguished men as Judge Ben B. Lindsey, Sir Harry Lauder, Jerome K. Jerome, Prince Charles of Sweden and hundreds of others. Write TODAY to

THE PELMAN INSTITUTE OF AMERICA
71 WEST 45th STREET DEPT. 610 N. Y. C.



\$100 to \$500 A Week Is Earned By Cartoonists Today

DO YOU LIKE TO DRAW? Billy Hon's Famous Cartoon Book Will Teach You

A short road to success for the beginner, as well as the advanced art student. A simple, complete and up-to-date course in cartooning, consisting of 30 lessons and over 300 drawings by Billy Hon, the celebrated newspaper cartoonist. Sent for \$1.00 postpaid; outside of U. S., \$1.25.

Billy Hon's Cartoon Studios, 210-A West 14th St., Los Angeles, Cal.

KNOTTING AND SPLICING

A new book for every man who ever uses ropes. "Knitting and Splicing" tells how to tie and splice all kinds of knots—from simple and useful to more fancy and intricate. Illustrated with 208 Engravings and Diagrams. Your money refunded if after examination you find that it is not what you want. Price 75c. Write for Free Catalog. **DAVID MCKAY CO., 604 So. Washington Square, Dept. 210, Philadelphia, Pa.**

Learn Furcraft

Learn by mail, evenings at home, to Renew, Repair and Make-up all kinds of fur garments. Learn glazing, ironing and storage. Big demand, big need for your service in every neighborhood. \$3 an hour in your spare time or a real business now and a fur shop later. We teach you secret processes. Earnings start in 30 days. Uncrowded field for men and women. **FREE BOOK—Send now for free book giving details. No obligation.**

Northwestern Fur Co. 3377 Sunderland Bldg. OMAHA, NEBRASKA

A PRACTICAL COURSE IN MECHANICAL DRAWING

By WM. F. WILLARD

An ideal book for home study. Each exercise is clinched in the mind of the student by practical application to every day practice. 160 Pages, 157 Drawings. Cloth. Price \$1.00 Postpaid

POPULAR MECHANICS PRESS 200 E. Ontario St. CHICAGO

EARNED \$500 SPARE TIME WITH RADIO

Coplay, Pa., June 4—(RA)—During the few months that Frank J. Deutsch has been a member of the Radio Association of America, he has made over \$500 out of Radio in his spare time.

"Four super-heterodyne sets of my own construction brought me a profit of \$60.00 each, and the other profit was from sales of supplies purchased through the Wholesale Department of the Association," he said. "The Association certainly has a great plan for ambitious men."

In a neighboring state, Werner Eichler, Rochester, N. Y., another member of the Association, has been making \$50 a week during his spare time.

They are only two of the hundreds of Radio Association members who are making money out of Radio in their spare time.

Becomes Radio Engineer in One Year

Toronto, Canada, May 20—(RA)—One of the newly admitted associate members of the Institute of Radio Engineers is Claude DeGrave, a member of the engineering staff of the DeForest Company of this city. "I knew nothing about Radio and started from the ground up," Mr. DeGrave stated, "when I enrolled a year ago in the Radio Association. Its easy lessons and superb training made it possible for me to become a Radio Expert in less than a year's time. My income is now about 225% more than at the time I joined the Association."

The Institute of Radio Engineers is a very exclusive organization, and its membership requirements are very rigid, so that Mr. DeGrave has reason to be proud of his election.

Clerk Doubles Income in Six Months Through Radio

Chicago, Ill., May 9—Even though his membership in the Radio Association has resulted in W. E. Thon securing the managership of a Radio Department in a large Chicago store, his ambition was not satisfied. Six months later, he started his own store.

"The Radio Association has an excellent plan for the man who wants to get out of the rut and succeed," says this man who quickly rose from clerkdom to the proprietorship of a profitable radio store. "I attribute my success entirely to the Radio Association of America. Six months after I had enrolled, I had doubled my income through its help."

5 Easy Ways to make \$3⁰⁰ an hour in Your Spare Time in RADIO

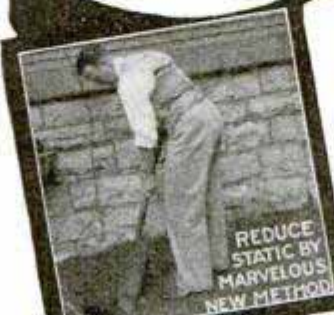

EACH of these plans, developed by the Radio Association of America, is a big money-maker. Set owners everywhere want to get rid of static, to have their sets operate from the electric light socket, the tone improved, and the volume increased, and transformed into single-dial controls. Phonograph owners want their machines electrified and radiofied. If you learn to render these services, you can easily make \$3.00 an hour for your spare time, to say nothing of the money you can make installing, servicing, repairing, building radio sets, and selling supplies.

Over \$600,000,000 is being spent yearly for sets, supplies, service. You can get your share of this business and, at the same time, fit yourself for the big-pay opportunities in Radio by joining the Association.

Join the Radio Association of America

A membership in the Association offers you the easiest way into Radio. It will enable you to earn \$3.00 an hour upwards in your spare time—train you to install, repair, and build all kinds of sets—start you in business without capital or finance an invention—train you for the \$3,000 to \$10,000 big-pay radio positions—help secure a better position at bigger pay for you. *A membership need not cost you a cent!*

The Association will give you a comprehensive, practical, and theoretical training and the benefit of our Employment Service. You earn while you learn. Our cooperative plan will make it possible for you to establish a radio store. You have the privilege of buying radio supplies at wholesale from the very first.

ACT NOW—If you wish No-Cost Membership Plan

To a limited number of ambitious men, we will give Special Memberships that may not—need not—cost you a cent. To secure one, write today. We will send you details and also our book, "Your Opportunity in the Radio Industry." It will open your eyes to the money-making possibilities of Radio.

Mail This Coupon NOW

RADIO ASSOCIATION OF AMERICA
Dept. PM-10, 4513 Ravenswood Ave.
Chicago, Ill.

Gentlemen: Please send me by return mail full details of your Special Membership Plan, and also copy of your book, "Your Opportunity in the Radio Industry."

Name.....

Address.....

City..... State.....



His Salary Was Raised while others were reduced

"Up to the time I enrolled for a course with the International Correspondence Schools, I had only a grade-school education. Since enrolling, I have advanced to a much better position, where my salary is nearly four times as much as I was making previously. I would not be able to hold my present position had I not taken your Course. Recently I received a nice increase in salary, while other men were being reduced."

Read that last sentence again—"Recently I received a nice increase in salary, while other men were being reduced."

There could be no better proof of the value of an I. C. S. course than that. It shows that the trained man is given preference over all others and paid more money, even in slack times, if his work deserves it. It shows that there are always bigger, better jobs open for men who have the foresight to prepare for them in spare time.

Why don't you study and get ready too? We'll be glad to help you if you will only make the start.

Choose the work you like best in the coupon below; then mark and mail it to the I. C. S. today. This doesn't obligate you in the least, but it will bring you information that will start you on a successful career. This is your opportunity.

Mail the Coupon for Free Booklet

INTERNATIONAL CORRESPONDENCE SCHOOLS
 "The Universal University"
 Box 5565-F, Scranton, Penna.

Without cost or obligation, please send me a copy of your booklet, "Who Wins and Why," and full particulars about the subject before which I have marked X in the list below:

BUSINESS TRAINING COURSES

- | | |
|--|---|
| <input type="checkbox"/> Business Management | <input type="checkbox"/> Salesmanship |
| <input type="checkbox"/> Industrial Management | <input type="checkbox"/> Advertising |
| <input type="checkbox"/> Personnel Management | <input type="checkbox"/> Business Correspondence |
| <input type="checkbox"/> Traffic Management | <input type="checkbox"/> Show Card and Sign Lettering |
| <input type="checkbox"/> Accounting and C. P. A. Coaching | <input type="checkbox"/> Stenography and Typing |
| <input type="checkbox"/> Cost Accounting | <input type="checkbox"/> English <input type="checkbox"/> Civil Service |
| <input type="checkbox"/> Bookkeeping | <input type="checkbox"/> Railway Mail Clerk |
| <input type="checkbox"/> Secretarial Work | <input type="checkbox"/> Common School Subjects |
| <input type="checkbox"/> Spanish <input type="checkbox"/> French | <input type="checkbox"/> High School Subjects |
| | <input type="checkbox"/> Illustrating <input type="checkbox"/> Cartooning |

TECHNICAL AND INDUSTRIAL COURSES

- | | |
|---|--|
| <input type="checkbox"/> Electrical Engineering | <input type="checkbox"/> Architect |
| <input type="checkbox"/> Electric Lighting | <input type="checkbox"/> Architects' Blueprints |
| <input type="checkbox"/> Mechanical Engineer | <input type="checkbox"/> Contractor and Builder |
| <input type="checkbox"/> Mechanical Draftsman | <input type="checkbox"/> Architectural Draftsman |
| <input type="checkbox"/> Machine Shop Practice | <input type="checkbox"/> Concrete Builder |
| <input type="checkbox"/> Railroad Positions | <input type="checkbox"/> Structural Engineer |
| <input type="checkbox"/> Gas Engine Operating | <input type="checkbox"/> Chemistry <input type="checkbox"/> Pharmacy |
| <input type="checkbox"/> Civil Engineer <input type="checkbox"/> Mining | <input type="checkbox"/> Automobile Work |
| <input type="checkbox"/> Surveying and Mapping | <input type="checkbox"/> Airplane Engines |
| <input type="checkbox"/> Plumbing and Heating | <input type="checkbox"/> Agriculture <input type="checkbox"/> Navigation |
| <input type="checkbox"/> Steam Engineering | <input type="checkbox"/> Mathematics <input type="checkbox"/> Radio |

Name.....
 Street Address.....
 City..... State.....
 Occupation.....
 Persons residing in Canada should send this coupon to the International Correspondence Schools Canadian, Limited, Montreal, Canada

Touchdown!

BOYS

Football Equipment
COST FREE
 to Ambitious Boys

HERE'S your chance to score the touchdown of your life. We need a boy in your neighborhood to deliver, to regular customers, three of the best known magazines. It takes only a small part of your spare time and you earn money and such dandy prizes as football and basketball equipment. Score at once by sending your name and address on the coupon below.

**Mr. Jim Thayer, Dept. 73,
 The Crowell Publishing Co.,
 Springfield, Ohio.**

Dear Mr. Thayer:
 I want to earn money and prizes. Send me a supply of magazines and full instructions.

My Name.....

Address..... State.....

Town.....

Scientist's Amazing Discovery Makes Old Cars Look Like New In 60 Minutes!

NAVON Restores Color and Finish in the Magic of a Single Hour—Easy as A-B-C! Gives Mirror-Like Lustre That Can't Come Off! Marvelous Money Maker—\$15 to \$25 a Day! Send for Special No-Risk Trial Offer. See Coupon Below!

Make \$150—\$500 A Week!

HERE'S a chance to make the quickest money you ever heard of! Tie up right now with NAVON, the astonishing liquid discovery that has taken the whole motor world by storm!

Already scores of demonstrators, agents, salesmen and service station operators are reporting astonishing earnings. Porter of Wisconsin took in \$98 in one day! Geiss of Illinois made \$698 his first six weeks! Hundreds of others are making up to \$5 and \$10 an hour in spare time alone—while the side line workers are reporting earnings up to \$100 and \$200 a month!

Just imagine a liquid so marvelous that it instantly restores showroom color and lustre without rubbing or hard work of any kind! NAVON is a harmless fluid that flows right on over your old paint—duco or enamel—like water from a sponge. You can do it right in your own garage without the slightest difficulty. It is almost as easy as washing—and dries smooth as glass without a streak.

And not only that, NAVON contains no injurious substances. Won't hurt metal, leather or wood. Not affected by heat or cold. Can't check, crack or peel. Retains its radiant gloss for months and months—and often adds as much as \$100 to \$150 to the resale value of used cars!

Get Details and FREE SAMPLE Offer

Why not be the NAVON representative in your locality and get your share of the profits that are simply waiting? We give you the most liberal proposition you can imagine and show you exactly how to start coining money from the first day. Send the coupon right now for our 14 tested money making plans— together with an amazing trial offer of enough NAVON to do your own car without one penny risk. Mail the coupon today.

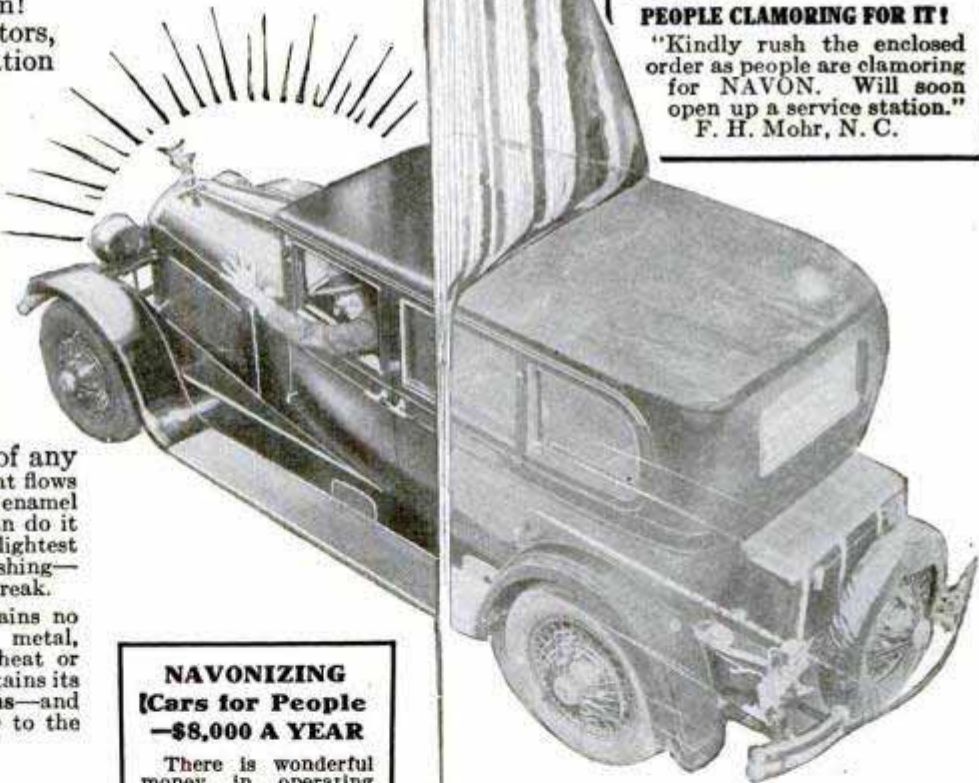

NAVONIZING [Cars for People —\$8,000 A YEAR

There is wonderful money in operating NAVON service stations—from \$5,000 to \$8,000 a year and more. You can start right in your own garage—or rent a vacant one—and make as high as \$65 a day. Just NAVONIZING cars for friends, townspeople, etc. Write for details how we start you out in business for yourself.

READ WHAT THEY SAY!

"Refinished my Ford car bought May 19, 1925, with NAVON and today it looks as good as when I bought it. I am surprised at the results and so is everybody else!" W. A. Burge, Mass.

"GREAT!"

"NAVON certainly exceeded my expectations. I think it is great and so do my friends. I am going to start a NAVON service station and have already secured a garage." Geo. Kelley, Pa.

PEOPLE CLAMORING FOR IT!

"Kindly rush the enclosed order as people are clamoring for NAVON. Will soon open up a service station." F. H. Mohr, N. C.

Consolidated Specialties Corporation
Dept. 56-R, 21 W. Elm St., Chicago, Ill.

SEND THIS TODAY!

Consolidated Specialties Corp. (NAVON Division), Dept. 56-R, 21 W. Elm St., Chicago, Ill.

Without obligation, send me details of the 14 NAVON Money Making plans together with no-risk trial offer of full size sample free.

Name.....
Address.....
Town.....State.....



Buried Treasure

Lies within
your reach

WILL YOU
FIND IT?

"The Golden Age of opportunity lies before you, young men of America," says Irving T. Bush, President of the Bush Terminal. Airplanes, radio, talking movies, are only an indication—opportunities are everywhere. Treasure is buried under your feet. Do you know how to make it yours?



Read what EDISON says: "Irving T. Bush is a great asset to the United States. I am one of his ardent admirers."

Don't Miss It

There has just been published a book by a man who found his treasure where others overlooked it—who built a mighty business and a national reputation on a waste sand lot. This man is Irving T. Bush. His book, dedicated to the young men of America, has one purpose; to help you find your opportunity and to make the most of it.

How This Book Can Help YOU

No man worthy of the name can read this book without gaining new ideas and new vigor for his job. It will make you able to see the golden opportunities where others miss them. This book is the key to your opportunity. Can you afford to let it slip? Thousands of ambitious men have found invaluable help in its pages. Don't think you are too smart to need it. The more brains you have the more you will get out of it. Your money back if you are not more than delighted.



MAIL THIS COUPON TODAY

THE ALDWYCH PRESS
133 West 41st Street, New York City P.M. 826
Enclosed please find \$2.50 for a copy of WORKING WITH THE WORLD or please send C. O. D.

Name
Address

If you are really out for
SUCCESS

Learn RADIO

---the most fascinating of
all professions

Well-paying positions
in this *live* industry
need *trained* men

RADIO offers you good pay from the start—rapid advancement—glorious adventure. It is a respected profession of fascinating brain-work, where your sincere efforts can win you Success. Our graduates are earning big money as radio designers, as executives with large radio organizations, in broadcasting work, as skilled mechanics, assemblers, service men, and radio dealers.

We have trained thousands of men to become successful radio operators on ships traveling to far corners of the globe—to become radio operators in shore stations. And now Opportunity is knocking at your door.

New Course Offered by the World's Oldest Radio School

After years of experience the Radio Institute of America has evolved a new and revolutionary course in radio. It takes you through every phase of radio—right through television, photoradiograms, and airplane radio equipment.

Complete Kit of Quality Equipment

We furnish all the parts—first quality—to make many different radio circuits—also the Peerless Signagraph and other instruments for code instruction—at no extra cost.

Radio Institute of America Spon- sored by RCA, G-E & Westinghouse

Conducted by the Radio Corporation of America and enjoying the advantages of RCA's associates, G-E and Westinghouse, the Radio Institute of America is equipped to give—and does give—the finest radio instruction obtainable anywhere in the world.

You can learn at home

Moreover, you can study at home, when you please and as long as you please. Our new catalog describing the course is now ready. If you want to learn more about the profitable and fascinating profession of radio, send the coupon now for your copy.



RADIO INSTITUTE OF AMERICA

Dept. P-10,
326 Broadway, New York, N. Y.

Gentlemen:
Please send me your new catalog.

Name

Address

City State

Medium Size **\$2.95**
Eveready
Layerbilt No. 485

Heavy Duty **\$4.25**
Eveready
Layerbilt No. 486

cost but little more

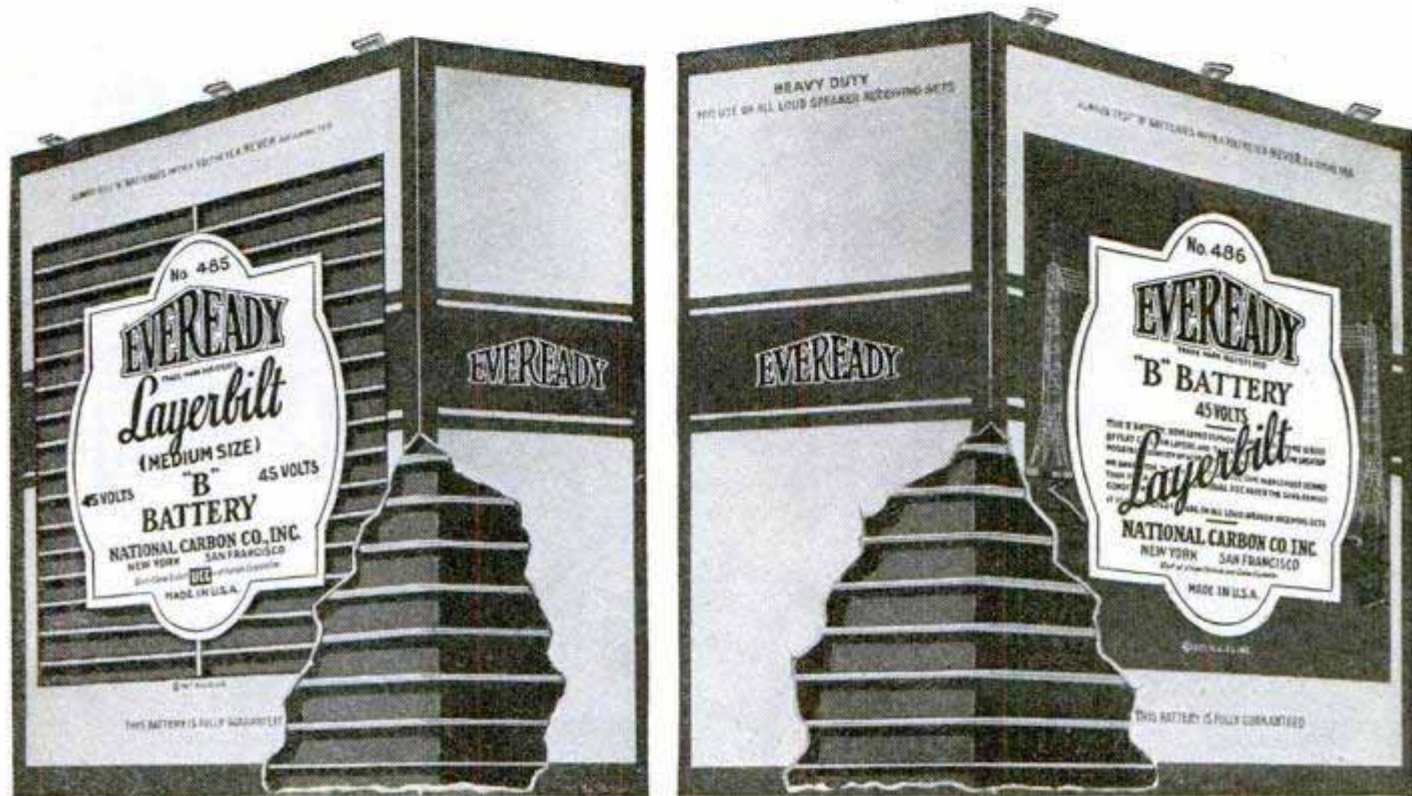

and last much longer

EITHER of these two Eveready Layerbilt "B" Batteries will cost you only a few cents more than cylindrical cell batteries of the same size, but they will last much longer.

One is the famous Eveready Layerbilt No. 486, which is made of flat cells instead of cylindrical ones. This is the largest of the Eveready Layerbilts, and lasts longest. It costs only 25c more than the cylindrical cell Eveready of the same size.

The other is the newer Eveready Layerbilt No.

485. This is the same size as the cylindrical cell Eveready "B" Battery No. 772. The flat cells of the new No. 485 make it last much longer. It is the most economical medium size Eveready "B" Battery, and costs only 20c more than the No. 772.

The flat cells of which Eveready Layerbilts are made fill all available space within the battery case, avoiding the useless holes between the cells of a cylindrical cell battery. More materials mean longer life. For economy, convenience and satisfac-

tion from "B" batteries, buy Eveready Layerbilts. NATIONAL CARBON CO., Inc. New York  San Francisco

Unit of
Union Carbide and Carbon Corporation

Tuesday night is Eveready Hour Night
East of the Rockies—
9 P. M. Eastern Standard Time
Through WEAJ and associated N. B. C.
stations.

On the Pacific Coast—
8 P. M. Pacific Standard Time
Through N. B. C. Pacific Coast network

EVEREADY Radio Batteries

Layerbilt construction is a patented Eveready feature. Only Eveready makes Layerbilt batteries.

1162

International News Service Copy
326 W. Madison
Chicago

WORLD PROGRESS SHOWN AT EXPOSITION IN WEST

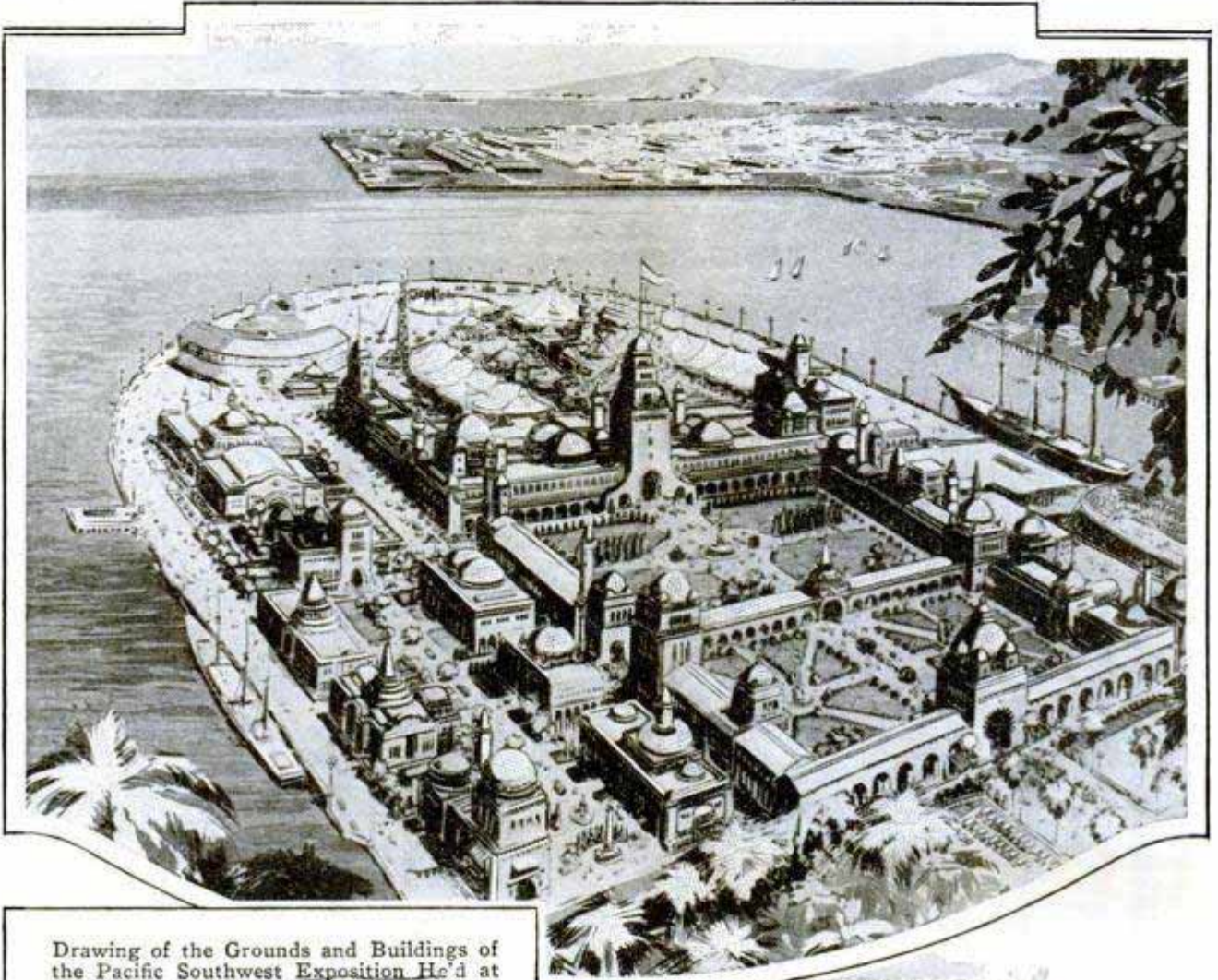

Drawing of the Grounds and Buildings of the Pacific Southwest Exposition Held at Long Beach, Calif.; a Peninsula, Extending into the Harbor, Was Converted into Roomy Space for the Big Show, Which Featured Exhibits Valued at Millions and Attracted Many Thousands of Visitors

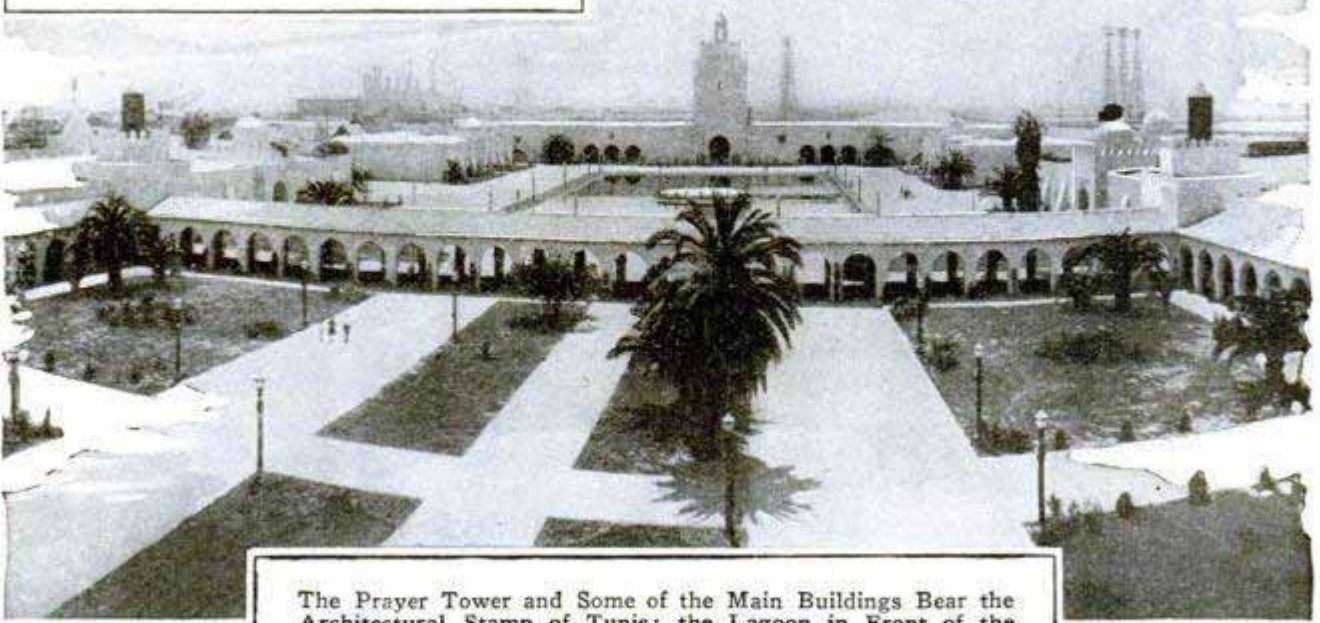

The Prayer Tower and Some of the Main Buildings Bear the Architectural Stamp of Tunis; the Lagoon in Front of the Tower Provided Beautiful Reflections at Night

Popular Mechanics Magazine

REGISTERED IN U. S. PATENT OFFICE

WRITTEN SO YOU CAN UNDERSTAND IT

Vol. 50

OCTOBER, 1928

No. 4

1190

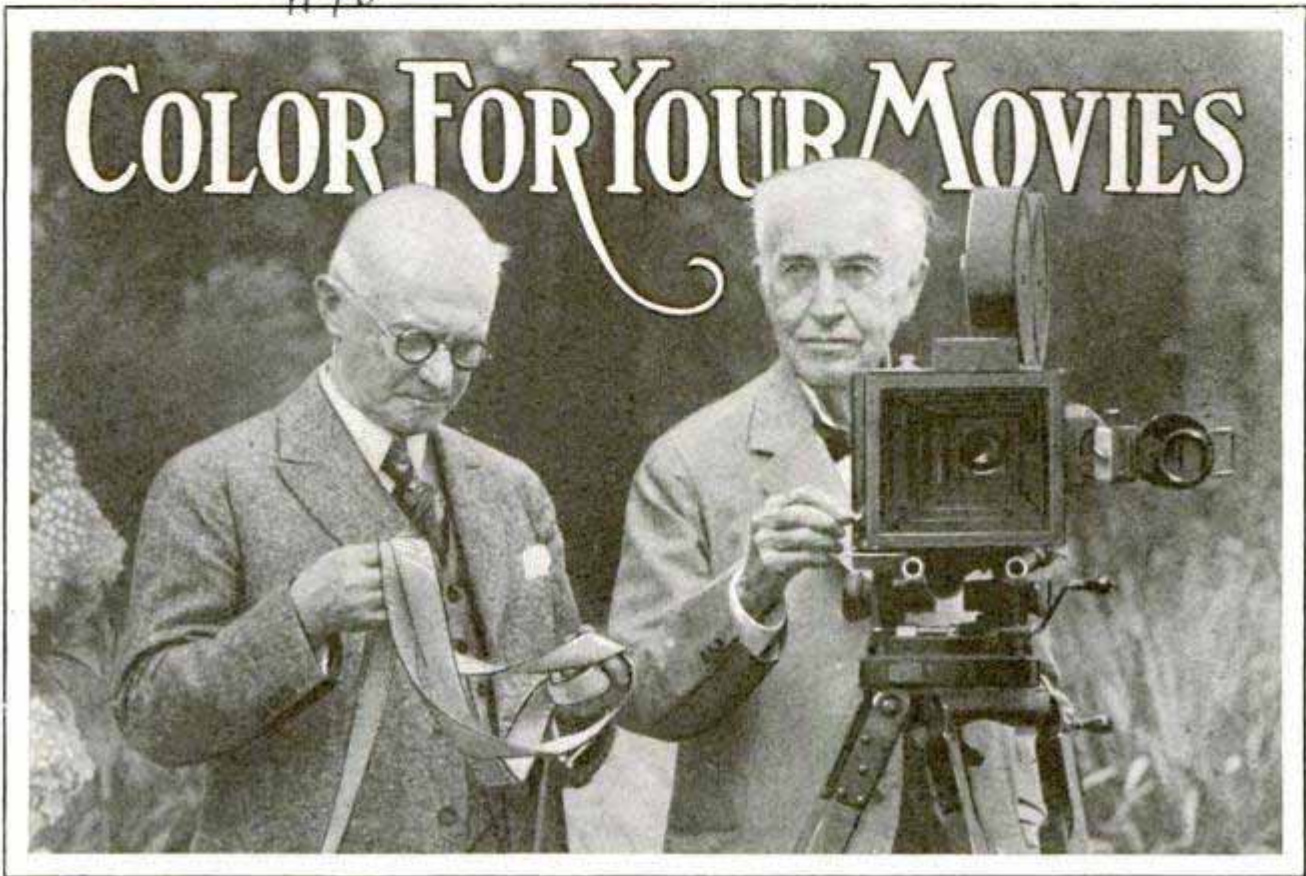

George K. Eastman, Left, and Thomas A. Edison at the Former's Rochester Home When He Demonstrated before the Inventor of the Movies the New Amateur Color-Film Process

MOVIES in color, produced by an inexpensive and practical process, the dream of producers for years, have arrived, but the infant of the movie industry, the amateur who makes his own pictures, will have the exclusive use of this invention.

When George K. Eastman, of Kodak fame, demonstrated the new color-movie process recently in his Rochester home before Thomas A. Edison, Gen. John J. Pershing and a host of other eminent guests, he pointed out that it will be of no value for professional use, for it cannot be reproduced in a large number of prints, the original film being the only one.

The colored movies are made without color in the film. Instead, a myriad of microscopic lenses, molded of the film material itself, and a pair of color filters, one on the camera and one on the projector, produce color as an optical illusion. When the amateur movie process was developed in 1923, it was brought within reach of the

average pocketbook by eliminating the expense of printing a positive film for projection from the negative made in the camera. Instead, the camera negative was, in the development process, reversed to form a positive. Because of this reversal of the original negative duplicate prints are impossible.

A comparatively unknown member of the Eastman research staff, John G. Capstaff, is given the major credit for developing the new process, but insists on sharing the honors with Dr. C. E. Kenneth Mees, director of the Eastman laboratories. It was Mr. Capstaff who worked out the process for the original black and white amateur movie film five years ago. The color process was developed from an idea patented in France before the war, but never perfected. The Eastman company bought the rights, and since 1918 Mr. Capstaff has been at work on it.

On the side of the film which is exposed

Chas. J. C. Royce, Consolidated Press, New York

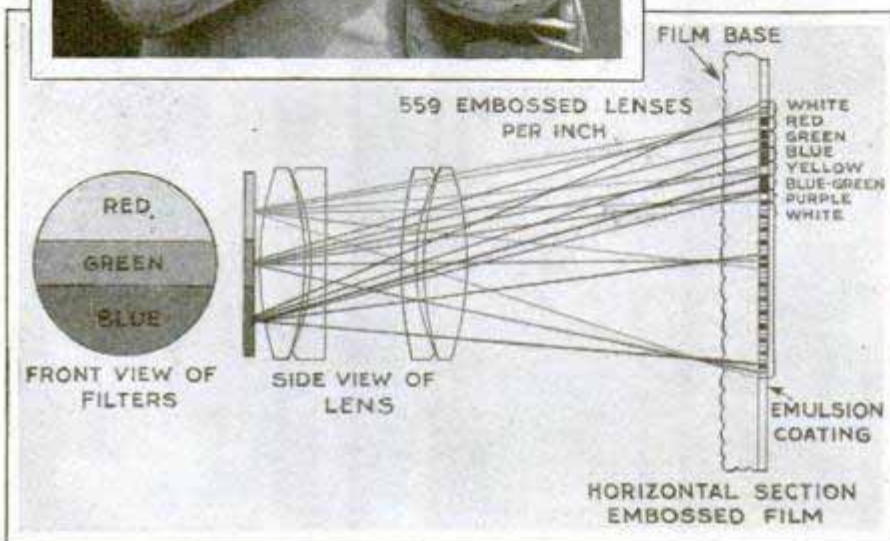

Dr. C. E. K. Mees, Head of the Eastman Laboratories, and a Diagram Showing How a Filter and Embossed Film Make Colored Movies Possible

to the light, millions of tiny lenses, hardly one-five-thousandth of an inch in depth, are embossed, placed so close together they completely cover the surface. On the opposite, the back side of the film, is the sensitive emulsion coating which records the picture.

In front of the lens of an ordinary amateur movie camera, a color filter is installed. The filter is divided into three segments colored red, green and blue. Slipping the filter into place and loading with the special film is all that is required to take colored movies.

When the lens is uncovered and the crank begins to turn, a third of the light entering the camera passes through each segment of the filter. One admits only red rays, one blue rays and one those that are green. The tiny embossed lenses focus parts of the light beams on their portion of the film. The rest of the process is no

different from the making of plain black-and-white movies. The film is developed in the usual way, and, to the eye, looks like an ordinary film, since it comes out in black and white and various shades of gray, with no hint of color. But when it is placed in the projector and a light passed through it, the embossed lenses reverse the process and refocus their particular rays to pass again through the proper sections of a color filter placed in front of the projector. Red of the original goes back through the red of the filter, and blue and green do the same.

The effect of the rapid movement of the pictures completes the optical illusion, just as the effect of movement in the film is itself an illusion when the eye is tricked by the succession of images.

Almost simultaneously with the Rochester demonstration, scientists of the Westinghouse electric and manufacturing company, at East Pittsburgh, gave a public exhibition of radio movies. Developed in the space of only two months' work, the radio-movie projector, which, in its

workings is not essentially different from television, may, it was said, soon be ready for the market.

While movie films have been transmitted by radio before, the Westinghouse demonstration was radically different in two prime factors. The first was the use of scanner disks of sixty holes each drawing sixty lines to the picture, and the second the use of a powerful mercury-vapor lamp for projection, instead of the red-tinted glow of a neon lamp.

Within the space of little more than a year, television apparatus has progressed from scanner disks of twenty-four lines to the inch, to more than thirty, then forty-eight, and now sixty. The addition of every few lines means more clarity in the received image. With sixty lines, the received picture is as clear as the average newspaper half-tone illustration, which has just about the same number of lines.

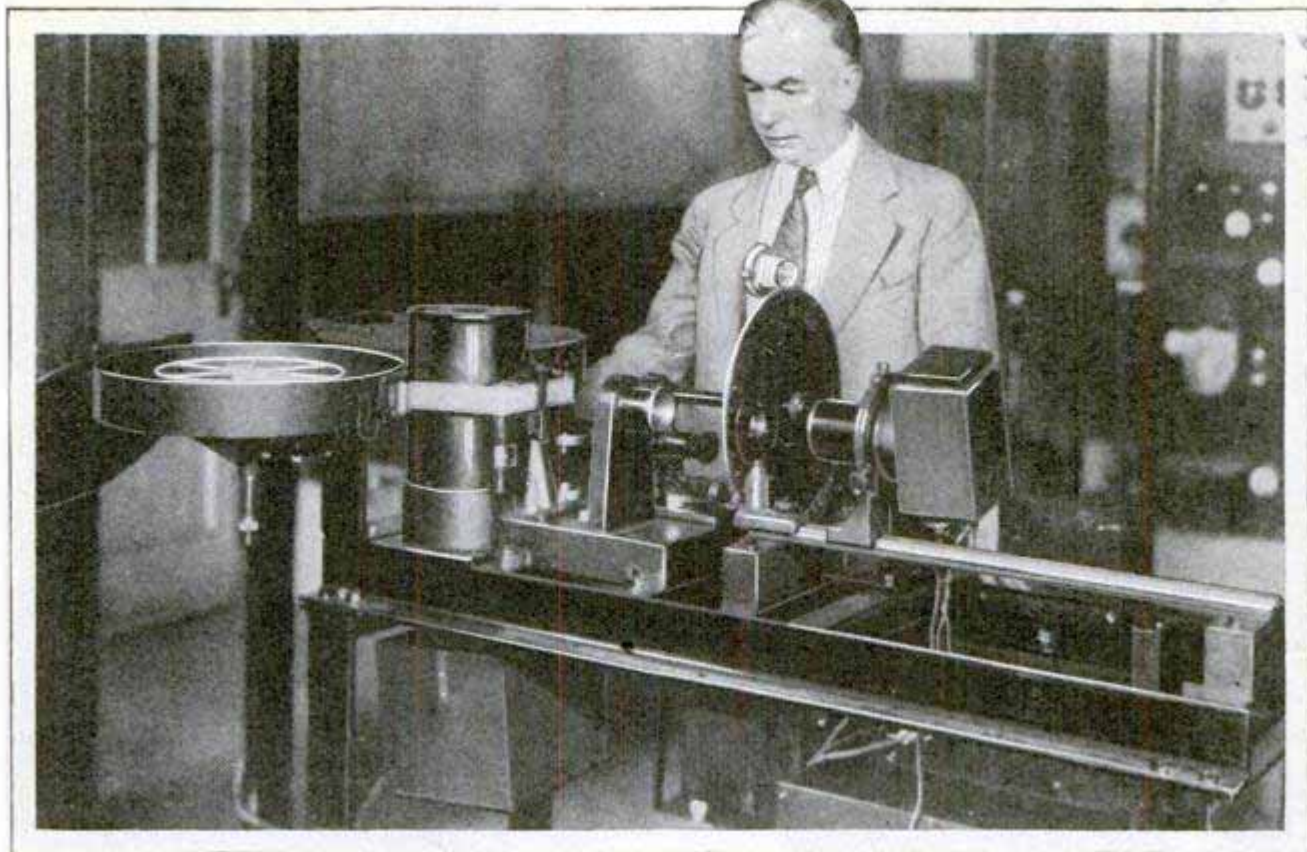

Dr. Frank Conrad, Assistant Chief Engineer of the Westinghouse Company, Demonstrating the Radio Motion Picture Projector; the Scanning Disk Is in the Center

The successful use of a powerful projection light, however, is even more important. All television processes heretofore have used the fluctuating beam of a neon lamp, operated directly by the received current, to produce the necessary gradations in color, which, in combination with the revolving scanner disk, produced the illusion of a picture.

The light output of a neon lamp of a size that could be operated by the fairly weak current available was necessarily low, and the picture could not be projected in any size onto a screen. With the Westinghouse discovery, the radio current is used to control the mercury-vapor lamp just as it controls the valve of a radio tube. As the received current varies in strength the mercury lamp grows bright or dim.

The increase in the number of scanner lines was made possible in turn by the development of a more sensitive photoelectric cell. The limit on the number of lines per picture is always the ability of the cell to absorb the fleeting impressions, transform them into electrical impulses, send the impulses and prepare itself to repeat the process for the next line. In

transmitting movies sixteen pictures pass before the scanner each second, and, as the new scanner has sixty lines for each picture, it means that 960 of the little holes in the scanner disk flash past the photoelectric cell each second. The new photoelectric cell employs caesium, a material which, because of its far greater sensitivity, is replacing the potassium and selenium cells used in the past. Although selenium cells have been used experimentally for some fifty years, science is just beginning to develop the substitutes.

New light on the romance of pictures, movie or still, was cast recently when Dr. Mees told the American Chemical society that the science of photography rests on the fact that cows eat mustard and other plants which in turn produce impurities in the cow's skin. From the skin, the gelatine which goes into film is made. The presence of the impurities, it has been found, is responsible for the chemical action of the metallic silver in the sensitive coating, which, instead of shining as metallic silver should, appears under the microscope like dark bits of coke. The sensitiveness of high-speed film is credited entirely to the action of these impurities.

MOVIE NOISE "FACTORY" ADDS REALISM TO FILMS

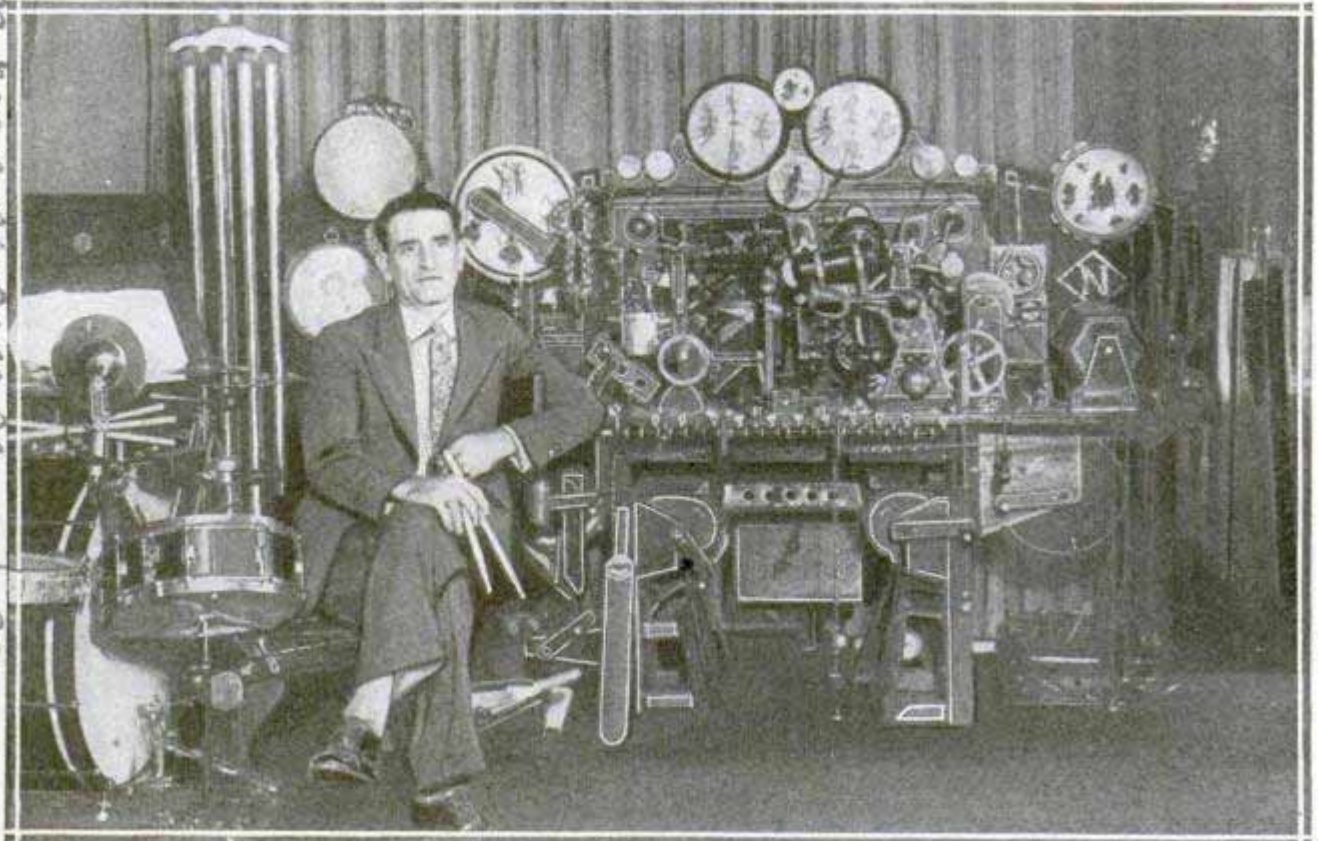

Inventor with Noise-Making Outfit Which Reproduces Scores of Different Sounds to Add Realism to the Films; Many of the Devices Are Operated by Electric Motors

Scores of different sounds are accurately reproduced on an electrically operated noise maker to be used with motion pictures. Small electric motors, controlled by push buttons, actuate most of the sound units which can be combined and altered to produce fading, distant and other effects. The entire outfit is compactly constructed in a single cabinet or table, about five feet high and less than two feet deep, and is intended to be operated by the drummer. The sound of falling trees, crashing glass, trolley cars, doors slamming, handsaw and acetylene torch are a few of the unusual noises that this unit successfully imitates. How the sound of the trolley car was produced gives an idea of the elaborate care the inventor took in constructing the apparatus. He first studied the noise carefully and then made repeated experiments at duplication, finally succeeding in imitating the sway of the trucks, the hum of the motor, the bell, airbrakes and other parts. The wheels of six pairs of roller skates, numerous gears and pulleys, two motors and compressed air were finally arranged to make all the usual noises of an electric car in motion, and

in starting and stopping. Lights are arranged to illuminate part of the machine when desired.

**ELECTRIC SEALING-WAX SET
ELIMINATES FLAME**

Sealing packages and letters with wax has been simplified with an electrically operated unit that eliminates the use of a flame and other bothersome hand processes. Wax is melted by an electric heating element in a small crucible and is applied through a hollow shaft connected to the wax container. The seal is at the base of this shaft. It is moistened with a sponge and then pressed upon the hot wax. The outfit is especially useful in offices where a large number of articles is handled daily of such nature and value that they need to be sealed for shipment.



Le Cusor - Papeteries de la Marine, 24 Rue

*Edw. A. W. Nichols
209 Wadsworth Ave
N.Y.C.*

*France.
Paris
Louis B. Paris, Paris
24 Rue*

Chemistry of the back
Northwestern University
109
533
Dr. Egloff

CHEMICALS TO REPLACE GUNS IN WARS OF FUTURE

A thousand airplanes, each carrying 5,000 pounds of chloroform, could put the inhabitants of cities as large as Chicago or New York to sleep in a few moments, in time of war, according to Dr. Gustav Egloff, a research chemist, who points out that scientists are developing means for making war more humane instead of more horrible. He suggests that anæsthetics, far more effective than are now known, may be introduced in the near future and that applications of them from planes flying above trenches, might put whole battalions of soldiers to peaceful slumber. They could be awakened later and suffer relatively little harm. To put a city to sleep, the chemist declares, it would only be necessary to mix the air with anæsthetic amounting to no more than one per cent by volume, and such doses could be so administered that the use of masks would be futile.

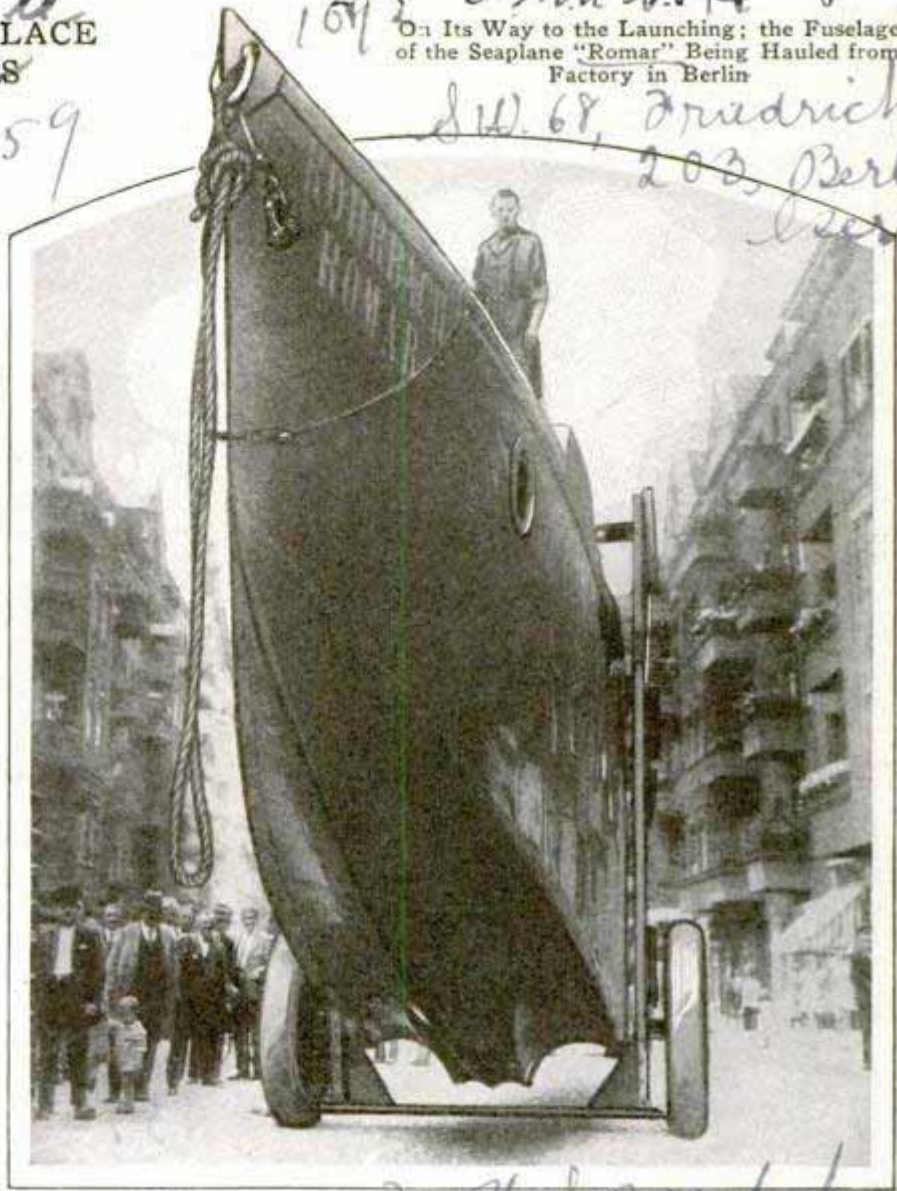

On Its Way to the Launching; the Fuselage of the Seaplane "Romar" Being Hauled from Factory in Berlin

1159
Dr. W. 68, Friedrichstr
203, Berlin
Germany

GIANT TRI-MOTOR SEAPLANE TRAVELS IN STREETS

To launch the huge seaplane "Romar" its fuselage was trundled from the factory through the streets of Berlin on a special truck recently. The big plane has three motors of a combined capacity of 7,200 horsepower, it can carry more than 2,000 gallons of gasoline in the wing tanks and other containers, and has a cruising radius of 2,500 miles.

SUGAR PREPARED FROM CORN MAKES "LEMONADE"

Lemonade or orangeade can be made without the fruit by using a special sugar that absorbs the acids of these products, chemists reported recently. The sugar is manufactured from corn by a process developed for this particular purpose.

WEED FATAL TO MOSQUITOES PUZZLES SCIENTISTS

Man has a valuable ally in his warfare against the mosquito in a humble aquatic plant that grows in many parts of the United States. According to University scientists, it not only prevents mosquito "wigglers" from growing to maturity, but actually kills them. The specific property that makes the plant deadly to the pests has not yet been discovered, and the plant itself is something of a mystery. In some ways, it seems to be related to the seaweed family, but, in others, it stands alone in the plant family, a sort of botanical orphan.

Prof. J. H. Matheson
and A. H. Heiman

not a agent known
Prof. C. J. Sturtevant
Prof. of our State College
Armed. Iowa.

Corn Products Co.
135 S. 2nd St.



"Roman" Riding on the Waves with Hobbyhorse Surfboards, a Popular Sport That Requires Skill in Balancing, Especially When Changing Positions on the Way

International

HOBBYHORSES AS AQUAPLANES TEST RIDERS' SKILL

Additional thrills are derived from the sport of aquaplaning with hobbyhorse boards. Each accommodates two riders or more and gives the passengers ample opportunity to test their skill at balancing while standing on the backs of the horses after the manner of Roman riding on real horses. A fast motor boat is used to tow the boards.

CORROSION OF OIL-PIPE LINES LAID TO ELECTRICITY

Corrosion of pipe lines that carry oil has perplexed scientists for some time, but bureau of standards investigators, after a number of tests, have announced that they are of the opinion the action is due to electricity. Running through soils where the ground is of different chemical composition and of varying moisture content, the pipe is subjected to the results of a discharge and a collecting of electrical current at different points. The earth, in other words, becomes a sort of huge battery of cells formed by the different soil sections. By measuring the electric current on several parts of an oil-pipe line, it was discovered that, at some points, elec-

tricity was being collected and, at others, it was being discharged. The places of discharge corresponded, on the whole, with the places where the line was corroded.

CRYSTAL BALL BURNS HOLES TO RECORD SUNSHINE

One of the instruments used at the British air ministry to record weather conditions, is a crystal ball that burns holes in a strip of cardboard as the sun shines through it. The board is marked off in hours and the ball acts as a burning glass, focusing the rays of the sun so that they record their shining in a parched path along the cardboard.



Part of Crystal Apparatus and Card That Has Been Scorched by the Sun's Rays

London, Eng.

International

Chicago Ill. Post 8/1/25

was a se. Calif.

1138

1137

1163

Science Service News Bulletin

at *Spring Reading* MECHANICS
9. Science 1112

MICROBE TO FIGHT CORN BORER AND SAVE CROPS

1169
Scientists in France are studying a malady somewhat like the silkworm disease which caused Pasteur so much trouble but also brought him fame. This sickness attacks the corn borer, and it is hoped that, if ways can be found to spread it among the pests, an effective means will have been discovered for checking the inroads of the destructive insects. The sickness is believed to be caused by tiny single-celled animals which are parasites and are found in the internal organs of the borer larva. Another disease that may be directed against the corn pest, spreads like an epidemic, destroying the digestive organs of the borer.

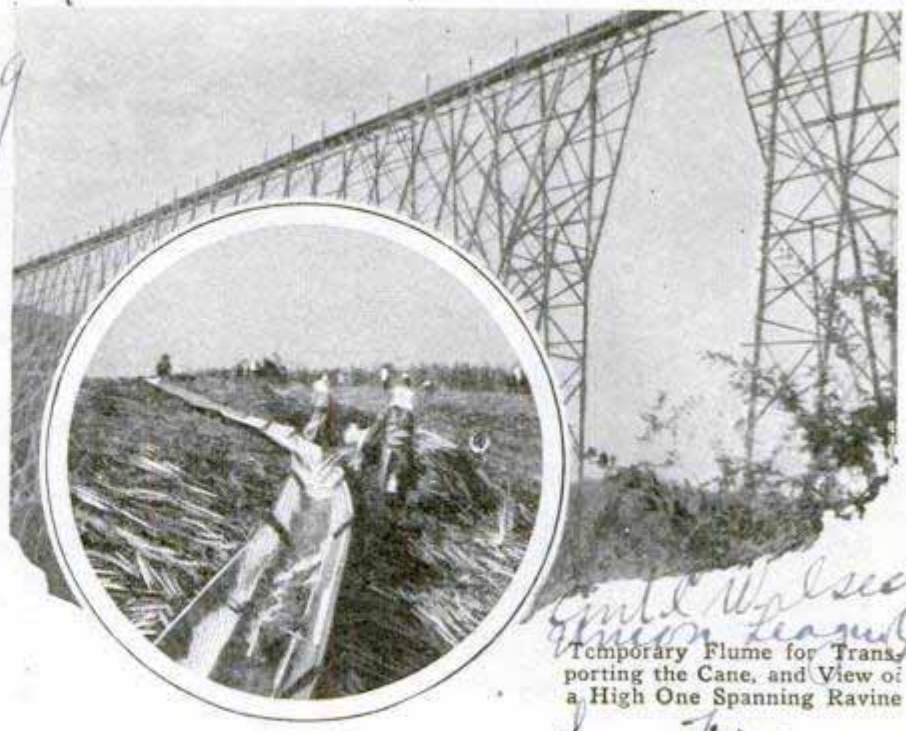

Temporary Flume for Transporting the Cane, and View of a High One Spanning Ravine

SUGAR CANE FLOATED TO CARS IN PORTABLE FLUMES

Portable wooden flumes are employed on some of the sugar plantations in the Hawaiian islands to convey the cane from the fields to the cars in which it is shipped to the mills. These movable flumes, which are placed from 250 to 300 feet apart, carry a powerful current of water which is turned on after the cane has been piled into the trough. The ducts lead to the permanent or main flume which takes the cane to the central loading station.

HOPPER FOR RECEIVING CHANGE PROTECTS GLASS COUNTER



1111 To eliminate the inconvenience of picking up small change from the top of a glass counter, and to protect the cabinet from breakage and stains, a hopper cup has been introduced. Coins are placed in the

top and the customer receives them by placing his hand under the hopper, raising a square tube underneath a trifle, which allows the money to fall into his open hand. There is nothing about the unit to get out of order, and the base may be used for advertising legends.

Those wishing further information on anything described in the editorial pages can obtain it by addressing Bureau of Information, Popular Mechanics Magazine, Chicago.

CHEMICAL EXPLODES IN WATER AND TAMES GAS

1168
Chemistry has given man another valuable aid in a substance that is expected to prove of great service in war and in peace, a preparation which explodes with great force in water and also neutralizes poison gases of various kinds. Dr. V. R. Kokatnur, a consulting chemist, recently described the compound as an organic peroxide. In some forms, it will explode with terrific power in water—a valuable characteristic when it is considered that most of our present explosives are useless when damp. It can also be used to tame vapors such as mustard gas. A counter cloud of it, the chemist declared, might render destructive gases harmless.

*Smith W. Walserger
Union League Club
San Francisco*

*Chemistry Society
North Western Union*

*A. W. & Infr. A. B. Co.
Archie C. DeLeonard*

Arlington, N.Y.

26115th Portland

1052

middle

Can Flyers Conquer

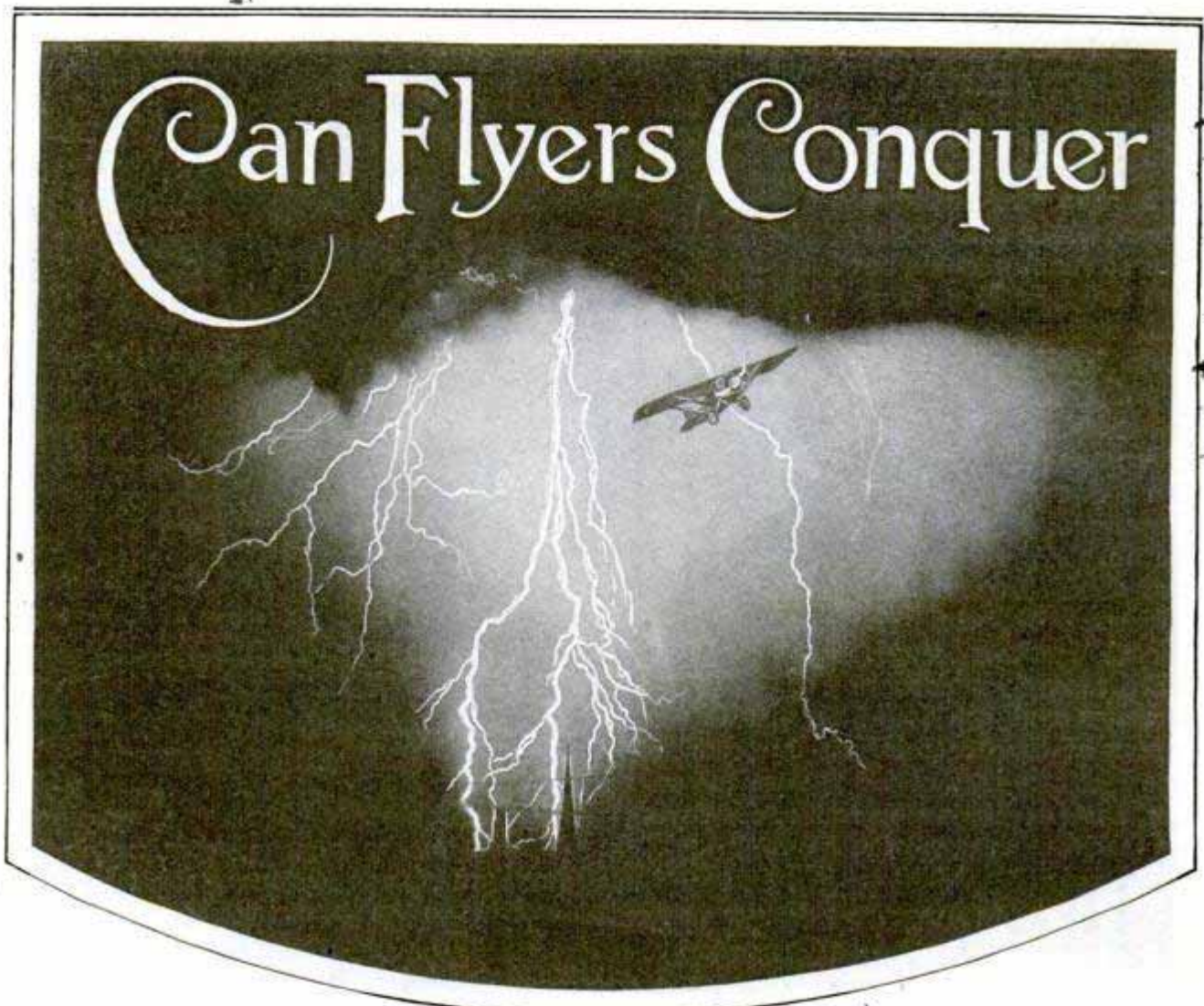

There Is No Authentic Record of a Plane in Flight Ever Being Struck by Lightning, Though Many Balloons Have Been Destroyed and Their Pilots Killed by Bolts

TWO airplanes crashed a few weeks ago, one in New Jersey and one in Pennsylvania, both, presumably, shattered by lightning. In the first Capt. Emilio Carranza, Mexican flying ace on a good-will voyage to the United States, died, and in the other perished Morris M. Titterington, inventor of the earth-inductor compass that guided Lindbergh to Paris, and a woman flying pupil.

Six weeks earlier, lightning destroyed three balloons in the national balloon race a few miles from the start at Pittsburgh. Two of the balloonists were instantly killed and a third terribly burned.

The question immediately arose whether an unlooked for peril had cropped up to menace aerial navigation.

That Capt. Carranza was a victim of lightning is in doubt, despite the first reports to that effect. A careful examination of the scene indicated he probably had lost his direction in a terrific thunder-

storm and flown blindly into the earth while under the impression that he was at a safe altitude. There were marks of his plane along the tree tops for 1,800 feet before the final crash.

That Titterington was killed either by a direct lightning bolt or by the wrecking of his plane by lightning is also doubted by both flyers and lightning experts, for in all the history of flying there is no proved case of a bolt striking a plane while in the air.

That the balloons were struck, however, is beyond question, and there are abundant cases of similar accidents on record for 200 years.

What happens when a balloon, filled with inflammable hydrogen, is struck, was graphically told by Ward T. Van Orman, the Goodyear-Zeppelin pilot, winner of many national and international races, whose bag was destroyed and whose aide, Walter Morton, was instantly killed.

Thunderbolts?

"I was looking directly at the flash," Van Orman said. "The thing that impressed me was its smallness, hardly thicker than my finger, certainly not more than five-eighths or three-quarters of an inch.

"It passed within two feet of my eyes. I had time after the flash to look up over the edge of the 'rain dodger' we had spread across the top of the basket and note that the bottom of the bag apparently was still intact. Probably it was two or three seconds after the flash before the concussion knocked me unconscious.

"How high we were, I don't know. A few moments before, in the terrific rain-storm, we had been blown down until we touched the ground, then bounded up again. It was a typical summer line squall, like the one that destroyed the 'Shenandoah,' with rising and descending air currents moving at high speed only a few feet apart. As we were blown down to the ground, we passed within 500 feet of Capt. E. W. W. Kepner's army bag, going up. We were so close, his aide, Lieut. W. O. Eareckson, shouted across to me.

"It was only a few minutes later that we were struck, probably the army balloon was within a few hundred feet of us, though neither of them saw our bag burn. We might have been 300 feet up, or we might have been a thousand.

"After I passed out, the bag burned and the basket, with Morton and me in it, fell to earth. It hit hard enough to burst the pontoons underneath, and cans of food among our stores were telescoped by the impact until they were an inch shorter than originally. The basket turned over on its side, and, still unconscious, I got a

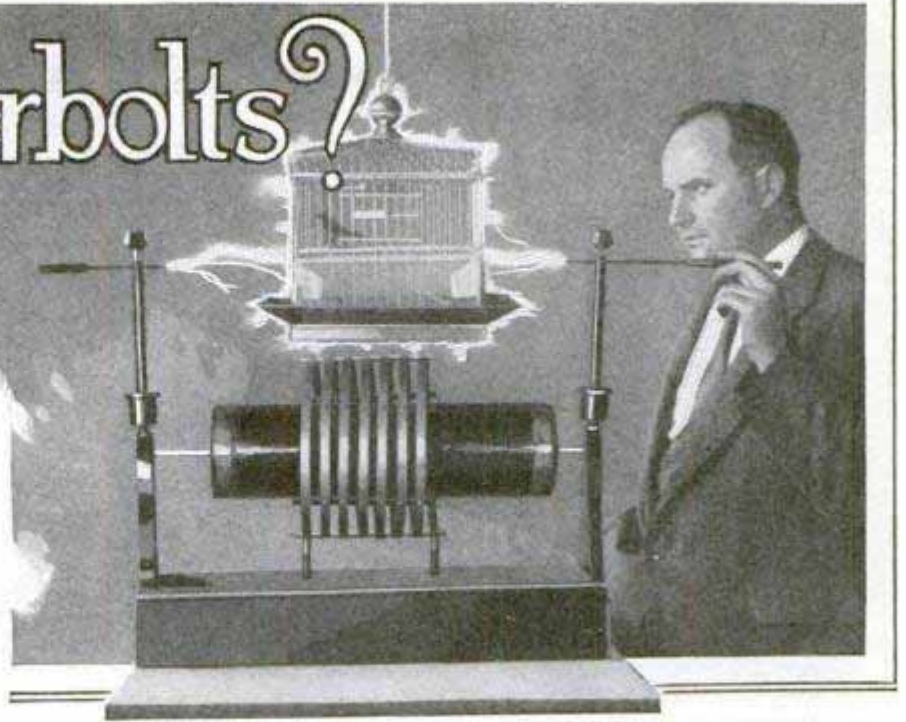

The Bird in a Cage, Immune Because the Current Passes through the Metal, Suggests a Way of Safeguarding Balloonists

bump on the back of the head that kept me out for three and a half hours.

"When I came to, my head was lying outside the basket, with rain falling on my face. I felt Morton beside me and tried to take his pulse, but could find no sign of life. Thinking he must be seriously injured, I jumped up to run for help, and discovered that my leg was broken and my back so badly injured I couldn't even crawl. I began to yell for help, and, fortunately, a farmer, living half a mile away, woke up just about that time, found his bedroom was getting stuffy, and, as the rain was nearly over, he got up to open the windows, heard my cries and came to the rescue."

As a result of the disaster to the balloon race, the army, navy, weather bureau, several universities and the Goodyear-Zeppelin company have set to work to make ballooning safe from lightning.

The solution, they believe, lies in an adaptation of an old laboratory stunt in which a canary in a metal cage is hung between the electrodes of a high-frequency machine and artificial lightning shot at it. The metal of the cage conducts the electricity, and the bird is perfectly safe.

A metal birdcage, built into the balloon basket, is to be tried in an effort to provide sufficient electrical capacity to save the pilots from shock. If the pilot can

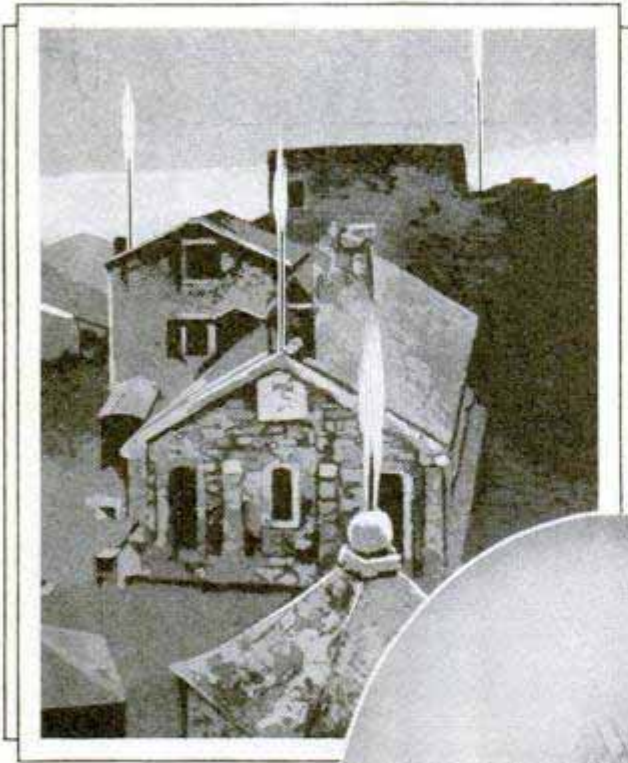

St. Elmo's Fire. Above, Flaming from Lightning Conductors in an Alpine Village, and, at Right, the Army "No 3" Leaving Pittsburgh Shortly Before Lieut. Paul Evert Was Killed by Lightning

be protected, the firing of the balloon bag is not a serious matter, as the balloonist can pull the rip cord, deflate the bag of its burning gas, and let the bag parachute within its net to bring him safely down, or, in case that should fail, can leave the basket with his own parachute.

When lightning hits a balloon, it always picks one of the two occupants as the target. Thus Morton was instantly killed while Van Orman escaped, and Lieut. Paul Evert, of Langley field, was killed and his aide escaped. In the third bag destroyed in the Pittsburgh race, James P. Cooper, aide of the "City of Cleveland," was struck and badly burned, but survived, the only man in history to live after being struck by lightning in a balloon.

Eight balloon accidents have been due to lightning in recent years. In 1897, a

balloon, not in a race, was destroyed and both occupants killed, one by lightning and the other in the fall. In 1923, when the international balloon race was held in Belgium, three bags were destroyed in the air and that of Captain Honeywell, the American, on the ground. Five of the six in the bags destroyed met death, the sixth pulling the rip cord and parachuting the bag until he was low enough to jump into a swamp, breaking both legs.

Two of the dead were Americans, Lieuts. Olmstead and Choptaw, in an army balloon. They were blown into another bag at the take-off, but managed to get clear, only to be struck by lightning, Olmstead being instantly killed and Choptaw dying in the fall.

The following year, 1924, two more American balloonists were killed in a storm in Illinois. They were Dr. C. LeRoy Meis-

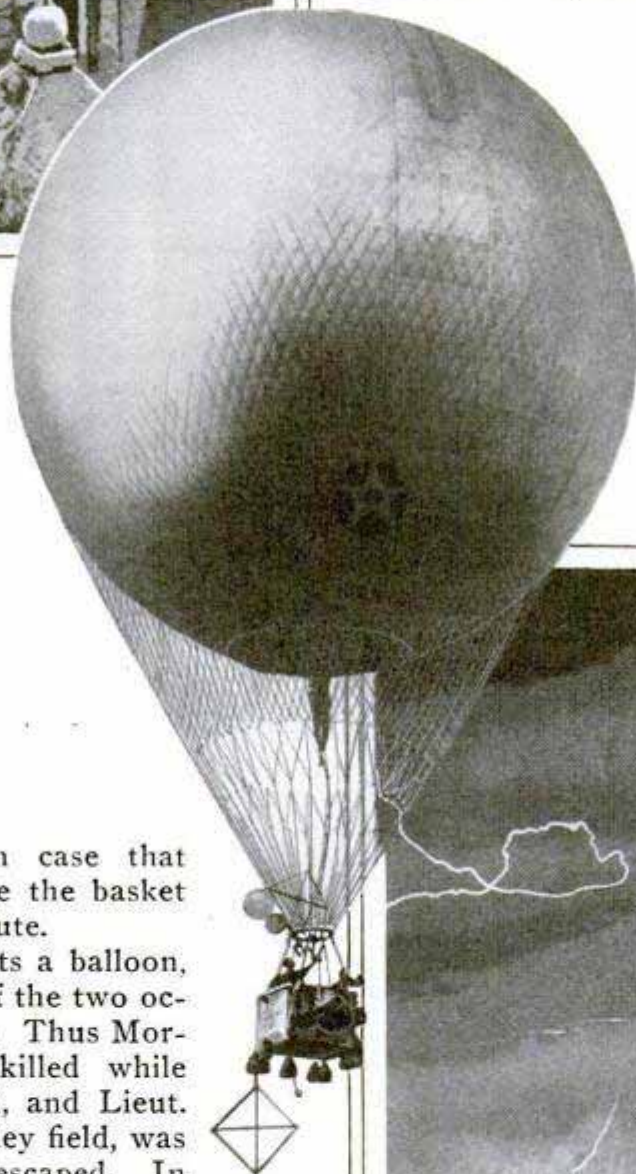

The World's Tallest Lightning Rod, the Thousand-Foot-High Eiffel Tower in Paris, Photographed Just as It Was Struck in a Storm

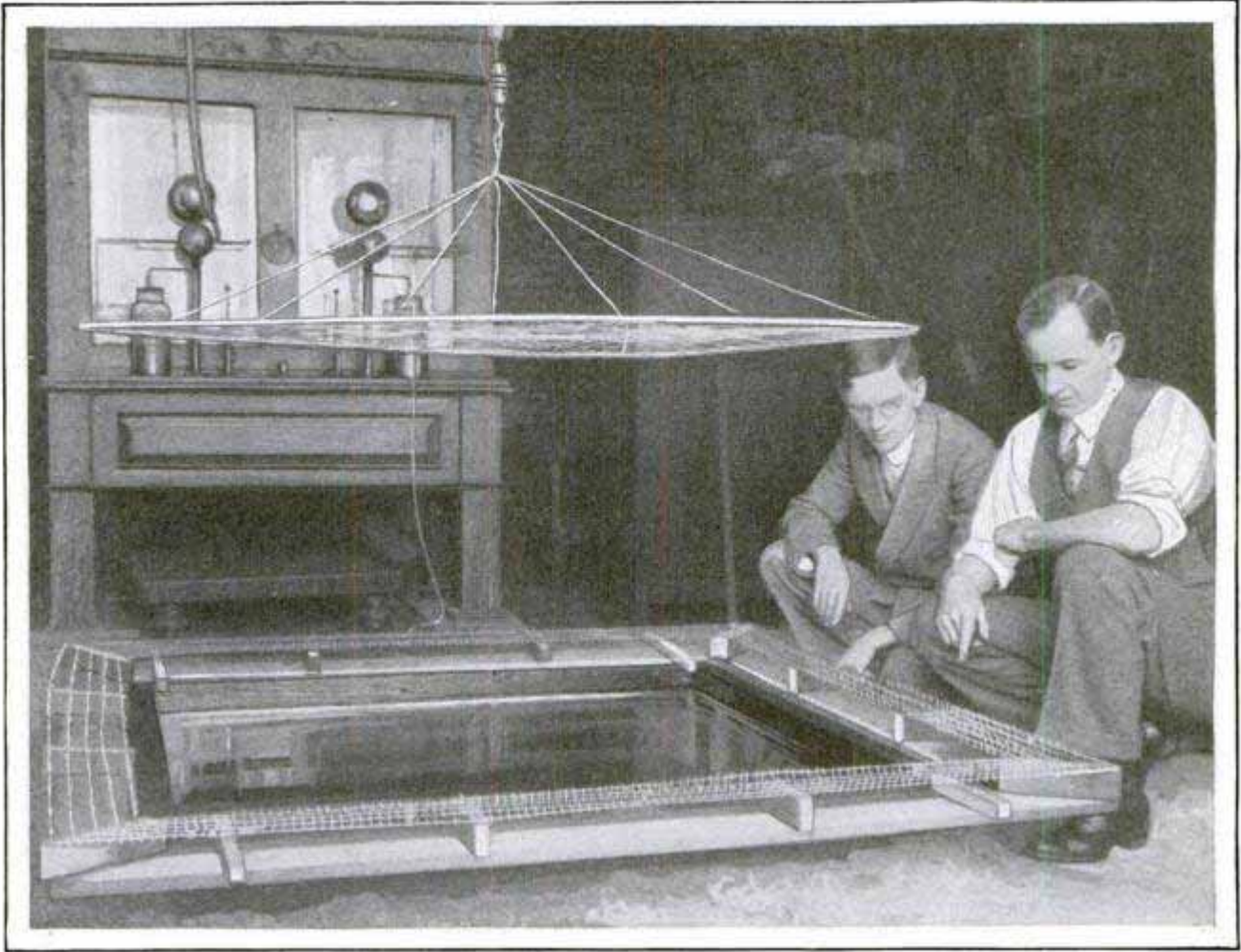

A Variation of the Birdcage Theory Being Tested in a Los Angeles Laboratory as a Means of Protecting Oil-Storage Tanks from Being Fired by Lightning

inger, a weather-bureau scientist, who had been making a study of thunderstorms by flying through them, and Lieut. James T. Neeley, an army-balloon pilot from Scott field, Belleville. Dr. Meisinger was struck and killed by the bolt. Lieut. Neeley did not have his parachute tied to him, but grabbed the rope and jumped, attempting to hold the rope in his hands. When his body was found, the palms were badly burned from friction, showing he had been unable to keep his hold until he reached the ground.

Curiously enough, the huge Zeppelins, with millions of cubic feet of hydrogen compared with the few thousands in a free balloon, are immune to lightning. More than 100 of them have been struck, but a Zeppelin never has been destroyed in that way. The birdcage nature of their metal framework is responsible for their immunity, it is believed. The great mass of the metal absorbs the shock. Part of the metal fuses under the intense heat, but the bolt passes out, leaving no serious dam-

age behind. The only dirigible on record as being destroyed by a bolt was one of the Italian semirigids, which had only a metal keel, instead of a complete metal framework.

There is no evidence, according to Van Orman and to lightning experts of the underwriters' laboratories, that either a balloon or an airplane, has any attraction for lightning. If one is hit, it is just the accident of fate that placed it in the path of a bolt passing between two clouds or from a cloud to the earth. A balloon, drifting before the wind, doesn't even build up a frictional static charge, since its speed is virtually the same as the wind, and hence there is no friction. This is shown by the absence of St. Elmo's fire on balloon rigging.

An airplane flying through a storm, on the other hand, is frequently covered with the ghostly radiance of the St. Elmo fire. Under such conditions sparks four or five inches long may be drawn from metal parts by advancing the finger toward them.

1052
540

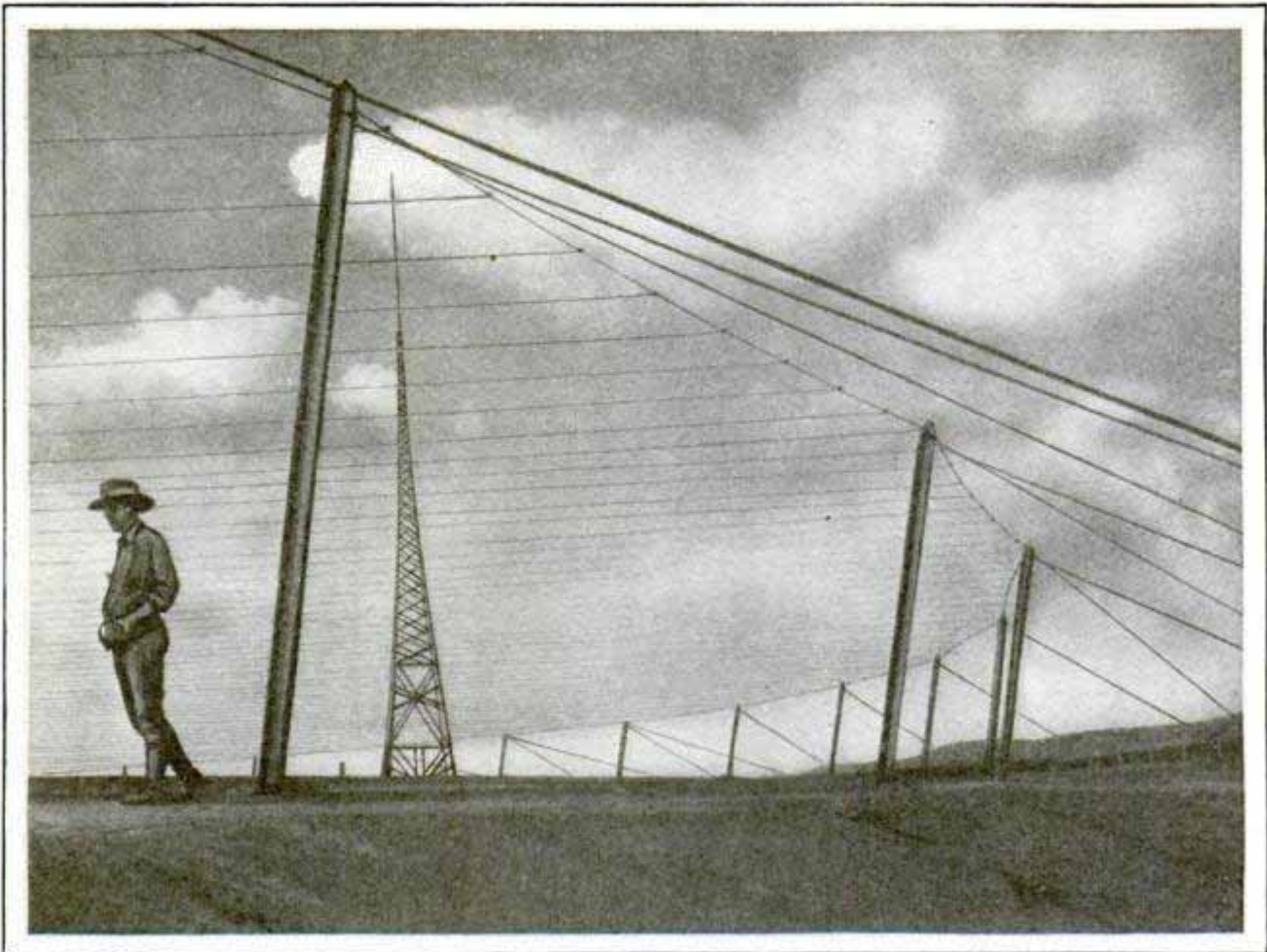

Another Birdcage Installed over a Huge Oil Reservoir in California; the Network of Grounded Wires Absorbs the Charge and Carries It Safely Away from the Liquid

One interesting possibility, which has been advanced to explain some of the airplane accidents in storms, is that the pilot received such a shock and was so surprised he lost control of his ship and went into a spin from which he could not recover. St. Elmo's fire is often seen at sea, playing about the rigging. It resembles the purple corona glow which can be produced by a Tesla coil when the electrodes are too far apart for the energy to jump the gap.

The problem of protecting balloons, and possibly airplanes, from lightning, opens a whole new field of research. Lightning protection on the ground is fairly easy, inasmuch as it only involves providing conductors of sufficient size to carry the current down to the ground. But in the air, with no ground connection, the problem is radically different. The success of the Zeppelins shows that, given metal of sufficient mass to absorb the shock, the airship is safe from destruction, but whether enough metal can be added to a balloon basket without destroying the lift of the bag remains to be seen.

The group working on the problem is collecting the experiences of all the flyers who have met lightning in the clouds, to study its manifestations and its actions. One difficulty is the fact that the eye may frequently be fooled. Stories of the queer pranks of so-called "ball lightning" are fairly common. Observers have described balls of fire coming into their homes, rolling down the stairs, across the floors, and disappearing through the windows. A famous ball-lightning story in the west is of a ball of fire that rolled along the backs of a tight-packed herd of cattle, until it finally fell off one cow's tail, hit the ground, exploded and killed a score of cattle.

Actually, scientists now believe, ball lightning does not and never did exist. It is merely an optical illusion. The eye has a habit of retaining bright images for some seconds. Look directly into an intensely bright light, an arc or one of the Kleig lamps used by the movies, then shut your eyes and turn your head away, and the image lingers in the eye for a period of several seconds.

In the same way a person dazzled by a blinding flash of lightning may shut his eyes and turn his head away, but the vision persists and seems to be a ball of fire rolling around the room, wherever the eyes are turned, until it gradually dims and finally vanishes.

One of the most interesting experiments with lightning is now being conducted in the foothills of the Allegheny mountains near Lake Wallenpaupack, Pa., where engineers have been making experiments to ascertain the effect of lightning on high-voltage transmission lines. The latest achievement is a photographic record of a lightning stroke.

This picture, taken on a Friday noon, the first of its kind ever made in the world, reveals a stroke on the transmission wires of approximately 2,500,000 volts. It was made automatically by a high-speed camera which can record what happens in a mil-

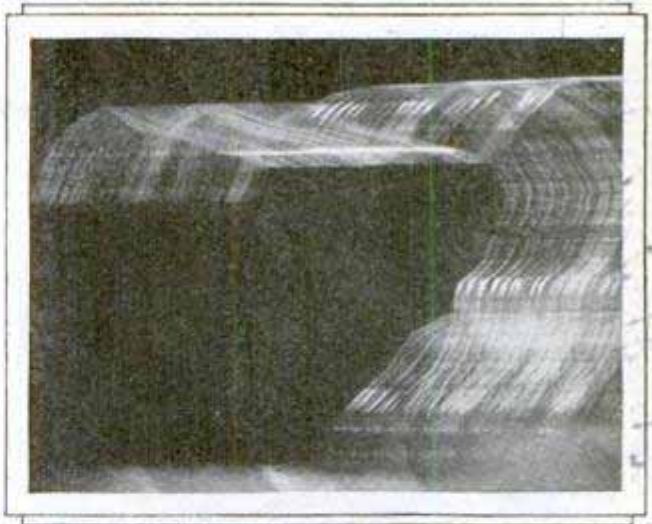

lionth of a second, or even a fraction of such a brief interval.

The negative showed that before five-millionths of a second had passed, the voltage wave on the 220,000-volt line had climbed to more than 1,500,000 volts. A local disturbance, due to an induction flash-over and reflection, caused a rise to 2,500,000 volts in a fraction of a millionth of a second. This

splash or ripple then died down in a millionth of a second and the wave passed to below dangerous value in about ten-millionths of a second and to zero—all in a total of forty-millionths of a second.

The mountain laboratory where the picture was made was planned with the expectation of continued observations on natural lightning, with the realization that a great deal of data will be required for practical solution of lightning control on transmission systems.



Photographing Electric Flashes with a Moving Camera; the Plate Separates the Discharges, Top Picture, into Many Separate Flashes

☞ Halibut weighing as much as 650 pounds have been caught.

works. Clancher

*Characterized by Pierce Petroleum Corp. 1149
1709 St. Louis Mo.*

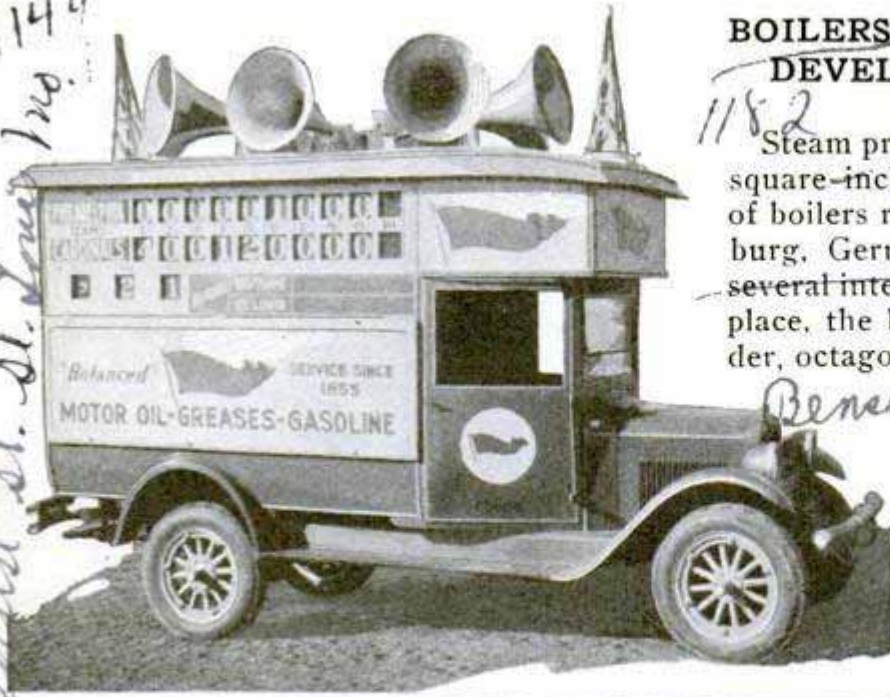

Truck Equipped as Scoreboard and Radio Apparatus, to Announce Progress of the Games; Phonograph Music Also Is Furnished

RADIO TRUCK SHOWS SCORES OF BASEBALL GAMES

Residents of a mid-western city, interested in sports, welcome the appearance of an advertising truck equipped with an efficient radio receiver on which the latest news of the baseball games is heard. As scores are announced, inning by inning, they are visibly shown in squares on the exterior of the truck. The traveling news station also has a phonograph with amplifying apparatus to entertain listeners with music when there is a lull in the game reports.

BLACK SHEETS INDUCE SLEEP

By using black sheets and pillow cases instead of white, an Italian physician reports good results in persuading unruly insane patients to go to sleep. The doctor declares that the plan is effective with sane persons in insomnia cases.

Mr. Marco Pongo, insanity

BOILERS SHAPED LIKE TOWERS DEVELOP HIGH PRESSURE

Steam pressure of 3,375 pounds to the square-inch is developed in a battery of boilers recently tested in Charlottenburg, Germany. The plant involves several interesting features. In the first place, the boilers are shaped like slender, octagonal towers and the fuel, coal dust, is blown in at the top together with a blast of preheated air. Combustion takes place in the open space at the center of the boiler which is surrounded by the water tubes. An extremely high fire-box temperature is produced in this manner and steam raised to over 3,000 pounds to the square inch and to a temperature of 450 degrees Centigrade. The amount of ash produced is small and falls out at the bottom, while the combustion gases are turned back to warm up the preheater for the air blast. So completely is the heat consumed that the outside of the towerlike boilers is said to be but little warmer than the air.

1182

Benson

Science Service news Bulletin no 384-F. 8/4/28

SUPPORT FOR ROD IN TROLLING HELPS HOOK FISH

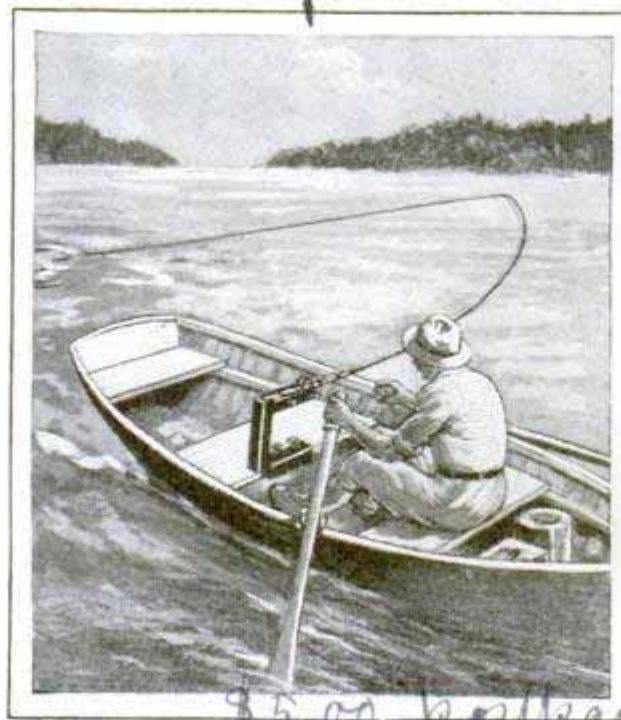

Pole Holder That Helps Hook the Fish

Clamped to the seat of the boat with thumbscrews, a steel support for the fishing rod is said to be of special aid when trolling for game fish because of the position in which it keeps the rod. It holds the pole rigid, so that when the fish strikes, the rod springs back, helping to set the hook. The holder may also be used when stillfishing from the boat, although not primarily made for that purpose.

\$5.00 postpaid

McArthur - Richards Mfg Co. Jackson City Pa

1498 Vernon St. Harrisburg, Pa.

ELEVATOR ON HOME STAIRWAY AID IN FIRM PERSONS

109

W. S. 1102 - Inclinator advised by Watson Elevator Co 407 W. 36th St. New York

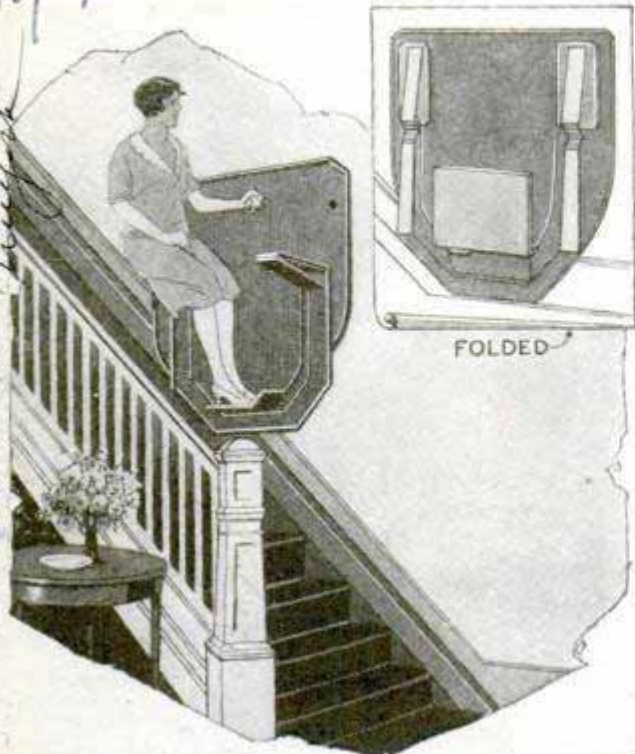

Elevator in Use, and As It Appears When Folded against the Wall at Bottom of Stairs

For installation on the stairway of a private home, an electrically operated elevator has been introduced. The occupant sits in a comfortable chair or seat and controls the lift with switch buttons on the car and at the top and bottom of the stairs. The carrier runs on a roller track alongside the stairs. When not in use, the platform and seats fold up against the wall so that they take up but little space and do not interfere with the ordinary use of the stairway.

BUFFALO HUNT CENTURIES AGO SHEDS NEW LIGHT ON MAN

American Museum of Natural History

Interesting evidence on the question as to when man first appeared in North America, has been discovered near Folsom, N. Mex., in stone arrowheads lying close to the bones of bison of a kind supposed to have been extinct long before the white man arrived on this continent. If the arrows were shot at the living game, as the evidence indicates, the conclusion of some scientists is that the hunters must have been there at least 25,000 years ago, possibly even several hundred thousand years. The bison bones were fossilized and there have been no discoveries to

show that animals of this variety have existed in America in recent times. Additional clues as to the age of the bones and of the weapons are the depth and formation of the earth in which they were found. The excavations were conducted by the Colorado and the American museums of natural history.

1147

NON-ELECTRIC DAYLIGHT SIGN SHOWS BRILLIANT LETTERS

Daylight is used as a substitute for electricity in an advertising sign recently marketed. It is of simple construction, consisting of but three parts, a special glass on which the legend is painted, a reflecting mirror and the inclosing box. The glass forms the top and is so made that its grained or pebbled surface functions as thousands of minute prisms which focus and intensify the light that shines through the glass. Letters in the sign are formed by blocking out the space around them with opaque paint, leaving the characters clear. They are projected through the open front of the box by means of a mirror set at an angle of forty-five degrees. By using stained glass, signs may be made in any color or combination of colors. The letters have no halo of light around them as often occurs in electric signs, so that they can be identified at great distances, there is no operating cost and practically no upkeep expense and the sign is simple to install. It is adapted especially for automobiles and trucks, store fronts, windows and road signs. Experiments are being made in illuminating the prismatic glass in order to achieve the same brilliant display effects after dark.



Drawing of the Lightless Sign, Showing How Letters Are Reflected by Mirror through Prism Glass

Five feet, five inches is the average height of human beings.

Conducted by Colorado Museum of Natural History

Light. Day Signs 281 W. Chicago Ave

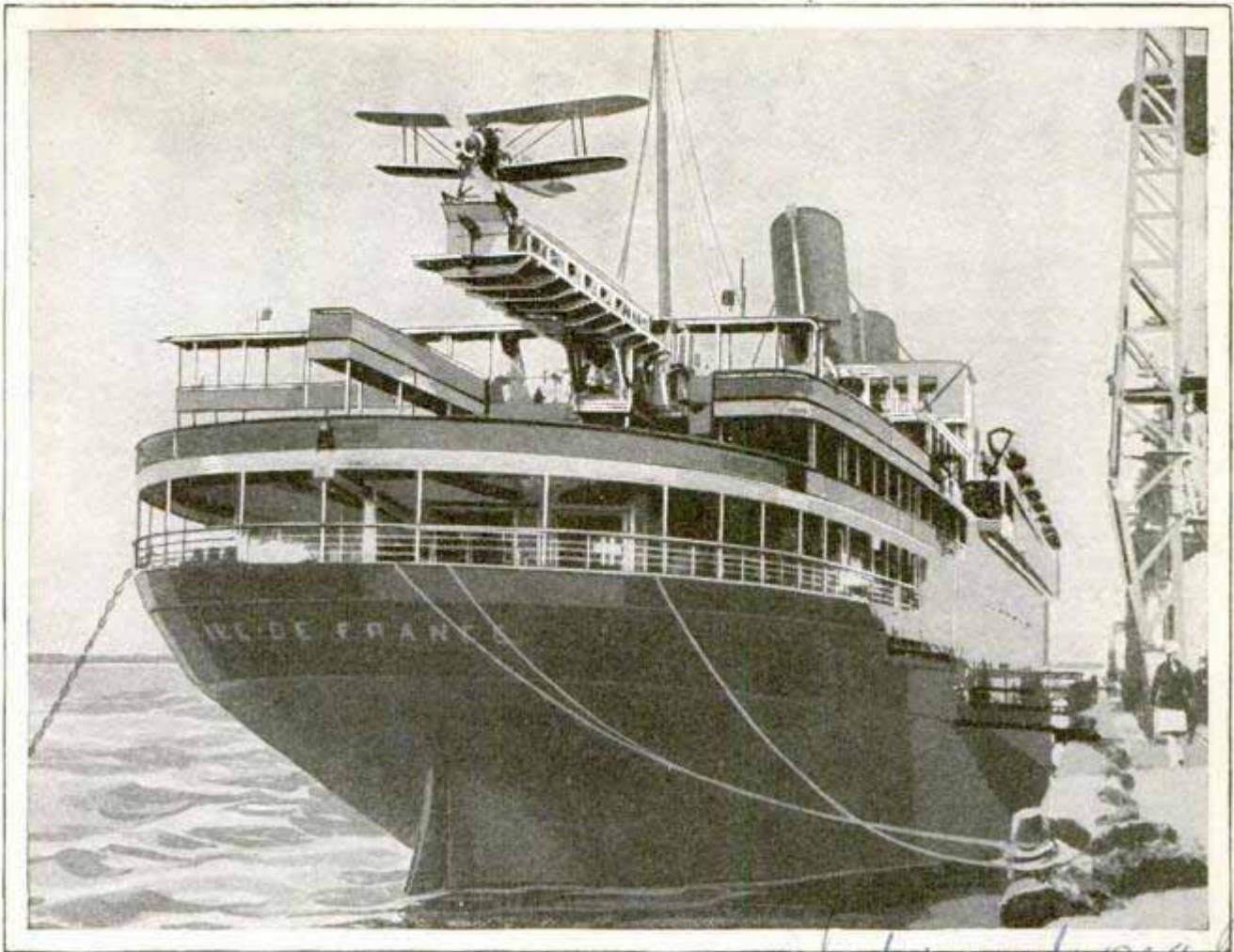

Catapult on Steamer "Ile de France" to Launch Planes; the Biplane Shown Here Was Superimposed on a Photograph of the Vessel

PLANES FLY FROM OCEAN LINER WITH AID OF CATAPULT

Flying service from the "Ile de France" to the shore is expected with the installation of a catapult to launch the planes from the liner's deck. The apparatus is similar to that used on battleships and will make possible quicker landings of passengers, mail and other "rush" cargoes.

ESCAPING GAS SOUNDS ALARM TO PREVENT ACCIDENTS

Gas is made to sound its own warning, should it escape from the mains, in an alarm device demonstrated by an eastern inventor. It is so sensitive that it will respond when the air space in a room contains as little as one one-hundredth part of gas, the inventor declares. In a recent test, an open bag of illuminating gas was held near the alarm, a boxlike contrivance, and in a few seconds, an electric bell connected to the box, rang the warning. The

signal is applicable to various home and industrial uses, and could also be employed to detect the presence of war gases, it is claimed. As a guard against explosions, it has been adapted to use in gas plants.

CIGAR LIGHTER WITHOUT WIRE LATEST AUTO CONVENIENCE

One of the chief features of a cigar lighter, especially adapted for use in an automobile, is that the heater itself may be removed from its socket and passed around in the car eliminating the bother of cords and reels. A clamp-on bracket for the base, simplifies installation, and there are cords for connection from the battery circuit to the lighter.



Will James 7/4/28

International Detroit Mich
Woolbridge
5 00 &

Handwritten notes at the bottom of the page, including numbers and names.

Guardians



EARLY in June an old-time windjammer set sail from the coast of Connecticut carrying beginners in the art of seamanship. The boys aboard came from all parts of the United States—from farm, office and shop. To many of them the voyage brought the first taste of the sea.

Three months later, the young landsmen went ashore at New London versed in the language of salt water and well grounded in the science of navigation. They were landsmen no more. Ninety days of brisk training had transformed them into sailors.

The cruise is a part of the plan for training men as officers of the United States coast guard, that arm of the government which maintains the life-saving service on stormy coasts and treacherous waterways. Their craft is the "Alexander Hamilton," practice ship of the coast-guard academy, with a colorful record in the navy as the gunboat "Vicksburg." In her new life, the vessel bears the name of the father of the coast guard—Alexander

Hamilton, first secretary of the treasury and the man whose formal recommendation resulted in the creation of the organization which was the foundation of the present service.

The coast-guard academy, at New London, has kinship with West Point and Annapolis as a training school for the officers of the future. Members of the cadet corps are selected youths, appointed for their seeming fitness. They receive pay and allowances similar to those granted West Pointers and navy midshipmen. Graduation is followed by appointment to the rank of ensign, as in the case of the man who graduates at Annapolis. From this commissioned grade the promotions follow the course prevailing in the navy, with the post of admiral as the ultimate possible goal.

The academy itself is the center of training and educational activities, but the real romance of the work belongs to the sea, aboard the barkentine practice

A promotion in Coast Guard. 6
and promotion in Coast Guard. 6
8 p. 50. 747. 2 En 5/2.
Appointment of cadet and cadet engineers.

of the Sea

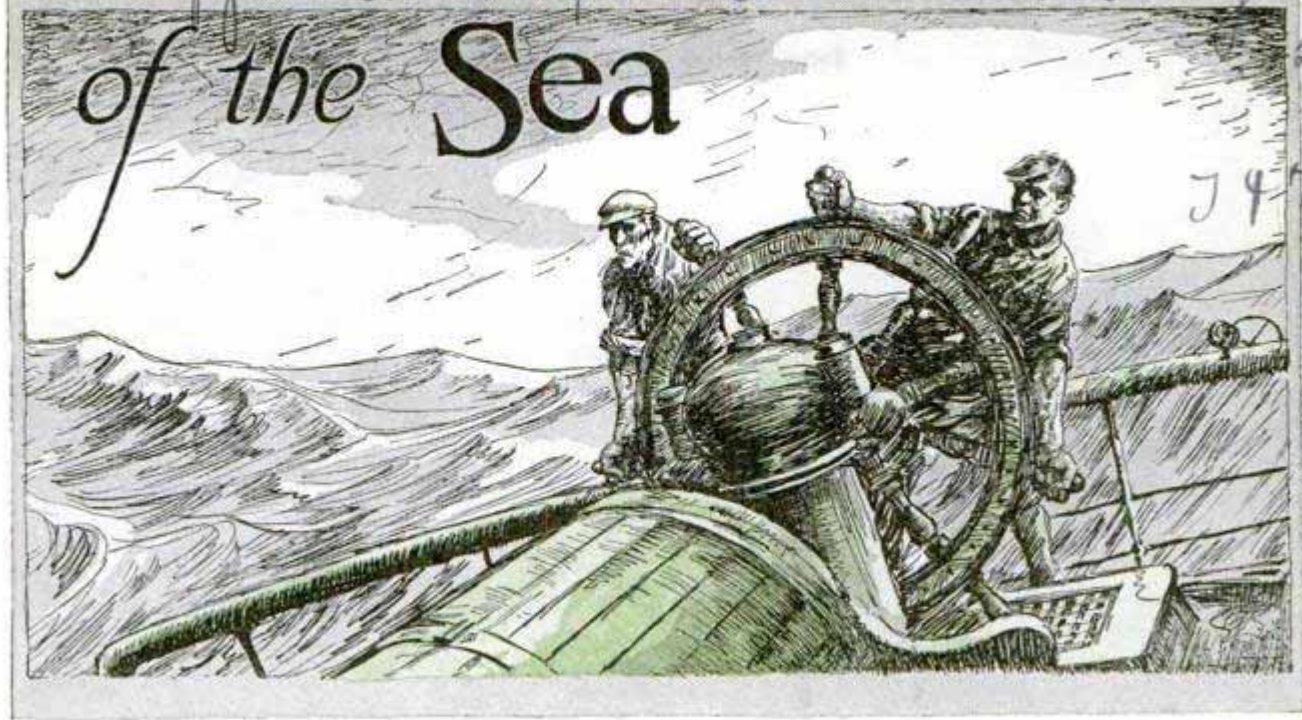

29 p.
56
7478.0
11/2

ship, a three-master of a thousand tons. In this craft, the cadets have a seagoing college, 168 feet long, thirty-six feet wide, and drawing twelve feet of water. In her early days as the "Vicksburg," the vessel formed a part of the blockading squadron off the harbor of Havana, during the Spanish-American war. Later, she carried Brigadier General Frederick Funston in the Philippines, for the capture of the rebel chief Aguinaldo, returning to Manila with the leader and his fellow-prisoners on board. The period of the European war found the vessel in active patrol duty on the Pacific coast.

When the youth from the farm or shop enters the coast-guard academy, his first contact with the sea comes with the practice cruise of the "Alexander Hamilton." The voyage may take him and his comrades to various European and north African ports, affording a touch of travel combined with a course of elementary training in seamanship. On this cruise, the green hand is taught to be a sailor in the real sense of the word, for the coast-guard policy is that no man belongs in the life-saving service until he is a full-fledged seaman, capable of doing everything that may be required of a sailor, and doing it in approved fashion.

This sea training carries the full flavor of the days when commerce was borne on sailing ships. From the beginning of his

course, the cadet is surrounded by the romance of the sea. He studies salt water as the collegian studies books. His campus is the broad Atlantic, his schoolroom a "Nautilus" of a past generation.

When the "Alexander Hamilton" puts out to sea, the new cadet goes through a course of training which gives him a true taste of the thing for which he entered the academy—the life of the ocean. Starting with such simple tasks as splicing knots and handling lines, he is taught to manipulate sails, man the small boats and carry on the general work of a sailor, including the care and upkeep of a ship at sea. That he escapes deck scrubbing is due to the custom of leaving this task to the crew while the student learns jobs of greater importance. Growing familiarity with the workings of the ship brings the newcomer's introduction to the mysteries of taking sights, "shooting" the sun and stars for calculating the vessel's position, figuring out the position by means of dead reckoning, and similar fundamentals of navigation.

This introductory cruise serves likewise to train the cadet in the work of the ship's lookout—the man who stands forward and reports "sail to starboard," "whale off the port bow," or "smoke dead ahead." Another bit of schooling connected with his future work as a life-saver is afforded by frequent turns at the "life-



buoy watch," during which the cadet stands by the buoys for prompt action in case of "man overboard" or similar emergency. He receives, too, a course of training at the wheel, with a second-year student instructing him in the proper handling of the steering apparatus.

The practice cruise affords practical application in the theoretical subjects taught in the academy. Added value arises from the opportunity given the officers aboard the ship to observe and study the individual inclinations of the cadets when they are away from their accustomed land environment, to note their fitness for a seagoing occupation, and to instill into them the traditions and standards of the coast-guard service.

After the first summer's cruise, there comes a winter's study at New London, during which the cadet is introduced in the theory of navigation in its scientific aspects. The following summer brings a second cruise, giving a chance to apply the theory acquired in the winter studies at

the academy. In this cruise, the student may become a coxswain, or he may attain the post of captain of a gun's crew. Either position affords a lesson in giving orders to the new crop of first-year men under him. Experience has shown that the work of the second summer does much to perfect the cadet's knowledge of navigation and to fit him for the post of cadet officer of the deck, achieved a year later, during his third cruise on the school ship "Alexander Hamilton."

The duties of the cadet officer of the deck tend to transform the student into a real navigator and captain of men. Under the watchful eye of a commissioned officer, the cadet takes responsibility for handling the ship at sea and in port, getting under way, dropping and raising the anchor, docking and undocking, and doing the various things that are supposed to be done by one of the mates. In this work the commissioned officer leaves the cadet officer

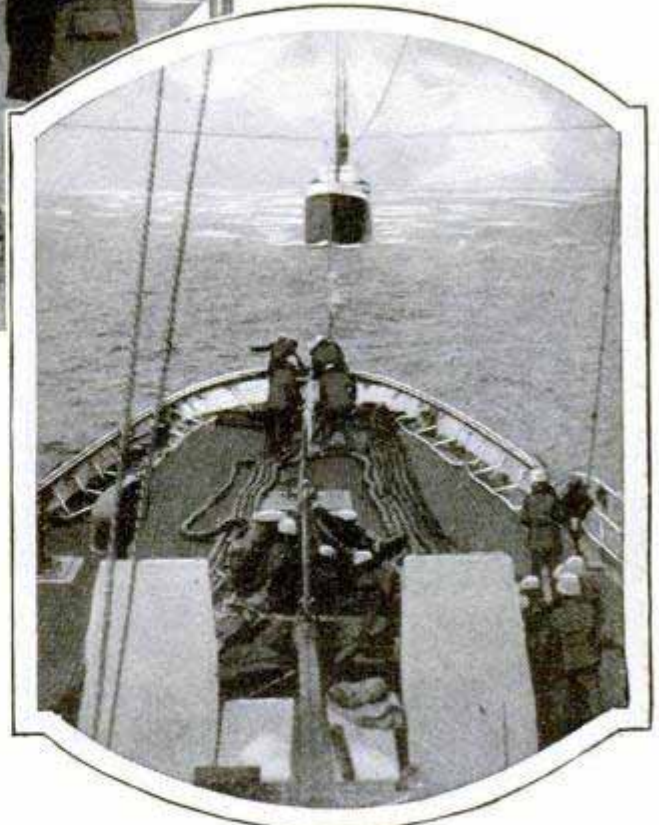

A Breeches-Buoy Rescue from the Mine Sweeper "Swan"; Life-Line Firing Practice, and a Cutter Towing a Disabled Steamer in Bering Sea

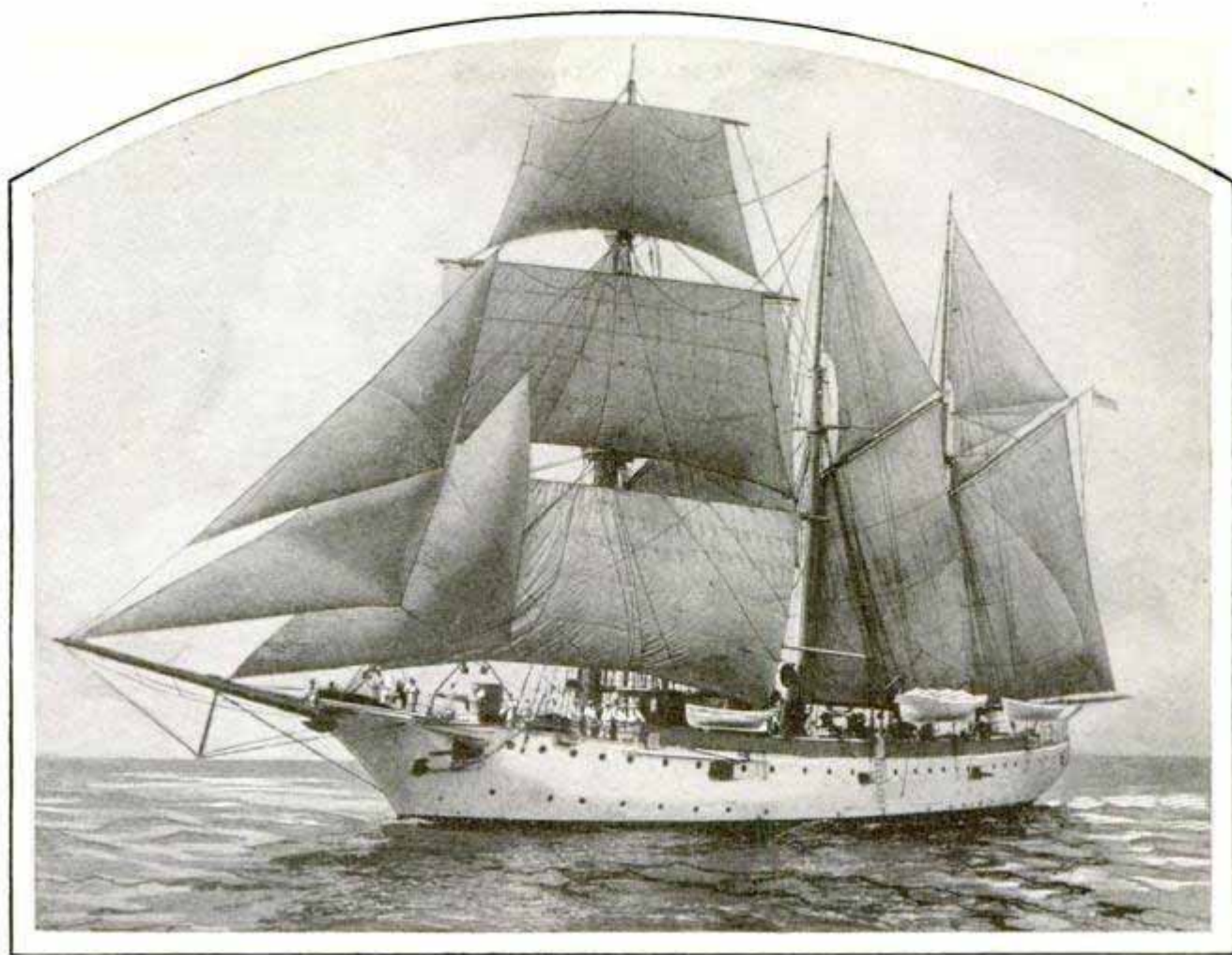

The Coast-Guard Training Ship "Alexander Hamilton," in Which the Recruits Are Taught Seamanship and the Handling of the Fast Disappearing Type of Sailing Cutter

to his own devices and does not interfere with his activities, except in cases of emergency where more seasoned skill is demanded. By the end of this cruise, the successful cadet is a qualified navigator.

The academy gives a comprehensive course of studies which is intended to produce well-rounded men for the commissioned personnel of the coast guard. As the oldest armed force for the protection of the American seacoast—antedating the navy—the service has built for itself a tradition covering 138 years of achievement. No branch of the national defense takes greater pride in living up to its traditional reputation for gallantry in action and for readiness to serve. The guard's sphere of usefulness is both civil and military, with the primary object of saving life and property, but with additional duties covering the various maritime functions of the federal government.

Because of its wide range of activity, the coast guard requires officers of superior type—men who are capable of

meeting situations of diversified character. For aiding vessels in distress and effecting rescues at sea, there is need for heroism of the highest type and the ability to lead men in the face of the utmost peril. The destruction or removal of wrecks, derelicts and other floating menaces to navigation calls for resourcefulness of another sort, requiring judgment and skill of more than ordinary character.

Still other forms of ability and training are demanded in the ticklish work of protecting the government against custom smugglers and rum-running enterprises. In these undertakings, the coast guard acts as an armed force which must be ready to compel respect through the use of three-inch guns whenever there is occasion for such drastic treatment of a situation.

Further duties involve the enforcement of navigation laws and quarantine regulations, the suppression of mutinies on merchant ships, the protection of seal and other fisheries in Alaskan waters, and the



All Night Long, the Coast Guards Patrol Their Beats, and When a Wreck Is Sighted, a Rocket Summons the Entire Crew with Surfboat, Breeches Buoys and Lyle Gun to Aid in the Rescue

summer patrol of the iceberg regions off the Grand Banks of Newfoundland. Added to these responsibilities is the task of policing regattas and marine parades in the interest of public safety.

With this varied program of routine work, and with the additional prospect of serving as a part of the navy in time of war, the coast guard stands forth as a versatile service requiring the highest type of commissioned officers. The training afforded by the academy and the practice ship is of a nature designed to produce the desired material. The cadet who masters the course acquires academic education as well as seamanship. His courses have embraced English and French, mathematics and such studies as mechanics and chemistry, gunnery and physics. He has studied the science of ballistics, dealing with the travel and force of projectiles, their pathways and their impacts. He has been schooled in drill regulations, service regulations, the custom laws of the United States and the general aspects of international law as pertaining to the seas. In short, his preparation for the coast

guard has qualified him to appear to good advantage wherever he may be thrown, and to uphold the traditions of the guard.

The full course occupies three years. Its satisfactory completion marks the beginning of the graduate's work in the general organization of which he has become a full-fledged part.

Life on the "Alexander Hamilton" possesses the lure of the sea in its fullest aspects. In the whole realm of American shipping, there is no better place for absorbing the traditions of salt water or obtaining the thrill that comes with a favoring wind and full sail ahead.

GRASS PUSHING BACK THE SEA TO AID FARMERS

Acres of land which is covered by the tide twice daily, are gradually being won from the sea and turned into valuable soil for farming, by means of a special kind of grass. It is a rushlike variety and collects mud about its fine roots and slender stalks. Inch by inch, it builds up the shore level.

*W. Journal? 29
The...
1084
Spartina
220 1/2 ins
Essex Eng*

*Box 407 Route 4,
Hayward, Calif.*

RIVETLESS BOAT CUTS PATH THROUGH ICE FIELD

1108

That the cutter "Northland," the successor to the veteran coast-guard boat "Bear," is well constructed for its duties in the north was shown by its recent victory over an ice field off Point Barrow. It came through unscathed after ripping and plowing its way through ice six inches thick. The test was considered a point for the special type of construction of the vessel. There are no rivets in the hull, the body being electrically welded throughout. Some engineers predicted that this form of hull would not stand the strain of the ice but would buckle. No such trouble occurred. On the other hand, the "Bear" once suffered a couple of cracked timbers while breaking through ice but three inches thick.

2701e Oklahoma Tribune

THREE-IN-ONE METAL WORKER

3963 **LATEST SHOP AID** *3963*

For general use in a sheet-metal shop, a bench machine with interchangeable faces has been introduced. It may be employed in wiring, turning or burring, the different faces being easily removed and attached to the shafts. Adjustments are made for material of different thicknesses and the gears are completely inclosed for longer life and added safety.

The Chicago Maple 2638 Chicago

pat. ap.

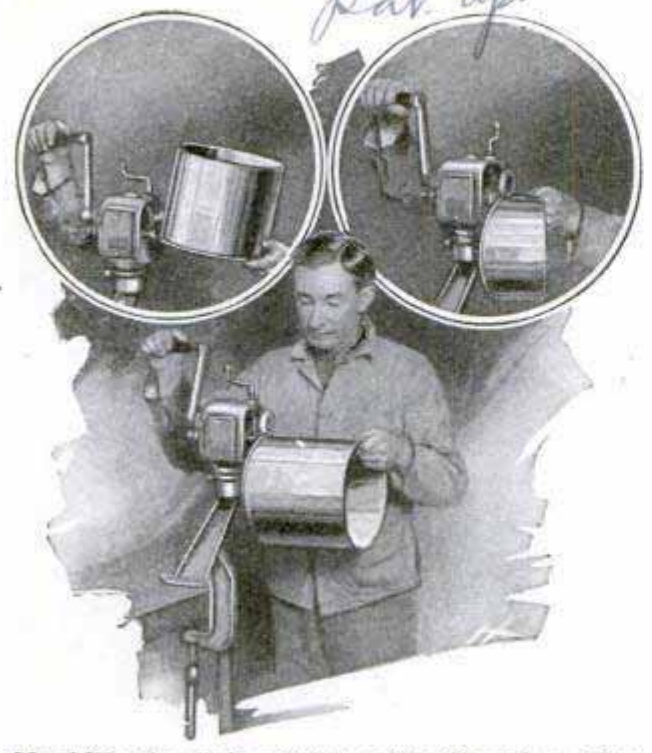

Metal-Working Unit and Three of Its Operations; Note the Inclosed Gears

Margarita machine... 637 Hayward



Airplane Thrill Is Provided for the Youngster in This Flying Swing

FLYING SWING LIKE AIRPLANE ADDS TO CHILD'S SPORT

Shaped like an airplane with a spinning propeller at the front, a child's swing now on the market holds three youngsters at a time and is suspended at four points so that it cannot tip. The wings are of wood, the body is four feet long and there is room for a passenger in front and behind the pilot's seat. The swing can be set up in a few moments and is suitable for outdoor or indoor use.

Henry - Harvard Co. Inc. 600 W. Diamond St. Hayward, Calif.

STAINLESS-STEEL PROPELLERS REDUCE SHIPPING COSTS

Stainless-steel propellers have been attached to four ferryboats operating in San Francisco bay, and their use is expected to effect a saving of at least \$25,000 a year by eliminating some of the drydock intervals necessary with the usual equipment for repairs and renewals. A further economy is promised in a reduction of fuel consumption, as the propellers are more efficient than the usual kind. The blades do not deteriorate so rapidly and can be re-pressed into shape more easily than those of cast steel.

Build by Harman... 1-Hull... 2-Propeller... 3-Blade...

1-Propeller... 2-Blade...

System perfected by the Aero Co. at Nassau and Broad Sts. Berlin Germany

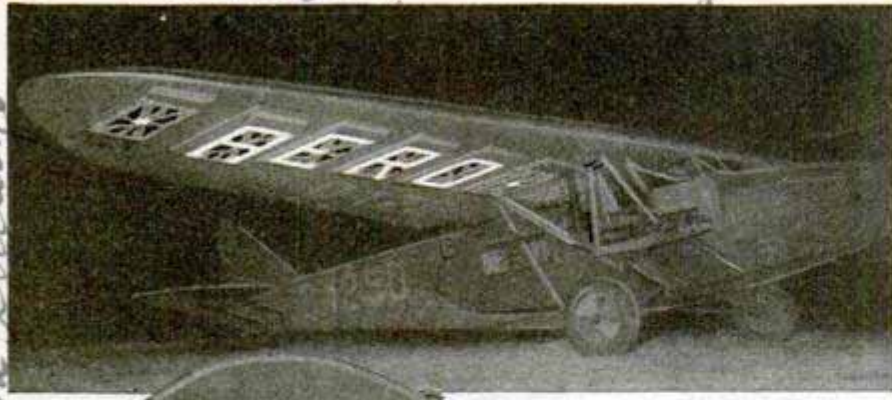

Lighted Letters on the Plane Wings Are Visible from Great Distance and Are Interchangeable

FLYING BILLBOARD HAS LIGHTS UNDERNEATH WINGS

Effective use of airplanes for night advertising is seen as a possibility in an experiment in Berlin, where a huge three-motored ship was fitted with lighted letters on the under surface of its wings which had a spread of ninety-five feet. The letters could be interchanged automatically to enable the display of more than one message. The sign could be read when the plane was more than a mile high.

BURROW UNDER SKYSCRAPERS WHILE DIGGING SUBWAYS

While millions of persons walk about in the heart of New York's financial district, a crew of men toils far below the surface, bolstering up the foundations of the huge buildings while the new subway is under

construction. They work in heat comparable with that of a Turkish bath, as they are surrounded by big steam pipes. The main problem involved is to extend the present foundations to a point below the level of the floor of the subway. The supports for the new foundations are steel cylinders in sections, varying in diameter from

twelve to sixteen inches, and in thickness, from one-eighth to three-eighths of an inch. In placing these sections, a small pit is dug under the column to be supported and a hydraulic jack set in position beneath. The cylinder is then pressed down by the jack, since the building column cannot be raised. When the jack has been extended to the limit, pressure is released, and another section of cylinder placed on top of the first and forced down until the bottom unit reaches such hard ground that it will go no farther. To hold up some of the columns, more than twenty steel piles will have to be forced down.

CULTIVATOR SAWS THE SOIL FOR BETTER PLANTING

Applying the principle of sawing to the soil, an Indiana man has devised an implement that plows, disks, harrows and rolls the ground, all in one operation. Large revolving blades with sawlike teeth are said to cut into the ground to a depth of ten inches, pulverizing it and, at the same time, destroying weeds and rodents.

Cultivator with Whirling Saw-Tooth Blades That Cut the Soil and Destroy Weeds

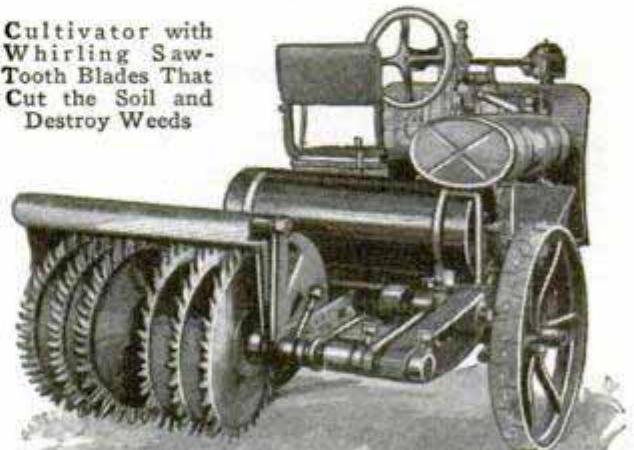

drawn by Jacob Hirschauer

Cont. George L. Paul, 537 S Dearborn Chicago

110 New York Sun 7/18/28

STEEL PILOT GUIDES PLANE WITHOUT HUMAN HELP

A "steel pilot" which operates an airplane without human help, was tested successfully recently at Istres, the great military airport near Marseilles, France, by French army flyers. The mechanical pilot, invented by Major Max Bouchard, weighs only sixty-seven pounds, and it is claimed for it that it is far more effective than a human pilot, and makes it impossible to get a plane into such a position that flying speed is lost, the trouble that usually precedes a tailspin. Flying blind, in fog or other conditions that make it impossible for the pilot to see some object by which he can fix his position, is the cause of many tailspin accidents. Unable to orientate himself by a glimpse of ground or sky, the pilot loses all sense of direction, unless he watches his instruments carefully and obeys them rather than his own sensations. The steel pilot consists of electric motors which operate the longitudinal and lateral controls and also steer the ship.

SLAMMING DOOR IS SILENCED BY RUBBER CUSHION

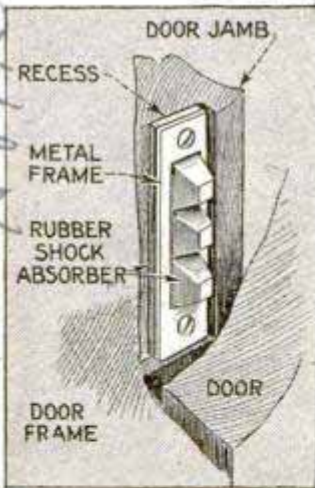

Mounted in the face of the door frame, a small rubber buffer effectually silences the slamming door. Projecting rubber tips absorb the shock. The cushion is easily attached, a small brass frame giving it a secure foundation.

WHEN GEESE WEAR SHOES

Geese are often driven long distances to market in central and southeastern Europe and, to protect their feet on hard roads, they are given curious "shoes" of tar and sand. They are first made to walk over an area that has been coated with the tar and when their feet are thoroughly smeared, they tread over sand. These shoes wear well, even for several days.



Changing Tire with Aid of Electric Lamps That Are Worn on Headband for Better Vision

TROUBLE LIGHTS WORN ON HEAD AID IN FIXING AUTO

Connected to the automobile batteries and worn on a band about the head, two efficient electric lamps direct their rays where most needed when repairing the car, are not in the way and need no extra adjustment after once put on. The headband is comfortable and secure, both hands are left free for use, and each light can be turned so that the rays may be thrown in any direction desired.

QUICK CLAMP ROLLER SKATE PREVENTS ACCIDENTS

Roller skates that can be put on in less than two seconds, the manufacturers state, have an adjustable clamp with a locking device that fits into a slot on the heel.

Once fastened, this catch cannot come loose accidentally. For stage work, the skate is especially desirable, as it is light and comfortable and may be put on in the wings, saving the risk of walking from the dressing room while wearing the rollers.



Carl Leonard Baird
220 46 Elmwood Road

Miss Wilcox's small bed
West strand
London W.C. Eng. kn

692
Silverbeam \$5.50

Chicago Roller Skate
Co. 4458 W. Lake, Chicago
Chadler Sales Corp. - 621 W. 9th St. - Chicago
692

POWER FROM A NEW KIND OF PERPETUAL MOTION

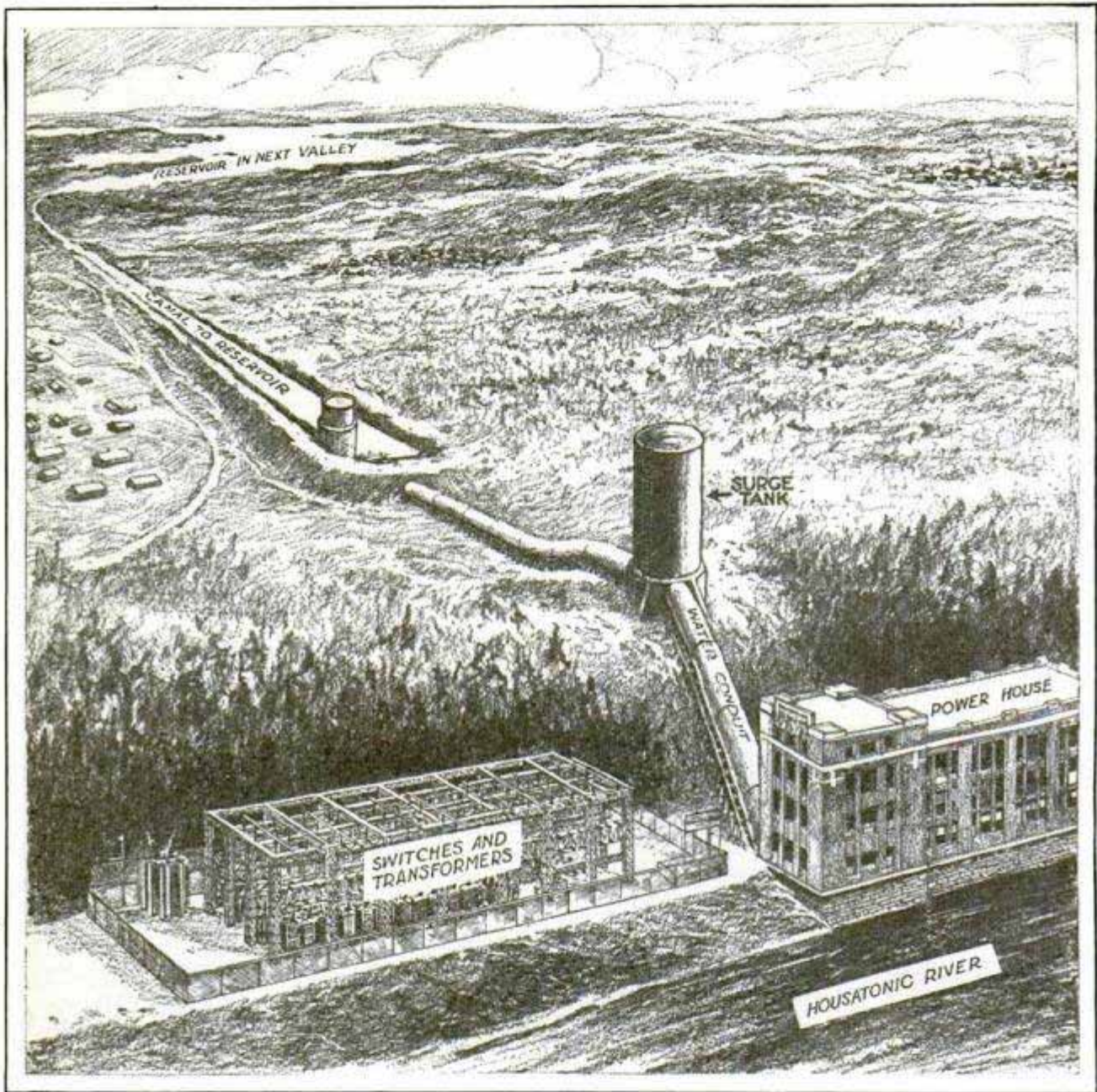

The Nearest Approach to Perpetual Motion Is This Hydroelectric Plant That Generates Current to Pump Water up a Hill, So It May Flow Down and Generate More Electricity

Generating electricity from water power, and using the current to pump the water back up the hill and let it run down again to generate more electricity looks like an attempt at perpetual motion, but is actually being done with success at the Rocky River plant of the Connecticut light and power company on the Housatonic river. As losses from friction, plant inefficiency and other causes make it impossible to pump as much water as was used to generate the current consumed to do the pumping, the arrangement does not appear profitable, at first glance, but actu-

ally it is. The answer is that the river is on the job twenty-four hours a day, generating current, without regard to noon hours, Saturday afternoons, Sundays, holidays and night time, when the demand for electricity drops as the factory load is shut off. The water flows whether or not current is required, and once it passes over the dam cannot be recalled. So the engineers did the next best thing and arranged to utilize the power that otherwise would be wasted. Two motor-driven centrifugal pumps, each with a capacity of 112,500 gallons a minute, elevate the water 230

number 5/20/28

Hayfield Resident Wheel Co. 36 Louisville Ave. Coatsmore, Pa.

...et up the hillside back of the power house and pour it into a reservoir in the next valley. Then, when a peak load comes and more generator capacity is needed, the water runs back down the same pipe and turns the turbine wheels, passes on into the river, and flows down to operate other power houses farther down the stream. Another advantage of the scheme lies in the fact that the storage reservoir in the next valley has a capacity of 45,000,000,000 gallons, but the natural drainage into its basin supplies only about one-quarter of that amount, leaving space for the pumps to fill.

TWIN TIRE ON AUTO WHEEL DECREASES JARS 1121

A new type of wheel having two tires, one within the other, and said to be adaptable either to motor or trolley cars was exhibited recently. The outer tire is of solid rubber, the other, inside it, is pneumatic and is incased in a steel frame next to the hub. This arrangement is said to take the strain from the outer tire while the inner one acts as a shock absorber. Punctures are also eliminated.

BOAT IS INFLATED LIKE TIRE AND FITS IN KNAPSACK 956

Designed especially for camping trips, a rowboat, exhibited in Germany recently, can be folded into a knapsack and, when ready for use, is blown up like a tire. In addition, it has a waterproof covering that fits over the top as a tent to protect the occupant from inclement weather.



"Tire" Boat in Use; It Is of Fabric That Can Be Folded into Small Bundle When Deflated

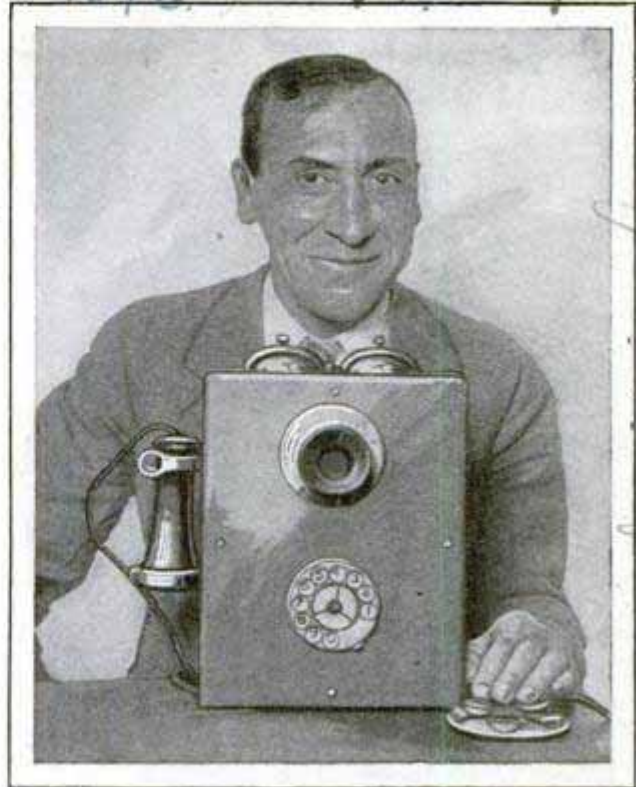

Automatic Telephone Box That Conceals a Motion-Picture Camera for Trapping Criminals

MOVIE CAMERA IN PHONE BOX HELPS TRAP CROOKS

Inclosed in an automatic-telephone box, a motion-picture camera devised by a western inventor, takes pictures of persons without their knowledge. It is intended to be of aid in trapping bank robbers and others. The camera carries sixteen feet of film, is operated automatically and, in tests, has taken pictures of persons eighty-five feet from the instrument.

NEW PAPER MONEY TO BE AGED TO PROLONG WEAR 1119

The life of paper bank notes is about eight months but this might be increased to a year, treasury officials declare, if the paper were aged properly before being circulated. The process delays cracking and tearing. Between 1917 and 1920, the calls for currency were so heavy that the bureau of printing and engraving was unable to keep the pace and new money was issued without the usual aging period. The new notes, which are to be about two-thirds the size of the present ones, are to be thoroughly aged before being issued, the treasury department reports. They will resemble those in use in the Philippines.

Mr. M. D. D. Struempfe Technick

Mr. J. P. ... 74/5 ...

Mr. John E. Seibold, ...

Wasser & Luftfahrzeug ...

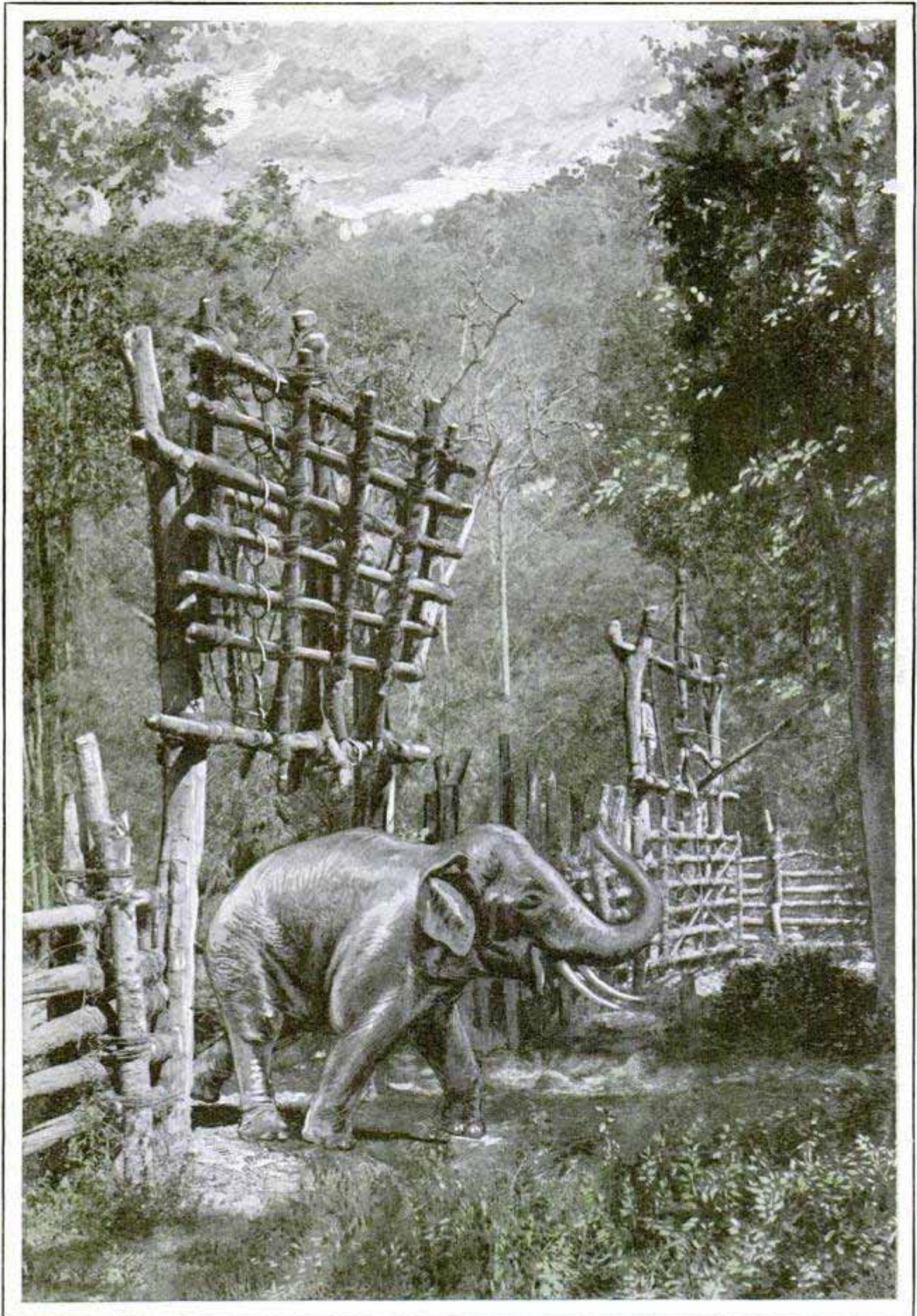

A Wild Elephant Charging through the Main Entrance to the Keedah, or Stockade, Used to Trap the Jungle Herds in the Round-Ups in Mysore State, India; the Guards on the Second Gate Are Armed to Check Any Attempted Stampede, and the Fence Is Protected by a Deep Ditch

Trapping Wild Elephants

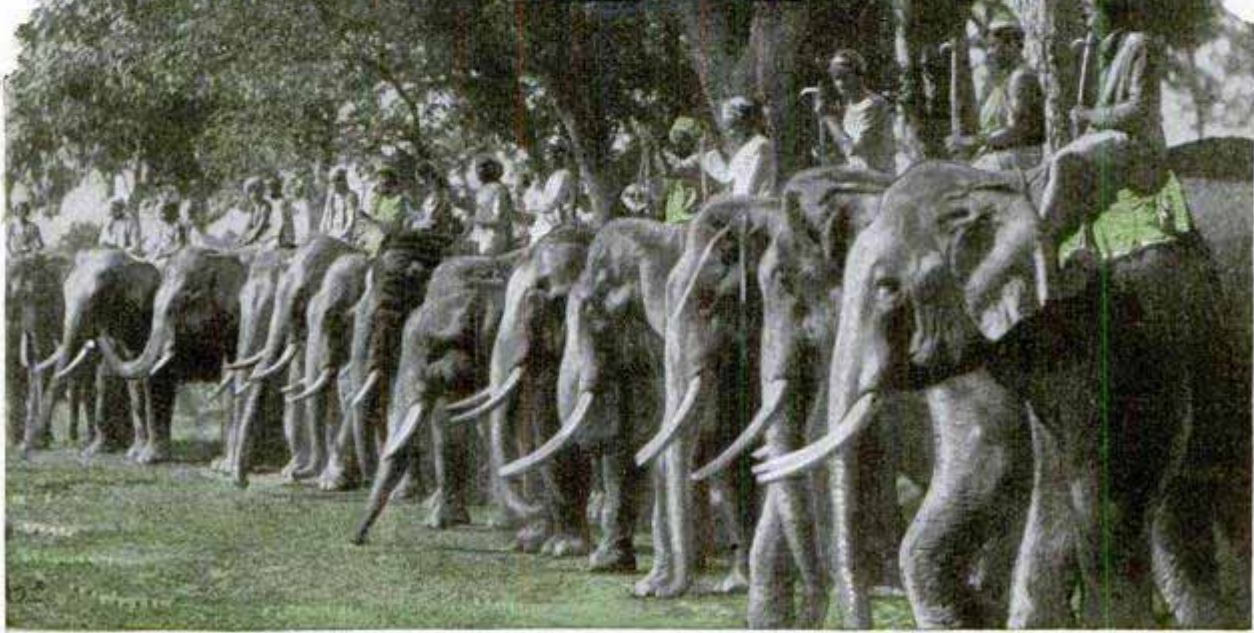

The Tame Squad Waiting for the Signal to Enter the Stockade and Start Cutting Out the Wild Animals, One by One, So They Can Be Hobbled and Chained to Trees

By CAPTAIN J. P. WILLIAMS

17 Cambridge Road,
Bangalore,
South India

TRAPPING wild Indian elephants, to be domesticated for circuses and parks throughout the world, or put to work piling teak and doing other heavy work at home, is a regularly organized business in the native state of Mysore.

A vast wild-elephant preserve, a hundred miles from the state capital, has been set aside to raise the tuskers. At least once a year a jungle round-up, carried out in many ways like a cattle round-up on a ranch in the western United States, brings scores of the animals, with their cows and calves, into the fold. Pleasure is usually combined with the business, and the round-up becomes a gala celebration in honor of distinguished guests.

Weeks of preparation are necessary before the actual elephant drive starts. An enormous stockade, built of logs driven into the ground and chained together, is erected in a jungle clearing. Inside the fence a deep ditch, carefully revetted with

sharpened poles, is dug around the clearing, except in front of the gates. The ditch discourages an organized attempt to uproot the fence, which probably would crash if an entire herd could run into it.

From the stockade, a long and broad avenue is cleared through the jungle, the undergrowth being piled along the edges to encourage the elephants to keep to the open path. Four to six hundred natives of the district usually are enlisted as beaters, and a herd of tame work elephants is brought down from Mysore city in specially constructed railroad cars, each built to hold one animal.

When the appointed day for the round-up arrives, the beaters, distributed around miles of territory, start their work, beating drums and pans, firing guns and fireworks, and making as much noise as possible. The startled elephants in the jungle begin to mill about, until they find in one quarter there is no noise, so they head in



that direction. The gathering herd eventually stumbles on the cleared roadway and takes to it, as offering an easier avenue of escape than the trackless forest.

Down the roadway the herd stampedes until they reach the stockade gate and pass through it. The watchers, hidden in near-by trees, release the catch and the gate falls, barring escape of the herd.

The tame elephants are then brought up and picketed near by, waiting until the captured wild animals get over their first fright. As they calm down, the gate is opened and a troop of wily old tuskers, able to fight if need be, and trained for the work, march in and surround the nearest animal, forcing him out away from his mates. Once outside, he is shoved and pushed around until he reaches a picket tree, when natives attach hobbles and chains and tie him up to get used to captivity. One by one the entire wild herd is treated in the same manner. Some fight,

some are stubborn and lie down and refuse to move, while others quickly accept the new order of things and yield.

For several days the captives are kept chained to trees. Then they are yoked one by one to tame elephants and led down to water, and permitted to take a dust or mud bath. The same training goes on day after day until they become sufficiently broken to be worked alone. It usually takes a month or so to tame them sufficiently to be yoked to work animals, and several weeks more before they are sufficiently

domesticated to be worked alone.

Then comes the annual elephant auction, attended by elephant buyers from all over India, as well as zoo and circus agents from foreign lands. The best of the work animals go to the lumbering operations, where they are able to carry enormous logs with their tusks.

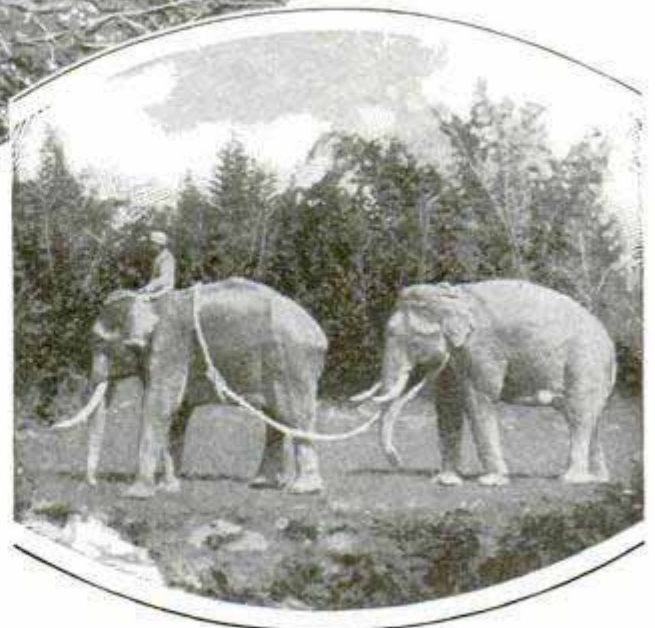
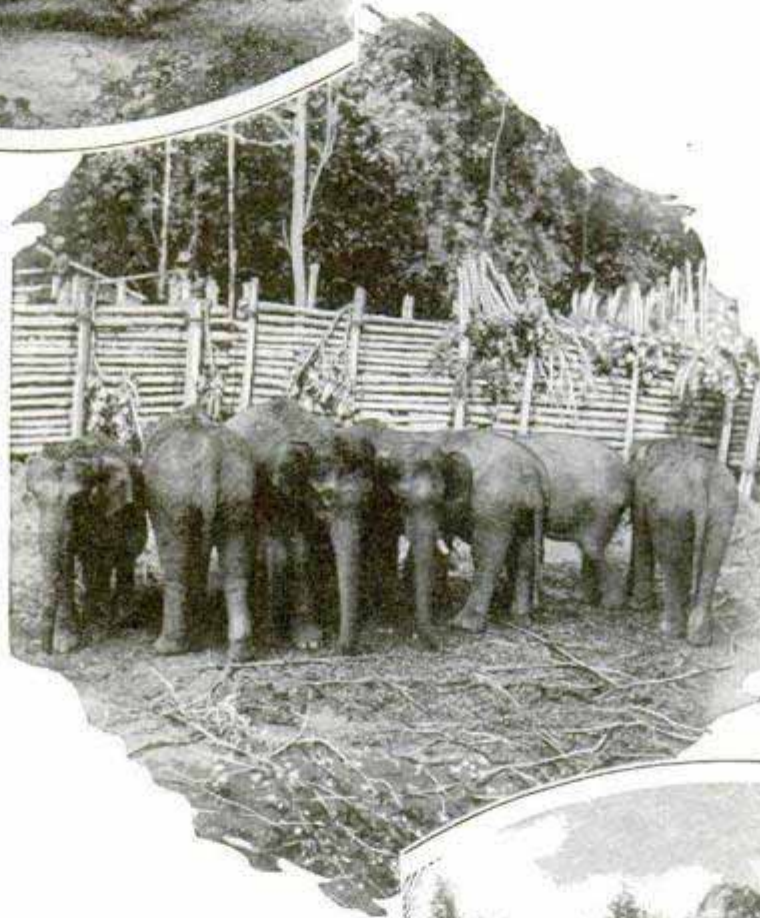

Going to the Round-Up by Bullock Cart; Half-Tamed Young Elephants in the Stockade, and a Wild One Being Led to Water

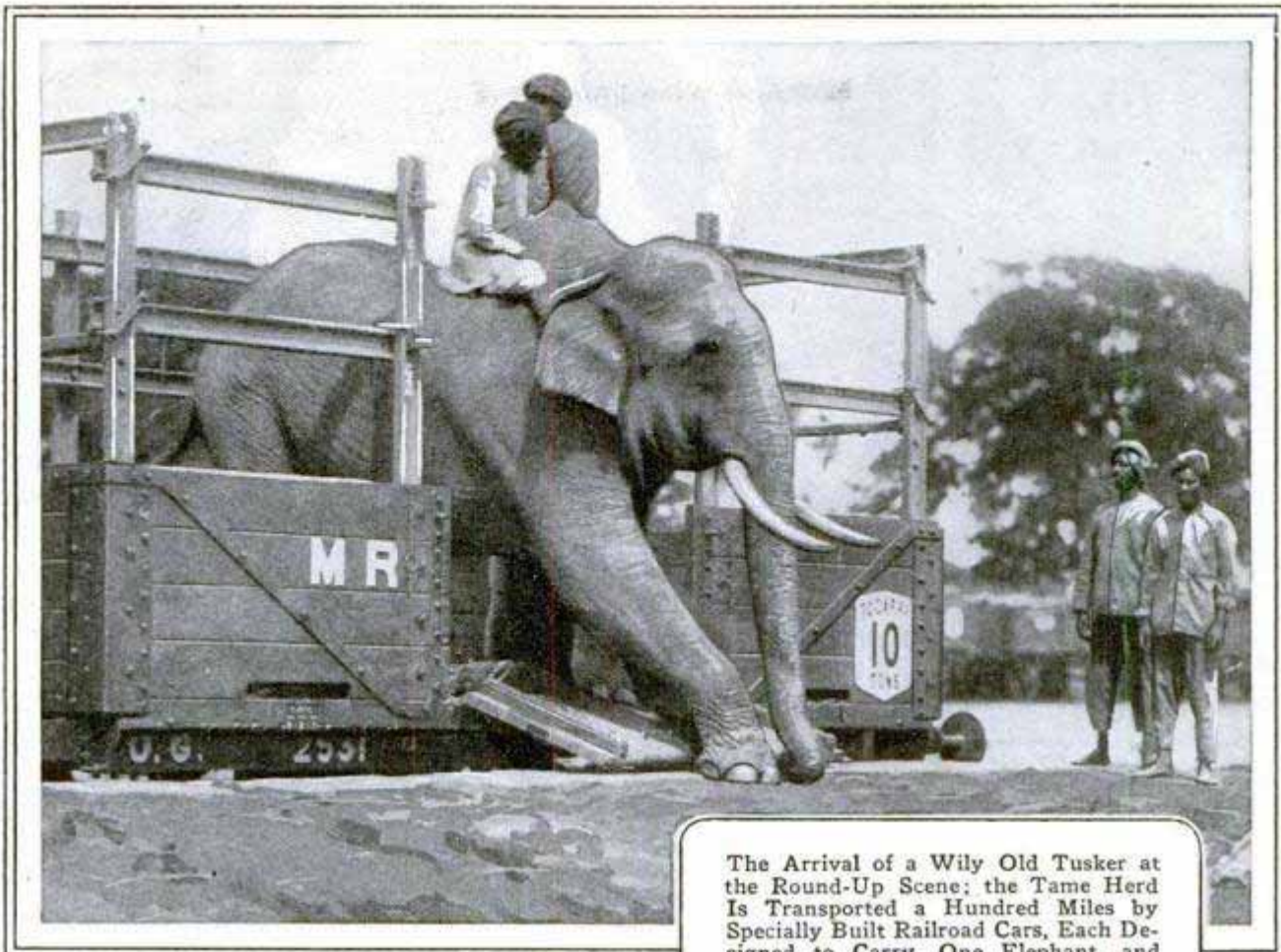

The Arrival of a Wily Old Tusker at the Round-Up Scene; the Tame Herd Is Transported a Hundred Miles by Specially Built Railroad Cars, Each Designed to Carry One Elephant, and Equipped with Special Shackles to Prevent an Accident if the Occupant Becomes Frightened during the Journey; Below, the Pit That Guards the Stockade against Attack by the Wild Herd; the Deep Ditch Is Revetted with Sticks to Further Discourage Any Attempt at Rushing the Wall



Canning Plant at Honolulu Hawaii

Paris 9^e arrondissement 17 Blvd. des Capucines

1048

U.S. Day - 215 Market St. Can. A. A. ...

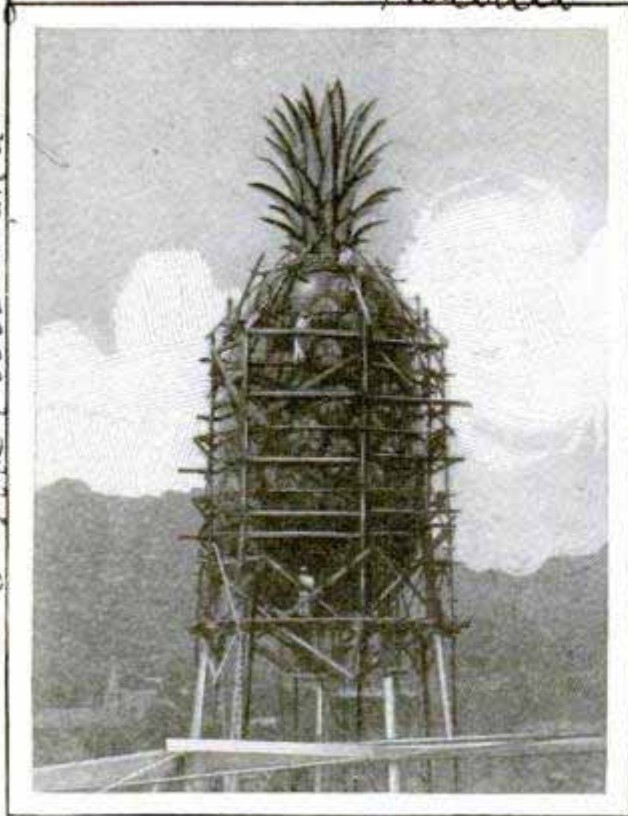

Water Tank in Form of Pineapple at Canning Plant in Honolulu

TANK IN FORM OF PINEAPPLE ADVERTISES PRODUCT

Water for the sprinkler system in a canning plant at Honolulu is contained in a huge tank, shaped like a pineapple to advertise the company's product. The tank holds 100,000 gallons, is sixty-four feet high and is mounted on a steel tower, 135 feet tall, so that it can be seen from almost any part of the city. Painted sheet-metal strips were used to form the crest of the "pineapple," which weighs fifty-five tons.

PUTTING MOLD TO WORK

Mold, a form of plant growth which spoils bread and other foods, is being put to constructive work. It long has been employed in the making of cheese and now scientists have found use for it in producing citric acid, formerly derived chiefly from lemons and other sour fruits, and to reduce the cost of another useful substance, gluconic acid. This formerly cost \$100 a pound. With the aid of mold, it can now be made for some thirty cents a pound. In the opinion of H. T. Herrick, of the department of agriculture, chemistry is just beginning to realize the possibilities of this queer fungus growth. It

may be harnessed to perform many other useful tasks, he believes, when the right kinds of food are supplied for it and more is known about its functions.

MAGIC LANTERNS IN SUBWAYS ENTERTAIN PASSENGERS

Patrons of a Paris subway line are enjoying picture shows as the trains speed through the tubes. Four magic lanterns have been installed in each car, two on each side, and the views are projected on the dark walls of the subway. Advertisements, pictures of celebrities and other features are shown. The lanterns operate automatically, and the show begins as soon as a train leaves the station.

RADIO AS DISEASE CURE

GIVEN NEW TESTS

To test various theories as to the efficiency of radio waves in treating disease, a special apparatus has been devised in France. It is so arranged that the radiations may be better directed upon the affected parts and, at the same time, there is a means for measuring the amount of absorption. In a test, a coil of copper



Part of the Apparatus Used in French Laboratory to Test the Curative Power of Radio

wire is wound around the arm, leg or other part, acting as a radio receiver.

Institute of Chemistry American Chemical Society

at the Institut d'Actinologie

Paris 9^e arrondissement 17 Blvd. des Capucines

1115

SUPER-HIGHWAYS FOR AUTOS TO CROSS THE NATION

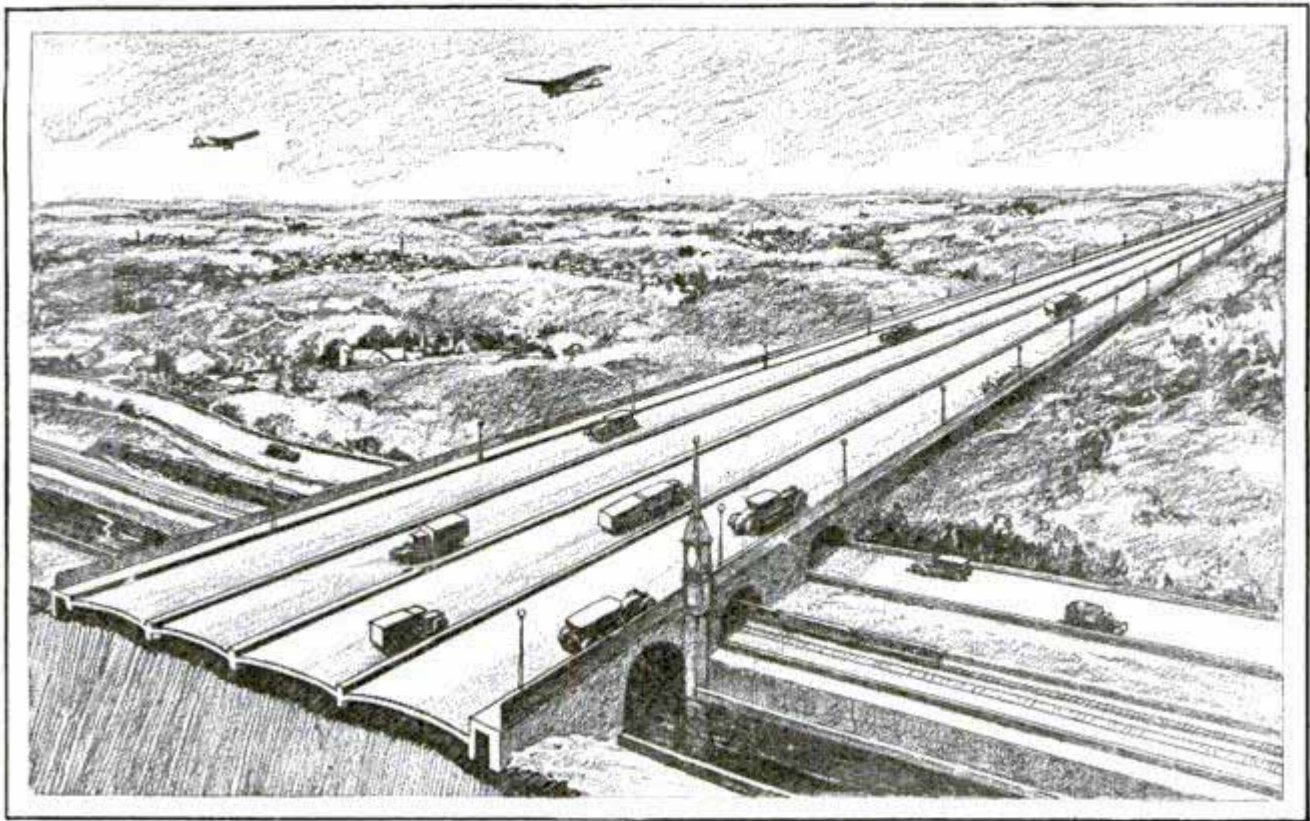

Sketch of Proposed Automobile Highway across the Country; the Inner Lanes Would Be Devoted to Heavy Bus Traffic, the Outer Ones for Pleasure Cars

Two wide automobile highways, spanning the country, one on the north and one on the south, are proposed by R. A. Carpenter, chief engineer of a Chicago park system, to provide for the great increase in motor traffic. The southern road would run from Savannah, Ga., to Los Angeles, Calif., a distance of approximately 2,800 miles. The northern route would extend from Boston to Portland, Oreg., some 3,350 miles. Each roadway would be 250 feet wide and have four different traffic lanes, two on the outside for lighter traffic and the two inner ones for heavy bus and truck business. The lanes would be separated by curbs and on each side of the highway would be a sidewalk, six and one-half feet wide. Mr. Carpenter proposes to have a right of way acquired for the roads, just as was done in building the railroads. He estimates that both lines could be constructed for \$4,600,000,000, including the cost of the land which could be obtained by condemnation proceedings. Although the sum is a large one, it is believed that a toll charge would rapidly defray the cost, and that the highways would be heavily patronized, as they would eliminate delays,

West Chicago Park Commissioner
 permit higher speeds than now maintained and eliminate detours. The big roads would be devoted chiefly to commercial and through traffic, entrances would be provided at intervals of ten miles or more, and it is thought that they would form the basis for a later system of lateral highways to connect them.

OILER FOR STORAGE BATTERY PREVENTS CORROSION

1078 Troublesome corrosion of automobile storage-battery terminals is prevented by an oiling unit devised by an Ohio inventor.

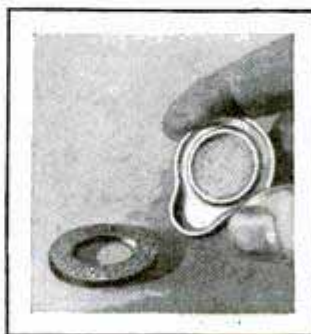

It consists of a lead oil reservoir, shaped like a large washer, which fits about the battery-terminal post, and a felt washer above the reservoir. The two pieces are held in place by the terminal clamp.

Lubricating oil is poured into the reservoir, a few drops being added each month. It forms a thin film on the terminal.

*W. A. Co.
 176 W. W. W. Ohio*

no data available
no data available
land E. H. Hinman

1074
Installed by Metro Station
Police, no data



Traffic Light with Alarm Attachment Rung If Car Crosses the Line; the Signal Wire Is Seen at Right

DANGER BELL TRAPS AUTOS RUNNING PAST LIGHTS

One policeman can supervise the lights along half a mile of streets under a system recently introduced in England. It operates in somewhat the same manner as the automatic signal controls except that the human attendant makes the changes by means of an electrically operated lever. Should a car run past the stop light, it passes over a wire which causes a bell to ring, warning the motorist and signaling the policeman at the same time.

BIG WINDMILL RAISES WATER NINE HUNDRED FEET

Using windmills to pump water, generate power and perform other tasks is not a new idea, but not many persons realize what great improvements have been made in the mills in the last few years. Wheels are now made as large as twenty-two and one-half feet in diameter, they have tapered roller bearings, unusual oiling capacity and are otherwise equipped for long service with a minimum of attention. On a southwestern cattle ranch is a wheel sixteen feet in diameter, used to pump water from a well 900 feet deep. It is mounted on a tower thirty-five feet high and the complete millhead weighs 2,800 pounds. In spite of this great lift, the pump is operated efficiently even with little wind.

The Artell Co, Fort Worth, Texas.

the borax should be used only where its effects on animals and on plant life will be of no serious consequence.

BORAX FATAL TO MOSQUITOES

One and one-half parts of borax to a thousand of water proved fatal to mosquito larvæ, Cornell University scientists have found. They used it with good results on rainwater barrels, cisterns and other places where the mosquitoes multiply, and discovered, also, that the borax holds its larvæ-killing powers for a long time. One experiment lasted nearly two months but the solution did not lose its strength. The investigators add, however, that

LOOK AT WORLD UPSIDE DOWN TO TEST SENSES

Glasses that show all objects as though inverted, are worn by subjects taking special tests at an eastern university. Since they isolate the sense of sight from its co-ordination with the other senses, they help determine how intimately the senses are related when the subject tries to perform tasks while gazing through them.



Looking at the World through Glasses That Show Objects Upside Down to Test the Senses

1136
Det. H. H. Hinman
1.3
Science

no Chicago

Hubbard, Secretary, Bureau of Standards

Solving the Secrets of Life

When At Re Y S
WHEN Ray Keech, daring motor racer, drove a specially built car at a velocity of 205 miles an hour, shattering all automobile-speed records, the world acclaimed his feat.

Yet the thrilling speed which he attained was a snail's gait compared with the possible velocity of atoms and their electrons. The latter, which are following circular and elliptical courses, make trillions of revolutions a second at speeds which man cannot even conceive. An atom of air moves a mile a second—twice as fast as a bullet moves.

In a single gram of radium, for example, many billions of atoms explode every second, each shooting a helium-atom nucleus 12,000 miles a second or sending out electrons with approximately the speed of light.

Radium emits a new kind of high-frequency radiation called "gamma rays." When exposed to these rays, iron is as transparent as glass. Eleven distinct explosions occur in the various transmutations of radium atoms and after each explosion, the atom changes into an entirely different element.

An atom is the smallest unit possessing the characteristic properties of any chemical element. Small wonder they are difficult to study, for forty thousand million million of them at rest would cover an area of but one square inch. If atoms were as large as baseballs, a mere thimbleful of air would provide enough to bury the United States under a blanket 1,000 feet thick. Despite the indescribable smallness of atoms, science has developed an effective method of weighing them

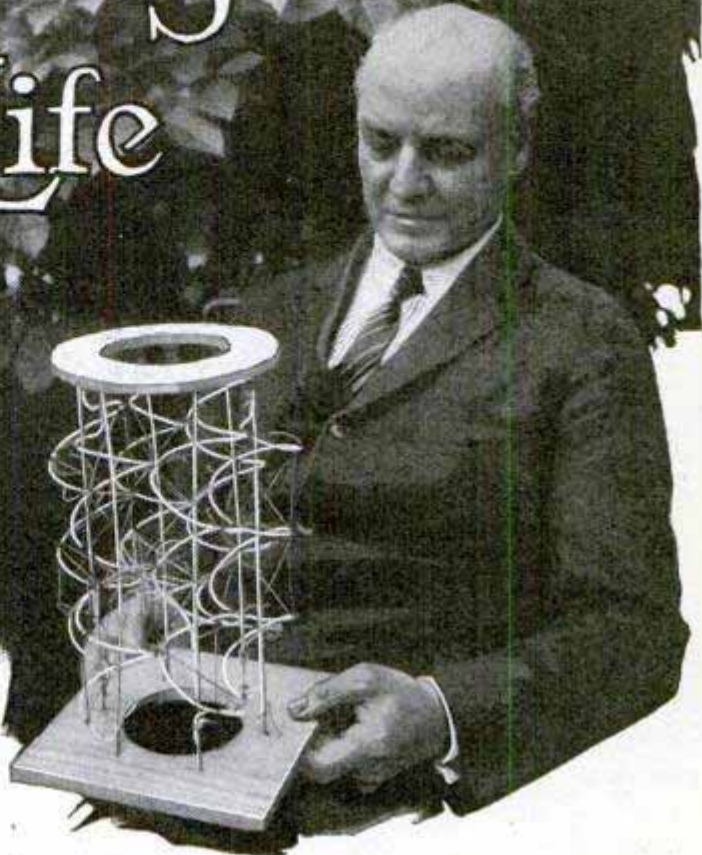

Model Illustrating, in Six Spirals, the Formation of the Quartz Crystal, with a Knotted Thread Marking Each Electron

after they are shot from electric guns. They also have been photographed. The atom in action resembles a shooting star speeding through space. Its collisions with other atoms produce light or fire. By proper amplification, the sound of an atom striking a target can be tuned to the perception of the human ear.

The cherished dream of the alchemists may eventually become a reality if future adventures in atom hunting yield such valuable discoveries as have past experimental quests. Atoms of many elements already have been broken up by shooting electrons from these atoms or shattering their nuclei. Scientists now seek to build up such nuclei at will. When they master that art, science will be qualified to transmute elements—an epochal eventuality.

Once the world thought there were four elements—fire, air, earth and water. Then the number kept on increasing until, about the middle of the last century, scientists thought the total probably was innumer-

cont. in the story, p. 63
... ..

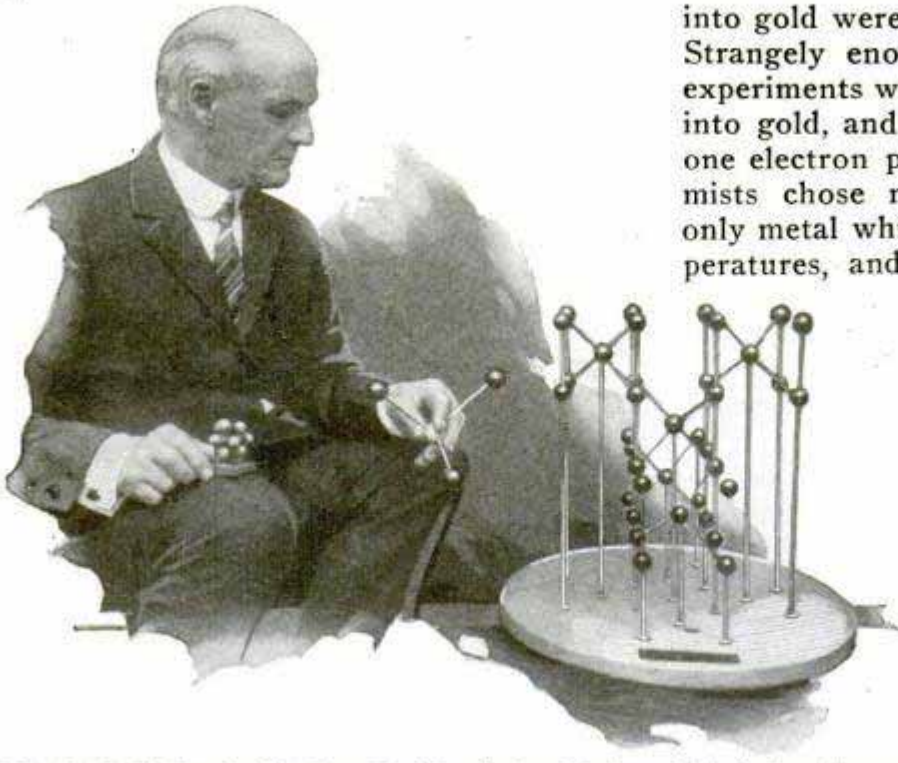

Mr. H. D. Hubbard with Three Models; Carbon Nucleus, Left, Carbon Atom, Center, and Diamond, at Right

able. Now science has cut the number down to just ninety-two, of which ninety are known. The question immediately arises of how science could write down the list from hydrogen, No. 1, to uranium, No. 92, and put a period there, definitely saying there is nothing beyond uranium, nothing before hydrogen, and nothing in between the elements on the list.

The answer is that every element is composed of atoms, and every atom is made up of one proton, a unit of positive electricity, and a varying number of electrons, or negative electricity, the latter revolving around the proton.

The atoms of the various elements are now believed to be made up this way, the difference between any two consecutive numbers in the list of elements being one electron per atom. In other words, hydrogen, first on the list, is made up of atoms having one proton and one electron—the simplest structure of all. Helium, the rare gas used to inflate American dirigibles, comes next, with one proton and two electrons per atom. Lithium is third. If science could find a way to add one electron to each atom of hydrogen, that highly inflammable balloon gas would be converted into safe helium.

In other words, the ancient alchemists who sought to transmute other elements

into gold were working on the right idea. Strangely enough, one of their favorite experiments was to try to change mercury into gold, and mercury and gold are just one electron per atom apart. The alchemists chose mercury because it is the only metal which is fluid at ordinary temperatures, and they reasoned it was already in such an unstable state that it might be easy to make gold out of it.

Recently scientists have demonstrated that it is probably entirely feasible to make the change, but that it would cost so much for electricity that it would not be profitable.

But why does science know that there are only ninety-two elements? The answer is that, as more electrons are added,

the structure of an atom becomes increasingly complex until finally it reaches a stage where it is no longer stable. The result is radioactivity, which is possessed not only by radium, eighty-eighth on the list, but also by the four that follow: actinium, thorium, uranium X, and uranium. These five, being unstable, are constantly breaking down and changing into simpler forms, and it seems certain that beyond uranium the atomic structure would be so intricate that it just could not live.

The alchemists, whose misplaced efforts were for so long a joke, really were scientific in their way, and laid the cornerstone for modern chemistry. One of them, Brand of Hamburg, Germany, sought to make gold by combining everything he could find in his retorts, and eventually discovered phosphorus, the first element ever discovered in a laboratory. More than fifty years later a Swedish chemist, Gustav Brandt, investigating some curious ore found in German copper mines, discovered another. The ore looked like copper, but the miners had found they could extract no copper from it, so they called the stuff "Kobold," after a demon who was supposed to be intent on annoying miners. From the ore Brandt extracted and named our modern cobalt. In 1751, the German chemist A. F. Cornstedt,

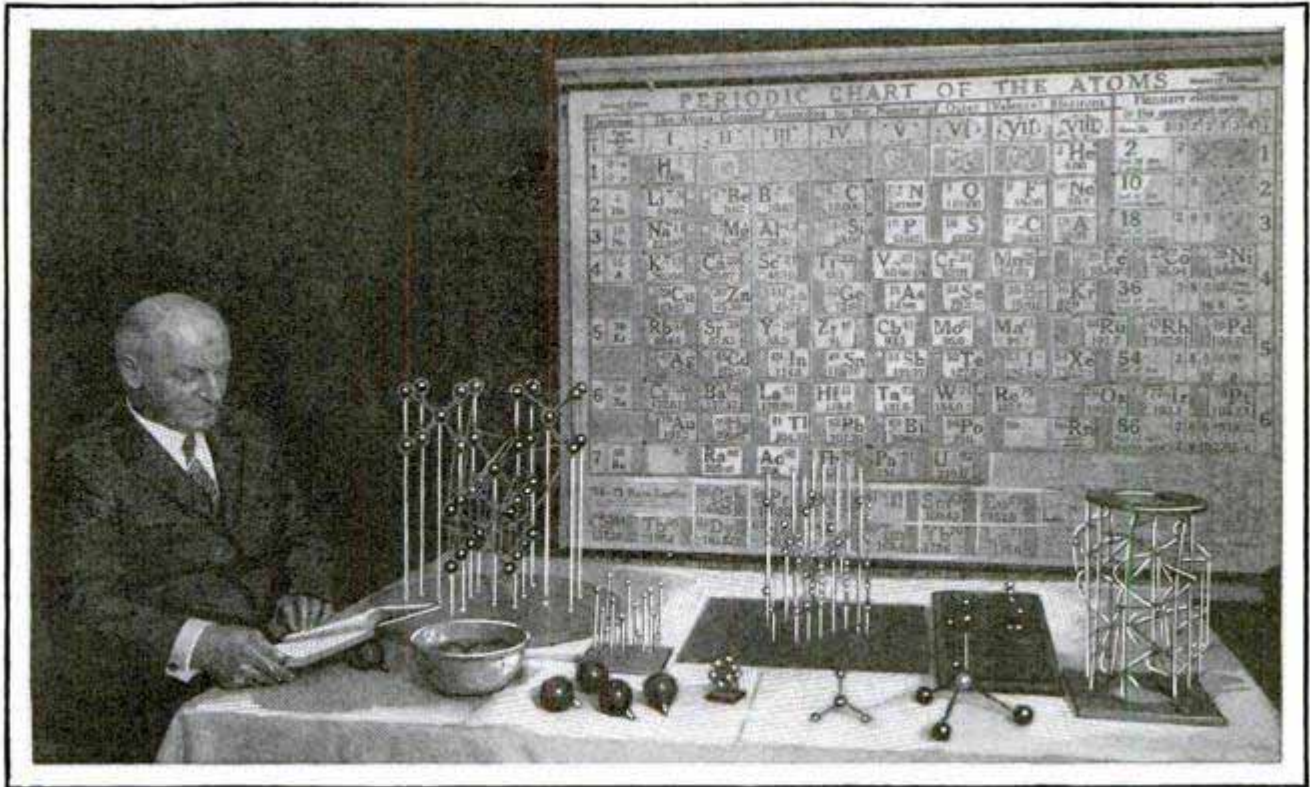

Periodic Chart of the Atoms and a Group of Atom Models Devised by H. D. Hubbard, Secretary of the Bureau of Standards, to Illustrate Theories of the Composition of Matter

by the same methods, extracted another element from the same ores, which he named nickel, taking the word from "kupfernickel," meaning "copper devil," another name the miners applied to the demon Kobold.

Those discoveries were the foundation of modern analytical chemistry. In the latter half of the eighteenth century, Henry Cavendish discovered an old formula written three centuries earlier by the great alchemist Paracelsus and from it prepared a gas he called "inflammable air." That gas was hydrogen, still used to fill balloons and airships when helium is not available.

The element nitrogen, that forms four-fifths of the air, was discovered by a botanist, Prof. Rutherford of the university of Edinburgh, in 1772. Two years later, Joseph Priestly, of Philadelphia, separated the life-giving element of air, oxygen. In the same year Scheele, of Sweden, discovered the element chlorine, first poison gas used in the World war, and the purifying agent in most municipal water plants.

By 1804, twelve new elements had been added to the list of such common ones as gold, silver, copper, iron, tin and a few others known to the ancients. Three years later, Sir Humphrey Davy, the inventor of the miners' safety lamp, added a whole list of new substances. Davy,

a druggist's clerk, had discovered nitrous oxide, and on the strength of that obtained a chemical appointment. Experimenting with the effects of an electric current on various chemicals, he discovered sodium, potassium, calcium, strontium and barium. His was one of the greatest achievements in chemical research, until the invention of the spectroscope initiated the method of investigation used today.

The spectroscope is simply an arrangement of prisms to break up light into its primary colors, producing artificial rainbows by refraction. Its value lies in the fact that when any element is heated to the point where it gives off light, that light, when analyzed, contains exactly the same wave bands as any other sample of light from the same material. It is because of this that astronomers know what elements are in stars millions of light years away.

With the spectroscope to aid them, scientists added new elements rapidly. By 1920, there were only six of the ninety-two missing, and now all but two have been found. The last one located, illinium, was found by Prof. B. S. Hopkins, of the University of Illinois, and named for his state.

The two missing ones are Nos. 85 and 87 in the scale. No. 85 is expected to be

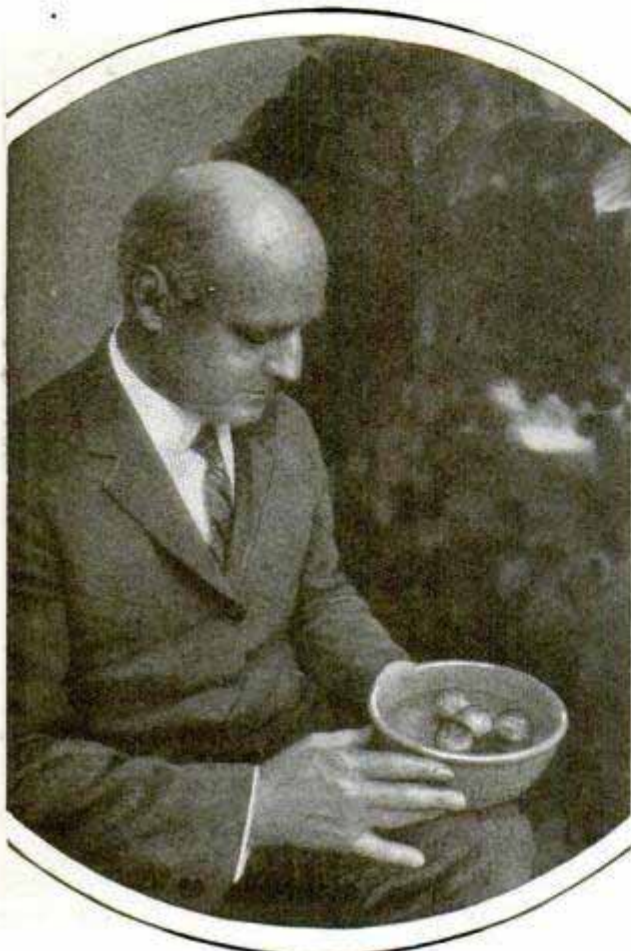

Demonstrating the Attraction of Unlike Electrons with Floating Magnets of Celluloid and Cobalt Steel

somewhat similar to the familiar element iodine, and No. 87 is expected to be like the series of alkali metals, that is, lithium, sodium, potassium, rubidium and caesium. Because of its location next on the list to radium, it also is considered probable that it will show traces of radioactivity.

Much of the credit for the elucidation of the atomic theory goes to Henry D. Hubbard, secretary of the U. S. bureau of standards and compiler of the periodic chart of the atoms used in classroom instruction. The chart is really the foundation of modern chemistry and the alphabet of the universe. He also has originated numbers of models to show the structure of various materials.

One of his sets of models, depicting the formation of carbon nuclei, carbon atoms and diamonds, visualizes the hidden reason for the diamond's exceptional hardness and strength, as well as its clarity. Strength and hardness are due to the arrangement of the atoms, and clarity to the "space patterns" which their peculiar arrangement provides. Pure silicon, gray Germanium and tin have about the same gen-

eral structure as the diamond, but lack both its stupendous strength and density and the space patterns that make the precious stone transparent.

Edison once said that "some day we shall say to an atom in a rose, 'come and go into this other flower.'" Science already is able to accomplish transformations much more subtle, for, by merely shooting electrons of the right speed or by use of rays of light of the right frequency, it can change the electron arrangement of an atom. "We are fast learning," says Mr. Hubbard, "the exact voltage to use in removing any electron from any atom, or for moving such electrons from any energy level to any other at will."

It is to further this work that the Germans are attempting to trap 30,000,000 volts of lightning on a Swiss mountain top, and scientists of the Carnegie Institution are attempting to produce equally high man-made lightning charges in the laboratory. With 30,000,000 volts it is believed any atom can be broken down, its energy released, or its nature converted into some other element.

With a group of cobalt magnets inclosed in celluloid balls about the size of golf balls, Mr. Hubbard illustrates the formation of atoms through the arrangement of electrons about the central proton. Placed on a smooth-glass desk top or floated in water, the magnetic balls always arrange themselves in characteristic patterns, according to their number. With one positive nucleus and three negative electrons, the four balls will always form a group with the positive one in the center and the three negatives grouped around it equidistant from each other. They can be jiggled about and moved at will, but when released will always return to their own arrangement.

One positive and two negatives always form a line, with the positive in the middle. Two positives and one negative form the same sort of line, with the negative between the other two. Three negative balls placed in a basin of water move as far apart as possible, for like charges repel. It is the attraction of opposites that keeps the electrons grouped about their proton in the atom, and the opposition of like charges that keeps the electrons distrib-

uted in their space pattern. In one of Dr. Hubbard's demonstrations, two positive and two negative balls form a cube in the water, with plus and minus alternating around the square. Each edge of the square, with one positive and one negative ball, represents a hydrogen atom, and the entire square a hydrogen molecule.

The arrangement of the atoms is responsible for the various characteristics of each element. Lead, aluminum and similar metals are soft and ductile because their flat, cubelike atoms are face-centered, that is, their flat surfaces face each other, and atoms in one layer can slip smoothly across those in the next. On the other hand, iron, tungsten and similar hard metals have body-centered atoms, interlocked so that they do not slip easily.

One of the marvels of modern chemistry is the way in which the experimenter takes the atoms and fits them together into new synthetic products.

Thousands of these atom groups have been produced by the chemist, such things as thein or caffeine, which stimulate gently without developing intoxication; like adrenalin, which duplicates nature's control of the heart and lungs; like the synthetic dyes that produce new colors, the synthetic perfumes that rival the flowers of nature, and like the many medicines that heal disease, relieve pain or produce sleep.

"Atoms are veritable wonder workers," concluded Mr. Hubbard. "They are responsive as living things, and they also may be energized like the human body; they labor industriously as jewelers of nature and crystal builders, while they are also the expert makers of molecules, and even manufacture far-away stars. We stand on the threshold of the very mastery of nature through the control of atom combinations and the release of the energies they can absorb."



Prä in Berlin
Leading Dog to the Training Grounds; Animal Is Watching the Man He Is to Attack

TRAINING SCHOOL FOR DOGS AID POLICE DEPARTMENT

To train dogs for police duties, special schools are maintained under the direction of experts who understand the animals and know the tactics of criminals. One of the teachers wears a padded coat so that the dog cannot injure him.

1039

GUARD FENCE AROUND PLANE PROTECTS AIRPORT CROWDS

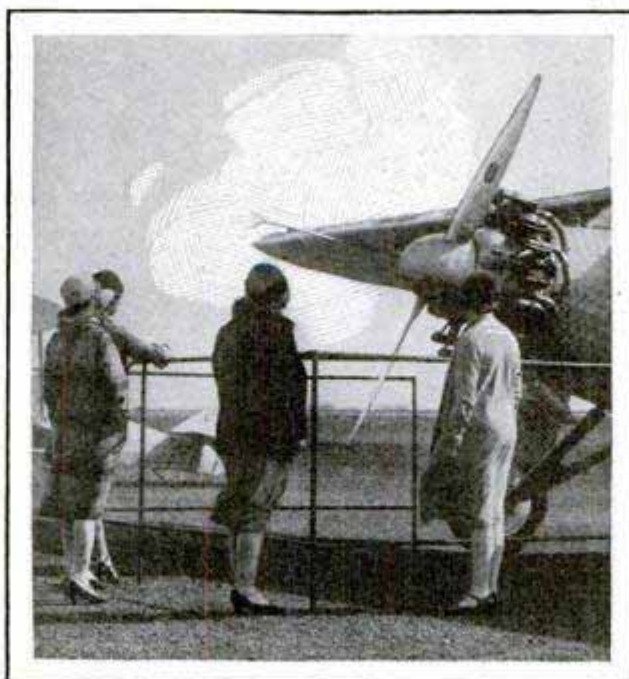

Fence in Front of Airplane to Protect Visitors

Spectators have caused so many near-accidents at the Oakland, Calif., airport that officials have constructed a portable fence to keep persons away from the propellers. As soon as a plane lands and has taxied to its position on the field, the guard is immediately set in place around the ship so that visitors are kept at a safe distance from the whirling propeller blades.

Municipal

See the big one, No. 204, Berkeley Calif

1059

Yonkers, N.Y.

slane lee job found

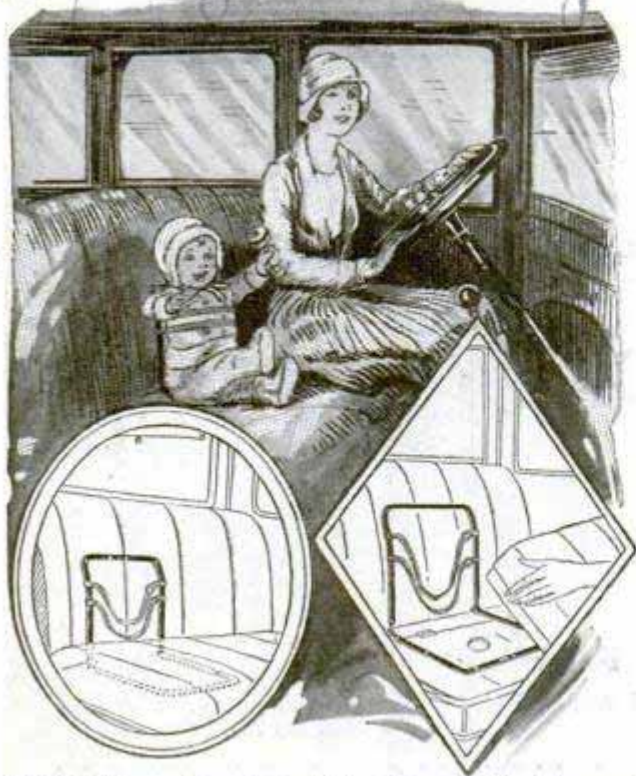

Seat in Place; How It Is Adjusted under Cushion, and in Use, with Straps about the Baby

SAFETY AUTO SEAT FOR BABY SAVES MOTHER WORRY

Infants ride in the automobile with safety when strapped to a special seat that rests securely by the driver's side. The bottom part fits under the cushion, which holds it in position, while bands attached to the back are carried about the baby's waist and chest. The unit is of special service when driving with small children.

ALTIMETER TO DEFEAT FOGS AIDS SAFER FLYING

Among the devices being tested by the army air corps for safer flying is an improved altimeter that registers the exact distance between the plane and the ground objects below at all times. This would give a pilot reliable information as to his altitude even if he were flying through fogs or in darkness. Instruments now in use are operated by atmospheric pressure and show distance above sea level. Few of them are effective below 1,000 feet. Other experiments are being made with an installation to reduce the danger of landings in bad weather. It is a series of wires, radiating from the center of the airport and from each wire signals are sent to the

Chicago Tribune 7/22/28

receiving apparatus in the plane, telling the pilot how to govern his descent when visibility is poor.

RICHES FROM THE JUNK PILE CUT RAILROAD EXPENSES

Bright new tin buckets, cups and other articles are being manufactured from old metal roofing, empty powder and carbide containers and other junk salvaged by the railroads. Old broom handles are made into staffs for signal flags, old canvas is transformed into curtains for the locomotive cabs and coaches, steam-pipe coverings and aprons. Thrift practices such as these save the carriers hundreds of thousands of dollars annually, according to the American Railway association.

Christian Science Monitor 7/24/28

RADIO TOWER ON MOUNTAIN REACHED BY CABLE CARS

Radio waves speed to all parts of the world from station WOKO at Mt. Beacon, N. Y., but to reach the broadcasting towers, visitors use a cable car on one of the steepest inclined railways in the country. The high steel supports, resembling huge spider webs, when viewed from below, are 1,540 feet above sea level.

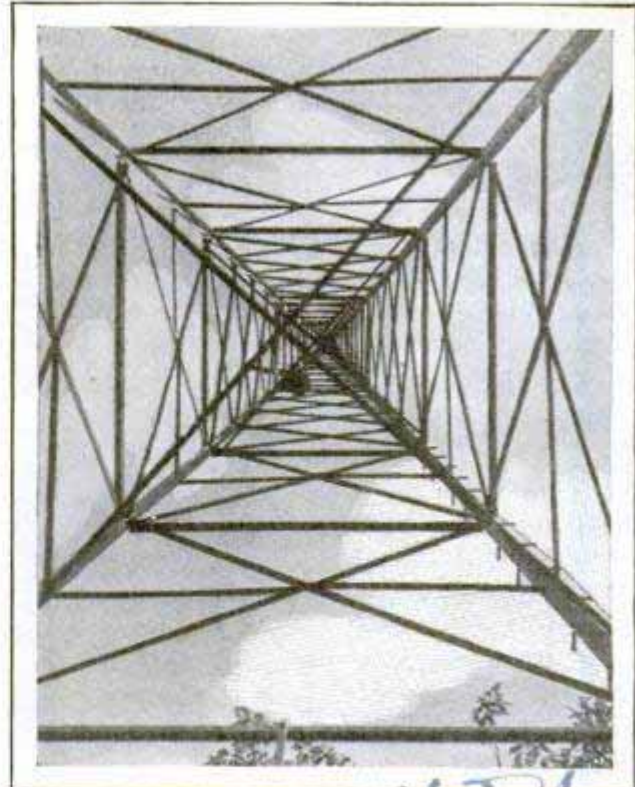

Looking Up under One of the Radio Broadcasting Towers at Mt. Beacon, New York

111 E 40th St New York

1081

TWO-DECK SLEEPING CAR HAS HOTEL COMFORTS

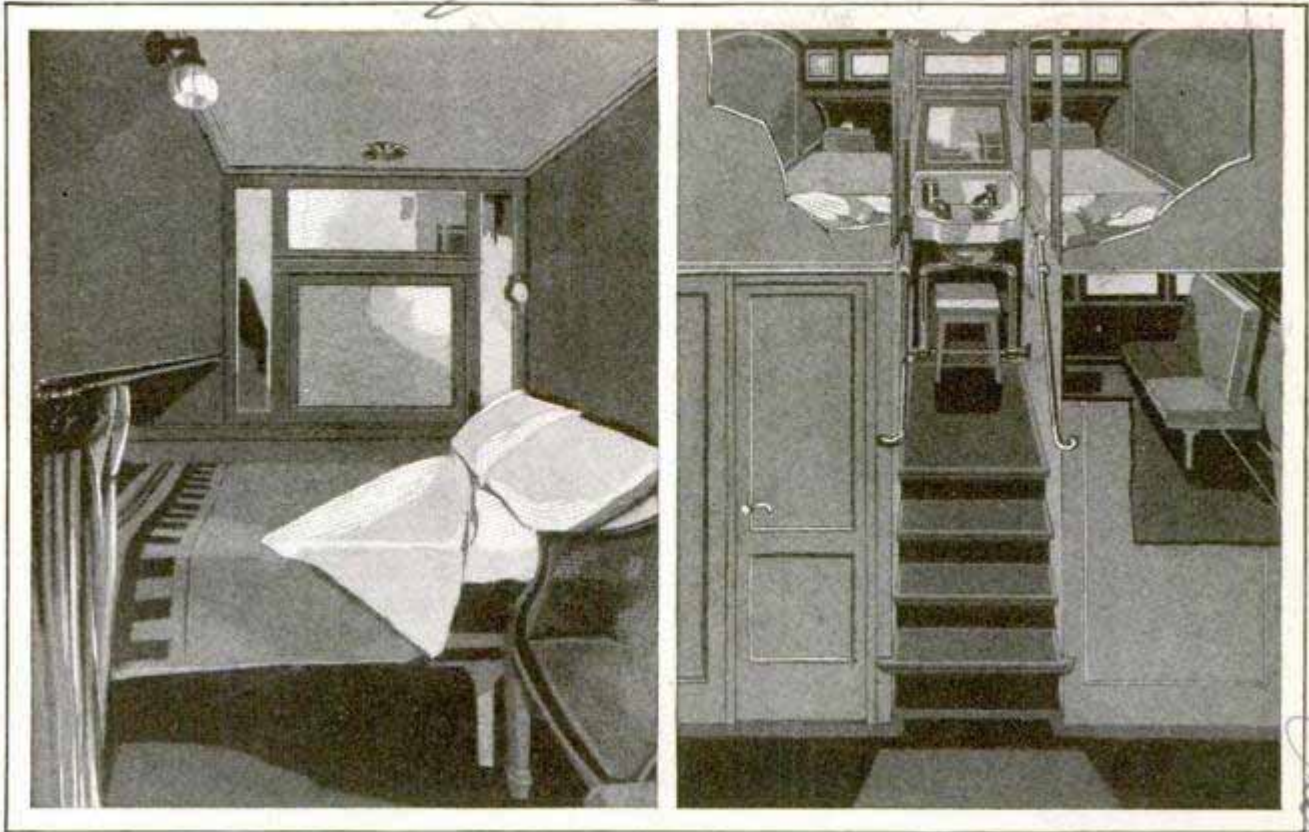

At Left, Lower Room of Double-Decked Sleeping Car, with Berth Made Up, and, at Right, Steps Leading to Platform, and View of the Upper Berths with the Washstand between Them

Conveniences of a hotel room or a liner cabin may be enjoyed on the railroad in a double-decked sleeping car designed by an eastern architect. It provides better facilities for dressing, greater privacy, and each berth, or room below, has an individual washstand and other plumbing, while the same advantages are provided for each pair of upper berths. Instead of the usual center aisle, a passageway runs along the side of the car for about two-thirds of its length. From this passage seven rooms open, each with complete plumbing. The ceiling height is about seven feet. There is a comfortable armchair and a seat which, at night, forms part of the double bed and, during the day, may be shifted to any position desired. An ample recess provides space for luggage. Between the rooms, and opening from the passageway, are steps leading to the upper berths. There are sixteen of these crosswise of the car, with a window at either end. There are also lockers for luggage and the berths are two feet longer than the usual kind. The steps lead to a platform between the berths. At the foot of each bed is a washbasin and other plumbing,

and under the basin is a stool that may be used in dressing and to assist a person in getting into bed. Passengers occupying these "duplex" berths also have access to a day room, which may take the place of the club or lounge car.

Hamfden Auto Sofa & Metal Co
TOP OVER AUTO RUMBLE SEAT
1066 QUICKLY TAKEN OFF

For the protection of persons in the auto's rumble seat, a top has been introduced that can be taken off or put on in a few moments. It is snapped into place

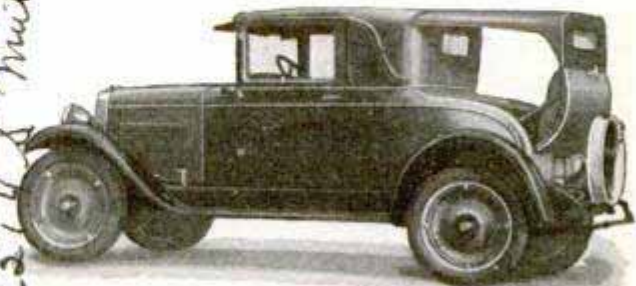

To Shield the Riders in the Rumble Seat, the Adjustable Top Stretched from Back

and keeps off sun and dust. Side curtains may be added for protection against rain.

Chicago Best Sales & Space 221 S Michigan

Model built by Constein National

Metal Co

Hamfden Auto Sofa & Metal Co.

33 1/2 W. 11th St.

4639 Montgomery Ave
Bellevue, Wash

41

Fighting Fire



In the Dugout Where Bureau of Standards Scientists Took the Pulse of a Burning Building by Batteries of Electrical Thermometers in the Search for New Facts about Fires

WHAT happens when the water hits the fire?

The fire goes out, true; but why, and does it go out right away, or does the water, as many experienced firemen claim, make the fire burn with a fiercer blaze just at first?

Firemen have been pouring water on fires since the days of volunteer bucket brigades, but ask any half dozen of them what happens when the water meets the flame and there is apt to be a disagreement.

On a recent Sunday morning the cream of Washington's fire department, supported by rows of policemen, turned out to watch the government burn down a five-story brick building with a two-story annex. It was a different sort of fire, for not a drop of water was spilt, and the firemen stood at ease while the floors crashed to the basement and the walls tumbled out on vacant lots on either side. For days afterward, they kept watch while flames continued to play through the debris until the last stick of inflammable ma-

terial had been consumed and the red-hot iron and almost molten bricks cooled down to normal temperature.

It was a scientific fire, and, in a heat-proof dugout several hundred feet away, groups of scientists, working in relays, kept watch for days over the recording ends of several score electric thermometers which had been placed throughout the building and crashed with it.

They learned things about fires which had never been known before, particularly the things that happen when a conflagration sweeps a section of the city and spreads so fast firemen can't reach the heart of it with their hose lines.

Keeping watch with them were representatives of every important office-safe and filing-cabinet maker in the country, for each had placed samples of his product, shiny in new paint, in the buildings, stuffed them with old ledgers and papers and then watched them go down with the ruins. Days later, when the ruins had cooled down, the safes and filing cabinets were

with - Fire

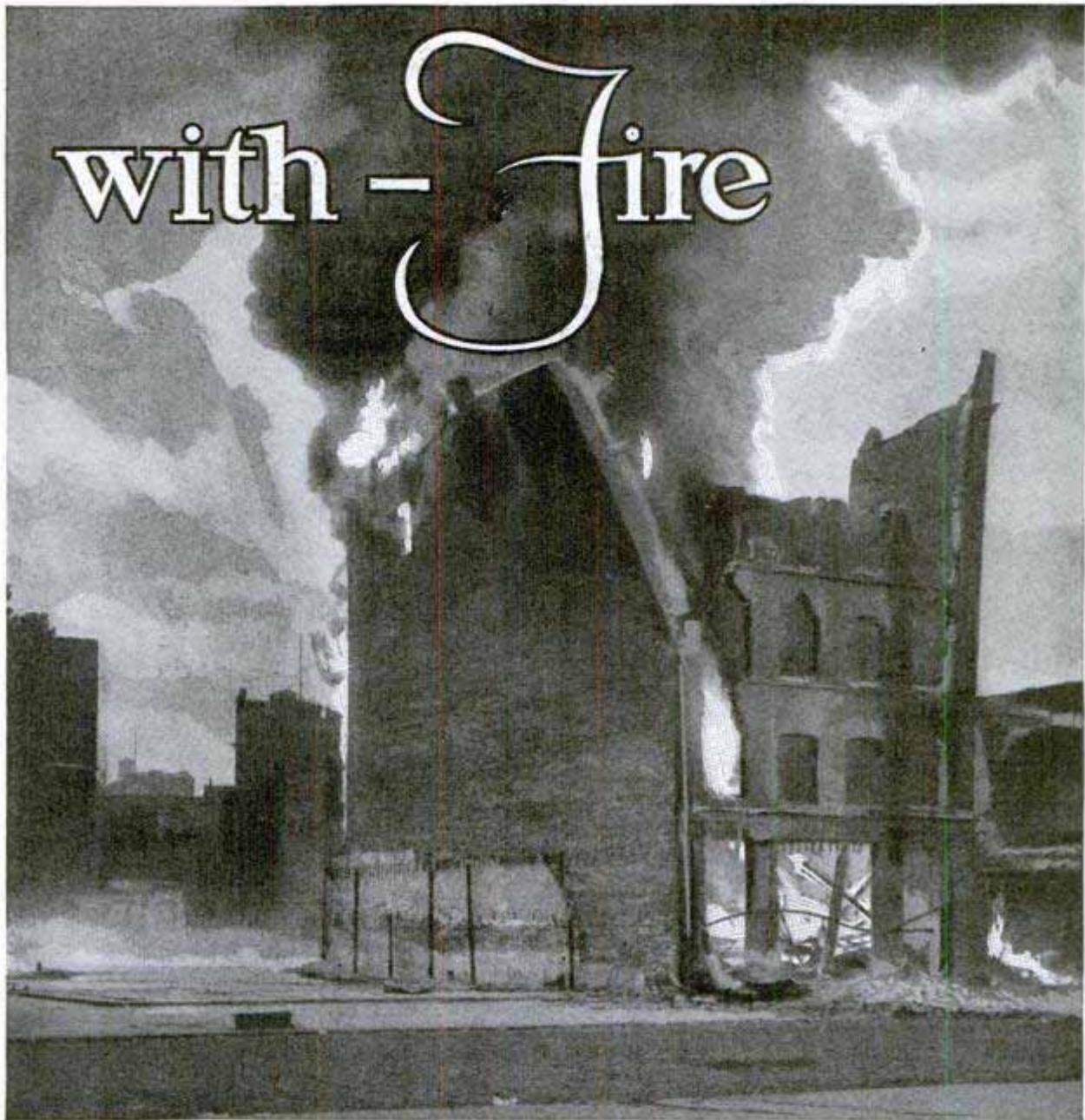

Just as the Walls Began to Fall; a View of the Five-Story, Washington, D. C., Building Burned by Government Scientists to Study the Effect of Fires on Office Safes

dug out, jimmied or burned open, and the contents examined to see if they had come through intact, charred but yet readable, or whether they had been completely destroyed.

For the first time science learned the temperatures which can be reached in an unchecked fire. Some of the 110 electric thermocouples recorded temperatures as high as 2,500 to 3,000 degrees. At noon the next day, thirty hours after the walls had crashed to the ground, recording instruments in the debris were still showing temperatures of 2,000 degrees, which is 400 degrees above the fusing point of iron.

Had water been turned on the fire at its

height, it is probable the firemen would have seen the flames increase for an instant, for at such temperatures the elements of water, hydrogen and oxygen, would be dissociated and burn as a gas. The same process, blowing steam into a furnace in which coal is heated to incandescence, is used in making water gas.

After the first flash, however, the fire would quickly subside, owing to the cooling of the burning material below the point of combustion. The water, and the steam generated from it, may also have some blanketing effect, excluding oxygen in the air from the flames, but the cooling effect is the chief one in putting out a fire.



The chief information the bureau of standards obtained from its personally conducted fire in Washington, however, is the temperatures a fire can reach when uncontrolled, and the time it can linger in the debris. The two buildings burned were part of a row being removed to make way for new government structures. To prepare them for the fire, a new steel roof was installed, to keep sparks from being carried upward and spread over the city, and the brick walls of the five-story structure were reinforced near the top with heavy steel rods, an inch and a half thick, stretching from wall to wall. The heat, however, was so intense that the mortar and bricks gave way, and fire experts estimated the rods did not hold the walls up for more than ten or fifteen minutes longer than they would have stood alone. When the bricks on one side gave way the red-hot bars whipped through the air like rubber bands and fell in an adjoining lot.

To duplicate conditions in an average office building, 150 tons of old lumber was stored in the building, representing the fuel that would be furnished by a normal quantity of office furniture. In one segment of the building, the fuel loading was seven and a half pounds per square foot

of floor space, in another double that, and in a third, it reached thirty pounds to the foot, the amounts representing three types of office and factory conditions.

Scattered on the various floors were the thirty-two safes and steel cabinets. In each one was an alarm clock, with an ingenious trip lever to stop it when the safe tumbled through the floor, giving the exact moment at which it fell. The safes ranged from 600 to 3,200 pounds in weight, and they fell from fifteen to fifty feet, depending on the floor on which they were placed. Besides the alarm clocks and their

load of books and papers, each safe contained from two to four maximum-temperature recording thermometers to show the greatest heat reached within the steel container.

The actual test, while the walls and floors held, was not so severe as that given safes in the

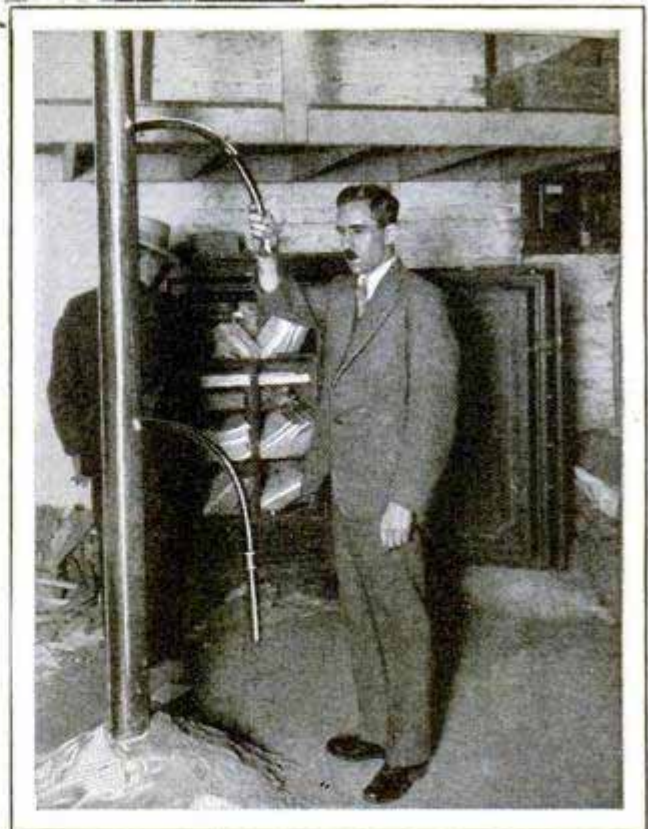

Rigging the Thermocouples, Setting an Alarm Clock in One of the Safes, and, Bottom, the Basement-Debris-Temperature Takers

fire underwriters' laboratories, where they are heated for hours in furnaces and then dropped three floors onto a hard concrete platform; but after the building collapsed the containers lay for days in the intense heat of the slowly cooling debris.

The bureau of standards has erected and burned a number of buildings during the last five years, most of them one-story brick, tile or wood structures, packed with obsolete furniture from various government departments. The opportunity, however, to destroy a five-story structure in the heart of a big city was unique. A mass of information has been collected from the fires and is being used to develop standards for fire-resisting building materials and construction.

Types of construction with different materials are first tested in gas-heated furnaces, and the time they will stand, for varying thicknesses, charted. Then experimental buildings are erected, loaded with furniture, and touched off, while electric thermometers record the temperatures reached. A sample office-building fire, with twenty pounds of combustibles to the square foot, is equivalent to a two-hour furnace test, and

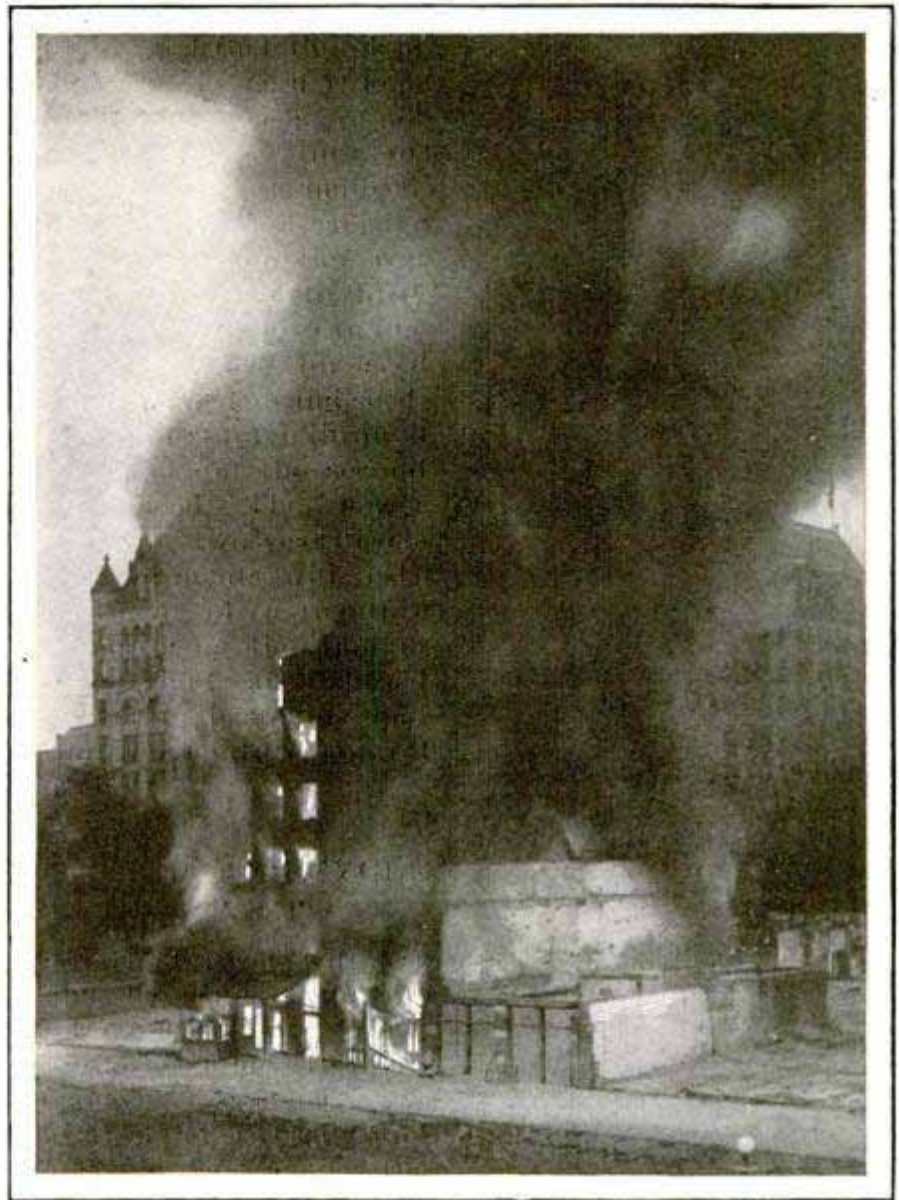

The Fire at Its Height, a Few Minutes after the Start; in the Background Is the Post Office Building

with fifty-five pounds to the square foot, it is equal to an eight-hour furnace fire.

Brick walls stood the flames for an hour, in the case of four-inch unplastered walls, to thirteen hours, for foot-thick ones. Plaster on both sides increased the wall's fire resistance about two and a half hours.

AUTO LIGHT THAT PIERCES FOG PROMOTES SAFETY

For automobile lamps or airplane landing-field lights, a special lens now on the market, projects an amber-colored beam which is said to penetrate fog much more effectively than the usual white light. The color is produced by the rays shining through a curious mixture of minute me-

talic particles that give the beam a contrasting shade as it is reflected from a highly polished metallic mirror. This makes it much more visible through the white mist, and the lens also reduces the glare. Pilots at a landing field in California report that one of the small lights, with a lens of this kind, can be seen through fogs and at distances when the big 7,500,000-candlepower beacon is invisible.

*Stone Fog Light Corp. Berkeley
901 3rd St. San Francisco*

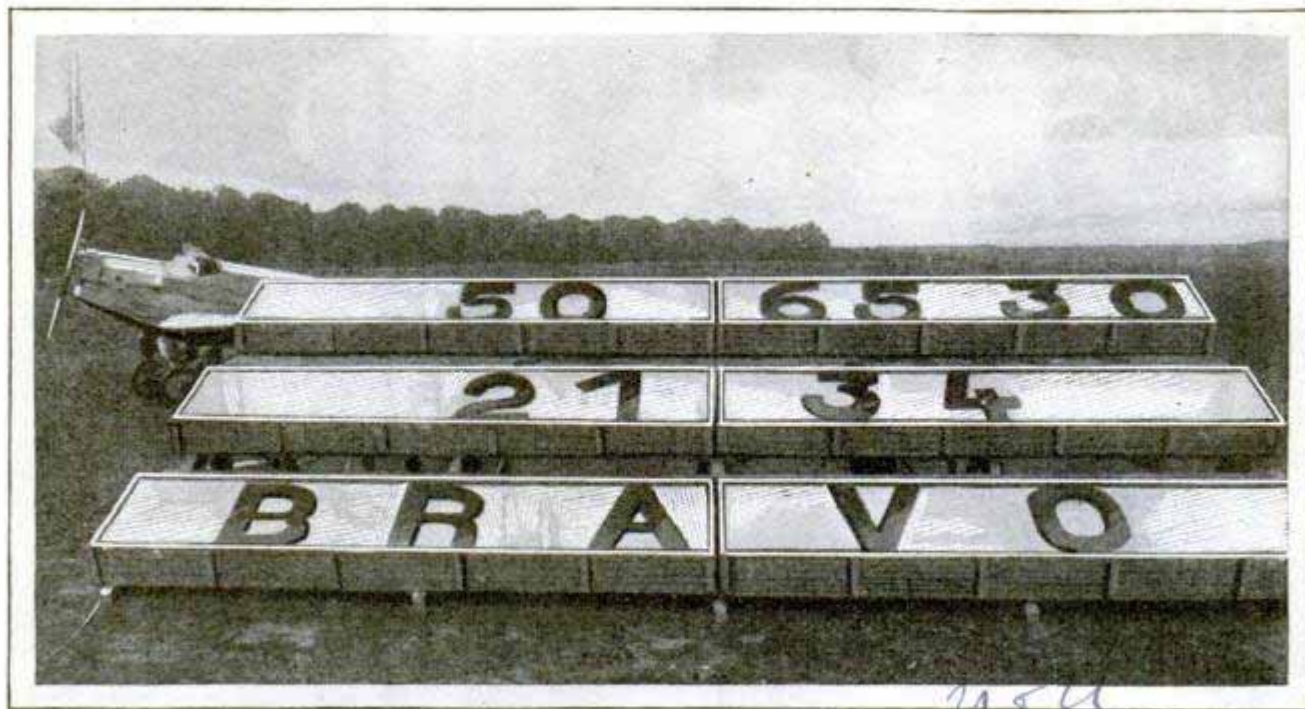

Scoreboard on Ground That Told the German Endurance Flyers How Many Hours They Had Remained Aloft and Gave Them an Encouraging "Bravo" to Cheer Them On

AIR SIGN BOARDS AID FLYERS WIN ENDURANCE RECORD

One of the aids to the German pilots who recently set a record of more than sixty-five hours of continuous flying, was a large scoreboard that showed the number of hours the men remained in the air. The figures were changed as the race progressed so that the flyers could tell at a glance by looking down on the board on the ground, just what performance they had made.

LIGHT WAVES EASILY BENT AROUND BALL

That light waves can be bent around a solid object as easily as sound waves overcome obstacles has been demonstrated by Mason E. Hufford, of Indiana University,

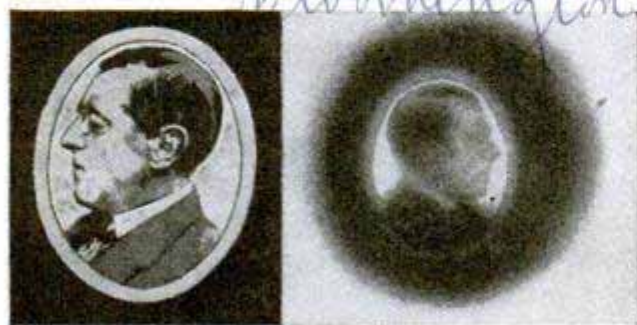

Original Photograph of Woodrow Wilson, Left, and Photo Made with Steel Ball as a Lens

who takes pictures using a steel ball for a lens. Mounting a picture in a small hole cut in a box, and focusing light waves from a carbon-arc lamp through the hole, Dr. Hufford suspended a steel ball half-way between the box aperture and a photographic plate, and succeeded in obtaining a clear photograph, instead of the shadow of the steel ball that might have been expected. The light waves, striking the ball, have their paths changed as they pass into the shadow behind the ball until they either unite or destroy each other, so that the ball acts as a focusing lens. By placing a figure of any kind in the opening in the box, an inverted image is obtained on the plate. Moving the ball closer to the negative enlarges the picture, while moving it toward the photographic plate reduces the size of the image.

SIX-HEADED CABBAGE PLANT HAS EIGHT-FOOT STALK

That controlled temperature has a more important effect on various crops than is generally known, has been shown by experiments at Cornell University, where a six-headed cabbage plant was grown on a stalk eight feet high after two years' cultivation under a constantly high temperature. Only when the plant was removed to a cooler place—it had been grown under seventy degrees Fahrenheit and above

leaf of 12 inches.

*Julian C. Miller
Science Service
New Columbia
D.C. 7/25/28*

RUBBISH BURNER IN TREE FORM
IMPROVES LOOKS OF YARD

—did it stop producing heads and form seeds. The tests indicated that the plant continues its growth so long as it is kept at a higher temperature, and seeds are not produced until a lower temperature, resulting in changes in the plant, is induced. Further experiments show that a cabbage plant requires only a two months' rest period in storage at thirty-five to forty degrees Fahrenheit before it can be transplanted to a greenhouse for seed production. Ordinarily, farmers and seed-growers put the plants in storage through the winter and set them out the second spring to produce seed. The newer method compresses the two-year cycle into one. Other experiments with cabbage by the department of agriculture have shown that increasing the amount of light to which the plants are exposed has little or no effect in hastening maturity, but that the temperature control is of prime importance.

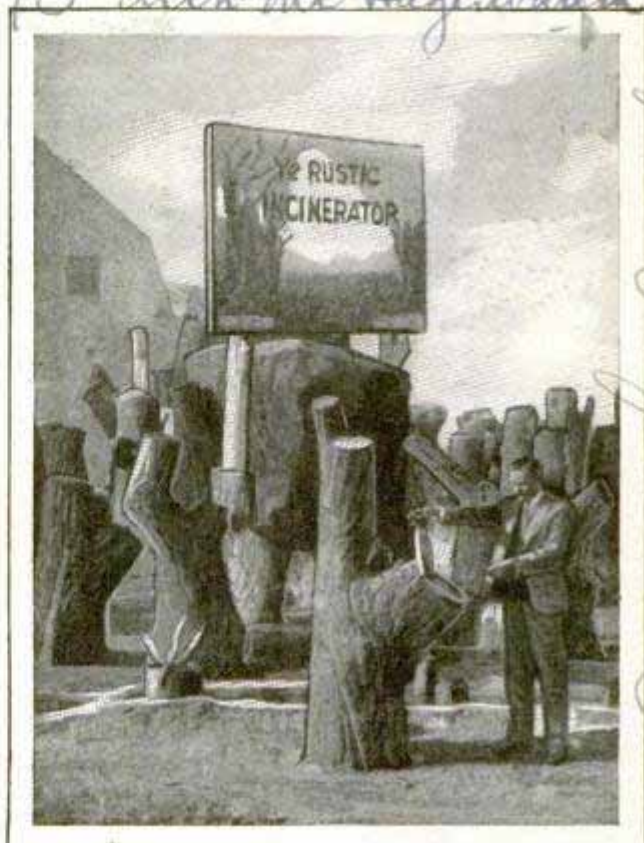

Rubbish Burner Disguised as a Tree Stump; It Is of Concrete and Realistically Grained

In place of the often unsightly incinerator, a concrete burner in the form of a tree trunk has been fashioned by a California man. It is finished in realistic color and graining to resemble a stump.

CENTER REST FOR MOTORCYCLE
AIDS FLYING START

Faster starts on the motorcycle with less trouble are possible by using a support that is adjusted to the bottom of the frame near the center of the machine. It eliminates lifting the rear wheel, as is necessary with the old type of stand, is easily and quickly attached and folds back against the



Support for Motorcycle Which Permits a Faster Get-Away and Is More Easily Lowered

footrests, out of the way, when the cycle is in motion.

WAR ON BLINDNESS

Although some fifteen per cent of the 100,000 blind men and women in the United States lost their sight through accidental causes, there has been a marked reduction in the number of persons blinded through industrial mishaps in the last few years, according to the national society for the prevention of blindness. Educational work has been done among more than 3,000,000 men and women in industry, during the last year, teaching them the importance of correct lighting and other ways to conserve their eyes and prevent accidents to them.

Whenever you find that you wish to know more about any article in this magazine, write Bureau of Information, Popular Mechanics Magazine, Chicago.

3329 Sunset Blvd Los Angeles Calif
575
9.3 Alt. Mrs. Haginbaum
H. W. Rogers, Los Angeles, Calif
invented
new
July 12 1928
Committee
370 7th Ave

Chas. J. ...
2. Clayton, Chief of Police

544

It Resembles a Plant, but Is a Section of Phone Cable with Smaller Wires Exposed



PHONE WIRES IN PLANT FORM SHOW CABLE STRUCTURE

To illustrate how a large cable is made up of many wires, a London company arranged the strands of a small section into the form of a plant. In all, there were 2,000 pairs of wires, and the novel display showed how they were wound and grouped.

FOODS MADE BY CHEMISTRY TO PREVENT FAMINE

Science will provide food no matter how rapidly the population increases, Dr. H. E. Barnard, an industrial chemist, declared recently in discussing a theory held by some persons that possibly a universal famine might result should the world become overcrowded with people. Legislation will prevent such an occurrence, Dr. Barnard believes, but even if the population should grow until there remained only one square yard of arable land for each human being, man still would be able to nourish himself with synthetic food. By putting yeast

plants to work to make food, thirty men, working in a factory the size of a city block, could produce as much food as 1,000 men cultivating 57,000 acres under present conditions. New types of vegetation that will store up solar energy with the same efficiency that coal has done, can be cultivated in parts of the earth such as the Sahara desert, where a section of land, forty miles square, receives in six hours as much solar heat as is produced by all the coal burned in twenty-four hours throughout the world. If necessary, chemists can extract fats and sugars from shale oil, coal or petroleum, and the vitamins necessary for growth and health can be synthesized in the laboratory. Science has reduced the average working day from fifteen hours to eight, Prof. Harry N. Holmes of Oberlin college declared.

MILL USES SALVAGED LUMBER AND CUTS LOGS IN SHAPES

Logs are cut into shapes instead of into flat boards by a system of sawmill operation introduced on the west coast. Salvaged lumber is also utilized to make built-up flooring. Scraps as small as one and one-quarter inches wide and sixteen inches long can be employed in fabricating room lengths in strips seven inches wide. The new method is said to offer distinct economies in mill operation and in freight costs.

FOLDING ARMREST FOR AUTOIST ADDS COMFORT IN DRIVING

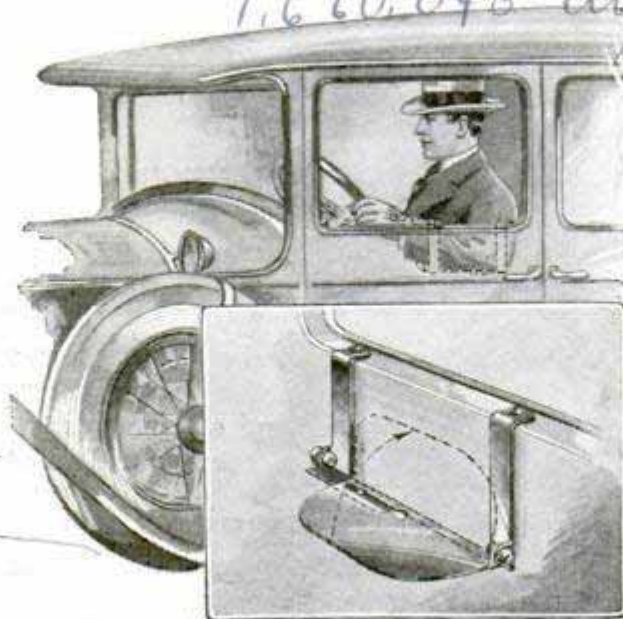

Drawing of the Armrest, Showing How It Tilts

For the convenience of the automobile driver, an armrest, easily attached to the door or interior of the body, has a folding sill that rises flat against the side when not in use so as to be out of the way. The attachment is of special benefit when the glass is closed, can be put on quickly and will not damage the upholstery.

Before of notable of Chemistry

of a coming...
Miss...
1917

1635...
Chicago
Mrs. Berk
1207...
Chicago

TEN-MESSAGE CABLE TO SPAN THE ATLANTIC

Ten messages may be transmitted at the same time, five outgoing and five incoming, on the latest Atlantic cable being laid from Newfoundland to the Azores. Engineers declare that it will be the fastest in the world. It incorporates an electrical principle known as "tapered loading" which permits it to be operated "duplex" or at full capacity, in both directions. The line will bring the number of Western Union cables in the Atlantic up to ten and will afford connection from New York to Germany, Italy and Africa through automatic relays at Newfoundland and the Azores. Since the beginning of the World war, cable traffic under the Atlantic has doubled, officials report. Last year, 93,000,000 words were handled, as compared with 39,972,000 words in 1913, the year before the war.

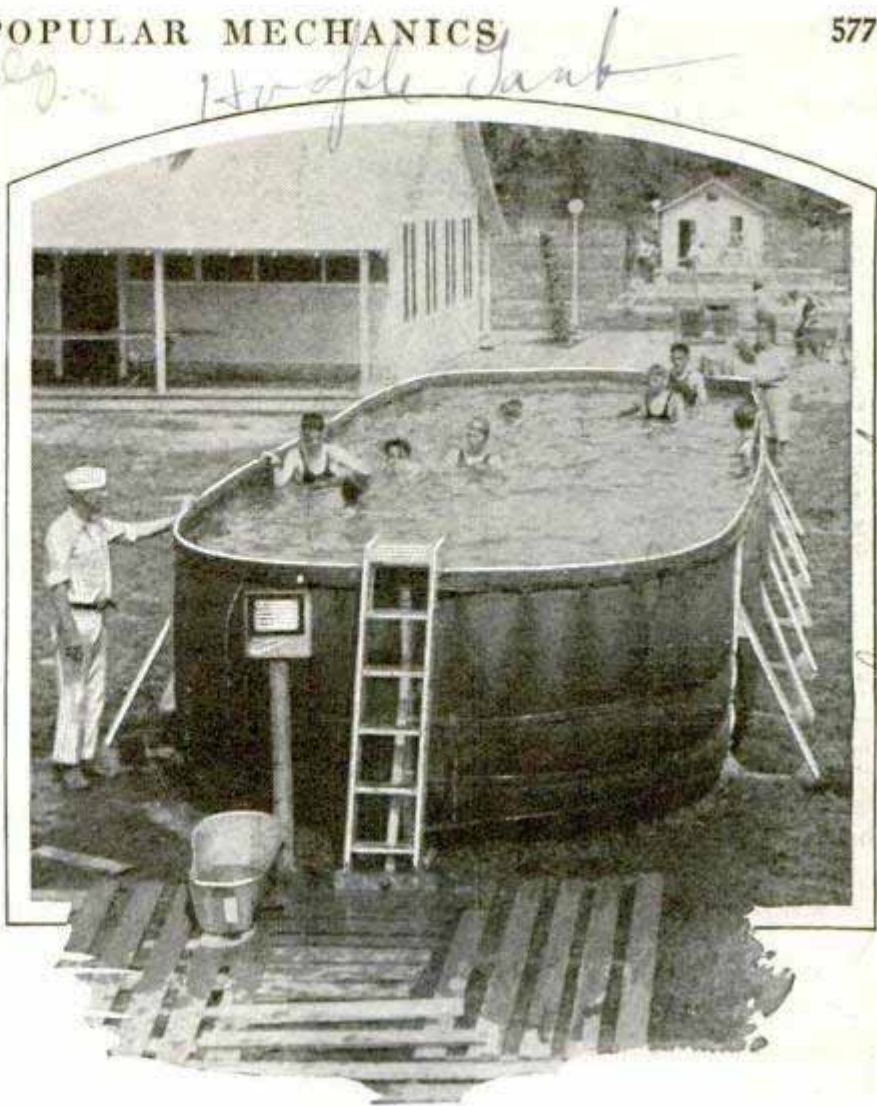

For Tired and Dusty Auto Tourists, the Portable Swimming Tank Set Up at Western Camp Accommodates a Number of Swimmers

PORTABLE CAMP BATHING POOL SERVES AUTO TOURISTS

Motorists visiting a western tourist camp enjoy the luxury of a swimming pool, provided in a portable canvas tank. It is easily moved from place to place, is large enough to accommodate a number of swimmers at once and can be set up in a short time.

TAP POWER FROM TROLLEY WIRE WITHOUT STOPPING CARS

Electric current may be tapped from the trolley wire with a recently introduced device which does not have to be removed when the street car passes beneath it and, so, does not interfere with traffic or with the work in progress. The unit consists of a special clamp that makes contact with the trolley wire and is attached to a support by a hinged arm so that the trolley wheel of the car can pass along the wire without interference.

DOOR SNUBBER ENDS SLAMMING AND HELPS FIGHT FLIES

Doors cannot be noisily slammed and are kept tightly closed by means of a simple snubber unit which can be attached to any door in a few moments. It is merely a plunger-and-cylinder arrangement, the cylinder being placed on the door frame and the plunger on the door, at top, middle or bottom, and directly opposite the cylinder so that the plunger will enter the cylinder when the door closes. A special feature of the device is the adjustment screw, whereby the plunger may be made to fit properly into the cylinder.

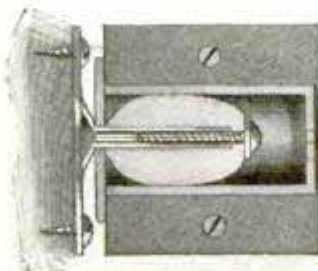

Out of business 11/23/18

Hope you

water tank

Washington

1153

Handwritten notes at the bottom left, including "K. S. 3" and other illegible scribbles.

Handwritten notes at the bottom right, including "West by Harold S. Co" and "A. Van...".

*Builders' Club
228 N. La Salle
Chicago*

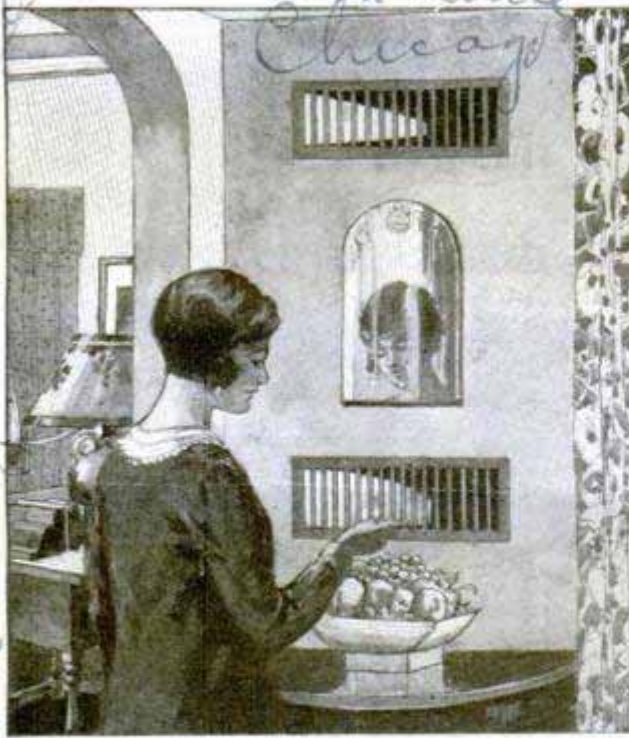

Drawing to Show Installation of the Air-Washing Cabinet; the Spray Is behind the Wall

AIR IN HOMES IS "WASHED" TO GUARD HEALTH

Connected to the main water-supply system and easily installed in new or old buildings, an air-washing unit has been introduced to maintain healthy humidity of the air inside at all times of the year. It is essentially a spray and air circulator which cleanses and moistens the air, evaporating sufficient water to keep an average humidity of about forty per cent. Water is tapped from the city main and passes out at the top of the cabinet, which is installed within the wall, through two fine spray nozzles. At the top of the cabinet is a register, flush with the wall, where the air is drawn in. The water falls as a fine mist to the bottom of the cabinet, where the excess flows off to a drain pipe. The humidified air is forced out through another register near the base of the washing chamber. A constant, even circulation is thus maintained and a regu-

lar supply of fresh, clean, moist air is always discharged. The washer operates cheaply and with practically no noise.

FLOWERS FIFTY CENTURIES OLD FOUND IN EGYPT

Varieties of plants and flowers that flourished in Egypt fifty centuries ago, still grow in the valley of the Nile just as they did in ancient times, study of specimens found in sepulchral monuments reveals. An interesting collection of floral mementoes has been gathered in the national museum of Egyptian antiquities at Bulak, near Cairo. They indicate that the same kinds of flowers that the boy Moses or the children of Joseph probably liked to pick, still bloom unchanged in form or color. The larkspur which loving hands laid upon the bodies of those who died 1,000 years before Abraham and Sarah went down into Egypt, still blossoms in sprays of blue as it did many centuries ago. In some of the tombs of later date, various fruits, vegetables and grain have been found with hollyhocks and chrysanthemums. Around the necks and upon the breasts of those who died at the time Solomon reigned in Jerusalem, garlands of celery were discovered. The plant does not appear to have been used as a vegetable at that time. Plants intended for funeral ceremonies were subjected to great heat, the process helping to preserve them.

OLD FIRE ENGINE AIDS AVIATION AS CLEANER FOR MOTORS

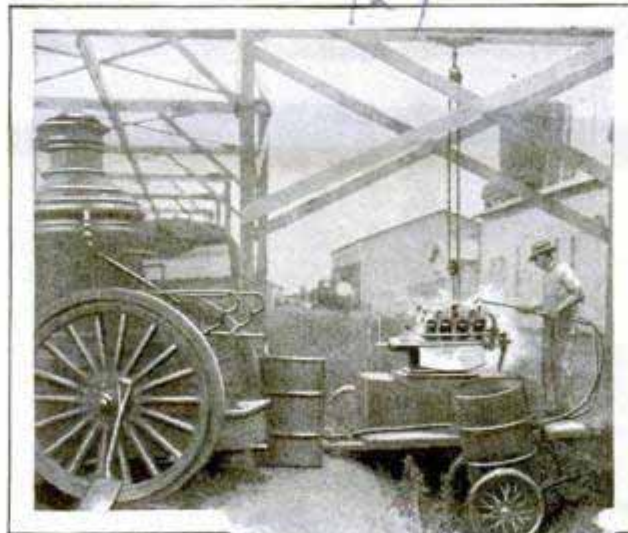

Old Fire Engine Cleaning Motor

No longer useful for fighting blazes, an old horse-drawn fire engine, in St. Louis, has been adapted by an airplane manufacturer to clean the motors. Steam is generated in it and blown over the engines through a flexible hose to remove grease and oil before and after the motors are overhauled and given running tests.

*McBarnett
Chicago
1124 Harmon Place*

*Zephyr Wash Air C
1124 Harmon Place*

Bra

Engels Flug New Brunswick

Before a notebook of Chemists 1/30/28

CHEMISTS DECLARE MAN IS WHAT HE EATS

1154

That man is modified by the soil on which he lives, just as plants adapt themselves to their surroundings, is the opinion of chemists who are studying the effects of various kinds of food upon the human body. The relation is not so direct as in the case of plants but is definite and far-reaching, the scientists declare. For instance, when food supplies were almost wholly of local production, various diseases were developed in certain sections more than in others and could be traced to deficiencies in the soil of those regions. In parts of Switzerland, dwarfishness and feeble-mindedness were pronounced. Examination of the soil showed that there was not a sufficient supply of iodine. In other sections of the world, there is not enough sulphur, lime or phosphorous materials and this lack is manifest in various racial characteristics among the people. The value of insulin in the treatment of diabetes, is believed to be due to the fact that it contains certain chemicals that are beneficial to the human system afflicted with the disease. The relation of food to the body is still involved in mysteries, the chemists admit, among them, the riddle of why certain persons are sensitive to certain substances. For instance, why do some persons acquire the hives after eating certain kinds of fruit, why do some sneeze when sleeping on a downy pillow or why do others cough when walking through the woods? These are mysteries, but chemistry may offer a solution, the experts believe.

□ Paper is being made from grape-vine cuttings in California.

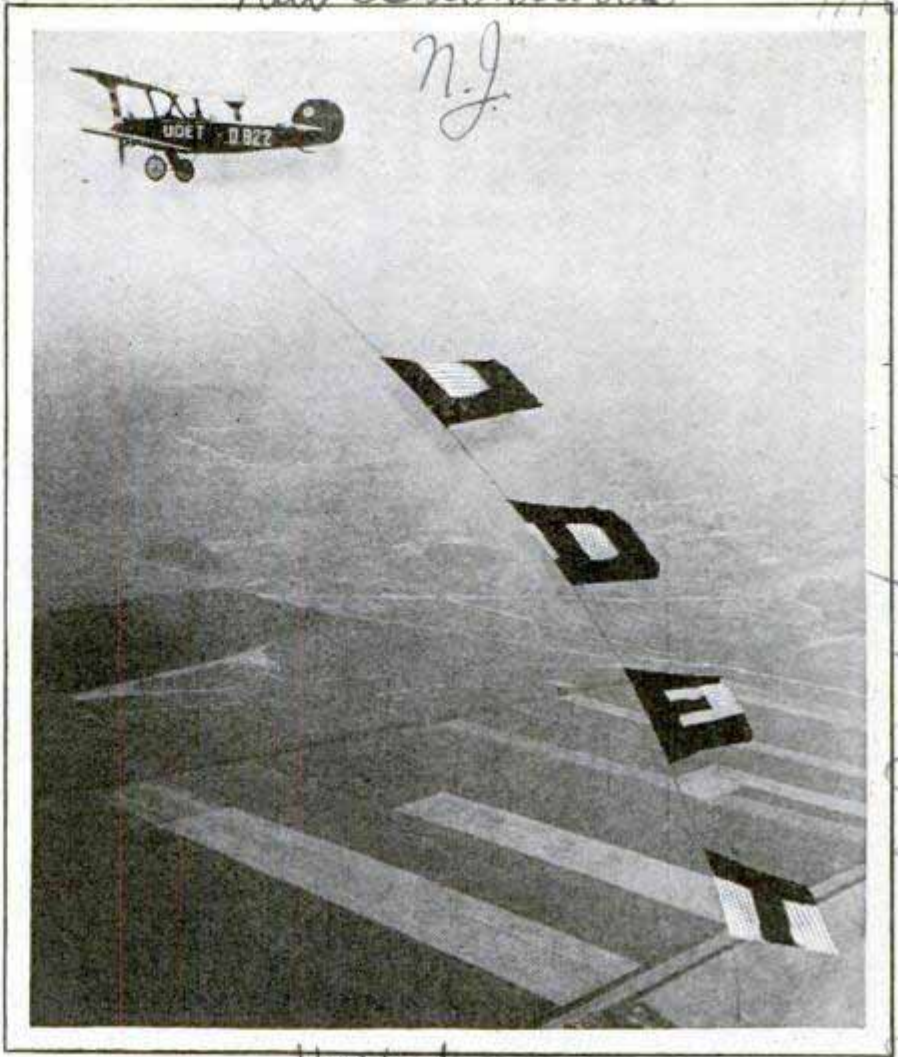

n.j.

Chain of Flags Bearing Letters and Towed from Plane to Form Message Which Is Visible for Many Miles

PLANE AS FLYING BILLBOARD SHOWS SIGNS BY FLAGS

Sky writing with flags is the system a foreign pilot employs in displaying advertising and other messages. There is a letter to each banner and the flags are carried in a cartridge-like container under the fuselage. When released, they drop out and form a chain of letters in the proper order, and trail behind the plane like the tail of a kite. The words are visible at a considerable distance.

HORSE'S HOOFS START FIRE *1136*

More than 2,000 acres of forest land in California were swept by fire recently, the blaze being started by sparks from a horse's hoofs, according to the report of the state forester. This is believed to be the first verified instance of an occurrence of this kind although other fires, starting in this manner, have been reported.

Ernest H. Gledy, Sarman

California Forest

985

Making Aircraft

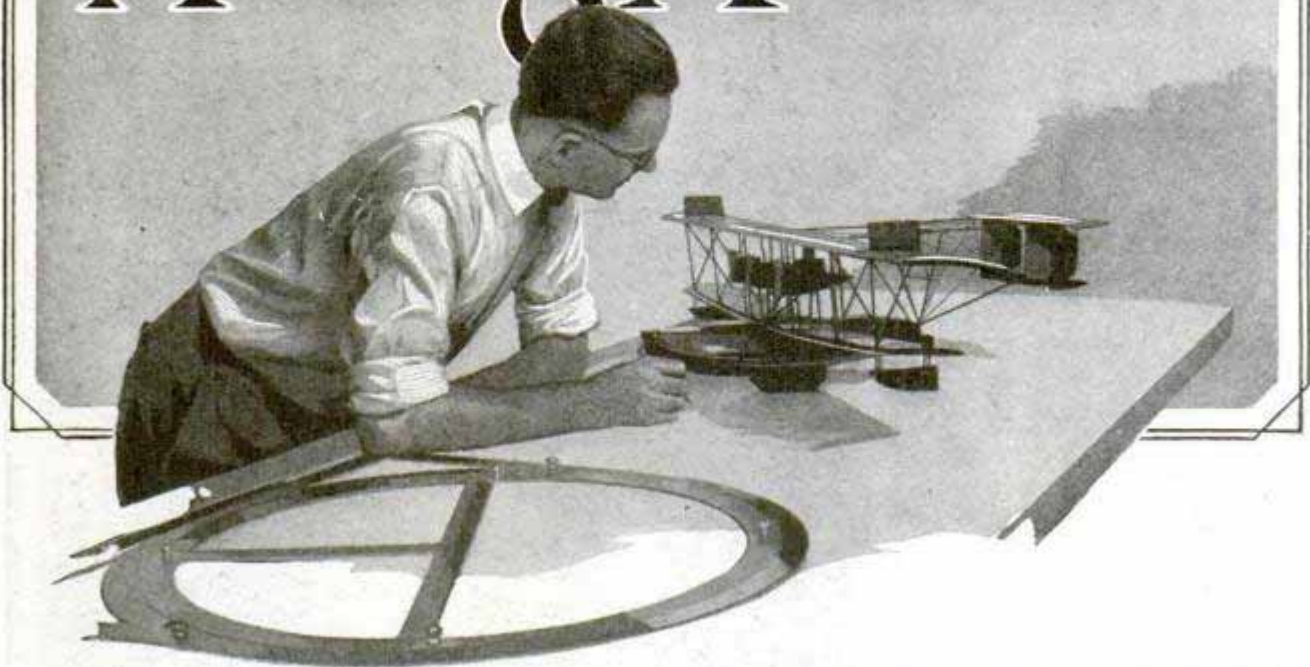

Examining a Model of One of the NC-Boats, the Navy's Flying Ship That First Crossed the Atlantic; Scale Models of Every Type of Airplane Are Built for Wind-Tunnel Tests

By K. M. PAINTER, *325 The Georgetown Washington, D.C.*

"IT CAN'T be done—a man might as well try to fly.' When a man said this," remarked Wilbur Wright, "he was understood as expressing the extreme limit of impossibility." From earliest records, the faculty of flight has been given to the spirits, the gods and their satellites of mythology and religion. Strange tales of flying deities, dragons, and demons; winged angels, aerial horses, the antics of witches and sorcerers, fill the poetry and legends of the centuries. But man willed to fly and the projects, attempts, achievements, and failures of aerial locomotion for centuries were targets for the shafts of short-sighted scientists, critics, authors, and the world at large. The invention of the balloon and Franklin's proposed addition of dirigibility added only new fuel to the inventive fire.

In the days when aviation was young, aircraft were designed on inspiration by geniuses who generally had nothing more exact than their own theories on which to base their designs. Every test of a new plane that might bring with it important improvement necessitated the actual risk

of the pilot's life, and even these tests, made at such great risks, were highly inaccurate as well as tremendously expensive. Designers were against a stonewall of fact. There was no way of predicting the performance of a plane without actually building it and attempting to fly it. That many of these attempts ended in disaster and retarded the progress of aviation was inevitable.

The wind tunnel was the means developed to remove the hazards and guesswork from the designing of aircraft and substitute a practical, exact, scientific way of testing new designs with no risk at all to human life. Thus, today, before a plane of a new design takes off, the wind tunnel has given an affirmative answer to the question, "Is this craft airworthy?"

One of the first tunnels to be built is located at the navy yard in Washington, and in it all the proposed designs for naval airplanes and airships are tested. The tunnel is made of wood and takes the form of an elongated doughnut. A large fan (or propeller), driven by a 500-horsepower motor, furnishes the wind at a maximum

Airworthy

rate of 180 miles an hour. When a new design is under consideration, an exact scale model of it is made at the government shops under the supervision of R. F. Smith, chief draftsman of the tunnel operations. This model is placed in the tunnel, attached to recording instruments that show the operator (in the control room above) the amount of pressure expended upon the model at varying wind velocities. And by exact calculations it is possible to figure the lift, drag, and pitching moments of the surfaces presented to the wind. By combining engine and propeller statistics (also determined by wind-tunnel tests) with these structural data, predictions are made with certainty as to the performance of the proposed craft: its high speed, cruising speed, landing speed, rate of climb, ceiling and controllability.

And in due course of operations, the new dirigible for which congress recently appropriated building funds is "on the block" at the navy yard wind tunnel. This leviathan of the skies is to take the place of the ill-fated "Shenandoah," having three times the capacity of its predecessor. It will be recalled that the "Shenandoah" was lost in a squall encountered near Zanesville, Ohio, in 1925. The force of the elements tossed the ship around until the structure broke in two, and the control car very quickly wrenched free in the air. To avoid a recurrence of this mishap, the new dirigible will have a larger diameter in proportion to its length—will be "fatter." Tunnel experiments have

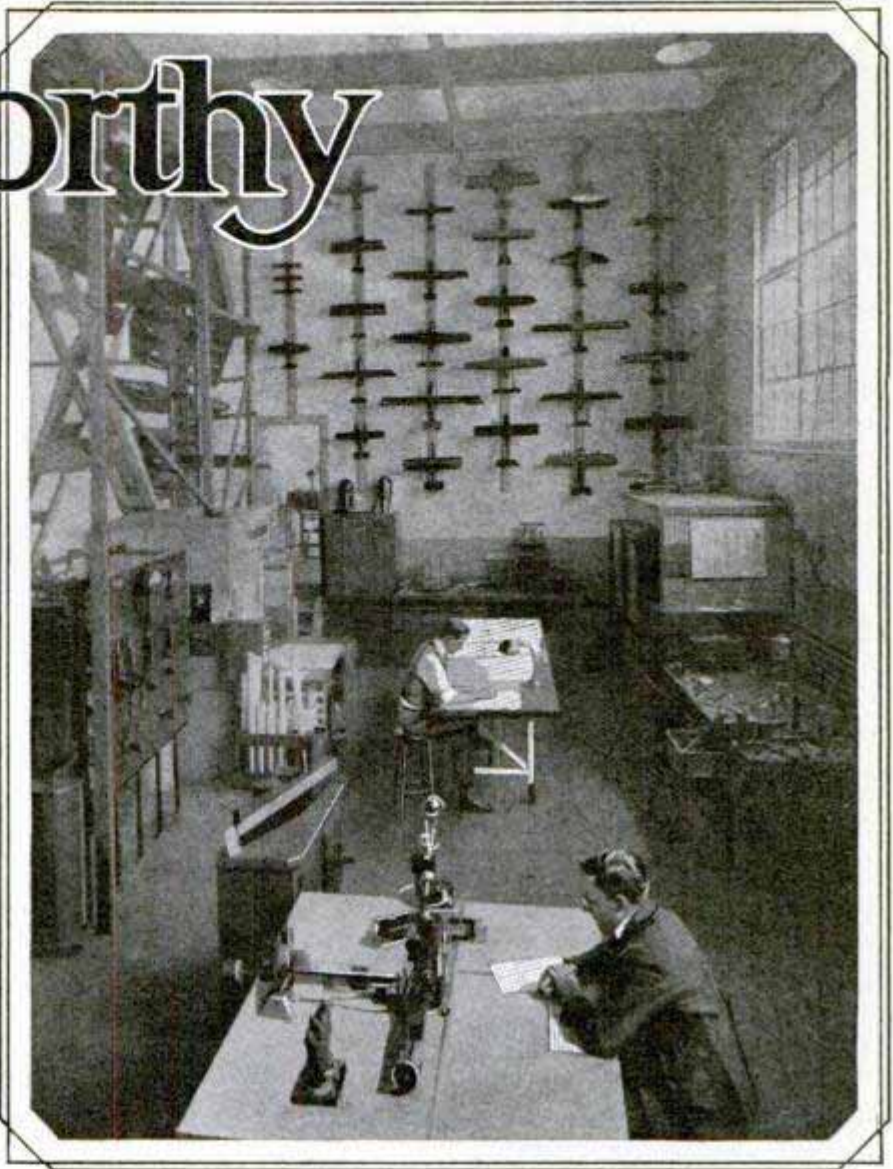

The Control Room of the Navy Wind Tunnel; the Operator at the Desk in the Foreground Charts the Returns from the Instruments

shown that the new shape affords much greater strength, and, surprisingly, presents less wind resistance, giving greater speed in proportion to power. Also for strength, it will have two keels instead of one, thus distributing the strain and giving the five engine nacelles or "power eggs" better support. The control car, instead of being merely fastened to the framework by a strut structure, will be directly attached to the frame of the ship.

When the proposed model of the dirigible was first tested in the tunnel it had eight control surfaces on the tail, but the wind tunnel showed this to be undesirable, and, eliminating one at a time, the most efficient number finally was found to be four. This elimination of tail surfaces saved thousands of dollars for the navy department, and was a direct result of the wind-tunnel findings.

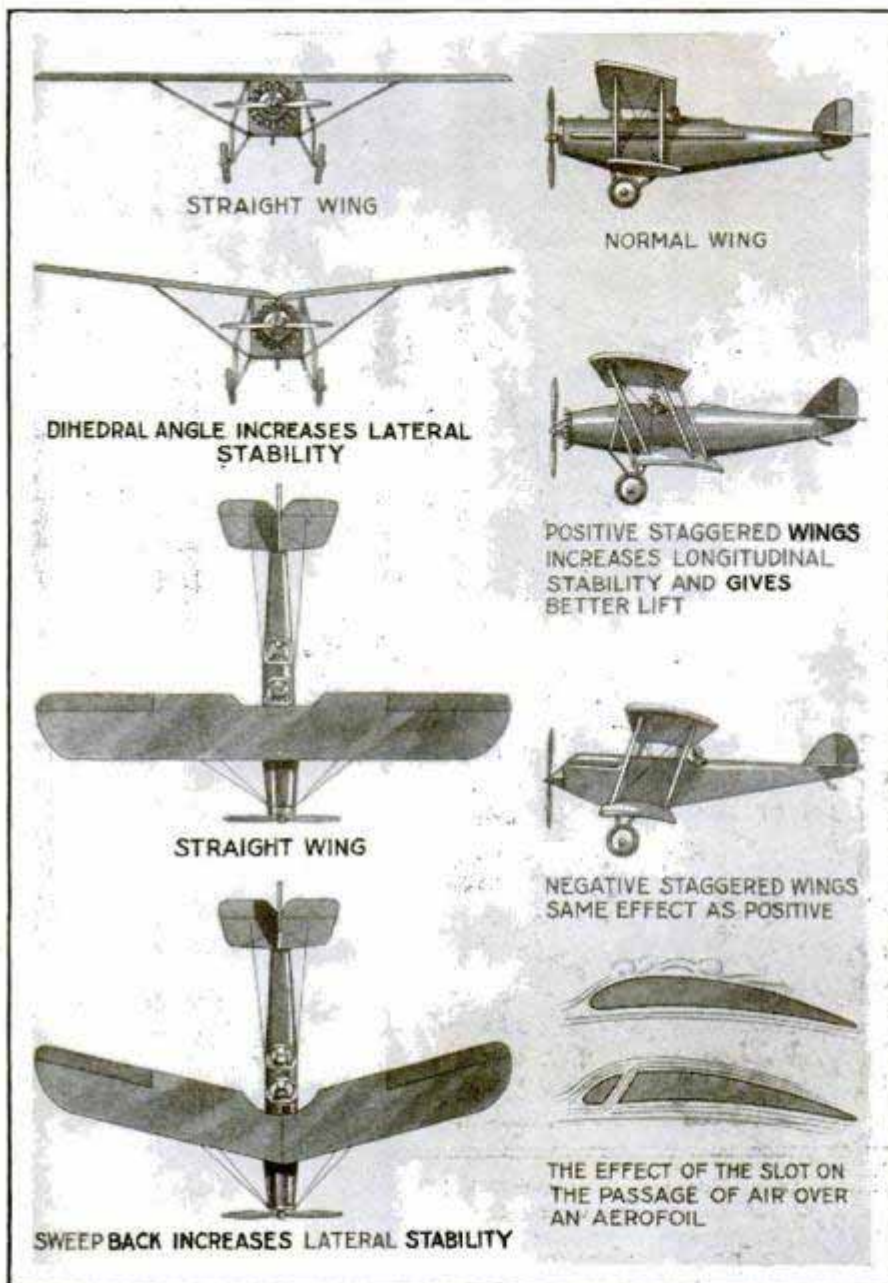

Some of the Important Things Airplane Designers Have Learned Since the Days of the Wright Brothers' First Crude Ship

The wind tunnel was largely instrumental in proving that as airships become larger, the ratio of useful-load capacity to structural weight improves materially, and that to double the volume and gross lift of an airship requires only an increase of twenty-six per cent in linear dimensions. From this it can be seen that it is perfectly possible and highly practicable to build dirigibles of enormous lifting capacity without reaching prohibitive dimensions. A ship of this type, inflated with 10,000,000 cubic feet of helium gas, would be able to accomplish a non-stop round trip to Europe, about 6,000 miles, returning with a reserve fuel supply for an additional 3,000 miles, and still transport a

military load of about 190,000 pounds.

And airship tests form a small part of the routine work in the tunnel. Through extensive research it is anticipated that the world airplane-speed record will soon be won again by the United States, and if it is, the wind tunnel should certainly share in the glory. Models of the record-breaking "Mercury" racer that is to be built for Lieut. Alford J. Williams, U. S. N., are now being tested for airworthiness. The plane will be powered with a new twenty-four-cylinder X-bank motor that develops about 600 horsepower. Wind-resistance experiments proved that the best type of craft to maintain the astounding speed that must be made by this hope of a nation would be a monoplane, and, further, that much speed could be gained by placing the wing midway of the height of the fuselage, that is to say, on a level with the engine crankshaft.

Racing planes are notoriously tricky and even racing pilots fear the effects of kinks in new designs, but this one has been thoroughly tested for unusual behavior and all the discoverable kinks eliminated in the wind-tunnel tests. The results of these tests are for the most part confidential, but there is little doubt that Lieutenant Williams will come very close to the unprecedented 400-mile-per-hour speed, and none at all that he will break all existing speed records.

Two extremes—our largest airship and the world's fastest airplane—owe their airworthiness to the wind tunnel. And then there are the usual everyday findings that save thousands of lives and millions of dollars in an unassuming, unrecognized

915

way. Little wonder that the pilot of today looks to the wind tunnel as to his closest friend, and takes the findings for life value.

The perfection of the new Handley-Page slotted wing, American rights to which, for military use, have been purchased by the government so that it can be applied to all army and navy planes, is credited to

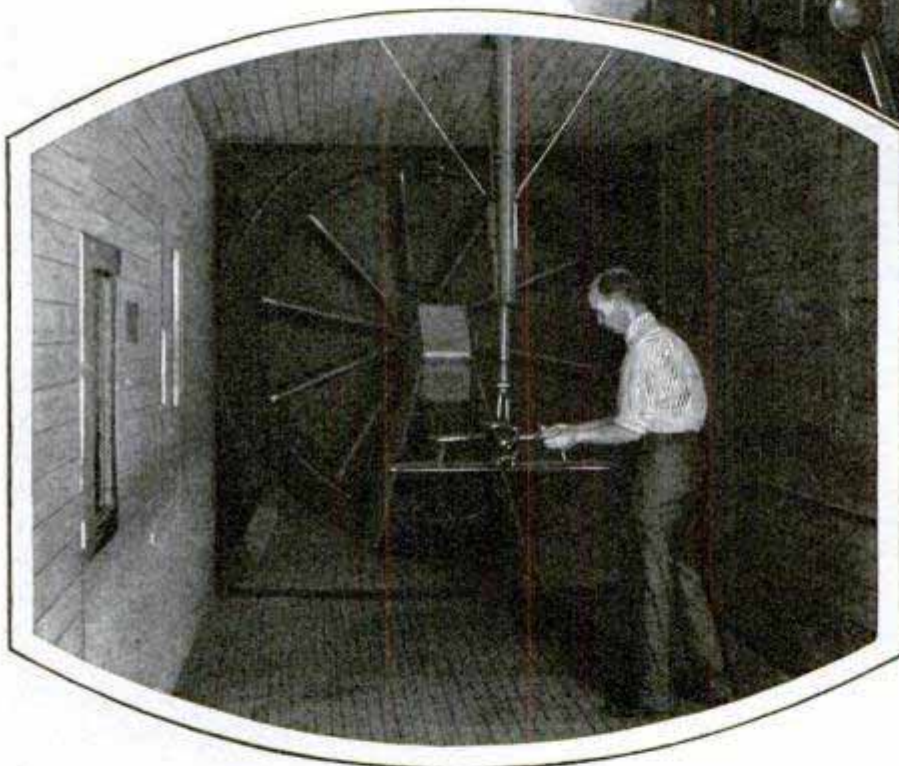
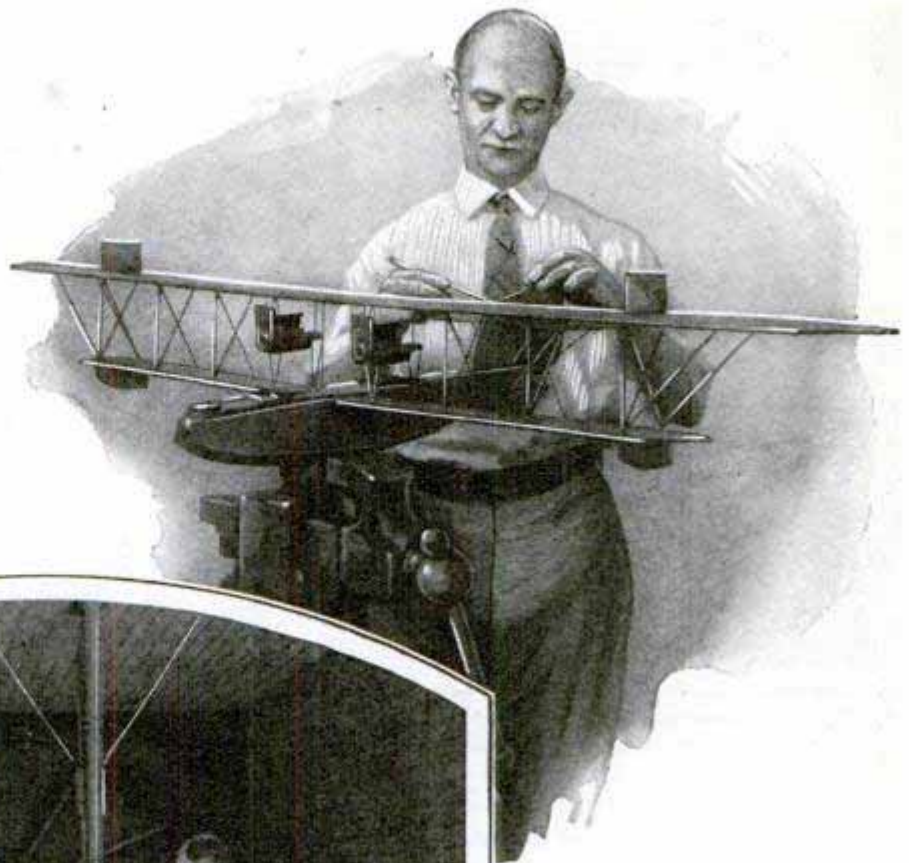

Preparing a Model for Test, Top, and Mounting One in the Wind Tunnel; in the Background Is the Blower

wind-tunnel observations. The slot is designed to eliminate the fatal accidents which result from stalling an airplane in flight. When the speed of the plane falls below flying speed, the air flowing over the top surface of the wing, where the greatest lift normally is exerted, becomes turbulent and broken into eddies, lessening the lift. When that happens, the wing slot opens automatically and begins feeding additional air to the top of the wing, drawing it from the underneath surface. With the additional air, the wind-tunnel tests showed, the air stream on the top of the wing was restored.

In actual flight, planes with slotted wings

can be put through strange maneuvers. Captain Geoffrey de Havilland, the famous British designer, whose war-time plane was produced in quantities for the American army, fitted slots to one of his light planes and found it impossible to put the ship into a tailspin from a stall, as the wing slots always brought it into level flight. He allowed

the plane to stall, and, with the slots working, came vertically downward until he struck the ground with sufficient force to crumple the landing gear—yet escaped unhurt in the crash.

Wind-tunnel tests also have done much to improve knowledge about the types of plane design that are most stable and safe in flight. They show how combinations of what airplane designers call the dihedral angle, sweepback and wind stagger, all make a plane less inclined to get out of flying position and go into a spin. The dihedral angle is the angle at which the wing tips are sometimes elevated above a straight line; sweepback is

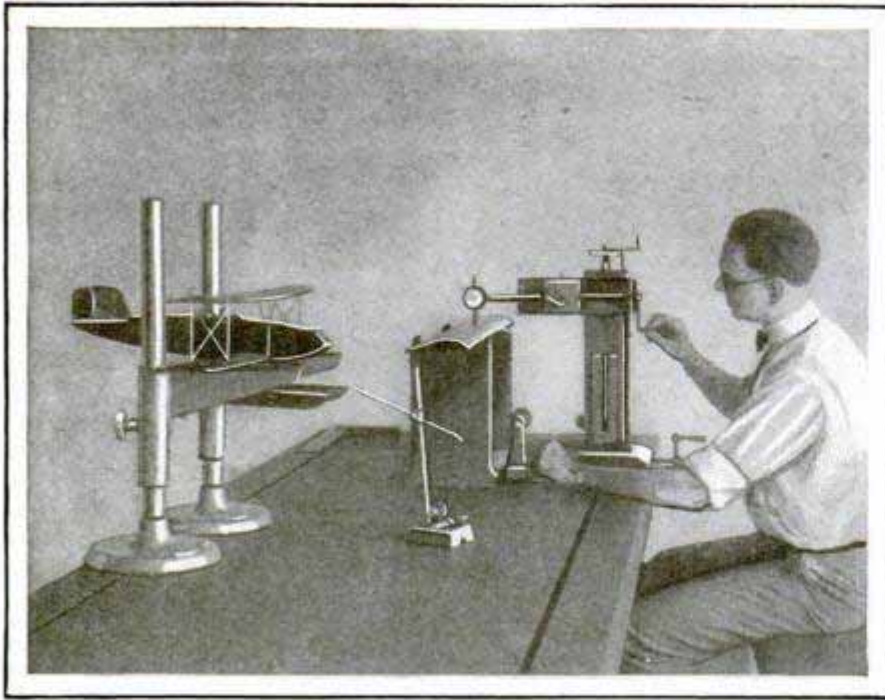

The Models to Be Tested Are Carefully Checked; the Tester Is Going Over a Wing Surface to See If the Curve Is True

a similar angle, seen when looking up to or down on a plane whose wings, instead of extending straight out at either side, are inclined backward at the tip; and stagger is the placing of the lower wing of a biplane either slightly back or slightly in front of the upper wing.

Boys who fly model planes learn much about the effect of a high dihedral angle and sweepback, for both give a plane more lateral stability, thus preventing the ship from falling off on one wing and going into a tailspin. The ship with a straight wing looks faster and more trim to the eye, but isn't nearly so safe.

Wing stagger, on the other hand, provides more longitudinal stability and increased lift, for the arrangement of the wings lessens air disturbance between them, increasing their lifting effect, and the ratio of total wing depth of the plane is greater, so it has less tendency to soar or dive.

A new plane designed at the California Institute of Technology has an adjustable lower wing, so the pilot can move it forward or back to reduce or increase the amount of stagger while in flight. As a result, he can vary the lift to suit the speed of the motor, and can diminish the landing speed of the plane so much that it will come to a stop within thirty feet after touching the ground.

The university of Michigan recently an-

nounced the opening of an air-research laboratory and a giant wind tunnel. The most outstanding research laboratory in the United States for airplane development, however, is that of the army air corps, at Wright field, near Dayton, in which air conditions are exactly controlled by ingenious mechanical means. The new dynamometer laboratory of the army air corps takes into consideration two outstanding features of modern aircraft engine development—air-cooled engines and greater horsepower. The facilities

for testing have been increased recently by fifty per cent and the large dynamometers will be capable of absorbing 100 horsepower in a single unit. A feature of the dynamometer laboratory is a blower system for furnishing a blast of air to the air-cooled engines that will simulate the speed of normal flight and cool the engines under test.

Another new apparatus will measure the performance of engines at simulated altitudes, that is, the air entering a specific carburetor will be conditioned so that the volume and temperature of air can be definitely measured and controlled and temperatures as low as sixty degrees below zero obtained. The wind-tunnel installation consists of a five-foot and a fourteen-inch tunnel. The former is capable of a wind speed of 240 miles per hour; the latter of 500 miles an hour. When funds become available, it is planned to erect a ten-foot tunnel which will materially enlarge the scope and accuracy of aerodynamical tests.

Aside from the improvements in airplane design, based on wind-tunnel experiments, the navy laboratories likewise have done much to improve engine design. The famous Wright "Whirlwinds" that carried Lindbergh, Byrd, Chamberlin, and a host of other flyers, overseas, were developed in co-operation with the navy department, to meet the navy's need for an efficient air-

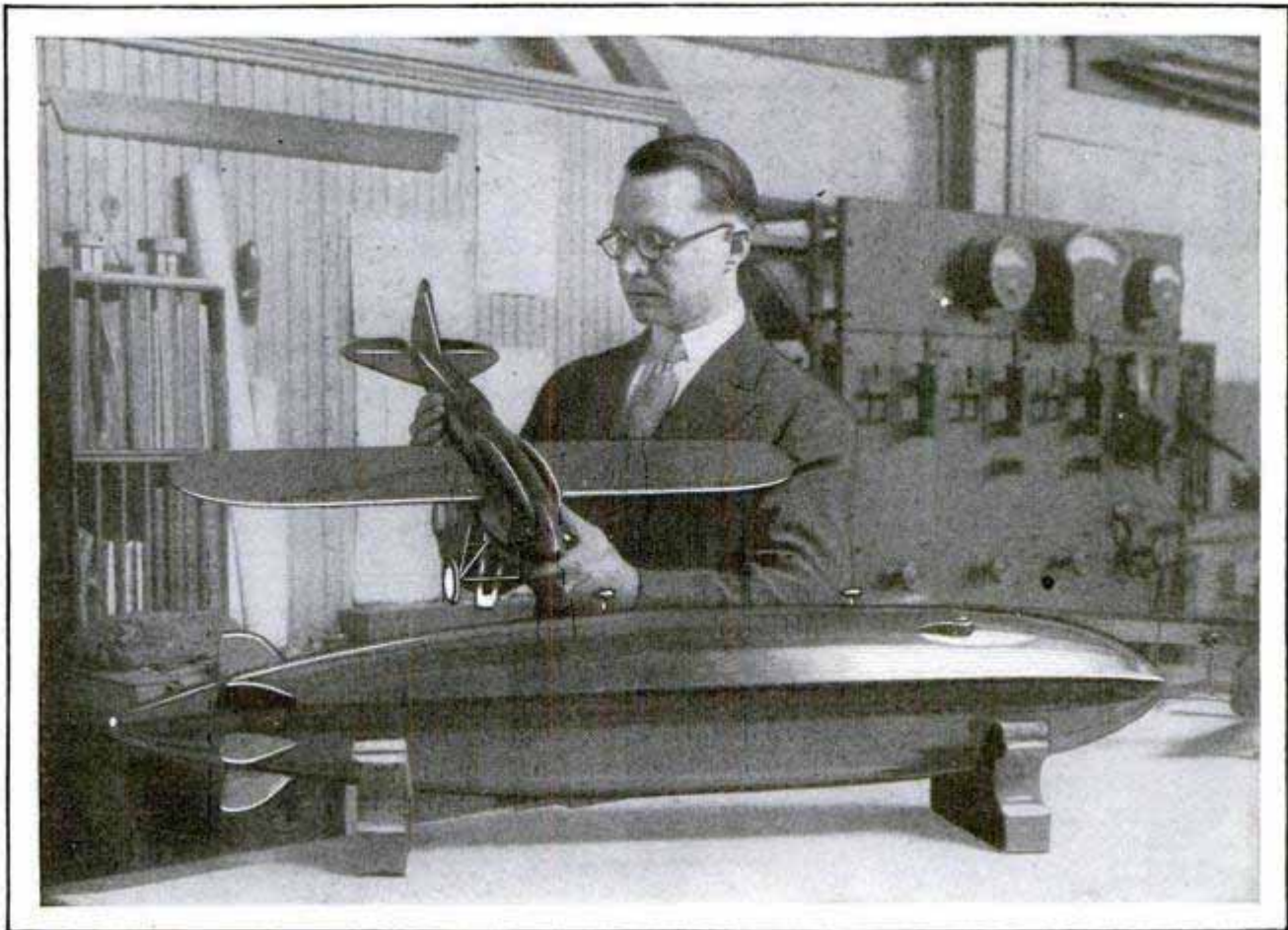

R. N. Smith, Chief Draftsman of the Navy, with a Model of the "Mercury" Racer, Which, It Is Hoped, Will Bring the Speed Record Back to the U. S.; on the Table Is a New Dirigible Model

cooled engine. The navy experts helped the makers until the engine had been perfected, and gave the initial orders which put the factory on a production basis. Similarly, naval orders were the incentive behind the development of the Curtiss racers that won the Schneider cup for America.

The making of an airplane engine that will stand up hour after hour under the grueling load of running "all out," or even at cruising speed of 1,900 revolutions or so a minute, is a miracle of science. Special alloys have been developed to give lightness and strength and, for every part, a metal particularly suited to its purpose is evolved.

The crankcase alone of the Wright "Whirlwind" has been described as the finest aluminum casting ever made. In its making, metallurgists, engineers, draftsmen, foundrymen and machinists have co-operated. The alloy which goes into it is mixed only from new and unused metal—no melted-down scrap being permitted—and from every crucible of molten alloy a bar is poured for rigid chemical

and physical tests, on the results of which the entire heat of metal is either accepted or rejected.

Each crankcase is subjected to heat treatment to assure full strength in every section; each is tested under water by air pressure to make sure there are no porous passages or blowholes, and each one is acid-etched to make sure that no minute defects may pass unnoticed. The machining, too, is an exacting and slow process.

The navy standard for several years has been fifty-hour tests. An engine had to run successfully for that length of time before its type was approved. At the time the test was established, no airplane had remained in flight for anywhere near that length of time, but within recent months the world's endurance record has been broken three times, and now is above sixty hours.

On the basis of past developments, it is probable that future refinements within a few years will produce engines capable of running for more than 100 hours at cruising speed, and that the endurance record will be boosted accordingly.

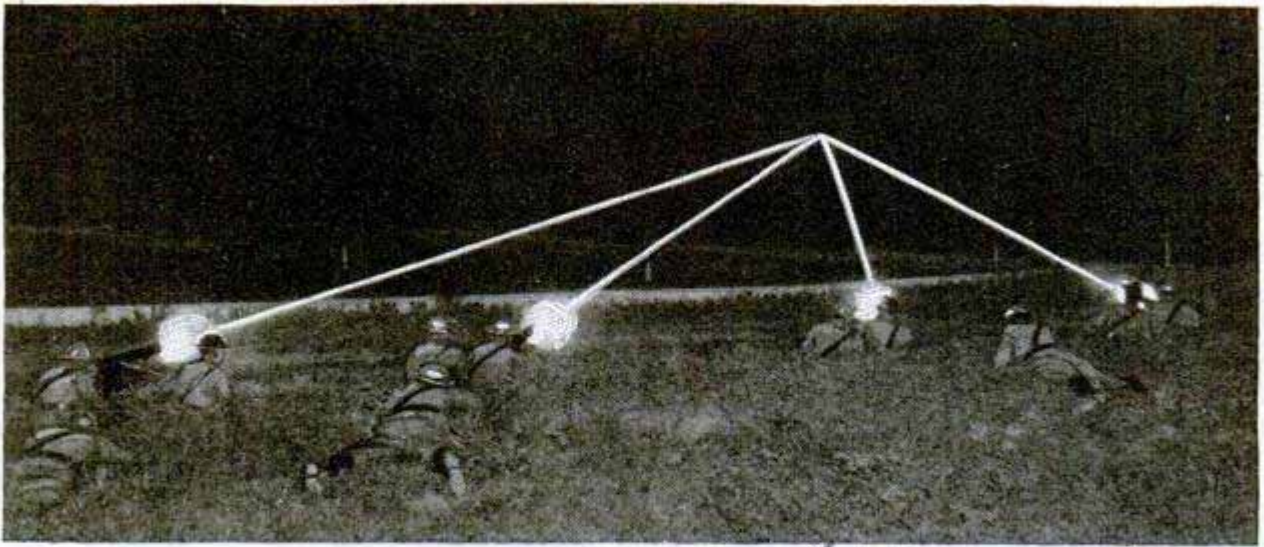

Geometrical Pattern in Lines of Light Formed by Tracer Bullets during Night Target Practice with Machine Guns; the System Provides a Visible Means of Sight Adjustment

BULLETS TRACE LINES OF FIRE TO AID MARKSMEN

Cadets at the University of Missouri used the sky as a blackboard and tracer bullets as chalk during gunnery practice at recent maneuvers. The bullets blazed lines of fire from the muzzles of the guns to the targets and, when several guns were being fired at once, a geometrical pattern was produced. The lines assisted the marksmen in adjusting their sights for night firing.

EDISON'S MINERS' SAFETY LAMP TO PREVENT EXPLOSIONS

Although he is past eighty, Edison is still busy with his inventions, and one of



Edison with Model of the Safety Lamp Which Has a Battery Involving 50,000 Experiments

the latest is a safety lamp for miners, to reduce the likelihood of gas explosions. Its special feature is a battery on which Edison is said to have performed more than 50,000 experiments, to improve it to its present high state of efficiency.

FOURTH OF ACCIDENTAL DEATHS OCCUR IN HOMES

Figures gathered by the national safety council show that approximately one-fourth of all accidental deaths in the United States occur in homes. Last year, between 23,000 and 25,000 persons were killed by falls, burns, suffocation or other causes in their dwellings, about the same number as died from industrial accidents. For each home fatality, an insurance company paid 200 claims for non-fatal accidents, so, on that basis, some 5,000,000 non-fatal mishaps occurred in American homes. Thirty-five per cent of the fatalities were due to falls, nineteen per cent to burns and but two per cent to electricity. During the four weeks, ending July 14 of this year, automobiles were responsible for the deaths of 514 persons in the seventy-seven large cities of the United States, the council reports. Last year, the figures show that approximately 23,250 persons were killed in automobile accidents throughout the country, not including fatalities in collisions of automobiles with trains or street cars or in motorcycle accidents. Counting these in, the total is nearly 25,800. The 1927 figures represent

1086 *Electric* *at the time*

an increase of nearly 21,000 over 1911, also an increase in the number of deaths per 100,000 population but a decrease per 100,000 automobiles registered. In 1926, there were but 170 airplane deaths as compared to 185 in 1920. Between 1918 and 1920, the average number of miles flown per fatality in airway operations was 97,587. Between 1924 and 1926, it was 1,387,964, showing there has been a marked improvement in safety.

Chicago, Ill. 7/19/28

MOTOR FUMES INJURE TREES WITH ROUGH LEAVES

1147

Chestnut and other trees with furrowed leaves along Paris boulevards, have been injured by sulphurous dust from motor-exhaust fumes, experts report. On the other hand, trees with smooth leaves have not suffered to any noticeable extent because rains and winds keep the leaves clean. Dust clogs the pores of rough leaves, interfering with their "breathing."

PORTABLE NEWSSTAND HELPS PATRONS CATCH CARS

654

An enterprising newsdealer in England has devised a way to give his patrons aid in catching street cars. On a rack above the stand are large numbers announcing the route number of the car next to leave, and his booth is on wheels so that he can reach more customers in the area.



News Booth on Wheels and That Carries Schedule of Departing Cars on Rack Above

RADIO HEADGEAR FOR AIRMEN TO AID COMMUNICATION

Aviator with Helmet That Carries Headphones; the Mouthpiece Is Adjusted for Convenient Talking

35



Private E. W. Taylor

Wireless messages will be received and sent more easily from airplanes, it is predicted, by using an improved headgear recently tested by men of the signal corps. The phones are inclosed in a snugly fitting helmet which shuts out most of the noise, and the mouthpiece of the transmitter is securely held to the chest in a convenient position for clear speaking.

CANDLES AT MOUNT VERNON REPLACED BY ELECTRICITY

1145

Without marring the beauty of the estate, electric lights have been installed to replace candles in most of the buildings at Mount Vernon, the home of George Washington and the shrine of the nation. All the structures except the mansion itself, are supplied with current through underground and carefully shielded conduits to make them inconspicuous and to reduce the fire hazard. The old kitchen, one of the most interesting spots at Mount Vernon, has been completely electrified. It now has an electric range and an electric refrigerating system. Other historic estates near Mount Vernon have also been electrified, many of the fixtures being exact reproductions of the candle holders on the walls of Washington's home.

Port. C. Co. 5

with a... 1700...

1103 UNUSUAL BUILDINGS SEEN IN EUROPEAN CITIES

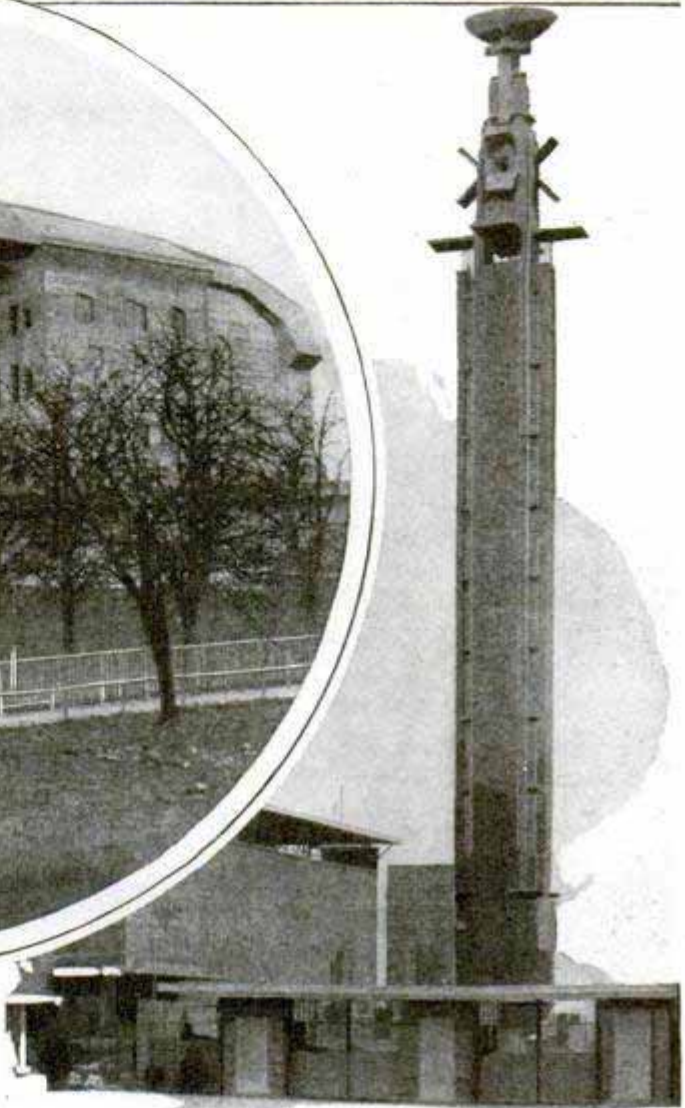
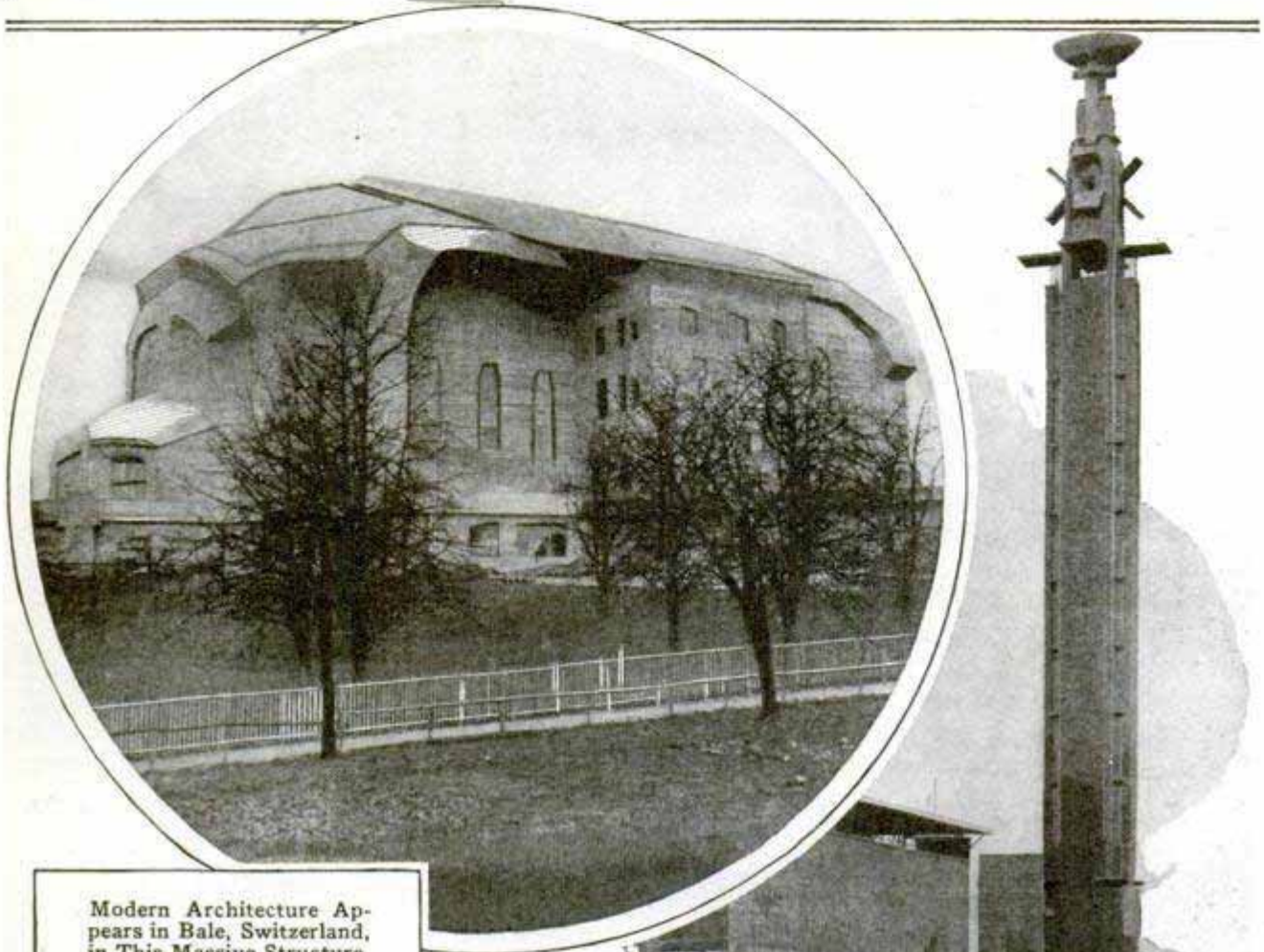

Modern Architecture Appears in Bale, Switzerland, in This Massive Structure, a Temple Erected in Honor of Goethe, the German Poet; at Upper Right Is Tower at the Entrance to Stadium, in Amsterdam, Where Olympic Games Were Held; It Harmonizes with the Modern Lines of Other Buildings Surrounding It



"Slums" of a Progressive City of Today; Building Erected by Amsterdam Municipal House Corporation for Its Poor; Design Affords Ample Light

1122

REFLECT NEW IDEALS OF BEAUTY AND UTILITY

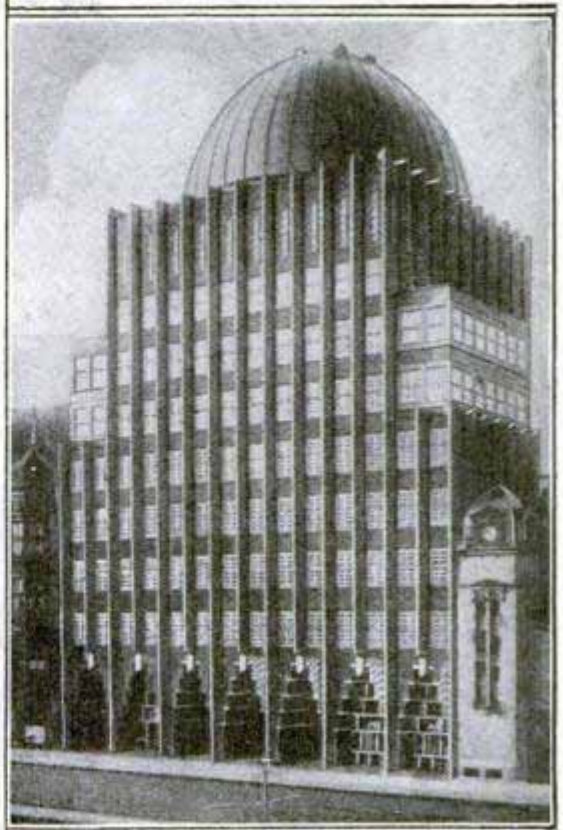
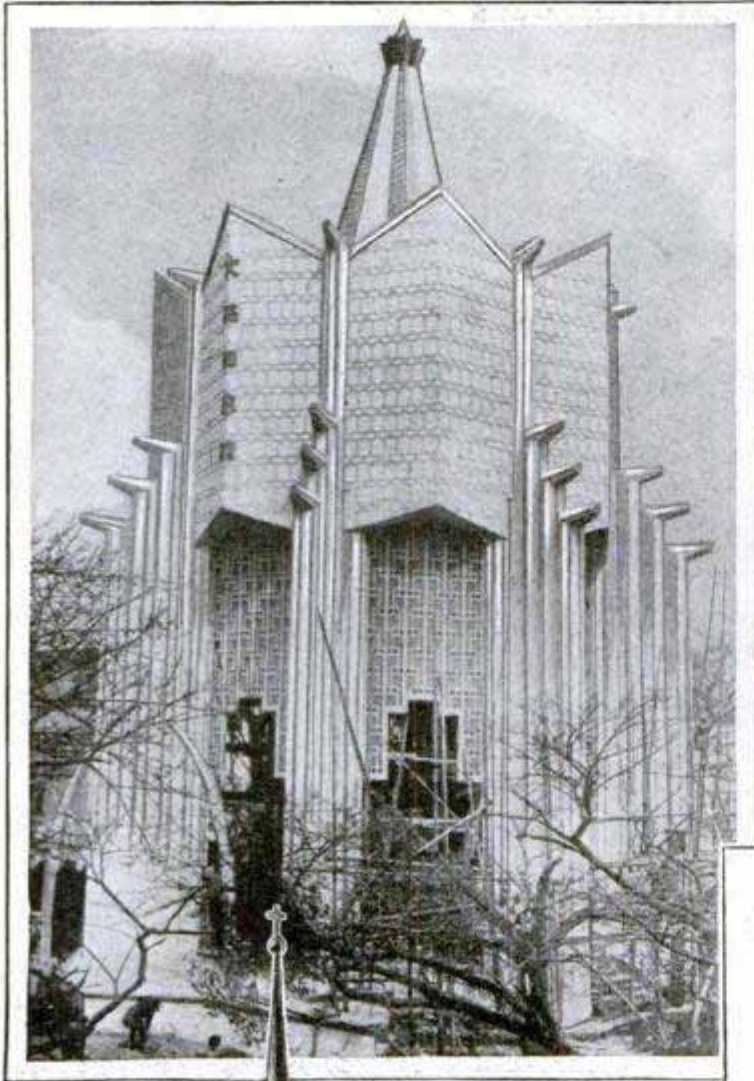

Modernism Reaches Out to Japan with the Result on the Left, a Building Being Erected in Commemoration of the Coronation of Emperor Hirohito; Little of the Pagoda Influence Is Seen; Above, an Office Building in Hanover, Germany, Which Is an Interesting Adaptation of the Dome and the Long Lines of a Modern Skyscraper

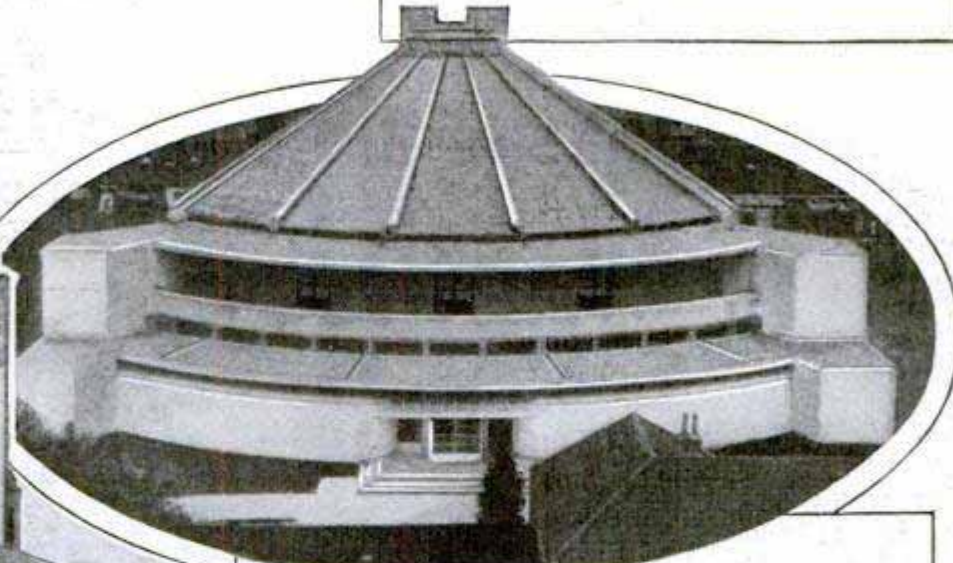
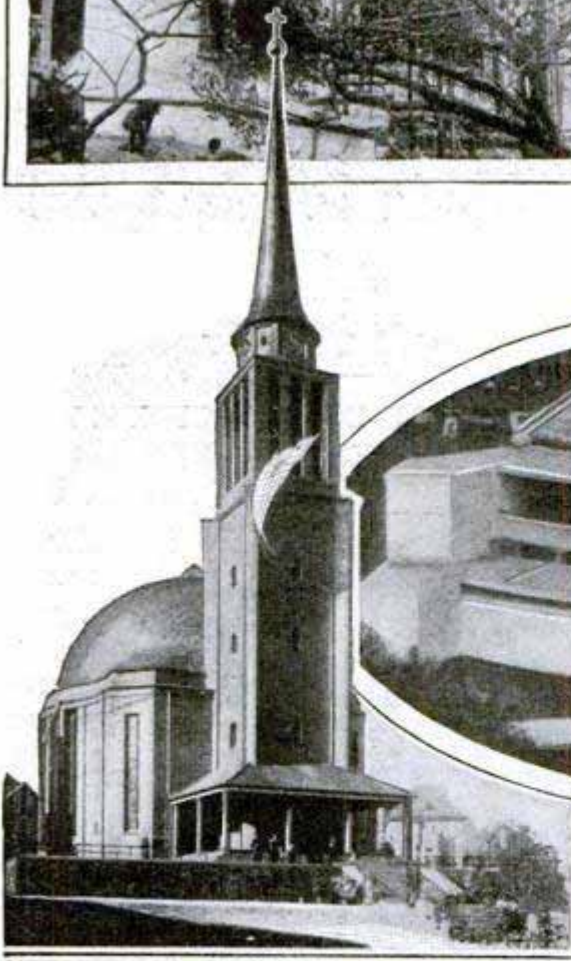

Church of St. George in Frankfort, Germany, Embodying Late Ideas in Architecture and, Above, the Oddly Shaped Structure Devoted to the Uses of a Modern Religious Cult; It Was Recently Dedicated in Amsterdam

u ou

MULELESS ARMY OF FUTURE SEEN IN MOTOR UNIT

torized unit has been assembled at Fort Leonard Wood, composed of about 200 vehicles and 1,100 men. A test march was recently staged, although old-time soldiers wondered



© U. & U.

Part of the Motor Unit in Muleless Army Column; in the Rear Is the Special Anti-Aircraft Gun on Its Truck

Just as the motor has replaced the horse to a large extent, so it promises to send the mule to the discard in one of its last strongholds, the army. A completely mo-

how "an outfit could do any marching without mules." One of the pieces of equipment was a special anti-aircraft gun, hauled on a fast four-wheel-drive truck and capable of being fired while in motion. Records were kept as to the speed made.

STUDY THE BRAIN WITH X-RAYS TO LOCATE TUMORS

Operations on the brain may become less hazardous as a result of a Swiss physician's use of the X-rays to examine the organ. He finds tumors with the aid of the rays by pumping air into the cavities of the brain. If one of the cavities contains a tumor, the air cannot penetrate, and the fact is disclosed on the X-ray photograph by the absence of the usual white patch that indicates a cavity filled with air. Oil is employed in examining the part of the brain just above the spine. The oil is heavier than the spinal fluid

and so flows down, appearing as a black strip. If there is a tumor in the canal, the strip stops at the edge of the growth. Experiments with a lighter oil may locate the lower edge of the tumor.

CHANGEABLE-DATE LICENSE TAG REDUCES EXPENSE

106



License Tag with Changeable Date Insert Which Eliminates Necessity of Attaching Complete New Tag

To reduce the cost of making automobile license tags, a marker, patented by an Oregon man, has a changeable date tag, the numbers remaining fixed. When a new license is necessary, the numerals forming the proper year are simply inserted in the slot that is cut for them.

Method perfected by Dr. Max Hering
investigations Hospital, Rochester, N.Y.

Chicago
W. O. Oster
1931

Cambridge, Mass

1080

168 Marlborough St. Boston Mass
1100 Adams Street Wash.
 POPULAR MECHANICS 591

FIVE TONS OF BEEF REQUIRED FOR BYRD EXPEDITION

1157
 Estimating food and other supplies to last sixty men two and one-half years is one of the tasks Sydney Greason, chief steward of the Byrd antarctic expedition, has had to handle, and his figures, compiled after determining the probable daily ration per man, will interest everyone who has had to plan a camping trip. Among the articles Greason is providing are two tons of ham, three of bacon, five of beef and one of chicken. Five hundred cases of eggs will be carried, two tons of tinned butter, a ton of powdered milk, 1,200 pounds of cookies and a ton of jams, jellies and marmalade. The men will be equipped with sixty razors and 1,200 packets of blades, nearly 9,000 cakes of hand soap and 1,200 sticks of shaving soap. Five tons of dried fruits will be taken and two and one-half tons of candy. The cooking utensils will weigh one ton. The expedition's stores will include 800 sheets, 400 pillow cases, five folding bathtubs and a number of folding cots and chairs, besides two electric washing machines, twelve barrels of washing powder, thirty dozen tooth brushes, five dozen hand brushes and the same number of hair brushes. Most of the equipment is for use at the base camp on the Ross sea.

Use Wm. movie camera

GAS CARRIER ON MOTORCYCLE LATEST ARMY UNIT

3410
 For rapid transportation of containers of poison gas in the army, the French have



Motorcycle Sidecar Equipped as Poison-Gas Carrier for a Unit of the French Army

devised a motorcycle carrier. A large holder is placed on a sidecar support. The new unit was demonstrated recently at special maneuvers.

Model of the Pick-Up Apparatus for Loading Planes in Flight; the Chute Is Shown in the Foreground



AIRPLANE LOADED IN FLIGHT FROM METAL CHUTE

Airplanes can pick up supplies while in flight from a special loading unit developed by a western inventor. It is of metal and is shaped somewhat like a funnel split in two, being wide at one end and tapering down to a narrow mouth where the package to be picked up is placed. A cable and ball on a reel are lowered from the plane into the wide part of the funnel, the package attached, and then automatically shot out to relieve the strain of a sudden jerk as the plane flies away.

SAILING BOATS WITH BIG KITES NOVEL WATER SPORT

1125
 Visitors at a Wisconsin lake enjoyed a novel form of boating by using large kites as substitutes for sails to propel the craft. One sportsman had good results with a five-foot kite which he released to an altitude of about 700 feet. By changing his position in the boat, he was able to be of help in guiding it.

Popular Mechanics Magazine does not publish the name of the maker or seller of any device described in its pages, but this information may be obtained, free, by addressing our Bureau of Information.

See if Cohen, Chicago

*U.S. Capt. George Wright
5406 Brookdale,
Berkeley, Calif.*

*2720 Maryland,
Baltimore, Md.*

**ELECTRIC LIFEBOAT LAUNCHED
IN THREE SECONDS**



Model of the Lifeboat Which Can Be Launched in Few Seconds by Pressing a Button

An electric apparatus by which lifeboats can be launched in three seconds, according to reports, has been devised by a western sea captain. The control buttons are in the pilot house and simply pressing one sends the boat down.

**OIL TANK BLASTS PREVENTED
BY WASTE GAS**

By utilizing the waste gases from the ship's boiler fires, a way has been found to prevent explosions on a large tank vessel. The method seems incongruous at first as the vapors leave the stack at a temperature of 400 to 500 degrees Fahrenheit and it would be supposed that they would prove a menace when introduced into the oil tanks. But the gases are first cooled with a salt-water spray before being let into the tanks and, as they are devoid of oxygen, they act as an effective "smothering blanket" to

*Ship - H. M. Corey
installed by Standard Oil Company
of California*

prevent an explosion. Experience has shown that one of the common causes of such accidents as the tanks are being pumped out, is that the atmospheric oxygen, mixing with the vapors remaining, form an explosive gas, extremely dangerous. The waste fire gases effectively remove the oxygen. An additional precaution has been taken when filling the tanks. Under old methods, explosions sometimes occurred when incoming oil drove out gases through vents in the tanks where they combined with the oxygen in the air and blew up. In this tank vessel, the vapors are forced into the hollow mast of the ship and discharged at the top at a safe elevation above the deck.

**GLIDER SAILS FOUR HOURS
ON AMERICAN FLIGHT**

Peter Hesselbach, German pilot, remained aloft over four hours in a glider during a recent flight above the cliffs of Cape Cod. The feat constituted an unofficial record for America, the previous mark being held by Orville Wright, who remained up nine minutes and forty-five seconds in 1911 while experimenting with planes. Hesselbach's American performance is far short of the world's record for gliders, however, as a solo flight of more than fourteen continuous hours was made in Germany some time ago. Hesselbach has flown in a motorless plane for more than five hours with a passenger. His glider is launched with elastic ropes.

**GASOLINE VAPORIZER FOR AUTO
REPLACES CARBURETOR**

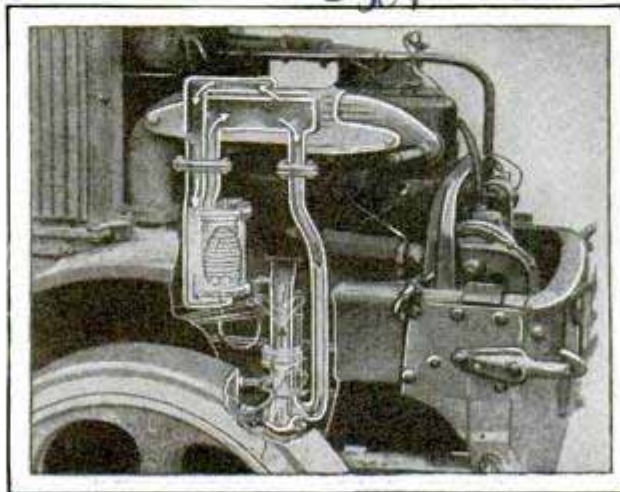

Drawing to Show the Vaporizer Installed

Saving of fuel and more efficient operation of the motor are claimed for a gasoline vaporizer that replaces the carburetor, according to reports. It is said to supply "dry" gas to the cylinders, reducing waste, giving more complete combustion and eliminating most of the carbon troubles.

*The Sullivan Vaporizer Corp.
37-31st St. Long Island*

at H. H. Reynolds night, near north

7/16/28 P. 41

1049

Used in Germany

PLANE SETS WORLD'S RECORD FOR NUMBER CARRIED

1095

What is probably a world's record for the number of people flown in one airplane within a short time was set recently in Scotland, when 2,100 people took joy rides in a single airplane in the course of two consecutive days. The plane, one of the giant twenty-passenger cross-channel air liners of the imperial airways, had flown to Scotland in a race with the "Flying Scotsman," the famous non-stop passenger train, beating the train by a good margin. It remained two days at the Glasgow airdrome and, in that time, the pilot made 105 flights with a full passenger list each time, at a price of half a guinea (\$2.50) per passenger, earning a total of more than \$5,000 in the two days. No trouble marred the unusual performance.

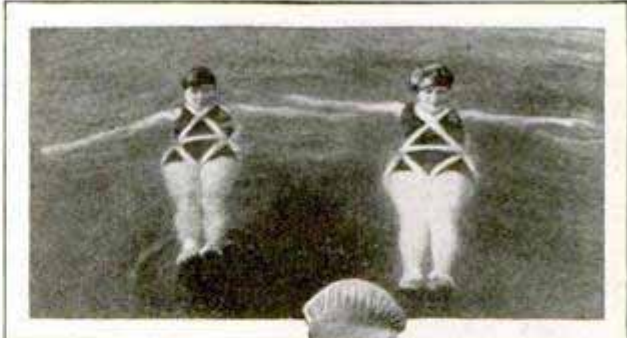

© Henry Miller
Floating with the Tube Suits, and How the Preservers Are Worn without Hampering Movements

AUTO AND BIKE COMBINED FOR DELIVERIES

1049

Features of an automobile and a motorcycle are combined in a delivery car that has a spacious compartment for packages in front and a saddle like that of a cycle for the operator to sit on. This is considered more efficient than an ordinary car seat as he can get in and out of it more quickly to attend to his deliveries. The vehicle has four wheels, but is said to be as

From Automobile Technic

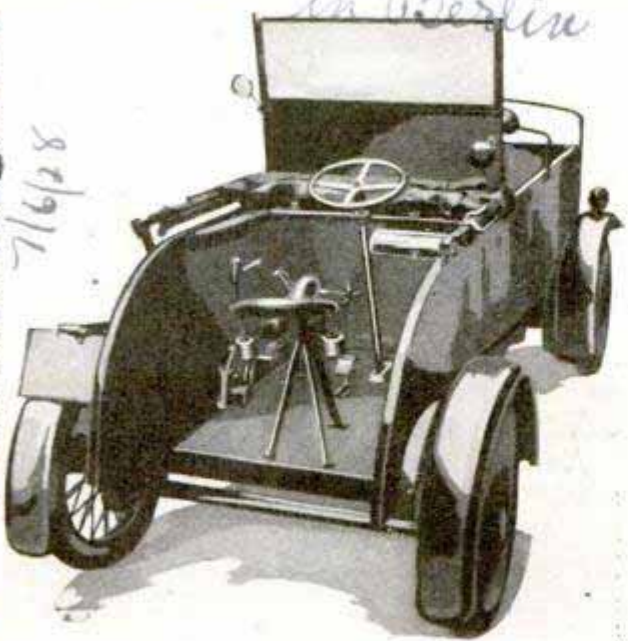

Rear View of Combination Auto and Cycle, Which Affords Fast Delivery Service

easily managed in heavy traffic as a motorcycle and develops high speed.

make my own

RUBBER TUBE SWIM HARNESS HELPS BEGINNERS

Pneumatic tubes, worn about the body in such a way that they offer a minimum of interference to the swimmer's movements, have been introduced to help the beginner. They are easily adjusted and there is no risk of their coming off.

CLOUDS BOMBED TO PREVENT HAILSTORMS

1049

In an effort to break up a hailstorm and prevent damage to crops, Swiss scientists recently bombed the clouds with high-explosive rockets. Opinion after the experiment was divided, however, as to the value of the results achieved. The hailstorm, which swept the Swiss-French frontier, caused enormous damage. Hailstones as large as plums stripped fruit trees and entire vineyards were washed away.

7/19/28
Hail
daily

Popular Mechanics Magazine does not publish the name of the maker or seller of any device described in its pages, but this information will be furnished, free, by our Bureau of Information.

Also Boston Transcript

Cont. of N. H. ...
168 ...
Boston ...

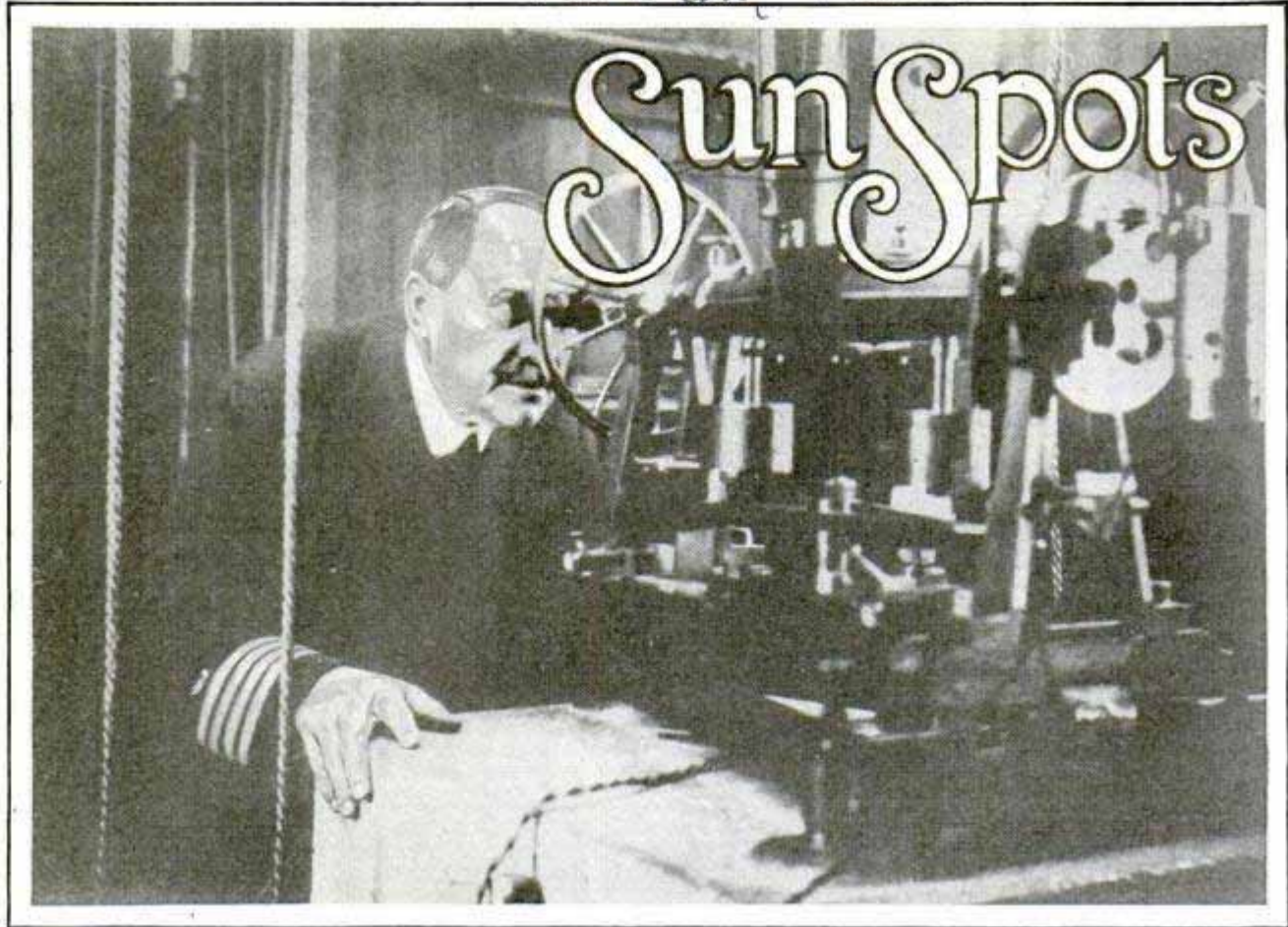

Captain T. J. J. See, Director of the United States Naval Observatory at Mare Island, California, at One of His Instruments; the Naval Astronomers Are Seeking New Stars

BBETTER radio reception for the next few years, and also a decrease in sunburn for summer bathers, were predicted recently when the Astronomical society of the Pacific met to compare notes on a year's observation of the heavens.

The good news for wireless fans and swimmers is credited to the same cause, a decrease in the number of sunspots, or solar hurricanes. Judging by past performances, the number of sun storms will decrease steadily for some years, and then slowly increase until they reach a maximum again in about eleven years. The present cycle, which reached its maximum about March, 1927, followed the previous one by only 7.3 years, but observations stretching over more than a century indicate it may be another hundred years before such a short cycle is reached again. The last previous one was the storm maxima of 1829 and 1837.

Sunspots are responsible for the magnetic storms and unusual displays of the northern lights, which register on the radio receiver as static. Also, according to Dr. Edison Pettit, there is a striking agree-

ment between the number and size of the spots on the sun and the amount of ultraviolet light reaching the earth, and ultraviolet rays are the ones that cause sunburn, when the body gets too much of them. For four years, Dr. Pettit has measured the ultraviolet rays received at Mt. Wilson observatory by passing the sunlight through a filter of thin gold and a similar filter of silver, the one cutting off the short violet rays and the other passing them without obstruction. At times, there was a fifty-per-cent variation in the amount of ultraviolet light within the space of a month, and each time the rise or fall of the amount of short rays coincided with the rise or fall in sun storms.

Another discovery made at Mt. Wilson as a result of work by Dr. Seth B. Nicholson, the astronomer who, in 1914, won for himself a place in star history by finding an unknown moon of the planet Jupiter, is the presence of boron, the chief element of the familiar boric-acid eye lotion, in the sun, thereby clearing up the identity of hitherto unknown lines in the sun's spectrum. None of the lines of boron

Forecast Better Radio

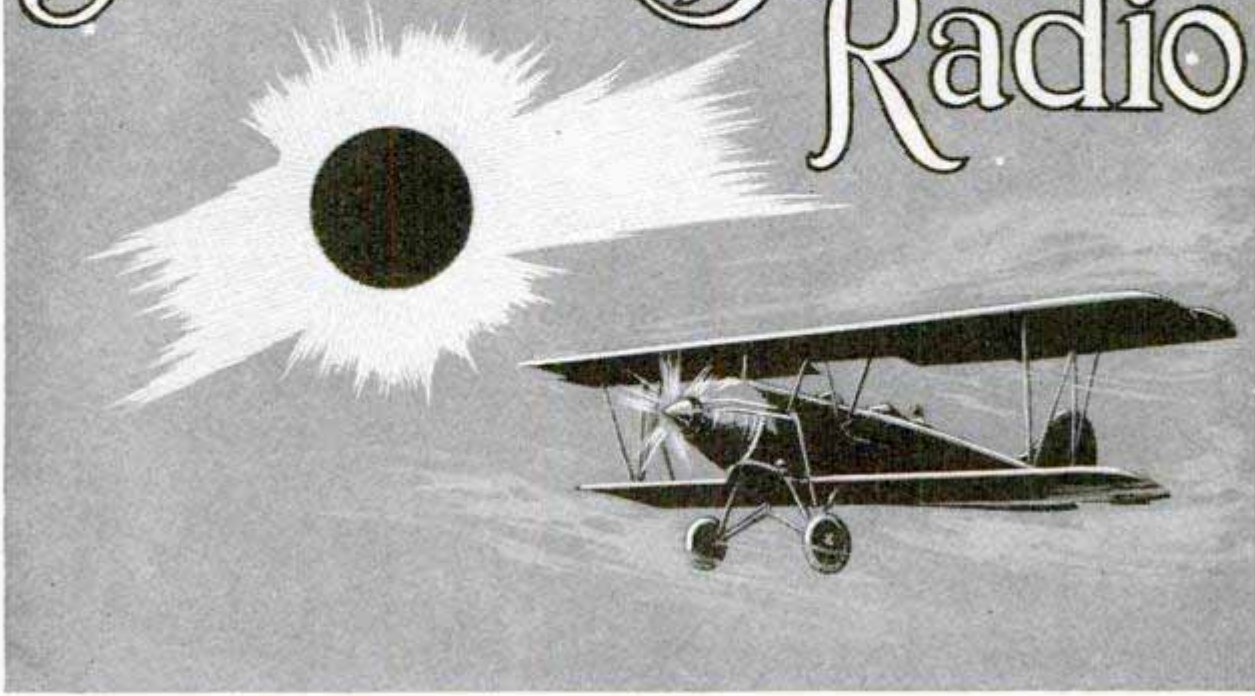

The Corona of the Sun during an Eclipse Seen in England Last Year; the Event Was Photographed by Astronomers Flying in Airplanes Far above the Cloud Line

alone have ever been found in an analysis of the sun's light, as it is broken up by the spectroscope, but when Dr. Nicholson combined boron with other chemicals, characteristic light bands in its spectrum checked with some of the unidentified elements of sunlight.

The present year may go down in astronomical history as one of the greatest since the invention of the telescope, for, somewhere out in space, near three billion miles away from the earth, a new planet may possibly be rushing into view.

Prof. William H. Pickering, head of his own observatory in Jamaica, has spent several years observing mysterious deviations in the orbits of Saturn, Uranus and Neptune, outermost members of our solar system. On the basis of his calculations, he has advanced the theory that the only explanation lies in the presence in their vicinity of an unknown planet, of a mass as great, or greater, than that of our earth.

Yerkes observatory, at Williams Bay, Wis., the Harvard observatory, at Cambridge, Mass., Mt. Wilson and Lick, on Mt. Hamilton, in California, the observa-

tory at Flagstaff, Ariz., and others in Peru and Chile have been busy for several months photographing the heavens in the region beyond Saturn's rings and between Uranus and Neptune in hope of finding a ninth planet, but so far without success.

That there probably is one more and possibly two undiscovered planets, is generally accepted by astronomers. While Dr. Pickering's calculations are not entirely approved, his standing as the discoverer of the ninth satellite of Saturn lends weight to his theory. More than thirty years ago, he calculated that this unknown moon must exist, and figured that it should be found in a certain location. When the telescope was trained on the spot, he found the satellite, to which the name "Phoebe" was given.

His theory of a ninth planet far out beyond the limits of the known solar system is based on the erratic behavior of Neptune. The eight known planets, in their order from the sun, are Mercury, Venus, Earth, Mars, Jupiter, Saturn, Uranus and Neptune.

Johann Elert Bode, a German astrono-



Flaming Storms on the Sun's Surface, with Streamers 85,000 Miles High; the Small Circle Indicates the Comparative Size of the Earth; at Right, Huge Spots When the Storms Were at Their Maximum in 1926

mer, who died in 1826, established the fact that the planets are arranged in regular order from the sun, in a proportion which is represented by adding four to each number of the series 0, 3, 6, 12, 24, 48, etc. In other words, as the distance of Mercury—36,000,000 miles—is represented by four, then three plus four represents the distance from the sun to Venus, and so on. The distribution of the planets, according to Bode's law, checked so perfectly that, when it was found there was none between Mars and Jupiter, where the distance represented by twenty-four plus four called for one, astronomers decided the planet in that location must have met with an accident, and so began looking for the fragments. Since that time, hundreds of small planetoids have been found, until the number known is now more than 700, and growing at the rate of about thirty a year. The two largest are only 400 miles in diameter, and the majority are probably not more than fifteen or twenty miles across.

If there is another planet outside Neptune's orbit, the Bode law fixes its position as almost inconceivably remote. It is 2,796,528,000 miles from the sun to Neptune, and 92,998,000 miles less from the earth, so that astronomers must look with the eyes of their cameras across nearly two and three-quarter billion miles of space before they reach the farthest known planet, at the period when it is closest to the earth, and, according to the Bode law, the next

member of the solar family, if it exists, must be a couple of billion miles farther away. How far, it is impossible to actually say, for Bode's law is only roughly correct, showing an appreciable error in the case of Neptune, for example. According to the rule, the planet should be nearly thirty-nine times as far from the sun as the distance from the sun to the earth, whereas actually the distance is about thirty times.



If another planet outside of Neptune is found, its period of rotation around the sun will be measured in hundreds of years. It takes Neptune 165 years to make the complete circuit, and, as it was not discovered until September, 1846, it has not as yet made one trip around its orbit under observation. Before Neptune had been discovered, however, its presence had been deduced from the eccentric conduct of Uranus, just as Neptune's deviation from its charted course gives rise to the conclusion that it is being drawn away by the force of gravity exerted by some tremendous mass farther away from us. As early as 1834, astronomers, following Uranus' path, began calculating the position of a possible planet farther away, and by 1846 had determined not only its probable location, but the path it must be traveling. The calculations were so exact that when, on a September night, the Berlin observatory started the search, the planet was located within a few hours.

The next year Sears Cook Walker, of the National observatory in Washington, started computing the past positions of the planet, and discovered that it was identical with a star observed twice by Lalande at Paris in 1795. Search of the records in Paris disclosed that the French astronomer,

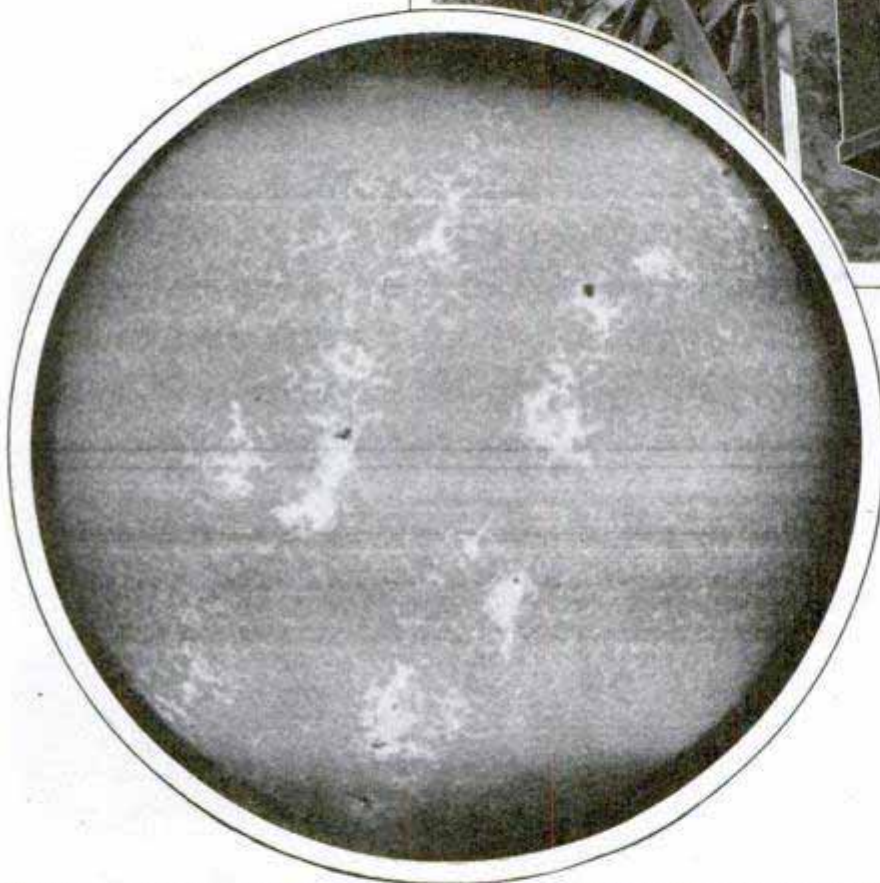
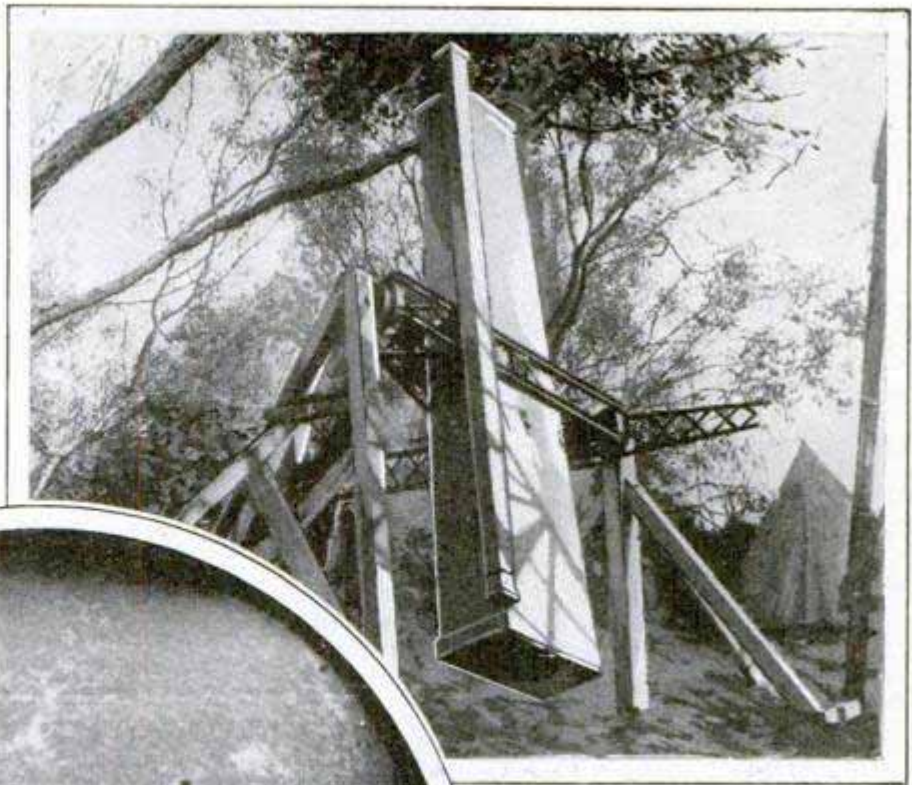

Spectroheliogram of the Sun on May 2 of This Year, Showing a Double Chain of Sunspots; Right, Telescopic Camera with Five-Inch Lens and Focal Depth of Fifteen Feet, Used at Lick Observatory in the Search for a New Zone of Planets

finding his two observations did not agree in position, decided one was in error and marked the other doubtful. Had he gone back to his telescope to determine which of his figures was correct, he would have found his supposed star had moved again, and thereby discovered the planet half a century before it was actually found.

The probable size of Pickering's supposed planet, if it exists, is also of interest to astronomers. Neptune, located because of its influence on the orbit of Uranus, is the larger of the two. The suspected ninth planet, being nearly twice as

far from Neptune as the latter is from Uranus, probably would have to be of even greater mass to have any observable effect. The orbit of Neptune has been more or less of a puzzle from the start, as it is more near a circle than the usual elliptic path of planets, stars and comets.

If found, the ninth planet probably will be a frozen world, for temperatures fall rapidly with distance from the sun. The normal temperature of Neptune is estimated

at 218 degrees below zero, centigrade, whereas the earth's normal, according to the same scale, is nineteen above zero.

FLOODLIGHTS IN CHURCH '63

At night and on dull days, persons attending an English church may still enjoy the effect of stained-glass windows by means of a special system of colored floodlighting. The lamps are controlled from central points and different effects can be produced to harmonize with the various stages of the services.

*St. Michael and
11th St. N.W. Wash. D.C.*

NON-SKID MOTOR ROAD MATERIAL STOPS ACCIDENTS

Interesting tests with a non-skid type of pavement on fifty miles of highway are being made in California. The surface consists of ninety-eight per cent of hard, crushed rock or gravel, screened so that no piece is more than three-eighths of an inch in greatest diameter. This is thoroughly mixed with asphalt and the composition is then spread and rolled into the asphaltic-concrete pavement while hot. Rolling is continued until the screenings are thoroughly impacted into the paving. The surface sheds water readily, resists accumulations of oil, is not expensive, and tests with it have been successful, according to the report of the highway commission.

MOTH PREVENTIVE IN HOLDER PURIFIES AIR

Besides destroying and preventing moths, a chemical inclosed in a small container is said to purify air in bathrooms, closed cars and similar places. It gives no unpleasant odor, is effective in protecting rugs, furniture and other articles, and although the chemical is volatile, a single filling will last about three months.



CHART GIVES CORRECT TIME ANY PLACE IN WORLD

A chart that tells the correct time any place in the world has been prepared by the bureau of standards for sale through the government printing office. It consists of a heavy cardboard disk mounted on a larger card. The revolving disk is

FOLDING BOAT FITS ON AUTO RUNNING BOARD

So compact that it can be collapsed into a small bundle for the auto running board, a folding boat is made of mahogany pieces joined by waterproof canvas and can be put together in less than two minutes. It weighs under 100 pounds, and is about ten feet long and three and one-half feet wide. No tools are required in assembling it, and it can be used with an outboard motor.

TIRE GAUGE AND DEFLATOR HELPS PROTECT VALVES

Fitted for testing all kinds of tires, a combination gauge, calibrated from ten to 160 pounds, has a deflator attachment so that air can be let out from the valves without using a match, the thumbnail or other means likely to damage the part. The unit is of a size that prevents its becoming lost easily, yet can be carried in the pocket, and is durably built.

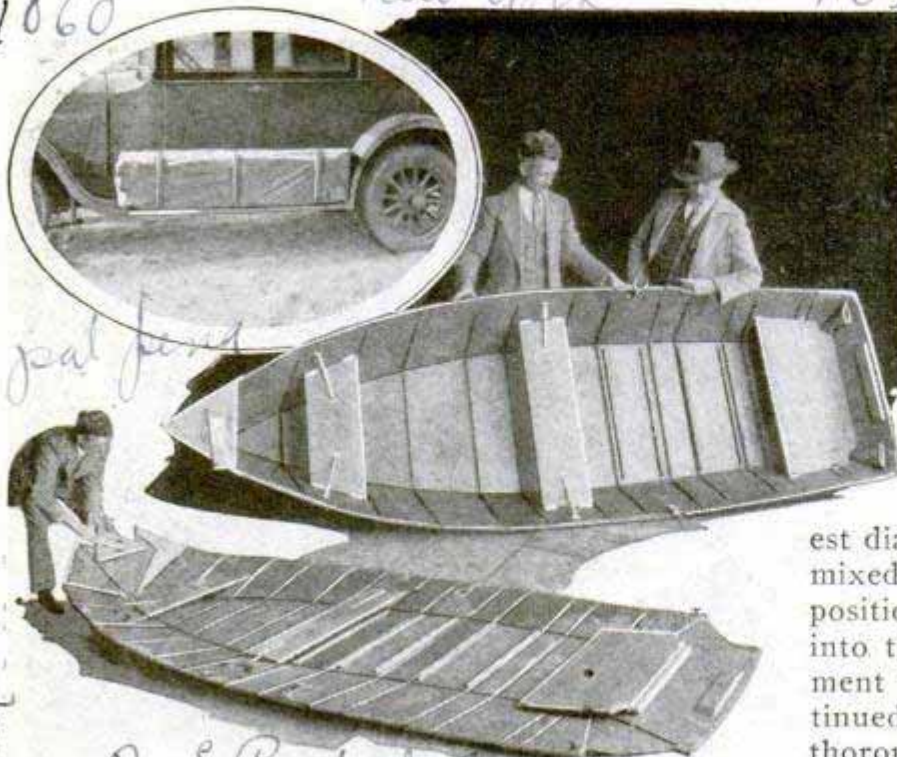

Boat on Auto Running Board, Ready for Use, and Partly Set Up; It Is Made of Mahogany Pieces Joined by Canvas

no Chicago

*498 U and 10th Ave
Chicago 1516 S. Wabash
A. Schrader, Inc.
Brooklyn, NY*

new York

*tar evaporators, inc.
5307 W. Harrison St.*

divided into fifteen-degree segments, half of which are in white, numbered from one to twelve, for the hours from midnight to noon, and half printed in black, with the same numbering, for the period from noon to midnight. The base card also contains a circle, laid off in fifteen-degree segments, with secondary lines every seven and a half degrees. The principle of the card is that time changes one hour for every fifteen degrees of longitude. Because the astronomical day starts at noon instead of midnight, time is reckoned from Greenwich, England, the base longitude line, and the international date line, where days change, is halfway around the world, on the 180th meridian. Knowing the local time, it is only necessary to revolve the inner disk until the correct time is opposite the operator's local time zone. The correct time and place around the earth can then be read from the outer circle.

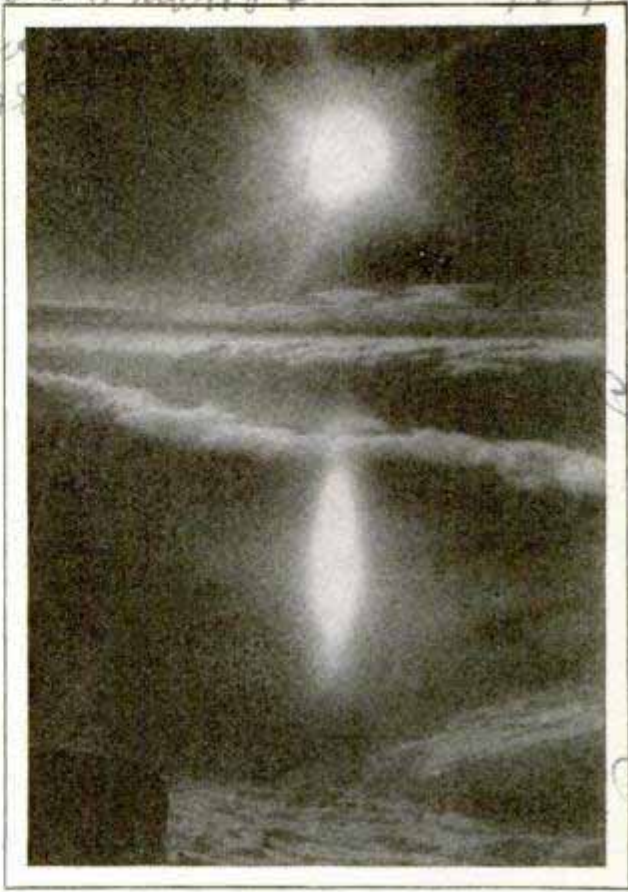

Reflection of the Sun on Clouds of Tiny Ice Particles; a Phenomenon Observed from Mountain Peaks

TEAR-GAS CLUB FOR POLICEMEN TO HELP CONQUER CROOKS

Tear-gas "billies" have been allotted to emergency squads of the New York police department to help them arrest criminals. The gas compartment is concealed in one end of what appears to be an ordinary club. This arrangement permits introducing the gas through narrow spaces and small openings that could be reached only with difficulty by ordinary gas bombs.



Tear-Gas Container in Policeman's Club for Emergency Use in Subduing Crooks

ICE-CRYSTAL CLOUDS MIRROR SUN AND MOON

A beautiful phenomenon, sometimes seen from airplanes or from the top of high mountains, is the reflection of the sun or moon upon clouds formed of tiny ice particles. It is not a common sight as the clouds that produce it must be at a high altitude and the reflection appears only on their upper surface. The accompanying illustration of the "under-sun" was taken from the summit of one of the peaks in the Tyrolean Alps. Occasionally, the image is surrounded by a circular or elliptical halo of small diameter. The phenomenon was first observed at an ascension of French balloonists in 1850.

WORKERS WEAR TAIL LIGHTS

"Trouble shooters" employed by the Cleveland electric railway are being equipped with belts of red reflectors similar to those used at dangerous highway curves, to help prevent accidents. They can be seen at a considerable distance and will warn other employes that men are working on the lines.

Photo from Box 40, Washington D.C.

Chas. James Scott
Maintenance Dept.

1041

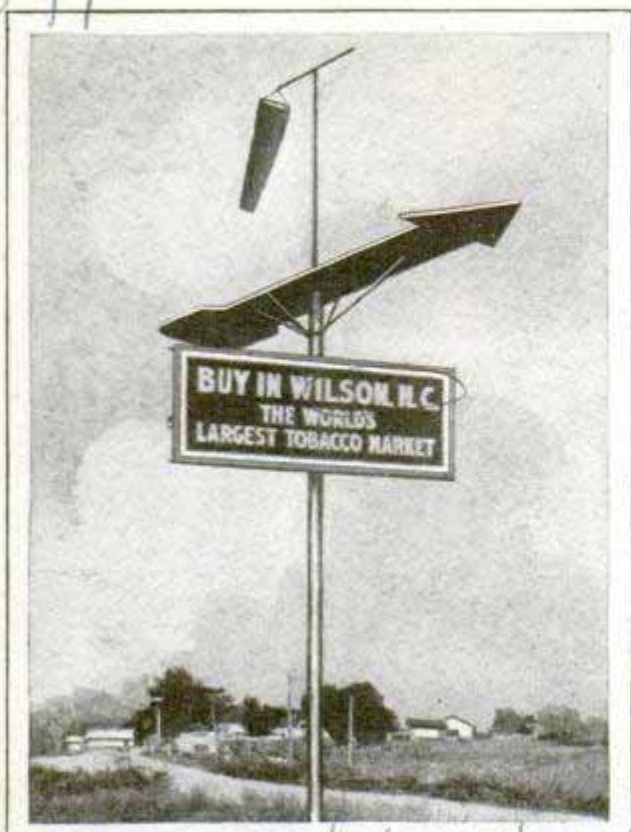

For the Guidance of Airmen, This Sign Shows the Wind Direction and Points to Town

ROAD SIGN FOR AIR TRAVELERS SHOWS WIND DIRECTION

Development of aviation has brought a need for special signs to guard the aviator by day and night. One of the latest steps in this direction has been taken along a southern air-mail route, where a marker has been set up with a "sock" to show the direction of the wind, a large arrow painted with the name of the city or town to which it points and a smaller arrow that points due north. The sign thus gives the pilot three essential bits of information. It can be seen, when the weather is clear, from an altitude of 3,000 feet.

IDEA OF EXPLOSION ENGINE OLDER THAN STEAM

Gasoline and other motors that operate by the force of an explosion are of such comparatively recent development, that few persons realize the basic idea of such engines was conceived long before the appearance of the steam engine. In 1680, Huygens described an explosion motor which was to be operated by discharging a quantity of powder to drive the air out of a cylinder and raise a piston. To that

Kansas City Star 7/14/28

point, his engine relied on a force somewhat similar to the working principle of those today, but the useful work was to be done by the piston being forced down by the pressure of the atmosphere against it, thus lifting a weight or doing some other task. There is no record that this engine ever was operated. The steam engine of 1705 functioned on about the same plan, that is, steam was used to lift the weight of the piston, and after this was done, the atmospheric pressure was relied upon for the real work. After Huygens, almost 100 years passed before inventors caught the vision of rotary motion from their engines. His idea simply involved a piston and a cylinder. In other respects, there was no more similarity between his engine and those of today than there is between a steam hammer and a stone hatchet.

RADIO FOR TAXI'S PASSENGERS HELPS ATTRACT FARES

Radio music drowns the click of the meter and helps draw fares to a taxicab an eastern driver operates. He installed a set for his own amusement when not on the road. He soon found, however, that it proved popular with his customers and arranged it as a permanent feature of his cab. It occupies a convenient space at



Radio Set, Installed beside Cab Driver, Attracts Attention of Public and Entertains Passengers

the driver's right where it does not interfere with the operation of the vehicle.

International

539

William J. Whitaker

© U. & U.

257 - can
Francisco Calif.

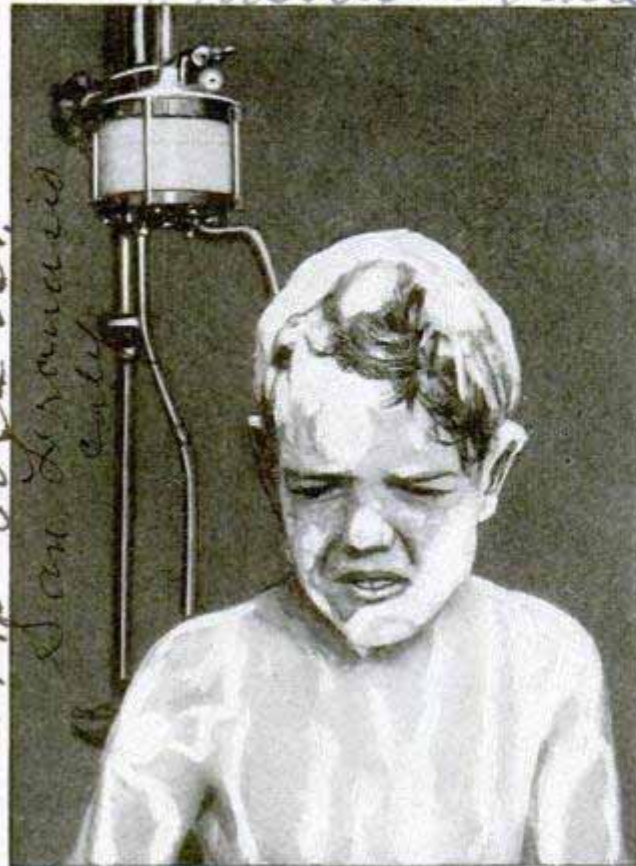

Suds Tank Dispenses Lather Directly without the Need of Working It Up during the Bath

SOAPSUDS FOUNTAIN FOR BATH LATEST TOILET AID

Press a button and soapsuds, salt water, scented water or other toilet preparations gush from a spout in a bath attachment a California inventor has introduced. As many containers as desired can be connected to the arrangement and they are installed in a convenient position for use while bathing.

PROPELLER RESEARCH AIMED TO IMPROVE FLYING

Two goals are being sought in the propeller experimental laboratory of the army at Wilbur Wright field, Dayton, Ohio, to make flying safer and better. One is a metal propeller, to be strong but lighter even than aluminum, and the other is a variable-pitch propeller, the pitch of which can be changed while in flight. Frank W. Caldwell, who developed the composition propeller known as "micarta," a pressed affair of fabric and glue, is in charge of the work. Present propellers are built with the most efficient pitch for the average speed at which they are to be flown,

but in landing and taking off, when the speed of the plane is below flying speed the pitch is entirely too high. Inventors for years have wrestled with the problem of designing such a propeller.

RADIO KEEPS MILK FRESH FOR SEVERAL DAYS

Wireless waves have been adapted by a Vienna scientist to keep milk from spoiling. A special generator is fitted to a pasteurizing outfit, or two cylinders are employed, the milk being heated slightly in one and then subjected to the radio waves in the other. According to reports, milk so treated, is kept from turning sour for four days and for a period of two to three weeks if it is cooled.

"CAT'S EYE" TRAFFIC LIGHTS GUIDE MOTORISTS

In addition to the regular safety zones for the protection of passengers boarding and leaving surface cars, "cat's eye" light signal towers have been introduced in Berlin. The units are simply reflectors that catch the glow from other sources and are mounted on vertical supports where they can be seen at a considerable distance. They are of particular service in warning motorists to detour around the safety areas.

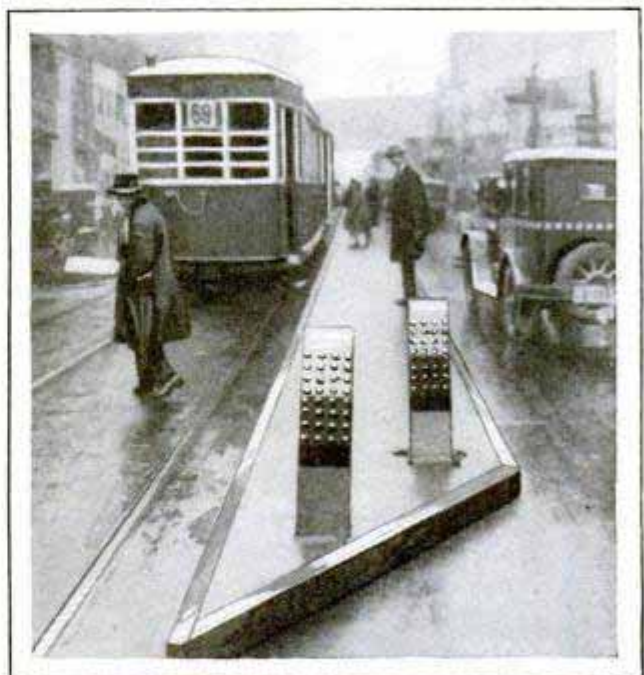

"Cat's Eye" Lights on Safety Guards at Street-Car Loading Station Help Protect Passengers

H. J. Cantrell
2440 Polk St.

dna

Vienna, Ind.
Apr 20
J. W. ...
...

Chicago Daily News
7/10/28.

Teaching Bees New Tricks

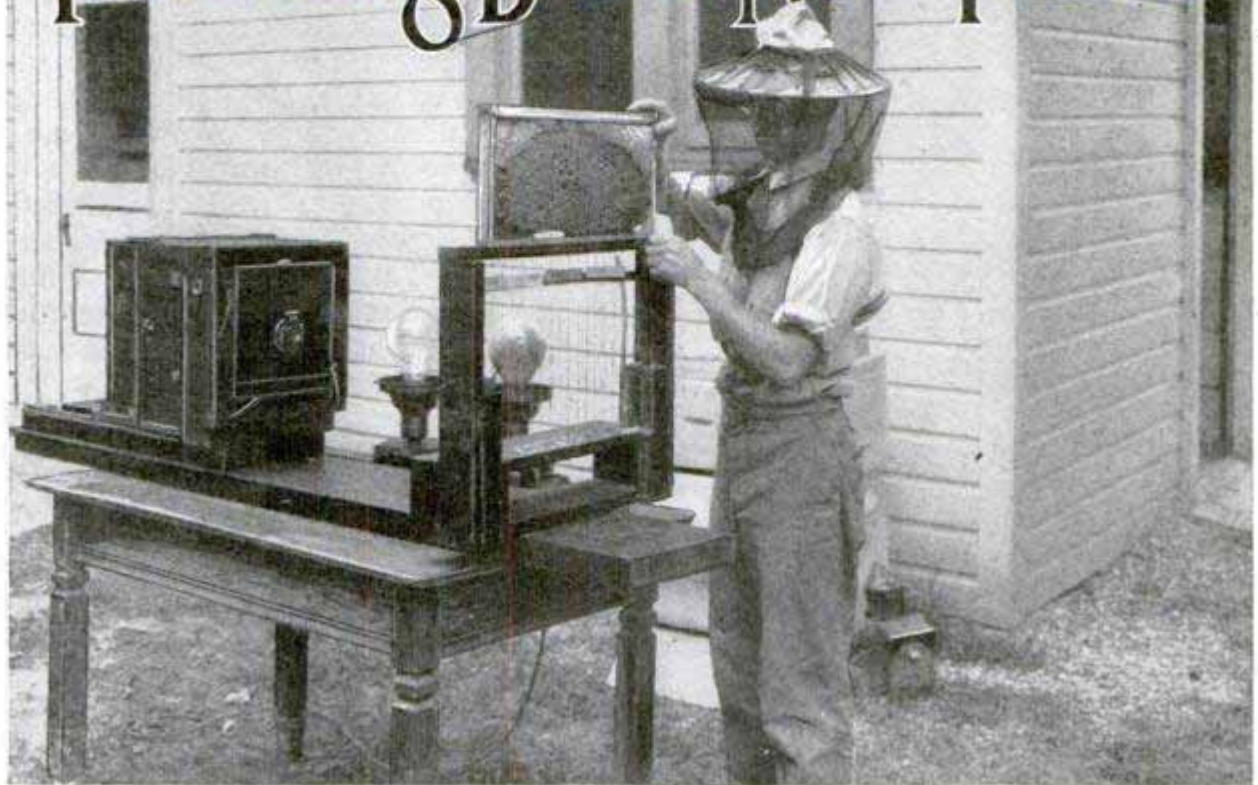

Ascertaining the Egg-Laying Ability of a Queen Bee by Photographing Her Brood Comb, and Then Counting the Sealed Egg Cells by Placing the Picture under a Magnifying Glass

By G. H. DACY

WHETHER to "bee" or not to "bee" is a puzzling question, of personal interest to millions of folks both in this country and abroad who would like to operate apiaries for profit and pleasure but are deterred because of the great amount of misinformation in circulation about honeybees.

Twenty-five years ago, your Uncle Sam established the world's largest bee-culture laboratory near Washington in order to solve mystifying secrets of apiculture and, as far as possible, to standardize commercial beekeeping. Bees win the blue ribbon as keepers of secrets. For some twenty centuries, scholars, scientists, philosophers and private experimenters have sought to unravel the baffling mysteries of the beehive and honeycomb, but how the bee makes honey remains an enigma.

The government search for authentic facts and figures about bees has hatched out into a conquest. Our national experts and various co-operative research agencies

have discovered more new facts about bees during the last decade than did the Egyptians, Greeks and Romans in several centuries. Comprehensive experiments have disclosed that bees have measurable capacity for learning and can be trained. Worker bees have been taught to distinguish between different colors. For example, a red light was placed near a food supply. The busy bees learned quickly to associate that color with food. No matter where the red light was placed, the bees would find it and fly to it whenever they were hungry. If the food was removed from the neighborhood of the red light to a position near a green light, the bees, instead of massing near the former, organized scouting parties and began explorations, seeking the disappeared food station. Having eventually found it near the green light, they soon learned to recognize that color as the dependable sign post that indicated food. This test was repeated time and again, until all the colors of the

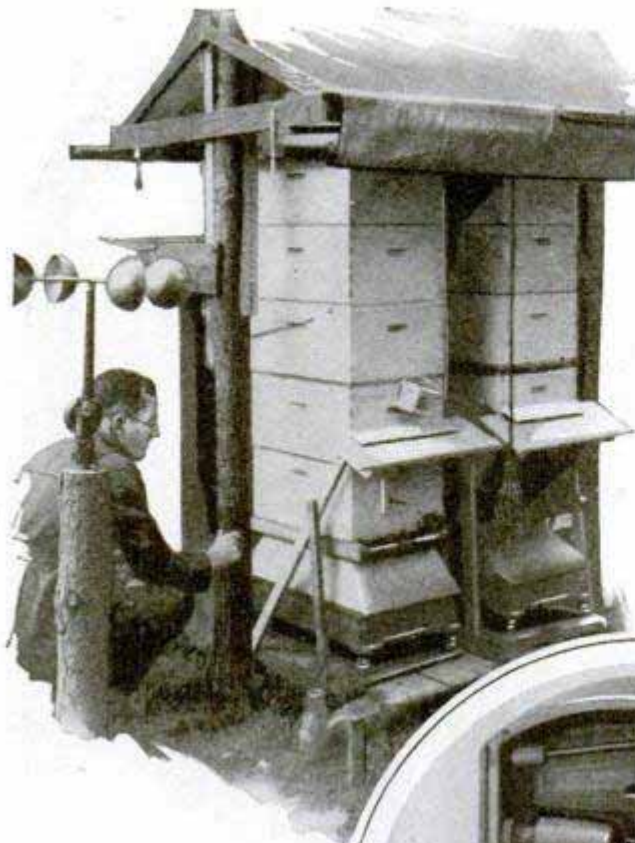

spectrum had been used, and the bees never failed to find the wandering food, nor to identify it for future reference, by the colored light which marked its position.

The average life of a worker bee, it has been found, is six weeks during the peak of the honey-making season. Four weeks of this period is devoted to nectar-gathering flights, while the balance is spent in the hive. Science, by producing more robust, vigorous worker bees that will live longer and spend only one additional week in the field, can eventually raise the American honey crop by about one-fourth. On the basis of last year's output, this would mean an increased cash return of over \$9,000,000.

The long-winded and better-flying bees of the future will facilitate the establishment of apiaries farther from satisfactory "pasturage." The general practice at present is to locate beehives not farther than two miles from an abundant and permanent source of flower nectar and

pollen. It may be that during the years to come this distance can safely be increased to four miles.

The selective breeding of bees will also make available nectar which under existing circumstances is accessible but to a limited class of bees. Red-clover blossoms, for example, have unusually deep corollas and their nectar content can be exploited only by bumblebees, whose tongues are quite long. Future selection will aid in vastly increasing the number of such bees. This will result in the conservation of valuable flower nectar which now "goes to seed," because ordinary bees cannot reach it.

Weather conditions vitally affect the honey-manufacturing activities of the beehive. Any beekeeper will inform you, for example, that, on warm and bright days, his bees are gentle, while during cold, cloudy weather the insects are irritable and more apt to sting

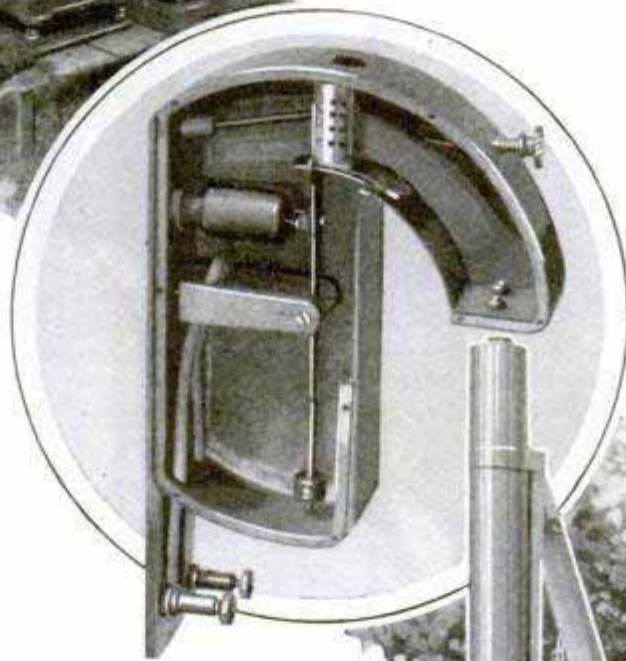

Studying the Effects of Weather on the Activities of Uncle Sam's Bees, and, Center, an Electric Flight Detector That Measures Their Trips

whoever comes near their hives. Selective breeding will facilitate the multiplication of workers endowed with remarkable resistance against weather hardships and disease. This also will be reflected in increased honey production. The winter losses in American apiaries throughout the snow and cold-weather belts range from \$8,000,000 to \$10,000,000 a year. Various bee diseases collect an additional annual tribute amounting to at least \$1,000,000. Such monetary losses can be curtailed by breeding better bees. And this is exactly what science purposes to do.

Special glass-faced hives which can be illuminated at night and are equipped with microscopes, so that the experts can keep tab on the events which occur in the honeycomb, have assisted markedly in untwisting the tangled skein of normal beehive history. The observation hive, originated by a Vermont banker who kept bees as a hobby, has been improved by the government. It is the dependable motion-picture show of honeycomb enterprises and beehive life cycles. Small wonder that national experts have sat by night and day with eyes glued to these microscopes. They have actually seen and interpreted the "daily doings" of these industrious insects.

You can watch the queen depositing the equivalent of her weight daily in eggs; eggs that are minute, elongated and no larger than two or three fine needle points. Three days after the egg is laid, the white, blind, footless larva emerges. During the next six days this larva performs a record feat in rapid growing. It increases 1,500 times in weight. If the average six-pound baby of the human family made corresponding growth, it would weigh four and one-half tons when one week old. Exactly twenty-one days after the egg is deposited, the adult bee is ready to emerge and assume the duties of a nurse bee.

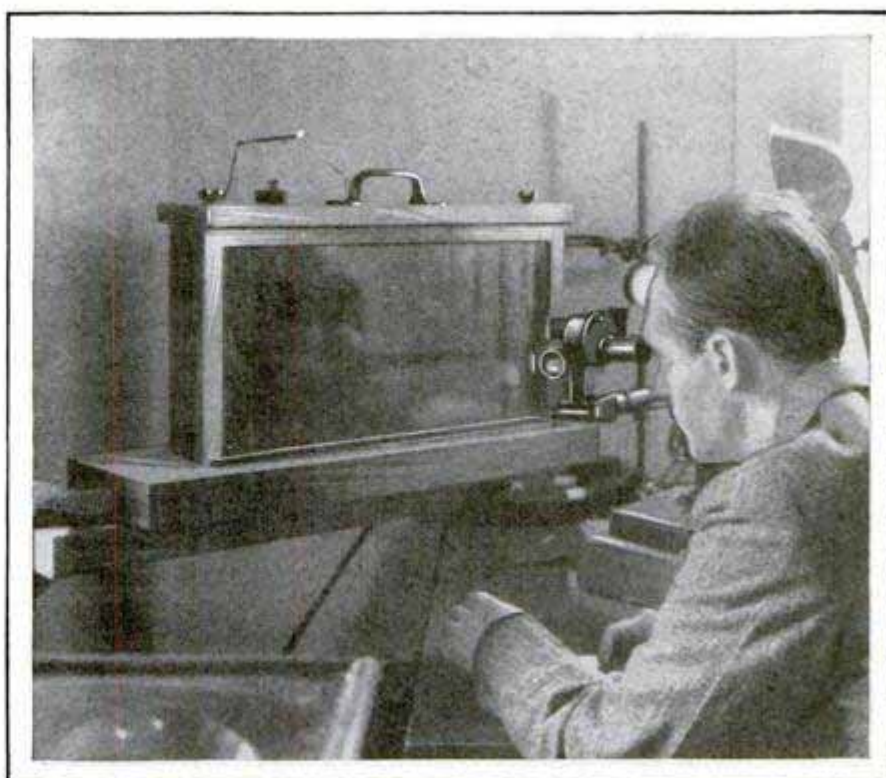

Science Solves the Beehive Secrets by Watching the Busy Workers Day and Night in a Special Glass-Faced Hive

You can even study the superior system of business management which dominates the beehive. Sanitary engineers maintain the honeycomb in cleanly, healthy condition. You can easily visualize bee policemen directing traffic throughout the congested chambers, cells and paths of this large insect tenement. Bees that become crippled or die are disposed of forthwith. The buzz of the beehive is an anthem of industry and not a signal of warning. To certain bees is delegated the task of ventilating the hive during warm weather and of heating it during the season of cold. They flap their wings in unison, simulating fans. To generate heat, they consume large quantities of honey—a ranking energy food—and indulge in bodily contortions. Bees have quickly increased the temperature in the hive from fifty-seven to as high as ninety-five degrees Fahrenheit. During the most severe winter weather, the bee-firemen maintain an almost constant temperature inside of the hive.

German scientists claim that bees chat with one another by means of a vibratory dance. Their American cousins at the federal bee-culture laboratory have never verified this pretty theory. Uncle Sam's experts, however, have observed these dances which are reputed to facilitate bee

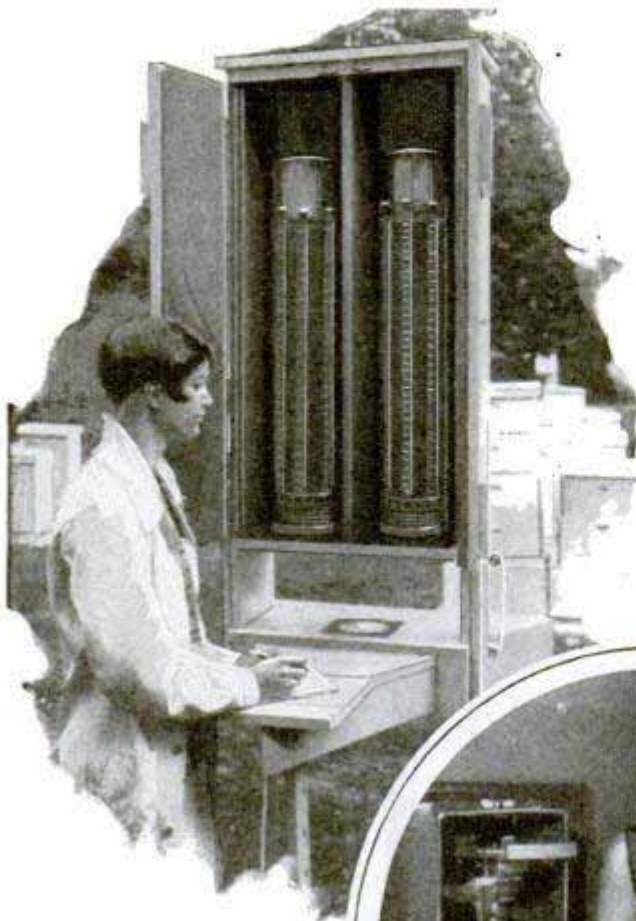

water in a sack, while pellets of pollen are stored in stiff bristle baskets located on the hindlegs.

In the basement of the government laboratory, a colony of bees—during the summer flower season it contains from 80,000 to 100,000 worker bees—rests on a delicately adjusted balance which is connected with a continuous chart recorder and weighs the daily production of the hustling honeybees. It records exactly the time in the morning when they leave the hive, the frequency of return trips, discriminates between good and bad days for honey making and indicates correctly the approach of a storm. Bees are excellent weather prophets and usually mass

back to the hive several hours before the rain or windstorm breaks.

This device has proved that bees do not observe regular hours, but, on bright warm days, leave the hive as early as 4:00 a. m. and continue their nectar flights until seven or eight in the evening. The

communication. There is this to be said, though, that constant activity is in progress in the honeycomb. Bees literally work themselves to death. The worker, at birth, is charged with a certain amount of energy. Each day of its life as an adult it becomes weaker. Bees rest occasionally, but these pauses in their labor are not productive of rebuilt tissue and restored energy. The worker bee resembles an electric battery. It starts out charged to capacity. Day by day, it runs down and finally dies when it has exhausted the original charge.

By placing a hive of bees on an island five miles from a source of flower nectar, it has been demonstrated conclusively that the workers will fly that far in quest of food. In the mountainous states of the west, apiculturists report that honeybees have flown as far as seven miles in search of raw materials for honey. The average worker bee weighs eighty milligrams and is able to carry a burden in flight equal to one-half its weight. It carries nectar and



More Weather Observations, Top; the Electric Penman, Center, and a Recorder That Charts the Comings and Goings of the Bees

1008

36 57 Broadway Co. Inc. W
33 4th Ave. N.Y.C.
New York City 607

various workers make from four to thirty flights each day, the water carriers bringing back more loads and making more frequent trips than do the nectar gatherers. Under ideal conditions, as much as twenty pounds of honey have been made in this experimental hive in twenty-four hours.

Another interesting apparatus now in use at Uncle Sam's scientific apiary is a technical simulation of a flower which contains a constant supply of nectar. The device accommodates ten bees at a time and is located outdoors near the sixty colonies, comprising a maximum population of 6,000,000 Italian honeybees. An electrical contact device is hooked up with a float in the dish of bee food and records on a chart the amount removed, the number of times the bees visit the feeder and the effects of varying weather conditions on these flights.

An efficient method of grading honey by color and flavor has been developed by the Washington specialists. An instrument originated by a physicist at Johns Hopkins university, which transmits various wavelengths of light through the honey samples, makes honey grading a rapid and simple process. Honey is now inspected and graded like wheat, potatoes, tobacco, cotton and apples.

Despite popular opinion to the contrary, worker bees do not recognize their owner and he is no more immune from stings by his own bees than the ordinary stranger.

"If a honeybee stings you," advises your Uncle Sam, "don't run for help but stand still and scratch. The bee that stings you injects its stinger, the poison sac and surrounding muscular tissue into the wound. It's your job to scratch this foreign material as speedily as possible from the wound with your fingernails. Dig it out at once and the wound will not swell while the pain will soon cease. The government experts have never discovered any remedy for bee stings. The wounds are so small that it is impossible to introduce any solution in sufficient quantity into the tiny puncture to accomplish any good."



Wheel for Rapid Assembly of Shoes; It Makes 600 Pairs in Eight Hours

WHEEL TO ASSEMBLE SHOES SPEEDS PRODUCTION

Six hundred pairs of shoes can be made in eight hours with an assembling-wheel apparatus introduced in France, according to reports. Separate parts of the shoes are placed on holders about the circumference of the wheel and the stitching and other processes quickly accomplished.

OUTBOARD HULL LIKE PLANE GIVES HIGH SPEED

Increased speed in outboard-motor boats has been attained in a craft with a body somewhat like the streamlined fuselage of an airplane. Features of the flying boat have also been applied to the craft to decrease bottom friction.

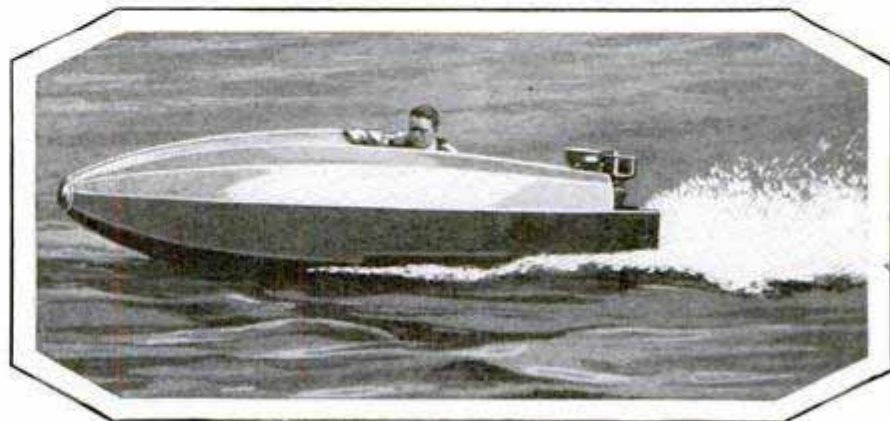

Outboard Boat with Hull like Fuselage of Plane, to Decrease Wind Resistance and Water Friction.

W. H. ...
New York City
411 W. 43rd St.
rate with ...
page m- ...

Richmond ... Co.
...
...

Chicago

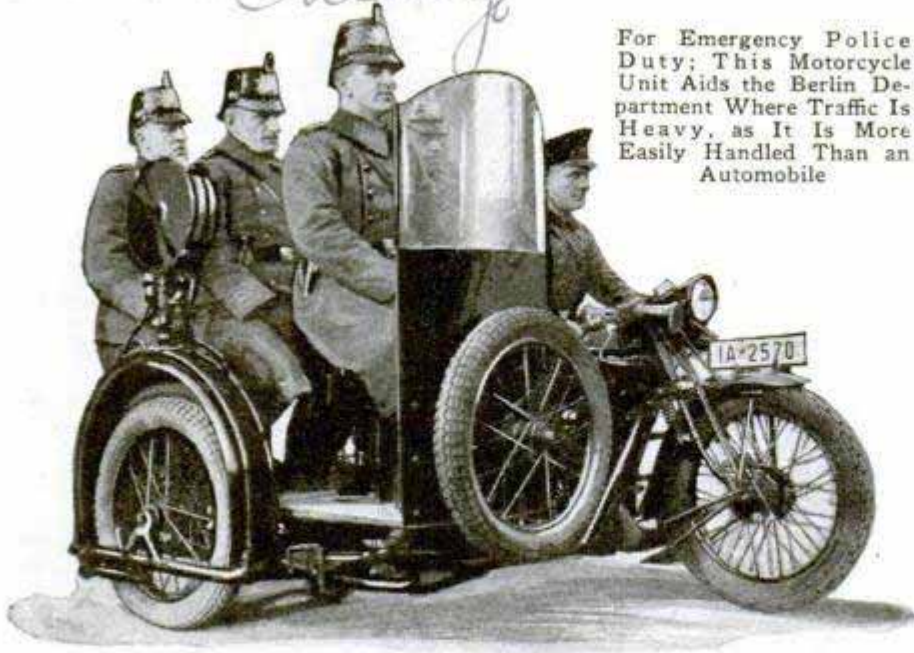

For Emergency Police Duty; This Motorcycle Unit Aids the Berlin Department Where Traffic Is Heavy, as It Is More Easily Handled Than an Automobile

outside the earth, the Kennelly-Heaviside layer. The vagrant waves being photographed apparently take an excursion several thousand miles more than the direct path from the transmitter to the receiver, in the opinion of Dr. J. Barton Hoag, one of the investigators, who is endeavoring to record and classify the signals in hope of co-ordinating them with definite phenomena on and above the surface of the earth.

MOTOR TRICYCLE FOR POLICE CARRIES FIVE MEN

Successful experiments have been conducted in Berlin with a motor tricycle that carries four policemen and a chauffeur. It is speedy, easy to handle in heavy traffic and strongly constructed for the sometimes rough service it has to perform.

He believes that some of the waves may circle the north pole and return. During a mimic game of warfare recently, a radio operator received the code "4," meaning to open the port of New York. The sender had relayed the message "V," meaning to close the port. The odd mistake had been caused by an echo. The receiving operator had caught a dot making the sign "4." In reality, it was not a dot but the echo of a dash of the signal "V." It had passed around the world but its echo had been received first.

RADIO-ECHOES SECRET SOUGHT HIGH ABOVE EARTH

One of radio's most perplexing mysteries, the strange "echoes" that sometimes cause serious confusion in receiving messages, is being investigated by scientists at the university of Chicago. A photographic film that moves five feet a second on a revolving drum, registers a series of multiple, diminishing "echoes" coming in at an interval too short for a complete journey around the world and too long for reflection from the peculiar strata of electrons that lie from seventy-five to 150 miles

FOLDING PARTITION LIKE DRAPE. 862 SUBSTITUTE FOR DOORS

Wall partitions that fold up when pushed back, and that may be covered with tapestry or other materials to match the scheme of decoration, have recently been introduced. They are constructed with a steel framework, do not sag or get out of order and, if desired, may be made fireproof. Another feature is that they absorb sound.

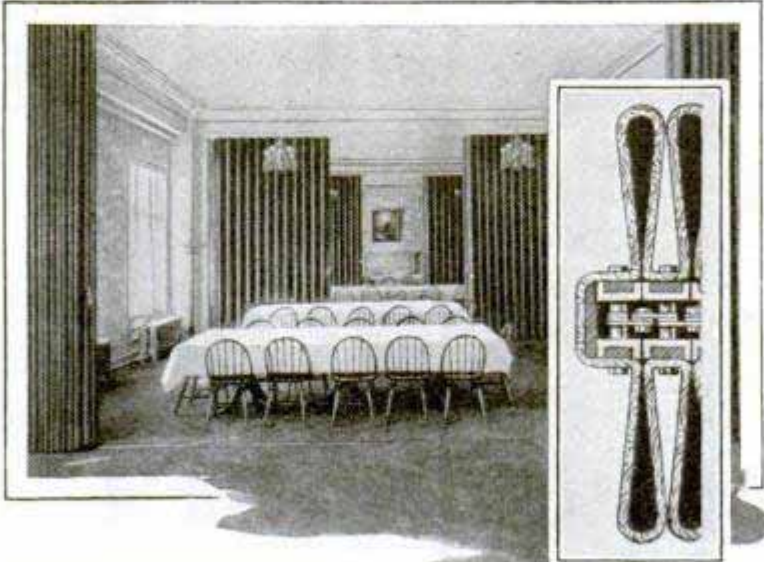

Folding Partitions in Use, and Cross Section of One

Folding Products Corp

Dr. J. Barton Hoag, Radio Operator

June Air Corp. 305 Barrett St. Portland Ore.
June Air Corp. 305 Barrett St. Portland Ore.
June Air Corp. 305 Barrett St. Portland Ore.

CALL LETTERS FOR AIRCRAFT AID RADIO CONTACT

To simplify radio communication to and from airplanes, the craft are assigned specified call letters so that the identification of a particular plane is positive and operators are spared time in sending and receiving messages. The purpose of the plan is essentially the same as the system of designating broadcasting stations by a series of letters. As worked out by the international bureau, at Berne, airplanes will have five letters in their calls. The first will signify the nationality and the other four will be the registration mark of the plane.

AIR MOISTENER FOR FURNACES PROMOTES HEALTH

To insure proper humidity in the home, a moistening outfit easily installed in the hot-air furnace is said to greatly promote health and comfort and to save fuel. Its essential feature is that, as the water is evaporated, a fresh supply is constantly

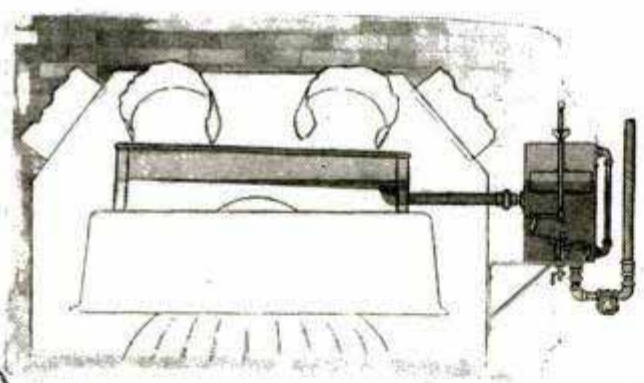

Drawing of the Moistening Outfit Installed in Hot-Air Furnace; Note Supply Chamber at Right

introduced from the house system through an automatically regulated valve that keeps the vaporizing pan filled to the desired point at all times. This eliminates the need of refilling the pan by hand.

PLANT THAT RESISTS FIRE TO HELP GUARD FORESTS

Further protection of forests from fires is seen in a plant imported from South Africa which is fire-resistant. It is composed largely of water yet is said to grow abundantly in arid regions and is good for cattle feed. It will especially help prevent brush fires, forest experts believe.

Dr. G. H. Merrill, Director, California



Inhaling Vapor to Relieve Air Sickness, through Apparatus Designed to Be Carried on Airplanes

AIR SICKNESS IS PREVENTED BY PUNGENT VAPOR

For the aid of persons who may become airsick while on flying journeys, an inhaling apparatus has been introduced. The subject breathes a pungent vapor through a mouth and nose piece, the gas being released in any quantity desired from a tank container. According to reports, the substance fortifies the system against nausea.

FOUR-WHEEL BRAKE TESTER AIDS SAFE DRIVING

The braking power on each auto wheel and on all four at once is quickly and accurately indicated on a testing outfit that takes into consideration the weight of the car. It provides an effective means for equalizing right and left wheels and balancing front with rear.

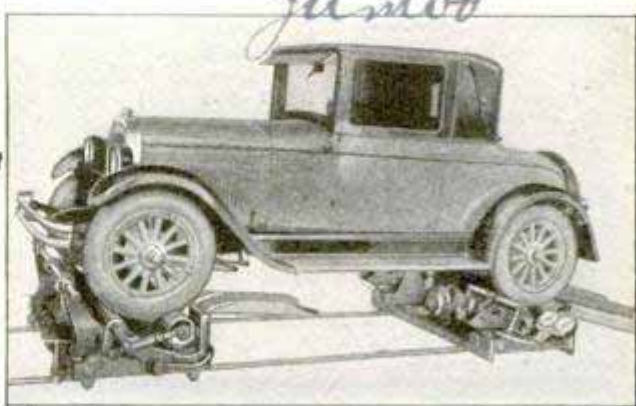

Testing Stand for Four-Wheel Brakes

Price - H. K. Lester Co.

no ads available
Emb. George D. Paul, P. 609
537 S. Dearborn

982

Chas W. Alliser, General Register
Aeronautics Service & Transport Co
203 N. Wabash Chicago

Alric
Hanning

Learning

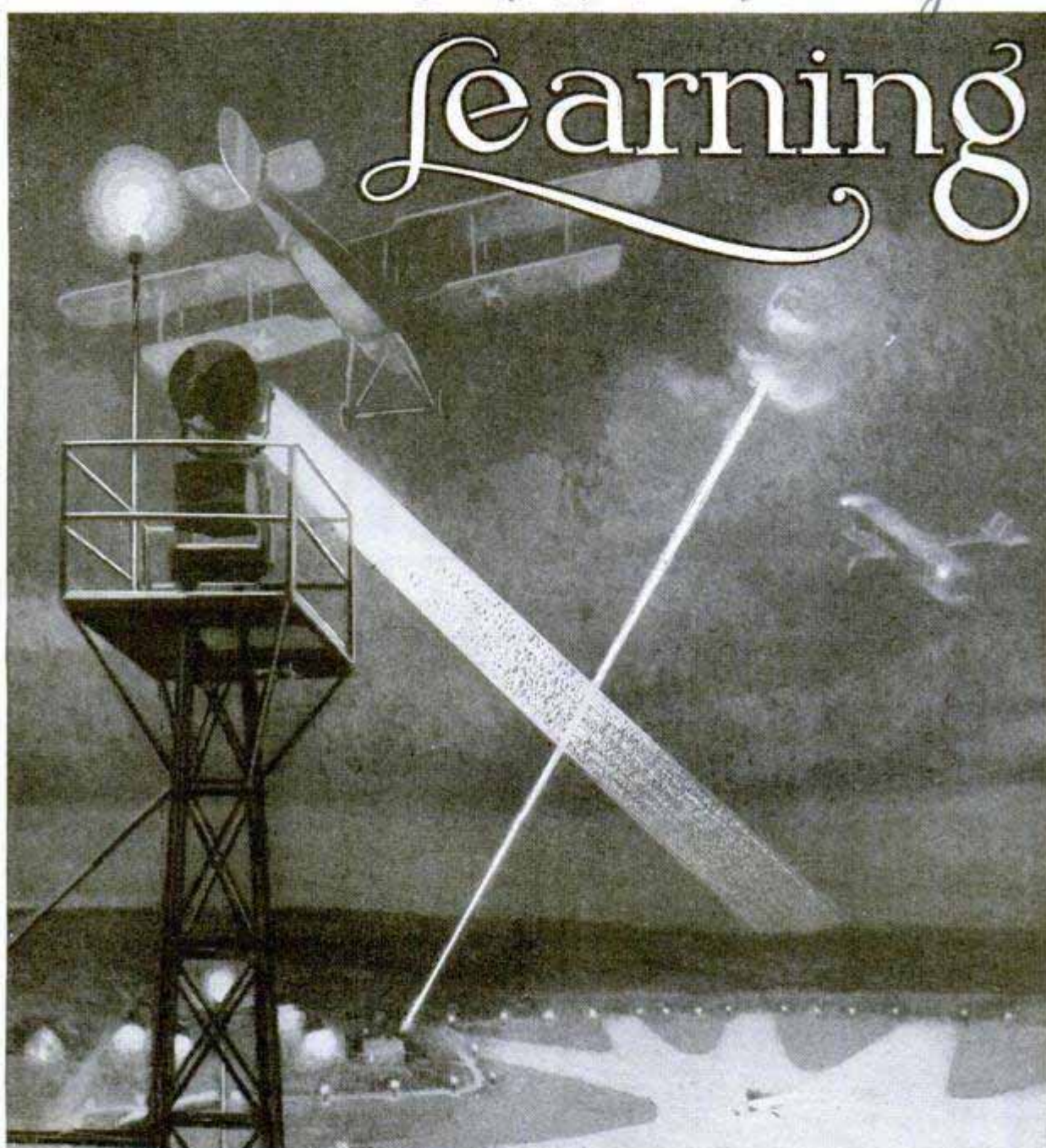

An Airport by Night; in Front is the Main Beacon Tower, with the Searchlight That Guides Flyers to the Field; behind It, Rising from the Hangar Roof, is the Wind Cone, Illuminated by a Cluster of Lights; the Runways Are Illuminated by Powerful Floodlights, So Arranged That Their Rays Are Spread across the Ground, Rising Only a Few Feet in the Air; the Border of the Field is Marked at Regular Intervals with Small Lights, While, in the Background, a Thin Pencil Beam, the Ceiling Light, is Thrown on the Clouds to Show Just How High Visibility Extends; the Lights Shown Are the Standard Equipment Recommended for a First-Class Airport by the Aeronautical Branch of the Department of Commerce

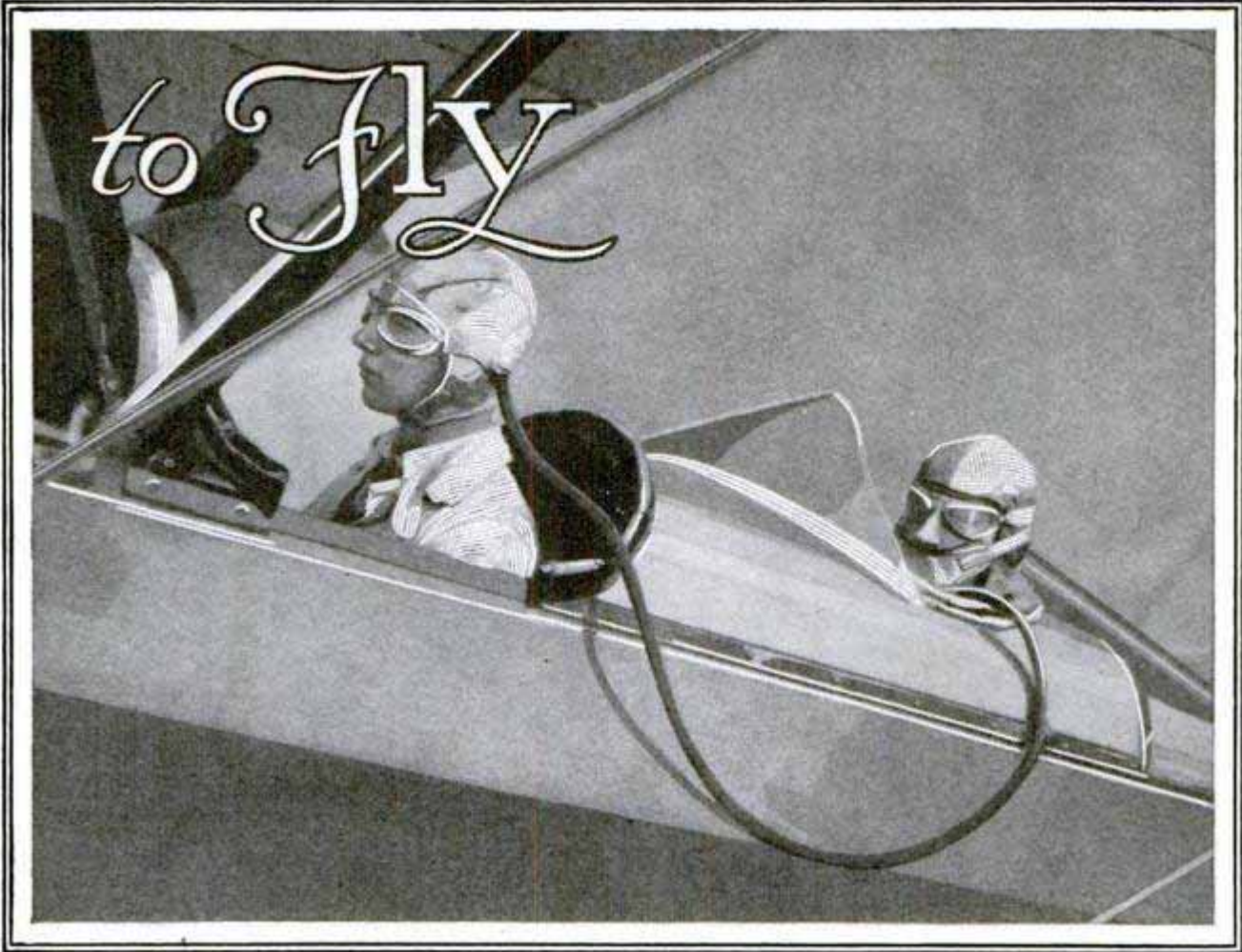

Courtesy Aviation Service

The Link between Instructor and Student Is a Voice Tube, Terminating in a Receiver Worn beneath the Helmet; after the First Flight the Student Moves to the Rear Cockpit

By J. EARLE MILLER

(Concluded from September Issue)

"WE WILL practice landings again today," says the instructor as the student straps himself into the rear cockpit; there is nothing new in the announcement. Taxi out to the end of the runway, turn the plane until it heads into the wind, open the throttle until the engine speeds up to 1,400 a minute, shove the stick all the way forward and keep it there until flying speed is reached and the pressure begins to lessen, then let it come slowly and smoothly back as the plane leaves the ground, point the nose up a few degrees for a slow, steady climb, and fly straight into the wind until you get enough altitude to make a bank safe.

You turn then and fly across the wind, keeping well out from the border line of the field, turn again and go down the side with the wind, turn and cross the other end until you are opposite the end of the runway from which you took off, keeping 1,500 feet from the end, as the field rules

require. A final turn, point straight for the runway, "cut the gun" until the engine idles down to three or four hundred revolutions, immediately drop the nose to keep flying speed, and glide in in a long, gentle descent. Keep your wings carefully leveled up, shift the rudder, if necessary, to keep the runway flowing smoothly toward you, pull up the nose a bit as you near the ground to level out and lose more flying speed, then, as the ship settles to the ground, ease the stick back farther and set the tail down just as the wheels touch.

That's landing practice, to be done over and over again. If you came in smartly, you set her down near the end of the runway and can at once open the throttle and take off, "drag" the field and repeat.

Two or three rounds, and the instructor, instead of signaling for the final bank around to land, motions to keep straight ahead out across country. You leave the scattered houses behind and are over the

Pictures from Aerial Photography ⁶¹¹
September 23rd 1918

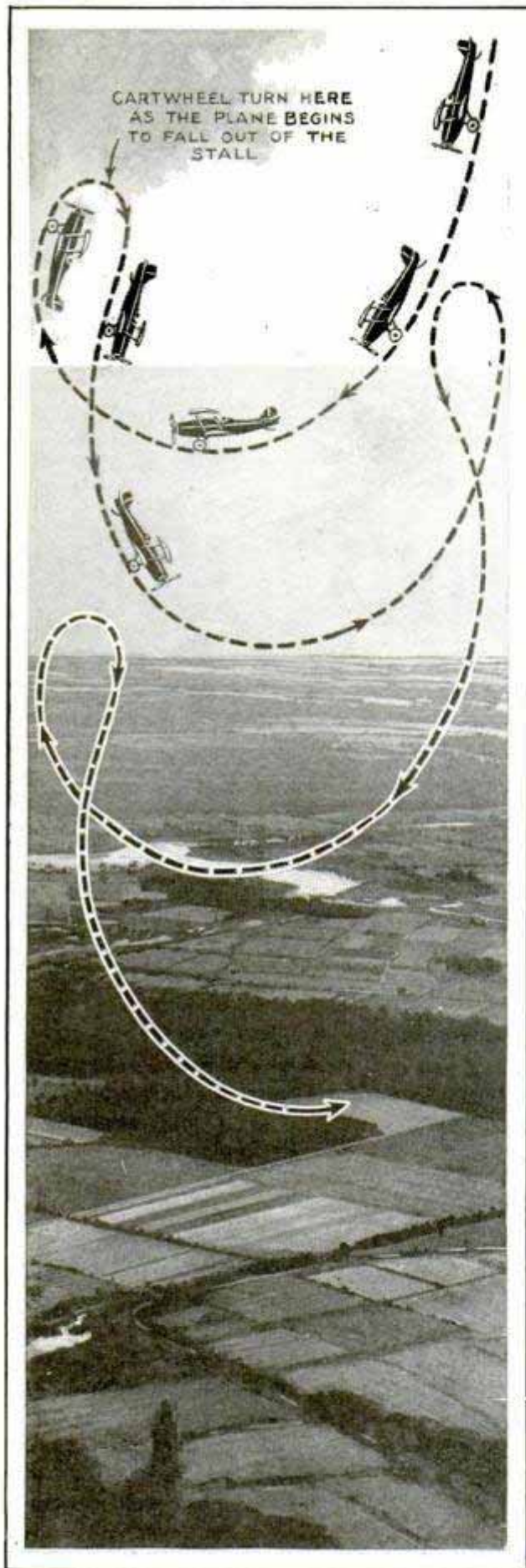

The "Split Ess" Is a Quick Way of Losing Altitude Gracefully: the Ship, with Power Off, Dives, Rises to a Stall, Does a Wing-Over and Dives Again

open farmland. Straight flying has become a habit, something to be done automatically. You remember your lessons, look first over the right side, then across and over the left, watching the fields beneath. Each time your eyes sweep across the instrument board you check the instruments, make sure the thermometer shows normal temperature, the pressure gauge the proper oil circulation, and the tachometer indicates that the engine is delivering the accustomed number of revolutions.

Occasionally a pointed hand to left or right signals for a turn, until you lose track of place and direction. Suddenly the even roar of the engine dies to a soft purr, and you instinctively nose down to keep flying speed—your first lesson in forced landings.

Ahead is a large level meadow, big enough to fly a brick house into. It looks easy, and your gliding angle is just right to clear the near fence. Everything is rosy until the instructor opens his throttle again and wildly waves both hands. Something is wrong, but what? He points off to the side, but you see nothing interesting over there. He continues to point, and you obligingly bank around to go over and see what all the excitement is about.

Immediately the throttle is jerked back, you nose down, and again the engine picks up its roar and you start to climb. Suddenly a distant smokestack, the black plume from a train or one of the many other wind gauges gives the clue. Teacher has caught the student napping with a forced landing and a tail wind. You should have circled into the wind and then picked out a field to land on, instead of trying to drop into the first one ahead. Another lesson has been learned: always to remember where the wind is, and be prepared to turn instantly into it in an emergency. A plane always lands and takes off into the wind, if there is time to pick a field and the size and shape of the ground permit it.

The lesson goes on, and at every turn you mentally recheck the wind, verifying your memory by watching for smoke, the rustle of the grass below, the movement of the trees, or even a washing flapping on a backyard clothesline.

That lesson out of the way, another fol-

lows in short order. The signal comes for a bank, and another to come out of it. All the indications are that the ship is being lined up on some object ahead. You check the wind, and find it dead ahead. The throttle comes back, you shove the stick a bit forward and begin to nose down. The best field is quite a bit ahead, just right to reach with a long, slow glide. At that angle, the engine cowling hides the view, but a glance over the side places the fence around the field, so you know you can make it easily. The fence glides beneath, you nose down to lose more altitude—and directly in your path is a tree!

Teacher has carefully lined you up on an obstacle which calls for quick thinking and quick acting, and you learn lesson number two of the day.

That's the way flying instruction goes. Very little is said on the ground before you start, and if you are flying by signals, nothing is said in the air. After each twenty-minute hop, you taxi in to the line and get a critical review of the day's mistakes. As training progresses, you may get in two or three hops in a day, if you have the time and other students are not waiting their turns, or you may take forty minutes in one hop to get more landings in one day.

Figuring eight hours dual instruction for the average student, three twenty-minute lessons to the hour, and allowing for bad weather, a flying course may stretch out for a month or more. Students have been soloed in one day, as a stunt, but instructors don't recommend trying to hurry things. Twenty minutes a day or forty later on, and then twenty-four hours to think it over, and digest what has been learned, is best, they say. Planes can fly in most any kind of weather, but students can't be taught landings on a windy, gusty day. It takes a trained pilot to keep his wings level in bumpy weather, and the slightest drop of a wing tip when landing at thirty-five or forty miles an hour may be serious for the ship, and probably for the passengers, too.

Army experience has shown that three twenty-minute hops, on successive days, are nineteen times as valuable as one flight of one hour's duration. Flying muscles have to be broken in to the work of con-

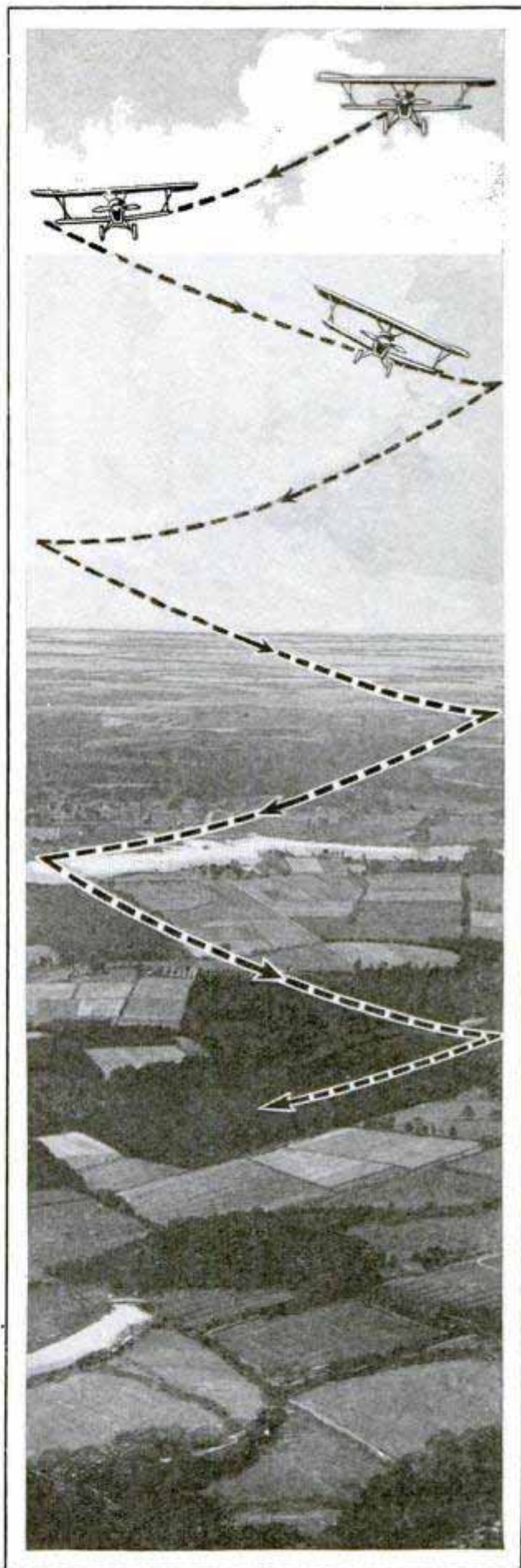

Most Graceful but About the Most Difficult of All Acrobatics Is the Falling Leaf, the Plane, Stalled in Level Flight, Sideslipping Back and Forth

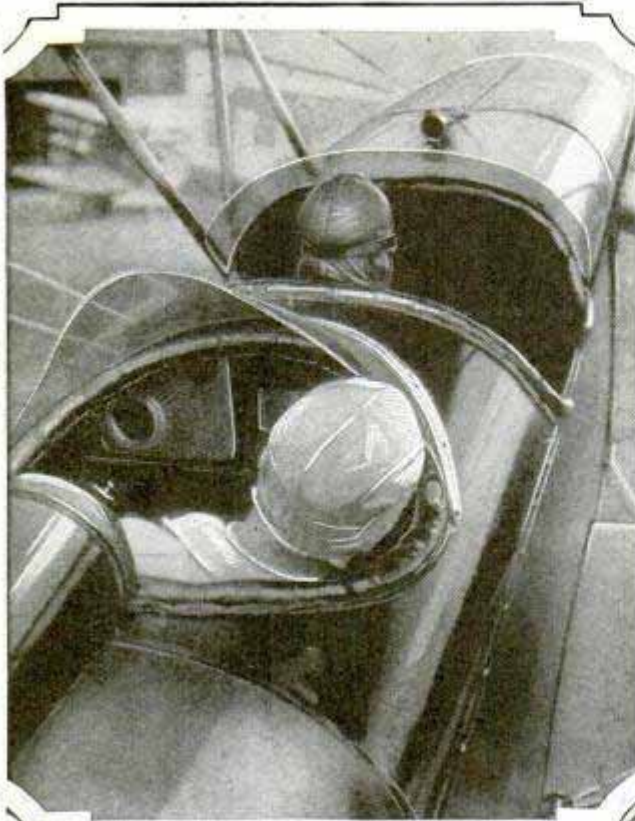

Taking Off in a "Swallow" Training Plane, and, at Right, the Whip Stall, in Which the Plane for an Instant Moves Backward before Whipping Around to Fall in a Nose Dive

trolling a ship. After twenty minutes they begin to tire, and the student loses the "feel" of the ship as well as his mental alertness. It is better to come down then, for continued flight is more or less wasted. The better schools will not allow more than twenty minutes to a hop, and require at least three hours on the ground between these flights.

Before the day comes for the solo flight, most of the schools give one lesson in "aerobatics," teaching how to get into and out of the dreaded tail spin. Strangely enough, the dangerous tail spin is one of the easiest of all flying stunts, and is usually the way out of all uncontrolled maneuvers, but is so easily stopped that, given sufficient altitude, there is never cause for alarm. The reason so many flyers have been killed by tail spins is that their spins occurred so close to the ground

there wasn't time to recover level flight and avoid a crash.

A spin usually starts when the plane loses flying speed, though some of the modern ships will stall, then nose down and pick up flying speed without spinning. The easiest way to deliberately spin a ship is to nose it up into a stall and give left or right rudder with corresponding stick. If the spin occurs while flying under power, you immediately close the throttle—"cut the gun" is the flyer's term—and come out of the spin by using opposite control. That is, if you got into the spin by pulling the stick back to lift the nose, then to the left rear corner, at the same time applying left rudder, you come out by shoving the stick forward to the right, applying corresponding right rudder. As soon as the ship gets out of the spin, you nose down to pick up flying speed and

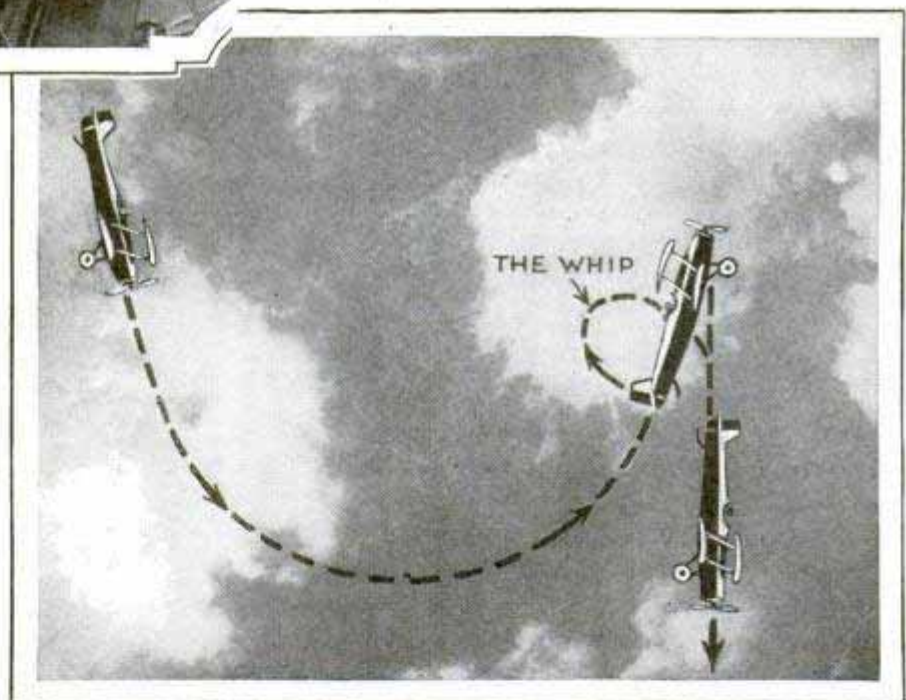

open the throttle. There is no hurry and no excitement about the stunt, given sufficient altitude to perform it safely. If you are using the voice tube, the instructor's voice, calm and collected, settles any feeling of panic.

You learn another thing about aerobatics—that there is one position in flying when your ailerons become reversed, just as your ailerons work in reverse order when taxiing on the ground. That is in a vertical bank, and in all the aerobatics in which the plane passes through such a

bank. In normal flight, the fore-and-aft movement of the stick turns the tail flippers, or elevators, up and down, to dive or climb the ship, and the rudder bar moves the rudder side to side, to turn to left or right. But when the plane is in a vertical bank, with one wing pointing straight down to the earth, the normally vertical rudder is in a horizontal position and acts as an elevator, so that the rudder bar climbs or dives the ship, and the usual horizontal elevators are in the vertical position, so they act as a rudder.

Outside of an emergency turn to miss another plane, the commercial flyer has no occasion

to make turns so tight as to require a vertical bank. In acrobatics, every half roll and roll and Immelmann turn includes a moment when the ship is banked into that position, but they, with the falling leaf and similar stunts, are left for more advanced instruction. The average training plane can do all but two of the aerobatic stunts. Those two are the Immelmann turn and the outside loop, which has been performed by less than half a dozen aviators. The training ships, usually fitted with an OX-5 motor, haven't the power to do the half roll at the top of an Immelmann turn. This particular stunt, the invention of the famous German war-time ace, starts like a loop, but at the top of the loop the plane is rolled over until it is right side up but facing in the opposite direction. To get up enough speed to do the roll at the top of a loop, a low-powered ship would have to be dived from a great height, and might not hold together under the strain.

It is possible, though, to do a cheat on the Immelmann, a tight, fast climbing turn, called a "chandelle," which, from the ground, would fool anyone but an expert.

All the while that air tricks are being learned, the landing practice continues.

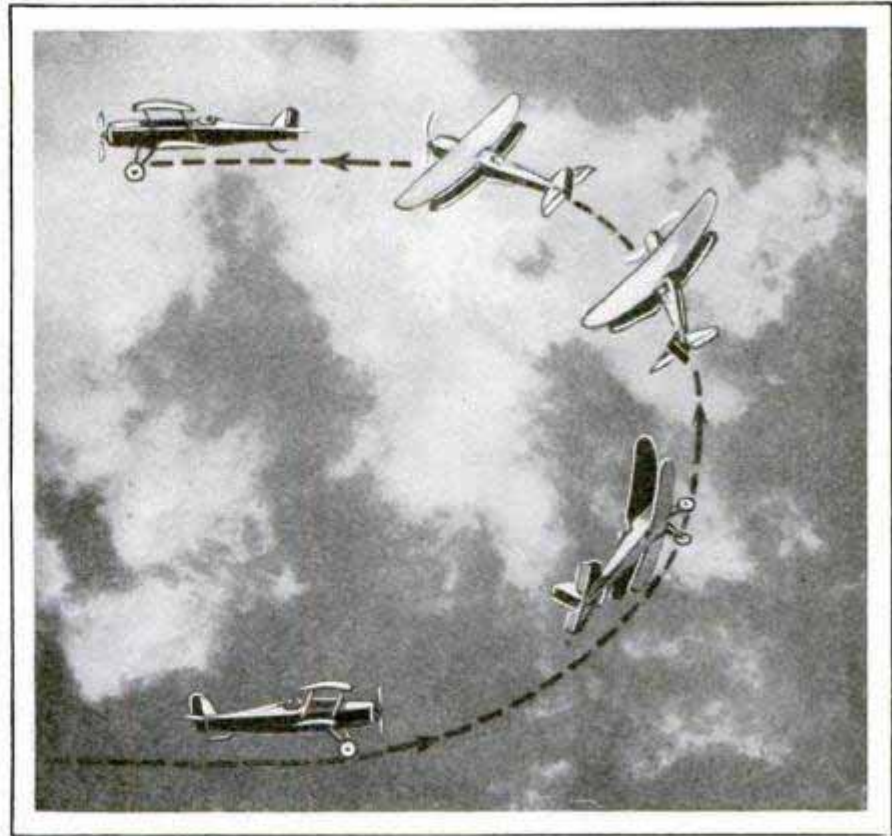

The Chandelle, a Cheat on an Immelmann Turn, Is a Tight, Fast Climbing Turn for Planes That Can't Roll at the Top of a Loop

A landing is easy to describe, but only constant repetition can make it perfect. You soon learn that a plane has but one landing speed—that at which the movement through the air ceases to be fast enough for the air to support its weight. It can't, therefore, land slower than that, and if you try to land faster, by forcing the nose down until the wheels touch, the result is a "two-point" landing, and as soon as you drop the tail, the wheels will bounce off the ground.

The trick is to learn to gauge height and distance so perfectly that you can cut the gun, glide into the field just above flying speed, level out a few feet above the runway and then hold the stick neutral, with the tail up and the ship in flying position, until you lose the forward speed and the craft begins to settle to the ground of its own volition. At that moment the stick is pulled back and the tail dropped until skid and wheels touch simultaneously in a perfect three-point landing.

The average student takes eight to ten hours before he is ready to solo—about three hours on straight air work and the rest on landings and air work combined. When the final check pilot takes him around without advice or assistance, sees

7/7/28

3445 N. Western Ave

Chicago

\$175.00 J. O. H. Chicago

ICE KING'S TOMB FOUND ON ALEUTIAN PEAK

The tomb of an ice king, who lived thousands of years ago, in what is known as the Stone Age, has been found in the Aleutian islands, off the Alaskan coast, by the Stoll-McCracken expedition of the American Museum of Natural History. The expedition went to the islands to seek mummies older than those of Egypt, as a link with the civilization that may have crossed the ancient land bridge of Bering strait, by which the animals of what is now the Gobi desert came to America. On the summit of an almost inaccessible island they found a double tomb, in one compartment the mummy of a person apparently of high rank, and in the other the bodies of two adults and a child. All four were perfectly preserved, with their clothes, weapons and other belongings. The ice king wore a tanned otter-skin coat over a shirt of bird skins, and was wrapped in a shroud of animal skins, which in turn was inclosed in a layer of sea-lion intestine. It is possible the bodies may prove to be Stone Age Eskimos, or, perhaps, early Indians of a still remoter time.

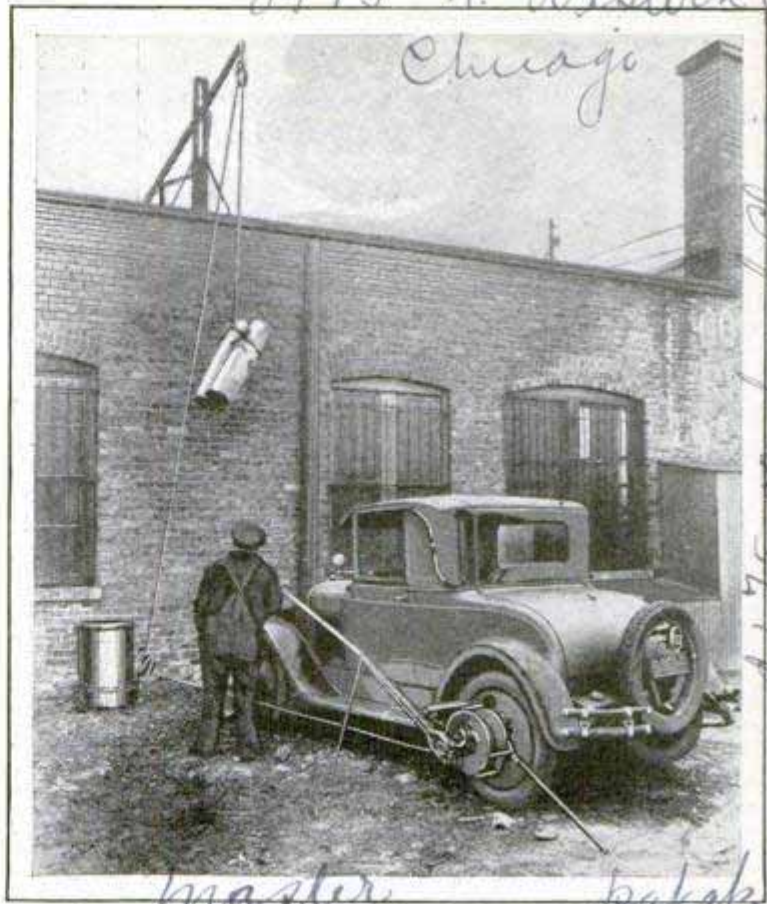

Auto Harnessed as a Hoist; Lowering of the Bucket without Reversal Is Done with the Lever Control

HOIST-RUN BY TRUCK OR CAR LATEST BUILDING AID

Easily installed on the motor truck or car, a hoisting outfit has been introduced to serve builders of all kinds. It can be adjusted in a few minutes, is detachable and interchangeable and is controlled by a single lever. It is quickly connected to a rear wheel, which is jacked up and is always turned in a forward direction, no reversing of the transmission and racing of the motor being necessary to lower the bucket.

Popular Mechanics Magazine does not publish the name of the maker or seller of any device described in its pages, but this information is kept on file and may be obtained, free, by addressing Bureau of Information.

AUTO BED CONCEALED IN TOP SIMPLIFIES TOURING

When not in use, a full-length bed inside the automobile is concealed under the top. It is quickly lowered and the upholstery of the top interior is unhooked to form covers for the sides. Further privacy is afforded by a special curtain around the front of the car over the windshield. The arrangement is practical for tourists and for doctors who use their cars as ambulances.

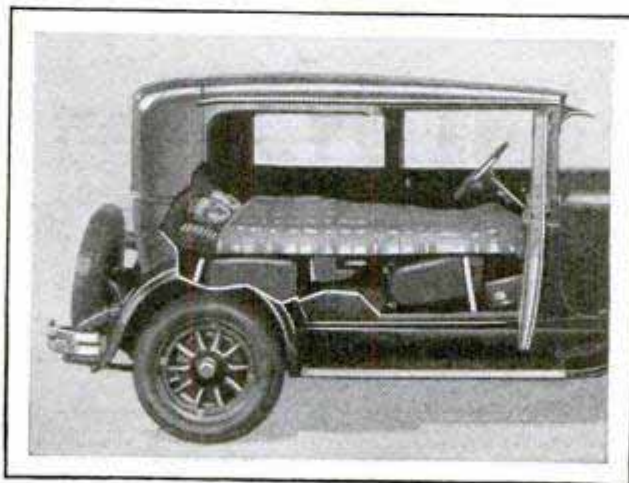

Auto Bed Lowered for Use; in Daytime It Is Raised and Concealed in the Top

Autobed Co. Lansing Mich.

3900

Mr. William Scholl
21 W. Schaller Street



Testing a Policeman's Walk on the Special Treadmill Which Helps Reveal Defects

TREADMILL TEST FOR POLICE REVEALS WALKING FAULTS

Correct walking is important to all, but especially to policemen who are on their feet most of the time they are on duty. To emphasize this fact, a foot specialist recently tested the policemen of Providence, R. I., in a special treadmill, which enabled him to illustrate various points as the subject "performed" and revealed faults in his carriage, the manner of placing his feet and other details.

HELIUM USED IN RADIO TUBES ALSO FOR DRYING

Once considered a rare element, and extremely costly to produce, helium is now available in commercial quantities and is being utilized for many purposes, besides inflating balloons and dirigibles. It is especially serviceable in the preparation of a synthetic atmosphere for deep-sea divers and caisson workers, where abnormally high pressures often cause "the bends" or caisson sickness. This painful and sometimes fatal ailment is believed to be due to the release of nitrogen previously dissolved in the blood. The advantage of helium, which is mixed with oxygen, is that

it is not only more inert than nitrogen, but has the lowest solubility in water of any gas known. Its use therefore increases the limits of the pressure at which work can be performed and also lessens the time of compression and decompression of the operator. Helium is gaining favor in annealing and other metal operations as it is practically insoluble in molten metals. It is being used for filling radio tubes, and glow lamps and tubes for signs, and as a cooling medium in electric transformers and high-speed generators. Because it is chemically inert, has high heat conductivity and low density, and can therefore be circulated rapidly, it is particularly suitable for drying organic and inorganic chemicals quickly. It is also used in toilet preparations.

PLANTS TREATED WITH RADIUM TO SPEED GROWTH

By coating flowerpots, vases and other containers with a substance that gives off radium emanations, a way has been found to stimulate the growth of plants and flowers. Used on stakes and other articles placed in the ground, it also helps trees and field crops. As the emanation is given off, it explodes and produces a gas which is beneficial to the plant. The ma-

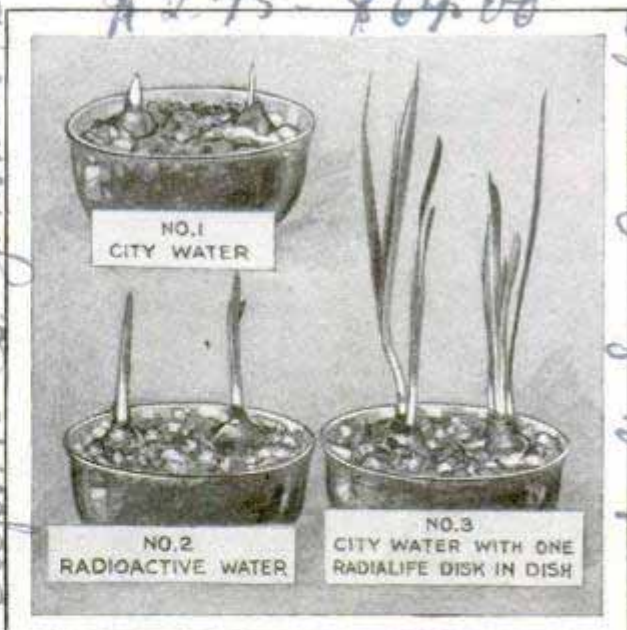

Results of Growth in Three Plant Specimens of the Same Kind, to Show Benefits of Radium Treatment

terial lasts for many years, so that its effects are not diminished and the action continues, night and day and at all seasons.

148-39
C. J. Gummer
Capt. H. C. Gummer

2.75 864.00

Sole Dist. U.S. & Canada
Helium sold 2/12/31

The Helium Co. Inc.
Logan, Utah

Pacific Coast Factors
1615 S. Vermont Ave.



Teaching Four Music Pupils at One Time with Lights and Special Keyboard

LIGHTS AID IN PIANO LESSONS ON MULTIPLE KEYBOARD

Several children can be taught at once on a multiple-keyboard arrangement for instruction in piano playing. As the teacher depresses a key, a small light appears above a corresponding key on the pupil's board. After a few minutes of practice with the lights, a trial is given without them from memory. The method is said to have been successful in helping the beginner to become familiar with the piano and to master both the white and black keys. The child is also amused by the lights and much of the drudgery of the lessons is eliminated.

GAS IS BOILED OUT OF METAL IN ELECTRIC FURNACE

Scrap metal is made to produce volumes of power gas by treating it in a high-frequency, induction vacuum furnace. An old automobile piston gave up thirty-three times its own volume in fuel gas. Two cubic feet of cast iron furnished vapor with energy equivalent to about ten horsepower for a duration of some twelve minutes. The gas burned with a clear flame and had a heating value equal to three-fourths that of illuminating gas. After the vapor has been removed, the metal is more satisfactory for making magnets than ordinary iron, has a brilliant



sheen and holds its luster for several months. The treating furnace is an odd contrivance for, though it melts the hardest metals quickly and would distil them like so much water were they left in long enough, it will not scorch a paper or burn the hand. The walls are of glass and the melting pot is a crucible surrounded by a coil of tubing. Electricity is directed into the tubing where it reverses itself 30,000 times a second, inducing a sympathetic current into the metal that has been placed in the crucible. Impurities evaporate and are pumped through suction tubes into containers for analysis.

AUTO TOP ROOF ROLLS BACK AT PULL OF TAB

To admit light and air into the closed car, a style of body now on the market is equipped with a roll-back roof. It is held in place by interlocking links like those on traveling bags, overshoes, and other articles. To release the roof, a tab is simply pulled along and the top is fastened by pulling the tab back. This makes the change from an open to a closed body an extremely simple and easy operation.

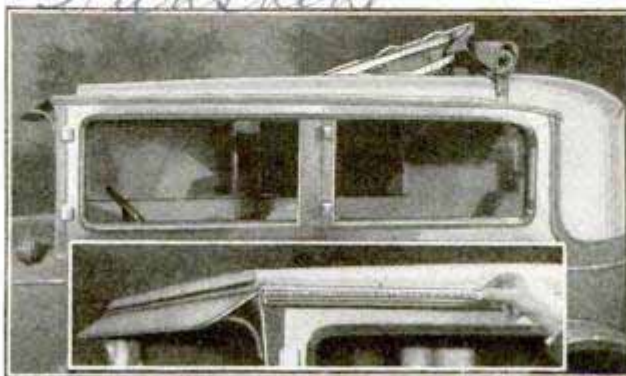

Top of Car Rolled Back, and Side View to Show the Interlocking System of Fastening

*N. G. Ziegler, Waddington & Co. Search Staff
Chicago, Ill.
New York*

Have America Co. Patent

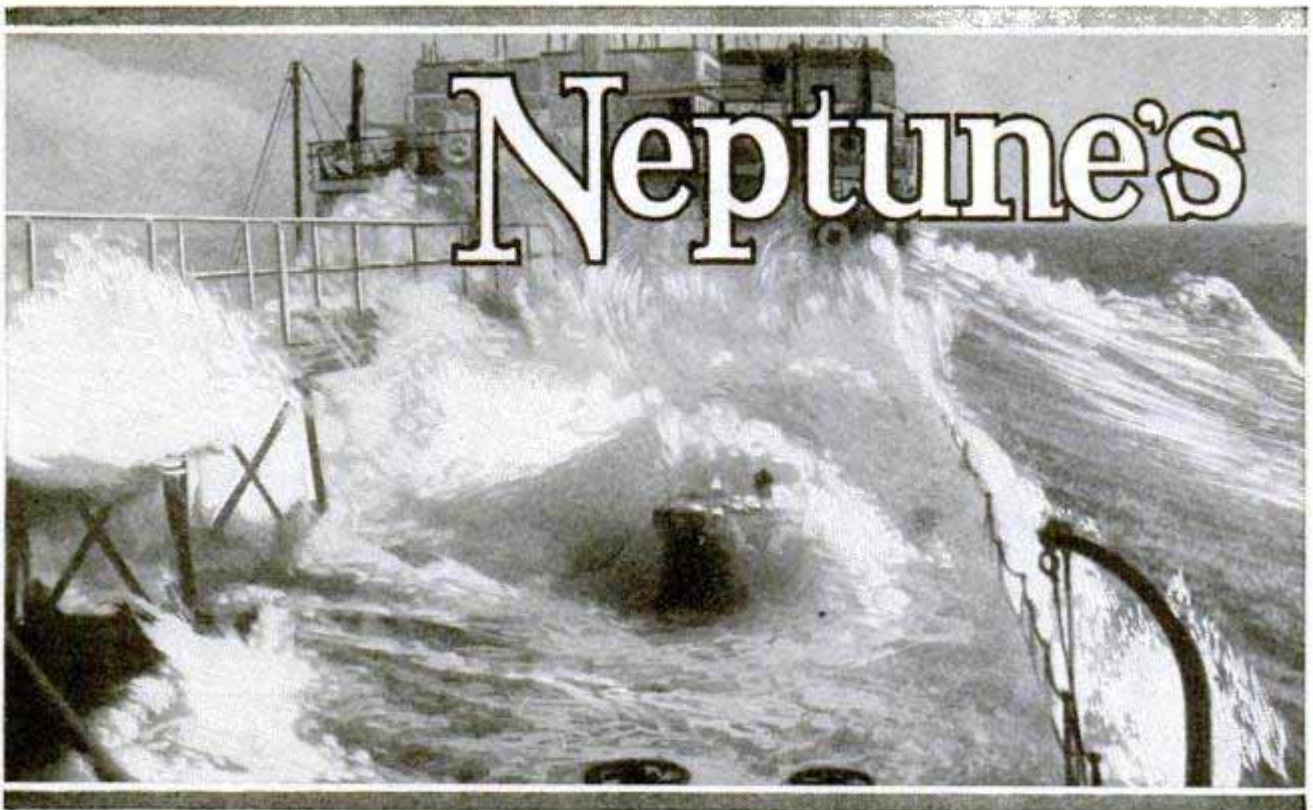

The American Steamer "Trimountain" with All Her Well Deck under Water as a Giant Atlantic Wave Rolls Over; the Battering of Tons of Water Can Do Immense Damage

By CALVIN FRAZER

LAST spring the "Leviathan," the world's largest ship, arrived at New York with her forecastle superstructure badly damaged as the result of an encounter with a huge wave. Her foredeck, sixty feet above the water, was stove in; seven steel stanchions supporting it were twisted; four large lifeboats were smashed to splinters; crew and third-class accommodations were flooded, and a searchlight on the foremast, eighty-five feet above the sea, was broken by solid water.

Many similar cases are recorded in the newspapers every year, and a great many more reported to the hydrographic office and the weather bureau. Some are much more disastrous in their effects. Just a few years ago, the Red Star liner "Arabic" came into port with seventy-five passengers on the injured list. They had been knocked about by an enormous wave which battered the ship from stem to stern and which, according to one account, was 100 feet high.

The steamship "Rheinland," Captain Randle, was nearly sunk by a "solitary" wave some years ago while crossing the Atlantic. Her commander, from his elevated position on the bridge, observed a

*The Picture and Co
Washington, D.C.*
gigantic wave coming toward the steamer at high speed; took precautions to insure a maximum of safety, and leaped from the bridge to a more lofty position. Soon the sea so completely submerged the vessel that Captain Randle, from his coign of vantage, could distinguish only her foremast and funnel. Her whole hull was buried for a time. One man was washed overboard; the second mate, the carpenter and several members of the watch suffered from broken limbs; every boat disappeared, and the engine room was almost full of water.

There has been a great deal of discussion about the extreme height attained by waves. The usual method of measuring their height from a ship is for the observer to climb the rigging or otherwise place himself at such an elevation that, as the wave advances, his eye will be just on a level with its crest and the horizon when the ship is in the hollow. The height of the eye above the ship's water line is then taken as the height of the wave. This method is subject to some errors, especially those due to variations in the altitude of the point of observation on account of pitching and rolling. In a few

Battering Rams

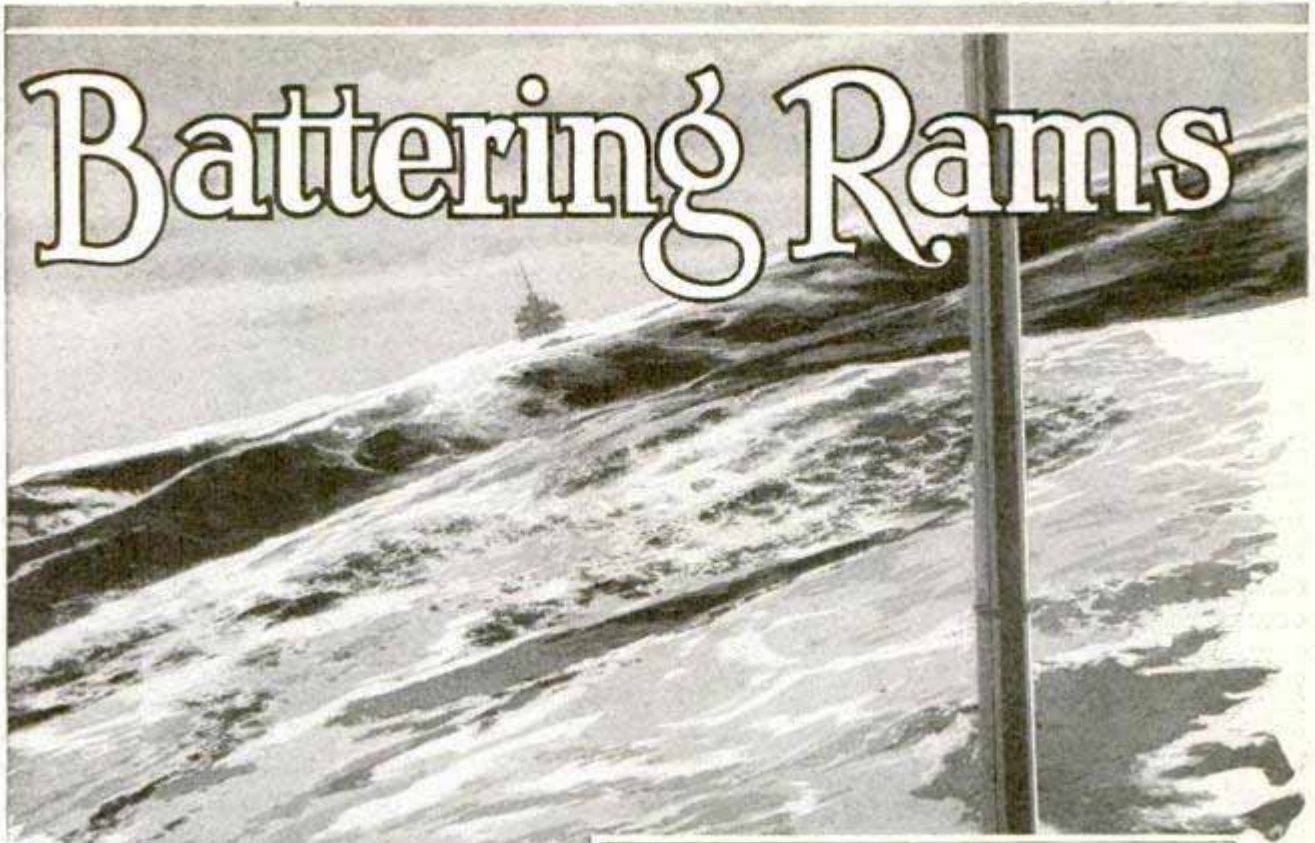

When the Sea Turns to Mountains; a Striking Photograph from the British Warship "Snapdragon" in the Bay of Biscay, Showing the Next Ship in Line in the Distance, While the "Snapdragon" Lies in the Trough of the Wave; Below, the Steamer "Discoverer" Bucking the Heavy Seas Crossing the Gulf of Alaska; Ships Bury Their Bows under the Waves, Then, as the Water Lifts, Hurl Tons of Water High into the Air and Backward over the Bridge; as the Bow Dips Down, the Angle Makes Waves Appear of Tremendous Height, Giving Landsmen an Exaggerated Idea of Their Size

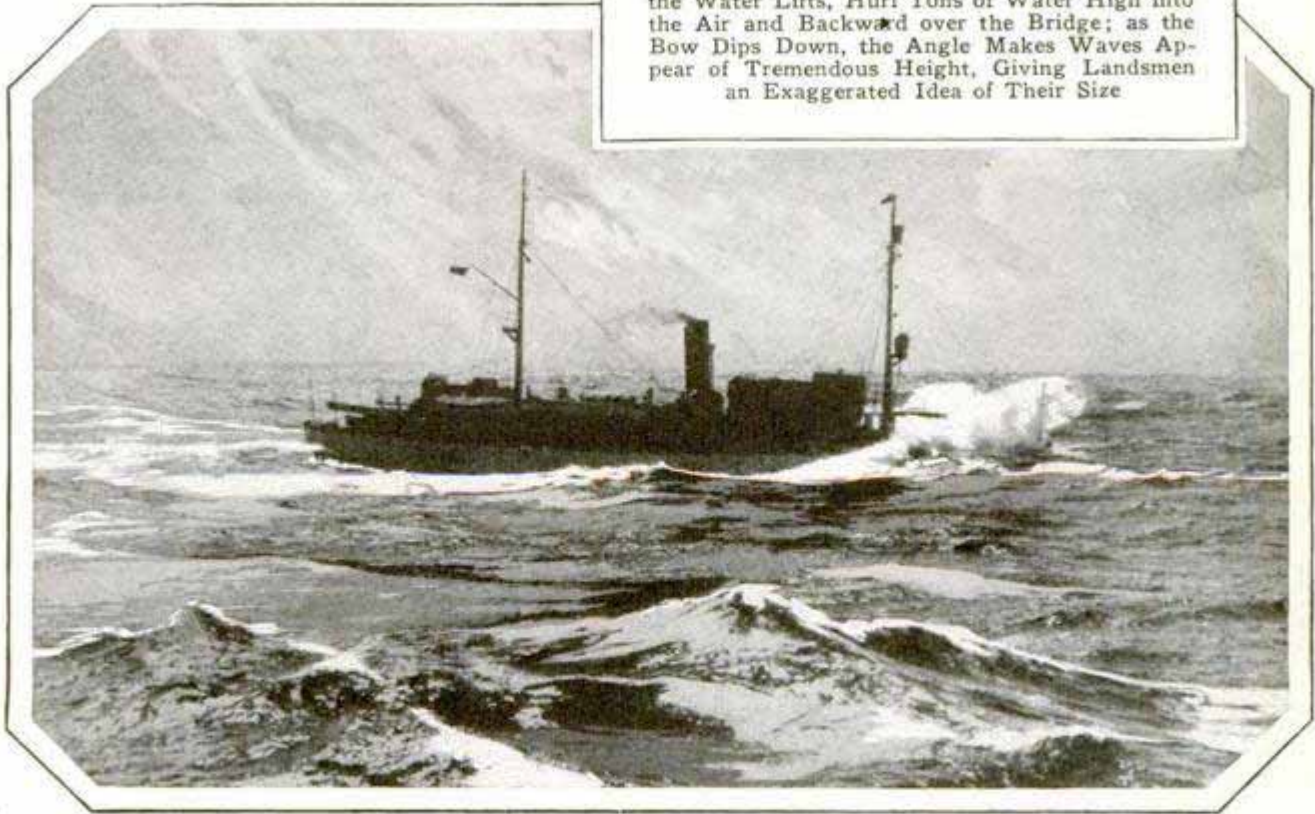

cases a very sensitive barometer has been used to measure the lift of a ship while she passes from trough to crest of waves. Many exaggerated reports concerning

the height of waves are explained by the fact that the breaking of a wave against an obstacle, such as the bow of a vessel, throws the water to a far higher point than the unbroken wave could attain. Moreover, a vessel may encounter a wave while pitching forward, as her stern is lifted by a preceding wave, so that normally lofty objects, such as the crow's-nest, are relatively near the water.

In December, 1922, waves of extraordinary size were observed during a storm from the White Star liner "Majestic." On account of the comparative steadiness of this great vessel, the conditions of observation were unusually favorable. Several officers, including Sir Bertram Hayes, the commander, estimated the height of the waves at between eighty and ninety feet. Dr. Vaughan Cornish, the well-known English authority on waves, has accepted this figure as probably correct, though it greatly exceeds the maximum hitherto believed to be possible for ocean waves caused by wind alone. Waves of this

height, or higher, sometimes are produced by submarine earthquakes.

Cornish states that the average height of the waves encountered in a severe storm at sea is twenty feet, while the tallest waves in the same storm reach about thirty feet. In storms of very exceptional violence the average may be thirty feet and the maximum forty-five feet. The same authority finds that, as a rough average, the height of a wave in the open sea, in feet, is about one-half the velocity of the wind in miles per hour.

How does the wind cause waves? Why should the movement of air over the surface of the ocean lift masses of water weighing thousands of tons far above their ordinary level? Complete answers to these questions cannot yet be given, despite the many studies of waves made by such brilliant scientists as Lord Kelvin, in the last generation, and Dr. Harold Jeffreys, within the last two or three years. It is well known that all winds near the earth's surface are "turbulent"—full of

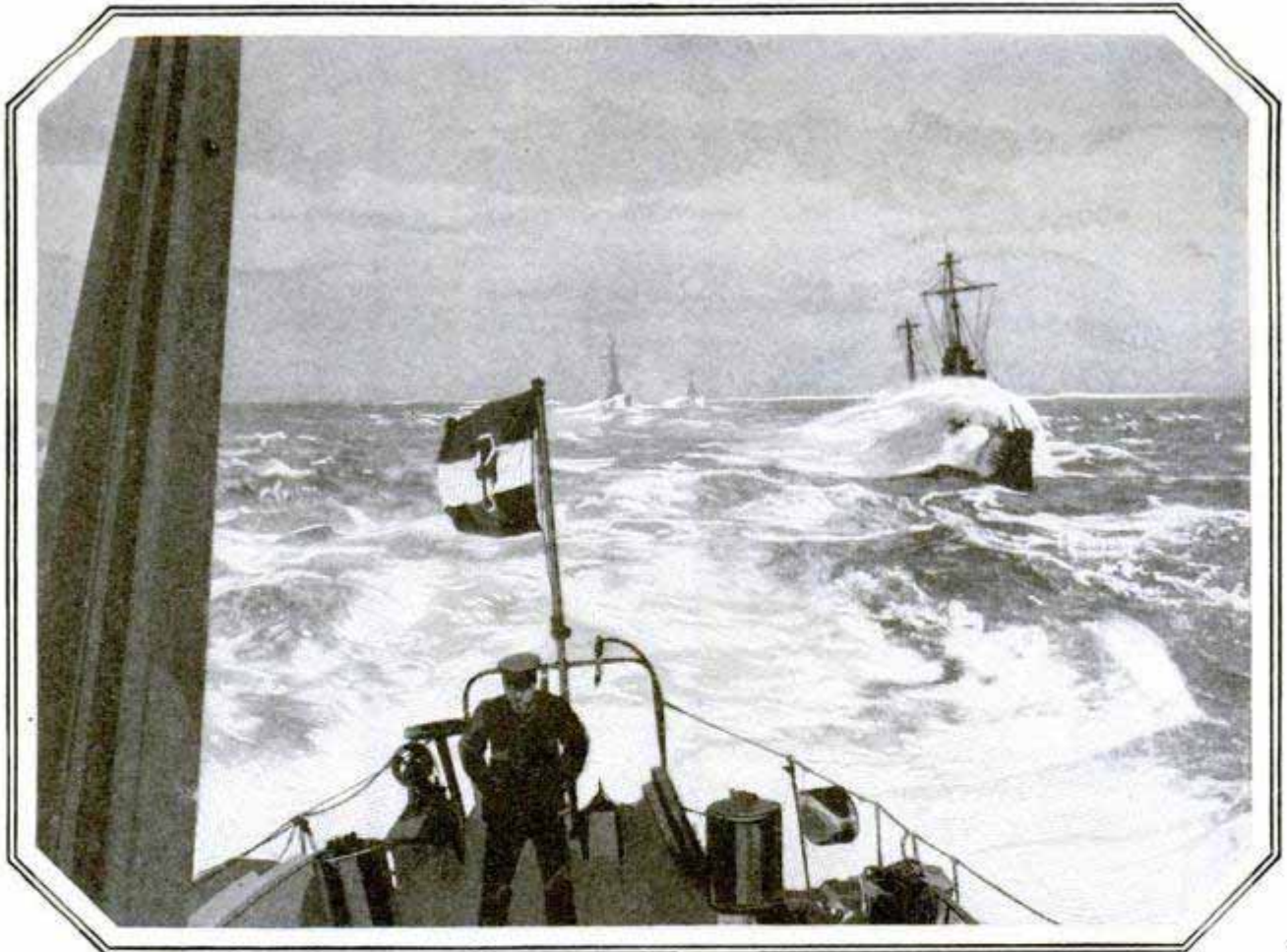

Courtesy The Illustrated London News

Destroyers, Those Lean, Overpowered, Tremendously Fast Terrors of the Sea, Are Among the Worst Storm Vessels Afloat, Continuously Swept by Waves in Every Tempest

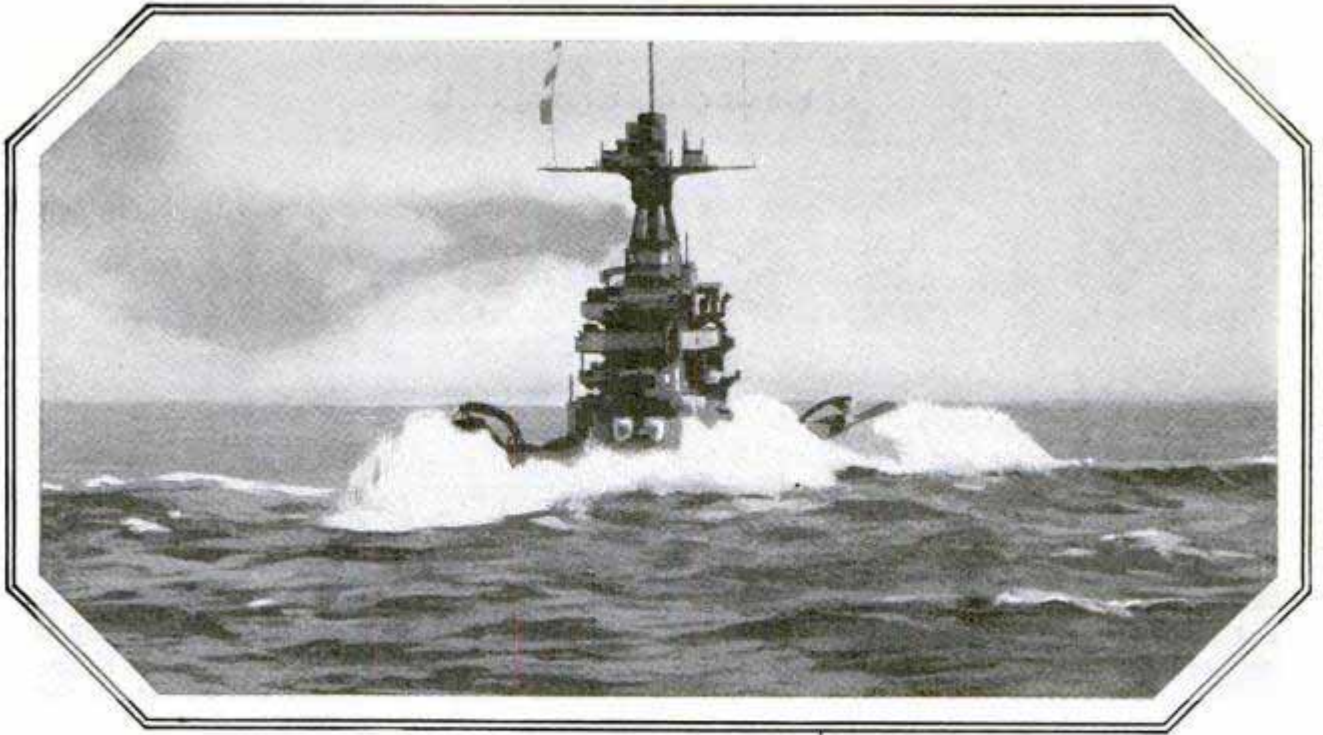

Courtesy The London Sphere

A Battleship Weathers the Storm; H. M. S. "Marlborough" Plowing through the Combers in the Bay of Biscay, Showing How Small a Part of a Huge Vessel May Be Visible in Heavy Weather

gusts and eddies, up-currents and down-currents. Thus a wind, besides tending to drag the water along by friction, must subject it to a great deal of unequal pounding, which depresses it in some places and heaps it up in others. Once waves are formed by this process, there are two agencies that tend to increase their size and movement. One is what Jeffreys calls the "shelter" effect, due to the difference between the wind pressures exerted on the windward and leeward sides of each wave. The other is the suction of the wind on the convex surface of the waves—the same upward pull that helps to lift the curved wings of an aeroplane.

Waves in the open sea, though they may race along at the speed of an express train, do not carry the surface water far with them. If we watch a floating log as a wave sweeps under it, we shall see that it makes little or no advance, but merely rises and falls and has a small movement to and fro. Each particle of water in a wave travels nearly in a vertical circle, returning approximately to its starting point. It is the form and not the substance of the wave that moves along the surface. The depth to which ocean disturbance extends is not certain. Laboratory experiments indicate that it may reach downward 350 times the height of the wave, so that a twenty-foot

wave would be felt at a depth of over 1,100 fathoms. The movement at this depth would, however, be only a small fraction of an inch.

The length attained by ocean waves—the horizontal distance from crest to crest or from trough to trough—is as impressive as their height. The length of a wave increases with the force of the wind producing it and also with the extent of open sea over which the wind has traveled, this distance being known as the "fetch." Waves 500 to 600 feet long are common. The longest ever reported was measured by Admiral Mottez, of the French navy, in the Atlantic ocean a little north of the equator. Its length was 2,700 feet. In general, the longest waves and also the tallest are those of the "Roaring Forties"—the region between latitudes forty and fifty south—where the "Brave West Winds" have an uninterrupted sweep encircling the globe. Nowhere else in the world do waves have such a fetch.

That a steel steamship should be bruised and battered by big waves breaking over her is not surprising when we consider the observed effects of waves on objects along exposed shores. According to Thomas Stevenson, who invented an instrument known as a "marine dynamometer" for measuring the impact of waves, the maxi-

651
 mum force of an Atlantic wave is three tons per square foot. French engineers, however, state that the force of the waves on the breakwater at Cherbourg sometimes amounts to three and a half tons per square foot.

At Peterhead, Scotland, water striking the breakwater has been thrown upward 120 feet and has displaced blocks of concrete weighing forty tons at heights of seventeen to thirty-six feet above low water. At the Bishop Rock lighthouse, which is exposed to the full force of the Atlantic waves, an iron column weighing over three tons was thrown up twenty feet and landed on top of a rock. At the harbor works of Bilbao, Spain, a solid block of the breakwater weighing 1,700 tons was overturned by the waves and dropped into the ocean. At Ymuiden, Holland, a block of concrete weighing twenty tons was lifted twelve feet by a wave and landed on a pier five feet above high water. The beating of the waves is constantly altering the shapes of the coasts, cutting cliffs, terraces and caves, and producing curious sculptural effects. This process is called "wave erosion." Some shores are worn back by this process at the rate of several

feet a year. The island of Heligoland, which in the year 800 A. D. had a circumference of 120 miles, today has a circumference of only three miles, and would probably have been completely worn away but for artificial protection.

The landsman generally describes all the ups and downs of the ocean surface merely as "waves," but the sailor distinguishes between two kinds of waves, which he calls "sea" and "swell." They may exist separately or together. Sea is produced by the wind blowing at the time and place of observation, while swell is due to winds prevailing over some other part of the ocean or winds that have blown previously at the place of observation. When waves are once set up in the open sea they may travel great distances, gradually decreasing in height but retaining their original length and velocity. Thus the ocean may be heaving with a long, regular undulation even when the air is perfectly calm. The appearance of swell is often the first indication of the approach of a storm, especially a tropical hurricane, as the waves produced near the storm center travel much faster than the storm itself.

When swell reaches a coast, its charac-



Rearing Dozens of Feet into the Air, Tons of Water Fall Back with a Mighty Crash; the Picture Shows a Huge Wave Striking the Sea Wall at Colombo, Ceylon, in the Far East

*McCurt's Hardware Co
College Hill
Cincinnati
Ohio.*

1046

teristics are often much changed. Shoaling water increases both its height and its velocity, and it therefore has much more powerful effects than in the open ocean.

The heavy seas, locally known as "resacas," that occasionally visit the Bay of Rio de Janeiro and the adjacent coasts, afford another interesting example of swell traveling for long distances and being converted from long, smooth undulations of the water into leaping and destructive waves. At Rio these waves, on striking the sea wall, sometimes send a solid sheet of water 100 feet high.

The dangerous swell that frequently occurs in the open roadsteads of Morocco is generally due to cyclonic storms crossing the Atlantic. For the past seven years it has been successfully predicted on the basis of wireless reports from Portugal and the Azores of sea disturbance in those regions. There is an interval of about fifteen hours between the occurrence of a northwest swell on the Portuguese coast and its appearance at Morocco.

"Tidal waves," so called, usually have no connection with true tides. This name is sometimes applied to abnormally large "solitary" waves encountered by ships at sea, but, in many cases, to submarine earthquakes, and sometimes to great waves or a sudden rise of the waters along low-lying shores, caused either by passing storms or by earthquakes. True tidal waves, due to the pull of the moon and sun, occur twice a day in all parts of the ocean, but their slope is so gradual that they are quite imperceptible as waves. Even at the head of the Bay of Fundy, where the tide rises and falls fifty feet, there is no appearance of a wave, but in the Petitcodiac river, which discharges into this bay, the conflict of tide and current produces a conspicuous wave, called a "bore." A similar effect is seen in several other tidal rivers.



Adjusting the Transparent Screen over Infant in Carriage; Protector Is Concealed When Not in Use

FLY SCREEN ON BABY CARRIAGE GUARDS INFANT'S SLEEP

To shield the baby from flies, dust and other disturbing and injurious things while in its carriage outdoors, an adjustable screen for the front has been introduced. It is securely attached and, when not needed, tucks back into the hood of the buggy, where it is entirely concealed and out of the way.

LATHE TO TRUE BRAKE DRUMS SIMPLIFIES SERVICING

Truing brake drums and doing general servicing to all sizes and types of automobile wheels are easily accomplished on a lathe with universal mandrel and bearing adapters. It does all the jobs that are performed on an ordinary type of lathe, but permits mounting the wheel on it in the same manner as it is mounted on the axle, so that tests and repairs may be made on the hub, the brake drum, felloe, hub flange and wheel rim. Accurate results are thus assured.

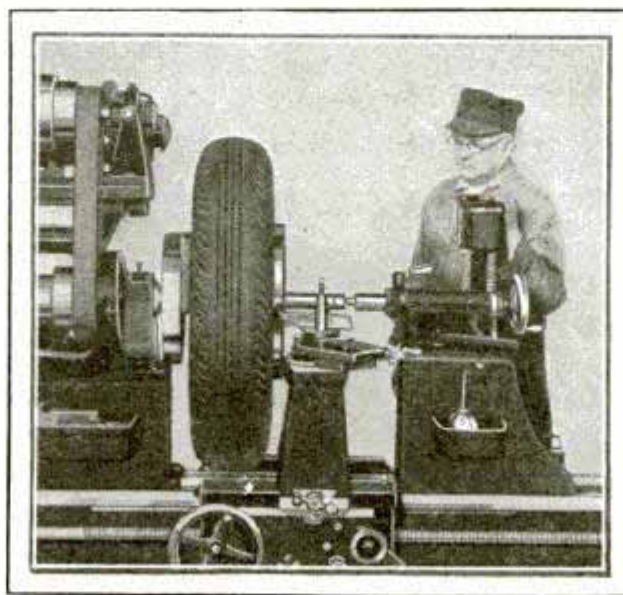

Auto Wheel Adjusted on Lathe Which Trues the Brake Drums and Performs Other Service Tasks

Auto Wheel Adjusted on Lathe Works

1011
13 W. 46 St. New York
\$ 1.00 with desc. in English

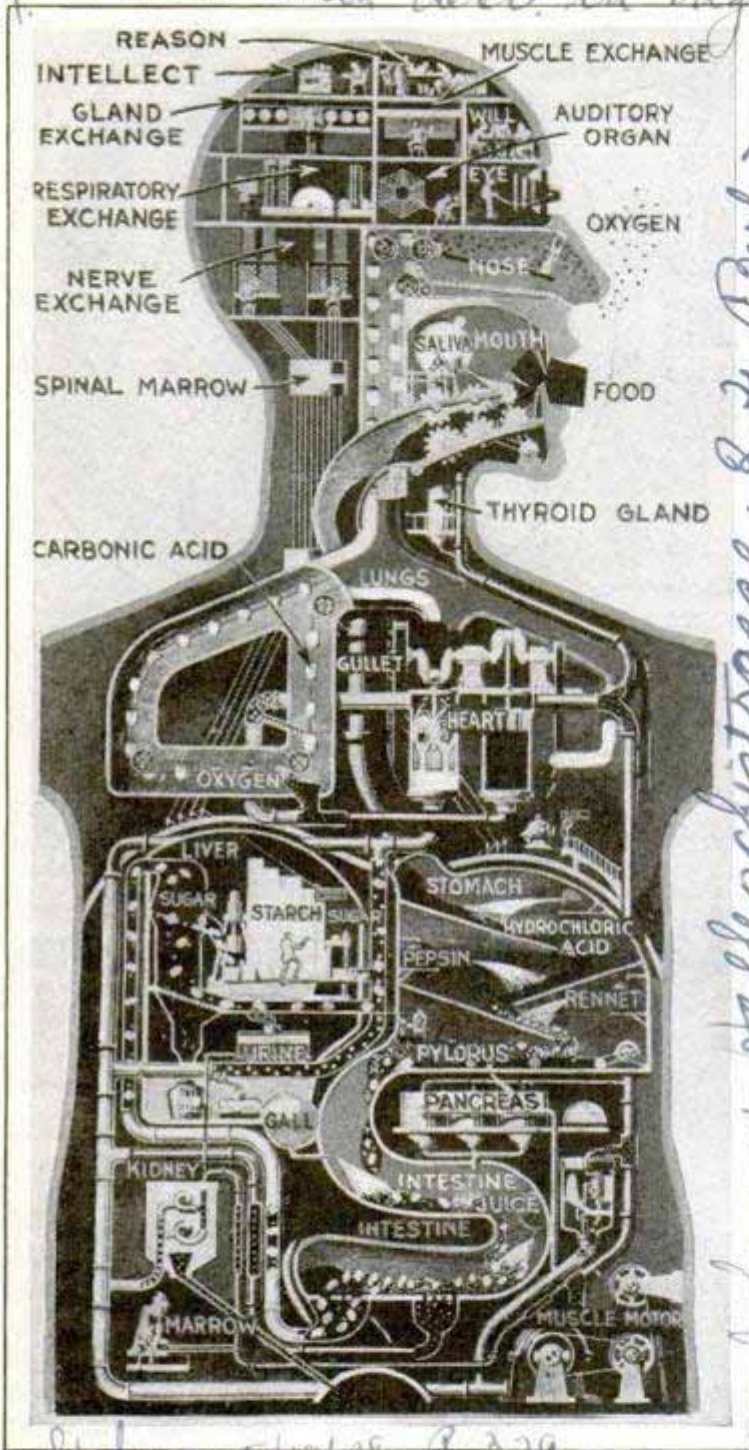

Paul Simon Hallestrasse 2 Berlin S.W. 11 Germany

the blood. The oxygen-charged blood is then conducted to the heart, represented by a pump and pressure gauge, and the pressure raised high enough to start the circulation through the system. The carbon dioxide set free by the various oxidations going on in the body is carried to the lungs and escapes through the nose. Next food is shown entering the mouth, to be ground up by the teeth, represented as shredding wheels, mixed with saliva and passed down the gullet into the stomach. Here hydrochloric acid, pepsin and rennet, the three secretions of the stomach, start the chemical process of digestion. The food is propelled on by a motor-driven conveyor, and passes through the pylorus, represented as a valve controlled by an attendant, and into the intestine, where three more juices, bile from the liver, the secretion of the pancreas and the intestinal juice, continue the chemical work. The effect of all these processes is to reduce food to its three great constituents: carbohydrate, protein and fat. The first, in the form of sugar tablets, and the protein as round disks, are shown entering the blood stream, by which they are taken to the liver. There both are further acted on, the sugar being stored as a variety of starch, and the protein reduced, until eventually it passes, with some of the starch, once more into the blood stream. Bone-marrow supply, muscle motors, kept running by a pipe line from the blood stream, the intricate chemical

plant centering in the kidneys, complete the bodily functions. The brain, controlling the entire operation by nerve centers, is represented as the offices.

Popular Mechanics Magazine does not publish the name of the maker or seller of any device described in its pages, but this information is kept on file and will be furnished, free, to anyone addressing our Bureau of Information.

© Photo Union, Berlin
The Human System as a Factory, a German Diagram That Explains How the Body Does Its Work

HUMAN BODY IS PORTRAYED AS A FACTORY

The human body as a mechanical factory was demonstrated at a recent exhibition of dietetics in Berlin. Starting with the introduction of oxygen molecules into the nose, the graphic drawing showed a bucket-conveyor system carrying the oxygen to the lungs, where it combines with the hæmoglobin in the red corpuscles of

A New Highway for an Old Empire



Combination Dynamite Drill, Stump Puller and Traveling Cook Shack. One of the Unique Tools Used to Build the Tamiami Highway through the Wilderness of the Everglades Jungle

AMERICA'S one tropical jungle, the waterlogged 5,000,000 acres of the Florida Everglades, home of giant alligators, furtive Seminole Indians, brilliantly plumed tropical birds and silent water moccasins, was opened to the world a few months ago, when six years of road-building ended with the completion of the Tamiami trail. The new highway across the jungle swamp is the shortest road between Tampa and Miami, and one of the scenic wonders of the world's highways.

The little party of pioneer surveyors who staked out the route, spent more than three weeks in forging their way across the narrow state, a distance of 110 miles. Their transport was a weird six-wheeled automobile that traveled on a roadbed of wire netting. While one roll was stretched in front of the car, another was being picked up behind it.

The automobile itself was a homemade freak. The drive was removed from the rear axle of a light car and fitted instead to a jackshaft stretching across the chassis. From this shaft it was carried to

a pair of huge tractorlike wheels, placed amidships. Their broad cleated treads furnished traction, and the smaller wheels fore and aft served only to balance the machine as it tilted and slithered through the muck.

Where they went in twenty-three days of hard traveling, the roadbuilders followed, with tractors, steam shovels, dynamite and drills. Their equipment was mounted mostly on endless treads and mud boats. The cook shack was carried along by building it as a second story over the scow that carried the drill used in setting dynamite charges. Now, after six years of work, automobiles can cross the Everglades in a few hours, and the state is pushing the work of draining the huge swampland to release its 5,000,000 acres of productive muck and marl land for agricultural exploitation.

Capt. George F. Cook, his son Erben, an experienced engineer, with four helpers, were the original trail blazers who conquered the riddles of gasoline travel through the tropical Gladelands. The

wheels of their homemade six-wheeled car, which they named a "gadget," were equipped with flat wooden tires, thirty inches wide. Steering was done by braking on first one wheel and then the other.

"We started our land cruise," Captain Cook said, "with the car loaded with one ton of supplies and two light pontoons for use, if necessary, when we reached the Gulf of Mexico. Erben drove the car. Two men on foot scouted a trail about one-half mile ahead, and a third with a shovel dug wells as we had to run the car constantly in low gear, so that the radiator was boiling all the time.

"Progress was as slow as snail travel. On good days, we advanced about six miles, while on rainy days in bad territory we frequently traveled from sunup to sunset only 300 yards. At times, we had to pull the car out of holes with block and tackle. On other occasions, we had to carry small trees long distances to get footing for the wheels. Sometimes, the car would sink so deep in the mire that all of us had to labor desperately with shovels to extricate the machine before it was hopelessly 'bogged down.'

"It was ten days before we sighted a human being. He happened to be a Seminole, a Shark river Indian. The gun he carried bore the manufacturing date of 1856. It was of the type that has hung largely on the walls of museums for the

last half century. Our car was the first automobile he had seen. After examining it, he said, 'Fool white man's canoe; everybody walk and feed him water.'

"We shook hands with the Everglades just as nature had left it, with difficult barriers of fallen trees and water courses getting deeper daily as we approached the Mexican gulf. Landmarks? There were none. We had no speedometer. Daily we retraced our steps many times. A pocket compass was our only guide. We had to feel our way through the swamplands and across the sawgrass prairies. But finally after many hardships, including short rations for several days, we completed the exploration. The back trail to Miami was almost as difficult. This first trip led to a second several months later in which we used a four-wheel-drive tractor and trailer. However, after breaking the king pin of the tractor, we were forced to abandon it and again employ the 'gadget' as the most dependable 'Glades vehicle available.'

The new highway is built of limestone rock blasted directly along its right of way. An abutting drainage canal was formed by this dynamiting campaign, the rock being deposited as foundation material for the highway. The Everglades is a region anchored on a rock-ribbed base. The decay of sawgrass and other organic material for generations has deposited a

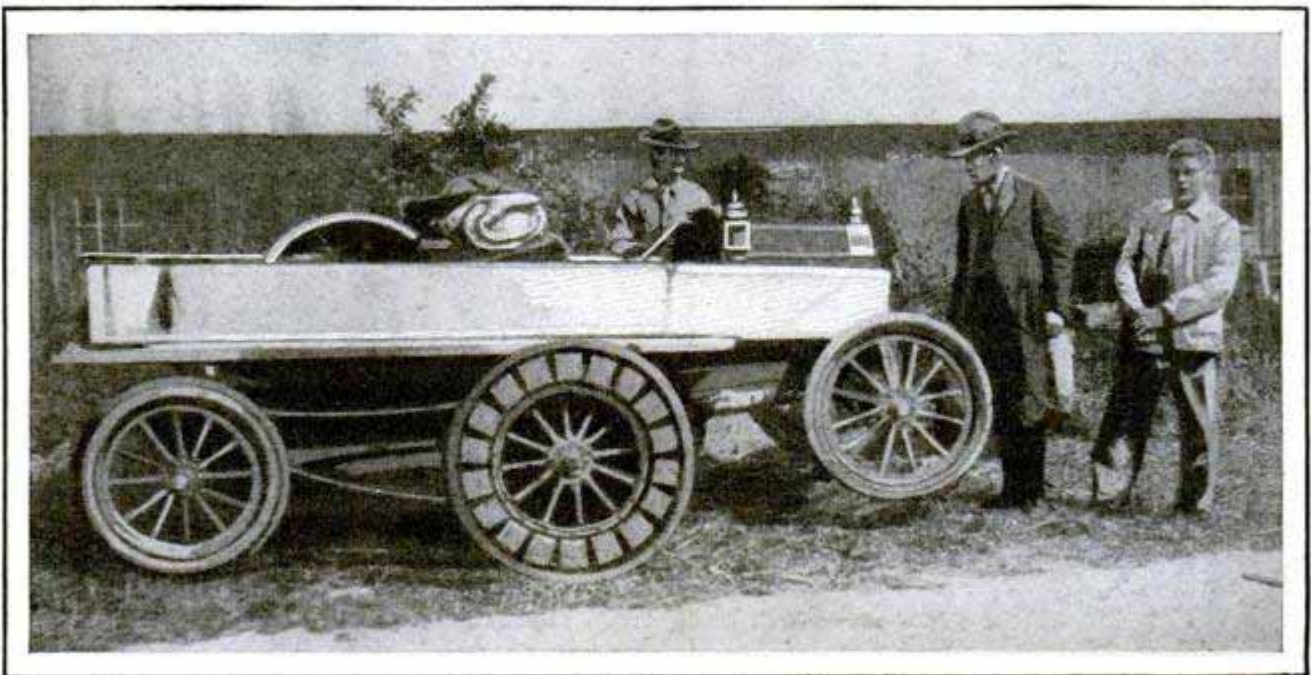

The "Gadget," a Homemade Six-Wheeled Auto, Balanced and Driven on the Two Huge Center Wheels, and Used by the Survey Party to Cross the Uncharted Everglades to Map the Road

layer of muck soil from one to eight feet deep on top of this rock. The roadbuilders excavated all the earth and constructed a pure rock-base highway.

It took three months of hard labor and cost \$6,000 to deliver and put to work a compressed-air dynamite hole driller on this job. This was but typical of the transportation difficulties involved in moving all the heavy machinery to and through the waterlogged, isolated, uninhabited domain. Ingenuity evolved unique uses of the machines when delivered "at the front." The compressed-air dynamite drill was mounted on a steel ditching frame, which was also provided with a drill sharpener, forge and similar tools, as well as commissary and living quarters for the crew of five men, to work many miles in advance of the excavating shovels.

Another interesting feature was the stump-pulling attachment of this remarkable machine. It was built in the form of a skidder and consisted of a small tractor with the wheels removed, mounted on a stoneboat and geared slow so as to produce a dead pull of thirty-five tons on a steel cable 600 feet long. This stump puller yanked forty-foot trees, twelve to eighteen inches in diameter, from the earth's crust as though they were no more firmly planted than jackstraws.

The Everglades is really a spacious prairie dotted with wooded hammocks elevated from one to three feet above sea level. The highest point along the Tamiami trail is about the center of the state, being only twelve feet above sea level.

☐ The tallest trees in Iceland are but fifteen feet high.

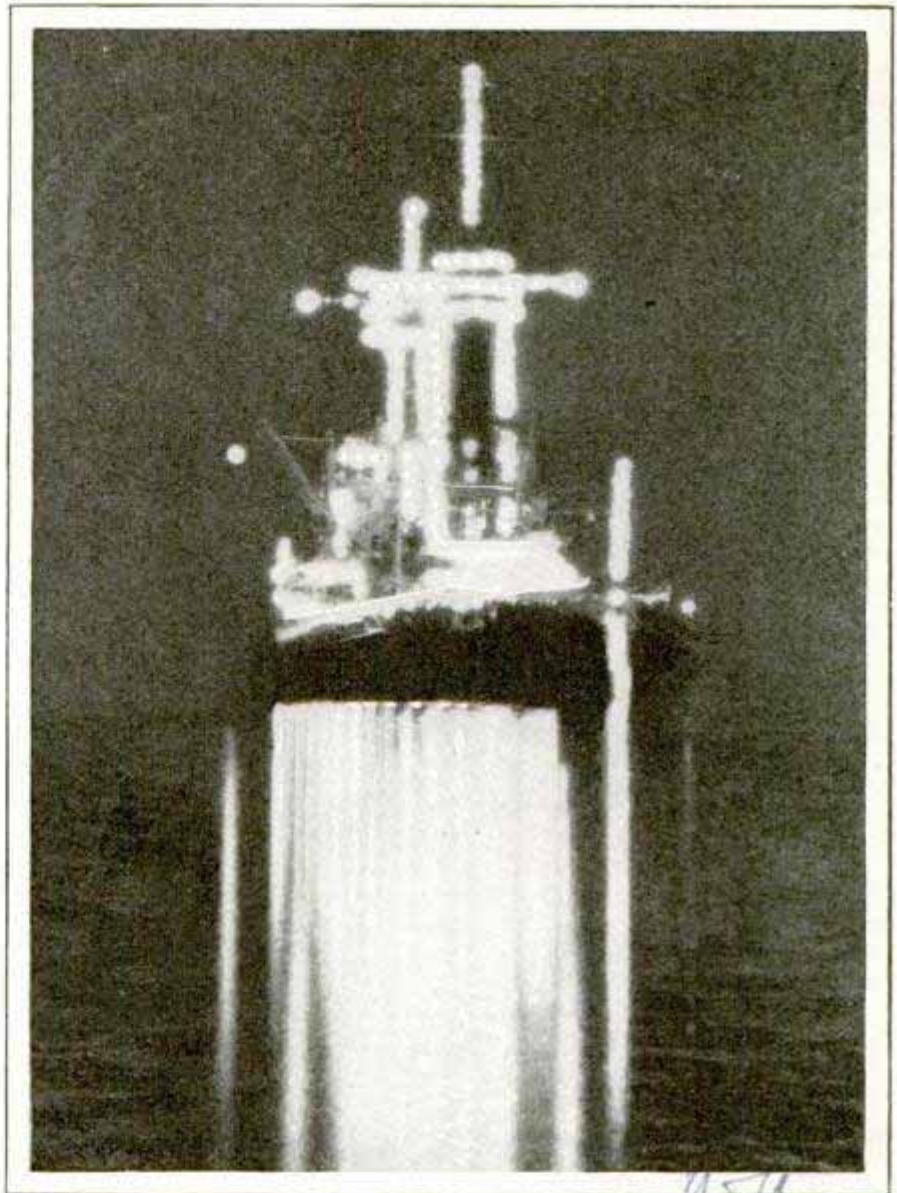

Flagship "California," as It Appeared during a Recent Display in the Harbor at Honolulu, a Weird Structure of Lights

FLAGSHIP PUZZLE OF LIGHTS IN FLEET DISPLAY

Residents of Honolulu witnessed an unusual spectacle recently when the U. S. S. "California," flagship of the fleet, was brilliantly illuminated at night while at anchor in the harbor. The reflection of the powerful batteries of lights added to the weirdness of the display.

PLOWSHARES FROM AUTOS 1012

Scrap steel from old automobiles is to be used at a western plant in the manufacture of plows and other farm implements. The steel mill is in a district where a supply of natural iron ore is difficult to obtain, but it is equipped to handle 10,000 tons of scrap each month.

*the plant - took iron
and helped it to work*

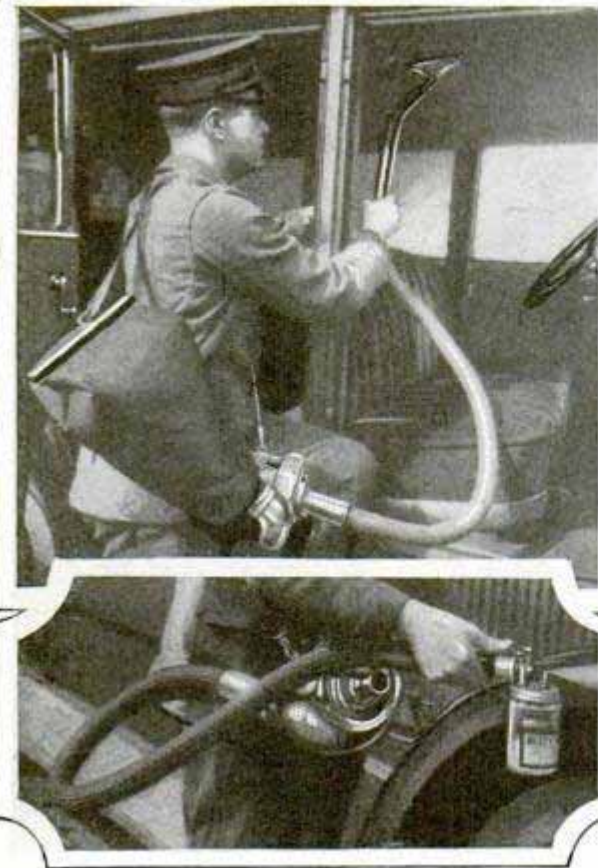

Using the Cleaner to Remove Dust from Car Interior and as a Sprayer for Painting

VACUUM CLEANER PAINTS CAR AND OILS SPRINGS

For the convenience of the automobile owner, a combination vacuum cleaner and sprayer has been placed on the market. The air pressure is utilized to operate a spray gun for applying paint, to oil the springs, cut grease from the undergear and for many other operations.

THREE-WAY SPOUT FOR PUMPS ELIMINATES ADJUSTMENTS

Easily attached to the pump, a three-way water conductor permits filling three separate containers without removing it or making special adjustments of the pipe. One opening is made in the form of a spout for convenient filling of buckets, and to turn the water in any direction, all that



is needed is to adjust a simple shifting device which is held in place by a notch. The unit is of special usefulness in connection with the farm pump.

UR TOMBS REVEAL ANCIENT SACRIFICIAL CUSTOMS

Fifty-nine servitors of a king and queen who died more than 5,000 years ago, were killed to serve their master and mistress in the next world, it was disclosed recently when the joint expedition of the University of Pennsylvania and the British Museum dug into the royal tombs of Ur of the Chaldees, better known as the home city of the patriarch Abraham. The king and queen whose retainers were slaughtered to serve them in death were the Sumerian rulers, Mes-Kalam-Dug and Queen Shub-Ad. Soldiers of the guard, women of the harem, men and women servants, grooms, wagon drivers, harpists, and even two children, probably pages at court, were the victims, as well as six oxen and two asses. The discovery of the tombs is the greatest find yet made in the excavation of the ancient civilization of the Euphrates, and, because of the far greater antiquity, equals if it does not surpass anything found in Egypt. The royal tombs were placed one above the other, indicating the king died first. The shaft through which he and his retainers had been buried had been filled with earth, but was later reopened down to the roof of the king's tomb, and a burial place excavated for the queen. The burial party apparently took advantage of the fact to break through into the lower tomb and loot it of almost everything of value. The queen's clothes chest was then placed over the opening to conceal the robbery. Among the few things left in the king's tomb, however, was a two-foot boat model in solid silver, which bears a striking resemblance to the boats still used on the near-by Euphrates marshes. Aside from the importance of the objects and the discovery of the sacrificial custom of killing a ruler's household, the excavators disclosed in the tomb entrance a true arch of baked bricks, the oldest example of this form of construction. The find moves the birth of one of the most important discoveries in architecture back many centuries.

and John Traut
of Peabody, Minn.

HUMAN SACRIFICES AT TOMB OF AN ANCIENT KING

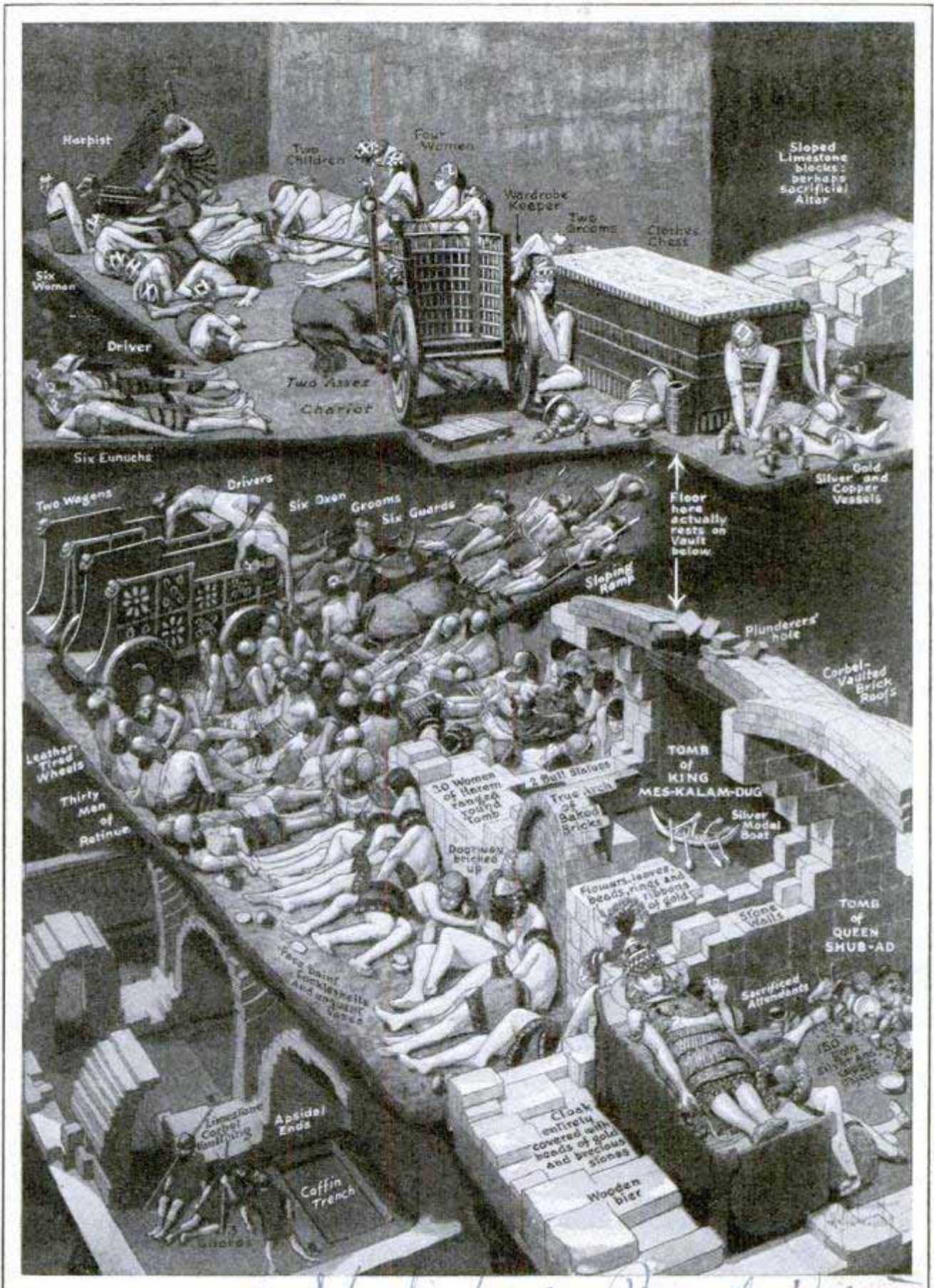

Copyright, S. W. Clatworthy, 18 Shakespeare Road, Herne Hill
 Artist's Reconstruction of the Slaughter of the Royal Household of King Mes-Kalam-Dug of Ur, to Provide Attendants for the King and Queen Shub-Ad in the Next World; the University of Pennsylvania-British Museum Expedition Found the Tombs While Excavating Ur of the Chaldees

Enam. et S. 24, Eng.

1029

Plane with Movable Lower Wing and Fuselage Tail Clipped Short. Produced by California Experimenters



QUEER NEW TAILLESS PLANE HAS MOVABLE WINGS

An airplane with its tail clipped short and the lower wing movable fore and aft, so that the pilot can change the amount of stagger at will while in flight, has been developed by a western flying school and successfully tested. Airplanes are built with the wings staggered, one being set behind the other, to improve their longitudinal stability and increase the lifting power. By building the lower wings as a single unit, suspended below the fuselage on pivoted struts, and then arranging a control to move it back and forth, the lift can be suited to the speed of the motor, making stalling of the ship almost impossible, while, in landing, the set can be fixed to bring the ship to a stop in thirty feet.

INVENTOR GIVES "PLANT PILL" DISCOVERY TO NATION

The "plant pill" discovered by Dr. W. F. Gericke, of the university of California, which makes rose cuttings and other plants grow in water, without any earth, is to be given free to the people, the inventor has decided. Dr. Gericke, who spent the summer lecturing in Europe, expects to place the formula of his discovery in the hands of state universities and agricultural colleges for free distribution next spring. Dr. Gericke found that small

see Aug 1926-1927

branches clipped from rose bushes in August, placed in jars of water with his concentrated plant food added, could be raised in the house and would supply blossoms for Christmas time.

HOT WAVES BORNE BY WARM AIR FROM GULF

Heat waves that afflict the eastern part of the country in the summer are caused by warm air from the Gulf of Mexico, weather experts declare. It passes over Texas and the central states, is heated during the long days and fails to cool sufficiently during the short night. The process may continue until cold air from Canada pushes down from the northwest and mixes with the heated air.

RIFLE FIRED WITH ONE HAND WINS BRITISH PRIZE

A prize of \$15,000 has been awarded Brig. Gen. John T. Thompson by the British war office for his rapid-fire rifle. It is operated in somewhat the same manner as a revolver, and is said to shoot twice as rapidly as the usual rifle.

302 Broadway New York



Looks Like a Revolver, but It Is a Rifle; the One-Hand Weapon That Won Big Prize

California Institute of Technology Pasadena, Calif. Permanently School

U.S. Weather Bureau Death from - Dr. George W. McCoy, Director, U.S.

Hygiene Laboratory

Study Science New Bulletin 025

June, 1928. 647

Los Angeles Calif
The E. J. Lawn Edge Co., 823 W. Vermont Ave.

COLOR-EATING GERMS BLAMED FOR FADING HUES 100/

Why colors fade, even though they may pass the usual light, damp and acid tests, has been solved by the analyzing microscope. The answer is a color-eating germ that thrives on the pigment in the paint, dye, ink or stain used. When it begins work on printed matter, the color gradually disappears, leaving first a yellow tint and then successive darker stages until all the pigment has been eaten away. Placing an infected sample under the microscope and adding a drop of water, the glass shows millions of spindle-shaped bacilli swimming about. Poster work for outside display is immune from destruction, as the sun quickly kills all germ life. Printed matter and colored fabrics should not be stored in damp, dark places.

HOE WITH ADJUSTABLE HEAD SAVES EXTRA TOOLS 904

Garden and field tasks that ordinarily would require different tools for satisfactory performance can be done with a hoe that has an adjustable head. It can be turned to any position simply by loosening a bolt. By virtue of this arrangement, it can be used for plain hoeing, scraping, weeding or trimming the edges of turf and similar purposes.

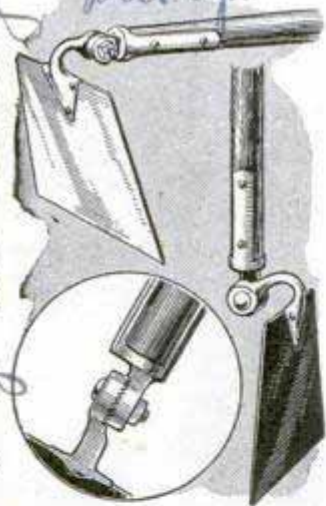

TAPE TO RECORD PHONE CALLS LATEST SERVICE AID 1058

Attached to the ordinary telephone instrument and operated through the regular circuit, a tape recorder enters the number of the telephone that makes the call when the person called is not present. The number is perforated by means of a key arrangement operated at the other end. When he returns, the person called can tell by a glance at the tape if his telephone has been rung during his absence.



For the Firemen Who Serve along the Wharves, This Rubber Suit Acts as Life Preserver

RUBBER SUITS FOR FIREMEN KEEP WEARERS AFLOAT

Designed especially for men who fight fires along the wharves at Long Beach, Calif., rubber suits have been devised. They keep the wearer cool and dry and prevent him from sinking should he fall into the sea, as, from the nature of his service, he is not unlikely to do. Successful tests were performed with the equipment during a recent trial.

SHARPENER FITS ON RAZOR AND WHETS BOTH EDGES 957

Both edges of the double safety-razor blade are sharpened without removal from the razor by a combination hone-and-stop device recently introduced. A few quick strokes back and forth are said to be sufficient to produce keen edges. The sharpener is quickly adjusted or taken off and strikes the blade while it is in the most suitable position for forming a sharp edge.



see June 1928, p. 66 - Fireman by fire

and further... 1000 - 36...
1000 - 36...

UNCLE SAM'S BIGGEST MINE-LAYING SUBMARINE

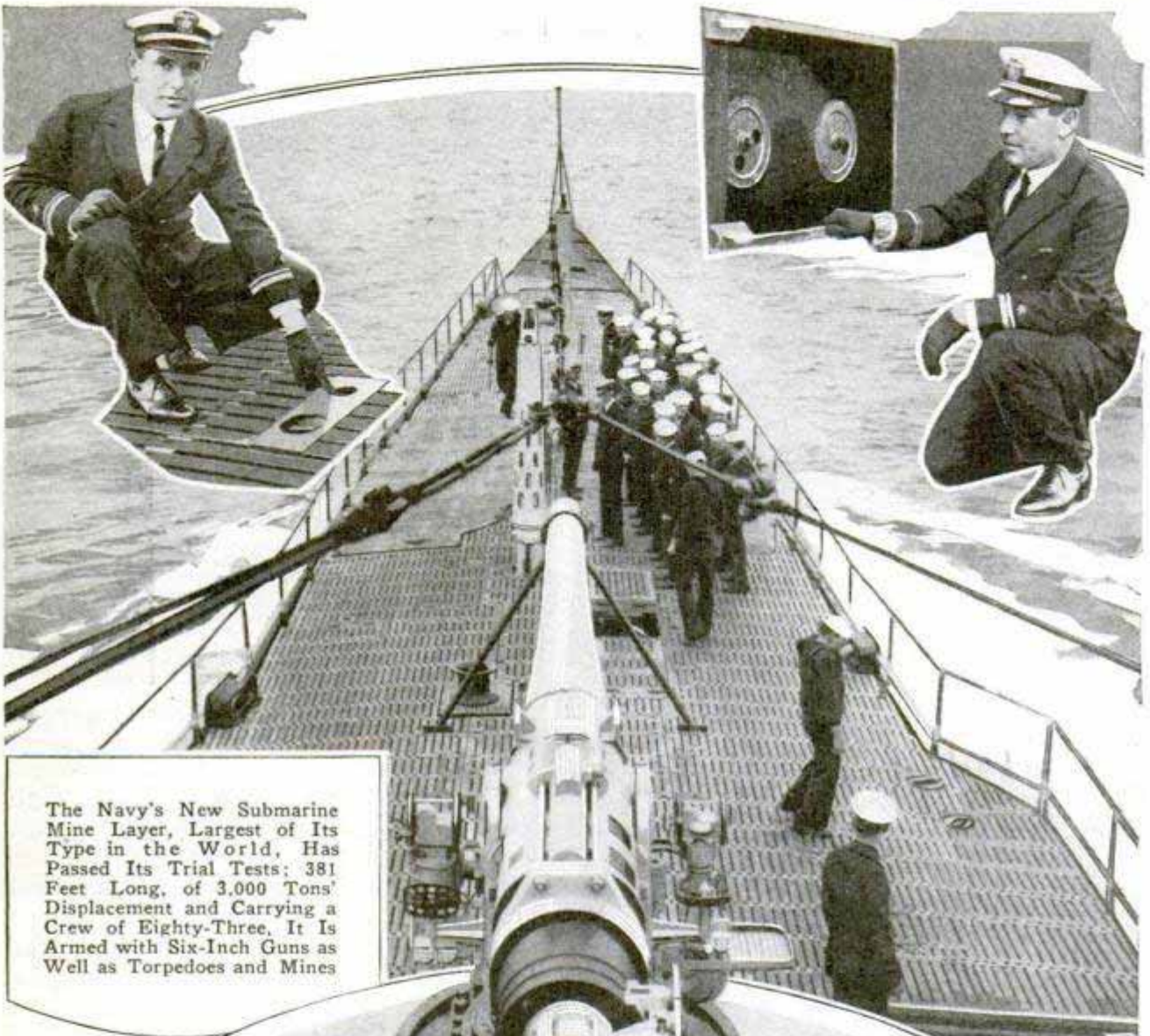

The Navy's New Submarine Mine Layer, Largest of Its Type in the World, Has Passed Its Trial Tests; 381 Feet Long, of 3,000 Tons' Displacement and Carrying a Crew of Eighty-Three, It Is Armed with Six-Inch Guns as Well as Torpedoes and Mines

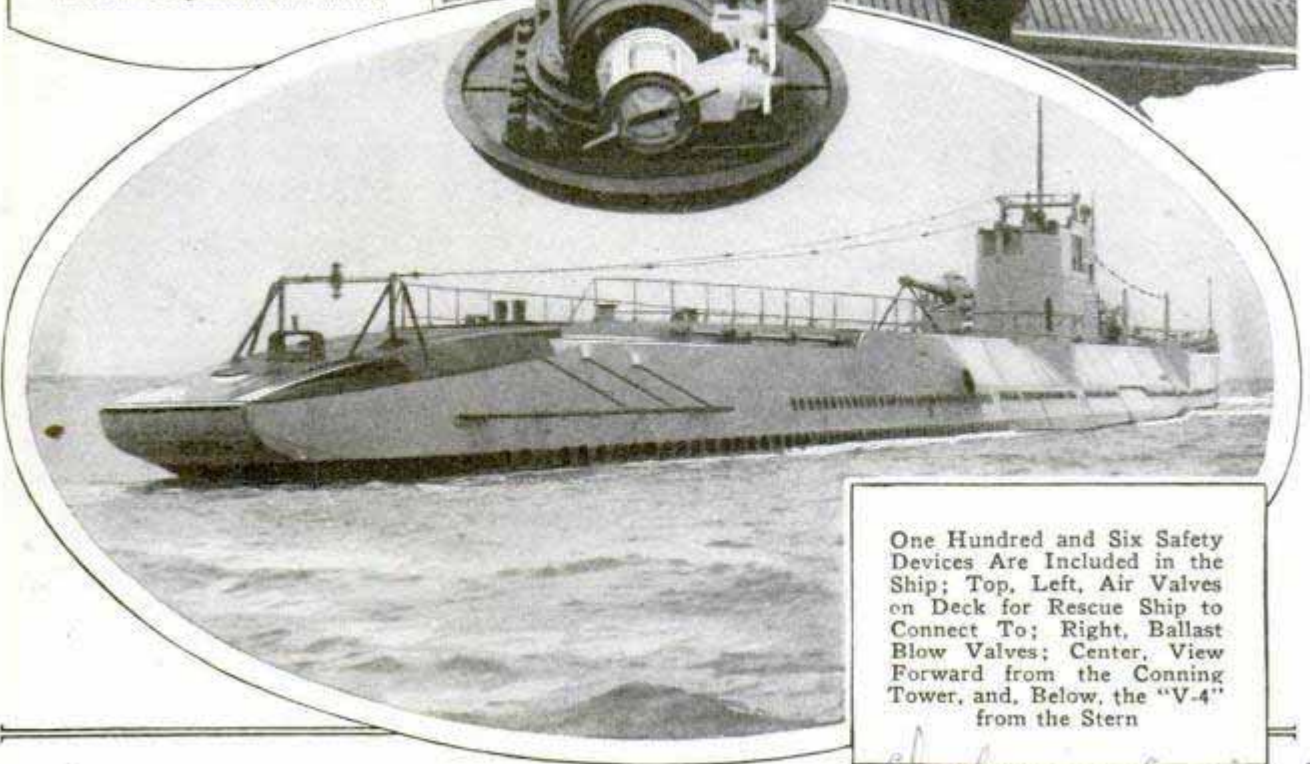

One Hundred and Six Safety Devices Are Included in the Ship; Top, Left, Air Valves on Deck for Rescue Ship to Connect To; Right, Ballast Blow Valves; Center, View Forward from the Conning Tower, and, Below, the "V-4" from the Stern

International

HOUSES BUILT FLAT ON GROUND LIKE SIDEWALKS 1014

Houses are built flat like pavements and then raised into position by a construction method that is intended to effect savings in time and money. The system was developed during the war in the rapid erection of barracks and is said to have been applied to peace-time homes with good results. The foundation walls are fashioned in special forms, using tar paper, concrete, reinforcing and an outside finish in rock-block or any other style desired. When the wall has dried thoroughly, it is hoisted into place on the foundation footings, cemented to them and the ends laced together with rods and steel mesh. The corners are poured in special forms. Spaces for floor joists are formed by wooden blocks, set at the right locations and removed from the wall. Side walls are built in the same manner as those for the foundations, except that an insulated fiberboard material is employed instead of tar paper, and window sash and doors are set while spaces for plumbing and other niches are allowed. This method is applicable to a wide variety of architectural styles and effects and is said to permit building a home that will compare favorably with old-world houses that have stood for centuries.

NEW KINDS OF CABBAGE TO REDUCE ROTTING 1026

Instead of cultivating larger cabbage heads, producers are now striving for smaller ones, to meet the needs of the small family and the city dweller whose storage space is limited. Heads that weigh but two or three pounds are preferred. One of the latest varieties is a real red-head cabbage of far deeper color, and another that has grayish purple leaves.

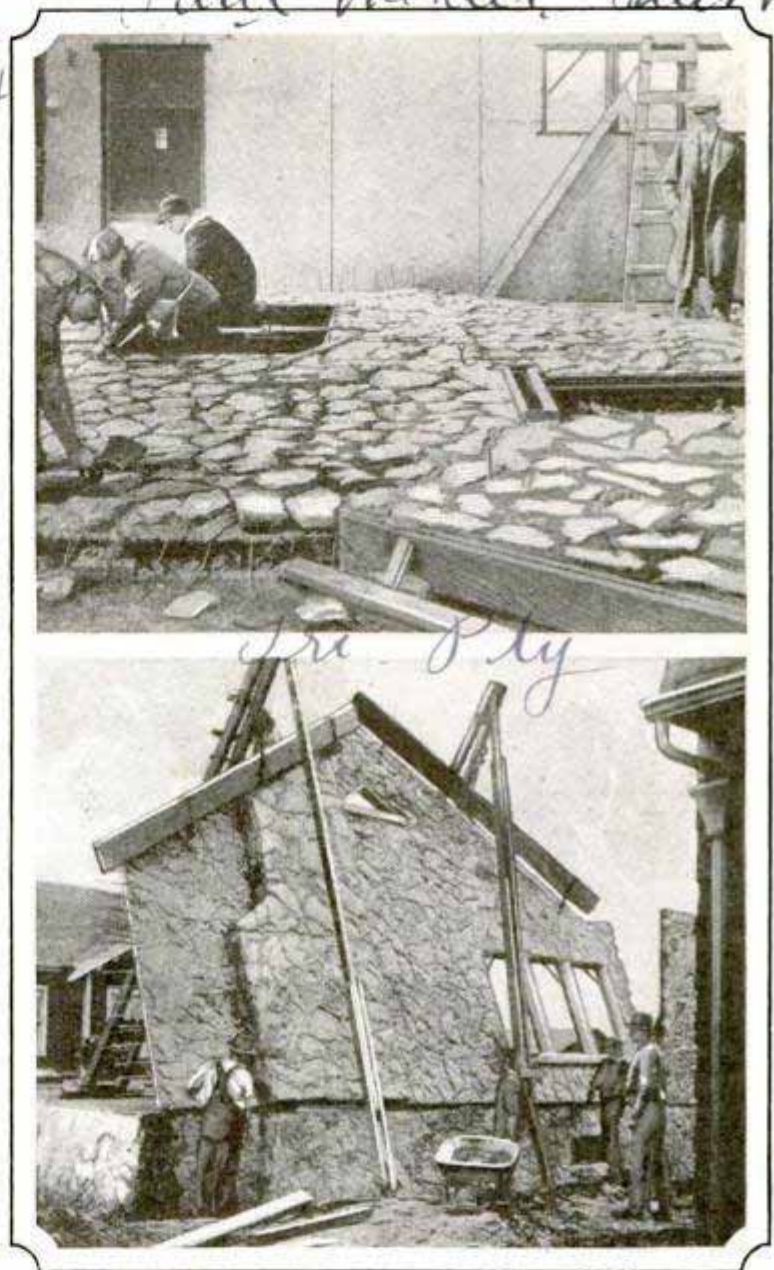

Top to Bottom, Finishing One of the Walls, Hoisting It, and View of Completed House

Handwritten notes:
 Water Mfg. Co., 100 N. Michigan Ave. Chicago
 Paul Mohler, Sales Mgr.
 L. C. H. Muro, Corner University

410.

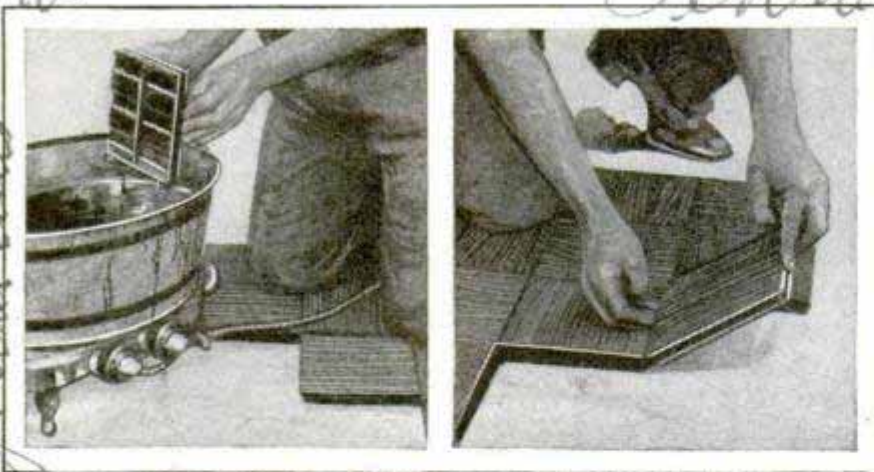

Dipping the Blocks in the Special Preparation That Helps Deaden Sound; Fitting Together, and Section of Finished Floor

**BLOCK FLOOR WITHOUT NAILS
 — DEADENS SOUND**

Handsome wood floors, in fabricated blocks put together with pegs instead of nails and laid in a special preparation that helps deaden sound, have been introduced to effect savings in construction costs and time. The blocks can be placed on top of cement or subfloors of wood, attractive patterns may be developed, and, when properly installed, they eliminate squeaking and sagging. The pieces are dipped in a special liquid preparation which is heated and quickly cools.

**SAFETY LIGHT IN ELECTRIC PLUG
 TO HELP PREVENT FIRES**

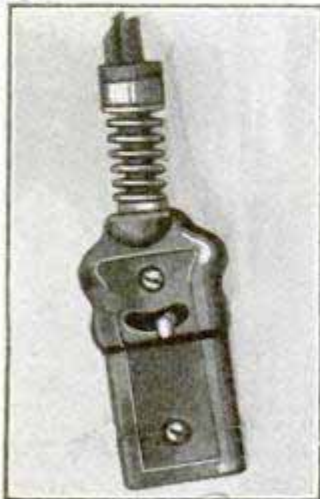

Intended to save current and prevent fires caused by leaving appliances connected too long, a safety light has been added to the plug. It shows through a small opening when the switch is on, giving a warning that the toaster, iron or other appliance is still connected.

**WORLD'S BIGGEST
 LENS TO SOLVE
 MARS RIDDLE**

1051

In a few years, a huge telescope, ten times as powerful as any now in use, may give an answer to the question whether Mars is inhabited and may solve other celestial mysteries. According to Prof. G. W. Ritchey, who has been working on the instrument for four years, it will make plainly visible the features of the landscape on Mars and, although the figures of any persons there cannot be seen, their habitations should be discernible, he

declares. The telescope is to be of the reflector type and will be mounted on the edge of the Grand Canyon in Arizona, according to present plans.

**CORKS ARE EASILY LIFTED OUT
 WITHOUT TURNING**

3235.

Bottle caps or corks, large and small, are easily removed with a small unit recently introduced. It has pins for taking out corks or milk-bottle caps, is simple to operate and saves purchasing extra tools.



**BRIGHT BINDINGS ON OLD BOOKS
 ATTRACT MORE READERS**

1033

Library workers have found that little-read books often become more popular when dull-colored or soiled covers are replaced with brighter bindings. A special cover, coated with a material similar to a chemical finish used on automobiles, has been introduced. It is waterproof, finger-marks and stains may easily be washed off, and it can be obtained in a wide variety of colors and designs.

Chicago 435 N. Michigan see lib for other books

Edna St. Baltimore + Edna St. Md. Baltimore Paris, France The neck 25

M. C. Pollock + Co. 1010 Patterson Bldg

E. J. du Pont de Nemours, Wilmington

Fabroid Ltd. Newburgh, N.Y.

1643 Acacia St

Los Angeles, Calif

345

YELLING HELPS CURE DIZZINESS IN HIGH-SPEED FLYING

Attacks of sudden ^{nausea} dizziness while flying in an airplane can sometimes be relieved by giving a loud high-pitched yell, emitting as little breath as possible, naval flight surgeons declare. This forces blood into the smaller veins in the region of the head. An aerial "jolt" often causes the blood to leave the veins temporarily, resulting in a sensation of dizziness. During certain maneuvers at high speeds, a decrease in the blood supply to the brain may cause fainting, although the effects vary with the individual. Yelling contracts the abdominal muscles, the diaphragm and chest muscles, and the pressure forces more blood toward the head.

GAS MASK PROTECTS DRIVER OF COTTON DUSTER

To rid cotton plants of the destructive boll weevil, a poison-gas treatment has been developed. The fumes are made from a special powder in a fire box on the machine, which is driven over the field. The heavy smoke settles and is confined in a relatively small space within a canvas shield close to the plants where it kills the weevils. Enough powder to cover a field of twenty acres is carried in the hopper, and the cost is about twenty cents an acre. The driver is protected by a gas mask. The mules or horses that pull the machine are out of the range of the gas.

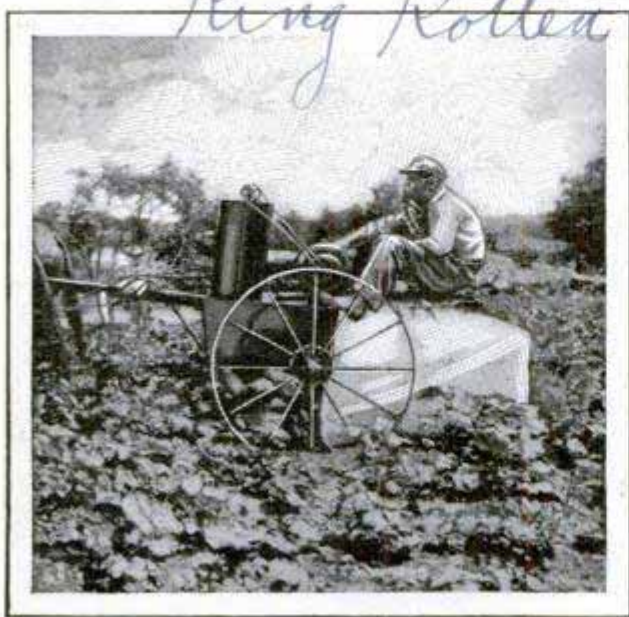

Treating Cotton Plants with Poison Gas to Kill Boll Weevil; Driver Is Protected by Mask

Camden

"Lighthouse Helmet" for Policemen on Foggy Days and Nights; Batteries Are Worn on Belt



FOG LAMP FOR TRAFFIC POLICE PROMOTES SAFETY

Traffic policemen in England have been equipped with head lamps, somewhat like those carried by miners, to aid them in guiding pedestrians and cars on foggy days and at night. The lights are supplied with electric current from batteries attached to the belt.

WAVES IN ASPHALT PAVEMENT REMOVED WITH SHAVER

To smooth the waves that form in asphalt pavements, a unit somewhat like a road grader has been introduced. It has specially designed blades that shave off the irregularities, often caused by the heat of the sun. A light covering of thin cement is pressed into the pavement with a small roller, to complete the repair.

Those wishing further information on anything described in the editorial pages can obtain it by addressing Bureau of Information, Popular Mechanics Magazine, Chicago.

P. J. Moran

South Temple 11086

New Ways to avoid



Added Amusement and Instruction Are Afforded Children in This Combination Desk, Game Rack and Table Set; as Illustrated, the Top with Holders for Games and Books, Folds Down to Become the Table Top

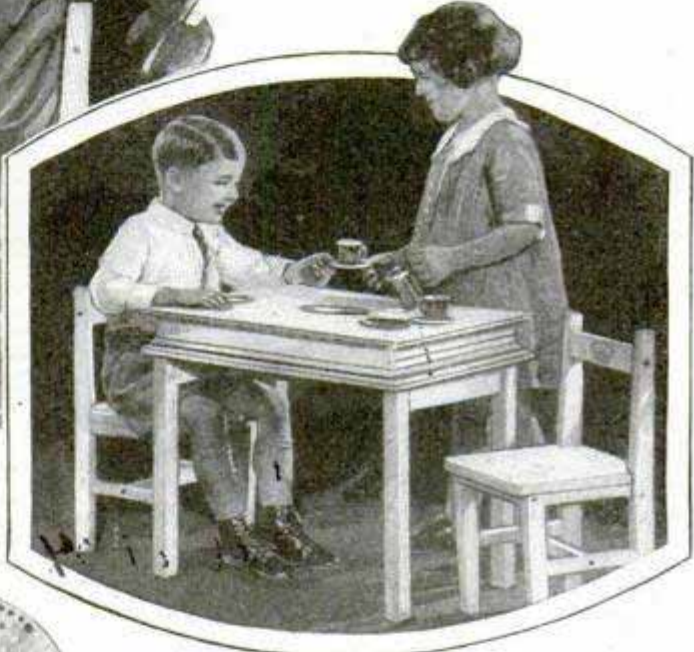

These Perforated Aluminum Plates Form Air Space between the Food and Cooking Utensil So That Contents of Dish Will Not Burn on Gas, Coal or Electric Stove; They Also May Be Used under Hot Dishes on Table

Many Uses Are Found for Sponge-Rubber Dish Washer, Below, Especially Fitted for Cleaning Interior of Bottles and Jars; It Has Extension Handle with Pan Scraper on One End

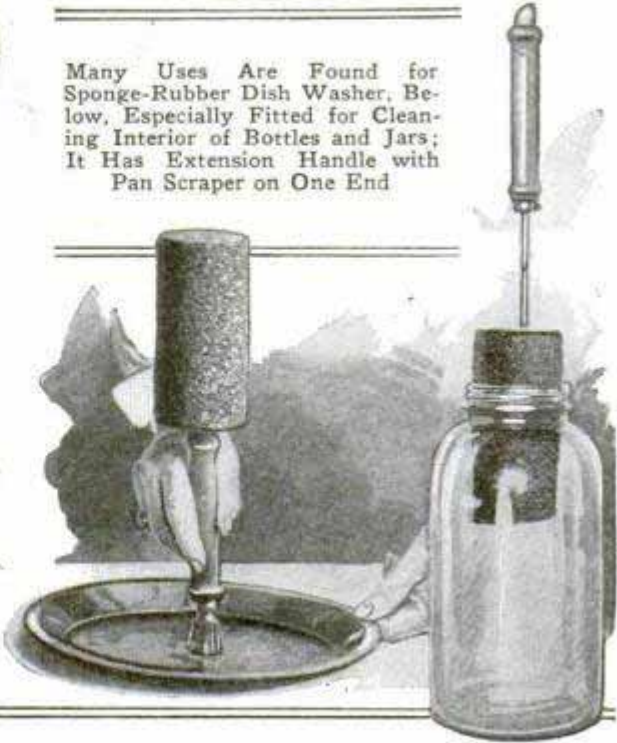

Clothespins Are Not Needed with This Twisted Line, Which Is Easily Spread, to Admit Garments, and Springs Back of Itself to Hold Them without Tearing

Home Drudgery



Decorative Window-Sill Shelves for the Flowerpots; Require No Screws, Protect the Sill and Keep Pots from Falling



Cleanliness and Convenience Are Features of This Mop That Unwinds Fresh, Clean Fabric from a Roll at the Center and Supplies Oil or Water from Tank at the Top



Baby Harness of Soft White Webbing, Easily Laundered, Keeps the Infant Securely in His Crib, Yet Permits Him to Roll Around in Comfort; It Is Especially Suited for Use When Traveling in Railroad Cars or Steamers and Requires but Little Space



To Protect Hands and Fingers While Sealing or Removing Jar Caps; a Rubber Wrench with Molded Threads Inside to Afford a Firm Grip

Chas. H. Moore Science Institute, Inc. Toledo, Oh.

94

MINER SCREENS BEACH SANDS FOR LOST VALUABLES



Screening the Sands at Swimming Beach in Hunt for Articles Lost by Bathers

Articles of jewelry, coins and other valuables lost by bathers at Venice, Calif., are often found by a former prospector who has been awarded the contract of keeping debris off the beach. He carefully screens the sands in a rocker sieve, which separates any lost objects from the material, and uses a hand scraper, specially made for the purpose, to collect the sand.

ELECTRIC ROADSTER FOR TWO GOES WHERE AUTO WON'T

Operated from automobile storage batteries, an electric roadster seating two persons has many uses in sport and business, for it can be turned around in a narrow driveway, may be parked almost anywhere and can be driven across the lawn without dam-

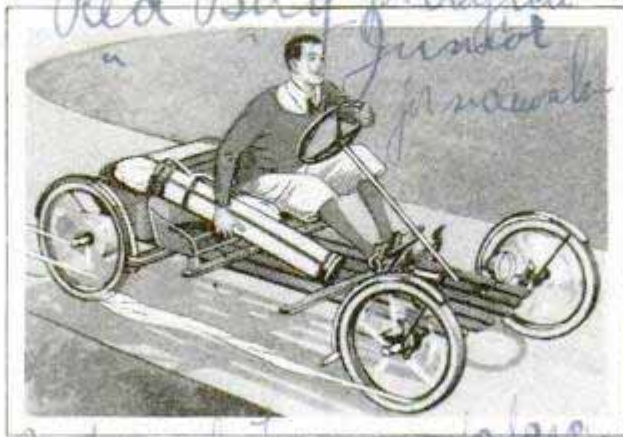

Electric Roadster Saves Time to Golf Links; It Can Make Twelve Miles an Hour

age to the grass. It develops a speed of twelve miles an hour, is fully equipped with emergency brake, parking lock, lights and other units common to the regular automobile, and is especially convenient for short trips when use of the larger car involves difficulties because it cannot always be driven all the way to the destination. A smaller electric roadster is designed for youngsters.

JUNE WEATHER ALL THE YEAR IN BIG BANK BUILDING

Electrical ice boxes will be hooked up with steam heat, air washers, air filters and giant ventilating fans to manufacture comfortable weather at all seasons of the year in the Union Trust bank building now under construction in Detroit. On a hot day, the tenant will simply open a register in his office, and clean, cool air, at a temperature of seventy degrees or less, will pour forth. Each room has its own air control. The building's refrigerating plant, if used for ice making, would freeze 700 tons a day. The ventilating fans will blow 440,000 cubic feet or 33,000 pounds of air per minute.

EXPLORE MYSTERIES OF EELS IN TWO YEARS' CRUISE

In order to learn more about the habits of eels, Prof. Johannes Schmidt, of the university of Copenhagen, has embarked on a two years' cruise. He will endeavor to solve the riddle of the spawning grounds and migration routes of the Pacific eels as he did for the Atlantic species. As far as it is now known, the story of the eel is one of the most interesting in natural history. For ages they were shrouded in mystery. Young eels were never seen descending a river but old ones never went any other way. No one had seen an eel's egg. The young ones came up from the sea, the old ones went down

W. C. B. Moberg, Venice, Calif.
Price \$135-200.00
Price of batteries \$135.00
100
1/27/11

1022

1021

7/6/11
780.8
new Miller

Automotive Standard, Inc.

The Home Cutting Tool Corp.

994-

115

*Loomis St
Rockford,
Ill.*

to the sea, but what happened there remained a mystery for centuries. For seventeen years, Prof Schmidt labored on the riddle. He discovered that the young eels come up out of the sea and persistently ascend the rivers. They live and feed in fresh water for several years. When full-grown, they go down to the sea, swim across the whole width of the North Atlantic to an area north-east and east of the West Indies, where they fertilize their eggs and die. The young eel larvæ are leaf-shaped, flat, thin and as transparent as glass. How they find their way back across the ocean without guides, still is a mystery. One of the strangest parts of the story is that, though American and European eels breed in the same general region of the ocean, their respective young always unerringly find their way back, each kind to its own proper side of the Atlantic, a migration which is said to take them three years more or less.

Operating the Saw, and as It Is Carried in the Folding Case



*Variety, June
are 3-5.00.*

PORTABLE ELECTRIC SAW IN KIT CARRIED LIKE BAGGAGE

Built in a sturdy frame that may be carried like a suitcase, a portable electric saw does rip or crosscut work, mitering, grooving and beveling, and will work lumber up to three inches in thickness. The quarter-horsepower motor may be used for driving other tools, and there is a long extension cord for power connection.

COOLER PLACED IN MILK CAN SIMPLIFIES HANDLING

Milk is quickly cooled without pouring it from the can by means of a revolving coil placed inside the container and connected to a faucet through a short length of hose. A small turbine, actuated by the water, turns the coil, which agitates the milk and so hastens the cooling process. Water circulates through the coil, emerges through small holes in the lid and then flows

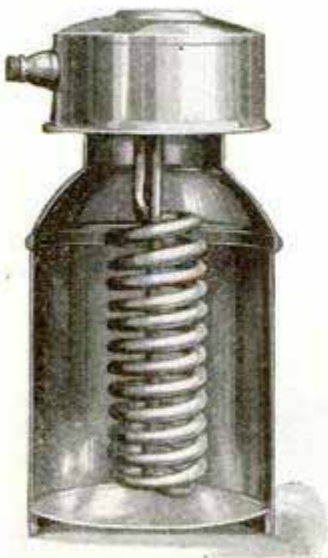

down on the outside of the can. The unit is so constructed that no water can get into the milk. When the content is cooled sufficiently, the apparatus is easily lifted out and placed in another can

DIRECTORY IN OUTDOOR BOOTH SERVES PUBLIC FREE

City directories are placed in outdoor booths at filling stations, and other convenient localities by a Cleveland publisher. The book is attached to the door of the booth, which opens like an old-fashioned desk, leaving the directory in convenient position for reference, and may be tightly closed to protect the volume from rain.



New and Martin

691 *near Miami - O. Jameson*
Kelly Field, San Antonio Tex

Growing Wings *for the*

252
W 32 Oct 5
Ally James
Flying Cadets of Air Corps
graduating as career pilots

AN AIR-corps primary training plane skimmed gracefully in front of the operations office at Brooks field, Texas. It hesitated, wavered for an instant and settled to the ground in a three-point landing. The instructor in the front cockpit raised his goggles to his forehead and turned around in his seat.

"You're pretty hot this morning; skidding a bit on your right banks, but you'll do." He climbed leisurely out. "Think you can take 'er around yourself without cracking up?" he asked.

"Yes, sir," the pupil replied confidently; "shall I take off?"

"Sure; and listen! The air's pretty rough and you'll have to watch your turns; remember to keep plenty of speed. Don't try to turn until you have three or four hundred feet altitude. Come in for a landing in a straight glide—no funny business yet. Don't level off too high; remember your tendency. Now, if you'll remember everything I've taught you, you won't have any trouble, but watch your step. You know how to get out of a spin, but if you fall into one, I'll break your neck, when I get to you!"

He added the last sentence with a smile.

"All right, sir," the young pilot laughed. He was feeling a bit nervous by this time. The instructor lighted a cigaret and then walked away. His nonchalance gave the student more confidence in himself. Yet he was somewhat doubtful. He wished the instructor would "stick around." He thought: "What if I do fall into a spin? Well, here's one flying cadet who's going to fly high!"

He eased the throttle open. The mo-

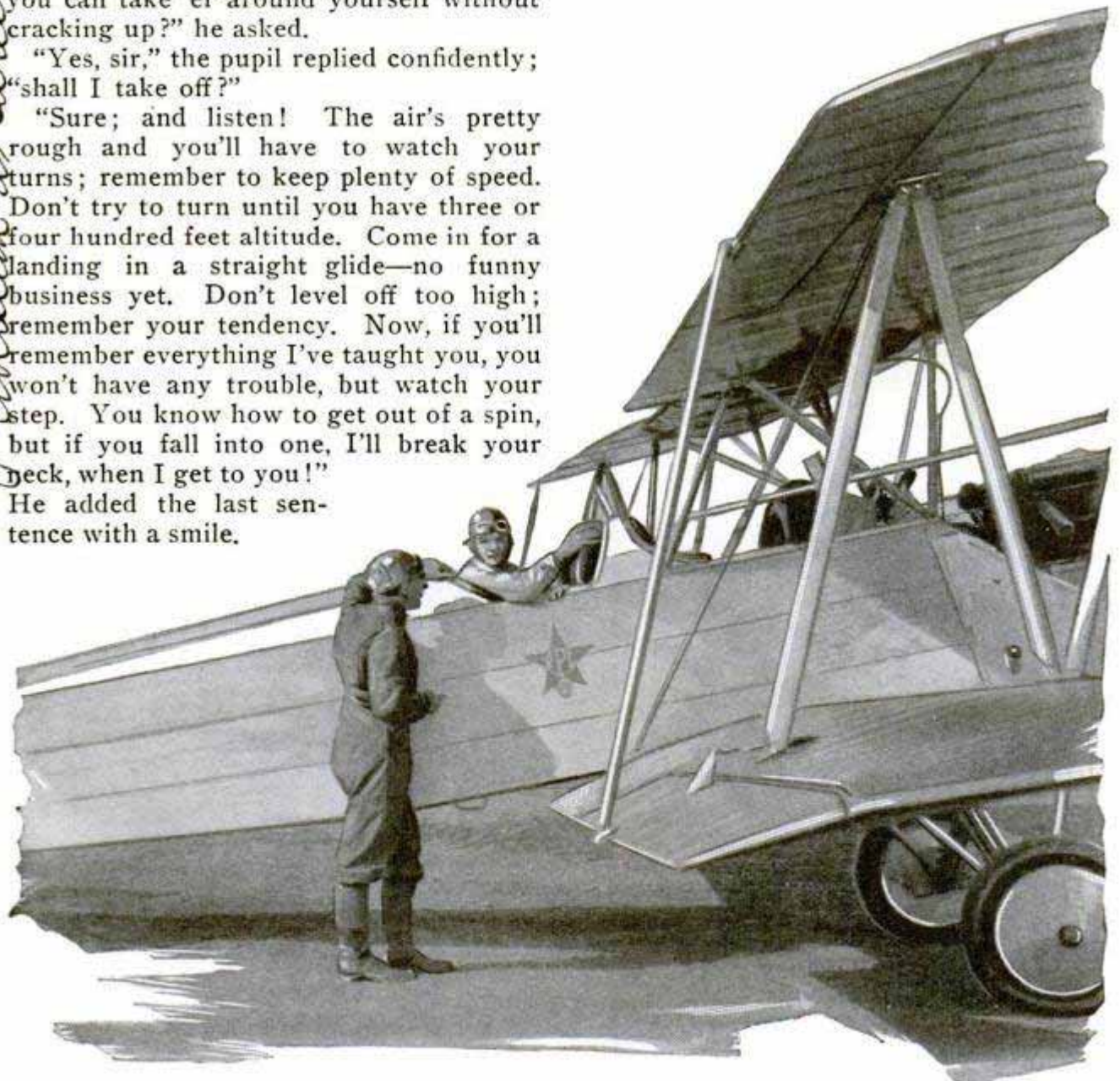

In Less Than Five Minutes He Will Be an Aviator; the Instructor Is Giving Final Orders to a Brooks Field Cadet Before He Takes Off on His First Solo Flight

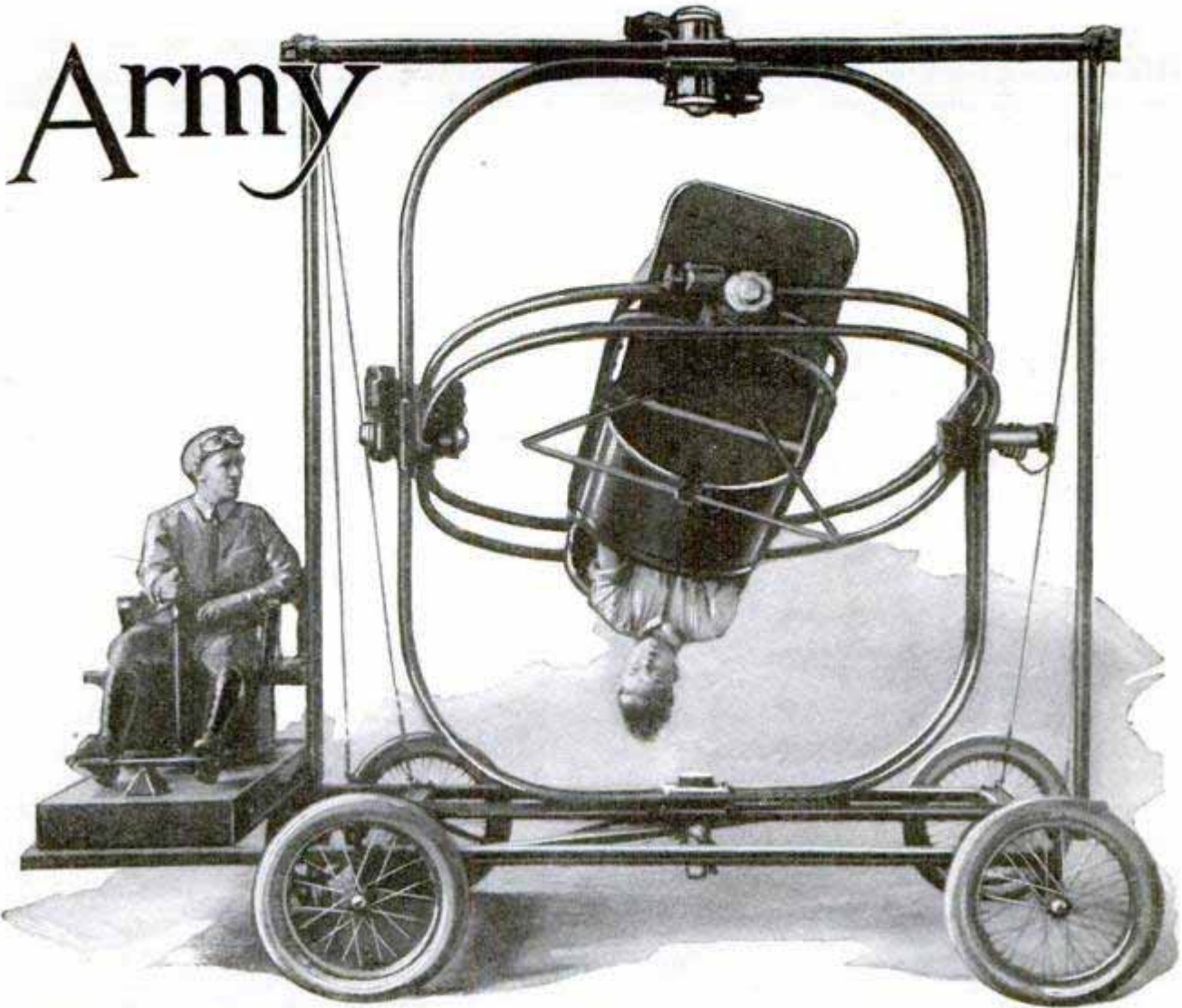

Testing Future Flyers on the Ground; the Pilot of the Ruggles Orientator Has Put the Student in an Upside-Down Position and Is Watching His Efforts to Right the "Ship"

tor ceased the plop-plop of idling and rose to a mighty roar. The ship quivered, moved slowly out across the field and picked up speed. The controls felt light to his touch, the plane was almost ready to come off the ground.

Cr-r-r-r-m-m-m! he heard the roar of another motor above his own. The sound came to him as an angry growl. A shadow flitted overhead and he caught a glimpse of a yellow-winged plane flashing past within ten feet of his upper wing! The man in the front cockpit was shaking his fist angrily. "What have I done wrong now?" the cadet muttered.

The ship was in the air, climbing steadily, holding straight to its course. The ground seemed far away, and there came the thought that he was far removed from every living being. The altimeter registered 800 feet; he was high enough.

He banked over, remembering the times his instructor had said: "Gosh, you're dumb! Get that stick and rudder action

together; get some coordination; want to spin us in? Easy now—that's better—take off a little more rudder." He followed instructions exactly and brought the ship around and headed back for a landing.

The time for landing had come, and he viewed it with some misgivings. He suddenly found that he was tense; that he gripped the controls with taut muscles; his legs ached from shoving on the rudder; there was cold perspiration on his hands. No excuse for that; maybe he was scared. He drew a deep breath to quiet the pounding of his heart, idled the motor and nosed the plane down. He listened to the whine of the wires and pulled the nose up—mustn't come in too fast, that was what made it hard to land. He thought of his instructions: "When you bounce, don't wait until the ship has killed its speed; you do that and you'll crack up. Gun'er right now!" He gripped the throttle tighter. "Don't level off too high; that's your trouble," he remembered.

Wh-u-m-p! There was a violent jolt. He slammed the throttle open and let the ship pick up speed again. Well, he had bounced, but he hadn't cracked up. He wondered if his landing gear was still intact; what if a wheel had given way under the strain! He looked back over his shoulder at the ground. There was no landing gear down there on the ground, so he decided nothing had broken. He tightened his lips into a grim, straight line and started around again.

The second time he came in slower. There was an agony of waiting just before his wheels touched. He juggled his stick a little and eased the plane down. The wheels rolled. He taxied back to where the instructor was standing, still puffing on a cigaret.

"Not bad," the latter said, "except you almost got killed. That ship almost landed on top of you; you know enough to look around before you take off. You pull a stunt like that again and I'll wash you out!"

"I won't, sir," the cadet replied. He is

one of nearly 700 young men between the ages of twenty and twenty-seven who annually begin flying training in the army air corps. His reactions, his fears and worries on his first solo flight are no different from those experienced by any man who flies alone for the first time. There are probably more emotions packed into the five minutes of the first solo than any other five minutes of a man's entire life.

The men to whom the army offers flying training are usually college graduates or have had two or three years of university work; they are physically almost perfect; they are without mental or moral flaw. In short, they are the pick of the young men throughout the country who wish to learn to fly. They are offered this training at no cost whatever; the army pays for everything connected with it.

The duration of the course is one year. Eight months of this time are spent at one of the primary schools, Brooks field at San Antonio, or March field, at Riverside, Calif. During the first eight months, students learn to fly; in the remaining

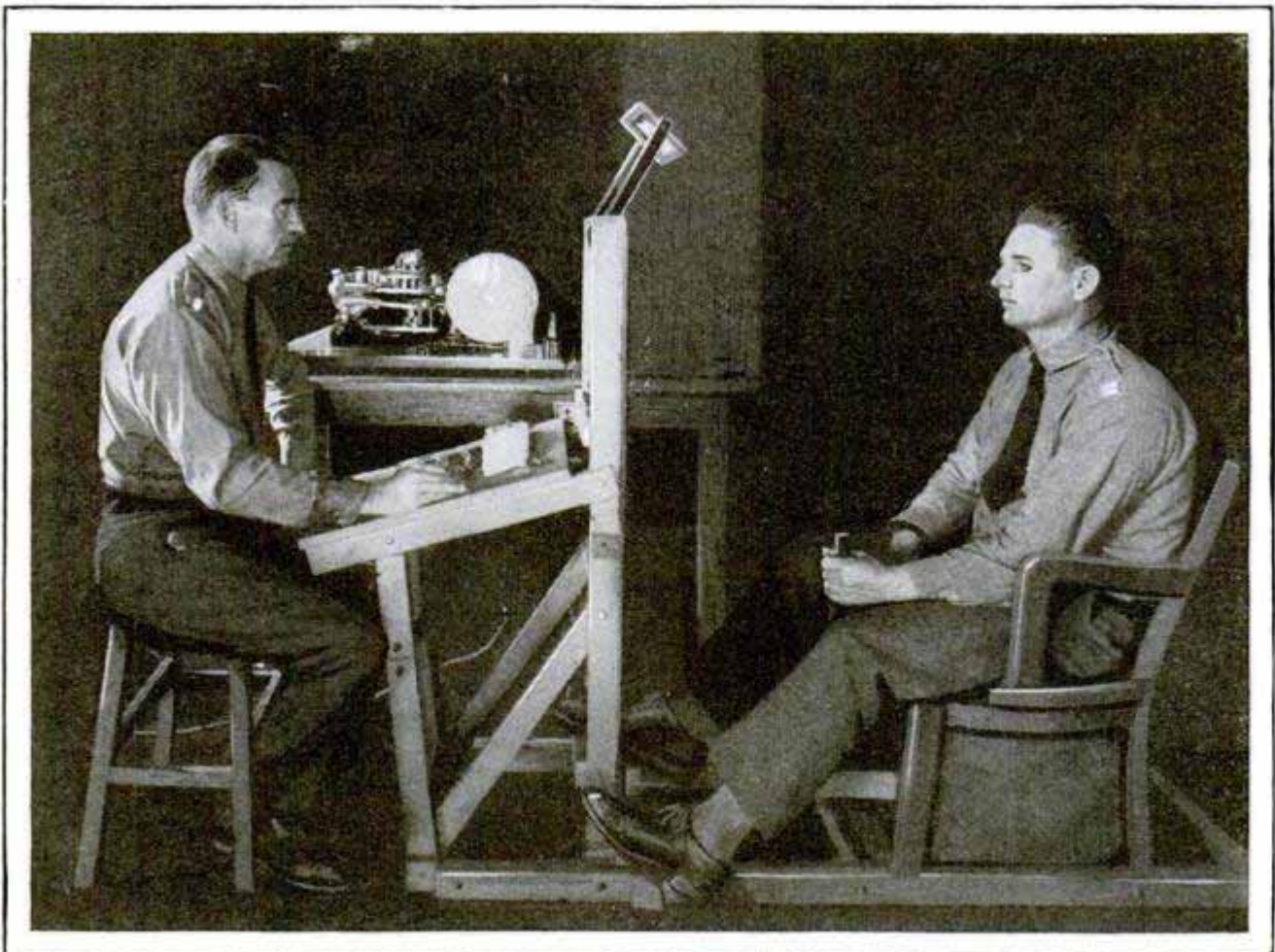

The Complex Coordinator, at Brooks Field Primary Training School, Tests the Ability of Flying Candidates to Make Their Hands and Feet Respond to Eye and Brain

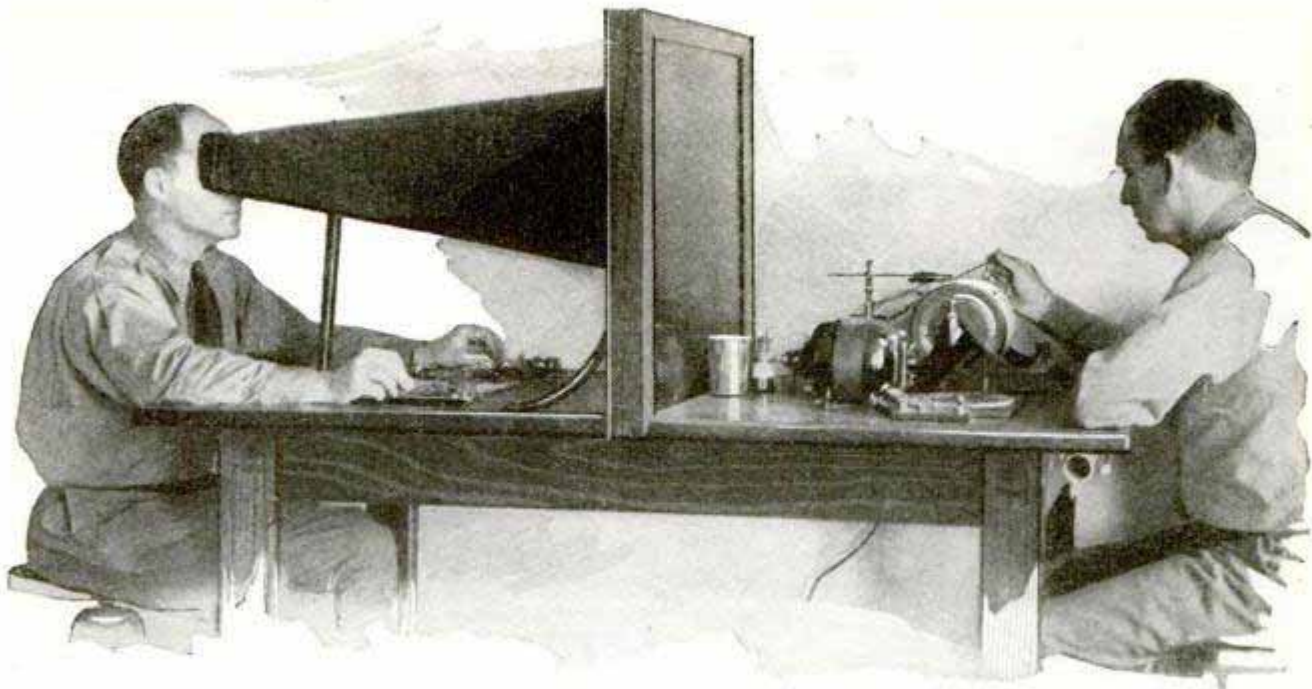

This Is the Reaction-Time Testing Machine, Which Measures the Interval It Takes the Hand to Respond to a Message Delivered through the Eye to the Cadet's Brain

months they learn to use airplanes as military weapons. They learn to fire machine guns from the air, to drop bombs accurately, to master any of the difficult problems which arise in military flying.

Flying is a misunderstood profession. A few days ago a man asked about the advisability of sending his boy to the air-corps schools. "Benny is a fine boy," he said; "he'd learn that stuff in a hurry. He's got brains, and he'll work hard; I'd rather have him learn to fly in the army than anywhere else."

"He might not get through if you send him to the army; he might be washed out," was the reply.

"Benny? Don't worry; he'll pass anything they have down there. That boy of mine has brains."

That seems to be the prevailing idea. If a young man applies himself, the layman thinks, he'll have no more trouble than if he were going to college—a combination of hard work, sand and persistence. But unfortunately that idea is erroneous. It seems never to occur to most laymen that there may perhaps be something of an art connected with flying an airplane. But there is an art, a very difficult art, and one which is as lacking in some students as the art of violin playing is to the average bricklayer.

The completion of the year of flying training in the air corps is to no individual

at all certain. There is a matter of "inherent flying ability," just as in athletics there is an inborn ability in some individuals which is more or less lacking in others. And for that reason, of each new class at the air-corps primary schools, perhaps only one of every five students will eventually become a skillful pilot, and graduate and receive his wings.

In military flying a man must be able to fly. He must daily perform maneuvers in the air which in commercial flying would be unnecessary and extremely dangerous. So, in the same way that perhaps only one person of any five or six might be trained to virtuosity as a piano player, only the same average can be trained sufficiently to be safe in military flying. And it makes no difference that a man works hard. He may actually slave to learn, yet be entirely incapable of overcoming his inherent lack of ability.

To overcome some of the waste and delay in money and time, and to avoid as much as possible the disappointment customary to those who fail to pass the course, the corps has devised several varied and interesting tests by which the relative degree of ability of each new student is determined. Flight surgeons and scientists have been working along these lines for several years, and are now able to tell with a fair degree of certainty whether or not a student will be able eventually to fly



Mechanics Working on a Curtiss Observation Plane; This Type Has a High Speed of 140 Miles an Hour

The first four months at the primary schools are spent on flying instructions of an elementary nature. The student is taught the ABC's of flying in a small, rather low-powered ship. He is expected, of course, to get the plane up and get it down without wrecking it, but quite often he flies counter to expectations. During the fourth month he is taught acrobatics, and in these maneuvers he learns to be comfortable in any position of the plane, whether hanging upside down by his belt or flying level.

In the last four months at the primary schools the student is given work with a service-type plane.

—and this before the student has been near an airplane.

One of these tests is performed with the aid of the Ruggles orientator. This is a device resembling the cockpit and fuselage of a modern airplane. The cockpit is equipped with controls which function exactly as do the controls of an airplane in flight. With the student in the cockpit of the apparatus, an operator on the ground handles another set of controls, and is able to put the fuselage in any desired position, regardless of the wishes of the student. The length of time the student requires to recover from a given position, such as upside down, furnishes an index to his reaction time, and hence to his native flying ability.

There are other, and more involved, tests. In one of these, the student is seated before a board containing a number of red, green and white lights. He has before him, in the same relative position as in an airplane, a set of controls, the movement of which will turn on certain lights. The problem is to line up certain lights on a given row. If the student is violent in his movement of the controls, that error shows immediately on a paper graph. Similarly, any and every mistake he makes is shown.

He undergoes a refining process, a developing of his skill to the point from which he can safely take up the problems to be encountered in military flying. He learns to fly the plane by feel. No longer must he thrust his head out of one side or the other to feel the wind blast for a side slip or a skid.

The student of flying at the primary school graduates to the advanced school with a new confidence in this ability. He is not overconfident to the point of cockiness, yet he has a healthy state of mind which brooks no fear of flying.

At the advanced school, at Kelly field, he has four branches of aviation from which to choose in preparing to be a military aviator. He has studied each at length and, depending upon his temperament, may choose either pursuit, observation, attack or bombardment.

In pursuit, he will be able to satisfy his fighting instinct. Pursuit is contemplated for the sole purpose of combat; the ships have been designed with that in view; the plane reminds one of a huge, formidable hornet.

The observation pilot and his observer, on the other hand, are not supposed to fight. Theirs is a peaceful mission—if possible; but on occasion they are capable

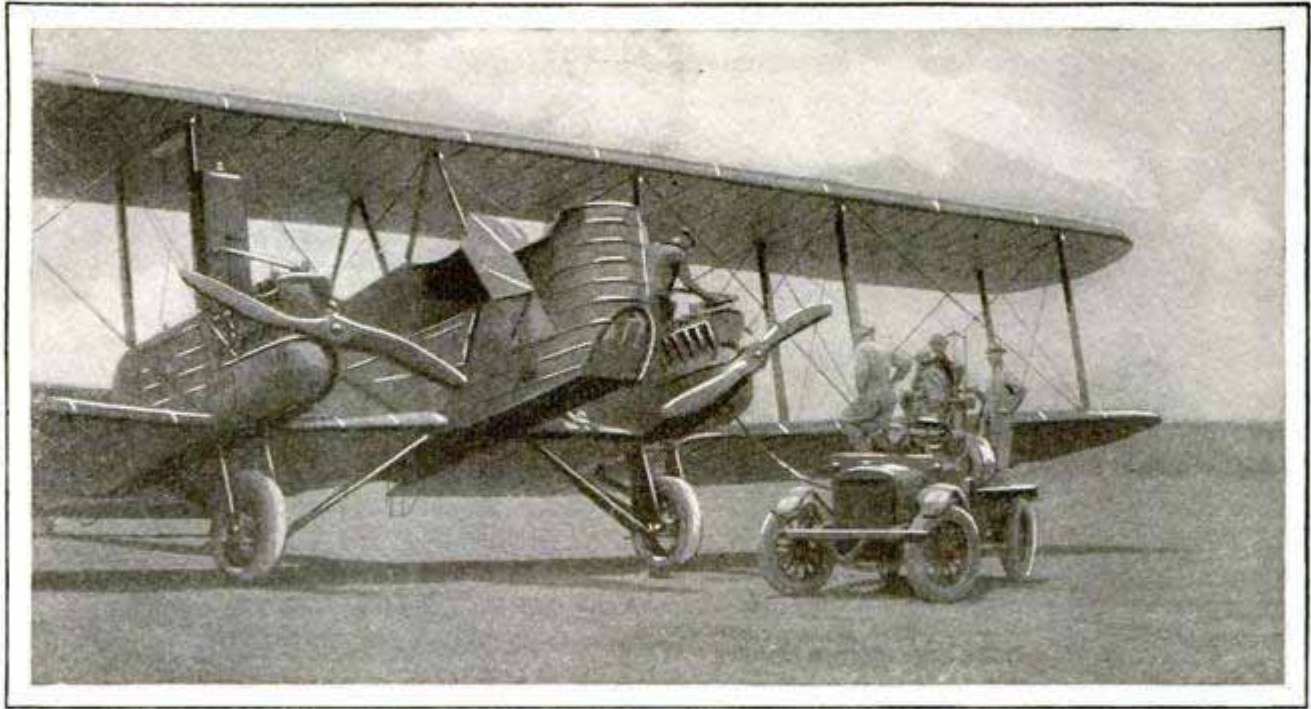

Filling the Gas and Oil Tanks of a Two-Engined Martin Bomber, One of the Biggest Planes the Cadets Learn to Fly; the Cockpit in the Nose Is the Forward Machine-Gun Nest

of just as stubborn a resistance against attack as the "pursuiter."

The students devoted to attack aviation are popularly termed the "Suicide Squad." Attack planes are those which sneak upon the enemy unawares, that dive over a hill and spray the enemy infantry with lead and bombs, and are gone as suddenly as they come. They fly just off the tree tops, fifty feet or less, and if a motor fails when the plane is over rough country, there is no possible way in which the pilot can avoid a crash.

Bombardment aviation is perhaps less spectacular than the other three branches. It operates at great altitudes and, usually unseen, drops the "pills" upon enemy towns and ammunition factories, far to the rear of the front lines. But while it may lack in appeal to the imagination, bombardment has its dangers, too. There is enemy pursuit to think about, and occasionally anti-aircraft fire. There is also the thought: "If a bullet should hit one of these bombs, we'd be blown out of the sky."

It requires a year to develop the student's wings, a year of constant, grueling work. But that year changes a man, it molds his mind to new ways of thinking. And as time goes on, and he flies day after day, he discovers a more complete mastery of his airplane, his nerves, his will. His sphere becomes the air; seated behind a roaring motor, with the wind whipping back into his face, he is in his element. The plane becomes a part of him, something to handle as subconsciously as one walks or talks or eats.

BOAT PROPELLED BY PUMPS DEVELOPS HIGH SPEED

As a substitute for the usual propeller arrangement, a western inventor has rigged a boat which is run by pumping water into two cylindrical pipes and discharging it at high pressure. The rudder is also eliminated, steering being accomplished by shutting the water off in one of the pipes while the other is left running to turn the boat.

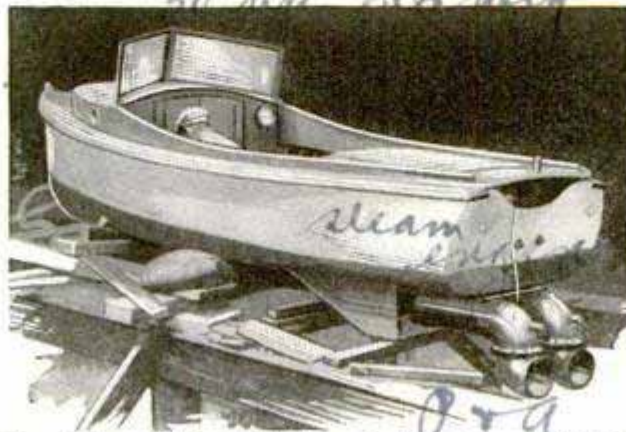

Rear View of Boat Showing Outlets through Which Water Is Forced to Propel the Craft

1677 Sacramento

*Mr. George P. Anderson
San Francisco Calif*

U.S. ... 117 Kentucky ... Super-E. S. Holstbury
 648 POPULAR MECHANICS
 64 Washington ... Phila

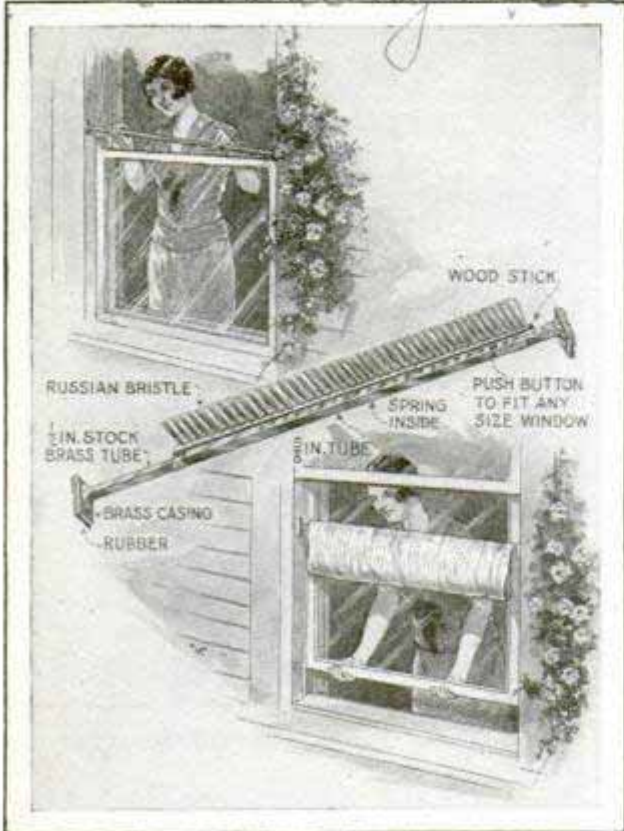

Adjusting the Window Brush; Close View of the Stick and Bristles, and Cleaner in Operation with Cloth

SAFETY BRUSH CLEANS WINDOW FROM THE INSIDE

Window panes are cleaned on the outside from the interior with a safety brush now on the market. It is attached within the sash groove and extends the full width of the window, the bristles resting against the glass. A cloth, dipped in warm water, with ammonia or kerosene added if soot has gathered on the panes, is placed on the brush and by raising and lowering the window, a thorough cleaning results. The unit may be used for either the upper or the lower sash and is furnished in two sizes, for windows of varying width.

NORTHERN LIGHTS HELP RADIO IN ALASKA, TESTS SHOW

While the northern lights often seriously interfere with radio reception and sending in various parts of the world, F. P. Ulrich, magnetic observer of the coast and geodetic survey, reports that, at Sitka, Alaska, where he has been making tests for five years, they do not cause such difficulties. In fact, he says, "good radio reception is very much more apt to occur than poor reception during a bright or

faint aurora." He declares, as a result of his findings, that the condition of the earth's magnetic field is no index of the quality of radio reception. The question remains one of the greatest scientific mysteries. For years, scientists have been making careful observations, recording the hourly and daily variations in the earth's magnetic forces at widely scattered observatories from Samoa to Honolulu and in Alaska. Efforts are also made to connect the phenomena with such occurrences as earthquakes and sunspots in order to gather more knowledge of these mysterious forces.

MOVING A FOREST

More than ninety trees, some of them over two feet in diameter at the base and from forty to fifty feet high, have been transplanted from a natural woodland to an eastern estate. The work was done in the winter when the earth was frozen in a ball around the roots. Holes to receive the trees were dug a foot larger than the root clump, the space between being filled with fresh earth and the roots kept undisturbed. Winter is the best time for such work as the sap is dormant.

SIPHON AND FILTER COMBINED RUNS AUTOMATICALLY

For filling bottles, removing cream, draining goldfish bowls, and many other purposes, a siphon starts and stops automatically, can be run at different speeds or



continuously and will not splash or foam, the manufacturers declare. It eliminates the unsanitary suction methods usually employed. Extra attachments are provided so that it can be used for washing dishes, or as a grease gun. The siphon filters as it fills and the tubing is equipped with a spring clip to prevent kinking.

Mad. Science News Bulletin 381. C, 7/11/28

The Siphon Products Corp. 60 ... Boston

Build This Compact B-Eliminator

By R. C. MORTON

THE B-ELIMINATOR described in this article is not only compact, but economical to build and highly efficient in operation, and will supply ample voltage for the operation of any standard receiver which may employ either a 112 or 171 power tube in the last stage.

Begin construction with the box. Four pieces of hardwood, 1 in. square and 4 1/4 in. long, or eight brass corner pieces, as in the model illustrated, may be used as braces. These brass corners can be purchased at most hardware stores for five

the lamp cord so that the instrument can be turned on and off. The top and front consist of bakelite panels, 3/16 by 7 1/4 by 8 in. and 3/16 by 4 1/4 by 8 in. in dimensions, respectively. All holes for mounting the various instruments are located by placing these in position and marking the points for drilling with a pointed tool. The back panel is 3/16 by 4 1/4 by 8 in., and the two side panels are 3/16 by 4 1/4 by 6 7/8 in. Bakelite may be used if desired for these panels, too, but veneered wood was used in the model described.

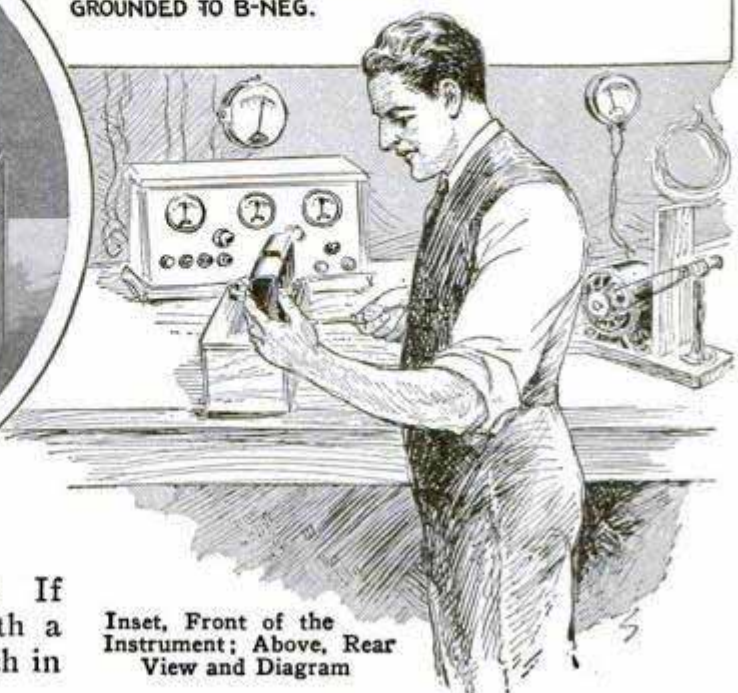
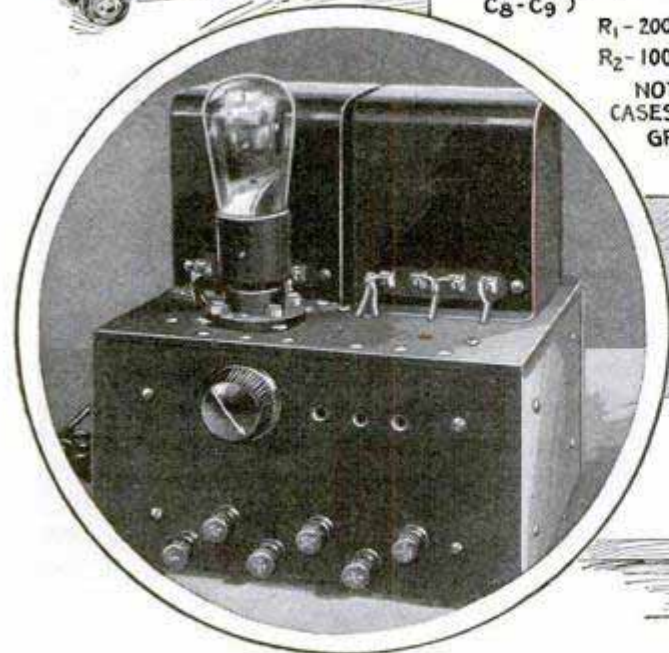
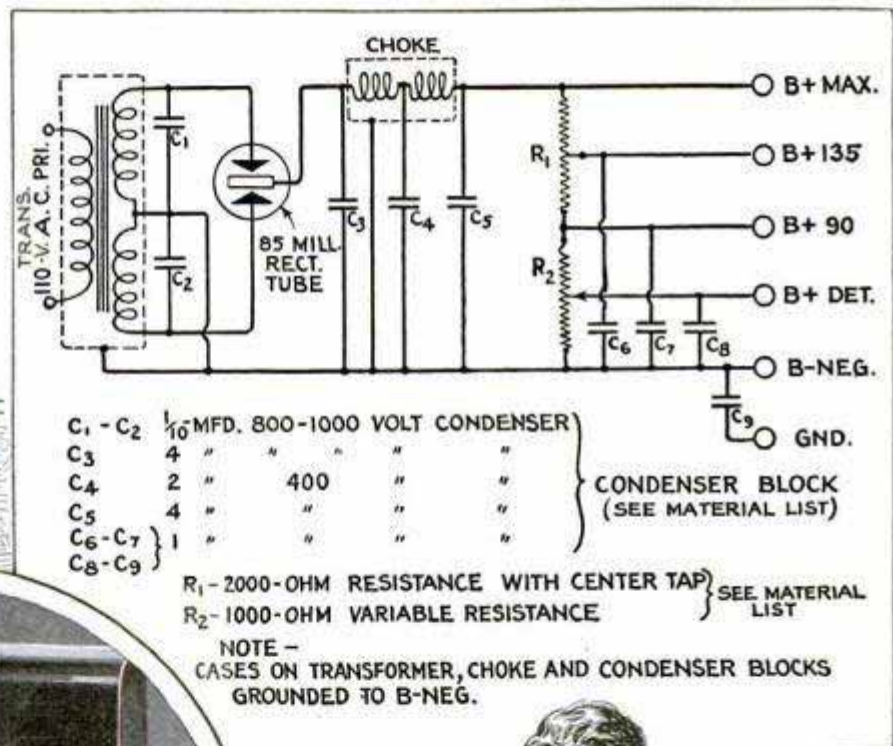

cents each and also the rubber feet. If the eliminator is not to be used with a relay, it is well to incorporate a switch in

Inset, Front of the Instrument; Above, Rear View and Diagram

former and filter-choke terminals, taps 2 and 3 on the filter choke being joined by soldering the lugs together. Use heavy rubber-covered flexible stranded wire for the circuit and run the leads down from the instruments mounted on the top panel through holes drilled at convenient points. Check all wiring with the diagram to make sure no mistakes have been made; then assemble the side of the box and tighten the screws.

The instrument is now ready for use. Insert the rectifier tube in the socket and connect the eliminator to the set. Before turning on the 110-volt 60-cycle house-lighting supply, place a 1-mfd. filter condenser in series with the ground lead from the receiver.

In order to do this, disconnect the ground wire from the receiver and connect it to one side of the 1-mfd. condenser, then run a wire from the other side of the condenser to the ground post on the set. The ground post on the eliminator is connected as shown in sketch. The condenser in series with the ground lead to the set is necessary where the 110-volt line is grounded outside the house, in which case the condenser will prevent any damage to the receiver.

Turn on the set before switching on the eliminator and always turn off the eliminator before shutting off the set. A relay can be employed for this purpose, enabling the operator to control the entire installation with the set switch.

The complete eliminator will cost about \$38.50, the parts used are all high-grade, insuring long service and maximum results. If the builder wishes to add a voltage-regulator tube, all that is necessary is to provide the additional tube and socket at an expense of about \$6.50. The connections for this tube are shown in the diagram at the upper right on page 650. The schematic diagram on page 649 is given for those who prefer it to the simplified type.

A material list specifying the make and cost of each item used in the construction of the eliminator will be mailed free to any address. A large blueprint of all wiring diagrams may be obtained from Popular Mechanics radio department, 200 E. Ontario st., Chicago, for 25 cents to cover cost and packing.

Dynamic Speaker Is Operated from Light Socket

Electrodynamic cone speakers are rapidly gaining popularity with those who wish to realize the full possibilities of



Left, Console Unit Showing Rectifier Element; Right, Unit Housed in Gothic-Type Cabinet

power amplification. The free-edge cone unit is of the usual type, but the loud-speaker unit operates on a different principle from that applied in the permanent-magnet type. A large field coil is excited by an external source of d.c. in order to produce the necessary magnetic force. A moving coil is suspended in the field of this coil and is fastened directly to the small free-edge cone. The drive is applied directly to the cone in speakers of this type and eliminates drive-rod troubles, which are a frequent cause of distortion in other types. There are several other advantages that make this type of speaker especially adapted for use with power amplification.

Novel Loud-Speaker Unit

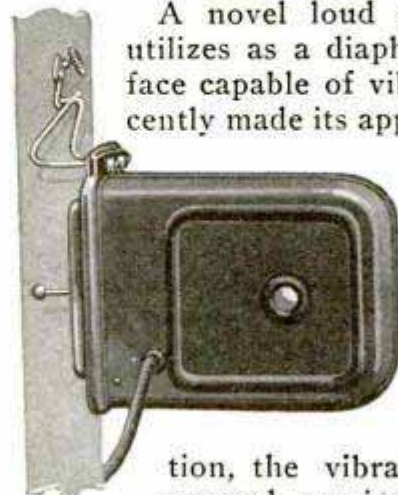

A novel loud speaker, which utilizes as a diaphragm any surface capable of vibration, has recently made its appearance on the market. It may be fastened to the wall of a room, the top of a table, or the glass in a window as shown in the illustration, the vibrating tip being pressed against the surface used as the diaphragm. It is claimed to give excellent rendition of music with any receiver capable of operating a speaker.

Atlantic Radio Corp. 1000 N. Chester, N.H.

Atlantic Radio, 33rd, New York
1897
\$75 - \$100
New Dynamic
Letter recd. 8/8/19
Atlantic Radio, 33rd, New York

the quality of reproduction except where the a.c. impulses are greatly amplified. If low power is used, these devices sometimes cause a sharp drop in volume and greatly impair the tone quality.

Better Reproduction

The filter shown in Fig. 1 is designed to eliminate extraneous noises and consists of a bank of low-capacity fixed condensers connected across the loud speaker. A switch, of the tapped type commonly used for inductances, may be mounted on a small board or panel and the condensers arranged for short connections. The fixed condensers, from left to right, should be of the following values: .001, .005, .01, .05 and .1 mfd. The greater the capacity in the speaker circuit, the better the elimination of the higher extraneous frequencies. Fig. 2 shows a variation, the degree of filtering being controlled by the variable resistance. In Fig. 3 the filter is designed not only to cut off the high-frequency noises, but also to compensate for peaked amplifiers and reproducers. As in Fig. 2, the degree of filtering is controlled by the variable resistance. Using the given constants, the filter will cut down audio frequencies around 3,000 cycles most of all, and diminish higher frequencies somewhat.

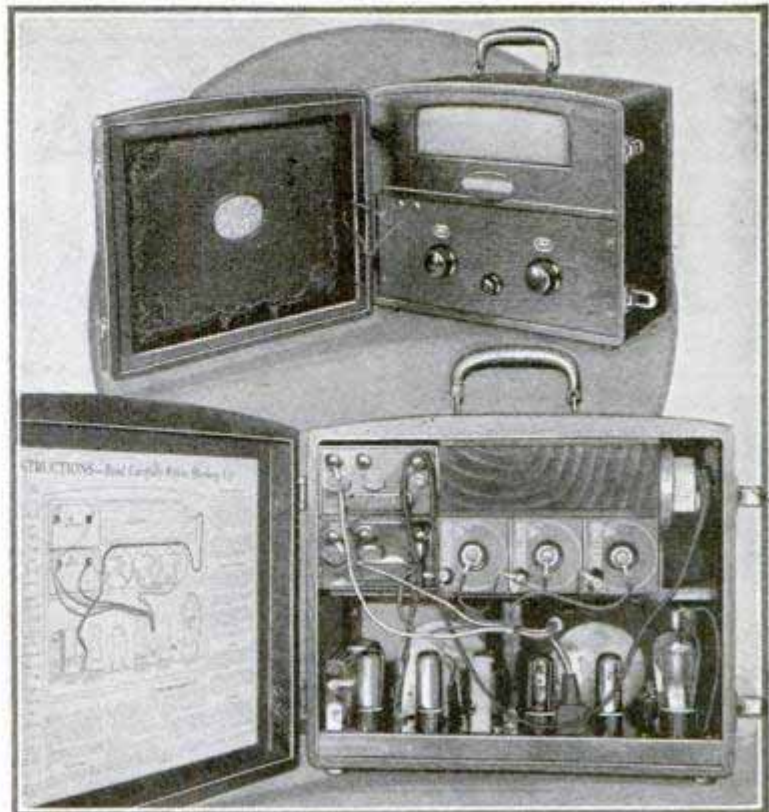
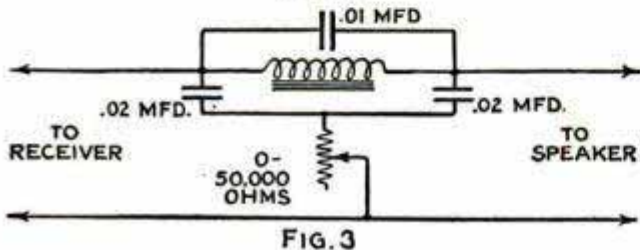
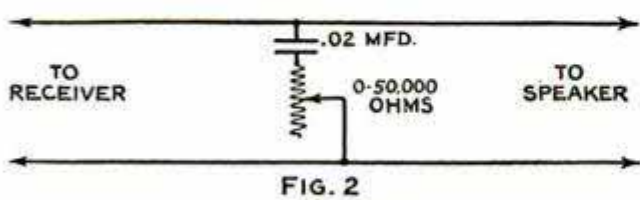
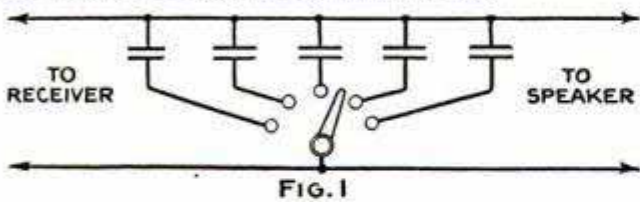

Front View Showing Portable Receiver Ready for Use; Below, Back Opened Showing Arrangement of Tubes and Batteries

Portable Receiver Is Equipped with Screen-Grid Tube

A portable radio set employing a screen-grid tube and four tubes of the 199-type is now available. It is so compact that it may be taken anywhere as easily as your luggage. Programs may be enjoyed from distant stations with this set because the screen-grid tube is many times more powerful than the ordinary tube, yet requires only .132 amp. and operates on 3.3 filament volts. Therefore such a tube is ideal for portable sets where dry cells must be used for the A-battery supply. The volume and fidelity of tone are surprising; the loop antenna is inclosed in a frame in the hinged cover and need not be detached. Binding posts are provided for external antenna and ground connections when extra-loud reproduction is desired on distant stations. The volume, when so connected, is equal to that of the average stationary, five or six-tube set. When fully equipped the set weighs only 30 pounds, and is not as large as the usual Gladstone bag. The rear cover is hinged to give easy access to the batteries. Three No. 6 dry cells furnish the A-supply and the B-battery consists of two medium-sized 45-volt units.

*Superior Electric Corp. Chicago
7/2/30
J.M.W.*

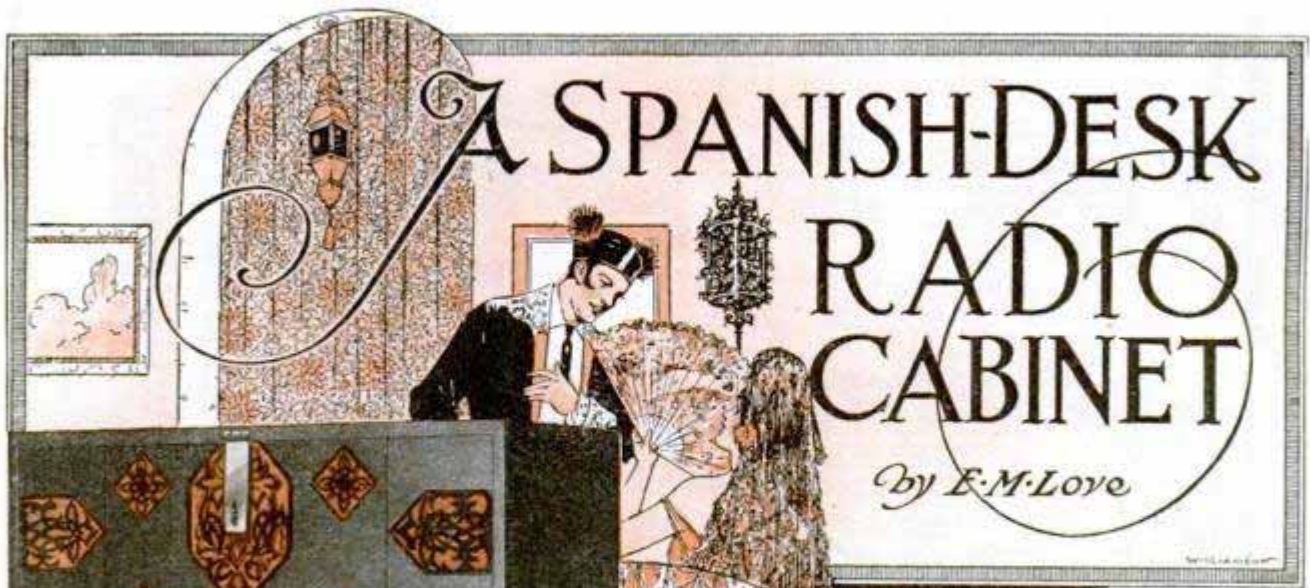

A SPANISH-DESK RADIO CABINET

by E.M. Love



PART I

THE CHEST desk or vargueno, a cherished article of furniture in the homes of old Spain, is a cabinet easily adapted to contain a complete modern radio set. It harmonizes delightfully with the Spanish furniture now in vogue. The cabinet illustrated was designed to suit the wood-working skill of the average home mechanic, as well as to economize in the needed amount of rather expensive walnut. It will accommodate a panel from 18 to 34 in. in length, provided the controls are grouped in the 18-in. center section. The over-all dimensions are: height, 52 in.; depth, 17 in., and width, 36 in.

The two center spindles of the stand ends, which carry the stretcher ends, are

detailed at left in Fig. 1. The 3 by 3-in. rough stock may be cut as short as 2 ft. 2½ in. in length, but 1 in. to spare on each end makes the turning easier. Center the piece accurately, so as to get the full diameter called for. The most certain way to duplicate accurately is to cut a thin wood pattern, which can be pushed against the spindles for direct comparison. Smooth the work at fairly high speed with No. 1 sandpaper, and then with No. 00. Stop the lathe, and finish by rubbing, with the grain, with No. ½ grit. Paint the turned parts with light-oak filler, diluted with gasoline. When this has dried dull, wipe off across the grain with a cloth.

The end corners of the square parts are slightly rounded, and a skilled lathe man can turn them. The pounding of the flying corners, however, makes this difficult, particu-

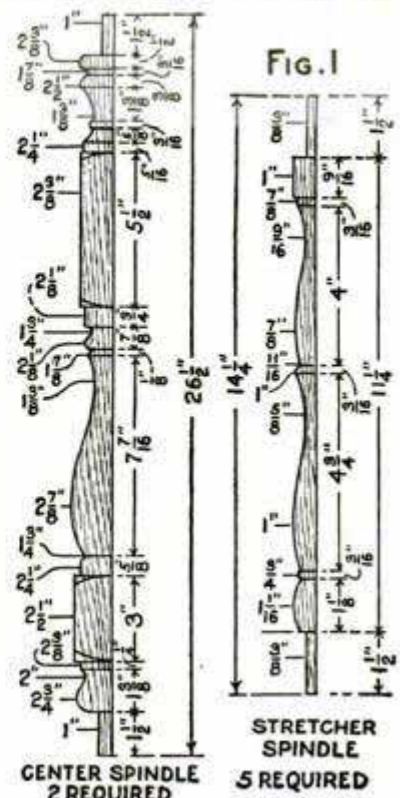

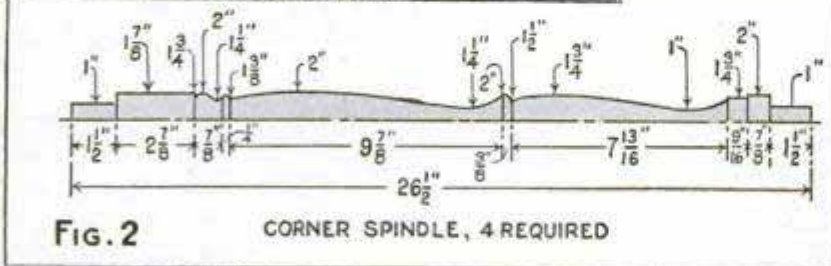
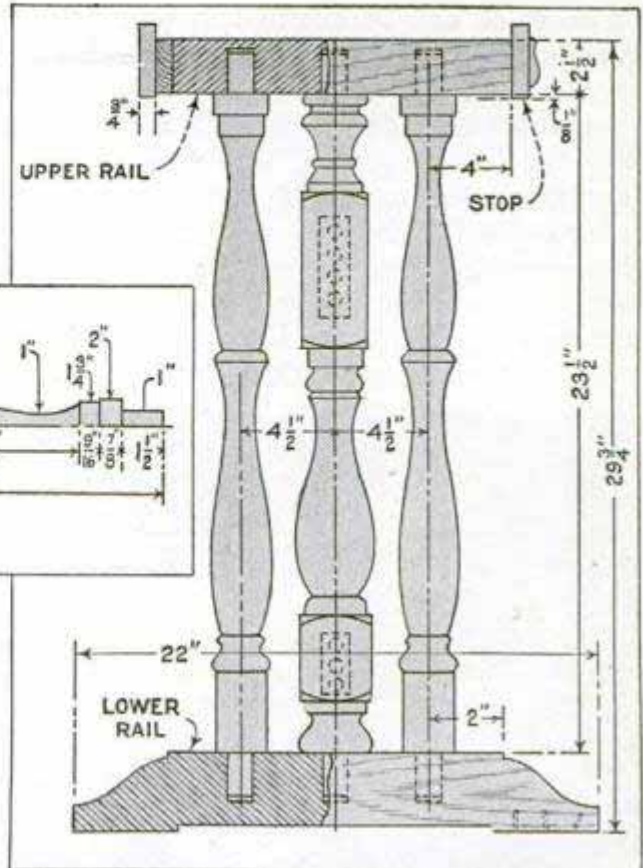
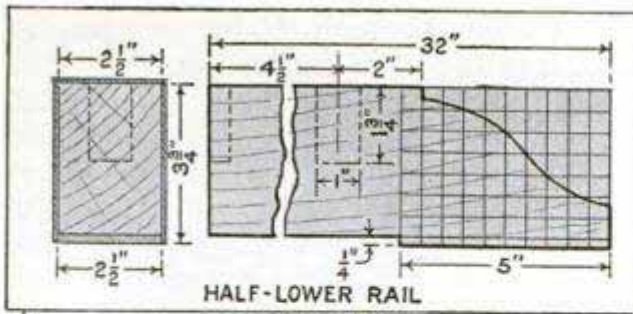

FIG. 2 CORNER SPINDLE, 4 REQUIRED



Left, Scribing the Centers of the Square Sections on the Center Spindles; Right, Rounding the Corners; Upper Right, End Elevation, Showing Rails, Corner and Center Spindles

larly if a good-sized skew chisel is not at hand, and the home mechanic may find it easier to trim them after squaring up, using a narrow chisel.

When the dowels of a center spindle are turned, remove the piece from the lathe and saw to length. Lay it on a bench, blocking the square sections if necessary, and with dividers set to the center, scribe lines on two opposite sides of the flat parts. From these base lines, draw lines establishing opposite sides and reduce one section to squareness. Then aline one face of the other section, testing by sighting over a straightedge balanced on corre-

sponding faces and finish squaring that part. Lastly, round the corners to a radius of 1/4 in., and fill. The corner spindles, shown in Fig. 2, are turned from rough 2 by 2-in. stock.

The upper rails are dimensioned in the end elevation at the right, Fig. 2. Cut 17-in. lengths of 3 by 3-in. pine or fir, which, mill-surfaced on four sides, is about 2 1/2 in. net. Bore the dowel holes before veneering the sides.

Surface a piece of walnut, 2 3/4 in. wide, gauging the edges for a veneer thickness of 1/8 in. Rip alternately from one edge and then the other. Veneers less than

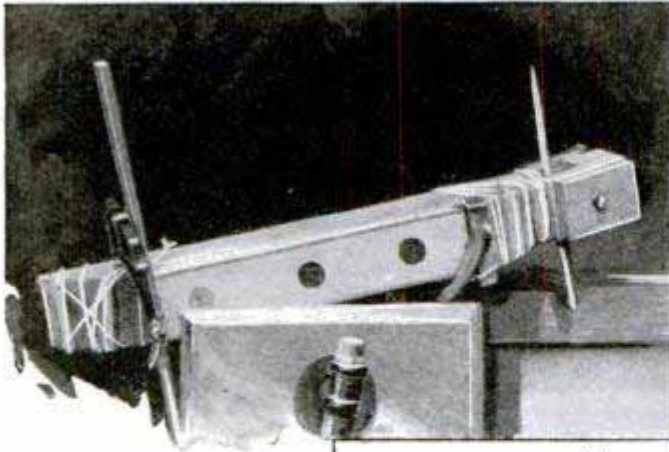

Above, End Veneer Clamped in Vise, Showing the Method of Lacing the Veneer to the Curves for Gluing; Below, Smoothing the Stretcher-Rail Arches with a Half-Round File; Right, Details of the Stop Blocks and the Carved Seashell Ornaments for the Stand Ends; Upper Right, Shaping the Lower Rail Ends, Chipping Out the Waste and Trimming Smooth with a Chisel

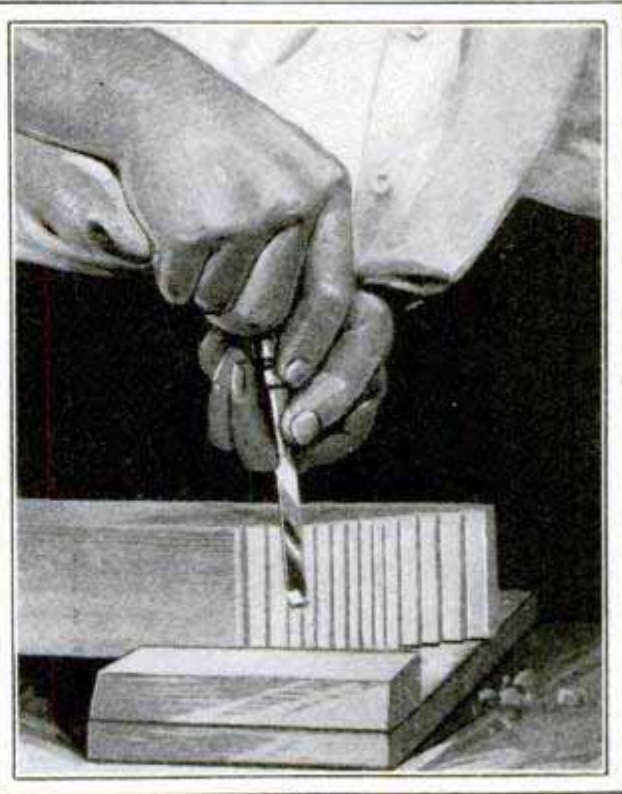
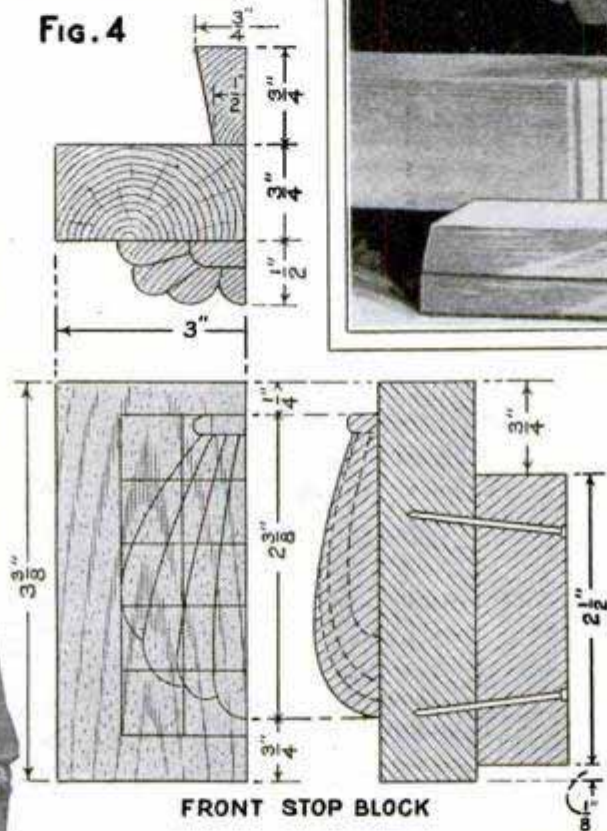

FIG. 4



The small vertical end veneers at the top of the curves can be held in place by the clamps holding the curved veneers, but the lower end veneers must be glued after the curves are trimmed, being secured by clamps lengthwise of the rails. The top veneers are put on last. When dry,



Size the end grain with glue so that it can dry while the veneers are being made. Glue on the side veneers as described for the upper rails, trimming them to the profile when dry. Cut the curve veneers less than $\frac{1}{16}$ in. thick and soak them in water. Glue in place while still wet, holding the upper ends with clamped blocks while lacing the rest to the curves and using thin blocks to distribute the pressure, as shown in the upper left-hand photo in Fig. 4. Small wedges, forced in here and there, will tighten contrary places. Hold the ends with clamps improvised from pairs of blocks held with bolts through the centers.

surface these to $\frac{1}{32}$ -in. thickness and round the corners slightly, to prevent wear of the finish at these points and also to hide the joints.

Fig. 3 dimensions the stretcher rails. The upper is cut from 1 by 4-in. rough walnut, hand-surfaced to get the maximum thickness. Cut to length and bore the four $\frac{1}{2}$ -in. dowel holes in each end. Lay out the carving and the arches, noting that the centers of the latter are $\frac{1}{8}$ in. above the lower edge, to avoid the effect of flatness. The lower edge of the carving is curved to a radius of $5\frac{3}{8}$ in., centered on the arch diameters and $2\frac{3}{4}$ in. below the centers.

Cut the arches with a keyhole saw. Smooth them with a half-round file moved

from left to right at right angles to the sides, pushing forward with a twisting motion at the same time to get a shearing cut. Occasionally trim off the back



Sanding the Arches

corners to prevent splinters from being raised. Use a sawed-out block for sandpaper backing.

The lower rail is $\frac{1}{8}$ in. shorter than the upper and bored with dowel holes in the upper edge to fit those in the upper rail. Most of the carving can be laid out with gauge and try-square. The curved centers are traced from a cardboard pattern. Outline the carving of both rails with a narrow chisel, held vertically between the fingers and struck lightly with a mallet. Keep $\frac{1}{16}$ in. inside the lines. Trim the center to a flat ground, $\frac{1}{8}$ in. deep, when the edges may be pared to the guide lines.

Make a matting tool by filing a flat end on a large spike, across which two pairs of V-shaped grooves are filed at right angles to each other with a three-cornered file. With this tool, go over the carved ground, striking it light blows with a small hammer. Cut the ends of the lower-rail ornaments to line with the borders and vertical bars, curving them back $\frac{1}{4}$ in. to give the appearance of passing under. The depth at these points is $\frac{1}{16}$ in.

The pyramidal center ornaments are cut with four vertical strokes of a $\frac{3}{8}$ -in. chisel, held beveled side in, the center then being sloped from the four sides. The blossom ornaments on the upper rail consist of four simple elliptical depressions. A $\frac{1}{2}$ -in. turning gouge is excellent for this part of the carving.

Turn the five spindles as dimensioned at right in Fig. 1, from 1-in. stock. If flats appear, turn them to the back in assembling, and they will not be seen. Fit the dowels loosely enough to the rails to permit trial assembling before gluing up. Assemble the end frames, and set them in such a position that the rails will line with each other. Test for squareness and allow the glue to dry.

The stop blocks that hold the case in place are detailed in Fig. 4. The dovetail cleats are both glued and nailed to their backs. The front blocks are enriched with a carved seashell on each. Make a paper pattern of the outline. With a coping saw cut out two blanks, to be shaped to the profile shown with a sharp chisel. Draw the veins with a pencil. Cut these deeply with an eye tool and round off the sections individually, smoothing well with a chisel. The high spots may be rubbed off with sandpaper. Put a dab of glue in the center of the carving and its block, and press the shell in place with the small end $\frac{1}{4}$ in. from the top.

When the stand ends are dry, mark the dowel-hole positions from the holes in the stretcher, and bore them $1\frac{1}{2}$ in. deep. Assemble the stand by clamping as directly over the rail ends as possible, squaring by holding a framing square against the stretcher and sighting across the tongue at the footrail. To attach the stop blocks, bore $\frac{3}{4}$ -in. holes, vertically centered $\frac{3}{4}$ in. from the ends of the upper rails. Saw out wedges $\frac{1}{2}$ in. wide in front. Drive the glued stop cleats in from above, until the blocks project $\frac{1}{8}$ in. below.

(To Be Continued Next Month)

Special Fuses Needed to Protect the A. C. Receiver

The modern a.c. receiver should be protected by small fuses in the supply line, as serious damage to the set might occur before the 10 or 15-amp. house-line fuse would blow. A small standard fuse of about 2 amp. should always be included as a part of the receiver installation and inserted in one side of the 110-volt line. The use of such fuses will meet with the approval of the fire-insurance underwriters and provide protection to the receiver and tubes at a cost of but a few cents.

154 E. Erie Chicago
 Facts and Fads for Radio Fans

1855-R
 6-R
 167952

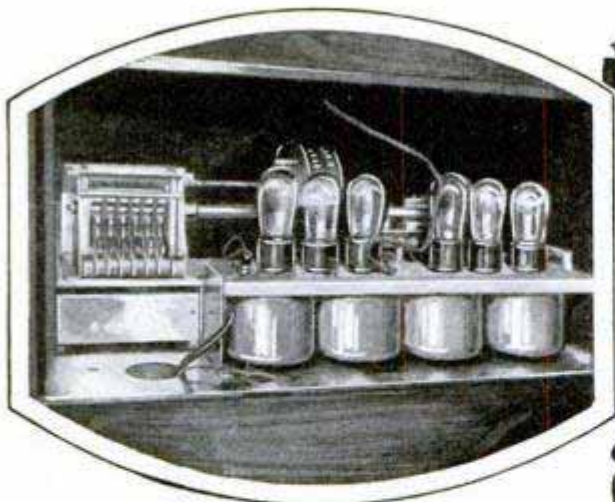

Right, Comm. E. F. McDonald, the Arctic Explorer, Demonstrating the New Automatic Radio Receiver Which Is Operated by Pressing One of a Series of Buttons That Automatically Tunes In the Particular Station Desired; Left, an Interior View, Showing the Tuning Mechanism

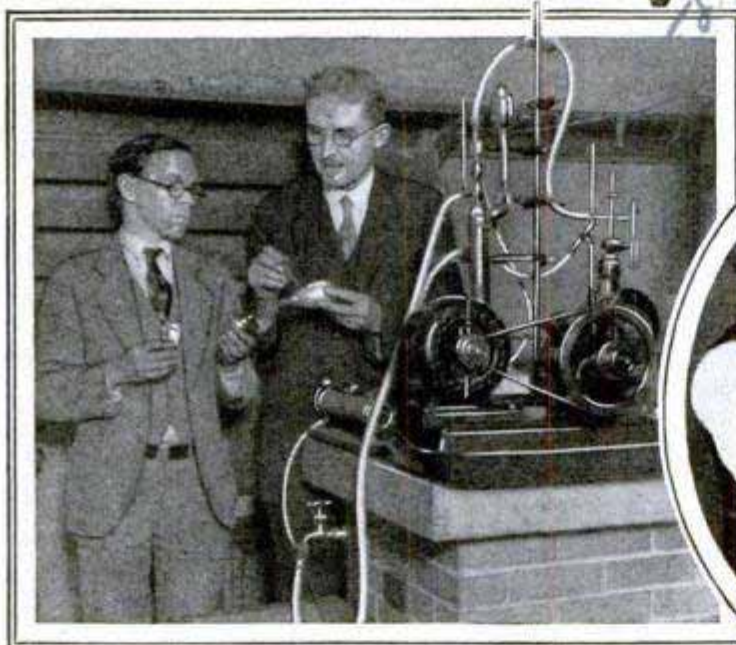

184153
 Prof. Knipp and Brown of Illinois University, with Their New Radio Tube Requiring No B-Battery

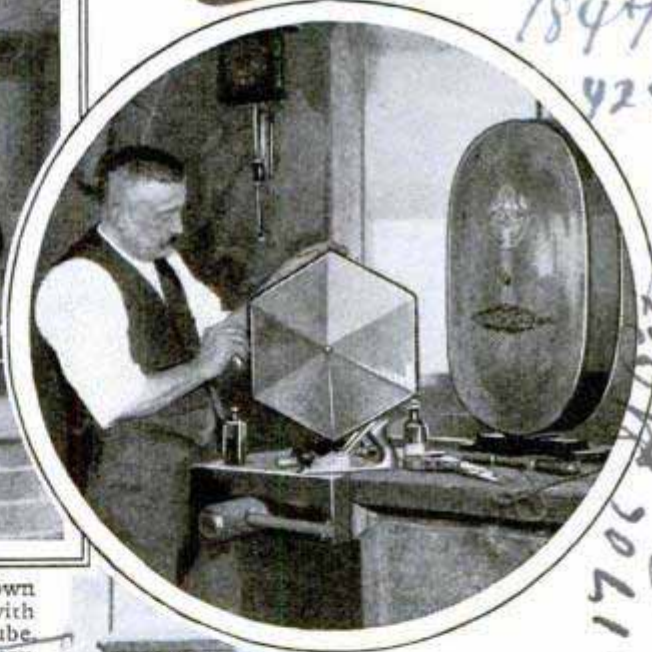

1847-R
 429859
 1706 St. Peter Ave
 Bronx, New York

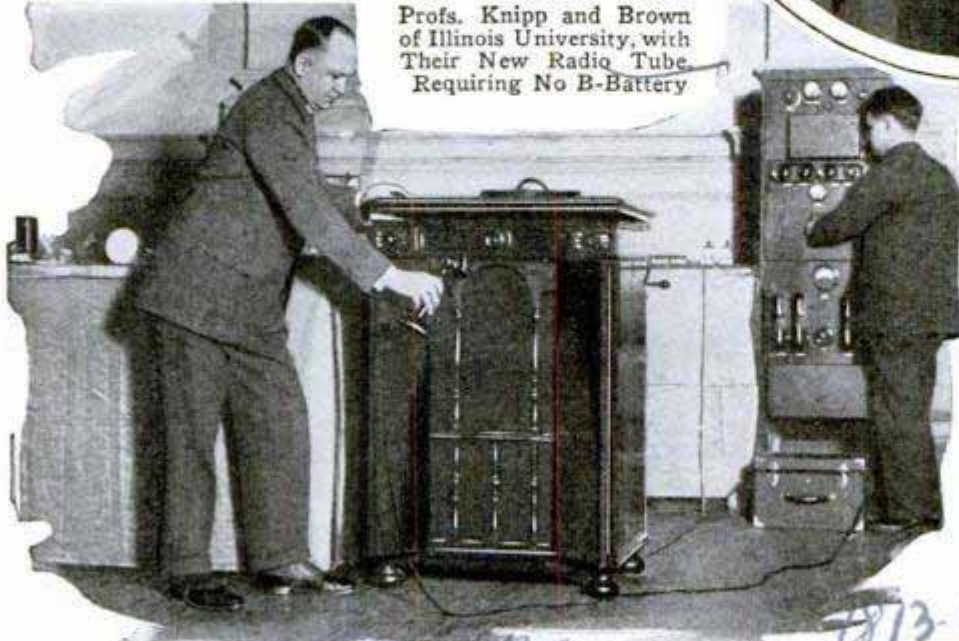

Above, Jerry Fasano, of New York City, Builds Loud Speakers in the Same Manner That a Violin, Mandolin or Guitar Is Made; These Speakers Are Said to Reproduce the Clear Tones of Each Instrument in the Orchestra as Sent Out from the Broadcasting Station; the Builder is a Musical-Instrument Maker and Has Devoted Much of His Time Recently to Perfecting Loud Speakers of This Type; Left, Sergius P. Grace, of the Bell Telephone Laboratories, Demonstrating a New Electrical Machine for Converting Speech into Gibberish and Turning It Back to Normal at the Radio-Receiving End for the Purpose of Transmitting Secret Telephone Messages

1873-R
 167990

Modernizing Old Installations

The radio installation of a year or so ago, with the old-style gooseneck speaker and batteries scattered around, is now

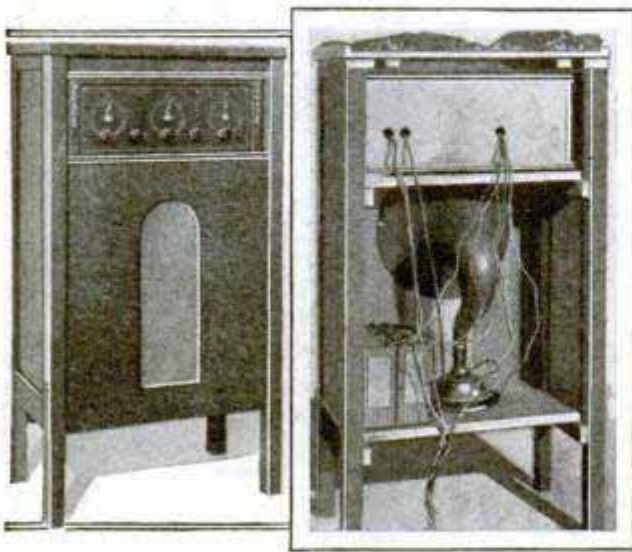

Left, Front View with Set in Position; Right, Rear View, Showing Arrangement of Speaker and Batteries

quite out of date, and justly so, both from a point of neatness and efficiency. The table cabinet housing the set is usually presentable and may be combined with a homemade console-type cabinet as shown. The cabinet is 44 in. high, 24 in. wide and 13 in. deep, the front and side panels being of three-ply veneer taken from an old wooden bed. The opening in the front panel may be cut with a coping saw or sharp knife and the edges neatly finished and stained. This opening is then backed with gold cloth in the manner of the usual console-speaker grill. The horn is placed just back of this opening, and the batteries may be arranged on either side. In building the cabinet, no set rules or dimensions were followed. There is no need of a back, except a curtain to keep out the dust.—Irvin L. Oaks, Pleasant Hill, Ohio.

Screen-Grid Tube Kinks

The wide-spread interest in the new screen-grid tubes encouraged many experimenters to build sets employing them, but in some cases the results were not what the builder expected, owing to his ignorance of their proper use and installation. It must be remembered that in dealing with these tubes certain precautions must be followed if the extraordinary possibilities of the tube are to be realized.

The first is that of careful and complete shielding of each r.f. stage and the second, correct design of the r.f. or coupling transformers. There is nothing about the new tube that will eliminate undesirable inter-stage coupling in electromagnetic and electrostatic forms, and therefore shielding in a two-stage screen-grid amplifier must receive approximately the same attention as would be given to a four-stage r.f. amplifier. To be at all effective, shielding must include not only the metallic protection used to isolate each r.f. stage but also some means of preventing coupling through the battery or eliminator circuits. Very thin shields are practically useless; aluminum used for the purpose should be .08 in. thick, copper may be thinner but should not be less than .05 in. in thickness. The lead from the plate of one tube to the coil of the next stage should be shielded by means of a small grounded metal covering such as tubing. To eliminate battery coupling, use r.f. chokes and by-pass condensers in the plate circuits.

Direct A-Supply from Charger

An A-filter device has recently made its appearance on the market which may be attached to any good 2-amp. charger for complete elimination of the A-battery. It consists of the necessary chokes combined

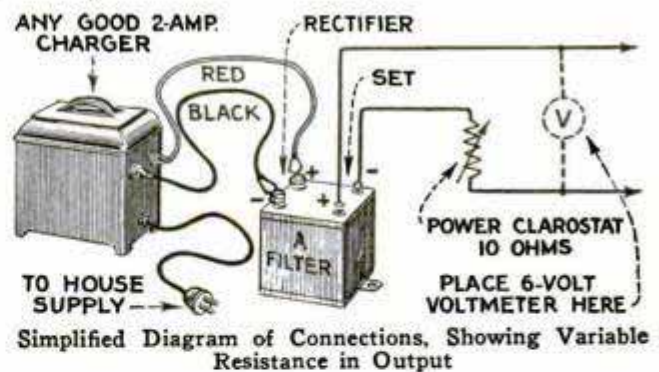

in a single case with a condenser block of 7,600 mfd. A battery charger capable of delivering 2 to 3 amp. and a means of voltage regulation, either by taps on the transformer or by a heavy-duty rheostat in the secondary, are required. A trickle charger cannot be used except possibly for dry-cell sets using the 199-tubes, with a total filament-current consumption not in excess of the charger output. Trickle chargers cannot be used for more than two of the A-type tubes.

*Take Deutchman's
"It's in the air" etc.*



Fading Signals in A. C. Sets

The radio user who has changed to an a.c.-operated set is often puzzled by fading signals that did not occur in the battery type. One moment the signal from a local station will be loud and then, apparently for no reason, it will fade below normal. The interesting thing about this is the length of time between the high and low-volume points, for the signal fades for prolonged periods unlike the fading caused by natural conditions. The trouble is not to be found where you would expect it. So, do not blame the tubes or the set, as all the trouble lies in the supply current. Upon checking up the current drawn from the house-lighting circuit, it will be found that fading occurs at the times when an extra load has been placed upon the supply. Most houses are wired to handle only a moderate amount of current, and when electric heaters, toasters, vacuum cleaners and flatirons, not to mention washing machines and refrigerating devices, are used, the load on the light circuit exceeds the carrying capacity of the

wiring. The result is a drop in the signal strength. This drop affects the household devices only slightly, but the transformers that furnish the current to the set are immediately affected by the reduced supply. Voltage-regulating devices are now on the market to relieve this situation, and closer attention to this factor at power houses will also do much to improve conditions.—J. B. Bayley, chief engineer, Station WAAT, Jersey City, N. J.

Razor Blades Make Headphone Diaphragms

Aboard ship, there are times when we have to use headphones in officers' quarters so as not to disturb those who might be sleeping. While experimenting with these in the usual loud-speaker jack to retain the full efficiency of the set, I hit upon the following idea which smooths the volume and brings out the bass notes with surprising results: Unscrew the phone caps, take out the diaphragms and use thin safety-razor blades instead, placing one in each unit. Cut note-paper disks, using the dia-



Phone Cap and Diaphragm Removed for Substituting Paper Disk and Razor Blade

phragm as a template, and place a disk in each unit so that the blade will not come in direct contact with the magnets of the phones; then replace the screw caps in the usual manner. Fairly heavy note paper of good quality may be used, although the writer made them from a magazine cover because that thickness seemed to give better results.—A. R. Snyder, radio operator, S. S. "Delta Queen," San Francisco, California.

Keeping the Set Dry

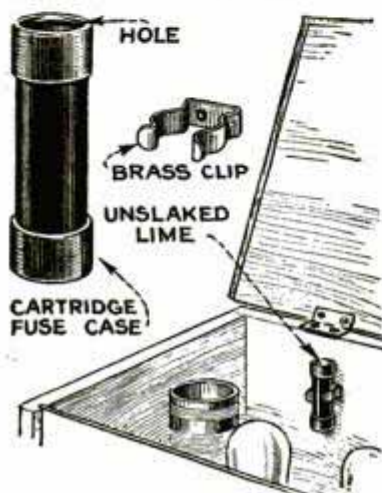

A handy device for keeping moisture out of the radio set may be made from an old cartridge-type fuse filled with unslaked lime. The case is cleaned and the fuse link taken out, the cap at the upper

end being left open by removing the large washer used for holding the link. This cap may be left off if there is no hole at the top, or a few small holes may be drilled in the cap. The case is then filled with unslaked lime, which absorbs moisture readily. A small clip, made of brass or copper, is fastened inside the cabinet as shown in the sketch, and the fuse case is then slipped into this clip. To test the efficiency of the device, place it under a glass with a few drops of water; if the lime is fresh the water will disappear almost immediately.—H. R. Wallin, commercial radio operator, Brooklyn, N. Y.

Proper Tube Selection

There are now a number of special-purpose tubes on the market designed for highest efficiency in the position they are to be placed in the set. More and more radio builders are realizing the importance of selecting such tubes for specific positions, yet many are still content to count the sockets and order as many A-type tubes. Needless to say, this is very poor practice and the results will not be those

obtained by proper selection. Manufacturers of radio tubes are well informed as to the characteristics of their product; therefore, if the carton states a certain B and C-voltage combination, use the voltages specified. Never increase the B-battery voltage beyond the limit marked on the packing slip and be sure the C-voltage is correct for that value. The operator may find that, when using 135 volts of B-battery, there is no noticeable difference in the loud speaker, whether $4\frac{1}{2}$ or 9 volts of C-battery is used, but it makes a big difference in the life of the tube and B-battery. Before deciding to use a 171, 112 or 240-tube, look over the data on these tubes and use the information to determine which you need in your particular set. Some experimenters are inclined to employ special-purpose tubes in positions where they are not specified in the circuit; sometimes they work, but appearances are deceiving and the tube will probably not last long. It is well to remember that the manufacturer has spent thousands of dollars to determine the proper conditions under which the tube is to be operated and the user will profit by following the directions carefully.—John B. Eccles, studio director, Station WJR, Detroit, Mich.

A Handy Aerial Kink

When an indoor or a very short outdoor aerial is used with the standard broadcast receiver, a great deal of distance-getting ability as well as volume is lost. This may be remedied by means of a small variable condenser of the midget, or balancing,

type. Remove the aerial lead from its binding post on the set and connect it directly to the grid of the first tube, with the midget condenser in series, as shown in the sketch.—Bert E. Smith, engineer, Allan D. Cardwell Mfg. Corp., Brooklyn, N. Y.

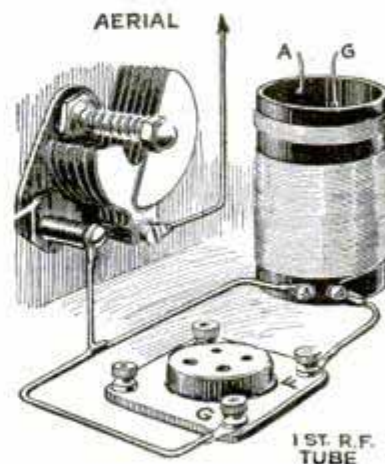

Remove the aerial lead from its binding post on the set and connect it directly to the grid of the first tube, with the midget condenser in series, as shown in the sketch.—Bert E. Smith, engineer, Allan D. Cardwell Mfg. Corp., Brooklyn, N. Y.

Safety Insulation for Screwdriver

When minor adjustments are necessary in a radio set, the handiest tool available is, of course, the screwdriver, but to be used safely its metal shaft should be well insulated in order to avoid damages to the set—often expensive—through short-circuiting. Select one having a long shaft which will permit clear vision when working in different locations and insulate the shaft with a length of rubber tubing long enough to cover all the exposed metal surface except the tip.—M. M. Paggi, chief engineer, Station KFWO, Catalina Island, California.

Misused Antenna Insulation

Insulators, properly used, are an important part of the antenna system, but many believe that the more insulators one uses the more effective will be the insulation. This is not altogether true, as a little thought will show. An antenna with the insulators placed as in Fig. 1 is a common sight. No doubt it works, but the designer is not getting full benefit of his insulators, as the total resistance of the latter, when connected in parallel, is much less than that of one single insulator, placed as shown in Fig. 2. If the insulator supply is plentiful, several may be used in series, as shown in Fig. 3, with greater efficiency, since the full resistance value equals the sum of the individual insulator values. Another misuse is shown in Fig. 4. The writer has noted that the tendency seems to be to use stand-off insulators for the lead-in wire at points where they are not needed. These insulators decrease the efficiency of the antenna and are unnecessary if the lead-in is extended beyond the building as shown in Fig. 5. In this case, the lead-in may be brought directly to the set.—C. Harold Campbell, engineering department, Station WICC, Bridgeport, Connecticut.

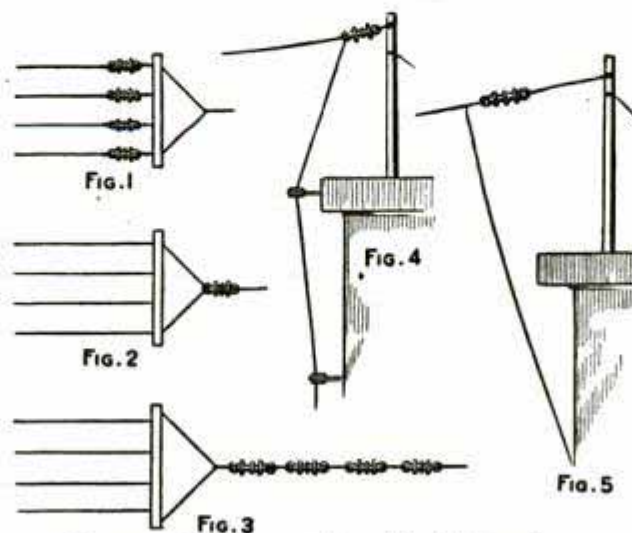

Proper and Improper Use of Aerial Insulators

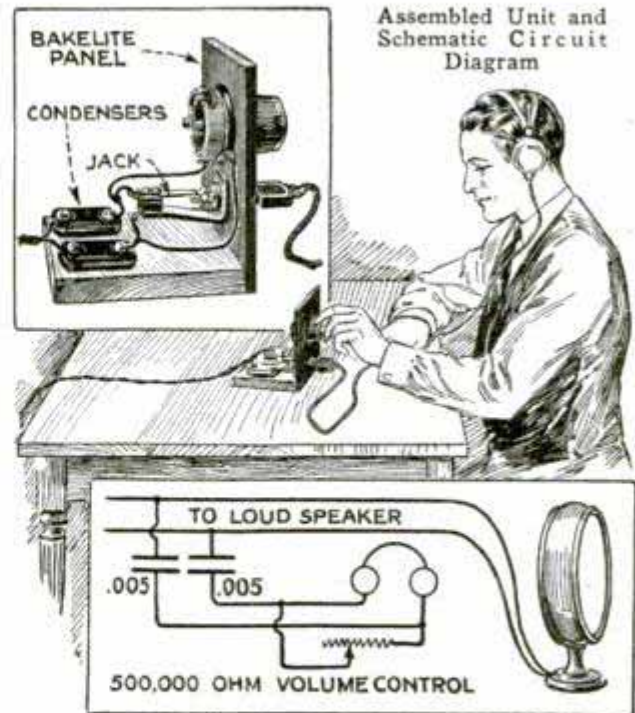

Headphones on Loud-Speaker Lines

An idea that I have found useful when small volume is required for operating headphones from the same lines that are operating loud speakers, may be helpful to others. The accompanying sketch and illustration show how this may be done without reducing the volume of the speakers. The idea is especially applicable to home receivers where no phone jack is installed in the set. It is also handy where several speakers are used at remote points and the listener at some particular point desires less volume. A 500,000-ohm variable resistance is placed across the phones to control the volume, and the fixed condensers in the line prevent shorting the loud-speaker leads which would reduce their volume. A simple panel arrangement, such as shown, will be handy for tapping the speaker line at any convenient point. This unit can be permanently connected to the speaker line and the phones plugged in whenever desired.—H. B. Nebe, chief engineer, Station WSMB, New Orleans, La.

Repairing A. F. Transformers

The writer was recently called upon to rewire a radio set employing a two-stage tuned-impedance a.f. coupling unit. After

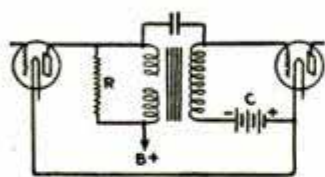

FIG. 1

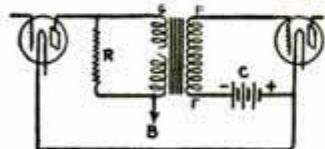
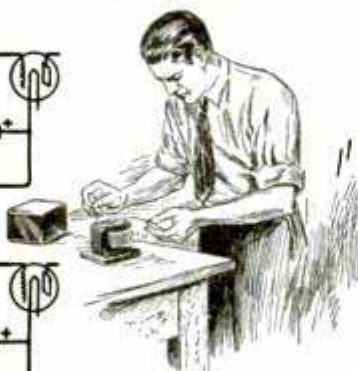

FIG. 2



the set was completely wired, it was found that the primary winding of the first tuned-impedance coupling unit was open, that is, it was burned out. As the customer was in a hurry and the writer did not have time to put in a new coupling unit, the repair method illustrated in Fig. 1 was used with good results. A non-inductive resistor R , of about 100,000 ohms, was shunted across the primary winding as shown, and the ear could not distinguish any difference in reception then and after a new coupling unit was installed. Later we had a similar case where the open was in the primary of an ordinary a.f. transformer. The same method was used here and with approximately the same results. A 100,000-ohm resistor was connected as in Fig. 2.—G. N. Garrison, consulting engineer, East Orange, N. J.

Neutralizing R. F. Stages

Oscillation in the r.f. stages may be controlled very simply by shunting a variable 800-ohm resistance across the primary of each r.f. transformer, as shown in the diagram. Receivers employing this method of neutralization have done amazing DX-work, and the quality of the signal is par-

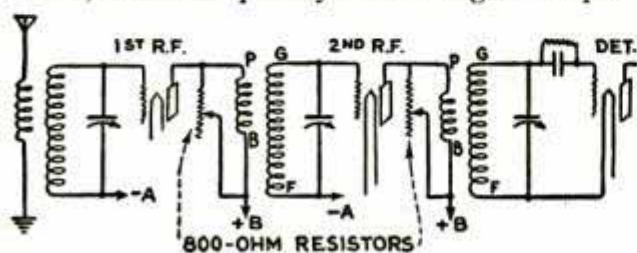

Diagram Showing the Variable Resistors Shunted across the Primaries

ticularly clear. The adjustment is very simple; set the dials at the lower end of the broadcast band and adjust each resistance so that no oscillation will occur at this point. At this setting, the receiver will not oscillate at any point within the broadcast band, and is ready for operation.—M. J. Weiner, chief engineer, Station WODA, Paterson, N. J.

Reducing Local Interference

Noises and interference picked up by a receiver in a building lighted by electricity are largely brought in over the supply line. These noises may be reduced and often eliminated by using r.f. choke coils in the lighting line. A coil consisting of 20 ft. of wire, of the same size as that used in the house wiring, may be wound on a broomstick and cut into each side of the line at the meter. The coils will not interfere with the light line but will choke r.f. currents that follow it, thereby reducing the noises. They also prevent r.f. energy generated by apparatus in the building from being transmitted to the neighbors.—Chas. Middleton, chief engineer, Station WRAF, LaPorte, Ind.

Aerial and Ground Connections

Frequently the housewife would like to dust behind the radio console or radio table, but hesitates to do so for fear she may seriously interfere with the aerial and ground connections. The very simple arrangement shown was devised by me and has solved the problem. A hole, about 2 in. wide and 3 in. long, was cut in the rear of the cabinet and covered with a piece of bakelite; two midget jacks were mounted as shown and leads soldered to them and connected to the ground and aerial posts in the set. The external leads were identified with tags and connected to midget plugs. These plugs may be withdrawn when cleaning and then replaced.—J. B. Bayley, chief engineer, Station WAAT, Jersey City.



MIDGET JACK AND PLUG

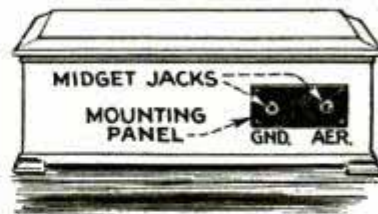

REAR VIEW OF SET

AMATEUR MECHANICS



More Speed from the Outboard Boat

By CLYDE HANSLEY

THE OUTBOARD motor fan who would like to increase the speed of his boat by from five to seven miles an hour will find the simple plan described in this article well worth a few hours of his spare time. It can be adapted to almost any type of hull, and, for those who like speed

but cannot afford a specially built boat, or who doubt their ability to build one, it offers a very satisfactory substitute. The writer tried it out on an ordinary skiff, and the results were splendid.

The first step is to take careful measurements of the keel of the boat. From these

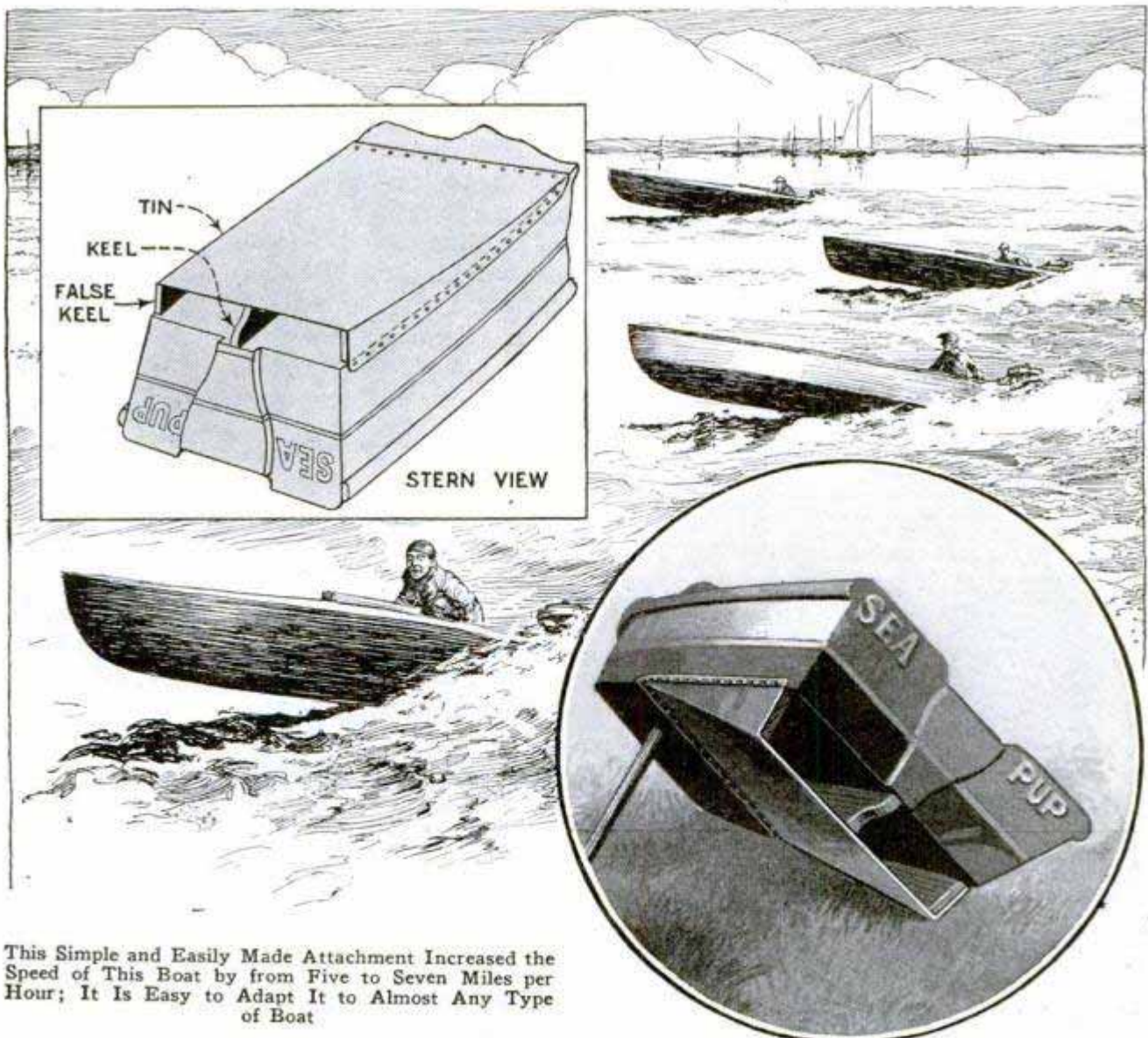

This Simple and Easily Made Attachment Increased the Speed of This Boat by from Five to Seven Miles per Hour; It Is Easy to Adapt It to Almost Any Type of Boat

measurements, make two duplicates of the keel—the false keels—and screw one of these to the underside of the stern, on each side, as shown in the accompanying drawing. It will be noted that, on the original boat, the keel, and consequently the false keels also, taper from the stern to a point 4 or 5 ft. forward. If the keel on your boat is straight, it is usually not a difficult matter to replace it with a keel that will taper from a 6 or 8-in. depth at the transom (sternboard) to a thin section forward. When attaching keels, use either galvanized or brass screws, or bolts. They can be nailed in place, but nails may cause leakage and cracking later on. Next a piece of tin or light galvanized iron is cut to fit, bent and screwed or bradded forward and along the sides of the false keels as in the drawing. That is all there is to it.

When the hull is at rest, there will, of course, be water between the metal plate and the bottom of the hull. When the boat is under way, and when a speed of more than eight miles an hour is attained, the hull will begin to "plane," and the stern section will glide along on the metal. This allows the water to drain out of the hollow stern, and seems to form an air cushion, which adds to the speed, as the stern, instead of dragging, now glides on the surface of the water.

Locks for Windows

Numerous houses in the vicinity had been entered by thieves, and the problem of making the windows as secure as possible, came up the last minute before going on a summer vacation. Window catches in general use are so easily broken or sprung that it was decided to fasten

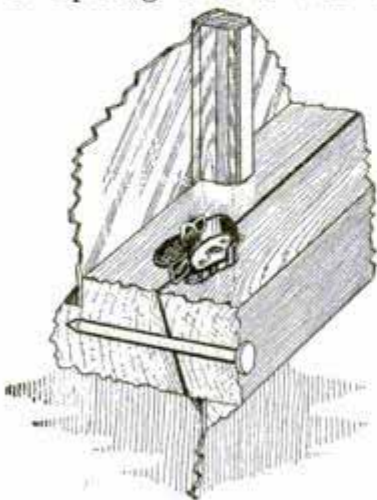

the sash by drilling a hole directly under the catch from the inside but not quite through the outer sash, and slipping in a ten-penny nail. This not only reinforced the catch, but prevented a blade

from being slipped in between the sash to unlock the catch.—C. D. Paterson, Worcester, Mass.

Repair of Rubber Balls

Rubber balls of the air-filled type lose their bounce, if there is a small hole in them through which the air escapes. An effective repair can be made by forcing air into the ball with a bicycle pump, holding the hose tightly over the hole while pumping. Then remove the hose quickly and apply a rubber patch, the surface of the ball having been previously cleaned and coated with rubber cement. The cement should be thoroughly dry before applying the patch.—F. H. Taylor, Stratford, Can.

Loosening Stiff Fishing-Rod Joints

Telescope joints of new fishing rods frequently stick so that it is extremely difficult to loosen them without damaging the rod. A Wisconsin fisherman, experiencing this difficulty, made a small bow

from a twig and split the ends to receive a length of fishline, as shown in the drawing. When the line is wrapped a few times around the joints of the rod, the bow is operated to slide the line over the joint.

This produces considerable heat, expanding the outer ferrule of the joint so that the rod sections can be pulled apart without the least difficulty.

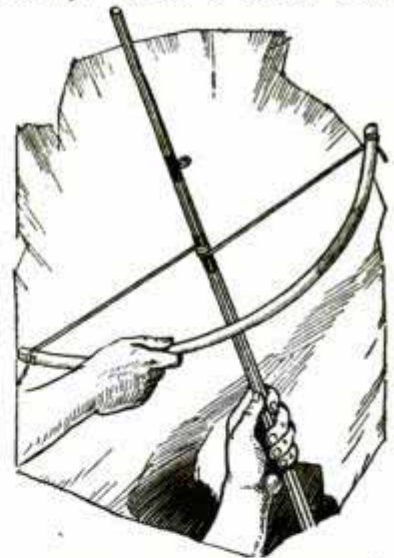

Corkscrew for Untying Knots

When one wishes to save a string in which there is a hard-tied knot that defies ordinary means of loosening it, it is well to try to unfasten it with the aid of a small corkscrew. One trial will convince you that it is about the handiest and most effective tool for this purpose.

Cleaning Old Paint Brushes

Old paint brushes, which have been allowed to become stiff or caked with paint to such an extent that turpentine does not loosen the bristles, can be softened in the following way: Take a package of any of the well-known brands of powdered soap and make a very thin paste, using cold water. Let the brushes soak in this paste until they are soft. Any brushes worth saving at all will come out clean and pliable.—John M. Lang, Portland, Oreg.

Pads for Winding Coils Prevent Finger Injuries

In winding radio coils or magnets one's finger tips are usually blistered by friction against the wire as it slides between them. A pair of small pads for the fingers will make the job much more comfortable in this respect. Sew a piece of felt to the inside of the thumb and forefinger of a pair of old gloves. When wearing these, the wire can be grasped and allowed to slide through without risk of injury.

House Numbers Made from Old Auto License Plates

When it is necessary or desirable to provide large house numbers in order to insure greater visibility, get some old auto-license plates. Cut out the numbers with a pair of tin snips, punch holes through each number at the top and bottom for small screws or nails, with which they are fastened. Such numbers are very neat and can be seen for a considerable distance.—Frank W. Bentley, Jr., Missouri Valley, Iowa.



Large, Visible House Numbers Can Be Made from Auto-License Plates

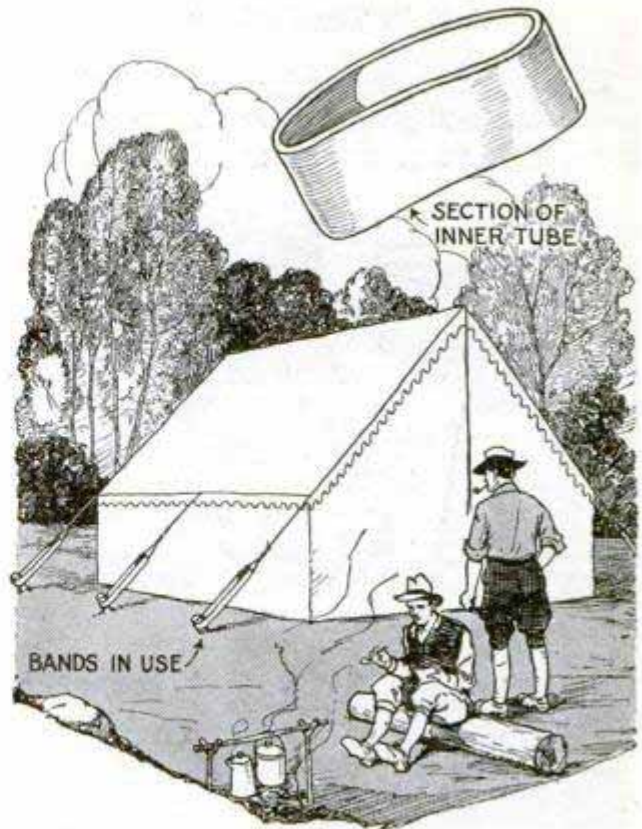

Elastic Stay Ropes for Tent Hold It Taut and Help Prevent Damage to Canvas

Elastic Stay Ropes for Tents

Rubber bands, made by cutting old inner tubes lengthwise, can be used as part of the stay ropes of a tent, and will keep the canvas taut, so that it sheds water more readily. Equipped with these, a tent will also withstand a high wind without damage as the elasticity of the rubber prevents sudden jerks, which strain the canvas. Similarly, damage is prevented if it should happen that a person or animal trips over the stay ropes.

Waxing Surface of Photographs

A pleasing finish can be given to photographs by waxing the surface with ordinary floor wax. It is applied and polished in the same way that it is used on woodwork. This kind of finish is especially suitable for photos that have been tinted with oil or water colors, as it forms a protective coating and at the same time removes many irregularities. Two applications may be necessary before a perfectly even coating is obtained.—Walter E. Burton, Kenmore, Ohio.

Erasers can be kept in good condition by rubbing them on fine sandpaper.

A Solo Tennis Game

Every tennis player has felt the desire to get out and play at times when neither court nor partner are available. As a

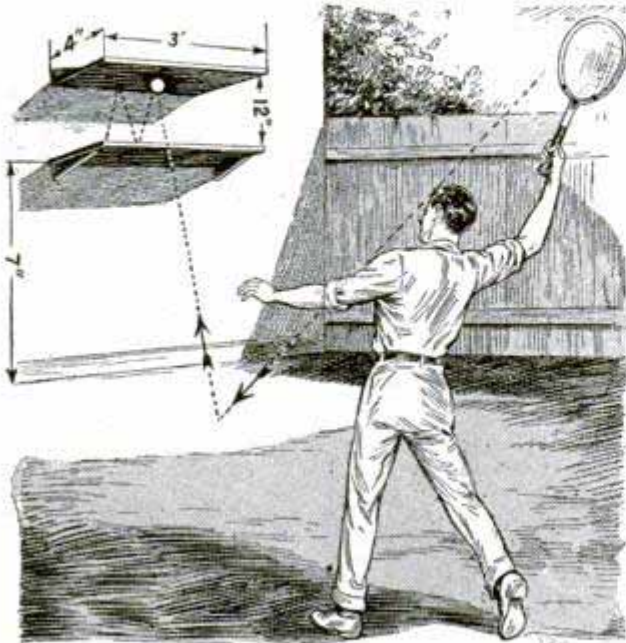

Game for the Lone Tennis Player Which Gives Exercise and Tests Skill

substitute outlet for one's energies, the simple game illustrated in the drawing has been found satisfactory. Two boards, 4 in. wide and 3 ft. long, are attached to a wall about 1 ft. apart, the lower one 7 ft. above the floor or ground. From a stand 12 ft. away, the player serves the ball against the ground so that it rebounds, strikes the upper board and rapidly vibrates between the boards for some time. Failing to do this, the ball rebounds and returns to the player so that, if he is skillful, he can return it time after time. One such set-up has often been in use continually the whole day, some players becoming able to place the ball between the boards several times in succession.

Improvised Blower for Church Organ

We have a large reed organ in our church, and it requires a great deal of pedal work to keep the bellows inflated. Electric blowers for reed organs could not be had for less than \$100, and we did not feel justified in making the purchase. A good substitute, however, was improvised. An ordinary vacuum cleaner was obtained and a hole was cut in both the back of the bellows and the floor, to ac-

commodate the length of hose which came with the cleaner. The hose was attached to the bellows, extended through the floor to the vacuum cleaner, which was set on a shelf just below the bellows. A switch near the keyboard controlled the cleaner. Plenty of pressure is obtained in this way. —Warren Brown, Galesburg, Mich.

Timesaving in Casting Type

In print shops that do casting from mats, it is often necessary to cut a hole in the finished cast, inside of the border, to insert the firm name, or a price, etc. The average shop does not have a router or jig saw with which to cut this hole, and it is a long and tiresome job to do the work by hand. A quick and efficient method of providing for the hole at the time the casting is done is to cut a block of wood, the size of the desired hole, and nail it to the mat in the proper place. The wood base of an old stereotype can be used for this purpose. When the cast is made, the metal will flow around the block and form the hole. —Fred Birch, Jr., Glendive, Mont.

Holder for the Fishing Pole

When fishing from a dock or pier, one cannot lay the fishing pole down without risking that it may be pulled into the water by an energetic fish that takes a notion to bite just when you are not looking or, occupied in preparing bait, etc. One fisherman experiencing this trouble had a simple holder made from a piece of flat iron, bent to the shape shown. It is nailed to the edge of the dock so that the end of the pole can be inserted in it and will then be held securely against the pull of any fish. —W. Kuecker, Chicago, Ill.

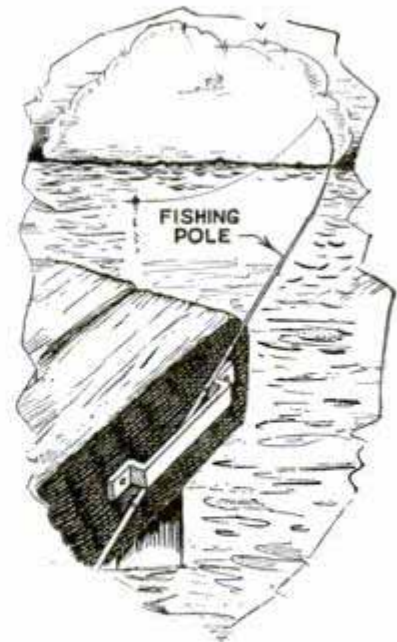

Make This Color Bookplate Stamp

For making a bookplate stamp, odd pieces of rubber tile and smooth linoleum flooring will be found handy, and this material can be obtained almost anywhere. Lay out the design on a piece of paper, making a reversed carbon copy on that paper and on as many other sheets as are

a good grade of glue. To insure that all the stamps register, or print in the proper space, a clamp of the kind shown in the



Attractive Bookplates in Several Colors Can Be Made by Means of This Simple Stamp, Which Is Cut from Rubber or Linoleum Flooring and Mounted on a Wooden Base Provided with a Handle

necessary to make up the desired number of stamps for the various colors of the bookplate. The outline of the stamp in actual size should be laid out at the same time so that both copies can be matched. Cut the linoleum or rubber to the size of the stamp, making two, three or more pieces, according to the number of colors to be used. On the smooth side of these pieces, glue carbon copies of the design. The parts to be of one color can be cut in relief by means of a sharp safety-razor blade. Cut away the part not to be printed, leaving only the design raised. To obtain a straight-line cut, press the sharpened edge of the blade straight down or at a slight angle into the material along the line, as shown at A in the detail, and cut away the undesired portion at an angle, as at B. After cutting the patterns, they can be mounted on wooden blocks to which suitable handles are attached. The mounting is done by means of tacks and

drawing can be made up. It consists of a base to which an L-shaped piece of wood is attached, a flat spring being fastened to this piece as indicated. In printing, several sheets at a time are held in the clamp, and the stamp is held against the corner of the L. Each stamp is printed in its color in turn. It is advisable to use printers' ink on these stamps. The ink is spread out on a flat piece of metal, and a hard-rubber roller is run over the ink, the ink adhering to the roller being transferred to the stamp by passing the roller over it. With reasonable care some fine prints can be made in this way.—F. Paulsen, Pittsburgh, Pa.

☐ Before storing rugs and carpets, clean them thoroughly and, after spreading them out, cover with paper that has been sprinkled with turpentine; this protects them against moths. Also wrap them in paper, gluing all overlapping edges.

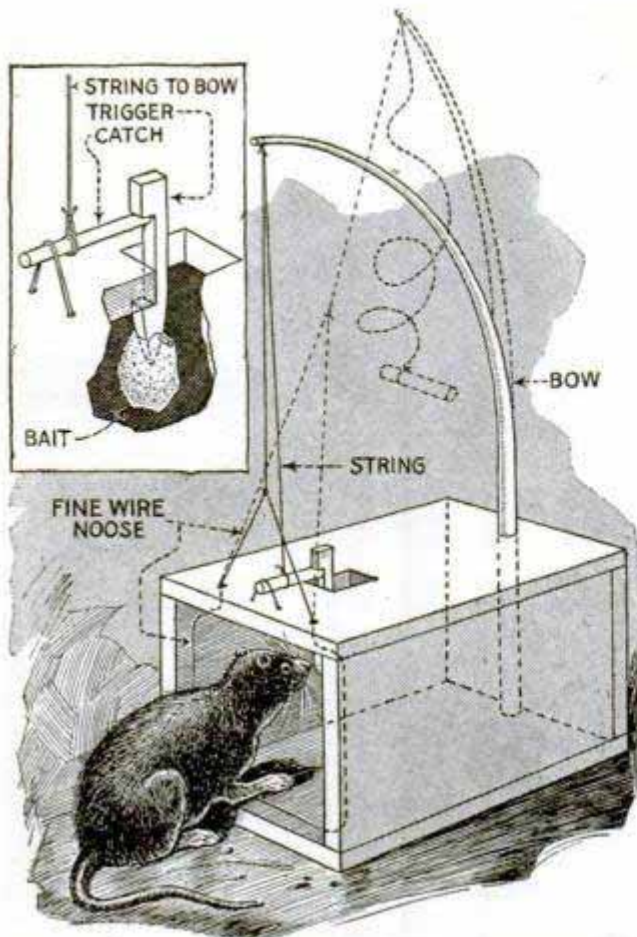

Any Boy Can Make This Bow Trap for Catching Rats and Mice

How to Make a Bow Trap

A bow trap is easily made and is very effective for killing rats and mice. To make one suitable for rats, nail together four boards, 8 in. long and 5 in. wide. Drill two holes, 1 in. from one end, to hold the bow as shown. Also cut an opening, 2½ in. from the opposite end, for the trigger. Drill two holes, 2 in. in front of the trigger hole, for the noose, which should be made of fine wire. The bow is then attached; it should be quite supple and strong. Whittle out the trigger and catch, and nail a small loop of string to the box to hold down one end of the catch, the trigger being used to hold the other end. Tie strings from the bow to the noose catch as indicated, carefully taking

up all slack from the noose. Adjust the catch string so that the noose will fill the space in the box opening when the trap is set.—W. A. Bonsfield, Wellesley, Mass.

Governor for Stationary Auto Motor

The drawing shows a simple governor to keep steady the speed of an auto motor used as a stationary engine. The device was built around the steering-knuckle clamp portion of a speedometer-cable fitting. The bearing housing for the governor spindle consists of a length of steel tubing, held by the clamp, and into the ends of which bronze bushings are pressed. It may be found necessary, with some clamps, to ream them out to fit the tubing. The shaft carries a V-pulley on one end, and a flange, turned from a Ford starting-clutch ratchet, on the other. The flange is slotted to carry the governor weight levers, and the slots must be no deeper than necessary, in order to prevent the weights from striking the bearing housing. The shaft is bored for a 3/16-in. rod, A, which is provided with a disk soldered to one end, and a 3 or 4-lb. coil spring. The shaft and rod are assembled as shown. The weight levers are filed from 3/16 by 1½-in. steel, and carefully fitted. The weights consist of 3/4-in. fiber tubing, filled with plaster of paris. Lead cannot be used because of its inertia at high speed. The control lever, B, must be made to suit the throw of the throttle lever on the carburetor used; 1/4-in. bronze rod was used for this part on the original. The bearing cup on rod A is filed and drilled as indicated, then soldered to

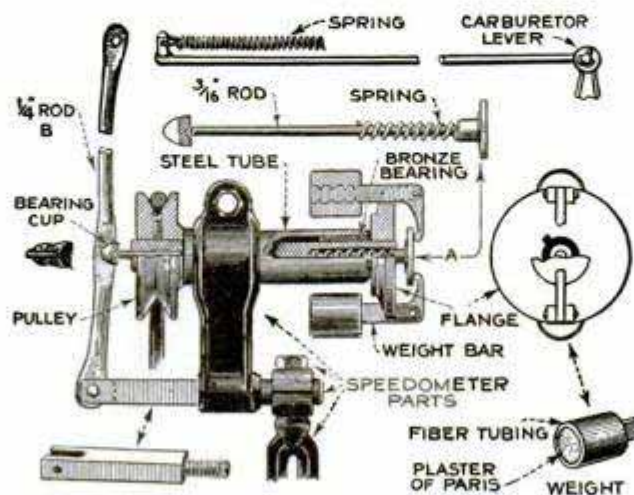

Constructional Details of a Homemade Governor for a Stationary Auto Motor

the end of the rod, after the bracket that supports the control lever has been screwed in place. A long rod, shown at the top, connects the control lever to the throttle lever on the carburetor, and a screen-door spring, fitted as indicated, serves to keep the throttle closed and to adjust the speed.

*Sam Brown
151 Carhart St.
Marion, Ohio*

Boomerang Throwing is Great Sport

by Keenan
H. Ward

ZIP! Away it goes, skimming the surface of the ground for a distance of 250 ft. or more, and then, rising like a bird in its flight, it wheels and comes hurtling back to the thrower, landing almost at his feet. Believe it or not, there's real fall sport in boomerang throwing.

The boomerang comes from Australia, where the flat country makes an ideal arena for their manipulation. The little brown Bushmen of the Arunta tribe, who depend on them almost entirely for hunt and defense, make no less than twenty different forms of boomerangs, ranging all the way from a 14-in. bird stick to the heavy 4-ft. war boomerang.

Most Australian boomerangs are in the shape of an obtuse triangle, flat on one side and convex on the other, measuring about 2½ ft. from tip to tip. The brown men use acacia wood in their construction, but your homemade one can be fashioned quite nicely from a piece of hickory or second-growth ash, 5/16 in. thick.

In making your own boomerang, the first step is to map out the paper pattern. Do this on a sheet of paper, 29½ by 12¾ in. The paper plan is shown in Fig. 2.

Only a rough adherence to the plan is necessary in order to insure a successful boomerang. Note that the width of the boomerang arms, near the angle, is 2 in., while they narrow down to 1 5/16 in. at the rounded extremities.

Cut out your paper model and draw two lines across it in positions somewhat similar to those shown in the lower drawing. Now, place your pattern on the wood stock and trace out each half of the boomerang, as in Fig. 3, the portion of the pattern between the two lines being part of both halves. After the outline has been penciled in, take a keyhole saw and cut out the two portions, as shown in Fig. 4. The next step is to cut each end of the boomerang, between the lines, into shape for a half-lap joint, as pictured in Figs. 5 and 6. A miter saw is the tool for this task, but a good

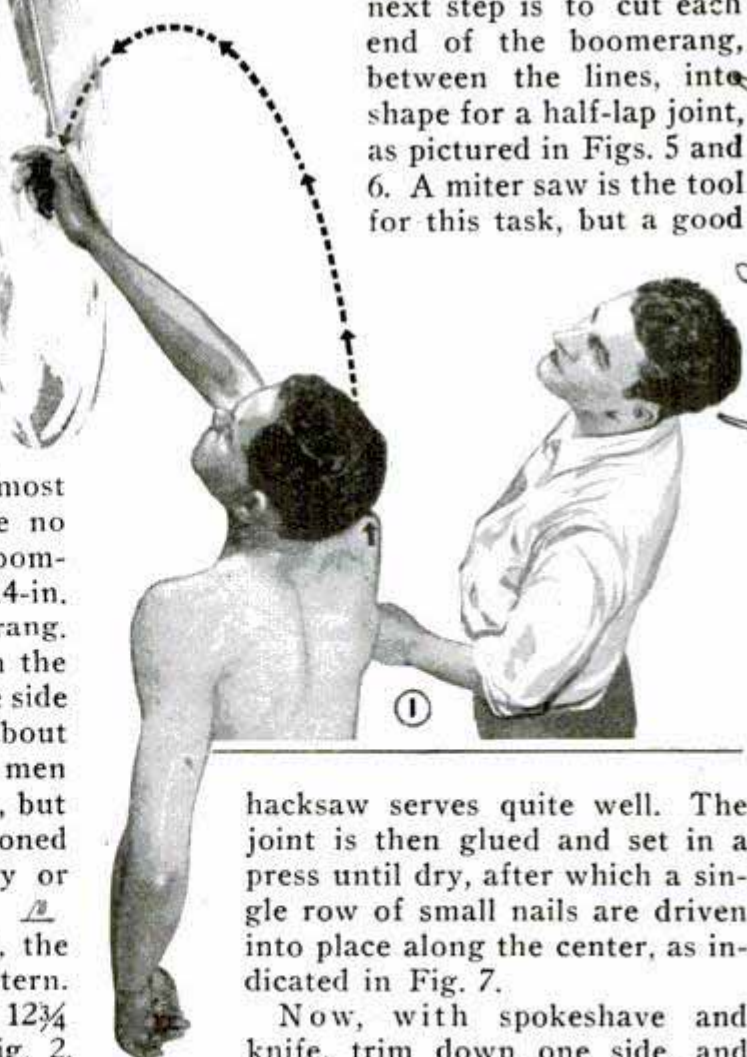

hacksaw serves quite well. The joint is then glued and set in a press until dry, after which a single row of small nails are driven into place along the center, as indicated in Fig. 7.

Now, with spokeshave and knife, trim down one side, and

*Illustrated by
The Filer Mfg. Co., 22 E. 42nd
New York
Alex. H. Taylor & Co.
makers*

*Antipodean Boomerang -
Alex. H. Taylor 22 E. 42nd St
671*

one side only, of your boomerang to a convex shape, as shown in Fig. 8. In shaving, only the sharp edge is taken from the wood at the center in order to leave the joint almost full strength, but the remaining part is cut down to a feather line at the edge while retaining the full $\frac{5}{16}$ -in. thickness at the center line.

Additional nails are then driven into the joint, and aluminum reinforcing strips, cut to shape with tin snips, are nailed to the center and tips of the boomerang on the flat side, as shown in Fig. 9.

The final operation, Fig. 10, consists in giving the whole thing a coat of stain or varnish. A bright color paint should be used instead of stain if you are contemplating throwing in deep grass, in order to make the boomerang more distinguishable where it falls.

And now to the throwing. The average person thinks that the throwing of a

own far more readily than the pulling of a forty-pound longbow.

The first rule is that the boomerang must always be thrown against the wind. It is against the wind only that the magic stick is self-retrieving.

So, facing the wind, you hold the boomerang in your right hand with the rounded side inward; that is, the round side should be the left side of the boomerang, when held in throwing position by a right-hand thrower. Holding firmly to one end, bring the stick over your head until you reach the position shown in Fig. 11. Then, bringing the arm forward in a straight overhand swing to the position shown in Fig. 12, release the stick with a short upward jerk of the hand, somewhat like that used in cracking a whip. This is important. Without this sharp jerk, the boomerang gets off to a slow spinning start and will not revolve fast enough to

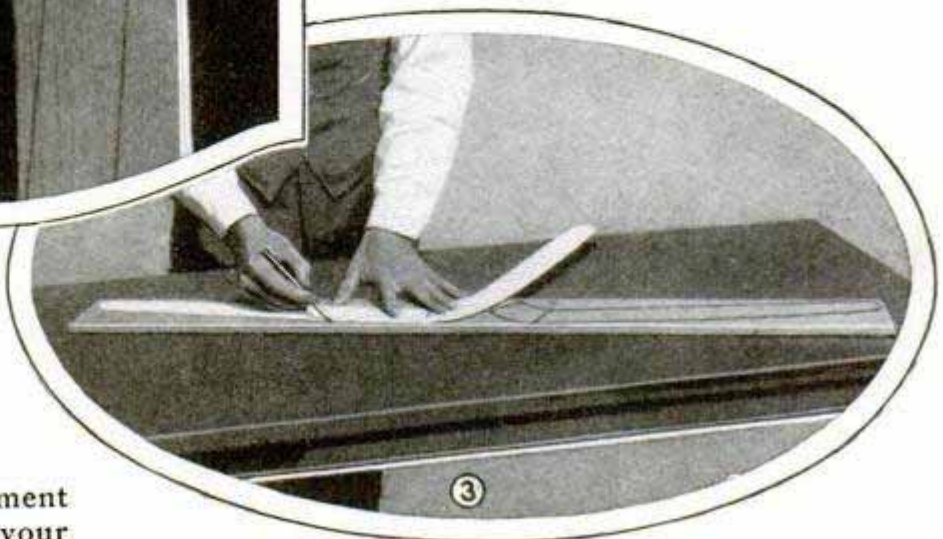
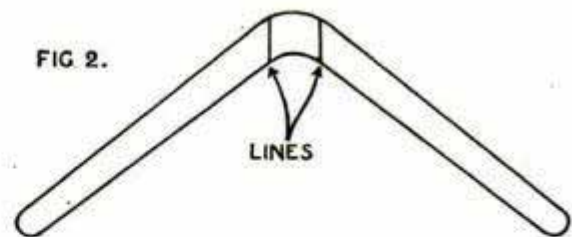
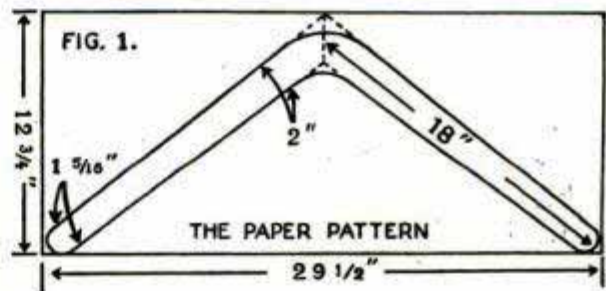
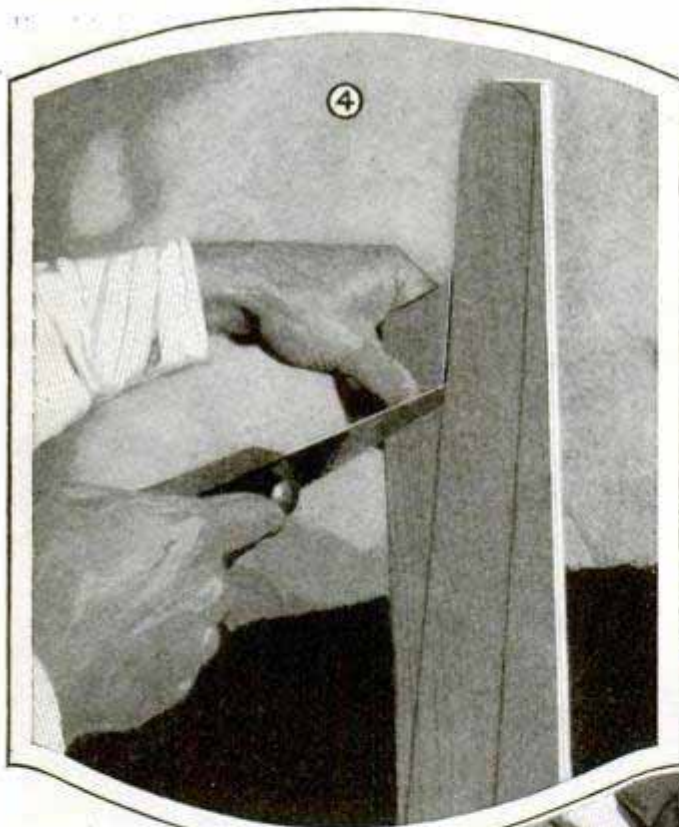

boomerang is something which can only be acquired through long and continuous practice, but that idea is entirely erroneous. Throwing the curving stick is an accomplishment which you can make your

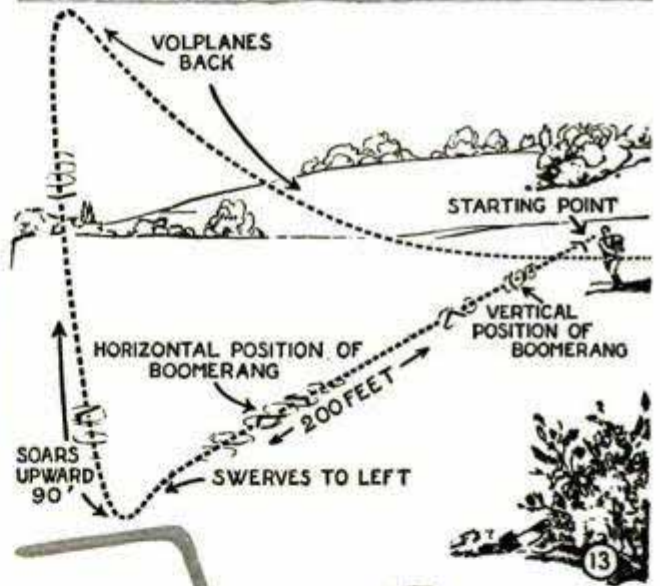
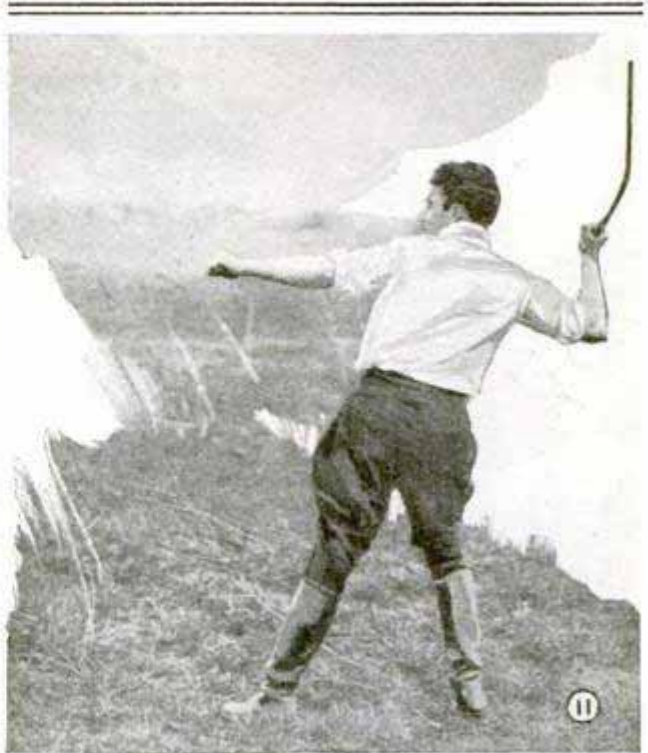

make the return journey; with the snap correctly done, the

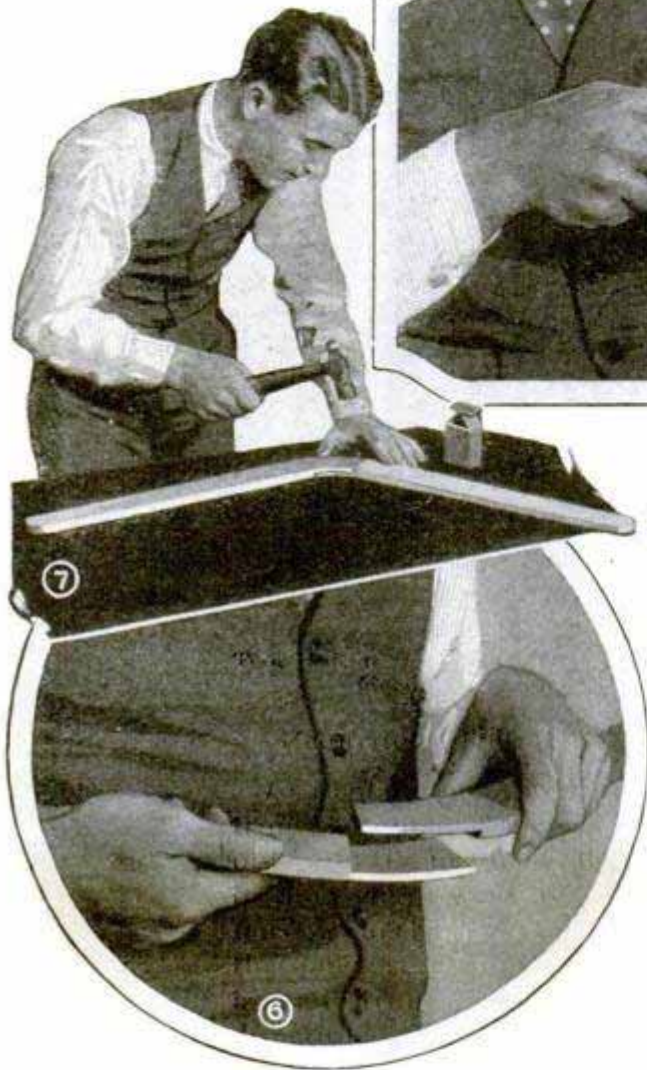

boomerang will fairly zoom forward, spinning so rapidly that it is apparently transformed into a circular plate of wood of a diameter equal to a straight line joining the two ends.

That's all there is to it. The average beginner learns boomerang throwing somewhat like this: He pitches a few into the ground; he sails anywhere from two to thirty times with no visible signs of a return journey; and then—success, after which the knack is very seldom lost.

In a successful boomerang flight, the missile will swoop straight forward in a nearly vertical plane for a distance ranging all the way from 100 to 350 ft. As it covers this distance, it changes to an almost horizontal plane, and then, swerving to the left, it soars aloft like a bird and then comes swooping back in a long vol-plane, to land at the thrower's feet.

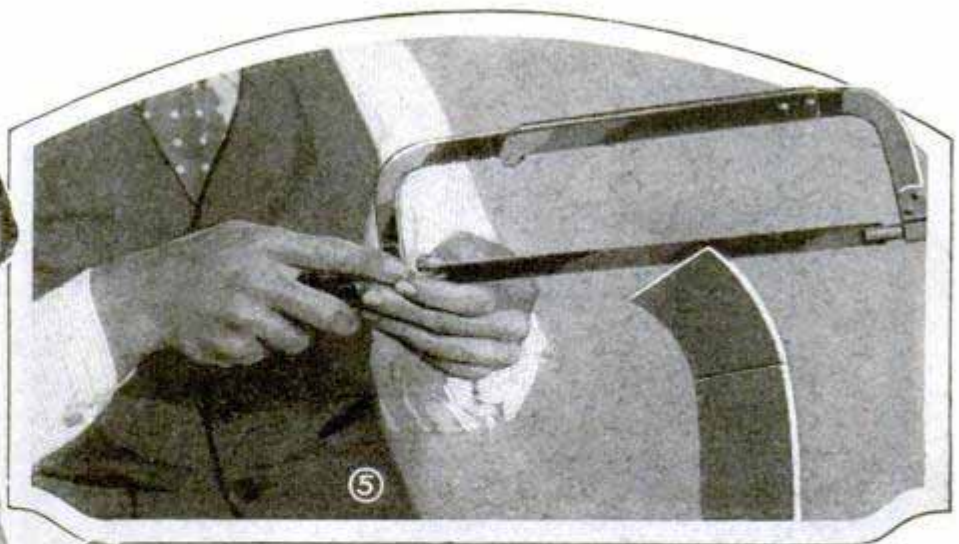

The parabolic flight of the boomerang is a beautiful thing to witness. Although the throw is generally as described, the magic stick can be made to perform a score of other graceful arcs. A slight variation of the snap, a small deflection of the throwing angle, and the boomerang can be made to shoot inward with terrific swiftness, curve outward in a lazy arc, or shoot upward in spinning flight. Almost any object, be it a rabbit hiding behind a stump or a pheasant on the wing, is a fit mark for the flying stick.

After some proficiency has been gained in directing the flight of the boomerang, you can erect a target consisting of a burlap sack filled with straw and aim your stick at this. You will soon acquire sufficient skill to score a hit fully half the time at a distance of from 40 to 60 yd.

And if you do miss, well, back it comes, like a trained eagle wheeling in the breeze!

Removing Cork from Bottle

It often happens that corks in bottles and jugs are shrunk or are pushed down into the neck so far that it is difficult to



remove them. An easy and effective method of overcoming this trouble is to drive a screw-eye or wood screw into the cork as indicated. With this arrangement, the cork can, in most cases, be removed without any trouble.—James F. Hobart, Chicago.

Preventing Loss of Outboard Motor Propeller

The propeller shaft of every outboard motor is provided with a small brass shear-off pin, which holds the propeller from turning on the drive shaft. The pin is designed to break off when the propeller strikes any submerged object, so that the motor will not be damaged. However, quite frequently a broken shear-off pin is the cause of losing the propeller, a part that cannot always be replaced easily, and which costs from \$3.50 to \$5. With a broken shear-off pin the propeller freely turns on the shaft and backs up against the end nut on the shaft, often with sufficient force to turn the nut and let the propeller slide off. After losing several propellers in this way, I decided to prevent recurrence of this loss. The end nut could not be keyed onto the shaft because the shaft is too hard to be easily drilled, so I arranged a metal claw as shown. To install this device, it is only necessary to remove the propeller, place it in a lathe and cut a $\frac{3}{16}$ -in. groove in the end next to the

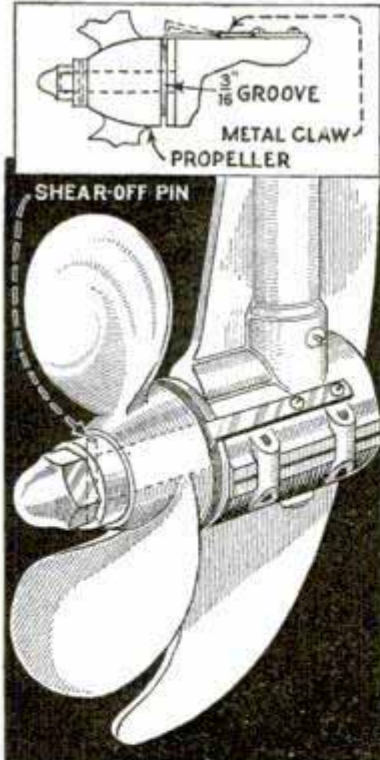

propeller-shaft housing. The claw is made of spring brass and is fastened to the housing with two screws. The lip of the claw rides in the groove cut in the propeller and keeps it from sliding off the shaft if the shear-off pin breaks. Inasmuch as the propeller cannot be forced back, it will not loosen the

end nut on the shaft, but even if the nut came off, the propeller would still be held on the shaft, free to rotate but not to slide off. As the claw is made of spring metal, the end can be lifted out of the slot in the propeller to remove the latter.—John Edwin Hoag, Los Angeles, Calif.



Pots and Pails Suspended over a Camp Fire by Means of an Old Auto-Tire Chain

Old Auto Chain Holds Pots over a Camp Fire

In the absence of a grate, an old auto-tire chain will be found convenient for holding pots and pails over a camp fire. One of the side chains and all but three or four of the cross links in the middle are removed, and the remaining part is then stretched between two stakes, as shown. The ends of the chain are fastened by means of short pegs, pushed through the end links. The pots and pails can be suspended from the cross chains, and the fire built underneath. Another cross chain, with a strong stick pushed through the end link, can be used for removing and handling the pots when hot, as in the upper detail.

Driving Ants Out of Ice Boxes

Ants are often difficult to drive out of ice boxes in the summer home. However, the following method will prove effective: Mix a solution, consisting of a small amount of tartar emetic, sugar and water, in a saucer, and apply it in the corners and around holes where the ants will come in contact with it in their attempt to get inside. They will soon disappear.—L. H. Georger, Buffalo, N. Y.

Preventing Double Clothesline from Slipping on Pulleys



Double clotheslines, used on pulleys as shown, have their disadvantages: When the wind blows, it often causes the line to shift, moving the clothes toward one end, until they may touch the pole or the side of the house and get

soiled. To prevent this, it is a good idea to slip a hook over both lines at each end. —Mrs. R. A. Jessen, Keansburg, N. J.

Trough for Testing Tires That Leak Slowly

Tires having slow leaks often fail to show any evidence of such leakage when the tubes, removed from the casings, are only partly inflated. The writer, experiencing this



trouble, made a testing trough from a section of discarded auto casing of large size. This was nailed to a piece of 4-in. wood, to hold the trough in an upright position, as shown. The wheel with the leaky tire is raised by means of a jack so that the trough can be slipped under the tire. —A. C. Brundage, Rochester, Minn.

Using Carborundum Stone on Razor

It is rather difficult to keep a straight-blade razor honed to barber-shop efficiency, but here is a method of doing it which I have used for fifteen years. Get a carborundum stone of the finest grain,

and give your razor a few strokes on the dry stone just before stropping. You will find the edge is improved by this treatment. —A. M. Parker, Edmonton, Can.

Getting More Mileage Out of Your Ford

I have a model-T Ford and I averaged 36 miles per gallon on ethyl-gasoline. To obtain this result, I had $\frac{1}{8}$ in. of the metal planed off the face of the cylinder head where it fits on the block. This brought the head closer to the pistons and thus increased compression without weakening the head, since the force of the explosion is taken by the bolts with which the head is held to the block. When replacing the head, $\frac{1}{8}$ -in. washers should be put under the bolts to prevent twisting them off. The valves and piston rings must also be in good condition, and the carburetor must be adjusted lean for the greatest fuel economy. After this alteration, I found it was impossible to make the motor knock except when going five or six miles an hour uphill and with the throttle wide open. I have run this car about 2,000 miles since and there is still no fuel knock. It is not advisable to use ordinary low-test gasoline with this high-compression head, but it can be used if care is taken in advancing the throttle slowly to prevent knocking. In a Ford motor, a $\frac{1}{8}$ -in. slice off the head reduces the compression space about 14.5 per cent, and compression will be correspondingly greater. —C. H. Howard, Hannibal, Mo.

Salt and Pepper Shaker for the Camper

To save space in the camping kit, every unnecessary item should be eliminated, and, if possible, one article made to serve several purposes. Instead of having separate salt and pepper shakers, the two can

be combined as shown in the drawing. Get a test tube of large size, which can be purchased at any drug store, and, with a file, cut off the closed end, smoothing off the sharp edge so that

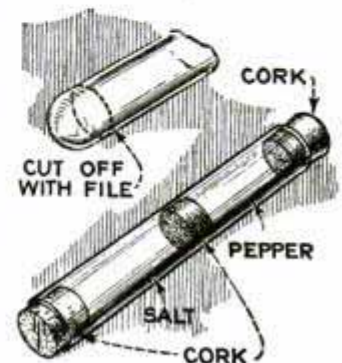

it will not cut. Push one cork to the center of the tube and provide two more for the open ends. You now have two separate compartments, one for salt and the other for pepper, and as the container is glass you can see which is in each. An unbreakable combination tube can be made from a section of bamboo, with a joint in the center, and the contents scratched on the outside.

Unusual Rat Trap

I had considerable trouble with a rat which always succeeded in keeping out of the spring trap I set for it. Determined to get it, I rigged up the unusual trap shown in the drawing. It consists of an old cabinet door, about 2 ft. square; a short stick 6 in. long, a weight and a spring trap. The latter is screwed to the floor; the cabinet door is raised so that one edge rests on the stick, which is set under the door as indicated. A suitable weight is laid on the inclined door. The spring part of the trap is connected to the stick with a stout cord. Another cord is tied to the trigger at one end, and to the bait at the other, which is laid on the floor under the center part of the door. The trap is then set so

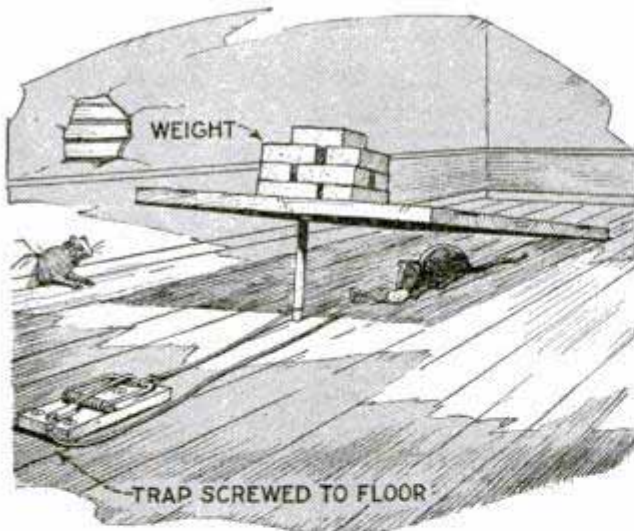

Novel Rat Trap Consisting of a Large Board Which Falls on the Victim

that, when sprung, it jerks the stick from its position, and the door, being unsupported, falls down. When the rat takes hold of the bait, and before it has time to get away, the door falls on it. The trap caught the rat that had evaded the former trap and did great execution among the others.—W. L. Hadlock, Chicago.

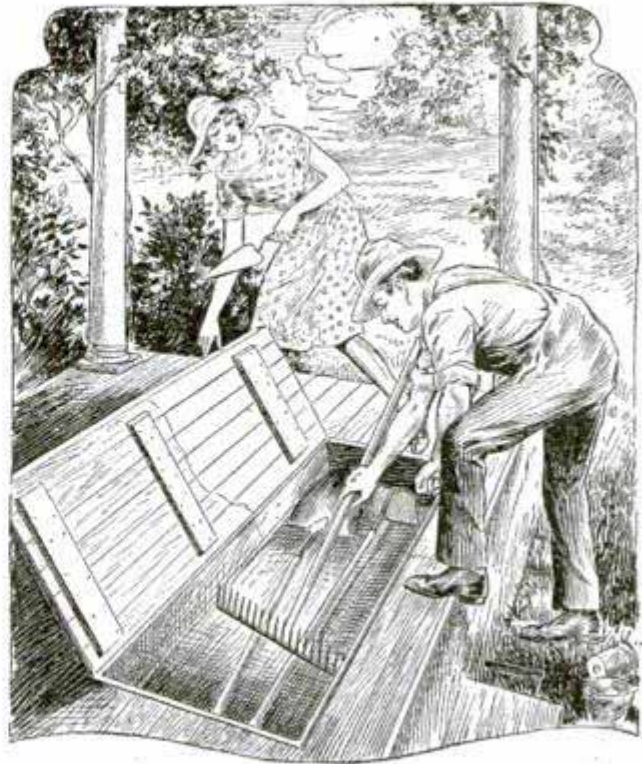

Handy Cabinet for the Garden Tools Can Be Built in the Porch Floor

Porch Cabinet for Garden Tools

In the absence of a suitable shed or garage, garden tools, such as hoes, rakes, spades and shovels, are usually kept in the basement, and this location is often rather inconvenient. One garden enthusiast found a much more suitable place for the tools. He built a cabinet in the porch floor, as shown in the illustration. It is long and wide enough to accommodate all the tools, with some room to spare. The lid, when closed, is flush with the porch floor, and sufficiently reinforced to allow walking on it safely. A sunken ring enables the door to be opened whenever necessary.—L. H. Georger, Buffalo, N. Y.

Saving Time in the Haying Season

Ordinarily hay is raked, loaded on the wagon and then hauled to the barn, if it is to be put in the mow. If it is stacked in the field, the hay is drawn to the stacker with sweeps, then stacked and hauled in on racks. One man has his hay shed only a few yards from the alfalfa field. Instead of hauling the hay in on a wagon, he lays one of the slings on the ground, sweeps the hay directly onto it from the field and then hoists it under cover, thus saving a good deal of time and labor.—Dale R. Van Horn, Walton, Nebr.

Keg Helps to Pull Stumps



When pulling stumps or large roots with a tractor, a strong keg can be used to good advantage. The cable is attached to the stump near the ground and the keg is then put under the cable near the stump as shown. When the tractor pulls

there will be an upward as well as a side-wise strain on the stump.—James W. Cottrell, Hammonton, N. J.

Hinging Porch Windows to Avoid Trouble

Glazing a porch is usually a simple job, the sash being made to fit the openings and hinged to permit swinging them up so that they can be fastened to the ceiling. This arrangement works well in many cases, but trouble is often encountered when the sash are at right angles to each other, as at the ends of the porch. The end windows should be arranged to swing up higher than the adjacent ones at the



front, which entails considerable calculation and careful adjustment. The difficulty can readily be avoided, however, by hinging the two windows, nearest to the corner on the front side, together, as shown in the drawing. After the end window is folded over the second one, which is hinged at the top, both can be

swung up together. In many cases, a pair of offset hinges are necessary. The detail in the drawing shows how these hinges are bent at right angles, so that the pivot section comes flush with the surface of the end sash when it is folded onto the other window. The bent part should be sunk also into the top member.

How to Prevent Loss of Tools in Overhauling Auto

Whenever I am working on my car outdoors I take along a flat box, turn it upside down and lay my tools on it. That is better than putting the tools on the ground where they may be lost. If the repair work is very extensive, the car can be run onto a piece of old canvas, so that all nuts, cotter pins, and other small pieces will be caught on it without chance of loss.—Arthur Flinner, Wichita, Kans.

Flashlight Carried on Boot

When out hunting, a small flashlight can be carried in a leather holster sewed to the boot, as shown in the drawing. In this position it is always handy, leaves both hands free and relieves the pockets. The holster consists of a piece of leather, 5 in. long and 4 in. wide. Place the flashlight against the leg of the boot and wrap the piece of leather across the light as indicated. Sew the two side edges to the boot so that it clamps the flashlight tightly and close the lower opening with a strip of leather. A tight fit is necessary to keep the light safe, no matter how violently the leg may be moved.—L. B. Robbins, Harwich, Mass.



Removing Ink Stains

Recently one of the clerks in the store where I am employed dropped a quart bottle of ink on the floor and broke it. The result was a large black stain, about 2½ ft. in diameter. I mixed up some car-

bonate of soda and chloride of lime, in equal parts, and added water until the fluid had the consistency of cream. This was rubbed over the ink stain with a damp cloth and left the floor clean. The method also works on clothing, and is the best I know of for removing photographic-developer stains from the hands.—Warren Hubbard, Decatur, Ill.

Heavy Stirring Rod for Chemists

A wooden stirring rod for the chemist or photographer is not practical because it absorbs the chemicals and therefore cannot be used in different solutions. A regular stirring rod is rather thin and unsuitable for use with large quantities of solutions. An ideal rod, which costs only 10 or 15 cents, depending on the size, is an ordinary towel-rack glass rod, which can be had at the 5 and 10-cent store. It has a knob at each end, which is excellent for crushing undissolved chemicals.

Two Handy Tools for the Fisherman

To facilitate keeping a string of fish where you want it, the handy tool shown in the insert will be found useful. It is made from a discarded auto or tractor valve, the end being ground to a point. Your muddy shoes or boots can be scraped clean quickly by using a similar valve, but preferably a smaller one having the end flattened and ground down as indicated.—F. W. Bentley, Jr., Missouri Valley, Iowa.

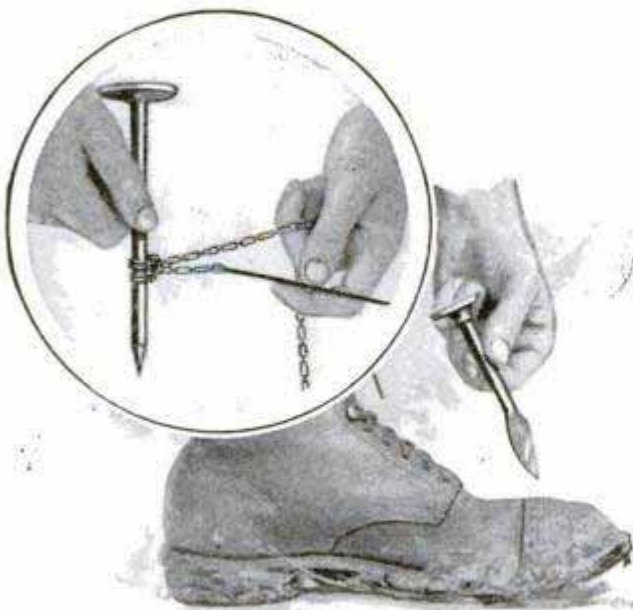

Fishermen May Find Good Use for Discarded Auto and Tractor Valves

Expanding Belt Buckle Made from Spring Wire



Expansion Belt Buckle

A novel expansion belt buckle can be made by using a 52-in. length of No. 10 gauge brass or steel wire, or any spring wire of similar size. The drawing shows a flattened portion at one end of the buckle, which, inserted in the belt holes, keeps it from slipping. The other end is shaped so that the belt can be attached in the usual way. The spirals are made by wrapping the wire snugly about a piece of strap iron, about $\frac{7}{32}$ by $1\frac{1}{16}$ in. in dimensions. If the turns are hard to make, hold the strap iron in a vise and also fasten one end of the wire, then wrap it as closely as possible, using a block of hardwood and a hammer to force the wire into shape. The belt will be found comfortable.—Truman R. Hart, Ashtabula, Ohio.

Brushing Lint from Heavy Fabrics

When lint accumulates on a garment of heavy fabric, it is almost impossible to remove it by ordinary brushing, as the friction of the dry brush creates static electricity and causes the fine fibers to cling more firmly than ever. If the brush is slightly dampened by holding it over a steaming teakettle, the lint can be removed without difficulty.

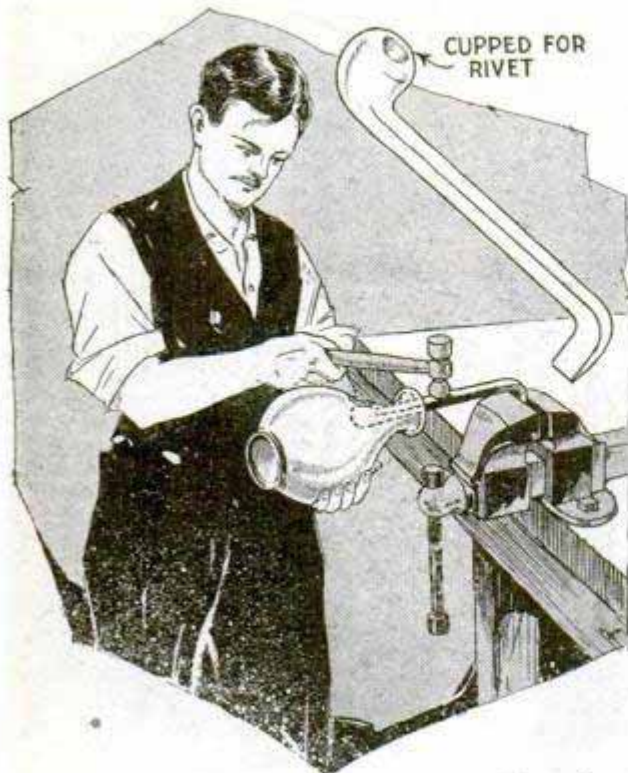

Tool Bent at Both Ends Helps to Remove Dents from Metal Ware with Narrow Necks

Removing Dents from Metal Ware

As dents in metal ware usually are made from the outside, they must be hammered out from the inside, which is difficult to do in the case of vases or other articles with narrow necks. A form of hammer for this purpose is shown in the drawing. It is made from a steel bar bent in opposite directions at the ends. After fastening the tool in a vise as shown, the vase is slipped over it until its other end is in contact with the dent. Hitting the bar with a hammer will cause the inner end of the bar to vibrate and strike rapid blows on the dent. Repetition of the operation while the vase is manipulated so that the blows hit the whole dented area, will soon remove the dent. To prevent serious marks, the tool should be padded. A similar tool can be used for riveting, in which case the hammer end should be cupped so that it fits the rounded end of the rivet.

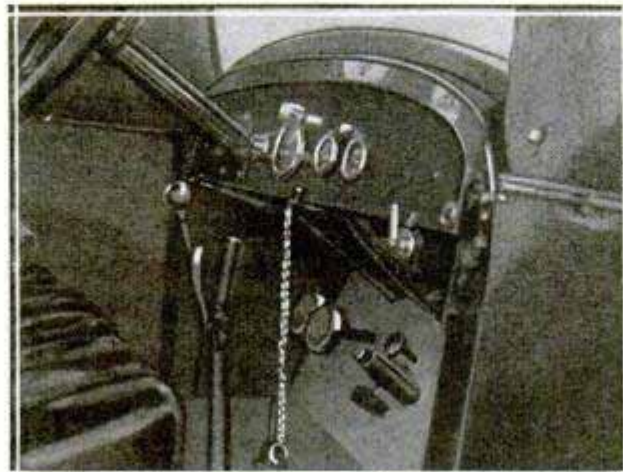

Guard Placed over the Starter of an Auto Prevents Children from Operating It

Simple Brace for Cellar Door Prevents Sagging

Cellar doors usually have a tendency to sag. To prevent this I braced the doors with a piece of 2 by 4-in. wood, long enough to rest on one of the middle steps when the doors were closed. The brace is hinged to one door and projects beyond it so that the other door also is supported by it. When the door is opened, the brace falls back and is out of the way. This particular door opened on a porch floor, and the brace made it possible to walk on the doors without causing them to sag.—C. J. Gose, Kinderhook, Ill.

Guard for the Auto Starter Keeps Children from Meddling

Children often get into autos and meddle with the switches, gear-shift lever, accelerator and starter. The consequences are usually not serious if the ignition key is removed, but the continual use of the starter soon runs down the battery. If the ignition key has been left in the lock, the youngsters can sometimes start the motor and may even start the car. For this reason, I placed a guard over the starter, which prevents the children from operating it. The guard consists of a length of 1-in. pipe and a pipe flange, which are slipped over the starter and screwed to the floorboard. The pipe extends about 3 or 4 in. beyond the starter, and only by inserting a short length of wood, such as a piece cut from a broom handle, in the pipe can the starter be forced down. When I leave the car, I

take this piece of wood along and the children have not yet discovered the trick.—Clifford L. Burdick, Milton, Wisconsin.

White sinks, bathtubs, washbowls and toilet bowls may be cleaned with a soft cloth, moistened with turpentine; use kerosene where there is rust.

Medieval Lantern Easy to Make

by E. Gilmore

HERE is an artistic antique lantern that gives a touch of beauty to any room or den, when hanging from an electric socket in the ceiling or from a bracket fixture on the wall.

It may be made at very little expense. With the exception of liquid glue and gesso, all the materials necessary are: an empty salt or oatmeal box, or any box of cylindrical shape (Fig. 1), and an electric-light socket, plug and cord, which may be bought at any 10-cent or hardware store for a total cost of about 40 cents.

The first step is to be sure that the top and bottom of the box are glued securely in place. Then cut a round hole in one end, of about half the diameter of the box, and slit the remainder of the end so as to form eight little tabs, as in Fig. 2. Bend alternate tabs up as indicated; these are to hold the lantern top in place with glue.

To make the top, take an old dry-goods box, or any similar piece of cardboard having the same thickness as the salt box and cut out a circular piece, with a diameter equal to one and one-half times the length of the round box (Fig. 3). Draw a line from the center to the outer edge. Cut on this line with scissors, then roll the disk into a conical shape, so that it will fit correctly over the top of the box, and glue the edges of the cone together. Now fasten the roof of your lantern on top of the box by gluing the tabs made for this purpose,



as shown in Fig. 4, on the inside.

In cutting the windows in the box be careful not to make them too large, as they would then weaken the walls. Cut out the rectangular window opening in the lantern first, then make an overlapping frame of cardboard with as many sections or lights as you desire. Glue this over the opening you have cut in the lantern (Fig. 5).

Colored isinglass, celluloid or paper may be glued in the windows and this gives the lantern a beautiful appearance, although a tinted bulb will serve just as well. The heads of heavy pins may be cut off, leaving a short shank, and pushed through the lamp as indicated in the headpiece, to simulate rivets.

Make a door in the bottom of the lantern by simply cutting out a square opening large enough to admit the electric bulb, and then make a cover of the same shape from heavy cardboard. Cut it larger than the opening in the box so it will not fall out. A bone ring is attached to the door in the lamp photographed, and another, heavier, ring is used at the top. Holes are punched in the upper ring, through which the electric cord is threaded, as indicated in Fig. 6.

The next step is the finishing: First apply a coating of liquid glue over the entire lantern and let it dry thoroughly. To make the gesso, mix a 1-gill can of liquid glue, $1\frac{1}{4}$ cups of whiting, 3 teaspoonfuls of varnish and 3 teaspoonfuls of linseed oil, and ap-



FIG. 1

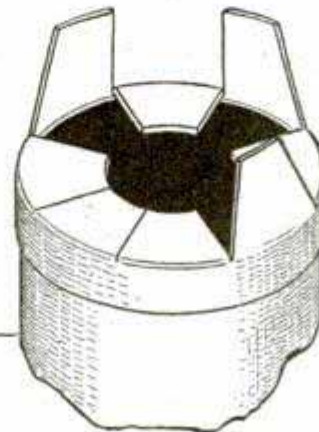

FIG. 2



ply this mixture all over the lantern, modeling it with the aid of a stiff brush or knife. Try to model the gesso so that the effect will be that of deeply pitted iron or bronze, but do not make the surface too rough. Allow the gesso to dry 24 hours, and you are ready to color.

First, cover the gesso with a coating of bronze powder mixed with banana oil. When this is dry, apply the paint, which may be burnt umber or green, with a touch of deep red here and there. Squeeze a small quantity of color from the tube onto a piece of

cloth, and rub this on the bronzed surface until the desired color is obtained. If you wish to procure a very ancient effect, dust powdered rottenstone over the entire surface and rub down very carefully.

Silencer for Rebound Clip

The small rebound clips on the springs of model-T and A Fords often become loose and rattle. By using a longer bolt and a coil spring, the clips can be kept tight without much attention. For the front springs of model-T cars, a 2½ or 3-in. machine bolt, ¼ in. in diameter, with a washer and a radius-rod ball-cap spring are needed. The rear spring requires the same outfit, except that the bolt should be 3¾ in. long. The model-A front spring, having a width of 1¾ in., uses a 3-in. bolt. The rear spring has a rebound clip, but the spring is nearly covered by the frame cross member, and

for this reason, it is impossible to substitute a longer bolt.—E. T. Gunderson, Jr., Humboldt, Iowa.

Novel Window Manikins

To emphasize a sign in a window display, some odd manikins were made from pipe cleaners. They are simple to make as they bend easily. Set before a dark background, they are quite noticeable. A single thumbtack over the foot of a vertical figure holds it nicely. Heads can be made from small corks.

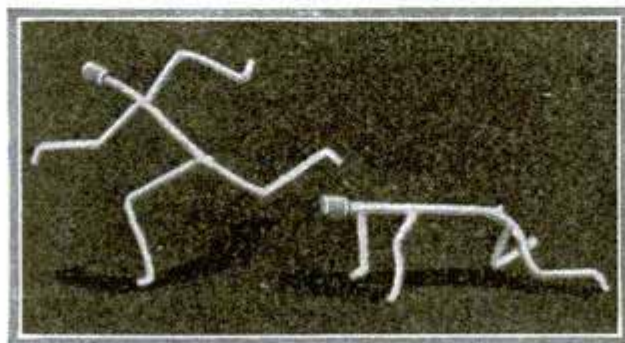

Small Manikins Made from Pipe Cleaners May Be Used for Changeable Window Display

Removing Dust from Inside of Violin

It is generally a quite difficult and tedious task to remove dust from the inside of a violin. A good method of doing this is to drop into the body a cupful of perfectly dry rice and shake the whole well. A rag should be held over the sound holes to prevent the rice from coming out during the shaking. You will be surprised how much dust can be removed in this way in a few seconds.—L. H. Georger, Buffalo, N. Y.

Handholds Facilitate Carrying Rowboat

Carrying a rowboat is usually an awkward task as there is no permanent equipment for lifting the boat. Of course, if it is turned upside down, it can be carried by two men, but a large boat may be too much of a load. Besides, it may not be desirable to turn the boat upside down. By providing the boat with oarlock pads having handholds as shown in the drawing, the task of carrying the boat will be

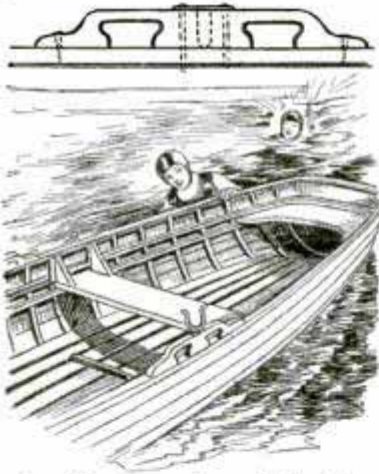

lightened considerably. Two holds are cut in each oarlock pad so that, when it is screwed down, there will be plenty of room for the hand to be inserted. The edges are nicely rounded. Four pairs of holds can be provided on a large rowboat to enable as many men to carry it at an even keel.—Newcomb Leonarde, Mystic, Conn.

Holder for the Basement Door

The illustration shows a cheap and easily made device for holding a cellar door open. It consists of a length of hoop or band iron, about 1 or 2 in. wide and long enough to be fastened to two joists, besides extending 6 or 8 in. beyond the door when it is swung open. Punch or drill two holes in the iron strip at points where it passes under the joists and attach it with nails or screws. Bend the free end of the



Spring-Metal Strip Nailed to Joists Holds Basement Door Open

strip to form a catch that will hold the door securely, yet not allow it to strike against the end of the strip as it is opened from the outside, but slide under the strip as indicated. The holder should be located as far from the hinges as possible.—C. D. Paterson, Worcester, Mass.

Splicing a Broken Shoestring

Instead of tying a knot in a broken shoestring when it has parted near the center and the ends are still in good condition, try splicing it as shown in the drawing. Anyone can do this, and the appearance of the repaired string will be much neater and less troublesome to lace than if the broken ends were knotted. First cut off the broken ends as in Fig. 1. Cross the two pieces to be joined and insert the tips into the cut ends. Then thread the tips through a small hole cut about $\frac{1}{2}$ in. from each end, as in Fig. 2. All that is left to do is to pull each end

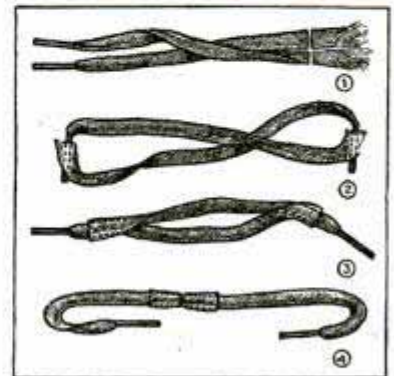

and the splice will look as shown in Figs. 3 and 4.—J. F. Goodman, Imlay City, Mich.

Handy Campfire Grate of Large Size Can Be Suspended Horizontally over the Fire, and When Folded, Takes Little Space among the Camping Equipment

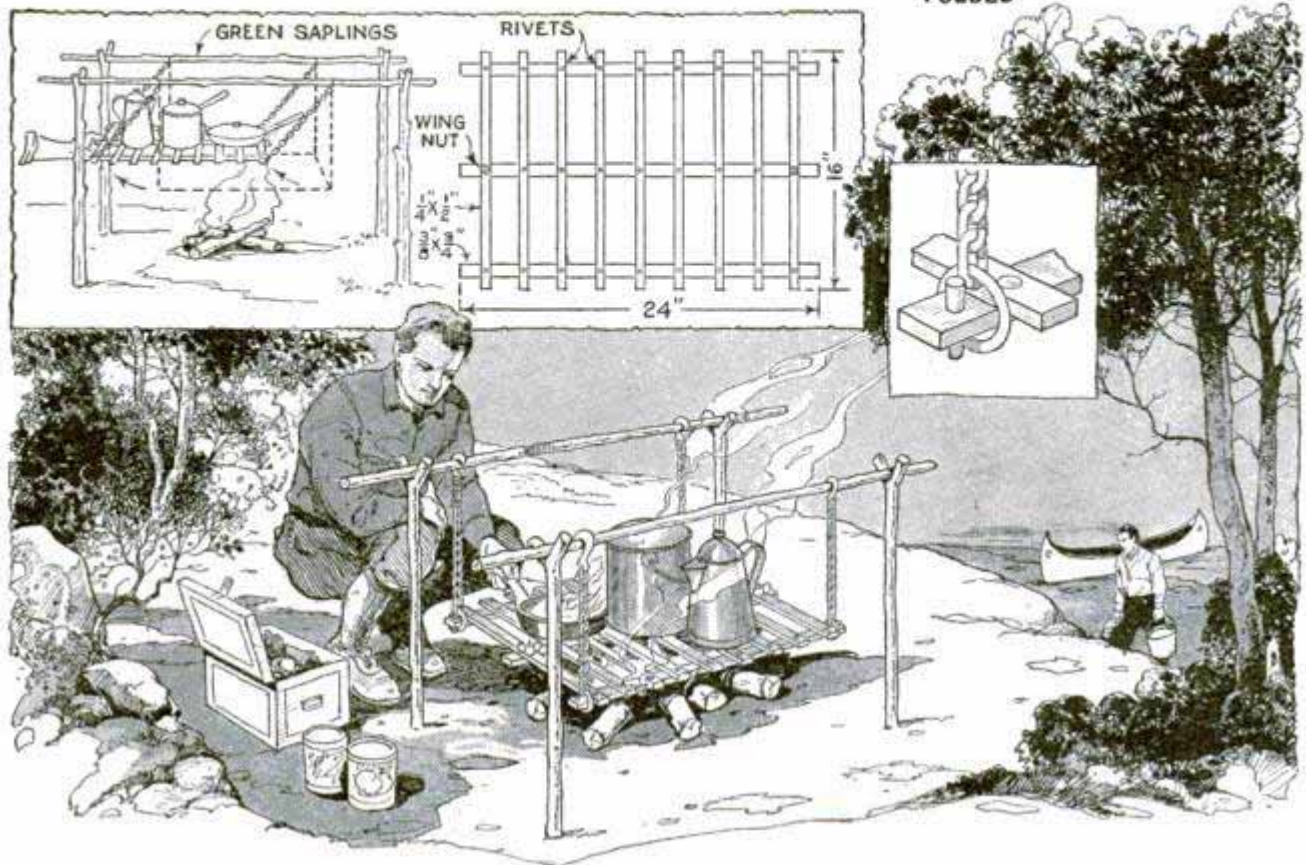

A Large Folding Campfire Grate

Many campers use a stove for cooking, but there are also many who get more "kick" from doing it over an open fire. To these, the large folding grate shown in the drawing will be a convenience. It is made from three 24-in. lengths of iron or cold-rolled steel bar, $\frac{3}{8}$ by $\frac{3}{4}$ in. in dimensions, to which are riveted, at equal intervals, nine 16-in. strips of $\frac{1}{4}$ by $\frac{1}{2}$ -in. stock. The rivets should be free enough to allow the grate to be folded. The end holes of the middle strip should be fitted with $\frac{1}{4}$ -in. bolts and wingnuts, which are tightened to make the grate rigid when in use. Four lengths of chain, provided with hooks at the ends, serve to suspend it over the fire, the chains being hooked to a suitable improvised framework made of wood. The chains are attached to the grate by slipping the end links over the ends of the bars and holding them in place with taper pins. No matter which way the grate is swung, it always remains horizontal and this prevents utensils from slipping off easily. When folded up as shown in the

upper detail, it takes very little space and can readily be carried along with the other camping equipment.

Clean-Out Plug for Sink Drain Is Simple and Efficient

The occupant of a cottage was greatly troubled by frequent clogging of the sink waste pipe, which had been run level for some distance, and hence required repeated visits of a plumber. To eliminate this trouble and expense, the owner drilled a hole in the vertical pipe and stopped the opening with a plug as shown. Whenever necessary, a wire can be passed into the horizontal pipe to loosen the obstruction so that it is easily washed away with water. The wooden plug was afterward replaced with a regular pipe plug, the hole being tapped to suit.

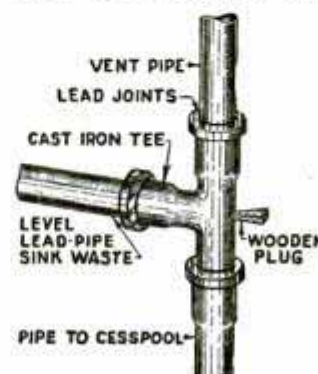

How to Detect Short Circuits in Toy Railroads

Sometimes the locomotive of miniature electric trains refuses to run. In such a case one should go about locating the trouble in a systematic way. Be sure that the battery or transformer switch is closed and determine whether the house-lighting circuit is in good condition by trying the lights. Test a storage battery with a hydrometer and dry cells with an ammeter. If the current flows as far as the tracks there may be a short circuit in a section of the latter. Test for this by touching one wire to an outside rail and one wire to the inside or middle rail. If a spark occurs, there is a short circuit; if not, the section is all right. Rail shorts are usually found in the clamps holding the third rail down to the ties. These may have cut through the insulation and caused a short with an outside rail. If so, bend up the clip, remove the old insulation and replace it with new, then bend down the clip again. The locomotive can be tested for short circuits by holding one wire on the shell of the machine and the other wire on one of the motor brushes.

A Sure-Catch Roach Trap



To make a good roach trap, get a small glass sirup or molasses pitcher, with the spout nearly level as shown in the drawing. It should be large enough to admit the big roaches. The cover of the pitcher has a lip which fits tightly down over the spout opening and must be turned aside when used as a trap, leaving the spout opening uncovered. Put some jelly, gravy or bits of fish in the bottom of the pitcher, and the roaches will find their way in through the open spout. They cannot get out, however, because they are unable to hold their bodies up while they attempt to get on the horizontal part of the spout from the inside.



Barbed Wire Is Hard to Unroll Single-Handed but Easy with This Rig

Unrolling Wire Single-Handed

All that is necessary to unroll a reel of wire single-handed is a good wheelbarrow, a broomstick or length of pipe and four 20-penny nails. These are driven into the sides of the wheelbarrow as shown in the drawing. The roll of wire is placed on the broomstick or pipe, which is then set across the sides of the barrow, between the nails. After the loose end of the wire on the roll is tacked or tied to a post, the wheelbarrow is pulled away from the post, which unrolls the wire without any trouble.—Joseph Enos, Brownsville, Oreg.

Cleaning Large Set Rings

It is often rather difficult to find some convenient and effective method of cleaning large set rings. An ordinary pipe cleaner can be used as indicated in the photo, and it will do the work without causing damage to set or mounting.



Chewing gum can be removed from different materials by soaking in turpentine.

Substitute for Broken Stove-Door Spring

When the spring of an oven door is broken, the door may drop unexpectedly,

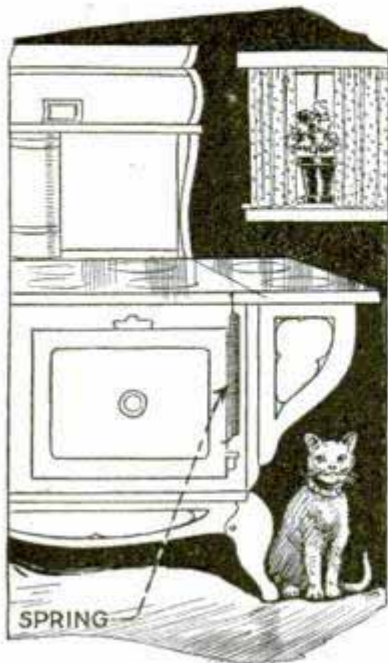

which means danger of breaking the hinges. A substitute for the spring can easily be provided. Drill a hole through the edge of the door about 2 in. from the hinge at the bottom, and drill another hole through the edge of the stove, as indicated.

Hook the ends of a coil spring of suitable length into these two holes.

Homemade Soft Soap and Its Use

A good soft soap for laundering can be made as follows: Dissolve $\frac{1}{2}$ lb. of sal soda in about 5 gal. of hot water and then add 20 bars of ordinary laundry soap. This will form a jellylike mass and, when it is cool, stir in 1 cupful of strong ammonia water, $\frac{1}{2}$ cupful of turpentine, $\frac{1}{2}$ cupful of kerosene, $\frac{1}{2}$ cupful of carbon tetrachloride, $\frac{1}{2}$ cupful of water glass, and 1 cupful of denatured alcohol. This mixture may be made in a boiler and kept stored in closed jars or crocks. Soak the clothes overnight in water to which the above mixture has been added in the proportion of 1 qt. to half a tubful of water. Hot water is best. The soap dissolves at once even in cold water, but its great value lies in saving the time needed to prepare the soaking solution for the clothes with ordinary soap. About 2 qt. of the mixture should be put into a crock, and collars, handkerchiefs, shirt sleeves and cuffs, and other very soiled pieces, are immersed in it. Set the crock in a tub, into which water is poured up to the edge of the crock. The next morning the contents of the crock should be emptied into the

washing machine, or tub, if washing is to be done by hand, and hot water added. Five minutes' washing will be sufficient. The water with the soap mixture in it will feel soft to the hands and will not injure the skin. Only extremely dirty pieces have to be rubbed, but after soaking in the strong soap mixture all night, only a little rubbing is necessary. The slight odor of turpentine will disappear if the clothes are rinsed in two waters, and the clothes will come out whiter than one would think possible with so little labor. In order to whiten clothes, such as workmen's shirts, that will not readily wash clean in this way, make up a mixture of equal parts of clear lime water, turpentine and kerosene and shake until creamy. Use a cupful of this mixture to a boilerful of water and boil the clothes for half an hour.

Anti-Rattlers for Auto-Hood Clips

Many makes of automobiles have no rubber anti-rattling devices on the handles that hold down the hood, and the spring clips used for the purpose often cause unpleasant rattling. The trouble can be eliminated by bolting short pieces of heavy rubber tubing or hose to the hood just under the spring handles, so that the rubber will bear with a slight pressure against the clips. The drawing shows how it was done in one make of

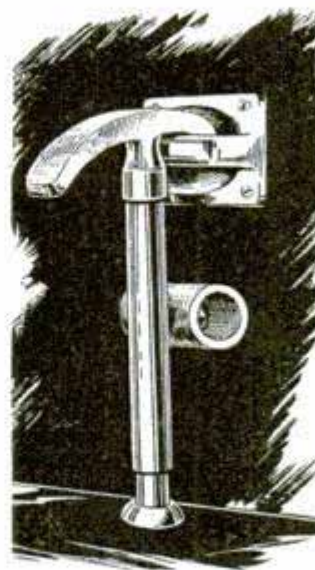

car. The same applies to practically any other make also. Four 1-in. lengths of heavy-walled rubber tubing, about $\frac{3}{4}$ in. in outside diameter, were used. They were fastened to the hood by means of 6-32 machine screws, 1 in. long. —Charles F. Felstead, Los Angeles, Calif.

☞ If a little turpentine is added to starch, it will prevent the iron from sticking to the goods.

SHOP NOTES



All Shop Notes published in 1927, in book form—Fifty Cents—from our Book Department

Attractive Wooden Trim for Cabinetwork

By CLAUDE WEST

WOODEN hinges, handles and escutcheons, worked out along artistic lines, are very pleasing as ornamental parts for cabinetwork, and afford an unlimited field for design. Such parts are especially attractive on pieces that otherwise are rather plain. Besides, they provide an excellent means of expressing individuality, and a touch of distinction may be given to a piece of furniture, which in every other way would be like innumerable others. With proper designing and finishing, pieces may be made to have an antique appearance, or at least suggestive enough of it to render them suitable to be used with period furniture. On the other hand, they may be designed and finished to suggest the most modern creation of the cabinetmaker's skill.

The cabinet shown in the photo, a semi-Priscilla design, is merely

used as an example, and no dimensions or details for its construction are given except for parts to be mentioned later, which are shown in Figs. 1 to 9. The hinges should be made of sound, straight-grained

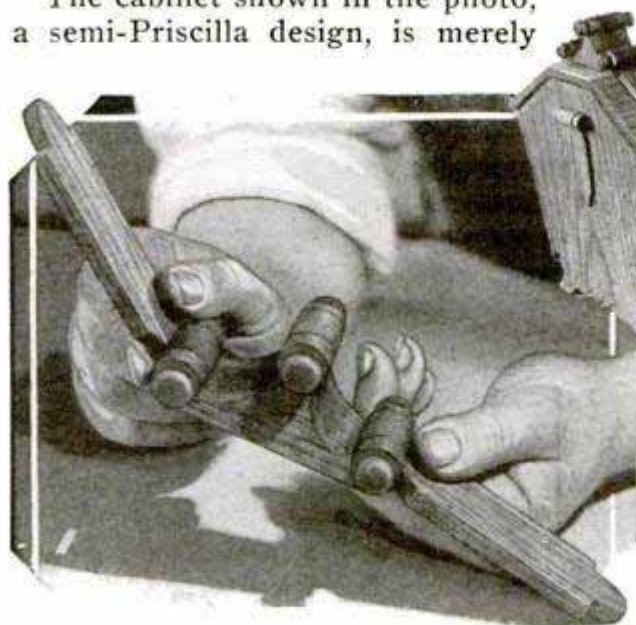

FIG. 2

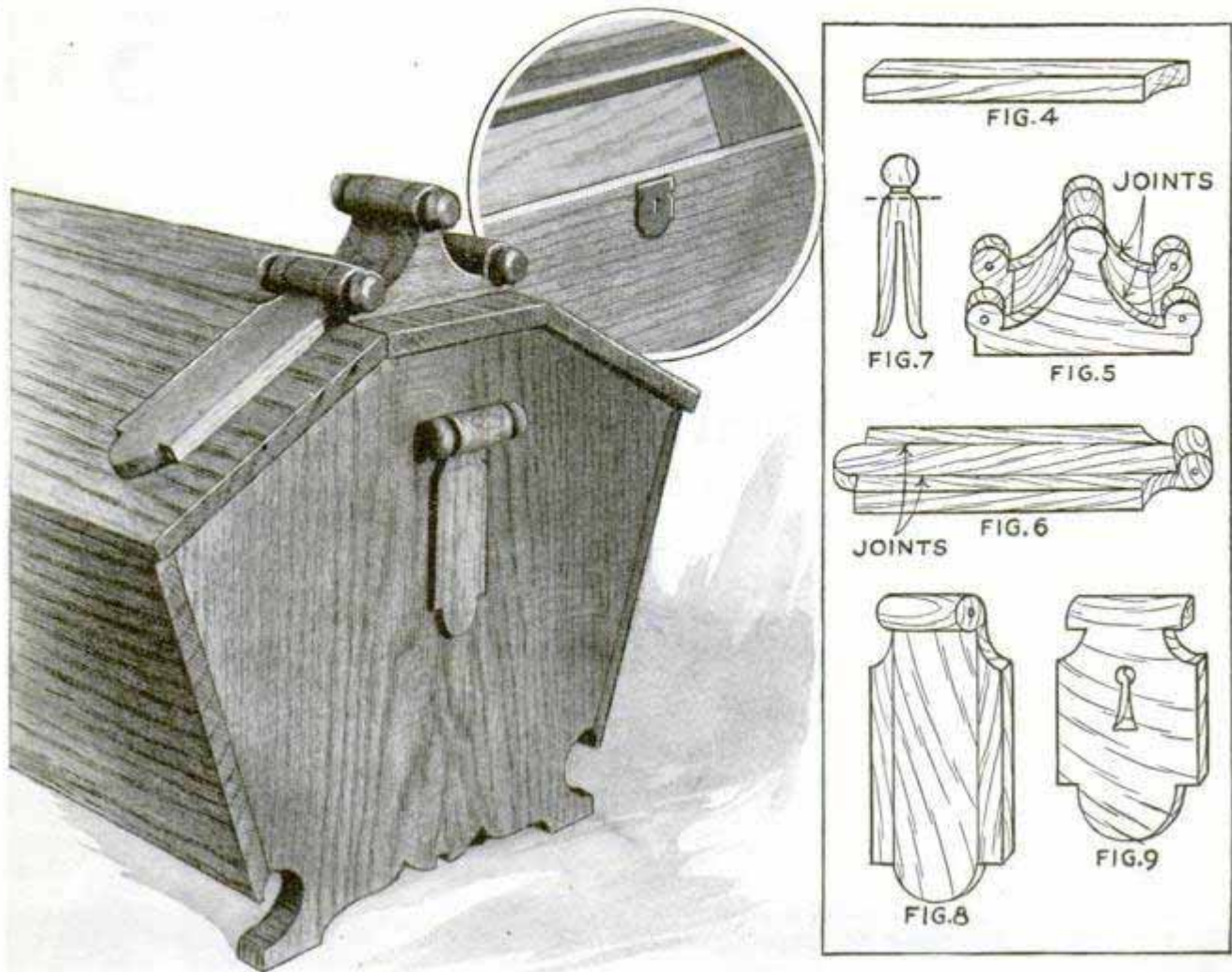

FIG. 1



FIG. 3

Ornamental Wooden Hinges of Many Designs Can Be Made by Cutting the Pieces Out with a Coping Saw and Gluing Them Together



Figs. 1 to 9 Show the Patterns for the Various Parts of the Fittings on the Box Shown in the Photos

hardwood and the handles and escutchions should match. In cases where it is possible to do the work on a bandsaw, the parts may be cut from solid stock of a thickness equal to the width of a hinge, and no gluing is necessary. However, as the work will be done by hand in most cases, the method illustrated shows how to cut out the pieces with a coping saw, and, as thinner stock must be used, the pieces will have to be glued together afterward. The drawings show a double hinge having one middle section and two end sections, each section being made of three pieces glued together. Pieces of the same thickness may be used so that their combined thickness equals the width of the hinge, but in this cabinet the middle piece is as thick as the outside pieces together. Fig. 1 gives a side view of these pieces of the middle section, two of them being required. The lines indicate the pattern laid out on the wood ready to be cut out. Fig. 2 shows the single center piece of the mid-

dle section, and Fig. 3 shows the center piece for the end section, two of these pieces being needed, one for each of the two sections. The material used for the latter should be of the same width as the material used for the piece shown in Fig. 2. Fig. 4 shows the outside pieces for the end sections, four pieces being required, two for each section. The material should be of the same thickness as that used for the piece shown in Fig. 1.

When the patterns have been laid out on the stock, as indicated by the lines, the cutting can be done with a coping saw. The stock should be long enough to be held down firmly on top of a bench or table, while the pattern being cut out projects over the edge to permit sawing. The saw should be held as nearly as possible at a right angle to the stock, so that the cutting will be done squarely, and the sawing must be done slowly and carefully, the pattern being followed just outside the lines. Any irregularities can

then be smoothed out later. When the pieces have been cut out, they should be glued together as shown in Figs. 5 and 6, the former showing the middle section and the latter the end sections. The gluing must be done with care, so as to be sure that each piece is exactly in its proper position. After the glue has set thoroughly, scrape off any surplus and work out all the irregularities with a wood rasp or with coarse sandpaper. Then drill the holes for the hinge pins, for which small nails with the heads cut off will serve. Put the hinges together and finish smoothing and sandpapering, using fine sandpaper. The knobs, which appear to be the heads of the hinge pins, are simply glued in place, the pins being cut slightly shorter than the width of the hinge, to prevent interference. The knobs used for the hinges shown in the photo were clothespin heads, cut off as indicated by the dotted line in Fig. 7. The handles in Fig. 8 are made up of three pieces, cut out according to the pattern shown in Fig. 3. After being glued up, they are cut out as shown in Fig. 8. The escutcheons are shown in Fig. 9. They should be made of stock about $\frac{1}{8}$ in. thick.

These examples are intended only as guides to the method of making up the pieces, and are capable of endless variation. The design, of course, should harmonize with the piece to which the trim is to be applied; therefore, in the cabinet illustrated, they are

rather plain. For more elaborate work, the trim can be scrollsawed, carved or decorated in any manner desired.

Chevrolet Inexpensive Farm Tractor for Light Work

The principal parts of the tractor shown in the photos are a Ford chassis and a light three-speed transmission. The front end of the extra transmission was milled to fit the rear end of the Ford universal joint, a piece was cut from the front end of the Ford drive shaft, and the remainder was milled to fit the rear end of the transmission. The rear spring was removed and the frame was bolted to the rear-axle housing. An extra rim was bolted to each wheel and the rear wheels were fitted with wooden lugs. A farm-implement seat was added and a few minor changes and additions were made, which made the cost of the completed tractor about \$17 besides the chassis, which the farmer had on hand. The two transmissions, working together, give this tractor a very wide range of power and speed, and it will pull a plow, harrow, pulverizer, roller or any other farm implement of about the same size.

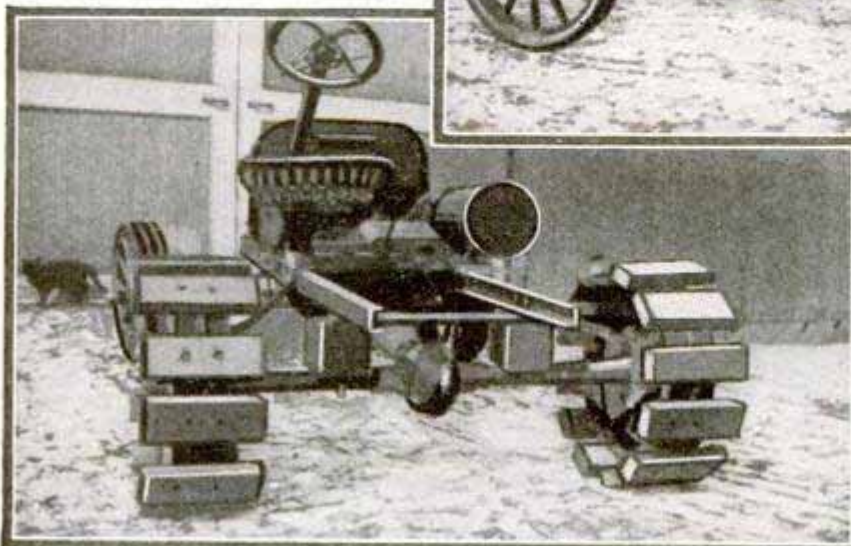

Two Views of a Light Farm Tractor, Consisting of a Ford Auto Chassis Equipped with an Extra Transmission of the Three-Speed Type; This Arrangement Gives a Wide Range of Power

By raising the rear end of the tractor, the large rear wheels may serve as pulleys in running belt machinery.—Leland A. Dye, Boston, N. Y.

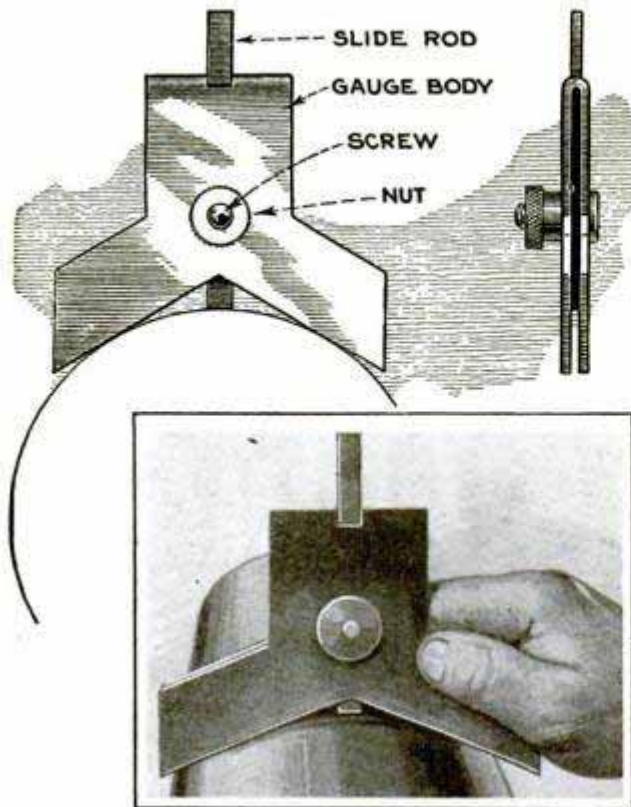

Handy Gauge for Duplicating Diameters Where Regular Calipers Cannot Be Used

Gauge for Duplicating Diameters Takes Place of Caliper

An unusual type of gauge that I have found handy on repair work is shown in the photo. It is not always possible to caliper a size when duplicating a piece, owing to obstructions caused by the piece being in place on a machine, or perhaps an auxiliary part fitted to it after it was turned. If I cannot get the calipers on a job, I use this gauge. It is made by bending a piece of sheet metal double and cutting it a V-shape on the contact end. A slot is then filed on the top to take a sliding rod, which is made of the same stock. A nut and screw, similar to those used on a depth gauge, complete it. For duplicating a diameter, the gauge is placed on the old piece and the slide rod is pressed down until it touches the surface; then the nut is tightened to hold

the rod immovable and the new piece is turned until the gauge fits it in the same way.—Harry Moore, Montreal, Can.

Cleaning Terra Cotta

In cleaning terra cotta the bureau of standards has found that sodium hydro-sulphite is effective and does not corrode the glaze. Fluo-silicic acid also cleans the material satisfactorily but attacks the glaze slightly. Trisodium phosphate is a good cleaner on standard finishes but unsatisfactory for glazed finishes. Soap powder cleans slowly and has a tendency to scour, thereby roughening the glazed surface, and hydrochloric acid, which is also a fair cleaner, has a slight corrosive effect on the glaze. Hydrofluoric acid should never be used on terra cotta.

Reading the Incubator Thermometer

Incubators are often located in places where darkness makes it almost impossible to read the thermometer without opening the machine and withdrawing the egg tray. As this is likely to chill the eggs, one poultryman devised a simple fixture by which the thermometer is held in place over the center of the egg tray, or can be swung into plain view against the glass at the front of the machine without opening the door. The holder consists of a stout wire, bent at right angles and inserted through a small hole in the top of the incubator. A loop at the end of the perpendicular arm rests on the top of the machine, and supports the bracket, so

Thermometer Read in Incubator with This Swinging Holder

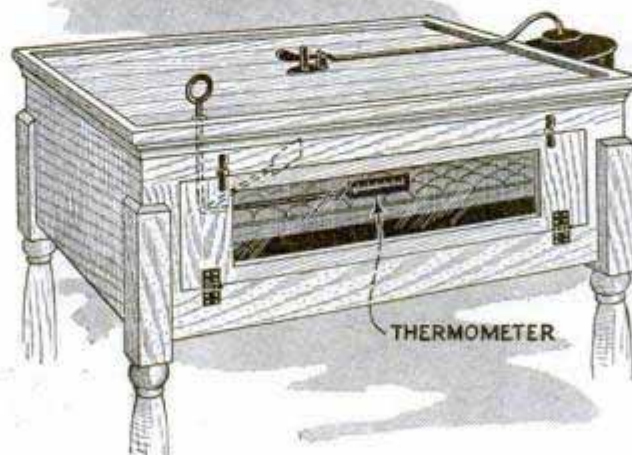

that the thermometer, attached at the end of the horizontal arm, is suspended at the proper distance above the eggs. Turning the loop at the top of the machine swings the thermometer against the glass of the door and after it has been read, it is swung back to its former position.—G. E. Hendrickson, Argyle, Wis.

Your Boy Will Like This Liner

By HI SIBLEY, 1954

*Brigden
Pasadena
Calif.*

THE toy-boat builder, having worked out ingenious designs in craft powered by clockwork, rubber bands and electric motors, will find a real steamer a fascinating novelty. Only a fraction of the countless ships that sail the seven seas are powered with anything besides steam, and a toy steamer affords a great thrill, for it has the action and sound of a full-size ship. There are no difficulties in making one, but if the young shipbuilder has a small upright steam engine among his toys, half the job is done.

Use white pine for the hull, which is made up of three pieces—bottom, main-hull block and deck. Lay out your outlines on the central block, which is 30 in. long, 6½ in. wide and 3 in. deep, and, after boring four holes at the corners of the hold, saw out the inside piece with a

the boiler. These can be bought at a very reasonable price; in fact, the engine used in the original of this model cost only eighty-five cents and is an exceptionally capable performer.

Set the engine amidships with quite a tilt aft so that the crankshaft will be nearly in line with the propeller-shaft position. Locate the engine, but do not fasten it. Now bore a hole through the stern just large enough to receive a brass tube of ⅜-in. inside diameter. This should line up with the center of the flywheel.

Cut a length of stiff brass wire for the propeller shaft and straighten it. The propeller can be cut from a tin-can lid or, better, a sheet of brass; solder it to the brass wire. Make two lead bearings, or plugs, for the ends of the propeller-shaft tube by pouring molten lead or babbitt,

the latter being preferable, into a hole bored in a block of wood having a nail, of the same diameter as the shaft, in the center. When cold, the nail is easily pulled out, leaving a hole for the pro-

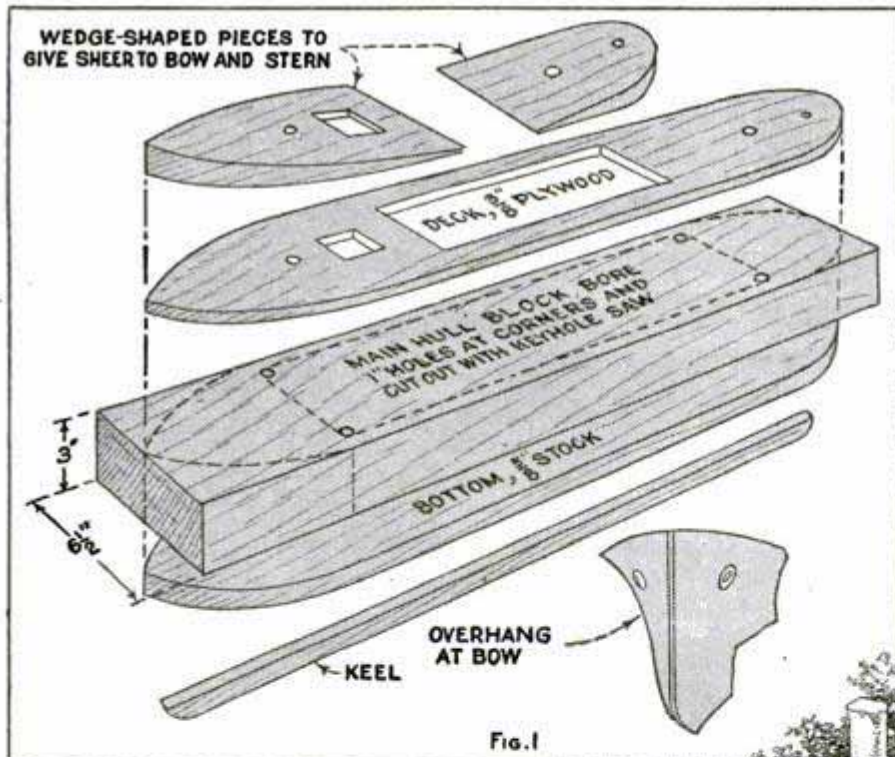

keyhole saw, and then cut away for the bow and stern, as indicated by the dotted lines in Fig. 1. Nail the ⅜-in. bottom board firmly to the main block, and you are ready to install your power plant.

The steam engine best adapted to this model is a small upright type, in which the crankshaft runs through the center of

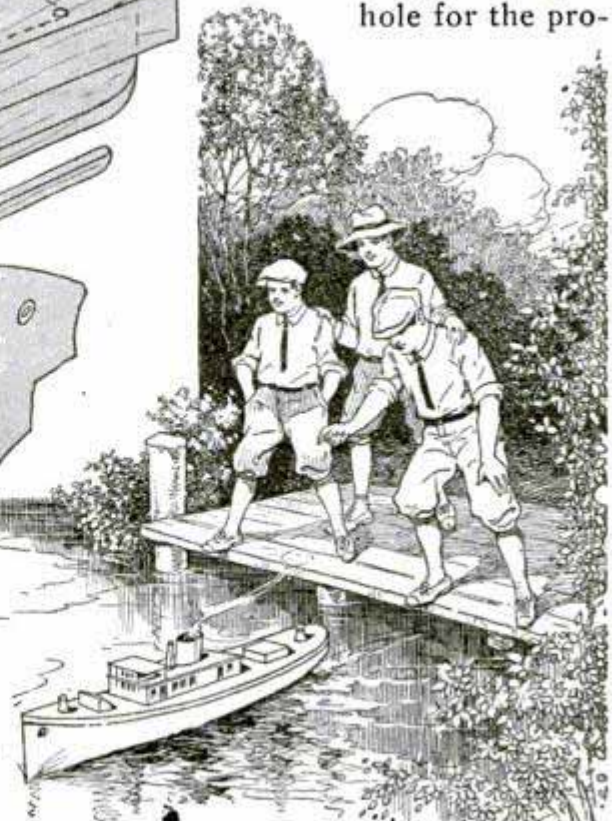

Any Toy Store - Marshall & Field

propeller shaft. File the plugs to a taper, so that they can be driven into the ends of the brass tube. The plug at the propeller end can be driven in permanently, but that at the other end should be loose enough to be taken out when assembling the various parts. Some sort of thrust washer, which may be a battery nut, for example, should be used between propeller and bearing.

It is almost impossible to line up an engine with a long propeller shaft accurately enough so that it will not bind, without using a universal joint. The latter, however, is simply made and permits the shaft to turn very freely at all times. Two brass or tin strips are cut, perforated and bent as shown, one for the flywheel and the other for the inner end of the propeller shaft. They are connected by means of a brass-wire "spider," shown in Fig. 2.

Most cheap steam engines have a lead

flywheel and hub, and the latter can be drilled a short depth to receive the small brass screw that holds the universal arm. A drop of solder will fasten it more securely. Having assembled your propeller shaft, bearings, etc., in the boat, you can solder the universal arm to the inner end of the shaft and insert the spider. When all turns freely, fasten the engine securely to the bottom of the boat with screws. At this point, you can test the boat out in the water, first having given the hull a coat of paint on the outside to prevent water soaking in. Also it would be well to set a tin shield around the engine, as high as the universal and open in front, so that the wood will not scorch.

Tin, lined with asbestos, such as is used in pipes for hot-air furnaces, is excellent material for this shield. Fasten the upper end of the propeller shaft tube to a notched crossbar so that it will not vibrate.

Assuming that your newly launched liner meets the "engineer's" specifications and expected performance, finish up with the deck and cabins. The main cabin, directly over the engine, is made of $\frac{3}{8}$ or $\frac{1}{4}$ -in. stuff, and lined with tin and asbestos. The roof is also of tin, asbestos-lined, with a large funnel soldered over the opening for the top of the engine. This funnel

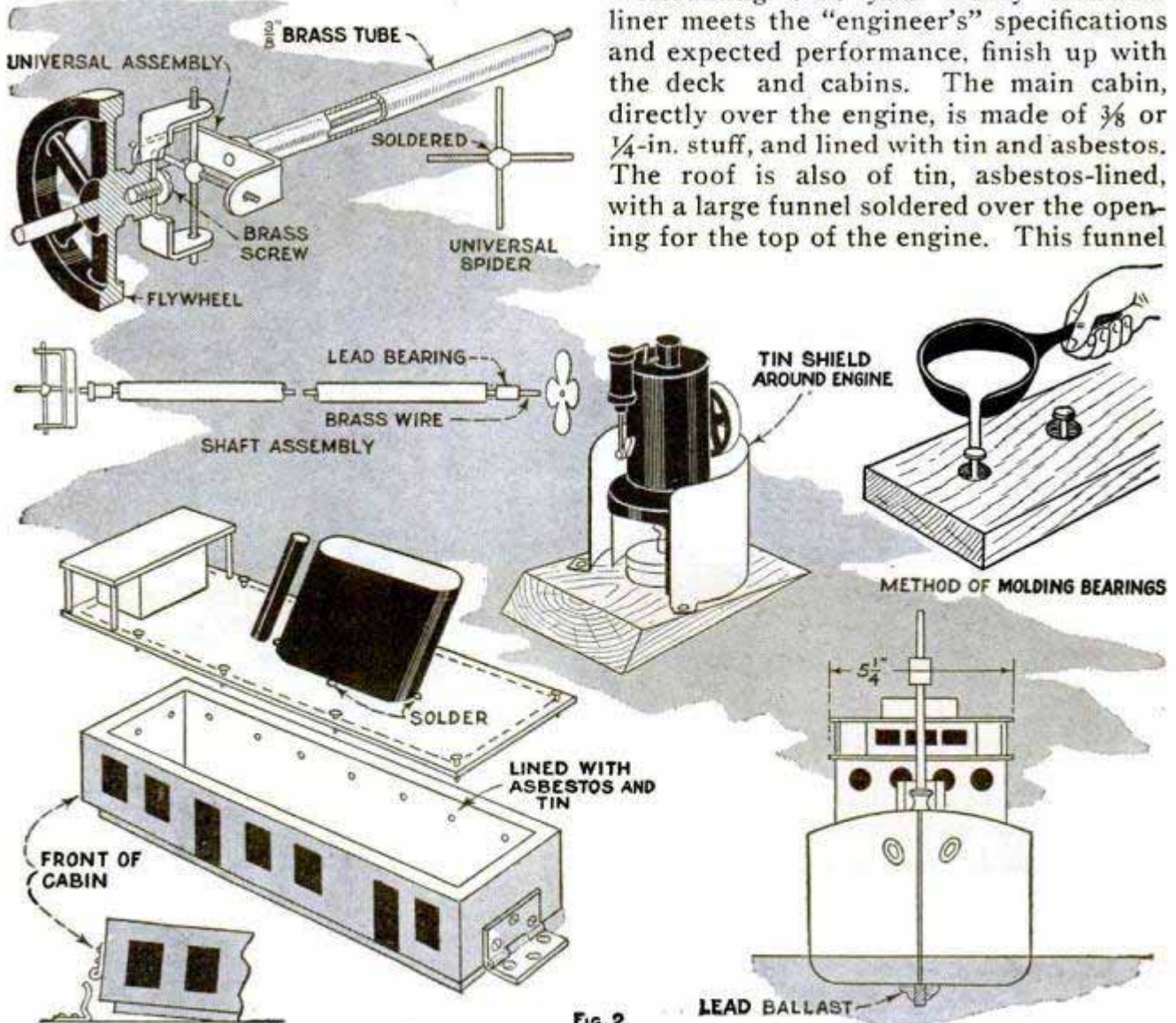

Fig. 2

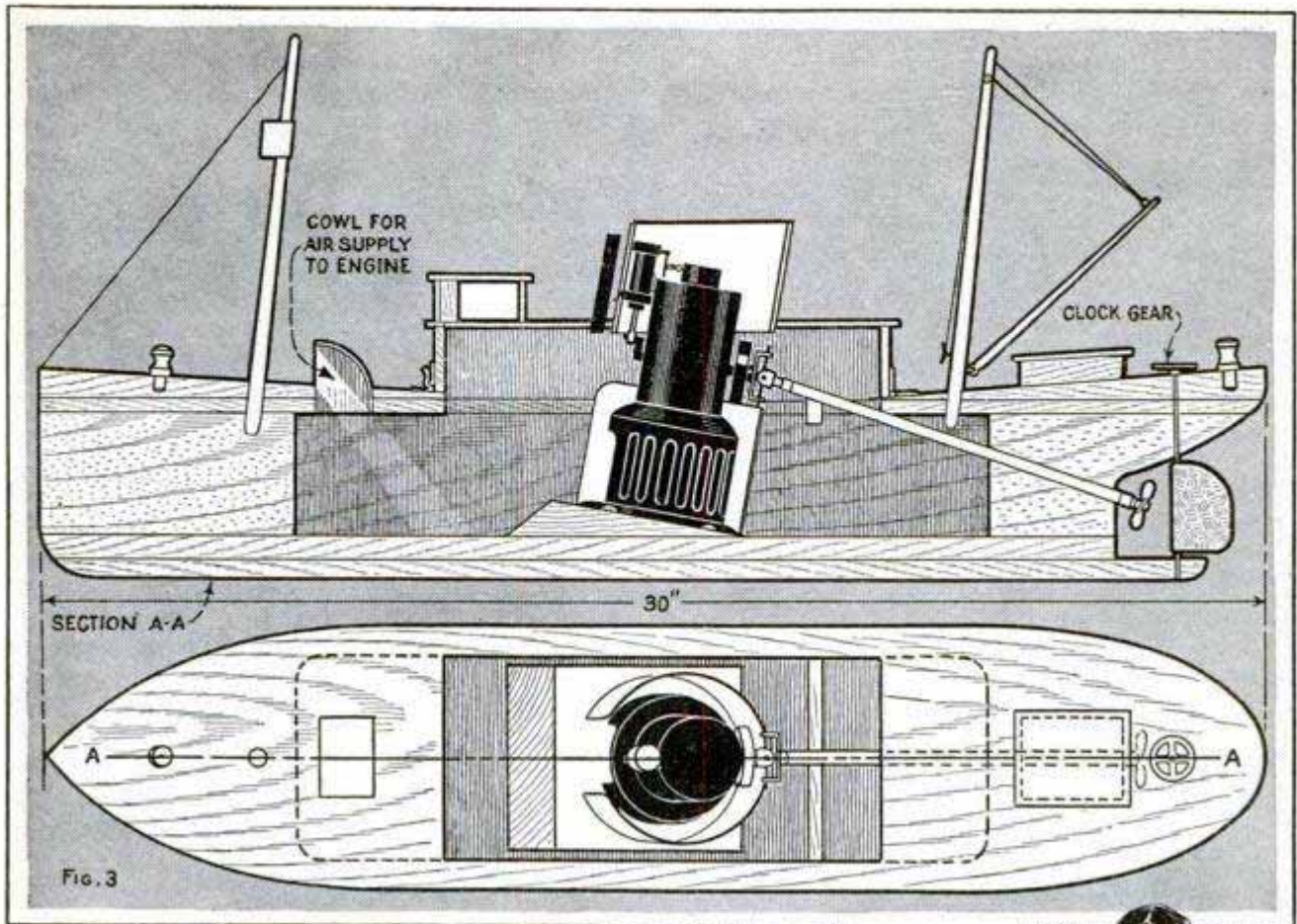

Fig. 3

must be of generous proportions, so that it can carry off the heat without danger of setting the boat on fire. The entire cabin is hinged at the back so that it may be tilted up when refueling or filling up the boiler. The catch at the front end can be made of tin or sheet brass. A solid block of wood will serve for the wheelhouse and also for the after cabin or hatch, which has no function except for appearance.

The rudder is of galvanized sheet iron or brass, with a large clock gear at the top of the rudder post for turning it. Masts, capstans, crow's-nest, etc., are made as indicated in Fig 3. An important item is the lead ballast, two triangular strips of lead, on the sides of the keel.

Paint the hull a bright red below the water line, black above, and deckhouses cream, with doors, windows and portholes outlined in green. Varnish the decks, and give the funnel a red band at the top.

Rubber Gasket for High Pressures

Even the best grades of sheet-rubber packing for use with high-pressure steam



work will sometimes blow out under pressures of 150 or 200 lb., while the cheaper grades are seldom satisfactory for pressures over 100 lb. But the latter can be used for high-pressure work if it is prepared in the following way: Cut out the gasket or washer in the usual way and give one side an application of fairly thick liquid shellac. Have ready some cuttings made by using a coarse rasp on a piece of babbitt. Lead raspings will do in most cases, but the babbitt is better. Sprinkle the raspings freely over the sticky surface. Install the gasket in the usual way and tighten well after the joint is heated up with steam. So prepared, a gasket will seldom leak, nor will it blow out any quicker than those made of the more expensive material.—James E. Noble, Toronto, Can.

Device Helps to Reline Brake Bands

When relining auto brake bands, the jig shown in the drawing will be found of

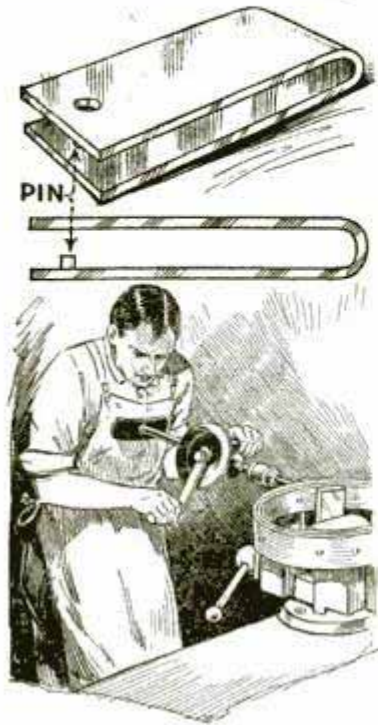

great assistance. It is made of $\frac{1}{4}$ by 2-in. flat-iron stock, bent double as shown. A small pin to fit the rivet holes in the bands is welded on as indicated, and a hole the size of the diameter of the pin, and exactly in line with it, is drilled in the opposite side of the jig. In use, the brake band and lining are held in the

jig, which is clamped in the vise. The hole in the jig guides the worker in drilling holes through the lining, the pin fitting in the hole of the band directly underneath.—A. C. Cole, Chicago, Ill.

Laying Out Angles Accurately

Dividing a circle into equal parts represented by degrees, and the further subdivision of these degrees into minutes, is a task that few mechanics accomplish accurately. However, here is a simple method of laying out angles by making use of the 18-hole and 27-hole index plates that are provided with a universal milling-machine dividing head. This method is based on the fact that 40 turns of the index crank are necessary to cause the work to make a complete revolution. Hence it is obvious that each turn advances the work an angle of 360 divided by 40 , or 9° . To subdivide this angle, use an index plate having a number of holes being an even multiple of nine. With an 18-hole plate a turn from one hole to the next represents $\frac{1}{2}^\circ$, or 30 min., and to the second 1° . By using the 27-hole plate, the movement from one hole to the next equals $\frac{1}{3}^\circ$, or 20 min. As an example, suppose you want to scratch two lines that

make an angle with each other of $20^\circ 20$ min. Proceed as follows: Set the work up in the dividing head and, with the 27-hole plate set on the index crankshaft, scribe a center line with the surface gauge. Two complete turns of the crank give 18° , and a turn equal to 7 times the distance from hole to hole (or 7 holes) is $\frac{7}{3}^\circ$, or $2^\circ 20$ min. By following this method, any angle can be laid out quickly and accurately. If you have to lay out an odd number of minutes, the following will be of help. It gives the number of minutes that a one-hole movement in the different standard index plates makes: 15-hole plate, 36 min.; 16-hole plate, 33.75 min.; 17-hole plate, 31.76 min.; 19-hole plate, 28.42 min.; 20-hole plate, 27.00 min.; 21-hole plate, 25.71 min.; 23-hole plate, 23.47 min.; 29-hole plate, 18.62 min.; 31-hole plate, 17.41 min.; 33-hole plate, 16.36 min.; 37-hole plate, 14.59 min.; 39-hole plate, 13.84 min.; 41-hole plate, 13.17 min.; 47-hole plate, 11.48 min., and 49-hole plate, 11.02 minutes.

Holder Prevents Soiling of Blueprints

A Wisconsin builder, noticing that his workmen soiled and eventually ruined many valuable blueprints, devised a simple

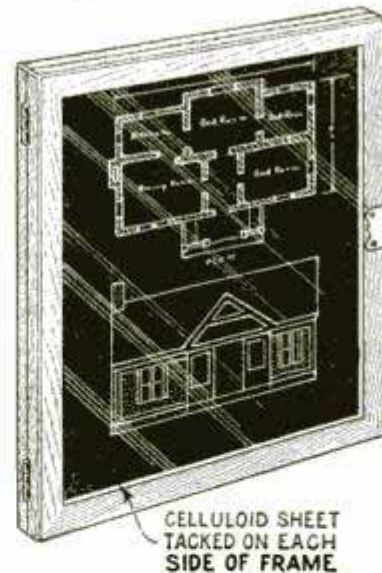

holder to protect them. It consists of two wood frames, hinged together and covered with celluloid sheets, obtained at a near-by auto-accessory store. The blueprints were inserted in the frame so that two

floor plans or two elevations were exposed to view at either side. A latch was provided to hold the frames together and facilitate the removal or replacement of the prints.—G. E. Hendrickson, Argyle, Wis.

☐ Stain putty to match the finish before applying it on high-grade work.

Prevention of Scale When Hardening Steel

One of the things to watch out for when hardening steel is the scale or oxide that forms on it. This is a matter for consideration when the piece must be true to size after hardening, because scraping off the scale usually makes it undersize. To avoid this, proceed as follows: Instead of placing the piece to be hardened in an open fire, as is usually done, put it in a container made from a length of pipe, threaded at each end for a cap or plug to shut out the air, and place the container in the fire. No scale can form because no air reaches the piece to be hardened. As a matter of fact, any sealed metal container can be used, depending on what is at hand. It is brought to the required heat in the usual way and quenched in water or brine.—James McIntyre, Hartford, Conn.

Counterboring Washers

Some washers, about $\frac{1}{8}$ in. thick, had to be thinned down to $\frac{1}{32}$ in. The only way to do this was by counterboring,

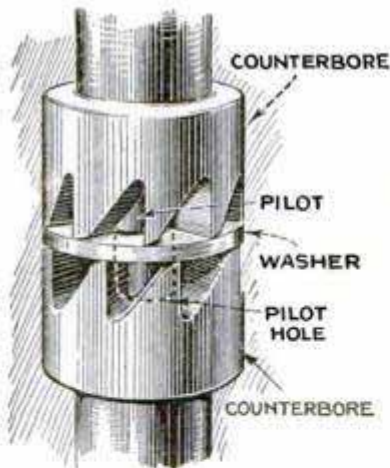

which involved the problem of holding the washers securely. I obtained duplicate counterbores and removed the pilot from one. This I held in a chuck bolted to the machine table. The one with the pilot still in place was held in the drill-press spindle. With this set-up I laid a washer on top of the pilotless counterbore, and brought the other one down until the pilot passed through the washer and into the pilot hole of the stationary counterbore. A glance at the set-up will show that one of the counterbores will cut. If the washer turns around with the moving counterbore, the stationary one will cut, and if the washer bites into the stationary counterbore, the moving one will cut.—Harry Moore, Hamilton, Can.

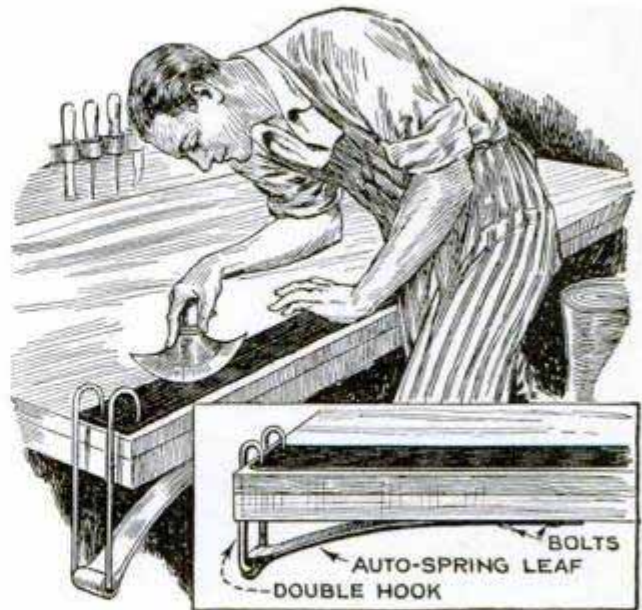

A Strong and Convenient Strap Holder Is a Timesaver for the Harness Repair Man

Clamp for the Harness Repair Man

Belt makers, harness repair men and other tradesmen who have to work with leather, rubber or fabric strips on a bench, will find the illustrated spring clamp very useful. The leaf of a discarded auto spring is bolted to the underside of the workbench at the end most convenient, and, through the eye of the spring, is fastened a double hook made from a length of $\frac{3}{8}$ -in. round steel with the ends sharpened. When splitting or trimming a belt or strap, it is placed flush with the end of the bench, as shown, the hooks being raised and then released to hold the strip securely at the far end, while the other is kept immovable by the left hand.

Handy Pocket Saw

Nearly every mechanical device used around the home seems to be assembled with screws.

When tightening or loosening them one is apt to spoil the slot in the head, but the slot can readily be deepened by means of a short piece of hacksaw blade. It will be found handy to keep such a piece on one's keyring.



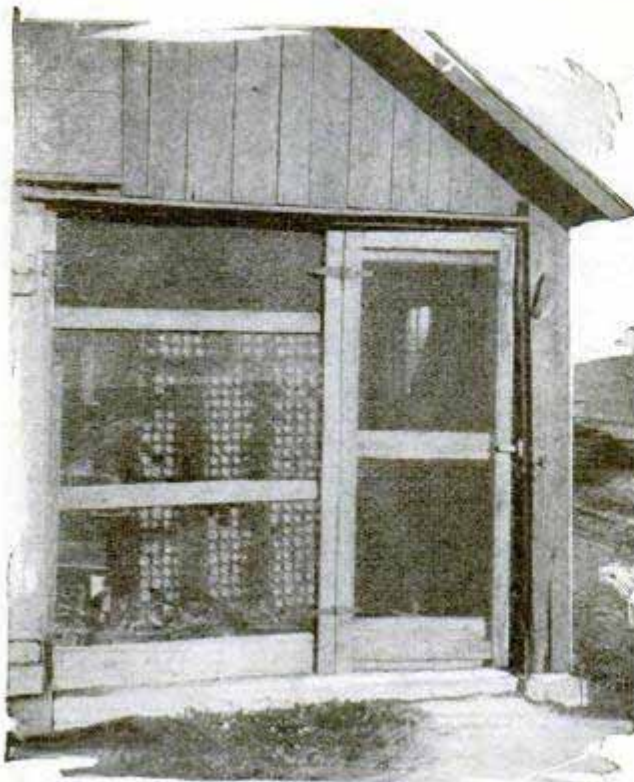

Wire Mesh, Replacing One Wall of Storage Shed for Seed Corn, Permits Proper Ventilation

Storage Shed for Seed Corn

Seed corn should have plenty of ventilation and also be adequately protected from chickens, mice and rats. A good storage shed which meets these requirements has been constructed by an Indiana farmer, and is shown in the accompanying photograph. The corn is held on a number of wooden racks near one end, the wall at this end of the shed being replaced with wire mesh. This permits plenty of air and sunlight. The foundation and floor are well fitted to prevent the entrance of rodents.—J. C. Allen, Lafayette, Ind.

Stop for Reaming with Drill Press

In the manufacture of certain interchangeable machine parts using a taper pin, difficulty was experienced in getting all the machine-reamed holes exactly the same depth. Various stops were tried on the drill-press spindle, but they always slipped and it took too long to set them up. Finally the operator hit upon the idea of drilling a hole of the correct depth in a parallel on which the piece was taper-reamed. The reamer cuts through the piece and the end comes against the bottom of the drilled hole in the parallel, which gives a positive stop. This method eliminates all worry about the reamer slid-

ing up into the chuck or the collar on the spindle slipping, and, of course, the time required for setting up is reduced to a minimum.—Arthur F. Parker, Philipsburg, Pennsylvania.

Tinning Cast Iron

To solder cast iron or fill a hole or crack in it is difficult, because the surface cannot be tinned readily. Grinding, filing or polishing does very little good, and a really satisfactory job of soldering is seldom obtained. However, a railroad shopman accidentally discovered that the surface could be effectively prepared for tinning by sandblasting. This method is especially adapted to the tinning of bearings that are to be babbitted. The sandblasting cuts away the carbon in the cast iron, but has little effect on the metal itself, except that it leaves it bright and clean. The solder clings to this clean surface almost as readily as it does to steel or tin plate. Sandblasting greatly assists in obtaining a good welding job with a gas torch. When tinning the sandblasted surface, regular soldering flux is used.—Avery E. Granville, LaGrange, Ill.

Milk-Can Rack for Auto Truck

One farmer who delivered milk to a neighboring town with a truck, was unable to load it with feed and other products on his return trip, because the empty cans, although light in weight, required all the space. To overcome this difficulty, the farmer built special racks on the sides of the truck to hold the empty cans, as shown in the photo. This left plenty of space for whatever extra load he wished to carry back home.



Racks Built on Sides of Auto Truck Hold Empty Milk Cans

Designing Radiator Furniture

By THOS. W. BENSON

THE USUAL steam or hot-water radiators are seldom things of beauty and when making furniture to improve their appearance, it is well to remember that the inclosure will influence the effectiveness of the heating system. Practically all the heat from the radiator is dissipated by convection, that is, by having the heat carried off by the air flowing over and through the radiator. Radiator inclosures sometimes increase, but too often decrease, the flow of air and thus lower the heating effect of the radiator.

In the accompanying illustration six general types of inclosures are shown diagrammatically. The following paragraphs

rate of flow and improves the heating. A change in proportions will usually result in reduced efficiency and the arrangement shown is possibly the best from the heating standpoint. Such an inclosure, on the other hand, does not prevent smudging of the wall and is not very decorative.

If screens are added, as in Fig. 2, with the opening B as in the previous case and A equal to R, the screens reduce the air flow and the arrangement is but 5 per cent better than the plain radiator.

In order to prevent smudging of the wall by dust carried up by the rising stream of warm air, it is necessary to use a solid top and discharge the warm air

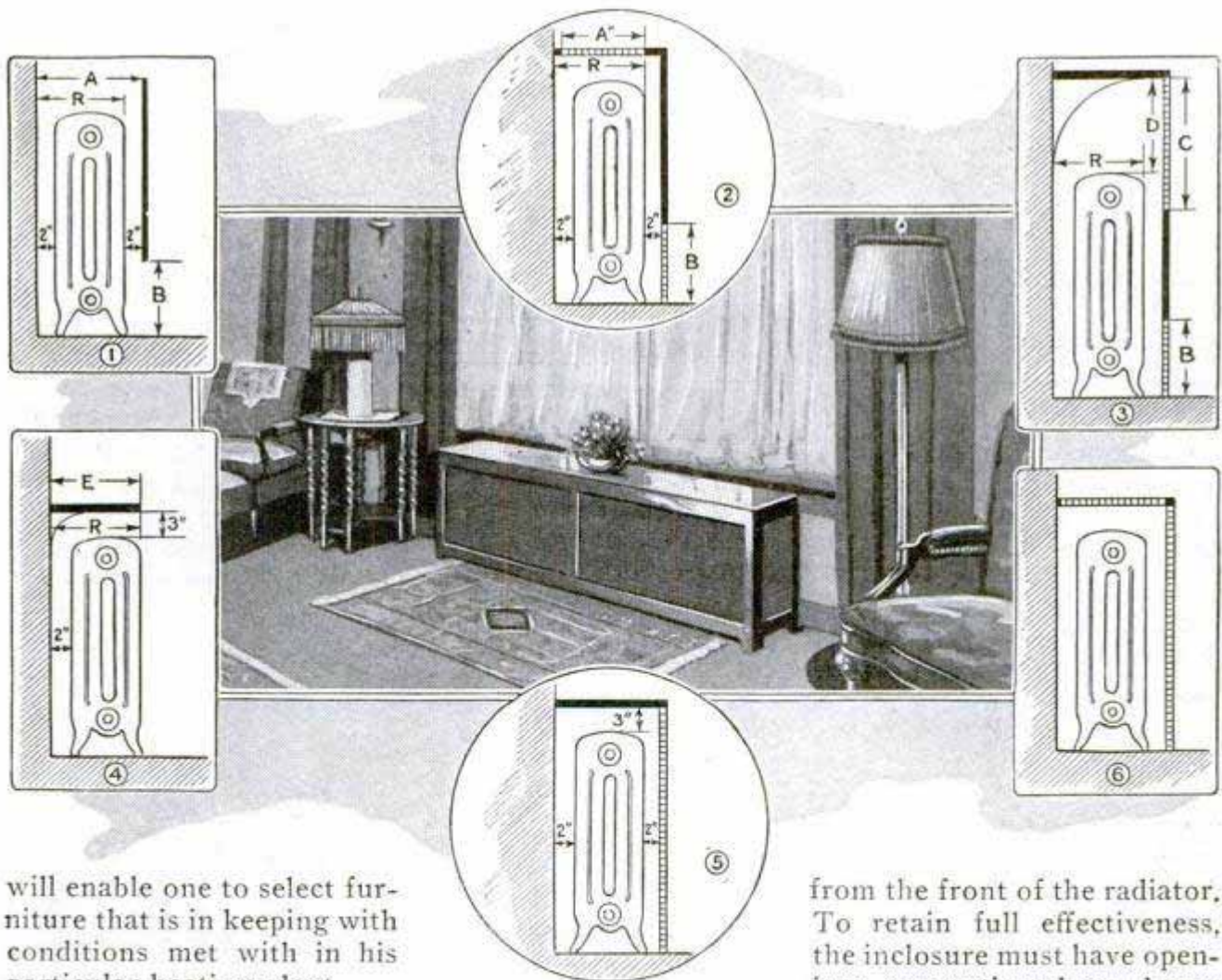

will enable one to select furniture that is in keeping with conditions met with in his particular heating plant.

In Fig. 1, when dimension B is equal to R, the radiator will be 10 per cent more effective than before. This is due to the solid screen forming a well-defined path for the air circulation, which increases the

from the front of the radiator. To retain full effectiveness, the inclosure must have openings proportioned as shown in Fig. 3, where D is equal to R and C is twice B. The structure is rather high but any lessening of the discharge opening will reduce the flow of warm air and the radiator becomes that much less effective.

The practice of mounting a shelf over a radiator for flowers or books, as in Fig. 4, is a very poor one, and affects heat radiation to a greater extent than would seem possible. When the width of the shelf E is but half of dimension A in Fig. 1, there is a drop of 10 per cent in heat radiation. When E equals A, the reduction is 20 per cent and, in extreme cases, where E is one and a half times A, the loss is 35 per cent. Putting a screen in front, as in Fig. 5, with the solid top E equal to A, results in a 30-per-cent loss, but an all-screen inclosure, as in Fig. 6, reduces the effectiveness only 5 per cent.

Summing up, it is apparent that any attempt to use a solid-top radiator inclosure,

except when it is arranged as in Fig. 3, will reduce the heat thrown off by the radiator. It is possible to disguise the radiator with open or screen-top inclosures, while still retaining heating efficiency, but the disadvantage of smudging the walls is still present. Loss of effectiveness of the radiators can be offset by carrying higher temperatures in hot-water systems and higher pressures in steam-heating systems, but the forcing of the heater leads to coal losses. Other alternatives are the use of larger radiators, or fans to circulate the air faster. It is for the individual to decide whether his heating plant will permit the use of radiator furniture, and these facts will aid in an intelligent decision.

Fitting Linoleum Snugly against Raised Concrete Border

Cutting linoleum to fit snugly against a raised concrete border is a task that re-

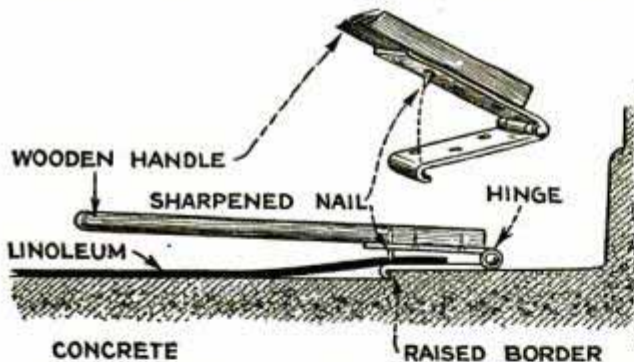

Device for Marking the Edges of Linoleum So That It Will Fit Snugly

quires considerable care, and the usual method of scribing is impractical in this particular case. The work is facilitated by the use of the simple tool shown in the illustration. It consists of a 4-in. strap hinge, screwed to a 12-ft. length of 1 by 2-in. board. The free portion of the hinge is bent over as indicated, and a sharpened nail or screw is driven into one of the holes in the other part, the point of the nail being directly over the bent edge and consequently directly in line with the edge of the raised border. In use, the loose leaf is fitted over the edge of the linoleum as shown, and the handle is depressed to make a punch mark, which indicates the exact point where the linoleum is to be cut to make a snug fit against the concrete border. The hinge is then slid along

the edge and the operation repeated at 1-ft. intervals, leaving a row of punch marks that serve as a guide in scribing the cutting line. This device eliminates the frequent shifting of the linoleum necessary when scribing in the usual way.—Mary Gleeson, San Francisco, Calif.

Turning a Large Pulley in a Small Lathe

We had a number of 16-in. pulleys to turn down on a 14-in. lathe, a job which seemed impossible at first thought. However, the illustrated set-up shows how the work was done. A mandrel, on which the pulley made a running fit so that it could be rotated, was mounted $1\frac{1}{4}$ in. off center, as indicated. A lathe dog was attached to the mandrel near the tailstock, the dog being large enough to project beyond the ways of the lathe bed in order to prevent the mandrel from turning. A bolt was fastened to the faceplate to serve as a dog for driving the pulley.—C. Kugler, Philadelphia, Pa.

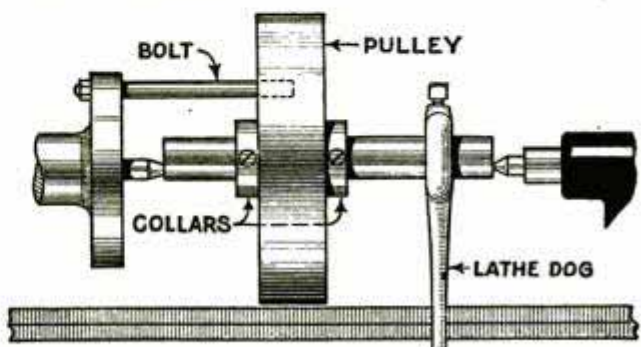

Set-Up Showing How a 16-In. Pulley Was Turned in a 14-In. Lathe

Sawdust Cakes for Kindling

Where a great deal of sawdust accumulates, as on the farm, good kindling cakes for the kitchen stove can be made as follows: Get a length of 3-in. tile and stand it on the fluted end on a smooth board. Make a plunger from a section of a small log and fit a handle to it on one end. Mix up sawdust with enough flour paste to make a crumbly but not too sticky mass. Throw some of this into the tile and tamp it down with the plunger. Then lift the tile off the cake and proceed to make another. When dry and hard, the cakes should be piled carefully in a dry place. One or two cakes will suffice to start the fire either by sprinkling with kerosene or placing them over lighted newspapers.—L. B. Robbins, Harwich, Mass.

How to Cut Duplicate Pieces on a Bandsaw

It is often necessary to cut out a number of duplicate pieces on a bandsaw. Sawing three or four at once means, of course, quite a timesaving, but the pieces must be

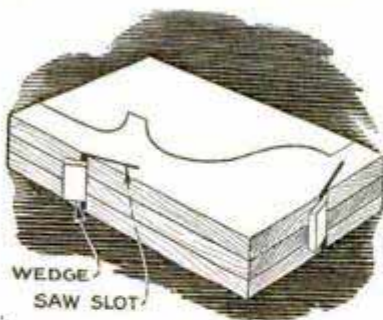

securely held together during the operation. An easy means to this end is to cut two or more tapered slots, about 1 in. deep, in two adjacent edges of the material as indicated and then drive a small wedge into each slot. The wedges will hold the pieces together firmly and prevent their slipping apart while the sawing is done.—Neil Nelson, Kansas City, Mo.

Aluminum castings may be ground on a disk grinder without filling the abrasive material, if a coat of paraffin is applied to the wheel.

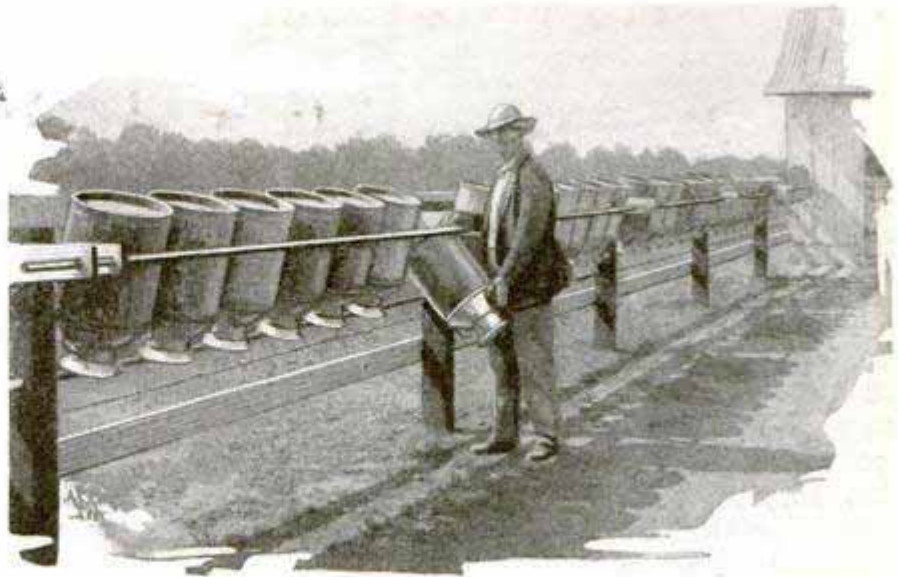

Rack Constructed from Lengths of Pipe Facilitates the Draining and Airing of Milk Cans

Rack for Draining Milk Cans

An Alabama farmer has constructed a simple rack for draining and airing milk cans. It consists of two lengths of iron pipe, arranged along a fence as shown. One of them is held securely in place by crosspieces, which are nailed to the posts and have holes drilled through them for the pipe. The other length of pipe is held in a similar way in holes drilled through the posts. The milk cans are set on the lower pipe, upside down, and lean against the upper pipe. To remove them the handle is grasped and the cans are dislodged from the lower pipe.—J. C. Allen, Lafayette, Ind.

Accurate Measuring of Keyways and Grooves

When cutting keyways and grooves in machine parts, a very simple method of measuring them accurately is to use a pair of steel wedges, or an adjustable parallel with which every shop man is familiar. Place the wedges in the groove and slide them together until they are tight in the groove, letting the ends project. Then, by using the micrometer on the outside of the wedges, a true size can be obtained.

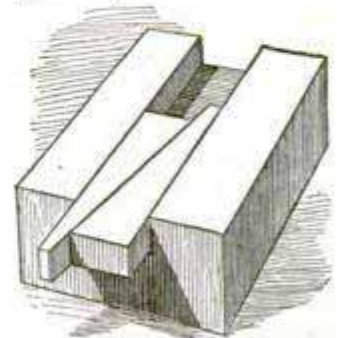

Washington
D.C.

How to Handle Brass Pipe

By HORACE G. WOODWARD

9th + 15th Sts N.W.

I AM "right handy with tools" and do a great deal of repair work about our place. When preparing to make a new service connection with the city water main, I decided to have all pipes carrying water for the house of brass. Before starting the job, however, I made some inquiries about brass pipe and to get "kinks" of knowledge about such jobs. I am passing on some of the main points which may be useful to others doing similar jobs.

It is necessary to remember that brass, being an easier metal to work, does not require the force that would be applied to iron pipe, either in the vise or the wrench, or the stock and dies. Working in standard iron-pipe-size brass pipe, it is desirable, for the vise, to split an iron-pipe coupling for such-size pipe with a hacksaw, lay a sheet of lead over each half and insert these on opposite sides of the brass pipe in the vise.

I was surprised to learn that threading may be done without any lubricant at all, but a characteristic squeak is then produced, which may be avoided by using soapy water or oil. The dies are the same as for iron pipe, but should have perfect teeth, and these in the best dies are shaped to advance in the work like a cultivator plow, lifting out the shaving. Experts say that the stock should not be jerked when cutting threads on brass pipe, but pulled with a steady movement in order to insure perfect threads, and I find this method gives fine results.

Another important thing in either brass or iron pipe is not to put too many deep

threads on the pipe; six or seven perfect threads are sufficient, and more will simply weaken the pipe beyond the joint. Fit-

tings should have a good reinforcing bead, and there is a fitting available that will extend upon the pipe beyond the perfect threads, giving great strength to the joint. The fittings should be of good quality brass, not iron.

Friction wrenches should be used on the pipe, and to turn elbows or tees, I use a monkey wrench, the jaws extending beside the part that projects sideways. A pipe wrench may be used on brass pipe, but has the same

objection as on galvanized-iron pipe, cutting the pipe excessively if not carefully handled. Pipe wrenches should not be used at all on fittings. Powdered rosin, applied to the faces of the vise clamps or the friction faces of the wrench, will overcome the tendency to slip on the pipe.

The amateur worker, and many plumbers, may not realize the importance of reaming both iron and brass pipe to remove the burr at the ends. I have used a round file for this purpose with satisfactory results. I have observed in 1/2-in. pipe a burr formed by a wheel cutter which reduced the capacity of the line fully one quarter. When pipe and fittings are accurately threaded no filling or dope is needed in the joints, but a paste of linseed oil and red lead is used by many plumbers to insure tight joints.

Brass pipe for laying in the ground should not be ordinary "yellow" brass, but annealed or otherwise suited to sustain settling strains.

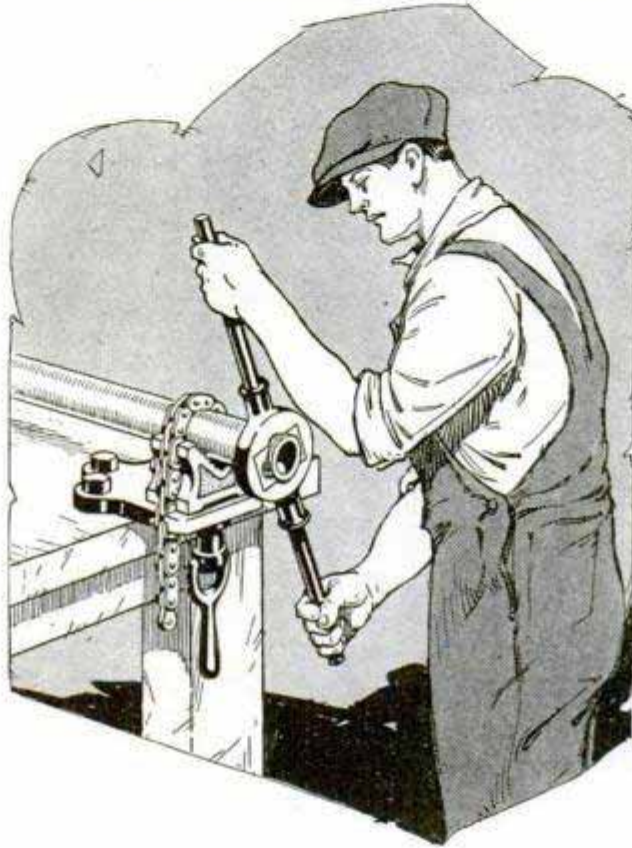

Cementing Tool Tangs in Handles

A quick-setting cement for anchoring the tangs of small tools in wood or fiber handles can be made from pure shellac. Buy the dry shellac and dissolve it in just enough alcohol to make a paste, which is then put in a tin dish or can and ignited. Immediately after the flame has died down, and before the shellac has a chance to cool and harden, fill the handles with the cement thus made, and drive in the tangs, which should be heated. When cool, the cement will be found to be very strong and practically waterproof.

Holding Small Steel Articles for Photographing

When small steel or iron articles are to be photographed without showing any support, a magnet can be used to hold them as shown in the drawings. Fig. 1 shows the general arrangement. The background is a sheet of cardboard which is held to the base by triangular pieces of wood at each side. Behind the background and close to it, a strong permanent magnet is supported by a wooden rod, to which it is fastened with a few turns of copper wire. If the object is set against the cardboard, the magnet will hold it securely. When one item has been photographed it is simply lifted off and the next one placed in position. In this manner a great deal of time can be saved and re-touching is reduced to a minimum because no support shows on the photo. A discarded magneto magnet is suitable for

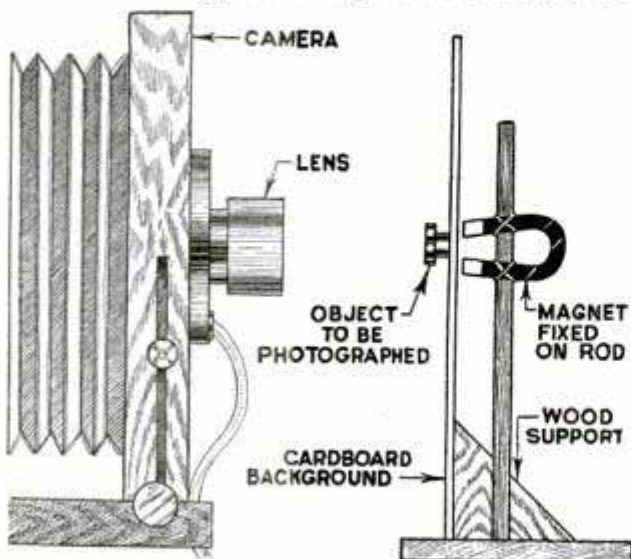

Permanent Magnet, Securely Supported on Rod, Holds Small Iron and Steel Objects for Photographing

this purpose and, for very heavy objects, several magnets may be placed side by side, or a small electromagnet may be used instead. The current is taken from

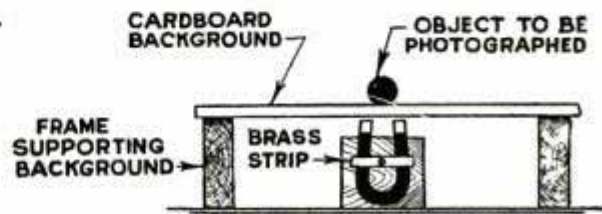
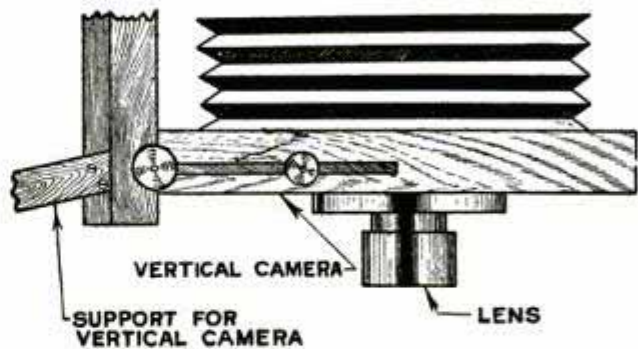

Spherical and Other Irregularly Shaped Pieces Can Be Held Securely on Flat Surfaces

a few dry cells, and as the current is only used for short periods of time, the batteries will last very long. Even with a vertical camera, a magnet support is sometimes valuable, especially if the object is irregular in shape or spherical, so that it may roll about or tip over during the process of photographing, particularly if some machinery is working close by, as in factories. The arrangement in this case is shown in Fig. 2. The magnet can be held by a block of wood, a strip of brass and a wood screw being used to fasten it to the block. Do not use a steel strip for this purpose as it will short-circuit the magnet.

This method is not confined to steel or iron objects. Many other articles can be held as suggested if a short iron pin can be inserted in them. For instance, if a smoker's pipe is to be photographed, an iron pin may be placed in the bore. The magnet will attract this and the object will cling to the background exactly like a solid steel body.—C. A. Oldroyd, Barrow-in-Furness, Lancs., England.

☛ When the drawers in a chest, cabinet, or other storage place for tools, stick or are hard to pull, apply a little grease along the sides and other bearing surfaces.

Kinks on Accurate Drilling

I have been using a few kinks in laying out jig work for the drill press with great

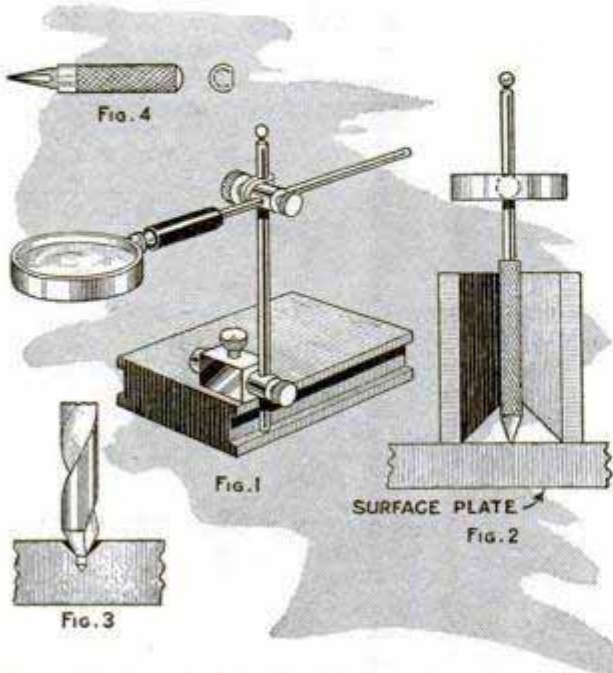

Sharp Tools and the Application of a Few Handy Kinks Will Help in Drilling Accurate Holes

success. A large magnifying glass, held by a clamp so that the worker's hands are free, is better than a small one. One method of holding the glass is shown in Fig. 1. It can be set to any angle. If no precision center punch is available, the surface gauge or a V-block can be used as in Fig. 2. This keeps the punch at right angles to the work. A flat scribe of the kind shown in Fig. 4 should be used, as a round one sometimes causes inaccurate work. The punch should be accurately ground to a sharp point, which will facilitate marking the work at the intersection of two lines. Use a center combination drill of a diameter smaller than that of the center-punch mark, and make the angle sharper. For instance, if the center punch has an angle of 60° , that of the drill should be about 70° . Then follow this up with a drill like the one shown in Fig. 3. This has a tendency to make the drill follow the hole. If dividers are used, keep them sharp at all times. Whenever possible, use a scale graduated in fiftieths or hundredths of an inch, because the lines on these scales are finer than those on more coarsely graduated rules. Such fine graduations enable you to set your dividers more accurately. If you are not sure of

the accuracy of a layout, drill small holes, that is, smaller than the finished size, insert the drill rod of the correct size and measure over all with a micrometer. If there is any error, use a round file to enlarge the holes so that the next-size drill corrects the error. I have found that it pays to blue the work, even though it costs more than rubbing bluestone on it, as this enables you to see the lines more clearly. If the above rules are strictly followed, and the tools are kept in good condition, no trouble will be experienced in drilling holes within limits from .003 to .005-in. center-to-center distance.—Charles Kugler, Philadelphia, Pa.

Spotting Wall Studs

The drawing shows how a carpenter's hammer may be used to space off for locating points in baseboards, hook strips, chair rails, etc., at which to nail them to the wall studs through the plaster. After finding one stud, by sounding or other methods, place the driving face of the hammer at this point and roll it forward over the claws, until the end of the handle strikes the surface of the board. The end has previously been scored, as shown, so that the mark comes exactly in line with the next stud, 16 in. from the first. This

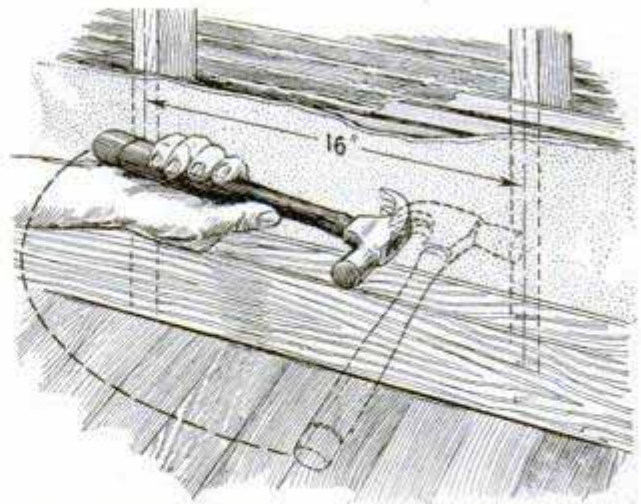

Marked Hammer Handle Enables Quick Measurement for Stud Nails in Baseboards and the Like

is an accurate and quicker method than sounding for each nail or using a rule.

Crude petroleum oil, diluted with gasoline, makes a good brown wood stain, resembling dark-oak finish.

975
2101 Blausdell Ave
Minneapolis, Minn

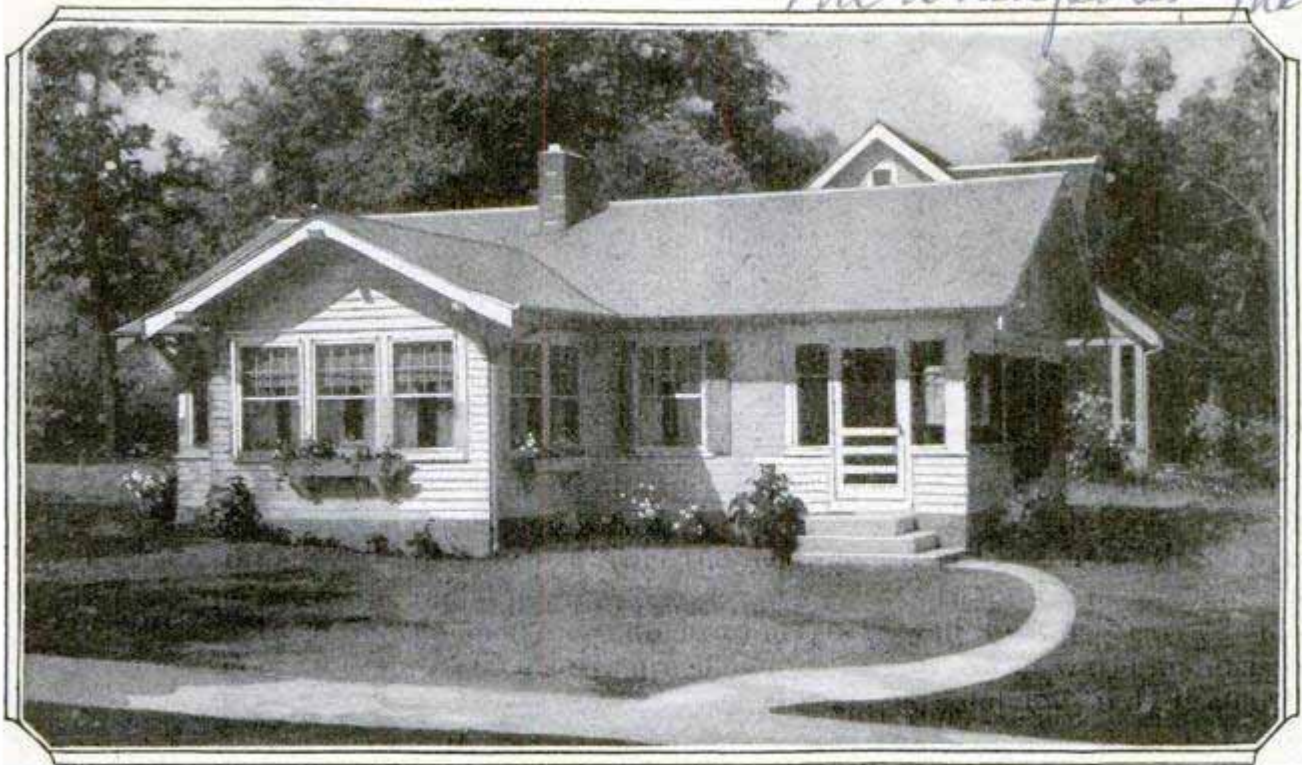

© POPULAR MECHANICS MAGAZINE

PLAN 61-L.F.

A House Complete for \$2500⁰⁰

NOW you can build that home and buy that car. If you are undecided which to spend your savings on, the following idea may suggest how to have both and without pinching your pocketbook for years to come.

Why not build a little house? Yes, a very little house. Equip it as efficiently as a modern city flat. Build only enough house to give you comfortable shelter, style and convenience. But don't doll it up to look like a miniature mansion. Dolling up costs money. Keep it simple. Remember that above everything else it must be a timesaver. You will need that time to drive your new car.

You would be willing to build such a house if it did not place a yoke of indebtedness around your neck for years to come. All right. Then study this plan and read the story of how the owner built this house complete for \$2,500.

It started out as a lake cottage on the outskirts of a

big city. The owner liked it so well, he decided to live in the house all year round. And in a climate where the winters are cold. Motoring to and from the city was a matter of only ten miles. What is ten miles when you can save on taxes, building costs, upkeep and at the same time enjoy the health, happiness and blessings of the countryside?

Here is how he did it: Partially excavated the cellar. Used a small hot-air furnace which keeps the house comfy in all kinds of weather. Fully insulated the floors, sidewalls and ceiling to make the house warmer in winter and cooler in summer. Used wallboard as an interior finish.

In every other respect the house is of standard construction: Frame with shingle roof, either wood or composition; siding exterior. The house would look well with shingled sidewalls. Or it might be stuccoed.

Now study the plan and see how

A NEW SERVICE

To help our readers get started on one of life's most glorious experiences—building and owning a home—Popular Mechanics Magazine will supply readers a one-sheet blueprint of the house here illustrated for \$2. This blueprint does away with the necessity of first purchasing a complete set of plans to find out whether you can afford to build. It contains floor plans, elevations, a section, detail, size of joists, studs, etc., and also a brief specification. Submit it to tradesmen and dealers for building estimates.

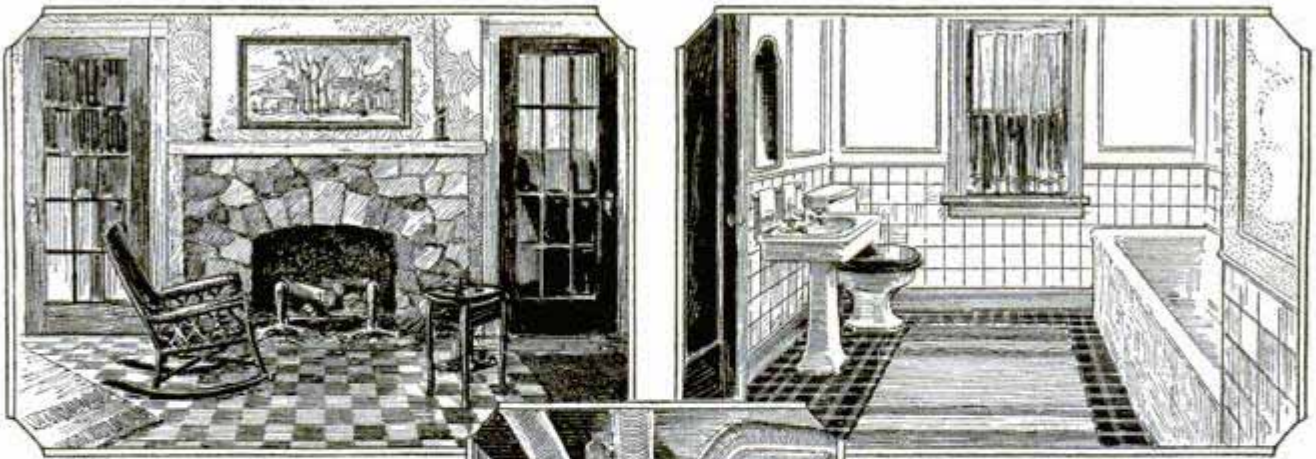

efficiently it works out to save time, space, labor and money. There's a large, inviting living room with stone or brick fireplace. A dining porch opens off the kitchen and living room. This, too, can be used for living purposes or even sleeping quarters in an emergency. A compact kitchen, fully equipped with cupboard space, a rear porch, a well-fitted bathroom and one bedroom complete the equipment.

While there is only one main bedroom, a closet or concealed bed opens into the living room from the closet beside the fireplace. This adds extra sleeping accommodations and saves the cost of another bedroom—a saving, according to builders, of between \$500 and \$1,000. A broad screened porch stretches across the entire front of the house. You may want to glaze this in for permanent living quarters.

Further savings were made by making space and materials do double duty. Wall-

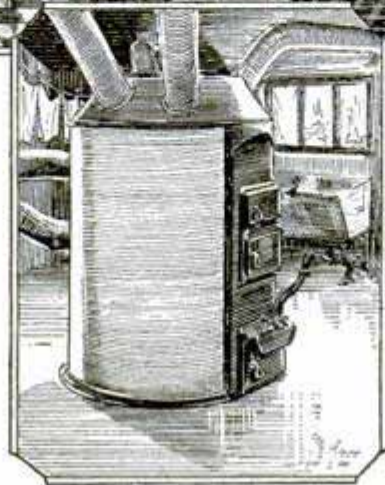

board replaced lath and plaster. A closet bed did away with a second bedroom. Partial cellar excavation saved a tidy sum.

This house may have started out as a summer cottage. It finished, however, as a mighty comfortable all-year dwelling. Savings were made without

sacrificing any of the comforts of the family, and there was enough cash left for the purchase of a more up-to-date automobile.

The cost of building this house obviously will depend upon how thoroughly you equip it, where you build, and what materials you select for it. If you are trying to make your dollars do double duty—provide a home and a better car at the same time—it's worth while to investigate this idea of making space also do double duty. It is one of the easiest and surest ways of accom-

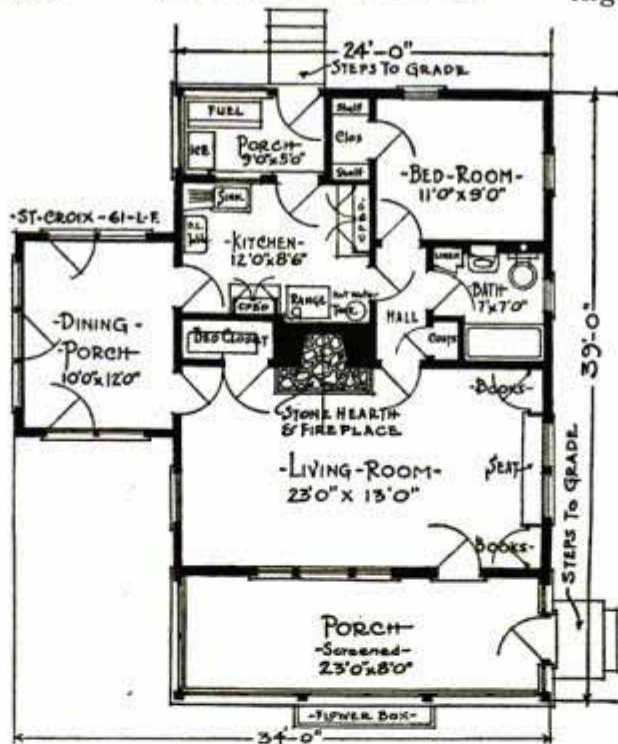

EDITOR'S NOTE: Popular Mechanics Magazine has prepared a new plan book, "Twenty Popular Low Cost Homes and Ten Commandments for Home Builders." These are selected homes and show labor, space and time-saving ideas. They are \$5,000 homes and less. Send 10 cents in stamps to cover postage. Address Building Editor.

plishing that desirable purpose by keeping down costs.

Handle goes back —but drill advances

For accuracy and speed, use "Yankee" Ratchet Breast Drill No. 1555.

This tool lets you "feel" your work, control it, know what you are doing all the time.

In tight places, "Yankee" DOUBLE Ratchet drives the drill *continuously*, on any forward - and - back movement of crank. No need to take down construction. No loss of time.

Five "Yankee" Ratchet adjustments and two speeds, make this the handiest and fastest breast drill ever designed. Speed changes made at finger touch, without removing drill from work.

No. 1555 (illustrated)—3-jaw; ½-in. Double speed. Length 17 in. No. 555—2-jaw; ½-in. Price, \$11.00.

No. 1545 Hand Drill—3-jaw; ¾-in. Double speed. Length 16 in. No. 545—2-jaw; ¾-in. Price, \$10.00.

No. 1530 Hand Drill—3-jaw; ¼-in. Single speed. Length only 10½ inches, but has same five ratchet adjustments as large drills. Price \$5.25.

"YANKEE" No. 1555

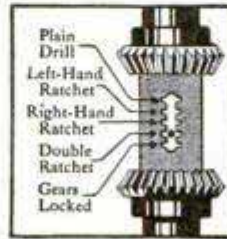

Five Ratchet Adjustments

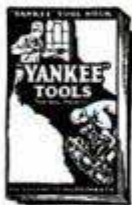

"Yankee"
Tool Book
FREE

Broken stud in valve cover, in close quarters, is drilled out with "Yankee" No. 1555 by a slight forward-and-back movement of crank.

"Yankee" Breast and Hand Drills are made in eighteen styles, ranging from \$3.00 up. All are shown, along with many other ingenious tools, in the "Yankee" Tool Book, sent free.

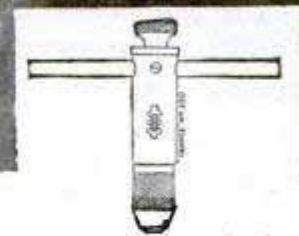

Tap the hole with the "Yankee" Tap Wrench, No. 250. Ratchet adjustments and sliding crossbar make awkward jobs easy. Price, \$1.85.

NORTH BROS..MFG. Co., Philadelphia, U. S. A.

"YANKEE" on the tool you buy
means the utmost in quality, efficiency and durability

MAKE THEM YOURSELF

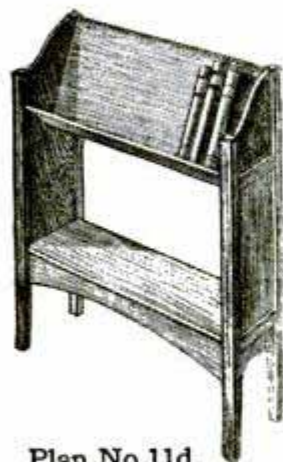

Plan No. 11d

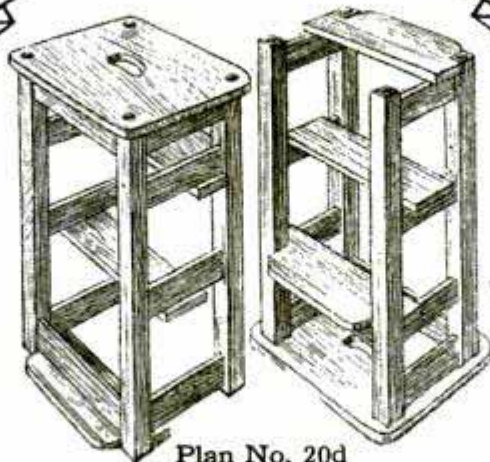

Plan No. 20d

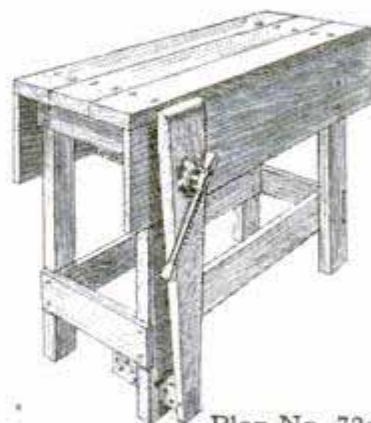

Plan No. 72d

Why envy men who "make things"?

Stanley Plans make woodworking easy—10¢ each

WHY not enjoy the best hobby of them all—the hobby of "making things?" The cost is little. The reward in pleasure and pride in your work is beyond reckoning. Now the simple Stanley Plans make good woodworking easy for *anyone*.

There are 25 different Stanley Plans. The list is shown in the center of this page. Each plan, covering every step, tells you just how to make the object—how to select and cut the wood, how to assemble the job, how to

- No.
- 1d—Book Rack
- 2d—Candle Stick
- 3d—Pipe Rack
- 4d—Flower Box
- 5d—Table Lamp
- 6d—Toy Automobile
- 7d—Sconce
- 8d—Dinner Gong
- 9d—Bird Houses
- 10d—Dog House
- 11d—Book Stand
- 12d—Smoking Cabinet
- 13d—Kitchen Cabinet
- 14d—Sewing Cabinet
- 15d—Cedar Chest
- 16d—End Table
- 17d—Tea Wagon
- 18d—Model Sailboat
- 19d—Combination Sail- and Row-boat
- 20d—Combination Kitchen Seat and Step Ladder
- 21d—Garden Seat
- 22d—Garden Trellises
- 70d—Small Tool Chest
- 71d—Large Tool Chest
- 72d—Work Bench

This book, "How to work with tools and wood," takes all the mystery out of woodworking.

185 pages
150 illustrations
cloth binding

At your dealer's or direct, \$1.00.

sandpaper, paint and finish it.

To do your best work you need good tools—of course! Practically every carpenter uses Stanley Tools. Manual training classes, too. Stanley makes the most complete line.

Buy your Stanley Plans from your hardware dealer. If he cannot supply you, write to us. Send 10c for each plan and ask for a free catalog of Stanley Tools. Address Advertising Department, The Stanley Works, New Britain, Conn.

The best tools are the cheapest to use



Ask your hardware dealer

STANLEY TOOLS

The choice of most carpenters

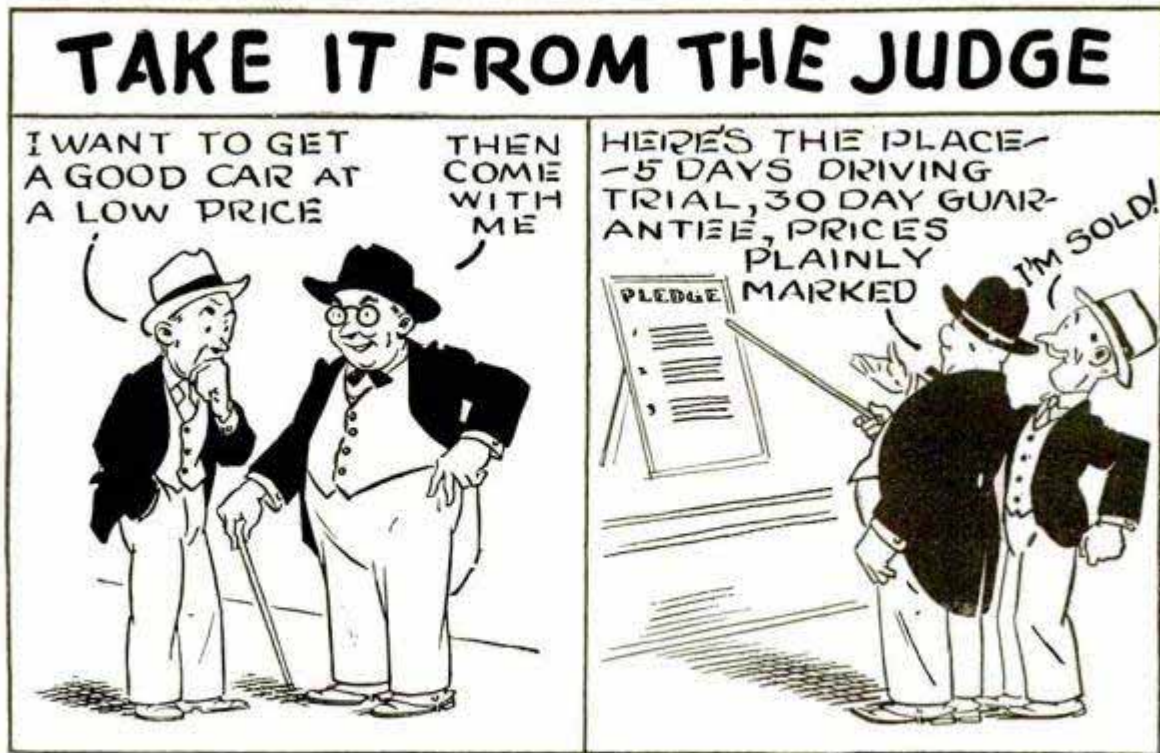

YOU can see many unusual used car values today—at the nearest Studebaker showroom. You will be fully protected in buying from the Studebaker dealer who sells used cars under the famous Studebaker Pledge—(1) the lowest price is marked on the car in plain figures, (2) Certified Studebakers are guaranteed for thirty days, and (3) you get 5 days driving trial with any car you select.

A book of expert advice—FREE!

Send the coupon below for a valuable free book, "How to Judge a Used Car." Thirty-two interesting pages of money-saving facts and pictures help you select any make of used car from any dealer—tell you what to look for and what to avoid. Get the advice of experts—for the price of a 2c stamp. You may save \$200 by mailing this coupon NOW.



Send for this FREE Book!

THE STUDEBAKER CORPORATION OF AMERICA

Dept. J-72, South Bend, Indiana

Please send me my copy of your valuable free booklet, "How to Judge a Used Car"

Name.....

Street.....

City..... State.....

STUDEBAKER

The Great Independent

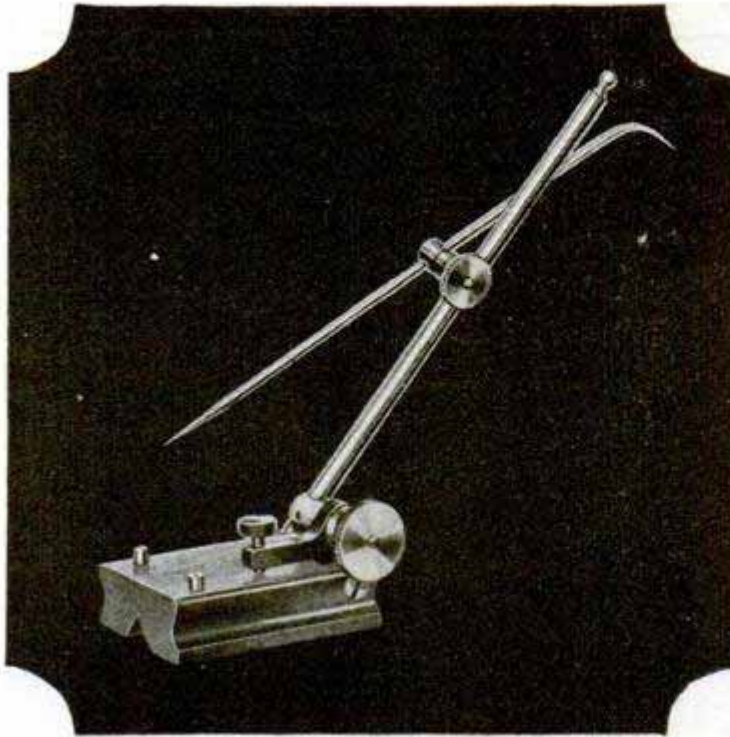

Brown & Sharpe Surface Gauge No. 621, illustrated above, permits a wide range of adjustments. A fine tool that any mechanic will be proud to own.

Fine Tools Increase A Man's Mechanical Ability

Because their unfailing accuracy increases the certainty of measurements, Brown & Sharpe Tools lower the percentage of loss and waste in mechanical work. The mechanic who makes use of these finely designed tools finds them an aid in bringing out his skill to best advantage and in increasing his value as a producer.

There are over 5,000 items listed in Catalog No. 30. Get a free copy from your dealer or from us direct. Dept. P. M., Brown & Sharpe Mfg. Co., Providence, R. I., U. S. A.

BROWN & SHARPE TOOLS



* PLANER AND SHAPER GAUGE No. 625



* STAINLESS STEEL RULE No. 350



* THICKNESS GAUGE No. 648



* DIE MAKERS SQUARE No. 552



* COMBINATION SET No. 438

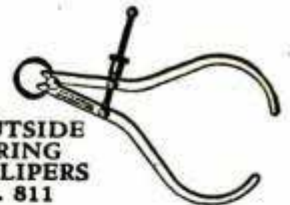

* OUTSIDE SPRING CALIPERS No. 811



* SCREW PITCH GAUGE No. 630



* ADJUSTABLE SQUARE No. 554

* A description of this tool appears in Catalog No. 30



"WORLD'S STANDARD OF ACCURACY"

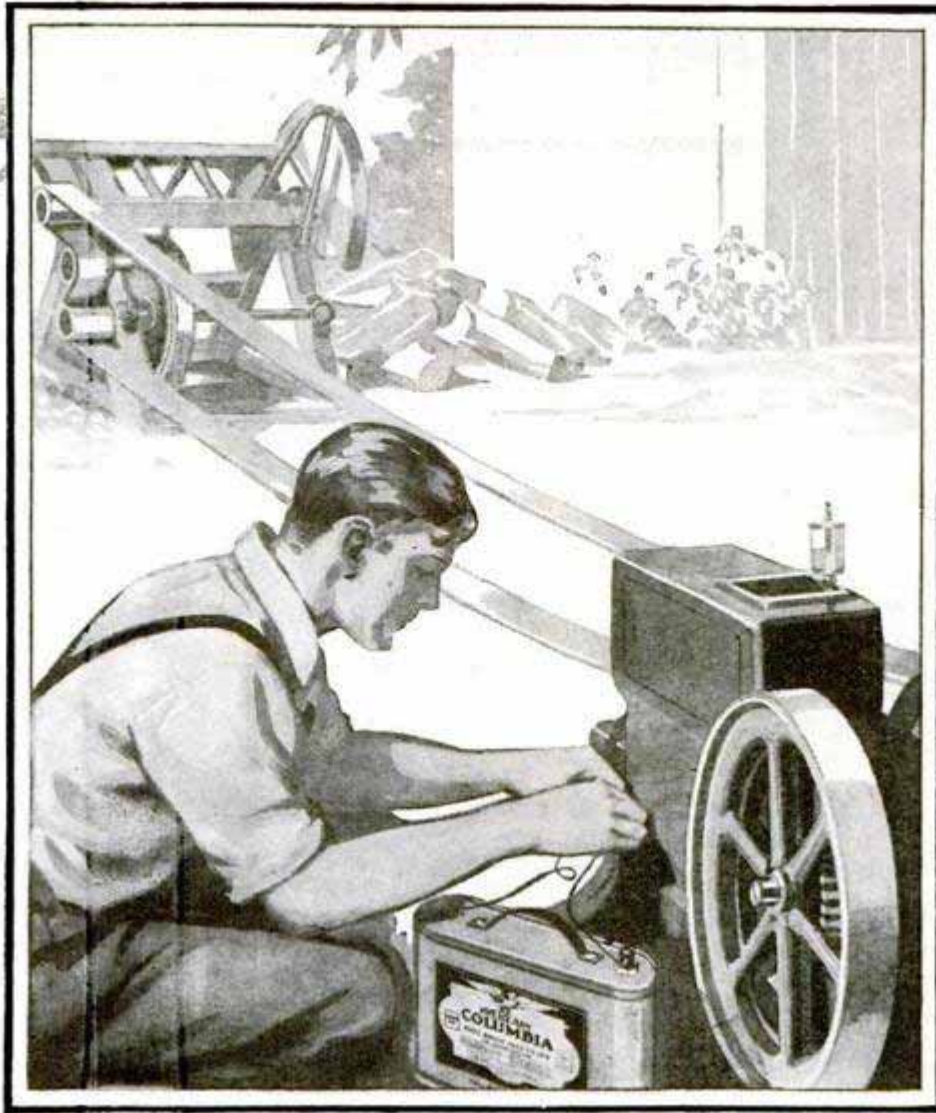

For that balky engine

PUT in Eveready Columbia Dry Batteries—their fat, hot sparks are great for starting engines of all kinds—stationary, tractor and automobile, two cycle or four cycle. They make a big difference in cold weather especially. Off the engine goes with a bang, to run steadily for hours on end with never a skip or miss.

For exposed engines, use the Eveready Columbia Hot Shot, for its water-proof steel case sheds rain, sleet, snow and fresh or salt water; besides standing abuse.

NATIONAL CARBON CO., Inc.
New York San Francisco



Unit of Union Carbide
and Carbon Corporation

**EVEREADY
COLUMBIA
Dry Batteries**
-they last longer

FOR RADIO: Just as the Eveready Columbia is the greatest general purpose cell, the Eveready Dry Cell Radio "A," No. 7111, is the superior cell for this one special use—on radio sets using dry cell tubes. It lasts longer.

This is the Clayton & Lambert No. 70 fire-pot with tinner's hood. Produces a working flame in ninety seconds. Flame controlled as easily as a lamp. The burner orifice cannot be enlarged by tightening the needle valve. No chance of ruining the fire-pot that way—that's an exclusive C & L feature. Will heat a pair of soldering coppers and melt a pot of metal at the same time.

On the job, *when you* *want it . . .* all the time

WHEN you're in a hurry; when you're working in a high wind; when it's bitter cold; when you've got an indoor job—any time you need a fire-pot you'll be better off if it's a Clayton & Lambert.

You can light it and have it heating things up for you in ninety seconds! Your generator is shielded from wind! And it's so fast-acting that cold weather can't slow it up. And if you're using either Clayton & Lambert No. 70 or No. 60 you've got such a quiet fire-pot you can't disturb anybody. Of course No. 22, the coil fire-pot, makes a bit of noise—but you can't expect such a tremendously powerful blast as that to whisper!

And here's something. They're built like a battleship, as far as strength goes. Everything rugged. Made for hard, rough work. Just take a look at that bright red, protecting ring around the base of the tank, if you want to see how we make Clayton & Lambert fire-pots give you



satisfying service, free from trouble.

But in spite of all that extra strength and protection, they're lighter than fire-pots have been. You won't get round shouldered carrying these around.

Just remember that name Clayton & Lambert next time you're buying a fire-pot. If you've got a fire-pot now that gives you exceptionally good service, take a look and see if you don't find the Clayton & Lambert name on it! And we can promise you better performance in the new models. See them at your regular supply house.

CLAYTON & LAMBERT

MANUFACTURING CO.

DETROIT, MICHIGAN

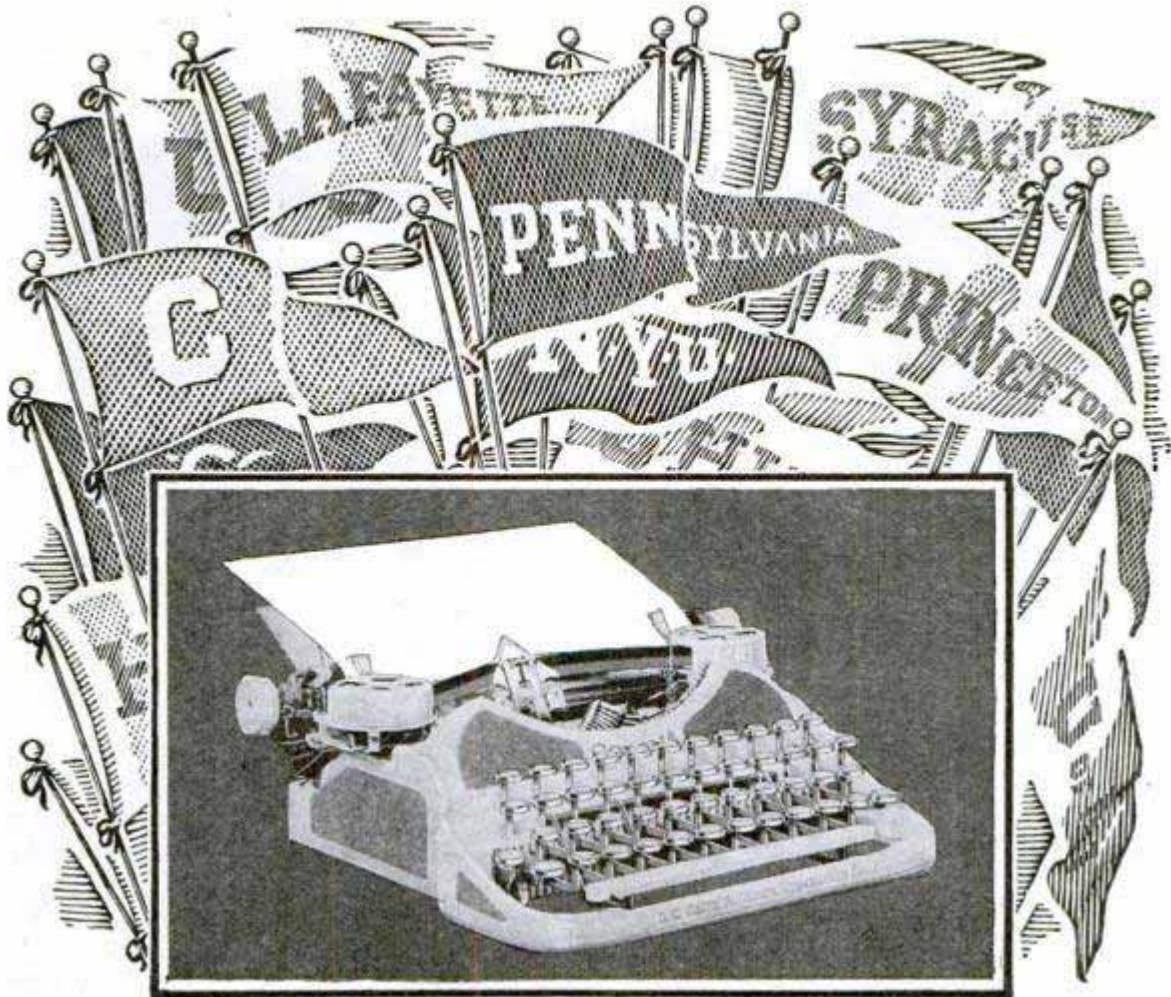

Why Corona leads in the Colleges

CORONA was the first portable to be used in college—and it has been the leader ever since because it fulfilled these three requirements of a college typewriter:

It is portable—light, compact, easily carried—easily lifted out of the way.

It is strong. Corona has an unequalled record for durability.

It is simple. Easy to use, easy to carry. Yet, in spite of compactness, lightness, simplicity, Corona is absolutely complete—standard 4 row keyboard—12-yard ribbon—full width carriage—every improvement modern skill can apply to a portable typewriter.

Beautiful Colored Coronas

Now, in addition to the standard black finish, we are offering a variety of attractively colored Coronas at no extra cost.

Buy on Easy Terms

Corona is the portable typewriter for you—at home—in business—or in college. Get one now. Pay for it in easy monthly instalments. The coupon will bring you full particulars. Mail it! Or phone our local representative and he will gladly leave a Corona at your home for you to examine at your leisure. No obligation.

L C Smith & Corona Typewriters Inc

Established 1903 Sales offices in principal cities of the world

L C Smith & Corona Typewriters Inc, 1012 E. Washington St., Syracuse, N. Y.

Please send me your latest catalog showing the new Duco finished Coronas in actual colors.



Name

Address

tool

facts!

List Prices
DRILL CHUCKS
 For 1/4 in. Shaft,
 No. 837, each \$2.50

For 3/8 in. Shaft
 No. 757, each \$2.50

For 1/2 in. Shaft
 No. 761, each \$3.30

For 5/8 in. Shaft
 No. 861, each \$4.00

SAW ARBORS
 For 1/4 in. Shaft
 No. 838, each \$2.50

For 3/8 in. Shaft
 No. 758, each \$2.50

**SAW ARBORS
 AND BUFFING
 SPINDLES**
 For 1/2 in. Shaft
 No. 762, each \$3.30

For 5/8 in. Shaft
 No. 862, each \$4.00

**BUFFING
 SPINDLES**
 For 1/4 in. Shaft
 No. 840, each \$1.10

For 3/8 in. Shaft
 No. 759-R. H.-
 each \$1.00
 No. 760-L. H.-
 each \$1.00



The Mark of a
 Complete Line of
 Super-Performance
 Electric Drills

Make Your Motor a Machine Shop!

Get more use out of that small motor which you have. With just a few attachments, you can make many hard jobs easy.

**Sawing — Drilling
 Polishing — Buffing
 Grinding**

To do any or all of these jobs—faster....better....more accurately—all you need is one or more of the attachments illustrated—of the proper size to fit the shaft of your motor.

Easy to Attach

Made with the care and precision characteristic of all Goodell-Pratt Tools, they fit snugly and are secured by set screws provided for the purpose.

Your local dealer probably has just what you want in stock; if not, write us.

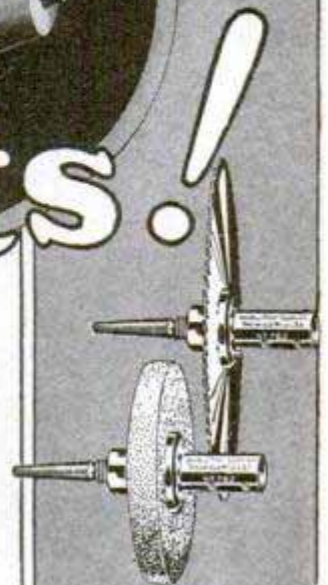

Figure 1

Showing the No. 762 Saw Arbor and Buffing Spindle equipped with a saw and with a grinding wheel.

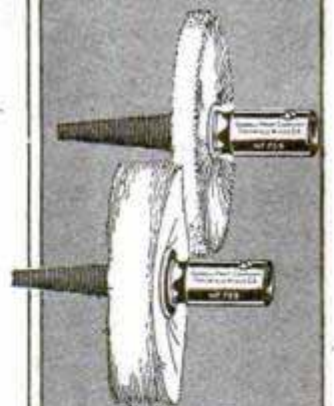

Figure 2

Showing the No. 759 Buffing Spindle equipped with a wire brush and a buffing wheel.

GOODELL-PRATT COMPANY *Toolsmiths* GREENFIELD, MASS. U.S.A.

GOODELL-PRATT

1500 GOOD TOOLS

"I spent many a dollar for hammers; then I bought a **PLUMB**"

"I'd always decided a cheap hammer would do for my few tinkering jobs; but after breaking a number of them I found I'd spent more than the price of a good tool, and had nothing to show for it.

"Now I own a Plumb. What a difference! Every blow goes where I aim it, so finely is it balanced. Those claws bite into the slimmest brad, and yank it out with ease.

"Why that patent screw wedge alone is worth the full price. Whenever shrinkage loosens the handle, I give the screw a

turn and it is tight as new again."

A. M. GALLAGHER
5824 Springfield Ave., Phila.

Get the "feel" of a Plumb hammer... how it fits your hand... how it tunes itself with the swing of your arm. Inspect those nipper claws that bite and hold; see the broad striking face that falls where you aim it.

You can be proud of a Red Handle and Black Head Plumb Hammer. It's the expert's tool. Yet the price is only a dollar fifty; and you'll never wear it out. Ask your hardware man.

FAYETTE R. PLUMB, Inc.
Philadelphia, U. S. A.



F. R. PLUMB, Inc., Phila., U. S. A.

Send me free booklet "How to Keep Tool Handles Tight".

Name

Address

for this **9" x 3' New Model SOUTH BEND Jr. Back Geared, Screw Cutting Precision LATHE**

Only \$12.40 MONTHLY PAYMENT

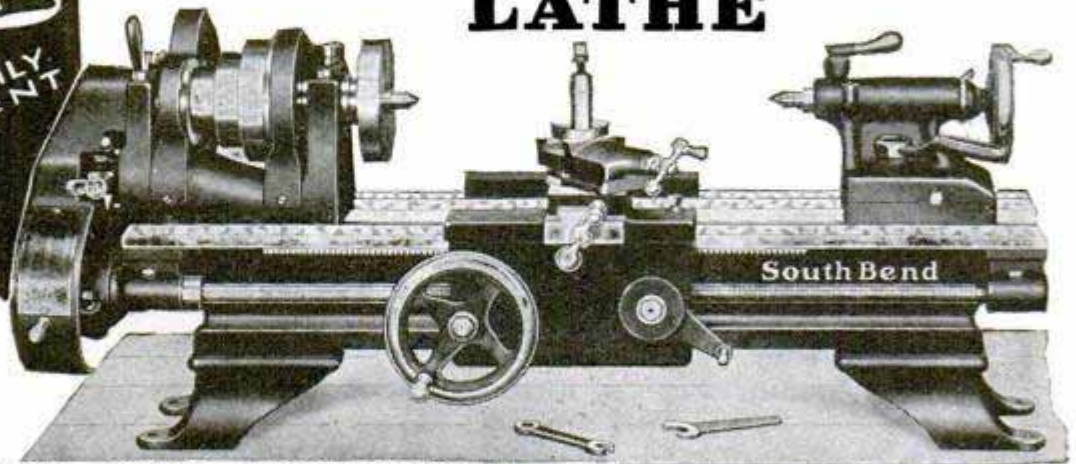

This Lathe Will

- Do Turning
- Boring
- Chucking
- Grinding
- Cut Screw Threads
- Make Bushings
- Reface Valves
- Finish Pistons
- Bore Connecting Rods
- Undercut Mica
- True Commutators
- and do hundreds of other jobs in the Machine Shop
- Manufacturing Plant
- Repair Shop
- Service Station
- Laboratory and Engineering Shop

Price \$155 — Weight 375 lbs.

We ship Lathe immediately upon receipt of small down payment, and give you 10 months to pay balance in equal installments. With each Lathe we send Free Complete Instruction Book "How to Run a Lathe."

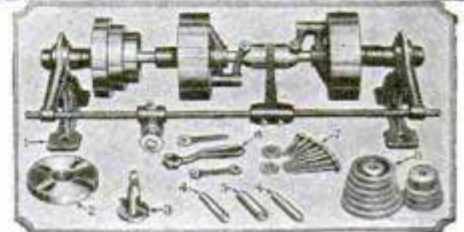

Prices and Terms of 9-Inch Junior Lathes

Size Lathe	Between Centers	Weight	Down Payment	Monthly Payment	Price Lathe
9" x 2 1/2'	11 in.	350 lbs.	\$30.00	\$12.00	\$150.00
9" x 3'	18 in.	375 lbs.	31.00	12.40	155.00
9" x 3 1/2'	23 in.	400 lbs.	32.00	12.80	160.00
9" x 4'	29 in.	425 lbs.	33.00	13.20	165.00
9" x 4 1/2'	36 in.	450 lbs.	34.00	13.60	170.00

Features and Specifications

Power Feed to Carriage
 Graduated Compound Rest
 Set-Over for Taper Turning
 Hole through Spindle—3-4 in.
 Spindle Speed—48 to 714 R. P. M.
 Width of Belt—1 in.
 Also furnished in three types of Motor Drive

Use Lathe While Paying for It

You can install any South Bend Lathe by making a small payment with your order and take care of the balance in small monthly payments over a period of ten months. We ship as soon as the down payment is received.

This new Easy Payment Plan brings you the opportunity to install an income-producing Lathe at our low factory prices, and we help you finance the purchase. You get the equipment you need to give better service to your customers, and the new business should more than take care of the monthly payments.

Prices and Terms on Other Popular Sizes

Size of Lathe	Weight	Down Payment	Monthly Payment	Total Price
11" x 4' Quick Change Gear	725 lbs.	\$67.00	\$26.80	\$335.00
13" x 5' Quick Change Gear	1110 lbs.	80.40	32.16	402.00
18" x 8' Quick Change Gear	2640 lbs.	140.00	56.00	700.00
32" x 5' Brake Drum Lathe	1225 lbs.	95.00	38.00	475.00
36" x 6' Brake Drum Lathe	2160 lbs.	130.00	52.00	650.00

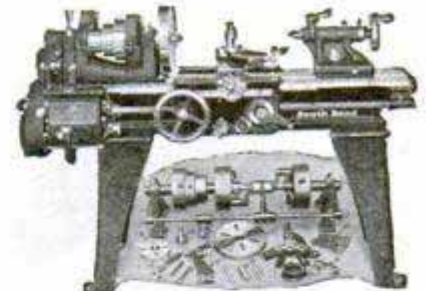

Only \$26.80 per Month
 for this 11" x 4' New Model Quick Change Back Geared Screw Cutting Lathe with Countershaft and Equipment. **Price \$335.**

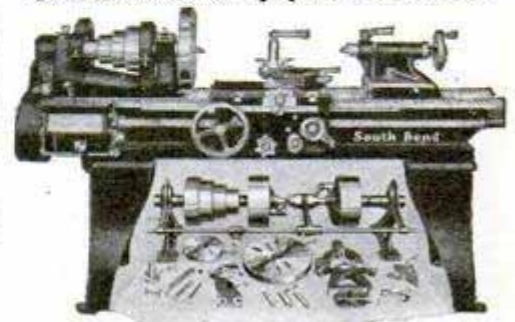

Only \$45.60 per Month
 for this 16" x 8' New Model Quick Change Back Geared Screw Cutting Lathe with Countershaft and Regular Equipment—**Price \$570.**

Write for Free Time Payment Catalog 40

—showing 210 sizes and types of New Model South Bend Lathes with Prices; Down Payments and Monthly Payments on each size. Check below the size Lathe in which you are interested.

- | | |
|--|--|
| <input type="checkbox"/> 9-inch Junior Lathe | <input type="checkbox"/> Time Payment Catalog 40 |
| <input type="checkbox"/> 9-inch Lathe | <input type="checkbox"/> 16-inch Lathe |
| <input type="checkbox"/> 11-inch Lathe | <input type="checkbox"/> 18-inch Lathe |
| <input type="checkbox"/> 13-inch Lathe | <input type="checkbox"/> Brake Drum Lathe |

SOUTH BEND LATHE WORKS

646 E. Madison St. South Bend, Ind., U. S. A.

Lathe Builders for Twenty-Two Years—40,000 South Bend Lathes in Use

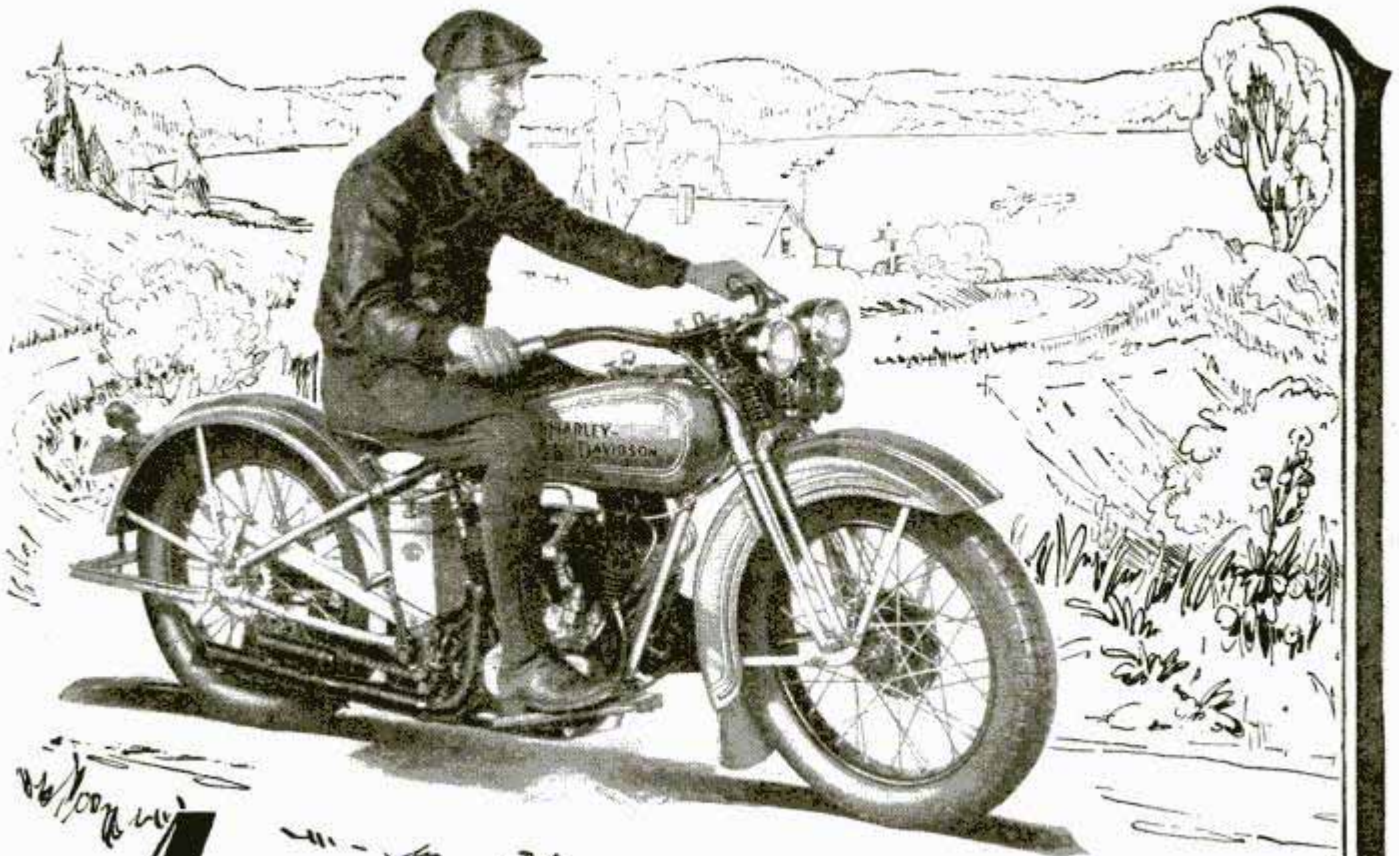

A New HARLEY-DAVIDSON

NEW, from trim double headlights to broad, crowned mudguards—the "45" Twin! It's the very model that the motorcycle world has been waiting for—lighter than the Big Twins, but wonderfully smooth-running, powerful, and fast enough to pass any mile-a-minute car.

Ride out on this latest Harley-Davidson—over highway or trail—and see for yourself what a marvelous performer it is. Then wonder how it can be sold at the low price of \$290, f. o. b. factory.

Ask your dealer about his Pay-As-You-Ride Plan. Mail the coupon for new literature.

HARLEY-DAVIDSON MOTOR COMPANY
DEPARTMENT P. MILWAUKEE, WIS.

The 1929 Single

— has all the 5 Big Features above, plus its famous 80-miles-per-gallon economy. Sells complete at \$235, f. o. b. factory.



5 BIG FEATURES

1. **Two Bullet Headlights**—Double lights—greater safety.
2. **Generator Controller**—Quick, handy control of current output.
3. **Electrical Panel**—Includes ammeter, parking light, and switches.
4. **4-Tube Muffler**—Makes exhaust wonderfully quiet.
5. **Clear-the-way Horn**—High-frequency — penetrating, pleasing note.

Mail the Coupon

HARLEY-DAVIDSON MOTOR CO.,
Dept. P., Milwaukee, Wis.

Interested in 45 Twin, Big Twins,
 Single. Send literature.

Name.....

Address.....

CHAMPION

world supremacy

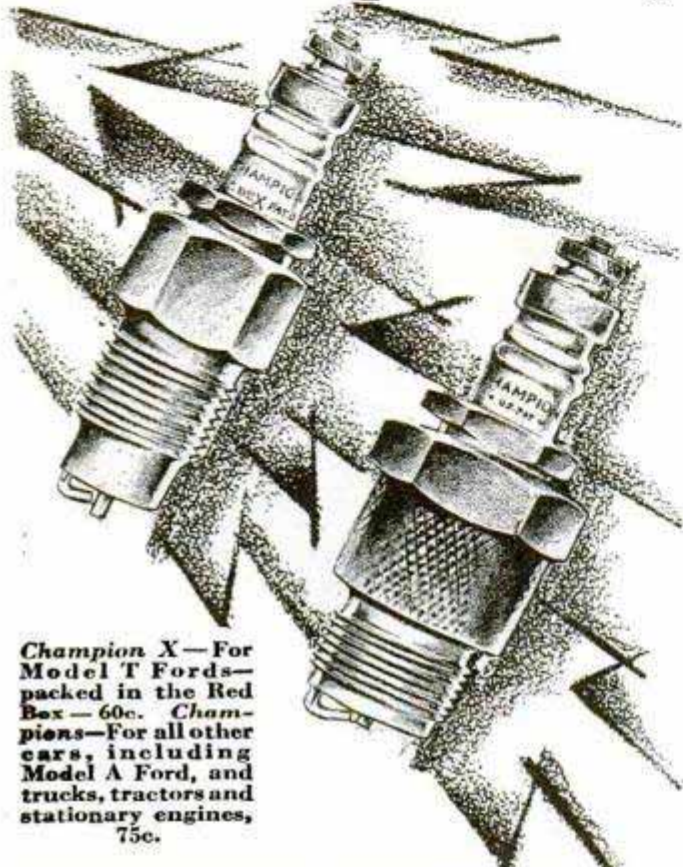

Champion X—For Model T Fords—packed in the Red Box—60c. **Champions**—For all other cars, including Model A Ford, and trucks, tractors and stationary engines, 75c.

CHAMPION Spark Plugs outsell all other makes throughout the world, by the amazing ratio of two to one. Champion is accepted as the better spark plug.

The exclusive sillimanite insulator is impervious to electrical current, possessed of high heat conductivity, remains remarkably free from carbon and oily deposits and is practically unbreakable.

Special analysis electrodes, and a positive compression-tight copper gasket seal, make Champion specially adapted for dependable service in modern, high-compression engines.

A complete new set of Champion Spark Plugs quickly pay for themselves in gas and oil saved. They bring to your engine better all around and more economical car performance.

CHAMPION

Spark plugs

TOLEDO • O

EDWARDS METAL ROOFING



BIGGEST VALUE · LOWEST COST

Buy your metal roofing, shingles, Spanish tile, sidings, etc., DIRECT from the world's largest manufacturer of sheet metal building materials, at BIG SAVINGS. Thousands of satisfied users.

We own our own rolling mills. Enormous output insures lowest production costs. Factory-to-consumer plan makes prices **rock bottom**. You get the benefit. Many varieties. Edwards metal roofs last longer, look better. Resist rust, fire and lightning. Roofing, shingles, etc., of **COPPER BEARING STEEL** at special prices. This steel stands the acid test. Outlasts the building to which applied.

Ready Made Garages and Buildings

Low in cost. Easily erected. Permanent. Good-looking. All types and sizes to suit your purse and purpose. Now's the time for action. Write for Roofing and Material Book No. 150 and for Garage Book.

— FREE — EDWARDS MFG. CO.
SAMPLES BOOKS ESTIMATES 1000-1050 Butler St., Cincinnati, Ohio

Start a Welding & Battery Shop

- Lead Burning Outfits.....\$18.00 up
- Welding Outfits..... 25.00 up
- Soldering Outfits..... 8.00
- Lead Burning Torches..... 6.00
- Welding Torches..... 10.50 up
- Cutting Torches..... 30.00 up
- Regulators and Gauges..... 9.50 up
- Paint Sprayers..... 14.00



Welding Supplies
 Superior Oxy-Acetylene Machine Co.
 P. O. Box 285 Hamilton, Ohio

Beautiful HOUSES \$900 and BUNGALOWS

CAN BE BUILT FOR AND UP
 This and many others in my new book, Building Plans for Modern Homes, will save you hundreds of dollars. One of the most complete and comprehensive books of plans ever published by any architect. New edition just off the press. Nearly 600 floor plans and photographs of Colonial houses, bungalows, etc., costing from \$200 up; gives sizes and cost to build. Sent postpaid for \$3.00.



FREDERICK H. GOWING
 ARCHITECT
 101 Tremont St., BOSTON, MASS.

Sport Bodies for Fords

AT FACTORY PRICES!

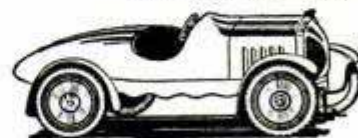

This Model in Grey Prime **\$38.50**

Write for Booklet A-2 Showing This and Other Models

SLIP-ON BODIES

For all models of Ford and Chevrolet

\$15.00 This Model, 12" high, 60" long.

Write for catalog X-1 of this and other models.

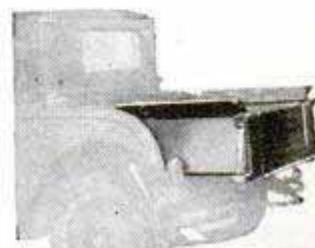

SPORT FACTORIES, AURORA, ILL.

See What These Amazing Lamps Will Do!



It Clamps... It Hangs...

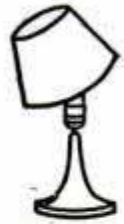
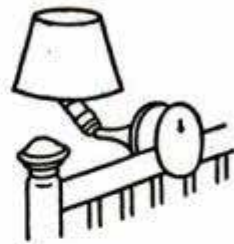

It Bends... It Tilts...



for...

- Bedroom
- Beds
- Dressing Table
- Night Table
- Bath Room
- Sewing, etc.

for...

- Parlor
- Reading
- Piano
- End Table
- Radio
- Deck, etc.



Sell 2 in Every Home at the Amazing Price

of \$3.00

BEFORE you know what wonderful things Falcon lamps will do, you just know you can sell them.

Falcon lamps are bits of striking beauty. Just the thing every woman wants in a dozen different places about the house. Three dollars is an almost unbelievably low price for them. Just as ornamental standing lamps you could sell them by the hundreds at this price.

When you show how the cleverly concealed base unscrews and clamps anywhere . . . how the jointed stem bends in any direction . . . and how the shade tilts to any position . . . then you know you can sell them by the thousands.

Demonstrates in 30 Seconds

The clamping device of Falcon Lamps is fascinatingly clever. With a twist of the wrist, you unscrew the disc of steel at the base. (When not in use you would never suspect it was there!) Unscrews 2 1/2 inches, grips tight, and holds! With the pressure of one hand you can bend the lamp stem. And with your fingers you can tilt the shade. You can demonstrate the whole thing in a split minute.

You can sell as many Falcon Lamps as there are homes in your territory. Most women want at least two. Think of the places in every home for Falcon Lamps . . . bed lamps, reading lamps, sewing lamps, radio lamps and desk lamps, etc. That gives you a glimpse of the possibilities. Now figure out the profits!

\$17.00 a Day and MORE!

Just think! You can demonstrate everything. Your prospects see the merchandise and see it work. There isn't any doubt about anything. There isn't a single question about quality, price or performance that you can't answer instantly and completely. Falcon Lamps are the biggest value for the money in the whole direct-selling field. You can make



VARIETY! Six Different Lamps

Above: One of four different translucent shades. Bases are metal. Finished in ivory as shown or in rich statuary bronze.
Below: All metal lamp. Statuary bronze base and metal shade to match. This lamp also furnished in Ivory finish.
Size: 11 1/2 inches high.

up to \$1.39 clear net profit on each lamp and you can sell at least 2 every hour.

That's almost \$17.00 a day if you only work six hours! And that isn't the limit. There isn't a single reason why you can't make \$25.00 a day. Sales of 6 to 12 lamps in an hour are common occurrences.

Send for Free Test Sales Plan

You can easily see that \$100.00 a week is not too much to expect. And you can prove it, too, without risking a penny! We've worked out a plan whereby you can test the Falcon proposition to your entire satisfaction and make sales and profits too without investing a cent. It's a self-starting plan.

We'll send it gladly—with full-color, large-size reproductions of all six Falcon Lamps, selling plans, profits, and all details. It's the most wonderful selling story you ever heard. Be sure you don't miss it. Territory is bound to go fast on this wonderful new item; so mail the coupon this very hour. Address Dept. M-90.

FALCON MFG. CO.
2550 SULLIVAN AVE. ST. LOUIS, MO.
Falcon Lamps
ADJUSTING

Falcon Mfg. Company, 2550 Sullivan Ave., Dept. M-90, St. Louis, Mo.

Gentlemen:

Send me at once your Free-Test Selling Plan, and all details of the Falcon Lamp Selling Proposition.

Name.....
Address.....
City..... State.....



YOU too were a Born Musician!

You ought to be playing a band instrument with your friends too. If you've put off starting—afraid you might not succeed, thought it beyond your means—we can help you start right now on a Pan-American saxophone—metal clarinet, trumpet, euphonium—or any other band instrument you like.



We'll put any Pan-American instrument in your hands, on free trial, and in one week you'll be delighted with your progress, the instrument's perfect tones, its easy blowing qualities, and our easy plan for paying for it. Why wait another day? Just mail coupon, select from our beautiful catalog—and be playing all the popular tunes before Christmas.

Mail this coupon

Pan-American Band Instrument & Case Co., Dept. G-21, Elkhart, Indiana.

Yes, I am interested. Send me catalog and full particulars.

I am interested in playing (instrument)

Name.....

Address.....

City.....State.....



NEW WAY LACQUER SPRAY

The New Electric Sprayer

The most practical, simple and strongly constructed Sprayer ever developed for the *easy* application of Duco, Lacquers and other paints. Inexpensive and light in weight, combines all latest improvements.

\$37⁵⁰

THE NEW ELECTRIC PORTABLE

Buy your spraying equipment from *spray headquarters*. Special hand and foot pump Sprayers and parts.

TYPE "C" DE LUXE FOOT PUMP SPRAYER, complete ready to operate.

Order today! We pay postage.



\$7⁹⁵

NEW WAY SPRAY GUN COMPANY
5713 EUCLID AVE. DEPT. G CLEVELAND, O.

FREE New Book
FACTORY PRICES

Save $\frac{1}{3}$ to $\frac{1}{2}$

New FREE book quotes **Reduced Factory Prices. Lower terms—year to pay. Choice of 5 colors in New Porcelain Enamel Ranges.**



Ranges **\$37⁷⁵ up**



Furnaces **\$54⁹⁵ up**

New Circulating Heaters—\$37.50 up. 200 styles and sizes. Cash or easy terms. 24-hour shipments. 30-day FREE trial. 360-day test. Satisfaction guaranteed. 27 years in business. 700,000 customers. Write today for FREE book.

KALAMAZOO STOVE CO.
391 Rochester Ave.
Kalamazoo, Mich.

"A Kalamazoo Direct to You"
Trade Mark Registered.

Ask for Keds by name

They are not Keds unless the name Keds is on the shoe



Sample, 50c

AGENTS—SALESMEN

ALL-IN-ONE patented Cigarette and Match Case. Holds a package of cigarettes and box of safety matches. Beautiful, grain finish Black or Brown Du Pont Fabricord. Keen and convenient.

A whirlwind seller for agents. Costs \$3.60 dozen, \$36.00 gross. Write today for complete details.

ALL-IN-ONE SALES CO.

Dept. A-10 4648 Grand Ave.
MINNEAPOLIS, MINN.

PIN A DOLLAR BILL TO THIS

and get this genuine leather 5-window gold corner pass case. Holds Railroad Passes, Auto License, Lodge Cards, etc. Masonic or Shrine Emblem stamped on in gold free. Your name or other stamping 35c extra per line. Cash must accompany order.

EVERYTHING MASONIC

Send for free catalogue No. 10 P. M. of Books, Monitors, Jewelry; No. 11 P. M. of Lodge Supplies.

We Have Been in Business 67 Years!

REDDING MASONIC SUPPLY CO.
200 Fifth Ave., Desk P. M. NEW YORK



The Modern Craftsman's Wonder Shop



Electric **Red Jacket** Workshop

Six Thousand Red Jacket Craftsmen have made a bargain possible for you without Waco sales volume, no manufacturer could give the equivalent of "Waco Shop No. 12" at its price—A Red Jacket Master Drill, the Waco Craftsman's Lathe, the electric power tools, the Jig Saw, the Red Jacket Band Saw, or the Crafts Courses.

This equipment was designed, tested, approved and is guaranteed by Wm. L. Aylward, a nationally known craftsman and manufacturer, who has developed his hobby into a co-operative association of five thousand craftsmen.

Portable—Interchangeable—Complete HOME WORK SHOP

The new 1928 Combination of Electric tools brings you a Red Jacket Band Saw and in addition the powerful Red Jacket Master Drill Motor with direct drive to the Waco Craftsman's wood turning lathe (capacity 9 in. x 38 in.); a bench saw that has depth and side gauges, scroll and jig saw; and all accessories for both portable and stationary power drilling, buffing, grinding and cleaning. Attaches to any light socket and converts your work bench into a complete private tool and machine shop.

It is a complete chest full of electrically driven tools designed by a master for the private use of tool lovers and men who create, repair and appreciate handy tools at home.

It Is Easy to Do These Things

Write or send coupon at once for valuable information to all interested in beautiful handwork. It is free. It tells you how easy it is to operate a Red Jacket set of tools and lists the advantages and privileges that are free to member craftsmen. Don't miss knowing all about Waco. It is free. You are invited.

The WACO GUARANTEE
If it is not what you want when you get it—send it back

Look out for imitations. There is only one Red Jacket—one Waco—Wm. L. Aylward, Mastercraftsman.

Special Crafts Course FREE

SPECIAL CRAFTS COURSE and blueprint service is free to Red Jacket Shop owners—all that there is to know about handcraft methods, raw materials, woods, carving, sawing, turning, designing, carpentering, decorating, is taught by special correspondence.

Buy On Your Own Terms

Only \$10.00 down. Liberal discounts for cash. Easy monthly payment plans. It is no hardship to own a Red Jacket.

SEND THE COUPON

Interesting Literature Free

Send the coupon. You will be surprised with all it contains. Beautiful, instructive, fascinating, interesting.

Complete Only
\$10.00
Down
10 DAY FREE TRIAL

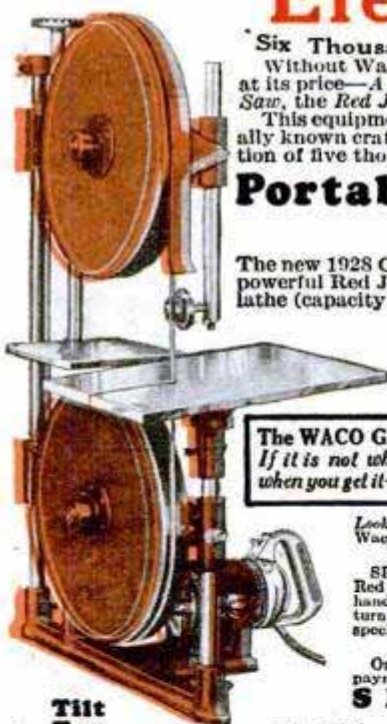

Tilt Top Table

FREE Blue Prints



Red Jacket MASTER DRILL

This Headstock furnished where no electricity is available.



The most elaborate and unusual drill motor ever designed as driving power.

WACO TOOL WORKS, Inc.
5216 W. Kinzie St.,
Chicago

Manager, Dept. 110. Please send me all free information and literature on Red Jacket Assemblies.

Name.....
Address.....

Shoot the Best Gun

The NEW BENJAMIN is the finest air rifle ever made. Unlike all others. Has amazing accuracy—shoots hard and far. It's the original American genuine AIR operated rifle. One to six pump strokes compress air to any desired degree of power. Same force as in air drills and air hammers except you control the shooting force. Never loses force—no springs or levers to get out of order. Makes crack shots quickly, inexpensively. Gives years of delightful recreation with utmost safety. At your dealer's, or sent postpaid for \$5.00.

Shoot 5 Days FREE

We give you five days, ammunition supplied, to test the NEW BENJAMIN. If in this time you don't believe it to be the finest air rifle you've ever seen or used, and if you don't believe it is the one and only air rifle for you, return it, postpaid, and your money will be refunded at once.

The NEW BENJAMIN AIR RIFLE

America's Original Air Rifle

\$5 at your dealer's or sent postpaid direct from factory on FREE Trial as above if dealer does not handle it—write for our wonderful offer.

Get This Book and Details FREE

BENJAMIN AIR RIFLE & MFG. CO.
645 N. Broadway, St. Louis, Mo.

Please send your amazing offer and free copy of "The Shooter's Art," telling how to become a crack shot, how to hold, aim, and handle guns and guide others in use of guns.

Name _____

Address _____

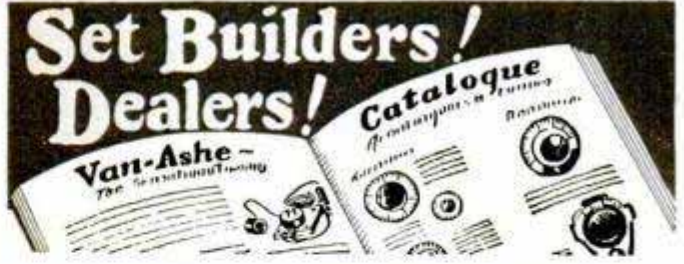

FREE - Big Catalogue

Hundreds of bargains in latest kits and parts at liberal discounts. See our new catalogue for

TELEVISION kits and parts.
SHORT WAVE Sets, kits, parts.

POWER PACKS—All kinds, including 250-tube and push pull circuits.

ELECTRIC PHONOGRAPHS—pickups, turn-tables, dynamic speakers.

SHIELD GRID Kits, coupling impedances, shields and other parts.

Van-Ashe has everything, at big discounts, ready for 12-hour shipment. Send post-card for new catalogue and discount sheet.

Van-Ashe Radio Co.

206 N. 10th St.

St. Louis, Mo.

Send for WESTERN RADIO

New 1929 Catalog

THE NEW 1929 Catalog is crammed full of the FINEST, NEWEST, Nationally known A. C. sets, consoles, cabinets, dynamic speakers, kits, eliminators and accessories at Lowest Prices. Largest stock of radio parts. Prompt delivery. Write for our Free catalog.

WESTERN RADIO MFG. CO.
128 W. Lake St. Dept. PM-10 CHICAGO



The Big Friendly Radio House

RADIO PANELS

BAKELITE - HARD RUBBER

Cut, drilled and engraved to order. Send rough sketch for estimate. Our complete Catalog on Panels, Tubes and Rods - all of genuine Bakelite or Hard Rubber. Mailed on Request.

STARRETT MFG. CO. 524 S. Green St. Chicago, Ill.



This 148 Page Radio Catalog and Encyclopedia

FREE

Containing 75 radio hook-ups, 500 illustrations, 1000 articles. Wholesale Prices

Build your own with Rasco parts. The lowest prices in the country.

Radio Specialty Company

98E Park Place NEW YORK, N.Y.

How's Your Radio?

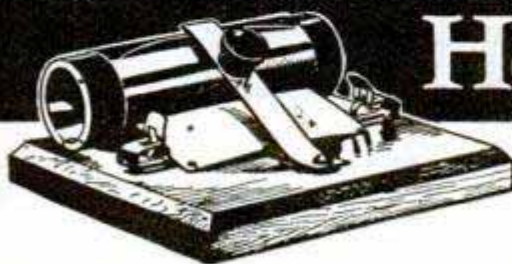

"Coast to Coast"

The Radio Clearatuner

Tunes your aerial. Simply hook it up between your aerial and radio.

The Radio Clearatuner

Tunes Your Aerial and Helps You Get Those Distant Stations

We guarantee it will give you greater distance, greater volume, greater selectivity, less static, less interference and better tone quality.

New improved model \$2.00. Sent postpaid anywhere. Money back if not satisfied.

RADIO CLEARATUNER COMPANY
347 GARDNER BLDG. TOLEDO, OHIO

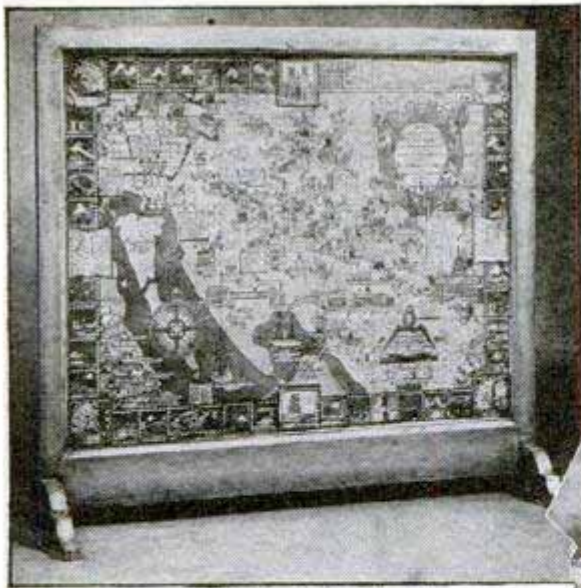

Modernistic Fire Screen
See LePage's Book, page 13



Cape Cod Chest of Drawers
See LePage's Book, page 3

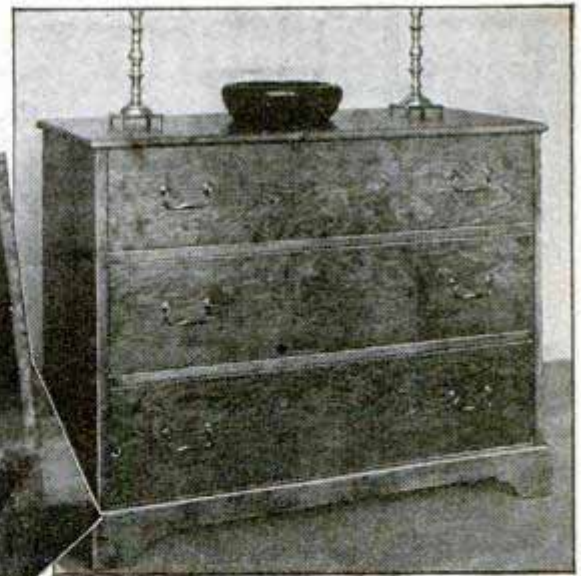

Vanity Case
See LePage's Book, page 22



Christmas Gifts of Fine Furniture You Can Make Yourself . . .

Popular, Modernistic or Colonial

12 NEW Job Plans, Too!

There is, of course, a limit to what we can give in LePage's New Third Home Work Shop Book for only a dime. But we realize many men want additional projects. Hence our 12 new Job Plans. These also were made by Mr. Klenke. They are projects that require more elaborate presentation than we can give in our book. Each Job Plan presents one project on a single large sheet of paper. Each is well worth its price, one dime. Look over these projects and order those you want by number (see coupon), enclosing 10 cents for each.

- 16 Sheraton Writing Desk
- 17 Sheraton Desk Chair
- 18 Colonial Hanging Book Shelves
- 19 Smoking and Reading Cabinet
- 20 Colonial Mirror
- 21 Tea Wagon
- 22 Telephone Cabinet
- 23 Stool for Telephone Cabinet
- 24 Manual Training Work Bench
- 25 Home Worker's Tool Cabinet
- 26 Spanish Galleon
- 27 Vanity Table

LePage's latest home work shop book shows how

If you like to work with tools and are not acquainted with LePage's Home Work Shop Books, you are missing something. If you like fine furniture in your home, without paying big prices for it, you can easily make it yourself. Any piece described in the New Book would certainly make a great Christmas gift, and you would always be proud of the fact that you made it yourself.

LePage's latest book, just published, the new "Third Home Work Shop Book," contains complete, easy-to-follow directions for making 20 attractive pieces of household furniture, of which 17 are entirely new and never offered before.

Designed by Expert

A full list, in addition to those illustrated, is given below. They include pieces of popular, modernistic or Colonial design. All the designs, dimension drawings, actual pieces and photographs were made by William W. Klenke, Instructor in Woodworking, Central Commercial and Manual Training High School, Newark, New Jersey. He was also the designer of the first two LePage's Books. His experience as an expert gives assur-

ance that each project and the directions for making it are thoroughly practical. Each project is presented in three parts—a photographic illustration of the finished project, a complete dimension drawing of its parts, and simple, easy-to-follow, step-by-step directions.

In addition to the three pieces shown above, the book includes the following: Alexandria Nest of Tables, Old Salem Ship's Cupboard, Plymouth Built-In China Closet, Lady Washington Sewing Cabinet, Set-Back Book Shelves, Modernistic Desk, Table, and Folding Screen, Chess and Checkers Table, Smoking Table, Caned Side Chair, China or Book Cabinet, Book Trough and Magazine Stand, Magazine Carrier, Book Stand, Fernery Stand and Folding Sewing Screen. Where else could you get complete directions for making all these for only 10 cents?

Send 10c for this NEW LePage's Home Work Shop Book.

Simply use the coupon below, sending it to us with 10 cents in coin or stamps, and we will at once send you a copy of this latest LePage's Book, postage paid.

MAIL THIS COUPON

LEPAGE'S CRAFT LEAGUE

615 Essex Ave., Gloucester, Mass.

Gentlemen: Enclosed please find 10 cents (coin or stamps) in payment for LePage's New Third Home Work Shop Book. Please send a copy of this book to:

Name.....

Street.....

City..... State.....

Please also send the following Job Plans..... (Indicate by number those you want. See column at left), for each of which I enclose an additional 10 cents.

LE PAGE'S GLUE

HANDIEST TOOL IN YOUR WORK SHOP

Hotter than Coal ~ and no dirt



**A New
Invention**

Do away forever with the drudgery of wood or coal. The most simple and economical invention on the market is now giving perfect satisfaction to enthusiastic users everywhere.

Burns 96% Air—4% Cheap Oil

The Okay Oil Burner fits in the fire box of your furnace or stove. Installed in a few minutes. No noisy motors or complicated parts.

Costs only a Few Dollars

Heats any stove or furnace just as well as a \$400 or \$500 oil burner without electricity or gas. Simply turn one valve and have all the heat you want. Cleaner and better for heating and cooking. Approved by engineers everywhere. Over 100,000 in use.

30 Days FREE Trial Offer

Try this wonderful Okay Oil Burner right in your own home at our risk. Act quickly and get our special low introductory price. Sold under absolute money-back guarantee. Write at once for our free booklet on home heating and free burner offer.

AGENTS—Our men are making big money introducing Okay Oil Burners. The demand is enormous. We want spare or full time workers immediately. If \$500 a month and more

*Listen in on our Weekly
Radio Programs.*

interests you, write or wire us for our protected territory offer.

----- Clip This Coupon -----

Okay Mfg. Co., 1501 South Spring Ave., St. Louis, Mo., Dept. O-201
Send your free booklet and free details on home heating for stove. } Also free burner offer.
furnace. }
Name.....

Address.....
 Check if interested in making money as an Okay representative with protected territory.

MOVIES AT HOME



Many models of genuine MOVIE MACHINES, some as low as \$3.75, all using standard size big theatre films. Our stock of films is the most complete and lowest in price—with an exchange service. Films of leading stars and religious subjects are available. **DON'T DELAY. WRITE FOR FREE INTERESTING CATALOGUE NOW!**

PARAMOUNT MFG. CO.
Dept. 1371-H BOSTON, MASS.

NEW VEST POCKET ADDING MACHINE

BABY CALCULATOR
CHICAGO, U.S.A.
PATENT APPLIED FOR

000000

ADDITION
SUBTRACTION
MULTIPLICATION
DIVISION

ADDS, SUBTRACTS, MULTIPLIES, DIVIDES

Does work of \$300 machine. Guaranteed 5 years. NOT A TOY.

Made of steel and indestructible. Million dollar capacity. Fits in pocket. Will not make mistakes. So simple child can operate it. Instructions furnished. Everybody should carry one for figuring.

FREE \$2.50 TRIAL Total Cost

SEND NO MONEY—Just name and address. We will ship Calculator immediately. On delivery pay postman \$2.50 (Plus few cents Postage). (If outside U. S. send cash 1.00 additional in Leatherette Case. If not satisfied after 10 days trial you get your money back. **THOUSANDS OF SATISFIED USERS.**

This is lowest priced practical calculator made. "Why pay more for inferior imitations?" Order from this ad.

Guaranteed

----- Mail Coupon Today -----

BABY CALCULATOR SALES CO., (MANUFACTURERS)

Dept. 41, P. O. Box 1118, CHICAGO, ILL., U. S. A.

I am enclosing \$2.50—send adding machine prepaid.

Send Adding Machine C. O. D. \$2.50 plus postage, (10c additional in Leatherette Case)

Name.....
Address.....
City..... State.....

AGENTS Write for big commission and territory proposition.

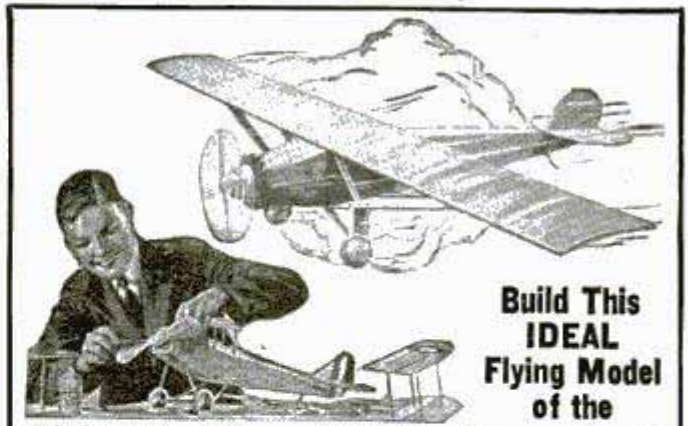

**Build This
IDEAL
Flying Model
of the**

"Spirit of St. Louis"

A perfect 3-foot miniature of the most famous Airplane in the world! Anybody can build and fly it. The **IDEAL Complete Construction Outfit** contains everything needed; all parts, fittings and materials, full plans, diagrams and instructions. The Model is guaranteed to fly when correctly built. **Complete Construction Outfit..... \$7.50**

(West of Denver, Colo., and in Canada \$8.00)

Ask Your Dealer or Order Direct.

Plans for Model Airplanes

Complete, accurate, 1/4-size Plans, with Building-Flying Instructions, for any one of the following: New York-Paris FOKKER; Curtiss; DeHAVILLAND; NC-4 Seaplane; Bleriot Taube or Nieuport; Cecil Pool; Model Book Free with each plan. Each **25c**



64-pg. Book for Model Builders

Contains plans for building Gliders and Racers, full information about Scale Models; and most complete catalog of Parts, Supplies, Materials and Fittings for all kinds of Models. **5c** Postpaid for.....

Ideal Aeroplane & Supply Co., Inc.

26 West 19th Street, New York City

NEW AND REBUILT EQUIPMENT

Everything for "The Movies." Machines, Screens, Chairs, Generators and Supplies. Complete Stationary and Traveling Outfits. Free Catalog. Write Dept. M.

MONARCH THEATRE SUPPLY CO.
395 SO. SECOND ST., MEMPHIS, TENN.

ROBIN HOOD

Would have liked our **FREE Catalog No. 12** SEND FOR IT!

BOWS—ARROWS
Targets — Accessories — Raw Materials

Australian Boomerang; 22" tip to tip; beautiful bent ash; with instructions. Postpaid **\$1.75**

L. E. Stemmer Co. (Box 12) Queens Village N. Y.
Est. 1912 Dealers write for prices also

Do Your PRINTING

Cards, stationery, circulars, tag, labels, paper. **Complete Outfits, \$8.85 up**, Job Presses \$11 up, Rotary \$149. Card Cutters, \$3. Save money. Print for others, big profits. All easy rules sent. Write for catalog presses, type, paper, cards, ink etc. **THE KELSEY CO., T-37, Meriden, Conn.**

SHOW All Wool Tailoring

LARGE SIZE SAMPLES DO IT MEN!

\$12 a day. \$75 a week. Cash daily **IN ADVANCE**. Liberal Bonus. 2000 men doing it. Hustlers make more selling our famous all-wool \$23.50 and \$33.50 tailored-to-measure union made clothes. Greatest values ever offered. **Customer satisfaction brings 90% repeat orders.** We train the inexperienced. Tailoring's most attractive outfit—over 100 extra large cloth samples—furnished **FREE** to reliable men willing to work for success. **Write Today.**

PIONEER TAILORING COMPANY
Congress and Throop
Dept. X-1116 CHICAGO

Make \$12 A DAY Full or Part Time

only
\$99 for **PACKARD**
this **SUPER 8—\$250 A. C.**
ELECTRIC RADIO

Direct From Our Factory

Today's greatest radio! A truly sensational offer! The 8-tube PACKARD A. C. Electric Radio set—a regular \$250 radio—shipped to any home in the U. S. at direct from factory price of only \$99. And to prove our claims we will ship this set to your home on

\$5,000.00
CASH BOND
to Back Our
GUARANTEE



The PACKARD Engineers

have invented this most unusual, powerful SUPER-Eight Tube Radio. Astonishing volume and tone quality. Remarkable selectivity and long-distance reception. Leading radio engineers unanimously agree that there is no better radio made—regardless of price.

Let us prove this by shipping a set to your home on 30 days' trial. Examine the set from A to Z. Let the most exacting critics pass on its merits. And if, after the 30 day trial period, you are convinced that the Packard Eight-tube Electric is fully the equal of any console radio set selling up to \$250—then, and only then, need you decide to keep it at our factory price of only \$99—otherwise, return it.

This marvelous set combines every new scientific development in receiving sets—possessing beauty, refinement, durability. Gets everything on the air from coast to coast—from Mexico into Canada, loudly, clearly, and distinctly. Only one dial to tune in all stations.

You Save the Jobbers', Dealers' and Salesmen's Profits

The PACKARD Radio is shipped direct from our factory. All the in-between profits are deducted from the price of the set and instead of paying \$250 you pay only \$99. Quantity production, economy in selling, and only a small profit for the manufacturer make this astounding offer possible.

MAIL COUPON NOW FOR
30 Days' Free Trial Offer

Don't miss this opportunity. Mail coupon at once for complete information about the PACKARD A. C.—8 TUBE ELECTRIC RADIO and our liberal 30 days' free trial offer. No obligation on your part. Our \$5,000.00 cash bond backs up our guarantee.

MAIL COUPON NOW

PACKARD RADIO CO.

2323 Milwaukee Ave., Dept. 306, Chicago, Ill.

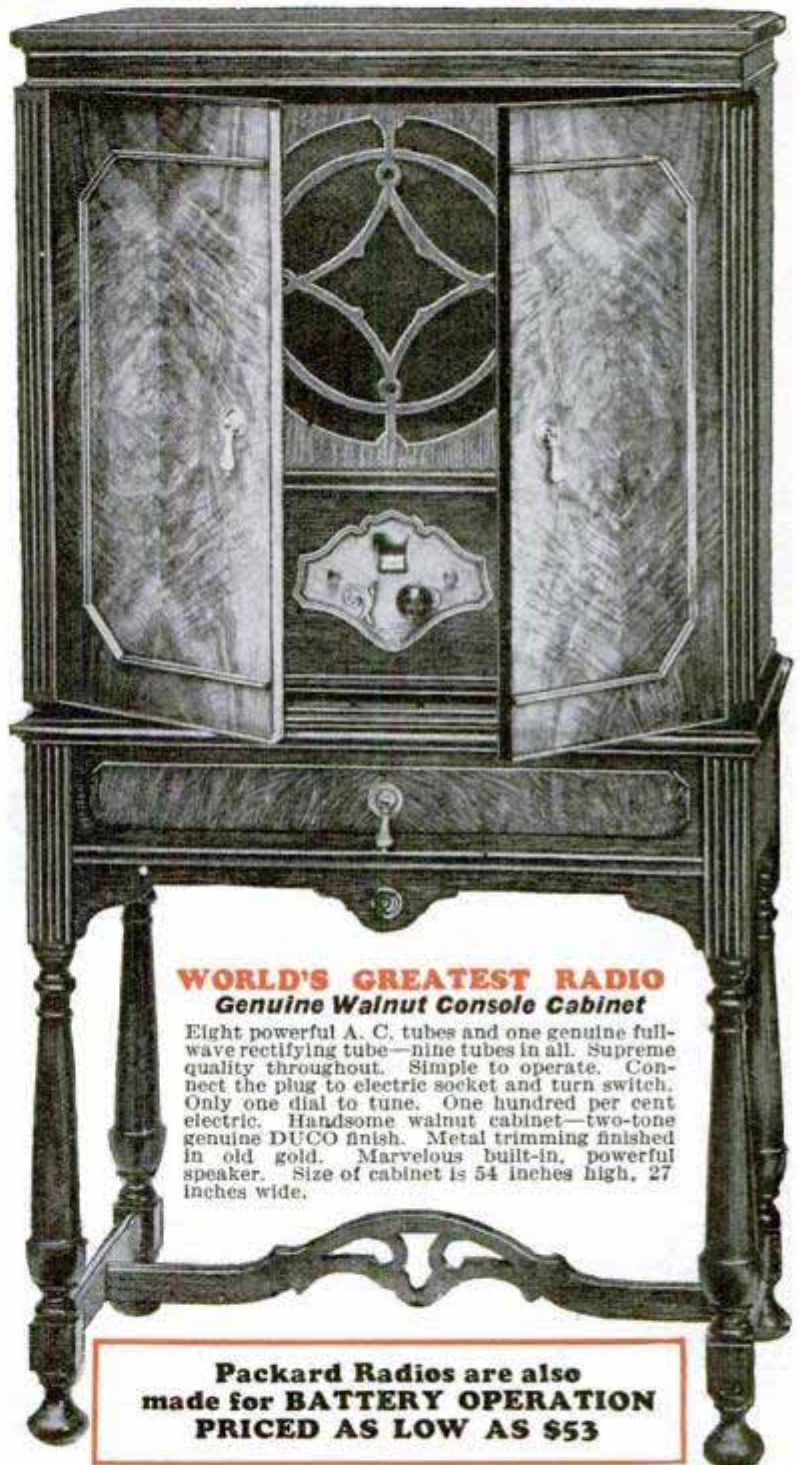

WORLD'S GREATEST RADIO
Genuine Walnut Console Cabinet

Eight powerful A. C. tubes and one genuine full-wave rectifying tube—nine tubes in all. Supreme quality throughout. Simple to operate. Connect the plug to electric socket and turn switch. Only one dial to tune. One hundred per cent electric. Handsome walnut cabinet—two-tone genuine DUCO finish. Metal trimming finished in old gold. Marvelous built-in, powerful speaker. Size of cabinet is 54 inches high, 27 inches wide.

Packard Radios are also
made for BATTERY OPERATION
PRICED AS LOW AS \$53

Packard Radio Company

2323 Milwaukee Ave., Dept. 306, Chicago, Ill.

I am interested in Packard Radios and your \$5,000.00 Bonded 30 days' free trial offer and guarantee. Send full details.

Name.....

Address.....

City..... State.....

\$351⁰⁰ CLEARED IN ONE DAY

So writes W. H. Adams of Ohio. Letter from California man reports \$11275 sales in three months; New Jersey \$4000 profits in two months; Pa. \$3000 profits in four months. Ira Shook \$365 sales in one day. Bram bought one outfit April 5 and 7 more by August. Iwata bought one outfit and 10 more within a year.

J. R. Bert says "only thing I ever bought that equaled advertisement." John Culp says: "Everything going lovely. Crispette wrappers all over town. It's a good old world after all." Kellog, \$700 ahead end of 2d week. Wholesale or retail. Big profits either way. No town too small. Business is pleasant, fascinating and dignified. You manufacture a food product.



WE START YOU IN BUSINESS
Furnish secret formulas, raw material and equipment. Little capital required; no experience needed.

Build a Business of Your Own
No limit to the sale of Crispettes. Everybody likes them. It's a delicious food confection. Write for facts about a business that will make you independent. Start now, in your own town.

PROFITS \$1000 MONTH EASILY POSSIBLE
Send postal for illustrated book of facts. It contains enthusiastic letters from others—shows their places of business, tells how and when to start, and all information needed. Free. Write now!

LONG-EAKINS COMPANY

1023 High Street

Springfield, Ohio

Chemical Tricks for Boys



Surprise and puzzle your friends with magic chemical tricks; make ink, dye cloth, test water and soil; write secret letters with invisible ink; pour blue, brown and black liquid from a pitcher of water. All these and many more chemical stunts are easy with ChemCraft Junior. It's the best box of fun you ever had! Get yours now.

ONLY 25c POSTPAID

FREE Magazine

of the ChemCraft Club to every boy who writes for it now. Full of new ideas and chemical stunts. Ask for yours!

The Porter Chemical Co.
113 Summit Ave. HAGERSTOWN, MD.



Big commission - MEN'S SUITS

\$8.88
FREE SALESKIT

Any one can earn \$2,000 extra money yearly in view of low price. Up to date styles, workmanship. Variety of beautiful patterns.

883 Co., Dept. K-7, Fort Wayne, Ind.



ONLY \$1⁰⁰ Down



10 Day FREE TRIAL

Never has there been such a TYPEWRITER BARGAIN on as EASY TERMS. A genuine SILENT Ball Bearing L C Smith—GUARANTEED 5 YEARS—at a 50% saving. Here's your chance to get the best typewriter money can buy for only \$1 down. Act now—save 1/2!

World's Only Ball Bearing Typewriter

Because of its ball bearings and other exclusive features, the L C Smith has for over 20 years been recognized as the world's finest, easiest running, longest wearing typewriter. U. S. Government purchases over 50,000. It is also the choice of railroads, big corporations like the Standard Oil Co., etc. All the latest operating attachments; beautifully re-newed; fully guaranteed.

\$3 Worth Extras FREE

Don't buy any typewriter until you have tried an L C Smith. For the sake of your future satisfaction, accept our FREE TRIAL OFFER. Use the ball-bearing L C Smith 10 days before deciding on any machine. By acting now you get Tools, Waterproof Cover, valuable Home Study Touch Typewriting Course FREE. Write today for details of our Special \$1 Offer and Free manual of typewriter information.

SMITH TYPEWRITER SALES CORP.

11A-360 E. Grand Ave.

CHICAGO



AIRPLANE

12-inch scale model of Lindbergh's Spirit of St. Louis. Scientifically designed and very realistic. Rises from ground by own power and flies 30 ft. or more. Stays in air 8 to 10 seconds.

Easily built in 2 or 3 hours. No tools needed. Construction set, with all parts and full directions, postpaid in U.S., only 50c. (no stamps). Satisfaction or money back. Send today. Mann & Benton, Box D, Chillicothe, O.



PLUMBING-HEATING-2 YOU SAVE HALF

Send for BIG FREE BOOK of Guaranteed Plumbing and Heating. Everything cut-to-ft. 50 yrs. in business. Thousands of customers. "You saved me \$400.00," says Mr. Edw. Borkosky of N. J. Write today. HARDIN-LAVIN CO., 107-17 C Pershing Rd., CHICAGO



DIE CUT OVAL PRINTS

Something new for kodakers. Send negative with dime for sample and catalog of specialties for kodakers. FRANK SCOBIE, 43-S, Sleepy Eye, Minn.

A Ring You Will Be Proud to Wear

Genuine Full Cut Diamonds [No Chips] SEND NO MONEY



\$25

No. 6132. Solid Gold Men's Initial or Emblem Ring. 2 Genuine Diamonds, 14-Kt. White Gold Top, Emblem (any lodge) or any initial (Old English) Yellow or White Gold in-laid in Genuine Hope Ruby or Black Onyx. Mention if desired in solid white gold or green gold, same price. Also give Initial or Emblem desired and finger size.

BUFFALO JEWELRY MFG. CO.

501 Washington St.

Dept. P

(or at your Jeweler's)

No. 6919. Ladies 14-Kt. white gold ring with genuine amethyst encircled by real seed pearls strung on gold wire. The mounting is beautifully pierced, contains flowers of green and yellow gold. Also be had with genuine topaz, sapphires, genuine Hope ruby, Zircon and golden sapphire.

Terms (6 Mos. to Pay) Give Finger Size

"The Mail Order House"

BUFFALO, N. Y.

Ask for Free Jewelry Catalog



6919

\$30

This Reg. Trade Mark guarantees you genuine diamonds.

**"I know they're right—
they're Starretts"**



No. 153
A popular
priced, pistol
grip frame.



No. 169
Easy grip
frame, excep-
tionally rigid
and with a
wonderful
"hang."



And there's the same quality of materials and workmanship in Starrett Hacksaw Blades and Frames that is to be found in the world famous Starrett Tools.

Designed and manufactured by the World's Greatest Toolmakers, Starrett Blades and Frames give you the most economical cutting combination you can buy. They cut quicker and last longer.

Have you tried the new Starrett High Speed Hacksaw?

Ask your tool dealer for Starrett Hacksaws. Write us for copy of Starrett Hacksaw Chart and Starrett Catalog No. 24 "AP" illustrating and describing more than 2500 Starrett Tools.

THE L. S. STARRETT CO.
World's Greatest Toolmakers
Manufacturers of Hacksaws Unexcelled
Steel Tapes Standard for Accuracy
ATHOL, MASS., U. S. A.



Use Starrett Hacksaws

Just Sign Here . . .

We'll send you a 10-day tube of this unique shaving cream, postpaid

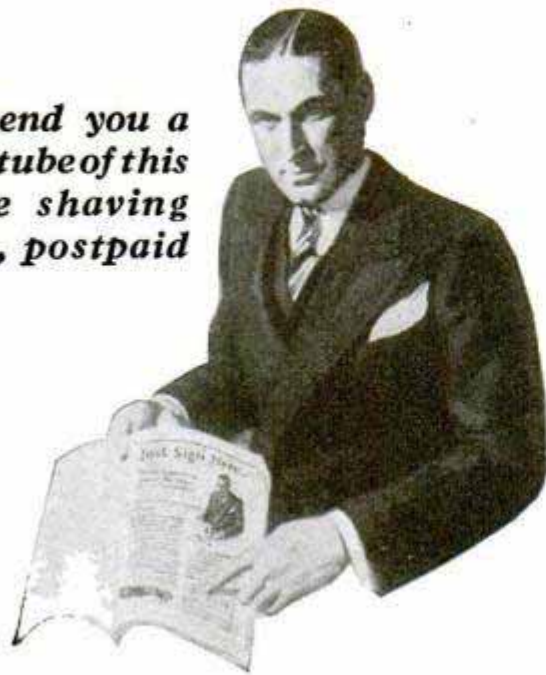

Gentlemen:

Palmolive Shaving Cream embodies the four great essentials 1000 men told us they wanted in a shaving cream, plus a fifth which we added.

Its success is a sensation. Men are flocking to it by the thousands.

We believe it will give you shaving comforts unknown to you before. That it will surpass your present method of shaving in five important ways.

In your interest and in ours, let us send you a 10-day tube to try. We know we can win you in this way. 85% of its present users thus were won from other preparations.

Five Advantages

1. Multiplies itself in lather 250 times.
2. Softens the beard in one minute.
3. Maintains its creamy fullness for 10 minutes on the face.
4. Strong bubbles hold the hairs erect for cutting.
5. Fine after-effects due to palm and olive oil content.

We're the makers of Palmolive Soap, as you know. Thus 65 years of soap study stands back of this creation. We made up and discarded 129 formulas before venturing it on the market.

Just send coupon

Your present method may suit you well. But still there may be a better one. This test may mean much to you in comfort. Send the coupon before you forget.

PALMOLIVE RADIO HOUR—Broadcast every Wednesday night from 9:30 to 10:30 p. m., eastern time; 8:30 to 9:30 p. m., central time over station WEAJ and 32 stations associated with the National Broadcasting Company.

With the new unbreakable Bakelite top.

3977

10 SHAVES FREE

and a can of Palmolive After Shaving Talc

Simply insert your name and address and mail to Dept. B-1561, Palmolive, 3702 Iron St., Chicago, Ill. Residents of Wisconsin should address Palmolive, Milwaukee, Wis.

.....

 (Please print your name and address)

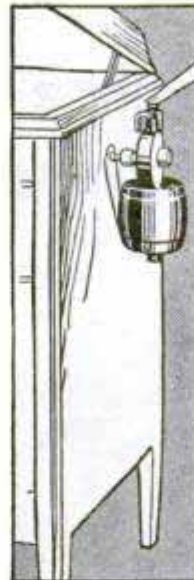

Press the button
and let the
MOTROLA

wind your phonograph

The Motrola is a small electric motor that replaces the winding crank on your phonograph. Readily attached to outside without marring the woodwork or affecting the mechanism. Merely press the button and the Motrola winds your phonograph more quickly and evenly than you can crank it. Stops automatically when spring reaches proper tension.

Quickly, easily applied

Anyone can apply or detach the Motrola in a few minutes, using only a screw driver. Winds any make or size machine. No parts to wear out—costs only a cent a month for electricity. Attractively finished, equipped with light socket plug and 10 feet of cord. Sold with our unqualified guarantee. Thousands now giving dependable, labor saving service. Ask your dealer for demonstration.

Your old phonograph—
with Motrola
and electric
pick-up to
your radio—
gives same
results as the
costly new
electric
machines.

Write us today for
[illustrated descriptive folder]

JONES-MOTROLA SALES CO.
370 Gerard Avenue New York City

NEW! NEVER SHOWN BEFORE

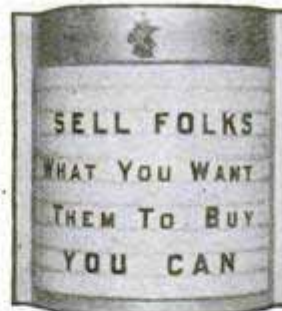

They can't tell you they've seen it for it's the liveliest new born baby you've ever seen kick. Action that's a knockout. Color too. Note the circle face. For inside or outside. You can sell it and get your money right now. Our deposit getting plan **CLICKS**.

TRADE IN DEAL

on our earlier numbers. Never heard of such a thing, did you? Well, we're Pioneers. High Binders lay off. Square shooters get the dope and territory immediately. **SHOW 'EM AND SELL 'EM**—That's the slogan. Turnover is what the merchant wants and he can see it in this Sales Maker. If you want to write today.

DISPLAY PRODUCTS COMPANY
405-7-9 E. 31st St. DEPT. A. KANSAS CITY, MO.

ENINGER WILL TRUST YOU
 SEND 50c INSTAMPS FOR CATALOGUES
BIG MONEY SAVING FOR YOU
 Used and rebuilt motorcycles \$25 to \$100,
 used bicycles \$9.50, tandems \$20.
 All machines fully guaranteed.
 New bicycles and motorcycles
 at factory prices, save dealers'
 profits. Motorcycle and auto-
 mobile tires \$3. Complete line
 frames, engines, supplies.
ENINGER PRICE CUTTER, ROCHESTER, N. Y.
PAY AS YOU RIDE



MOTORCYCLES

WE WILL TRUST YOU
Pay As Low As \$2.00 per Week

Hendersons, Harley-Davidsons, Indians

Slightly used and rebuilt. Hundreds to select from.

Send 10c for list today.

MYEROW BROS. CO., 15 Berkeley St., Boston, Mass., U. S. A.



Here's Good News *Motorcycle Riders*

Modern performance from a distinctly modern machine. Don't look for this new day value in a motorcycle designed two or three years ago.

IN appearance a vastly-better looking motorcycle, in performance a new machine with improvements from end to end.

Motorcycling on this new Indian 4 will be an entirely new sensation. Smooth-flowing power that speaks in a whisper. Four cylinders! Plenty of reserve—twist throttle on the last fifty feet of hill and your sporting blood will tingle at the surge of power that sends you over the top.

Pick-up! With added power, and ingenious redesigning of the transmission, changing second gear ratio and giving a faster, more positive method of gear shifting, a brand new degree of pick-up has been attained.

ASK YOUR DEALER for a Demonstration

The **NEW**
Indian **4**

And—to balance this pick-up—there are both front and rear wheel breaks. A new, simple foot action on clutch “locks-out” easily in traffic.

Go to your dealer's—take the new Indian 4 for a spin—all by yourself. Stop by the roadside and look at the improved construction. Give it your own private “Road Test.” Take the old familiar runs and *compare the performance and pleasure* with any motor you have ever ridden.

Send coupon for illustrated details. If you don't know the name of your local dealer, ask us.

INDIAN MOTORCYCLE CO., Springfield, Mass.

Name..... Age.....

Address

City..... State.....

Send literature on new Indian 4. Give name of nearest dealer (check only if unknown to you.)

P. M. 10-28.



LUMINOUS PAINT

Make Your Watches, Clocks, Etc., Visible by Night The very latest discovery in the scientific world. Hitherto, practically unobtainable except at an exorbitant price, we have at last succeeded in producing this remarkable LUMINOUS PAINT, which, applied to the surface of any article, emits rays of white light, rendering it perfectly visible in the dark. **THE DARKER THE NIGHT, THE MORE BRILLIANT IT SHINES.** Quite simple to use. Anyone—you can do it. A little applied to the dial of your watch or clock will enable you to tell the time by night. You can coat the push buttons or switch plates of your electric lights, match boxes, and innumerable other articles; make your own Luminous Crochures, Luminous Rosaries, etc. Small bottle, price 25c. Larger sizes, 50c and \$1 postpaid. **JOHNSON SMITH & CO., Dept. 828 RACINE, WIS.**



CIGARETTE MAKER

Roll your own and save money. Better and quicker than any other. Use your favorite brand of tobacco. Neat, useful, handy. Pocket size, weighs 1/2 oz. Made entirely of metal, nickel plated. 25c, 3 for 65c postpaid anywhere.



GOOD LUCK RING

Very striking, quaint and uncommon. Silver finish; skull and crossbones design; two brilliant, flashing gems sparkle out of the eyes. Said to bring good luck. Only 25c ppd.



Exploding Cigarettes

JUST LIKE ORDINARY CIGARETTES. BUT SUCH REAL STARTLERS! The box contains ten genuine cigarettes of excellent quality. They appear so real, but when each cigarette is about one-third smoked, the victim gets a very great surprise as it goes off with a loud BANG! A great mirth provoker yet entirely harmless. Price 25c box.

NOVELTY BADGES



Kissing Permit 10c Two very novel metal badges, nickel plated that you can wear, giving you fun out of all proportion to their trifling cost. 10c, each badge, 3 for 25c, or 75c per doz. postpaid anywhere.

GARTER INSPECTOR

These clever locks cannot be opened unless you know the combination. No key necessary. For your locker, bicycle, tool chest, mail box, thousands of uses. Shells and tumblers nickel plated. Weights trifling over one ounce. Small yet strong. Secret and full instructions with each lock. Price 25c or 3 for 65c postpaid.

SURPRISE MATCHES

More fun than fighting with your wife. Look just like ordinary matches. Put up in boxes just like regular Safety Matches. As the victim tries to light one he gets quite a surprise. Price 10c per box, 3 boxes for 25c, 12 for 75c cents.



Keyless Lock

These clever locks cannot be opened unless you know the combination. No key necessary. For your locker, bicycle, tool chest, mail box, thousands of uses. Shells and tumblers nickel plated. Weights trifling over one ounce. Small yet strong. Secret and full instructions with each lock. Price 25c or 3 for 65c postpaid.

MIDGET BIBLE

GREAT CURIOSITY Smallest Bible in the world. Size of a postage stamp. 200 Pages. Bound to bring good luck to the owner. A genuine work of art. Must be seen to be appreciated. Make good money selling them to friends, church acquaintances, etc. PRICE 15c each, 3 for 40c, 12 for \$1.35, 100 for \$7.50. Also obtainable in Leather Binding, with gold edges. Price 50c each, 3 for \$1.25, \$4.50 per doz. Magnifying Glass for use with Midget Bible. 15c.

STAGE MONEY

With a bunch of these bills, it is easy for each person of limited means to appear prosperous by flashing a roll of these bills at the proper time and peeling off a genuine bill or two from the outside of the roll, the effect created will be found to be all that can be desired. Prices, postpaid: 40 Bills 20c, 120 for 50c, or \$3.50 thousand postpaid.



Comical Motto Rings

Lots of harmless fun and amusement wearing these rings. Made in platinum finish (to resemble platinum), with wording on enameloid, as illustrated. Price, only 25c Postpaid. **JOHNSON SMITH & CO.**

JOHNSON SMITH & CO., Dept. 828 RACINE, WIS.

A De Luxe Edition of our new 1928 CATALOG mailed on receipt of 25c. Handsome binding. Bigger and better than ever. Only book of its kind in existence. Nearly 600 pages of all the latest tricks in magic, the newest novelties, puzzles, games, sporting goods, rubber stamps, unusual and interesting books, curiosities in seeds and plants, etc., unobtainable elsewhere. Remit by Stamps, Coin, Money Order, Check, etc. Unused U. S., Canadian and Foreign Stamps also accepted.

BLANK CARTRIDGE PISTOL



Protection against Burglars, Tramps, & Dogs. Special Offer 1 Blk. Cartridge Pistol 100 Blank Cartridges 1 560-page Novelty Catalog **ONLY \$1.50** The Lot Shipped by Express Only Cash With Order Only

Well made and effective, modeled on latest type of Revolver; appearance alone is enough to scare a burglar. When loaded it may be as effective as a real revolver without danger to life. It takes standard .22 Cal. Blank Cartridge—obtainable everywhere. Special cash with order offer: 1 Superior quality Blank Cartridge Pistol, 100 Blank Cartridges, and our new 560 page Big Catalog of latest novelties; all for **ONLY \$1.50**. Shipped by Express only. Cannot go by parcel post. Extra Blank Cartridges 50c per 100, Special Heister (Cowboy Type) for pistol 50c. No C. O. D. shipments.

THROW YOUR VOICE



Into a trunk, under the bed or anywhere. Lots of fun fooling the teacher, policeman or friends.

THE VENTRILO

a little instrument, fits in the mouth out of sight, used with above for Bird Calls, etc. Anyone can use it.

Never Fails. A 16 page course on ventriloquism, the Ventrilo, ALL FOR 10 CENTS

MAGICIAN'S BOX OF TRICKS

Apparatus and Directions for a Number of Mysterious Tricks, Enough for an Entire Evening's Entertainment... **\$1.00**



Anyone Can Do Them It is great fun mystifying your friends. Get this Cojurer's Cabinet, and you will be the cleverest fellow in your district. It contains the apparatus for ten first-class tricks, including: The MAGIC BALL and VASE TRICK (a wooden ball placed inside, and upon replacing the lid has disappeared and is found in someone else's pocket); The HINDOO TRICK CARDS (can be made to change completely no less than five times); DISAPPEARING COIN BOX (a coin, placed in the wooden box, vanishes entirely or changes into a coin of another denomination); The GLASS GLOBE TRICK (a coin is dropped into a glass of water and when the water is poured out the coin has vanished and is found somewhere else); The RIBBON FACTORY FROM THE MOUTH TRICK (a seemingly endless supply of colored paper ribbons comes out of your mouth); The DISAPPEARING HANDKERCHIEF (a handkerchief held in the hand mysteriously vanishes); The WIZARD'S RING COIN TRICK; the ENCHANTED BOTTLE (no one but yourself is able to make it lay down); the GREAT HAT AND DICE TRICK (a large dice is placed on top of a hat, disappears, and is found under the hat, yet no one has touched the hat); and last, but not least, the GREAT PHANTOM CARD TRICK, or two from five leaves nothing. Full instructions are sent for performing each trick. In addition to the above, a number of other feats and illusions are fully explained, for which you can easily make or procure the necessary apparatus. Price complete \$1.00 postpaid.

U. S. BABY TANK



It goes with real Yankee Pep—by its own power. Most remarkable toy ever invented. By drawing the Tank backward, either with the hand or over the floor or table and then placing it down, it will crawl along, overcoming all obstacles, in the same lifelike manner as the larger Tank that proved so deadly in the great war. What makes it go is somewhat of a mystery, for there is no mechanism to wind up as is usually understood with mechanical toys, yet this tank will keep plodding along ten times longer than the ordinary run for toys. It will perform dozens of the most wonderful stunts; it will go backward or forward at will; 2 1/4 inches long. Price only 25c prepaid. **JOHNSON SMITH & CO.**

Look 35¢ Look Wonderful Instrument.



Greatest thing yet. Nine separate articles in one. Everybody delighted with it. Odd, curious and interesting. Lots of pleasure as well as very useful. It is a double Microscope for examining the wonders of nature. It is also an Opera Glass, a Stereoscope, a Burning Lens, a Reading Glass, a Telescope, a Compass, a pocket Mirror, and a Laryngoscope—for examining eye, ear, nose and throat. It is worth all the cost to locate even one painful cinder in the eye. Folds flat and fits the pocket. Something great—you need one. Don't miss it. Sent by mail. Only 35c or 3 for \$1.00

JOHNSON SMITH & CO., DEPT. 828 RACINE, WIS.

New!

WONDERFUL RADIO!
Super-Eight—100% Electric
8 TUBES — SINGLE DIAL
Coast-to-Coast

Shipped Direct from our Factory on

30 Days Free Trial

[Battery or Electric]

Metro's latest achievement—the world's greatest electric radio set. Powerful long distance 8 tube receiver—clearness of tone that is astounding—ultra-selective. Radio engineers pronounced it the ultimate for all-around perfection. To prove our claims, we will send this marvelous set to you direct from our factory on **30 days' free trial**. Compare its quality, beauty and price with any other radio on the market, and decide to keep it only after you are satisfied that the new 1929 Metrodyne Super-Eight is the peer of them all.

Metrodyne

SUPER-EIGHT ELECTRIC

Save 1/2—Low Price a Big Feature

Amazingly low price! Console or table cabinet. Low cost of distribution direct from our factory enables us to save you about half regular value. Never before have you been offered such sets at such low prices. We are so sure of their quality, beauty and performance pleasing you that we will let you **try one for 30 days** before deciding to keep or return it.

SUPER QUALITY THROUGHOUT

Eight powerful tubes. Highest quality low loss parts. Illuminated single dial. Positive switch control—simply turn a knob and it's on. Select your stations with accuracy at any desired volume. Beauty of tone unsurpassed. Console and table cabinets are handsomely grained genuine walnut, hand rubbed, in two-tone effect—artistically carved trimmings. All metal parts finished in two-tone gold. Seeing is believing. **YOU WILL BE THE JUDGE.**

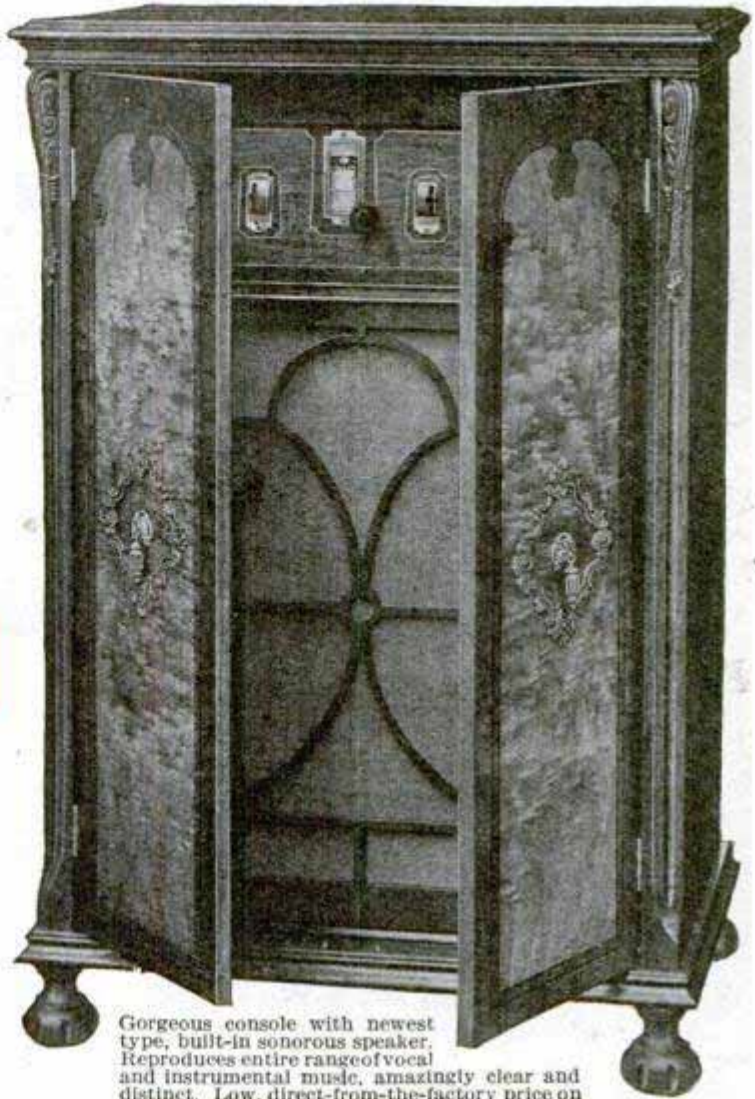

Gorgeous console with newest type, built-in sonorous speaker. Reproduces entire range of vocal and instrumental music, amazingly clear and distinct. Low, direct-from-the-factory price on **30 DAYS' FREE TRIAL.**

**METRODYNE
 RADIO SETS**
Are Equipped For
**BATTERY or
 ELECTRIC
 OPERATION**

Agents and Dealers

The 1929 Super-Eight line offers great money making opportunities. Nothing like them for high quality—nothing near them in price. Let us prove this by shipping you a **DEMONSTRATION SET** on

30 Days' Free Trial

Test it—compare it—demonstrate it to prospective radio buyers. Get our liberal discounts—exclusive territory—newspaper and billboard advertising offer that will help sell Metrodyne radios quickly.

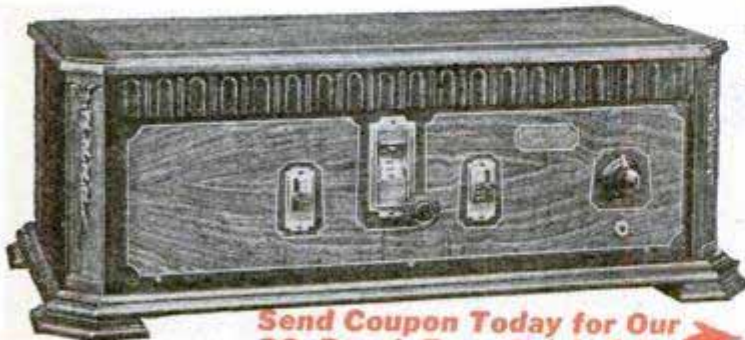

Send Coupon Today for Our **30 Days' Free Trial Offer** →

Metro Electric Company

2161-71 North California Avenue
 Dept. 21 CHICAGO, ILLINOIS

We are one of the pioneers of radio. The success of Metrodyne sets is due to our liberal **30 days' free trial offer**, which gives you the opportunity of trying before buying. Thousands of Metrodynes have been bought on our liberal free trial basis. We will send you hundreds of letters from owners who acclaim the Metrodyne as the greatest radio set in the world. A postal letter or the coupon brings complete information, testimonials, wholesale prices and our liberal **30 days' free trial offer**—**WRITE TODAY!**

METRO ELECTRIC COMPANY
 2161-71 N. California Avenue, Dept. 21
 Chicago, Illinois

Gentlemen:

Send me full particulars about Metrodyne Super-Eight sets and your **30 days' free trial offer.**

Name.....

Address.....

If you are interested in **AGENT'S proposition**, place an "X" in the square →

PATENT

Protect Your Ideas

Take the First Step Today

If you have a useful, practical, novel idea for any new article or for an improvement on an old one, you should communicate with a competent Registered Patent Attorney AT ONCE. Every year thousands of applications for patents are filed in the U. S. Patent Office. Frequently two or more applications are made for the same or substantially the same idea (even though the inventors may live in different sections of the country and be entirely unknown to one another). In such a case, the burden of proof rests upon the last application filed. Delays of even a few days in filing the application sometimes mean the loss of a patent. So lose no time. Get in touch with me at once by mailing the coupon on the opposite page.

Prompt, Careful, Efficient Service

This large, experienced organization devotes its entire time and attention to patent and trade mark cases. Our offices are directly across the street from the U. S. Patent Office. We understand the technicalities of patent law. We know the rules and requirements of the Patent Office. We can proceed in the quickest, safest and best ways in preparing an application for a patent covering your idea. Our success has been built on the strength of careful, efficient, satisfactory service to inventors and trademark owners located in every state in the Union.

NO CHARGE for Information On How to Proceed

The booklet shown here contains valuable information relating to patent procedure that every inventor should have. And with it I will also send you my "Record of Invention" form on which you can sketch your idea and establish its date before a witness. Such evidence may later prove valuable to you. Simply mail the coupon and I will send you the booklet, and the "Record of Invention" form, together with detailed information on how to proceed and the costs involved. Do this NOW. No need to lose a minute's time. The coupon will bring you complete information entirely without charge or obligation.

My Patent Law Offices
Just Across
Street From
U.S. Pat. Office



Above is a view of my drafting and specification offices where a large staff of experienced experts are in my constant employ. All drawings and specifications are prepared under my personal supervision.

NEWS

Inventors

Write for these

Free Books

Strict Secrecy Preserved

All communications, sketches, drawings, etc., are held in strictest confidence in strong, steel, fireproof files, which are accessible only to authorized members of my staff. Feel free to write me fully and frankly. Your case will have my personal attention. It is probable that I can help you. Highest references. But **FIRST**—clip the coupon and get my free book. Do **THAT** right now.

Clarence A. O'Brien

Registered Patent Attorney

Member of Bar of: Supreme Court of the United States; Court of Appeals, District of Columbia; Supreme Court, District of Columbia; United States Court of Claims. Practice confined exclusively to Patents, Trade marks and Copyrights

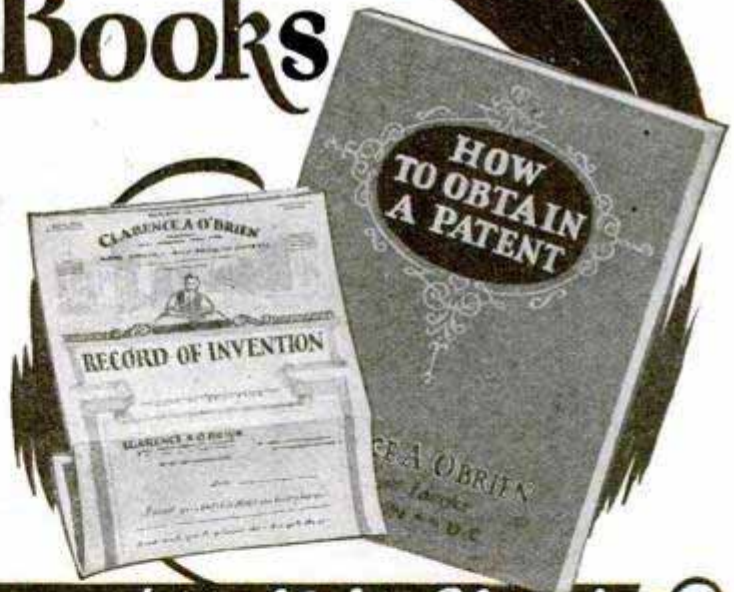

Clip this Coupon and Mail it Now!

CLARENCE A. O'BRIEN, Registered Patent Attorney

70-F Security Savings and Commercial Bank Bldg., Washington, D. C.

Please send me your free book, "How to Obtain a Patent," and your "Record of Invention" form without any cost or obligation on my part.

Name.....
(Important: Write or Print name clearly.)

Address.....

PATENTS TRADE MARKS COPYRIGHTS

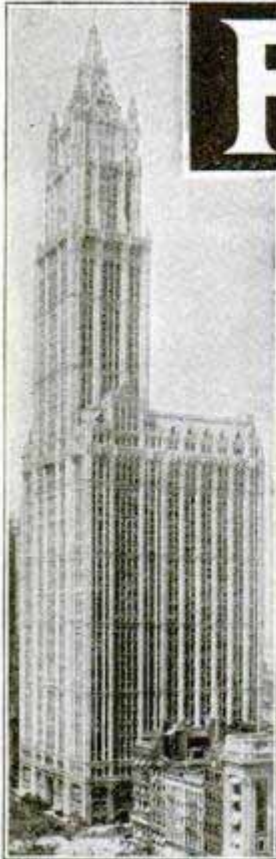

Our New York Office
Suite 1007 Woolworth Bldg.



Our Philadelphia Office
Suite 518-519 Liberty Bldg.



Our Washington Office, Victor Bldg.



Have You An Idea?
Our Offer: FOR THE PROTECTION
OF YOUR INVENTION

YOUR FIRST STEP

The inventor should write for our blank form

"RECORD of INVENTION"

This should be signed and witnessed and returned to us together with model or sketch and description of the invention for

INSPECTION AND ADVICE

No Charge for the Above Information

Our Five Books Mailed Free to Inventors

Our Illustrated Guide BOOK

How to Obtain a Patent

Contains full instructions regarding U. S. Patents. Our Methods, Terms, and 100 Mechanical Movements illustrated and described.

Our Trade Mark Book

Shows value and necessity of Trade Mark Protection. Information regarding *Trade Marks and unfair competition in trade.*

Our Foreign Book

We have Direct Agencies in Foreign Countries, and secure Foreign Patents in shortest time and lowest cost.

Progress of Invention

Description of World's Most Pressing Problems by Leading Scientists and Inventors.

We Regard a Satisfied Client as our best advertisement, and furnish anyone, upon request, lists of clients in any state for whom we have secured patents.

*Highest References—Prompt Service
—Reasonable Terms*

VICTOR J. EVANS & CO.

PATENT ATTORNEYS

Main Offices: 789 9th St., N. W., Washington, D. C.

Opposite U. S. Patent Office

DELAYS ARE DANGEROUS IN PATENT MATTERS

IMPORTANT! To Avoid Delay!

YOU SHOULD HAVE YOUR CASE MADE SPECIAL IN OUR OFFICE to save correspondence, secure protection and early filing date in the Patent Office. To secure special preparation of your case send \$25.00 on account with model or sketch and description of invention.



MAIN OFFICE, VICTOR J. EVANS & CO.—VICTOR BUILDING, WASHINGTON, D. C.

Our Lawyers Practice in all U. S. Courts and defend Clients in Suits involving Patents, Trademarks and Copyrights

All Communications and Data Strictly Confidential. Interference and Infringement Suits Prosecuted

OUR ORGANIZATION OFFERS PERSONAL SERVICE By Experienced Patent Lawyers, Solicitors and Draftsmen



Our Chicago Office Suite 1110 Tacoma Building



Our Pittsburgh Office Suite 514 Empire Building



Our San Francisco Office Suite 1010 Hobart Building

**FREE
COUPON**

**VICTOR J. EVANS & CO.
PATENT ATTORNEYS**

NEW YORK OFFICES
1007 Woolworth Bldg.

CHICAGO OFFICES
1110 Tacoma Bldg.

PHILADELPHIA OFFICES
518-519 Liberty Bldg.

PITTSBURGH OFFICES
514 Empire Bldg.

SAN FRANCISCO OFFICES
1010 Hobart Bldg.

MAIN OFFICES: 789-9th Street, N. W., WASHINGTON, D. C.

Gentlemen: Please send me *Free of Charge* your books as described on preceding page.

Name

Address

PATENTS

To the Man with an Idea

I offer a comprehensive, experienced, efficient service for his prompt, legal protection and the development of his proposition.

Send sketch, or model and description, for advice as to cost. Preliminary advice gladly furnished without charge.

My experience and familiarity with various arts frequently enable me to accurately advise clients as to probable patentability before they go to any expense.

Booklet of valuable information and form for properly disclosing your idea free on request. Write Today.

IRVING L. McCATHRAN, Patent Lawyer

Formerly with and successor to Richard B. Owen

200 Owen Bldg.
Washington, D. C.

41-E Park Row
New York City

TRADE-MARKS REGISTERED



\$300,000 For This Invention

That's what Eastman Kodak paid for the Autographic idea. Thousands of other inventions are needed and offer enormous opportunities for earning fortunes. If you are of an inventive turn of mind why not concentrate on things that are really NEEDED. Get

Raymond Yates's new book

"1000 NEEDED INVENTIONS"

Costs only \$1.25 and may start you thinking along the right lines. You'll get nowhere just fussing around. Concentrate on what the industries need, and on what the public wants. Mr. Yates's book tells you what these things are. Send no money. Just write postal. Pay mail man \$1.25 plus postage when book arrives. Your money back if you want it. This offer limited. Write now and get on the right track. (Outside U. S. \$1.45, cash with order.)

BUREAU OF INVENTIVE SCIENCE
Dept. 310, Wisner Building, Rochester, N. Y.

PATENTS

Don't Lose Your Rights To Patent Protection

Before disclosing your invention to anyone send for blank form "EVIDENCE OF CONCEPTION" to be signed and witnessed. As registered patent attorneys we represent hundreds of inventors all over the United States and Canada in the advancement of inventions. The form "Evidence of Conception," sample, instructions relating to obtaining of patents and schedule of fees sent upon request.

LANCASTER & ALLWINE

480 Ouray Bldg.

WASHINGTON, D. C.

Originators of forms "Evidence of Conception."

PATENTS

Booklet Free Highest References
Promptness Assured Best Results

Send drawing or model for preliminary examination of Patent Office records.

ALL BUSINESS GIVEN PROMPT AND PROPER ATTENTION

Listed Patent Lawyer in the latest editions of the Rand-McNally Directory of Bankers and Bonded Attorneys, published by Rand-McNally & Co., Chicago, Ill.; The Baggott & Ryall Directory of Guaranteed Attorneys, published by the Ryall Legal Directory Company, New York City; Flugel's List, published by the Legal Directory Publishing Co. of St. Louis, Mo.; the American Lawyers Annual, published in Cleveland, Ohio; Eyre's Law List, Bush Terminal Building, New York City.

WATSON E. COLEMAN,
REGISTERED PATENT LAWYER

Victor Building, 724 Ninth Street, N. W.
WASHINGTON, D. C.

PATENTS

TRADE-MARKS · DESIGNS
FOREIGN PATENTS

MUNN & CO.
PATENT ATTORNEYS

Associated since 1846 with the Scientific American

SCIENTIFIC AMERICAN BUILDING
24 W. 40th St., New York City

SCIENTIFIC AMERICAN BUILDING
Washington, D. C.

TOWER BUILDING
Chicago, Ill.

VAN NUYS BUILDING
Los Angeles, Cal.

HOBART BUILDING
San Francisco, Cal.



Books and Information on Patents and Trade-Marks by Request.
Associates in All Foreign Countries.

INVENTORS PROTECT YOUR IDEAS

Send for our Guide Book, **HOW TO GET A PATENT**, and Evidence of Invention Blank, sent Free on request. Tells our terms, methods, etc. Send model or sketch and description of your invention for INSTRUCTIONS. No charge for the above information.

RANDOLPH & CO.
301 Victor Bldg., WASHINGTON, D. C.

NAME.....

STREET.....

CITY..... STATE.....



Patents

Inventors who derive largest deserved profits know and heed certain simple but vital facts **BEFORE** applying for patents. Our book **PATENT-SENSE** gives these facts. Sent **FREE**.

LACEY & LACEY
WASHINGTON, D. C.
ESTABLISHED 1869

Lacey & Lacey, 646 F St., N. W. Washington, D. C.
Please send me your **FREE** book **PATENT-SENSE**.
Name.....
Address.....
City.....
State.....

One Year **To Pay**



No. 290—\$60.
\$5 Deposit—\$1 a Week
 A magnificent cluster of 7, fine quality, full cut, sparkling, blue-white, genuine diamonds is set in a solid platinum disk. Disk is set in an exceptionally popular, beautifully hand engraved, 18 Kt. solid white gold mounting. This gorgeous cluster has every appearance of a \$600 solitaire.

No Red Tape **10 Days Trial**

18 KARAT

SEND NO MONEY After you get the ring, pay only \$5.00 to the postman. If you keep it, pay only \$1.00 a week for one whole year. **DON'T BOTHER WRITING A LETTER:** Just pin this ad to a piece of paper with your name, address and finger size on it and state whether white or colored.

PRICE CUT TO \$60.00—WORTH \$100.00
 You can now buy this gorgeous ring at the wholesale price. Compare it with similar rings at \$100. We guarantee it to stand any test or comparison. Greatest bargain offered by any Diamond Importer. We allow 8% annual increase in exchange for a larger diamond ring. **Write for FREE Illustrated Catalog** It brings our large Jewelry Store right into your home. Gives weights, grades and complete description so you can buy diamonds like an expert. Gives information other jewelers dare not tell.

AGENTS WANTED—EARN \$200 WEEK. WRITE FOR DETAILS

STERLING DIAMOND & WATCH CO. INC.
 DIAMOND IMPORTERS—\$1,000,000 STOCK—ESTABLISHED 1879
 1540 BROADWAY DEPT. 2519 NEW YORK

PATENTS

Trade Marks, Copyrights, Patent Litigation Handbook with illustrations, 100 mechanical movements. Sent free on request.

ALBERT E. DIETERICH
 formerly member examining corps U. S. Patent Office
PATENT LAWYER and SOLICITOR

621-A, Ouray Bldg.
 27 Years' Experience Washington, D. C.

New Way TO Make Money

Easy Cash—Sure And Quick You can easily earn \$15 a day or more taking orders from your friends and neighbors for our fine tailoring. Orders come easy when you show our swell samples and smart styles. **We show you how**—you don't need to know anything about tailoring—simply follow our directions—we make it easy.

YOUR SUIT FREE
 Our new plan enables you to get one of our fine made-to-order suits, in any style you want, without one penny cost to you.

FREE New, Big New style, convenient carrying case **OUTFIT** outfit, large all-wool samples, all supplies necessary to start at once—furnished **FREE. WRITE AT ONCE.**

Progress Tailoring Co., Dept. X216, Chicago



\$75 to \$125 Weekly

5 Down Charging Batteries Starts You



Let meshow you how to make big money right from the start. I've prepared a **FREE** book explaining all details. First week's profit pays for all equipment. You can get all the battery charging business in your community with my **Service Station Charger**—it's years ahead of ordinary chargers—handles 50% to 70% more batteries. I explain everything—start you in a business of your own and put you on the way to big money. Write for **FREE** Book.

C. F. HOLMES, Chief Engineer, Dept. PM
 Independent Electric Works, 5116 Ravenswood Ave., Chicago

FREE BOOK—Just Out



MAKE YOUR FORD Into The "LARK"

\$5.00 Red-i-Kut life size patterns **Class—Snap**



38-inch Easy Riding Seat

Famous sure-fit **RED-I-KUT** life-size patterns and picture instructions show how you can easily convert your Ford into this **Fast, Saucy, Sport-Car** as thousands have done with easily obtained materials. No need to lay up the car. Rear seat folds, making 4-passenger car. Send 10c coin for actual body photo and new manual of other distinctive sport body patterns from \$5.00 up—**"RKO" Steel "Swing-Lo" irons, Tops and Windshields. ORDER RIGHT NOW**

KUEMPEL COMPANY, 101 Kuempel Bldg., GUTTENBERG, IOWA

30 Days' Free Trial

New Models now ready for delivery direct from our factory. Astonishing low prices and terms. Do not buy until you get them.

Tires **Mead** **CYCLE CO. Dept. R-108 CHICAGO**



Catch Fish!



Eels, Mink, Muskrats with our new folding galvanized **STEEL WIRE TRAP**. Write for our **FREE TRAP OFFER** and Bargain Catalog. \$1 Box of our famous Fish Bait **FREE** to introduce our traps.

WALTON SUPPLY CO., 3502 JUNIATA AVE., ST. LOUIS, MO.

EDGAR M. KITCHIN
Attorney & Counsellor at Law
 Patent and Trade Mark Specialist 805 G St. N. W., Washington, D. C.

PATENTS Write for **FREE** Instructions. Send Drawing or Model for Examination.

CARL MILLER, Patent Attorney
 former member examining corps U. S. Patent Office
 260 McGill Building Washington, D. C.

BLUE BOOK ON PATENTS
 AND PRIORITY RECORD BLANK GRATIS.

MONROE E. MILLER, PATENT LAWYER
 411-1/2 Ouray Building, WASHINGTON, D. C.
 ELECTRICAL AND MECHANICAL EXPERT

DIE-CASTING MACHINES

R. BYRD. R. D. 8 COR. BUFFALO & SALTSMAN ROADS **ERIE PA.**

ALL GIVEN

10 year guar. Watch with chain and ring, large Eastman Roll Film Camera or 25 cal. Hamilton Rifle yours for introducing finest assorted liquid perfume at 15c a bottle. Send for 20 bottles and choose gifts as per offer in our catalog. We trust you—just write to **BELL PERFUME CO., Dep. A153, Chicago, Ill.**



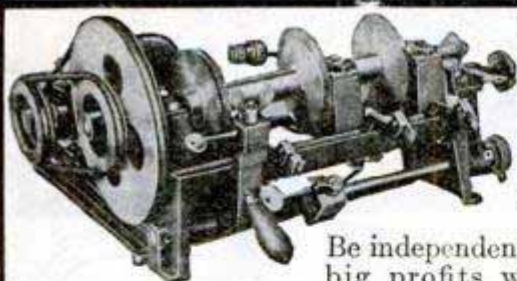

**DON'T
BE A
SLAVE**

Be independent and make big profits with the—
NEW IMPROVED BEISSER KEY MACHINE
You can start a business of your own, no experience necessary. The only key machine that cuts ALL kinds of keys. No hand-filing. Make first keys by number without taking locks apart. Locksmith instructions furnished free. Good Proposition for Agents. Write Today.

BEISSER KEY MACHINE COMPANY

407 Fort St. East

Detroit, Mich., U. S. A.

BIG MONEY FOR YOU

AGENTS—You'll find big profits falling in your lap—letting your friends see this Marvelous **Sunshine Radiant Heater**. Every home a hot prospect. Gives clean, live gas heat no matter where you live for 1½¢ an hour. No servicing; no installation—no investment nor stock. You collect profits in advance. Thousands in use!



SUNSHINE RADIANT HEATER

Makes and Burns Its Own Gas.

FREE Most Startling Offer Ever Made! Try one in your own home 15 days. Write quick for full details and make territory reservations.

SUNSHINE SAFETY LAMP CO.

331 Factory Building, Kansas City, Missouri

**BUILD YOUR OWN CLOCK
WITH OUR HELP**

Turn idle hours into welcome dollars building clocks, very profitable spare time work. We furnish plans, instructions, works, dials and all materials at low prices.

BANJO CLOCKS, MANTEL CLOCKS

WORKS AS LOW AS \$1.65

GRANDFATHER CLOCKS WITH CHIMES

Ask for our attractive **FREE** Blueprint plan and catalog.

AMERICAN CHIME CLOCK COMPANY, Dept. M

1670 Ruffner Street

PHILADELPHIA, PA.

Boils 50 Gallons

In Less Than Hour

No Other Compares With This

Improved Oil Burner

Use Ordinary Kerosene or Coal Oil

[Burns Outdoors as Well as Indoors]

THE most remarkable Kerosene Burner ever built. Boils down apple cider, maple syrup, molasses, etc., in half the ordinary time. Ideal burner for dairies, butchers, indispensable on the farm.

**PRODUCES TERRIFIC HEAT WITH
SILENT BLUE FLAME**

**NO
NOISE
SMELL
SMOKE
SOOT**

So efficient it produces twice the amount of heat of City gas at half the cost. So simple anyone can install and operate. Double generator assures continuous operation without shut-downs. Nothing to wear out, starts in a jiffy, will last a life time. Every burner guaranteed fully. Write for special introductory price and free catalog of outdoor utility and kitchen stove oil burners.

HOME MFG. CO., Dept. 2413, 18 E. Kinzie St., CHICAGO



WURLITZER

REG. U.S. PAT. OFF.

**"Bill Carola"
Landaus
Seranaders**



**Couldn't Play a
Note—Now Makes**

**\$100
a week**

"When I sent for your catalog, I didn't know a note of music. A few months after I bought my Wurlitzer instrument, I had taken my place in a professional orchestra. Now I am making \$100 a week, three times what I made as clerk. I wish everybody knew how easy it is—anyone who can whistle a tune can learn to play a musical instrument."

—Bill Carola

**Free Trial
Easy Payments**

You may now have any Wurlitzer instrument for an ample free trial in your own home. Examine the instrument, note the fine workmanship, the full, rich tone value and especially how easy it is to play. No obligation to buy—no expense for the trial. We make this liberal offer because we want you to try for yourself a genuine Wurlitzer instrument, the result of 200 year's experience in musical instrument building.

Easy payments are arranged to suit your convenience. This is your opportunity to try a famous Wurlitzer instrument in your own home. Send for

Free Book

Illustrates and describes every known musical instrument—more than 3000 articles, many of them shown in full colors. All genuine Wurlitzer instruments—buy direct from Wurlitzer and save money. Special offers on complete outfits.

We also give you our Free Trial, Easy Payment Plan. No obligation.

Send Coupon Today!

The Rudolph Wurlitzer Co., Dept. 1777

117 E. 4th St., Cincinnati

Send me your Free Book on musical instruments. Also your Free Trial, Easy Payment Plan. No obligation.

Name

Address

City State

Instrument

Copyright, 1928, The Rudolph Wurlitzer Co.

WITTE FARM and RANCH ENGINES at New Low Prices - Cash or Easy Terms

Easy Terms



WITTE Log & Tree Saw

with ALL-PURPOSE, ALL-FUEL ENGINE. Cuts up 15 to 40 cords of wood a day on just a few cents worth of cheap fuel, also cross ties, fence posts, etc.—safe, easy to operate. All-purpose engine can be used for all other power jobs around the farm or ranch—running Feed Grinders, Milking Machines, Cream Separators, Pumping Water for Home and Farm use, etc. Lifetime Guarantee for your protection.

MY Throttling Governor Engines furnish smooth, steady power, and I make a type and size for every farm and ranch need. Built of alloy-steel, to increase strength and reduce weight. WITTE all-fuel carburetor successfully burns low grades of distillate or kerosene. WICO Magneto with retard lever assures quick and safe starting regardless of weather conditions. Lifetime Guarantee for your protection.

FREE Catalog

describing WITTE Types "F" and "H" and Heavy Duty Engines and all improvements, also labor saving power outfits—log and buzz saws, pumper outfits, etc.—all at direct factory-to-you new low cash or easy term prices. Send today for your copy.

Cash or Your Own Terms

No interest to pay. Yes, I will give you a full year to pay for your WITTE Engine or Outfit. I want it to pay its own way while you pay me. It's so much cheaper to have your work done with a WITTE than it is to hire help

ED. H. WITTE, Pres.,
WITTE ENGINE WORKS
1747 Oakland Avenue,
1747 Liberty Street,
KANSAS CITY, MO.
PITTSBURGH, PA.

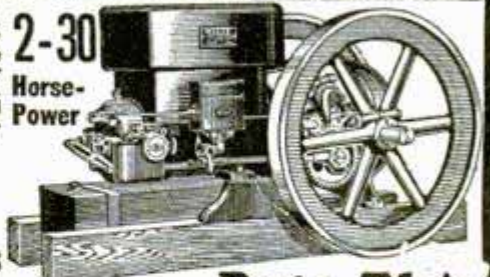

\$500 Puts This WITTE To Work for You

WITTE Type "F" on Wood Skids, 2 to 6 H-P.—Runs milking machines, feed grinders, cream separators, pumps water for home and stock, irrigating, etc. Easily and quickly taken wherever power is needed. Send for catalog. **A Size For Every Need!**

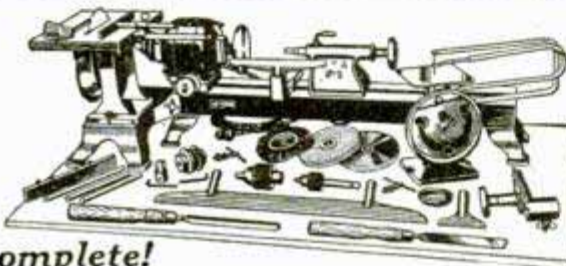

Complete! H & A UNIT PLAN CRAFTSHOP

Now you can buy a complete, practical, home work shop on the unit plan—get just the items you want or can afford now, and add others as you need them. Consists of the famous H & A Wood Lathe, plus Tiltng Table, Rip Saw, Scroll Saw, and complete assortment of accessory tools. Double spindle 1/4 H.P. motor furnishes power for the whole outfit. 1-3 H.P. motor if desired. JUST PLUG INTO THE NEAREST LIGHT SOCKET. Write for complete description and prices. All items priced separately so you can make up your own assortment.

HESTON & ANDERSON, 610 Western Avenue, FAIRFIELD, IOWA

\$25 To \$50 Make \$25 to \$50 per day and be Your Own Boss! Per Day Drilling Wells!

Cash in on demand for good wells in every community! Any man with mechanical turn of mind can easily operate one of our drills, make big money, be independent, work the year 'round! A few hundred dollars starts you in this big paying business—pay balance out of earnings! Write for FREE CATALOG describing ARMSTRONG ALL STEEL WELL DRILLS—gasoline traction or non-traction models. Write now—today—Armstrong Mfg. Co., 810 Chestnut St., Waterloo, Iowa.



"Interlox" MASTER SLIDE RULE

Speeds up all measuring. Slides in and out—no folding. Direct-reading for instant inside measurements, as well as outside. Any length, 2 to 8 ft., 20c lineal ft. If not at dealers, sent postpaid.



MASTER RULE MFG. CO., 813 E. 136th Street, NEW YORK
Dealers and Agents: Write for attractive proposition.

\$1500 WITHOUT MOTOR SCHROETERS No. 15 Motor Driven SCROLL SAW for Home or Small Shop

The saw is mounted on a neat wood base and has a 7 1/2-inch nickel plated tilting table which is essential for inlay work. The work which can be accomplished is marvelous. Has a range of work from the finest inlay up to 7/8-inch white pine. A practical machine for sawing Radio panels such as bakelite, sheet brass, hard rubber, bone, fibre, etc. Has 16-inch swing. Weight only 21 pounds without motor. We supply a catalog of 250 miniature scroll saw designs with each machine.

Add \$500 when bearing attachment is wanted

For More Information Write for Our Scroll Saw and Tool Catalog
SCHROETER BROS. HARDWARE CO.
810 Washington Ave., ST. LOUIS, MO.

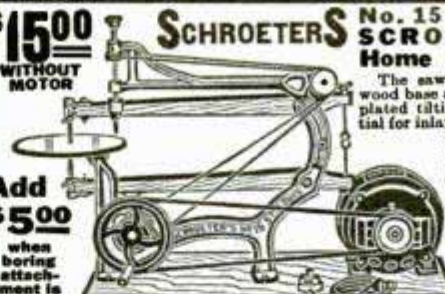

the
Drill
of many
Uses

C-O Utility Drill

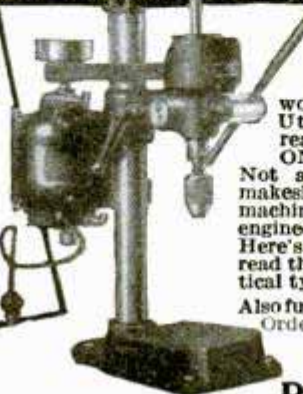

The Makers of the famous C-O Garage Tools and Equipment, known the world over, offer you a Utility-Drill complete, ready for the job, for ONLY \$34.00.

Not an attachment nor a makeshift, but a real drilling machine designed by master engineers. Here's real drill value — just read these specifications: Vertical type motor, 110 volt, 60

cycle, single phase, AC, with cord and switch; belt drive; 3-jaw chuck; 11x6" bench space; 23" high; weight 62 pounds.

Bores holes up to 3/4"; works in 9" circle; 2 1/2" up and down spindle run; 7 1/2" range on column; 1100 to 2200 spindle speed.

Ideal for garages, repair and service plants, factories, all mechanics and farm and home craftsmen.

Also furnished in other voltages and cycles. Prices on request. Order today or if you need more information write for circular.

FULLY GUARANTEED
CANEDY-OTTO MFG. CO.
Dept. PM. Chicago Heights, Ill.

ONLY
\$34.00
COMPLETE WITH MOTOR

SIMONDS

SAWS FILES KNIVES STEEL

BAND SAWS

Too tough to quit on the hardest job!

You should use Simonds Band Saws because their remarkable tension and edge-holding qualities permit faster feed and better cutting, thereby increasing lumber production and raising the grade of the output of the mill. The endurance and superior life of Simonds Saws decrease expense and increase mill profit.

Specify Simonds for Economy

SIMONDS SAW AND STEEL COMPANY

"The Saw Makers"

Fitchburg, Mass.

Established 1832

BRANCH OFFICES AND SERVICE SHOPS IN PRINCIPAL CITIES



Saw Books FREE

"SAWS IN THE HOME" gives many helpful hints for home workshops; "SAW SENSE" tells about Hand Saws, their use and care. Both booklets are FREE. Write us today.

E. C. ATKINS & CO., Dept. P, Indianapolis, Ind.

ONE HANDLE TAKES THE PLACE OF MANY WITH THIS NEW FLEXIBLE SOCKET SET

1/4" square connection. Six sockets 7-10", 1/2", 9-16", 5-8", 11-16", 3/4" hex openings. Chrome Vanadium steel. Speedy. Guaranteed. Money back if 10 days' trial doesn't satisfy. \$3.65, prepaid, cash with order; \$3.90, C. O. D. Handle only, \$1.75 cash, \$1.90 C. O. D. Arts. Wm. Tool Service Sales Co., Box 4605, Sellwood Sta., Portland, Oregon



Illustration clearly shows flexibility of handle.

Makes Old Ford a Tractor

Now you can convert that old Ford car into a useful farm tractor without altering any Ford parts. We furnish the traction wheels, drive gears and auxiliary axle and mountings, ready to clamp on to the Ford frame. Pulls 16" plow.

We supply a Belt Pulley also



Write for Free Particulars. Shaw Mfg. Co., Dept. 4510, Galesburg, Kan.

LIGHTING FIXTURES

Ready to hang

Direct from the manufacturer. Completely wired, including glassware. Send for new catalogue No. 29. Just Reduced Prices. Special Proposition to Dealers.

Erie Fixture Supply Company, Inc. Station A ERIE, PA.



CORNWELL

QUALITY TOOLS

in Convenient Kits

A KIT of "CORNWELL" tools is a prized possession of the expert mechanic. Valued not alone for their high quality but because they do better work in less time than any other tools. 65 different tools for almost every purpose. Their remarkable performance in difficult work is simply amazing.

There Is No Substitute for CORNWELL QUALITY

Every CORNWELL tool is hand made under our exclusive CORNWELL processes from Swedish or Chrome Molybdenum steels.

Tools of Amazing Strength

No other tools are like them. They withstand the most severe tests to which any tools can be put. Try them at our risk.

Let Us Demonstrate

Ask for salesman to call and show you many startling demonstrations of CORNWELL QUALITY TOOLS. Or send for free catalog, order tools, and make these tests yourself.

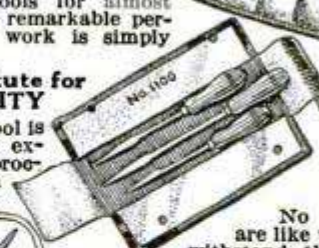

COUPON BRINGS CATALOG-FREE

The Cornwell Quality Tools Co., Dept. C, Mogadore, Ohio. (Formerly at Cuyahoga Falls, Ohio)

Send me new illustrated catalog with prices on full line of CORNWELL Hand-made Tools.

Where Employed
Name
Address
City State

AIR-CON UTILITOO

THE KING OF THEM ALL

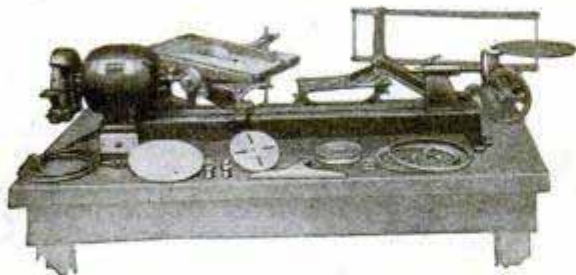

A Workshop Worthy of the Master Workman

You who have been waiting for a real home work shop to measure up to your standards of quality workmanship—whether for profit or pleasure—will find your ideals realized in the Ar-Con Utilitool.

Not a toy, nor a makeshift, but a substantial, well-built outfit which enables even the novice to turn out work of the highest quality with amazing speed and accuracy.

Fully illustrated descriptive circular, with prices, will be mailed upon request. Just write your name and address on the margin of this advertisement, tear it out and mail to

THE AR-CON TOOL COMPANY
500 Fassett Street, TOLEDO, OHIO



Effective and Positive System
is secured by

Gerstner TOOL CASES

for MACHINISTS and TOOL-MAKERS. Avoid lost, mislaid or damaged tools. Catalog free.

Gerstner Sons

458 Columbia St., Dayton, Ohio

PARKS

WOODWORKING MACHINES

Cabinet Shop
Special No. 10

\$290

With Motor

You ought to have this handy Parks in your shop. Compact, complete machine designed like a big production outfit at 1/3 the cost. Fits in a corner of your basement. Does any kind of cabinet and joinery work. Write for circular.

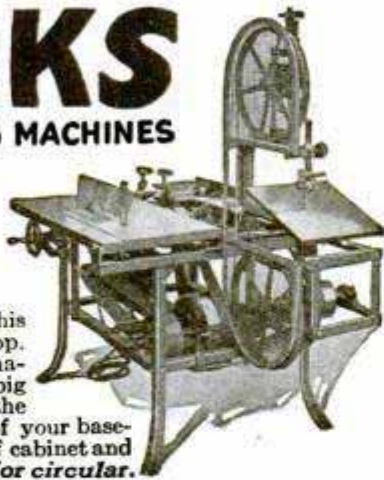

The Parks Woodworking Machine Co.

1500-40 Knowlton St. Cincinnati, Ohio

Canadian Factory: 208 Notre Dame East, Montreal



WADE AMATEUR MECHANICS, REPAIR SHOPS, INVENTORS, STUDENTS

BENCH LATHE
A real machine tool for the home work bench—capacity 4" dia. x 12" length. For Metal-Wood-Composition materials. Turning-Facing-Boring-Drilling-Winding-Thread Cutting. Accurate Strong-Quiet—Compact. Slide-rest has travel entire length of bed. Leadcrew inside bed. No. 1 Lathe, plain headstock, \$28.00. No. 2 Lathe, back-gearing headstock, \$58.00. Extra for lathes with 18 inches between centers, \$7.00. Complete line of accessories at equality low prices. Write for free catalog.

THE GEROLD CO.

Dept. P-47

120 Liberty St.

New York

"From Nothing
to \$15,000.00
a Year!"



"My success has been all that a man could desire as I have built a business up from nothing to \$15,000.00 a year. I owe my success to your Haywood Plant."

L. E. Berry, Barnesville, Ohio

**Let Me Put You into a
\$15,000.00 a Year Business!**

This is not a dream. It is an actual fact. My proved, successful, workable plan has made over 16,000 men independent for life. Berry is only one example. We furnish everything. You put up only \$95.00—and you are immediately backed by a 19 year old internationally known firm. Quick action is important.

FREE TRAINING

Over 16,000 other men have become Haywood experts through my Free course. You, too, will find this course easy to master, whether you decide to learn at home with my simple diagrams and instructions, or come up here to my factory, with expenses paid while you are here.

WRITE FOR MY FREE BIG BOOK "HAYWOOD STEPS TO SUCCESS"

It's so easy to start. Our big book explains everything, and tells you of scores of Haywood Successes. We want good men to join us. The need for Tire Repair Stations is far greater than our present staff can handle. If you are ambitious, write me today!

J. A. Schreiber, President.

Haywood Tire Equipment Company

2330-N Ogden Ave., Chicago

Cable Address—FANBRO

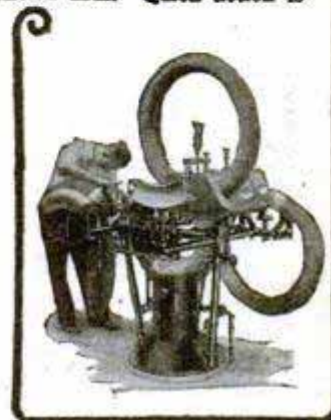

SALESMEN! \$100 WEEKLY SELL COX HOLDFAST SCREW DRIVERS



Also made to use in Yankee or Ratchet Handle. Sells on sight to

Garages, Radio Men, etc. Self Holding, Self Releasing. Sample and Proposition, 50c. S. J. COX, Dept. F, Franklin, Pa.

BURN YOUR NAME ON TOOLS

WITH THE ARKOGRAF

PROTECT YOUR TOOLS FROM THEFT

Write with electricity any name or design on the hardest and finest tools and instruments, or any metal, like writing on paper with pen or pencil. Complete Outfit \$3.50—Prepaid Anywhere. Interesting illustrated circular free. Write today. Agents wanted.

ARKOGRAF PEN CO., 1171 E. Stark St., Portland, Oregon

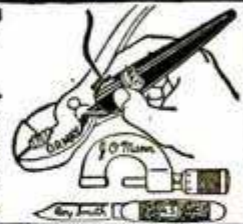

DO YOU WANT a new business profession of your own, with all the trade you can attend to? Then become a foot correctionist, and

in a few weeks earn big income in service fees,—not medical nor chiropody—easy terms for home training, no further capital needed, no goods to buy, no agency. Address

Stephenson Laboratory, 1 Back Bay, Boston, Mass.

\$450 PROFIT IN ONE DAY

Without experience, A. L. Bradley made that much showing amazing new 38,000 candle power automobile light. Easy to install. Sells instantly. 300% to salesmen. Write today.

Aerial Electric Co. 347 West Ohio Street, Chicago, Ill.



Charge It By Mail

SENT FOR \$1

NO C. O. D. TO PAY

BR1 Elgin or Waltham movement, hand engraved, 20 year guaranteed gold filled case. \$2.12 a month. \$26.50

Wear this standard American watch and take a full year to pay—Send \$1 with order and this watch comes to you prepaid—no C. O. D. to pay on arrival

FREE A FULL YEAR TO PAY

10 DAYS FREE TRIAL

After examination and 10 day free trial, pay balance in 12 equal monthly payments. No interest. No extras. All transactions strictly confidential. You take no risk—satisfaction absolutely guaranteed or money back.

Established 1895

ROYAL DIAMOND & WATCH CO.

ADDRESS DEPT. 11-K 170 BROADWAY, N.Y.

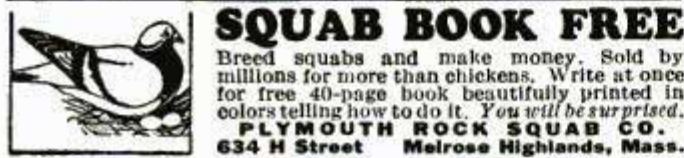

SQUAB BOOK FREE

Breed squabs and make money. Sold by millions for more than chickens. Write at once for free 40-page book beautifully printed in colors telling how to do it. You will be surprised.

PLYMOUTH ROCK SQUAB CO.

634 H Street Melrose Highlands, Mass.



MOTORCYCLES

Price \$10 and up purchased through our Co-Operative Plan for as low as \$1.00 down and \$1.00 per week

Indians Harley-Davidsons Ace Henderson and Clevelands

Send ten cents for Bulletin A.

Motorcycles shipped to all parts of the world

WALKER-INDIAN CO., 78 Brookline Ave., BOSTON



AGENTS

ADDING PENCIL

STARTLING INVENTION

ADD'S CALCULATES COUNTS CHECKS

AGENTS

ADD-O-GRAPH CO., Dept. 10, Saffille, Miss., U.S.A.

W R I T E

GUARANTEED Absolutely accurate. No more mistakes. Size of Fountain Pen. Millions want one. Send for yours TODAY. Make \$20 or more daily. Easy to sell. Great opportunity. Reserve territory immediately.



Take Orders

Good Tailoring

Show Gibson tailoring and make \$100 a week and more. Real style, finest made-to-measure tailoring, all-wool fabrics. Remarkable values at \$23.50 and \$31.50. Your customer's satisfaction is always sure and repeat orders come fast for you. Liberal commissions paid in advance. We handle deliveries, collections and give active co-operation in helping you build a big paying business. High grade sample outfit, with over 100 large wool samples, style book, supplies, etc., furnished you free. Don't delay, write at once.

W. Z. Gibson, Inc., Dept. X-516, 500 Throop St. Chicago, Ill.

ALL WOOL SUIT \$23.50

Pay \$100 a Week



Throw away that brush

Give your face a treat!

Apply **MOLLE** with palm of hand

No brush-no lather-no rubbing

Shave **FASTER** than you ever shaved before

Without danger of cutting skin

DRY face with towel—**That's all!**

No steaming, lotions or powder

Makes Your face feel Like a Million Dollars

Take the word of a million men

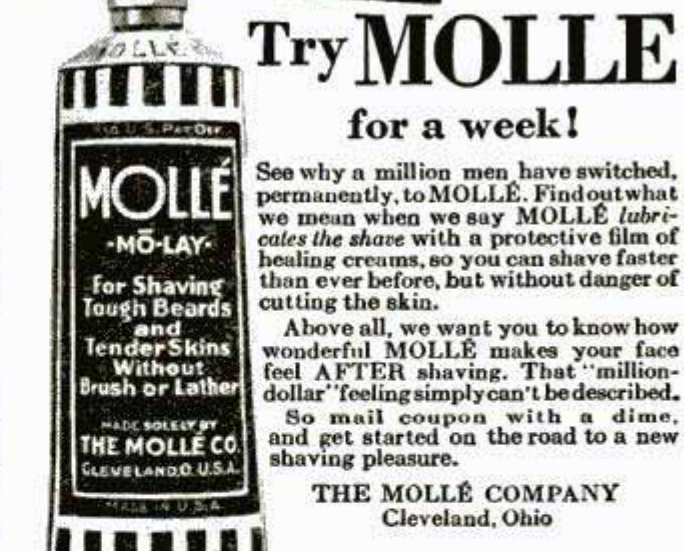

Try MOLLE for a week!

See why a million men have switched, permanently, to MOLLE. Find out what we mean when we say MOLLE lubricates the shave with a protective film of healing creams, so you can shave faster than ever before, but without danger of cutting the skin.

Above all, we want you to know how wonderful MOLLE makes your face feel AFTER shaving. That "million-dollar" feeling simply can't be described.

So mail coupon with a dime, and get started on the road to a new shaving pleasure.

THE MOLLE COMPANY
Cleveland, Ohio

THE MOLLE COMPANY, Dept. 79, Cleveland, Ohio

I enclose 10c (coin or stamps). Please send postage paid big tube containing a week of MOLLE Shaves, to

Name _____

St. Address _____

City _____ State _____

A Whale of a Tube, 50c —at your druggist

NOW—
GET MY GREATEST Log Saw Offer

Fastest Cutting

Saws 15 Cords a Day

ONLY \$39

Used by The United States Government

It's easier, now, than ever before to own this fastest-cutting, easiest-moved, most powerful Log Saw. Now you can make big money sawing firewood, stove-bolts, ice, shingle timber, etc. **WRITE TODAY FOR FULL DETAILS.**

Try 30 Days **OTTAWA** **Make Big Money**— Wood selling at \$3 a cord brings owner \$45.00 a day. Go into the wood business. Don't let the lack of ready money stop you—Remember, we sell on very easy terms.

ONE WHOLE MONTH to use the OTTAWA at your own sawing. Every saw shipped on trial only—

Backed by 10-Year Guarantee

FREE Send me your name and address on a postcard today for my wonderful new edition of the "Wood Sawing Encyclopedia." Be sure to investigate—it will help you to make big money.

C. E. WARNER, Pres., OTTAWA MFG. COMPANY
 1745-L Wood St., Ottawa, Kans.

Putts the OTTAWA Working For You!

350 Cuts a Minute!
 Now you have a log—in a few seconds it's all sawed up—without any hard work!

FREE Wood Sawing Encyclopedia





ENJOY the THRILL of ELECTRIFIED RADIO at SMALL COST

only \$6.85 complete

FREE TRIAL

Banish forever all the annoyance and expense of buying new "B" Batteries with a TOWNSEND "B" POWER UNIT. Hooked up in a few moments—and you have permanent power from your light socket!

that time on. Use same tubes now in your set. No changes. You'll be amazed at the way Townsends improve your reception and add to distance getting. More than 50,000 now in use. Send coupon today for full information and free trial offer.



Townsend Laboratories, Chicago, Ill.

-----**COUPON**-----

TOWNSEND LABORATORIES, Dept. 15, 713 Townsend St., Chicago, Ill. 10/28

Please send me full information on the Townsend "B" Power and Free Trial Offer.

Name.....

Address.....

FORALL Flux Solders ALUMINUM, Pewter and other metals with REGULAR SOLDER like soldering tin. Big money repairing Aluminum Ware. Household size sent prepaid for 25c and dealer's name. Money back guarantee. R. H. and H. C. GRAY, 2011 Miller, Seattle, Washington

MAKE BIG MONEY SELLING PERSONAL CHRISTMAS GREETING CARDS

Unusual novelties. Reasonable prices. Every prospect will buy. Cards sell at sight. Handsome Sample Book FREE. Large commission on all sales. Also beautiful line of boxes of assorted cards. Best value on the market.

Write immediately

Rochester Art Co., Dept. H., Rochester, N. Y.

SIDE LINE

Sold to Rated Trade Only

For use in their own building. Sold from Pocket Portfolio: 30 day trial when requested. Removes stoppages from waste pipes. Give full information about yourself in first letter. Replies confidential.

J. E. Kennedy Corp., Dept. 4-G, 79 Madison Ave., New York



RAISE BELGIAN HARES

NEW ZEALAND REDS—Chinchillas—Flemish Giants

MAKE BIG MONEY—We supply stock and pay you following prices for all you raise: Belgian Hares \$2 each—New Zealand \$3 each—Chinchillas \$4 each—Flemish Giants \$5 each. 32-page illustrated book, catalog and contract, also copy of Fur Farming magazine, tells how to raise skunk, mink, fox, etc., for big profits, all for 10c. Address

OUTDOOR ENTERPRISE CO., Box 25, Holmes Park, Mo.



FOY'S BIG PIGEON BOOK

In NATURAL COLORS, a complete guide to successful Squab and Poultry Raising. Tells how to feed, breed, grow and make money raising squabs. Quotes low prices. Write today. **FREE.**

F. FOY Box 18 CLINTON, IOWA



NOW! You Can Do Your Own NICKEL-PLATING

For Plating Nickel, Brass, Copper, Silver, Gold, etc.

Make \$150 to \$500 a Week

New Scientific Invention Enables Anyone To Nickel-Plate Anywhere with Aladdin Portable Outfit

This marvelous Invention enables anyone to NICKEL-PLATE anything—anywhere; in the Home, Garage, Office, Store or Shop—in fact, you can do all the NICKEL-PLATING on any automobile with the ALADDIN ELECTRO PORTABLE OUTFIT in a very short time—without removing any of the parts. This interests every auto owner (and others) because you can **SEE THE NICKEL FLOW** NOW take the Plater to the job instead of taking the job to the Plater. This offers wonderful ECONOMY to users and BIG MONEY-MAKING possibilities to AGENTS. Positively guaranteed to do as we claim. **WRITE FOR FREE BOOKLET.**

\$6.50 Introductory Offer Plus Postage

P. J. F. BATENBURG Dept. 40 RACINE, WISCONSIN

AGENTS WANTED EVERYWHERE



Now-Make Your Radio Clear as a Bell~

with **MARVELOUS** new **GROUND AERIAL!**



"After testing many Aerials in my Laboratory I find your Sub-Aerial is the best for Clarity of tone and elimination of static, also for greater volume and selectivity. It will fill a long felt want among the Radio Fans."

A. B. Johnson, Radio Engineer.

Get Amazing Distance, Greater Volume and Selectivity Without Distortion

Why go on listening to terrible static and other maddening outside noises? Now you can get the real music your present Radio is capable of giving, by hooking your set onto the clear, practically static free ground waves with Sub-Aerial. The air is always full of static and your overhead aerial picks it up and brings it to your speaker. So why stay in the air—when you can use the whole earth as a static and noise filter with Sub-Aerial?

Low Original Cost—No Upkeep Cost

SUB-AERIAL costs no more than an overhead or loop aerial and less than many. Its first cost is the only one. SUB-AERIAL is permanent. No trouble—no hard work, or risking your neck on roofs.

25 YEAR GUARANTEE

SUB-AERIAL is guaranteed against any defects in workmanship or material and against deterioration for 25 years. Any SUB-AERIAL which has been installed according to directions and proves defective or deteriorates within 25 years, will be replaced free of charge; and also we will pay \$1.00 for installing any such new replacement.

TRY IT FREE!

We know so well the surprising results you'll get that we'll let you put in a Sub-Aerial entirely at our Risk. You be the Judge. Don't take down your overhead Aerial. Pick a summer night when static and noise interference on your old Aerial are "Just Terrible." If Sub-Aerial doesn't Sell Itself to You Right Then on Performance—you needn't pay us a cent. Send for "All the Dope on Sub-Aerial." You'll be surprised. Do it NOW.

Can Be Installed in a Few Minutes

UNDERGROUND AERIAL SYSTEMS

St. Clair Bldg., Dept. 8-N.
Cor. St. Clair and Erie Sts.,
CHICAGO, ILL.

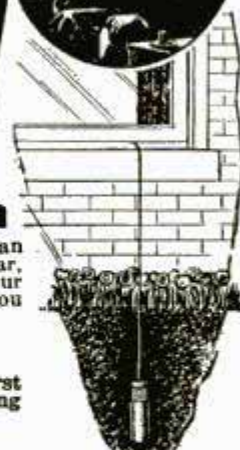

Underground Aerial Systems, Dept. 8-N, St. Clair Bldg., Cor. St. Clair & Erie Sts., Chicago, Ill.

Send me complete information on Sub-Aerial, Proof and Free Trial Offer. No obligation.

Name.....

Address.....

City..... State.....



FREE Wholesale Radio Catalog

Set Builders-Dealers! Save Money!

Send for the most complete book of nationally known Parts, Kits, Cabinets, Consoles, Speakers, Power Units, Sets, etc. All at lowest wholesale prices. Quick service on all your needs. Write now, it is FREE—

SETBUILDERS SUPPLY CO., Dept. 12-2
Romberg Bldg., Madison and Market Sts. CHICAGO, ILL.



Do you run your radio, or does it run you?

Do you control your loud speaker volume to fit the occasion—from soft, mellow musical background to loud, sharp, fascinating and attention-arresting entertainment? "THE GATEWAY TO BETTER RADIO" tells how to make the radio do your bidding, how to avoid distortion, deals with a hundred and one things. 25c a copy and worth it many times over. From your dealer or direct from

CLAROSTAT MFG. CO., Inc.
Specialists in Variable Resistors
285-7 N. Sixth St., Brooklyn, N. Y.

Add \$3000 to your income

In spare time making collections and checking up on sales of "NEVERON" which prevents runs and triples the wear of silk hose. No canvassing. Write immediately for full information. QUINCY CO., Quincy Bldg., Dept. 843, CHICAGO

New Model Men's Strap Watch

CUT PRICE SALE

\$3.85

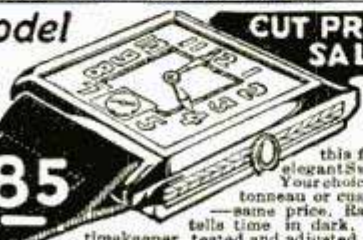

Two years written guarantee given with this full jeweled elegant Swiss watch. Your choice in square, tonneau or cushion shape—same price. Radium dial, tells time in dark. Accurate timekeeper, tested and adjusted. Rush your order. Quantity limited. Send no money, pay postman \$3.85. JENKINS, 621 Broadway, New York, Dept. 23-F-10.

EARN Establish **Income for Life**
\$20.00 Selling for \$1.00 a year a
a DAY \$1,500 Accident Policy.
Write **W. C. STONE, Dept. 9**
11 So. LaSalle St., Chicago

Wholesale Prices on RADIO

Get our big new 1929 Radio Catalog—hot off the press. Contains thousands of amazing bargains. Latest, nationally advertised Radio equipment. Latest in Ham Transmission equipment. Everything at lowest wholesale prices.

NEW RADIO CLUB—Big Prizes

Get all the facts about "Ether Trappers" Club, now. No dues. Many advantages. Write for **FREE** Membership at once.

This Big Book of money-saving bargains is yours **FREE**. A regular Radio encyclopedia. Write today for your copy of this book. **AMERICAN RADIO & MERC. CO.**
Dept. 26
American Radio Building
KANSAS CITY, MO.



18 Tools In One S&B SAW Money Back Guarantee

8" Combination S.B. SAW 12" Band Saw

The only machine that you can tilt the table to 45° without removing insert. Big advantage on pattern work.

Sent to You on 15 days approval

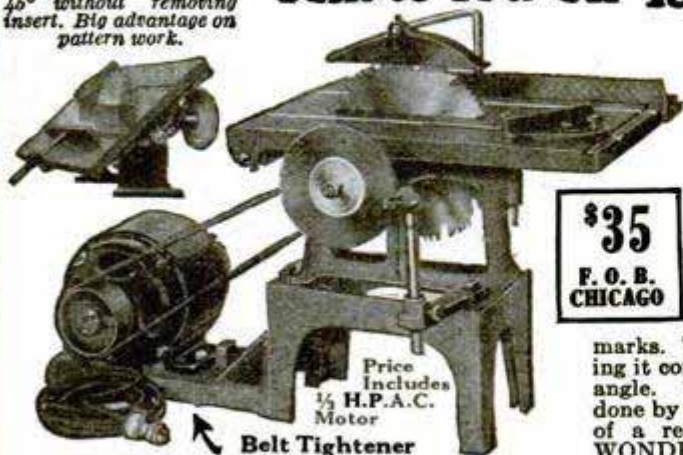

\$35
F. O. B. CHICAGO

Price includes 1/2 H.P.A.C. Motor

Belt Tightener

{ 1/2 H. P. Motor-40°-100% overload Double Shaft Extension }

18 Tools in One—Greatest Machine You Ever Saw

THE S&B 8-in. COMBINATION SAW (18 tools in one) is the ideal machine for the shop, factory or the home; will rip, cross cut, bevel, miter, mortise, groove, drill, tenon, grind, rabbet, buff and polish. Motor is mounted on a base that is a part of the machine proper. Run from any light socket, also provides power for other purposes when the saw is not in use. Complete with attachments and price includes 1-3 H. P. Motor, 60-cycle, 110-Volt A. C. Price \$35.00 F. O. B. Chicago. Shipping Weight 100 lbs.

(Planer attachment to fit on table top will smooth pieces up to 2 in. wide, \$10 extra.)

SCOTT-BANSBACH MACHINERY CO.
130 So. Clinton St., Dept. 89, CHICAGO, ILL.

12" Band Saw

Positively a sensation and at this LOW PRICE you can NOW do the 1001 things you wanted quick and easy. This 12" BAND SAW has a tilting table, with Miter and sturdily built. Ideal for the shop or home.

S&B Scroll Saw

Here is the outfit of practical usefulness. Will cut wood and light metal true to marks. Table top tilts to 45 degrees, making it convenient and easy to cut at proper angle. Thousands of jobs can NOW be done by any man or boy with the accuracy of a real mechanic. This S&B WONDER SCROLL SAW is free from vibration.

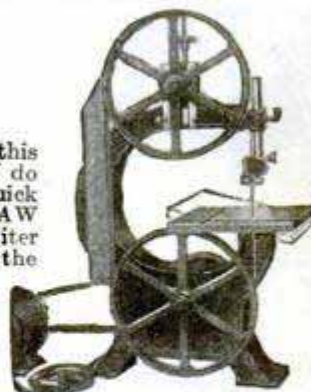

\$35.00 F. O. B. Chicago without Motor
Scroll Saw



Delights Every Boy

\$15.00

F. O. B. CHICAGO
1/2 H. P. A. C. Motor \$15 extra

Write for Complete Illustrated Folder—Dealers Wanted.

BOYS! VALUABLE GIFTS FREE



Sell White's Christmas Cards
Get White's Gift Certificates, or make your selection from over 150 different articles, knives, sporting goods, cameras, pens, jewelry, tools, etc.—given to you for White's Gift Certificates. Send today for free catalogue and details how you can get these gifts without cost to you.
White's Quaint Shop, Dept. C, Westfield, Mass.

CAN YOU SELL GAS at 5c PER GAL.?

If so write me quick. My Distributors make as high as \$3,000.00 per month. Let me show you how.

SEND FOR FREE TRIAL

Proof of astounding success and my \$15.00 a day Guarantee to Distributors.

Frank Andrews, Dept. 805-N. B., 154 E. Erie St., Chicago, Ill.



AGENTS 500% PROFIT

GENUINE GOLD LEAF LETTERS

guaranteed to never tarnish. Anyone can put them on stores and office windows. Enormous demand, large profits. Paul Clark says: Smallest day \$28.70. R. L. Reel made \$920 in two months. Write today for free sample and liberal offer to general agents.
METALLIC LETTER CO., 433-B N. Clark St., CHICAGO

This is the BANJO

YOU have been wanting—brilliant, powerful, musical tone, easy-playing qualities, expert craftsmanship, handsome appearance. Beginners and professionals choose the Gibson Mastertone.

Payment plan makes it easy to own a Gibson. Send the coupon for details.



Gibson stringed instruments are today's most popular instruments. Mention which interests you: Banjo; Mandolin; Guitar; Ukulele.

Gibson

GIBSON, Inc. 1003 Parsons St. Kalamazoo, Mich.
Gentlemen: Send Free Book and details of payment plan on

[Instrument]

Name.....
St. or R.F.D.....
City..... State.....



Big Money

Selling Ties! Beautiful Silk and wool ties in scores of live, snappy patterns. Four-in-hands, or new patented S N A P - O N BOWS! Show samples we furnish. See how quick men will buy when you mention the sensational low factory prices. You collect big profits in advance.

\$100 a WEEK

Outfit FREE to You
All you do is to take orders. We show you how. You invest nothing to start. No experience necessary. Work spare time if you wish. Send name and address to-day for trial outfit FREE, and special offer whereby you get a full line of samples without cost.

NASH NAWCO NECKWEAR CO., Inc., Dept. M-105 COVINGTON, KY.



An Amazingly Better Work Shop That You Can Enjoy In Your Own Home For 10 Days ABSOLUTELY FREE!

Fast—Accurate—Complete

This workshop is absolutely complete. Lathe, scroll and circular saws, drill, electric glue pot—everything you need for any kind of wood-working operation. Many amazing work-saving features. Units also sold separately if desired.

Could we afford to make such an astonishing trial offer if MAC—"The Popular Mechanic"—was just an ordinary workshop? Now you can expect new things—amazing new improvements—new easy ways to make and repair a thousand and one different articles right in your home! Here is everything you

need to gratify your creative instincts—to make big money in full or spare time. Even in unskilled hands, results are surprising. And to prove to you how quickly you can become an expert under our guidance, we will let you judge this wonderful outfit in your own home without a dollar's deposit. You use and enjoy it as much as you please for 10 days. If you keep it, take a year to pay on easy terms. Mail coupon for full illustrated details at once! No obligation and no salesman will call.

**NO DEPOSIT
A YEAR TO PAY!**

For Mechanic, Inventor, Repairman Mail Coupon Farm and Home Craftsmen NOW!

DEALERS: Write for unusual profit-building proposition.

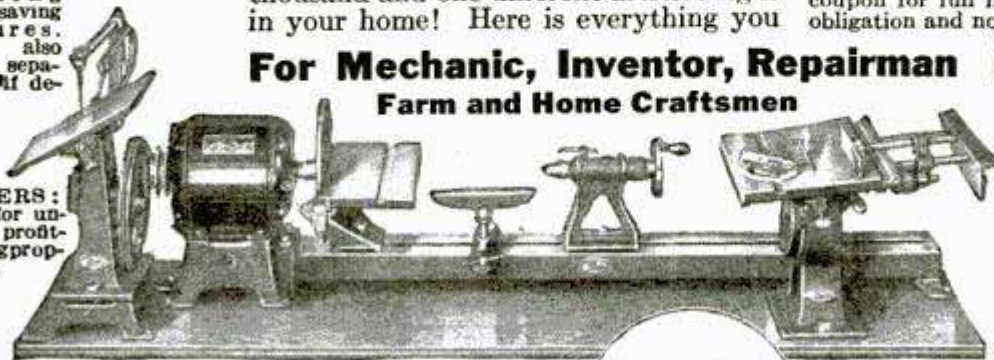

Precision Tools

Every unit of MAC—"The Popular Mechanic"—is of the highest quality that can be manufactured. WAGNER Universal electric motor plugs in any light socket, no special wiring. BLACK & DECKER high-speed quality drill. Every part designed and built by master mechanics, unconditionally guaranteed.

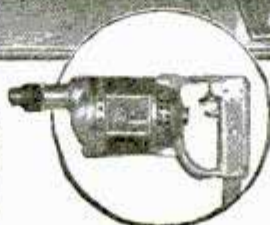

Black & Decker
1/4" Drill

Midland Appliance Corporation, Dept. M-10, 219 N. Michigan Ave., Chicago, Ill. Send illustrated literature on MAC—"The Popular Mechanic" and details of your unusual no-deposit Trial Offer.

Name

Address

City.....State.....

MIDLAND APPLIANCE CORPORATION Dept. M-10, 219 N. Michigan Ave. CHICAGO, ILL.



Match Your Coat and Vest With New Trousers. Free Sample

DON'T DISCARD YOUR OLD SUIT. Wear the coat and vest another year by getting new trousers to match. Tailored to your measure. With 90,000 patterns to select from we can match almost any pattern. Send vest or sample of cloth today, and we will submit FREE best match obtainable.

AMERICAN MATCH PANTS CO.,
Dept. B.A., 6 W. Randolph St., Chicago, Ill.

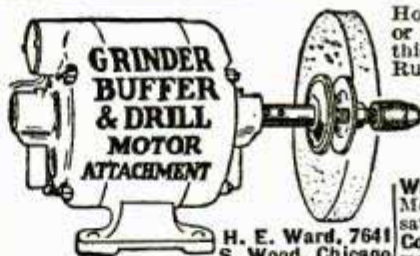

Holds saws, buffing, grinding, or scratch wheels up to 1 1/2" thick. Hard steel, nickeled. Runs true. Fits 1/2" shaft.

WHEELS TO FIT
6"x1/2"—Grinding\$1.05
6"x1/2"—Buffing45
6"x5/16"—Wire95
6"x1" Bristle Brush 1.45

Write for Catalog Motors, pulleys, saws, grinders. Complete Attachment Postpaid **1.95** Each

H. E. Ward, 7641 S. Wood, Chicago



AGENTS AMAZING DISCOVERY Abolishes Metal Polish

Experience unnecessary. Astonishing new cleaner for silver, copper, brass, nickel, etc. No liquid. No paste. Clean, dry floss. Touch, and article shines like new, instantly. Demonstrations amazing! Everyone a sale. Sell Lightning Polishing CLOTHS and FLOSS to Housewives. Autoists, Stores, Offices, Factories buy large quantities of both. Sure, big, quick money getters. **SAMPLE FREE!** Exclusive territory. Double profit. Don't delay. Clinch your territory NOW. Write H. Lightning Corp., 416 S. Dearborn, Chicago

The SILVER ACE FOKKER TYPE



This newest SILVER ACE Flying Model is a beauty, with a 34 inch wing span. And like all models we design, it is a very long flier. This giant Fokker weighs only seven ounces, and to fly, only the central motor is used. The other two, like the tapered wings, are detachable.

You can build this flying *Friendship* as quickly and surely as our celebrated models of the Ryan, Stinson, or Fairchild Types. A complete construction set, with all patterns directly printed on Balsa Veneer, ready to cut out, all parts, instructions, drawings, three SILVER ACE dummy motors, and a winder.

Price \$9.00 plus 50c for delivery, if your store cannot supply you. Pair Pontoons \$4.00 extra.

Catalog—10 cents.

THE AERO MODEL COMPANY
329 Plymouth Court • Chicago

Cal. 30-40 Six Shot



KRAG CARBINE

Price
\$9.75

All the qualities of a high price rifle. In fine used condition, all working parts guaranteed for one year. Send today for our Free 60-page illustrated catalog of money saving values; Guns, Ammunition, Cutlery, Sports and Gov't goods. Deposit required on all orders. Money refunded if not satisfactory.

W. Stokes Kirk, 1627-P.M. North 10th St., Philadelphia, Pa.

I Offer You **\$8.00 a Day** ~and a

Write quick for new proposition. We offer \$8.00 a day and a new Chevrolet Coach for demonstrating and taking orders for Comer Suits. Spare time. No experience required. Sample outfit free. Write now.



COMER MFG. CO., Dept. SW-5135, Dayton, Ohio



**ARTISTIC
PORTRAIT
ENLARGEMENTS**
only **98¢ each**
FROM ANY PHOTO
or **SNAP-SHOT**
SIZE 16 x 20 INCH

(or smaller if desired)
The usual price of this work is \$5.00 but by taking advantage of this **Special Offer** you can get a beautiful life-like enlargement of that favorite picture of mother, dad, sweetheart, baby or any friend for **only 98 cents.**

SEND NO MONEY—Just mail us the photo—any size (Full figure, bust or group) and in about a week you will have your enlargement guaranteed never to fade. It comes to you C.O.D. On arrival pay postman 98c plus a few cents postage, or send one dollar cash with order and we pay postage. Money back if not delighted. You can send us your most treasured photograph, it will be returned to you unharmed.

FREE In order to advertise this remarkable offer we send free with every enlargement ordered, a **Highly-Glazed Hand Painted** miniature reproduction of the photo sent. These miniatures alone are worth the whole price charged for the enlargement. Take advantage of this really **Amazing Offer** and send your order today. **DO IT NOW.**

ALTON ART STUDIO, Dept. 14
5654 West Lake St., Chicago, Ill.

Please enlarge artistically the enclosed photo, Return enlargement and **FREE Hand Painted** miniature, C.O.D. 98c plus postage. (If \$1.00 is enclosed you are to send postage paid.)

Name _____

Address _____

Town _____ State _____

Check Size Wanted

16 x 20 in.

10 x 16 in.

11 x 14 in.

8 x 10 in.

\$1023⁰⁰ in 1 Month

an average of \$1000 a month for 36 months is sales record of H. J. Hirsch, Okla., J. A. Weisbrod, Ind., averaged \$700 a month, B. Guehrer, Wis., \$650. Scores earning more—all with

Radiolite

The Electric Advertising Campaign
Combines color, movement, novelty. With each beautifully framed Radiolite Unit—flashing on and off continuously—comes a big supply of colored illustrated display slides which can be changed weekly. Special series for each line of business. Most economical and effective advertising campaign any business man can secure. Hundreds of thousands of prospects in every line of business. Over 50,000 Radiolite campaigns now in use. Demand growing month by month. Nothing else like it. No competition. Manufacturing rights fully protected. Write at once for big money-making proposition.
E. C. THIEL & CO., Dept. 158
3731 N. Clark St. Chicago, Ill.



WRITE TO-DAY

**Introducing the
Time-o-lite**

Yes readers, here it is. The ingenious combination lifetime **Lighter** and fully jeweled **Watch** in one. Smart, up-to-the-minute young men and women everywhere are flashing the **TIME-O-LITE**. Its latest page— attracts attention and arouses admiration. Makes an ideal gift.

The **TIME-O-LITE** is small and compact. Fits in pocket or purse. Durable construction, covered with genuine imported leather in various colors. Fittings are **CHROMIUM** plated, guaranteed never to tarnish. The watch is 6 jewel lever, imported movement, 2 adjustments, fitted in beautiful artistic hand made engraved case. **Radium Dial**—tells time in dark. This cigarette lighter watch combination regularly sells for \$25.00. Get one at our Special In-**\$7.95** introductory Price of only \$7.95. Packed in handsome case with full instructions.

Every TIME-O-LITE is fully guaranteed!

Send No Money: When the **TIME-O-LITE** is delivered pay postman the special introductory price of only \$7.95. We pay postage.

PASOJO CO., Dept. 18
270 Lafayette St., New York

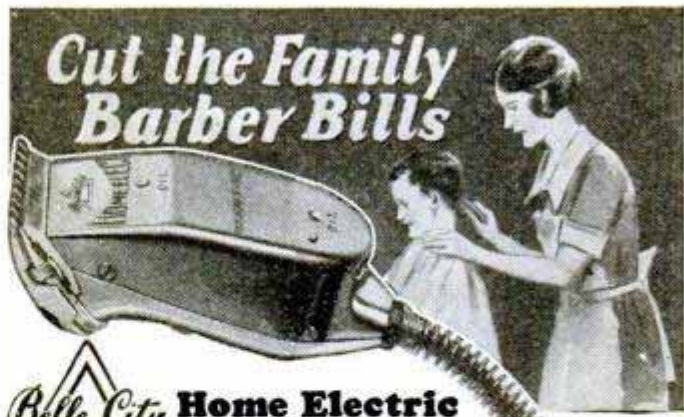
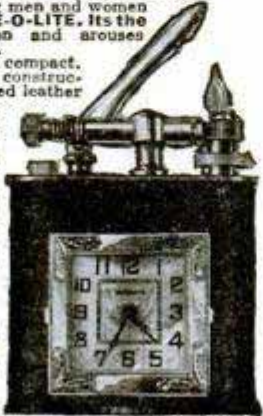

Belle City Home Electric Hair Clipper

Anyone can trim or bob hair, shorten bangs, clip neck or underarms in a shape almost impossible with hand clippers or shears. Operates on direct and alternating current. Will not clog or cut the skin, and cuts as cleanly as a razor. Thousands in use. Rigidly guaranteed.

TEN DAYS' FREE TRIAL
If your hardware or electrical dealer can't supply you, write for interesting booklet, or order from this ad. Send no money—pay postman \$8.75. Return it in ten days if not satisfactory. State whether 110, 220 or 32 volt current is used.
Dealers and Representatives Wanted
Belle City Appliance Co., 1022 12th St., Racine, Wis.

Fits Any Light Socket

INKOGRAPH
10 DAY FREE TRIAL
Writes with ink smoothly, answering purpose of pen and pencil. Never blots, scratches, leaks or dries up. **Makes 3 carbon copies** at one time with original in ink.

THE PENCIL POINTED PEN
\$1.50
SAME SIZE AS \$7 AND \$8.75 FOUNTAIN PENS

SEND NO MONEY. Pay postman \$1.50 plus postage, sent with order. Money back if not satisfied, within 10 days.

INKOGRAPH COMPANY, INC.
199-647 Centre Street, New York

Send for Inkograph or write for free sales plan booklet. Big value—sells on sight—no investment—no competition.

Free Trial!

SPEEDWAY SHOP Easy to make things at home with this big new metal and wood-working shop. Attaches to any lamp socket. \$10.00 down—easy payment. Make money in your spare time. Big free illustrated book gives full particulars, including free trial offer. Send 25c for instructions for making attractive magazine basket. Write Electro Magnetic Tool Co., Dept. 2-0, 1830 S. 52nd Av., Cicero, Ill.

WRIST WATCH GIVEN

Sell my Grape Gum, Gumballs, Candy Mints, etc., at 5c pack. Everybody will buy from you. I give wrist watch and other dandy presents **FREE** and besides you make money every day. Write today for agent's package.
Chas. David, Sta. V, Cincinnati, O., Dept. 376

\$4.99 22 Cal. Blank Automatic

Free!

WITH You need no license or No Permit Required
100 permit to own this 6-shot Automatic. Use for CART—fun or self-defence. keeps away tramps, RIDGES—frightens thieves, scares away dogs—Same as an expensive automatic in construction, finish, appearance, durability; automatic magazine loading and ejection of cartridges. Instantly and powerful report. Guaranteed absolutely safe. Send no money. Pay expressman \$4.99 for automatic with 100 cartridges. **JENKINS, 621 Broadway, New York, Dept. 23-J-10**

HB PAINT SPRAY DOES THE WORK OF FIVE MEN

QUICK, EASY PROFITS!
Practically no investment. Small space required. Steady demand and **BIG PROFITS**—ITS refinishing autos, furniture—painting houses and barns with **HB** quick spray method. One man does the work of five with brushes. Pays for itself on easy monthly payments. **30 DAYS' TRIAL.** Write today for details.

EASY TERMS. 30 DAYS TRIAL QUICKLY PAYS FOR ITSELF.

HOBART BROS. CO.
Box M1082, Troy, Ohio

"Where'd you get the new car, Bob?"
"Say, Mac, you may not believe me
but I got it out of this can of
RENUZIT!"

Sounds Like a Miracle

It IS a Miracle—a scientific Miracle that is astounding the motor world! If YOU had seen Bob's car before he found out about Renuzit, and could see it NOW—you'd hardly believe your eyes! It's as snappy looking as on the day he bought it. Yes, without doubt—RENUZIT is proving one of the great sensations of the motor age.

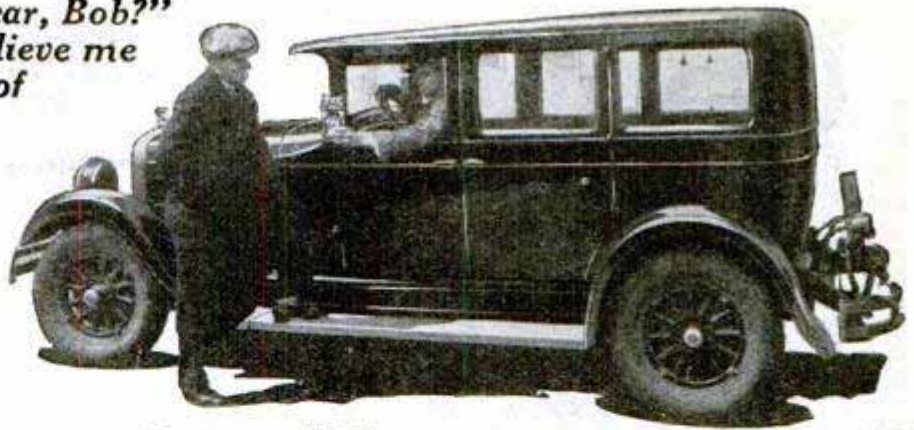

Miraculous Fluid Renews Original Finish of Any Car in 30 Minutes!

You just flow RENUZIT onto any automobile with a piece of cheese cloth and immediately the ORIGINAL color and lustre of that car is like new again. It's not a polish, cleaner, wax or paint—but a marvelous chemical discovery that restores the original color and glowing lustre of any painted, enameled or lacquered surface. No tiresome polishing or rubbing. Harmless—Lasting—Sure.

Car Stays Like New!

RENUZIT not only restores instantly the original smart sheen to any faded, dull or worn surface—but **KEEPS IT THAT WAY.** Simple to apply as "A B C"—Dries almost immediately. No trouble—No Bother—No Mess, not even a brush is needed.

Test RENUZIT Free

You have the privilege of trying RENUZIT yourself right now without risk or obligation. Prove to yourself what miracles it accomplishes. See your own car being transformed to a thing of glistening beauty! Send coupon TODAY for full details and Free Test Order.

CURTAN MFG. CO.

154 E. Erie St., Dept. 805-N.R., Chicago, Ill.

RENUZIT →

AGENTS—\$200 a Week Easy

So like a miracle is this wonderful fluid that agents all over the country are making almost unbelievable profits. Full or spare time—RENUZIT sells like the wind. Car Owners simply can't resist it! One glance at what it does—and they are more than eager to try it. And our proposition is so GOOD that no one could help making money with it. Live wires should make \$200 and up a week without any trouble. If you are the man with selling sense we are looking for—you will realize at once what a big opportunity you have as a RENUZIT representative. Here's the coupon. Use it for big results.

CURTAN MFG. CO.,
 154 E. Erie St., Dept. 805-N. R., Chicago, Ill.

Rush full details of RENUZIT, with Free Trial Offer. No obligation.

Name.....
 Address.....
 City..... State.....

- Not a Polish
- Not a Paint
- Not a Cleaner
- Not a Wax

New Free Catalog!
 Send today for our new Catalog! Smashing bargains in **Plumbing, Heating, Hardware, Millwork, Roofing, Paint and Electrical Supplies.**
Absolutely Free!
STANLEY PLUMBING SUPPLY CO., Inc.
 400 N. 12th St. Phila., Pa.

AGENTS Make big earnings, taking orders for made-to-individual measure suits at less than ready-to-wear prices. Giant Chicago wholesale house makes world's greatest values at \$23.50 and \$29.50. Your profit \$4 and \$5 per sale in advance—we deliver and collect. No experience needed, work full or part time. **FREE OUTFIT** Send no deposit. Write for details of our unique money-making plan. Nothing like it ever before offered. Act at once.
GENERAL TAILORING CO., DEPT. 10A, 529 South Franklin St., Chicago

Any Band Instrument FREE TRIAL
 Saxophone, cornet, trumpet, trombone, clarinet, flute—choose any Conn instrument for band or orchestra; try it in your own home FREE. Easy payments if you decide to buy. With Conn's easy-playing features, you make quick progress. Take your place in a band or orchestra after a short period of pleasurable practice.
 Send for Free Book, illustrating and describing instruments, and details of free trial offer. Mention instrument interesting you.
C. G. CONN, Ltd.
 1031 Conn Bldg. Elkhart, Ind.

CONN BAND INSTRUMENTS
 WORLD'S LARGEST MANUFACTURERS

Old Cars Made NEW in 30 Magic Minutes

KOTAL gives the BEAUTY and LUSTRE of an Expert Paint Job at 1/20th the Cost!

NOT A POLISH—NOT A PAINT
 This Amazing New Liquid, discovered in a famous industrial research laboratory, has startled the Motor World. Just flow KoTaL on with a cheesecloth pad as easy as wiping a car with a chamois. **NO Rubbing—NO Hard Work.** Results are Amazing—with one sweep of your hand you restore BOTH the COLOR and Original Mirror-like FINISH to Dull—Drab—Faded Cars. Gives a glass hard protective coat that does not hold dust and the Lustre Lasts for months. Makes shabby OLD cars look like the day they were driven NEW off the dealer's floor. Words cannot describe the startling transformation. Warranted harmless to any finish. Manufactured by a long established highly rated, financially responsible concern and sold under the STRONGEST GUARANTEE ever put on any product.

AGENTS EARN \$5 to \$10 Every Hour You Work \$200 a Week is Easy Money \$1000 Would Not Buy the Start We Give You FREE. Get the Facts

We furnish FREE every sales help conceivable. We back you to the limit. *Man Alive!* Here is the Biggest thing in the motor industry today—it's going over like a house afire. Everybody claims big money—KoTaL men actually make it. Hustlers laugh at \$100 per week. Millions of cars need this Quick—Economical—Magic finish which adds 25 to 40% to resale values. Demonstrates itself instantly. No Talking Needed. Men who have tried to sell everything on earth and failed are making good with KoTaL. Even inexperienced country boys make money hand over fist. Strike while the Iron is Hot. Get the facts and get them now. We will send you our Big FREE BOOK illustrated in colors, and Agents' FREE TRIAL OFFER. Good territory is going fast. Act NOW—Act at once. **Send TODAY.**

E. RICHWINE & CO., 17 W. Jackson Blvd., Dept. 121, Chicago

CHROME



The Watch Dog of Power

CHROME, a preservative, guards power when your Burgess "Super B" Batteries are not in use. Thus extra life and service are added. The valuable properties of Chrome in lengthening battery life were long known to scientists, but it remained for Burgess engineers to discover the secret of utilizing Chrome in battery construction.

The year's noteworthy achievement in radio enjoyment and economy is the Burgess "Super B" Batteries

"Super B" No. 22308

is a medium size heavy-duty 45-volt battery designed for general, all around use.

"Super B" No. 21308

is the largest size Burgess heavy-duty 45-volt battery—made especially for heavy-current consuming sets.

These two "Super B" Batteries answer practically all radio set requirements.

BURGESS BATTERY COMPANY
General Sales Offices: CHICAGO
In Canada: Niagara Falls & Winnipeg

BURGESS "SUPER B" BATTERIES



Build a Daven Television Receiver

Complete Essential Kit, \$60.00

THE first complete Kit. Furnished with either T-24, T-36 or T-48 Scanning Disk, Motor, Bushing, Rheostat, Daven Television Tube, 3 Complete Stages of Daven Television Amplification and Instructions for Building.

Daven Television Receiver, Complete, including Television Tube—\$100.00 (Less amplifier Tubes.)

DAVEN TELEVISION APPARATUS

Daven Television Scanning Disks	Each	
24 T-24		\$ 5.00
36 T-36		7.50
48 T-48		10.00
Comb. Disc with 24, 36 and 48 Apertures T-468		15.00
Daven Tele. Amp. T-3		12.50
Daven Spec. Telev. Amp. T-4 for 2 Hi Mu Tubes and 2 power Tubes		
171, 210, 250 Types		17.50
Daven Telev. Neon Lamp, 20 to 80 Milliamperes Striking Voltage 100 Plate 1 1/2" x 1 1/2"		12.50
Daven Telev. Motor		27.50
Daven Bushing to fit 1/4", 3/8" and 1/2" Motor Shafts		1.00
Daven Bushing for 48 Aperture disc		3.50
Daven Rheostat		3.50
Daven Telev. Photo Elect. Cell 1 1/2" Bulb		20.00
Daven Telev. Photo Elect. Cell 3" Bulb		37.50
Daven Television Couplers		
1st Stage No. 421x D-421xx		
2nd Stage No. 422x D-422xx		
3rd Stage No. 423x D-423xx		
x Glastors are used for Grid and Plate resistors		2.15
xx Super Davohms in Plate and Glastors in Grid		4.65
Daven AC 71 for output tubes in series with Television Lamp		3.50
Daven AC 10 (for brighter illumination)		9.00
Daven Mu 20 Hi Mu Tubes for Amp. Stages		2.25
Daven Mu 6 Power Tube		3.50

Send 2c stamp for new Television Booklet

THE DAVEN CORPORATION

Amplification Specialists

160 Summit Street

Newark, N. J.

LYNCH

3 stage resistance-coupled amplifier \$9.00
kit for quality television reception.
Arthur H. Lynch, Inc., 1775 Broadway, N. Y. C.

SEND
FOR
FREE
BOOK

SOLDERALL

METAL IN PASTE FORM

The only convenient metal solder

25¢

Every Electrical Connection needs Solderall for perfect reception

The SOLDERALL CO., NEWARK, N.J.

All-Metal-Plane Build and Paint it Yourself!

23 1/2" long, wing spread 19 1/4" Have barrels of fun! A fascinating wholesale pastime. SEND NO MONEY—When "Air King" Aeroplane building outfit is delivered, pay postman \$1.95 and postage.

AIR-O-PLANE CO., 248—5th Ave., Dept. 50, NEW YORK

Everybody doing it. Wonderful sport—building your own aeroplane and then paint it your own way. We send you complete "Air King" outfit consisting of all metal parts, also three bottles of special colored paint and two brushes. Full instructions enclosed.



AMERTRAN DE LUXE

First Stage turn ratio 3 } \$10.00
Second Stage turn ratio 4 } Each

Standard of Excellence in Audio Amplification

AmerTran De Luxe Transformers are but two of more than 30 quality Radio Products bearing the name AmerTran, including power transformers, choke coils, push-pull systems and allied products. Each AmerTran device is designed for a specific use. Full and authoritative information will be given on any audio or power problem.

AMERICAN TRANSFORMER COMPANY
Transformer Manufacturers for 28 Years
252 Emmet St., Newark, N. J.



MODEL SHIPS Build a beautiful scale model of the Flying Cloud, Constitution, Pirate Ship, Mayflower, Galleon and other types. Also the slickest 30-inch racing sail model you ever saw. Reproductions of photos of the above models and many others are shown in our large illustrated catalog which contains prices on construction sets, special fittings such as blocks, deadeyes, anchors, steering wheels, guns, etc., books, blueprints, model makers tools, etc. sent postpaid upon receipt of 10 cents.

Model Ship Supply Co., Dept. E., Mineola, N. Y.



Ends continuous wiping. RUBBER takes off dirt, FELT puts on chemical that keeps vision area clear for hours, in rain, fog, mist or snow.

CHRISTEN'S SAFETY WINDSHIELD BLADE WIPER

Fits any style windshield wiper—just take out old blade—insert Christen blade. Once "broken in"—after two or three hard rains—a few strokes clear glass—and it stays clear. Guaranteed for 1 year. Protects glass from ugly scratches—adds to driving safety and pleasure. Over 1½ million in use. Standard 7½-in. size. Special 9 in. size, 50c. Wherever auto accessories are sold.

35¢

V. H. CHRISTEN MFG. CO.
521 Orleans St., Detroit, Mich.

HFL

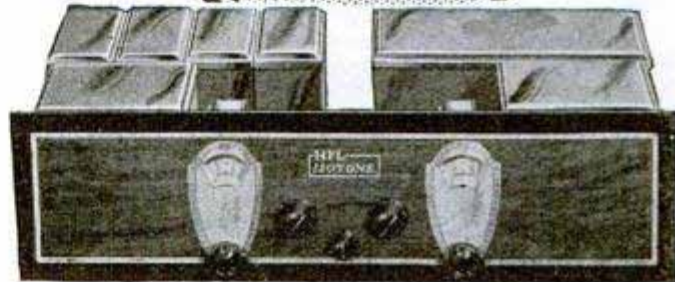

DESTINED to startle the entire nation, the ISOTONE has amazed all who have witnessed its performance. Already this instrument has shattered the long distance records of its predecessors. Uncanny in its ability to reach out to the four corners of the continent, the ISOTONE is unquestionably the most sensitive radio receiver ever designed.

Over two years in the laboratory—the ISOTONE has taken the radio world by storm and is nationally famous two months after its public release. And why not—for it has the largest combination of modern features ever assembled into one instrument.

Screened grid tubes—3 stage push pull phonograph amplifier—complete shielding—automatic control—marvelous tone quality. These and over thirty other radically new features make the ISOTONE the finest custom built receiver in America.

Designed by two of the world's greatest radio engineers the ISOTONE is years ahead of everything else in the radio field. The kind of set you've always wanted. Power—snap—action—that goes right out and gets the weakest stations. Full loud speaker volume from every station on the continent. Write for all information on the greatest receiver ever designed. Just fill in the coupon below.

FREE CIRCUITS AND INFORMATION

HIGH FREQUENCY LABORATORIES
Office B. 28 N. Sheldon St., Chicago, Ill.

Gentlemen: Without obligation please send complete information on the ISOTONE receiver and the ISOTONIC A. B. C. power supply.

Name

Address

City State

PLEASE PRINT PLAINLY

MAIL TODAY

DEVITT 8" COMBINATION SAW

8,000 IN USE!

A SHOPFUL OF TOOLS WITHIN ARMS REACH!

SAW TABLE RAISED SHOWING EMERY WHEEL, SAW GUARD AND DRILL ATTACHMENT



PLANER ATTACHMENT ON SAW TABLE

SHOWING SANDING DISC ATTACHED



TABLE TILTED FOR BEVELING

DADO HEAD ATTACHED FOR GROOVING

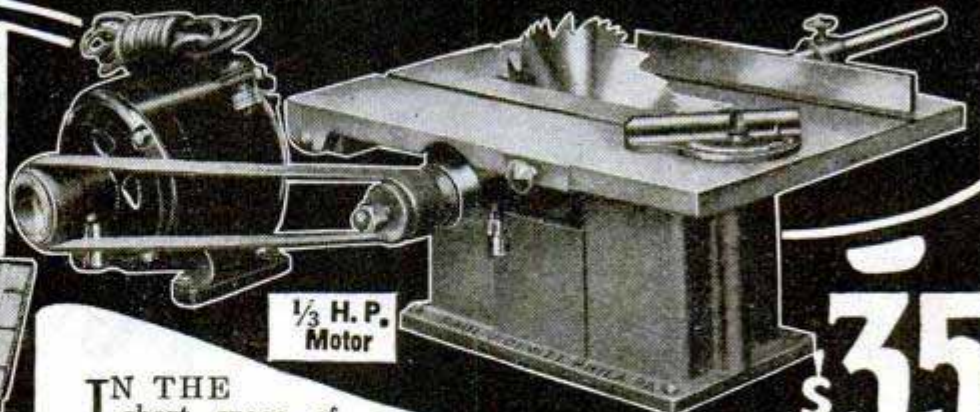

1/3 H.P. Motor

\$35

F.O.B. PHILA

IN THE short space of four years, the Devitt 8-Inch Combination Saw has become a practical necessity in thousands of shops, factories and households everywhere. Many imitators have sprung up, but Devitt leads them all. Think of the convenience and economy of this handy little machine that will rip, cross cut, bevel, miter, groove, mortise, tenon, drill, rabbet, grind, buff and polish. Attachments are easily and quickly adjusted. The saw and motor, when set up for work, occupy very little room. Saw is equipped with 1/3 H.P. 60 cycle, 1750 R. P. M. 110-volt A. C. Motor which can be attached to ordinary light socket, and provide power for other purposes when wanted. A cut up to 2 1/4" can be made without planing. Comes complete with following attachments—12"x16" table, 8" Combination Saw, iron pulley for saw table, 10" ripping fence, adjustable cut off miter gauge, motor-specifications as above, 1 1/4" endless leather belt, wood pulley, 8 ft. cord and plug, 6" buffing wheel, 3/8" 3 jaw drill chuck, 5" emery wheel, 6" sander, saw guard, and 2" dado insert. \$35.00 F. O. B. Phila. Height 7 1/2", shipping weight, 100 lbs.

(Only \$12 extra for Planer Attachment to fit on table top. Can smooth pieces up to 2 inches wide. Price, F. O. B. Phila.)

Send today for our attractively illustrated 4-page circular

PAUL J. DEVITT

Dept. L 1102 SOUTH 2ND ST. PHILA., PA.



SPEED LATHE \$10.50

complete as shown. 7 in. swing, 24 in. metal bed, 3 speed cone pulley. Longer bed \$1.00 per additional foot.

GOODWIN MFG. CO.

435 Keota St. Ottumwa, Iowa

Agents: \$2 an Hour

Wonderful new selling plan for prepared cake flour. Jiffykake contains eggs, milk, sugar, shortening, baking powder and flavoring—all ready to bake. We have plan that sells it in every home. Repeat business. Steady income.



\$50.00 to \$100.00 a Week

Write now and we will tell you how to make \$2,000 cash and a free automobile in six months. 350 High quality, low price Zanol Products. All fast sellers. No capital or experience required. Write today for territory, free auto offer and details of our new selling plan.

American Products Co., 748 American Bldg., Cincinnati, O.



Weekly Pay—Monthly Bonus to Sparetime Workers

No Selling Experience Required Get this book — America's

Greatest Money-Making Opportunity. A stenographer made over \$1000 in lunch hours. Mrs. B. C. Woodward, a housewife, \$800 in spare time. C. L. Lee, \$52.50 in 2 hours, through the fascinating and profitable Hertel Plan.

Investigate — \$10.00 Outfit Free This is the opportunity of a lifetime. Christmas Cards are used by everyone. **Hertel Cards Sell on Sight.** Simply show wonderful samples and take orders. It is the easiest, quickest, surest way of making money on earth. **Weekly pay and monthly bonus checks.** Write now. **The John A. Hertel Co., 318 W. Washington St., Dept. 5558, Chicago, Ill.**



\$150 to \$300 Monthly Profit Charging Batteries—Start NOW!

HB One Day Charging starts you making big money recharging auto and radio batteries. \$150 to \$300 monthly profits easily made. **Only \$35 cash brings complete HB One Day Battery Charging Outfit.** Easy payments. No experience needed. **Lowest-Priced complete One Day Charging Outfit on the market.** 33 days' trial on money back guarantee. Write for free bulletin.

HOBART BROS., Box M1081, Troy, Ohio

DEPENDABLE ECONOMICAL HEAT at LOWER COST

PRICE
\$240.⁰⁰
COMPLETE WITH FULL
AUTOMATIC CONTROL

The *Proved!* **LACO**

(OIL) GAS BURNER

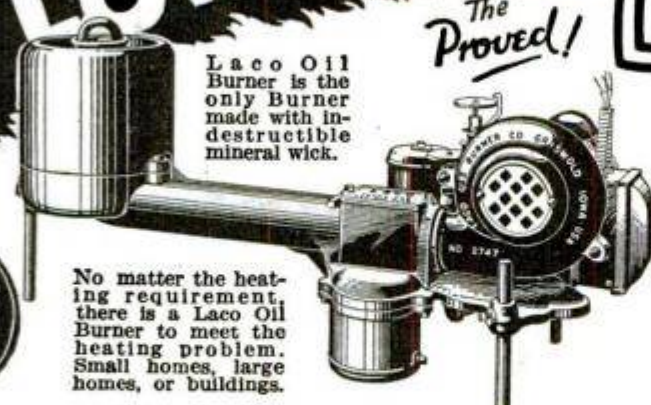

Laco Oil Burner is the only Burner made with indestructible mineral wick.

No matter the heating requirement, there is a Laco Oil Burner to meet the heating problem. Small homes, large homes, or buildings.

With the Laco Oil Burner installed in your present heating plant, your worries over the heating problem have ended. You will then have automatic, quiet, clean, economical heat. There will be no more trips to the basement to poke up an indifferent fire—no more shoveling of coal and carrying out of ashes. No matter the degree of temperature out-doors, you can have just the temperature you wish all through your home. Simply set the thermostat at the temperature you like the best. Laco will do the rest, for it is fully automatic. There will be no dirt smoke, soot, or odor. There is no reason for a homeowner to have the trouble which always comes with coal heating. The Laco is made to heat all sizes of homes, and is more economical.

DEALERS
The Oil Burner Season Is Here

Now is the time for dealers to cash in on the wonderful Laco sales franchise. Give your customers automatic, clean, odorless heat, at lowest cost and upkeep. Fill in the coupon today.

The LACO is lower in cost in each of its adaptable sizes. It gives economical and dependable heating service. There is nothing to get out of order. It is practically noiseless: it is guaranteed not to interfere with radios. It is actually safer than the ordinary gas range used in a kitchen. Thousands of installations, in every section of the country will prove its superior service. The man who buys a Laco saves money on the original cost, saves money on the economy of fuel—saves worry by virtue of the clean, odorless, practically noiseless and simple operation. There are seven sizes—EACH THE LOWEST PRICED FOR ITS HEATING CAPACITY. Write us today and find out more details and prices of the remarkable and guaranteed LACO.

LACO Gas Burner Co.
112 Union St., Griswold, Ia.

Gentlemen: I want to know more about LACO for my home of rooms. Check square if interested in agency

Name.....
Address.....
City.....State.....



The Musical Sensation
ACCORDEON
Played by Music Rolls

Without any knowledge of Music or Notes you play in a few minutes, perfect like an Artist, latest hits, songs and dances. No study or practice. Nobody can see the arrangement. Three models. \$40.00, \$55.00, \$70.00. Every instrument guaranteed. Interesting circular No. 1 and Roll List mailed free.

TREASURE SALES COMPANY, 1690 Boston Road, New York

BASHFUL?

"Shame on you!" Are you nervous, embarrassed in company of the other sex? Stop being shy of strangers. Conquer the terrible fear of your superiors. Be cheerful and confident of your future! Your faults easily overcome so you can enjoy life to the fullest. Send 25c for this amazing book.

RICHARD BLACKSTONE, 88-4710, FLATIRON BLDG., NEW YORK

Discarded Tires Run 20,000 Miles

SALESMEN make big money demonstrating TIRE ARMOR, the amazing new tire protector. It is a powerful tire re-inforcement preventing punctures, blowouts, stone bruises, etc. Guaranteed for 3 years. Discarded tires if equipped with TIRE ARMOR give as high as 20,000 additional miles of use and good tires often as high as 40,000 miles of service.

Write today for particulars and FREE Sample



MOTOR PRODUCTS CO.,
Dept. P
1760 Lunt Ave., Chicago, Ill.

YOUR CHANCE for \$5,000 to \$12,000 a Year

A straight forward opportunity—No magic or "get rich quick" scheme about it. The skill is built in the Clarke. No tuition necessary—we show you how.

\$300.00 investment with part time payments if you can qualify for this opportunity.

"Pointing the Way" gives the FACTS—illustrates by photographs the work—and contains the written testimony of men who are making big money as Clarke Flor-Kraftsmen. NOW, while it's on your mind



Send the Coupon Today

CLARKE SANDING MACHINE CO.

Dept. T-10, 3831 Cortland St., Chicago, Ill.

Please send me illustrated copy of "Pointing The Way to Greater Profits" which shows actual Proof of Performance and money-making facts of the Clarke Vacuum Portable Sander.

Name.....
Address.....
City.....State.....



"Lava-clean"

**hands
are
clean!**



Men—you who love to tinker—here's just the soap you need. Cleans quickly and thoroughly the toughest-looking pair of hands that ever fussed around a work bench. Makes more lather in 15 seconds than ordinary soap in 60, and even hard or cold water won't discourage it. Millions use it. "Good old Lava," they call it. Gets hands *clean!* Not just "surface clean," but clean 'way down deep. As easy on your hands as fur-lined gloves—because it's made from the finest of vegetable oils. All grocers sell it.

Full size cake of Lava Soap FREE!

Mail this coupon

Procter & Gamble (Dept. W 1028)
Cincinnati, Ohio

Please send me, FREE, a full size cake of LAVA, the hand soap that removes *all* the dirt and grease.

Name.....
Street.....
City.....
State.....

BEFORE You Buy PLUMBING

or Heating equipment—such as Bathtubs, Lavatories, Closets, Sinks, Water Supply and Sewage Disposal Systems—Furnaces, Steam and Hot Water Heating Plants—or Pipe and Parts, Fittings, Accessories, Tools, Supplies—or Paint, Varnishes—you should

Send for FREE CATALOG

60 pages, 4,000 offers and sizes—also on hand Fencing, Tinning, Roofing—largest variety and stock in U.S.—over 1,000,000 items. Some articles on Easy Payments—anything on Open Account if in business and rated. Satisfaction Guaranteed.

Cut Prices

You save one-third to one-half on highest grade, perfect goods—no "seconds." We ask you less than many plumbers pay their jobber. You can "Be Your Own Plumber"—easy to do your own installing—our Free Book tells how. Get it—compare our quality and prices with others—see for yourself.

Write Today—NOW!

—while you are thinking about it! You need it. You will like it. And at the same time will you be so kind as to add the name of one or more persons whom you will want goods in our line? Thank you. But be sure to write NOW!

BURKE & BROS. Dept. 1639C, 433 Liberty Ave. PITTSBURGH, PA.

6 Shot 22 Cal. BLANK Automatic



A real home protector. Shoots six loud—powerful shots—like expensive automatic in appearance. Construction, finish, durability—use for fun or self defence. Frightens thieves, tramps, dogs—fool your friends. Guaranteed absolutely safe. Automatically loads magazine and ejects cartridges. Send no money. Pay on arrival \$4.99. 100 cartridges given Free. Federal Mail Order Corp., 561 Broadway, N. Y. C., Dept. 8119

NO PERMIT or LICENSE REQUIRED

You Can Have

\$50 Every Saturday



RAY C. HAHN

If you are a reliable, honest man I will give you an opportunity to make \$50.00 or more a week looking after our business in your locality. Just take care of my established business with theatres, hotels, stores, home owners, filling stations, etc. Inspect these places and demonstrate our new improved "Super" Fyr-Fyter and arrange for their installment. I don't ask you to invest any money in stock—no experience needed—if you are the kind of a man I want, I will show you how to handle the business. We deliver and look after collections.

PAY TO START AT ONCE

If you are in earnest and are responsible, your earnings can start at once. Checks mailed every Saturday. An established Ohio Corporation is behind you. Write at once.

Ray C. Hahn FYR-FYTER CO. 90-K Fyr-Fyter Bldg. Dayton, Ohio

Take YOUR OWN MOVIES

New Pathex Movie Camera Special \$18.

Boys, here's your chance to get a real \$47.50 Pathex Movie camera for only \$18. Lots of fun on vacations, Boy Scout outings, etc. Film your friends and family. Camera takes 9 mm. film—30 ft. reel, \$1.75 including developing. Pathex Projector for home entertainment, \$20. Mail orders filled.

WILLOUGHBY'S, NEW YORK

110 W. 32 Street

JUST OUT Spors No. 9 Combination Pen and Pencil

AGENT'S SAMPLE 66c Sells for \$1.35. Make 8 different colors. \$15 daily easily.

Guaranteed 2 years. Money back if not pleased.

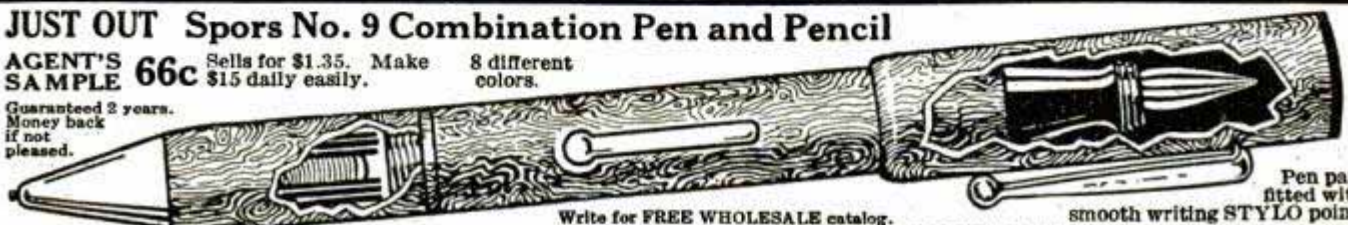

Write for FREE WHOLESALE catalog.

Pen part fitted with smooth writing **STYLO** point.

F. SPORS & CO., 828 MAIN STREET, LESUEUR CENTER, MINNESOTA

A Successful Method of Drugless Gland Stimulation Has Been Found

A pioneer scientist . . . in the field that has recently achieved discoveries of world wide importance . . . now offers an amazing new treatment for men past forty. Already fifty thousand men have used this treatment . . . victims of prostate trouble . . . bladder sufferers . . . victims of other symptoms common to men past forty. Not a medicine, vibrator or violet ray. Remarkably easy to secure for a no-risk trial in your own home.

A NEW type of treatment is now being used by physicians, specialists and health institutions in all parts of the world for those torturous symptoms so common to men past a certain age.

A noted sanitarium has advised a wonderful new appliance—the discovery of an Ohio scientist—for home use.

This revolutionary treatment is simple and easy to use, harmless and convenient. Fifty thousand men have used it. While going to the direct region of the trouble, it also acts as a general tonic for the whole body. Unlike certain drugs, it has no harmful effects on the heart or other vital organs. Men 90 years old have used it successfully.

Thousands of users say they feel 10 and 20 years younger. Many tell of having avoided a painful gland operation. Score upon score tell of relief from the painful conditions that reach to every part of the body when the prostate gland goes wrong—often when all other methods had failed. Millions of men suffer with prostate disorder without knowing it. Your chances are 6 out of 10 of having prostate disorder if you are past a certain middle age, say medical authorities. Many wrongly attribute their suffering to disordered kidneys or bladder.

Are you aging too soon—getting up 5 to 10 times at night . . . is vitality ebbing steadily away? Are you on the down grade, half living, blue, nervous, subject to chronic fatigue, constipation? Weakness in back, legs or feet? You should not delay a minute

SUBANTENNA — Try it FREE

Write at once for full particulars on the first satisfactory device to pick up e'ear ground waves—improved SUBANTENNA. Get loud, sharp distance reception, like local. Free trial guarantee offer. Write today.

CLOVERLEAF MFG. CO., 2711-F Cana! St., Chicago, Illinois

NEW DISCOVERY Grows Hair Quickly!



Noted surgeon has discovered amazing way to grow hair called Dermo-Ray. Employ infra-red rays. In thirty days no more dandruff. Scalp tissues given new life! Then within a few weeks luxuriant new hair! Two years ago the discoverer was himself bald. Today his hair is full and thick. Sent on Free Trial. Results or no pay. If you have electricity in your home write at once for Free, startling, thirty-two page booklet. Address the LARSON INSTITUTE

216 N. Wabash Ave. Dept. 334 Chicago, Illinois



in finding out full details of this remarkable discovery—so easy to use in your own home, so remarkable in its results.

You incur absolutely no obligation by mailing the coupon now. It will bring you full information including an interesting illustrated free book. The edition of this vitally interesting little book is limited so mail the coupon at once to be sure of getting a copy.

W. J. KIRK, President
2110 Morris Ave., Steubenville, Ohio

If you live West of the Rockies, mail your inquiry to
The Electro Thermal Co.
303 Van Nuys Building, Dept. 21-K
LOS ANGELES, CALIF.

In Canada, address—21-K, 44 Young St., Toronto, Ontario, Canada

W. J. Kirk, President,
2110 Morris Ave., Steubenville, Ohio.

Please mail at once a FREE copy of the booklet, "Why Many Men Are Old at 40," and all details about the new treatment. I'm not obligated in any way.

Name.....
Address.....
City..... State.....

BUCHSTEIN'S FIBRE LIMB



Is soothing to your stump—strong, cool, neat, light. Easy payments. Braces for all deformities. D. BUCHSTEIN CO. 610 3rd Ave., So. MINNEAPOLIS, MINN.

Send for Catalog Today

A PERFECT LOOKING NOSE

Can Easily Be Yours
Trados Model No. 25 corrects now ill-shaped noses quickly, painlessly, permanently and comfortably at home (excepting cases caused by improper bone structure). It is a safe and guaranteed patent device of precise adjustment that will actually give you a perfect looking nose. Over 90,000 satisfied users. For years recommended by physicians. 16 years of experience in manufacturing Nose Shapers in at your service. Model 25 Junior for children. Write for testimonials and free booklet, which tells you how to obtain a perfect looking nose.



M. TRILETY, Pioneer Nose-shaping Specialist
Dept. 3070 Binghamton, N. Y.

A $\frac{1}{4}$ Century House, Financially Rated over \$1,000,000.00, offers the following:—

Actual Regular PRICES \$55 to \$65

21 Jewels \$29⁴⁸

Hamilton '992' ILLINOIS Bunn Special ELGIN B.W. Raymond and Others

High grade, Hamilton, Illinois, Elgin and other famous railroad makes, perfect condition, 21 jewel adjusted movements—each and every watch has sold—sell now—at \$35.00 to \$65.00. Yet offered here at only \$29.48. Why?—Simply because they have been carried in the pocket a short time and used as collateral for loans at this big association of 10 loan firms combined. Of course not all loans are repaid. These, the real opportunities for you to buy at forced sale prices—pay merely the amount loaned plus interest, charges.

Forced Sale for Loan and charges Only

Guaranteed to Pass Railroad Inspection
No better running watches—no better timekeepers—than these. Then, why pay full prices for the identical makes and grades of foremost railroad timepieces we offer you here at a fraction of original costs,—

Low as 33c on the \$1 (of original costs)
Of course you wouldn't want to sell your perfectly good watch, keeping perfect time, at any such tremendous loss in price to you—unless you just had to have the money. Well, these watches were never intended to be sold by the individuals who owned them. These represent circumstances where money was borrowed. The owners expected to repay. They failed to meet their obligations. Hence, these watches must be sold to get back the cash loaned and accrued charges only.

Send for Latest List—Examine Watches Free
See one of these 21 jewel, guaranteed perfect condition watches at \$29.48, entire cost. Includes delivery to your very door. Or send for one of our lot No. 47—Elgin "B. W. Raymond" 19 jewel adjusted timepieces at just \$19.99. Or lot No. 63—one of the famous Howard 21 jewel adjusted railroad chronometers, originally made by factory, priced here at only \$39.25. These and many other unusual offers in latest list. Mail coupon below. Examine any watch on approval—no risk, no expense to you. No obligation to buy if not acceptable.

Don't Delay! Just a limited number in Each Lot. Fill in below for Free List.

JOS. DeROY & SONS, (10 Large Loan Firms Combined)
Opposite Post Office 1973 DeRoy Bldg., Pittsburgh, Pa.

References by permission—
—Bank of Pittsburgh
—N. A. Marine National Bank—Union Trust Co., Pittsburgh, Pa. Your bank can look us up in mercantile agencies.

Name _____
Address _____

Low as \$60 a Carat for Diamonds

Ford Owner Stop that ruinous chatter on your car. **MAKE THIS TEST**—take out your floor boards, pull your emergency brake back and forth. If you notice play at the ball joint, you need Bredar's Ball Shim. Price \$3.50. Ask your Dealer or order direct. Demand Bredar's Shim. **NIC BREDAR'S SON MFG. CO., Rock Island, Ill.**

NEW! STA-PUT GARAGE DOOR CONTROL

Opens Up Tremendous Earning Possibilities For You!

See Miles Away
Big 3½ Ft. Telescope

Lend wings to your eyes! People and objects miles away seem close. Wonder telescope brings new pleasures to home, farm, camp, travel, sport. Study the mysterious Sun spots; see Moon and Stars as never before. See people on the beach, on the mountains, etc.

FREE Yes, absolutely free! A handsome leatherette Carry- ing case and Shoulder Strap. Also Solar Eye Piece to view the sun—a special feature, found only on expensive instruments.

5 Sections
8 Power Lenses
Brass bound; measures 12 in. closed; powerful achromatic lenses protected by dust caps.

Thousands Pleased
P. Brush wrote: "Watched submarines three miles off coast." C. Scribner: "See lighthouse 18 miles away." M. A. Yarr- brough: "Could tell color of aeroplanes four miles away." S. M. Gearhart: "Can see men working seven miles away."

SEND NO MONEY
On delivery of Telescope, free Case, Strap and Eye Piece pay Postman only \$1.85, plus postage (2 complete outfits \$3.50), or send price with order and we'll pay postage. Satisfaction guaranteed or money refunded. Send today, entertain your friends! Be first.

FERRY & CO., Dept. 9777, Chicago, U. S. A.

Save Your Feet
When all else fails, end your suffering with the **Heefner Arch Support No Metal**

Fully patented. It re-adjusts the entire foot. Write for free book and statements from doctors and users.

Heefner Arch Support Co. 665 N. E. Taylor Bldg. Louisville, Ky.

GRAY HAIR No Harmful DYE!
NEW unusual discovery. For men and women. Quickly restores youthful color, lustre and beauty. Easily applied. Helps relieve dandruff. Not greasy or sticky. Not affected by curling or waving. No one will know you use it. Results guaranteed. Get booklet and free trial offer today. **RAY LABORATORIES, 648 N. Michigan Ave. Dept. 677 CHICAGO, ILL.**

PSORIASIS

CAN BE CURED. I SUFFERED MANY YEARS WITH THIS DREADFUL SKIN DISEASE. WRITE R. S. PAYNE, 234 E. SECOND ST., COVINGTON, KY.

Ends Garage Door Troubles Forever!

Holds Doors Rigid—Open or Shut
Stops Danger Monoxide Poisoning

Sta-Put is amazingly human. By a slight pull on one door, both doors open automatically. Shuts both doors same way. Holds doors open or shut in highest wind. Prevents swinging or slamming. Eliminates propping of doors to hold open. Protects damage to car. Prevents risk of monoxide gas poisoning by doors blowing shut while engine is running.

Sta-Put Garage Door Control consists of two arms, attached to doors, working on pivots from two "shoulders" which operate on auger-type gears. Powerful steel springs furnish tension which opens or shuts both doors with a slight pull on either—and holds the doors open or shut. Shipping weight, 18 pounds. Sells under \$10.00.

Sells Easily to Garage Owners
They will gladly pay you a profit of \$3.50 to \$4.00 a pair. One man sold 4,000 in 6 weeks. Exclusive territory given distributors and salesmen. Write today.

Door Operators Corp.
Dept. F-10
1217-19 W. Monroe St. Chicago, Ill.

This is the device written up on page 446 in Sept. 1928 issue of POPULAR MECHANICS

9th Anniversary Offer!

ENJOY ANY MIRACO 30 DAYS - RETURN EVERYTHING AT OUR EXPENSE UNLESS DELIGHTED



View of marvelous new, 3-year guaranteed, lighted 1-dial control. All Metal Super Shielded AC-9 chassis (with front switch), built-in AC power section, phonograph pick-up connection and all latest features removed from cabinet. AC tubes and cabinet extra.

NEW LOW FACTORY PRICES
SAVE 50%

Choice of Cabinets AC or Battery Sets
30 Days' Trial

Richly designed genuine walnut console of finest type. Electro-dynamic or magnetic power speaker.

Graceful Spinet console, genuine walnut. Choice of speakers. Also comes in Radio-Phonograph Comb'n.

A Le-Boy Console that costs little. Dynamic Power Speaker.

Popular inexpensive combination. Set on table speaker.

New-type arm-chair console of genuine walnut—latest speakers.

MIRACO Radio gets 'em Coast to Coast

Latest • Powerful • New

MIRACO

TRADE MARK REGISTERED

Cathedral Toned, Super Selective, Long Distance Getters

Battery or Electric AC Sets

Celebrating its 9th successful year, America's big, old, reliable Radio Corporation springs a genuine sensation in high-grade sets. With its latest, Super-powered, 1-dial Miracos—the All Electric wholly self-contained, hum-free, AC-8 and AC-9, using AC tubes or the new 8-tube ultra for batteries or Eliminators—you are guaranteed the greatest values and savings in the fine set field.

Compare a Miraco with highest-priced radios, for 30 days in your home. Surprise and entertain your friends—get their opinions. Unless 100% delighted, don't buy it! Return everything—the complete outfit—at our expense. Your decision is final—absolutely!

Only exceptionally fine radios, of the very latest approved type, at rock-bottom prices, could possibly back up so liberally unconditional a guarantee. Send coupon now for *Amazing Special Factory Offer!*

Don't Confuse with Cheap Radios

With its rich, clear Cathedral tone, hum-free operation, tremendous "kick" on distant stations and razor-

edge selectivity—with its costly sturdy construction, latest features, including phonograph pick-up connection, ease of tuning, beauty, and economy—a Miraco will make you the envy of many whose radios cost 2 to 3 times as much!

Many thousands of Miracos—bought after 30 day home comparisons—are cutting through locals and getting coast to coast, Canada, Cuba, Mexico, with the tone and power of costly sets. Miracos are laboratory-built with finest parts, and embody 9 years' actual experience in constructing fine sets. Approved by Radio's highest authorities.

Deal Direct with Big Factory

Everything reaches you splendidly packed and rigidly tested to insure your instant enthusiasm. Enjoy the outfit 30 days—then decide. Liberal 3-year guarantee on each set. Play safe, save lots of money, and insure satisfaction by dealing direct with Radio's old, reliable builders of fine sets—9th successful year.

Ultra 8
\$49⁸⁸

Electric AC-8
\$71⁵⁰

Electric AC-9
\$83⁷⁵



Metal or wood compact style cabinets. Wood cabinets in walnut or new shaded silver-chrome finishes. Cathedral Electro-Dynamic or Magnetic Power Speaker to match!

MIDWEST RADIO CORP'N, 407-A0 Miraco Bldg., Cincinnati, Ohio, U. S. A.
BEAUTIFULLY ILLUSTRATED CATALOG, AMAZING SPECIAL FACTORY OFFER

Testimony of Nearby Users—All the proof you want—of our honesty, fairness, size, financial integrity, radio experience and the performance of our sets—including Amazing Factory Offer—sent with catalog.

Free!

MIDWEST RADIO CORPORATION
Pioneer Builders of Sets—9th Successful Year
407-A0 Miraco Bldg., Cincinnati, Ohio

THIS COUPON IS NOT AN ORDER

WITHOUT OBLIGATION, send free catalog, Amazing Special Factory Offer, testimony of nearby users, etc. User Agent Dealer
 Check here if interested in an EXCLUSIVE TERRITORY PROPOSITION
NAME _____ ADDRESS _____

Violet Ray

New Health
Beauty
Vigor



Let us tell you how thousands of men and women suffering from rheumatism, paralysis, neuritis, nervousness, skin diseases, headaches, constipation, sprains, prostate trouble, goitre and many other ailments, even hay fever and asthma, have found quick relief, new health and vitality with this marvelous, scientific invention. Pains vanish almost instantly.

Violetta 10 Days FREE TRIAL

For Health--Beauty--Vigor

Endorsed and used by hospitals, sanitariums and physicians. Every home should have one. Saves hours, days, months of suffering. No medicine. Painless, pleasant treatment. Only the violet ray can penetrate to every nerve affected. Simple, safe, painless—anyone can use VIOLETTA. Don't suffer pain and poor health when you can try VIOLETTA 10 days FREE.

This Book Free

Tells all about violet rays—how this marvelous discovery by Nikola Tesla, the electrical wizard, now brings this mysterious curative power to all. Contains many astounding testimonials from our hundreds of satisfied users. Send for all the facts and our liberal trial offer. Mail the coupon now.

VI-REX CO., Dept. 1031
2304 Warren Av., Chicago

Vi-Rex Co., 2304 Warren Ave., Dept. 1031, Chicago

Please send me your free book on Violet Rays and details of your 10-day free trial offer.

Name

Address

City State

Allment

HAIR GROWS!

when our Vacuum Cap is used a few minutes daily. Sent on 60 days' FREE trial at our expense. No drugs or electricity. Stops falling hair, cures dandruff. A postal brings illustrated booklet.

MODERN VACUUM CAP CO.
557 Quincy Denver, Colorado



NO JOKE TO BE DEAF

—EVERY DEAF PERSON KNOWS THAT

I make myself hear, after being deaf for 25 years, with these Artificial Ear Drums. I wear them day and night. They stop head noises and ringing ears. They are perfectly comfortable. No one sees them. Write me and I will tell you a true story, how I got deaf and how I make you hear. Address



GEO. P. WAY, Artificial Ear Drum Co. (Inc.)
80 Hoffman Bldg., Detroit, Mich.



FREE BOOK

For You—Just what you want. Get it before you buy. Crammed full of up-to-date offers at

Money Saving Opportunities
Home Owners—Contractors—Businessmen
SAVE 1/3 TO 1/2

PLUMBING AND HEATING
Welding, Brass, Tinning, Painting, Plumbing, Fencing
Warranted Done To The Best

60 Pages 4000 Offers— Everything you could think of
Send TO DAY

BURKE 4 BROS
433 LIBERTY AVE. PITTSBURGH PA.

Bargain Prices
—Lowest anywhere. Everything is high grade, perfect
No "Seconds"! Our goods are of the kind that last and please all the while

→ YOU Need It
Get it—compare our quality and prices with others—We save you 1/3 to 1/2—you pay us less than many plumbers pay their jobbers. "Be Your Own Plumber"—it's easy—Book tells how. 60 pages—4000 offers and sizes—everything in **Plumbing—Heating—Tinning—Paint**

Such as Bathtubs, Lavatories, Closets, Sinks, Laundry Tubs, Water Heaters, Range Boilers, Water Supply Systems, Pumps, Tanks, Pipe, Sewage Disposal Systems—Furnaces, Steam and Hot Water Heating Plants—Parts, Fittings, Tools, Accessories, Supplies—Paint, Varnishes—and on hand also Fencing, Roofing, Tinning—anything you want—all at cut prices—over 1,000,000 items—largest stock and variety in U.S. Some articles on **Easy Payments**—anything on **Open Account** if in business and rated. Write for **Free Book Today—NOW.**
BURKE 4 BROS Dept. 1639C, 433 Liberty Ave. PITTSBURGH, PA.

RESHAPE your NOSE
to beautiful proportions—while you sleep!

ANITA NOSE ADJUSTER
is SAFE, painless, comfortable. Speedy, permanent results guaranteed. Doctors praise it. No metal to harm you. Small cost. Write for FREE BOOKLET

ANITA INSTITUTE, 1012 Anita Bldg., Newark, N. J.

Stop Using a Truss

STUART'S ADHESIF PLAPAO-PADS are entirely different from trusses—being mechano-chemico applicators made self-adhesive purposely to keep the muscle-tonic "PLAPAO" continuously applied to the affected parts, and to minimize painful friction and danger of slipping.

No straps, buckles or springs attached



Soft as velvet—easy to apply—inexpensive

For almost a quarter of a century satisfied thousands report success without delay from work. Stacks of sworn statements on file. Process of recovery natural, so no subsequent use for a truss. Awarded Gold Medal and Grand Prix. Trial of "PLAPAO" will be sent you absolutely **FREE** No charge for it now or ever. Write name on coupon and send **TODAY.**

PLAPAO CO., 588 Stuart Bldg., St. Louis, Mo.

Name

Address

FREE—Trial Plapao—FREE

Be Your Own Broadcaster

Fool Your Friends



**THE SKY IS THE LIMIT
A NEW IDEA FOR A RADIO PARTY!**

The mystic Home Broadcaster is attached to any radio set in a jiffy. No skill required. Stretch long extension cord into another room or closet, press the switch button on the microphone which automatically cuts off radio reception and you begin to broadcast! THEN THE FUN BEGINS! Sing—Joke—Play—The sky is the limit! Release the button and radio reception comes through once more. Slip a Home Broadcaster in your pocket when you go to the next radio party and see what happens.

SEND NO MONEY. Pay postman \$7.50 plus postage for the Home Broadcaster outfit consisting of Microphone, Special extension cord and adaptor plug. State whether you want the Type U.X. or Type A. C. Money Back Guaranteed.

BROOKLYN METAL STAMPING CO.
718 to 728 Atlantic Avenue, BROOKLYN, N. Y., Dept. 42



Be the Life of the Party



Play a Tune in 10 Minutes

Popularity—new friends—money-making opportunities come to those who can play!

Now you can pick up your favorite stringed instrument and play a tune almost instantly. NO knowledge of music is needed. NO expensive lessons. NO weeks of tiresome practice. Play tunes from the start. Play by numbers. Surprise and astonish your friends. **Amazing new invention makes it easy to play Ukulele, Banjo Ukulele, Tenor Banjo, Guitar, Mandolin.** Just press the keys and play.

Trixie Friganz, famous Vaudeville Star, wrote: "I played in 3 minutes and never touched a stringed instrument before." John A. Crusier: "I was skeptical about anyone playing tunes instantly but have changed my ideas completely." W. B. Matthis: "Your advertisement didn't tell the half of it." Mrs. A. Kase: "My friends and I play wonderful tunes. The more we play the better it gets."

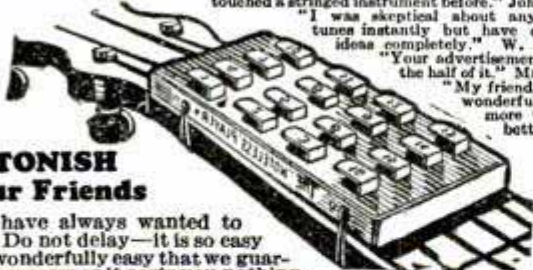

ASTONISH Your Friends

You have always wanted to play. Do not delay—it is so easy—so wonderfully easy that we guarantee success or it costs you nothing.

SEND FOR FREE BOOK!

More popularity—more fun from life—new friends—money-making opportunities. If you want to play tunes at once—send today for a free book about FERRY E-Z PLAYING INSTRUMENTS. Soon, you, too, can know the joy of making your own music. "No play, no pay." E-Z Playing Instruments are sold complete or the E-Z Player can be attached to your own stringed instrument in a jiffy.

Mail Coupon Today!

FERRY & CO., Dept. 1777, Chicago, U. S. A.

Send free book telling how I can get more fun out of life, make more friends, have greater opportunities for getting ahead by learning to play my favorite stringed instrument in 10 minutes. No obligation.

Name.....
Address.....
City..... State.....

Sent to You



for Only \$1

A Sensational Offer!
Only \$1.00 and you get the famous 21-Jewel Studebaker Watch direct from factory. Balance in easy monthly payments!

Lowest prices ever named on similar quality. You save 30% to 50%.

DOWN

21 JEWEL-Extra Thin STUDEBAKER The Insured Watch

Ladies' Bracelet Watches, Men's Strap Watches. Diamonds and Jewelry also sold on easy payments. This company is directed by the Studebaker Family of South Bend, known throughout the world for three-quarters of a century of fair dealing. 100,000 satisfied customers. Send coupon at once for full particulars of our amazing offer. Studebaker 21-Jewel Watches have 8 adjustments—heat, cold, isochronism and 5 positions. An insurance policy is given free—insuring the watch for your lifetime!

WRITE FOR FREE CATALOG!

A copy of our beautiful, new, six-color catalog will be sent free to anyone sending the coupon below. Shows 80 magnificent, new Art Beauty cases and dials. Latest designs in yellow gold, green gold and white gold effects. Exquisite thin models. Masterpieces of the watchmaker's craft.

Special Offer: Watch Chain FREE

To those who write at once for free Catalog we will include particulars of our special offer of an exquisite Watch Chain free. This offer is for a limited time only. Send coupon at once—before it expires.

Studebaker Watch Co.
Directed by the Studebaker Family—three-quarters of a century of fair dealing
WATCHES—DIAMONDS—JEWELRY

Dept. W907 South Bend, Ind.
Canadian Address: Windsor, Ont.



SPECIAL OFFER COUPON

STUDEBAKER WATCH COMPANY
Dept. W907 South Bend, Indiana
 Please send me your free Catalog of Advance Watch Styles and particulars of your \$1 down offer
 Please send me Jewelry Catalog free.

Name.....
Street or R. F. D.....
City or Post Office.....
State.....

TOBE A FILTER

— A New Development

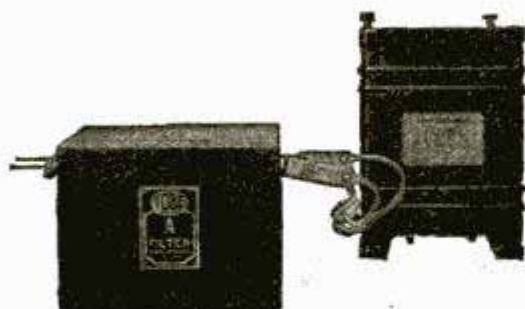

Attach to any good 2 or 5 Amp. charger such as Westinghouse, Tungar, Balkite, Elkon, etc., bulb or electrolytic will do.

Filter consists of 2 chokes and 8000 microfarads of condensers. The unit is dry, measures but 8 x 4 x 5, thoroughly guaranteed and sold with the understanding that your money will be refunded if you are not completely pleased with the results.

The TOBE TRANS-A-FORMER has been designed to take the place of a charger, if you are without the standard charger. The TRANS-A-FORMER consists of a 2½ dry rectifier and a step down transformer. The unit is completely wired and fits neatly on top of the A-FILTER—making a complete ALL DRY 6 volt A Eliminator.

A Filter \$18.00
TRANS-A-FORMER 15.00

Try your dealer; if unable to obtain A Filter send check or money order and we will ship direct.

TOBE DEUTSCHMANN CO.

CANTON, MASSACHUSETTS

Get This Motor Attachment!

Complete with drill chuck Only

\$2.75



Without drill chuck

\$1.75

Multiplies the Service of ALL Small Motors

Holds grinding and polishing wheels, wire brushes, drills, saws, etc. Quickly pays its small cost. In sizes to fit 3/8, 1/2 and 3/4 inch shaft (state which). Complete, with drill chuck only \$2.75. Without drill chuck \$1.75. Send check or money order—we pay postage. **THE BARSTEEL PRODUCTS CO., 1111 Power Ave., Cleveland, Ohio.**



SPRAYIT ELECTRICALLY

New Superior Model

Rotary compressor type. For fine professional work such as one-coat enamel on fixtures, or in automobile and cabinet work where job is rubbed between coats. Price, \$39.50. Write for complete details on this and other models.

THE ELECTRIC SPRAYIT CO.
210 E. Colfax South Bend, Ind.

FREE BULLETIN

Crescent Wood Working Machines

Quality Made — Moderately Priced



Enable you to turn out big quantities and a wide range of work speedily, accurately. Simple, easy to operate, carefully guarded; portable machines plug in any light socket—Band Saws, Bench Saws, Saw Tables, Jointers, Combination Wood Workers. We also make heavy equipment for planing mills, furniture factories, etc. Write today for free bulletins.

THE CRESCENT MACHINE CO.

93 Columbia St.

Leontonia, Ohio

Boys! Girls! Get the Bug!

Biggest Novelty In Radio



Handsomely Modeled Bug—Beautiful Onyx Art Pottery—9 in. long. It's worth your cost as an ornament—but in it is mounted our

"MYSTIC" CRYSTAL RADIO SET

No tubes or batteries—attach aerial, ground and phones—gets local stations fine—distant ones under some conditions—Delight your family and friends—Order Sample Today.

PRICE \$187 PREPAID

Anywhere in U. S.—Agents Wanted.

The Brush Pottery Co.
Zanesville, Ohio

A BIG MACHINE at a LOW PRICE!

DOES 20 DISTINCT WOODWORKING OPERATIONS

ON EASY TERMS

TURN YOUR HOBBY INTO INCOME!

No trick at all with this amazingly low price Woodworker, which you may try, and pay for, on terms, to turn idle hours into profit.

FREE TRIAL

Does 20 woodworking operations. Ideal size, capacity for shop, home or the job. Economical.

COMPLETELY EQUIPPED!

Comes complete with 8-in. Cross Cut, 8-in. Rip Saw; 12-in. Band Saw; Jointer, Lathe, Borer, Sander, Guides, Electric Motor. Investigate it!



FREE Working Drawings of 60 Items You Can Make with Saw
SEND FOR FULL DETAILS! Without obligation, send me details on the Woodworker, and the Free Trial and Easy Terms Plan.

NAME

ADDRESS

A. S. ALOE CO.
1832 Olive St.,
St. Louis, Mo.

SAVE \$100⁰⁰ ON WORLD'S FINEST CUSTOM-BUILT SETS!

This new 80-page Hi-Q Construction Manual is the most important radio book of the year—shows you how to save at least \$100.00 or how to make a big, steady income through the New CUSTOM-BUILT Hi-Q Receivers—Junior Hi-Q 29 at \$54.35; Junior A.C. Hi-Q 29 at \$103.95; Master Hi-Q 29 at \$99.50; Master A.C. Hi-Q 29 at \$151.80—4 wonderful completely shielded "coast-to-coast" instruments—acknowledged to be the last word in sensitivity and knife-like selectivity—unequaled in tone quality by any ready-made

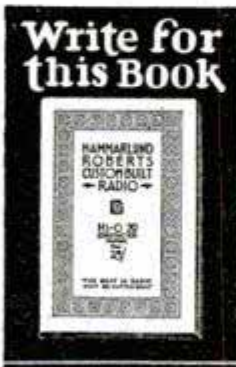

set selling for \$50.00 to \$100.00 more. This greatest of all Hi-Q Manuals is complete with text, photos and diagrams. Covers every detail of Hi-Q building. Gives full information on power amplifiers, short wave adaptors, installation, antennae, house wiring and a wealth of other data. Shows you how to save money on your own set and how to make money building for others.

Price 25 cents postpaid.

**Hammarlund
Roberts
Custom-Built
Radio**

Write for your copy today before first edition is exhausted.

Hammarlund-Roberts, Inc., 1182-X Broadway, New York City

Mechanical Toys Ship Models, Colonial Bric-a-Brac, Leather and Celluloid articles and hundreds of other useful things are described in our new book, *Make It Yourself*. 480 Pages. Illustrated. Price \$3 Postpaid.
POPULAR MECHANICS PRESS, 200 E. Ontario St., Chicago

EASY \$100 a Week

FUGO FIRE EXTINGUISHER

Unusual opening for live agents in every locality. Make \$5000 or more a year—easily. Fugo—the instantaneous automatic fire extinguisher—is needed and wanted in every home, store, theatre, garage, shop, school, automobile, etc. Cheapest fire protection available today. Within reach of all.

1 Qt. Size \$5.00 2 Qt. Size \$7.50

Recharged in a jiffy

Amazing 30-second demonstration clinches sale—each one sold sells others. Territory going fast. Write at once for wonderful proposition that will make you big money.

THE NATIONAL FORMETAL CO.
6539 Metta Ave., N. E. Cleveland, Ohio

**On your feet—
In a good Paying Business**

We start you in the shoe and hosiery business. Inexperienced workers earn \$5000 yearly with our Direct-to-Wearer plan. Just show Tanners Famous Line of Footwear. We tell how and where to sell. Perfect fit through Patented System. Collect your pay daily. We furnish \$40.00 Sample Outfit of actual shoes and hosiery. 72 styles. Send for free book "Getting Ahead" and full particulars. No obligation.

TANNERS SHOE MFG. CO.
5019 South C Street, Boston, Mass.

Heats Home for 25c a Week!

"I can run my Bulldog furnace steady for fourteen days in normal weather conditions on the actual cost of fifty cents." So writes F. R. Redetzke, of Cleveland, North Dakota. He adds: "Hard to believe is it? That's what some of my neighbors thought until I showed them! We have an unlimited amount of grain screenings in this country. That's the fuel I am using."

That's what the Bulldog does with about the lowest grade fuel you can think of! Here's what it does with coal: "With the Bulldog Furnace I used 3 tons of hard coal last winter to heat our 8 room house."
—Lester F. Coons, Ellenville, N. Y.



If you are even thinking of a pipeless furnace, or any furnace, write for our free catalog. The Bulldog is one furnace you MUST investigate. Comes completely erected. Fits any height of basement and you install it yourself.

No Money Down

Small Monthly Payments

The Bulldog is sent for free inspection. Then, if satisfied, you make only small monthly payments at our amazingly low price. Factory connections in both East and West. We ship from nearest point. Don't consider buying any furnace until you find out about the Bulldog. Write at once for our special offer and our free catalog together with the wonderful record of Bulldog success. Mail this coupon today.

Bulldog Furnace Co.

Babson Bros. Sole Distributors

19th and California Ave., Dept. 13-57 Chicago
Without obligating me in any way please send me your free catalog and special offer on the Bulldog Furnace.

(Print Name and Address plainly)

Have you a basement? Yes No

Name.....
Address.....

A REMARKABLE

NEW

SUPER TRANSFORMER

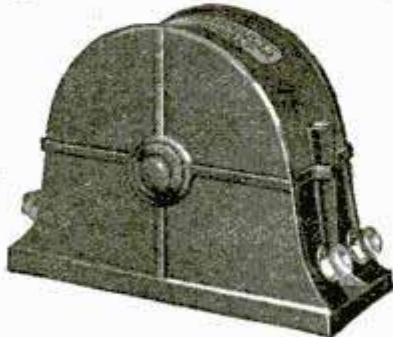

After long and particularly exacting tests the new Victoreen Super Transformer is now announced as a radically new and better product—one that will be as outstanding in its superiority during the 1929 season as the previous type has been in years past.

Write for **FREE Blueprint** of the new and perfected Victoreen A.C. Circuit, using this marvelous new Transformer. The set is easy to build—of unsurpassed tone quality and reliability.

The George W. Walker Company
Merchandisers of Victoreen Radio Products
2825 Chester Ave., Cleveland, O.



Victoreen

AGENTS AND SIGN MEN

Now Making \$50.00 to \$100.00 and Up Per Week Selling Our
GOLD LEAF SIGN LETTERS

R

For store and office windows, board signs, trucks and glass signs. We also make to order script signs and business emblems singly or by the thousands. A permanent business. No capital or experience required. Big demand in every city. *Samples and Literature Free.*

CONSOLIDATED SIGN LETTER CO. 71-X W. Van Buren
CHICAGO, ILL.

WANTED—Men for Saw-Filing Business!

Here's your chance to get into a good steady paying business of your own. Many are making big money with the Foley Automatic Saw Filer. There's a year 'round demand for saw-filing from carpenters, factories, farmers, construction companies, home-owners, etc. T. P. Wilson, Vancouver, B. C., writes, "I get plenty of saw-filing from all sources. Am now getting circular saws from the newspapers."

FOLEY Automatic SAW FILER

is the only machine that files all hand saws, band saws $\frac{1}{8}$ inch to $4\frac{1}{2}$ inch wide and circular saws 3 inch to 24 inch diameter. Easy to run, rapid, accurate. Adam Bagley, Fort Wayne, Ind. says, "I love to operate it." No experience needed, no canvassing. Our **FREE** plan starts you right. Make \$15 to \$20 a week in spare time while building a permanent business. Address

Foley Saw Tool Co., Inc., 232 Foley Bldg., 11 Main St. N. E., Minneapolis, Minn.

Ask about Foley Automatic Grinders for large Circular Saws.

**"My Delta Handi-Shop
does Everything!"**
from Grinding Tools, Repairing
Machinery, to Building Furniture

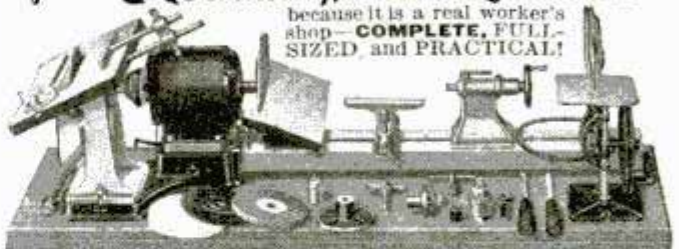

because it is a real worker's
shop—**COMPLETE, FULL-
SIZED** and **PRACTICAL!**

Sent on 10-Day Trial

You can have this husky, man-sized electric Workshop for 10 Days' Trial in your own Home. Test it to your heart's content. Make the things you've always wanted to make. Save money on repair work. See how you can earn the cost of the shop in a few months' of spare time work. The Handi-Shop includes all necessary equipment for woodturning, face turning, circular sawing, scroll-saw work, sanding, drilling, dado and joining work, grinding, buffing, tool-sharpening, and carving. Complete set of working drawings **FREE** with each outfit.

Many Exclusive Features!

A few of them are: Powerful, constant-speed, two-shaft motor that enables you to handle two or three jobs at one time without dismantling set-up; Heavy U-shaped lathe bed (no rods) guaranteed not to spring or chatter; Improved circular saw, sanding disc, scroll-saw, each equipped with special tilting table; All completely assembled on heavy veneered wood base; **Maximum machine value per dollar!**

Easy Terms—Write Today

for beautifully illustrated literature giving complete description of Delta Handi-Shop and pictures of its many exclusive advantages. Also full details of **10-Day Trial Offer**, and your choice of 5 convenient methods of payment.

DELTA SPECIALTY COMPANY

Dept. MP 1028 1661-1667 Holton St., Milwaukee, Wis.

CLASS PINS 35¢
FREE CATALOG SHOWING 200 DESIGNS
EITHER DESIGN SHOWN, SILVER PLATE 35¢ EA. 12
OR MORE, \$3.50 DOZ.; STERLING SILVER OR GOLD
PLATE, 50¢ EA. 12 OR MORE, \$5.00 DOZ.; 1 OR 2
COLORS ENAMEL, ANY 3 LETTERS AND DATE.
BASTIAN BROS. CO. 893 BASTIAN BLDG. ROCHESTER, N. Y.

MEN WANTED



to become floor surfacing contractors—Pay averages \$30.00 per day—no lay offs—your own boss—work the year round—demand ever increasing—New "American" machines do the finest work and are easiest to handle. Complete information sent free without obligation. Write today.

**AMERICAN FLOOR SURFACING
MACHINE COMPANY**

523 S. St. Clair Street Toledo, Ohio





The Best Thing you can do for Your Boy

Fun! Social advantage! Good friends! Constructive use of time! A pleasant, easy way to work his way through college! A source of lifetime satisfaction!

These are the things you do for your boy when you help him secure a

BUESCHER

True Tone Saxophone

Only a Buescher gives you these extra features: Snap-on Pads, greatest improvement, easy to replace, no cementing—Patented Automatic Octave Key—perfect Scale Accuracy—convenient key arrangement.

We Make It Easy for Boys to Start

Any boy who can whistle a tune can master a sweet-toned Buescher Saxophone—easiest of all instruments to learn to play.

Six Days' Trial You can get any Buescher Instrument on six days' trial, and pay for it on easy terms to suit your convenience. Also Buescher Cornets, Trumpets, Trombones and other instruments. Fill out and mail coupon below for full information.

Buescher Band Instrument Co.
2601 Buescher Block Elkhart, Indiana

BUESCHER BAND INSTRUMENT CO. (477)	
2601 Buescher Block, Elkhart, Ind.	
Gentlemen: Without obligating me in any way please send me your free literature. Mention instrument interested in.	
Age?.....	Name instrument.....
Name.....	
Address.....	

WET CELLARS MADE DRY from the Inside!

DAMP musty cellars are unsanitary, a danger to health and a poor place to store valuable material.

Where water or moisture seep in through cracks or porous spots in the floor or walls, you can make and keep your cellar dry and sweet—a fit place to work, free from odor, mold and rust—by filling the cracks and coating the moist surface with Smooth-On No. 7.

This is the one practical waterproofing that you can apply yourself, easily, from the inside, to wet or dry surface and with every assurance of thorough watertightness, even in the wettest seasons.

Excellent also for patching concrete floors, waterproofing garage, stable and washroom floors, brick walls, cisterns, septic tanks, water troughs, fountains, fish ponds, swimming pools, manure pits, etc.



Write for **FREE BOOK**



About 25 pounds of Smooth-On No. 7 are required for each 100 square feet of surface covered, and no experience is necessary. Complete instructions on the package.

Sold in 5-pound cans and 25, 50 and 100-pound kegs.

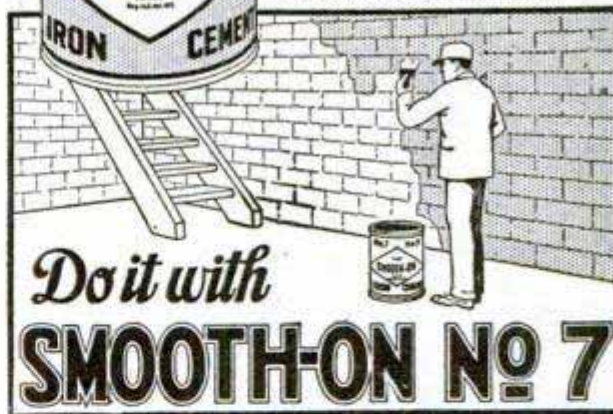

SMOOTH-ON MFG. CO., Dept. 37,
574 Communipaw Ave., Jersey City, N. J.
Please send the free Smooth-On Repair Book.

Name.....
Address.....

**Return this coupon for
FREE copy of Booklet**

OIL HEAT



INCANDESCENT
ROTATING FLAME →

**THE
VAPO-GAS
OIL BURNER**

in your heating plant (Hot Water, Steam or Hot Air) will automatically and economically maintain the desired temperature under all weather conditions. The simplest, most efficient yet lowest priced Oil Burner in the field.



**OXO-GAS
Oil Burners**

Will Heat Stoves, Ranges, Coffee Urns, Steam Tables, Tanks, Boilers, Vulcanizers, Water Coils, Rendering Kettles, Bake Ovens, Griddles, Lead Pots, Pressing Machines, etc.

**No Noise—No Smoke—No Soot—No Ashes
Require No Mechanical Skill to Operate
Can be Installed in 30 Minutes
Last a Lifetime**

Responsible Distributors Wanted
Write for illustrated catalog.

GLORIA LIGHT COMPANY
111-10 No. May St. CHICAGO, ILL.

6-TUBE RADIO COMPLETE

\$34.75 to \$66.66

Licensed R. C. A. Circuits. Shielded. One Dial
Write for catalog. Big discounts to agents

Consumers Radio Co., Dept. 170, 4721 Lincoln Ave., Chicago

\$1000 Profit for Agents! Sell

DIAMONDS WATCHES & JEWELRY CASH OR CREDIT

Here's your opportunity to make an easy extra \$1,000 in 90 days time. Everyone is always thinking of buying jewelry for themselves or as a gift for some dear one. Show them our plan of easy payments. Show how they can have a beautiful diamond ring, watch, silverware or any jewelry they may desire and yet have 12 months in which to pay. You can earn \$50 to \$200 weekly representing our nationally known house. Sell on cash or credit. We put you in the jewelry business for yourself. You make no investment. You merely take orders and earn very liberal commissions. No matter what you are selling, this is your opportunity to make extra profits.

Send for FREE Outfit

**FREE
OUTFIT STARTS
YOU EARNING AT ONCE**

We will send **ABSOLUTELY FREE** by return mail everything necessary to start you earning **LIBERAL COMMISSIONS** at once. We include complete outfit containing handsome catalogue beautifully illustrated in colors, order blanks and full instructions to insure your immediate success. **SEND NO MONEY.** Just send your name and address—write today—**NOW!**

STERLING DIAMOND & WATCH CO.
1540 Broadway, Dept. A197 New York, N.Y.

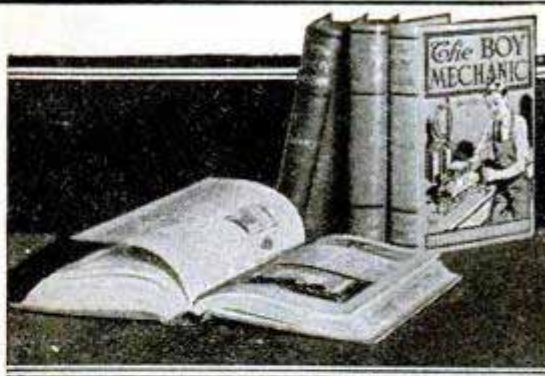

BOYS

It's Fun to Make Things

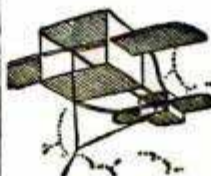

Let the other boys wonder how you can make so many interesting things. Make your own automobile. Make your own radio. Make your own kites and gliders. You can learn how to make almost anything that any boy could want by following the pictures and the simple directions in

The Boy Mechanic Library

And just think of it, there are nearly 4,000 separate articles in the four beautiful volumes! Some of the most fascinating subjects are listed below:

How to Make Things

- | | |
|-------------------|-----------------------|
| Boats | China painting |
| Winter sports | Decorative metal work |
| Camping | Furniture making |
| Ice boats | Farming |
| Water sports | Poultry |
| Toboggans | Models |
| Tents | Laboratory helps |
| Skis | Household helps |
| Indian snowshoes | Wood working |
| Skating | Electrical devices |
| Gymnasium | Photography |
| Wind wagons | Music |
| Motor sleds | Outdoor games |
| Radio | Stoves |
| Magic | Furnaces |
| Trapping | Wireless |
| Pets | Tricks |
| Leather work | Puzzles |
| Carpentry | Bicycle |
| Trays | Flowers |
| Fishing | Hunting |
| Fruit growing | Kites |
| Entertainments | Metal working tools |
| Automobile | Secret locks |
| House decorations | Swings |
| Drafting | Sleds |
| | Power devices |

Buy the complete library, including Book 1, Book 2, Book 3 and Book 4, for \$7, thus saving \$1 as single volumes are \$2. If you want individual books at \$2 each order by number 1, 2, 3 or 4.

When the postman delivers the books to your door, pay him the price of the books and the postage. That is all. If outside U. S. remit when ordering and include 28 cents per volume extra for postage.

POPULAR MECHANICS PRESS
200 E. Ontario St.
Room 610 CHICAGO, ILL.

Now! YOU CAN AIRPAINT EVERYTHING QUICK AND EASY

ONLY \$10.50

- FREE -
15-foot roll of Paasche Masking Tape with each Unit. Used for clean-cut color edges, shielding and stenciling.

Anyone can now do perfect painting without the mess of the old paint brush

This Outfit Will Brighten Any Old Thing Like New

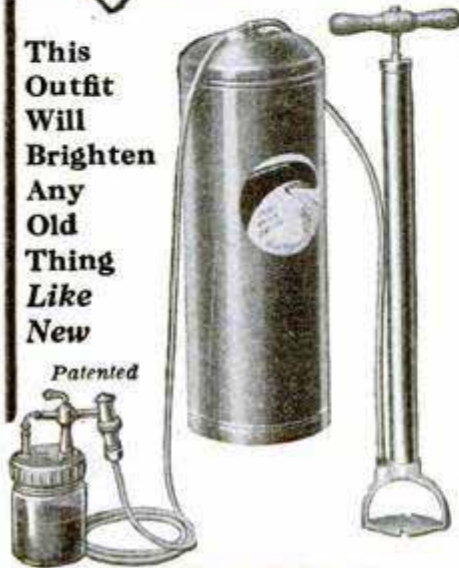

PAINT YOUR OWN AUTO, FURNITURE, Etc.

Until now the home owner had to be content with the old-style slow hand brush, with its unsightly laps and brush marks and uneven coverage. Now you can spray lacquers, paints, varnishes, enamels, shellacs and bronzes and make the work easier, look better and finished much faster. Now you can brighten up the home with your choice color schemes. This outfit has been tested and approved for home use.

With this unit you can obtain beautiful results, always smooth and uniform—spray intricate pieces as easily as flat surfaces—produce rich blends—veiling effects, and any finish, and as an aid in antiqueing furniture, this unit has no equal. Also don't overlook your auto—now you can keep it bright and new looking. Now you can do it better with this low-priced Paasche Air Painting Unit.

Also Finer Outfits for Artists and Larger Power Outfits for Painters and Manufacturers.



Paasche Airbrush Co. Write for FREE FOLDER
Mfgs. Most complete line of Airpainting and Airfinishing Equipment.

1953 Diversey Pkwy., CHICAGO, ILLS.

THIS UNIT CONSISTS OF
Paasche J. D. 1/2 Pint Sprayer, Hand Pump, Tank with Fittings and 5 foot braided Highest Quality Hose.

10 Inches Off Waistline In 35 Days

"I reduced from 48 inches to 38 inches in 35 days," says R. E. Johnson, of Akron, O., "just by wearing a Director Belt. Stomach now firm, doesn't sag and I feel fine."

The Director Belt gets at the cause of fat and quickly removes it by its gentle, kneading, massaging action on the abdomen, which causes the fat to be dissolved and absorbed. Thousands have proved it and doctors recommend it as the natural way to reduce. Stop drugs, exercises and dieting. Try this easy way.



Sent on Trial

Let us prove our claims. We'll send a Director for trial. If you don't get results you owe nothing. You don't risk a penny. Write for trial offer, doctors' endorsements and letters from users. Mail the coupon NOW!

LONDON & WARNER
332 S. La Salle St., Chicago, Ill.

Landon & Warner, Dept. 10-M, 332 S. LaSalle, Chicago

Gentlemen: Without cost or obligation on my part please send me details of your trial offer.

Name.....

Address.....

ENGINEITE

THE WONDER FLUID FOR YOUR MOTOR COOLING SYSTEM

ENGINEITE prolongs the life of your motor, by giving free circulation to water in the radiator, preventing and removing rust, scale and corrosion. Surest remedy for overheating motors. Gives more pep and power. ENGINEITE is as important as gas and oil. Guaranteed satisfactory or money refunded. \$1. (West of Rockies 25c extra.) Dealers write.

Manufactured by
ENGINEITE CO. INC.
120 W. 42nd Street
NEW YORK CITY

\$1

BIGGER Radio Guide

LATEST RADIO GUIDE

Elections have brought back Custom Set building. Business is booming. Thousands of old-timers are cleaning up. Let Barawik show you the way to bigger profits, more sales. Send today for Barawik's Big Bargain Book—the radio man's bible.

FREE BARAWIK CO. 1010 Canal Sta., CHICAGO, U. S. A.

Books on all subjects are sold by Popular Mechanics Press, 200 East Ontario Street, Chicago, Illinois.

A SHIP MODEL FOR \$4.98



Build an exact replica of the historic Santa Maria, the Mayflower or the La Pinta. We will furnish the parts complete for only \$4.98 plus a few cents for postage. No tools needed except a small hammer. Parts for the Constitution (Old Ironsides) may be had for \$6.98.

Write for our illustrated catalog.
MINIATURE SHIP MODELS
Dept. P-13, 3815-24 Bering St. PHILADELPHIA, PA

**NOW—
A Startling New
Principle in
Broadcast Reception**



**The AERO
"CHRONOPHASE"**

Here is proof positive that you can build better than you can buy. Aero engineers, after months of experimenting, have developed a new principle in radio frequency amplification. A new system of coupling now makes possible the transfer of a much greater amount of energy between r. f. amplifying tubes than ever before. Shield grid tubes particularly are made to deliver much more of their theoretical amplification than by any other coupling method. This new principle—called the "Chronophase"—results in a remarkable increase in distance range and, by means of a handy control, any degree of selectivity may be obtained, even so that side bands of local broadcasting stations may have been overcome and shielding has been made unnecessary.

Kit is Complete

The "Chronophase" principle is incorporated in new 5, 6 and 7 tube receivers. Everything necessary to build these sets is included in complete kits which you can obtain from your dealer. A beautiful two-tone metal cabinet, high-lighted with silver and with a handsome escutcheon plate of oxidized silver, is a part of each kit. Also included are the world-famous Aero Coils, audio transformers of a type heretofore used only in broadcasting stations, condensers and all necessary wires, screws, etc. There is absolutely nothing else to buy. Large schematics and full-size pictorial wiring diagrams make building easy.

Complete Kit for Aero "Chronophase" five tube receiver.....	\$74.50
Complete Kit for Aero-Dyne six tube receiver.....	93.80
Complete Kit for Aero-Seven seven tube receiver.....	97.85

Specify what type of tubes you intend to use.

Aero Coils

If you prefer to build your own set, incorporating the "Chronophase" principle, use Aero Coils, specially designed for this purpose. Ask your dealer. If he is temporarily out of stock, wire direct to us.

SEND FOR THE NEW AERO BOOK.

AERO PRODUCTS
INCORPORATED

Dept. 478, 4611 Ravenswood Ave.
Chicago, Ill.

Single dial control

7 TUBE

SUPERPHONIC

RADIO

All parts mounted

Only \$16.95

COAST to COAST RECEPTION

Superphonic 7 is a world beater! An exceptionally high grade receiver that is amazing the Radio World. Latest 7 tube tuned radio frequency circuit, using 4 radio frequency amplifiers, detector and 2 stages of audio. Power tube can be used in last audio stage. Extremely selective, marvelous sensitivity. Single drum dial control. Straight line wave length condensers permit accurate, equally spaced tuning over entire wave band. All sockets spring cushioned to eliminate microphonic noises. Bakelite subpanel (8 1/2" deep) insures minimum dielectric losses. Clear and realistic reception guaranteed. An exceptionally beautiful, walnut finish, metal front panel 7" x 18". Complete chassis. No extra parts to buy. All parts mounted ready to wire. No special tools needed. All hook-up wire and colored battery cable included. Value \$60.00; our price \$16.95.

TESTED AND APPROVED

Severe laboratory tests have proved the remarkable efficiency of this set. Owners everywhere are sending us letters praising its wonderful receptive qualities.

Simple Wiring Directions

NO RADIO KNOWLEDGE NEEDED!

Very easy to wire this set with the instructions we furnish. Just connect a few wires. All you have to do is to follow numbers. Simple as adding 2 and 2. Can be wired in a few minutes by anyone. No radio knowledge needed. Make money by wiring these sets in your spare time and selling them to your friends.

SEND NO MONEY

Just write your name and address on a post card and ask us to send you this wonderful outfit. We ship right away. Upon arrival pay only \$16.95 plus a small delivery charge. (Foreign countries send \$19.50 with order. We pay shipping charges.)

Radio Equipment Co., Dept. 10-K, 549 South Wells Street, Chicago, Ill.

Makers of High Quality
Condensers and
Resistors

AEROVOX

Built Better

TOM WASHINGTON ST. BROOKLYN N.Y.

Write for THE RESEARCH WORKER—A FREE MONTHLY PUBLICATION.

SIMPLIFIED RADIO BLUEPRINTS

Blueprints for the most popular sets described in Popular Mechanics Magazine can be obtained for a charge just sufficient to cover the cost of production and mailing. The sets for which blueprints are available are:

Three-Tube, Loud Speaker, Loop Set.....	Dec. 1926 — 25c
Three-Tube, 15 to 550 Meter Set.....	Nov. 1926 — 25c
Four-Tube, Loop Set, for Car or Home.....	Aug. 1926 — 25c
Six-Tube, Portable, Loop Set.....	June 1926 — 25c
Electrolytic B-Eliminator.....	Feb. 1927 — 25c
Non-Radiating Unit.....	May 1926 — 25c
Simple Tube Tester and Chart.....	July 1926 — 25c
Two-Tube Loud Speaker Set.....	Oct. 1927 — 25c
Economy Nine Superheterodyne; Sixty dollars builds this Super. Complete drilling templates and blueprint diagrams.....	Nov. 1927 — 50c
Loop Set for Cabinet Speaker.....	Dec. 1927 — 25c
Aero-Dyne Six Receiver.....	Jan. 1928 — 25c
Homemade A-Battery and Charger.....	Jan. 1928 — 25c
B-Eliminator for Direct Current.....	Feb. 1928 — 25c
Fifteen Dollar B-Eliminator.....	Mar. 1928 — 25c
Short-Wave Converter.....	Mar. 1928 — 25c
All-Electric Five.....	April 1928 — 25c
Three-Tube All-Wave Set.....	May 1928 — 25c
Push-Pull Power Amplifier and Power Supply Unit.....	June 1928 — 25c
Edison Type Storage B-Battery.....	July 1928 — 25c
Browning-Drake Screen-Grid Tube Receiver.....	Sept. 1928 — 25c
A Compact B-Eliminator.....	Oct. 1928 — 25c
New Screen-Grid Perfect-Tone Six.....	Nov. 1928 — 15c

Address the RADIO DEPT.
Popular Mechanics Magazine, 200 E. Ontario St., Chicago
Back numbers of the magazines describing the construction of the sets can be obtained from our Circulation Department, price 25 cents each.



Licensed by Rider Radio Corporation. Patented 5-3-'16; 7-27-'26. Pat. Pending.

For Better Radio Results! PHASATROL

Reg. U. S. Patent Off.

A True Balancing Device for Radio Frequency Amplifier

In constructing a receiver using R. F. amplification, it is important to insert a Phasatrol for each stage of R. F. amplification to suppress and control R. F. oscillations.

Also excellent for purchased sets to cure them of the R. F. oscillation habit. Very easy to install. Price \$2.75 each.

TRUVOLT

U. S. Patent 1,676,869 and Patents Pending

ALL-WIRE RESISTANCES

Truvolt Variables simplify B-Eliminator construction by eliminating difficult calculation and making all adjustments easy. (22 Stock Sizes \$3.50 each.)

Truvolt Fixed Resistances are adjustable to different values by sliding clip taps—an exclusive feature! Made in all desirable resistance values and current ratings.

Tear out and mail coupon for full information



Electrad specializes in a full line of Controls for all Radio Purposes.

U. S. Patent 1,676,869 and Patents Pending

Electrad, Inc., Dept. F-10, 175 Varick Street, New York.

Please send me descriptive circulars on the following products and put me on your mailing list for similar literature.

—General Circular

—Tonatrol Volume Controls

—Phasatrols

—Royalty Variable Resistors

—“Electrad Control Manual” (Enclose 10c for mailing)

—“What B Eliminator Shall I Build?” (Enclose 10c for mailing)

I am particularly interested in

Name.....
Address.....

ELECTRAD

Inc.

Don't Be Afraid To Tackle That Concrete Job!

What is it you want to make out of concrete?



A Garage floor—Garden seat—Bird bath—Auto Drive-way—Curbs and Gutters—Flower boxes—Rural Mail Box Post—Garden Fountain—Ornamental Pool—Drinking Fountain—Boat Landing—Cistern Cap—Milk House—Engine Foundation—Watering Trough—Sidewalk—Steps—Gateposts—Fence Posts—Tile—Blocks—Silo—Pedestal—Vases—Forge—Smokehouse—Chimney Cap—Horse Stalls—Foundation Support—Cyclone Cellar.

With the instructions found in Popular Mechanics Concrete Handbook you can make 173 different useful articles.

Build With Ease for Permanence and Beauty

With the Concrete book we send you another remarkable book called Home Mechanics. This contains 329 valuable discoveries for doing the various jobs that come up about every home, both in the house and outside. These articles cover Furnaces, Stoves and Fireplaces—Homemade Furniture and Repairs—Building Refinements—Home Shop—Home Plumbing—Kitchen Equipment—Devices for Men—Home Electric Work—Outdoor Work—Water Supply—Garden—Bees—Miscellaneous.

Simply write and ask us to send you these two books. When postman hands you the package pay him 98 cents plus the postage. If outside U. S. remit when ordering and include 15 cents extra for mailing.

POPULAR MECHANICS PRESS
Room 610 200 E. Ontario Street CHICAGO

REMLER

"29"

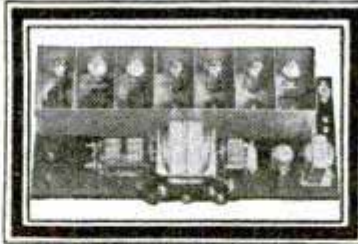

... different ...

Remler has designed a new circuit.

It is different and a long step ahead in radio research. Let us tell you all about it and why it will outperform any factory built receiver. Sign and mail the coupon. We will forward an eight-page, two-color folder and set-builders' bulletin.

P.M. 10 REMLER Division of GRAY & DANIELSON MANUFACTURING CO., 260 First Street, San Francisco, Calif.

Please send me

- All the "dope" on the "29"
- Bulletin Service for Professional Set Builders

NAME.....

ADDRESS.....

CITY..... STATE.....

Do you build and sell sets?



On Land, Sea, or in the Air DURHAMS are Supreme!

— wherever the perfect operation of radio apparatus is of paramount commercial and governmental importance—in radio transmitting or receiving apparatus—in power amplification units—in the sensitive resistance-coupled amplifiers of the photoelectric cell circuit in Television apparatus—there you will find that experienced radio engineers use and endorse DURHAM Resistors, Powerohms and Grid Suppressors! Why? Because years of experiment have proved the indisputable value of the DURHAM Metallized principle. Because these resistances are calibrated accurately according to their stated ratings. Because they are available for every practical resistance purpose from 250 ohms to 100 Megohms and in power ratings. We will be glad to send you descriptive literature explaining the entire Durham line.

- 1 Durham Resistors—500 Ohms to 10 Megohms; standard brass end tip, mould or pigtail type.
- 2 Durham Grid Suppressors—250 Ohms to 3,000 Ohms; in steps of 100; standard brass end tip.
- 3 Durham Powerohm—1 Watt; 250 to 1,000,000 Ohms; standard brass end tip or pigtail type.
- 4 Durham Powerohm—2½ Watts; 500 to 250,000 Ohms; standard brass end tip type.
- 5 Durham Powerohm—2½ Watts; 500 to 250,000 Ohms; knife-end type.
- 6 Durham Powerohm—2½ Watts; 500 to 250,000 Ohms; soldered end tapped type.
- 7 Durham Powerohm—2½ Watts; 500 to 250,000 Ohms; screw-end type.
- 8 Durham Powerohm—5 Watts; 250 to 250,000 Ohms; soldered end tapped or screw-end type.
- 9 Durham Powerohm—10 Watts; 250 to 250,000 Ohms; soldered end tapped and screw-end type.
- 10 Durham Powerohm—25 Watts; 250 to 250,000 Ohms; soldered and tapped.
- 11 Durham Powerohm—50 Watts; 250 to 250,000 Ohms; soldered and tapped.
- 12 Durham Mounting supplied in various lengths to carry any required number of Powerohms where quick change of resistance is necessary.

DURHAM

METALLIZED

RESISTORS & POWEROHMS

INTERNATIONAL RESISTANCE COMPANY
2006 Chestnut Street, Philadelphia, Pa.

FREE

140-page Book of actual bookkeeping forms, completely filled in to illustrate uses. Will answer your record-keeping problems—office or factory.

Book Sent **FREE**
when requested on business stationery

John C. MOORE Corpn.
(Established 1839)
5030 Stone St., Rochester, N. Y.

MOORE'S LOOSE LEAF SYSTEMS
Used In 300,000 Offices

Ask about the New
MOORE'S VISIBLE RECORDS



PANTS MATCHED!

WHY THROW AWAY THAT COAT AND VEST?

Save \$25 or more! Let us match your coat and vest with new trousers, and save the price of a new suit. Hundreds satisfactorily matched every day. Each pair tailored to your measure. Over 80,000 patterns. We submit sample of cloth for your approval. Just mail sample of the suit, or your vest.

MATCH PANTS COMPANY
Dept. 10, 20 W. Jackson Blvd., Chicago

Do Away with Handsanding



TAKE ABOUT Sander

Large or small surfaces easily sanded with this little machine. Handles like a plane, leaving a flat even finish, due to the smooth action of belt. Sands five times faster than by hand. Fine for refinishing furniture, woodwork, stairs, floors, etc. Works from any light socket. No experience required to operate.

PORTER-CABLE MACHINE CO.
1704-10 No. Salina St.
SYRACUSE, N. Y.

pin this ad to your inquiry

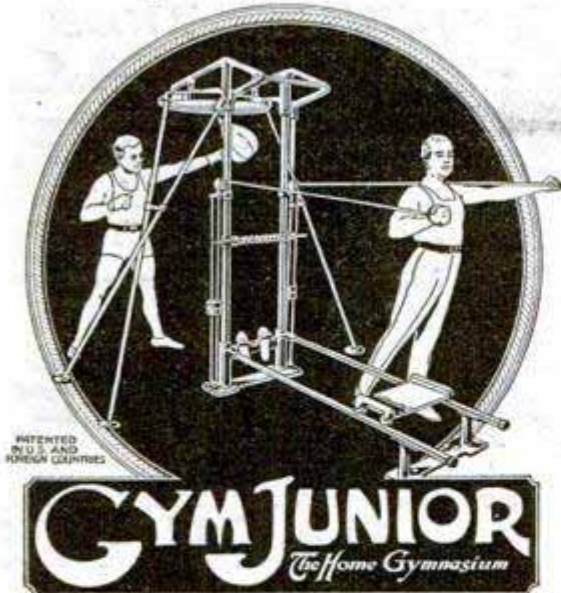

Play Your Way To Strength A compact, malleable iron home gymnasium consisting of a Rowing Machine, Punching Bag, Chest Weights, Parallel Bars, Chinning Bar, Wrist Machine, Wall Ladder, Massage Roller, etc. Fits in any spare space, 7½ x 9 feet. Durable, attractively finished and easily erected.

Hundreds sold to indoor workers and others who want to enjoy daily gymnastics and to keep physically fit. An adult's equipment, priced reasonably and sold on easy terms. Write for Booklet.

GYM JUNIOR CO.

530 Gregory Avenue WEEHAWKEN, N. J.

LATHES! \$6 to \$75!

Largest line and best quality small lathes in America. Send six cents for 32 page catalog of lathes, drill presses, bench, jig and hand saws, etc. Deferred payments if desired. A Sypher lathe is the best money can buy and prices right.

SYPHER MFG. CO., Dept. D, Toledo, O.



NEW ELECTRIC BENCH LATHE

Length over all 40 inches

TYPewriter PRICES CUT

All Standard Makes

your choice of the World's best typewriters—Underwood, Remington, Oliver—full size, late model, completely rebuilt and refinished brand new. Prices smashed down to half. Act quick.

\$2 and it's yours

Just send your name and address and we will mail you our complete **FREE CATALOG** prepaid, fully describing and showing actual photographs of each beautiful machine in full colors. Tells every detail of our direct-to-you small-payment plan. Write now for tremendous saving. No obligation whatever. Still time if you act now.

International Typewriter Exchange

184 W. Lake St. Department 1094 Chicago, Illinois



Free Trial

New 21 Jewel BURLINGTON



Write!—while this special offer lasts!—for the NEW Burlington Book, showing in colors the NEW 21 Jewel Burlington in all the latest designs—including the New Burlington Bulldog, the New Lady Burlington, new strap watches—in fact, a watch for everyone! Always a masterpiece, the New Burlington is now better than ever! 21 Ruby and Sapphire jewels; adjusted to the Second, to Temperature, to Isochronism, to Positions; 25 Year Gold Strata Case.

\$3.50 a Month 30 Days Trial

Yes! Carry this watch masterpiece for 30 days, with no obligation to buy unless delighted! And then you pay only \$3.50 a month at our rock-bottom, direct-to-you price, saving you from 25% to 40%! But don't delay! Take advantage of this offer NOW!

Write! While this Special Offer Lasts!

Find out about this special offer of 30 Days Trial and \$3.50 a month—made for a limited time only. And get our **FREE New Burlington Book**. It shows how to judge the real value of a watch and avoid purchasing watches that are overpriced. Just fill out the coupon and mail it TODAY.

Burlington Watch Co., Dept. 13-57

19th St. and Marshall Blvd., Chicago

Canadian Address: 118 Princess St., Winnipeg, Man.

Please send me (without obligation and prepaid) your new free book on watches, together with your special 30 day trial offer on the New Burlington Watch.

Print name and address plainly.

Name.....

Address.....

Short-Wave RADIO FANS

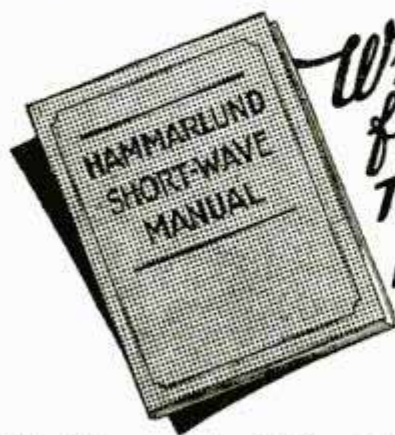

Write
for
THIS
BOOK!

10¢

The Hammarlund Short-Wave Manual will save you many costly errors. Chock-full of practical data every short-wave fan and experimenter will welcome.

Send 10c for mailing expense.

Address Short-Wave Department
HAMMARLUND MANUFACTURING CO.,
424-438 W. 33rd St., New York

Get a Grip of STEEL!

Send Only 25c for My Krusher Grip

INCREASE the size and strength of your arm overnight. A strong grip is the barometer of your personality. With each KRUSHER GRIP I will give FREE a beautiful illustrated booklet filled with handsome pictures. It tells you how you can possess a manly figure packed with energy and power. How to put inches on your chest, neck, arms, and legs and get a body as shapely as Sandow.

The world's finest athletes posed for this booklet which I offer for a limited time only.

Fill in the coupon and mail with your remittance and get your copy NOW.

THE JOWETT INSTITUTE OF PHYSICAL CULTURE

326 Poplar St., Scranton, Pa.

Dear Mr. Jowett: 4-KK

Enclosed is 25 cents for your double strength Krusher Grip, with which I am to receive your illustrated booklet FREE.

Name.....

Address.....

For ANY Tube
D.C. or A.C.

AMPERITE automatic filament control increases tube efficiency and lengthens tube life. \$1.10 with mounting (in U. S. A.)

Radiall Company
50 FRANKLIN ST., NEW YORK



FREE New "Amperite Plus Book" of latest radio information and circuit diagrams. Write Dept. P. M. 10

AMPERITE

REG. U.S. PAT. OFF.

The "SELF-ADJUSTING" Rheostat



PATENTS

Send us sketch or model for advice and exact cost of patent. Our book "How to Obtain a Patent" sent free. It tells how to apply for Patents, Trade Marks, Foreign Patents, Copyrights, etc.; gives information on Patent Procedure; tells what every inventor should know. Thousands of inventors, who are our clients, are our reference.

CHANDLEE & CHANDLEE, 25 Years' Experience
410 Seventh St. Washington, D. C.

CHLORINE HOME TREATMENT

For those who suffer from Colds, Bronchitis, Catarrh, Whooping Cough and respiratory diseases is now available for home use. Pour the contents of ampoule into vessel and breathe the medicated air in your room for one hour. Treats one to six at a time. This simplified treatment, endorsed by thousands, produces the same results as treatments with elaborate apparatus has shown 94% cured and improved.

Special Offer Three Home Treatments

Mailed prepaid on receipt of \$1.00

Medical Products Corporation 153 E. Elizabeth Street
Detroit, Mich.

AUTO REPAIRMEN EARN GREATER PROFITS

Get your share of the big money being spent on automobile upkeep.

Put improved time, labor and money-saving ideas to work in your shop to-day. Take advantage of our special bargain offer and secure 3 valuable kink books at a reduced price.

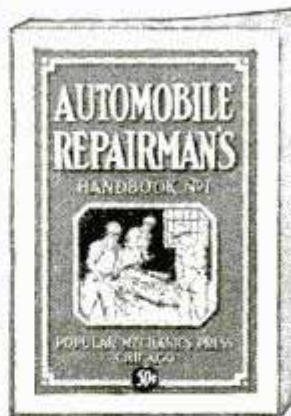

1. 334 Valuable Discoveries made by auto mechanics in our Automobile Repairman's Handbook. 337 Illustrations.

2. 361 Ways to use drills, drill presses, taps and dies more effectively in our Drilling and Thread Cutting Handbook. 298 Illustrations.

3. 259 Kinks furnished by the most expert Lathe Operators in our Lathe Handbook. 212 Illustrations.

Special Offer—These 3 books (regular price 50 cents each, \$1.50 value) are offered for a limited time for only 98 cents plus postage. Pay postman C. O. D. when he delivers or if outside U.S. send 98 cents and 15 cents extra for postage.

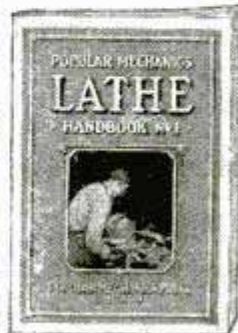

POPULAR MECHANICS PRESS

Room P10

200 E. Ontario St.

CHICAGO



Tobacco Is Hurting You

Look at the facts square in the face, Mr. Tobacco User. You may think tobacco is not hurting you.

That is because you haven't as yet, perhaps, felt the effects of the nicotine poison in YOUR system. For you know that nicotine, as absorbed into the system through smoking and chewing tobacco, is a slow working poison. Slow, yes—but sure.

Tobacco is lowering your efficiency. It slows a man down. Makes it harder for you to concentrate your mind on your work. You haven't near the amount of "pep" and energy you would have if you stopped using it. There's many a man twice as old as you in years who's twice as young in energy, simply because he lets tobacco alone.

Some day you will realize to what an alarming extent tobacco has undermined your system.

When your hands begin to tremble—
and your appetite begins to fail—
and your heart seems to "skip a beat" now and then—
and slight exertion makes you short of breath—
then you have a right to suspect that
TOBACCO is getting the upper hand.

Any well-informed doctor will tell you that these are only a few of many symptoms of tobacco poisoning.

And YOU know that the use of tobacco in any form is an expensive, utterly useless habit. You know you ought to quit.

Tobacco Habit Banished Let Us Help You

It doesn't make a particle of difference whether you've been a user of tobacco for a single month or 50 years, or how much you use, or in what form you use it—whether you smoke cigars, cigarettes, pipe, chew plug or fine cut or use snuff—**Tobacco Redeemer** will positively remove all craving for tobacco in any form in a very few days. Not the slightest shock to the nervous system. Your tobacco craving will usually begin to decrease after the very first dose—there's no long waiting for results.

Tobacco Redeemer contains no habit-forming drugs of any kind and is marvelously quick, scientific and thoroughly reliable.

It is in no sense a substitute for tobacco. After finishing the treatment you have absolutely no desire to use tobacco again or to continue the use of the remedy. It helps to quiet the nerves and make you feel better in every way.

Results Guaranteed A single trial will convince you. Our legal-binding, money-back guarantee goes with each full treatment. We will refund every cent you pay for the treatment if after taking it according to the easy-to-follow directions, it should fail to banish the tobacco habit completely.

SEND Coupon for Free Proof Let us send you our free booklet on the deadly effects of tobacco, together with testimonial letters from men all over the country telling how they have been absolutely freed from the tobacco habit by this simple home treatment. You could not ask for stronger proof that **Tobacco Redeemer** will free you from the habit than the evidence we will gladly send on request. Just mail the coupon—or a postal will do.

NEWELL PHARMACAL CO.

Dept. 300

Clayton Station

St. Louis, Mo.



Free Book Coupon

NEWELL PHARMACAL CO.

Dept. 300 Clayton Station St. Louis, Mo.

Please send, without obligating me in any way, your free booklet regarding the tobacco habit and proof that **Tobacco Redeemer** will positively free me from the tobacco habit or my money will be refunded.

Name

Street and No.

Town..... State.....

The Old Reliable Credit Jewelers

LOFTIS BROS. & CO. EST'D. 1858

DEPT. E-894
108 North State St., Chicago, Ill.

DIAMONDS GENUINE DIAMONDS GUARANTEED CASH OR CREDIT

Diamonds for Christmas!
Diamonds make a happy Christmas! Special offering of brilliant blue white Diamonds at importer's prices—all set in beautiful mountings of solid 18-k white gold. Our direct importing and huge sales make lower prices for you. Order right from this ad!

Credit Terms: Pay one-tenth down; balance in weekly, semi-monthly, or monthly terms at your convenience. All goods delivered on first payment. Satisfaction Guaranteed or Money Back.

Wedding Rings

No. 875 \$50 \$1.25 a wk.

No. 876 \$37.50 \$1.00 a wk.

No. 27 \$75 \$1.75 a wk.

No. 31 \$100 \$2.50 a wk.

No. 824—The "Elite" solid 18-k white gold \$750

Set with 3 Diamonds, \$22.50; 5 Diamonds, \$32.50; 7 Diamonds, \$42.50; 9 Diamonds, \$52.50; 12 Diamonds, \$67.50. All platinum, \$25. With 3 Diamonds, \$50; 5 Diamonds, \$70; 7 Diamonds, \$80; 9 Diamonds, \$100; circled by Diamonds, \$200.

17 Jewel Elgin No. 14 Thin Model
White gold filled, 20 year quality case; 12 size; silver dial; assorted patterns, \$23.50. \$2.35 down and \$2.35 a month.

No. 861—Ladies' Wrist Watch
Solid 14-k white gold case. 15 jewels, \$25. \$2.50 down, \$2.50 a month.

CHRISTMAS CATALOG FREE!
Send for Free 132-Page Catalog. Shows over 2000 amazing bargains in Diamonds, Watches and Jewelry. On request we will ship any article (NO MONEY DOWN) subject to your free examination and approval.

Ship Model Builders

Before purchasing your model supplies at prohibitive prices, send for our big, new, illustrated catalog showing nearly all the hard-to-make materials such as caps, tops and cross-trees of celluloid, brass pumps, figure-heads, tall rail posts, blocks, deadeyes, etc. Also model speed boat fittings and construction sets at very reasonable prices. Catalog 10c coin.

ROY HANCOCK, 323 Douglas Ave., Portsmouth, Va.

KINGSBURY BLUE BIRD \$350
(West of Miss. \$3.85)



Most Exciting Toy of the Year

EVERY red-blooded boy who wants SPEED wants this toy—this 19 in. steel model of the famous speed car that raced over 207 miles an hour down in Florida—Capt. Campbell's "Blue Bird." Lifelike in every detail—long slim blue body—rudder-like back end—external radiators—built-in wheel guards—real Dunlop rubber tires. Has clock-spring racing motor that is making speed records of its own! A companion toy to the KINGSBURY SUNBEAM RACER copied after Maj. Segrave's famous speedster, the first car to go over 200 miles an hour! Price \$3.00. (West of Miss. \$3.30.)

Special Offer—Both Toys \$6
(West of Miss. \$6.60)

You must show this ad to your dealer in order to secure the special price. If he doesn't sell Kingsbury Toys, order direct from us. Money back if you're dissatisfied.

Kingsbury Mfg. Co., 83K Myrtle St., Keene, N. H.

KINGSBURY Motor Driven TOYS

SEND 10c for Novel Eraser made from a Disc Wheel. Set of four, 35c.

A POPULAR AVIATION GUIDE at a Popular Price

Prepared to meet the demand for a simplified book on Aviation suitable for young people, beginners, and all persons desiring general information.

Everybody's Aviation Guide by V. W. Page, just published. 256 pages, 140 Illustrations, tells all about flying in simple, easily understood language.

Aviation terms, operating principles, elementary rules, forms of air craft, functions of parts, types of power plants, machines, control systems and methods of flying. Learn now and prepare for the future. Price \$2

Will be sent C. O. D. in U. S. Pay postman price and postage.

POPULAR MECHANICS PRESS
Room P10, 200 E. Ontario St., Chicago



These Boice Bargains Can't Be Beat

Send 10c in stamps or coin for Boice's latest catalog, describing the finest collection of Bench Woodworking Machines ever offered. Boice-Crane Bench Circular Saws, 14" Band Saw, 4" Jointer, Lathes, Jig Saw, and Books of Designs.



\$12.00

Universal Jig Saw
Table 8 inch dia., tilts 45 deg. both ways. Saw to frame 10 inches. Uses 1/4 inch fret blades, and heavy power blades 3/8 inch to 1/2 inch wide. Unexcelled in the volume and variety of work it will do.



Price \$13.50 for Woodturning.
With Compound slide rest as illustrated, add \$10.50. Swing 7' 17" between centers. Longer lengths 28" and 38" C to C. Bed, heavy channel iron.



\$30.00

Universal Handisaw
Table elevates for grooving. Cuts 2 1/2 inch stock. Takes 6 inch x 1 inch dado head, 8 inch sand disc, sand drum, 2 inch jointer attachment, boring table.

W. B. & J. E. BOICE
Dept. P. M. 10-D Toledo, Ohio



21 Jewels

Send No Money

Watch Sent on 30 Days Free Trial

In addition to our New Low Price, I will send for your approval one of these Standard Watches, guaranteed for a lifetime of satisfactory service, not only by the Santa Fe Watch Company, but by the Great Illinois Watch Factory. They are found in the pockets of men in the service on every railroad in this country. Senators, Congressmen and Governors keep their official appointments by "Santa Fe Special" time. Army officers and privates carried them all through the Greatest War in history—thousands of these splendid watches are in use all over the World. If you want one on my liberal new LOW PRICE PLAN, you had better write for my Free Watch Book today and make your selection without delay. I will send the Watch for you to see WITHOUT ONE PENNY DOWN—I will even allow you to wear the Watch 30 days FREE—then sell it to you on a binding money-back guarantee.

Why Not Own A 21 Jewel Watch

You will never miss the few cents a day that will make you own one of these watches—SEND FOR WATCH BOOK—illustrating in beautiful colors hundreds of designs and combinations in cases in the POCKET WATCH, MEN'S STRAP WATCH and LADIES' WRIST WATCH. You can have your name or monogram and any emblem you may desire engraved in the Case to suit your own ideas.

New Case Designs I want you to see the new models and wonderful case design in the Santa Fe Special, the Santa Fe Mogul, the Santa Fe Strap Watch and the Petite Santa Fe Princess Watch. No matter what your choice of a watch may be there is a Santa Fe Watch to please you. Send coupon for our beautiful FREE catalogue showing hundreds of designs and models in watches and newest creations in Diamond Rings and Jewelry.

WRITE FOR SPECIAL CASH OFFER — GOOD FOR 30 DAYS

Mail **SANTA FE WATCH COMPANY**
 Dept. A, 6 **THOMAS BUILDING, TOPEKA, KANSAS**

Coupon

for Beautiful
FREE Watch
 and
Diamond Book

.....
 Santa Fe Watch Company,
 Dept. A, 6, Thomas Building, Topeka, Kansas.
 Please send prepaid and without obligation your Watch Book
 Free, explaining your "No Money Down" Offer on the Santa
 Fe Special Watch.
 Name

Address

City State

FREE A limited offer!
 With every Santa
 Fe Special,
 a beautiful gold
 chain or strand of exquisite
 pearls. Write today.

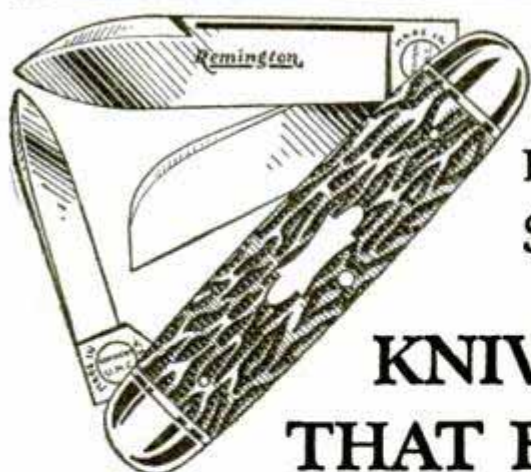

R 4223

\$1.50

KNIVES THAT BITE

HERE'S a knife especially designed and built for carpenters and skilled mechanics, professional or amateur. It belongs in every tool kit.

Remington steel is hardened and tempered by a special process, to produce blades with keen, uniform, and lasting cutting edges. Every blade is hand-honed at the factory. When you buy your Remington every blade will bite, and you can keep a biting edge on Remington blades.

R4223 has a heavy spear blade for general use; a sheep foot blade for scribing or coping, and a pen blade for delicate work.

Ask to see this knife at your dealer's. Get your hand around the fine stag handle and test the "feel" of it. Notice the fine finish, brass linings, and nickel silver mountings. You'll want to own one at once. And if your dealer shouldn't have R4223 in stock, send us his name with \$1.50 and we will forward the knife to you promptly.

REMINGTON ARMS COMPANY, Inc.
25 Broadway - Established 1816 - New York City
Originators of Kleanbore Ammunition

Remington

ARMS AMMUNITION CUTLERY
CASH REGISTERS SERVICE MACHINES

©1928 R.A.Co.

1708



SPEED — LUXURY — LOW COST

The Quad Super Elto

4 Cylinder Outboard Motor

FINEST runabout performance is now yours at a fraction of usual costs! The Quad, sensational 4-cylinder portable outboard motor drives big, comfortable boats

25 miles an hour. Instant starting, utterly vibrationless, absolutely dependable. Drives racing craft at 35 miles and better. Send for book on Super Elto motors, also complete directory of outboard boats and builders.

ELTO OUTBOARD MOTOR COMPANY
Ole Evinrude, President
Mason Street Dept. AA, Milwaukee

FREE RADIO CATALOG

Since the dawn of Radio, Barawik has been known the world over as headquarters for radio set builders and fans. Here, under one roof, is everything you need—sets, parts, supplies—thousands of products—ready to ship to you the same day your order arrives. Barawik prices save you money. Barawik service saves you time. Barawik merchandise always pleases. A quarter million satisfied customers say, "Barawik is Best." Let us send you the Big Barawik Book free and prove it to yourself.

BARAWIK CO., 1010 Canal St., CHICAGO, U. S. A.



Is Your Car..... A Gas Eater

New Invention Increases
Mileage on Auto Gas
Eater from 13½ to 34.6
Miles on a Gallon

An astonishing new device has been perfected that is amazing car owners everywhere. Goerzen reports increase from 13½ to 34.6 miles on his Dodge. Thousands have been installed and users report 30-40 and more miles on a gallon of gas. In addition power is increased, instant starting and flashy pick-up is noticed and carbon formation disappears. Every car owner in the country needs this new invention. Its cost is so trivial it pays for itself in a few days' time, yet it will save hundreds of dollars for its owners in gasoline.

\$100 a Week Territory Open

\$5.00 an hour for spare time. Men are needed in every locality to take care of the tremendous local demand. Sales ability is not required. Every car owner will buy on sight. Ideal for spare time workers.

FREE To help our workers we furnish them with this marvelous Whirlwind gas saver free for their own cars. Quick action is necessary. Be the one in your locality to cash in on this device which every auto owner will buy. Send today for full particulars and free sample offer.

Whirlwind Mfg. Co. 999 326-E Third Street
MILWAUKEE, WISC.



ELKON REPLACEMENT RECTIFIERS Are Saving Radio Fans MILLIONS of DOLLARS



Type BNK for replacing the acid jars in Balkite Types N and K Trickle chargers

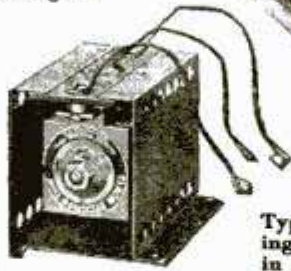

Type BJ for replacing the acid jars in Balkite Type J chargers



Type V-4 for replacing the rectifiers in 6 makes of Trickle chargers

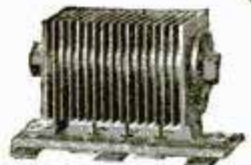

Type M-16 for replacing the rectifiers in 11 makes of "A" Eliminators and 3 Ampere chargers



Type EBH for replacing the BH type Tubes in "B" Eliminators

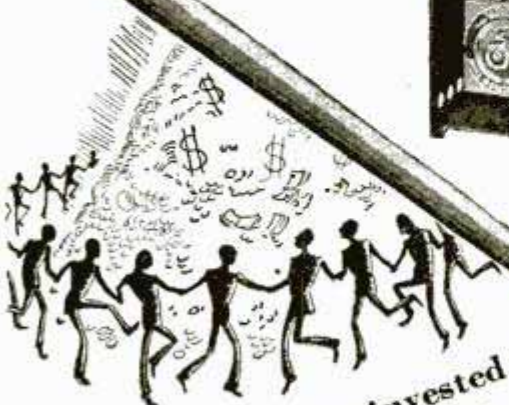

Millions of dollars are invested in radio chargers, eliminators, etc. which would be lost if it were not possible to replace the rectifying units when their life has been exhausted. All Elkon Rectifiers are replaceable.

HOW TO TELL IF YOUR RECTIFIER NEEDS REPLACING?

If your trickle charger no longer keeps your storage battery up the way it did when it was new, you need a new rectifier.
If your set has not the same pep as it did when you installed your "A" Eliminator, you need a new rectifier.

Do not void the Manufacturers' Guarantee on your Balkite Power Units
The Elkon Replacement Units and those made by the Fansteel Products Company containing an Elkon Rectifier, are the only ones authorized for replacement of the acid jars in Balkite Power Units.

See your dealer today—there are thousands of hours of good reception left in your power units as soon as you have replaced your rectifier or acid jar with a new dry Elkon.

ELKON, INC.
Port Chester, N. Y.
Division P. R. Mallory & Co., Inc.

ELKON, Inc., Radio Department
230 Fox Island Road, Port Chester, N. Y.
Please send me complete information on the Elkon Radio Products.

Name.....
Address.....

Every Elkon Rectifier goes through these exacting tests.





Pocket Ben



The Westclox watch

\$1.50

THE same careful workmanship and precision standards that make all Westclox dependable are applied to building this universally popular watch.

Reliability, sturdiness and good looks make Pocket Ben a world wide favorite. Sold everywhere.

Built by the makers of Big Ben and other Westclox

WESTERN CLOCK COMPANY
La Salle, Illinois



New Westclox Auto Clock

Attractive, convenient, reliable. Fits any car. Quickly attached on dash or above wind-shield

\$2.50

TWO HANDY TOOLS

for the
Outdoorsman's
Kit



No. 654
Long Nose
Side Cutting
Pliers
6 in. — \$1.30

These long nose, side cutting pliers are indispensable in the kit of every camper, hunter and fisherman. They are ideal for keeping tackle, guns and equipment ship-shape. Drop forged of special analysis steel, fully polished and absolutely guaranteed.

This cabinet screw driver with its forged alloy steel shank riveted thru the hardwood handle is another useful tool in the outdoor kit as well as home shop.

See them at your hardware dealers.

CRESCENT TOOL COMPANY
210 Harrison Street
Jamestown, N. Y.



No. 1315
Screwdriver
20c. to 80c.

CRESCENT and Smith & Hemenway TOOLS

Books on 31 Subjects

Popular Mechanics Press specializes in supplying books on any subject. Look over this list. Check the books you want, and mail this advertisement as your order blank. Catalog with lists on 2,000 subjects free.

- | | |
|---|---|
| AEROPLANE
Construction and Operation..... \$2.50 | MIRRORS
Silvering..... \$1.00 |
| AUTOMOBILE
ELECTRICITY
Wiring Diagrams New Ford and Other 1928 Models..... \$5.00 | OUTDOOR OCCUPATIONS
Outdoor Opportunities..... \$2.00 |
| BLUE PRINT READING
Machine..... \$2.00 | PHOTOGRAPHY
Making the Camera Pay \$3.50 |
| BOYS
How to Put on an Amateur Circus..... \$1.75 | PLUMBING
Plumber's and Fitter's Handbook..... \$1.00 |
| BUILDING TRADES
Building Trades Handbook..... \$1.00 | PUBLIC SPEAKING
For Business Men..... \$2.50 |
| CHALK TALKER
Chalk Talk and Crayon Presentation..... \$1.25 | PUZZLES
Mathematical..... \$1.50 |
| DICTIONARY
Simplified, 1500 Pages, 3000 Illus..... \$5.00 | RADIO
Theory and Operating... \$3.50 |
| DOGS
Training..... \$1.50 | RUSTIC WORK
Rustic Carpentry..... \$1.00 |
| ELECTRICITY
Practical Applied Electricity..... \$2.00 | SHEET METAL WORKER
1000 Aids For..... \$5.00 |
| FLIGHT
A B C of..... \$1.50 | SLIDE RULE
How to Use..... \$3.00 |
| FURNITURE
Finishing, Decoration and Patching..... \$5.00 | SPEECH
18,000 Words Often Mispronounced... \$2.00 |
| GARDENING
Garden Guide All Kinds..... \$1.50 | STEAM ENGINEER
Steam Engineer's Handbook..... \$1.00 |
| LETTERING AND DESIGN
For Artists and Advertisers..... \$3.00 | STEEL SQUARE
A B C of the Steel Square..... \$1.00 |
| MILLWRIGHT
Erecting and Operating Machinery..... \$2.00 | THEATRE PATRONAGE
Building..... \$5.00 |
| | THINGS TO MAKE
Make It Yourself..... \$3.00 |
| | TOOLS (Using)
Tinkering with Tools... \$2.00 |
| | WINDOW TRIMMER
Handbook of Window Display..... \$5.00 |
| | WOOD WORKING
For Amateur Craftsmen..... \$1.00 |

--- SEND NO MONEY ---
Just check the books you want, and mail the whole advertisement. It is your order blank. When postman hands you books, pay him the price and the postal charges. If outside the U. S. remit when ordering and include 10 cents per book extra for postage.
POPULAR MECHANICS PRESS, Room P10, 200 East Ontario St., Chicago, Ill.

Here's Amazing Weatherstrip for Complete In This Tube

New Metal \$1.50 a Window Ready To Tack On!

Now, homes can be weather-stripped for \$30 instead of \$130! Now, one window or fifty sold in ready-cut units at \$1.50 per window. Labor cost entirely eliminated. Anyone can tack it up in thirty minutes without removing window. Yes! *Red-d-ply* is all metal—finest bronze—cleverly designed on a revolutionary new principle that makes weather stripping windows, casements, and doors as simple as A-B-C. *Red-d-ply* is wonderful news for America's home-owning millions — and it opens up fortunes for salesmen in an entirely new field where opportunities are unlimited.



SALESMEN WANTED

**For \$5000 to \$10,000
OPPORTUNITIES**

At last, real metal weather stripping that can be sold in unit packages! Now salesmen can get their share of the millions spent for weather stripping. *Red-d-ply* offers you \$5000 a year in quick easy cash profits—and another \$5000 from automatic repeat business.

A New Principle

Red-d-ply is made of pure spring bronze, ready-cut holes punched clear through, no raw edges, hemmed, and ready to apply. One edge is tacked flat against the frame of door or window. The other edge floats free, maintaining a spring pressure on the door or window, thus closing the crack. So cleverly are these strips constructed that anyone who never saw them before could weather strip a window in thirty minutes or less. You do not have to remove anything to apply it.

Pays for Itself In Fuel Saved

Every year *Red-d-ply* saves \$30 to \$60 in fuel bills alone. Stops cold air in winter—keeps hot air out in summer. Ends window rattles, and stops dust, soot and rain that leaks in around every window and door.

Low Price—Sells Easily

Put up in neat packages, with nails and instructions and priced at \$1.50 a window. That's cheaper than felt! Compare it with metal stripping which costs up to \$10 a window!

The field is absolutely new for salesmen. The

RED-D-PLY

The Metal Weatherstrip You Tack On



**Sales of \$1.50 to
\$35 per Home!**

low price is revolutionary. The repeat business is unlimited. Seldom, if ever, have salesmen had an opportunity such as is now offered to you with *Red-d-ply*. Figure it out for yourself!

A Permanent Growing Business

You can sell at least one or two units to every man or woman who owns a home. Even these simple sales mean cash profits to you of around \$100 a week. But that is only the beginning of the story. You can go back a week later and sell units for every window in the house. One man tells another. You can sell everyone in a block.

Repeat business easily doubles your earnings. On top of this you can sell big quantity orders to schools, hospitals and public buildings of all sizes. You often make a good week's pay in a single day. Walter Vernohm, St. Louis, earned \$142.00 in one day. That's why \$5000 a year is easy, and \$10,000 a year, entirely possible. The longer you work the easier it is. You go right on making big money in the same territory, and every year your earnings get bigger and bigger.

Make Free Sales Test

Write today for our free test offer. We furnish everything. No capital required. No investment of any kind. Let us show you how to test this proposition without a penny of investment. Simply mail the coupon. It will bring you one of the greatest opportunities ever offered to salesmen.

RED-D MFG. CO., Dept. P-10, St. Louis, Mo.

Red-D Mfg. Co., Dept. P-10,
St. Louis, Mo.

Gentlemen: Send me your 10-day Free Test Offer and all details of your \$5,000 opportunity with *Red-d-ply*.

Name.....

Address.....

City.....State.....





Here's an Amazing New Business THAT PAYS UP TO **\$1,000** A MONTH

MEN, here is a real, red hot money-making opportunity! It's a chance to jump into business for yourself and make more money every week than the average man makes in a month.

Surprising as it may sound, we actually put you in a business, with the first day's profits often running from \$18 to \$55. \$350 to \$600 the first month is not unusual for ambitious men.

Cut in on the Big Money

All you need is the ambition to make real money. We supply you with complete equipment to make and sell that famous new food specialty—Brown Bobby—a greaseless doughnut baked by electricity!

It's a crispy, flaky, delicious new kind of doughnut cooked without one drop of oil or grease. Easily digested by everyone. More appetizing than old-style doughnuts ever were. Costs less to make. Sells four times as fast. No baker's skill required. Just add water to our prepared "Mix." You can open a shop; rent cheap floor space in a grocery, delicatessen, lunch-counter, drug store, etc. Or start at home—and make up to \$250 your very first week.

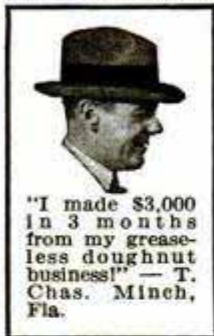

"I made \$3,000 in 3 months from my greaseless doughnut business!" — T. Chas. Minch, Fla.

Start At Once ANYWHERE!

Men and women everywhere are starting in this business daily! YOU cannot afford to delay! Details will gladly be sent without obligations of any sort. Such an amazing money maker may never come your way again. So fill in and send the coupon at once! TODAY!

MAIL COUPON NOW!

Food Display Machine Corp.,
Dept. 13-57, 500-510 N. Dearborn St., Chicago, Ill.

Gentlemen: Please send me the plan by which I can cash in on Brown Bobby, the Greaseless doughnut. It is understood that this obligates me in no way whatever.

Name.....

Address.....

City..... State.....

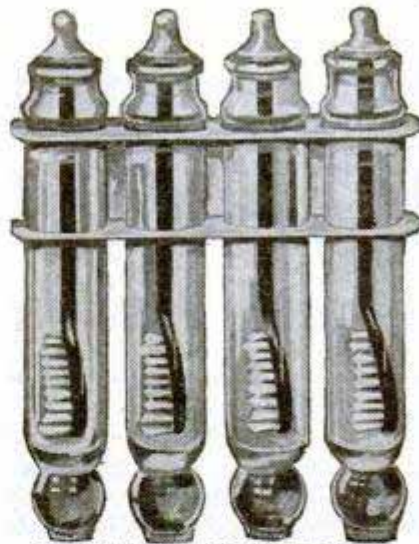

THE STERAL TOOTH BRUSH
Comes in units of one, two or four. The charge in the bulb in the bottom gives off germ killing fumes. The brush comes out sweet and clean and sterile. The Steral sells on sight to a person who believes in the individual drinking cup and individual towel.

Sample Outfit \$3.50

Includes: 1 black sample case; 1 adult, 1 baby and 1 junior size; 1 plate brush; 1 tube paste; 1 order book ready for work. Send money order or check and get on the road to real money at once.

Agents Make Big Money

Our agents are making good. Start a crew or take a territory yourself. Write today.

Dr. Thompson's

STERAL TOOTHBRUSH CO.

804 So. St. Clair St.

Toledo, Ohio

128 Sold the First Week by Beginner

STERAL agents make big money. For example one lady in Elmore, O., who never sold before took 128 orders the first week. The Steral insures a clean tooth brush. You wouldn't hang your knife and fork on the bathroom wall and eat with it the next day. No one else would and they will buy the Steral brush after you tell them about it.

Where did I put that . . . ??

WHERE *did* you put that gadget, thingamabob or whatsit that you saved for just such an occasion as this? Closets will have to be searched, the basement looked into, and you may even desperately ransack the attic. Use a *good flashlight*. Don't trust matches in dry, dusty places. One careless spark may burn you out. Look safely with your Eveready.

Get the flashlight habit when there are things to be found. And learn your batteries! Eveready Batteries carry a bigger load of daylight—they're built to last. They come through with service—*real service*. The longest-lasting batteries that ever filled a flashlight—Evereadys. The battery *makes* a flashlight. Make yours the help it ought to be. Keep it loaded with genuine Eveready Batteries always.

WORKACE Electric WOODWORKER

Complete Outfit Including Planer, Saw, Lathe and Electric Motor and Many Useful Attachments

Wallace
PORTABLE MACHINES

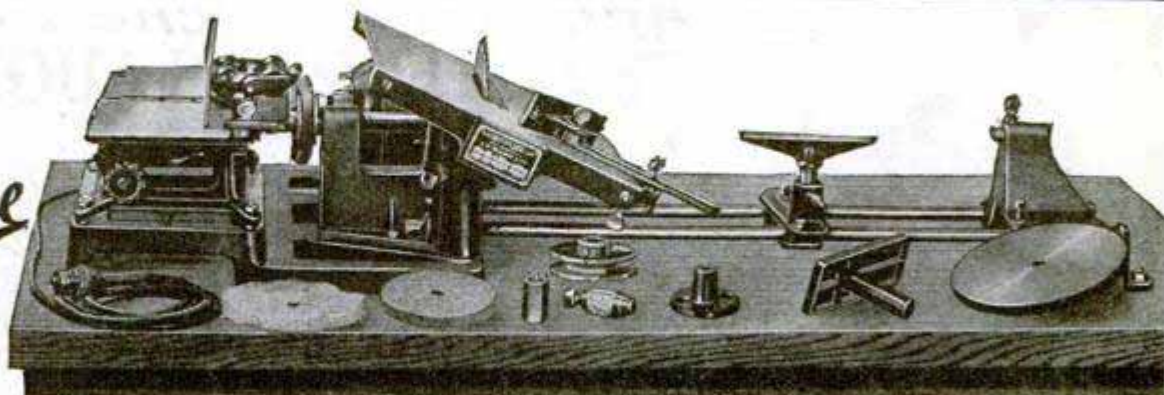

Fast-Accurate-Complete *For every kind of woodworking operation*

A COMPLETE all-electric shop to use at home or in business. Costs a lot less than most other outfits. Fast and accurate for every kind of

woodworking operation: Planing, sawing, turning, drilling, grinding, sanding, buffing, etc. Saves time, does better and cleaner work, too.

Amazing low price **\$89** Easy Terms—

The Workace Woodworker has power, strength, and capacity to handle any job quickly and economically—mitering, tapering, rabbetting, beveling, slotting, turning, cross-cutting, ripping. Every unit works from motor—parts are sturdy and well fashioned. The WALLACE GUARANTEE assures replacement of defective parts for one year.

Become an expert woodworker—make tables, chairs, stools, screens, lamps, lattices, fences, cabinets, doll houses, book cases, chests—make woodworking your hobby and turn it to profit, as hundreds do.

The Planer and Circular Saw are each complete units and may be purchased separately at the corresponding low price of \$25.00 each.

Terms are all in your favor. Small down payment brings the Workace COMPLETE. Monthly payments so small you'll never miss the money. Many pay for their Workace out of profits it makes—so can you.... Send the coupon now and we'll see that you get full details immediately.

J. D. Wallace & Co.,
Adams Street and California Ave.,
Chicago, Ill.

That Workace Electric Woodworker sure looks good to me. I want to know all about it, including your easy terms, right away.

Name..... City.....

Address..... State.....

AMAZING CAP OUTFIT



Free!

Just out! Absolutely new! Write or wire today for amazing new Taylor Cap Outfit. S. W. Allen of California made \$40.80 in one day. Just showing beautiful styles and rich RAINPROOF fabrics. Charles Horstman walked off with 53 orders in 8 hours. Scores of men making big money this new, easy way.

\$20 A Day Easy!

YOU can also make more money than ever, by showing wonderful Taylor Caps. Guaranteed rain-proof, an exclusive feature

which sells the caps with lightning speed. You pour water on Taylor Cap and it rolls off without moistening fabric. Wear cap in rain or snow and it remains perfectly dry. Amazing three-minute demonstration convinces every man. You keep big commissions in advance on every order. Every cap made-to-measure and carefully tailored throughout. Delighted customers tell their friends.

Send Name and Address

New summer styles and fabrics most beautiful of season. Complete equipment now ready. Write today. Let us send you this big money-making opportunity FREE—without obligation.

TAYLOR CAP MFGRS.

Dept. 22-K

Cincinnati, Ohio

**FREE
CAPS
TO
AGENTS**

wanted

**100,000 CARPENTERS
and Home Mechanics to
Try this IRWIN AUGER Bit**



A sincere trial is all that is needed to convince you of the speed, toughness and superior cutting qualities of the Irwin Mainbor Bit No. 62-T, specially designed and manufactured for carpenters, cabinet makers, home mechanics and handy men.

Made to cut quick and clean. Made to save time. Made to save effort.

Just try this Irwin Bit—you're sure to like it.

Special Offer

To those who have never used the Irwin Mainbor Bit we will send postpaid, for 25c, one Mainbor No. 62-T in the one-half inch size, that lists at 65c.

This is well below the cost of production. In fact we make the price of 25c just to cover the cost of handling and mailing, and to eliminate the idle inquiry.

We want to receive requests for this sample bit from sincere workers—interested in learning of a better tool. Just mail the coupon, with 25c and we will send the sample bit postpaid. Only the one size will be sent, and only one will be sent to an individual.

If you don't feel, after buying the bit, that it is the best you have ever used—send it back, tell us why and we will refund your money by return mail. Send the coupon today.



The Irwin Auger Bit Co.
Wilmington, Ohio

**"Largest Makers of Wood Boring
Tools in the World"**

The IRWIN Bit

REG. U.S. PAT OFF

The Irwin Auger Bit Co.
Wilmington, O.
Enclosed find 25c. for which please mail postpaid, one of
your Mainbor No. 62-T bits.

CLIP THIS COUPON

Name.....

St. Address.....

City and State.....

Earn \$150 TO \$300 MONTHLY PROFITS



HB 8-Hour Battery Charger Only \$16 Monthly

A Big Money Maker for the exclusive Battery Shop—and an unequalled Trade Builder and Profit Booster as an added Department in any Automotive Service Shop. Check coupon below for more information.



HB Hydraulic Car Washer Only \$20 Monthly

Lets you take advantage of the big demand for clean cars developed by the bright colors now in vogue on auto bodies. Saves labor and supplies. Brings customers for other departments besides big profits from washing. Check coupon below for more information.



HB Portable Paint Spray Only \$16 Monthly

Lets you handle profitable re-finishing and touch-up jobs for car owners and other dealers. Big demand for low and medium priced paint jobs, using new and quick drying lacquer. Only an HB Paint Spray lets you in on the big profits in this line. Check coupon below for more information.

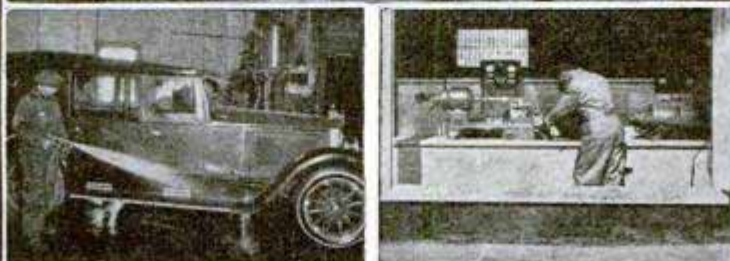

Start Making More Money with New Method Auto Service

With practically no investment you can start an HB 8 Hour Battery Service Shop and add \$150 to \$300 monthly to your present income. HB Constant Potential method draws business from other shops and brings bigger profits than any other equipment for charging either auto or radio batteries of all kinds. Charges batteries in $\frac{1}{4}$ the time required by old, rectifier-equipped shops. Saves 30% to 50% on electric bills. No expensive bulbs to replace. Requires only small space, no special experience and no expense to you after the small down payment. Pays for itself out of profits it brings with a handsome profit for you besides.

ONLY \$16 MONTHLY

- — a small part of the profits
- — gives you all advantages

For as low as \$16 monthly you can let an HB 8-Hour Battery Charger pay for itself in a small, unused corner. An Iowa shop reports that the savings on electric current alone carried the small monthly payments. Lee of Indiana says cost of charging is only 4c per battery. Price for recharging is \$.50 to \$1.25 per battery. Figure the profit! King of Wisconsin earns \$300 monthly with an HB, while Swango of Kentucky earns \$800 to \$1000 monthly with two outfits.

30 DAYS TRIAL

- — to prove all claims
- — on absolute money back guarantee

There's the test. 30 Days Trial—in actual use—at our risk. No other manufacturer of similar equipment has such confidence in his equipment. We KNOW it will make BIG MONEY FOR YOU. Hundreds of letters on file from enthusiastic HB users confirm it. That's why we offer you 30 Days Trial, subject to return, if you wish, FOR ANY REASON WHATSOEVER.

Investigate now. Get the whole story about HB 8-Hour Battery Charger—and the other HB Money-Makers mentioned on this page. Check the coupon below and mail it today.

HOBART HB BROTHERS
Successful manufacturers  since 1893 ~
Box M 108 TROY, OHIO



HB Electrical Test Bench Only \$16.50 Monthly

Tests complete electrical system of any car. Saves time locating and repairing starting - lighting - ignition troubles and gives accurate check on every job. Lets you keep all the profits on every job and impresses customers with your up-to-date service. Check coupon below for more information.



HB Dependable Air Service Only \$12 Monthly

Draws added business to any auto service shop, battery shop, tire shop, garage, filling station, etc. Increased trade it brings will more than pay the small monthly payments. No need to let your business suffer with inferior air service when you can get an HB Silent Twin Automatic Air Compressor on such easy terms. Check coupon below for more information.



HB Contractors' Paint Spray Only \$30 Monthly

Does the work of 5 men painting houses, barns, garages, business rooms — all kinds of buildings inside and out. Big profits. Easy to operate. Gasoline drive lets you use it anywhere. Check coupon below for more information.

TEAR OFF COUPON BELOW * MAIL TODAY * NO OBLIGATION

To Hobart Brothers, Box M108, Troy, Ohio.

Without obligating me in any way, tell me the whole story of how I can make more money with the Equipment I've checked at the right. Send details of the HB 30 Days Trial and Easy Monthly Payments.

Name.....

Address.....

- HB 8-Hour Battery Charger
- HB Hydraulic Car Washer
- HB Portable Paint Spray
- HB Electrical Test Bench
- HB Automatic Air Service

LATHES *for the Tool Room- Manufacturing- Machine Shop-Repair Shop-Service Station*

New Model South Bend Back-Geared Screw Cutting Precision Lathes

Built in the same plant where 40,000 other fine South Bend Precision Lathes have been manufactured for the United States Government, Ford, Westinghouse, Bethlehem Steel Company, U. S. Steel Corporation, and hundreds of other large industries in the United States and 78 Foreign Countries.

Easy Payments if Desired

A small down payment brings you any Lathe to use while you are paying for it. We ship immediately upon receipt of the down payment.

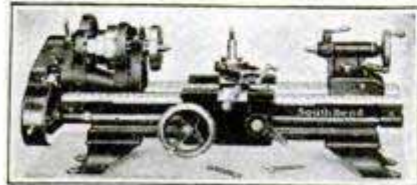

9" x 2½' Junior Back Geared
Screw Cutting Bench Lathe **\$150**

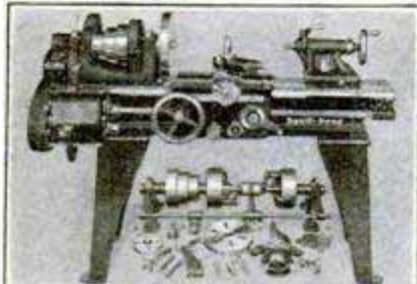

11" x 4' Quick Change Gear
Lathe, Straight Bed - - **\$335**

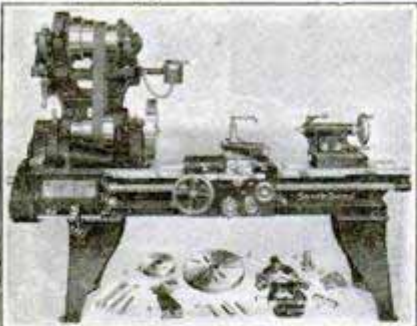

18" x 8' Quick Change Gear
Motor Driven Lathe - - **\$908**

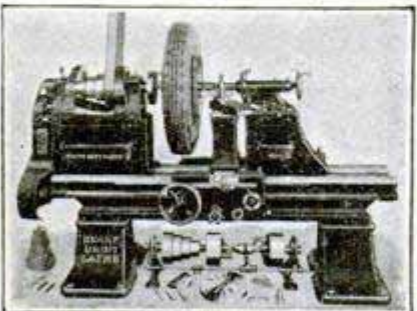

Brake Drum Lathe

Handles all Brake Drum work without removing tire.

No. 1 Lathe, Wheels to 32" diam. **\$475**

No. 2 Lathe, Wheels to 36" diam. - **650**

No. 3 Lathe, Wheels to 42" diam. **1400**

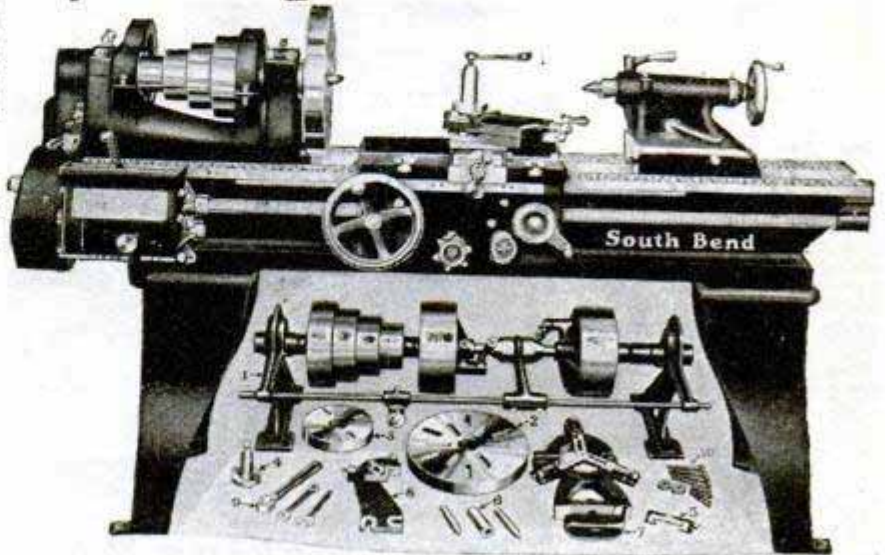

16" x 6' New Model South Bend Quick Change
Gear, Back Geared Screw Cutting Lathe - **\$540**

Other Popular Selling Sizes

The Prices of Popular Selling Sizes with Countershaft and Equipment

Size of Lathe	Shipping Wt.	Standard Change Gear	Quick Change Gear
9" x 3'	490 lbs.	\$235.00	\$270.00
11" x 4'	725 lbs.	300.00	335.00
13" x 5'	1110 lbs.	352.00	402.00
15" x 6'	1550 lbs.	430.00	490.00
16" x 8'	2035 lbs.	510.00	570.00

Used by America's Largest Industrial Plants

The best proof of the quality and accuracy of South Bend Lathes is that they are used in production, tool room work and in general machine work by America's largest industrial plants. For example: General Electric Co., Western Electric Co., Packard Motor Co., Oldsmobile Co., Houdaille Engineering Co., Victor Talking Machine Co., Black & Decker Mfg. Co., International Harvester Co., and in many departments of the United States Government.

FREE — Write for No. 89-A Catalog

describing 210 sizes and types of New Model South Bend Lathes. Check off in the squares below, indicating Lathes in which you are interested.

- | | |
|--|---|
| <input type="checkbox"/> 9" Junior Lathe | <input type="checkbox"/> New General Catalog No. 89-A |
| <input type="checkbox"/> 11" Lathe | <input type="checkbox"/> "How to Run a Lathe," 25c |
| <input type="checkbox"/> 13" Lathe | <input type="checkbox"/> Auto Mechanics' Service |
| <input type="checkbox"/> 16" Lathe | Book, 25c |
| <input type="checkbox"/> 18" Lathe | <input type="checkbox"/> Brake Drum Lathe Circular |

SOUTH BEND LATHE WORKS

Main Office and Works

642 E. Madison St., South Bend, Ind., U.S.A.

New York City, J. E. BEGGS CO., 183 Centre Street

Carried In Stock by Machinery Supply Dealers in Principal Cities
Throughout the World.

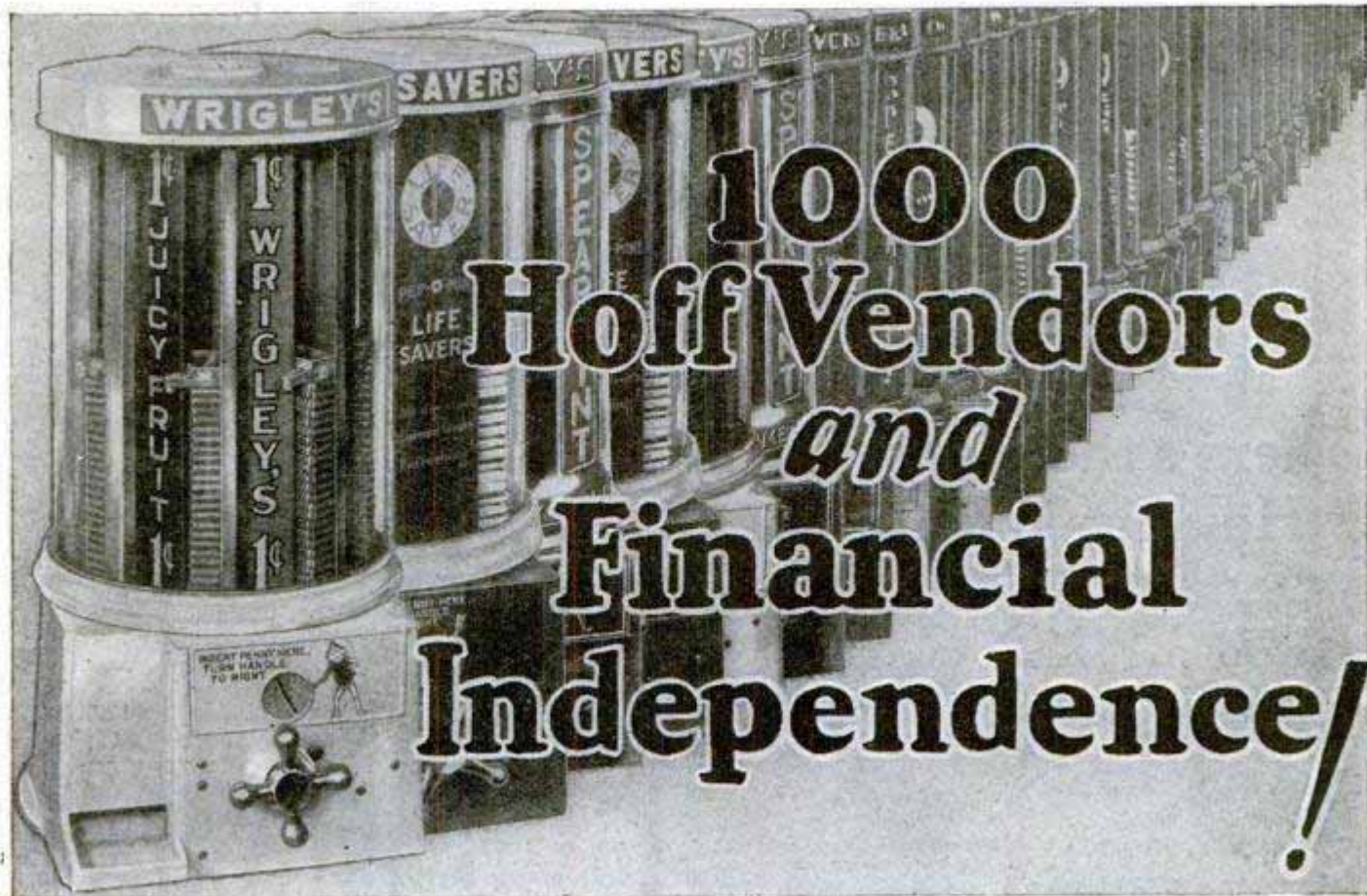

FEW of those not in the vending machine business have any conception of the importance that the humble penny assumes when judged by the yearly volume of sales made by penny vending machines. In a single year it amounts to the striking total of over six hundred million pennies. Right now there is an opportunity for a limited number of financially responsible individuals to enter the vending machine field, and to make a large profit from the operation of a comparatively small number of vending machines.

THE FAMOUS HOFF VENDING MACHINES

We make the famous Hoff Vending Machine, over 30,000 of which are now in operation, and control the exclusive franchise for distributing in penny vending machines two of the world's largest selling, best advertised, and most popular confections—a famous gum and a famous candy. It is the enormous demand for these two products that accounts for the large intake of Hoff Vendors. To further increase this demand, more than \$7,500,000 will be spent in 1928 alone to advertise them.

The owner of a chain of Hoff Vendors has a real business. Earnings from month to month vary little. Practical chains consisting of from 250 to 1000 vendors show net earnings of from \$2,820.00 to \$13,800.00 yearly.

A ONE-MAN BUSINESS

A chain of up to 1000 Hoff Vendors can easily be serviced by one man or woman. The work is easy

and pleasant. No previous experience or special training is required. There is no waiting for customers. Earnings start the day a vendor is placed on location. It is a business that can be run right from one's own home.

INTERESTING BOOKLET

We have prepared a book entitled "1000 Hoff Vendors and Financial Independence" which gives the full facts concerning this unusual business opportunity. It tells where vendors can be located, their average earnings, details of the Hoff location franchise, cost of vendors, cost of gum and candy, and cites the experiences of present established Hoff operators, of which there are now more than 70. Write for this book today. Bear in mind that Hoff Vendors are sold by a division of a five million dollar corporation, and every co-operation is furnished to Hoff operators.

HOFF VENDING CORPORATION OF AMERICA
Division of General Vending Corporation
 200 Hudson Street, Dept. 18, New York City
Hoff Vendors awarded gold medal, Sesqui-Centennial Exposition, Philadelphia, 1926.

HOFF VENDING CORPORATION OF AMERICA,
 Dept. 18, 200 Hudson Street, New York, N. Y.
 Please send your book, "1000 Hoff Vendors and Financial Independence" to the undersigned. I am looking for an unusual business opportunity.

Name.....
 Address.....



There's the Man Who's Holding You Down

Yes, sir! There's the man! You see him every time you look in the mirror. His name isn't Brown or Smith or Jones but Y-O-U. He's your real boss. He's the man who decides whether your salary will be \$35 a week or \$100 or \$150.

If you want to get ahead there's just one sure way to do it—train yourself to do the day's work better than any other man in the office. Ability is bound to count. Your employer will be glad to pay you more money if you show him you *deserve* it.

A home-study course with the International Correspondence Schools will prepare YOU for the position you want in the work you like best. All it takes is an hour a day of the spare time that now goes to waste.

At least find out how by marking and mailing the coupon that has meant the difference between Failure and Success to so many other men. It doesn't obligate you in any way to fill in this coupon, yet it may be the means of changing your entire life. *Do—it—now!*

Write for Free Booklet

INTERNATIONAL CORRESPONDENCE SCHOOLS
"The Universal University"
Box 5566-F, Scranton, Penna.

Without cost or obligation, please send me a copy of your booklet, "Who Wins and Why," and full particulars about the course before which I have marked X in the list below:

BUSINESS TRAINING COURSES

- | | |
|--|--|
| <input type="checkbox"/> Business Management | <input type="checkbox"/> Business Correspondence |
| <input type="checkbox"/> Industrial Management | <input type="checkbox"/> Show Card Lettering |
| <input type="checkbox"/> Personnel Management | <input type="checkbox"/> Stenography and Typing |
| <input type="checkbox"/> Traffic Management | <input type="checkbox"/> English |
| <input type="checkbox"/> Accounting and C.P.A. Coaching | <input type="checkbox"/> Civil Service |
| <input type="checkbox"/> Cost Accounting | <input type="checkbox"/> Railway Mail Clerk |
| <input type="checkbox"/> Bookkeeping | <input type="checkbox"/> Mail Carrier |
| <input type="checkbox"/> Secretarial Work | <input type="checkbox"/> Common School Subjects |
| <input type="checkbox"/> Spanish <input type="checkbox"/> French | <input type="checkbox"/> High School Subjects |
| <input type="checkbox"/> Salesmanship | <input type="checkbox"/> Cartooning |
| <input type="checkbox"/> Advertising | <input type="checkbox"/> Illustrating |
| | <input type="checkbox"/> Lumber Dealer |

TECHNICAL AND INDUSTRIAL COURSES

- | | |
|--|---|
| <input type="checkbox"/> Architect | <input type="checkbox"/> Automobile Work |
| <input type="checkbox"/> Architectural Draftsman | <input type="checkbox"/> Airplane Engines |
| <input type="checkbox"/> Building Foreman | <input type="checkbox"/> Plumber and Steam Fitter |
| <input type="checkbox"/> Concrete Builder | <input type="checkbox"/> Plumbing Inspector |
| <input type="checkbox"/> Contractor and Builder | <input type="checkbox"/> Foreman Plumber |
| <input type="checkbox"/> Structural Draftsman | <input type="checkbox"/> Heating and Ventilation |
| <input type="checkbox"/> Structural Engineer | <input type="checkbox"/> Sheet-Metal Worker |
| <input type="checkbox"/> Electrical Engineer | <input type="checkbox"/> Steam Engineer |
| <input type="checkbox"/> Electrical Contractor | <input type="checkbox"/> Marine Engineer |
| <input type="checkbox"/> Electric Wiring | <input type="checkbox"/> Refrigeration Engineer |
| <input type="checkbox"/> Electric Lighting | <input type="checkbox"/> R. R. Positions |
| <input type="checkbox"/> Electric Car Running | <input type="checkbox"/> Highway Engineer |
| <input type="checkbox"/> Telegraph Engineer | <input type="checkbox"/> Chemistry |
| <input type="checkbox"/> Telephone Work | <input type="checkbox"/> Pharmacy |
| <input type="checkbox"/> Mechanical Engineer | <input type="checkbox"/> Mining Engineer |
| <input type="checkbox"/> Mechanical Draftsman | <input type="checkbox"/> Navigation <input type="checkbox"/> Assayer |
| <input type="checkbox"/> Machine Shop Practice | <input type="checkbox"/> Iron and Steel Worker |
| <input type="checkbox"/> Toolmaker | <input type="checkbox"/> Textile Overseer or Supt. |
| <input type="checkbox"/> Patternmaker | <input type="checkbox"/> Cotton Manufacturing |
| <input type="checkbox"/> Civil Engineer | <input type="checkbox"/> Woolen Manufacturing |
| <input type="checkbox"/> Surveying and Mapping | <input type="checkbox"/> Agriculture <input type="checkbox"/> Fruit Growing |
| <input type="checkbox"/> Bridge Engineer | <input type="checkbox"/> Poultry Farming |
| <input type="checkbox"/> Gas Engine Operating | <input type="checkbox"/> Mathematics <input type="checkbox"/> Radio |

Name.....

Address.....

City..... State.....

REGAL OCTOFONE



“UKE” players, the Regal Octofone is made for you. This new, uniquely shaped instrument has the deep mellow tone of the Spanish Guitar, and can be tuned and played just the same as a “uke”! Nothing new to learn—no lessons. The same chords on a brand new instrument.

Can Be Tuned Like 8 Different Instruments

By mere changes in tuning the Octofone can be tuned and played like 8 different instruments—the “uke,” tenor guitar, tenor banjo, mandolin, mandola and other instruments played with a pick. FREE booklet of instructions accompanying each instrument tells you how to tune the OCTOFONE eight different ways.

Your dealer will be glad to give further information, or write us.

Regal Musical Instrument Co.
3207 Grand Ave., CHICAGO

Do You Play a Uke?

\$15.00



BARGAIN!

ONLY 39¢

GUARANTEED RADIO TUBES

For clear reception on election news, market news, etc., your radio set should have new tubes. Why pay \$2.00? Here's the chance to get guaranteed high quality 201A type radio tubes for only 39c each. Send check, money order, or sent C. O. D.

Send for Free Radio Guide. These bargain tubes and other bargains are shown in Barawik's Big Radio Guide. Send for free copy today—now! Thousands of other radio bargains—newest coast-to-coast sets, speakers, parts, supplies—all at lowest prices.

Send Now for Free Radio Guide

BARAWIK CO., 1010 Canal Sta., Chicago, U. S. A.

\$9.65

MEN'S ALL PURPOSE SUITS!

\$2.50 Commission in Advance! Workmanship, Fit, Guaranteed! For Semi-Work or Dress! Looks, Feels Like Wool! Wears Like Iron! FREE Kit! **FITZ-U-TAILORING CO., Dept. 170, South Whitley, Ind.**

NEW AUTOMATIC WINDOW WASHER

Washes-Cleans-Dries-Polishes in ONE Quick Operation.



Amazing new invention completely revolutionizes window washing. Carries its own water supply! It eliminates all the drudgery and unpleasantness. Five times as fast as old methods! No pail. No brush. No sponge. No chemicals. Your hands never touch water with the NEW AUTOMATIC. Can be used with or without pole. Every housewife, auto-owner, storekeeper and factory owner a live prospect. Sensational demonstration. Sells at sight. Big repeat business. Year 'round seller.

MAKE \$90 TO \$150 A WEEK!

Agents coin tremendous profits. Going like wildfire. Sells for only \$1.95. Liberal profits for agents, \$10 to \$25 a day easy; \$200 to \$300 a week possible.

WRITE FOR OUR FREE SAMPLE OFFER

You risk nothing. Don't delay. Write for money making proposition today.

NATIONAL INDUSTRIES, Wrigley Bldg., Dept. 1510, CHICAGO

**Start to play
very first day**

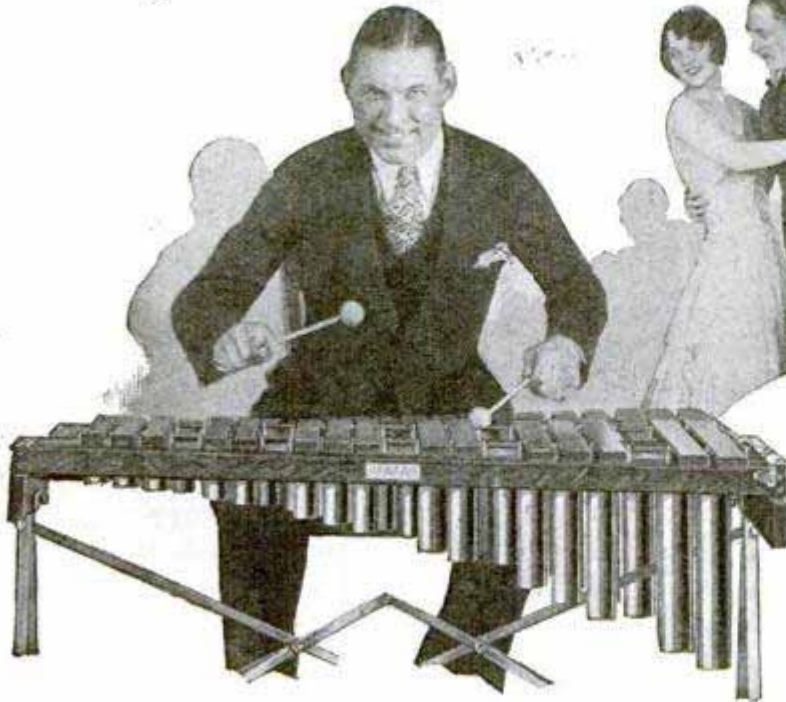

**Free, Easy Lessons
...5 Days' Trial...
A Year to Pay!**

**To You Red-Blooded Fellows
Who Want MORE FUN OUT OF LIFE . .
MORE POPULARITY and BIG EXTRA-
TIME MONEY . . . This Is Good News!**

TO YOU who have so often remarked, "If only I could be as popular as some fellows," this is an opportunity. To you who a thousand times have said, "If only I could play some musical instrument," we now say, "There is no reason why you shouldn't."

Even if you can't read a note of music right now, you can, by following the free easy lessons furnished with each instrument, play a simple melody on the day you get your Xylorimba! Before you realize it, you will be playing well enough to amaze friends and relatives. Then a new life opens to you. Long, happy evenings of joy; not only invited to parties but the center of attraction—the pride of every girl and the envy of every fellow present. The thrill of having your friends listen to you over the radio! Last but not least, the same chance to earn \$5 to \$25 a night as Ralph Smith, Chicago, who says: "I played twenty minutes at a wedding—received \$20." Or the Hallmann family, Reading, Pa.—"Made \$300 in five weeks, spare time. Had never played instrument before."

We don't ask you to take our word for this. We offer to send you the

Xylorimba of your choice for five days' trial in your own home, so you can judge for yourself. See how easy it is to play. Look over the simple lessons, prepared by experts, which make a teacher unnecessary.

Keep the instrument only if you are satisfied—and then take an entire year to pay!

Was a fairer offer ever made? We make it because we want you to know the joy of creating your own music, the pleasure of being looked up to wherever you go, the profit of big extra money. Remember, this is the most fascinating of all instruments—the same make as used by national stage, radio and phonograph artists. Remember, too, you begin to play at once—no finger

or lip exercises; no teacher; no tiresome practice.

Hundreds will take advantage of this chance. Will you be one of them? The coupon will bring, without obligation, our big FREE book which tells more about this amazing offer. Send it in today!

MAIL COUPON TODAY!

J. C. Deagan, Inc., Dept. 1457, 1770 Berteau Ave., Chicago

Send me, without obligation, full details of Free Trial offer and easy payment plan on the Deagan Xylorimba.

Name.....

Address.....



Fame and Money
Broadcasting



Center of Attraction
at Gatherings



Big Money at
Dances

**5 Days' Trial
in Your
Own Home**

...
**A Year to
Pay!**

CROSLEY

DYNACONE



A simple explanation of the new, amazing power dynamic speaker that has swept the radio market at \$25

The dynamic principle of radio speakers means **POWER**-combined with the finest attainable **QUALITY**.

Dynamic speakers get their **POWER** by the use of an *electromagnetic field*. Translated from Engineering into English this means that the permanent field

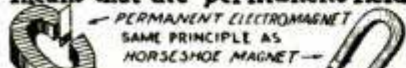

magnet of the average radio speaker is replaced by a powerful electromagnet.

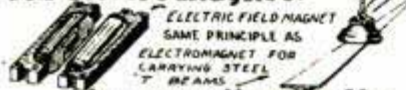

Comparing the possible **POWER** of electromagnets and permanent magnets is like comparing a magneto to a dynamo.

The magneto uses permanent field magnets. It will serve admirably as a shocking machine but cannot light a single lamp bulb.

The dynamo uses electro-magnets. Even a moderate sized dynamo will run the lights of an entire village.



Heretofore, the use of

dynamic speakers was limited to a comparative few who could afford them because they required a separate battery to supply the current for their electromagnet coils.

DYNACONE eliminates the battery — and utilizes current from the set to operate its field coils.

A continuous direct current is always flowing in the plate circuit of the power output tube of the radio set.

Upon this direct current is superimposed the fluctuations of the signal.

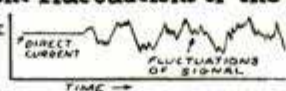

It has been customary to keep the direct current out of the loudspeaker because so strong a current would tend to *paralyze* the speaker by pulling its armature over against the field magnet.



To get rid of this strong direct current, a transformer,

or a condenser is used,

which allows only the signal fluctuations to

enter the speaker armature. **DYNACONE** uses the latter method for keeping the direct current out of its armature but makes use of this very current, which other speakers throw away, for energizing its field electromagnets.

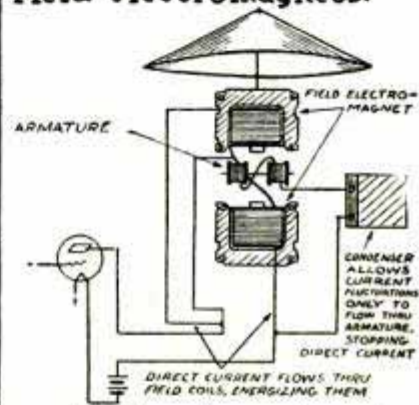

By thus ingeniously utilizing energy heretofore thrown away, **DYNACONE** achieves **POWER** and **QUALITY** only attainable with the dynamic principle, without any special batteries or other apparatus. It is simply connected directly in the output circuit of any set using a 171 type power tube operating at 180 volts on the plate.*

* If the set has an output transformer, this is disconnected by the dealer when **DYNACONE** is installed.

The above description applies to the Type E **DYNACONE**. The Type F **DYNACONE**, which has four connections to the set, takes its direct current from ahead of the output transformer instead of using a condenser to effect its separation from the voice current which actuates the armature.

THE CROSLEY RADIO CORPORATION

DEPARTMENT 15

Cincinnati, Ohio

Powel Crosley, Jr., Pres.

Montana, Wyoming, Colorado, New Mexico and West prices slightly higher

"Plug In!" start work

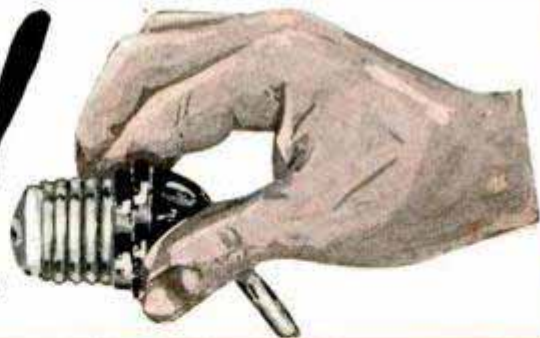

Up-to-Date Home Craftsman Shop

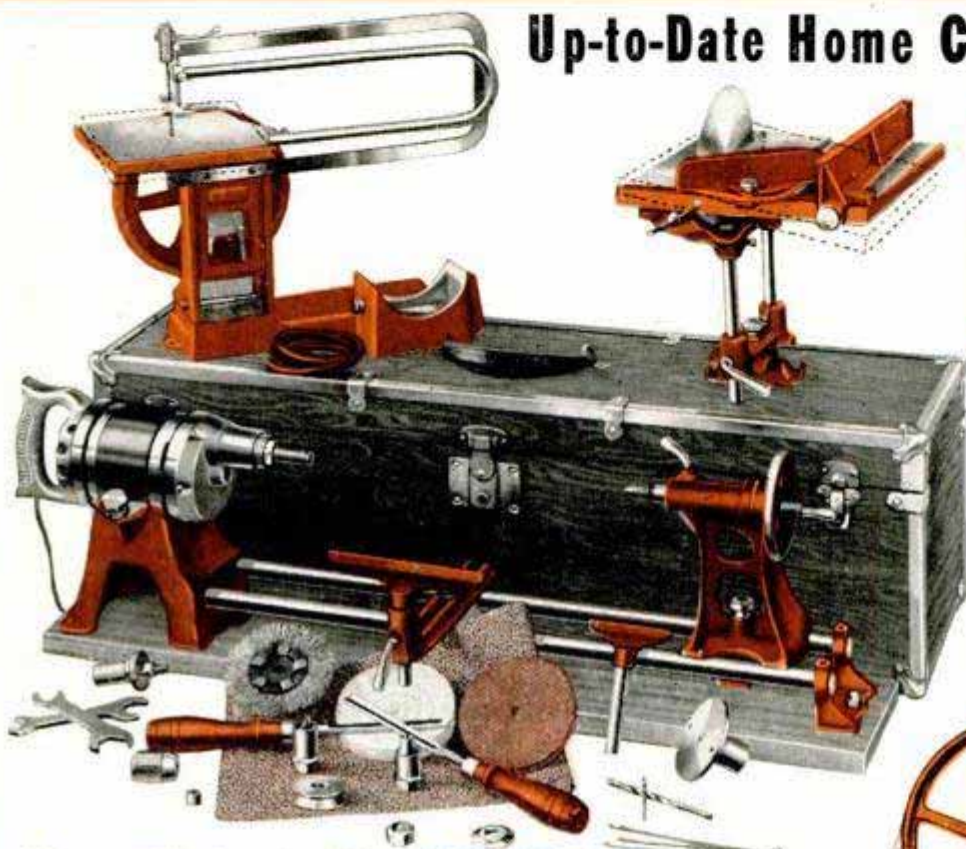

FREE CRAFTS COURSE

Under personal supervision of Master Craftsman Eugene E. Maurey, a special correspondence crafts course is given in simple detail with full information on wood handiwork.

FREE BLUE PRINTS

Blueprint service giving plans and details for making hundreds of pieces of wood handiwork included in this course FREE to our users.

Home Mechanics Easy With This Equipment

The Up-to-Date Electrical Home Craftsman Shop can be used in any home lighting fixture, thus making of your old-fashioned work bench a complete machine shop, made of a Super-power Motor, an accurate Lathe (10" x 34"), a 6" circular saw, which features the bevel, miter, side and depth gauges, a Tilting Table, Jig Saw, and all accessories for buffing, grinding, clearing and all portable or stationary drilling and sawing. This collection of electrically driven tools, complete in every detail, will make you an advanced craftsman. Master mechanics have designed and skilled engineers have constructed this equipment which, after inspection, you will agree is the best of its kind. For those who build, invent, create and construct at home, it is unexcelled.

NEW 12" BAND SAW

Newly developed, of the latest design in Band Saw equipments, this 12 inch Band Saw is guaranteed vibrationless, and accurate in every detail. This saw may be purchased on time payment basis at \$39.00, \$10.00 down and \$10.00 per month. With this plan anyone can own a real Band Saw.

\$35⁰⁰
F. O. B.
Chicago, Ill.

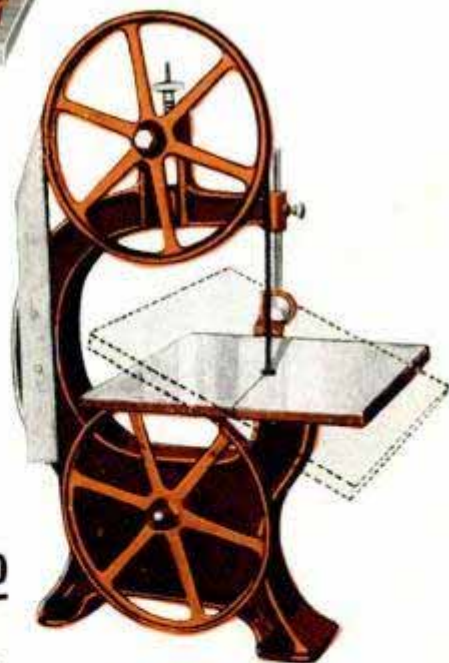

MAIL THIS

for full particulars to

Up-to-Date Machine Works,
2915 S. Wabash Ave., Chicago, Ill.

Manager, Dept. 20. Without any obligation, please send me all particulars about your shop, 10-day free trial, free blue prints, free crafts course, also \$10.00 down payment offer.

NAME.....

ADDRESS.....

**ONLY \$10.00 DOWN—10-DAY TRIAL
FREE CRAFTS COURSE BLUE PRINTS
USE COUPON—SEND FOR DETAILS**



"Jack, let me get a movie of you smoking that cigarette . . ."

"All right . . . watch me register 'They Satisfy'."

Chesterfield cigarettes are mild . . . not strong or harsh. Chesterfield cigarettes have character . . . they are not insipid or tasteless.

The tobaccos in Chesterfield cigarettes are blended

and cross-blended in a different way from other cigarettes and *the blend can't be copied!*

They are MILD . . . yes, mild enough for anybody . . . and yet . . . they SATISFY.



LIGGETT & MYERS TOBACCO CO.