

BULLDOG FURNACE

Heats Home for 25¢ a Week!

"I can run my Bulldog furnace steady for fourteen days in normal weather conditions on the actual cost of fifty cents." So writes F. R. Redetzke, of Cleveland, North Dakota, and he adds: "Hard to believe is it? That's what some of my neighbors thought until I showed them! We have an unlimited amount of grain screenings in this country. That's the fuel I am using."

That's what the Bulldog does with about the lowest grade fuel you can think of! Here's what it does with coal:

After 6 Years—"Heats as Good as Ever"

"Our furnace has been in use 6 years and heats as good as ever."
—Arthur Cloepfl, R. F. D. No. 1, Rockport, Mo.

"Does the Work of 3 Stoves"

"This is my third winter with the Bulldog. It does the work of 3 coal stoves that I used, which only warmed up part of the house and not very well at that. My Bulldog not only does that, but 3 rooms upstairs, with great satisfaction. My house is located in a very cold place, with no protection at all. It is the easiest furnace to handle I have yet seen." E. C. Diplock, 105 Elm St., Camden, Me.

Cuts Coal Bill in Half

"I had a hot air furnace in our 7-room house before I got the Bulldog and our house was always cold. With the Bulldog it only takes *half as much coal* and we had weather below zero, and the house was nice and warm in the morning when we got up. We never have the draft on more than half an hour at a time, and it has the place red hot. It keeps the fire all day in mild weather."
—Jess T. Conrad, 1211 W. Arch St., Shamokin, Pa.

No Money Down!

Small Monthly Payments—Installed Almost as Easily as a Cook Stove!

The Bulldog is sent to you for *free inspection*. Then, if satisfied, you make only small monthly payments at our remarkably low price. Write today! *Don't miss this chance to cut down your fuel bills! Install a Bulldog Furnace.* It comes to you completely erected—goes through any door—fits any height of basement—and you install it yourself in less than two hours! In fact, you can install the Bulldog just about as easily as you

would a kitchen stove. *Don't put up with the old fashioned stove heat or some outworn furnace—when you can so easily get the greatest advance in scientific heating at an astonishingly low price.* The Bulldog burns almost *any kind of fuel*, from hard coal to cheap screenings. Keeps a wood fire over night. **We have factory connections in both east and west and ship from the nearest point.**

Send for Free Book

Learn how to have all the heat you want—where you want it—and save money! Remember the Bulldog is *different—and better!* Complete combustion of gases save 25% of your fuel bill. Exclusive Gable-Top Radiator receives *all* the direct rays of the fire. Exclusive oblong fire-pot is not only ideal for coal, but enables you to keep a wood fire over night. Remember—the Bulldog is sent for *free inspection*—then small monthly payments at an amazingly low price! Send for Free Book TODAY!

BULLDOG FURNACE CO.—Babson Bros. Sole Distributors
19th Street and California Ave. Dept. 13-56 Chicago, Ill.

Bulldog Furnace Co. Babson Bros. Sole Distributors

19th St. and California Ave., Dept. 13-56 Chicago, Ill.

Canadian Address. 110 Princess St., Winnipeg, Man.

Without obligating me in any way, please send me your free catalog and special offer on the Bulldog Furnace.

Have you a basement? Yes
No

Name

Address

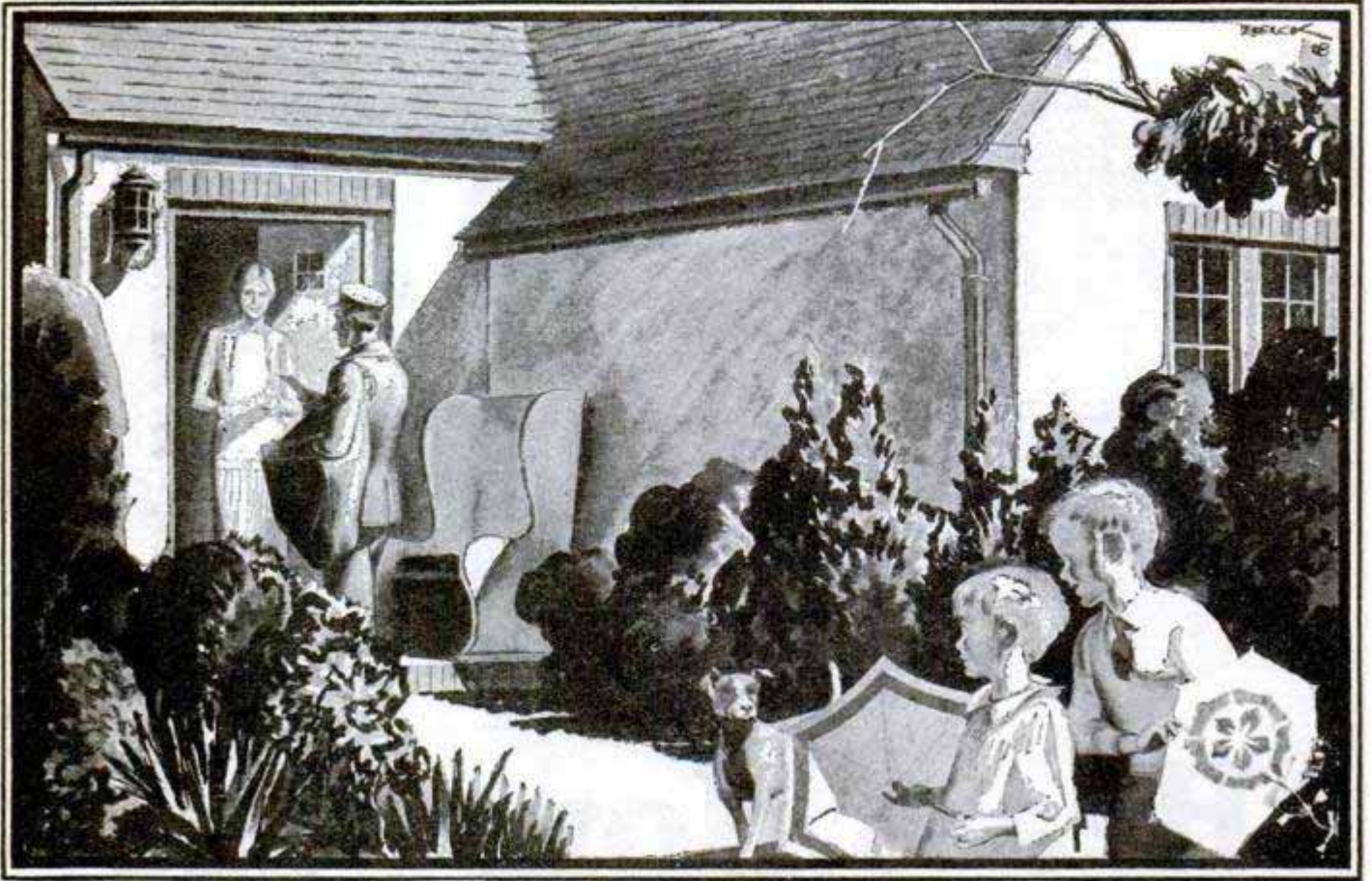

Where the Bell System's profit goes

*An Advertisement of the
American Telephone and Telegraph Company*



THERE is in effect but one profit paid by the Bell Telephone System. This profit is not large, for it is the policy of the Bell System to furnish a constantly improving telephone service at the least cost to the public.

The treasury of the American Telephone and Telegraph Company receives dividends from the stock of the operating companies. It receives a payment from the operating companies for research, engineering and staff work. It receives dividends from the Western Electric Company—makers of supplies for the Bell System—and income from long distance operations.

Only one profit is taken from this money in the American Telephone and Telegraph Company's treasury. That is the regular dividend to its stockholders—now more than 420,000 in number—which it has never missed paying since its incorporation in 1885.

Money beyond regular dividend requirements and a surplus for financial stability is used to give more and better telephone service to the public. This is fundamental in the policy of the company.

The Bell System accepts its responsibility to provide a nation-wide telephone service as a public trust.

Popular Mechanics Magazine

200 E. Ontario Street, Chicago, U. S. A.

H. H. WINDSOR, Founder

H. H. WINDSOR, Jr., Editor and Publisher

London: Hachette & Cie.,
16-17 King William Street, Charing Cross, W. C. 2

Paris: Hachette & Cie.,
111 Rue Reaumur

Melbourne: Gordon & Gotch
509-513 Little Collins St.

ISSUED MONTHLY

SUBSCRIPTION:

SINGLE COPY, 25 CENTS

In United States and its possessions, also Canada, Cuba, and Mexico, per year, postpaid - \$2.50

To all other countries in the Postal Union - 3.00

All subscriptions are discontinued at expiration. Please examine the date printed on your wrapper.

Entered as Second Class Matter Sept. 15, 1903, at the Post Office at Chicago, Illinois, under Act of March 3rd, 1879.

Entered as Second Class Matter at the Post Office Department, Canada.

Published monthly by POPULAR MECHANICS CO.

Copyright, 1928, by Popular Mechanics Co.

Copyright in Australia. Copyright in France

Vol. 50

Contents for September, 1928

No. 3

Special Features

Blowing Bubbles to Aid Science	370
The Flying Cameraman	378
How to Stop without Skidding	387
Uncle Sam's Latest Weapons	403
Are Your Senses Perfect?	419
Dog Fighters of the Air	435
The Ghost Towns Come Back	442
A Jungle Mystery	451
Learning to Fly	466
Advertising	
small car's super-balloon tires advertise station	423
store front of glass booths helps draw trade	402
Airplanes	
army seeks silent aid in attacks	413
landing wheels fold to increase speed	401
that carries torpedo and several bombs	390
vacuum brake stops them in few feet	461
world's largest monoplane weighs fifteen tons	449
Airship—luxuries aboard an air liner	429
Architecture	
modernistic city hall and water tower combined	456
quake-proof buildings mark new construction styles	461
Automobiles	
roads over railways to speed traffic	426
with rear door give backward view	384
Automobiles—Accessories	
automatic starter control promotes safety	384
cigaret dispenser contains a humidifier	416
clamp to hold luggage protects body of car	417
drip pan guards cowl when tank is filled	453
traffic-light mirror promotes safe driving	449
Automobiles—Cleaning—revolving brush on hose	399
Automobiles—Tires—jack on wheel simplifies change	432
Aviation	
champion airwoman wins 8,000-mile race	457
conquer ice peril in flying with thermometer	464
novel float tests airplane engines on water	385
queer aerial cargoes	448
seat on pivot steadies plane for safer flying	432
what's wrong when a plane crashes?	392
wire's shadow guides plane flying across sea	375
Bed—portable for the baby, weighs thirteen pounds	427
Billiards—guide teaches correct stroke	447
Birds—kept away from reservoirs by crossed wires	460
Boats and Boating—foot harness for oarsman aids in paddling	391
Bridge	
big steel has span of 500 feet	441
guarded against collisions by old ships	459
Building Construction—concrete slab walls simplify	413
Cabin—quickly built for camping requires no nails	417
Camping—lunch carrier and table combined in one	385
Cigarets—coin-in-slot dispenser talks to advertise goods	465
Clothesline—kept taut by rust-proof hook	390
Coal	
better ways of storing to prevent fires	447
soft turned into hard to reduce smoke	440
Coin Carrier—in vanity case	398
Concrete—asphalt emulsion aids curing	401
Don Quixote—carved in wood assumes different poses	447
Door, Screen—metal guard prevents breaking mesh	441
Dredge—stranded, liberated with ice	450
Electric Motor—tiny, keeps time for accurate metering	459
Exploration—most of the world yet unknown	391
Ferry—run over river by auto to save long delays	433
Fire Fighting	
mules carry pumps to help guard forests	460
tower of steel gangplanks to save lives	427
Fireplace—portable furnace saves fuel	399
Garage—control for doors reduces accidents	446
Garbage Truck—dustless, promotes health	446
Gardening	
fork is tilted to increase leverage	456
paper covers over gardens help prevent weeds	385
Gardens—revealed at night by electric floodlights	449
Golf—tee that aids long shots and doesn't get lost	453
Grain—shocker for bundles saves hand labor	448
Grocery—automatic, allows motorists to shop in cars	374
Highway—among volcanoes opened in Hawaii	459
Hose, Garden—sprinkles more lawn through mist nozzles	390
Household Devices	462
House Plan	527
Hydroglider—huge built for Atlantic record	415
Icebergs—seek birthplace, to protect shipping	398
Iron—deposits created by bacteria	441
Ladder—folds in small space and holds heavy weight	450
Lemon Squeezer—and strainer fits over glass	441
Linoleum—baseboard helps keep rooms clean	464
Locomotive—cab in front of big engine	398
Log—split by exploding wedge to save hand labor	374
Mail Box—combined with porch lantern	401
Meat	
flavor added before killing	432
springer makes tender and does not tear	376

Cutter Plant Shaker
Aids War. Dole Weevil
354

Drift indicator

And mine

[Continued on Page 4]

Wheeler goes
operated by
the

Es. K. K. K.

440

DRAKE'S PRACTICAL MECHANICAL BOOKS

THEY WILL RAISE YOUR PAY—

ORDER ON 5-DAY TRIAL

The books listed below will perfect you in your chosen trade—pave the way to the big positions. Written in non-technical language—easy to read and understand. Every book covers its subject completely. An entire course of instruction condensed into one volume. Your choice sent postpaid—you benefit 5 days—money refunded in full if not entirely satisfactory. Order direct from this page.

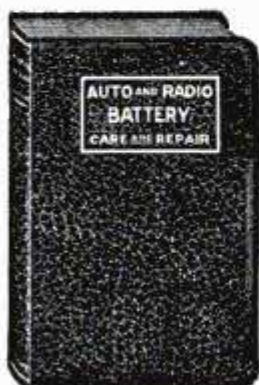

Automobile Books

- Automobile Starting, Lighting and Ignition, by Manly... 700 pp. \$3.00
- Brookes' Automobile Handbook... \$2.00
- Ford Motor Car, Truck and Tractor, by Manly... Cloth \$1.50
- Auto and Radio Battery, Care and Repair, by Manly... Leatherette \$2.00
- Motorcycle Handbook, by Manly... \$1.50



Shop Practice Books

- Practical Heating Systems, Trouble Jobs and Ventilation... \$4.00
- Sheet Metal Workers' Manual... \$2.00
- Oxy-Acetylene Welding and Cutting... Cloth \$1.25
- Slide Rule and Logarithmic Tables... \$2.00
- Handbook for Millwrights... Cloth \$2.00
- Machine Shop Practice... Cloth \$2.00
- Mechanical Drawing and Machine Design... Cloth \$2.00

ORDER DIRECT FROM THIS PAGE —ON OUR MONEY-BACK PLAN

The books listed above are only a few of the many in our catalogue, which you will receive promptly after filling out and mailing us the attached coupon. For quick action order direct from this page—cross name of each book wanted and send in with price quoted. We prepay postage and send the books on our money-back plan.

FREDERICK J. DRAKE & CO.

Publishers

R508—179 No. Michigan Ave. CHICAGO

Drake Books Are For Sale at All Book Stores

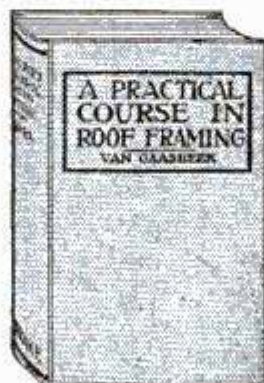

Carpentry Books

Cloth Binding

- Modern Carpentry, 2 vols... \$3.00
- The Steel Square, 2 vols... \$3.00
- Modern Estimator... \$1.50
- Timber Framing... \$2.00
- Builders' Architectural Drawing... \$2.00
- Concrete... \$1.50
- Practical Bungalows... \$1.00
- Roof Framing, by Van Gaasbeek... \$1.50

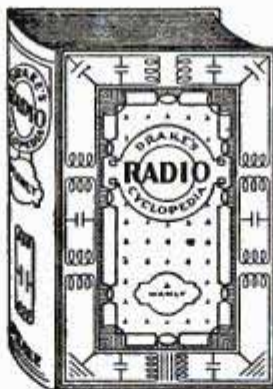

Drake's Radio Cyclopeda

June, 1928 Edition
By H. P. Manly

920 Pages, 1025 Illustrations, 1700 Subjects, arranged alphabetically. For Service and Repair Men, Dealers, Salesmen, Experimenters and Designers. Bound in Art Buckram. Price... \$6.00



Painting and Decorating

- Furniture, Furniture Finishing, Decoration and Patching... \$5.00
- Ross Crane Book of Home Furnishing and Decoration... Cloth \$3.00
- House Painting Methods with the Brush and Spray Gun, by Vanderwalker... Cloth \$2.00
- Interior Wall Decoration, by Vanderwalker... Leatherette \$4.00
- The Mixing of Colors and Paints, by Vanderwalker... Cloth \$2.00
- Studio Handbook—Letter and Design... \$3.00
- A Show at Sho' Cards... Cloth \$4.00
- Sign Painting, by Atkinson... Cloth \$4.00
- Strong's Book of Designs, Leatherette \$4.00
- Modern Painters' Cyclopeda... Cloth \$2.00
- Automobile Painting... Cloth \$1.50
- New Hardwood Finishing... Cloth \$1.50
- Wood Finishing, Plain and Decorative... Cloth \$2.00
- Owen's Paint Guide... Cloth \$1.00

Steam Engineering

- Swingle's Handbook for Steam Engineers and Electricians... Leatherette \$4.00
- Examination Questions and Answers for Marine and Stationary Engineers... Leatherette \$2.00
- Steam Boilers... Leatherette \$2.00
- Swingle's Catechism of Steam, Gas and Electrical Engineering... Leatherette \$1.50

Modern Languages

- By Prof. P. S. Allen, U. of Chicago
- French without a Teacher... Cloth \$1.25
- Spanish without a Teacher... Cloth \$1.25
- German without a Teacher... Cloth \$1.25
- Everyday French... \$1.25
- Everyday Spanish... \$1.25

FREDERICK J. DRAKE & CO.
R508—179 No. Michigan Avenue
Chicago, Ill.

GENTLEMEN:—Please send me free, postage paid, your illustrated catalogue which lists and describes 200 Practical Mechanical Books for Home Study.

My: This One



JUY1-Y7S-TU1P

Mail Coupon For Free Catalogue
Your Guide to Home Study

Do you really want Bigger Earning Power— Larger Success?

*There's only one sure way to get it,
and here's the "secret formula"—*

Do you know that in four words you can sum up every success in business—and do you know that this simple formula is just as sure to work for you as for any other man who ever lived?

Here is the formula, then—in just four words—and if you'll try it even for so short a period as six months, you'll be amazed at the things it will do for you! The formula is—**DEFINITE OBJECTIVES, SYSTEMATICALLY FOLLOWED!**

To put the formula another way—it's knowing what you want and preparing steadily to get it!

In Peoria there lives a man named Paul F. Bourscheidt, who a number of years ago began to apply this formula.

At this time Mr. Bourscheidt was Assistant Actuary of the Peoria Life Insurance Company, one of the outstanding insurance companies of the Middle West. He wanted to broaden his knowledge of business, so as to fit himself for larger responsibilities. That was his **DEFINITE OBJECTIVE**. So he enrolled with LaSalle for home-study training in Business Management.

Eleven months later he had completed the training; and if you were in business in 1922, you will remember what troublous times they were—profits shrinking, payrolls slashed, and only the fittest able to stand the gaff.

"As a result of my training," wrote Mr. Bourscheidt at that time, "I notice a big improvement in my work and my ability to cope with difficult situations. Already I can report a promotion and an increase of 30 per cent, which in these days is no small item."

* * *

Since that date, men have come and gone in the Peoria Life Insurance Company, but still Mr. Bourscheidt has held to that simple formula of **DEFINITE OBJECTIVES**.

Realizing the importance of legal knowledge in business, he enrolled again with LaSalle—this time for home-study training in Law. He set as his goal the Illinois Bar examinations, which he passed successfully in the fall of 1924.

Was it merely by chance, do you think, that in October of that year Mr. Bourscheidt was made Assistant Secretary and Office Manager of this great company, or that today he is being entrusted with greater and greater responsibilities?

Significant of the worth of this plan—in the eyes of Mr. Bourscheidt's associates—is the fact that 23



PAUL F. BOURSCHIEDT
Assistant Secretary, Peoria Life Insurance Co.

other people in the Peoria Life Insurance Company have enrolled with LaSalle for home-study business training. These other executives—both men and women—are out to compel larger success through the speeding up of practical experience.

Set Your Goal—Then Start Today

Why not pursue this plan of **DEFINITE OBJECTIVES**—try it out, at least, in the next few months?

In what field do you hope to gain success? Study the coupon below—then check the training that most clearly meets your needs, enter your name, address and present position, and mail the coupon to LaSalle.

It will bring you promptly—and without obligation—an interesting book descriptive of that field, together with a copy of "Ten Years' Promotion in One," the inspiring story that has set thousands of men on the shorter route to greater earning power.

Are you dreaming—drifting—or do you work toward **DEFINITE OBJECTIVES**? Answer that question with pen or pencil—on the coupon **NOW**.

— — — Find Yourself Through LaSalle! — — —

LaSalle Extension University

The World's Largest Business Training Institution

Dept. 964-R

Chicago

I would welcome an outline of the LaSalle plan, together with a copy of "Ten Years' Promotion in One," all without obligation.

- | | |
|---|---|
| <input type="checkbox"/> Business Management | <input type="checkbox"/> Law—Degree of LL.B. |
| <input type="checkbox"/> Modern Salesmanship | <input type="checkbox"/> Commercial Law |
| <input type="checkbox"/> Higher Accountancy | <input type="checkbox"/> Credit and Collection Correspondence |
| <input type="checkbox"/> Traffic Management | <input type="checkbox"/> Industrial Management |
| <input type="checkbox"/> Railway Station Management | <input type="checkbox"/> Modern Foremanship |
| <input type="checkbox"/> Banking and Finance | <input type="checkbox"/> Personnel Management |
| <input type="checkbox"/> Modern Business Correspondence | <input type="checkbox"/> Expert Bookkeeping |
| <input type="checkbox"/> Business English | <input type="checkbox"/> Commercial Spanish |
| <input type="checkbox"/> Effective Speaking | <input type="checkbox"/> C. P. A. Coaching |
| <input type="checkbox"/> Telegraphy | <input type="checkbox"/> Stenography—Stenotypy |

Name.....

Present Position.....

Address.....

BUILDERS TRADE GUIDES

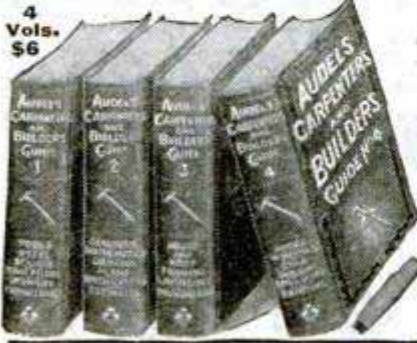

4 Vols. \$6

AUDELS CARPENTERS AND BUILDERS GUIDES—4 VOLS. \$6

Inside Information for Carpenters, Builders, Joiners, Building Mechanics—all Woodworkers. **1600 pages; 3700 diagrams; flexible; pocket size.** Short-cut instructions, new methods, ideas, solutions, plans, systems—money saving suggestions. An easy progressive course for the apprentice. A practical daily helper and Quick Reference for the master worker. A Helping Hand to Easier and Better Work and Better Pay. To get this aid for yourself, simply fill in and mail the FREE COUPON below.

INSIDE TRADE INFORMATION ON:

How to use steel square; How to file and set saws; How to build furniture; How to use mitre box; How to use chalk line; How to use rules; How to make joints; Carpenters' arithmetic; Mensuration problems; Estimating strength of timbers; How to set girders and sills; How to frame houses and roofs; How to estimate costs; How to build houses, barns, garages, bungalows, etc.; How to read and draw plans; Drawing up specifications; How to excavate; How to use settings 12, 13 and 17 on the steel square; How to build hoists and scaffolds—skylights; How to build stairs; How to put on interior trim; How to hang doors; How to lay floors; How to paint.

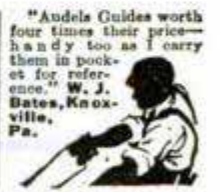

4 Vols. \$6

AUDELS PLUMBERS AND STEAMFITTERS GUIDES—4 VOLS. \$6

A new set—just out! A practical, illustrated, Reference Library and Study-Course for Master Plumbers, Journeymen and Apprentice Steamfitters, Gas Fitters and Helpers, Sheet Metal Workers, Draughtsmen, Master Builders, Engineers and all Building Trade Students. **1670 pages; 3642 diagrams; flexible; pocket size.** Guides explain all the principles, advances and short cuts of the Plumbing and Heating trade. Contains instructions on how to figure and estimate jobs. Use FREE COUPON below to examine, without obligation, this valuable work.

INSIDE TRADE INFORMATION ON:

Soldering, tinning, joint wiping, bending, beating. Pipe—iron—steel, threading. Mathematics, tables, physics. Materials—iron, steel, copper, brass, lead, tin, antimony. Sheet metal—galvanized—plate. Sanitation, syphonage, tanks. Drainage, sewage, purification. Fixtures—bath—kitchen. Pipe fittings, soil pipe, tools. Laying out work. Roughing. Screwed fittings, flanges, joints. Pipe bending, examples. Elbows. Heating, ventilation, refrigeration. Water supply, mains, wells, tanks. Gas-fittings. Underwriters. Sheet metal work, problems, methods, brazing, heating, lead burning. Welding, various welds, methods. Blacksmithing, forges, tools.

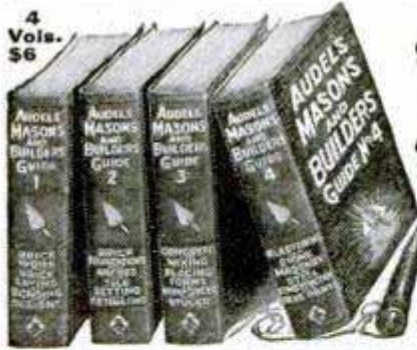

4 Vols. \$6

AUDELS MASONS AND BUILDERS GUIDES—4 VOLS. \$6

A new, complete, illustrated trade reference library, for Bricklayers, Cement Workers, Plasterers, Tile Setters and Stone Masons, including a practical outline of Steel Construction. **1100 pages; 2067 diagrams; flexible; pocket size.** A practical Trade Assistant explaining modern methods of masonry construction. Easy to understand and apply. A reliable and authentic reference work and study-course for Master Journeyman and Young Mechanic. Use FREE COUPON below and find out for yourself, without obligation, whether this set will benefit you.

INSIDE TRADE INFORMATION ON:

Bricklaying, tools, materials; Brick designs, patterns, bonds; Setting frames and foundations; Mortars, scaffolds, estimating; Mortars and mortar mixing; Tile setting, mosaic, hollow tile; Straight edge test, troweling; How to figure brick work; Safe loads, piers, chimneys; Boiler settings, anchors, fire stops; Labor tables; Concrete, forms; How to figure concrete work; Stucco—on old and new buildings; Plastering—wood lath—metal; Plasterers agreement; Plastering on various surfaces; Stonemasonry; Cutting, finishing, estimating stone; Derricks, rigging; Steel construction; Fire proof; How to read blue prints.



PRACTICAL ELECTRICITY — 1 VOL. \$4

Audels Handy Book of Practical Electricity is a simplified Ready Reference and Study Course in one pocket size, leather bound volume—for Engineers, Professional Electricians and Students. **1040 pages; 2600 diagrams; flexible red leather bound.** A reliable authority and handy helper for every electrical worker. Contains important and valuable wiring diagrams, calculations, machine sketches, helps on maintenance and repair. Use this FREE COUPON today and find out, without obligation, how this handy book will help you in your daily work.



INSIDE TRADE INFORMATION ON:

Electro-Therapeutics, X-Rays, Shocks, Welding, Brazing, Radio Hook-ups, Motion Pictures, Telephone, Telegraph, Cranes, Bells, Elevators, Pumps, Tools, Ship Drive, Railways, Vehicles, Automobile Electric Systems, Ignition, Generation, Lighting, Plant Management, Power Plans, Armature Winding, Repairing, A. C. Motors and Apparatus, D. C. Motors and Apparatus, Alternator Construction, Dynamos, Wiring Diagrams, Sign Flashers, Cable Splicing, Power Wiring, Outside Wiring, Switches, Lighting, Rectifiers, Converters, Transformers, Fuses, Circuit Breakers, Rheostats, Electro Plating, Electrolysis, Storage Batteries, Magnetism, Electrical Energy, Conductors, Insulators, Static, Dynamic, Radio Electricity, Applications, Ready Reference and Index Covering the entire field of Modern Electricity.

Learn More and You Will Earn More!

Know your job and you'll never be without one. The skilled man is always in demand. Knowledge is power. Learn your trade thoroughly by easy reading. This coupon is your opportunity for advancement and better pay. You risk nothing in sending for Audels Guides for free examination. Send it NOW!

FREE EXAMINATION COUPON

THEO. AUDEL & CO.,
65 W. 23 ST., NEW YORK CITY

Please mail me for free examination the books marked (x) below. If I find them satisfactory, I agree to mail \$1 in 7 days, on each set ordered, and to further mail \$1 monthly on each set until I have paid the purchase price.

4 CARPENTERS GUIDES \$6 4 PLUMBERS GUIDES \$6

4 MASONS GUIDES \$6 1 ELECTRICIANS HANDY BOOK \$4

NAME

ADDRESS

OCCUPATION

EMPLOYED BY..... 9T30



LEARN LEARN AUTOS AT HOME! *this New Easy* "JOB-WAY"

**SENT
FREE**

**AVIATION
COURSE also
INCLUDED
FREE of
Extra Cost**

**This book shows the way
TO QUICK SUCCESS - BIG PAY**

**Earn Up to
\$100 a Week**

Get out of the small pay crowd. Make pay-day a real event every week! Be an electrical and mechanical AUTO EXPERT. Unlimited opportunities for trained men in the World's Biggest Business—AUTOS! Mail coupon and get the facts. Learn how you can get in line for a big auto job paying up to \$100.00 a week by training at home in spare time. See how "JOB-WAY" Training has made quick success possible for hundreds of men who previously knew nothing of autos.

**DO IT
NOW!**

**MAKE
MONEY
QUICK**

"JOB-WAY" Training brings quick results. Many students make real money just a few weeks after starting. Listen to this: Morrision of Parkersburg, W. Va., when less than half through his course was making over \$50 a week; Deal of High River, Alberta, Can., a \$10 a week farm hand now makes \$100 a week; Summers of Statesville, N. C., was getting \$25 a week—now making \$50 to \$75. They give "JOB-WAY" full credit.

**GET INTO BUSINESS
FOR YOURSELF**

**COMMON SCHOOLING
ALL YOU NEED**

Don't work for someone else all your life. Be your own boss—give orders to others. Open a shop of your own and get big money. Start small and grow big—quick! Look at Ernest Tucker of Cotton, Minn. Within 15 weeks after enrolling he made as high as \$215.00 in a single week. "Job-Way" Training did it," says Tucker.

You don't need high school education—you don't need previous auto experience. If you like autos—if you're over 15 and under 55 and can read and write you can take "JOB-WAY" Training. Many men with but little education are becoming foremen, superintendents and shop owners after taking "Job-Way" Training.



Mail Coupon for Free Book!

Let me show you how this simple, easy "JOB-WAY" Training teaches you everything about autos, by mail, in your spare time. Learn what it has done for others—what it can do for you. Find out about the 4 Big Testing and Repair Outfits you get, and the Aviation Course, all without extra charge. Learn of the big money-making opportunities that are yours—if you ACT QUICK!

**I'LL HELP YOU GET
A JOB**

My Auto Book tells all about my employment service that is free to "JOB-WAY" Students as long as they live, how it helps them get the good jobs, promotions, raises in pay. Learn about my lifetime consultation service, also free of extra cost, and my money-back agreement. Clip coupon NOW!

B. W. Cooke, Directing Engineer,
Chicago Motor Training Corp.,
Dept. 11-66, 1916 Sunnyside Ave., Chicago.
Send me your free Auto Book which tells all about
"JOB-WAY" Training and how it will prepare me for
a big pay auto job. Also about the 4 big outfits and
the Aviation Course I get. No obligation to me.

Name.....
Address.....
Town..... State.....
Age..... Occupation.....

**B. W. COOKE, Directing Engineer
CHICAGO MOTOR TRAINING CORPORATION
Dept. 11-66, 1916 Sunnyside Ave., Chicago**

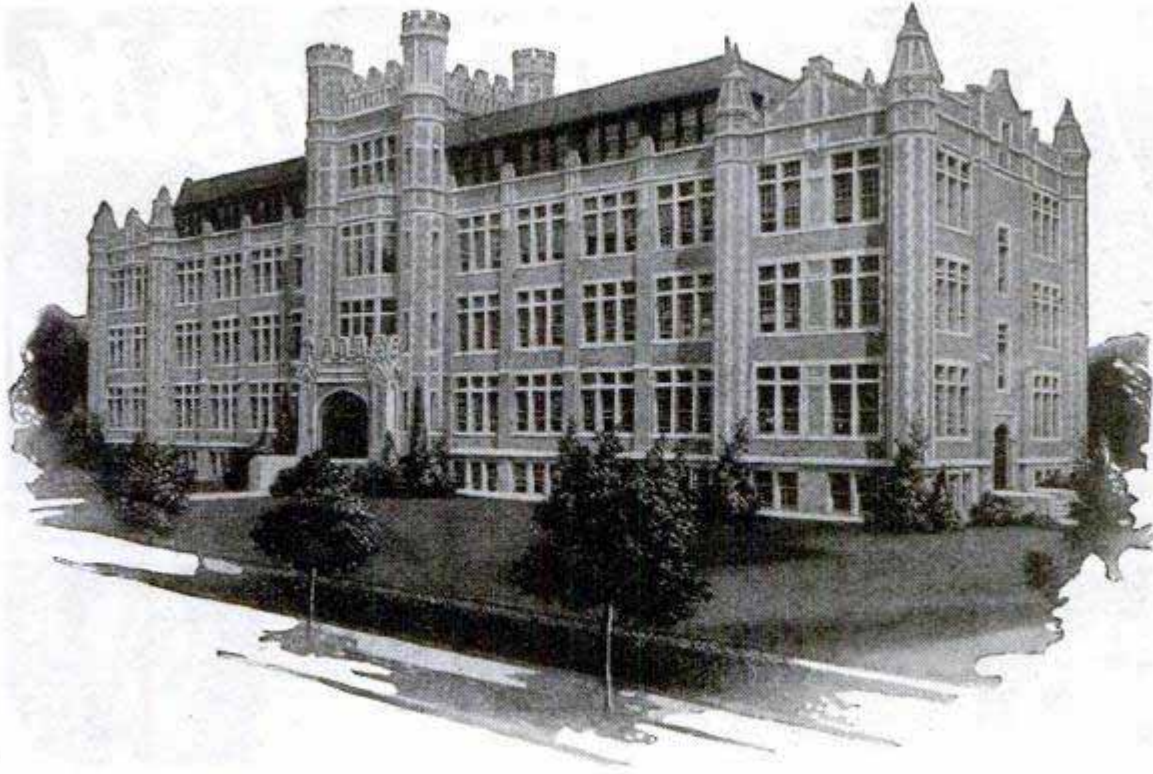

Go to High School at Home

You can secure a high school education right at home by studying the splendid new courses recently prepared by the International Correspondence Schools.

These courses are equivalent to the courses given in resident high schools. They have been specially arranged for men and women who wish to meet college entrance examinations, to qualify for a business position, or to make up the education they missed when forced to leave school too soon.

The College Preparatory Course, the High School Commercial Course and the High School English Course include English, algebra, ancient, medieval, modern and U. S. History, physiology, literature, geography, Latin, book-keeping, drawing, geometry, shorthand, physics, chemistry, salesmanship, advertising, civics, trigonometry, economics, American business law, corporation finance, money and banking, business and trade economics, etc. A diploma is given at graduation.

The lessons are easy to understand and you will make rapid progress because you will be *in a class by yourself* and you will study under the guidance of instructors who are sincerely interested in helping you to get ahead and achieve the bigger things in life.

Just mark and mail the coupon and we will gladly send you interesting free booklets

describing the High School Courses of the International Correspondence Schools or any other subject in which you are interested.

INTERNATIONAL CORRESPONDENCE SCHOOLS

"The Universal University"

Box 5557-F Scranton, Penna.

Without cost or obligation, please send me a copy of your booklet, "Who Wins and Why," and full particulars about the subject before which I have marked X in the list below:

- College Preparatory Course
- High School Commercial Course
- High School English Course
- High School Vocational Course
- High School Agricultural Course

BUSINESS TRAINING COURSES

- | | |
|--|---|
| <input type="checkbox"/> Industrial Management | <input type="checkbox"/> Advertising |
| <input type="checkbox"/> Personnel Management | <input type="checkbox"/> Business Correspondence |
| <input type="checkbox"/> Traffic Management | <input type="checkbox"/> Show Card and Sign Lettering |
| <input type="checkbox"/> Accounting and C. P. A. Coaching | <input type="checkbox"/> Stenography and Typing |
| <input type="checkbox"/> Cost Accounting | <input type="checkbox"/> English |
| <input type="checkbox"/> Bookkeeping | <input type="checkbox"/> Civil Service |
| <input type="checkbox"/> Secretarial Work | <input type="checkbox"/> Railway Mail Clerk |
| <input type="checkbox"/> Spanish <input type="checkbox"/> French | <input type="checkbox"/> Common School Subjects |
| <input type="checkbox"/> Salesmanship | <input type="checkbox"/> High School Subjects |
| | <input type="checkbox"/> Illustrating <input type="checkbox"/> Cartooning |

TECHNICAL AND INDUSTRIAL COURSES

- | | |
|---|--|
| <input type="checkbox"/> Electrical Engineering | <input type="checkbox"/> Architect |
| <input type="checkbox"/> Electric Lighting | <input type="checkbox"/> Architects' Blueprints |
| <input type="checkbox"/> Mechanical Engineer | <input type="checkbox"/> Contractor and Builder |
| <input type="checkbox"/> Mechanical Draftsman | <input type="checkbox"/> Architectural Draftsman |
| <input type="checkbox"/> Machine Shop Practice | <input type="checkbox"/> Concrete Builder |
| <input type="checkbox"/> Railroad Positions | <input type="checkbox"/> Structural Engineer |
| <input type="checkbox"/> Gas Engine Operating | <input type="checkbox"/> Chemistry <input type="checkbox"/> Pharmacy |
| <input type="checkbox"/> Civil Engineer | <input type="checkbox"/> Automobile Work |
| <input type="checkbox"/> Surveying and Mapping | <input type="checkbox"/> Airplane Engines |
| <input type="checkbox"/> Metallurgy and Mining | <input type="checkbox"/> Agriculture <input type="checkbox"/> Navigation |
| <input type="checkbox"/> Steam Engineering | <input type="checkbox"/> Mathematics <input type="checkbox"/> Radio |

Name.....

Street Address.....

City..... State.....

Occupation.....

Persons residing in Canada should send this coupon to the International Correspondence Schools Canadian, Limited, Montreal, Canada

You Daring Young Men Seize Life's Biggest Thrill!



The famous "Spirit of St. Louis" which flew from New York to Paris in the memorable non-stop flight May 20-21. Wide World Photo.

Get into Aviation

WHAT thrill could compare with this—what sport could bring you the tingling, breath-taking adventure of this fascinating, new occupation—the game for men with sporting blood! See life—win applause—thrills—big money—step into a field of excitement and daring—away from the monotony of tame, narrow humdrum everyday life!

Think what Aviation offers you. Thrills such as you never had before! The praise and plaudits of the multitude. And a chance to get in on the ground floor where rewards may be unlimited!

Amazing Opportunities

Aviation is growing so swiftly that one can hardly keep track of all the astonishing new developments. Air mail routes have just been extended to form a vast aerial network over the entire U. S. Airlines and airplane factories are springing up all over the country. Men like Henry Ford are investing millions in the future of commercial Aviation in America! The possibilities are so tremendous that they stagger imagination!

Everything is set for one of the greatest booms in history. Big fortunes came out of the automobile industry and out of motion pictures. Big fortunes will also come out of Aviation. The development of Aviation as an industry is bringing with it a call for trained men. Those who qualify quickly should find themselves on the road to

unusual earnings—success—popularity—and prominence.

Easy to Get Into Aviation by This Home Study Method

Get into the thrilling business at once while the field is new and uncrowded. Now—by a unique new plan—you can quickly secure at home, during spare time, the preliminary training necessary to get a start in the Aviation Industry. Experts will teach you the secrets—give you the inside facts that are essential to your success. And the study of Aviation by our method is almost as fascinating as the actual work itself. Every lesson is chock-full of interest—and so absorbing that you actually forget you are studying. But best of all are the ultimate rewards you are fitting yourself to gain.

Send for FREE Book

Send the coupon for our new, free booklet—*Opportunities in the Airplane Industry*. It is unusually interesting, reads like a romance, and gives vital facts about Aviation you probably never even dreamed of. You owe it to yourself to at least read it. We offer you a free copy now. No obligation. Mail the coupon for yours today.

American School of Aviation

Dept. 1356

3601 Michigan Ave.

Chicago, Illinois

NOW FREE



Pick Your Job!

Flying
Airplane Repairman
Airplane Mechanician
Airplane Inspector
Airplane Salesman
Airplane Assembler
Airplane Builder
Airplane Pilot
Airplane Instructor
Airplane Contractor
Airplane Engineer
Aerial Photography
Aerial Advertising

American School of Aviation,
Dept. 1356, 3601 Michigan Ave.,
Chicago, Ill.

Without obligation, please send me your FREE book, *Opportunities in the Airplane Industry*. Also information about your Home Study Course in Practical Aviation.

Name.....Age.....

Address.....

City.....State.....

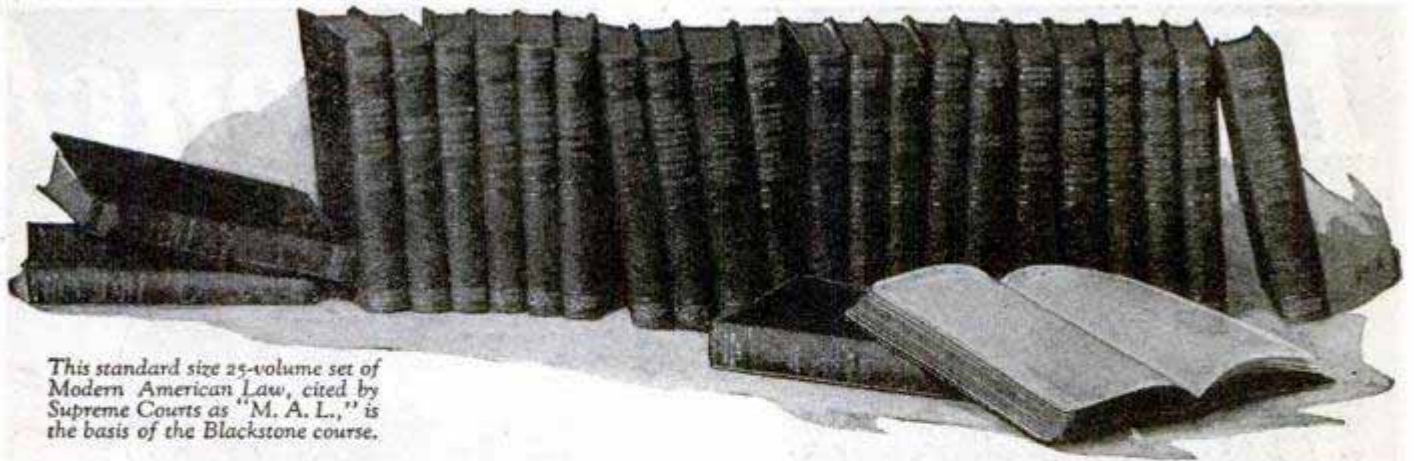

This standard size 25-volume set of Modern American Law, cited by Supreme Courts as "M. A. L.," is the basis of the Blackstone course.

LAW TRAINING=SUCCESS

THIS message is directed to the man who is contemplating the study of law—
And where is the man who has not at some time yearned for law training and the certainty of success it brings?

The Aristocrat of Studies

Law is the aristocrat among training courses. Law students are stamped as men of discernment and dignity. They are looked upon with respect.

A knowledge of law is an absolute necessity in every line of business or professional activity. Law enhances earning power and serves as the means of certain advancement. The demand for a law training is growing constantly.

For years the Blackstone Institute, through its home-study law course and service has been meeting and satisfying this demand. Today the Institute can point to more than 50,000 people, among them being corporation officials, business executives, bankers, lawyers, public accountants and others, who have received financial, personal or business benefits from this training. Graduates of the course are practicing law in every state.

The Outstanding Course

The Blackstone Institute delivers to its students immediately upon enrollment the complete set of text books for the entire course—not one volume at a time.

This is the famous 25-volume *Modern American Law* library, cited as standard and authoritative by the courts of last resort. (See illustration in miniature above.) This library forms the basis of the course and serves immediately as a valuable reference work upon the entire field of modern-day law. Many students have said that the library alone is worth the modest tuition fee asked for the entire course.

Elaborate Lesson Material

But the set of text books is only one part of this rather unusual course. There is, in addition, the elaborate lesson material mailed at regular intervals. The lessons direct the student's study efforts care-

fully, provide him with the written work to be done, and call his attention to rules of law pertaining to his regular daily affairs. LL. B. degree conferred.

This text and lesson material was prepared by a group of eighty of the most prominent law authorities in the United States. Included in the list of authors are Justices Taft and Sutherland of the United States Supreme Court, the deans of eight leading resident law schools, university law professors, and state supreme court judges.

No Exaggerated Claims

The Institute makes no claim that the study of its course will bring a startling increase in income to every student. Yet most students have reported increases, some as high as 200% before completing the course.

Neither does the Institute claim that a law training will enable you to earn from \$10,000 to \$35,000 a year, yet a great many law-trained men earn in excess of that.

The Institute does claim that a law training is the best foundation for a successful business or professional career, and that its course is without a peer in the field of non-resident law instruction.

Mail Coupon Today

The Institute prides itself on the value in text and lesson material delivered and the quality of educational service rendered. Full details may be had by asking for a copy of the Institute's 128-page book, "The Law-Trained Man."

Here again is definite value and full recompense for the effort involved in writing for your copy, for this little book contains some valuable legal tips and pointers which you can apply at once in your daily business affairs.

There is no charge for the book. It is free, and you may have a copy with our compliments if you will send a post card request or use the convenient coupon below. Address Blackstone Institute, Dept. 56, 307 N. Michigan Ave., Chicago, Ill.



GOOD REASONS

- 1 Blackstone Institute teaches one subject only—Law, and its present course is based on 36 years of experience in non-resident educational work.
- 2 The instruction method is a combination of text reading and study of leading illustrative cases—a method recognized as the best and most thorough plan yet devised.
- 3 The authors of the Blackstone course are outstanding authorities in the field of law. They know what law you need and how to teach it to you.

BLACKSTONE INSTITUTE

Dept. 56, 307 N. Michigan Ave., Chicago, Ill.

Please send me by mail, and without obligation, a copy of your 128-page book, "The Law-Trained Man," and details of your law course and service.

Name _____
 Business Position _____
 Business Address _____
 City _____ State _____

Here's 3 Free Lessons! in Auto Painting



We Furnish All Equipment!

Cars everywhere need painting! Painters' incomes running into thousands. That's the situation all over the United States today. Doesn't that move you to fill out and mail the coupon below to get the proof? The 3 free lessons are yours and you won't owe me a cent.

Are you making \$60.00 to \$125.00 a week now? Is your work so easy? **CAN YOU EVER BE YOUR OWN BOSS?**

Just your name and address brings full details—and the 3 free lessons to prove that you too can learn to be a real Auto Painter through my simple, easy shop-type method of home training.



You can practice at Home

You don't have to give up your present job. You can get ready in your spare time—in the evenings. It's fascinating. I furnish 13 big outfits with the course so you get actual experience on wood and metal panels as you go along—right at home. I'll soon have you fully prepared for a job anywhere. Places waiting for first class men at high pay.

You can tackle anything in the auto painting line with the utmost confidence after you've had my training. I'm "right at your elbow" to help you anytime you need me. I'm right here for *lifetime* consultation. All this for only a few pennies a day. Mail coupon! This may be the turning point of your life. Men like yourself now making \$5000 to \$10,000 a year!

I help you go into business

BOSS YOUR OWN BUSINESS! Get others to do the work for you. That's the way the **BIGGEST MONEY** is made. It is so easy to start an auto painting business of your own that you'll wonder why you never thought of it! I don't care whether you have a cent in the bank or not. *I'll show you the way.* And how this trade does grow! Set your stakes for the biggest Auto-painting business. By my plan you can *have it* some day and not so far in the future either. This business is here to stay—and now is the time to get into it.

GET THE PROOF

G. King Franklin, Supt.
American Auto Painting School
Dept. 1801, 425 S. Ashland Ave., Chicago

Send sample shop-tickets free and information on how I may learn auto painting and Duco at home in spare time.

Name.....
Street No.....
City..... State.....

FREE!



G. King Franklin
Superintendent

BIG PAY EVERYWHERE

Just get this—these opportunities are waiting for you NOW. And a few months puts you in line to go right up and grab one off. No long tedious course—nothing technical. I don't care what schooling you've had or have not had. If you are a normal red-blooded man with ambition I can give you just as fine an opportunity as any man in the business. The point is will you act now? Sign and mail the coupon—3 free lessons. No obligation.

G. KING FRANKLIN, Supt.
AMERICAN AUTO PAINTING SCHOOL
Dept. 1801, 425 South Ashland Avenue, CHICAGO



Speechless...When a Few Words Would Have Made Me!

But now I can face the largest audience without a trace of stage fright

THE annual banquet of our Association—the biggest men in the industry present—and without a word of warning the Chairman called on me to speak—and my mind went blank! I half rose from my seat, bowed awkwardly and mumbled. "I'm afraid you'll

have to excuse me today," and dropped back in my chair.

Speechless—when a few words would have made me! The opportunity I had been waiting for all my life—and I had thrown it away! If I could have made a simple little speech—giving my opinion of trade conditions in a concise, witty, interesting way, I know I would have been made for life!

Always I have been a victim of paralyzing stage fright. Because of my timidity, my diffidence, I was just a nobody, with no knack of impressing others—of putting myself across. No matter how hard I worked, it all went for nothing—I could never win the big positions, the important offices, simply because I was tongue-tied in public.

And then like magic I discovered how to overcome my stage fright—and I was amazed to learn that I actually had a natural gift for public speaking. With the aid of a splendid new method, I rapidly developed this gift, until, in a ridiculously short time, I was able to face giant audiences—without a trace of stage fright!

Today I am one of the biggest men in our industry. Scarcely a meeting or banquet is held without me being asked to speak. My

real ability, which was hidden so long by stage fright, is now recognized by everyone. I am asked to conferences, luncheons and banquets as a popular after-dinner speaker. This amazing training has made me into a self-confident aggressive talker—an easy, versatile conversationalist—almost overnight.

* * * *

No matter what work you are now doing nor what may be your station in life; no matter how timid and self-conscious you now are when called upon to speak, you can quickly bring out your natural ability and become a powerful speaker. Now, through an amazing new training you can quickly shape yourself in to an outstanding influential speaker, able to dominate one man or five thousand.

In 20 Minutes a Day

This new method is so delightfully simple and easy that you cannot fail to progress rapidly. Right from the start you will find that it is becoming easier and easier to express yourself. Thousands have proved that by spending only 20 minutes a day in the privacy of their own homes they can acquire the ability to speak so easily and quickly that they are amazed at the great improvement in themselves.

Send for this Amazing Booklet
This new method of training is fully described in a very interesting and informative

booklet which is now being sent to everyone mailing the coupon below. This booklet is called *How to Work Wonders with Words*. In it you are told how this new, easy method will enable you to conquer stage fright, self-consciousness, timidity, bashfulness and fear. Not only men who have made millions but thousands of others have sent for this booklet and are unstinting in their praise of it. You are told how you can bring out and develop your priceless "hidden knack"—the natural gift within you—which will win for you advancement in position and salary, popularity, social standing, power and real success. You can obtain your copy absolutely free by sending the coupon.

Now Sent Free



NORTH AMERICAN INSTITUTE
3601 Michigan Ave.
Dept. 1356 Chicago

- What 20 Minutes a Day Will Show You**
- How to talk before your club or lodge
 - How to address board meetings
 - How to propose and respond to toasts
 - How to make a political speech
 - How to tell entertaining stories
 - How to make after-dinner speeches
 - How to converse interestingly
 - How to write better letters
 - How to sell more goods
 - How to train your memory
 - How to enlarge your vocabulary
 - How to overcome stage fright
 - How to develop self confidence
 - How to acquire a winning personality
 - How to strengthen your will-power and ambition
 - How to become a clear, accurate thinker
 - How to develop your power of concentration
 - How to be the master of any situation

North American Institute
3601 Michigan Avenue
Dept. 1356, Chicago

Please send me FREE and without obligation my copy of your inspiring booklet, *How to Work Wonders with Words*, and full information regarding your course in Effective Speaking.

Name.....
Address.....
City..... State.....

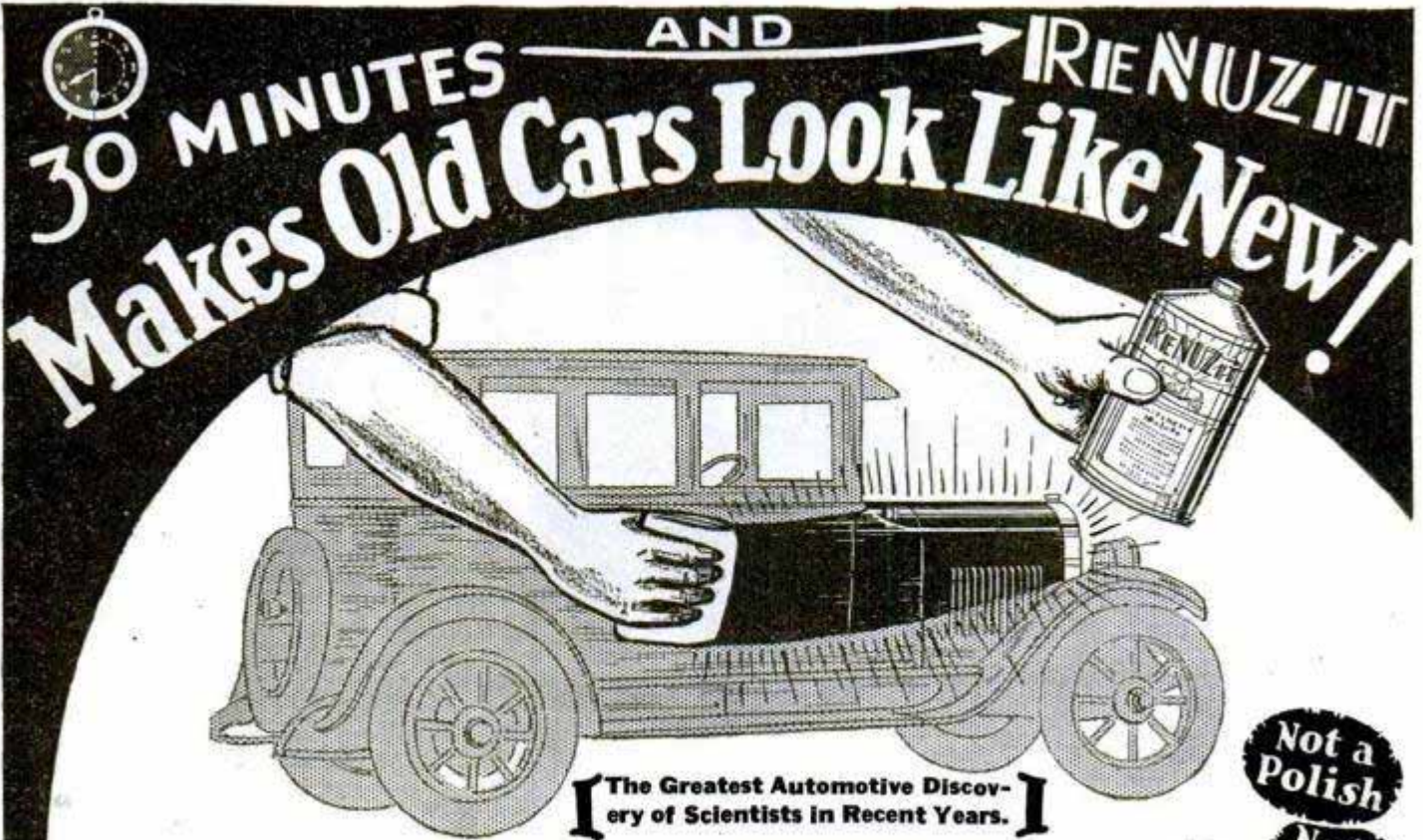

The Motor World is astounded at this marvelous scientific Fluid that transforms old, run-down looking cars into smartly gleaming new ones in the time it takes the minute hand of your watch to travel from "12" to "6"—not more than 30 minutes. Try it yourself without risking a cent. You'll get a thrill you won't forget!

Not a Polish
Not a Paint
Not a Cleaner
Not a Wax

AGENTS NEW PLAN—MAKE \$50. A DAY

Millions are waiting to buy ReNUZit. For every one of the thousands of new cars on the streets today there are at least 20 OLD ones—and more are losing the bloom of youth every day. What a whale of an opportunity for the man who thinks quick enough to seize a good thing when it's new! That is why ReNUZit Agents all over the country can make almost unbelievable profits. ReNUZit is the big sensation they are all talking about and eager to try. And our proposition is so GOOD that you should have no trouble making \$50.00 a day and up. It costs nothing to investigate. You can't afford not to.

How This New Miracle Fluid Works

You just flow ReNUZit onto any automobile with a piece of cheesecloth and instantly the ORIGINAL color and lustre of that car is like new again! Not a polish, cleaner, wax or paint, but a marvelous chemical discovery that restores the sparkling beauty of any automobile or any painted, lacquered or enameled surface in the twinkling of an eye. No tiresome rubbing or polishing. Harmless—Lasting—Sure. Simple to apply as "A B C"—Dries almost immediately. No trouble—No bother—No mess.

MAIL THIS COUPON

Car Stays Like New!

ReNUZit not only restores the faded, dull or worn surface of any car to its original showroom beauty but **KEEPS IT THAT WAY.** Just mail coupon for free trial and see for yourself.

Test ReNUZit Free!

You have the privilege of trying ReNUZit yourself right now without risk or obligation. Prove to yourself what miracles it accomplishes. See your own car being transformed to a thing of glistening beauty! Send coupon TODAY for full details and Free Test Offer.

CURTAN MFG. CO.
154 E. Erie St.

Dept. 805-M.R., Chicago, Ill.

ReNUZit Service Stations Bring \$1,000 a Month

It is easy to see why so many men can get into the big money class operating ReNUZit Service Stations. By this we mean real money—\$10,000 to \$12,000 a year! They can make big incomes transforming Auto-Owners' old cars into New ones in 30 minutes! This is the sensational new business that is taking the motor world by storm. Think of the millions of cars in use that need refinishing. Car owners are crying for just such a LASTING Finish as ReNUZit. The need is far greater than the number of service stations. This is YOUR chance to get into a fine big-paying business, without risking any capital. Send coupon for the thrilling story of ReNUZit and Your wonderful opportunity to make \$12,000.00 a year. Do it Now!

Curtan Mfg. Co.,
154 E. Erie St.,
Dept. 805-M.R.,
Chicago, Ill.

Rush full details of ReNUZit, with Free Trial Offer, and Agent's New Plan on how I can make \$50.00 a day. No obligation.

Name.....
Address.....
City..... State.....

How Strong Are You?

Can You Do These Things?

Lift 200 lbs. or more overhead with one arm; bend and break a horseshoe; tear two decks of playing cards; bend spikes; chin yourself with one hand.

CAN you do any of them? I can and many of my pupils can. It is remarkable the things a man really can do if he will make up his mind to be strong. It is natural for the human body to be strong. It is unnatural to be weak. I have taken men who were ridiculed because of their frail make-up and developed them into the strongest men of their locality.

I Want You for 90 Days

These are the days that call for speed. It once took four weeks to cross the ocean—now it takes less than one. In olden days it took years to develop a strong, healthy body. I can completely transform you in 90 days. Yes, make a complete change in your entire physical make-up. In 30 days I guarantee to increase your biceps one full inch. I also guarantee to increase your chest two inches. But I don't quit there. I don't stop till you are a finished athlete—a real strong man. I will broaden your shoulders, deepen your chest, strengthen your neck. I will give you the arms and legs of a Hercules. I will put an armor plate of muscle over your entire body. But with it come the strong, powerful lungs which enrich the blood, putting new life into your entire being. You will be bubbling over with strength, pep and vitality.

A Doctor Who Takes His Own Medicine

Many say that any form of exercise is good, but this is not true. I have seen men working in the factories and mills who literally killed themselves with exercise. They ruined their hearts or other vital organs, ruptured themselves or killed off what little vitality they possessed.

I was a frail weakling myself in search of health and strength. I spent years in study and research, analyzing my own defects to find what I needed. After many tests and experiments, I discovered a secret of progressive exercising. I increased my own arms over six and a half inches, my neck three inches and other parts of my body in proportion. I decided to become a public benefactor and impart this knowledge to others. Physicians and the highest authorities on physical culture have tested my system and pronounced it to be the surest means of acquiring perfect manhood. Do you crave a strong, well-proportioned body and the abundance of health that goes with it? Are you true to yourself? If so, spend a pleasant half hour in learning how to attain it. The knowledge is yours for the asking.

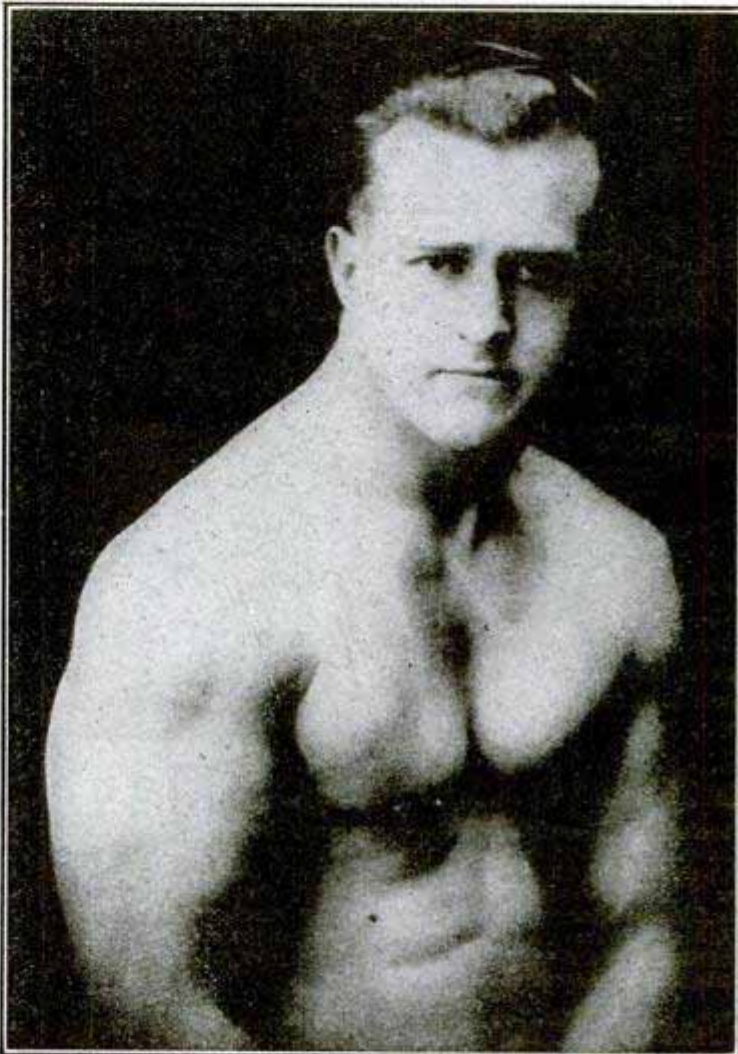

EARLE LIEDERMAN, The Muscle Builder
 Author of "Science of Wrestling," "Muscle Building,"
 "Secrets of Strength," "Here's Health," "Endurance," Etc.

Send For My New
 64 Page Book

"Muscular Development"

IT'S FREE

It contains forty-eight full-page photographs of myself and some of the many prize-winning pupils I have trained. Some of these came to me as pitiful weaklings, imploring me to help them. Look them over now and you will marvel at their present physiques. This book will prove an impetus and a real inspiration to you. It will thrill you through and through. This will not obligate you at all, but, for the sake of your future health and happiness, do not put it off. Send today—right now, before you turn this page.

EARLE LIEDERMAN

Dept. 2009, 305 Broadway, New York City

DON'T
 SEND ONE
 PENNY
 —
 YOUR
 NAME AND
 ADDRESS
 ON A
 POSTAL
 WILL DO

EARLE LIEDERMAN

Dept. 2009, 305 Broadway, New York City

Dear Sir: Please send me, without any obligation on my part whatever, a copy of your latest book, "Muscular Development." (Please write or print plainly.)

Name.....

Street.....

City..... State.....

We Will Train You in a Few Months



Day and Night Schools in Chicago Detroit Cleveland Boston Phila.

Experts Earn Up To \$125 a Week

as MECHANICAL DENTISTS

We teach you to make rubber plates, crowns, bridge work, metal base dentures, etc., for dentists. After graduating you are ready for a job or can open your own laboratory. We assist you.



Big Demand for Men!

Mechanical Dentistry is the laboratory bench work which the dentist turns over to the laboratory worker. Master this profession and help meet the demand of 64,000 dentists for laboratory work. Every city and every town where dentists are located offers work to the mechanical dentist. We train you in a few months in day or night school for this uncrowded field—no classes—no books—no mechanical experience necessary.

Work Your Way Thru School

We will help you find a job to meet your expenses while taking our training. And we will help you find satisfactory living quarters when you arrive. Schools located in *Chicago, Detroit, Cleveland, Boston, Philadelphia.* Day and night schools.

INTERESTING FREE BOOK

Our illustrated, free book on Mechanical Dentistry will acquaint you with some surprisingly interesting facts. It tells about the thriving profession of Mechanical Dentistry—the way to swift and certain success. And it tells about the progress of many of our graduates—men who have succeeded beyond their expectations, also full details of our liberal offers. Mail the coupon and find out more about this fascinating opportunity.

McCarrie School of Mechanical Dentistry
1338 S. Michigan Ave., Dept. 179, Chicago, Ill.

McCARRIE SCHOOL OF MECHANICAL DENTISTRY
1338 S. Michigan Ave., Dept. 179, Chicago

Without cost or obligation, send me your illustrated book on Mechanical Dentistry, and complete information as to my opportunities in dental laboratory work.

Name.....

Address.....



Young men needed by Davey Tree Expert Co.

Interesting, vigorous outdoor work in a growing organization where merit wins advancement. Good starting wages. Permanent positions and a real future for men who make good. Our present field force of Davey Tree Experts cannot meet the increasing demand. So we are selecting now, to enter our employ, a few sturdy, clean young men, thorough Americans, single, between 20 and 30 years old, free to travel, industrious, with good practical education, and able to give good references. Write for qualification blank to serve in place of personal interview. The Davey Tree Expert Co., Inc., 119 Federal Bldg., Kent, Ohio.

IF YOU STAMMER

Write for my free book "Millard's Advanced Natural Corrective Course" and a free copy of my speech magazine. 10,000 cases successfully treated. Est. 24 years. Largest school for stammerers in world. Millard Inst. of Normal Speech, 2317 Millard Bldg., Milwaukee, Wis.



TRAVEL for "Uncle Sam"

New Bandit Proof Railway Mail Car

U.S. GOVERNMENT JOBS \$1140 TO \$3000 YEAR

Men—Boys, 18 Up

Steady Work
Paid Vacations
Common Education
Usually Sufficient
Mail Coupon
—Today
SURE

FRANKLIN INSTITUTE
Dept. G173, Rochester, N. Y.

Gentlemen: Rush to me without charge 52-page book with list of U. S. Government big paid positions now obtainable and sample coaching. Advise me regarding the salaries, hours, duties, vacation and full particulars.

Name.....
Address.....

COUPON

Last Year's Pay Looks Like Small Change to These Men Today!



\$525 a Week

Wm. Shore, Neenach, Cal., a former cow-puncher, reports earning \$525 in a single week as a salesman. He earned \$3,000 in 5 months just after completing N. S. T. A. training.



\$2,500 Increase

As a pattern-maker, the income of Kingsley Rowland, Audubon, N. J., was limited to \$1,500 a year. Now he writes that it is about \$4,000, thanks to N. S. T. A.



\$10,000 a Year

R. B. Hansen, Akron, O., writes that he jumped his earnings from \$160 a month to \$10,000 a year as a result of reading the amazing book, "Modern Salesmanship."



\$7,200 a Year

F. J. Walsh, Springfield, Mass., thanks N. S. T. A. training for his sensational rise from \$1,000 a year as a clerk to over \$7,200 a year.



\$700 a Month

L. O. Halloman, Roswell, New Mex. was a farmer. He wanted to be a salesman and N. S. T. A. helped him. Now he says his earnings are \$700 in one month.



\$4,800 More

F. B. Englehardt, Chattanooga, Tenn., writes that he raised his pay \$4,800 after reading "Modern Salesmanship." He credits N. S. T. A. with a great deal of his success.

Here Are Six Men Who Were Formerly Caught in the Hopeless Treadmill of Low-Pay Jobs. Today Every One of Them Reports Earnings from \$4,000 up to \$10,000 a Year! Right Now — the Same Opportunity That Changed Their Lives So Completely Is Open to YOU! Don't Fail to Read Every Word of This Vital Message!

WHEN a man who has been struggling along in a low-pay job suddenly steps out and starts earning real money—\$5,000, \$7,500 or \$10,000 a year, he usually gives his friends quite a shock. It is hard for them to believe that he is the same man they used to know. Take one of the men whose pictures appear on this page—Kingsley Rowland of New Jersey, for example. His pals in the shop where he was working as a pattern-maker laughed at his ambitions to make more money. But he knew what he wanted, and he set about getting it in the shortest possible way. A remarkable free book, "Modern Salesmanship," opened his eyes to the opportunities in the selling profession. This book proved that Master Salesmen are *made*, not "born." It told facts and secrets about money-making that were a positive revelation. And best of all, it outlined a simple plan that enables men from all walks of life to quickly reach the top without spending years on the road—without losing a day or a dollar from their present positions!

A Few Weeks—Then Bigger Pay

Rowland seized the opportunity to qualify as a Master salesman, and has richly profited by it. He now reports an increase of \$2,500 in his pay, and his future possibilities are unlimited. Some of his former friends perhaps say he was "lucky." He was. But his "luck" lay in his decision to cast his lot with the N. S. T. A. Thousands of other men have been similarly "lucky." Some report increases ranging up to 900%. They have forgotten the days when they were caught in the rut—but they never forget that they owe a great part of their success to N. S. T. A. training.



Dept. M-101, N. S. T. A. Bldg., Chicago, Illinois

Send for This FREE BOOK



National Salesmen's Training Assn.
Dept. M-101, N. S. T. A. Bldg.,
Chicago, Ill.

Without cost or obligation I will accept a copy of your book, "Modern Salesmanship," and details of your System of Training and Free Employment Service.

Name.....

Address.....

City..... State.....

Age..... Occupation.....

You may have doubts in your own mind about how salesmanship can help you to solve your own problem. If so, we cannot urge you too strongly to read the same fascinating message that inspired Rowland, Shore, Englehardt, and the thousands of others who took this remarkable short cut to success. If we were asking two or three dollars a copy for "Modern Salesmanship," you might hesitate. But it is now FREE! See for yourself what salesmanship has done for others—and what the National Salesmen's Training Association stands ready to do for you. No matter what your present thoughts on selling are, "Modern Salesmanship" will give you a new insight into this fascinating and highly-paid profession. Mail the coupon for your Free copy Now!

Amazingly Easy Way to Get Into *Where Thousands Earn*

Don't spend your life waiting for \$5 raises in a dull, hopeless job. Now . . . and forever . . . say good-bye to 25 and 35 dollars a week. Let me show you how to qualify for jobs leading to salaries of

Learn on Actual Electrical Machinery in 90 Days

LACK of experience—age or advanced education bars no one. I don't care if you don't know an armature from an air brake—I don't expect you to! It makes no difference! Don't let lack of money stop you. Most of the men at Coyne have no more money than you have. That's why I have worked out my astonishing offers.

Free Employment Service

Many of my students earn a good part or all their living expenses and should you need this assistance we will help you. Then, in 12 brief weeks, in the great roaring shops of Coyne, I train you as you never dreamed you could be trained . . . on one of the greatest outlays of electrical apparatus ever assembled . . . real dynamos, engines, power plants, autos, switchboards, transmitting stations . . . everything from door-bells to farm power and lighting . . . full-sized . . . full operation every day!

Now in Our New Home

This is our new, fireproof, modern home, wherein is installed thousands of dollars worth of the newest and most modern Electrical Equipment of all kinds. We now have a larger amount of floor space devoted to the exclusive teaching of practical electricity. Every comfort and convenience has been arranged to make you happy and contented during your training.

COYNE

500 South Paulina St.
Est. 1899 H. C. Lewis, Pres.



ELECTRICITY

Salaries of \$60 to \$200 a Week

\$50, \$60 and up, a week, in Electricity—NOT by correspondence, but by an amazing way to train, that makes you a practical electrician in 90 days! Getting into Electricity is far easier than you imagine!

Not a Correspondence School

Learn by doing . . . all real actual work . . . building real batteries . . . winding real armatures, operating real motors, dynamos and generators, wiring houses, etc. That's a glimpse of how we help to make you a practical electrician, and fitting you to hold big jobs after graduation.

Jobs—Pay—Future

Don't worry about a job. Coyne training settles the job question for life. Big demand for Coyne trained men. Our employment department gives you lifetime service. Two weeks after graduation, Clyde F. Hart got a position as electrician with the Great Western R. R. at over \$100 a week. That's not unusual. We can point to many Coyne men making up to \$600 a month. \$60 a week is only the beginning of your opportunity. You can go into radio, battery or automotive electrical business for yourself—and make \$3000 a year and up.

GET THIS BIG BOOK FREE

Coyne is your one great chance to get into electricity. Every obstacle is removed. This school is 29 years old—Coyne training is tested—proven beyond all doubt—endorsed by many large electrical concerns. You can find out everything absolutely free. Simply mail the coupon and let me send you the big, free Coyne book of 150 photographs . . . facts . . . jobs . . . salaries . . . opportunities. Tells you how many earn expenses while training and how we assist our graduates in the field. This does not obligate you. So act at once. Just mail coupon.

ELECTRICAL SCHOOL

Dept. 68-72, Chicago, Ill.

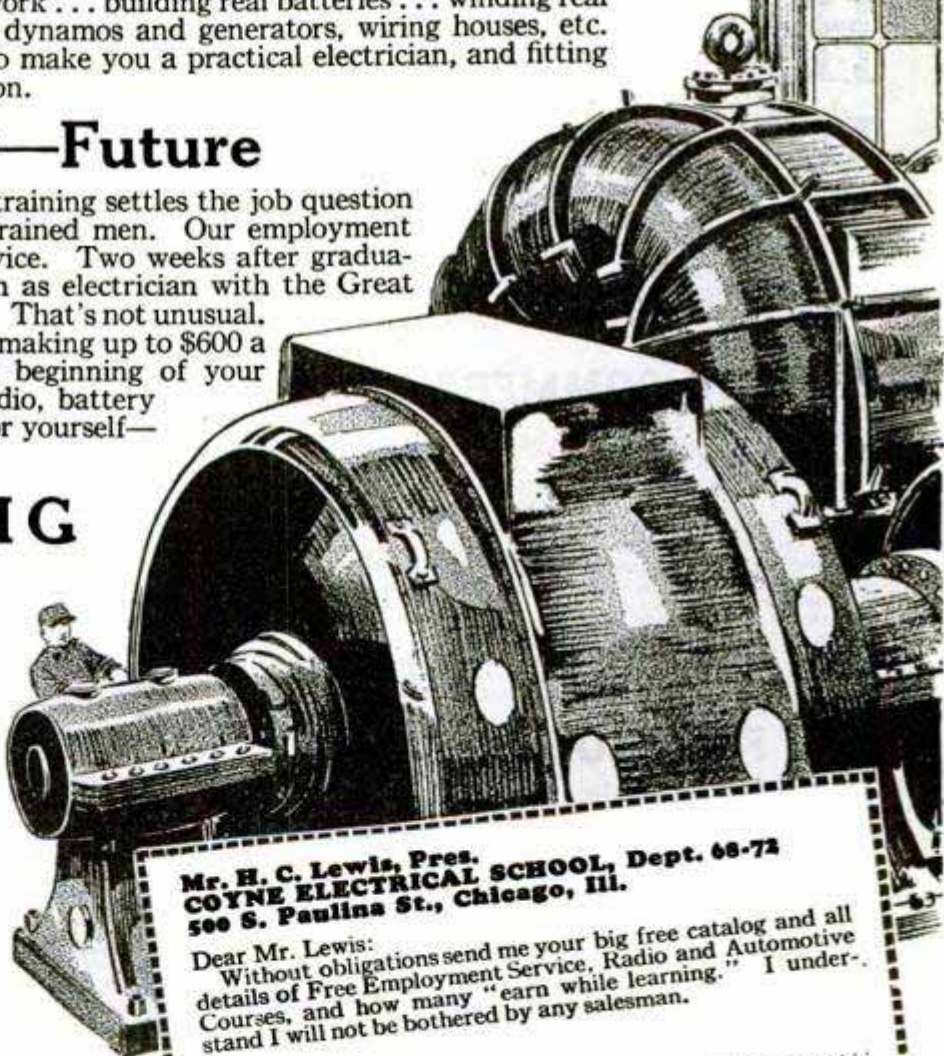

Mr. H. C. Lewis, Pres.
COYNE ELECTRICAL SCHOOL, Dept. 68-72
500 S. Paulina St., Chicago, Ill.

Dear Mr. Lewis:
Without obligations send me your big free catalog and all details of Free Employment Service, Radio and Automotive Courses, and how many "earn while learning." I understand I will not be bothered by any salesman.

Name.....

Address.....

City.....

State.....



Here is Edwin McTeer (address on request) and some of his work. The crude pen drawing was made before he had any training and the striking story illustration (worth \$100) was made after he took the Federal Home Study Course.

He did it— Why don't you?

Edwin McTeer is only one of the hundreds of young men (and young women, too) who are succeeding in commercial art with the help of the practical training offered by the Federal Home Study Course. Well trained artists earn \$50, \$75, \$100, \$150 a week and more.

SUCCESS IN COMMERCIAL ART

begins with a liking for drawing and the ambition to follow through with the right training. Mr. McTeer was thirty years old when he clipped a coupon like the one at the bottom of this ad, and took up the Federal Course. He progressed rapidly, increasing his earnings each year until, at the end of five years he was making around \$10,000 a year. Read what he wrote us:

"I was not very talented when I entered this training with you people as you certainly know, and I had not even had high school training and I know any one with a love for the work can accomplish even more than I if they will just let you people, the Federal Schools, help them.

"I suppose you remember I opened my own independent commercial art studio and to make a long story short, my earnings are now at the rate of over \$10,000.00 a year."

SEND FOR "YOUR FUTURE"

If you like to draw—send for book "Your Future" and find out what amazing progress you can make with the right art training. Use the coupon now, giving age and occupation.

Federal
School
of Commercial Designing



637 Federal Schools Bldg., Minneapolis, Minn.
Please send me "Your Future."

Present
Age Occupation

Name

Address

THE CHICAGO DAILY NEWS School and College Bureau

Offers You Its Specialized Services in Choosing a School

Last year the School and College Bureau of The Chicago Daily News saved many busy parents and questioning boys and girls both time and worry by sending them prompt, reliable information about just the kind of school they wanted—personal requirements as to location and tuition charges being considered in each individual case.

Again this year many young people will be perplexed by the problem of finding the right school. Why not let us help you?

The Chicago Daily News maintains this service absolutely free of charge to you. No need to hurriedly select a school on mere hearsay when expert advice can be obtained by telephoning Dearborn 1111, writing or calling for a personal interview at

THE CHICAGO DAILY NEWS
School and College Bureau
Dept. K, 15 N. Wells St., Chicago, Illinois

**Learn Watchwork, Jewelrywork
and Engraving** A fine trade commanding a good salary, and your services always in demand. Address **Horological**, Dept. P, Bradley Institute, PEORIA, ILLINOIS, for our latest catalog.



WHY NOT spend Spring, Summer and Fall gathering butterflies, insects? I buy hundreds of kinds for collections. Some worth \$1 to \$7 each. Simple outdoor work with my instructions, pictures, price-list. Send 10 cents (not stamps) for my illustrated Prospectus before sending butterflies.
MR. SINCLAIR, DEALER IN INSECTS,
Dept. G, Box 1424, San Diego, Calif.



U. S. GOV'T TRAVELING OR LOCAL
\$110 TO \$250 MONTH

[] Railway Mail Clerk	[] Meat Inspector
[] P. O. Clerk	[] Special Agent
[] P. O. Laborer	[] (Investigator)
[] File Clerk	[] Stenographer-Typist
[] Matron	[] Immigrant Inspector
[] General Clerk	[] City Mail Carrier
[] Chauffeur-Carrier	[] U. S. Border Patrol
[] Skilled Laborer	[] Typist
[] Watchman	[] Seamstress
[] Postmaster	[] Steno-Secretary
[] RFD carrier	[] Auditor

MENT INSTRUCTION BUREAU, Dept. 111-A, St. Louis, Mo.
Send me particulars about positions marked "X"; salaries, locations "How to Qualify" opportunities, etc.

Name

Address

IF —

you pledge yourself
to secrecy we will teach you the secrets
of Real Professional

Magic

For the first time in the history of Magic the age-old, sacredly guarded secrets of the Mystic Art are being revealed. Now at last you can learn to be a Real Professional Magician. Yes, and you can learn this wonderful art *easily and quickly* AT HOME! — BY MAIL! You are taught the mysterious *Principles* by which the Professional Magician works. You are taught everything from wonderful impromptu effects to massive stage illusions.



Dr. Harlan Tarbell
Master of Magic
who has mystified magicians
as well as laymen with his
marvelous tricks.

Earn \$250 to \$1000 a Month

There's a big demand for Magic entertainment. Magicians get big money. Dr. Tarbell gets as high as \$250 for a half hour's work. Unlimited opportunities for you!

but

—before you can study, you must sign the Magician's Solemn Pledge of Secrecy. This means that you are getting the jealously *guarded secrets* of the Magic Profession. Think of that!

Magic Book FREE →

Write! Mail coupon now for big free Magic Book telling all about the great Tarbell Course in Magic. Find out how you can learn to be a real magician—easily and quickly!—at home!—by mail! Learn what I have done for others—people just like yourself. **Get our Low Prices and Easy Payment Plan. Mail coupon NOW!**

Tarbell System, Inc., Studio 13-56
1920 Sunnyside Avenue, Chicago, Ill.

Gentlemen: Without any obligation send me your free literature and information all about your wonderful "Tarbell Course in Magic." Also tell me about your low prices and Easy Payment Plan.

Name

Address

Age



Freedom
from a
Small-Pay Job

Come to New York
the city of 100,000 jobs

ANY MAN who can read and write and use a pair of pliers can become an electrical expert and free himself forever from the long hours and drudgery of a small pay job.

And you can learn the **BIG PAY** profession of electricity right in New York City—the heart of the electrical world—the city of 100,000 jobs. At the same time you are learning the **BIG PAY** profession you can be enjoying the sights and wonders of New York, the modern Bagdad.

Be An Electrical Expert

Graduates of the **NEW YORK ELECTRICAL SCHOOL** are in demand by all the big electrical companies. Or, if you prefer the independence of a business of your own, there are thousands of opportunities for efficient, **dependable** men to become electrical contractors. When you are your own boss the money you can make is limited only by your own energy and ability.

Personal Instruction

The **NEW YORK ELECTRICAL SCHOOL** is not a correspondence school. You learn by doing—by personal instruction on full size standard electrical equipment under the personal supervision of trained instructors.

At **N. Y. E. S.** you train your hands and mind at the same time. You learn the theories of electricity—and then you are shown how to put the theories into actual practice by solving the problems with **your own hands**.

The man who has learned electricity by actually doing electrical work under intelligent personal instructors can go to any part of the world and be sure of a good living. There are **N. Y. E. S.** graduates in all the countries of the world.

Write today for the 48-page booklet giving full information about the **N. Y. E. S.** Course and showing pictures of the equipment available for your personal use in our two seven-story buildings. Mail coupon *now!* The New York Electrical School, 44 W. 17th Street, New York.

The New York Electrical School
44 W. 17th Street, New York

Please send me **FREE** your 48-page booklet. It is understood that this request puts me under no obligation.

Name.....

Address.....

GIVEN TO YOU



Choose **ANY**
\$20 Musical Instrument

Yes, we will give you without extra cost a \$20.00 quality **Violin, Tenor Banjo, Hawaiian Guitar, Banjo, Banjo-Guitar, Cornet, Guitar, Mandolin or Banjo-Mandolin.** Learn to play by note. We teach men, women, boys and girls by mail. Amazing new, simplified method. A few cents a day pays for Lessons. Instrument and first lesson sent on **FREE TRIAL.** Over 500,000 successful pupils. Write today.
CHICAGO CORRESPONDENCE SCHOOL OF MUSIC, INC.
1632 North Halsted Street, Dept. 708, Chicago, Illinois.

LEARN WATCH REPAIRING



You can learn by our modern and original system of instruction every part of the **Watch Repairing Trade** at home as good or better than at a shop. You can earn money while learning and secure a well paying position or start in business after completing our course of instruction. Good watch repairers are always in demand and earn from \$50 to \$75 per week. For particulars apply to the **Wisconsin School of Watch Repairing**
166 Mason St., MILWAUKEE, WIS.

A VOCATIONAL TRADE



OPEN TO MEN OF ALL AGES
EARN UP TO \$125 A WEEK
Great demand now and always will be. Easy to learn by actual practice. Three to six months' training. Special rates now, starting fees as low as \$15. R. R. Fare to nearest school included. Part time positions to help you pay expenses. Ask for Catalog 2.
BODEE INSTITUTE

New York
1756 Broadway

Philadelphia
1805 North Broad Street

Brooklyn
85 Court Street

Learn Advertising at HOME

Send your name and address for free booklet giving interesting information and vital facts about Advertising. Find out how we prepare you at home, in your spare time, for the opportunities open in this fascinating business. Practical work. No text books. Old established school. Successful graduates everywhere. Just the plan you have always wanted. Write today. No obligation.

PAGE-DAVIS SCHOOL OF ADVERTISING
Dept. 1358 3601 Michigan Ave. Chicago, U. S. A.

Learn to PAINT SIGNS and SHOW CARDS

We quickly teach you by mail, or at school, in spare time. Enormous demand. Big future. Interesting work. Oldest and foremost school.
EARN \$50 TO \$200 WEEKLY
John Vassos, N. Y., gets \$25 for single show card. Crawford, B. C., writes: "Earned \$200 while taking course." Don't delay. Send today for complete information, samples and guarantee.



DETROIT SCHOOL OF LETTERING
150 Stinson Ave. Est. 1899. DETROIT, MICH.



Wonderful, new device, guides your hand; correct your writing in few days. Big improvement in three hours. No failures. **Complete outline FREE.** Perfect Penmanship Inst. D-34, St. Louis, Mo.

Get this great work for your own use
ENCYCLOPEDIA BRITANNICA
Write for **FREE** Booklet and full details. Dept. PM2
THE ENCYCLOPEDIA BRITANNICA, INC.
342 Madison Ave., New York City

Learn Photography at HOME

Make money taking pictures. Prepare quickly during spare time. Also earn while you learn. No experience necessary. New easy method. Nothing else like it. Send at once for free book, **OPPORTUNITIES IN MODERN PHOTOGRAPHY** and full particulars

AMERICAN SCHOOL OF PHOTOGRAPHY
Dept. 1358 3601 Michigan Ave. Chicago, U. S. A.

Earn \$75 to \$100 a Week as AUTO MECHANIC—

Learn Easily in 8 Weeks on Real Machinery— No Dry Books No Lectures

Eight short weeks of pleasant, fascinating, practical auto work in my big shops—and then a real job paying \$75.00 to \$100.00 a week! You can step right out of low pay, long hours, and no future into the job of a high-salaried auto mechanic. Everywhere jobs are waiting for men trained as I train them. Change the whole course of your life in 8 weeks!



I'll Pay Your R. R. Fare
Clyde H. Pratt
President

Employment Dept. Helps My Graduates

Come to my shops. I will make you a mechanic able to handle the hardest auto jobs quickly and easily. I'll teach you to know autos inside out. You don't need education. You don't need previous experience. All you need is ambition. You learn by doing—by working on actual cars with real tools. This is not a correspondence course.

Short Cut to Big Pay

Learn how easy it is to get a steady, big-pay job in the great auto field. Learn what other fellows like you have done with CLEVELAND Auto Training.

Mail Coupon for Book

CLEVELAND
AUTO SCHOOLS
1815 E. 24th St.,
Cleveland, Ohio

Clyde H. Pratt, Pres.,
CLEVELAND AUTO SCHOOLS,
1815 E. 24th St., Dept. 11-A, Cleveland, O.
Please send me FREE BOOK on Auto Mechanics, and details of spare-time work and Employment Help.

Name.....
Address.....
City.....State.....



Earn While You Learn
"I help you find spare time work."
C. H. P.

How to Straighten Bow and Knock-kneed Legs!

Improve your personal appearance by using the new patent "Lim-Straitner," Model 18. Corrects bow Bow and Knock-kneed legs safely, quickly and permanently at home. No costly operation or discomfort. Is worn at night. Easy to adjust; its result will save you soon from further humiliation and will improve your personal appearance 100 per cent. Write today for copyrighted Physiological and Anatomical book and experience of others without obligation. Enclose a dime for postage.

M. TRILETY, Specialist Dept. 1842L BINGHAMTON, N. Y.

Does Your English Help or Hurt You?

Wonderful new way to improve your English. No rules to learn. No hard study. Grammar, spelling, punctuation, and expression, taught in 15 minutes a day—at home. Self-correcting feature makes it fascinating as a game. Write today for free book "How to Speak and Write Masterly English." Address

SHERWIN CODY SCHOOL OF ENGLISH
59 Searle Building Rochester, N. Y.

LEARN CARTOONING AT HOME DURING SPARE TIME

with the course that has trained HUNDREDS of beginners successfully. The Landon Picture Chart Method of teaching ORIGINAL drawing by mail makes cartooning easy to learn. This school is a Member of The National Home Study Council. Write today for sample picture chart to TEST YOUR ABILITY and examples of the work of successful students now earning from \$50 to \$200 and more per week. Enclose 6c in stamps and STATE YOUR AGE.

THE LANDON SCHOOL, 2838 National Bldg., Cleveland, Ohio



TRAVEL—for 'UNCLE SAM'

RAILWAY POSTAL CLERKS
MAIL CARRIERS—POSTOFFICE CLERKS
\$1700 to \$3300 a Year for Life

No "lay-offs" because of strikes, poor business, etc.—sure pay—rapid advancement. City and country residents stand same chance. Common sense education usually sufficient.

STEADY WORK
Cut coupon and mail it before turning the page.

MEN—BOYS
18 to 45

Use Coupon Before You Lose It

COUPON

FRANKLIN INSTITUTE, Dept. G-177, Rochester, N. Y.
Rush to me, entirely free of charge, (1) A full description of the position checked below; (2) 32-page book, with list of positions obtainable and sample coaching; (3) Particulars telling how to get the position checked.

Railway Postal Clerk (\$1900 to \$2700) General Clerk (\$1140 to \$1860)
 Postoffice Clerk (\$1700 to \$2300) Prohibition Agent (\$1860 to \$3000)
 City Mail Carrier (\$1700 to \$2100) Rural Mail Carrier (\$2100 to \$3300)

Name.....
Address.....





"He saves \$100 a month"

"SEE that man at the receiving teller's window? That's 'Billy' King, Sales Manager for The Browning Company. Every month he adds \$100 to his savings account.

"Three years ago he started at Browning's at \$25 a week. Married, had one child, couldn't save a cent. One day he came in here desperate—wanted to borrow a hundred dollars—wife was sick.

"I said, 'Billy, I'm going to give you something worth more than a loan—some good advice—and if you'll follow it I'll let you have the hundred too. Take up a course with the International Correspondence Schools and put in some of your evenings getting special training. The schools will do wonders for you, I know. We've got several I. C. S. men here in the bank.'

"That very night Billy wrote to Scranton, and a few days later he had started studying at home. Why, in a few months he had doubled his salary! Next thing I knew he was put in charge of his department and two months ago they made him Sales Manager. It just shows what a man can do in a little spare time."

* * * *

Employers are begging for men with ambition—men who really want to get ahead in the world and are willing to prove it by training themselves in spare time to do some one thing well.

Prove that you are that kind of man! The International Correspondence Schools are ready and anxious to help you prepare for something better if you will only make the start. Do it now! At least find out what the I. C. S. can do for you.

Mail the coupon for Free Booklet

INTERNATIONAL CORRESPONDENCE SCHOOLS

"The Universal University"
Box 5559-F, Scranton, Penna.

Without cost or obligation, please send me a copy of your booklet, "Who Wins and Why," and full particulars about the subject before which I have marked X in the list below:

BUSINESS TRAINING COURSES

- | | |
|--|---|
| <input type="checkbox"/> Business Management | <input type="checkbox"/> Salesmanship |
| <input type="checkbox"/> Industrial Management | <input type="checkbox"/> Advertising |
| <input type="checkbox"/> Personnel Management | <input type="checkbox"/> Business Correspondence |
| <input type="checkbox"/> Traffic Management | <input type="checkbox"/> Show Card and Sign Lettering |
| <input type="checkbox"/> Accounting and C. P. A. | <input type="checkbox"/> Stenography and Typing |
| Coaching | English <input type="checkbox"/> Civil Service |
| <input type="checkbox"/> Cost Accounting | <input type="checkbox"/> Railway Mail Clerk |
| <input type="checkbox"/> Bookkeeping | <input type="checkbox"/> Common School Subjects |
| <input type="checkbox"/> Secretarial Work | <input type="checkbox"/> High School Subjects |
| <input type="checkbox"/> Spanish <input type="checkbox"/> French | <input type="checkbox"/> Illustrating <input type="checkbox"/> Cartooning |

TECHNICAL AND INDUSTRIAL COURSES

- | | |
|---|--|
| <input type="checkbox"/> Electrical Engineering | <input type="checkbox"/> Architect |
| <input type="checkbox"/> Electric Lighting | <input type="checkbox"/> Architects' Blueprints |
| <input type="checkbox"/> Mechanical Engineer | <input type="checkbox"/> Contractor and Builder |
| <input type="checkbox"/> Mechanical Draftsman | <input type="checkbox"/> Architectural Draftsman |
| <input type="checkbox"/> Machine Shop Practice | <input type="checkbox"/> Concrete Builder |
| <input type="checkbox"/> Railroad Positions | <input type="checkbox"/> Structural Engineer |
| <input type="checkbox"/> Gas Engine Operating | <input type="checkbox"/> Chemistry <input type="checkbox"/> Pharmacy |
| <input type="checkbox"/> Civil Engineer <input type="checkbox"/> Mining | <input type="checkbox"/> Automobile Work |
| <input type="checkbox"/> Surveying and Mapping | <input type="checkbox"/> Airplane Engines |
| <input type="checkbox"/> Plumbing and Heating | <input type="checkbox"/> Agriculture <input type="checkbox"/> Navigation |
| <input type="checkbox"/> Steam Engineering | <input type="checkbox"/> Mathematics <input type="checkbox"/> Radio |

Name.....
Street Address.....
City..... State.....
Occupation.....
Persons residing in Canada should send this coupon to the International Correspondence Schools Canadian, Limited, Montreal, Canada

\$75 A WEEK BUILDING RADIO SETS

now being made

Join the Radio Association of America. Let it train you to build and repair sets, to be the "radio doctor" of your community. \$3.00 an hour easily made in spare time.



\$500 Earned in Spare Hours

Lyle Follick, Lansing, Mich., writes: "Have already made over \$500 in spare time." He is just one of many. Our members are starting radio stores, securing better positions, passing radio operator examinations, qualifying as big-pay Radio Experts, as well as making money spare time. 6-Tube Radio Set FREE to members.

Join the Association Now! By our Special Plan your membership need not cost you a cent. Number of these memberships limited. Write for details NOW!
RADIO ASSOCIATION OF AMERICA, 4513 Ravenswood Ave., Dept. PM-9, Chicago, Ill.

BE AN ARTIST

WE CAN TEACH YOU DRAWING in your own home during your spare time. Twenty-five years of successful teaching proves our ability. Artists receive large salaries. Write Today for Art Year Book



SCHOOL OF APPLIED ART
ROOM NO. 2 BATTLE CREEK MICH.

PIANO JAZZ

By Note or Ear. With or without music. Short Course. Adult beginners taught by mail. No teacher required. Self-Instruction Course for Advanced Pianists. Learn 259 styles of Bass, 684 Syncopated Effects, Blue Harmony, Oriental, Chime, Movie and Café Jazz, Trick Endings, Clever Breaks, Space Fillers, Sax Slurs, Triple Bass, Wicked Harmony, Blue Obligato, and 247 other Subjects, including Ear Playing. 133 pages of REAL Jazz, 25,000 words. A Postal brings our FREE Special Offer.

Waterman Piano School, 1826 W. Adams St. Los Angeles, Cal.



1,000 Hotel Positions Open!

HOTELS, restaurants, clubs, apartments, hospitals, institutions, schools and colleges everywhere need trained men and women. Over 70,000 high-class positions paying \$2,500 to \$10,000 a year open annually in the hotels of the United States. Nearly one and three-quarter billions of dollars' worth of NEW HOTELS, CLUBS AND INSTITUTIONS being built this year will need over 200,000 trained men and women. Hotels start you at salaries up to \$3,500 a year, with living usually included. At any time there are over 1,000 hotel positions open.

Previous Experience Unnecessary

You can have one of these fascinating, big-pay positions. Through our Simplified Study Plan we give you the valuable knowledge that it has taken some of the most successful hotel men years to obtain. Age is no obstacle—young and old alike have equal chance for success. Past experience absolutely unnecessary. A common school education is all you need.

We train you in your spare time and put you in touch with big opportunities. All of your training under the personal supervision of Clifford Lewis, Managing Consultant for over 225 hotels throughout the United States. Our students employed by leading hotels everywhere.

Send coupon today for Free Book, "Your Big Opportunity," showing how we can train you for one of these splendid positions and explaining our Money-Back Agreement.

FREE BOOK COUPON

LEWIS HOTEL TRAINING SCHOOLS,
Room AZ-385, Washington, D. C.
Send me without obligation the Free Book "Your Big Opportunity."
Name.....
Address.....
City..... State.....



EASY AS A, B, C

IT'S fun



HELLO, POPULARITY!

Learning to play your favorite instrument this "no-teacher" way — *takes only a few months!*

ALL your life you've wanted to play a musical instrument. And now at last you can realize your ambition! Just choose your favorite instrument—the piano, the violin, the saxophone, whatever it may be—and then let the U. S. School of Music prove that you can learn to play it in an amazingly short time—*right in your own home—and without any private teacher.*

Mail the coupon NOW—and you will immediately receive an interesting Free booklet that tells you all about this wonderful new system—which has already taught over one-half million students to play their favorite musical instrument.

Musical Talent Not Needed

Even if you have never touched an instrument before you can't go wrong this amazingly easy way. For every step, from beginning to end, is right before your eyes in print and picture. You always know what to do and how to do it. No guess work. No delays. If you make a mistake you correct it yourself and continue. The whole course is as simple as A, B, C—and any child will tell you that studying music this new way is even easier than learning to read.

There are no tricks—no stunts—no long tedious exercises—no dull, monotonous finger practice. Everything is clearly explained and simplified so that you get all the essentials of a thorough musical education—in short-cut fashion. In a few short months you will be able to render popular selections with ease and expression.

Some of our most successful students say that this home course in music is real fun—more fascinating than the most enjoyable game! For you study when you please—and as much as you please—in

your spare time. You're not tied down to any specific practice hour either. You go fast or slow—it doesn't make a bit of difference because there isn't any expensive private teacher to pay. With this new form of instruction, the cost averages the same in every case—*a few cents a lesson.*

How to be Popular

You'll be surprised to see how music will give you a greater joy and interest in life. It will enlarge your circle of friends—and will attract many new admirers. If you can play a musical instrument you will never feel "alone in a crowd." For as you dash off the latest song hit—or play some lovely melody from a well-known classic—you will always be in demand—you can't help being popular.

Free Booklet and Demonstration Lesson

If you are in earnest about wanting to join the crowd of entertainers and be a "big hit" at any party—if you really do want to play your favorite instrument, or become a professional performer whose services will be in demand for band and orchestra work, as a stage or radio artist—fill out and mail the convenient coupon asking for our Free Booklet and Demonstration Lesson. These explain our wonderful method fully and show you how easily and quickly you can learn to play at little expense. Instruments are supplied when needed—cash or credit. U. S. School of Music, 79 Brunswick Bldg., New York City.

Play Any Instrument

Piano	Hawaiian Guitar
Organ	Drums and Traps
Violin	Plectrum Banjo
Mandolin	5-String Banjo
Ukulele	Tenor Banjo
Clarinet	Harmony and
Flute	Composition
Harp	Sight Singing
Cornet	Piccolo
Cello	Trombone
Guitar	Saxophone
Voice and Speech Culture	
Automatic Finger Control	
Piano Accordion	

U. S. School of Music,
79 Brunswick Bldg., New York City.

Please send me your free book, "Music Lessons in Your Own Home," with introduction by Dr. Frank Crane, demonstration lesson and particulars of your easy payment plan. I am interested in the following course:

Have you instrument?

Name.....
(Please Write Plainly)

Address.....

City..... State.....

Learn Electricity IN LOS ANGELES

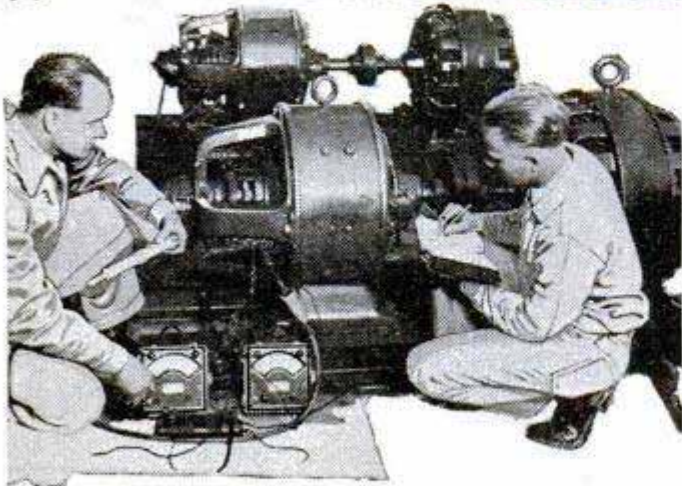

FREE Employment Service!

There are more calls for "National-Trained-Electrical-Men" than we can supply. Jobs are open now paying \$50 and up a week—but you must first get the right training. Get it at National—a world-famous institution with a quarter century record of success in training big pay men.

All These Advantages:

1. Unlimited Training Until Competent.
2. Free Employment and Welfare Service.
3. Million Dollar Training Shops.
4. Personal, Individual Training Guaranteed.
5. You actually perform work that employers pay big money for.



6. Official Diploma and certified record of work performed.
7. Unexcelled training; 32 instructors.

FREE!

Read how National insures your success. Send for this free Electrical catalog—illustrated by actual photos of students training under instructors on a half million dollars' worth of new electrical equipment. Mail coupon now.



National Electrical School

Dept. 522, 4006 Figueroa St., Los Angeles, California.

Send me your big free illustrated catalog of Electrical Opportunities.

Name.....
 Address.....
 Age..... City..... State.....



You can make BIG MONEY with this line

You can make \$20.00 a day and up, starting at once, taking orders for Goodwear Guaranteed All Wool Clothes made to measure for only \$23.50. Experience unnecessary. We train and equip you with powerful \$20.00 outfit and supply valuable advertising and selling book that tells you exactly what to do to make the big money. Write at once for full facts about opportunity offered you in this pleasant and tremendously profitable business. Fill out Coupon and mail to—



GOODWEAR, Inc., Dept. 658
844 West Adams Street, Chicago

Gentlemen: If I can make \$20.00 a day with your line, I'm interested. Give me the full facts please, without obligation.

NAME.....
 ADDRESS.....
 TOWN..... STATE.....

Learn to Write



I Teach by Mail

Begin Today—Write for My FREE Book. I can make a good penman of you at home during sparetime. Write for my FREEBOOK, "How to Become a Good Penman." It contains specimens and tells how others mastered penmanship by the Tambllyn System. Your name will be elegantly written on a card if you enclose stamp to pay postage. Write today for book.
 F. W. Tambllyn, 418 Ridge Bldg., Kansas City, U.S.A.

MUSIC LESSONS IN YOUR HOME



Write today for our FREE booklet. It tells how to learn to play Piano, Organ, Violin, Mandolin, Guitar, Banjo, etc. Beginners or advanced players. Your only expense about 2c per day for music and postage used. **American School of Music, 51 Manhattan Bldg., Chicago.**

LEARN WATCHMAKING AND ENGRAVING BY OUR PROFIT-SHARING PLAN OUR GRADUATES SUCCEED

One of our Iowa students started in a very small way—now doing over \$30,000 a year. Another in Wisconsin, over \$10,000 the first year. Day or night classes. Call or write for FREE BOOK.
Chicago School of Watchmaking, Dept. 4401, 549 W. Randolph St., CHICAGO



"BECOME A LIGHTNING TRICK CARTOONIST"

Send \$1.00 for Laugh Producing Program of 23 Trick Drawings with Instructions. Catalog of Chalk Talk Supplies Free.
BALDA ART SERVICE, Dept. 1, Oshkosh, Wis.

ILLINOIS COLLEGE of PHOTOGRAPHY

Prepares you in from 6 to 8 months to earn \$200 to \$500 a month as a photographer or photo-engraver. Thorough practical training. Expenses low. Constant demand for our graduates. 35th year. Enroll immediately. Free catalog. **Box 498, Effingham, Illinois.**

Energize Your Body Through STRONGFORTISM



Your body can be and should be dynamic in its energy and powerful in every muscle. If you are a weakling—a make-believe man—a skinny, flabby outfit—it's your fault and yours alone. You don't have to be a weak, nervous, useless fellow. You can be strong—and you will be if you have the sand to follow the path thousands of others like you have followed under my guidance.

Maybe you are one of those fellows who have thought they could run wild without destructive results. Maybe you've gone the speed limit in the use or abuse of your physical powers. Maybe you thought there was no end to your vitality—that you could go it day and night and dissipate to your heart's content. Now you know better—you've learned your lesson—and what are you going to do about it? I'll tell you what you can do. I'll tell you what I've done for weak men all over the world.

Strongfortism Will Make a Man of You Men who were afflicted with all sorts of ailments—annoying, destroying weaknesses—men who were ashamed of their lack of stamina and muscular power—men who had well-nigh given up hope of ever being strong again—these men—thousands of them—in this country, in South America, in Europe, in Australia, in Cuba, in India even—came to me and they were put on their feet, restored to health and strength and became men who were proud of their physique and who feared no one.

If you will take the time to read some of the fine testimonial letters that come from pupils everywhere you will realize the extent of the good that STRONGFORTISM has done. You will have no doubt of its value. You won't hesitate to apply it to yourself if you want robust health, vitality and muscular strength.

My Record In Body Building is Unparalleled

You can get rid of Constipation, Catarrh, Nervousness, Rheumatism, Indigestion, Dyspepsia, Weak Back, Insomnia, Palpitation and a whole string of other ailments if you will take up Strongfortism in dead earnest. I want to help you—and I can help you if you will give me a chance—if you will write and tell me what troubles you.

For over 27 years I have devoted myself to the development of men's bodies into fine specimens of manhood—not that they all wanted to be athletes, but because they wanted to possess full physical powers and feel like real men. No one in history has done more in the way of body building and restoration.

STRONGFORT

Dr. Sargent of Harvard University, U. S. A., declared Lionel Strongfort to be unquestionably the finest specimen of physical development he had ever seen.

SEND FOR MY FREE BOOK

This book of many pages and dozens of pictures tells of my wonderful experience—how I became the outstanding athlete of the world, performing feats others dared not attempt; how I turned the knowledge gained through developing my own body to the benefit of others, and then how STRONGFORTISM was evolved. It tells what I have done for others, what I can do for you. It doesn't mince words. It tells plain truths. "Promotion and Conservation of Health, Strength and Mental Energy," points the way from disease and weakness to health and strength. It is priceless. I'll send it to you on request—FREE. Write for your copy today.

STRONGFORT INSTITUTE

LIONEL STRONGFORT, DIRECTOR.

Physical and Health Specialist
DEPT. 604 NEWARK, NEW JERSEY, U. S. A.

NOTE: Lionel Strongfort Institute is owned solely by Lionel Strongfort, its founder,—not by any advertising or publishing house.

Send this FREE Consultation Coupon

ABSOLUTELY CONFIDENTIAL

Mr. Lionel Strongfort, Strongfort Institute, Dept. 604, Newark, N. J.—Please send me absolutely free my copy of your book, "PROMOTION AND CONSERVATION OF HEALTH, STRENGTH AND MENTAL ENERGY." I am enclosing 10c (one dime) to help cover mailing expense, etc., and have marked (X) before the subjects in which I am most interested.

- | | | |
|-------------|-----------------|-------------------------|
| .. Catarrh | .. Overweight | .. Weak Heart |
| .. Colds | .. Constipation | .. Great Strength |
| .. Asthma | .. Weak Back | .. Lung Troubles |
| .. Headache | .. Weak Knees | .. Round Shoulders |
| .. Rupture | .. Rheumatism | .. Stomach Disorders |
| .. Thinness | .. Nervousness | .. Increased Height |
| .. Pimples | .. Short Breath | .. Muscular Development |
| .. Insomnia | | |

Other Ailments.....

Name.....

Age..... Occupation.....

Street.....

City..... State.....

Here Is Where to Find What You Want

REALIZING the difficulty one frequently encounters in locating information that may be sorely needed in pursuit of a line of work or study, we have adopted a plan that we believe will be of real service to our readers. To a greater extent than ever before knowledge pertaining to practically every kind of human endeavor is made available through the medium of books. Each month, therefore, we will give descriptions of new and outstanding books that we think will be of the greatest interest.

We suggest that you send for our catalog of over 5000 books listed alphabetically under 2000 subject headings. If the subject you are interested in is not covered, write us about it, and we will try to find something that will be helpful.

New and Outstanding Books

Opportunities for You in Aviation

Air travel has arrived. Think of the countless opportunities in this new field for those who have the foresight now to prepare for the future. The greatest need at present is for men who have a real working knowledge of the modern aircraft engine. In "Dyke's New Aircraft Engine Instructor" you get thorough, up-to-the-minute information on all the latest types of engines. 400 Pages. 400 Illus. Flexible. Price \$5.00.

House Wiring a Profitable Trade

House Wiring and other branches of the electrician's trade will pay you well for the time and effort spent in their mastery. An up-to-date course in House Wiring of unusual excellence has just been published in the form of one simplified and convenient book. We can highly recommend it. "House Wiring" by Wolber and Rose. 320 Pages. 650 Ills. Flexible. Price \$2.50. For other branches of the electrician's trade, we recommend "American Electricians' Handbook" by Croft. 823 Pages. 900 Ills. Pocket size. Price \$4.00.

Your Answer May Be Wrong

Save yourself from embarrassing moments by being sure you are right when you start to figure. Figures are easy to handle. You need only to go about things the right way. Let Howe show you quickly and simply by common sense methods that remove all the difficulties. You need only arithmetic to begin with. "Mathematics for the Practical Man." By G. E. Howe. 143 Pages. Cloth. Price \$1.50.

Increase Your Earning Power

Apply time and labor-saving kinks to your work and increase your efficiency. If you do machine shop work of any kind, sheet metal work, painting, carpentry, auto repairing, farming, concrete work, plumbing, electrical work, welding, building, repairing, tool-making, masonry or home repair work you will find the 6000 easily understood short cuts to every-day jobs in "Shop Notes Library" of 16 volumes of inestimable value. Price for complete set \$6.25.

Make Your Camera Pay

You can make your camera pay if you know what will sell and where to sell it to best advantage. All this and everything else you will need to know about taking good pictures is told by French in his book "Photography for the Amateur." Price \$3.50.

Make It Yourself

An unusually attractive book for those who take pride and delight in making things. Just published by Popular Mechanics Press. An almost unlimited variety of things to make among its 900 different articles—ship models, mechanical toys, novel amusement devices, furniture, useful appliances, things of beauty and utility. 480 Pages. 823 Illustrations. Cloth. Price \$3.00.

The Complete Practical Machinist

By J. Rose. New, revised edition of one of the best-known books on machine-shop work. Written for the practical workman in the language of the workshop. Full, practical instructions on the use of all kinds of metal-working tools, both hand and machine, and tells how the work should be properly done. 547 Pages. 432 Illus. Cloth. Price \$3.00.

The New Ford

A complete, illustrated description of the new Model A Ford car is given in the entirely new edition of the Modern Gasoline Automobile by V. W. Page. In addition, every recent improvement in autos and their component parts is shown and illustrated. An up-to-date and authoritative book of 1150 pages. 1000 Illustrations. Fabricated binding. Price \$5.00.

Any of the above books sent postpaid upon receipt of price. If in the U. S. and you prefer to have books sent C. O. D. we will do so, charging in addition to the price, a small fee to defray the extra expense involved for the service.

What You Want to Know About Flying

Just the kind of information you have wanted for a long time. The important facts for the layman told in simple, understandable language. W. L. Le Page explains stability and control, the building of an airplane, engines, and gives flying instructions in his new book "The A B C of Flight." 141 Pages. Cloth. Price \$1.50.

How to Run Your Garage at Greater Profit

Don't wait for business. You must go after it and fight to keep it by using tested business-building ideas. Think of it! Five billion dollars spent last year for auto upkeep and more will be spent this year. Get your share of this big money. Let J. E. Mills of the Michigan State Auto School show you just as he has thousands of others, the 553 money-making plans in his book "Garage Management and Control." Price \$3.00.

10,000 Money-making Facts for You

Make and save money by using recipes and formulas. Make things to sell at a profit. Save money by making many of the things you use daily. Many a successful business has been founded on one good formula. You have 10,000 to choose from in Henley's 20th Century Home and Workshop Formulas, Recipes and Processes. 809 Pages. Cloth. Price \$4.00.

Make Your Patent Pay

Inventors! There are certain precautions to take before your vision of rewards can become a reality. Pitfalls and traps must be avoided. Let Milton Wright of the New York Bar guide you aright with the sound, practical advice he gives in his book "Inventions and Patents, Their Development and Promotion." 225 Pages. Cloth. Price \$2.50.

Make Money in Real Estate

Increase your income by using the successful methods employed by experts. "How to Make Money in Real Estate" by S. L. McMichael is the most practical and profitable book ever written on this subject. Price \$6.00.

Save Labor Costs

Train yourself to do the various odd jobs that have to be attended to in every household. You can learn enough about such mechanical tasks as wood-working, painting, varnishing, floor-finishing, plumbing, masonry, brick work, electric wiring, etc., from H. H. Saylor's clearly written book "Tinkering With Tools" to enable you to do much of your own work. 250 Pages, Illustrated, Cloth. Price \$2.00.

Add Built-in Conveniences to Your Home

You can easily build a cozy breakfast nook, comfortable seats, book-case, buffet, china-closets, mantel-shelves, clothes-chute or any one of a great variety of the very latest styles in built-in features at slight cost. The plans and instructions in our new book "Built-In Furniture" are easily followed. 30 different articles. 198 Pages. Fully Illus. Cloth. Price \$2.50.

Outdoor Opportunities

You can develop a profitable business raising small animals, birds and plants on a small amount of land. It will pay you to look into this. Eighteen money-making ways are described in the book "Outdoor Opportunities." 256 Pages. Illus. Cloth. Price \$2.00.

\$4223.00 Profit from a Town Lot

In one year H. C. Sheppard took a net profit of the above amount from his small poultry plant on a town lot. During his earlier disastrous experiences he would have gladly paid \$100 for the information that later on enabled him to realize such a handsome profit. You many have this information not for \$100 but for \$1. Sheppard's Poultry Book. Price \$1.00.

Button Rupture Newest Way [Without Pressure]



I take pleasure in informing you through the use of the New Science System my rupture is entirely relieved. At the time I ordered your System I had been ruptured 20 years.

*M. P. Brumbaugh,
Juniata, Pa.*

I am writing to let you know that my rupture does not trouble me any more and I think in a little while it will be gone. Your appliance has all you claim for it. Before I got it I could work only part of the time. Now I can do almost anything.
*Mrs. C. W. De Long, Gilboa,
N. Y.*

SCIENCE now advises discarding cruel steel springs, barbarous leg straps, and other harness that press against the rupture and thus prevent nature from healing it. A new sensible method has been perfected, after thousands of test cases, called Magic Dot—entirely different from any other way. Instead of “pressing” it “seals” rupture, and of course allows users to run, jump, bend and cough in perfect safety.

Breathes Air

With this 1-25th oz. device is a new kind of pad, air-porous and washable. It actually breathes air, and cannot slip off the rupture—a feature, you’ll frankly admit, that is lacking in your present appliance. In fact, it is so superior and different that it is praised by physicians as “an entirely new departure.” Users report they have forgotten they are wearing it. But don’t buy it yet.

See It First

By a special arrangement you can now have it sent to your home without obligation to wear it. Don’t send a penny or order it now. Just mail the coupon for full description of “Magic Dot” and details of this unusual offer. Act now for quick relief. Write your name and address on the coupon and mail it today!

NEW SCIENCE INSTITUTE

2152 Clay St.

Steubenville, O.

New Science Institute,
2152 Clay St., Steubenville, O.

Please send me free your illustrated book and sample of Airtex. Include also your offer which permits me to see the New Science System without cost or obligation.

Name.....

Address.....

City.....State.....

(Print Address and Be Sure of Reply.)

You can play the HAWAIIAN GUITAR just like the Hawaiians!

Play all the latest hits just as the Hawaiians do. Be the most popular member of your set, a happy crowd always around you, everybody enjoying and admiring your playing. Get in on all the good times. Entertain your friends—or play professionally. We will help you.



Native Hawaiian expert directs you

You get expert instruction, directed by a world-famous player and teacher, Prof. Walter Kolomo-ku. He quickly reveals to you the secrets of this fascinating instrument.

Complete Conservatory Course

You get 52 complete printed lessons. Nothing is omitted. Pictures explain every move. And no matter how little you know about music when you begin, no matter if you have never touched a musical instrument, you can positively learn to play by our plain, easy picture method. You are sure to learn! What we can do for others we can do for you. 51,000 successful students. This record assures your success.

Learn at home in spare time

Study in spare time—in absolute privacy—when you like—as long as you like. Even if you don't know one note from another, our method is so simple you begin a piece your first lesson. In half an hour you can play it!

Only 4 motions to learn

Then you can play any music—popular songs, classical, old-time melodies, native Hawaiian airs—or real jazz—separately or with accompaniment. You'll never be lonesome after you learn to play on this beautiful Hawaiian Guitar.

GIVEN when you enroll— \$18 to \$20 Hawaiian Guitar

With Genuine Seal Grain Fabrikoid Cover and Complete Playing Outfit

Reliable retailers ask \$18 to \$20 for a similar instrument and outfit without the fine Fabrikoid Case, which alone is valued at \$3.50. Yet you receive this sweet-toned splendidly built Hawaiian Guitar, case and entire playing outfit, including picks, steel playing bar, tuning pipe, etc., without one penny of expense, as soon as you enroll.

Pay as you play

We make it easy for you. Start any time with a small first payment—then pay while learning. It comes to only a few cents per lesson. And bear in mind: Your only investment is the cost of the course—we furnish everything else.

FREE Our new illustrated book, "The Romance and Enchantment of Hawaii—Its Music and Its People." A book you will want to keep. You won't lay it down until you have read it from cover to cover. Send for your copy today.

OTHER COURSES: Tenor Banjo, Violin, Tiple, Tenor Guitar, Ukulele, Banjo Ukulele—well-known instructors.

FIRST HAWAIIAN CONSERVATORY OF MUSIC, Inc.
9th Floor Woolworth Bldg., Dept. 548, New York, N. Y.
Approved as a Correspondence School Under the Laws of the State of New York.
Member of National Home Study Council.

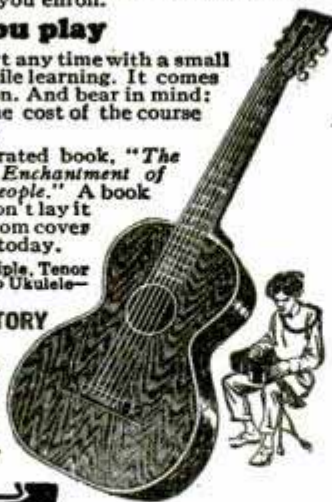

Send This Coupon for Liberal Offer!

FIRST HAWAIIAN CONSERVATORY OF MUSIC, Inc.
9th Fl., Woolworth Bldg., Dept. 548, New York, N. Y.

Please send full information about your 52-lesson Hawaiian Guitar Course. I am not obligated to enroll unless I want to.

Name _____

Address _____

City _____ State _____

PREPARE FOR AN ART CAREER

—thru the only art school operated as a department of a large art organization, who have actually produced over a quarter million drawings for leading advertisers. Where else can you get so wide an experience? Home study instruction. Write for illustrated book telling of our successful students.

MEYER BOTH COMPANY
Michigan Ave. at 20th St. Dept. 16, Chicago, Ill.

CHIROPODY

MAKE \$5,000 TO \$15,000 A YEAR

In dignified profession. Doctors of Surgical Chiropody needed everywhere. Best known College in America gives you full course, prepares you for practice in 2 years. Largest foot clinic in the world. Faculty of leading physicians, chiropodists. Finest equipment. 15th year. Study in Chicago. Varied interests of city life—opportunities all around. Earn while you learn. Write for catalog. No obligation. Dept. 611.

Illinois College of Chiropody, 1327 N. Clark St., Chicago

MEN TO LEARN

MOTION PICTURE PROJECTION

A BIG-MONEY PROFESSION—\$2,000 TO \$4,000
We Assist Students to Earn While Learning

MOVIE OPERATORS SCHOOL

61 Sproat Street

Detroit, Michigan



easily, permanently corrected. Win happiness and success. Ask for full information and special phonograph record. Send dime for postage 153 Stimson Ave., The LEWIS INSTITUTE, Detroit

LEARN RADIO

Good Pay—Advancement
—Phenomenal Success in
A Life Profession of
Fascinating Brain-work.



R. L. DUNCAN
Director, R. I. A.

You Can Learn At Home!

We have trained thousands of men to earn big money as radio designers, as radio executives, in broadcasting work, as skilled service men and radio dealers. Now opportunity knocks at your door. Are you going to plod along at thirty-five dollars a week when real money is waiting for you in radio?

New Course with A-1 Equipment

Radio Institute now offers a new, revolutionary, up-to-the-minute course in radio. A large kit of first-quality equipment is included without extra charge—parts for making a hundred different radio circuits and the Peerless Signagraph and key and buzzer set for code instruction.

R. I. A. backed by RCA, G-E and Westinghouse

Moreover, you can STUDY AT H when you please and as long as you please. A new booklet describing the course is ready. If you want to learn more about the lucrative and fascinating profession of radio send the coupon now for your copy.



RADIO INSTITUTE OF AMERICA
Dept. P-9, 326 Broadway, New York City
Dear Mr. Duncan:
Please send me your new catalog.
Name _____
Address _____

ELECTRICITY

PAYS BIG!

LEARN IN 90 DAYS ON ACTUAL MACHINERY—NO BOOKS I'LL PAY YOUR R·R· FARE TO CLEVELAND

Don't let the world bluff you. Get into electricity—earn \$50.00 to \$150.00 a week—and hold your head as high as the next man. You can do it easily by coming to my famous electrical school. In 12 short weeks you'll pack in many years of practical knowledge. You work shoulder to shoulder with expert instructors on full-sized, moving, whirling motors, generators, batteries,



Big Illustrated Book Sent FREE

Today, right now, take the first step out of that low pay rut. Mail the coupon to me for big, illustrated book on ELECTRICITY. Act to-day. Get my special Railroad Fare offer and Remarkable Tuition offer.

Just Mail Coupon!



IT'S EASY THIS WAY
Fascinating, practical shop work in my big school fits you. Not a correspondence course.



No Education or Experience Needed
No books to read. No dry lectures to listen to. You learn by doing. I don't care if you can't tell a motor from a horse-and-buggy now. When you graduate I guarantee that you'll know electricity from "A" to "Z." If you're not fitted to fill a big-pay job I'll refund every penny of your tuition.



Employment Department Helps You!
I help my students find spare time jobs while they attend school—and my Employment Department assists my graduates to locate good positions after graduation. McSweeney trained men are in demand.



J. H. McSweeney, Pres.
McSweeney Electrical School
Dept. 51-M, Cleveland, O.
Dear Mac: Without obligation send me a copy of your big book on ELECTRICITY; also Railroad Fare offer, and details of Employment Service.

Name.....
Address.....
Town..... State.....

Earn While You Learn!
McSWEENY ELECTRICAL SCHOOL
Dept. 51-M Cleveland, Ohio

Study LAW AT HOME
Lincoln did it! Also thousands of other great lawyers, politicians and business men. YOU, too, can become a lawyer or law trained businessman through home study guided by the successful practicing lawyers of our faculty. Write today for free book.
AMERICAN CORR. SCHOOL OF LAW
3601 Michigan Ave., Dept. 1356, Chicago

Learn Watchwork, Jewelrywork and Engraving
A fine trade commanding a good salary, and your services always in demand. Address **Horological**, Dept. P, Bradley Institute, PEORIA, ILLINOIS, for our latest catalog.



Travel on "UNCLE SAM'S" PAYROLL RAILWAY POSTAL CLERKS \$158 TO \$225 MONTH MAIL COUPON BEFORE YOU LOSE IT

**Steady Work — No Layoffs—Paid Vacations — See Your Country—Common Education Sufficient
Many Government Jobs Open to Boys — Men — 18 Up**

Franklin Institute, Dept. G175, Rochester, N. Y.
Sirs: Rush to me without charge, (1) 32-page book describing positions as Railway Postal Clerk and City Mail Carrier; (2) tell me how to get a U. S. Government Job; (3) send me list of positions now obtainable and sample coaching.

Name.....
Address.....

Show Card Lettering

HERE is the very course you need if you want to get a good paying position as a Show Card Letterer or Sign Letterer, or have a business of your own. This course is complete and practical and especially arranged to meet the needs of the student who studies at home. It was written by E. L. Koller, Principal of the International School of Art, member of the American Federation of Arts, and The National Society of Craftsmen.



Learn at Home
Mail Coupon for Free Booklet

H. L. Wood, a clerk, made more than \$700 "on the side" before he had completed this course. Harry Lord writes that he has more than doubled his salary. William Whitman is earning three times as much as he did before enrolling with the International School of Art.

INTERNATIONAL SCHOOL OF ART
Division of the International Correspondence Schools
Dept. 5563-F, Scranton, Penna.

Without cost or obligation, please send me full details of your home-study course in

SHOW CARD LETTERING
 ILLUSTRATING CARTOONING

Name.....
Address.....



*If You
Want a Job*

*or a
Hobby*

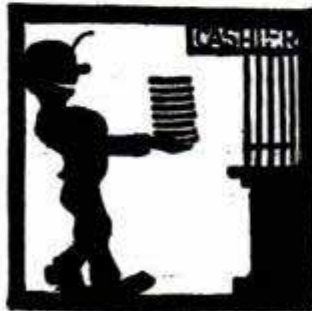

*that Pays
Well*

*Where You
can be Your
Own Boss*

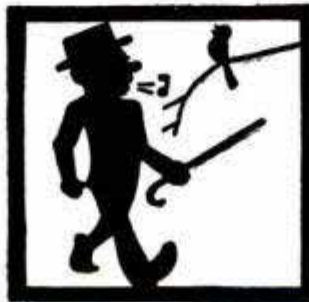

*and Keep Your
Own Hours*

*learn
Illustrating*



Our new catalog "A Road to Bigger Things" tells you how. You will also be interested in the illustrations and comments by Neysa McMein, Leyendecker and other nationally known artists who are among the Federal authors and contributors. Just write your name and address on the margin of this page. Tear it out and mail it to us and we will send you your copy.

**Federal
School
of Illustrating**

9138 Federal School Bldg., Minneapolis, Minn.

Learn MECHANICAL DENTISTRY

EARN UP TO \$5000 A YEAR

WHY spend the best years of your life at uncertain jobs at small pay? You can **EARN WHILE LEARNING** this modern money making business and become your own boss. **BIG DEMAND.** You **LEARN BY DOING PRACTICAL** work. **DAY AND NIGHT SCHOOL.** **INDIVIDUAL** instruction. Easy terms. **Railroad Fare Allowed—No Extra Cost.** Address **SECRETARY, N. Y. SCHOOL OF MECHANICAL DENTISTRY, 147 W. 33rd St., NEW YORK, N. Y.**

SEND FOR FREE BOOK

YOUR SUCCESS

Write or Mail Coupon: ;

Name.....
Street.....
City..... State.....

"STAMMERING Its Cause and Cure"

You can be quickly cured if you stammer. Send 10 cents coin, or stamps, for 288 page cloth bound book on Stammering and Stuttering. It tells how I cured myself after Stammering and Stuttering for 20 years. **BENJAMIN N. BOGUE**
11109 Bogue Building, 1147 N. Ill. St. Indianapolis

LEARN PIANO TUNING AT HOME

Send for **FREE** copy of the 30th ANNIVERSARY EDITION of our book, "Winning Independence". Read how students master tuning with our **TUNE-A-PHONE**, and **WHY** our graduates head the profession in all parts of the world. With Bryant's patented devices, tools, charts and lessons, one learns quickly and easily. Low tuition; easy terms. Diploma granted. **MONEY-BACK** if not satisfied. \$10.00 to \$25.00 a day, exceptional opportunities and an ideal profession awaits you. **BRYANT SCHOOL OF TUNING, 31 Bryant Bldg., Augusta, Michigan**

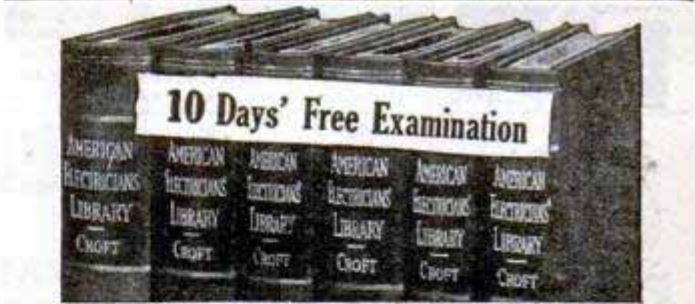

Get into the electric wiring field—big demand—big money!

THE whole wiring field covered. Kinks; helps; short cuts; practical, on-the-job electrical data, written particularly to help wiremen, trouble shooters, maintenance men, armature winders, electrical contractors and students.

American Electricians' Library
6 volumes, 2000 pages, illustrated, \$17.50 payable \$1.50 in ten days and \$2.00 a month

The books tell you all you must know about conduit wiring, armature winding, wiring for lighting circuits and switches, wiring for machinery, circuit troubles, circuit testing, or electrical machinery erection. Through a study of this great set you can push yourself into a big-pay job for life.

See it FREE—Send no money—ACT

FREE EXAMINATION COUPON

McGraw-Hill Book Co., Inc.
370 Seventh Avenue, New York

Send me the American Electricians' Library for 10 days' free examination. If satisfactory, I will send you \$1.50 in 10 days and \$2 monthly until the full price, \$17.50, is paid. If not wanted, I will return the books at your expense.

Name.....
Address.....
City and State.....
Position.....
Company..... P. M. 9-28

If you're a Man of Action Read Every Word on this Page



Walter Hinton
Pilot of the NC-4—first plane to cross the Atlantic. First to fly from North to South America—and first to explore the jungles of the Upper Amazon. During the War he was an expert Navy flight instructor. Today he is training ambitious men for Aviation. He can help YOU!

TWO YEARS from now will be *two years too late* to capitalize the opportunity that is **YOURS TODAY** in *Aviation!* Not that you wouldn't be able to break into the field then. But you'd be handicapped and outdistanced by the wiser ones who started when the time was ripe.

Don't make the mistake of thinking that the big boom in Commercial Aviation is five or ten years off. It's here **NOW!—TODAY** there is tremendous growth, tremendous profits in the Air. A vast network of mail, express and passenger service blankets the country; and it's getting bigger all the time. Almost every month more millions are being invested in planes, plants, airports, airways. The right start, rapid progress and the **Biggest Success** depend on getting into Aviation **NOW!** This is no time for doubting or hesitation. Thousands of good jobs—*big-pay jobs*—are open in over 40 fascinating branches of work both in the air and on the ground. They will be filled as fast as men can be trained for them. The man who **ACTS TODAY** is the man who two years from now will thank his lucky stars that he **KNEW** enough to *start SOON enough!* **YOU** can be that man!

I Will Train You Right at Home for the Job You Want at the Pay You Want

In every part of the country, my students are stepping into jobs that *pay*. The training I give them—and am ready to give **YOU**—covers the fundamental facts; a real working knowledge of motors, plane design and construction, rigging, instruments, repairs, theory of flight—Aviation, the Airplane and the Airport. Understand, you take this training *right at home*. My course is backed up by over 12 years in Aviation and over 400,000 miles of flight. It is endorsed by some of the biggest men and biggest corporations in the

field today. It trains you thoroughly, gives you a foundation for a real start, real progress and a real future in the liveliest, fastest growing industry the world has ever seen!

The book shown below talks facts. It shows you exactly *where* you can fit into Aviation—*how* I train you and how to get started.

It is **FREE** to men who are ready to take a hand in the development—a share in the profits—of this great, twentieth century industry of the Air. Wake up to the opportunity that is yours **TODAY!** Recognize in the coupon below a right-at-hand means to find out where **YOUR** future lies! Mail it **NOW!**

Rush back to Washington Quick

Walter Hinton, Pres.,
Aviation Institute of U.S.A.,
1115 Conn. Av., Washington, D.C.

1-J

Dear Lieut. Hinton: I want to know how you can train me right at home for a real place in Aviation. Rush me your **FREE** Book.

Name.....

Street..... Age.....

City..... State.....

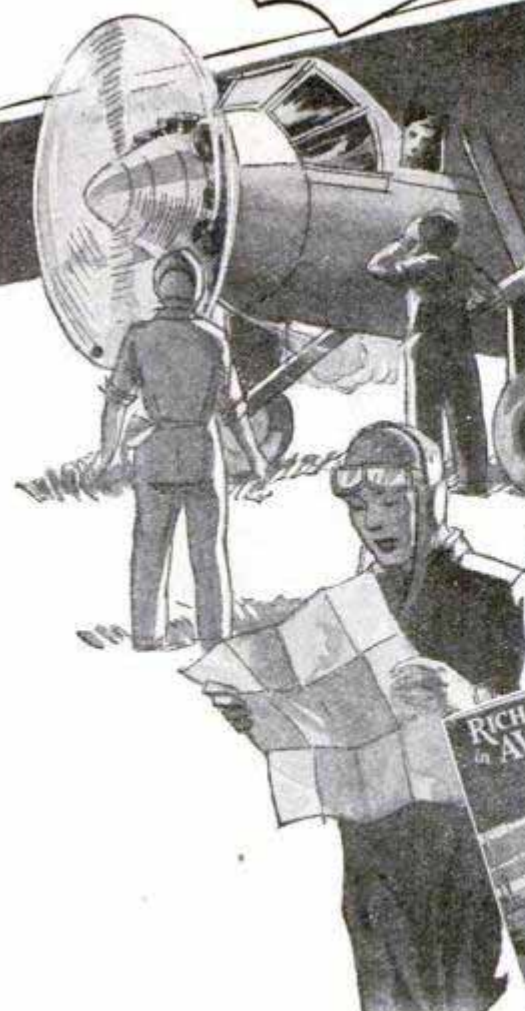

O. C.
MILLER
Director
Extension
Work
American
School



The American School

A two million Dollar *No-Profit* Educational Institution, now offers men a *double* service—training for a specific job, then help in finding the job. For one small price, on terms of only \$6.00 a month, you are now assured of definite benefits, both in position and salary. Write for complete information—*today!*

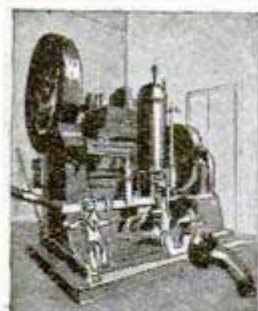

No machine can be built until the Draftsman first builds it on paper. This training prepares you for this work.



Never has the world seen anything like the building boom of today. This has created enormous demand for real Draftsmen.

5 BIG-PAY Branches

The big money in Drafting goes to men who specialize in Machine Design, or Electrical Drafting, or Architectural Drafting, or Structural, or Automotive. It is not enough merely to know *general* Drafting practice. You must know how to calculate and design and plan original work. You need many Engineering subjects to fill the kind of a Drafting position that pays \$40 to \$100.00 a week. The American School now includes this specialized training in its *Drafting course.*

Win Success Thru Drafting

Drafting is easy, fascinating work. Short hours. Big pay. And the Draftsman is always in line for promotion to executive positions. This training is *complete.* It includes high school subjects (if you need them) and all the Engineering and Mathematics Drafting experts require.

The American School

Drafting

to prove you can

We have invented a new simplified way to teach Drafting—the first real improvement in Drafting home instruction in history. We want you to see a few of these new Job-lessons, try them, test your own ability to master them—without one penny of cost or obligation. For instance, you will see how we get away from the “copying” methods used in the past, you develop into a DRAFTSMAN, instead of a “tracer.” See for yourself the ingenious new method which compels you to think, to solve problems, to do actual Drafting room jobs from the very first lesson!

A New, Rapid, Simplified Training

Copying drafting lessons prepares you to be only a “tracer.” This new “Job-Method” gives you actual drafting-room jobs in a new one-step-at-a-time way. With pictures which you can understand almost without reading the “lessons.” And that is why the American School-trained Draftsmen can qualify for a good job at big pay when they graduate.

FREE Job Service

The American School now offers its students and graduates, without cost, the service of an efficient employment department keeping in constant touch with employers of Draftsmen all over the U. S. We have placed hundreds of men in good, big-pay Drafting positions. We've made the training so complete, so practical, so easy to master, that our students are bound to make good. And so, because the demand for real Draftsmen continues to exceed the supply and because the training actually prepares men for good Drafting positions we back it with a Free Employment Service.

Dept. D-674
Drexel Avenue and
58th St., CHICAGO

Lessons *Actually* FREE

Learn at home in spare time!
Draftsmen Wanted!
\$40 to \$100 a Week!

yourself. Plan your future in Drafting. Even if you have only common schooling, even if you know nothing of Drafting, we guarantee to make you a real Draftsman or to refund your money!
 Coupon brings complete information.

70,000 fine jobs advertised last year. Get ready to fill one. Get out of the rut. Make something of

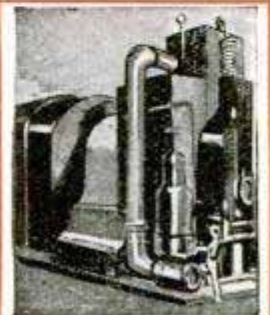

Electricity needs draftsmen who know Electrical principles as well as general Drafting practice. I give you this training.



The demand for Draftsmen experienced in concrete and structural steel work is enormous. Many big-pay positions open.



Every great Auto factory employs Draftsmen who specialize in Automotive work—men who design bodies, plan engines, etc.

I Will Make This Contract With You



American School
 —the two Million Dollar Educational Institution



- WHEN you enroll for our home-training in Drafting, we agree to give you:
1. Complete Drafting training, by the new Practice-Method.
 2. We will help you get a good Drafting position at a substantial increase in pay,
 3. or we'll refund every cent of your money.

O. C. Miller
 Director Extension Work

Coupon Brings 3 Lessons FREE!

Get them. Test your own ability to learn Drafting and get ready for a fine job and big pay. Coupon also brings complete information about your opportunities for success in Drafting. *Mail It Today!*

Read These Letters!

City of Chicago
 Department of Buildings
 Gentlemen: The same day I received my diploma I got word that I was one of the two candidates who had successfully passed the examination for Deputy Commissioner of Buildings of the City of Chicago, a position paying \$3600 per year.

There were eight applicants examined besides myself, all men well known to the architectural and engineering profession. Seven of these failed to obtain a passing grade of 70%. My grade was 84.69. Inasmuch as I failed to pass this same examination three years before, my present success is mainly due to the knowledge gained through your school.

Yours very truly,
ROBERT KNIGHT

Got His Draftsman's Job

"I wanted to let you know how I came out in getting that job at the Brownell Co., Dayton, Ohio. I was to start and have a trial at Drawing, and I am still in the Drawing room. The engineer seems to like the work I make, and also the other draftsmen. I thank the school very much for getting me in at this place, because your letter of recommendation helped me a whole lot to get the job."

BERNARD WEBER,
 730 St. Nicholas Ave., Dayton, O.

Liberty High School
 Bethlehem, Pa.

Dear Sirs:—This is to thank the American School for all that you have done for me since I signed up for the Drafting and Design Course.

In the eight years since then, I have gradually climbed from the position of tracer to that of Head of the Department of Machine Drawing and Design in our magnificent new \$2,000,000 High School here, at many times the salary which I received at that time.

The officials of the Pennsylvania State Department, and Dr. Wm. C. Ash of the University of Pennsylvania, all claim that our Course in Drafting and Design is the best now being taught in this state. Every drafting graduate that we have turned out has proved successful, and one is now Chief Draftsman in a local steel concern. Yours sincerely,

J. S. LEAR

Has Charge of Large Jobs

"Even before I had finished my course, I was put in charge of large construction jobs in different cities. I have been doing that ever since, and the jobs are getting larger all the time. I owe my success to the American School because of the knowledge I gained in mathematics and calculations."

ELMER L. LAMB,
 1396 Smith St., Peoria, Ill.

3 Drafting Lessons *Actually* FREE

O. C. MILLER, Director Extension Work
AMERICAN SCHOOL
 Dept. D-674, Drexel Ave. and 58th St., Chicago.
 Rush 3 Free Drafting Lessons, Job and Raise Offer, complete information, money-back guarantee, etc., to prove I can become a real Draftsman at home in spare time.

Name.....
 Street No.....
 City.....State.....
 Age.....Occupation.....



NOW → **ONLY \$2.00**

Giant Chest Expander

and

Progressive Exerciser

Be a muscular marvel. Have the muscles of a superman. Become strong for your health's sake or to astound your friends with extraordinary feats which only men of giant strength can do. In a few short weeks you will easily do stunts which now seem difficult—then real muscles and strength will be yours—and yours to keep.



Send No Money Use This Money Saving Coupon

How the Giant Chest Expander and Progressive Exerciser is Made

The Giant Chest Expander and Progressive Exerciser is made with new live, springy rubber so as to give it long wearing and great resisting qualities. Do not pay more for an exerciser that has forty or less rubber strands to each cable. Get the best and most durable. The Giant Progressive Exerciser has 50 strands of the finest rubber procurable to each cable.

Free Instructions

We do not think it enough to send you an exerciser worth double what we ask so for a limited time, we will also include instructions absolutely free. These instructions are interesting and simple to follow—they show you the short cut to health and strength. Order today before this wonderful offer is withdrawn.

Your Guarantee

The Giant Chest Expander is sold with a guarantee that you will say it is the finest you ever saw or your money back.

5 Cables or double 10 Cables for strength for

\$2 The double strength exerciser has resistance of over 200 lbs. **\$4**

How to Order—Send No Money

Sign your name and address to coupon below and get your Giant Exerciser at the present low introductory price by return mail. The price is made low because we want everyone to enjoy muscles and strength at the lowest possible cost. Don't pay more—order from us—get the most for your money. Use coupon now.

PROGRESSIVE EXERCISER CO.,
4009 Langdon Bldg.,
Broadway and Duane Street, New York

Please send Your 10 cable Progressive.
 Your 5 cable Exerciser.

Check the Exerciser you want, and it will be sent you by return mail. Pay postman introductory price, plus few cents postage on arrival. It is understood that if you are not entirely satisfied with your exerciser you may return it within 5 days and get your money back.

Name.....

Street.....

City..... State.....

If you live outside the United States, send cash with order.

\$25.00 DRAWING COURSE for \$2.98



Haven't you often wished that you could draw cartoons illustrate some idea, sketch some pretty face, etc. You can do all of these things. One of America's most famous Cartoonists and Illustrators has developed a great, simple system for success in all branches of Commercial Art. This system has revolutionized the entire theory of drawing. It means that drawing can be as easy for you as writing—much simpler than learning shorthand, bookkeeping or typewriting. We are now placing this original system for learning Drawing, Art and Cartooning consisting of 34 lessons with over 500 illustrations within reach of every one. If you will devote a few hours each week to the Course WE ABSOLUTELY GUARANTEE that you will learn to draw and draw well before you have half finished the Course. If we fail to make this claim good, we will refund every cent paid us. By eliminating a large office force for answering correspondence, expensive catalogs, etc., we are enabled to make a price of \$2.98 the cheapest price ever known for a high-grade home study course. Many have sent us letters similar to that of Rob't P. Davis of Detroit, who wrote "I can't see how you ask so little. It is more than I expected." Learn to draw. It is a big asset no matter what field you are in.

Send No Money

Just order the course and **\$2.98** on arrival pay postman plus a few cents postage, payment in full for the entire Course and Drawing Outfit. If not entirely satisfied, return within five days and we will Refund Money. Address:

If you order the course at once, we will include a drawing outfit, consisting of artist's pencils, paper, erasers, thumb tacks, etc., enabling you to go to work without any additional cost.

LEDERER SCHOOL of DRAWING, Dept. 9706-B, Chattanooga, Tenn
Orders from outside the U. S. A. are payable \$3.28 cash with order

\$100 a Week for Taking Pictures

We Furnish Camera and Teach You How

Men and Women Everywhere! Make Big Money!

FREE BOOK Explains opportunities as Motion Picture Camera Man, Portrait, News or Commercial Photographer. You can learn at home or in our New York Studios. Spare or full time. Job Chart Free.

N. Y. Institute of Photography
10 W. 33rd St., N. Y. Dept. 49

Be A Movie Operator
We furnish projector and teach you at home. Get a good pay job with Movie or Vaudeville Theatre. Write for folder.

TELEGRAPHY

(Morse and Wireless) and RAILWAY ACCOUNTING, taught thoroughly. B. salaries; great opportunities. Oldest, largest school. Endorsed by Telegraph Railway, Radio, and Government officials. Expenses low—opportunities to earn large portion. Catalog free. **DODGE INSTITUTE, Jones St., Valparaiso, Ind**

LEARN WATCHMAKING

and become independent. We help you secure a position. Easy to learn. Send for FREE CATALOG.
ST. LOUIS WATCHMAKING SCHOOL, Dept. 5, ST. LOUIS, MO

I'll Pay You

\$30 a Day



To Show My Rain Proof FITS-U Caps to Men

I'll pay you \$30 a day to show my marvelous line of rain-proof Fits-U Caps. More for active workers. With my liberal commission of \$1.00 on every sale—it's a cinch to clean up \$5.00 or more an hour in spare time. "In two hours," writes one successful salesman, "I made \$15.70." It's the rain-proof and made-to-measure features that get the orders so quick.

FREE Outfit

By a secret process, every Fits-U Cap is made absolutely rain-proof! Rain has no effect on the Fits-U Cap. You collect big commissions in advance. EVERY CAP MADE TO INDIVIDUAL MEASURE! Many other fast selling numbers: Men's Felt Hats, Ladies' Hats, Mufflers, Ties, etc. Don't Wait—Act Now. I'll send elaborate selling outfit to you FREE. Get started immediately. Just send name and address. Postal will do. Write today!

FITS-U CAP CO., Dept. U-75, CINCINNATI, OHIO

Get Your Share of the BIG MONEY

Why be satisfied with \$25, \$30 or \$45 a week when the good jobs in Radio pay \$50, \$75 and all the way up to \$250 a week. The astounding growth of Radio has already created three hundred thousand jobs in a few short years. Small and large fortunes are coming out of this new business every year. Twenty different branches offer you work that's almost romance. Manufacturing, selling, repairing, servicing, assembling, installing sets, operating on board ship which gives you world-wide travel without expense, operating a broadcasting station, and many other lines of work are fully explained in "Rich Rewards in Radio," my 64-page FREE book. Send for it today.

Learn at Home in Spare Minutes
No need to leave home. Hold your job. You can learn during your spare time. My easy-to-learn, practical course has put hundreds of fellows who had only a few minutes a day to study into big pay jobs. You don't have to be a college or high school graduate to become a Radio Expert. Many of my students and graduates now making big money didn't even finish the grades.

You Get Six Big Outfits Without Extra Charge

I teach Radio the right way—the practical way. I give you six big outfits of Radio parts (not toys) and show you how to build approximately 100 different circuits, locate, repair and remedy receiving set troubles. Three outfits you build are shown on this page. Thus you learn the "why" and the "how"—get a complete, thorough, rounded-out knowledge that shows its worth in your pay envelope. Full details in my big book.

Earn \$15, \$20, \$30 a Week Extra While Learning

Deloss Brown, South St., Foxboro, Mass., made \$1,000 from spare time jobs before he even finished his course. G. W. Page, 1807 21st Ave. S., Nashville, Tenn., made \$935 in spare time. No need to skimp, save and deny yourself good things to pay for this course. It's the world-famous course that pays for itself.

Your Money Back if Not Satisfied

That's the agreement I make with you when you enroll. It's my way of showing you that I'll give you the training and service you need and want. You are the only Judge.

64-Page Book FREE for the Asking

I will gladly send you my 64-page book of information on N.R.I. training and the money-making opportunities in Radio without a penny's cost. Send for it NOW. Clip or tear out the coupon today. Find out what Radio offers you and how my Employment Department helps you get into Radio after you graduate.

Address: **J. E. Smith, Pres., National Radio Institute Dept. 9 H Washington, D. C.**



Read What Big Money these N.R.I. men are making



\$375 One Month Spare Time

"Recently I made \$375 in one month in my spare time installing, servicing, selling Radio sets."

Earle Cummings, 18 Webster St., Haverhill, Mass.



\$1597 In Five Months

"The N. R. I. is the best Radio school in the U. S. A. I have made \$1597 in five months. I shall always tell my friends that I owe my success to you."

Henry J. Nickle, Jr., 392 Safford Av., Tarpon Springs, Fla.

Learn Radio the Practical Fascinating Way



You can build 100 circuits with the 6 big outfits of Radio Parts I give you

3 of the 100 you can build



RADIO

I'll Show you how MANY MEN are MAKING

\$50 to \$250

A WEEK

in this New Business

Send for FREE 64 Page Book giving facts on this new opportunity

Act Today

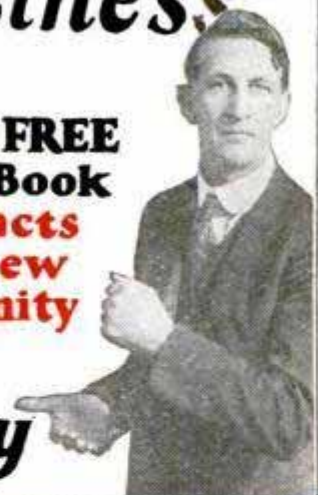

Mail This FREE COUPON NOW

J. E. Smith, President, Dept. 9 H National Radio Institute, Washington, D. C.

Dear Mr. Smith: Without obligating me in any way please send me your Free book, "Rich Rewards in Radio" with information on your Practical Home Study Radio Course.

Name _____ Age _____
Address _____
City _____ State _____



Originators of Radio Home Study Training



"The Boss Was Stumped"

"He was trying to figure out a way to speed up the machines. I could see he was stumped and I asked him if he would let me try my hand at it.

"Go ahead," he said, "but I don't believe you can help much. Looks like an outside job to me."

"So I started right in and pretty soon I had the whole thing worked out. The boss was watching me and I could see he was surprised.

"How did you learn all that?" he asked in that quiet way of his. And then I told him I'd been studying at home nights through the International Correspondence Schools.

"He didn't say anything more and I thought he had forgotten all about it until he called me in his office a few weeks later and said he was going to make me foreman and increase my salary \$75 a month.

"Keep on studying," he told me, "and you'll get another promotion soon. You can't beat those International Correspondence Schools text-books for good, sound, practical knowledge."

That's a true story of what spare-time study has done for just one man. There are thousands of others. Why don't you take up a home-study course with the International Correspondence Schools and prepare yourself to earn more money? At least get the facts.

Mail the Coupon for Free Booklet

INTERNATIONAL CORRESPONDENCE SCHOOLS

"The Universal University"

Box 5560-F, Scranton, Penna.

Without cost or obligation, please send me a copy of your booklet, "Who Wins and Why," and full particulars about the subject before which I have marked X in the list below:

BUSINESS TRAINING COURSES

- | | |
|--|--|
| <input type="checkbox"/> Business Management | <input type="checkbox"/> Business Correspondence |
| <input type="checkbox"/> Industrial Management | <input type="checkbox"/> Show Card Lettering |
| <input type="checkbox"/> Personnel Management | <input type="checkbox"/> Stenography and Typing |
| <input type="checkbox"/> Traffic Management | <input type="checkbox"/> English |
| <input type="checkbox"/> Accounting and C.P.A. Coaching | <input type="checkbox"/> Civil Service |
| <input type="checkbox"/> Cost Accounting | <input type="checkbox"/> Railway Mail Clerk |
| <input type="checkbox"/> Bookkeeping | <input type="checkbox"/> Mail Carrier |
| <input type="checkbox"/> Secretarial Work | <input type="checkbox"/> Common School Subjects |
| <input type="checkbox"/> Spanish <input type="checkbox"/> French | <input type="checkbox"/> High School Subjects |
| <input type="checkbox"/> Salesmanship | <input type="checkbox"/> Cartooning |
| <input type="checkbox"/> Advertising | <input type="checkbox"/> Illustrating |
| | <input type="checkbox"/> Lumber Dealer |

TECHNICAL AND INDUSTRIAL COURSES

- | | |
|--|---|
| <input type="checkbox"/> Architect | <input type="checkbox"/> Automobile Work |
| <input type="checkbox"/> Architectural Draftsman | <input type="checkbox"/> Airplane Engines |
| <input type="checkbox"/> Building Foreman | <input type="checkbox"/> Plumber and Steam Fitter |
| <input type="checkbox"/> Concrete Builder | <input type="checkbox"/> Plumbing Inspector |
| <input type="checkbox"/> Contractor and Builder | <input type="checkbox"/> Foreman Plumber |
| <input type="checkbox"/> Structural Draftsman | <input type="checkbox"/> Heating and Ventilation |
| <input type="checkbox"/> Structural Engineer | <input type="checkbox"/> Sheet-Metal Worker |
| <input type="checkbox"/> Electrical Engineer | <input type="checkbox"/> Steam Engineer |
| <input type="checkbox"/> Electrical Contractor | <input type="checkbox"/> Marine Engineer |
| <input type="checkbox"/> Electric Wiring | <input type="checkbox"/> Refrigeration Engineer |
| <input type="checkbox"/> Electric Lighting | <input type="checkbox"/> R. R. Positions |
| <input type="checkbox"/> Electric Car Running | <input type="checkbox"/> Highway Engineer |
| <input type="checkbox"/> Telegraph Engineer | <input type="checkbox"/> Chemistry |
| <input type="checkbox"/> Telephone Work | <input type="checkbox"/> Pharmacy |
| <input type="checkbox"/> Mechanical Engineer | <input type="checkbox"/> Mining Engineer |
| <input type="checkbox"/> Mechanical Draftsman | <input type="checkbox"/> Navigation <input type="checkbox"/> Assayer |
| <input type="checkbox"/> Machine Shop Practice | <input type="checkbox"/> Iron and Steel Worker |
| <input type="checkbox"/> Toolmaker | <input type="checkbox"/> Textile Overseer or Supt. |
| <input type="checkbox"/> Patternmaker | <input type="checkbox"/> Cotton Manufacturing |
| <input type="checkbox"/> Civil Engineer | <input type="checkbox"/> Woolen Manufacturing |
| <input type="checkbox"/> Surveying and Mapping | <input type="checkbox"/> Agriculture <input type="checkbox"/> Fruit Growing |
| <input type="checkbox"/> Bridge Engineer | <input type="checkbox"/> Poultry Farming |
| <input type="checkbox"/> Gas Engine Operating | <input type="checkbox"/> Mathematics <input type="checkbox"/> Radio |

Name.....
 Address.....
 City..... State.....



Why Miss Half the Fun in Life?

BE POPULAR—Learn to dance well! Arthur Murray, America's greatest dancing teacher, has invented a remarkable new easy method which enables anyone to learn all the newest dances at home—in a few hours—at very little cost! No music or partner needed. Success positively guaranteed! "200,000 learned dancing by mail."

FREE 5 DANCING LESSONS— To prove you can learn easily and quickly, Arthur Murray will send you Five FREE lessons, including Fox Trot, Secret of Leading, and How to Gain Confidence. To pay cost of mailing, printing, etc., enclose 10c. Act NOW and be a good dancer soon.

Arthur Murray, Studio 832, 7 East 43rd Street NEW YORK

Electrical Engineering

Course for men of ambition and limited time. Over 5000 men trained. Condensed course in Theoretical and Practical Electrical Engineering including the closely related subjects of Mathematics and Mechanical Drawing.

Students construct motors, install wiring, test electrical machinery. Course designed to be completed in one college year. Prepare for your profession in the most interesting city in the world. Est. 1893. Catalog on request.



Bliss Electrical School

119 Takoma Ave., Washington, D. C.

LAW STUDY AT HOME

Become a lawyer. Legally trained men win high positions and big success in business and public life. Be independent. Greater opportunities now than ever before. Big corporations are headed by men with legal training. Earn \$5,000 to \$10,000 Annually

We guide you step by step. You can train at home during spare time. Degree of LL.B. conferred. LaSalle students found among practicing attorneys of every state. We furnish all text material, including fourteen-volume Law Library. Low cost, easy terms. Get our valuable 108-page "Law Guide" and "Evidence" books FREE. Send for them NOW.

LaSalle Extension University, Dept. 964-L, Chicago
 The World's Largest Business Training Institution

Learn to PAINT SIGNS and SHOW CARDS

We quickly teach you by mail, or at school, in spare time. Enormous demand. Big future. Interesting work. Oldest, foremost school.

EARN \$50 TO \$200 WEEKLY

John Vassos, N. Y., gets \$25 for single show card. Crawford, B. C., says: "Earned \$200 while taking course." Send today for free information, samples and guarantee.

DETROIT SCHOOL OF LETTERING
 154 Stimson Ave., Est. 1899 Detroit, Mich.

WANT THIS JOB?

\$1700 to \$2300 a Year
MAIL CARRIERS — POSTAL CLERKS
 Men 18 up

Steady Work Paid Vacation

Write immediately for FREE list of positions and full particulars telling how to get a position.

FRANKLIN INSTITUTE
 (Not connected with U. S. Government)
 Dept. G314 Rochester, N. Y.

Raise Poultry MAKE BIG MONEY

Results Quick—Part or Full Time

Take up poultry raising. It's interesting, healthful, PROFITABLE. Easy to sell all you can produce at big prices. Our new course by Henry M. Lamon, former gov't expert, gives short cuts to success. Write for free book, "How to Raise Poultry for Profit."

NATIONAL POULTRY INSTITUTE, Dept. 411, Washington, D. C.

I'll Pay Your Railroad Fare to Chicago Without Extra Cost

UP TO \$15,000 a year for GREER GRADUATES

ELECTRICITY, AUTOS, AVIATION now pay hundreds of trained men up to \$200 A WEEK. Here are THE 3 WORLD'S GREATEST BUSINESSES. BILLIONS—not millions, but BILLIONS of dollars are spent in them every year. CHOOSE ONE OF THESE THREE, HERE and NOW.

GREER trained men are NEEDED. I HAVE MADE hundreds of \$10,000 A YEAR MEN. 90,000 in the last 26 years have come to GREER. THOUSANDS MORE in the future will likely come here. BE ONE OF THEM. Send coupon to me for openings.

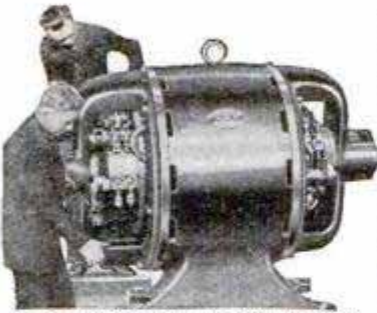

Rotary Converter, used by students for testing

Amazing Opportunities for you in one of World's 3 Biggest Businesses

MEN WANTED

I will help you get a position while learning, also after graduation. Never before such unusual opportunities. GET MY FREE BOOK NOW. LEARN ABOUT THE BIG PAY. ELECTRICITY. AUTOS. AVIATION lead WORLD'S BUSINESS. That's why GREER College selected these Fields and ONLY THESE.



Learn to Boss the Job

ELECTRICITY

AUTOS

Learn in Only 3 Months in GREAT GREER SHOPS ON LARGE LIVE EQUIPMENT

Mine is NOT A CORRESPONDENCE COURSE. You can start any day or any evening. It is PRACTICAL, EASY, QUICK, FASCINATING training. You learn on Great, running, live Equipment in tremendous GREER SHOPS. AUTO Business a BIGGEST BUSINESS in the world. ELECTRICITY is FASTEST GROWING, and yet in its Infancy. AVIATION, most fascinating, alluring business today, is already a Billion Dollar Industry.

Choose one of these 3 wonderful professions today. Trained men are needed by scores, for positions up to \$200 a week and up. Find out now, about my great Shops training.

full of HARD THEORY—NO HEADACHES in GREER PRACTICAL SHOPS TRAINING. You learn to DO BY DOING. You learn to fly by flying.

You Get Real Help to BIG JOBS!

TWELVE PEOPLE are in my Big EMPLOYMENT DEPARTMENT getting jobs for Greer men. You get their help AS OFTEN AS YOU NEED IT, both BEFORE and AFTER Graduation.

Quickest, Easiest of Ways to Become Expert

I'LL PAY YOUR FARE HERE FREE of extra cost, then help you to a JOB WHILE LEARNING. Then I not only FIT YOU to get BIG PAY JOB but I'll help YOU HOLD IT. Young and Old, Educated and Uneducated, Inexperienced and Experienced have found GREER SHOPS training EASY, FASCINATING and VALUABLE. Coupon below brings details.

Not Correspondence Course

Here at GREER SHOPS you learn on BIG, ACTUAL FULL SIZE Machinery, like you will work on out on the Big Pay Job. You get close personal supervision. NO Guess work—NO books

Erwin Greer



GREER COLLEGE

Electricity—Autos—Aviation
Dept. B01
2024 So. Wabash Ave.
CHICAGO, ILL.

Get My FREE BOOK NOW

Don't let money hold you back. Get my Free Book. Find out NOW, how I PAY YOUR FARE HERE, let YOU ATTEND EITHER DAYS or EVENINGS and help you find DAY or EVENING WORK to PAY YOUR EXPENSES while learning. Then when ready we help you find the real BIG PAY JOB. LEARN how I get you ready, so Employers WANT YOU, and GLADLY pay you what you are worth.

90,000 Students 26 Years Tremendous Success

Above is the important history of GREER COLLEGE. Note the steady 26-years growth, thru genuine SERVICE, from the tiny Shops on the left to the tremendous Building on the right, filled with GREAT TRAINING Equipment. These

moves to always greater quarters mean GROWTH—PROGRESS and SERVICE. What is it you like—ELECTRICITY—AUTOS—or fascinating AVIATION? GREER will train you in EITHER, as YOU SHOULD BE TRAINED.

Get My Big Offer Now!

Would an offer of \$100 a week be OPPORTUNITY or DISAPPOINTMENT for you? If you could HOLD THE JOB it would truly be OPPORTUNITY. If you can't hold the \$100 a week job, PREPARE. Be ready. Don't invite disappointment. Learn about GREER SHOPS. Right now if you act quick, I can make you a most unusual short time offer. Clip coupon NOW and find out. Address me personally
ERWIN GREER, President

SCISSORS FOR FREE BOOK

ERWIN GREER, President
Dept. B01
2024 So. Wabash Avenue,
Chicago, Illinois
Send Free Book indicated below and details of Special offer, without obligation to me.
 Autos Electricity Aviation

Name.....
Address.....

\$25 Extra Each Week for YOU—Easy

Make **BIG MONEY**—Spare-Time or Full-Time—with Hawaiian Guitar

Be the life of every party—be paid big for your spare time hours! Dances, parties, orchestras—all pay **REAL CASH** for the sweet melodious music of the Hawaiian (Steel) Guitar. YOU can make \$25 a week and up extra, or \$64 to \$100 a week full-time pay! Just give me a few minutes each evening and I'll give you your passport to popularity, fun and plenty of **EXTRA DOLLARS!**

No Musical Knowledge Needed; Learn Quick Right at Home in 1 to 3 Months

Never mind about reading notes; few of my students know one thing about music when they start. My easy method explains everything. No hard practice, no tiresome "neals" to learn. You play real tunes from the very first! And in only 1 to 3 short months you can actually be playing for pay. I'll prove it to you without cost; get my **FREE Book** below.



PROOF

"Had learned only a few chords when I was asked to play at a dance. Received sixteen dollars (\$16) for one night's playing."
—R. A. Fritzman, Lehighton, Pa.

"Only quarter way through course and already playing 3 evenings a week, spare time, for \$10."
—J. Krulicki, Kitchener, Ont., Can.

"Have made almost \$200 with my Hawaiian Guitar in spare-time."
—John B. McMillin, Cedar, Mo.

PHONOGRAPH RECORDS

and Complete Outfit at No Extra Cost

In addition to beautiful Hawaiian Guitar—Complete Outfit—easy lessons and instructions—you receive clear, correct, fool-proof Demonstration Phonograph Records of every selection in the course. And **NOT ONE CENT OF EXTRA COST** to you!

FREE BOOK Shows You How

Everything explained, every last bit of proof is given you, in this **FREE Book**. It shows how I train you at home quickly to play Hawaiian Guitar; how you risk absolutely nothing to learn; how I send you everything you need. Get your copy without one day's delay. Clip the coupon and send it today. **NOW!**

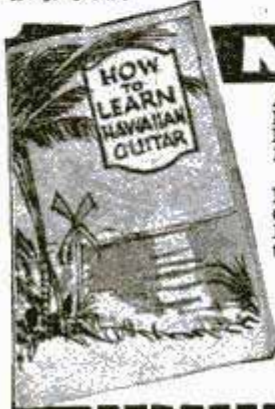

MAIL NOW!

A. F. Bloch, President, Hawaiian Studios 52098 of New York Academy of Music, 100 Fifth Avenue, New York City.

Without obligation, send me **FREE Book** "How to Learn Hawaiian Guitar," with facts on how I can make **BIG MONEY**, spare-time or full-time.

Name.....

Address.....



High School Course in Two Years!

You Want to Earn Big Money!

And you will not be satisfied unless you earn steady promotion. But are you prepared for the job ahead of you? Do you measure up to the standard that insures success? For a more responsible position a fairly good education is necessary. To write a sensible business letter, to prepare estimates, to figure cost and to compute interest, you must have a certain amount of preparation. All this you must be able to do before you will earn promotion. Many business houses hire no men whose general knowledge is not equal to a high school course. Why? Because big business refuses to burden itself with men who are barred from promotion by the lack of elementary education.

Can You Qualify for a Better Position

We have a plan whereby you can. We can give you a complete but simplified high school course in two years, giving you all the essentials that form the foundation of practical business. It will prepare you to hold your own where competition is keen and exacting. Do not doubt your ability, but make up your mind to it and you will soon have the requirements that will bring you success and big money. **YOU CAN DO IT.**

Let us show you how to get on the road to success. It will not cost you a single working hour. Write today. It costs you nothing but a stamp.

American School

Dept. H-674, Drexel Ave. and 58th St., Chicago

American School

Dept. H-674 Drexel Ave. and 58th St., Chicago
Send me full information on the subject checked and how you will help me win success.

- | | |
|-----------------------------|---------------------------|
|Architect |Business Law |
|Building Contractor |Lawyer |
|Automobile Engineer |Machine Shop Practice |
|Automobile Repairman |Mechanical Engineer |
|Civil Engineer |Shop Superintendent |
|Structural Engineer |Employment Manager |
|Business Manager |Steam Engineer |
|Cert. Public Accountant |Foremanship |
|Accountant and Auditor |Sanitary Engineer |
|Bookkeeper |Surveyor (& Mapping) |
|Draftsman and Designer |Telephone Engineer |
|Electrical Engineer |Telegraph Engineer |
|Electric Light & Power |High School Graduate |
|General Education |Wireless Radio |
|Vocational Guidance |Undecided |

Name.....

Address.....

CHEVROLET
40.8 Miles per Gallon

BUICK
36 Miles on a Gallon

OLDSMOBILE
1300 Miles of Free Gasoline

FORD
40 Miles on a Gallon

SAVED \$340 in Gasoline

CHRYSLER
38 Miles per Gallon

ENDS CARBON Without Touching the Engine

BATTLING NELSON
The Durable Dane

Bat made 40 miles on a gallon with a roadster and 33½ miles a gallon with a touring car.
Bat writes: "Most of the public know me well enough to know that I never bunked them in my life. And when I say your vaporizer is all you say it is, I mean it."

Who Else Wants to Save Gasoline?

FORD
"I have used one on my Ford for over five years and have traveled over 35,000 miles. Never had any spark plug trouble. Have averaged 28 to 30 miles on gal."
J. H. Alruth, Iowa.

CHEVROLET
"You people claim a saving of 25% to 50%. I found I was obtaining 40.8 miles to a gal. on a Chevrolet, whereas formerly I had been getting only 19.5. Actual test surpasses your claim."
M. E. Miller, Kansas City.

BUICK
G. M. Rathburn, Charleston, W. Va., has a Buick Six. Having an old engine, it was getting only 8 or 9 miles to a gal. On a 287-mile trip he got 19 miles to a gal. He says it has saved him \$40.00 on one trip.

NASH
"I had a large Nash Six I drove from Los Angeles to San Francisco on 20 gals. of gas, whereas I have usually taken from 50 to 55."
H. T. McCalon, California.

A SOUTH DAKOTA man has discovered an amazing gas-saving invention now installed on over two million cars of every make. . . . Already over ten thousand car owners say it increases gas mileage 25% to 50% . . . cleans out carbon without touching the engine . . . adds more speed and power . . . and saves an astonishing amount of money in gasoline and repair expense. There is a model for every car, truck, tractor or gasoline engine. Anybody can install it in a few minutes.

This invention is based on newly discovered facts about potential gasoline power that few car owners know about. For example, it is now found that the average man wastes at least 20% to 30% of his gasoline through improper combustion. And many more interesting discoveries too detailed to mention here.

Read on the left what other car owners say about it. Then accept the inventor's special introductory offer. He will send you

samples to test without obligation to buy. If you find it doesn't do for you what it has done for other car owners, he will pay a cash forfeit for the few minutes you've spent in testing it.

Don't send a penny now. Simply send your name in coupon below. J. A. Stransky Mfg. Co., L-10, Stransky Block, Pukwana, S. D.

MEN WANTED

Herrick made \$157 in a day, letting Stransky vaporizers sell themselves. Territories open everywhere. Full or spare time. Check coupon below.

J. A. STRANSKY MFG. CO.,
L-10, Stransky Block, Pukwana, S. D.

Yes, send me full description of this new way to save gasoline. This request does not obligate me in any way.

My Name is.....

Street.....

City..... State.....

Check here if you want agent's proposition.



\$1,000 Reward

For the Capture of This Man

CONVICT 6138, escaped from the State Penitentiary; Name, Charles Condray; age 37; Height, 5 feet 8 inches; Weight, 141 pounds; Hair, light brown; Eyes, gray.

Easy enough to identify him from his photograph and this description, you may say — but, Condray took the name of "Brown," dyed his hair, darkened his skin, grew a mustache, put on weight and walked with a stoop.

Yet he was captured and identified so positively that he knew the game was up and returned to the penitentiary without extradition. How was it accomplished? Easy enough for the Finger Print Expert. They are the specialists, the leaders, the cream of detectives. Every day's paper tells their wonderful exploits in solving mysterious crimes and convicting dangerous criminals.

More Trained Men Needed

The demand for trained men by governments, states, cities, detective agencies, corporations, and private bureaus is becoming greater every day. Here is a real opportunity for YOU. Can you imagine a more fascinating line of work than this? Often life and death depend on finger print evidence—and big rewards go to the expert. Many experts earn regularly from \$3,000 to \$10,000 per year.

Learn At Home in Spare Time

And now you can learn the secrets of this science at home in your spare time. Any man with common school education and average ability can learn Finger Printing in a surprisingly short time.

FREE The Confidential Reports No. 38 Made to His Chief!

IF YOU ACT QUICK—We will send you free and with no obligation whatsoever, a copy of the gripping, fascinating, confidential report Secret Service Operator No. 38 made to His Chief. Mail coupon NOW!

Write quickly for fully illustrated free book on Finger Prints which explains this wonderful training in detail. Don't wait. Mail the coupon now. You may never see this announcement again! You assume no obligation. You have everything to gain and nothing to lose. Write at once. Address

University of Applied Science
Dept. 13-56 1920 Sunnyside Avenue, Chicago

UNIVERSITY OF APPLIED SCIENCE
Dept. 13-56, 1920 Sunnyside Avenue, Chicago, Ill.
Gentlemen: Without any obligation whatever, send me your new, fully illustrated, FREE book on Finger Prints and the free copy of the Confidential Reports Operator No. 38 made to His Chief.

Name.....

Address.....

Age.....



Air Mail Pilots Teach You to Fly

The skilled pilots who regularly fly the U. S. Mail between St. Louis and Chicago, instruct and "check" our advanced students. No other school offers this advantage.

Ten Licensed Transport Pilots on teaching staff. Army School system of instruction. No bond required. No charge for breakage.

9½ Years—Over 550 Graduates
—No Accidents

Get this Inspiring Book: Send 25c, stamps or coin, for illustrated book "Making Good in Aviation"

Full of valuable suggestions. Contains story of Col. Lindbergh as our Chief Air Mail Pilot and Instructor.

Robertson Flying Services, Inc. Dept. P

Affiliated with Robertson Aircraft Corporation
Lambert-St. Louis Field, Anglum, St. Louis Co., Mo.

MR519



The Proved! LACO ^{OIL} GAS Burner of LOWEST PRICE... HIGHEST PERFORMANCE

The LACO OIL BURNER is the only burner using an indestructible mineral wick—the simple operation which is used in the ordinary kerosene lamp. The double fire pot is completely ventilated, thereby preventing over-heat and formation of residue.

There is nothing to get out of order; practically noiseless; does not bother radios; has its own pilot light. It will not cause dirt, smoke, soot or odor. It is actually safer than a gas range. There are no adjustments to make. Made in seven sizes—each the lowest priced in its size. There is a size for every heating requirement—for small homes—large homes, or buildings. Can be used for warm air, steam, hot water or vapor heating systems. Mail the coupon for more information about this proved (L) gas burner. Priced from \$125 to \$475.

LACO GAS BURNER CO.
111 Union St.,
Griswold, Iowa, U. S. A.

DEALERS:
LACO sales are increasing each month. This will be a banner year in the oil burner business. Dealers are invited to write for details of the extraordinary LACO SALES opportunity. Use the coupon today.

LACO Gas Burner Co.
111 Union St.
Griswold, Iowa
U. S. A.

Gentlemen:
I want to know more about LACO for my home of rooms. Check square if interested in LACO agency.

Name.....
Address.....
City..... State.....



BEFORE "My friends called me 'Slats,'" writes Wesley Webb, describing his condition before taking Titus Training. You can see for yourself what a puny, undeveloped youngster he was.



AFTER You'd never recognize this as the same man as the one on the left. Look at that wonderful set of muscles Titus Training built! Send for the Free Book that tells how Titus performs these "Miracles."

Make This Test TO-NIGHT!

BEFORE you hop into bed tonight, try this: strip down to your birthday suit and stand in front of your mirror. Look yourself over.

What do you see? A fine, up-standing specimen of a MAN—splendidly proportioned, superbly muscled, glowing with health and vitality? Or do you see a flabby, sickly sort of fellow, with sunken chest, bloodless-looking flesh, scrawny arms and legs?

Compare yourself with the pictures on this page. Which do you resemble most—the ones labelled "BEFORE," or the ones labelled "AFTER"?

But don't worry if you're not the man you'd like to be. We'll soon fix that. You see what I did for the boys shown here—well, that's what I'm going to do for YOU. Yes sir, just give me a few minutes a day in your own home—and watch your muscles GROW! Say, a few weeks of Titus Training will make you over!

I'll Give You a New Body in 30 Days

I don't care what your present condition is. Don't think it's only the strong man and athlete who takes Titus Training. Thousands of the men I've re-built were absolutely down and out physically. Some of them looked like scarecrows. Some of them were actually *cripples*.



BEFORE AND AFTER

Here's another chap who had no more muscle on his body than a chicken. The second picture shows you what a few weeks of Titus Training did—fairly loaded his body with muscle.

pling, fast as lightning, strong

as steel—CHAMPION muscles. But, oh man! You should see these men today! You would never believe such an improvement was possible. They didn't believe I could do so much for them. They wrote to me as a last resort, hoping against hope that I might help them. Did I? Boy!—and HOW!

Now I want to get to work on YOU! How would you like me to add INCHES of tough, powerful muscles to your arms, your shoulders, your chest, your legs. Not just chunks of clumsy beef, but magnificent PANTHER muscles—smooth, rip-

The Amazing Discovery of Muscle Concentration

Take a tip from the man who has built world champion strong men: *it's not the mere size of muscles that counts.* I give you that

marvellous power of **MUSCLE CONCENTRATION**—my own exclusive discovery. It's the last word in scientific muscle - building. You suddenly become capable of feats of strength and endurance you never thought possible.

Strong men all over the world wear it. Made of solid statuary bronze and given to you free. Mail coupon for full details.

WEAR THIS MEDAL



RUSH THIS COUPON

FOR THE MOST AMAZING BOOK YOU EVER SAW

"Miracles in Muscle"—that's the title of my big new book, and it's a WOW. I want you to have a copy—you'll eat it up. It gives the real low-down on Titus Training—HOW and WHY it achieves such astounding results. It's packed with stories and pictures of what I've done for others. You'll open your eyes at some of these demonstrations of muscle-building. On the level, this is a real book, and you'll find every page filled with interesting and valuable tips. I'll gladly send you a copy with my compliments if you'll just write your name and address on the coupon, and send along a nickel to pay postage. Better do it NOW!

THE ONE AND ONLY **TITUS** 105 E. 13th St., New York City

TITUS, Dept. M-1210
105 E. 13th St., New York City

Dear Titus: Sure, I want that big new book of yours. Here's a nickel to help pay postage.

Name.....

Address.....

Town.....State.....



**Stop
That
Pain!**

**With Violet Ray Vibration
Ozone Medical Electricity**

*The Four Greatest Curative Powers
Generated by This*

Great New Invention!



Elco Health Generators at last are ready for you! If you want more health—greater power to enjoy the pleasures and delights about you, or if more beauty is your desire—write! Ask for the book on these inventions which has just been prepared. It will be sent to you without cost. It tells you how Elco Health Generators aid you in leaving the lethargy and hopelessness of bad health and weakness behind forever. Re-vitalize yourself. Bring back energy. Be wholly alive. Write today!

Here's What Elco Users Say—

"Wouldn't take \$1000 for my Elco."
"Has done me more good in 2 weeks than doctors did in three years."
"Cured my Rheumatism."
"My Eczema gone."
"Cured my stomach trouble."
"Cured my weakness."
"Now I sleep soundly all night."
"Thanks to Elco my strength and vigor are back."
"No more pain."
"Colds never bother me now."
"Chronic Constipation banished."



These great new inventions generate Violet Ray, Vibration, Electrotricity and Ozone—combined or separate. They operate on the electric light in your home or on their own motive power at less than 50 cents per year. Elco Health Generators are positively the only instruments which can give you in one outfit Electricity, Violet Ray—Vibration and Ozone—the four greatest curative agents. Send the coupon below. Get the Free Book NOW!

**MAIL COUPON
for FREE BOOK**

Do not put this paper down without sending the coupon. Don't go on as you are with pains and with almost no life and energy. You owe it to yourself to be a better man or woman. You were put here to enjoy life—not just to drag through it. So do not rest another day until you have put your name on the coupon here. That will bring the whole story of these great new inventions. Do it today—now.



Lindstrom & Company

30 West Lake St. Dept. 13-16 Chicago

Please send me your free book, "Health—Power—Beauty" and full information of your 10-day Free Trial Offer.

Name.....

Address.....



**Learn
AVIATION**

Money—fame—adventure! They all await you in Aviation. Experts who can fly—who can design, build and repair airplanes and motors, are in big demand everywhere. You can make from \$75.00 to \$500.00 a week after thorough training. You may be internationally famous in a year!

Prepare for Big Pay Jobs

We give you complete and thorough flying and ground instructions on modern equipment such as Travel Air and other new-production ships, and on Whirlwind, Caminez and other new engines. You'll be taught Air Navigation, Meteorology, Aerodynamics, Airplane Construction and Maintenance, Motor Overhaul, Airport Management—and you'll learn to fly by flying with expert transport pilots. You'll find yourself in a hotbed of aviation activity. You'll see all the latest planes zooming and roaring, coming and going at our field. Parks is not a correspondence school.

**FREE
This
Inspiring Book!**

Send at once for "Skyward Ho!" the free aviation book that gives facts about opportunities—shows how you can get into this great industry that is making fortunes for many almost over night. Special offer for this month saves you half the cost—if you write at once.



212-F Mo. Theatre Bldg.

ST. LOUIS, MO.



MEN NEEDED FOR RAILROADS

Nearest their homes—everywhere—to train for Firemen, Brakemen; beginners \$150-\$250 monthly. Promoted to Conductor or Engineer—\$3,000-\$4,000 yearly—highest wages on railroads. Also clerks. Railway Educational Association, Dept. D1-9, Brooklyn, N. Y.

**Engineering Degree
in 2 Years**



**Degrees Granted by Authority of the
State of INDIANA**

No entrance exams required. And if you haven't a high-school diploma we'll give you the essential subjects.

If you want to be a graduate ENGINEER and earn \$50 to \$150 a week, come to TRI-STATE College. We are interested in helping men who may be short of money and time, but are strong in the desire to improve themselves. Time cut to 96 weeks by eliminating frills and concentrating on Science, Mathematics, Drafting, Laboratory and field-work.

**LOW TUITION
—small living expense**

Rooms in private homes \$2.00 to \$3.00 a week. Meals \$3.50 to \$5.00 a week. Tuition about half the average. Employment service for graduates, free. Wonderful bunch of students. Terms start Sept., Jan., March, June. Mail coupon for free catalog.



B. S. (Bachelor of Science) degrees conferred in Electrical, Civil, Mechanical, Chemical and Administrative Engineering

**TRI-STATE COLLEGE
Box E-6113, Angola, Indiana**

Tri-State College, Box E-6113, Angola, Indiana

- Civil
 - Electrical
 - Mechanical
 - Chemical
 - Administrative
- Send free book and complete information of your 2 year Engineering Courses. (Mark X at left.)
Name.....
Address.....

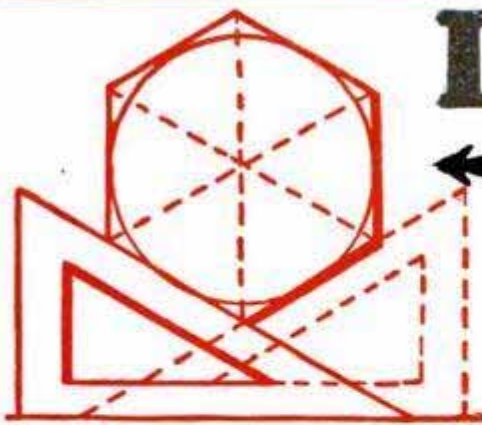

Draw This

← Hexagon

Draftsman's

And Get This Pocket Rule

FREE

Make this drawing and send it in today. Copy the Hexagon as quickly as you can. It will give me some idea of what kind of a draftsman you will be.

If you are 16 years or older

and will mail me your drawing, at once, I will send you FREE, and prepaid, the Draftsman's Vest Pocket Rule shown here. This will come to you entirely with my compliments. In addition I will send you my book on Successful Draftsmanship and My Pay-Raising Plan.

Genuine Draftsman's Pocket Rule

Auto Work

The automobile industry is one of the greatest in America. Thousands of draftsmen needed. I'll train you for the work.

Building Work

There will always be building. No structure can be erected without plans drawn by draftsmen. I'll train you for an Architectural Draftsman's job at home.

Draftsmen Needed In

Motor Bus Work

Motor bus building and motor bus transportation have become leading world industries. Hundreds of draftsmen engaged in this work. I'll show you the way.

Electricity

Electricity is the coming motive force of the world. Draftsmen are needed in every department of this fascinating work. I'll train you at home.

Aviation

Aviation is just in its infancy. It is bound to expand to enormous proportions. Draftsmen are essential to it. I'll train you quick at home for drafting position.

Free—My Pay-Raising Plan

Write to me. I will send you this new book. Not a catalog. My Pay-Raising Plan and Money Making Advice. I can prove that John Savadge, trained by me, makes \$300 a month. Earl J. Dupree, trained by me, refused \$600 a month because he makes more in his own business. A. H. Bernier, trained by me, earns \$7000 to \$9000 a year. Arthur Dewalt, trained by me, makes more than \$400 a month. D. C. Stroop, trained by me, makes \$475 a month. L. V. Broughten, trained by me, makes \$300 a month.

I can give you many more names of Dobe trained draftsmen who are making big salaries. They wrote to me just as I am asking you to write. They asked for my Free Book. They saw that opportunities in all of great industries were tremendous for draftsman. Through drafting you can get into almost any industry you want.



Money Back if Not Satisfied

What could be fairer than that? I don't ask you to take any chances. I train you under a positive Money Back Agreement. If my training does not satisfy you after you have finished you get every penny back.

Earn While You Learn

You can start earning extra money a few weeks after beginning my training. I give you special work and tell you how to make money.

Age or Lack of Education No Drawback

You do not need previous experience. You do not need to be a high school graduate. My practical, home study course gives you just the kind of training you need to become successful. Your spare time is all that is necessary.

My Money-Making Tools—I Furnish Them



Employment Service

After training you I help you to get a job without charging you a cent for this service. Employers of draftsmen come to me for men because they know that men I train make good.

I Train You at Home, New, Quick, Sure Way

My practical working method makes every step in learning drafting, as clear as a moving picture. That's why I train you so fast to be a draftsman.

YOU GET THESE FINE QUALITY, GENUINE, IMPORTED DRAFTSMAN'S TOOLS, just as soon as you become my student. No finer tools can be made for practical drafting work.

FREE RULE COUPON!

ENGINEER DOBE

1951 Lawrence Ave., Div. 13-56 Chicago

Here's the sketch. Send me free rule; also send me free of all cost books "Successful Draftsmanship" and "My Pay-Raising Plan"—how to earn money while learning and proof of big money paying positions.

Name.....Age.....

Address.....

Post Office.....State.....



"I will train you at home."—Engineer Dobe

If You Earn Less Than \$70 a Week

Write Me Today!

ACT NOW Before You Put this Magazine Down. Let me send you my books "Successful Draftsmanship" and "My Pay Raising Plan". Remember Draftsmen are needed everywhere. That's the kind of profession to get into. Get started now. Get into a better position, paying a good straight salary the year around.

Engineer Dobe 1951 Lawrence Avenue Div. 13-56 Chicago, Ill.

Learn to Fly the Right Way

Flyers do not become expert from studying textbooks — nor from attending lectures — nor from watching others fly. There is but one way — get up into the Sky, and **LEARN TO FLY BY FLYING.**

Actual experience, under the guidance of expert pilots, quickly enables you to master aviation here at Marshall. The Sky is our classroom — modern, dual-control planes are our principal textbooks. That's why Marshall students so quickly attain success — why they are so enthusiastic over our school.

Besides actual flying experience you learn every phase of the aviation industry — to build, repair, and assemble ships and motors. Write today for FREE book, "Get Up Into the Sky" and learn the truth.

MARSHALL FLYING SCHOOL INCORPORATED

630 N. English St., Marshall, Missouri

Gentlemen:
Please send me your FREE book,
"Get Up Into the Sky."
NAME:
ADDRESS:

25th Year

CHICAGO TECHNICAL COLLEGE

**Engineering
Architecture
Electricity
Drafting**

Intensely practical training. 2 year Diploma; 3 year B. S. Degree; special 3 and 4 months' short courses. Courses adapted to your needs. No time wasted. Expert instructors. Graduates in constant demand. Opportunities for self-support while studying. Day and evening classes. Athletics. Enter any time. Low tuition—easy terms. Desirable boarding accommodations. Write today for your copy of 80-page illustrated Blue Book, mailed free.

Chicago Technical College
Dept. M-76, 118 East 26th Street, Chicago

ELECTRICITY

Finlay Men are in Demand. There is a Reason. Promising Future for Practical Trained Electricians and Engineers at Big Salaries. Fascinating work, rapid advancement, opportunities unlimited.

12 Weeks Intensive Courses in Practical Electricity and Power Plant Operation covering Wiring, Motors, Generators, Armature Winding, Radio, Farm Lighting, Switchboards, Electric Refrigeration, Automotive Electricity, etc. **These Courses Open To You Now.** ONE and TWO YEAR COURSES in Electrical Engineering leading to degrees. Registration for these courses open Sept. 18 to Oct. 18. Laboratories extensively equipped with modern machinery and apparatus. Faculty of recognized experts. 27th year. Free employment service for graduates. Part-time work secured during training. Catalog free.

FINLAY ENGINEERING COLLEGE
1001 A Indiana Ave. Kansas City, Missouri

DRAW CARTOONS

Turn Your Talent Into Money

Cartoonists earn from \$50 to \$250.00 per week—some even more. Remarkable new Circle System of Drawing teaches you in half the usual time. Send for **booklet** and sample **lesson plate** explaining full details of the Course.

THE NATIONAL SCHOOL OF CARTOONING
623 Penton Building Cleveland, Ohio



Pathfinder

TRIAL
EVERY WEEK 13 WEEKS
\$1 A YEAR 15 CENTS

Your neighbors know the Pathfinder and you will like it—the every-week news digest from the Nation's Center. Bright, interesting, dependable, different—nothing else like it. Washington gossip, politics, science, travel, fun, lots of pictures, instruction, entertainment. Trial 13 weeks—13 big issues—only 15 CENTS—or \$1 for full year. Send now. Address: Pathfinder, Dept. 25 Washington, D.C.

YMCA TRADE SCHOOL

Learn Auto Mechanic, Auto Electrical, Battery, Machine, Electrical, Radio Mechanic, Welding, Bricklaying, Plastering, Plumbing, Tiling, Drawing, Estimating, Show Card, Sign Painting, Window Dressing, Fine And Commercial Art.

Write for Catalog 50.
BROOKLYN ENGINEERING INSTITUTE
(Operated by Bedford Br. Y. M. C. A.)
1125 Bedford Ave., Brooklyn, New York City.

- takes only 8 weeks to get a big job



George Smith owns an agency and repair shop in West Alexandria, Ohio. He makes \$200 a week.

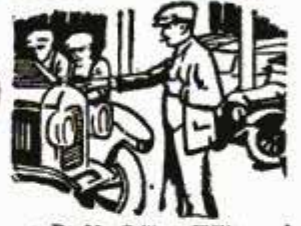

D. M. Collins, Williams-ville, West Virginia, writes: "After finishing McSweeney training, I started as manager of a garage at \$300 a month."

and Earn \$75 to \$125 a Week As Auto Expert

Learn the auto and tractor business by the McSweeney method, then step out and get a good job at \$75 to \$125 a week or open your own repair shop and make up to \$10,000 a year. Trained men are needed everywhere. Opportunities galore! Eight weeks training fits you to open repair shop or go with one of the big firms waiting for trained men. Read what George Smith, D. M. Collins and C. E. Gillespie have done. Hundreds of other McSweeney trained men can tell as interesting facts. Every month McSweeney men who complete their training are taking the place of half-trained and incompletely self-trained men.

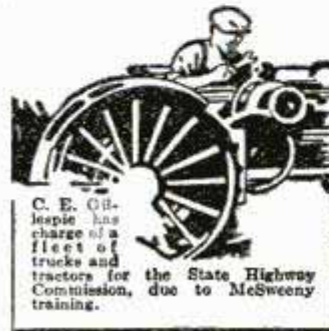

C. E. Gillespie has charge of a fleet of trucks and tractors for the State Highway Commission, due to McSweeney training.

Learn in 8 Weeks

Simple, thorough, practical shop methods. You learn the "why" of everything you do then learn to do it right. You do real work, with real tools and real equipment. No book studying. Very little schooling necessary. Any man from 16 to 60 can learn. Write today for Big Special Limited Time Tuition Offer, including

R. R. FARE PAID and BOARD PAID

While Learning Also FREE ELECTRICAL COURSE to those who enroll soon. Don't delay—write at once for complete details and BIG AUTO BOOK FREE. Mail coupon today—NOW!

FREE
Course in
Electrical Work
to those who enroll soon. Not a cent extra to pay. No extras to buy. Get my big special offer today.

Money Back Guarantee

If, after completing my training, you are not satisfied, if you are not qualified to accept a big-pay job, your tuition will be refunded. Don't miss this remarkable opportunity. Save by enrolling at once. The sooner you start, the sooner you will be ready to earn big pay or go into business for yourself.

(Mail Coupon today—NOW)



McSweeney Auto and Tractor Schools,
Dept. 11-M, Cincinnati, O.

Without cost or obligation, send me your big FREE book on Autos; also, full details of your big offer including R. R. Fare and Board Paid, and FREE electrical course.

Name.....

Street.....

Town..... State.....

MC SWEENEY

AUTO AND TRACTOR SCHOOLS

Dept. 11-M CINCINNATI, OHIO

Be a drummer!

Trap Drumming made easy in a short time. Our free instruction course furnished with genuine Ludwig Trap-Drum Outfit. Develop your natural sense of rhythm. Go to your nearest dealer or write for full details.

LUDWIG & LUDWIG, 1611 North Lincoln Street, Chicago

LEARN ELECTRICAL TRADES

Practical Training on Massive Lay-Out of Expensive Electrical Equipment. Armature Winding, House Wiring, Electric Welding, Electric Refrigeration, Power Plants, Switchboards, Transformers, Motors, Generators, Radio Batteries. Automobile Course included without extra cost. Write Today for Free Catalog.

COLEMANELECTRICALSCHOOL, 1628 S Main St., Kansas City, Missouri

ACCOUNTING

The uncrowded, highly paid profession of Accountancy offers marvelous opportunities to ambitious men and women. Send for our 80-page book, "How to Learn Accounting," and the first easy lesson. Both will be sent free.

INTERNATIONAL ACCOUNTANTS SOCIETY, Inc.
A Division of the
Alexander Hamilton Institute
Dept. 72, 3411 South Michigan Ave., Chicago, Ill.

Learn Watchwork, Jewelrywork and Engraving

A fine trade commanding a good salary, and your services always in demand. Address Horological, Dept. P, Bradley Institute, PEORIA, ILLINOIS, for our latest catalog.

DRAFTING—Learn at home

F. E. KING was "a poorly paid clerk" when he enrolled for the home-study Drafting Course of the International School of Drafting. Through study and perseverance he became Chief Draftsman of the U. S. Steel Furniture Co. He is now earning more in a day than he used to earn in a week.

A. J. Hutchins became Chief Draftsman for the American Strawboard Company and increased his salary 300%—also as a result of our training.

There is no doubt that Drafting offers a real opportunity to ambitious men and it will pay you to investigate it.

INTERNATIONAL SCHOOL OF DRAFTING
Division of the
International Correspondence Schools
Box 5562-F, Scranton, Penna.

Without cost or obligation, please send me full details of your home-study course in

Drafting Civil Engineering
 Mechanical Engineering Architect
 Contractor and Builder Architects' Blueprints

Name.....

Address.....

Mail Coupon for Free Booklet

You Fellows Who Want **BIG PAY**

Get into

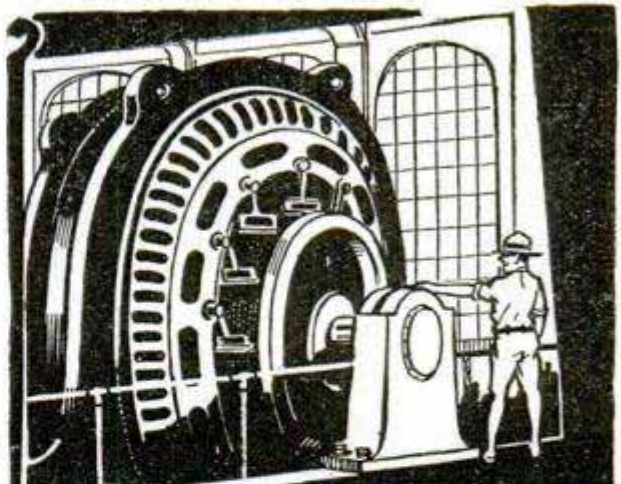

WHY earn \$15 or \$20 or \$30 a week, when in the same six days as an Electrical Expert, you can make \$70 to \$200 — and do it easier — not work half so hard. Why, then, remain in a small-pay, no-future job that offers no chance for big promotion — no chance for big income? Fit yourself for a real job. **Get into Electricity.** That's where the big money is being made, and always will be made.

Electricity — The Big Pay Field

Today even the ordinary Electrician — the "screw driver" kind — is making money — big money. But it's the trained man — the Electrical Expert, — who makes the really big money, — \$12 to \$30 a day — \$70 to \$200 a week. Be a Big-Pay man, yourself. Get in line, now, for one of these "Big-Pay" Jobs.

I'll Train You At Home

I'll train you at home, — in your spare time. You work just as you are working now — at your same job. My now famous "Work-Sheet and Job-Ticket" method, guarantees you simplified, practical training along work-shop lines. In a few short months you can step out of your old job into a new job — into electrical work where you can be a Big-Pay man in this Big-Pay field.

You Earn As You Learn

To learn Electricity my way you don't have to be a College man, or even a High School graduate. You can read. You can write. That's enough. With me, you get experience as you go along and make good money while learning. I'll show you how, — and I'll give you, without extra cost tools and apparatus to work with — 6 Big Outfits in all.

Money Back If Not Satisfied

That's what I agree to do. And back of me in this agreement stands the Chicago Engineering Works, a \$2,000,000 Illinois Corporation. There's nothing like "Cooke" Training, anywhere. It's the Training that big Electrical men are praising; it's the Training that employers recommend; it's the Training that one of our greatest Engineering societies, has endorsed 100 percent. It's the Training for you.

If You're Earning Less Than \$70 A Week — Investigate

Don't wait a minute! Find out today why "The Cooke Trained man is the Big-Pay Man", everywhere! Find out how "Cooke" Training will help you boost your pay! Mail coupon right now for my Big FREE Book of Facts. See the Six Big Working-Outfits I give you without extra charge. See the hundreds of pictures, the proofs, the Big-Pay letters of other "Cooke" Trained Men. Get this great free Book. Send for it today. Clip, sign, and mail coupon RIGHT NOW!

L. L. COOKE, Chief Instruction Engineer

**L. L. COOKE SCHOOL
OF ELECTRICITY**

Dept. 16
2150 Lawrence Ave.
Chicago, Illinois



\$30 A DAY
Dear Mr. Cooke:
I was making \$25 a week when I enrolled. Now with my own Electrical Shop I make an high as \$30 a day.
A. J. Duignan,
225 Worcester,
Southbridge,
Mass.



\$1.50 AN HOUR
Dear Mr. Cooke:
I had to work like a slave for 45c an hour before I enrolled. Now, thanks to you, Mr. Cooke, I make \$1.50 an hour.
G. W. Oppen,
4220 N. Moore Av.,
Chicago, Ill.

**6 BIG
OUTFITS
NO EXTRA
COST**



ELECTRICITY

**Hundreds of Men
I have trained
are now earning**

**\$70 to \$200
A WEEK!**

So Can You

**If you
earn less
than \$70
a week
INVESTIGATE
ACT
NOW**



I'll train you at home in a few short months.
L. L. COOKE

FREE BOOK COUPON

L. L. COOKE, Chief Instruction Engineer,
Dept. 16, 2150 Lawrence Ave., Chicago, Ill.

Send me FREE and prepaid, your Big Book "Secrets of Success in Electricity," with all details about your Home Study Course in Electricity.

Name _____

Address _____

City _____ State _____

Residents of Canada send coupon to R. A. Farrow, Special Representative, 7 Hedbury Lane, East, Windsor, Ontario, Canada.

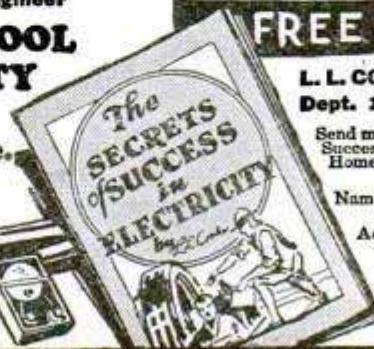

The "Cooke" Trained Man is the "Big Pay" Man

Classified Advertisements

WORLD'S BEST WANT AD MEDIUM

Advertisements in this section, 30 cents per word, each insertion, minimum 10 words, payable in advance. To be inserted under proper classification in October issue, copy should be in our office August 18th

ADVERTISING AGENCIES

ADVERTISERS—If you intend advertising, don't fail to write for our new 60 page Improved Rate Book with United States map in colors, just off the press. Gives complete information best paying daily, weekly and monthly newspapers and magazines. Your 24 word advertisement inserted in the following 10 leading Sunday papers for \$10.00. (1,500,000 circulation). Constitution, Atlanta; Journal-Transcript, Peoria; Times Picayune, New Orleans; Pioneer Press, St. Paul; Courier, Buffalo; News and Observer, Raleigh; Enquirer, Cincinnati; World, Tulsa; Commercial Appeal, Memphis. 31 years of advertising experience at your command. Frank W. Lenhoff Advertising Agency, 66 East Lake St., Chicago. Chicago's Most Progressive Agency.

ADVERTISE in 24 Big Sunday Newspapers, 24 words \$15.00. Excellent for securing agents, salesmen and business opportunities. Catalog listing 1,000 leading dailies, weeklies, mail order magazines. Everything. Free. Wade Advertising, Baltimore Bldg., Chicago.

GET into advertising. Learn quickly at home. Experience unnecessary. New easy plan. No text books used. Practical work. Old established school. Send name and address for interesting free booklet. Page-Davis School of Advertising, Dept. 343-B, 3601 Michigan, Chicago.

ADVERTISE 50 Magazines three months 10c word; old, reliable and result producing. King Advertising, Box 672PA, Wilmington, Dela.

ADVERTISERS: Your "Ad" in 277 rural newspapers; 28 words, \$10. Other bargains. Lists free. Roberts' Agency, Forrester, Ill.

TIME Counts in applying for patents. See pages 138 and 139. Clarence A. O'Brien, Registered Patent Attorney, Washington, D. C.

BEFORE Advertising get our catalogue. No charge. 25 years in business. The largest classified agency in the world. Ankrum Advertising Agency, 20 W. Jackson Blvd., Chicago Ill.

LOWEST Rates. Catalog free. Owl Agency, Times Bldg., New York.

FREE—New 1928 Advertisers Rate Guide. 36 pages. Includes everything. Lowest rates. E. H. Brown Advertising Agency, 140 S. Dearborn, Chicago.

INCH Display 50 Monthlies Thrice \$8.00. Meyer Agency, 4112M Hartford, St. Louis, Mo.

FOR ADVERTISERS

PROMOTERS, Merchants, salesman—Our ultra blue-brown line process will produce in colors 1,000 copies from a single typewritten master. Let the sun and your kitchen table cut your printing costs. System, chemicals, sensitized paper—\$1.00 C. O. D. Engineering Specialties, Lincoln, Nebr.

ADVERTISE in weekly papers. Lists free. Keator, Hartford Bldg., Chicago.

40 WORDS Insert 50 magazines \$2.00. Empire Agency, Shawano, Wis.

SALES PROMOTION

\$50 TO \$50,000 Daily Sales Developed during 28 years for clients by our direct mail plans, copy, campaigns. One product, 1923, an idea; this year \$100,000 orders booked. Fifty year old concern desired 50 national representatives in 1925; we produced 40 in three months. 700 dealers in 10 months at \$3 each, for another. Ten years Sales Promotion Manager Larkin Co. Submit sales problems for free diagnosis. James C. Johnson, 118A Woodbridge Ave., Buffalo.

TYPING SERVICE

TYPING, Mimeographing, addressing furnished; manuscripts 50c thousand words. 335 Rockwall, Tex.

LETTER SPECIALISTS

BUSINESS-BUILDING Masterpieces! Letters and literature that distinctively, forcefully accomplishes results! Gets orders, inquiries, checks, agents! Satisfaction guaranteed. Moderate charges. Consultation free. Finkel-Advertising, 15-P Fairview, Jersey City, N. J.

BUSINESS ADDRESSES

BROADWAY 200—Best address in New York. Two blocks from Wall street. Desk room or mail privilege. Rates exceedingly reasonable. We forward your mail daily. Room 404.

AUTOMOBILE SUPPLIES

BRAND New Basco ignition switches, can be used for cars or motor boats, special 20c each; retails for \$3.00. Brand new \$15.00 Jewel volt and ammeters, 4" diameter, at \$4.00 each. Satisfaction guaranteed. General Distributing Company, Duluth, Minn.

PAINT Your own automobile, a beautiful, durable finish, with one quart of Pilot Auto Enamel, one pint top dressing, brush, and sandpaper; regular \$4.25 assortment sent postpaid for \$3.00; buy two for \$5.00, sell one. Attractive agent's proposition. Pilot Paint Products Co., Box 579, Dallas, Tex.

RADIATORS At wholesale prices. All standard makes. Satisfaction guaranteed. Send for prices, stating make and model. Independent Radiator Co., 1119 S. Wabash Ave., Chicago.

SAVE Money on auto and truck repairs. Gears, axles, bearings, motor and transmission parts at 50 to 75% off factory list prices. Satisfactory parts guaranteed. Prompt service. Price lists free. Century Parts Co., 1712 Lafayette Ave., St. Louis, Mo.

TOOL Salesmen and mechanics with some sales ability sell our line electrical tools to auto mechanics and garages. Easy sales, and very liberal commissions. Barker Specialty Co., Girard, Pa.

AUTO Parts, New, Used—Lowest prices, largest stocks, bankrupt supplies, motors, wheels, rear ends, radiators, transmissions, generators, gears, tops. Brightman, 2065 Main St., Hartford, Conn.

42 MILES On 1 gallon. Wonderful moisture gas saver. All autos. 1 free. Critchlow, K1-805, Wheaton, Ill.

AUTOMOBILES

TIME Counts in applying for patents. See pages 138 and 139. Clarence A. O'Brien, Registered Patent Attorney, Washington, D. C.

AUTO Touring Atlas of the U. S. With this fine atlas we include a valuable tourist's handbook of 133 practical plans for making touring more enjoyable and economical. Both for 98c plus the postage. Pay postman when he delivers package. Popular Mechanics Press, Room 807, 200 E. Ontario st., Chicago.

AUTOMOBILE SERVICE EQUIPMENT

VULCANIZING Tires and converting old tires into salable mdse. is a money-making business with our equipment. We have plants near you \$100 up; also paint spraying outfits, \$63, delivered. Catalog free. Equipment Exchange, 108 East 11th, Los Angeles, Calif.

BARGAINS in reprocessed battery chargers, rectifiers of all kinds and a few Constant Potential 8 Hour Chargers, two of them practically new. Lowest prices; terms if wanted; 30 days' trial. Write today to I. C. Helmick, Box M985, Troy, Ohio.

SAVE Money—Garage equipment reconditioned and guaranteed like new. Unusual bargains in test stands, car washers, battery chargers, air compressors, etc. Shipped on trial—easy terms. What do you need to complete your equipment? E. C. Galbreath, Box M984, Troy, Ohio.

OWN A battery shop and make money. One of the improved transformer type Scioto Battery Chargers will do it for you. Four sizes. Investigate now! Send for price list. Adams-Barr, Columbus, Ohio.

YOU Are wanted to resilver mirrors at home. Immense profits plating autoparts, tableware, etc. Write for information. Sprinkle, Plater, 77, Marion, Ind.

BIG Profits in automotive service with use of new 8 hour battery charging equipment. Low in price—small down payment brings it; pays for itself with handsome profit besides. Write for details. No obligation. E. M. Connor, Box M983, Troy, Ohio.

SET Eight spiral expansion reamers, \$10.95. Catalog. W. Barnitz, 203 Briggs, Harrisburg, Penna.

FOR FORD OWNERS

AURORA Underslung parts and 3.1 racing gears, speedster bodies, headlights. See Sport Factories ad, page 144.

42 MILES On 1 gallon. Wonderful moisture gas saver. All autos. 1 free. Critchlow, K2-805, Wheaton, Ill.

UNDERSLUNG With "RKO" Swing Lo Irons. See "Red-I-cut" ad page 124.

MOTORCYCLES, BICYCLES AND SUPPLIES

MOTORCYCLES Cheaper than bicycles, \$25 to \$50. Easy terms. Tires \$2.50; Frames \$3; Forks \$3; Tanks \$5; Wheels \$4; Chains \$2; Saddles \$5; Handle Bars \$5; Engines \$15; Motorcycle Tires \$2.50; Truck Tires \$7; Airplane Engines \$15; Bicycle Tires \$1.25. Send 50c for catalog. Price Cutter Deninger, Rochester, N. Y.

SLASHING Price Reduction! Fine Harley-Davidson motorcycle bargains. New, used and rebuilt motorcycles, \$50.00 and up. Send for our new free bargain bulletin just off the press. Knuth's Harley-Davidson Agency, 2525 Fond du Lac Ave., Milwaukee, Wis. Exclusive Harley-Davidson Distributors.

USED Motorcycle bargains. All makes. Lowest prices. Guaranteed. Shipped on approval. New easy payment plan. Motorcycle parts—supplies. Catalog free. Floyd Clymer, "Largest Motorcycle Dealer in the West," Denver, Colo.

BARGAINS in used motorcycle parts for all makes. No Catalogs. J. B. Dahl, 3661 Archer Ave., Chicago, Ill.

NEW And used motor cycle parts. Tower Cycle Co., 3528 Maywood Ave., Pine Lawn, Mo.

AVIATION

HOME Study course in aviation by pioneer school at new low price. Complete, including motors, wings, nomenclature, meteorology, navigation, flying and 100 other fascinating subjects. Endorsed by experts. Diplomas given. Free employment service. Complete details sent free. National Aviation Training, Dept. 12, 1031 So. Broadway, Los Angeles, Calif.

IT'S New! The modern airplane, 128 pages, 49 illustrations, tells everything you want to know about flying. Recommended by leading pilots and flying schools. Sent postpaid for \$1.00 or write for free descriptive circular. Roth Downs Airways, 2502 University, St. Paul, Minn.

SAVE Money by building your own sport-plane. Blueprints and instructions for 18-60 horsepower monoplane, \$2.50. Biplane two seater, 28-60 horsepower, snappy performance, blueprints \$5. Sketches with price list, 10c each. Sample wing rib, \$3.50. Allison Airplane Co., Lawrence, Kans.

AVIATION! If it is worth learning—Learn it right. Complete practical training in every branch of aeronautics, actual flying taught on new planes. We qualify for all government licenses. Aviation Engineering School, 225 West 57th St., at Broadway, New York City.

AND Now the Super Parasol! Complete bill of material to construct \$199.00. Large illustrated folder 10c. Heath Airplane Co., Chicago.

CURTISS "Jenny" OX5 motor, excellent condition. Bargain. McMullen Aircraft Company, Tampa, Fla.

BUILD Our wonderful one place monoplane. Adapted to motorcycle or other air-cooled motors to 35 hp. Detailed blueprints \$2.00. Hawley Aircraft, 3366 Grim, San Diego, Calif.

THE Age of the Air Is Here. For reliable information on both airplane building and flying we recommend "Aeroplane Construction and Operation," by Rathbun, a book used in government schools. All features of construction treated. Send no money. Pay postman \$2.50 and postage. Popular Mechanics Press, Room 807, 200 E. Ontario St., Chicago, Ill.

TIME Counts in applying for patents. See pages 138 and 139. Clarence A. O'Brien, Registered Patent Attorney, Washington, D. C.

NEW Aircraft magnetos, 6 or 8 cylinders, cost government \$75.00, sacrificed \$7.50. Real airplane propellers, 8 foot long, given away, \$5.00. Air Transport Co., Carle Place, N. Y.

BLUEBOOK Design, construction, flying, \$1.50. Sportplane blueprints \$5.00. Johnson, 7408 Chappel St., Chicago.

MODERN Aircraft—New book describing fully all latest developments in newest planes and engines used in recent trans-oceanic flights. Just what every student of flying needs. Covers every phase of aeronautical science. 855 pages. Over 500 illus. Pay postman \$5 and postage when he delivers the book. Popular Mechanics Press, Room 807, 200 E. Ontario St., Chicago, Ill.

BUILD Model airplanes that fly. Our 52 page catalog illustrates 26 flying and exhibition models. Most complete line of accessories and supplies. Send 10 cents for our big catalog. U. S. Model Aircraft Corporation, 341 Monroe St., Brooklyn, N. Y.

"SKYWARD Ho!" New book by Derek White on your future in aviation. Opens road to career, fame, fortune. Sent free. Write at once. Parks Air College, 213 Missouri Theatre Bldg., St. Louis, Mo.

THE American School of Aviation announces a new correspondence course in Mechanics of Aviation. A thorough training in Practical Aeronautics. American School of Aviation, Dept. 1871, 3601 Michigan Ave., Chicago, Ill.

JUST Out—Book and blue prints on design, construction of small sport plane. Dependable information on motors to use, etc. Includes flying lessons and weather map reading. All for one dollar. Chas. Russell, 545 Stadium Drive, Ft. Wayne, Ind.

NEW! Three models in one. Perfect scientific reproductions. Catalog free. Stewart Marshall, Rome, Ga.

"AERODRIVE" Propeller boat attachment blueprints, 50c. Propellers, 4', \$8.75; 5', \$13.25; 6', \$16.50; others proportionately. Leather helmets, \$1.50; goggles, \$3.00. Ostergaard Aircraft, 4309 N. Narragansett, Chicago.

BUNDLE Of model aeroplane material. Various sizes wood, reeds, bamboo, rubber band. Also circulars on free three-foot plane. All for dime (coin). Aero Shop, 3050 Hurlbut Ave., Detroit, Mich.

SCALE Model Airplanes ready to fly—all types. Send dime (3 for 25c) for Flying Glider and catalog. The Clinton Toy Co., Box 141, North Haven, Conn.

BIGGEST, Best Catalog Model Airplanes, Parts, Supplies; 5c postpaid. Ideal Company, 19 West 18th Street, New York.

SIMPLEX Air Model Co., Auburn, Mass. Send five cents for supply booklet.

AVIATION For Everybody. Coming rapidly. New book, just issued, suitable for beginners, young people, students of flying, etc., who want something non-technical to teach them the control systems and methods of flying all types of land and sea flying machines. Strictly up-to-date. 256 pages. Illustrated. Price \$2.00. Sent C. O. D., if preferred. Popular Mechanics Press, Room 807, 200 E. Ontario St., Chicago, Ill.

BOOKS AND PERIODICALS

4TH EDITION Just off press, "Radio Theory and Operating," by Mary Texanna Loomis. The standard radio text and reference book of America. Nearly 900 pages, over 700 illustrations, flexible binding. Price \$3.50 postage paid. For sale by hundreds of bookdealers throughout America and many foreign countries. Or may be purchased direct from the publishers. Send check or money order to Loomis Publishing Company, Dept. 18, Washington, D. C.

SAVE On plumbing bills—Repair your own plumbing and heating system. A practical book written expressly for the home owner by an experienced plumber, is easily understood and will enable you to make your own plumbing repairs with a great deal of satisfaction. Price of book only \$1, plus postage. Send no money. Pay postman when he delivers the book C. O. D. Popular Mechanics Press, Room 807, 200 E. Ontario St., Chicago.

HYPNOTISM—Learn the secrets of this strange power. Complete course 25 lessons 25c. Catalog free. Franklin Publishing Company, 800 North Clark St., Dept. 159, Chicago.

BLACK Art; mock trials; astrology; ventriloquism, wizards' manual; hypnotism. Your choice 30c. Smith's Novelty, M, 7137 So. Racine Ave., Chicago.

AUTOMOBILE—Make your own motor car, toy size, operated with motorcycle engine. Any boy can make it. Costs little aside from engine. Full directions with drawings and dimensions in *The Boy Mechanic*, Book 3. Send No Money. Pay postman postage and \$2. Popular Mechanics Press, Room 807, 200 E. Ontario St., Chicago, Ill.

BOOKS, 6th and 7th Book of Moses, 50c; Albertus Magnus, 50c; Pow-Wow, 50c; Silent Friend, \$1.00; Book of Luck, 25c. The F. & R. Co., 87 Fourth Ave., Dept. "L," New York.

HYPNOTISM Easily learned. Lessons guaranteed. Postpaid, \$1.10. Smith Pub. Co., Dept. 3, Springfield, Mass.

CURIOUS Books, Unique Novelties, Stunning Pictures. Samples, 10 cents prepaid. Linds, 214 W. 34th St., New York.

BOOKS, Magazines, art publications in French, Spanish, English. Photo novelties, etc., samples, lists, 20 cents stamps. Villaverde Co., Dept. 207, Box 1329, Havana, Cuba.

INDUSTRIAL Alcohol, Wright's book. Full directions for making, fully illustrated. \$2.50. Spon & Chamberlain, 120 P.M. Liberty Street, New York, N. Y.

FAMOUS Dyke's Automobile Encyclopedia—Just out, 15th edition. Fully revised to include all latest facts regarding newest developments. Information on repairing and adjusting every part of all motor cars. How to find trouble and fix it. 1,250 Pages, 4,200 illus. Price, cloth, \$6. Flexible Morocco \$7.50. Will be sent C. O. D. anywhere in U. S. Pay postman price and postage when he delivers book. Popular Mechanics Press, Room 807, 200 E. Ontario St., Chicago.

PICTURES AND POSTCARDS

PERSONAL Photos 1½c. Samples 2c stamp. National View, Winona, Minn.

ART Pictures—300 all different. Particulars 10c. Howard Sales Co., Dept. 15, Box 529, San Francisco, Calif.

272 PEPPY, Attractive, art poster pictures 25c. Smith's Novelty, M7137 So. Racine Ave., Chicago.

PRESIDENT Coolidge's vacation grounds. Postcard size photographs, 3 for 30c; 6 for 50c; all different. Photocrafts, Box 126, West Duluth, Minn.

MAGIC TRICKS, BOOKS AND JOKER NOVELTIES

"**THE Book of 1,000 Wonders**" will be sent postpaid for 10c. Explains many mystifying tricks with coins, cards, handkerchiefs, etc., you can do. Also, contains complete catalog of magic tricks, jokes, puzzles, books, escapes, mindreading acts, spiritualistic effects, illusion plans, curios and imported novelties from many foreign lands. Large assortment, lowest prices. You will amaze and mystify your friends! Send 10c today. Lyle Douglas, Station A-5, Dallas, Tex.

MAGIC—Tricks, Books and Supplies. For amateurs as well as the great professionals. Anyone can learn through our instructions. Feature Acts in Mind-Reading, Spiritualism, Rope Ties, etc. Large illustrated professional catalog, 20c. Chicago Magic Co., 140 So. Dearborn St., Dept. B, Chicago, Ill.

200 TRICKS You Can Do—Thurston describes in this illustrated book of 200 pages, 200 mystifying tricks that may be performed by the beginner without elaborate equipment. Pay postman \$1 and postage when he delivers book. Popular Mechanics Co., Room 807, 200 E. Ontario St., Chicago, Ill.

FREE with \$25 order die box. Send 20c for our large catalogue of tricks, wigs, sensational escapes. Oaks Magical Co., Dept. 548, Oshkosh, Wis.

FREE Surprise! Mystify your friends. Fun, magic, mystery catalog 10c (coin). Riverdale Novelty Shoppe, Box 296-B, Riverdale, Md.

BOOKS, Magic, herbs, incenses, perfumes, novelties. Catalog, sample 10c. Marelle Company, 55 E. Washington, Chicago.

FIFTEEN Tricks including one 50c card trick 10c. Catalog free. Chester, 403 North State, Chicago.

MAGIC Catalog 20c. Free trick. Lynn's, 105 Beach, Jersey City, N. J.

ELECTRIC Fun! Seventy stunts, 110 volts, \$1. Cooper Sons, Campbell, Calif.

25 MARVELOUS Magician's secrets, including disappearing lady; floating head mystery; astounding mind tricks. 30c (coin). Smith's Novelty, M, 7137 So. Racine Ave., Chicago.

ESCAPE from Sacks, Rope Ties and Chains. Easy with these complete instructions. Give an evening's entertainment and mystify the "wise ones." Let them tie you hand and foot, place you in a bag and seal the bag. In a minute you are out. Complete instructions in "33 Rope Ties" and "Sack Escapes." Send no money. Pay postman \$1.50 and postal charges for these two books. Popular Mechanics Press, Room 807, 200 E. Ontario St., Chicago, Ill.

GAMES, ENTERTAINMENTS AND PLAYS

250 CLEVER Entertainments; 360 snappy toasts; 100 new Ford jokes. Postpaid 30c (coin). Smith's Novelty, M, 7137 So. Racine Ave., Chicago.

LEARN Ventriloquism by mail—small cost, 2c stamp brings particulars. Geo. W. Smith, Room S-289, 125 N. Jefferson St., Peoria, Ill.

NOVELTIES, CURIOS, ETC.

"**THE Book of 1,000 Wonders**" will be sent postpaid for 10c. Explains many mystifying tricks with coins, cards, handkerchiefs, etc., you can do. Also, contains complete catalog of magic tricks, jokes, puzzles, books, escapes, mindreading acts, spiritualistic effects, illusion plans, curios and imported novelties from many foreign lands. Large assortment, lowest prices. You will amaze and mystify your friends! Send 10c today. Lyle Douglas, Station A-5, Dallas, Tex.

NOVELTIES, Illustrated catalog free. Paris-Picture publishers at Neuilly-Plaisance (S-&O), France.

STAMP COLLECTING

ANCHERS \$\$\$ Outfit—only 12c! Fine triangle stamp; set German stamps with (pre-war) value forty million dollars (interesting!); perforation gauge, mme. scale; small album; airmail set; scarce stamp from smallest republic on earth; newspaper set; packet good stamps from Travancore, Malay, Dutch Indies, etc. Entire outfit for 12c to approval applicants! (Nice pocket stock book, value 25c, with every order!) Ancher Stamp Co., 148½ Clerk St., Jersey City, N. J.

A DOZEN New Scott sealed packets. Here are a dozen bargains in guaranteed genuine stamps just added to our Scott Sealed Packet list. No. 404, 10 diff. Irish Free State, 15c; No. 405, 10 diff. Ecuador, 10c; No. 406, 25 diff., Ecuador, 25c; No. 407, 10 diff. Siam, 10c; No. 408, 20 diff. French Morocco, 25c; No. 409, 10 diff. Newfoundland, 10c; No. 410, 20 diff. Irish Free State, 35c; No. 411, 20 diff. Indo China, 25c; No. 412, 10 diff. Barbados, 20c; No. 413, 10 diff. Jamaica, 10c; No. 414, 10 diff. Salvador, 10c; No. 415, 12 diff. Latvia, 10c. When you order ask us to send you free our 80-page price list of more than 1,100 stamp packets and sets. Scott Stamp and Coin Co., 1 West 47th St., New York, N. Y.

500 DIFFERENT Stamps for 25c! Big collection 500 different stamps from Bosnia-Herzegovina, Crete, Epirus, Hon: Kong, Iceland, Kenya and Uganda, Liberia, Malta, Nyassa, North Borneo, Orange River Colony, Siam, Wallis and Futuna, and other "hard" countries. Catalog value \$10.00. Price only 25c to approval applicants! Special bargains, 1,000 different 79c; 15 triangle stamps 49c; 100 Africa 45c; 100 Asia 50c; 100 Balkan States 35c; 100 British Colonies 25c; 100 French Colonies 30c; 100 Portuguese Colonies 50c. All 8 packets for \$3.00! Illustrated lists free. Loma Stamp Co., 3926 32nd St., San Diego, Calif.

MYSTIC "Queer Country" Packet! Contains scarce stamps from the following strange lands: San Marino, Antioquia, Congo, Cyprus, Fiji Islands, Gwallor Hyderabad, Iceland, Jhond, Kenya, Uganda, Lebanon, Monaco, North Borneo, Nyassa, St. Thomas Prince, Eastern Roumelia, Siam, Sierra Leone, Tanganyika, Trinidad Tobago, Ubangi, Upper Volta, Wallis Futuna, Alaouites. Get this wonderful packet of "freak countries" and make your friends envious! Price only 10c to approval applicants! Write today. Mystic Stamp Company (Dept. 8), Camden, N. Y.

\$1.00 FREE. Black U. S. Postage. Given away with each order. Pioneer Stamp Album with 500 illustrations. 150 different stamps from 40 countries, Syria, Lebanon, Hejaz, Liberia, New French Colonies, British, Portuguese Colonies, South Africa, Australia, 500 hinges, 36 page illustrated catalogue. All for 15c. Big Commission to Agents for the Best approval sheets of stamps ever offered. Write for sample outfit. Hussman Stamp Co., Dept. M, 620 Olive St., St. Louis, Mo.

78 FAR-OFF Countries, only 10c. Angola, Dahomey, Travancore, Jamaica, St. Pierre, Schleswig, Martinique, Ivory Coast, Esthonia, Luxemburg, Peru, Newfoundland, South Africa. Marvelous packet 78 different stamps from 78 different countries, including all above and 65 more. Bargain price 10c. Big lists and approvals with each order. C. D. Reimers Company, 9 Flatiron Bldg., Fort Worth, Tex.

NEW ZEALAND—I will post fifty New Zealand stamps, including old issues, to anyone sending me correspondence instructional course—any description whatever. Hancox, 70 the Crescent, Roseneath, Wellington, New Zealand.

1,000 DIFFERENT Genuine foreign stamps, catalog value around \$25.00, for only 60c. Guaranteed satisfactory. If you don't like the collection, just send it back and we will refund your money, plus your postage. A. I. Nickles, 213 Seaton, Washington, D. C.

300—300—300 ALL Different stamps (\$6.00 catalog); 300 hinges; 5 approval sheets; duplicate stamp album; perforation gauge; millimeter scale and ruler to approval applicants for only 20c. Edgewood Stamp Company, Milford, Conn.

BEST One cent approvals in America. F. P. Hand, 1117 So. 60th St., Philadelphia, Pa.

DANDY Mint stamps 2c to those requesting approvals. Harvey Teple, Decatur, Ind.

U. S. AND Foreign approvals. Wantlists. References. Van's Stamp Co., 811 Chestnut St., Bellingham, Wash.

1,000 ALL Different stamps \$1.00. New price list of all United States stamps free. Voorhees, 7 South Dearborn St., Chicago.

100 VARIETIES Stamps 2c, applicants requesting approvals. H. Hunziker, Jordan, Minn.

100 DIFFERENT Foreign stamps from 100 different foreign countries, including Africa, Asia, Australia, Europe, West Indies, etc., for only 20c. Free with each order, our pamphlet which tells "How to Make a Stamp Collection Properly," together with our price lists of albums, supplies, and hundreds of bargains in sets, packets, etc. Queen City Stamp & Coin Co., Room 36, 604 Race St., Cincinnati, Ohio.

U. S. STAMPS On approval, all grades. Reference please if you mean business and state your wants. We price according to condition. Small coll. of 30 varieties, 10c; 50 varieties, 20c; 100 varieties, 60c. Larger if desired. Park Stamp Co., 389 Beacon St., Boston, Mass.

200 DIFFERENT Stamps, Zanzibar; Album, 12c. Liberty, 3974 Arsenal, St. Louis, Mo.

STAMPS On approvals 1/2c up. Free premium. Herbert Kelgwin, Middletown, N. Y.

GREECE—Bought, sold, exchanged. Approvals, \$1.00 deposit. Pop-Goo, Bx471, New York.

FREE—Surprise packet to approval applicants. McEwen, 755 Wilson, Columbus, Ohio.

1,000 NICELY Mixed stamps, 25c postfree; 1,000 hinges, 10c; 2,000, 17c. Approvals. Price lists. Sunshine Stamp Co., 549 East Maryland St., St. Paul, Minn.

FUME: 10 Varieties 10c postpaid. Lists free. Allison, Angola, Ind.

FIVE Different United States airmail 25c. Fred Lawrence, 9 Third Ave., San Francisco.

500 MIXED U. S., old and new, 10c. Weatherby, Lakewood, Ohio.

STAMPS—Panama Lindbergh set \$1. Leonard Foote, Pedro Miguel, Canal Zone.

DANZIG Stamps free—Interesting packet from Danzig with big catalogs free for 2c. Midland Stamp Company, Toronto, Can.

ONE-CENT Approvals. Fine fillers, big bargains. State countries desired. George Ludlum, Box 123, Seattle, Wash.

LINDBERGH Panama issue complete, 40c. 10 sets \$3.00. Wirth, 139 Shepherd Ave., Brooklyn, N. Y.

ALBUM, 1,000 Hinges, 200 foreign, 25 Cuba, 25 Japan, 35c. Burtiss Company, Saratoga, N. Y.

FREE 50 British Colonials, if approvals requested. Postage 4c. Berkeley Stamp Co., South Berkeley, Calif.

FREE, 12 DIFF. British Colonies for a request for my popular approvals of large showy picture stamps, at 50% disc. Postage 2c. Chas. Bushnell, 4728 Princeton Ave., Tacony, Phila., Pa.

FINEST Approvals 50% discount. Reference required. Premium with every purchase. Ioor, 802 State Life Bldg., Indianapolis.

NEWFOUNDLAND Postage stamps. 40 standard varieties \$1.00. 16-page catalog free. Rev. Butler, St. Georges, Newfoundland.

105 CHINA, Etc., 2c. Album (300 illustrations) 3c. Bullard, Sta. BB, Boston.

110 DIFFERENT Stamps, many unused, high values, free to collectors requesting our Net Approvals. Postage 2 cents. Christensen, Milwaukee, Wis.

ONLY 5c! 10 Airmail stamps, including scarce Esthonia triangle; Greece Red Cross set; packet fifty different stamps—all unused—from Guyane, Ubangi, etc. All for 5c! Approvals and free lists with each order. Curhan Stamp Company, Gloucester, Mass.

STAMPS, 100 all different, Postage 2c. Lists free. P. M. Quaker Stamp Co., Toledo, Ohio.

REVENUES—Telegraphs—Every country. Pretty—Intriguing—Cheap. Mint \$3.00 revenue free to applicants with references. Vanderhoof, 1114 Logan, Denver, Colo.

HIGH-CLASS Approvals. References Required. Pikes Peak Stamp Co., Colorado Springs, Colo.

STAMPS, 100, all different, 2c to approval applicants. Glenn R. Knight, Box 3, Sausalito, Calif.

110 NEW Europe All Different, a wonderful collection cataloguing several dollars, free to collectors requesting our Net Approvals. Postage 2 cents. Badger Stamp Co., Milwaukee, Wis.

PACKET Bargains, first-grade quality. 10 different triangle stamps, 25c; 15 different, 40c; 25 different birds and beasts, 20c; 25 different portraits, 15c; 25 different scenes, 20c; 25 different airmail, 15c; 50 different, 75c; 1,000 fine hinges, 10c. Premium with each order. Charles Baretta, Box 617, San Mateo, Calif.

STAMP Collecting Hints. This booklet free to beginners. T. E. Bottome, 2934 Shriner, Indianapolis, Ind.

FREE: 5 Varieties Ireland to approval applicants. A. & L. Stamp Co., 3905 Norfolk Ave., Baltimore, Md.

MOST Sensational values; over 140 diff. Algeria, Airplanes, Azerbaijan, Barbadoes, Cameroun, Babon, Guyane, Irish set, large French Colony packet, largest stamp, 40 year old U. S., gauge, etc., for 10c to approval applicants. List free. 100 diff. U. S. 30c—1,000 hinges 9c—50 Bavaria 9c. Hawkeye Stamp Co., Cedar Rapids, 39, Iowa.

STAMPS sent on approval at 70% discount. Reference required. Emory Renoll, Hanover, Pa.

101 DIFFERENT Free with 50% Approvals, 2c postage. Neomus Stamp Co., 312 East 23rd St., New York.

UNITED States and Canadian 32-page price list free. Stamps bought. Stanley Gibbons, Inc., 38p Park Row, New York City.

FINEST One Cent Approvals in the United States. Stanton, Niantic, Conn.

FREE, 12 Diff. large, showy picture stamps for a request for my popular approvals. Postage 2c. Premiums with every purchase. A. Bauer, Palmyra, N. J.

200 DIFFERENT stamps 10c; 1,000 Hinges 10c. R. H. Carlton, 380 W. So. Temple, Salt Lake, Utah.

COVERTCO Packet, 100 different stamps 10 cents, with 60% discount approvals. Covert Stamp, 39 State, Rochester, N. Y.

1,000 VARIETIES For 69c! Approvals. Kenmore Stamp Co., 703 Kenmore Place, Brooklyn, N. Y.

THOUSAND Foreign stamps 50c; twenty foreign coins \$1. Prof. McCreery, Chatham, Ontario.

PENNY Approvals that Satisfy. Neil Gronberg, Box 5441, Philadelphia, Pa.

FREE Germany air mail (5 var.) for new applicant of my 1, 2c and 3c approvals and also my 50% discount. Chas. W. Schmidt, P. O. Box 4832, Frankford Sta., Philadelphia, Pa.

FREE! 115 Different stamps to approval applicants, 2c postage. Paige Stamp Co., Oak Park, Ill.

500 MIXED U. S., old and new, 10c. Weatherby, Box 2628, Lakewood, Ohio.

STAMPS, 100 varieties, Africa, Brazil, Peru, Cuba, Mexico, etc., 10c; 25 different U. S. 25c; 1,000 mixed, 40c; 1,000 hinges, 15c. List free. C. Stegman, 5941 Cote Brillante, St. Louis, Mo.

24 VARIETIES Cuban stamps, 10 cents. List of 6,000 low-priced stamps free. Address Chambers Stamp Co., 111P, Nassau St., New York City, N. Y.

RARE COINS

40 OLD Coins, all different, \$1.00; 100 mixed foreign coins, \$1.00; Grant half-dollar, unc., \$1.00; Monroe half-dollar, unc., \$1.00; Stone mountain half-dollar, unc., 75c; 12 dates large cents, \$1.00; Mexico two-peso gold, \$1.25. Claud Denny, Box 315, Dallas, Tex.

OLD Money wanted. Do you know that coin collectors pay up to \$100.00 for certain U. S. cents? And high premiums for all rare coins? We buy all kinds. Send 4c for large coin folder. May mean much profit to you. Numismatic Co., Dept. H-2, Fort Worth, Tex.

RARE United States and foreign coins, war medals and decorations, Chinese coin and catalog 10c. Alexis Mengelle, Colorado Springs, Colo.

UNITED States high values, blocks, covers, sets, packets. Lists free. Nagy, 8P South 18th, Philadelphia, Penna.

CALIFORNIA Gold—Quarter size, 27c; 3/4 size, 53c; 3c piece and catalog, 10c. Norman Shultz, Box 746, Salt Lake, Utah.

UNITED STATES, Large cent, two-cent bronze, three-cent nickel and Bargain List, 25c. Fifteen dates large cents, \$1.00. George Coffin, Greenwood Mountain, Me.

GET Profit and pleasure in collecting old coins. Send 10c for large illustrated coin catalogue. You'll be delighted with it. Send for it right now. B. Max Mehl, Numismatist, Mehl Bldg., Dept. P, Forth Worth, Tex. Largest Rare Coin Firm in the U. S.

AMERICAN 3c Silver ancient China coin, French 10c piece, 2 crisp notes and catalog 20c. George Best, Cedar Rapids, Iowa.

LINDBERGH, Bremen, Earhart medals 27c each. Durso, 25 Mulberry, New York City.

100 ASSORTED Foreign coins \$1.00. 100 assorted foreign bills, \$1.00. Oddehon, Box 681, Kansas City, Mo.

\$2 TO \$500 Each Paid for hundreds of old and odd coins. Keep all old money, it may be very valuable. Send 10 cents for illustrated coin value book, 4x6. Get posted. Guaranteed prices. We buy and sell. Clarke Coin Office, LeRoy, N. Y.

OLD Coins, large Fall selling catalog of coins for sale free to collectors only. Catalog quoting prices paid for coins, ten cents. William Hesselein, 101A Tremont St., Boston, Mass.

FOR BOYS

"THE Book of 1,000 Wonders" will be sent postpaid for 10c. Explains many mystifying tricks with coins, cards, handkerchiefs, etc., you can do. Also, contains complete catalog of magic tricks, jokes, puzzles, books, escapes, mindreading acts, spiritualistic effects, illusion plans, curios and imported novelties from many foreign lands. Large assortment, lowest prices. You will amaze and mystify your friends! Send 10c today. Lyle Douglas, Station A-5, Dallas, Tex.

MYSTERY Speed boat, all metal 9 inches long, green hull, red deck, blue and white sailer. Makes noise like real motor boat, no clock work. Can be operated in ordinary wash tub or bath tub. Cash or money order, \$1.00. Instructions included. Rosa Sales Co., Progress, Pa.

CAMERAS AND PHOTO SUPPLIES

PHOTOGRAPHIC Equipment and accessories of every description are listed and illustrated in our 228-page catalog. It will pay you to secure a copy which is issued free, as our prices are low. We also deal in used goods which are sold under the same guarantee as new goods. Ask for our Bargain Book. Central Camera Co., Dept. E133, 112 S. Wabash Ave., Chicago, Ill.

TRIAL Offer. First film developed, 6 prints, enlargement given, 25c silver. Superior Photo Finishers, Desk 9, Waterloo, Iowa.

EASY Money developing films the "Ideal" way. Inexpensive, efficient. Circular free. A. P. Davis, Binghamton, N. Y.

BIG Money in photography. Catalog 49A free. New York Institute of Photography, 10 West 33rd St., New York.

TIME Counts in applying for patents. See pages 138 and 139. Clarence A. O'Brien, Registered Patent Attorney, Washington, D. C.

FIRST Order, six glossy prints, 15c. Young's Studio, Sedalia, Mo.

MAKE money in photography. Learn quickly at home. Spare or full time. New Plan. Nothing like it. Experience unnecessary. American School of Photography, Dept. 3431, 3601 Michigan Avenue, Chicago.

ROLL Developed—Six prints, one beautifully tinted, 25c. 8x10 enlargement, 30c. Falls Foto Finishers, Dept. A, Glens Falls, N. Y.

HAVE You a Camera? Write for Free sample of our big magazine, showing how to make better pictures and earn money. American Photography, 116 Camera House, Boston, 17, Mass.

FILMS Developed. Special Trial Offer. Any Size Kodak film developed 5c. prints 3c each. Trial 6x10 Enlargement in handsome folder 40c. Overnight Service. Roanoke Photo Finishing Co., 209 Bell Ave., Roanoke, Va.

SAMPLE Enlargement—dime, and negative (returned). Trial roll, glossy prints, 25c silver. Brown, Warsaw, N. C.

\$50.00 FOR Photographs—This price paid for photographs if they meet our requirements. Perhaps one of your pictures will bring this amount. For particulars, address Redkrafts, Dept. 11, Denver, Colorado.

611 PICTURES From \$4 camera brought \$2,126.84! Complete plan \$1.00. Dale Van Horn, Lincoln, Nebr.

MOTION PICTURES

NEW \$150 Spring movie camera, \$29.50; 35mm film, 2 1/2c foot; Filmo Camera \$100; Cine Kodak 16mm camera, \$50; 16mm, 100 ft. negative film, \$4.50 postpaid; 100 ft. complete 16mm comedy, western travel, or war reel, \$4.50. Cameras, projectors and films bought and exchanged. New twin arc movie lamps \$10. 3 1/4x5 1/2 Kodak, \$9; Remington typewriter, \$16. Ray, 296, Fifth Ave., New York.

JUST Out! Fourth edition Motion Picture Projection by Cameron, 1,248 pages. Largest work ever published. Includes 150 pages on talking movies. Covers all known makes of projectors, including amateur. A liberal education. Yours for \$6.00 postpaid anywhere in the United States. Foreign, \$6.25. Circular on request. Bass Camera Company, 179 West Madison St., Chicago.

STARTLING Bargains in motion-picture cameras, projectors, apparatus. Send stamp for the 192nd issue of the Bass Bargain-gram. Never in history has such startling bargains been offered in guaranteed apparatus. Write for your copy now. Remarkable motion-picture exposure meter, \$2.00. Sixty-six page catalogue. Send stamp. Bass Camera Company, 179 W. Madison St., Chicago, Ill.

\$1,250.00 FOR A photoplay story by an unknown writer and sold through our sales department. We revise, copyright and market. Located in the heart of the motion picture industry. We know the demand. Established 1917. Postal brings free booklet with full particulars. Universal Scenario Company, 206 Western and Santa Monica Bldg., Hollywood, Calif.

TAKE Moving pictures of professional quality. Complete outfit, consisting of 200 foot "Universal" dissolve camera, two lenses, six magazines, masks, tripod, cases. All for less than market price of camera alone—\$490.00. Thomas Baker, 605 W. Mercury St., Butte, Mont.

TIME Counts in applying for patents. See pages 138 and 139. Clarence A. O'Brien, Registered Patent Attorney, Washington, D. C.

BIG Money in photography. Catalog 49A free. New York Institute of Photography, 10 West 33rd St., New York.

1,000 FEET of comedy, \$2.00. No lists. Sunset Film Exchange, 298 Turk St., San Francisco, Calif.

NEW and Rebuilt Projectors for Theaters, Schools, Churches, Traveling Shows. Supplies and Complete Theater Equipments. Bargain Prices. Free Catalog. Monarch Theatre Supply Co., Memphis, Tenn.

MOVIE Films, 1,000 ft. reels, \$2.50 each; shipped anywhere on receipt of remittance. Particulars on request. Independent Films, 177 Golden Gate Ave., San Francisco, Calif.

SCENERY TO RENT

WORLD'S Most Beautiful Settings for operas, plays, minstrels. Amelia Grain, Philadelphia.

EDUCATIONAL AND INSTRUCTION

STORY Ideas wanted for photoplays, magazines. Big demand. Accepted any form for revision, development and submission to markets. Established 1917. Free booklet gives full particulars. Universal Scenario Company, 406 Western and Santa Monica Bldg., Hollywood, Calif.

U. S. GOVERNMENT wants men. \$1,700-\$1,900 and up at start. Railway Mail clerk examination coming. Let our expert (former Government examiner) prepare you for this and also Rural Carrier, Post Office, Customs, Internal Revenue, and other branches. Write today for free booklet. Dept. 8, Patterson School, Rochester, N. Y.

WORK For "Uncle Sam." Life jobs. Steady work, \$105.00-\$275.00 month. Men—boys, 18-50. Thousands 1928 appointments. Common education usually sufficient. Experience unnecessary. Sample coaching, list positions and particulars free. Write today sure. Franklin Institute, Dept. G14, Rochester, N. Y.

SELF-INSTRUCTIVE Books, 50 subjects. Best Stenography, 25c. Circulars. Will Marr, B605, Nashville, Tenn.

STUDY A Scientific Profession. Sanitation—Bacteriology—Microbiology. Extension—Residential courses. Diplomas—Degrees granted. Urinalysis outfit and prospectus free. Int. College of Microbiology, 722 Calumet Ave., Hammond, Ind.

QUALIFY For fireman, brakeman, baggageman, colored sleeping car, train porter. Standard roads, \$150-\$200. Experience unnecessary. 810 Railway Bureau, East St. Louis, Ill.

DON'T Prepare for any civil service examination without seeing our catalog. Free. Columbian Correspondence College, Washington, D. C.

BIG Money in photography. Catalog 49A free. New York Institute of Photography, 10 West 33rd St., New York.

WANTED—Boys—men. Become auto mechanics. Sample training free. Franklin Institute, Dept. G400, Rochester, N. Y.

MORE Startling than hypnotism! A new thought discovery. A dynamic force. All can develop it. Ambitious people ask for free and highly interesting information. Modern Supply Co., Help Dept., 514 Fidelity Bldg., Cleveland, Ohio.

MEN Wanting railway mail, postoffice clerk, mail carrier and outdoor positions; qualify immediately. Write for list. Bradley Institute, 210R Cooper Bldg., Denver, Colo.

STAMMERING. Stuttering, other speech troubles, corrected. Wilson Schools, Dayton, Ohio.

\$1,700 TO \$2,700 Year. Men—18-45. Mail carriers, railway postal clerks. Steady. Full particulars and sample free. Write immediately. Franklin Institute, Dept. G3, Rochester, N. Y.

SONG Poem writers: "real" proposition. Hibbler, D15X, 2104 N. Keystone, Chicago.

OUTLINE Of short story and market \$5. John Murray, 914 Wylie Ave., Pittsburgh, Pa.

MAKE Money in photography. Learn quickly at home. Spare or full time. New plan. Nothing like it. Experience unnecessary. American School of Photography, Dept. 131-B, 3601 Michigan Ave., Chicago.

DOUBLE Entry Bookkeeping mastered in 60 hours with 8 keys; guaranteed; diplomas. International Bookkeeping Institute, Dept. 8, Springfield, Mo.

ARE You willing to qualify for government position, \$120-\$250 month. Write. Osmont Instruction Bureau, 101, St. Louis, Mo.

RADIO OUTFITS AND SUPPLIES

AMAZING New radio invention increases volume, clarifies reception, prolongs life of tubes, puts more pep in your set. Startling results. One 2Bleak required for each tube. Fits all makes. Each 45c, postpaid. Satisfaction guaranteed, or money back. Circular free. Radio Accessories Co., Dept. C-1, Cincinnati, Ohio.

6 TUBE Radio \$9.95. Write for literature. Oman, 156 Concord, St. Paul, Minn.

RADIO Power transformers, chokes, meters and miscellaneous material for sale. Write for lists and specifications. Radio Parts Co., Orange, N. J.

BUY Your B. power devices direct from factory. Send for particulars. D. L. & G. Mfg. Co., 2941 W. Lake, Dept. 11, Chicago.

TIME Counts in applying for patents. See pages 138 and 139. Clarence A. O'Brien, Registered Patent Attorney, Washington, D. C.

RADIO Trouble Shooting—Here is the book all radio men have been waiting for. Greatest book ever published from the point of view of assisting the repairman as well as showing how the radio owner can do his own repairing. 328 Pages. Over 300 Illustrations. Flexible. Pay postman price \$3 and postage when he delivers it. Popular Mechanics Co., Room 807, 200 East Ontario St., Chicago, Ill.

TRADE AND TECHNICAL SCHOOLS

YOUNG Men—No experience. Become R. R. station agents or telegraphers. Earn \$150 to \$300 monthly; no layoffs; rapid advancement. For free information write Illinois Telegraph, 1608 W. Madison St., or Room 711, 117 N. Dearborn St., Chicago, Ill.

OUR Commercial radio operating and junior engineering course pays our graduates \$150 to \$300 monthly from start. Rapid advancement. Fall term begins in September. Write for catalog of course including Extension Course. Loomis Radio College, Dept. 5-E, Washington, D. C.

WANT A foreman's job? You may be a good mechanic but if you can't read blueprints you haven't a chance. I train you quickly. Write me your trade. Carroll Rumsey, 266 Drexel Building, Philadelphia.

TELEGRAPHY—Both Morse and wireless—taught thoroughly. Big salaries. Wonderful opportunities. Expenses low; chance to earn part. School established fifty-four years. Catalog free. Dodge's Institute, Fern St., Valparaiso, Ind.

MEAT Cutters make big money. Steady jobs everywhere; learn quick; particulars free. National School, Toledo, Ohio.

BUSINESS OPPORTUNITIES

LOCAL Managers Wanted for Phelps power and light plants. A great industry is developing. The potential market in some counties is estimated in the neighborhood of 1,000. One county would make a good business and a permanent income. Experience is necessary. Only men who know how to sell electrical goods and install them are wanted. If you want to get into a permanent business this is your opportunity. Particulars free. Phelps Power and Light Corp., Rock Island, Ill.

READ The Mail Order News—America's Pioneer Mail Trade Journal. Quarter Century Old. Approximately 600 pages yearly of valuable information for beginners and established mail-order houses. Analyzes mail-order business, its opportunities. Practical mail-order ideas, legitimate money-making schemes, instructive articles. Tells how to start, what to sell. Published monthly. Subscription \$3.00 yearly. Send 25c for sample copy. None free. Mail Order News, 260 Bristol Bldg., New York.

DIE-CASTING And electro-plating plant needs expert man to take full charge. It is the only plant of the kind in Brazil and it offers splendid opportunities. Articles manufactured are protected by high import duty. Labor cheap and no competition in prices. Machinery new. Applicant will be asked to invest five thousand dollars in business. Address communications to J. W. Hadden, care Du Bois Iron Works, Du Bois, Pa.

MANUFACTURE Loidlac. Scientist's amazing discovery restores color and finish to old cars in sixty minutes. Not a cleaner. Wax, paint or polish with my simple guaranteed formula. You'll clean up thousands of dollars making and distributing this instant refinish. Particulars free. Miller, Chemist, Miller Chemical Building, Tampa, Fla.

INCOME Increaser—Newly enlarged 36-page monthly magazine of best, latest ideas, plans, schemes, tips, pointers, starters. One year, \$1; sample, 10c. Income Increaser, 88 Pearl, Boston, Mass.

NOW 25c For year's subscription to Postal Success-Porter's Magazine combined. Tips and news of interest to mail order dealers and beginners. Porter's Publications, 9416a, 115th St., Richmond Hill, N. Y.

NO Peddling. Start own business. Home, office. Free folder describes 27 money-making opportunities. No outfits. Elite Co., 38 Elizabeth St., New York.

COMPOSITION Floor Making earns industrious men \$12 and more daily if used as trade. Or make business of it with profits up to \$10,000 yearly. Openings everywhere. Semi-Tite, Box-43, Hollis, N. Y.

MACHINE And mill supply business, good location. Brigrance Machine Company, Franklin, Ky.

EXTRA Money and a chance to establish your own independence can be made with well chosen spare-time occupation. We help you find it. Write Avocational Service, Dept. B, 7417 Latona Ave., Seattle, Wash.

TOOL Salesmen—Sell to auto mechanics, guaranteed line of 120 Oldforge tools—wrenches, pliers, chisels, screw drivers, punches, tool boxes. Exclusive territory. Give complete information about yourself, first letter. Quality Tools Corporation, New Wilmington, Pa.

ANYONE Handy with paint brush can earn five thousand dollars or more yearly installing Walex—a beautiful plastic paint of many shades and textures. Walex is installed in homes or buildings where beautiful appearances are desirable. Sells on sight. Get full particulars. Everlastone Products Corp., Everlastone Square, Baltimore, Md.

AN Opportunity. Promotion rapid. Five million dollar company entering direct selling field with product every woman wants. One sale brings another. Openings for district managers. Rapid advancement, crew managers, canvassers. The Strong Manufacturing Co., Sebring, Ohio.

BUSINESS Information of every character. We divulge actual supply source of American-made goods, how to sell locally, by mail or through agents. Chemical analysis, formulas, money-saving business information, opportunities. Write for catalog. Business Information Syndicate, Box 1071, Knoxville, Tenn.

YOU Want to buy profitably established mail order business, or do you wish to sell? Write wants. Eastern Exchange-1, 112-Smith, Millville, N. J.

10 MONEY-MAKING Plans \$1. John Murray, 914 Wylie Ave., Pittsburgh, Pa.

BUSINESS Profession of your own and earn big income in service fees. See Stephenson Laboratories, display ad page 133.

BIG Money managing concessions at resorts, parks, stadiums. See page 254 August. Coin-controlled seat, Allen inventor, 14 Auzeais Bldg., San Jose, Calif.

FOUNDRY For lease. Write Box 287, Liberty, Ind.

LOS ANGELES. See Jean Campbell advertisement under

UNUSUAL Opportunity. \$300.00 total investment. \$5,000.00 to \$12,000.00 year income. Nationally known manufacturer backs this offer. No schooling necessary—simple, easy. Earnings at once. Give age and experience. Write Florkraft, 3831 Cortland St., Chicago, Ill.

KING System mail order business, co-operation idea; make the right start. Big profits. Complete details with King's Magazine 25c. Satisfaction guaranteed. King Company, Box 672PB, Wilmington, Dela.

10c BRINGS You mail from everywhere and our opportunity information by return mail free. Witham, Box 153, Cathlamet, Wash.

TIME Counts in applying for patents. See pages 138 and 139. Clarence A. O'Brien, Registered Patent Attorney, Washington, D. C.

HOW I got a job with the biggest experimental laboratory in the world, \$1.00. Box 97, North End, Detroit.

MAKE Toys, novelties, children's furniture. Instructions, patterns, including scroll saw. \$1.00. Wm. Bogren, 2264 Hermany Ave., New York.

TIME Counts in applying for patents. See pages 138 and 139. Clarence A. O'Brien, Registered Patent Attorney, Washington, D. C.

DELAWARE Incorporator. Charters; fees small; forms. Chas. G. Guyer, 901 Market St., Wilmington, Del.

LEGITIMATE Personal or business commissions reliably executed for resident or non-resident firms and individuals in New York or vicinity. Edward Boyle, 1441 Broadway, New York.

WRITE Today if interested in selling by mail. Pruitt System, "M," Brookfield, Ill.

SIXTY Successful mail order propositions. K. Home, 3949 Metropolitan, Chicago.

COUNTY Rights open for new automatic fire extinguisher. Small capital required. Large profits realized right from the start DeGarmo Research Corporation, Kingston, N. Y.

SMALL Capital starts profitable route of money-making vending machines. Information free. Chewit Co., Dodworth St., Brooklyn, N. Y.

CAPITAL—For copy of the "Promoter's Hand Book," a leaflet on financing, an eye opener for capital seekers, send \$1.00 to Auster Leonard, East Orange, N. J.

MIRRORS Resilvered at home. Costs less 5 cents per square foot; you charge 75 cents. Immense profits plating like new, brassy worn-off autoparts, reflectors, tableware, stoves, etc. Outfits furnished. Details free. Sprinkle, Plater, 127, Marion, Ind.

PROFITABLE Jobs for home work shops; Build utility bulletin boards. We sell and rent space. H. E. Jones, Sign Studio, 1606 W. Locust St., Davenport, Iowa.

DON'T Sell for others. Employ agents yourself. Make your own products. Toilet articles, household specialties, etc. 500% profit. Valuable booklet free. National Scientific Laboratories, 1984W Broad, Richmond, Va.

MAIL Order business your opportunity. Brenner's famous hand books by expert 25 years' experience show how to start selling articles you make or buy—all or part time—small capital. Fascinating, profitable. Set eleven books, \$3.25. Brenner Company, 1607 P. Sansom, Philadelphia. Sample book, 25c, pay \$3 for other ten if satisfied.

ARTIFICIAL Marble sanitary flooring instructions, covering wood or cement flooring 1/2 inch thick, fireproof, waterproof, all colors, low cost. Ornamental casting, concrete, plaster, papier-mache decorations, garden furniture, statuary, flexible molds. 18 years instructing the public; particulars and illustrations free. Chris. Mahler, Huntington, N. Y.

CHARTERS: Delaware; best, cheapest; free forms. Colonial Charter Co., Wilmington, Del.

UNPATENTED Ideas can be sold. I tell you how and help you make the sale. Free particulars (Copyrighted). Write W. T. Greene, 810 Baltic Building, Washington, D. C.

"SCHEMER" Subscribers; surely succeed. One reports \$50,000 from one tip; another \$25,000 from three Schemes; another \$10,000 from one formula. Try your luck! Year, \$1.00; three months, 30c. Patterson, Publisher, Alliance, Ohio.

SUPPLIES For making chipped glass house numbers and signs. Tinfoils, glass and frames. Osborne Sims, 13380 Tuller, Detroit, Mich.

START A Crispette shop. Delightful confections. Everybody likes them. Make a lot of money. Adams reports \$364 profits in two days. We start you. Write, Long Eakins, 1962 High St., Springfield, Ohio. (Samples 10c.)

MONEY For working capital; incorporate and sell shares in your business. 27 years organizing and raising money for businesses of merit. Terms reasonable. Prompt and confidential service. W. Harrison Cole, 507 5th Ave., Suite 510, New York.

NEW Specialized business—yet you can make \$1,000 per month. Start an Auto Glass Shop, replace broken glass in cars. Accidents increasing—garages send you work. I'll tell you how to start, but reserve Milwaukee territory. Write Auto Glass Shops, 752, 53 National, Milwaukee, Wis.

A BUSINESS of Your Own Making—Sparkling Glass Name and Number plates. Checkerboards, Signs. Big book and sample free. E. Palmer, 540, Wooster, Ohio.

MECHANICS, Painters, carpenters, start furniture refinishing, painting, handyman shop on nearly nothing; winning plan brings customers quickly. John Braceland, 1439 So. Ninth, Philadelphia, Pa.

WE Start you in business, furnishing everything; men and women, \$20.00 to \$100,000 weekly operating our "New System Specialty Candy Factories" anywhere. Opportunity lifetime; booklet free. W. Hillyer Ragsdale, Drawer 4, East Orange, N. J.

SELL Better books by mail. Details, samples, circulars, 10c. Green, 15788 Parkside, Detroit, Mich.

THE Latest, most amazing products! 200% to 500% profit! Make them yourself. Write for free, valuable literature. Scheid, Chemist, Box 1199, New Haven, Conn.

A "VISOVA" Patent Multicolor on your typewriter increases speed. No typists' eye or fatigue. Fitted instantly. State make. \$1.00 (bill). Agents wanted. G. Holden, Highfield View, Chesterfield, England.

PATENTS, Trade marks, designs and copyrights. Parker & Snyder, Barrister Bldg., Washington, D. C.

SUCCEED With Your Own Products. Make them yourself. Formulas, Processes, Trade-Secrets. All lines. Catalog, circulars free. B. Thaxly Co., Washington, D. C.

LEARN the collection business. Good income, quick results. Interesting booklet, "Skillful Collecting" free. National Collectors Assn., Long St., Newark, Ohio.

MAKE Big Profits with a Fur Farm in your backyard. Chinchilla Rabbits, Muskrat, Mink. Write for facts. 252 Conrad's Ranch, Denver, Colo.

SELL by Mail! Books, novelties, bargains! Large profits! Particulars Free! B-Efco, 525 South Dearborn, Chicago.

I MADE \$30 a Week Home. French Breadmaking. 15 years' experience; Free Booklet tells. Ashbrook 67, Marengo, Ohio.

CHEMICAL Expert will furnish formulas and trade secrets. All lines. Lists free. W. L. Cummings, Ph. D., 228 Gordon Ave., Syracuse, N. Y.

TELEGRAPHY

TELEGRAPHY—Both Morse and wireless—taught thoroughly. Big salaries. Wonderful opportunities. Expenses low; chance to earn part. School established fifty-four years. Catalog free. Dodge's Institute, H St., Valparaiso, Ind.

CHEMISTRY

YOUR Chemical problems solved and working formula or process furnished for \$5.00. Write me. W. Stedman Richard, Industrial Chemist, Box 2402, Boston, Mass.

FORMULAS AND TRADE SECRETS

INDUSTRIAL Chemist furnishes formulas, plans, trade secrets. All lines. Work guaranteed. Lists free. J. F. Mazur, 941 20th, Lorain, Ohio.

MONEY Making Ideas for women—One dollar bill. Formula for "Carmen Beauty Bleach" and special bleach for tan, freckles, etc., dollar bill. Guaranteed. C. D. Welch, Herrick, Ill.

POLISHING Pad, excellent for polishing fine furniture, violins, etc.; 300% profit. Tremendous demand. Complete formula with sample \$2.00. Reserve Oregon territory. C. Stevens, 702 Umatilla Ave., Portland, Oreg.

LATEST Valuable trade secrets, guaranteed formulas for starting world's fastest big money business making newest sure-fire specialties. All lines, small investment. Immense profits! Write immediately for eye-opening valuable literature. Miller, Chemist, 1706-E Jetton, Tampa, Fla.

DON'T Sell for others. Employ agents yourself. Make your own products. Toilet articles, household specialties, etc. 500% profit. Valuable booklet free. National Scientific Laboratories, 1984W Broad, Richmond, Va.

FORMULAS—Any kind, \$1.00 each. Guaranteed. Mark Twain Laboratory, Harnibal, Mo.

SUCCEED With Your Own Products. Make them yourself. Formulas, Processes, Trade-Secrets. All lines. Catalog, circulars free. B. Thaxly Co., Washington, D. C.

FORMULAS—170 Money makers and big illustrated catalog 20c. Ideal Book Shop, (K) Park Ridge, Ill.

3,000 VALUABLE Formulas prepaid \$1.00. National Service, 3937 Marburg, Cincinnati, Ohio.

10,000 FORMULAS. A real Gold Mine of money-making ideas. Tells how to make almost everything under the sun. You can make and sell cosmetics, mucilage, anti-freeze solutions, battery solutions, beverages, cheese, chewing gum, cleaning preparations, extracts, hair preparations, inks, bluing, leather polish, mirrors, perfumes, polishes, typewriter ribbons, carbon paper, washing powders, liquid soap, and hundreds of other profitable articles. Send No Money. Just write a postal for "Henry's 20th Century Book of Formulas." Pay postman postage and \$4. Popular Mechanics Press, 200 E. Ontario St., Room 807, Chicago, Ill.

AGENTS WANTED

MEN—Women \$90 a week. Write orders for finest line guaranteed hosiery ever shown. 126 styles, colors. Finest silks. 35% commission paid daily. Producers earn auto. We give you fine silk hosiery for your own use. Write quick for samples. Wilkint Hosiery Co., Dept. 5431, Greenfield, Ohio.

HOW Would you like to own a store? I'll put you in business for yourself without a single cent investment. Prove you are energetic and ambitious and I'll do the rest. Send for my free outfit containing latest lingerie, men's shirts and underwear samples all manufactured by our own mills and sold direct. Take orders. Prove you mean to work and I will furnish a store for you on a main street in your town. You get paid liberally each day when selling. To convince me of your qualifications, write for free outfit and full particulars about my store plan today. Tellson Mills, Dept. 1909, 1107 Broadway, New York.

MAKE Money with Christmas Greeting Cards in box assortments, \$2.00 to \$4.00 per hour easily made. Nothing ever sold compares with the sale of Christmas greeting cards; sell on sight. Our magnificent assortment contains 21 high-grade Christmas greeting cards and folders, each with envelopes, steel engraving, French water coloring, sparkling metallic gold and silver effects, panelling and bordering. Sells for only \$1.00, costs you 50c. Write immediately for full particulars and free samples. Waltham Art Publishers, 7 Water St., Dept. TS, Boston, Mass.

PRIVATE Brand toilet articles, household specialties, perfumes, soaps, extracts, etc. We pack these goods for you under your private label. With your name on the goods you get all the repeat business. Don't sell for others but build up a profitable business for yourself. Highest quality merchandise. Extremely low prices. Quick shipments on both large and small orders. Write immediately for lowest wholesale prices and complete information regarding our amazing offer. Address Supply Department, National Scientific Laboratories, 1904W Broad, Richmond, Va.

DISTRIBUTORS Wanted—For new, patented specialty selling through dealers. Exclusive territory is now available on a fast selling, low-priced specialty which is taking the country by storm. If quick sales and enormous profits interest you and if you can finance and organize your own territory we have a wonderful proposition to offer. Write for full particulars and mention details. Gordon Manufacturing Co., Dept. C4, 110 E. 23rd St., New York City.

AGENTS—\$13.80 Daily in advance, introducing new insured hosiery for men, women, children. Must wear or replaced free. 57 styles, 39 colors including latest "Silk to the Top" ladies' hose. Nyland made \$595 in one month. Edwards, \$400.69, Mrs. Bone, \$425.45. Why not you? Even spare time should pay you \$3.00 an hour. No experience needed. We furnish samples. New plan. Write quick. Macochee Company, Park 2569, Cincinnati, Ohio.

OUR Agents earn from \$50 to \$200 weekly selling genuine diamonds, watches, jewelry through beautifully illustrated catalog. Cash or credit. Unusually liberal proposition. Free outfit by return mail. No investment! Any hustler can do it easily. Write Sterling Diamond & Watch Company, Nationally Known Jewelers, Est 1879, 1540 Broadway, Dept. A197, New York.

YOUR Favorite Products: Manufacture them yourself. Guaranteed manufacturer's formulas supplied. All lines. Latest specialties. Romig, Box 103, X Station W, New York.

MASTER Barber Shampoo. Men and women, write quickly for money-making proposition. 100% profit. Gray, Box 313, New London, Conn.

TAKE Orders newly patented valveless water bowl. Absolutely prevents backflow, pipe clogging, overflow. Low priced. Dairy-men eager buyers. Big profit. Free particulars. G. A. Hatton, Box 426, New Castle, Penna.

EXPENSIVE Silk dresses. Our slightly handled showroom samples sacrificed. Peddlers, storekeepers, dress parlor people, write Hirschlar's, 249 West 34th, New York.

AGENTS, 75-100% Profit! Every auto owner buys Nob-Urn Combination Ash Tray and Shifting Lever Ball. In three beautiful Duco colors and fits all cars. Write now! Schonig Brothers, Homewood, Ill.

AGENTS—I'll pay your bills, give you steady income for rest of your life if you will take care of my business in your locality, full or part time. You be my partner, make \$15 a day. Ride in Chrysler sedan. Distribute teas, coffees, spices, extracts, things people eat. I furnish everything, world's finest super sales outfit containing 30 full sized packages low prices, big repeat business; \$25,000 guarantee on quality. I go 50-50 with you. Get my amazing offer. C. W. Van de Mark, 117 Duane St., Dept. 102-J, Cincinnati, Ohio.

AGENTS, Crewmen—Make big money! handling our Mystic "Zippo"! Splendid profit on a snappy 50c "Go-Getter" repeat article sells on 10-second demonstration. Performs while you watch it! Demonstrate value while others make claims! Greatest scientific triumph of the age! Write immediately for proposition! Karam-Smith Company, 609 Bozart St., Fort Wayne, Ind.

AGENTS, Portraits, photo-pillow tops, frames, sheet pictures, medallions, photo-jewelry, soaps, perfumes, laundry tablets, food products, toilet preparations, luminous crucifixes. Catalog 200 specialties free. 30-days' credit. Jas. C. Bailey Co., Station C-9, Chicago.

WANT Money? Sell Snappy Sue; latest joke novelty for men. Sample 25c. American Specialty Co., Swampscott, Mass.

AGENTS Wanted: Make \$15.00 a day selling the original patented phone memo recorder. Sells itself. No competition. Golden opportunity. Write for territories. Rudley Mfg. Co., 52 S. 60th, Philadelphia, Pa.

\$15-\$25 DAILY: Sensational device, washes windows in one minute; sells on sight in homes, stores, garages, factories; no competition; first time offered in your territory. Write immediately for details and free sample offer. 4inl, Inc., 1900 Southport, Dept. G-9, Chicago.

AGENTS—We start you in business and help you succeed. No capital or experience needed. Spare or full time. You can easily earn \$50-\$100 weekly. Write Madison Company, 566 Broadway, New York.

AGENTS—Best seller; Jem Rubber Repair for tires and tubes; supersede vulcanization at a saving of over 800 per cent; put it on cold, it vulcanizes itself in two minutes, and is guaranteed to last the life of the tire or tube; sells to every auto owner and accessory dealer. For particulars how to make big money and free sample, address Amazon Rubber Co., Philadelphia, Pa., Dept. 505.

ELECTRIC Cigar lighters. Make \$100 week. Brilliant flashing advertisements. Three beautiful models. Used by dealers everywhere. Write Drake Mfg. Company, Dept. M, Milwaukee, Wis.

NO Experience necessary. You'll sell Wonder Changeable Signs fast. We show you how. Write Currier Mfg. Co., 7 Northwestern Terminal, Minneapolis, Minn.

AGENTS: Send for our proposition. Dow Mfg. Co., West Lebanon, N. H.

AGENTS, Sell stores 5c candy specialties; big profits. Colonial Co., 314 East 33d, New York.

AGENTS, Hosiery 8 cents pair. Butz Hosiery Mfg. Allentown, Pa.

IMPORT Your own goods. German export magazine published in English, offers numerous bargains latest novelties; opportunities for obtaining profitable agencies. Copy 60c. Square Deal Supply, P-246 Fifth Ave., New York.

AUTO Owner tire agent wanted each locally to use free demonstrating tires and take orders for new heavy duty Mellinger tires, guaranteed 15 months against all road trouble. Shipped on free trial. Get your own tires and earn \$300 monthly—no capital or experience needed. Write Mellinger Tire Co., Dept. 282, Kansas City, Mo., Warren, Ohio, Oakland, Calif.

DON'T Sell for others. Employ agents yourself. Make your own products. Toilet articles, household specialties, etc. 500% profit. Valuable booklet free. National Scientific Laboratories, 1984W Broad, Richmond, Va.

AGENTS, Become a regular established McConnon dealer! buy on credit; sell for cash or credit. 228 absolute household necessities; all repeaters. Enjoy a sure income 52 weeks per year, year after year. City or country trade. Capital, experience unnecessary. McConnon & Co., Dept. M909, Winona, Minn.

SALES AGENTS—Take orders high-grade tailored neckwear. Hand made. Guaranteed for 6 months. Insured never to roll, twist, stretch or bunch. Not sold in stores. Patented. Samples furnished. Write quick. Better Made Cravat Co., Wholesale Dept. 6, Columbus, Ohio.

MIRRORS Resilvered at home. Costs less 5 cents per square foot; you charge 75 cents. Immense profits plating autoparts, reflectors, tableware, stoves, refinishing metalware, etc. Outfits furnished. Details free. Write Sprinkle, Plater, 128, Marion, Ind.

AGENTS, \$300 Month. Bonus besides. Dri-Kleanit makes any car look like new. Slickest thing you ever saw. Removes dirt, grease, tar, all one operation. No soap or water used. Cleans any car for 10c. Wonderful seller. Write for sample. American Accessories Co., Desk 3231, Cincinnati, Ohio.

SELL Personal Christmas cards, names embossed in gold. \$1 dozen up. 50% commission. Samples free. Also box assortments. Dunbar Corp., New Brunswick, N. J.

AGENTS Make liberal commission selling high-grade advertised "Shear Grinder" to barber shops, hardware stores and dry goods stores. Or, make \$10 to \$15 per day sharpening shears. Write F. H. Smith Mfg. Company, 3047 Carroll Ave., Chicago.

AGENTS—Highest commission, bonus selling dress goods at wholesale prices. Full-spate time. Sample outfit furnished. North American Importing Co., 1123-A Broadway, New York.

FLAVORING Extracts—Bottle yourself! Concentrated, add water! Free labels, whirlwind sellers! 500% profit! Money-making opportunity. Write Thomas Manufacturing Company, Indianapolis, Ind.

\$50.00 WEEKLY. Men wanted to demonstrate and take 10 orders daily direct from motorists. Amazing Magnetic Trouble Light. Sticks anywhere! More orders, bigger pay. Write for demonstrator and particulars. Magna Co., 6 Beacon St., Dept. 169C, Boston, Mass.

AGENTS Wanted to advertise our goods and distribute free samples to consumers; 90c an hour; write for full particulars. American Products Co., 1895, Monmouth, Cincinnati, Ohio.

IF I send you a suit made in latest style from finest goods, will you wear it and show it to your friends as a sample of my sensational values? Could you use \$3.00 an hour for a little spare time? If so, write at once for my wonderful new proposition. Address Sales Manager, Peoria and Adams, Dept. 924, Chicago.

MAKE \$50 To \$75 a week. Everyone needs shoes. Sell Mason's all-leather shoes, amazingly low prices. 85 styles—Men's, women's, children's. No experience needed. Big outfit free. Mason Shoe Mfg. Co., Dept. 229, Chippewa Falls, Wis.

AGENTS—Biggest seller yet! Four shirts for \$5.00. Your commission \$1.00. Wide variety materials insure quick orders. Experience unnecessary. We specialize on made-to-measure shirts. Send for free outfit. D. Menzlin, President, Menzlin Shirt Co., Inc., 481 E. Tremont Ave., New York.

TONE-O Gasoline Tonic, fast seller everywhere. Amazing profits. Ready repeater. Darnell, 730 N. Hays, Jackson, Tenn.

MAKE \$2.00 Every hour. Sell every home wonderful preparation; mends hosiery and clothing without sewing. Invisible. Results guaranteed. Send for free sample of work. Queen City Laboratories, PM-9, Cincinnati, Ohio.

AGENTS: \$20.00 Daily with electric belts. Get our free offer. Wholesale Supply Co., Valdosta, Ga.

\$15 A DAY Sure. Sell guaranteed solid leather shoes. Unequaled low prices. 85 styles; men's, women's, children's. Free outfit offers complete line shoes, raincoats, leather coats, puttees. Consolidated Shoe System, Dept. 915, Eau Claire, Wis.

MANUFACTURE Loidiac. Scientist's amazing discovery restores color and finish to old cars in sixty minutes. Not a cleaner. Wax, paint or polish with my simple guaranteed formula. You'll clean up thousands of dollars making and distributing this instant refinish. Particulars free. Miller, Chemist, Miller Chemical Building, Tampa, Fla.

AGENTS: Embossed signs, biggest selection. latest colors, every merchant buys. A dime for 50c worth samples. Also changeable signs, flashing plugs. Franklin, 3322 3rd Ave., New York.

AGENTS \$72 A week. Best line guaranteed cutlery ever offered. Knives, razors, etc. Makes useful Christmas presents. We give exclusive territory. Big commission. Big money for spare time. Write for samples. Novelty Cutlery Company, Desk 2431, Canton, Ohio.

WOMEN: \$2 An hour spare time; 100% commission; new idea sanitary necessity; sells on sight; every woman buys; new feature never before used; designed by physician; revolutionizes old uncomfortable methods; pay every day; no deliveries; no collections; no experience or capital required. Write Mary P. Coleman, Meriden, Conn.

AMAZING Profits showing new Polly wrench, 10 wrenches in one. Guaranteed seller at sight. Agents making \$10-\$25 daily! Get yours free. Gellman Mfg. Co., Dept. 6C, Rock Island, Ill.

AGENTS—Sell raincoats. (31) samples furnished. Write for free raincoat offer. Barton Co., 8 Marshfield, Mass.

\$20.00 DAILY—Easily made under our proven selling plan. Airweave ventilated cushions sell on sight to offices. We deliver and collect, paying you a liberal commission on all orders as booked. Irvin Co., 331 Madison Ave., New York.

AGENTS—Easy Money. Only pipe reamer, folds flat. Cuts out carbon, true to bore. Reams out heels, bit and bowl top. Every pipe smoker buys on sight 35c. Seller sample 25c coin. Write Maier Reamer, Charlestown, Md.

GOLD-LEAF Sign Letters; copyrighted Manufacturing Instructions; profits 1,000%. Johnston Co., Quincy, Ill.

NO Peddling. Start own business. Home, office. Free folder describes 27 money-making opportunities. No outfits. Elite Co., 38 Elizabeth St., New York.

ARTISTIC Stone houses, \$50! (Patent allowed.) Fireproof, stormproof, everlasting; government recommendation; agents' bonanza. C. Bradley, Box 1586, Cincinnati.

AGENTS, \$240 Month. Sell silk hosiery. Guaranteed 7 months. Producers earn auto. Samples furnished. Free silk hosiery for your own use. Write today; state size of hose worn. Betterkalt Hosiery Co., Silk 3231, Greenfield, Ohio.

AGENTS Wanted to sell "Instantfreeze" for freezing ice cream, sherbets, soft drinks, etc., in from 3 to 30 seconds. Money-making opportunity for salesmen of both sexes with consumer and dealer contacts. For particulars write the Stover Signal Engineering Company, Racine, Wis.

AGENTS—If you need money write for free sample So Easy Mystery Polishing Cloth. Mohler, Box 453-B, Chicago.

42 MILES On 1 gallon. Wonderful Moisture gas saver. All autos. 1 free. Critchlow, K4-805, Wheaton, Ill.

AGENTS! \$20 Daily! Latest patented ironing board pad and cover combination. Guaranteed. Low price. Sample for yourself free. American Braiding, F-329 West Monroe, Chicago.

GLARE Shields sell like lightning at \$1. cost 50c. Jehu, Sanford, Fla.

TIME Counts in applying for patents. See pages 138 and 139. Clarence A. O'Brien, Registered Patent Attorney, Washington, D. C.

AGENTS Wanted—New interchangeable show cards. Merchants everywhere buying. 300% profit. Write for free sample offer. Modern Sign Works, 816 No. Wells, Chicago.

FREE "Guide to full pocketbook." New ideas, original business plans, money-making secrets; other valuable information. Elite Co., 38 Elizabeth St., New York.

\$50,000 PICTURE Man Friedman made canvassing. Beginners can make \$100.00 weekly with my sales talk. Experienced men make more. Free book. "Profits in Portraits" explains. Sample free. Picture Man Friedman, Dept. 8-L, 541 W. Lake, Chicago.

AGENTS—Steady income. Large manufacturer of handkerchiefs and linens. wishes representative in each locality. Factory to consumer. Big profits, honest goods. Credit given. Send for particulars. Freeport Mfg. Co., 59 Main St., Brooklyn, N. Y.

\$100 WEEKLY Selling better-quality, all- wool, made-to-measure suits and overcoats at \$23.50. Highest commissions. Extra bonus for producers. Large swatch samples free. W. Z. Gibson, Inc., 500 Throop St., Dept. W-517, Chicago.

GREATEST Specialty for rural agents. Write Hawbaker Co., Elmore, Minn.

SENSATIONAL New invention, sponge holding hose nozzle auto washer. Works like play; don't get wet. Retail \$2.00. Write how to get yours free. Sponge Nozzle Co., 909 Ford Bldg., Detroit, Mich.

IT'S New—It's great. Sells everywhere—and how! Metal polish in tubes. An opportunity you can't afford to miss. Trial tube free. P. M. Reid, 1619 Clark, St. Louis.

AGENTS For novelty every motorist wants and must have. You don't have to show it twice. A fast seller with 100% profit. Write Germania Novelty Co., 409 Produce Exchange Bldg., Minneapolis, Minn.

ARVEO Polishing cloths—they produce results. Be our local representative—big profits for you. Testing sample free. Arveo Industries, Dept. F, Grosse Ile, Mich.

\$90.00 WEEKLY Wearing and showing my beautiful new free raincoat and giving away free hats. Write today for yours. Robert King, 230 S. Wells, Dept. AB-9, Chicago.

CONTRACTORS' Danger signal or territory on radio device available. Write Kinley 441 E. Ferry St., Buffalo, N. Y.

TAKE Orders for new orthophona and make \$125 week—an invention that furnishes latest music. Simple, inexpensive. Beats radio; part time brings \$3 hour, paid daily. Write quick for sample. Orthophona Mfg. Co., 757-F, Broadway, New York.

HIGH Grade specialty. Excellent side line. Every customer a prospect. Sell internationally known trade-mark protected "Keelocks." Send 25 cents for sample. Keelock Manufacturing Co., 529 56th St., Brooklyn, N. Y.

CASH Paid for Butterflies, Insects. See Sinclair Display Advertisement on page 20.

20-YEAR-OLD Firm offers you chance to make \$60.00 to \$100.00 every week handling nationally-advertised tailored-to-measure suits and overcoats. \$25.00 sales outfit free to honest, energetic men. Write at once. Madison Brothers, 131 So. Peoria, Dept. 523, Chicago.

DON'T Sell for others. Employ agents yourself. Make your own products. Toilet articles, household specialties, etc. 500% profit. Valuable booklet free. National Scientific Laboratories, 1984W Broad, Richmond, Va.

\$60-\$200 A WEEK. Genuine Gold Let- ters for store windows. Easily applied. Free samples. Liberal offer to general agents. Metallic Letter Co., 438-B North Clark, Chicago.

AUTOMOBILE Specialties. Guaranteed formulas for all latest money makers. Lowest prices. Write for free lists. Murphy, Chemist, Tujunga, Calif.

AGENTS, Our cigar lighters and sales- boards sell quick. Large wholesale catalog free. Joseph Sales Company, 223 Madison St., Chicago.

\$1,000.00 REWARD If this is not the greatest money-making house to house proposition ever known. N. R. G. tablets wash clothes in 10 minutes without rubbing. Free samples. N. R. G. Co., H 500 W. Division, Chicago.

AGENTS Wanted—Sell Xmas cards. Big profits. Great demand. Finest assortment. Deal with manufacturer. C. M. Kightlinger, Millburn, N. J.

\$75 WEEKLY. Man or woman wanted with ambition and industry, to distribute Rawleigh's Household Products to steady users. Fine openings near you. We train and help you so you can make up to \$100 a week or more. No experience necessary. Pleasant, profitable, dignified work. Write today. W. T. Rawleigh Co., Dept. 53PPM, Freeport, Ill.

THE Latest, most amazing products! 200% to 500% profit! Make them yourself. Write for free, valuable literature. Scheld, Chemist, Box 1199, New Haven, Conn.

SHOW Us the housekeeper who likes to clean stair-corners; earn by money selling Corner Dust Shields. Write today. Ideal Stairway Equipment Co., Dept. PM, Canton, Ohio.

EASY To sell groceries, summer drinks, auto oils, paints to consumers. Our representatives make \$3,000 yearly and up. No capital or experience necessary. We furnish sample case free and guarantee sales. Write Loverin & Browne, H-1602 S. State, Chicago.

AGENTS—Sell \$1 Christmas card assortments. Also beautiful personal greetings. Unequaled values. Highest commissions in advance. Samples free. Harry Dochla, Dept. 1-R, Fitchburg, Mass.

\$54.40 PROFIT In 24 hours made by agent selling Duplex Sifters. Sells itself to the housewife. They all want it. Sifts and resifts without removing flour. Send for sample and try it; 60c postpaid. Sales guaranteed. Four colors. Uneek, 4515 Lexington, Chicago.

\$25 DAILY Selling \$2.85 colored raincoats. Hat free. 3 dresses \$4.75. Beats all competition. Outfit of 50 numbers free. American Waterproof, G724 Roosevelt, Chicago.

WELLS Cleared \$620.00 in one month with "Business Guide" and free legal service. Write for free outfit. Prof. Nichols, Dept. 19, Naperville, Ill.

HARVEY Wants \$100 week man for district agency. Sensational \$17.50 and \$23.50 men's tailoring values. Money back guarantee. Fall woollens now ready. Free outfit. Write Manager, Dept. 603, Box L, Chicago.

STRANGE Invention! Pays \$25 daily. Keeps telephone and iron cords from tangling and kinking. Prevents iron scorching. Saves electricity. Sample free. Never-knot, Dept. 9-A, 4503 Ravenswood, Chicago.

DON'T Sell for others. Employ agents yourself. Make your own products. Toilet articles, household specialties, etc. 500% profit. Valuable booklet free. National Scientific Laboratories, 1984W Broad, Richmond, Va.

LOWER Prices on gold-eyed needle cases. Finest agent's article; sell fast, immense profits, \$50 to \$300 weekly. Proof free. Sample 10c. Paty Needle Co., College Ave., Somerville, Mass.

FREE Sample mail order agency specialty Flinger, 5003-C Gateway, Kansas City, Mo.

NO Competition; new electric hot dog machine; sells \$18.50; commission \$6.50; ready buyers everywhere. Leonard E. Dickerson, Dept. E-3, Springfield, Mo.

AGENTS: Make \$3.00 an hour taking orders for our 40 fascinating kitchen specialties. No competition. Write quick. General Products Co., Dept. J-207, Newark, N. J.

NEW Way to make money and get your own clothes free, taking orders for our fine made-to-measure tailoring. Write today for new style outfit, all wool samples, etc. Furnished free. Progress Tailoring Co., Dept. W-217, Chicago.

AGENTS—Just out! \$8.88 for men's suits! Anyone can sell. Big commission in advance! Free sales kit. 888 Company, Dept. W-7, Fort Wayne, Ind.

IF You write quick, I'll send beautiful Rosecliff selling outfit absolutely free. Shows latest shirt styles, fabrics. Every shirt guaranteed for one full year. Liberal advance commissions. Write Rosecliff Shirts, Dept. J-31, 1237 Broadway, New York.

42 MILES On 1 gallon. Wonderful moisture gas saver. All autos. 1 free. Critchlow, K3-805, Wheaton, Ill.

IF You want to establish independent cash, repeat life income, in a brand new, sensational, high-class business, demonstrating mysterious, scientifically approved, secret invention that is without competition, write Cedarwood Fumi-Teurs Corp., Throver Bldg., Atlanta, Ga.

MAKE \$11.00 Daily selling our Lucky 11 toilet goods assortment at \$2.25 giving free 2 piece carving set. Each sale makes steady customers. Davis Household Products Co., 511 Vedder, Chicago.

SELL Beautiful "Style Tailored" shirts and neckties direct to wearer at factory prices! Many beginners earn \$50 first week in spare time. \$100 weekly full time easy. Selling outfit free. Howard Shirts, 1213 VanBuren, Factory 15, Chicago.

AGENTS Sell carded specialties. Gifts, P5419 W. Chicago Ave., Chicago.

ARE You old at 40? See our advertisement on page 157 of this issue. The Electro Thermal Company, 2109 Morris Ave., Steubenville, Ohio.

AGENTS Wanted for fastest selling specialties on earth. Write Gilsud Co., 325 S. Flower, Los Angeles, Calif.

10,000 REPRESENTATIVES Wanted immediately. National Information Bureau, Brazil, N. Dak.

PROFITS In advance—low priced, quick selling gas (self-making) radiant heater—on installments or cash. No investment. We collect and deliver. Exclusive territory. Write quick. Sunshine Co., 410 Factory Bldg., Kansas City, Mo.

AMSCO Magnetic Health Belts made in our own factory, \$15. Guaranteed none better. Agents wanted. Genuine Wilshire Ionacos, \$22.50. AmSCO Health Belt Co., 721 Eighteenth St., Oakland, Calif.

\$12.00 DAILY Showing new table cloth. Looks like linen. Wash like oilcloth. No laundering. You just take orders. We deliver. Pay daily. Sample free. "Besco," 4517-NW Irving Park, Chicago.

PATENTED Window lock. Every home needs several. No obligation. Write for proposition and free sample. H-C Sales Co., 114 E. Fourth St., Springfield, Ohio.

AGENTS—Make \$2.00 an hour selling our remedies. Full or spare time. 100% profit. Write Elvee Company, Dept. A, 2919 W. North Ave., Baltimore, Md.

FREE Sample! Latest novelty signs, biggest 1928 moneymakers. Sell on sight. 500% profit. Ever-Ready, 52-A East Ninth St., New York.

AGENTS Wanted—To sell Electric Hair Clippers. Retail at \$8.75. Guaranteed. Useful in every home. The Master Appliance Co., Box 33, Racine Junction, Wis.

SELL Kepple's Products—Act as our representative in your district. The leading drug stores throughout the east buy regularly. Dentists and homes from all parts of the world buy our line. Agents receive benefit from all mail orders in each district. Write Kepple's Products Co., Wilkingsburg, Penna.

BIG Pay every day, showing Nimrod's all-year sellers! Dress, work and flannel shirts, overalls, pants, sweaters, underwear, pajamas, leather coats, lumberjacks, playsuits, etc. Experience unnecessary. Big outfit free. Nimrod Co., Dept. 8, 4922-28 Lincoln Ave., Chicago.

THE Christensen Mop Wringer rubs, scrubs, cleans the mop. For sale by H. K. Christensen, Fort Atkinson, Wis.

HOUSEHOLD Brushes, complete line; sample outfit and credit furnished to responsible men. National Fibre Broom Co., St. Louis, Mo.

200% PROFIT—Demonstration gives you immediate sale. A 25c item that to every housewife is an absolute necessity. C. Seed Manufacturing Co., 73 Franklin St., New York City.

SELL Supreme No-Cement tube and tire patches. 400% profit. Particulars. Write Supreme, 135 Winder, Detroit, Mich.

MAKE \$1,000 Before Christmas selling exclusive personal Christmas cards, steel engraved designs. Expensive sample book free. Wetmore, Janes and Sugden, Rochester, N. Y.

32 SECONDS Complete tire change by Detmer, Ohio, with Morey Quick Action Rim Tool. Sold, singly, 49 three days, cleared \$100. Anderson, Mont., sold 1,400 in 14 weeks. Get details for good territory. Harvest time now. M. Morey Rim Tool, Buffalo, N. Y.

"HOW To Secure Agents," a specially prepared booklet, tells of one of the most inexpensive methods in which to secure good live producing agents. It is free; write for your copy today! M. L. Rund, Mgr. Classified Advertising, Popular Mechanics Magazine, 200 E. Ontario St., Chicago, Ill.

HANDSOME Profits supplying leading self-repeating auto necessity; no competition; pay daily; write today; best season. Topco Mfg., Dept. X, Sta. H, Cleveland, Ohio.

A BUSINESS of your own—Making sparkling glass name and number plates, check-boards signs. Big book and sample free. E. Palmer, 512, Wooster, Ohio.

AGENTS—Mosco Corn and Callous Remover will build you a steady repeat business. Send today for pocket-size trial outfit. The Moss Company, 412 Searle Bldg., Rochester, N. Y.

MAKE Big money. Be the electrical dealer in your town. Sell a big line of low priced, quality appliances. Write for our selling plan. Dandyline Products, 4420 N. Western Ave., Chicago, Ill.

GOLD-LEAF Window letters and script signs. No experience; 500% profit. Samples free. Meyer writes 5 days profits \$141.36. Consolidated, 69-T West Van Buren, Chicago.

CAN You sell a washing machine for \$9.75? Agents are making \$75.00 to \$300.00 weekly showing new automatic washer to housewives. Thoroughly cleans and sterilizes. No rubbing necessary. Write for protected territory. Storm Royalty Co., Inc., 3601 Enright, St. Louis, Mo.

AGENTS—Sell Trousers' Friend. Keeps trousers spick and span. Sells easily. 100% profit. Trousers Friend, Dept. 1, Box 531, San Francisco, Calif.

NO Dull times selling food. People must eat. Federal distributors make big money; \$3,000 yearly and up. No capital or experience needed; guaranteed sales; unsold goods may be returned. We furnish you with sample case, license and free samples for customers—Sure repeat orders. Exclusive territory. Ask now! Federal Pure Food Co., A2307 Archer, Chicago.

SELL Gillette style razor blades. Good seller. Package 10 blades 35c; 200 blades, \$3.50. J. Kramer, Iselin, N. J.

WRITE Atlas Sign Works for free working equipment. Beautiful window sign letters. Penny each! Any size. Wonderful offer to general agents. K1032 E. 55th St., Chicago.

WE Start You Without a Dollar. Soaps, Extracts, Perfumes, Toilet Goods, Experience Unnecessary. Carnation Co., 2480, St. Louis, Mo.

AGENTS: Stamping names on pocket-key protectors. Sample check with your name and address, 25c. Stamping outfits. Emblem checks, check-fobs, name plates. Hart Mfg. Co., Desk 2, 303 Degraw St., Brooklyn, N. Y.

WIDESPREAD Demand for Our New Food Drink and new Flavorings (Black Walnut, Peach, Dixie Bouquet, etc.). Many other fine products. More agents needed. Blair Laboratories, Lynchburg, Va.

INSTANT Weld Welds Rubber Instantly. Stock's Profit One Day \$72.25. Enormous demand. Exclusive territory. Free sample. Tourists Pride Manufacturing Co., Desk G, Minneapolis, Minn.

BIG Money and Fast Sales. Every owner buys Gold Initials for his auto. You charge \$1.50; make \$1.35. Ten orders a day easy. Write for particulars and free samples. American Monogram Co., Dept. 40, East Orange, N. J.

MONOGRAM Automobiles, \$1.35 Profit ten minutes' work; every owner wants them; millions without; particulars free. Motorists Accessories Co., Mansfield, Ohio.

AGENTS—Clever Invention! Inkspon makes every pen a fountain pen. Fast office seller; big profit, demand increasing everywhere. Exclusive territory offered. Sample free. H. Marui Company, Tribune Bldg., New York, N. Y.

MAN In each town to plate auto parts, reflectors, bathroom fixtures, refinish beds, mirrors, chandeliers; by new method. No capital or experience required. Simple plan of manufacturing at home starts you in big money-making business. Outfit furnished. Free particulars and proofs. Gun Metal Co., Ave. H. Decatur, Ill.

AGENTS—Here's a New One. "Bestever Powdered Hand Soap." Sells like wildfire. Marvelous Discovery. Removes grease, paint, ink, oil, in fact anything from hands. Cannot harm skin. 150% Profit. Great Repeater. Agents simply coining money. "Free Samples Get the Business." Write immediately. Bestever Products Co., 4315W Irving Park, Chicago.

RESTORO Cleaner and polish outsells and outclasses other because new, different, amazingly effective. Big profits and permanent lifetime business awaits you. Write for free sample and starter offer. Economy Laboratories, Alameda, Calif.

SUCCEED With Your Own Products. Make them yourself. Formulas, Processes, Trade-Secrets. All lines. Catalog, circulars free. B. Thaxly Co., Washington, D. C.

FIBRE Brooms—detachable handles, fine finish. Good profits, repeat sales. The Fibre Broom People, 147-C New Jersey Ave., Brooklyn, N. Y.

REMNANT Store, Bethel, Ohio. Greatest Dry Goods Bargains on Earth. Agents and Dealers.

NEW Unusual necessities paying phenomenal profits. Make money as you've never made it. Unequaled, amazing detailed offer, free. Concentrated Products Co., Box 3772-P, Tampa, Fla.

GET Our Free Sample Case—Toilet articles, perfumes and specialties. Wonderfully profitable. La Derma Co., Dept. A, St. Louis, Mo.

POLMET Polishing Cloth removes tarnish from metals without the use of liquid, paste or powder. Our agents say it sells like "hot cakes." Retail 25c; sample free. Gale & Co., Inc., 15 Edinboro St., Boston, Mass.

DON'T Sell for others. Employ agents yourself. Make your own products. Toilet articles, household specialties, etc. 500% profit. Valuable booklet free. National Scientific Laboratories, 1984W Broad, Richmond, Va.

CALIFORNIA Perfumed beads selling like hot cakes. Agents coining money. Big profits. Catalog Free. Mission Factory P, 2328 W. Pico, Los Angeles, Calif.

PHOTO Medallion Men and Women, the largest line of Photo Novelties in the world. Lowest prices, quickest service. Send for catalogue showing over 200 money makers. Photo medallions, photo medallion clocks, photo mirrors, photo fountain pens, photo powder compacts, photo jewelry and photo buttons. Gibson Photo Jewelry Co., 608-614 Gravesend Ave., Brooklyn, N. Y.

REPLATE brassy worn-off Automobile Parts, Reflectors, Bath Room Fixtures, Worn Spoons, Forks, etc. with pure silver. Looks like new. Use U-Kan-Plate Polish. Positively no mercury. \$1.00 half pints. Post Paid. Satisfaction Guaranteed. Agents wanted. Dept. A, U-Kan-Plate Co., Philadelphia.

\$50.00 WEEKLY easy. Applying Gold initials on Automobiles. No experience needed. \$1.45 profit every \$1.50 job. Free samples. "Ralco Monograms," X1043 Washington, Boston, Mass.

WANT Distributing Agent for Handslick, powdered hand soap; removes anything from hands; everybody a customer; sample free. Solar Products Co., J-2142 S. Troy, Chicago.

GENUINE Gold Leaf Letters anyone can put on store windows. Guaranteed to never tarnish. Large Profits. Enormous Demand. Free Samples. Write today. Metallic Letter Co., 438-D North Clark, Chicago.

TWO Money makers for agents. "Francis" Pocket Adding Machine retails \$4.85. To you \$1.00. "Excellograph" Rotary Stencil Duplicator \$37.50 retail. Write Type-writer Supply, 102 Hersch Bldg., Pittsburgh, Pa.

MAKE And sell your own goods. No machinery. Guaranteed formulas. Catalog free. Clover Laboratories, (E) Park Ridge, Ill.

AGENTS—Sell stores 5c candy Specialties, Lorrac Products, Albany, N. Y.

AGENTS Wanted to sell Men's Hats direct from factory. Write for catalog. Model Hat Mfg. Co., Dept. M-14, East Orange, N. J.

OUR Luminous Crucifix Shines in the Dark. Every one amazed at the wonderful effect. Easily demonstrated—easily sold. W. G. Hannan Co., 2543 So. State St., Chicago.

AGENTS—Engraved name plates, signs, numbers, etc., easily sold, profits large. Brett Bros., Roxbury Crossing, Boston, Mass.

SOMETHING New. Every motorist a buyer of our electro-magnetic-emergency Wenderlamp; takes only one minute to demonstrate and make a sale; no experience necessary; \$5.00 an hour easily made; full time or evenings. Write for sample. Wenderlamp Co., 926 Fisk Bldg., Dept. 10-A, New York.

SELL men's neckwear; wonderful proposition. Astor, 318-M Broadway, New York.

15c PROFIT On every 25c sale. Box 500, Shreveport, La.

HIGH-GRADE SALESMEN WANTED

SALESMEN—A chance to clean up \$10,000 per year. We manufacture a "New Small Personal Steel Letter File" with lock and 2 keys, now selling in large quantities in New York and direct by mail. Reliable salesmen calling on the stationery and office supply dealers wanted. Both in and outside of the United States. Must be a hustler. A good proposition to the right man. This is a real business, not hot air. Liberal commission on repeat orders. We also want agents and general agents for direct sales to colleges, universities and house to house work. Enclose small photo or snapshot of yourself with reply. Address Arthur Paulson, 200 Broadway, New York.

UNEMPLOYMENT. Elections, make slow collections for all merchants. Give them what they need. Not just collection system. Complete automatic credit and collection plan. Gets cash and keeps customer for merchant and for you. You get half cash on repeat orders for supplies without call-backs. Automatic income for you. 250% on original sale. Full or spare time. Judge by results! Commonwealth J Publishing Co., 508 So. Dearborn, Chicago.

WONDERFUL Free selling outfit with actual samples of Bostonian broadcloth gets quick sales for our nationally known Bostonian shirts at 3 for \$4.95. Postage paid. \$9.00 value; guaranteed fast colors. Liberal cash commission of \$1.50 on each order of 3 shirts means big money for you. Bostonian Mfg. Co., Dept. M. 3, Boston, Mass.

EVERY Home a prospect. Make big money. Take orders trees, shrubbery. Experience unnecessary. No dull season. Commissions paid weekly. We deliver, collect. Write Perry Nurseries, Dept. R-9, Rochester, N. Y.

SALESMEN—Earn \$100 weekly taking orders for Dazzler and Rainbow Glow electric signs. Big commissions. Exclusive territory. High grade proposition. Write Chicago Sign Sales Co., Dept. 25, Charlotte, N. C.

\$100 WEEKLY Easily earned selling new patented electric water heater. It sells for \$6.50 and you pay us \$3.00. Write to Jiffy Electric Water Heater Co., 842 Maxlow, Royal Oak, Mich.

EXPERIENCED Salesman to sell complete line of trunks, bags, cases, ladies' pocket-books, and other leather novelties. The line pays straight 10% commission. No money advanced. Unless you can finance yourself and can produce, don't answer. Apply "Luggage," Box 352, Petersburg, Va.

SELL Buttlog walnut gunstock blanks, \$1.00 up, any thickness. Stamp brings particulars. Robert Parkhill, Rochester, Minn.

BIG Season just ahead. Advertising pencils most popular every day—every business prospect. Our line repeats. Big commissions. Established in 1902. North American Pencil Works, 126 So. Clinton, Dept. 55Q, Chicago.

CLOTHING Salesmen: Lowest priced men's clothes of quality sold direct today. Going like hot cakes. Only \$18.50 for suit or overcoat. Commission \$4 plus bonus. Preston Tailoring Co., Denver, Colo.

TAILORING Salesmen: Amazing line. All-wool suits \$27.50. Extra pants free. Union made. \$6.00 commission. Free outfit. Garfield Tailoring, 3113 Armitage, Dept. A-9, Chicago.

MR. BRUSH Salesman, old established New York brush manufacturers require services of men in all territories to sell their extensive line of sanitary twisted in wire brushes. We pay larger commission than any other brush house in the country. Write immediately for our proposition. Wire Grip Sanitary Brush Corporation, 41-51 East 11th St., New York.

SALESMEN Selling to stores. Opportunity to handle unusual specialty line, main or side; commissions immediate, connection permanent, with large old-established manufacturer. Union Specialty Works, Dept. 222, Booneville, N. Y.

NEW Discovery astounds America. Elastigline will revolutionize the auto painting industry. Salesmen cleaning up \$75 to \$125 weekly. Flows on like magic over old paint. Brush marks disappear instantly. Guaranteed not to chip, peel or crack. Write quick. Southern Products, Dept. 10, Hopkinsville, Ky.

BANG-UP Good new sideline! Sells everywhere, all merchants, banks, mfrs. Big comms. advanced daily. Pocket outfit free. Carroll, 319 N. Albany, Dept. YA-322, Chicago.

HIGHEST Commission, tailoring field. One suit or overcoat \$22.50. Union made. \$5.00-\$6.00 commission. Free outfit. Armitage System Tailors, 3111 Armitage, Dept. A-18, Chicago.

\$10 TO \$20 Daily easily earned selling shoes for the largest direct to wearer concern in the world at saving of \$2 to \$3 pair; some good protected territory still open. Doublewear Shoe Co., Minneapolis, Minn.

AMERICA'S Greatest tailoring line free. 130 large Swatch samples, all wool, tailored-to-order; union made; sensational low price. Get outfit at once. Address Dept. 657, Goodwear, 814 Adams, Chicago.

MANUFACTURER Wants salesmen to sell tires and auto accessories to tire stores, garages, etc., on a liberal commission basis; no objection to sideline. Economy Rubber Products Co., 420 Master St., Dayton, Ohio.

SALESMEN—Main or sideline: Sell tires and auto accessories to tire stores, garages, etc. Protected territory. Liberal commission. U. S. Auto Supply Co., Dept. 118, Dayton, Ohio.

PUNCHBOARD Salesmen. \$200 weekly. Liberal plan assures sales. Latest assortments. Nothing to carry. Full commissions on repeats. M&L Sales Co., 301 W. Adams, Chicago.

MANAGE Concessions, life-time business. See page 254 August. Coin-Controlled Seat, 14 Auzeais Bldg., San Jose, Calif.

SELL Union label printing. Brand new proposition. Copyright cuts and elaborate outfit free. 40% commissions advanced. Beats all competition. Meyerson, R1132 So. Racine, Chicago.

TO Market 3A garage door holders, simple automatic action, quickly installed, instantly attracts garage owners, builders, dealers. Write for exclusive territory proposition. Knowlson-Stevenson Co., 1118 Packard, Ann Arbor, Mich.

TAILORING Salesmen: Sell Simpson's new \$23.50 pure virgin-wool, union made-to-measure suits and overcoats; commissions in advance; exclusive territory; big outfit, 175 samples free. J. R. Simpson, 843 Adams, Dept. 1508, Chicago.

WONDERFUL Invention. Seals fifty envelopes minute. Sells on sight at \$3.50. Attractive proposition. Square deal. Bank references. Kendall Sealer Co., C3, East Jaffrey, New Hampshire.

SELL Printing—Biggest line. 27 items, 600 free cuts defy competition. Largest commissions advanced. Pocket outfit free. Kaeser & Blair, Dept. 13, Cincinnati, Ohio.

NEW! Fast seller! Make \$3.00 an hour daily. Sell "Advertising Work Suits." Every workman, business a prospect. High-grade low-priced coveralls, shop-coats, 2-piece overalls. Firm name and advertisement woven on back. Outfit free. John Leeding Co., Dept. PM9, 70 E. 18th, Chicago.

SELL Advertising lead pencils; lowest prices, highest quality. Liberal commission. Dandy side-line; new Christmas numbers ready. U. S. Pencil Works, Quincy, Ill.

\$18 TO \$25 Daily; biggest selling line of 2-piece suits, \$9.95 and \$12.50; 3-piece wool suit, \$17.95 (regular \$28.00 value). All-wool overcoats, \$18.50. Splendid raincoats, slickers and boys' suits. Biggest commissions. Free outfits. "Jim" Foster, Inc., Dept. 29, 2250 S. Spalding Ave., Chicago, Ill.

SELL Automobile seat covers. Enormous field. Money-making opportunity. Largest factory in America. Gates Manufacturing Co., Indianapolis, Ind.

88 AN Hour selling electrical advertising. 265 sales messages 7c each. Gilco Manufacturing Company, 217-A, No. Des Plaines, Chicago.

\$50 TO \$75 Weekly selling new improved coveralls and service coats with customer's name embroidered on back to garages, oil stations, etc. Advertising value and unusual construction gets the big orders. We pay biggest commission. Free outfit. Am. B. Co., 329 West Monroe, Chicago.

CHRISTMAS Cards—Start early. \$2.00 hourly spare time. 87 samples free. Windermere Press (Established 1900), 6702 Dorchester, Chicago.

SALESMAN Handling hardware, paint, sporting goods and automobile accessory dealers, for fast selling sideline specialty; commission basis. Manufacturer, 1186 Grove St., Irvington, N. J.

BIG Profits easy. Millions Christmas cards sold yearly. Demand increasing. Our \$1 box 24 beautiful engraved cards and folders beats competition. 40% and more profit to agents. Also big demand for greeting cards with personal or business imprints. Large commissions. Take orders now. Write for sample box and instructions. Helen Acree Studios, 35 E. 30th St., New York, N. Y.

BIG Pay every day, showing Nimrod's all-year sellers! Dress, work and flannel shirts, overalls, pants, sweaters, underwear, pajamas, leather coats, lumberjacks, play-suits, etc. Experience unnecessary. Big outfit free. Nimrod Co., Dept. 65, 4922-28 Lincoln Ave., Chicago.

FURNACE Carburetor for any heating furnace or boiler. Eliminate 80% of smoke and soot. Reduces coal bill one-third. Easily installed and operated. We offer you a permanent business with a big profit. Give sales experience, reference and territory covered when answering. The Campbell-Hausfeld Company, Box 9, Harrison, Ohio.

\$1.00 PROFIT On \$5.00 sale—"Free sample." New specialty. Money getter. Every storekeeper, doctor buys quickly. Experience unnecessary. Territories open. Federal Association, Hartford, Conn.

\$60-\$200 A WEEK. Genuine Gold Letters for store windows. Easily applied. Free samples. Liberal offer to general agents. Metallic Letter Co., 438-A North Clark, Chicago.

ALL-YEAR-ROUND Profitable business selling wonderful new water softener and cleaner. Removes grease, oil, ink and dirt quickly. Every home and business place a live prospect. 100% profit. Big repeat orders. Exclusive territory. Write for free sample. Seacoast Laboratories, Sea Bright, N. J.

PUNCHBOARD Salesmen. 2 hours daily. \$100 every week. New line. Lowest prices. Full commission on repeat business. Catalog free. Puritan Novelty Co., 1409 Jackson, Chicago.

PUNCHBOARD Salesmen—making small towns. One sale a day nets you \$105 weekly. Full commission on repeats. K&S Sales Co., 4395 Ravenswood Ave., Chicago.

SALESMEN—Four \$15.00 sales to merchants net you \$40.00 daily. Sayers Systems, 2813 Sheffield, Chicago, Ill.

PUNCHBOARD Salesmen: It's easy to earn repeat commissions with the "Lincoln Line." Merchants everywhere use punchboards. Someone sells them! Why not you? Big pay every day. Catalog free. Lincoln Sales Co., 9 South Clinton, Chicago, Dept. D.

DON'T Sell for others. Employ agents yourself. Make your own products. Toilet articles, household specialties, etc. 500% profit. Valuable booklet free. National Scientific Laboratories, 1984W Broad, Richmond, Va.

EARN \$20 A day. Establish income for life selling for \$1 a year \$1,500 accident policy. Write W. C. Stone, 11 So. LaSalle, Chicago.

PUNCHBOARD Salesmen. New fascinating game. Excitement; legal all states; \$200 weekly easy; one minute sales talk; pay daily. Cigar Stores Novelty Co., Dept. A, Peoria, Ill.

SALESMEN—Become independent. Own your business; experience unnecessary, selling our \$7,500 Accidental Death; \$50 Accident; \$25 Sick Weekly Benefits—\$10.00 yearly. Other amounts proportionate. Guaranteed steady income from renewals. \$250,000 deposited Insurance Department, Universal Policy, Dept. A, 40 Clinton Street, Newark, N. J.

40% COMMISSION Selling printed business stationery at knockout prices. Part or full time. Free outfit. L Process Service, Minneapolis, Minn.

GOLD-LEAF Window letters and script signs. No experience; 500% profit. Samples free. Meyer writes 5 days profits \$141.36. Consolidated, 69-V, West Van Buren, Chicago.

TWO Suits or one suit and overcoat \$39.50. Commission \$7.00-\$9.00. Union made. Free outfit. Square Merchant Tailors, 3115 Armitage Ave., Dept. A-27, Chicago.

HELP WANTED

WHY Not sell us your spare time? \$2.00 an hour, \$19.70 daily easy full time. Introduce 12 months guaranteed hosiery—47 styles. 39 colors for men, women, children, including latest "Silk to the Top" ladies' hose and men's fancies. No capital or experience needed. We furnish samples. New plan. Macochee Hosiery Company, Park 2609, Cincinnati, Ohio.

ARE You old at 40? See our advertisement on page 157 of this issue. The Electro Thermal Company, 2109 Morris Ave., Steubenville, Ohio.

LOS ANGELES Positions and business opportunities of all kinds. Impartial daily lists 50 cents each. Jean Campbell, 124 West 4th St.

FORTUNE And fame for which you don't have to wait years—in modern aviation. Get September issue McClure's Magazine. Read "How to Become an Aviator." Written by foremost authority. Tells how to start and where, and what type men and women make best aviators. Don't put this off—Stop at next newsstand.

\$2.00 AN Hour for pleasant introductory work among local families. Experience unnecessary; permanent position; pay starts immediately. Write American Products Company, 1900 Monmouth, Cincinnati, Ohio.

SILVERING Mirrors, French plate. Patented process, easily learned. Immense profits. Plans free. Wear, Excelsior Springs, Mo.

CASH Paid for Butterflies, Insects. See Sinclair Display Advertisement on page 20.

PERMANENT Business your own; men and women, earn \$35 to \$100 weekly operating our original "Specialty Candy Factories." Few dollars starts you home spare time; we instruct and furnish everything. Booklet free. W. Hillyer Ragsdale, Drawer 350, East Orange, N. J.

OBTAIN Employment! Get positions you want, quickly, anywhere. Use clever "Ways That Win." One person was offered 70 jobs! Complete methods, 50 cents. Money promptly returned if wanted. New Idea Service, Box 39-1, Station K, New York.

BECOME A Landscape Architect. Uncrowded profession; wonderful opportunity for money-making. Easily mastered by mail. Earn while you learn. Est. 1916. Write for details. American Landscape School, 56, Newark, N. Y.

INFORMATION

INVESTIGATING And tracing. Work home or travel. Experience unnecessary. Write, American System, 2188 Broadway, New York.

MAILING LISTS

LATE Names, opportunity seekers. Live, fresh, active. Guaranteed correct. Priced right. De Muth Company, Englewood, N. J.

CLASSIFIED Lists, new, typewritten. Cheap. Write for catalog. The Espe Co., Box 248, Spring Lake, N. J.

1,000 MEN'S, 1,000 Women's addresses. 368 towns, 14 states, \$2 per 1,000. Albert Brownly, Upton, Mass.

25,000 NAMES Auto owners, \$10.00, 1928 registrations, Washington state. Motor List Company, Denny Building, Seattle, Wash.

1,000 1928 WOMEN Buyers names, \$1.00. Sheagreen, PM1427 North Penn, Minneapolis, Minn.

TYPEWRITERS AND SUPPLIES

TYPEWRITERS, all standard makes, \$10 up. Fully guaranteed. Free trial. Write for complete illustrated lists. Northwestern Typewriter Exchange, 121 N. Francisco Ave., Chicago.

TYPEWRITERS—Factory Rebuilt Royals, Remingtons, Underwoods, New Royal, Remington and Corona Portables. New "Excelsior" Rotary Stencil Duplicator \$37.50. Terms, Catalog Free. Pittsburgh Typewriter Supply, 945-339 Fifth Ave., Pittsburgh, Pa.

TYPEWRITERS, Motorcycles, \$3.99 to \$24.99. Knights, 1512 Locust, St. Louis, Mo.

TYPEWRITERS—All makes, \$6 to \$32. Fully guaranteed. Dee Typewriter Exchange, Ada, Okla.

PRINTING, ENGRAVING AND MULTIGRAPHING

\$3.00 DELIVERED—500 Monogram Letterheads, 7 1/2 x 8 1/2, 250 Envelopes, Cash. Label catalog. Eastern Label Co., C, Clintonville, Conn.

200 **LETTERHEADS** And 100 envelopes, \$1.10, postpaid. Oberman Company, Box 989, Los Angeles.

"**NEARGRAVURE**" Processes business stationery. "Nuf sed. Samples (stamp appreciated). Solldays, Knox, Ind.

BETTER Printing for less money! Write for samples and price list. Letter Service, 1706 East 8th, Kansas City, Mo.

200 **LETTERHEADS** And 100 envelopes \$1.10. Thiacomas, Martinsburg, W. Va.

TWO-COLOR Letterheads, one color price. Samples. Ad Builders, 1857 Holly, Kansas City, Mo.

3 1/2 x 6 **FOUR-PAGE** Folders, \$1.08 thousand in quantities. All printing low prices. Samples. Good's Printery, Harrisonburg, Va.

5,000 **ENVELOPES**, White (printed) 6 1/2 x 4 1/2, \$8.50. We print anything. Lawrence Envelope Co., 700 So. Kedzie Ave., Chicago.

1,000 **MULTIGRAPHED** Letters \$1.75. Profit. Box 1071R, Knoxville, Tenn.

500 **BOND** Letterheads 8 1/2 x 11, 250 envelopes, \$3.00 delivered. Neatness, quality. Samples. H. Curtis, 811 Harrigan, Kalamazoo, Mich.

250 **BOND** Letterheads, Envelopes, Billheads, Cards, \$1.35 each. Economic Press, Leonia, N. J.

QUALITY Printing! Reasonable Prices! Send for Free Standardized samples and prices. Folders, Circulars. Catalogs our specialty. Earnest Fantus, 525 South Dearborn, Chicago.

BUSINESS Stationery. Lowest prices. Excellent workmanship. Modern type faces. Moulton Printing Company, 1410-P East 8th, Kansas City, Mo.

MULTIGRAPHING Business correspondence two dollars thousand. Hammermill letterheads, four dollars; inexpensive quality, three dollars. Miscellaneous printing. Mayera Corporation, Monmouth, Ill.

PRINTING—Stationery, circulars, booklets, publications. Superior work, prices low. Battlefield Press, Gettysburg, Penna. Free battlefield souvenir.

200 **LETTERHEADS** And 100 envelopes, \$1.10, postpaid. Oberman Company, Box 1268, Chicago.

PRINTING, OUTFITS AND SUPPLIES

PRINT Your own stationery, cards, bookplate, Christmas cards, circulars, books, pamphlets, etc.; complete outfits, \$8.85; larger, \$11, \$29 rotary \$149. Print for others. Easy and interesting rules sent. Write for catalog presses, type, paper, etc. Kelsey Company, K-11, Meriden, Conn.

PRE-USED Printing Presses. Type supplies. List for 2c stamp. Popular Bargains, Richland, Pa.

PRINTING Outfits—Presses, type supplies, type novelties. Send stamp for catalogue. Model Press, York, Penna.

DUPLICATORS AND DEVICES

YOU can make 50 to 100 copies of a letter, notice, etc., at a cost of three cents on a Heyer Quality Duplicator. Write for free trial offer. The Heyer Duplicator Co., 909 Jackson Blvd., Chicago, Ill.

ADDING MACHINES

NEW \$3.50 Automatic Adding Machine. Adds, subtracts, multiplies, absolutely accurate. Capacity \$999,999.99. Fully guaranteed. 75,000 pleased users. Makes adding easy, positive, quick. Eliminates mistakes. Saves time. Postpaid \$3.50. Bassett Co., 1458W. Hollywood Ave., Chicago.

FOR THE HOME

GRANDFATHER'S Clock Works. \$5.00. Build your own case; instructions free; make good profits selling your friends. Clock works with chimes for old or new cases. Write for full particulars. Clock Co., Ruffner St., Philadelphia.

KITCHEN Daylight unit with enameled ceiling fixture opal glass, ready to install. \$1.48. Will ship C. O. D. General Distributing Co., Duluth, Minn.

CEDAR chests only \$11.65—"Red-I-Kut" complete with rich copper trim—you assemble and save half—send for pictures. Kuempel Furniture Company, Guttenberg, Iowa.

BOATS AND LAUNCHES

BUILD Yourself a serviceable, satisfactory boat during your spare time using our ready cut materials. Row, sail, duck, runabouts, cruisers, outboard motor speedsters, etc. 55 designs. Send 25c for catalog. Brooks Boat Company, Inc., Rust Ave., Saginaw, Mich.

TWENTY Mile outboard motor boat, plans 25 cents. Sixteen foot outboard cabin cruiser, plans 50 cents. Free boatbuilding catalog. The Rudder, 15 Murray St., New York.

FORD Engine propellers, all sizes at reduced prices; example: 14x16, \$8.00. Send five stamps for catalog of marine conversion parts, and "How" Redwing Propeller Co., (Ballard) Seattle, Wash.

HUBBELL Marine Coolers convert Ford engines into marine motors. Booklet free. Ford speedboat, easily built, large blueprint and directions one dollar. C. C. Hubbell, Perry Ave., Norwalk, Conn.

GUNS, SPORTING GOODS, ETC.

FIELD Glasses 5X, \$7.95; Luger carbine stocks, \$1.50; Krag rifles, \$10.50; genuine Springfield, \$27.00; exersers, \$1.20. Write for catalog. Hudson Sporting Goods, W54 Warren St., New York.

FIELD GLASSES, TELESCOPES AND MICROSCOPES

C-FAR Field Glasses \$2. Consists of two rimmed lenses in neat leather case, slips into vest pocket, weighs only 1½ ounces. Gives 6 diameters magnification. Money back if not satisfied. Send \$2 today to Buffalo Optical Co., Dept. PM-1, 574 Main St., Buffalo, N. Y.

USED Fieldglasses; \$2 to \$75. J. Alden Loring, Dept. J, O-we-go, N. Y.

ANTIQUES, WAR RELICS AND INDIAN GOODS

WAR Relics—Indian pottery, helmets, medals. Catalog 25c. Dare, 440 55th, Brooklyn, N. Y.

FINE Specimen buffalo body robe, with sun dance symbols. Other articles. Hunter's Indian Store, 5511 Broadway, Chicago.

LARGE Illustrated list curios. Indian relics, old arms, ten cents. N. Carter, Elkhorn, Wis.

SEND 5c for fine new list Indian relics, antique firearms. F. E. Ellis, Webster Groves, Missouri.

FOR SMOKERS

AUTOMATIC Cigarette Making Machines. Rolls and glues 50 cigarettes for 10 cents. Ask illustrated catalog. Postpaid \$2.50. For home use. Automatic Cigarette Machine Maker, 6247-51 Broadway, Chicago, Ill.

PIPE Smokers—We have specialized in pipe tobaccos for 23 years. Factory to smoker. Wonderful blends and flavors. Write for free catalog. The Planters Tobacco Co., Henderson, Ky.

TOBACCO Or snuff habit banished in one week or no pay. Sent on trial. \$1 if cured. J. Pownall, Box 1531, San Francisco, Calif.

PHONOGRAPHS AND RECORDS

BUILD Your own phonograph. Catalog and instructions to build new type horn mailed for 10c. American Phonograph Co., 4116 West 24th Place, Chicago.

MUSIC AND MUSICAL INSTRUMENTS

WHY Pay \$150.00 or more for a high-class professional model Tenor or Plectrum Banjo? Three styles offered at \$39.00, \$36.00 or \$45.00. Made by the originators of the "Regal" Tenor Guitar and Octofone. Ask your dealer or write us. Regal Musical Instrument Co., 3211 Grand Ave., Chicago.

SONG Writers: Send for our "Publishing Agreement." McKinley Music Printers, 1501 E. 55th St., Chicago.

LEARN To play piano at home—Melody Way Self-Instructor Course, tested, successful. 12 lessons, music, charts, complete. \$3.00 postpaid. Messner Institute, 443 Broadway, Milwaukee.

SONG Poem writers—"real" proposition. Hibbele, D1, 2104 N. Keystone, Chicago.

SONG-POEM Writers: Address Monarch, 236 W. 55th, Dept. 204, New York.

UKULELES—Own a genuine Hawaiian Koa Ukulele. Send \$5.23. Hawaiian Studios, Box 2537, Honolulu, Hawaii.

ARTHURLAMB'S "The Picture That Faded Away" and book of music, postpaid 10 cents. Frank Harding, Music Publisher, 228 East 22nd, New York City.

SONGWRITERS: Submit your song or poem. Same returned immediately if not accepted. Chester Escher, 1547 Broadway, New York City.

SONG Poems solicited. A different proposition. Richard Broughton, Sioux Falls, S. Dak.

VIOLINS, Deep, mellow, soulful—on credit. Easy terms for wonderful instrument. Get details today. Gustav F. Henning, 302 University Building, Seattle, Wash.

CORNETISTS—Trombonists—Saxophonists—Clarinetists. Get "Free Pointers." Name instrument. Virtuosi School, Buffalo, N. Y.

PLAY Piano by Ear. A Sound System. Booklet free. Boucher's Harmony Studio, Ottawa, Can.

SONG Poem Writers. Write Sequoia Songwriters' Service, Sherman Branch, Los Angeles, Calif.

"BANJOS" Should interest all musicians on account of the popularity of the Banjo, as it easily increases a Player's income. Illus. Catalog of 48 pages free. The Bacon Banjo Co., Inc., Groton, Conn., U. S. A.

I WANT Song Poems. Casper Nathan, 3544 N. Raine, Chicago.

"MUSIC Composed" to words. Bauer Bros. (formerly of Sousa's Band), Oshkosh, Wis.

WRITE Songs. Big money and reputation. Write for information. J. Gordon Pub. Co., 201 N. Hoine Ave., Chicago.

FREE—"Song Writers' Guide," Beaver, 1257 Elm, Green Bay, Wis.

PATENT ATTORNEYS

PATENTS—Write for our free book, "How to Obtain a Patent" and Record of Invention Blank. Send model or sketch of inventions for inspection and instructions free. Terms reasonable. See advertisements on pages 146 and 141. Victor J. Evans & Co., 934 Ninth, Washington, D. C.

PATENTS Procured, prompt service, personal, careful and efficient service. Highest references. Moderate fees. Send sketch or model for actual search and advice. George P. Kimmel, Master of Patent Law, 541, Legal Bldg., Washington, D. C.

PERCY S. WEBSTER, 203 Saving and Loan Building, Stockton, Calif. Patent booklet free.

PATENTS—Free advice. Confidential, prompt personal service of Registered Patent Attorney, former Patent Officer Examiner. Booklet. Albert Jacobs, 727 Barrister Bldg., Washington, D. C.

INVENTORS: Send sketch or model for advice and exact cost of patent. Ask for our Free book: "How to Obtain a Patent." Tells what every inventor should know. Established twenty-eight years. Highest references. Prompt service. Reasonable charges. Chandler & Chandler, 414 Seventh, Washington, D. C.

PATENTS, Trade-marks, designs and copyrights. Parker & Snyder, Barrister Bldg., Washington, D. C.

LANCASTER and Allwine, 221 Ouray Bldg., Washington, D. C. "Originators of the Form Evidence of Conception." Before disclosing your invention to anyone send for blank form to be signed and witnessed. Form and patent information bulletin free.

PATENTS, Trade-Marks, Designs. This firm has 27 years' experience and gives expert personal service at reasonable rates. We properly protect your invention. Write for free information and exact cost of procuring patent before proceeding. John B. Thomas & Co., 902 F St., N. W., Washington, D. C.

ADVICE Free! Patents procured—Reasonable—efficient Service. 25 years' experience. Chester W. Brown, Registered Patent Attorney, 510 Van Buren Street, Chicago.

PATENTS. Booklet free. Highest references. Best results. Promptness assured. Send model or drawing for preliminary examination. Watson E. Coleman, Patent Lawyer, 724 Ninth St., Washington, D. C.

LACEY'S Patent Sense. Valuable book free. See ad page 143.

TIME Counts in applying for patents. See pages 138 and 139. Clarence A. O'Brien, Registered Patent Attorney, Washington, D. C.

PATENTS—Write for Instructions. Carl Miller, Registered Patent Attorney (former Patent Office examiner), 211-A McGill Building, Washington, D. C.

PATENTS, Trade-marks, Copyrights. Reliable services by an experienced practitioner devoting personal attention to each case. Inquiries invited. References furnished. B. P. Fishburne, Patent Lawyer, 525-A McGill Bldg., Washington, D. C.

RICHARD E. BABCOCK, Patent Lawyer, Washington Loan & Trust Bldg., Washington, D. C. Booklet.

PATENTS Procured: Trade Marks Registered—A Comprehensive, experienced, prompt service for the protection and development of your ideas. Preliminary advice gladly furnished without charge. Booklet of information and form for disclosing idea free on request. Irving L. McCathran, 200 Owen Bldg., Washington, D. C., or 41-R Park Row, New York.

"INVENTOR'S Guide" sent free: contains valuable information. Frank Ledermann, Registered Attorney-Engineer, Woolworth Building, 1712, New York.

MONROE E. MILLER, Ouray Bldg., Washington, D. C., Patent Lawyer; Mechanical, Electrical Expert. Booklet and Priority Record blank gratis.

ESTABLISHED 1864. Milo D. Stevens Company. Free Booklet. Patents, Trade-Marks, Copyrights. Offices, Monadnock Block, Chicago; Barrister Building, Washington, D. C.

INVENTORS—Write for our Guide Book, "How to Get Your Patent," and Evidence of Invention Blank. Send model or sketch of your invention for our prompt examination and instructions free. Randolph & Co., Dept. 430, Washington, D. C.

INVENTORS Having ideas to patent: Write for booklet explaining co-operative plan for handling your applications. Tells how to sell and safeguard inventions at lowest cost. Ralph Burch, Patent Lawyer, 900 F St., Washington, D. C.

SELL Your invention before patenting. Write for free particulars. W. T. Green, 801 Baltic Bldg., Washington, D. C.

UNPATENTED Ideas can be sold. I tell you how and help you make the sale. Free particulars (Copyrighted). Write W. T. Greene, 806 Baltic Building, Washington D. C.

INVENTIONS—Your crude ideas developed into practical form for your patent application. Model not necessary. Send rough sketch and description for estimate of cost and advice. 27 years' experience. Albert E. Dieterich, Engineer and Registered Patent Attorney, 621½ Ouray Building, Washington, D. C.

PATENTS Procured at reasonable rates with time to pay. Sales negotiated. Staff of registered attorneys and engineers. A complete service for inventors. Write for particulars. Inventors Service Bureau, Box 1648, Washington, D. C.

FOR INVENTORS

PATENTS. If you have an invention which you wish to patent you can write fully and freely to Munn & Co., for advice in regard to the best way of obtaining protection. Please send sketches, or a model of your invention and a description of the device, explaining its operation. All communications are strictly confidential. Our Hand-Book on Patents is sent free on request. This explains our methods, terms, etc., in regard to Patents, Trade Marks, Foreign Patents, etc. "Scientific American" contains Patent Office Notes, Decisions of interest to inventors and particulars of recently patented inventions. Munn & Company, Solicitors of Patents, 1523 Scientific American Building, 24 W. 40th St., New York City; 524 Scientific American Bldg., Washington, D. C.; 1313 Tower Bldg., Chicago, Ill.; 666 Hobart Bldg., San Francisco, Calif.; 521 Van Nuys Bldg., Los Angeles, Calif.

A CORPORATION With resources of over a million dollars and over thirty years' experience in the direct selling field, and now doing an international business through an organization of over one thousand men, specially trained as house to house men, will consider the marketing on an exclusive basis of patented or meritorious articles that are adapted to this method of distribution. Wonderful opportunity for patentees, or others seeking distribution through direct sellers. If you have something that you feel has real merit, send complete details to Box 509. % Popular Mechanics Magazine, 200 E. Ontario St., Chicago.

INVENTIONS—Write for our free book, "How to Obtain a Patent" and Record of Invention Blank. Send model or sketch of inventions for inspection and instructions free. Terms reasonable. See advertisements on pages 140 and 141. Victor J. Evans & Co., 157 Ninth, Washington, D. C.

LACEY'S Patent Sense. Valuable book free. See ad page 143.

WANTED—Patented medical or health device to manufacture on royalty basis. Cincinnati Automatic Machine Co., Cincinnati, Ohio.

INVENTORS Universal - Educator—contains 900 mechanical movements; 50 perpetual motions. Tells how to obtain and sell patents. Suggests new ideas. Explains how to select your attorney and avoid patent sharks. Price (revised edition) \$1.00 postpaid. Albert E. Dieterich, 621 Ouray Bldg., Washington, D. C.

PATENTS—Write to B. P. Fishburne (a South Carolinian), Registered Patent Lawyer, 525-E McGill Bldg., Washington, D. C.

I AM in touch with hundreds of moneyed men and manufacturers who wish to buy good inventions. Write Hartley, 38 Court St., Bangor, Maine.

SELL Your invention before patenting. Write for free particulars. W. T. Greene, 892 Baltic Bldg., Washington, D. C.

I SELL Patents. A personal, experienced service with a national reputation, in your interests. Charles A. Scott, 773PM Garson Ave., Rochester, N. Y.

GET your own patents. Legal blanks, complete instructions \$1. Cutting Sons, Cambell, Calif.

UNPATENTED Ideas can be sold. I tell you how and help you make the sale. Free particulars (Copyrighted). Write W. T. Greene, 892 Baltic Bldg., Washington, D. C.

WANTED To manufacture on royalty basis, appliances pertaining to health or surgery. Send full details. Cincinnati Automatic Machine Co., Cincinnati, Ohio.

INVENTORS—Cash in on your invention now! Don't delay the sale any longer! Send for a free copy of our specially prepared booklet, "Turn Your Patent Into Money," today! It contains helpful information for all inventors. M. L. Rund, Mgr. Classified Advertising, Popular Mechanics Magazine, 200 E. Ontario St., Chicago, Ill.

TIME Counts in applying for patents. See pages 138 and 139. Clarence A. O'Brien, Registered Patent Attorney, Washington, D. C.

PATENTS Sold and leased. Long practical experience. Free literature. Williams, 716 Pacific Bldg., San Francisco, Calif.

PATENTS FOR SALE

SEPTIC Tank. Best concrete sewage disposal system yet. Suburban homes, schools, etc. Cheaply made, easily handled and installed. Patents United States, Canada. 12 claims allowed. Already huge success in Michigan. Outright or state. J. Frappy, Stirling, Ont.

OUTRIGHT Or royalty—U. S. 1,658,947—gas-operated soldering iron. Furnace not needed; practical and economical for shop and household. H. Wigge, 2325 Fullerton Ave., Chicago, Ill.

OUTRIGHT—Door lock and holder. Prevents opening from outside—stays open regardless of draft. R. Neubert, 1921 Tower Ave., Superior, Wis.

COMPRESSIBLE Piston—Eliminates cylinder regrinding. Market unlimited. James Watson, 2828 W. Dauphin St., Philadelphia.

OUTRIGHT Or royalty—Holder for writing instrumentalities; large market exists; cheap manufacture. Vincent Niznansky, Hillcrest Ave., Southmont, Johnstown, Pa.

OUTRIGHT Or royalty—Key protector for hotels and public places. Nothing like it on market. Cheap manufacture. Vincent Niznansky, Hillcrest Ave., Southmont, Johnstown, Pa.

FOR Sale—New solderless lead pipe joint. Saves time and money and is better than solder joint. Patent pending. Joseph Caldarà, 3233 Barnes Ave., New York City.

NEW Tool that all garage, electric, telegraph, telephone and radio workers will use. Arthur Earnhart, Pond Creek, Okla.

OUTRIGHT Or royalty basis, newly patented interchangeable clipper, hair dryer and vibrator set. F. Sanders, 932 S. Main St., Los Angeles, Calif.

OUTRIGHT—Camphor holder for pianos. Easily attached; no screws. John De Carlo, 331 Court St., Brooklyn, N. Y.

FOR Sale—Novel screen or storm door latch; proven success. B. Johnston, Rosedale, Alta, Can.

SHOCK Absorbing, rigidly connected side bumper. Wm. Dinker, 359 Dean St., Brooklyn, N. Y.

PATENTS For sale cheap: Household laundry sprayer, key guide, shaving brush holder; new ideas; cheap to manufacture; unlimited sales. Write S. Satake, %716 Pacific Bldg., San Francisco, Calif.

ROYALTY Basis nine U. S. patents on closely related types of water distilling apparatus for domestic use. Ernon V. Oliver, 1116 No. Catalina Ave., Pasadena, Calif.

AUTOMOBILE Lock for any car. Positively prevents unauthorized use. Box 152, Albuquerque, N. Mex.

CARBON Black patent. Entirely new and revolutionary process. H. A. Pagenkopf, Milam Building, San Antonio, Tex.

LO-TIRE Warner warns motorists of low or flat tire. Outright or royalty. P. O. Box 274, Baton Rouge, La.

CARBURETOR Patent for sale or royalty. Gasoline saver. Boyd Hayes, Pegram, Tenn.

FOR Sale, patents. No cost for power automobile. E. Coffey, 111 So. 2nd St., Terre Haute, Ind.

OUTRIGHT—Novel metal match box of ornamental nature. Stanley Szastalo, 1301 No. Hoyle, Chicago.

SEE Page 254 August. For concessions, territory and shop rights. Coin-Controlled Seat, 14 Auzerals Bldg., San Jose, Calif.

AUTO Inner tube tester, tests tubes under high pressure. Royalty or outright. Geo. Mancos, Rt. 2, Richmond, Va.

WILL Sell valuable patent your terms. Elizabeth Smith, 3634 Suttland Road, Washington, D. C.

OUTRIGHT. Patent applied; cleaning composition; will clean or polish anything. Also electric dishwasher, patent allowed. L. Gergele, 2416 Burling St., Chicago, Ill.

COMBINATION Motor truck, concrete and mortar mixer; establishing a new mixing principle and will prove a big money maker to manufacturer. Chas. Payne, 27 Fulton Ave., Waukegan, Ill.

TIME Counts in applying for patents. See pages 138 and 139. Clarence A. O'Brien, Registered Patent Attorney, Washington, D. C.

OUTRIGHT Or royalty—Automobile shock absorber controls both upward and downward motion. Cheap to manufacture. Ferdinand Lenser, 1509 Barton St., Cincinnati, Ohio.

BATHROOM And water heater patent and business for sale. Louis A. Faust, Comfort, Tex.

WE Commercialize inventions. Communicate with us if you have patent to sell or wish to buy one. North American Finance and Development Corp., 915 15th St., N. W., Washington, D. C.

YOUR Idle patent can be turned into ready cash, quickly! One inventor sold his patent at a cost of only \$3.50. Send today for a free copy of our booklet, "Turn Your Patent Into Money." M. L. Rund, Mgr. Classified Advertising, Popular Mechanics Magazine, 200 E. Ontario St., Chicago, Ill.

SURVEYING INSTRUMENTS

REAL Bargains in rebuilt transits and levels. All kinds and makes. Guaranteed. Terms if desired. Write today for descriptive list M-9. Warren-Knight Company, 136 N. 12th St., Philadelphia, Penna. Makers of "Sterling" instruments.

LARGEST Stock of new and used surveying instruments in the country direct from factory. Satisfaction guaranteed or money refunded. Also farm levels. Wisler, 619 N. Broadway, St. Louis, Mo.

SURVEYING Instruments, new and used, guaranteed, lowest price. Griner, 313 East 10th St., Kansas City, Mo.

DRAWING INSTRUMENTS AND DRAFTING SUPPLIES

DRAWING Instruments. Set genuine German silver 11 pieces; value fifteen dollars only five dollars. Griner, 313 East 10th St., Kansas City, Mo.

WATCH REPAIRING

WATCH Repairing and making shows how to clean and repair all kinds of watches. 214 page book with over 200 illustrations. Pay postman \$3 and postage when he delivers book. Popular Mechanics Co., Room 807, 200 E. Ontario St., Chicago, Ill.

MODELS AND MODEL SUPPLIES

AUTO Chassis; complete working model. Gear shift, differential, brakes, etc; fully illustrated instructions. 10c. Meccano Company, Inc., Dept. H, Elizabeth, N. J.

WE Make models, tools, dies, special parts, stampings and general manufacturing. Badger Tool Co., 134 So. Clinton St., Chicago, Ill.

SPECIAL Machine builders, tool and die makers, inventors' models production work of all kinds. Dept. L, Quality Hardware & Machine Corporation, Ravenswood and Thorndale Aves., Chicago, Ill.

TIME Counts in applying for patents. See pages 138 and 139. Clarence A. O'Brien, Registered Patent Attorney, Washington, D. C.

LET Our experience be your guide. Models that are models; tools and equipment for economic manfg. Patterns of all types; manufacturing in all branches. Satisfaction guaranteed. United Machinery Company, Cincinnati, U. S. A.

MODELS, Tools, Dies and General manufacturing. Logan Machine Co., 652 W. Lake, Chicago, Ill.

MODEL and Experimental Work at lowest cost. Wagar Model & Machine Works, 115 So. Clinton Street, Chicago.

WE make working models for inventors and do experimental work and carry a complete stock of brass gears and model supplies. Send for catalogue. The Pierce Model Works, Tinley Park, Ill.

MODEL Steam engines and boilers for miniature boats. Compressed air plants for model airplanes. New catalog 15c. Model Machine Shop, 212 Price St., Rahway, N. J.

THE Modelmaker, a magazine for all interested in making working models, boats, etc. Sample 10c. Modelmaker, 122 Liberty St., New York.

SHIP Model Fittings: Send Dime for booklet. A. J. Fisher, 1002 Etowah Ave., Royal Oak, Mich.

DEAD EYES— $\frac{1}{8}$ " 3-16" \$3.50 hundred, belaying pins 18c dozen. C. Libby, Tuckahoe, N. Y.

Do you like to make things? If so, you should have a copy of Popular Mechanics new book entitled "Make It Yourself." A large book of 480 pages describing how to make 900 different articles. 823 illustrations. Price \$3 postpaid. A full description will be sent upon request. Popular Mechanics Press, Room 807, 200 E. Ontario St., Chicago, Ill.

ELECTRICAL

X-RAY Machine installation and repairing is a big money making field. Write Ira Williams, 3124 37th Ave., S, Minneapolis, Minn.

NEW Electrical Dictionary. Complete up-to-date electrical dictionary to which has been added a special dictionary of radio words and terms together with illustrations of electrical symbols, radio diagrams and other wiring diagrams. 191 Pages—Vest pocket size. Price only 35c postpaid. Popular Mechanics Co., Room 807, 200 East Ontario St., Chicago, Ill.

SAVE Money on Electrical Books—While they last we will supply the following books: Practical Electric, Electrical Circuits and Diagrams, Electric Bells and Alarms, Induction Coils, Experimenting with Induction Coils, Experiments in Static Electricity, Wimshurst Machine, Small Accumulators, your choice of any four books for \$1, postpaid. Regular price 35 cents per volume. Popular Mechanics Press, Room 807, 200 E. Ontario St., Chicago, Ill.

MANUFACTURING

ACME Model Works, 200 North Jefferson St., Chicago, Ill.—Working models, mechanical, electrical and optical apparatus designed and built. Screw-machine work. Stamping.

MANUFACTURING Models, dies, stampings, brass work, one or thousands. Circular free. Baum's Metal Specialties, Kansas City, Mo.

SPECIAL Machinery or parts, dies, tools, metal specialties, models, special gears, stock gears and model supplies. Send for Catalogue. The Pierce Model Works, Tinley Park, Ill.

ECONOMICAL Manufacturing from sheet, bar, wire or tubing. Models, dies, special machinery. Swanberg, 5124 N. Kildare Ave., Chicago.

WIRE goods made to order. Cooley Mfg. Co., 530 N. Western Ave., Chicago.

MACHINERY, TOOLS AND SUPPLIES

18x8' GRAY Engine lathe, \$110.00; 18x10' Steptoe engine lathe, \$135.00; No. 1 Brown & Sharpe milling machine, \$145.00; 10x5' Barnes engine lathe, complete, \$95.00; 5 hp. electric motor, \$45.00; No. 60 Head cylinder grinder, \$250.00; 36"x16" Fay & Scott engine lathe, \$800.00; 24" Barker Shaper, \$375.00; 10" Bench drill press, \$19.00; 24" J. A. Fay wood pony planer, \$175.00. Terms if desired. Write for catalog. Cincinnati Machinery & Supply Company, 27 West Second St., Cincinnati, Ohio.

SPECIAL Heavy duty portable electric drills that cannot be stalled by two men on each side. Quarter inch heavy duty, \$22.00; $\frac{1}{2}$ "", \$45.00; $\frac{3}{8}$ "", \$58.00; $\frac{1}{4}$ "", \$68.00. Five dollars down, balance easy terms. Money back if you want it. Over 20,000 sold last year. General Distributing Company, Security Building, Duluth, Minn.

START business of your own, small investment required, doing nickel, copper and silver plating. This work in big demand. Information free. Electro Platers Supply Co., 547 Considine Ave., Cincinnati, Ohio.

FOR Sale—No. 1 Kempsmith universal miller, dividing head, etc., almost new; 1 Baxter Whitney cylinder grinder in good shape. Opocensky Bros., South Omaha, Nebr.

BLOOMQUIST Machine works, 1002 So. 8th Ave., Wausau, Wis. Prices cut on bench saws, band saws, lathes and jointers. Save 25c on every dollar. Write for catalog.

CONCRETE Building Block Machines and Molds. Catalog free. Concrete Machine Co., 5 North Main St., St. Louis, Mo.

753 TIME, Labor and Money Saving Ideas for all who own, drive or repair autos. These practical kinks are based upon the actual experiences of hundreds of owners and repairmen. Three books, Auto Owners', Auto Repairman's and Auto Tourists' Handbooks, regular \$1.50 value will be supplied at 98c plus the postage C. O. D. for a limited time only. Send your order today to Popular Mechanics Press, Room 807, 200 E. Ontario St., Chicago.

ENGINES, MOTORS AND DYNAMOS

EQUIP Your farm, summer resort, etc., with brand new Westinghouse 1 KW, 32 volt, light and battery charging generators at \$48.00 each. Brand new $\frac{1}{4}$ hp. 32 volt, ball-bearing motors, \$9.75 each. New Everlite 32 volt, 1,250 watt lighting plants, complete with engine at \$169.75. Brand new quart type standard make, gasoline blow torches, \$4.95 each; retails at \$8.00. Six inch, 110 volt, brand new desk fans for home or office, \$2.95. Satisfaction guaranteed. General Distributing Company, Duluth, Minn.

NEW $\frac{1}{2}$ Hp. repulsion Westinghouse motors \$27.50; $\frac{1}{4}$ hp., \$6.00; 110 volt direct current, \$6.00; 32 volt motors, \$7.50; desk fans, 32 volt, \$5.95; eight-day time switches, \$6.75. Many other barbains in larger motors and generators. Queen City Electric Co., 1736 Grand Ave., Chicago, Ill.

JUST Received another lot of brand new $\frac{1}{4}$ horse, 110 volt, 60 cycle, 1,750 speed, alternating motors with cord, plug, flat pulley and two-year factory guarantee, \$7.00 each, \$6.50 each, lots of six. Also other sizes of motors and generators. Alternating and direct current. Electrical Surplus Company, 1911 West Chicago Ave., Chicago.

EDISON Phonograph electric universal motors with speed governor, finest small motor made. \$5.00 plus postage, 9 pounds. Geo. Schulz, Calumet, Mich.

FOR Sale—For Duco and small spraying jobs, also small tire shops, 2x2 twin cylinder compressors, $\frac{1}{4}$ hp. motors, J. Truckman & Sons, Inc., Evansville, Ind.

FOR Sale: 1-6 hp. motors, 110 volt, 1,750 R.P.M., 60 cycle, alternating current. Slightly used. Good running condition. \$4.50 each, while they last. Cash with order. The Maytag-Chicago Co., 337 W. Madison St., Chicago, Ill.

MAKE your own—half and one horsepower electric motors. A. C. Induction motor model shows winding connections plain sight. Quick easy way. Gaines Bros., Box 481, Gainesville, Texas.

STEAM Engines—One H. P. \$18.00; $\frac{1}{2}$, \$12.00. James Chambliss, Bessemer, Ala.

WRITE for bargain catalogs on electric motors, generators, electric drills, etc. Do not buy, consult us first. General Distributing Co., Security Bldg., Duluth, Minn.

TIME Counts in applying for patents. See pages 138 and 139. Clarence A. O'Brien, Registered Patent Attorney, Washington, D. C.

BENDING MACHINES

THE Famous Hossfeld "Wrenchless" Universal Iron Bender is the last word in bending machines. Bends metal, cold or hot, into most any conceivable shape, including Eye Bolts and Automobile Spring Eyes. Bends up to 1" bars or $1\frac{1}{2}$ " pipe cold. Thousands in use by all classes of trade, from the smallest shops to the largest railway systems. Write for circular and prices. Hossfeld Mfg. Co., Winona, Minn.

BLACKSMITHS

BE a Master Mechanic Blacksmith and Expert Tool Maker and Dresser with colored tempering charts. Price \$1.00. Valuable samples free. W. M. Toy, Sidney, Ohio.

WANTED—MISCELLANEOUS

WANTED: False teeth. For full sets we pay high as \$10. Any condition. We buy crowns, bridges, gold, platinum, silver. Western Metal Company, Metals Dept., Bloomington, Ill.

MAIL Us your discarded jewelry, gold, crowns and bridges, watches, diamonds, silver, platinum. Money promptly mailed. Goods returned if offer refused. United States Smelting Works (The Old Reliable), Dept. 71, Chicago.

FOR SALE—MISCELLANEOUS

FOR Sale—New Willys Knight motor. J. R. Hornbrook, Marshall, Ill.

ADDRESSOGRAPHs, Letter folders, multi-graphs, envelope sealers, duplicators, less than half price. Guaranteed. Pruitt Co., 117 No. Market, Chicago.

FARMS AND FARM LANDS

LAND Opening—A new line under construction in Montana opens a million acres of good wheat and stock country. Send for New Line book, Minnesota, North Dakota and Montana offer best opportunity in two decades to secure good improved farms from banks, insurance and mortgage companies at a fraction of their real value. Send for lists. Improved farms for rent. Washington, Oregon and Idaho have exceptional opportunities in fruit and poultry raising and dairying with mild climate and excellent scenic surroundings. Write for free book on state you prefer. Low homeseekers rates. E. C. Leedy, Dept. 857, Great Northern Railway, St. Paul, Minn.

OZARKS—40 Acres, house, spring, fruit, fencing, \$500.00, \$50 down, \$10 month. Box 198, Mt. Vernon, Ill.

GREAT Opportunity. 580 acres, very desirable. 18 ten acre tracts yet unsold; \$25.00 down, \$10.00 monthly. C. F. Woods, Meridian, Miss.

FIG Orchard—60 acres, bearing, 15 minutes from city of 70,000. Want partner or sell part cheap. Owner: Leo J. Marler, 265 Bush St., San Francisco.

BLACK HILLS, S. Dak., \$5.00 up. Grimm alfalfa seed produces \$25.00-\$30.00 acre. Mikmak, 2549 No. Clark, Chicago.

SMALL Fruit and poultry farms near Los Angeles. Ten years to pay. Send for free illustrated booklets. Fontana Farms Co., owners, Room 617, 631 S. Spring St., Los Angeles, Calif.

SELL your property quickly for cash, no matter where located. Don't pay big commission. Particulars free. Real Estate Salesmen Co., Desk B, Lincoln, Nebr.

PECAN-Orange-Fig Groves "On the Gulf" Monthly payments. Guaranteed care. Big, quick returns. Suburban Orchards, Dept. M, Biloxi, Miss.

MONEY made in Mich. potatoes, \$10 down now and easy terms buys land near markets, lakes, streams. Write today. Swigart & Co., P-1276, 1st Nat'l Bank Bldg., Chicago.

OZARKS—10 acres near White Bluff and proposed power dam, \$100, \$5 monthly. Alvin Zimmerman, 1802 N. 5th, Kansas City, Kans.

ROOTS AND HERBS

MEDICINAL Herbs and roots for all ailments. Over 1,000 varieties. Catalog free! Botanics, 145 West 112th St., Chicago.

GINSENG

GINSENG! The famous health drink of the orient. Sample order 25 cents, with invaluable herb book free. S. Bernstein, Herbalist, 1360 Boston Rd., Bronx, N. Y.

MUSKRATS

MAKE Money From Muskrat Fur—Raise Muskrats in dry land pens or hutches. Get the facts. 652, Conrad's Ranch, Denver, Colo.

RABBITS

MAKE big profits with Chinchilla Rabbits. Real Money-makers. Write for facts. 852 Conrad's Ranch, Denver, Colo.

SWINE

OHIO Improved Chester White boars, sows (pigs no kin, \$10 each), vaccinated, pedigreed. Fred Ruebush, Sciota, Ill.

DOGS AND PETS

ENGLISH Bull puppies, catalog 10c. Triangle Kennels, Box 37, Jackson Center, Ohio.

FOR Sale. Minks, squirrels, raccoons, foxes, ferrets, muskrats, ginseng, rabbits, skunks, wolf pups, opossums. B. Tippman, Caledonia, Minn.

FOR Sale. Minks, squirrels, raccoons, foxes, ferrets, muskrats, ginseng, rabbits, skunks, wolf pups, opossums. B. Tippman, Caledonia, Minn.

SAMOYEDES, Scottish and Wire Fox Terriers. Reasonable. Loganbrae Kennels, Rutland, Vt.

HUNDRED Hunting hounds, cheap. Trial. Dog supplies. Catalog. Kaskaskennels, 8032, Herrick, Ill.

ST. BERNARDS, Registered thoroughbred Puppies from Championbred parents. Prices reasonable, duty free, photos submitted. Helvetia Kennels, 181-P McKenna, Montreal, Que.

PERSONAL

RECEIVE Mail from everywhere. Mail-order agency, homework propositions. Your name listed 20c. Larson, P-3410 North Ave., Chicago.

INGROWING Nails corrected, no knife, no pain; information free. Write Eugene Eaton, D106, Bandon, Oreg.

TOBACCO Or Snuff habit cured or no pay! \$1.50 if cured. Sent on trial. Frances Willard, Box 796, Los Angeles, Calif.

ADVICE, Information, any subject, 25c coin. Fred Klotz, Reading, Pa.

DRY Clean your brain. Results amazing. Money back if not satisfied. Morris, 3608 Warren St., Philadelphia.

YOU Need a better grip on mathematics? Tell us to send you a copy of "Mathematics for the Practical Man," only \$1.50. By common sense methods it removes the mystery and difficulties so algebra and calculus are made simple. Assuming your knowledge is limited to arithmetic you quickly and easily gain a working knowledge of algebra, geometry, trigonometry and calculus. Simply pay postman when he hands you the package. Address Popular Mechanics Press, Room 807, 200 E. Ontario St., Chicago, Ill.

MISCELLANEOUS

ARTISTS, Cartoonists. Sell your drawings. Write Castle Studios, Independence, Mo.

TEXTILE Gives you silk stockings and underwear at one-third former cost. Send 50c (coin) for full size package. Agents wanted. The S. G. Kurtz Co., Mifflinburg, Penna.

MIRRORS Resilvered at home. Costs less 5 cents per square foot; you charge 75 cents. Immense profits plating autoparts, reflectors, tableware, stoves, refinishing metalware, etc. Outfits furnished. Details free. Write Sprinkle, Plater, 288, Marion, Ind.

A PENCIL portrait or cartoon of your photo for \$1.10; both for \$1.70. L. Tashjian, Madera, Calif.

EMBOSS Your stationery with hand embosser. Circular free. Midwest, Box 47, Springfield, Ill.

EXCHANGE Radios, cameras, guns, anything. Get on our list 25c. American Exchange, Box 97, North End, Detroit.

TIME Counts in applying for patents. See pages 138 and 139. Clarence A. O'Brien, Registered Patent Attorney, Washington, D. C.

ARTISTS And art students are printing 250 signs or pictures an hour without machinery. Sample and particulars 10c. Straco, 1013 Mulberry, Springfield, Ohio.

CASH Paid for Butterflies, Insects. See Sinclair Display Advertisement on page 20.

YOUR Cartoon on business cards. Write for samples and particulars. Seamann Studio, 2104 Liberty Ave., Terre Haute, Ind.

TATTOOING—Learn how with my outfits. Descriptive circulars sent anywhere. Sergt. Bonzey, 367 South Main, Providence, R. I.

TOYS And Furniture easy to build from my blueprints. Send two-cent stamp for list. Address, Woodcraft, Box 436, Troy, N. Y.

TATTOOING Outfits, supplies. Illustrated list free. "Waters," 965 Putnam, Detroit.

WEEDS—Cut them with cutter bar on Shaw Garden Tractor. Also plows, cultivates and runs belt machinery. Low prices. Immediate delivery. Shaw Manufacturing Company, Department C, Galesburg, Kans.

CUTS anybody can make. Simple, cheap process. \$1. Specimens, particulars. 2c stamp. M. Day, Windfall, Ind.

AMATEUR Cartoonists: Make money in spare time with new cartoon selling plan. Write Smith's Service, PM1194, Wenatchee, Wash.

MEXICAN Made Holsters, lariats, horse-hair articles; rattlesnake belts. Send four cents for catalog. Tex-Mex Leather Co., 309 Esperson Bldg., Houston, Texas.

HOMEOPATHIC And Biochemic preparations sent postpaid to all parts of the world. Manual and booklet free. Halsey Bros. Co., 5547 Ravenswood Ave., Chicago, Ill. Established 1855.

OUTDOOR Opportunities. Instructions for raising and selling rabbits, guinea pigs, milch goats, silver foxes, ferrets, white rats, white mice, dogs, cats, pigeons, pheasants, bantams, canaries, bees, frogs, mushrooms, ginseng and golden seal all profitably on town lot. Just write for "Outdoor Opportunities." Pay postman \$2 and postage. Popular Mechanics Press, Room 807, 200 E. Ontario St., Chicago, Ill.

THE Manual of locksmithing solves the money making and labor saving problems of the key men. Price \$3.00. McLean, 1656 Lawrence, Denver, Colo., or K. N. Gerow, 394 Danforth Ave., Toronto, Ont.

TELL An army of 3,000,000 live readers all about your offer! If you have anything to sell, buy or exchange, or if you have any reasonable proposition, tell our readers all about it—they'll respond quickly. Our booklet "How to Create More Business" contains some very interesting, helpful facts. Write today for your copy—it's free. M. L. Rund, Manager Classified Advertising, Popular Mechanics Magazine, 200 E. Ontario St., Chicago, Ill.

Daring Young Men!
Heed the
Call to...
Aviation.

Quickly Train at Home for BIG PAY

Get in on the ground floor now and be one of the pioneers in Aviation. Thrills, adventure, fame, BIG PAY are offered to red-blooded young men who act at once. Aviation is growing over 100% each year. Over 50 different trades already represented.

N. A. T. offers you, for the first time, a complete, practical EASY-TO-GRASP Course in Aviation fundamentals—at a new low price. You receive the basic training necessary to qualify for Pilot, Designer, Mechanician, Inspector or any position in Aviation. Included are Motors, Wings, Assembly, Construction, Design, Meteorology, Navigation, Nomenclature, Theory of Handling Ships in Air and on ground and 100 other fascinating subjects. Lessons profusely illustrated with charts, diagrams, plans, etc. so you can quickly grasp each subject. You receive experience of famous pilots, technicians, shop experts and designers. Endorsed by experts. No previous mechanical knowledge necessary. Learn at home in spare time. Diploma on graduation.

Every day manufacturing, transport, air-port service and sales organizations are springing up—with valuable openings for high priced, skilled men. We render free Employment Service. The big money—the fame and glory—are coming to those who get in NOW.

Now Sent FREE Write today for your FREE copy of "Aviation" telling quickest, least expensive way to get into Aviation.

NATIONAL AVIATION TRAINING
1031 So. Broadway Dept. 14 Los Angeles, Cal.

AMAZING
CAP OUTFIT
Free!



Just out! Absolutely new! Write or wire today for amazing new Taylor Cap Outfit. S. W. Allen of California made \$40.80 in one day, just showing beautiful styles and rich RAINPROOF fabrics. Charles Horstman walked off with 53 orders in 8 hours. Scores of men making big money this new easy way.

\$20 a Day Easy!

YOU can also make more money than ever by showing wonderful Taylor Caps. Guaranteed rainproof, an exclusive feature which sells the caps with lightning speed. You pour water on Taylor Cap and it rolls off without moistening fabric. Wear cap in rain or snow and it remains perfectly dry. Amazing three-minute demonstration convinces every man. You keep big commission in advance on every order. Every cap made-to-measure and carefully tailored throughout. Delighted customers tell friends.

Send Name and Address

New styles and fabrics most beautiful of season. Complete equipment now ready. Write today. Let us send you this big money-making opportunity FREE—without obligation.

TAYLOR CAP MANUFACTURERS
Dept. 22-J Cincinnati, Ohio

How I Made \$100,000 With a "Fool" Idea

Learn my money-making secret—Be a Real Estate Specialist—Start at home, in your spare time—Use my successful System—Free book shows how

"IT'S a fool idea!"

That's what my friends said, when I told them about my idea for starting a real estate business "on the side."

But with that "fool" idea I made more than one hundred thousand dollars net profit.

No matter who you are, where you are, or what your sex or present occupation, if you want to do what I did—if you want to get out of the \$25-a-week crowd and build up a high-class, money-making, business of your own—right at home—in your spare time—send at once for my free book which opens wide the door of the biggest and best money-making business opportunity you ever heard of in your whole life.

Use My Successful System

When I started in real estate, I tossed overboard all the hit-or-miss, haphazard, rule-of-thumb methods of the past, and put into operation a system of my own which is as superior to the old way as the modern Mazda lamp is superior to the tallow candle of our forefathers.

With little education—no experience—no influence—and less than five dollars capital—I started in my spare time and met with instant success.

If you want to follow in my footsteps—if you want to use my amazingly successful system—send for my free book now. It tells how I succeeded—how I have helped other men and women win big success—how you, too, can succeed—how you can have a splendid business of your own and make more money than you ever made before.



A well-known cartoonist's conception of my idea

A Wonderful Business

Real estate—conducted my way—is a great business. It is as permanent as the earth itself. It is getting bigger and bigger as the country grows. It doesn't require years of study to learn like most other businesses and professions. It offers enormous earnings to ambitious men and women. Users of my system are making \$1,000—\$5,000—\$10,000—on single deals—as much as the average man gets for months and years of hard work. And the business is practically unlimited. Ten million properties are now on the market for rent, sale or exchange. And you can start with little or no capital—

right at home in your spare time. I did. So did others. So can you. My free book tells you how.

Read These Records

Here are just a few brief extracts from the many letters received from happy users of my money-making real estate system:

"Made \$5,500 on first deal after getting your system."—Mrs. Evalynn Balster, Chicago (Former School Teacher). "Sold a lot by your methods in less than one hour and my commission was \$800."—J. A. Ferguson, Fort Lauderdale, Fla. (Former Dry Cleaner). "Sold over \$100,000 worth of property my first year with your methods."—H. D. VanHouten, Passaic, N. J. (Former Grocery Clerk). "Have sold thousands of dollars worth of property your way. Have deals that will go beyond the \$300,000 mark."—Carrie Marshall, Ocean Springs, Miss. (Former Housekeeper). "My first day's work in real estate netted me \$435. I recommend your system to anyone wishing to get into a pleasant and profitable business."—F. B. Bennett, San Diego, Cal. (Former Planing Mill Man). "Have sold one \$5,000 lot and 3 houses so far, with your system."—Mrs. B. H. Morehouse, Brooklyn, N. Y. (Former Housewife).

These are just a few samples of success that you will read about in my free book. Get it. Read it. Follow its instructions. Make big money my way.

Get Free Book Now

My big, new, illustrated book is filled with fascinating facts about my kind of a real estate business—what I did—what others are doing—what you can do.

Mail coupon right now and get this valuable, money-making information free. It doesn't cost you a nickel to find out what this book can do for you. So, act at once. You will never forgive yourself if you turn your back on this unusual chance to win big, business success. Address PRESIDENT, American Business Builders, Inc., Dept. 44-9, 18 East 18 Street, New York.

\$1,000 REWARD

We do not claim that all who follow our instructions make such amazing profits so quickly and so easily. But we do say that the fact that so many have done so is proof that the average person can make more money in less time our way than in any other way we know of. And we back up this statement with an offer of one thousand dollars in gold, to anyone furnishing proof of any other course of any kind that is helping as many men and women make as much money in as short a time as our Real Estate Course.

AMERICAN BUSINESS BUILDERS, INC.

PRESIDENT,
American Business Builders, Inc.
(Authorized Capital, \$500,000.00)
Dept. 44-9, 18 East 18 St., New York, N. Y.

Mail me your free book telling how you made \$100,000 in a new kind of real estate business—how others are making big money—and how I can do the same.

Name.....
Please print or write plainly

Address.....

City.....State.....

AUTO

BOOKS SENT FREE!

Mail the coupon and we'll send you a set of these remarkable auto books, just off the press. Whether you are mechanic or helper, expert or student, auto-owner or driver, if you're interested in autos, by all means take advantage of this opportunity to see the latest and most complete work on autos we have ever published. Built by eighteen of America's greatest automotive engineers. Simple enough for men with little schooling to understand, yet in daily use by hundreds of engineers, service station superintendents and foremen as an authoritative REFERENCE Cyclopeda.

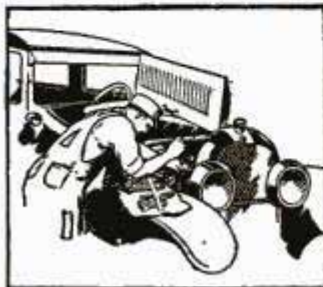

Put the JIFFY INDEX to work for you!

The billion-dollar auto industry offers rich prizes to men with gumption enough to really learn all branches of automotive mechanics. A better job, bigger pay—a chance to go into business and get a share of the huge profits, are waiting for any man who even half tries to improve his ability to deliver service. And here's the shortest, easiest way: No tedious studying, no memorizing, no lessons or examinations. Just LOOK UP the facts you seek. You'll find the answer to any auto problem literally at your finger-tips, in the famous JIFFY INDEX.

"Was garage hand—now have shop of my own," writes W. Sidle of Toledo, O. "I got a raise," says P. Ervin of Yarmouth, N. S., shortly after getting his books. And D. S. Reid of Siluria, Ala., was offered \$4000 for invention worked out with these Auto Books.

CAN YOU FIX IT?

Can you take out "play" in differential? Can you kill the "shimmy" in steering? Can you reset TIMING? Can you put your finger on engine trouble without guessing or tinkering? Can you pull the starter off and fix it? Can you adjust and repair transmission, engine, rear axle, bearing?

These Books Tell How

and they tell you how to do any and every auto job right the first time.

5 Big Volumes

2400 pages, over 2000 illustrations, wiring diagrams, equipment charts, etc. De Luxe edition with gold-stamped flexible binding. Sent FREE for 15 days' use. If not wanted return express collect. If kept, send only \$2 after 15 days, then \$3 a month until special advertising price, \$24.80, is paid.



A Year's Consulting Membership FREE!

Privilege of consulting engineers of million-dollar American Technical Society on any automotive problem for one year without charge, if you mail coupon immediately.

American Technical Society

Dept. A-619, Drexel Ave. & 58th St.

Chicago, Ill.

Dont Send a Penny!

AMERICAN TECHNICAL SOCIETY
Dept. A-619, Drexel Ave. & 58th St., Chicago, Ill.

I would like to see the new 5-volume edition of your AUTO BOOKS, but without obligating me to buy them. I will pay the few cents delivery charges only, but if I choose to, I will return them express collect. If after 15 days' use I prefer to keep them, I will send you \$2 and pay the balance at the rate of only \$3 a month, until \$24.80 is paid. Please include free membership you offer above.

Your Name.....
 Your Address.....
 Employer's Name.....
 Employer's Address.....

BE A RAILWAY TRAFFIC INSPECTOR



Earn up to
\$250
 per month
SALARY

NO HUNTING
 for a Position After
 Completing Your
 Training

Read what Dan'l M. Mack says:

"I received my certificate on April 15, was on my way to take a position on the evening of April 16, and started to work on April 17. If this is not quick work, I don't know what it is. I found the school very thorough."

plus expenses
 Our students never worry about a position as they are assisted to one within a few days after completing the Traffic Inspection course. You get at least \$120 or more per month plus expenses and advance rapidly to \$185, \$250. Our contract shows why you take no risk.

As a Railway Traffic Inspector, you are practically your own boss, see new faces and places each minute, report only to high officials, are rapidly advanced. It's healthful outdoor work with regular hours.

Hundreds of Satisfied Graduates

Write today for free booklet giving full details and contract agreeing to assist you to a position, or refund your tuition.

Standard Business Training Inst. Div. 2 BUFFALO, NEW YORK

\$2.00 BOOK for 25¢



"Look—look!" she gasped. Pale with horror, she recoiled from the desk. King's face was bloodless, the eyes glazed and staring. It was the face of a dead man. The entire story of "The Crookhaven Murder" complete in the current issue of Complete Detective Novel Magazine. A full booklength (\$2.) novel for 25c. Now at all news stands, or send 25c for your copy to:

COMPLETE DETECTIVE NOVEL MAGAZINE
 225 VARICK ST. Dept. 504, NEW YORK, N. Y.

FREE to BOYS!



Sample Copy of OPEN ROAD for BOYS Magazine . . . 50 pages thrilling stories, pictures, sports, mystery, etc. Free membership in WINNIT CLUB, badge-button, big outfit, catalog and new plan for getting easy money and swell prizes. Big surprise too. ALL FREE! No obligation. Write today to

WINNIT CLUB, 31, 130 Newbury St.

Open Road for Boys BOSTON, MASS.

YOU CAN OIL PAINT

Amazing new method teaches men or women to earn after first lesson. OIL PAINT photos—portraits, landscapes or art subjects. Earn \$18 to \$50 and more a week. OIL PAINT OUTFIT GIVEN. Send now for free illustrated book. PICTORIAL ART STUDIOS Inc. Dept. MP, 2526 Broadway, Chicago, Ill.



ZIP-ZIP SHOOTER

THOUSANDS of boys are made happy with this wonderful Zip-Zip shooter, something every boy wants and never gets tired of. Zip-Zip shooter is scientifically and practically

made; if you like hunting and outdoor sports, get a Zip-Zip shooter with plenty of pep and force. If your dealer happens not to have them, order from us. Zip-Zip shooter 35c or three for \$1.00; send stamps, coin or money order.



AUTOMATIC RUBBER CO., Dept. B. B. COLUMBIA, S. C.



FREE BLUE PRINTS

AND FREE BOOK "HOW TO READ BLUE PRINTS"

SHOW YOU THE WAY TO

9 BIG PAY JOBS

- | | |
|---|--|
| 1 Building Superintendent — \$5,000 to \$12,000 | 6 Building Estimator — \$6,000 to \$10,000 |
| 2 Building Inspector—\$4,800 to \$8,000 | 7 Real Estate Expert—\$5,500 to \$12,000 |
| 3 Appraiser — \$6,000 to \$10,000 | 8 Construction Foreman—\$4,500 to \$8,500 |
| 4 Material Buyer—\$5,000 to \$7,500 | 9 CONTRACTOR AND BUILDER IN A BUSINESS OF YOUR OWN—\$5,000 to \$12,000 |
| 5 Material Salesman—\$5,000 to \$12,000 | |

FIND OUT HOW

Easy it is to Make \$4,500 to \$12,000 a Year

Learn to read Blue Prints this amazing new way! Get into the world's richest industry—Building! See how quickly and easily you can train to make \$4,500 to \$12,000 a year! My FREE Book "How to Read Blue Prints" discloses all the so-called "mysteries" of Blue Print Reading—also gives some startling facts about the nine best jobs in America. Don't send one penny—just mail the coupon!

NO longer need you spend years trying to pick up the "mysteries" of Blue Print Plan Reading. For now a quick, sure practical method has been perfected that has made thousands of men Blue Print Experts in a surprisingly short time.

This is no ordinary "school course." It is practical from start to finish. It is based on many sets of real Blue Prints—plans that would cost thousands of dollars if purchased from architects. Twenty famous experts in all lines of construction work talk over these Blue Prints with you in plain simple language. Show you every detail. Explain every short cut. Tell you the "secrets" of quick, accurate estimating. Explain Superintending. Give you for the first time many inside facts and money-making methods used by the "Giants" of the Building Industry. This is the kind of training that quickly puts men into \$4,500 to \$12,000 a year jobs—or into profitable contracting businesses of their own. Yet now you get it right at home in only 2 or 3 months. It requires no extensive education. If you can read and understand what is written here you can easily master it.

See what this training has done for others: Bartholomew, Calif., became a contractor at an in-

crease of over 300% his first year; Blair, Okla., stepped up to Superintendent at 100% increase; Dickerson, R. I., increased his salary 700% in 12 months; Marchand, La., says: "My income has increased 200% and I now have more contracting work than I can do."

Over seven billion dollars will be spent this year in new construction! No wonder then, such tremendous opportunities are open to you when you have this "head-work" training in Blue Prints.

If you want more money—real big money! Then choose a "Blue Print" job in Building. Clerk or Salesman, Carpenter or Bricklayer, here is the one field where there are unlimited opportunities for advancement.

So accept my FREE gift of a complete set of real working Blue Prints, and my fascinating Book, "How to Read Blue Prints" that tells all the interesting and instructive facts about Blue Print Plans. Don't send one penny—pay no C. O. D.—It's all FREE. Just fill out and mail the coupon today—NOW!

TWO BOOKS also FREE



IF YOU LIVE NEARBY

Visit our big day or evening school attended by over 1000 Builders. You can get the same training at home by mail—same plans, lessons and instructors. Your spare time is enough.

Chicago Technical School for Builders—Dept. M-141, Chicago Tech. Building, 118 East 26th Street, Chicago, Ill.

Please send me your free book, "How To Read Blue Prints," and complete set of real Blue Prints. I understand these are mine to keep without obligation. It is also understood that no salesman will call on me.

Name.....
 Address.....
 City..... State.....
 Age..... Occupation.....

Chicago Technical SCHOOL for BUILDERS

Dept. M-141, 118 East 26th St., Chicago, Ill.



PAIN and DISEASE

Quickly Conquered by

VIOLET RAY



Let us tell you how thousands of men and women suffering from rheumatism, neuritis, paralysis, nervousness, skin diseases, headaches, constipation, sprains, prostate trouble, goitre and many other ailments, even hay fever and asthma, have found quick relief—new health and vitality with this marvelous, scientific invention. Pains vanish almost instantly.

Violetta

Ten Days FREE Trial

For Health—Beauty—Vigor
Endorsed and used by hospitals, sanitariums and physicians. Every home can now have one. Saves hours, days, months of suffering. No medicine. Painless, pleasant treatment. Only the violet ray can penetrate to every nerve affected. Simple, safe, painless—anyone can use VIOLETTA. Why suffer pain and poor health when you can try VIOLETTA 10 days FREE.

This Book FREE

Tells all about violet rays—how this marvelous discovery by Nikola Tesla, the electrical wizard, now brings this mysterious curative power to all. Contains many astounding testimonials from our thousands of satisfied users. Send for the facts and our liberal trial offer today. Mail the coupon now.



VL-REX CO., Dept. 931
2304 Warren Avenue, Chicago

VL-REX CO., 2304 Warren Ave., Dept. 931 Chicago
Please send me your free book on Violet Rays and details of your 10 days' free trial offer.

Name.....
Address.....
City..... State.....
Ailment.....

QUIT TOBACCO



No man or woman can escape the harmful effects of tobacco. Don't try to banish unaided the hold tobacco has upon you. Join the thousands of inveterate tobacco users that have found it easy to quit with the aid of the Keeley Treatment.

KEELEY TREATMENT STOPS Tobacco Habit

Quickly banishes all craving for tobacco. Write today for Free Book telling how to quickly Free yourself from the tobacco habit and our Money Back Guarantee.

THE KEELEY INSTITUTE
Dept. A 913
Dwight, Illinois

Write today for our 168 page FREE Book on Deafness

and learn how Perfect Hearing is now being restored in every condition of deafness or defective hearing. Our "Little Wireless Phones for the Ears" require no medicine but effectively replace what is lacking or defective in the natural ear drums. They are simple devices, which the wearer easily fits into the ears where they are invisible. Soft, safe, and comfortable.

WILSON EAR DRUM CO., Incorporated
377 Todd Bldg. LOUISVILLE, KY.

NEW DISCOVERY Grows Hair Quickly!



Noted surgeon has discovered amazing way to grow hair called Dermo-Ray. Employs Infra-Red Rays. In thirty days no more dandruff. Scalp tissues given new life. Then within a few weeks luxuriant new hair! Two years ago the discoverer was himself bald. Today his hair is full and thick. Sent on Free Trial. Results or no pay. If you have electricity in your home write at once for Free, startling, thirty-two page booklet.

Address the LARSON INSTITUTE
216 N. Wabash Ave. Dept. 316 Chicago, Illinois

BUCHSTEIN'S FIBRE LIMB



is soothing to your stump—strong, cool, neat, light. Easy payments. Braces for all deformities.
D. BUCHSTEIN CO.
610 3rd Ave., So. MINNEAPOLIS, MINN.

Send for Catalog Today

Stop Using a Truss

STUART'S ADHESIF PLAPAO-PADS are entirely different from trusses—being mechanico-chemico applicators made self-adhesive purposely to keep the muscle-tonic "PLAPAO" continuously applied to the affected parts, and to minimize painful friction and danger of slipping.

No straps, buckles or springs attached.



Soft as velvet—easy to apply—inexpensive.

For almost a quarter of a century satisfied thousands report success without delay from work. Stacks of sworn statements on file. Process of recovery natural, so no subsequent use for a truss. Awarded Gold Medal and Grand Prix. Trial of "PLAPAO" will be sent you absolutely FREE No charge for it now or ever. Write name on coupon and send TODAY.

PLAPAO CO., 588 Stuart Bldg., St. Louis, Mo.

Name

Address

FREE—Trial Plapao—FREE

LEARN AUTOS IN LOS ANGELES

Jobs Open Now—\$40 to \$100 a Week

You are urgently needed to help repair the one and a half million autos in California. Trained auto repair men are also needed badly in every other state. The rapidly increasing number of cars means prosperity and big pay for auto men—more garages, tire shops, battery stations are needed. You can be one of the highly paid men in this fastest growing industry—if you get

YOU CAN BE An Auto Expert!

the right training. National Automotive special, practical Shop Training makes it easy for you to become an Auto Expert. In a quarter century this great institution has trained

16,000 men for bigger pay. It will help YOU make more money by giving you individual instruction on repairing Packards, Buicks, Cadillacs, Fords, etc., all types of electrical equipment, machine shop equipment, etc. You learn everything RIGHT at National.

Paul Briggs Earns \$4000 a Year

"I want to thank you for the big part National has played in helping me to success in auto work. I am now assistant sales manager and made \$4,000 this year—which is more than I would have made in three years at my former work."—Paul Briggs, Portland, Ore.

Money-Making Book



Earn While You Learn

Free employment service. Spare time jobs help pay expenses while training. All tools included. No extras. Send for big free illustrated catalog explaining how National trains you for bigger pay. Learn the opportunities for you in California. Mail coupon now.

Million Dollar Training Headquarters for Auto Experts



NATIONAL AUTOMOTIVE, Dept. 714, 4006 Figueroa St., Los Angeles, Calif.

Send me, absolutely free, your big illustrated catalog of Automotive Opportunities.

Name.....
 Address.....
 Age..... City..... State.....



BECOME A PILOT AIRPLANE BUILDER AERIAL NAVIGATOR

Aviation Needs Men for Big-Pay Positions RIGHT NOW!

A marked shortage of planes exists today due to a lack of skilled mechanics and designers to construct and repair. Few airports and hangars now have enough competent licensed mechanics to take care of the present and rapidly growing demands for repairs.

BIG - PAY JOBS—Unlimited Opportunities

The new Air Commerce Regulations require Transport Pilots to pass tests and examinations on airplane and engine mechanics, meteorology and practical navigation.

On y thorough training can these subjects be learned. We have the experts to show you how in a practical, simple way—within a very short time.

EARN WHILE YOU LEARN

You can start on a Home Study Course or come at once to our large Shops and Hangar in Chicago, the Aircraft Hub of the Country, Full Time or Spare Time Plan with Employment Service assistance.

We assure you of the latest modern equipment and methods of training for either flying, mechanics or navigation on the most reasonable basis consistent with safety.

Send for our book of facts, "THE AIRWAY" and be convinced. A limited number will be distributed FREE to those writing at once, giving their age, experience and qualifications. Be one who cashes in on TODAY'S BIGGEST OPPORTUNITY.

Department PM 9

AVIATION SERVICE and TRANSPORT, Inc., 203 No. Wabash Avenue, CHICAGO



Men! Extra Money Quick

Here's An Easy Way!

—to bring you a fine cash income! Without taking any time away from your job. Pleasant easy work at home. Decorate beautiful giftwares the Fireside way. You can do it—in spare moments. No previous training required. No special ability needed. No tedious study. No memorizing. With the Three Simple Steps sent you by Monsieur Petit the great artist—Director of Fireside Industries, it is just fun! We want men in every community. Be the first!

Fireside Industries, Dept. 66-M, Adrian, Mich.

Begin Right Now!

Thousands are making Fireside decorations—making from hundreds to thousands of dollars and doing their own work besides. We supply you with everything you need. Big Generous Complete Kit WITHOUT EXTRA COST. It's a cinch! We absolutely guarantee your success.

FREE!

Fill out and mail coupon at once. Without any obligation it brings you wonderful Fireside Book in colors. Explains everything. Act now!



Fireside Industries, Dept. 66-M, Adrian, Mich.

Send me your wonderful Free Book in colors. This does not put me under any obligation.

Name.....

Address.....



BOYS

Make Big Spare Time Money Surprise your chums

ELECTRICITY

This Quick Easy Way

Electricity is great fun! And it pays. Lots of my boys still in school are making \$10 to \$15 a week in spare-time—and getting a real training besides for a regular he-man's Big-Pay Job in Electricity when school days are over. You can, too! I'll show you how. Begin right now to prepare for a big future in this fascinating field of great opportunity. Your chances of success are simply wonderful!

Learn Right at Home

With my easily-learned, spare-time Electrical Course I will train you at home like I trained hundreds of other boys who are now big successful men. It won't interfere with your school work. And you'll find it so enjoyable it will be more like play than study. It's just the thing for you fellows who are ambitious to get somewhere and be somebody after you have finished school.

I Train You RIGHT!

My training is practical—you learn along work-shop lines by doing. I furnish you with all necessary equipment to work with. And it doesn't cost you a penny extra! Six Big Outfits of tools, material and apparatus, including a real electric motor—not toys, but the real thing. And they're yours to keep—to learn right with, and to help you do the spare-time work I tell you how to get and how to do.

Mail Coupon for Book

If you want lots of spending money—if you want to be ready to jump into a Big-Pay Electrical Job when you're through school—my Big Book will show you how. Get it—you'll like it—it's full of "dope," data and pictures that will thrill you. And it's FREE—won't cost you a penny—mail coupon for it right now!

L. L. COOKE

Chief Instruction Engineer
Dept. 016, CHICAGO, ILL.

RADIO COURSE NO EXTRA CHARGE

Every fellow wants to learn radio. And this Course is a dandy. It's simple—it's thorough. You'll be surprised what it will teach you about Radio. And it's yours without a penny of extra cost!

6 BIG OUTFITS given including a REAL MOTOR

What a thrill you'll get from these Six Big Outfits of tools and apparatus! There's enough equipment in this fine layout for you to tackle any kind of spare-time work. Imagine having all this for "keeps."



Use this SPECIAL OFFER Coupon

L. L. COOKE, Chief Instruction Engineer,
L. L. Cooke School of Electricity,
Dept. 016, 2150 Lawrence Ave., Chicago, Ill.

Send me free and fully prepaid your Big Book about Electricity, and full particulars about your Electrical Course and extra Radio Course. This does not obligate me.

Name.....

Address.....

City..... State.....

(This coupon only for use of boys 15 years old or more)

AVIATION NEEDS MEN!

and There Is Money for YOU If—



You Get THOROUGH TRAINING NOW!

There is honor and prosperity ahead for those who start now with the proper training and grow with Aviation. Our courses will give you this training—they cover EVERYTHING about planes, motors, their maintenance and construction, etc. EVERYTHING a pilot or mechanic must know to secure a good paying position.

WE TEACH YOU BY PRACTICAL TRAINING
Our School Registered, All Instructors and Airplanes Licensed by U. S. Government

Realizing that the highest type of equipment and ablest and most experienced instructors are necessary, our courses are taught under the direction of U. S. Licensed Transport Pilots and Mechanics. Our equipment is new and of modern design, every ship is licensed and instructors and all equipment subject to daily U. S. Government Inspection. (This school has a resident Federal U. S. Government Inspector on the field—think what this means to you.)

THOROUGH INSTRUCTION AT LOW COST



We teach by actual flying and practical instruction; no long course needed. We guarantee sufficient hours in the air to make each student master of his ship; pilot it safely and efficiently without assistance. No student bond required. Our ground course gives thorough instruction in ground work and will qualify you for any ground position or you can take the course combining ground instruction and flying which will qualify you for a private, industrial, or limited commercial pilot. The cost is low considering daily flying and thoroughness of theoretical and

ground instruction on latest modern type planes, Wright Whirlwind and other standard motors. Our big new book "Aviation and You" tells all the facts. Write for it NOW—it is FREE.

VON HOFFMANN AIRCRAFT SCHOOL
110 Lambert—St. Louis Flying Field, ANGLUM, MO.

Don't Envy The Plumber—BE ONE!

\$11.00-\$16.00 PER DAY and work EVERY day, is the Plumber's wage.

LEARN IN 8 to 12 WEEKS without previous experience.

If you are making less than \$60.00 a week you owe it to yourself to investigate. Get FREE catalog that tells in pictures and words how we teach this trade. Special rates now.

UNIVERSAL PLUMBING SCHOOL, 2030 Truxtun Avenue, KANSAS CITY, MO.

TELEGRAPH-RADIO

Operators earn \$150 to \$350 month and up. Learn in Chicago or at home. Chance to work while training. We furnish operators to U. S. Govt., Railroads, Com'l Cos., Broadcasting Stations and Ships.

CHICAGO TELEGRAPH INSTITUTE, Dept. 1-9-8, 1338 So. Michigan Ave., CHICAGO, ILL.



LUCKY POCKET PIECE, triple horse shoe puzzle, always keep one with you—10c, 4 sets 25c pp., with secret solution. Western Puzzle Works, St. Paul, Minn.

Learn How to BOX

JIMMY DeFOREST BOXING COURSE

Teaches by mail the Same System he taught Champion JACK DEMPSEY

In 20 weeks, under the System of Jimmy DeForest, WORLD'S GREATEST TRAINER AND MAKER OF CHAMPIONS, you will master the priceless knowledge that made Jack Dempsey his millions, and fortunes for a host of other Jimmy DeForest-trained ring stars. Boys who were once rank amateurs are today earning big money; weaklings have been made strong, courageous; men have learned the art of self-defense. Send today for the now famous book, "THE GOLDEN AGE OF BOXING," greatest book of its kind ever written; full of valuable information, photos of great fighters and pupils who became successes over night. Enclose 10c to cover cost of mailing, etc. WRITE NOW.



JIMMY DeFOREST BOXING COURSE
347 Madison Avenue, Box 134, New York City



New!

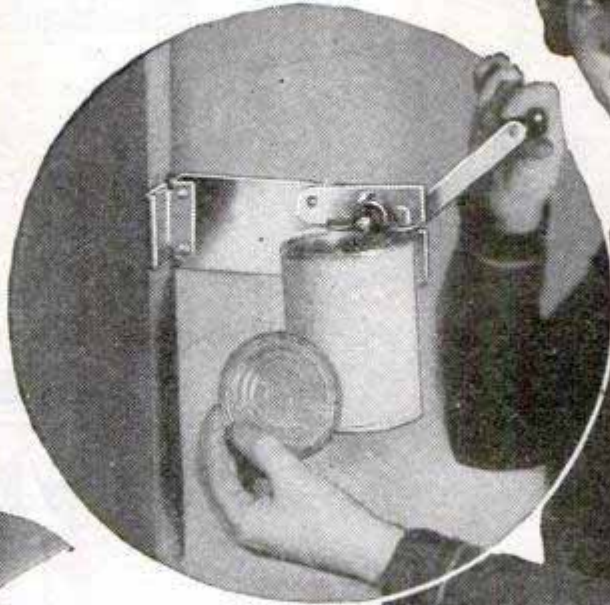

Patented

Just A Twist Of The Wrist

Banishes Old-Style Can Openers to the Scrap Heap and Brings Agents \$6 to \$8 in an Hour

WOMEN universally detest the old-style can opener. Yet in every home in the land cans are being opened with it, often several times a day. Imagine how thankfully they welcome this new method—this automatic way of doing their most distasteful job. With the Speedo can opening machine you can just put the can in the machine, turn the handle, and almost instantly the job is done.

End This Waste and Danger

You undoubtedly know what a nasty, dangerous job it is to open cans with the old-fashioned can opener. You have to hack your way along slowly—ripping a jagged furrow around the edge. Next thing you know, the can opener slips. Good night! You've torn a hole in your finger. As liable as not it will get infected and stay sore a long time. Perhaps even your life will be endangered from blood poisoning!

You may be lucky enough to get the can open without cutting yourself. But there's still the fact to consider that the ragged edge of tin left around the top makes it almost impossible to pour out all of the food. Yet now, all this trouble, waste and danger is ended. No wonder salesmen everywhere are finding this invention a truly revolutionary money maker!

The Speedo holds the can—opens it—flips up the lid so you can grab it—and gives you back the can without a drop spilled,

without any rough edges to snag your fingers—all in a couple of seconds! It's so easy even a 10-year-old child can do it in perfect safety! No wonder women—and men, too—simply go wild over it! No wonder Speedo salesmen often sell to every house in the block and make up to \$10 an hour.

Generous Free Test Offer

Frankly, men, I realize that the profit possibilities of this proposition as outlined briefly here may seem almost incredible to you. So I've worked out a plan by which you can examine the invention and test its profit without risking one penny.

Get my free test offer while the territory you want is still open—I'll hold it for you while you make the test. I'll send you all the facts about \$75 to \$150 a week. I'll also tell you about another fast selling item that brings you two profits on every call. All you risk is a 2c stamp—so grab your pencil and shoot me the coupon right now.

**CENTRAL STATES MFG. CO., Dept. L-702,
4500 Mary Ave. (Est. over 20 years) St. Louis, Mo.**

SPEEDO

Central States Mfg. Co.,
4500 Mary Ave., Dept. L-702,
St. Louis, Mo.

Yes, rush me the facts and details of your FREE OFFER.

Name.....

Address.....

City..... State.....

AGENTS!

**\$265
in a
Week**

"Here is my record for first 30 days with Speedo:
June 13, 60 Speedos;
June 20, 84 Speedos;
June 30, 192 Speedos;
July 6, 288 Speedos.
Speedo sells to 9 out of 10 prospects."
M. Ornoff, Va.

**PART TIME
14 Sales in 2 Hours**

J. J. Corwin, Ariz., says: "Send more order books. I sold first 14 orders in 2 hours."

**SPARE TIME
Big Money Spare Time**

Barb, W. Va., says: "Was only out a few evenings and got 20 orders."

A "Million Dollar" Can Opening Machine

The Speedo holds the can—opens it—flips up the lid so you can grab it—and gives you back the can without a drop spilled,



Use HYPNOTISM to Gain Popularity.. Success.. Big Money!

NOW the amazing science of hypnotism will help you win the big things of life—now you can learn the secrets of Hypnotism—that strange subtle power which enables you to make others love you—to overcome bashfulness—to strengthen your memory, mind and will power—to realize your ambitions—to develop a strong, magnetic personality and gain control over others! In a startling book, written by the most famous hypnotist in the world you are told exactly how the great operators handle their subjects—you are given all the facts and methods that are necessary for a full knowledge of the practice of Hypnotism.

Learn How to Influence Others

Can you sway others—can you make them follow your suggestions, adopt your plans? Are you making enough money? Is your personality strong enough to cope with others? Are you perfectly at ease before an audience or among strangers? Now through this wonderful book you can, if you have an active and intelligent mind, quickly develop yourself into a cultured magnetic person who will be admired and envied by everyone.

This amazing book was written by L. W. de Lawrence, one of the greatest hypnotists that has ever lived. In simple, clear, forceful terms he tells all about the theory and practice of Hypnotism—he explains the psychology, history and philosophy of Hypnotism. Prepared especially for self-instruction, this is the only Practical Course in Hypnotism, which starts the student out upon a plain, commonsense basis.

Send No Money—5 Day Trial

For a short time we are enabled to offer this great book, *Hypnotism*, by de Lawrence for only \$2.50—the lowest price at which scientific, technical books of this kind have ever been sold. Send no money—just fill out and mail the coupon below. When the package arrives pay the postman \$2.50 plus a few cents postage. Inspect this revealing volume for five days, then if you are not delighted return it and your money will be refunded. Get the coupon in the mail this instant—we have only a limited edition at this low price. Franklin Publishing Co., Dept. L-70, 800 N. Clark St., Chicago.

Mysteries of Hypnotism Revealed

- How to Hypnotize at a Glance
- How to Make Others Obey You
- How to Overcome Bad Habits
- Magnetic Healing
- Agency of Death
- Methods of Inducing Hypnotism
- How to Wake a Subject
- Duration of Hypnotic Sleep
- Susceptible Subjects
- Methods of Fascination
- Snake Charms



Franklin Publishing Co.,
800 N. Clark St., Dept. L-70
Chicago.

Please send me a copy of *Hypnotism* by L. W. de Lawrence. When package arrives I will pay postman only \$2.50 plus few cents postage. If not delighted I am at liberty to return the volume within five days and my money will be refunded.

Name.....

Address.....

City..... State.....

If you live outside U. S. send cash with order.

Brush DOLLARS INTO YOUR POCKET

Learn SHOWCARD WRITING; it pays big. Steady positions; countless side jobs. BEGINNER'S OUTFIT with DAILY'S SHOWCARD WRITING COURSE without extra charge—complete in 34 lessons—\$3. Best investment you ever made. Master this course, earn real money right off the reel. Get started—write today—every day you delay costs you plenty. I have not hundreds on the ladder to steady jobs at big pay. Can do it for you.

BERT L. DAILY
122 East Third St., Dayton, Ohio

Be a Movie Operator

EARN \$40 TO \$100 A WEEK.

WE GIVE PROJECTOR AND TEACH YOU AT HOME. Big demand by Movie and Vaudeville Theatres. N. Y. INSTITUTE OF PHOTOGRAPHY, 10 W. 33rd St., New York, Dept. P49.

Learn Watch Repairing

by correspondence in a few weeks in your own home by the DeSelms Chart System. As good or better than at a shop. You can earn money while learning and secure a well paying position or start in business—earn \$50 to \$75 per week. Ask for FREE BOOK.

DeSelms Watch School Logansport, Ind.

6 Ft. LONG GIVEN

Boys! Here's the great Navy model Airship. Large 6-foot air bag with inflators, parachute with automatic release and complete instructions for flying. Will fly for miles at height of 1000 feet. Great chance to study aerial navigation. Send name and we'll send 6 of our new art pictures to dispose of on special 25c offer. Send the \$1.50 you collect and as a reward for this service we will send this wonderful Airship with full instructions free.

C. M. THOMAS, 337 W. Madison St. 8K91 Chicago

NO JOKE TO BE DEAF

—EVERY DEAF PERSON KNOWS THAT

I make myself hear, after being deaf for 25 years, with these Artificial Ear Drums. I wear them day and night. They stop head noises and ringing ears. They are perfectly comfortable. No one sees them. Write me and I will tell you a true story, how I got deaf and how I make you hear. Address

GEO. P. WAY, Artificial Ear Drum Co. (Inc.)
80 Hoffman Bldg.; Detroit, Mich.

GRAY HAIR No Harmful DYE!

NEW unusual discovery. For men and women. Quickly restores youthful color, lustre and beauty. Easily applied. Helps relieve dandruff. Not greasy or sticky. Not affected by curling or waving. No one will know you use it. Results guaranteed. Get booklet and free trial offer today.

RAY LABORATORIES, 648 N. Michigan Ave. Dept. 676 CHICAGO, ILL.

Beautify your NOSE

to shapely proportions—while you sleep!

ANITA NOSE ADJUSTER is SAFE, painless, comfortable. Speedy, permanent results guaranteed. Doctors praise it. No metal to harm you. Small cost.

Gold Medal Won 1923

Write for FREE BOOKLET

ANITA INSTITUTE, 912 Anita Bldg., NEWARK, N. J.



He Tried Home-Study Training

In Seven Years It Multiplied His Income Seven-fold

Seems too good to be true—that a man can double his income just by devoting a few spare hours each week to home-study training—

But—maybe it is true," said B. J. Mertz to himself—and within seven years home-study training had increased his income better than 700 per cent!

Mertz was principal of a rural high-school in Texas, at \$80 a month, when the idea came to him to enroll with LaSalle for training in Higher Accountancy.

Upon completing the course, he first took a place as Assistant Bookkeeper, in Chicago—then joined a firm of Certified Public Accountants, chiefly to get experience. Then he became Office Manager and Acting Secretary of a foundry in southern Ohio. *Already—in only four years—his salary had increased 500 per cent.*

Today, he is Comptroller of the Buckeye Union Casualty Company, Jackson, Ohio, and in addition conducts a private accounting practice which brings him back the entire cost of his training every month in the year.

You Have the Same Good Opportunity

Why not resolve just to double your salary? Get the training—grasp your opportunities—and the future will take care of itself!

Two books placed B. J. Mertz on the path to greater earning power. They are "Ten Years' Promotion in One"—and "Accountancy, the Profession that Pays." LaSalle will send them to you free.

Your biggest opportunity is as near you as the point of your pencil. If you are determined to make progress, clip and mail the coupon NOW!

— — — Find Yourself Through LaSalle! — — —

LaSalle Extension University

The World's Largest Business Training Institution

Dept. 964-HR Chicago

I would welcome details of your salary-increasing plan, together with copy of "Accountancy, the Profession that Pays," also a copy of "Ten Years' Promotion in One," all without obligation.

Higher Accountancy

Training for position as Auditor, Comptroller, Certified Public Accountant, Cost Accountant, etc.

Other LaSalle Opportunities:

LaSalle opens the way to success in every important field of business. If more interested in one of the fields indicated below, check and mail now.

- | | |
|---|---|
| <input type="checkbox"/> Business Management | <input type="checkbox"/> Law—Degree of LL.B. |
| <input type="checkbox"/> Modern Salesmanship | <input type="checkbox"/> Modern Business Correspondence |
| <input type="checkbox"/> Traffic Management | <input type="checkbox"/> Stenography—Stenotypy |
| <input type="checkbox"/> Railway Station Management | <input type="checkbox"/> Expert Bookkeeping |
| <input type="checkbox"/> Banking and Finance | <input type="checkbox"/> C. P. A. Coaching |
| <input type="checkbox"/> Commercial Law | <input type="checkbox"/> Business English |
| <input type="checkbox"/> Industrial Management | <input type="checkbox"/> Commercial Spanish |
| <input type="checkbox"/> Modern Foremanship | <input type="checkbox"/> Effective Speaking |
| <input type="checkbox"/> Personnel Management | <input type="checkbox"/> Telegraphy |
| <input type="checkbox"/> Credit and Collection Correspondence | |

Name

Present Position

Address



Follow this Man

Secret Service Operator 38 is on the job

FOLLOW him through all the excitement of his chase of the counterfeit gang. See how a crafty operator works. Telltale finger prints on the lamp stand in the murdered girl's room! The operator's cigarette case is handled by the unsuspecting gangster, and a great mystery is solved. Better than fiction. It's true, every word of it. No obligation. Just send the coupon and get—

FREE!

The Confidential Reports No. 38 Made to His Chief

And the best part of it all is this. It may open your eyes to the great future for YOU as a highly paid Finger Print Expert. More men are needed right now. This school has taken men just like you and trained them for high official positions. This is the kind of work you would like. Days full of excitement. Big salaries. Rewards.

Can you meet this test?

Can you read and write? Are you ambitious? Would you give 30 minutes a day of your spare time preparing yourself for this profession? Would you like a life of excitement, thrilling adventures and high pay? Answer "yes" and I'll show you how to attain all this.

Send the coupon and I'll send the Free Reports—also a wonderful illustrated book telling of the future awaiting you as a Finger Print Expert.

T. G. COOKE, Pres.

UNIVERSITY OF APPLIED SCIENCE
1920 Sunnyside Ave., Dept. 93-56 Chicago, Ill.

University of Applied Science
1920 Sunnyside Ave., Dept. 93-56 Chicago, Ill.

Gentlemen:—Without any obligation whatever, send me the Reports of Operator No. 38, also your illustrated Free Book on Finger Prints and your low prices and Easy Terms Offer.

Name

Address

Age



"Four Raises in Two Years"

"AND it hasn't been hard to get them, either. Why, it seems only yesterday that I was wondering if I would ever make as much as \$45 a week. And now I'm making \$75.

"Tom Dawson was speaking about it today. 'Gee,' he said, 'I wish I had started studying with the I. C. S. when you did. Here I am plugging away at the same old job and the same old salary while you've gone 'way up. I bet you're making twice as much as I am. And to think that two years ago we were working side by side.'

"I told him it wasn't too late if he would only make the start and he said he was going to send in one of those I. C. S. coupons right away.

"I hope he does, because an I. C. S. course is the very thing he needs to get out of the rut. I wouldn't be making anywhere near \$75 a week if I hadn't started to study just when I did."

How much longer are you going to wait before you take the step that will bring you advancement and more money? To earn more you've got to learn more. And to learn more you've got to study in that hour after supper that most men throw away.

One hour a day, spent with the International Correspondence Schools in the quiet of your own home, will prepare you for the position you want in the work you like best. Put it up to us to prove it.

Mail the Coupon for Free Booklet

INTERNATIONAL CORRESPONDENCE SCHOOLS

"The Universal University"

Box 5561-F, Scranton, Penna.

Without cost or obligation, please send me a copy of your booklet, "Who Wins and Why," and full particulars about the subject before which I have marked X in the list below:

BUSINESS TRAINING COURSES

- | | |
|--|---|
| <input type="checkbox"/> Business Management | <input type="checkbox"/> Salesmanship |
| <input type="checkbox"/> Industrial Management | <input type="checkbox"/> Advertising |
| <input type="checkbox"/> Personnel Management | <input type="checkbox"/> Business Correspondence |
| <input type="checkbox"/> Traffic Management | <input type="checkbox"/> Show Card and Sign Lettering |
| <input type="checkbox"/> Accounting and C. P. A. Coaching | <input type="checkbox"/> Stenography and Typing |
| <input type="checkbox"/> Cost Accounting | <input type="checkbox"/> English <input type="checkbox"/> Civil Service |
| <input type="checkbox"/> Bookkeeping | <input type="checkbox"/> Railway Mail Clerk |
| <input type="checkbox"/> Secretarial Work | <input type="checkbox"/> Common School Subjects |
| <input type="checkbox"/> Spanish <input type="checkbox"/> French | <input type="checkbox"/> High School Subjects |
| | <input type="checkbox"/> Illustrating <input type="checkbox"/> Cartooning |

TECHNICAL AND INDUSTRIAL COURSES

- | | |
|---|--|
| <input type="checkbox"/> Electrical Engineering | <input type="checkbox"/> Architect |
| <input type="checkbox"/> Electric Lighting | <input type="checkbox"/> Architects' Blueprints |
| <input type="checkbox"/> Mechanical Engineer | <input type="checkbox"/> Contractor and Builder |
| <input type="checkbox"/> Mechanical Draftsman | <input type="checkbox"/> Architectural Draftsman |
| <input type="checkbox"/> Machine Shop Practice | <input type="checkbox"/> Concrete Builder |
| <input type="checkbox"/> Railroad Positions | <input type="checkbox"/> Structural Engineer |
| <input type="checkbox"/> Gas Engine Operating | <input type="checkbox"/> Chemistry <input type="checkbox"/> Pharmacy |
| <input type="checkbox"/> Civil Engineer <input type="checkbox"/> Mining | <input type="checkbox"/> Automobile Work |
| <input type="checkbox"/> Surveying and Mapping | <input type="checkbox"/> Airplane Engines |
| <input type="checkbox"/> Plumbing and Heating | <input type="checkbox"/> Agriculture <input type="checkbox"/> Navigation |
| <input type="checkbox"/> Steam Engineering | <input type="checkbox"/> Mathematics <input type="checkbox"/> Radio |

Name.....

Street Address.....

City.....State.....

Occupation.....

Persons residing in Canada should send this coupon to the International Correspondence Schools Canadian, Limited, Montreal, Canada

Where Will You Learn To Fly?

The Porterfield Flying School offers

NEW AMERICAN EAGLE PLANES
VETERAN INSTRUCTORS
A MODERN FACTORY As Your Laboratory

YOUNG MAN! We challenge you to choose a career which offers more action, greater adventure, better pay and a more golden future than Aviation. Qualify now at Porterfield, where you study airplane construction and all popular motors in one of America's foremost factories. Where you fly in new American Eagles, with competent, experienced pilots. And where you study and associate with practical men who are leaders in the industry.

Write now for the interesting booklet,
"A Flying Message"

PORTERFIELD FLYING SCHOOL, Inc.
2802 E. 13th St. KANSAS CITY, MO.

Electrical Engineering

Foremost, best equipped electrical school in America, 24 years old, offers a complete practical course in Commercial Electrical Engineering in one year. B. S. Degree in 2 years. Lacking credits can be made up. Shorter courses available in: Residential Courses in Armature Winding, Radio, Broadcasting, Automotive Elec., Elec. Refrigeration. Recognized expert faculty. Splendid laboratory facilities.



Learn While You Earn We will aid you earn your way partly thru college.

Board and room at cost. Write today for illus. catalog. Mention age, education and course interested in.

FREE SCHOOL OF ENGINEERING CATALOG Dept. P.M. 928A
163 E. Wells St. Milwaukee, Wis.

Are you a student of Art, Nature-lover, Hunter, Fisher or Kodaker? Our splendid magazine is for you. Best Magazine for Home, School, or Correspondence Art Students.

CUT THIS OUT Send Today \$1 for 4 mo. Trial Sub. or ask for FREE Story Booklet.

ART and NATURE Dept. 280 Kalamazoo, Mich.

WANTED!

Ornamental Iron and Bronze Draftsmen. \$50.00 to \$65 a week to trained men—up to \$500.00 a month to experienced men. We train you at home and help place you when ready. Demand greater than supply. Get out of the rut—write today for full information and booklet "Knowledge—Your Greatest Asset."

American Institute of Ornamental Iron & Bronze
3071 Hennepin Avenue, Minneapolis, Minn.

RADIO LATEST CATALOG OF NEWEST PARTS AND KITS **FREE**
Fresh from the press. Shows all the newest standard parts, sets, kits at big savings. Most complete line in America.
Big discounts to set builders. Send name and address at once.

BARAWIK COMPANY 109 Canal Sta., CHICAGO, ILL.

FULL TIME

KRISS-KROSS offers you substantial profits from \$300 to \$750 a month on a full-time basis. Not a makeshift or a dollar gimcrack. It pays real profits on every sale, measured in dollars not just in cents.

\$300 to \$750 a Month



"KRISS-KROSS profits are astonishing, even to an old hand at the game like myself. \$28 for one hour—and \$68 for one day—are new experiences even for me."
N. C. PAIGE, Missouri.

SIDE LINE

So successful has KRISS-KROSS proved as a side-line, that hundreds of tailoring, shirt, auto accessory, and other salesmen are adding \$60 to \$175 a week to their regular incomes this easy way. The logical side-line for salesmen calling on men.

\$60 to \$175 a Week



"I have sold over 100 orders in 7 days in addition to my regular line of work. I think over \$200 at part time speaks well for KRISS-KROSS."
J. C. KELLOG, Kansas.

SPARE TIME

KRISS-KROSS is ideal for spare-time workers because of its uncanny ability to sell itself. Even a man of limited experience can make \$8 to \$15 an evening easily—and if a man knows something about selling, KRISS-KROSS is a gold-mine.

\$8 to \$18 an Hour



"In my first four days of work, I averaged over fifty dollars (\$50) a day in profits and I never had any previous sales experience. KRISS-KROSS sure is a sales getter."
EMIL HAM, California.

Any Way You Look At It!

KRISS-KROSS Offers You The Most Sensational Money of Your Life!

Marvelous New Shaving Invention Upsets All Big-Profit Records in Direct Selling Field. Brings Salesmen \$30 to \$70 a Day With Clock-like Regularity. Investigate Details of This Amazing Money-Maker Without Delay.

SEARCH the whole country over—you'll never find such an opportunity to make real money as KRISS-KROSS offers you today! All the big magazines such as Saturday Evening Post, Liberty, American, etc., carry smashing ads on KRISS-KROSS! Millions of men who've read about it are anxious to see and test it for themselves. As KRISS-KROSS is never sold in stores, it creates a sensational opportunity for salesmen to make big profits—\$30 to \$60 a day and better!

QUICK PROFITS—AND BIG ONES!

Proof? Here's plenty. Take H. King of Mass. He made \$66 in one day—\$10 while he was waiting at a gas station for gas. D. R. Bushnell, of Idaho, made \$8 exactly in one minute. And Emil Ham, of Cal., averaged over \$50 a day his first four days without previous selling knowledge!

FREE MYSTERY RAZOR BOOSTS SALES

We give you a brand new kind of razor you can offer FREE to every man. This unusual razor is really three razors in one! Instantly adjustable. Exclusive feature cuts beard resistance 45% giving the smoothest shave imaginable. As an attention-getter this new razor has no equal.

RUSH COUPON FOR DETAILS

Thousands of dollars are being spent to pave the way for you through advertising. Territories are going fast. Find out all about this sensational, money-making business without delay. See how simple it is to make \$100—\$225 a week with KRISS-KROSS. Clip the coupon immediately.

Rhodes KRISS-KROSS Stropper
RHODES MFG. CO.

Dept. M-373
1418 Pendleton Avenue, St. Louis, Mo.

"AMAZING SELLER" SAYS \$50-A-DAY AGENT

"Most remarkable selling item in my 20 years experience," writes G. O'Leary. "Watch me break my \$50 a day record again when the thermometer hits 90°!"

\$20 FIRST DAY

"I have no trouble whatever in selling KRISS-KROSS stropper. They nearly all take it right out of my hands. I made \$20 my first day."—R. S. HOPKINS, Michigan.

CLEAR \$30 IN ONE DAY!

"I am 67 years old and have never seen an article that sells like KRISS-KROSS. They eat it up. I am sending orders I picked up today—\$30 profit."—M. Y. FITZGERALD, California.

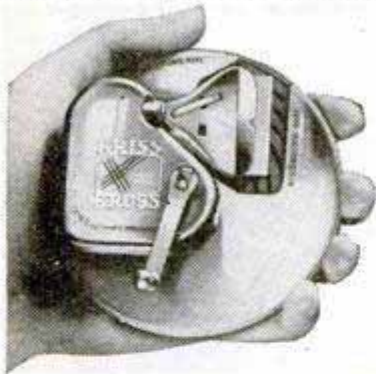

Most Startling Invention Ever Patented

KRISS-KROSS—the marvelous self-seller—is a super-stropper or blade rejuvenator. Unlike anything ever introduced before. This astonishing invention prolongs the life of any make blade for months, even years! Its ingenuity is little short of marvelous. Strops with diagonal stroke just like a master barber—but with unvarying accuracy no human being can ever hope to attain. Eight "lucky leather grooves" do the trick in 11 seconds. KRISS-KROSS strops heavy at start—light at finish—leaves blades with the keenest cutting-edge steel can take.

Think what you offer a man in the KRISS-KROSS! Keen, velvety shaves such as he's only dreamed of! Sharp, "new" blades every day! Freedom from 83% of shaving expense! And finally, the amazing Rhodes guarantee to keep him in razor blades for life!

Rhodes Mfg. Co., Dept. M-373,
1418 Pendleton Ave., St. Louis, Mo.

Please send me full details of your nationally advertised KRISS-KROSS stropper—and explain your unusual sales plan. Also tell me how I can make big money, giving away KRISS-KROSS razors FREE.

Name.....
Address.....
City.....State.....



Aviation Needs Trained Radio Men

Air mail planes, commercial, passenger, express and freight planes, aviators in long distance flights are depending more and more upon their invisible but trusted guide—RADIO. Many new jobs mostly on land are being created for men who know Radio. In airplanes and in airports Radio is taking its place as one of the most essential parts of aviation's equipment to insure safe flying. Many Radio beacon stations for directing planes at night and over long distances are now in operation. Many more are under contract. The Department of Commerce regards a knowledge of Radio so essential to safe flying that they are considering requiring a knowledge of the fundamentals of Radio before granting a pilot his license.

There Are Many Other Fine Jobs in Radio for the Man With the Right Training

In addition to the Radio jobs the expansion of Aviation is making, every year there are hundreds of fine jobs among the many other branches of the Radio business. Broadcasting stations, Radio factories, jobbers, dealers, freight and passenger ships, commercial land stations, and others need men trained in Radio. "Rich Rewards in Radio" points out these openings. Get a copy.

So Many Opportunities Many Make \$10, \$20, \$30 a Week in Spare Time While Learning

Many of my students make \$10, \$20, \$30 a week extra money while learning. I'll show you the plans and ideas that have proven successful for them—show you how to begin making extra money shortly after you enroll, and I'll be training you for aviation, land or air and all other branches of Radio at the same time. G. W. Page, 1807 21st Ave., S., Nashville, Tenn., made \$935 while taking our course. Al Johnson, 1409 Shelby St., Sandusky, Ohio, made over \$1000 in four months working only in the mornings.

I Will Train You at Home in Your Spare Time. Six Big Outfits of Radio Parts Given

You can fit yourself for one of these fine jobs in Aviation or any branch of Radio right at home in your spare time. Don't lose a day from your regular job—not even one hour's pay. I bring my training to you. You don't have to be a college or high school graduate. Many of my graduates now making big money didn't even finish the grades. Boys 14, 15 years old and men up to 60 have finished my course successfully. My practical method of training makes learning easy, fascinating. You can build 100 circuits with the six big outfits of Radio parts I give you.



J. E. Smith
President

64-Page Free Book Tells What Radio Offers You

Get a copy. Clip the Coupon—sign and mail at once. This book has started hundreds of men and young men on the road to bigger success. It is free to ambitious men and young men. Sending in the coupon does not obligate you in the least to enroll. Do it now.

Address J. E. SMITH, President

Dept. 9HH, National Radio Institute
Washington, D. C.

Get this book NOW—it explains what Radio offers YOU

J. E. Smith, President,
Dept. 9 HH, National Radio Institute,
Washington, D. C.

Dear Mr. Smith: Send me your book. I am interested in knowing what the different branches of Radio offer me and how I can learn in my spare time; further how your practical method of teaching with six big outfits gives me practical experience while learning. This request does not obligate me in the least.

Name.....Age.....

Address.....

City.....State.....

Occupation.....



GET INTO AVIATION



Take YOUR place, now. In the business of air navigation. Either as ground expert or flyer, the field is wide. Get thorough practical training NOW, —an intensive course under experts, at this old established School, the "Michigan State."

SERVICE MEN NEEDED. "Aviation in the service field," says executive of Aircraft Development Corporation, Detroit, "wants fellows willing to learn the game from the ground up. The fellow who masters the care of planes from the smallest detail, can go far."

GROUND MEN NEEDED NOW

Learn aviation in Detroit, the aviation center. 20 trained service men needed, to every flyer. Here at the Michigan State we SPECIALIZE in ground instruction. Instead of a few "hourly lessons" we give 132 HALF DAY sessions—over 400 hours in all. You get thorough ground training. Endorsed by Eddie Stinson, holder of U. S. sustained flight record and President of Stinson Aircraft Corp., and other leaders. Write for full particulars of this course, backed by 17 years experience in training.

MICHIGAN STATE AVIATION SCHOOL
A. G. Zeller, Pres. & Gen. Mgr.
3709 Woodward Ave., Detroit, Michigan

How To Secure A Government Position

Why worry about strikes, layoffs, hard times? Get a Government job! Increased Salaries, steady work, travel, good pay. I'll help you become a Custom House Clerk, Railway Postal Clerk, Post Office Clerk, City Mail Carrier, Rural Carrier—or any other Government job you want. I was a Secretary-Examiner of Civil Service Commission for 8 years. Have helped thousands.

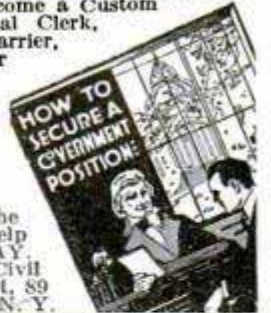

Now FREE

My 32-page book tells about the jobs open—and how I can help you get one. Write TODAY. ARTHUR R. PATTERSON, Civil Service Expert, PATTERSON SCHOOL, 89 Wisner Building, Rochester, N. Y.

The Expert PAINT MIXER

A new book for House and Structural Painters. Thorough instruction in mixing all paints for interior and exterior use, with directions for applying. Also much practical knowledge of color, bases, pigments and liquids. Sent for \$1.25 with return privilege. Write for catalog of PAY-RAISING BOOKS.

DAVID McKAY CO.
Dept. 29, 604 So. Wash. Sq., Philadelphia, Pa.

FLY The Finest Opportunity to Get Into the Airplane Game

Through the combined efforts of one of Chicago's leading AIRCRAFT factories and airplane sales agency we can offer you a course in flying and ground work that is complete in every detail. You learn to build real airplanes. You fly in modern and government licensed ships piloted by licensed pilots. Employment assistance given to students who must earn while they learn. A reasonable amount will start you. Commercial Aircraft Sales., 400 No. Michigan Avenue, Chicago

RADIO LATEST CATALOG OF NEWEST PARTS AND KITS FREE

Fresh from the press. Shows all the newest standard parts, sets, kits at big savings. Most complete line in America. Big discounts to set builders. Send name and address at once.

BARAWIK COMPANY 109 Canal Sta., CHICAGO, ILL.

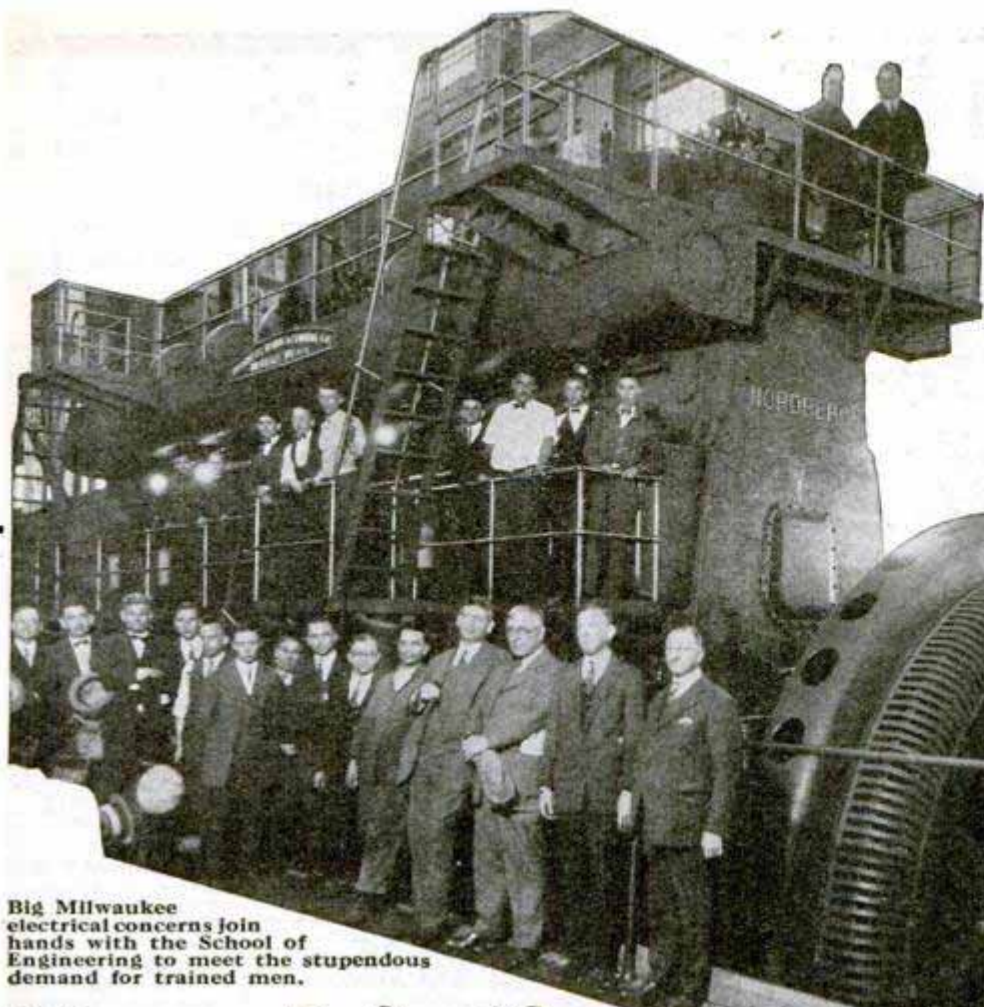

At the request of the United States Government, S. of E. Students Made the Acceptance Test of this Huge Electrical Generating Unit, consisting of 4,000 H.P. Nordberg Diesel Engine direct connected to 3125 K. W., 2300 Volt Allis-Chalmers Generator built for the Panama Canal.

Big Milwaukee electrical concerns join hands with the School of Engineering to meet the stupendous demand for trained men.



Men of Action WANTED FOR COMMERCIAL ELECTRICAL ENGINEERING

Takes you out of the class of the common laborer of which there is always an over plentiful supply at cheap rates of pay. Makes you a Graduate Electrician, Junior Electrical Engineer, or Commercial Electrical Engineer in 12 short months. Puts you in line for a job where big manufacturers are actually pleading for trained men and glad to pay Big Salaries ranging from \$2,000 to \$10,000 a year. Not a dream—A DEAD SURE FACT! For 24 years we have trained men for the electrical profession and Our Graduates Have Succeeded in All Parts of the World. Our 12 months' intensive training is the boiled down essence of what We Know fits men for big paying positions. It is work you'll love. No limit to advancement. Practical engineers teach you. They know What to teach and How to teach it, so you can earn money with it. Hundreds of thousands of dollars' worth of actual commercial machinery to work on in this school.

Uncle Sam Asks S. of E. OK!

Think of the opportunity to test plants such as this. The Nordberg Manufacturing Company is only one of many large concerns that is co-operating with School of Engineering students. This type of practical work, while in school, insures your future when you graduate. That's why our men are always in demand and always command big salaries. You can be one of these men if you ACT!

Earn While You Learn

By our special system you may earn part of your way while learning. Our Employment Department will help you secure a position to which you may devote a part of each day, spending the remainder at the school. This plan both solves the students' financial problems and provides splendid experience at the same time. Low tuition fee. Board and room reasonable. Daily Broadcasting WISN (formerly WSOE). School Orchestra. Fraternities.

Write for FREE Catalog

Write today for our free, illustrated catalog. Read about this wonderful institution and the great opportunities that lie before you. Find out about our specialized method of training and the details of our "Earn While You Learn" plan.



Radio and Electrical Refrigeration

Learn in three months—just 90 days and you can be one of the new group of trained men who will guide and develop the newest and best paying of America's gigantic industries. Radio and Electric Refrigeration are tremendous money makers for the trained man who gets into the game early. Experts are needed for big, responsible, well-paying jobs. We train you quick and help place you in a good position. ACT NOW!

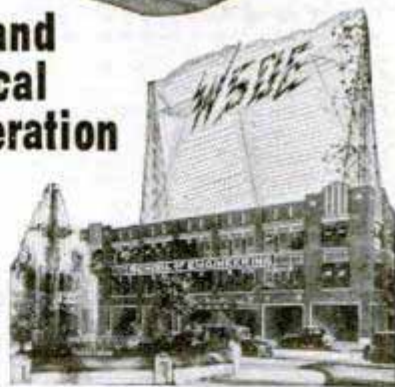

TERMS OPEN Sept. 4th—Oct. 1st.

School of Engineering of Milwaukee,
Dept. PM 928, Milwaukee, Wis.

Without obligating me in any way, please mail free illustrated book, "Electricity and the One Best Way to Learn It," and particulars regarding the course I have marked with an X.

- | | |
|--|---|
| <input type="checkbox"/> Commercial Elec. Eng. for High School Grad. 1 year. | <input type="checkbox"/> Home Lab. Service. |
| <input type="checkbox"/> Commercial Elec. Eng. others 1 to 2 years. | <input type="checkbox"/> Elec. Refrigeration. |
| <input type="checkbox"/> Elec. Eng., B. S. 3 yrs. | <input type="checkbox"/> Radio. |
| <input type="checkbox"/> Automotive Elec. | <input type="checkbox"/> Armature Winding. |
| <input type="checkbox"/> I am interested in your Earn While You Learn Plan. | <input type="checkbox"/> Light, Heat & Power. |
| | <input type="checkbox"/> Practical Electricity. |

Name.....Age.....

Address.....

City.....State.....

Education.....

Discovered!

The Scientific Secret of Caruso's

Amazing Vocal Power

A post mortem of Caruso's throat showed superb development of his *Hyo-Glossus* muscle—again proving the soundness of Eugene Feuchtinger's theories of voice production.

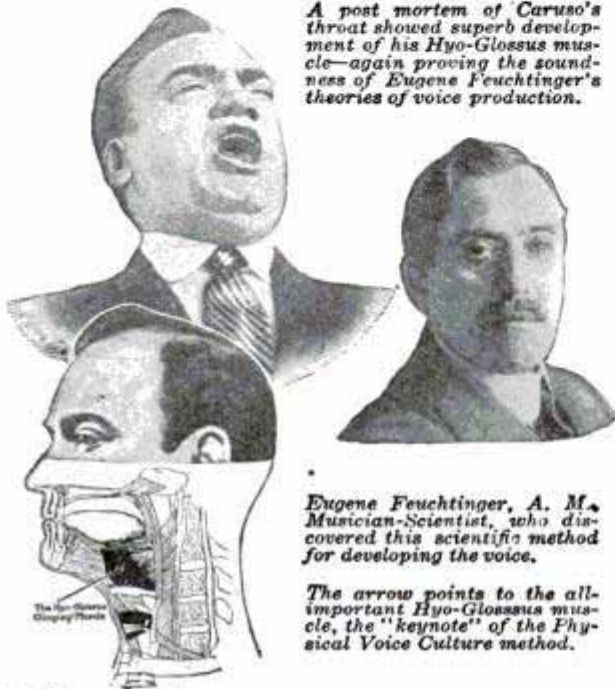

Eugene Feuchtinger, A. M., Musician-Scientist, who discovered this scientific method for developing the voice.

The arrow points to the all-important *Hyo-Glossus* muscle, the "keynote" of the Physical Voice Culture method.

The Great Discovery

Professor Feuchtinger, A. M.—famous in the music centers of Europe—discovered the secret of the *Hyo-Glossus* muscle. He devoted years of his life to scientific research and finally perfected a system of voice training that will develop your *Hyo-Glossus* muscle by simple, silent exercises right in your own home.

Since the Professor brought his discovery to America—over 10,000 happy pupils have received his wonderful training.

100% Improvement Guaranteed

The Perfect Voice Institute guarantees that Physical Voice Culture will improve your Voice 100%. You are to be your own judge—take this training—if your voice is not improved 100% in your own opinion, your entire tuition will be refunded.

Inspiring Book FREE Send the coupon below and we'll send you FREE this valuable work, "Physical Voice Culture". You assume no obligation. It may be the first step in your career. Do not delay.

Perfect Voice Institute

1922 Sunnyside Ave., Studio 13-56 Chicago

Perfect Voice Institute 1922 Sunnyside Ave. Studio 13-56 Chicago

Please send me a copy of your new book, "Physical Voice Culture", FREE. I understand that it is mine to keep and there is no obligation on my part. I am interested in

Singing Speaking Stammering Weak Voice

Name _____

Address _____

Age _____

Learn AVIATION

WHERE LINDBERGH STARTED!

GET TRAINING THAT ASSURES SUCCESS!

COME to the Lincoln Airplane School—where Lindbergh started. Get the same thorough, complete instruction—now under greatly increased facilities. Here you get *practical* Ground and Flying Training. You work on real planes and motors supplied by the Lincoln Aircraft factory. You go right up into the sky in our famous Lincoln-Page planes. Competent, experienced instructors. Write at once for full information!

LINCOLN AIRPLANE SCHOOL
Successors to the Lincoln Standard Aircraft School
2417 O Street, Lincoln, Nebraska

DEVELOP POWER

AT HOME

to *initiate, persevere, achieve*; carry on through life your education; earn credit toward a Bachelor degree, by using the 450 courses

The University of Chicago Gives by Correspondence

Inquire, or check the advertisement to show desire and mail to 327 Ellis Hall, University of Chicago, Chicago, Illinois.

Learn to Mount Birds



Learn at home by mail, to mount birds, animals, game heads; tax furs, make rugs and robes. Complete lessons. Easily and quickly learned by men, boys and women.

FREE Write today for Free Taxidermy Book. Tells all about it. Every Sportsman, Hunter, Trapper and Nature lover should know this wonderful fascinating art. Save your trophies. Big profits. Success guaranteed. Our school is 20 years old—100,000 graduates. Investigate today. Write for Free Book.

Northwestern School of Taxidermy 9376 Elwood Bldg., Omaha, Neb.



I POSITIVELY GUARANTEE

to increase your arms one-half inch in size, chest one full inch, strength 25%, health 100% in one week's time, by following my instructions and using my exerciser 10 minutes mornings and at night. Send \$1 for complete course and exercisers. Satisfaction guaranteed or \$1 refunded. Prof. J. A. DRYER, Box 1850-P, Chicago, Ill.

HEAVIER PROFITS—LIGHTER SALES MASTERLITE CIGAR LIGHTER



Guaranteed for life. Sells on a flash demonstration to smokers and dealers at big profits. Each sale brings everlasting repeat business. \$3.50 brings sample dozen (on which you make \$5.50 clear) in handsome display box, with sure-fire selling plans. Sample 50c.

RADIO GAS LIGHTER

Lights Gas Without Flame or Friction

Lights Mantles, Hold Directly Over Gas Stoves, Jets, Gas Flow. Lights and Heaters. Instantly.
A big 25c seller, paying 300% profit. A gross, easily sold in a day, nets you \$26.00 profit. Rush \$10.00 for gross, or \$1.00 for sample dozen with sure-fire self-selling plans.

MASTERLITE MFG. CO., Dept. J-23
110 E. 23rd St. NEW YORK CITY



Get into the Big Game!

Be a Radio Operator

Take the Radio Way to Bigger Pay

Now for the first time an entire course of training for Radio Operator or Inspector is presented in a big handbook—the most complete and up-to-date book on the subject. Prepared by two of the highest authorities; 16 chapters developed from the elementary stage right through the whole subject so that a beginner with no knowledge of electricity may get from it a thorough knowledge of radio operation. Meets every need of the student who wants to fit himself for the highly paid profession of Operator or Inspector and prepares him to qualify for government license.

A Complete Course in Radio Operation

In a Single Volume

THE RADIO MANUAL

Full Preparation for Government License

There is a rapidly growing need for trained radio operators and inspectors in aviation, on ships, and in commercial stations. The entire course of study needed to pass the Dept. of Commerce examination for any grade of operator's license is presented in this one book.

Prepared by Official Examining Officer

"The Radio Manual" has been prepared by G. E. Sterling, Radio Inspector and Examining Officer, Radio Division, U. S. Dept. of Commerce. It has been completely edited by R. S. Kruse, for five years Technical Editor of Q. S. T., the magazine of the American Radio Relay League.

16 Chapters Cover: Elementary Electricity and Magnetism; Motors and Generators; Storage Batteries and Charging Circuits; The Vacuum Tube; Circuits Employed in Vacuum Tube Transmitters; Modulating Systems; Wavemeters; Piezo-Electric Oscillators; Wave Traps; Marine Vacuum Tube Transmitters; Radio Broadcasting Equipment; Arc Transmitters; Spark Transmitters; Commercial Radio Receivers; Radio Beacons and Direction Finders; Radio Laws and Regulations; Handling and Abstracting Traffic.

New Information never before available, such as a complete description of the Western Electric 5 Kilowatt Broadcasting Transmitter; description and circuit diagram of Western Electric Superheterodyne Radio Receiving Outfit type 6004-C; Navy Standard 2-Kilowatt Spark Transmitter; etc., etc. Every detail up to the minute.

Special Price—Free Examination

"The Radio Manual" is now on the press and will be ready shortly. Regular price after publication will be \$6.00. Orders received now will be accepted at the special advance price of \$4.95—an amazingly low price for the best Radio book available. Sent for free examination. Pay or return in ten days.

ORDER ON THIS COUPON

D. Van Nostrand Co., Inc., 8 Warren St., New York.

Send me as soon as published THE RADIO MANUAL for examination. Within ten days after receipt I will either return the volume or send you \$4.95—the special advance price.

Name..... (Pop. Mech. 9-28)

St. & No.....

City and State.....

Over 900 Pages Profusely Illustrated. Bound in Flexible and Durable Fabrikoid. A handy book for shop, desk or bag.

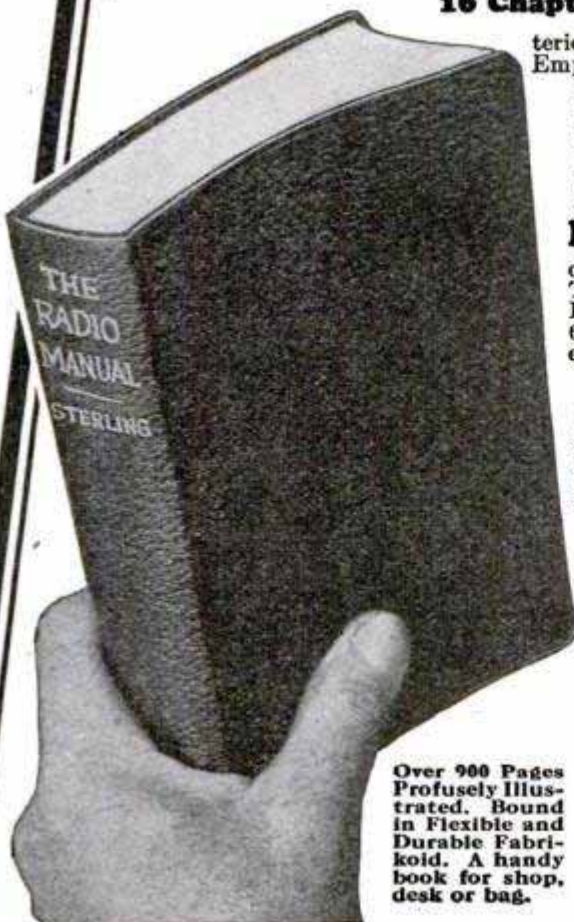



DRAFTING BOOKS SENT FREE



Only 15 minutes a day with these WONDER BOOKS will prepare you for a good Drafting job in less than a year! Mechanical and Architectural Drafting from simple straight lines to important, complex plans, *one-step-at-a-time!* Built especially for BEGINNERS, for men with only grammar school education.

For Beginners 4 Big Volumes

Written so you can understand every word, by 18 noted Engineers and Architects. De Luxe, flexible binding. 1750 pages, 1050 blue-prints, charts and diagrams; revised edition at reduced price, *on easy terms.*

Competent Draftsmen are urgently needed right now in all building construction and manufacturing lines. Fascinating work in pleasant surroundings, offering large salaries and splendid chances for advancement. *Any man who can read blue-prints and draw plans is always sure of a well-paid position and first in line for promotion.*

Year's Consulting Membership Included

The right to consult the Engineers and Architects of the American Technical Society is included with these books. Many say this service alone is worth as much as the books.

Jobs Paying \$50 to \$100 a Week!

Easy to Learn In Spare Time

Thousands of men like you have learned Drafting with these books. *You can too.* Mail coupon and we'll prove it at our risk. Pay-raising opportunity for mechanics, clerks and other ambitious men.

American Technical Society

Dept. D-619
58th St. and Drexel Ave., Chicago, Illinois



Modern American Homes FREE!

American Technical Society
Dept. D-619, 58th & Drexel Ave., Chicago

Send for 15 days' free use 4-volume set of DRAFTING. In return for mailing this coupon promptly send absolutely FREE "Modern American Homes," 112 plates, exteriors, interiors and plans. I will pay only the few cents delivery charges. If I wish I may return books in 15 days and owe you nothing. But if I prefer to keep them I will send \$1.80 after 15 days, then \$2.00 a month until \$14.80 (special reduced price) is paid.

Your Name.....
 Your Address.....
 Reference Name.....
 Reference Address.....

Boys

WIN A BICYCLE LIKE THESE FELLOWS



These boys all won their bicycles from The Crowell Publishing Company. Each week they deliver to regular customers The American Magazine, Woman's Home Companion and Collier's The National Weekly. It takes only a small part of their spare time and they earn cash commissions as well as many other dandy prizes.

You Can Do the Same

Answer this ad and learn how easily you can have a bicycle.

The Cost is Free

Let us tell you how to find the readers of these well known magazines who are located in your neighborhood. It's as easy as play and you need no experience to start.

Mail this Coupon - Now

Mr. Jim Thayer, Dept. 70,
 The Crowell Publishing Co.,
 Springfield, Ohio.
 Dear Mr. Thayer: I want to start earning prizes.
 My Name.....
 Address.....
 Town.....State.....



**SALESMEN AND AGENTS
WANTED!**

Scientist's Amazing Discovery Makes Old Cars Like New!

Goodbye, Shabby Old Cars! New and Amazing Discovery Brings Back Original Finish Like Magic! Easy to Apply—Just Flow It On! Lasts Indefinitely! Sells Like

Wildfire Netting Agents as High as \$25 a Day and Better! Right Now the Inventor Will Send You FULL-SIZE Sample at His Own Risk! See Coupon Below.

MAKE \$150 A WEEK...AND MORE!

HERE is an astonishing new liquid discovery that restores show-room lustre and color to old cars—and adds 100% to their appearance in a single hour, yet actually costs less than a good inner tube! Nothing like it has ever been known before. It is not a wax—not a polish—not a paint—not a cleaner! It is simply a transparent liquid that possesses the mysterious power of rejuvenating original color and producing a mirror-like gloss at the same time. It LASTS, TOO—for month after month!

So surprising and amazingly successful is this remarkable discovery (called NAVON) that salesmen all over the country are piling up big, liberal commissions for just a few hours work. J. Porter (Wis.) took in \$98 in a single day. And H. Geiss (Ill.) made \$300 in one week just showing it to motorists and friends.

Easy To Apply!

NAVON comes in a handy container ready for instant use. Just put it on the car as it comes out of the can, guiding its flow with a piece of cheese cloth. No fussing with brushes or tiresome rubbing. It flows smooth and dries without streaks. No experience necessary to get perfect results. Dozens of enthusiastic

NAVON

INSTANT REFINISH
FOR ALL SURFACES

CONSOLIDATED SPECIALTIES CORP., Dept. 56-M
21 W. ELM ST. CHICAGO, ILL.

users write that it is "easy as washing a car"—and "not half the trouble of waxing."

And not only that, NAVON is guaranteed harmless and safe. Contains no acids, alcohol, benzol, or other injurious substance. Acts both as a protection and preservative. Fine for metal, leather and wood.

Sensational Money-Getter!

Nothing offered to the auto public has ever made such an instant hit as NAVON. 9 out of 10 motorists want it on sight. Agents and demonstrators are pocketing surprising profits—up to \$150 and \$300 a week. Even spare-time workers are making \$10 to \$15 an evening or Sat. afternoon just showing NAVON to friends, neighbors, etc.

Be the NAVON representative in your locality—and get your share of the profits that are awaiting. Wonderful money, too, in operating a Service Station—from \$5000 to \$10,000 a year. NAVON-izing cars for people in your town. You can start right away in your own garage—or rent one, clearing as high as \$65 a day!

SEND FOR DETAILS and our 14 Tested Money-Making plans—together with a TRIAL OFFER that allows you to test NAVON on your own car without a penny's risk! No obligation. Mail the coupon today!

READ

what users say of this amazing discovery.

"SURPRISED!"

"I refinished my 1925 Ford with NAVON and it looks as good as the day I bought it. I am surprised at the results and so is everybody else." W. A. Burge, Mass.

"GREAT!"

"NAVON certainly exceeded my expectations. I think it is great and so do my friends. I am going to start a NAVON Service Station and have already secured a garage." Geo. Kelley, Pa.

Consolidated Specialties Corp., Dept. 56-M
21 W. Elm St., Chicago, Ill.

Without obligation, send me your No-Risk TRIAL OFFER, together with special Money-Making proposition on NAVON.

Name.....

Address.....

Town..... State.....

908.

and. x. sailing.

BOAT'S SAILS ARE SHAPED LIKE AIRPLANE WINGS

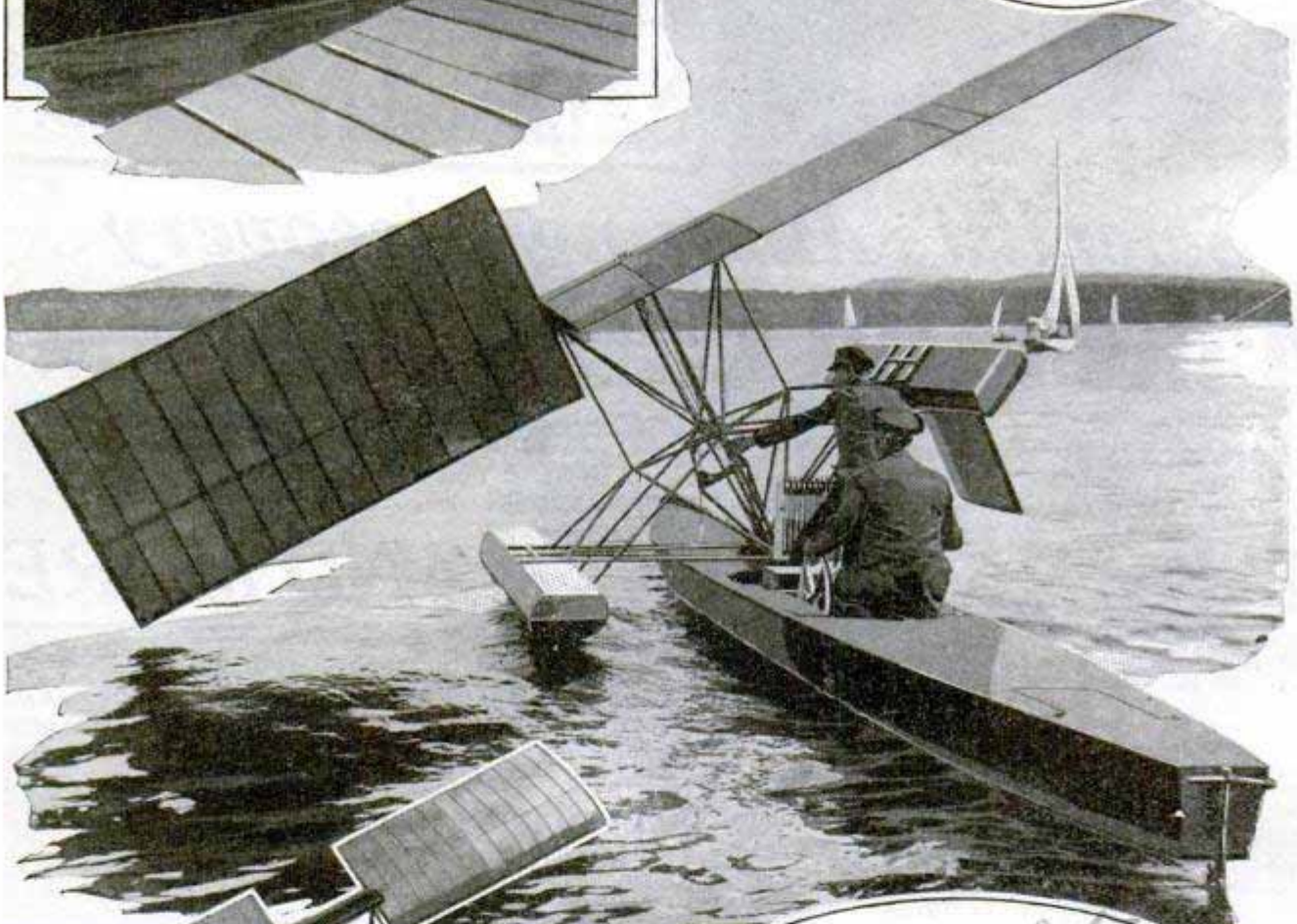
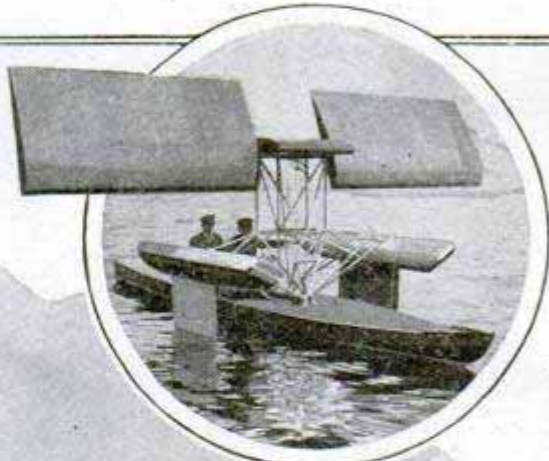

Pro
 Something New in Sailing Craft Is This Boat, a Racing-Shell-Type Hull, Fitted with Pontoons, Each with a Deep Keel and Arranged So They Can Be Raised or Lowered, and a Sail Plant Adapted from an Airplane's Wing; the Sail Is Pivoted, So It Can Be Inclined to Either Side, and the Wing Tips Likewise Are Pivoted to Be Turned to Catch Varying Winds; the Boat Is Handled Entirely by Gear Levers, Instead of by Hauling on Ropes.

Hotograms

The Adjustable Wing Sails and the Movable Pontoons of the Queer Airplane Sailboat as They Appear in Different Positions; the Entire Sail Structure Is Pivoted

Popular Mechanics Magazine

REGISTERED IN U. S. PATENT OFFICE

WRITTEN SO YOU CAN UNDERSTAND IT

Vol. 50

SEPTEMBER, 1928

No. 3

Radio Phones Link Ship to Shore

By F. B. HOWE

"SAY, BILL, this is the 'Avalon.' We've been held up by a storm and will be three hours late in docking. Have the stevedores ready and I'll call you again if we run into any further delay."

Such conversations as this are being carried on every hour between Los Angeles harbor and the fleet of steamers and tugboats that scurry about in southern California waters as a result of the perfection of a radio telephone which enables conversation to be carried on between the various ships and from the boats to shore with the same ease as over ordinary land telephones.

R. D. Lemert, radio operator, some time ago conceived the idea of equipment that would enable a man on the dock to pick up an ordinary telephone, lift the receiver off the hook, and immediately talk with any one of the eight tugboats or three steamers operated by the Wilmington Transportation company.

After a year and a half of experiment, the equipment is in daily operation and looked upon as a matter of course by the ship officers. Where heretofore a tugboat finishing the job of taking a steamer out to sea had to return to the dock—with loss of an hour's time and burning of con-

siderable oil—the captain now drops the lines of his charge, picks up an ordinary telephone, lifts off the receiver and turns a single dial to the wavelength of the particular office on the dock to which he wishes to talk.

Communication between the various ships of the fleet is similarly accomplished. If the captain of a steamer of the line, upon arriving in a harbor, finds he needs a tug where he had thought one would not be necessary, he no longer anchors and frantically blows signal blasts on the ship's whistle until someone hears the call. Instead he phones to any tug he sees in the vicinity and, in a jiffy, the ship is on its way again.

Tugboat Captain Receives Instructions from Shore While Towing a Ship, through Radio Telephone Installed on Deck



*James C. Oldy
Home, 3rd Floor, Los Angeles, Calif.
Photographs by Frank R. Howe*

*Inventor, R. D. Lemert
Wilmington Transportation Co*



Radio-Phone Office at the Docks, with Loud Speaker and the Radio Instrument in Use; at Right, the Ship Captain Talking with Men on Shore by Wireless

Although the system has not been in operation long, there have been numerous interesting instances of the radio telephone's immense value. At least one shipwreck has been avoided through its use. This occurred when one of the tugs was taking a ship to sea and the steamer's steering engines suddenly broke, leaving the craft helpless. With only the single tug to aid her, the ship began to drift rapidly shoreward. The captain of the tug grabbed his phone.

"The ship I'm towing just broke her steering engine," he told the dock. "She's starting to drift ashore and I can't hold her off without some help. Get three tugs out here quick."

There wasn't a single tug idle at the dock, but that didn't handicap the dispatcher. Quickly he called three of his tugs, all at sea or under way in the channel, and informed them of the situation. In ten minutes they were at the scene of the trouble and the steamer was saved.

On another occasion a German merchantman arriving in the harbor was taken in tow by one of the phone-equipped tugs. The German skipper thought he was supposed to go to one dock; the tugboat captain understood another, and the pilot had been told it was to be a third.

"Come down on my tug and I'll let you telephone to shore and find out," offered the captain. With difficulty he was per-

sueded to descend to the deck of the tugboat. The captain handed him a telephone. "Go ahead and ask them," he said. "That's your man on the phone now."

When the German master had been con-



vinced that the offer was legitimate, he went ahead with the conversation and in five minutes had the information and was on the way to the dock. A saving of not less than two hours was effected thereby, while the time of a hundred stevedores and further delay for the ship were spared.

Describing his accomplishment, Mr. Lemert says:

"At present all tugs and steamers are equipped with telephones operated on 2,750 kilocycles or 109 meters with a radius of 200 miles on the smaller tugs and 500 miles on the larger ones. This is by voice entirely. There is practically no variation in day and night operation.

"The equipment is very simple and has very few controls. The transmitter itself has but one dial for the control of the transmitted frequency. It is possible to vary the frequency of these sets from 70 to 140 meters with this one control. After the set has been tuned to the wavelength it is licensed to operate, this dial is locked and left alone.

"The equipment consists of a regular desk phone and loud speaker. When the person operating one of the stations de-

sires to call another station, he simply takes the receiver off the hook, which, in turn, starts the transmitter. The connection is made by speaking the call letters of the station wanted and the conversation begins.

"Further elaboration has been made on the steamers 'Catalina' and 'Avalon' by having the ship's wireless operator act as a sort of central station from which calls are connected to the bridge, captain's cabin, engineering room or purser's office as may be desired."

COTTON-PLANT SHAKER AIDS WAR ON BOLL WEEVIL

One of the latest units in the battle against the boll weevil, which does more than \$300,000,000 damage in this country annually, is a plant-shaking machine which treats twenty acres a day and at little expense. It is drawn by horses, straddles two rows at a time, and as it passes along, the plants are bent and shaken in such a way that infected bolls, trash, weevils and other insects fall into a pan of oil carried on the machine below. The oil is fatal to the weevils. When the pan is filled, it is easily cleaned and the contents may be burned. Waste oil, such as is drawn from automobile crank-cases, can be used, hence the expense of the treatment is slight. The shaking is said not to damage the plants or the sound bolls. The mechanism that performs the shaking is an elaboration of the hand method of executing the same operation.



Shaking Weevils from Cotton Plants; the Pests Fall into a Pan of Oil and Are Killed

802

Propeller of This Model of the "Spirit of St. Louis" Does Duty as an Electric Fan

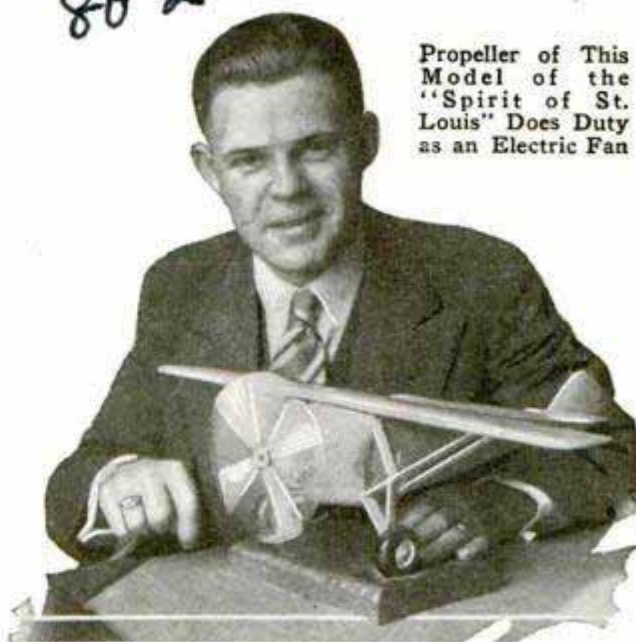

FAN LIKE LINDBERGH'S PLANE KEEPS COURTROOM COOL

Modeled after the famous "Spirit of St. Louis," an electric fan has been devised by a California jurist to keep his courtroom cool. The propeller corresponds to the usual blades in an ordinary fan and furnishes a pleasant breeze on sultry days.

Judge Samuel Blake

CLIPPER-SHIP LINES RETURN FOR OCEAN YACHTS

Removal of the ten-per-cent luxury tax on the over-all length of pleasure yachts has brought about a return to the long graceful lines of the clipper-ship era, marked by ornamental bows, long bowsprits and flaring overhang at the stern. Yacht design has changed radically in recent years, largely because of the turn to Diesel engines for power. A 175-foot yacht with heavy-oil engines has as much room for owner, guests and crew as a steam yacht 250 feet in length, due to the saving of engine and fuel space. The engine room need only be about one-half as long in the Diesel-engined craft, and the casing above it, carrying the smokestack and covering the upper part of the boilers in a steam vessel, is much smaller. Another advantage of Diesel power is the decreased weight of machinery, providing more space and tonnage for fuel, water and supplies, so that the yacht has a greatly increased range. The low center of gravity of this engine also increases the stability of the boat.

Los Angeles. The Sporterman July, 1928

% Alamo Iron Works, San Antonio, Texas

Morcotton Ball Weevil Machine

Mrs. A. A. Lehburg, 825 Sadie St. E. H. Street 945

Faculty of Medicine
86/ Lyons University, Lyons, France.

POPULAR MECHANICS

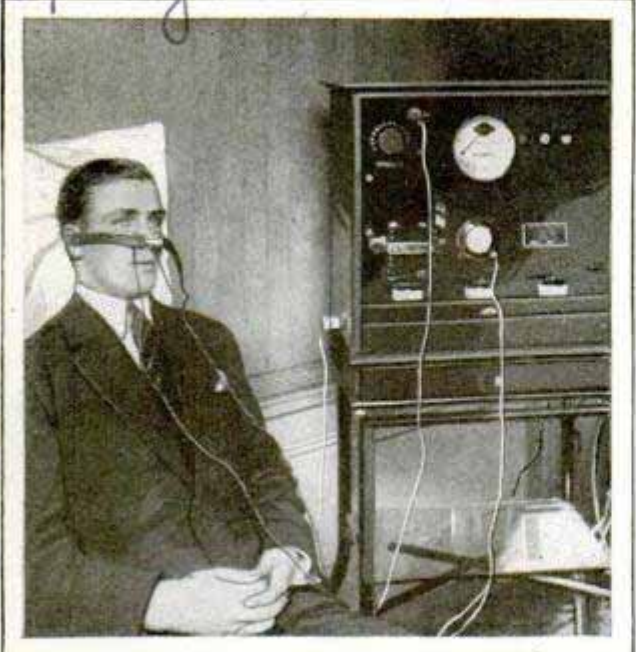

Treating Nose Tissues with High-Frequency Electric Current to Help Cure Cold

"ELECTRIC DOCTOR" IS USED TO TREAT COLDS

Beneficial results in treating colds with an "electric doctor" are reported from France. The instrument employs high-frequency current to generate heat that penetrates the nose linings and thus destroys germs. Relief has been obtained in ten minutes or less, it is said. The treatment does not injure the nose tissues.

VACUUM-BOTTLE FREIGHT CAR CARRIES MOLTEN METAL

Tons of molten iron are transported from furnaces to the rolling mills in Ohio, in big ladle cars that resemble giant vacuum bottles. They are lined with fire brick and fitted with lids somewhat like those of the familiar containers. To empty them, they are tilted by an electrically operated mechanism and the molten iron



Special Ladle Car for Hauling Molten Iron

runs out like so much water. When filled, the car weighs more than 340 tons. Each is fifty-six feet long. To prevent accidents, the tilting machinery can be operated only when the car is stationary.

ROCKET PLANE IS SUCCESSFUL IN-FIRST FLIGHT

A rocket airplane, built by Fritz Opel, the German automobile builder who produced a rocket-driven automobile a few months ago, has been successfully flown in a secret test in the German mountains. The craft, a monoplane, is of the tail-in-front type, with no fuselage behind the wings, thus giving a clear space for the rocket discharge. A shield back of the pilot protects him against accidental explosion of the ammunition, and from the heat generated in its discharge. Prior to the test of the big machine, a six-foot model was flown successfully for about 1,000 feet under power, gliding safely to earth after the last rocket had exploded. Another German inventor, working along the same lines, flew a model biplane of conventional design, with the tail behind the wings. Following Herr Opel's experiments with his rocket automobile, which attained speeds of 125 miles an hour within a few seconds after the start, he built a rocket railroad car which came to a disastrous end about the same time the plane was being tested. Through some fault in the ammunition, all of the rockets became ignited at once, blew the car high in the air and killed a cat which had been placed aboard to test the effects of wind pressure.

WASHABLE WALLPAPER

Dust, grease and even ink stains can be washed from a special wallpaper that is colored in soft tones and has none of the high gloss usually associated with washable wall coverings. A damp cloth will remove most of the marks. The paper is especially suited to kitchens, bathrooms and rooms where children play and are likely to smear the walls with their fingers.

Between Hamilton and Middletown, Ohio

974

98/

Germanical & chobit
Technical & chobit
Curelms & unia

1023

Columbus Union Oil Cloth Co

FLYING FIREWORKS LATEST THRILL OF GERMANS

New Opel Rocket Plane in Full Flight, and, Below, the Rear of the Fuselage, Which Carries Its Tail in Front; the Arched Shield Protects the Pilot from Heat and Possible Premature Explosion of the Rockets

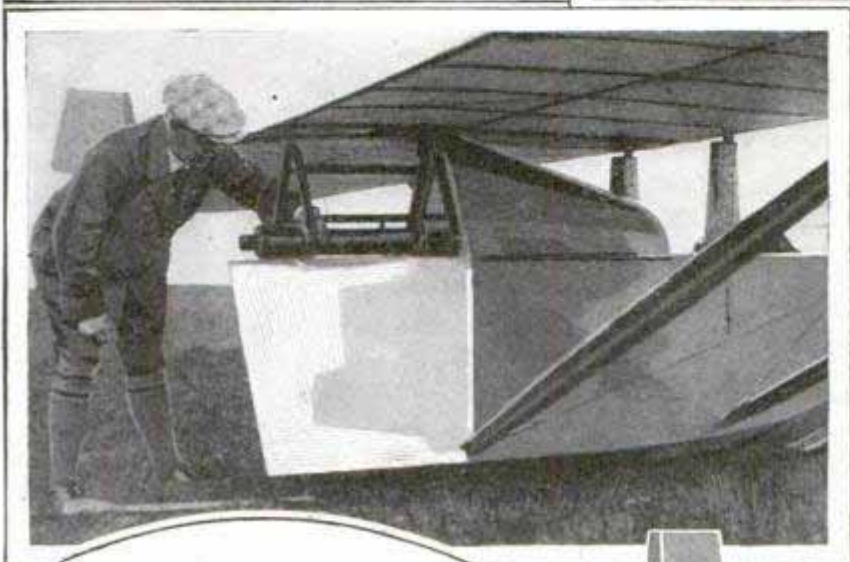
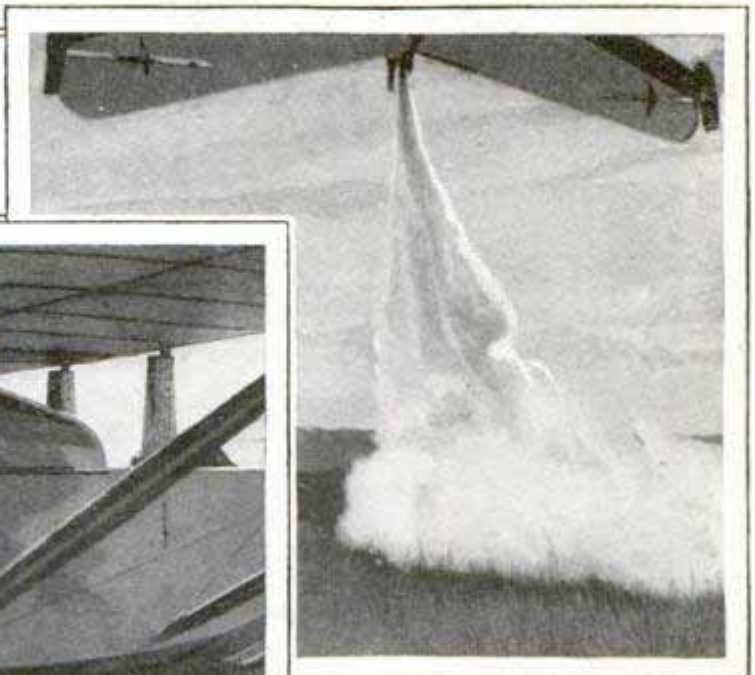

The Pilot's Cockpit of the Opel Rocket Plane; the Shield behind Him Covers the Rocket Compartment, While, in Front of Him, the Fuselage Is Carried Forward to Support the Stabilizer, and the Rudders, as Shown Below, Are Built above the Wing Tips; the Insert Shows the Machine in Flight, the Figure of the Watcher on the Ground Giving an Idea of Its Size; These Pictures of the Secret Tests of the Rocket Airplane Were Taken at the Trials Conducted by Herr Opel in the German Mountains, Following the Tryouts of the Rocket Idea on an Automobile and a Railway Car; the Former Developed a Speed of More Than 125 Miles an Hour, the Rail Car Being Even Faster

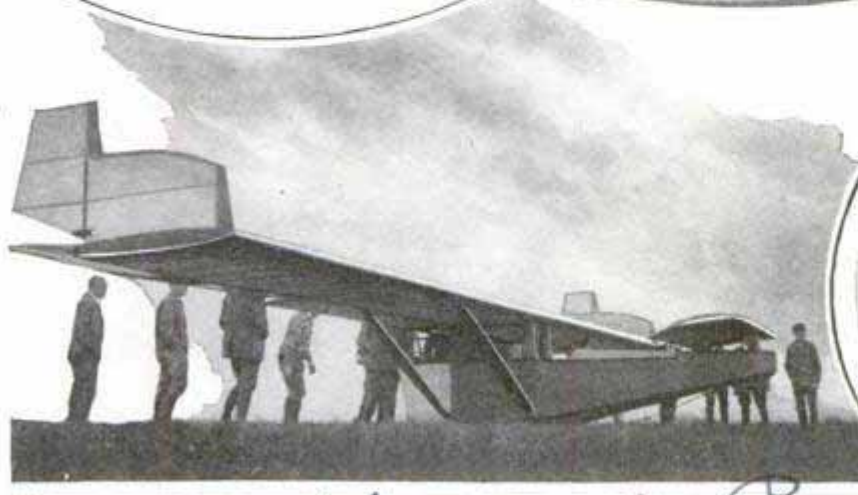

*Emb George H Paul
A-809 5378
Chicago*

983

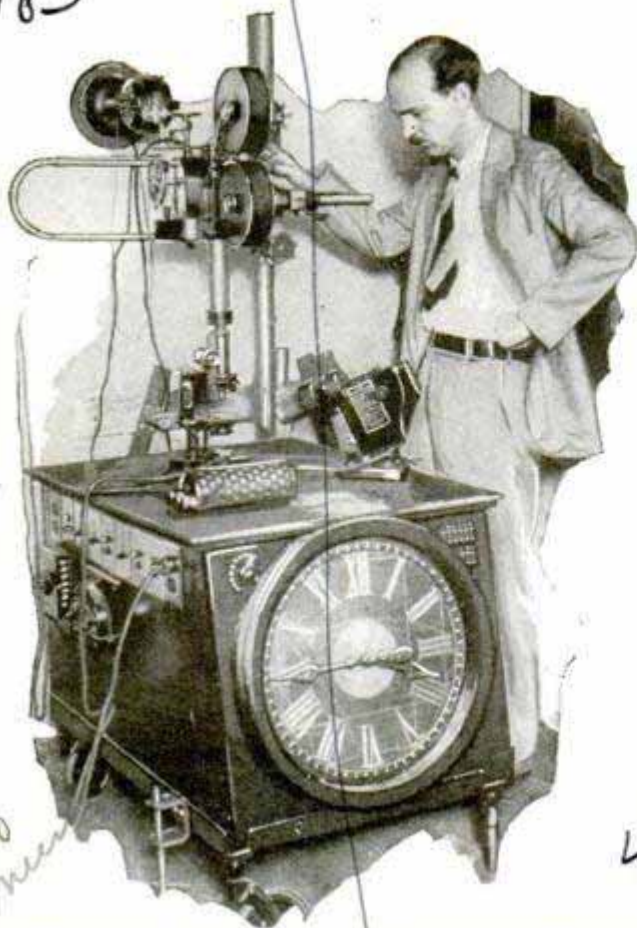

Combination Motion-Picture Camera and Microscope
Operated by Clockwork for Filming Germ Life

FILM MYSTERIES OF GERM LIFE WITH CLOCKWORK CAMERA

Photographic records of the life of a chicken within the egg, of the beating of a turtle's heart, how germs and flowers develop, and many other interesting phenomena, are accurately made with a combination microscope and moving-picture camera apparatus devised by a student of the University of Maryland. A feature of the apparatus is that exposures are made at regular intervals and at almost any frequency desired, by setting the clockwork mechanism that operates the shutter and moves the film, so that, after the instrument has once been properly adjusted, it needs but little attention.

College Park, Md.

BRIDGE TWELVE MILES LONG TO SPAN FRISCO BAY

Stretching a slender white arm across the blue waters of San Francisco bay, a bridge, twelve miles long, will soon be at the service of motorists. It reaches from Mt. Eden, near Oakland, to San Mateo, just south of San Francisco, the bridge

proper being seven miles long and the approaches five miles. With the exception of five steel spans near the western shore, the center being a lift span to permit the passage of vessels through the ship channel, the bridge is constructed entirely of concrete, piles, decking, sills and hand-rails all being of this material. The piles for the structure are being sunk with what is known as a four-lead driver which sends down two piles at the same time. Special cranes have been built to handle the piling and the deck slabs from the barges. Although extremely stiff, concrete piling has to be lifted with care, so, in order to distribute the weight evenly, the crane is equipped with a system of equalizing blocks which automatically distribute the weight, to the pound, between four lifting points, before the piling leaves the form.

BELL WEIGHING NINETEEN TONS CAST FOR CHURCH CHIMES

444

One of the largest bells in the world has been cast at Croydon, Eng., for the chimes to be installed in the Laura Spelman Rockefeller carillon of the Riverside church in New York City. It weighs nineteen tons and is ornamented with an angel figure in bas-relief. Many smaller bells will be needed for the finished set.

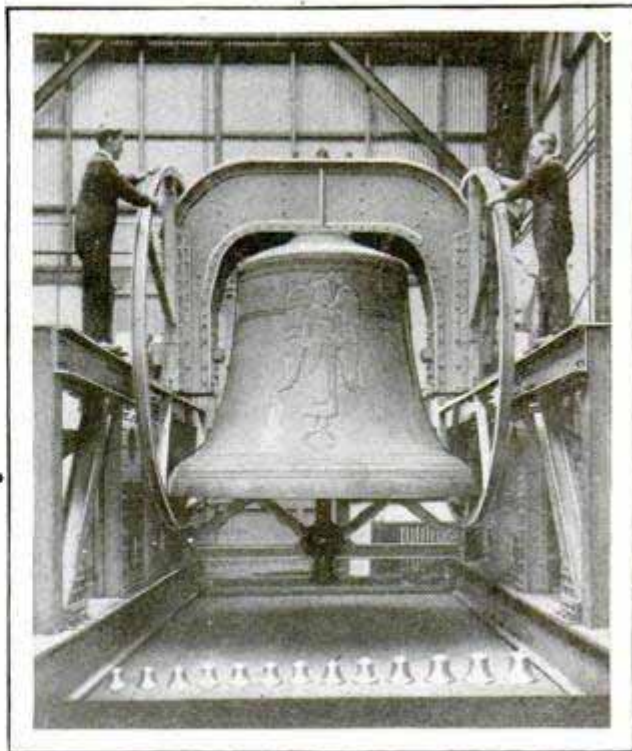

Nineteen-Ton Bell for Carillon in New York Church;
Compare Its Size with Little Bells in Front

Croydon Bell Foundry

Photo
Culley
Calameda,
Bar 44
white
1015
Cnd Tom

GOLF COURSE FOR HOTEL GUESTS BUILT ON ROOF

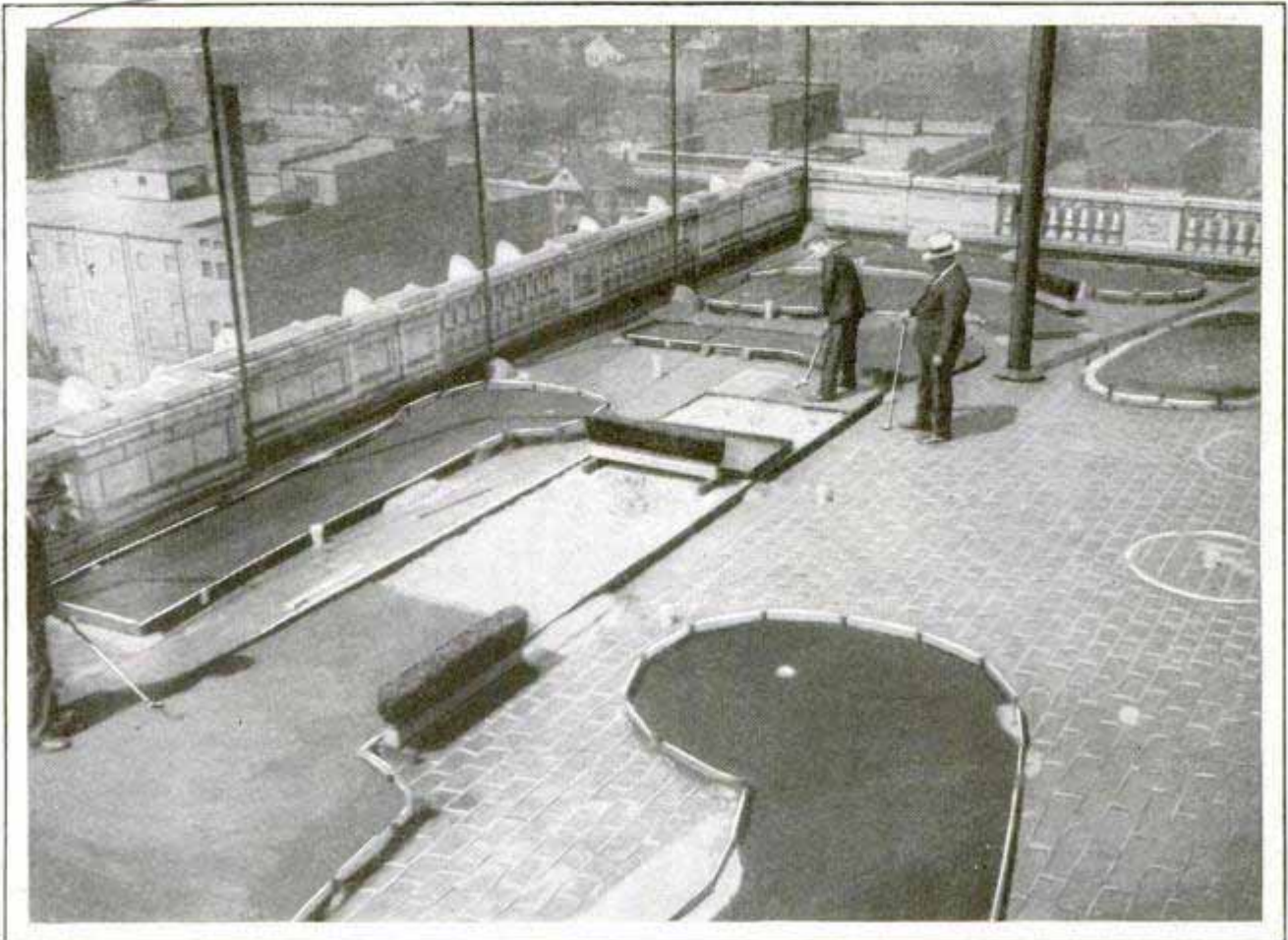

Golf Course on Hotel Roof Has Many Hazards and Tests the Skill of the Best Players; a Round of the Eighteen Holes Gives Helpful Practice in Putting and Other Strokes

Golfers at a southern hotel may keep in practice and enjoy their sport even when unable to go to the regular playing links, as an eighteen-hole course has been laid out on the roof of the building. There are fourteen sand traps, six water hazards, and the fairways average six feet in width and forty feet in length. A player of average skill requires thirty-five to forty minutes to complete the course. To keep the balls from falling to the street, a wire netting has been placed around the building at the edge of the roof. It curves several feet over the course.

water-proof circular wall, thirty-six feet deep, around the foundation. When this is completed, they believe it will be possible to force cement into the well so fashioned and stop the inroads of the water.

PLAN TO SAVE TOWER OF PISA BY FREEZING GROUND *1065*

Engineers have discovered that the leaning Tower of Pisa is being undermined by subterranean springs and a way to halt the damage has been proposed by refrigeration experts. They hope to keep the water at bay by freezing the ground with refrigerating machinery, then build a

BUTTON TURNS ON GAS HEATER SAVING TRIP TO CELLAR *932*

One of the latest conveniences for the home is an electric push-button device to turn on the gas water heater in the basement. It saves many trips up and



downstairs, is easily installed and is safe and certain in operation, the manufacturers assert. If forgotten, it automatically shuts off the gas when the water reaches a predetermined temperature.

*Compressed Air
July 1928*

*Isas. Isard Co. Inc
375 E. Main St*

842

Polar

Despite the long roll of men who have disappeared into the frozen seas, never to be seen again, the lure of the earth's poles remains as great as ever, and probably will not die until the north and south have yielded their last bit of information.

Wireless and airplanes can keep the world informed from hour to hour of the dangers and perils of the explorers, but neither can overcome the obstacles of ice, fog and storms and insure prompt relief,

SAILING home to its base ship after a successful flight over the North Pole, the dirigible "Italia," became loaded down with ice, then crashed and broke up, leaving one dead and nine living men on the ice, while the gas bag, freed of the weight of control-car and engine gondolas, floated away and disappeared, with six men aboard. Some time later, a great column of smoke, twenty-five miles or more away, indicated its probable fate, and another mystery had been added to the toll of the polar seas.

Three parties had already been to the North Pole before Gen. Umberto Nobile and his companions started their last flight. Peary had arrived on foot some twenty years before; Byrd and Floyd Bennett flew over and back in a plane; and Amundsen, Ellsworth and Nobile had crossed in the "Norge." Two expeditions, that of Amundsen and that of the ill-fated Captain Scott, had stood at the South Pole within a few weeks of each other, yet at the moment the "Italia" started on its last voyage, Commander Byrd was organizing an expedition to explore the antarctic ice continent by air.

The Ill-Fated "Italia" in Flight, Leaving Spitzbergen for Its Last Trip to the North Pole

so that polar exploration, despite all the aids of science, remains virtually as dangerous as when the greatest polar tragedy of all time swallowed the 129 men of Sir John Franklin's expedition. The "Italia" party was in touch with civilization within a few days after the crash—as soon as the radio could be repaired—but fourteen years passed before searchers found a clue to the fate of the Franklin expedition, and it remains as great a mys-

Mysteries



Sir George Wilkins, the Australian Explorer, Using a Dog Team to Tow His American-Made Plane to the Starting Point at Point Barrow, Alaska, for His Flight to Spitzbergen

tery today as it was sixty years or more ago. For the 129 men died, apparently from starvation, while surrounded with tons of canned food and in a land abounding in seal, walrus, polar bears and food of similar nature.

Sir John Franklin set out from England in May, 1845, with two ships and his 128 companions, the pick of the British navy. A third vessel, carrying supplies, accompanied them to Greenland. The food supplies included 32,000 pounds of tinned meat, 17,416 pints of soup, 2,176 pints of gravy, and vast supplies of navy salt rations. On July 26, 1845, a whaler met them in Lancaster sound—and they were never seen again by white men.

Years later, after nearly a score of searching parties had patrolled the northern coast of Canada and the arctic lands stretching toward the pole, a party of Hudson's Bay company men, coming overland from the north, met Eskimos who had seen a large party of white men six years before. They were dragging heavy sledges overland toward the south. Following up the clue, thirty-five skeletons were found, and the Eskimos produced silver spoons and other articles obtained from the sleds. Assuming these thirty-five had starved in a land abounding in game, what had become of the other ninety-four?

Fourteen years after the expedition had disappeared, Lady Franklin's final expedition in search of her husband came across a cairn at Point Victory, and in it was a message from one of the officers, dated May 18, 1847, telling of the death of Franklin and twenty-four others. The 105 remaining (including the thirty-five whose bodies had already been found) were that day abandoning their ice-locked ships to start overland to a trading post. The rescuers followed the trail and eventually came on a ship's boat mounted on runners. In it lay two bodies but no food. Nine years before, a great pile of canned meat had been found, where it apparently had been cast aside. It was generally accepted that it had spoiled and therefore had been abandoned, but in the far north temperatures are seldom high enough to permit bacterial growth which might have ruined the meat. In 1926, one of these cans was opened in England, and its eighty-one-year-old content was fed to two rats, with no ill effects.

Five years ago Knud Rasmussen, Danish explorer, born in Greenland and speaking the Eskimo dialects like a native, gathered the final facts. Natives told him that their fathers had found a great ship caught in the ice, had gone below and found men lying dead in their bunks, apparently Franklin and the twenty-four who died

842

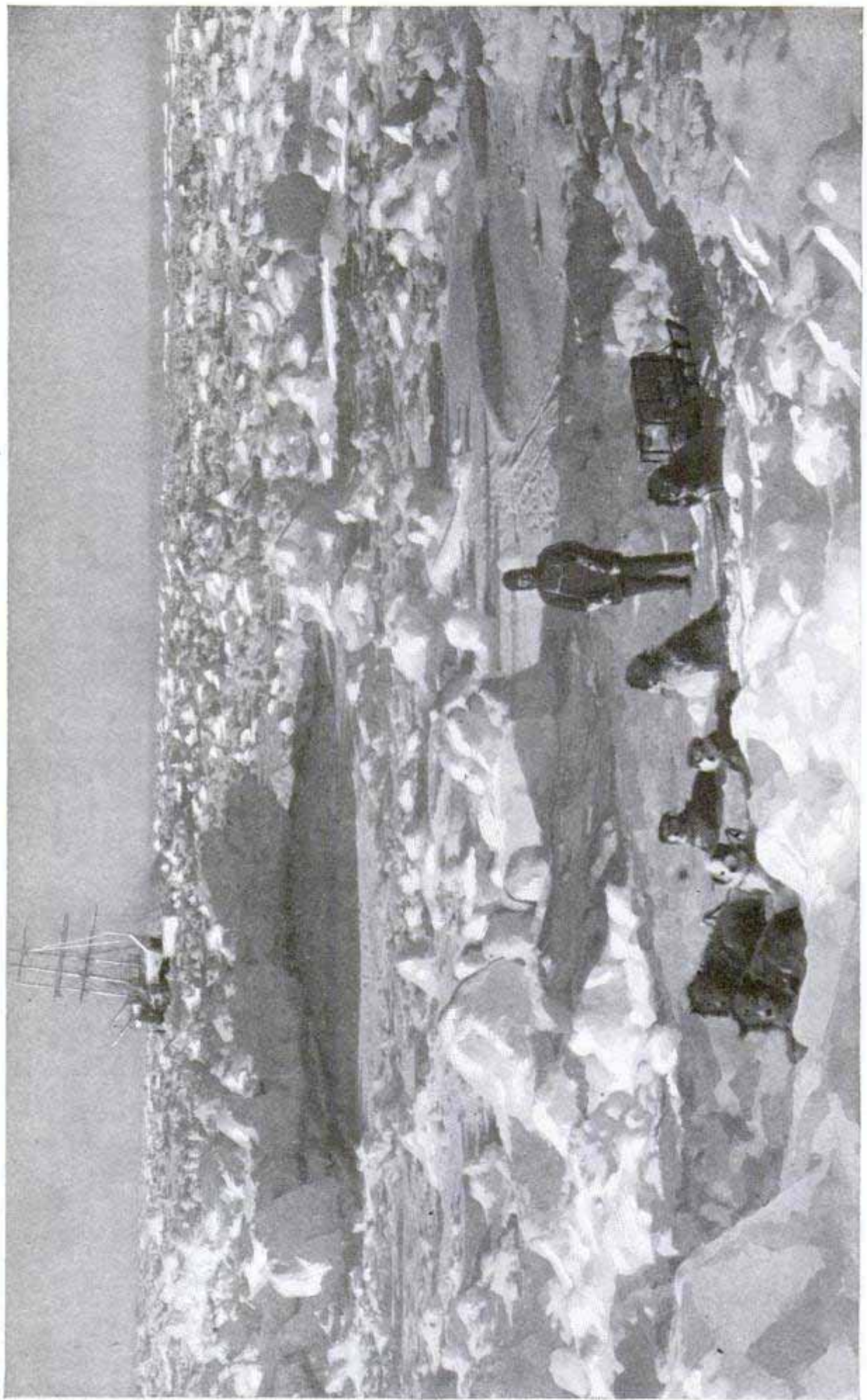

The Last of Sir Ernest Shackleton's Ship "Endurance," as the Ice Pack Crushed In Its Sides, Leaving the Explorer and Twenty-Two Companions Stranded on the South-Polar Ice



The Ground Crew Holding the "Italia" Down. Just before the Signal Came to Release the Ship for Its Final Flight, the Trip over the North Pole from Which It Never Returned

with him. The natives, knowing little about ships, cut a hole in the side to admit more light, but the hole was below the water line and the ship filled and sank.

No record has ever been found to explain whether some of the food was bad, why the canned meats were abandoned or how and why the men died.

Equally unexplained is the tragic disappearance of Major Andree and his two companions, first to try to fly over the North Pole. Andree was an expert balloonist, a trained scientist and head of the Swedish patent office.

On July 11, 1898, the three climbed aboard the basket and their balloon left its moorings on lonely Dane's island, driving northward before a fresh wind, for which they had waited for weeks.

The balloon expedition was one of the best equipped ever to enter the polar seas. The bag was fitted with automatic safety valve and emergency rip panel; it carried buoys, landing grapnel and ropes, sledges, spars, electric batteries, medical supplies, charts, compasses, three months' food supplies, alcohol stoves, guns, sleeping equipment and a collapsible boat and oars,

and, in addition, several carrier pigeons.

A pigeon was shot by a fisherman in the far north. It carried a message written on the second day out, reporting due progress, and stating that it was the third pigeon message dispatched. The message, translated from the Swedish, read:

"Andree Polar Expedition,

"To the Aftonbladet, Stockholm,

"July 13, 12:30 p. m., 82 degrees, 2 minutes north latitude, fifteen degrees, 5 minutes east longitude. Good journey eastward, 10 degrees south. All well on board. This is the third message sent by pigeon. Andree."

The other two pigeons were never seen. Two cork buoys were picked up containing somewhat similar messages. But the thirteenth buoy, which, according to pre-arranged plan, would have been discarded near the pole, did not turn up until two years later, and it was empty.

If the balloon kept to the air, they should have crossed the pole in four or five days after leaving Dane's island, but what became of them, their balloon and their instruments and equipment remains an unsolved mystery.

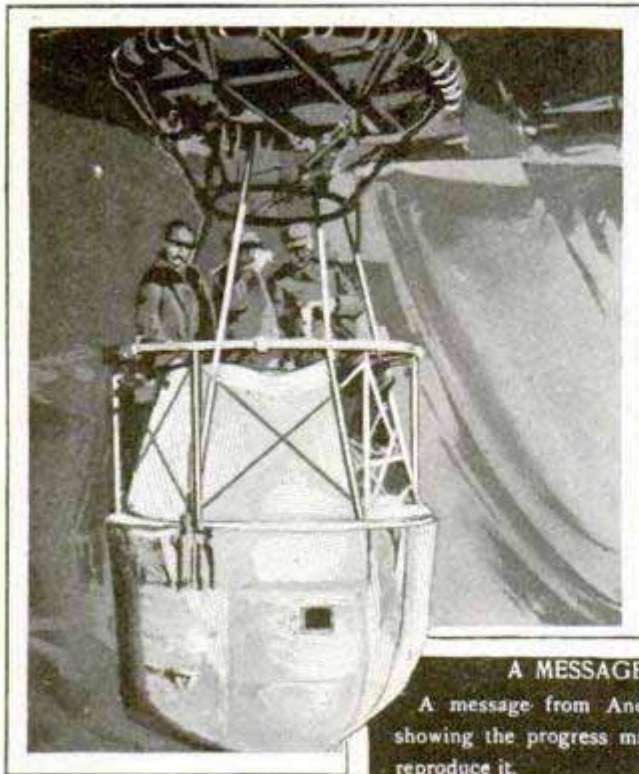

The Car of Andree's Balloon, Which Carried Three Men and Five Tons of Supplies; His Last Message, Sent by a Carrier Pigeon, and the Crew on Top the Gas Bag Overhauling the Rigging

The fate of Captain Scott's expedition, in contrast, is well known, for the bodies, the records, diaries and equipment, all were found. But the why and wherefore of their death for a time was as inexplicable as the disappearance of Sir John Franklin.

Scott and his companions crossed the antarctic ice cap, and, after weeks of terrible suffering, arrived at the pole, only to find the Norwegian flag which Amundsen had planted there but a few weeks before. Weary and discouraged, they started the long trek back to their base ship. Immediately things began to grow wrong. A terrific blizzard, blowing almost without interruption for a month, sapped their strength

and shortened their marches, throwing them far behind schedule. The blinding snow dust blew with such fury that it cut away pillars of ice and even ate an eighth of an inch off their wooden supply boxes.

Then Captain Oates, one of the leaders, became ill, further delaying the party. Finally he got up from his sick bed, announced he was going out and might be gone some time, and deliberately walked away into the storm to die, that his presence might not handicap the others. Lying on his death bed in a snow and ice hut, only eleven miles from a supply depot that might have saved them, Captain Scott wrote the full story in his diary.

"I do not think human beings ever came through such a month as we have come through," he wrote, "and we should have gotten through in spite of weather but for the sickening of Captain Oates and a shortage of fuel in our depots, for which I cannot account, and finally for the storm which has fallen on us within eleven miles of the depot, at which we hoped to secure final supplies."

The rescuers who discovered the bodies found also

A MESSAGE FROM ANDREE.

A message from Andree has been forwarded to us showing the progress made by the hardy explorer. We reproduce it.

FRÅN ANDRÉE Polarexped
till Aftonbladet Stockholm
d. 13 Juli
kl. 12:30 mitt.
Lat. 82° 2'
Long 15° 5' ost.
god fart åt
ost 10° syd.
Allt väl
ombord.
Detta är
Fredje dug-
borten. 1
Andree

TRANSLATION.

"ANDRÉE POLAR EXPEDITION,
" TO THE Aftonbladet, STOCKHOLM.

" July 13th, 12:30 p. m., 82° 2' north latitude,



that the oil-fuel cans were firmly stoppered, but empty, or nearly so. Science, years later, advanced the explanation, setting at rest the first guess that the oil had evaporated through the stoppers. B. T. Brooks, of the Mellon institute of industrial research, and Dr. Alan W. C. Menzies, professor of chemistry at Princeton, suggest what probably is the true explanation.

Tin, at low temperatures, is attacked by a disease which turns ordinary metal into the allotropic form, a gray powder. This change reaches its maximum rate at fifty-four degrees Fahrenheit, below zero. With the tin plating gone, air or acid in the oil would come in contact with the iron of the container and oxidize it rapidly, leaving the can spotted with small holes.

The searching party which found Scott and his companions reported that food supplies, seven feet below the oil cans in the depot cairns, were oil-soaked.

When Commander Byrd's expedition enters the antarctic ice continent, they will meet conditions totally unlike those encountered at the North Pole. The northern tip of the world is a sea, in which no land has yet been found. Through it the ice pack drifts, leaving open water lanes, making it possible for polar bear, seal and walrus to live there.

The ice barrier of the South Pole presents an unbroken front that endangers explorers long before they even set foot on the plateau. Sir Ernest Shackleton's expedition, which planned to cross the ice cap from the side below South America, was prevented from even landing. It was on August 4, 1914, that the king summoned Shackleton to Buckingham palace and presented the flag which he planned to carry across Antarctica, passing the

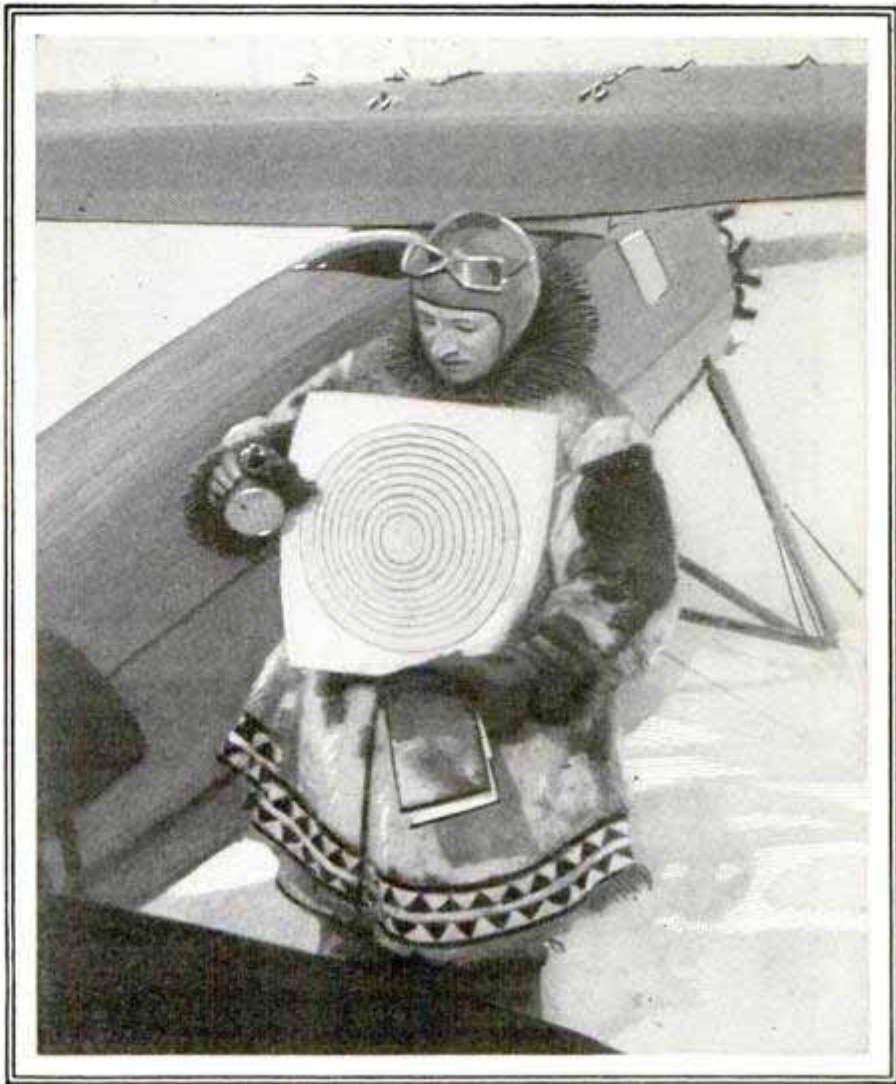

Captain Wilkins with His North-Pole Map and Navigating Instruments, Just before Leaving Point Barrow

pole where Amundsen and Scott already had been. That same night war was declared, and Shackleton offered his services, but was ordered to proceed.

Two years later the leader, with five foot-sore men, staggered into a lonely trading village in South Georgia, off the tip of South America, with a tale of incredible hardships and bravery. Their ship had been ice-locked and drifted for months, until finally it was crushed in the ice and abandoned. In open boats the crew started to civilization. After months of hardships they reached Elephant island, practically without food, and their boats battered and patched. Leaving most of his men there, Shackleton and five men started in one boat over 800 miles of stormy open sea to South Georgia.

Three expeditions by boat were led to Elephant island before one finally succeeded in penetrating the pack ice and accomplishing the rescue.

967 *Am. College Railway*



Like a Flying Boat without the Wings; Paddle-Wheel Craft, Operated by Hand, with Its Roomy Body and Folding Top; It Is Safe and Comfortable

QUEER HAND-PROPELLED BOAT HAS FOLDING TOP

Propelled by a hand-operated paddle wheel, a small pleasure boat of unusual design was tested recently in New York. The body is shaped somewhat like the fuselage of a flying craft and has a folding top of bright-colored material that protects the occupants from rain or sun.

QUAKE RECORDERS ON DAMS TO WARN OF COLLAPSE 7079

By placing seismographs, the sensitive instruments used to record earthquakes, upon dams, warning of an impending collapse of the structures might be received so that life and property could be saved. In the opinion of R. M. Wilson, of the Hawaiian volcano observatory, had such apparatus been used on the St. Francis dam, which burst not long ago in California, inspectors might have realized the condition of the dam days in advance, and so have given adequate warning. The dam crumbled because of weakened foundations, engineers have

found. Although seismographs in the neighborhood gave no evidence of earthquakes, such an instrument on the dam might have registered the slight motions of the structure as it settled and yielded.

VISUAL AUTO-BRAKE TESTER PROMOTES SAFETY 866

Adaptable to cars with two or four-wheel brakes, a brake tester recently introduced registers the true condition of the brake on each wheel on gauges, prominently displayed, so that there is slight chance for error and no need of guesswork. The unit is especially serviceable in assuring exact equalization and balance of brakes to eliminate skidding.

Testing the Car Brakes; Readings Are Shown on the Dials at the Right

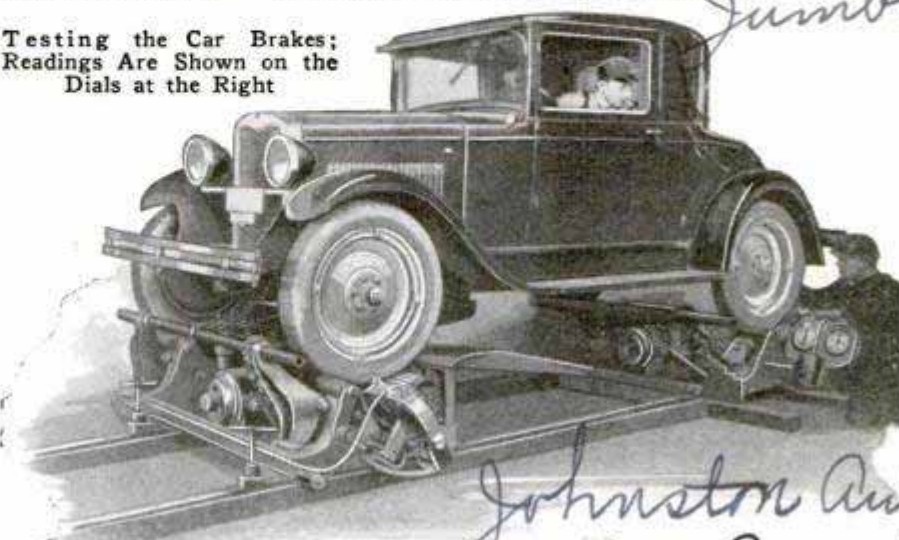

U.S. Navy 7/5/28

Jumbo

Report to Geological Survey

Johnston Automobile Wagon + Machine Co. 160 N. Harlem

999
368

A. 809. 537 S. Dearborn
POPULAR MECHANICS

Chicago
Tribune
7/8/28

Chicago

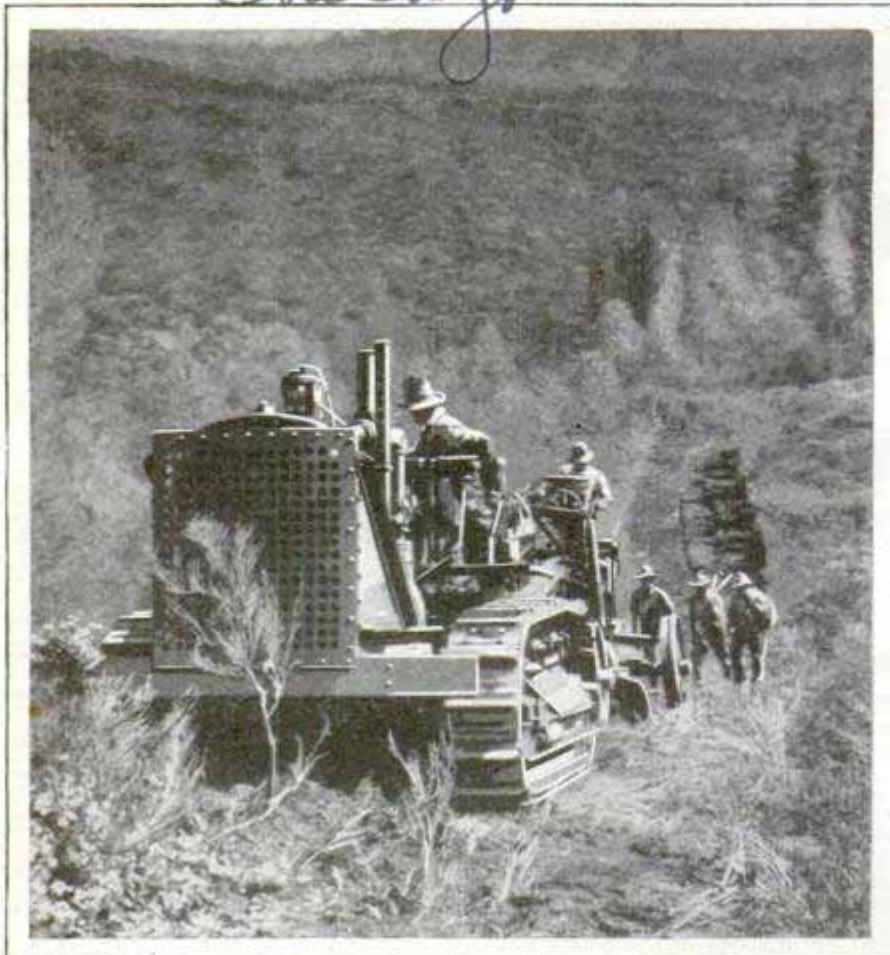

Cutting a Firebreak through Brush and Grass with the Big Tractor Outfit That Helps Protect California Forests

ernment sold more than \$200,000 worth of trees from the forest.

RABBIT SKINS RIVAL LEOPARD FUR

To supply the large demand for furs of various kinds, rabbit skins are being treated to imitate the pelts of leopard, mink, seal and other animals. Millions of skins are imported from Australia each year, and workers have become so skillful in preparing them that the imitations are difficult to detect even by experts. In making the leopard, for instance, the rabbit skins are carefully sewed together and the markings applied with brush and dye through a stencil that in turn has been prepared from a real leopard skin. The process takes about four days. Goat

ROAD BREAKER GUARDS FORESTS FROM PERIL OF FIRE

Stands of valuable timber in the Stanislaus national forest in the California sierras are carefully guarded from fire, and one of the means employed to prevent the spread of blazes is to cut wide firebreaks like rough roads so that the flames cannot leap across them. Some of this work is done with a big tractor outfit, a "logging cruiser" and a sturdy leaning-wheel grader that tears through brush and scrub trees, leaving a barren swath that acts as an effective arrester of fires. The value of the timber in this tract is seen by the fact that, last year alone, the gov-

skins are made into quite convincing imitations of wolf, although the Manchurian dog furnishes a still better substitute.

LICENSE PLATE LOCKED ON END HELPS FOIL AUTO THIEF

To thwart automobile thieves, an Australian has devised the simple plan of tipping the license plate on end when he leaves the car and locking it in this position. The adjustment is made with a lever and the plate cannot be straightened again without the key. Should a car be found with it tipped on end in this way, it would afford immediate proof that the car had been stolen.

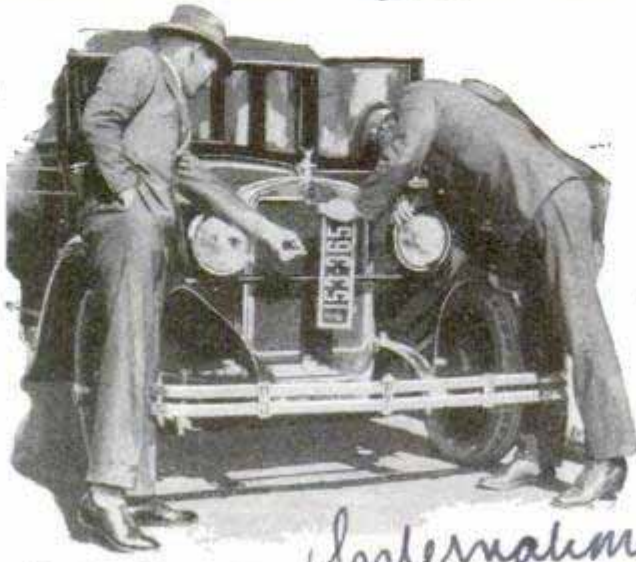

Locking License Plate on End, to Prevent Theft

International
Used in Sydney

*american
Miller Co.
333 W. 25th
place
Chicago*

*same as Dec. 1928 - 187
Process controlled in U.S. by*

**PURIFY WATER BY ELECTRICITY
INSTEAD OF DISTILLING**

Pure water is obtained commercially by an electric process which is reported to be fully as efficient, and more economical, than the familiar method of distillation. The whole of the electrical energy is used in the purification and the crude water required is never more than four times the amount of pure water produced. In distilling, from forty to 100 times the quantity of crude water is used. The method is based on a physical phenomenon known as osmosis, which manifests itself as follows: If two liquids are placed in a container and separated by a porous diaphragm, some of the liquid on one side of the partition will pass through to the other side and vice versa. If an impure water solution is placed in a semi-permeable container and then stood in a vessel of pure water, some of the water of the impure solution will pass into the pure water but the impurities, usually in the form of salts, will not penetrate.

*water - no. 1 at the City of Chicago
Phillips & Baird Co., Inc.
Jantzen, Paris, Tex.*

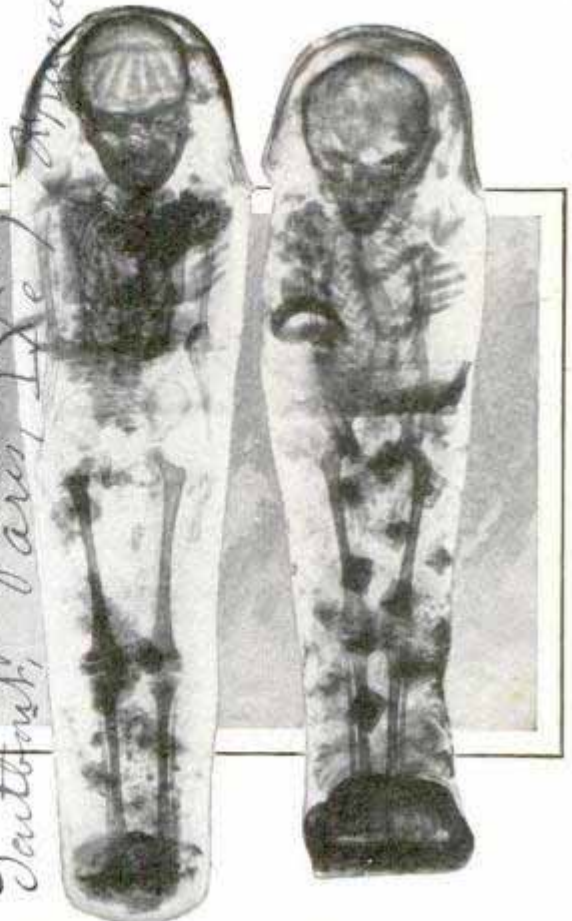

Courtesy Field Museum of Natural History
Diseases and Malformation in Egyptian Children Revealed in X-Ray Photographs of Mummies

**X-RAY STUDIES OF MUMMIES
REVEAL SECRETS OF PAST**

That Egyptian children who lived centuries ago had diseases common among youngsters of today, is one of the interesting facts revealed by X-ray studies of mummies at the Field Museum of Natural History. Photographs taken with the penetrating rays show cases of curvature of the spine and of malnutrition. The latter condition is disclosed by transverse lines of irregular calcium development in the bones and is caused by improper and inadequate feeding. The X-ray apparatus is used not only on mummies but also on various other specimens and helps to establish many scientific facts without doing any damage. The Field museum is the first institution of its kind to adopt this method of examining relics of the past.

540
**SHELTER FOR TRAFFIC OFFICER
HELPS GUIDE MOTORISTS**

Automobile drivers in Jersey City, N. J., are warned of a dangerous intersection by a large booth in the center of it. The shelter protects the traffic policeman from inclement weather and has wide windows to give him an unobstructed view.

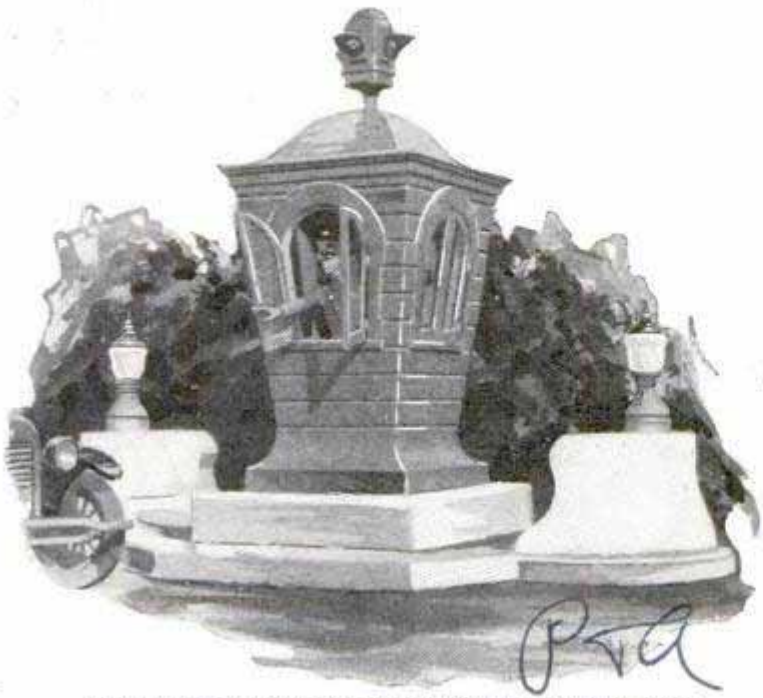

Ornamental Shelter for Traffic Officer in Jersey City

Ⓞ About 16,000,000 tiny eggs are produced by a single oyster.

Emb. S. B. Winters Electric Washinton
National Bank Bldg

Blowing Bubbles

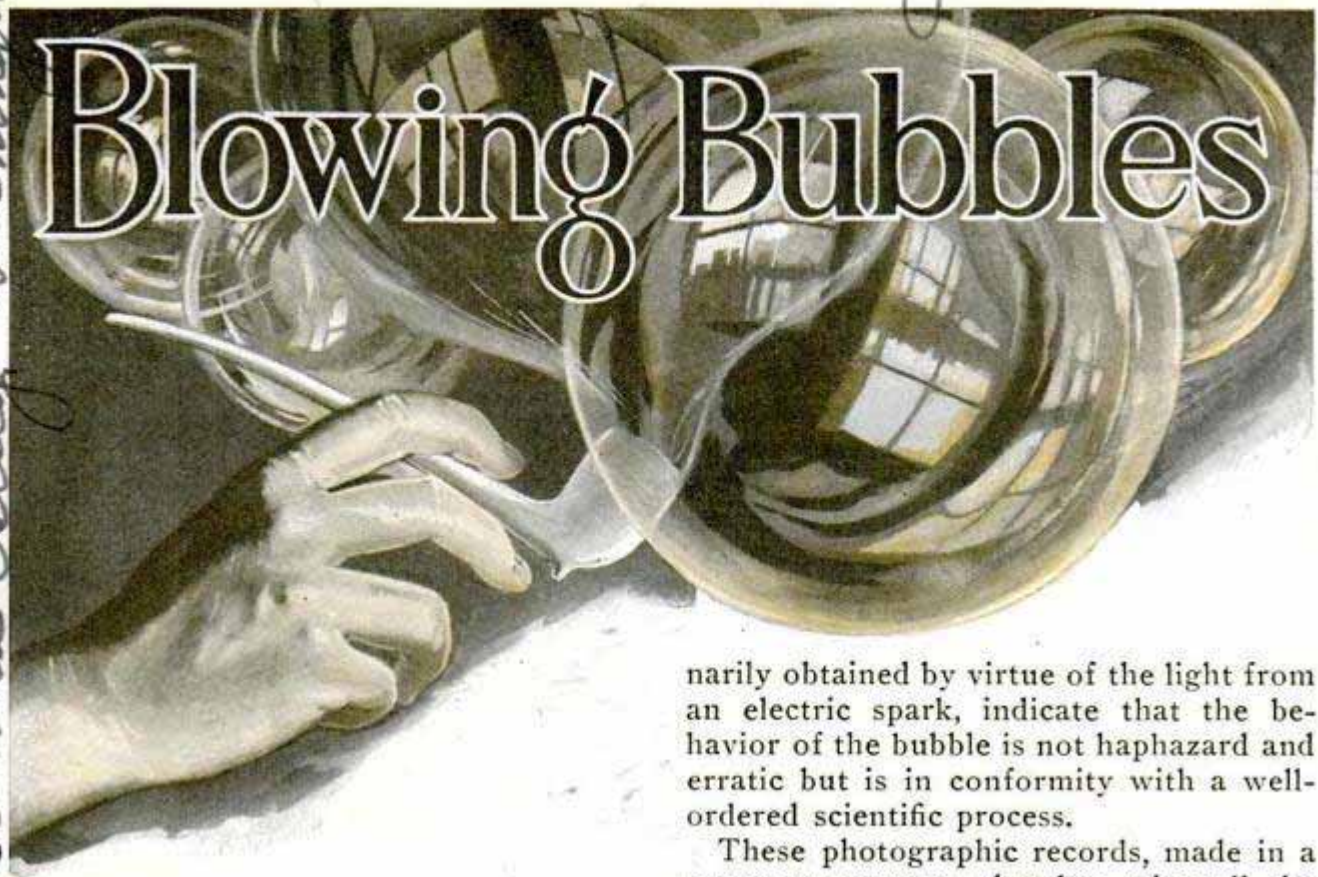

BLOWING bubbles, once an exclusively childish pastime, now is a research activity of vast scientific significance. The lowly soap bubble has already demonstrated its usefulness as a replica of the internal-combustion engine; as a miner of gold and other precious metals; as an object in studying the properties of light, and, for the first time, defines the rates at which gases explode.

Formerly regarded as an extremely simple thing, science has disclosed that the soap bubble represents a complicated process. This is true to such an extent that the heat division of the bureau of standards is consulting this flimsy mixture of soap and water to determine the exact behavior of our automobile and airplane engines. In fact, when the bubble is filled with a charge of explosive gases, Uncle Sam accepts it as a perfect internal-combustion engine—operating without bearings, cylinder or piston.

The gaseous bubble is fired by a spark from the center. The extreme delicacy and transparency of the soap film permit a continuous photographic record to be made of the progress of the explosive reaction, from the instant the ignition spark passes to the moment the reaction is completed. The photographic records, ordi-

narily obtained by virtue of the light from an electric spark, indicate that the behavior of the bubble is not haphazard and erratic but is in conformity with a well-ordered scientific process.

These photographic records, made in a constant-pressure chamber, give all the quantitative dimensions necessary for a precise study of the behavior of an internal-combustion engine; for the degree of disassociation of the fuel or combustion products, and, in the event an inert gas is present in known quantity, for the specific heat of that gas at the high temperature of the explosion. All of the relationships involved in the determination of these magnitudes are essential to a complete knowledge of what goes on when fuel is exploding in automobile and airplane engines.

The soap bubble, other than being an internal-combustion engine, is an important factor in the mining industry. It separates the dross from the gold. Rocks containing precious minerals are reduced to a powder and placed in water, to which has been added a small amount of special oil. This mixture is agitated, resulting in a froth of bubbles rising to the surface of the container of the liquid. Each soap bubble is a bearer of a particle of gold or other precious mineral. The dross or worthless rock remains at the bottom of the liquid. A valuable concentrate of mineral is obtained when this froth of soap bubbles is skimmed. Scientifically, this process is known as flotation and it ranks high as a modern development in



to Aid Science

the mining industry in all its branches.

At least two divisions of the bureau of standards are exploring into the mysteries of soap bubbles—the heat and sound sections. The latter laboratory has, by use of light from an electric spark, made hundreds of photographs of bullets being fired through soap bubbles. These pictures, snapped with incredible rapidity, apparently show the bubble and bullet at rest. “When a bubble once gives way its complete disappearance is so rapid as to lead to the common impression that it is instantaneous,” notes Dr. Paul R. Heyl, of the bureau. “The very rapid spark photographs taken of a breaking bubble show that the bursting is a progressive process, though a very rapid one.

“Photographs have been obtained of a bubble which has had a bullet fired through it. For a few millionths of a second (long enough to be photographed) the bubble stands as if in amazement, with a hole in each side. The holes rapidly increase in size, the water film spraying off at the edges into fine drops, until, in a thousandth of a second or thereabouts, the bubble is gone entirely.

“One of the first things to catch the attention when a bubble has been successfully blown,” reports Dr. Heyl after analyzing hundreds of bubbles, “is the shimmering play of colors reflected from its surface. These colors, we notice, are formed somehow in the act of reflection of the colorless light of day from the surface of the bubble. It is possible, with a little practice, to detach the bubble from the pipe by which it was blown, and to catch it upon a piece of cloth, where it may remain for some time. If we closely examine the distribution of colors on such a quiet bubble, we may be fortunate enough to perceive colored bands moving

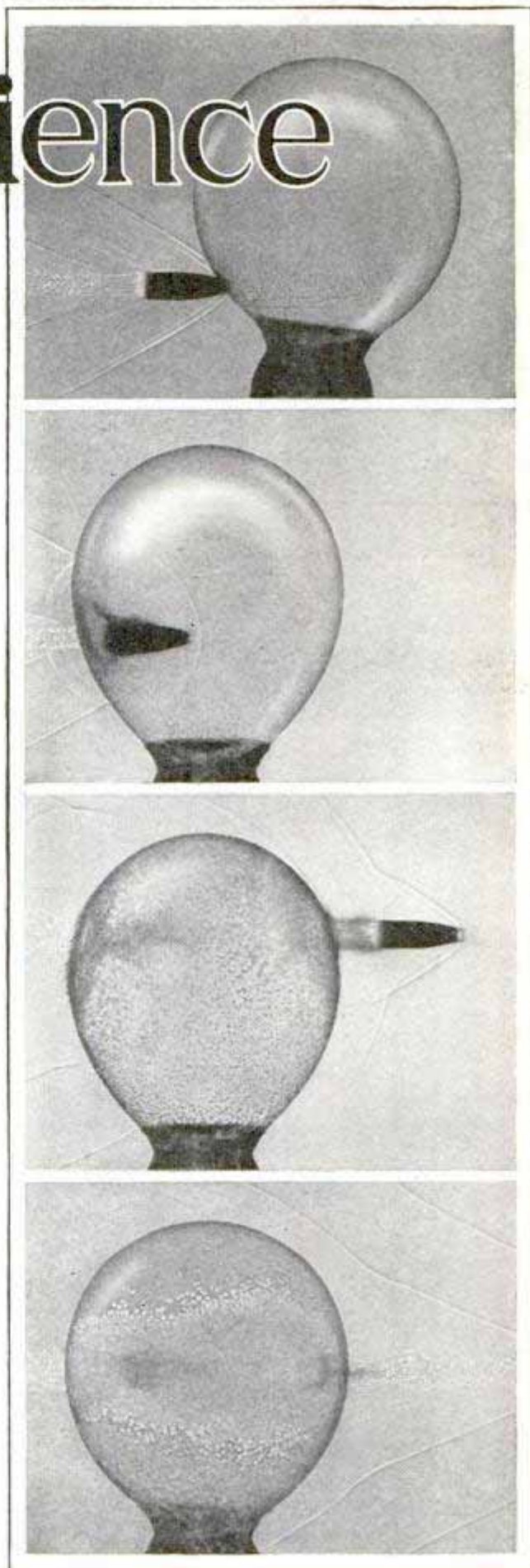

Slow-Motion Movies of a Bullet Shot through a Soap Bubble; the Curious “V” Lines Are Sound Waves; Note Disturbed Air in the Bubble

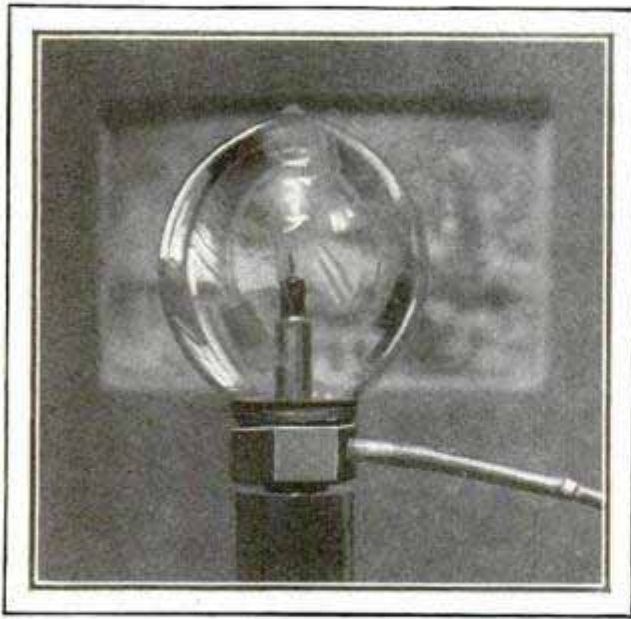

Soap Bubble Filled with Explosive Gas Ready to Be Touched Off by the Spark Plug in Its Center

downward from the top of the bubble to the bottom. The north pole of the bubble seems to be the storehouse whence the bubble draws these colors in succession. And if we are exceptionally lucky, we may see at the north pole, just before the bubble breaks, a black spot. It is as if the store of colors had been exhausted.

"It may be perhaps a new idea that anything can be so thin that it cannot reflect light; but the study of thin films, such as found in bubbles, teaches us that light is not reflected strictly from the surface of bodies, but that it must penetrate a very little way into the substance of the body itself before it can be turned and sent back. Like a motor car, the beam of light requires a little room in which to turn. And if this necessary turning space is not to be found, the light will not be able to turn at all, but will pass through the film and out at the other side.

"This is true in the case of bodies ordinarily considered to be opaque, such as polished surfaces of metal. But even metals are transparent in thin enough layers, as is evidenced by ordinary gold leaf.

"In penetrating the reflecting surface to this minute depth, certain qualities characteristic of the reflecting material are impressed upon the light, so that by exam-

ining the reflected beam, even many miles away from the reflecting body, we can tell something about the material of the reflector. In fact, some scientists have attempted to gain by this means an idea of the different materials composing the surface of the moon. The moon shines by reflected sunlight, and the idea is that the light reflected from different areas of the moon's surface may, by its characteristically altered quality, betray the nature of the material which has reflected it.

"How thin is this black spot in a bubble, and what sets a limit to it? Why cannot a bubble thin out indefinitely? These questions lead to one of the most interesting things which a bubble can teach us. Water is made up of molecules, particles so inconceivably small that a soap bubble when freshly formed may be many molecules thick. But as the film thins out it is gradually reduced to a thickness of but a few molecules; and obviously this process cannot go on forever. The film cannot be less than one molecule thick. Any further thinning out is bound to break the bubble.

"Every liquid acts as though it were incased in a stretched elastic skin. Liquids in quantities such as ordinarily handled do not show this property because so much of them is inside and so little on the outside, and the surface properties are

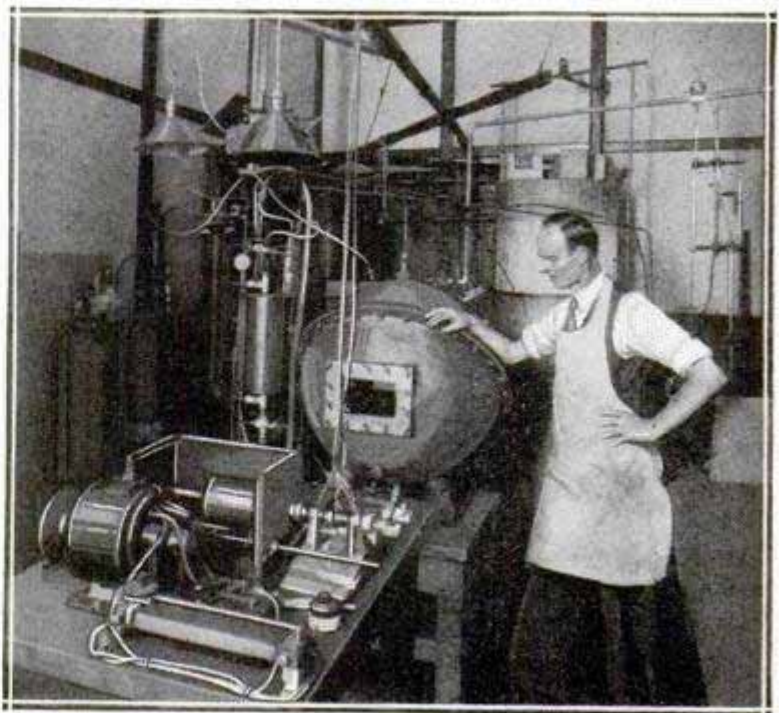

Soap Bubbles Are Blown inside the Steel "Bomb" and Then Exploded While the Slow-Motion Camera Records the Result

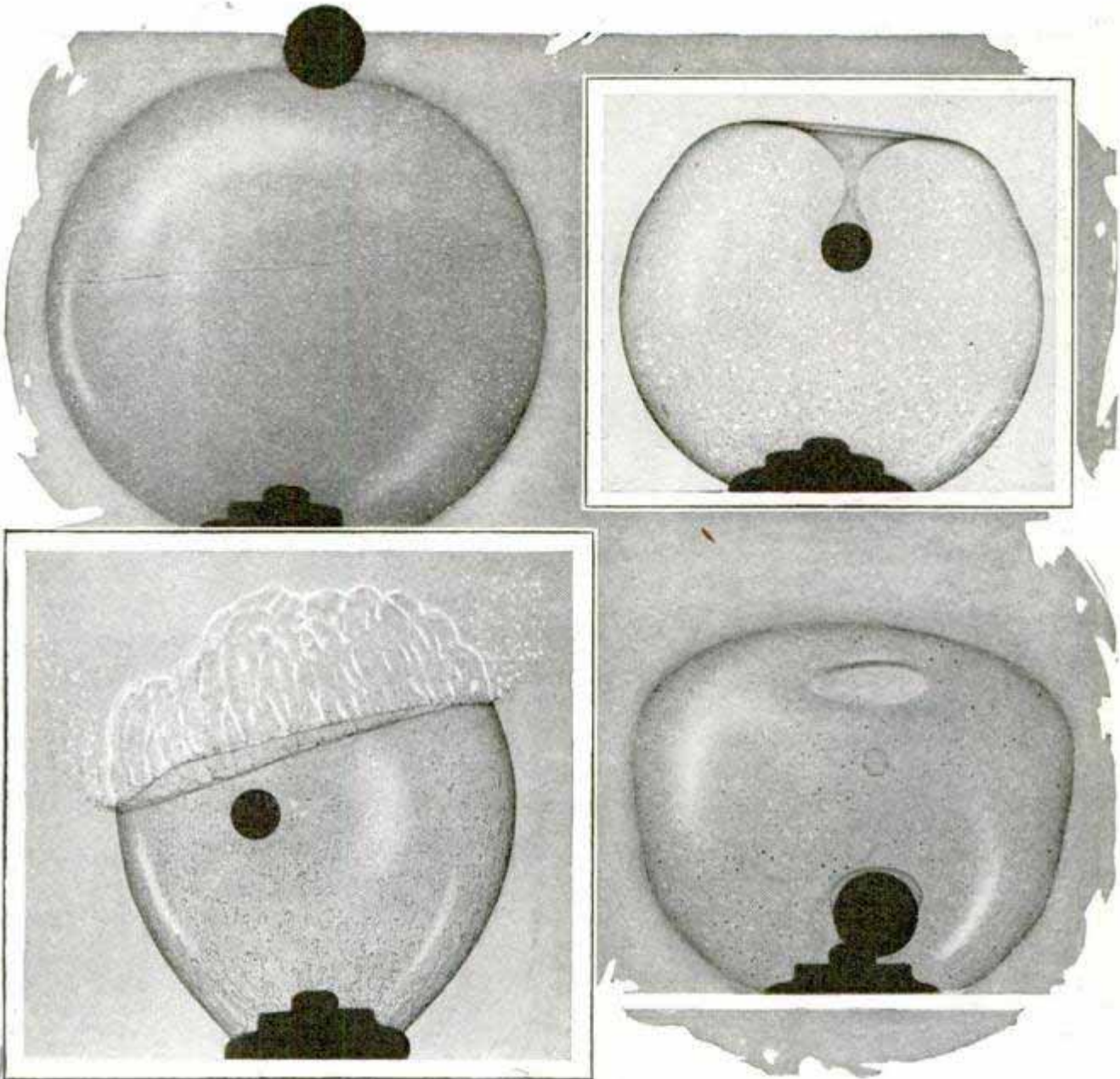

Dropping a Steel Ball into a Soap Bubble; the Bubble Surface Is Bending, but Not Broken, in the Upper Left Picture, Has Been Flattened in the Second, and Broken in the Third and Fourth

masked by the properties characteristic of the inside. But a soap film is nearly all surface, and very little inside, and the contractile property of the surface becomes evident. This contractile property (surface tension is its scientific name) is responsible for a great many happenings in nature. It is the cause of the globular shape of a dew drop, for instance."

FOOD AS MEDICINE

Nourishing food and plenty of it, is regarded as one of the most beneficial "medicines" used in treating nervous and mental diseases at a Louisiana hospital. Some of the violent inmates, whose activity burns up so much energy that it is almost

impossible to keep them properly nourished, are fed as often as seven times a day. A basis for the treatment is the theory that good physical condition leads to mental recovery.

Boyd - \$10.00
PLASTER CUTTER BORES HOLES WITHOUT MAKING DUST
3/4 or 4 for 8.00 79.

To make round holes in plaster for electrical and other installations, a saw-tooth cutter now on the market is said to perform the task quickly and efficiently. A special feature is an apron that prevents dust from falling into the workman's eyes or upon the floor.



Seena Derris, Washington, D.C. 1/25

869

land H. Kelfer

Paul W. Koch

Statem - Chicago

959

The Automobile Co. 18th floor, Inter. Southern

POPULAR MECHANICS

Day Louisville, Ky

MOTORISTS SHOP IN CARS IN AUTOMATIC GROCERY



Interior of the Automatic Grocery in Which Persons Select Goods without Leaving Their Cars; Cans Are Displayed on Revolving Shelves within Reach of the Purchaser as He Rides By

"Drive in and do your shopping," is the message of an automatic grocery to motorists. The customer can make all his purchases without getting out of the car or even opening the door. One side of the store is devoted to a driveway with curbs on each side of the track, to guide the car so that the driver does not have to touch the wheel. A turntable at one end, swings the car around to enable its return on the other side of the store. Goods are displayed on slowly revolving shelves. The purchaser picks them off as he wants them and places the articles in a metal container moving on a conveyor that takes them to the cashier, where they are sacked and handed to the buyer after payment as he drives out. Only four men are required to operate the store, the cashier, a butcher, a man to run the turntable and another to keep the display shelves filled. Particular care has been taken in planning the ventilating system.

Large fans, revolving in ducts along the walls, keep the air in circulation and draw off gases produced by the automobiles. In the rear of the building are large double doors which may be thrown open in case of fire, to permit rapid exit. The butcher shop is the only part of the establishment that does not operate automatically for the simple reason that, so far, no mechanism has been found that will slice off a desired quantity of meat, wrap it and hand it to the customer.

EXPLODING WEDGE SPLITS LOGS SAVING HAND LABOR

To save time and labor, an exploding wedge has been introduced for splitting logs. It has a chamber into which a charge of powder is poured and set off by means of a fuse. The wedge may be used repeatedly, as the explosions do not damage it, and the process is safe and

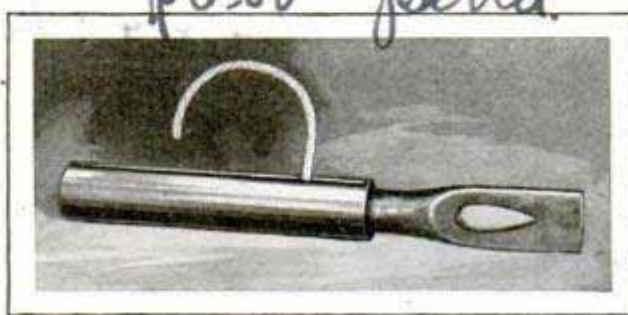

Wedge with Powder Chamber for Splitting Logs

Hutchinson

Mfg. Co.

Puttsburg, Pa.

\$6.00

pend.

new signal corps

certain, it is claimed. The wedge also may be used effectively for the splitting of stumps, thus facilitating their removal considerably.

WHISTLES ON CARRIER PIGEONS KEEP HAWKS AWAY 986

Light bamboo whistles, strapped to the tails of carrier pigeons are proving effective in protecting them from hawks and other birds preying on the useful messengers, army signal-corps officers report. The whistles blow of themselves as the pigeons fly rapidly along, and the noise tends to frighten the birds of prey. The plan is an innovation in this country, but has been used for many years in China.

ARTIST USES VACUUM CLEANER AS PAINT BRUSH 938

The household vacuum cleaner has been adapted to artistic as well as useful ends by a Cleveland artist. She sprinkles flour on a piece of carpet and then, by using the window-drape attachment of the cleaner, removes portions of the flour to create different designs and figures. She has



Drawing Portrait with the Vacuum Cleaner; Window-Drape Attachment Is Used to Remove Flour

developed considerable skill in portraiture with this method. The flour is worked into the nap of the carpet to prevent it from falling off, and the carpet may be left on the floor or tacked to an easel. The results are rather pleasing in effect.

Picture from *Boole*

911

Pelorus
Drift Indicator Used on the "Southern Cross" to Help in Its Flight across the Pacific; Plane's Position Is Gauged by Shadow of Wire on the Lined Board



WIRE'S SHADOW GUIDES PLANE FLYING ACROSS SEA

The shadow of a slender wire was one of the aids that helped the crew of the "Southern Cross" in reaching their destinations across thousands of miles of sea. The shadow fell across a special drift indicator that served essentially as a compass without the usual magnetic needle. The unit is a semicircular metal plate, mounted horizontally on the fuselage and graduated in degrees. At intervals on the degree lines are holes into which an upright post, carrying a vertical wire, is inserted. The navigator places the post in the hole at the end of the proper degree line according to his course, so that the shadow of the wire falls on the center of the scale. By observing when the shadow falls to one side or the other, and measuring the degrees of departure as indicated on the gauge, the pilot is able to tell the number of degrees the plane drifts from its course.

*Dr. W. Theodore S. Lindgren
439 Columbia Ave. Los Angeles, Calif.*

The Popular Mechanics Bureau of Information offers its free service to all readers of this magazine. Names and addresses of manufacturers and dealers in articles described, and any other details in our possession, will be promptly furnished upon application to the bureau.

WRINGER MAKES MEAT TENDER WITHOUT TEARING IT

2965

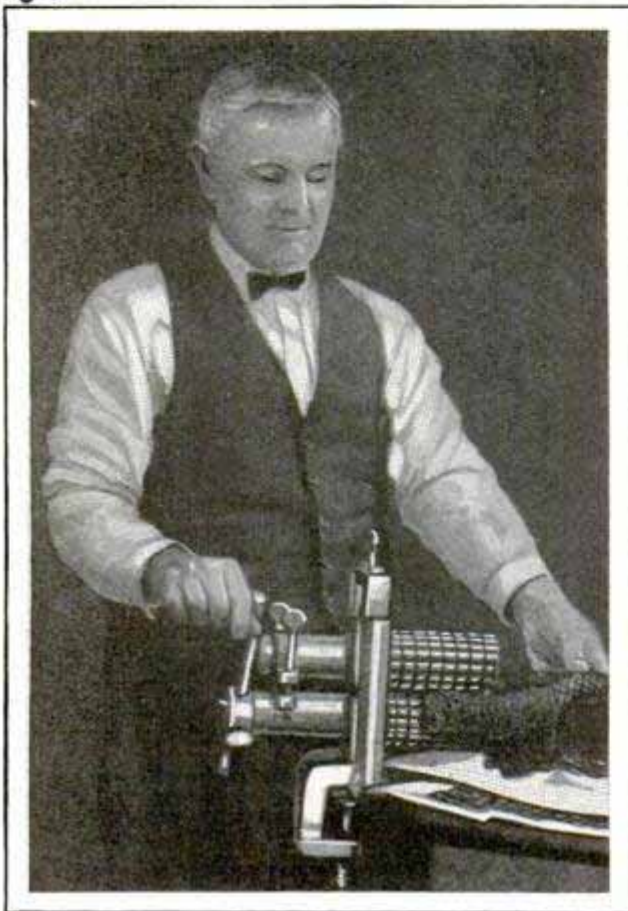

Putting Steak through the Corrugated Wringer, to Make It More Tender

To make the steak tender, a wringer with special rolls has been introduced as a substitute for the usual hammers or choppers. The meat is not torn as it passes through, and the rolls are adjustable to different degrees, according to the thickness of the meat.

JUNGLE FOWL HATCHES CHICKS IN LONDON ZOO

For the first time in forty years, chicks have been hatched by the jungle fowl of Ceylon at the London zoo. This is considered remarkable as the birds have never done this in captivity in Ceylon. All domestic fowls are supposed to be descendants of the jungle variety, but the Ceylon bird has a number of peculiarities. For instance,

the cock does not crow as does the domestic rooster, but merely stretches on its toes and makes a weird cry as though calling a person by name. The tones resemble the spoken words "George Joyce," and the sound is repeated several times.

Answers 6/30/28

988 WHY GLOWWORMS GLOW

Why does a glowworm glow? Scientists cannot answer the question with certainty, but the light is believed to be caused by emanations possibly similar to X-rays, as it penetrates various substances. Apparently, the illumination is generated with the act of breathing. There are more than 500 glow-producing insects, the familiar glowworm being a species of beetle and not a worm at all. The purpose of the light is also a mystery. Some scholars believe that it helps the insect find its way, that it scares enemies away or lures on smaller insects to be devoured as prey.

POTATO DIGGER AND SACKER

738 SAVES HAND WORK

Potatoes are dug and sacked by a single unit that will harvest from 600 to 800 bushels a day, performing labor equivalent to that ordinarily done by seven or more men. As the potatoes are removed from the hills, they are passed into the bags by means of an elevator. One man picks out the weeds and other foreign matter, and another manages the sacks, while a third drives. According to reports, potatoes are bruised less with this harvester than in the usual way of gathering them by hand. The parts are lined with rubber to protect the tubers.

no Chicago



Digging Potatoes and Sacking them in One Operation; the Outfit Will Harvest 600 to 800 Bushels in One Day

J. M. P. Stahlman

J. Stahlman

The

The Daily Mail 6/19/28

6/30/28.

**QUAKE UNCOVERS
GEMS BURIED IN
OLD TOMB**

990

Fifteen beautifully carved jade objects slid out of an ancient tomb in the mysterious mountain city of Monte Alban, Oaxaca, Mexico, the other day, giving scholars possible further clues as to the origin of the Mayas and indicating that other treasures may be buried in this crumbling town that long has been a riddle to explorers. The tomb was cracked by a violent earthquake that shook the entire state. Faces and other details carved on the jade articles pointed back to early Mayan times, suggesting that the city of Monte Alban may have been a forerunner of the later cities that flourished farther south. Monte Alban crowns a mountain ridge 1,000 feet high, and today is a huge pile of pyramids, terraces, sunken courts and old fortifications. No one knows why it should have been built so high above the green valley below, as no other ancient cities of the region are found similarly located.

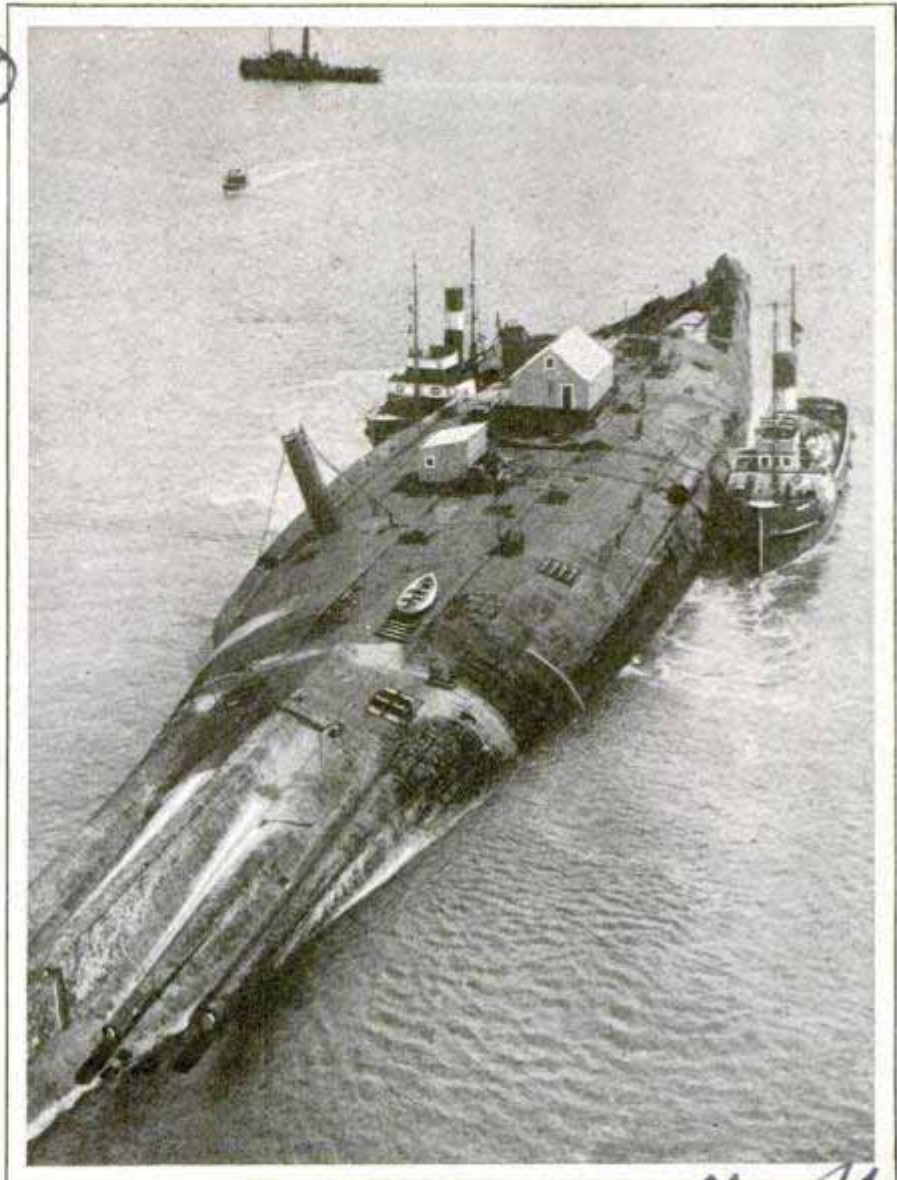

Bottom Up, the Cruiser "Moltke" Is Being Towed In for Dismantling and Salvaging as Steel Scrap

**CRUISER SALVAGED BOTTOM UP
FROM ENGLISH CHANNEL**

Scuttled by the Germans during the war, the cruiser "Moltke" has been raised from Scapa Flow and towed to port to be broken up and utilized as scrap. In salvaging, the big warship was turned completely over so that it was brought in bottom up. The broad bottom of the hull afforded ample space for workshops.

(Nearly one-third of Europe is covered with forests.

**SMALL-SIZE CAMERA COPIER
HAS THREE LENSES**

737

Used with a small camera that takes fifty exposures on one loading, a copying outfit has been introduced to simplify the task of making reproductions of prints, drawings, etc. Three extra lenses are furnished with it.

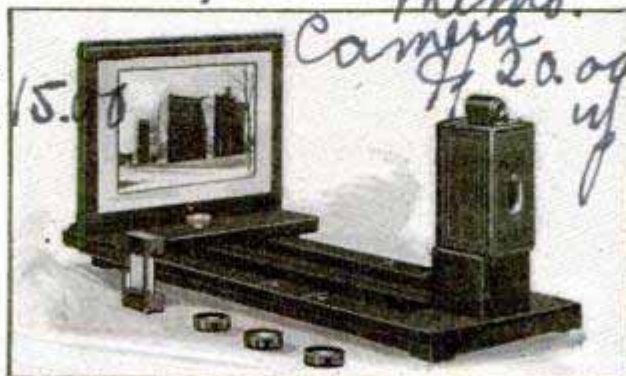

Copying Outfit for Camera Which Takes Fifty Exposures on One Loading

Chicago-318 W. Washington

Agfa Ansco Corp. Binghamton, N.Y.

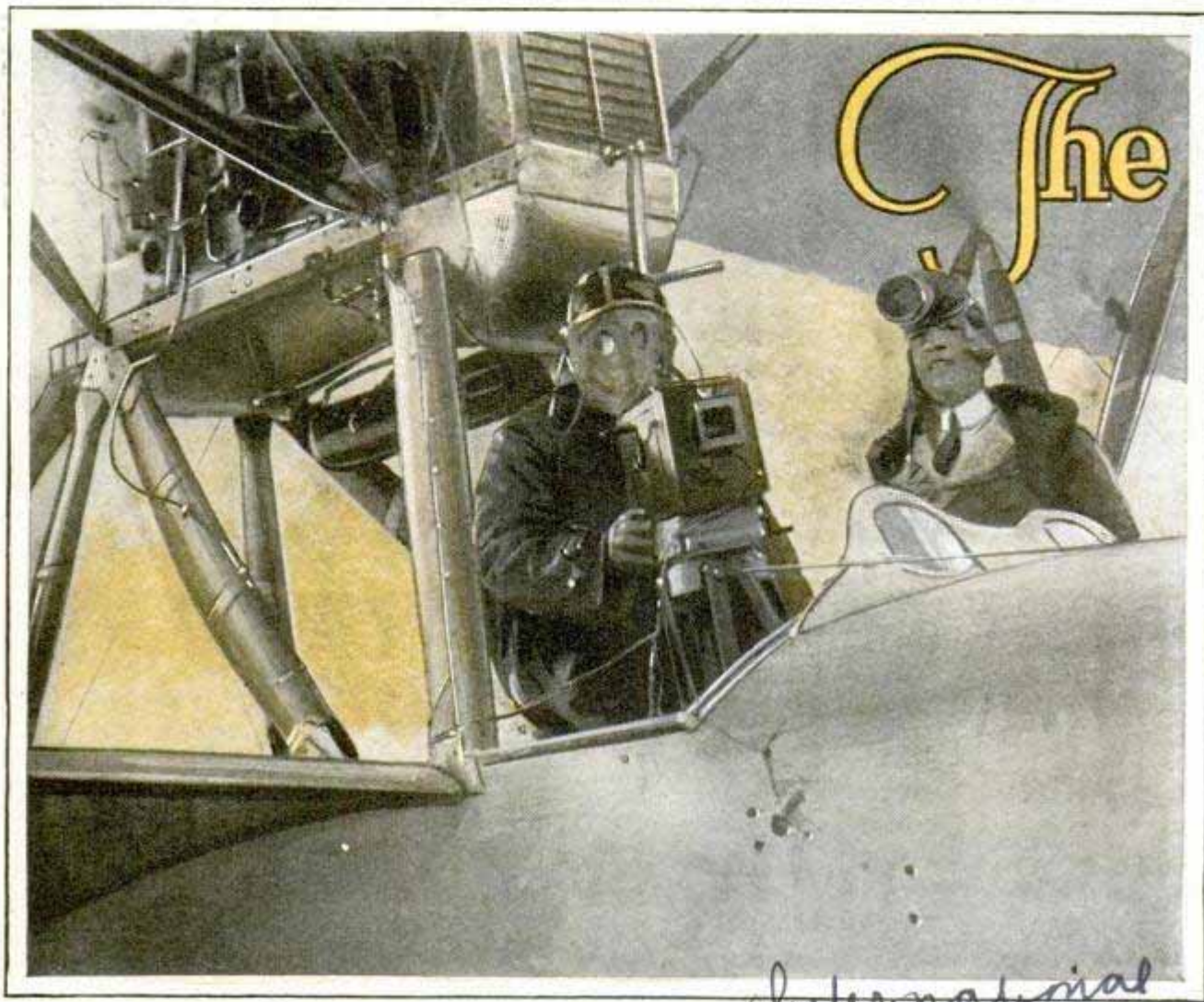

Umberto Romagnole, Rome Photographer for an American News Reel, in the Plane in Which He Flew over Vesuvius during an Eruption, to Film the Boiling Fire Pit from the Air

By BERYL D. and ORVILLE H. KNEEN

CLARENCE Chamberlin is more than a member of the "transatlantic hoppers." He is a graduate in the newest fine art of flying photography. For five years before his greatest flight, he shot news pictures from the air. Harry Schoenhals, of New York, recalls that he worked the camera while Chamberlin piloted, in the days when low flying was essential to obtain sufficiently clear views.

"One day," Schoenhals relates, "while we were air cruising, we spotted burning woods toward Hoboken. We soon arrived in our Morse single-seater, an old stunt ship, where clouds of smoke revealed a great fire. I sat astride of the gas tank, high up behind the pilot.

"As Chamberlin drove into the huge column of flames and smoke, the draft, like that of a huge chimney, suddenly tossed us hundreds of feet into the air. Then it dropped us like a chunk of lead.

Chamberlin stepped on the gas, then looked around, certain that he had lost me, as there was no way of strapping me in. I was still there, but had nearly squeezed a leak in the tank with my knees. Later on he almost flew into the flames. I yelled: 'You're flying pretty low, aren't you?' He never batted an eye—all he said was: 'And you're getting pictures, aren't you?'"

All flying cameramen are oblivious of danger, as long as they are getting pictures. Chamberlin learned how to release his joystick and to take his own pictures, a stunt few pilots would undertake. Once he shot a motion-picture reel and dropped it to be picked up. The reel caught on the tail of his plane, and he had to go through his entire bag of acrobatics before he could shake it off. When it dropped it landed miles away. He took views of storm wreckage on Long Island

Flying Cameraman

while he was testing the "Columbia" for its long hop.

It was the Frenchman Montgolfier who made the first bird's-eye view possible to earthbound men, just 145 years ago. As he soared a few hundred feet on that first daring balloon ascension, no doubt he longed for a means of recording the marvelous picture of field and city and sea that spread under his feet. But not till the Wrights invented wing warping and a controllable plane, did aerial pictures become feasible. The telephoto lens is only a few years old.

Comm. Richard E. Byrd, on his scientific expedition to the Antarctic, will be the first polar explorer to bring back a complete photographic record of the regions he traverses.

"We are planning to take a special mapping camera," he said recently, "which will take photos as we fly over the Antarctic at 100 miles an hour. This camera will enable us to obtain pictures of a strip of the continent eight miles wide. The pictures may reveal unknown mountain ranges. We want to put something on the maps where now there is just a big white space. We shall look into regions never seen before."

Thus for the first time we at home shall see with the eyes of a bird or a pilot the vast wastes of dazzling snow and ice—probably enormous icebergs, a half-mile in depth and five miles long. Man-made wings and the "recording eye," two marvels of the age, have brought into being a new profession requiring the highest daring and skill—the flying cameraman's.

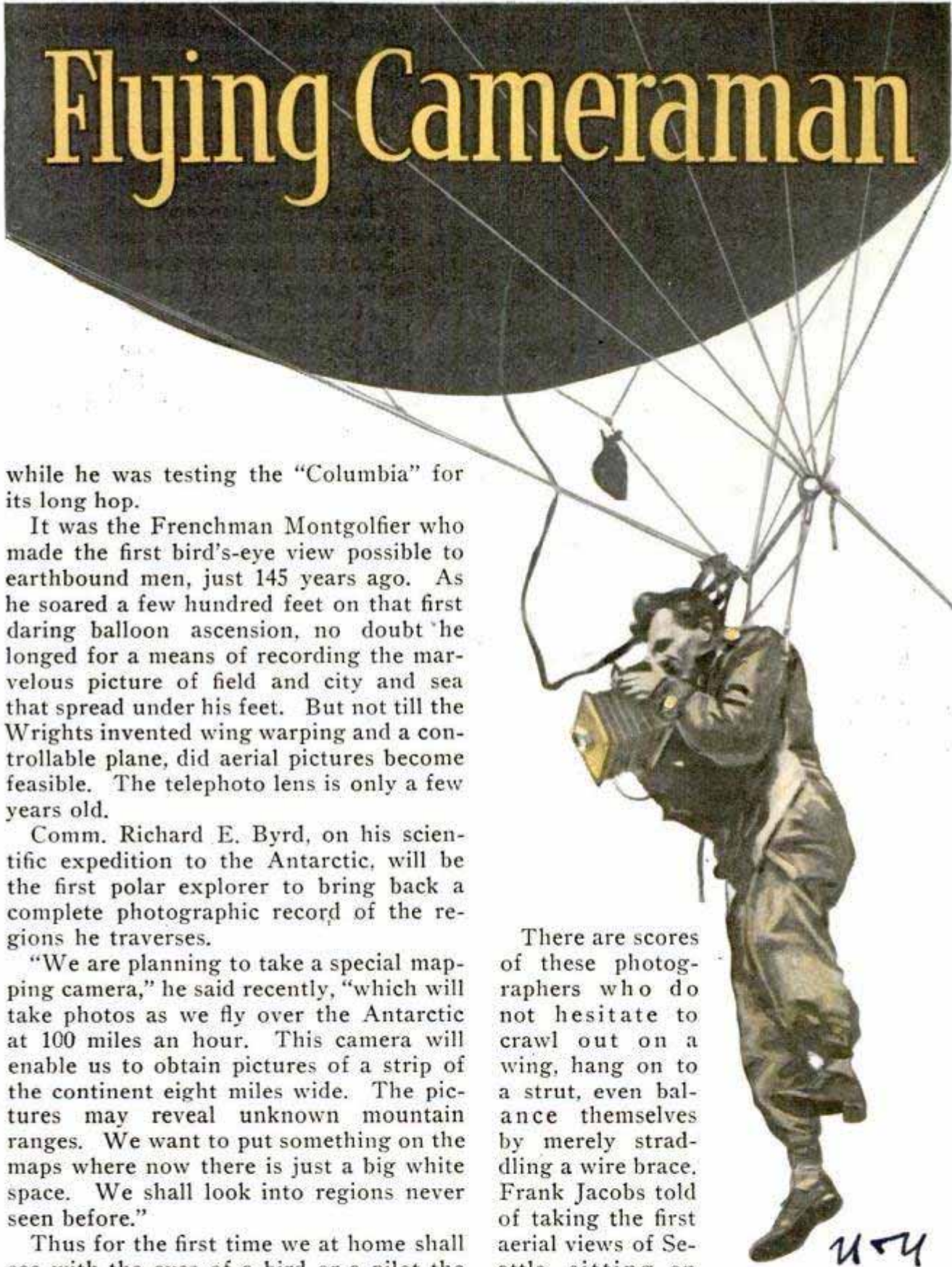

There are scores of these photographers who do not hesitate to crawl out on a wing, hang on to a strut, even balance themselves by merely straddling a wire brace. Frank Jacobs told of taking the first aerial views of Seattle, sitting on the edge of a wing and dangling his feet in space. This on a plane so old it was expected to "crack up" at any trip.

Marine disasters, such as that of the "S-4," offer plenty of hazards to the camera-

254
An Irish Cameraman, Suspended from a Balloon, "Shot" the Start of the "Bremen's" America Flight

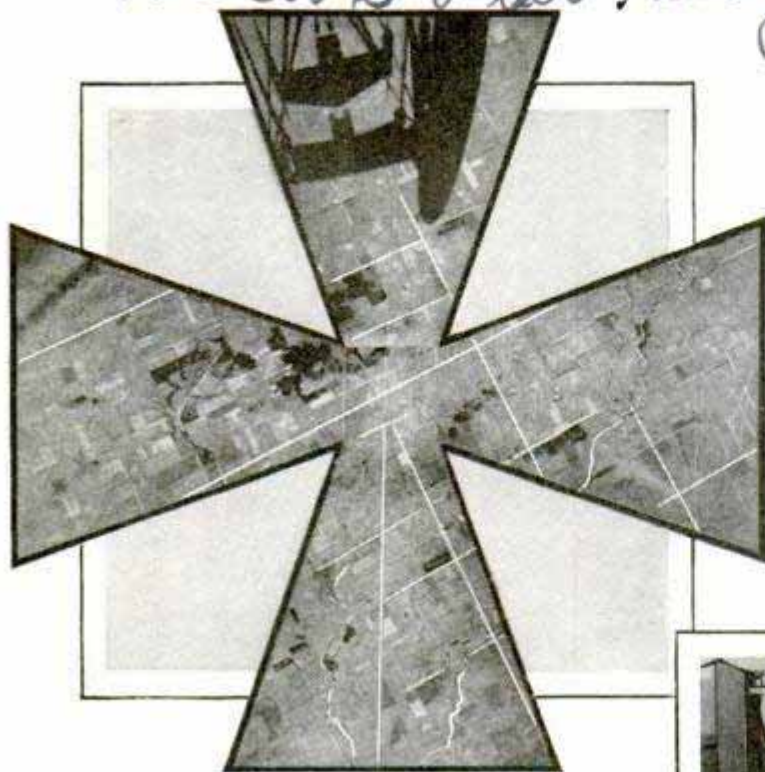

Single Exposure of a Hundred Square Miles of Ohio, Made with a New Five-Lens Mapping Camera, Above, and, at the Right, a New Electric Mapping Camera Which Is Used in England

man. When the "S-51" went down off Block island, Martin McEvelly was sent by a New York newspaper in a land plane. Forty miles from land—and safety—they circled and swooped and tilted. His paper got a "beat" of five hours on the pictures, and for a week McEvelly made a flight of 176 miles daily, 1,050 miles in all, to picture the salvage work. A stalled motor would have meant a plunge and oblivion.

Greater calamities now mean flocks of planes sent by the big news agencies and news-film concerns. Norman Alley made numerous flights over the flooded Mississippi basin, where no safe landing could be made. He not only got some very fine pictures, but spotted refugees and even dropped food to some. News films during the early stages, shown to the president and the cabinet, proved the necessity for prompt relief.

Alley was staying overnight in Pittsburgh, on his vacation, when the dirigible "Shenandoah" was wrecked in a storm. In the middle of the night he received a wire, rushed out, doubled the price for the only airplane available, which reporters had already hired, and zoomed into the air. Twenty miles from his destination the plane crashed. Alley crawled out, dusted himself off, routed out the owner of a fast

car, and reached the crumpled gas bag hours ahead of any other cameraman. Scores of others flew to the scene, and some crashed, while several, on their first trip, were airsick. But they all got good pictures.

Few who see movie or still pictures of dangerous stunts realize that the photographer may be experiencing even greater hazards. When the famous parachute jump of Sergeant Boes was made, John A. Bockhorst, news-reel man, had to "shoot" the falling body from another plane. He had to ride astride a slender bar in the bomb

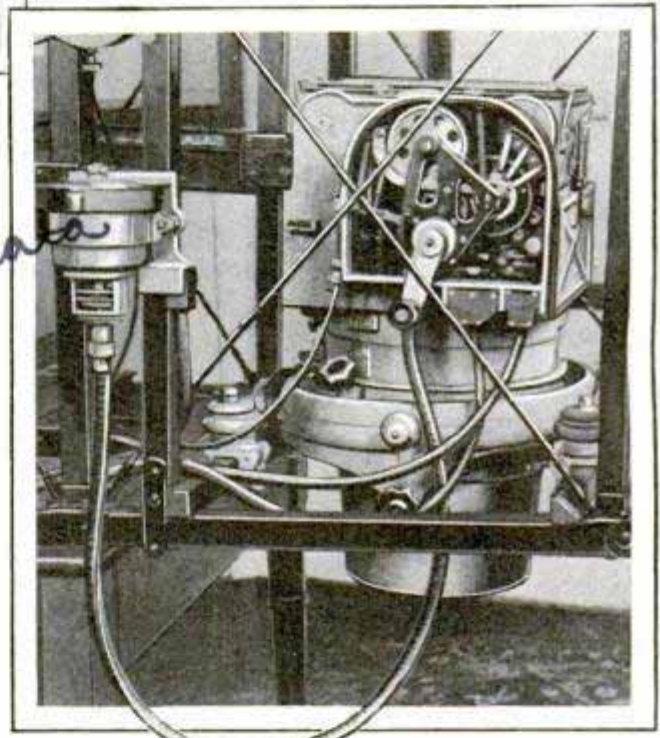

pit, his camera lashed to another bar, its nose pointing downward. If he had lost his balance, he would have plunged 3,000 feet to the earth.

As Sergeant Boes stepped off, Bockhorst started grinding his camera. His pilot pointed the plane's nose straight downward, paralleling the swiftly falling body of Boes, who dropped 1,500 feet before he opened his parachute. Thus Bockhorst made pictures which have never been equaled, for it was the first and only time that anyone tried to fly straight downward for such a distance—an extremely hazardous stunt.

Bockhorst met the army round-the-world flyers in Maine and accompanied

Al Mayer, New York.

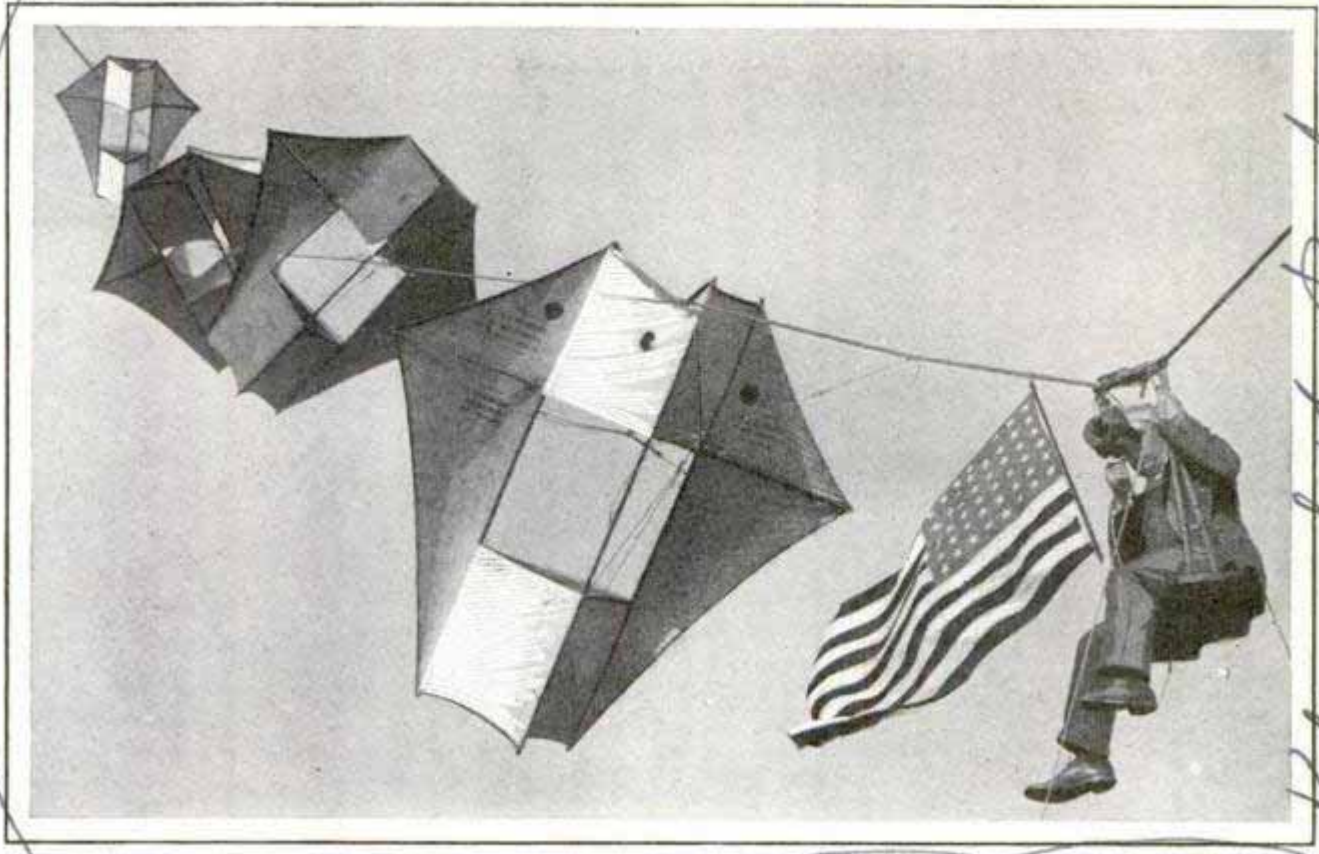

Kites. S. J. Terhino.

Movie Cameraman Aloft, Attached to a String of Box Kites to Film a Fair; Box-Kite Flying, Once Used in Army Observation Work, Is Almost Passe Nowadays

them to Seattle. He has flown across the continent several times, and went with the air expedition to the Panama zone, being lost with it for several months in dense jungle. Recently he varied his stunts by flying through the Grand Canyon of the Colorado, where the slightest touch of the wings on the sides of the great chasm would have meant disaster.

Aerial pictures have been taken of the eruptions of Mt. Vesuvius, of the Miami tornado, and similar hazardous events. It is even proposed that Mt. Everest be photographed, to aid future climbers. When pictures were made at Teller, Alaska, as Amundsen's dirigible landed from its north-pole flight, a photographer carried them by plane to Nome, thence over the highest range of mountains on the continent to Juneau. They were placed aboard a vessel just leaving for Seattle.

But 300 miles before they reached Seattle, T. G. Randolph took them off by airplane, made prints at Seattle for the papers there, and then flew to Elko, Nev., to catch the air mail for the east. By these devious and highly hazardous maneuvers, a beat of several days was made.

The same company had Robert Hartman at Spitzbergen when Comm. Byrd re-

turned from his north-pole flight, who also snapped the take-off of Amundsen twenty-four hours later. By some unexplained means, Hartman induced a Norwegian gunboat at Spitzbergen to take him and his precious films to Oslo, where he hired an airplane and flew over snowclad ranges, crossing Sweden, Denmark and the Baltic into Germany. From there he made a non-stop flight to Southampton, England, arriving just in time to place the pictures aboard a liner pulling out for New York.

Aerial-surveying (photographing) concerns permit flying only in perfect weather, with planes in tiptop condition. Thus they have few accidents. A large firm in New York reports never having had a serious accident, and only one of any kind. But two of the most mysterious accidents of record befell aerial-survey parties. Last July, a Canadian government machine, near Lake Manitoba, was seen to enter a cloud bank. When it emerged it acted erratically, and suddenly three bodies came hurtling from the plane, falling a thousand feet in a few seconds. The machine was wrecked in a nose dive. The engineers were experienced and careful.

Count de Lesseps and his mechanic, also on an aerial-survey trip, disappeared com-

pletely along the St. Lawrence river, in the eastern part of Quebec. Some days later the wreckage of their plane was found along the river bank, but the bodies of the noted airman and his companion have never been discovered.

These are exceptional cases, but the photographer who takes to the air must accept hazards rather heavier than those of the pilot. Even the stunt acrobat and the plane changer have their hands to use in maintaining their hold, while the cameraman usually must have both hands free to operate his machine. When the plane swoops over such a raging inferno as at Lake Denmark at the time the naval arsenal blew up, with fourteen-inch shells bursting and enormous dumps going up with a roar, the photographer can make good use of his "charmed life."

Probably the medal for narrow escapes goes to Eddie Dowling, who was a lieutenant in the air service during the war, and was later assigned to get official pictures of the aerial bombing of the "Iowa" and other obsolete vessels off Hampton Roads. He was operating from the "D-2," a lighter-than-air craft from Langley field. "Off Cape Charles on our way home,"

said Dowling reminiscently, "the motor went bad and worked only at intervals. We decided to free-balloon as far as Aberdeen. At Princess Anne, however, the wind shifted and carried us seaward. So we decided to try to land. We saw a ball game going on, and dropped messages and a rope. But the high wind whipped the rope across the field and the two men who did grab it were flung flat.

"The only thing left to do was to pull open the rip panels placed under the bag, which, when opened, convert the ship into a huge parachute. Letting out gas would not help. One of the pilots and I worked hard on the ropes, but could not rip the panels. The ship was then drifting rapidly toward the seashore, and one of the officers began to get nervous and impatient.

"So he jumped and seized one of the rip cords, and swung his whole weight on the rope. The jerk pulled the panel clear out, and the big bag broke in two. We hit the ground a few seconds later, the wreckage on top of us. When I came to, with the radio set in my lap, I was so sure my bones were all broken that I did not dare move.

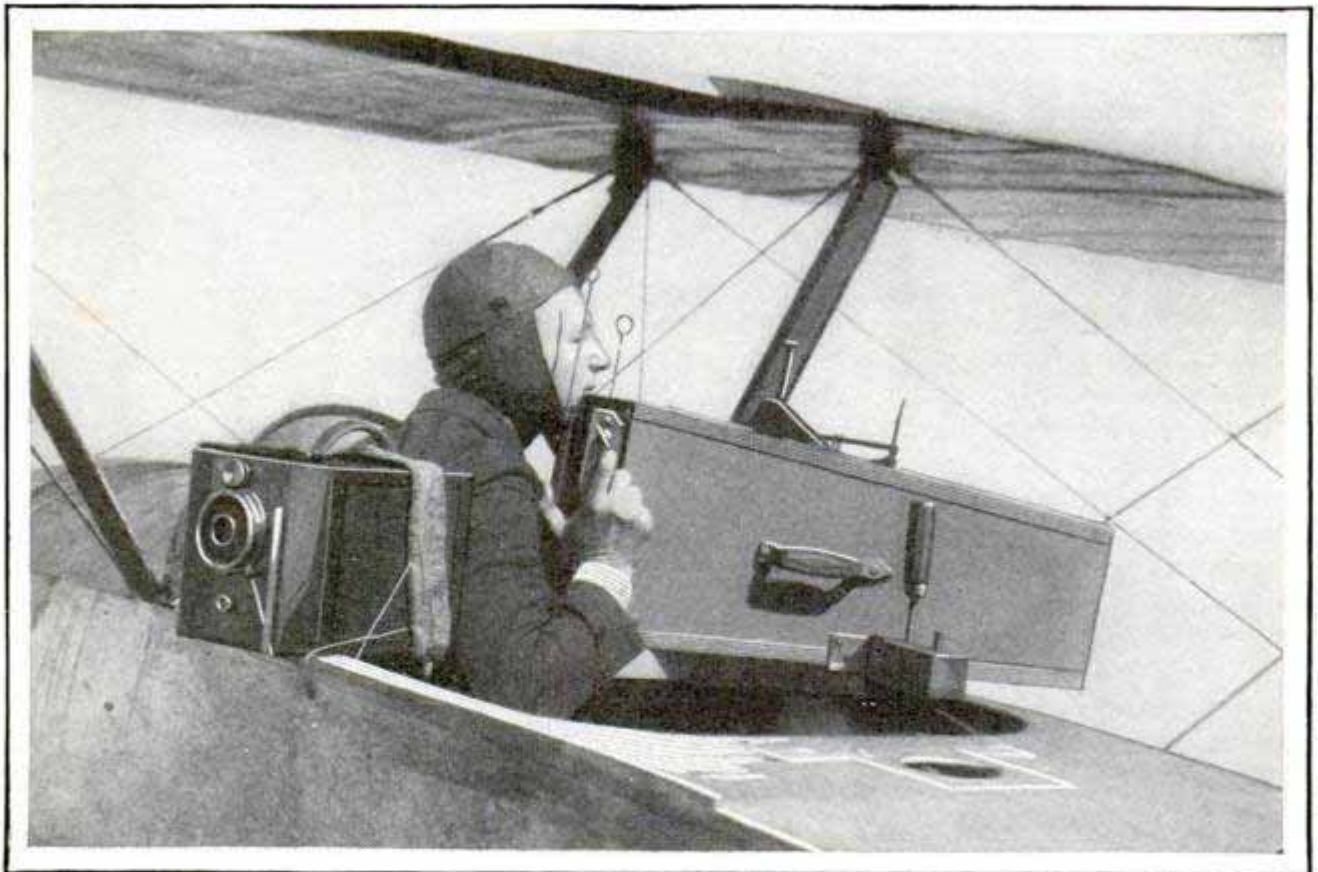

Clarence D. Chamberlin, Pilot of Charles Levine's New-York-to-Germany Plane, as a Cameraman; Aerial Cameras Shoot Straight Down or over the Side, as in This Case

"Just then a farmer came running up and inquired in earnest tones: 'Do you fellows always come down like that?' I was the only man aboard who was unhurt."

The aerial cameraman flies "high wide and handsome," but he has a good time just the same, and he gets the pictures!

NAVY TO TEST FOUR THOUSAND SUBMARINE SAFETY IDEAS 99 2

Sixty thousand proposed inventions to make submarines safe, the product of the brains of more than 6,800 people scattered all over the world, were submitted to the navy following the sinking of the "S-4" last December by the coast-guard destroyer "Paulding." This fact was disclosed recently when the navy department, in accordance with an act of congress, appointed a board to study 4,000 of the ideas which were considered worthy of investigation and, possibly, actual trial. The "S-4," reconditioned at Boston navy yard, has been set aside as an experimental ship and turned over to the board, with authority to try out on it any of the devices which appear practical. Congress appropriated \$200,000 for the work.

WHISTLE ON TIRE AIR GAUGE STOPS OVERINFLATION 37/5

As it can be adjusted to sound a warning whistle at any predetermined pressure from twenty to sixty pounds, a patented pressure gauge eliminates the necessity of making a separate test. The adjustment is obtained by turning a graduated sleeve on the handle. In use, the head of the gauge is slipped over the tire valve, while the air-hose valve is pushed down on the top of the gauge. When the pressure inside of the tire corresponds to the reading on the gauge, a whistle warns the user to remove the hose.



Estab. Gauge Co.
2129 S. Michigan



Pouring Water over Waterproof Silk Hose, to Demonstrate Their Protection from the Wet

WATERPROOF SILK STOCKINGS LATEST LUXURY

Silk stockings, specially treated so that they will shed water, were demonstrated recently in successful tests. Besides helping to protect the health of the wearer, they are said to be more easily kept clean.

OLD BUILDINGS ARE SAFEST FROM VIBRATION 99 6

Alarmed by the peril to some of London's most famous historical buildings from the constant vibration of modern traffic, engineers have installed vibration recorders in Westminster Abbey, St. Paul's Cathedral, the Nelson Column in Trafalgar Square and the National Gallery to determine the extent of the danger and plan measures to offset it. The increase in automobile traffic, particularly of heavy motor busses, and the vibration from the subway trains have set up stresses the buildings were never designed to stand. Strangely enough, according to H. V. Lancaster, a London architect, the modern steel-frame buildings are giving more alarm than the older ones. The old buildings of brick and stone are so loosely built that they absorb much of the vibration.

Espresso 6/17/28

*Paraffine Compagnies
L'Union Francaise
Sole*

W. Walpole Mass.
POPULAR MECHANICS
100 & 42nd New York
PAPER COVERS OVER GARDENS
HELP PREVENT WEEDS 894

By the use of a paper mulching system demonstrated by the department of agriculture, weeds are kept from growing in fields and gardens. The paper is made of an asphalt preparation to render it impervious to water and is applied in narrow strips between the rows. It helps prevent evaporation from the soil, aids in maintaining a more even temperature and is said to increase the fertility of the ground. Spinach, sweet potatoes, beets and other products have been raised in this way with notable increase in yield.

L. H. Hunt.

NOVEL FLOAT TESTS FLYING ENGINES ON WATER 825

Tests of the assembly and gearing of pairs of English-built Bristol Jupiter engines for a huge new Dornier Super-Wal flying boat, being built in Switzerland, have been carried out on a novel hydroplane, used as a floating test bed. The pairs of engines, one equipped with a tractor and the other with a pusher propeller, were mounted on a dummy engine nacelle, just as they will be in the airplane. A pilot, seated below the engine mount, handled the boat, while a mechanic riding above him carried out the test work on the motors. Two and four-engine Dornier flying boats have been built in numbers, but the plane now under construction is to have twelve motors. The Jupiter is the largest and most widely used radial air-cooled engine in Europe, being built both in England and at several licensed factories on the continent.



The Floating Testing Ground for Airplane Engines: Hydroplane with Motors Installed for Trial Run

The Bristol Aeroplane Co Ltd Bristol 6/2/28



Carrier Packed and Unfolded as a Table; If Desired, Long Legs Are Furnished for Standard Height

CAMPING TABLE AND CARRIER COMBINED IN ONE

For the convenience of automobile picnickers, a holder for the luncheon, and other things, is quickly converted into a small dining or card table. It is easily carried in the car and is also furnished with standard-length legs, if desired.

JUDGING THE WIND'S SPEED 864

When the tree leaves are still, there is no appreciable wind, or its speed is usually less than two miles an hour. Faintly stirring leaves indicate a wind speed of about five miles an hour. When the branches move slightly, the speed is nearly ten miles an hour and, if they bend a little, the wind is moving in the neighborhood of fifteen. A twenty-mile wind will cause the branches to rock and sway. At twenty-five miles leaves will sometimes be blown from the trees, and when small branches are broken off, the rate is thirty-five miles an hour or more.

Chicago - 180 N. Wacker

779
J. Durrois & Maine Portland, Maine

804 (Anno. Morgan, Norfolk, Va.) POPULAR MECHANICS

The Milk Protector Co
2119 Chesapeake Drive Road
Norfolk, Va.

Milk-Bottle Holder with Lock Top, to Prevent Theft



LOCK HOLDER FOR MILK BOTTLE PREVENTS THEFT AND DIRT

To keep the milk bottle safe and sanitary until it is taken into the house, a lock container has been introduced. The bottle is inserted through the bottom and is securely held by springs that close over the neck ridge and prevent it from being drawn out except at the top. This is unlocked with a key. The holder is easily attached in any convenient position, is made of heavy metal and is quite attractive in appearance.

960

RADIO SAVES SCORES OF SHIPS IN GREAT LAKES STORMS

Radio, the modern right arm of the lighthouse, saved more than forty ships on the Great Lakes during the past year, according to the department of commerce. The radio compass is taking most of the danger out of navigation, particularly on the lakes, which are swept by wireless signals from twenty radio-beacon broadcasting stations, serving 300 vessels equipped

Lighthouse
Lighthouse

with receiving apparatus. Four times each day, regardless of weather conditions, these stations send out messages for a half-hour period on a wavelength of 1,000 meters, far above the channels used for entertainment broadcasting, to eliminate interference. The compass includes a loop antenna over the ship's pilot house with axis extending downward and carrying sight wires over a compass in the house. The loop is connected to a radio receiver and can be revolved by the observer swinging the sight wires over the compass. After picking up the station, the observer turns the loop and notes the varying strength of the signals until a point is reached where they are lost entirely or nearly so. At this point, the loop is perpendicular to a line connecting the ship and the station heard and the sight wires are placed so that they point directly to the station. By referring to the compass beneath the wires, the observer is thus able to get his direction from the station.

QUICK-ADJUSTING WRENCH FITS TEN SIZES OF NUTS

For quick adjustment, a wrench now on the market, is fitted to the nut by means of a notched spring release and catch which is arranged to work on ten different sizes of nuts for each wrench. This plan saves turning a screw and gives an exact fit that prevents slipping. There are ten different sizes of wrenches so that the set is equivalent to thirty wrenches.

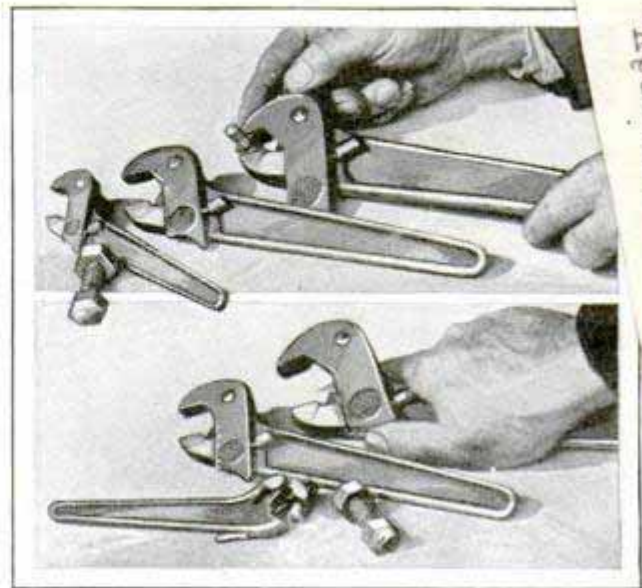

Three Wrenches Equal to Thirty; the Different Sizes and Method of Adjusting to Fit the Nut

Sellman Mfg. Co.
Chicago, Ill.

J. H. Kennedy,
820 N. Cass St.,
Chicago, Illinois.

How to Stop Without Skidding

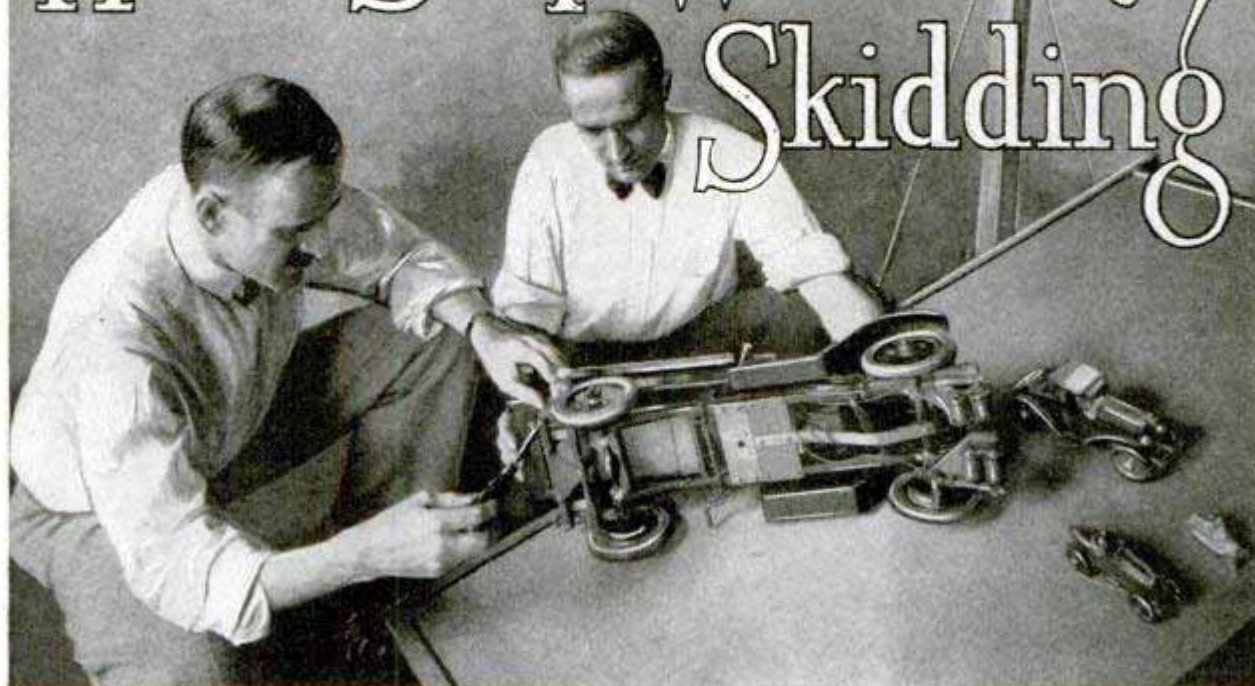

Tuning Up Midget Models for Spins down an Inclined Plane; the Bureau of Standards in This Way Studied the Cause and Effects of Skids and Discovered the Remedies

By G. H. DACY,

*4639 Montgomery Ave
Bethesda, Md.*

IN ORDER to eliminate the millions of motoring accidents due to skidding from the American records, Uncle Sam is playing a novel laboratory game with midget models and a simulated hill whose steepness can be varied.

Automobile pivoting, as you know, is one of the most serious menaces of modern cross-country transportation. The majority of spills and smash-ups during wet, slippery weather are due directly or indirectly to skidding. If science can solve the secret of skidding, subsequent publicity will educate drivers about practical control measures, and this frightful annual loss in life and limb can be blotted from the motoring picture.

Even today, the automotive industry knows but little about motor-car pivoting, its causes and control. It is a question which has given rise to innumerable undemonstrated viewpoints. So the national engineers devised an adjustable imitation hill whose angle or grade could be changed rapidly by lowering or raising control cables. The midget motor cars used in the

practical experiments are toy models. Their skidding, scooting, sliding spins down this inclined plane with brakes in various adjustments imitate the pivoting and pirouetting of automobiles which descend mountainsides during wet weather to crash in dangerous accidents.

One of the test cars is a metal model of a truck. Its wheels are equipped with rubber tires and have small electric magnets which act as instantaneous brakes on each wheel. The arrangement is such that the toy truck can be started by gravity down the inclined plane and then, by manipulation of the magnets, maximum braking power can be applied to the various wheels. Three smaller models with free-turning wheels, which are braked with pieces of wire or wood, have also been used in these simple tests.

The plane is covered with white paper over which carbon or ordinary tracing paper is placed in the tests with the three models. Their metal wheels thus write a permanent record of the course of the car in each descent under different brake ad-

*Bureau of Standards 387
U.S.C.*

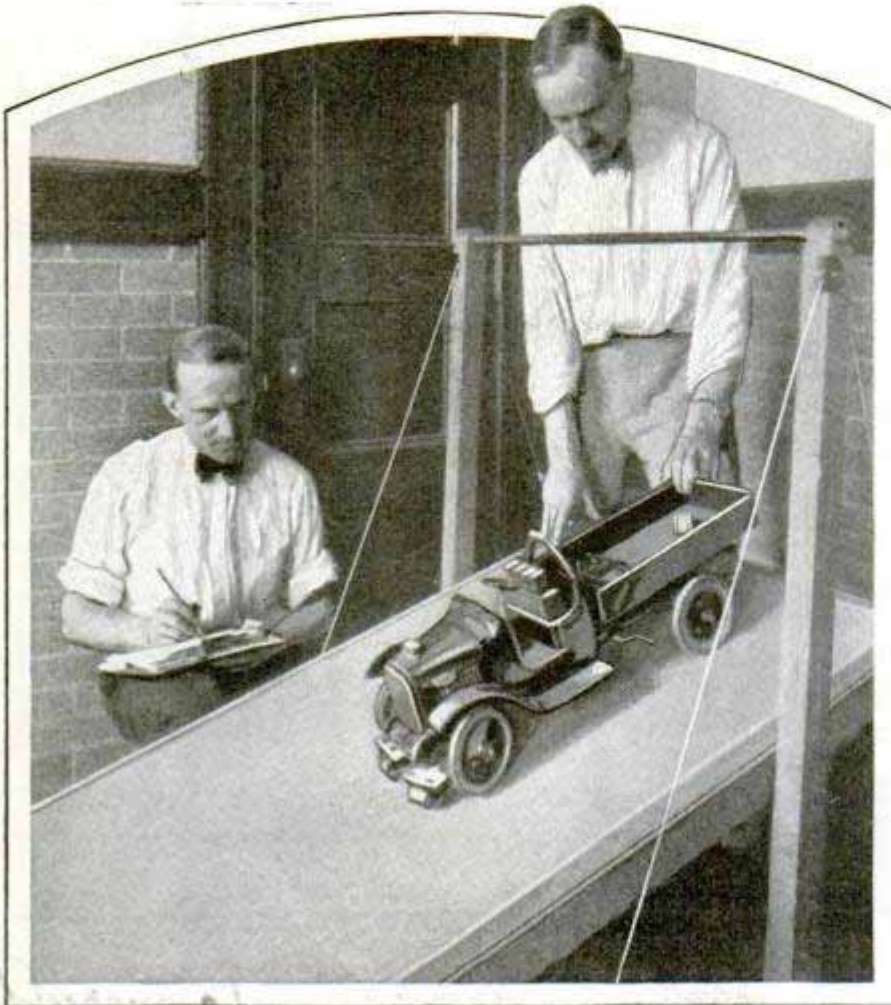

Toy Automobile Equipped with Electric Four-Wheel Brakes for Government Tests of Cause and Effect of Skids

justments. These diagrams have brought to light important information about motor-car pivoting.

The maximum skid results when the front wheels of an automobile are turning and the rear wheels are locked suddenly by emergency braking. Although the center of gravity of the car will continue along a straight course during the resultant pivot, the rear wheels, acting as rubber-mounted skids, will carry the machine through a curve of 180 degrees—or more. At the end of the skid, the car will be pointing uphill, having completed a half turn during its pivot. Skids made at high speed on a very slippery pavement are even more dangerous. The tests show that there is no way of predicting in which direction the car will skid.

The government specialists have ascertained that by applying from sixty to seventy per cent of the braking power to the front wheels, on a car equipped with four-wheel brakes, and the balance to the rear wheels, skidding can be eliminated at the

momentary sacrifice of steering control. These laboratory results have been verified by road tests made with several different makes and models of automobiles. Where the majority of braking force is concentrated on the front wheels of an automobile traversing a very slippery highway or curve at a speed of twenty-five to thirty-five miles an hour, the car will not skid when the brakes are applied suddenly, but will continue straight forward in its course until the brake control brings the machine to a standstill.

The popular objection among automobile drivers to dominant front-wheel braking is that it results in a temporary loss of steering control. The national authorities, who are deeply interested in the reduction of motor-car

mishaps, answer this objection by saying that steering control can be regained immediately, in the case of an emergency, merely by releasing the brake and steering the car in the desired direction away from any dangers that may occur in its straight-ahead path.

Inventors for several years have been occupied in the perfection of various appliances designed to control motor-car pivoting. Several devices have been originated that function satisfactorily, but which are so complicated and costly that their use as standard equipment on ordinary automobiles is out of the question. One man has even gone so far as to invent a contrivance which is qualified mechanically to shift the majority of braking power from the rear to the front wheels, and vice versa, simply by pulling a control like the gasoline choke on the ordinary automobile instrument board. Uncle Sam's research indicates that the adjustment of four-wheel-brake cars so that the preponderance of power is centralized

on the front wheels is practical, efficient—much to be preferred to, and far less costly than, the installation of such emergency accessories.

The experiments were also productive of important information for the owner who drives an automobile equipped with two-wheel brakes. If his car skids on a curve, or because of a slippery pavement and the sudden application of rear-wheel brakes, Uncle Sam recommends that the driver steer his machine in the direction it skids. The natural tendency, which has resulted in untoward accidents, is to steer in the opposite direction to that of the pivot. This tends to increase the skid and spin of the car wheels. On the other hand, if the driver steers in the direction of the skid, the bearing surfaces of the front wheels aid in curtailing the severity of the

pivot. Where the motorist has his four-wheel brakes adjusted so

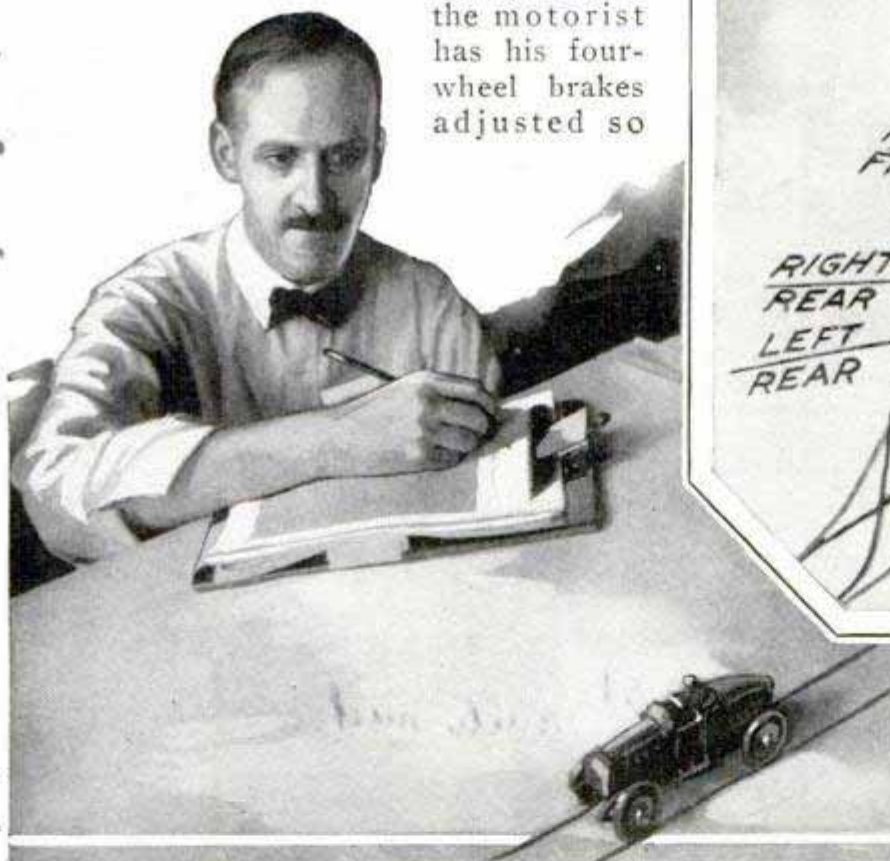
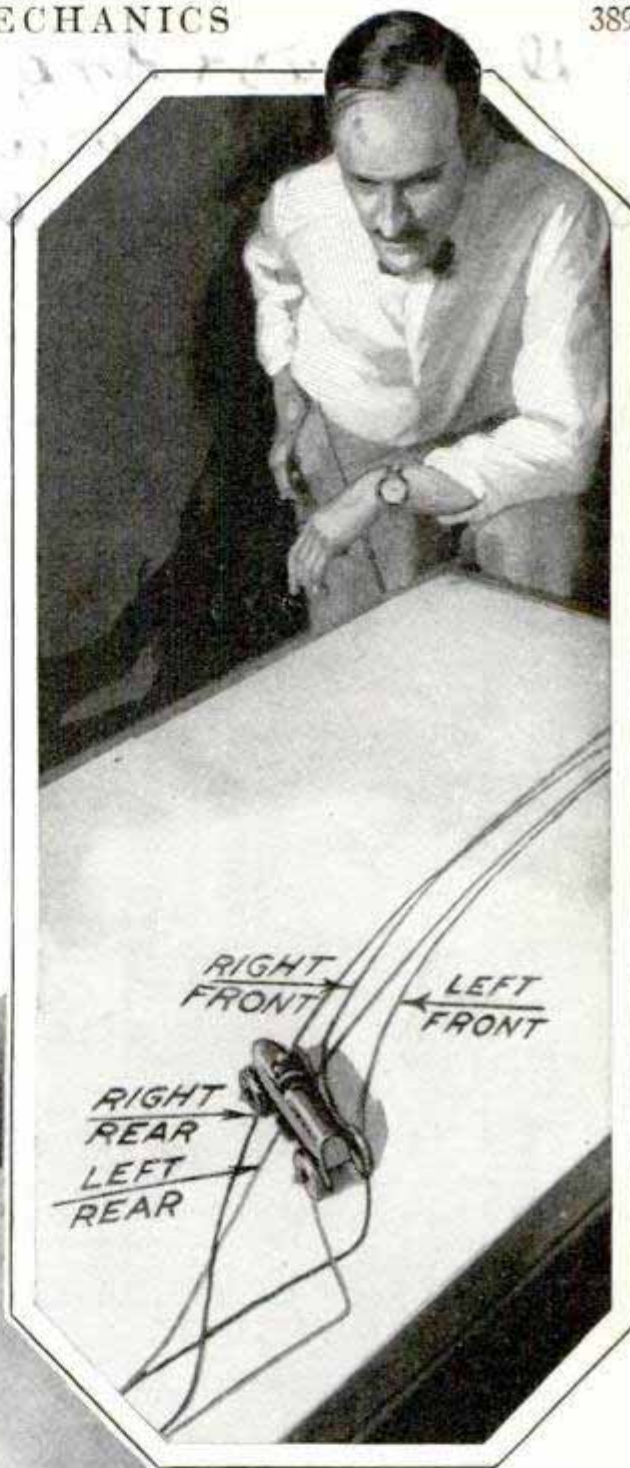

Above, with Rear Wheels Locked on a Steep Grade, the Model Skids and Comes to a Stop Facing in the Opposite Direction, Whereas, with the Braking Force Mostly on the Front Wheels and the Rear Ones Free to Revolve, It Continues in a Straight Line Until It Stops

that the maximum braking force is directed on the front wheels, he must drive his car more carefully during dry weather. If the brakes are applied suddenly at ordinary driving speed, the car will come to such an abrupt halt as to hurl any passengers from their seats. Another danger comes from the trailing car which is unable to stop as quickly as the machine with extra-power front-wheel brake con-

trol. This may mean a collision from the rear, if the driver of the first car applies his brakes suddenly without due warning to the motorist in his wake. Mastery of dry-weather driving, with four-wheel brakes adjusted as the national experts suggest, requires some little practice. Drivers who have tried out the new system are most pleased and report it a practical step toward control of skidding.

Blackburn Aeroplane & Motor Co. Ltd.
12 Norfolk St. W.C.2, London Eng.

14 New Burlington St
London W.C.1, Eng.

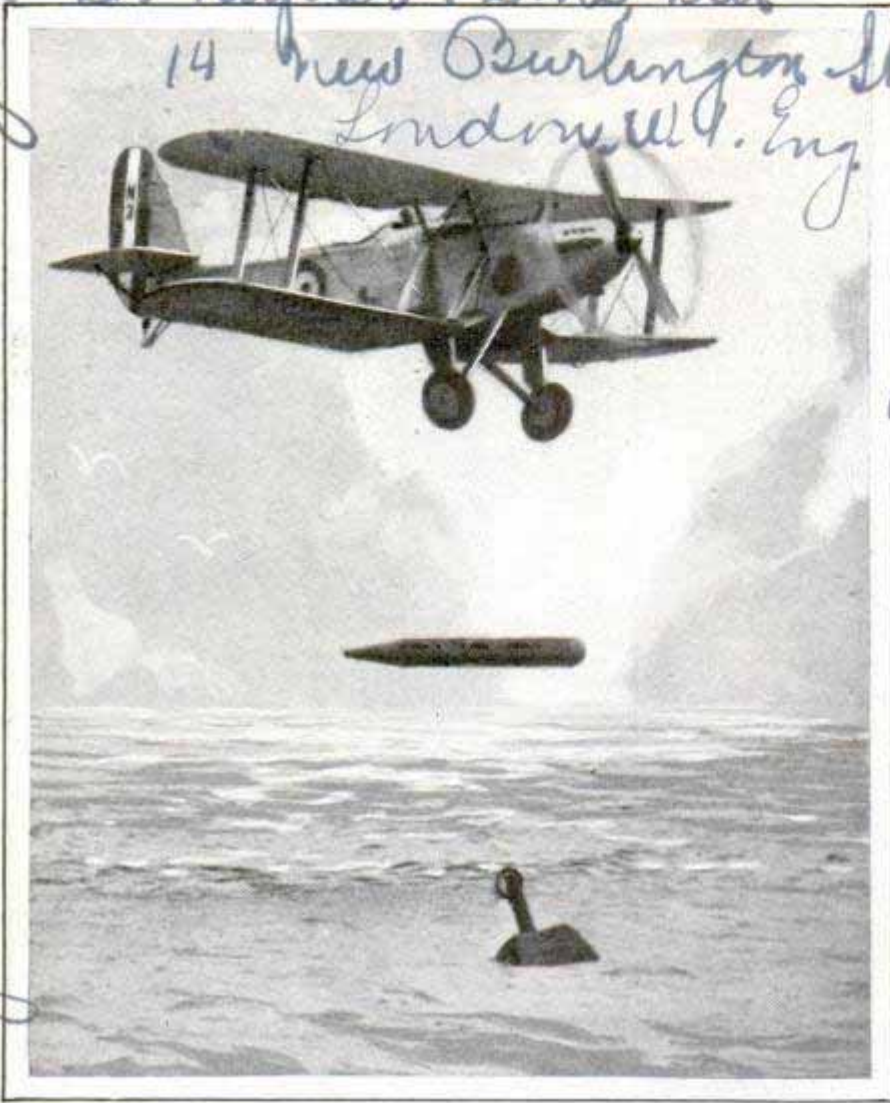

Dropping Big Torpedo from War Plane Which Can Carry More Than a Ton of High Explosives

**TORPEDO CRAFT OF THE SKIES
LATEST WAR UNIT**

An airplane developed in Great Britain, can carry a torpedo weighing a ton besides several bombs, according to reports. It has a speed of 150 miles an hour, can remain aloft for twelve hours with a full load, takes off after a run of only fifty yards and will ascend almost vertically.

**HOOK KEEPS CLOTHESLINE TAUT
AND IS RUST-PROOF**

Clotheslines are kept tight, without the need of tying knots, with a pair of holders recently introduced. They are made of steel, are plated with a rust-proof metal, fit a flat or rounded surface and are



592

The Midland Co., 211...

suited either for indoor or outdoor use. A slotted hook and curved guards keep the rope taut, prevent sagging and help preserve the line by eliminating kinks.

**THOUSAND-FOOT
SHIP TO COST
30 MILLION**

A White Star liner, over 1,000 feet long, with a beam of 100 feet and tonnage of 60,000, will be ready for ocean travel at some future date, the keel already having been laid in a Belfast shipyard. The vessel will cost \$30,000,000. Engineers have not yet decided as to exactly what type of machinery to install, as the ship is not scheduled for completion until 1932 and many developments are anticipated before that time. The liner will be named the "Oceanic." It will be larger than any steamer now in service.

934

Oceanic

Harland & Wolff, Belfast, Ireland

The largest vessels at present are the "Leviathan," the "Majestic," the "Beren-garia," the "Olympic," the "Aquitania" and the new French liner "Ile de France."

**HOSE SPRINKLES MORE LAWN
THROUGH MIST NOZZLES**

551 Multi mist



One length of hose can be made to do the work of three or more by inserting special spraying nozzles at intervals. These distribute a fine mist in all directions, preventing injury to tender plants and insuring a thorough watering of a wide area. The sprinklers have no moving parts and are easily attached at the section joints of the hose.

Our Bureau of Information is for your benefit. Use it as often as you please.

And Peterson 1345 Arroyo St.

SPEED OF PARACHUTE JUMPER HUNDRED MILES AN HOUR

Parachute experts at Wright field have been surprised to discover by actual tests that, after leaping from an airplane, a man does not fall as rapidly as had been supposed. After a jump of 1,600 feet, and just before the parachute is opened, the body's velocity is between 100 and 120 miles an hour, the experts showed. Delayed openings, such as have been popular among daring jumpers in recent years are hazardous enough, but after the first 2,000 feet, the increasing density of the air tends to check somewhat the speed of the fall, the tests disclosed. The trials were made at night by dropping a dummy with flare attached and filming the descent with a camera whose shutter opened and closed at second intervals. The finished picture shows a broken streak of light to denote the fall of the dummy. The flare is lighted before the dummy is released, and as the plane flies at right angles to the camera, its path is marked by a horizontal line.

930
Staylor

Pauline Coast Diaclores
1615 S Vermont
Los Angeles
Calif



Chemist with Plant Restored to the Appearance of Life by Application of a Radium-Paint Preparation

RADIUM PAINT REVIVES PLANTS APPARENTLY DEAD

Plants and flowers, apparently withered and dead, are said to be restored to the appearance of life with a radium paint a western chemist has prepared. Care is taken in the application and manufacture of the mixture, to have just the right proportions of chemicals to achieve the results desired without injury to the blossom.

MOST OF WORLD YET UNKNOWN EXPLORER FINDS 914.

Only about two-sevenths of the world has been properly mapped, according to Dr. Hamilton Rice, a South American explorer. The remaining five-sevenths must still be accurately measured and charted before we will have a true picture of the lands in which we live. The development of air transportation will greatly stimulate and simplify this task, Dr. Rice believes, after using a small hydroplane and radio sending and receiving sets to complete the mapping of 500,000 square miles of little-known territory in Brazil, Colombia and other countries. He advocates the establishment of courses in exploration at some of our colleges.

FOOT HARNESS FOR OARSMAN AIDS IN PADDLING

By the addition of a foot-power apparatus, worked in harmony with the arm strokes while paddling, a German inventor has introduced an effective aid for the oarsman. Pedals are connected to the shaft that actuates the paddle in such a way that depressing each in turn, with the strokes, gives additional power.

822

in Potsdam



Foot Gear Shown Helping Oarswoman Move Paddle

Wide World Photos Monitor 6/13/28

3849

Capt. H. C. June
Los Angeles, Calif.

International
Pauline Coast Diaclores
1615 S Vermont
Los Angeles, Calif.

843

What's Wrong When a Plane

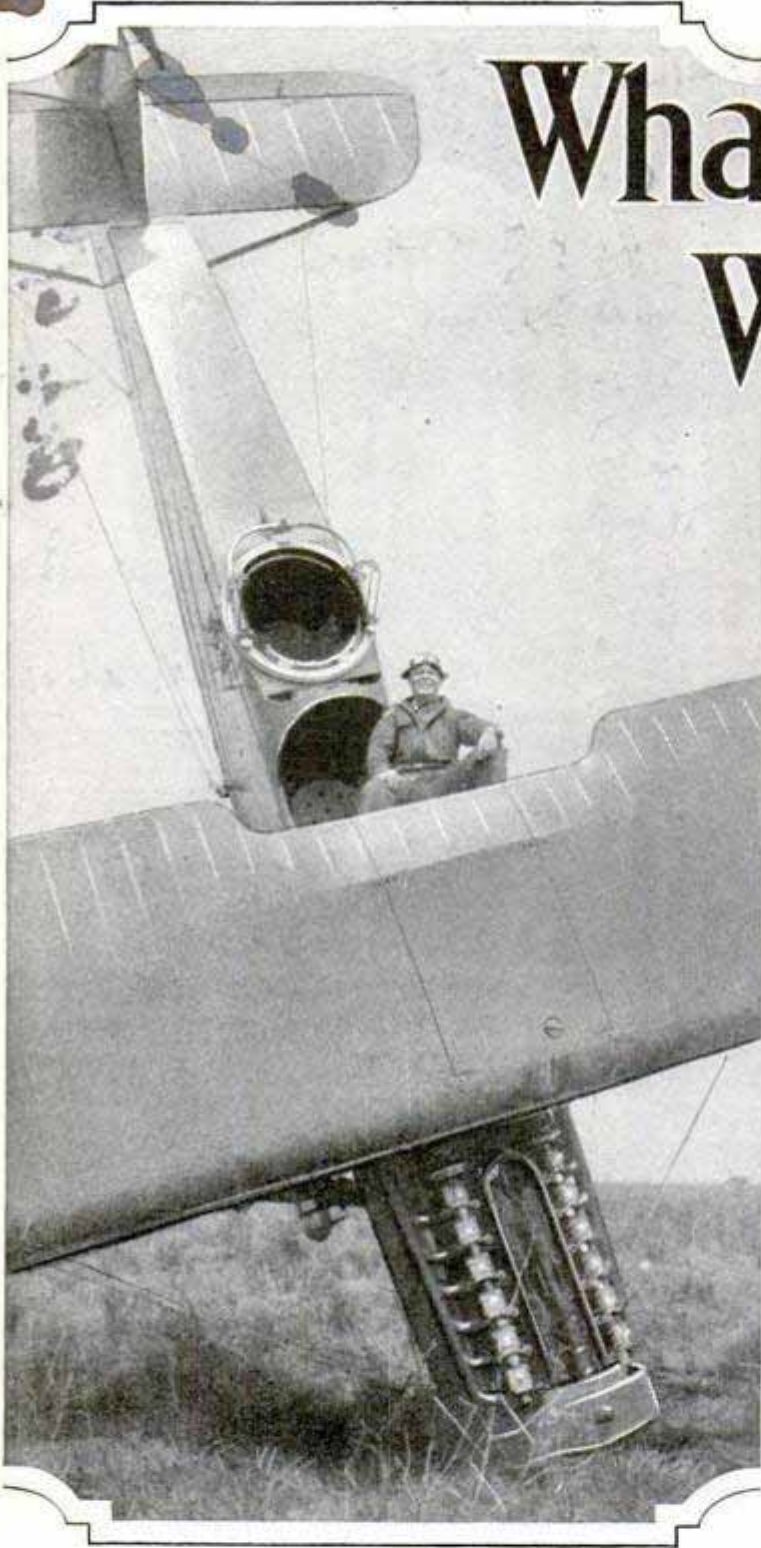

An Army DeHaviland Standing on Its Nose after "Pancaking" into a Field in an Attempt to Land

Lieut By LELAND S. JAMIESON

FIFTY per cent of the airplane crashes in which the pilot is killed go unexplained. A crash occurs and a crowd of morbidly curious people gather about the wreck. The pilot's friends examine the wreckage for a broken part, but usually there is no tangible fact upon which to build a conclusion. For lack of better

explanation, the investigator is apt to say: "No, the motor was working all right—I heard it myself and she was turning wide open when she hit. Controls seemed all right, too. I think it was just another case of human error—nobody to blame except the pilot." And more often than not, the investigator is right.

An answer to the question "But what's the trouble?" can be given only through a study of some of the elements of flying, of human nature and human error, for it is safe to say that fully eighty-five per cent of the accidents in flying can be traced directly to the human element. Structural failure in an airplane of modern design is so rare as to be disregarded entirely. Steel construction, plus exacting inspections, has reduced mechanical failures—with the exception of motor failures—to the very minimum. But failure of the human mind to cope with difficult situations is not at all rare. No man is infallible, and regardless

of his native flying ability, or the skill developed by extensive training and experience, any man will at times make mistakes.

Of all the factors contributing to accidents in flying—with the exception of lack of flying ability—carelessness is perhaps the most common. It would seem that in any profession as hazardous as flying the pilots and mechanics would be cautious to a fault. Some of them are,



An Army Parachute Jumper Falling, Head First, over the Side of the Ship in a "Free" Jump; the Jumper Must Fall Several Seconds to Insure That His Chute Will Clear the Tail

but a great many are not. Some pilots, as they become more experienced, tend toward greater caution, yet at the very same time they are prone to think that by their very experience they will be able to successfully overstep the bounds of sound judgment. There comes a day of reckoning, however. In the final analysis, it may be said that the foolhardy individual eventually becomes careful, or eventually he becomes by trade a plumber or a mechanic or a care to the undertaker—at any rate he quits flying.

When a plane runs out of gasoline and is forced to land, it may or may not be the fault of the pilot. But usually it is the result of the tendency of the careless man to think: "I've got enough to get me through—I'll take a chance on it." And a thousand things may happen to cause a plane to use more gas than contemplated. It is enlightening to know that of the forced landings caused by failure of the motor, about sixty per cent result from running out of gas.

While any sort of accident in an airplane is usually of some seriousness, there are quite often amusing incidents in connection with near-accidents and forced landings. An officer of the air corps, named McIntosh, when returning from a "port of call" some 500 miles distant, was disposed to land at his home field on the last quart of gasoline rather than at an out-of-the-way field to replenish his supply. One evening he ran into an unlooked-for head wind, and, thus delayed, he was some fifty miles from home when darkness overtook him. Fifty miles is a matter of some thirty or thirty-five minutes, yet the sky can become unbelievably dark within that length of time, especially when one is counting the minutes and doubting that there is enough gas to get him in. When within about two miles of home, and over a large area of very black ground, the ship ran out of gas.

McIntosh was an experienced pilot and had a steady nerve. Furthermore he was flying his own pet ship. He could, of

Kelly Field Tex.

Report by Capt. C. A. Lindbergh on the collision in an letter S.E. S.E. No 50 piloted by Lt. MacAllister and S.E. S.E. No 55 piloted by Cadet C. A. Lindbergh about 8:50 A.M., Nov. 6, 1925 approximately 10 miles north of Kelly Field

A wire ship S.E. 5 formation commanded by Lt. Blockman was attacking a 2,147, B. flown by Lt. Mungion at about a 5,000 ft. altitude.

I was flying on the left of the top unit. Lt. MacAllister was on the right and Cadet Ben Reaking

When we moved down on the D.H. I attacked from the left and Lt. MacAllister from the right. After Cadet Ben pulled up I continued to dive closer to the D.H. before pulling up to the left. At the time I saw no other ship nearby.

I passed by the D.H. and a moment later felt a slight jolt followed by a crash. My head was thrown against the cowling and the plane seemed to shift position and hang nearly motionless for an instant. I closed the throttle and saw Lt. MacAllister in his S.E. 5 on my left. He was apparently undisturbed and getting ready to jump. Our planes were lashed together with their

fuelage approximately parallel. My right wing was damaged and folded back slightly covering the forward right hand corner of the cockpit.

When the wires began to whistle the ship started rattling around and the damaged wing commenced vibrating and striking my head at the bottom of each oscillation.

I removed the rubber safety, unhooked the belt, and climbed out past the trailing edge of the right wing and with my feet on the cowling in the right under the cockpit, which was then nearly vertical, I jumped backwards as far from the plane as possible.

The winging was falling nearly straight down when I jumped and for some time I fell in line with it and only slightly to one side. Hearing the ship would fall on me I did not pull the rip cord for several hundred feet until I had fallen several hundred feet.

I have had him no falling sensation and I had no difficulty in locating the rip cord.

The parachute functioned perfectly almost as soon as I pulled the rip cord the rears jerked on my shoulders, the leg straps tightened, and the chute was fully opened.

course, have jumped and landed safely; but after a moment's consideration he decided to make the best of a bad situation and try to save the ship. So he stalled the ship down as slowly as possible, "feeling" for the ground as he descended. It was an agony of waiting. At last there was a terrific bump, the ship bounced through the air and a moment later came to rest. To be on the ground with a whole skin was to Mac as much relief as a reprieve to a doomed man.

McIntosh rid himself of his parachute while still in his cockpit and jumped lightly over the side. There was a sound of breaking wood, followed by an agonized cry. Mac had fallen nearly thirty feet and had broken an ankle. His ship had landed in one tree, bounced into another and remained perched there like some huge bird of the night.

I saw Lt. MacAllister floating above me and the uninjured plane about 100 yards to one side continuing to spin to the right and leaving a trail of lighter fragments along their path until they crashed in the mesquite about 2,000 ft. below. I plummeted into flames a few seconds after impact.

Next I turned my attention to locating a landing place. I was over mesquite and drifting in the general direction of a flower field which I reached by slipping the chute.

I halted before landing I was drifting backwards but was able to twist around on the harness just as I hit on the side of a ditch less than 100 ft. from the mesquite.

Altho the impact of landing was too great for me to remain standing I was not injured in any way.

Col. Lindbergh's Report, in His Own Writing, on His First Forced Parachute Jump Following a Collision with Another Ship While a Cadet at Kelly Field

Another cause of a great number of accidents is low flying. Depending upon its load, an airplane will glide from five to fifteen feet forward for every foot of descent. Thus, if a plane has a gliding ratio of ten to one and its motor stops at an altitude of 1,000 feet, it may glide nearly 10,000 feet before it is necessary to land. If a suitable landing field lies within a radius of 10,000 feet, there is practically no danger that the ship will be damaged; but if there is no field available, as when flying over large cities or very rough country, the ship will in all probability be wrecked.

If the ceiling is sufficient to obtain a safe altitude and there is no necessity for such flying, it is nothing but foolhardiness or carelessness that causes a pilot to fly dangerously low over cities or other inhabited areas.



Wreck of an Army Scout Plane; the Pilot Misjudged His Speed in Landing. Crashed His Landing Gear and Then Nosed Over on the Plane's Back, Yet Escaped without Serious Injury

Of the accidents untraceable to carelessness, those caused by inexperience are most numerous. Pick up any Monday morning's paper and you will immediately find from one to a dozen accounts of airplane accidents. The cause usually is not stated with any attempt to be strictly accurate, the reader being left with a bald narrative of what occurred. It is probably described as being the result of a wing slip or a tailspin or a stall, and the reader probably finishes reading the story with very little knowledge of why these accidents must happen. He knows, however, that he will see to it that he shall never be involved in one.

The large majority of the pilots, figuring in accidents where passengers are killed or injured, are men who have had very limited training and practically no experience in flying. They are in all probability using planes of war-time vintage, or craft in a more or less serious state of disrepair. They cannot be blamed for wishing to fly, for flying is a fascinating business, but it is likewise expensive, and to the novice with little money, the older-type plane offers the only means of flying at all. But regardless of his love for flying, no young flyer should carry passengers until he has had in the neighborhood of 100 hours as a pilot, and then such

passenger carrying should be allowed only when done in ships of modern design and construction.

The accidents of inexperience may take almost any form from digging a wing tip into the ground to spinning the ship in. Even with the number of war-time-type ships yet remaining in the United States, a report of a collapse of a plane is comparatively rare, the accident usually running true to form when the account describes it as: "..... the plane took off and climbed a short distance before attempting to turn. When well in the turn, the pilot seemed to lose control and the ship went into a tailspin and crashed to the ground."

Some years ago a young man was eliminated from one of the air corps' flying schools because of extremely poor judgment, coupled with lack of flying ability to such a degree that he was dangerous in the air. He had received a total of perhaps 100 hours in the air when he returned to his home. With that much experience he considered himself a good pilot in spite of his inability to pass the tests in the army and, with his father's financial aid, purchased a plane of war-time construction and went into the business of passenger carrying, or "barnstorming."

In the course of his travels he chanced

to go into a mountainous district where he had to fly rather high; and having obtained all of his flying training and previous experience at very low altitudes, he did not take into consideration the rarefied air. One Sunday afternoon business was very good. He had, in previous flights, taken some care that he did not fly over the city near the flying field, but when two young men approached him with the proposition of going up over town to get some pictures and offered him a good price for the flight, he decided he would risk it. His motor had been functioning perfectly and there could be no danger, he reasoned.

It was late in the afternoon when the plane finally got into the air. At the request of one of the photographers, the pilot was hurrying to get his altitude before the light became too poor for the work. He was flying almost directly over the center of the city, climbing as fast as possible, and the air speed was dangerously low. Without warning the motor suddenly stopped. He was in such a position that he could perhaps have glided to an outlying field. Why he did not do this is a matter for conjecture. But instead of flying the plane away from the town, he tried to turn and go back toward the flying field. He pulled back harder on the control stick and kicked full rudder in an attempt, in a pilot's language, to "wish" the ship around without losing altitude—and the plane fell into a tailspin.

Here Is What Happened to the Plane of a Novice Flyer When the Engine Suddenly Quit, Making It Necessary for Him to Attempt a Landing

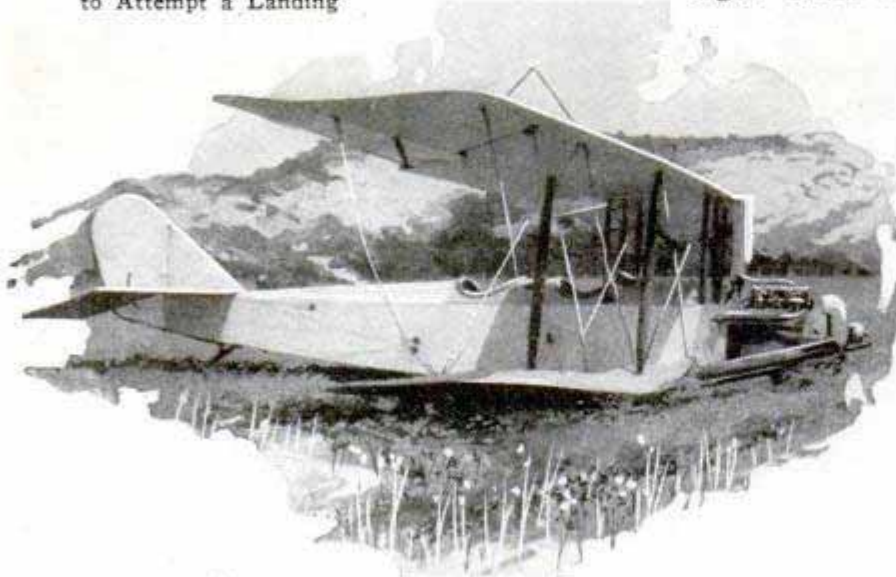

Whether he "lost his head" and forgot how to recover from a spin will never be known, for afterward he was unable even to remember how he had been injured. So, with the stick full back and full rudder on, the plane spun into a street in the city and struck an automobile. Fortunately, the car broke the fall to some extent, and the trio escaped with more or less serious injuries.

In any kind of activity accidents are bound to occur. Man-made machinery, regardless of how skillfully designed and expertly constructed, will at times fail. Hence in flying there are accidents which must be termed "legitimate." When the ship is flown by an experienced man who is exercising all possible caution; when the plane is in seemingly perfect condition; the weather fine and still an accident occurs, it must be laid to the doorstep of fate. There can be no other explanation. Yet, in a case of that kind, fate is always a combination of forces and coincidences.

A number of years ago the army maintained an aerial border patrol. The pilots were made up of war-trained men, and the problem of flying the length of rock-bound and mesquite-covered border became in the end a process of elimination. Motor failures were quite frequent, even for those days, and the failure of a pilot to return at night was a matter of no great moment. Usually he came in on a train or an automobile the next day.

One of these border-patrol pilots had flown a year and had had no forced landings. Naturally, in flying over the rough country, he operated with a constant thought of being forced down, and took all the possible precautions against being caught "short." He developed, in time, a habit of checking landing fields as he passed over them, so that he could tell with precision just when he was within reach of a place to land.

The border along the Rio Grande is subject to periodic fogs at certain times of the year. These

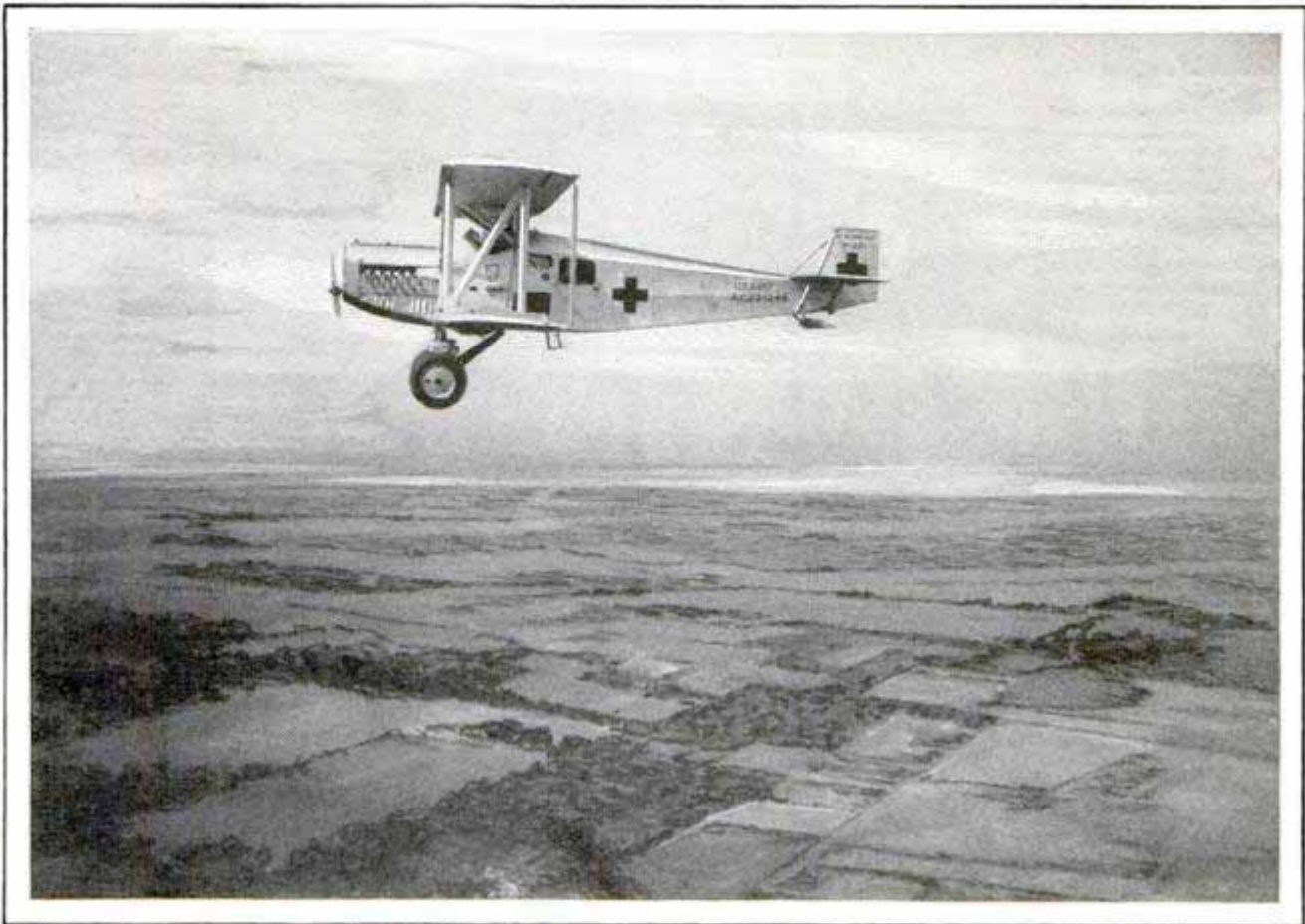

The Army Air Corps Operates These Hospital Planes to Bring in Injured Flyers Who Have Crashed Some Distance from Their Home Fields, Thereby Saving Several Lives

fogs may lift in a few long minutes—long minutes to the pilot flying in one—or may last a day or a week. Usually the fog lies just above the mesquite, and a plane may be forced through when caught a short distance from the home field.

This pilot was caught thus late one day. He debated for some time whether to hunt a field and land immediately or try to go through. Finally he chose to plow ahead, flying blind a good portion of the time. His motor was running sweetly, the slight wind was at his back pushing him home fast. At last there came a feeling of security, and he relaxed somewhat, yet continued to watch for hills that extended high enough toward the base of the fog to offer a menace. Then, with no warning, the motor quit. There was no stuttering. Just a steady rumble—then silence. Not half a second before, he had seen a field. So he swung around on his excess speed and flopped the ship down. There was mud on the ground, and the plane sank in but did not turn over. If he had not developed the habit of looking for landing fields, he would never have been quick enough to get the ship down safely.

So, when a plane crashes, something is wrong. I have outlined by illustration the most outstanding causes: carelessness, ignorance or lack of ability, and mechanical failure. By training, pilots may overcome ignorance. They can overcome carelessness if they will. To some extent, they can overcome their lack of flying ability by exercising proper caution in their work.

A solution of the trouble may be reached by training the thought process of pilots to the point that they will avail themselves of all possible odds, that they will at all times fly in such a way and over such ground that, if "something happens," they can get safely down. That method of thinking, plus adequate flying training, will reduce flying accidents to a minimum.

936 **HANDBAG WITH ELECTRIC LIGHT SAVES SEARCH IN DARK**

One of the latest conveniences for the traveler is a handbag equipped with an electric light inside, to eliminate the bother of hunting for articles in the dark. The light is furnished from a small battery and the bags have many pockets.

Paris.

Wasome made by Universal Leather Goods Co., 442 S. Wells, Chicago

Southern Pacific RR Sacramento shops
no information available 706

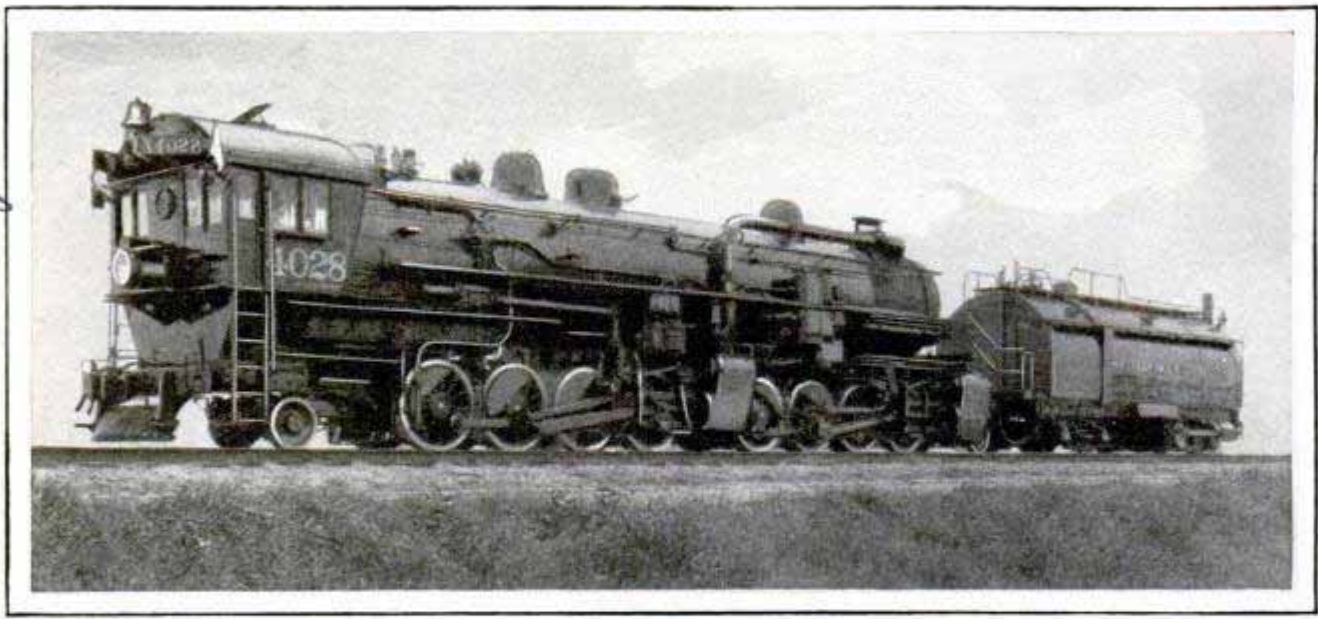

Remodeled Locomotive, with the Cab in Front for Easier Control of the Engine, Weighs 322 Tons and Is More Than 104 Feet Long

CAB IN FRONT OF BIG ENGINE AFFORDS BETTER CONTROL

So that the engine men can more easily control it, the cab of a huge rebuilt locomotive on a western line has been placed in front, directly over the cowcatcher. The engine and tender together are more than 104 feet long, weigh over 322 tons, and a tractive effort of 105,340 pounds is possible.

COIN CARRIER IN VANITY CASE SAVES TIME AND TROUBLE

Attachable either to the inside or the outside of the vanity case, a secure carrier



Vanity Case Equipped with Coin Compartments at the Top, to Save Time and Prevent Loss

for loose coins has been introduced for the convenience of women. It saves disturbing the other articles in the bag when searching for money, helps prevent loss and takes up but little room.

SEEK BIRTHPLACE OF ICEBERG TO PROTECT SHIPPING

Coast-guard explorers this summer are cruising the waters between Labrador and Greenland to study the birthplace of the icebergs that menace navigation in the Atlantic. They will endeavor to discover more accurately how and where the bergs drift so that their paths may be predicted and their menace thus reduced. Before 1912, comparatively little was known about these roving mountains of ice, but following the sinking of the "Titanic," with a loss of 1,500 lives, extensive research has been conducted. During the last ten years, more than 3,000 observations have been compiled by ice-patrol vessels. Studies have been made as to the temperature and saltiness of the water at various depths and in various locations. From these data, ocean currents have been computed in accordance with mathematical formulas. One of the principles involved is that the currents are in a large measure due to differences in the specific gravity of the water, which will flow from the place where it is relatively light to another region where it is proportionately heavy. This, combined with the fact of

949 23

Science Service Washington D.C.

earth rotation, permits the issuance of regular weekly current maps, similar to weather maps. Among other questions, the investigators will endeavor to determine whether a branch of the Gulf Stream dives to the bottom of the Atlantic ocean and emerges in Baffin bay.

**ODD MINERAL USED IN PAINTS
 MINED ONLY IN UTAH** *955*

One of the oddest minerals in the world is gilsonite, a black substance used in the preparation of paints and varnishes and in the manufacture of different kinds of buttons, telephone mouthpieces and other articles. It is mined only in Utah, where it was first discovered in 1862. It was at first believed to be a kind of coal, but when it was burned, it created a dense black smoke, a peculiar odor and, instead of forming ashes, it was reduced to a stringy residue somewhat like tar. Getting the gilsonite to market is a tedious process, as it starts over one of the steepest and most crooked railroads in the world.

U.S. Bureau of Mines
**REVOLVING BRUSH ON HOSE
 HELPS CLEAN AUTO** *885*



25.00
 Attached to the garden hose, a special brush lightens the task of cleaning the automobile. Its chief feature is a whirling center portion that revolves under the force of the water from the hose, while on the rim are stationary bristles that catch the water from the moving center and help polish the finish. The user of the brush is spared

considerable labor and water is less likely to spatter upon his clothing.

Our Bureau of Information will answer all questions regarding articles appearing in this magazine.



Operating the Private Central Box in Automatic Phone System; It Is Specially Suited for Office Use

**PRESS-BUTTON PHONE SYSTEM
 LATEST OFFICE AID**

For business houses having a number of branch or extension telephones, a special exchange system has been devised. It is an automatic arrangement, but eliminates a central and, instead of turning a dial to obtain a number, a master button is pressed. The unit is so adjusted that ten different numbers may be called.

**PORTABLE FIREPLACE FURNACE
 SAVES FUEL** *925*

Increased comfort and efficiency are enjoyed from the fireplace by means of an air-circulating unit that reduces fuel waste and helps prevent heat from going up the chimney. It is simply a set of pipes that pass under the grate, arch back of it and extend to the top of the fireplace where they open out. Colder air, being heavier, sinks to the lower part of the room where it enters the pipes under the grate, is heated, rises and passes out the openings at the top. This promotes better circulation in the room and gives more heat.

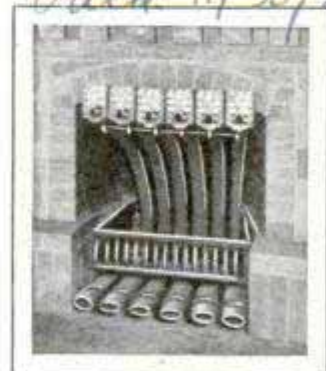

Am. Santos
Can't locate New York 10/29/26

Made World

Dakland, Calif. 9/17/30
Ex. 1, room 114 30/26
Solbeck Fireplace Furnace Co. Chic.

Syco Brush Co.

DUMMY THAT SELLS TICKETS HELPS ADVERTISE THEATER



Obtaining Ticket to Theater Performance from the Dummy Salesman near the Entrance

At the entrance to a small theater in Arras, France, is a lifelike dummy that dispenses tickets when the correct amount of money is placed in a container. The automatic salesman attracts attention to the playhouse and has become a favorite with children because of the jovial expression on its face and the novelty of obtaining tickets in this way.

CAMERA DETECTIVE CONVICTS POOR-BOX THIEF

A camera detective, invented by a New York patrolman, recently won its first case when it produced the photograph of a man who had robbed the poor box in a New York city church. The device, called a "photo-detect," consists of a concealed camera and a flashlight charge, electrically connected to the safe, strong-box, or whatever else it is set to guard. The inventor built twenty of them, and obtained permission from various friends, including the priest in charge of the church, for their installation. The man arrested for the theft was on probation from the penitentiary for a similar offense, but denied he had committed the second one. The

photo-detect, however, provided a picture, three inches square, showing him kneeling at the altar rail in front of the box. As the camera could only have been touched off by tampering with the lock on the box, the court found him guilty.

LOST CITY FOUND BY PICTURES TAKEN FROM AIRPLANE

Aerial photography has proved of aid in finding the borders of the ancient city of Opis in Mesopotamia. The pictures, taken from an airplane, showed the differences between mounds formed by nature and those which were made by the heaped-up ruins of the sun-dried-brick homes that were destroyed when invaders pillaged the city. Following its location, the ancient settlement was excavated, resulting in the discovery of undisturbed foundation stones, coins, vases and other evidences of ancient civilizations.

HANDMADE SMOKE SCREEN AIDS MINE SAFETY

To detect air flow and measure its velocity in mine shafts, a little bulb instrument developed by the bureau of mines ejects a puff of smoke which can be photographed to show the direction of the air currents. The unit is serviceable also in the study of other ventilating problems.



Studying Air Currents in Mine with the Aid of a Smoke Screen That Drifts with the Breeze

Waterman
Chair. J. Mich
Ana. Toledo
Musquin
6/22/28
Exhibition
monitors

James O. Connell
114 Bridge St
Coburn, N.Y.
9/15

928

ASPHALT EMULSION ON CONCRETE TO AID CURING

1000

Applied to finished concrete in the form of a fine spray, an asphalt emulsion is said to result in better curing for the material and also reduces work. It is suitable not only for sidewalks but for floors, foundations, bridge decks and practically any flat-surfaced type of construction. One of its chief functions is to prevent the too rapid evaporation of water from the concrete mixture. The asphalt sticks to the cement as a continuous film which absorbs heat from the sun and so is said to accelerate curing. There is no chemical effect, as the emulsion is chemically inert. To apply the asphalt, a compressed-air outfit is employed, the supply being held in a large tank and distributed to the concrete through a flexible hose. The weight of the machine, loaded, is about 300 pounds and a hose, fifty feet long, is suitable for most jobs. According to the manufacturers, it is possible to apply the emulsion to the finished concrete at a rate of 150 to 200 square yards per hour.

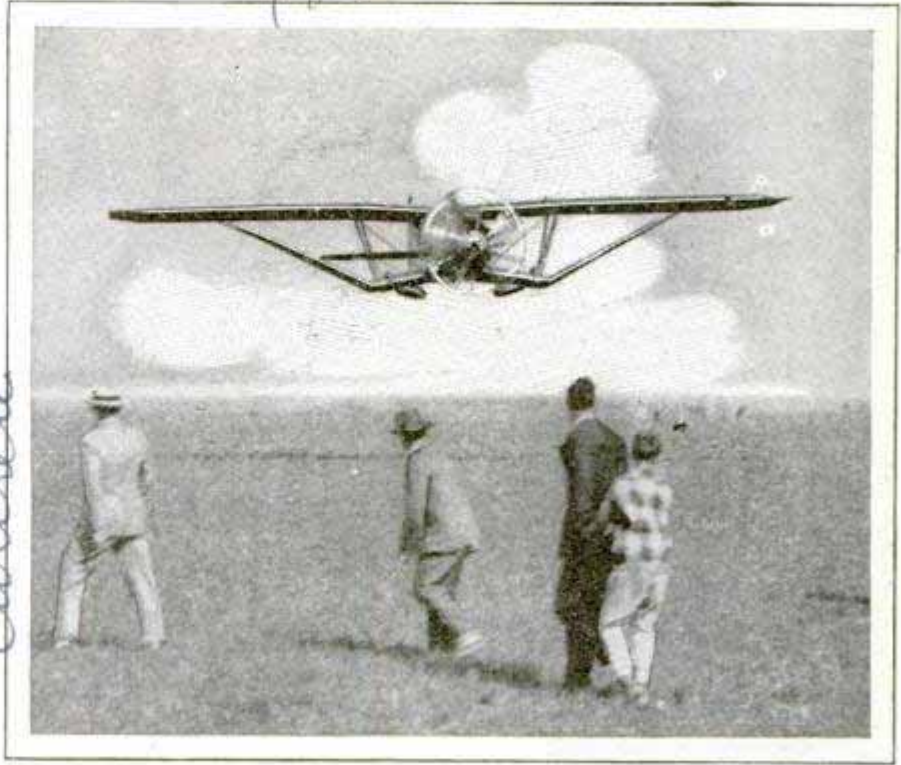

In Flight, with the Landing-Gear Wheels Folded Inward to Decrease Resistance from the Air, the Plane Develops More Speed

AIRPLANE'S LANDING WHEELS FOLD TO INCREASE SPEED

Decreasing wind resistance is one of the objectives in airplane design as success in this direction means greater speed. The monoplane 'Roma' has landing wheels that can be folded up close to the fuselage, just as a bird folds its legs when flying.

SEEING THROUGH METAL

1001

To protect eyes, a Hungarian oculist has devised a pair of spectacles that have an exceedingly thin piece of metal foil between two sheets of plain or curved glass. This not only keeps out rays of light that would be hurtful to the eyes, but is also said to exert a healing effect as it admits short waves of daylight which are beneficial to the organs. In case of inflammation of the iris, platinum foil is recommended, as it passes but two per cent of visible light.

Pat. 6/30/28

MAIL BOX AND PORCH LANTERN COMBINED IN ONE

613

Illuminated mail boxes, bearing the house number and having a holder below for magazines, have been introduced for convenience and to add an attractive touch. The light makes a handsome porch lantern at night and the number is visible from a considerable distance.



Mail Box and Lantern with Illuminated House Numerals

Chicago 208 N. Wabash

Victory Lamp Co. no other data.

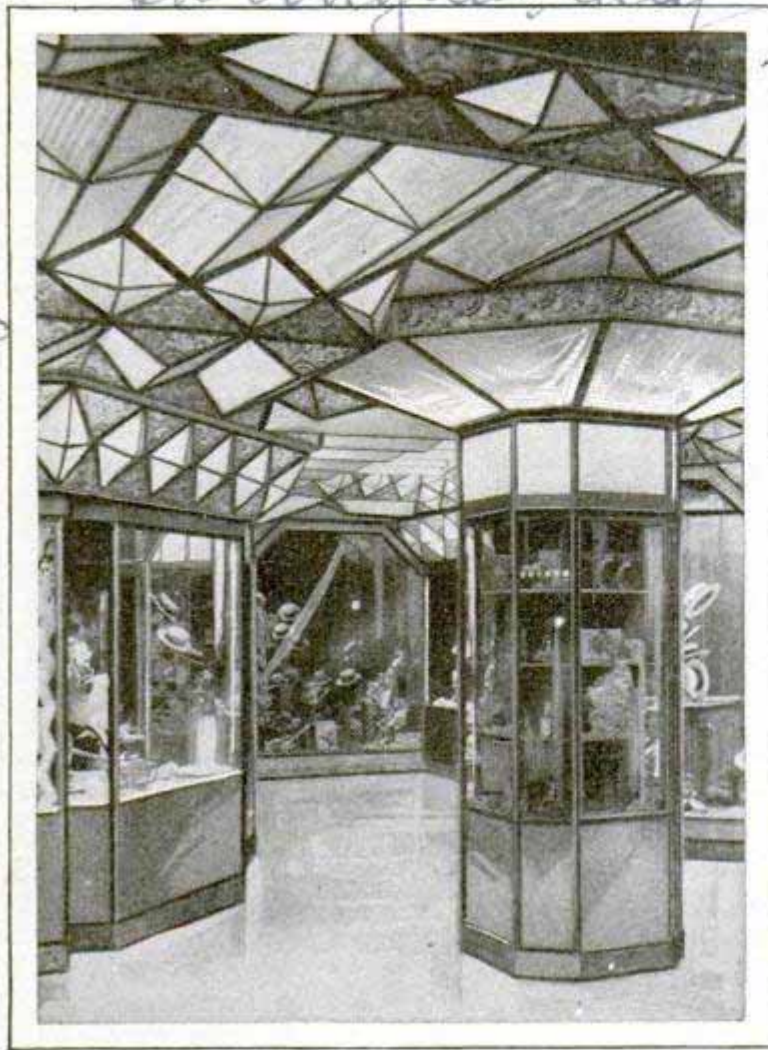

Decorated Glass Panels and Transparent Ceiling with Colored Lights Make This Store Front Very Attractive

STORE FRONT OF GLASS BOOTHS HELPS DRAW TRADE

Instead of the usual plain store window, a shop in Los Angeles has many decorated glass panels and small booths, all illuminated with striking color effects, to help display the goods and attract customers. The entire ceiling over the entrance is also of glass and concealed lighting produces novel illumination. The appearance of the store is doubly attractive at night.

WHY "JOHN HANCOCK" MEANS YOUR SIGNATURE

"Put your John Hancock here," is one of America's most familiar slang expressions, but few people know why the revolutionary-war statesman should be associated with the act of signing one's name. The answer is that John Hancock was the first person to sign the Declaration of Independence, and his signature has since

become symbolic of authority, particularly when one is first to sign important papers. Hancock was a member of the continental congress from 1775 to 1780, the first governor of Massachusetts, serving from 1780 to 1785, and, after two years' respite, governor again until his death in 1793.

MAGNETIC PROBE FINDS FLAWS IN STEEL

Magnetic analysis to detect hidden flaws in steel, without cutting, scratching or marring the surface, has been developed so far that the American society for testing materials has awarded the Charles B. Dudley medal to Alfred V. de Forest, Bridgeport, Conn., research engineer, for his success in making it practical. Dozens of scientists have worked for years to make magnetic probing practicable. Under the methods developed, a chunk of steel, five or six inches thick, can be examined as carefully as though it were made of transparent glass. A sensitive galvanometer will detect a flaw no bigger than a pinhead in the center of the mass. The most important use for the system at present is the inspection of steam-turbine bucket wheels. As these operate at high speeds, a flaw which might cause one of them to burst could produce enormous damage.

ONE-PIECE AUTOMATIC PENCIL SELDOM NEEDS FILLING

Absence of complicated parts and leads more than five inches long are the chief features of an automatic wooden pencil now on the market. The lead is inserted at the tip and is brought forward or backward simply by turning the eraser holder. One filling is sufficient for several weeks.



Alexander and Co. Wash Bldg

*Morgan, 2437
Echo Park Ave
Los Angeles, Calif*

Phila.

475

Pencil 2.50 with leads 36¢

456

973

American Walnut Imps

Scripto Pencil Co

Science Service

at station

war

Uncle Sam's Latest Weapons

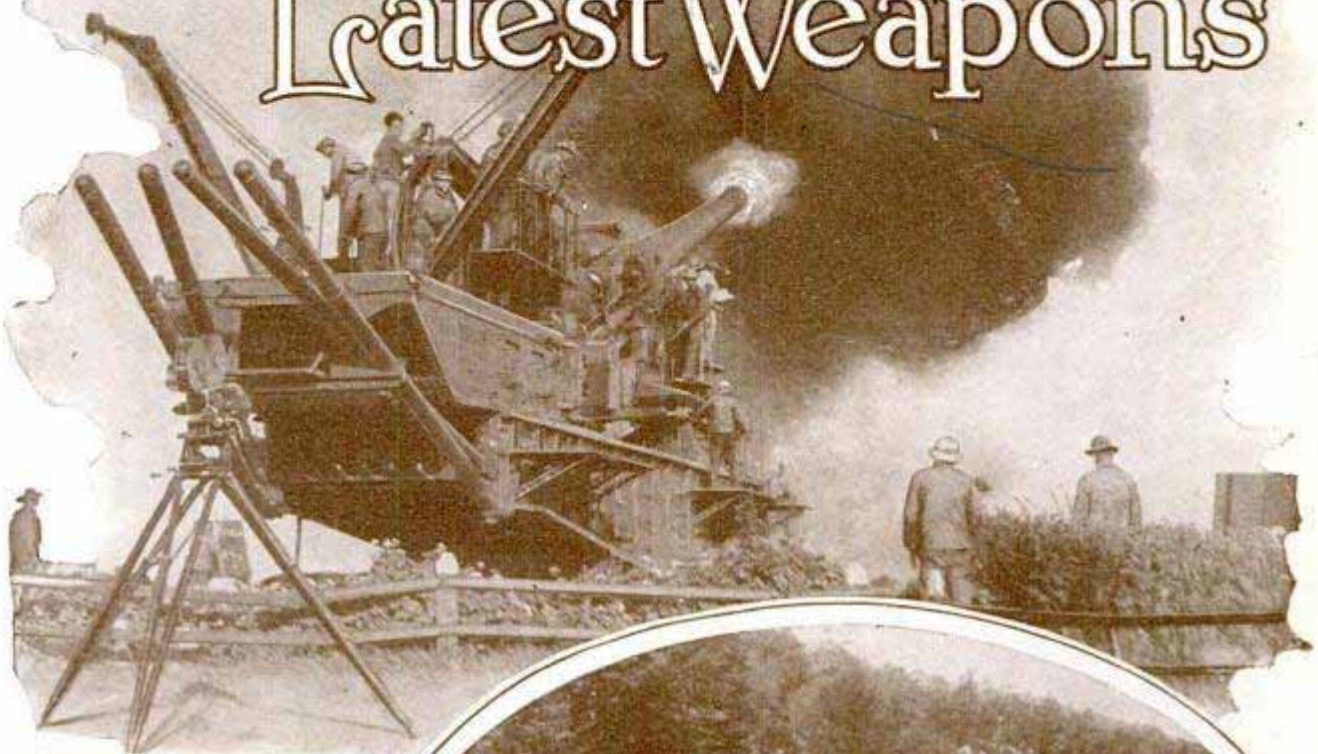

The Latest Coast Defense on the Pacific Is This Giant Railway Gun, Which Can Be Moved up and down the Shore Wherever an Attack Threatens; It Hurls a Powerful Shell 20,000 Yards Out to Sea; the Mount Is a Complete Unit, Including Cranes for Hoisting the Shells; at Right, Soldiers of an Infantry Regiment at Pistol Practice

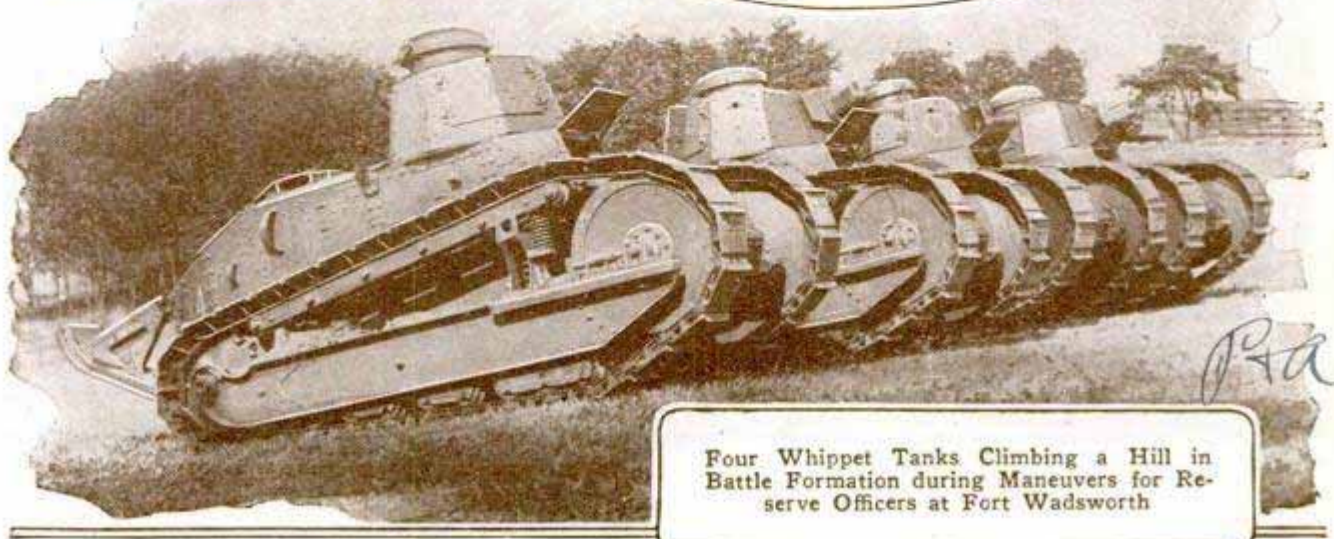
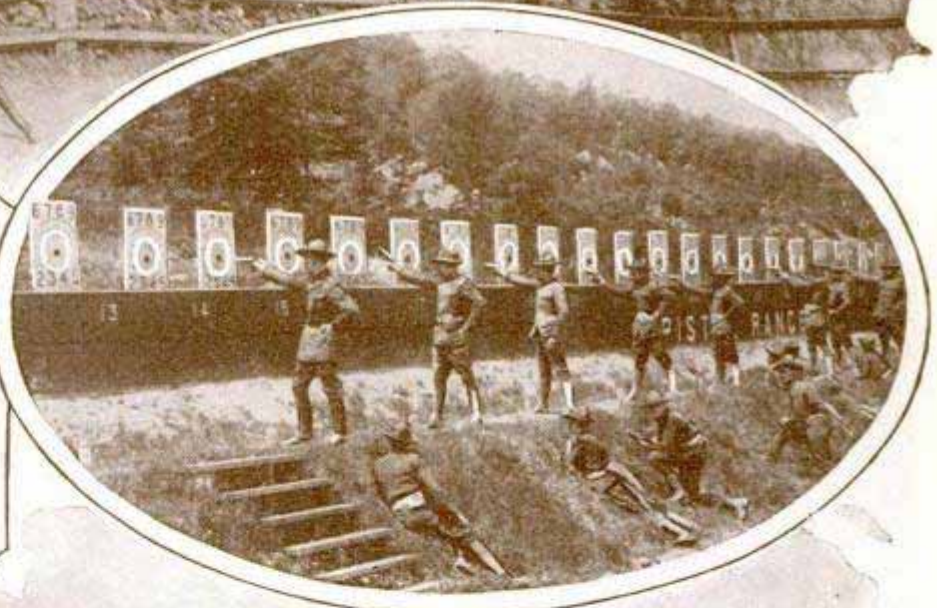

Four Whippet Tanks Climbing a Hill in Battle Formation during Maneuvers for Reserve Officers at Fort Wadsworth

RA

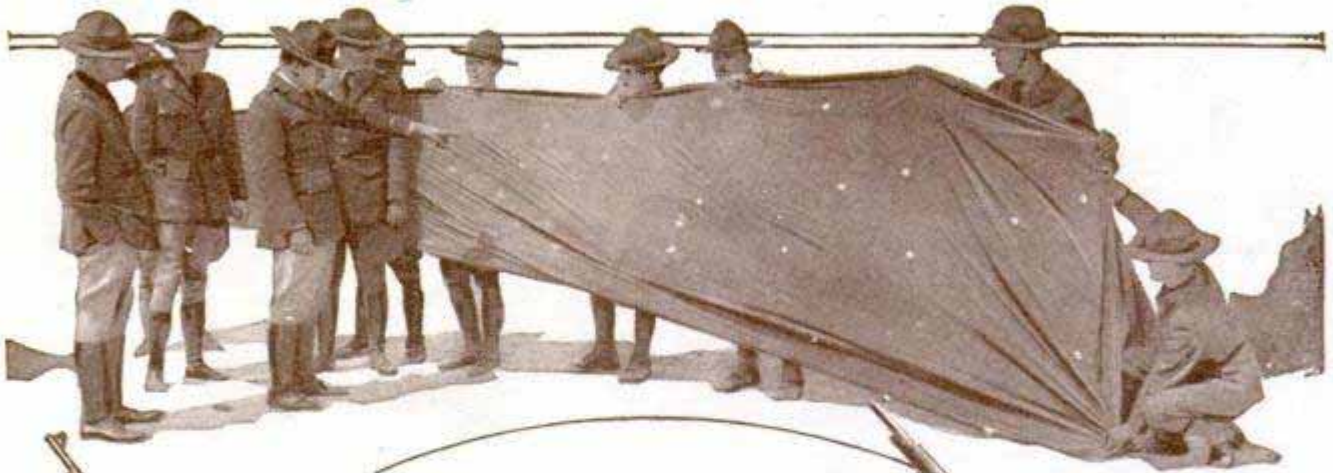

Officers Checking the Holes in a Sleeve Target Towed behind an Airplane for Gunnery Practice of an Anti-Aircraft Battery; the Cloth, No Larger a Target Than a Plane Itself Would Be, Has Been Riddled with Machine-Gun Bullets, as the Many Holes Show. In the Next War the Doughboy Will Have a New and Lighter Pack; at the Left, Sergt. James Laughlin Is Bowed Down under the Seventy-Nine-Pound Weight of World-War Equipment, While, at the Right, Corp. LeRoy Nicholson Steps Briskly Out with the Fifty-One Pounds of the New and Scientifically Designed Equipment; Many Things That the Infantryman in France Carried on His Own Back Will Be Hauled by the Accompanying Motorized Transport in the War of the Future; the New Pack Is Said to Be the Lightest Carried by Infantry in Any Army in the World



New York Is Ringed to Seaward with Coast-Defense Cannon and Anti-Aircraft Batteries; Here Soldiers of the Sixty-Second Are Repelling an Imaginary Night Attack by Enemy Planes; Powerful Searchlights Sweep the Skies as the Quick-Firing Guns Pour a Hail of Shrapnel and Machine-Gun Bullets into the Air; with Newly Developed Devices, It Is Easier to Locate Unseen Airplanes by the Sound of Their Engines, and Controls Operated from the Listening Station Automatically Train All Guns in the Battery on the Target





The Army's Latest Twin-Engine Curtiss Bomber; Instead of a Third Engine in the Nose It Carries a Machine Gunner There, While Another, behind the Pilot, Fires toward the Rear, and the Bomber Drops His Missiles through the Floor; Left, a 4,000-Pound Bomb

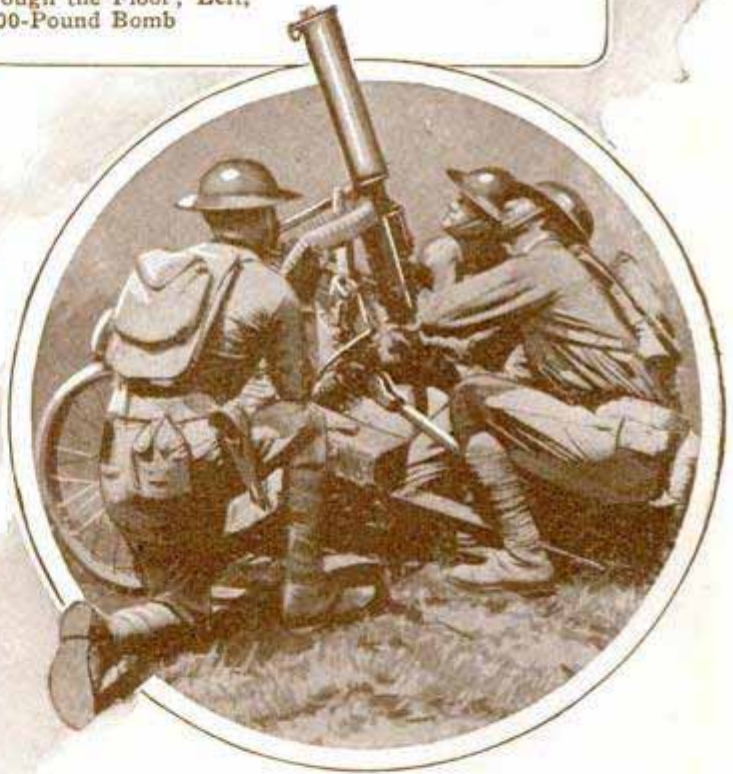

An Infantry Machine Gun Built to Protect Troops on the March from Airplane Attack, and, Below, the Same Gun Mounted on Its Carriage, Which, with the Ammunition Cart, Uses One Missouri Mule for Motive Power
© Henry Miller

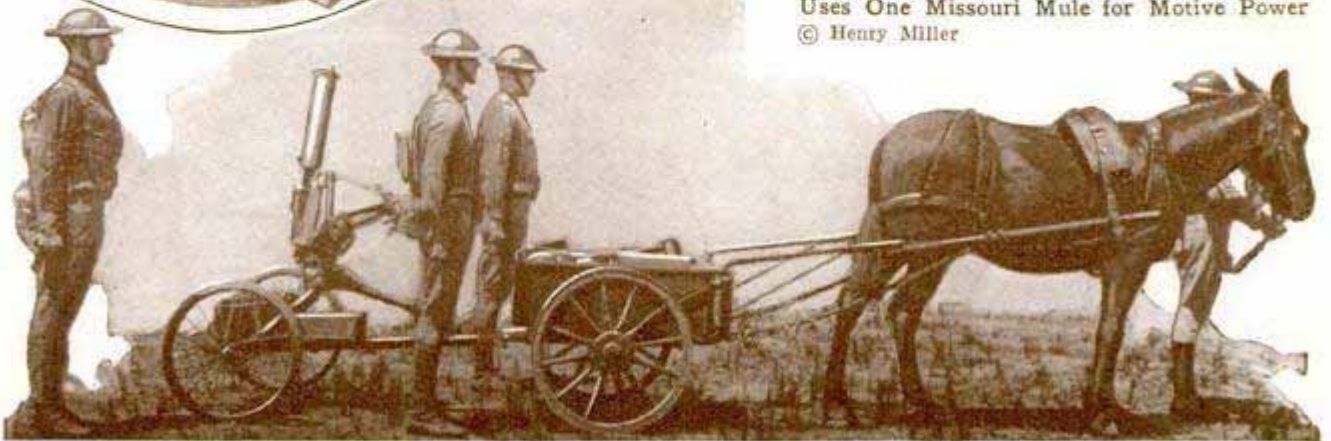

483

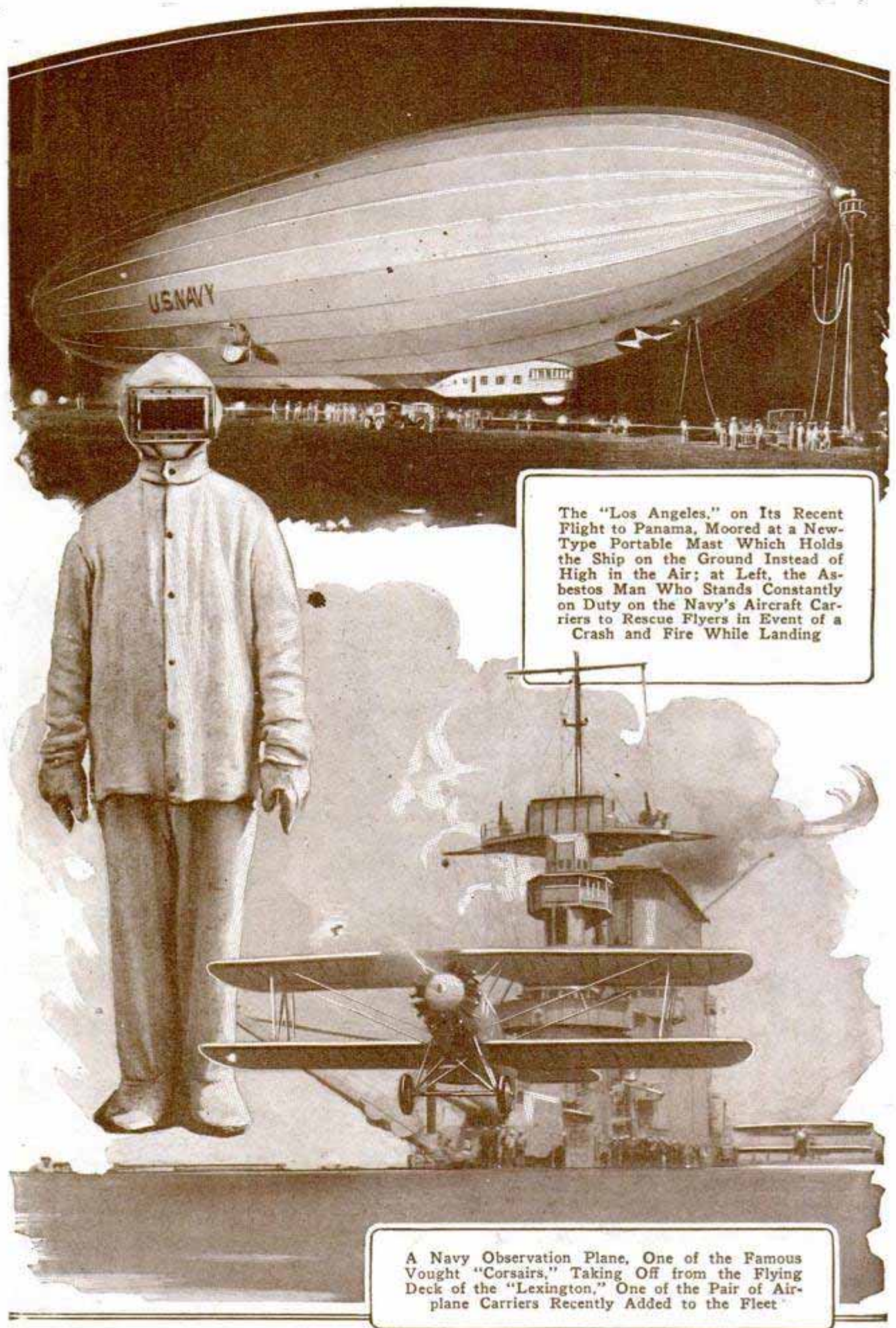

The "Los Angeles," on Its Recent Flight to Panama, Moored at a New-Type Portable Mast Which Holds the Ship on the Ground Instead of High in the Air; at Left, the Asbestos Man Who Stands Constantly on Duty on the Navy's Aircraft Carriers to Rescue Flyers in Event of a Crash and Fire While Landing

A Navy Observation Plane, One of the Famous Vought "Corsairs," Taking Off from the Flying Deck of the "Lexington," One of the Pair of Airplane Carriers Recently Added to the Fleet

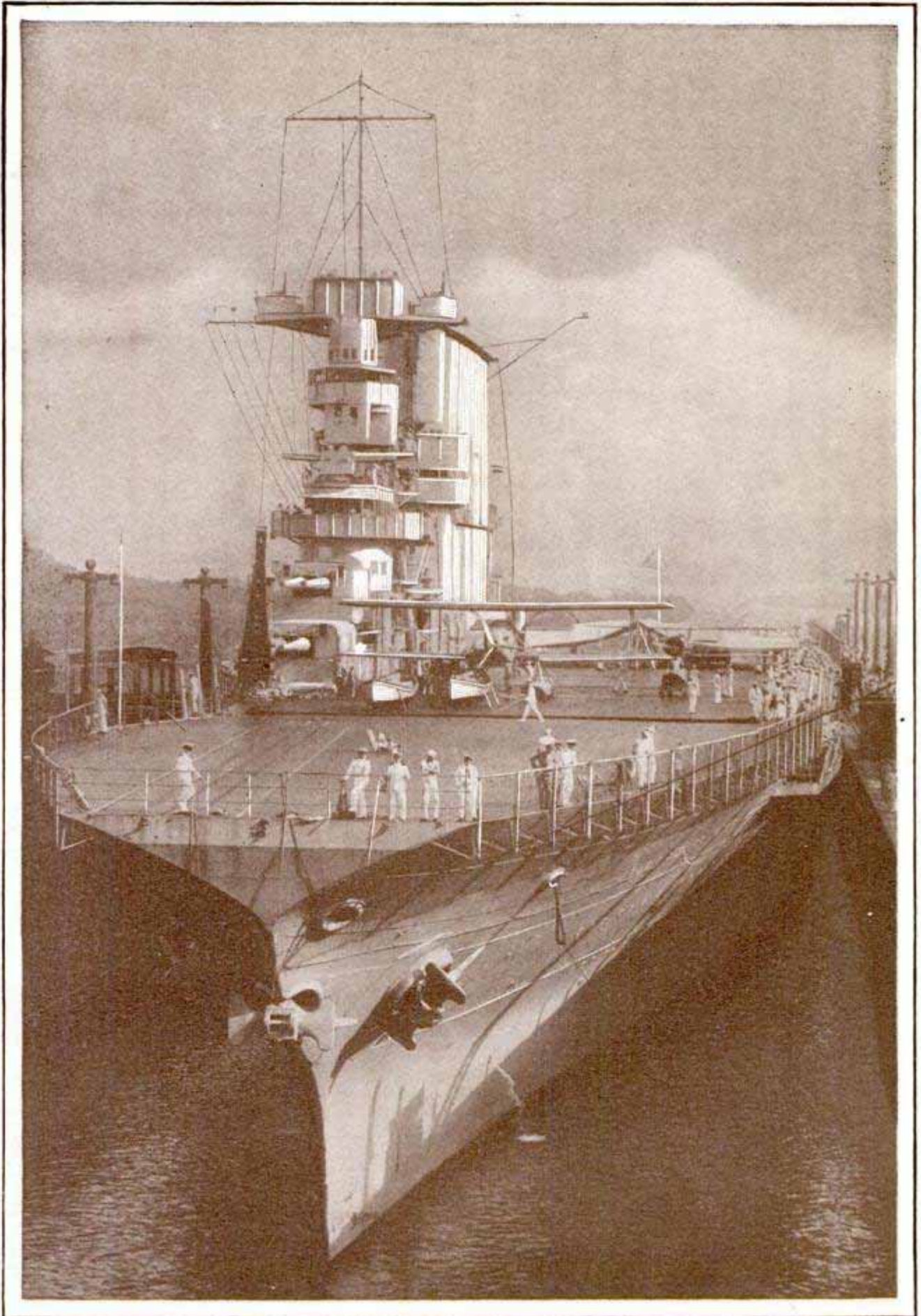

The "Saratoga," Sister Ship of the "Lexington," Passing through Gatun Locks in the Panama Canal; with a Clearance of Only Two Feet on Either Side, Part of the Superstructure Overhung the Lock Walls

487



For Contrast with the Army's Whippet Tanks, Here Is a Trio of British Land Forts Maneuvering in the Clinging Mud of Salisbury Plain, a Terrain Still Remembered by Many American Soldiers Who Camped There en Route to France; the British Army Is Experimenting with Complete Mechanization on a Large Scale; at the Left, Navy Officers Inspecting the Latest Thing in Complete Gas Protection for the American Soldier; Even the Suit Has Been Chemically Treated to Resist the Attack of Mustard Gas and the Flaming Phosphorus Used in Incendiary Shells



War-Time Lessons in Trying to Keep the Artillery Up with the Infantry in the Final Weeks of the War Led to This Mount for Six-Inch Guns

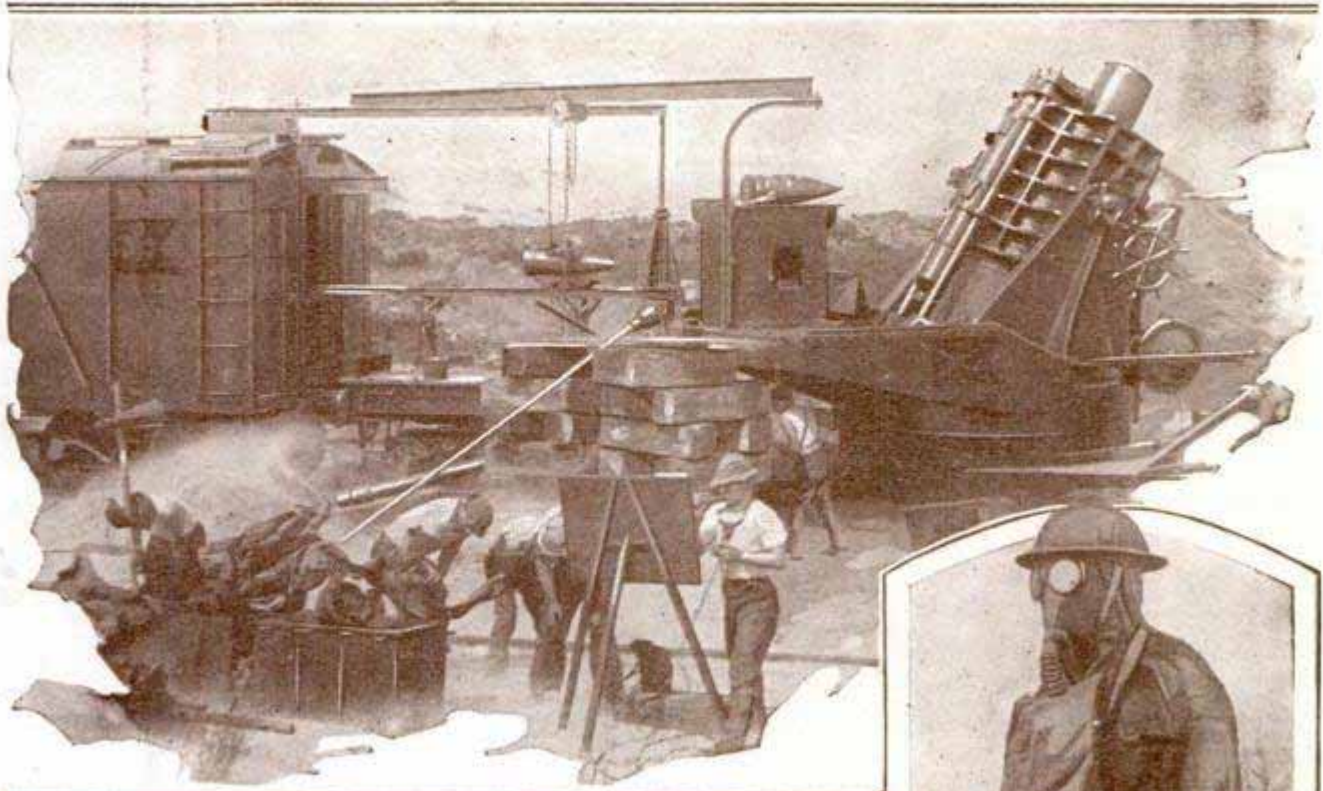

A Twelve-Inch Railway Mortar of the Coast Defense, Complete with Its Ammunition Car and Conveyor Hoist to Handle the Shells, Firing Gas Missiles at Imaginary Battleships off the Virginia Capes; Sixteen-Inch Howitzers and Eight-Inch Guns on Railway Mounts (Below) Also Were Used in the Demonstration



Another Type of Gas-Proof Uniform, Which May Be What the Well-Dressed Soldier Will Wear in the Future, If Tests Prove It to Be Successful

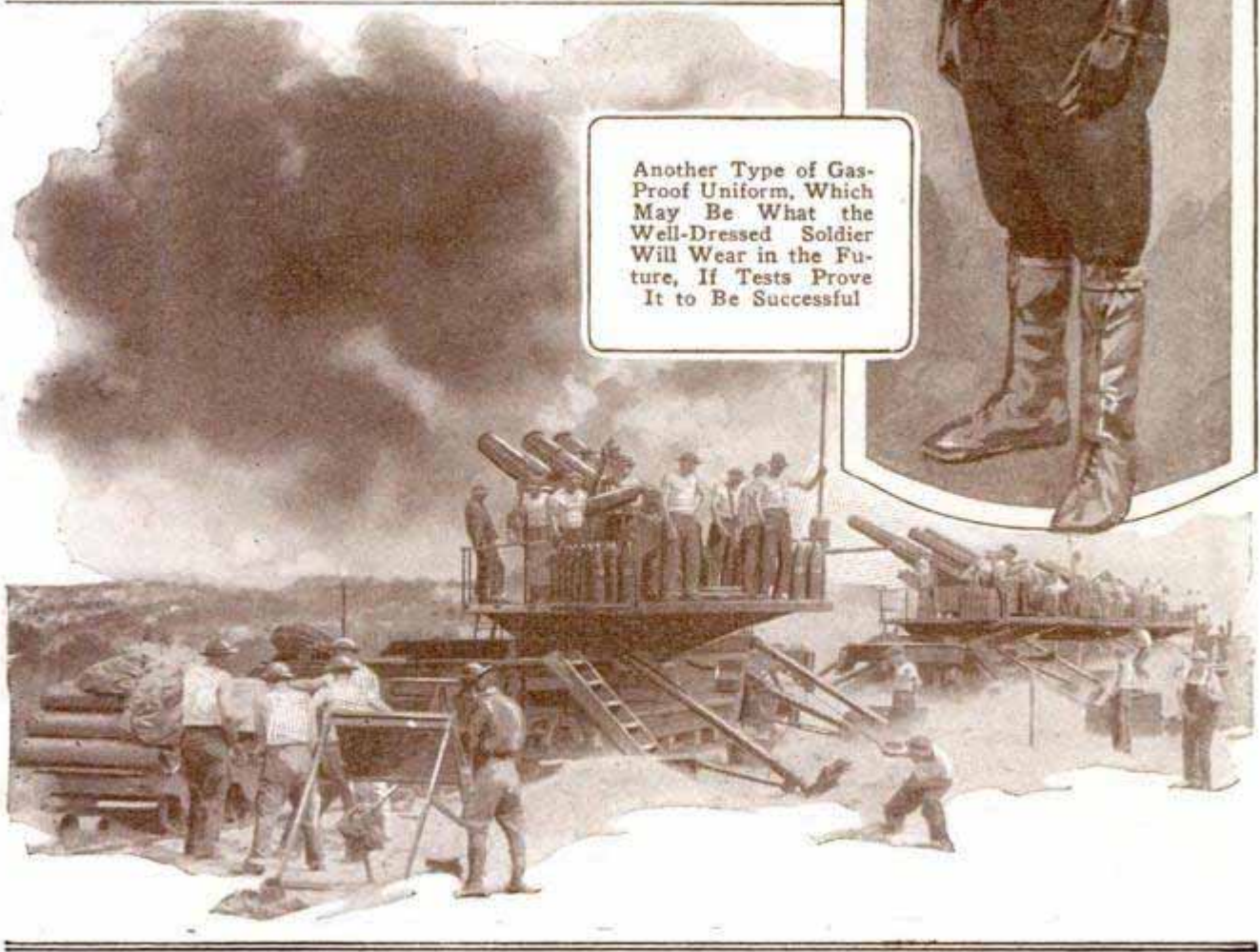

483

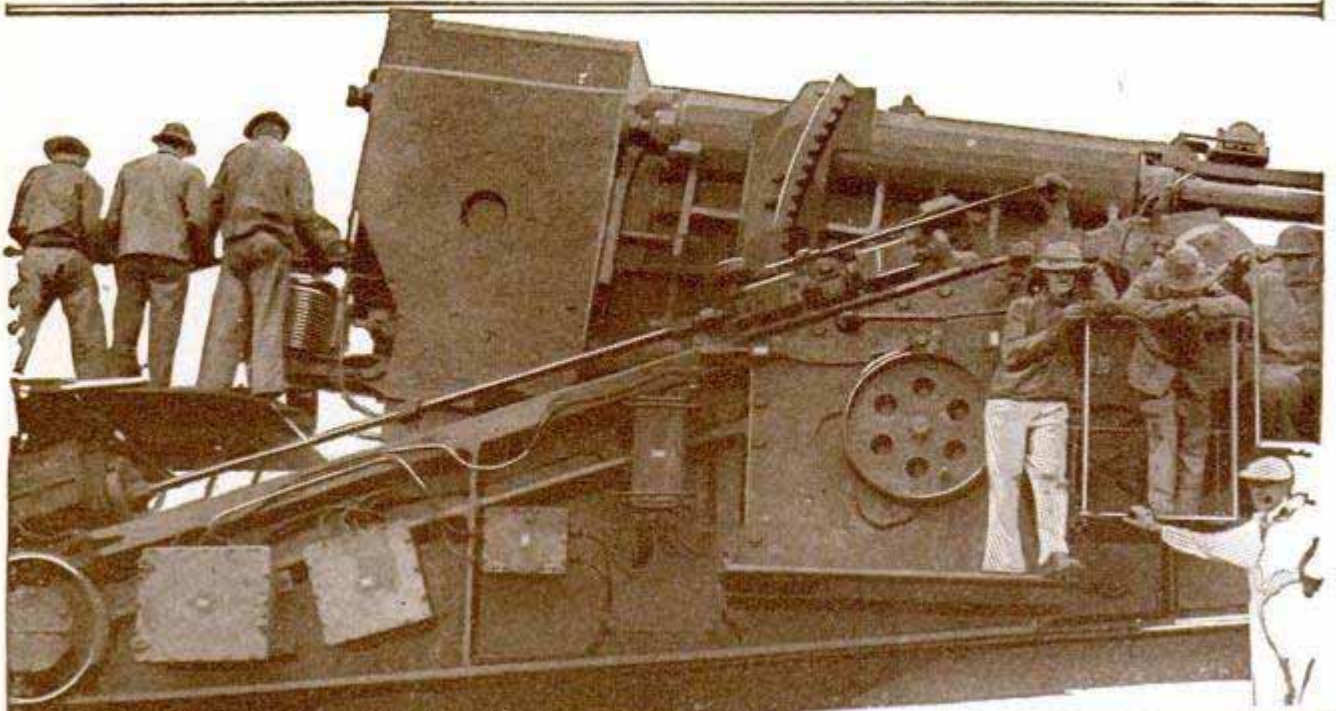

The Breech of a Fourteen-Inch Railway Gun Tested in California; Specially Built Concrete Emplacements Are Necessary to Take Up the Shock of the Recoil, but They Can Be Built in Advance at Every Vulnerable Point along the Coast

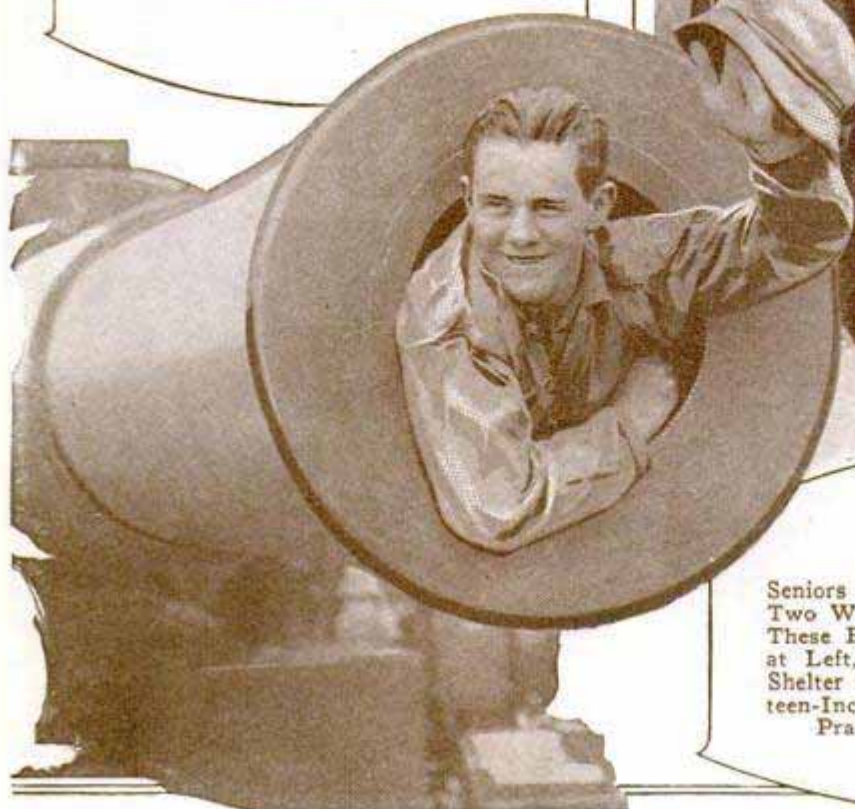
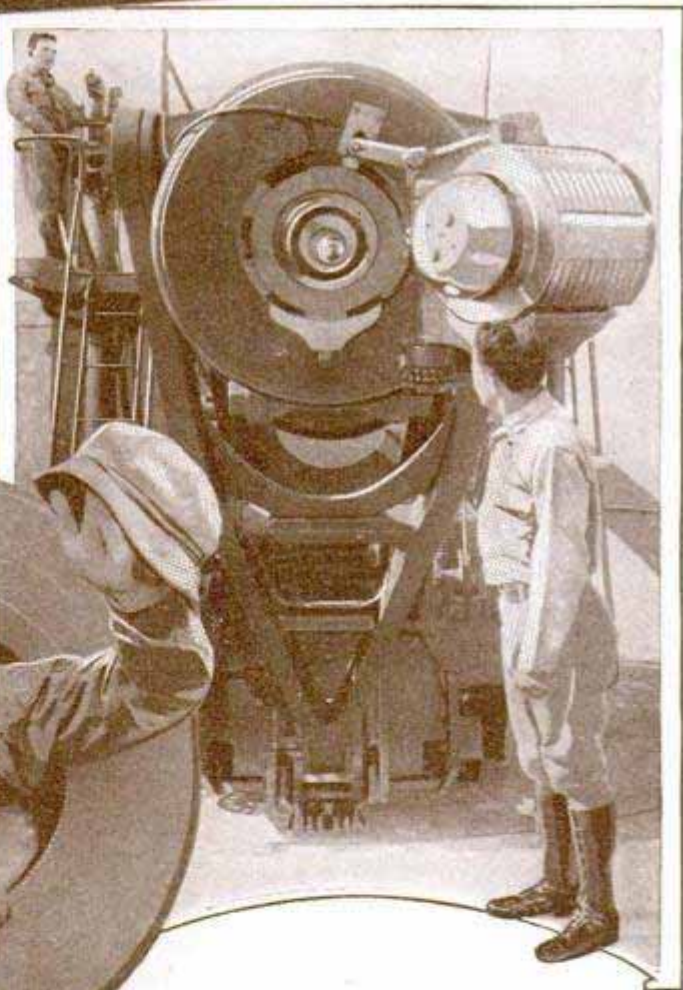

Seniors of West Point Each Year Spend Two Weeks at Fort Wright, Operating These Big Coast-Defense Guns, Above; at Left, a Coast Artilleryman Seeks Shelter in the Muzzle of One of the Sixteen-Inch Howitzers Used in the Battle Practice at Fort Story, Virginia

Here's Another View of One of the Sixteen-Inch Howitzers at Fort Story, with the Crew Perched along the Giant Barrel; It Fires a 2,100-Pound Projectile Twelve Miles and Helps Guard the Virginia Capes

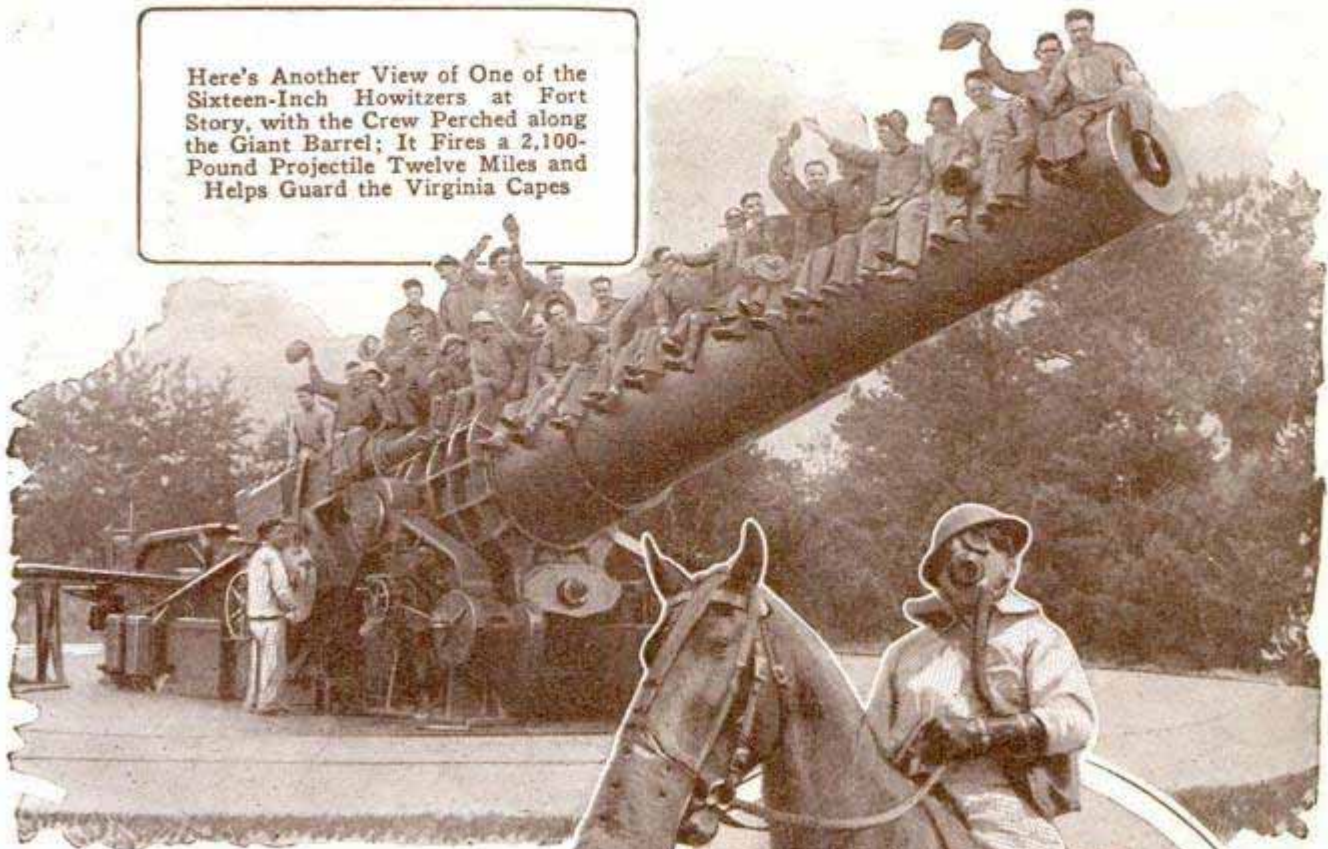

Even the Horse Must Wear a Gas Mask Now, While Its Rider Blossoms Out in Gas-Proof Suit, Boots, Gloves and a Mask to Protect Him against the Burns of Mustard Gas and the Flaming Particles of Phosphorus from Incendiary Shells or from Flame Throwers

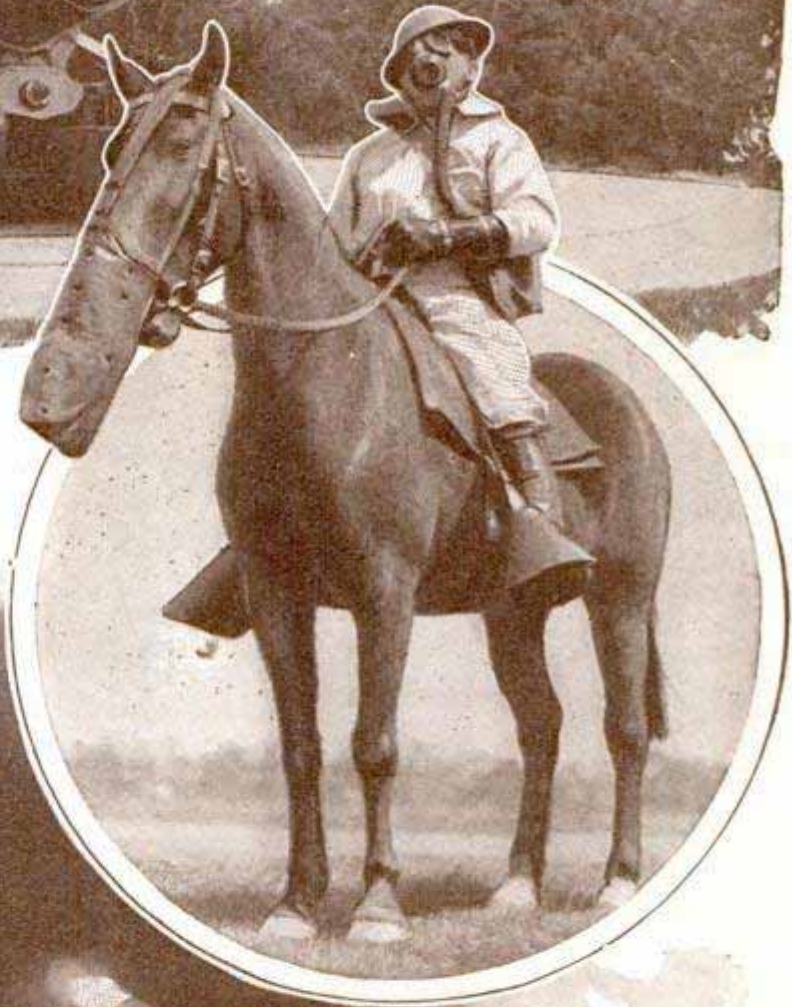

Uncle Sam's Mightiest Gun Roars at Aberdeen When the Army Presents Its Latest Weapons; This Huge Sixteen-Inch Rifle Was the Feature of the Greatest Display of Fighting Equipment Since the Close of the World War

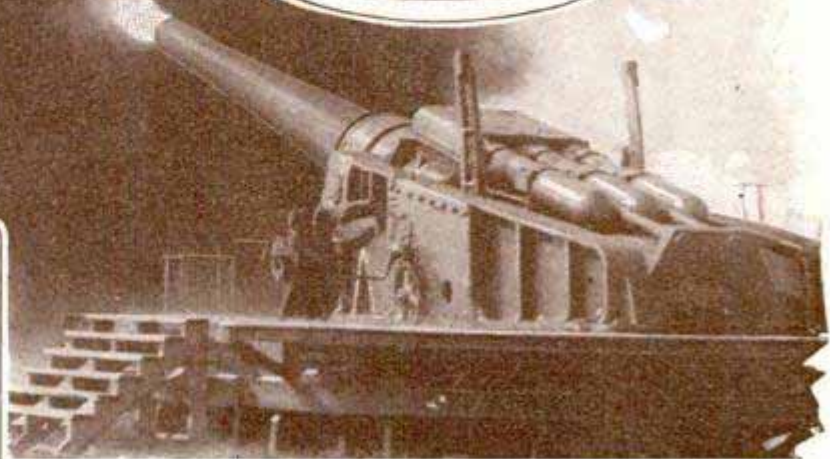

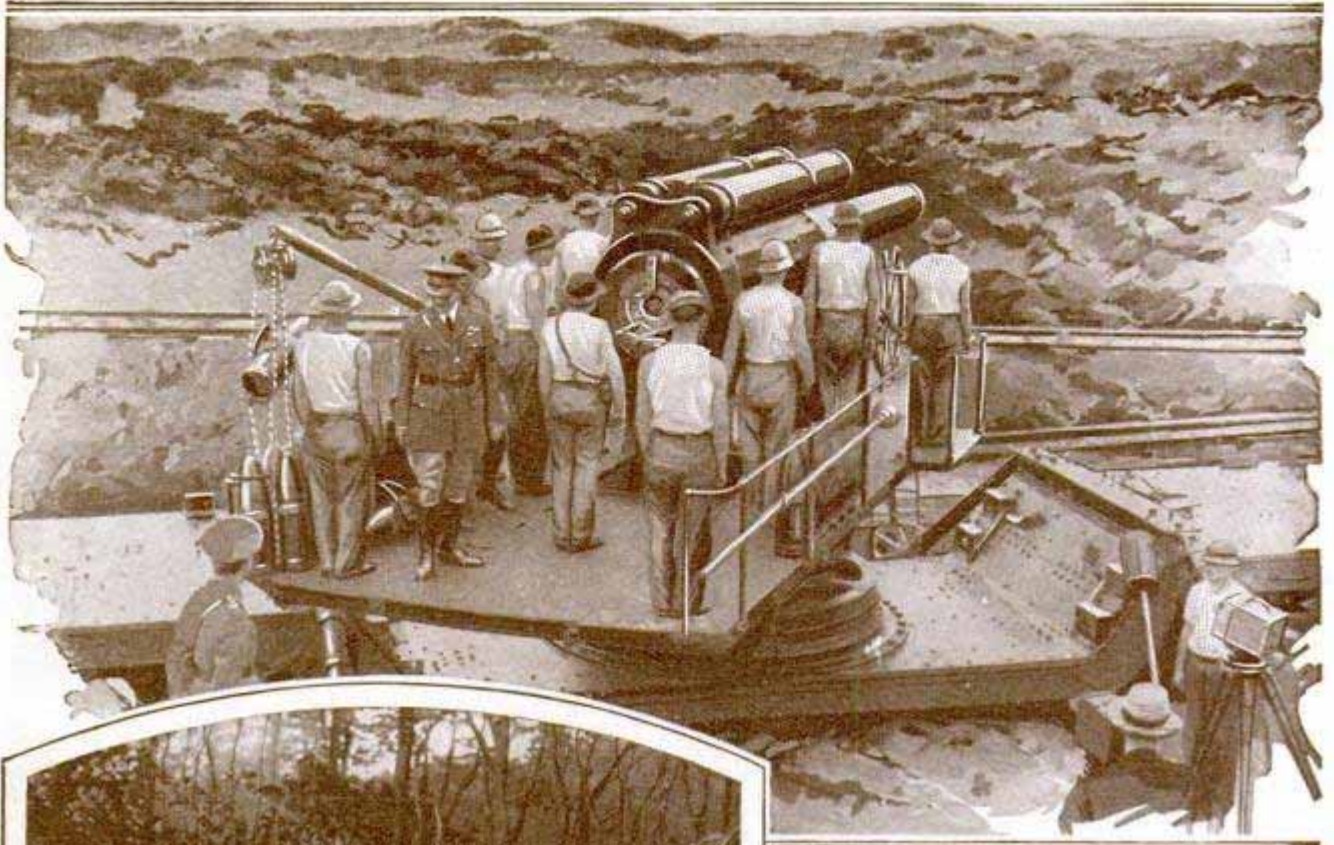

Brig. Gen. R. E. Callam Inspecting One of the Eight-Inch Railway Guns, Which Joined the Sixteen-Inch Howitzers and Twelve-Inch Mortars at Fort Story



Firing Gas and Smoke Projectiles from a Four-Inch Stokes Mortar at a Demonstration by the Chemical Warfare Service at Edgewood, Md.



Laying Out the Ammunition for an Anti-Aircraft Battery before Rapid-Firing Practice during a Demonstration against Targets Towed by Airplanes over Fort Totten, Guarding New York

Chief. Army Air Corps

964

ARMY SEEKS SILENT AIRPLANE TO AID IN ATTACKS

989

Extensive experiments have been conducted by the army air corps in an effort to develop a plane that will be noiseless in flight, so that an enemy might be surprised by an attack from the skies. Merely making the planes less noisy will be of little use, as they must be perfectly silent to carry out their mission. By muffling the engine, the noise from that source has been checked considerably, but the propeller presents the most difficult problem. It makes the greatest din of all. As the blades whir through the air, thousands of revolutions per minute, they create a sound easy to identify and carrying for a considerable distance, so that it is not difficult to detect with the aid of special listening apparatus. Mufflers on the engine reduce the power and, as yet, no way has been found to eliminate the propeller noise. However, the experiments are to be continued and one of the immediate objects is to devise a muffler that will cause a total loss of not more than one-half horsepower. A five-per-cent reduction of power is not uncommon with the mufflers already introduced.

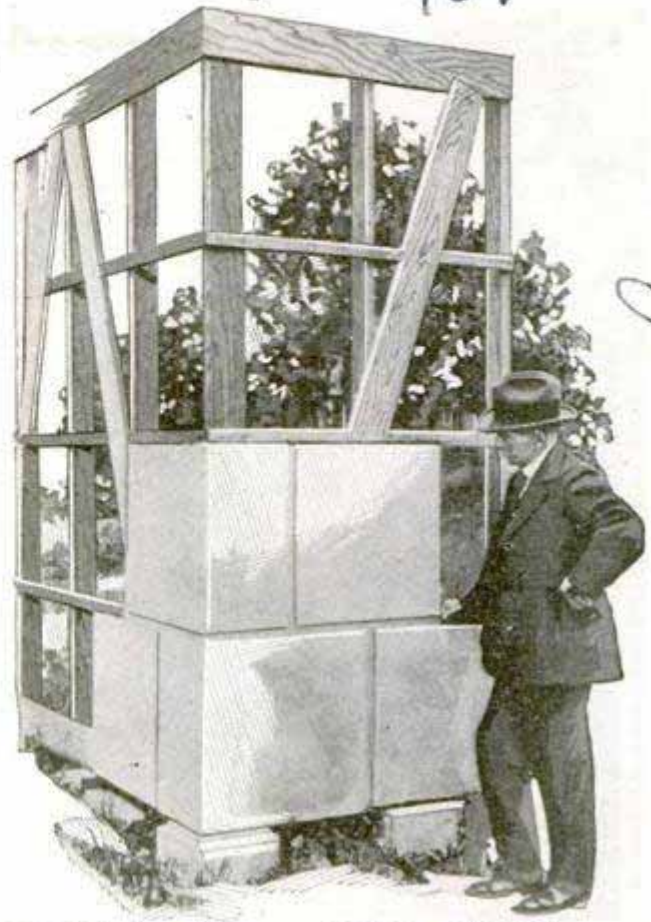

Model Section of Concrete-Slab Plan of Wall Construction for Houses and Other Buildings

CONCRETE-SLAB HOUSE WALLS SIMPLIFY BUILDING

Three houses can be built in the time required to erect two of brick, by using a patented form of concrete-slab construction, the inventor claims. The method is illustrated in the accompanying illustration, showing a model section. The slabs are attached by screwing or nailing them to strips fastened to the studs, and the wooden frame back of the concrete units is built to give greater strength and to permit faster construction than is possible with the usual methods. Between the slabs is a one-inch groove which is filled with waterproof cement to cover the joints. A recess is left for appearance. In case the building settles, cracks will occur only at these joints, it is said, as the slabs are stronger.

GASOLINE HEATER AND COOKER LIGHTS INSTANTLY

926

Immediate lighting without preheating of any kind, is the chief feature of a portable combination heater and cooker that burns gasoline and requires no hose or pipe connections. The burner lights instantly after a valve is opened and a match applied. The reflector or heating element revolves in a ninety-degree angle so that it can be set in a horizontal plane and used as a cooking or heating grid as well as a heater. The outfit is especially serviceable for campers, for an emergency water heater and to warm bathrooms or any other parts of the house where auxiliary heat is required.



Heater in Use as a Stove, and as a Portable Unit for Warming a Cold Room

The Coleman Lamp & Stove Co

Chicago

*Blun can be seen
214 7th St
Lake Park Ave.*

*Letter ret'd.
7/11/01*

Chicago 511 7th St. Clearing

156 E. Monte Vista, Calif

872 pak af for

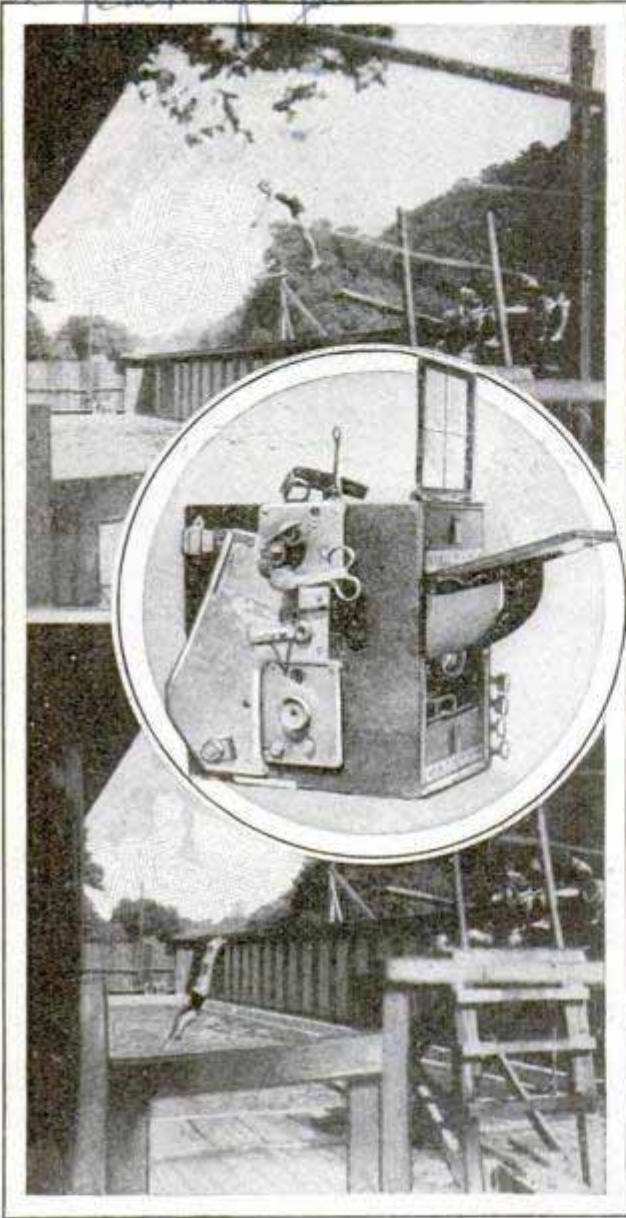

Semi-Automatic Camera Is Specially Useful in Taking Pictures of Sports Events

SIX PICTURES IN THREE SECONDS WITH SPORTS CAMERA

Designed especially for making photographs of sporting events, a semi-automatic camera makes six exposures in about three seconds. The shutter is tripped and a fresh section of film is wound up, all with one stroke of a hand lever, and a quick focusing device permits adjustment to any desired distance simply by pressing a button. The inventor asserts that the camera is also well adapted to airplane work and will eliminate the need of an extra man. A direct-vision folding finder, compartments for extra rolls of film, and a special thumb-and-finger stall to help steady the camera, are other features.

JUNKERS REVEALS HIS SECRET OF HANDLING DURALUMIN

"When we first began experimenting with aluminum and duralumin, its alloy, we had a terrific fright," Prof. Hugo Junkers, famous engineer and designer of the first plane to cross the Atlantic from east to west, says. "The stuff literally dissolved after but little use. We feared it would be entirely unsuited to airplane construction. Our men, entirely familiar with the handling of steel and other metals, had been treating aluminum in the same way as these other materials. They heated it and hammered it. But we soon discovered that aluminum and duralumin could not be subjected to steel-handling methods and still retain its strength. In riveting, for instance, we found that if we pounded too hard, the metal was weakened. So we measured the force necessary to drive a single rivet, controlled the weight of the hammer, and, in actual driving, we used a container filled with a measured quantity of compressed air. This had to drive the rivet. Long experience proved that the amount of air could not be increased or diminished if we wished to achieve the maximum strength and service from the material. In our laboratories, we have a dozen special machines just to work with duralumin, testing and applying it."

PORTRAIT PLAQUES IN BRONZE RECALL ANCIENT ART

Photographic portraits in special finish and mounted on bronze plaques have been copyrighted and placed on sale. They eliminate the need of a frame and glass and the figure is in bas-relief, suggesting a medallion. A decorative background is used for mounting.



Whenever you find that you wish to know more about any article in this magazine, write our Bureau of Information.

Chis + Hayry Studios

HUGE HYDROGLIDER BUILT FOR ATLANTIC RECORD

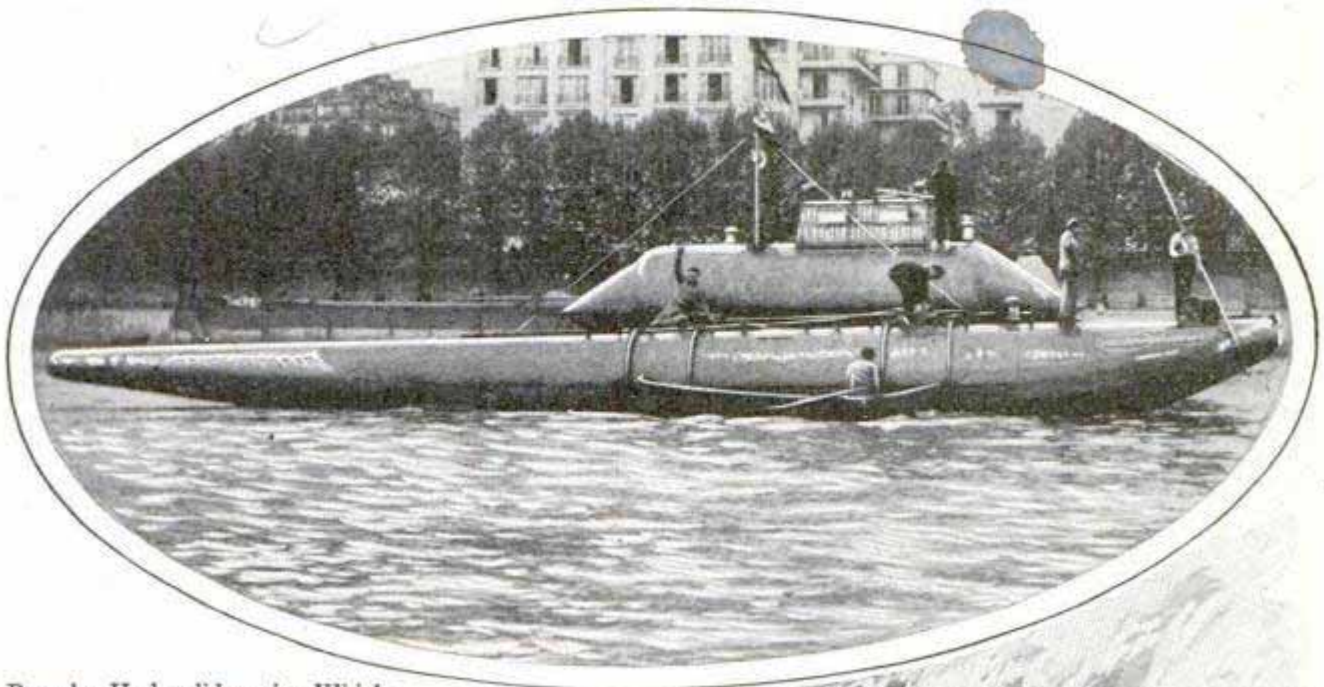

Remy's Hydroglider, in Which He Hopes to Break All Records by Crossing the Atlantic in Less Than Fifty Hours; the Photograph Above Was Taken Following Its Launching on the River Seine, and the Sketch Below Shows How It Will Appear at Full Speed

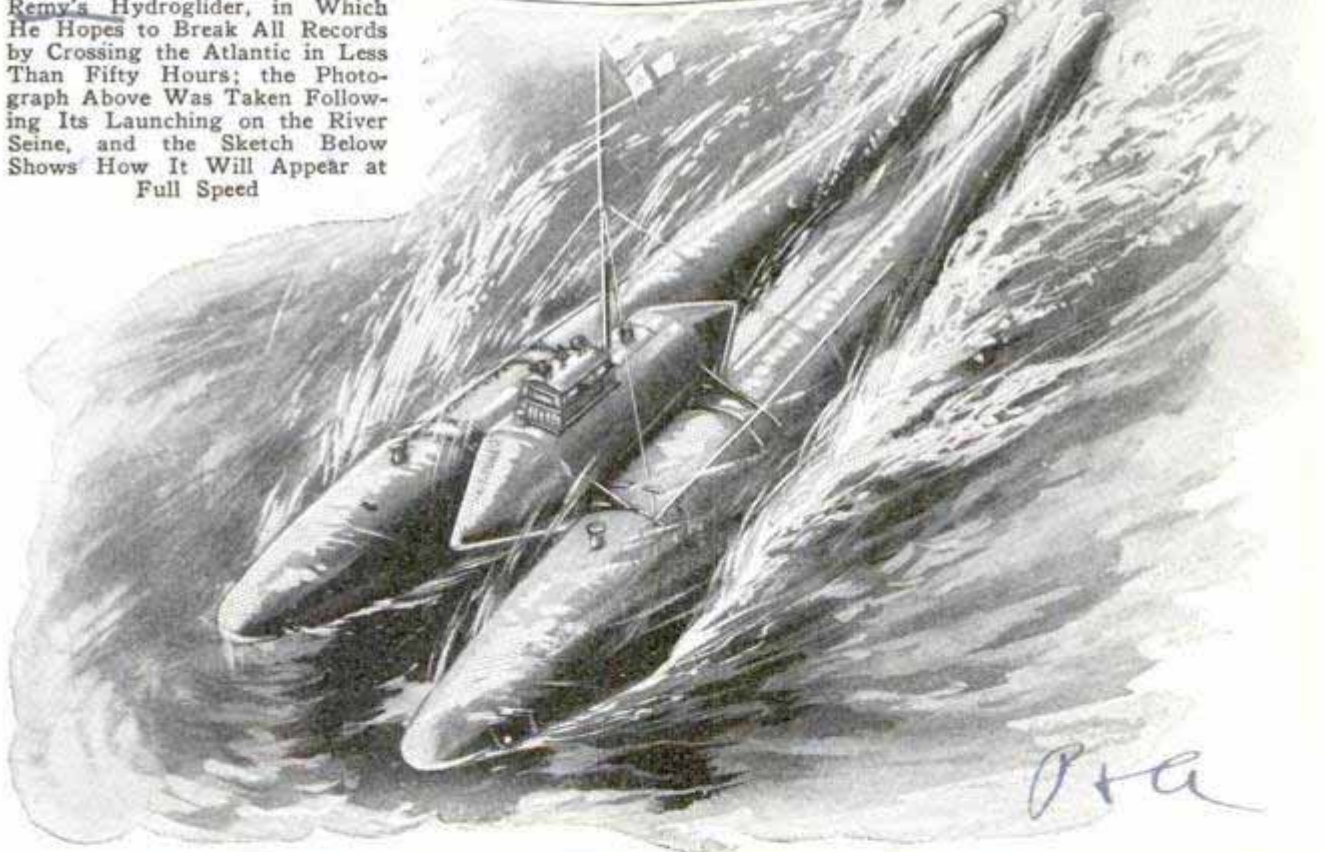

Designed to try for a new speed record in the crossing of the Atlantic ocean from Cherbourg, France, to New York, a queer hydroglider, designed by a French engineer, M. Remy, was launched recently on the River Seine. Remy hopes to make the crossing in less than fifty hours, cutting the time of the fastest liners in far less than half. The ocean glider has been developed from a smaller craft that was tried out some months ago on the English

channel, crossing from Calais to Dover in twenty minutes. Essentially the craft consists of three metal pontoons, fastened together and supporting a motor superstructure, which houses engines that drive airplane propellers, and a pilot house. The two main pontoons, carefully streamlined to reduce friction and resistance to the minimum, glide along the water surface at full speed; at least that is the action in fairly calm water.

Cont George F. Paul

GLASS SIGNS ON STREET LIGHT EASILY READ AT NIGHT

81

Transparent Street Sign on Lamp Post, Where It Can Easily Be Read

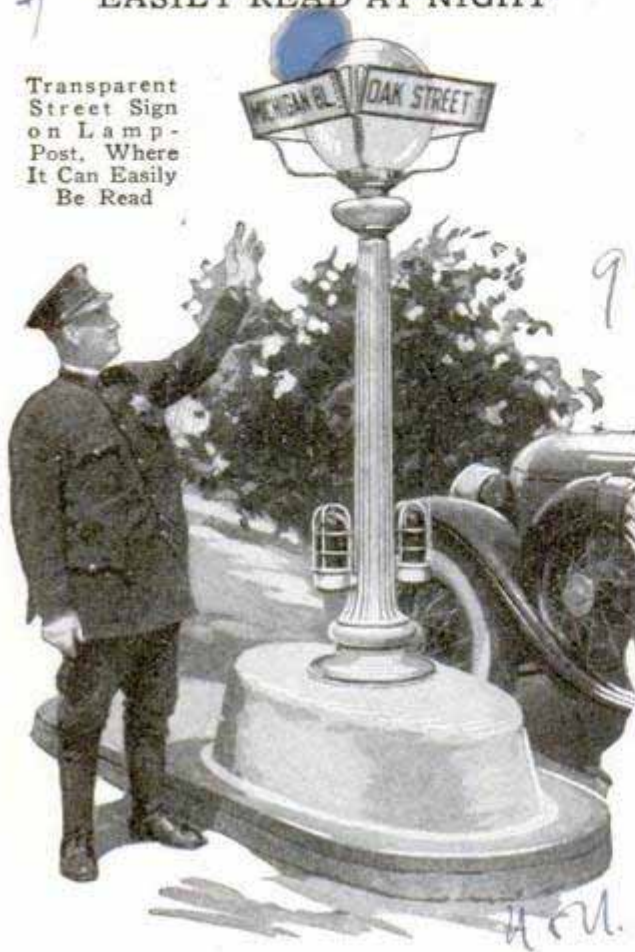

940

To assist motorists and others in finding street locations at night, a physician's widow has devised a plan to have the signs painted on glass and attached to a frame about the electric-light globe in the center of an intersection. In this position, the names are visible at a considerable distance by night, and by day from almost any point of the compass. The plan is the result of difficulties experienced by her husband in reaching his destination when responding to night calls. The frames are adjustable to globes of different sizes, and the strips of glass do not appreciably decrease the effectiveness of the light.

MIDGET RAILROAD USES AUTOS AS SUBSTITUTE FOR STEAM

924

Combination motor cars that haul freight, express, mail and passengers, and that are propelled by a familiar make of auto engine, are now in use on the Tabor and Northern, Iowa's nine-mile railroad. Private and public automobiles greatly reduced the line's business so that the directors decided to enter the competi-

tion on even terms. Steam trains were discarded for the combination cars of home manufacture. Three are now in service. They maintain a thirty-mile-an-hour average and make two round trips over the line each day.

WHITE CRUST ON BRICK WALLS CAUSED BY SALTS

Nearly everyone has noticed the white formation that sometimes discolors brick walls, particularly after a season of damp weather. It somewhat resembles mildew and may occur on comparatively new as well as old walls. The crust is caused by the solidification on the surface of various kinds of chemical salts that become dissolved within the brick and gradually seep to the surface. Usually the formation disappears after a few seasons, as the salts gradually are washed away. Better design of walls to prevent moisture penetration and careful mixture of the brick and mortar are effective preventives in many cases.

Bureau of Standard

CIGARET DISPENSER FOR CAR CONTAINS A HUMIDOR

3663

Clamped to the steering column of the auto, a cigaret dispenser exposes one of the contents at each turn of a little knob, and also has a humidor within to keep the cigarets fresh. The attachment saves the trouble of searching through the pockets while driving, does not interfere with operation of the car and is finished in attractive styles.

pat. pend. Keystone Dispenser

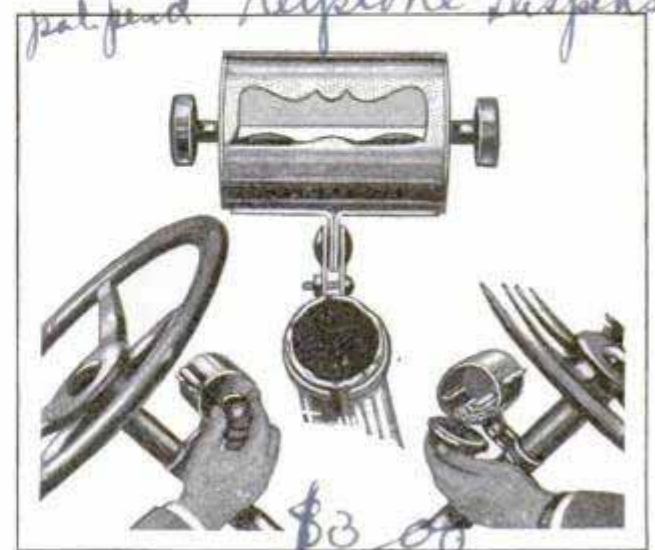

Views of the Cigaret Dispenser Attached to Steering Post Column; a Humidor Keeps Contents Moist

E. L. Stoffer, Agent, Tabor, Iowa.

Carl G. C. Esiswold, Omaha

The Norfolk Co. Chicago

San Francisco Calif

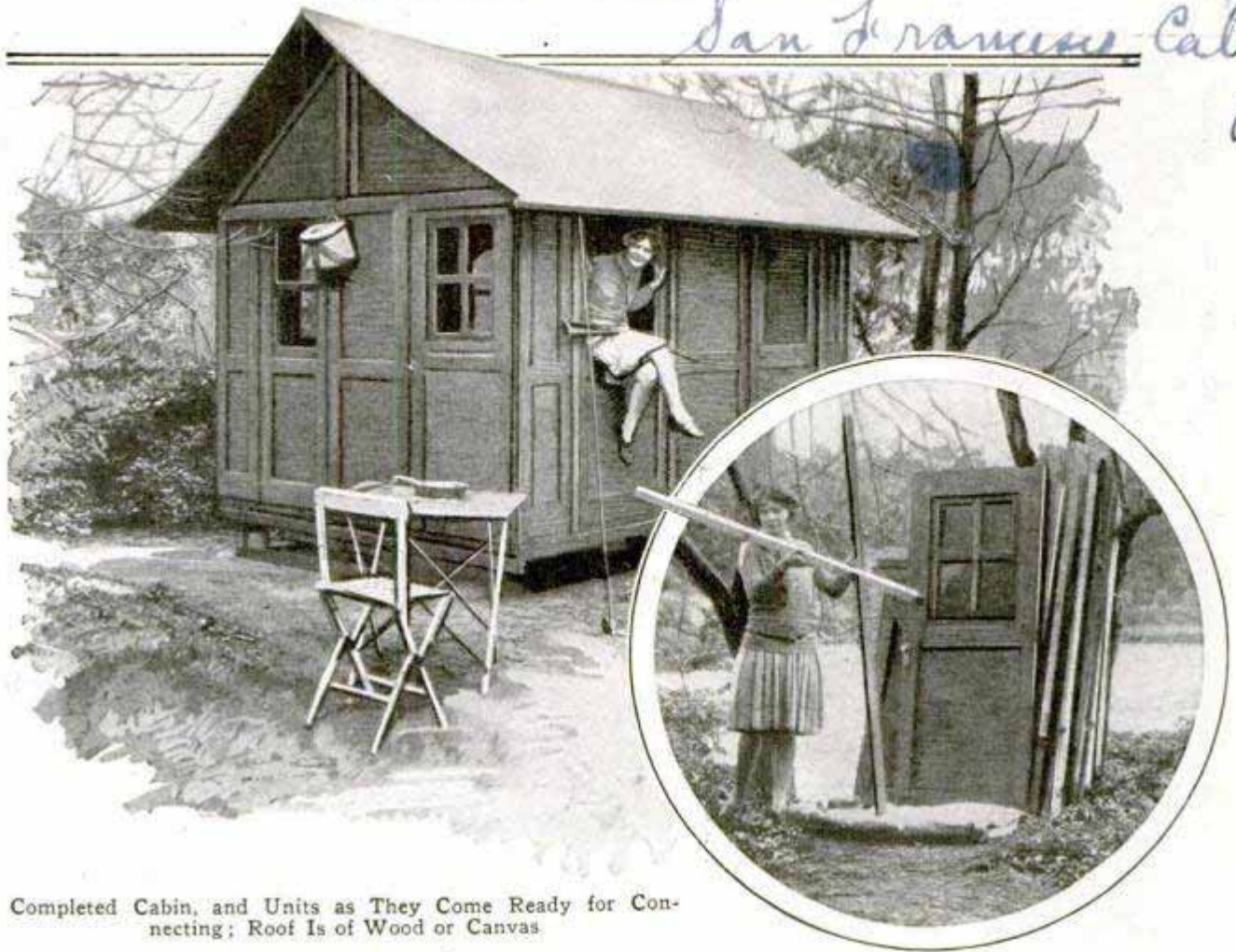

Completed Cabin, and Units as They Come Ready for Connecting; Roof Is of Wood or Canvas

CAMP CABIN BUILT IN HOUR REQUIRES NO NAILS

Consisting of about twenty-five pieces and assembled in an hour or less, a folding cottage for camping requires neither hammer nor nails for erecting, as it is held together with a few screws. The various units are plainly marked so that almost anyone can connect them. The roof is of wood or double canvas with an air space that helps to keep the interior cool in summer. There are five windows.

QUARTER-HOUR AIR TAXI LINE ACROSS ENGLISH CHANNEL

An aerial taxi service connecting France and England and making the hop from Calais to Dover in fifteen minutes, is being inaugurated by a French company. The planes operate in conjunction with the boat trains from London and Paris, and eliminate the terrors of a channel crossing. As the hop is made in a quarter of an hour, there is hardly time for the most susceptible passenger to become

either seasick or airsick. Seaplanes are to be used exclusively, so they can land on the water in case of trouble. The first ships carry two and three passengers each, but later, larger vessels may be built.

CLAMP TO HOLD AUTO LUGGAGE PROTECTS BODY OF CAR

Easily attached and inconspicuous when in use, a simple luggage-holder unit has

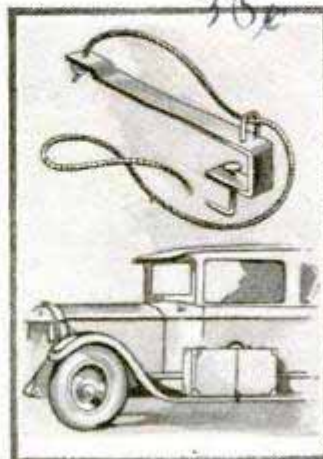

been introduced for the motorist. It consists of two clamps, which are fastened to the underside of the running board, and lengths of rope tied to them that are passed around the articles to be carried. Luggage is kept from rubbing the body of the car, is quickly removed and the clamps do not disfigure the auto.

Compagnie Aérienne Roche & Moore, Inc. Cochran, Pa.

3790

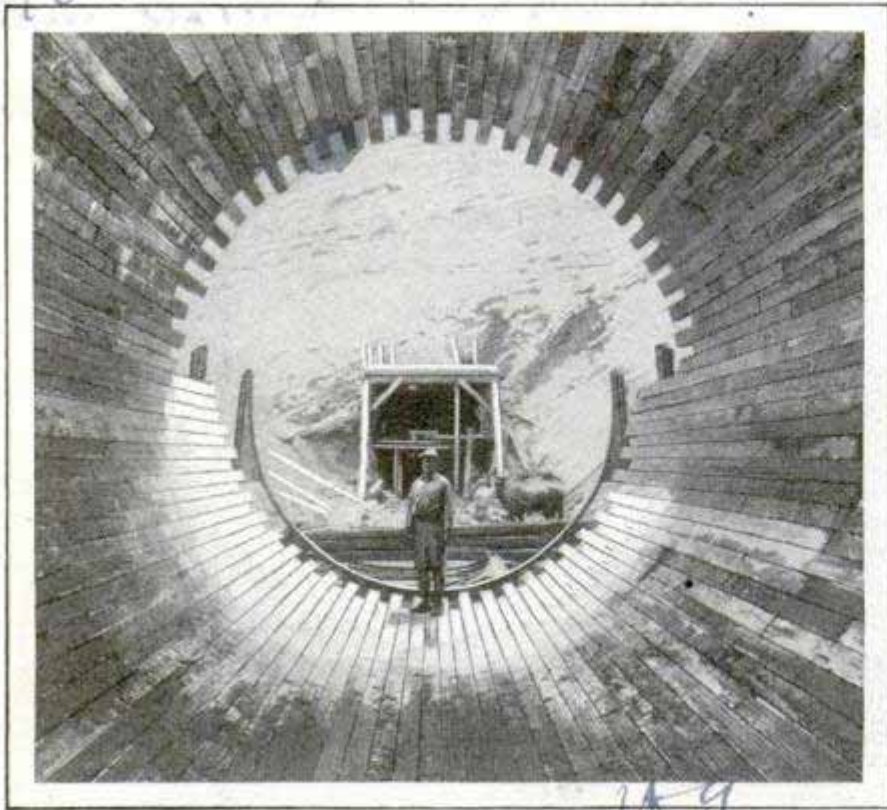

Figure of Man Illustrates the Enormous Size of the Wooden Stave-Pipe Line for Hydroelectric Company

PIPE LINE FOR WATER POWER BIG ENOUGH TO HOLD RIVER

A pipe line being constructed by a hydroelectric power company in California is large enough to hold a good-sized river, as it is sixteen feet in diameter. It is several miles in length and is made of wooden staves. The line crosses mountain and desert country.

TEST CONCRETE PAVING'S SAG TO MAKE BETTER STREETS

Civil engineers at Cornell University have been making a number of interesting tests on concrete pavings to find out why they break. An apparatus that duplicates the effect of a loaded vehicle on the road is one of the instruments used. It bends a concrete beam a fraction of an inch. This is what happens when a heavy vehicle passes over the pavement. The concrete bends downward under the wheels while the material ahead and behind is actually bent upward at the same time. A moving load causes waves in the concrete as it progresses. The result is a reversal of stress that renders the material even more liable to fracture by fatigue. To counteract this difficulty, engineers are

endeavoring to find better ways of placing the steel reinforcing, improving the foundations under the pavements and otherwise fashioning the slabs so that they will be enabled more successfully to resist these strains.

MYSTERY OF INDIAN MOUNDS CLEARED BY RECENT FIND

Additional proof that not all the Indian mounds were built by a mysterious race who vanished long before the coming of the white man, has been discovered near Joliet, Ill., in a mound that was partly filled with funeral gifts of European manufacture. A number of silver spoons, a crucifix,

bangles and other ornaments were among the objects taken from the diggings along with Indian skeletons. Brass pots, a pair of scissors and knives bearing a French trade-mark were also found.

CUTTER TO SHRED CORNSTALKS HELPS CURB BORER

To help keep the corn borer in check, an Indiana inventor has devised an outfit which cuts the cornstalks into inch lengths on the field after the grain has been harvested. A rapidly rotating cutter drum is the essential part of the apparatus, which is run by a motor.



Motor-Driven Cutter That Chops Cornstalks into Small Pieces and Helps Check Spread of Insect Pest

93/

Daily News 6/20/28

Build by Agricultural Eng. Dept. Purdue Univ. Liquid & Gas Gases Lafayette, Ind

876
Carhart St
Marion Ohio

Are Your Senses



A Test for the Taste Buds on the Tongue; a Clean Glass Rod, Tapped against the Tip of That Member, Should Produce a Sweet Taste, and Farther Back at the Side a Sour Acrid Sensation

THE TELEPHONE jangles. You pick up the receiver.

"Hello! Who? What's the name, please? Oh yes! Speak a little louder, can't you? You say you'll meet me at Sea Shells? Oh—Three Bells. Yeh! Huh? All right! All right! G'by."

You hang up the receiver viciously, disgusted.

"Thunderation, but that fellow can't talk over the phone. Why....."

And then you think of something—a little sneaking thought: "Maybe it's me; maybe these auditory channels of mine are not quite up to snuff."

It only happens occasionally, but once in a while you wonder if your hearing is as good as the next fellow's; if you can see with the keenness necessary for the full enjoyment of life; if your meals taste as good as Bill Jones'; you wonder vaguely, "Are my senses perfect?"

It means a lot to have the five major senses—sight, hearing, smell, taste and touch—in good working order. And are they? Well, here's the answer: Give yourself the following tests and see how your senses measure up.

First your ears. There is no common sound which is always uniform at a given distance, and modern doctors giving tests for hearing invariably use the audiometer or a tested tuning fork. In your case, however, the ordinary pocket watch will serve quite well. Some of these tick a little louder than others, but most of them you should be able to hear beat quite distinctly at a distance of one yard. By testing several persons with the same watch, you can establish a definite average at which the watch tick should be heard by anyone possessing normal hearing.

That's one test—old but reliable. The next thing is this: Your sense of hearing may be normal as regards density, but has it perception enough to distinguish between various sounds? Can you let a friend strike a safety match on a box, rub his wet finger over a glass, play a tune on a comb, operate a typewriter, turn the pages of a book and unhesitatingly name at least three of the tasks at which he is employed. Try it! You will be surprised how unfamiliar a sound can be when dissociated from its accustomed combination with a visual setting.

So much for the hearing. Next comes something which is considered relatively unimportant—the taste. Only a very few classes of people—food testers, chemists and pharmacists—appreciate the value of a delicate sense of taste. They alone know that the taste organs must be fully developed before anyone can enjoy to the full a really delicious meal.

Taste alone is not really taste. Although the various taste buds in the mouth give distinct sensations of taste, most foodstuffs must be smelled as well before we really taste them.

That fact is best illustrated by the following little test: Ask an inveterate smoker if one cigaret tastes differently from another. He will invariably say that his favorite brand, has an entirely different taste from all others. And yet, blindfold this smoker, plug his ears with cotton, bid him hold his nose, place him in a room where the temperature is eighty or above and let him take irregular puffs at a lighted cigaret and an unlighted one, and, in the course of two minutes, he will be unable to distinguish the lighted cigaret from the unlighted one by normal inhaling and exhaling. His sense of taste alone is insufficient; it is only through the contributory sensation of smell that a smoker can really distinguish his favored cigaret.

In the same manner, the average person finds it extremely difficult to taste any difference between raw potato and ripe apple if the sense of smell has been shut off.

So, taste is really taste and smell combined. The taste organ itself can be tested quite apart from the organ of smell. Like this: Take a clean glass rod and gently tap the tip of your tongue. A normal tongue will immediately register a sweet taste because the sweet-taste buds, which are situated at the tip of the tongue, have been stimulated into action. If these buds have been dulled through a diet heavy in sweet stuffs, the sensation will not be distinct, and in some cases, especially in that of a continually candy-eating individual, the glass-rod test will fail entirely. The same glass rod, if tapped against the side of the tongue, far back, will give rise to a bitter acid taste.

Smell, in itself, can be tested by blindfolding yourself and then smelling several



Testing the Eyes for Seeing at a Distance, and a Simple Test for Astigmatism; the Lines Should Appear, at Ten Feet, to Be of Equal Blackness, Otherwise the Eyes Are Wrong

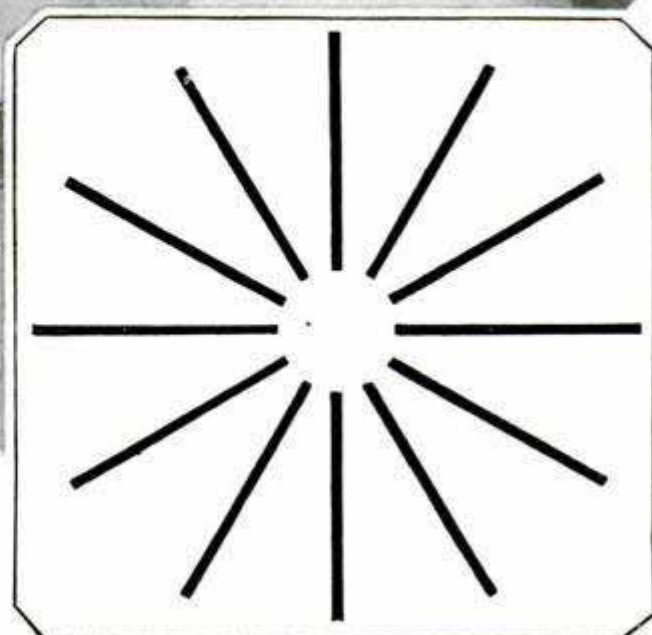
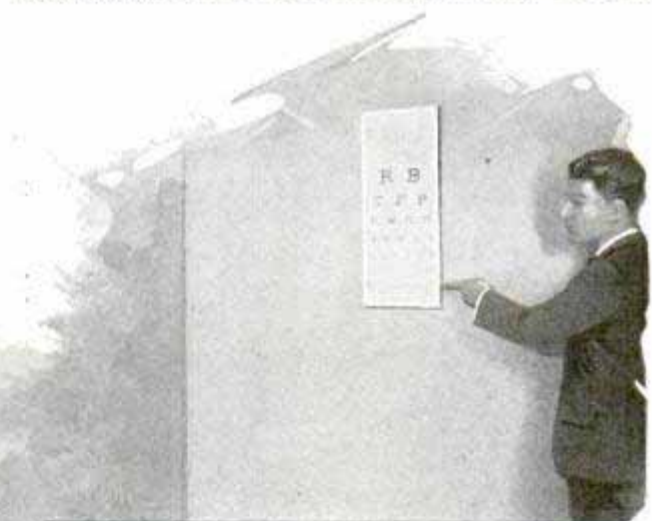



Making One Marble Feel Like Two, and Getting One Sensation from Neck Nerves and Two from Finger Tips

familiar odors. Official tests of smell, as used by large medical institutions, employ from eight to twenty odors, and of these the average person can distinguish but twenty-one and a half per cent.

For your own test, then, use an onion, a weak solution of chocolate, cinnamon, ammonia, cloves, roses, coffee, tea, lemonade and castor oil. Of these ten very familiar odors, you should distinguish five for a fair average. It's not so easy as it sounds. Without the aid of a picture of the object, as seen by the eye, the sense of smell alone can roughly distinguish the odor, but not to the extent of labeling it with a name in fully half of the test objects.

The sense of touch is quite important. The girl who clicks a typewriter for a livelihood illustrates the importance of this sense, as does also the safe-lock picker, although in an entirely different manner.

Sense of touch varies but very little in the average group of persons. It is either entirely all right or decidedly wrong. At the tip of the fingers and tongue, touch is much more delicate than on the back.

Testing with a sharp pair of scissors, you can easily distinguish the two points at a distance of one-eighth inch apart at your finger tips, but will need to separate the points fully two inches before two distinct pricking sensations are experienced on the back of the shoulder.

Another peculiar experiment in touch is performed with an ordinary marble. By crossing the first and second fingers in the manner shown and rotating them on the marble, the average person will get the sensation of two marbles instead of one.

Finally in the list of senses comes sight. It is by far the most important, the most studied and, perversely, the most neglected of all the senses.

896



Trying, with the Back Turned, to Identify Various Sounds, and, Below, a Smoker Discovering He Can't Tell the Difference between a Lighted and an Unlighted Cigaret by Taste Alone

Tests for your sight are three in number: Simply can you see at a distance; can you see close at hand; are your eyes free from astigmatism?

For the first, you should be able to read the following line at a distance of fifteen feet:

S H F K

You also should be able to read, easily, the large type which is found in the average magazine at a distance of fifteen inches.

The test for astigmatism is taken with the aid of a chart with a circle of lines as shown. Set this magazine up at a distance of ten feet and look at these lines. If they appear of uniform blackness, there is no astigmatism, but if one set of lines appear blacker than the others, astigmatism is present in that direction. Normally, most eyes are slightly astigmatic.



than those of the average person. By quickness of eye is meant the co-ordination of visual impressions with nervous and muscular reactions. This is an exceedingly important factor also in boxing, where dodging and delivering blows on split-second schedules is constantly demanded. Automobile racers, at a speed of 200 miles an hour, must be able to see clearly 1,500 feet ahead, and efficient co-operation of eye, hands and feet is essential to guide the car safely. In golf, even greater exactness is required. Lack of accurate eyesight and response is one of the chief causes of automobile accidents. The all too frequent statement, "I didn't see him coming," as heard in court cases, is substantial evidence of this.

QUICKNESS OF EYE BIG FACTOR FOR SUCCESS IN SPORTS

Babe Ruth's batting skill, a wonder of the baseball world, is largely due to his remarkably keen and accurate eyesight. Tests in the laboratory have proved that his visual reactions are far more rapid

945
 Com. Mr. George C. Barron, R. 4
 1200 1/2 ...

**MOTHPFREE HOMES
MEAN CONSTANT
VIGILANCE**

Well-heated homes and factories provide excellent breeding conditions for moths with the result that the pests are on the increase, L. E. Jackson, of the Mellon Institute, declares. Instead of there being a short "open season" for hunting moths in the family closets, the housewife must be vigilant at nearly all times of the year. Where formerly but one generation of the insects was produced during the warm summer months, now there are two or more generations, due to the conditions of artificial heat. Exhaustive studies have been made in search of chemicals that will kill the pests without damaging fabrics or producing unpleasant odors. Certain products of the cinchona tree have been found to meet the varied requirements, it was said.

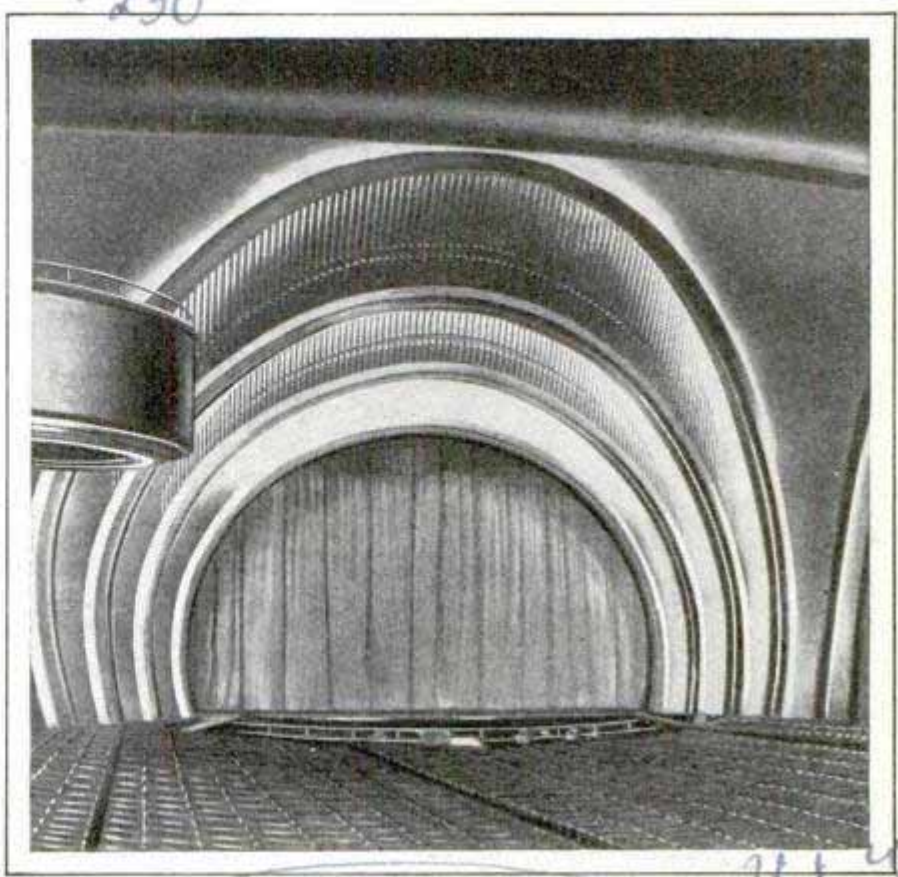

Interior of Berlin Theater, Where Circular Style of Decoration Supplants the Customary Angles and Corners

**THEATER INTERIOR OF CIRCLES
LATEST MOVIE STYLE**

A firm of Berlin architects has introduced an innovation in theater interiors with a movie palace designed in curves and circles. An oval stage, curved balconies and a tremendous rounded arch in which the pipe-organ units are installed over the stage, are special features.

**AUTO'S SUPER-BALLOON TIRES
ADVERTISE SERVICE STATION**

To attract attention to an automobile-accessory shop in Los Angeles, the proprietor has equipped a small car with 44 by 10 tires. As a stationary display, it causes considerable comment and, when the car is driven about the city, it never fails to excite curiosity and amusement.

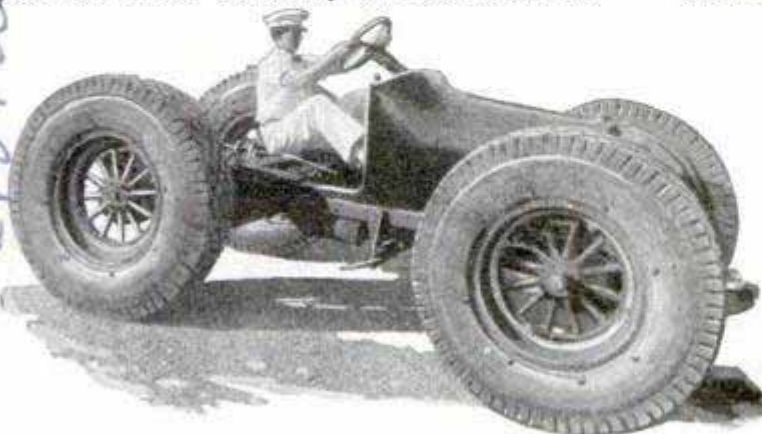

More Tire Than Car; Display Auto Equipped with Super-Balloons to Advertise an Accessory Shop

**REINDEER MEAT BY AIRPLANE
SERVED IN ALASKA**

An Alaskan village was thrown into excitement recently when an airplane dropped from the skies with a cargo of reindeer meat. It was the first plane they had seen and their amazement was increased when the chief of an Indian tribe that long had been hostile to them, stepped out of the cockpit for a friendly visit. The plane was piloted by C. P. Crawford, an American. During favorable seasons, fortnightly trips are planned to take supplies to mining camps 150 miles from Shungnak, the base of the meat supply.

Cont. Willard H. Morgan, Los Angeles, Calif. 2437 Echo Park

Arctic Prospecting Alaska

230

244

246

927

913

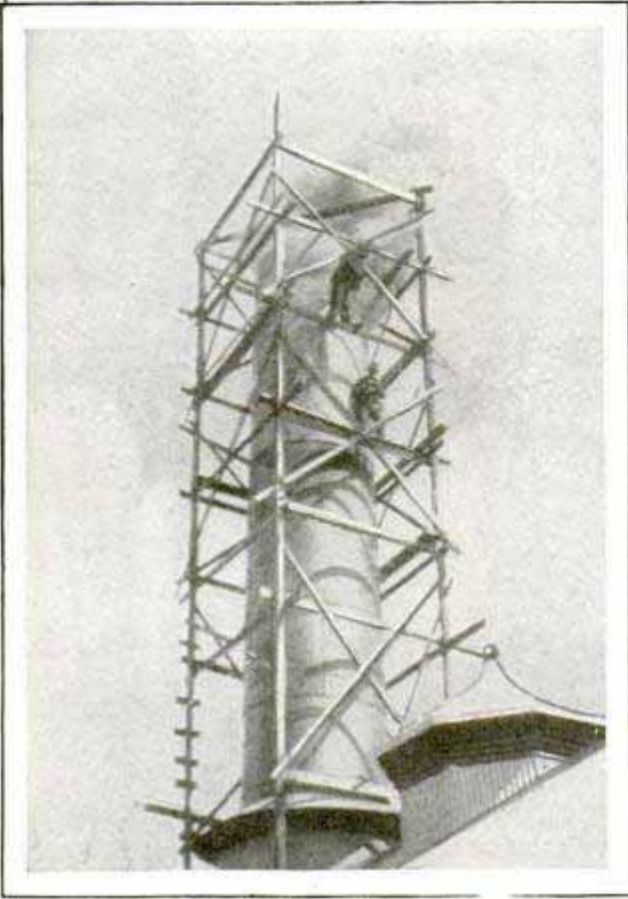

Adding Section to Big Smokestack While Fires Burned Below; Workmen Completing Second Half of a Joint

BUILD STACK WHILE FIRES BURN TO KEEP PLANT RUNNING

Engineers accomplished the "impossible" the other day in adding a twenty-foot extension to the smokestack of a gasworks in Seattle, Wash., while soft-coal fires burned under twelve boilers. Skeptics said it couldn't be done. The plant could not be shut down, for the city needed the gas. Clouds of smoke poured continually from the stack and the temperature at the mouth was about 300 degrees Fahrenheit. The job was accomplished by a special method of construction and with the co-operation of the firemen. The stack sections, which were of metal plate and eight feet in diameter, were rolled to fit the stack, the holes punched and then each joint was split in half. After a good head of steam was up, a

fan was set running and a damper in the stack was closed to lower the temperature to about 150 degrees and to decrease the smoke. By putting up half a joint at a time, the men were able to screen themselves from the smoke. When the steam pressure was lowered, the work was temporarily halted while the firemen shoveled on more coal and brought the pressure back to the required point, ready for another period at the stack. A pair of ten-foot tongs was used to help hold the two halves of the sections together, and when they were finally in place, they were electrically welded to make a secure joint.

OIL IS REMOVED FROM STEAM BY ELECTRIC PROCESS

An electric method of removing oil from water condensed in a steam engine has been developed by a German scientist. He passes a direct current through the water. This collects the oil in small foam flakes, destroying the emulsion and making filtration possible. A relatively small quantity of electricity is required. The oil gets into the water from the pistons, becomes atomized and is carried away in the waste steam. The milky emulsion that is thus formed in the condensed water creates a residue which, if left there, interferes with the efficient operation of the engine.

LEAD ON STREET-CAR GEARS DECREASES NOISE

Lead has been employed effectively to deaden the noise of the gears on street cars being built in San Francisco. Rubber pads between the trucks and the body and a sound-deadening material under the car floor have also decreased the usual unpleasant noises.

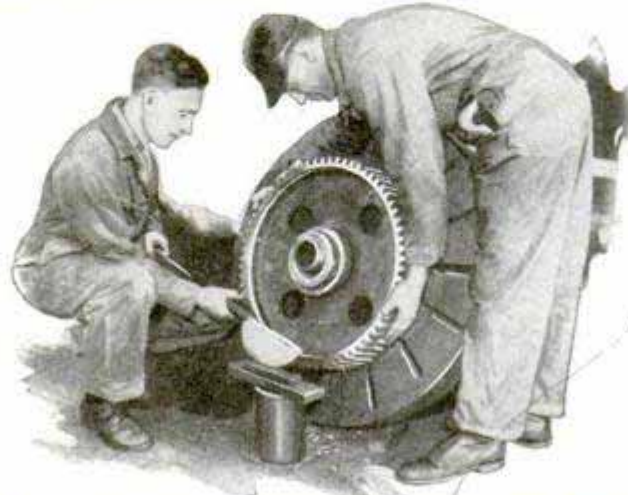

Pouring Lead around Rim of Street-Car Gear Wheel, to Help Deaden the Noise

Air pumps have been insulated to make them quieter and, at crossings, the rails are sealed with asphalt to eliminate the loud pounding of the wheels in passing.

Mazkel Street

Vertical text on the right margin: ... Central N.Y.C. ...

Handwritten notes at the top: Pacific Coast ... Jack ... Wash.

SLOW MOVIES OF VOICE TO AID PICTURE STARS

Metro. Goldwyn Mayer & Technicolor Co. Calif.

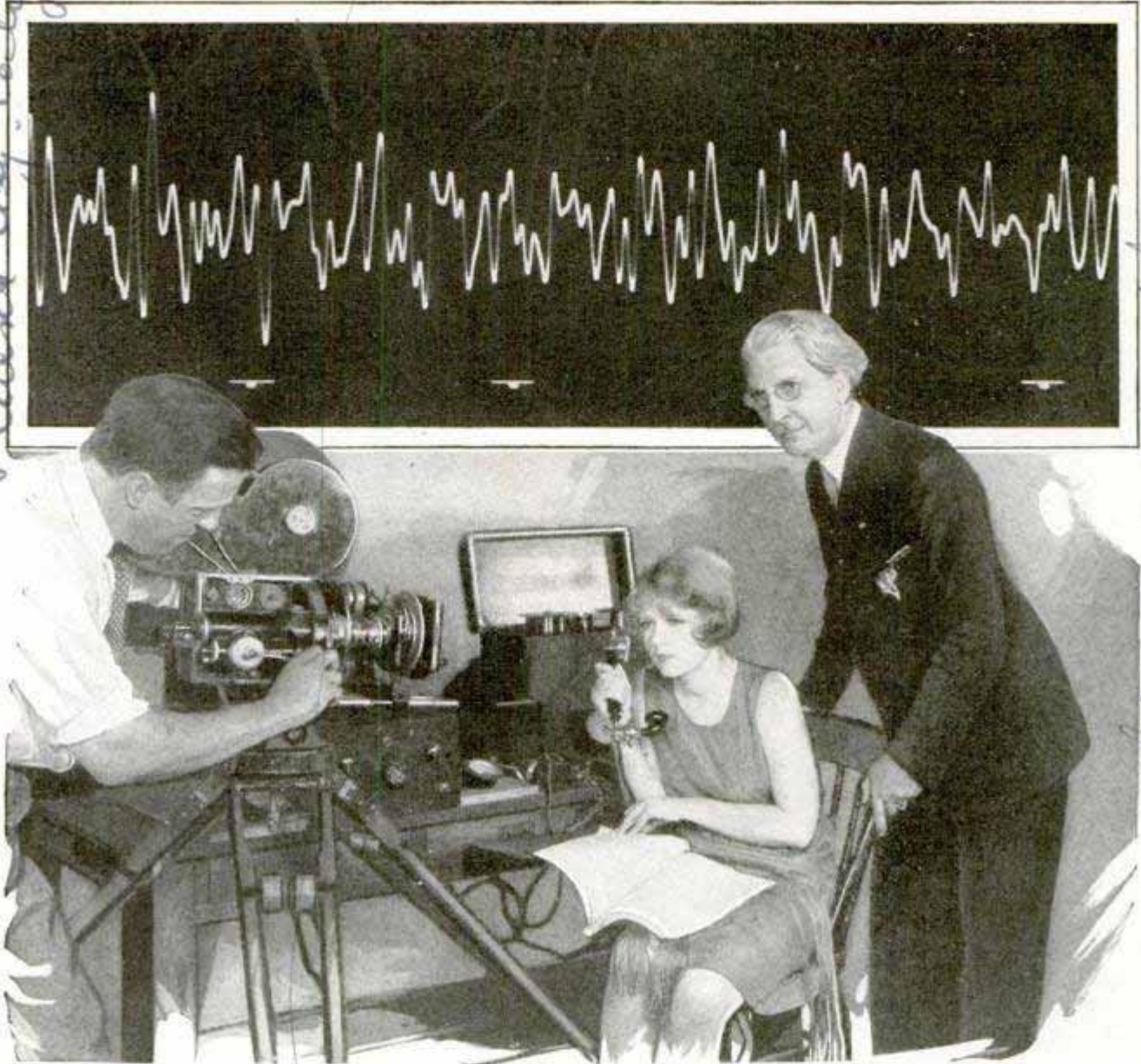

Pohlsen Telegraphone

To Improve the Talking Movies; This Apparatus Films the Actress While She Speaks, and, at the Same Time, a Record Is Made of the Vibrations of Her Voice as Shown Above

Introduction of talking movies has made a new demand on the actors, and many of them are requiring special training to fit their voices for satisfactory recording and reproduction. In this connection, an apparatus, developed by scientists at the University of Southern California and experts of a motion-picture company, has proved helpful, according to reports. A visual record of the voice vibrations is prepared directly from the spoken tones of the subject and this can later be shown in movie fashion and at a slow rate of speed so that defects can be recognized and corrected. While actors for the talking motion pictures do not need loud voices, their pronunciation must be dis-

tinct, and many of them require special teaching to attain this. The visual record helps the speaker to recognize and correct his own mistakes.

visometer
GAUGE SHOWS QUALITY OF OIL AS MOTOR RUNS 408

To eliminate guesswork and prevent lubrication troubles, an oil-quality gauge mounted on the dash shows the condition of the oil at all times. When installed in connection with the filter, the unit not only gives this indication but also warns of any irregularities in the functioning of the lubricating system, so that they may be remedied before serious damage is done.

Los Angeles.

The Automatic Life Saver
Co. 416 N. 1st St. Phila.

AUTO ROADS OVER RAILWAYS TO SPEED TRAFFIC

*Board of Municipal Engineering Regulation
and Public Safety
City Council City of Chicago*

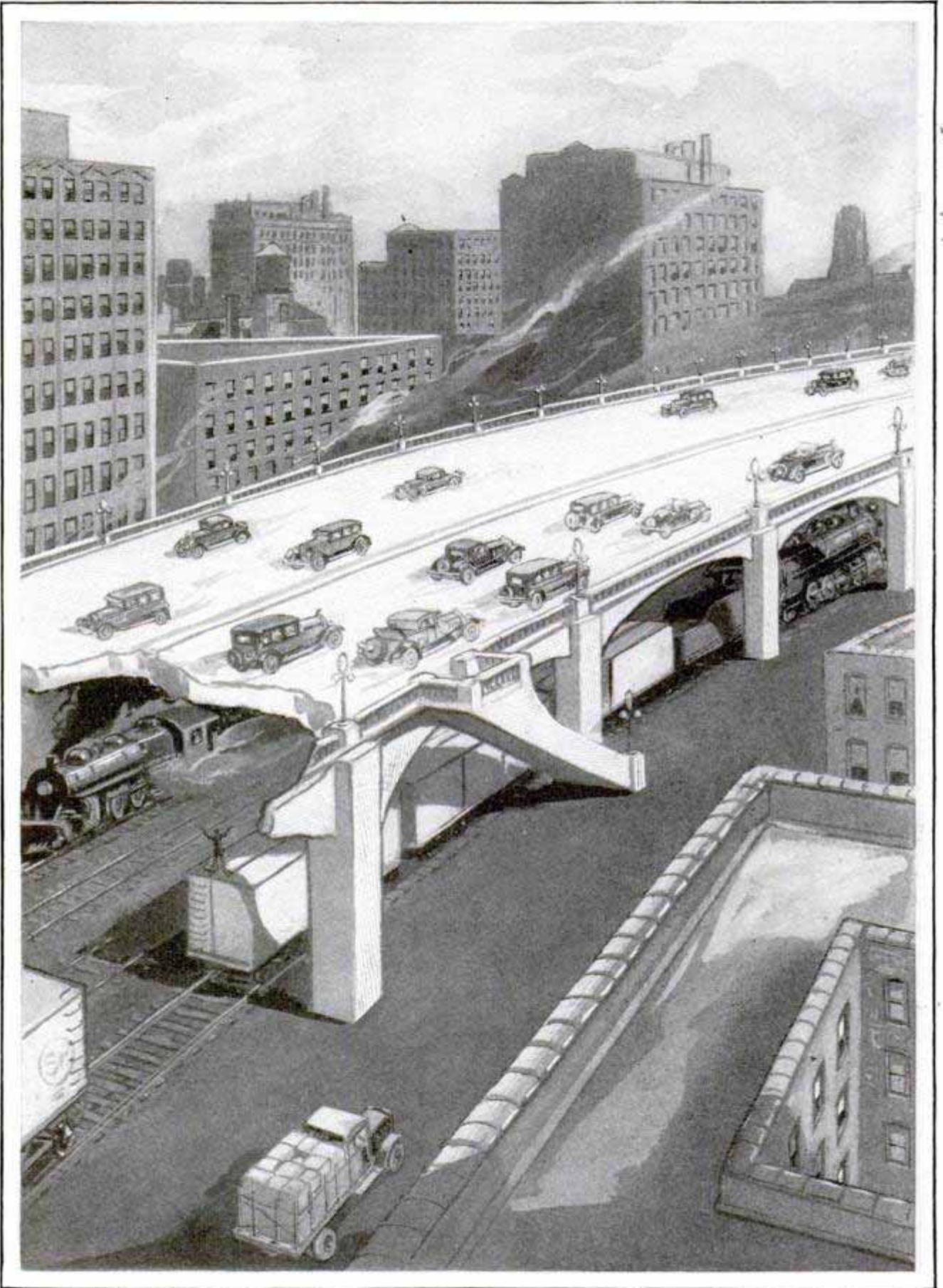

Drawing of Proposed Auto Highway to Be Constructed over Railway Lines Entering Chicago; Cars Would Enter and Leave the Special Drive by Means of Ramps; Cost of the Project Is Placed at \$250,000,000

MOLASSES POURED ON WAVES SAVES SHIP IN STORM 961

Molasses as a substitute for oil in calming the sea during a storm was used successfully recently by a ship captain off the northern coast of Cuba. When the vessel was threatened by the high waves, its cargo of molasses was opened and more than 70,000 gallons poured on the water. Gradually the sea about the ship became still and the vessel was able to proceed safely out of the storm zone.

WATER HYACINTHS ARE TURNED INTO CHEMICALS 962

Long considered a pest in southern rivers, the water hyacinth has commercial possibilities as a producer of chemicals and alcohol, a Calcutta scientist has discovered. From it, he has obtained pure potassium chloride and power alcohol, he reports, and the pulp that remains after the dried plant has been treated, is suitable for making strawboard.

TOWER OF STEEL GANGPLANKS TO SAVE LIVES AT FIRES 708

A series of collapsible steel gangplanks and platforms on a wagon has been introduced in Germany as a means of rescuing persons trapped in burning buildings. The set can be raised or lowered to various levels, affording exits from two or more stories simultaneously.

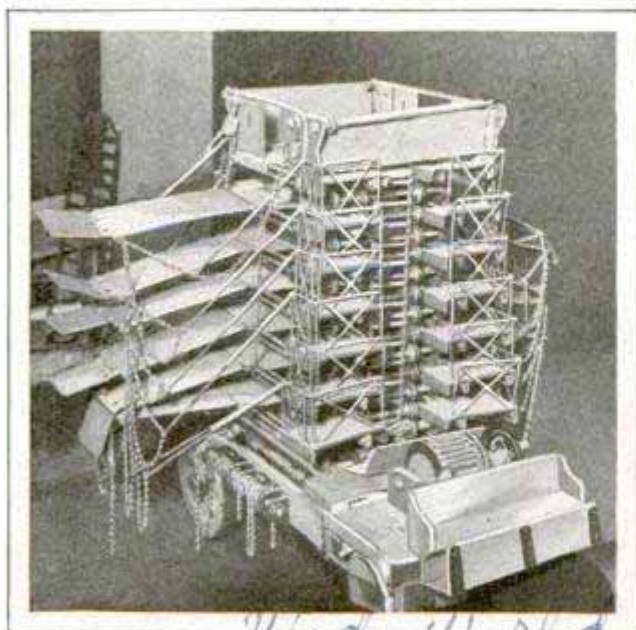

Model of Life-Saving Tower and Platforms for Rescuing Persons Trapped in Burning Buildings



Packing Bed in Suitcase, and How It Looks When Set Up for Use

PORTABLE BABY BED WEIGHS THIRTEEN POUNDS

A collapsible outfit for the baby, weighing, with its carrying case, but thirteen pounds, has been invented by a Chicago woman. The outfit includes a bed, built of strong aluminum tubing and brass fittings, a sunshade, mosquito net, pillow and canvas side walls, and the case contains pockets for the baby's clothes, bottles and other accessories. The canvas side walls and cover of the cot bed are removable for washing. Packed in the case, the outfit can be carried in the automobile or on the train, and set up in a moment.

Those wishing further information on anything described in the editorial pages can obtain it by addressing Bureau of Information, Popular Mechanics Magazine, Chicago.

87 3
Mrs. Lydia Hagedornfeldt 5156 N. Chicago
Illustrated by -
Seller sold 5/26/33

\$19.50 - Used \$9.00

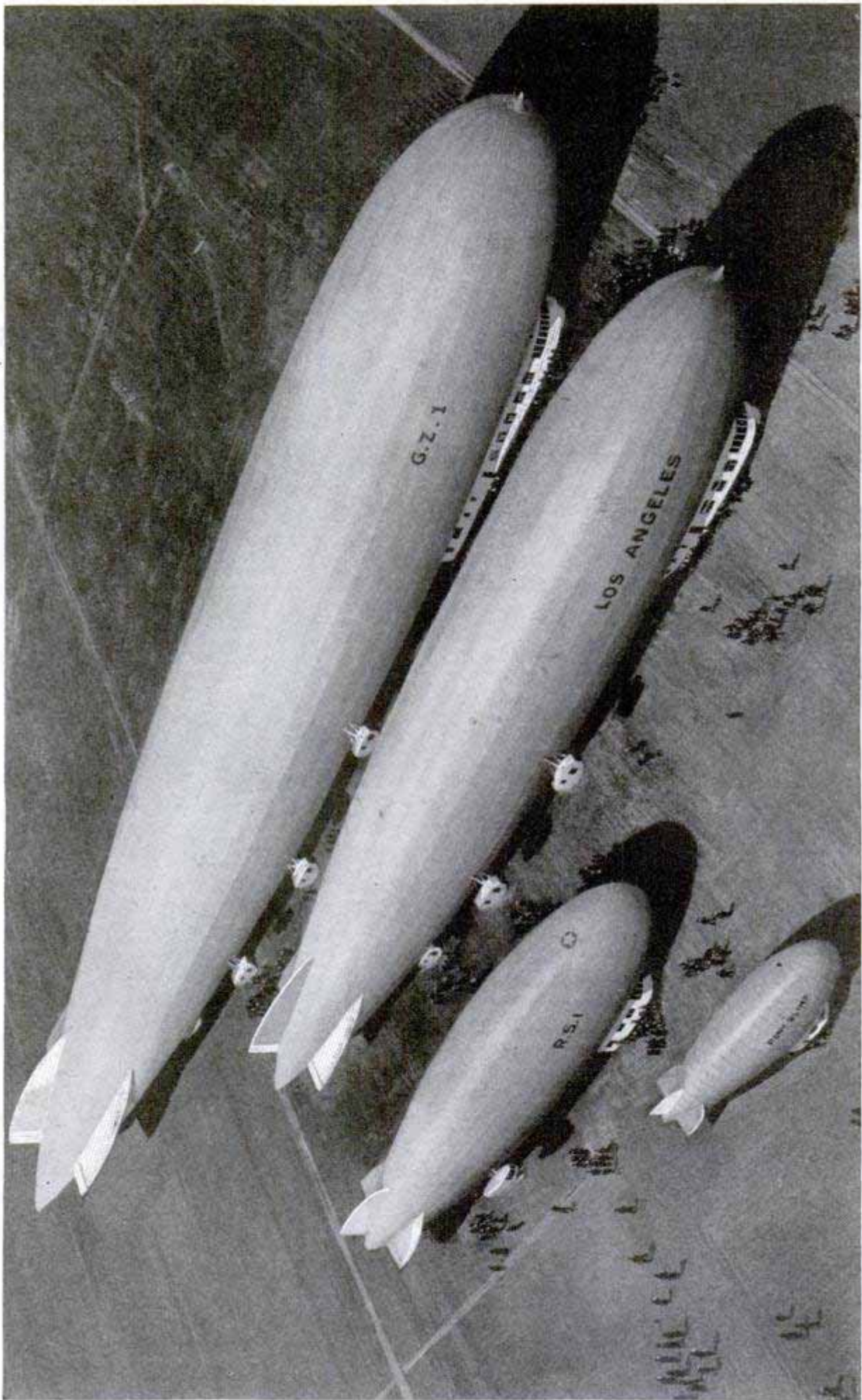

One of the Navy's Proposed New Airships, the "Los Angeles," the Army's Largest Semirigid "RS-1," and a Pony Blimp; the New Ships Are to Be 756 Feet Long and Have a Gas Capacity of Six and a Half Million Cubic Feet

Krosslerstrasse 20,
Berlin-Friedenau, Germany



The Lounge and Card Room aboard the "LZ-127," Germany's Latest and Biggest Zeppelin, Now Nearing Completion; the Huge Dirigible May Make a Flight around the World

THE biggest Zeppelin ever built—127th in the line from Count Zeppelin's first ship—has been completed at Friedrichshafen, on Lake Constance. Besides being the largest, with a length of 770 feet, a diameter of 100 feet and a maximum height of 110 feet, it is the first to be designed for transatlantic passenger and freight service, and the first to use gas, instead of a liquid, for fuel.

When it takes to the air this summer, its construction name, "LZ-127," will be changed to "Count Zeppelin" in honor of the inventor, who gave his fortune and his lifetime to perfecting the rigid airship.

Six reversible Maybach engines, of the same type used in the "Los Angeles," will furnish 2,650 horsepower to drive the ship, or 2,150 horsepower at cruising speed. The engines are designed to run either on a special carbohydrate gas or on ordinary gasoline. The new gas fuel is the most interesting innovation, for it has exactly the same weight as air. As a result, the weight and lifting capacity of the ship do not change as the fuel is used.

The problem of keeping the weight of an airship constant, as fuel is used, is the most important in dirigible operation. The

American navy developed a water-recovery system that extracted water from the exhaust gases to offset, as nearly as possible, the gasoline consumed. With the new German gas, the additional weight and complication of the water-recovery apparatus are eliminated. Some gasoline will be carried, so that, if it is necessary to lighten the ship to rise to a higher altitude, it can be done either by burning the gasoline as fuel, or, in an emergency, dumping the gasoline, tanks and all, because it would be dangerous to release the volatile fuel into the air, as the ship would fly in a cloud of gas which might be ignited from a motor exhaust.

The ship will have a total lift of 129 tons under normal atmospheric conditions. The cruising radius depends on the amount of freight carried and the speed desired, but with 33,000 pounds of useful load, it is possible to fly 6,200 miles at a speed of sixty-two to sixty-eight miles an hour. The top speed under full power will be 79.36 miles an hour. A crew of twenty-six will be carried, including the navigators, radio men, cooks, waiters and others. Ten cabins, each with two berths, are provided for passengers.

The first flight of the new airship this summer is to be made to England, marking the first visit of a German dirigible to the British isles since the war-time raids over London ten years ago. For the visit, the British government has placed a moor-

ing mast at the disposal of Dr. Eckner, head of the German Zeppelin works, who commanded the "Los Angeles" when its German crew flew it to America for delivery to the navy. A Spanish company is negotiating for lease of the airship, if it passes its flight tests successfully, proposing to operate it on a passenger, mail and express run between Spain and Buenos Aires. It is possible, however, that Dr. Eckner first may carry out his plan for a flight around the world.

The new ship, with its length of 770 feet, outranks the two 720-foot ships now nearing completion in England, and will be longer than the proposed two 756-foot ships authorized for the U. S. navy, but its gas capacity of 3,800,000 feet is considerably under the 5,000,000-cubic-foot English dirigibles, and much below the 6,000,000-foot capacity of the vessels planned for the American navy. The reason for its smaller capacity lies in its slowness. The "Los Angeles," the biggest Zeppelin actually in operation, measures but 656 feet.

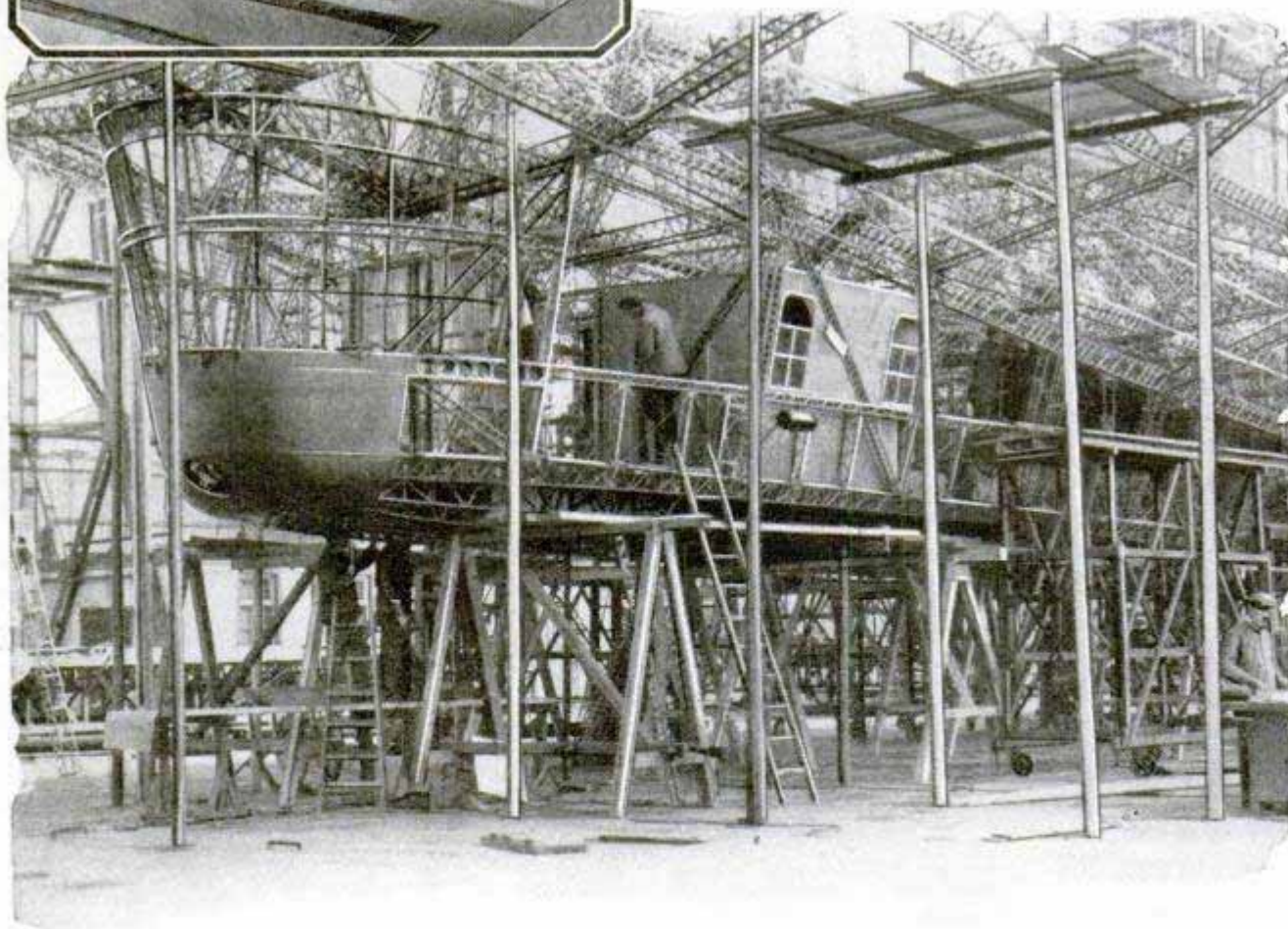
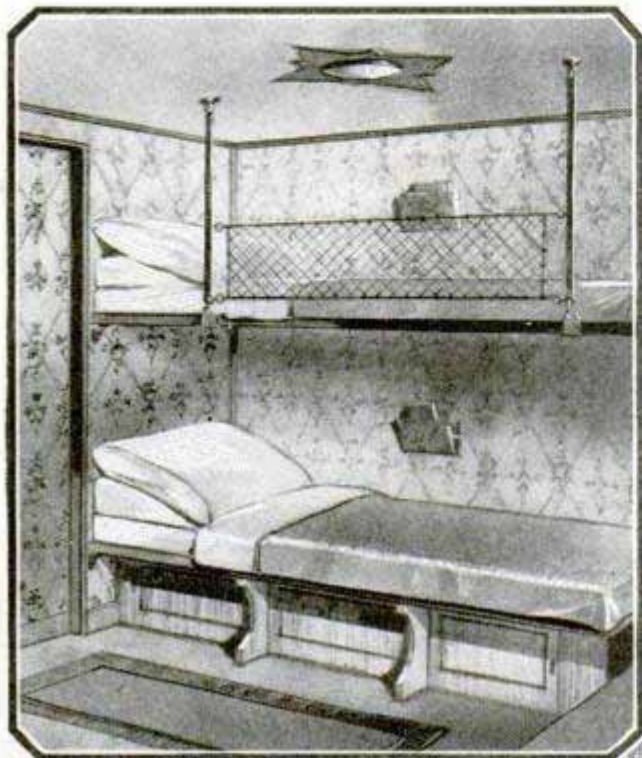

One of the Staterooms of the "LZ-127" and the Passenger and Control Gondola under Construction; the Walls in the Center Inclose the Radio Operator's Compartment

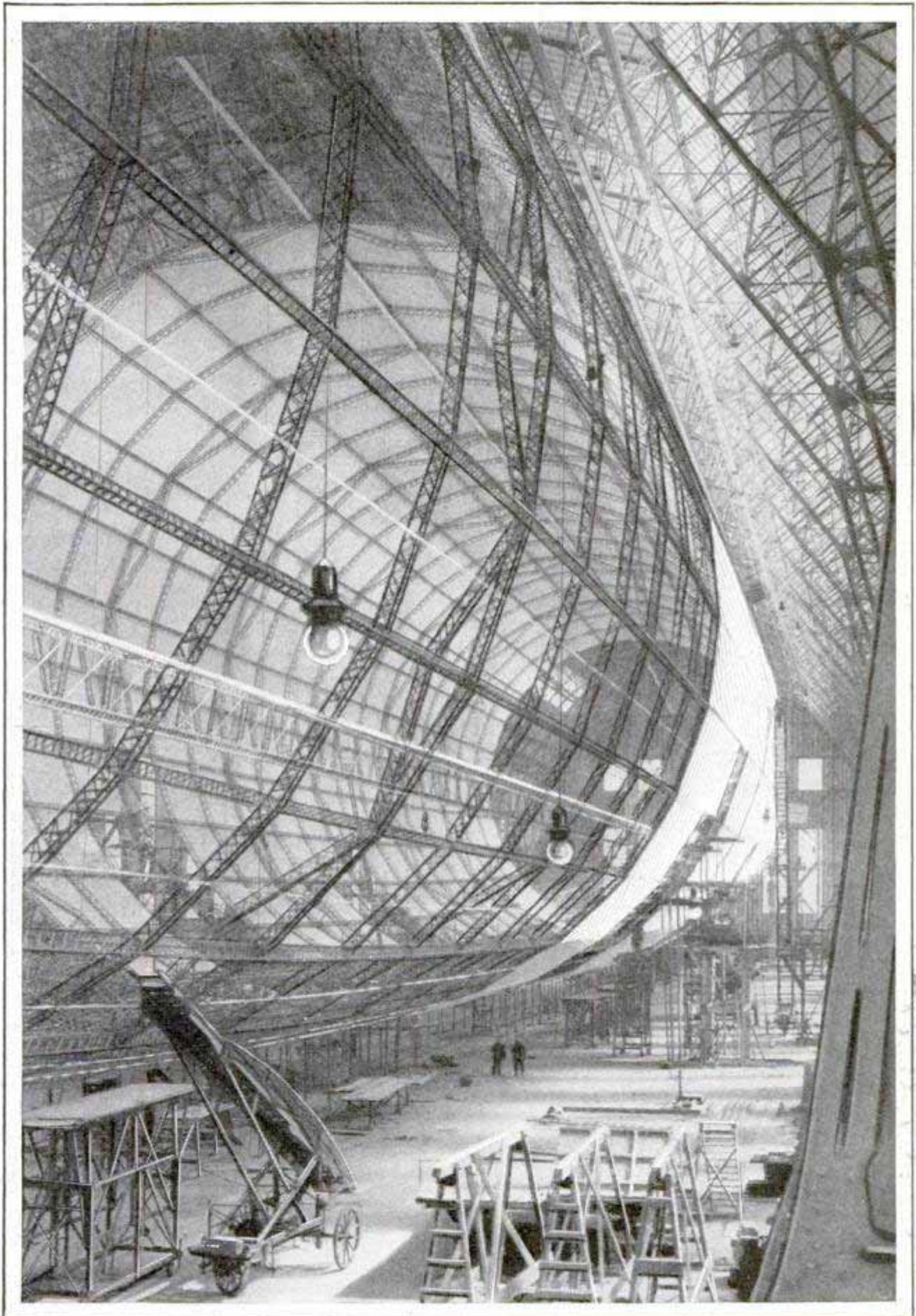

The Skeleton of Germany's Latest Zeppelin, with Part of the Outer Envelope in Place; the Workmen Standing below the Keel Give an Idea of the Immense Size of the Airship

915
432

Hyder Alaska
POPULAR MECHANICS

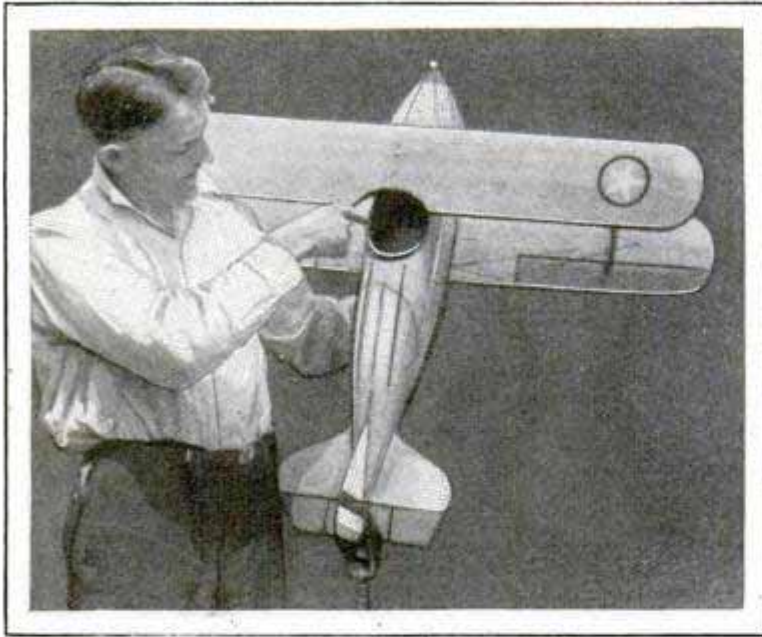

Model Plane Equipped with Pivot Seat, Which Is Connected to the Controls for Automatically Steadying Ship

SEAT ON PIVOT STEADIES PLANE FOR SAFER FLYING

By suspending the pilot's seat on a pivot arrangement and connecting it to the ailerons with wires, an Alaskan engineer has developed a stabilizing device for safer flying. The working principle of the installation is that, should the plane go into a dive, the seat would slip forward, pulling the elevators in a position to correct the difficulty. Side slips would be stopped in the same manner, it is claimed, and the stabilizing apparatus is said not to interfere with the ordinary controls.

AUTO JACK FIXED TO WHEEL SIMPLIFIES TIRE CHANGE

Easier tire changing on pavements or dirt roads is afforded by an auto jack devised by a western taxicab driver. The jack itself is a piece of iron weighing about three and one-half pounds, and is inserted in permanent clips that are attached to the inside of the wheels. By driving the car a short distance, the iron support comes in contact with the road and elevates the car so that the

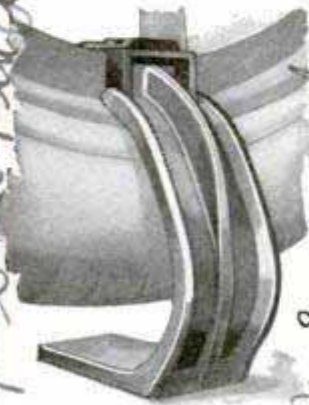

tire can easily be slipped off. The entire process is said to require only a few moments.

NEW PAINT TO PREVENT BARNACLES

953

Use of a special paint developed by the chemical-warfare service of the army will effect great savings in shipping, it is predicted, as it is believed to prevent barnacles from attaching themselves to the underwater portion of a ship's hull. It is estimated that these troublesome pests involve an extra fuel expense of at least \$75,000,000 a year, while great sums are spent in docking and cleaning the hulls of vessels. Effective

prevention of barnacles would effect a saving of in all nearly a billion dollars a year, including time losses, it is estimated.

ALARM BOX INSTEAD OF PHONE SPEEDS CALL FOR POLICE

Instead of having to telephone for the police, users of a special alarm system in Berlin, simply pull a ring attached to a box when they are menaced by burglars or otherwise need aid. The signal is relayed to a central office and brings response within seven minutes at the most, according to reports.



FLAVOR IS ADDED TO MEAT BEFORE KILLING

951

Housewives will be able to purchase meat already seasoned if a process developed in France proves successful. Various kinds of flavoring are injected by means of a hypodermic needle into the blood of the animal, experiments having been tried on 200 different subjects, including poultry, sheep and pigs. At the same time, coloring matter may be introduced to make the meat an even hue.

Mr. Edward Brown
1844
27th St.
Alaska

Edward Brown
10 Kellar Crutch Co

Discovered by Mr. A. Brandt

Salme Spruce

⁹⁸⁴
BELIEF IN SEA SERPENTS FADED WITH DAY OF MODERN SHIPS

Tales of sea serpents and other monsters of the deep belong to an age that is past, but stories of these creatures have ceased, not because of any radical change in marine life, but largely because of the modern ocean liners, in the opinion of Austin H. Clark, of the Smithsonian Institution. When men knew less of the sea and sailed in tiny ships, comparatively close to the water and subjected to many dangers no longer present, such things as sharks, squids, cuttlefish and leaping porpoises assumed terrifying proportions. The tails of the squids, for instance, might easily have been the basis for legends of fearful serpents. The squid is sometimes fifty feet long, and about twelve inches in circumference. It has long arms that branch out at the ends and these may have been the fabled sea vipers. Porpoises, approximately in line and leaping in and out of the water, as they do, may have been mistaken for a single huge snake.



⁹³⁹
MOTOR SANDER SAVES TIME ON SCROLLWORK

As a substitute for files, a motor-driven sander has been introduced to smooth the edges of scroll and jig-saw work. It is said to perform the operation more accurately and, with the outfit, one man can do what ordinarily would require three or four using files or other hand-operated tools, it is claimed.

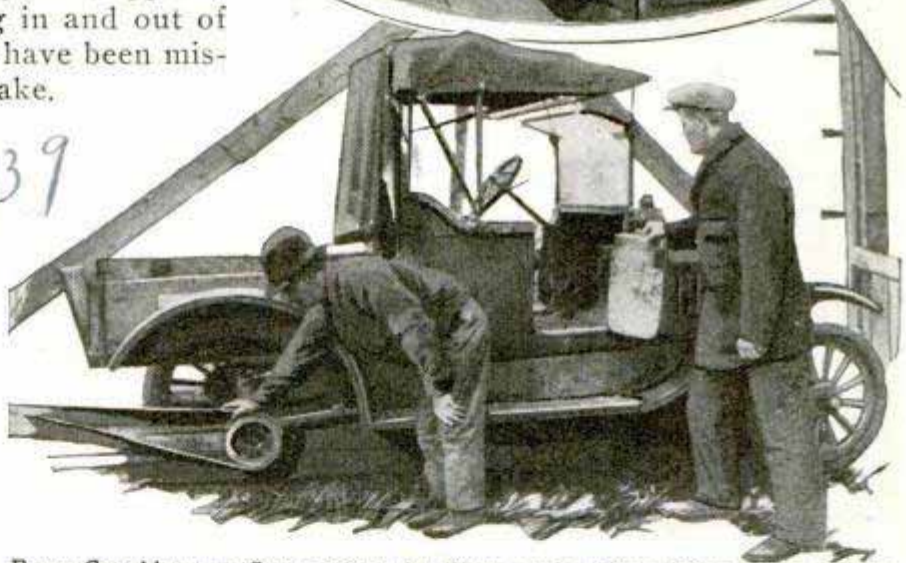

Ferry Car About to Start across the River, and a Close View of the Motive Power, the Old Automobile with Shaft Attachment

AUTO RUNS FERRY OVER RIVER SAVING LONG DELAYS

Ferry service across the Saskatchewan river in Canada continued in spite of running ice, low water and other difficulties, due to the ingenuity of W. E. Kilgour, an operator at Nipawin. He rigged an old automobile to furnish the power that pulled the car back and forth on its cable. The carrier itself was of his own craftsmanship, being constructed of timbers and steel strips, fashioned in his own shop.

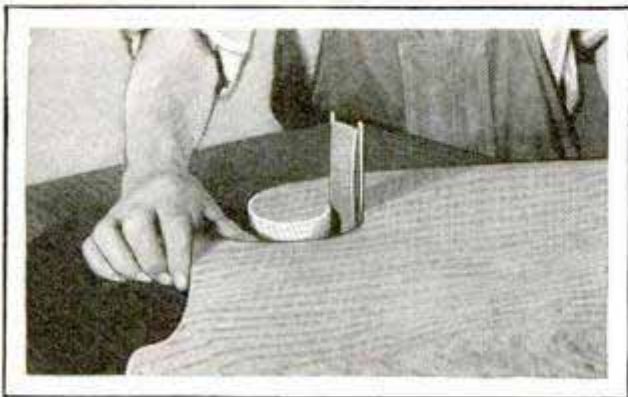

Smoothing the Sides of a Scrolled Edge with the Motor-Driven Sander

☐ The Indians made hominy before the time of Columbus.

Chicago. 5 49 W Washington

Oliver Machinery Co. Inc.

262
Airplane
Military

at Camp Street,
Ascodia, Mich.

Dog Fighters



with motor wide open, shoves the ship's nose down into a dive. Like one ship, the squadron follows suit. The whine of wind through the taut brace wires of the little single-bay wings rises to a shriek as the needles of air-speed indicators whirl from 150 to 200,

Wide World

A LONG line of little clipped-winged fighting ships, 450-horsepower motors roaring, cruises across the sky at 150 miles an hour. In groups of three, the squadrons rise like giant stair steps in the sky, flying in echelon, each plane and each group slightly to the side, slightly behind and slightly above the one ahead.

At 15,000 feet they are alone, the world beneath blanketed under billowing seas of fleecy white clouds that rise and fall and twist and roll as they drift along before an idle wind. Suddenly, through the mist pops a little plane, climbing steeply, and an instant later, on either side of the leader, appear his flying mates, to be followed again, in a long echelon off to the right, by the successive trios of his squadron.

The leader of the patrolling flight catches the glint of sun on bright yellow wings, shakes his joystick to waggle his ship's wings in signal to his followers, and,

250 and mount toward 300 miles an hour.

The leader below sees the diving menace from above and flips his ship over to dive back into the protecting cloud bank, but, laboring from a steep climb and with maneuverability lessened by the rarefied air of the upper altitudes, he and his flight are not quick enough to dodge an



Major Tom Lanphier beside His Personal Plane, "Man-O'-War," with the Arms of the Pursuit Service on Its Side, and Four of the Squadron Insignia Made Famous in France

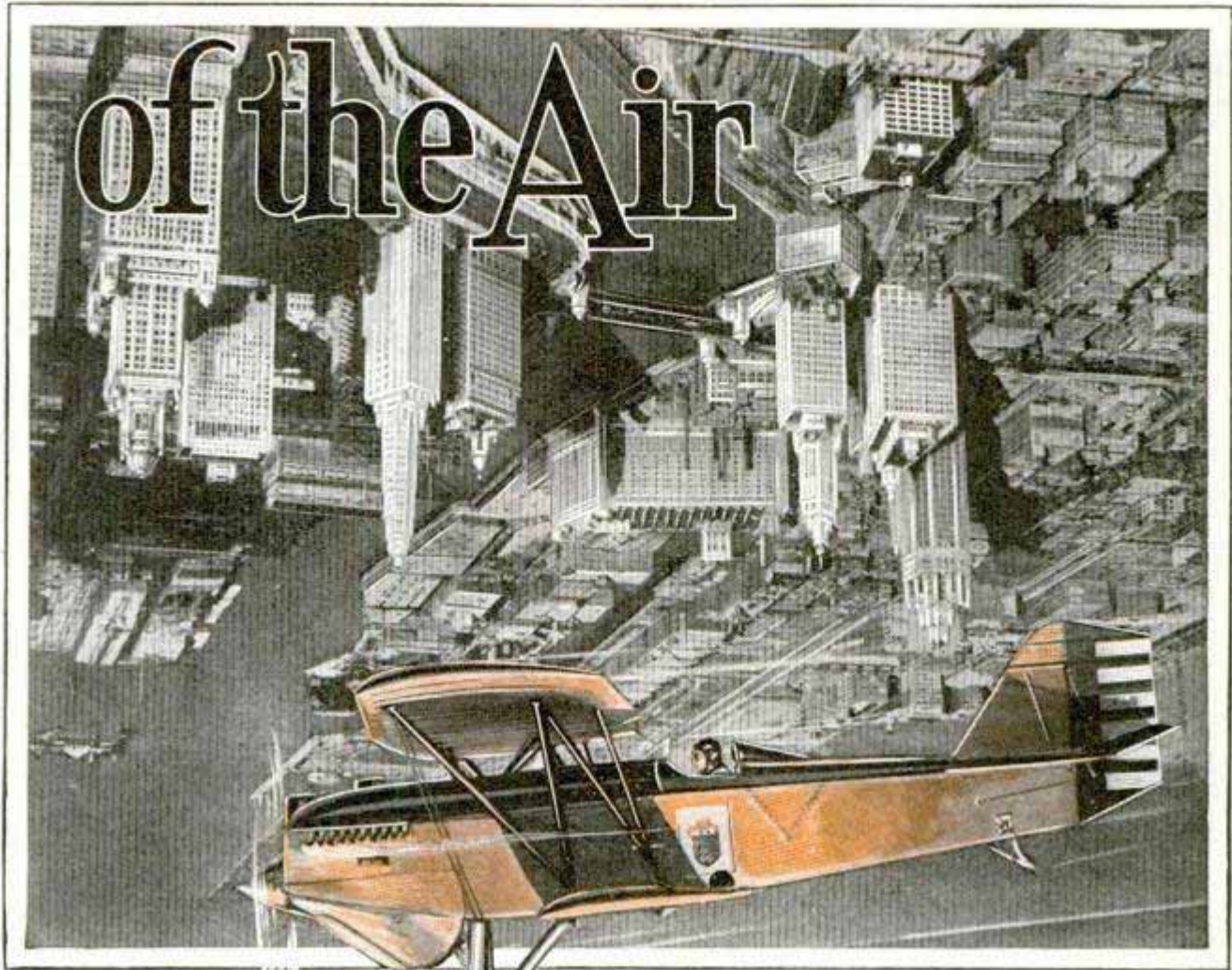

The Way the World Looks to
and You See How the Flyer

the Pilot at the Top of a Loop; Turn the Page Upside Down
Looks to the World Craning Necks from Far Below

attack that drops straight out of the sky at nearly 300 miles an hour.

The attackers and attacked meet just above the cloud line in a roaring, whirling mass of planes, and the dog fight is on. The first pursuit group of Selfridge field has started the day's play.

A dog fight in the air is like a dog fight on the ground, one of those free-for-all dog fights in which all the town's mongrels for blocks around join in, with one notable exception, for the first pursuit fights in a three-dimensional world, free to move not only to left and right, but up and down, in zoom and dive, as it seeks an advantage that will bring the sights of the dummy machine gun to bear on a vital spot of an opposing plane.

There is nothing else like it in all the army flying corps. The little short-winged pursuit planes are built for one purpose—to attack. There is no machine gun trained out to the rear, or down below

or pointed aloft to ward off attackers and fight a rear-guard action. Instead there are two fixed guns, firing ahead through the propeller, and aimed by pointing the roaring projectile of the plane itself directly at the target.

The man whose nerves hold out the longest and who can keep his ship pointed straight at the foe is the winner, and the pages of the record of the first pursuit, formed originally in France, are filled with accounts of men who had steel nerves—Lieut. Frank Luke, the balloon buster from the southwest, Eddie Rickenbacker, America's ace of aces, Raoul Lufberry, Malcolm Campbell, Norman Hall, Lieut. Meissner, and a host of others.

Take the story of Lieut. White, of the seventeenth, the squadron that sported on its planes a white owl, diving with open beak and outstretched talons. Lieut. White led a patrol of the seventeenth one day when they met a flight of Fokkers.

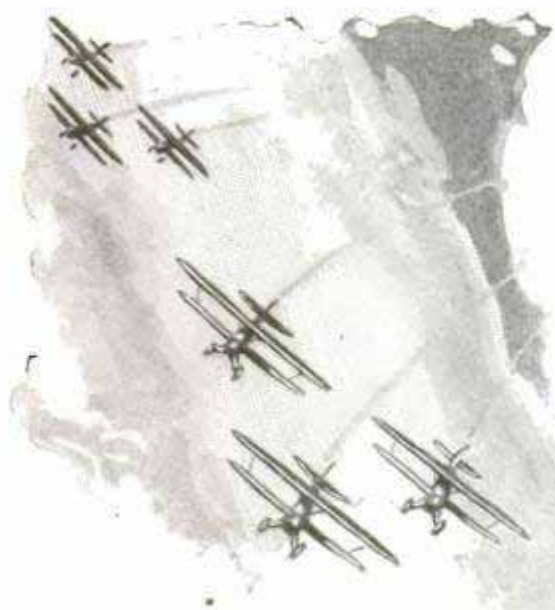

Lieut. Cox, a new pilot fresh at the front and inexperienced in aerial battle, was attacked by a German plane and in difficulty. White, the patrol leader, had disposed of an enemy plane and was for a moment free, when he saw Cox' difficulty. With motor wide open, he roared past the new flyer, and held straight on until he rammed the enemy ship. Both planes, meeting at better than a hundred miles

an hour, shed their wings under the terrific impact and dropped to earth in flames.

How does one become a flyer in the branch that produces the aces of aces? There are still some old-timers in the first pursuit who graduated from war-time schools and fought in France, Maj. Tom Lanphier, the flight leader, for example. But with those few exceptions all the rest are products of the army school at Kelly field, in Texas.

A couple of thousand likely candidates apply each year for admission at Kelly. In the first rigorous preliminary examination, nine out of ten fall by the wayside and the best two hundred or so are selected. Out of 200, about twenty per cent may last through the Kelly course. The



Pursuit Pilots of Selfridge Field Ready to Take Off for Winter Maneuvers in Northern Michigan, and, Above, Nine of the Little Fighting Ships Roaring Down in Formation

others are shunted aside for training in other and less strenuous branches of flying. Of the twenty per cent who get through Kelly, five per cent may qualify for pursuit flying. The class that graduated Colonel Lindbergh was an exceptionally good one—of 200 there were six, including the "Lone Eagle," who made the grade and were qualified to fly the world's fastest fighting ships.

The first is the one and only pursuit group actually organized within the United States. There are pursuit planes stationed at Panama, Hawaii, and in the Philippines, but the flyers at Selfridge field, twenty-five miles north of Detroit, are unique in continental United States. They are unique, too, in other ways. Instead of training under the lazy skies of Texas, or beneath the warm sun of California or Florida, they have been set down beside Lake St. Clair, on the Canadian border, where for three months out of

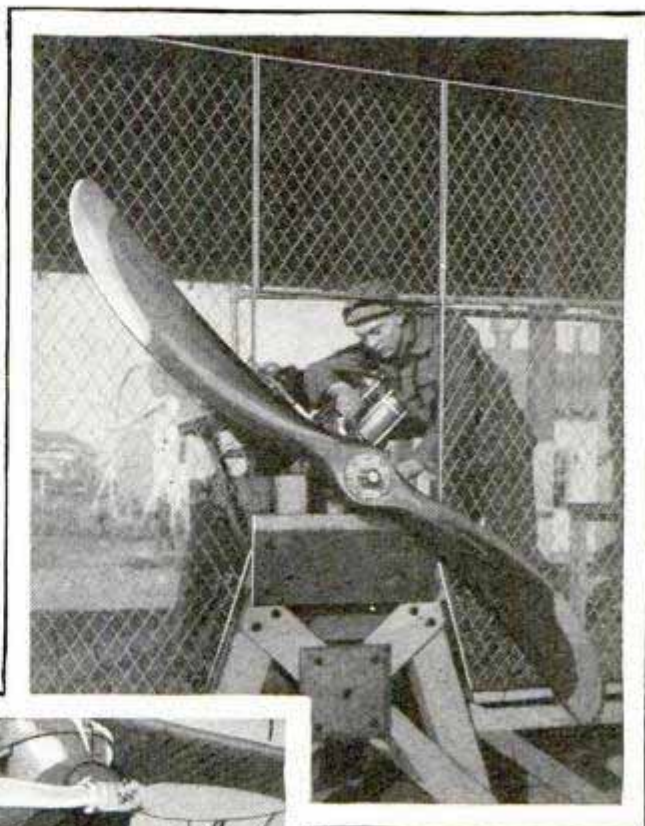

the year they can take the wheels off their landing gears, substitute skis, and fly off snow and ice, in temperatures that often fall to thirty or forty below zero in the higher altitudes.

They have a bomb and gunnery school far up in northern Michigan on an ice-locked lake at Oscoda, and here each winter they set up a camp, ferrying in their supplies by air. It is so cold at Oscoda in winter that ether is used to start the engines in the morning, and stoves are used to keep the oil in the crankcases liquid overnight. At first they used heaters, set on the ice, and piped the hot air around the engine through canvas tubing. Then a clever sergeant designed a two-burner gas heater that remains permanently attached to the engine, draws its fuel supply from the plane's gasoline tank, and heats the cooling water at the lowest point in the engine. Thermostatic action takes care of the circulation, and the motor remains warm through the coldest night.

Inventing gadgets to improve the planes is an active side line in the pursuit group.

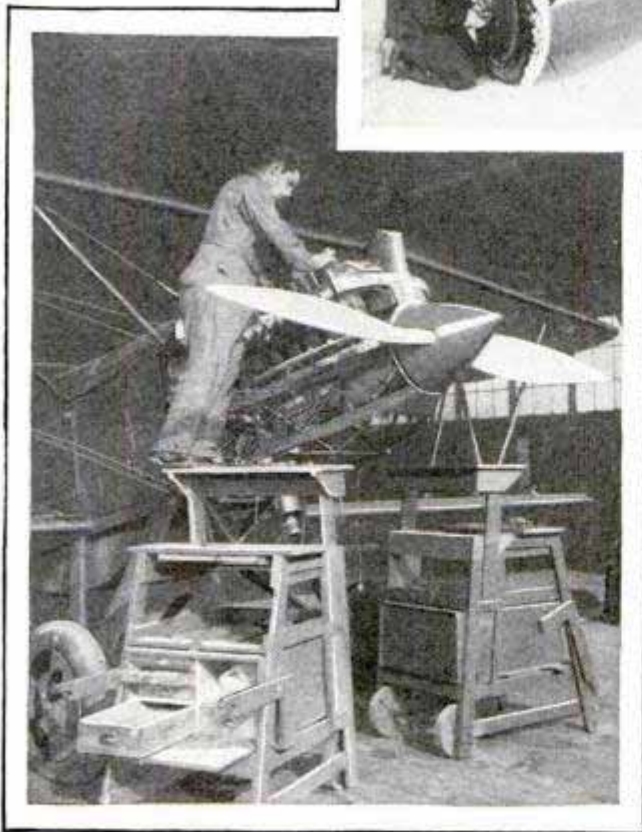

Each Pursuit Ship Has Its Own Crew of Mechanics to Keep It Flying; Center, Changing from Wheels to Skis for Winter Work

As befits their position as the premier flyers of the air corps, the pursuit pilots each has an individual plane assigned to him. On one side the engine cowling, in a neat panel beneath the flying-wing insignie of the service, is the pilot's name. And on the opposite side, in a similar panel, is the name of the sergeant who acts as crew chief to take care of that particular ship, and the privates who assist him. With pilot and crew interested in the upkeep of only one ship, rivalry is naturally intense and the planes are washed and groomed to the last minute.

The pursuit planes—Curtiss "Hawks"—are tiny things, as planes go. Like Lindbergh's "Spirit of St. Louis," they are one-man affairs, and after all the instruments, the machine guns and ammunition, the bomb releases and other attachments are installed, the pilot, in flying suit, can barely squeeze into the cockpit. Spurred by the constant cry for speed and more speed—Major Lanphier hopes to have 200-mile-an-hour ships next year—the designers are faced with the problem of reducing the frontal area of the plane, for it is the front section that offers the wind resistance. To keep the front as small as possible, water-cooled engines are used. A radial air-cooled engine cuts the speed twelve to fourteen miles an hour. Each successive model has a bit clipped off here, or

weight lessened there, to make it faster. Aviation leaders are even seriously considering creating a special class of small-sized jockey pilots, picked for their light weight, as riders are picked for the horse races. Around them would be designed a new type of ship, with cockpit tailored down to their small size.

Most of the present pilots are husky fellows, in fact, present army regulations fix a minimum for height and weight. Instead of trying to save a few pounds by skimping on the ship, it may be that in the future fifty pounds or so may be saved on the pilot, and the speed or load-carrying capacity of the plane correspondingly increased.

The present ships can carry about 350 rounds of light machine-gun ammunition, 250 rounds of heavier cartridges for the larger guns, or can take on a bomb rack with one 300-pound bomb, three of 100 pounds each, or a dozen of the small twenty-five pound size, used to harass enemy troops when caught marching along the road or lining a trench fire step.

If a long flight is planned, the load must be decreased to carry more gas. A "belly" tank is attached in place of the bomb rack beneath the fuselage. After the gas in it has been consumed, the tank can be dropped off, while the engine is switched to the regular fuel supply.

A squadron of the first pursuit in action is the finest sight that aviation has produced. Flying with wing tips almost touching, keeping perfect formation through the most intricate maneuvers, the entire flight moves like one ship. With their tremendous speed and consequent high maneuverability, they dive and loop, sideslip and zoom, and perform the rest of the fighting acrobatics with ease. On a big field, such as the mile square at Selfridge, as many as two squadrons—thirty-six planes—can take off and land without breaking formation. In

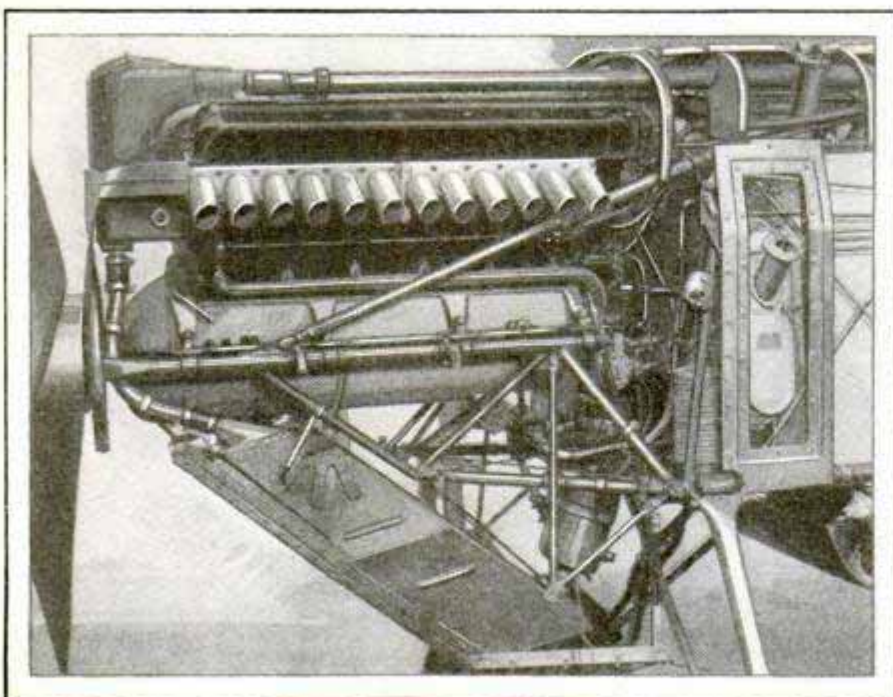

The Power Plant of the Curtiss "Hawk," the World's Fastest Single-Seater Fighting Plane

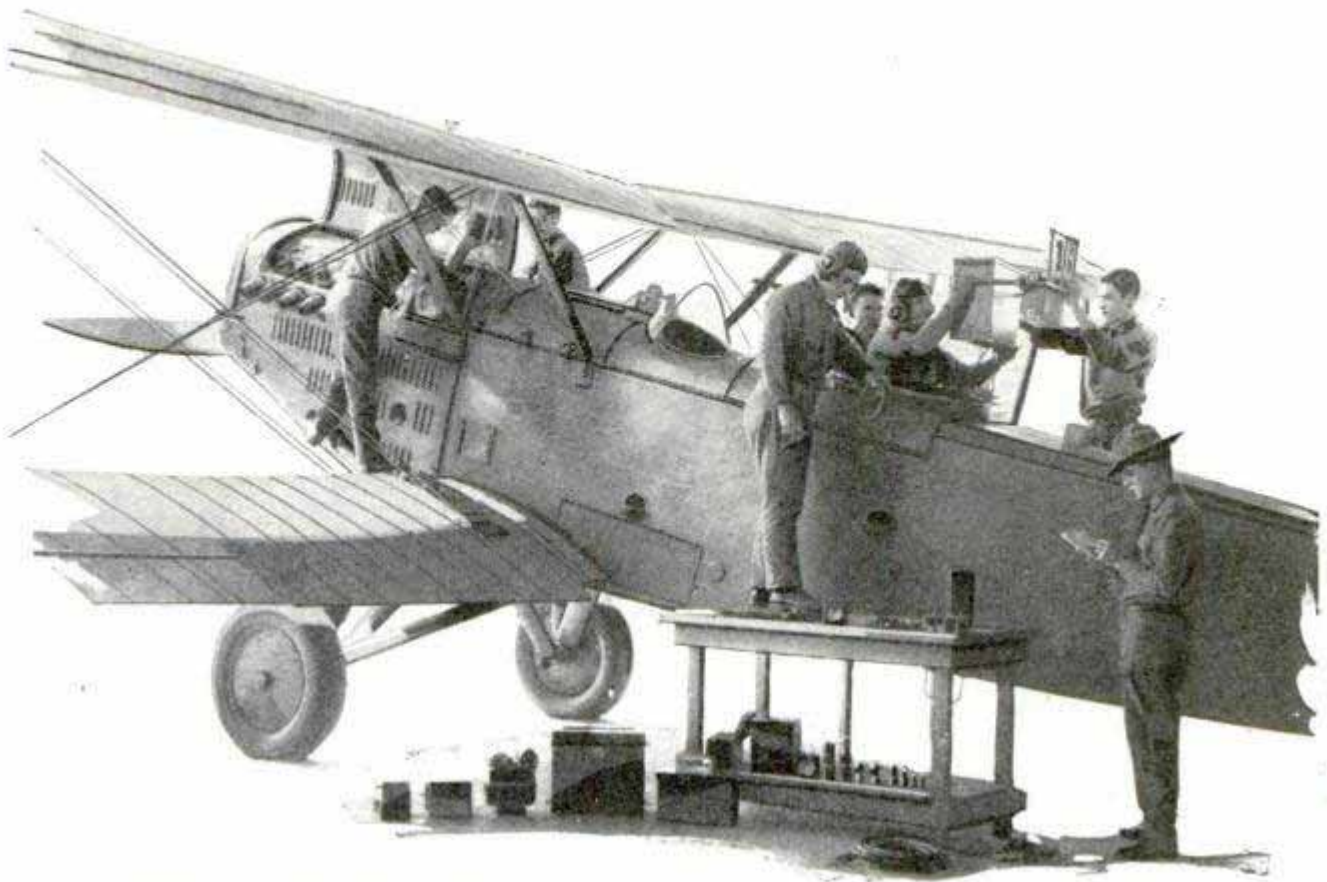

One of the Flock the Dog Fighters Shepherd over the Enemy Lines; Signal Corps Men Fitting Radio to a Big Douglas Communication Plane for Observation Service

flight they have improved on nature as represented by the high-flying goose, for they fly but one side of the "V" instead of both sides, as do the slower ships. Flying in echelon leaves them free to turn in either direction, without danger of running into an opposing line.

The fighting group is three ships, a leader, and, behind, at either side, and slightly above it, the two mates. When the leader turns or climbs or dives, the two followers perform the same evolution like one plane.

Off to the side, behind and slightly higher in the sky, is the next group of three, and each successive group follows in order.

The squadrons of the pursuit group boast the war-time insignia made famous in France—the falcon of the twenty-seventh, the white owl of the seventeenth, the kicking Missouri mule of the ninety-fifth, and the hat in the ring and Indian head which followed it, of the ninety-fourth.

Although the youngest branch of the fighting service, the first came home from France with a history and a set of heroes that cannot be surpassed by the century of history of many of the famous ground units. Take the twenty-seventh—

the falcon squadron. Its war-time fighting strength was twelve planes, but it took fifty-four pilots to keep it going from May until November, 1918. Eleven were killed in battle, seven made prisoners and three wounded, while one died in an accident.

Six distinguished service crosses went to the twenty-seventh alone.

The seventeenth—the white-owl squadron—boasted Second Lieut. J. H. Stevens, hero of one of the most famous incidents of the aerial war. Six pursuit planes had been assigned to escort an observation machine on a photographic mission into German territory. The observer had taken his pictures, which were badly wanted at headquarters, and was on his way back when his machine was forced down behind the enemy lines because of engine trouble.

It looked as if all the work had been wasted, when Lieut. Stevens swooped down in his fast little ship, took the negatives aboard, and got away safely before the Germans could reach him. The world war saw many such exploits in the air, for aerial battle tactics were only in the process of evolution. In the next war, says Major Lanphier, pursuit fighting will be a thing of perfectly kept formations,

Dr. P. Res. Carnegie Institute of Technology

for the side that will win will be the one that can keep its man and gun power together and deliver a telling blow, instead of separating into individual duels.

TRAVELING DESERT SHOE SHOP SERVES FARM WORKERS

2804

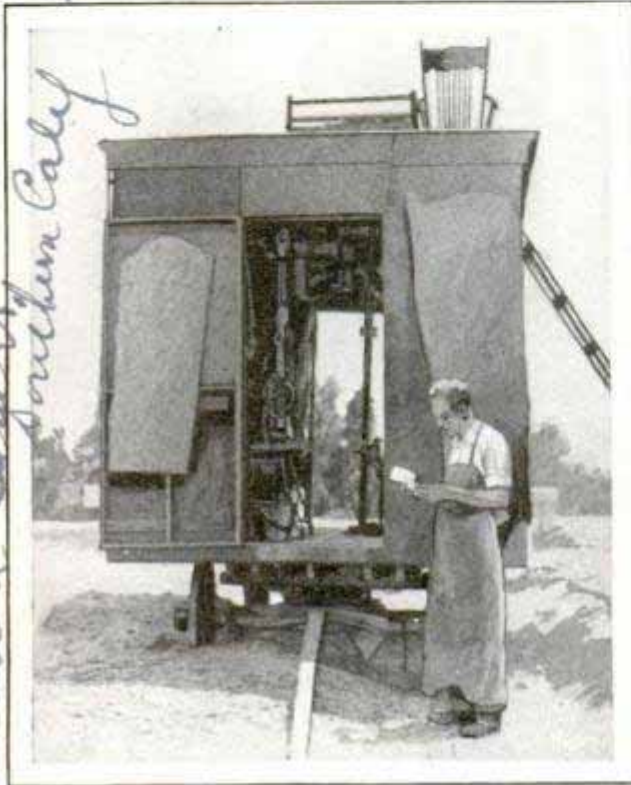

Traveling Cobbler's Shop and Dwelling for the Shoemaker Installed in Wagon

One hundred and sixty miles from Los Angeles and 120 feet below sea level, is an odd cobbler's shop, serving farm workers and others on the large ranches about. It is rigged in a wagon and also has living quarters for the shoemaker who hitches a team of mules to his outfit and drives to a new location when business lags.

EXPLOSIVE IS MORE POWERFUL THAN T. N. T.

Interesting experiments with an explosive, said to be more powerful than T. N. T. or dynamite, have been conducted by army engineers. The substance, known as radium atomite, can be produced for about one-half the cost of T. N. T., the inventor declares; it is more stable, and is not affected by dampness. It is a light greenish powder, dry and very finely divided. Tests showed that it had greater force than other kinds of explosives and acted more rapidly.

SOFT COAL TURNED INTO HARD TO REDUCE SMOKE

By transforming soft coal into artificial anthracite, engineers vision a marked reduction of the smoke evil and a greater efficiency in fuels. The process is already in operation in Germany, and plans for the establishment of a large plant in this country have been announced. By the German method, soft coal is distilled at comparatively low temperatures of 900 to 1,200 degrees. Volatile oils and gases are driven off in the formation of coke, which is made at temperatures of 2,000 degrees and higher, but in the low-distillation process, only part of these valuable products is lost. The new fuel is said to be smokeless, free-burning and suitable for stoves, ranges and house furnaces. In its earlier stages, natural anthracite coal was bituminous in nature but was transformed under centuries of heat and pressure, brought on by geologic changes. The artificial method is an adaptation of nature's own way of making hard coal.

DUSTLESS SANDER FOR FLOORS ALSO WORKS ON BENCH

Operated by current from a lighting socket, an electric sanding machine now on the market may be used for floors or bench work, and the dust is sucked up in a catch bag attached to it. This is accomplished by a suction fan on the revolving sanding drum. The outfit is light in weight and is easily converted for use as a bench sander, jointer or even as a surfacer for floors.

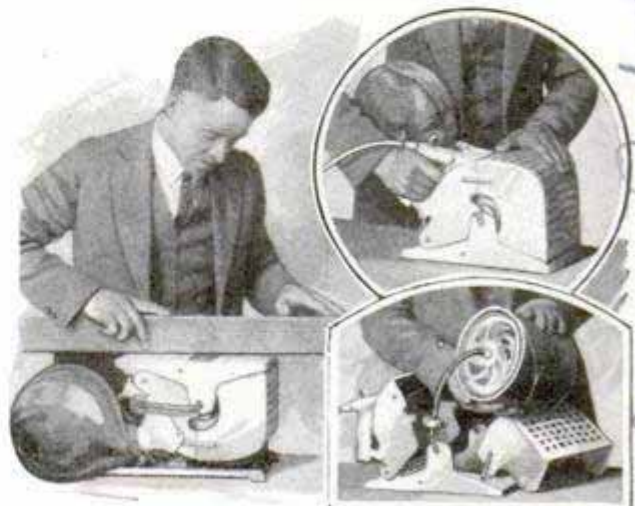

Sander in Different Positions and the Dust Bag; Outfit Is Operated from Lighting Socket

Owner W. C. Everhart, Coachella Desert, Southern Calif.

Capt. H. G. Zimner Los Angeles, Calif.

Cedar Rapids, Iowa

1/2 Pacific Coast

The Reid-Way Co

One of the
geology
Allen L. Benson 695
**IRON DEPOSITS
CREATED BY
BACTERIA** *968*

Some of the largest iron deposits in the world have been caused by tiny bacteria, according to a well-known geologist. The iron was first extracted from rocks and carried away in water where it was taken into the systems of these minute organisms and transformed into solid material. The particles, gradually accumulating, formed the big iron fields known today. A single deposit of this character is said to extend far below the surface from New York to Alabama. It crops out near Birmingham. Bacteria caused the large iron deposits in the Lake Superior region, which have yielded millions of tons.

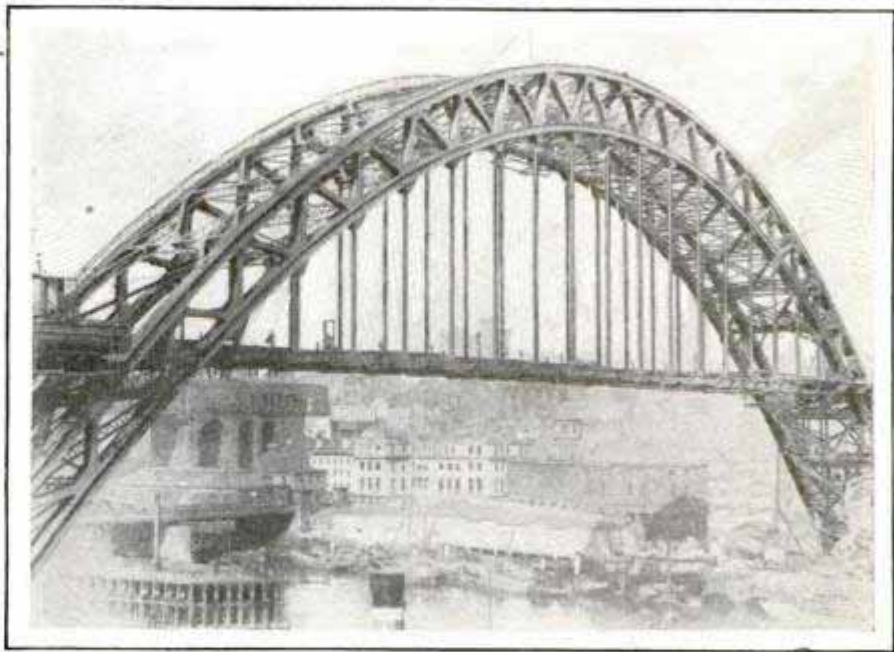

Long Span of the Tyne Bridge between Newcastle and Gateshead, England; the Structure Cost Nearly \$5,000,000 *824*

**SPAN OF FIVE HUNDRED FEET
IN BIG STEEL BRIDGE**

One of the most important features of the new Tyne bridge, constructed at a cost of nearly \$5,000,000, is the main span, 500 feet long. This is said to be the longest in Great Britain. The bridge has been erected to care for the ever-increasing traffic between Newcastle and Gateshead on the south bank of the river.

**METAL GUARD ON SCREEN DOOR
PREVENTS BREAKING MESH** *824*

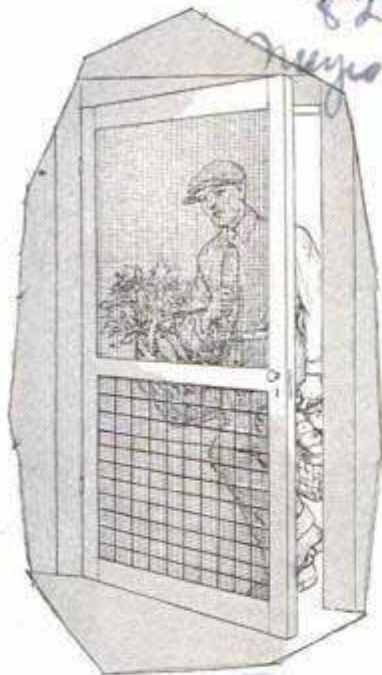

To prevent breaks in the mesh of the lower part of a screen door, an attractive metal grill has been introduced. It is adjustable to doors of different widths, is easily installed and, besides adding to the appearance of the door, effects an economy in

the fact that repairs to the mesh are reduced to a minimum.

**LEMON SQUEEZER AND STRAINER
FITS OVER GLASS** *860*

Easily fitted over a tumbler or other handy receptacle, a cone-shaped extractor simplifies the task of removing juice from lemons. The liquid is thoroughly strained through the meshes of the squeezer which is cleansed simply by holding it under a stream of water. The cone is shaped to reach far into the half of the lemon so that as little of the juice as possible may be wasted.



Write our Bureau of Information if you wish to know who makes or sells any article described in this magazine. Send no postage; the service is free.

The Fred J. Meyers

Sold by Woodward

The Ghost Towns

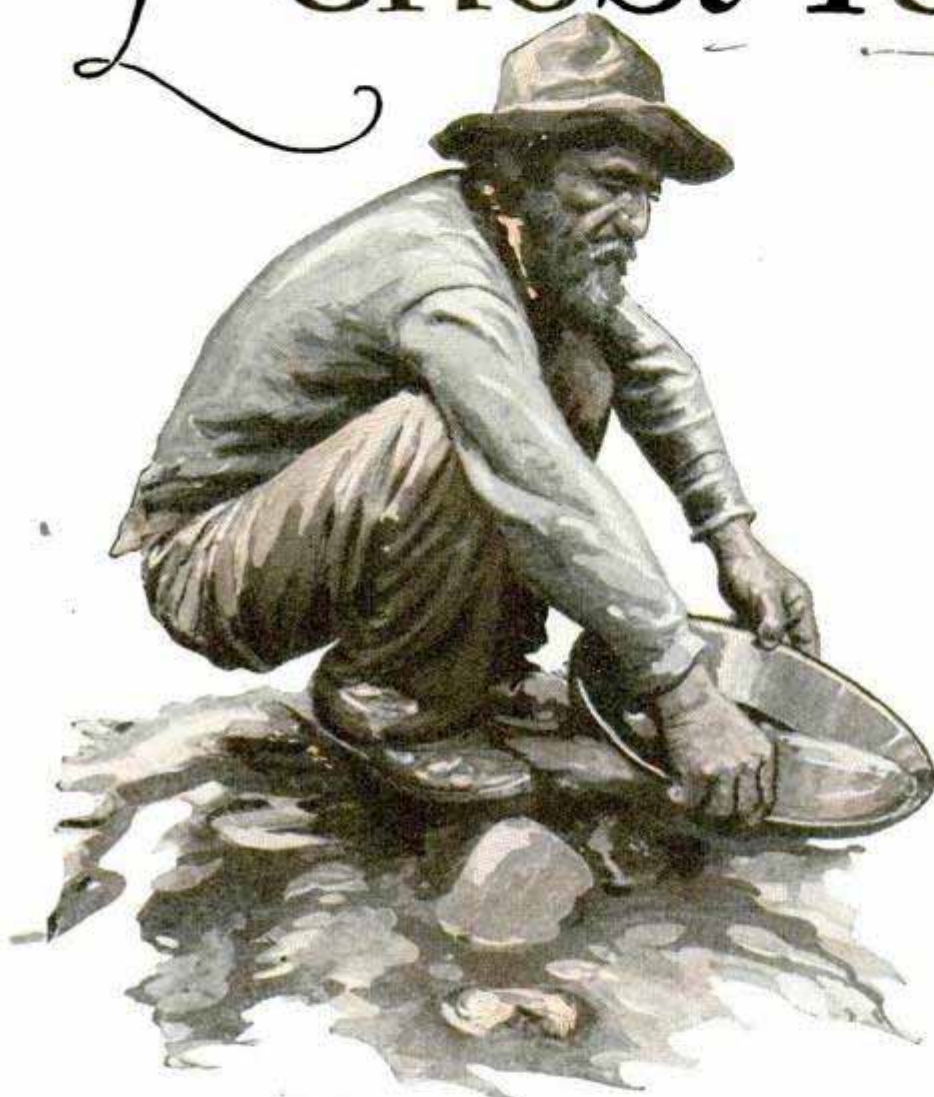

Panning Gold from the Sand of a Creek Bed, the Method Made Famous by the Argonauts of the Days of Forty-Nine

By IRWIN F. HARRISON

2866 Dahlia St. Denver, Colo.

SCIENTIFIC mining and improvements in the technic of ore dressing are making it increasingly difficult for the famous ghost towns of the Rockies to retain their ghostliness.

A few of them have been shocked completely out of peaceful slumber and suddenly have become thriving communities again. Others, uncomfortably disturbed by revived mining activity near by, are stirring restlessly and threaten to shake off the cobwebs and dust heaps of long neglect.

This is happening despite the fact that, within the last few years, there have been few important discoveries of new ore

bodies in the ghost-town belt. Exaggerated reports of gold and silver "strikes" have resulted in occasional rushes into the hills, suggesting mildly the old-time wild scrambles to new diggings, but none of these temporary waves of excitement affected the old camps that had declined from boom-time glory to groups of tumble-down buildings.

Then, along came advanced methods of selective flotation for the treating of low-grade ores. Invention stepped in to offset those continued failures of plodding prospectors to stumble upon new veins of rich minerals. An unexpected impetus was felt in the western mining country. Hopes were revived, even in the face of low metal prices. New capital became available, flotation mills sprang up and ghost towns awoke.

Selective flotation, developed by continuous experimenting, showed the way for taking profits out of ores that formerly were spurned by the miner as worthless. Discarded tailings on the dumps of the silver and gold mines of the old bonanza days became valuable, and mining companies found it worth while to dig into the lower levels of the old mines and take out those low-grade complex ores present, by the hundreds of thousands of tons, at many places in Colorado, Utah, Idaho, New Mexico and Arizona.

Less than a dozen inhabitants, more or less hopeful, remained three years ago in Rico, Colo., which at the height of its prosperity had made proud claim to a pop-

one of these, International P...

Come Back

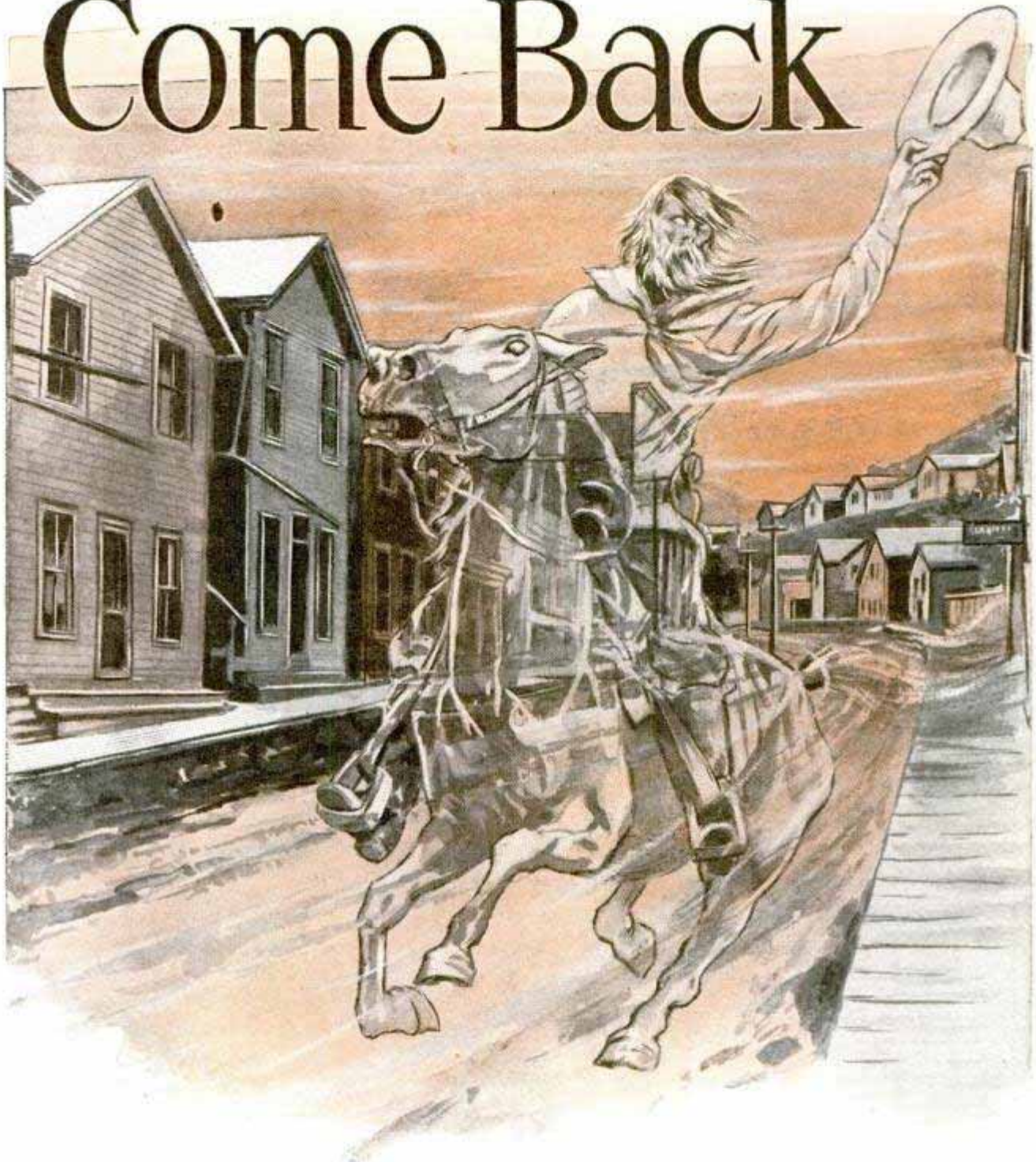

Blackhawk, Colorado, One of the Ghost Towns of the West; Stampede Camps Sprang into Cities Overnight, but When the Yellow Gold Was Worked Out, They Died Just as Quickly

ulation of 2,000. It had become a town of memories, of smokeless stacks on shaft houses, of abandoned schools and churches, grass-grown streets and long rows of unoccupied dwellings. Then a smelting company leased ore properties in the vicinity, erected a 250-ton flotation mill and began extracting profitable quantities of lead, zinc and silver from the low-grade material left in the mines by earlier operators. Rico came back with a bang, providing for the citizenry of the San Juan

country a surprise something like that occasioned by the inconsiderate arising of a corpse at a funeral. Vacant houses were repaired and reinhabited, new buildings went up, and miners tramped along streets that were no longer ghostly.

Eureka, another of the old mining camps of the San Juan region of Colorado, also was well on the road to oblivion when flotation came to the rescue. One of the mills at that place, famous in old days, was reopened with new equipment, becom-

721

W.A. McGraw 359 p. illus \$4.00 POPULAR MECHANICS



Demonstrating the Flotation Process with a Soap-Bubble Pipe and a Few Small Shavings of Lead

ery of metals from ore." Flotation is nothing new, of course. The basic process, now called "bulk flotation," was being used in the treating of American ores fifteen years ago. But it was not until the selective feature had been developed that the invention became a godsend to the Rocky mountain mining interests. Up to that time, there had been no satisfactorily profitable way of treating the region's low-grade complex ores, particularly abundant in Colorado.

Even in this age of magic invention, the flotation process, which apparently defies the laws of gravity, is apt to strike the uninitiated as a scientific miracle. It accomplishes the seemingly impossible in making heavier particles float above lighter material, thereby enabling the ore mills to float off the minerals they wish to save.

The explanation of what happens is quite simple. Why it happens is still puzzling the brightest minds among the metallurgists. Briefly, flotation effects the separation of mineral particles from a crushed-ore pulp by means of air or gas bubbles. Adding of water to finely crushed ore produces the pulp, which flows into the tanks or cells of the flotation machine. The bubbles are formed by introducing air or gas into the pulp by suction or pressure. Certain mineral particles, which may or may not be heavier than other particles in the pulp, attach themselves to the bubbles, which act as balloons in carrying these particles to the surface. The froth formed by the bubbles resembles soapsuds, though it is grayish.

It has been found that addition to the pulp of pine oil, or certain other oils, promotes a firmer froth that will serve as a raft for support of the bubbles and facilitate the removal of the attached loads of mineral particles. There is a constant overflow of the froth into a trough, which carries the concentrated mineral thus collected to a bin. There it is filtered in preparation for shipment to the smelter for further treatment. The concentrate still contains some worthless material, but the percentage of values is high.

The earlier bulk flotation, in which the bubbles carried off a combination of all floatable mineral particles in the ore pulp, had its value in separating the useful minerals from the other substances in the

suggested as source of information

ing the first plant to practice selective flotation on the zinc-lead-iron-sulphide ores of the Rocky mountain territory. Eureka prospered again and the revival was felt, too, in near-by Silverton and Ophir, which had been struggling along amid dreams of the years when they had been "gems of the Rockies."

At Central City, Colo., a flotation mill was established in an abandoned brewery, and similar projects injected new life into Pearl, Idaho, and into Wardner and other towns of the Coeur d'Alenes district of that state. A new mill at Kellogg is extracting wealth from ore tailings tossed aside after having given up only a part of their valuable content to the operators of twenty-five or thirty years ago.

The improved ore-dressing process is given chief credit for reinvigorating mining around Goodsprings and Arden, and in other Nevada communities. New Mexico has a successful 12,000-ton flotation mill at Hurley and a smaller one at Goriotta. This later process has replaced other ore-dressing methods in nearly all the mills of Arizona.

In view of what it has done for the mining industry, it is not surprising that Prof. Arthur J. Weinig, of the Colorado school of mines, writes of the flotation process as "the most important development of the present century in the recov-

Arden, Colo

rock that goes into the mills. But something more was especially needed in the case of zinc-lead-iron and other complex ores, which usually carry percentages of silver and gold. Sending to the smelter of train loads of mixed concentrate of lead, iron and zinc might easily run the mine operator into bankruptcy. Smelting charges often ran so high that profits vanished.

Developing of the selective feature of flotation solved this problem. It was discovered that one mineral could be made to float ahead of another. This is accomplished by adding to the ore pulp certain chemicals and oils which increase the floatability of the mineral chosen to be treated first. Other reagents may be put into the pulp at the same time to retard the floating of other minerals.

Thus, in the case of a zinc-lead-iron ore, the lead could be floated off (carrying with it most of the gold and silver contained in the ore) and the zinc concentrate could be produced by a later floating. The process makes possible the same sort of selection in the handling of other kinds and varieties of ore.

Selective flotation does not require expensive machinery, and the comparatively small quantities of chemicals and oils do not add greatly to the cost. In fact, it is such a cheap method of mineral separation, and results in such a high percentage of recovery of values, that it has made profitable the handling of complex ores that do not assay more than \$6 to \$8 a ton.

Nor has the process reached the limit of its possibilities. Important improvements are predicted, both in the use of the reagents and in the flotation machinery. Experiments in laboratories and in the ore mills are making available much

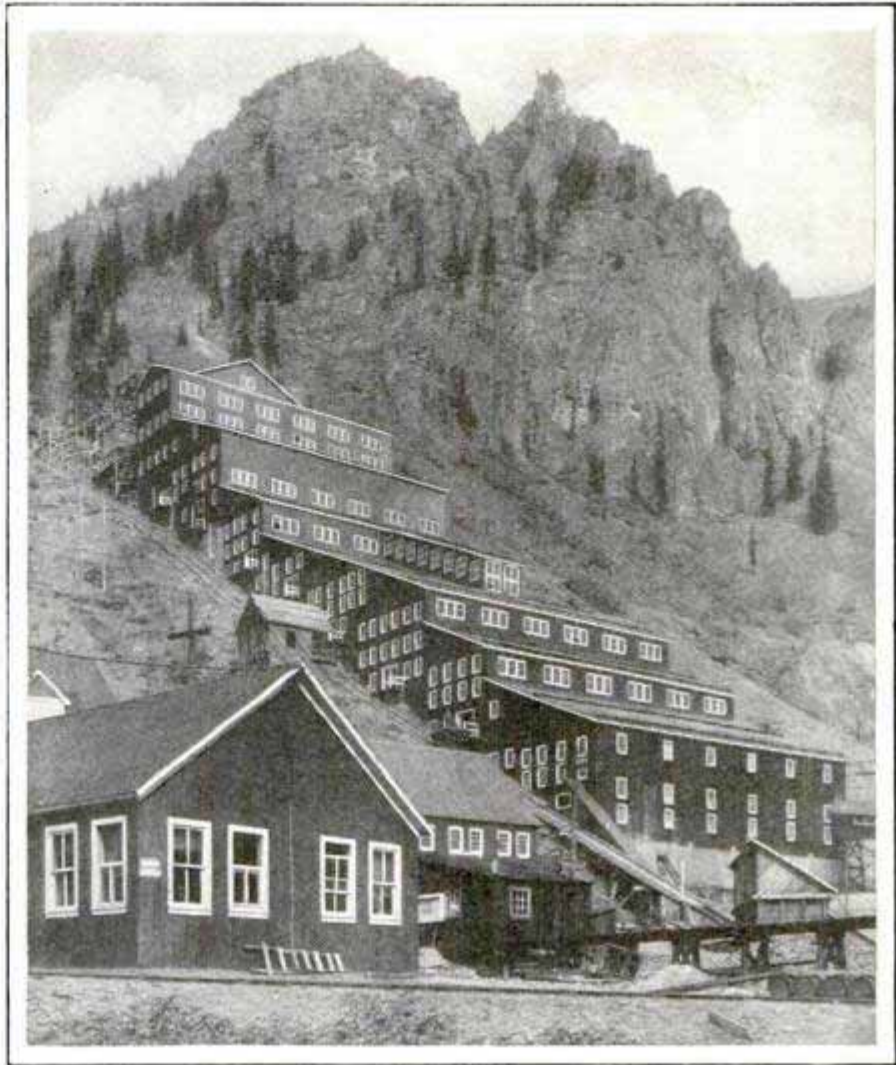

A Giant Ore Reducer in Colorado; Convenient Hill-sides Solve the Conveyor Problem and Gravity Does the Work

new information on how to employ various chemicals and oils so as to produce the best results in the treating of specific types of ores.

Besides resurrecting some of the old ghost towns and aiding other mining camps, the flotation process has brought into existence new towns that, without its help, probably never would have been born; Pecos, in New Mexico, for instance, and Climax, Colo., the molybdenum town.

John T. Joyce, Colorado mining commissioner, optimistically predicts additional results in his own state and in the other areas of large quantities of low-grade ores. So convinced is he that a mining revival in the Rockies will gather momentum, that he confidently expects bustling activity to break in upon the brooding silence of such confirmed ghost towns as Nevadaville and Blackhawk, slumbering in the Clear Creek region of the state, and Robinson and Kokomo, of the San Juan country.

948

DUSTLESS TRUCK FOR RUBBISH PROMOTES HEALTH

in a few seconds by elevating it and allowing the contents to pour from a large opening at the rear. The main body of the truck can be rotated back and forth by the motor so that the material inside is equally distributed and settled to the bottom, thereby continually providing room for more rubbish. The tank has a capacity of about ten cubic yards. The smaller

bins are filled by placing the garbage cans against the side doors, which do not



Filling the Garbage Truck through the Side Doors and Emptying a Load; the Tank Is Elevated by Hydraulic Mechanism

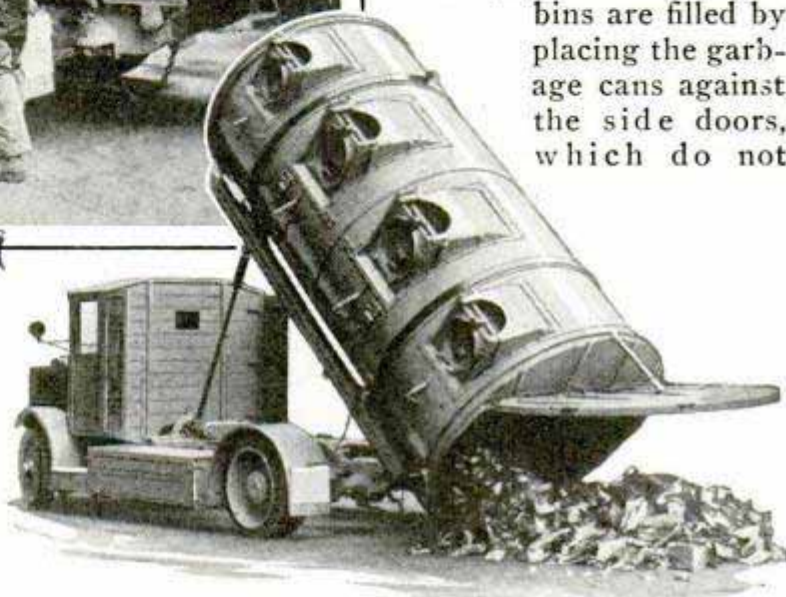

Greater cleanliness in collecting and hauling away rubbish from streets in London is promoted by means of a special truck equipped with side doors that can be tightly closed to prevent the spread of dust and odors. The smaller bins, in which the refuse is kept, are easily dumped into the truck which is emptied

open until then, but close automatically after they are removed.

CONTROL FOR GARAGE DOORS REDUCES ACCIDENTS

Both swinging garage doors are held open or shut by a simple gear control that can be quickly installed and requires no attention after it is in place. An iron arm for each door is connected to a steel coil spring and a gear arrangement over the center of the door opening. The doors are held under the tension of this spring.

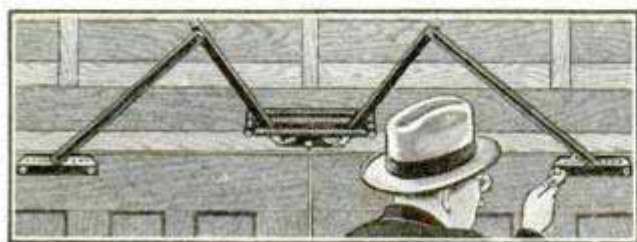

Close View of the Gear Control for Garage Doors, Showing Method of Installation

A slight pull on either door, opens or closes both, and the spring is of such strength that there is no danger of their blowing shut after once opened.

PENNY'S WORTH OF ELECTRICITY MILKS TEN COWS

At the average rural rate, a cent's worth of electricity will perform any one of the following tasks, according to data collected by the New York state committee on public-utility information: shell eight bushels of corn, grind half a bushel, thrash one bushel of barley, separate sixty gallons of milk, cut 300 pounds of ensilage, cut 200 pounds of fodder, stuff 200 pounds of sausages, churn thirty-three pounds of butter, and provide enough energy to milk ten cows or groom two horses.

Berman invention

*Door Operators Corp.,
1217 W. Monroe
Chicago*

*Terminal
Central
New York
Island
New York*

*NY State Committee on
Pub. Util. & Bus. Reg.*

BETTER WAYS OF STORING COAL TO PREVENT FIRES 992

Interesting tests to determine the best methods of storing coal in order to prevent spontaneous combustion, have been conducted by the bureau of mines. It has been found that all coals, except anthracite, undergo some spontaneous heating, but that the greatest hazard is involved with coals of the inferior grades. Care should be taken in the segregation of fine coal in the storage pile. All foreign matter should be excluded. The investigators differ as to the effect of moisture in coal. Generally speaking, the results are believed to be dependent largely on the storage conditions. In some coals, application of water may reduce the temperature sufficiently to prevent spontaneous combustion, but in others, if the pile is wet, the ventilation may be curtailed, resulting in dangerous overheating. The experiments proved that allowing adequate ventilation for the coal pile, so that excess heat could be carried off, is one of the most important factors to prevent fires from spontaneous combustion.

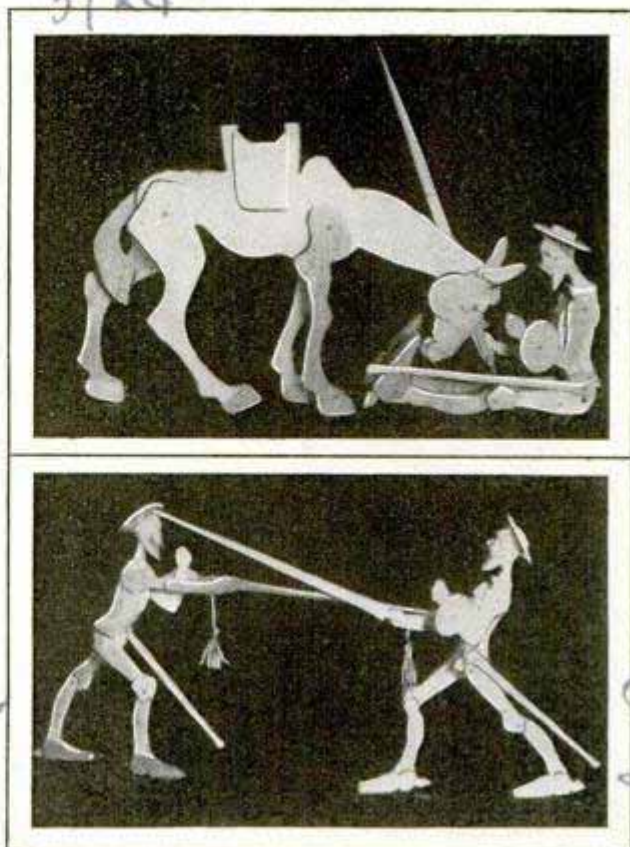

Don Quixote in Wooden Figure That Can Be Adapted in Many Poses, as Limbs Are Jointed

DON QUIXOTE CARVED IN WOOD ASSUMES DIFFERENT POSES

Don Quixote fights with his shadow, rides his horse and "performs" numerous other stunts in wooden figures that a New York artist has carved. The units are jointed so that they can be posed in many positions, and the models reflect much of the humor contained in the story.

GUIDE FOR BILLIARD PLAYERS TEACHES CORRECT STROKE

For the novice at billiards, a special support and guide has been devised for the cue, enabling the player to hit the ball at the desired spot and to hold the cue in the correct position. In connection

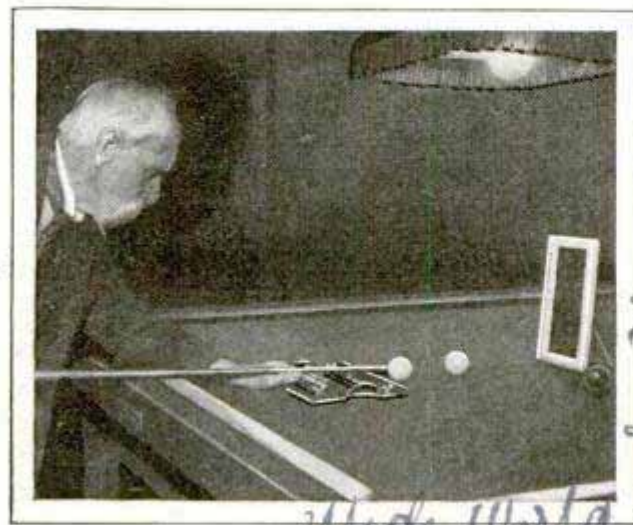

Billiard Practice with the Special Cue Rest, and a Mirror to Study the Stroke

with the guide, a small mirror is used to study the proper method of play

"CREAM" FROM SUGAR CANE SUBSTITUTE FOR SIRUP 991

Cane cream, a sugar-cane product recently developed in the south, is being used as a satisfactory substitute for sirup, as it does not spoil so easily, retains the flavor and food value of the sirup, and has many uses in cooking. It is essentially a mixture of very small sugar crystals surrounded by a film of sirup which remains after crystallization has occurred. The thickness of the mixture can be altered to suit the purpose for which the cream is intended. It is said to be especially suited for making icings, for eating with pancakes or cookies, and has the great advantage that it can be handled the year round with little danger of spoiling.

Carbohydrate des.

Frank Mucci
and Dept. of Agriculture
Washington, D.C.

589
D. Stanley 6/2/27

Made World

English invention

and J. S. Halper.

Colomberie Barnehard Road, Berley Heath near London, Eng

no address available.

3018

900

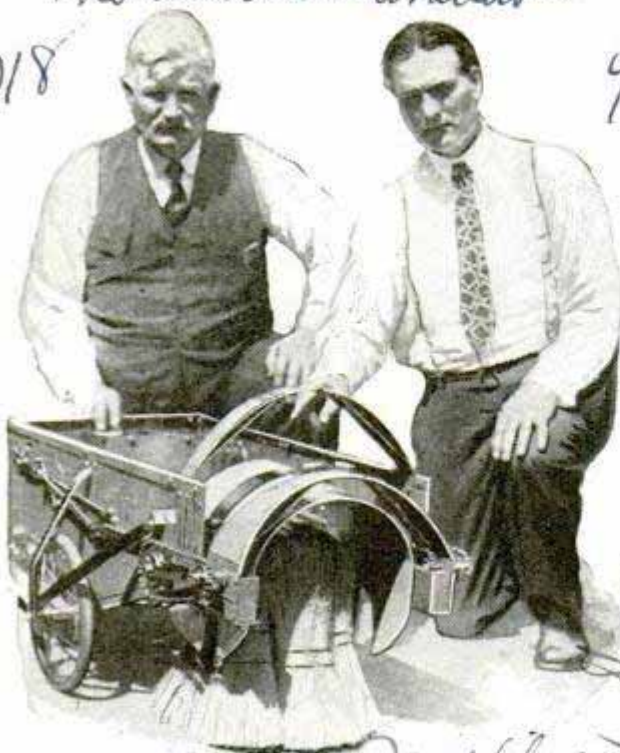

Model of the Grain-Bundle Gatherer That Piles Bundles in Shocks, Saving Hand Operation

SHOCKER FOR GRAIN BUNDLES SAVES HAND LABOR

To pile the bundles in shocks after the grain has been cut and bound by the harvester, a western farmer and mechanic have devised a labor-saving unit. It is said to take the place of the ordinary bundle carrier and is controlled by a pedal, leaving the shocks in straight rows along the field for easier pitching into wagons. The shocker also reduces loss of grain.

TIME TRAP TO SHUT WINDOWS SAVES GETTING UP

Windows may be closed at any time desired without the necessity of getting out of bed by a simple clock mechanism that fits on the sill. It operates, on somewhat the same principle as similar units for opening furnace doors or drafts, is easily regulated and, owing to its simplicity of construction, is positive in action.

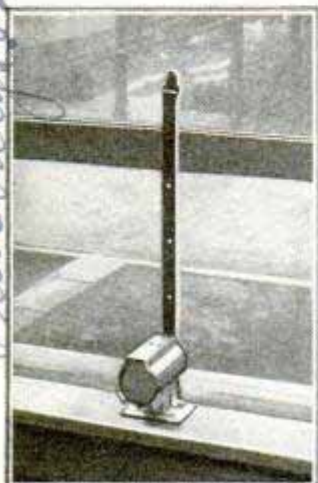

ROTATING RADIO-BEAM SYSTEM TO AID COMMUNICATION

Experiments with a revolving radio-beam transmitter and receiver are being conducted by Senator Marconi, who visions the system as of particular aid especially when establishing contact with fleets or other objectives, whose location at the moment is uncertain. The aerial and its reflector, he explains, will turn about in somewhat the same manner as a searchlight is revolved so that the beam can be directed upon any point wanted.

FILMS OF AMATEUR MOVIES DEVELOPED AT HOME

Film strips of small cameras and short pieces of standard motion-picture film are developed with precision and a minimum of trouble in a reel tank now on the market. Advantages claimed for the unit are that the film is retained in a separated condition, permitting the solution to have free access to all parts of the surface and there is no handling of wet film to cause scratches. With a little practice, the reel may be loaded in darkness, eliminating the need of a special dark room and red light, and when the film is all on the reel, in the tank and the cover on, the rest of the developing may be done in the light. Tanks are made to handle three reels at a time. There are also smaller sizes accommodating one or two.



QUEER AERIAL CARGOES

Airplanes have often flown queer cargoes, ranging from an African lion to a grand piano, but in their regular daily travels the cross-channel planes, linking England with France, Germany and other continental countries, regularly get unusual mixtures of freight. On one recent trip a big aerial freighter carried a package of diamonds valued at \$60,000, half a ton of gold and 500 one-day-old chickens.

Airways 1/28

Handwritten notes on the left margin: 'modern mfg Co. rural Bldg. Indiana 400 Elgin' and '38 13'.

Handwritten notes on the right margin: 'Pat. filed', 'Miller', '10th St. New York City', 'Maher & Lertz due 60', 'Alm. E. L. Reed, 1019 Toland Bldg. San Francisco, Cal.', and '882'.

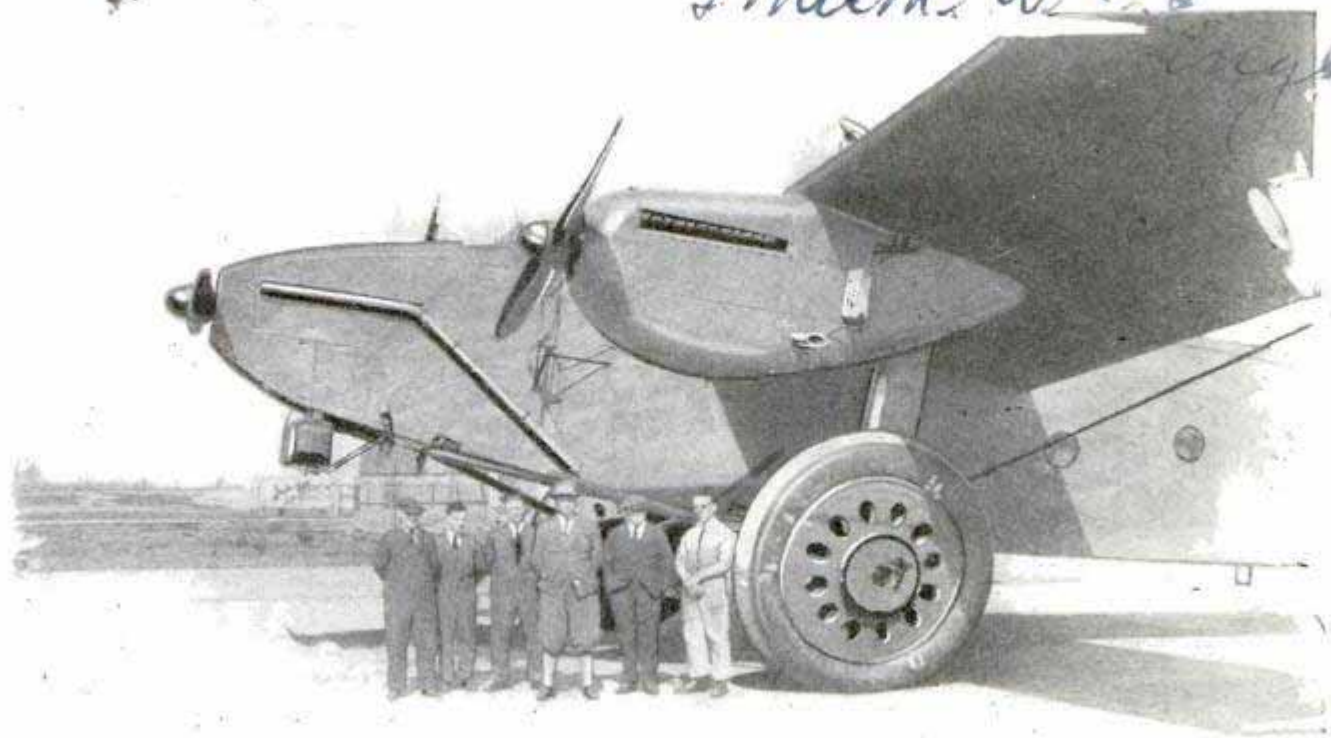

Giant Tires Were Required When England's Newest Bomber, the Beardmore "Inflexible," Took the Air; the Huge Tri-Motored Monoplane Is the World's Biggest Ship of Her Type

WORLD'S LARGEST MONOPLANE WEIGHS FIFTEEN TONS

The world's largest all-metal monoplane, the Beardmore "Inflexible," built recently for the British air service, boasts the biggest aviation tires ever built. To support the shock of landing fifteen tons at high speed, the huge wheels are equipped with specially designed rubber tires, seven feet six inches in diameter. The ship, a three-engined bomber, has a wing spread of 150 feet. Instead of a tail skid, the plane has a third wheel, mounted as a caster and fitted with a tire larger than the ordinary landing-gear tire of smaller planes. The Beardmore company also is producing a Diesel engine for dirigible airships. Running on heavy oil, the fire risk of gasoline in the neighborhood of hydrogen-gas bags, is eliminated.

GARDENS PAINTED WITH LIGHT FOR NIGHT DISPLAYS

By the use of electric floodlights, gardens and lawns at an eastern suburb are revealed in pleasing color effects at night. Special lenses of different hues and producing unusual color values are employed in illuminating individual rose bushes or flower groups, for instance, while spot-

lights bring out bits of rock decoration or other details. The equipment is carefully concealed so that it does not mar the gardens during the day.

TRAFFIC-LIGHT MIRROR IN AUTO PROMOTES SAFE DRIVING

Easily attached in a convenient position on the dash, a chromium-plated reflector gives the driver an opportunity to observe any change in overhead traffic-light signals by day or night. This saves him the trouble of peering out of the car with its consequent risk.



Drawing to Show Traffic-Light Mirror Installed for Reflecting Overhead Light Signals

3796
Reflectable
The Auto Parts Distributing Co. Inc. 5917, Euclid Ave. Cleveland, Ohio

North Shore Mass. 905
nat. Elec. Light Assn
420

STRANDED DREDGE IS LIBERATED WITH ICE

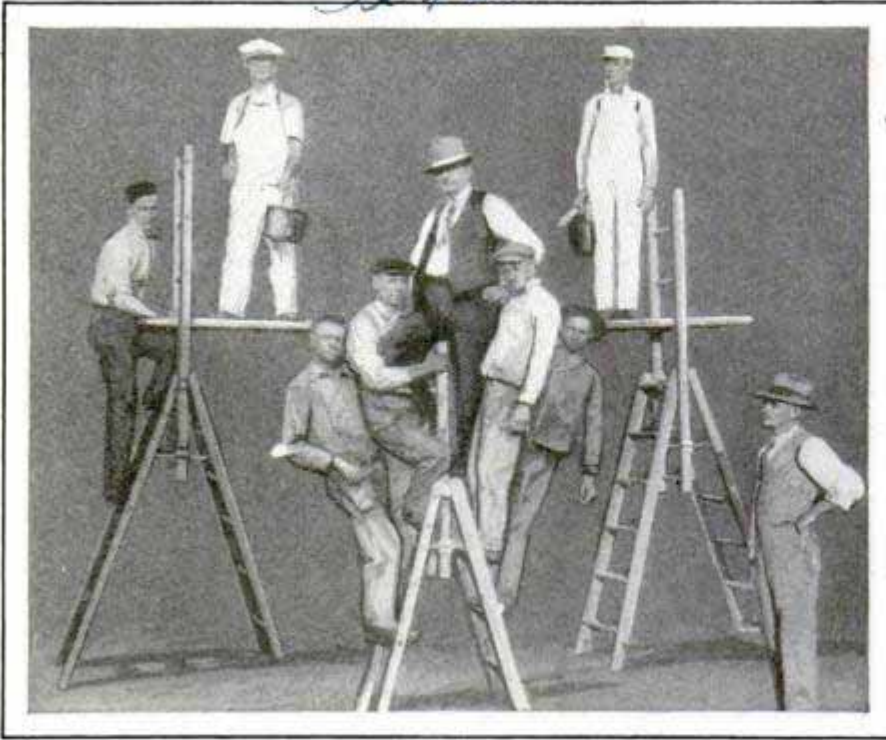

Extension Ladder Arranged as a Scaffold and Showing How It Supports Heavy Weights

LADDER FOLDS IN SMALL SPACE AND HOLDS HEAVY WEIGHT

Several interesting features are claimed for a ladder that can be collapsed into a unit no larger than a stepladder of six rungs, but which provides twelve rungs when extended. The inventor demonstrated that it would support the weight of five men, while resting wholly on its own standards.

FRENCH BUILD CHINESE WALL

Following the example of the ancient Chinese, the French are about to build a wall of concrete and steel from the North sea to the Mediterranean as a war defense to guard the border. A preliminary sum of \$10,000,000 is being spent on the first section in Lorraine and lower Alsace, where Marshal Petain, the famous French military leader, is supervising the work. Fortresses are to be built underground in connection with it and will be linked up by more walls of steel and concrete.

How ice was used to salvage a million-dollar dredge employed in the construction of the Port Nelson terminal of the Hudson bay railway, is an interesting story of modern engineering resourcefulness. The huge unit, weighing 2,000 tons, by an odd twist of a terrific gale, was lifted up and deposited squarely across a stone-and-timber mole at the end of a steel bridge. How to get it down again, proved a puzzling problem. The usual method of timbering

was considered, but there was not enough of the right sort of material for the work in the whole Hudson bay region, and to wait for it, meant a delay of months. A mechanic conceived the idea of waiting until the river was covered with ice and then building up cribs of ice blocks under the bow and stern of the dredge. In the spring, the craft would be allowed to settle as the ice melted. The plan was improved upon by building up a sort of ice monolith, under the dredge, using a reservoir made of ice blocks, filling it with water and allowing it to freeze. Instead of waiting for spring, the ice was melted with steam.

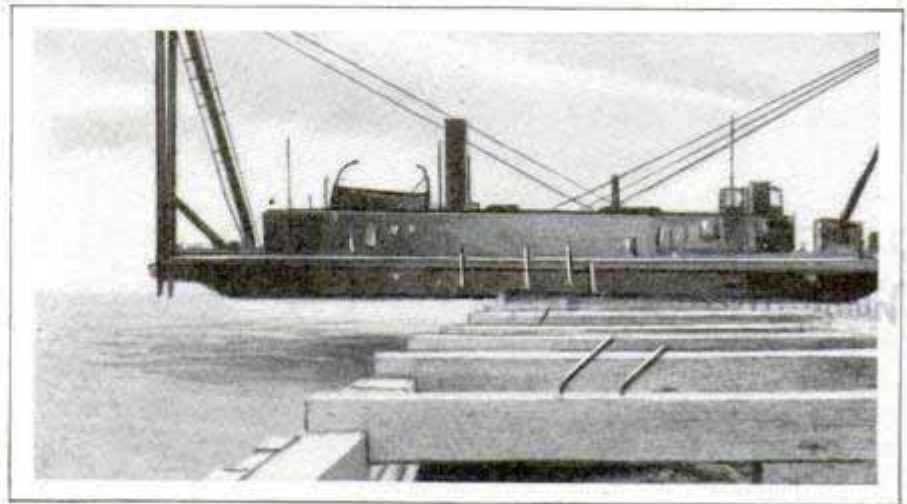

Big Dredge Washed upon Mole during Gale; It Was Removed and Floated again by Using Ice Blocks and Thawing Them

Cannot locate
Penley death
in London
Cvt. Harold J. Wilbur
Columberie; D. A. ...

Wichita Falls
Texas.
The 6 players Club
New York

A Jungle Mystery

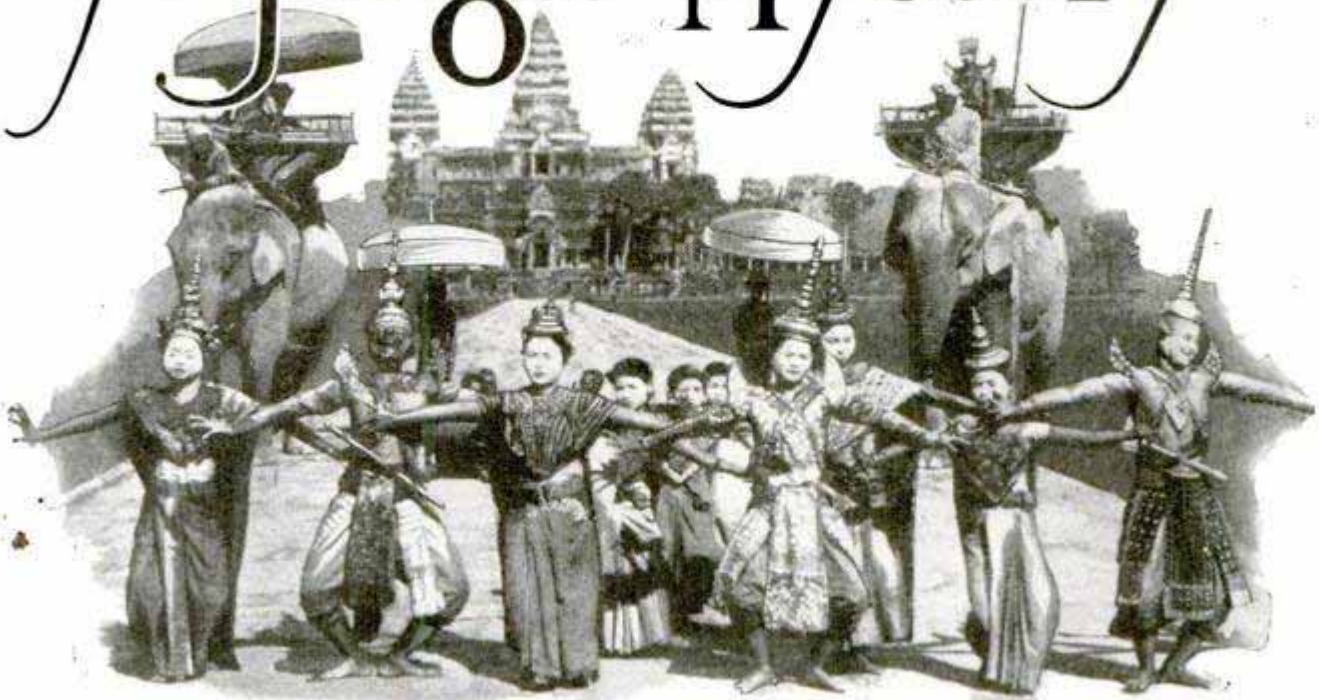

Dancing Girls before the Temple at Angkor-Vat, the Religious Center of Ancient Cambodia; These Dancers Are Trained from Infancy and Are Highly Proficient in Their Art

FOR the traveler who wants to leave the beaten trails, a land packed with romance and adventure is waiting in Cambodia, the southwestern section of Indo-China. Lost cities and forgotten temples are locked within its tangled jungles which may hold further clues to a mystery that still perplexes scholars. Just who were the people that built these shrines and cities, and what happened to them? They were as skillful as the artisans who built the cathedral of Notre Dame; they had developed a high degree of culture and civilization and, at one time, they had hundreds of miles of seacoast in their control and millions of men under arms. But they suddenly vanished, and no trace of them has been discovered.

Within the last two years, nearly sixty of the forgotten temples have been found. Recently, Robert J. Casey, of the Chicago Daily News, lured by the fanciful tale of a native guide, fought his way through the jungle 100 miles east of Angkor and stumbled upon one of the lost cities, a huge pile of crumbling ruins apparently as large as Angkor. So far as is known,

he is the first white man to have reached this city. Hundreds of square miles of jungle territory yet remain to be explored in that region.

This land of mystery has been surrounded by civilization for centuries, but, so far as men living today are concerned, it is a frontier. It was opened up only sixty years ago when French explorers found Angkor, at the head of a large lake. Since that time, scholars and engineers have been at work digging and hunting, but they have learned comparatively little of the people who originally settled here. It is believed that they came out of India, mixed with the natives and slowly built up a powerful nation. Then, an invasion, a plague, or some other disaster, occurred and the entire people disappeared. Save for the ravages of time, their cities and temples have been found much as they were when the occupants departed.

Tales of buried treasure persist, adding to the interest in searching through the ruins. So far, none has been found, but lists of golden Buddhas, jeweled ornaments and other valuables, apparently the



Carved Detail from a Temple Wall, Showing the Expert Craftsmanship of Cambodian Stonecutters

temple invoices, have been discovered. The story is that the priests discouraged the people from returning to the cities by making them believe that the curse of Siva, the Destroyer, was on the land. But before they left, they hid their treasures in secret vaults and sealed the doors. Possibly invading tribes found the jewels and took them away, but there is a chance that riches may be discovered.

Among the interesting features of these stone temples and cities are the arches.

The builders did not know the curved or keyed arch but constructed flat ones and were such skillful masons that they fitted the big blocks together without the use of mortar. Metal clamps were used in places, but the strength of the structures lay mainly in the exact fit of the pieces.

Mr. Casey found that the jungle city was surrounded by a swamp, apparently the remains of the deep moat that had been dug about it for protection. He was unable to enter the city proper, but obtained the first movie photographs of it ever taken. Because of the intense heat, his camera became so hot that he could scarcely touch it, and the emulsion on some of the film was melted, ruining many of the pictures.

Iron mines are being developed in the district, and the French are building roads. In a few years, this part of the jungle may become as familiar to the tourist as the section around Angkor is today, but in the meantime, there is ample opportunity for exploration. Small automobiles are driven into the wilderness over rude trails, but much of the jungle can be traversed only on foot and the traveler stakes his chances against tigers and wild elephants.

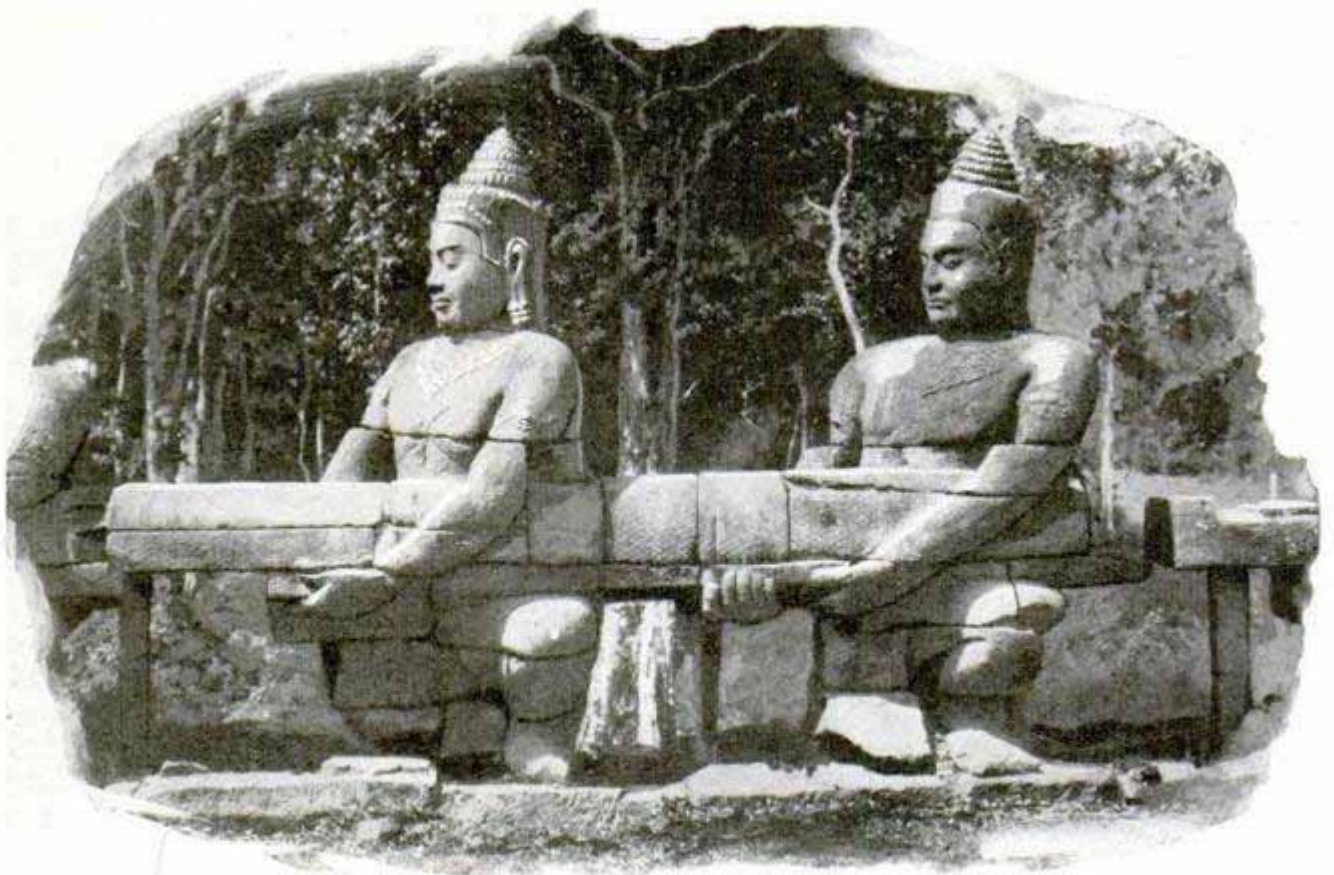

Row of Giants Bearing Balustrade That Leads to the Gate of Victory at Angkor-Thom; This City Once Had 1,000,000 Inhabitants; What Became of Them Is a Mystery

Borgerding,
820. 32nd St.
Oakland
Calif.

ENGINEERS SEEK RICH MINERALS IN METEOR

Diggers are at work in Arizona, trying to find what is believed to be a gigantic meteor that shot from the skies ages ago and buried itself in the desert sands, hundreds of feet below the surface. It formed a natural crater as it hurled aside the soil in its swift descent and this odd scar, together with fragments strewn about the area, have convinced most authorities who have studied the matter, that a meteor did fall there and may lie buried far below the top of the ground. Engineers are sinking a shaft and expect to make a cross cut over to the point where the big meteor is believed to be. Iron, nickel and small quantities of platinum and iridium have been discovered in the fragments. At current prices, the minerals make the material worth about \$85 a ton.



Model of Dummy Policeman and Traffic Lights for Installation at Intersections, to Replace a Human Attendant

DUMMY AS TRAFFIC POLICEMAN SUBSTITUTE FOR LIGHTS

In place of the usual control lights or traffic policeman to guide automobiles at intersections, an electrically operated dummy figure has been tested in a western city. It is six feet high and stands on an illuminated concrete base, three feet thick. The figure turns half or quarter way around, according to the setting, and at the same time, the hands and arms are moved to signal cars to stop or go. On the uprights about the dummy are red and green lights that flash in harmony with the signals. Greater visibility and economy of operation are claimed for this system.

DRIP PAN GUARDS AUTO COWL WHEN TANK IS FILLED



One of the first accessories to be introduced for the new Ford car, is a drip pan to keep gasoline from spilling on the cowl when the tank is filled. It is

shaped to fit evenly, the underside is covered with heavy felt to prevent scratching the finish, and there is a rubber ring that fits snugly around the tank inlet.

The Popular Mechanics Bureau of Information offers its free service to all readers of this magazine. Names and addresses of manufacturers and dealers in articles described, and any other details in our possession, will be promptly furnished upon addressing the bureau.

GOLF TEE AIDS LONG SHOTS AND DOESN'T GET LOST

Fitted with a spring that throws it back into place after a shot is made, a golf tee now on the market offers little resistance to the ball so that longer and more accurate shots are possible. It is non-breakable, cannot easily become lost and may be used with practice balls as well as in actual play.

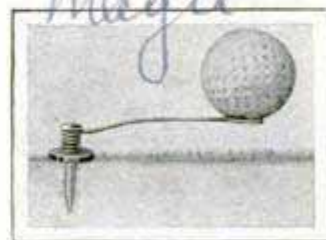

V. H. Christler
12/17/28
12/19/28
12/20/28
12/21/28
12/22/28
12/23/28
12/24/28
12/25/28
12/26/28
12/27/28
12/28/28
12/29/28
12/30/28
12/31/28
1/1/29
1/2/29
1/3/29
1/4/29
1/5/29
1/6/29
1/7/29
1/8/29
1/9/29
1/10/29
1/11/29
1/12/29
1/13/29
1/14/29
1/15/29
1/16/29
1/17/29
1/18/29
1/19/29
1/20/29
1/21/29
1/22/29
1/23/29
1/24/29
1/25/29
1/26/29
1/27/29
1/28/29
1/29/29
1/30/29
1/31/29
2/1/29
2/2/29
2/3/29
2/4/29
2/5/29
2/6/29
2/7/29
2/8/29
2/9/29
2/10/29
2/11/29
2/12/29
2/13/29
2/14/29
2/15/29
2/16/29
2/17/29
2/18/29
2/19/29
2/20/29
2/21/29
2/22/29
2/23/29
2/24/29
2/25/29
2/26/29
2/27/29
2/28/29
2/29/29
2/30/29
3/1/29
3/2/29
3/3/29
3/4/29
3/5/29
3/6/29
3/7/29
3/8/29
3/9/29
3/10/29
3/11/29
3/12/29
3/13/29
3/14/29
3/15/29
3/16/29
3/17/29
3/18/29
3/19/29
3/20/29
3/21/29
3/22/29
3/23/29
3/24/29
3/25/29
3/26/29
3/27/29
3/28/29
3/29/29
3/30/29
3/31/29
4/1/29
4/2/29
4/3/29
4/4/29
4/5/29
4/6/29
4/7/29
4/8/29
4/9/29
4/10/29
4/11/29
4/12/29
4/13/29
4/14/29
4/15/29
4/16/29
4/17/29
4/18/29
4/19/29
4/20/29
4/21/29
4/22/29
4/23/29
4/24/29
4/25/29
4/26/29
4/27/29
4/28/29
4/29/29
4/30/29
5/1/29
5/2/29
5/3/29
5/4/29
5/5/29
5/6/29
5/7/29
5/8/29
5/9/29
5/10/29
5/11/29
5/12/29
5/13/29
5/14/29
5/15/29
5/16/29
5/17/29
5/18/29
5/19/29
5/20/29
5/21/29
5/22/29
5/23/29
5/24/29
5/25/29
5/26/29
5/27/29
5/28/29
5/29/29
5/30/29
5/31/29
6/1/29
6/2/29
6/3/29
6/4/29
6/5/29
6/6/29
6/7/29
6/8/29
6/9/29
6/10/29
6/11/29
6/12/29
6/13/29
6/14/29
6/15/29
6/16/29
6/17/29
6/18/29
6/19/29
6/20/29
6/21/29
6/22/29
6/23/29
6/24/29
6/25/29
6/26/29
6/27/29
6/28/29
6/29/29
6/30/29
7/1/29
7/2/29
7/3/29
7/4/29
7/5/29
7/6/29
7/7/29
7/8/29
7/9/29
7/10/29
7/11/29
7/12/29
7/13/29
7/14/29
7/15/29
7/16/29
7/17/29
7/18/29
7/19/29
7/20/29
7/21/29
7/22/29
7/23/29
7/24/29
7/25/29
7/26/29
7/27/29
7/28/29
7/29/29
7/30/29
7/31/29
8/1/29
8/2/29
8/3/29
8/4/29
8/5/29
8/6/29
8/7/29
8/8/29
8/9/29
8/10/29
8/11/29
8/12/29
8/13/29
8/14/29
8/15/29
8/16/29
8/17/29
8/18/29
8/19/29
8/20/29
8/21/29
8/22/29
8/23/29
8/24/29
8/25/29
8/26/29
8/27/29
8/28/29
8/29/29
8/30/29
8/31/29
9/1/29
9/2/29
9/3/29
9/4/29
9/5/29
9/6/29
9/7/29
9/8/29
9/9/29
9/10/29
9/11/29
9/12/29
9/13/29
9/14/29
9/15/29
9/16/29
9/17/29
9/18/29
9/19/29
9/20/29
9/21/29
9/22/29
9/23/29
9/24/29
9/25/29
9/26/29
9/27/29
9/28/29
9/29/29
9/30/29
10/1/29
10/2/29
10/3/29
10/4/29
10/5/29
10/6/29
10/7/29
10/8/29
10/9/29
10/10/29
10/11/29
10/12/29
10/13/29
10/14/29
10/15/29
10/16/29
10/17/29
10/18/29
10/19/29
10/20/29
10/21/29
10/22/29
10/23/29
10/24/29
10/25/29
10/26/29
10/27/29
10/28/29
10/29/29
10/30/29
10/31/29
11/1/29
11/2/29
11/3/29
11/4/29
11/5/29
11/6/29
11/7/29
11/8/29
11/9/29
11/10/29
11/11/29
11/12/29
11/13/29
11/14/29
11/15/29
11/16/29
11/17/29
11/18/29
11/19/29
11/20/29
11/21/29
11/22/29
11/23/29
11/24/29
11/25/29
11/26/29
11/27/29
11/28/29
11/29/29
11/30/29
12/1/29
12/2/29
12/3/29
12/4/29
12/5/29
12/6/29
12/7/29
12/8/29
12/9/29
12/10/29
12/11/29
12/12/29
12/13/29
12/14/29
12/15/29
12/16/29
12/17/29
12/18/29
12/19/29
12/20/29
12/21/29
12/22/29
12/23/29
12/24/29
12/25/29
12/26/29
12/27/29
12/28/29
12/29/29
12/30/29
12/31/29

Carter Golf Tee Mfg. Co.
12/17/28
12/19/28
12/20/28
12/21/28
12/22/28
12/23/28
12/24/28
12/25/28
12/26/28
12/27/28
12/28/28
12/29/28
12/30/28
12/31/28
1/1/29
1/2/29
1/3/29
1/4/29
1/5/29
1/6/29
1/7/29
1/8/29
1/9/29
1/10/29
1/11/29
1/12/29
1/13/29
1/14/29
1/15/29
1/16/29
1/17/29
1/18/29
1/19/29
1/20/29
1/21/29
1/22/29
1/23/29
1/24/29
1/25/29
1/26/29
1/27/29
1/28/29
1/29/29
1/30/29
1/31/29
2/1/29
2/2/29
2/3/29
2/4/29
2/5/29
2/6/29
2/7/29
2/8/29
2/9/29
2/10/29
2/11/29
2/12/29
2/13/29
2/14/29
2/15/29
2/16/29
2/17/29
2/18/29
2/19/29
2/20/29
2/21/29
2/22/29
2/23/29
2/24/29
2/25/29
2/26/29
2/27/29
2/28/29
2/29/29
2/30/29
3/1/29
3/2/29
3/3/29
3/4/29
3/5/29
3/6/29
3/7/29
3/8/29
3/9/29
3/10/29
3/11/29
3/12/29
3/13/29
3/14/29
3/15/29
3/16/29
3/17/29
3/18/29
3/19/29
3/20/29
3/21/29
3/22/29
3/23/29
3/24/29
3/25/29
3/26/29
3/27/29
3/28/29
3/29/29
3/30/29
3/31/29
4/1/29
4/2/29
4/3/29
4/4/29
4/5/29
4/6/29
4/7/29
4/8/29
4/9/29
4/10/29
4/11/29
4/12/29
4/13/29
4/14/29
4/15/29
4/16/29
4/17/29
4/18/29
4/19/29
4/20/29
4/21/29
4/22/29
4/23/29
4/24/29
4/25/29
4/26/29
4/27/29
4/28/29
4/29/29
4/30/29
5/1/29
5/2/29
5/3/29
5/4/29
5/5/29
5/6/29
5/7/29
5/8/29
5/9/29
5/10/29
5/11/29
5/12/29
5/13/29
5/14/29
5/15/29
5/16/29
5/17/29
5/18/29
5/19/29
5/20/29
5/21/29
5/22/29
5/23/29
5/24/29
5/25/29
5/26/29
5/27/29
5/28/29
5/29/29
5/30/29
5/31/29
6/1/29
6/2/29
6/3/29
6/4/29
6/5/29
6/6/29
6/7/29
6/8/29
6/9/29
6/10/29
6/11/29
6/12/29
6/13/29
6/14/29
6/15/29
6/16/29
6/17/29
6/18/29
6/19/29
6/20/29
6/21/29
6/22/29
6/23/29
6/24/29
6/25/29
6/26/29
6/27/29
6/28/29
6/29/29
6/30/29
7/1/29
7/2/29
7/3/29
7/4/29
7/5/29
7/6/29
7/7/29
7/8/29
7/9/29
7/10/29
7/11/29
7/12/29
7/13/29
7/14/29
7/15/29
7/16/29
7/17/29
7/18/29
7/19/29
7/20/29
7/21/29
7/22/29
7/23/29
7/24/29
7/25/29
7/26/29
7/27/29
7/28/29
7/29/29
7/30/29
7/31/29
8/1/29
8/2/29
8/3/29
8/4/29
8/5/29
8/6/29
8/7/29
8/8/29
8/9/29
8/10/29
8/11/29
8/12/29
8/13/29
8/14/29
8/15/29
8/16/29
8/17/29
8/18/29
8/19/29
8/20/29
8/21/29
8/22/29
8/23/29
8/24/29
8/25/29
8/26/29
8/27/29
8/28/29
8/29/29
8/30/29
8/31/29
9/1/29
9/2/29
9/3/29
9/4/29
9/5/29
9/6/29
9/7/29
9/8/29
9/9/29
9/10/29
9/11/29
9/12/29
9/13/29
9/14/29
9/15/29
9/16/29
9/17/29
9/18/29
9/19/29
9/20/29
9/21/29
9/22/29
9/23/29
9/24/29
9/25/29
9/26/29
9/27/29
9/28/29
9/29/29
9/30/29
10/1/29
10/2/29
10/3/29
10/4/29
10/5/29
10/6/29
10/7/29
10/8/29
10/9/29
10/10/29
10/11/29
10/12/29
10/13/29
10/14/29
10/15/29
10/16/29
10/17/29
10/18/29
10/19/29
10/20/29
10/21/29
10/22/29
10/23/29
10/24/29
10/25/29
10/26/29
10/27/29
10/28/29
10/29/29
10/30/29
10/31/29
11/1/29
11/2/29
11/3/29
11/4/29
11/5/29
11/6/29
11/7/29
11/8/29
11/9/29
11/10/29
11/11/29
11/12/29
11/13/29
11/14/29
11/15/29
11/16/29
11/17/29
11/18/29
11/19/29
11/20/29
11/21/29
11/22/29
11/23/29
11/24/29
11/25/29
11/26/29
11/27/29
11/28/29
11/29/29
11/30/29
12/1/29
12/2/29
12/3/29
12/4/29
12/5/29
12/6/29
12/7/29
12/8/29
12/9/29
12/10/29
12/11/29
12/12/29
12/13/29
12/14/29
12/15/29
12/16/29
12/17/29
12/18/29
12/19/29
12/20/29
12/21/29
12/22/29
12/23/29
12/24/29
12/25/29
12/26/29
12/27/29
12/28/29
12/29/29
12/30/29
12/31/29

Ad. of Inventions
10/10/28
Secy. & Treas.
W. H. Johnston

between delay staff & Wines

magic

NON-STOP TRAIN CARRIES SPARE CREW IN COACH

686
Shakespeare
Eq. 18
Clatworthy
Road
London E.C. 2 4
England

Shakespeare
Eq. 18
Clatworthy
Road
London E.C. 2 4
England

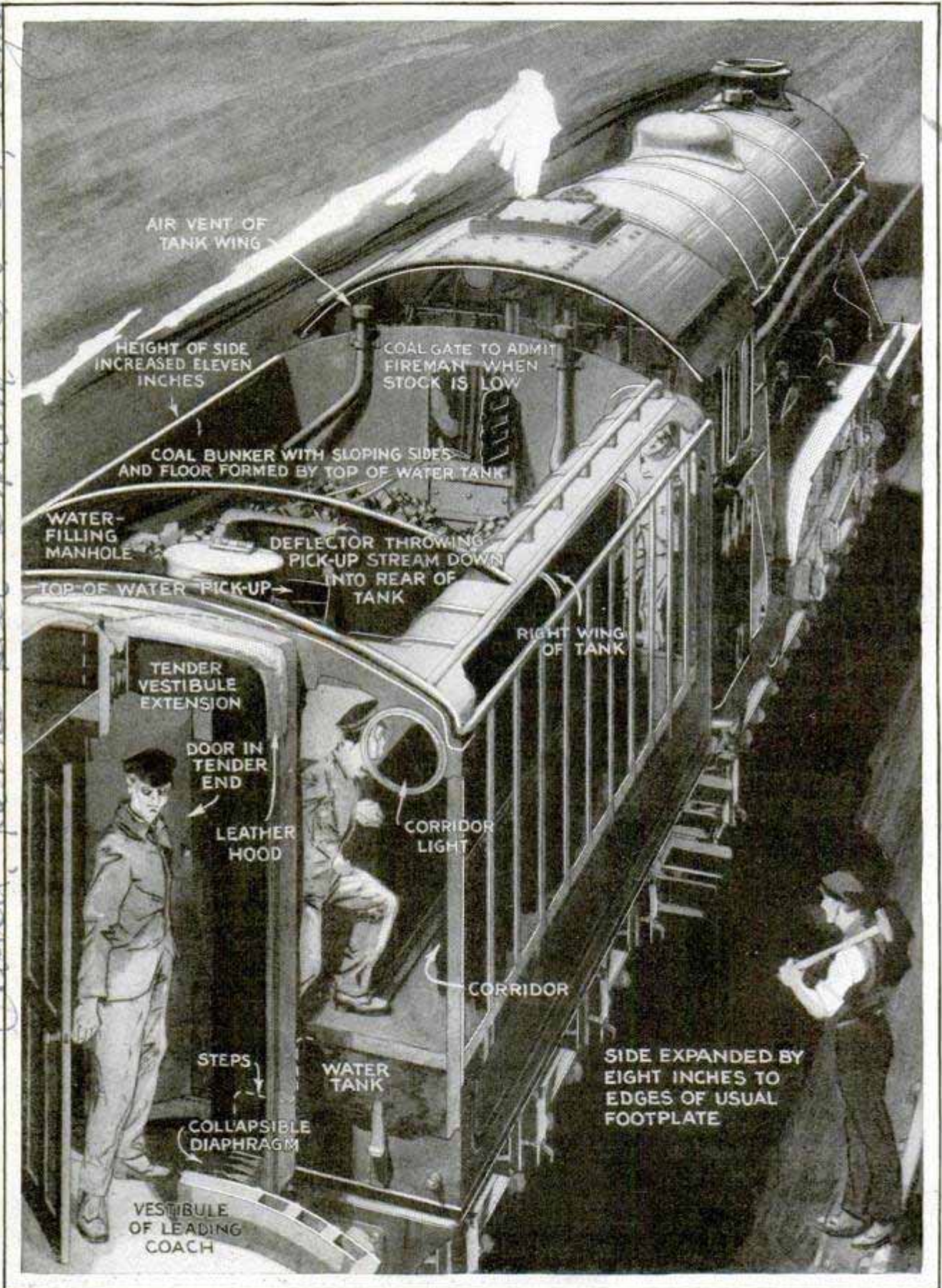

© S. W. Clatworthy

The Famous "Flying Scotsman," Which Runs from London to Edinburgh, Now Makes a 392-Mile Non-Stop Run between the Two Cities; Crews Are Changed Midway by Means of a Corridor through the Tender, the Spare Crew Riding as Passengers in a Baggage-Car Compartment

**ENGLAND'S CRACK TRAIN TAKES
— NON-STOP RECORD**

The famous "Flying Scotsman," the crack train between London and Edinburgh, recently lifted the world's non-stop-run record from another British railway, when it began running the 392 miles without a pause. Previously a stop had been made to change engine crews, the fast run being too much of a strain on one crew, though it is only eight and a quarter hours long. Elimination of the stop was made possible by building a special tender, with a corridor to connect the engine cab with a passenger compartment built into the first baggage car. The spare crew ride as passengers, and midway in the journey walk through the tender corridor, relieve the original crew, and the latter move back for lunch and rest. Despite the fact that it is a non-stop run, the running time of the Scotsman is not particularly fast, averaging 47.515 miles an hour. The New York Central's Twentieth Century, covering 960.6 miles in twenty hours, including time out for some ten stops, averages 48.03 miles, or more than half a mile an hour faster than the English train. There are several faster trains both in England and on the continent. The Great Western express from London to Exeter covers 173.7 miles in 175 minutes, or 59.55 miles an hour. The fastest train in the world is credited to France. The "Fleche d'Or," or "Golden Arrow," runs from Paris to Calais, 187 miles, at 60 miles an hour. Another French train, the "Etoile du Nord," or "North Star," runs from Paris to Brussels, 193 miles, at 56 miles an hour. The fastest trains in the United States are on the Pennsylvania's Philadelphia-Atlantic City line, making 59.7 miles in 65 minutes.

Those wishing further information on anything described in the editorial pages can obtain it by addressing Bureau of Information, Popular Mechanics Magazine.



Cylindrical Electric Oven in Which Heat Is Distributed Evenly from Elements in Top and Bottom

**CASK-SHAPED ELECTRIC OVEN
SPREADS HEAT EVENLY**

One of the chief features of a cylindrical electric oven is that the heat is more evenly distributed than in ordinary kinds. The heating elements are placed both in the top and bottom of the oven.

**RADIO STATION SET ON INCLINE
TO HELP CONTROL WAVES**

At a German radio station in Nauen, where extensive experiments are being conducted in controlling the direction of wireless waves, an incline has been built. It is intended to place the apparatus at such an angle that the "beam" waves may be concentrated more fully.

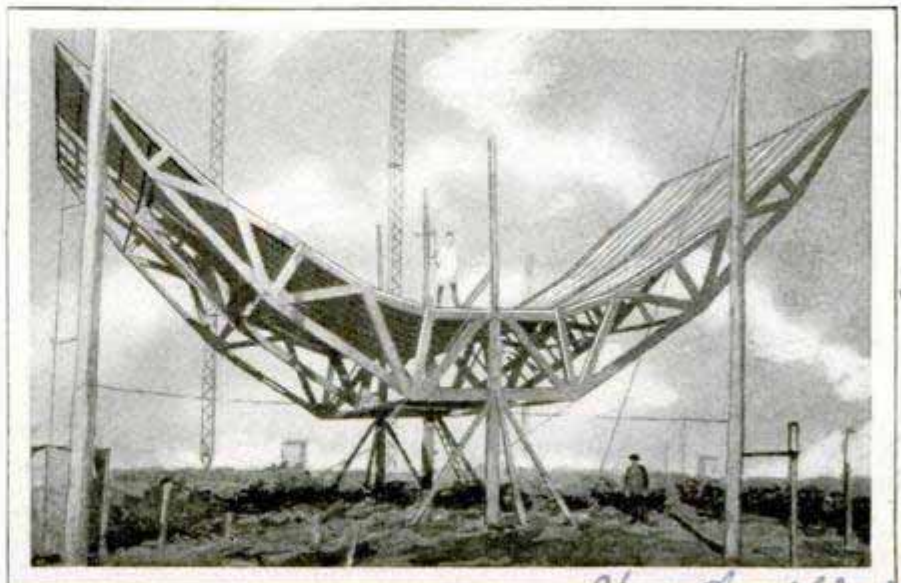

Incline at Radio Station in Germany, Where Experiments Are Being Made in Directing and Focusing Wireless Waves

(Great Britain) Ltd. 109

Very easy to handle. England.

Out of business 4/3/01

704

Wed World

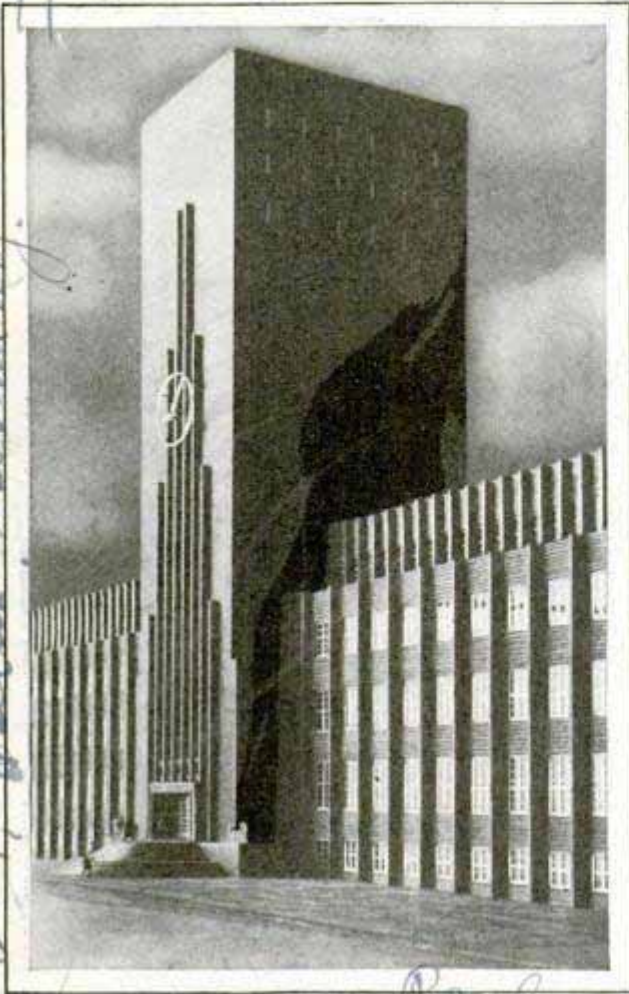

Modern Art in Exterior Design; Front of the New City Hall at Raestringen, Germany

CITY HALL AND WATER TOWER COMBINED IN ONE

Modernism is the outstanding feature of the design of the new city hall at Raestringen, Germany. Straight lines predominate and colored brick have been used effectively with gold-glazed tile to produce an unusual effect. The top of the structure conceals a water tower that helps supply the city.

MYSTERIES OF PLANT GROWTH REVEALED BY RAYS

Recently scientists, affirming a discovery announced in 1924 by Prof. Alexander Gurwitsch, of Moscow, have found that the tip of certain rapidly growing vegetable and animal tissues emits some sort of invisible radiation which has the power to stimulate the growth of living matter with which it is not in contact. Apparently, these radiations are akin to ultraviolet rays. Gurwitsch found that if the tip of one of the rootlets of an onion or

turnip was fixed so as to point at right angles to the side of another root, though as much as a quarter of an inch away, the cells in the side nearest the tip would multiply more rapidly than elsewhere and so bend the root away. That the influence was not due to the emission of some sort of gas from the root tip was proved by interposing a thin sheet between the two roots. Glass and gelatin sheets stopped the transmission of the growth-stimulating power but quartz did not. This is characteristic of ultraviolet rays. N. Wagner, a German botanist, discovered that, in bean and onion roots, the number of new cells produced by this stimulation was as high as seventy per cent. Other experiments are reported to show that growing animal tissues, such as cancer, emit such rays.

FORK FOR GARDEN IS TILTED TO INCREASE LEVERAGE

To save time and work, a garden fork now on the market is tilted at a much greater angle than is usual and, besides this, it has a crossbar handle to afford a better grip. In using it, the worker does not have to stoop so far. The tool is also provided with a spade arrangement which may be attached over the prongs.



Tilted Garden Fork Which Affords Additional Leverage for Use in Tilling Tough Soils

Schneibergstr. 3-4, Duerben, Germany
Paul
Used in Paris
The Siemens Electrical Co. U. S. A. H. H. H.

514

254

Schuchterke s.m. & H. A. A.



The Hon. Lady Mary Bailey, Wife of Sir Abe Bailey, the South African Mine Magnate, and, in the Front Seat, Mrs. Geoffrey DeHaviland, Wife of the Famous Designer of Airplanes

By HAROLD T. WILKINS

SEPARATED by a distance of 8,000 miles of land and sea, with two continents in between, two women recently set out to fly alone—one from London to Capetown, S. A., the other in the reverse direction from Capetown to London. They expected to pass each other in the clouds, somewhere in central Africa, but actually the one woman reached Capetown fifty-one days late, and the other woman completed the trip only after a long delay, due to an attack of fever.

Lady Abe Bailey, the first woman to make the solo flight from London to Capetown, regarded the flight as a holiday and used a light plane, a DeHaviland "Moth," equipped to carry only one passenger. There was an extra gasoline tank in front of the cockpit, and all her luggage was packed in two suitcases. She was her own engineer.

"My intention is to fly in easy stages, and to prove to people that anyone who

can drive an auto can make the trip by air from London to Capetown," she declared before the start.

On the first lap of the run over the gusty straits between Dover and Calais, France, she headed into a gale and her little plane was rather badly buffeted. Then a fog came on, and so hid landmarks that she was forced to land at Sacy le Petit, about twenty miles north of Paris. She reached Le Bourget airdrome, the airport of Paris, in a blinding snowstorm. Next morning, she took off for Lyons, in the south of France, and had great difficulty in beating up against swirling snowstorms, which blotted out the landscape. Also, she discovered that her compass was faulty, and this gave her a lot of trouble until she landed at Lyons.

Crossing the gulf of Genoa, Pisa, Italy, was reached three days after leaving England. Then came a flight over the Mediterranean to Tripoli, on the edge of the

desert of north Africa. Here, she landed safely, overhauled the little plane, and then took off for Cairo, where her adventures began in earnest. The Egyptian government tried to persuade her not to proceed on the perilous trip over the Nile and across the burning sands of the Libyan desert into the even hotter Sudan. She would not listen, and the authorities seized her plane, locked it up in a shed and set an armed sentry to guard it.

The Sudan government pointed out that if Lady Bailey were forced to alight on the desert sands, she ran a risk of abduction or even murder at the hands of fierce and fanatical desert Moslem tribes. If she wanted to fly over the Sudan, they said, she would have to take an escort with her. She flatly refused. In this battle between a determined woman and an equally determined government, neither would give way, and it looked as though the flight would have to be abandoned. Then a British lieutenant, who was flying to Cairo with his wife, agreed to escort her.

Lady Bailey's plane was at once re-

leased and she flew along the Nile to Luxor, near Thebes, the city of dead Pharaohs, which she reached nineteen days after quitting London.

After passing Assuan, above the first cataract, she encountered a fierce sandstorm, which blew up in choking clouds from the Libyan desert and blotted out the ground. At last she landed at Wady Halfa, just over the border of the Sudan. The heat was intense. Approaching Tabora, in old German East Africa, she met with an accident which might easily have cost her life. The airdrome there is 4,000 feet above sea level and the air is hot and bumpy.

"I am afraid I took insufficient notice of the conditions of the atmosphere and the landing place," said Lady Bailey. "I crashed heavily, and my machine turned right over, breaking the fuselage and a spar. Luckily, I wasn't hurt, but my little 'Moth' was smashed and only the engine and petrol tanks could be saved."

This accident took place in the middle of central Africa, 300 miles south of the



Courtesy The London Mail

Lady Bailey and a French Officer After She Landed at Le Bourget Airdrome, Paris, in a Snowstorm on Her Outward Trip from London to Her Cape Colony Home

equator, thousands of miles from any big airplane depot, but a new plane was obtained from Capetown and the flight continued to Broken Hill, where Lady Bailey fell ill of influenza. Four days later she struggled on to Livingstone. A strong wind buffeted her plane on the next stretch to Bulawayo, in Rhodesia, and a few days later she landed at Capetown.

"Anybody who can drive an auto could do it," she said. "My flight was long but uneventful, and not extraordinarily difficult. In fact, my only difficulty was when my machine was locked up in Cairo."

As a matter of fact, however, her solo flight was a perilous undertaking. In March, 1928, four royal air force planes, flying from Capetown to Cairo, crashed in Rhodesia, and so badly injured the crew that they could not go on.

Lady Bailey looked quite fresh after her fifty-two days in the air and on the ground. She learned to fly in 1926, and, in 1927, flew a light plane to a record height. She was the first woman to fly solo across the Irish sea, and, in January, this year, the international league of aviators conferred on her the title of champion airwoman of the world.

OLD SHIPS GUARD BIG BRIDGE AGAINST COLLISIONS 823

To protect the center pier of the huge steel bridge that spans the Carquinez straits, near San Francisco, the hulks of famous old windjammers have been securely anchored in V-shaped formation at the central pier. Two are placed on the upstream and two on the downstream side. Big steamers, loaded with raw sugar, as well as other large craft, pass under the bridge and, should one of them collide with the pier, serious damage might result. The wooden ships are intended to bear the brunt of any such mishaps.

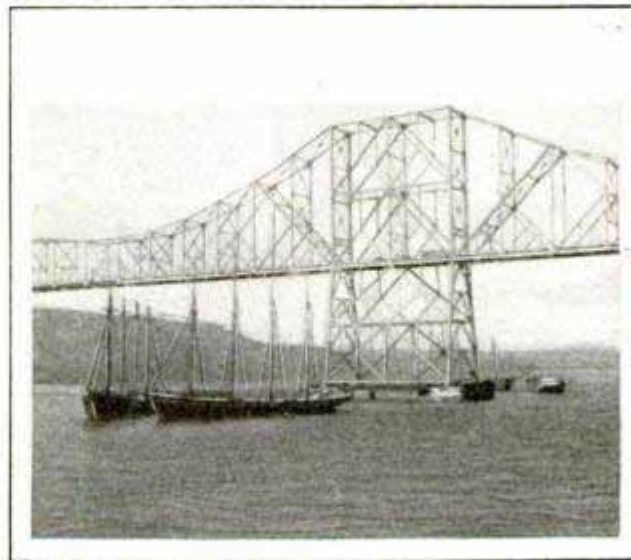

Old Wooden Ships Guarding the Central Pier of Big Steel Bridge from Damage by Collisions

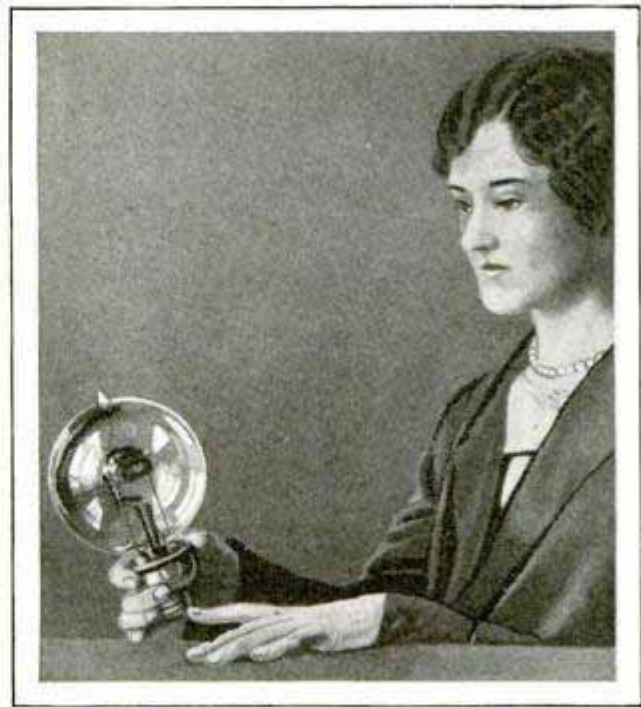

Midget Motor Used to Keep Time in Metering Operations at Electrical Laboratory

FLY-POWER MOTOR KEEPS TIME FOR ACCURATE METERING

Weighing less than three ounces, a tiny motor developed by Westinghouse engineers, keeps accurate time for various metering operations. Supplied with steady electric power, it makes exactly 600 revolutions per minute. A clock run by it will vary not more than ten seconds in an entire year. Some 200,000 of these motors would develop only a single horsepower.

ROAD AMONG VOLCANO CRATERS OPENED IN HAWAII 853

Steaming volcanic areas and miniature lava flows are visible from a picturesque automobile highway just opened in Hawaii. The road, nearly seven miles long, cost nearly \$160,000 and is especially constructed for motor cars. Besides offering tourists new thrills, it will help geologists and other investigators.

*Cent. Tom White
Box 44, Alameda*

U.S. Library 3/28/28



Testing the Portable Fire-Engine Units for Combating Blazes in Western Forests; a Burro Brigade in Action, to Show Efficiency of the Traveling Apparatus

819 **MULES CARRY FIRE ENGINES TO HELP GUARD FORESTS**

Portable pumps on burros have been used effectively in fighting forest fires in areas of the west, where rough country makes it difficult to employ motor equipment. Portable reservoirs are also provided for small fires. Five pumps, working together, project a fifty-foot stream of considerable volume, recent tests of the apparatus revealed.

879 **CROSS WIRES OVER RESERVOIRS KEEP BIRDS AWAY**

By stretching wires over city reservoirs near San Francisco, engineers have been successful in keeping seagulls from alighting on the water. The birds became a serious pest, and various means, such as automatic exploders to frighten them away, were tried without avail. It was finally found that the gulls would not pass through a network of wires forty to fifty feet apart. Strands were therefore stretched tightly over the surface of the

reservoirs in crisscross fashion and allowed to hang about a foot above the surface of the water. On longer spans, pipes were driven into the reservoir, projecting above it as props to hold the wires from sagging into the water. The plan has proved successful on ponds of wide area.

780 **LONG-BLADED WEEDER PULLS OUT DANDELION ROOTS**



and pulling, the complete plant, roots and all, is extracted.

Effective removal of dandelions and other bothersome weeds is achieved with a long-bladed rooter that pulls out the entire plant. Its sharp blades are pushed deeply into the soil on either side of the weed; then, by squeezing the handle grips

Denver, Colo

*Schaefer Lent
Lumber Co. 1421*

*Engineering News-Record
5/31/28*

Esocome, Idomachi
3906
Kojimachi, Ky.
Tokyo
Japan

COTTON LETS ULTRAVIOLET RAYS REACH BODY 886

Tests with textiles of different kinds have shown that silk or woolen garments are best suited to the prevention of sunburn, while cotton or linen allows much of the beneficial ultraviolet rays to reach the skin. Among the factors that determine the protective qualities of the cloth are the looseness of the fibers, and whether they are of vegetable or animal material. The latter, which is found, for instance, in silk and wool, will absorb most of these rays and therefore protect the wearer against sunburn.

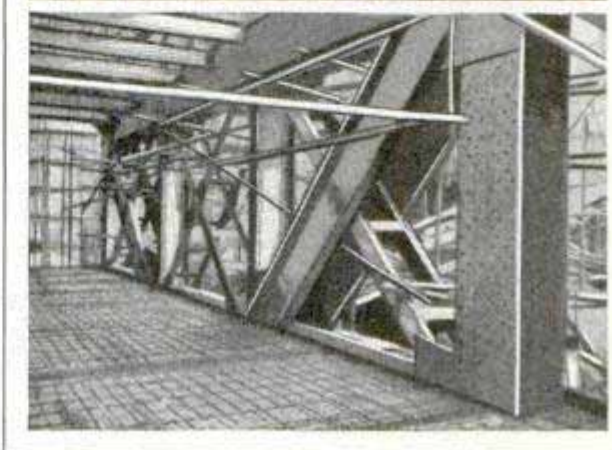
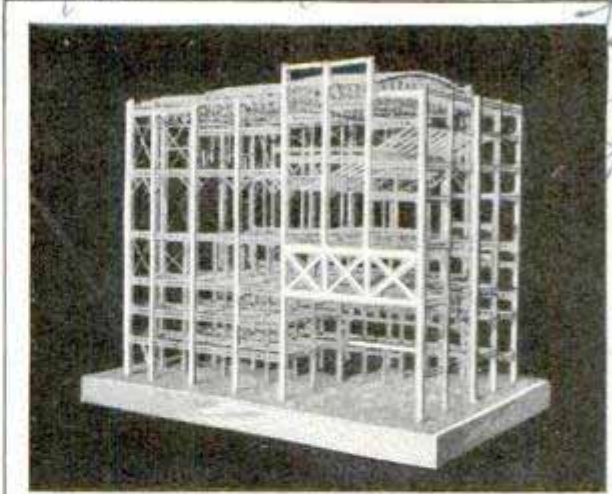

Details of Truss Bracing, and Model Showing How Japanese Builders Are Fortifying against Quakes

VACUUM BRAKE FOR AIRPLANES STOPS THEM IN FEW FEET 115

Airplanes can be brought to a stop within a few feet after they land, it is reported, by means of a braking device controlled by an automatic clutch in the cockpit and adaptable to almost any style of plane. It consists of two duralumin wings, or "ears," that swing out from the side of the fuselage, offering greatly increased wind resistance and a powerful restraining effect at the rear since the extensions are cup-shaped at the back. The inventor says that the brakes afford fifty-four square feet of air-resisting surface and that an airplane can be brought to a halt within fifty feet of the point where it touched ground in landing.

QUAKE-PROOF BUILDINGS MARK NEW CONSTRUCTION STYLES

Japanese engineers are developing new styles in architecture through their efforts to erect structures that will be proof against earthquakes. By an inner-truss system of bracing, and other innovations, a steel building has been made to withstand shocks twice as great as the last most serious temblor there, when the "vibrating width" was placed at four and one-half inches. It is said that this new building can stand vibrations having an amplitude of ten inches.

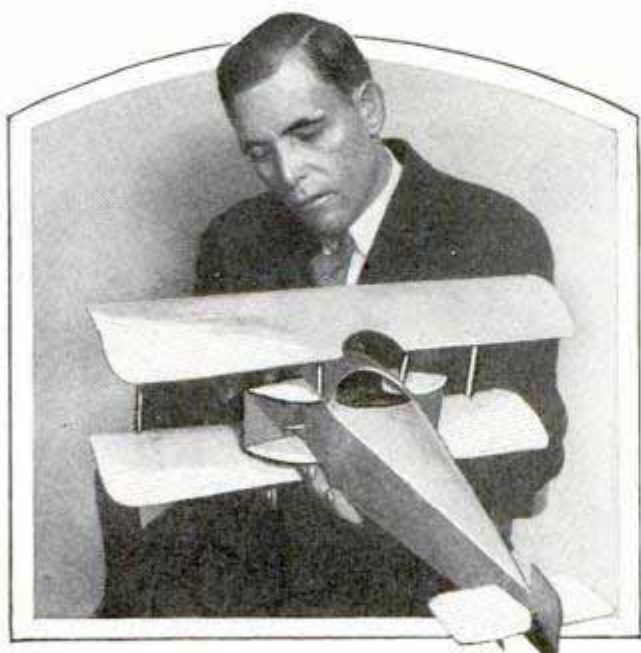

Model Plane with the Brake System Installed on Each Side of the Cockpit

TURTLES FROZEN FOR SHIPPING ON LONG OCEAN VOYAGE 890

Turtles to supply the London markets are being sent from Australia, by an elaborate freezing method. About 200 a month are being transported in this manner. Turtle catchers along the great barrier reef, get about twelve cents a pound for the turtles, while the price of turtle meat in London often is as high as \$5 a pound.

d.w. St. J. Mc Laughlin
433 Coronado

489

2200

TIME and MONEY



Dust Receiver on Wheels Eliminates Unsanitary Practice of Shaking Mops and Cloths Out of Windows; Dirt Is Collected in Sliding Drawer

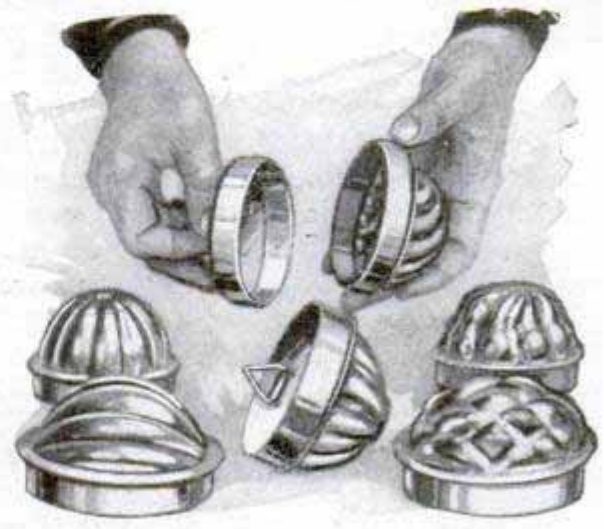

Molds for Freezing Custards or Creams in Fancy Shapes; after Filling, They Are Packed in Ice or Snow and Salt

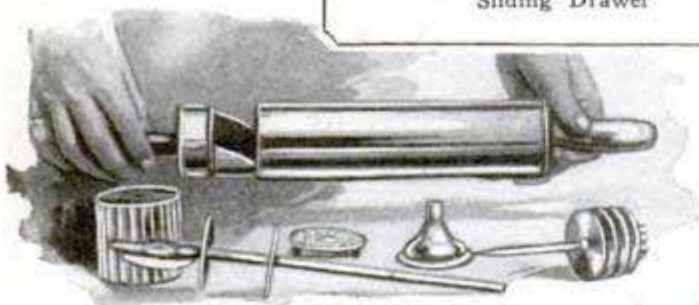

Rolling Pin as a Pantry; It Holds Eleven Different Articles and Is Made of Nickel-plated Metal



Cork-Handled Bath Brush Will Not Warp, Always Floats and Is Pleasant to Use

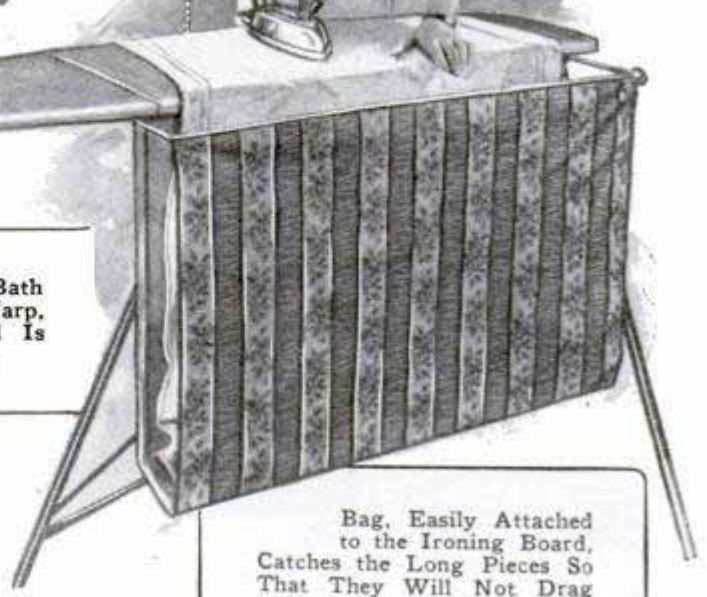

Bag, Easily Attached to the Ironing Board, Catches the Long Pieces So That They Will Not Drag on the Floor

489

SAVING THINGS for Your Home

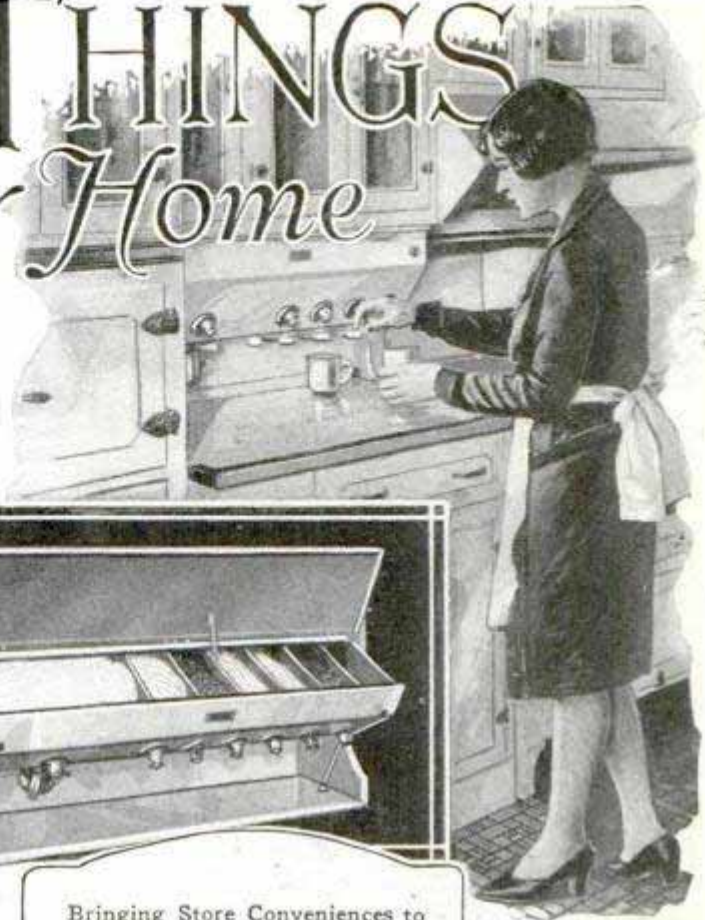

To Prevent Staining the Tablecloth, This Drip Catcher Is Easily Attached to the Sauce Bottle and Keeps Its Neck Clean

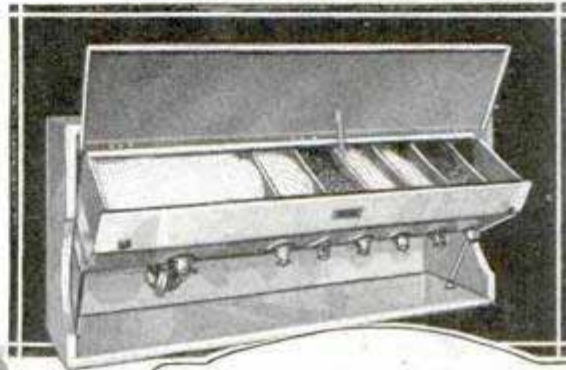

Bringing Store Conveniences to the Kitchen; This Row of Bins Holds Sugar, Flour and Other Supplies, and Dispenses Them through Handy Valves



Pocket-Size Washboard for Women Travelers Is Made of Rust-Resisting Metal and Has Rounded Corners to Prevent Damaging Fabrics



Wash Your Gloves on Celluloid Form to Preserve Their Shape and Save Work; Perforations Speed Drying

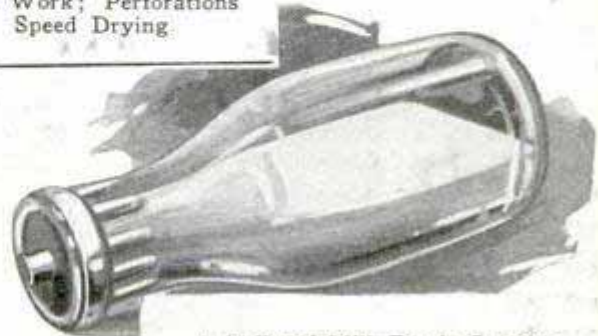

Acid-Proof Milk-Bottle Stopper of Rubber Keeps Out Air and Is Simple to Wash

Be
Ch
N.
Poc
Cru
Glo
100
Wit
right
A.
ag
ka
C
C

Carpe Welington, d.d.

801
Cut to a depth of 30 feet.

an electric shovel is speeding operations at a coal strip mine in Illinois, where strata of dirt have to be removed to get at the coal beneath. The shovel moves along at the rate of 250 feet a day, cutting a channel thirty feet

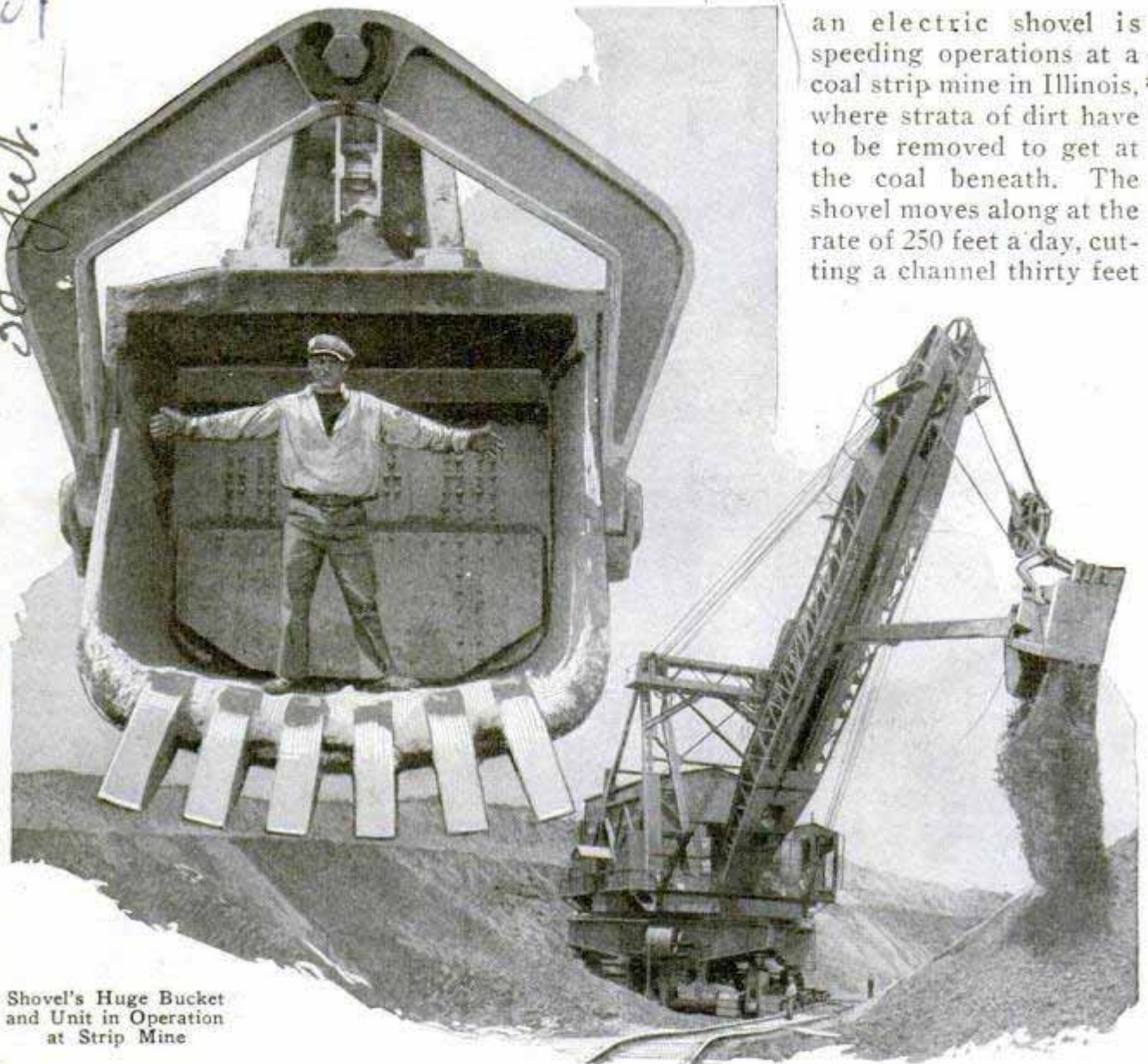

Shovel's Huge Bucket and Unit in Operation at Strip Mine

GIANT ELECTRIC SHOVEL SPEEDS WORK AT COAL MINE

Weighing 875 tons and capable of taking twelve cubic yards of earth at a "bite,"

deep and several feet wide. According to engineers, there is enough coal in the field to keep the shovel busy for thirty-five years, removing the material at the rate of 1,000,000 tons a year.

LINOLEUM BASEBOARD HELPS KEEP ROOMS CLEAN

An easily cleaned, weather-tight continuation of the linoleum floor covering up the side wall is afforded by linoleum baseboards now on the market. They are united with the floor linoleum by a cemented joint



which eliminates the usual crack at that point. The boards may be installed in old or new rooms and in bathrooms.

CONQUER ICE PERIL IN FLYING WITH THERMOMETER

A way to reduce the hazard of ice forming on the wings and struts of airplanes has been discovered at Langley field, Va. The dangerous formation occurs only within a very narrow range of temperatures close to the freezing point, it has been found. At a few degrees above or

no Chicago

my C. U. O. also in

6/5/28

Merchandising Corp
465
840 285 Madison

POPULAR MECHANICS

below that point, there is freedom from the ice danger, and it is therefore suggested that pilots be equipped with a reliable thermometer which will give ample warning of the approach of the ice-forming cold. Flying toward a cloud that might clog his plane with sleet, the pilot can thus determine whether to descend to a warmer level or rise to a greater height where the increased cold would protect him. In case the cloud were too deep to permit rising above it, and the temperature near the ground so close to the freezing point that a descent would merely increase the danger, the flyer could pass through the cloud at the higher level with greater safety. At the lower temperatures, the vapor does freeze, but it clings to the wings of the plane merely as a light, fluffy snow which is shaken off by shifting the angle of the ship and adds but little to the weight of the plane.

ENDLESS-TREAD WHEELBARROW GOES THROUGH MUD

Soft soils, ruts and other obstructions are less likely to interfere with a wheelbarrow recently introduced, for it is fitted with an endless-tread arrangement, common to the tractor. Demonstrations have shown that it can be pushed through miry ground that stopped the ordinary wheelbarrow with a narrow wheel.



Close View of the Wheelbarrow Tread, and in Use on Muddy Ground



Coin-in-Slot Cigaret Dispenser Which Says "Thank You" and Talks about the Goods

MACHINE SELLS AND TALKS TO ADVERTISE GOODS

Cigarets are dispensed from a coin-in-the-slot machine that also says "Thank you," and pronounces a few words in praise of the particular brand selected. This is done by a phonograph attachment which operates as the package is delivered. A change-making machine that provides the customer with the proper coins for insertion in the slot is an added feature of the installation.

JAP CHILDREN GROW TALLER PLAYING WESTERN SPORTS

From 1902 to 1920, Japanese boys between twelve and eighteen years old increased, on the average, half an inch over the normal height for their age, while girls grew almost an inch taller than the average. These results are reported by the ministry of education and are believed to be due to the effect of playing western games like tennis, baseball and basketball and wearing western clothing.

Messrs. J. Allen & S. M. Cox

Messrs. J. Allen

are my e

767

Curran & Sons Montreal

893
203 N. Wabash Chicago

The Waller General Register
Aviation Service & Transport



Learning to Fly

Watching Another Ship Take Off from the Rear Cockpit of a "Swallow," a Typical Two-Place Instruction Plane Powered with the War-Time Curtiss OX-5 Ninety-Horsepower Engine

Are, Nancy

By J. EARLE MILLER

"PUT YOUR feet on the rudder bar," says a loud, clear voice that seems to be shouting in your ear, "and keep the ship on a straight course."

You are a thousand feet off the ground on the first hop of the great adventure—learning to fly an airplane. Your hands are lying, according to instructions, on your knees, while a control stick gyrates between your legs as the pilot in the rear seat moves it forward and back or from side to side, keeping the ship in lateral and longitudinal trim.

Gingerly you plant the soles of your shoes against the rudder pedals and concentrate all your attention on keeping the distant horizon coming straight at you over the engine cowling. To your surprise, the horizon immediately starts swinging off to one side in a crazy fashion, and you wake up to the realization that your craft has begun to turn. A desperate push on the opposite pedal halts the

process, but the ground, still trying to fool you, reverses itself and starts traveling the opposite way. The trouble is you have overcontrolled, so you take a cautious little stab at the other rudder, ease up and peck it again with your toe, trying to come around just enough and not too much.

"Don't be afraid of it," says the loud voice, and a pair of much more purposeful feet in the rear cockpit begin flaying the rudder from side to side until the ship wiggles through the air. Emboldened, you try the same thing, and behind you the tail of the ship wiggles across the sky, and, surprisingly, nothing serious happens. You have learned the first lesson of flying: that a little pressure isn't going to break anything, nor is a bit of movement going to send the ship immediately into a tailspin.

Helmeted, goggled and incased in coveralls, you have strapped yourself into the

892

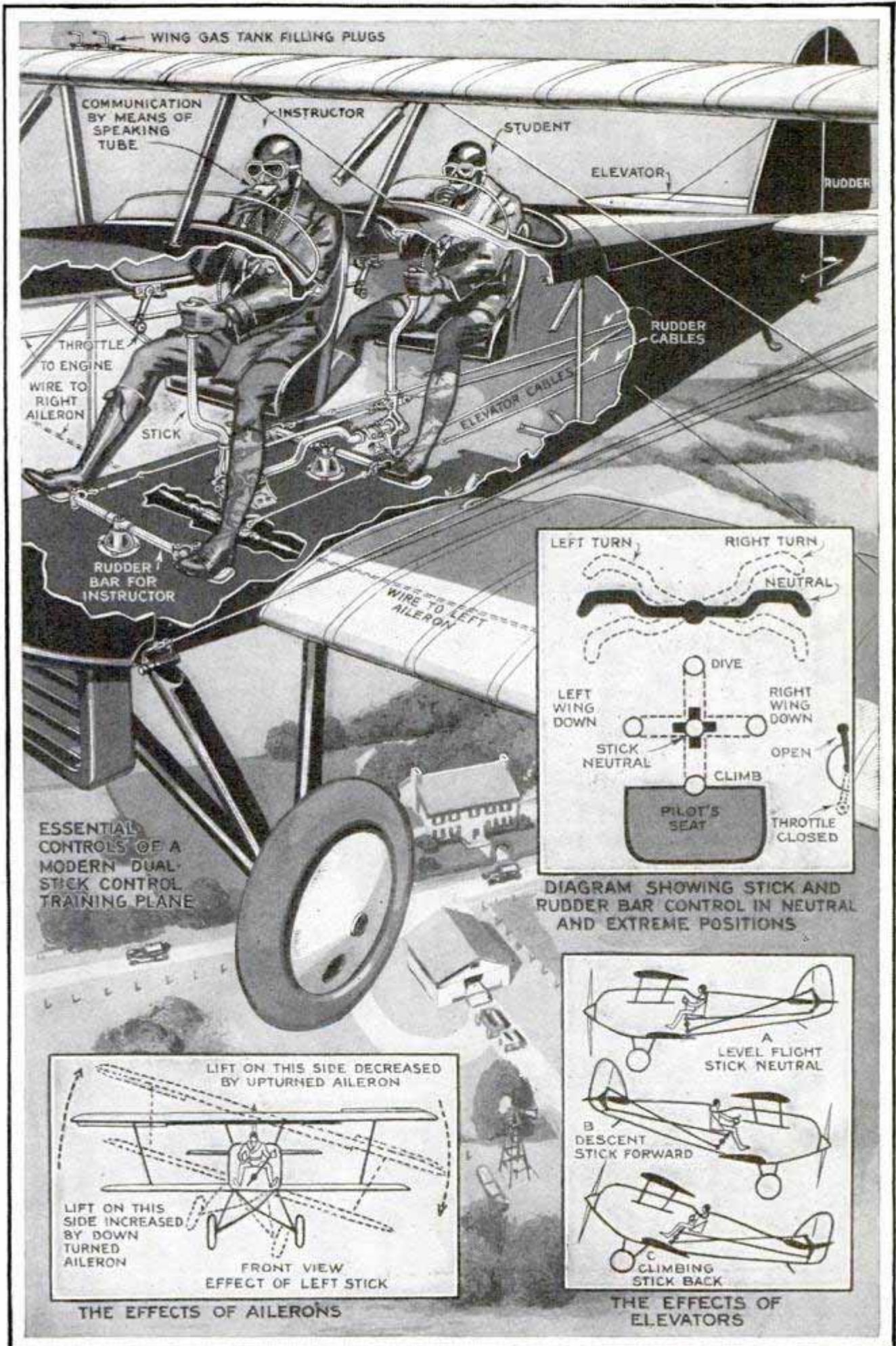

ESSENTIAL CONTROLS OF A MODERN DUAL-STICK CONTROL TRAINING PLANE

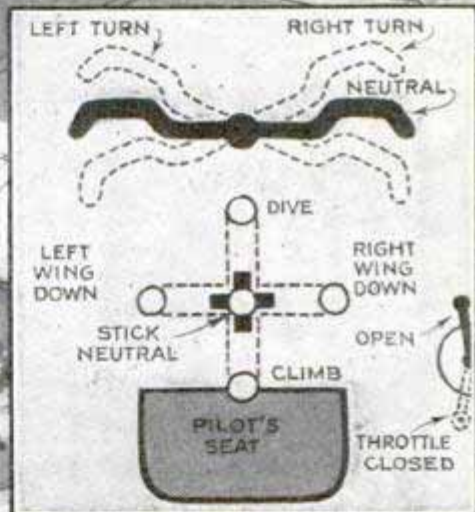
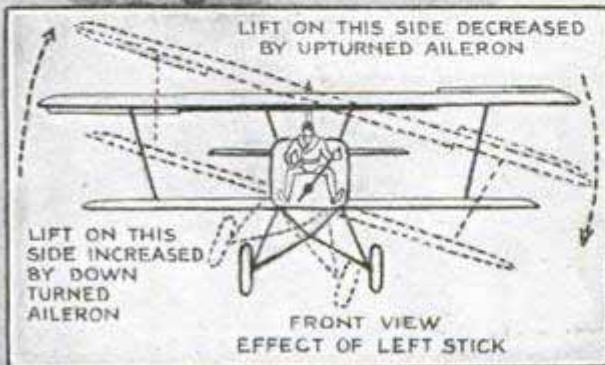
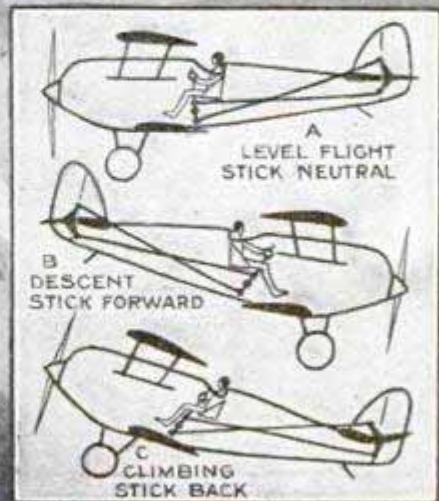

DIAGRAM SHOWING STICK AND RUDDER BAR CONTROL IN NEUTRAL AND EXTREME POSITIONS



THE EFFECTS OF AILERONS



THE EFFECTS OF ELEVATORS

893

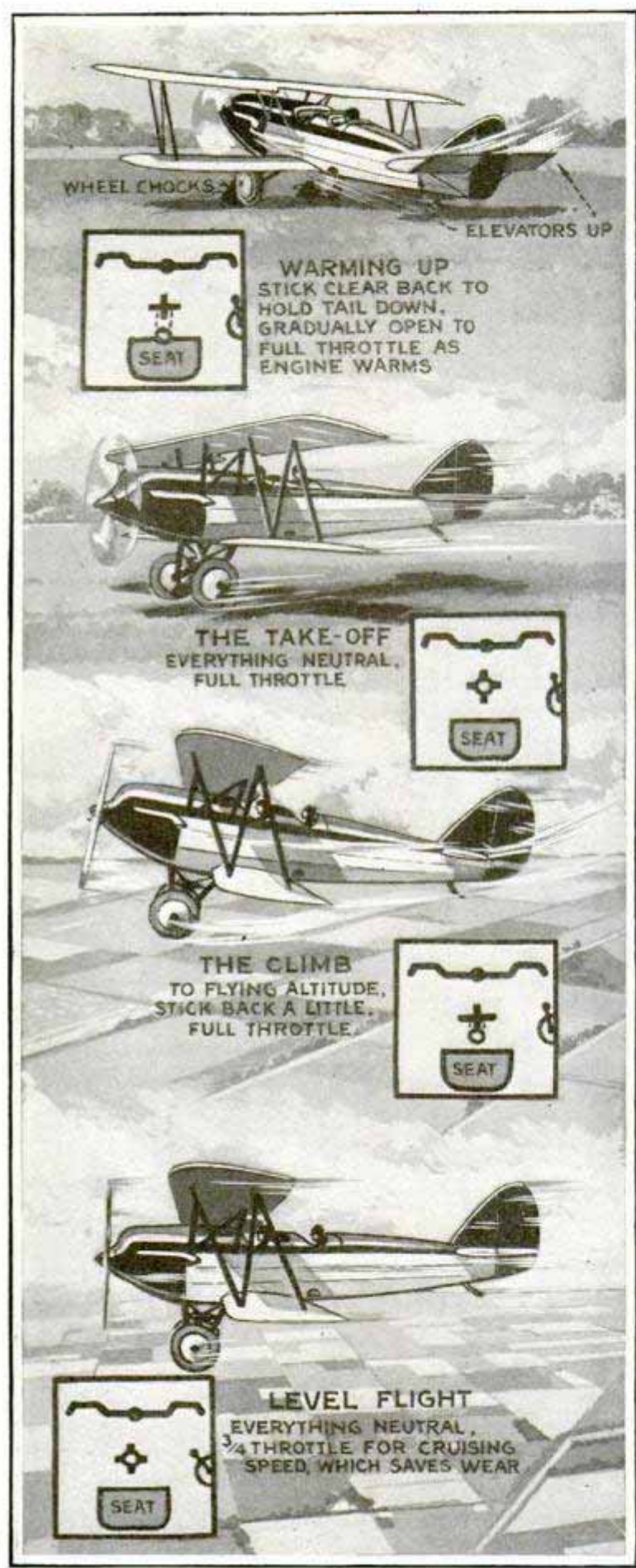

front seat of the dual-control training plane for this first lesson. You have been told it will be only twenty minutes, which seems an awfully short time for your first day's schooling, but before the day is much older you will know all about why one short hop is considered enough. In front of you is a bare, black instrument board, ornamented only with an ignition switch and, beyond it, the motor, which, in most training planes, is that war-time surplus product, a Curtiss OX-5 of ninety horsepower.

For your first lesson, the instructor, with the leather mask of his voice tube strapped across his face, rides the rear cockpit, delivering orders through a receiver wedged inside your helmet, over the left ear. As the ship taxis clumsily out to the runway, races down it and faces upwind for the take-off, he has explained the program for the day.

"I will take you up," says the voice in your ear, "I will take you up a thousand feet and then let you try flying the ship."

Simple instructions follow. If the ship is rigged with throttle levers on the right side, you are to fly with the left hand on the stick, and the right, for the present, lying relaxed on your right knee. You are to sit in the center of the seat, and if the pilot tells you to release the controls or waggles the stick from side to side to indicate he is taking over, you are to release all pressure instantly. When flying the ship, you are not to "freeze" to the stick with a tightly clenched hand, but to grasp it firmly between the finger tips, for little pressure is needed.

By the time these instructions are over, the ship is off the ground and climbing rapidly, while a checkerboard of green fields slips by beneath. Then comes the order to put your feet on the rudder bar, and you have started to become an aviator.

An Airplane Is Always Warmed Up on the Ground, to Bring It to the Best Operating Temperature; Then It Takes Off, Climbs for Altitude, and Levels Out

893

The rudder lesson proceeds apace. Turn right, straighten out, turn left, straighten out, turn right, and on and on for five minutes, while you master the workings of the foot controls. At each maneuver the stick between your knees swings from side to side as the instructor banks the ship on the turns to keep it from skidding across the sky, just as an automobile would skid if trying to turn at high speed on a level road. Always the bank and turn must coincide—not enough bank and the plane skids outward; too much, and it slips toward the inner side of the turn. Finally comes the order to take the stick, and then your troubles begin, for you have to keep the ship leveled fore and aft and from side to side and steer a straight course, and do all three at the same time.

All the control movements are instinctive. If you want to climb, you pull the stick back, and that pulls the nose up by changing the angle of the elevators at the rear. If you want to descend, you push the stick forward, and the nose drops. If a wing begins to drop, you push the stick in the opposite direction to raise it, and if you want to drop a wing to bank for a turn, you push the stick toward the wing that is to fall, and at the same time apply rudder on that side.

It sounds easy, and it is easy after you learn how, but if you let the stick move forward or aft as you push it from side to side, the nose will fall or rise, or if you get it slightly off center as you pull or push, one wing will drop. The voice droning away in your ear apprises you of all these perils.

“Keep your nose down; keep your nose down,” the instructor half chants. “What are you trying to do—loop this ship? Get that left wing up; get that left wing up. Don’t let your ship wobble around. Keep your nose down. Line it up on the horizon.

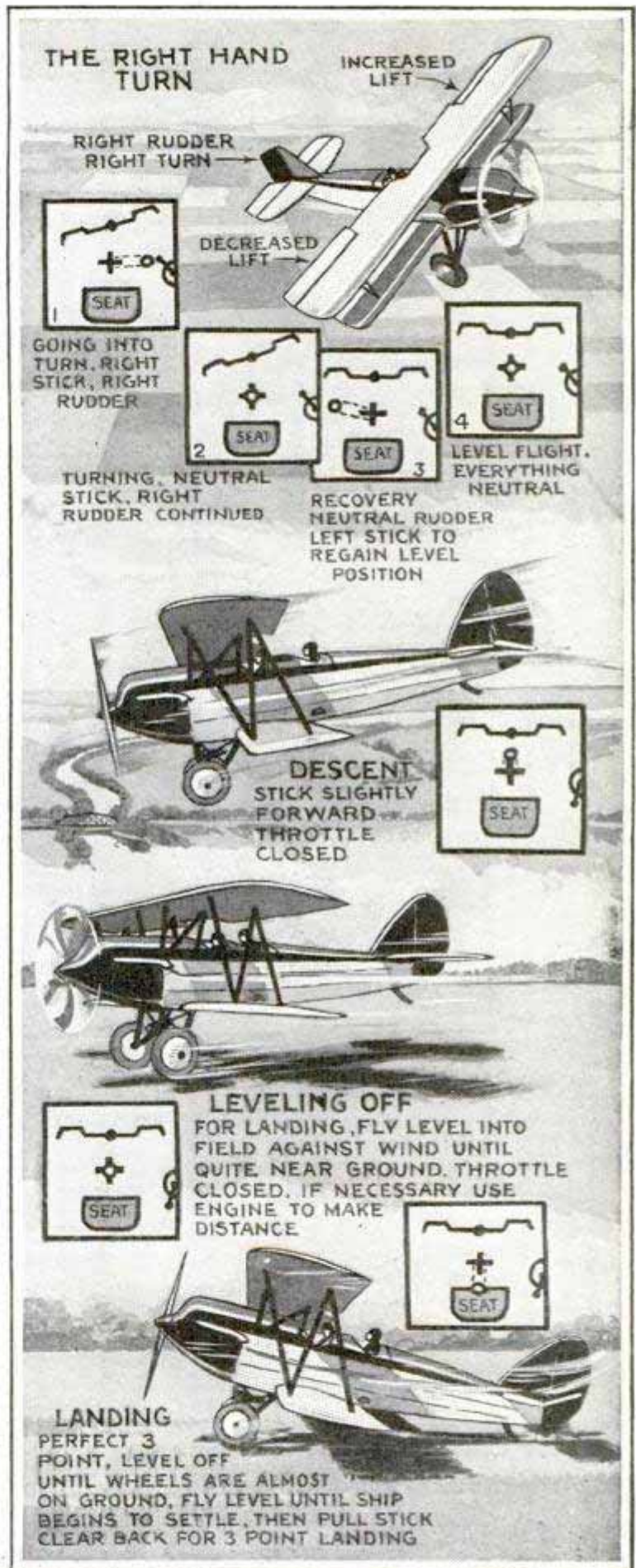

Turns, Glides and Landings Illustrated, to Show How the Stick, Rudder Bar and Throttle Are Manipulated to Maneuver a Plane in the Air and on the Ground



you will jerk the stick. You can't fall out, and if you crash the ship being on the top side of the seat isn't going to make any difference with you."

You follow the cynical advice—and learn to trust

When you can just see over the nose that line where earth and sky meet, your ship is level fore and aft. No, don't drop it so fast. What do you think you're running—an elevator!"

The voice talks on and on, as you wrestle with the controls, trying to make your hands and feet conform with your sense of balance. It's the rudder lesson all over again. First you overcontrol and, in trying to get out of one difficulty, you go too far and fall into its exact opposite. Then you become overcautious and peck away with little half-hearted movements, until a firmer hand jerks the stick away from you, throws it all around the cockpit, while the ship lurches in ungainly fashion. You get it back again, and the lesson goes on, with your confidence in airplane builders restored.

"Turn left," comes the order through the voice tube, and you kick the left rudder and apply the left aileron with the stick. As the left wing drops and the ship begins to bank to a steep angle, you forget about the safety belt that holds you fast to your seat and make a futile grab for the support of the cockpit side, at the same time trying to lean away from the bank, just as an automobile rider holds the side and leans away from a sharp turn.

"Don't lean away from it," says the voice. "Lean with the ship, otherwise



Class in Motors and One in Wing Building; the Ground Work at a Flying School Turns Out Qualified Mechanics, and Also Teaches Navigation, Meteorology and Similar Subjects

your safety belt and that a steep bank is really a pleasant feeling, if you don't fight the ship. Suddenly the even roar of the engine dies away, a hand behind you shoves the stick forward under your unresisting hand, and you look over in surprise to see the airport runway coming up to meet you. Until the engine idled down to lose flying speed, you hadn't the faintest idea where the airport might be.

You cast off your safety belt as the plane taxis in to the line, climb out, and feel pretty good. But that feeling doesn't last long. If you are a normal person, in a half hour or so there is going to be a sinking feeling in the pit of your stomach, a weakness at the knees, and you are going to burst into a violent perspiration. That's why there is only one lesson the first day—for the instructor knows how the reaction is going to hit.

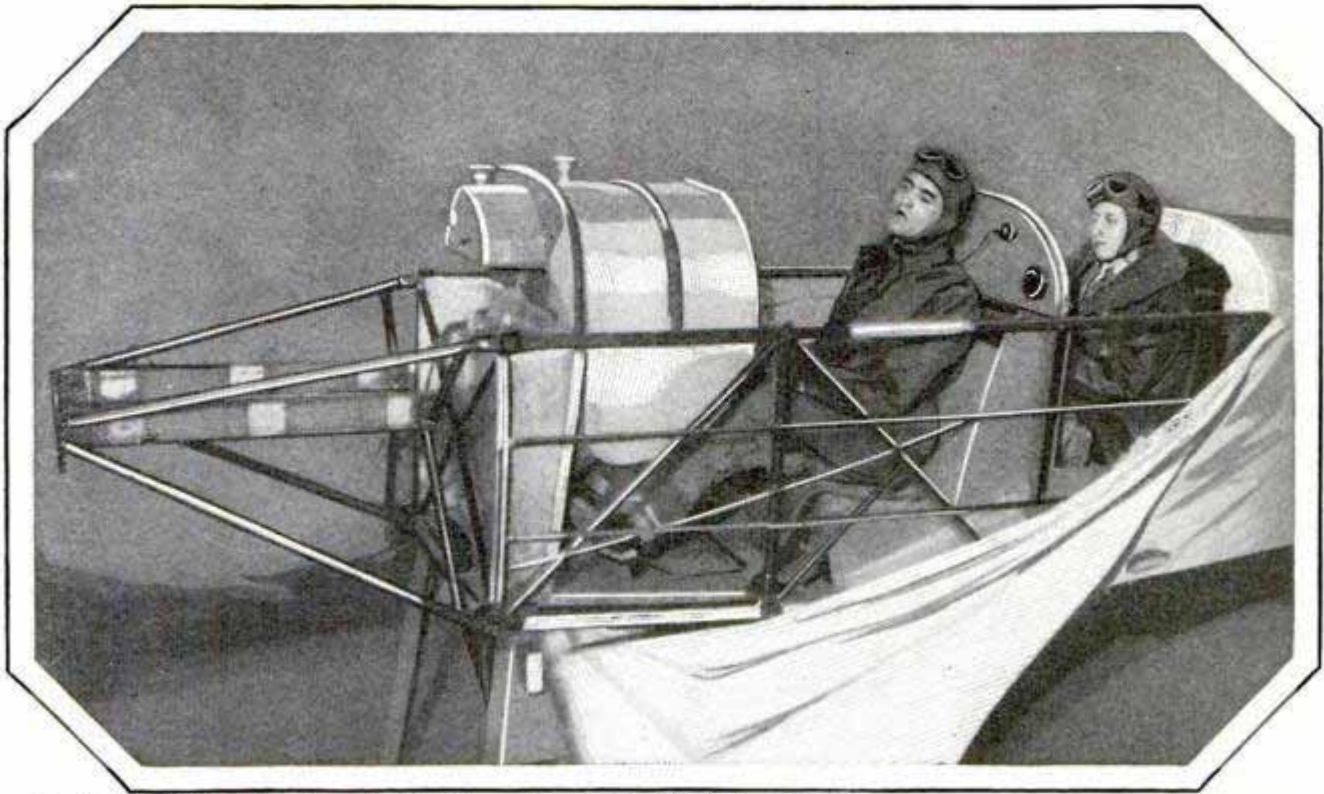

Typical Steel-Tube Fuselage of a Training Plane with Fabric Covering Removed, to Show the Interior Arrangements and the Gas and Oil Tanks in Front of the Instructor

Next day, everything is changed. You have been shifted to the rear cockpit, where the view is better, the ship easier to fly, and a whole instrument board full of interesting gadgets takes your mind, and your eyes, too, off the controls. The instructor may keep on with the voice tube, or he may switch to signals. A finger pointed up means to climb; pointed down, it means to descend; pointed to either side it means to turn, and a hand clapped to one side of the face means you are skidding, so apply more rudder on that side, or, in a bank, give it more aileron. A finger tapping the pilot on top of the head, or a hand shaking the stick means the same thing: He wants to take over the controls.

As soon as the ship is well off the ground, you get the controls, with orders or a signal to keep on climbing straight into the wind. Instead of the uncertainty of the first lesson, there is absolute confidence in yourself and the ship. You know you can fly it, and rather enjoy the air bumps that throw the plane out of trim, for they give a chance to exercise your new knowledge and bring it back again. Not that it is necessary, for a modern ship almost flies itself, and if you keep the controls steady, it will recover automatically.

You fly round and around, left turns,

right turns and straight ahead. No climbs or glides, just straight air work, learning to keep a ship level, to hold a course, that for every degree of bank the controls act a bit differently, that once you have reached the desired angle of bank, the stick comes back to neutral, or even carries a bit opposite control, if you are to keep your nose on the horizon and keep the horizon flowing past it evenly and steadily. You learn just how much right rudder must be carried to offset the torque of the engine when you want to go straight ahead, for the propeller is always trying to pull you around to the left.

And so it goes on for the first two or three hours. If you are lucky, there will be a windy day or two when the motor labors like a car climbing a steep hill in high gear, when you have to fight the elements every second of the time, and when, flying across or quartering the wind, you seem to make more side drift than you get speed ahead.

Along about the fifth lesson the instructor turns around as you climb aboard and announces that you can taxi the plane out, and take it off, too. The ship that answers to a finger touch on the air is a sluggish, perverse thing on the ground. Some are almost impossible to steer; the rudder bar must be worked like lightning;

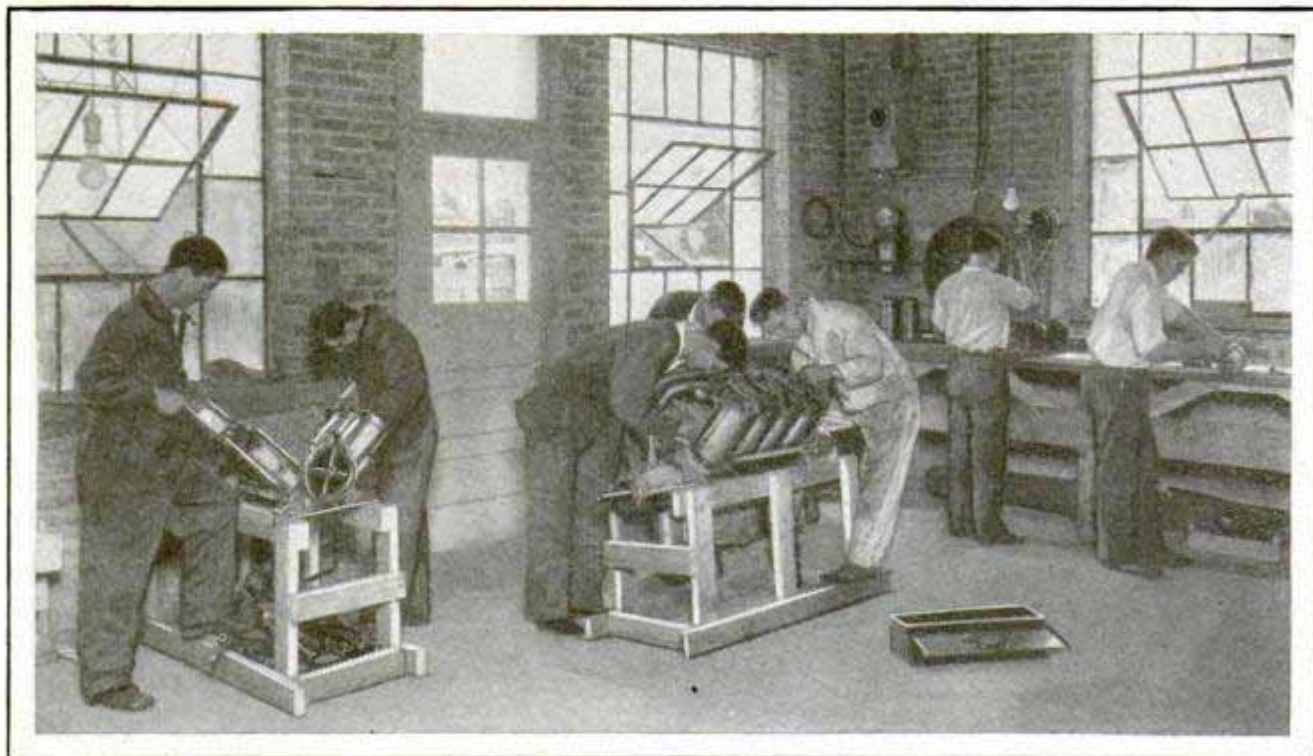

Class in Motors at a Flying-Field Hangar; the Ground Course Includes a Thorough Training in Repairing All Types of Water and Air-Cooled Aviation Engines

the ailerons work just the opposite of the way they do in the air, and if a good wind is blowing, the student may have to get out and run along, guiding one wing tip, until the runway is reached.

The take-off isn't so hard. You ease your throttle lever smoothly forward until the engine is turning up to flying speed—1,300 r.p.m. is the cruising speed for OX-5-engined training planes—push the stick all the way forward and hold it there. It takes pressure to do that, for you seem to be lifting the tail off the ground with brute force. But as the ship picks up flying speed, the pressure drops, and you let the stick ease back almost of its own accord, until the ground drops away.

In all the preliminary training, the pilot has been preparing you for the day you will try your first landing—the most difficult feat in flying. Each time he comes down, you keep hand and feet on the controls and feel the way he does it. You watch him nose down to keep flying speed as he throttles down the engine for the glide into the field; sense the easy, quick shifting of rudder as he turns to keep the nose pointed straight at the runway, and feel the stick shift a bit from side to side as wing tips are leveled up, lest a stray air current or a bump send the plane side slipping to a crash.

Watching over the side as the ground comes up, your finger tips telegraph the message when the pilot pulls the stick back just enough to level the ship out of the glide and let it lose more speed as it settles toward the earth, and catch the final pull back to drop the tail so that landing wheels and skid will all touch ground together in a perfect three-point landing.

When the time comes to try it yourself, with the instructor's hands and feet ready to correct your errors, the feat is no longer an unknown mystery, but something you know well how to do, if you can co-ordinate your movements and make hands and feet answer your brain fast enough.

All the time you are practicing landings, the drilling in air work goes on. If there is a good wind, the instructor signals to bank around until you are flying across the wind, then points out a road or a fence line or a railroad track parallel to your course and signals the student to follow it. In a cross wind, the plane drifts sideways at virtually the same speed as the wind, and to offset this and follow a straight course, it is necessary to turn the plane at an angle toward the wind. Holding a ship at the right angle in a twenty or thirty-mile wind requires your constant attention.

(To Be Continued)

Improving the Battery Hookup



ALTHOUGH A and B-battery eliminators are becoming increasingly popular among radio owners, a large number are still using batteries as a source of filament and B-supply and will continue to do so, especially where suitable power lines are not available. Every set owner using batteries should know not only how to take care of them and keep them in good operating condition, but also the proper methods of connecting them to the set to obtain best results.

Corroded terminals, acid-eaten wires and wrong connections are a common source of trouble that may easily be avoided. Fig. 1 shows a very untidy battery installation, which not only is almost sure to breed difficulties but, of course, is also most offensive to the eye. Such an installation may be satisfactory for temporary use when testing but should never be permanent. Instead of separate leads, the use of multi-wire cables, similar

to the type shown in Fig. 2, is advised, and the batteries and charger should be kept out of the way, and out of sight if possible. If a radio console or table with battery compartment is not available, a neat closed box of suitable size may be used, in which holes are drilled to provide air circulation.

Attention should be given to binding posts. Loose posts and poor terminal connections cause crackling noises and high-resistance contacts, with which no radio receiver can possibly give good results. The posts may loosen from vibration or may not have been turned down tightly when the receiver was first installed.

The correct and incorrect methods of attaching the bared ends of the leads to the binding posts are shown in Fig. 3. After the insulation has been removed from the end of the wire (see insert), the wire is scraped to free it from all trace of rubber, and the strands are twisted so that they will not spread apart when the

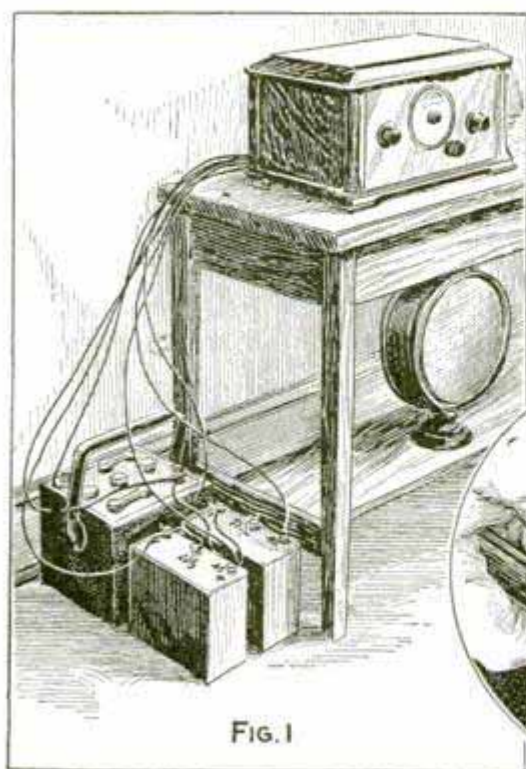

FIG. 1

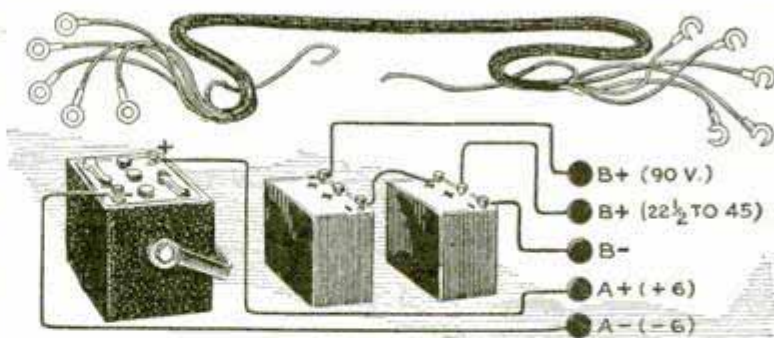

FIG. 2

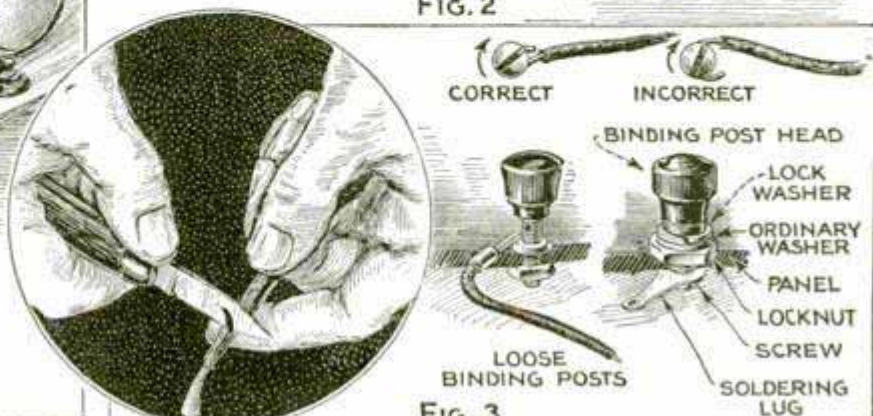

FIG. 3

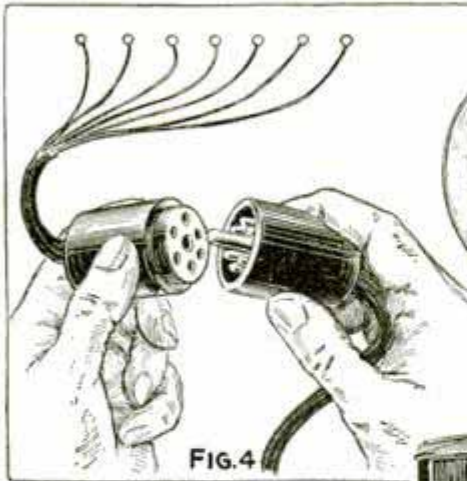

FIG. 4

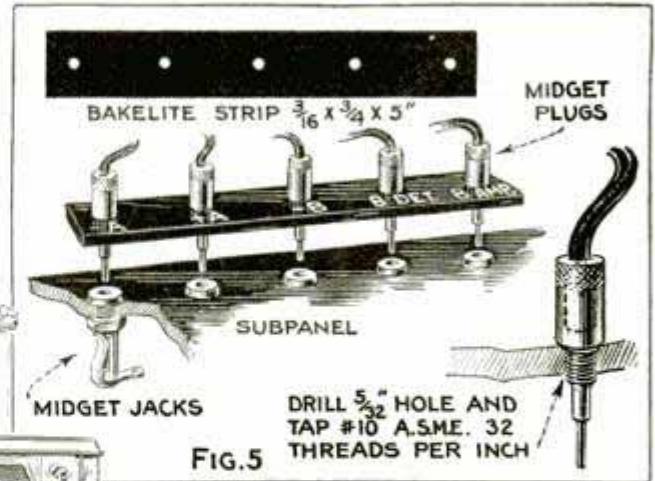

FIG. 5

binding posts are tightened. As a further precaution, and to make the end easier to connect, it may be coated with solder. The wire should be bent around the post in the same direction that the head turns, which is clockwise. This tends to keep the wire securely under the head. Some binding posts have a hole drilled in the shank, through which the wire is inserted, whereupon the head is screwed down tight. Cord tips or midget jacks also are useful here.

If you are annoyed by binding-post heads coming loose repeatedly, it is a good idea to use a washer and then a lock washer, if the binding-post head is removable, as shown in Fig. 3. Figs. 4 and 5 show two handy methods of attaching battery leads to receivers. The separable plug and socket provided with the multi-wire cable, shown in Fig. 4, provide a quick method of connecting or disconnecting all battery leads. These are of different colors and identified with markers, and the plug is designed so that it is impossible to make a mistake when inserted in the socket whose corresponding terminals are connected to the posts in the set. In Fig. 5, a homemade device, built up from midget plugs and jacks, answers the same purpose.

Another safety method against short-circuiting the leads and making quick

connections possible is shown in Fig. 6. The bare ends of the leads are securely soldered to the inside ends of the tips on a discarded X-type vacuum-tube base, from which the glass shell has been removed. An X-type socket is fastened to the sub-panel at a convenient location and the leads from the

wiring of the receiver are connected to it. Be sure that the receiver leads are all connected to the terminals on the socket in correct relation to the battery leads fastened to the tips on the tube base. The same illustration clearly shows the idea, and if there are more connections to be provided for, an additional socket and

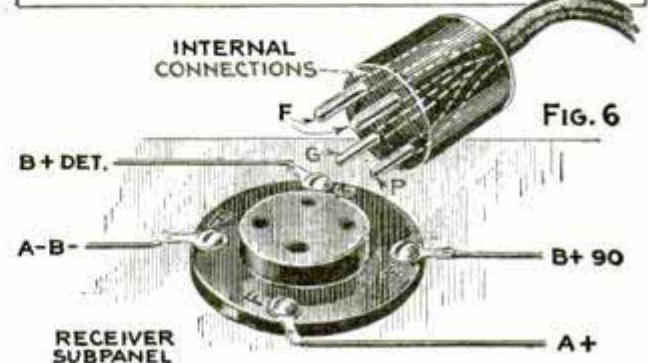
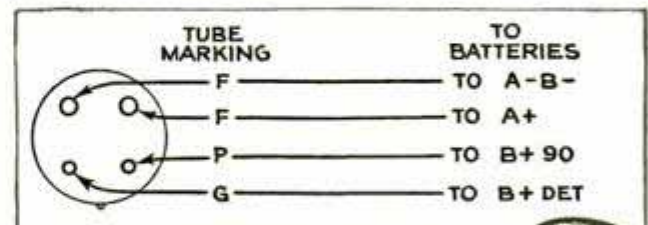

FIG. 6

1190- R
Coil-Winding Kink

tube base may be used. The connections will, of course, vary according to the type of set used, and in all cases the various leads should be tagged carefully so that they can be identified easily.

Loose connections at the battery terminals often make trouble. It is, therefore, a good idea to solder lugs to the ends of the leads that are connected to the batteries, to insure good contact. The lugs are flat and will be held more firmly by the terminal heads than the bared ends.

In all cases use well-insulated, stranded wire, not less than No. 18, for battery connections—never bell wire or wire of similar gauge with thin insulation, as short circuits are sure to occur sooner or later.

Small coils wound on tubing in usual radio practice may have the primary over the secondary as shown in the photo. Empire cloth, paraffin paper or other insulating material is used between them. Coils wound in this manner will be found effective and are neat in appearance as well.

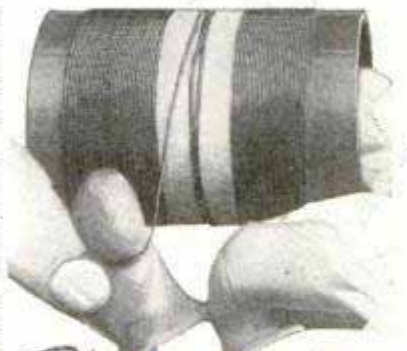

Allograms

Service Hint for Power Units

To obtain the maximum results possible with power units, have the service man set the variable resistances to definite values, or else check them with a suitable voltmeter. Once set, do not disturb them until tubes are changed or other alterations are necessary. Constant meddling with variable resistances upsets the balance of the receiver and causes many unnecessary service calls.

Quieting Loud-Speaker Units

Owing to the greater power available from the new amplifiers now in use, some loud speakers are required to handle more volume than they are designed for, with the result that rattles and other extraneous noises will be heard which were not noticeable with low power. One of the most common causes of rattle is contact of the drive rod with the adjacent cross member which, in most units, extends across the magnet. This noise may be eliminated by slipping a rubber tubing over the drive rod, as shown. Tubing of the right size may be obtained from rubber-insulated flexible or stranded wire.

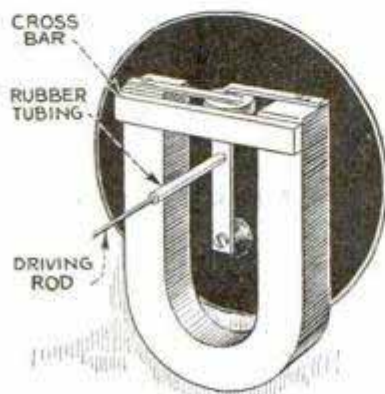

Light Plug from Tube Base



Handy electric-light plugs may be made from old X-type tube bases, as shown in the photo. After removing the tube from the base, two of the prongs are cut off. The ends of the light cord are bared and slipped through the hollow prongs where they are secured at the ends with a drop of solder. Sealing wax, which may be taken from an old battery, is poured into the base, care being taken to keep the wires separated so as to prevent a short circuit. The prongs may be filed to fit a wall socket of the plug-in type, or a socket may be made from a piece of bakelite and two standard contacts, for use at the workbench.—W. J. Rose, St. John's, Newfoundland.

ⓘ The tube life in many receivers may be greatly lengthened by operating the filaments below their normal rating; reduce the filament current to as low a point as possible without interfering with the tone of the receiver.

Facts and Fads for Radio Fans

1839 R.

1765 R.

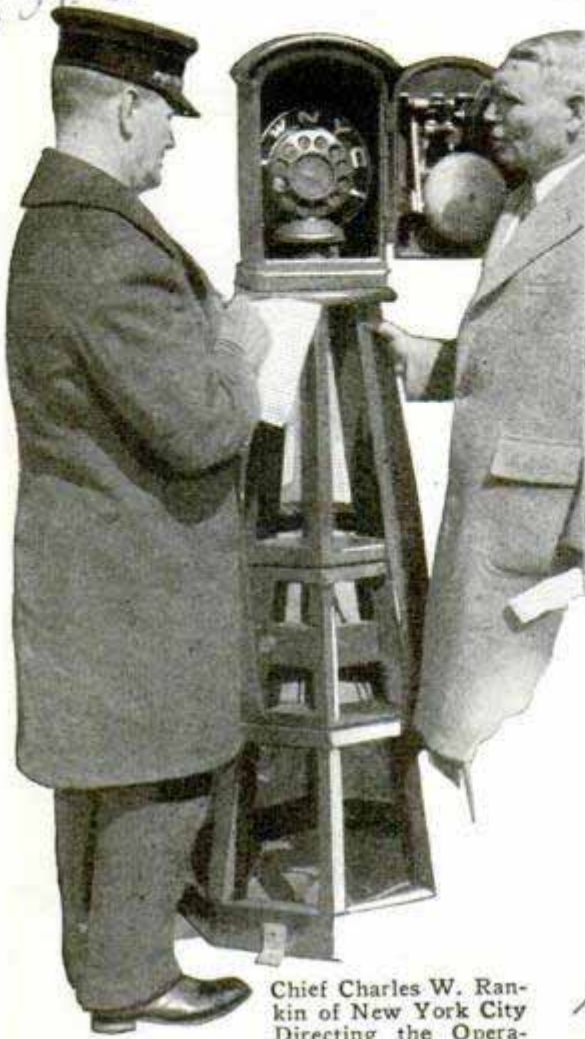

Chief Charles W. Rankin of New York City Directing the Operation of a Fire Boat by Distant Radio

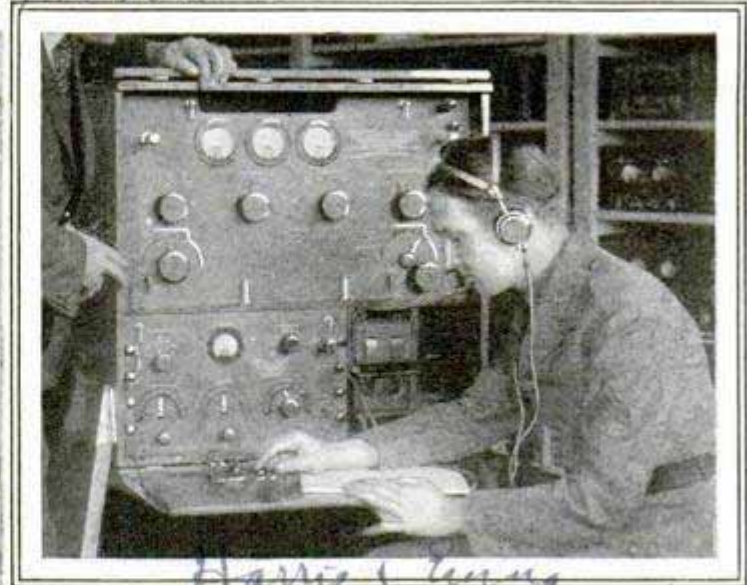

Harris & Ewing

© Harris & Ewing
New Aircraft Radio Equipment, Designed by the Signal Corps, Which Permits Both Telephone and Telegraph Communication, Sending and Receiving at the Same Time



Left, Automatically Controlled Broadcast Receiver, Recently Demonstrated by Its Inventor, Harry N. Marvin, Eliminates Tuning with Dials, the Station Being Obtained by Merely Pressing a Button or Throwing a Lever; Above, Scene in the Office of J. L. Baird, the English Television Expert, When Living Images Were Transmitted for the First Time across the Atlantic; Parts for Elementary Sets Are Now on Sale in a London Department Store on Which Silhouettes Broadcast after Midnight by Mr. Baird May Be Received



type ny

Use Care with Power Apparatus

With the increasing popularity of power amplifiers and packs, radio has entered the field of high-voltage equipment. In many power packs the voltages supplied to the power tubes will exceed 400. In using such equipment, no danger is involved either to persons or equipment if ordinary precautions are taken, but it is well to remember that the current source should always be turned off before changing tubes, equipment or wiring.

Reactivating Radio Tubes

A very simple tube booster, or reactivator, may be made with a bell-ringing transformer tapped for 6, 12 and 18 volts, which can be bought at any electrical store. The circuit provides for both the 199 dry-cell tubes and 201-A storage-battery types. The socket A is for the 199-tube and B for the 201-A type; two d.p.d.t. switches are required to change the tube from the flashing voltage to a lower voltage for aging. The same time is applied

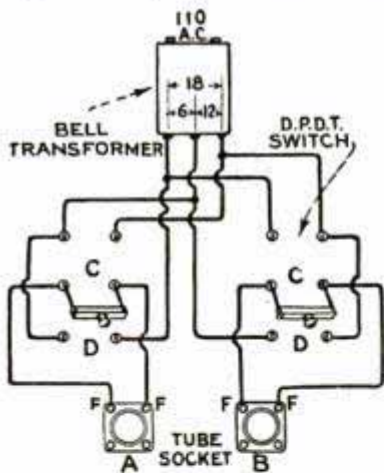

to both types of tubes. They are flashed for one minute at C, and then changed to position D and left on this lower voltage for ten minutes. After reactivating, the tube will be greatly improved, if there was sufficient thorium left in the filament to complete the operation; if there was not, the tube cannot be brought back to normal.—D. A. Brown, Marion, Ohio.

1725-Q

Home Broadcasting Device

The simple device shown in the illustration enables the set owner to broadcast voice or music through his own set, without making any changes in the set or battery connections. The voice is amplified by means of the a.f. stages and is heard in the loud speaker in the same manner as a station. The microphone unit is pro-

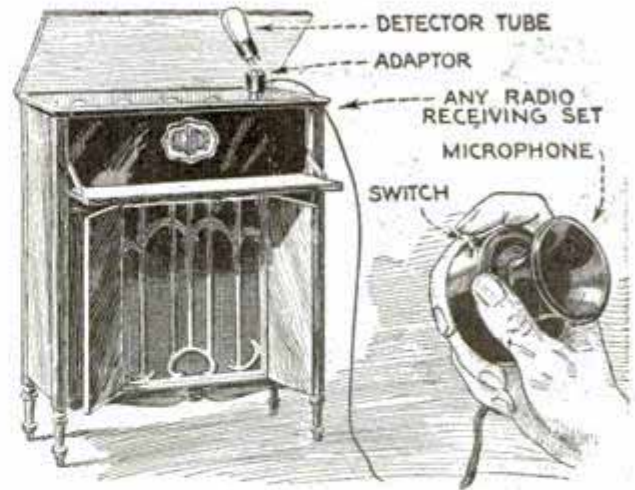

Microphone, Showing the Adapter Inserted in the Detector Socket of the Set

vided with a small switch, which, when pressed down, cuts off the radio program and enables the operator to speak; when the switch is released, the radio program is resumed. To install the device, it is only necessary to remove the detector tube and insert a special adapter in the socket; the tube is then plugged into the adapter, and the instrument is ready for use. A long cord is supplied with the outfit so that the microphone may be located in the next room. If it is desired to broadcast phonograph music, the microphone is placed against the sound chamber of the phonograph and the switch button pressed. A device of this kind may be used for many novel stunts for the mystification of those listening in.

Comb Spaces Battery Leads

In making some alterations in the radio set, the writer disconnected the battery leads and found it necessary to provide some means of keeping them separated, to prevent shorting, and in their proper order for replacing. An ordinary pyroxylin comb was used for the purpose and the various voltages marked on the comb. By stretching a rubber band lengthwise about the comb the wires will retain their respective positions.—Millard Comstock, Buffalo, N. Y.

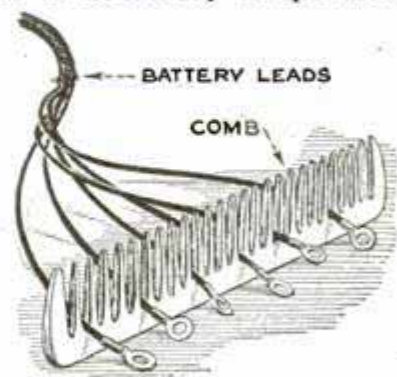

*Brooklyn Metal & Lamp Co
718 Atlantic Ave Brooklyn NY*

New Browning-Drake Uses Screen-Grid Tube

Tube

by
Glenn H. Browning

THE screen-grid tube has a number of advantages when used as a r.f. amplifier, and it has been employed in this capacity in the latest Browning-Drake receiver, with the further

refinement of single control. Too much cannot be said in favor of the new screen-grid tube as a r.f. amplifier. The amplification is so great that this set, using one stage of r.f. amplification with regeneration, and operated on a 10 to 20-ft. antenna, provides as much volume as the writer has ever obtained with a receiver.

The screen-grid tube has two grids, one forming a complete shield around the plate, while the other, which is known as the control grid, and is connected to a terminal at the top of the tube, corresponds to the grid of the standard tube. This tube has two advantages; one is the very small capacity between the plate and

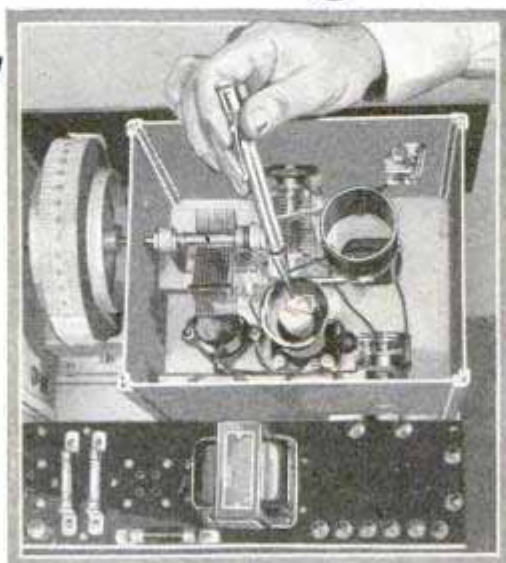

the control grid, the other is tremendous amplification owing to the effect of the screen grid on the mutual conductance of the tube. The small capacity between plate and control grid

makes neutralizing unnecessary in many cases, but, when regeneration is employed on the r.f. transformer, as in this set, any capacity, small though it may be, must be neutralized in order to secure the greatest efficiency.

For the information of those who wish to alter earlier Browning-Drake sets to employ the screen-grid tube in the r.f. stage, the following change is necessary in the circuit. The plate of the screen-grid tube is connected through a .5-mfd. condenser directly to the stator plates of the second tuned circuit instead of to the primary of the r.f. transformer. Thus, as will be noted, the primary of this trans-

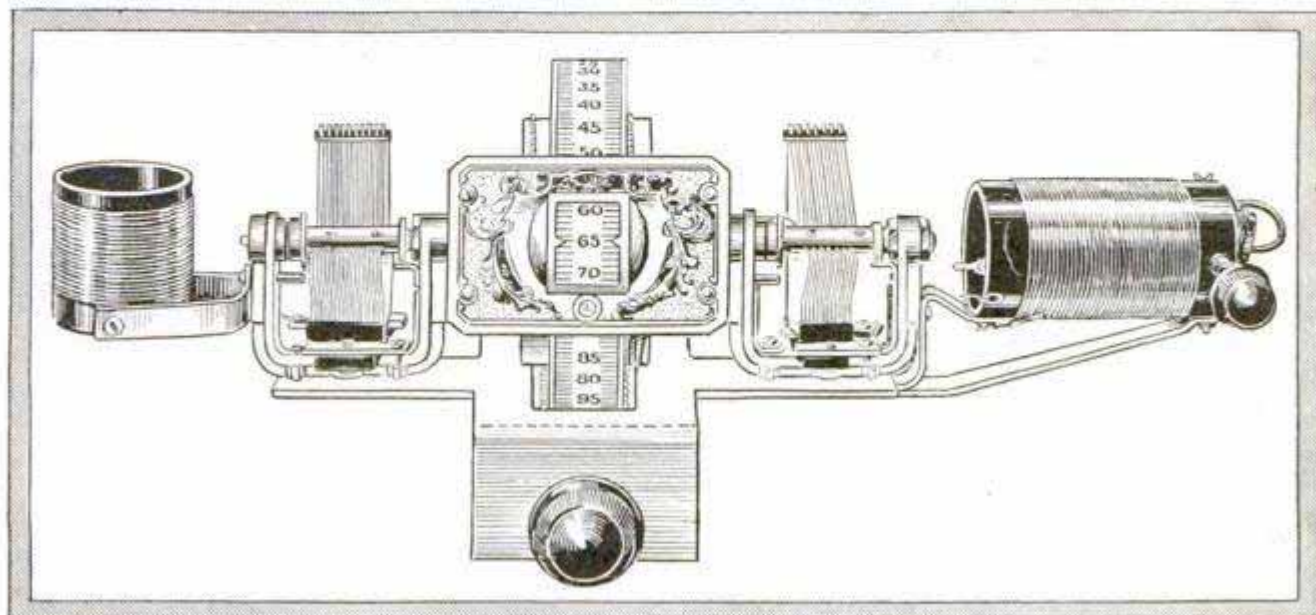

Single-Drum Control Unit with Condensers and Coils Ready for Mounting on Front Panel

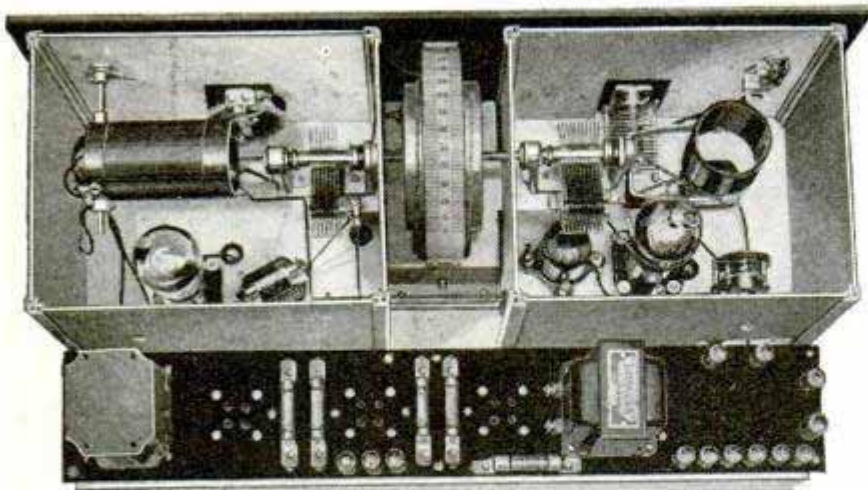

Completed Receiver with Tops of the Compartment Shields Removed, Showing the Screen-Grid and Detector Tubes in Position, and at the Right, Schematic Diagram of the Circuit

former is not used when the screen-grid tube is employed, but it is not detrimental to leave this primary in position; in fact, it is preferable, as the builder might wish to change to a.c. tubes later on.

It is, of course, necessary to provide the resistors shown, to supply the required 3.3 filament voltage and a filament current of .132 amp. for the screen-grid tube; also the .5 mfd. condenser connected between the screen grid and the ground. If the constructor wishes to use the 199 tubes for detection and amplification, and three No. 6 dry cells for supplying the filaments of these tubes, he will find that the screen-grid tube can be quite satisfactorily operated with 3 volts. In this case, the fixed filament resistances are the only pieces of apparatus in the set herein described that must be changed.

The assembled unit shown in the illustration on page 479 is now available and saves the builder a large part of the assembly work. This well-built unit comprises the necessary coils, variable condensers and illuminated vernier dial neatly mounted and ready for installation. The small trimmer and neutralizing condensers are not included, but a neat escutcheon plate for the front panel is provided, and

the vernier knob at front controls the ganged condensers.

The r.f. portion of the circuit and the detector unit must be completely shielded, and suitable heavy aluminum shields are obtainable for this purpose, as shown in the illustration on this page. These shields are easily assembled on the heavy alumi-

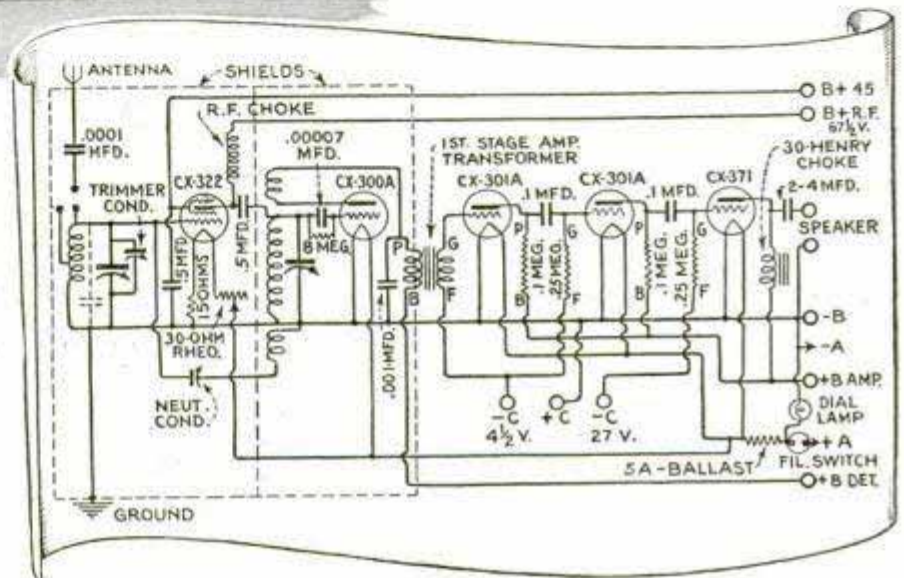

num base by means of grooved uprights and short machine screws, the sides and backs being placed in position after the wiring has been completed, as shown in the upper photo on the opposite page. The front plates are of course assembled when the tuning elements are screwed to the rear of the front panel.

The complete wiring diagram (given on page 478) shows every wire in position. Note that the audio-amplifier portion of the set is mounted on a bakelite shelf at the rear and consists of a transformer-coupled first stage, followed by two resistance-coupled stages. The power-tube output is filtered through the choke coil and either a 2 or 4-mfd. condenser, making an ideal a.f. amplifier. The shelf is supported above the aluminum subpanel on six metal rods screwed to the subpanel. Note that this panel is grounded to negative-A, and is utilized as a negative-A connection at the point indicated by X in the circles; it also completes the circuit to the dial lamp through the metal dial

housing. Rubber gaskets or fiber insulating rings may be used in the holes where leads come through the subpanel, but, as all wiring should be done with flexible rubber-covered hookup wire this is not essential.

The schematic wiring diagram is given on page 480 for those who prefer it to the simplified type. Note in this diagram the taps indicated on the antenna coil for obtaining the effect of either a long or short antenna. A suitable antenna switch may be obtained from any dealer in radio supplies for this purpose if desired, or a simpler method is to use an additional post. It is necessary in some cases to place a small fixed condenser of about 15-mmf. capacity across the first tuned circuit; this condenser is shown dotted in the schematic diagram. However, connecting the .0001-mfd. condenser in series with the antenna, as shown in both diagrams, is usually sufficient to make the trimmer condenser effective.

Little comment is necessary on the audio end of the receiver, as every detail has been taken care of in the simplified diagram. A power tube of the CX-371 type is recommended in the last stage and the proper biasing batteries are shown. The C-bias on the two resistance-coupled stages may be varied from $1\frac{1}{2}$ to $4\frac{1}{2}$ volts, the proper voltage to be found by trial. The C-bias on the power tube, when used with 135 volts of B-battery as shown, will be 27 volts, but, if 180 volts of B is applied, this bias must be increased to 40 or 45 volts. The C-battery for the resistance-coupled stages remains the same. If a B-eliminator is used, it has been found advisable to lower the grid-resistor value

on the power tube to .1 meg., to eliminate any tendency to "motorboat." The .1-mfd. blocking condensers are mounted directly under each of the double resistor mounts, and the terminals are indicated at X in the wiring diagram; each of these condensers is connected directly across G and P of each resistance-coupled stage. When wiring the socket for the screen-grid tube, note that the negative-A connection is taken from the socket-mounting screw at the front, which, being connected to the metal subpanel below carrying the negative-A supply, eliminates extra wiring. This negative-A connection is taken to the negative filament post on the socket through the 15-ohm resistor. Also note that one side of the .5-mfd. fixed condenser nearest this socket is grounded to the subpanel through the other mounting screw of the socket, both of these points being indicated by the X in the circles. The negative filament connection for the

Right, Assembling the Shields After Wiring Is Done; Below, Rear View of Completed Instrument

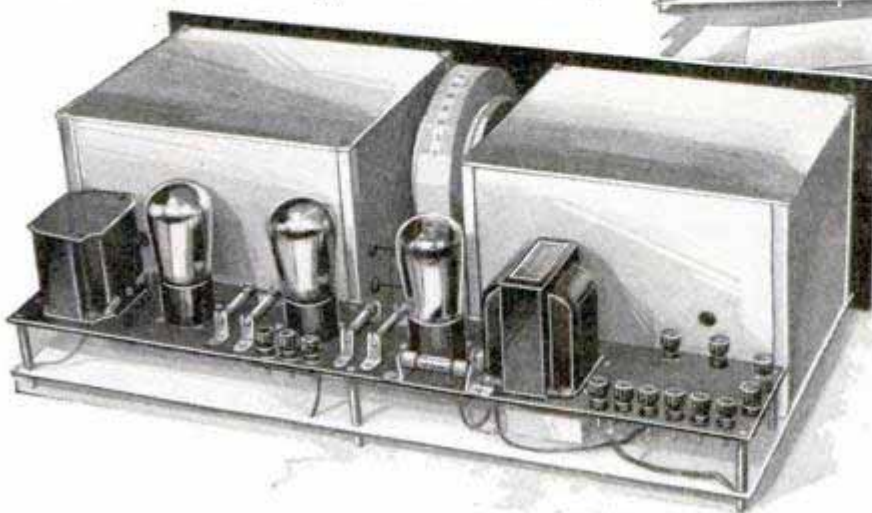

detector tube is also taken directly to the metal subpanel either through a wire run to the socket-mounting screw or by extending the negative binding-post screw down through the subpanel.

When the receiver is

completely constructed and connected, neutralization may be effected in the following manner: The compartments which



Front Panel Showing, from Left to Right, Switch and Trimmer Condenser Knobs, Dial Knob, and Rheostat and Tickler Knobs

contain the r.f. and detector circuits should have the shields completely on and screwed down as shown in the lower photo on page 481. The operator should then set the dial at about 20 on the scale and turn the tickler by means of the knob on the front panel, either in one direction or the other, until a distinct click is heard in the speaker or headphones. Next adjust the tickler coil until the detector circuit is not oscillating. A test to determine whether or not the set is oscillating is to place the finger on the terminal of the .5-mfd. condenser, which is connected to the grid of the second tuning circuit (to get at this condenser the top of the shield on the screen-grid tube compartment must be removed). The terminal referred to is the one with the lead running through the side of the shield. A distinct click will be heard if the circuit is oscillating. Then turn the tickler back to where oscillation just ceases. Turning the trimmer condenser will then throw the circuit into oscillation if the neutralizing condenser is not properly set. The neutralizing condenser should be adjusted until the trimmer condenser has no effect on oscillations produced in the detector circuit. It will be found that the neutralizing condenser must be set almost at a minimum value. Stations may now be tuned in at will with the vernier dial knob without further adjustments. Where extreme selectivity is required, a short aerial will give the best results, but try various lengths from 10 to 40 ft. for best results.

A postal card will bring you, free, a list of parts for this set, with prices, and enlarged blueprints of the circuit diagrams may be obtained by sending 25 cents to Popular Mechanics Radio Department. Specify blueprint No. 135.

Simple Panel for Speaker Connection

In wiring connections to various parts of the house for the loud speaker, a small phone-tip-jack panel proves a convenience. The usual speaker jack, because of its size and shape, is not easily concealed. It can be replaced, however, by a little panel that can be screwed underneath a window ledge. Procure two $\frac{3}{4}$ -in. nickered brackets from the hardware store, or bend two such brackets from $1\frac{1}{2}$ -in. lengths of $\frac{1}{2}$ -in. wide brass, drilling a hole near each end to take the bolts and screws. Cut a strip of bakelite, $\frac{3}{4}$ by $2\frac{1}{4}$ in., from a scrap of old radio panel. Lay the brackets on it, flush with one edge and the ends, and mark and drill the bolt holes. Get two small phone-tip jacks, and drill and mount them on the panel between the brackets. Saw off the ends of the bolts, and attach the panel, wiring the speaker extension to the jacks.

Gauging Reamed-Hole Sizes

The writer recently lost a front panel and considerable layout time, all because

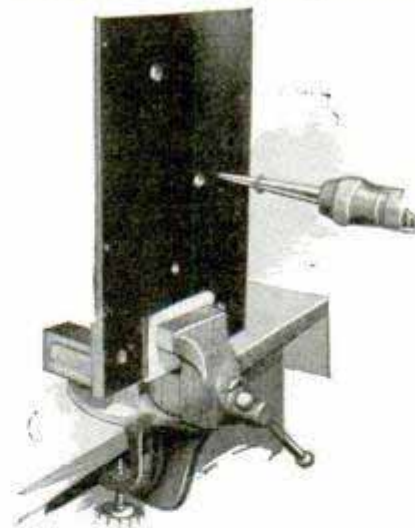

he reamed one hole a bit oversize. This has happened to many others, and it is not irreparable, but, in this case, the job was not for personal use, and it had to be just right. To prevent a possible repetition,

I obtained some ordinary flat iron washers with from $\frac{1}{4}$ to $\frac{5}{8}$ -in. holes. The washers were reamed to the sizes desired and to clean out the holes, then heated over a gas jet and dropped into water to harden them. Now, when reaming a hole in a panel with a taper reamer, I just slip the proper size of washer over the end of the reamer, and, as it butts against the panel when the reamer has gone deep enough, I cannot make the hole too large.—E. R. McCoubrey, Pawhuska, Okla.

*1695. A. ...
2300 Western Ave.
Chicago*

How to Obtain C-Voltages

It is universally agreed that C-batteries are necessary in the present-day receiver for economical and satisfactory operation.

4½-volt tap in the C-battery, and so on. The B-battery shown in Fig. 4 is a convenient size, having five taps and weighing only two pounds. To use this same battery as a C-unit, as shown in Fig. 5, some man-

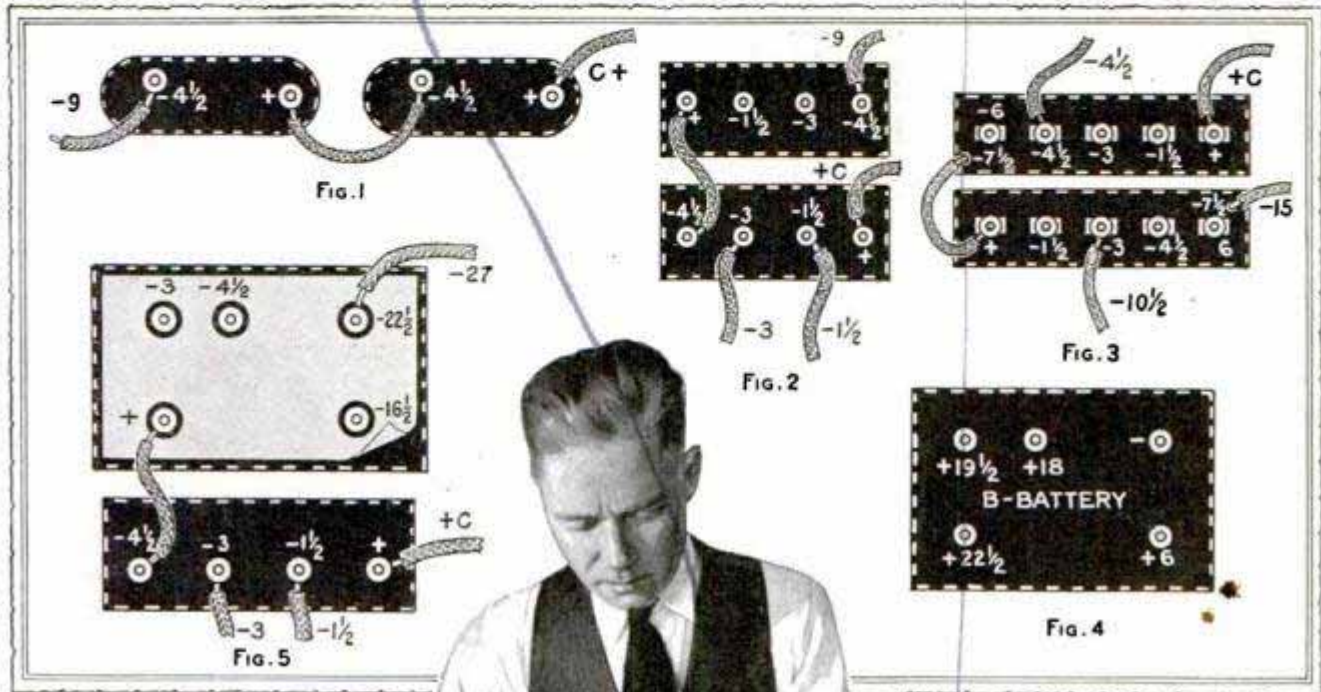

The correct C-voltage for various types of tubes, when used with specific B or plate voltages, is important, and charts giving this information come with the tubes, but as the voltages vary over a wide range it is often quite difficult to obtain single C-battery units for the purpose. Small standard C-batteries may be connected in series to obtain the common lower values as shown in Figs. 1, 2 and 3, but for the higher voltages this is not practical and a larger unit is necessary. In this case the B-battery shown in Fig. 4 may be utilized for C-battery purposes and combined with a small standard C-battery as shown in Fig. 5, or with an additional B-block to give any required biasing voltage.

However, when using B-batteries for C-battery purposes it should be kept in mind that B-batteries are marked from the negative end, the 22½-volt terminal being the positive, as shown in Fig. 4, while C-batteries are marked from the positive end and the high-voltage terminals are negative. The intermediate values vary in the same way, what was the positive 18-volt tap in the B-battery becoming the negative

manufacturers supply a perforated, white cardboard sheet correctly marked for C-battery values, as shown in the illustration. If this cover is not supplied, it is a simple matter

to cut one out and mark it in the same manner, noting carefully the reversed voltage values.

Electric Plugs of Soft Rubber

A new electrical plug of unusual design has made its appearance on the market. It is made of solid, soft rubber and may be dropped and knocked about without injury. Several designs are available for household appliances, office and radio equipment, portable shop tools, and all other devices requiring plugs. They are shaped to form a handy finger grip.



⊠ Oscillator tubes work best at the lowest practical plate voltage, which is from 17 to 15 volts, according to the circuit used.

1691-A

Chicago - 111 W Monroe

Burgess Battery Co.

Allen C. Caravelle N.Y. & 81 Prospect St. Brooklyn, N.Y.
Giant Air Dielectric Condenser

Two condensers of the type shown were recently built for use in a 50,000-watt broadcasting station, which are believed to be the largest ever built as an article of sale by a manufacturer of a standard line of radio condensers or accessories. As may be seen, the plates differ from the ordinary form in that they have rounded edges of fairly large radius, which reduce leakage. Laboratory tests have shown that voltages, approximately two-thirds higher than would be possible with flat plates, may be safely used with this design. This condenser will stand pressures up to 60,000 and 70,000 volts. It is approximately 42 in. high, 30 in. in diameter and weighs about 350 pounds.

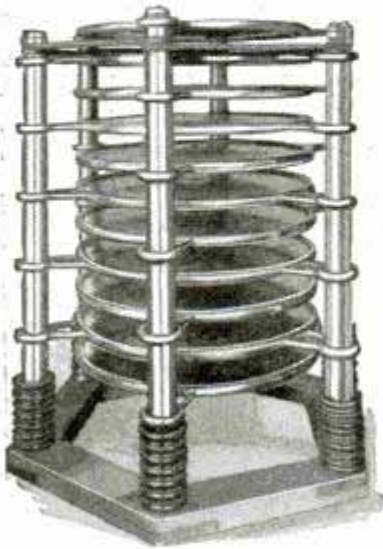

Contacts for Vibrating Charger

The writer uses a charger of the vibrating type, and the little kink illustrated saved a good program and a 40-mile trip for new contact points when the original ones burned out. The vibrator spring was taken from a Ford coil and the end indicated by dotted lines cut off. Two extra holes were then drilled in the spring to take the small mounting screws in the charger. The lower contact was obtained from the local accessory store, and although the contacts were smaller than the original ones they have given

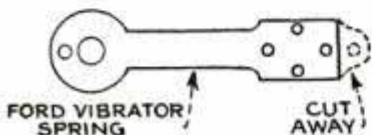
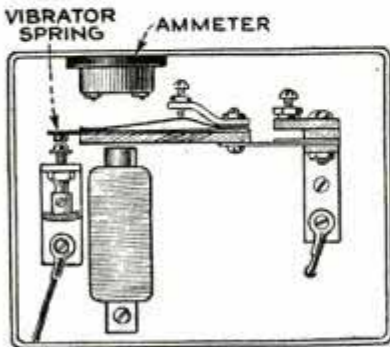

good service. The new spring was mounted under the old one and the setscrew above readjusted until the ammeter indicated the proper charging rate.—C. S. Cook, Mount Hamilton, Ontario, Can.

Heavy Wire for A.C.-Tube Circuits

One of the most important things to watch in using the new a.c. tubes of the CX-326 and C-327 types is that the wire for the connections to the filaments should be heavy enough to carry the required current. Ordinary battery cable is not heavy enough; rubber-covered twisted pair lengths, not smaller than No. 18, and larger if possible, should be used.

Handy Hint for Set Builders

When building radio sets, it is often necessary to place nuts in positions not accessible with the fingers. To meet this difficulty, saw the end off of a cheap screwdriver, or other similar tool, provided with a round shank slightly larger than the opening in the nuts. Thread the end to take one of the nuts, then cut a piece of spring brass to the shape shown and slip it over the shank of the screwdriver. The nut can now be screwed on tightly and locked in position by means of a center punch or by heading up the end of the shank. Bend the projecting tabs of the brass piece over the side of the nut as shown, and clamp them in position in a vise, after which they may be soldered firmly in place. Nuts can now be picked up from any flat surface and will stick in the opening until placed on the screw. If heavy brass is used for the clamping flanges, the nuts may be tightened sufficiently without using any other tool. It is, of course, necessary to make a tool for each size of nut used.

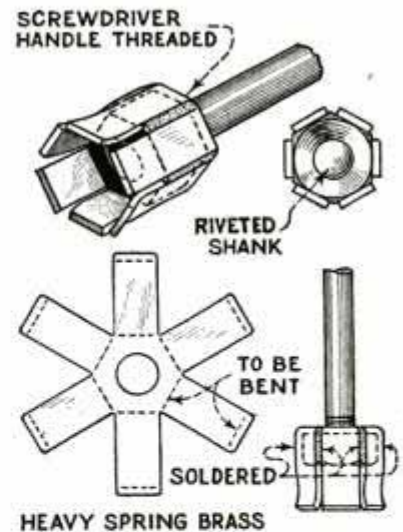



A New Use for Old Tubes

Here is an idea I have found useful and no doubt there are many radio experimenters who would like to try it. Most experimenters possess some discarded old-style 1-amp. tubes. These can be used to good advantage as rectifiers. The writer has a B-eliminator employing a Raytheon tube and by accident the tube was broken. Filament rectifiers are very efficient, and having a number of old-style C-300 and C-301 tubes, I decided to alter the eliminator so that they could be used. The eliminator had a $7\frac{1}{2}$ -volt winding for lighting the filaments of the tubes. Where the eliminator is used with sets having less than four tubes, two C-300 or C-301 only will be necessary. Four tubes are used as rectifiers in order to insure a uniform output where there is a heavy load on the eliminator, as in the case of multi-tube sets. The old tubes will give an even flow of B-current and will continue to do so for a long time. In case there is no provision in the eliminator for a $7\frac{1}{2}$ -volt filament supply, old tubes of the C-301A type may be employed as rectifiers if an ordinary bell-ringing transformer is used for the filaments.

Four of these tubes require but 1 amp., and the bell-ringing transformer can sup-

ply a maximum of $1\frac{1}{4}$ amp. at 8 volts. If the filaments burn too bright, a heavy resistance should be put in series with the filament lead.—G. Niemann, engineer, Benjamin Electrical Mfg. Co., Chicago.

Paste Protects Battery Terminals

A paste that will prevent corrosion at battery terminals may be prepared very cheaply at home. Corrosion is checked by service men by the use of grease or vaseline, but although this prevents creeping of the acid, some alkaline preparation should be used in connection with either to neutralize the acid. Fill a $\frac{1}{2}$ -pt. cup with a cheap grade of vaseline, transfer this to a pan and melt it over a slow fire. When melted, add 3 tablespoonfuls of common baking soda, remove the pan from the fire and stir the mixture until cool. Spread the paste over the battery terminals after they have been thoroughly scraped and cleaned. Any acid solution that has been sprayed over the top of the

battery when charging or spilled when a hydrometer reading is taken, should be carefully removed with a rag that has been moistened with a weak solution of household ammonia.—

Harry Saine, chief engineer, Station KQW, San Jose, Calif.

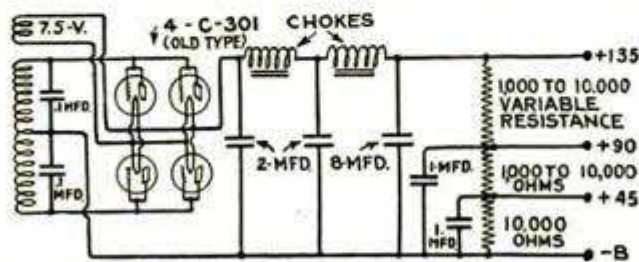

Schematic Diagram, Showing the Method of Using Old Tubes as Rectifiers

Voltage Supply for Test Table

Connecting and disconnecting batteries and power supply, to test or demonstrate radio sets or other apparatus on the ex-

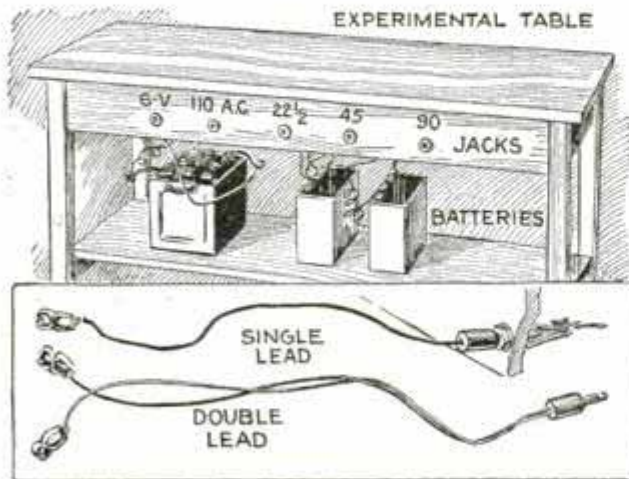

Above, Table Showing Jacks with the Various Voltages Indicated; Below, Single and Double Leads

perimeter's table, is not only tedious but mistakes are likely to occur. The idea illustrated in the sketch was used in a busy radio store where several sets an hour had to be demonstrated, and anyone can use the same idea and will find it very handy. Several holes were drilled at the side of the table, and radio jacks were inserted and wired to the batteries hidden under the table. Several plugs with long leads, either single or double, were used for connecting the various voltages to the sets demonstrated. The jacks may be placed under the top of the table if desired.—H. R. Wallin, radio operator, Brooklyn, N. Y.

Insulating the Screwdriver

It is frequently necessary to make slight adjustments within a radio set when it is in operation. It is common practice to use a screwdriver for this purpose, but, even in the hands of an expert, this may cause a short circuit that will result in burned-out tubes. To prevent this, the screwdriver should be insulated, and there are three ways of doing this effectively: The first and simplest con-

sists in carefully covering all but the edge with insulating tape; the second is to slip a length of rubber tubing over the metal shank, and the third, for small screwdrivers, is to use spaghetti.—E. Stuart Capron, consulting engineer, Buffalo, N. Y.

Simple Control Relay

There is a tendency to control some of the new trickle chargers and B-eliminators by means of the filament battery switch on the panel of the radio set. Actually this does not perform the desired function in all cases, owing to the fact that most of the trickle chargers should be disconnected from the 110-volt supply when the set is in use. The simple relay shown in the diagram is an inexpensive homemade affair, and controls both the charger and B-eliminator, automatically switching the 110-volt a.c. supply from the trickle charger to the B-eliminator when the set is in operation.

The heart of the device is a good doorbell buzzer, and, in selecting this, there are three points to bear in mind: First, make sure the contacts are good; second, see that the magnets and contacts can be removed for remounting, and third, that the magnet coils are of fairly heavy wire. A piece of scrap bakelite or hard rubber, about 4 by 4 in., is required for the mounting base. Disassemble the buzzer from its metal base and drill a hole, to pass a 6-32 screw, in the base of the contact point. Then drill two holes in the base of the magnet assembly for the same size screws, and one in the armature base. Take a spring with a good contact from an old jack, and bend it so that the contact point will come opposite the armature contact when both are remounted on the bakelite base. Now mark the holes

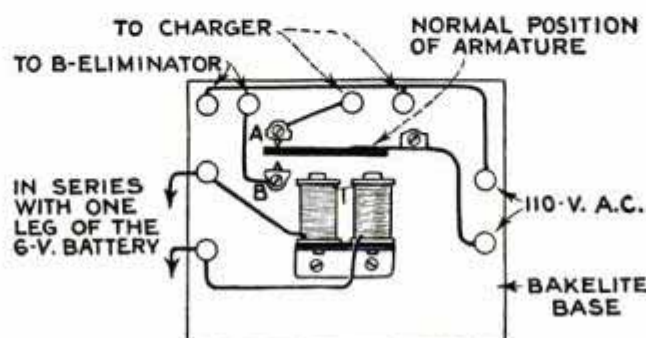

Layout and Wiring Diagram for Control Relay

for mounting these parts according to the layout. No exact dimensions have been given because they will vary with the type of buzzer selected. The assembled relay may be mounted under the table or in the battery compart-

ment of the console, where the wiring may be hidden. When, in operation, the filament switch on the set is turned to the on-position, the filament-current drawn by the tubes closes the B-eliminator contacts at B, automatically supplying B-power to the set and at the same time shutting off the a.c. supply to the trickle charger. In this way the tubes are protected from surges in the line of voltage, and much hum is eliminated.—J. B. Bayley, chief engineer, Station WAAT, Jersey City, N. J.

Two Sets on One Aerial

Frequently it is desirable to use separate broadcast receivers in different parts of the house, or to experiment in the workshop with several receivers. Even if only one aerial is available, this can be done by the arrangement shown which quickly shifts the aerial and ground from one set to the other. Two d.p.d.t. switches of the small panel-mounting type are required and may be mounted under the table or at any convenient location near the installation. With switch A thrown to the right and switch B to the left, the aerial and ground will be connected with

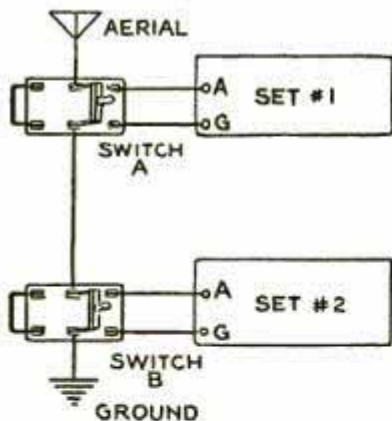

set No. 1, and reversing the switch arms will cut out set No. 1 and throw the aerial and ground to set No. 2. This method is handy in conducting comparative tests of receivers.—J. M. Pawson, chief engineer, Station WOO, Philadelphia, Pa.

Power Installations Require Air

If you are using a console or cabinet and house the power unit in an inclosed compartment, air vents should be provided, because some rectifier tubes generate considerable heat. The simplest way to do this is to drill holes in the back of the compartment as shown. A few other timely hints on the proper installation of power apparatus may be appreciated, as

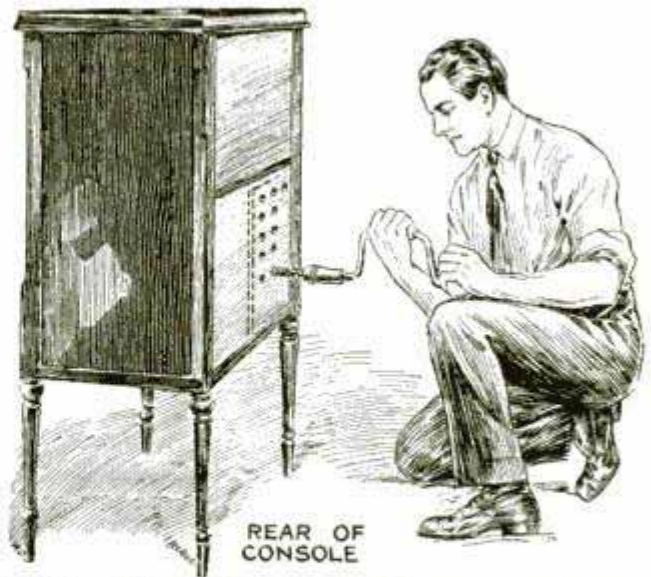

Drilling Holes, to Provide Air Circulation in Power-Unit Compartments

a great deal of the present apparatus was built before the new high-voltage rectifiers came into use. Careful attention should be given to insulation. Use the heavy insulated wire now available for power-unit connections and see that jacks or switches are not of antiquated, poorly insulated types. There are a number of safe and efficient relays to throw the 110-volt a.c. supply off and on the B and A-eliminators, or charging apparatus. Another precaution well worth while is to put a piece of asbestos under the rectifier tube, and between it and other near-by apparatus.—J. B. Bayley, chief engineer, Station WAAT, Jersey City, N. J.

Cone-Speaker Kink

In some cones used for loud speakers, the paper is much too thin to respond properly to the volume available, resulting in poor reproduction. To remedy this condition, pour melted paraffin in the apex of the cone as shown. This will lower the pitch of the speaker and slightly drop the volume, but this loss may be compensated for by readjusting the volume-control on the set. The method may be applied to practically any type of cone speaker and is well worth trying.—M. G. Goldberg, engineer, Beacon Radio Service Co., St. Paul, Minn

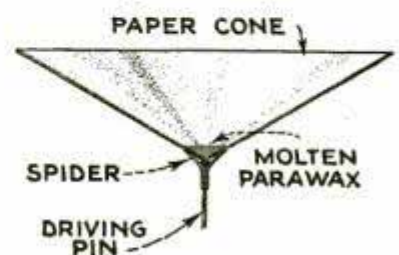

Homemade Underground Antenna

A homemade antenna of this type may be made for experimental purposes at a small cost, although, of course, it cannot be compared with the manufactured article.

The simple antenna described will produce good results. A section of rubber garden hose, from 50 to 100 ft. long, is required. A length of No. 14 rubber-covered wire, one end of which is taped, is pushed through this hose, and the hose is sealed by bending it over as shown, tying it with wire or by means of a wooden plug. Examine the hose carefully for holes through which moisture can enter, and if none are found, bury it as deep as possible in a narrow trench. The end of the hose nearest the building is turned up as shown. A length of lead pipe should be slipped over the wire at this point, several inches of the pipe being inserted in the ground. This pipe shields the antenna wire to a point as close to the aerial binding post on the set as possible. —H. R. Wallin, radio operator.

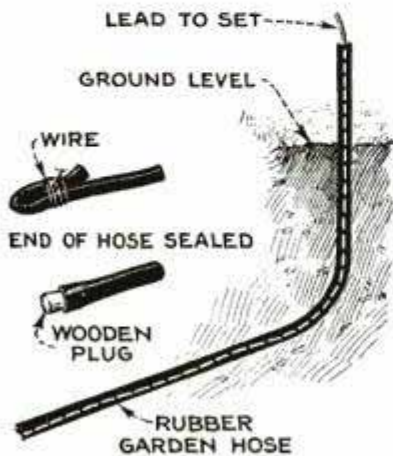

Repairing Headphones

Many sets of headphones are discarded because of burned-out coils, although they could be salvaged by a simple repair. I am offering the following suggestion. Usually there is only one open circuit when the phones fail to work, and as most phones have two coils of very fine



wire, shorting each phone enables the operator quickly to locate the faulty unit. It will be found that the coils are connected in series, and the

simple expedient of shorting out the defective coil will complete the circuit as shown in the diagram. Of course the repaired unit will be somewhat weakened but not seriously so.—C. R. Yarger, chief operator, Station KFNF, Shenandoah, Ia.

Simple Method of Testing B-Batteries

Sometimes B-batteries will check properly for voltage but, when hooked up in the circuit, fail to work. This is due to the run-down condition of the battery and, though the voltage reads high on an open circuit, it immediately drops when a load is placed on the battery. In order to determine just how much service may be expected from the battery, the writer has used the following method for the past six years with unfailling results: A 40 or 50-watt lamp of the Mazda (not carbon) type is used as shown in the sketch. A wire is soldered to the screw base of the bulb and another to the tip connection on the base. One wire is then connected to the negative post of the B-battery and the other wire momentarily touched to the positive post of the battery. If the bulb lights to about half the brilliancy obtained when used on the ordinary house supply, the B-battery is in good condition. On the other hand, if the bulb fails to light, or is very dim, the battery is exhausted and should be replaced. This test is not very hard on the battery, as the resistance of the bulb is in series with the battery, and very little current is therefore consumed in making the test.—Edward Stanko, chief engineer, Station WGR, Buffalo, N. Y.



Popular Mechanics' radio department offers its information service free to all readers of our magazine.

AMATEUR MECHANICS



Getting the Most Out of Your Outboard Motor

By DICK COLE

AN OUTBOARD motor, like any other mechanical device must receive a certain amount of intelligent attention and care if it is to function at its best. This can be given only when the mechanical workings are understood. So let us review the mechanics of the outboard motor.

At the present writing, all outboard motors are of the two-cycle type. Nearly everyone, in this age of automobiles, has at least a limited understanding of the

four-cycle motor. He knows that each cylinder fires once with every two revolutions of the crankshaft; that each stroke of the piston constitutes a cycle, and that the four cycles are: intake, compression, explosion and exhaust.

In the so-called two-cycle motor the four cycles, or operations, take place dur-

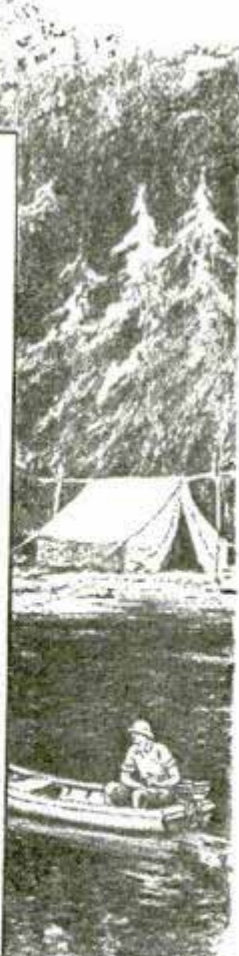
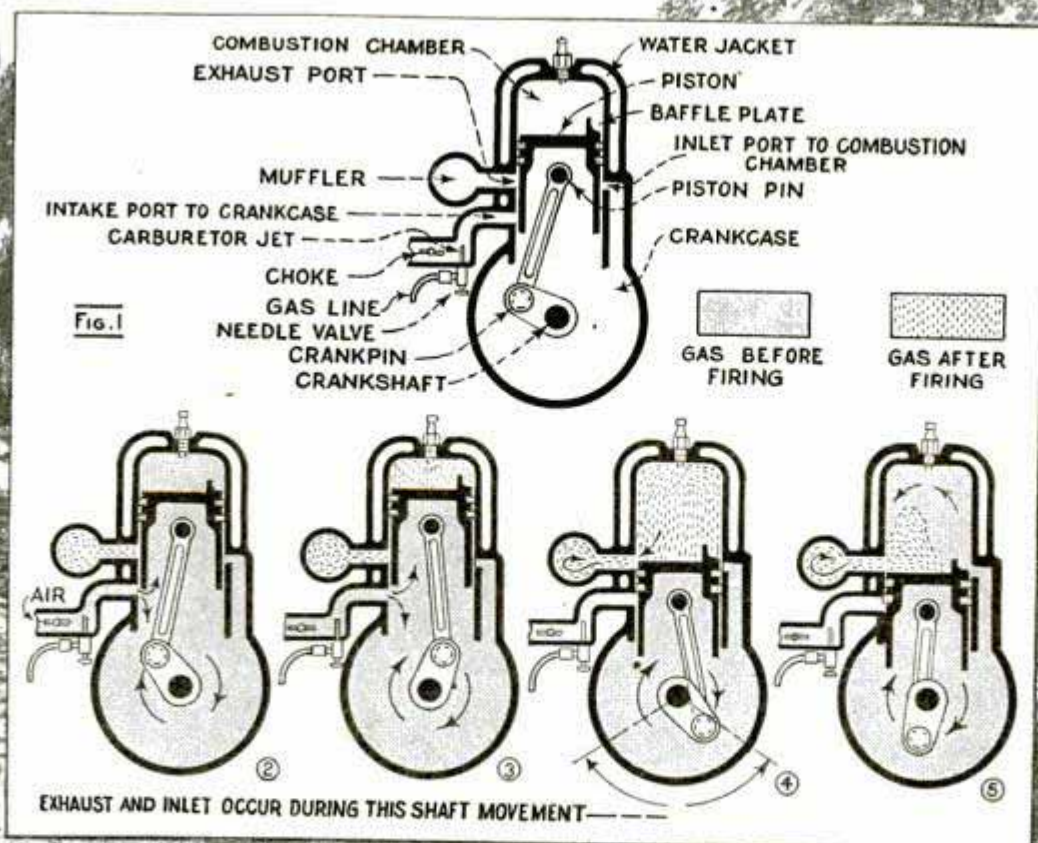

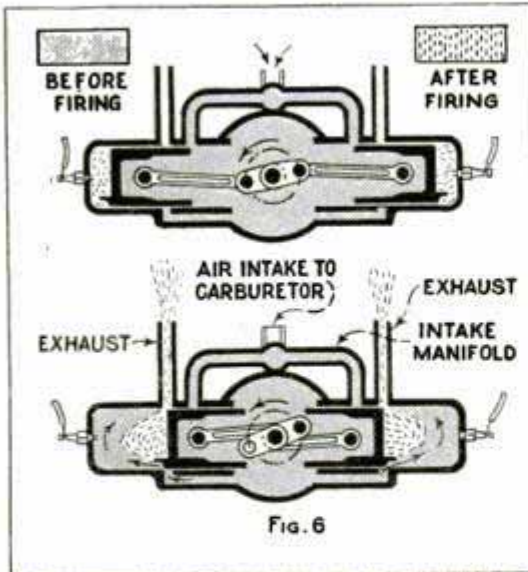

Fig. 6

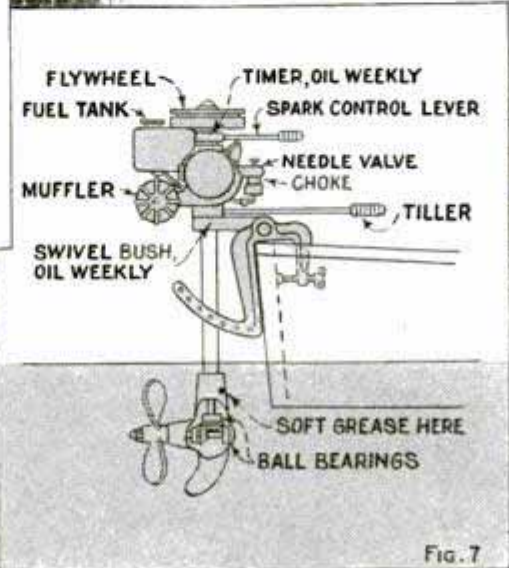
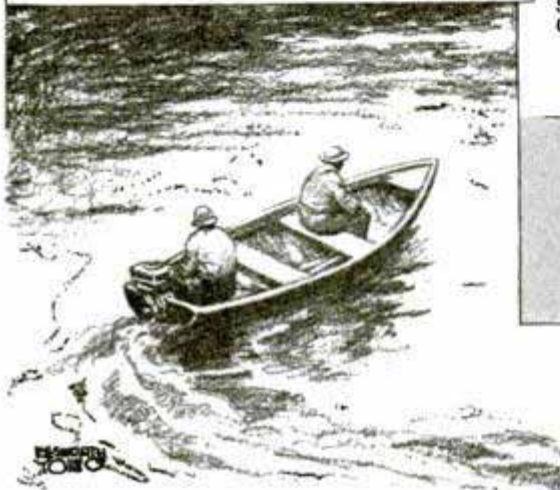

Fig. 7

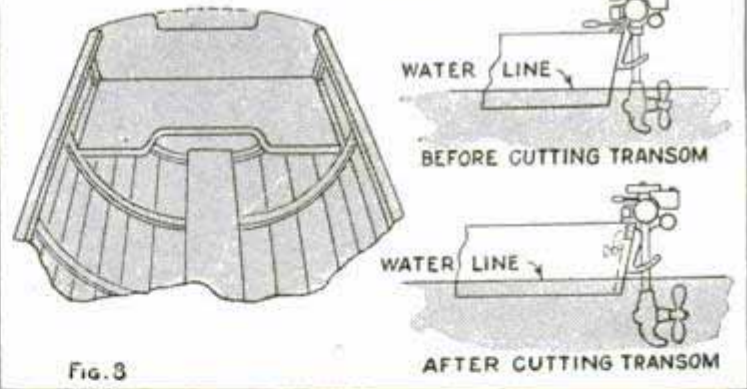

Fig. 8

ing two strokes of the piston, instead of four. The name two-cycle is really a misnomer. Two-stroke four-cycle defines it better. However, I will continue to call it two-cycle. Fig. 1 shows this type in its simplest form. The upper sketch designates the principal parts of the motor. Let us assume that the motor is running, and we start analyzing its operations, beginning with the piston as shown in Fig. 2. It is nearly at the top of the stroke and has compressed the gas above it. At the same time a partial vacuum has been created in the crankcase. At the position shown in Fig. 2, a port, communicating with the carburetor, is uncovered by the bottom rim of the piston. There is an inrush of gas mixture into the crankcase from the carburetor or mixer valve. Fig. 3 shows the piston just over top center. The spark occurs at this point, firing the gas taken in during a previous stroke. The piston is forced downward on the explosion, or impulse,

stroke, compressing, at the same time, the mixture already drawn into the crankcase. When the piston reaches the position in Fig. 4, the exhaust port is uncovered by the top rim of the piston and the gases rush out into the muffler. A fraction of an inch farther down on the stroke the piston uncovers another port, diametrically opposite the exhaust port. (See

Fig. 5.) This communicates with the crankcase, in which a volume of gas mixture already has been compressed. This gas rushes into the combustion chamber, strikes against the baffle plate on the piston and is diverted upward, displacing most of the exhaust gases of the previous explosion. The piston is now ready to resume the position of Fig. 2 and repeat the cycles.

It is obvious that the four cycles take place (intake, compression, explosion and exhaust) but the exhaust and intake cycles occur during the brief period from the uncovering of the exhaust port on the downstroke to its closing on the upstroke. The compression and explosion strokes are the same as in a four-cycle motor.

For outboard-motor use, the single-cylinder motor has been almost entirely supplanted by the opposed-type twin-cylinder. Fundamentally, it is the same as the single-cylinder. Fig. 6 shows its operation. Note that the cycles in each cylinder coincide with each other.

Contrary to the belief of many people, the two-cylinder two-cycle opposed-type motor does not double the number of explosions per revolution. Both cylinders fire simultaneously. What, then, you might ask, is its advantage? The two-cylinder construction affords perfect mechanical balance of the reciprocating parts. Even the explosions are balanced, as it were, all of which tends to lessen vibration. Also, by the addition of the second cylinder, the power can be doubled with only a slight increase in weight.

While we are examining the two-cycle motor, it may be well to call attention to several points where its operation

differs radically from the four-cycle type. This should enlighten the outboard-motor operator as to why he must not fail to do certain things.

The older two-cycle motors cannot be satisfactorily controlled with a throttle. Reference to the internal workings explains why. Regardless of engine speed, a full charge of fresh gas mixture is always necessary to displace the burnt, or exhaust, gas of the previous explosion in the cylinders. If the amount were skimped, as would be the case if the throttle were

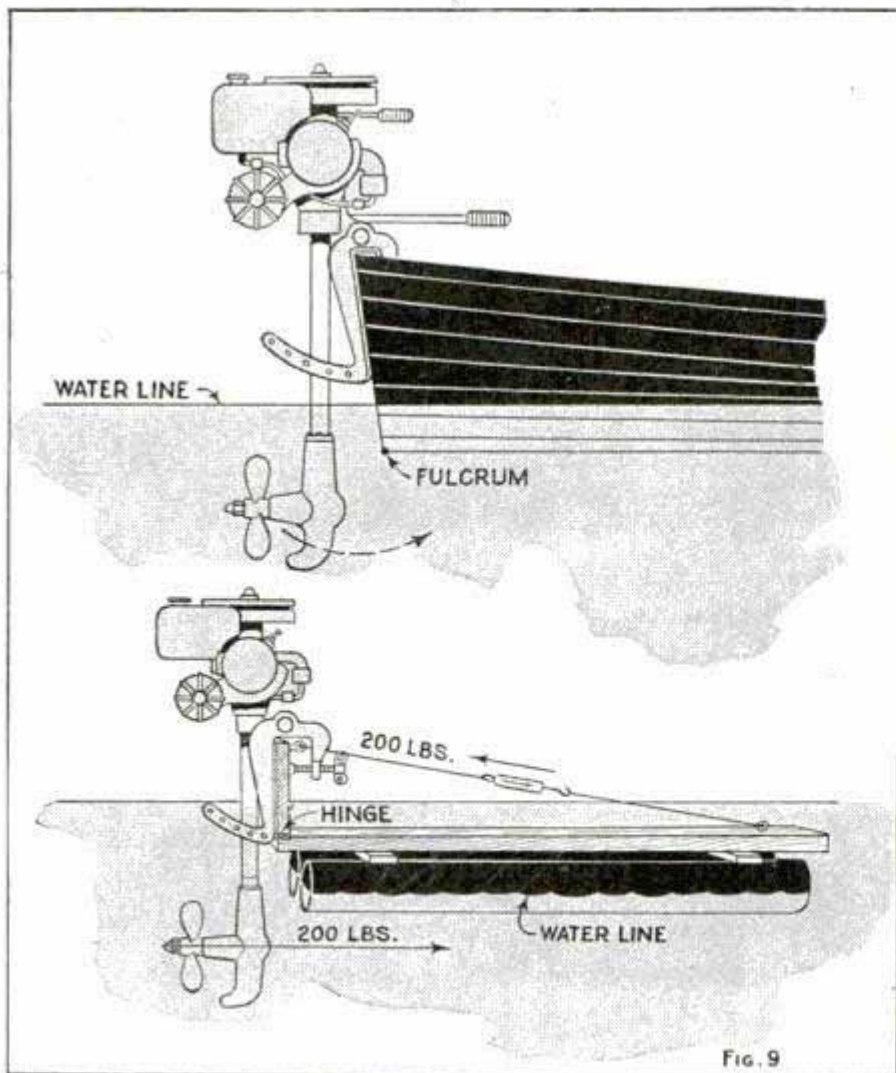
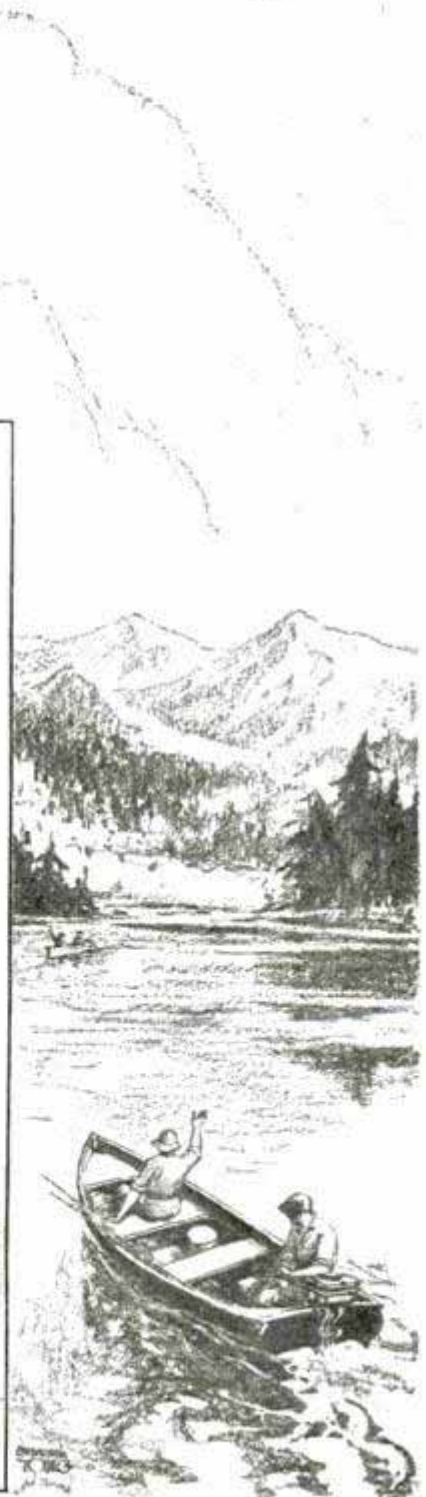

FIG. 9



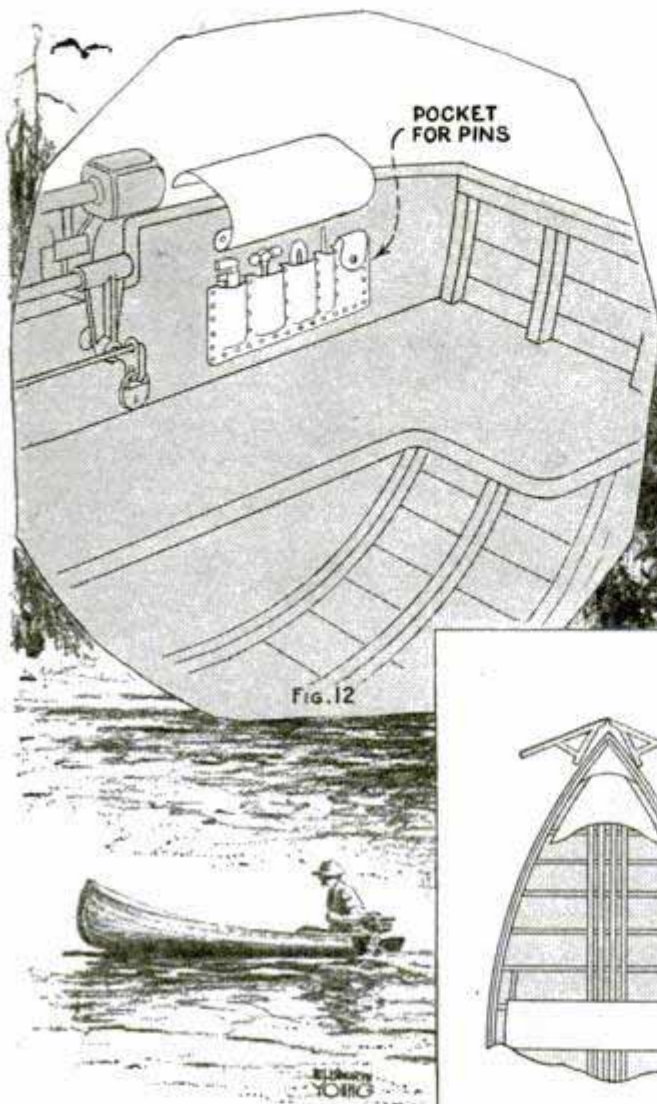

Fig. 12

partly closed, then the fresh charge drawn into the crankcase and later injected into the cylinder, would be so diluted with the residue of burnt gas of the previous explosion that the spark could not ignite it. Only to a very limited degree can the older two-cycle motors be controlled by a throttle. The speed is regulated by varying the spark position, and the manufacturers allow for a wide range of spark. Motor manufacturers have overcome this trouble, however, and modern outboard engines are quite satisfactorily controlled by the throttle.

Another feature of the two-cycle motor that differs widely from the four-cycle is the method of lubrication. The splash or pressure systems, as used in the automobile, cannot be employed in the two-cycle motor. The reason is obvious. If an unrestricted amount of oil were permitted

in the crankcase, it would be carried with the gas mixture into the combustion chamber on the intake cycle. Fouled spark plugs immediately would result.

The two-cycle motor is lubricated by mixing a quantity of oil with the gasoline. This oily mixture is drawn into the crankcase and the revolving crank throws it upon the cylinder walls. It also finds its way to all bearing surfaces. Much of the

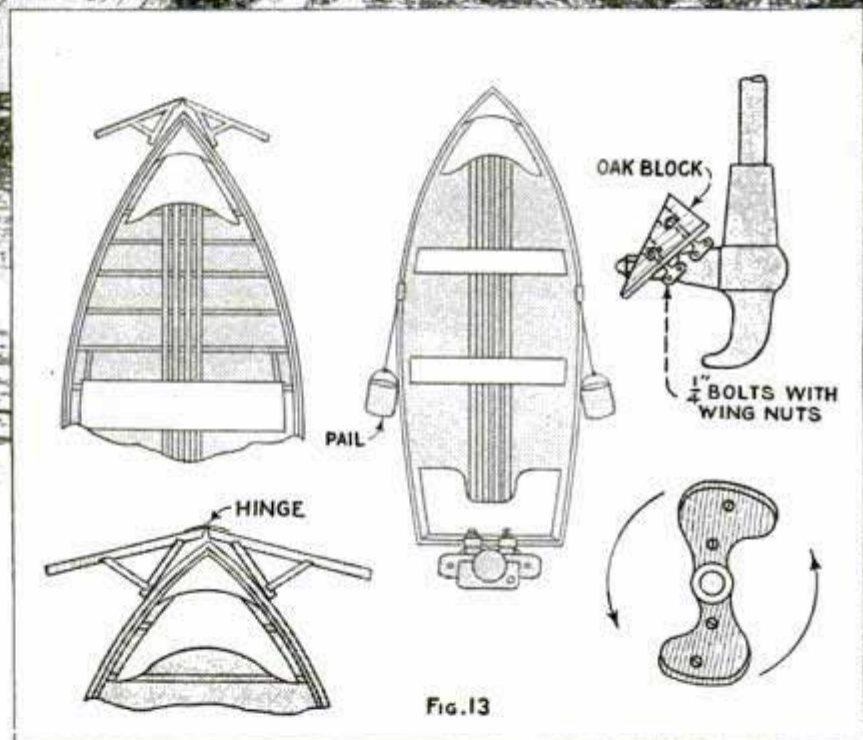
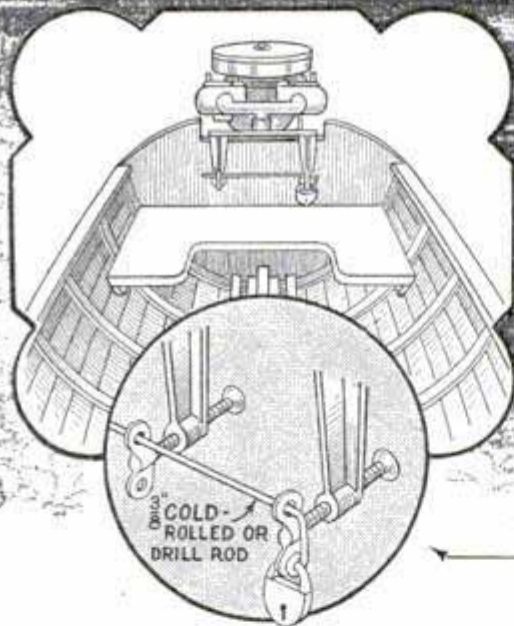
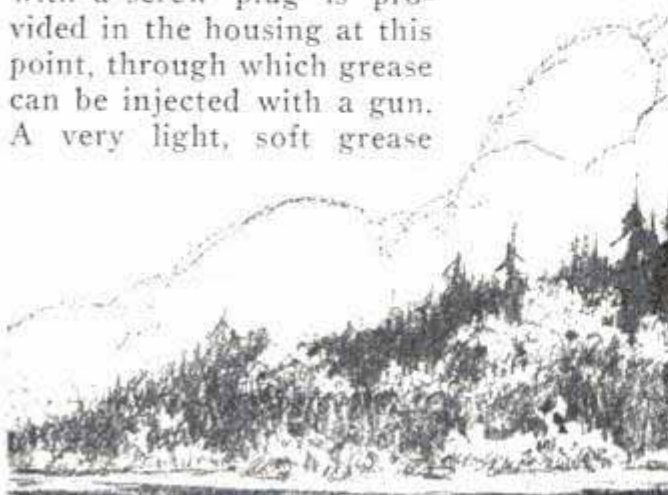
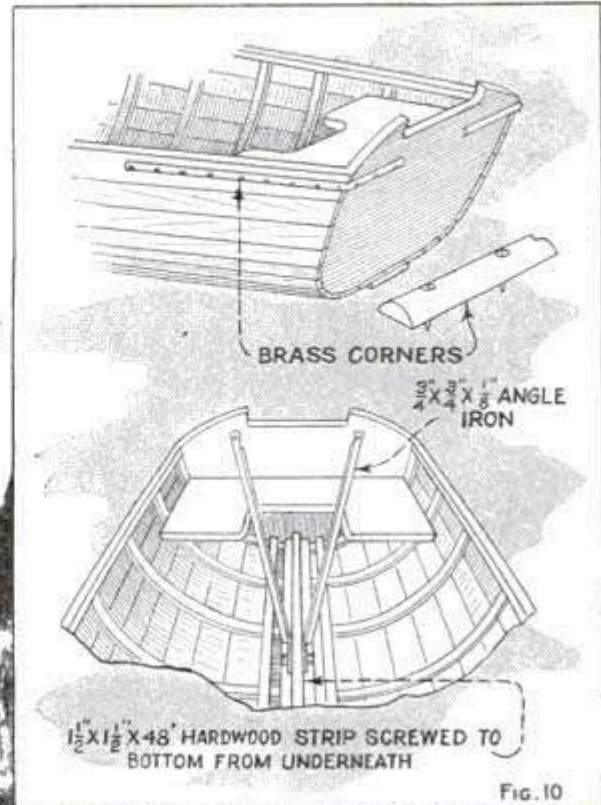

Fig. 13

gasoline will evaporate, but the lubricating oil, being less volatile, remains behind and maintains a protective film upon the friction surfaces.

The proper amount of oil to mix with the gasoline has been accurately computed by the manufacturers. To deviate from the established proportion will not profit the operator. Too much oil means carbon formation and loss of power; too little oil may result in scored cylinders or burnt-out bearings. Furthermore, the operator should bear in mind that the best results can be obtained only by using high-grade oil. The writer suggests Pennsylvania oil—paraffin-base oil.

The bearings of a modern outboard motor are usually of the ball or roller type. Those of the motor crankshaft receive their lubrication from the oil-mixed fuel in the crankcase. But the bearing on the lower end of the vertical driveshaft, and those on the horizontal shaft, must be lubricated from another source. A hole with a screw plug is provided in the housing at this point, through which grease can be injected with a gun. A very light, soft grease



those of the automobile motor, so they need be touched upon only briefly. The exact details of a

motor can be had from the manufacturer. Ignition is by means of a battery and coil or by a high-tension magneto. Either system is practically fool-proof. Each is thoroughly waterproofed, and the only attention either needs is the occasional adjusting and surfacing of contact points.

should be used. Thorough greasing of the bearings and bevel gears is essential. Since these parts are always in comparatively cold water, the use of heavy, non-fluid grease must be avoided. (See Fig. 7.) The only other points on an outboard motor which require oiling are the pivot bushing upon which the whole motor swings when steering, and the magneto, or timer, shaft. The latter needs a drop of good light oil occasionally.

Other features of the outboard motor, ignition, carburization and water circulation, vary with the makes of motors, but fundamentally all differ very little from

The carburetor of an outboard motor is of the simplest construction. A needle valve is the principal adjustment. This is opened a turn or two to provide a rich mixture for starting, and afterward is screwed down as the motor warms up.

One can feel out the needle-valve position to find the point where the motor runs smoothest. This will be the most efficient point. Most motors are also fitted with a choke to facilitate starting.

The water circulation is maintained by a pump or by a scoop device which picks up and circulates the water when the boat is under way. The only trouble likely to arise with the circulation is due to foreign matter lodging in the intake. Should an outboard motor suddenly overheat, the cause usually can be located at that point.

Now let us deal with the motor in its application to the boat. First of all, know your boat. See that the top of the transom (sternboard) is low enough to permit complete submersion of the propeller. Sometimes it will be found necessary to cut a wide notch in this board (Fig. 8) several inches deep, to lower the outboard motor. Also be sure that the board is sufficiently strong and well braced to withstand the strain that a powerful motor will put upon it. Contrary to general belief, this stress is not toward the bow of the boat. The thrust of the propeller tends to tilt the sternboard back. The whole motor assembly acts as a lever with the junction of the board and keel as the fulcrum. This can be better understood by studying Fig. 9.

Of course, if one buys a boat especially designed for an outboard motor, provision will have been made for all stresses and strains. But many people buy a motor and fit it to the old rowboat. In that case it is probable that the sternboard will need extra bracing. There are several ways of doing this, of which Fig. 10 shows two. One consists in fitting corner brackets, made of half-round brass rod, around the sternboard and gunwales. In the other, two angle-iron brackets extend from the sternboard to a hardwood strip screwed to the inside bottom of the boat. The application of both methods is still better.

When attaching the motor, never use a wrench or other tool to tighten the thumbscrews of the bracket clamp. Ample pressure can be supplied with the fingers only. If the vibration of the motor tends to loosen these screws, they can be made permanently secure as shown in Fig. 11. Holes to allow clearance for a $\frac{3}{8}$ -in. round rod are drilled in the wings of the thumb-

screw heads. A length of $\frac{3}{8}$ -in. cold-rolled rod—drill rod is even better—is passed through a hole in each thumbscrew. If a right-angle bend and loop is made in one end of the rod, a padlock can be attached.

The operator should always carry extra propeller pins. These pins are usually made of annealed brass and secure the propeller to its shaft. They will withstand the normal driving strain, but if the propeller hits an obstruction, the pin will be sheared off, thereby saving the propeller and running gear from injury. (See Fig. 11.) Sometimes these pins will shear off without the propeller hitting an obstacle. This is due to the fact that the propeller does not fit tightly upon the shaft. When the flywheel of the motor is rocked to start, the propeller is thrown against one side of the pin and then the other, thereby weakening it. Then it may shear off at the most unexpected and inconvenient time, possibly at night or during a storm. This can be guarded against by inspecting the propeller occasionally. If it is found to be shaky upon the shaft, a new pin should be fitted immediately.

Ordinarily, the fitting of a new propeller pin is but a minute's work, if one has an extra pin and the necessary tools. An outboard-motor owner should always have an adjustable wrench, hammer, pliers, a slender punch, and, of course, extra propeller pins. A convenient way to carry this equipment is shown in Fig. 12. A canvas case, with pockets for the tools and pins, is tacked to the sternboard with copper tacks. A flap, with snap fasteners close together around the edges, covers the case. Should the boat meet with a mishap, or be tilted on its side to drain, the tools and pins will remain intact.

An outboard motor never should be run, for any length of time, with the spark fully retarded. The only people this ruling will affect, however, are the fishermen who use the outboard motor for trolling. Even with a fully retarded spark, the speed of a light boat sometimes cannot be sufficiently checked to permit deep, slow trolling. It is better to reduce speed by other means. Maneuvering rudders and special devices can be purchased, or one of the means shown in Fig 13 can be used.

The first, a snowplowlike frame, made of 1 by 10 by 24-in. pine, is suspended in

front of the bow of the boat, and speed is controlled by varying the depth of submersion. A second simple way is to drag pails, attached to the oarlocks with a short piece of rope, through the water, and still another method consists in bolting an oak block to each propeller blade and then shaping these blocks, with a draw-shave or plane, so as to change the pitch of the built-up propeller. These blocks are fastened to the blades with $\frac{1}{4}$ -in. bolts and wingnuts. With these blocks in place, the spark can be advanced and the motor run much faster without increasing the boat speed. Of course, any of the foregoing methods are handy makeshifts for the amateur mechanic. If one uses his motor much for trolling, he should buy one of the special devices for that purpose.

An annoying feature of some outboard-motor boats, particularly the converted, round-bottom rowboats, with low bow and freeboard, is their faculty of throwing spray when running into a head wind.

boat, are thrown up perpendicularly and the wind blows the water into the boat. An easy way of preventing this, and, at the same time, adding a safety element to the boat, is shown in Fig. 14. A strip of canvas, 12 ft. long and 9 in. wide, is fitted with eyelets, 6 in. apart, along one edge. The other edge is tacked, with copper tacks, to the sides of the boat, about $3\frac{1}{2}$ in. below the top of the gunwales. The canvas should extend around the bow of the boat and 6 ft. along each side. A 12-ft. tube is made of sections of old $3\frac{1}{2}$ -in. inner tubes and the two ends are sealed. This tube is placed in the canvas pocket and the eyelet edge is drawn over the gunwales and laced to small screweyes along the inside. The tube is then inflated until the canvas is drawn taut. The bulge thus formed will divert the upward waves striking against the bow and sides and throw the water off horizontally. A boat so fitted can run into a heavy white-cappy sea without shipping any water.

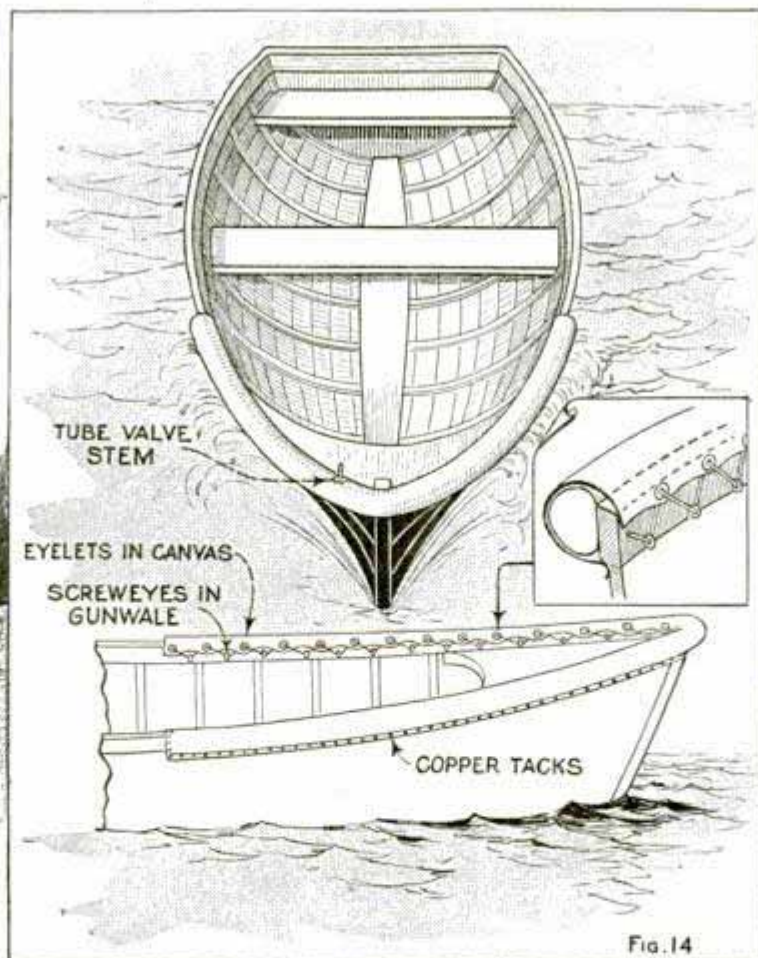

Even in a slightly choppy sea, the passengers will become drenched. The small waves, striking against the bow of the

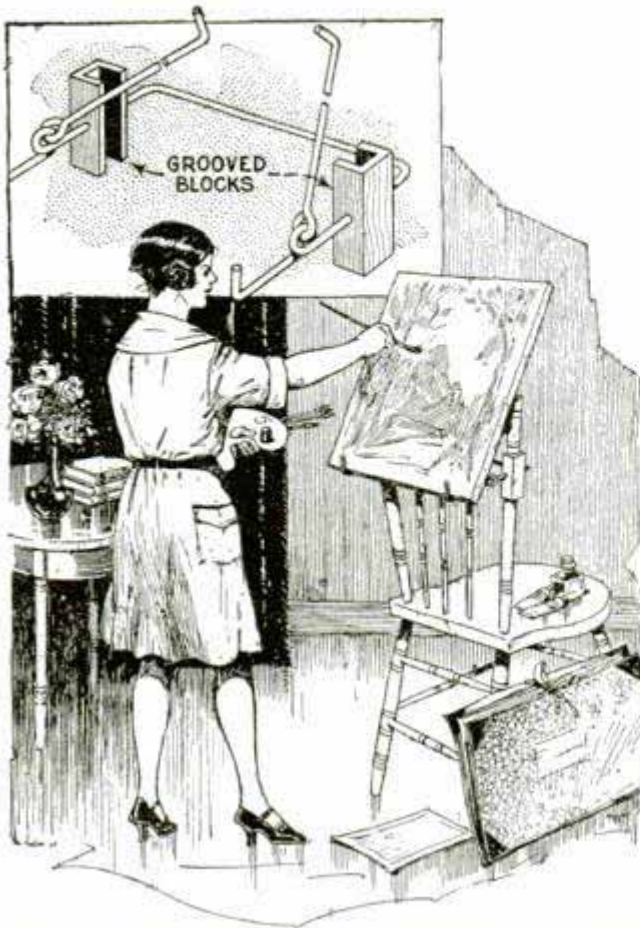

Improved Easel Made to Fit on the Back of a Kitchen Chair by Means of Simple Mounting

Easel Improved with Kitchen Chair

Where no easel was available, an artist on vacation improvised one by means of a simple attachment to a kitchen chair. It consisted of two wooden blocks, grooved to fit the chair. They were attached to a length of heavy wire spanning the back of the chair and two hooks were provided to hang the device from the top rail of the chair. Two ends of the wire project and are bent upward to serve as holders for the canvas. The details of construction are clearly indicated in the drawing.

Easily Made Pin Gauge



point in line with that of the other. The points are tempered to prevent wear and

The pin gauge shown herewith is simple to make. The two rods are of steel wire, one having the end offset to bring its

the spring is made from a piece of hack-saw blade. After annealing it, the slots are cut at the ends, and it is then spring-tempered again.

Cement in Whitewash Prevents Flaking

Ordinary whitewash that we used in the interior of a poultry house, flaked off soon after its application. Acting on the theory that possibly Portland cement would tend to make the mixture more adhesive, a half pint of cement was stirred into two gallons of whitewash. It was necessary to keep the whitewash well agitated to prevent the cement from settling on the bottom of the container. The addition of the cement overcame the difficulty.—C. M. Wilcox, Torrington, Conn.

Guide for Windmill Pump Rod

There is no part of a windmill that gives more trouble than the wood pump rod. This is caused by the guides wearing the rods until they are so weakened that they are unable to stand the strain. The illustration shows a method of providing

suitable guides which will not wear the rod. The guides are made from old coil springs, which can be taken from machinery about the farm. One end of each spring is fastened to the wood rod, as indicated,



while the outer ends are fastened to the three legs of the tower and should be drawn up quite tight. They must, of course, be of equal strength.—W. O. Hendrickson, Argyle, Wis.

ⒸA brilliant polish may be given to tarnished nickel by immersing it in a solution of alcohol and 2 per cent of sulphuric acid from 5 to 15 seconds; take it out, wash it in running water, rinse in alcohol, and rub dry with a linen cloth.

Compensating for Stripped Starter Teeth

If the tops of the teeth on the starter gear of your flywheel are stripped in one or more places, it is not necessary to send the car to a shop to have a band shrunk on. Simply take your starter off and file the holes in the starter shelf larger on the side toward the engine. Elongate the holes with a round file about the depth of the broken teeth. Put the starter back and, holding it tightly toward the engine, bolt it in place. Sometimes it is advisable to put small pieces of steel next to the lag bolts on the outside of the hole to prevent the bolts from taking their original place. The starter, thus held against the wheel, will work as well as ever and will not strip any more teeth from the flywheel. Of course, if the teeth are stripped clear down to the roots, this remedy is useless, and a new gear ring is necessary.—Guy E. Clark, Everett, Wash.

Tinning Pigtail Connections

Tinning pigtail connections is usually a tiresome job when performed with a soldering copper, which, if light, quickly loses heat, and, if heavy, soon tires the worker. I have used a much better and quicker method. Heat a small pan of solder and place a can of flux close to it. Take the cleaned wire pigtail, hold it for a few moments over a gas flame but not close enough to oxidize. Insert it into the flux and then dip the treated end in the molten solder, which will coat it effectively. Then it will stick after it has been soldered.—Paul E. Gardner, Washington, D. C.

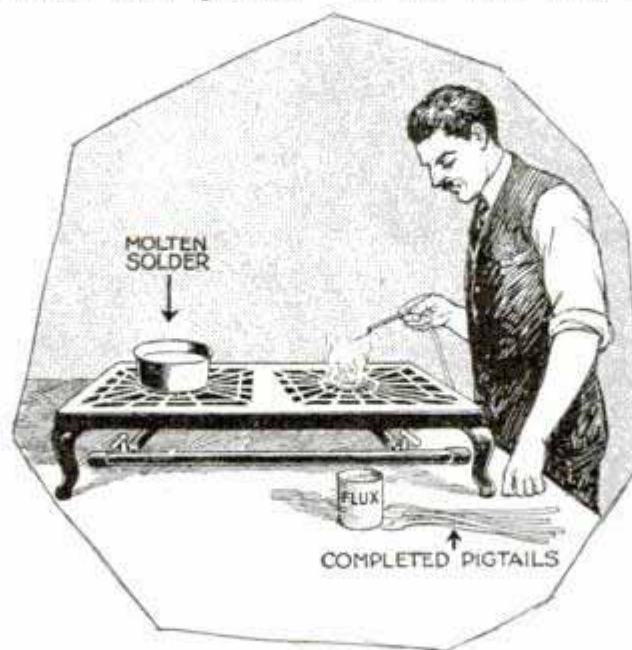

Quick and Effective Method of Tinning Pigtail Connections over a Gas Flame

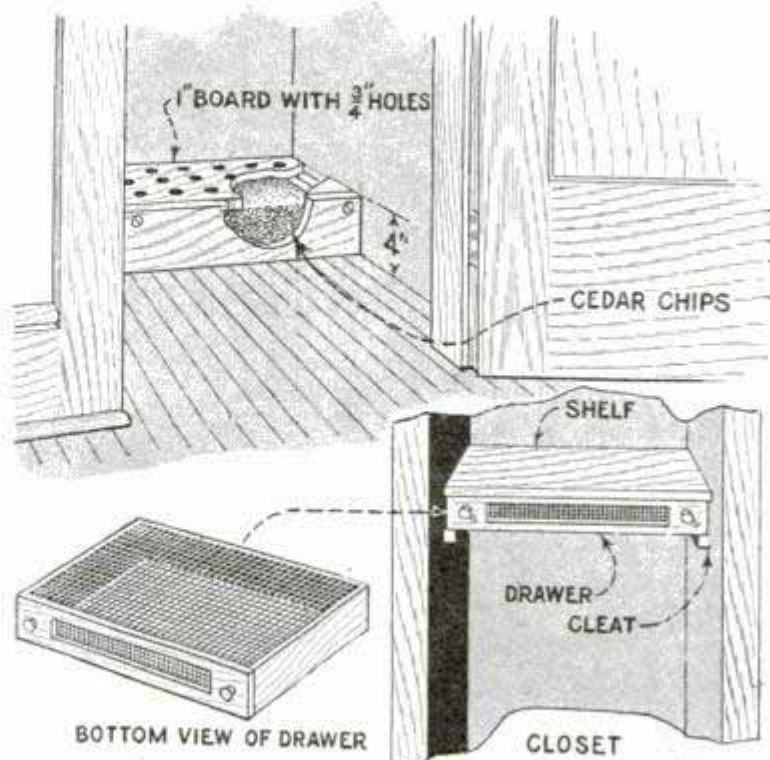

By Providing Holders Filled with Cedar Chips in the Clothes Closet, It Will Become Mothproof

Make Your Clothes Closet Mothproof

A neighbor who is handy about the house, fixed his bedroom closet so that it is mothproof. The idea is simple and it cost him very little besides his own time. Against the back side of the closet, on the floor, a 1 by 4-in. board was placed on edge and nailed in the position shown. Cleats were nailed along the walls on a level with the top edge, and the interior of the box thus formed was filled with cedar chips and shavings. A lid with several holes drilled through it was then provided. For months no moths were found in this closet. Another place to store cedar chips is the combination drawer and shelf shown in the lower detail. The bottom of the drawer is made of wire mesh, and the drawer should be just as wide as the shelf.—Dale R. Van Horn, Walton, Neb.

Better Visibility When Driving in Fog

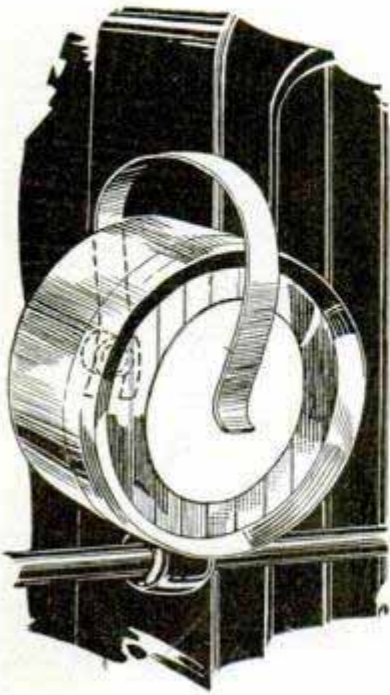

Every motorist knows that the piercing beams from the headlights are useless to light the way when driving through fog at night. In fact, their dazzling glare is a detriment instead of an aid. A simple method of increasing the visibility is to place disks of "frosted" celluloid in front of each headlight, as shown in the drawing. The disks can be held in place by means of spring clips, made from a phonograph or clock spring. The disks are frosted by rubbing the surface with fine sandpaper. With the disks in place, the light is diffused so that the road is visible for some distance. —Richard P. Cole, Paterson, N. J.

Padded Skids for the Stepladder

There are several objections to the use of a stepladder on polished floors. In the first place, dirty marks and scratches are often caused by the ladder, unless the feet are well padded. In the second place, the



cross braces of old stepladders may be unsafe, and the legs may spread unexpectedly, with annoying experiences or, it might be, even disastrous results for the worker. To prevent such troubles a pair of skids will be found to be of considerable advantage. They consist of two 1 by 3-in. boards having cleats near

the ends to hold the legs of the ladder. Strips of carpet tacked on the underside will prevent injury to polished floors.

Transferring Newspaper Pictures

Children can be entertained on a rainy day by transferring newspaper pictures, including the colored comic sections. Prepare a liquid by dissolving one tablespoonful of ordinary yellow soap in 1 pt. of hot water, and when cool, add three tablespoonfuls of turpentine. Shake thoroughly, and then apply this mixture liberally to the surface of the picture to be transferred, allowing it to soak for a short time. Dampen a piece of white paper, place the picture on it, and apply moderate pressure for a few moments. On separating the two, a reverse transfer of the original picture will be found on the white paper.—A. T. Bawden, Ottawa, Kans.

How to Dry a Fishing Line

An expensive fly-casting line should always be thoroughly dried before it is rewound on the reel. In wet weather this presents quite a problem, particularly to the camper. A good method of drying a line is shown in the sketch. It is simply wound around a large tin can filled with hot water, the free end being held to the can with a small piece of gum. The part of the line wound on the can will soon dry out, and if the line is very long, the operation is repeated until the whole of it is dry.

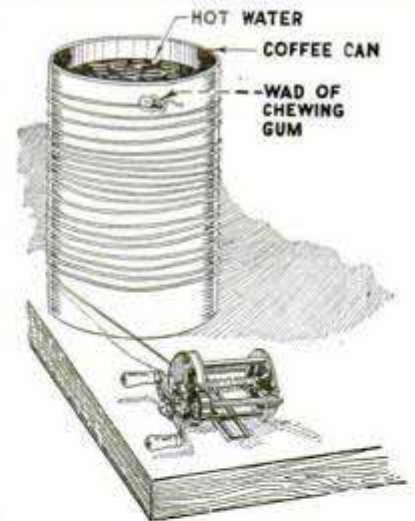

Removing Iodine Stains

To remove iodine stains from flesh, make a thin paste of any good white soap and peroxide hydrogen and apply, rubbing it on thoroughly. It takes but a moment or so to remove all traces of the iodine and the parts are then bathed with water.

Materials } A. H. Abbott & Co, 235 S Wabash
 Wm. Campana Co, 318 S Michigan

The Art of Imitating Porcelain



by



ALBERT DREYFUSS

232 W. 14th St New York

flowerpots, jardinières, plates, etc.; some sheets of colored paper prints, representing birds, flowers, insects, Chinese figures or other ornaments; paint-brushes; several round and flat hog's-hair brushes, and some camel's-hair brushes of various sizes; a bottle of liquid adhesive glue, or preferably rubber cement; a bottle of turpentine; one of purified linseed oil, and one of copal varnish; prepared colors for grounds, preferably artists' tube colors; a package of gold powder; two pairs of fine scissors, one large and one small, and a bottle of gum-arabic water. This can be made by dissolving 4 oz. gum arabic in a pint of boiling water. Decant into a bottle when cool.

MANY of the beautiful and expensive porcelain vases that you have so often admired in shop windows, and have perhaps longed to own, can be made at home. Of course, the art of making genuine porcelain is beyond the scope of the amateur, but the making of imitation porcelain, which closely resembles the real article, can readily be performed by anyone interested in this kind of work. The art is called "potichimanie" in Paris, where it is in vogue, and may be freely translated as "china-mania." It has become very popular abroad and is awakening an almost equal interest here. By means of this art, good imitations of every kind of porcelain—Sevres, Etruscan, Japanese, Assyrian, Persian and Chinese—can be produced.

All that is required to do the work is some degree of neatness and taste; very little expense is involved. When properly done, the work is simple but beautiful, and no one will fail to succeed if he carefully follows instructions. The materials required are as follows: glass vases, bottles or similar objects, match holders,



The vases are of plain glass in various shapes and sizes, and the sheets of paper are printed in black silhouette or colored designs. Some have figures in the Etruscan style, others display dragons, trees, flowers, birds and similar designs of Chinese type. There are eccentric Assyrian figures and decorations, besides other subjects exclusively French, and borders of different sorts.



Place all the materials on a table, as well as a towel, some old soft linen and a small basin of water. First clean the vase or bottle thoroughly, both the inside and the outside, with alcohol or benzine, as glass gathers an oily film on its surface, which prevents the colors and cement from adhering to it properly. After the cleaning, apply a coat of gum-arabic water to both sides of the vase, and allow this to dry thoroughly before applying any color. Now prepare an oil color for the ground, mixing it with sufficient turpentine to make it run freely. Take equal quantities of copal varnish, purified linseed oil and clear white turpentine, one-third of each, mix together in a clean bottle and shake up well. Add a tablespoonful of this to a saucepan of the prepared color and pour it into the vase or bottle through a small tin funnel, as shown in Fig. 2. Turn and twist the vase around until the color has completely covered every part of the inside, as indicated in Fig. 3. Pour the remainder back into the saucepan, let the vase dry and then pour a mixture of linseed oil, turpentine and copal varnish, one-third of each, over the color, on the inside of the

vase. When this has dried the inside is completed.

Cut out the paper figures with care. It would be well for beginners to select such subjects as are fairly compact. Running patterns, with the various parts connected only by long stems, or flowers with the pistil and stamens projecting are much more difficult to arrange than the simpler patterns. Every part of the background of the paper must be cut out, such as the space between



the body and the bent arm, in any figure where that occurs.

Fold a sheet of blotting paper into several thicknesses, lay one of the cut-outs on it, face down, and, with one of the brushes, completely cover the back with a thin layer of gum or rubber cement, as shown in Fig. 4. Let the cement dry thoroughly, and then lay the cut-out on the glass surface, as in Fig. 5, rubbing down every part smoothly with your nail, so that no air is left between the paper and the glass, as this would spoil the work. Proceed in this way with each figure,



flower, or other design, until sufficient patterns are placed on the glass. Borders may be added, if desired, but they should always harmonize with the rest of the design. When the cut-outs are perfectly dry, examine them to make sure that no air bubbles are left. A thin coat of varnish should be brushed over the cut-out. In doing this, use great care not to touch the glass. After it has dried, remove all spots of gum or varnish that may have fallen on the vase with a damp cloth. The glue or gum is soluble in warm water and the rubber cement can readily be removed with benzine.

In the vase shown below Fig. 3, the upper and lower parts are done in black, while the center is a light color. When this effect is to be produced, the color bands must be applied with brushes on the outside of the vase and the color is not poured in as

The choice of the ground should be carefully considered, as on it greatly depends the truthful hue of the porcelain. A peculiar blue and green are frequently seen in Oriental china, black and soft salmon pink are usual for the grounds of Etruscan subjects, and the blue of Sevres is well known. A vase with a running floral design in gray, edged with gold, on a soft



previously directed. Each band should also dry thoroughly before the next one is applied. Colors on such parts as handles, etc., must also be applied with a brush, as indicated in Fig. 4.

pink ground was found very pleasing. The silhouettes so popular on lampshades are well adapted for this kind of work.

Cement Repair for Old Water Tank

When the old galvanized stock tank begins to leak around the edge at the bottom, where it gives away first, its life can be prolonged by applying a quantity of strong cement to stop the leaks. The mixture should consist of common sand and cement in equal proportions. It may be laid in 3 in. thick on the bottom of the tank on the inside, and should be applied at the sides as high as the consistency of the mixture will allow.—Willis Mehanna, Bussey, Iowa.

Poultryman's Hopper for Dry Mash

A hopper that will hold 100 lb. of grit or 35 lb. of mash can be made from one

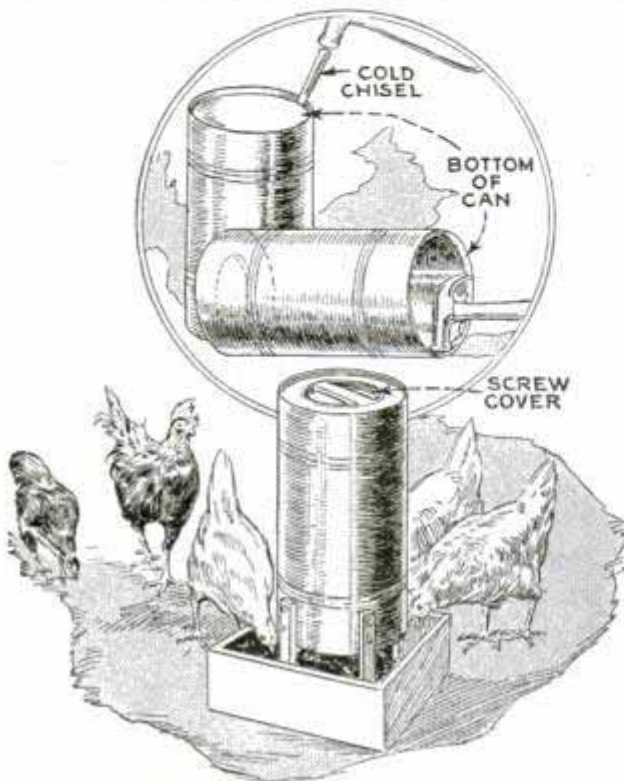

Poultry Hopper Made from Old Carbide Can Holds Large Supply of Food

of the drums in which calcium carbide is shipped. These drums can be bought very cheaply and are often even given away by those who have acetylene lighting installations. Many farmers use this gas and have these drums lying around. Turn the drum bottom up, and cut out the entire bottom with a sharp cold chisel. Now, lay the drum on its side and hammer down the rough edges. Next take a tape measure, or string, and measure the circumference of the drum, then divide this figure into four equal parts. Wrap the tape around the lower end of the drum and make a mark at each of the four division points. With a punch, file or ten-penny nail, make two holes from 2 to 4 in. apart at these points, one above the other. These holes are to receive $\frac{1}{8}$ -in. stovebolts or screws, for fastening four wooden legs, about 10 in. long and 1 in. square, to the drum, as shown. Each leg should project about 4 in. beyond the bottom of the drum. Get an empty cheese or cracker box, or make a square box, about 6 in. wider than the diameter of the drum and having sides 6 in. high. An old, round dishpan may be used as a sub-

stitute, if desired. Set the drum in the box, and you will have an automatic hopper that will hold several days' supply of mash or grit, depending on the size of your flock. By driving nails through the bottom of the box into the legs the hopper will be steadied so it cannot tip over. A good coat of paint on the outside will add to the appearance and lasting qualities. A 50-lb. lard can may be remade in the same way.—J. Herbert Ferris, Elberta, Michigan.

Ridding Upholstered Furniture of Moths

Confronted with the problem of ridding upholstered furniture of moths without removing the covering, one home owner devised the insecticide spray shown in the drawing. It consists of an empty pickle bottle with a good screw cap and a veterinarians' 16-gauge hypodermic needle, which can be inserted through the tapestry or velour without damage to the material. The needle is slipped over the end of a length of tubing, which projects inside of the bottle and is bent at right angles as indicated. The tubing should have an inside diameter of $\frac{3}{32}$ in. A tube of smaller size is soldered to the inside end, as shown, and extends to the bottom. An angle valve is soldered to the cover. With a tire pump connected to this valve, a liquid insecticide can be ejected through the needle. The operation should be repeated daily until the moths are exterminated.

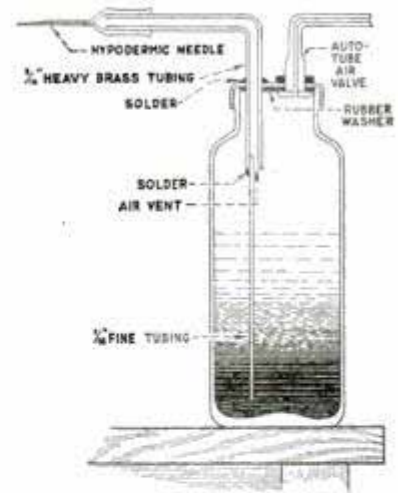

Dull Finish on Aluminum Articles

A dull finish on aluminum articles is often desired. The following method gives a more uniform appearance than painting. All that is necessary is to suspend the articles in hot caustic soda for a few moments. This solution will give a smooth, dull appearance that cannot be equaled by any other method.

An Effective Trap with Live Bait

I have used a number of different kinds of traps but the most successful of them is that shown in the drawing. Many small fur-bearing animals are fond of chicken meat. The fox will catch a chicken and carry it off, the mink and weasel will cut the throat and bite the head, etc., and a coon will catch one if he has a good chance. I give them a good chance, or at least they think so, by baiting my trap with a live chicken. The way I do it is to make a box about 12 in. square and 3 ft. long. This box is made of old lumber so that the animals will not be suspicious of it. Each end of the box is covered with wire mesh, the wooden ends being removed entirely. The mesh at one end is attached to a frame hinged to the box to permit putting a chicken in and taking it out. Two more boxes are made of similar size with one end screened securely, and a screen trapdoor fastened in the other end. The three boxes are then taken to the place frequented by fur bearers. The chicken is put into the center box, the hinged end is securely fastened, and the boxes are then placed in a row with the chicken box in the center as indicated. The trapdoors are set and all is ready for the catch. At night an animal will try to get the chicken by

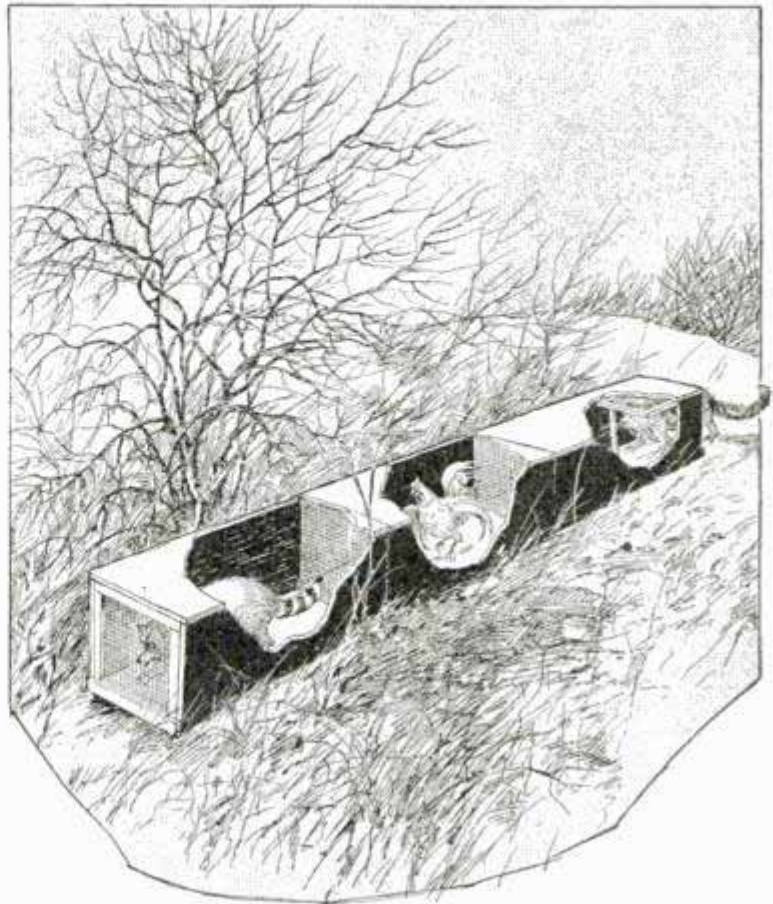

Three-Compartment Trap Capable of Holding Two Animals, the Center Box Being Baited with a Live Chicken

crawling into one of the end boxes. Once in the box the door closes and it is caught. The chicken box is long enough to prevent the animals from molesting the chicken in any way, except frightening it. This is the only way I ever was able to catch a live fox without hurting it. I have caught several this way and mink, weasel, coon and even an opossum will occasionally crawl in.—R. B. Rushing, Simpson, Ill.

Cement Repair Job on a Tile

While leveling a lawn, a workman used a pick, and accidentally fractured a tile drain connecting with the sewer. To

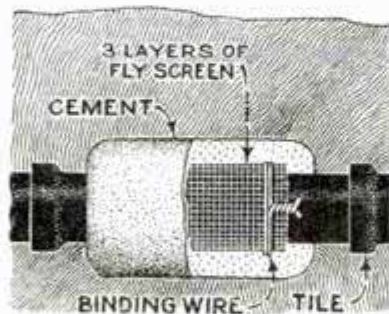

avoid the work of uncovering the whole pipe and inserting a new section, an effective repair was made with cement as shown in the drawing. The glazed surface of the tile not being satisfactory for bonding the

cement, a cover was made of screen, wrapped around the pipe to form three layers, and fastened with ordinary iron wire. A mixture of equal parts of sand and cement was applied around the screen until it reached a thickness of 3 in. The ground under the pipe was filled in to form a mold. This repair was found entirely satisfactory, and there was no leakage even though the cement had not hardened entirely before water was permitted to flow through the pipe.

☐ Turpentine is often used to remove fresh paint from clothing, but, unfortunately, it is apt to leave a stain; this can be deleted by rubbing with alcohol.



Contents of Mail Box Attached to Door Jamb Cannot Be Removed Unless the House Door Is Open

Theft-Proof Mail Box

Theft of letters, etc., out of mail boxes can be prevented to a great extent by providing a box from which the contents cannot be removed unless the house door is opened, or the box destroyed. The box is mounted on the door jamb, with the open side against the door. Only the mail slot is exposed when the door is closed.

Slot in Bottle Cork Permits Sprinkling

Some hair tonics and similar preparations come in bottles with plain corks, making them rather inconvenient to use.



slot to prevent evaporation and spilling.—John Russell, Chattanooga, Tenn.

A simple sprinkler can be made by cutting a slot down the side of the cork with a sharp knife. Several slots can be made if desired. After use of the tonic, a match stem or peg may be inserted in the

How to Keep Flies Out of the House

There are fly swatters, fly papers and various kinds of poisons for getting rid of house flies, but all of these have some disadvantages. A better and more effective way is to take a small clean sponge and place it in a dish after dipping in very hot water. Immediately after dipping the sponge, apply a few drops of oil of lavender on it. Flies do not like the odor, and will leave any place where it is present. If the sponge is moistened about twice a day, flies will not come around.—L. H. Georger, Buffalo, N. Y.

Asbestos-Covered Coffeepot Handle

Coffeepot handles of wood often have to be replaced due to burning, and this is more or less annoying, although not expensive. A handle which is not affected by heat can be made in the following way: Get a 14-in. length of old gas pipe of small size and, after flattening the ends, drill a small hole through each flat, about $\frac{1}{2}$ in. from the end, for machine screws or stove bolts with which the handle is to be fastened to the pot. Attach the handle, and wind asbestos cord over it, which will keep it sufficiently cool to insure comfort. I have had such a handle in use for four years.—George L. Michel, Jersey City, N. J.



Wallboard as Substitute for Canvas for Oil Paintings

Pieces of wallboard, trimmed square, can be used as boards for oil paintings. All that is necessary is to give one side two coats of heavy white or cream-colored paint as a filler and primer. When dry, the colors can be applied on this surface as well as on canvas. A nice blackboard also can be made of wallboard by surfacing with a filler and then painting it a dull black, made by mixing dropblack in turpentine to which a little drier has been added. Another suggestion is that long

strips can be nailed directly to an old bench top and will give a clean, smooth surface, which is free from cracks and holes through which nails, screws and small tools are so easily lost.

Removal of Mercurochrome Stains from Clothing

Mercurochrome is now commonly used as an antiseptic, instead of iodine. If it is accidentally spilled on clothing it leaves a noticeable red spot. The bureau of standards states that fresh mercurochrome stains on silk can be removed by an application of benzaldehyde, allowing it to stand for a few minutes, repeating the application, and following it with a 25-percent solution of hydrochloric acid. Then sponge with alcohol and rinse freely in clean water. It has also been found that an application of glacial acetic acid to the fresh stain is fairly effective. If only partly effective, the spot should then be treated with ether. Only fresh mercurochrome stains can be removed.

Homemade Candle Lantern

For the camp, cottage or farm, the candle lantern shown in the drawing is very useful, as it cannot blow out in a strong wind and reflects the light where it is needed. It consists of a base made of $\frac{3}{4}$ -in. wood, an upright nailed to the base, and a tin can fastened to the upright. A hole is then punched through the can to fit the candle, the edges around the hole being bent inward so the candle can be pushed up as it is consumed. A number of ventilation holes are drilled in the can above the candle.

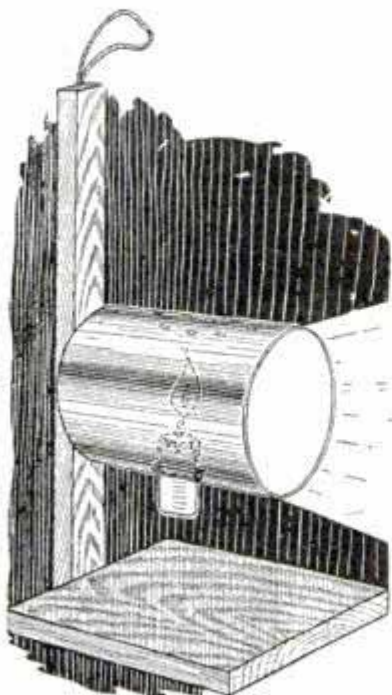

Water Trap in Kerosene-Stove Oil Line

The writer has used one of the large multi-burner oil ranges in the kitchen and has occasionally been troubled by water and dirt, in the kerosene, getting down into the oil line and plugging the burners or soaking the wicks. The

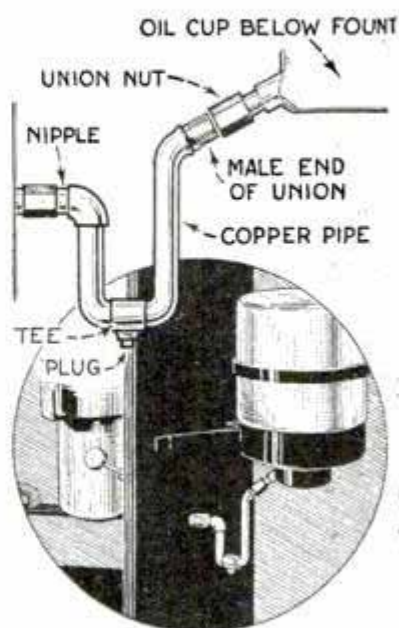

kerosene runs from the fount into a small basin from which it goes to the burners. After the basin had become filled with water the trouble commenced. Several times I removed all the burners in order to clean them and dry out the wicks. This task was more or less inconvenient, so I devised a trap which was inserted in the line as shown. Most oil ranges take their fuel in much the same manner, and the idea can be applied in other cases, with minor variations. The oil-pipe union was disconnected from the basin, and the pipe cut off close to the stove side. This end was then threaded. The trap was made of copper pipe and fittings as indicated. All the water and dirt is removed each month by simply taking out the plug at the bottom.—L. B. Robbins, Harwich, Mass.

Polishing Plate-Glass Windows

Clean, polished plate-glass windows add much to the appearance of a store. To obtain a luster, wash the inside with lukewarm water, applied with a chamois skin. It is not advisable to use any soap or chemical unless there is a deposit of grease or an oily film on the glass. The outside is also cleaned with lukewarm water to remove the dirt and then the following solution is applied with a soft cloth: pulverized whiting, 1 oz.; denatured grain alcohol, 1 oz.; liquid ammonia, 1 oz.; and water, 1 pt. The solution is left to dry on the glass, and is then polished off with a soft dry rag.

Flowerpot Sprinkler



and eliminates the cost of a sprinkler.—H. R. Harrington, Berkeley, Calif.

Blue Pictures on Glass

Old negatives can be used to good advantage for making blue pictures on glass. To do this, the image must be removed from the gelatin and the gelatin cleared so that it is ready for the sensitizing solution. Make a strong solution of hypo decidedly yellow by adding powdered red prussiate of potash. Lay the plate in this solution until the image wholly disappears. If the solution acts slowly, add more potash. Then give a good washing for about one-half hour in running water. The sensitizing fluid to be used is a mixture of two solutions, one of ferric ammonium citrate, 110 gr., in 1 oz. of water, and the other of potassium ferricyanide, 40 gr., in 1 oz. of water. These should be made separately and then mixed, and filtered. The mixture will keep several months if it is not exposed to light. The green ferric ammonium citrate is preferable, and it is best to wash away every trace of powder from the potassium ferricyanide crystals, if any adheres. Lay the clear plate in this sensitizing bath for 15 minutes, which must be done by gas or lamp light or with as little of any kind of light as possible. Remove the plate and

take it by the edges in the hand and twirl it vigorously to remove the superfluous solution. Then dry in the dark. Print like blueprint paper, from 10 to 15 minutes in direct sunlight. After experimenting with a few plates, a good idea can be obtained as to the proper time of exposure, taking into consideration the density of the negative, strength of the sunlight, etc. After exposure, place the plate in a tray of water for one-half hour, covering the tray to exclude the light. Then rinse in several changes of water and dry. If the picture is found to be printed too deep, it can be reduced with 5 drops of ammonia in 4 oz. of water, washed and then dried. Of course, it will be necessary to cover the emulsion side of these blue pictures with clear glass in order to protect it and then bind the edges with neat strips of paper. Such pictures are really prettier than those on paper as they show finer detail. Black and white pictures on glass can also be made by modifying this process. Clear the negatives as in the blueprinting method and, when the plate is well washed, soak it for 10 minutes in the following bath: Chloride of ammonium, 25 gr.; citrate of soda, 5 gr., and water, 5 oz. Then twirl to remove the superfluous solution. When dry, sensitize in a solution consisting of 50 gr. of nitrate of silver to 1 oz. of water. Print rather deep. Wash the printed plate in several changes of water to remove the free silver, and then tone in the usual gold bath. Fix in the same way as paper prints.—H. E. Zimmerman, Mt. Morris, Ill.

Hanging a Bucket on the Pump Spout



the spout with a large file or a hacksaw, as shown.—L. B. Robbins, Harwich, Mass.

Most small pitcher pumps have no provision for hanging a bucket on the spout, making it necessary to hold the bucket with one hand, or place it on the ground while pumping. A simple remedy is to cut notches in

A Toy Submarine That Dives

By J. C. EDDIE

THE making of toy boats is one of the most, if not the most, popular of hobbies. This self-propelling and submerging boat gives us a little variation from the regular line of sail boats, ship models, etc. It is weighted so that the water comes within $\frac{1}{2}$ to $\frac{3}{4}$ in. of the top of the deck. With the fins shaped and placed as they are, it takes but little motion through the water to cause it to submerge. The power for propelling it is derived from a rubber-band motor directly underneath.

Obtain a block of soft wood, 3 by 3 by 16 in. in size. If you are going to use a lathe to turn the hull, about 1 in. more in length should be allowed. To make the hull by hand, first square up the work, center the ends and draw a circle on each end so that it just touches the four sides. A line drawn in the middle of each side, from end to end, may help some. Now plane the block until it is round, using the circles on the ends to gauge your work by. To shape the ends, mark the points at each end from which the hull begins to taper and, with a piece of heavy paper, draw the lines all the way around the

block. Shape roughly with hand ax and finish with spokeshave. Determine which is to be the top, and plane off a flat place $1\frac{1}{2}$ in. wide. Now, exactly opposite this, chisel out a mortise, $\frac{5}{8}$ in. wide by $\frac{7}{8}$ in. deep by 7 in. long. Drive two nails at an angle in the bottom of this groove. This is to hold the lead which is melted and poured in. Use $1\frac{1}{2}$ lb. of lead, and if this should cause the hull to sink too deeply, remove some lead by boring holes in it, thus lightening the ship.

The rudder and fins are made from not too light sheet metal, to the dimensions given, and fastened to the hull with short round-head screws at such an angle that the hull will be drawn under when in motion. The fins can be bent to a different pitch, if it is found necessary after boat is completed and in use.

The struts to hold the "motor" a peller are made from fairly heavy metal, $\frac{1}{2}$ in. wide, shaped as in the drawing. Care must be taken to allow clearance enough so that the propeller shaft will turn freely. The shaft and crank can be made from eight-penny nails bent to

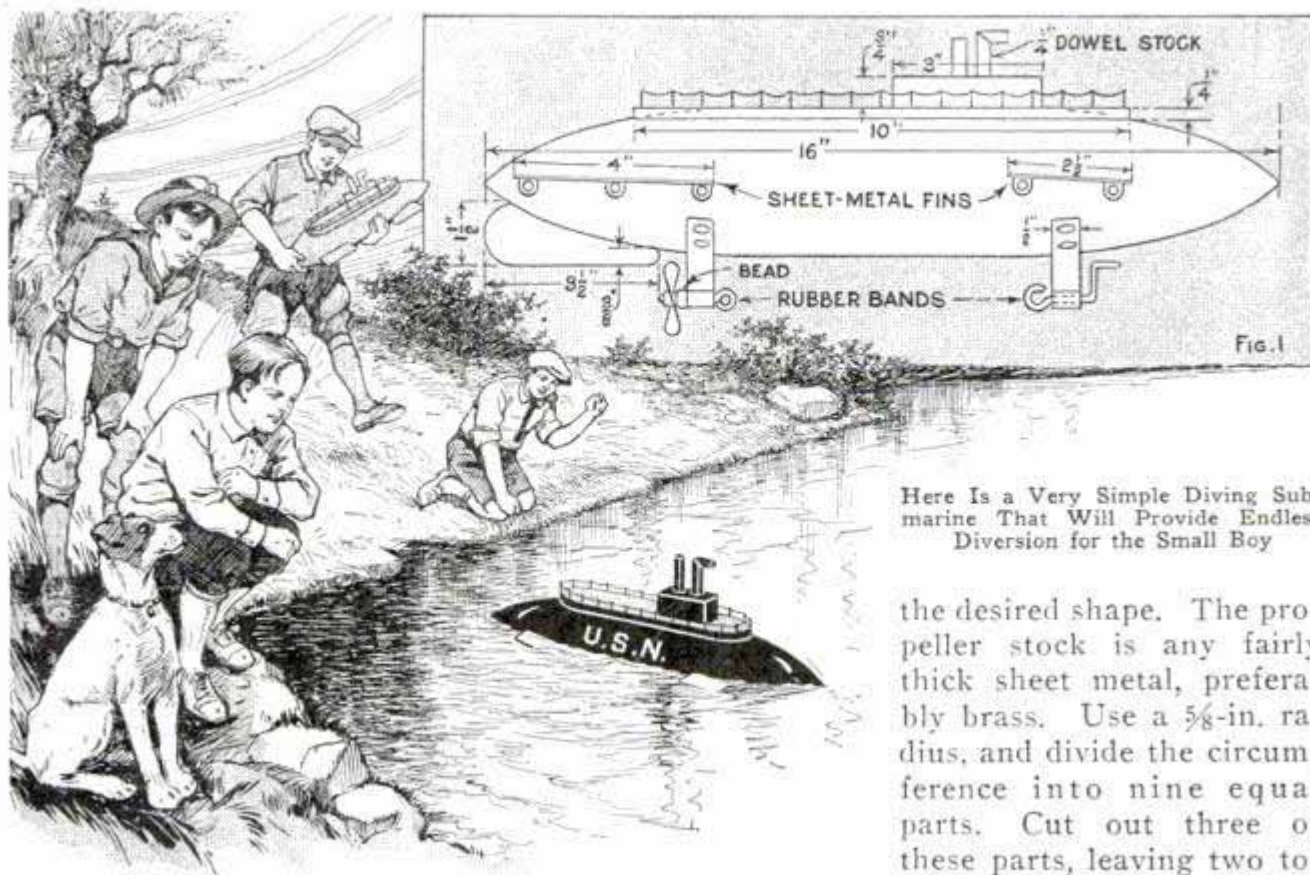

Here Is a Very Simple Diving Submarine That Will Provide Endless Diversion for the Small Boy

the desired shape. The propeller stock is any fairly thick sheet metal, preferably brass. Use a $\frac{5}{8}$ -in. radius, and divide the circumference into nine equal parts. Cut out three of these parts, leaving two to-

gether for each blade of the propeller. Round off the corners of the blades and drill a hole through the center for the

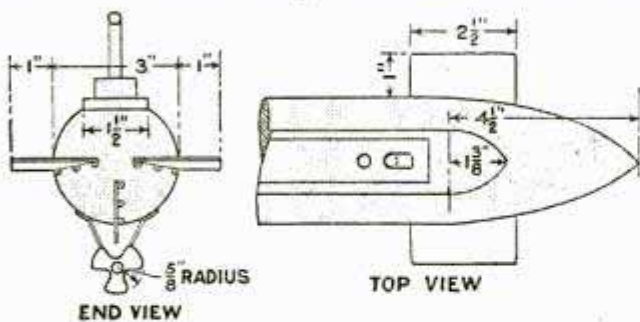

Fig. 2

shaft. Now bend the blades to such a shape that a clockwise rotation will propel the boat, and solder the propeller to the shaft. This bending or pitch can be adjusted later to conform to the needs of the rubber-band motor. A bead should be placed on the shaft between propeller and strut. The struts are fastened to the hull with four short round-headed screws.

The deck is made of $\frac{1}{4}$ -in. material, cut to the shape and size shown in the drawing. The periscope is made from $\frac{1}{4}$ -in. dowel rod. Fasten the deck with brads and screws to the flat surface on the hull. The rail is made by driving in brads at equal intervals, and soldering on some small copper wire. To finish, give the hull two coats of shellac. When this is dry, paint with aluminum paint, letter and decorate with black or red to suit.

This is exactly the way we made several models. However, due to the difference in the weight of woods, it might be necessary to make a few minor changes.

Food Chopper Used for Clamp

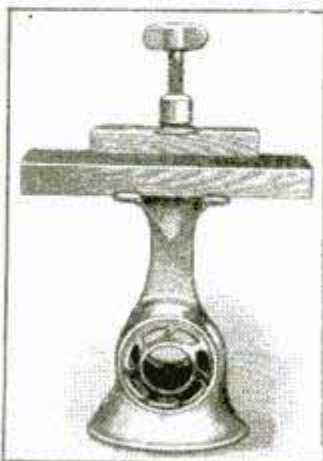

sary to use blocks of wood to prevent the jaws from "biting" into the work.

When you need a small clamp for odd jobs where a larger clamp is too clumsy, use the kitchen food chopper. It is set on the table or bench, upside down, and the work is clamped between the jaws. It may be neces-

Dressing Floor in Small Hallway

After laying a hardwood floor in a small hallway, I was at a loss as to the easiest method of dressing it, because the space was too small to use a scraper and no sander was available. I came to the conclusion that if I used a block plane to smooth the surface, I could fasten a block of wood to a weighted floor polisher, tack a sheet of No. 2 sandpaper to the block, and do a very good job of dressing. I tried it and found that it worked very well, in fact, better than I expected.—C. J. Gose, Kinderhook, Ill.

House Numbers Painted on Curbing

It is often a difficult matter to find and read house numbers from the street, especially when driving along in an automobile. In one case, where the houses were located a considerable distance from the street, one owner painted the numbers on the street curbing in front of his house, as shown in the accompanying illustration. This was found a great improvement.



Hints on the Use of Aluminum Paint

The property of aluminum paint to prevent evaporation losses has been realized by large oil-refining companies who have used it on their storage tanks. This paint reflects a great deal of heat that would otherwise be absorbed. Accordingly, this quality is used to advantage for retaining heat where it is most needed, as in boiler and engine rooms. In addition, the paint has a high degree of lighting efficiency, does not collect dirt easily, and can be cleaned readily. Its waterproofness is another desirable quality recommending it for use in dairies, garages and similar places where moisture may attack wood or structural steel.

The best general-purpose vehicle is so-called "kettle-bodied" linseed oil, diluted with an equal amount of turpentine or mineral-spirits thinner. The aluminum powder to be added is about 2 lb. per gallon of vehicle. Spar and pyroxylin varnishes can be used as vehicles to suit special conditions. When painting woodwork it is best to apply a thin coat first. This seals the pores and prevents absorption of moisture, the effect being increased greatly by the second or finishing coat. For waterproofing, a finishing coat of almost any kind and color of paint can be used, provided a good undercoating of aluminum paint is applied.

For structural steel work, the best results are obtained by priming with some of the basic lead chromates or American vermilion. Sublimated blue lead, red lead and inhibitive iron oxides may all be used under aluminum paints. Concrete and brickwork, as well as other surfaces, can be painted and waterproofed satisfactorily with aluminum paint, although, in the case of concrete, the free lime in the material has a tendency to react with linseed oil, and paints containing this oil therefore should be avoided. The best paints for such work are those made with aluminum-bronze powder in long-oil spar varnish, containing a relatively high percentage of Chinawood oil. Just enough aluminum paint should be mixed at a time for a day's work, as the covering quality of the material is reduced somewhat by permitting it to stand.

Muffling the Alarm Clock

The morning din of an alarm clock can be damped by slipping a section of an inner tube, about 3 in. wide, around the clock. The alarm will be loud enough to awaken anyone in the same room, but it will not awaken other occupants of the house. The rubber band is easily slipped on or off as required.—Willard D. Morgan, Los Angeles, Calif.

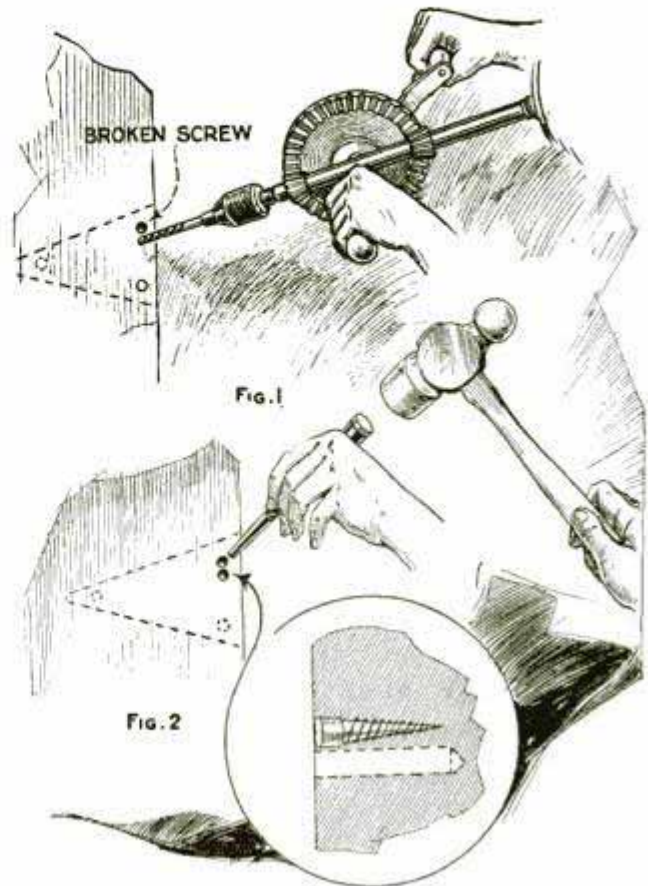

Here Is a Simple Method of Removing a Broken Wood Screw with a Punch

Removal of Broken Wood Screw .

Screws sometimes break off in wood, particularly in hardwood, and it is impossible to substitute another screw until the broken one has been removed. Anyone who has experienced trouble of this kind knows the difficulty of doing this. There is a method, however, which is neither hard nor slow. A hole is first drilled beside the broken section and in line with the grain of the wood, as shown in Fig. 1. A punch can then be used to drive the broken screw into this hole, as indicated in Fig. 2, so that it can be lifted out. The hole is then filled with a wooden plug and a new screw is driven into the original hole.—G. A. Luers, Washington, District of Columbia.

Cleaning Cretonne Chair Covers

Cretonne chair covers can be effectively cleaned by using a solution consisting of two teaspoonfuls of ammonia in 1 pt. of boiled water. It is a good idea to boil a bag of bran in the water. This mixture will clean quickly and only slight pressure is required.

Uses for Old Screen Wire

Old screen wire is usually thrown away, but it can be made serviceable for various purposes, as shown in the photo. Bunched

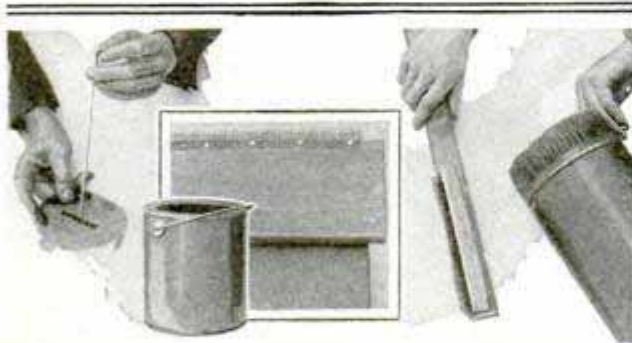

Screen Wire Can Be Used for Many Purposes After It Has Served for Doors or Windows

together and tacked to a stick, it makes a handy wire brush for cleaning stovepipes. It is not always safe to tap stovepipes with a stick to clean them, especially if they are old and nearly worn through. We had several bird houses for small birds, but the large birds bothered the tenants by perching on the roof ridges. To prevent them from doing this, we tacked a short strip of screen along the edge of the roof so that the sharp, ragged edge projected upward. This was found to be an effective cure. From another piece of old screen, we made a false bottom in a minnow pail to facilitate catching minnows. They are difficult to catch with the fingers, even in a small pail, but by raising the false bottom they cannot get away and you can readily get any one of them.—Frank W. Bentley, Jr., Missouri Valley, Iowa.

Inflation of Ford Balloon Tires

Underinflation of a balloon tire costs the owner just 700 miles of service per pound under the correct pressure, according to the results of a series of experiments conducted by the Ford company, in connection with a campaign to help owners of its cars to get the most out of their tires. To determine at just which point the Ford balloon tires yielded the maximum comfort consistent with maximum mileage, all makes of tires were tested. At the end of the test period, the exact loss per pound of underinflation was calculated in terms of mileage. A number of common tire ailments were

traced directly to underinflation. Among the most common are rim cuts, tread separation, overheating and stone bruising, in addition to a more rapid rate of natural wear and deterioration. On the other hand, every pound of overinflation takes its toll of comfort, and the fundamental value of balloon equipment is lost. Other advantages of low-pressure tires, namely, greater traction, ability to travel over soft ground without sinking, and quick stopping without skidding, are also nullified in a direct ratio to the excessive inflation. The following pressures have been found to be best for both riding comfort and long life of 29 by 4.40 balloon tires: The front tires on all types of Ford cars and the rear tires of the roadster, coupe and touring-car types should have 27 lb., while 30 lb. is right for the rear tires of a Tudor, Fordor and runabout with a pick-up body.

Keeping Rugs from Turning Up

Most rugs have a tendency to turn up at the corners or ends, which not only causes annoyance but will shorten their life. To prevent the trouble, get a length of spring-steel wire, about No. 14 gauge.

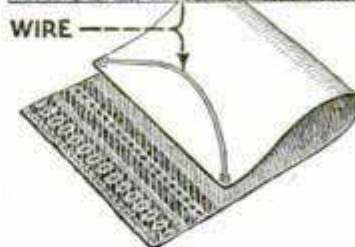

For small mats this wire should be about 6 in. longer than the width of the rug. A small cloth pocket is sewed onto the underside of the rug near each corner and the wire is

slipped in place as indicated. The larger rugs are treated in the same way, except that two lengths of wire are provided at each corner and arranged as shown.

☛ A little turpentine poured into the corners of wardrobes, trunks and drawers will keep moths away, but does not kill moths already present; therefore clothes should be given a good brushing and airing in the sunshine before they are laid aside.

Ballotini - Framingham, Mass
626 Grand St Chicago
no longer available

SHOP NOTES 2/3/36



All Shop Notes published in 1927, in book form—Fifty Cents—from our Book Department

Making Attractive "Ballotini" Lampshades

By H. C. McKAY, *2101 Myra Court, Brooklyn, N.Y.*

A SHORT time ago, floor and bridge lamps were used for one purpose, namely, to give light. They were sufficiently ornamental not to look out of place in a well-furnished living room, but

there the decoration stopped. The parchment lampshade brought into being a new era. The shade was accepted as an ornament in itself, and then began the development of the modern floor lamp.



Two Steps in Making the "Ballotini" Shades: Sewing the Cotton Sheeting to the Shade Frame; Above, Painting the "Sea" to Meet the Transfer Pattern

There is no one development which has furthered its value as much as has the "ballotini" shade. For the benefit of those readers who have not yet had the opportunity of seeing such a shade upon a lighted lamp, it may be

Below, Applying the Ballotini to the Shellacked Panel, and at the Right, the Completed Shade



ing; transfer designs; transparent photo oil color; one tube plastic embroidery compound; one jar non-spread fluid; one jar best white shellac; vials of ballotini of the proper shades for the design, and the necessary braid and trimming.

said that the ballotini resembles nothing so much as a beautiful opalescent crystal shade, with soft colorful designs apparently cast in the glass. No stained-glass shade could be more beautiful, yet it may be made in a few hours, and in addition to this, the design may be applied by anyone, regardless of artistic ability.

The ballotini shade is made upon a foundation of a closely woven white sheeting of good grade. The best quality pillow-slip material makes a very good material. This is sewed to the usual wire frame, and stretched as tightly as possible. The design is then painted or transferred onto the shade and finally the ballotini is applied, changing the shade from a rough, crudely decorated, amateurish article to a thing of enduring beauty.

The materials needed are: wire shade frame; one yard finest white-cotton sheet-

ing; transfer designs; transparent photo oil color; one tube plastic embroidery compound; one jar non-spread fluid; one jar best white shellac; vials of ballotini of the proper shades for the design, and the necessary braid and trimming.

The ballotini is nothing but tiny, round glass beads in various colors, and transparent. These beads are sold in sprinkler-top vials.

The cloth is applied to the shade as usual in making any cloth shade. In this description the details of the shade illustrated will be given, but these may be changed to suit any design in hand.

The cloth is given a coating of the non-spread fluid, which, as its name implies, prevents excessive spreading of the color. This is allowed to dry. Then, in the center of each panel, a transfer design of a ship is placed. These transfers may be obtained from any paint, art or ten-cent store. They are given a thin coating of glue and fastened to the shade. The colored side is placed down, the side with the outlined design outward. This is allowed to dry for a half hour. Then the transfers are soaked with lukewarm water and the

paper backing slid off. This leaves the design, a ship in full color, firmly attached to the cloth.

Conventional wave designs are now roughly sketched to meet the waves of the transfer design. Then cloud forms are marked irregularly in the sky. The waves and clouds are outlined in "plastic embroidery." This is a compound like thin putty, sold in a collapsible tube with a long spout point. It should be allowed to dry for four or five hours.

Now, in transparent photo oil color, the sea is given a coat of bluish-green, thinned in turpentine. Upon this, rough, jagged strokes of dark green are drawn carelessly. The upper part of the sky is given a dark-blue coat and the lower sky a coating of light blue, which is blended out to the white cloth about 1 in. above the waves. The white space between waves and sky is now filled with a mixed red and yellow blended-stripe design to simulate sunset. The red and yellow are placed on fairly strongly. The clouds are tinged on the underside with red or pink, and the tops left white. This color is allowed to dry. Do not get discouraged at this time, though the color is garish and the design rough.

When the color is thoroughly dry, the shade is ready for the ballotini. This is applied a panel at a time. The sea of the first panel is given a good coat of shellac and the ballotini (green) is sprinkled upon the wet shellac until it appears dry, showing that the shellac will take up no more. Shake the excess off and go to the next panel. When the green ballotini has been applied to the sea of all six panels, start with number one again and coat the clouds with shellac and cover this with cashmere ballotini. Cashmere is the name given a mixture of pastel shades which is very delicate yet effective. When the clouds are completed, start again, and this time coat the entire sky with light-blue ballotini. In this step, do not coat the ship, but leave the transfer uncoated. The shade is allowed to dry for 24 hours.

The shade is now lined with the usual lampshade material, and the trimming applied. The ribs of the frame are covered with a double-edged braid. The top and bottom edges are covered with tinsel-ruffled lampshade braid, and the decorative braid is applied to the lower edge.

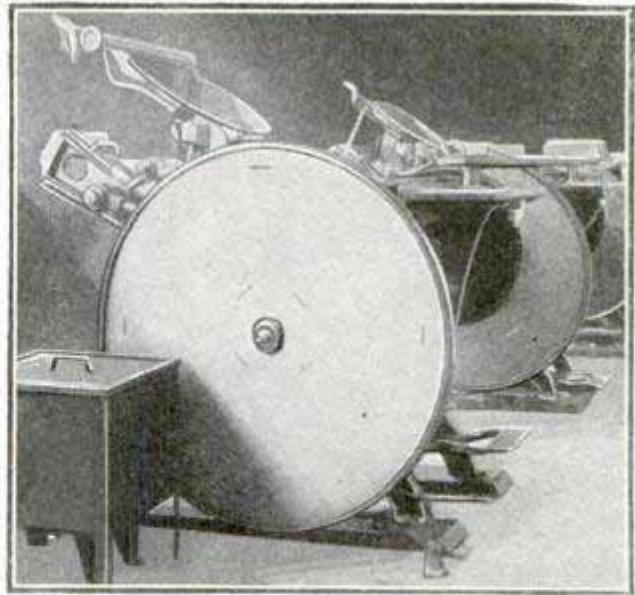

Wallboard Disks Attached to the Flywheels of Printing Presses Insure Safety

Disks on Flywheels Protect Workers

In a printing establishment, it was found that large disks of wallboard attached to the flywheels of the presses helped to insure safety to the workmen. After cutting the board to fit the wheel, holes were made at a number of places so that the board could be laced to the spokes with wire. It is, of course, advisable to twist the ends of the wire together on the inside of the wheel so that the outside surface of the disk will be perfectly smooth.

Handy Method of Snipping Wire

When short pieces of wire are needed for pins, rivets, or other purposes, the usual method of cutting it without snips is to lay the wire over a sharp corner and

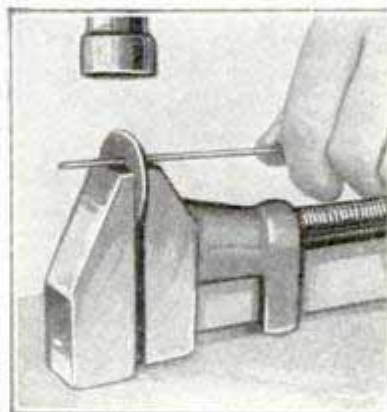

then crush it with a hammer. A better method is shown in the photo. Slip the wire through a small washer, lay the wire and washer over a monkey wrench as indicated, the jaws being set so that there is just enough space for the washer to slide between them. Hit the washer a smart blow with a hammer, and the wire will be sheared off squarely.

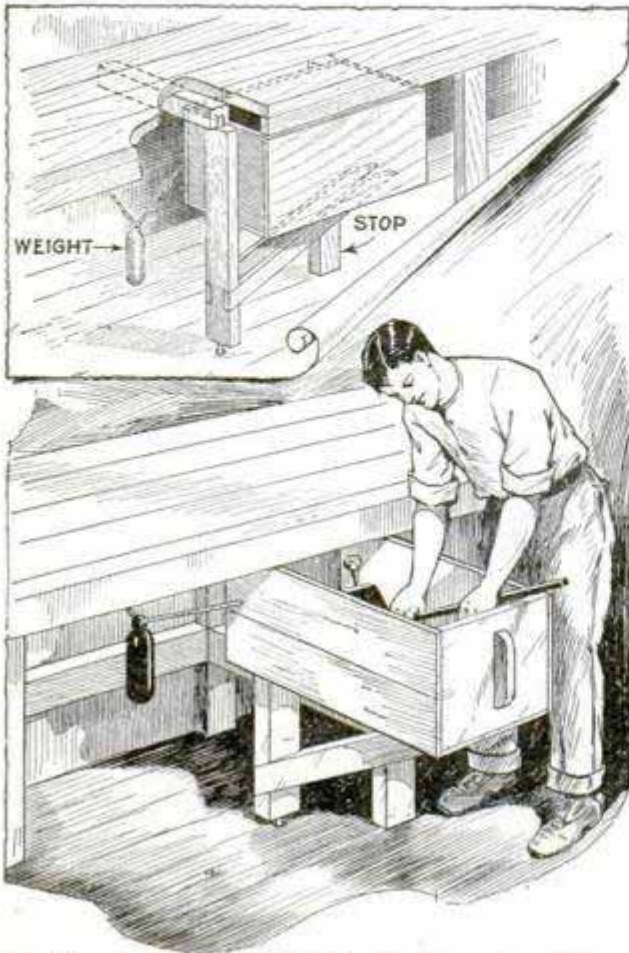

Workbench Drawer Which Can Be Opened and Closed Easily, No Matter How Heavily Loaded

Swinging Drawer for Workbench

It often happens that deep workbench drawers accumulate so many heavy items that they either stick or are hard to pull out. This difficulty can easily be overcome by providing a swinging drawer, as shown. A soap box, a length of 2 by 4-in. wood to stand vertically under the bench, two large spikes and a weight are all the materials needed. At the lower end of the two-by-four, a spike should be driven in permanently, after first drilling a guide hole a trifle smaller than the diameter of the spike, so that the wood will not split. The head should project about 1 in. Drill a hole in the floor, slightly larger than the head of the spike and about $\frac{3}{8}$ in. deep, preferably over a floor joist. It is well to drill a hole in the top of the workbench first so that the bottom hole can be located directly under it by a plumb line. The top spike should be a loose fit in the two-by-four, so it can be withdrawn when necessary. A diagonal brace, underneath the drawer, a weight to make it swing under the bench, and a stop complete the job.

Inasmuch as this type of drawer can always be opened with little exertion, no matter how heavy, it will be found a great convenience in the workshop.—H. Sibley, Pasadena, Calif.

Removing Sulphate from Storage-Battery Plates

Badly sulphated battery plates, which do not yield to the usual treatment of a long slow charge, may be saved from the scrap pile by the following means: Pour out the electrolyte, fill the cells with distilled water and allow them to stand until any acid in the plates has been soaked out. This may take several hours. Then the cells are emptied again and filled with a solution of pure sodium sulphate. The strength of this solution is not very important, although 7 oz. of the sulphate dissolved in 1 qt. of distilled water has been found satisfactory. The cells are now put on charge in the usual way and the sulphate will slowly disappear. Before refilling the cells with electrolyte, it is, of course, important to remove all traces of sodium sulphate by soaking the plates in water, one or two changes being needed before the process is complete. Then the electrolyte is replaced and the cells are connected for charging.

"Rumble Seat" for Dogs

A sort of rumble seat to provide comfortable transportation for dogs when they are taken for exhibition at shows, has been built on an auto by a dog fancier of Peekskill, N. Y. They are protected by a screen, and in bad weather the compartment can be covered.

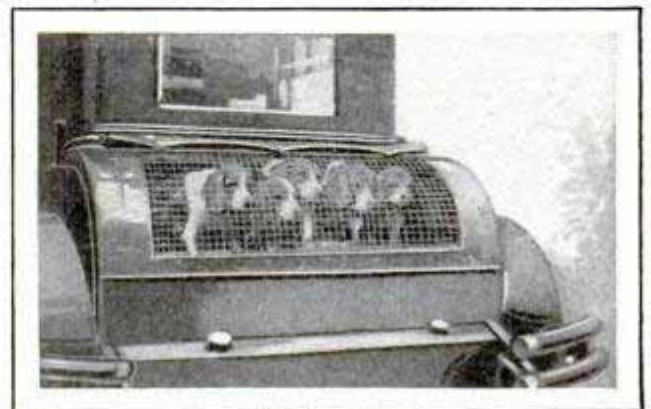

Screen-Covered Compartment for Carrying Dogs on a Roadster

Household Bluing Helps Detect Punctures in Tire Tubes

Finding small punctures in an auto tube is sometimes rather difficult, even if the tube is immersed in water, as defects or small holes in the rubber frequently close up when the tube is only partly inflated. However, if ordinary household bluing of the powdered kind is placed in a new tube before it is put in use, by removing the valve and pouring about a tablespoonful of the powder into the tube through a small paper funnel, the bluing will sift out through the opening and leave an easily seen smudge when a puncture occurs.

Laying Off a Cam

In cases where strict accuracy is not required, a cam with a uniform rise can be laid off by the method illustrated. If the cam required is to have a rise of 2 in., take a piece of wood and turn it down until its circumference is 2 in. Then wind a length of string around it a few times and place it in the position indicated. A pencil

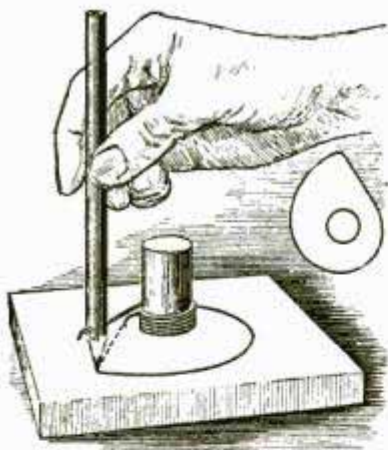

is slipped through a loop tied at the outer end of the string and is drawn over the material on which the cam is to be laid out, the string being unwound and the pencil held so that the string is taut.—Harry Moore, Rosemount, Can.

Measuring Voltage

Sometimes it is necessary to measure the potential of a power line, and the only voltmeters at hand are of too low a range to do the work. Then it is a good thing to know that two or three voltmeters may be hooked up in series, connected across the line, and the individual readings added to obtain the correct potential. For instance, two 110-volt voltmeters can be used in this manner to ascertain the exact voltage of 220-volt mains.

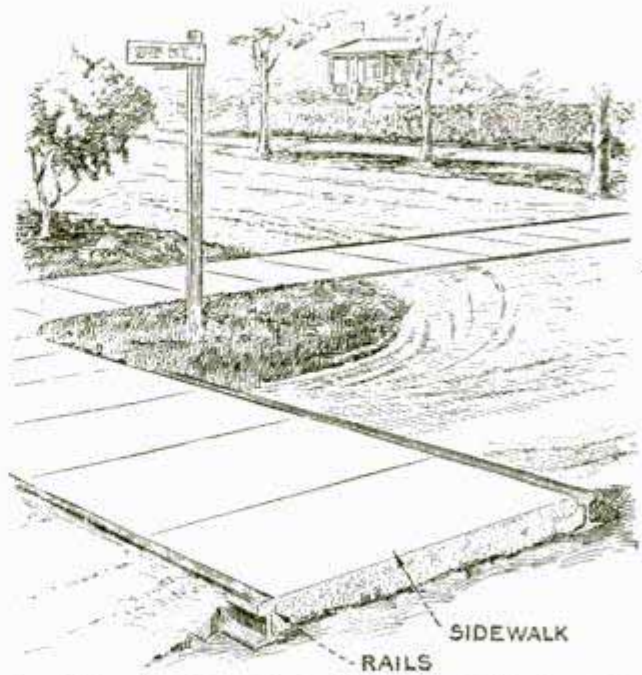

Road-Crossing Sidewalks Laid between Rails Are Fully Protected against Breakage

Protecting Concrete Sidewalk Crossings

In small towns having unpaved streets, one of the problems is to provide sidewalk crossings that will resist traffic shocks without breaking down. A good concrete crossing can be laid between two old railroad rails as shown. Earth or other road material should always be used to fill in level with the shoulders of crosswalks, in order to protect the concrete, but it is not unusual to see this precaution neglected in many towns. If rails are used as above, the concrete will be protected whether or not the earth fill is maintained.—W. F. Schaphorst, Newark, N. J.

Handle for Holding Small Blades

Small spokeshaves, cabinet scrapers, etc., can be conveniently held in the handle shown in the drawing. It is made from a piece of hard-

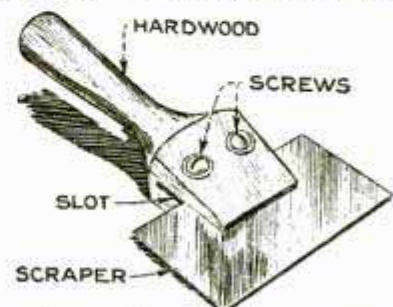

wood, cut down to the shape indicated. A slot is cut to admit the tool and two holes are drilled for screws, which, when driven tight, compress the sides of the holder against the blade, keeping it securely in place.—J. A. Stevens, East Boothbay, Me.

Adjustable Staging Found Convenient

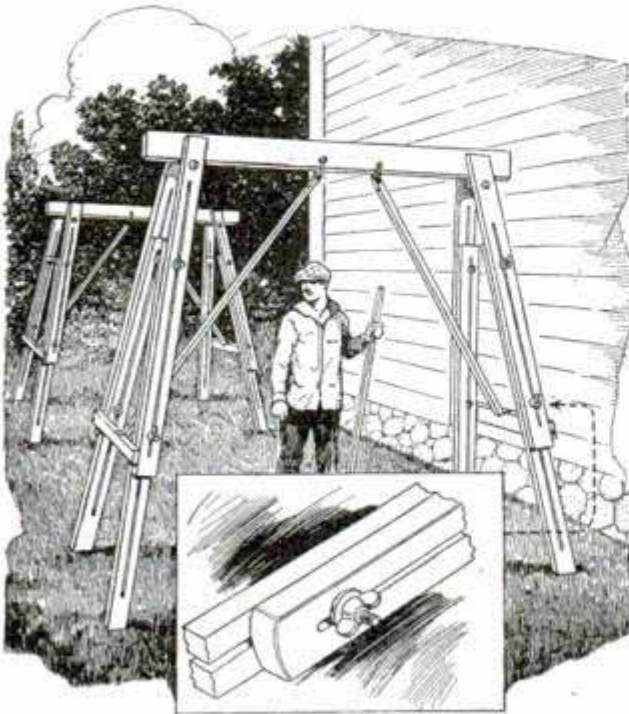

Adjustable Staging Used by Workers Engaged in Building Operations

Many workers will find the adjustable staging shown in the drawing convenient, as it can be set to any desired height. Each leg consists of two lengths of 2 by 4-in., or other suitably sized wood, slotted lengthwise and held together by means of bolts and wingnuts. Suitable braces are provided to keep the legs apart and to support the ridge piece. All the necessary constructional details are clearly shown.—Carlton Groat, Portland, Oreg.

Ball Mounting for Roll

A novel method of mounting a light roll so that it revolves with very little friction is shown in the illustration. This particular roll had to revolve by the action of paper passing over it and therefore must move very freely. Both ends are similarly mounted. A

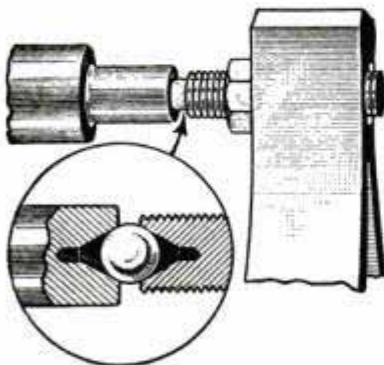

V-shaped center was machined in each end of the roll, which was supported by specially made brackets. These were drilled and tapped for small screws, also

having V-centers. The screws were provided with pins for turning to obtain the correct adjustment, and nuts to lock them in position. A steel ball was inserted between the vees of the roll and the mounting screws, the latter being turned so that the ball had just a little play. The nut was then tightened.

Repair for a Broken Oilstone

To repair a broken oilstone assemble the parts on some piece of heavy steel metal or a stove lid. Apply heat until the parts are fairly warm and then coat the fractured ends with heavy shellac. Hold the parts together with a clamp and reheat them, allowing the stone to cool gradually. After cooling, the parts will adhere and the stone will be fit for further use.

Covering Prevents Dirt from Sticking to Tamp in Clayey Soil

Workmen tamping clayey soil are usually inconvenienced by a large amount of dirt sticking to the tamp, increasing its weight and making it ineffective. A remedy for the trouble is to tie a piece of canvas, burlap, or other heavy cloth, over the tamp as indicated in the drawing. One working crew used denim from discarded overalls. The reason for the effectiveness of this method is that the cloth sags down each time the tamp is lifted, which causes the clay picked up to crack and fall off.—H. E. Benson, Denver, Colo.



Darkened Brooders Stimulate Chickens' Growth

A Wisconsin poultry man has proved by repeated tests, that the growth of brooder chicks is stimulated approximately 25 per cent if the brooder is darkened a few minutes several times each day. This

method is followed naturally by the mother hen, who calls her chicks to her from time to time for the same purpose. The reason for the increased growth of the chicks when this is done, is that the temporary darkness induces them to nap and doze, which, it seems, helps to digest food previously eaten. It was formerly thought that a brooding hen did this to provide warmth for the flock but the same instinct seems to rule in hot weather.

Burning Out Carbon

Carbon is usually burned out by blowing oxygen into the spark-plug openings. A quicker way is to draw the oxygen into the cylinders while the motor is running. Attach the hose from the oxygen tank to the intake manifold by unfastening the tube to the vacuum tank and connecting the oxygen hose to the fitting of the vacuum-tank lead. Ordinarily the tank will hold sufficient gasoline to run the motor during the oxidation. Be sure that the radiator is full of water. Start the motor and run it slightly faster than idling speed. Turn on the oxygen gradually and at the same time close the choke slowly. Adjust the oxygen valve until the motor receives so rich a mixture that it will miss. Then let the motor run for ten minutes. The surplus oxygen combines with the carbon in the combustion chamber. Not only is the combustion chamber thoroughly cleaned in this way, but also the exhaust ports and valve stems, and the spark plugs.—R. P. Cole, Paterson, N. J.



Small Waterwheel Installed in a Brook Operates a Pump Which Raises Water to a Near-By Reservoir

Small Waterwheel Provides Farm with Water

In the hill country near San Antonio, Tex., there is a small waterwheel which pumps water from a brook to a near-by farm house. The installation consists of

an ordinary paddle wheel placed in the stream so that the current causes it to revolve. The wheel operates a walking beam to which a pump is connected, as shown. The pump forces the water through a pipe line to a reservoir. There is a constant flow of water in the brook, which insures the continuous operation of the wheel. It has supplied water for the farm house and garden for several years and needs no other attention than an occasional oiling.

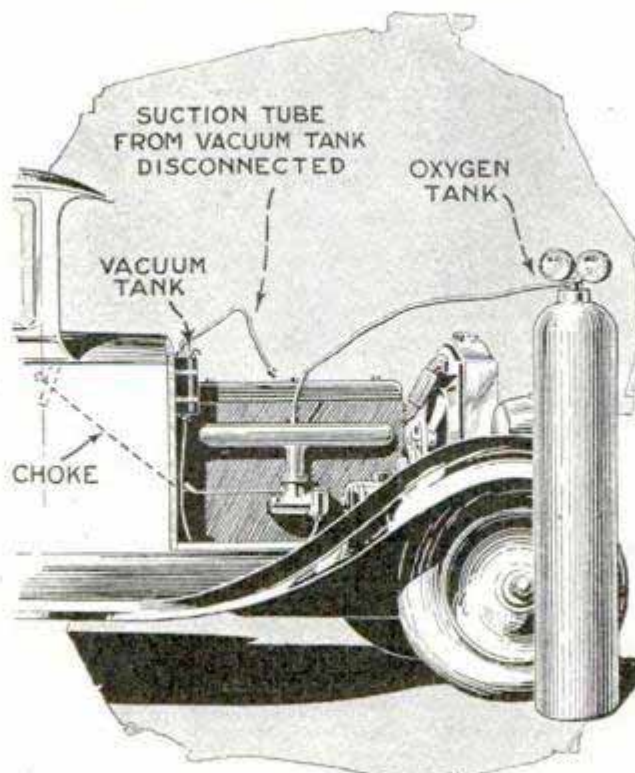

Easy Method of Burning Out Carbon with Oxygen While the Motor Is Running

Easy Access to Well Pit

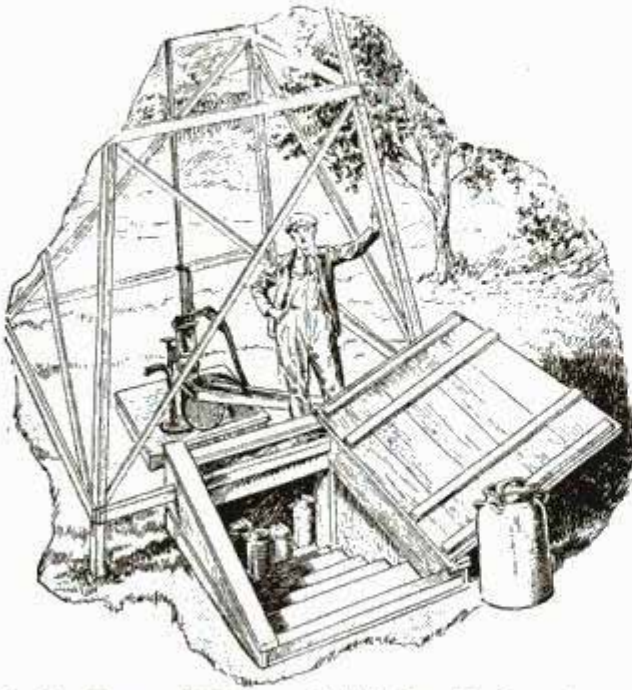

A Trapdoor and Stairway Which Provide Easy Access to the Well Pit

Many farmers use their well pit as a cooling room. Although convenient for this purpose, it is rather troublesome to raise the boards of the platform. An access which has been found handy is shown in the drawing. It is merely a trapdoor and a stairway, leading down into the pit. The arrangement is also useful during the winter when it is often necessary to wrap the pump pipe in order to prevent freezing. Obviously, it is easier to get at the pipe for this purpose, and for occasional inspection, through the trapdoor than through the platform.—Geo. R. Harrison, Council Bluffs, Iowa.

Loosening Rear-Axle Nut of Truck

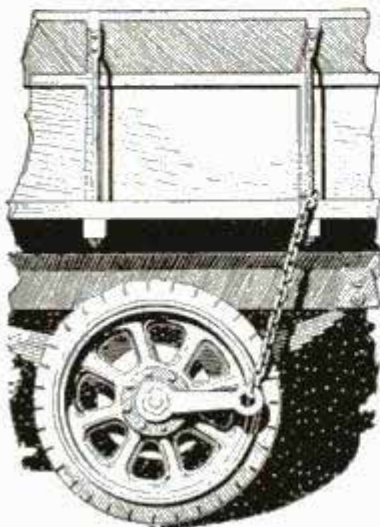

It frequently happens that the nut which holds the rear wheel on a motor-truck axle shaft of the semi-floating type, becomes rusted or otherwise jammed so that it can neither be loosened nor

tightened by ordinary methods. When such a condition exists, a sure relief will be found and much time saved, by setting the regular wrench in place on the nut, and attaching a chain between its outer end and the frame or body of the truck as indicated. The truck is then run backward a few feet. The nut will be held securely by the wrench but will be loosened by the turning of the axle shaft and wheel. To tighten a nut that cannot be run up snugly by hand, place the wrench on the nut with the handle to the left, attach the chain as before and run the truck forward as far as necessary. Many expensive axle shafts are ruined by being run loose in the rear-wheel hub and "wallowing" the keyway, and in most cases this results from the fact that a nut has been fitted improperly.—G. C. Douglas, Raleigh, N. C.

Self-Opening and Closing Cover

For a can containing a fluid that must be kept inclosed at all times, except when pouring, the cover shown in the drawing will be found convenient. Instead of the usual lid closing the entire top, a semi-circular piece, with two loops for a pin, was soldered in place, and another piece, shaped as indicated, hinged to it. To make the lid open and close automatically a small weight is attached to the central strip of the lid, which is bent down at right angles. When the can is tipped to pour, the weight swings forward and opens the lid, and when the can is set upright it closes.

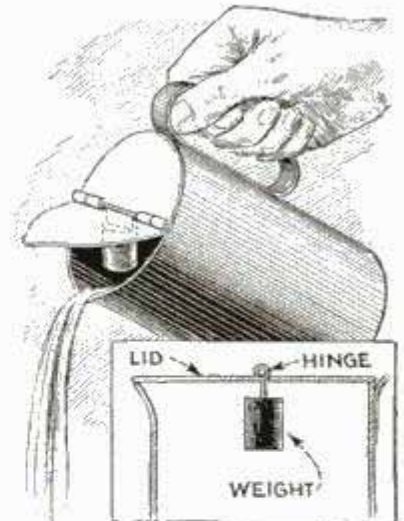

When dismantling a machine having hardened parts it is often necessary to mark the various parts to assist in reassembling them; this can be done by applying a copper-sulphate solution to form a coppered surface on which a mark can be made with a scribe.

the bottom shelf are the measurements. (See Fig. 2.) Pencil letters beside these marks to identify them. Square the upper ends of the sides. Catch the rod block against these ends, and lay out the dado positions. Score lines for the upper sides with a knife, providing for grooves 6 in. long.

The cupboard sides, which have square edges, are cut 2 ft. 8 in. long and $7\frac{7}{8}$ in. wide. Mark the upper edges of all grooves and mortises, remembering that the sides must be in pairs, with grooves matching those of the outer sides. Lay out the positions of the drawer rails and cupboard shelf, on the cupboard sides, as follows: 3 in. to the upper rail; $3\frac{1}{2}$ in. to the next; $4\frac{1}{4}$ in. to the drawer shelf, and 1 ft. $1\frac{3}{8}$ in. to the bottom shelf. Notice that the door-rail mortise is $\frac{3}{8}$ in. lower than the shelf dado, giving a margin on the shelf edge to serve as a stop.

The two thin shelves are dimensioned in Fig. 6. Make these of $\frac{1}{2}$ -in. stock (easily surfaced down from $\frac{5}{8}$ -in. baseboard) cut exactly $6\frac{1}{4}$ in. long. Be very careful in squaring the ends, or the cabinet will twist when assembled. Gauge fine pencil lines across the upper sides $\frac{1}{4}$ in. from the ends, representing the depth to which they sink into the side grooves. Measuring from the back edges, lay out on these lines the exact width of the mating sides with a rod marked directly from them and draw a line for the front edge. Locate the right edge of the partition dado on the left shelf $3\frac{3}{4}$ in. from the right end, and that of the right shelf $3\frac{1}{8}$ in. from the end.

The two thin partitions (Fig. 7) are $\frac{1}{2}$ in. thick, and about $6\frac{15}{16}$ in. and $7\frac{1}{8}$ in. wide, respectively, the exact width to be taken from the thin shelves. The left piece is 1 ft. $3\frac{1}{4}$ in. long, and the right, 1 ft. $6\frac{1}{4}$ in. The lower corners are notched $\frac{1}{4}$ in. to fit over the blind ends of the grooves.

To determine the width of the shelf grooves, set the ends of the partitions with one side of each accurately on the mark.

Then, with a knife, as in Fig. 11, mark the positions of the other sides, and square across. Gauge the back of each dado for a depth of $\frac{1}{4}$ in. Since the groove is not open in front, a mortise, $\frac{3}{4}$ in.

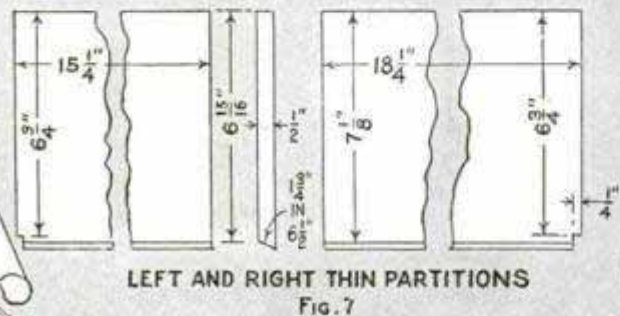
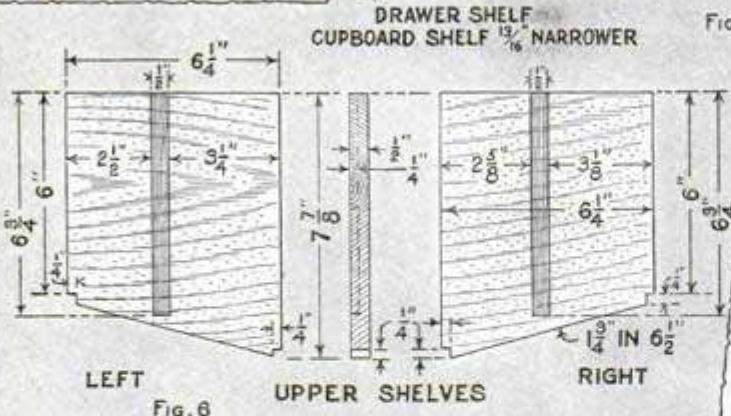
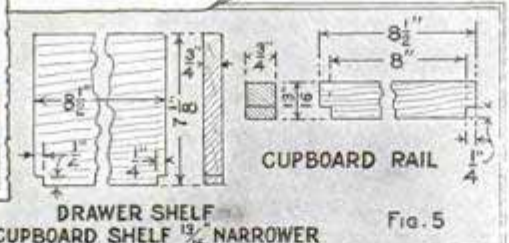
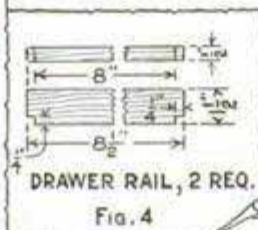

long, must be chiseled at the blind end to give room for a saw stroke. Make a chisel cut across the grain in the middle, and work toward it from both sides, thus avoiding bruising the sides of the dado and making an unsightly joint. Then, with a back or crosscut saw, splitting the line and sawing in the waste wood, cut to depth at the back and gradually work forward until the saw cuts full length

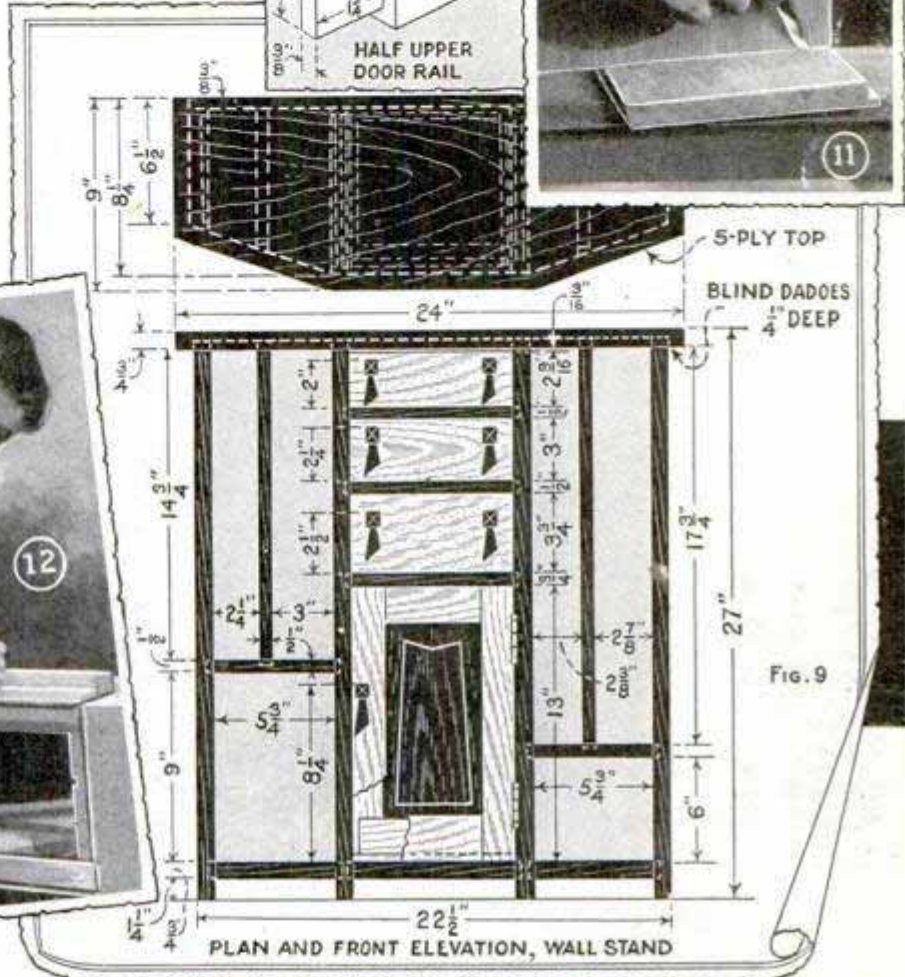
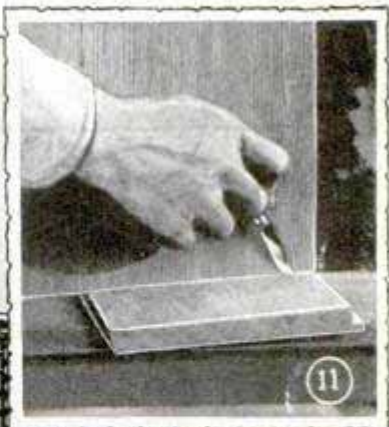
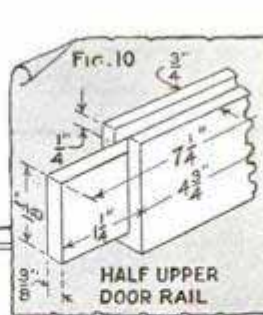

of the groove. Guide the saw with the thumb of the left hand. (See Fig. 18.) If the saw is centered on the lines, the groove will be nearly $\frac{1}{16}$ in. too wide. Chisel out the waste to a depth of $\frac{1}{4}$ in. This must be reasonably accurate. If a router is available, so much the better. Cut the front edges of the shelves and notch to fit the sides. The lower shelves are like the upper, except that they are $\frac{3}{4}$ in. thick and are not grooved.

The drawer shelf, Fig. 5, is a rectangle of $\frac{3}{4}$ -in. stock, $7\frac{7}{8}$ in. wide and $8\frac{1}{2}$ in. long, with the front corners notched $\frac{1}{4}$ by $\frac{1}{4}$ in. to fit. The bottom shelf is $7\frac{1}{16}$ in. wide, without notches.

The two drawer rails are detailed in Fig. 4. These are $\frac{1}{2}$ by $1\frac{1}{2}$ in., by $8\frac{1}{2}$ in., with front corners notched $\frac{1}{4}$ by $\frac{1}{4}$ in. The cupboard rail (Fig. 5) is $\frac{3}{4}$ by $1\frac{1}{16}$ by $8\frac{1}{2}$ in., notched $\frac{1}{4}$ by $\frac{1}{4}$ in.

Five-ply veneer is preferable for the

top, Fig. 9, though a well-seasoned piece of 1 by 10-in. stock will do. If veneer is used for stained work, the edges of the plies should be concealed with a flat band, glued around and smoothed off flush at the top and underside, and for paint they should be well filled.

The total length is 2 ft. Lay out the underside for dados to receive the upper ends of the sides, getting dimensions from parts already made. After cutting the dados, mark the front edge of the top by measuring $\frac{3}{4}$ in. from them and scribing accordingly. Rabbet the back between the end grooves.

Before assembling the cabinet, try every joint for fit. If some are too snug, surface off the entering pieces until a fit is obtained. Do not try to trim the grooves with a chisel. Size all end grain with glue, and smooth with No. $\frac{1}{2}$ sandpaper.

Assemble the center section, using liquid

glue, since the process is likely to be slow. Use smooth soft-wood blocks to protect the parts from scars and to distribute the clamp pressure across the width of the

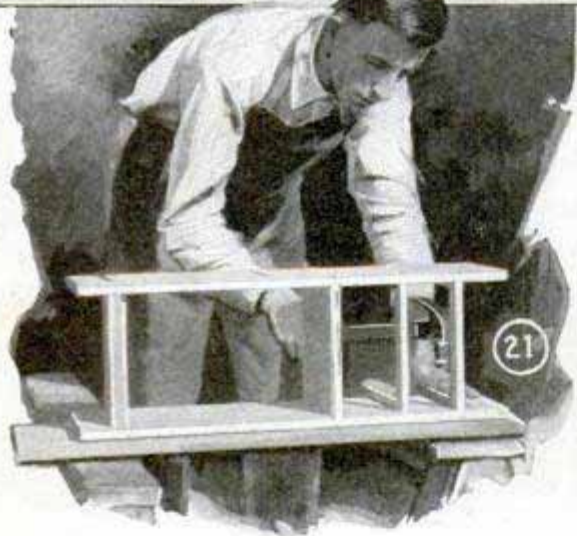
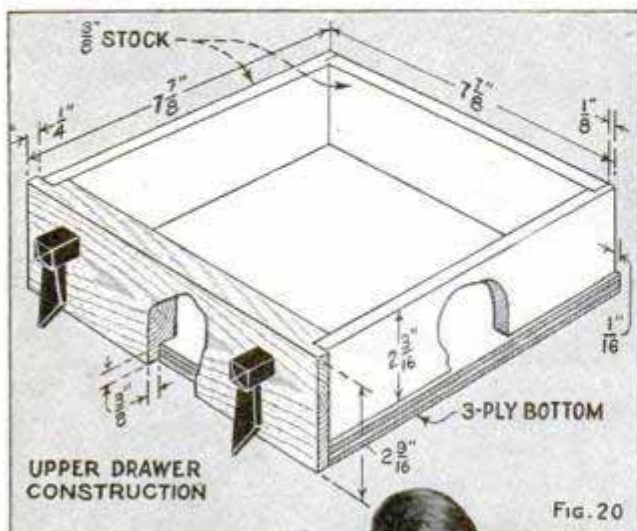

boards. Apply glue to all joining parts, and when assembled, clean off squeezed-out glue before it hardens. Test the section for squareness by measuring from opposite corners, tacking a strip across the back to hold the assembly rigid while drying. Nails may be driven from the underside of the shelves (Fig. 19) and the overhanging edges of the top.

For drawer runs, nail $\frac{1}{2}$ by $\frac{1}{2}$ -in. hardwood strips inside the sides behind the rails (Fig. 21) and glue a $\frac{3}{16}$ -in. rail under the top in the upper drawer opening.

While this section dries, make the door. The upper rail is $\frac{3}{4}$ by $1\frac{5}{8}$ by $7\frac{1}{4}$ in. Mark one face and one edge, and plow a $\frac{3}{8}$ -in. groove $\frac{1}{4}$ in. deep in the latter, $\frac{3}{16}$ in. from the face. From the face side, square across the edges for tenon shoulders, and square across the faces from the grooved edge. The tenons are $1\frac{1}{4}$ in. long and

$1\frac{1}{8}$ in. wide, and the distance between shoulders is $4\frac{3}{4}$ in. Gauge for thickness from the face side. Cut in the waste wood, just splitting the line, first ripping the cheeks, then the width, and finally cutting the shoulders. (See Figs. 13 and 14.) The lower rail is 2 in. wide, with tenons $1\frac{1}{2}$ in. wide.

The two stiles are $\frac{3}{4}$ by $1\frac{5}{8}$ in., cut 1 ft. 1 in. long, as in Fig. 16. Chisel mortises in the grooved edges, $1\frac{3}{8}$ in. deep, to fit the rail tenons. They are $9\frac{7}{8}$ in. apart, placing the inner edges of the rails $9\frac{3}{8}$ in. apart. Glue the door together, enclosing a panel of three-ply veneer cut $4\frac{1}{8}$ by $9\frac{3}{4}$ in. Remember that if the door does not lie flat naturally when assembled, it will twist in use, even though dried flat under pressure.

While the door is drying, fit the molding that forms the design on the door. The side strips are $9\frac{3}{8}$ in. long, varying in width from $\frac{3}{8}$ to 1 in., and are slightly more than $\frac{3}{16}$ in. thick. The upper mold tapers on the lower edge from a width of 1 in. at the center to $\frac{1}{2}$ in. at the ends, while the lower mold is straight, and $\frac{3}{4}$ in. wide. Lay each in turn on the door panel and with a sharp pencil trace the inner edges for 1 in. from the ends. The intersections of these lines are squared up on the edges of the strips, and connected with the panel corners by straight lines. These are cut for the joints, and the strips are glued in place and put under pressure.

Assemble the rest of the cabinet parts with the center, carefully aligning the lower shelves, and squaring the whole. Fit a piece of three-ply veneer into the back rabbets, nailing with brads. Mark for the lower ends of the two outer sides, and mark the others by laying the square

MATERIAL LIST

- 1 piece, 1 by 10 in. by 14 ft., hardwood, fir or white pine, S4S, sanded.
- 1 piece, 1 by 4 in. by 6 ft., (resaw as needed for thin stock).
- 1 piece, $\frac{5}{8}$ by 8 in. by 4 ft., baseboard.
- 1 piece, $\frac{3}{8}$ by 24 in. by 4 ft., three-ply veneer (or $\frac{1}{4}$ in. thick).
- 1 pair $1\frac{1}{2}$ by $1\frac{1}{2}$ -in. loose-pin butts.
- 1 $\frac{1}{4}$ -in. forg catch.
- 1 set $\frac{1}{2}$ -in. "domes of silence."

across, as in Fig. 22. Square lines across the faces and cut the feet. Glue on $\frac{3}{8}$ -in.

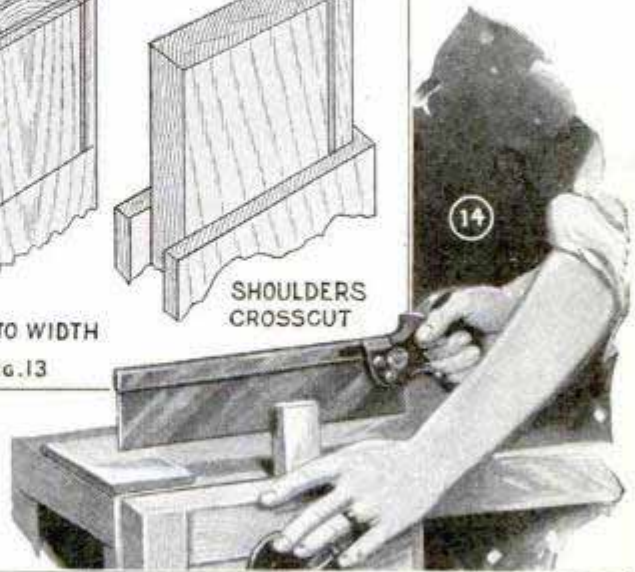
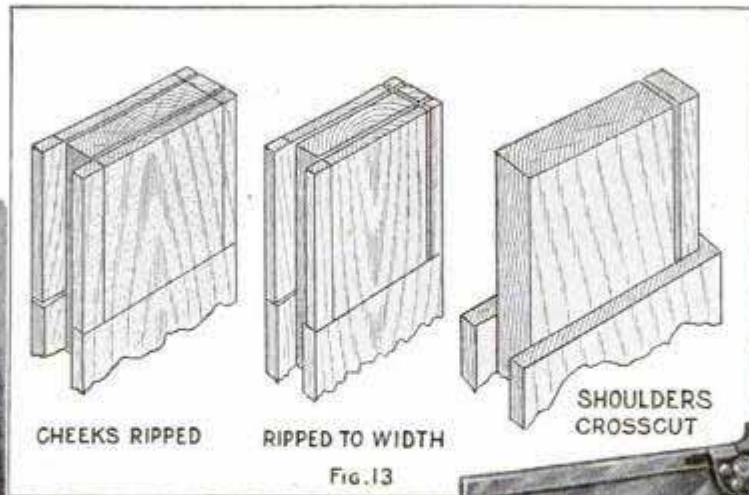
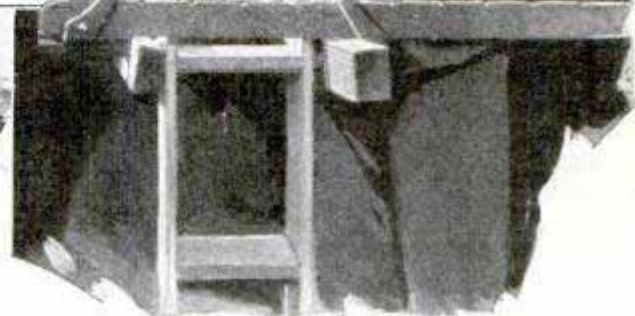
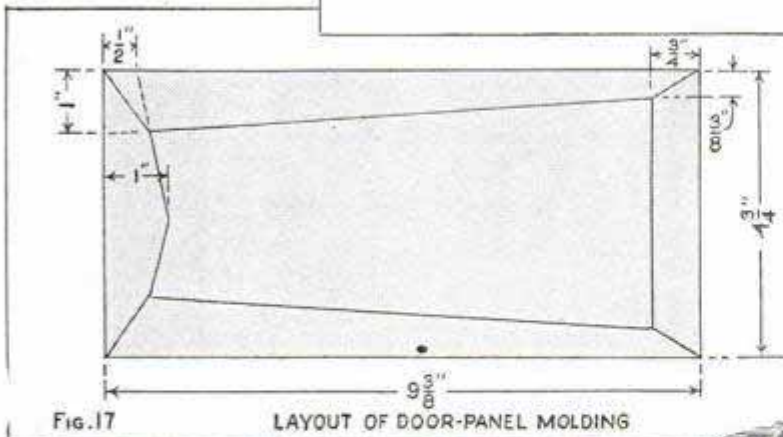
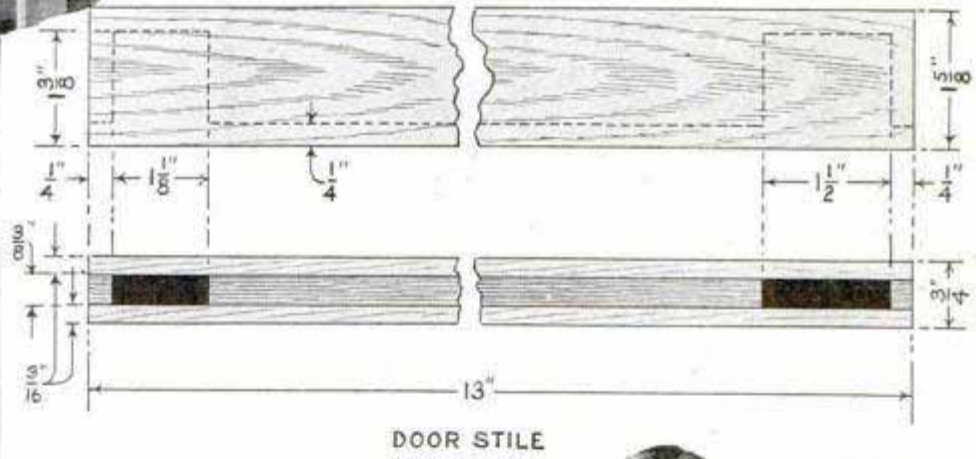

Fig. 14, Cutting a Tenon; Fig. 15, Planing Down the Sides of the Cabinet; Fig. 18, How the Saw Is Used in Cutting a Dado, and Fig. 19, Nailing In the Shelves



blocks to fill out the rabbets and middle feet to the thickness of the back veneer.

The construction of the drawers is illustrated in Fig. 20. First square up a piece of three-ply stock for the bottom, 8 by $8\frac{1}{4}$ in., and joint the width to an easy-sliding fit between the sides in the upper drawer space. The clearance should be less than $\frac{1}{16}$ in. Set it in place and scribe the underside with a sharp pencil guided on the front edge of the rail. Remove, and draw a second line $\frac{1}{4}$ in. inside of the first one.

Now cut a piece of $\frac{3}{4}$ -in. stock, $\frac{1}{2}$ in. longer than the drawer opening, and joint it to the width. Surface it to a thickness of $\frac{5}{8}$ in., and rabbet the lower edge $\frac{3}{8}$ by $\frac{3}{8}$ in. Rabbet the ends $\frac{3}{8}$ in. deep, making the length between shoulders $1\frac{3}{16}$ in. less than the width of the bottom. Make two sides of $\frac{3}{8}$ -in. stock, $\frac{3}{8}$ in. narrower than the drawer opening and $\frac{1}{4}$ in. shorter than the veneer. Rabbet the back ends $\frac{1}{4}$ by $\frac{3}{8}$ in., and make a back. Nail the sides to the front, and the back between the sides. Lastly, nail on the bottom, giving a uniform clearance overhang of $\frac{1}{16}$ in. on both sides. Fit the drawer into the opening with $\frac{1}{32}$ in. clearance. Build the other two drawers in the same way. The front of the middle one is 3 in. wide, and that of the lower drawer, $3\frac{3}{4}$ in. (See Fig. 15.) When all are fitted, draw a line across the front ends with a straightedge (Fig. 26) and cut off the projecting horns. Fit the fronts with a clearance of $\frac{1}{32}$ in. all around.

Seven drawer pulls are required. Each is cut from $\frac{3}{8}$ by $\frac{1}{2}$ by $1\frac{3}{4}$ -in. stock, having one end cut at an angle of 30° with the square. Work a tenon on each, $\frac{1}{8}$ in. thick, centering on the width, and $\frac{1}{4}$ in. wide, flush with the back, making it $\frac{5}{16}$ in. long. Trim the tapers to shape last. For the supports, make a stick $\frac{1}{2}$ by $\frac{9}{16}$ in., working a pyramidal end, $\frac{1}{8}$ in. high. Cut a $\frac{1}{8}$ by $\frac{1}{4}$ -in. mortise $\frac{1}{4}$ in. from the point base, centering on the thickness, to take the handle tenon. Glue in a handle, and cut the support to a length of 1 in. Proceed with the others in the same way.

Surface the door molding and joints flush, cut off the projecting ends of the stiles, and with an eye tool, guided by a straightedge, trace around the joint between the molding and frame, smoothing

the groove with a bit of folded sandpaper. On each side of the cabinet, a panel is outlined with the same gouge, as in Fig. 25. Square a light pencil line across, $1\frac{3}{4}$ in. from the underside of the top. From this line another, $1\frac{5}{8}$ in. from the back and parallel to it, extends to within $2\frac{1}{2}$ in. of the bottom. The front of the panel runs parallel to the front, $1\frac{1}{4}$ in. from it for $8\frac{1}{2}$ in., then drops back 1 in. and continues for $7\frac{1}{2}$ in., then moves back $\frac{3}{4}$ in. to the bottom of the panel.

Sponge the case with a water-dampened cloth to raise the grain, and, while it dries, fit and hang the door. Give it a clearance of $\frac{1}{32}$ in. The hinges are placed $1\frac{5}{8}$ in. and 2 in. from top and bottom, respectively. Since the door is so narrow, the front edge must be beveled considerably to clear in opening and shutting.

Before finishing, sand the cabinet glass smooth, rounding off the corners with sandpaper, and give a coat of shellac, if it is to be painted. The stand illustrated was finished with lacquer, applied with a hand spray costing \$2.50. The nail holes in the back were puttied with thick lacquer from the bottom of the can. The back, end borders and door border were sprayed light green. Newspapers were then tied around under the top, and the latter was sprayed with orange. The end panels were exposed for the orange by tracing the grooves through the paper with a pencil and tearing out the center, little dabs of glue keeping the edges of the mask in place while in use. The papers were next removed for spraying the tops of the shelves with orange. Cardboard covers fitted between the partitions screened the shelves while the insides of the compartments received their coats of dark violet.

The front edges of the shelves, sides, and partitions, were coated orange by means of a small brush, as were also the door molding and the drawer pulls. The edges of the side panels were made crisp by brushing orange in the grooves.

Well-hardened lacquer can be sanded smooth and polished down with pumice and rottenstone as easily as varnish. The hand spray leaves the surface with a granular texture, which, however, is much more easily smoothed than brush laps.

Put on the drawer pulls with wood screws entered from the backs of the

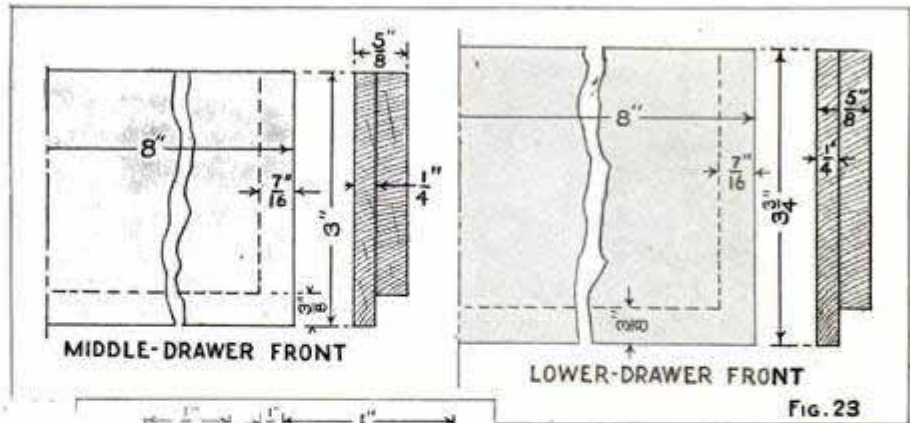

A Few of the Operations Involved in the Making of the Simple Modern Wall Stand Described in This Article; Fig. 22 Shows How the Sides Are Squared across for Cutting Off at the Feet; Fig. 26, How the Drawer Front Is Marked for Cutting, and Fig. 27, How a Twist Bit Is Held in the Fingers to Bore the Hole for the Forc Catch

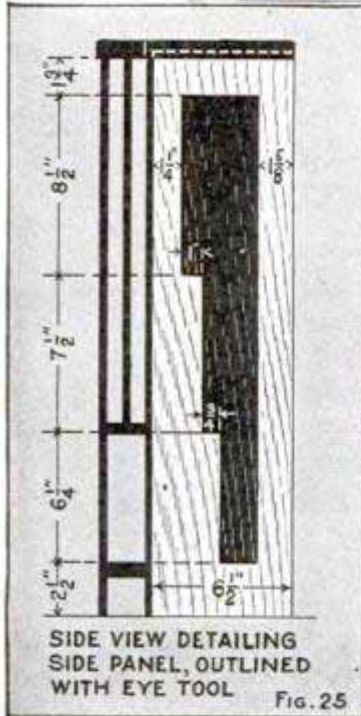
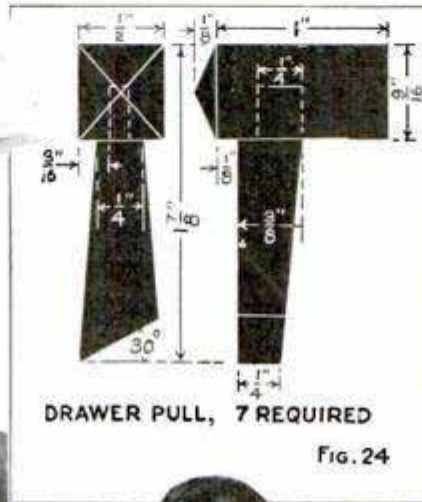

drawer fronts, the outer edges being 1 1/4 in. from the drawer sides. Put a 1/4-in. forg catch on the top of the lock stile of the door, Fig. 27, with the bolt in the underside of the drawer shelf. The hole can be quite easily bored by twisting the bit in the fingers. The stand should be raised from the floor by sliding casters.

and we therefore publish herewith a diagram which gives the correct method of boosting the voltage of a bank of dry cells in parallel. All that is necessary is to connect one end cell in series with the remainder of the bank.

Correction

Tire-Valve Spring Substitute for Distributor-Cap Spring

In the June issue of Popular Mechanics, on page 1036, the article entitled "Increasing the Voltage of Run-Down Dry Cells," was, in part, erroneous

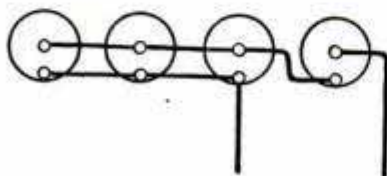

The spring forcing down the central brush in the distributor cap of a motor-car ignition unit, will sometimes fall out and become lost when the cap is removed for roadside examination of the breaker points. In an emergency, the spring of a tire valve will replace the missing part.



A Simple Jig Which Will Facilitate the Making of Links of Equal Size

Fixture for Forming Wire Links

An inexpensive fixture for forming eyes or loops in wire links is shown in the accompanying illustration. It is designed to be held in a bench vise and consists of a block, A, into which are fitted two pins, the distance between their centers being equal to the distance between the centers of the loops or eyes to be formed. Two smaller pins, also driven into the block, locate the preformed wire centrally with the eyes. A hole, D, equal in depth to the length of the wire forming the eye, is drilled in the end of the block, and an adjustable stop, E, is tapped into the end as shown, and locked by a nut. The lever L, which is used for forming the link eyes around the pins, has a pin, G, and it is drilled at F to fit the link-forming pins.

The process of making wire links is as follows: First cut off the wire to the developed length of the links. Next insert one end of the wire in hole D and bend it until it touches stop E. Repeat this bending operation at the opposite end of the wire, being careful to keep the bends in the same plane, so that the partly formed link will lie flat in the fixture. At this stage of the forming operation the link is shaped as shown in the detail. The lever L is placed in position on one of the pins so that pin G engages the wire

and the eye is then formed by rotating the lever about the pins, after which the forming operation is repeated at the other end of the wire, producing the complete link as shown in detail S.—Leonard Keiser, Jr., Hawthorne, N. J.

Double Doors for One-Way Passage

Almost everyone at some time or other has experienced the annoyance of having a door pushed in his face just as he was about to open it. Here is a method of arranging double doors which make such accidents impossible. The doors can be made in any design to suit the builder, but the hinges must be put on opposite sides, so that each will work one way only. This is further assured by arranging latches as shown. These are made from rods, formed into a handle at one end and bent to a right angle at the other end, which rests against the wall when the door is shut. The latches are held to the door with two straps. The only way to open the door is to grasp the handle and pull it up to a horizontal position. Thus, although most people keep to the right, the



Self-Locking Handles on Double Doors Allow One-Way Passage Only

doors are made proof against the few who persist in doing the wrong thing.—Harry Moore, Rosemount, Can.

Ⓒ In the process of hardening, the fine cutting edges of a tool should never be exposed to the hottest place in the fire; heat the heavy part first, allowing the heat to run to the thin edge.

826

2101 Blairdell Ave
 Minneapolis, Minn

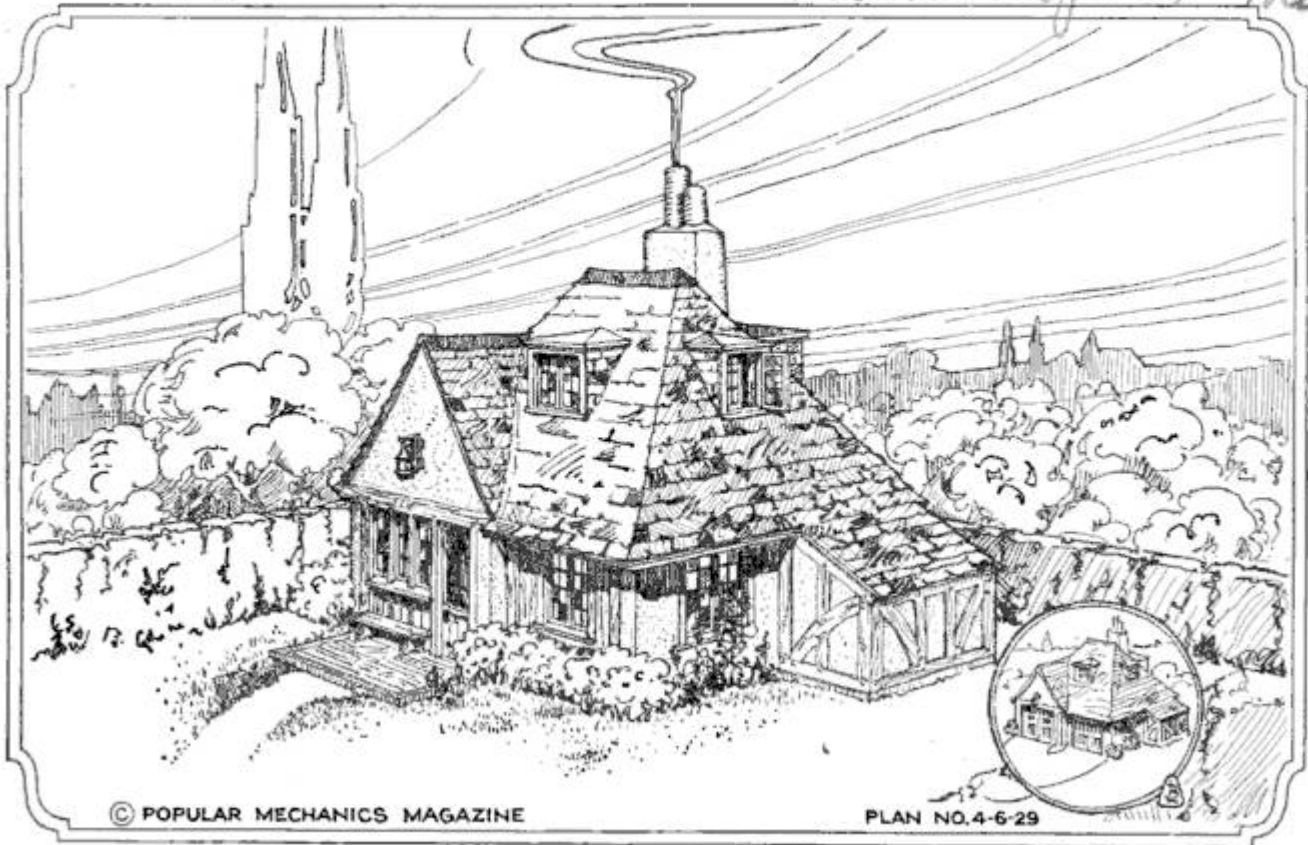

Attention Newlyweds!

Build This Five-Room English Cottage on the Rear of Your Lot for Around \$2,000 and Later Make It into a Garage

HERE is a practical idea that tunes in with the heart and purse strings of newlyweds and others getting started on the road to home ownership who want to make a little money go a long way.

According to the estimate of the designer, you can build this charming five-room English cottage for around \$2,000. But build it on the rear of your lot exactly where you plan your future garage. Live in the cottage during the time you are saving money to build your dream home on the front of your property. When that time comes, you convert the cottage into a two-car garage. You salvage the casement windows, floors and, perhaps, the plumbing. Use them in the new house. Hang garage doors where the large windows

now appear. Use one stall for your own car. Rent the other to a friend or neighbor. You have an income-producing property which over a period of years pays for the original cottage.

Suppose you rent one-half the garage for \$5 per month. That's \$60 a year. The designer says that salvaging the windows, plumbing, floors, etc., would save about \$750. That brings the original cost down to \$1,250. Each stall represents \$625. Now \$60 per year return from garage rent is almost ten per cent on \$625. Not a bad proposition.

But more than this. You live on your property and avoid paying rent to a landlord during the time you are saving for your larger house. You enjoy all the privileges to be had from complete mastery

A NEW SERVICE

To help our readers get started on one of life's most glorious experiences—building and owning a home—Popular Mechanics Magazine will supply readers a one-sheet blueprint of the house here illustrated for \$2. This blueprint does away with the necessity of first purchasing a complete set of plans to find out whether you can afford to build. It contains floor plans, elevations, a section, detail, size of joists, studs, etc., and also a brief specification. Submit it to tradesmen and dealers for building estimates.

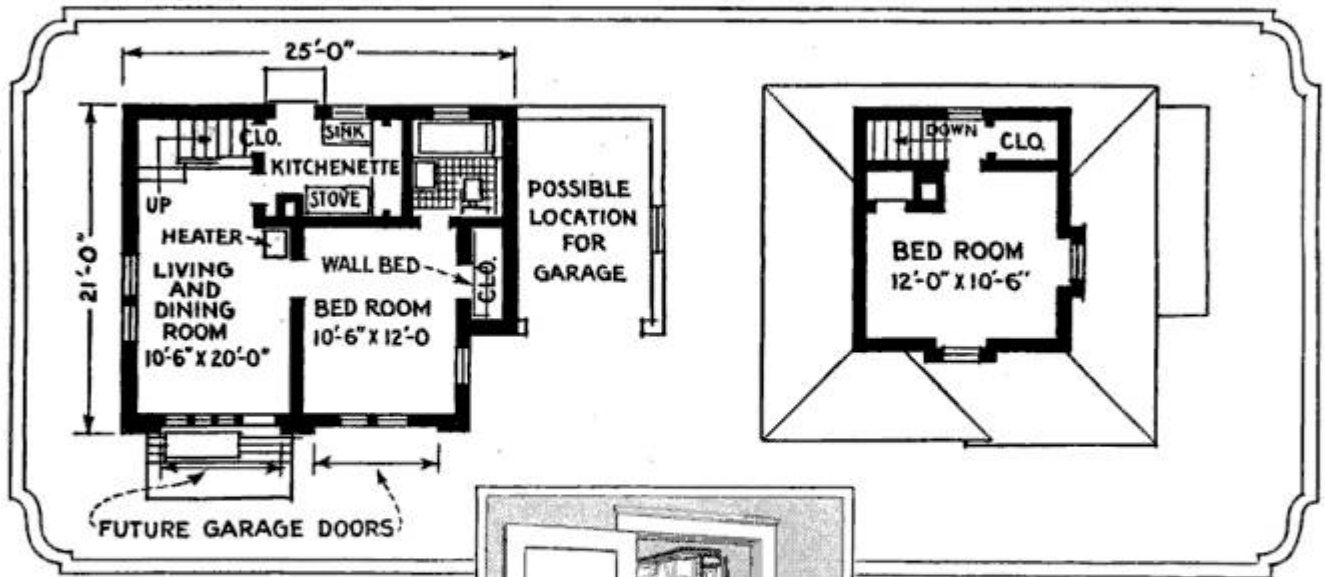

of the sweetest little kingdom you can possibly ask for.

Everybody who sees this plan and investigates the idea likes it—practical builders, real-estate men, carpenters, newlyweds. It is not a trick, stunt or makeshift in any way. It is a simple, inexpensive and highly practical stepping stone to home ownership. You pay as you go. And the financial obligations are easy. That's one reason why so many people approve the idea.

This temporary home is so attractive, charming and refined in its external appearance that you can live in it without loss of social standing in your community. Friends and neighbors may know that eventually your little cottage may be your garage. Even so, because of its small but highly attractive appearance and setting, it will in all probability be one of the most talked of homes for miles around.

What does the house contain? In the first place it offers you the efficiency and compact service of a modern city flat. But you have it all in a detached small dwelling—a distinct advantage.

The style is English. There is a snug-fitting, low-down, close-to-the-ground quality about it. You feel it grows out of the landscape. Note the broken roof lines, perky gables and snubby dormer windows. These things add greatly to the charm and character. Casement windows, rough-stuccoed walls, dark-stained exterior woodwork, and variegated shingles

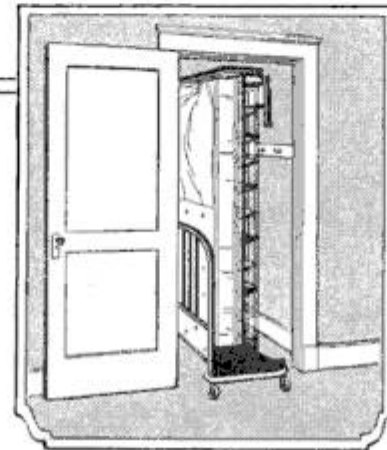

The Folding Bed Disappears into the Closet by Day

in either wood or composition are in perfect keeping with the style.

Now about equipment. The plan is compact but livable. There is a combination living room, kitchenette, bath, two bedrooms and good closet space. The downstairs area can easily be opened up into one large

room. A concealed or closet bed permits the downstairs bedroom to do double duty.

The house is heated by a first-floor heating plant. There is no basement, although you may have one if you wish. The "lean-to" garage takes care of your present car. The house is of frame construction and fully insulated. There is no variation from tried and proven methods of construction.

One more brief picture and this story is complete. Placed at the rear of your lot, the cottage would look well flanked by box hedges and greenery and perhaps rambler roses will climb the side walls.

What more can you ask for as a stepping stone to home ownership and especially if you do not want to plunge into heavy expenditure to start with?

EDITOR'S NOTE: Popular Mechanics Magazine has prepared a new plan book, "Twenty Popular Low Cost Homes and Ten Commandments for Home Builders." These are selected homes and show labor, space and time-saving ideas. They are \$5,000 homes and less. Send 10 cents in stamps to cover postage. Address Building Editor.



Power

"YANKEE" No. 90 Screw-driver is made for the man with *power* in his grip . . . Made for all men who use a screw-driver as an all-purpose tool and depend on it to take all sorts of punishment.

"Yankee" No. 95, a lighter screw-driver, has the same dependability in finer work.

The handle of a "Yankee" can't loosen, wobble or turn on blade. Every "Yankee" blade is twice tested by experts and won't crack, break, twist, or bend on the edge.

No. 90. Standard Style—15 sizes: 1½" to 30" blades. Price for 4", 40c; 6", 55c; 8", 75c.

No. 95. Cabinet Style—11 sizes: 2½" to 15½" blades. Price for 4½", 40c; 6½", 50c; 8½", 65c.

YANKEE Vise No. 1993

Removable from base
for continuous work

Means accuracy and time-saving. Work is center-marked, then press-drilled and milled, and back to bench, without removing from vise. Block with V-shaped grooves holds rounds or irregular shapes. No. 1993, length 8¼", jaws open 3½"; price, \$9.90. Other sizes, from 1½" to 4" opening, at \$3.75 up.

Ask dealer for "Yankee".
Look for the name.

"YANKEE" on the tool you buy means
utmost in quality, efficiency and durability.

"YANKEE" Tool Book, free. It is filled with the kind of action pictures (ingenious tools in use) that readers of Popular Mechanics like to see. Write to—



NORTH BROS. MFG. CO., Philadelphia, U. S. A.

"YANKEE" TOOLS

Make Better mechanics



C & L 158

This blow-torch is especially made and priced for the man who likes to do odd jobs around the house, or to tinker with mechanical things. It will last a lifetime if it is not abused. The usual retail price is about five dollars. Most hardware, electrical and automobile accessory stores have it—or can get it for you quickly. Look for the red handle.

Whatever you need in a blow-torch you'll find in the Clayton & Lambert line



PERHAPS you use a blow-torch only once in a while. In that case you don't need a torch built for hard use on every kind of a job, every day and all day. And you don't need to pay the higher price, either. Not when you can buy the new Clayton & Lambert 158.

It's a low-priced blow-torch, but we don't know where you can buy a better blow-torch at any price, outside of the Clayton & Lambert line. It's husky, with a strong, thick base that protects the tank. Everything in it is made to exacting precision standards, so that it works right—and keeps on working right as long as it is not abused. It holds its compression. And it gives you a hot flame in a jiffy.

On the other hand, if you do use a blow-torch in your daily work, we believe you'll find the Clayton & Lambert 32

better suited to your needs. For in addition to the excellent qualities of the 158, it has the new, patented Clayton & Lambert gas orifice. That orifice is made to the exact size for perfect operation. And it cannot be spread and enlarged by the needle-valve. Nor can it clog; every time you turn the torch off, the needle-valve cleans the orifice.

Blow-torch users have made the Clayton & Lambert line the most popular in the world. Hardware, electrical and supply houses sell these Clayton & Lambert blow-torches — you can identify them easily by the *red handle*.

CLAYTON & LAMBERT

MANUFACTURING CO.

DETROIT, MICHIGAN

GASOLINE + ETHYL = *high compression performance*

YOU are hearing much about "high compression"... "high compression engines"... "high compression fuel"... "high compression performance."

"What," a great many car owners are asking, "does 'high compression' mean to me?" Here is a simple explanation:

Each cylinder of your engine may be likened to a muzzle-loading gun. The cylinder is the gun; the piston is the bullet; and the mixture of gasoline and air is the powder charge.

The tighter you pack the powder charge in the gun before firing, the greater the force to the bullet. Similarly, the tighter you squeeze—or compress—gas vapor and air in the combustion chamber before ignition, the greater the force of the piston's stroke. In other words, the higher the compression the greater the power.

Higher compression in a gasoline engine is obtained by decreasing the size of the combustion chamber—either by mechanical design or by carbon formation.

Up to the advent of Ethyl Gasoline, the compression of automobile en-

gines was limited by the compression limits of gasoline. For gasoline is not a perfect fuel. It explodes too soon ("knocks") and loses power when squeezed beyond a certain point.

That is why General Motors Research Laboratories developed ETHYL fluid, a compound which controls the combustion rate of gasoline so that as engine compression is raised the "knock" is eliminated. And that is why oil companies are mixing ETHYL fluid with gasoline to form *Ethyl Gasoline*—the standard high compression fuel.

Within the last year, car manufacturers have been able to produce new models of higher compression and greater power. *But the most immediate benefits of Ethyl Gasoline are found among the millions of owners of cars of ordinary compression, because with its use in such cars carbon becomes an asset.*

Ride with ETHYL. See what a great difference it makes on hills and in traffic. No "knocking." Less shifting. Faster pickup. Stop at an ETHYL pump today—it bears the emblem shown at the left.

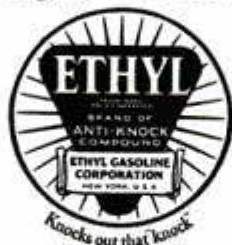

ETHYL GASOLINE CORPORATION, 25 Broadway, New York City. 56 Church Street, Toronto, Ont., Can.

ETHYL GASOLINE

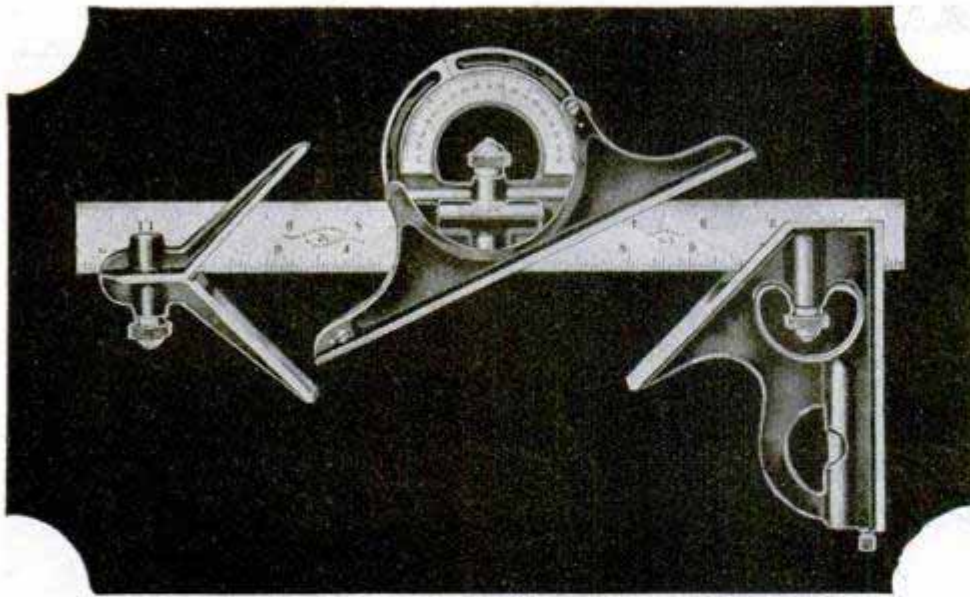

Brown & Sharpe Combination Set No. 438, illustrated above, has tempered blade and reversible protractor head. The level is accurately set. A high class tool for the work intended.

The Traditional Choice for Careful Work

Many a skilled worker today has been "brought up" so to speak, on Brown & Sharpe Tools. Among the mechanically expert, it has become traditional to link the name of Brown & Sharpe with fine workmanship and unfailing accuracy.

The tradition persists because the quality persists. Brown & Sharpe Tools continue to satisfy the most exacting demands of the mechanic, to do the hardest work in the most accurate and practical way.

Get Catalog No. 30 listing 2300 Brown & Sharpe Tools and over 5,000 items at your hardware dealer's; or write direct to us for it. Dept. P. M., Brown & Sharpe Mfg. Co., Providence, R. I., U. S. A.

BROWN & SHARPE TOOLS



* MICROMETER CALIPER
No. 11 RS

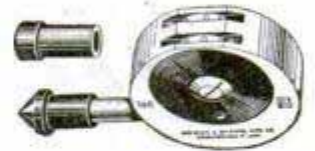

* VEST POCKET SPEED
INDICATOR
No. 746

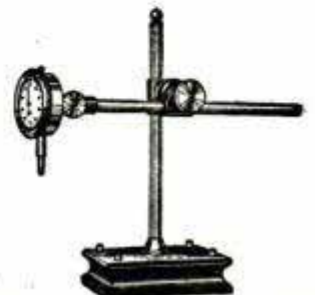

* DIAL TEST INDICATOR
No. 733



* TWIST DRILL AND
STEEL WIRE GAUGE
No. 705



* RULE DEPTH GAUGE
No. 615



* AUTOMATIC CENTER
PUNCH
No. 771

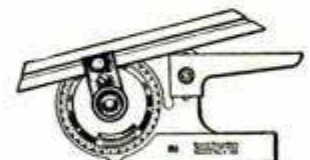

* UNIVERSAL
BEVEL PROTRACTOR
No. 496

* A description of this tool
appears in Catalog No. 30



"WORLD'S STANDARD OF ACCURACY"



When you build a working model

FOR power to run a working model, we recommend a miniature electric motor, powered with a set of Eveready Columbia Dry Batteries. This is a combination that's light enough to make the model and its self-contained power plant fully portable. The batteries have long-lasting pep and power, and furnish current wherever they

are, independent of outside wires. This is the simplest, cheapest and safest power for models. But be sure you get Eveready Columbias, for theirs is the stamina that puts a demonstration through to a flying finish.

NATIONAL CARBON CO., INC.

New York  San Francisco

*Unit of Union Carbide
and Carbon Corporation*

**EVEREADY
COLUMBIA
Dry Batteries**
-they last longer

FOR RADIO: *You'll buy fewer and better dry cell "A" batteries if you insist on the Eveready Dry Cell Radio "A," No. 7111. This special cell, 1½ volts, is built by a new process and lasts unusually long in radio service.*

This FREE BOOK answers all questions—

this famous **PLEDGE**
removes all risk *in*
buying a used car!

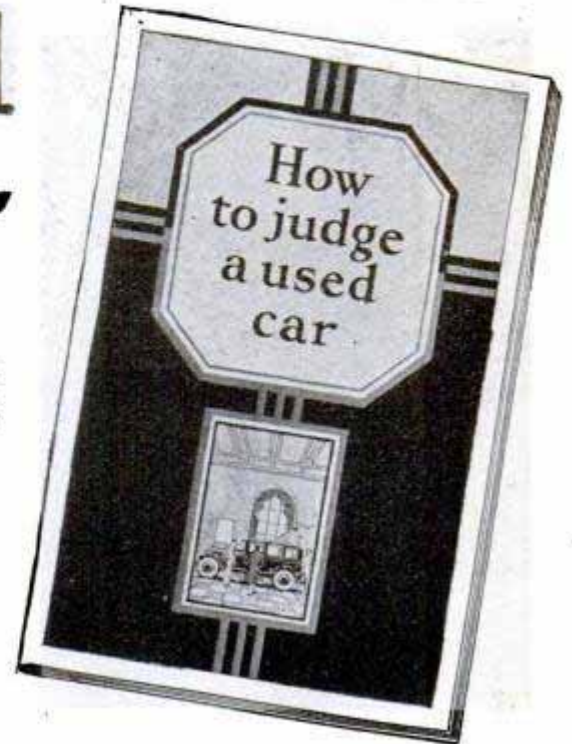

At last, a real guide, to help you save money in buying a used car—and yours for the asking! "How to Judge a Used Car" has been written out of the experience of men who buy thousands of used cars for resale—in 32 interesting pages and 19 pictures these experts show you step by step how to pick a good used car at lower cost! Send the coupon now for your free copy.

This valuable free book explains in a simple, graphic way how to judge a used car's actual condition, how to learn the year model, how to set a fair price on a car offered you by a friend, what speedometer figures show, how to avoid "orphans," what code prices mean—why you get five days' driving trial on a used car backed by the famous Studebaker Pledge. Much of this trade information has never before been made public at any price—

Mail This Coupon Today!

THE STUDEBAKER CORP. OF AMERICA

Dept. I-72, South Bend, Ind.

Please send me my copy of your valuable free booklet, "How to Judge a Used Car."

Name.....

Street.....

City..... State.....

now the coupon below will bring all of this expert counsel to you without cost.

Before you buy or trade a used car it will pay you to read this free book, "How to Judge a Used Car"—use the coupon below now!

Pledge to the Public on Used Car Sales

- 1 Every used car is conspicuously marked with its price in plain figures, and that price, just as the price of our new cars, is rigidly maintained.
- 2 All Studebaker automobiles which are sold as CERTIFIED CARS have been properly reconditioned, and carry a 30-day guarantee for replacement of defective parts and free service on adjustments.
- 3 Every purchaser of a used car may drive it for five days, and then, if not satisfied for any reason, turn it back and apply the money paid as a credit on the purchase of any other car in stock—new or used. (It is assumed that the car has not been damaged in the meantime.)

© 1927 The Studebaker Corporation of America

Where this Pledge is displayed by Studebaker dealers, you can buy a used car safely.

STUDEBAKER

The Great Independent



ONE MINUTE We haven't taken a vote, but we're willing to wager that most men take but one minute for lathering. Hurried morning schedules cut down the time you can spend with soap and shaving brush to soften your beard—but they can never change the smooth comfort you get from your Gillette Blades.



THREE FULL MINUTES This man likes his comfort. He prepares his face thoroughly. He used to be the exception. But now more men are giving more time and thought to this important job of lathering. Three minutes—and then the swift, sure sweep of your smooth Gillette Blade!

The longer you lather the better the shave —

*But whether you lather much or little,
your Gillette Blade does its swift, sure job*

IF you're like most of the Gillette users in America, you lather as much as you have time for and leave the rest to the Gillette Blade.

If you're one of the careful leisurely minority, you lather a full three minutes. Then your face is thoroughly prepared. But while you may often lack time, you need never lack comfort. Just slip in a fresh Gillette Blade and enjoy the smoothest possible shave per second.

This comfort is a family trait in all Gillette Blades, put there by Gillette's own patented machine processes. During the past ten years, Gillette has spent millions in improving these

processes and in perfecting one of the most scrupulous inspection systems ever devised. Four out of every nine Gillette workers are inspectors, paid a bonus for every blade they discard. Hence when you take the finished inspected blade from the little green envelope which is its certificate of perfection, you can be sure that shaving comfort is waiting for you, ready for whatever lather you see fit to use.

Your Gillette Blade always does its job well, or eight out of ten American men wouldn't stick to it as faithfully as they do. They judge a shave on its face value and they choose—the Gillette.

GILLETTE SAFETY RAZOR CO., BOSTON, U.S.A.



To be sure of a smooth, comfortable shave under any conditions, slip a fresh Gillette Blade in your razor.

Gillette



SOUTH BEND LATHES

Back Geared Screw Cutting Precision Lathes
 For Tool Room
 Manufacturing—Machine Shop
 Repair Shop—Service Station

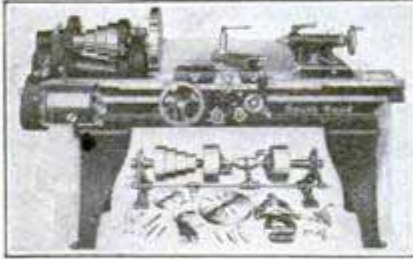

16' x 8' Quick Change Gear Lathe, Straight Bed..... **\$570**

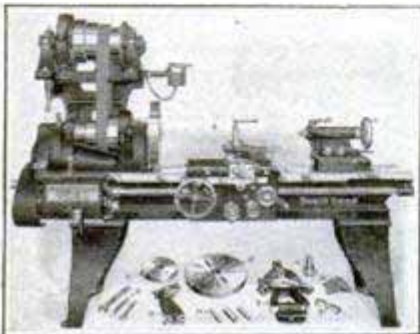

18' x 8' Quick Change Gear Motor Driven Lathe **\$908**

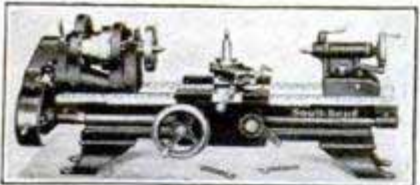

9' x 2 1/2' Junior Back Geared Screw Cutting Bench Lathe. **\$150**

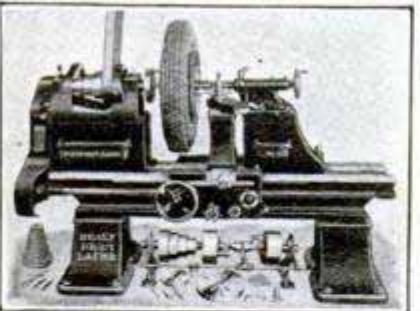

Brake Drum Lathe
 Handles all Brake Drum work without removing tire or rim.
 No. 1 Lathe, Capacity 32" Diameter **\$475**
 No. 2 Lathe, Capacity 36" Diameter **\$650**
 No. 3 Lathe, Capacity 42" Diameter
 Price on Application

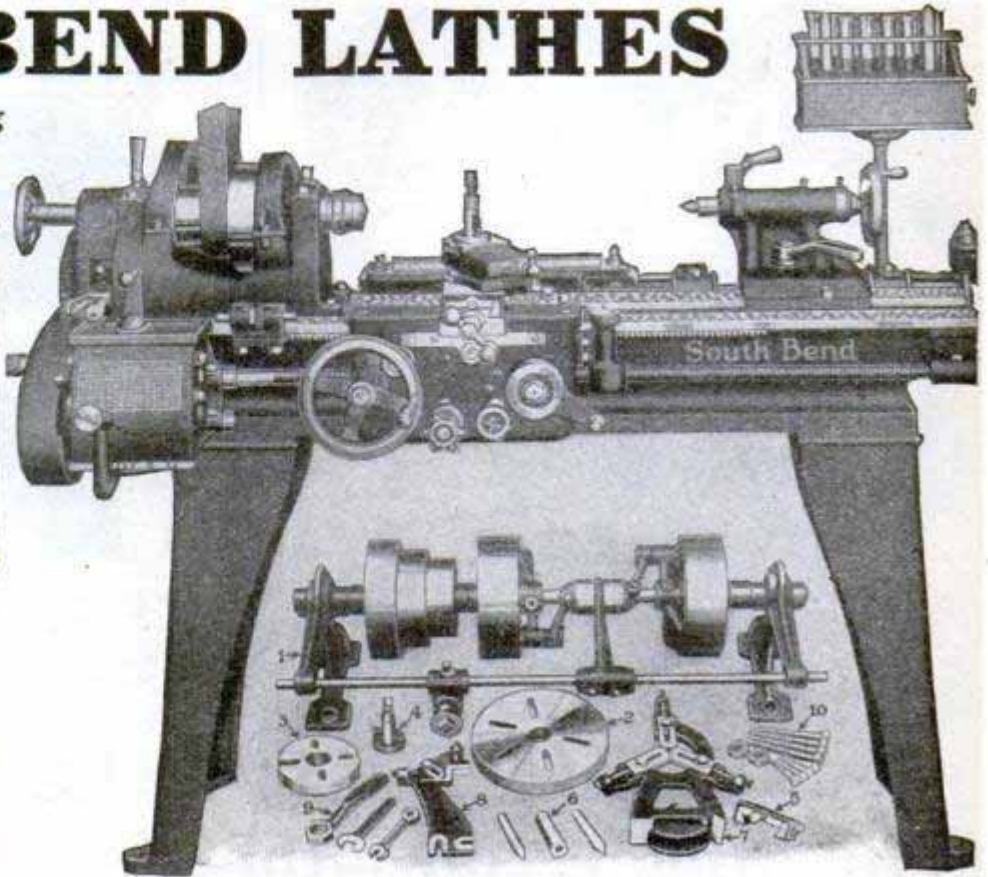

11' x 4' New Model Precision Tool Room Lathe with Counter-shaft and Regular Equipment..... **\$335**

Other Popular Selling Sizes

The Prices of Popular Selling Sizes with Countershaft and Equipment

Size of Lathe	Shipping Weight	Standard Change Gear	Quick Change Gear
9" x 3'	490 lbs.	\$235.	\$270.
11" x 4'	725 lbs.	\$300.	\$335.
13" x 5'	1110 lbs.	\$352.	\$402.
15" x 6'	1550 lbs.	\$430.	\$490.
16" x 6'	1875 lbs.	\$480.	\$540.

Easy Payment Plan—10 Months to Pay

Small down payment, balance in 10 equal monthly payments, or you can purchase through your nearest machinery dealer.

FREE—Write for No. 89A Catalog

describing 210 sizes and types of NEW MODEL South Bend Lathes. Check off in the squares below, indicating the lathes in which you are interested.

- 9" Junior Lathe
- 11" Lathe
- 13" Lathe
- 16" Lathe
- 18" Lathe
- New General Catalog No. 89A
- "How to Run a Lathe," Price 25c
- Auto Mechanics Service Book, 25c
- Brake Drum Lathe Circular

SOUTH BEND LATHE WORKS

Main Office & Works, 641 E. Madison St., South Bend, Ind., U. S. A.

Carried in Stock by Machinery Supply Dealers in Principal Cities Throughout the World

ATLANTA, GA.—Fulton Supply Co., 70 Nelson St.
 BALTIMORE, MD.—Carey Mach. & Supply Co., 119 E. Lombard St.
 BIRMINGHAM, ALA.—Moore-Handley Hdwe Co., 21st & Ave. "A"
 BOSTON, MASS.—Joseph Beal & Co., 465-71 Atlantic Ave.
 CHICAGO, ILL.—Scott Bausbach Mach. Co., 130 S. Clinton St.
 CINCINNATI, OHIO—The E. A. Kinsey Co., 335 Fourth St., W.
 CLEVELAND, OHIO—Clark Machinery Co., 1235-45 St. Clair Ave.
 DALLAS, TEX.—Huey & Philip Hardware Co., 1029 Elm St.
 DENVER, COL.—Hendrie & Bolthoff Supply Co., 1621 17th St.
 DETROIT, MICH.—Lee Machinery Co., 6318 E. Jefferson Ave.
 HOUSTON, TEX.—Wessendorf, Nelms & Co., 317 Preston Av.
 KANSAS CITY, MO.—H. J. Brunner Mach. Sup. Co., 1512 Grand Av.
 LOS ANGELES, CAL.—Eccles & Davies Mach. Co., 320 S. San Pedro St.
 MILWAUKEE, WISC.—Western Iron Stores Co., 145 W. Water St.

NEW ORLEANS, LA.—Oliver H. VanHorn Co. Inc., 522-534 Camp St.
 NEW YORK CITY, N.Y.—J. E. Beggs Co., 183 Centre Street
 OMAHA, NEB.—Interstate Mach. & Supply Co., 1006-10 Douglas St.
 PHILADELPHIA, PENN.—Delta Equipment Co., 148 N. Third St.
 PITTSBURGH, PENN.—Somers, Fidler & Todd Co., 329 Water St.
 PORTLAND, ORE.—The Portland Machinery Co., 62-4-6 First St.
 PROVIDENCE, R.I.—The E. A. Eddy Mach. Co., Eddy & Clifford Sts.
 ST. LOUIS, MO.—Blackman-Hill & Co., Inc., 1513 N. Broadway St.
 ST. PAUL, MINN.—Robinson-Cary & Sands Co., 4th & Wacouta Sts.
 SAN FRANCISCO, CALIF.—C. F. Bulotti Mach. Co., 829 Folsom St.
 SEATTLE, WASH.—Perine Machinery Co., Inc., 209 First Ave., S.
 TOLEDO, OHIO—The Kirkby Mach. & Supply Co., 20-22 St. Clair St.
 MONTREAL, QUE.—Can. Fairbanks-Morse Co., 84 St. Antoine St.
 TORONTO, ONT.—A. R. Williams Machinery Co., 66 Front St., W.

Here they are!

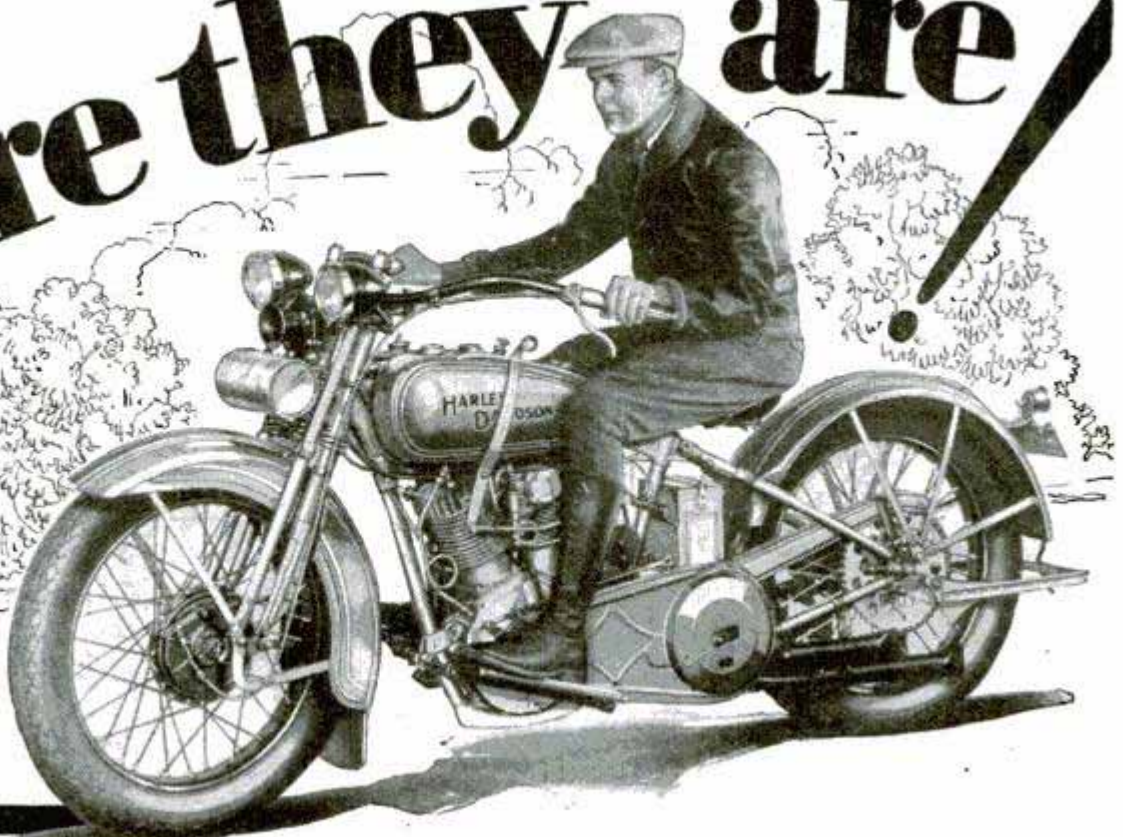

5

BIG, NEW FEATURES

1
Two Bullet Headlights. Double lights—greater safety.

2
Generator Controller. Quick, handy control of current output.

3
Electrical Panel. Includes ammeter, parking light, and switches.

4
4 - Tube Muffler. Makes exhaust wonderfully quiet.

5
Clear - the - way Horn. High frequency—penetrating, pleasing note.

1929 MODELS BY HARLEY-DAVIDSON

BBETTER equipped, better looking, better performing than ever, the 1929 Harley-Davidsons are ready now to show you the latest and finest in motorcycle design. Never before such power—such comfort—such convenience!

Motorcycle enthusiasts everywhere are flocking to the local Harley-Davidson Dealers to see the new models.

Join them there! Let your local dealer show you how much motorcycle you can buy for little money, and on easy terms. Let him give you a demonstration. If you aren't a rider already, he'll gladly teach you to ride, free.

Write us—on the coupon—for our new literature.

HARLEY-DAVIDSON MOTOR CO.
DEPARTMENT P. MILWAUKEE, WIS.



1929 Single — the famous 80-mile-per-gallon solo mount—has all the new Harley-Davidson features. Sells at \$235, f. o. b. factory.

HARLEY-DAVIDSON MOTOR CO.,
Dept. P., Milwaukee, Wis.

Interested in Twins; Single. Send literature.

Name.....

Address.....



Where's the can of PLASTIC WOOD?

(Reg. U. S. Pat. Off.)

A sail boat broken, a damaged toy—it's a real tragedy in child life. But Plastic Wood, which Handles like Putty, Hardens into Wood, and holds fast to wood, metal, fabric, plaster, porcelain or glass will quickly effect cures that would make a surgeon or magician green with envy. Keep it on hand for toy accidents—and use it for repairs of all kinds around the house; floor, baseboard and door cracks; loose casters, handles, and furniture; mouse holes, screw holes, nail holes; cracked tiles and porcelain bathroom fixtures.

Waterproof Tile Cement

For the bathroom, when tile or porcelain splits, cracks open up around the tiles, or a wall fixture comes loose, Plastic Wood White Waterproof Tile Cement is of immediate value. It will hold broken pieces, seal cracks, is impervious to water, and dries to a hard flat white. At the same prices as Plastic Wood.

Plastic Wood Solvent

Plastic Wood dries rapidly, and often when working it becomes necessary to soften or thin it. A few drops of Plastic Wood Solvent will renew the wood that has started to dry. Plastic Wood Solvent, in 25 and 50-cent cans, can be bought through your dealer, but it cannot be shipped by mail.

**Handles
Like
Putty**



**Hardens
Into
Wood**

At Hardware and Paint Stores

1 lb. can \$1.00.

$\frac{1}{4}$ lb. can 35 cts.

ADDISON-LESLIE COMPANY

403 Bolivar Street

Canton, Mass.

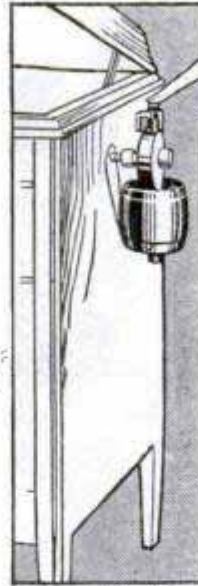

Press the button and let the MOTROLA

wind your phonograph

The Motrola is a small electric motor that replaces the winding crank on your phonograph. Readily attached to outside without marring the woodwork or affecting the mechanism. Merely press the button and the Motrola winds your phonograph more quickly and evenly than you can crank it. Stops *automatically* when spring reaches proper tension.

Your old phonograph—with Motrola and electric pick-up to your radio—gives same results as the costly new electric machines.

Quickly, easily applied

Anyone can apply or detach the Motrola in a few minutes, using only a screw driver. Winds any make or size machine. No parts to wear out—costs only a cent a month for electricity. Attractively finished, equipped with light socket plug and 10 feet of cord. Sold with our unqualified guarantee. Thousands now giving dependable, labor saving service. Ask your dealer for demonstration.

[Write us today for
illustrated descriptive folder]

JONES-MOTROLA SALES CO.
370 Gerard Avenue New York City

SALESMEN! \$100 WEEKLY
SELL COX HOLDFAST SCREW DRIVERS

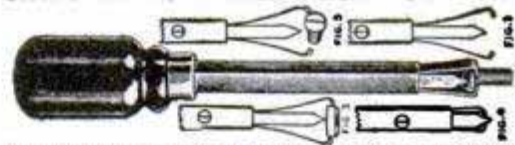

Also made to use in Yankee or Ratchet Handle. Sells on sight to

Garages, Radio Men, etc. Self Holding, Self Releasing. Sample and Proposition, 50c. S. J. COX, Dept. F, Franklin, Pa.



"H&A," the Better Wood Lathe

WRITE FOR
PRICES ON
SAW TABLES
BAND SAWS
SWING SAWS
JOINTERS
SCROLL SAWS

MOUNTED on heavy structural steel bed—vibrationless, accurate, perfectly balanced—a wonderfully fine tool at modest cost. Made with 3, 4 or 5-foot bed; complete home shop accessories furnished. Write for details.

HESTON & ANDERSON, 609 Western Ave., Fairfield, Ia.

PLUMBING-HEATING

YOU SAVE HALF

FREE BOOK

Send for **BIG FREE BOOK** of Guaranteed Plumbing and Heating. Everything cut-to-fit. 50 yrs. in business. Thousands of customers. "You saved me \$400.00," says Mr. Edw. Borkosky of N. J. Write today.

HARDIN-LAVIN CO., 107-17 C Pershing Rd., CHICAGO

DENINGER WILL TRUST YOU

SEND 50c IN STAMPS FOR CATALOGUES
BIG MONEY SAVING FOR YOU

Used and rebuilt motorcycles \$25 to \$100, used bicycles \$9.50, tandems \$20. All machines fully guaranteed. New bicycles and motorcycles at factory prices, save dealers' profits. Motorcycle and automobile tires \$1. Complete line frames, engines, supplies.

DENINGER PRICE CUTTER, ROCHESTER, N. Y.

PAY AS YOU RIDE

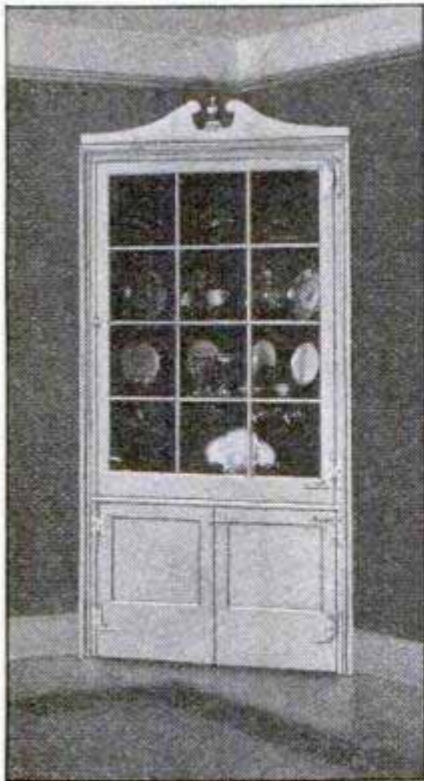

PLYMOUTH BUILT-IN CHINA CLOSET
See LePage's Book, page 6

12 NEW Job Plans, Too!

There is, of course, a limit to what we can give in LePage's New Third Home Work Shop for only a dime. But we realize many men want additional projects. Hence our 12 new Job Plans. These also were made by Mr. Klenke. They are projects that require more elaborate presentation than we can give in our book. Each Job Plan presents one project on a single large sheet of paper. Each is well worth its price, one dime. Look over these projects and order those you want by number (see coupon) enclosing 10 cents for each.

- 16 Sheraton Writing Desk
- 17 Sheraton Desk Chair
- 18 Colonial Hanging Book Shelves
- 19 Smoking and Reading Cabinet
- 20 Colonial Mirror
- 21 Tea Wagon
- 22 Telephone Cabinet
- 23 Stool for Telephone Cabinet
- 24 Manual Training Work Bench
- 25 Home Worker's Tool Cabinet.
- 26 Spanish Galleon
- 27 Vanity Table



CHESS AND CHECKERS TABLE
See LePage's Book, page 15

At right
SET-BACK BOOK SHELVES
See LePage's Book, page 9

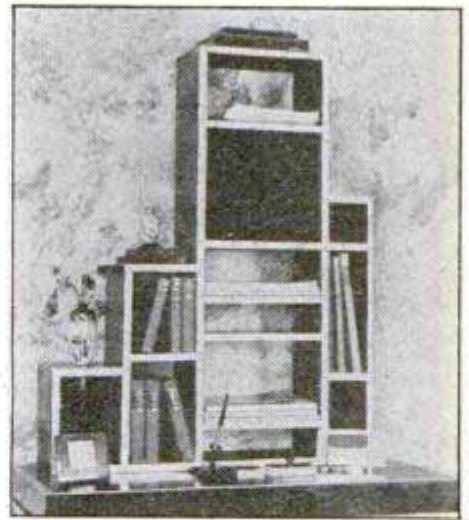

LE PAGE'S NEW BOOK

will show you how to make 20
attractive pieces of furniture

Yes, a *New Book*, just printed, the third in the series of LePage's Home Work Shop Books. New and better designs. Made by an expert. Complete, easy-to-follow directions for making 20 attractive pieces of household furniture. Any man handy with tools can easily make these handsome, useful articles right at home.

Big Improvement

The first LePage's Home Work Shop Book, two years ago, sold 30,000 copies. Last year the second book sold 55,000 copies. That's popularity for you. An enormous quantity for books of this kind. Now the third new book is better yet. Of its 20 complete projects, 17 are entirely new and never offered before.

Each project is presented in three parts—a photographic illustration of the finished project, a complete dimension drawing of its parts, and simple easy-to-follow, step-by-step directions.

This year the designs are divided into three groups. One group is based on famous old colonial pieces. Another group follows the furniture in popular demand for American homes of today. The third group is known as modernistic furniture, showing the influence of the modern skyscraper set-back architecture of New York City. To buy 20 such pieces would cost about \$1000. You can make them for a fraction of that. And yet be the owner of truly fine furniture.

Designed by Expert

All the designs, dimension drawings,

actual pieces and photographs were made by William W. Klenke, Instructor in Woodworking, Central Commercial and Manual Training High School, Newark, New Jersey. Also the designer of the first two LePage's Books. Each project and the directions for making it are perfectly practical.

In addition to the three pieces shown above, the book includes the following: *Cape Cod Chest of Drawers, Alexandria Nest of Tables, Old Salem Ship's Cupboard, Lady Washington Sewing Cabinet, Modernistic Desk, Table, Folding Screen and Fire Screen, Smoking Table, Caned Side Chair, China or Book Cabinet, Book Trough and Magazine Stand, Magazine Carrier, Vanity Case, Book Stand, Fernery Stand and Folding Sewing Screen.* Where else could you get complete directions for making all these for only 10 cents?

Send 10 cents for this NEW LePage's Home Work Shop Book

Simply use the coupon below, sending it to us with 10 cents in coin or stamps and we will at once send you a copy of LePage's New Third Home Work Shop Book, postage paid. Address: LePage's Craft League, 614 Essex Ave., Gloucester, Mass. Tear out coupon, so you won't forget it.



MAIL THIS COUPON

LePage's CRAFT LEAGUE,
614 Essex Ave., Gloucester, Mass.
Gentlemen: Enclosed please find 10 cents (coin or stamps) in payment for LePage's New Third Home Work Shop Book. Please send a copy of this book to:

Name.....

Street.....

City..... State.....

Please also send the following Job Plans..... (indicate by number those you want. See column at left), for each of which I enclose an additional 10 cents.

LE PAGE'S GLUE

Handiest Tool in
Your Work Shop

AMERTRAN PF-250

Power Transformer for UX 250 Power Tubes

A husky transformer built for doing the job, not for looks. The PF-250 is rated at 1100-600 volts plate, 7 1/2 volts power tube, 7 1/2 volts rectifier tube filament. Center taps are provided on each of the filament windings. Continuous rated capacity of plate windings, 160 M.A., continuous rated capacity of each 7 1/2 volt winding, 3 Amperes. DC plate output with two UX 250's full wave, up to 450 volts with sufficient excess for "C" Bias. Ask for Bulletin No. 1033 describing fully the PF-250.

Price, each—\$30.00

Slightly higher West of Rocky Mountains

AMERICAN TRANSFORMER COMPANY

Transformer Builders for more than 28 Years

251 Emmet St.

Newark, N. J.

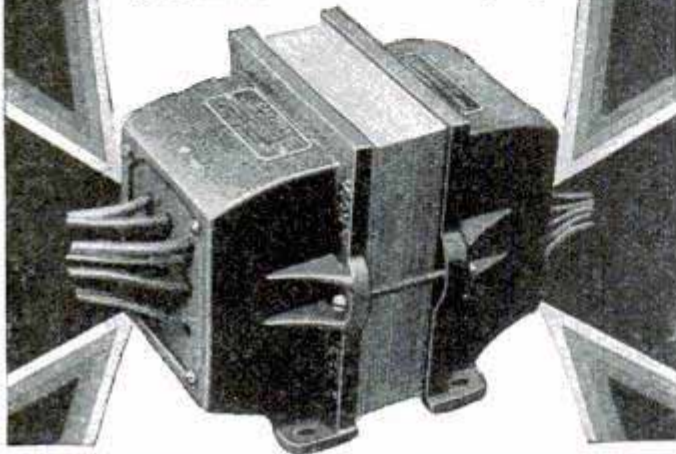

Set Builders! Dealers!



FREE—Big Catalogue

Hundreds of bargains in latest kits and parts at liberal discounts. See our new catalogue for

TELEVISION kits and parts.
SHORT WAVE Sets, kits, parts.

POWER PACKS—All kinds, including 250-tube and push pull circuits.

ELECTRIC PHONOGRAPHS—pickups, turn-tables, dynamic speakers.

SHIELD GRID Kits, coupling impedances, shields and other parts.

Van-Ashe has everything, at big discounts, ready for 12-hour shipment. Send post-card for new catalogue and discount sheet.

Van-Ashe Radio Co.

206 N. 10th St.

St. Louis, Mo.

Wholesale Prices on RADIO

Get our big new 1929 Radio Catalog—hot off the press. Contains thousands of amazing bargains. Latest, nationally advertised Radio equipment. Latest in Ham Transmission equipment. Everything at lowest wholesale prices.

NEW RADIO CLUB—Big Prizes

Get all the facts about "Ether Trappers" Club, now. No dues. Many advantages.

Write for **FREE** Membership at once.

This Big Book of money-saving bargains is yours **FREE**. A regular Radio encyclopedia. Write today for your copy of this book.

AMERICAN RADIO & MERC. CO.
Dept. 26
American Radio Building
KANSAS CITY, MO.



Six Tube Radio

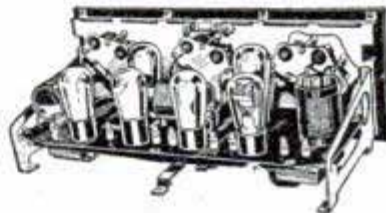

\$25.00

30 Days Free Trial

Your run no risk. Try it in your own home for volume, selectivity,

distance, and tone. If not perfectly satisfied, return it. \$25.00 model operates from batteries, or if preferred we have

A. C. Radio \$50.00

operates from electric light socket. No batteries or eliminators necessary. Also sold on 30-day Free Trial. Write today for **FREE BOOKLET**.

VIKING RADIO LABORATORIES
431 North LaSalle Street, CHICAGO

MAKE YOUR FORD Into The "LARK"

\$5.00 Red-I-Kut life size patterns **Class-Snap**



Famous sure-fit **RED-I-KUT** life-size patterns and picture instructions show how you can easily convert your Ford into this **Fast, Saucy, Sport-Car** as thousands have done with easily obtained materials. No need to lay up the car. Rear seat folds, making 4-passenger car. Send 10c coin for actual body photo and new manual of other distinctive sport body patterns from \$5.50 up—**"RKO" Steel "Swing-Lo" Irons, Tops and Windshields.** **ORDER RIGHT NOW**

KUEMPEL COMPANY, 100 Kuempel Bldg., GUTTENBERG, IOWA

RAISE BELGIAN HARES

NEW ZEALAND REDS—Chinchillas—Flemish Giants
MAKE BIG MONEY—We supply stock and pay you following prices for all you raise: Belgian Hares \$2 each—New Zealand \$3 each—Chinchillas \$4 each—Flemish Giants \$5 each. 32-page illustrated book, catalog and contract, also copy of *Fur Farming* magazine, tells how to raise skunk, mink, fox, etc., for big profits, all for \$10c. Address

OUTDOOR ENTERPRISE CO., Box 25, Holmes Park, Mo.

150 TO 300 MONTHLY FROM ONE DAY BATTERY CHARGING



Start a **Big Profit-Making Business** of your own—"One Day Battery Charging." Requires **small space** and **practically no investment**. Anyone can successfully operate. Charges batteries 1/2 the usual time at 1/2 the cost. **Every car owner a customer.** The **HB One Day Battery Charger** will pay for itself on easy monthly payment plan with practically no expense to you—and bring you a handsome profit besides. Write for full particulars in **Bulletin M.** **NOW!** **HOBART BROS. CO., Box M-981 TROY, OHIO**

ONLY \$16 MONTHLY—MORE THAN PAID BY INCREASED PROFITS

30 DAYS FREE TRIAL
ON ABSOLUTE MONEY BACK GUARANTEE

No. DJ 6
1/2" Heavy Duty

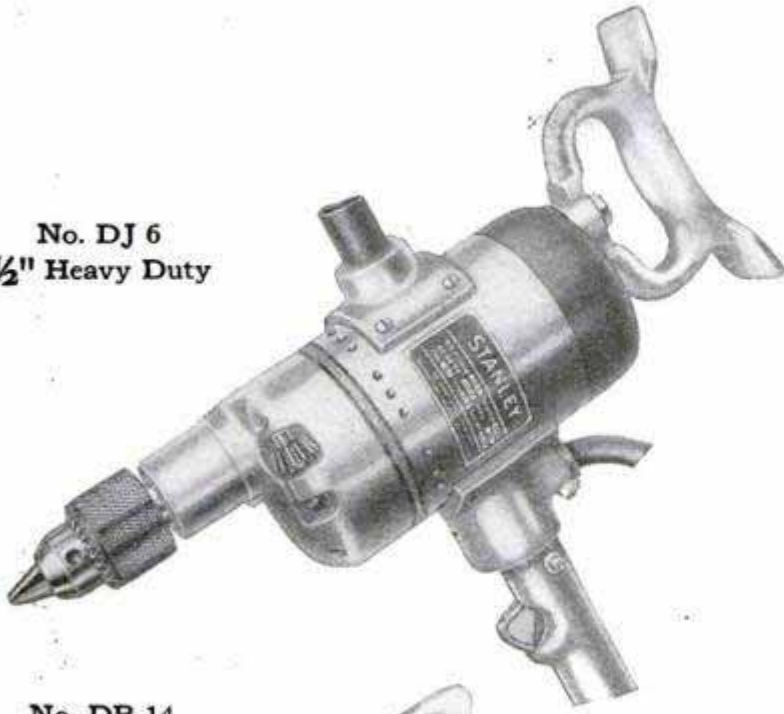

No. DB 14
1/4" Heavy Duty



No. DG 23
1/4" Standard Duty



INTRODUCING new efficiency in electric drill performance

Stanley Electric Drills will operate continuously at full rated capacity with only an 8° rise in temperature. A new and unique design in ventilating systems makes this feat possible.

Stanley Electric Drills are also equipped with exceptionally powerful motors that give adequate reserve power. Simple, compact design eliminates projecting parts and makes the drills both strong and rigid. The handle fits the hand and the switch is so placed that it can be operated without releasing the firm grip necessary to hold a drill against the work.

The new Stanley Electric Drills can be inspected at your dealer's. Try them

out on steel. Try them out on iron. Try them out on hard wood. You will thus prove to yourself, point by point, that they do the hardest work with the least strain or effort.

Send coupon for catalog No. Sd59 which describes the line of Stanley Electric Drills.

The Stanley Works, New Britain, Conn.

Please send me Booklet Sd59, describing Stanley Electric Drills.

Name _____

City _____ State _____

STANLEY TOOLS

The choice of most carpenters

SUPREME

*In Life
and Power*

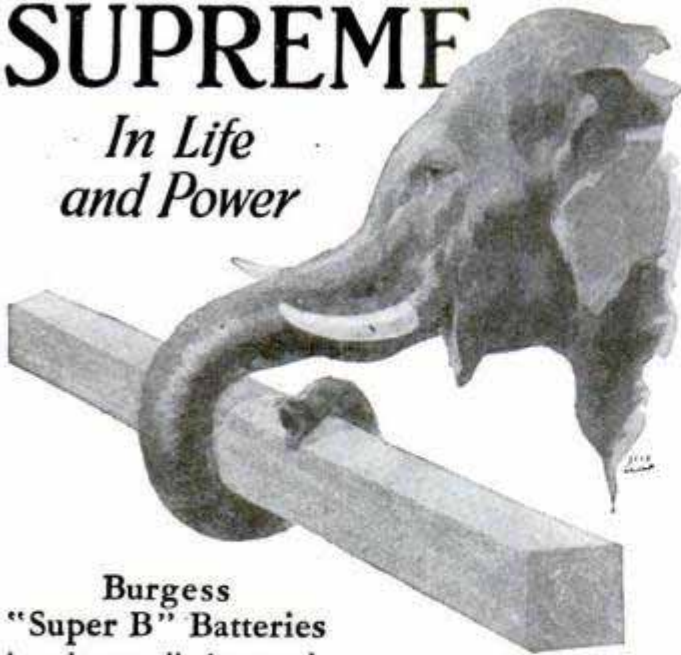

Burgess
"Super B" Batteries have larger cells than standard batteries. Extra power and life are thus provided. Uniformity is insured by scientific precision in manufacture. Radio's cost is lowered appreciably by the use of "Super B" No. 22308, a medium size heavy-duty 45-volt battery, designed for general, all around use . . . or "Super B" No. 21308, the largest size Burgess heavy-duty 45-volt battery, made especially for heavy-current consuming sets.

BURGESS BATTERY CO.
General Sales Offices: CHICAGO
In Canada: Niagara Falls & Winnipeg

Chrome

CHROME is a preservative that guards power when your Burgess "Super B" Battery is not in use. Extra life and service are thus added. It is a patented feature of the two Burgess "Super B" Batteries, which answer practically all radio set requirements.

BURGESS "SUPER B" BATTERIES



Amazing New Ground Antenna



Get Far Away Stations Loud and Clear Regardless of Static Conditions. Radio Engineers and hundreds of users report that Aer-O-Liminator, the sensational new Ground Antenna, gets better long distance reception, almost unbelievable freedom from static and outside noises, far greater selectivity and marvelously clear and sweet tone quality. Curtis, of Ill., says "There's no such thing as static trouble since I got my Aer-O-Liminator. I get stations I never got before—so loud and clear I would almost swear they were in the next room." In addition you are free from troublesome overhead aerials that everyone now knows are static-gatherers. Aer-O-Liminator (Ground Antenna) is simple and easy to install. Takes but a few minutes.



FREE TRIAL

Make this thrilling test at our risk!

Install an Aer-O-Liminator (Ground Antenna). Leave your old overhead aerial up. Try out on a night when static is bad. If you do not get a wonderful improvement in freedom from static, greater selectivity and clear sweet tone without interfering noises, if you can't get good reception on stations that are drowned by static on your old aerial, you need not pay us a red cent for this test. Write us today for scientific explanation of Aer-O-Liminator (Ground Antenna), proof of performance, and our conclusive iron-bound guarantee and remarkable Free Trial Offer. Write today!

CURTAN MFG. CO.
154 E. Erie St. Dept. 805-M.A.
Chicago, Ill.

SOLDERALL

METAL IN PASTE FORM



RADIO PANELS

BAKELITE—HARD RUBBER
Cut, drilled and engraved to order. Send rough sketch for estimate. Our complete Catalog on Panels, Tubes and Rods—all of genuine Bakelite or Hard Rubber. Mailed on Request.

STARRETT MFG. CO. 524 S. Green St. Chicago, Ill.

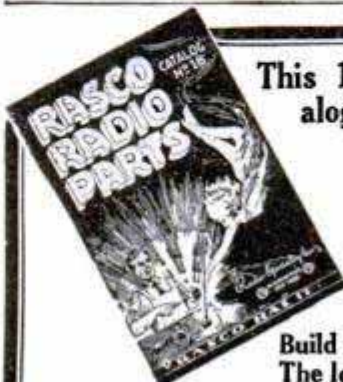

This 148 Page Radio Catalog and Encyclopedia

FREE

Containing 75 radio hook-ups, 500 illustrations, 1000 articles. Wholesale Prices

Build your own with Rasco parts. The lowest prices in the country.

Radio Specialty Company
98E Park Place NEW YORK, N.Y.

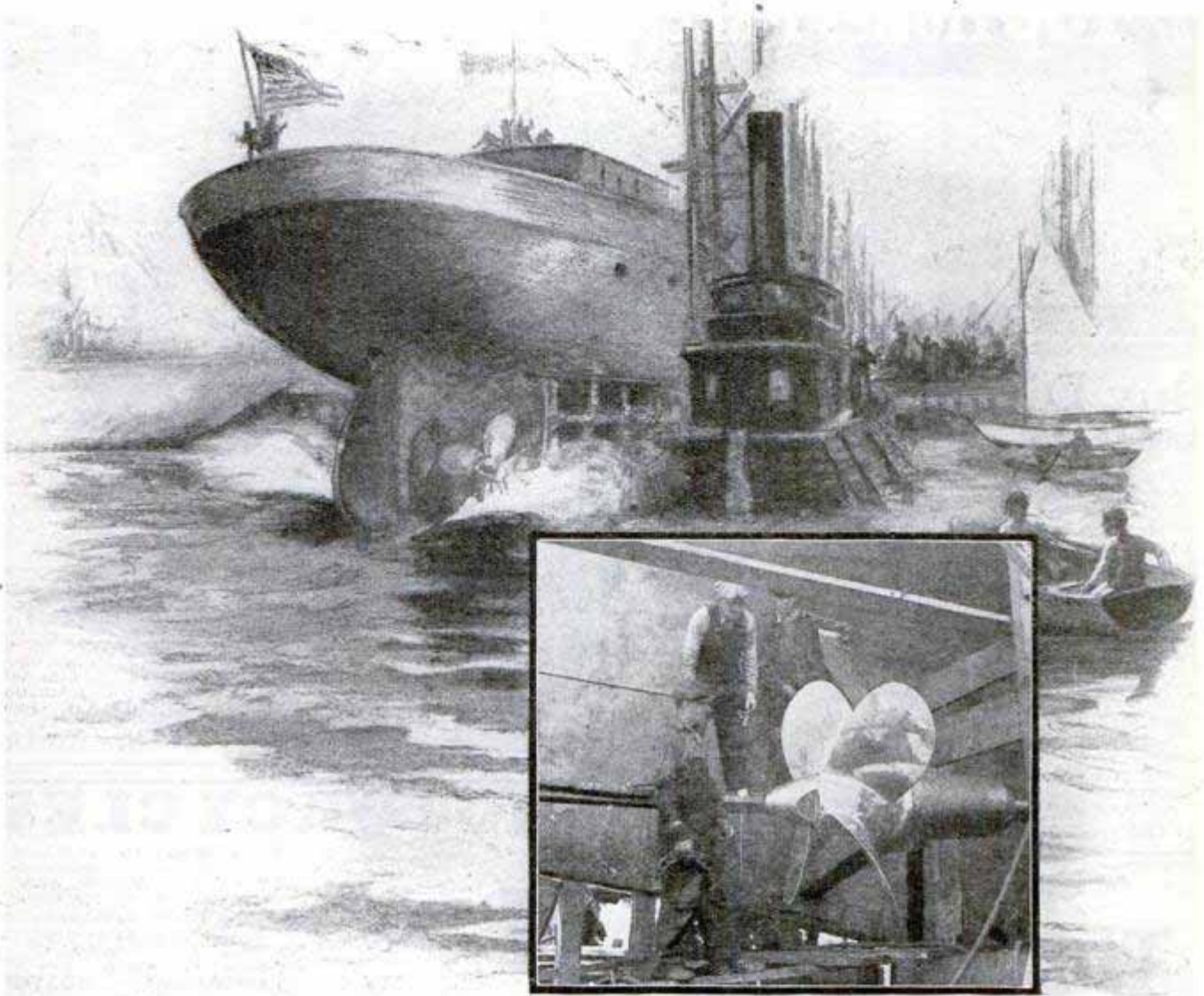

Down to the sea with Starrett's

From the ways at Lawley's yard slides the largest Diesel powered yacht ever built. Up through Belle Isle races forty feet of spray hidden Mahogany. Off Montauk an express cruiser maintains her steady twelve knots.

Every shipyard is equipped with Starrett Tools. Marine machinists and carpenters have come to rely upon Starrett accuracy that the development of marine transportation may keep pace with that of land and air.

In industry or in the home shop, wherever accuracy and good workmanship count, you'll find Starrett Tools the favorites. Write for free copy of Starrett Catalog No. 24 "AP."

THE L. S. STARRETT CO.

World's Greatest Toolmakers
Manufacturers of Hacksaws Unexcelled
Steel Tapes—Standard for Accuracy
ATHOL, MASS., U.S.A.

2093



Use Starrett Tools

Book of 100 Homes FREE!

"The Stratford"

5 Rooms, Bath; Materials \$2013



Buy Direct from Mill!

Build Plan-Cut—Save Up to \$2,000—Write!

We furnish lumber, millwork and other materials. Plan-Cut at mill, shipped to your station. Each piece sawed, cut and notched to fit—Save 30% labor cost and 18% lumber waste. Gives you stronger tighter home. Easy to build—many put up own homes. Architect's plans and full instructions furnished Free. One guaranteed price covers all materials. Send for Free Book of 100 Home Plans and lowest wholesale prices.



Gordon-Van Tine Company
1221 Case St., Davenport, Iowa

Please send catalogs.

I expect to build.....

Name.....

Address.....

This book 10c

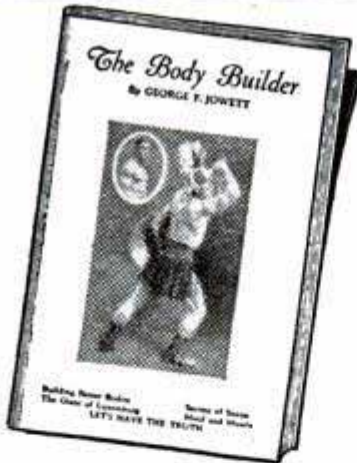

PACKED with live, honest information of interest to the body builder. Throbs with vital, gripping truths and soul-stirring facts. The truth on false exercise, theory and practice, is bared and you are given instruction of acknowledged merit. Methods are described that will teach you how to build up your nervous and muscular systems.

To every purchaser of *The Body Builder*, I will give a free copy of my book, *The Thrill of Being Strong*. This explains the Jowett Health and Muscle Making method. Muscles that fail to respond to other methods grow like magic the Jowett way. Lost health and lost manhood are quickly restored. Within 90 days you become a new man—all man from head to heels. This, I guarantee.

If you would like to lay your case before me in a personal letter, I will give you a personal reply without any cost. Let me show you how you can become as well built and as strong as America's greatest.

Send for *The Body Builder* now, while it is on your mind. It's easy. Just mail the coupon with a dime.

THE JOWETT INSTITUTE OF PHYSICAL CULTURE
597 Fifth Avenue, New York, N. Y.

Dear Mr. Jowett:
I am enclosing 10c. Please send me a copy of *The Body Builder* and a free copy of *The Thrill of Being Strong*.

Name.....

Address.....

4-JJ

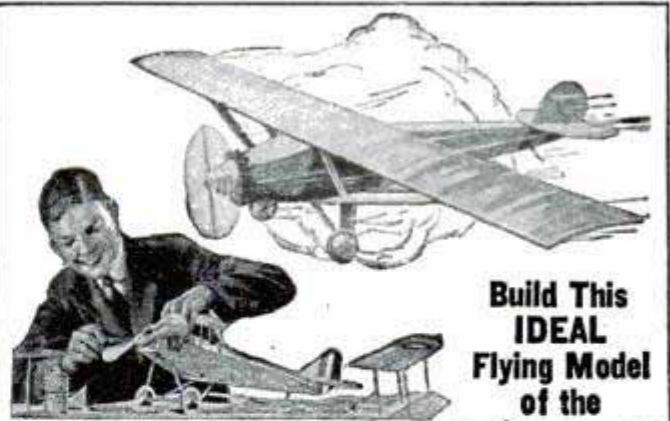

Build This IDEAL Flying Model of the

"Spirit of St. Louis"

A perfect 3-foot miniature of the most famous Airplane in the world! Anybody can build and fly it. The IDEAL Complete Construction Outfit contains everything needed; all parts, fittings and materials, full plans, diagrams and instructions. The Model is guaranteed to fly when correctly built. Complete Construction Outfit..... **\$7.50**

Plans for Model Airplanes

Complete, accurate, 1/4-size Plans, with Building-Flying Instructions, for any one of the following: New York-Paris FOKKER; Curtiss; DEHAVILLAND; NC-4 Soplane; Bleriot Faubert; Nieuport; Cessna; Pugh—25c Model Book Free with each plan. Each

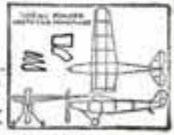

64-pg. Book for Model Builders

Contains plans for building Gliders and Racers, full information about Scale Models; and most complete catalog of Parts, Supplies, Materials and Fittings for all kinds of Models. 5c Postpaid for.....



Ideal Aeroplane & Supply Co., Inc.
26 West 19th Street, New York City

MOTORCYCLES

Price \$10 and up purchased through our Co-Operative Plan for as low as \$1.00 down and \$1.00 per week
Indians Harley-Davidsons Ace Henderson and Clevelands
Send ten cents for Bulletin A.
Motorcycles shipped to all parts of the world
WALKER-INDIAN CO., 78 Brookline Ave., BOSTON

30 Days' Free Trial
New Models now ready for delivery direct from our factory. Astonishing low prices and terms. Do not buy until you get them.
RIDER AGENTS WANTED to ride and exhibit sample. Make big money. Many models \$21.50 up.
Tires Guaranteed \$1.50 each, wheels, lamps, horns, equipment at half usual prices. Send No Money. Write for our marvelous prices and terms on RANGER Bicycles.
Mead CYCLE CO. Dept. P-108 CHICAGO

\$75 to \$125 Weekly

Charging Batteries Starts You

Let me show you how to make big money right from the start. I've prepared a FREE book explaining all details. First week's profit pays for all equipment. You can get all the battery charging business in your community with my Service Station Charger—it's years ahead of ordinary chargers—handles 50% to 70% more batteries. I explain everything—start you in a business of your own and put you on the way to big money. Write for FREE Book.

C. F. HOLMES, Chief Engineer, Dept. PM
Independent Electric Works, 5116 Ravenswood Ave., Chicago

FREE BOOK—Just Out



"The Wonder of the Age" OXO-GAS BLUE FLAME OIL BURNERS

Burn Gas Made From Kerosene
(Coal Oil) and Air

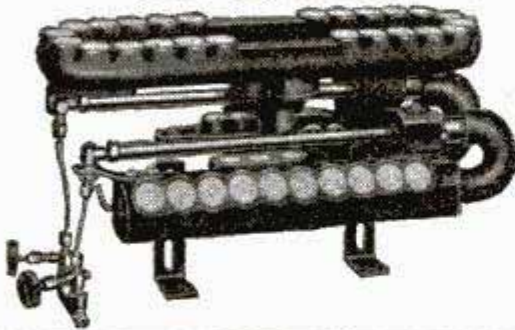

Will Heat Stoves, Ranges, Coffee
Urns, Steam Tables, Tanks,
Boilers, Vulcanizers, Water Coils, Rendering
Kettles, Bake Ovens, Griddles, Lead Pots,
Pressing Machines, etc.

No Noise—No Smoke—No Soot—No Ashes
Require No Mechanical Skill to Operate
Can be Installed in 30 Minutes
Last a Lifetime

Responsible Distributors Wanted
Write for illustrated catalog.

GLORIA LIGHT COMPANY
111-9 No. May St. Chicago, Ill.

BUILD YOUR OWN CLOCK WITH OUR HELP

Turn idle hours into welcome dollars building clocks, very profitable spare time work. We furnish plans, instructions, works, dials and all materials at low prices.

**BANJO CLOCKS, MANTEL CLOCKS
WORKS AS LOW AS \$1.85
GRANDFATHER CLOCKS WITH CHIMES**

Ask for our attractive **FREE** Blueprint plan and catalog.
AMERICAN CHIME CLOCK COMPANY, Dept. K
1691 Ruffner Street PHILADELPHIA, PA.



NEPCO ELECTRIC IRON CORD COILER

The only practical device on the market for keeping the cord on an electric iron up and out of the way. Every woman owning an electric iron will buy on sight.

OVER 100 PER CENT PROFIT
Act quick. Be first in your territory to make clean-up. Write for circular and prices.
NATIONAL ELECTRIC PROD. CO.
Dept. P. M., 3947 Armitage Ave., Chicago

Cal. 30-40 Six Shot



KRAG CARBINE

Price
\$9.75

All the qualities of a high price rifle. In fine used condition, all working parts guaranteed for one year. Send today for our Free 50-page illustrated catalog of money saving values: Guns, Ammunition, Cutlery, Sports and Gov't goods. Deposit required on all orders. Money refunded if not satisfactory.

W. Stokes Kirk, 1627-P. M. North 10th St., Philadelphia, Pa.

**New Model
Men's
Strap
Watch**

\$3.85

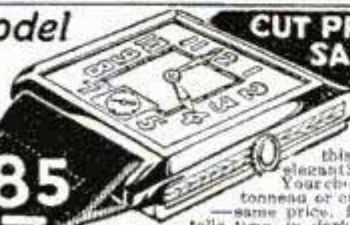

**CUT PRICE
SALE**

Two years written guarantee given with this full jeweled elegant Swiss watch. Your choice in square, tonneau or cushion shape—same price. Radium dial, tells time in dark. Accurate timekeeper, tested and adjusted. Rush your order. Quantity limited. Send no money, pay postman \$3.85. **JENKINS**, 621 Broadway, New York, Dept. 23-F-9.

STOP THAT LEAK WITH SMOOTH-ON No. 1



YOU can apply Smooth-On with radiator full or empty, hot or cold, without removal from the car and without putting inside anything that clogs the circulation.

Merely roll the Smooth-On into a stiff putty, press it against and into the leak with your thumb or pack it into the defect with a knife blade or screw-driver, and scrape off the excess. The leak will stop instantly, and the repair is permanent. For a few cents and in a few minutes you will have avoided all the delays and expense of a professional repair job that couldn't be any better.

Cracked Water Jackets. Water jackets of automobile, stationary or marine gas engines which have developed long or short cracks or have even had pieces broken entirely out from freezing can be made thoroughly and lastingly serviceable by similar repair, or by applying Smooth-On under straps or a plate.

Smooth-On No. 1 can be used in a hundred ways in the household, and it often saves from \$50.00 to \$100.00 on the first job.

Keep a can of Smooth-On No. 1 with your tool kit and some day when caught with a repair job you will thank yourself for your forethought.

Get Smooth-On No. 1 in 7 oz., 1-lb. or 5-lb. tins at any hardware store or if necessary direct from us.



Write for
FREE BOOK

FREE

This booklet tells how to stop not only water leaks in radiators, cracked water jackets, and at loose hose connections, but also how to stop gas leaks from the tank, gasoline lines and exhaust system, and oil leaks at gaskets and at cracks in crank or gear case. It also tells how to make headlight posts, nuts, hub caps and bolts and grease cups stay tight, and shows dozens of simple money saving Smooth-On repair jobs.

Send free if you return the coupon
SMOOTH-ON MFG. CO.
Dept. 37, 574 Communipaw Ave.
JERSEY CITY, N. J.



Do it with SMOOTH-ON

SMOOTH-ON MFG. CO., Dept. 37,
574 Communipaw Ave., Jersey City, N. J.
Please send the free Smooth-On Repair Book.

Name.....

Address.....

9-28.....



Pocket Ben

THERE'S more good time-keeping service, more real value in Pocket Ben than you'd ever expect in a \$1.50 watch.

Pocket Ben is both sturdy and thoroughly reliable, and mighty good looking, too. It's the kind of a time-piece that you can carry with pride and confidence.

*Built by the makers of
Big Ben and other Westclox.
Sold everywhere*

WESTERN CLOCK COMPANY
La Salle, Illinois



New Westclox Auto Clock

Attractive, convenient,
reliable. Fits any car.
Quickly attached on dash
or above wind-shield

\$2.50

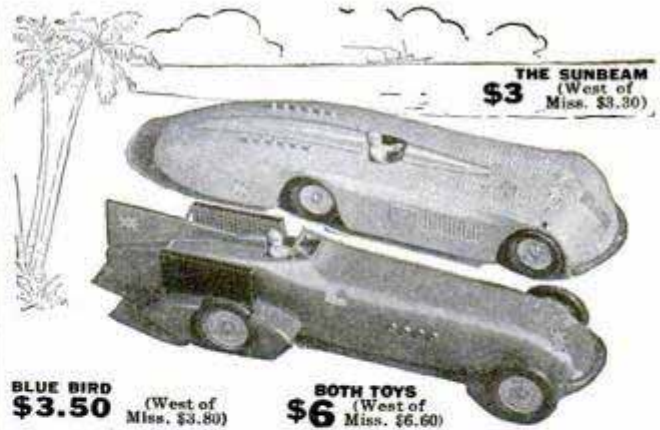

BLUE BIRD
\$3.50 (West of
Miss. \$3.80)

BOTH TOYS
\$6 (West of
Miss. \$6.60)

THE SUNBEAM
\$3 (West of
Miss. \$3.30)

Most Thrilling Race of All Time

PICTURE two monster racing cars—one brilliant red, one shining blue—imagine them, side by side, thundering down an endless stretch of glittering sea sand. Fast—faster! Fifty miles—one hundred—hundred fifty—two hundred miles an hour—and still the speed increasing! Can you imagine such a race? It is what would happen if Major Seagrave's "Sunbeam" and Captain Campbell's "Blue Bird" could be raced together at Daytona Beach, where they made their famous world speed records. But—

YOU CAN STAGE A RACE LIKE THIS WITH TOYS!

For you can now have the Sunbeam and the Blue Bird in toy form—beautifully made, all of steel, equipped with clock-spring racing motors. Exact in shape and color, all details correct—even genuine rubber tires made by Dunlop!

SPECIAL COMBINATION OFFER—BOTH TOYS \$6

Show this ad to your dealer to secure this special price. Bought separately, the Sunbeam \$3, the Blue Bird \$3.50. If your dealer is not yet selling these toys, order direct from us.

KINGSBURY MFG. COMPANY, 83-1 Myrtle St., Keene, N.H.

KINGSBURY Motor Driven TOYS

Send 10c for Novel Eraser. A disc wheel from a Kingsbury Toy with a big tire of solid eraser rubber. Set of four, 35c. Write for Complete Kingsbury Toy Catalog—Free.

AGENTS 500% PROFIT GENUINE GOLD LEAF LETTERS



guaranteed to never tarnish. Anyone can put them on stores and office windows. Enormous demand, large profits. Paul Clark says: Smallest day \$28.70. R. I. Reel made \$920 in two months. Write today for free sample and liberal offer to general agents.

METALLIC LETTER CO., 433-B N. Clark St., CHICAGO

FREE

CATALOGUE SHOWING OVER 150 GIFTS

Send your name and address at once for our FREE catalogue showing over 150 different gifts, baseballs, footballs, wrist watches, cameras, fountain pens, toy tools, etc. They are yours without cost for selling White's Christmas Cards at \$1 per box—a \$2 value. If you sell only one box, you can get baseball, bat, harmonica, etc. Easy Pleasant Work for Your Spare Time.

White's Quaint Shop, Dept. C

Westfield, Mass.

camp first aid

for small insect bites and sunburn
ivy poisoning; sore muscles; scratches and
other vacation mishaps that become camp kill-
joys. Absorbine Jr. is a powerful liniment
and dependable antiseptic.

At all druggists', \$1.25. Send for free trial bottle
W. F. YOUNG, Inc. SPRINGFIELD, MASS.

Absorbine Jr.

All those in favor of LIGHT

—say "Eveready." That's the good word wherever it's a question of flashlight or flashlight battery. "Eveready" means what it says—on the job every time you need it—coming through with a big, white beam that drives a bright path through the blackest gloom. When it's so dark outside that a Senegambian looks like a Nordic blonde, the flashlight habit will keep you on the side of safety.

Get the flashlight idea, and get this one with it: No flashlight is better than its battery and no battery is better than Eveready. Eveready Batteries are packed full of power, stacked to the rim with endurance. They're full of the stuff that makes light, as they prove in record service. Insist on genuine Eveready Batteries when you reload your flashlight.



CORONA IN COLORS!

Beautiful Duco finishes.
Write for new illustrated folder.

L C Smith & Corona Typewriters Inc 912 E. Washington St., Syracuse, N. Y.

Beautiful HOUSES \$900 and BUNGALOWS

CAN BE BUILT FOR AND UP
This and many others in my new book, **Building Plans for Modern Homes**, will save you hundreds of dollars. One of the most complete and comprehensive books of plans ever published by any architect. New edition just off the press. Nearly 600 floor plans and photographs of Colonial houses, bungalows, etc., costing from \$200 up; gives sizes and cost to build. Sent postpaid for \$3.00.



FREDERICK H. GOWING
ARCHITECT
101 Tremont St., BOSTON, MASS.

PIN A DOLLAR BILL TO THIS

and get this genuine leather 5-window gold corner pass case. Holds Railroad Passes, Auto License, Lodge Cards, etc. Masonic or Shrine Emblem stamped on in gold free. Your name or other stamping 35c extra per line. Cash must accompany order.

We carry

EVERYTHING MASONIC

Send for free catalogue No. 10 P. M. of Books, Monitors, Jewelry; No. 11 P. M. of Lodge Supplies.

We Have Been in Business 67 Years!

REDDING MASONIC SUPPLY CO.
200 Fifth Ave., Desk P. M. NEW YORK



To new shavers —and old:

Make this 10-day test before you decide you've found the ultimate in a shaving cream that suits your face

GENTLEMEN:

When we decided to go into the making of a shaving cream we were told that men were fickle—that they changed shaving creams as easily as they changed their shoes.

But this we believe is wrong. For in the few years this new shaving cream has been sold, we find there is a peculiar loyalty to it. We find the younger generation is "going Palmolive" when it comes to shaving.

And we know for fact that the great majority of those who take our 10-day test, remain wedded to it.

These 5 exclusive new features

1. Multiplies itself in one minute.
2. Softens the beard in one minute.
3. Maintains its creamy fullness for 10 minutes on the face.
4. Strong bubbles hold the hairs erect for cutting.
5. Fine after-effects due to palm and olive oil content.

Now make the trial, please

No doubt your present shaving preparation suits you, yet there may be a better way. We've tried to find one for you, and will thank you to give it a test. Just send the coupon now.

Palmolive Radio Hour

Broadcast every Wednesday night—from 9:30 to 10:30 p. m., eastern time; 8:30 to 9:30 p. m., central time—over station WEAJ and 32 stations associated with The National Broadcasting Company.

With the new unbreakable Bakelite top.

3976

10 SHAVES FREE and a can of Palmolive After Shaving Talc

Simply insert your name and address and mail to Dept. B-1560, Palmolive, 3702 Iron St., Chicago, Ill. Residents of Wisconsin should address Palmolive, Milwaukee, Wis.

(Please print your name and address)

DIAMONDS-WATCHES

CREDIT AT CASH PRICES



No. 892
\$37.50.
\$3.75 down
and \$1.00
a wk.

No. 891
\$100. \$10
down and
\$2.50
a week

WEDDING RINGS
No. 824—The "Elite" solid 18-k white gold Set with 3 Diamonds, \$22.50; 6 Diamonds, \$32.50; 7 Diamonds, \$42.50; 9 Diamonds, \$52.50; 12 Diamonds, \$67.50.

WRIST WATCH
No. 866
Solid 14-k white gold, 15 Jewels, \$15.00. \$1.50 down and \$1.50 a mo.

Send for FREE Catalog!

Realize your ambition to own a beautiful Diamond or fine watch—buy on payments so easy you'll never miss the money! Write today for your free copy of our big Catalog showing over 2000 illustrations of Diamond Rings, Watches, Fancy Jewelry of all kinds, Silverware, Gifts, etc. Every article guaranteed to be exactly as represented and **all goods delivered on first payment.**
The rings illustrated are solid 18-k white gold set with genuine brilliant blue white Diamonds

RAILROAD WATCHES—Guaranteed to Pass Inspection
Hamilton No. 992, 21 Jewels, Adjusted to 6 positions, Gold filled 20-Year Qual. Case, \$5.50 \$5 Down and \$5.50 a Month

Elgin's Latest Raymond, 21 Jewels, 8 Adjustments, Gold filled 20-Year Qual. Case, \$5.50 \$5 Down and \$5.50 a Month



No. 893
\$200. \$20
down and
\$5.00
a week

No. 875
\$50. \$5 down
and \$1.25
a week

19-JEWEL ADJUSTED WALTHAM NO. 846
—14-k white gold filled; assorted patterns, \$42.50; \$4.25 down and \$1.00 a week.

ORDER DIRECT FROM THIS AD

ELGIN STRAP WATCH
No. 894. A \$20 Value. Special at \$15.00, \$1.50 down and \$1.50 a month.

LOFTIS

BROS. & CO. F&S
NATIONAL CREDIT JEWELERS
Dept. D-894 108 North State Street, Chicago, Ill.
Stores in Leading Cities

\$35100 CLEARED IN ONE DAY

So writes W. H. Adams of Ohio. Letter from California man reports \$11275 sales in three months; New Jersey \$4000 profits in two months; Pa. \$3000 profits in four months. Ira Shook \$365 sales in one day. Bram bought one outfit April 5 and 7 more by August. Iwata bought one outfit and 10 more within a year. J. R. Bert says "only thing I ever bought that equaled advertisement." John Culp says: "Everything going lovely. Crispette wrappers all over



town. It's a good old world after all." Kellog, \$700 ahead end of 2d week. Wholesale or retail. Big profits either way. No town too small. Business is pleasant, fascinating and dignified. You manufacture a food product.

WE START YOU IN BUSINESS

Furnish secret formulas, raw material and equipment. Little capital required; no experience needed.

Build a Business of Your Own

No limit to the sale of Crispettes. Everybody likes them. It's a delicious food confection. Write for facts about a business that will make you independent. Start now, in your own town.

PROFITS \$1000 MONTH EASILY POSSIBLE

Send postal for illustrated book of facts. It contains enthusiastic letters from others—shows their places of business, tells how and when to start, and all information needed. Free. Write now!

LONG-EAKINS COMPANY

928 High Street

Springfield, Ohio

Introduce 40 Handy Things \$75 to \$125 Every Week! FOR THE KITCHEN

EGG BOILER

JAR WRENCH AND BOTTLE OPENER

PIE CRIMPER

Even beginners make sensational earnings with our line of 40 fascinating "Handy Things" for the kitchen. New, novel, practical, and low priced. Women buy on sight. You show samples we furnish and walk off with a good profit. 100 per cent to 200 per cent **CLEAR PROFIT!** That's what you earn. And agents report that 9 out of 10 calls pay a profit. \$1 to \$3 an hour easy for part time workers. No experience required. Rush name today for details of amazing proposition and **FREE SAMPLE OFFER.** Good territories going fast, so write today.

GENERAL PRODUCTS CO.
Dept. 7-J, Newark, N. J.

FREE Samples to Agents



Here's \$60 a Week and a

Make \$60 a week just taking orders for new fast-selling, All-Weather Coat at only \$3.98. Finely tailored of high-quality, rubberized fabric. Popular styles. Six striking colors. Wind-proof, dust-proof, water-proof. Every man, woman and child a prospect. Stone made \$605 in 30 days. Brooks, \$90 in 1 day.



Send for Free Outfit

No capital or experience needed. I furnish everything—including Sample Coat **FREE** to workers. Write at once to **Comer Mfg. Co., Dept. W-5134, Dayton, O.**

NEW AND REBUILT EQUIPMENT

Everything for "The Movies," Machines, Screens, Chairs, Generators and Supplies. Complete Stationary and Travelling Outfits. Free Catalog. Write Dept. M.

MONARCH THEATRE SUPPLY CO.
395 SO. SECOND ST., MEMPHIS, TENN.



DIE CUT OVAL PRINTS

Something new for kodakers. Send negative with dime for sample and catalog of specialties for kodakers. **FRANK SCOBIE, 43-0, Sleepy Eye, Minn.**

Part-Time Men Get This Suit FREE

Make \$45 a Week and up

Cash profits paid in advance
No question about it, any man can easily earn \$45 a week and up, just showing our wonderful outfit and taking orders for our high-grade tailoring. Never before such low prices and beautiful styles.

Your Own Clothes FREE

To introduce our unbeatable values, classy styles and perfect tailoring, we make this introductory free suit offer—something different, better, bigger, more liberal than any offer ever made.

Handsome Carrying Case Outfit
of large real cloth samples—everything furnished **FREE.**

Write today for free suit and big money-making offer.
SPENCER MEAD CO., Wholesale Tailors, Dept. W816, Chicago



FREE New Book FACTORY PRICES

Save 1/3 to 1/2

New FREE book quotes Reduced Factory Prices. Lower terms—year to pay. Choice of 5 colors in New Porcelain Enamel Ranges.

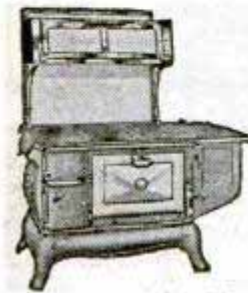

New Circulating Heaters—\$37.50 up. 200 styles and sizes. Cash or easy terms. 24-hour shipments. 30-day FREE trial. 360-day test. Satisfaction guaranteed. 27 years in business. 700,000 customers. Write today for FREE book.

Furnaces \$54⁹⁵ up

KALAMAZOO STOVE CO.
391 Rochester Ave.
Kalamazoo, Mich.

Ranges \$37⁷⁵ up

"A Kalamazoo Direct to You"
Trade Mark Registered

\$4.99 22 Cal. Blank Automatic



WITH You need no license or No Permit Required
100 permit to own this 6-shot Automatic. Use for
CART- fun or self-defence. keeps away tramps,
RIDGES Frightens thieves, scares away dogs—
Free! a real home protector. Fool your friends.
Same as an expensive automatic in construction, finish, appearance, durability; automatic magazine loading and ejection of cartridges. Instantly and powerful report. Guaranteed absolutely safe. Send no money. Pay expressman \$4.99 for automatic with 100 cartridges. JENKINS, 621 Broadway, New York, Dept. 23-J-C

PRINT Your Own

Excelsior

Cards, Stationery, Circulars, Labels, paper, tags, menus, book etc. Save money and time, cut cost in half. Pays for itself in a short time. Sold direct from factory only. Print for Others, Big Profits. Complete Outfits, \$3.85 up. Job Presses \$11 up, Rotary \$149. All easy, rules sent. Write catalog presses, type, paper, cards, ink etc. THE KELSEY CO., 2-37, Meriden, Conn.

DO YOU

WANT a new business profession of your own, with all the trade you can attend to? Then become a foot correctionist, and in a few weeks earn big income in service fees,—not medical nor chiropody—easy terms for home training, no further capital needed, no goods to buy, no agency. Address Stephenson Laboratory, 1 Back Bay, Boston, Mass.

AIRPLANE

12-inch scale model of Lindbergh's Spirit of St. Louis. Scientifically designed and very realistic. Rises from ground by own power and flies 30 ft. or more. Stays in air 8 to 10 seconds.

Easily built in 2 or 3 hours. No tools needed. Construction set, with all parts and full directions, postpaid in U.S., only 50c. (no stamps). Satisfaction or money back. Send today. Mann & Benton, Box D, Chillicothe, O.

WURLITZER

Trade Mark Reg. THE WORLD'S LARGEST MUSIC HOUSE

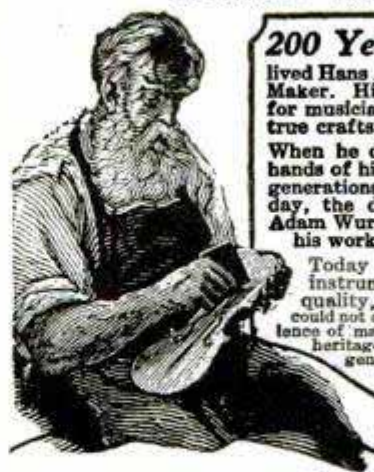

200 Years Ago in the little Saxony town of Saxeck lived Hans Adam Wurlitzer, Master Violin Maker. His shop was a gathering place for musicians of the time, for he was a true craftsman.

When he died his shop passed into the hands of his eldest son, and for seven generations, down to the present day, the descendants of Hans Adam Wurlitzer have carried on his work.

Today in every Wurlitzer instrument you will find a quality, a character, that could not come from mere excellence of manufacture. It is the heritage of these seven generations of music craftsmanship.

Try any Wurlitzer Instrument in your Own Home

YOU may now have any Wurlitzer instrument for a generous free trial in your own home. Examine the instrument, show it to your friends, play it as much as you wish. No obligation to buy—no expense for the trial. We make this liberal offer because we want you to try for yourself these wonderful instruments, the result of 200 years' experience in musical instrument Building. Easy payments are arranged to suit your convenience. This is your opportunity to try a famous Wurlitzer instrument in your own home.

Send for New Catalog

The greatest musical catalog ever published. Over 3,000 articles—every known instrument described and illustrated; many of them shown in full colors. Gives you lowest prices and all details of Free Trial, Easy Payment plan. All sent FREE—no obligation.

Send this Coupon

THE RUDOLPH WURLITZER CO., Dept. 1776
117 E. 4th St., Cincinnati

Send me absolutely free, your new illustrated catalog, with prices and description of every known musical instrument. Also tell me how I may try any instrument in my own home and pay for it in small monthly sums. No obligation.

Name.....

Address.....

City..... State.....

Instrument.....
(State instrument in which you are interested)

DEVITT 8" COMBINATION SAW

8,000 IN USE!

A SHOPFUL OF TOOLS WITHIN ARMS REACH!

SAW TABLE RAISED SHOWING EMERY WHEEL, SAW GUARD AND DRILL ATTACHMENT



PLANER ATTACHMENT ON SAW TABLE

SHOWING SANDING DISC ATTACHED



TABLE TILTED FOR BEVELING

DADO HEAD ATTACHED FOR GROOVING

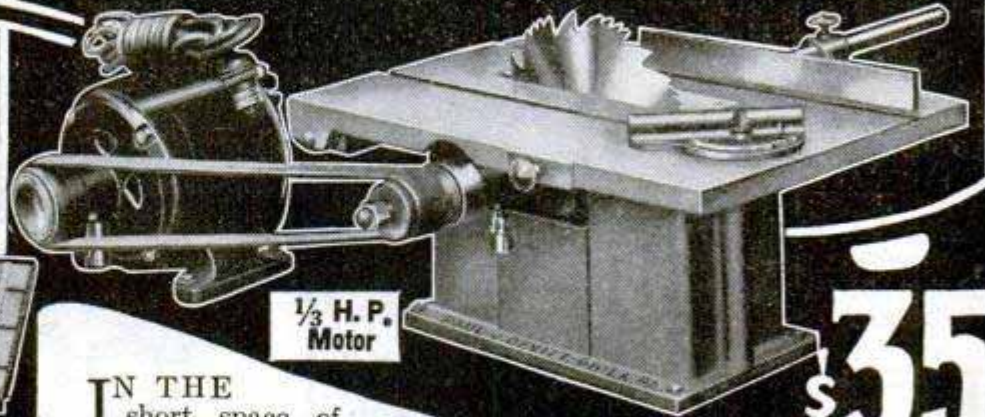

1/3 H.P. Motor

\$35

F.O.B. PHILA

In the short space of four years, the Devitt 8-Inch Combination Saw has become a practical necessity in thousands of shops, factories and households everywhere. Many imitators have sprung up, but Devitt leads them all. Think of the convenience and economy of this handy little machine that will rip, cross cut, bevel, miter, groove, mortise, tenon, drill, rabbet, grind, buff and polish. Attachments are easily and quickly adjusted. The saw and motor, when set up for work, occupy very little room. Saw is equipped with 1/3 H.P. 60 cycle, 1750 R. P. M. 110-volt A. C. Motor which can be attached to ordinary light socket, and provide power for other purposes when wanted. A cut up to 2 1/4" can be made without planing. Comes complete with following attachments—12"x16" table, 8" Combination Saw, iron pulley for saw table, 10" ripping fence, adjustable cut off miter gauge, motor-specifications as above, 1 1/4" endless leather belt, wood pulley, 8 ft. cord and plug, 6" buffing wheel, 3/8" 3 jaw drill chuck, 5" emery wheel, 6" sander, saw guard, and 2" dado insert. \$35.00 F. O. B. Phila. Height 7 1/2", shipping weight, 100 lbs.

(Only \$12 extra for Planer Attachment to fit on table top. Can smooth pieces up to 2 inches wide. Price, F. O. B. Phila.)

Send today for our attractively illustrated 4-page circular

PAUL J. DEVITT

Dept. K 1102 SOUTH 2ND ST. PHILA., PA.

"Interlox" MASTER SLIDE RULE

Speeds up all measuring. Slides in and out—no folding. Direct-reading for instant inside measurements, as well as outside. Any length, 2 to 8 ft., 20c lined ft. If not at dealers, sent postpaid.



MASTER RULE MFG. CO., 813 E. 136th Street, NEW YORK
Dealers and Agents: Write for attractive proposition.

GOODSELL-PRATT COMPANY *Toolmakers*, GREENFIELD, MASS., U.S.A.

GOODSELL-PRATT

1500 GOOD TOOLS



A Gerstner CHEST

is the right Chest for your needs. Toolmakers and Machinists—select your Cases and Chests from our free catalog.

Gerstner & Sons

457 Columbia St., Dayton, Ohio

MEN WANTED

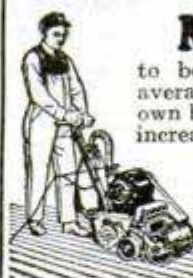

to become floor surfacing contractors—Pay averages \$30.00 per day—no lay offs—your own boss—work the year round—demand ever increasing—New "American" machines do the finest work and are easiest to handle. Complete information sent free without obligation. Write today.

AMERICAN FLOOR SURFACING MACHINE COMPANY

523 S. St. Clair Street Toledo, Ohio



\$10⁰⁰
DOWN
Brings this Lathe to You

Lathes \$6.00 to \$75.00. Largest line of small lathes in America. Send six cents for 32 page catalog of lathes, drill presses, bench saws, jig saws, band saws, etc.

SYPPER MANUFACTURING COMPANY

Dept. D Toledo, Ohio

SIMONDS

SAWS FILES KNIVES STEEL

PLANER KNIVES

THAT SPEED UP PRODUCTION AND LOWER COSTS

THE best planer man in the world cannot turn out a profitable day's work unless he is furnished with proper cutting edges.

Give him Simonds Planer Knives and watch production speed up.

Simonds cutting edges are made of the finest scientifically treated steel and backed by three-quarters of a century's experience in the manufacture of cutting edges that cut costs and lengthen profits. Specify Simonds for economy!



SIMONDS SAW AND STEEL COMPANY

"The Saw Makers"

Fitchburg, Mass.

Established 1832

BRANCH STORES AND SERVICE SHOPS IN PRINCIPAL CITIES

BURN YOUR NAME ON TOOLS WITH THE ARKOGRAF

PROTECT YOUR TOOLS FROM THEFT
Write with electricity any name or design on the hardest and finest tools and instruments, or any metal, like writing on paper with pen or pencil. Complete outfit \$3.50—Prepaid Anywhere Interesting illustrated circular free. Write today. Agents wanted. ARKOGRAF PEN CO., 1171 E. Stark St., Portland, Oregon

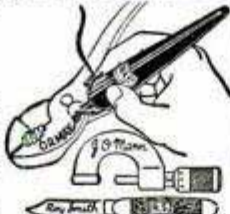

\$25 To \$50 Make \$25 to \$50 per day and be Your Own Boss! Per Day Drilling Wells!

Cash in on demand for good wells in every community! Any man with mechanical turn of mind can easily operate one of our drills, make big money, be independent, work the year 'round! A few hundred dollars starts you in this big paying business—pay balance out of earnings! Write for FREE CATALOG describing ARMSTRONG ALL STEEL WELL DRILLS—gasoline traction or non-traction models. Write now—today—Armstrong Mfg. Co., 810 Chestnut St., Waterloo, Iowa.



\$1500 WITHOUT MOTOR SCHROETERS No. 15 Motor Driven SCROLL SAW for Home or Small Shop

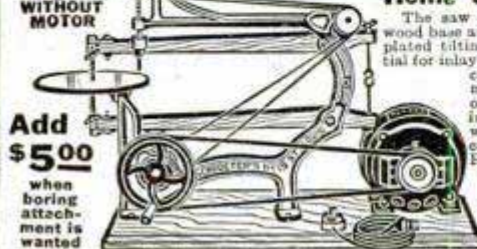

Add \$500 when boring attachment is wanted

For More Information Write for Our Scroll Saw and Tool Catalog SCHROETER BROS. HARDWARE CO. 810 Washington Ave., ST. LOUIS, MO.

The saw is mounted on a neat wood base and has a 7 1/2-inch nickel plated tilting table which is essential for inlay work. The work which can be accomplished is marvelous. Has a range of work from the finest inlay up to 7/8-inch white pine. A practical machine for sawing Radio panels such as bakelite, sheet brass, hard rubber, bone, fibre, etc. Has 16-inch swing. Weight only 21 pounds without motor. We supply a catalog of 250 miniature scroll saw designs with each machine.

This **CORNWELL** Expert Mechanics **Only \$8.60** **KIT**

Amazing Tests Prove Quality

Catalog describes remarkable tests by which the phenomenal strength and guaranteed quality of CORNWELL tools may be tested. Your money back for any tool that fails to do what we claim.

HERE is a convenient kit of CORNWELL chisels and punches that are forged from the very highest grade Chrome Molybdenum steel. They are hardened, heat treated and specially tempered by our exclusive CORNWELL process. They will withstand the hardest usage, and will accomplish results that no other similar tools will do. While costing slightly more than ordinary tools, figured in man-hours of performance and the resultant satisfaction from their use they are the cheapest in the end. CORNWELL tools will enable you to do better work in considerably less time.

There Is No Substitute for Cornwell Quality

Mechanics are proud of their CORNWELL tools because they know there are no others like them. They meet the most exacting requirements for hard usage. They withstand the most severe tests to which any tools can be put.

Money Back Guarantee

You are fully protected by our guarantee that covers every CORNWELL tool. You take no risk. If tools are not all we claim for them send them back and your money will be immediately refunded.

This Catalog-FREE

The Cornwell Quality Tools Co. Dept. B, Mogadore, Ohio. (Formerly at Cuyahoga Falls, Ohio.)

Send me new illustrated catalog with prices on full line of Cornwell Hand-Made Tools.

..... Where employed
Name.....
Address.....
City..... State.....

WITTE FARM and RANCH ENGINES at New Low Prices - Cash or Easy Terms

Easy Terms



WITTE Log & Tree Saw

with ALL-PURPOSE, ALL-FUEL ENGINE. Cuts up 15 to 40 cords of wood a day on just a few cents worth of cheap fuel, also cross ties, fence posts, etc.—safe, easy to operate. All-purpose engine can be used for all other power jobs around the farm or ranch—running Feed Grinders, Milking Machines, Cream Separators, Pumping Water for Home and Farm use, etc. Lifetime Guarantee for your protection.

MY Throttling Governor Engines furnish smooth, steady power, and I make a type and size for every farm and ranch need. Built of alloy-steel, to increase strength and reduce weight. WITTE all-fuel carburetor successfully burns low grades of distillate or kerosene. WICO Magneto with retard lever assures quick and safe starting regardless of weather conditions. Lifetime Guarantee for your protection.

FREE! Catalog.

describing WITTE Types "F" and "H" and Heavy Duty Engines and all improvements, also labor saving power outfits—log and buzz saws, pumper outfits, etc.—all at direct factory-to-you new low cash or easy term prices. Send today for your copy.

Cash or Your Own Terms

No interest to pay. Yes, I will give you a full year to pay for your WITTE Engine or Outfit. I want it to pay its own way while you pay me. It's so much cheaper to have your work done with a WITTE than it is to hire help

ED. H. WITTE, Pres.,
WITTE ENGINE WORKS
1746 Oakland Avenue,
1746 Liberty Street,
KANSAS CITY, MO.
PITTSBURGH, PA.

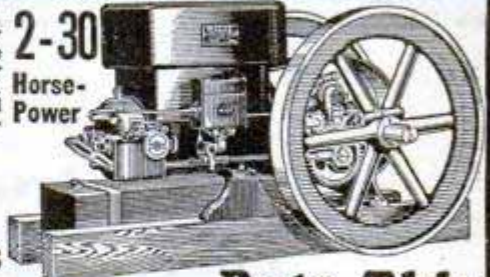

2-30 Horse Power
\$5.00 Puts This WITTE To Work for You

WITTE Type "F" on Wood Skids, 2 to 6 H.P.—Runs milking machines, feed grinders, cream separators, pumps water for home and stock, irrigating, etc. Easily and quickly taken wherever power is needed. Send for catalog.
A Size For Every Need!

AGENTS

Sell Genuine Diamonds on Cash or Credit

Everyone is always thinking of buying real jewelry for themselves or as a gift for some dear one. Show them our plan of CASH OR CREDIT. Show them how they can have a beautiful genuine diamond ring, high grade watch, standard-make silverware or any solid gold jewelry they desire, CASH OR CREDIT with 12 months to pay. You will find customers everywhere ready to order Sterling merchandise. We put you in the diamond and jewelry business for yourself without a single cent investment. We have a line that beats anything seen—yet is lower in price! Guaranteed.



OVER \$85 Weekly! Easy!

No matter what you are selling you have the opportunity to make extra profits with this new remarkable line. The genuine diamond and jewelry business is not seasonal. Every day people have occasion to buy for an anniversary, wedding, birthday, etc. Show our nationally advertised line and get these sales that mean big profits for you.

SEND FOR FREE OUTFIT
Write for complete free outfit which contains illustrated catalog in colors, order blanks and full instructions. We send by return mail everything to start you earning without delay—no investment—write today—NOW.
STERLING DIAMOND & WATCH CO., Inc.
1540 Broadway, Dept. A-179, New York, N.Y.



Champion Swivel Bench Vise

Only \$2.25 \$2.25 A Bargain
Just the Vise for the Home Workshop. Draw Bar, Handle and Serew made of Steel. Jaws high-grade steel, knurled and ground. Machine Cut Thread on Serew. All steel parts highly polished. Body and Base are Ducoed. No. 30 Radio, Garage and Home Workshop. Vise. Width of Jaw 3 inches, opens 3 inches, weight 13 lbs. Shipped in Carton.

Now Is Time to Buy—Order Today
Dept. "V"
Champion Blower & Forge Co., Lancaster, Pa.

Ask for Keds by name
They are not Keds unless the name Keds is on the shoe

ONE HANDLE TAKES THE PLACE OF MANY WITH THIS NEW FLEXIBLE HANDLE SET

5/8" square connection. Six sockets 7-10", 1 1/2", 9-10", 5-8", 11-10", 3/4" hex openings. Chrome Vanadium steel. Speedy. Guaranteed. Money back if 10 days' trial doesn't satisfy. **\$3.65**, prepaid, cash with order; **\$3.90**, C. O. D. Handle only, \$1.75 cash, \$1.90. C. O. D. Acts. Wntd. Tool Service Sales Co., Box 4605, Sallwood Sta., Portland, Oregon

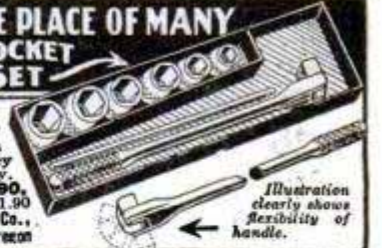

Illustration clearly shows flexibility of handle.

MOTORCYCLES

WE WILL TRUST YOU Pay As Low As \$2.00 per Week
Hendersons, Harley-Davidsons, Indians
Slightly used and rebuilt. Hundreds to select from.
Send 10c for list today.
MYEROW BROS. CO., 15 Berkeley St., Boston, Mass., U. S. A.

ONE-MAN SAW MILL

Makes boards, strips, shingles, lath, crating, etc., from logs | Splits blocks into firewood, or lumber shorts.

\$39 BRINGS IT TO YOU

Hundreds of uses. Needed by every farmer, timber owner, contractor. Pays for itself in a week, or on one job. Guaranteed. Sold direct from factory. Write today for Special Offer and Free Book "How To Make Lumber."

BELSAW MACHINERY CO.
Box 104 PLEASANT HILL, MO.

Cash or Easy Terms

PARKS

WOODWORKING MACHINES
Cabinet Shop Special No. 10
\$290
With Motor

You ought to have this handy Parks in your shop. Compact, complete machine designed like a big production outfit at 1/2 the cost. Fits in a corner of your basement. Does any kind of cabinet and joinery work. Write for circular.



The Parks Woodworking Machine Co.
1500-40 Knowlton St. Cincinnati, Ohio
Canadian Factory: 208 Notre Dame East, Montreal

Now Make Your Radio Clear as a Bell ~

with **MARVELOUS** new **GROUND AERIAL!**

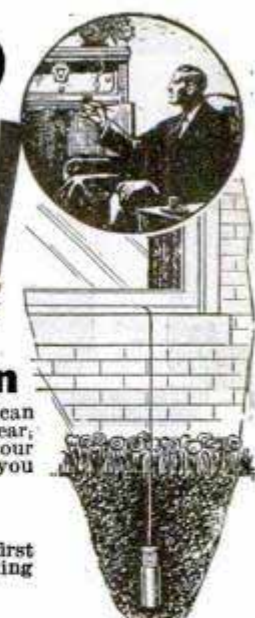

"After testing many Aerials in my Laboratory I find your Sub-Aerial is the best for Clarity of tone and elimination of static, also for greater volume and selectivity. It will fill a long felt want among the Radio Fans."

A. B. Johnson, Radio Engineer.

Get Amazing Distance, Greater Volume and Selectivity Without Distortion

Why go on listening to terrible static and other maddening outside noises? Now you can get the real music your present Radio is capable of giving, by hooking your set onto the clear, practically static free ground waves with Sub-Aerial. The air is always full of static and your overhead aerial picks it up and brings it to your speaker. So why stay in the air—when you can use the whole earth as a static and noise filter with Sub-Aerial?

Low Original Cost—No Upkeep Cost

SUB-AERIAL costs no more than an overhead or loop aerial and less than many. Its first cost is the only one. SUB-AERIAL is permanent. No trouble—no hard work, or risking your neck on roofs.

25 YEAR GUARANTEE

SUB-AERIAL is guaranteed against any defects in workmanship or material and against deterioration for 25 years. Any SUB-AERIAL which has been installed according to directions and proves defective or deteriorates within 25 years, will be replaced free of charge; and also we will pay \$1.00 for installing any such new replacement.

TRY IT FREE!

We know so well the surprising results you'll get that we'll let you put in a Sub-Aerial entirely at our Risk. You be the Judge. Don't take down your overhead Aerial. Pick a summer night when static and noise interference on your old Aerial are "Just Terrible." If Sub-Aerial doesn't Sell Itself to You Right Then on Performance—you needn't pay us a cent. Send for "All the Dope on Sub-Aerial." You'll be surprised. Do it NOW.

Can Be Installed in a Few Minutes

UNDERGROUND AERIAL SYSTEMS

St. Clair Bldg., Dept. 8-M,
Cor. St. Clair and Erie Sts.,
CHICAGO, ILL.



Underground Aerial Systems, Dept. 8-M, St. Clair Bldg., Cor. St. Clair & Erie Sts., Chicago, Ill.

Send me complete information on Sub-Aerial, Proof and Free Trial Offer. No obligation.

Name.....
Address.....
City..... State.....

COASTER WAGON GIVEN

HEAVY BUILT RUBBER SEND TIRES NO MONEY We Trust You

BOYS! Here is 16 x 36 inch Wagon 10-in. heavy disc wheels with roller bearings; 1-inch rubber tires. Specially made body of seasoned wood—heavily reinforced with steel braces. Send for 12 boxes famous UCA-MENTHO Heating and Vapor Salve which sells at 25¢ a box. We also send 12 packs perfume which you Give Away FREE (to help sell the salve), and easy plan for obtaining this Coaster Wagon. Don't send a penny. We are reliable.

UCA MFG. CO. Dept. 3B78, CHICAGO

Big commission - MEN'S SUITS

\$8.88 FREE SALES KIT

Any one can earn \$2,000 extra money yearly in view of low price. Up to date styles, workmanship. Variety of beautiful patterns.

888 Co., Dept. J-7, Fort Wayne, Ind.

AGENTS AND SIGN MEN

Now Making \$50.00 to \$100.00 and Up Per Week Selling Our **GOLD LEAF SIGN LETTERS**

R For store and office windows, board signs, trucks and glass signs. We also make to order script signs and business emblems singly or by the thousands. A permanent business. No capital or experience required. Big demand in every city. Samples and Literature Free.

CONSOLIDATED SIGN LETTER CO. 71-X W. Van Buren CHICAGO, ILL.

Hotter than Coal ~ and no dirt

A New Invention

Do away forever with the drudgery of wood or coal. The most simple and economical invention on the market is now giving perfect satisfaction to enthusiastic users everywhere.

Burns 96% Air—4% Cheap Oil

The Okay Oil Burner fits in the fire box of your furnace or stove. Installed in a few minutes. No noisy motors or complicated parts.

Costs only a Few Dollars

Heats any stove or furnace just as well as a \$400 or \$500 oil burner without electricity or gas. Simply turn one valve and have all the heat you want. Cleaner and better for heating and cooking. Approved by engineers everywhere. Over 100,000 in use.

30 Days FREE Trial Offer

Try this wonderful Okay Oil Burner right in your own home at our risk. Act quickly and get our special low introductory price. Sold under absolute money-back guarantee. Write at once for our free booklet on home heating and free burner offer. **AGENTS—Our men are making big money introducing Okay Oil Burners. The demand is enormous. We want spare or full time workers immediately. If \$500 a month and more interests you, write or wire us for our protected territory offer.**

----- Clip This Coupon -----

Okay Mfg. Co., 1501 South Spring Ave., St. Louis, Mo., Dept. E-11
Send your free booklet and free details on home heating for stove. } Also free burner offer.
furnace. }

Name.....

Address.....

Check if interested in making money as an Okay representative with protected territory.

New Free Catalog!

Send today for our new Catalog! Smashing bargains in **Plumbing, Heating, Hardware, Millwork, Roofing, Paint and Electrical Supplies.**

Absolutely Free!

STANLEY PLUMBING SUPPLY CO., Inc. 400 N. 12th St. Phila., Pa.

PATENT

Protect Your Ideas

Take the First Step Today

If you have a useful, practical, novel idea for any new article or for an improvement on an old one, you should communicate with a competent Registered Patent Attorney AT ONCE. Every year thousands of applications for patents are filed in the U. S. Patent Office. Frequently two or more applications are made for the same or substantially the same idea (even though the inventors may live in different sections of the country and be entirely unknown to one another). In such a case, the burden of proof rests upon the last application filed. Delays of even a few days in filing the application sometimes mean the loss of a patent. So lose no time. Get in touch with me at once by mailing the coupon on the opposite page.

Prompt, Careful, Efficient Service

This large, experienced organization devotes its entire time and attention to patent and trade mark cases. Our offices are directly across the street from the U. S. Patent Office. We understand the technicalities of patent law. We know the rules and requirements of the Patent Office. We can proceed in the quickest, safest and best ways in preparing an application for a patent covering your idea. Our success has been built on the strength of careful, efficient, satisfactory service to inventors and trademark owners located in every state in the Union.

NO CHARGE for Information On How to Proceed

The booklet shown here contains valuable information relating to patent procedure that every inventor should have. And with it I will also send you my "Record of Invention" form on which you can sketch your idea and establish its date before a witness. Such evidence may later prove valuable to you. Simply mail the coupon and I will send you the booklet, and the "Record of Invention" form, together with detailed information on how to proceed and the costs involved. Do this NOW. No need to lose a minute's time. The coupon will bring you complete information entirely without charge or obligation.

My Patent Law Offices
Just Across
Street From
U.S. Pat. Office



Above is a view of my drafting and specification offices where a large staff of experienced experts are in my constant employ. All drawings and specifications are prepared under my personal supervision.

NEWS

Inventors

Write for these **Free Books**

Strict Secrecy Preserved

All communications, sketches, drawings, etc., are held in strictest confidence in strong, steel, fireproof files, which are accessible only to authorized members of my staff. Feel free to write me fully and frankly. Your case will have my personal attention. It is probable that I can help you. Highest references. But **FIRST**—clip the coupon and get my free book. Do **THAT** right now.

Clarence A. O'Brien

Registered Patent Attorney

Member of Bar of: Supreme Court of the United States; Court of Appeals, District of Columbia; Supreme Court, District of Columbia; United States Court of Claims. Practice confined exclusively to Patents, Trade marks and Copyrights

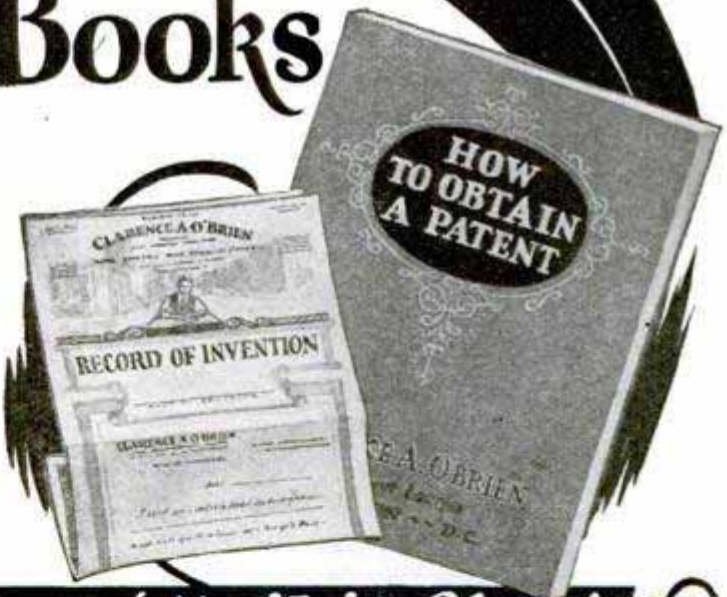

Clip this Coupon and Mail it Now!

CLARENCE A. O'BRIEN, Registered Patent Attorney

70-E Security Savings and Commercial Bank Bldg., Washington, D. C.

Please send me your free book, "How to Obtain a Patent," and your "Record of Invention" form without any cost or obligation on my part.

Name.....
(Important: Write or Print name clearly.)

Address.....

PATENTS TRADE MARKS COPYRIGHTS

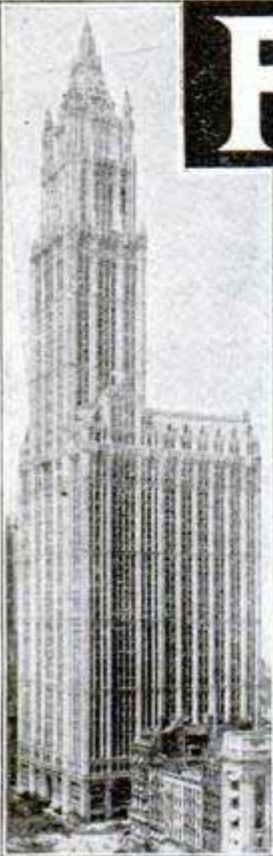

Our New York Office
Suits 1007 Woolworth Bldg.



Our Philadelphia Office
Suits 518-519 Liberty Bldg.



Our Washington Office, Victor Bldg.



Have You An Idea?
Our Offer: FOR THE PROTECTION
OF YOUR INVENTION

YOUR FIRST STEP

The inventor should write for our blank form

"RECORD of INVENTION"

This should be signed and witnessed and returned to us together with model or sketch and description of the invention for

INSPECTION AND ADVICE

No Charge for the Above Information

Our Five Books Mailed Free to Inventors

Our Illustrated Guide BOOK

How to Obtain a Patent

Contains full instructions regarding U. S. Patents. Our Methods, Terms, and 100 Mechanical Movements illustrated and described.

Our Trade Mark Book

Shows value and necessity of Trade Mark Protection. Information regarding *Trade Marks and unfair competition in trade.*

Our Foreign Book

We have Direct Agencies in Foreign Countries, and secure Foreign Patents in shortest time and lowest cost.

Progress of Invention

Description of World's Most Pressing Problems by Leading Scientists and Inventors.

We Regard a Satisfied Client as our best advertisement, and furnish anyone, upon request, lists of clients in any state for whom we have secured patents.

**Highest References—Prompt Service
—Reasonable Terms**

VICTOR J. EVANS & CO. PATENT ATTORNEYS

Main Offices: 789 9th St., N. W., Washington, D. C.
Opposite U. S. Patent Office

DELAYS ARE DANGEROUS IN PATENT MATTERS

IMPORTANT! To Avoid Delay!

YOU SHOULD HAVE YOUR CASE MADE SPECIAL IN OUR OFFICE to save correspondence, secure protection and early filing date in the Patent Office. To secure **special preparation** of your case send \$25.00 on account with model or sketch and description of invention.



MAIN OFFICE, VICTOR J. EVANS & CO.—VICTOR BUILDING, WASHINGTON, D. C.

Our Lawyers Practice in all U. S. Courts and defend Clients in Suits involving Patents, Trademarks and Copyrights

All Communications and Data Strictly Confidential. Interference and Infringement Suits Prosecuted

OUR ORGANIZATION OFFERS **PERSONAL SERVICE** By Experienced Patent Lawyers, Solicitors and Draftsmen



Our Chicago Office Suite 1114 Tacoma Building



Our Pittsburgh Office Suite 514 Empire Building



Our San Francisco Office Suite 1010 Hobart Building

**FREE
COUPON**

**VICTOR J. EVANS & CO.
PATENT ATTORNEYS**

NEW YORK OFFICES
1007 Woolworth Bldg.

CHICAGO OFFICES
1114 Tacoma Bldg.

PHILADELPHIA OFFICES
518-519 Liberty Bldg.

PITTSBURGH OFFICES
514 Empire Bldg.

SAN FRANCISCO OFFICES
1010 Hobart Bldg.

MAIN OFFICES: 789-9th Street, N. W., WASHINGTON, D. C.

Gentlemen: Please send me *Free of Charge* your books as described on preceding page.

Name.....

Address.....

PATENTS

TRADE-MARKS · DESIGNS
FOREIGN PATENTS

MUNN & CO.
PATENT ATTORNEYS

Associated since 1846 with the Scientific American

SCIENTIFIC AMERICAN BUILDING
24 W. 40th St., New York City

SCIENTIFIC AMERICAN BUILDING
Washington, D. C.

TOWER BUILDING
Chicago, Ill.

VAN NUYS BUILDING
Los Angeles, Cal.

HOBART BUILDING
San Francisco, Cal.



Books and Information on Patents and Trade-Marks by Request.
Associates in All Foreign Countries.

New Patent Law Revisions

1927 revisions of the Patent laws; amendments to the rules of practice of the Patent Office; new forms; and material bringing the law of employer-employee rights up to date, are included in this edition, just published, of

ROBB'S PATENT ESSENTIALS

For the Executive, Engineer, Lawyer, and Inventor

(NEW AND REVISED EDITION)

By John F. Robb, LL.B., LL.M., M.P.L.

The standard in its field—for laymen and attorneys alike. It gives in non-technical language a practical explanation of the nature of patents, the mechanics of their procurement, the scientific drafting of patent claims, conduct of cases, and special proceedings, including forms, together with complete illustrative cases. An indispensable guide for every one interested in patents.

485 pages, with 9 full-page illustrations and charts.

Price \$5.00, net; \$5.18, post-paid.

At All Booksellers or From

Funk & Wagnalls Company, 354-350 Fourth Ave., New York City

PATENTS

**Don't Lose Your Rights
To Patent Protection**

Before disclosing your invention to anyone send for blank form "EVIDENCE OF CONCEPTION" to be signed and witnessed. As registered patent attorneys we represent hundreds of inventors all over the United States and Canada in the advancement of inventions. The form "Evidence of Conception," sample, instructions relating to obtaining of patents and schedule of fees sent upon request.

LANCASTER & ALLWINE

480 Ouray Bldg.

WASHINGTON, D. C.

Originators of forms "Evidence of Conception."

PATENTS

**Booklet Free Highest References
Promptness Assured Best Results**

Send drawing or model for preliminary examination of Patent Office records.

ALL BUSINESS GIVEN PROMPT AND PROPER ATTENTION

Listed Patent Lawyer in the latest editions of the Rand-McNally Directory of Bankers and Bonded Attorneys, published by Rand-McNally & Co., Chicago, Ill.; The Baggott & Ryall Directory of Guaranteed Attorneys, published by the Ryall Legal Directory Company, New York City; Flugel's List, published by the Legal Directory Publishing Co. of St. Louis, Mo.; the American Lawyers Annual, published in Cleveland, Ohio; Eyre's Law List, Bush Terminal Building, New York City.

WATSON E. COLEMAN,
REGISTERED PATENT LAWYER

Victor Building, 724 Ninth Street, N. W.
WASHINGTON, D. C.

PATENTS

To the Man with an Idea

PATENTS Procured. Trade Marks Registered. —A comprehensive, experienced, prompt service for the protection and development of your ideas. Preliminary advice gladly furnished without charge. Booklet of information and form for disclosing idea free on request.

IRVING L. McCATHRAN, Patent Lawyer,
Formerly with and successor to RICHARD B. OWEN
200 Owen Bldg., Washington, D. C.
41-E Park Row, New York City

TRADE-MARKS
REGISTERED

PATENTS

Trade Marks, Copyrights, Patent Litigation Handbook with illustrations, 100 mechanical movements. Sent free on request.

ALBERT E. DIETERICH
formerly member examining corps U. S. Patent Office
PATENT LAWYER and SOLICITOR

621-A, Ouray Bldg.
27 Years' Experience Washington, D. C.

BLUE BOOK ON PATENTS

AND PRIORITY RECORD BLANK GRATIS.

MONROE E. MILLER, PATENT LAWYER
411-2 Ouray Building, WASHINGTON, D. C.
ELECTRICAL AND MECHANICAL EXPERT

EDGAR M. KITCHIN
Attorney & Counsellor at Law

Patent and Trade Mark Specialist 805 G St. N. W., Washington, D. C.

INVENTORS who derive largest profits know and heed certain simple but vital facts before applying for Patents. Our book *Patent-Sense* gives those facts; sent free. Write **LACEY & LACEY**, 646 F St., Washington, D. C. Established 1869.

DIE-CASTING MACHINES
R. BYRD, 318 REED, ERIE, PA.

Shoot the Best Gun

The NEW BENJAMIN is the finest air rifle ever made. Unlike all others. Has amazing accuracy—shoots hard and far. It's the original American genuine AIR operated rifle. One to six pump strokes compress air to any desired degree of power. Same force as in air drills and air hammers except you control the shooting force. Never loses force—no springs or levers to get out of order. Makes crack shots quickly, inexpensively. Gives years of delightful recreation with utmost safety. At your dealer's, or sent postpaid for \$5.00.

Shoot 5 Days FREE

We give you five days, ammunition supplied, to test the NEW BENJAMIN. If in this time you don't believe it to be the finest air rifle you've ever seen or used, and if you don't believe it is the one and only air rifle for you, return it, postpaid, and your money will be refunded at once.

The NEW BENJAMIN

AIR RIFLE

America's Original Air Rifle

\$5 at your dealer's or sent postpaid direct from factory on FREE Trial as above if dealer does not handle it—write for our wonderful offer.

Get This Book and Details FREE



BENJAMIN AIR RIFLE & MFG. CO.
645 N. Broadway, St. Louis, Mo.

Please send your amazing offer and free copy of "The Shooter's Art," telling how to become a crack shot, how to hold, aim, and handle guns and guide others in use of guns.

Name _____

Address _____

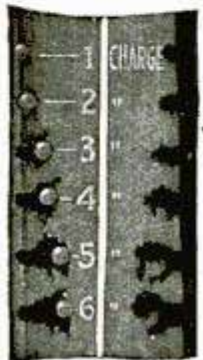

\$300,000
For This Invention

That's what Eastman Kodak paid for the Autographic idea. Thousands of other inventions are needed and offer enormous opportunities for earning fortunes. If you are of an inventive turn of mind why not concentrate on things that are really NEEDED. Get Raymond Yates's new book

"1000 NEEDED INVENTIONS"

Costs only \$1.25 and may start you thinking along the right lines. You'll get nowhere just fussing around. Concentrate on what the industries need, and on what the public wants. Mr. Yates's book tells you what these things are. Send no money. Just write postal. Pay mail man \$1.25 plus postage when book arrives. Your money back if you want it. This offer limited. Write now and get on the right track. (Outside U. S. \$1.45, cash with order.)

BUREAU OF INVENTIVE SCIENCE
Dept. 39, Wisner Building, Rochester, N. Y.

INVENTORS PROTECT YOUR IDEAS

Send for our Guide Book, **HOW TO GET A PATENT**, and Evidence of Invention Blank, sent Free on request. Tells our terms, methods, etc. Send model or sketch and description of your invention for INSTRUCTIONS. No charge for the above information.

RANDOLPH & CO.
301 Victor Bldg., WASHINGTON, D. C.

NAME _____
STREET _____
CITY _____ STATE _____

Special Values

\$1 Brings Your Choice

WHAT YOU DO—
Send one dollar with Name and Address, article desired and brief note telling us something about yourself.

Simply state: (1) how long at address; (2) age; (3) married or single; (4) name and address of employer; (5) nature of work; (6) how long in employ.

All information held strictly confidential — no direct inquiries to employer.

WHAT WE DO—
Upon arrival of your order, we will open a 10 month Charge Account and send selection for approval and 15 DAY TRIAL. If satisfied, pay balance in ten equal monthly payments; otherwise return and dollar will be refunded. No articles sold to persons under 20 years of age.



19B—Five blue white diamonds in 18K white gold wedding ring carved with orange blossoms.

\$29.50

\$2.85 a month.



8B—A quality 1.00 carat white diamond in symbolic ring of 18K white gold. A real bargain.

\$45.00

\$4.40 a month.



10B—1.00 carat and blue white diamond on genuine opal; 14K white gold ring for men.

\$32.50.

\$3.15 a month.



14B—2 blue white diamonds; 4 blue sapphires; 14K solid white gold wrist watch; 15 Jewels; flexible bracelet.

\$39.50

To Any Adult interested in purchasing diamonds, watches or jewelry, we will send free of charge our complete booklet. Ten months to pay on everything.



18B—Gents Bulova strap watch; 14K rolled gold plate; 15 Jewel movement.

\$29.75—\$2.88 a month.

L.W. SWEET Inc.
DEPT. 68-P, 1660 BROADWAY NEW YORK

EDWARDS METAL ROOFING



BIGGEST VALUE—LOWEST COST

Buy your metal roofing, shingles, Spanish tile, sidings, etc., DIRECT from the world's largest manufacturer of sheet metal building materials, at BIG SAVINGS. Thousands of satisfied users.

We own our own rolling mills. Enormous output insures lowest production costs. Factory-to-consumer plan makes prices rock bottom. You get the benefit. Many varieties. Edwards metal roofs last longer, look better. Resist rust, fire and lightning. Roofing, shingles, etc., of COPPER BEARING STEEL at special prices. This steel stands the acid test. Outlasts the building to which applied.

Ready Made Garages and Buildings

Low in cost. Easily erected. Permanent. Good-looking. All types and sizes to suit your purse and purpose. Now's the time for action. Write for Roofing and Material Book No. 150 and for Garage Book.

— FREE — **EDWARDS MFG. CO.**
SAMPLES BOOKS ESTIMATES
900-950 Butler St., Cincinnati, Ohio

Start a Welding & Battery Shop

- Lead Burning Outfits..... \$18.00 up
- Welding Outfits..... 25.00 up
- Soldering Outfits..... 8.00
- Lead Burning Torches..... 6.00
- Welding Torches..... 10.50 up
- Cutting Torches..... 30.00 up
- Regulators and Gauges.... 9.50 up
- Paint Sprayers..... 14.00

Welding Supplies

Superior Oxy-Acetylene Machine Co.
P. O. Box 285 Hamilton, Ohio



NEW VEST POCKET ADDING MACHINE

BABY CALCULATOR
CHICAGO U.S.A.
PATENT APPLIED FOR

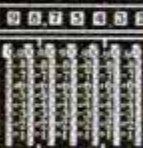

ADDITION
SUBTRACTION
MULTIPLICATION
DIVISION

ADDS, SUBTRACTS, MULTIPLIES, DIVIDES
Does work of \$300 machine. Guaranteed 5 years. NOT A TOY.

Made of steel and indestructible. Million dollar capacity. Fits in pocket. Will not make mistakes. So simple child can operate it. Instructions furnished. Everybody should carry one for figuring.

FREE TRIAL \$2.50 Total Cost

SEND NO MONEY—Just name and address. We will ship Calculator immediately. On delivery pay postman \$2.50 (Plus few cents Postage). (If outside U.S. send cash) 10c additional in Leatherette Case. If not satisfied after 10 days trial you get your money back. THOUSANDS OF SATISFIED USERS.

This is lowest priced practical calculator made. "Why pay more for inferior imitations?" Order from this ad.

Guaranteed

--- Mail Coupon Today ---

BABY CALCULATOR SALES COMPANY
Dept. 41, P. O. Box 1118, CHICAGO, ILL., U. S. A.
 I am enclosing \$2.50—send adding machine prepaid.
 Send Adding Machine C. O. D. \$2.50 plus postage. (10c additional in Leatherette Case)

Name.....
Address.....
City..... State.....

AGENTS Write for big commission and territory proposition.

HB PAINT SPRAY
DOES THE WORK OF FIVE MEN

QUICK, EASY PROFITS!
Practically no investment. Small space required. Steady demand and BIG PROFITS refinishing autos, furniture—painting houses and barns with HB quick spray method. One man does the work of five with brushes. Pays for itself on easy monthly payments. 30 DAYS' TRIAL. Write today for details.

EASY TERMS. 30 DAYS TRIAL. QUICKLY PAYS FOR ITSELF.

HOBART BROS. CO.
Box M982, Troy, Ohio

Sport Bodies for Fords AT FACTORY PRICES!

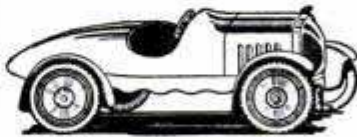

This Model in Grey Prime **\$38.50**

Write for Booklet A-2 Showing This and Other Models

SLIP-ON BODIES

For all models of Ford and Chevrolet

\$15.00 This Model, 12" high, 60" long.

Write for catalog X-1 of this and other models.

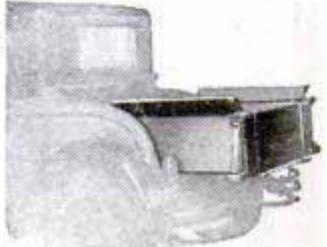

SPORT FACTORIES, AURORA, ILL.

The Up-to-Date Home Craftsman Shop

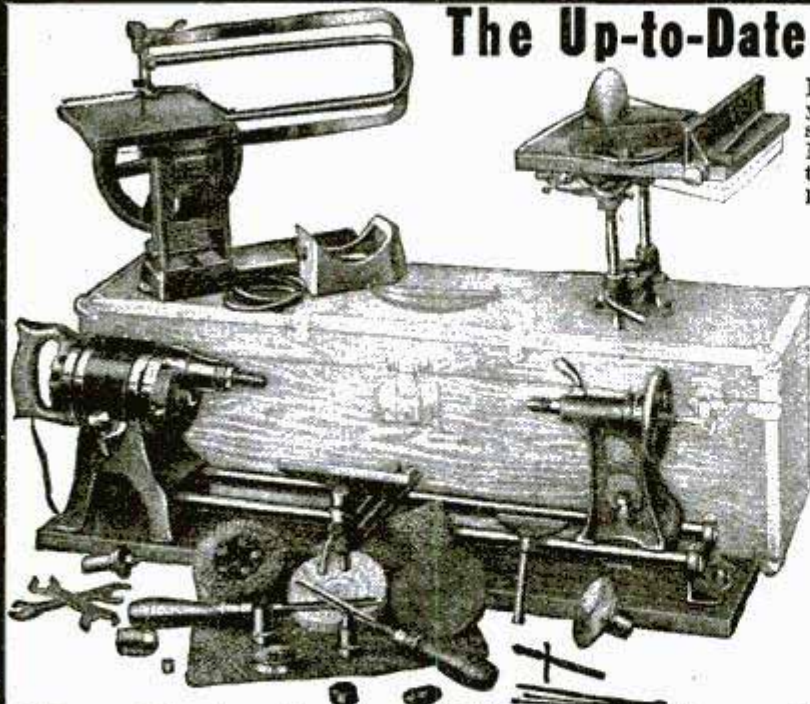

Plug in on any light socket and go to work. Make your old work bench a modern Up-to-Date workshop. Convenient, portable and simple to operate. Now! You can build, or repair furniture, cabinets, toys, boats, novelties and hundreds of other wood projects. Send for Free literature today.

ONLY \$10 DOWN

GUARANTEE

If upon receipt of the Up-to-Date Home Craftsman Shop you are not satisfied, without question every cent refunded and return express charges paid.

NEW 12" BAND SAW

Newly developed, of the latest design in Band Saw equipments, this 12 inch Band Saw is guaranteed vibrationless, and accurate in every detail. It is supplied with a tilting table, miter and side gauge.

\$35.00

F. O. B. CHICAGO



May be purchased on time payment basis at \$39.00, \$10.00 down and \$10.00 per month. With this plan anyone can own a real Band Saw.

Use our shop for 10 days at our expense. If not satisfied — return — express charges collect.

Mail This —

for full particulars to
Up-to-Date Machine Works
 2915 S. Wabash Ave., Chicago, Ill.
 MANAGER, Dept. 19. Without any obligation, please send me all particulars about your shop, 10-day free trial, free blue prints, free craftcourse, also \$10 downpayment offer.

NAME.....

ADDRESS.....

Home Mechanics Easy With This Equipment

The Shop Complete consists of a Super-power Motor, an accurate Lathe (10" x 34"), a 6" circular saw which features the bevel, miter, side and depth gauges, a Tilting Table, Jig Saw, and all accessories for buffing, grinding, cleaning and all portable or stationary drilling and sawing. **Blueprints and Craftcourse Free to Users.** Under supervision of Master Craftsman Eugene Maurey, blueprints and craftcourse giving complete information on home handicraft and details for making hundreds of pieces of woodwork. This service **Free** to Up-to-Date Home Craftsman Shop users. **Your own terms on purchase \$10.00 down.** Liberal discount for cash.

Our Literature Gives All Details

SENT ON TRIAL

Makes Old Ford a Tractor

Now you can convert that old Ford car into a useful farm tractor without altering any Ford parts. We furnish the traction wheels, drive gears and auxiliary axle and mountings, ready to clamp on to the Ford frame. Pulls 16" plow.

Write for Free Particulars.
 Shaw Mfg. Co., Dept. 4509, Galesburg, Kan.



AGENTS Make big earnings, taking orders for made-to-individual measure suits at less than ready-to-wear prices. Giant Chicago wholesale house makes world's greatest values at \$23.50 and \$29.50. Your profit \$4 and \$5 per sale in advance—we deliver and collect. No experience needed, work full or part time. **FREE OUTFIT** Send no deposit. Write for details of our unique money-making plan. Nothing like it ever before offered. Act at once.

GENERAL TAILORING CO., DEPT. 9A, 529 South Franklin St., Chicago

FREE to BOYS!



Sample copy of OPEN ROAD for BOYS Magazine . . . 50 pages thrilling stories, pictures, sports, mystery, etc. Free membership in WINNIT CLUB, badge-button, big outfit, catalog and new plan for getting easy money and swell prizes. Big surprise, too. **ALL FREE!** No obligation. Write today to

WINNIT CLUB: 32 Open Road for Boys

130 Newbury St.

Boston, Mass.

SILVER ACE NEW MODELS



fly 800 feet

**STINSON • FAIRCHILD • RYAN
CABIN TYPE**

Wing spread 30 in. Weight 3 3/4 oz. Bright colors. Convertible Monoplane — Biplane — Seaplane. The new Silver Ace dummy whirlwind motor. Deluxe (silk covered) Ready to Fly \$12.50. Partly assembled \$9.00. Knocked down \$8.00. Extra pair covered wings \$3.50. Silver Ace celluloid pontoons \$4.00 a pair. Add 50 cents for shipping if your dealer cannot supply you.

Circular and price list of models, sets and supplies, 10 cents.

**AERO MODEL COMPANY
329 Plymouth Court • Chicago**

THOMPSON BETTER BUILT DUCK BOATS

\$36 AND UP

Swift, silent gliders, exceptionally steady—even in rough waters. Four models for open lake and river use and for still hunting in marshes and shallows. Two big Factories. Quick delivery from either one. Write for Free Catalog.

THOMPSON BROTHERS BOAT MFG. COMPANY
 213 Ann Street, Peshtigo WISCONSIN
 113 Elm Street, Cortland NEW YORK



NOW—
GET MY
GREATEST
Log Saw
Offer



Saws 15 Cords
a Day

ONLY
\$39

Used by
The United States
Government

It's easier, now, than ever before to own this fastest-cutting, easiest-moved, most powerful Log Saw. Now, you can make big money sawing firewood, stave-bolts, ice, shingle timber, etc. **WRITE TODAY FOR FULL DETAILS.**

Try 30 Days **OTTAWA** **Make Big Money** — Wood selling at \$3 a cord brings owner \$45.00 a day. Go into the wood business. Don't let the lack of ready money stop you—Remember, we sell on very easy terms.

— ONE WHOLE MONTH to use the OTTAWA at your own sawing. Every saw shipped on trial only—
Backed by 10-Year Guarantee!

FREE Send me your name and address on a postcard today for my wonderful new edition of the "Wood Sawing Encyclopedia." Be sure to investigate—it will help you to make big money.

HARRY OVERMAN, Pres., OTTAWA MFG. COMPANY
 1745-L Wood St., Ottawa, Kans. 1745-L Magee Bldg., Pittsburgh, Penna.

Puts the OTTAWA Working For You!

350 Cuts a Minute!
 Now you have a log—in a few seconds it's all sawed up—without any hard work!



You too can play a

MANDOLIN

IT'S so easy to bring sweet music from the Gibson you learn to play quickly, just like Peggy Eames, little heroine of "Our Gang" comedies. At home, in camp, on the beach, wherever music is wanted, you can take your Gibson. It makes you the life of the party. Gibsons are today's most popular stringed instruments, on the air and records.

EASY PAYMENT Plan. Send coupon for details. Mention instrument: Mandolin, Guitar, Banjo, Ukulele.



Gibson

Gibson, Inc., 903 Parsons St., Kalamazoo, Mich. Please send literature and details of payment plan on

.....(Instrument)
 Name.....
 St. or R. F. D.....
 City..... State.....

GIVEN



THIS Large Size Movie Machine operates on same principles as expensive professional models, uses standard size films same as big theatres. Imported double Convex Lenses show large, clear pictures. Complete outfit furnished—enough for a full hour's show, including Tom Mix film, etc. Easy to operate, guaranteed for life. Just send for 12 large bottles *Salut D'Ame* Perfume that sells at 25 cents each. This is a real bottle size 2 1/2 inches. We also send 12 Perfume Novelties which you give away free of charge and easy plans for obtaining **MOVIE Machine**. Send no money. We trust you.

TREVAUX Perfume Co.
 Dept. 7B76 CHICAGO

LIGHTING FIXTURES

Ready to hang

Direct from the manufacturer. Completely wired, including glassware. Send for new catalogue No. 29. Just Reduced Prices. *Special Proposition to Dealers.*

Erie Fixture Supply Company, Inc.
 Station A ERIE, PA.

SQUAB BOOK FREE

Breed squabs and make money. Sold by millions at higher prices than chickens. Write at once for free 40-page book beautifully printed in colors telling how to do it. *You will be surprised.*

PLYMOUTH ROCK SQUAB CO.
 634 H Street Melrose Highlands, Mass.

FOY'S BIG PIGEON BOOK
 In **NATURAL COLORS**, a complete guide to successful Squab and Poultry Raising. Tells how to feed, breed, grow and make money raising squabs. Quotes low prices. Write today. **FREE.**

F. FOY Box 18 CLINTON, IOWA



the
Drill
of many
Uses

C-O Utility Drill



The Makers of the famous C-O Garage Tools and Equipment, known the world over, offer you a Utility-Drill complete, ready for the job, for **ONLY \$34.00.**

Not an attachment nor a makeshift, but a real drilling machine designed by master engineers.

Here's real drill value — just read these specifications: Vertical type motor, 110 volt, 60

cycle, single phase, AC, with cord and switch; belt drive; 3-jaw chuck; 11x6" bench space; 23" high; weight 62 pounds.

Bore holes up to 1 1/2"; works in 9" circle; 2 1/2" up and down spindle run; 7 1/2" range on column; 1100 to 2200 spindle speed.

Ideal for garages, repair and service plants, factories, all mechanics and farm and home craftsmen.

FULLY GUARANTEED

CANEDY-OTTO MFG. CO.
 Dept. PM. Chicago Heights, Ill.

ONLY
\$34.00
COMPLETE WITH MOTOR

LUMINOUS PAINT

Make Your Watches, Clocks, Etc., Visible by Night

The very latest discovery in the scientific world, hitherto practically unknown, is producing this remarkable LUMINOUS PAINT, which, applied to the surface of any article, emits rays of white light, rendering it perfectly visible in the dark. THE DARKER THE NIGHT, THE MORE BRILLIANT IT SHINES. Quite simple to use. Anyone—you can do it. A little applied to the dial of your watch or clock will enable you to tell the time by night. You can coat the push buttons or switch plates of your electric lights, match boxes, and innumerable other articles; make your own Luminous Crucifixes, Luminous Rosaries, etc. Small bottle, price 25c. Larger sizes, 50c and \$1 postpaid. JOHNSON SMITH & CO. Dept. 827 RACINE, WIS.



CIGARETTE MAKER

Roll your own and save money. Better and quicker; saves more than half. Use your favorite brand of tobacco. Neat, useful, handy. Pocket size, weighs 3/4 oz. Made entirely of metal, nickel plated. 25c, 3 for 65c postpaid anywhere.



GOOD LUCK RING

Very striking, quaint and uncommon. Silver finish; skull and crossbones design. Two brilliant, flashing gems sparkle out of the eyes. Said to bring good luck. Only 25c ppd.



Exploding Cigarettes

JUST LIKE ORDINARY CIGARETTES. BUT SUCH REAL STARTLERS! The box contains ten genuine cigarettes of excellent quality. They appear so real, but when such cigarette is about one-third smoked, the victim gets a very great surprise as it goes off with a loud BANG! A great mirth provoker yet entirely harmless. Price 25c box.

NOVELTY BADGES



Kissing Permit 10c Two very novel metal badges, nickel plated, that you can wear, giving you fun out of all proportion to their trifling cost. 10c, each badge, 3 for 25c, or 75c per doz. postpaid anywhere.

Garter Inspector 10c

MIDGET BIBLE

GREAT CURIOSITY Smallest Bible in the World. Size of a postage stamp. 200 Pages. Said to bring good luck to the owner. A genuine work of art. Must be seen to be appreciated. Make good money selling them to friends, church acquaintances, etc. PRICE 15c each, 3 for 40c, 12 for \$1.35, 100 for \$7.50. Also obtainable in Leather Binding, with gold edges. Price 50c each, 3 for \$1.25, \$4.50 per doz. Magnifying Glass for use with Midget Bible. 15c.

STAGE MONEY

With a bunch of these bills, it is easy for each person of limited means to appear prosperous by dashing a roll of these bills at the proper time and peeling off a genuine bill or two from the outside of the roll, the effect created will be found to be all that can be desired. Prices, postpaid: 40 Bills 20c, 120 for 50c, or \$3.50 thousand postpaid.



Comical Motto Rings

Lots of harmless fun and amusement wearing these rings. Made in platinum finish (to resemble platinum), with wording on enameloid, as illustrated. Price, only 25c Postpaid. Johnson Smith & Co.

JOHNSON SMITH & CO.

Dept. 827 RACINE, WIS.

A De Luxe Edition of our new 1928 CATALOG mailed on receipt of 25c. Handsome binding. Bigger and better than ever. Only book of its kind in existence. Nearly 600 pages of all the latest tricks in magic, the newest novelties, puzzles, games, sporting goods, rubber stamps, unusual and interesting books, curiosities in seeds and plants, etc., unprocureable elsewhere. Remit by Stamps, Cash, Money Order, Check, etc. Unused U.S., Canadian and Foreign Stamps also accepted.

BLANK CARTRIDGE PISTOL

Protection against Burglars, Tramps, & Dogs. Special Offer



Well made and effective, modelled on latest type of Revolver; appearance alone is enough to scare a burglar. When loaded it may be as effective as a real revolver without danger to life. It takes standard .22 Cal. Blank Cartridge—obtainable everywhere. Special cash with order offer: 1 Superior quality Blank Cartridge Pistol, 100 Blank Cartridges, and our new 550 page De Luxe Catalog of latest novelties; all for ONLY \$1.50. Shipped by Express only. Cannot go by parcel post. Extra Blank Cartridges 50c per 100. Special Holster (Cowboy Type) for Pistol 50c. No C. O. D. shipments.

THROW YOUR VOICE

Into a trunk, under the bed or anywhere. Lots of fun fooling the teacher, policeman or friends.

THE VENTRILO

a little instrument, fits in the mouth out of sight, used with above for Bird Calls, etc. Anyone can use it. Never Fails. A 16 page course on ventriloquism, the Ventrilo, ALL FOR 10 CENTS

MAGICIAN'S BOX OF TRICKS

Apparatus and Directions for a Number of Mysterious Tricks, Enough for an Entire Evening's \$100 Entertainment... Anyone Can Do Them

It is great fun mystifying your friends. Get this Conjuror's Cabinet, and you will be the cleverest fellow in your district. It contains the apparatus for ten first-class tricks, including The MAGIC BALL AND VASE TRICK (a wooden ball is placed inside, and upon replacing the lid has disappeared and is found in someone else's pocket); The HINDOO TRICK CARDS (can be made to change completely no less than five times); DISAPPEARING COIN BOX (a coin, placed in the wooden box, vanishes entirely or changes into a coin of another denomination); The GLASS GLOBE TRICK (a coin is dropped into a glass of water and when the water is poured out the coin has vanished and is found somewhere else); the RIBBON FACTORY FROM THE MOUTH TRICK (a seemingly endless supply of colored paper ribbons comes out of your mouth); the DISAPPEARING HANDBERCHIEF (a handkerchief held in the hand mysteriously vanishes); the WIZARD'S RING COIN TRICK; the ENCHANTED BOTTLE (no one but yourself is able to make it lay down); the GREAT HAT AND DICE TRICK (a large dice is placed on top of a hat, disappears, and is found underneath yet no one has touched the hat, and last, but not least, the GREAT PHANTOM CARD TRICK, or two from five leaves nothing. Full instructions are sent for performing each trick. In addition to the above, a number of other feats and illusions are fully explained for which you can easily make or procure the necessary apparatus. Price complete \$1.00 postpaid.

U. S. BABY TANK

It goes with real Yankee Pep—by its own power. Most remarkable toy ever invented. By drawing the Tank backward, either with the hand or over the floor or table and then placing it down, it will crawl along, overcoming all obstacles, in the same lifelike manner as the larger Tank that proved so deadly in the great war. What makes it go is some sort of a mystery, for there is no mechanism to wind up as is usually understood with mechanical toys, yet this tank will keep plodding along ten times longer than the ordinary run for toys. It will perform dozens of the most wonderful stunts; it will go backward or forward at will; 2 1/2 inches long. Price only 25c prepaid. JOHNSON SMITH & CO.

Look 35c Look Wonderful instrument.

Greatest thing yet. Nine separate articles in one. Everybody delighted with it. Odd, curious and interesting. Lots of pleasure as well as very useful. It is a double Microscope for examining the wonders of nature. It is also an Opera Glass, a Stereoscope, a Burning Lens, a Reading Glass, a Telescope, a Compass, a pocket Mirror, and a Laryngoscope—for examining eye, ear, nose and throat. It is worth all the cost to locate even one painful cinder in the eye. Folds flat and fits the pocket. Something great—you need one. Don't miss it. Sent by mail. Only 35c or 3 for \$1.00. JOHNSON SMITH & CO., DEPT. 827 RACINE, WIS.

SURPRISE MATCHES

More fun than fighting with your wife. Look just like ordinary matches. Put up in boxes just like regular Safety Matches. As the victim tries to light one he gets quite a surprise. Price 10c per box, 3 boxes for 25c, 12 for 75 cents.

These clever locks cannot be opened unless you know the combination. No key necessary. For your locker, bicycle, tool chest, mail box, thousands of uses. Shackle and tumblers nickel plated. Weighs 1 1/2 lbs. over one ounce. Small yet strong. Secret and full instructions with each lock. Price 25c or 3 for 65c postpaid. Postpaid



Wonderful X-Ray Tube

A wonderful little instrument producing optical illusions both surprising and startling. With it you can see what is apparently the bones of your fingers, the lead in a lead pencil, the interior opening in a pipe stem, and many other similar illusions. A mystery that no one has been able to satisfactorily explain. Price 10c, 3 for 25c, 1 dozen 75c. Johnson Smith & Co.

Every Boy His Own Toy Maker

A great book for boys. It gives plain, practical instructions for making all manner of toys, machines and other articles, amusing and useful. Tells how to make a Steam Engine, a Photographic Camera, a Windmill, Microscope, Electrical Machine, Galvanic Battery, Electric Telegraph, Electrotyping Apparatus, Telephone, Radio-gram, Magic Lantern, Acoustic Harp; how to make Boats of all kinds, Kites, Balloons, Paper Toys, Masks, Card Tricks, Wagon, Cart, Toy Houses, Bows and Arrows, Pop Guns, Slings, Fishing Tackle, Rabbit and Bird Traps, etc. 200 Illustrations. PRICE 25c Postpaid. JOHNSON SMITH & CO.

Serpent's Eggs

Box contains 12 eggs. When lit with a match, each one gradually hatched itself into a snake several feet long, which curls and twists about in a most life-like manner. Price per box, 10c postpaid, 3 for 25c.



I PAY \$100 PER WEEK MEN

I pay men \$100.00 a week and up by my plan which I want to send you at once. Be your own boss, work where and when you like. You can do fine even without previous experience. **Biggest values — positively sell on sight.**



Profits in Advance

My plan pays biggest profits and commissions in this line, all paid in advance, we attend to delivering orders and collections.

Sell fine Tailoring

Astonishing values get orders easy when you show samples of our tailored to order, all wool, suits and overcoats at \$23.50, \$31.50. Our advertising helps you take orders quick.



FREE

This big, fine sample outfit furnished free contains 100 all wool big samples at \$23.50 and \$31.50, fine colored fashions, stationery, supplies, tape, etc. All in classy, fine carrying case. Also complete sales manual, we place you in Big Money Class.

Popular Prices
\$23.50
AND
\$31.50

W.Z. Gibson

W. Z. GIBSON, Inc., Chicago, Ill.
500 Throop St., Dept. W-516

Please send me your plan for \$100 a week and up, also FREE outfit and sales manual.

Name _____

Address _____

City _____ State _____

MOVIES AT HOME



Many models of genuine MOVIE MACHINES, some as low as \$3.75, all using standard size big theatre films. Our stock of films is the most complete and lowest in price—with an exchange service. Films of leading stars and religious subjects are available. **DON'T DELAY. WRITE FOR FREE INTERESTING CATALOGUE NOW!**

PARAMOUNT MFG. CO.
Dept. 1371-B BOSTON, MASS.

6 TUBE SUPERPHONIC RADIO—\$16.95
FREE—6 tubes, tested and matched.

An amazing value that can't be beat! Latest 6 tube tuned radio frequency circuit. Metal chassis, shielded. Extremely selective. Long distance reception. Send for complete descriptive circular. Value \$60.00, our price \$16.95. Write today.

RADIO EQUIPMENT CO., DEPT. 10-J, 549 S. WELLS ST., CHICAGO, ILL.

Charge It By Mail

SENT FOR \$1 NO C.O.D. TO PAY

Wear this standard American watch and take a full year to pay—Send \$1 with order and this watch comes to you prepaid—no C.O.D. to pay on arrival

FREE A FULL YEAR TO PAY

After examination and 10 day free trial, pay balance in 12 equal monthly payments. No interest. No extras. All transactions strictly confidential. You take no risk—satisfaction absolutely guaranteed or money back.

Established 1895

ROYAL DIAMOND WATCH CO.

ADDRESS DEPT. 11-J 170 BROADWAY, N.Y.

BR1 Elgin or Waltham movement, hand engraved, 20 year guaranteed gold filled case. \$2.12 a month. \$26.50

10 DAYS FREE TRIAL

Ship Model Builders

Before purchasing your model supplies at prohibitive prices, send for our big, new, illustrated catalog showing nearly all the hard-to-make materials such as caps, tops and crosspieces of celluloid, brass pumps, figure-heads, tall rail posts, blocks, deadeyes, etc. Also model speed boat fittings and construction sets at very reasonable prices. Catalog 10c coin.

ROY HANCOCK, 323 Douglas Ave., Portsmouth, Va.

See Miles Away

Big 3 1/2 Ft. Telescope

Lend wings to your eyes! People and objects miles away seem close. Wonder telescope brings new pleasures to home, farm, camp, travel, sport. Study the mysterious Sun spots; see Moon and Stars as never before. See people on the beach, on the mountains, etc.

FREE Yes, absolutely free! A handsome leatherette carrying case and Shoulder Strap. Also Solar Eye Piece to view the sun—a special feature, found only on expensive instruments.

5 Sections 8 Power Lenses

Brass bound; measures 12 in. closed; powerful achromatic lenses protected by dust caps.

Thousands Pleased

P. Brush wrote: "Watched submarines three miles off coast." C. Scribner: "See lighthouse 18 miles away." Mrs. Yarbrough: "Could tell color of aeroplane four miles away." E. M. Gearhart: "Can see men working seven miles away."

SEND NO MONEY

On delivery of Telescope, free Case, Strap and Eye Piece pay Postman only \$1.85, plus postage (2 complete outfits \$3.50), or send price with order and we'll pay postage. Satisfaction guaranteed or money refunded. Send today, entertain your friends! Be first.

FERRY & CO., Dept. 1776, Chicago, U. S. A.

ALL GIVEN

10 year guar. Watch with chain and ring, large Eastman Roll Film Camera or 22 cal. Hamilton Rifle, yours for introducing finest assorted liquid perfume at 15c a bottle. Send for 20 bottles and choose gift as per offer in our catalog. We trust you—just write to **BELL PERFUME CO., Dep. L153, Chicago, Ill.**

22 CAL. RIFLE

This Home \$28⁰⁰ a Month!



Pay Like Rent

Now you can build your Liberty Home and pay for it like rent—less than rent! Liberty just perfected an amazingly thrifty time payment plan by which you can get complete materials for this beautiful home for only \$239.00 down and \$28.00 a month. Cash price \$796. 5 large rooms, bathroom, 2 closets, roomy porch. 43 other homes from \$14.00 to \$45.00 a month.

No Red Tape—No Mortgage—No Delay

No extra charges beyond monthly payments. Price includes all highest quality lumber cut to fit, doors, windows, stairs, high grade interior woodwork, lath, shingles, hardware, glass, paints, nails, etc., complete. Working plans, instructions Free. All materials fully guaranteed. Freight paid to your station.



WRITE FOR HANDSOME BIG BOOK OF HOMES—FULL COLOR

Describes 44 home plans from the cozy 4, 5 and 6-room bungalows to the 9-room 2-story. Shows how skyscraper system of buildings will give you a solid, substantial, permanent home at 30 to 40% saving. No waste, no worry. *Your rent will pay for your home.*

Owners Save \$200 to \$1500
No middlemen—you deal direct with mill and save 4 big profits. Mrs. Coombs saved \$1000. B. A. Anderson saved \$500. F. E. Davis saved \$1000 to \$1500 the Liberty way. You can do as well. 31 years of square dealing behind our guarantee. Write or send coupon for Free Book Today.

FREE



Liberty Homes,
Lewis Mfg. Co.,
Dept. 12-L,
Bay City, Mich.

Please send me Free your new Book of Homes, illustrated in color. I understand that this puts me under no obligation whatever.

Name

Address

City State

LIBERTY HOMES Lewis Mfg. Co., Dept. 12-L Bay City, Michigan

STYLED ON 5th Avenue TIES PAY BIG

You can make \$90 a week

with this great line—the best paying full time or spare time proposition in the country!

Beautiful patterns, sturdy long-wearing fabrics at factory prices sell on sight to men and women. Ideal to work with any other line you handle. Collect liberal commissions in advance. Write for big new FREE selling outfit today. Start earning big money immediately.

Public Service Mills, Inc. 4945P Hudson Blvd. North Bergen, N. J.
Canadian Office, 110 Dundas St., London, Ontario, Canada

Catch Fish!

Eels, Mink, Muskrats with our new folding galvanized STEEL WIRE TRAP. Write for our FREE TRAP OFFER and Bargain Catalog. \$1 Box of our famous Fish Bait FREE to introduce our traps. WALTON SUPPLY CO., 3502 JUNIATA AVE., ST. LOUIS, MO.

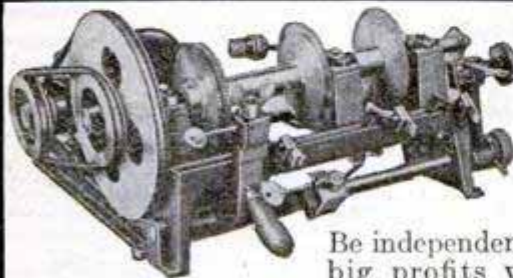

DON'T BE A SLAVE

Be independent and make big profits with the—

NEW IMPROVED BEISSER KEY MACHINE

You can start a business of your own, no experience necessary. The only key machine that cuts ALL kinds of keys. No hand-filing. Make first keys by number without taking locks apart. Locksmith instructions furnished free. Good Proposition for Agents. Write Today.

BEISSER KEY MACHINE COMPANY

407 Fort St. East

Detroit, Mich., U. S. A.

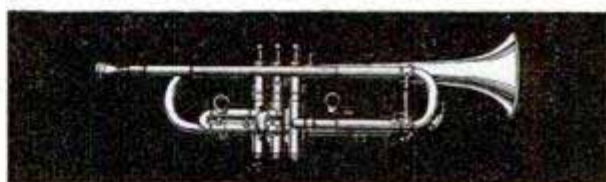

FREE TRIAL

on any Conn

SELECT any instrument for S band or orchestra; we will permit you to try a Conn in your own home free, without obligation. Conn easy-to-play features enable you to play tunes from the start. With all their exclusive features, Conn cost no more.

Send Coupon Now for free literature and details of trial offer.



Sousa uses and endorses Conn instruments

C. G. Conn, Ltd. 931 Conn Bldg. Elkhart, Ind. **CONN** Mail This Coupon BAND INSTRUMENTS WORLD'S LARGEST MANUFACTURERS

Please send literature and details of free trial offer on (Instrument)

Name

St. or R. F. D.

City

State, County

Old Cars Made NEW in 30 Magic Minutes



KOTAL gives the BEAUTY and LUSTRE of an Expert Paint Job at 1/20th the Cost!

NOT A POLISH—NOT A PAINT
This Amazing New Liquid, discovered in a famous industrial research laboratory, has started the Motor World. Just flow KOTAL on with a cheesecloth pad as easy as wiping a car with a chamol. **NO Rubbing—NO Hard Work.** Results are Amazing—with one sweep of your hand you restore BOTH the COLOR and Original Mirror-like FINISH to Dull—Drab—Faded Cars. Gives a glass hard protective coat that does not hold dust and the Lustre Lasts for months. Makes shabby OLD cars look like the day they were driven NEW off the dealer's floor. Words cannot describe the startling transformation. Warranted harmless to any finish. Manufactured by a long established highly rated, financially responsible concern and sold under the **STRONGEST GUARANTEE** ever put on any product.

**AGENTS
EARN
\$5 to \$10**

Every Hour You Work
\$200 a Week
is Easy Money

**\$1000 Would Not Buy the Start
We Give You FREE. Get the Facts**

We Furnish FREE every sales help conceivable. We back you to the limit. *Man Alive!* Here is the *Biggest* thing in the motor industry today—It's going over like a house afire. Everybody claims big money—KOTAL men actually make it. Hustlers laugh at \$100 per week. Millions of cars need this Quick—Economical—Magic finish which adds 25 to 40% to resale values. Demonstrates itself instantly. No Talking Needed. Men who have tried to sell everything on earth and failed are making good with KOTAL. Even inexperienced country boys make money hand over fist. Strike while the iron is hot. Get the facts and get them now. We will send you our **Big FREE BOOK** illustrated in colors, and Agents' FREE TRIAL OFFER. Good territory is going fast. Act NOW—Act at once. Send TODAY.
E. RICHWINE & CO., 17W. Jackson Blvd., Dept. 100, Chicago



Ford Owner Stop that ruinous chatter on your car. **MAKE THIS TEST**—take out your floor boards, pull your emergency brake back and forth. If you notice play at the ball joint, you need Bredar's Ball Shim. Price \$50. Ask your Dealer or order direct. Demand Bredar's Shim.
NIC BREDAR'S SON MFG. CO., Rock Island, Ill.

The New Business of GOLD STAMPING



Engrave monograms, initials, names, lodge emblems in 23K Gold with this amazing new invention—the KWIKPRINT. Gold stamp billfolds, luggage, fountain pens, golf clubs, cigar lighters—and endless variety of goods made of leather, wood, rubber, celluloid, etc.

Everyone Wants Personal Belongings Engraved—**Big Profits for You!** KWIKPRINT can earn you \$15 to \$25 a day. Very simple machine to operate with our "Secrets of Gold Stamping." You can be an expert in a few hours. You owe it to yourself to send TODAY for our interesting

FREE
BOOK on how to make Big Money in your Own Business.



MUTUAL GOLD STAMPING ASSN.
564 W. Monroe St., Dept. P-9, Chicago

KWIKPRINT "Strikes Gold Every Time"

Books on 65 Practical Subjects

Popular Mechanics Press specializes in supplying the outstanding best book on any subject. Check the books you want, and mail this advertisement as your order blank.

- AIRCRAFT**
Modern (Just Out).....\$5.00
- AIRCRAFT ENGINES**
Dyke's New Instructor (Just Out).....\$5.00
- ARCHITECT**
Design and Lettering.....\$2.00
- ARTIFICIAL FLOWERS**
How to Make for All Purposes.....\$2.50
- AUTOMOBILE**
Dyke's Encyclopedia.....\$6.00
- AVIATION**
Popular Guide.....\$2.00
- BOAT BUILDING**
and Outdoor Sports.....\$2.00
- BOOKKEEPER**
Bookkeepers' Handbook.....\$1.00
- BOYS' BOOKS**
The Boy Mechanic (4 vols.).....\$7.00
- BRICKLAYER**
Plain and Fancy Brickwork.....\$1.50
- BUILDER'S BLUEPRINTS**
How to Read.....\$2.00
- CABINET MAKER**
Furniture Making.....\$3.50
- CALCULATOR**
Ropp's Calculator.....\$1.00
- CARBURETORS**
Everything About All Makes.....\$2.00
- CARPENTER**
366 Carpentry Kinks.....\$1.50
- CARTOONING**
How to Draw Cartoons.....\$3.00
- CIVIL SERVICE**
Course in Civil Service.....\$1.50
- CONCRETE**
173 Ways of Using and Home Mechanics.....\$1.00
- COOKING**
Settlement Cook Book.....\$2.50
- DIESEL ENGINES**
Diesel Engines, Marine, Locomotive, Stationary.....\$5.00
- DOG FANCIER**
Dog Encyclopedia.....\$2.00
- DRAWING**
Freehand and Perspective.....\$1.50
- ELECTRICIAN**
214 Electrical Kinks.....\$1.50
- ELECTROPLATER**
Electroplating.....\$1.00
- ENGINEER**
Bailey's Handbook for Stationary, Marine, Diesel.....\$2.00
- ENGLISH**
Self-Improvement in English.....\$2.50
- ENTERTAINMENTS**
Producing Amateur Entertainments.....\$2.00
- ETIQUETTE**
Book of Etiquette (2 vols.).....\$2.00
- FARMERS' HANDBOOK**
and Handbook for Farmers' Wives.....\$1.00
- FORD (New)**
Treated in Modern Gasoline Auto.....\$5.00
- FORMULAS**
10,000 Formulas.....\$4.00
- FURNITURE MAKING**
Mission Style.....\$3.00
- GARAGE**
Management and Control.....\$5.00
- HAND FORGING**
Hand Forging and Wrought Iron Ornamental Work.....\$2.00
- HOME REPAIRS**
Practical Book of Home Repairs.....\$2.50
- HOUSEHOLD CONVENIENCES**
Built-In Furniture.....\$2.50
- INTERIOR DECORATOR**
Interior Wall Decoration.....\$4.00
- INVENTOR**
Inventions and Patents.....\$2.50
- JOINT WIPING**
and Lead Work.....\$1.00
- LANDSCAPE GARDENING**
Practical.....\$2.50
- LATHE WORK**
and Drilling and Thread Cutting.....\$1.00
- LEATHER WORKER**
Leather Work.....\$1.50
- LETTER WRITING**
Effective.....\$3.00
- LIFE WORK**
Choosing.....\$2.50
- LOOM FIXER**
Practical Loom Fixing.....\$1.50
- MACHINIST**
419 Machinists Kinks.....\$1.50
- MAGIC**
200 Tricks You Can Do.....\$1.00
- MAIL-ORDER AND DIRECT-MAIL**
Selling.....\$5.00
- MATHEMATICS**
Mathematics for the Practical Man.....\$1.50
- MECHANICAL DRAFTSMAN**
Practical Course in Mechanical Drawing.....\$1.00
- MODEL AIRPLANES**
Building and Flying.....\$2.50
- MOVIE MAKING**
For Amateurs.....\$3.00
- OUTDOOR OPPORTUNITIES**
Fur Farming.....\$4.00
- PAINTING**
House Painting Methods.....\$2.00
- PLASTERING**
and Stucco Work.....\$1.25
- PLUMBING**
Repair Your Own.....\$1.50
- RADIO**
Trouble Shoot'ng.....\$3.00
- REAL ESTATE**
Making Money In.....\$5.00
- SHIP MODELS**
Ship Model Making.....\$2.50
- SHOP NOTES**
and Auto Repairman.....\$1.00
- TAXIDERMIST**
Methods in Taxidermy.....\$3.50
- TOURING KINKS**
and Atlas.....\$1.00
- TOY MAKER**
Toy Manufacture.....\$1.50
- TREE REPAIR**
Practical.....\$2.50
- WELDER**
Welding Encyclopedia.....\$5.00
- WIRING**
House Wiring.....\$2.50
- WOOD FINISHING**
Plain and Decorative.....\$2.00

Books sent C. O. D. anywhere in U.S.

Just check the ones you want, write your name and address below, and mail the whole advertisement. It is your order blank. When postman hands you books, pay him the price and the postal charges. If outside the U. S. remit when ordering and include 10 cents per book extra for postage. We have many other books on these and 2,000 other subjects. Catalog free.

Name.....

City.....State.....

Address.....

Mail to Popular Mechanics Press,
Room P9—200 East Ontario St., Chicago, Ill.

New!

WONDERFUL RADIO!
Super-Eight—100% Electric
8 TUBES — SINGLE DIAL

Coast-to-Coast

Shipped Direct from our Factory on

30 Days Free Trial

[Battery or Electric]

Metro's latest achievement—the world's greatest electric radio set. Powerful long distance 8 tube receiver—clearness of tone that is astounding—ultra-selective. Radio engineers pronounced it the ultimate for all-around perfection. To prove our claims, we will send this marvelous set to you direct from our factory on **30 days' free trial**. Compare its quality, beauty and price with any other radio on the market, and decide to keep it only after you are satisfied that the new 1929 Metrodyne Super-Eight is the peer of them all.

Metrodyne

SUPER-EIGHT ELECTRIC

Save 1/2—Low Price a Big Feature

Amazingly low price! Console or table cabinet. Low cost of distribution direct from our factory enables us to save you about half regular value. Never before have you been offered such sets at such low prices. We are so sure of their quality, beauty and performance pleasing you that we will let you **try one for 30 days** before deciding to keep or return it.

SUPER QUALITY THROUGHOUT

Eight powerful tubes. Highest quality low loss parts. Illuminated single dial. Positive switch control—simply turn a knob and it's on. Select your stations with accuracy at any desired volume. Beauty of tone unsurpassed. Console and table cabinets are handsomely grained genuine walnut, hand rubbed, in two-tone effect—artistically carved trimmings. All metal parts finished in two-tone gold. Seeing is believing. **YOU WILL BE THE JUDGE.**



Send Coupon Today for Our **30 Days' Free Trial Offer** →

Metro Electric Company

2161-71 North California Avenue
 Dept. 20 CHICAGO, ILLINOIS



Gorgeous console with newest type, built-in sonorous speaker. Reproduces entire range of vocal and instrumental music, amazingly clear and distinct. Low, direct-from-the-factory price on **30 DAYS' FREE TRIAL.**

METRODYNE RADIO SETS
 Are Equipped For
BATTERY or ELECTRIC OPERATION

Agents and Dealers
 The 1929 Super-Eight line offers great money making opportunities. Nothing like them for high quality—nothing near them in price. Let us prove this by shipping you a **DEMONSTRATION SET on 30 Days' Free Trial**
 Test it—compare it—demonstrate it to prospective radio buyers. Get our liberal discounts—exclusive territory—newspaper and billboard advertising offer that will help sell Metrodyne radios quickly.

We are one of the pioneers of radio. The success of Metrodyne sets is due to our liberal **30 days' free trial offer**, which gives you the opportunity of trying before buying. Thousands of Metrodynes have been bought on our liberal free trial basis. We will send you hundreds of letters from owners who acclaim the Metrodyne as the greatest radio set in the world. A postal letter or the coupon brings complete information, testimonials, wholesale prices and our liberal **30 days' free trial offer—WRITE TODAY!**

METRO ELECTRIC COMPANY
 2161-71 N. California Avenue, Dept. 20
 Chicago, Illinois

Gentlemen:

Send me full particulars about Metrodyne Super-Eight sets and your **30 days' free trial offer.**

Name.....

Address.....

If you are interested in AGENT'S proposition, place an "X" in the square

BEFORE YOU BUY PLUMBING

or Heating equipment—such as Bathtubs, Lavatories, Closets, Sinks, Water Supply and Sewage Disposal Systems—Furnaces, Steam and Hot Water Heating Plants—or Pipe and Parts, Fittings, Accessories, Tools, Supplies—or Paint, Varnishes—you should

Send for FREE CATALOG

60 pages, 4,000 offers and sizes—also on hand Fencing, Tinning, Roofing—largest variety and stock in U.S.—over 1,000,000 items. Some articles on Easy Payments—anything on Open Account if in business and rated. Satisfaction Guaranteed.

Cut Prices

You save one-third to one-half on highest grade, perfect goods—no "seconds." We ask you less than many plumbers pay their jobber. You can "Be Your Own Plumber"—easy to do your own installing—our Free Book tells how. Get it—compare our quality and prices with others'—see for yourself.

Write Today—NOW!

—while you are thinking about it! You need it. You will like it. And at the same time will you be so kind as to add the name of one or more persons who soon will want goods in our line? Thank you. But be sure to write NOW!

Dept. 1639B, 433 Liberty Ave.
BURKE & BROS. PITTSBURGH, PA.

TOUR in COMFORT

Before you start that auto trip send for these inexpensive yet practical books that show you how to make touring easier, less expensive and more enjoyable.

Everything you could wish to know about homes on wheels, making camps, cooking, beds, packing and carrying luggage, carrying food, etc., as well as all kinds of emergency repairs and kinks are given in our Automobile Owners' and Auto Tourists' Handbooks, regular price 50 cents each.

As a special offer we will include a copy of Clason's Touring Atlas of the U. S. free with every order for these two books.

Pay postman only 98 cents plus postage when delivered C.O.D. or send remittance and include 15 cents extra for postage.

POPULAR MECHANICS PRESS

ROOM P8

200 E. Ontario Street

CHICAGO

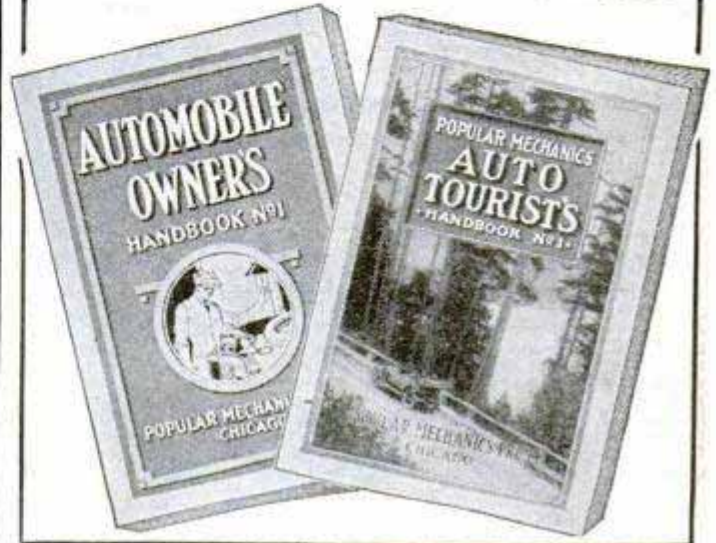



USE ENGINITE FOR YOUR MOTOR COOLING SYSTEM

STOP MOTOR OVERHEATING

ENGINITE prolongs the life of your motor, by giving free circulation to water in the radiator, preventing and removing rust, scale and corrosion. Surest remedy for overheating motors. Gives more pep and power. ENGINITE is as important as gas and oil. Guaranteed satisfactory or money refunded. \$1. (West of Rockies 25c extra.) Dealers write.

Manufactured by

INDUSTRIAL REFINING COMPANY
120 West 42nd Street NEW YORK CITY

FREE Wholesale Radio Catalog

Set Builders-Dealers! Save Money!

Send for the most complete book of nationally known Parts, Kits, Cabinets, Consoles, Speakers, Power Units, Sets, etc. All at lowest wholesale prices. Quick service on all your needs. Write now, it is FREE—

SETBUILDERS SUPPLY CO., Dept. 12-1
Romberg Bldg. Madison and Market Sts. CHICAGO, ILL.

6-TUBE RADIO COMPLETE

\$34.75 to \$66.66

Licensed R. C. A. Circuits. Shielded. One Dial

Write for catalog. Big discounts to agents
Consumers Radio Co., Dept. 169, 4721 Lincoln Ave., Chicago



WADE AMATEUR MECHANICS, REPAIR SHOPS, INVENTORS, STUDENTS

BENCH LATHE

A real machine tool for the home work bench—capacity 4" dia. x 12" length. For Metal—Wood—Composition materials. Turning—Facing—Boring—Drilling—Winding—Thread Cutting. Accurate—Strong—Quiet—Compact. Slide-rest has travel entire length of bed. Leadscrew inside bed. No. 1 Lathe, plain headstock, \$28.00. No. 2 Lathe, back-gear headstock, \$58.00. Extra for lathes with 18 inches between centers, \$7.00. Complete line of accessories at equally low prices. Write for free catalog.

THE GEROLD CO.

Dept. P-46

120 Liberty St.

New York

RADIO

LATEST CATALOG OF NEWEST PARTS AND KITS

Fresh from the press. Shows all the newest standard parts, sets, kits at big savings. Most complete line in America. Big discounts to set builders. Send name and address at once.

BARAWIK COMPANY
109 Canal Sta., CHICAGO, ILL.

FREE

Mechanical Toys

Ship Models, Colonial Bric-a-Brac, Leather and Celluloid articles and hundreds of other useful things are described in our new book, Make It Yourself. 460 Pages. Illustrated. Price \$3 Postpaid.
POPULAR MECHANICS PRESS, 200 E. Ontario St., Chicago

Boice-Crane Machines for Real Mechanics

Mechanics who KNOW machinery choose Boice-Crane machines for their workshops. They appreciate the tremendous advantages of individual machines—a saw for sawing, a lathe for turning and a jig or band saw for fancy curves. Once mounted on your bench they are set up for good and ALWAYS ready for work. You waste no time changing attachments. Use one or all at the same time. The Boice-Crane costs no more than "combination" types but gives ten times the satisfaction.

Boice-Crane's Ideal workshop is made up of the universal handisaw and universal jig saw shown here and an 8-inch lathe. A full 1-3 h. p. double shaft motor provides plenty of power. Get a Boice-Crane which thousands of real mechanics the world over are using.

Universal Handisaw. Elevates for grooving. Cuts 2½-inch stock. Insert takes 6-inch x 1-inch dado head, cope heads and 8-inch sand disc.

Universal Jig Saw. Table 8-inch dia. tilts 45 deg. both ways. Saw-to-frame 10 inches. Uses blades ¾-inch to ¾-inch wide.

Send 10c for new catalog "B" describing the complete line of Boice-Crane circular saws, band saws, jig saws, lathes, jointers and books of designs.

W. B. & J. E. BOICE

Dept. PM. 9-D

Toledo, Ohio

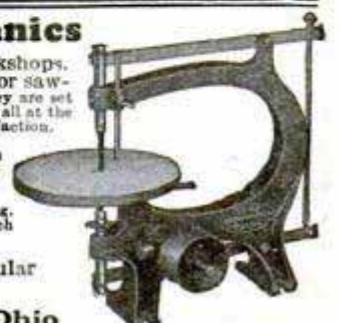

Increase Your Earning Power

Apply time and labor-saving kinks to your work. Your efficiency will soon be recognized and you will be in line for advancement.

If you do machine shop work of any kind, sheet-metal work, painting, carpentry, auto repairing, farming, concrete work, plumbing, electrical work, welding, building-glass work, general repairing, tool-making, poultry raising, masonry or home repair work, get this

LIBRARY OF 6000 TIME AND LABOR SAVING IDEAS FOR SHOPMEN AND HANDYMEN

15 BIG VOLS.

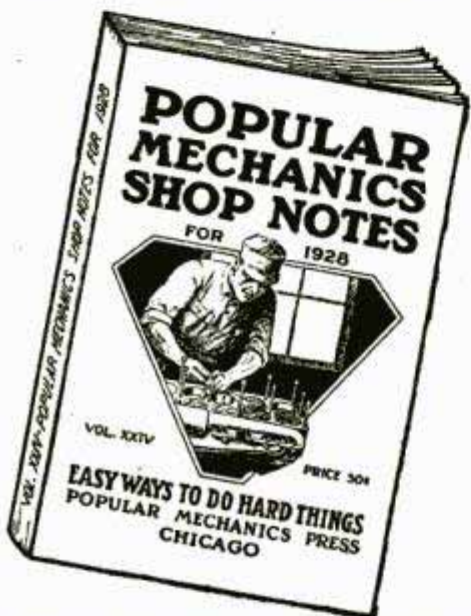

LIKE THIS

Think what it would mean to you to have the 15-volume Shop Notes Library of 6,000 easily understood short cuts, to every-day jobs. Here are some of the subjects taken from just one of the volumes as an illustration:

- | | | |
|----------------------|--------------------------|--------------------------------------|
| Sheet Metal Working | Electrical Kinks | Cutting Glass |
| Painting Kinks | Battery Charging | Flagstone Walks |
| Carpentry | Culvert Work | Hints for the Builder |
| Automobile Repairing | Automobile Repainting | Refinishing Soft-Wood Floors |
| Machine Shop Work | Hot-Flame Blowpipe | Setting Window Glass |
| Farm Mechanics | Lawn Mower Repairing | Etching Brass and Copper |
| Tool Repairing | Beautifying Your Home | Glue and Its Use |
| Lock Repairing | Portable Air Compressor | Proper Hot-Water Heater Installation |
| Key Making | Gasoline Pump Extension | |
| Concrete Work | Log Cabin Construction | |
| Poultry Appliances | Folding Bed for Roadster | |
| Plumbing Kinks | | |

Each volume contains approximately 500 articles and 400 illustrations and has 224 Pages. At the regular price of 50 cents per single volume this library costs you \$7.50 but for a limited period we will supply the 15 vols. when ordered at one time at the special reduced price of only \$4.50.

SEND NO MONEY

SPECIAL OFFER COUPON

POPULAR MECHANICS PRESS, 200 E. Ontario St., Room P9, Chicago, Ill.

Send me, as per your special offer the following books. I will pay postage and the price of books when they arrive. My money will be refunded if I am not satisfied. (Check what you want.)

- 1928 Shop Notes and Lathe Handbook, 98¢ Complete Shop Notes Library (15 vols.) \$4.50

Name.....

Street and No.....

City..... State.....



3 Food Experts Invent a New Business That Pays Up To \$1,000 a Month

Now Anyone Can Own a Big Food Business and Pocket Steady Profits of \$50 to \$250 a Week! Investment SMALL! Profits ENORMOUS! Mail the Coupon for the Amazing Details.

CHICAGO food experts have discovered a remarkable new food! A crispy, delicious new kind of *Greaseless* doughnut! Easily digested! More captivating than old-style doughnuts ever were! Yet cooked at the rate of 1 dozen every three minutes by an *inexpensive* electrical device that operates from any ordinary light socket!

THE SECRET OF BIG MONEY

These experts knew that millions of old-style doughnuts are sold every day—hundreds of people are making fortunes in the doughnut business. No wonder they were surprised, yes, literally astounded at the possibilities! And now they have devised a unique co-operative plan. They agree to start every honest, ambitious man or woman in this big-money business. They supply complete manufacturing equipment—free advertising material—sure-fire sales plans—prepared doughnut mix, etc.



\$1,000 a Month
 "My business was successful from the first day. I made over \$3,000 my first 3 months—more money than ever before in my whole life!"—Thos. Minch, Fla.

F. Costopolis, Ill., says, "The first machine paid for itself in a few days—it is not unusual for me to take in \$15 in a couple of hours and my trade is growing constantly."

WRITE QUICK FOR DETAILS!

Food Display Machine Corp., Dept. 13-56, 28 E. Jackson Blvd., Chicago, Ill.

I want to make \$50 to \$250 a week in a business of my own. Without obligation to me, send details of your new co-operative plan.

Name.....

Address.....

Town..... State.....

Sillimanite makes CHAMPION the better Spark Plug

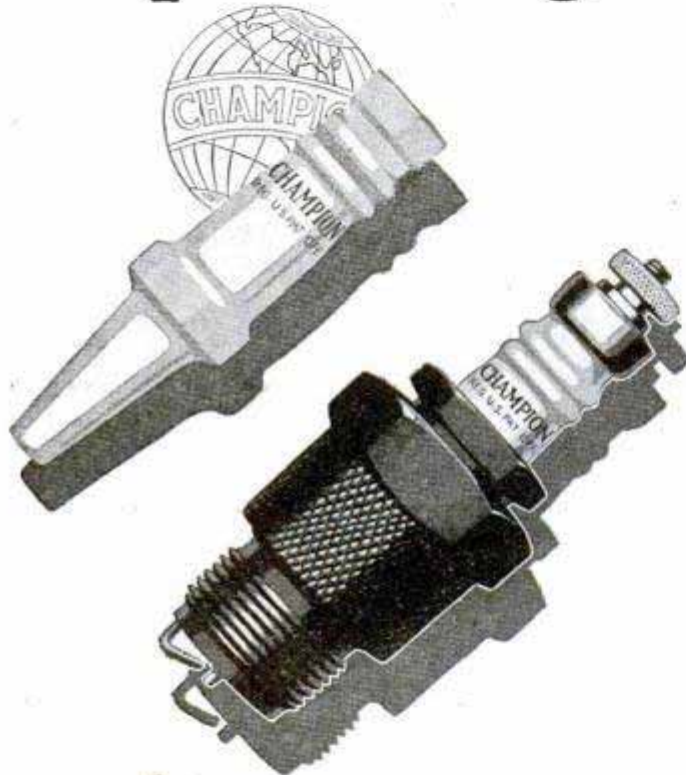

It has been conclusively demonstrated that Champion is the better spark plug largely because of the Champion sillimanite insulator.

Sillimanite is a rare mineral exclusive to Champion.

Champion sillimanite has made possible refinements and improvements in design, structure, and ultimate performance, impossible of attainment with any other ceramic material.

You can buy Champions with every assurance of better and more economical car operation, as do two-thirds of the world's motorists.

CHAMPION

Spark Plugs
TOLEDO, OHIO

7 Years of Perfect Service

AMPERITE, the self-adjusting filament control has been time-tested by the world's leading radio designers. Entirely unlike fixed resistors. A type for every tube—battery or A.C. \$1.10, with mounting (in U.S.A.) at all dealers.
Demand AMPERITE.

FREE
"Amperite Blue Book" of latest circuits and construction data.
Write Dept. P. M. 9,
RADIAL CO.
50 Franklin St.
New York



AMPERITE

REG. U.S. PAT. OFF.
The "SELF-ADJUSTING" Rheostat



The International Motor Saw

does every sawing job from straight cutting to intricate scroll and design work; crosscuts, rips, miters, bevels, inside and outside jig sawing and scroll cutting. One saw instead of several.

Write for full description. Dept. S,
The International Stamping Co.,
400 N. Leavitt St., Chicago, Ill.



Motorize Your work shop!

Free Trial!

SPEEDWAY SHOP Easy to make things at home with this big new metal and wood-working shop. Attaches to any lamp socket. \$10.00 down—easy payment. Make money in your spare time. Big free illustrated book gives full particulars, including free trial offer. Send 25c for instructions for making attractive magazine basket. Write Electro Magnetic Tool Co., Dept. 2-S, 1830 S. 52nd Av., Cicero, Ill.

LEARN TO Mount Birds

We teach you **At Home by Mail** to mount Birds, Animals, Heads, Tax Furs and Make Rugs. Be a taxidermy artist. Easily, quickly learned by men, women and boys. Tremendously interesting and fascinating. Decorate home and den with beautiful art. *Make Big Profits from Spare Time Selling Specimens and Mounting for Others.*

Free Book—Yes absolutely **Free**—beautiful book telling all about how to learn taxidermy. Send Today. You will be delighted. **Don't Delay!**
Northwestern School of Taxidermy 3376 Elwood Bldg., OMAHA, NEB.



MAKE A MOTORCYCLE

OUT OF YOUR BICYCLE with a **STEFFEY MOTOR ATTACHMENT. RELIABLE—ECONOMICAL—EFFICIENT.** Easy to attach. Fits any wheel. **Send 10 cents for circulars.**

STEFFEY MFG. CO., Dept. P, 3924 Fairmount Ave., Phila., Pa.

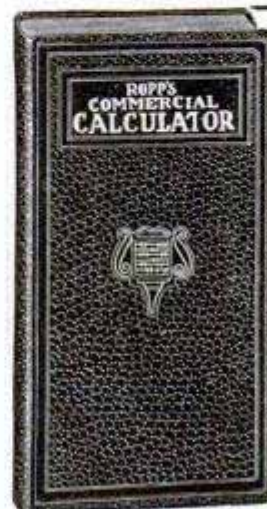

Mathematics Made Easy by ROPP'S CALCULATOR AND SHORT-CUT ARITHMETIC

Shows the Answer as Quickly as a Watch shows the Time to all Problems likely to occur in the Office, Store, Shop, Bank, Farm, or Factory.

Over 2,000,000 Sold
Explains and simplifies every principle in Arithmetic, Mechanics, and Mensuration.

PRICES POSTPAID
Desk Size, Flexible Keratol Binding..... \$2.00
Pocket Size, Art Leather Binding..... \$1.00
Pocket Size, Cloth Binding, \$0.50

POPULAR MECHANICS PRESS
Room P-9 200 E. Ontario St. Chicago

MODERN AIRCRAFT

By V. W. Page, just published, is a most complete and informative treatise on every phase of modern aeronautical science and aviation.

Written in simple language for the practical man by an experienced instructor, this book covers types of craft, construction, principles of operation and commercial applications. How any plane flies and is controlled. Parts, their functions and how repaired. Latest engines, instruments and accessories. Deals with all types of planes, engines, etc., used in recent epoch making flights.

A special chapter on aerial navigation. The equipment of airports, airways and landing fields is considered. Dictionary of terms prepared with the help of Army and Navy authorities and civilian airplane constructors.

The completeness of the book may be judged by its 855 pages and 400 illustrations.

Price \$5⁰⁰

Will be sent C. O. D. in U. S. Pay postman price and postage.

Popular Mechanics Press

Room P-7

200 E. Ontario St. CHICAGO



Neverknot Takes Kinks Out of



Telephone and Electric Iron Cords

\$25 to \$40 Daily!

A new strange invention opens up entirely new field for salesmen. Sell only device in existence that prevents kinking, snarling and tangling of telephone and electric iron cords. Housewives and business men buying 1 to 50. Large companies equipping all phones. Sales of 10 to 150 with immense profit to salesman not uncommon.



ABOLISH THIS NUISANCE FOREVER



New Kind of Cord Set FREE

Every Neverknot salesman is given a complete Neverknot Switch Plug Cord Set free. This new kind of ironing cord automatically coils itself out of the way and a new kind of switch plug prevents scorching and saves electric bills. This set is a "gold mine" for house-to-house workers as customer sees that it saves its own cost. It's yours free if you accept our agency. Don't delay! Send now for free offer!

NEVERKNOT CO., Dept. 9-V, 4503 Ravenswood CHICAGO, ILL.

BREAKFAST NOOK and 26 other splendid articles of Built-In Furniture in our new book on this subject. 198 pages. Illustrated. Price \$2.50 Postpaid.

POPULAR MECHANICS PRESS, 200 E. Ontario St., Chicago

RADIO LATEST CATALOG OF NEWEST PARTS AND KITS **FREE**
Fresh from the press. Shows all the newest standard parts, sets, kits at big savings. Most complete line in America. Big discounts to set builders. Send name and address at once.
BARAWIK COMPANY 109 Canal Sta., CHICAGO, ILL.

SIDE LINE

Sold to Rated Trade Only

For use in their own building. Sold from Pocket Portfolio: 30 day trial when requested. Removes stoppages from waste pipes. Give full information about yourself in first letter. Replies confidential.

J. E. Kennedy Corp., Dept. 4-F, 79 Madison Ave., New York



NEW Superior Model Electric Sprayit (Rotary Compressor Type)

For fine professional work such as one-coat enamel on fixtures or in automobile and cabinet work where job is rubbed between coats.

Price, \$39.50



New Improved Master Model Electric Sprayit

For general utility use, such as walls, radiators, lacquered furniture, touching up cars, etc.

Price, \$34.50



Sprayit Vacuum Cleaner Attachment

For general home use; sprays paints, lacquers, insecticides, etc.

Price, \$4.95

SPRAYIT Electrically

REG. U.S. PAT. OFF. 12-20-27

Here's Just the Model You Need

No matter what the job is—there's just the right model *Electric Sprayit* for the work you want to do. You can Sprayit Electrically—any finish on any surface. Sprays any liquid or powder. Saves time, improves results, increases income. In your business—the New Superior Model or Improved Master Model will do quality work, quickly. Simply plug into any light socket and press the trigger. For home use, there's the Sprayit that attaches to any vacuum cleaner. Built like the Improved Master Model. Nothing like it, because strong, broad patents protect *Electric Sprayits*.

Act Now—Mail the Coupon

You owe it to yourself to own an *Electric Sprayit*. They're sweeping the country—new, quick, efficient. Workmanship and material fully guaranteed. Order the model desired. Just check the coupon. Further information sent if desired.

THE ELECTRIC SPRAYIT CO., Inc.
209 E. Colfax Ave., South Bend, Ind.

Used in any trade, industry or home. Does better work — makes bigger profits. Quickly pays for itself.

Send me immediately Superior Model; New Improved Master Model; Sprayit Vacuum Cleaner Attachment, at price listed above, f. o. b. South Bend. Check Money order enclosed.

Send me complete information regarding Superior Vacuum Cleaner Attachment; Sprayit

Name.....
Address.....
City.....
State.....
(Check Model Desired)

The ELECTRIC SPRAYIT CO., Inc., 209 E. Colfax Ave., South Bend, Ind.

I Want to Send You a Santa Fe Special Watch

for You to see and examine

Our 21 Jewel Santa Fe Special Guaranteed for Life

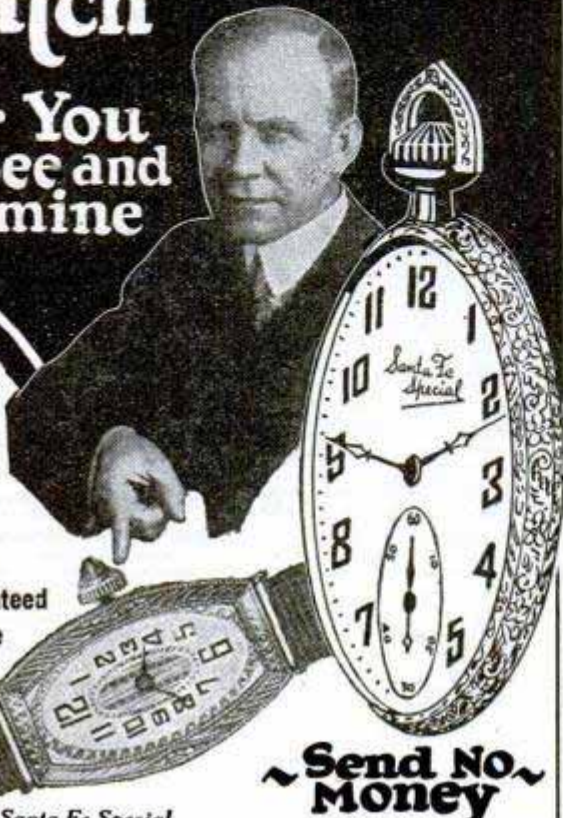

Send No Money

Watch Sent on 30 Day Free Trial

Santa Fe Special Watches are today being shipped to every civilized country in the world, and are probably the best and most favorably known watch in both Army and Navy.

In addition to our NEW LOW PRICE, I will send for your approval one of these Standard Watches, guaranteed for a lifetime of satisfactory service, not only by the Santa Fe Watch Company, but by the Great Illinois Watch Factory. So accurate, Government officials carry them; so perfect and beautiful, jewelers say they are worth 1-3 to 1-2 more than we ask for them. I will send you one to see WITHOUT ONE PENNY DOWN—allow you to wear it 30 days FREE—then sell it to you on easy payments.

WHY NOT OWN A 21 JEWEL SANTA FE SPECIAL WATCH?

You will never miss the few cents a day that will make you own one of these watches—SEND FOR WATCH BOOK—illustrating in beautiful colors hundreds of designs and combinations in cases in the POCKET WATCH, MEN'S STRAP WATCH and LADIES' WRIST WATCH. You can have your name or monogram and any emblem you may desire engraved in the Case to suit your own ideas. Write today for Free Watch Book, and make your selection at once, while this offer lasts.

FREE A limited offer! With every Santa Fe Special, beautiful gold chain or strand of exquisite pearls. Write today. Mail coupon for both Watch and Diamond Catalog

SANTA FE WATCH COMPANY
96 Thomas Building Topeka, Kans.
(Home of the Great Santa Fe Railway)

Mail coupon to-day!

SANTA FE WATCH COMPANY
96 Thomas Building, Topeka, Kansas

Please send prepaid and without obligation your Watch Book Free, explaining your "No Money Down" Offer on the Santa Fe Special Watch.

Name.....

Address.....

City..... State.....

"My Delta Handi-Shop does Everything"

from Grinding Tools, Repairing Machinery, to Building Furniture

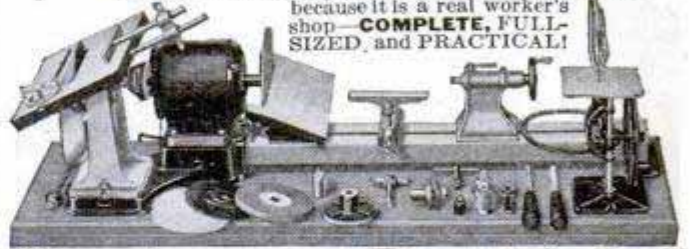

because it is a real worker's shop—COMPLETE, FULL-SIZED, and PRACTICAL!

Sent on 10-Day Trial

You can have this husky, man-sized electric Workshop for 10 Days' Trial in your own Home. Test it to your heart's content. Make the things you've always wanted to make. Save money on repair work. See how you can earn the cost of the shop in a few months' of spare time work. The Handi-Shop includes all necessary equipment for woodturning, face turning, circular sawing, scroll-saw work, sanding, drilling, dado and joining work, grinding, buffing, tool-sharpening, and carving. Complete set of working drawings FREE with each outfit.

Many Exclusive Features!

A few of them are: Powerful, constant-speed, two-shaft motor that enables you to handle two or three jobs at one time without dismantling set-up; Heavy U-shaped lathe bed (no rods) guaranteed not to spring or chatter; Improved circular saw, sanding disc, scroll-saw, each equipped with special tilting table; All completely assembled on heavy veneered wood base; Maximum machine value per dollar!

Easy Terms—Write Today

for beautifully illustrated literature giving complete description of Delta Handi-Shop and pictures of its many exclusive advantages. Also full details of 10-Day Trial Offer, and your choice of 5 convenient methods of payment.

DELTA SPECIALTY COMPANY
Dept. MP 928 1661-1667 Holton St., Milwaukee, Wis.



Eliminates much hand scraping, planing, and sanding. Attachment allows sanding butt ends of floor with the grain right up to the base-board.

A larger edition of the popular Take-About Sander. Same usefulness but more power; a wider belt giving greater sanding surface. Just the machine to sand floor edges, nooks, stairs, and refinish furniture. A handy machine tool that sands ten times faster than by hand. Quick belt change. Works from light socket. Easy to operate. Will soon pay for itself.



Write for details.
Porter-Cable Machine Co.
1704-10N. Salina St.
Syracuse, N. Y.

**Make \$1000.
Extra Before Xmas!**



**"Handiest Tool
in the Kitchen"**

1. Meat Tenderer
2. Mince Knife
3. Cleaver
4. Ice Tool
5. Food Chopper
6. Fish Scaler
7. Nut Crumbler

**FREE SAMPLE
ON APPROVAL**

MONEY for a new car, for new clothes, for the biggest, happiest Xmas you've ever had and plenty left over for a wonderful start on the New Year! Just demonstrate **THE IDEAL FIBER CUTTER** in your neighborhood. No experience needed—Every housewife says "Just what I want!" Make \$20 to \$40 weekly in spare time; . . . more for full time. McHaney, Ill.; "Made \$9.50 in one hour today." Mrs. Ferguson, Ohio: "Have made \$600 a year for last four years spare time selling cutters." Write today for details and free sample—no obligation. The Tyler Mfg. Co., Dept. PM-9, Muncie, Indiana.



McHANEY

Is Your Car..... A Gas Eater

**New Invention Increases
Mileage on Auto Gas
Eater from 13½ to 34.6
Miles on a Gallon**

An astonishing new device has been perfected that is amazing car owners everywhere. Goerzen reports increase from 13½ to 34.6 miles on his Dodge. Thousands have been installed and users report 30-40 and more miles on a gallon of gas. In addition power is increased, instant starting and flashy pick-up is noticed and carbon formation disappears. Every car owner in the country needs this new invention. Its cost is so trivial it pays for itself in a few days' time, yet it will save hundreds of dollars for its owners in gasoline.

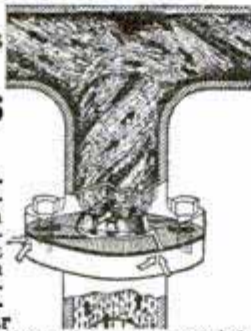

\$100 a Week Territory Open

\$5.00 an hour for spare time. Men are needed in every locality to take care of the tremendous local demand. Sales ability is not required. Every car owner will buy on sight. **Ideal for spare time workers.**

FREE To help our workers we furnish them with this marvelous Whirlwind gas saver free for their own cars. Quick action is necessary. Be the one in your locality to cash in on this device which every auto owner will buy. Send today for full particulars and free sample offer.

Whirlwind Mfg. Co. 999 318-E Third Street MILWAUKEE, WISC.

RADIO LATEST CATALOG OF NEWEST PARTS AND KITS **FREE**
Fresh from the press. Shows all the newest standard parts, sets, kits at big savings. Most complete line in America.

BARAWIK COMPANY 109 Canal St., CHICAGO, ILL.

Let us recommend the best books to study on any subject. Popular Mechanics Press, Chicago, Illinois.

FREE!
30 DAY TRIAL

Radio's most amazing bargains, direct from big, reliable maker (8th successful year). All Electric or Battery sets, Consoles or table cabinets. Don't buy unless 30 days trial proves Miraco unbeatable at 2 to 4 times the price for selectivity, distance, volume and rich, Cathedral tone. Turn 1 dial for all stations. Completely assembled, fully guaranteed set!

Powerful 6-7 or 8 Tube Guaranteed RADIO

Free literature, users' testimony and **BIG SPECIAL OFFER**

MIDWEST RADIO CORPORATION
Pioneer Builders of Sets
407-D Miraco Bldg., Cincinnati, O.

RETAIL
\$36.75 to \$69.75

BIG DISCOUNTS to User Agents

You can now Own a Typewriter!

\$3.00 DOWN
and it's yours

Guaranteed for 5 years

Be up-to-date—know the pleasure and convenience of having one in your home. You'll be amazed at the uses everyone in your household will find for this real Underwood typewriter. Every member of the family will use and enjoy it! Don't send a cent—but do get our big special offer—our valuable book on typewriters and typewriting—FREE.

Any One Can Learn to Operate a Typewriter!

You can learn to write on this standard-keyboard machine in one day; it's so simple that even a child can use it. A week after the expressman has brought it, you'd feel LOST without it. A trial will PROVE it—and doesn't cost you a penny!

SPECIAL FREE TRIAL OFFER

We don't want a penny now. Nor any money at all unless this proves the typewriter bargain of your life. The trial is FREE. If you buy, our easy terms make it a pleasure to pay. There's no excuse now, for not owning a typewriter—and the finest make!

We include all tools, a cover, etc., all complete, all ready to write. Write us now. Deal direct; we are the largest factory of the kind.

Our plan gives you the opportunity of a thorough trial before you buy. You run no risk whatever. You start to pay for your typewriter AFTER you have found it the only machine for you!

But get the facts before this lot of machines is all in use. Clip the information coupon before you turn the page. It will pay you! Note the very useful book you will receive free! Write for full particulars at once.

The Greatest Typewriter Offer Ever Made

If you know typewriters, you know the perfect work and the ease and speed of a Shipman Ward rebuilt Underwood typewriter.

New machines are guaranteed for only one year; WE GUARANTEE EVERY ONE OF OUR MACHINES FOR FIVE YEARS! If you have never owned a typewriter, start with the finest! You can try this one at our risk. But, the time to act is NOW. Don't miss out on this present bargain offer whereby you can get this genuine Underwood at a big savings. Don't do longer without the convenience of a typewriter.

FREE! Get our catalog free; lowest prices and terms. A manual free, too; valuable instruction for learning rapid typing.

Mail Today!

Shipman Ward Manufacturing Co.
2126 Shipman Building, Chicago, Ill.

Please send me your Free Trial Plan and Typewriter Book, together with your special offer on prices, terms, free course in Touch Typewriting and also how I can make money with this typewriter, without obligation. This is not an order.

Name

Street or R. F. D.

City

State



THIS SIX ROOM
English-Type
Bungalow

NOW
\$865
FREIGHT PAID

**Save more
than ever**

*We Loan You
Money to Build*

We ship you this modern home complete, lumber cut-to-fit, and **ADVANCE YOU CASH** to help you build. You pay us in small amounts monthly—about what you pay for rent. This year, prices are lower than ever. Our customers claim average savings of 47% compared with what local contractors charge.

PAY AS LOW AS \$16 PER MONTH

Payments are even lower on other Sterling homes. Send 25c in coin today for beautiful Color Book of Sterling Home Plans and see how easy it is now to make your dream of a home come true.

INTERNATIONAL MILL & TIMBER CO.
894 S. Wenona Ave., Bay City, Mich.



**Start
Your Own
Business
With Puffles**

Great New Food Confection!

Fast seller. Year round business. Easy to run. We help establish you. Invest only \$115. For Summer parks, barbecue stands, resorts and in stores. With each Puffles outfit we include 50 lbs. raw Puffle flakes. When cooked and sold they repay entire cost of outfit.

Get started now. Write for information.

PUFFLES, INC.
Dept. P. M. 9, 3027 S. Wabash, Chicago

NEW AUTOMATIC WINDOW WASHER

*Washes-Cleans-Dries-Polishes
in ONE Quick Operation.*



Amazing new invention completely revolutionizes window washing. Carries its own water supply! It eliminates all the drudgery and unpleasantness. Five times as fast as old methods! No pall. No brush. No sponge. No chamois. Your hands never touch water with the **NEW AUTOMATIC**. Can be used with or without pole. Every housewife, auto-owner, storekeeper and factory owner a live prospect. Sensational demonstration. Sells at sight. Big repeat business. Year 'round seller.

MAKE \$90 TO \$150 A WEEK!

Agents coin tremendous profits. Going like wild-fire. Sells for only \$1.95. Liberal profits for agents. \$10 to \$25 a day easy; \$200 to \$300 a week possible.

WRITE FOR OUR FREE SAMPLE OFFER

You risk nothing. Don't delay. Write for money making proposition today.
NATIONAL INDUSTRIES, Wrigley Bldg., Dept. 159, CHICAGO

**You
can earn
BIG MONEY!**



with this handsome sample case filled with Rawleigh Good Health Food Products, Flavors, Spices, Toilet Preparations, etc. Hundreds of families will buy from you. No experience needed

—we show you how. Low prices. Liberal terms. Advertising literature and sales helps free. Good locations for 1500 men and women. Write

The W. T. RAWLEIGH Co.

DEPT. 1-977M
FREEPORT, ILL.

FREE BULLETIN Crescent Wood Working Machines
Will Save You Time and Money



You can perform all wood working operations accurately, speedily and economically with Crescent Wood Working Machines. Portable, convenient, sturdy, simple, operate from any lamp socket. Write today for free bulletins of Band Saws, Saw Tables, Self Feed Rip Saw, Shapers, Jointers, Variety Wood Worker, Planes, Planer and Matcher, Disk Grinders, Cut Off Table, Swing Saws, Borers, Hollow Chisel Mortisers, Tenoners, Universal Wood Workers.

THE CRESCENT MACHINE CO.
93 Columbia St. Leontia, Ohio

LYNCH

Dynohmic Resistors are non-inductive and non-capacitative.
Arthur H. Lynch, Inc., 1775 Broadway, N. Y. C.

**SEND
FOR
FREE
BOOK**

RADIO LATEST CATALOG OF NEWEST PARTS AND KITS **FREE**
Fresh from the press. Shows all the newest standard parts, sets, kits at big savings. Most complete line in America. Big discounts to act builders. Send name and address at once.
BARAWIK COMPANY 109 Canal Sta., CHICAGO, ILL.

**NEED A BETTER GRIP
ON MATHEMATICS?**



SEND for a copy of "Mathematics for the Practical Man," only \$1.50. By common sense methods it removes the mystery and difficulties so that algebra and even calculus are made simple.

Assuming your knowledge is limited to arithmetic you quickly and easily gain a working knowledge of Algebra, Geometry, Trigonometry and Calculus. Simply pay postman price of book plus the postage when he hands you the package.

Popular Mechanics Press
Room P9
200 E. Ontario Street, Chicago

AUTO REPAIRMEN EARN GREATER PROFITS

Get your share of the big money being spent on automobile upkeep.

Put improved time, labor and money-saving ideas to work in your shop to-day. Take advantage of our special bargain offer and secure 3 valuable kink books at a reduced price.

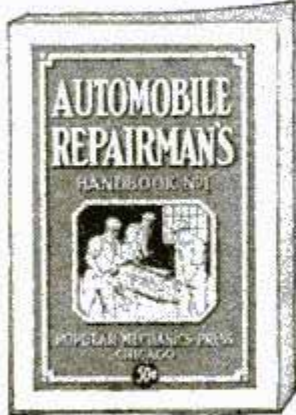

1. 334 Valuable Discoveries made by auto mechanics in our **Automobile Repairman's Handbook**. 337 Illustrations.

2. 301 Ways to use drills, drill presses, taps and dies more effectively in our **Drilling and Thread Cutting Handbook**. 298 Illustrations.

3. 259 Kinks furnished by the most expert Lathe Operators in our **Lathe Handbook**. 212 Illustrations.

Special Offer—These 3 books (regular price 50 cents each, \$1.50 value) are offered for a limited time for only 98 cents plus postage. Pay postman C. O. D. when he delivers or if outside U.S. send 98 cents and 15 cents extra for postage.



POPULAR MECHANICS PRESS
Room P8
200 E. Ontario St. CHICAGO

Build Your Own Boat

New, revised Boat Book contains approved plans and instructions for building 14 different popular types of craft as follows:

- | | |
|----------------------------------|---------------------------------|
| Rowboat for Outboard Motor | Fishing Sleigh and Boat |
| Canoe | Long Island Scooter |
| Speed Boat for Outboard Motor | Portable Folding Boat |
| Portable Canvas Boat | Convertible House Boat and Camp |
| Fast Motorboat | Sea Gull |
| Cabin Scow Driven by Auto Engine | Pile Driver Punt |
| | Inexpensive Motor Boat |
| | Power-Driven Catamaran |

In addition to the above there is much valuable information on:

- Boat Trailer for Auto
- Picking Your Canoe
- Handling Outboard Motors
- Fitting Outboard Motors

- Laying Up Boats for Winter Boathouse
- Making Boats Watertight
- Painting, Repairing Leaks, etc.

Auto Tourists' Handbook

This offer also includes a copy of our valuable **Auto Tourists' Handbook** which gives 133 practical plans for camp equipment, stoves and fires, homes on wheels, beds for car and camp, luggage carriers, tables, pantry boxes, making and improving tents, portable radio, repairing tires, getting out of mud, carrying food, making camp, camp cooking, chairs and stools, car repairs, roads and landmarks, etc.

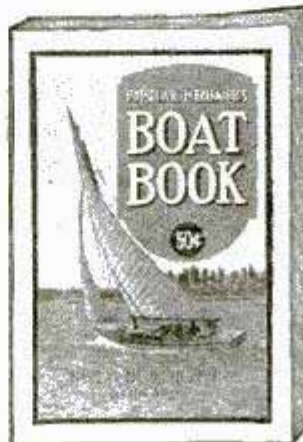

Both books for 98 cents. Pay postman price plus postage when he hands you the package.

Popular Mechanics Press
Room P6, 200 East Ontario St.
Chicago

Bigger Money for You . . ! Run Your Own Garage . . !

Think of it! Last year alone F-I-V-E B-I-L-L-I-O-N D-O-L-L-A-R-S was spent for automobile upkeep! and more will be spent this year. The biggest money is being made by those that are their own boss—run their own garage. Be independent and make REAL money running your own shop. J. E. Mills, Instructor Michigan State Automobile School, will show you how just as he is showing thousands of others in "Garage Management and Control." Don't miss out on your share of this big money. Get these know-hows for making more money for yourself—now! **Send no Money!** Find out about this practical way to bigger money as your own boss in your own shop. Tear out coupon and mail right now.

Guarantee!

If, within 5 days after receipt of the book you don't see how it can show you at least 553 ways to run your garage at a bigger profit, return the book, and your money will be promptly refunded.

MAIL COUPON NOW!

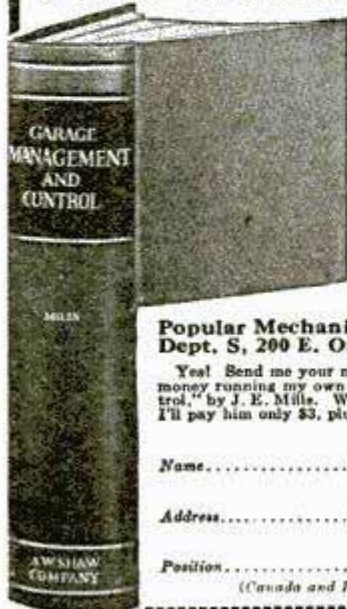

Popular Mechanics Press
Dept. S, 200 E. Ontario St., Chicago

Yes! Send me your new book that tells how to make bigger money running my own shop, "Garage Management and Control," by J. E. Mills. When the postman hands me the package I'll pay him only \$3, plus the postage.

Name

Address

Position

(Canada and Foreign, \$3.50 cash with order)

TRAIN FOR FOREMANSHIP

It Will Pay You Dividends

Leading factory managers agree that of all the officers of a plant the trained foreman is most responsible for profits. And industry is willing to pay the trained foreman who can get results his own price. Now you can master the "know-hows" of foremanship—train for the big paying jobs in industry right at home. For G. L. Gardiner, formerly Director, Foremanship Development, Oakland Motor Car Co., tells you exactly how in his new 6-volume set "Foremanship." This practical man tells you how to get others to work for you, how to stop leaks that lessen profits, how to train for foremanship and bigger pay. See these six practical handbooks now at our expense. You risk nothing.

EXAMINE FREE—Send Coupon



SEND NO MONEY—MAIL COUPON

Popular Mechanics Press, Dept. S.
200 E. Ontario St., Chicago

Please send me, on approval, G. L. Gardiner's "Foremanship," 6 volumes, buckram binding, gold stamped. Within ten days after their receipt I'll send you \$4 plus few cents for postage and packing, and \$4 a month for two months, \$12 in all. Otherwise I'll return the books and that will end the matter.

Name

Address

Occupation

Employed by

(Canada and Foreign \$15.50, cash with order)

1-3/16
Ct.
\$118



Ask Why

Diamonds

HERE (Every Quality)
60% of Market Price

Legitimate Offers of
a 3/4 Century House
Jos. DeRoy & Sons

See why this 1 less 3/16 ct. faultlessly cut blue-white diamond is just \$118. Try to match at 60% more, this, or other startling cash offers. Examination free, of course. A 3/4 century institution, now of 10 large loan companies rated financially over a million dollars, operating as the world's largest diamond banking house. Loans made over \$35,000,000.00 on Diamonds, Jewels, Watches, in sums of \$5.00 to \$5,000.00.

**All Details Free
With Latest List**

Jos. DeRoy & Sons, 1972 DeRoy Bldg.
Opposite Post Office, Pittsburgh, Pa.

Yes, you can send me free, in plain envelope, detailed reasons, for startling diamond offers to individuals, dealers, wholesalers alike. Mail this coupon now!

Name

Address

Low as \$60 a Carat for Diamonds

Send for WESTERN RADIO

New 1929 Catalog

THE NEW 1929 Catalog is crammed full of the FINEST, NEWEST, Nationally known A. C. sets, consoles, cabinets, dynamic speakers, kits, eliminators and accessories at Lowest Prices. Largest stock of radio parts. Prompt delivery. Write for our Free catalog.

WESTERN RADIO MFG. CO.
128 W. Lake St. Dept. PM-9 CHICAGO

The Big Friendly Radio House



RADIO LATEST CATALOG OF NEWEST PARTS AND KITS **FREE**
Fresh from the press. Shows all the newest standard parts, sets, kits at big savings. Most complete line in America.
Big discounts to set builders. Send name and address at once.
BARAWIK COMPANY 109 Canal Sta., CHICAGO, ILL.

FREE RADIO BOOK!

AND NEW SUPPLEMENT C

44 pages chock-full of vital information for set builders and all radio enthusiasts. 16 new easy-to-build circuits—receivers, transmitters, radiophones, short wave. Complete construction data, schematics, photos, etc. Also full information about Aero air-dielectric coils. Write for FREE copy TODAY. Address AERO PRODUCTS, Inc., Dept. 103, 4611 Ravenswood Ave., Chicago, Ill.

New REMLER Tone Triumph

Custom-Built Sets Use
Unique Audio-System



Almost everybody claims tone quality. Now Remler makes good with a new, improved, and novel system of Audio-Transformers. Six new items meet every audio need.

Keep up with the progress of Radio. Learn what the Remler Audio System is and what it does. Write today for Bulletin No. 15.

Send For This

P.M.9 REMLER Division of GRAY & DANIELSON MANUFACTURING CO., 260 First Street, San Francisco, Calif.

Please send me

- Literature about new parts.
- Bulletin Service for Professional Set Builders

NAME

ADDRESS

CITY STATE

Do you build and sell sets?

Simplified Radio Blueprints

Blueprints for the most popular sets described in Popular Mechanics Magazine can be obtained for a charge just sufficient to cover the cost of production and mailing. The sets for which blueprints are available are:

Three-Tube, Loud Speaker, Loop Set	Dec. 1926	25c
Three-Tube, 15 to 550 Meter Set	Nov. 1926	25c
Four-Tube, Loop Set, for Car or Home	Aug. 1926	25c
Six-Tube, Portable, Loop Set	June 1926	25c
Electrolytic B-Eliminator	Feb. 1927	25c
Non-Radiating Unit	May 1926	25c
Simple Tube Tester and Chart	July 1926	25c
New Perfect-Tone Six	Mar. 1927	25c
Two-Tube Loud Speaker Set	Oct. 1927	25c
Economy Nine Superheterodyne; Sixty dollars builds this Super. Complete drilling templates and blueprint diagrams	Nov. 1927	50c
Loop Set for Cabinet Speaker	Dec. 1927	25c
Aero-Dyne Six Receiver	Jan. 1928	25c
Homemade A-Battery and Charger	Jan. 1928	25c
B-Eliminator for Direct Current	Feb. 1928	25c
Screen-Grid Special	Feb. 1928	50c
Fifteen Dollar B-Eliminator	Mar. 1928	25c
Short-Wave Converter	Mar. 1928	25c
All-Electric Five	April 1928	25c
Three-Tube All-Wave Set	May 1928	25c
Push-Pull Power Amplifier and Power Supply Unit	June 1928	25c

Address the RADIO DEPT.

Popular Mechanics Magazine, 200 E. Ontario St., Chicago
Back numbers of the magazines describing the construction of the sets can be obtained from our Circulation Department, price 25 cents each.

PSORIASIS

CAN BE CURED. I SUFFERED MANY YEARS WITH THIS DREADFUL SKIN DISEASE. WRITE R. S. PAYNE, 234 E. SECOND ST., COVINGTON, KY.

The man who studies gets ahead. Popular Mechanics Press will advise you what books to read to advance in your trade. 200 East Ontario Street, Chicago, Illinois.

34 in. Waco Craftsman's Lathe

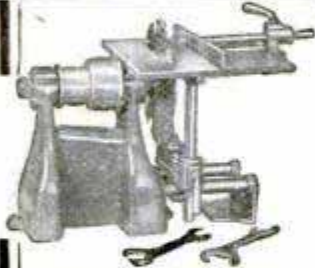

START YOUR SHOP NOW — ONLY \$30.00

Use any kind of power—any motor, 1/4 H.P. or greater and in this offer you get the **BEST LATHE EVER MADE AT TWICE ITS COST.** Complete with NEW two-step cone pulley Belt Drive Ballbearing Headstock—screw tightening tailstock, 45 in. rail lathe bed, wood center, dead center, face plate, turning tools and wrenches—complete with WACO guarantee of complete satisfaction. **ASK ANY OWNER.**

SAME TOOLS — SAME QUALITY AS OUR FAMOUS **Red Jacket** EQUIPMENT

- WACO Power Bench Saw Complete with 6 inch blade.....\$24.00
- New Two-Step Cone Pulley, Belt Drive Ballbearing Headstock..\$15.00
- WACO Buffer set—scratch, emery rag, with attachments, set..\$5.00

WRITE FOR OUR LITERATURE—IT'S FREE—IT'S INTERESTING

The New Waco Headstock

allows the use of any motor you now own—enable you to start a Home Work Shop at small cost. Be sure to get our new **IDEA CATALOG**—send the coupon now.

Waco Tool Works, Inc.
542 No. Parkside Ave.
Chicago, Ill.

This Coupon Brings All the New "Shop Dope"
No obligation—Simply fill in and mail

Waco Tool Works, Inc., Dept. 109,
542 N. Parkside—Chicago.

Please send me your free Idea Catalog.

Name.....

Address.....

City.....

A SHIP MODEL FOR \$4.98



Build an exact replica of the historic Santa Maria or the Mayflower with your own hands. We will furnish the parts cut to fit and ready to assemble complete for only \$4.98 plus a few cents for postage. No tools needed except a small hammer. Parts for model of Constitution may be purchased for \$6.98. Write for our illustrated catalog.

MINIATURE SHIP MODELS
Dept. P-11, 3818-20-22-24 Baring St., PHILADELPHIA, PA.



LACQUER YOUR FURNITURE WITH POWER FROM YOUR VACUUM CLEANER

Most practical spray device—gives results that are readily taken for professional work. Easily done, costs less, no effort at all. Women, too, become instant experts. New Royal Spray Attachment slips right onto vacuum cleaner hose—which is attached to cleaner after bag has been removed. Press of thumb button gives full, instant electric spraying power. Fascinating, thrilling; nothing to get out of order. Use it dozens of ways—refinishing furniture, automobiles, spraying plants, oiling car springs, etc. Every home with vacuum cleaner needs one—sent post paid upon receipt of money order or check for \$4.95.

In addition to your own need for Royal, let it earn spare money for you doing jobs for neighbors, or on special agent's proposition. Write today—send \$4.95 check or money order.

Sold in Canada by The Continental Electric Co., Ltd., 505 King St., East Toronto, Ont.



ROYAL
Spray Attachment

MAIL THIS COUPON NOW

THE P. A. GEIER CO., 540 E. 105th St., Cleveland, Ohio.
Enclosed find \$4.95 for one Royal Spray Attachment.

Name.....

Address.....

Town..... State.....

EASY to Play

EASY to Pay

Only a **BUESCHER**

TRUE TONE SAXOPHONE

Gives You All These:

- Patented Snap-on Pads—the greatest improvement for beauty of tone—easy to replace—no more cementing. Found only on the Buescher.
- Patented Automatic Octave Key—always positive.
- Perfect scale accuracy—every tone always full, clear and true.
- Convenient key arrangement, simplifies fingering of rapid passages.

6 Days' Trial on any Buescher Saxophone, Cornet, Trombone, Trumpet or other instrument, without obligation to keep it.

FREE Saxophone Book shows all models and many famous professionals, also first lesson chart. Sent free. Write name in margin and mail.

BUESCHER BAND INSTRUMENT CO.
2580 BUESCHER BLOCK, ELKHART, IND.

Now! HOUSEHOLD LACQUERING UNIT

You can easily dress up
Your own Furniture, Screens, etc.

ONLY
\$15.00

FREE MASKING TAPE

15-foot roll of Paasche Masking Tape with each Unit. Used for clean-cut color edges, shielding and stenciling.

It's Amazing how easy you can now paint with this Outfit

Brighten Up The Home

Until now the home owner had to be content with the old-style slow hand brush, with its unsightly laps and brush marks and uneven coverage. Now you can spray lacquers, paints, varnishes, enamels, shellacs and bronzes and make the work easier, look better and finished much faster. Now you can brighten up the home with your choice color schemes. This outfit has been tested and approved for home use and is the latest product of the world's most complete line of airbrush equipment.

Paint Your Own Auto

With this unit you can obtain beautiful results, always smooth and uniform—secure any shade—spray intricate pieces as easily as flat surfaces—produce rich blends—veiling effects, and any finish, and as an aid in antiqueing furniture, this unit has no equal. Also don't overlook your auto—now you can keep it bright and new looking. Manual training classes of high schools everywhere find this an inexpensive unit and valuable in teaching this finishing method. Now do it better with a Paasche Spray Outfit.

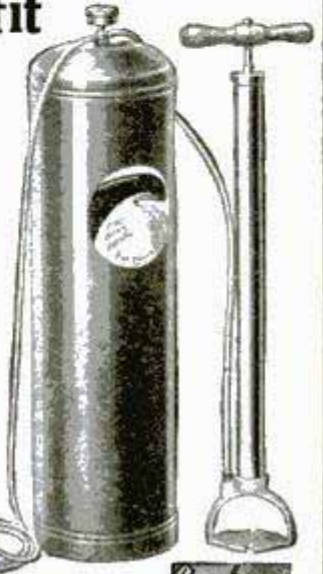

Paasche



THIS UNIT CONSISTS OF
One Paasche J. D. 1/2 Pint Sprayer, Hand Pump, Tank with Gauge, Fittings and 8 foot Hose.

Paasche Airbrush Co.
J. A. PAASCHE, President

Also Finer Outfits for Artists and Larger Power Outfits for Painters and Manufacturers.

Write for FREE FOLDER

1952 Diversey Pkwy., CHICAGO, ILLS.

Discarded Tires Run 20,000 Miles

SALESMEN make big money demonstrating TIRE ARMOR, the amazing new tire protector. It is a powerful tire re-inforcement preventing punctures, blowouts, stone bruises, etc. Guaranteed for 3 years. Discarded tires if equipped with TIRE ARMOR give as high as 20,000 additional miles of use and good tires often as high as 40,000 miles of service.



Write today for particulars and FREE Sample

MOTOR PRODUCTS CO.,
Dept. P
1760 Lunt Ave., Chicago, Ill.

Gas Heat - 1 1/2¢ an hour Anywhere

38 Below Zero is not too cold for the Sunshine Radiant Heater. New beautiful model just out, makes and burns own gas. No piping, no installing; no soot, smoke, dirt, odor nor ashes. Brings you clean, healthful, safe heat. Easy to carry from room to room. Sent on 15-days' trial. Thousands in use. Guaranteed.



FREE Startling money saving offer—big book. Write today.

AGENTS—Big money, part-time. Write for choice territory.

\$450 PROFIT IN ONE DAY

Without experience, A. L. Bradley made that much showing amazing new 38,000 candle power automobile light. Easy to install. Sells instantly. 300% to salesmen. Write today.

Aerial Electric Co. 345 West Ohio Street, Chicago, Ill.

COMBINATION BENCH SAW \$9.80 ONLY

Runs with 1/4 horse power motor. Will RIP and CROSS-CUT. Consists of 6 inch SAW, GRINDING, DRILLING, POLISHING, SANDING ATTACHMENTS.

100 OTHER BARGAINS
Washing Machine Motors \$5.50, 1/2 H. P. \$15.75. Electric Drills \$13.95. Electric Grinders \$7.55, etc.

Send for Bargain Bulletin No. 633.
ACME TOOL CO., 627 Washington St., CHICAGO, ILL.

GLIDERS RACING TYPE 10c 3 for 25c - AIRPLANES -

FREE Catalog with each glider order Showing Ready to Fly Model Airplanes—Construction Outfits and Supplies—Order To-day.



CLINTON TOY CO.
DEPT. 1A NORTH HAVEN, CONN.

JUST OUT Spors No. 9 Combination Pen and Pencil

AGENT'S SAMPLE 66c Sells for \$1.35. Make 8 different colors. \$15 daily easily.

Guaranteed 2 years. Money back if not pleased.



Write for FREE WHOLESALE catalog.

Pen part fitted with smooth writing STYLO point.

F. SPORS & CO., 728 MAIN STREET, LESUEUR CENTER, MINNESOTA

Swear Off Tobacco

Tobacco Habit Banished Let Us Help You

Quick Results

Trying to quit the tobacco habit unaided is often a losing fight against heavy odds, and may mean a serious shock to your nervous system. So don't try it! Make the tobacco habit quit you. It will quit you if you will just take Tobacco Redeemer according to directions.

It doesn't make a particle of difference whether you've been a user of tobacco for a single month or 50 years, or how much you use, or in what form you use it. Whether you smoke cigars, cigarettes, pipe, chew plug or fine cut or use snuff—Tobacco Redeemer will positively remove all craving for tobacco in any form in a few days. Your tobacco craving will usually begin to decrease after the very first dose—there's no long waiting for results.

Tobacco Redeemer contains no habit-forming drugs of any kind and is marvelously quick, scientific and thoroughly reliable.

Not a Substitute

Tobacco Redeemer is in no sense a substitute for tobacco, but is a radical, efficient treatment. After finishing the treatment you have absolutely no desire to use tobacco again or to continue the use of the remedy. It helps to quiet the nerves, and will make you feel better in every way. If you really want to quit the tobacco habit—get rid of it so completely that when you see others using it, it will not awaken the slightest desire in you—you should at once begin a course of Tobacco Redeemer treatment for the habit.

Results Absolutely Guaranteed

A single trial will convince the most skeptical. Our legal, binding, money-back guarantee goes with each full treatment. If Tobacco Redeemer fails to banish the tobacco habit when taken according to the plain and easy directions, your money will be cheerfully refunded upon demand.

Let Us Send You Convincing Proof

If you are a slave of the tobacco habit and want to find a sure, quick way of quitting "for keeps" you owe it to yourself and to your family to mail the coupon below or send your name and address on a postal and receive our free booklet on the deadly effect of tobacco on the human system, and positive proof that Tobacco Redeemer will quickly free you from the habit.

Newell Pharmacal Company
Dept. 300, Clayton Station, St. Louis, Mo.

Free Book Coupon

NEWELL PHARMACAL CO.,
Dept. 300, Clayton Station, St. Louis, Mo.

Please send, without obligating me in any way, your free booklet regarding the tobacco habit and proof that Tobacco Redeemer will positively free me from the tobacco habit or my money will be refunded.

Name.....

Street and No.....

Town..... State.....



Tobacco Tells on
Nervous System



Tobacco Ruins
Digestion



Tobacco Stunts
Boy's Growth



Tobacco Robs
Man of Vitality



Tobacco Steals
from You the
Pleasures, Com-
forts, Luxuries
of Life





"From Nothing to \$15,000.00 a Year!"

"My success has been all that a man could desire as I have built a business up from nothing to \$15,000.00 a year. I owe my success to your Haywood Plant."
L. E. Berry, Barnesville, Ohio.

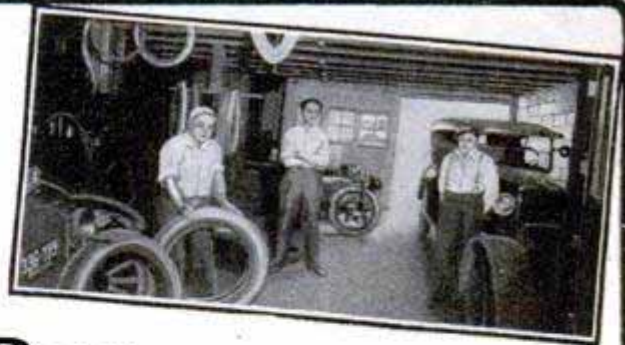

Will YOU Pay \$95.00 for a Business that EARNS \$15,000.00 a year?

This is not a dream. It is an actual fact. My proved, successful, workable plan has made over 16,000 men independent for life. They are enjoying prosperity they never hoped for. Berry is only one example. They did not need experience or large capital. They only needed to study my plan and then get started. We furnish everything. You put up only \$95.00—and you are immediately backed by a 19-year-old internationally known firm. Quick action is the important thing for YOU. I do the rest.

SUCCESS A SURE THING!

Haywood Tire Surgery is the one business I know of today which offers sure success and big money, right from the start. I know this because I've proved it. The business is waiting for you to take. More big men, in this business as well as any other, have been made by quick decision than by any other thing. Will you be one of them? Then get started today by getting your request for "Haywood Steps to Success," in the next mail.

Write for My Free Big Book "Haywood Steps to Success."

As I said before, this success is not a dream. It is a practical, everyday fact with Haywood Service Stations. And it's so easy to start. Our big book explains everything, and tells you of scores of Haywood Successes. It costs you nothing to send for it and read it. You owe it to yourself not to pass up this valuable opportunity. We want good men to join us. The need for Tire Repair Stations is far greater than our present staff can handle. If you are truly ambitious, and desire to join the ranks of successful, independent men, you will write me today for my free book that I have prepared for men who recognize a big chance when it's offered and want to get ahead. Do it now!

J. A. SCHREIBER, President

HAYWOOD TIRE EQUIPMENT COMPANY
2330-M Ogden Ave., Chicago, Ill. Cable Address — FANBRO



FREE TRAINING
Over 16,000 other men have become Haywood experts through my Free course and stepped into big money. You, too, will find this course easy to master, whether you decide to learn at home with my simple diagrams and instructions, or come up here to my factory, with expenses paid while you are here. My wish is to help you if you are sincerely interested in my proposition. For by helping another ambitious man to success, I help Haywood.

FREE! The Proof that you can make

\$5000 to \$12000 a year

EARNEST men—young and old—can take advantage of this opportunity. There is no magic about it—only \$300 capital required. No risk involved. You don't need to leave your present job until you are sure of the greater earnings from Clarke FlorKraftsmanship. At the very worst—you can pay yourself back for your investment in a short time.

Many who have seen our announcement in Popular Mechanics are now making \$25 to \$75 per day. No tuition—no long training necessary. You and the Clarke Vacuum Portable Sander, can do the work of many men.

Investigate thoroughly. Get the proof of performance shown in "Pointing the Way." Better be glad than sorry you did not investigate this opportunity. It costs nothing to find out. Mail the coupon, and do it today.

CLARKE SANDING MACHINE CO.

Dept. T-9, 3831 Cortland St., Chicago, Ill.
Originators and, for over 11 years, manufacturers of Portable Sanding Machines



CLARKE SANDING MACHINE CO.,
3831 Cortland St., Dept. T-9, Chicago, Ill.
Please send me illustrated copy of "Pointing the Way to Greater Profits" which shows actual Proof of Performance and money-making facts of the Clarke Vacuum Portable Sander.

Name.....
Address.....
City..... State.....

ONLY \$1.00



Down 10 Day FREE TRIAL

Never has there been such a TYPEWRITER BARGAIN on as EASY TERMS. A genuine SILENT Ball Bearing L C Smith—GUARANTEED 5 YEARS—at a 50% saving. Here's your chance to get the best typewriter money can buy for only \$1 down. Act now—save 1/2!

World's Only Ball Bearing Typewriter

Because of its ball bearings and other exclusive features, the L C Smith has for over 20 years been recognized as the world's finest, easiest running, longest wearing typewriter. U. S. Government purchases over 50,000. It is also the choice of railroads, big corporations like the Standard Oil Co., etc. All the latest operating attachments; beautifully re-newed; fully guaranteed.

\$3 Worth Extras FREE

Don't buy any typewriter until you have tried an L C Smith. For the sake of your future satisfaction, accept our FREE TRIAL OFFER. Use the ball-bearing L C Smith 10 days before deciding on any machine. By acting now you get Tools, Waterproof Cover, valuable Home Study Touch Typewriting Course FREE. Write today for details of our Special \$1 Offer and Free manual of typewriter information.

SMITH TYPEWRITER SALES CORP.
119-360 E. Grand Ave. CHICAGO

WORKACE

Product of J. D. WALLACE & CO.



Portable electric planer for woodworking

Pulley Drive
Only \$25

J. D. WALLACE & CO.

Adams St. and California Ave., CHICAGO, ILL.



BOW LEGS?

THIS GARTER (Pat'd)
Makes Trousers Hang Straight
If Legs Bend In or Out

Free Booklet—Plain Sealed Envelope
THE T. GARTER CO., Dept. E
South Bend, Ind.

NEW! NEVER SHOWN BEFORE

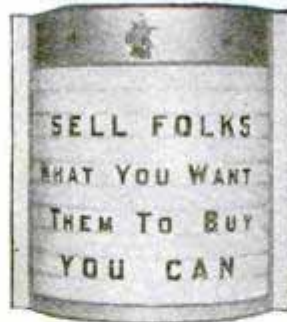

They can't tell you they've seen it for it's the livest new born baby you've ever seen kick. Action that's a knockout. Color too. Note the circle face. For inside or outside. You can sell it and get your money right now. Our deposit getting plan **CLICKS.**

TRADE IN DEAL

on our earlier numbers. Never heard of such a thing did you? Well, we're Pioneers. High Binders lay off. Square shooters get the dope and territory immediately. **SHOW 'EM AND SELL 'EM**—That's the slogan. Turnover is what the merchant wants and he can see it in this Sales Maker. If you want in write today.

DISPLAY PRODUCTS COMPANY
405-7-9 E. 31st St. DEPT. A, KANSAS CITY, MO.

Can You Sell Gas at 5c Per Gal.?

If so, write quick. My distributors make as high as \$3,000.00 per month selling amazing new automatic carburetor device. Send for free trial, proof and my \$15.00 a day guarantee to Distributors.
FRANK ANDREWS, 143 East Erie St., Dept. 805-M.B., Chicago, Ill.



FREE To Men Past 40

A WELL-KNOWN scientist's new book about old age reveals facts, which, to many men, will be amazing. Did you know that two-thirds of all men past middle age are said to have a certain seldom mentioned disorder? Do you know the frequent cause of this decline in vitality?

Common Old-Age Symptoms

Medical men know this condition as hypertrophy of the prostate gland. Science now reveals that this swollen gland—painless in itself—not only often cheats men of vitality, but also bears on the bladder and is often directly responsible for sciatica, back-ache, pains in the legs and feet, frequent nightly risings, and dizziness denoting high blood pressure. When allowed to run on it is frequently the cause of the dreaded disease cystitis, a very severe bladder inflammation.

65% Have This Gland Disorder

Prostate trouble is now reached immediately by a new kind of home treatment—a new, safe hygiene that goes directly to the gland itself, without drugs, medicine, massage, lessons, diet or the application of electricity. It is absolutely safe. 40,000 men have used it to restore the prostate gland to normal functioning. The principle involved in this treatment is recommended by

practically all the physicians in America. Amazing recoveries are often made in six days. Another grateful effect is usually the immediate disappearance of chronic constipation. Usually the entire body is toned up, as much of your youthful vigor is restored. These results are guaranteed. Either you feel ten years younger in six days or the treatment costs nothing.

Send for FREE Book

If you have this gland trouble or if you have any of the symptoms mentioned above, you should not lose a day in writing for the scientist's free Book, "Why Many Men Are Old at 40." It will enable you to ask yourself certain frank questions that reveal your true condition. Every man past 40 should make this test, as insidious prostate disorder often leads to surgery. This book is absolutely free, but mail coupon immediately, as the edition is limited. Address

ELECTRO THERMAL CO.

2109 Morris Avenue, Steubenville, Ohio

If you live west of the Rockies, mail your inquiry to
The Electro Thermal Co.
303 Van Nuys Building, Dept. 21-J.
LOS ANGELES, CALIFORNIA

THE ELECTRO THERMAL COMPANY.
2109 Morris Avenue, Steubenville, O.
Please send me Free, and without obligation, a copy of your booklet, "Why Many Men Are Old at 40." Mail in plain wrapper.

Name.....
Address.....
City.....State.....



"KNIVES
THAT
BITE"

R4413
\$1.50

A LIGHT WEIGHT KNIFE FOR HEAVY WORK

THE blades in this knife are super-sharp—hand-honed at the factory.

They are made of the best high-carbon blade steel obtainable, uniformly hardened and tempered to the proper degree. The edge that bites will last.

This knife is light in weight. You can carry it in your pocket without knowing it's there, but it is sturdy—built for hard, practical use by carpenters, skilled mechanics and amateur craftsmen.

Has a good-size, heavygauge clip blade, a pen blade, and a cut-off pen blade for scribing, cutting builder's paper, canvas or other heavy material. Shinbone stag handle with spun rivets—no cracked handles due to hammered rivets. Nickel silver bolsters and shield. Brass linings. Beautiful finish throughout.

Ask for Remington Knife No. R 4413. Sold wherever good cutlery is sold. If your dealer hasn't it in stock, send us his name and \$1.50. The knife will be forwarded promptly, postpaid.

REMINGTON ARMS COMPANY, Inc.
25 Broadway New York City
Originators of Kleanbore Ammunition

Remington

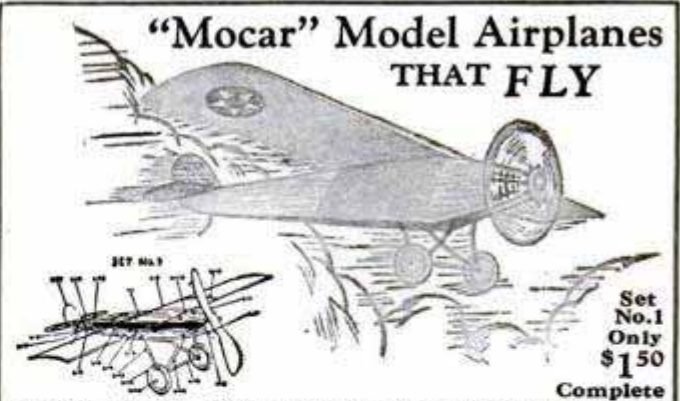

"Mocar" Model Airplanes
THAT FLY

Set
No. 1
Only
\$1.50

Complete

BOYS — at last, here is a genuine aluminum model airplane that really flies. And at a small price.

The "Mocar" monoplane—Set No. 1—is a copy of the famous Spirit of St. Louis. Wing spread 18 inches, fuselage 12 inches, powerful motor, ball bearing propeller, rubber tired disc wheels. Weight complete only about 2½ oz. This is a practical, simple, real model plane that gives you a whole lot of fun for the moderate cost. The all metal construction makes a sturdy plane that will stand a lot of abuse. The outfit is mounted on cardboard with all parts plainly marked and full instruction for assembly. Pliers only tool necessary. Complete with rivets, bolts, nuts, wheels, wing and fuselage covering material, only \$1.50 post paid (3 for \$4.00).

Great fun, learn how to make and fly airplanes. Order now.
Jobbers, dealers and schools write for net prices.

THE
MOUNT
CARMEL
MFG. CO.

Dept. M

Mount
Carmel,
Conn.

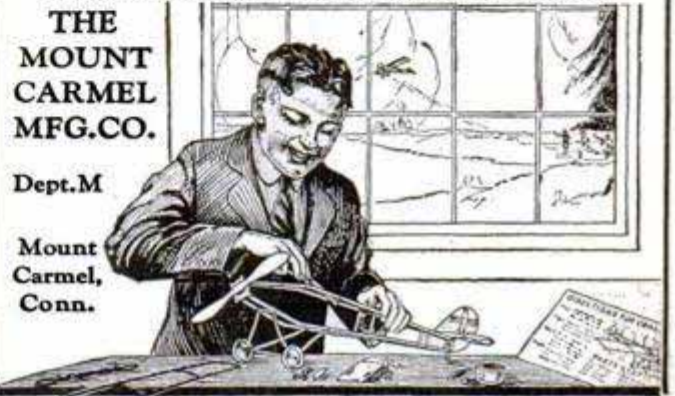

SPEED — LUXURY — LOW COST

The Quad

Super Elto

4 Cylinder Outboard Motor

FINEST runabout performance is now yours at a fraction of usual costs! The Quad, sensational 4-cylinder portable outboard motor drives big, comfortable boats 25 miles an hour. Instant starting, utterly vibrationless, absolutely dependable. Drives racing craft at 35 miles and better. Send for book on Super Elto motors, also complete directory of outboard boats and builders.

ELTO OUTBOARD MOTOR COMPANY
Ole Evinrude, President
Mason Street Dept. AA, Milwaukee

FREE BOOK

For You—Just what you want. Get it before you buy. Crammed full of up-to-date offers at Bargain Prices.

—Lowest anywhere. Everything is high grade, perfect.

No "Seconds"! Our goods are of the kind that last and please all the while.

→ YOU Need It

Get it—compare our quality and prices with others—We save you up to 50% on plumbing. Book tells how. 60 pages—4000 offers and sizes—everything in

Plumbing—Heating—Tinning—Paint

Such as Bathtubs, Lavatories, Closets, Sinks, Laundry Tubs, Water Heaters, Range Boilers, Water Supply Systems, Pumps, Tanks, Pipe, Sewage Disposal Systems—Furnaces, Steam and Hot Water Heating Plants—Parts, Fittings, Tools, Accessories, Supplies—Paint, Varnishes—and on hand also Fencing, Roofing, Tinning—anything you want—all at cut prices—over 1,000,000 items—largest stock and variety in U.S. Some articles on Easy Payments—anything on Open Account if in business and rated. Write for Free Book Today—NOW.

BURKE & BROS. Dept. 1639A, 433 Liberty Ave. PITTSBURGH, PA.

Money Saving Opportunities
 HOME OWNERS—CONTRACTORS—BUILDERS—PLUMBERS—PAINTERS—FARMERS—SHOPS AND FACTORIES

PLUMBING AND HEATING
 BUILDING—REPAIRING—PAINTING—FINISHING—ELECTRICAL—WATER SUPPLY—SEWERAGE—RANGE BOILERS—WATER HEATERS—TANKS—PIPE—SINKS—CLOSETS—LAVATORIES—BATH TUBS—LAUNDRY TUBS—WATER SUPPLY SYSTEMS—PUMPS—TANKS—SEWAGE DISPOSAL SYSTEMS—FURNACES—STEAM AND HOT WATER HEATING PLANTS—PARTS—FITTINGS—TOOLS—ACCESSORIES—SUPPLIES—PAINT—VARNISHES—AND ON HAND ALSO FENCING—ROOFING—TINNING—ANYTHING YOU WANT—ALL AT CUT PRICES—OVER 1,000,000 ITEMS—LARGEST STOCK AND VARIETY IN U.S. SOME ARTICLES ON EASY PAYMENTS—ANYTHING ON OPEN ACCOUNT IF IN BUSINESS AND RATED. WRITE FOR FREE BOOK TODAY—NOW.

BURKE & BROS. 433 LIBERTY AVE. PITTSBURGH, PA.

SAVE 1/3 to 1/2

60 Pages of 4000 Offers—Everything you could think of

Send TODAY

Sent to You

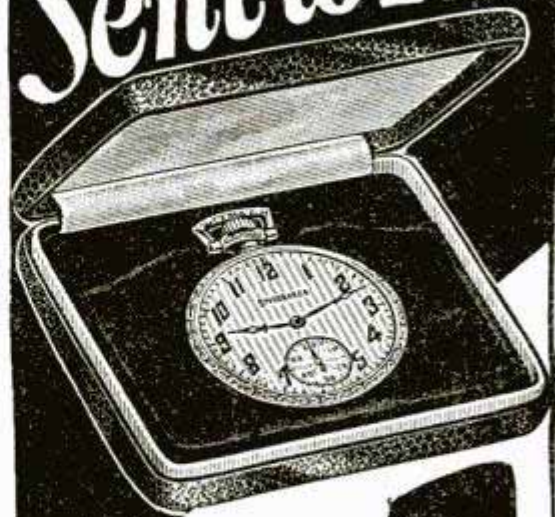

for Only \$1

DOWN

21 JEWEL-Extra Thin STUDEBAKER
The Insured Watch

A Sensational Offer!
 Only \$1.00 and you get the famous 21-Jewel Studebaker Watch direct from factory. Balance in easy monthly payments!
 Lowest prices ever named on similar quality. You save 30% to 50%.

21 JEWEL-Extra Thin STUDEBAKER
The Insured Watch

Ladies' Bracelet Watches, Men's Strap Watches, Diamonds and Jewelry also sold on easy payments. This company is directed by the Studebaker Family of South Bend, known throughout the world for three-quarters of a century of fair dealing. 100,000 satisfied customers. Send coupon at once for full particulars of our amazing offer. Studebaker 21-Jewel Watches have 8 adjustments—heat, cold, isochronism and 5 positions. An insurance policy is given free—insuring the watch for your lifetime!

WRITE FOR FREE CATALOG!

A copy of our beautiful, new, six-page color catalog will be sent free to anyone sending the coupon below. Shows 80 magnificent, new Art Beauty cases and dials. Latest designs in yellow gold, green gold and white gold effects. Exquisite thin models. Masterpieces of the watchmaker's craft.

Special Offer: Watch Chain FREE

To those who write at once for free Catalog we will include particulars of our special offer of an exquisite Watch Chain free. This offer is for a limited time only. Send coupon at once—before it expires.

Studebaker Watch Co.

Directed by the Studebaker Family—three-quarters of a century of fair dealing
WATCHES—DIAMONDS—JEWELRY
 Dept. 907 South Bend, Ind.
 Canadian Address: Windsor, Ont.

SPECIAL OFFER COUPON

STUDEBAKER WATCH COMPANY
 Dept. 907 South Bend, Indiana

- Please send me your free Catalog of Advance Watch Styles and particulars of your \$1 down offer
- Please send me Jewelry Catalog free.

Name.....
 Street or R. F. D.....
 City or Post Office.....
 State.....



Magic Eyes \$7.95

8 Lenses Magic Eyes that will extend your vision over 15 to 25 square miles. See the multitude of things these powerful lenses will show you. They conquer distance and bring distant objects before your very eyes. Wonderful for hunters, naturalists, tourists, etc. Only 8 Lens Galilean Binocular under \$30. Eight fine sparkling precision ground day and night lenses. No wonder they give crisp, clear cut detail, expansive field and great range. Only 4 1/2" high. Fine compass on top. Graduated focusing scale 1 to 12 on middle bar. Case and straps free. Order one today while they last. Only \$7.95 C. O. D. Free Trial for Five Days. Money back if you want it.

CATALOG OVER 200 GLASSES ALL MAKES—\$1—\$110

Everything in binoculars, field glasses, telescopes and optical instruments. The finest and largest assortment in America. Catalog gives all information how to choose the best for your individual needs at the LOWEST PRICE.

Try America's Leading Binocular House First
DUMAURIER CO. Dept. 209 **ELMIRA, N. Y.**

Boils 50 Gallons In Less Than Hour

No Other Compares With This

Improved Oil Burner

Use Ordinary Kerosene or Coal Oil

(Burns Outdoors as Well as Indoors)

THE most remarkable Kerosene Burner ever built. Boils down apple cider, maple syrup, molasses, etc., in half the ordinary time. Ideal burner for dairies, butchers, indispensable on the farm. **PRODUCES TERRIFIC HEAT WITH SILENT BLUE FLAME**

**NO NOISE
 NO SMELL
 NO SMOKE
 NO SOOT**

So efficient it produces twice the amount of heat of City gas at half the cost. So simple anyone can install and operate. Double generator assures continuous operation without shut-downs. Nothing to wear out, starts in a jiffy, will last a life time. Every burner guaranteed fully. Write for special introductory price and free catalog of outdoor utility and kitchen stove oil burners.

HOME MFG. CO., Dept. 2313, 18 E. Kinzie St., CHICAGO



18 Tools In One S&B SAW Money Back Guarantee

8" Combination S&B SAW 12" Band Saw

The only machine that you can tilt the table to 45° without removing insert. Big advantage on pattern work.

Sent to You on 15 days approval

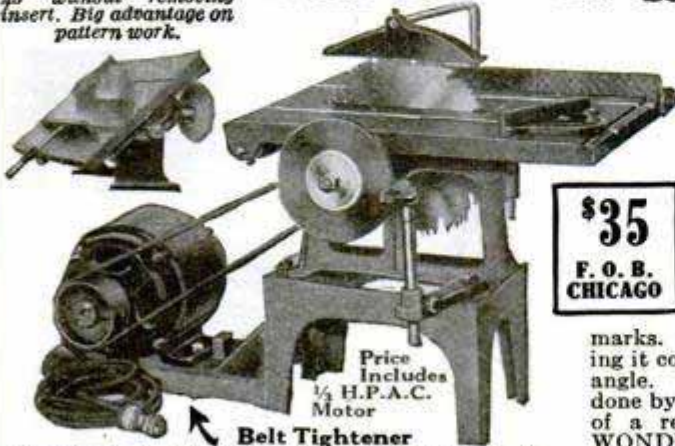

\$35
F. O. B. CHICAGO

Price Includes 1/2 H.P.A.C. Motor

Belt Tightener

{ 1/2 H. P. Motor-40°-100% overload Double Shaft Extension }

18 Tools in One—Greatest Machine You Ever Saw

THE S&B 8-in. COMBINATION SAW (18 tools in one) is the ideal machine for the shop, factory or the home; will rip, cross cut, bevel, miter, mortise, groove, drill, tenon, grind, rabbet, buff and polish. Motor is mounted on a base that is a part of the machine proper. Run from any light socket, also provides power for other purposes when the saw is not in use. Complete with attachments and price includes 1-3 H. P. Motor, 60-cycle, 110-Volt A. C. Price \$35.00 F. O. B. Chicago. Shipping Weight 100 lbs.

(Planer attachment to fit on table top will smooth pieces up to 2 in. wide, \$10 extra.)

SCOTT-BANSBACH MACHINERY CO. Write for Complete Illustrated Folder—Dealers Wanted.
130 So. Clinton St., Dept. 84, CHICAGO, ILL.

12" Band Saw

Positively a sensation and at this LOW PRICE you can NOW do the 1001 things you wanted quick and easy. This 12" BAND SAW has a tilting table, with Miter and sturdily built. Ideal for the shop or home.



\$35.00 F. O. B. Chicago without Motor

Scroll Saw

Delights Every Boy



\$15.00

F. O. B. CHICAGO 1/2 H. P. A. C. Motor \$15 extra

DO YOU GET \$2.00 TO \$3.00 AN HOUR FOR YOUR TIME?

You can make that much in an hour easily filing saws on a Foley. Just read this: "I filed six saws in 40 minutes at \$.50 each."—Chas. E. Fuller, Lima, Ohio. "I get all the work I can handle."—H. F. Myers, Burlington, Iowa. Get a Foley, and before you know it you'll have a big, steady, year around business of your own. File saws for carpenters, contractors, schools, factories, meat markets, farmers and homes.

FOLEY Automatic SAW FILER

The Foley is the only machine that files all kinds of saws, and automatically joints as it files. No experience needed to run it. Makes saws cut better than new. More than twice as fast as hand filing. No canvassing. Good extra money while on your present job. We'll help you get started in business for yourself. Write now for the valuable FREE Plan and special demonstration offer to Popular Mechanics' readers. No obligation. Address—

Foley Saw Tool Co., Inc., 231 Foley Bldg., 9 Main St. N. E., Minneapolis, Minn.
Ask about our automatic grinders for wood and metal cutting saws.



NOW! You Can Do Your Own NICKEL-PLATING



For Plating Nickel, Brass, Copper, Silver, Gold, etc.

See the Nickel Flow

Make \$150 to \$500 a Week

New Scientific Invention Enables Anyone To Nickel-Plate Anywhere with Aladdin Portable Outfit
This marvelous invention enables anyone to NICKEL-PLATE anything—anywhere; in the Home, Garage, Office, Store or Shop—in fact, you can do all the NICKEL-PLATING on any automobile with the ALADDIN ELECTRO PORTABLE OUTFIT in a very short time—without removing any of the parts. This interests every auto owner (and others) because you can SEE THE NICKEL FLOW NOW take the Plater to the job instead of taking the job to the Plater. This offers wonderful ECONOMY to users and BIG MONEY-MAKING possibilities to AGENTS. Be the first in your locality. WRITE FOR FREE BOOKLET.

Introductory Offer **\$6.50** Plus Postage

P. J. F. BATENBURG Dept. 37 RACINE, WISCONSIN —AGENTS— WANTED EVERYWHERE

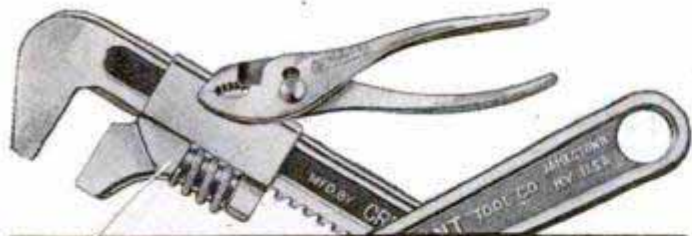

QUICK REPAIRS



From the famous easily-adjusted Crescent Wrench to nimble, clean-cutting pliers there is a Crescent Tool for every repair job.

Crescent Tools are made of special steel, heat-treated and tempered by exclusive Crescent methods that insure perfect action and long life. All moving parts are machine made and every tool is guaranteed. Write for catalog.

CRESCENT TOOL COMPANY
210 Harrison St. Jamestown, N. Y.

CRESCENT and Smith & Hemenway TOOLS

Made under the supervision of and guaranteed by the originators of the Crescent Wrench



When They Ask You to Join Them!



It will take only a few weeks of easy practice until you too can join the others—at home or school—with a clarinet, flute, saxophone, trumpet, or any other instrument of your choice. The slight effort needed to start on any Pan-American instrument is offset by the years of enjoyment ahead!

Pan-American instruments make it tenfold easier for you. Put a new Pan-American "Brilliant" Metal Clarinet into your hands for a few weeks, and you'll be playing all of the popular music.—Or a Pan-American saxophone, trumpet, or any instrument of your choice. Accepted for their quality by teachers, band masters and schools everywhere. Yet costing you less, in easy payments, than you realize. Factory guaranteed. Today is the time to return the coupon below for a beautifully illustrated Pan-American catalog. No obligation.

MAIL THIS TO

The Pan-American Band Instrument & Case Co.,
Dept. G-20, Elkhart, Indiana.
Yes—I would like to try a Pan-American Band Instrument.
Send catalog and complete information.
I would like to learn to play.....

(Instrument)

Name.....
Address.....
City..... State.....

Start an HB Equipt Shop Earns \$150 to \$300 Monthly

Established Garages—Battery Stations and mechanics are adding substantial profits without expense to them. Start in business yourself with HB One Day Battery Service—Paint Spray—or Starting, Lighting, Ignition Service Equipment. HB guarantees bigger profits and enables you to do far better work than the other fellows with less expense to yourself.

Only \$16 Monthly Easily Paid By Increased Profits



One Day Battery Charging

Gives you the edge on competitors. Saves 30 to 50% on electric bills over rectifier and turns out work in one-third the time. Recommended by leading car and battery manufacturers.



Free Air Service

With \$12 Monthly you can have constant Automatic Air Service to bring customers to your doors. Beltless, Silent, Ball Bearing.

Quantity production makes possible the low price.



Paint Spray

Does the work of five men with brushes. Paints Cars, Furniture, Houses, Barns, Garages. You can earn bigger profits yet charge far less than any competitors. Thirty days trial to prove our claims.

HB Test Bench

The best paying line in Automotive Electrical Work. Tests starting, lighting and ignition systems. Brings you business from other shops. Priced \$100 to \$150 below similar quality outfits.

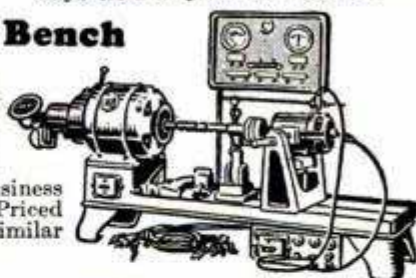

HOBART HB BROTHERS

Successful manufacturers ~ since 1893 ~

Box M98 Troy, Ohio
Tear Off And Mail Today

Hobart Brothers Co.
Box M98, Troy, Ohio.

Send me complete information on the items I've checked with your 30 day trial offer, easy payment terms, and information on how HB equipment will increase my earnings.

- One Day Battery Service Profits.
- Electrical Test Bench Opportunities.
- Portable Paint Spray Business.
- Better Automatic Air Compressor.

Name.....
Address.....



GEORGE F. JOWETT, *Champion of Champions*

"I will give you muscles like mine"

I WILL make you a TWO-FISTED FIGHTING MAN with nerves of steel and muscles like iron. I will send the good red blood coursing through your veins like the onrush of electricity. In 90 days I will build you a new body that every man will envy and make you feel like a lion, ready to tackle anything.

I Was Once a Weakling

I built my own body and I can build yours. My methods are endorsed by HERMAN GORNER, the strongest man in the world; ARTHUR DANDURAND, the Canadian Sandow; HENRY STEINBORN; JIM LONDOS, the Greek god; and ARTHUR GAY, winner of the first prize in America's Most Perfect Man Contest.

My lessons are physiologically and scientifically correct. They build without strain. They build from the inside out. They put new life and vitality into your internal organs as well as in your biceps. You'll be strong, but you won't be muscle bound—as pliant as a whip and as strong as a steel trap.

Pair of Dumbbells Free

To every person who takes my course I will give a pair of the patented Jowett Progressive Disk Dumbbells. They cannot be equalled for workmanship and muscle building. Here's another point—my course is laid out personally for each pupil. Every week you receive a new set of exercises in order of progression. You get Twelve Courses covering the Twelve Principles of Life and on conclusion of your course receive an emblem as a graduate of the Jowett Institute of Physical Culture. I guarantee to build you over in 90 days or return every penny you have paid me. My easy payment plan provides a way for every person to be a Jowett Pupil.

Get My Big Free Book

All I ask is this: Send for my big free book, "The Thrill of Being Strong." You'll get a real kick out of it because of the photographs and because it shows how easily you, too, can have nerves of steel and muscles of iron. If you would like to lay your case before me in a personal letter, I will give you a personal reply without cost. Let me show you how you can become as well built and as strong as America's greatest.

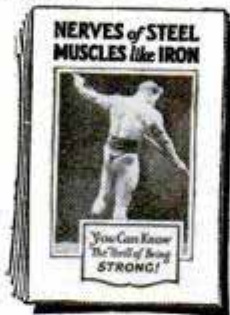

JOWETT INSTITUTE OF PHYSICAL CULTURE

Dept. 4-J
597 Fifth Avenue, New York, N. Y.

Dear Mr. Jowett:
Without cost or obligation, please send me a copy of your illustrated booklet, "The Thrill of Being Strong."

Name.....
Address.....

One Year To Pay

No. 40 — \$62
\$5 Deposit — \$1.25 Week

This exquisite diamond ring is considered extremely handsome. The best quality, full cut, genuine blue-white diamond full of fiery brilliance and sparkling colors, is set in this popular 18 kt. solid white gold mounting. It makes a wonderful engagement ring or friendship ring. Your friends will think you paid \$100.00 for it. Everyone will admire it. The gift case is free. Write for illustrated Catalog.

No Red Tape 10 Days Trial

18 KARAT

SEND With your order to show good faith. **ONLY \$1** When postman delivers ring, pay C. O. D. \$4, balance of deposit. Take 10 days for trial. If you keep it, pay only \$1.25 a week for one year. **Don't bother writing a letter:** Just pin this ad with a dollar to a piece of paper with your name and address on it.

PRICE CUT TO \$62.00 — WORTH \$100.00
You can now buy this gorgeous ring at the wholesale price. Compare it with similar rings at \$100. We guarantee it to stand any test or comparison. Greatest bargain offered by any Diamond Importer. We allow 8% annual increase in exchange for a larger diamond ring.

Write for It brings our large **Catalog** right into your home. Tells how to buy diamonds like an expert. Gives information that other jewelers dare not tell. State if white or colored.

AGENTS WANTED—EARN \$200 WEEK. WRITE FOR DETAILS

STERLING DIAMOND CO. & WATCH INC.
DIAMOND IMPORTERS—\$1,000,000 STOCK—ESTABLISHED 1879
1540 BROADWAY DEPT. 2505, NEW YORK

"Be the Life of the Party"



Play a Tune in 10 Minutes

Anyone can play the Ukulele, Tenor Banjo, Guitar, Banjo Uke or Mandolin with an amazing new invention. NO knowledge of music required. Play tunes from the start by numbers instead of notes, or by notes if you wish. Simple as 1-2-3, "just press the keys and play."

Astonish your friends by playing latest "hits" and old favorites. NO more costly lessons! NO weeks of tiresome practice! So simple a child can use it. Over 50,000 delighted Users—young and old, men and women now playing.



10 DAYS FREE TRIAL **CLIP THIS AD**

Free Book

Send for free book telling the amazing story of this marvelous device. Contains letters from hundreds now playing who could never play before. E-Z Player can be attached to your own instrument in a jiffy. Or we'll send you choice of instruments with Player attached on easy payment terms. Satisfaction guaranteed. "No play, no pay!" Have more fun, popularity, money-making chances, more friends—send today for free book. No obligation.

FERRY & CO., Manufacturers
1750 N. Robey St. Dept. 9776, Chicago, U. S. A.

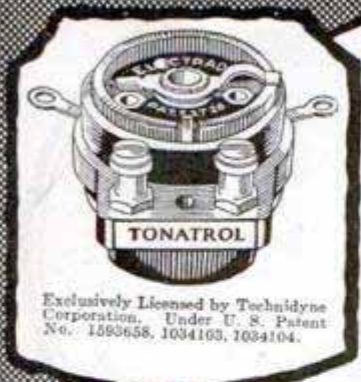

Exclusively Licensed by Technidyne Corporation, Under U. S. Patent No. 1593658, 1034103, 1034104.

Sentinels of Satisfaction!

TONATROL

Trade Mark

A Complete Line of Volume Controls

The ace of volume controls—in different types specifically designed for all circuits—A. C. or battery type. With or without filament or power switch as desired. \$1.50 to \$3.00.

TRUVOLT All-Wire Resistances

Reg. U. S. Pat. Off.

Unequaled for voltage control in power supply units. Potentiometer type saves difficult calculations. 22-Stock Types \$3.50 each. Fixed Truvolts adjustable to any values by sliding clip taps. Made in all desirable resistance values and current ratings.

Electrad Specializes in a Full Line of Resistance Controls for all Radio Purposes

Dept. F-9, 175 Varick Street, New York

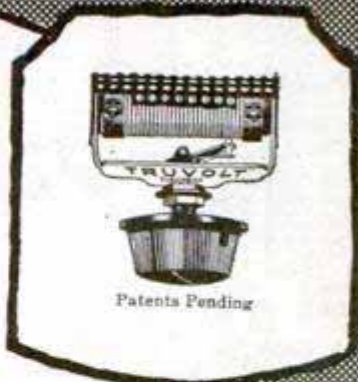

Patents Pending

Electrad, Inc., Dept. F-9, 175 Varick Street, New York.

Please send me descriptive circulars on the following products and put me on your mailing list for similar literature.

- General Circular
- Tonatrol Volume Controls
- Phasistrols
- Royalty Variable Resistors
- Truvolt Divider Manual (Enclose 10c for mailing)
- “Electrad Control Manual” (Enclose 10c for mailing)
- “What B Eliminator Shall I Build?” (Enclose 10c for mailing)

I am particularly interested in

Name.....

Address.....

ELECTRAD

Inc.



Getting the most out of your radio?

No matter if your set is home-made, custom-built or factory product, there are dozens of little items in installation and operation which determine between average and wonderful results. Invest a quarter in "The Gateway to Better Radio" and know you enjoy the best. Your dealer has your copy or order direct from

CLAROSTAT MFG. CO., Inc.
Specialists in Variable Resistors
285-7 N. Sixth St., Brooklyn, N. Y.



MODEL SHIPS

Build a beautiful scale model of the Flying Cloud, Constitution, Pirate Ship, Mayflower, Galleon and other types. Also the slickest 30-inch racing sail model you ever saw. Reproductions of photos of the above models and many others are shown in our large illustrated catalog which contains prices on construction sets, special fittings such as blocks, deadeyes, anchors, steering wheels, guns, etc., books, blueprints, model makers tools, etc. sent postpaid upon receipt of 10 cents.

Model Ship Supply Co., Dept. N., Mincola, N. Y.

MODEL AIRPLANES

GIVEN AVIATORS HELMET

25c to \$10 Complete CONSTRUCTION SETS

Raw materials, blue prints, everything needed to make your own models.

GLIDERS—TRACTORS—RACERS—CABIN MONOPLANES

Write for Illustrated Folder "P"

"SKY PIRATE" MODEL

Amazing, sensational—takes off ground; flies fast, forward and far. Wing spread 20 in.; wheels and rudder of balsa wood; beautifully finished; wings silver; fuselage, green; rudder red; metal trimmings. Aviator's helmet GIVEN, packed with each "Sky Pirate" complete; postpaid..... **\$1**

Clip this ad, and enclose dollar bill.

Satisfaction or money back—Order TODAY

BROADFIELD AEROPLANE CO., Hempstead, N. Y.
Est. 1919 Dealers Inquiries Invited

ENJOY the THRILL of ELECTRIFIED RADIO at SMALL COST

only **\$6.85** complete
FREE TRIAL

Banish forever all the annoyance and expense of buying new "B" Batteries with a TOWNSEND "B" POWER UNIT. Hooked up in a few moments—and you have permanent

power from your light socket from

that time on. Use same tubes now in your set. No changes.

You'll be amazed at the way Townsends improve your reception and add to distance getting. More than 50,000 now in use. Send coupon today for full information and free trial offer.



Townsend Laboratories, Chicago, Ill.

COUPON

TOWNSEND LABORATORIES, Dept. 15, 713 Townsend St., Chicago, Ill.

9/28

Please send me full information on the Townsend "B" Power and Free Trial Offer.

Name.....

Address.....

AEROVOX

Makers of high quality resistors and condensers that are Built Better—to endure.

Write for The Research Worker. A free monthly publication.

AEROVOX WIRELESS CORPORATION
68 Washington Street Brooklyn, N. Y.



Mechanical Engineering Learn at Home

MECHANICAL Engineering embraces the design, construction and operation of machines and machine tools.

It is a profession which offers almost unlimited opportunities for advancement to men who combine natural mechanical ability with special technical training.

For this is The Age of Machinery. Almost every convenience, luxury or necessity which we enjoy today depends on machinery for its production or adaptability to our needs. Every new invention multiplies the opportunities for competent designers, builders, erecting engineers, etc.

One of the best ways to train yourself to secure a position as a Mechanical Engineer is through the home-study courses of the International Correspondence Schools.

These courses are especially arranged to meet the needs of the student who studies at home. The theoretical work is stated in simple and clear language and engineering data is reduced to a form in which it is easily applied.

The courses are also particularly helpful because they are written by well-known mechanical engineers who have had years of practical experience in this field.

Just mark and mail the coupon and we'll gladly send you Free Booklets describing the I. C. S. courses in Mechanical Engineering or any other course in which you are interested.

Mail the Coupon for Free Booklet

INTERNATIONAL CORRESPONDENCE SCHOOLS

"The Universal University"

Box 5558-F, Scranton, Penna.

Without cost or obligation, please send me a copy of your booklet, "Who Wins and Why," and full particulars about the subject before which I have marked an X:

- | | |
|---|--|
| <input type="checkbox"/> Mechanical Engineering | <input type="checkbox"/> Toolmaking |
| <input type="checkbox"/> Mechanical Course | <input type="checkbox"/> Blacksmithing and Forging |
| <input type="checkbox"/> Drafting | <input type="checkbox"/> Patternmaking |
| <input type="checkbox"/> Mechanical Drawing | <input type="checkbox"/> Foundrywork |
| <input type="checkbox"/> Complete Shop Practice | <input type="checkbox"/> Machine Shop Practice |
| <input type="checkbox"/> Electrical Engineering | <input type="checkbox"/> Architects' Blueprints |
| <input type="checkbox"/> Electric Lighting | <input type="checkbox"/> Contractor and Builder |
| <input type="checkbox"/> Radio | <input type="checkbox"/> Architectural Draftsman |
| <input type="checkbox"/> Railroad Positions | <input type="checkbox"/> Concrete Builder |
| <input type="checkbox"/> Civil Engineer | <input type="checkbox"/> Structural Engineer |
| <input type="checkbox"/> Surveying and Mapping | <input type="checkbox"/> Chemistry <input type="checkbox"/> Pharmacy |
| <input type="checkbox"/> Metallurgy <input type="checkbox"/> Mining | <input type="checkbox"/> Airplane Engines |
| <input type="checkbox"/> Steam Engineering | <input type="checkbox"/> Agriculture and Poultry |
| <input type="checkbox"/> Architect | <input type="checkbox"/> Mathematics |

BUSINESS TRAINING COURSES

- | | |
|--|---|
| <input type="checkbox"/> Industrial Management | <input type="checkbox"/> Advertising |
| <input type="checkbox"/> Personnel Management | <input type="checkbox"/> Business Correspondence |
| <input type="checkbox"/> Traffic Management | <input type="checkbox"/> Show Card and |
| <input type="checkbox"/> Accounting and | <input type="checkbox"/> Sign Lettering |
| <input type="checkbox"/> C. P. A. Coaching | <input type="checkbox"/> Stenography and Typing |
| <input type="checkbox"/> Cost Accounting | <input type="checkbox"/> English |
| <input type="checkbox"/> Bookkeeping | <input type="checkbox"/> Civil Service |
| <input type="checkbox"/> Secretarial Work | <input type="checkbox"/> Railway Mail Clerk |
| <input type="checkbox"/> Salesmanship | <input type="checkbox"/> Common School Subjects |
| <input type="checkbox"/> Spanish | <input type="checkbox"/> High School Subjects |
| <input type="checkbox"/> French | <input type="checkbox"/> Illustrating <input type="checkbox"/> Cartooning |

Name.....

Street Address.....

City.....State.....

If you reside in Canada, send this coupon to the International Correspondence Schools Canadian, Limited, Montreal



Every "Up-to-Date" Boy Plays the Harmonica

VACATION days aren't half so much fun unless you can pull out a harmonica and show the crowd how you can play—or join with the other fellows in harmonizing the latest popular songs as well as the old-time melodies.

Everybody plays the harmonica now—that is, everybody who is up-to-date. Don't be the exception.

Send today for the free instruction book which will show you in pictures how you can learn to play the harmonica in an amazingly short time. A penny post-card will bring it free by return mail. Do it NOW before you forget!



FREE

INSTRUCTION book, fully illustrated.

M. HOHNER, Inc.
114 East 16th St.
Dept. 508-J, New York



MAKES A COMPLETE MACHINE SHOP

EVERY-USE ELECTRIC MOTOR ATTACHMENT

ONLY \$3.95



Fastens directly on motor shaft, no pulleys or belts necessary. Holds grindstones, buffs, saws, wire scratch brushes, drills, etc. Serves as pulley. Made to fit 3/8, 1/2 and 5/8 inch shafts. State size. Postage prepaid if remittance accompanies order.

United Electric Motor Co., 178C-9 Centre St., N. Y.

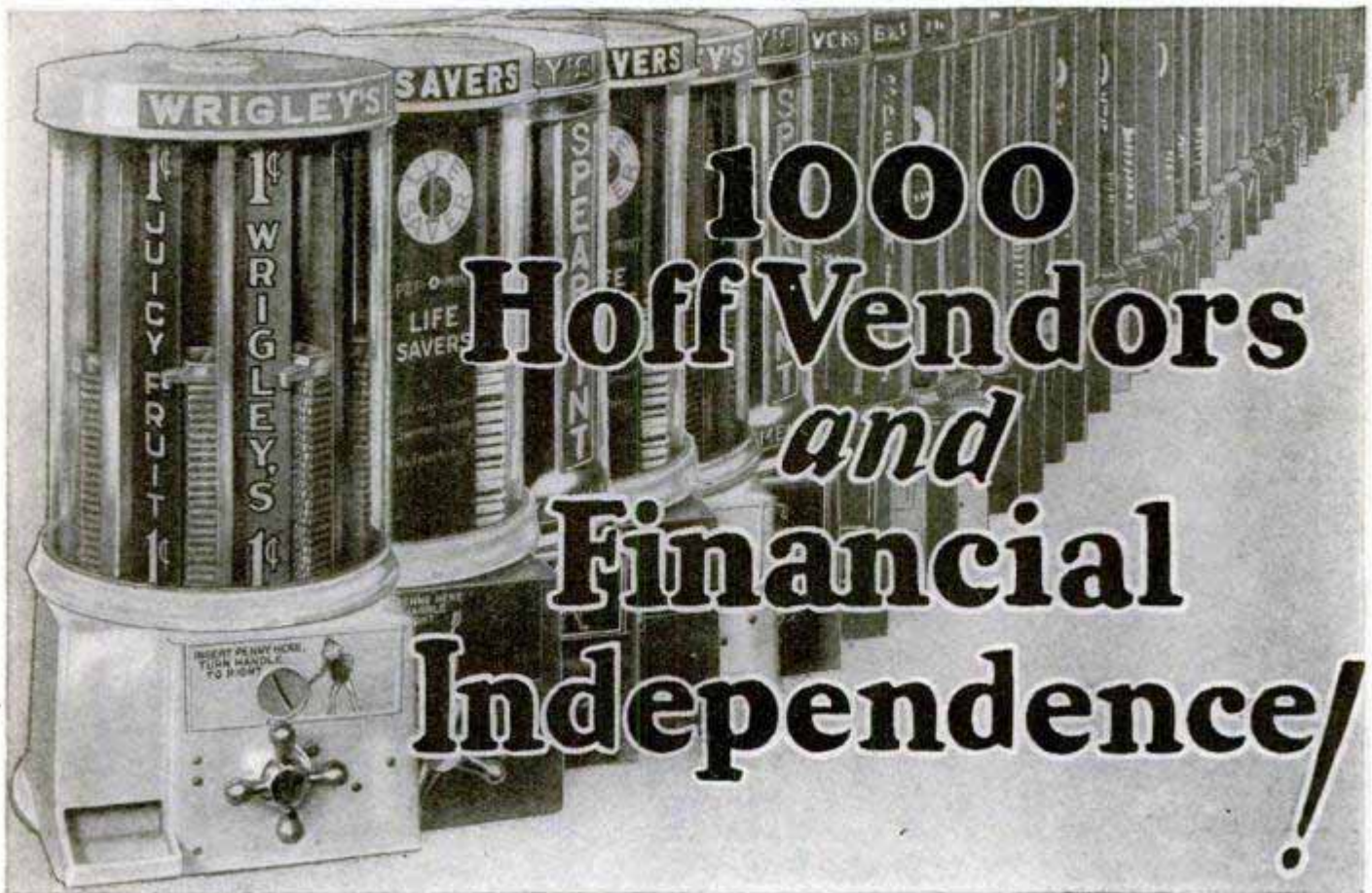

THE owner of a chain of vending machines is an independent business man whose duties are easy and pleasant, and who makes permanently, month after month and year after year, extremely high profits on a nominal investment. This statement is based on the experiences of more than 70 chain operators of Hoff Vending Machines, more than 30,000 of which are now in operation.

ENORMOUS DEMAND

The Hoff Vending Corporation of America, a division of a fifteen million dollar corporation, controls the exclusive franchise for distributing in penny vending machines two of the world's largest selling, best advertised, and most popular confections—a famous gum and a famous candy. Because of their enormous demand, monthly sales by Hoff vendors are large and steady. This demand is annually maintained and increased by enormous sums spent in advertising—during 1928 alone, more than \$7,500,000.

HIGH EARNINGS

Practical chains, consisting of from 200 to 1000 vendors, which can be easily serviced by one man or woman, show net earnings

of from \$2,820.00 to \$13,800.00 yearly. No special experience or training is required. There is little to learn. Operating expenses are practically nil. The business can be run right from one's own home. The work is easy and pleasant, and most of it out of doors.

INTERESTING BOOKLET

Full details concerning the Hoff system of Penny Vending, including earnings of vendors, franchise details, cost of machines, cost of gum and candy, and the experiences of established operators, are gladly furnished on request. Write today for our new book "1000 Hoff Vendors and Financial Independence." It gives all the facts you need to know. Write today.

HOFF VENDING CORPORATION OF AMERICA
Division of General Vending Corporation
 Dept. 16, 200 Hudson Street, New York City
Hoff Vendors awarded gold medal, Sesqui-Centennial Exposition, Philadelphia, 1926.

HOFF VENDING CORPORATION OF AMERICA,
 Dept. 16, 200 Hudson Street, New York, N. Y.
 Please send your book "1000 Hoff Vendors and Financial Independence" to the undersigned. I am looking for an unusual business opportunity.

Name.....

Address.....

.....

EASY PAYMENT PLAN

For
South Bend
Back Geared
Screw Cutting
Precision
LATHE

Weight of
9" x 3'
Jr. Lathe
375 Lbs.

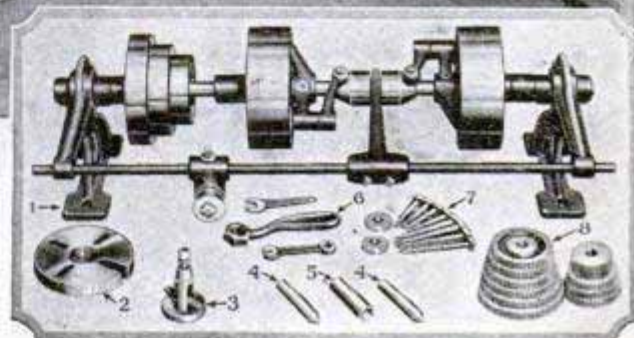
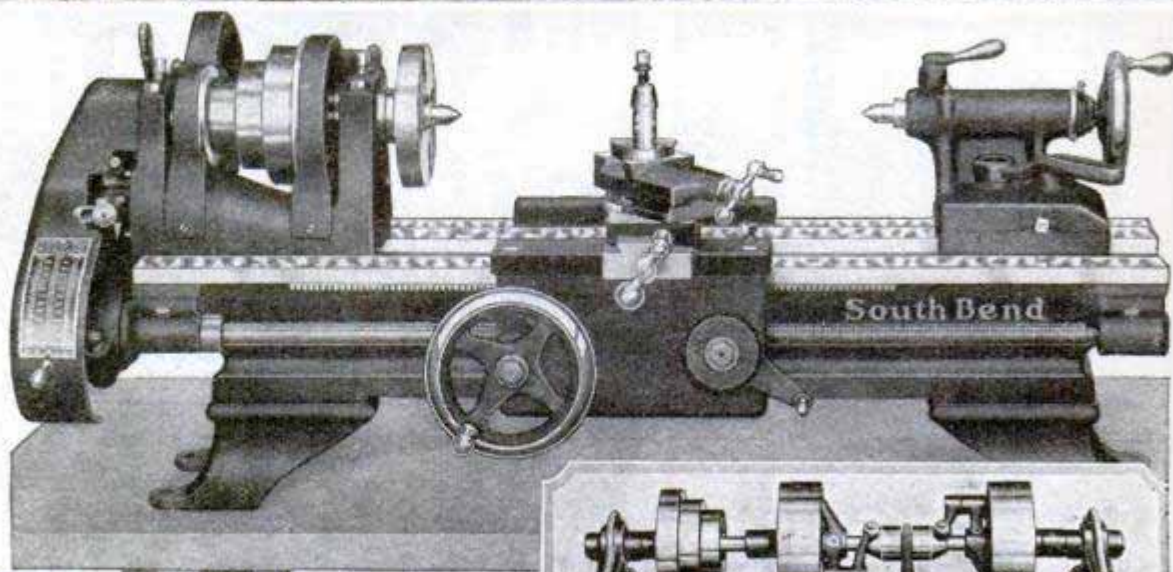

\$31⁰⁰ Down
Payment
\$12⁰⁰ Monthly
Payment

9" x 3' Junior
New Model Bench
Lathe with Counter-
shaft Drive and
Equipment **\$155**

Features & Specifications
Power Feed to Carriage
Graduated Compound Rest
Set-Over for Taper Turning
Hole through Spindle— $\frac{3}{4}$ in.
Spindle Speed—48 to 714 R. P. M.
Width of Belt—1 in.
Also furnished in three types
of Motor Drives

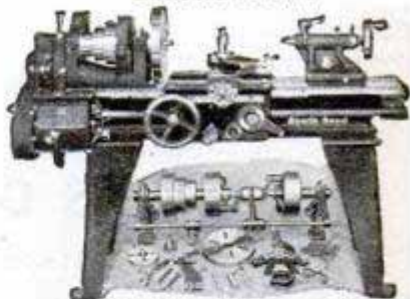

\$67.00 Down Payment
\$26.80 per Month
11" x 4' New Model Quick Change
Back Geared Screw Cutting Lathe
with Countershaft and Equipment
Price **\$325.00**

Prices and Terms of 9-Inch Junior Lathes

Size Lathe	Between Centers	Weight	Down Payment	Monthly Payment	Price Lathe
9"x2½'	11 in.	350 lbs.	\$30.00	\$12.00	\$150.00
9"x3'	18 in.	375 lbs.	31.00	12.40	155.00
9"x3½'	23 in.	400 lbs.	32.00	12.80	160.00
9"x4'	29 in.	425 lbs.	33.00	13.20	165.00
9"x4½'	36 in.	450 lbs.	34.00	13.60	170.00

As Low as \$12 Monthly Payment

You can install any South Bend Lathe by making a small payment with your order and take care of the balance in small monthly payments over a period of ten months. We ship as soon as the down payment is received.

This new Easy Payment Plan brings you the opportunity to install an income-producing LATHE at our low factory prices, and we help you finance the purchase. You get the equipment you need to give better service to your customers, and the new business should more than take care of the monthly payments.

Prices and Terms on Popular Sizes

Size of Lathe	Down Payment	Monthly Payment	Total Price
11"x4' Quick Change Gear	\$67.00	\$26.80	\$335.00
13"x5' Quick Change Gear	80.40	32.16	402.00
18"x8' Quick Change Gear	140.00	56.00	700.00
32"x5' Brake Drum Lathe	95.00	38.00	475.00
36"x6' Brake Drum Lathe	130.00	52.00	650.00



\$114 Down Payment—\$45.60 per Month
16"x8' New Model Quick Change
Screw Cutting Lathe with Countershaft and
Regular Equipment—Price **\$570.00**

Write for Free Time Payment Catalog 40

Showing 210 sizes and types of New Model South Bend Lathes with Prices, Down Payments and Monthly Payments on each size. Check below the size lathe in which you are interested.

- | | |
|--|--|
| <input type="checkbox"/> 9-inch Junior Lathe | <input type="checkbox"/> Time Payment Catalog 40 |
| <input type="checkbox"/> 9-inch Lathe | <input type="checkbox"/> 16-inch Lathe |
| <input type="checkbox"/> 11-inch Lathe | <input type="checkbox"/> 18-inch Lathe |
| <input type="checkbox"/> 13-inch Lathe | <input type="checkbox"/> Brake Drum Lathe |

SOUTH BEND LATHE WORKS

645 E. Madison St. South Bend, Ind., U. S. A.

*Lathe Builders for Twenty-Two Years
— 40,000 South Bend Lathes in Use*

**Start to play
very first day**



**Free, Easy Lessons
... 5 Days' Trial...
A Year to Pay!**

**To You Red-Blooded Fellows
Who Want MORE FUN OUT OF LIFE . .
MORE POPULARITY and BIG EXTRA-
TIME MONEY . . . This Is Good News!**

TO YOU who have so often remarked, "If only I could be as popular as some fellows," this is an opportunity. To you who a thousand times have said, "If only I could play some musical instrument," we now say, "There is no reason why you shouldn't."

Even if you can't read a note of music right now, you can, by following the free easy lessons furnished with each instrument, play a simple melody on the day you get your Xylorimba! Before you realize it, you will be playing well enough to amaze friends and relatives. Then a new life opens to you. Long, happy evenings of joy; not only invited to parties but the center of attraction—the pride of every girl and the envy of every fellow present. The thrill of having your friends listen to you over the radio! Last but not least, the same chance to earn \$5 to \$25 a night as Ralph Smith, Chicago, who says: "I played twenty minutes at a wedding—received \$20." Or the Hallmann family, Reading, Pa.—"Made \$300 in five weeks, spare time. Had never played instrument before."

We don't ask you to take our word for this. We offer to send you the

Xylorimba of your choice for five days' trial in your own home, so you can judge for yourself. See how easy it is to play. Look over the simple lessons, prepared by experts, which make a teacher unnecessary.

Keep the instrument only if you are satisfied—and then take an entire year to pay!

Was a fairer offer ever made? We make it because we want you to know the joy of creating your own music, the pleasure of being looked up to wherever you go, the profit of big extra money. Remember, this is the most fascinating of all instruments—the same make as used by national stage, radio and phonograph artists. Remember, too, you begin to play at once—no finger

or lip exercises; no teacher; no tiresome practice.

Hundreds will take advantage of this chance. Will you be one of them? The coupon will bring, without obligation, our big FREE book which tells more about this amazing offer. Send it in today!

MAIL COUPON TODAY!

J. C. Deagan, Inc., Dept. 1456, 1770 Berteau Ave., Chicago

Send me, without obligation, full details of Free Trial offer and easy payment plan on the Deagan Xylorimba.

Name.....

Address.....

**5 Days' Trial
in Your
Own Home
...
A Year to
Pay!**



Fame and Money
Broadcasting



Center of Attraction
at Gatherings



Big Money at
Dances

Replace your old radio!

Seven and a half million sets now obsolete

1928 Features

Few radios AT ANY PRICE combine ALL of these features which are absolutely essential to today's new radio reception.



AMPLIFICATION
Neurodyne 10-10-10-1000
Other systems 5-5-5-125

Crosley Radios tune efficiently

Crosley Neurodyne circuit is sharp, sensitive and selective. Distant stations are easily found. Local stations tune without squealing.



Crosley Radios are shielded

Each element shielded from each other provides maximum selectivity and is featured in the most expensively made sets.



Crosley Radios are very selective

In crowded districts where many local stations fill the air you find in Crosley radio a means of listening to ONE at a time.



Crosley Radios have great volume

Volume may be increased to tremendous proportions without distortion. This provides plenty of volume for power speakers.



Crosley Radios can be softened to a whisper

A positive volume control enables operator to cut any program down to faint and scarcely audible reception.

Crosley Radios have illuminated dials

Your set has served you well *but you will not be satisfied with its strained stringy tones when you hear a new full toned power speaker Crosley set*



\$25 New Dynamic **DYNAONE**
Amazing Speaker

6 tube **GEMBOX** \$65
AC ELECTRIC

Five Days' Free Trial in Your Own Home

Crosley originated the idea of a national policy of home demonstration. Compare a Crosley radio set with any other and you will choose the Crosley.

If you have electric current in your home, your set should be a modern AC electric receiver. A converted battery set is out of date. If you pay more than \$65 for a radio set, it should have two 171 output tubes, push-pull instead of one, eight tubes instead of seven. To be up-to-date, your new radio set should be designed to take and supply the current for a power or dynamic type of speaker. Crosley sets are so designed. Other sets designed for power speaker use are much more costly. Your set should be completely shielded and incorporate the highly sensitive, genuine, neurodyne circuit. It should have a modern illuminated dial. An examination of Crosley radio sets will show you many other modern exclusive features.

\$25.00 New Dynamic Dynacone Amazing Speaker

The Dynacone is a new revolutionary speaker at a price less than many good magnetic speakers. Crosley manufacturing speed and straight line methods permit the extremely low price.

Why Pay More Than Crosley Prices?

We urge you to listen to a Crosley radio set, try it, put it to any test you can think of. No sets that approximate Crosley prices can compare in performance. Why pay a high price for a set that can compare favorably with Crosley?

Six Tube Gembox AC Electric, \$65.00

Self-contained AC electric receiver. It utilizes two radio, detector, two audio and a rectifier tube—171 power output tube. Designed for use with the new Crosley Dynamic power speaker.

1928's greatest radio



8 tube SHOWBOX \$80

AC Electric
Genuine Neurodyne. Newly perfected audio frequency system creates marvelous tone quality. Modern illuminated dial.



8 tube JEWELBOX \$95

AC Electric
Genuine Neurodyne. Shielded coils, modern illuminated dial, highly selective and powerful.



6 tube BANDBOX \$55

Battery Type Receiver
An improved model of the 1927 receiver that led the world to better radio. Genuine Neurodyne—every modern fitting and refinement including illuminated dial.



5 tube BANDBOX Jr. \$35

Dry Cell Receiver
Operates entirely from dry cells and is especially designed where no electric current is available.



Improved MUSICONE \$15

The outstanding Magnetic type speaker available, still maintaining its leadership, today, from its inception in 1925. Improved, it is without question the greatest speaker value you can find.

CROSLLEY

When the pennant winners meet...

...You're there with a Crosley

The Crosley Radio Corporation

Powel Crosley, Jr., Pres
Cincinnati, Ohio.
Montana, Wyoming,
Colorado, New Mexico
and West, prices slightly higher.

Your name _____

Address _____

5 DAY FREE TRIAL COUPON

Mail this coupon to the factory. We want to hear from you. No money back.

Please let me try the _____
_____ with _____
I have checked it out and I am
without obligation for a trial.

JEWELBOX SHOWBOX
GEMBOX BANDBOX BANDBOX Jr.

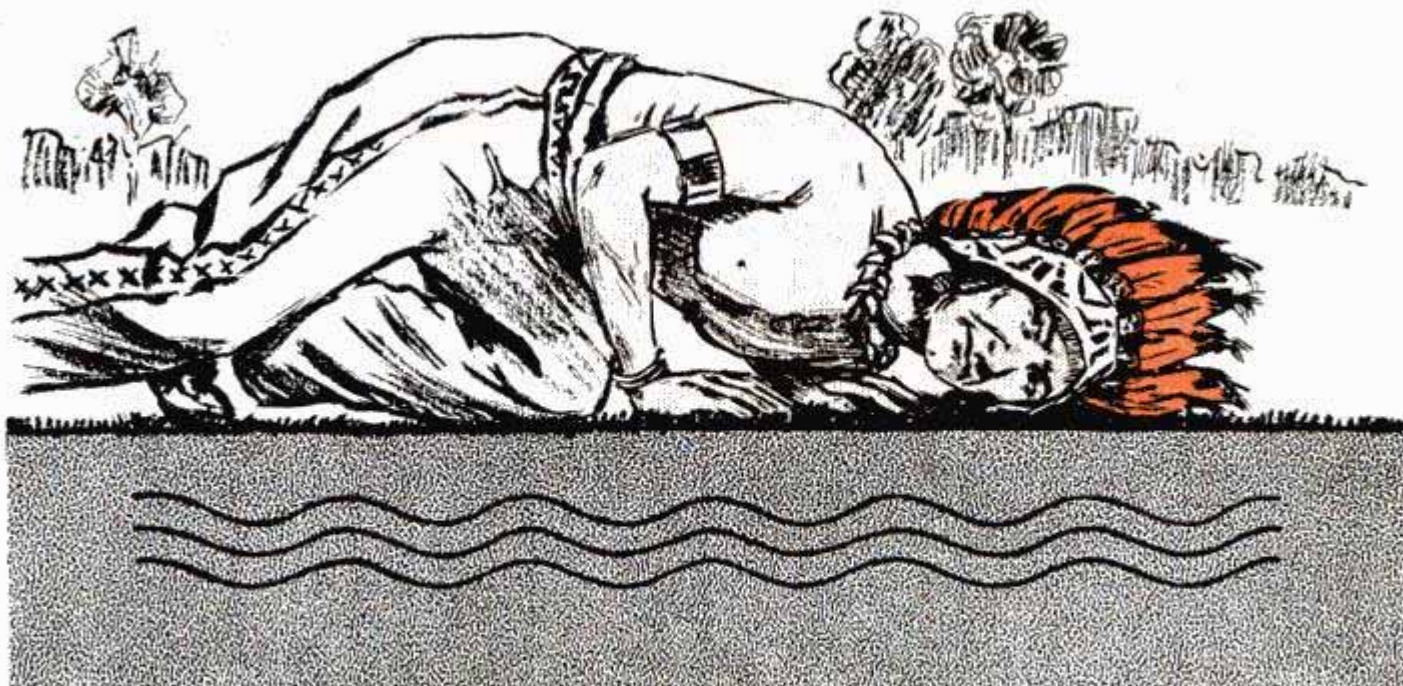

Listen in to Mother Earth's Clear "Constant Potential" **GROUND WAVES**

Even the primitive Indian knew the greater carrying power and absence of interference in sound waves transmitted through the ground. That's why he put his ear to the ground to detect the approach of prey or enemy. Radio waves are the same way—as science has long known. Ground waves are stronger, clearer, less subject to interference.

VIAGROUND, the new Radio Wave Collector, offers you science's latest development in the field of ground-wave radio reception. It gives you amazing distance, clarity and wonderful reduction of static when air waves cannot be received due to impossible air static conditions. Gives you an entirely new kind of reception in Summer, during storms, and other air disturbances.

Marvelous invention of great radio scientist

VIAGROUND is one of the remarkable achievements of Earl C. Hanson, inventor of the Piloting Cable System used in the harbors of New York, Southampton, Cherbourg and Brest for the guidance of ocean liners; also inventor of the Radio Cable System for guiding airplanes and of the Vactophone and a pioneer in Television. The Electrola and Panatrope also are based in all major respects on Hanson patents and applications.

VIAGROUND is compact, takes up no valuable space and is easily installed in a few minutes. No unsightliness as with an aerial. No lightning hazard. No reduction in

volume. Installed underground, or simply grounded, VIAGROUND taps the intensive, practically unbroken underground radio wave energy—instead of the static-laden air waves.

Improved ground reception at half the usual cost

Our exceptional manufacturing facilities and large volume enable us to offer VIAGROUND at less than you would pay for installing an unsightly roof aerial—and at half the price usually paid for an underground antenna of comparable efficiency and quality.

Try VIAGROUND on your own set, and see for yourself the amazing difference it makes in tone, distance and static reduction. Works on any set, A. C. or D. C. Your money refunded if you are not satisfied.

\$1

WITH ORDER Balance C. O. D.

If your dealer has not yet stocked VIAGROUND we will accept your order direct. VIAGROUND costs only \$5.00, f.o.b. Chicago. Furnished with 12 ft. of flexible armored cable lead-in wire. Additional lead-in wire 5c per ft. A one dollar bill brings VIAGROUND to you, balance C. O. D. Just send a dollar with the coupon below. Do this now. Clip the coupon and mail forward to you for trial.

TODAY. VIAGROUND will go forward to you for trial.

VIAGROUND

RADIO WAVE COLLECTOR

"In Tune with Mother Earth"

General Antenna Co.

4508-12 Drexel Blvd.

Chicago, Ill.

DEALERS: markedly low in price for ground antenna. Unusually attractive proposition is offered you.

Write today for full particulars

VIAGROUND will make new friends for you. Its unusually attractive proposition is offered you.

General Antenna Co., Chicago
4508-12 Drexel Blvd., Chicago
I am enclosing one dollar, balance C. O. D.—
(Total cost \$5.00 f.o.b. Chicago). Send
me VIAGROUND for trial on my set.
If I am not satisfied you agree
to refund my money. (Write
name and address
plainly in margin.)

H A V E A

C A M E L



*It's fair sailing—once you've
chosen Camels*

They're smooth and mellow-mild and their
taste as refreshing as a salt sea breeze.

CAMELS