

# POPULAR MECHANICS

## MAGAZINE

WRITTEN SO YOU CAN UNDERSTAND IT

REG. U.S. PAT. OFF.

#26

REG. U.S. PAT. OFF.

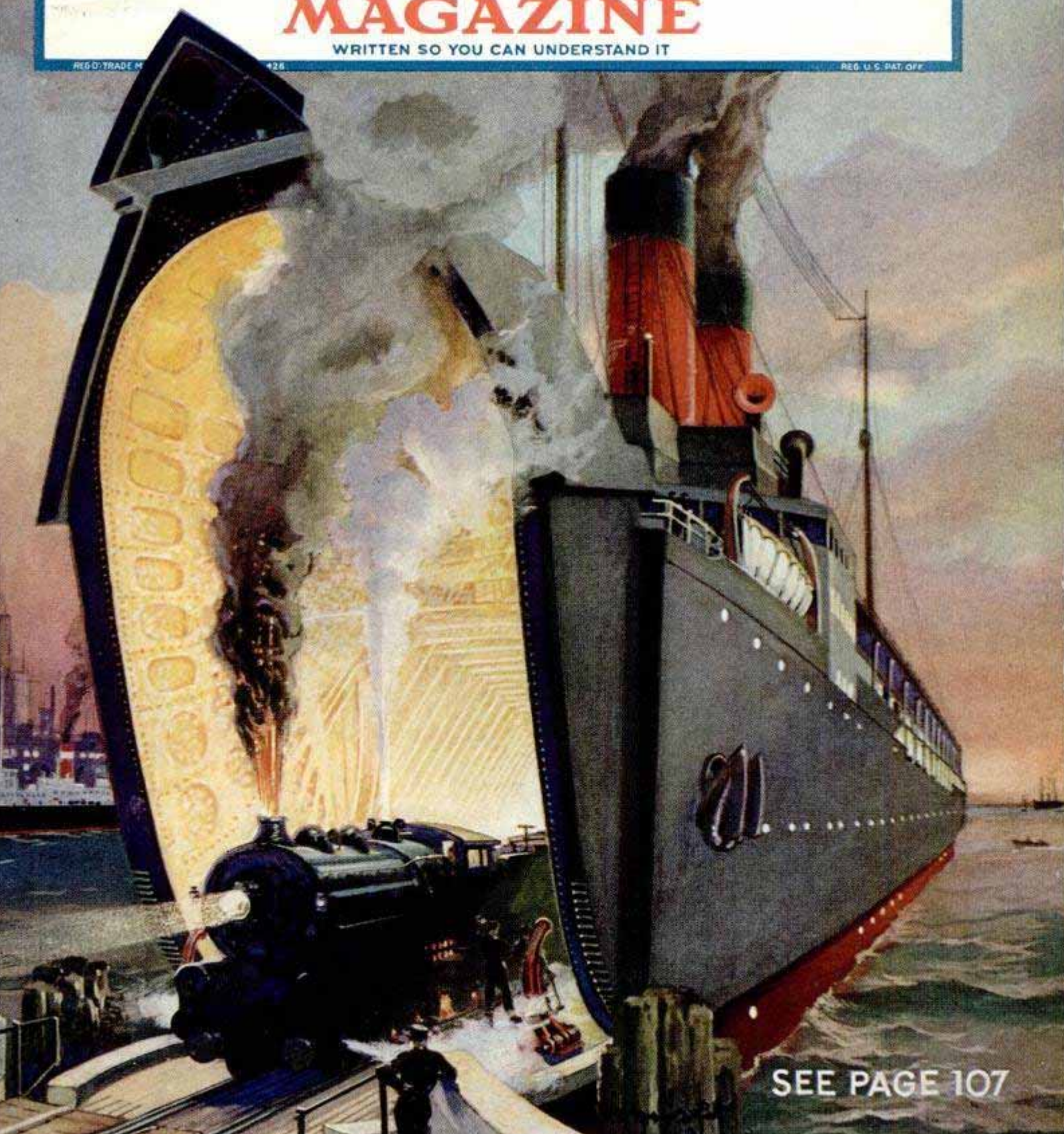

SEE PAGE 107





## In YOUR Home, or on the Job — Anywhere

*You Can Cut Metal Faster and Easier with ATKINS New "Silver Steel" Hack Saws — The Blue End Blades*

**W**HETHER you use a hack saw to build and repair things in your home workshop, or to cut metal in your daily work—you can do any metal-cutting job faster, easier and better, if you use ATKINS Silver Steel Hack Saw Blades.

These wonderful new blades actually cut **TWICE** as fast and last at least **SIX** times as long as any other blade you ever used. Think what big savings of time, money and effort this means to you.

**YOUR** Hardware Store has these ATKINS Blades, and other ATKINS Saws for cutting all kinds of wood or metal. Ask for ATKINS and accept no substitute. To get a sample hack saw blade for your frame, just tell us what metal you want to cut, and enclose 25c; we'll send you a Silver Steel Blade by return mail.

**E. C. ATKINS & CO.** *Established 1857*

426 S. Illinois St., INDIANAPOLIS, IND.



**Valuable  
Saw Books FREE**

Write us for "Saw Sense" and "Saws in the Home." Every man who has good tools should have these helpful books on Saws, their use and care. Write today —NOW.

*Leading Manufacturers of  
Highest Grade  
Saws for Every  
Use; Saw Tools,*



*Saw Specialties,  
Plastering  
Trowels, Machine  
Knives, Grinding  
Wheels and Files.*

# ATKINS SILVER STEEL SAWS



# Why "Ride" the Roof to put up an Aerial?



## SUBANTENNA

(Installed Underground)

Needs No Repairs

REDUCES STATIC

Gives Louder, Clearer DX

No need to climb that roof again—except to take down the aerial that disfigures your home. The amazing invention of the SUBANTENNA puts that clutter of sticks and wires in the discard. Risk and annoyance saved—and a better, louder, clearer tone. Static reduced even in mid-summer or during storms.

### Proof From Users

"I tune in WEA F with the Subantenna and actually have to turn down my volume control almost to a quarter away from "OFF." When I switch to the aerial, I can hear scarcely a sound." N. C. S., New Jersey.

"Last evening I got station KFI at Los Angeles which came loud and clear on the Subantenna. Changed to outdoor aerial and could not get this station at all." H. R. T., New York.

"Am located on car line with 3 transformers across street and high power wires near by. Aerial brings in distance with continuous roar. Subantenna gets Los Angeles and Charlotte, N. C.—practically coast to coast selectivity. Clear bell-like tones." W. J. P., Texas.



Installed in  
5 Minutes



### Uses Static-Free Ground Waves

The secret of the wonderful volume and clarity of tones obtained with Subantenna lies in the fact that it is installed underground. The same broadcast waves travel through the ground as through the air but contain less static and are affected less by disturbing noises. Subantenna receives these ground waves and transmits every note pure and audible. Even sounds from far distant stations seem as clear as those from locals heard over the aerial.

Thousands of tests made by users everywhere comparing Subantenna with the aerial have established the superiority of this amazing underground device beyond question—and on our free trial offer, you can have the privilege of making your own test on your own set at our risk.

### Removes Lightning Danger

Subantenna not only gives better selectivity and stronger tones, but safety from accidents possible on a steep or slippery roof and from lightning. An aerial can carry a lightning bolt into the house. With the Subantenna, the current would go into the ground.

### Use It With Any Type of Set

No matter what type or make of set you have, Subantenna will work perfectly with it. And it takes only about 5 minutes to install it. Then your aerial troubles and your roof climbing are over, for Subantenna, sealed in a permanent container, needs no attention, no repairs.

## Free Trial Offer

Try Subantenna at our risk. Install it and make comparison with aerial by switching from one to the other. Do this under the most trying conditions. If you don't find that Subantenna gives greater distance, volume, loudness and clarity the test is free. Obtain a Subantenna from your dealer, or send the coupon for complete scientific explanation of Subantenna and particulars of our Free Trial Offer.

**CLOVERLEAF MFG. CO.**  
2714-R Canal St. CHICAGO

**MAIL THIS COUPON TODAY**

Cloverleaf Mfg. Co.,  
2714-R Canal St., Chicago.

Tell me all about SUBANTENNA, your unqualified guarantee and FREE TRIAL OFFER.

Name .....

Address .....





## Telephone service, a public trust

*An Advertisement of the  
American Telephone and Telegraph Company*

THE widespread ownership of the Bell Telephone System places an obligation on its management to guard the savings of its hundreds of thousands of stockholders.

Its responsibility for so large a part of the country's telephone service imposes an obligation that the service shall always be adequate, dependable and satisfactory to the user.

The only sound policy that will meet these obligations is to continue to furnish the best possible service at the lowest cost consistent with financial safety.

There is then in the Bell System no



incentive to earn speculative or large profits. Earnings must be sufficient to assure the best possible service and the financial integrity of the business. Anything in excess of these requirements goes toward extending the service or keeping down the rates.

This is fundamental in the policy of the company.

The Bell System's ideal is the same as that of the public it serves—the most telephone service and the best, at the least cost to the user. It accepts its responsibility for a nation-wide telephone service as a public trust.



# Popular Mechanics Magazine

200 E. Ontario Street, Chicago, U. S. A.

H. H. WINDSOR, Founder

H. H. WINDSOR, Jr., Editor and Publisher

London: Hachette & Cie.,  
17 King William Street, Charing Cross, W. C. 2

Paris: Hachette & Cie.,  
111 Rue Reaumur

Melbourne: Gordon & Gotch  
509-513 Little Collins St.

ISSUED MONTHLY

SUBSCRIPTION:

SINGLE COPY, 25 CENTS

In United States and its possessions, also Canada, Cuba, and Mexico, per year, postpaid - \$2.50

To all other countries in the Postal Union - 3.00

All subscriptions are discontinued at expiration. Please examine the date printed on your wrapper.

Entered as Second Class Matter Sept. 15, 1908, at the Post Office at Chicago, Illinois, under Act of March 3rd, 1879.

Entered as Second Class Matter at the Post Office Department, Canada.

Published monthly by POPULAR MECHANICS CO.

Copyright, 1928, by Popular Mechanics Co.

Copyright in Australia. Copyright in France

Vol. 50

Contents for July, 1928

No. 1

## Special Features

Aviation	18		
Secrets of the Great Smokies	26		
Diving for Sea Food	35		
Life from an Oil Well	43		
Work with the Air Patrol	50		
New Magic in Treasure Hunting	58	Color Blind	19
Work with Uncle Sam's Devil Dogs	67		
Fire Fighting Underground	75		
Was the Garden of Eden in America?	82		
Food Treated by Ultraviolet Rays	91	Cutter, Hole	43
The Mystery of Bird Migration	99		
Auto Window		Hand Hole	12
Advertising		Bookkeeper—mechanical	105
aided by signs set in flashing jewels	56	Burglar Alarm	
latest aid is truck with revolving signs	81	bell on doorknob	95
pictures thrown onto clouds for	106	sound waves set off	78
Airplanes—latest navy amphibian carries guns and bombs	80	Carpet—holder for stair, saves cleaning time	63
anaemia—copper shown as preventive by rat tests	64	Clippings—cutter for is substitute for shears	42
tunnels—tunnel 65 feet to reach water supply	89	Clock—animals' eyes tell time on novelty	31
Army, Russian—soldiers on wheels to fight in gas masks	95	Dogs—tested by walking wheel	24
Astronomy—model moon carved in plaster	96	Drums—grip for metal, to prevent accidents	45
Automobiles		Dyeing—indelible crayons simplify	89
car run like rocket develops high speed	42	Eyes—rested after strain by picture chart	49
tiger face features hunting car	62	Fatigue—treadmill test for athletes aids study	79
Automobiles—Accessories		Ferry—ship that swallows trains used as	107
casing of shock absorber is moisture-proof	96	Fire Escape—wall-gripping ladder prevents swaying	40
cord control of rear shade for driver	34	Fire Fighting	
folding luggage trunk holds big load	17	automatic hand extinguisher will not damage goods	96
permanent jacks simplify repairs	106	oxygen tube in hose to help save lives	112
springs on tilting seat add to comfort	40	Floods—concrete mats to prevent Mississippi river	45
Automobiles—Driving—light-colored clothes help at night	105	Floor Surfacers—sands edges saving hand labor	109
Automobiles—Tires		Garage—Accessories—hand-size brake tester	64
meter shows pressure while inflating	42	Golf	
red dot guides in balancing	33	ball retriever saves loss	17
Aviation		coin-in-slot games test skill	88
France honors Lilienthal with museum model	39	guide teaches putting	80
lighted airplane targets aid night shooting	78	indoor game played with cards	90
paraffin oil on airplane wings prevents ice formation	32	press for clubs keeps shafts from bending	57
portable searchlight helps planes land	41	Hafnium—found in sun	33
Baby Carriage—motor, saves nurse maid walking	23	Highway—automobile, on canyon wall	114
Bank		Hose	
target drill for clerks helps curb robbers	66	garden, holder saves steps	64
vault open from inside to foil robbers	74	garden, oval-shaped washer prevents loss	90
Basket-Weaving—where human beings serve as burden carriers	46	Hotel—stranded on old street level	23
Bass Viol—made of aluminum is warp proof	47	Household Devices	110
Boats and Boating		House Plan	176
boat leaps 35 feet in motor test	32	Ice	
retarder on outboard motor slows speed for trolling	89	automatic shaver cuts cost of drinks	31
		machine for tourists run by auto	24
		Ice Cream—stand like igloo	47
		Ironing Board—on bed springs saves space	74
		Jewels—fifty centuries old found in queen's tomb	55
		Key—with bottle-opener top	73

[Continued on Page 4]

*Hose nozzle holds soap* *Brush Steel Wood Scrub*



Kindling—cubes for campers simplify starting fires	113	Tumblers—easy tricks with	115
Lightning		Typewriting Supplies—light for keys and copy	55
artificial, sets new record with flash	66	Vapor Bath—portable, for face, latest beauty aid	113
safest spot, when strikes	62	Wall Paper—steam remover also cleans surface	81
Lock—keyless, helps prevent theft	25	Water-Filter—tractor cleaner for	40
Locomotives—direct steaming ends smoke evil	63	Weather—rings of trees to solve mysteries	48
Maps—folding, for autoists easy to handle	109	Whales—value of	90
Mineral—mystery, curbs fire and prevents rust	95	Wheat—grown in thirteen weeks under electric lights	57
Models		Windows	
marvels of mechanical age explained in exhibit	34	one-way	61
miniature flying field built for planes	57	washed from the inside with spring swab	114
Mousetrap—fruit-jar top, is always set	41		
Moving Pictures			
film nightmares get zest from distortograph	112		
puzzle of wheels solved by painting	41		
"shooting" thrilling fire rescues	108		
Oil Well—time bomb reduces hazard	17		
Pads—felt, keep glass table tops in place	49		
Photography			
"mirror" effect obtained on dry days	63		
rapid printer helps political campaign	33		
Plants			
effect of electric lights on growth	25		
roots as miners	80		
Pulse—visible record taken with electricity	39		
Radio			
cause of hum in A. C. sets	132		
cleaning the soldering iron	135		
handy tone and volume control	124		
handy tool for set builder	133		
new socket of universal type	136		
Radio—Adapter—compact short-wave	131		
Radio—Aerial			
new, easily installed	126		
pipe lengths for masts	136		
Radio—Applications—amplifier for phone aids deaf	32		
Radio—Batteries			
auto generator for	132		
building an Edison-type B	127		
correct grid bias saves	126		
vibrator charger changed to tungar	135		
Radio—Condenser—low-loss midjet	124		
Radio—Installation—worth-while hints on wiring	136		
Radio—Loud Speaker			
artistically designed	131		
compact exponential-type	126		
in colonial type tilting table	124		
using two or more	134		
Radio—Pictorial	125		
Radio—Receiver—in loud speaker	133		
Radio—Reception—extra grounds bring DX record	132		
Radio—Repairs—drum, hums and crackles	121		
Radio—Transformers—iron-core R. F.	134		
Radio—Tubes			
detector, kinks	131		
glow, often cause hum	124		
homemade filament-control units from old rheostats	126		
look out for bad	136		
new, has five elements	124		
protecting filaments	135		
testing amplifier	133		
Rivers—hidden, explained by nature of soil	34		
Salvage—Ford's junk pile is grave of many ships	56		
Shaving Supplies—dispenser for cream promotes sanitation	79		
Ship Models—knockdown yacht easily assembled	62		
Ships and Shipping			
model of four-day liner tested	25		
ships fitted with two rudders to steer backward	39		
speed and distance registered by meter	73		
speed tested with models	65		
Siphon—keeps carbonated beverages fresh	95		
Snowplow—double-motored, clears Swiss roads	104		
Soil—simple testing outfit to improve lawns	94		
Spraying—automobile runs outfit to save extra pump	47		
Steel—nitrated, to improve automobiles	31		
Steel Wool—scrub brush simplifies cleaning pans	25		
Sugar—hunt cane by airplane to increase U. S. yield	74		
Sundial—pocket, with compass for hikers	56		
Surface Car—like motor bus makes less noise	96		
Target—flags score automatically	33		
Target Practice—for bank clerks helps curb robbers	66		
Tear Gas—traps murderers in jungle valley	23		
Telephone—life of, tested with phonograph	105		
Thermometer—of fused-quartz registers extreme heat	94		
Tools—hole cutter for electrician	73		
Toothbrush—adjustable, gives better cleaning	73		
Tower—of Charlemagne falls into ruins	97		
Traffic—autos stopped at crossing by touch of button	97		
Transom—adjusted to chain and locked	42		
Trees—fruit, ice packed around to foil frostbite	47		

## AMATEUR MECHANICS

Automobiles—carrying outboard motor	157
Automobiles—Repairs	
anti-rattlers for hoods	146
cure for rattling of brake rods	145
removing stubborn headlight rims	157
Automobiles—Tires—homemade spreader	154
Bearings—replacing ball retainers	140
Bicycle—how to make a coaster	145
Chairs—new dowels in	142
Cleaning—effective cleaner for fabrics	142
Corn—improvised planter works quickly and saves stooping	154
Drawing Table—attached to door	143
Electric Lights—reflector made of tinfoil	141
Electric Meter—cabinet to hide	158
Fertilizer—spray gun for	142
Fish and Fishing—checking boat speed for trolling	144
Flashlight—holder for	157
Flowerpots—how to hold on shelves	143
Gears—pulling tight	140
Hats—how to prevent sweat marks on felt	140
Hose—garden, sturdy support for nozzle	141
Jewel Trees—how to make	137
Lanterns, gasoline—carrying case for	158
Lawn—easily made concrete roller	154
Linotype—holder for ejector blades	139
Locks—repairing	141
Paints and Painting—stenciling with lacquer	147
Plaster of Paris—kinks for using	153
Pump—guard prevents splashing	145
Rain Gutters—protection against clogged	157
Saxophone—proper care of	158
"Shadow-Sketching"—as a pastime	146
Ship Models—wave cradle for	140
Stove, gas—improving the oven	144
Tools—homemade beading	144
Toothpaste—key deflates tubes	153
Truck—wheeled, for home moving	141
Valuables—secret compartment for	146
Water Wings—made from rubber balls	143
Wick—removing from oil stove	142
Windmill—"Tim Turner"	155

## SHOP NOTES

Advertising—motion sign for printer	164
Automobiles—trucks for unloading	162
Automobiles—Repairs—making brake bands round	172
Belt—shifter installed on lineshaft	173
Blowtorch	
cleaning nozzle	172
paint-removing fitting for	174
Cable—stand for linemen	172
Chuck—simple magnetic	174
Fence	
old boiler flues used as posts	173
tool for driving posts	164
Garage—build your own	165
Iron, Sheet—cutting and bending	161
Linotype—burr remover for matrices	160
Oil—draining from wooden barrels	164
Photography—focusing cloth for windy days	174
Piano—re-gluing ivory tops of keys	175
Pipes—closing small leaks in fittings	164
Printing—casting box for printers	173
Railroads—permanent stop sign on tracks	171
Rock Drill—counterweight for electric	171
Tape Line—holder for the stock room saves time and material	161
Telegraph—getting line over flooded river	161
Torch—to illuminate writing pad	163
Tractor—to prevent rising	171
Trees—help for the trimmer	163
Valves—grinding kink	172
Watch—keeping clean	174
Woodwork—to keep white fresh	163
Workshop—handy and compact home	159

*Cracker (Nestor)*  
*Bucket 15*  
*Yacht 6*  
*Orange Casings 49*



# DRAKE'S PRACTICAL MECHANICAL BOOKS

## THEY WILL RAISE YOUR PAY—

### ORDER ON 5-DAY TRIAL

The books listed below will perfect you in your chosen trade—pave the way to the big positions. Written in non-technical language—easy to read and understand. Every book covers its subject completely. An entire course of instruction condensed into one volume. Your choice sent postpaid—you benefit 5 days—money refunded in full if not entirely satisfactory. Order direct from this page.



#### Automobile Books

- Automobile Starting, Lighting and Ignition, by Manly... 700 pp. \$3.00
- Brookes' Automobile Handbook... \$2.00
- Ford Motor Car, Truck and Tractor, by Manly... Cloth \$1.50
- Auto and Radio Battery, Care and Repair, by Manly... Leatherette \$2.00
- Motorcycle Handbook, by Manly... \$1.50

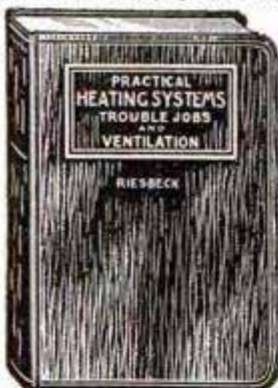

#### Shop Practice Books

- Practical Heating Systems, Trouble Jobs and Ventilation... \$4.00
- Sheet Metal Workers' Manual... \$2.00
- Oxy-Acetylene Welding and Cutting... Cloth \$1.25
- Slide Rule and Logarithmic Tables... \$2.00
- Handbook for Millwrights... Cloth \$2.00
- Machine Shop Practice... Cloth \$2.00
- Mechanical Drawing and Machine Design... Cloth \$2.00

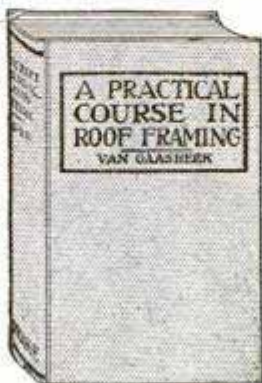

#### Carpentry Books

- Cloth Binding
- Modern Carpentry, 2 vols... \$3.00
  - The Steel Square, 2 vols... \$3.00
  - Modern Estimator... \$1.50
  - Timber Framing... \$2.00
  - Builders' Architectural Drawing... \$2.00
  - Concretes... \$1.50
  - Practical Bungalows... \$1.00
  - Roof Framing, by Van Gaasbeek... \$1.50

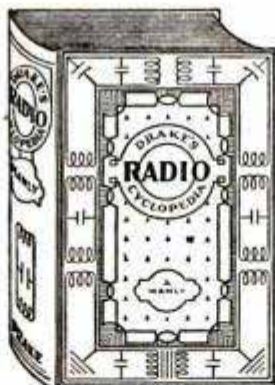

#### Drake's Radio Cyclopedia

By H. P. Manly

870 Pages, 985 Illustrations, 1700 Subjects, arranged alphabetically. For Service and Repair Men, Dealers, Salesmen, Experimenters and Designers. Bound in Art Buckram. Price... \$6.00



#### Painting and Decorating

- Furniture, Furniture Finishing, Decoration and Patching... \$5.00
- Ross Crane Book of Home Furnishing and Decoration... Cloth \$3.00
- House Painting Methods with the Brush and Spray Gun, by Vanderwalker... Cloth \$2.00
- Interior Wall Decoration, by Vanderwalker... Leatherette \$4.00
- The Mixing of Colors and Paints, by Vanderwalker... Cloth \$2.00
- Studio Handbook—Letter and Design... \$3.00
- A Show at Sho' Cards... Cloth \$4.00
- Sign Painting, by Atkinson... Cloth \$4.00
- Strong's Book of Designs, Leatherette \$4.00
- Modern Painters' Cyclopedia... Cloth \$2.00
- Automobile Painting... Cloth \$1.50
- New Hardwood Finishing... Cloth \$1.50
- Wood Finishing, Plain and Decorative... Cloth \$2.00
- Owen's Paint Guide... Cloth \$1.00

#### Steam Engineering

- Swingle's Handbook for Steam Engineers and Electricians... Leatherette \$4.00
- Examination Questions and Answers for Marine and Stationary Engineers... Leatherette \$2.00
- Steam Boilers... Leatherette \$2.00
- Swingle's Catechism of Steam, Gas and Electrical Engineering... Leatherette \$1.50

#### Modern Languages

- By Prof. P. S. Allen, U. of Chicago
- French without a Teacher... Cloth \$1.25
  - Spanish without a Teacher... Cloth \$1.25
  - German without a Teacher... Cloth \$1.25
  - Everyday French... \$1.25
  - Everyday Spanish... \$1.25

### ORDER DIRECT FROM THIS PAGE — ON OUR MONEY-BACK PLAN

The books listed above are only a few of the many in our catalogue, which you will receive promptly after filling out and mailing us the attached coupon. For quick action order direct from this page—cross name of each book wanted and send in with price quoted. We prepay postage and send the books on our money-back plan.

## FREDERICK J. DRAKE & CO.

Publishers

R508—179 No. Michigan Ave. CHICAGO

Drake Books Are For Sale at All Book Stores

**FREDERICK J. DRAKE & CO.**  
R508—179 No. Michigan Avenue  
Chicago, Ill.

GENTLEMEN:—Please send me free, postage paid, your illustrated catalogue which lists and describes 200 Practical Mechanical Books for Home Study.

My

This One

and

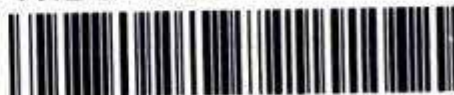

YUYX-A7D-6Q1X

Mail Coupon For Free Catalogue  
Your Guide to Home Study



# How dare you say, "I have no opportunity"

—when men, through home-study training, are making records such as these?



*Harry J. Williams, Accounting Engineer, Lehigh Valley R. R. Mr. Williams chose the Accountancy route, and within comparatively few months won a 60 per cent "raise" and promotion to a position that spells opportunity.*



*Ralph H. Berndt, Treasurer and General Manager, W. C. DuComb Co., Inc., Detroit. "LaSalle has been the instrument to my success."*



*Charles W. Sheldon, Sheridan, Wyoming. At forty Mr. Sheldon, then telegrapher and station agent on the C. B. & Q., left railroad work and took up selling. He increased his income 500 per cent.*

**Y**OU seek a better opportunity to get ahead in business—and you want a definite program for advancement, backed by positive proof that that program *works!*

Listen, then, to these actual experiences—and when you have heard them, tell us, if you can, how you *dare* to say, "I have no opportunity!"

## Mill Man Becomes Auditor—then Treasurer and General Manager

At sixteen, Ralph H. Berndt—his schooling ended with the eighth grade—entered the Carnegie Union Steel Mills.

Six years later he was assistant roller—drawing good wages and with prospect of promotion.

Looking ahead, however, he saw himself "an old man at fifty—and with nothing then to look forward to but retirement and probable poverty."

He writes, "I decided to give my brain a business training. Accordingly, I enrolled with LaSalle for home-study training, gave up the mills forever, and made a humble start in my new profession."

His apprenticeship was short. An opening came with W. C. DuComb Co., Inc., Detroit, as Accountant, then Auditor! Raise followed raise.

In 1925 he was made Treasurer and General Manager, and so highly does he value his LaSalle training that he is now on his second course—in Business Management.

## Clerk Becomes Accounting Engineer—Wins 60% Raise

"You've picked a blind alley." That was what many good friends of Harry J. Williams thought when he took a job as clerk with the Lehigh Valley Railroad.

"Blind for some, perhaps," said Harry Williams, "but not for the man with the specialized training!"

Acting on his conviction, he enrolled with LaSalle

for Higher Accountancy training—and soon won the position of Accounting Engineer, with an increase in salary of better than 60 per cent.

"Mr. Williams proves exceptionally competent in his new capacity," writes Francis N. Loughnane, Division Engineer. "He shows marked ability and is a very creditable product of your great university."

## Send for These Free Books

You will find it of vital importance to learn more of the success-methods which Berndt and Williams and thousands of others have employed so profitably.

We have therefore prepared a special 64-page book which outlines these methods in detail. It also points out the big opportunities in the field you are in or wish to enter—shows you how you can fit yourself to grasp them. The coupon brings it to you *free*.

Measure your will to succeed by what you do with this coupon—NOW!

— — — — Find Yourself Through LaSalle! — — — —

## LaSalle Extension University

The World's Largest Business Training Institution

Dept. 764-R

Chicago

I would welcome an outline of the LaSalle plan, together with a copy of "Ten Years' Promotion in One," all without obligation.

- Business Management
- Modern Salesmanship
- Higher Accountancy
- Traffic Management
- Railway Station Management
- Law: Degree of LL. B.
- Commercial Law
- Industrial Management
- Modern Business Correspondence
- Credit and Collection Correspondence
- Telegraphy

- Banking and Finance
- Modern Foremanship
- Personnel Management
- Expert Bookkeeping
- Business English
- Commercial Spanish
- Effective Speaking
- C. P. A. Coaching
- Stenotypy—Stenography



Name.....

Present Position.....

Address.....



# BUILDERS TRADE GUIDES

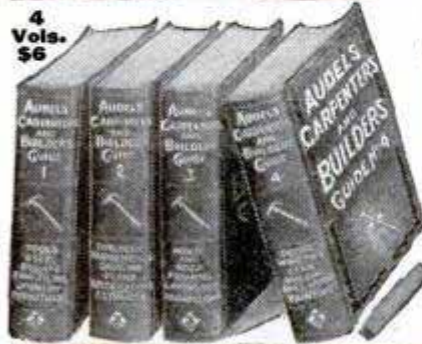

4 Vols. \$6

## AUDELS CARPENTERS AND BUILDERS GUIDES—4 VOLS. \$6

Inside Information for Carpenters, Builders, Joiners, Building Mechanics—all Woodworkers. **1600 pages; 3700 diagrams; flexible; pocket size.** Short-cut instructions, new methods, ideas, solutions, plans, systems—money saving suggestions. An easy progressive course for the apprentice. A practical daily helper and Quick Reference for the master worker. A Helping Hand to Easier and Better Work and Better Pay. To get this aid for yourself, simply fill in and mail the FREE COUPON below.

**INSIDE TRADE INFORMATION ON:**  
 How to use steel square; How to file and set saws; How to build furniture; How to use mitre box; How to use chalk line; How to use rules; How to make joints; Carpenters' arithmetic; Mensuration problems; Estimating strength of timbers; How to set girders and sills; How to frame houses and roofs; How to estimate costs; How to build houses, barns, garages, bungalows, etc.; How to read and draw plans; Drawing up specifications; How to excavate; How to use settings 12, 13 and 17 on the steel square; How to build holts and scaffolds—skylights; How to build stairs; How to put on interior trim; How to hang doors; How to lath—lay floors; How to paint.



"Audels Guides worth four times their price—handy too as I carry them in pocket for reference." W. J. Bates, Knoxville, Pa.



4 Vols. \$6

## AUDELS PLUMBERS AND STEAMFITTERS GUIDES—4 VOLS. \$6

A new set—just out! A practical, illustrated, Reference Library and Study-Course for Master Plumbers, Journeymen and Apprentice Steamfitters, Gas Fitters and Helpers, Sheet Metal Workers, Draughtsmen, Master Builders, Engineers and all Building Trade Students. **1670 pages; 3642 diagrams; flexible; pocket size.** Guides explain all the principles, advances and short cuts of the Plumbing and Heating trade. Contains instructions on how to figure and estimate jobs. Use FREE COUPON below to examine, without obligation, this valuable work.

**INSIDE TRADE INFORMATION ON:**  
 Soldering, tinning. Joint wiping, bending, beating. Pipe—iron—steel, threading. Mathematics, tables, physics. Materials—iron, steel, copper, brass, lead, tin, antimony. Sheet metal—galvanized—plate. Sanitation, syphonage, tanks. Drainage, sewage, purification. Fixtures—bath—kitchen. Pipe fittings, soil pipe, toilets. Laying out work. Roughing. Screwed fittings, flanges, joints. Pipe bending, examples. Elbows. Heating, ventilation, refrigeration. Water supply, mains, wells, tanks. Gas-fittings. Underwriters. Sheet metal work, problems, methods. Brazing, heating, lead burning. Welding, various welds, methods. Blacksmithing, forges, tools.



"Audels Guides are practical, easy to understand, reliable. Cover the field in plain language." W.F. Arminger, Annapolis, Md.

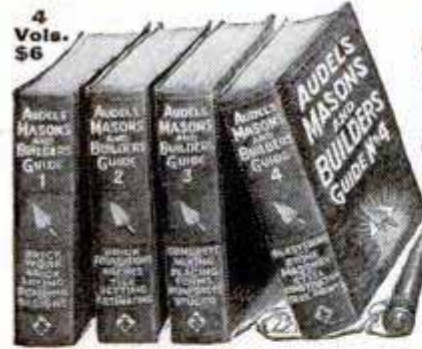

4 Vols. \$6

## AUDELS MASONS AND BUILDERS GUIDES—4 VOLS. \$6

A new, complete, illustrated trade reference library, for Bricklayers, Cement Workers, Plasterers, Tile Setters and Stone Masons, including a practical outline of Steel Construction. **1100 pages; 2067 diagrams; flexible; pocket size.** A practical Trade Assistant explaining modern methods of masonry construction. Easy to understand and apply. A reliable and authentic reference work and study-course for Master Journeyman and Young Mechanic. Use FREE COUPON below and find out for yourself, without obligation, whether this set will benefit you.

**INSIDE TRADE INFORMATION ON:**  
 Bricklaying, tools, materials; Brick designs, patterns, bonds; Setting frames and foundations; Mortars, scaffolds, estimating; Mortars and mortar mixing; Tile setting, mosaic, hollow tile; Straight edge test, troweling; How to figure brick work; Safe loads, piers, chimneys; Boiler settings, anchors, fire stops; Labor tables; Concrete, forms; How to figure concrete work; Stucco—on old and new buildings; Plastering — wood lath — metal; Plasterers agreement; Plastering on various surfaces; Stonemasonry; Cutting, finishing, estimating stone; Derricks, rigging; Stee construction; Fire proof; How to read blue prints.



"Audels Masons Guides are the best books on the subject. Have laid brick 12 years and am able to judge." H.A. Sonnett, Corliss, Pa.

## PRACTICAL ELECTRICITY — 1 VOL. \$4

Audels Handy Book of Practical Electricity is a simplified Ready Reference and Study Course in one pocket size, leather bound volume—for Engineers, Professional Electricians and Students. **1040 pages; 2600 diagrams; flexible red leather bound.** A reliable authority and handy helper for every electrical worker. Contains important and valuable wiring diagrams, calculations, machine sketches, helps on maintenance and repair. Use this FREE COUPON today and find out, without obligation, how this handy book will help you in your daily work.



Complete in one handy, red leather bound volume

1040 Pages 2600 Diagrams

### INSIDE TRADE INFORMATION ON:

Electro-Therapeutics, X-Rays, Shocks, Welding, Brazing, Radio Hook-ups, Motion Pictures, Telephone, Telegraph, Cranes, Bells, Elevators, Pumps, Tools, Ship Drive, Railways, Vehicles, Automobile Electric Systems, Ignition, Generation, Lighting, Plant Management, Power Plans, Armature Winding, Repairing, A. C. Motors and Apparatus, D. C. Motors and Apparatus, Alternator Construction, Dynamos, Wiring Diagrams, Sign Flashers, Cable Splicing, Power Wiring, Outside Wiring, Switches, Lighting, Rectifiers, Converters, Transformers, Fuses, Circuit Breakers, Rheostats, Electro Plating, Electrolysis, Storage Batteries, Magnetism, Electrical Energy, Conductors, Insulators, Static, Dynamic, Radio Electricity, Applications, Ready Reference and Index Covering the entire field of Modern Electricity.

## Learn More and You Will Earn More!

Know your job and you'll never be without one. The skilled man is always in demand. Knowledge is power. Learn your trade thoroughly by easy reading. This coupon is your opportunity for advancement and better pay. You risk nothing in sending for Audels Guides for free examination. Send it NOW!

**FREE EXAMINATION COUPON**

**THEO. AUDEL & CO.,**  
 65 W. 23 ST., NEW YORK CITY

Please mail me for free examination the books marked (x) below. If I find them satisfactory, I agree to mail \$1 in 7 days, on each set ordered, and to further mail \$1 monthly on each set until I have paid the purchase price.

4 CARPENTERS GUIDES \$6 |  4 PLUMBERS GUIDES \$6

4 MASONS GUIDES \$6 |  1 ELECTRICIANS HANDY BOOK \$4

NAME .....

ADDRESS .....

OCCUPATION .....

EMPLOYED BY..... 7T30



# Now Free

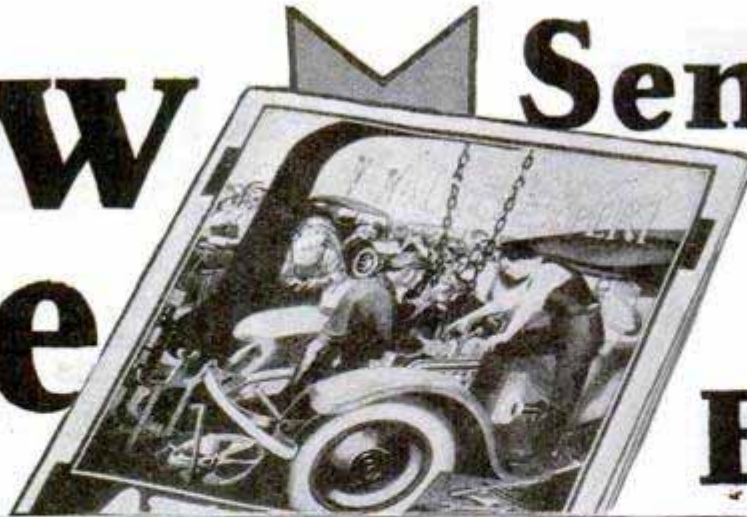

# Send for this New Book

# LEARN AUTOS

## Earn up to \$100 a WEEK

Say goodbye to low pay. Get into the Auto Business, where big pay—extra money—raises come quick! A brilliant future awaits you in the World's Biggest Business. If you're earning a cent less than \$60 a week, clip that coupon. Learn how \$50—\$75—even \$100 a week is possible for you now! Find out about this training which boosted Yancy of Perla, Ark., from \$30 a week up to \$90!

### OPEN YOUR OWN AUTO SHOP

My Free Book tells how men make extra money while training, and then go into business with no further Capital. It's the Training that counts, and it is complete training that I give you.

### Common Schooling ALL YOU NEED

Men between 15 and 60, with very little education, are becoming Garage Owners, Superintendents, Foremen. Whether you have had years of Auto Experience, or never touched a car before, send for this Free Book Now. I'll show you the quick way to get in line for real success in the Auto Business.



# AT HOME!

Send coupon for Free Auto Book. See how I train you right at home, in every branch of Auto work—Learn how I prepare you, quickly and easily, for the Big Jobs, paying up to \$100 a week and more. "Job-Way" Training includes all Mechanical and Electrical work—Starting, Lighting, Ignition — also Welding, Brazing, Vulcanizing—everything you need to get in line for a big pay Job as an Electrical and Mechanical Auto Expert.

### 4 TESTING OUTFITS

I train you the new, easy and practical "Job-Way." I give you actual Auto Jobs to do, and I give you the Tools and Equipment Free of extra cost too!

### REPAIR Included

Outfits include a complete set of Tools, Self opening Tool Bag, Portable Electrical Test Bench, Electrical Experimental Outfit, and 365 Auto Wiring Diagrams.

## I'll Help You Get a Good JOB

My Employment Department will help you get a good job whenever you want one. You don't have to wait until you have graduated to use this service. No sir, as soon as you have shown that you know enough about Autos to hold the Job I'll give you this help, whenever you ask for it! What is more, you can use it as long as you live!

### Get All the Facts!

Send for my new Free Book now! See what "Job-Way" has done for hundreds. See what it can do for you. Learn all about my legal money-back agreement—and the many added features. Clip coupon now!

**B. W. COOKE** Directing Engineer

## MAIL THIS COUPON

**FREE!** B. W. Cooke, Directing Engineer, Chicago Motor Training Corporation, Dept. B16, 1916 Sunnyside Ave., Chicago, Ill.

Send me your Book, "Auto Facts," Free of Charge. Also full particulars of your 4 working outfits offer and of "JOB-WAY" Training. This obligates me in no way whatever.

Name.....

Address.....

Town..... State.....



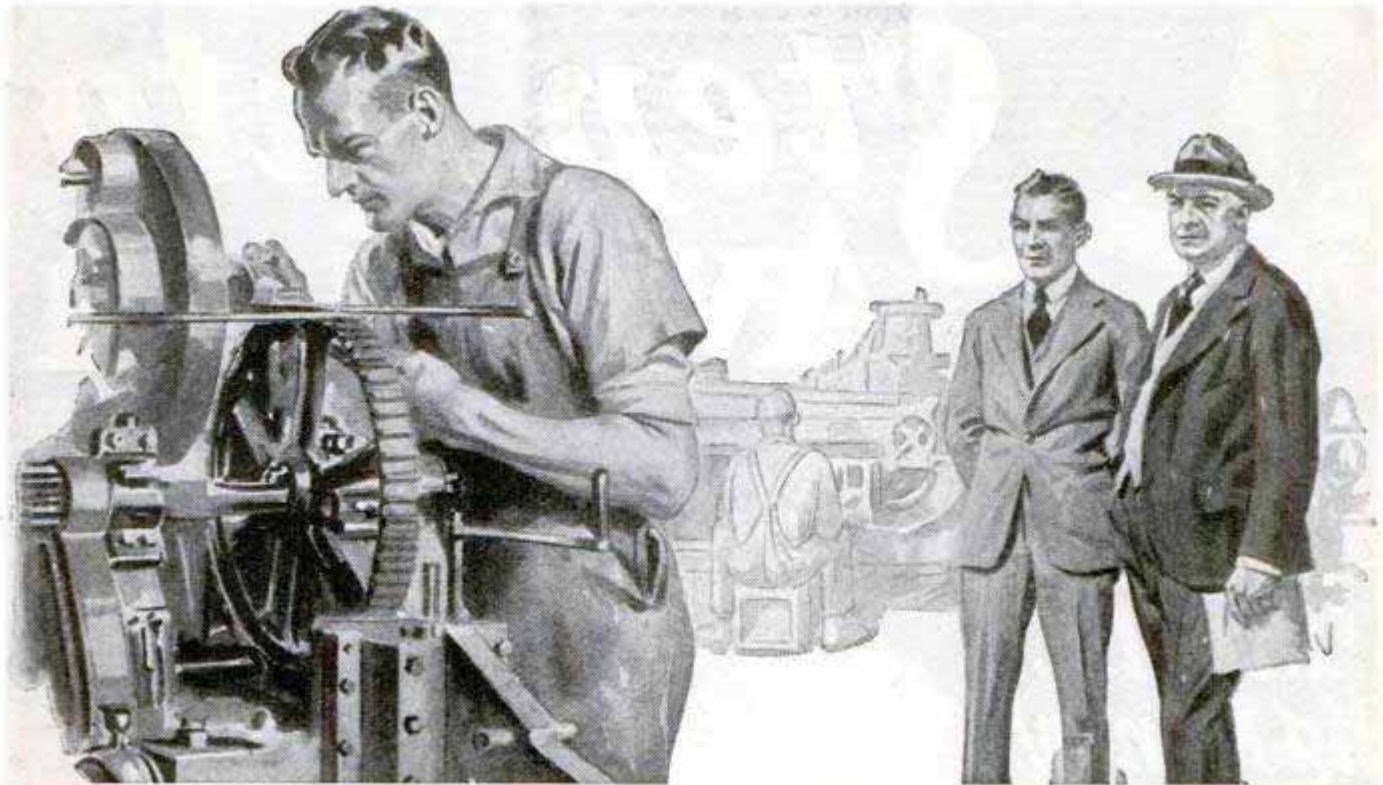

# “He’s Already Patented Four Inventions”

“**F**UNNY thing, too . . . When he first came here he was just an ordinary worker. For a time, when things were slack, I even thought that we might have to let him go.

“Then, gradually, I noticed an improvement in his work. He seemed to really understand what he was doing.

“One day he came into my office and said he had worked out a new arm for the automatic feeder. I was a little skeptical at first, but when he started explaining to me, I could see that he had really discovered something. And when I started questioning him, I was amazed. He certainly did know what he was talking about.

“So we sat down and talked for over an hour. Finally, I asked him where he had learned so much about his work. He smiled and took a little book from his pocket.

“There’s no secret about it,” he said. “The answer’s right here. Four months ago I saw one of those advertisements of the International Correspondence Schools. I had been seeing them for years, but this time something inside of

me said, *Send in that coupon.* It was the best move I ever made—I knew it the minute I started my first lesson. Before, I had been working in a sort of mental fog—just an automatic part of the machine in front of me. But the I. C. S. taught me to really understand what I was doing.”

“Well, that was just a start. Three times since he has come to me with improvements on our machines—improvements that are being adopted in other plants and on which he receives a royalty. He is certainly a splendid example of the practical value and thoroughness of I. C. S. training.”

Every mail brings letters from students of the I. C. S. telling of advancements and larger salaries won through spare-time study. There’s still a chance for you, if you will only make the start.

Just fill out and mail the coupon printed below and, without cost or obligation, get the full story of what the I. C. S. can do for you. To-day—not To-morrow—is the day to take that first definite step toward Success.

*These inventors and many others once studied with the I. C. S.*

**JESSE G. VINCENT**

Vice-president of Packard Motor Car Co., inventor of the Packard Twin-Six and co-inventor of the Liberty Motor.

**JOHN C. WAHL**

Founder of The Wahl Co., inventor of the Wahl Adding Machine, the Eversharp Pencil and the Wahl Fountain Pen.

**W. J. LILLY**

Inventor of the Lilly Mine Hoist Controller.

**H. E. DOERR**

Chief Mechanical Engineer, Scullin Steel Co., St. Louis.

TEAR OUT HERE

**INTERNATIONAL CORRESPONDENCE SCHOOLS, Box 5541-F, Scranton, Penna.**

Without cost or obligation on my part, please tell me how I can qualify for the position or in the subject before which I have marked an X in the list below:

- |  |   |   |   |
|--|---|---|---|
| <input type="checkbox"/> Automobile Work       | <input type="checkbox"/> Civil Engineer                             | <input type="checkbox"/> Concrete Engineer  | <input type="checkbox"/> Secretarial Work                                 |
| <input type="checkbox"/> Gas Engine Operating  | <input type="checkbox"/> Surveying and Mapping                      | <input type="checkbox"/> Chemistry <input type="checkbox"/> Pharmacy                              | <input type="checkbox"/> Advertising                                      |
| <input type="checkbox"/> Airplane Engines      | <input type="checkbox"/> Metallurgy <input type="checkbox"/> Mining | <input type="checkbox"/> Industrial Management  | <input type="checkbox"/> Stenography and Typing                           |
| <input type="checkbox"/> Radio                 | <input type="checkbox"/> Steam Engineer                             | <input type="checkbox"/> Personnel Organization   | <input type="checkbox"/> Business Correspondence                          |
| <input type="checkbox"/> Electrical Engineer   | <input type="checkbox"/> Marine Engineer                            | <input type="checkbox"/> Traffic Management   | <input type="checkbox"/> Civil Service                                    |
| <input type="checkbox"/> Electric Lighting     | <input type="checkbox"/> Architect                                  | <input type="checkbox"/> Accountancy (including C.P.A.)   | <input type="checkbox"/> Railway Mail Clerk                               |
| <input type="checkbox"/> Mechanical Engineer   | <input type="checkbox"/> Architects' Blueprints                     | <input type="checkbox"/> Cost Accounting  | <input type="checkbox"/> Common School Subjects                           |
| <input type="checkbox"/> Mechanical Draftsman  | <input type="checkbox"/> Contractor and Builder                     | <input type="checkbox"/> Bookkeeping  | <input type="checkbox"/> High School Subjects                             |
| <input type="checkbox"/> Machine Shop Practice | <input type="checkbox"/> Architectural Draftsman                    | <input type="checkbox"/> English <input type="checkbox"/> Spanish <input type="checkbox"/> French | <input type="checkbox"/> Illustrating <input type="checkbox"/> Cartooning |
| <input type="checkbox"/> Railroad Positions    | <input type="checkbox"/> Structural Engineer                        | <input type="checkbox"/> Salesmanship   | <input type="checkbox"/> Show Card Lettering                              |

Name.....Street Address.....

City.....State.....Occupation.....

Persons residing in Canada should send this coupon to the International Correspondence Schools Canadian, Limited, Montreal, Canada





**Adventure...  
Thrills...  
Big Money!**

# The Game for Daring Young Men

**G**ET away from the dull, prosaic grind of humdrum work—the narrow restrictions of petty, uninteresting jobs! Break into one of the most fascinating, most thrilling occupations since time began—Aviation—the virile, exciting, romantic game for men of sporting blood!

Many of the big men of the coming generation will be men with the foresight to get into Aviation now—while opportunities abound. They can see that the Golden Age of Aviation has just begun—that the future is almost too stupendous to be imagined.

What other occupation offers you more amazing opportunities? Thrills such as you never had before—the praise and plaudits of the multitude—and a chance to get in on the ground floor where rewards may be unlimited.

Aviation is growing so swiftly that one can hardly keep track of all the astonishing new developments. The skies are dotted with daring young men—from every country come stories of new feats—new victories—new heroes! Everything is set for one of the greatest booms in history. Big fortunes came out of the automobile industry and out of motion pictures. Big fortunes will also come out of Aviation! The development of Aviation as an industry is bringing with it a call for trained men. Those who qualify quickly should find themselves on the road to undreamed of money—success—popularity—and prominence!

## Easy to Get Into Aviation by This Home Study Method

Get into this thrilling business at once while the field is new and uncrowded. Now—by a unique new plan—you can quickly secure the preliminary training necessary to get a start in the Aviation Industry, either flying or ground work, at home during your spare time. Experts will teach you the secrets—give you the inside facts

that are essential to your success. And, the study of Aviation by our method is almost as fascinating as the actual work itself. Every Lesson is chock-full of interest—and so absorbing that you actually forget you are studying. But best of all are the ultimate rewards you are fitting yourself to gain!

### PICK YOUR JOB!

- Flying
- Airplane Instructor
- Airplane Engineer
- Airplane Repairman
- Airplane Assembler
- Airplane Mechanician
- Airplane Inspector
- Airplane Builder
- Airplane Salesman
- Exhibition Manager
- Airplane Contractor
- Airplane Motor Expert
- Airplane Designer

### Send for FREE Book

Send the coupon for our new, free booklet—*Opportunities in the Airplane Industry*. It is vitally interesting, reads like a romance and tells you things about this astonishing profession you probably never even dreamed of. You owe it to yourself at least to read it. We offer you a free copy now, no obligation. Mail the coupon for yours, today.



### American School of Aviation

Dept. 135-B  
3601 Michigan Ave.  
CHICAGO, ILLINOIS

American School of Aviation,  
Dept. 135-B, 3601 Michigan Ave.  
Chicago, Ill.

Without obligation, please send me your FREE book *Opportunities in the Airplane Industry*. Also information about your Home Study Course in Practical Aviation.

Name..... Age.....

Address.....

City..... State.....



# Coyne Students Learning on Actual Machinery

electricity

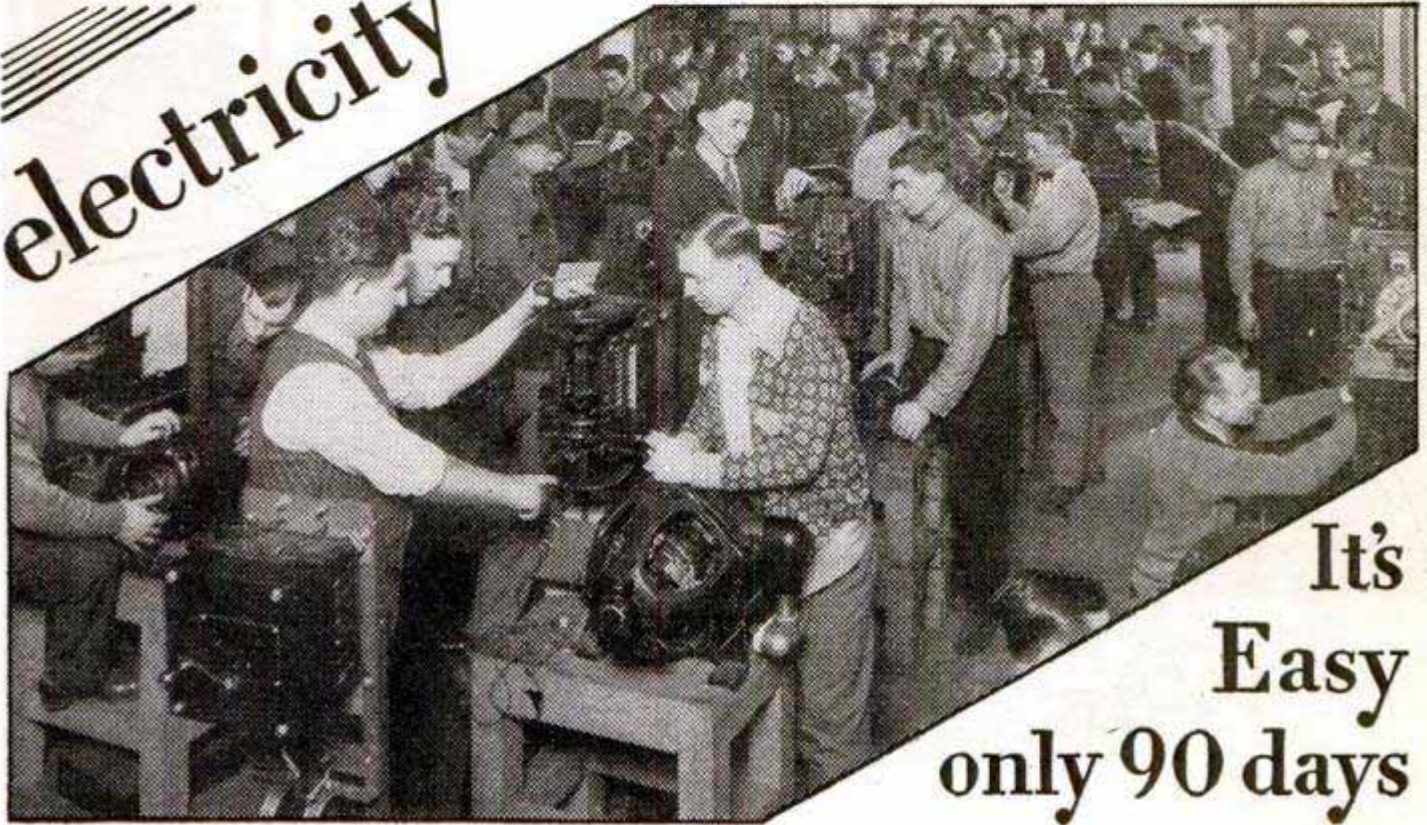

It's  
Easy  
only 90 days

## \$60 TO \$200 A WEEK

*Is earned by Many in Electricity*

See those fellows working away on real live electrical machinery? They're learning to earn \$60 to \$200 a week. In a short time their services will be in big demand. They'll step right out and get big jobs. Not one of them will have to worry about small pay checks—lay offs—or shudder at losing their jobs. They'll be in that great fascinating electrical profession of unlimited opportunity—where a wonderful future is assured.

You can do the same. It's the sure, quick, amazingly easy short cut to big salaries. You don't need advanced education or any previous experience. You learn by doing—not by correspondence. You can earn while you learn. My Employment Department will assist you in getting part-time work. FREE EMPLOYMENT SERVICE WHEN YOU GRADUATE—and from then on COYNE BACKS YOU FOR LIFE.

My Course Includes Training in **Aeroplane Electricity**

# COYNE Electrical SCHOOL

H. C. LEWIS, President—Founded 1899  
500 S. Paulina St. Dept. B-872 Chicago, Ill.



H. C. Lewis,  
Pres.

**Send for Big Book**

**Free** I've got a big 58-page book, "The Book of Big Pay Facts". Get your copy Now—fill in the coupon this minute. It's absolutely free—So act At Once. Don't Wait!



**Railroad Fare Allowed—**

I'll allow you railroad fare to Chicago and give you two Special Courses—Radio and Automotive—without extra charge.

Mr. H. C. Lewis, Pres., COYNE ELECTRICAL SCHOOL  
Dept. B-872 500 S. Paulina St., Chicago, Ill.

Dear Mr Lewis: Without obligation send me your big, free catalog and all details of Employment Service, Radio, and Automotive Courses, and how many "earn while learning." Also tell me about your railroad fare offer.

Name .....

Address .....

City .....

State .....



# You can make the BIG Money



## in Auto Painting

—Because here is the biggest uncrowded field in the world today. Prove it to yourself by the next 20 cars you see. Yes Sir, 17 out of 20 need painting.



**G. KING FRANKLIN**  
Famous Auto  
Painting Authority

**I will have you ready  
in a few months**

NOW—how many auto painters do you know? . . . I thought so. Well, who's going to do the work? You are—after you get the right training and you're going to make more money than you ever dreamed of! The world is looking for trained auto painters. Cash in on this big demand!

## You Can Own Your Own Business!

In auto painting it's no trick to be your own boss—own your own business and be independent!

You don't have to start out with the biggest building on the busiest corner. You can begin small with little or no capital, but I don't know of another business where you can get big so fast.

## You Can Make from \$60 to \$125 a Week

After you get my training you can get a job anywhere. You can travel and know at your destination there will be a job waiting for you that pays big money. Remember—I don't forget you when you complete the course. I help you get a real job. You also get a life consultation service without extra charge.

## 17,000,000 Cars Need Painting

Just imagine! There are t-w-e-n-t-y m-i-l-l-i-o-n cars in the U. S. alone—and 17 million need priming, surfacing, painting, ducoing, varnishing, striping and the whole works—and take it from me, I teach you the whole works so you can get in on the Big Money—or I'll refund every penny of the small price you pay.

I realize that you are up against quite a problem in deciding what field to enter, but on my say-so, and my guarantee to you, just come into auto painting with me and you'll be glad of it all your life.

Men like yourself who have taken my advice are now making \$5,000 to \$10,000 a year.

### TESTIMONIALS

Chicago Duco says: "Skilled Duco men are scarce. We can place many at \$1.00 to \$1.25 an hour." Binks, one of the largest auto equipment manufacturers says "The big auto manufacturers are insisting that their dealers repaint all used cars." Stockton, Illinois says "No shop here. All work must go to Freeport. Believe plenty of work to make paying business." Nash says: "This is a big field and splendid opportunities for your graduates in repainting cars." Many, many more like these.

## MAIL the COUPON

G. King Franklin, Supt.,  
American Auto Painting School,  
Dept. 1601, 425 S. Ashland Ave., Chicago.

Send sample shop tickets free and information on how I may learn auto painting and Duco at home in spare time

Name.....

Street No.....

City.....

State.....

## LEARN at HOME!

And the beauty of my proposition is that you can learn at home—in your spare time—in the evenings—and keep your present job while learning.

A few pennies a day puts you in line for a job in this big uncrowded industry. It doesn't obligate you or cost you a penny, to clip the coupon.

So get this information now—while Byrd and Chamberlin were talking about flying the Atlantic, Lindbergh did it. Nuff said! Act now!

**G. KING FRANKLIN, Supt.**

**American Auto Painting School**  
Dept. 1601, 425 South Ashland Avenue, CHICAGO





# FREE BLUE PRINTS

AND FREE BOOK "HOW TO READ BLUE PRINTS"  
SHOW YOU THE WAY TO

## 9 BIG PAY JOBS

- |  |   |
|--|---|
| <b>1</b> Building Superintendent — \$5,000 to \$12,000 | <b>6</b> Building Estimator — \$6,000 to \$10,000                             |
| <b>2</b> Building Inspector—\$4,800 to \$8,000         | <b>7</b> Real Estate Expert—\$5,500 to \$12,000                               |
| <b>3</b> Appraiser — \$6,000 to \$10,000               | <b>8</b> Construction Foreman—\$4,500 to \$8,500                              |
| <b>4</b> Material Buyer—\$5,000 to \$7,500             | <b>9</b> CONTRACTOR AND BUILDER IN A BUSINESS OF YOUR OWN—\$5,000 to \$12,000 |
| <b>5</b> Material Salesman—\$5,000 to \$12,000         |   |

## FIND OUT HOW

Easy it is to Make  
\$4,500 to \$12,000 a Year

Learn to read Blue Prints this amazing new way! Get into the world's richest industry—Building! See how quickly and easily you can train to make \$4,500 to \$12,000 a year! My FREE Book "How to Read Blue Prints" discloses all the so-called "mysteries" of Blue Print Reading—also gives some startling facts about the nine best jobs in America. Don't send one penny—just mail the coupon!

**N**O longer need you spend years trying to pick up the "mysteries" of Blue Print Plan Reading. For now a quick, sure practical method has been perfected that has made thousands of men Blue Print Experts in a surprisingly short time.

This is no ordinary "school course." It is practical from start to finish. It is based on many sets of real Blue Prints—plans that would cost thousands of dollars if purchased from architects. Twenty famous experts in all lines of construction work talk over these Blue Prints with you in plain simple language. Show you every detail. Explain every short cut. Tell you the "secrets" of quick, accurate estimating. Explain Superintending. Give you for the first time many inside facts and money-making methods used by the "Giants" of the Building Industry. This is the kind of training that quickly puts men into \$4,500 to \$12,000 a year jobs—or into profitable contracting businesses of their own. Yet now you get it right at home in only 2 or 3 months. It requires no extensive education. If you can read and understand what is written here you can easily master it.

See what this training has done for others: Bartholomew, Calif., became a contractor at an in-

crease of over 300% his first year; Blair, Okla., stepped up to Superintendent at 100% increase; Dickerson, R. I., increased his salary 700% in 12 months; Marchand, La., says: "My income has increased 200% and I now have more contracting work than I can do."

Over seven billion dollars will be spent this year in new construction! No wonder then, such tremendous opportunities are open to you when you have this "head-work" training in Blue Prints.

If you want more money—real big money! Then choose a "Blue Print" job in Building. Clerk or Salesman, Carpenter or Bricklayer, here is the one field where there are unlimited opportunities for advancement.

So accept my FREE gift of a complete set of real working Blue Prints, and my fascinating Book, "How to Read Blue Prints" that tells all the interesting and instructive facts about Blue Print Plans. Don't send one penny—pay no C. O. D.—It's all FREE. Just fill out and mail the coupon today—NOW!

**TWO BOOKS also FREE**



### IF YOU LIVE NEARBY

Visit our big day or evening school attended by over 1000 Builders. You can get the same training at home by mail—same plans, lessons and instructors. Your spare time is enough.

**Chicago Technical School for Builders—Dept. H-141, Chicago Tech. Building, 118 East 26th Street, Chicago, Ill.**

Please send me your free book, "How To Read Blue Prints," and complete set of real Blue Prints. I understand these are mine to keep without obligation. It is also understood that no salesman will call on me.

Name.....  
Address.....  
City..... State.....  
Age..... Occupation.....

## Chicago Technical School for BUILDERS

Dept. H-141, 118 East 26th St., Chicago, Ill.







# High School Course in Two Years!

## You Want to Earn Big Money!

And you will not be satisfied unless you earn steady promotion. But are you prepared for the job ahead of you? Do you measure up to the standard that insures success? For a more responsible position a fairly good education is necessary. To write a sensible business letter, to prepare estimates, to figure cost and to compute interest, you must have a certain amount of preparation. All this you must be able to do before you will earn promotion. Many business houses hire no men whose general knowledge is not equal to a high school course. Why? Because big business refuses to burden itself with men who are barred from promotion by the lack of elementary education.

### Can You Qualify for a Better Position

We have a plan whereby you can. We can give you a complete but simplified high school course in two years, giving you all the essentials that form the foundation of practical business. It will prepare you to hold your own where competition is keen and exacting. Do not doubt your ability, but make up your mind to it and you will soon have the requirements that will bring you success and big money. **YOU CAN DO IT.**

Let us show you how to get on the road to success. It will not cost you a single working hour. Write today. It costs you nothing but a stamp.

### American School

Dept. HB-74, Drexel Ave. and 58th St., Chicago

### American School

Dept. HB-74, Drexel Ave. and 58th St., Chicago

Send me full information on the subject checked and how you will help me win success.

- |                             |                           |
|-----------------------------|---------------------------|
| ....Architect               | ....Business Law          |
| ....Building Contractor     | ....Lawyer                |
| ....Automobile Engineer     | ....Machine Shop Practice |
| ....Automobile Repairman    | ....Mechanical Engineer   |
| ....Civil Engineer          | ....Shop Superintendent   |
| ....Structural Engineer     | ....Employment Manager    |
| ....Business Manager        | ....Steam Engineer        |
| ....Cert. Public Accountant | ....Foremanship           |
| ....Accountant and Auditor  | ....Sanitary Engineer     |
| ....Bookkeeper              | ....Surveyor (& Mapping)  |
| ....Draftsman and Designer  | ....Telephone Engineer    |
| ....Electrical Engineer     | ....Telegraph Engineer    |
| ....Electric Light & Power  | ....High School Graduate  |
| ....General Education       | ....Wireless Radio        |
| ....Vocational Guidance     | ....Undecided             |

Name.....

Address.....

## THE CHICAGO DAILY NEWS School and College Bureau

### Offers You Its Specialized Services in Choosing a School

Last year the School and College Bureau of The Chicago Daily News saved many busy parents and questioning boys and girls both time and worry by sending them prompt, reliable information about just the kind of school they wanted—personal requirements as to location and tuition charges being considered in each individual case.

Again this year many young people will be perplexed by the problem of finding the right school. Why not let us help you?

The Chicago Daily News maintains this service absolutely free of charge to you. No need to hurriedly select a school on mere hearsay when expert advice can be obtained by telephoning Dearborn 1111, writing or calling for a personal interview at

## THE CHICAGO DAILY NEWS

School and College Bureau

Dept. K, 15 N. Wells St., Chicago, Illinois

## LEARN WATCH REPAIRING



You can learn by our modern and original system of instruction every part of the **Watch Repairing Trade** at home as good or better than at a shop. You can earn money while learning and secure a well paying position or start in business after completing our course of instruction. Good watch repairers are always in demand and earn from \$50 to \$75 per week. For particulars apply to the **Wisconsin School of Watch Repairing** 166 Mason St., MILWAUKEE, WIS.

## PIANO JAZZ

By Note or Ear. With or without music. Short Course. Adult beginners taught by mail. No teacher required. Self-instruction Course for Advanced Pianists. Learn 259 styles of Bass, 684 Syncopated Effects; Blue Harmony, Oriental, Chime, Movie and Café Jazz, Trick Endings, Clever Breaks, Space Fillers, Sax Sturs, Triple Bass, Wicked Harmony, Blue Obligato, and 247 other Subjects, including Ear Playing. 133 pages of REAL Jazz, 25,000 words. A Postal brings our FREE Special Offer.

Waterman Piano School, 1826 W. Adams St. Los Angeles, Cal.

## YMCA TRADE SCHOOL

Learn Auto Mechanic, Auto Electrical, Battery, Machine, Electrical, Radio Mechanic, Tiling, Bricklaying, Plastering, Plumbing, Welding, Drawing, Estimating, Show Card, Sign Painting, Window Dressing, Fine And Commercial Art.

Write for Catalog 50.

BROOKLYN ENGINEERING INSTITUTE

(Operated by Bedford Br. Y. M. C. A.)

1125 Bedford Ave., Brooklyn, New York City.

## BE AN ARTIST

WE CAN TEACH YOU DRAWING in your own home during your spare time. Twenty-five years of successful teaching proves our ability. Artists receive large salaries.

Write Today for Art Year Book

SCHOOL OF APPLIED ART ROOM NO. 2 BATTLE CREEK MICH.





# Escape—and Be Happy!

Escape from the limitations which hold men down, and be happy. You were born to do big things, and if you are willing to work a little, you can do them, too. You don't have to take orders all your life. You can give them. Be the leader—set the pace—show the way, and stand out from your crowd like a thumb from the fingers on a hand.

It's so easy for anyone with a little zipper and pep—so easy to escape from drudgery and get the real thrill of living—the thrill untold thousands would enjoy, if they but knew the secret path to follow. Let me guide you.

Come with me. I will pump new energy, new pep, new strength and life into you. In 30 days I will increase the size of each of your arms one full inch, and in the same time add two full inches of rippling muscular strength across your chest. But those are just samples. Let me tell you about the thrills that are in store for you.

## The First Thrill

Did you ever see a child of six and then have ten years pass before you see him again, when he is sixteen? He is bigger, stronger, more capable, better developed mentally and physically. It is hard for you to realize that he is the same lad, isn't it? The change is so great.

That is something like what happens to you when you follow my instructions for a few months. There's a new thrill, a wonderful thrill, in watching yourself develop day by day—inch by inch. To find your arms beginning to bulge and show through the sleeves of your coat. To find your shoulders straightened and growing broader almost overnight. It's a thrill you can never forget, because it stays with you.

Your strength will increase by leaps and bounds. Objects that once were too heavy for you, will be lifted with ease. You will quickly gather the reputation of being the strongest man in your town, and everyone will look up to you and be utterly amazed at your marvelous power.

## The Second Thrill

Remember how you got up this morning? Well, how'd you like to jump out of bed tomorrow morning, eat like a kid at breakfast, then stride off to work with a spring to your step and a song in your heart to wade through a mountain of work as though it were play? That's a thrill for you. The thrill of learning to enjoy life—the thrill of holding down a good job and doing that job so well that you can't help but attract the attention of your boss.

## The Greatest Thrill of All

But the greatest thrill of all comes when you realize that your friends are beginning to look to you for advice and help. Where you were just one of the crowd before, now you've become a leader. Somehow, your newly acquired energy and strength have placed you a step above them. You've grown to be somebody.

Your wife or sweetheart will wonder what has come over you. Why you so completely dominate her. How you've become so much bigger, finer, and more wonderful in her eyes during the past few months.

But it's simple to understand. That energetic, virile, newly rebuilt body of yours just won't get into a rut. You've become a real, rip-snortin', two-fisted he-man, and the battles of life become like so many ten-pins to knock over.

Well, that's what I guarantee to do, if you follow my instructions. But let me tell you more about it.

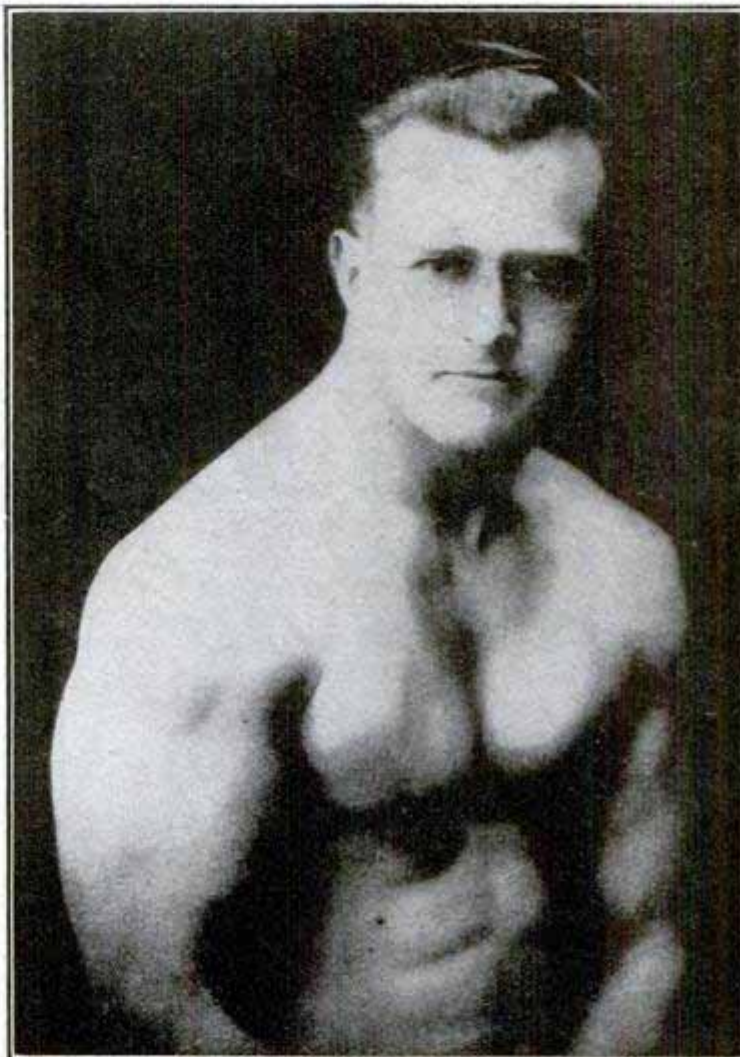

EARLE E. LIEDERMAN, *The Muscle Builder*

Author of "Science of Wrestling," "Muscle Building," "Secrets of Strength," "Here's Health," "Endurance," etc.

Send For My New  
64 Page Book  
"Muscular Development"  
IT IS FREE

It contains forty-eight full-page photographs of myself and some of the many prize-winning pupils I have trained. Some of these came to me as pitiful weaklings, imploring me to help them. Look them over now and you will marvel at their present physiques. This book will prove an impetus and a real inspiration to you. It will thrill you through and through. This will not obligate you at all, but for the sake of your future health and happiness do not put it off. Send to-day—right now before you turn this page.

**Earle E. Liederman**

Dept. 2007 305 Broadway, New York City

DON'T  
SEND ONE  
PENNY  
—  
YOUR  
NAME  
AND  
ADDRESS  
ON A  
POSTAL  
WILL DO

**EARLE E. LIEDERMAN**

Dept. 2007, 305 Broadway, New York City

Dear Sir: Please send me, without any obligation on my part whatever, a copy of your latest book, "Muscular Development." (Please write or print plainly.)

Name.....

Street.....

City..... State.....



Why haven't  
you  
clipped this  
coupon

TEAR OUT HERE

INTERNATIONAL CORRESPONDENCE SCHOOLS

"The Universal University"  
Box 5543-F, Scranton, Penna.

Without cost or obligation, please send me a copy of your booklet, "Who Wins and Why," and full particulars about the subject before which I have marked X in the list below:

**BUSINESS TRAINING COURSES**

- |  |   |
|--|---|
| <input type="checkbox"/> Industrial Management                   | <input type="checkbox"/> Advertising                                      |
| <input type="checkbox"/> Personnel Management                    | <input type="checkbox"/> Business Correspondence                          |
| <input type="checkbox"/> Traffic Management                      | <input type="checkbox"/> Show Card and Sign Lettering                     |
| <input type="checkbox"/> Accounting and C. P. A. Coaching        | <input type="checkbox"/> Stenography and Typing                           |
| <input type="checkbox"/> Cost Accounting                         | <input type="checkbox"/> English  |
| <input type="checkbox"/> Bookkeeping                             | <input type="checkbox"/> Civil Service                                    |
| <input type="checkbox"/> Secretarial Work                        | <input type="checkbox"/> Railway Mail Clerk                               |
| <input type="checkbox"/> Spanish <input type="checkbox"/> French | <input type="checkbox"/> Common School Subjects                           |
| <input type="checkbox"/> Salesmanship                            | <input type="checkbox"/> High School Subjects                             |
|  | <input type="checkbox"/> Illustrating <input type="checkbox"/> Cartooning |

**TECHNICAL AND INDUSTRIAL COURSES**

- |   |  |
|---|--|
| <input type="checkbox"/> Electrical Engineering | <input type="checkbox"/> Architect                                       |
| <input type="checkbox"/> Electric Lighting      | <input type="checkbox"/> Architects' Blueprints                          |
| <input type="checkbox"/> Mechanical Engineer    | <input type="checkbox"/> Contractor and Builder                          |
| <input type="checkbox"/> Mechanical Draftsman   | <input type="checkbox"/> Architectural Draftsman                         |
| <input type="checkbox"/> Machine Shop Practice  | <input type="checkbox"/> Concrete Builder                                |
| <input type="checkbox"/> Railroad Positions     | <input type="checkbox"/> Structural Engineer                             |
| <input type="checkbox"/> Gas Engine Operating   | <input type="checkbox"/> Chemistry <input type="checkbox"/> Pharmacy     |
| <input type="checkbox"/> Civil Engineer         | <input type="checkbox"/> Automobile Work                                 |
| <input type="checkbox"/> Surveying and Mapping  | <input type="checkbox"/> Airplane Engines                                |
| <input type="checkbox"/> Metallurgy and Mining  | <input type="checkbox"/> Agriculture <input type="checkbox"/> Navigation |
| <input type="checkbox"/> Steam Engineering      | <input type="checkbox"/> Mathematics <input type="checkbox"/> Radio      |

Name.....  
Street Address.....  
City..... State.....  
Occupation.....

Persons residing in Canada should send this coupon to the International Correspondence Schools Canadian, Limited, Montreal, Canada

BE A TRAFFIC INSPECTOR

**Healthful Outdoor Work. Travel as Your Own Boss—No Selling NO HUNTING FOR JOBS**

Every graduate is assisted to a position as Traffic Inspector paying at least \$120 a month to start, plus expenses, or tuition money is refunded. No strings to this understanding. There are actually more traffic inspection jobs waiting for graduates than can be filled. It is common knowledge that transportation companies prefer men with SBTI training.

Three months spare time study and you start immediately on a fascinating, profitable career in traffic inspection—one of the few uncrowded professions today.

A traffic inspector you will travel as your own boss, apparently on a pleasure jaunt. Enjoy healthful outdoors—no drab factory walls or musty office to confine you. Ever-changing panorama of interesting scenes and places. New faces and new experiences. Every day of your life you'll find new pleasures in your work.

**Earn \$250 Per Month**

With a little experience you will be rapidly advanced to \$160, \$185, \$200 and \$250 a month plus expenses, as our graduates are doing every day. The very nature of your work aids rapid promotion. You report to high officials.

**Write for Free Booklet**

telling of the actual successes of our many graduates during the last nine years. And read for yourself the tuition refund contract that goes with every course to make your future a certainty.

**Standard Business Training Institute**  
Div. 2 Buffalo, N. Y.



**LEARN WATCH REPAIRING**

Be a watchmaker—you can learn this profitable trade by correspondence in a few weeks in your own home by the DeSelms Chart System. After you complete the course you will know a watch from A to Z. You will know just what the matter is and how to repair one. When you graduate you will be a practical watchmaker and repairer and competent to fill any position. Positions for our graduates. Ask for our Free Book. It explains our system and terms.

**THE DeSELMS WATCH SCHOOL**  
LOGANSPORT, INDIANA



**MUSIC LESSONS IN YOUR HOME**



You can read Music like this quickly

Write today for our FREE booklet. It tells how to learn to play Piano, Organ, Violin, Mandolin, Guitar, Banjo, etc. Beginners or advanced players. Your only expense about 2c per day for music and postage used. **American School of Music, 51 Manhattan Bldg., Chicago.**

*Pho-Li-Phis*

Wonderful; new device, guides your hand; correct your writing in few days. Big improvement in three hours. No failures. **Complete outline FREE.** Perfect Penmanship Inst. D-34, St. Louis, Mo.

Learn to **PAINT SIGNS and SHOW CARDS**

We quickly teach you by mail, or at school, in spare time. Enormous demand. Big future. Interesting work. Oldest and foremost school.

**EARN \$50 TO \$200 WEEKLY**

John Vassos, N. Y., gets \$25 for single show card. Crawford, B. C., writes: "Earned \$200 while taking course." Don't delay. Send today for complete information, samples and guarantee.

**DETROIT SCHOOL OF LETTERING**  
150 Stinson Ave. Est. 1899. DETROIT, MICH.





# -and They Started By Reading This Amazing Book!



**300% Increase** reported by A. F. Thompson of Sioux City, Iowa, former creamery employee, after completing N.S.T.A. Course.

From \$8 to \$125 a Week was the jump made by Mark Barichievich, San Francisco, California, who rose from dishwasher to salesman through N.S.T.A.

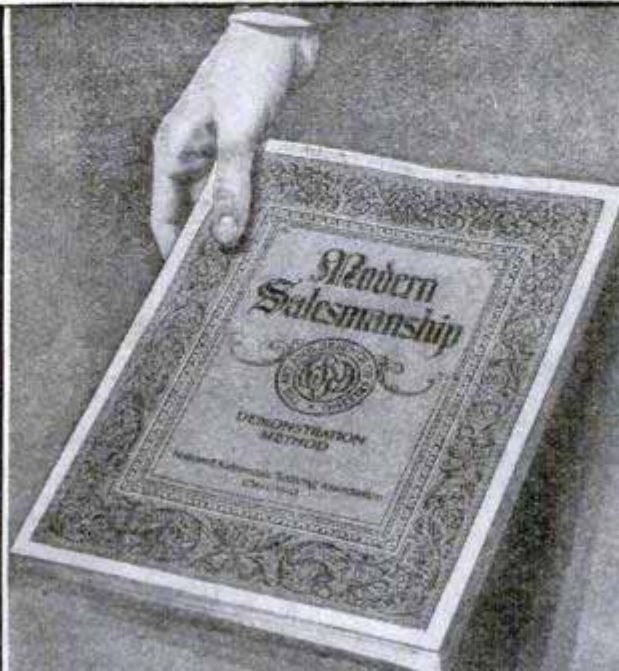

**\$7200 A Year** or a 400% increase is record of L. D. Mather, former clerk of Richmond, Virginia, thanks to N.S.T.A.



**600% More Money** now being made by L. H. Lundstedt, Chicago. N.S.T.A. training helped raise him from a stenographer to the head of a business.



## Where Shall We Send Your Copy... FREE?

**A** book! Just seven ounces of paper and printer's ink—but it contains a most vivid and inspiring message that every ambitious man should read! It reveals facts and secrets that have led hundreds of men from every walk of life into success beyond their fondest expectations! So powerful and far-reaching has been the influence of this little volume that it is no wonder a famous business genius has called it "The Most Amazing Book Ever Printed!"

This vital book, "Modern Salesmanship," contains hundreds of surprising and little-known facts about the highest paid profession in the world. It reveals the real truth about the art of selling. It blasts dozens of old theories, and tells exactly how the great sales records of nationally-known star salesmen are achieved. And not only that—it outlines a simple plan that will enable almost any man to master scientific salesmanship without spending years on the road—without losing a day or a dollar from his present position!

### What This Astonishing Book Has Done!

The men who have increased their earning capacities as a result of reading "Modern Salesmanship" are numbered in the thousands. For example, there is E. E. Williams of Pomona, Cal., who was struggling along in a minor position at a small salary. "Modern Salesmanship" opened his eyes to opportunities he had never dreamed of—and he cast his lot with the National Salesmen's Training Association. Within a few short months of simple preparation, he was earning \$10,000 a year! Today he receives as much in 30 days as he formerly received in 365!

And then there is J. E. Muzzall, of Hopkinsville, Ky. He, too, read "Modern Salesmanship" and found the answer within its pages. A former freight clerk and department head at \$200 a month, he recently reported yearly earnings running into five figures. B. F. Boilon of Columbus, Ohio, wrote that his work as a salesman brought him annual earnings of \$5000—\$7000, an increase of 300% over his former income as a decorator. And F. L. Real of Wheeling, W. Va., a former cigar-maker, stepped into a position paying him \$4600 a year drawing account alone!

### A Few Weeks—Then Bigger Pay

There was nothing "different" about these men when they started. Any man with average intelligence can duplicate the success they have achieved. For their experience proves that

salesmen are **made**—not "born," as some people have foolishly believed.

Salesmanship is just like any other profession. It has certain fundamental rules and laws—laws that you can master as easily as you learned the alphabet. Hundreds of men who never had a day's selling experience before acquiring this remarkable training have been extraordinarily successful, often beating the records of men with years of experience from the very first day.

### Free To Every Man

If we were asking several dollars a copy for "Modern Salesmanship" you might hesitate. But it is now FREE. So get your copy now. Learn the real facts about the selling profession, and about the tremendous demand for trained salesmen in every line, to fill city and traveling positions paying up to \$5000 and \$10,000 a year. (Last year this association received calls for 50,335 N.S.T.A. members from Wholesalers, Manufacturers and Jobbers.) "Modern Salesmanship" tells the complete story in a vivid, inspiring way. A copy is yours for the asking, and your request entails no obligation. Simply fill out and mail the coupon. Do it now!

**NATIONAL SALESMEN'S TRAINING ASSOCIATION**  
 WORLD'S OLDEST AND LARGEST *Exclusive* SALES TRAINING INSTITUTION

Dept. H-101

N. S. T. A. Bldg.

Chicago, Ill.

National Salesmen's Training Assn.,  
 Dept. H-101, N.S.T.A. Bldg., Chicago, Ill.

Without obligating me in any way, send a copy of your Free Book, "Modern Salesmanship," and details of your System of Training and Free Employment Service.

Name .....

Address .....

City ..... State .....





Nelson's work (1) before and (2) after Federal School training.

## Now he **DRAW\$** the things he wants

LOOK at drawing No. 1 above. Then compare it with No. 2 and note the improvement Federal School training has made in the work of Art Nelson. He formerly worked as a surveyor's assistant at \$18.00 a week. Today as an illustrator he makes \$75.00 a week. He says, "The Federal Schools made this possible through their training and co-operation as I had only average ability before enrolling as a student." Nelson is one of hundreds of young people making big money because of Federal training.

Publishers buy millions of dollars worth of illustrations every year. If you like to draw, let your talent make your living. The Federal Course includes illustrating, cartooning, lettering, poster designing, window card illustrating, etc. The Federal Staff includes such famous artists as Sid Smith, Neysa McMein, Fontaine Fox, Clare Briggs, and over fifty others. It's easy to learn the "Federal Home-Study Way."

### Test Your Drawing Talent

How well can you draw? Will you make an artist? These questions are fully answered by our free Vocational Art Test. Send us your name, address, age and occupation and we will send you our book, "A Road to Bigger Things," which will show you how to get started right.



**Federal School of Illustrating**  
7138 Federal School Bldg., Minneapolis, Minn.

## Don't Envy The Plumber BE ONE!

**\$11.00-\$16.00 PER DAY and work EVERY day, is the Plumber's wage.**

Every skilled workman will tell you that Plumbers have the best of it. WINTER and SUMMER the Plumber is busy at top wages. No skilled Plumber is ever out of a job—compare his opportunities with any trade, plus the opportunities of having your own shop.

We teach you Plumbing with TOOLS (not books) under Licensed Master PLUMBERS in one of the finest equipped schools in America. We make you a Plumber, every branch is taught thoroughly—Lead Work—Blue Print for plan reading—all other tricks.

**LEARN IN 8 to 12 WEEKS** without previous experience.

If you are making less than \$80.00 a week you owe it to yourself to investigate. Get FREE catalog that tells in pictures and words how we teach this trade. Special rates now.

**UNIVERSAL PLUMBING SCHOOL**  
2030 Troost Ave. KANSAS CITY, MO.

## CHIROPODY

**MAKE \$5,000 TO \$15,000 A YEAR**

In dignified profession. Doctors of Surgical Chiropody needed everywhere. Best known College in America gives you full course, prepares you for practice in 2 years. Largest foot clinic in the world. Faculty of leading physicians, chiropodists. Finest equipment. 15th year. Study in Chicago. Varied interests of city life—opportunities all around. Earn while you learn. Write for catalog. No obligation. Dept. 411.

**Illinois College of Chiropody, 1327 N. Clark St., Chicago**

*Raise Poultry* **MAKE BIG MONEY**

**Results Quick—Part or Full Time**

Take up poultry raising. It's interesting, healthful, PROFITABLE. Easy to sell all you can produce at big prices. Our new course by Henry M. Lamon, former gov't expert, gives short cuts to success. Write for free book, "How to Raise Poultry for Profit."

**NATIONAL POULTRY INSTITUTE, Dept. 411, Washington, D. C.**

# AUTO

**BOOKS SENT FREE!**



### Can you fix it?

These wonder books tell step by step **JUST HOW** to take out "play" in differential—how to kill the shimmy in steering—how to set **TIMING**—how to put your finger instantly on engine trouble and then the quick expert way to **FIX** it. Equal to a complete trade course at less than a fourth the cost.

**FREE!**  
Privilege of consulting Automotive Engineers of American Technical Society for one year without cost if you mail coupon immediately.

Just mail the coupon and we'll send you a set of these remarkable auto books, just off the press. Whether you are a mechanic or helper, expert or apprentice, auto owner or driver, if you're interested in knowing all about automobile mechanisms, then by all means take advantage of this Free Offer.

### Don't Send a Penny!

A better job—in the gigantic auto industry—**BIGGER PAY**—a chance to go into business for yourself and get a share of the huge profits, are waiting for any man who even half tries to improve himself. Learn Auto Engineering with these wonder books a new way—without studying or memorizing. Simply use the **JIFFY INDEX** to look up the answer to any auto problem. Built by eleven of America's greatest automobile engineers, and written in simple language so you can understand it!

**5 BIG VOLUMES**  
2400 pages, 2000 illustrations, wiring diagrams, etc. DeLuxe edition, gold-stamped flexible binding.

**AMERICAN TECHNICAL SOCIETY**  
Dept. AB-19, Drexel Ave. & 58th St., Chicago, Ill.

**AMERICAN TECHNICAL SOCIETY**  
Dept. AB-19, Drexel Ave. & 58th St., Chicago, Ill.  
I would like to see the new 5-volume edition of your AUTO BOOKS. I will pay the few cents delivery charges only, but if I choose to, I will return them express collect. If after 15 days' use I prefer to keep them, I will send you \$2 and pay the balance at the rate of only \$3 a month, until \$24.80 is paid. Please include free membership, your offer above.

Name \_\_\_\_\_  
Address \_\_\_\_\_  
Reference \_\_\_\_\_  
Address \_\_\_\_\_



**\$350 a month**

**\$500 a month**

**\$450 a month**

"I feel proud of my success in Radio to date. My profit during the last two months amounts to \$700. I am making good and I have not finished my N. R. I. course yet. I am grateful for your training and co-operation to date and look forward to still bigger success when I graduate."

Clarence Heffelfinger,  
Temple, Penna.



"When I enrolled with the N. R. I., I was a motorman on a trolley car. Now I have a fine, fast-growing Radio business. When only half way through the course started bringing in extra money I made \$420 in my spare time. Now I have a bank account of \$2800 and about \$300 worth of stock. It has all come from Radio since graduating less than six months ago. I cannot begin to express my thanks to you and all those connected with N. R. I. for what you have done for me."

Richard Butler, 1419 No. 17th St.  
Philadelphia, Pa.

"In addition to my regular work in what I believe to be the largest and best equipped Radio Shop in the Southwest, I am now operating KGFI. I am proud of the fact that I installed and put KGFI on the air without help of anyone except the N. R. I. I am averaging \$450 per month."

Frank M. Jones,  
922 Guadalupe St., San Angelo, Tex.



# Proof that RADIO is today's BIG MONEY Business for You

\$350, \$450, \$500 a month. That's making real money. What business other than Radio offers such opportunities after six to twelve months training? None that I know of. More proof—last year electricians, farmers, mechanics, clerks, railroad men, bookkeepers, preachers, doctors, and men from 78 other trades and professions enrolled with me to prepare for the Radio field.

## Big Growth Making Many Big Jobs

A WONDERFUL business, you will say, to make men trained for other fields, give them up for Radio. Yes, but they had their eyes wide open. They know what you and I know—that big growth makes big jobs and many opportunities to earn big money. Heffelfinger, Jones, and Butler couldn't make anything like this money before, although they probably worked just as hard—maybe harder. Trained men are needed for the big jobs the amazing growth of Radio is creating.

## Salaries Up To \$250 a Week

WHY go along at \$25, \$30, \$35 a week when the good Radio jobs pay \$50 to \$250 a week? Cut loose from drudgery, small pay, no-future jobs. Get into a live-wire field that offers you a real chance. You don't need a high school or college education to become a Radio Expert. Many of my most successful graduates didn't finish the grades.

## Practical Experience With Course

I GIVE you six big outfits of Radio parts. With them you can build and experiment with one hundred different circuits—learn the "how" and "why" of practically every type of set made. This makes learning easy, interesting, fascinating, your training complete. Nothing else equals my method.

You can build 100 circuits with 6 big outfits of Radio parts I give you



HERE ARE THREE YOU BUILD

## Here's Work That's Almost Romance!

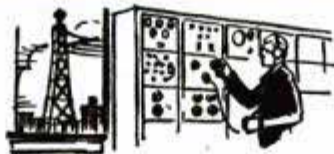

Over six hundred broadcasting stations are licensed in the U. S. Each one employs from three to twenty Radio operators and engineers. Here's fascinating work that you can put your whole heart into.



\$500,000,000 were spent last year for Radio sets. Manufacturing, selling, servicing sets yields big profits. Get your share. I am continually being asked for trained men for such jobs.



Go in business for yourself. Radio offers you a wonderful chance. Start small without capital and build up. I show you how. My big Free book tells you about many other branches of Radio.



## I Will Train You at Home in Your Spare Time



NO NEED to leave home. Hold your job, give me one-half to one hour a day of your spare time. In six to twelve months you can be a trained Radio Expert, ready to step into a new job with a real future.

### \$10 to \$30 a Week While Learning

MANY of my students make \$10, \$20, \$30 a week extra while learning. I teach you to begin making money shortly after you enroll. G. W. Page, 1807 21st St., Nashville, Tenn., made \$935 in his spare time.

### Money Back If Not Satisfied

I KNOW the kind of training you need. I have put hundreds of men and young men ahead. I am so sure that I can satisfy you too that I will agree to refund your money if you are not satisfied when you complete my course.

### Find Out What Radio Offers You

MY 64-page book explaining where the big jobs are and what you can make is FREE. Mail coupon. No obligation. Address: Dept. 7-H, J. E. Smith, Pres., Nat'l Radio Institute, Washington, D. C.



## Send this Coupon

J. E. Smith, President,  
Dept. 7-H National Radio Institute,  
Washington, D. C.

Dear Mr. Smith—Send me your book. I want to know about the opportunities in Radio and your practical method of teaching at home with six big outfits of Radio parts. This request does not obligate me to enroll.

Name ..... Age.....  
Address .....  
City ..... State.....



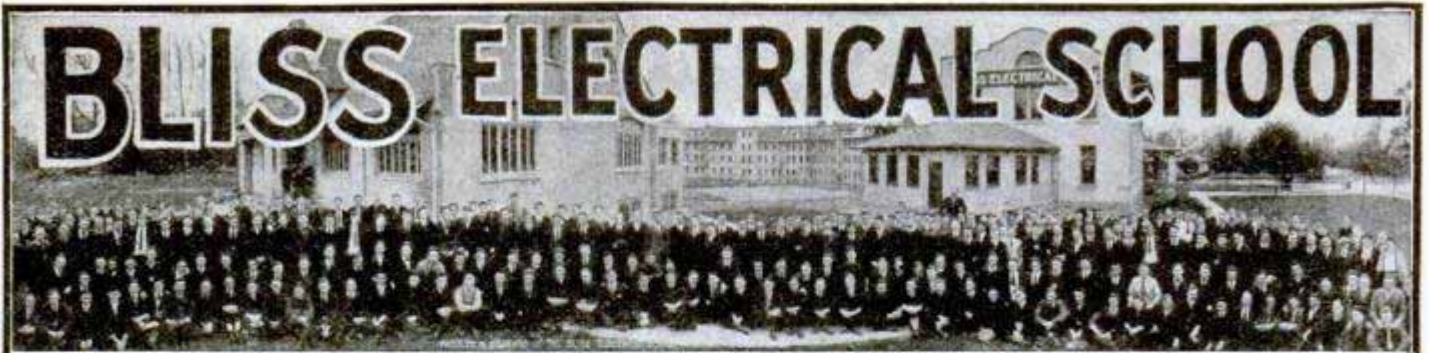

# BLISS ELECTRICAL SCHOOL

A special technical school with concise but comprehensive course in Electrical Engineering designed to be completed in **ONE COLLEGE YEAR**. Thorough knowledge of underlying principles emphasized.

## ELECTRICAL ENGINEERING



The course is designed for earnest, ambitious young men of limited time and means. Curriculum includes mathematics, mechanical drawing and intensive shop work. Students construct motors, install wiring, test electrical machines. Graduates are qualified to enter the electrical field at once.

Bliss men hold responsible positions throughout the world. Thoroughly equipped fireproof dormitories, dining hall, laboratories and shops. Prepare for your profession in the most interesting city in the world. School established 1893. Catalog on request. Address

BLISS ELECTRICAL SCHOOL, 117 Takoma Avenue

Washington, D. C.

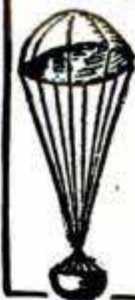

**Boys!**  
Look at  
**THIS BIG  
OFFER!**

## GIVEN GREAT NAVY MODEL AIRSHIP Complete with Parachute

Here's the great Navy model Airship. Large 6-foot air bag with inflators, parachute with automatic release and complete instructions for flying. Will fly for miles at height of 1000 feet. Great chance to study aerial navigation. Send name and we'll send 6 of our new art pictures to dispose of on special 25c offer. Send money you collect and as a reward for this service we will send this wonderful Airship with full instructions free.

C. M. THOMAS

337 West Madison Street

6K91

CHICAGO

# LEARN CARTOONING

## AT HOME DURING SPARE TIME

with the course that has trained HUNDREDS of beginners successfully. The Landon Picture Chart Method of teaching ORIGINAL drawing by mail makes cartooning easy to learn. This school is a Member of The National Home Study Council. Write today for sample picture chart to TEST YOUR ABILITY and examples of the work of successful students now earning from \$50 to \$200 and more per week. Enclose 6c in stamps and STATE YOUR AGE.

THE LANDON SCHOOL, 2838 National Bldg., Cleveland, Ohio



# TRAVEL - for 'UNCLE SAM'

**RAILWAY POSTAL CLERKS  
MAIL CARRIERS—POSTOFFICE CLERKS  
\$1700 to \$3300 a Year for Life**

No "lay-offs" because of strikes, poor business, etc.—sure pay—rapid advancement. City and country residents stand same chance. Common sense education usually sufficient—no political influence.

## STEADY WORK

Cut coupon and mail it before turning the page.

**MEN—BOYS  
18 to 45**

Use Coupon Before You Lose It

### COUPON

FRANKLIN INSTITUTE, Dept. E-177, Rochester, N. Y. Rush to me, entirely free of charge, (1) A full description of the position checked below; (2) 32-page book, with list of positions obtainable and sample coaching; (3) Particulars telling how to get the position checked.

- Railway Postal Clerk (\$1900 to \$2700)
- General Clerk (\$1140 to \$1860)
- Postoffice Clerk (\$1700 to \$2300)
- Prohibition Agent (\$1860 to \$3000)
- City Mail Carrier (\$1700 to \$2100)
- Rural Mail Carrier (\$2100 to \$3300)

Name .....

Address .....





**\$8 Extra Each Night for Reikane  
Over \$1000 Extra for Scarbro**



**YOU, too, Can Make Many Friends and EASY, EXTRA MONEY Quick with the HAWAIIAN GUITAR**

Look what Roy Reikane, Muir, Pa., writes: "Didn't know a note when I started Hawaiian Guitar. But it was easy to learn your way. Began making more friends right away. Now going strong; have been making \$5 to \$6 every evening and now have contract with theatre at \$8.00 per night. Have made over \$200 in 1 1/2 months." Then read this from Carlton E. Scarbro, Fitzpatrick, W. Va.: "Your Course and Service can't be beat. They're easy, understandable and full of help. Have become very popular since learning. Have played at opera houses and many parties—all told have made \$1,000 through your wonderful Course."

**Learn to Play the Real Hawaiian Way--Quick--Right at Home in Only 1 to 3 Months' Spare Time**

No previous musical training necessary; no long tiresome hours of practising. The New York Academy of Music's amazing Hawaiian Guitar Course can teach you right at home, in 1 to 3 months' spare-time, to play this rich, melodious, romantic instrument. Every step is made clear and easy; progress is rapid yet training is thorough. It's like play to learn this pleasant, fascinating way.

**Makes \$200 in Spare-Time**

"Had only finished my 7th lesson when I played at a Ball and made my first Five Dollars. Have made almost \$200 with my Hawaiian Guitar in spare-time."

—John B. McMullin, Cadet, Mo.

**Paid \$8 for 4 Hours**

"When I enrolled with you I didn't know one string from another. With first lesson, learned notes in just a few hours. Played first piece second evening. Now have plenty of good times and friends. Am making \$8.00 per evening for just 4 hrs. playing at dances."

—Granville M. Smith, Mohawk, Oregon.

**Popular Radio Artist**

"Your Course is easy! Knew nothing of music before taking it, but now can play any piece. Have been broadcasting over Station KVOO—have all the engagements I can fill—and am popular. Couldn't ask for more."

—Ployd Price, Hulbert, Okla.

**Special Demonstration Phonograph Records Included**

We supply everything you need. With your very first lesson you receive FREE of extra cost a beautiful, rich-tone, genuine Hawaiian Guitar worth \$20 at any store—Kno-All Chart—complete Outfit of tuner, picks, etc., etc.—clear, easy instruction—and specially made Demonstration Phonograph Records in which Robert Yap, the famous Native Hawaiian, correctly plays each piece in the Course. No effort is spared—no stone left unturned—to help YOU become an expert and accomplished player quick.

**Radio's Most Popular Instrument**



Broadcasting Stations the country over are eager for Hawaiian Guitarists. The public demands this stirring, unique music. Radio is only one of many opportunities for the Hawaiian Guitarist to win popularity and prosperity quick! Our students have gained widespread reputations and are paid handsomely.

**No Need to Wait for All the Fun and All the Money You Want—Get this FREE BOOK Now!**

Here is the revealing Book that has shown thousands of others the way to make good with the Hawaiian Guitar. The book that has meant hundreds and hundreds of dollars—and dozens and dozens of new friends—for people who were right in your shoes just a few months ago. Yet you are welcome to a copy absolutely FREE. Learn at once how YOU can quickly get in line for plenty of fun, friends and EXTRA MONEY. It costs you nothing to find out. The big book explains everything, proves everything. The coupon below brings your FREE copy. Mail it today!

**Get this FREE BOOK Now!**



**Clip - Sign - Send**

A. F. Bloch, President,  
Hawaiian Studios 52078 of  
NEW YORK ACADEMY OF MUSIC,  
100 Fifth Ave., New York City.

Dear Mr. Bloch: Please send me at once your FREE Book, "How to Learn Hawaiian Guitar," showing me how to have popularity and Big Pay QUICK.

Name.....

Address.....

City.....State.....

**Big Money for You Full Time or Spare-Time**

Our students learn to cash-in quick. Playing in either an amateur or professional way, many make anywhere from \$15 extra money to \$100 full-time pay each week. We show you how to turn pleasure into profit—turn music notes into bank notes! Our FREE Book explains every step. Get it at once!



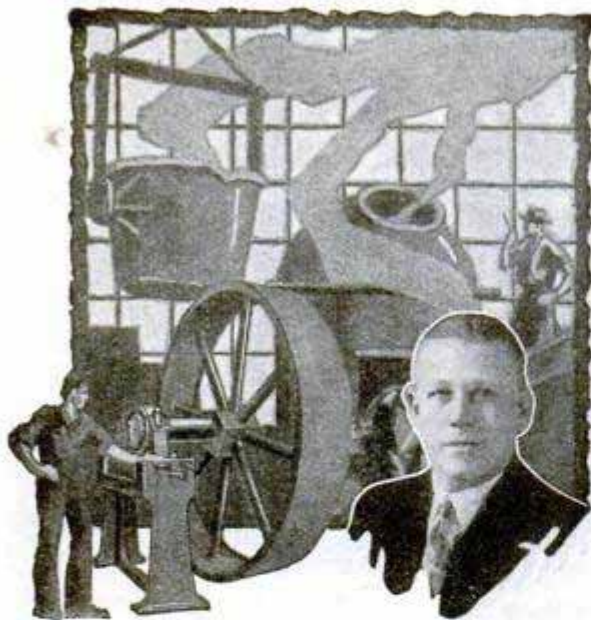

## An Easier Way to Make Money!

What chance has the wage-earner? "A mighty good one," says Ralph H. Berndt—but read his story . . .

Berndt had had only an elementary education. He was assistant roller at the Carnegie Steel Mills, Youngstown, Ohio.

"Realizing that hands and feet would not do for me any longer," he writes, "I decided to give my brain a business training." Today, thanks to Higher Accountancy training with LaSalle, he is Auditor for W. C. DuComb Co., Inc., Detroit—with easier hours, work that he likes, and a larger income. "LaSalle," he adds, "has been the instrument to my success."

Send for Free Book—

### "Accountancy, the Profession that Pays"

"Get the facts—then use the facts—to get results." That's a slogan of ours, writes W. C. DuComb, president. And you'll agree it's good sound sense!

The facts about LaSalle training in Accountancy and the opportunities in this highly profitable field are clearly outlined in a 64-page book which LaSalle will send you free. It started Berndt on the path to success. No earthly reason why it can't do just as much for you.

If you have the urge and the will to increase your income—clip and mail the coupon NOW.

— — — Find Yourself Thru LaSalle! — — —

**LA SALLE EXTENSION UNIVERSITY**  
The World's Largest Business Training Institution  
Dept. 764-HR Chicago

I should be glad to have your 64-page book, "Accountancy, the Profession that Pays," also a copy of "Ten Years' Promotion in One," all without obligation.

### Higher Accountancy—

Training for positions as Auditor, Comptroller, Certified Public Accountant, Cost Accountant, etc.

### Other LaSalle Opportunities

LaSalle opens the way to success in every important field of business. If more interested in one of the fields indicated below, check here:

- |   |  |
|---|--|
| <input type="checkbox"/> Business Management        | <input type="checkbox"/> Personnel Management                        |
| <input type="checkbox"/> Modern Salesmanship        | <input type="checkbox"/> Banking and Finance                         |
| <input type="checkbox"/> Traffic Management         | <input type="checkbox"/> Modern Business Correspondence and Practice |
| <input type="checkbox"/> Railway Station Management | <input type="checkbox"/> Expert Bookkeeping                          |
| <input type="checkbox"/> Law—Degree of LL.B.        | <input type="checkbox"/> C. P. A. Coaching                           |
| <input type="checkbox"/> Commercial Law             | <input type="checkbox"/> Business English                            |
| <input type="checkbox"/> Industrial Management      | <input type="checkbox"/> Commercial Spanish                          |
| <input type="checkbox"/> Modern Foremanship         | <input type="checkbox"/> Effective Speaking                          |



Name .....

Present Position .....

Address .....

LEARN BY DOING

Every phase of all branches of

## ELECTRICITY

taught by

### Actual Practice

In one of America's foremost institutions for trade training

ESTABLISHED 1902

### No Books Used

Individual Instruction  
Start Any Day

Write for FREE 64-page catalog

## THE NEW YORK ELECTRICAL SCHOOL

44 West 17th St., New York City

## LEARN MECHANICAL DENTISTRY

making crowns, plates, bridges, etc. for dentists. Unusual demand now and always will be—a human necessity. Steady, dignified Professional Trade. Three to six months training. Easily learned by actual practice. R. R. Fare to nearest school included. Part time positions to help pay expenses while training.

Ask for Catalog No. 2.

**BODEE DENTAL INSTITUTE**

New York 1755 Broadway  
Philadelphia 1305 North Broad Street  
Brooklyn 85 Court Street

## Learn Photography at HOME

Make money taking pictures. Prepare quickly during spare time. Also earn while you learn. No experience necessary. New easy method. Nothing else like it. Send at once for free book, OPPORTUNITIES IN MODERN PHOTOGRAPHY and full particulars.

**AMERICAN SCHOOL OF PHOTOGRAPHY**

Dept. 135-B 3601 Michigan Ave. Chicago, U. S. A.

## IF YOU STAMMER

Write for my free book "Millard's Advanced Natural Corrective Course" and a free copy of my speech magazine. 10,000 cases successfully treated. Est. 24 years. Largest school for stammerers in world. Millard Inst. of Normal Speech, 2317 Millard Bldg., Milwaukee, Wis.

## YOU CAN OIL PAINT

Amazing new method teaches men or women to earn after first lesson. OIL PAINT photos—portraits, landscapes or art subjects. Earn \$18 to \$50 and more a week. OIL PAINT OUTFIT GIVEN. Send now for free illustrated book. PICTORIAL ART STUDIOS Inc. Dept. MP, 2926 Broadway, Chicago, Ill.

## WHY NOT spend Spring, Summer and Fall gathering butterflies, insects?

I buy hundreds of kinds for collections. Some worth \$1 to \$7 each. Simple outdoor work with my instructions, pictures, price-list. Send 10 cents (not stamps) for my illustrated Prospectus before sending butterflies.

**MR. SINCLAIR, DEALER IN INSECTS,**  
Dept. G. Box 1424. San Diego, Calif.



# In this FREE BOOK

a World-Famous Flier shows  
how YOU can get into

## AVIATION

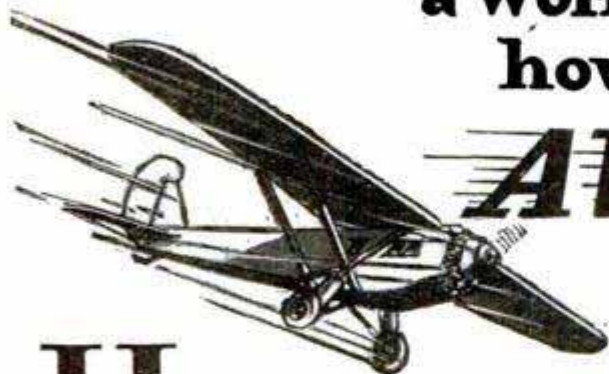

**H**ERE is the book that tells you straight from the shoulder what Aviation offers YOU. You've been wondering how to break into the field—wanting all the facts, all the information. Here it is! A story more exciting, more thrilling, more inspiring than fiction—yet a man-to-man message of FACTS from cover to cover. Walter Hinton—hero of history-making flights—gives you the brass tacks of Aviation Today. He shows you exactly *where* your opportunities lie—exactly *what* to do to make the most of them—exactly *how* to fit yourself for them. Here is a book for men with too much backbone to stay chained to a small-pay job—too much adventure in their blood for a hum-drum grind—too much good sound business sense in their heads to let this opportunity of a lifetime out-grow them!

### The Richest, Fastest Growing Industry the World Has Ever Known

Look at the unemployment, slowed-up production and tight markets in other industries. But you haven't heard anything about this being a "bad year" for Aviation! Men like Ford, DuPont—millionaires—are investing fortunes in the field. Cities everywhere are building more airports; 24 hour shifts are racing construction on new plane and equipment plants. Air lines, air service of every kind is doubling and re-doubling itself almost while you watch! There's no doubt about there being BIG PAY plus a real future for YOU in Aviation. Your one sure move is to get the right training—QUICK!

### Aviation Is Ready, Hinton Is Ready—Now It's Up to YOU

Hinton will train you for Aviation, right at home in spare-time. Get your ground-work at once. Hinton's proved, successful course will teach you all the essential facts about plane construction, rigging, repairs, motors, instruments, theory of flight, navigation, commercial Aviation. Whether you plan to fly, or to cash-in on one of the more than forty Big-Pay ground jobs, you must have this ground-work to land the job you want at the pay you expect. Learn just where you stand and what first steps to take. This Free Book tells how. Clip the coupon and send it TODAY. Hinton will rush your book by return mail.

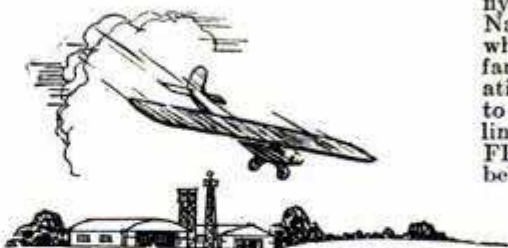

## 40

### Jobs on the Ground for Each One in the Air

Fliers are in demand—certainly! But for every man in the air, trained men are needed in over 40 highly-paid jobs on the ground. Hinton's training gives you your ground-work to earn real money as one of these:

Engineers, Designers and Draughtsmen, Pilots, Engine and Plane Mechanics, Riggers, Electricians, Welders, Instrument Makers, Wood and Metal Workers, Plane and Motor Inspectors, Airport Operators, Radio Experts, Assemblymen, Aerial Surveyors and Photographers, Aerial Transport Managers, Salesmen.

### Walter Hinton

Trail-blazer, pioneer, explorer, author, instructor, AVIATOR. The first man to pilot a plane across the Atlantic—the famous NC-4—and first to fly from North to South America. The man who was a crack flying instructor for the Navy during the War; who today is training farsighted men for Aviation. Hinton is ready to back YOU up to the limit. His Book is yours FREE for the coupon below.

## Rush Back to Washington!

Walter Hinton, Pres.,  
Aviation Institute of U. S. A.,  
1115 Conn. Ave., Washington, D. C.

Dear Lieut. Hinton: Send me your FREE Book telling how I can train under you right at home for Aviation.

Name.....

Street..... Age.....

City..... State.....

## Aviation Institute of U. S. A.

Walter Hinton, President

1115 Connecticut Ave., Washington, D. C.





# Magic

**Learned Easily At Home**



**Dr. Harlan Tarbell**  
Master of Magic who has mystified magicians as well as laymen with his marvelous tricks.

## Astonish Your Friends

Gain that magnetic popularity that makes you the center of any crowd. Business and social success is assured the man who can perform mystifying tricks. You can earn big money either on the side or as a professional, as well as being the most popular person in your crowd. Why envy others' skill? You can learn Magic yourself, quick and easy.

## Earn \$250 to \$1000 a Month

Even sleight-of-hand, generally supposed to require long practice, is NOW made simple to learn. For Dr. Harlan Tarbell, one of the really Great Magicians, has finally opened up the secrets of his profession in a completely illustrated course offered at a merely nominal cost. Through the wonderful Tarbell System you will be able to mystify and entertain your friends with simple tricks taught in your very first lesson. After that Dr. Harlan Tarbell takes you through the entire maze of sleight-of-hand, card tricks and elaborate stage diversifications. The apparently superhuman doings of the accomplished magician become as simple as ABC when you just know how.

## FREE Magic Book!

There is a tremendous demand for magic entertainment. Clubs, Lodges, Charity and Social affairs—all will pay high fees to the man who knows Magic. Dr. Harlan Tarbell really gets as high as \$250 for an half hours work right now. Opportunity everywhere to make money aside from your regular occupation. Salesmen find it a tremendous asset. Write today for big free Magic Book telling all about the amazing Tarbell course in Magic. Get our low prices and EASY Terms. Mail coupon today!

### Tarbell System, Inc.

1926 Sunnyside Ave., Studio B-135 Chicago

### Tarbell System, Inc.

1926 Sunnyside Ave., Studio B-135 Chicago

Tell me all about Dr. Tarbell's new and simple system by which I can learn the secrets of MAGIC. No obligation on my part.

Name.....

Address.....

25th Year



## CHICAGO TECHNICAL COLLEGE

**Engineering  
Architecture  
Electricity  
Drafting**

Intensely practical training. 2 year Diploma; 3 year B. S. Degree; special 3 and 4 months' short courses. Courses adapted to your needs. No time wasted. Expert instructors. Graduates in constant demand. Opportunities for self-support while studying. Day and evening classes. Athletics. Enter any time. Low tuition—easy terms. Desirable boarding accommodations. Write today for your copy of 80-page illustrated Blue Book, mailed free.

**Chicago Technical College**  
Dept. H-76, 118 East 26th Street, Chicago

*Learn to Write*



## I Teach by Mail

Begin Today—Write for My FREE Book. I can make a good penman of you at home during spare time. Write for my FREEBOOK, "How to Become a Good Penman." It contains specimens and tells how others mastered penmanship by the Tamblin System. Your name will be elegantly written on a card if you enclose stamp to pay postage. Write today for book.  
F.W. Tamblin, 418 Ridge Bldg., Kansas City, U.S.A.

## "STAMMERING

*Its Cause and Cure*"

You can be quickly cured if you stammer. Send 10 cents coin; or stamps, for 288 page cloth bound book on Stammering and Stuttering. It tells how I cured myself after Stammering and Stuttering for 20 years. BENJAMIN N. BOGUE  
11107 Bogue Building, 1147 N. Ill. St. Indianapolis

## LEARN PIANO TUNING AT HOME

Send for FREE copy of the 30th ANNIVERSARY EDITION of our book, "Winning Independence". Read how students master tuning with our TUNE-A-PHONE, and WHY our graduates head the profession in all parts of the world. With Bryant's patented devices, tools, charts and lessons, one learns quickly and easily. Low tuition; easy terms. Diploma granted. MONEY-BACK if not satisfied. \$10.00 to \$25.00 a day, exceptional opportunities and an ideal profession awaits you.

BRYANT SCHOOL OF TUNING, 31 Bryant Bldg., Augusta, Michigan

MEN TO LEARN

## MOTION PICTURE PROJECTION

A BIG-MONEY PROFESSION—\$2,000 TO \$4,000  
We Assist Students to Earn While Learning

MOVIE OPERATORS SCHOOL

61 Sprout Street

Detroit, Michigan

## LEARN WATCHMAKING AND ENGRAVING



**BY OUR PROFIT-SHARING PLAN  
OUR GRADUATES SUCCEED**

One of our Iowa students started in a very small way—now doing over \$30,000 a year. Another in Wisconsin, over \$10,000 the first year. Day or night classes. Call or write for FREE BOOK.

Chicago School of Watchmaking, Dept. 4201, 549 W. Randolph St., CHICAGO.



# What could be easier!

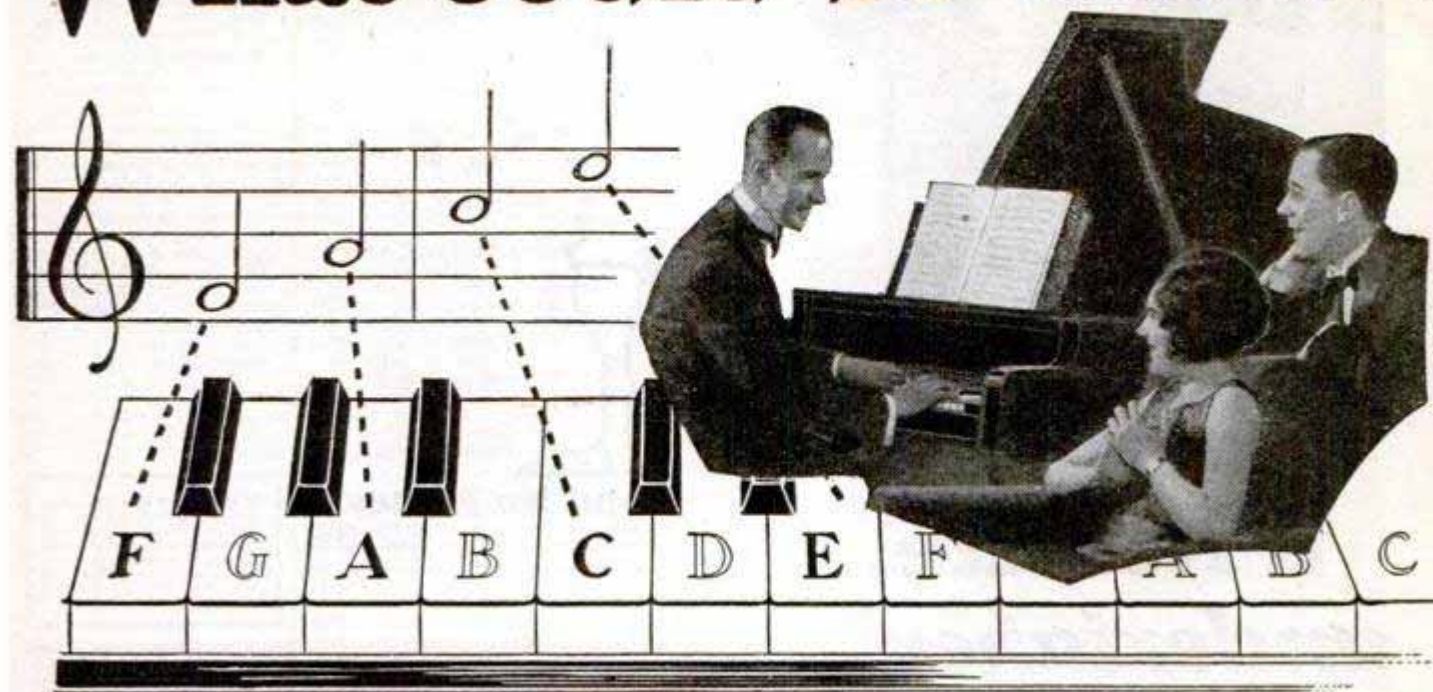

## Play any instrument in a few short months ... learn this delightfully simple way

**L**EARNING music is no longer a difficult task. If you can read the alphabet, you can now quickly learn to play your favorite instrument! A delightful new method has made it positively easy to read and play music within just a few months. And the cost is only a fraction of what people used to spend on the old, slow methods!

You don't need a private teacher. You study entirely at home, in the privacy of your own room, with no one to interrupt or embarrass you. And strange as it may seem; you'll enjoy every minute of it—because the new method is agreeable as well as rapid!

### No Tricks or Stunts—You Learn from "Regular" Music

You don't have to know the first thing about music in order to begin. You learn to play from actual notes, just like the best musicians do. And almost before you realize your progress, you begin playing real tunes and melodies instead of just scales. There are no trick "numbers," no "memory stunts." When you finish the U. S. School of Music course, you can pick up any piece of regular printed music and play it! You'll be able to read music, popular and classic, and play it from the notes. You'll acquire a life-long ability to please your friends, amuse your-

self, and, if you like, make money. (Musicians are highly paid for their pleasant work.)

Whether you like the piano, violin, cello, organ, saxophone, or any other instrument, you can now learn to play it in an amazingly short time. By means of this wonderful newly perfected method reading and playing music is made almost as simple as reading aloud from a book. You simply can't go wrong. First, you are told how a thing is done, then a picture shows you how, then you do it yourself and hear it. No private teacher could make it any clearer. The lessons come to you by mail at regular intervals. They consist of complete printed instructions, diagrams, all the music you need, and music paper for writing out test exercises. And if anything comes up, which is not entirely plain you can write to your instructor and get a full, prompt, personal reply!

you meet the kind of people you have always wanted to know. So don't miss this exceptional opportunity.

### Free Book and Demonstration Lesson

The whole interesting story about the U. S. School course can not be told on this page. So a booklet has been printed—"Music Lessons in Your Own Home." You can have a copy absolutely free by mailing the coupon below. With it will be sent a demonstration lesson which shows better than words how delightfully quick and easy this wonderful method is. If you are really anxious to become a good player on your favorite instrument, mail the coupon now—today. Instruments supplied when needed, cash or credit. U. S. School of Music, 77 Brunswick Bldg., New York City.

### Choose Your Course

- |                                     |           |
|-------------------------------------|-----------|
| Piano                               | Violin    |
| Organ                               | Clarinet  |
| Ukulele                             | Flute     |
| Cornet                              | Saxophone |
| Trombone                            | Harp      |
| Piccolo                             | Mandolin  |
| Guitar                              | 'Cello    |
| Hawaiian Steel Guitar               |           |
| Sight Singing                       |           |
| Piano Accordion                     |           |
| Voice and Speech Culture            |           |
| Harmony and Composition             |           |
| Drums and Traps                     |           |
| Automatic Finger Control            |           |
| Banjo (Plectrum, 5-String or Tenor) |           |

### The Surest Way to Be Popular and Have a Good Time

Do you sit "on the sidelines" at a party? Are you out of it because you can't play? Many, many people are. It's the musician who claims attention. If you play, you are always in demand. Many invitations come to you. Amateur orchestras offer you wonderful afternoons and evenings. And

U. S. SCHOOL OF MUSIC  
77 Brunswick Bldg., New York City

Please send me your free book, "Music Lessons in Your Own Home," with introduction by Dr. Frank Crane, Demonstration Lesson and particulars of your easy payment plan. I am interested in the following course:

Have You Instrument? .....

Name.....  
(Please write plainly)

Address.....

City.....State.....



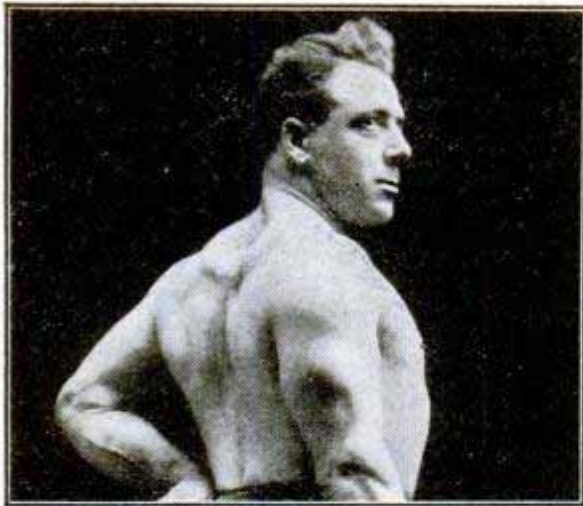

# “Don't flirt with the.. undertaker!”

If you were FLAT ON YOUR BACK today or parked between the white sheets of a hospital cot, you'd give every red cent you possess for HEALTH. But it might be TOO LATE. The wealth of John D. himself wouldn't help you then.

Why wait until DISEASE gets you in a HALF-NELSON and throws you for a fall before you wake up? You can't expect that body of yours to go on forever the way you're treating it now. For all you know—or seem to care—you're deliberately SHORTENING YOUR LIFE and inviting ILL HEALTH and suffering without doing one single thing to prevent it.

## I Will Make You Strong

Come to me—you men who value LIFE and LIVING—and I will help you to build up reservoirs of protection against disease.

I will put COLOR into pale cheeks. I will show you what to EAT and how to EXERCISE to avoid headaches and constipation. I will give you the endurance to tackle any job and carry it through.

Above all, I will show you the way to glorious, radiant HEALTH because I build from the inside out. I'll put NEW LIFE into every organ. From head to heels I'll make you A MAN—REAL MAN—ALL MAN. If I don't do it, I'll refund every penny.

## Get My Free Book

Make me prove every word I say here by tearing out this coupon and getting a copy of my book—“THE THRILL OF BEING STRONG.” It gives the names and photographs of famous athletes who endorse my course and tells why George F. Jowett's system gets results. All it takes is a two-cent stamp, yet it may be the means of adding years to your life. Come on, partner—LET'S GO.

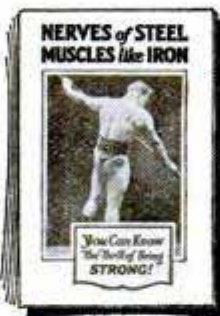

### JOWETT INSTITUTE OF PHYSICAL CULTURE

Dept. 4-B, 597 Fifth Avenue, New York, N. Y.

Dear Mr. Jowett:

Without cost or obligation, please send me your illustrated booklet, “The Thrill of Being Strong,” and the special lecture I have checked:

- “Muscular Proportions You Can Get”
- “The Cause and Cure of Hernia”
- “Muscle Building Before and After Thirty”

Name.....

Address.....



# \$2500 DRAWING COURSE for \$298



Haven't you often wished that you could draw cartoons, illustrate some idea, sketch some pretty face, etc.? You can do all of these things. One of America's most famous Cartoonists and Illustrators has developed a great, simple system for success in all branches of Commercial Art. This system has revolutionized the entire theory of drawing. It means that drawing can be as easy for you as writing—much simpler than learning shorthand, bookkeeping or typewriting. We are now placing this original system for learning Drawing, Art and Cartooning, consisting of 34 lessons with over 500 illustrations, within reach of every one. If you will devote a few hours each week to the Course WE ABSOLUTELY GUARANTEE that you will learn to draw and draw well before you have half finished the Course. If we fail to make this claim good, we will refund every cent paid us. By eliminating a large office force for answering correspondence, expensive catalogs, etc., we are enabled to make a price of \$2.98, the cheapest price ever known for a high-grade, home study course. Many have sent us letters similar to that of Rob't P. Davis of Detroit, who wrote: “I can't see how you ask so little. It is more than I expected.” Learn to draw. It is a big asset, no matter what field you are in.

## Send No Money

Just order the course and \$2.98 on arrival pay postman plus a few cents postage, payment in full for the entire Course and Drawing Outfit. If not entirely satisfied, return within five days and we will Refund Money. Address:

If you order the course at once, we will include a drawing outfit, consisting of artist's pencils, pens, paper, erasers, thumb tacks, etc., enabling you to go to work without any additional cost.

LEDERER SCHOOL OF DRAWING, Dept. 9398-X, Chattanooga, Tenn. Orders from outside the U. S. A. are payable \$3.28 cash with order.

## LAW Free Book

Write today for FREE 96-page book, “THE LAW-TRAINED MAN”, which shows how to learn law in spare time through the Blackstone home-study course prepared by 80 prominent legal authorities, including law school deans and U. S. Supreme Court justices. Combination text and case method of instruction used. All material necessary furnished with the course, including elaborate 26-volume law library, delivered immediately upon enrollment. Many successful attorneys among our graduates. LL. B. degree conferred. Moderate tuition, low monthly terms. Money-Back Agreement. Write for free book today.

BLACKSTONE INSTITUTE, 397 N. Michigan Ave. Dept. 50-B Chicago

## Learn Advertising at HOME

Send your name and address for free booklet giving interesting information and vital facts about Advertising. Find out how we prepare you at home, in your spare time, for the opportunities open in this fascinating business. Practical work. No text books. Old established school. Successful graduates everywhere. Just the plan you have always wanted. Write today. No obligation.

PAGE-DAVIS SCHOOL OF ADVERTISING  
Dept. 135-B, 3601 Michigan Ave. Chicago, U. S. A.

## The Expert PAINT MIXER

A new book for House and Structural Painters. Thorough instruction in mixing all paints for interior and exterior use, with directions for applying. Also much practical knowledge of color, bases, pigments and liquids. Sent for \$1.25 with return privilege. Write for catalog of PAY-RAISING BOOKS.

DAVID MCKAY CO.  
Dept. 27, 604 So. Wash. Sq., Philadelphia, Pa.

## Get this great work for your own use

# ENCYCLOPEDIA BRITANNICA

Write for FREE Booklet and full details. Dept. PM2  
THE ENCYCLOPEDIA BRITANNICA, INC.  
342 Madison Ave., New York City

# GOV'T. POSITIONS

## \$35 TO \$75 WEEKLY

**MEN - WOMEN**      **AGE 18 TO 55**

( ) Ry. Mail Clerk	( ) Steno-Typist
( ) Prohibition Inv.	( ) Immigrant Inspector
( ) R. F. D. Carrier	( ) Seamstress
( ) Special Agent (investigator)	( ) Auditor
( ) City Mail Carrier	( ) Steno-Secretary
( ) Meat Inspector	( ) U. S. Border Patrol
( ) P. O. Clerk	( ) Chauffeur-Carrier
( ) File Clerk	( ) Watchman
( ) General Clerk	( ) Skilled Laborer
( ) Matron	( ) Postmaster
	( ) Typist

OZMENT INSTRUCTION BUREAU, 111 Arcade Bldg., St. Louis, Mo. Send me FREE particulars How To Qualify for positions marked “X”. Salaries, locations, opportunities, etc. ALL SENT FREE.

NAME.....  
ADDRESS.....



I'll Pay Your Railroad Fare to Chicago Without Extra Cost

**UP TO \$15,000 a year for GREER GRADUATES**

ELECTRICITY, AUTOS, AVIATION now pay hundreds of trained men up to \$200 A WEEK. Here are THE 3 WORLD'S GREATEST BUSINESSES. BILLIONS—not millions, but BILLIONS of dollars are spent in them every year. CHOOSE ONE OF THESE THREE, HERE and NOW.

GREER trained men are NEEDED. I HAVE MADE hundreds of \$10,000 A YEAR MEN. 90,000 in the last 26 years have come to GREER. THOUSANDS MORE in the future will likely come here. BE ONE OF THEM. Send coupon to me for openings.

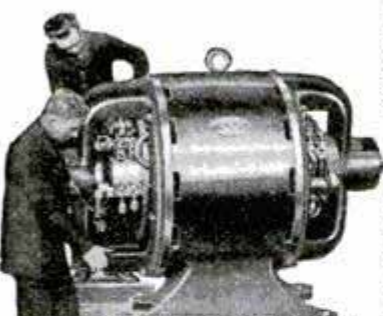

Rotary Converter, used by students for testing

**Amazing Opportunities for you in one of World's 3 Biggest Businesses**

**MEN WANTED**

I will help you get a position while learning, also after graduation. Never before such unusual opportunities. GET MY FREE BOOK NOW. LEARN ABOUT THE BIG PAY. ELECTRICITY. AUTOS. AVIATION. LEAD WORLD'S BUSINESS. That's why GREER College selected these fields and ONLY THESE.



Learn to Boss the Job

**ELECTRICITY**

**Learn in Only 3 Months in GREAT GREER SHOPS ON LARGE LIVE EQUIPMENT**

Mine is NOT A CORRESPONDENCE COURSE. You can start any day or any evening. It is PRACTICAL, EASY, QUICK, FASCINATING training. You learn on Great, running, live Equipment in tremendous GREER SHOPS. AUTO Business is a BIGGEST BUSINESS in the world. ELECTRICITY is FASTEST GROWING, and yet in its Infancy. AVIATION, most fascinating, alluring business today, is already a Billion Dollar Industry.

Choose one of these 3 wonderful professions today. Trained men are needed by scores, for positions up to \$200 a week and up. Find out now, about my great Shops training.

full of HARD THEORY—NO HEADACHES in GREER PRACTICAL SHOPS TRAINING. You learn to DO BY DOING. You learn to fly by flying.

**You Get Real Help to BIG JOBS !**

TWELVE PEOPLE are in my Big EMPLOYMENT DEPARTMENT getting jobs for Greer men. You get their help AS OFTEN AS YOU NEED IT, both BEFORE and AFTER Graduation.

**Get My FREE BOOK NOW**

Don't let money hold you back. Get my Free Book. Find out NOW, how I PAY YOUR FARE HERE, let YOU ATTEND EITHER DAYS or EVENINGS and help you find DAY or EVENING WORK to PAY YOUR EXPENSES while learning. Then when ready we help you find the real BIG PAY JOB. LEARN how I get you ready so Employers WANT YOU, and GLADLY pay you what you are worth.

**Quickest, Easiest of Ways to Become Expert**

I'LL PAY YOUR FARE HERE FREE of extra cost, then help you to a JOB WHILE LEARNING. Then I not only FIT YOU to get BIG PAY JOB, but I'll help YOU HOLD IT. Young and Old, Educated and Uneducated, Inexperienced and Experienced have found GREER SHOPS training EASY, FASCINATING and VALUABLE. Coupon below brings details.

**Not Correspondence Course**

Here at GREER SHOPS you learn on BIG, ACTUAL FULL SIZE Machinery, like you will work on, out on the Big Pay Job. You get close personal supervision. NO Guess work—NO books

Erwin Greer



**GREER COLLEGE**

**Electricity—Autos—Aviation**  
Dept. 701  
2024 So. Wabash Ave.  
CHICAGO, ILL.

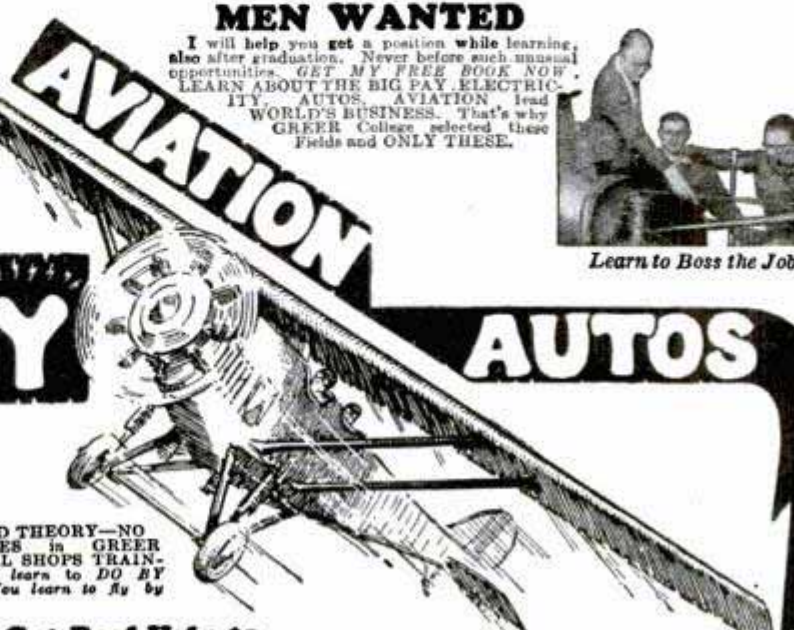

**AUTOS**

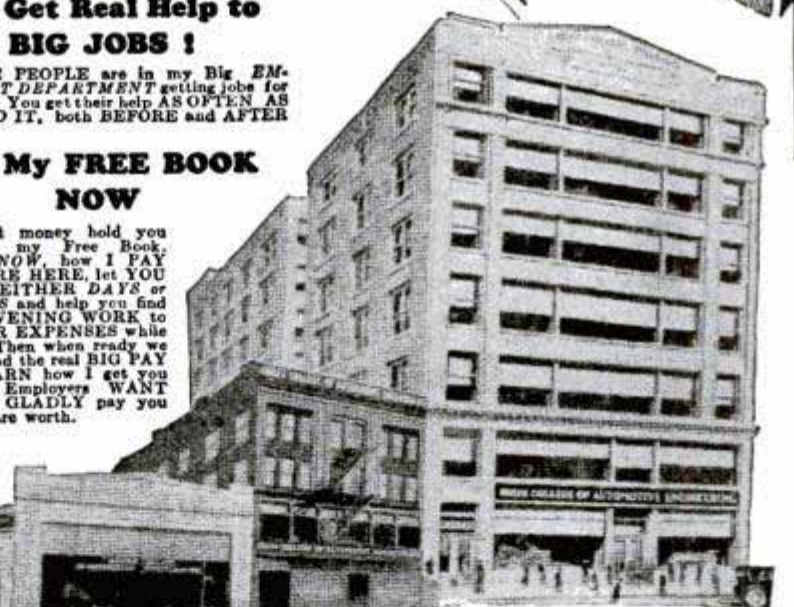

**90,000 Students 26 Years Tremendous Success**

Above is the important history of GREER COLLEGE. Note the steady 26-years growth, thru genuine SERVICE, from the tiny Shops on the left to the tremendous Building on the right, filled with GREAT TRAINING Equipment. These

moves to always greater quarters mean GROWTH—PROGRESS and SERVICE. What is it you like—ELECTRICITY—AUTOS—or fascinating AVIATION? GREER will train you in EITHER, as YOU SHOULD BE TRAINED.

**Get My Big Offer Now!**

Would an offer of \$100 a week be OPPORTUNITY or DISAPPOINTMENT for you? If you could HOLD the JOB it would truly be OPPORTUNITY. If you can't hold the \$100 a week job, PREPARE. Be ready. Don't invite disappointment. Learn about GREER SHOPS. Right now if you act quick, I can make you a most unusual short time offer. Clip coupon NOW and find out. Address me personally  
ERWIN GREER, President

**SCISSORS FOR FREE BOOK**

Autos  Electricity  Aviation

Name.....  
Address.....

**ERWIN GREER, President**

Dept. 701  
2024 So. Wabash Avenue,  
Chicago, Illinois

Send Free Book indicated below and details of Special offer, without obligation to me.



# You can play the HAWAIIAN GUITAR just like the Hawaiians!

Play all the latest hits just as the Hawaiians do. Be the most popular member of your set, a happy crowd always around you, everybody enjoying and admiring your playing. Get in on all the good times. Entertain your friends—or play professionally. We will help you.



### Native Hawaiian expert directs you

You get expert instruction, directed by a world-famous player and teacher, Prof. Walter Kolomo-ku. He quickly reveals to you the secrets of this fascinating instrument.

### Complete Conservatory Course

You get 52 complete printed lessons. Nothing is omitted. Pictures explain every move. And no matter how

little you know about music when you begin, no matter if you have never touched a musical instrument, you can positively learn to play by our plain, easy picture method. You are sure to learn! What we can do for others we can do for you. 51,000 successful students. This record assures your success.

### Learn at home in spare time

Study in spare time—in absolute privacy—when you like—as long as you like. Even if you don't know one note from another, our method is so simple you begin a piece your first lesson. In half an hour you can play it!

### Only 4 motions to learn

Then you can play any music—popular songs, classical, old-time melodies, native Hawaiian airs—or real jazz—separately or with accompaniment. You'll never be lonesome after you learn to play on this beautiful Hawaiian Guitar.

# GIVEN when you enroll— \$18 to \$20 Hawaiian Guitar

With Genuine Seal Grain Fabrikoid Cover and Complete Playing Outfit

Reliable retailers ask \$18 to \$20 for a similar instrument and outfit without the fine Fabrikoid Case, which alone is valued at \$3.50. Yet you receive this sweet-toned splendidly built Hawaiian Guitar, case and entire playing outfit, including picks, steel playing bar, tuning pipe, etc., without one penny of expense, as soon as you enroll.

### Pay as you play

We make it easy for you. Start any time with a small first payment—then pay while learning. It comes to only a few cents per lesson. And bear in mind: Your only investment is the cost of the course—we furnish everything else.

**FREE** Our new illustrated book, "The Romance and Enchantment of Hawaii—Its Music and Its People." A book you will want to keep. You won't lay it down until you have read it from cover to cover. Send for your copy today.

**OTHER COURSES** Tenor Banjo, Violin, Tiple, Tenor Guitar, Ukulele, Banjo Ukulele—well-known instructors.

### FIRST HAWAIIAN CONSERVATORY OF MUSIC, Inc.

9th Floor Woolworth Bldg., Dept. 548, New York, N. Y. Approved as a Correspondence School Under the Laws of the State of New York.

Member of National Home Study Council.

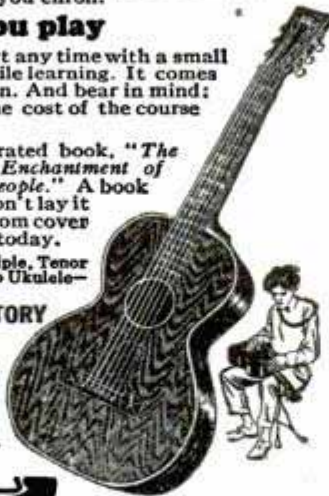

### Send This Coupon for Liberal Offer!

FIRST HAWAIIAN CONSERVATORY OF MUSIC, Inc. 9th Fl., Woolworth Bldg., Dept. 548, New York, N. Y.

Please send full information about your 52-lesson Hawaiian Guitar Course. I am not obligated to enroll unless I want to.

Name \_\_\_\_\_  
 Address \_\_\_\_\_  
 City \_\_\_\_\_ State \_\_\_\_\_

### PREPARE FOR AN

# ART CAREER

—thru the only art school operated as a department of a large art organization, who have actually produced over a quarter million drawings for leading advertisers. Where else can you get so wide an experience? Home study instruction. Write for illustrated book telling of our successful students.

**MEYER BOTH COMPANY**  
 Michigan Ave. at 20th St. Dept. 16, Chicago, Ill.

**\$100 a Week for Taking Pictures**

We Furnish Camera and Teach You How

Men and Women Everywhere! Make Big Money!

WRITE FOR FREE BOOK Explains opportunities as Motion Picture Camera Man, Portrait, News or Commercial Photographer. You can learn at home or in our New York Studios. Spare or full time.

N.Y. Institute of Photography, 10 W. 33rd St., N.Y. Dept. 49

### 30 Days' Free Trial

New Models now ready for delivery direct from our factory. Astonishing low prices and terms. Do not buy until you get them.

**RIDER AGENTS WANTED** to ride and exhibit sample. Make big money. Many models \$21.50 up.

**Tires** Guaranteed \$1.50 each, wheels, lamps, horns, equipment at half usual prices. Send No Money. Write for our marvelous prices and terms on RANGER Bicycles.

**Mead CYCLE CO. Dept. 1108 CHICAGO**



# 1,000 Hotel Positions Open!

**HOTELS**, restaurants, clubs, apartments, hospitals, institutions, schools and colleges everywhere need trained men and women. Over 70,000 high-class positions paying \$2,500 to \$10,000 a year open annually in the hotels of the United States. Nearly one and three-quarter billions of dollars' worth of **NEW HOTELS, CLUBS AND INSTITUTIONS** being built this year will need over 200,000 trained men and women. Hotels start you at salaries up to \$3,500 a year, with living usually included. At any time there are over 1,000 hotel positions open.

### Previous Experience Unnecessary

You can have one of these fascinating, big-pay positions. Thru our Simplified Study Plan we give you the valuable knowledge that it has taken some of the most successful hotel men years to obtain. Age is no obstacle—young and old alike have equal chance for success. Past experience absolutely unnecessary. A common school education is all you need.

We train you in your spare time and put you in touch with big opportunities. All of your training under the personal supervision of Clifford Lewis, Managing Consultant for over 225 hotels throughout the United States. Our students employed by leading hotels everywhere.

Send coupon today for Free Book, "Your Big Opportunity," showing how we can train you for one of these splendid positions and explaining our Money-Back Agreement.

### FREE BOOK COUPON

**LEWIS HOTEL TRAINING SCHOOLS,**  
 Room AX-385, Washington, D. C.

Send me without obligation the Free Book "Your Big Opportunity."

Name \_\_\_\_\_  
 Address \_\_\_\_\_  
 City \_\_\_\_\_ State \_\_\_\_\_





## Let Air Mail Pilots Teach You to Fly

The regular pilots of the U. S. Air Mail are the most capable, loyal, dependable flyers in the world. They **KNOW** flying. They **HAVE** to. The very success of the Air Mail depends upon them.

These are the men who teach the advanced students at the Robertson Aviation School — the very same pilots who fly the mail between St. Louis and Chicago every day—in every kind of weather—and do it 98% on time.

Col. Chas. A. Lindbergh was our Chief Air Mail Pilot and Instructor before he obtained his release to perfect plans for his epochal trans-Atlantic flight.

The Robertson School of Aviation is one of the oldest and largest in this country. Going into its tenth year with over 500 graduates. Courses are thorough and complete — flying, ground work, lectures, text book study. Airplane factories right here at the field offer exceptional facilities for gaining practical mechanical knowledge and experience.

The combination of all these advantages is something you should consider seriously. They are important.

The demand for well trained pilots is growing by leaps and bounds. Get in on the ground floor of this great, new, thrilling industry by getting the right kind of training **NOW**, from regular Air Mail Pilots. They teach you so well that we require no bond and make no charge for breakage.

*Complete catalog on request. Write today.*

### Robertson Flying Services, Inc.

Department P

**Affiliated with Robertson Aircraft Corporation**

(Operators St. Louis-Chicago U. S. Air Mail Route)

Lambert-St. Louis Flying Field, Anglum, St. Louis Co., Mo.

Robertson Aviation School, Dept. P.  
Lambert-St. Louis Flying Field, Anglum, St. Louis Co., Mo.

Please send catalog telling how I can get  
flying instruction from U. S. Air Mail Pilots.

Name..... Age.....

Street Address or Rural Route .....

City..... State.....

MR240





## "I'm going to raise his salary"

"I've had my eye on him for some time and I know he can handle bigger work."

"He studies those I. C. S. textbooks every chance he gets, and I want to tell you it has made him a valuable man for this business."

"I'm going to raise his salary and give him that new job we were talking about. I wish we had more men like him."

How do you stand when your employer checks up his men for promotion? Does he pass you by as just a routine worker, or does he think of you as a man who is ambitious to get ahead? Won't you be far more likely to get the promotion if he knows you are studying at home and are really preparing yourself to handle bigger work?

Think it over. Then act. It takes only a moment to mark and mail the coupon and find what the International Correspondence Schools can do for you, yet that one simple little step may be the means of changing your whole life.

### Mail the Coupon for Free Booklet

#### INTERNATIONAL CORRESPONDENCE SCHOOLS

"The Universal University"

Box 5542-F, Scranton, Penna.

Without cost or obligation, please send me a copy of your booklet, "Who Wins and Why," and full particulars about the subject before which I have marked X in the list below:

#### BUSINESS TRAINING COURSES

- |  |   |
|--|---|
| <input type="checkbox"/> Industrial Management                   | <input type="checkbox"/> Advertising                                      |
| <input type="checkbox"/> Personnel Management                    | <input type="checkbox"/> Business Correspondence                          |
| <input type="checkbox"/> Traffic Management                      | <input type="checkbox"/> Show Card and Sign Lettering                     |
| <input type="checkbox"/> Accounting and C. P. A. Coaching        | <input type="checkbox"/> Stenography and Typing                           |
| <input type="checkbox"/> Cost Accounting                         | <input type="checkbox"/> English  |
| <input type="checkbox"/> Bookkeeping                             | <input type="checkbox"/> Civil Service                                    |
| <input type="checkbox"/> Secretarial Work                        | <input type="checkbox"/> Railway Mail Clerk                               |
| <input type="checkbox"/> Spanish <input type="checkbox"/> French | <input type="checkbox"/> Common School Subjects                           |
| <input type="checkbox"/> Salesmanship                            | <input type="checkbox"/> High School Subjects                             |
|  | <input type="checkbox"/> Illustrating <input type="checkbox"/> Cartooning |

#### TECHNICAL AND INDUSTRIAL COURSES

- |   |  |
|---|--|
| <input type="checkbox"/> Electrical Engineering | <input type="checkbox"/> Architect                                       |
| <input type="checkbox"/> Electric Lighting      | <input type="checkbox"/> Architects' Blueprints                          |
| <input type="checkbox"/> Mechanical Engineer    | <input type="checkbox"/> Contractor and Builder                          |
| <input type="checkbox"/> Mechanical Draftsman   | <input type="checkbox"/> Architectural Draftsman                         |
| <input type="checkbox"/> Machine Shop Practices | <input type="checkbox"/> Concrete Builder                                |
| <input type="checkbox"/> Railroad Positions     | <input type="checkbox"/> Structural Engineer                             |
| <input type="checkbox"/> Gas Engine Operating   | <input type="checkbox"/> Chemistry <input type="checkbox"/> Pharmacy     |
| <input type="checkbox"/> Civil Engineer         | <input type="checkbox"/> Automobile Work                                 |
| <input type="checkbox"/> Surveying and Mapping  | <input type="checkbox"/> Airplane Engines                                |
| <input type="checkbox"/> Metallurgy and Mining  | <input type="checkbox"/> Agriculture <input type="checkbox"/> Navigation |
| <input type="checkbox"/> Steam Engineering      | <input type="checkbox"/> Mathematics <input type="checkbox"/> Radio      |

Name.....

Street Address.....

City..... State.....

Occupation.....

Persons residing in Canada should send this coupon to the International Correspondence Schools Canadian, Limited, Montreal, Canada



## Why Miss Half the Fun in Life?

BE POPULAR — Learn to dance well! Arthur Murray, America's greatest dancing teacher, has invented a remarkable new easy method which enables anyone to learn all the newest dances at home—in a few hours—at very little cost! No music or partner needed. Success positively guaranteed! "125,000 learned dancing by mail."

**FREE 5 DANCING LESSONS —** To prove you can learn easily and quickly, Arthur Murray will send you Five FREE lessons, including Fox Trot, Secret of Leading, and How to Gain Confidence. To pay cost of mailing, printing, etc., enclose 10c. Act NOW and be a good dancer soon.

Arthur Murray, Studio 827, 7 East 43rd Street NEW YORK



## GIVEN TO YOU

**\$20 Musical Instrument**  
Choose ANY  
Yes, we will give you without extra cost a \$20.00 quality Violin, Tenor Banjo, Hawaiian Guitar, Banjo, Banjo-Guitar, Cornet, Guitar, Mandolin or Banjo-Mandolin. Learn to play by note. We teach men, women, boys and girls by mail. Amazing new, simplified method. A few cents a day pays for Lessons. Instrument and first lesson sent on FREE TRIAL. Over 500,000 successful pupils. Write today.  
**CHICAGO CORRESPONDENCE SCHOOL OF MUSIC, INC.**  
1632 North Halsted Street, Dept. 706, Chicago, Illinois.

## Anyone CAN LEARN

No talent or experience necessary. Fascinating work. Pays big money. Complete instruction book tells about: Alphabets, Colors, How to Mix Paints, Show Cards, Window Boards and Wall Signs, Ready made letters, Gilding, Tricks of the Trade, also gives 100 Alphabets and Designs. Book bound in flexible int. leather-gold edges, and four ball bearing Show Card Pens. Sent postpaid \$3.00. (C. O. D.) 10c ex. Gellvie Pub. Co., 57 Rose St. Dept 20, N. Y. City

**EARN MONEY IMMEDIATELY— WE FURNISH EQUIPMENT TO START!!**

## Great Athletic Book 10c

Be strong and athletic. Learn wrestling, self defense, jiu-jitsu. Let Farmer Burns, Mgr. Frank Gotch, World's Champion, teach you. Great opportunity for young men. Makes you strong, healthy and skillful.

**Send 10c** for 32-page book showing great holds and tricks by Burns and Gotch. Only a few at this price. Write today, giving your age.

Farmer Burns School of Wrestling, 8337 Range Bldg., Omaha, Neb.

## Book on Law Free

Write today for this new book. It tells you how a law training will shorten your road to success. It also carries a vital and inspiring message to every ambitious man. Find out about the opportunities that await the law trained man. Find out how you can learn law right in your own home. No obligations. The book is absolutely FREE.

**Write Today**—now—while low tuition fee is in force.

American Correspondence School of Law  
3601 Michigan Ave. Dept. 138-B Chicago, Ill.

## Skin Troubles

**Cleared Up—Often in 24 Hours.**

To prove you can be rid of Pimples, Blackheads, Acne Eruptions on the face or body, Barbers' Itch, Eczema, Enlarged Pores, Oily or Shiny Skin, simply send me your name and address today. **CLEAR-TONE** since 1910 over 500,000 users—simply magical in prompt results. Use like toilet water. You can repay the favor by telling your friends; if not, the loss is mine. **WRITE TODAY.**

**E. S. GIVENS, 528 Chemical Bldg., Kansas City, Mo.**



# FREE

This Genuine  
Ivory Pocket  
Rule



Get out your  
pencil and  
copy the Jack  
right now

← You get  
this rule  
for copying  
this Jack →

Can you copy it? Try it. How you copy it may give me some idea of what kind of a draftsman you would be. If you are 16 years old or older and will mail me your sketch at once, I will send you, free, and prepaid, a draftsman's Ivory Pocket rule, shown here.

This will go to you entirely with my compliments.

In addition I will send you my book on Successful Draftsmanship. Don't wait. Copy the sketch now and mail it to me.

## Draftsmen Needed In

### Auto Work

The automobile industry is one of the greatest in America. Thousands of draftsmen needed. I'll train you for the work.

### Electricity

Electricity is the coming motive force of the world. Draftsmen are needed in every department of this fascinating work. I'll train you at home. Get a job here.

### Aviation

Aviation is just in its infancy. It is bound to expand to enormous proportions. Draftsmen are essential to it. I'll train you quick at home for drafting position.

### Motor Bus Work

Motor bus building and motor bus transportation have become leading world industries. Hundreds of draftsmen engaged in this work. I'll show you the way.

### Building Work

There will always be building. No structure can be erected without plans drawn by draftsmen. I'll make you an architectural draftsman at home.

Copy me  
and get  
Ivory Rule  
Free. — Jack

## Get My Free Pay-Raising Plan



Write to me. I will send you this new book. Not a catalog. My Pay Raising Plan and Money Making Advice. I can prove that John Savadge, trained by me, makes \$300 a month. Earl J. Dupree, trained by me, refused \$600 a month because he makes more in his own business. A. H. Bernier, trained by me, earns \$7000 to \$9000 a year. Arthur Dewalt, trained by me, makes more than \$400 a month. D. C. Stroop, trained by me, makes \$475 a month. L. V. Broughten, trained by me, makes \$300 a month.

I can give you many more names of Dobe trained draftsman who are making big salaries. They wrote to me just as I am asking you to write. They asked for my Free Book. They saw that opportunities in all of the great industries were tremendous for draftsman. Through drafting you can get into almost into any industry you want.

### Money Back if Not Satisfied

What could be fairer than that? I don't ask you to take any chances. I train you under a positive Money Back Agreement. If my training does not satisfy you after you have finished you get every penny back.

### Earn While You Learn

You can start earning extra money a few weeks after beginning my training. I give you special work and tell you how to make money.

### Age or Lack of Education No Drawback

You do not need previous experience. You do not need to be a high school graduate. My practical, home study course gives you just the kind of training you need to become successful. Your spare time is all that is necessary.



"I will train you at home." — Engineer Dobe

**If You Earn  
Less Than  
\$70 a Week  
Write Me Today!**

**ACT NOW** Before You Put this Magazine Down. Let me send you my books "Successful Draftsmanship" and "My Pay Raising Plan". Remember Draftsmen are needed everywhere. That's the kind of profession to get into. Get started now. Get into a better position, paying a good straight salary the year around.

**Engineer Dobe** 1951 Lawrence Avenue  
Div. B-135 Chicago, Ill.

### Employment Service

After training you I help you to get a job without charging you a cent for this service. Employers of draftsmen come to me for men because they know that men I train make good.

### I Train You at Home, New, Quick, Sure Way

My practical working method makes every step in learning drafting, as clear as a moving picture. That's why I train you so fast to be a draftsman.

You GET THESE FINE QUALITY, GENUINE, IMPORTED DRAFTSMAN'S TOOLS, just as soon as you become my student. No finer tools can be made for practical drafting work.



You get these tools as my student

## FREE RULE COUPON!

### ENGINEER DOBE

1951 Lawrence Ave., Div. B-135 Chicago

Here's the sketch. Send me free rule; also send me free of all cost books "Successful Draftsmanship" and "My Pay-Raising Plan" — how to earn money while learning and proof of big money paying positions.

Name.....Age.....

Address.....

Post Office.....State.....



# We Will Train You in a Few Months



**Day and Night Schools in Chicago Detroit Cleveland Boston Phila.**

**Experts Earn Up To \$125 a Week**

## as MECHANICAL DENTISTS

We teach you to make rubber plates, crowns, bridge work, metal base dentures, etc., for dentists. After graduating you are ready for a job or can open your own laboratory. We assist you.



## Big Demand for Men!

Mechanical Dentistry is the laboratory bench work which the dentist turns over to the laboratory worker. Master this profession and help meet the demand of 64,000 dentists for laboratory work. Every city and every town where dentists are located offers work to the mechanical dentist. We train you in a few months in day or night school for this uncrowded field—no classes—no books—no mechanical experience necessary.

## Work Your Way Thru School

We will help you find a job to meet your expenses while taking our training. And we will help you find satisfactory living quarters when you arrive.

Schools located in *Chicago, Detroit, Cleveland, Boston, Philadelphia.* Day and night schools.

## INTERESTING FREE BOOK

Our illustrated, free book on Mechanical Dentistry will acquaint you with some surprisingly interesting facts. It tells about the thriving profession of Mechanical Dentistry—the way to swift and certain success. And it tells about the progress of many of our graduates—men who have succeeded beyond their expectations, also full details of our liberal offers. Mail the coupon and find out more about this fascinating opportunity.

**McCarrie School of Mechanical Dentistry**  
1338 S. Michigan Ave., Dept. 174, Chicago, Ill.

McCARRIE SCHOOL OF MECHANICAL DENTISTRY  
1338 S. Michigan Ave., Dept. 174, Chicago

Without cost or obligation, send me your illustrated book on Mechanical Dentistry, and complete information as to my opportunities in dental laboratory work.

Name.....

Address.....

# LEARN COSMETIC MANUFACTURE

AT HOME IN YOUR SPARE TIME

Easily learned. Experience unnecessary. Millions made manufacturing and selling Cosmetics. Taught you by the largest Cosmetic College in the world. We teach you at home in few weeks. Send for FREE Book today.

AMERICAN SCHOOL OF COSMETIC MANUFACTURE  
743 So. Maple Avenue, Dept. B, Los Angeles, Calif.

# LEARN FLYING "THE MODERN AIRPLANE" ONLY

READ THE NEW BOOK

Tells in plain English why an airplane flies, how it is controlled, how to become a pilot, etc., complete in 112 pages, fully illustrated and right up to date.

\$1.00

Here's the quickest way to understand FLYING! Send \$1 to  
ROTH-DOWNS AIRWAYS 2518 UNIVERSITY AVE. SAINT PAUL, MINN.

# LAW STUDY AT HOME

Become a lawyer. Legally trained men win high positions and big success in business and public life. Be independent. Greater opportunities now than ever before. Big corporations are headed by men with legal training. Earn \$5,000 to \$10,000 Annually

We guide you step by step. You can train at home during spare time. Degree of LL.B. conferred. LaSalle students found among practicing attorneys of every state. We furnish all text material, including fourteen-volume Law Library. Low cost, easy terms. Get our valuable 108-page "Law Guide" and "Evidence" books FREE. Send for them NOW.

LaSalle Extension University, Dept. 764-L, Chicago  
The World's Largest Business Training Institution

# Learn to PAINT SIGNS and SHOW CARDS

We quickly teach you by mail, or at school, in spare time. Enormous demand. Big future. Interesting work. Oldest, foremost school.

EARN \$50 TO \$200 WEEKLY

John Vassos, N. Y., gets \$25 for single show card. Crawford, B. C., says: "Earned \$200 while taking course." Send today for free information, samples and guarantee.

DETROIT SCHOOL OF LETTERING  
154 Stimson Ave. Est. 1899 Detroit, Mich.



## Get into the electric wiring field—big demand—big money!

THE whole wiring field covered. Kinks; helps; short cuts; practical, on-the-job electrical data, written particularly to help wiremen, trouble shooters, maintenance men, armature winders, electrical contractors and students.

**American Electricians' Library**  
6 volumes, 2000 pages, illustrated, \$17.50 payable \$1.50 in ten days and \$2.00 a month

The books tell you all you must know about conduit wiring, armature winding, wiring for lighting circuits and switches, wiring for machinery, circuit troubles, circuit testing, or electrical machinery erection. Through a study of this great set you can push yourself into a big-pay job for life.

See it FREE—Send no money—ACT

**FREE EXAMINATION COUPON**

McGRAW-HILL BOOK CO., Inc.  
370 Seventh Avenue, New York

Send me the American Electricians' Library for 10 days' free examination. If satisfactory, I will send you \$1.50 in 10 days and \$2 monthly until the full price, \$17.50, is paid. If not wanted, I will return the books at your expense. Upon receipt of my first payment I am to receive a copy of Croft's Signal Wiring free of charge.

Name.....

Address.....

City and State.....

Position.....

Company..... P. M. 7-28



# Oh You Skinny!

## Are You Laughed At On The Beach?

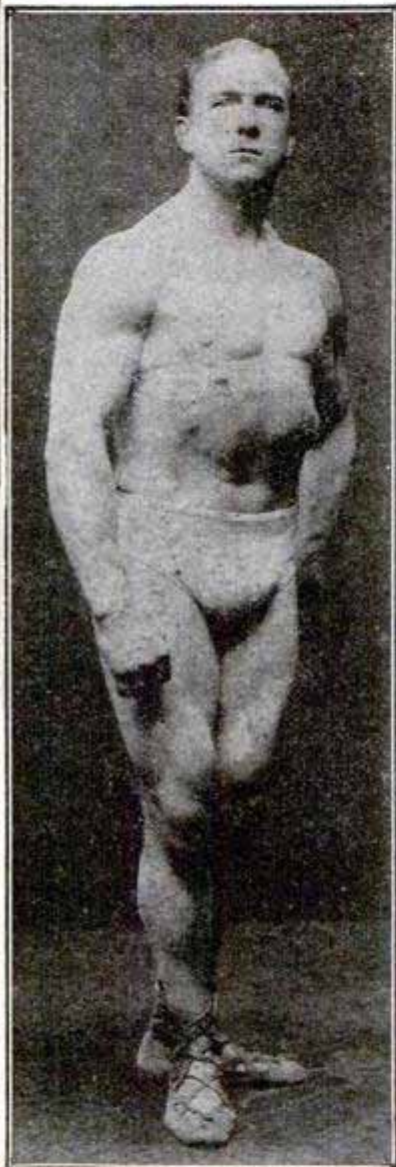

**STRONGFORT**  
Builder of Men

### I Want To Send You MY FREE BOOK

This book of many pages and dozens of pictures tells of my wonderful experience—how I became the outstanding athlete of the world, performing feats others dared not attempt; how I turned the knowledge gained through developing my own body to the benefit of others, and then how STRONGFORTISM was evolved. It tells what I have done for others, what I can do for you. It doesn't mince words. It tells plain truths. "Promotion and Conservation of Health, Strength and Mental Energy," points the way from disease and weakness to health and strength. It is priceless. I'll send it to you on request—FREE. Write for your copy today.

## STRONGFORT INSTITUTE

LIONEL STRONGFORT, DIRECTOR

PHYSICAL AND HEALTH SPECIALIST  
DEPT. 485 NEWARK, NEW JERSEY, U. S. A.

Are you a puny, bony, skinny outfit at whom everybody laughs? Are you a curiosity on the beach, inviting all sorts of ridicule? Do girls titter as you pass them? Do they shun your society? If this is your sorry plight, young fellow, just take a hunch from me—snap out of your skinniness—put on flesh and muscle, build up strength and straighten up your back. **YOU CAN DO IT.** You can be a duplicate of that bronzed and much admired life-guard over whom the girls rave. You can develop a symmetrical form, rounded out chest, rippling muscles on your arms and legs. You can be a powerful swimmer, a graceful dancer, a peppy boxer, a swift runner—just what you'd like to be.

### Let STRONGFORT Make a Man of You

I've taken thousands of young fellows, skinny as a lath, and built them up into strapping, powerful men who commanded respect and admiration wherever they went. Some of these chaps had set too fast a pace for themselves, others had wasted their vitality and broken down their manhood, others had gone stale from neglect of their bodies or other abuses and excesses. No matter how despondent their state of mind or how physically broken they were, they quickly came back when they adopted

## STRONGFORTISM

### The Science of Health and Strength

STRONGFORTISM works wonders with run-down, weakly, skinny men. It builds them up to health through internal muscular development, then rounds them out into robust physical specimens, by bringing into play every muscle and making every muscle do its work as Nature intended. You'll be astonished how quickly you'll feel the benefits of this best of all health and strength Courses. You'll feel like a new man almost from the first day you start under my instructions. You'll be surprised at the lazy muscles you wake-up when you begin, and they'll wake you up in turn. You'll quickly realize that a new day has dawned for you as you feel the red blood coursing through your whole body like a bounding mountain stream. That old, stupid, sluggish feeling will disappear like magic. That gloomy outlook will vanish as though a heavenly hand had brushed it away. Oh, it's a great feeling! Great to feel like a man! And you surely will when you adopt Strongfort as your instructor and guide — Strongfort, "the builder of men."

#### Send this FREE Consultation Coupon

#### ABSOLUTELY CONFIDENTIAL

Mr. Lionel Strongfort, Strongfort Institute, Dept. 485, Newark, N. J.—Please send me absolutely free my copy of your book, "PROMOTION AND CONSERVATION OF HEALTH, STRENGTH AND MENTAL ENERGY." I am enclosing 10c (one dime) to help cover mailing expense, etc., and have marked (X) before the subjects in which I am most interested.

- |             |                 |                         |
|-------------|-----------------|-------------------------|
| .. Catarrh  | .. Overweight   | .. Weak Heart           |
| .. Colds    | .. Constipation | .. Great Strength       |
| .. Asthma   | .. Weak Back    | .. Lung Troubles        |
| .. Headache | .. Weak Eyes    | .. Round Shoulders      |
| .. Rupture  | .. Rheumatism   | .. Stomach Disorders    |
| .. Thinness | .. Nervousness  | .. Increased Height     |
| .. Pimples  | .. Short Breath | .. Muscular Development |
| .. Insomnia |                 |                         |

Other Ailments.....

Name.....

Age..... Occupation.....

Street.....

City..... State.....



O. C.  
MILLER  
Director  
Extension  
Work  
American  
School



## The American School

A two million Dollar No-Profit Educational Institution, now offers men a double service—training for a specific job, then help in finding the job. For one small price, on terms of only \$6.00 a month, you are now assured of definite benefits, both in position and salary. Write for complete information—today!

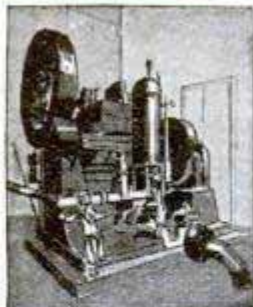

No machine can be built until the Draftsman first builds it on PAPER. This training prepares you for this work.



Never has the world seen anything like the building boom of today. This has created enormous demand for real Draftsmen.

# 3 Drafting

to prove you can

We have invented a new, simplified way to teach Drafting—the first real improvement in Drafting home instruction in history. We want you to see a few of these new Job-lessons, try them, test your own ability to master them—without one penny of cost or obligation. For instance, you will see how we get away from the "copying" methods used in the past, so you develop into a DRAFTSMAN, instead of a "tracer." See for yourself the ingenious new method which compels you to think, to solve problems, to do actual Drafting-room jobs from the very first lesson!

## A New, Rapid, Simplified Training

Copying drafting lessons prepares you to be only a "tracer." This new "Job-Method" gives you actual drafting-room jobs in a new one-step-at-a-time way. With pictures which you can understand almost without reading the "lessons." And that is why the American School-trained Draftsmen can qualify for a good job at big pay when they graduate.

## Win Success Thru Drafting

Drafting is easy, fascinating work. Short hours. Big pay. And the Draftsman is always in line for promotion to executive positions. This training is complete. It includes high school subjects (if you need them) and all the Engineering and Mathematics Drafting experts require.

# 5

## BIG-PAY Branches

The big money in Drafting goes to men who specialize in Machine Design, or Electrical Drafting, or Architectural Drafting, or Structural, or Automotive. It is not enough merely to know general Drafting practice. You must know how to calculate and design and plan original work. You need many Engineering subjects to fill the kind of a Drafting position that pays \$40 to \$100.00 a week. The American School now includes this specialized training in its Drafting course.

## Costly Drafting Outfit Given!

Fine, imported instruments like these help you learn Drafting quickly and easily. These standard quality, full size instruments, board, triangles, T square, ink, protractor, etc., given to every student without extra cost.



## FREE Job Service!

The American School now offers its students and graduates, without cost, the services of an efficient employment department keeping in constant touch with employers of Draftsmen all over the U. S. We have placed hundreds of men in good, big-pay Drafting positions. We've made this training so complete, so practical, so easy to master, that our students are bound to make good. And so, because the demand for real Draftsmen continues to exceed the supply and because this training actually prepares men for good Drafting positions we back it with a Free Employment Service.

The American School

Dept. DB-74  
Drexel Avenue and  
58th St., CHICAGO



# Lessons *Actually* FREE

learn at home in spare time!  
**Draftsmen Wanted!**  
**\$40 to \$100 a Week!**

yourself. Plan your future in Drafting. Even if you have only common schooling, even if you know nothing of Drafting, we guarantee to make you a real Draftsman or to refund your money!  
 Coupon brings complete information.

70,000 fine jobs advertised last year. Get ready to fill one. Get out of the rut. Make something of

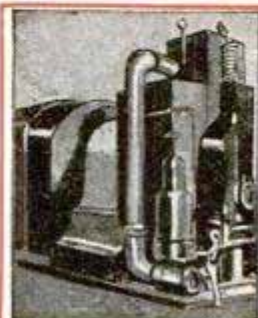

Electricity needs draftsmen who know Electrical principles as well as general Drafting practice. I give you this training.



The demand for Draftsmen experienced in concrete and structural steel work is enormous. Many big-pay positions open.



Every great Auto factory employs Draftsmen who specialize in Automotive work—men who design bodies, plan engines, etc.

**I Will Make This Contract With You**

WHEN you enroll for our home-training in Drafting, we agree to give you:

1. Complete Drafting training, by the new Practice-Method.
2. Professional Drafting outfit, as illustrated.
3. We will help you get a good Drafting position at a substantial increase in pay.
4. or we'll refund every cent of your money.



American School  
 —the Million Dollar Educational Institution



*O. C. Miller*  
 Director Extension Work

**Coupon Brings 3 Lessons FREE!**

Get them. Test your own ability to learn Drafting and get ready for a fine job and big pay. Coupon also brings complete information about your opportunities for success in Drafting. *Mail It Today!*

**Read These Letters!**

City of Chicago  
 Department of Buildings  
 Gentlemen: The same day I received my diploma I got word that I was one of the two candidates who had successfully passed the examination for Deputy Commissioner of Buildings of the City of Chicago, a position paying \$3600 per year.

There were eight applicants examined besides myself, all men well known to the architectural and engineering profession. Seven of these failed to obtain a passing grade of 70%. My grade was 84.69.

Inasmuch as I failed to pass this same examination three years before, my present success is mainly due to the knowledge gained through your School.

Yours very truly,  
 ROBERT KNIGHT

**Got His Draftsman's Job**

"I wanted to let you know how I came out in getting that job at the Brownell Co., Dayton, Ohio. I was to start and have a trial at Drawing, and I am still in the Drawing room. The engineer seems to like the work I make, and also the other draftsmen. I thank the school very much for getting me in at this place, because your letter of recommendation helped me a whole lot to get the job."

BERNARD WEBER,  
 730 St. Nicholas Ave., Dayton, O.

**Liberty High School Bethlehem, Pa.**

Dear Sirs:—This is to thank the American School for all that you have done for me since I signed up for the Drafting and Design Course.

In the eight years since then, I have gradually climbed from the position of tracer to that of Head of the Department of Machine Drawing and Design in our magnificent new \$2,000,000 High School here, at many times the salary which I received at that time.

The officials of the Pennsylvania State Department, and Dr. Wm. C. Ash of the University of Pennsylvania, all claim that our Course in Drafting and Design is the best now being taught in this state. Every drafting graduate that we have turned out has proved successful, and one is now Chief Draftsman in a local steel concern. Yours sincerely,

J. S. LEAR

**Has Charge of Large Jobs**

"Even before I had finished my course, I was put in charge of large construction jobs in different cities. I have been doing that ever since, and the jobs are getting larger all the time. I owe my success to the American School because of the knowledge I gained in mathematics and calculations."

ELMER L. LAMB,  
 1306 Smith St., Peoria, Ill.

## 3 Drafting Lessons *Actually* FREE

O. C. MILLER, Director Extension Work  
 AMERICAN SCHOOL  
 Dept. DB-74, Drexel Ave. and 58th St., Chicago.

Rush 3 Free Drafting Lessons, Job and Raise Offer, complete information, money-back guarantee, etc., to prove I can become a real Draftsman at home in spare time.

Name .....

Street No .....

City ..... State .....

Age ..... Occupation .....





**With Violet Ray Vibration  
Ozone Medical Electricity**

*The Four Greatest Curative Powers  
Generated by This*

**Great New Invention!**



Elco Health Generators at last are ready for you! If you want more health—greater power to enjoy the pleasures and delights about you, or if more beauty is your desire—write! Ask for the book on these inventions which has just been prepared. It will be sent to you without cost. It tells you how Elco Health Generators aid you in leaving the lethargy and hopelessness of bad health and weakness behind forever. Re-vitalize yourself. Bring back energy. Be wholly alive. Write today!

**Here's What Elco Users Say—**

"Wouldn't take \$1000 for my Elco."  
"Has done me more good in 2 weeks than doctors did in three years."  
"Cured my Rheumatism."  
"My Eczema gone."  
"Cured my stomach trouble."  
"Cured my weakness."  
"Now I sleep soundly all night."  
"Thanks to Elco, my strength and vigor are back."  
"No more pain."  
"Colds never bother me now."  
"Chronic Constipation banished."



These great new inventions generate Violet Ray, Vibration, Electricity and Ozone—combined or separate. They operate on the electric light in your home or on their own motive power at less than 50 cents per year. Elco Health Generators are positively the only instruments which can give you in one outfit Electricity, Violet Ray—Vibration and Ozone—the four greatest curative agents. Send the coupon below. Get the Free Book NOW!

**MAIL COUPON  
for FREE BOOK**

Do not put this paper down without sending the coupon. Don't go on as you are with pains and with almost no life and energy. You owe it to yourself to be a better man or woman. You were put here to enjoy life—not just to drag through it. So do not rest another day until you have put your name on the coupon here. That will bring the whole story of these great new inventions. Do it today—now.



**Lindstrom & Company**  
30 West Lake St. Dept. B-135 Chicago  
Please send me your free book, "Health—Power—Beauty" and full information of your 10-day Free Trial Offer.

Name.....  
Address.....

**Books on 65 Practical Subjects**

Popular Mechanics Press specializes in supplying the outstanding best book on any subject. Check the books you want, and mail this advertisement as your order blank.

- AIRCRAFT**  
Dyke's Aircraft Engine Instructor (Just Out) \$5.00
- ARCHITECT**  
Design and Lettering \$2.00
- ARTIFICIAL FLOWERS**  
How to Make for All Purposes 50c
- AUTOMOBILE**  
Dyke's Encyclopedia \$6.00
- BOAT BUILDER**  
14 Popular Types \$0.50
- BOOKKEEPER**  
Bookkeepers' Handbook \$1.00
- BOYS' BOOKS**  
The Boy Mechanic (4 vols.) \$7.00
- BRICKLAYER**  
Plain and Fancy Brickwork \$1.50
- CABINET MAKER**  
Furniture Making \$3.50
- CALCULATOR**  
Ropp's Calculator \$1.00
- CARBURETORS**  
Everything About All Makes \$2.00
- CARPENTER**  
366 Carpentry Kinks \$1.50
- CARTOONING**  
How to Draw Cartoons \$3.00
- CIVIL SERVICE**  
Course in Civil Service \$1.50
- CONCRETE**  
173 Ways of Using Concrete \$0.50
- COOKING**  
Settlement Cook Book \$2.50
- DIESEL ENGINES**  
Diesel Engines, Marine, Locomotive, Stationary \$5.00
- DOG FANCIER**  
Dog Encyclopedia \$2.00
- DRAWING**  
Freehand and Perspective \$1.50
- DRILLING**  
Drilling and Thread Cutting \$0.50
- ELECTRICIAN**  
214 Electrical Kinks \$1.50
- ELECTROPLATER**  
Electroplating \$1.00
- ENGINEER**  
Bailey's Handbook for Stationary, Marine, Diesel \$2.00
- ENGLISH**  
Self-Improvement in English \$2.50
- ENTERTAINMENTS**  
Producing Amateur Entertainments \$2.00
- ETIQUETTE**  
Book of Etiquette (2 vols.) \$1.98
- FARMER**  
Popular Mechanics Handbook for Farmers \$1.00
- FORMULAS**  
10,000 Formulas \$4.00
- FUR FARMING**  
For Profit \$4.00
- FURNITURE MAKING**  
Mission Style \$3.00
- HAND FORGING**  
Hand Forging and Wrought Iron Ornamental Work \$2.00
- HOME REPAIRS**  
Practical Book of Home Repairs \$2.50
- HOUSEHOLD CONVENIENCES**  
Built-In Furniture \$2.50
- INTERIOR DECORATOR**  
Interior Wall Decoration \$4.00
- INVENTOR**  
Inventions and Patents \$2.50
- JOINT WIPING**  
and Lead Work \$1.00
- LANDSCAPE GARDENING**  
Practical \$2.50
- LATHE WORK**  
Lathe Handbook \$0.50
- LEATHER WORKER**  
Leather Work \$1.50
- LETTER WRITING**  
Effective \$3.00
- LIFE WORK**  
Choosing \$2.50
- LOOM FIXER**  
Practical Loom Fixing \$1.50
- MACHINIST**  
419 Machinists Kinks \$1.50
- MAGIC**  
200 Tricks You Can Do \$1.00
- MAIL-ORDER AND DIRECT-MAIL**  
Selling \$5.00
- MATHEMATICS**  
Mathematics for the Practical Man \$1.50
- MECHANICAL DRAFTSMAN**  
Practical Course in Mechanical Drawing \$1.00
- MODEL MAKING**  
Model Making \$3.00
- MOVIE MAKING**  
For Amateurs \$3.00
- OUTDOOR SPORTS**  
Outdoor Sports the Year 'Round \$1.50
- PAINTING**  
House Painting Methods \$2.00
- PLUMBING**  
Repair Your Own \$1.00
- POULTRY RAISER**  
Breeding and Management \$2.00
- RADIO**  
Trouble Shooting \$3.00
- REAL ESTATE**  
Modern Practice \$5.00
- REFRIGERATION**  
Homemade Refrigerating Machine \$0.50
- SHIP MODELS**  
Ship Model Making \$2.50
- SHOP WORK**  
Shop Notes (16 vols.) \$6.25
- SPIRITUALISM**  
Behind the Scenes with the Mediums \$1.50
- TAXIDERMIST**  
Methods in Taxidermy \$3.50
- TOY MAKER**  
Toy Manufacture \$1.50
- TREE REPAIR**  
Practical \$2.50
- WALKS**  
Laying Attractive Entrance and Garden \$0.50
- WELDER**  
Welding Encyclopedia \$5.00
- WIRING**  
House Wiring \$2.50
- WOOD FINISHING**  
Plain and Decorative \$2.00

**Books sent C. O. D. anywhere in U. S.**

Just check the ones you want, write your name and address below, and mail the whole advertisement. It is your order blank. When postman hands you books, pay him the price and the postal charges. If outside the U. S. remit when ordering and include 10 cents per book extra for postage. We have many other books on these and 2,000 other subjects. Catalog free.

Name.....  
City.....State.....  
Address.....

Mail to Popular Mechanics Press, Room P5—200 East Ontario St., Chicago, Ill.





**Makes \$18 First Day**

"Received my first 24 Speedos yesterday; the entire lot is now delivered and more sold. In all my years of selling I never saw anything that met with such universal approval."  
—W. R. Duncan, Mont.



**\$5.00 His First Hour**

"Received Speedo outfit April 1st. Left the house at 6:30 P. M. Returned just one hour later with 6 orders. Speedos are a necessity in every home."—W. W. Marshall, Ill.



*Let These Twin Inventions Hand You*

**Double Profits...\$5 to \$11 IN AN HOUR!**

Men, here's a proposition that's amazingly simple. Yet the profit possibilities are nothing short of startling! For now, an old, well-known manufacturer offers you direct, TWO unique, patented inventions. Items used every day in every home. Yet so revolutionary that they positively sell on sight! So just read the facts below. Then mail coupon for FREE OUTFIT and FREE TEST OFFERS.



**Works Like a Charm**

Just insert can in holder and turn crank. Top is cut completely out inside the "lid." Juices can't spill out.



**Food Pours Right Out**

No fuss or muss. No scraping or "spooning." Even foods frozen in the can slip out easily.



**No Jagged Edges**

Speedo cuts the top out, smooth, slick, and clean. Ends danger of cut fingers.

EVERY man who has cut his eye teeth in the selling game knows this! The big clean-ups are always made by men who get in on the ground floor with something new and sensational. Think, then, what a doubly sensational chance to coin money is now yours! For here are offered you two unique devices—pronounced by experts everywhere to be absolutely revolutionary—approved by Good Housekeeping Institute, Modern Priscilla, etc.—and real necessities in every home. In your wildest dreams, could you conjure up such an amazing opportunity for quick, easy profits?

**A Real Million-Dollar Can Opener**

Imagine an automatic machine that opens any can, round, square or oval, simply at the turn of a crank. Cuts the entire top out, slick, smooth and clean! No more stabbing and hacking with old-style can openers. No more fingers cut and infected on jagged tin-can edges. For Speedo holds the can—strips the top out—flips up the lid—all in a couple of seconds! No wonder women simply go wild over it. And no wonder 4 out of 5 buy on a 10-second demonstration!

**The "Magic Groove" Sharpener**

Women never saw anything even remotely like this other "twin" invention, the Speedo Sharpener. Just demonstrate the "Magic Groove" and watch their eyes

pop open with amazement. Now anyone can put a keen, smooth edge on everything that cuts. Even scissors! Every woman sees instantly that here is an end to the drudgery of dull knives and tools. That's why agents report as much as \$10 and \$12 in a single hour with Speedo sharpener alone!

**Generous Co-operation**

This company has been in business over 20 years. Speedos are made entirely in our own old factories, under exclusive patents. Each item is backed by a printed guarantee of 5 years' perfect service. We give you exclusive territory. Over 100% profit! We train you from A to Z, and supply you with a complete selling outfit FREE.

**Mail The Coupon TODAY**

Any ambitious man with just ordinary common sense can see the possibilities of the proposition at a glance. If you are that kind of a man, I want to send you my FREE OUTFIT and FREE TEST OFFERS. I want to show you what real big money means. Mail the coupon today. Then get set to test the fastest, dizziest profit makers of your life. Write me this minute!



**Sharpens Like Magic**  
Just rest blade on Magic Groove, turn handle. Sharpens a ten-inch knife in six seconds. Puts a razor edge on everything that cuts.



**Grinds Scissors Perfectly**  
Rest blade against guide, give handle a couple of turns—Presto! Scissors are sharp as new.

Central States Mfg. Co., Dept. H-701, 4500 Mary Ave., St. Louis, Mo.  
Rush me details of your proposition and FREE TEST OFFER.  
Name.....  
Address.....  
Town..... State.....

**CENTRAL STATES MANUFACTURING CO.**  
Dept. H-701, 4500 Mary Avenue, St. Louis, Mo.





"Due to your well prepared training, I received my appointment eight days after my name was placed on the register.  
David W. Tucker."

# WORK FOR "UNCLE SAM"

\$1700 to \$3000 Year

## RAILWAY POSTAL CLERKS MAIL CARRIERS



**TRAVEL—See Your Country**  
**MEN, BOYS, 17 UP SHOULD MAIL COUPON IMMEDIATELY**  
*Steady Work No Layoffs Paid Vacations*

**FRANKLIN INSTITUTE**  
 Dept. E175, Rochester, N. Y.

Sir: Rush to me without charge (1) Specimen Railway Postal Clerk and Mail Carrier coaching (2) FREE 32 page book with list of U. S. Government positions now obtainable.

Name.....  
 Address.....



# Want Some Money?

Here's a wonderful way to get it

Our beautifully illustrated book tells how. - It tells all about our new methods of art decoration, art treatment, and how anybody can learn without previous training or experience. It contains page after page of handsome color illustrations of what you can make and sell. You can make good money and this book is **FREE** Our system is amazingly easy to learn and the profits are larger than in almost any other business. You can produce beautiful finished art objects almost from the beginning. You don't have to know how to draw or have any experience. Begin making money now.

All supplies are sent by us with the instructions and many have made \$25 the first week. Some society women have taken up this work for their own amusement. Either way, pleasure or profit, it's the most delightful home work you can imagine. Write Now for your copy of this valuable book: it's FREE.

**Fireside Industries**  
 DEPT. 66-H. - ADRIAN, MICH.



**GET INTO AVIATION RIGHT!**

Train with large company actually engaged in air transport service! Complete army and navy air corps ground courses adapted to commercial needs. Solo flying in shortest possible safe time! Start with home study; then transfer to day or night courses here! Latest licensed planes and equipment. Modern shops and hangar on nation's busiest airport. Only licensed military and air mail pilots, mechanics and instructors. 50 hours in air on club plan. Easy payment plan and **FREE EMPLOYMENT SERVICE** help meet tuition and living expenses. "THE AIRWAY" sent free. In writing state age. Aviation's present needs demand quick action.

**AVIATION SERVICE & TRANSPORT, Inc.**  
 Dept. P. M. 7, 203 N. Wabash Ave. Chicago



## Stop Making Mistakes in English

Wonderful new way to improve your English. No rules to learn. No hard study. Grammar, spelling, punctuation, and expression, taught in 15 minutes a day—at home. Self-correcting feature makes it fascinating as a game. Write today for free book "How to Speak and Write Masterly English." Address



**SHERWIN CODY SCHOOL OF ENGLISH**  
 57 Searle Building Rochester, N. Y.  
**LEARN WATCHMAKING**  
 and become independent. We help you secure a position. Easy to learn. Send for FREE CATALOG.  
 ST. LOUIS WATCHMAKING SCHOOL, Dept. 5, ST. LOUIS, MO.



## ZIP-ZIP SHOOTER

THOUSANDS of boys are made happy with this wonderful Zip-Zip shooter, something every boy wants and never gets tired of. Zip-Zip shooter is scientifically and practically

made: if you like hunting and outdoor sports, get a Zip-Zip shooter with plenty of pep and force. If your dealer happens not to have them, order from us. Zip-Zip shooter 35c or three for \$1.00; send stamps, coin or money order.



**AUTOMATIC RUBBER CO., Dept. B. B., COLUMBIA, S. C.**

# There is no mystery about CARTOONING

MANY famous artists and cartoonists of this country are making thousands of dollars yearly from their pens.

They earned their success through years of work and tedious search for "the right way."

Today, the courses in Cartooning and Illustrating of the International School of Art, by showing you the short cuts, will save you years of work and bring success much sooner than if you stumble along alone.

These courses will not only teach you how to draw, but will also develop your originality. They are acknowledged to be among the best and most modern courses in Cartooning and Illustrating offered today.



Mail Coupon for Free Booklet

**INTERNATIONAL SCHOOL OF ART**  
 Division of the Schools, Dept. 5546-F, Scranton, Penna.  
 Please send me—free—I can succeed as a Cartoonist or Illustrator.

Name.....  
 Address.....



# From "PUNY" to PANTHER-MAN



**BEFORE**

This lad looked pretty hopeless when he came to me. His arms looked like sparrow wings with the feathers removed. His ribs stood out and his bones tried to poke through his skin all over his body. His chest was hollow, his neck was scrawny. He had sluggish blood circulation and jumpy nerves. He couldn't sleep. Then he took my course.

**L**OOK at these two pictures! **LOOK** at them!! Then go peek into your mirror and see which one of them is more like you. Never mind blushing! Don't waste time being ashamed! There's no need of staying that way!

The chap in the picture got next to himself. They nicknamed him "Puny"—once. But the man who calls him "puny" now will have a battle on his hands. And the best part of it is that not only his appearance but his whole **LIFE** has been changed! Instead of waking up in the morning with burning eyes and heavy head, instead of ducking all sports that require strength, he eats 'em up! He's full of pep, stamina, strength and vitality. He never knows when to quit—and it doesn't matter. His body can stand the gaff, whatever it is. Do **YOU** want a body like that?

## Panther Muscles OR CLUMSY BEEF?

The **TITUS** System, the system that has trained thousands of the world's strongest men, the system that covers bodies with panther muscles will make a new man of **YOU!**

But there's a big bag of tricks that the "Daddy of 'em All" never opened. There is only one **TITUS!** There is only one place on earth where the **TITUS** panther-building system can be bought! That place is **TRAINING HEADQUARTERS**—the home of physical culture! You don't want an imitation body, you want a real one! Then get your training from a **real** trainer.

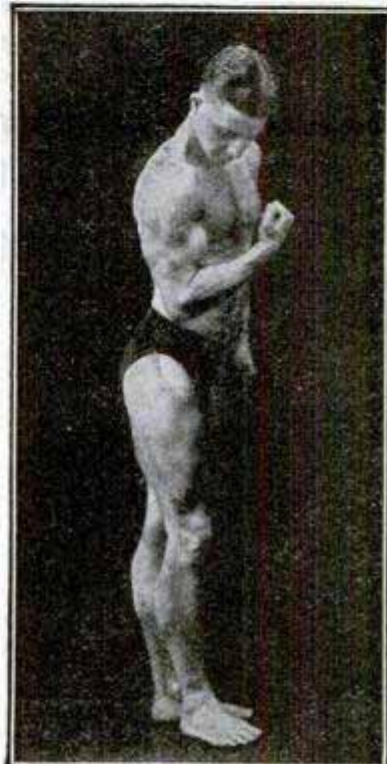

**30 DAYS AFTER**

What a man! In thirty days I built the fellow you see above. I loaded his bones with muscles! I gave him a body that laughs at hardships and illness. He says, "No other apparatus and instruction can touch yours! When the human body will hold another muscle—Titus will put it there!"

### Wear This Medal

Strong men all over the world wear it. Made of solid statuary bronze and given to you free.



### Win \$1,000

My mammoth \$2,000 Prize Contest for 1928 is now under way. First Prize \$1,000. Other big cash prizes, too. You don't have to be Hercules to win one of these prizes. Awards are made for the biggest gain—the biggest improvement. Everyone has the same chance to win. Full particulars included with my **FREE BOOK**. Mail the coupon **NOW**.



**Mail this Coupon TO-NIGHT!**

**Get My Big New Book**

**"Miracles in Muscle"**

It contains true stories—stories of miracles worked in muscles. It's chock-full of actual photographs of myself and bodies I have rebuilt all over the world. Learn how Physical Culture Authorities keep in the "Pink" of condition. Read for yourself, the story of Mr. I. R. Gaynor, a former invalid, who couldn't stand on his feet. See what a Physical Marvel and Athlete I made of him in 30 days. My record in muscle building will open your eyes.

Fellow, if that body of yours is worth 10 cents—slip it in an envelope with the coupon and shoot it along **NOW** for your copy of this wonderful book. Make this day the turning point in your life. Do it **now**—you may forget!

TITUS, Dept. M-128  
105 E. 13th St., New York, N. Y.  
Dear Titus: Sure I'd like to have your Great, New Book, "MIRACLES IN MUSCLE."  
I enclose 10c (stamps or coin) to cover mailing. No other cost or obligation.

Name.....

Address.....

Town..... State.....

The One and Only **TITUS** 105 East 13th Street NEW YORK CITY



# Our Classroom is the SKY



## FREE!

Write for your copy of this book—tells of your opportunity in aviation—how others have made good with our training. Send for it today.

The essential to flight instruction is FLIGHT. We take you right up into the air, with expert pilots who teach you to build, assemble and repair all makes of motors; you build and assemble planes; you learn the principles of aviation in a thoroughly practical manner. We are affiliated with Nicholas-Beasley Airplane Co., Inc. If you want a school that is 100 per cent practical—come to Marshall. Present low tuition rates must be increased—act quick and save money.

**MARSHALL FLYING SCHOOL, Inc.**  
630 N. English St.  
MARSHALL, MO.

Degrees Granted by Authority of the State of INDIANA

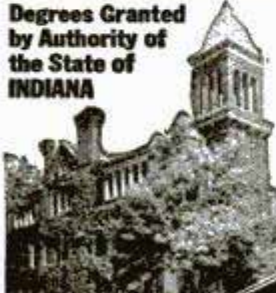

**LOW TUITION**  
—small living expense

Rooms in private homes \$2.00 to \$3.00 a week. Meals \$3.50 to \$5.00 a week. Tuition about half the average. Employment service for graduates free. No extra fees except for chemistry laboratory materials. Wonderful bunch of students. Terms start Sept., Jan., March, June. Mail coupon for free catalog.

## ENGINEERING DEGREE in 2 Years!

No entrance exams required. And if you haven't a high school diploma we'll give you the essential subjects.

If you want to be a graduate ENGINEER and earn \$50 to \$150 a week, come to TRI-STATE College. We are interested in helping men who may be short of money and time, but are strong in the desire to improve themselves. Time cut to 96 weeks by eliminating frills and concentrating on Science, Mathematics, Drafting, Laboratory and field-work. B. S. (Bachelor of Science) degree in Engineering conferred by State authority.

**Electrical**  
**Civil**  
**Mechanical**  
**Chemical**  
**Administrative**

**TRI-STATE COLLEGE, Box E-B 113, ANGOLA, IND.**  
Tri-State College, Box E-B 113, Angola, Indiana

Civil      Send free book of complete information of your 2-year Engineering Courses. (Mark X at left.)

Electrical

Mechanical      Name.....

Chemical      Address.....

Administrative

# ELECTRICITY

Tremendous demand for Practical Trained Electricians and Engineers at Big Salaries. Fascinating work, rapid advancement, opportunities unlimited.

**12 Weeks Intensive Courses in PRACTICAL ELECTRICITY and POWER PLANT OPERATION** covering Wiring, A. C. and D. C. Motors and Generators, Transformers, Armature Winding, Radio, Farm Lighting, Power and Light Switchboards, Electric Elevators, Electric Refrigeration, Batteries, Power Plant Operation, Automotive Electricity. **These courses open to you NOW.**

**ONE and TWO YEAR COURSES in ELECTRICAL and MECHANICAL ENGINEERING** leading to degrees open in September. Laboratories and shops extensively equipped with modern machinery and apparatus. Faculty of recognized experts. 27th successful year. Free employment bureau. Send for free catalog.

**FINLAY ENGINEERING COLLEGE**  
367 Finlay Bldg.      Kansas City, Mo.

## Be a Good Boxer

Complete course \$1.97! Teaches blows professionals use. Every blow illustrated. Also Jiu-Jitsu and Wrestling. History of Boxers. 6 books. Hundreds of pages. Deposit \$1.97 with postman. Return course in 10 days for refund if not satisfied. Order now. (Foreign—cash with order).



**Marshall Stillman Association**  
Dept. 14-M, 247 Park Ave., New York, N. Y.



**\$100 to \$500 A Week Is Earned By Cartoonists Today**

**DO YOU LIKE TO DRAW?**  
Billy Hon's Famous Cartoon Book Will Teach You

A short road to success for the beginner, as well as the advanced art student. A simple, complete and up-to-date course in cartooning, consisting of 30 lessons and over 300 drawings by Billy Hon, the celebrated newspaper cartoonist. Sent for \$1.00 postpaid; outside of U. S., \$1.25.

**Wasley Publishing Co., 210-A West 14th St., Los Angeles, Cal.**

## Learn Watchwork, Jewelrywork and Engraving

A fine trade commanding a good salary, and your services always in demand. Address **Horological**, Dept. P, Bradley Institute, PEORIA, ILLINOIS, for our latest catalog.

# Are You Ever Ashamed of Your English?

Do you say "who" when you should say "whom"? Do you say "between you and I" instead of "between you and me"? Do you mispronounce common words in your speech or use them incorrectly when you write? Many a man has been held down all his life and suffered untold embarrassment because of mistakes in English.

You do not need to make these mistakes any longer. Right at home, in the privacy of your own room, you can make up the education you missed in the days that you should have been at school.

The International School of English will teach you, just as it has taught thousands of other men and women, by a simple new method which shows you instinctively which word to use and how to use it.

**INTERNATIONAL SCHOOL OF ENGLISH**  
Division of the International Correspondence Schools  
Dept. 5545-F, Scranton, Penna.  
Without cost or obligation, please send me full details of your home-study course in ENGLISH

Name.....

Address.....

Mail Coupon for Free Booklet





# KRISS KROSS

## Makes Vacation Trip

### Pay Him \$114 in a Day!

**I**MAGINE starting on a month's vacation trip with practically no money and coming back with all expenses paid and \$175 in your pocket! Picture a device so remarkable that just showing it to people you meet pays as much as \$114 in a single day! Then you will understand why James E. Tillotson of Wilcox, Nebr., will long remember the day he first learned about KRISS-KROSS! Here's what he writes:

week and more! When even spare-time workers like Emil Ham of California can make as much as \$200 in four days—when Bradford can make \$40 on a Saturday afternoon, and J. C. Kellogg \$200 in a week working evenings only—Isn't it clear that KRISS-KROSS offers something that nothing else can approach?

### Fastest Seller Ever!

Of course, the chief reason why KRISS-KROSS puts these astonishing profits in your pocket is KRISS-KROSS itself. This uncanny little device literally fascinates everyone you show it to! Moreover, the sensational KRISS-KROSS advertising (in such big national magazines as Collier's, Liberty, Saturday Evening Post, American Magazine, Cosmopolitan and hundreds of others) has whetted interest everywhere.

As an added help, we give you an astonishing new kind of razor that you present FREE to your customers. Entirely different from anything you ever saw before. Comes with 5 special-process, hollow-ground blades. Users report as many as 1,500 cool, clean shaves from a single blade. Is it any wonder that KRISS-KROSS representatives are making such surprising sums with ease?

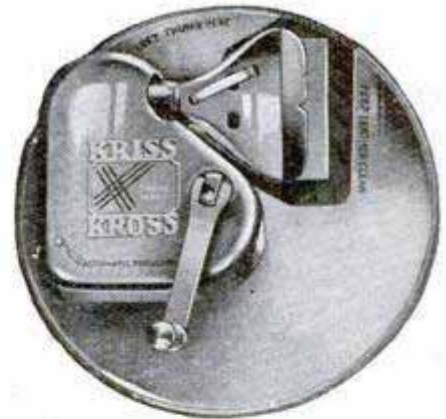

### Most Amazing Shaving Invention Ever Patented

No wonder experts call KRISS-KROSS Stropper "the most astonishing shaving invention ever patented." Stroppers any blade (except Durham Duplex) on the diagonal. Employs master barber's secret stroke (now for the first time duplicated mechanically). Automatic decreasing pressure. Has been bought at sight by over a million satisfied shavers in every state in the Union!

### Get Details at Once

There isn't a reason on earth why you shouldn't start at once getting your share of these KRISS-KROSS profits! Right now is the best time to start. Hot weather makes beards grow faster and faces tender—men need KRISS-KROSS more than ever. Write quick for details of this amazing money-making business. Fill out and mail the coupon now!

Wilcox, Nebr.

Dear Mr. Rhodes:

I want to thank you and KRISS-KROSS for a wonderful vacation. I started out in my car with my wife and two daughters for a 30 day trip to the Rocky Mountains. KRISS-KROSS profits paid all our expenses, including the car, hotels and meals. Moreover, I came back with \$175 in my pocket.

One day I made \$114 with no effort at all. I think ANY man, even without selling experience, should make \$25 a day at least.

Sincerely,  
(Signed) Jas. E. Tillotson.

Tillotson's amazing experience with this new invention that makes new razor blades out of old ones, is proof that KRISS-KROSS is the most astonishing self-seller in business history! The wave of KRISS-KROSS popularity that is sweeping the country has made it possible for salesmen without previous experience to clear profits that in many cases average \$90-\$125 a

**Rhodes' KRISS-KROSS**  
Rhodes' KRISS-KROSS CORP. STROPPER

Dept. H-372 1418 Pendleton Ave. St. Louis, Mo.

**Rhodes' KRISS-KROSS CORP., Dept. H-372, 1418 Pendleton Ave., St. Louis, Mo.**

Without obligation, send special offer with details of KRISS-KROSS and FREE Razor. Also include special agents' price list, together with plan showing how you help me start cashing in.

Name.....

Address.....

Town..... State.....



# Here Is Where to Find What You Want

**R**EALIZING the difficulty one frequently encounters in locating information that may be sorely needed in pursuit of a line of work or study, we have adopted a plan that we believe will be of real service to our readers. To a greater extent than ever before knowledge pertaining to practically every kind of human endeavor is made available through the medium of books. Each month, therefore, we will give descriptions of new and outstanding books that we think will be of the greatest interest.

We suggest that you send for our catalog of over 5000 books listed alphabetically under 2000 subject headings. If the subject you are interested in is not covered, write us about it, and we will try to find something that will be helpful.

## New and Outstanding Books

### Dyke's Aircraft Engine Instructor

Just out. A big book on a big subject. Many firms, magazines, government departments, engine manufacturers and individuals all cooperated with A. L. Dyke, eminent gasoline engine expert, to make possible this up-to-date book dealing exclusively with modern aircraft engines. The greatest need of the industry is for men who have a working knowledge of these engines. This work is the most authoritative on the subject. 400 Pages. 400 Illus. Flexible. Price \$6.00

### Everybody's Aviation Guide

Aviation for everybody is coming—rapidly. This new book by Major V. W. Page avoids technical detail and answers the demand for a simplified book to provide young people, beginners, students and all others with information of general interest such as the control systems of all types of land and sea flying machines, etc. 256 Pages. 140 Illustrations. Cloth. Price \$2.00

### The Complete Practical Machinist

By J. Rose. New, revised edition of one of the best-known books on machine-shop work. Written for the practical workman in the language of the workshop. Full, practical instructions on the use of all kinds of metal-working tools, both hand and machine, and tells how the work should be properly done. 547 Pages. 432 Illus. Cloth. Price \$3.00

### Mathematics for the Practical Man

By GEO. HOWE. Many need a better grip on mathematics. Are you one? This book will help you. By common sense methods it removes the mystery so that algebra and even calculus are made comparatively simple. Even though your knowledge is limited to arithmetic you gain a working knowledge of higher mathematics. Book includes answers to problems. Cloth Binding. Price \$1.50.

### Ropp's Calculator

This famous book of which over two million copies have been sold has been issued by the publisher in new and attractive styles of bindings. Shows the answer as quickly as a watch shows the time to all problems in office, store, shop, bank, farm or factory. Should be carried in the pocket or kept handy on the desk for reference. Desk size, flexible, \$2.00. Pocket size, art leather, \$1.00. Pocket size, cloth, 50 cents

### Bailey's Questions and Answers for Stationary, Marine and Diesel Engineers and Firemen

Insistent demand from engineers all over the U. S. and Canada has resulted in the publication of this handy pocket edition. Any candidate for any grade of license will be enabled to pass the examination by mastering this book. The plan used is adapted to those wishing to learn in the shortest time possible and the method is simple and concrete. 264 Pages. Flexible Cover. Price \$2.00

### Popular Mechanics Boat Book

New, revised edition, just published. Nowhere else at the low price of 50 cents will you find such a fund of valuable information on building and handling a large variety of craft. The new edition covers rowboats, canoes, outboard motors, portable folding boats, motor boats, scows, house and sail boats, punts, trallers, boat houses, catamarans and speed boats. In addition, painting and calking hulks, laying up for winter, etc.

### Inventions and Patents, Their Development and Promotion

A new book prepared by Milton Wright, member of the New York Bar, to guide the inventor on the road he must travel before his vision of rewards can become a reality. One of the most valuable features of this book is the pointing out of pitfalls to be avoided. 225 Pages. Cloth. Price \$2.50.

Any of the above books sent postpaid upon receipt of price. If in the U. S. and you prefer to have books sent C. O. D. we will do so, charging in addition to the price, a small fee to defray the extra expense involved for the service.

### Built-In Furniture

Complete plans and directions that will enable any handy man to add to the beauty and convenience of his home by building in buffets, china closets, clothes closets, mantel shelves, bookcases, seats, breakfast nooks, radio sets, writing desks, kitchen cupboards, clothes chutes, etc. 198 Pages. Fully Illustrated. Cloth. Price \$2.50.

### Make It Yourself

An unusually attractive book for those who take pride and delight in making things. Just published by Popular Mechanics Press. An almost unlimited variety of things to make among its 900 different articles—ship models, mechanical toys, novel amusement devices, furniture, useful appliances, things of beauty and utility. 480 Pages. 323 Illustrations. Cloth. Price \$3.00.

### Shop Notes for 1928

The annual edition of Shop Notes needs but little introduction to readers of Popular Mechanics. It consists of a reprint of all the Shop Notes articles that have appeared in the magazine during the year past in book form and indexed for quick reference. Price 50c per volume. A set of these books covering several years makes a valuable library of shop helps. Reduced price for set of 16 volumes—\$6.25.

### Wood Finishing, Plain and Decorative

By F. N. VANDERWALKER. A new book of methods, materials and tools for natural, stained, varnished, waxed, oiled, enameled and painted finishes. Antiqued, stippled, streaked and rough glazed finishes together with stain making formulas. 360 Pages. Fully Illustrated. Cloth. Price \$2.00.

### Dyke's Automobile Encyclopedia

Newly revised 15th edition. Changing times in the automotive world necessitate frequent and thorough revision of this standard work. The modern automobile man cannot "get by" with old fashioned methods. Dyke's is a dependable source of up-to-date information. 1371 Pages. 4300 Illustrations. Cloth. Price \$6.00. Flexible Binding, Price \$7.50.

### House Wiring

A new practical handbook by J. G. Wolber and O. K. Rose, two instructors who have been for fifteen years compiling material for this book. A working manual for student and electrician that goes into the practical aspects of house wiring in simplified form. 320 Pages. Over 650 Illustrations. Flexible Binding. Price \$2.50.

### 200 Tricks You Can Do

The very name of Thurston summons to one's mind the art of magic. In this book he gives two hundred mystifying tricks that may be performed by the average person or beginner in magic without the aid of elaborate apparatus. 200 Pages. Illustrated. Cloth. Price \$1.00

### Tinkering With Tools

Are you self-reliant when it comes to the common arts of wood-working, wood joinery, painting, varnishing, floor-finishing, plumbing, masonry, brickwork, electric wiring and the odd jobs that are bound to arise in any house? This 250-page book by H. H. Saylor, fully illustrated, will enable you to experience the thrill of skilled craftsmanship. Cloth binding. Price \$2.00.

### The New Ford

A complete, illustrated description of the new Model A Ford car is given in the entirely new edition of the Modern Gasoline Automobile by V. W. Page. In addition, every recent improvement in autos and their component parts is shown and illustrated. An up-to-date and authoritative book of 1150 pages. 1000 Illustrations. Fabricoid binding. Price \$5.00.



**My Tires Cost Me Nothing!**



**This Little Invention Saves Me Enough Money to Buy My Tires...and then Some!**

**T**HE money I save on gasoline more than keeps me in new tires. Figure it out—I was getting 13 miles per gallon on my Nash. With gas at 18c plus 2c tax it cost me \$46 to drive 3,000 miles. Now I'm getting better than 26 miles per gallon. It takes just half the gas and I save \$23 to \$25 every 3,000 miles—more than the price of a new tire."

No matter what make of car you drive, the Stransky Vaporizer is unconditionally guaranteed to give you 50% to 100% more miles per gallon or it costs you nothing. As a matter of fact, it is not uncommon for the Stransky Vaporizer to more than double gasoline mileage!

**Note These Records**

Forty and eight-tenths miles per gallon from a Chevrolet, reported by F. S. Carroll. Forty miles on one gallon in a Ford, reported by J. T. Jackson, Michigan. Forty miles per gallon in a Dodge from Brownsville, Tex., to Tampico, Mex., reported by T. L. Brown.

Records like these are reported in every mail for every make and model car—from 72 different countries—the world over.

**GUARANTEED To Save You Gas OR COSTS YOU NOTHING**

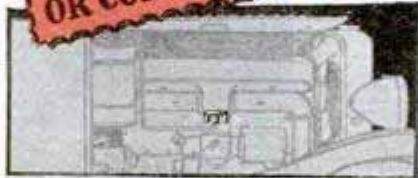

More than two million Stransky Vaporizers have been installed.

No bigger than a dollar coin—no more expensive than a good wrench—no more trouble to attach than a fan

**AGENTS**

Men are making wonderful earnings showing the Stransky Vaporizer to car owners in spare time and full time. Sells fast under our guarantee. Foster made \$357 in two weeks. G. F. Fuller earned \$114 in 5 days. Eberlein sold 23 Vaporizers in 35 minutes! J. W. Cronk actually earned \$51 in an hour. Simply mail coupon at once.

belt! Attaches to the intake manifold of any car in five minutes. Anyone can do it.

The vaporizer supercharges your gasoline after it leaves the carburetor. Completely vaporizes the gasoline. Under this ideal condition you get more complete explosion. Both power, pickup and speed are noticeably increased. Starting is not interfered with as the Vaporizer automatically shuts itself off when the motor is idle.

**Make This Test**

Mail the coupon below for full details, guarantee, and amazing trial offer, which is even more remarkable than we can tell you here. There is no obligation whatever. J. A. STRANSKY MFG. CO., H-10 Stransky Block, Pukwana, So. Dakota.

J. A. Stransky Mfg. Co.,  
H-10 Stransky Block,  
Pukwana, So. Dakota.

Without obligation send me full details of your free trial offer.

Name.....

Address.....

City.....State.....

( ) Check here for Distributor's Sample Offer and the selling plan.



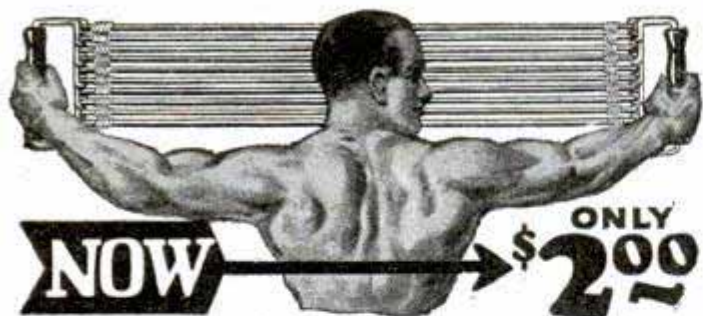

**NOW** → **ONLY \$2.00**  
**Giant Chest Expander**

and

**Progressive Exerciser**

Be a muscular marvel. Have the muscles of a superman. Become strong for your health's sake or to astound your friends with extraordinary feats which only men of giant strength can do. In a few short weeks you will easily do stunts which now seem difficult—then real muscles and strength will be yours—and yours to keep. If you want exercise to just keep in good shape you can reduce the strength of the Progressive Exerciser by eliminating as many cables as you wish. If you want great resistance so as to build up big solid muscles then use the full strength.

**Send No Money Use This Money Saving Coupon**

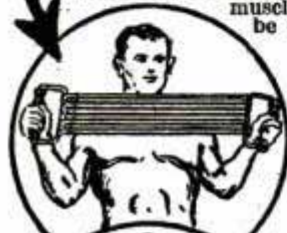

**How the Giant Chest Expander and Progressive Exerciser is Made**

The Giant Chest Expander and Progressive Exerciser is made with new live, springy rubber so as to give it long wearing and great resisting qualities. Do not pay more for an exerciser that has forty or less rubber strands to each cable. Get the best and most durable. The Giant Progressive Exerciser has 50 strands of the finest rubber procurable to each cable.

**Free Instructions**

We do not think it enough to send you an exerciser worth double what we ask, so for a limited time, we will also include instructions absolutely free. These instructions are interesting and simple to follow—they show you the short cut to health and strength. Order today before this wonderful offer is withdrawn.

**Your Guarantee**

The Giant Chest Expander is sold with a guarantee that you will say it is the finest you ever saw or your money back.

**5 Cables or double 10 Cables for strength for**

**\$2** The double strength exerciser has resistance of over 200 lbs. **\$4**

**How to Order—Send No Money**

Sign your name and address to coupon below and get your Giant Exerciser at the present low introductory price by return mail. The price is made low because we want everyone to enjoy muscles and strength at the lowest possible cost. Don't pay more—order from us—get the most for your money. Use coupon now.

**PROGRESSIVE EXERCISER CO.,**  
 4007 Langdon Bldg.,  
 Broadway and Duane Street, New York

Please send  Your 10 cable Progressive.  
 Your 5 cable Exerciser.

Check the Exerciser you want, and it will be sent you by return mail. Pay postman introductory price, plus few cents postage on arrival. It is understood that if you are not entirely satisfied with your exerciser you may return it within 5 days and get your money back.

Name.....

Street.....

City..... State.....

If you live outside the United States, send cash with order.



**Tobacco Slaves FREED!**



**Free Book Shows AMAZING EASY WAY to Quit Tobacco**

Are you nervous? Do you suffer from heart-burn, head aches, sleeplessness, inability to work at full capacity, etc? If you do, you may not be aware that tobacco is the cause. No man or woman can continue using tobacco and escape its harmful effects. The Keeley Institute has published a valuable and helpful book that every tobacco user should read—it tells how to quit the tobacco habit easily and quickly—at home—and without a bit of trouble. Tells how The Keeley method quickly banishes all craving for tobacco.

**Send for Your Copy Today**

The Keeley Institute has proven positively that anyone can quit tobacco by their simple, easy method. They have helped thousands restore themselves to glorious new vitality and health when tobacco had almost ruined them and robbed them of success. The method is simple and absolutely harmless. Don't try to banish unaided the firm hold tobacco has upon you. Write today for your copy of this valuable book. Banish tobacco forever! Enjoy the mental vigor and hearty appetite, the sound, sweet sleep, and the sheer joy of health that freedom from tobacco will give you. Write Now—no obligation.

**The Keeley Institute**

Dept. A-911 DWIGHT, ILLINOIS

**NO JOKE TO BE DEAF**

—EVERY DEAF PERSON KNOWS THAT



I make myself hear, after being deaf for 25 years, with these Artificial Ear Drums. I wear them day and night. They stop head noises and ringing ears. They are perfectly comfortable. No one sees them. Write me and I will tell you a true story how I got deaf and how I make you hear. Address



**GEO. P. WAY, Artificial Ear Drum Co. (Inc.)**  
 80 Hoffman Bldg., 2539 Woodward, Detroit, Mich.

**Stop Using a Truss**

**STUART'S ADHESIF PLAPAO-PADS** are entirely different from trusses—being mechanico-chemico applicators made self-adhesive purposely to keep the muscle-tonic "PLAPAO" continuously applied to the affected parts, and to minimize painful friction and danger of slipping.

No straps, buckles or springs attached.



Soft as velvet—easy to apply— inexpensive.

For almost a quarter of a century satisfied thousands report success without delay from work. Stacks of sworn statements on file. Process of recovery natural, so no subsequent use for a truss. Awarded Gold Medal and Grand Prix. Trial of "PLAPAO" will be sent you absolutely **FREE** No charge for it now or ever. Write name on coupon and send **TODAY**.

**PLAPAO CO., 588 Stuart Bldg., St. Louis, Mo.**

Name .....

Address .....

**FREE—Trial Plapao—FREE**



# One Little Ounce of Magic Dots Will Hold 25 Ruptures!!

**Free!**

Amazing new book explains new discoveries on rupture relief. Now sent free to rupture sufferers. Also get free sample of Airtex, the new way to hold rupture without pressing. Not a penny to pay, now or future. Simply tear out coupon below!

**N**O wonder over 20,000 rupture sufferers have switched to this new way to relieve rupture!

Magic Dot is so light in weight, so small and inconspicuous, that twenty-five of them weigh only one ounce! It would take fully three hundred of them to equal the weight of one truss that consists of steel springs, leg straps and hard cushions!

Think what this invention means to rupture sufferers in convenience alone! Yet convenience is only one of Magic Dot's many benefits in the correction of rupture and the end of constant pain, discomfort and embarrassment!

## How it works

If you could always hold your rupture together with your thumb and forefinger, your rupture would probably disappear

in time. That is all the pressure it needs. And that is exactly the way Magic Dot operates. It weighs less than a feather, measures little larger than a quarter. Once fixed in place, it stays in place until you take it off.

But how does it stay always fixed against the rupture despite any movement of the body? The answer is Airtex—the most radical improvement in rupture appliances yet discovered. It is a flesh-soft pad about the size of your palm—filled with myriad air cells that sweep a constant flow of fresh cool air in, through and around the rupture.

## You be the judge

You cannot fully appreciate the radical difference and marvelous improvement of Magic Dot until you see it fully described in the book now being sent free to rupture sufferers . . . until you feel the velvet-like softness of Airtex. Read the case histories below. Probably these cases and many others relieved by Magic Dot were worse

than yours. Why suffer needless pain, discomfort and embarrassment? Mail the coupon below now! New Science Institute, 2150 Clay St., Steubenville, Ohio.

**Mail  
This  
NOW!**

New Science Institute, 2150 Clay St., Steubenville, Ohio.  
Yes, send me your interesting free book describing the wonders of the New Science System of rupture relief. This request does not obligate me.

Name . . . . .  
Address . . . . .  
City . . . . .  
State . . . . .

### Were These Rupture Cases Worse Than Yours?

"Am nearly 75 years old so consider the results of my case remarkable. The appliance I purchased from you a year or so ago was beginning to give out, so I thought I should get a new outfit. I took off the old one and my rupture was all gone. Have not worn either the old or new appliance for over a week, have worked every day, and still no sign of rupture." John Terweale, Park Rapids, Minn.

"My rupture is entirely cured. I believe the cure was complete within sixty days after I put on the appliance. However, I kept wearing it for six months, but now I use nothing of the appliance. I have been ruptured 20 years and my rupture dropped clear down into the scrotum." M. P. Brumbaugh, Juniata, Penn.

"My rupture was entirely cured in less than 90 days. I have had no trouble from it since. I will be 80 years old in November next. I do not give your truss full credit for the recovery. Think my extreme youth had something to do with the healing." F. B. Hubbard, Centralia, Wash.



# How Finger Prints Got HICKMAN



Barlow Taking Hickman's Finger Print After Capture

You know the hideous tale — little Marian Parker kidnapped, foully murdered, her torn, mutilated body stuffed in a suitcase—delivered to her grief-stricken father for ransom—and the fiend drives off in the night—lost, unnamed, unknown—safe but for FINGER PRINTS! Yes, these

telltale marks cleared the mystery surrounding this crime of unprecedented brutality and absolutely identified William Edward Hickman as the fiendish murderer. Fame and rewards go to the Finger Print Expert in this case. Fame and rewards await you, too, if you learn Finger Printing!

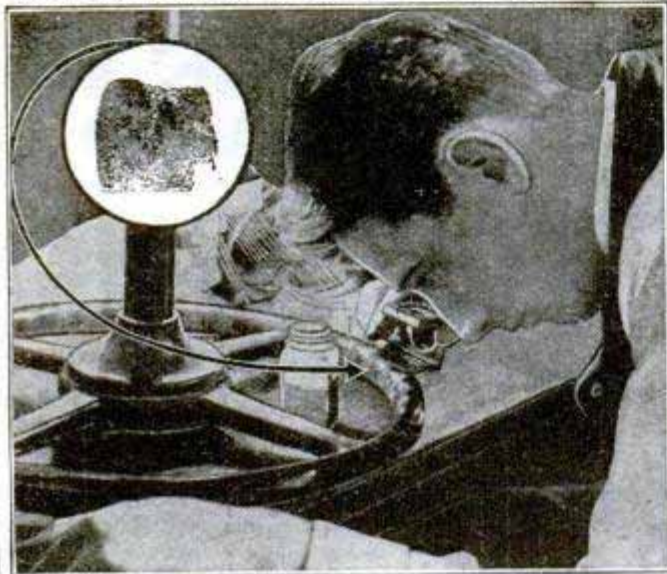

Barlow Discovers Hickman's Finger Print on Steering Wheel

## Barlow Does Great Work!

It was Sergeant H. L. Barlow, Finger Print Expert of the Los Angeles Police Department who, after working continuously for 72 hours with intense concentration, forged link by link the finger print evidence which indisputably identified the ghoulish murderer as William Edward Hickman and made his actual capture only a matter of time. Today Barlow is famous the world over as a master Finger Print Expert! You can become a Finger Print Expert, too! Easily!—Quickly!—at Home!

## FREE BARLOW'S OWN STORY!

We will send you Sergeant Barlow's own story—the inside story of this great case—absolutely FREE. Barlow's rewards for this alone may amount to \$25,000.00! Think of it! How would YOU like to be a Finger Print Expert, unravel gripping mysteries, enjoy national fame and win big rewards? Mail coupon now and learn how you CAN learn Finger Printing, quickly, easily at home by mail—during your spare moments. Sergeant Barlow endorses the University of Applied Science. Get his own story free. Mail coupon NOW!

University of Applied Science,  
1922 Sunnyside Ave., Dept. B-135, Chicago, Ill.

Dear Sirs: Please rush me by return mail Sergeant Barlow's own story of the Hickman case and tell me how I may learn the science of Finger Printing! No obligation on my part.

Name \_\_\_\_\_

Address \_\_\_\_\_

## Learn How to BOX

### JIMMY DeFOREST BOXING COURSE

Teaches by mail the Same System he taught Champion JACK DEMPSEY

In 20 weeks, under the System of Jimmy DeForest, WORLD'S GREATEST TRAINER AND MAKER OF CHAMPIONS, you will master the priceless knowledge that made Jack Dempsey his millions, and fortunes for a host of other Jimmy DeForest-trained ring stars. Boys who were once rank amateurs are today earning big money; weaklings have been made strong, courageous; men have learned the art of self-defense. Send today for the now famous book, "THE GOLDEN AGE OF BOXING," greatest book of its kind ever written; full of valuable information, photos of great fighters and pupils who became successes over night. Enclose 10c to cover cost of mailing, etc. WRITE NOW.

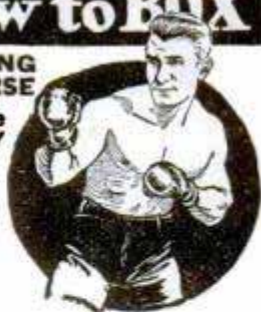

JIMMY DeFOREST BOXING COURSE  
347 Madison Avenue, Box 132, New York City

## LEARN ELECTRICAL TRADES

Practical Training on Massive Lay-Out of Expensive Electrical Equipment. Armature Winding, House Wiring, Electric Welding, Electric Refrigeration, Power Plants, Switchboards, Transformers, Motors, Generators, Radio Batteries, Automobile Course included without extra cost. Write Today for Free Catalog.

COLEMAN ELECTRICAL SCHOOL, 1628 Q Main St., Kansas City, Missouri



## "BECOME A LIGHTNING TRICK CARTOONIST"

Send \$1.00 for Laugh Producing Program of 23 Trick Drawings with Instructions. Catalog of Chalk Talk Supplies Free. BALDA ART SERVICE, Dept. 1, Oshkosh, Wis.

Learn Watchwork, Jewelrywork and Engraving A fine trade commanding a good salary, and your services always in demand. Address Horological, Dept. P, Bradley Institute, PEORIA, ILLINOIS, for our latest catalog.

## STAMMERING

easily, permanently corrected. Win happiness and success. Ask for full information and special phonograph record. Send dime for postage 153 Stimson Ave., The LEWIS INSTITUTE, Detroit

## BE AN OIL EXPERT!

Trained men needed! Geologists, Drillers, Refiners (Chemists and Still Men), Oil Salesmen, earn 2 to 10 times more than in other fields. Write today! FREE Booklet! Petroleum Engineering University, Dept. 227, Fort Wayne, Ind.



### BUCHSTEIN'S FIBRE LIMB

is soothing to your stump—strong, cool, neat, light. Easy payments. Braces for all deformities. D. BUCHSTEIN CO., 610 3rd Ave., So. MINNEAPOLIS, MINN.

Send for Catalog Today

Write today for our 168 page FREE Book on **Deafness**

and learn how Perfect Hearing is now being restored in every condition of deafness or defective hearing. Our "Little Wireless Phones for the Ears" require no medicine but effectively replace what is lacking or defective in the natural ear drums. They are simple devices, which the wearer easily fits into the ears where they are invisible. Soft, safe, and comfortable.

WILSON EAR DRUM CO., Incorporated  
358 Inter-Southern Bldg. LOUISVILLE, KY.



## NEW DISCOVERY Grows Hair Quickly!

Noted surgeon has discovered amazing way to grow hair called Derm-Ray. Employs infra-red Rays. In thirty days no more dandruff. Scalp tissues given new life. Then within a few weeks luxuriant new hair! Two years ago the discoverer was himself bald. Today his hair is full and thick. Sent on Free Trial. Results or no pay. If you have electricity in your home write at once for Free; starting, thirty-two page booklet.

Address the LARSON INSTITUTE  
216 N. Wabash Ave. Dept. 279 Chicago, Illinois



# NOW Boys <sup>earn</sup> Men's Wages

\$75<sup>00</sup> to \$125<sup>00</sup> Weekly, Paid to

# AUTO MECHANICS

Why go on begging for a raise? Why growl and complain because you don't get it? Why, when every city, town and farming community is pleading for more auto and tractor mechanics — trained as McSweeney students are trained, to know cars of every make and to know them "inside out"?

Every month my men are taking fine jobs formerly filled by half-trained students or half-baked, self-trained mechanical tinkers.

## I Train You in 8 Weeks

Think of it! Working with real tools on real equipment you become in only EIGHT WEEKS a better auto mechanic than men who have "fiddled" around an ordinary garage for years trying to learn. Let me send you the proof, letters from former McSweeney students now earning up to \$10,000 a year. "Mac's SHOP WAY Means Bigger Pay."

## Your Money Back Guaranteed

If, when you have finished your training, you are not perfectly satisfied; if you are not qualified to fill a big pay job, I will re-

fund every cent of your tuition. There is a reason for my making such a convincing offer. Ask yourself why. Then write quick for my remarkable SPECIAL TUITION OFFER. Save one-third now. See what you get:

## Special OFFER I'LL PAY YOUR RAILROAD FARE

For a limited time only, and when you enroll, I will pay your railroad fare to Cincinnati or Cleveland. Send the coupon NOW—before it is too late—for full particulars of this amazing offer. Don't delay.



**McSWEENEY**  
AUTO, TRACTOR AND ELECTRICAL SCHOOLS  
CINCINNATI, OHIO CLEVELAND, OHIO

**McSWEENEY Auto, Tractor and Dept. 11-J, Electrical SCHOOLS**  
Cincinnati, Ohio; 654 McMillan St.  
Cleveland, Ohio

Please send your Special Offer and Big Illustrated Book.

Name .....

Address .....

City.....State.....

**MECHANICAL DENTISTRY**  
Earn Up to \$5000 a Year THIS money-making profession easily learned in a few months in day or evening sessions. Practical training. Individual instruction. Easy terms. Railroad fare allowed—no extra cost. Write NOW for free catalog P and special tool offer. Address—  
N. Y. SCHOOL OF MECHANICAL DENTISTRY, 147 W. 33rd St., N. Y.



**BART SUPPLIES**  
Special 48 p. catalog "S"—Show Card and Sign Writer's supplies. Also catalog "A"—Art Supplies. Save Money—write—  
BART SUPPLIES, 510 Euclid Bldg., MINNEAPOLIS, MINN.

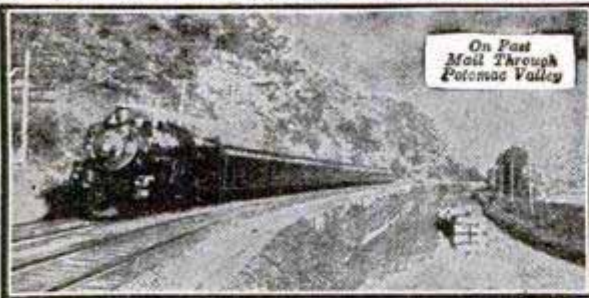

## Travel for "Uncle Sam" \$158 TO \$225 MONTH

**FRANKLIN INSTITUTE, Dept. E 173, Rochester, N. Y.**

Sirs: Rush to me, without charge, (1) Full particulars, telling how to become a Railway Postal Clerk; (2) send copy of 32-page book, "How to Get U. S. Government Jobs," with sample coaching and list of many positions obtainable.

Name .....

Address .....

Many Other Government Jobs Obtainable  
Steady Work—No Layoffs—Paid Vacations  
Common Education Usually Sufficient  
MEN—BOYS 17 Up—Mail coupon immediately

# MECHANICAL ENGINEERING

Learn at home



Mail the Coupon for Free Booklet

MECHANICAL Engineering embraces the design, construction and operation of machines and machine tools. It is a profession which offers almost unlimited opportunities to men who combine mechanical ability with technical training.

One of the best ways to train yourself to secure a position as a Mechanical Engineer is through the home-study courses of the International School of Engineering.

These courses are complete, up-to-date and especially arranged to meet the needs of the student who studies at home. They are particularly helpful and practical because they are written by well-known mechanical engineers.

**INTERNATIONAL SCHOOL OF ENGINEERING**

Division of the International Correspondence Schools  
Dept. 5547-F, Scranton, Penna.

Without cost or obligation, please send me full details of your home-study course in  
**MECHANICAL ENGINEERING**

Name.....

Address.....



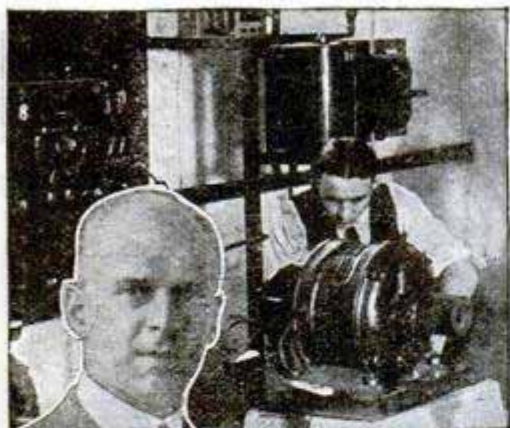

C. A. Finch, 8 Maryland Ave., Middletown, N. Y., makes \$7,500 a year



Automotive Electricity pays W. E. Pence, Box 921, Palo Alto, Calif., over \$9,000 a year



J. R. Morgan, 46 1/2 Green St., Dayton, Ohio, makes \$30 to \$50 a day in business for himself



# Electrical Experts Are in Big Demand I Will Train You at Home To Fill a Big Pay Job

## 4 Things You Want to Know

1. Can I make big money in Electricity?
2. Can I learn Electricity at Home?
3. Can I get more money Quick?
4. Will Cooke Training Bring me the Job I want?

These 4 questions are answered in my big FREE book—Mail Coupon.

It's a shame for you to earn \$15 or \$20 or \$30 a week, when in the same six days as an Electrical Expert you could make \$60 to \$100—and do it easier—not work half so hard. Why then remain in the small pay game, in a line of work that offers no chance, no big promotion, no big income? Fit yourself for a real job in the big electrical industry.

## Be an Electrical Expert Learn to Earn \$3,000 to \$6,000 a Year

Today even the ordinary electrician—the “screw driver” kind is making money—big money. But it's the trained man—the “Electrical Expert”—who is picked out to “boss” the ordinary Electricians—to boss the Big Jobs—the jobs that pay \$3,000 to \$6,000 a Year. Get in line for one of these “Big Jobs.” Start by enrolling now for my easily learned, quickly grasped, right up-to-the-minute, Spare-Time Home Study Course—now.

### Age or Lack of Experience No Drawback

You don't have to be a College Man; you don't have to be a High School Graduate. As a practical engineer in charge of large projects, I have learned exactly the kind of training you need, and I will give you that training. My course in Electricity is simple, thorough and complete, and offers every man, regardless of age, education, or previous experience the chance to become an “Electrical Expert,” able to make from \$60 to \$100 a week and more.

### Six Working Outfits—No Extra Charge

With me, you do practical work—at home. You start right in after your first few lessons to work at your profession in the regular way and make extra money in your spare time. For this you need tools, and I give to you five complete outfits.

### Money Back if Not Satisfied

So sure am I that you can learn Electricity—so sure am I that after studying with me, you, too, can get into the “big money” class in electrical work, that I will agree in writing to return every single penny paid to me in tuition, if when you have finished my course, you are not satisfied it was the best investment you ever made, and back of this agreement stands a

million dollar institution, thus assuring to every student enrolled, not only a wonderful training in Electricity, but an unsurpassed Student Service as well.

### Get Started Now—Mail Coupon

I want to send you my Electrical Book and Proof of what 150 other men are doing—all free. These cost you nothing and you'll enjoy them. Make the start today for a bright future in electricity. Send in Coupon—NOW.

L. L. Cooke, Chief Instruction Engineer,  
**L. L. COOKE SCHOOL OF ELECTRICITY**  
 2150 Lawrence Avenue Dept. 1-B Chicago, Ill.

### Use This Coupon Now

L. L. COOKE, Dept. 1-B  
 2150 Lawrence Ave., Chicago

Send me at once your big free book and particulars of your home-study course in Electricity, including your outfit, employment service and other features.

Name.....

Address.....

Occupation.....

**The “Cooke” Trained Man is the “Big Pay” Man**



# Classified Advertisements

WORLD'S BEST WANT AD MEDIUM

Advertisements in this section, 30 cents per word, each insertion, minimum 10 words, payable in advance. To be inserted under proper classification in August issue, copy should be in our office June 18th

## ADVERTISING AGENCIES

**ADVERTISE** in 24 Big Sunday Newspapers, 24 words \$15.00. Excellent for securing agents, salesmen and business opportunities. Catalog listing 1,000 leading dailies, weeklies, mail order magazines. Everything. Free. Wade Advertising, Baltimore Bldg., Chicago.

**GET** into advertising. Learn quickly at home. Experience unnecessary. New easy plan. No text books used. Practical work. Old established school. Send name and address for interesting free booklet. Page-Davis School of Advertising, Dept. 343-B, 3601 Michigan, Chicago.

**INCH** Display 50 Monthlies Thrice \$8.00. Meyer Agency, 4112M Hartford, St. Louis, Mo.

**ADVERTISE** 50 Magazines 5c word, \$4.00 inch; thrice 10c word, \$8.00 inch. King-Advertising, Box 6723, Wilmington, Del.

**BEFORE** Advertising get our catalogue. No charge. 25 years in business. The largest classified agency in the world. Ankrum Advertising Agency, 20 W. Jackson Blvd., Chicago Ill.

**LOWEST** Rates. Catalog free. Owl Agency, Times Bldg., New York.

**FREE**—New 1928 Advertisers Rate Guide. 36 pages. Includes everything. Lowest rates. E. H. Brown Advertising Agency, 140 S. Dearborn, Chicago.

## FOR ADVERTISERS

**50 WORDS** Or less, 4 times \$1; inch display 4 times \$2. Popular Service Magazine, 1706 E. 8th St., Kansas City, Mo.

**ADVERTISE** in weekly papers. Lists free. Keator, Hartford Bldg., Chicago.

**40 WORDS** Insert 50 magazines \$2.00. Empire Agency, Shawano, Wis.

**1,000 AGENTS' Names** \$4.75. Pennell Standard, Covington, Ky.

## SALES PROMOTION

**\$50 TO \$50,000** Daily Sales Developed during 28 years for clients by our direct mail plans, copy, campaigns. One product, 1923, an idea; this year \$100,000 orders booked. Fifty year old concern desired 50 national representatives in 1925; we produced 40 in three months. 700 dealers in 10 months at \$3 each, for another. Ten years Sales Promotion Manager Larkin Co. Submit sales problems for free diagnosis. James C. Johnson, 118A Woodbridge Ave., Buffalo.

**MAKE** Your business grow! Have us find agents, salesmen, or write letters, folders, ads and complete campaigns that get results. Outline your problem to "Mail Merchandisers," 578 Macabee Bldg., Detroit.

**WE** Will analyze your advertising, advise you on your best plan of marketing, and otherwise counsel you on your sales problems. Fee reasonable. P. A. Porter, Sales Counselor, 156 Fifth Ave., New York.

**RESULT** Getting copy; letters, folders, booklets. Whole campaigns prepared. Nominal charge. Write now. Shaffer, 14 Polk St., Indianapolis.

**BUSINESS**—Building letters, circulars, advertisements, campaigns; scientific methods guarantee results; long experience; reasonable rates. Finkel-Advertising, 15p Fairview, Jersey City, N. J.

**MAIL-ORDER** And Direct-Mail Selling. Let S. Roland Hall, a man of wide experience in this field, tell you through his new book of the methods used successfully by large and small companies of various types. 490 pages. Illus. Pay postman \$5 and postage when he delivers the book. Popular Mechanics Co., Room 807, 200 E. Ontario st., Chicago, Ill.

## TYPING SERVICE

**EXPERT** Typing with carbon copy, 5c hundred words. Julius Goldin, 926 Southern Boulevard, New York.

## LETTER SPECIALISTS

**EXPERT** Sales letters prepared. \$3 each. S. F. Woodbridge, Hastings, Nebr.

## AUTOMOBILE SUPPLIES

**SAVE** Money on auto and truck repairs. Gears, axles, bearings, motor and transmission parts at 50 to 75% off factory list prices. Satisfactory parts guaranteed. Prompt service. Price lists free. Century Parts Co., 1725 S. 18th St., St. Louis, Mo.

**REBUILT** Generators, starters, armatures, Bendix exchanged. New guarantee; wholesale and retail. No catalog. Write for prices on units you are in need of. Rhoads Elec. Parts & Ser. Co., 4142 Olive St., St. Louis, Mo.

**BIG** Profits in automotive service with the use of new 8-hour battery charging equipment. Low in price—small down payment brings it—pays for itself with handsome income besides. Write for details, no obligation. E. M. O'Connor, Box M785, Troy, Ohio.

**AUTO** Parts, New, Used—Lowest prices, largest stocks, bankrupt supplies, motors, wheels, rear ends, radiators, transmissions, generators, gears, tops. Brightman, 2065 Main St., Hartford, Conn.

**YOU** Are wanted to resilver mirrors at home. Immense profits plating autoparts, tableware, etc. Write for information. Sprinkle, Plater, 77, Marion, Ind.

**TIRE** Valve Tester Co., Elgin, Ill. Particulars free. Sample 35c.

## AUTOMOBILES

**PATENTS.** Time counts in applying for patents. Don't risk delay in protecting your ideas. Send sketch or model for instruction or write for free book "How to Obtain a Patent" and "Record of Invention" form. No charge for information on how to proceed. Communications strictly confidential. Prompt, careful, efficient service. Clarence A. O'Brien, Registered Patent Attorney, Security Bank Building (directly across street from Patent Office), Washington, D. C. See pages 140 and 141.

**TRUCK** Owners—Stop shoveling, dump your loads. Dependable Hoist Co., Streator, Ill.

## AUTOMOBILE SERVICE EQUIPMENT

**TESTING** Equipment for electrical work. Biggest profits in automotive work come from complete electrical service. Equipment pays for itself without expense to you, on easy monthly payments. Write for full information without obligation. HB Equipment Co., Box M784, Troy, Ohio.

**JUNK** Tires converted into saleable mds. with our Hoxie. \$200 starts you. Vulcanizing tires pays 100%. Have shop outfits near you \$50 up. Portable electric paint spraying outfits complete, only 50 lbs. \$61 delivered. Equipment Exchange, 108 East 11th, Los Angeles, Calif.

**BARGAINS** In repossessed battery chargers, rectifiers of all kinds and a few constant potential 8-hour chargers, two of them practically new. Very low prices and terms arranged if wanted. Get these while they last. I. C. Helmick, Box M783, Troy, Ohio.

**SET** Eight spiral expansion reamers, \$10.95. Catalog. W. Barnitz, 203 Briggs, Harrisburg, Penna.

**PORTABLE** Paint Sprays, automatic air compressors in sizes to suit the largest and smallest business. Only equipment of its kind on the market using the silent, spiral, bevel transmission. Low prices, easy terms. Automatic Compressor Co., Box M782, Troy, Ohio.

**WHOLESALE** Prices on tire and battery shop equipment. Own your business. We start you. Adams-Barr, Columbus, Ohio.

## BATTERIES AND BATTERY SUPPLIES

**BATTERIES:** How to make and repair; plate formulas and complete instructions, \$1. Any formula or information on any subject \$1. Information Bureau, Arthur Clarke, Paris, Tex.

## FOR FORD OWNERS

**STOP** That bearing knock—forever. Kil-Nock Bearing Bolts automatically take up wear in connecting rods. Over 100,000 sets in use. Honest money-back guarantee. \$2.75 postpaid or C.O.D. Kil-Nock Corporation, Cedar Rapids, Iowa.

**UNDERSLUNG** With "RKO" Swing Lo Irons. See "Red-I-Cut" ad page 132.

**AURORA** Underslung parts, 3:1 racing gears, speedster bodies. See Sport Factories ads, pages 130 and 132.

**SPEEDOMETERS**—Transmission drives for Fords. Complete with head, \$7.00. Drive unit, less head, \$3.00. Patterson Manufacturing Co., Clintonville, Wis.

## MOTORCYCLES, BICYCLES AND SUPPLIES

**MOTORCYCLES** Cheaper than Bicycles, \$25 to \$50. Easy terms. Tires \$2.50; Frames \$3; Forks \$3; Tanks \$5; Wheels \$1; Chains \$2; Saddles \$5; Handle Bars \$5; Engines \$15; Auto Tires \$3; Airplane Engines \$15; Bicycle Tires \$1.25. Send 50c for catalog. Price Cutter Deninger, Rochester, N. Y.

**SLASHING** Price Reduction! Fine Harley-Davidson motorcycle bargains. New, used and rebuilt motorcycles, \$50.00 and up. Send for our new free bargain bulletin just off the press. Knuth's Harley-Davidson Agency, 2525 Fond du Lac Ave., Milwaukee, Wis. Exclusive Harley-Davidson Distributors.

**SPECIAL** Low prices on latest models of renewed Harley-Davidson motorcycles, in perfect order, unconditionally guaranteed. Big bargains. Write for free list. Heinz Motor Co., 610 W. North Ave., Baltimore, Md., Harley-Davidson Distributors.

**USED** Motorcycle bargains. All makes. Lowest prices. Guaranteed. Shipped on approval. New easy payment plan. Motorcycle parts—supplies. Catalog free. Floyd Clymer, "Largest Motorcycle Dealer in the West," Denver, Colo.

**BARGAINS** in used motorcycle parts for all makes. No Catalogs. J. B. Dahl, 3661 Archer Ave., Chicago, Ill.

## AVIATION

**FLYING** Instruction by air mail pilots—the finest and most experienced flyers in the world. Col. Lindbergh was our chief air mail pilot and instructor. With such instruction, this school has operated over 9 years without an accident, graduating over 500 students. Our course and our equipment are of the very best and strictly modern. Average student flies by himself in two weeks, but we guarantee to solo you regardless of time required. No charge for breakage. First-class flyers are in great demand. Enroll now in one of the oldest and best known flying schools in America. Booklet on request. Write Dept. O, Robertson Flying Services, Lambert-St. Louis Field, Anglum, St. Louis County, Mo.

**GET** into flying now—learn at America's finest aviation school in Chicago—the center of air activity—on the finest field in the middle west—where the air mail lands. We give you complete instruction in our big downtown factory—you actually work on motors and ships. You fly at our airport in brand new ships with licensed instructors. No limit to your flying time. Write for our "big free book "How to Fly." Free to you for the asking. Chicago Aviation Company, 735 S. Clark St., Chicago, Ill.



**AIRPLANES.** Motors and aircraft supplies; 2 cyl. 28 hp. Lawrence, \$150.00; 9 cyl. 130 hp. Clerget rotary, \$150; gold wings with vertical propeller for coat lapel, \$1.00; Dandy leather helmet, \$4.00; nonshatterable, wide-vision goggle, \$4.00, or oval goggle \$2.25. Flying suit, white or khaki with hookless fasteners and insignia, \$9.00. Logan Aircraft, 716 W. Superior, Cleveland.

**FOR SALE**—2 new 9-cylinder Gnome airplane engines; with propeller. Weight each 292 lbs. Each 165 hp. The one engine is complete but in the other the magnetto is missing. Price \$150 for the two of them F. O. B. Juneau. \$75 with order and balance C.O.D. Fine for speed boats, plane or sea sled. P. Swendsen, Box 60, Juneau, Alaska.

**GET INTO aviation, fame, fortune, adventure** via National Aviation training. Oldest popular priced home study course in America. 30 lessons, thorough, complete, diploma given, free employment service. Write today for special anniversary offer. National Aviation training, Detwiler Bldg., Dept. P., Los Angeles, Calif.

**MODERN Aircraft**—New book describing fully all latest developments in newest planes and engines used in recent trans-oceanic flights. Just what every student of flying needs. Covers every phase of aeronautical science. 855 pages. Over 500 illus. Pay postman \$5 and postage when he delivers the book. Popular Mechanics Press, Room 807, 200 E. Ontario st., Chicago, Ill.

**BUILD Model airplanes that fly.** Our 52 page catalog illustrates 26 flying and exhibition models. Most complete line of accessories and supplies. Send 10 cents for our big catalog. U. S. Model Aircraft Corporation, 341 Monroe St., Brooklyn, N. Y.

**"SKYWARD Ho!"** New book by Derek White on your future in aviation. Opens road to career, fame, fortune. Sent free. Write at once, Parks Air College, 213 Missouri Theatre Bldg., St. Louis, Mo.

**THE American School of Aviation** announces a new correspondence course in Mechanics of Aviation. A thorough training in Practical Aeronautics. American School of Aviation, Dept. 1871, 3601 Michigan Ave., Chicago, Ill.

**JUST OUT**—Book and blue prints on design, construction of small sport plane. Dependable information on motors to use, etc. Includes flying lessons and weather map reading. All for one dollar. Chas. Russell, 545 Stadium Drive, Ft. Wayne, Ind.

**NEW!** Three models in one. Perfect scientific reproductions. Catalog free. Stewart Marshall, Rome, Ga.

**BUILD Your own sportplane.** 18-60 horsepower monoplane, cheap to build; blueprints and instructions \$2.50. Biplane, two seater, 28-60 horsepower; blueprints \$5. Sketches, 10c each. Allison Airplane Co., Lawrence, Kans.

**ADVICE** in glider and airplane construction. Blueprints price list, 25 cents. J. P. Schroeter, 445 Milwaukee St., Milwaukee, Wis.

**SIMPLEX Air Model Co., Auburn, Mass.** Send 5 cents for supply booklet.

**PIERCE'S Library**—Dictionary of aviation, \$3.90. French-English Dictionary Aviation 61c. Languages Publishing Company, 15 West 18th St., New York.

**NEW Aircraft magnetos,** 6 or 8 cylinders, cost government \$75.00, sacrificed \$7.50. Real airplane propellers, 8 foot long, given away, \$5.00. Air Transport Co., Carle Place, N. Y.

**SCALE Model Airplanes** ready to fly—all types. Send dime (3 for 25c) for Flying Glider and catalog. The Clinton Toy Co., Box 141, North Haven, Conn.

**BIGGEST, Best Catalog Model Airplanes.** Parts, Supplies: 5c postpaid. Ideal Company, 19 West 18th Street, New York.

**AVIATION For Everybody.** Coming rapidly. New book, just issued, suitable for beginners, young people, students of flying, etc., who want something non-technical to teach them the control systems and methods of flying all types of land and sea flying machines. Strictly up-to-date. 256 pages. Illustrated. Price \$2.00. Sent C. O. D., if preferred. Popular Mechanics Press, Room 807, 200 E. Ontario st., Chicago, Ill.

**"AERODRIVE"** Propeller boat attachment blueprints, 50c. Propellers, 4', \$8.75; 5', \$13.25; 6', \$16.50; others proportionately. Leather helmets, \$1.50; goggles, \$3.00. Ostergaard Aircraft, 4309 N. Narragansett, Chicago.

**BUNDLE** Of model aeroplane material. Various sizes wood, reeds, bamboo, rubber band. Also circulars on free three-foot plane. All for dime (coin). Aero Shop, 3050 Hurribut Ave., Detroit, Mich.

**FLYERS, Students:** Get our ground course in aviation. Shows how to figure wing areas, horsepower, speed, etc. Also a treatise on flying, postpaid 25c coin. Dix Engineering, Dept. B, Box 302, Allentown, Pa.

**FLY!** With motorcycle engine. Booklet with drawings tells how to design and build sport monoplane. Price \$1.00. T. A. Hodgdon, 324 Bay St., Springfield, Mass.

**SIMPLEX Air Model Co., Auburn, Mass.** Send five cents for supply booklet.

**12 GENUINE Photo** miniatures of famous planes only 35c (coin or stamps). G. W. Hesse, 449 Troutman St., Brooklyn, N. Y.

**AIRPLANE Covers** 1924 cochets 75c. Meisel, Clintonville, Wis.

**FLYING Instruction** complete. Two lessons, \$1.00 each. Church, Box 2518, San Francisco.

**SEND 25c** (No stamps) for aviation booklet. Tells what others omit. Box 36, Strong, Ark.

**PATENTS.** Time counts in applying for patents. Don't risk delay in protecting your ideas. Send sketch or model for instruction or write for free book "How to Obtain a Patent" and "Record of Invention" form. No charge for information on how to proceed. Communications strictly confidential. Prompt, careful, efficient service. Clarence A. O'Brien, Registered Patent Attorney, Security Bank Building (directly across street from Patent Office), Washington, D. C. See pages 140 and 141.

**PARACHUTES.** Specify weight. Thompson Bros. Balloon Co., Aurora, Ill. Established 1903.

#### BOOKS AND PERIODICALS

**JUST OFF the press:** Thoroughly revised; down to the minute with much new material never published; greatly improved and enlarged; no advance in price. Fourth edition, "Radio Theory and Operating," by Mary Texanna Loomis, President, Loomis Radio College; member Institute of Radio Engineers. Nearly 900 pages. Over 700 illustrations. Beautifully bound in flexible red craft leather, stamped in gold. Complete text and reference book on radio; special chapter on "Aircraft Radio"; much European material added, especially British. Ever since publication of first edition in 1925 this book has been used as a text by practically all the leading radio schools in the United States and Canada, also many universities, technical colleges and high schools, and all government radio schools. Recognized as America's standard radio text book. Contains wealth of practical and systematically arranged information. Different from other works on the subject; is understandable and interesting; not just page after page of dry theory. Fills a long felt want in the line of radio text and reference books. Is a library in itself and you should have a copy. If interested in radio. For sale at nearly all bookstores in United States, also in Shanghai, China; London, England; Melbourne, Australia; Wellington, New Zealand; Calcutta, India; Honolulu, T. H.; Manila, P. I.; Vancouver, B. C. Price \$3.50. Buy of your bookdealer, or send check or money order for prompt delivery to Loomis Publishing Company, Dept. 18, Washington, D. C.

**LATEST and best House Wiring book**—just published—This new book of over 250 pages and 600 illustrations represents 15 years of work in perfecting the material for the best House Wiring manual it is possible to produce. The work of two men high up in the fields of mechanical arts and electricity. Price \$2.50 postpaid. Sent C. O. D. anywhere in the U. S. or possessions. Popular Mechanics Press, Room 807, 200 E. Ontario St., Chicago, Ill.

**"FUN-Magic-Mystery.** New book explains tricks with cards, coins, handkerchiefs, etc., you can do. Amaze your friends! It's easy. Postpaid 10c. Lyle Douglas, Station A-5, Dallas, Tex.

**"YOUR Life History in the Stars,"** new astrology book. Tells everything you want to know. One dollar. Haasans Osiris, Box 5853, Ybor, Tampa, Fla.

**BOOKS, Magazines, art publications** in French, Spanish, English. Photo novelties, etc., samples, lists, 20 cents stamps. Villaverde Co., Dept. 207, Box 1329, Havana, Cuba.

**NEW York's Sights** at your door. Book all photographs, clearly described, \$1.00. Free samples. Zmora, 321 Avenue "A," New York City.

**INDUSTRIAL Alcohol.** Wright's book. Full directions for making, fully illustrated, \$2.50. Spon & Chamberlain, 120 P.M. Liberty Street, New York, N. Y.

**HYPNOTISM** Easily learned. Lessons guaranteed. Postpaid, \$1.10. Smith Pub. Co., Dept. 3, Springfield, Mass.

**20TH Century Manual** of Ry. and Commercial Telegraphy and Radio Telegraphy, by F. L. Meyer. Of this excellent book F. H. Tubbs, Superintendent Western Union Tel. Company, in Chicago, says: "I consider this work of distinct advantage to students of telegraphy, and am glad to recommend it." Pay postman \$2.00 and postage when he delivers it. Popular Mechanics Co., Room 807, 200 E. Ontario St., Chicago.

#### PICTURES AND POSTCARDS

**DEATH Valley** and Mount Whitney—Highest and lowest spots in the United States. Both in one genuine photo. Also windshield sticker in four colors, all for 10c. Square Deal Novelty Co., Lone Pine, Calif.

#### MAGIC TRICKS, BOOKS AND JOKER NOVELTIES

**MAGIC**—Tricks, Books and Supplies. For amateurs as well as the great professionals. Anyone can learn through our instructions. Feature Acts in Mind-Reading. Spiritualism, Rope Ties, etc. Large illustrated professional catalog, 20c. Chicago Magic Co., 140 So. Dearborn St., Dept. B, Chicago, Ill.

**AMAZE And Mystify!** New 1928 "Fun-Magic-Mystery," profusely illustrated; explains many tricks. Also catalogs 750 Tricks—Illusions—Jokes—Puzzles—Books—Imported novelties at reduced prices. Postpaid 10c. Lyle Douglas, Station A-5, Dallas, Tex.

**MYSTO Disappearing Ink**—Used by magicians. Great at parties. Send secret messages. Only those who know make it appear and disappear. Send 25 cents to Box 35, Station D, New York.

**250 TRICKS, 10c.** Fully explained. Henemco, 38a Young, Waterbury, Conn.

**CARD Tricks,** coin tricks, hypnotism, ventriloquism. Instructive 64-page books 10c each. Geo. Fenner, 2401 Jefferson, Louisville, Ky.

**FREE** with \$25 order die box. Send 20c for our large catalogue of tricks, wigs, sensational escapes. Oaks Magical Co., Dept. 548, Oshkosh, Wis.

**SEVEN Magical Delusions and Catalogs**—25c. Gilmagico, Morgan Park, Ill.

**ILLUSION** And trick catalog 20c. Lynn's, 105 Beach, Jersey City, N. J.

**ELECTRIC Fun!** Seventy stunts, 110 volts, \$1. Cooper Sons, Campbell, Calif.

#### GAMES, ENTERTAINMENTS AND PLAYS

**SURPRISE Trick-Joke novelties** for all occasions. 100-page catalog 10c. Lyle Douglas, Station A-5, Dallas, Tex.

**LEARN Ventriloquism** by mail—small cost, 2c stamp brings particulars. Geo. W. Smith, Room S-287, 125 N. Jefferson St., Peoria, Ill.

**PUNCH** And Judy, ventriloquism, imitations learned by mail. Information 2c stamp. Scott, 719 First, New Orleans, La.

#### NOVELTIES, CURIOS, ETC.

**EUROPEAN Novelties, Puzzles, Fun-makers.** 100 page catalog 10c. Lyle Douglas, Station A-5, Dallas, Tex.

**NOVELTIES.** Illustrated catalog free. Paris-Picture publishers at Neuilly-Plaisance (S-&O), France.

#### STAMP COLLECTING

1,000 **NICELY Mixed stamps,** 25c post-free; 1,000 hinges 10c; 2,000 17c. Price lists. Sunshine Stamp Co., 549 East Maryland St., St. Paul, Minn.



**500 DIFFERENT Stamps for 25c!** Big collection 500 different stamps from Bosnia-Herzegovina, Crete, Epirus, Hong Kong, Iceland, Kenya and Uganda, Liberia, Malta, Nyassa, North Borneo, Orange River Colony, Siam, Wallis and Futuna, and other "hard" countries. Catalog value \$10.00. Price only 25c to approval applicants! Special bargains, 1,000 different 79c; 15 triangle stamps 49c; 100 Africa 45c; 100 Asia 50c; 100 Balkan States 35c; 100 British Colonies 25c; 100 French Colonies 30c; 100 Portuguese Colonies 50c. All 8 packets for \$3.00! Illustrated lists free. Loma Stamp Co., 3926 32nd St., San Diego, Calif.

**A SPECIAL Summer packet selection** Famous buildings and statues, packet No. 384, 25 all different, only 10c; No. 385, 50 different 25c; animal packets, No. 386, 20 different, 15c; No. 387, 30 different, 35c; beautiful views and scenes, No. 389, 20 different, 10c; No. 390, 50 different, 50c; portraits of men and women who have fashioned the destinies of nations, No. 382, 25 different, 10c; No. 383, 75 different 35c; No. 388, 150 different, \$1.00. When you write ask for our free price list listing more than 1,100 packets, sets and dime sets, albums, catalogs and accessories. Scott Stamp and Coin Co., 1 West 47th St., New York, N. Y.

**MYSTIC "Queer Country" Packet!** Contains scarce stamps from the following strange lands: San Marino, Antioquia, Congo, Cyprus, Fiji Islands, Gwalior Hyderabad, Iceland, Jhind, Kenya, Uganda, Lebanon, Monaco, North Borneo, Nyassa, St. Thomas Prince, Eastern Roumelia, Siam, Sierra Leone, Tanganyika, Trinidad Tobago, Ubangi, Upper Volta, Wallis Futuna, Alaouites. Get this wonderful packet of "freak countries" and make your friends envious! Price only 10c to approval applicants! Write today. Mystic Stamp Company (Dept. 8), Camden, N. Y.

**\$1.00 FREE. Black U. S. Postage. Given Away with each order.** Pioneer Stamp Album with 500 illustrations. 150 different stamps from 40 countries, Syria, Lebanon, Hejaz, Liberia, New French Colonies, British, Portuguese Colonies, South Africa, Australia, 500 hinges, 36 page illustrated catalogue. All for 15c. Big Commission to Agents for the Best approval sheets of stamps ever offered. Write for sample outfit. Hussman Stamp Co., Dept. M, 620 Olive St., St. Louis, Mo.

**ANCHERS \$\$\$ Outfit—only 12c!** Fine triangle stamp; set German stamps with (pre-war) value forty million dollars (interesting!); perforation gauge, mme scale; small album; airmail set; scarce stamp from smallest republic on earth; newspaper set; packet good stamps from Travancore, Malay, Dutch Indies, etc. Entire outfit for 12c to approval applicants! (Nice pocket stock book, value 25c, with every order!) Ancher Stamp Co., 148 1/2 Clerk St., Jersey City, N. J.

**A SNAP—300 different foreign and 60 different U. S. stamps, including \$1 and \$2 revenues, all for only 25c.** Free, with each order, our pamphlet which tells "How to Make a Stamp Collection Properly," together with our price lists of albums, supplies and hundreds of bargains in sets, packets, etc. Queen City Stamp & Coin Co., Room 36, 604 Race St., Cincinnati, Ohio.

**FREE Germany air mail (5 var.) for new applicant of my 1, 2c and 3c approvals and also my 50% discount.** Chas. W. Schmidt, P. O. Box 4832, Frankford Sta., Philadelphia, Pa.

**EXTRAORDINARY Packet, including stamp valued at \$1.00; only 10c to approval applicants.** Graef, 1523 43d St., Brooklyn, N. Y.

**600 WORTH-WHILE Stamps 50c.** Can't be duplicated for the price. Dare (440 55th St., Brooklyn, N. Y.)

**ONE-CENT Stamp approvals.** Values that will amaze you! Stamps from all over the world, cataloging up to 10 cents, sold by us at one cent each. Send today for trial selection. Fred F. Frasier Stamp Galleries, 4043 Lyndale Ave. S., Minneapolis, Minn.

**EXCHANGE Foreign stamps for good current United States Basis Scott.** John L. Sperry, Randolph, N. H.

**DANDY Approvals, 50% discount.** Ref. O. K. Stamp Co., Box 581, Utica, N. Y.

**\$10.00 FOR 25c.** A choice assortment of 500 all different stamps guaranteed to catalog over \$10.00, offered to approval applicants for only 25c. Edgewood Stamp Co., Milford, Conn.

**YOUR Government has nearly 100 different stamps to sell collectors at face value.** Pamphlet describing Government Philatelic Agency, list of stamps, and sample of "Washington Stamp News," all for 10c. A. G. Nickles, 213 Seaton, Washington, D. C.

**LINDBERGH Cuba airmail stamp unused, only 10c.** Skillman, Titusville, N. J.

**FREE! 115 Different stamps to approval applicants, 2c postage.** Paige Stamp Co., Oak Park, Ill.

**FREE: 20 Different animals, 200 foreign, 100 Austria, 50 Italy.** Cheese one. Remit 25c, three months' subscription. Meckel's Stamp Weekly, Beverly, Mass.

**TRIANGLES—10 Different triangle stamps 15c to approval applicants.** Fenway Stamp Co., 161 Massachusetts Ave., Boston.

**50 STAMPS Free with approvals.** Hodge Stamp Co., Lennoxville, Que., Canada.

**DENMARK: 30 Varieties, 10c postpaid.** Lists free. Allion, Angola, Ind.

**500 MIXED U. S., old and new, 10c.** Weatherby, Box 2628, Lakewood, Ohio.

**100 FOREIGN Stamps 3 cents.** Lufbery Route 3, North Branford, Conn.

**FRENCH Colonies free—Jungles, Tigers, Native Chief.** 2c postage. Empire Stamp Co., Toronto, Canada.

**FREE: 5 Rare Siam to approval applicants.** Winthrop Smith, 3611 Cedardale Rd., Baltimore, Md.

**50 AIRMAIL, Nyassa, Belgium, Olympics, triangle, etc., 10c.** C. Lacombe, 1800 W. Fayette St., Syracuse, N. Y.

**SPECIAL—25 Diff. airmail 10c, 100 diff. Austria 10c.** Splendid approvals 50% discount. Webster Stamp Co., Box 11, Tremont Station, New York.

**THREE Lindy stamps, Panama, Cuba, Premium, \$1.00.** A. Atlas Leva, Syracuse, N. Y.

**ANNIVERSARY Offer! 15c six beautiful sets: "Occupation," "Commemorative," "Airmail," "Charity," "Pictorial," "War."** Also three packets: (International), (British) French, Portuguese Colonies), (Bulgaria). Approvals, lists, discounts. Deering, Fairmount, Marlborough, Mass.

**110 DIFFERENT Stamps, many unused, high values, free to collectors requesting our Net Approvals.** Postage 2 cents. Christensen, Milwaukee, Wis.

**ONLY 5c! 10 Airmail stamps, including scarce Estonia triangle; Greece Red Cross set; packet fifty different stamps—all unused—from Guyane, Ubangi, etc.** All for 5c! Approvals and free lists with each order. Curhan Stamp Company, Gloucester, Mass.

**STAMPS, 100 all different, Postage 2c.** Lists free. P. M. Quaker Stamp Co., Toledo, Ohio.

**REVENUES—Telegraphs—Every country. Pretty—Intriguing—Cheap.** Mint \$5.00 revenue free to applicants with references. Vanderhoof, 1114 Logan, Denver, Colo.

**HIGH-CLASS Approvals. References Required.** Pikes Peak Stamp Co., Colorado Springs, Colo.

**STAMPS, 100, all different, 3c to approval applicants.** Glenn R. Knight, Box 3, Sausalito, Calif.

**STAMPS sent on approval at 70% discount.** Reference required. Emory Renoll, Hanover, Pa.

**BEAUTIFUL Picture Stamps Sent Free.** Paul Cornish, Schenectady, N. Y.

**110 NEW Europe All Different, a wonderful collection cataloging several dollars, free to collectors requesting our Net Approvals.** Postage 2 cents. Badger Stamp Co., Milwaukee, Wis.

**STAMP Collecting Hints.** This booklet free to beginners. T. E. Bottome, 2934 Shriver, Indianapolis, Ind.

**MOST Sensational values; over 140 diff. Algeria, Airplanes, Azerbaijan, Barbadoes, Cameroun, Babon, Guyane, Irish set, large French Colony packet, largest stamp, 40 year old U. S., gauge, etc., for 10c to approval applicants.** List free. 100 diff. U. S. 30c—1,000 hinges 9c—50 Bavaria 9c. Hawkeye Stamp Co., Cedar Rapids, 39, Iowa.

**101 DIFFERENT Free with 50% Approvals, 2c postage.** Noemus Stamp Co., 312 East 23rd St., New York.

**STAMPS, 100 varieties, Africa, Brazil, Peru, Cuba, Mexico, etc., 10c; 25 different U. S. 25c; 1,000 mixed, 40c; 1,000 hinges, 15c.** List free. C. Stegman, 5941 Cote Brillante, St. Louis, Mo.

**24 VARIETIES Cuban stamps, 10 cents.** List of 6,000 low-priced stamps free. Address Chambers Stamp Co., 111P, Nassau St., New York City, N. Y.

**LIBERIA Snake Triangle and two other triangles in our packet of 53 genuine foreign stamps for five cents.** Crowder Company, Waverly, Baltimore, Md.

**PENNY Approvals that Satisfy.** Neil Gronberg, Box 5441, Philadelphia, Pa.

**105 CHINA, etc., 2c. Album (500 illustrations) 3c.** Buillard, Sta. A. Boston.

**200 DIFFERENT stamps 10c; 1,000 Hinges 10c.** R. H. Carlton, 380 W. So. Temple, Salt Lake, Utah.

**COVERTCO Packet, 100 different stamps 10 cents, with 60% discount approvals.** Covert Stamp, 39 State, Rochester, N. Y.

**1,000 VARIETIES For 69c! Approvals.** Kenmore Stamp Co., 703 Kenmore Place, Brooklyn, N. Y.

**FREE—25 Portuguese Colonial stamps to approval applicants.** 2c stamp. Light-brown's, Osborne Rd., Southsea, England.

**DANZIG Stamps free—Interesting packet from Danzig with big catalogs free for 2c.** Midland Stamp Company, Toronto, Can.

**NEWFOUNDLAND-LABRADOR: Forty standard varieties only \$1.00.** 16-page catalog free to all. Wholesale list, for dealers only. Rev. Butler, St. Georges, Newfoundland.

**THE Big Four! New set 6 Greece (beautiful scenes); new set 3 Turkey (blacksmith and dog); 5 Costa Rica (gbv't adv. bag coffee); 6 Japan (famous earthquake set).** Regular price 50c. Special to approval applicants 10c. Dennie, 7763 Logan, Detroit, Mich.

**600 DIFFERENT \$5.00, 1,100 \$1.00.** Fred Onken, 630 79th St., Brooklyn.

**40 DIFFERENT United States, 10c.** 60% approvals. Seidenberg, Baroda, Mich.

**FINEST One Cent Approvals in the United States.** Stanton, Niantic, Conn.

**FREE, 12 Diff. large, showy picture stamps for a request for my popular approvals.** Postage 2c. Premiums with every purchase. A. Bauer, Palmyra, N. J.

**BEST One-cent approvals in America.** F. P. Hand, 1117 So. 60th St., Philadelphia, Pa.

**UNITED States and Canadian 32-page price list free.** Stamps bought. Stanley Gibbons, Inc., 38p Park Row, New York City.

**FREE—Sample copy of Stamp Collector's Magazine.** World's best stamp paper. Philatelic Publishing Co., 15 John St., New York.

**THOUSAND Foreign stamps 50c; twenty foreign coins \$1.** Prof. McCreery, Chatham, Ontario.

**200 DIFFERENT Stamps, Zanzibar; Album, 12c.** Liberty, 3974 Arsenal, St. Louis, Mo.

**HOW Be stamp dealer: book 25c.** Delbert Green, Leslie, Mich.

**RARE COINS**

**40 OLD Coins, all different, \$1.00; 100 different coins, \$3.00; 100 mixed foreign coins, \$1.00; Monroe half-dollar, Unc., \$1.00; Stone Mountain half-dollar, Unc., \$1.00; 12 dates large cents, \$1.00.** Claud Denney, Box 315, Dallas, Texas.

**ANCIENT Coin about 2,000 years old. 2 foreign coins, 2 crisp notes and catalog 20c.** Geo. Best, Cedar Rapids, Iowa.

**PRIVATE Party will dispose in bulk large collection valuable coins; also complete set large cents.** Louis Consos, 416 Drayton St., Savannah, Ga.

**OLD Coins, large Fall selling catalog of coins for sale free to collectors only.** Catalog quoting prices paid for coins, ten cents. William Hesslein, 101A Tremont St., Boston, Mass.

**CALIFORNIA Gold—Quarter size, 27c; 3/4 size, 53c; 3c piece and catalog, 10c.** Norman Shultz, Box 746, Salt Lake, Utah.

**COIN Catalog, two war coins, 10c.** Wacker-Dickman, Minster, Ohio.

**\$10,000,000 IN Foreign money for \$1.00.** Dare, 440 55th, Brooklyn, N. Y.



**\$2 TO \$500 Each Paid** for hundreds of old and odd coins. Keep all old money, it may be very valuable. Send 10 cents for illustrated coin value book, 4x6. Get posted. Guaranteed prices. We buy and sell. Clarke Coin Office, LeRoy, N. Y.

**OLD Money Wanted.** Will pay fifty dollars for nickel of 1913 with Liberty head (no Buffalo). We pay cash premiums for all rare coins. Send 4c for large coin folder. May mean much profit to you. Numismatic Co., Dept. H, Fort Worth, Tex.

**UNITED STATES and Foreign Money;** Military Decorations Catalogue and Greek coin 10c. Alexis Mengelle, Colorado Springs, Colo.

**GET Profit and pleasure** in collecting old coins. Send 10c for large illustrated coin catalogue. You'll be delighted with it. Send for it right now. B. Max Mehl, Numismatist, Mehl Bldg., Dept. P, Forth Worth, Tex. Largest Rare Coin Firm in the U. S.

**UNITED STATES.** Large cent, two-cent bronze, three-cent nickel and Bargain List. 25c. Fifteen dates large cents, \$1.00. George Coffin, Greenwood Mountain, Me.

**100,000,000 MARK Bill** and list 10c. Greenclay, 1626 Washington, Denver, Colo.

#### FOR BOYS

**AMAZE And mystify!** Fool your friends—earn money giving shows. Easily learned. Big book. "Fun-Magic-Mystery" tells how. Postpaid 10c. Lyle Douglas, Station A-5, Dallas, Tex.

**BOY Scouts!** Get the illustrated "Help-book for Boy Scouts," covering the scout tests, also catalog of books and supplies for scouts. Send ten cents to Boycraft Company, Dept. A, Tuckahoe, N. Y.

**O BOY!** Latest aeroplane novelty: Kite Aeroplane, "Spirit of Youth," by mail 50c. Arrow Mfg. Co., 3134 S. W. 9th., Des Moines, Iowa.

**SHIP Models—Worth while.** Easy to make. Decorative Ships Picturesque Barbary Pirate Felucca and Beautiful Spanish Treasure Galleon (both 17th century). Instructions so simplified that any handy person can make these models with a few household tools almost without expense. No personal knowledge of ships or naval architecture required. New book only one of its kind. Pay postman \$2.50 plus postage when book is delivered. Popular Mechanics Press, Room 807, 200 E. Ontario St., Chicago, Ill.

#### CAMERAS AND PHOTO SUPPLIES

**PHOTOGRAPHIC Equipment** and accessories of every description are listed and illustrated in our 228-page catalog. It will pay you to secure a copy which is issued free, as our prices are low. We also deal in used goods which are sold under the same guarantee as new goods. Ask for our Bargain Book. Central Camera Co., Dept. E131, 112 S. Wabash Ave., Chicago, Ill.

**MAKE money in photography.** Learn quickly at home. Spare or full time. New Plan. Nothing like it. Experience unnecessary. American School of Photography, Dept. 3431, 3601 Michigan Avenue, Chicago.

**EARN big money** with your camera in your spare time, using Halldorson Home Portrait Lamp. Write for booklet "Home Portrait Photography" and catalog—both free. The Halldorson Company, 4747 N. Western Ave., Chicago.

**MASTERCRAFT Enlargements** (from negatives) 8x10 65c, duplicates 55c. Money back guarantee. None better. The Hobby Shop, Six Traffic Station, Minneapolis, Minn.

**ROLL Developed—Six prints,** one beautifully tinted, 25c. 8x10 enlargement, 30c. Falls Foto Finishes, Dept. A, Glens Falls, N. Y.

**HAVE You a Camera?** Write for Free sample of our big magazine, showing how to make better pictures and earn money. American Photography, 116 Camera House, Boston, 17, Mass.

**AMATEURS—Develop and print** your own kodak films. Ten tested and guaranteed formulas sixty cents postpaid. Monarch Sales Co., O-we-go, N. Y.

**FILMS Developed.** Special Trial Offer. Any Size Kodak film developed 5c, prints 3c each. Trial 6x10 Enlargement in handsome folder 40c. Overnight Service. Roanoke Photo Finishing Co., 209 Bell Ave., Roanoke, Va.

**SAMPLE Enlargement—dime,** and negative (returned). Trial roll, glossy prints, 25c silver. Brown, Warsaw, N. C.

**\$.50.00 FOR Photographs—This price** paid for photographs if they meet our requirements. Perhaps one of your pictures will bring this amount. For particulars, address Redkrafft, Dept. 11, Denver, Colorado.

**GERMAN Cameras, lenses.** Bartiro, 6436 La Riba Way, Los Angeles, Calif.

#### MOTION PICTURES

**STARTLING Bargains** in motion-picture cameras, projectors, apparatus. Send stamp for the 192nd issue of the Bass Bargain-gram. Never in history has such startling bargains been offered in guaranteed apparatus. Write for your copy now. Remarkable motion-picture exposure meter, \$2.00. Sixty-six page catalogue. Send stamp. Bass Camera Company, 179 W. Madison St., Chicago, Ill.

**\$1,250.00 FOR A photoplay** story by an unknown writer and sold through our sales department. We revise, copyright and market. Located in the heart of the motion picture industry. We know the demand. Established 1917. Postal brings free booklet with full particulars. Universal Scenario Company, 206 Western and Santa Monica Bldg., Hollywood, Calif.

**BARGAINS—Machines, Films, Stereopticons, Slides, National Equipment Company, Duluth, Minn.**

**FILMS 1c Foot.** List. Bert Younkin, Huron, S. Dak.

**SALE: Two theatre projectors,** \$125 each. Aubrey Barnes, Chanute, Kans.

**MOVIE Films 1c ft.;** 200 ft., \$1; reels, \$2.50 up. Stamp brings samples and list. X. Sales Co., Box 1506, New Haven, Conn.

**FILMS 200 Feet** full of action \$1.00. J. Brink, 43 Winchester St., Boston, Mass.

**FILMS—100 Feet 65c.** Eastin, Box 424, Galesburg Ill.

**MOVIE Films, 1,000 ft. reels,** \$2.50 each; shipped anywhere on receipt of remittance. Particulars on request. Independent Films, 177 Golden Gate Ave., San Francisco, Calif.

**FILMS—200 Feet 95c.** Reels \$2.50 List. Edward Tieman, P. O. Box 155, Blue Island, Ill.

**NEW and Rebuilt Projectors** for Theaters, Schools, Churches, Traveling Shows. Supplies and Complete Theater Equipments. Bargain Prices. Free Catalog. Monarch Theatre Supply Co., Memphis, Tenn.

#### SCENERY TO RENT

**WORLD'S Most Beautiful Settings** for operas, plays, minstrels. Amelia Grain, Philadelphia.

#### EDUCATIONAL AND INSTRUCTION

**BE A Landscape Architect—Splendid earnings,** real success awaits you in this uncrowded profession. We train you by correspondence. Personal guidance by noted authorities, helping you get started. Immediate income possible. Catalog free. Write today. National School of Landscape Design, 518 Equitable Bldg., Des Moines, Iowa.

**STORY Ideas** wanted for photoplays, magazines. Big demand. Accepted any form for revision, development and submission to markets. Established 1917. Free booklet gives full particulars. Universal Scenario Company, 406 Western and Santa Monica Bldg., Hollywood, Calif.

**MEN—BOYS, 18-50.** Get U. S. government life jobs. Commence \$95.00 to \$158.00 month. Steady work. Paid vacations. Common education sufficient. 32-page book with list positions, sample coaching and full particulars, free. Write immediately. Franklin Institute, Dept. E-14, Rochester, N. Y.

**ARE You willing** to qualify for government position, \$120-\$250 month. Write, Ozment Instruction Bureau, 101, St. Louis, Mo.

**BECOME Auto mechanics.** Earn \$1,900 year. Sample lessons free. Franklin Institute, Dept. E-400, Rochester, N. Y.

**\$175-\$250 MONTH—Railway mail,** other government positions. Expert coaching. Booklet free. Standard Institute, 4554-M Broadway, Chicago.

**INVESTIGATING** And tracing. Work home or travel. Experience unnecessary. Write, George Wagner, 2188 Broadway, New York.

**YOUNG Men,** with some high-school education, learn radio business. Big paying positions. Write Mgr., Box 331, Milwaukee, Wis.

**U. S. GOVERNMENT wants men.** \$1,700-\$1,900 and up at start. Railway Mail clerk examination coming. Let our expert (former Government examiner) prepare you for this and also Rural Carrier, Post Office, Customs, Internal Revenue, and other branches. Write today for free booklet. Dept. 8, Patterson School, Rochester, N. Y.

**YOUNG Men,** with some high-school education, learn electrical refrigeration. Big paying positions. Write Mgr., Box 331, Milwaukee, Wis.

**TRAIN For fireman, brakeman, baggage-man,** colored sleeping car, train porter. Standard roads, \$150-\$200. Experience unnecessary. 810 Railway Bureau, East St. Louis, Ill.

**WATCHMAKER'S Course \$5.00.** Fossberg, 1528 E. Lake St., Minneapolis, Minn.

**YOU Need a better grip on mathematics?** Tell us to send you a copy of "Mathematics for the Practical Man," only \$1.50. By common sense methods it removes the mystery and difficulties so algebra and calculus are made simple. Assuming your knowledge is limited to arithmetic you quickly and easily gain a working knowledge of algebra, geometry, trigonometry and calculus. Simply pay postman when he hands you the package. Address Popular Mechanics Press, Room 807, 200 E. Ontario St., Chicago, Ill.

**LEARN Magic!** Earn big money on stage or spare-time entertaining. 112 page book, "Fun-Magic-Mystery" teaches you. Postpaid 10c. Lyle Douglas, Station A-5, Dallas, Tex.

**MAKE Money in photography.** Learn quickly at home. Spare or full time. New plan. Nothing like it. Experience unnecessary. American School of Photography, Dept. 131-B, 3601 Michigan Ave., Chicago.

**STUDY Mechanical dentistry** and earn up to \$125 per week. Learn at home in spare time to make crowns, inlays, etc. Write for information. Modern Dental Institute, 49 South Main St., Salt Lake City, Utah.

**WATCH Repairing and making** shows how to clean and repair all kinds of watches. 214 page book with over 200 illustrations. Pay postman \$3 and postage when he delivers book. Popular Mechanics Co., Room 807, 200 E. Ontario St., Chicago, Ill.

**TRACE Missing People.** Excellent paying work. Open to all. Write National Headquarters, 169 East 83rd Street, New York.

**USED educational matter** sold on re-purchase basis. Also rented and exchanged. Money-back guarantee. Catalog free. (Books, etc. bought.) Lee Mountain, Fisgah, Ala.

**DOUBLE Entry Bookkeeping** mastered in 60 hours with 8 keys; guaranteed; diploma. International Bookkeeping Institute, Dept. 8, Springfield, Mo.

**MAIL Carriers, clerks, railway postal clerks.** \$158.00 to \$225.00 month. Steady jobs. Men, 18-45. Sample lessons free. Write immediately. Franklin Institute, Dept. E-3, Rochester, N. Y.

**DON'T Prepare** for any Civil Service examination without seeing our catalog. Free. Columbian Correspondence College, Washington, D. C.

**753 TIME, Labor and Money Saving Ideas** for all who own, drive or repair autos. These practical hints are based upon the actual experiences of hundreds of owners and repairmen. Three books, Auto Owners', Auto Repairman's and Auto Tourists' Handbooks, regular \$1.50 value will be supplied at 98c plus the postage C. O. D. for a limited time only. Send your order today to Popular Mechanics Press, Room 807, 200 E. Ontario St., Chicago.

#### LANGUAGES

**WORLD-ROMIC System, Masterkey 5,000 languages.** Primers, \$1.98; Arabic, Chinese, French, German, Italian, Japanese, Russian, Spanish. Languages Publishing Company, 15 West 18th Street, New York.

**PIERCE'S Library—Phonic Texts World-Romic System; Poe's Raven, 49c postpaid; La Maison que Pierre a batie, 13c; House Jack Built, 13c; Old Mother Hubbard, 13c; Gospel According to Mark, first chapter, 25c. Languages Publishing Co., 15 West 18th Street, New York.**



**PIERCE'S Library**—Phonic Charts. Chart of Organs of Speech, 37c; Chart Universal Alphabet, 37c; Chart French Alphabet, 37c; Chart Spanish Alphabet, 37c. Languages Publishing Company, 15 West 18th Street, New York.

### RADIO OUTFITS AND SUPPLIES

**RADIOLAS** No. 16 Chassis \$25. Atwater-Kent 5-tube sets \$20. Saal speaker units \$2.00. Kodel A Eliminators \$3.50. Require slight repairs and 2 ampere Tungar tube. 30 Henry chokes \$1.00. 2 microfarad condenser blocks 60c. Stepup transformers \$1.75. Send money order with order. Charles Hoodwin Co., 4240 Lincoln Ave., Chicago, Ill. Dealers in bankrupt stocks.

**POPULAR Mechanics Super; Radiola; sacrifice.** DuMaurier, Elmira, N. Y.

**TRANSFORMERS**—100 Watt 650v and 7½v for UX281, \$5.50; 500v and 5v for UX280 or Raytheon \$4.00. Chokes, 30 Henry 60MA, \$1.50, 100 MA \$2.00. Adjustable 160MA \$5.00. Write for lists. Radio Parts Sales Co., Orange, N. J.

**BE** The licensed radio doctor in your community. \$7-\$10 spare time evenings. Our cooperative plan secures all the work you want. Secure franchised territory. Free booklet. Co-Operative Radio Doctors, Dept. M, 131 Essex St., Salem, Mass.

**BUY** Your B. power devices direct from factory. Send for particulars. D. L. & G. Mfg. Co., 2941 W. Lake, Dept. 11, Chicago.

**CROSLEY** Radio Pups, \$2.75 new. Also electric cigar lighters, two-year guarantee, \$1.85. Pay postman. General Distributing Company, Security Storage Building, Duluth, Minn.

**WRITE** About our efficient power devices. Kinley Electric Co., 441 E. Ferry St., Buffalo, N. Y.

**WHOLESALE** Prices. Nationally advertised sets. List free. Lyle's Radio Shop, 200 W. Main, Richmond, Ind.

**RADIO** Trouble Shooting—Here is the book all radio men have been waiting for. Greatest book ever published from the point of view of assisting the repairman as well as showing how the radio owner can do his own repairing. 328 Pages. Over 300 Illustrations. Flexible. Pay postman price \$3 and postage when he delivers it. Popular Mechanics Co., Room 807, 200 East Ontario St., Chicago, Ill.

### TRADE AND TECHNICAL SCHOOLS

**WANT** A foreman's job? You may be a good mechanic but if you can't read blueprints you haven't a chance. I train you quickly. Write me your trade. Carroll Rumsey, 266 Drexel Building, Philadelphia.

**TELEGRAPHY**—Both Morse and Wireless—taught thoroughly and quickly. Tremendous demand. Big salaries. Wonderful opportunities. Expenses low; chance to earn part. School established fifty years. Catalog free. Dodge's Institute, Fern St., Valparaiso, Ind.

**MEN** To learn bricklaying. Large contractor needs men. Full pay after 8 weeks' training. Earn while learning. Write American Building Trades, B4341 W. Harrison St., Chicago, Ill.

**OUR** Commercial radio operating and junior engineering course pays our graduates \$150 to \$300 monthly from start. Rapid advancement. Fall term begins in September. Write for catalog of course including Extension Course. Loomis Radio College, Dept. 5-E, Washington, D. C.

### BUSINESS OPPORTUNITIES

**READ** The Mail Order News—America's Pioneer Mail Trade Journal. Quarter Century Old. Approximately 600 pages yearly of valuable information for beginners and established mail-order houses. Analyzes mail-order business, its opportunities. Practicable mail-order ideas, legitimate money-making schemes, instructive articles. Tells how to start, what to sell. Published monthly. Subscription \$3.00 yearly. Send 25c for sample copy. None free. Mail Order News, 360 Bristol Bldg., New York.

**MAIL-ORDER** Business is your opportunity. Brenner's famous handbooks, for fifteen years have shown beginners practically how to get into this fascinating and profitable business. Continually revised, always up to date. Set of ten, \$3. One book and descriptive catalog 25c. None free. Brenner Publisher, 1607 P. Sansom, Philadelphia.

**AN** Unusual opportunity to make big profits in a business of your own. Actual manufacturer about to retire will furnish formula and complete process for manufacturing, without machinery or special equipment, a household preparation used in practically every home. Big seller. Enormous profits. Easily manufactured. Write for facts. Box F, % Popular Mechanics, Chicago.

**\$1 PAYS \$20**—I start you in world's fastest big money business. You supply salesmen and agents with new sure-fire selling specialties. Write immediately for eye-opening literature, describing guaranteed formulas, latest valuable trade processes. All lines. Small investment. Immense profits! Start anywhere. Miller, Chemist, 1706-D Jetton, Tampa, Fla.

**BIG** Profits are yours if you handle Braxold. The new brake lining renewer. Makes brakes hold instantly, stops squeaks. Nothing like it on the market. No competition. Write for our proposition today. Exclusive territory open. Means a permanent business for you of your own. Braxold Products Corporation, Dept. "P," 228 South Ave., Rochester, N. Y.

**BECOME** A heating engineer. Increase your sales from year to year. We tell you how to start right in and land the jobs that might have been. 11 Cross, Newport, N. H.

**CAPITAL**—For copy of "The Promoters' Hand Book," a leaflet on financing, an eye-opener for capital-seekers, send \$1.00 to Amster Leonard, East Orange, N. J.

**EXTRA** Money—We help you choose, begin and continue a profitable spare-time occupation. Ask Webster for information; 223 Mowat, New Westminster, B. C.

**MONEY** For working capital; incorporate and sell shares in your business. 27 years organizing and raising money for businesses of merit. Terms reasonable. Prompt and confidential service. W. Harrison Cole, 507 5th Ave., Suite 510, New York.

**NEW** Specialized business—yet you can make \$1,000 per month. Start an Auto Glass Shop, replace broken glass in cars. Accidents increasing—garages send you work. I'll tell you how to start, but reserve Milwaukee territory. Write Auto Glass Shops, 752, 53 National, Milwaukee, Wis.

**SELL** By mail; Booklet, circulars. Samples, 10c. Harvey Teeple, Decatur, Ind.

**DON'T** Sell for others. Employ agents yourself. Make your own products. Toilet articles, household specialties, etc. 500% profit. Valuable booklet free. National Scientific Laboratories, 1984W Broad, Richmond, Va.

**WE** Carry a complete stock of peanut and ball gum machines selling same at \$5.00 each. If you are looking for a legitimate business this is the time to start on a small scale. Write for full particulars. Liberty Novelty Co., 3557 W. 22nd St., Chicago.

**MIRRORS** Resilvered at home. Costs less 5 cents per square foot; you charge 75 cents. Immense profits plating like new, brassy worn-off autographs, reflectors, tableware, stores, etc. Outfits furnished. Details free. Sprinkle, Plater, 127, Marion, Ind.

**DISTRIBUTOR** For 100 store route this county; experience unnecessary; no selling, distribute and collect; should net \$70.00 weekly. Peris Mfg. Co., Florin, Pa.

**NO** Peddling. Start own business. Home office. Free folder describes 27 money-making opportunities. No outfits. Elite Co., 38 Elizabeth St., New York.

**WE** Start you in business, furnishing everything; men and women, \$30.00 to \$100,000 weekly operating our "New System Specialty Candy Factories" anywhere. Opportunity lifetime; booklet free. W. Hillyer Ragsdale, Drawer 4, East Orange, N. J.

**BUSINESS** Profession of your own and earn big income in service fees. See Stephenson Laboratories, display ad page 128.

**START** A profitable business. Small capital. Particulars free. Roy Burnham, "A" Lockport, N. Y.

**YOUR** Favorite products, manufacture them yourself. Guaranteed manufacturer's formulas supplied. All lines. Latest specialties. Romig, Box 103A, Station W., New York.

**EARN \$150 To \$300** monthly with repossessed, slightly used machines. Portable Paint Sprays, 8-hour battery chargers, both offer opportunity in big field. Practically no investment required—small down payment brings them—pay for themselves with handsome profit besides. Write for details, no obligation. Clayton Jenkins, Box M785, Troy, Ohio.

**DISTRIBUTE** Our literature to friends and acquaintances in spare time. Profitable and pleasant work. Homestead Co., 538 Broadway, New York.

**GENUINE** Broadcloths shirts, white. Extra special \$3.00 each, 3 for \$8.00. State size. Paul Seyfert, Thiensville, Wis.

**TOOL** Salesmen—Sell to auto mechanics, guaranteed line of 120 Oldforge tools—wrenches, pliers, chisels, screw drivers, punches, tool boxes. Exclusive territory. Give complete information about yourself, first letter. Quality Tools Corporation, New Wilmington, Pa.

**CHEMICAL** Expert will furnish formulas and trade secrets. All lines. Lists free. W. L. Cummings, Ph. D., 228 Gordon Ave., Syracuse, N. Y.

**\$10 A DAY** and more, with manufacturing rights, national seat-cover sensation. Instructions and material furnished. National Trimmers, Los Angeles, Calif.

**YOU** Can have steady work all the year round. Learn how to build artificial stone-houses. Stronger than concrete and cost only one-fifth the price of frame houses. No experience needed. Write P. Swendsen, Box 60, Juneau, Alaska.

**WONDERFUL** Opportunity; sell your own products. Famous formulas; get free list. Jordan, Angelica, N. Y.

**MAKE** Toys, novelties, children's furniture. Instructions, patterns, including scroll saw, \$1.00. Wm. Bogren, 2264 Hermany Ave., New York.

**\$5 TO \$10** Daily in home workshop. Garretson Co., Mt. Pleasant, Iowa.

**SIX** Months big mail—samples, magazines, offers, 25 cents. Larkin, 453 27th Ave., Milwaukee, Wis.

**MAGICAL** Demonstrators! Entertain and sell. Make money both ways. Tricks-Jokes-Puzzles, etc. Easily learned. Book "500 Tricks" and wholesale list 25c. Lyle Douglas, Station A-5, Dallas, Tex.

**ARTIFICIAL** Marble sanitary flooring instructions, covering wood or cement flooring ½ inch thick, fireproof, waterproof, all colors, low cost. Ornamental casting, concrete, plaster, papier-mache decorations, garden furniture, statuary, flexible molds. 18 years instructing the public; particulars and illustrations free. Chris. Mahler, Huntington, N. Y.

**CHARTERS:** Delaware; best, cheapest; free forms. Colonial Charter Co., Wilmington, Del.

**UNPATENTED** Ideas can be sold. I tell you how and help you make the sale. Free particulars (Copyrighted). Write W. T. Greene, 810 Baltic Building, Washington, D. C.

**"SCHEMER"** Subscribers; surely succeed. One reports \$50,000 from one tip; another \$25,000 from three Schemes; another \$10,000 from one formula. Try your luck! Year, \$1.00; three months, 30c. Patterson, Publisher, Alliance, Ohio.

**SUPPLIES** For making chipped glass house numbers and signs. Tinfoils, glass and frames. Osborne Sims, 13580 Tuller, Detroit, Mich.

**START** A Crispette shop. Delightful confections. Everybody likes them. Make a lot of money. Adams reports \$364 profits in two days. We start you. Write, Long Eakins, 1962 High St., Springfield, Ohio. (Samples 10c.)

**CIRCULAR** Free. Learn how to sell novelties by mail under my instruction. Had-well, 96A, 74 Cortlandt St., New York.

**A BUSINESS** of Your Own Making—Sparkling Glass Name and Number plates. Checkerboards, Signs. Big book and sample free. E. Palmer, 540, Wooster, Ohio.

**MECHANICS,** Painters, carpenters, start furniture refinishing, painting, handyman shop on nearly nothing; winning plan brings customers quickly. John Braceland, 1439 So. Ninth, Philadelphia, Pa.



**PATENTS.** Time counts in applying for patents. Don't risk delay in protecting your ideas. Send sketch or model for instruction or write for free book "How to Obtain a Patent" and "Record of Invention" form. No charge for information on how to proceed. Communications strictly confidential. Prompt, careful, efficient service. Clarence A. O'Brien, Registered Patent Attorney, Security Bank Building (directly across street from Patent Office), Washington, D. C. See pages 140 and 141.

**SUCCEED With Your Own Products.** Make them yourself. Formulas, Processes, Trade-Secrets. All lines. Catalog, circulars free. B. Thaxly Co., Washington, D. C.

**LEARN** the collection business. Good income, quick results. Interesting booklet, "Skillful Collecting" free. National Collectors Assn., Long St., Newark, Ohio.

**MAKE Big Profits with a Fur Farm** in your backyard. Chinchilla Rabbits, Muskrat, Mink. Write for facts. 252 Conrad's Ranch, Denver, Colo.

**SELL** By Mail. Wonderful opportunity. Particulars free. Mason, 3902 Broadway, Room 5, Chicago.

**KING System Mail Order Business.** sample, details free. King Company, Box 6722, Wilmington, Del.

**SELL** by Mail! Books, novelties, bargains! Large profits! Particulars Free! B-Elco, 525 South Dearborn, Chicago.

**ATTENTION!** Establish for yourself new system real estate, brokerage and insurance agency; office at home; earn \$5,000 year. Stamp free booklet. Hayes Realty Association, Cincinnati, Ohio.

**I MADE \$30 a Week Home.** French Breadmaking. 15 years' experience; Free Booklet tells. Ashbrook 67, Marengo, Ohio.

#### TELEGRAPHY

**TELEGRAPHY**—Both Morse and wireless—taught thoroughly and quickly. Tremendous demand. Big salaries. Wonderful opportunities. Expenses low; chance to earn part. School established fifty years. Catalog free. Dodge's Institute, H St., Valparaiso, Ind.

#### CHEMISTRY

**YOUR** Chemical problems solved and working formula or process furnished for \$5.00. Write me. W. Stedman Richard, Industrial Chemist, Box 2402, Boston, Mass.

**UNUSUAL**, Unique, usable formulas, \$1.. Chemical analyses. Commercial Chemists, 128 Talleyrand, Jacksonville, Fla.

**CHEMICAL** Analysis, processes, technical information. Robert Henderson, Laboratory, Madison, Me.

#### FORMULAS AND TRADE SECRETS

**FORMULAS** That are right chemically. Not the "stock" or book type but the kind that give your products distinction and commercial value. Manufacturing processes and ideas, chemical analysis of any product. Reasonable rates. Nielco Laboratories, Inc., 5401 Cicotte, Detroit, Mich.

**LATEST** Valuable trade secrets, guaranteed formulas for starting world's fastest big money business making newest sure-fire specialties. All lines, small investment. Immense profits! Write immediately for eye-opening valuable literature. Miller, Chemist, 1706-E Jetton, Tampa, Fla.

**A FIND!** "Mother's Golden Ointment," a wonderful product—a whirlwind seller. Formula worth \$100.00. Clean up big on this. Complete formula \$1.00. Orange Blossom Laboratories, 430-A South Grand Ave., Los Angeles, Calif.

**PUNCTURE** Stop solution simple to make. Formula \$3.00. J. Godwin, P. O. Box 775, Winnipeg, Canada.

**DON'T** Sell for others. Employ agents yourself. Make your own products. Toilet articles, household specialties, etc. 500% profit. Valuable booklet free. National Scientific Laboratories, 1984W Broad, Richmond, Va.

**SUCCEED With Your Own Products.** Make them yourself. Formulas, Processes, Trade-Secrets. All lines. Catalog, circulars free. B. Thaxly Co., Washington, D. C.

**INDUSTRIAL** Chemist furnishes formulas, plans, trade secrets. All lines. Work guaranteed. Lists free. J. F. Mazur, 941 20th, Lorain, Ohio.

**FORMULAS**—170 Money makers and big illustrated catalog 20c. Ideal Book Shop, (K) Park Ridge, Ill.

**15,000 FORMULAS** in "Scientific American Cyclopedia of Formulas." Includes following and many others: Accidents and emergencies, agriculture, alloys and amalgams, artist's materials, beverages, cements, glues, pastes, mucilages, bleaching, renovating, coloring metals, dyeing, glass, heat treatment of metals, household formulas, ice cream, confectionery, chewing gum, lapidary work, exterminating vermin, lubricants, paints, varnishes, photography, condiments, canning formulas, rubber, soap, candles, soldering, toilet preparations, perfumes, waterproofing, fireproofing, writing materials. Send no money. Just write a postal. When postman hands you book pay \$5.50 and postal charges. Popular Mechanics Press, Room 807, 200 E. Ontario St., Chicago, Ill.

**MASTER** Barber Shampoo. Easily made at home. Wonderful results. Used in my family three generations. Sell to others. Big profits on repeat orders. First time offered. Complete formula \$5.00. Gray, Box 313, New London, Conn.

**SAWDUST**—Chemicals makes Sanitary Marble Flooring. Directions \$2.00. Universal Supply Co., Auburn, N. Y.

**3,000 VALUABLE** Formulas prepaid \$1.00. National Service, 3937 Marburg, Cincinnati, Ohio.

**10,000 FORMULAS.** A real Gold Mine of money-making ideas. Tells how to make almost everything under the sun. You can make and sell cosmetics, mucilage, anti-freeze solutions, battery solutions, beverages, cheese, chewing gum, cleaning preparations, extracts, hair preparations, inks, bluing, leather polish, mirrors, perfumes, polishes, typewriter ribbons, carbon paper, washing powders, liquid soap, and hundreds of other profitable articles. Send No Money. Just write a postal for "Henry's 20th Century Book of Formulas." Pay postman postage and \$4. Popular Mechanics Press, 200 E. Ontario St., Room 807, Chicago, Ill.

#### AGENTS WANTED

**PRIVATE** Brand toilet articles, household specialties, perfumes, soaps, extracts, etc. We pack these goods for you under your private label. With your name on the goods you get all the repeat business. Don't sell for others, but build up a profitable business for yourself. Highest quality merchandise. Extremely low prices. Quick shipments on both large and small orders. Write immediately for lowest wholesale prices and complete information regarding our amazing offer. Address Supply Department, National Scientific Laboratories, 1904W Broad, Richmond, Va.

**AGENTS**—I'll pay your bills, give you steady income for rest of your life, if you will take care of my business in your locality, full or spare time. You be my partner, make \$15 a day, ride in Chrysler sedan. Distribute teas, coffees, spices, extracts, things people eat. I furnish everything; world's finest super sales outfit containing thirty-two full-sized packages; low prices; big repeat business; \$25,000 guarantee on quality. I go 50-50 with you. Get my amazing offer. C. W. Van De Mark, Dept. 102G, 117 Duane St., Cincinnati, Ohio.

**MAKE** Your own medallions. New sensational invention makes wonderful profits possible in photo medallion business. Now finest medallions can be made right in your own home. No machinery necessary—no investment—we furnish all parts. Costs less than 50c each. Positively new patent—first announcement. Get in on ground floor. Experienced medallion salesmen will reap fortune quick. Wonderful chance for new salesmen. Write quick. Send 50c for sample (stamps or coin). A. B. Dale, Sales Mgr. Medallion Division, Campbell Ave. and Jackson, Chicago, Ill.

**AGENTS**—Best seller; Jem Rubber Repair for tires and tubes; supersedes vulcanization at a saving of over 800 per cent; put it on cold, it vulcanizes itself in two minutes, and is guaranteed to last the life of the tire or tube; sells to every auto owner and accessory dealer. For particulars how to make big money and free sample, address Amazon Rubber Co., Philadelphia, Pa., Dept. 505.

**MANY** Of our agents working part time or full time are earning \$200 to \$400 monthly by selling direct to consumer, Apex Powdered Soap, Apex Powdered Bleacher, Apex Furniture and Auto Polish and other easy selling products. Big sellers, fast repeaters. For men and women of ability, we can offer exclusive territory and factory co-operation. We send mail to your Apex users, that gets you sub-agents. Our products are sold on money-back guarantee. Write at once, Apex Distributing Corporation, Manufacturers, 657-661 S. Main St., W. E., Pittsburgh, Pa.

**DRINKS.** The best you ever tasted, concentrated true fruit flavors, cherry raspberry strawberry, grape, etc. Just add water and sugar. Can be kept on ice for a week. 30 quarts (150 glass size) \$1.00; 3 for \$2.50 postpaid. 80c clear profit on every dollar selling at 5c a glass—beautiful signs free. Also 10c packages soft drink powders, makes 10 big glasses delicious drinks. Big sellers to families and stores. Seven packages, assorted flavors (70 glasses), with full particulars, 50c postpaid. Chas. E. Morrissey Co., 4417 Madison St., Chicago.

**CAN** You sell house paint at \$1.98 per gallon and barn paint at \$1.30? Lowest prices in America. Beat all competition, dealers and mail order houses. Money back guarantee to every customer. Experience unnecessary, no delivering or collecting. Just talk to property owners about these low prices. \$50 to \$100 weekly easily made. Check mailed you each Friday. Write at once for free sales outfit, with complete information. Farm & Home Paint Co., Dept. 126, Kansas City, Mo.

**AGENTS.** Crewmen—Make big money! Handling our Mystic "Zippo"! Splendid profit on a snappy 50c "Go-Getter" repeat article sells on 10-second demonstration! Performs while you watch it! Demonstrates value while others make claims! Greatest scientific triumph of the age! Write immediately for proposition! Karam-Smith Company, 607 Bozart St., Fort Wayne, Ind.

**AGENTS:** Large profits selling our eighteen money-making specialties, including patented All-In-One combined cigarette and match case. Holds package cigarettes and box safety matches. Beautiful, compact, flexible container. Write today for complete information. All-In-One, Dept. A-7, 2810 Portland Ave., Minneapolis, Minn.

**AGENTS:** Portraits, photo-pillow tops, frames, sheet pictures, medallions, photo-jewelry, guaranteed hose, laundry tablets, food products, toilet requisites, liminous crucifixes. Catalog 50 specialties free. 30-days' credit. Jas. C. Bailey Co., Sta. C-7, Chicago.

**MAKE** \$2.00 Every hour. Sell every home wonderful preparation; mends hosiery and clothing without sewing, invisible. Results guaranteed. Send for free sample of work. Queen City Laboratories, Dept. PM-7, Cincinnati, Ohio.

**AGENTS,** \$300 Month. Sell guaranteed silk hosiery. Must wear 7 months or replaced. New selling plan. Auto given when earned. Free silk hosiery for your own use. Write for samples. Betterknit Textile Co. Silk 2831, Greenfield, Ohio.

**AGENTS,** Our cigar lighters and sales-boards sell quick. Large wholesale catalog free. Joseph Sales Company, 223 Madison St., Chicago.

**\$1,000.00 REWARD** If this is not the greatest money-making house to house proposition ever known. N. R. G. tablets wash clothes in 10 minutes without rubbing. Free samples. N. R. G. Co., H 500 W. Division, Chicago.

**\$15 A DAY** Sure. Sell guaranteed solid leather shoes. Unequaled low prices. 85 styles; men's, women's, children's. Free outfit offers complete line shoes, raincoats, leather coats, puttees. Consolidated Shoe System, Dept. 715, Eau Claire, Wis.

**IF** We send you two of our newest inventions—Wringer and Dust Mop—will you demonstrate and take orders? Every housewife eager prospect. Pays \$75 weekly. No money required—samples loaned free. Write Delphos Mop Co., 1017 Washington, Delphos, Ohio.

**SELL** Fence repairing wire stretcher, handiest tool for mending faulty wires. Excellent sideline. Hawbaker Co., Elmora, Minn.



**BRIDGE:** Agents wanted to sell bridge scorer (made of aluminum and celluloid). New, practical device for figuring bridge scores quickly and accurately. No experience or capital needed. No high pressure salesmanship necessary. Sells on sight. Nearly everybody plays bridge—therefore, unlimited possibilities. Write immediately for proposition. H. & R. Corp., Suite 516, 90 West St., New York City.

**MAKE \$50 To \$75 a week.** Everyone needs shoes. Sell Mason's all-leather shoes, amazingly low prices. 85 styles—Men's, women's, children's. No experience needed. Big outfit free. Mason Shoe Mfg. Co., Dept. 227, Chippewa Falls, Wis.

**MAGICAL Demonstrators!** Entertain and sell. Make money both ways. Tricks-Jokes-Puzzles, etc. Easily learned. Book "500 Tricks" and wholesale list 25c. Lyle Douglas, Station A-5, Dallas, Tex.

**NEW Way to make money and get your own clothes free,** taking orders for our fine made-to-measure tailoring. Write today for new style outfit, all wool samples, etc. Furnished free. Progress Tailoring Co., Dept. U-217, Chicago.

**AGENTS! \$20 Daily!** Latest patented ironing board pad and cover combination. Guaranteed. Low price. Sample for yourself free. American Braiding, AL, 329 West Monroe, Chicago.

**EVERY Home will buy summer drinks,** food products, auto oils, paints. Big profits. Write for free outfit and amazing offer. Loverin & Browne, F1602 So. State, Chicago.

**STRANGE Invention!** Pays \$25 daily. Keeps telephone and iron cords from tangling and kinking. Prevents iron scorching. Saves electricity. Samples free. Neverknot Dept. 7-A, 4503 Ravenswood, Chicago.

**AGENTS—Something new.** \$75-\$200 weekly selling \$7.50 washing machine. Does work of high-priced machines. Biggest profits. We deliver—collect. Free sample offer. (Weighs ½ pounds.) Act. Merle Mfg. Co., (Manufacturers), Desk 4-D, Aurora, Ill.

**\$50,000 PICTURE Man Friedman made canvassing.** Beginners can make \$100.00 weekly with my sales talk. Experienced men make more. Free book. "Profits in Portraits" explains. Sample free. Picture Man Friedman, Dept. 8-J, 541 W. Lake, Chicago.

**WHY Not sell us your spare time? \$2.00 an hour, \$19.70 daily** easy full time. Introduce 12 months guaranteed hosiery—47 styles, 39 colors for men, women, children, including latest "Silk to the Top" ladies' hose and men's fancies. No capital or experience needed. We furnish samples. New plan. Macochee Hosiery Company, Park 5867, Cincinnati, Ohio.

**FLAVORING Extracts—Bottle yourself!** Concentrated—add water! Free labels, whirlwind sellers! 500% profit! Money-making opportunity. Write Thomas Manufacturing Company, Indianapolis, Ind.

**AGENTS, Become a regular established McConnon dealer;** buy on credit; sell for cash or credit. 228 absolute household necessities; all repeaters. Enjoy a sure income 52 weeks per year, year after year. City or country trade. Capital, experience unnecessary. McConnon & Co., Dept. 882, Winona, Minn.

**\$20 DAILY Easy** introducing amazing gasoline tonic. Every motorist buys over and over. Experience unnecessary. Amazing profits. Investigate. Darnell, 730 N. Hays, Jackson, Tenn.

**WELLS Cleared \$620.00 in one month** with "Business Guide" and free legal service. Write for free outfit. Prof. Nichols, Dept. 14, Naperville, Ill.

**AGENTS—Clean up on pearls;** large profits; low cost. Write Oriental Pearl, 151 Fifth Ave., New York.

**SALESMEN—\$4 In your pocket every half hour.** Write orders for Hollywood News. New idea advertising service for store windows. No competition; every store prospect. Permanent repeat business. Free sales outfit. Retail Stores Service Corp., 1160 Broadway, Dept. B2, New York.

**SELF-FILLING Fountain pen and pencil set complete.** Colors red, green, black. Sample set and sales proposition \$1.00. Hogan Company, 967 Thomas St., St. Paul, Minn.

**\$75 WEEKLY.** Man or woman wanted with ambition and industry, to distribute Rawleigh's Household Products to steady users. Fine openings near you. We train and help you so you can make up to \$100 a week or more. No experience necessary. Pleasant, profitable, dignified work. Write today. W. T. Rawleigh Co., Dept. 53PPM, Freeport, Ill.

**AGENTS: Liberal commissions and bonuses** selling high quality hosiery, handkerchiefs, scarfs, men's ties, curtains, bedspreads, linens. Also a big line of dress goods, silks, etc. 1,000 samples furnished. Write quickly. The National Importing Co., 573 Broadway, Dept. G-100, New York, N. Y.

**BETTER Than bootlegging!** 400% profit taking orders liquid quick mend for fabrics and hosiery. Steps runs. Every woman buys. 100 other fast sellers. Johnson Co., Dept. 467, 6129 Wentworth, Chicago.

**AGENTS \$240 Month.** Take orders for finest line guaranteed pocket knives you ever saw. Name and address on handle or emblem of any society or fraternal order. Big demand. Territory given. Write quick. Novelty Cutlery Co., Desk 2031, Canton, Ohio.

**AGENTS—Mosco Corn and Callous Remover** will build you a steady repeat business. Send today for pocket-size trial outfit. The Moss Company, 412 Searle Bldg., Rochester, N. Y.

**IMPORT Your own goods.** German export magazine published in English, offers numerous bargains latest novelties; opportunities for obtaining profitable agencies. Copy 60c. Square Deal Supply, P-246 Fifth Ave., New York.

**EXPENSIVE Silk dresses.** Sacrificing showroom samples cheap. Peddlers, storekeepers, dress shop ladies, write Hirschlar's, 249 West 34th, New York.

**FREE Sample mail order and agency specialty.** Filmer, 5003G Gateway, Kansas City, Mo.

**AGENTS Make \$3.00 an hour** taking orders for our 40 fascinating kitchen specialties. No competition. Write quick. General Products Co., Dept. 4207, Newark, N. J.

**AGENTS: Unique proposition,** telephone recorder. Exclusive territory given if you act immediately. Exporters Exchange, 126 West 34th St., New York City.

**BIG Pay every day!** Complete guaranteed line direct to wearer. Dress shirts, work shirts, overalls, coveralls, work pants, sweaters, underwear, playsuits. \$10-\$15 daily; experience unnecessary. Big outfit free! Nimrod Co., Dept. 8, 4922-28 Lincoln Ave., Chicago.

**AGENTS Everywhere—New outfit ready.** Make \$15 daily selling shirts, underwear, sweaters, raincoats, boysuits, hosiery. Northern Sales, 101 S. Wells, Chicago.

**AGENTS—We have whirlwind seller.** Get details. Webster, 608 Wrightwood, Chicago, Ill.

**GENUINE DuPont Fabrikoid Tablecloths.** No laundering—Wash like oilcloth. Look like imported linen. \$75.00 weekly. Pay daily. Samplebook free. Dollette Corporation, C1018 Wabash, Chicago.

**AGENTS—New invention;** automobile owners buy instantly. No competition. 100% profit. Exclusive territory. Gayton Co., Providence, R. I.

**\$25 DAILY—Sell raincoats \$2.85.** Hat free. Biggest line and commission. Outfit free. American Waterproof, A724 Roosevelt, Chicago.

**CEE-DAR Kills moths, chases flies, mosquitoes, cockroaches.** New form. No powder or liquid. Hangs on hook. Guaranteed. Repeater. Women buy one to six. Particulars free. Sample 10c. Cee-dar, D77 W. Washington, Chicago.

**AGENTS—For Aladdin polishing cloth.** Enormous demand everywhere; 200 per cent profit. Sample free. L. Dougherty, 518 West 39th St., New York.

**AGENTS—Biggest seller yet!** Four shirts for \$5.00. Your commission \$1.00. Wide variety materials insure quick orders. Experience unnecessary. We specialize on made-to-measure shirts. Send for free outfit. D. Menzin, President, Menzin Shirt Co., Inc., 481 E. Tremont Ave., New York.

**DON'T Sell for others** Employ agents yourself. Make your own products. Toilet articles, household specialties, etc. 500% profit. Valuable booklet free. National Scientific Laboratories, 1984W Broad, Richmond, Va.

**AGENTS—100% Profit** selling our low-priced, beautiful and attractive felt rugs. Perfect color combinations win instant admiration, insuring quick sales. Excellent opportunity to build substantial business. Eastern Mills, Everett, Mass.

**EARN \$3.90 An hour!** No experience necessary. Introducing an entirely new appliance to housewives. Each representative given exclusive territory. Write Ideal Stairway Equipment Company, Dept. PM, Canton, Ohio.

**FREE "Guide to full pocketbook."** New ideas, original business plans, money-making secrets; other valuable information. Elite Co., 38 Elizabeth St., New York.

**NO Peddling.** Start own business. Home, office. Free folder describes 27 money-making opportunities. No outfits. Elite Co., 38 Elizabeth St., New York.

**ENERGETIC Men every city make \$10 to \$20 daily** handling our new big money-making specialties. Quick sales. Repeat orders. Try today. Make \$10. Free particulars. Research Laboratories, Savage, Minn.

**AGENTS Wanted to sell newly designed** loud speakers direct from mfg. Write for circular. Sample \$9.45. Speaks for itself. Edw. Kays, Lab., 41 N. Centre St., Orange, N. J.

**SELL Rebuilt watches** and take up watch repairs. International, Box 5P, Fordham Station, New York.

**AGENTS—90c An hour** to advertise our goods and distribute free samples to consumers. Write quick for territory and particulars. American Products Co., 1893 Monmouth, Cincinnati, Ohio.

**AGENTS—Sell new burglar alarm window lock.** Earn big money. No experience needed. Part or full time. Write Locked-Open, 809 W. Madison, Chicago.

**MAKE \$1 Every ten minutes** showing new Polly wrench; 10 wrenches in one. Special plan demonstrator free. Guaranteed seller at sight. Amateurs make \$12.50 daily. Experienced distributors \$110. Gellman Mfg. Co., Dept. 6, Rock Island, Ill.

**AGENTS Sell Shynzall Metal Polishes.** Polishes all metal, glass, etc.; something new, different from other polishes. Send 25c for can and terms. O. Martinson, 17 South Terrace St., Fargo, N. Dak.

**AGENTS Wanted—Make \$2.00 an hour** selling our remedies. Full or spare time. 100% profit. Write today. Elvee Company, Dept. A, 2919 W. North Ave., Baltimore, Md.

**NEED No experience,** deposit \$3.25 for sample case and samples of face creams, etc. Refund on first \$25 of orders. Commission 50%. Write Pure Drug Products Co., P., Station "D," Cincinnati, Ohio.

**AGENTS: Embossed signs,** biggest selection, latest colors, every merchant buys. A dime for 50c worth of samples. Also exchangeable signs and flashing plugs. Franklin, 3322 3rd Ave., New York.

**MY Agents earn \$90 a week!** Wear and show my beautiful new free raincoat and give away free hats. Write today for yours. Robert King, 230 So. Wells, Dept. AA-7, Chicago.

**AGENTS—\$10.00 Daily** selling patented can opener. Guaranteed device proves "best seller." Sold through agents only. Exclusive territory. Samples furnished. Jiffy Appliance Co., Otis Bldg., Chicago.

**EVERYBODY Fears fire,** our new patented fire extinguisher sells easily. Want reliable men to manage unoccupied territory. \$50 weekly and more easy. We deliver and collect. Good opportunity to right man. Fyr-Fyter Co., 1723 Fyr-Fyter Bldg., Dayton, Ohio.

**AGENTS—District managers! \$8.88 for men's utility suits!** Resists sparks, snags, water! No competition! Free kit! 888 Company, Dept. GC-7, Fort Wayne, Ind.

**THE B. & G. Rubber Co., Pittsburgh, Pa.,** makes one of the fastest selling, best paying lines on the market. Write Dept. 372, for the proposition.



**RADIO!** Big money made on amazing new invention. Simple device makes marvelous loud speaker of any piano in one minute. 10,000,000 radio set owners need this. A wonderful opportunity for quick profits. Write at once for circular and confidential price. Tunbar Radio Co., Dept. PM-26, Cortlandt St., New York City.

**\$14.85 DAILY** In advance (spare time will do). Introducing 12 months insured hosiery. 57 styles, 39 colors, for men, women, children. "Silk to Top" ladies' misses' "Sport", men's "Fancies." Capital, experience unnecessary. We furnish samples, New plan. Milton Mathews, Park 2567, Cincinnati, Ohio.

**DON'T Sell** for others. Employ agents yourself. Make your own products. Toilet articles, household specialties, etc. 500% profit. Valuable booklet free. National Scientific Laboratories, 1984W Broad, Richmond, Va.

**YOUR Favorite Products:** Manufacture them yourself. Guaranteed manufacturer's formulas supplied. All lines. Latest specialties. Romig, Box 103B, Station W, New York.

**FREE Samples,** bargain lots of chemical specialties. Peoples Chemical Laboratory, 2519 So. Crawford Ave., Chicago, Ill.

**UNIVERSITY,** College, high school students everywhere earn ten to twenty dollars day during vacation. You supply names, we sell, collect by mail. Commissions sent daily. "Runtru," 305 Union Oil Bldg., Los Angeles.

**MAKE \$11.00 Daily** selling our Lucky 11 toilet goods assortment at \$2.25 giving free 2 piece carving set. Each sale makes steady customers. Davis Household Products Co., 511 Vedder, Chicago.

**\$60-\$200 A WEEK.** Genuine Gold Letters for store windows. Easily applied. Free samples. Liberal offer to general agents. Metallic Letter Co., 438-B North Clark, Chicago.

**WE Trust Agents!**—Starter Stock and Records on Credit—no bond signers. Finest line 200 guaranteed Extracts, Pure Foods, Toilettries, Big Profits. Write for details. Perkins Products, E-3, Hastings, Nebr.

**AUTOMOBILE Specialties.** Guaranteed formulas for all latest money makers. Lowest prices. Write for free lists. Murphy, Chemist, Tujunga, Calif.

**WE Have** the finest needle case, self-threading needles, needle threaders. \$50.00 to \$200.00 weekly. Samples 25c, particulars free. Empire, 1549 N. Wells, Dept. 201, Chicago.

**WRITE Atlas Sign Works** for free working equipment. Beautiful window sign letters. Penny each! Any size. Wonderful offer to general agents, K1032 E. 55th St., Chicago.

**WE Start You Without a Dollar.** Soaps, Extracts, Perfumes, Toilet Goods, Experience Unnecessary. Carnation Co., 2480, St. Louis, Mo.

**AGENTS:** Stamping names on pocket-key protectors. Sample check with your name and address, 25c. Stamping outfits. Emblem checks, check-fobs, name plates. Hart Mfg. Co., Desk 2, 303 Degraw St., Brooklyn, N. Y.

**AGENTS—America's greatest sensation.** New record-breaking sellers. Enormous demand; tremendous profits. Write quick for details. United Service, 500 Fifth Ave., New York.

**AUTO Men** earn \$10.00 per hour—Amazing invention. Send no money. Agents wanted. Write immediately. Runtru Co., 305-D Union Oil Bldg., Los Angeles.

**HERE It Is—**newly invented auto necessity that goes big with new Ford; particulars free. Suburban Box 10, Mt. Washington, Ohio.

**AGENTS—**Sell stores 5c candles specialties, big profits. Colonial Co., 312 E. 33d, New York.

**GOLD-LEAF Sign Letters;** copyrighted Manufacturing Instructions; profits 1,000%. Johnston Co., Quincy, Ill.

**MAKE Big money** selling tires, all or part time. Handsome profits; sell your friends; buy your own tires and save the middleman's profit. Guaranteed 15,000 miles. Write at once for territory and full details. Acme Supply Company, Lafayette, Ind.

**AGENTS—\$60 Week—**Dri-Kleanit makes any car look like new. Removes mud, grease, tar, all one operation. No soap or water used. Free sample. American Accessories Co., Desk 2831, Cincinnati, Ohio.

**AMSCO Magnetic Health Belts** made in our own factory, \$15. Guaranteed none better. Agents wanted. Genuine Ionacos \$22.50. Amso Health Belt Co., 721 Eighteenth St., Oakland, Calif.

**BIG Profits** with your own merchandise. Formulas and recipes for anything. Four cents stamps brings complete list. P. Adlard, 21 E. 13th St., Brooklyn, N. Y.

**EARN \$48.00 A week** and expenses introducing our soap and washing powder. Auto earned by producers. Buss-Beach Company, Dept. A42, Chippewa Falls, Wis.

**CASH Paid** for Butterflies, Insects. See Sinclair Display Advertisement on page 22.

**POLISHING Cloths** with new sales plan. Sample free. C. A. Black & Co., Foot W. 6th St., Cleveland, Ohio.

**SPINNING,** Red, white and blue auto light colors for cowls. See page 152 this magazine. Get in on ground floor.

**ARE You Old at Forty?** See our advertisement on page 68 of this issue. The Electro Thermal Company, 2107 Morris Ave., Steubenville, Ohio.

**VALVE Keeper** pliers, fast selling 75c tool to auto mechanics and those who repair own cars. Also accessory houses. M. Berry, 6416 Stony Island Ave., Chicago, Ill.

**MIRRORS Resilvered** at home. Costs less 5 cents per square foot; you charge 75 cents. Immense profits plating autoparts, reflectors, tableware, stoves, refinishing metalware, etc. Outfits furnished. Details free. Write Sprinkle, Plater, 128, Marion, Ind.

**"HOW To Secure Agents,"** a specially prepared booklet, tells of one of the most inexpensive methods in which to secure good live producing agents. It is free; write for your copy today! M. L. Rund, Mgr. Classified Advertising, Popular Mechanics Magazine, 200 E. Ontario St., Chicago, Ill.

**A BUSINESS of your own—**Making sparkling glass name and number plates, check-boards signs. Big book and sample free. E. Palmer, 512, Wooster, Ohio.

**32 SECONDS** Complete tire change by Detmer, Ohio, with Morey Quick Action Rim Tool. Sold, singly, 49 three days, cleared \$100. Anderson, Mont., sold 1,400 in 14 weeks. Get details for good territory. Harvest time now. M. Morey Rim Tool, Buffalo, N. Y.

**SELL "Grip-It"** screwdrivers. Holds the screw until it is started. Send 50c for sample and proposition and try it in spare time. Your profit 100%. Apex Stamping Co., Riverdale Station, Chicago, Ill.

**AGENTS Send** for free sample "Fretnot." Washes clothes snow white without rubbing. \$5.00 daily and more easily made. Credit given. Empire, 1549 N. Wells, Dept. 101, Chicago.

**\$1 PAYS \$20—**Start the world's fastest big money making business. Make and supply agents, salesmen with new sure-fire selling specialties. Write immediately for eye-opening literature, describing guaranteed formulas, latest valuable trade processes. All lines. Small investment. Immense profits! Start anywhere. Miller, Chemist, 1706K, Jetton, Tampa, Fla.

**ANY Salesman** can earn \$75.00 to \$200.00 a week selling our patented real art genuine gold leaf window letters. No experience necessary. Sell on sight. Big demand all year round. Any one can put them on.\* Buy for cash and sell for huge profit. General agents can collect big commission on original and repeat business. Free liberal samples. Write today for complete proposition. The Tablet & Ticket Co., 1015-1021 West Adams St., Chicago, Ill.

**MAKE Money—**Spare time. Men, women, boys, girls. Easiest method; absolutely something different. No selling; no canvassing. Free particulars. Federal, 561 AA Broadway, New York.

**THE Christensen Mop** Wringer rubs, scrubs, cleans the mop. For sale by H. K. Christensen, Fort Atkinson, Wis.

**SELL Supreme No-Cement** tube and tire patches. 310% profit. Particulars. Write Supreme, 135 Winder, Detroit, Mich.

**NO Dull times** selling food. People must eat. Federal distributors make big money; \$3,000 yearly and up. No capital or experience needed; guaranteed sales; unsold goods may be returned. We furnish you with sample case, license and free samples for customers—Sure repeat orders. Exclusive territory. Ask now! Federal Pure Food Co., A2307 Archer, Chicago.

**SELL Gillette** style razor blades. Good seller. Package 10 blades 35c; 200 blades, \$3.50. J. Kramer, Iselin, N. J.

**NAM-O-LENE—**New, self-selling auto wonder—300%—Prepaid—Free sample. Diamond Spear, Texarkana, Ark.

**ENGRAVED Nameplates,** signs, numbers, initial, desk, city nameplates. Big profits. Hilton Specialty, 90 Stewart, Providence R. I.

**THE Latest,** most amazing products! 200% to 500% profit! Make them yourself. Write for free, valuable literature. Scheid, Chemist, Box 1199, New Haven, Conn.

**GOLD-LEAF Window** letters and script signs. No experience; 500% profit. Samples free. Meyer writes 5 days profits \$141.36. Consolidated, 69-T West Van Buren, Chicago.

**CAN You** sell a washing machine for \$9.75? Agents are making \$75.00 to \$300.00 weekly showing new automatic washer to housewives. Thoroughly cleans and sterilizes. No rubbing necessary. Write for protected territory. Storm Royalty Co., Inc., 3601 Enright, St. Louis, Mo.

**AGENTS—Sell** Trousers' Friend. Keeps trousers spick and span. Sells easily. 100% profit. Trousers Friend, Dept. 1, Box 521, San Francisco, Calif.

**75c PROFIT** On \$1.00 sale. Auto furniture and glass cleaner. Your name on label. Exclusive rights. Free sample. MFG. E, 213 Griswold, Detroit, Mich.

**SURPRISE Housewives!** Leaky utensils repaired free instantly. Knockout demonstration sells Mendets amazingly. Twelve dollars daily easy. Free samples, selling secrets. Get territory quick. Collette Mfg. Co., Dept. 7A, Amsterdam, N. Y.

**COUNTY Agents** Wanted. 50% commission on tried and proved automobile spring offer. Nothing else like it. Sells on sight—every motorist wants them. This is a good proposition; don't pass it up. Send for full particulars. Harvey Spring and Forging Co., Racine, Wis.

**WRITE For** New Low Prices, direct from manufacturer, Flashy Felt Rugs. Attractive colors and patterns. Popular size \$13.50 dozen. Sample Rug \$1.40. Newark Felt Rug Co., 416-F Morris Ave., Newark, N. J.

**NEW Unusual** necessities paying phenomenal profits. Make money as you've never made it. Unequaled, amazing detailed offer, free. Concentrated Products Co., Box 3772-P, Tampa, Fla.

**STOP: 300** Fast-selling specialties from many parts of world. Proposition hard to beat. Write for Free Wholesale catalog. Spors Co., Lesueur Center, Minn.

**MANUFACTURE** Radiant glass name and number plates, mirrors, signs, etc. Besides teach others! Investigate! Radiant Signs, 15905 Alden, Detroit, Mich.

**\$75-\$200 WEEKLY.** Genuine gold leaf letters for store windows, easily applied. Get the styles good sign painters use. Sign Painters Letter Co., 11416 Forest Ave., Chicago.

**MAN** in each town to plate auto parts, reflectors, bathroom fixtures, refinish beds, mirrors, chandeliers; by new method. No capital or experience required. Simple plan of manufacturing at home starts you in big money-making business. Outfit furnished. Free particulars and proofs. Gun Metal Co., Ave. H. Decatur, Ill.

**AGENTS—Here's a New One.** "Bestever Powdered Hand Soap." Sells like wildfire. Marvelous Discovery. Removes grease, paint, ink, oil, in fact anything from hands. Cannot harm skin. 150% Profit. Great Repeater. Agents simply coining money. "Free Samples Get the Business." Write immediately. Bestever Products Co., 4315W Irving Park, Chicago.

**POLMET** Polishing Cloth removes tarnish from metals without the use of liquid, paste or powder. Our agents say it sells like "hot cakes." Retail 25c; sample free. Gale & Co., Inc., 15 Edinboro St., Boston, Mass.



**PATENTS.** Time counts in applying for patents. Don't risk delay in protecting your ideas. Send sketch or model for instruction or write for free book "How to Obtain a Patent" and "Record of Invention" form. No charge for information on how to proceed. Communications strictly confidential. Prompt, careful, efficient service. Clarence A. O'Brien, Registered Patent Attorney, Security Bank Building (directly across street from Patent Office), Washington, D. C. See pages 140 and 141.

**MAKE Big money.** Be the electrical dealer in your town. Sell a big line of low priced, quality appliances. Write for our selling plan. Dandyline Products, 4120 N. Western Ave., Chicago, Ill.

**DON'T Sell for others.** Employ agents yourself. Make your own products. Toilet articles, household specialties, etc. 500% profit. Valuable booklet free. National Scientific Laboratories, 1984W Broad, Richmond, Va.

**AGENTS \$240 Month.** Bonus besides. Introduce new guaranteed hosiery—126 styles, colors. Finest silks. Credit given. Producers earn auto. Samples furnished. Wilkint Hosiery Co., Dept. 5031, Greenfield, Ohio.

**WIDESPREAD Demand for Our New Food Drink and New Flavorings** (Black Walnut, Peach, Dixie Bouquet, etc.). Many other fine products. More agents needed. Blair Laboratories, Lynchburg, Va.

**INSTANT Weld Welds Rubber Instantly.** Stock's Profit One Day \$72.25. Enormous demand. Exclusive territory. Free sample. Tourists Pride Manufacturing Co., Desk G, Minneapolis, Minn.

**DON'T Sell for others.** Employ agents yourself. Make your own products. Toilet articles, household specialties, etc. 500% profit. Valuable booklet free. National Scientific Laboratories, 1984W Broad, Richmond, Va.

**CALIFORNIA Perfumed beads** selling like hot cakes. Agents coining money. Big profits. Catalog free. Mission Factory P, 2328 W. Pico, Los Angeles, Calif.

**PHOTO Medallion Men and Women,** the largest line of Photo Novelties in the world. Lowest prices, quickest service. Send for catalogue showing over 200 money makers. Photo medallions, photo medallion clocks, photo mirrors, photo fountain pens, photo powder compacts, photo jewelry and photo buttons. Gibson Photo Jewelry Co., 608-114 Gravesend Ave., Brooklyn, N. Y.

**AT Last! Diamond Rival Discovered!** Amazing blue white Rajah Gem astounds and deceives. Beautiful case free, \$100 weekly. Rajah Diamond Company, F20, Salisbury, N. C.

**SELL men's neckwear;** wonderful proposition. Astor, 318-M Broadway, New York.

**15c PROFIT On every 25c sale.** Box 500, Shreveport, La.

**THREAD-CUTTING Thimble 25c.** Seller Sample 15c. Irvel, 3973 Elston, Chicago.

**KWIK Straw Hat Cleaner** is demanded by millions. Need more agents. Allan, Harahan, La.

**BIG Money selling 25c article** you make yourself. Costs you 5c. No license required. 25c pkg. free. C. C. Manufacturing Co., B-522, Dayton, Ohio.

**MAKE And sell your own goods.** No machinery. Guaranteed formulas. Catalog free. Clover Laboratories, (E) Park Ridge, Ill.

**SUCCEED With Your Own Products.** Make them yourself. Formulas, Processes, Trade-Secrets. All lines. Catalog, circulars free. B. Thaxly Co., Washington, D. C.

**EASY Money—\$50.00 to \$150.00 weekly** selling "Jiffy Huller," a device every housewife wants. Saves time and labor shelling peas and beans. Retail \$1.00. Commissions 90% to 140%. Send \$1.00 for demonstrating model. Jiffy Specialty Co., Marietta, Ohio.

**AGENTS make \$10.00 Daily** selling Non-Splash Water Filters on sight. Best canvasser's article on market. Investigate. Write for particulars. Desk 14, Seed Filter Company, 73 Franklin Street, New York.

**FIBRE Brooms—detachable handles,** fine finish. Good profits, repeat sales. The Fibre Broom People, 147-C New Jersey Ave., Brooklyn, N. Y.

**REMNANT Store,** Bethel, Ohio. Greatest Dry Goods Bargains on Earth. Agents and Dealers.

**TIRE Agents—Car Owners.** \$5 to \$10 allowed on old tires, free 7 day mileage test on new Mellinger heavy duty tires, 15 months guaranteed, free tire offer to agents. Make \$50 weekly spare time. Write for amazing offer, powerful selling kit given agents and wholesale prices. Mellinger Tire Co., Dept. 282, Kansas City, Mo., Warren, Ohio, Oakland, Calif.

**REPLATE** brass worn-off Automobile Parts, Reflectors, Bath Room Fixtures, Worn Spoons, Forks, etc., with pure silver. Looks like new. Use U-Kan-Plate Polish. Positively no mercury. \$1.00 half pints. Post Paid. Satisfaction Guaranteed. Agents wanted, Dept. A, U-Kan-Plate Co., Philadelphia.

**\$50.00 WEEKLY easy.** Applying Gold Initials on Automobiles. No experience needed. \$1.45 profit every \$1.50 job. Free samples. "Balco Monograms," X1043 Washington, Boston, Mass.

**WANT Distributing Agent for HandSlick,** powdered hand soap; removes anything from hands; everybody a customer; sample free. Solar Products Co., J-2142 S. Troy, Chicago.

**GENUINE Gold Leaf Letters** anyone can put on store windows. Guaranteed to never tarnish. Large Profits. Enormous Demand. Free Samples. Write today. Metallic Letter Co., 438-D North Clark, Chicago.

**TWO Money makers for agents.** "Francis" Pocket Adding Machine retails \$4.85. To you \$1.00. "Excellograph" Rotary Stencil Duplicator \$37.50 retail. Write Typewriter Supply, 102 Hersch Bldg., Pittsburgh, Pa.

**AGENTS—Sell stores 5c candy specialties.** Lorrac Products, Albany, N. Y.

**AGENTS Wanted to sell Men's Hats** direct from factory. Write for catalog. Model Hat Mfg. Co., Dept. M-14, East Orange, N. J.

**OUR Luminous Crucifix Shines in the Dark.** Every one amazed at the wonderful effect. Easily demonstrated—easily sold. W. G. Hannan Co., 2543 So. State St., Chicago.

**AGENTS—Engraved name plates,** signs, numbers, etc., easily sold, profits large. Brett Bros., Roxbury Crossing, Boston, Mass.

**\$16 A DAY Easy—I start you in auto** accessory business; no investment; no experience necessary. Landin, 4206 Montrose Ave., Chicago.

**\$10 DAILY.** New, highly practical, useful 50c article for every home and office. Sells on sight. Hydraulik Corp., Roselle, N. J.

**BIG Money and Fast Sales.** Every owner buys Gold Initials for his auto. You charge \$1.50; make \$1.35. Ten orders a day easy. Write for particulars and free samples. American Monogram Co., Dept. 40, East Orange, N. J.

**MONOGRAM Automobiles,** \$1.35 Profit ten minutes' work; every owner wants them; millions without; particulars free. Motorists Accessories Co., Mansfield, Ohio.

**AGENTS—Clever Invention!** Inkspoon makes every pen a fountain pen. Fast office seller; big profit, demand increasing everywhere. Exclusive territory offered. Sample free. H. Marui Company, Tribune Bldg., New York, N. Y.

**GET Our Free Sample Case—Toilet** articles, perfumes and specialties. Wonderfully profitable. La Derma Co., Dept. A, St. Louis, Mo.

**AGENTS make \$100 week** furnishing Cigar Lighters to merchants on free advertising plan. Particulars sent free, write at once. Drake Mfg. Co., Dept. M, Milwaukee, Wis.

**SOMETHING New.** Every motorist a buyer of our electro-magnetic-emergency Wonderlamp; takes only one minute to demonstrate and make a sale; no experience necessary; \$5.00 an hour easily made; full time or evenings. Write for sample. Wonderlamp Co., 926 Fisk Bldg., Dept. 10-A, New York.

**AGENTS—We start you in business** and help you succeed. No capital or experience needed. Spare or full time. You can earn \$50-\$100 weekly. Write Madison Company, 566 Broadway, New York.

#### HIGH-GRADE SALESMEN WANTED

**PUNCHBOARD Salesmen.** New fascinating game. Excitement; legal all states; \$200 weekly easy; one minute sales talk; pay daily. Cigar Stores Novelty Co., Dept. A, Peoria, Ill.

**UNEMPLOYMENT, Elections,** make slow collections for all merchants. Give them what they need. Not just collection system. Complete automatic credit and collection plan. Gets cash and keeps customer for merchant and for you. You get half cash on repeat orders for supplies without call-backs. Automatic income for you. 250% on original sale. Full or spare time. Judge by results! Commonwealth J Publishing Co., 508 So. Dearborn, Chicago.

**INSURANCE Men and solicitors.** Greatest selling accident policy, guaranteed by \$14,000,000. Pays up to \$15,000 death benefit; \$100 per month disability. Coverage for all accidents. Cost \$5.65 first year; one-cent-a-day thereafter. Solicitor makes \$2 each policy sold. Address Hugo W. Greb, Myers Bldg., Springfield, Ill.

**SALESMEN—Cleancut.** Capable. Line for manufacturing industries. Utility proven in demonstration. Extensive market. Little traveling. Unlimited possibilities. Large remuneration. Permanent. House of 40 years' standing. Ensign Co., 10703 Quebec Ave., Cleveland.

**EXCLUSIVE Territory** going fast! Men selling to stores or handling agents making big money with "Marvtex," biggest seller and repeater of the year. Sets color, doubles wear, and prevents runs in silk hosiery. Guaranteed. Write quick or send 50 cents for package and be convinced. Marvtex, 1727 West Morris, Indianapolis, Ind.

**JUST One Changeable Letter Electric** window display with moving colors and light—The Luminate. Our boys get the big money. Don't risk patent infringements—sell the original. 1928 refinements and added features make today's Luminate irresistible. A weather-proof number for outdoor use. Join the Luminate money-makers. Display Products Company, Ltd., 405-9A, East 31st St., Kansas City, Mo.

**SALESMEN—Become Independent.** Own your business; experience unnecessary, selling our \$7,500 Accidental Death; \$50 Accident; \$25 Sick Weekly Benefits—\$10.00 yearly. Other amounts proportionate. Guaranteed steady income from renewals. \$250,000 deposited Insurance Department, Universal Policy, Dept. A, 40 Clinton Street, Newark, N. J.

**NEW! Fast seller!** Make \$3.00 an hour daily. Sell "Advertising Work Suits." Every workman, business a prospect. High-grade low-priced Coveralls, Shop-coats, 2-piece Overalls. Firm name and advertisement woven on back. Outfit free. John Leeding Co., Dept. NII-7, 70 E. 18th, Chicago.

**MAKE Big money—Sell our nationally** known all wool tailored to individual measure suits \$23.50-\$29.50. Commissions \$4.00-\$5.00. Your big opportunity! Large sample outfit free. Write General Tailoring Co., Dept. 7, 529 S. Franklin, Chicago.

**EACH \$10.00 Sale nets you \$5.00.** Unique advertising service sold only to merchants. Have some exclusive territory open. Full time or sideline. State your territory. Southern States Specialty Company, Box 909, Athens, Ga.

**CHRISTMAS Cards.** If you have sold Christmas cards or think you can obtain orders, we will send you best sample book in U. S. A.; 50% commission, payment weekly. Write now. \*Wm. N. Toothill Co., 329 Madison, Chicago.

**\$18 TO \$25 Daily;** Biggest selling line of 2-piece suits, \$9.95 and \$12.50; 3-piece wool suit, \$17.95 (regular \$28.00 value). All-wool overcoats, \$18.50. Splendid rain-coats, slickers and boys' suits. Biggest commissions. Free outfits. "Jim" Foster, Inc., Dept. 27, 2250 S. Spaulding Ave., Chicago, Ill.

**WONDERFUL Free selling outfit** with actual samples of Bostonian broadcloth gets quick sales for our nationally known Bostonian shirts at 3 for \$6.95. Postage paid. \$9.00 value; guaranteed fast colors. Liberal cash commission of \$1.50 on each order of 3 shirts means big money for you. Bostonian Mfg. Co., Dept. M. 3, Boston, Mass.

**COMMISSION In advance** selling auto seat covers, we deliver and collect; experience not necessary. Write today for samples and proposition. Horne Motor Co., Magnolia, N. C.



**IMITATION Ice Cream.** Amazing new product. No freezing. Made at home in 2 minutes. Solidifies milk into delicious dessert; 8-dish sample with money-making plan 10c. Creamojell Co., St. Paul, Minn.

**TAILORING Salesmen:** Sell Simpson's new \$23.50 pure virgin-wool, union made-to-measure suits and overcoats; commissions in advance; exclusive territory; big outfit, 175 samples free. J. B. Simpson, 843 Adams, Dept. 1506, Chicago.

**WALKER Made \$165 first day selling collection systems to merchants.** Retail \$6.50. Collects \$65.00. Costs \$1.50. Adjustment Bureau, Mobile, Ala.

**EASY Sales and big profits** are made without a penny cost or investment, selling groceries, auto oils, paints. \$50.00 to \$100.00 a week easily made. Write for free samples. Lovell & Browne, 2016 S. State, Chicago.

**\$4.00 PROFIT On \$5.00 sale—"Free sample."** New specialty. Money getter. Every storekeeper, doctor buys quickly. Experience unnecessary. Territories open. Federal Association, Hartford, Conn.

**SALESMEN—Protected territory.** Standard merchandise, permanent position with responsible manufacturer. Only experienced, ambitious salesmen considered. References required. The Atlas Globe China Co., Cambridge, Ohio. Dept. H.

**A SURE Seller—New Electric Hot Dog Machine;** sells \$18.50; commission \$6.50; ready buyers everywhere. Leonard E. Dickerson, Dept. H-E, Springfield, Mo.

**EARN \$20 A day.** Establish income for life selling for \$1 a year, \$1,500 accident policy. Write W. C. Stone, 11 So. LaSalle, Chicago.

**SALESMEN—With established territories;** sell complete line guaranteed low-priced tires. Good commissions, territory protected, factory co-operation. Write The Hadji Rubber Company, Sandusky, Ohio.

**EXPERIENCED Salesmen,** fast selling self-answering door bells. Sells \$5.00; big commission. Must invest \$125.00; references. Manage salesmen in your district. Silent Servant, 7024 Melrose Ave., Los Angeles, Calif.

**\$100 WEEKLY** Easily made selling complete line vending machines to retailers. Free selling outfit. Robbins Company, 28A Dodworth St., Brooklyn, N. Y.

**DON'T Sell** for others. Employ agents yourself. Make your own products. Toilet articles, household specialties, etc. 500% profit. Valuable booklet free. National Scientific Laboratories, 1984W Broad, Richmond, Va.

**MR. BRUSH Salesmen—Old established New York brush manufacturers** require services of men in all territories to sell their extensive line of Sanitary Twisted in Wire Brushes. We pay larger commission than any other brush house in the country. Write immediately for our proposition. Wire Grip Sanitary Brush Corporation, 41-51 East 11th St., New York City.

**MEN—Sell dependable shrubbery, fruit trees, etc.** Steady demand. Complete co-operation. Commissions paid weekly. We deliver and collect. Write Perry Nurseries, Dept. R-7, Rochester, N. Y.

**BIG Season just ahead.** Advertising pencils most popular every day—every business prospect. Our line repeats. Big commissions. Established in 1902. North American Pencil Works, 126 So. Clinton, Dept. 55-0, Chicago.

**\$100.00 WEEKLY** Selling better-quality, all-wool, made-to-measure suits and overcoats at \$23.50. Highest commissions. Extra bonus for producers. Large swatch samples free. W. Z. Gibson, Inc., 500 Throop St., Dept. U-517, Chicago.

**SALESMEN—Main or sideline—Sell high-grade union printed stationery** at half price. 40% commission advanced. Copyright cuts, and outfit free. Meyerson, C1132 So. Racine, Chicago.

**SALESMEN, 125 Varieties brushes.** 60% commission. \$25-\$100 weekly on agents. Neway Brush Factory, Hartford, Conn.

**SALESMEN—Cemetery, Memorial Park, Mausoleum.** Experienced and inexperienced. Urgent need of men. You can earn more. Free information. J. Joerg, 326 Mt. Vernon, Grand Rapids, Mich.

**NO Canvassing from house-to-house—Make \$10 daily, full or spare time, acting as our district sales manager.** A dignified, respectable, good paying position open to honest, reliable men and women. Write for details. No obligation. Badger Co., Ft. Atkinson, Wis.

**TOOL Salesmen and mechanics** with some sales ability sell our line electrical tools to auto mechanics and garages. Easy sales, and very liberal commissions. Barker Specialty Co., Girard, Pa.

**40% COMMISSION** Selling printed business stationery at knockout prices. Part or full time. Free outfit. L Process Service, Minneapolis, Minn.

**GOLD-LEAF Window letters and script signs.** No experience; 500% profit. Samples free. Meyer writes 5 days profits \$141.36. Consolidated, 69-V, West Van Buren, Chicago.

**SALESMEN—Four \$15.00 sales to merchants** net you \$40.00 daily. Sayers Systems, 2813 Sheffield, Chicago, Ill.

**ANY Salesmen Can Sell Them!** Merchants everywhere use punchboards. Someone sells them, why not you? Collect big commissions daily. Newest, largest, elaborate catalog sent upon request. Lincoln Sales Co., 9 So. Clinton, Chicago, Dept. D.

**\$60-\$200 A WEEK.** Genuine Gold Letters for store windows. Easily applied. Free samples. Liberal offer to general agents. Metallic Letter Co., 438-A North Clark, Chicago.

**ALL-YEAR-ROUND** Profitable business selling wonderful new water softener and cleaner. Removes grease, oil, ink and dirt quickly. Every home and business place a live prospect. 100% profit. Big repeat orders. Exclusive territory. Write for free sample. Seacoast Laboratories, Sea Bright, N. J.

**PUNCHBOARD Salesmen.** 2 hours daily. \$100 every week. New line. Lowest prices. Full commission on repeat business. Catalog free. Puritan Novelty Co., 1409 Jackson, Chicago.

**TO Market 3A garage door holders,** simple automatic action, quickly installed, instantly attracts garage owners, builders, dealers. Write for exclusive territory proposition. Knowlson-Stevenson Co., 1118 Packard, Ann Arbor, Mich.

**PUNCHBOARD Salesmen—making small towns.** One sale a day nets you \$105 weekly. Full commission on repeats. K&S Sales Co., 4395 Ravenswood Ave., Chicago.

#### HELP WANTED

**AGENTS—\$13.80 Daily** in advance, introducing new insured hosiery for men, women, children. Must wear or replaced free. 57 styles. 39 colors including latest "Silk to the Top" ladies' hose. Nyland made \$95 in one month. Edwards, \$460.60. Mrs. Bone, \$425.45. Why not you? Even spare time should pay you \$3.00 an hour. No experience needed. We furnish samples. New plan. Write quick. Macochee Company, Park 2607, Cincinnati, Ohio.

**GET Any job you want quickly—send dollar bill** for book "Making Most of Your Personality and Ability" and "Three Ways to Sell Your Experience and Services." Get \$40, \$50, \$60 a week and up, now. The Open Door, Box 179, South Norwalk, Conn.

**OBTAIN Employment!** Get positions you want, quickly, anywhere. Use clever "Ways That Win." One person was offered 70 jobs! Complete methods, 50 cents. Money promptly returned if wanted. New Idea Service, Box 39-1, Station K, New York.

**IMMENSE Profits** making French plate mirrors; patented process; easily learned. Plans free. Wear, Excelsior Springs, Mo.

**CAN You use \$30 extra every week?** If so, write for my new money-making plan. No interference with present work. Particulars free. Albert Mills, 1898 Monmouth, Cincinnati, Ohio.

**CASH Paid** for Butterflies, Insects. See Sinclair Display Advertisement on page 22.

**BECOME A Landscape Architect.** Uncrowded profession; wonderful opportunity for money-making. Easily mastered by mail. Earn while you learn. Est. 1916. Write for details. American Landscape School, 56, Newark, N. Y.

**YOU Are wanted** to resilver mirrors at home. Immense profits plating autoparts, tableware, etc. Write for information. Sprinkle, Plater, 287, Marion, Ind.

**PATENTS, Trade marks, designs and copyrights.** Parker & Snyder, Barrister Bldg., Washington, D. C.

**PRACTICAL Tree Repair—Only American book on "tree surgery."** Save your nice trees. Covers repair of damage by accident, decay, fungous diseases and insects; also prevention of attacks of decay and insects. 270 Pages. Illustrated. Price \$2.50. Pay postman price and postage when he delivers book. Popular Mechanics Co., Room 807, 200 E. Ontario St., Chicago, Ill.

#### INFORMATION

**MISSING Heirs—Send \$1.00** and four printed or typewritten family names. Index advertisement files searched and report made at once. American Claim Agency, Masonic Temple, Francesville, Ind.

**861 PRACTICAL Ways to Reduce Farm Labor and Expense and Increase Income.** One farmer writes he would not part with this information for \$100, if he could not duplicate it. Nothing experimental. These ideas have all been put to test and proven practical. Send today for a copy of our Handbook for Farmers and get ready to put these ideas into operation for your own benefit. Pay postman only 98 cents and the postage when he hands you the package. Popular Mechanics Press, Room 807, 200 E. Ontario St., Chicago, Ill.

#### MAILING LISTS

**99% GUARANTEED Mailing lists.** Accurate. Reliable. Guaranteed. The kind that produces business; compiled for every possible business or individual. Lists of every kind of any business or individuals compiled for your individual needs any where. Catalog and information on request. National List, 847 Broad, Newark, N. J.

**1,000 1928 WOMEN Buyers names.** \$1.00. Sheasgreen, PM1427 North Penn, Minneapolis, Minn.

**GUARANTEED Lists—All classifications,** type-written, \$4.00 up. Healy, Box 7-G, Joplin, Mo.

**NEW List, first release,** 500 names of men, 75c. "Hou-Tex," 502 Keystone Bldg., Houston, Tex.

#### TYPEWRITERS AND SUPPLIES

**TYPEWRITERS,** all standard makes, \$10 up. Fully guaranteed. Free trial. Write for complete illustrated lists. Northwestern Typewriter Exchange, 121 N. Francisco Ave., Chicago.

**TYPEWRITERS—Factory Rebuilt Royals,** Remingtons, Underwoods. New Royal, Remington and Corona Portables. New "Excelsior" Rotary Stencil Duplicator \$37.50. Terms. Catalog Free. Pittsburgh Typewriter Supply, 945-339 Fifth Ave., Pittsburgh, Pa.

**TYPEWRITERS, Motorcycles, Radios,** \$4.99 to \$34.99. Knights, 1512 Locust, St. Louis, Mo.

**TYPEWRITERS—All makes, \$7 to \$29.** Fully guaranteed. Dee Typewriter Exchange, Ada, Okla.

#### PRINTING, ENGRAVING AND MULTIGRAPHING

**200 BOND Letterheads, 8½x11.** 150 envelopes \$2.00. 250 business cards \$1.00. 500 statements \$2.00. Dept. E, Hoosier Print Shop, Portland, Ind.

**MAIL Order multigraphing and mailing service.** Box 1071R, Knoxville, Tenn.

**HAMMERMILL Bond—100 letterheads,** 100 envelopes, 50 note-sheets, \$1.00. Shaw, Box 151, Dunkirk, N. Y.

**PRINTING—Stationery, circulars, booklets, publications.** Superior work, prices low. Battlefield Press, Gettysburg, Penna. Free battlefield souvenir.

**LETTERHEADS, Envelopes, cards, statements, billheads,** \$2.85 1,000; 500, \$1.50. Classic Printery, 108 Eureka, San Francisco. Agents wanted.

**5,000 ENVELOPE Slips, \$5.00;** four-page folders, \$14.00, prepaid. All printing lowest prices. Samples free. Good's Printery, Harrisonburg, Va.

**SAMPLES Raised letter printing** with special prices free. LaClyde Service, Westfield, Mass.

**DISTINCTIVE—Imitation typewritten letters** (mimeographed) samples, price list upon request. Letter Service, 1706 East 8th, Kansas City, Mo.

**BOND Letterheads, 500 \$1, prepaid.** Printing, multigraphing; low prices. Samples free. Boggs, Box 826, Columbus, Ohio.



**FOR MEN**

DO you like to make things? If so, you should have a copy of Popular Mechanics new book entitled "Make It Yourself." A large book of 480-pages describing how to make 900 different articles. 823 illustrations. Price \$3 postpaid. A full description will be sent upon request. Popular Mechanics Press, Room 807, 200 E. Ontario St., Chicago, Ill.

REFRIGERATING Machine, homemade. Operates successfully. Gives better service than ice. This and 328 other practical articles in our book "Home Mechanics." Just ask for this and "Handbook for Women," containing 394 valuable household helps and pay postman 98 cents and postage for the two books. Popular Mechanics Press, Room 807, 200 E. Ontario St., Chicago, Ill.

SAVE On plumbing bills—Repair your own plumbing and heating system. A practical book written expressly for the home owner by an experienced plumber, is easily understood and will enable you to make your own plumbing repairs with a great deal of satisfaction. Price of book only \$1, plus postage. Send no money. Pay postman when he delivers the book C. O. D. Popular Mechanics Press, Room 807, 200 E. Ontario St., Chicago.

**PHONOGRAPHS AND RECORDS**

BUILD Your own phonograph. Catalog and instructions to build new type horn mailed for 10c. American Phonograph Co., 4116 West 24th Place, Chicago.

**MUSIC AND MUSICAL INSTRUMENTS**

SONGWRITERS: Submit poems. Valuable song sales information. Brennen, Dept. L, 1660 Bway, New York.

MUSIC Arranged for piano and orchestra. Mimeograph copies made of songs, 10 to 100 copies. Southern Melody Shop, Box 267, Montgomery, Ala.

STORYWRITERS! Poetry and song composers. Make real money. My free book shows you how. Write at once. Richard Abbott, BA-22 E. 12th, Cincinnati, Ohio.

REAL Composer of music, wants good song poems at once. Publication guaranteed on all accepted poems. Cora Broadwell, P. O. Box 92, Medford, Mass.

VIOLINS, Deep, mellow, soulful—on credit. Easy terms for wonderful instrument. Get details today. Gustav F. Henning, 302 University Building, Seattle, Wash.

SONGWRITERS. Substantial Advance royalties are paid on publishable work. Anyone having original ideas for songs may submit poems for examination and free advice. Walter Newcomer, 1674 Broadway, N. Y.

FREE—"Song Writers Guide," Beaver, 1257 Elm, Green Bay, Wis.

CORNETISTS—Trombonists—Saxophonists—Clarinetists. Get "Free Pointers." Name Instrument. Virtuosi School, Buffalo, N. Y.

PLAY Piano by Ear. A Sound System. Booklet free. Boucher's Harmony Studio, Ottawa, Can.

SONG Poem Writers, Write Sequoia Songwriters' Service, Sherman Branch, Los Angeles, Calif.

MUSICAL Merchandise, instruments, plating, repairing. Guaranteed work. Sternberg's, 59 E. Adams St., Chicago, Ill.

"BANJOS" Should interest all musicians on account of the popularity of the Banjo, as it easily increases a Player's income. Illus. Catalog of 48 pages free. The Bacon Banjo Co., Inc., Groton, Conn., U. S. A.

I WANT Song Poems. Casper Nathan, 3544 N. Racine, Chicago.

"MUSIC Composed" to words. Bauer Bros. (formerly of Sousa's Band), Oshkosh, Wis.

MAKE Violins—Complete plans \$3.00. William Mullen, Duff Building, New Bedford, Mass.

SONG-POEM Writers: Address Monarch, 236 W. 55th, Dept. 204, New York.

I BUY, sell, publish songs. Chester Escher, 1547 Broadway, New York City.

SONG Poem writers address Hibbeler, DI, 2104 N. Keystone Ave., Chicago.

WRITE Songs. Big money and reputation. Write for information, J. Gordon Pub. Co., 201 N. Hayne Ave., Chicago

SONG Writers: Send for our "Publishing Agreement." McKinley Music Printers, 1501 E. 55th St., Chicago.

SAVE Money on Electrical Books—While they last we will supply the following books: Practical Electrics, Electrical Circuits and Diagrams, Electric Bells and Alarms, Induction Coils, Experimenting with Induction Coils, Experiments in Static Electricity, Winshurst Machine, Small Accumulators, your choice of any four books for \$1, postpaid. Regular price 35 cents per volume. Popular Mechanics Press, Room 807, 200 E. Ontario St., Chicago, Ill.

**GUNS, SPORTING GOODS, ETC.**

NEW Automatic ejector, nickelplated breech twelve or four hundred ten gauge shot guns, seven dollars ninety cents, delivered anywhere in U. S. Quarter horsepower electric motors twelve fifty here. Phillips Hardware, San Benito, Tex.

ENGLISH War Office Field Glasses, \$7.95; exercisers, \$1.20; air pistols, \$11.95. Free catalog. Hudson Sporting Goods, W-54 Warren St., New York.

**BOATS AND LAUNCHES**

OUTBOARD Motor Racer and family speed boat. blueprint and directions for building \$1.00. S. E. Wien, 4th St., E. Norwalk, Conn.

RUDDERS, Steerers, propellers, pumps, stuffing boxes, etc. Wm. H. Baker, Pond St., Quincy, Mass.

TWENTY Mile outboard motor boat, plans 25 cents. Sixteen foot outboard cabin cruiser, plans 50 cents. Free boatbuilding catalog. The Rudder, 15 Murray St., New York.

HUBBELL Marine Coolers convert Ford engines into marine motors. Booklet free. Ford speedboat, easily built, large blueprint and directions one dollar. C. C. Hubbell, Perry Ave., Norwalk, Conn.

NEW Boat Book—Revised edition of Popular Mechanics boat building book contains valuable new information on building row-boats, speed boats and portable folding boats for tourists for use with out-board motor as well as other valuable articles on canoes, motor and sailing craft of various types. In addition a valuable book on Outdoor Sports the Year 'Round. Both for \$1.98. Pay postman price plus postage when he delivers package. Popular Mechanics Company, Room 807, 200 E. Ontario St., Chicago, Ill.

**WATCH REPAIRING**

DEAD Watches brought to life. We repair watches for our customers everywhere. Use Uncle Sam's mails and get the best at lower prices. Strain's National Watch Shop, Frances Bldg., Brookfield, Mo.

**PRECIOUS STONES**

AUSTRALIAN Opals, black opals, fire opals, cabinet specimens. List free. Norman Seward, Optician, Melbourne, Australia.

**FIELD GLASSES, TELESCOPES AND MICROSCOPES**

C-FAR Field Glasses \$2. Consists of two rimmed lenses in neat leather case, slips into vest pocket, weighs only 1 1/2 ounces. Gives 6 diameters magnification. Money back if not satisfied. Send \$2 today to Buffalo Optical Co., Dept. PM-1, 574 Main St., Buffalo, N. Y.

BINOCULARS. Field glasses, telescopes, microscopes; largest assortment in America. Low prices. Catalog. DeMaurier Company, Elmira, N. Y.

**ANTIQUES, WAR RELICS AND INDIAN GOODS**

FOR Dens, Relics and medals from Europe's battlefields. Illustrated catalog, 25c. International, 885 Flatbush Ave., Brooklyn, N. Y.

WAR Relics, Indian pottery, curios, helmets, medals, swords. Catalog 25c. Dare, 440 55th St., Brooklyn, N. Y.

LARGE Illustrated list curios, Indian relics, old arms, ten cents. N. Carter, Elkhorn, Wis.

SEND 5c for fine new list Indian relics, antique firearms. F. E. Ellis, Webster Groves, Missouri.

**FOR SMOKERS**

HOMESPUN Tobacco—Guaranteed. Chewing, 5 lbs., \$1.25; 10, \$2.00. Smoking, 5 lbs., \$1.00; 10, \$1.50. Pay when received. Farmers Union, Mayfield, Ky.

NEARGRAVURE Processes business stationery if particular. Exclusive samples (stamp appreciated). Sollidays, Knox, Ind.

1,000 LETTERHEADS \$4.00; 1,000 Envelopes \$3.00. Postpaid. Fred. W. Payne, Plymouth, Pa.

200 LETTERHEADS And 100 envelopes, \$1.10, postpaid. Oberman Company, Box 1268, Chicago.

150 LETTERHEADS 8 1/2 x 11, 150 envelopes 6 3/4 printed \$1.00 postpaid. Coyle & Kimballs, Newport, New York.

BUSINESS Stationery. Lowest prices. Excellent workmanship. Modern type faces. Moulton Printing Company, 1410-P East 8th, Kansas City, Mo.

MULTIGRAPHING Business correspondence two dollars thousand. Hammermill letterheads, four dollars; inexpensive quality, three dollars. Miscellaneous printing. Mayera Corporation, Monmouth, Ill.

500 BUSINESS Cards 98c. Other printing reasonable. Samples free. Hanzer's, 1039 S. Cleveland, Philadelphia, Pa.

SPECIAL: \$2.95 Delivered; 1,000 printed envelopes, business cards or statements. Letterheads, \$3.95. Free samples. Z. Process Service, Minneapolis, Minn.

WE print Stationery, Booklets, Catalogs, Circulars. Samples. Commercial Press, Batavia, Ohio.

250 BOND Letterheads, Envelopes, Billheads, Cards, \$1.35 each. Economic Press, Leonia, N. J.

QUALITY Printing! Reasonable Prices! Send for Free Standardized samples and prices. Folders, Circulars. Catalogs our specialty. Earnest Fantus, 525 South Dearborn, Chicago.

**PRINTING, OUTFITS AND SUPPLIES**

COMPLETE Printing outfits, presses, type, ink, paper, supplies. Write for catalog. Kelsey Company, G-11, Meriden, Conn.

PRINTING Outfits—Presses, type supplies, type novelties. Send stamp for catalogue. Model Press, York, Penna.

**DUPLICATORS AND DEVICES**

YOU can make 50 to 100 copies of a letter, notice, etc., at a cost of three cents on a Heyer Quality Duplicator. Write for free trial offer. The Heyer Duplicator Co., 909 Jackson Blvd., Chicago, Ill.

**RUBBER STAMPS**

RUBBER Stamps! Name, address, two lines 25c. Supplies. Newman & Son, Auburn, Nebr.

COMPLETE 5-A font of 3-16 inch. letters, figures, type holder, with pad and tweezers. Send only \$1.00 bill for complete outfit. St. Paul Stamp Works, 74 E. 15th St., St. Paul, Minn.

**ADDING MACHINES**

NEW \$3.50 Automatic Adding Machine. Adds, subtracts, multiplies, absolutely accurate. Capacity \$999,999.99. Fully guaranteed. 75,000 pleased users. Makes adding easy, positive, quick. Eliminates mistakes. Saves time. Postpaid \$3.50. Bassett Co., 1458W, Hollywood Ave., Chicago.

**FOR THE HOME**

GRANDFATHER'S Clock Works. \$5.00. Build your own case; Instructions free; make good profits selling your friends. Clock works with chimes for old or new cases. Write for full particulars. Clock Co., Ruffner St., Philadelphia.

CEDAR chests only \$11.65—"Red-I-Kut" complete with rich copper trim—you assemble and save half—send for pictures. Kuempel Furniture Company, Guttenberg, Iowa.

KITCHEN Daylight unit with enameled ceiling fixture opal glass, ready to install, \$1.48. Will ship C. O. D. General Distributing Co., Duluth, Minn.

FOR The Home. Add conveniences to your home at slight cost. Cozy breakfast nook, comfortable seats, bookcases, mantel shelves, clothes chute, linen closet or any other latest style built-in feature. With the easily followed instructions in the new Popular Mechanics book entitled "Built-in Furniture" the handy man will experience no difficulty whatsoever. Send no money. Write us to send book and when postman delivers it pay him the price \$2.50 and few cents postage. Popular Mechanics Press, Room 807, 200 E. Ontario St., Chicago.



**PATENT ATTORNEYS**

**PATENTS.** Time counts in applying for patents. Don't delay in protecting your ideas. Send sketch or model for instruction or write for free book "How to Obtain a Patent" and "Record of Invention" form. No charge for information on how to proceed. Communications strictly confidential. Prompt, careful, efficient service. Clarence A. O'Brien, Registered Patent Attorney, Security Bank Building (directly across street from Patent Office), Washington, D. C. See pages 140 and 141.

**INVENTORS** Having ideas to patent: Write for booklet explaining co-operative plan for handling your applications. Tells how to sell and safeguard inventions at lowest cost. Ralph Burch, Patent Lawyer, 900 F St., Washington, D. C.

**JOHN PATTEN DUFFIE**, Registered patent attorney, Victor Building, Washington, D. C. Reasonable rates. Advice free. Booklet.

**PATENTS**—Write for Instructions, Carl Miller, Registered Patent Attorney (former Patent Office examiner), 211-A McGill Building, Washington, D. C.

**PATENTS, Trade-marks, Copyrights.** Reliable services by an experienced practitioner devoting personal attention to each case. Inquiries invited. References furnished. B. P. Fishburne, Patent Lawyer, 525-A McGill Bldg., Washington, D. C.

**RICHARD E. BABCOCK**, Patent Lawyer, Washington Loan & Trust Bldg., Washington, D. C. Booklet.

**PATENTS** Procured: Trade Marks Registered—A Comprehensive, experienced, prompt service for the protection and development of your ideas. Preliminary advice gladly furnished without charge. Booklet of information and form for disclosing idea free on request. Irving L. McCathran, 200 Owen Bldg., Washington, D. C., or 41-R Park Row, New York.

**LANCASTER and Allwine**, 221 Ouray Bldg., Washington, D. C. "Originators of the Form Evidence of Conception." Before disclosing your invention to anyone send for blank form to be signed and witnessed. Form and patent information bulletin free.

**PATENTS**—Free advice. Confidential, prompt personal service of Registered Patent Attorney, former Patent Office Examiner. Booklet, Albert Jacobs, 727 Barrister Bldg., Washington, D. C.

**PATENTS, Trade-Marks, Designs.** This firm has 27 years' experience and gives expert personal service at reasonable rates. We properly protect your invention. Write for free information and exact cost of procuring patent before proceeding. John B. Thomas & Co., 902 F St., N. W., Washington, D. C.

**ADVICE** Free! Patents procured—Reasonable—efficient service. 25 years' experience. Chester W. Brown, Registered Patent Attorney, 510 Van Buren Street, Chicago.

**PATENTS.** Booklet free. Highest references. Best results. Promptness assured. Send model or drawing for preliminary examination. Watson E. Coleman, Patent Lawyer, 724 Ninth St., Washington, D. C.

**PERCY S. WEBSTER**, 203 Saving and Loan Building, Stockton, California. Long established organization. Patent booklet free.

"**INVENTOR'S Guide**" sent free; contains valuable information. Frank Ledermann, Registered Attorney-Engineer, Woolworth Building, 1712, New York.

**MONROE E. MILLER**, Ouray Bldg., Washington, D. C., Patent Lawyer; Mechanical, Electrical Expert. Booklet and Priority Record blank gratis.

**ESTABLISHED 1864.** Milo D. Stevens Company, Free Booklet, Patents, Trade-Marks, Copyrights, Offices, Monadnock Block, Chicago; Barrister Building, Washington, D. C.

**INVENTORS**—Write for our Guide Book, "How to Get Your Patent," and Evidence of Invention Blank. Send model or sketch of your invention for our prompt examination and instructions free. Randolph & Co., Dept. 430, Washington, D. C.

**INVENTORS:** Send sketch or model for advice and exact cost of patent. Ask for our Free book: "How to Obtain a Patent." Tells what every inventor should know. Established twenty-eight years. Highest references. Prompt service. Reasonable charges. Chandler & Chandler, 414 Seventh, Washington, D. C.

**SELL** Your invention before patenting. Write for free particulars. W. T. Greene, 801 Baltic Bldg., Washington, D. C.

**UNPATENTED** Ideas can be sold. I tell you how and help you make the sale. Free particulars (Copyrighted). Write W. T. Greene, 806 Baltic Building, Washington D. C.

**INVENTIONS**—Your crude ideas developed into practical form for your patent application. Model not necessary. Send rough sketch and description for estimate of cost and advice. 27 years' experience. Albert E. Dieterich, Engineer and Registered Patent Attorney, 621½ Ouray Building, Washington, D. C.

**PATENTS** Procured at reasonable rates with time to pay. Sales negotiated. Staff of registered attorneys and engineers. A complete service for inventors. Write for particulars. Inventors Service Bureau, Box 1648, Washington, D. C.

**PATENTS** Procured, prompt service. Personal, careful and efficient service. Highest references. Moderate fees. Send sketch or model for actual search and advice. George P. Kimmel, Master of Patent Law, 54-G, Legal Bldg., Washington, D. C.

**PATENTS**—Write for our free book, "How to Obtain a Patent" and Record of Invention Blank. Send model or sketch of inventions for inspection and instructions free. Terms reasonable. See advertisements on pages 146 and 147. Victor J. Evans & Co., 934 Ninth, Washington, D. C.

**PATENTS, Trade-marks, designs and copyrights.** Parker & Snyder, Barrister Bldg., Washington, D. C.

**LACEY'S Patent Sense.** Valuable book free. See ad page 143.

**FOR INVENTORS**

**PATENTS.** If you have an invention which you wish to patent you can write fully and freely to Munn & Co., for advice in regard to the best way of obtaining protection. Please send sketches, or a model of your invention and a description of the device, explaining its operation. All communications are strictly confidential. Our Hand-Book on Patents is sent free on request. This explains our methods, terms, etc., in regard to Patents, Trade Marks, Foreign Patents, etc. "Scientific American" contains Patent Office Notes, Decisions of interest to inventors and particulars of recently patented inventions. Munn & Company, Solicitors of Patents, 1523 Scientific American Building, 24 W. 40th St., New York City; 524 Scientific American Bldg., Washington, D. C.; 1313 Tower Bldg., Chicago, Ill.; 666 Hobart Bldg., San Francisco, Calif.; 521 Van Nuys Bldg., Los Angeles, Calif.

**HERE'S** Your chance—An organization with complete facilities, equipment, unsurpassed resources and experience, is available for enhancement of meritorious inventions. Nothing too large; none too small; preferably patented, but good ideas will receive thorough consideration. Address Box W, Popular Mechanics, Chicago, Ill.

**INVENTIONS**—Write for our free book, "How to Obtain a Patent" and Record of Invention Blank. Send model or sketch of inventions for inspection and instructions free. Terms reasonable. See advertisements on pages 146 and 147. Victor J. Evans & Co., 157 Ninth, Washington, D. C.

**INVENTORS**—Investigate before investing in a patent. Complete advisory, developing and manufacturing service for the Man with an Idea. (Whether idea is patented or unpatented.) Jas. S. Douglass, Jr., Licensed Professional Engineer, Canandaigua, N. Y., New York State License.

**PATENT** Sales: New, practical, easy plan, sent free. Owl, Times Bldg., New York.

**DESIRE** Purchase mail order business or patented article suitable sell through agents. Bucknam, Box 383, Madison Square Station, New York.

**WILL** Finance and market new products. An organization of sound financial responsibility and wide selling experience seeks specialties or novelties with wide sales appeal. Prefer articles in production and ready for national marketing, but if necessary will finance manufacturing too. Write in detail. Madden-Schenkel Company, 19 West 44th St., New York City.

**PATENTS.** Time counts in applying for patents. Don't delay in protecting your ideas. Send sketch or model for instruction or write for free book "How to Obtain a Patent" and "Record of Invention" form. No charge for information on how to proceed. Communications strictly confidential. Prompt, careful, efficient service. Clarence A. O'Brien, Registered Patent Attorney, Security Bank Building (directly across street from Patent Office), Washington, D. C. See pages 140 and 141.

**INVENTORS:** Write for free information concerning our patent sales and development system. Williams Engineering Service, 716 Pacific Bldg., San Francisco, Calif.

**LET** Us develop your ideas. Have complete plant for producing metal specialties. Steubenville Pressed Steel Company, Steubenville, Ohio.

**LACEY'S Patent Sense.** Valuable book free. See ad page 143.

**INVENTORS**—Cash in on your invention now! Don't delay the sale any longer! Send for a free copy of our specially prepared booklet, "Turn Your Patent Into Money," today! It contains helpful information for all inventors. M. L. Rund, Mgr. Classified Advertising, Popular Mechanics Magazine, 200 E. Ontario St., Chicago, Ill.

**WANTED**—Patented medical or health device to manufacture on royalty basis. Cincinnati Automatic Machine Co., Cincinnati, Ohio.

**ONE** Hundred facts for inventors mailed to any address for one dollar. Donald L. Sellman, Lincoln, Kans.

**INVENTORS** Universal Educator—contains 900 mechanical movements; 50 perpetual motions. Tells how to obtain and sell patents. Suggests new ideas. Explains how to select your attorney and avoid patent sharks. Price (revised edition) \$1.00 post-paid. Albert E. Dieterich, 621-Ouray Bldg., Washington, D. C.

**GET** your own patents. Legal blanks, complete instructions \$1. Cutting Sons, Campbell, Calif.

**I** SELL Patents. A service of nationally-known reliability since 1900. Charles A. Scott, 773PM Garson Ave., Rochester, N. Y.

**PATENTS**—Write to B. P. Fishburne (a South Carolinian), Registered Patent Lawyer, 525-E McGill Bldg., Washington, D. C.

**I** AM in touch with hundreds of moneyed men and manufacturers who wish to buy good inventions. Write Hartley, 38 Court St., Bangor, Maine.

**IDEAS**—How to get them. Marvelous new method tells how to succeed at inventing. Complete details 50c. No stamps. L. Harold Dunlap, Box 703, Sherman Branch, Los Angeles, Calif.

**UNPATENTED** Ideas can be sold. I tell you how and help you make the sale. Free particulars (Copyrighted). Write W. T. Greene, 807 Baltic Bldg., Washington, D. C.

**SELL** Your invention before patenting. Write for free particulars. W. T. Greene, 802 Baltic Bldg., Washington, D. C.

**INVENTORS**—Cash in on your invention now! Don't delay the sale any longer! Send for a free copy of our specially prepared booklet, "Turn Your Patent Into Money," today! It contains helpful information for all inventors. M. L. Rund, Mgr. Classified Advertising, Popular Mechanics Magazine, 200 E. Ontario St., Chicago, Ill.

**PATENTS FOR SALE**

**AUTOMATIC** Talking Machine; plays twelve records, both sides; does not injure records. Also device automatically closes window when it rains. Paul Wilber, Glenwood Ave., Syracuse, N. Y.

**HAVE** Patented disc attachment for garden rake. Wonderful sales possibilities. Will sell outright or on royalty. Stamping job. Write C. A. Sherman, 505 Electric Bldg., Omaha, Nebr.

**OUTRIGHT**—Blackboard eraser cleaner, \$1,000. John E. Bermier, 396 Hawthorn St., New Bedford, Mass.

**OUTRIGHT** Or royalty—self-adjustable rim tool. Very simple, requires one pull, and manufactured at very low cost. Wm. Weisenbach, 65 Thirteenth Ave., Newark, N. J.



**SMALL**, Simple, stamped kitchen appliance, ideal as display-card seller or advertising novelty. Albert Frost, 1519 William St., Vancouver, B. C., Canada.

**TOOL**—Simple, extremely accurate, facilitating overhead valve adjustment. Dr. Anderson, Mitchell, S. Dak.

**FOR Sale**—U. S. No. 1342330, patented, new, wonderful invention; lamp. Write Mr. Rayfield Geer, No. 2 R., London, Madison county, Ohio.

**ROYALTY Basis**—Lunch serving tray for tourists and campers. Eliminates tables; hold it on your lap. W. W. Wood, 228 E. 35th St., Portland, Oreg.

**PORTABLE Stand** for rural mail boxes. W. Gibson, Waldo, Ark.

**PATENT 1,628,496**, Six circuit single button unitary control, electrical switch, chiefly for motor vehicle headlights, spotter, horn, etc. Small, compact, inexpensive. Outright or half interest. Harry W. Faust, Greenville, Ohio.

**PATENT Pending**, Crank shaft grinder for auto repair shops. Self-adjusting any crank throw. John Johnson, 391 Communipaw Ave., Jersey City, N. J.

**FOR Sale**—Outright, U. S. and Canadian patent rights on twine holder. This is a simply constructed article, which should prove very profitable. For particulars address C. V. Woolman, P. O. Box 633, Tacoma, Wash. (Illus. and description April Patent News.)

**WE Commercialize** inventions. Communicate with us if you have patent to sell or wish to buy one. North American Finance and Development Corp., 915 15th St., N. W., Washington, D. C.

**EDUCATIONAL Devices**, Teachers' desk combination. J. T. Harrison, Dwight, Ill.

**OUTRIGHT Or Royalty**—Toy automatic shooting gallery. L. McVey, Rulo, Nebr.

**FURNACE Cleaner**—6 turns of the crank cleans radiator. Cleaner stays in radiator all the time. Albert Brest, 525 Bell Ave., Newcastle, Pa.

**PATENT For sale or royalty**—Bowling table useful for clubs, parks, pool rooms and homes. Interesting game for the young and old. A. C. Barnes, 15 N. Frederick St., Baltimore, Md.

**LINE Tightener**—So arranged that the tightening of a line may be effected by pulling the running end of it, without manually swinging the lever. Patent 1661045. F. J. Lee, 545 Graham Ave., Brooklyn, N. Y.

**FOR Sale**—Recently patented, outright or royalty basis, safety razor blade holders for stropping of blades of various styles and makes. Very simple in construction, cheap to manufacture, may be molded or stamped. Superior to all others. Nothing like it on the market. Ed. Bardet, 270 West 4th St., New York, N. Y.

**CIGAR-Ash Retainer**—Receives cigar, holds ashes. Eliminates fire hazard and burned clothing. Patent 1661035. Sale plus royalty. A. E. Falkenburg, Whitehall, N. Y.

**PATENT On rolling screen No. 1667607**, Improvements pending. Outright or royalty. Models for inspection. Write to Peter Schnurr, 4921 Ellis Ave., Chicago.

**OUTRIGHT**, Adjustable cartridge belt. Patent 1421451. Angelo Garberding, 1132 Ingraham St., Los Angeles, Calif.

**CADDIE Junior**, New light weight (steel stampings) Combination Roller and Stand. Fits bottom of any golf bag. Unlimited market. Small fortune ahead for company able to purchase patent and market this winner. J. H. Pflaum, 312 Kieth Bldg., Dayton, Ohio.

**MATTRESS Display rack**, Inexpensive, made of wood. Meets dealer's needs. Jennings, Winnsboro, Tex.

**OUTRIGHT**—Machine for reconditioning worn bowling pins. Simple, efficient, cheap to manufacture; no experiment. F. Johnson, 811 Longview Ave., Akron, Ohio.

**PATENT For sale**: Automatic rocking chair, chairs tried if saleable. Stransky, 200 Greenway Ave., Darby, Pa.

**ELECTRIC Hammer**, more powerful and durable. Just patented; royalty. Also nut lock, practical and cheap. John Karcevsik, 1847 Superior St., Chicago.

**OUTRIGHT Or royalty**, Electric hair curler. No. 1,460,305. C. B. Smeeton, 118 No. LaSalle St., Chicago.

**OUTRIGHT**—Improvement in internal combustion engines. Double acting engine. J. M. Eisler, 6426 Waterloo, Detroit, Mich.

**YOUR Idle patent can be turned into ready cash, quickly!** One inventor sold his patent at a cost of only \$3.50. Send today for a free copy of our booklet, "Turn Your Patent Into Money." M. L. Rund, Mgr. Classified Advertising, Popular Mechanics Magazine, 200 E. Ontario St., Chicago, Ill.

**YOUR Idle patent can be turned into ready cash, quickly!** One inventor sold his patent at a cost of only \$3.50. Send today for a free copy of our booklet, "Turn Your Patent Into Money." M. L. Rund, Mgr. Classified Advertising, Popular Mechanics Magazine, 200 E. Ontario St., Chicago, Ill.

**SURVEYING INSTRUMENTS**

**LARGEST Stock** of new and used surveying instruments in the country direct from factory. Satisfaction guaranteed or money refunded. Also farm levels. Wissler, 619 N. Broadway, St. Louis, Mo.

**MODELS AND MODEL SUPPLIES**

**MODEL Steam engines and boilers** for miniature boats. Compressed air plants for model airplanes. New catalog 15c. Model Machine Shop, 212 Price St., Rahway, N. J.

**BUILD Your own ship model** for \$4.98. See ad on page 145.

**THE Modelmaker**, a magazine for all interested in making working models, boats, etc. Sample 10c. Modelmaker, 122 Liberty St., New York.

**SHIP Model Fittings**: Send Dime for booklet. A. J. Fisher, 1002 Etowah Ave., Royal Oak, Mich.

**PATENTS**, Time counts in applying for patents. Don't delay in protecting your ideas. Send sketch or model for instruction or write for free book "How to Obtain a Patent" and "Record of Invention" form. No charge for information on how to proceed. Communications strictly confidential. Prompt, careful, efficient service. Clarence A. O'Brien, Registered Patent Attorney, Security Bank Building (directly across street from Patent Office), Washington, D. C. See pages 140 and 141.

**INVENTORS**—We build models. Send us your rough idea. Our master mechanics will develop it for you into a practical working model. Thirty years successful experience doing this very thing. Best shop equipment. Expert advice. Confidential service guaranteed. Bank reference furnished. Send for free booklet "The Road To Success." Crescent Tool Co., Dept. A, Cincinnati, Ohio.

**HOW To Make Clipper Ship Models**, by E. W. Hobbs, one of the best books published on this subject. Price \$3.00. Fore An' All, Huntington, N. Y.

**MODELS, Tools, Dies and General manufacturing**, Logan Machine Co., 652 W. Lake, Chicago, Ill.

**MODEL and Experimental Work** at lowest cost. Wagar Model & Machine Works, 115 So. Clinton Street, Chicago.

**WE make working models** for inventors and do experimental work and carry a complete stock of brass gears and model supplies. Send for catalogue. The Pierce Model Works, Tinley Park, Ill.

**MODELS, Experimental Work, Light Manufacturing, and Stamping**, Frostholt Bros., Syracuse, N. Y.

**SPECIAL Machine builders, tool and die makers**, inventor's models production work of all kinds. Dept. L. Quality Hardware & Machine Co., Ravenswood and Thorndale Avenues, Chicago, Ill.

**LET Our experience be your guide**. Models that are models; tools and equipment for economic manfg. Patterns of all types; manufacturing in all branches. Satisfaction guaranteed. United Machinery Company, Cincinnati, U. S. A.

**DEADEYES**— $\frac{1}{8}$ " 3-16" \$3.50 hundred, delaying pins 18c dozen. C. Libby, Tuckahoe, N. Y.

**ELECTRICAL**

**PROTECT Your home**. Marpex Fire Detector sounds instant warning. \$1.00 postpaid. Wilmax, 819 DeKalb Ave., Brooklyn, N. Y.

**ELECTROPLATING**. New printing of popular book by H. C. Reetz. Complete instructions for plating with all kinds of metals. Send no money. Just write a postal asking for "Electroplating." Pay postman the postage and \$1.00. Popular Mechanics Press, Room 807, 200 E. Ontario St., Chicago, Ill.

**FOR MECHANICS**

**MECHANICS!** Stop losing your steel rule with the Snugtite holder. Brass. One dollar. Anthony Dachowski, 8500 Bartram Ave., Philadelphia, Pa.

**TIME And Labor-Saving Shop Kinks**—hundreds of them—in our newest edition, Shop Notes for 1928, only 50 cents; also altogether there are 6,000 shop helps in the 16 volumes published covering the years 1927, 1926, 1925, 1924, 1923, 1922, 1921, 1920, 1919, 1917, 1916, 1914, 1913, 1912 and 1908. Any two numbers for 98 cents plus postage. Pay postman when he delivers package. Popular Mechanics Co., Room 807, 200 E. Ontario St., Chicago.

**FOR MANUFACTURERS**

**MANUFACTURERS!** Let me introduce your line to the Brazilian market. Positive results guaranteed for the right goods. Please send catalogs, price lists and other literature, also details of exclusive selling rights for Brazil to Joao Cagni Cesar, Rua Martin Francisco, No. 28, Sao Paulo, Brazil.

**MANUFACTURING**

**COMPLETE Manufacturing**, Dies and stampings and Special Machinery. Our Engineering department will design and perfect your article; our tool room will tool it for production. Our shop will make any quantity you may need. Models made if necessary. Barth Stamping & Machine Company, 3816 West 34th St., Cleveland, Ohio.

**SPECIAL Machinery or parts, dies, tools, metal specialties, models, special gears, stock gears and model supplies**. Send for Catalogue. The Pierce Model Works, Tinley Park, Ill.

**ECONOMICAL Manufacturing** from sheet, bar, wire or tubing. Models, dies, special machinery. Swanberg, 5124 N. Kildare Ave., Chicago.

**WIRE goods made to order**. Cooley Mfg. Co., 530 N. Western Ave., Chicago.

**MACHINERY, TOOLS AND SUPPLIES**

**20" HENDY Metal Shaper \$225**, 20"x 14" Reed engine lathe \$350, 14"x6" Monarch lathe, late type, \$250, 20" Kerns Drill Press, \$55, No. 1 Brown & Sharpe Milling Machine, \$150, 10" Drill Press, \$19, 5 hp. Electric Motor \$47.50, No. 60 Heald Cylinder Grinder \$375, 24" Fay Pony Planer \$175, Air compressor with tank, \$37.50, Buss 2 Spindle Shaper \$125. Terms if desired. Write for catalog. Cincinnati Machinery & Supply Co., 27 West Second St., Cincinnati, Ohio.

**HOEPNER Automatic Filling and Sealing Machine**, for pound coffee packages, etc. Never used. Very cheap. Milwaukee Malt Extract Company, Milwaukee, Wis.

**START business of your own**, small investment required, doing nickel, copper and silver plating. This work in big demand. Information free. Electro Platers Supply Co., 547 Considine Ave., Cincinnati, Ohio.

**SHEET Metal and machine shop tools** in good condition at attractive prices. Full particulars upon request. B. F. Sturtevant Company, Hyde Park, Boston, Mass.

**CONCRETE Building Block Machines and Molds**. Catalog free. Concrete Machine Co., 5 North Main St., St. Louis, Mo.

**ENGINES, MOTORS AND DYNAMOS**

**FOR Sale**: 1-6 hp. motors, 110 volt, 1,750 R.P.M., 60 cycle, alternating current. Slightly used. Good running condition. \$4.50 each, while they last. Cash with order. The Maytag-Chicago Co., 337 W. Madison St., Chicago, Ill.

**EQUIP Your farm, summer resort, etc.**, with brand new Westinghouse 1 KW. 32-volt light and battery charging generators at \$48.00 each. Brand new  $\frac{1}{4}$  hp., 32 volt, ball-bearing motors, \$9.75 each. New Ever-lite 32-volt, 1,250 watt lighting plants, complete with engine at \$169.75. Brand new quart type standard make, gasoline blow torches, \$8.00 value at \$4.95 each. Satisfaction guaranteed. General Distributing Company, Duluth, Minn.



**GOVERNORS** For all auto engines where used for power plants. Send for circulars. A. C-S Governor Co., Springville, N. Y., or 215 W. Manchester, Los Angeles. Also 54 Carliston St., St. Catharines, Ontario.

**NEW 3 HP.** motor \$75; one hp. motor \$30; 1/2 hp. motor \$18; 1,200 watt generator \$45; Victrola and records \$35. E. P. Cummings, Harrisburg, Va.

**NEW 32 Volt farm plants** \$140.00. New 1/2 horse repulsion Westinghouse motors \$27.50; 3/4 horse, \$7.50; 110 volt direct current, \$6.50; new battery charging generators, 8 volts, 10 amperes, \$8.50; 110 volts, 1 ampere, \$8.50. Eight-day time clocks with 30 ampere switch, \$6.75. Many other bargains in larger motors and generators. Queen City Electric Co., 1736 Grand Ave., Chicago, Ill.

**BARGAINS—Motors, machinery, wash. machine motors** \$5.55 1/2hp., \$17.50; electric drills, \$14.75; electric grinders, \$7.45; farm plant motors, \$3.45; generators, \$15.95; electric vacuum cleaners, \$8.95. 100 other bargains. Send for bargain bulletin No. 630. Acme Tool Co., 627 Washington St., Chicago.

**MOTOR Bargains, all new stock from factory, 500 1/4 horse power, 110 volt, 1,750 speed new General Electric alternating current motor; complete cord plug and pulley each \$8.75. Lots of six \$8.00. Other sizes of motors and generators to 5 horse power at 1/2 price. Electrical Surplus Company, 1911 Chicago Ave., Chicago.**

**MOTORS: New General Electric, 1/4 hp., \$11.90; 1/2 hp., \$27.75; 1 hp., \$38.50. New catalog. Special discounts. Motor Specialties Co., Crafton, Penna.**

**FOR Sale—Air compressors, 2x2 twin cylinder 1/4hp. motors, a.c. 110 or 220 volts. All guaranteed. J. Trockman & Sons, Inc., 110-112 Lincoln Ave., Evansville, Ind.**

**EDISON Phonograph electric universal motors with speed governor, finest small motor made. \$5.00 plus postage, 8 pounds. Geo. Schulz, Calumet, Mich.**

**MAKE your own—half and one horsepower electric motors. A. C. Induction motor model shows winding connections plain sight. Quick easy way. Gaines Bros., Box 481, Gainesville, Texas.**

**STEAM Engines—One H. P. \$18.00; 1/2, \$12.00. James Chambliss, Bessemer, Ala.**

**WRITE for bargain catalogs on electric motors, generators, electric drills, etc. Do not buy, consult us first. General Distributing Co., Security Bldg., Duluth, Minn.**

#### BENDING MACHINES

**THE Famous Hossfeld "Wrenchless" Universal Iron Bender is the last word in bending machines. Bends metal, cold or hot, into most any conceivable shape, including Eye Bolts and Automobile Spring Eyes. Bends up to 1" bars or 1 1/2" pipe cold. Thousands in use by all classes of trade, from the smallest shops to the largest railway systems. Write for circular and prices. Hossfeld Mfg. Co., Winona, Minn.**

#### BLACKSMITHS

**BE a Master Mechanic Blacksmith and Expert Tool Maker and Dresser with colored tempering charts. Price \$1.00. Valuable samples free. W. M. Toy, Sidney, Ohio.**

#### WANTED—MISCELLANEOUS

**MAIL us your discarded Jewelry, Gold, Crowns and Bridges, Watches, Diamonds, Silver, Platinum and old False Teeth. Money promptly mailed. Goods returned if offer refused. United States Smelting Works (The Old Reliable), Dept. 71, Chicago.**

#### FOR SALE—MISCELLANEOUS

**ADDRESSOGRAPHS. Letter folders, multigraphs, envelope sealers, duplicators, less than half price. Guaranteed. Pruitt Co., 117 No. Market, Chicago.**

**BEST Radio Book—New Third Edition, 1927, Revised—Radio Theory and Operating by M. T. Loomis of the Loomis Radio College is America's Standard Radio Text-Book. Used by the various gov't depts, and schools and leading radio schools. 885 pages, 700 illus., flexible krafty leather binding. Sent C. O. D. Pay postman \$3.50 and the postage when package is delivered. Popular Mechanics Press, Room 807, 200 E. Ontario St., Chicago.**

#### FARMS AND FARM LANDS

**150 ACRES** Pike county, Pa., unimproved, some good timber, trout stream, excellent hunting or vacation tract, only \$10 per acre. Many others with lakes and buildings. W. A. Dunmore, Phoenixville, Pa.

**MONEY** made in Mich. potatoes, \$10 down now and easy terms buys land near markets, lakes, streams. Write today. Swigart & Co., P-1276, 1st Nat'l Bank Bldg., Chicago.

**OZARKS—10 acres** near White River and proposed power dam, \$100, \$5 monthly. Alvin Zimmerman, 1802 N. 5th, Kansas City, Kans.

**GEORGIA Pecan groves** pay. At Albany, world's acknowledged pecan center; \$750, payable \$10 monthly, buys one acre grove, including care and taxes for 7 years. Pecan Groves, Inc., 11 West 42nd St., New York.

**SELL your property** quickly for cash, no matter where located. Don't pay big commission. Particulars free. Real Estate Salesmen Co., Desk B, Lincoln, Nebr.

**PECAN-Orange-Fig Groves** "On the Gulf" Monthly payments. Guaranteed care. Big, quick returns. Suburban Orchards, Dept. M. Biloxi, Miss.

**ATTENTION!** Get acquainted, cash for your property, farm, hotel or retail store, no matter where located; confidential service. Hayes Business Agency, Cincinnati, Ohio.

#### ROOTS AND HERBS

**OVER 1,000 Varieties** medicinal herbs and roots. Tested and proved. Dime brings valuable recipe book and complete information. Botanics, 145 West 112th St., Chicago.

#### SEEDS, PLANTS, TREES, ETC.

**300 LARGE Frost proof** cabbage, 300 tomato and 25 pepper plants prepaid \$1.25. Jacksonville Plant Co., Jacksonville, Tex.

#### MUSKRATS

**MAKE Money** From Muskrat Fur—Raise Muskrats in dry land pens or hutches. Get the facts. 652, Conrad's Ranch, Denver, Colo.

#### POULTRY

**BABY Chicks C.O.D.,** also pure bred pullets. Free folder. Sunnycrest Hatcheries, Huntington, W. Va.

#### RABBITS

**MAKE big profits** with Chinchilla Rabbits. Real Money-makers. Write for facts. 852 Conrad's Ranch, Denver, Colo.

#### DOGS AND PETS

**ENGLISH Bull puppies, registered catalog 10c. Triangle Kennels, Box 37, Jackson Center, Ohio.**

**FOR Sale. Minks, squirrels, raccoons, foxes, ferrets, muskrats, ginseng, rabbits, skunks, wolf pups, opossums. B. Tippman, Caledonia, Minn.**

**ENGLISH Bull pups** and wire-haired fox terriers. Rare quality. Murray's Kennels, LaGrange, Ind.

**FOX Terriers, Collies, English, German Shepherds, Barnes Farm, Fairfield, Nebr.**

**ST. BERNARDS, Registered** thoroughbred Puppies from Championbred parents. Prices reasonable, duty free, photos submitted. Helvetia Kennels, 181-P McKenna, Montreal, Que.

#### PERSONAL

**TROUBLED** With foot ailments? Then don't experiment. There's an easier, quicker, pleasanter way. Eaton, the foot correctionist, will banish your foot worries. Free booklet on request. Eaton, Foot Correctionist, D106, Bandon, Ore.

**TOBACCO Or Snuff habit** cured or no pay! \$1.50 if cured. Sent on trial. Frances Willard, Box 796, Los Angeles, Calif.

**ADVICE, Information, any subject, 25c coin. Fred Klotz, Reading, Pa.**

**TOBACCO Or Snuff Habit Cured** or no pay. \$1.50 if cured. Remedy sent on trial. Superba Co., N3, Baltimore, Md.

**COMPLETE book on Magic, 563 pages; 318 illustrations. Hundreds of tricks. The standard book for years. Make money giving magic entertainments. Send No Money. Just ask for Prof. Hoffman's "Modern Magic." Pay postman postal charges and \$2.00. Popular Mechanics Press, Room 807, 200 E. Ontario St., Chicago, Ill.**

**ARE You Old at Forty?** See our advertisement on page 68 of this issue. The Electro Thermal Company, 2107 Morris Ave., Steubenville, Ohio.

**ENTERTAIN** With magic and joke novelties! Easy. Latest craze. Book "500 Tricks" 10c. Lyle Douglas, Station A-5, Dallas, Tex.

#### MISCELLANEOUS

**AMAZE And Mystify!** Fool your friends—earn money giving shows. Easily learned. Big book "Fun-Magic-Mystery" tells how. Postpaid 10c. Lyle Douglas, Station A-5, Dallas, Tex.

**TOYS And Furniture** easy to build from my blueprints. Send two-cent stamp for list. Address, Woodcraft, Box 436, Troy, N. Y.

**EVERY Mechanic** should have the new Isenite Sharpener and Oilstone for fine tools, pen knives, etc. Sell to your shopmates and make extra money. 100 for \$9.00. Entirely different; Worth a dollar. Samples 25c prepaid. Technical Products Company, East Liberty, Pittsburgh, Pa.

**YOUR Cartoon** on business cards. Write for samples and particulars. Seaman Studio, 2104 Liberty Ave., Terre Haute, Ind.

**MIRRORS** Resilvered at home. Costs less 5 cents per square foot; you charge 75 cents. Immense profits plating autoproducts, reflectors, tableware, stoves, refinishing metalware, etc. Outfits furnished. Details free. Write Sprinkle, Plater, 288, Marion, Ind.

**ARTISTS, Cartoonists.** Sell your drawings. Write Castle Studios, Independence, Mo.

**OUTDOOR Opportunities.** Instructions for raising and selling rabbits, guinea pigs, milch goats, silver foxes, ferrets, white rats, white mice, dogs, cats, pigeons, pheasants, bantams, canaries, bees, frogs, mushrooms, ginseng and golden seal all profitably on town lot. Just write for "Outdoor Opportunities." Pay postman \$2 and postage. Popular Mechanics Press, Room 807, 200 E. Ontario St., Chicago, Ill.

**AUTOMATIC Cigarette Making Machines.** Rolls and glues 50 cigarettes for 10 cents. Ask illustrated folder. Postpaid \$2.50. For home use. Automatic Cigarette Machine Maker, 6247-51 Broadway, Chicago, Ill.

**DANCING—Full instructions** 50c. Stewart's, 3446 North Third St., Philadelphia, Penna.

**FALSE Teeth—How to clean** both teeth and plates, \$1.00. Box H, Deer River, Minn.

**GILDING, Polychroming, composition, tar moulds, ornament casting instructions.** One dollar. Brad Hardacker, Jamul, Calif.

**CASH Paid for Butterflies, Insects.** See Sinclair Display Advertisement on page 22.

**TATTOOING** Outfits, supplies. Illustrated list free. "Waters," 965 Puttnam, Detroit.

**WEEDS—Cut them** with cutter bar on Shaw Garden Tractor. Also plows, cultivates and runs belt machinery. Low prices. Immediate delivery. Shaw Manufacturing Company, Department C, Galesburg, Kans.

**CUTS anybody can make.** Simple, cheap process. \$1. Specimens, particulars. 2c stamp. M. Day, Windfall, Ind.

**AMATEUR Cartoonists: Make money** in spare time with new cartoon selling plan. Write Smith's Service, PM1194, Wenatchee, Wash.

**MEXICAN Made Holsters, lariats, horse-hair articles; rattlesnake belts.** Send four cents for catalog. Tex-Mex Leather Co., 309 Esperson Bldg., Houston, Texas.

**HOMEOPATHIC And Biochemic preparations** sent postpaid to all parts of the world. Manual and booklet free. Halsey Bros. Co., 5547 Ravenswood Ave., Chicago, Ill. Established 1855.

**PRINT 250 Signs or pictures** an hour without press, type or machinery. Sample and particulars 10c. Straco, 1013, Springfield, Ohio.

**TELL An army of 3,000,000 live readers** all about your offer! If you have anything to sell, buy or exchange, or if you have any reasonable proposition, tell our readers all about it—they'll respond quickly. Our booklet "How to Create More Business" contains some very interesting, helpful facts. Write today for your copy—it's free. M. L. Rund, Manager Classified Advertising, Popular Mechanics Magazine, 200 E. Ontario St., Chicago, Ill.



# If YOU Were Down and Out



AND I agreed to start you in a big, new, money-making business of your own—WITHOUT CAPITAL OR EXPERIENCE—a business in which I have helped other ambitious men and women double, triple and QUADRUPLE their earnings, would you jump at it? You BET YOU WOULD!

Well, you may not be down and out. But if you are earning A CENT LESS than \$100 a week—\$5,000 a year—here is your chance to break into real estate MY WAY—build a big profit business of your own—right at home—in your spare time—without capital or experience. My free book tells the whole story. Get it now!

## From Failure to Success

I like to get hold of the down-hearted—the discouraged—the “has-beens” and the “also-rans.” It gives me a big “kick”—a real thrill—every time I help a man or woman who felt they were failures. It’s easy enough to make successful men more successful. But give me the man who is struggling along—trying to make both ends meet—who has never had a real “look-in” on business success. The most fun I get out of life is turning such men into happy, contented, prosperous, independent business men. And I’m doing it right along! There’s E. G. Baum, past 50, lost his job as bookkeeper, sick, discouraged, down-hearted. I got Baum started and he cleaned up \$8,000.00 his first year. And J. M. Patterson. He’d just landed in Texas with a baby, a sick wife and only \$10.20 in his pocket. He started to use my Successful Real Estate System, and writes me that he will clean up \$20,000.00 in profits this year. Send for my free book. Learn how I am helping others—and how I can help you—win big business success.

## New Lives for Old

I teach ambitious men and women my way of making big money in the Real Estate Business, without capital or previous experience. I give them new lives for old. I transform them from low-salaried employees to successful employers—in business for themselves—independent—prosperous—contented—men and women from 21 to 79—from all walks of life—former mill-hands, clerks, railroad men, barbers, hotel employees, grocers, salesmen, bookkeepers, teachers, ministers, printers, musicians, insurance solicitors, etc., etc. Take “Bill” Dakin for example. He worked for fifty years in Buffalo, N. Y., steel plant. Never had any schooling to speak of. Never had any real estate experience. Bill jumped at my offer. Writes me that last month he earned \$1,125.00 my way. Write for a free copy of my book today. Learn how wide-awake men and women are changing their jobs—trading old lives for new—with my System for Becoming a Real Estate Specialist. Address President, American Business Builders, Inc., Dept. 44-7, 18 East 18 St., New York.

## Amazing Profits

**\$17,000 IN ONE DEAL**

Eugene Walrath, formerly in the clothing business. Got my scientific System for making money in real estate. Cleaned up \$17,000 in one deal. Free book tells how he did it.

**\$5,500 IN 1 WEEK**

Evalynn Balster, Chicago widow, school teacher, three children to support, got my System, made \$5,500 in one week on her first real estate deal. Free book tells how!

**\$8,500 IN 17 WEEKS**

That’s the big money Chas. F. Worthen, Fall River, Mass., made with my successful Real Estate System. Free book tells you how I helped him to do it!

**\$14,400 IN 6 MONTHS**

That’s the fat profit H. G. Stewart, Baltimore, Md., made with my remarkable System for making big money in real estate. Stewart is a live wire. Are You? Get my free book and find out!

**\$248 FIRST PROFIT**

That’s the first pin-money Mrs. J. H. Hastings, Jackson, Mich., made with my System for Becoming a Real Estate Specialist. She has a fine business lined up. Free book tells how!

**200% MORE MONEY**

Alfred J. Bennett, Ford Salesman, was earning \$300 a month. Got my Real Estate System. Increased income 200%. Has well equipped office. Just bought new Chrysler Sedan. Free Book tells how!

### \$1,000 Reward

We do not claim that all who follow our instructions make such amazing profits so quickly and so easily. But we do say that the fact that so many have done so is proof that the average person can make more money in less time *our way* than in any other way we know of. And we back up this statement with an offer of *one thousand dollars* in gold to anyone furnishing proof of any other course of any kind that is helping as many men and women make as much money in as short a time as our Real Estate Course.

American Business Builders, Inc.

## FREE “How To Become A Real Estate Specialist”



American Business Builders, Inc.  
(Authorized Capital, \$500,000.00)  
Dept. 44-7  
18 East 18 St., New York

Send me—without cost or obligation—your free illustrated book “How to Become a Real Estate Specialist.”

Name.....  
(Please print or write plainly)

Address.....

City..... State.....





# Use HYPNOTISM to Gain Popularity, Success, Big Money!

NOW the amazing science of hypnotism will help you win the big things of life—now you can learn the secrets of Hypnotism—that strange subtle power which enables you to make others love you—to overcome bashfulness—to strengthen your memory, mind and will power—to realize your ambitions—to develop a strong, magnetic personality and gain control over others! In a startling book, written by the most famous hypnotist in the world you are told exactly how the great operators handle their subjects—you are given all the facts and methods that are necessary for a full knowledge of the practice of Hypnotism.

### Learn How to Influence Others

Can you sway others—can you make them follow your suggestions, adopt your plans? Are you making enough money? Is your personality strong enough to cope with others? Are you perfectly at ease before an audience or among strangers? Now through this wonderful book you can, if you have an active and intelligent mind, quickly develop yourself into a cultured magnetic person who will be admired and envied by everyone.

This amazing book was written by L. W. de Lawrence, one of the greatest hypnotists that has ever lived. In simple, clear, forceful terms he tells all about the theory and practice of Hypnotism—he explains the psychology, history and philosophy of Hypnotism. Prepared especially for self-instruction, this is the only Practical Course in Hypnotism, which starts the student out upon a plain, commonsense basis.

### Send No Money — 5 Day Trial

For a short time we are enabled to offer this great book, *Hypnotism*, by de Lawrence for only \$2.50—the lowest price at which scientific, technical books of this kind have ever been sold. Send no money—just fill out and mail the coupon below. When the package arrives pay the postman \$2.50 plus a few cents postage. Inspect this revealing volume for five days, then if you are not delighted return it and your money will be refunded. Get the coupon in the mail this instant—we have only a limited edition at this low price.

FRANKLIN PUBLISHING CO.,  
Dept. H-70, 800 N. Clark St., Chicago.

Franklin Publishing Co.,  
800 N. Clark St., Dept. H-70  
Chicago.

Please send me a copy of *Hypnotism* by L. W. de Lawrence. When package arrives I will pay postman only \$2.50 plus few cents postage. If not delighted I am at liberty to return the volume within five days and my money will be refunded.

Name.....

Address.....

City..... State.....

If you live outside U. S. send cash with order.

### Mysteries of Hypnotism Revealed

- How to Hypnotize at a Glance
- How to Make Others Obey You
- How to Overcome Bad Habits
- Magnetic Healing
- Agency of Death
- Methods of Inducing Hypnotism
- How to Wake a Subject
- Duration of Hypnotic Sleep
- Susceptible Subjects
- Methods of Fascination
- Snake Charms



**LACO**  
The PROVED Oil Burner

SIMPLE AS THE  
ORDINARY KEROSENE LAMP

For every kind of heating system, for every size of building, large or small, the LACO is a proved Oil Burner. It is the only wick type Oil Burner for domestic heating purposes, using an indestructible mineral wick which converts the oil into a high powered gas before coming into contact with the flame.

It is nearly noiseless, because it is burning gas. Made in 7 sizes; from \$125.00 to \$475.00. Write for sales opportunities.

**LACO GAS BURNER CO.**  
Griswold Iowa

# WANTED!

Ornamental Iron and Bronze Draftsmen. \$50.00 to \$65 a week to trained men—up to \$500.00 a month to experienced men. We train you at home and help place you when ready. Demand greater than supply. Get out of the rut—write today for full information and booklet "Knowledge—Your Greatest Asset."

American Institute of Ornamental Iron & Bronze  
3067 Hennepin Avenue, Minneapolis, Minn.



### MEN NEEDED FOR RAILROADS

Nearest their homes—everywhere—to train for Firemen, Brakemen; beginners \$150-\$250 monthly. Promoted to Conductor or Engineer—\$3,000-\$4,000 yearly—highest wages on railroads. Also clerks.  
Railway Educational Association, Dept. D-17, Brooklyn, N. Y.

### Learn Watchwork, Jewelrywork and Engraving

A fine trade commanding a good salary, and your services always in demand. Address **Horological**, Dept. P, Bradley Institute, PEORIA, ILLINOIS, for our latest catalog.



# Be a drummer!

Trap Drumming made easy in a short time. Our free instruction course furnished with genuine Ludwig Trap-Drum Outfit. Develop your natural sense of rhythm. Go to your nearest dealer or write for full details.

LUDWIG & LUDWIG, 1611 North Lincoln Street, Chicago



# ELECTRICITY 12 SHORT WEEKS— THEN A BIG PAY JOB

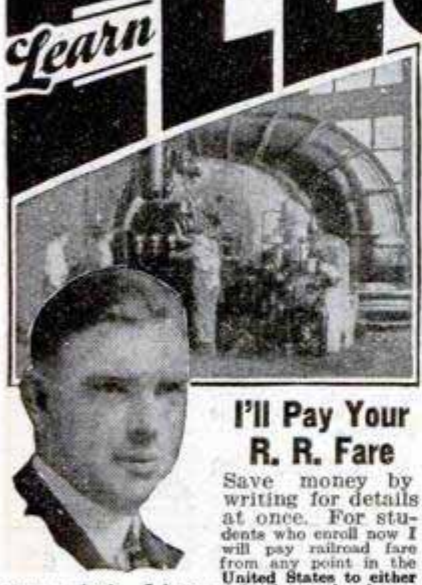

**I'll Pay Your R. R. Fare**

Save money by writing for details at once. For students who enroll now I will pay railroad fare from any point in the United States to either

of my schools. I have made thousands of men independent and successful. Ask me to do the same for you. Mail the coupon. "Mac."

**Work On Real Machines In My Big Shops**  
**Not a Correspondence Course—No Books—No Lectures**

Why go on wishing for a raise? Why keep on working for small pay? Why—when every city, town and farming community is pleading for men trained in electricity—trained as McSweeney students are trained, to know electricity from "A" to "Z". In 12 short weeks my shop plan of working on actual machines will make you fit to fill a big-pay job in the electrical field.

**McSweeney Graduates Earn \$50 to \$200 a Week**

You'll never have to worry about money after you become a McSweeney graduate. Trained instructors work with you shoulder to shoulder on real full sized motors, generators, batteries, switchboards, telephone and telegraph systems, etc. Nothing important left out.

fill a big-pay job, I will refund every cent of your tuition.

**No Experience or Education Necessary**

My course is so simple and practical that anyone can master it. I'll make you an electrical man even if you can't tell a motor from a horse-and-buggy now. If, after you have finished the course, you are not completely satisfied; if you aren't qualified to

**Employment Department Helps You**

I help my students find sparetime jobs while they attend school—and my Employment Department assists my graduates to locate good positions after graduation. McSweeney trained men are in demand.

**Big Illustrated Book FREE**

Today, right now, take the first step out of that low pay rut. Mail the coupon to either school for big, illustrated book on ELECTRICITY. Act today for special R. R. Fare offer.

**McSWEENEY ELECTRICAL SCHOOLS**  
 CINCINNATI, OHIO CLEVELAND, OHIO

**Earn Money While You Learn**

J. H. McSweeney, Pres.,  
 McSweeney Electrical Schools,  
 Dept. 51-JG Cincinnati, O., or Cleveland, O.  
 Dear Mac: Without obligating me send me a copy of your big book on ELECTRICITY; also Railroad Fare Offer, and details of Employment Service.

Name.....  
 Address.....  
 Town..... State.....

## ACCOUNTING



The uncrowded, highly paid profession of Accountancy offers marvelous opportunities to ambitious men and women. Send for our 80-page book, "How to Learn Accounting," and the first easy lesson. Both will be sent free.

INTERNATIONAL ACCOUNTANTS SOCIETY, Inc.

A Division of the  
**Alexander Hamilton Institute**

Dept. 58, 3411 South Michigan Ave., Chicago, Ill.

## Big Money for You as an Automobile Mechanic

These four practical books, written by five well known teachers of automobile practice, will teach you right in your own home during your leisure time just what you need to know about automobile troubles and repair. They will teach you automobile construction, maintenance and repair as practiced by experts and will help you to earn an expert's pay.

**Practical Automobile Library: Four Books—\$1.50 in 10 days and \$2 monthly for 6 months—only \$13.50 in all!**

Hundreds of question-answering diagrams—hundreds of clearly-marked illustrations—make the books plain and readily understandable. All the explanations and descriptions are clear, simple, direct. Every chapter is packed with definite, step-by-step, how-to-do-it information. Here is your opportunity to enter a big-pay field.

**Send No Money Mail the Coupon**

**FREE TRIAL**



## FLY The Finest Opportunity to Get Into the Airplane Game

Through the combined efforts of one of Chicago's leading AIRCRAFT factories and airplane sales agency we can offer you a course in flying and ground work that is complete in every detail. You learn to build real airplanes. You fly in modern and government licensed ships piloted by licensed pilots. Employment assistance given to students who must earn while they learn. A reasonable amount will start you.  
**Commercial Aircraft Sales., 644-Diversey Pkwy., Chicago**

## Learn to Dance This New Easy Way

You can learn all the modern dances—Charleston, Black Bottom, Valencia, Canter, French Tango, St. Louis Hop, Latest Waltzes, Fox Trots, etc., at home easily and quickly. New chart method makes dancing as simple as A-B-C. No music or partner required. Learn anywhere, anytime. Win new popularity. Be in demand at parties. Same course of lessons would cost \$20 if taken privately.



**Send No Money**  
 Just send your name and address. We'll ship the complete course—323 pages, 49 illustrations—without one cent in advance. When package arrives, hand postman only \$1.98, plus delivery charges, and this wonderful course is yours. Try for 5 days. Money back if not delighted. Send your name NOW.  
 FRANKLIN PUB. CO., 800 N. Clark St., Dept. 9415, CHICAGO

### FREE EXAMINATION COUPON

McGraw-Hill Book Co., 370 Seventh Ave., New York

Send me for 10 days' free examination the New Practical Automobile Library. If satisfactory, I will send you \$1.50 in 10 days and \$2.00 monthly until the special price of \$13.50 is paid. If not wanted, I will return the books at your expense.

Signed.....  
 Address.....  
 City and State.....  
 Position.....  
 Employer..... P. M. 7-28



**POINTS THE WAY TO MORE PAY**

**OUTFIT Free**

DOES THIS HIT YOU? Are you a mechanic? Do you follow carpenter trade? Are you a wood worker, sheet metal worker, millwright, etc.? Here's great news.

**Short and Practical Course Puts More Pay in Envelope**

Learn blue print reading and elements of drafting. Merit promotion. Put yourself in line for advancement. Turn your spare hours into profitable investment. Study fascinating lessons in practical way. No dreary book reading. No complicated problems. Our course is so easy, pleasant and interesting. Practical men teach you. No theory. Just matter-of-fact instruction. You're bound to learn. Our course one of the

**Lowest Priced Ever Offered**

Endorsed by employers. Opens way to more pay for you. We teach you in few weeks what many men have taken years to learn! FULL DRAWING EQUIPMENT sent the very minute you enroll. Write. Get our wonderful proposition. Our low price and extremely easy terms will interest you. Fill out the coupon.

**BLUE PRINT READING SCHOOL, Inc.**  
1722 Nicholas Bldg. Toledo, Ohio

SEND COUPON

Name \_\_\_\_\_  
Address \_\_\_\_\_

**LEARN RADIO**

**Good Pay—Advancement—Phenomenal Success in A Life Profession of Fascinating Brain-work.**



R. L. DUNCAN  
Director, R.I.A.

**You Can Learn At Home!**

We have trained thousands of men to earn big money as radio designers, as radio executives, in broadcasting work, as skilled service men and radio dealers. Now opportunity knocks at your door. Are you going to plod along at thirty-five dollars a week when real money is waiting for you in radio?

**New Course with A-1 Equipment**

Radio Institute now offers a new, revolutionary, up-to-the-minute course in radio. A large kit of first-quality equipment is included without extra charge—parts for making a hundred different radio circuits and the Peerless Signagraph and key and buzzer set for code instruction.

**R. I. A. backed by RCA, G-E and Westinghouse**

Moreover, you can STUDY AT HOME—when you please and as long as you please. A new booklet describing the course is now ready. If you want to learn more about the lucrative and fascinating profession of radio send the coupon now for your copy.



**RADIO INSTITUTE OF AMERICA**  
Dept. P-7, 326 Broadway, New York City  
Dear Mr. Duncan:  
Please send me your new catalog.  
Name \_\_\_\_\_  
Address \_\_\_\_\_

**HEAVIER PROFITS, LIGHTER SALES! MASTERLITE CIGAR LIGHTER**



Guaranteed for life. Sells on a flash demonstration to smokers and dealers at big profits. Each sale builds an everlasting repeat business. \$3.00 brings sample dozen in handsome display box with sure-fire selling plans. Sample, 50c.

**RADIO GAS LIGHTER**

Lights Mantles, Gas Stoves, Jets, and Heaters. Hold Directly Over Gas Flow. Lights Instantly.

A big 25c Seller, paying 300% profit. A gross, easily sold in a day, nets you \$26.00 profit. Rush \$10.00 for gross, or \$1.00 for sample dozen with sure-fire self-selling plans.

Lights Gas Without Flame or Friction  
Masterlite Mfg. Co., Dept. 23G, 110 E. 23rd St., New York

**DRAW CARTOONS**

**Turn Your Talent Into Money**

Cartoonists earn from \$50 to \$250.00 per week—some even more. Remarkable new Circle System of Drawing teaches you in half the usual time. Send for booklet and sample lesson plate explaining full details of the Course.



THE NATIONAL SCHOOL OF CARTOONING  
623 Penton Building Cleveland, Ohio

**TELEGRAPH-RADIO**

Operators earn \$150 to \$350 month and up. Learn in Chicago or at home. Chance to work while training. We furnish operators to U. S. Govt., Railroads, Com'l Cos., Broadcasting Stations and Ships. CHICAGO TELEGRAPH INSTITUTE, Dept. 1-7-8, 1338 So. Michigan Ave., CHICAGO, ILL.

**LEARN TO Mount Birds**

We teach you At Home by Mail to mount Birds, Animals, Heads, Tax Furs and Make Kugs. Be a taxidermy artist. Easily, quickly learned by men, women and boys. Tremendously interesting and fascinating. Decorate home and den with beautiful art. Make big profits from Spare Time Selling Specimens and Mounting for Others. **Free Book**—Yes absolutely Free—beautiful book telling all about how to learn taxidermy. Send Today. You will be delighted. Don't Delay! Northwestern School of Taxidermy B337 Elwood Bldg. OMAHA, NEB.



**I POSITIVELY GUARANTEE**

to increase your arms one-half inch in size, chest one full inch, strength 25%, health 100% in one week's time, by following my instructions and using my exerciser 10 minutes mornings and at night. Send \$1 for complete course and exercisers. Satisfaction guaranteed or \$1 refunded. Prof. J. A. DRYER, Box 1850-P, Chicago, Ill.



**Test Your Art Ability, FREE**

Do you like to draw? Our simple scientific Art Ability Questionnaire will tell if your talent is worth developing and how much training you will need. Your true score given. Commercial artists make big money. Learn at home, in spare time, with the Federal course. Write today for your Questionnaire, giving age and occupation. FEDERAL SCHOOL OF COMMERCIAL DESIGNING 635 Federal Schools Bldg. Minneapolis, Minn.



**Beautify your NOSE**

to shapely proportions—while you sleep!



**ANITA NOSE ADJUSTER**

is SAFE, painless, comfortable. Speedy, permanent results guaranteed. Doctors praise it. No metal to harm you. Small cost. Write for FREE BOOKLET



ANITA CO., 712 ANITA Bldg., NEWARK, N. J.



# Complete training in AVIATION



WITH

## New American Eagles

The Porterfield Flying School is operated under the management of the American Eagle Aircraft Corporation, Kansas City, Mo., the third largest aircraft factory in the United States.

Unlimited opportunities in all departments of Aviation are waiting for properly trained men. More than one hundred airplane factories are turning out thousands of planes. The American Eagle Company alone is now producing ten ships per week. It is impossible to keep up with the tremendous demand for aircraft. Only the great shortage of pilots, airplane riggers, mechanics and builders is holding up the faster development of Aviation.

Porterfield graduates have fine opportunities to accept big paying jobs with new American Eagle distributors and dealers that are being appointed every week all over the country. All instructors are army trained licensed transport pilots. Your individual training is on modern equipment and government approved American Eagle airplanes.

Send for illustrated catalog describing complete ground school and flying course. State age and occupation.

**PORTERFIELD FLYING SCHOOL, Inc.**  
Dept. 1017, 2800 E. 13th St., Kansas City, Mo.



# Choose as Your Profession Electrical Engineering

Electricity offers a brilliant future to the young man who is about to choose his career. Never before has there been such a wonderful opportunity in this great field. Big paying positions in electrical work the world over are open to trained men—men who possess specialized, practical knowledge. Come to the School of Engineering of Milwaukee—the foremost and best equipped electrical school in America. Here you are trained in both theory and practice by a faculty of experts. You learn in large, completely equipped laboratories. If you have 14 high school credits or equivalent, you can become an Electrical Engineer with a Bachelor of Science degree. Any credits you may lack can be made up in the short intensive course covering Electricity and technical high school subjects.

**B.S. Degree  
in 3 Years**

## A Complete, Practical, Electrical Education

Learn by the thorough, approved scientific methods which our 24 years of specializing enable us to give you. In addition to Electrical Engineering, the following complete courses are given: **A. C. and D. C. Armature Winding—Wiring and Testing—Commercial Electrical Engineering—Automotive Electricity—Radio Sales Service and Broadcasting—Electrical Refrigeration.**

## Earn While You Learn

By our special system you may earn part of your way while learning. Our Employment Men will secure you a position to which you may devote a part of each day, spending the remainder at the school. Co-operation with large Milwaukee electrical industries affords Students splendid opportunities. Low tuition fee. Board and room reasonable. Daily Broadcasting. School Orchestra. Fraternities.

**New Term  
Begins Now**

## Write for FREE Catalog

Write today for our free, illustrated catalog. Read about this wonderful institution and the great opportunities that lie before you. Find out about our specialized method of training and the details of our "Earn While You Learn" Plan.



**SCHOOL OF ENGINEERING OF MILWAUKEE**  
Dept. P. M. 728, E. Wells and Jackson, Milwaukee, Wis.

Without obligating me in any way, please mail free illustrated book, "Electricity and the One Best Way to Learn It," and particulars regarding the course I have marked with an X.

### RESIDENT COURSES:

- .....  Electrical Engineering, B. S. Degree. (3 years)
- .....  Commercial Electrical Engineering. (H. S. graduates 1 year—others 2 years)
- .....  Armature Winding.
- .....  Light, Motor Wiring and Testing.
- .....  Electrical Refrigeration.
- .....  Master Electrician.
- .....  Automotive Electricity.
- .....  Radio Sales Service and Broadcasting.
- .....  Home Laboratory Service. (Home Study Course)
- .....  I am interested in your "Earn While You Learn" plan.

Name..... Age.....

Address.....

City..... State.....

Education.....



# Be An Auto Expert!

**LEARN IN LOS ANGELES**

Be an auto expert! Earn \$40 and more every week. If you are earning less, stop wasting your life away. The auto industry will pay you more and offer you greater opportunity. You can qualify for big-pay auto jobs through National's famous job-experience training method. Over 17,000 successful graduates have proved its genuine efficiency. You learn auto mechanics, ignition, repairs, construction, etc., by actual practice. You are definitely certain to qualify. Life scholarship. No age limit. Million-dollar training institution. Est. 1905. Free employment service. Write for free illustrated auto book—Explains everything. **FREE BOOK**

## NATIONAL AUTOMOTIVE SCHOOL

Dept. 713 4006 Figueroa St., Los Angeles, Calif.

Send me the big, FREE National Auto Book that explains how I can get a big pay auto job.

Name.....

Address.....

City..... State.....



# MORE MONEY for EVERYBODY!

**Write for Big Free Outfit** showing men's made-to-measure caps. Also men's hats, mufflers, topcoats, and charming Lovette Hats for women. Show line—take orders everywhere—\$15.00 a day easy. Experience unnecessary. Free Caps given. **Fits-U Cap Co.**, Dept. Z-70, Cincinnati, Ohio.

**Business of your own!** Make \$68.00 a week and up. We furnish everything. Sell all wool made-to-measure suits direct from factory \$23.75. It's easy—real \$45.00 values. No experience needed. Advertising and sales training course furnished. Write **Fairbanks Tailoring Co.**, 2301 Wabasha Ave., Chicago, Ill.

**Men!** Make \$15 to \$30 daily selling super Value Breeches and Pants to outdoor workers, garage men, sportsmen; \$2.50 for you on 3 pants sale. Outfit given absolutely free. **BIG BOB**, Dept. B., 489 Broome Street, New York.

**\$75 Weekly.** Man or Woman Wanted with ambition and industry, to distribute Rawleigh's Household Products to steady users. We train and help you. No experience necessary. Pleasant, profitable, dignified work. Write today. **W. T. Rawleigh Co.**, Dept. 53 C Q S, Freeport, Ill.

**Men!** Build a steady repeat business selling men's guaranteed tailored-to-measure clothes. Make \$4.00 to \$10.00 on suit orders. Over 150 pure wool fabrics at \$24.50; \$29.50; \$37.50; \$47.50. Efficient selling equipment furnished. Write today, giving references. **The Individual Tailoring Co.**, 803 Sycamore St., Cincinnati, Ohio.

**Salesmen—earn \$100 weekly** taking orders for Dazzler and Rainbow Glow electric signs. Big commissions. Exclusive territory. High grade proposition. Write **Chicago Sign Sales Co.**, Dept. 17, Charlotte, N. C.

**Agents, Distributors—\$250 to \$500** monthly selling new Auto necessity. Makes gas cost 9c. gal. Sales Guaranteed. Write for big free profit and sample offer. **Blanche Auto D. Co.**, 152 E. Erie, Chicago.

**Auto Owners Get \$10 for Old Tires.** Free to agents heavy duty 7 ply new Mellinger Tire Guaranteed 15 months and Big Sales Outfit. Write **Mellinger Tire Co.**, Dept. 300, Kansas City, Mo.; Warren, Ohio; Oakland, California.

**America's Greatest Tailoring Line FREE.** 130 large Swatch Samples. All Wool. Tailored-to-Order. Union Made. Sensational low price. Get outfit at once. Address Dept. 428, Goodwear, 844 Adams, Chicago.

**Not an ordinary offer!** Weekly income about \$55 to live agents. Introduce unbreakable fountain pen at 1/4 price. Write for Free plan or send only \$2 for sample demonstrating pen worth \$8. Bonded Reservoir Pen. Dept. 1307, 147 Nassau Street, New York.

**Self-Selling Display Carton On 20** Store Counters Brings You \$60 a Day! I'll Start You in a Business of Your Own Over Night. Ask For My 4 Amazing Selling Plans. **W. J. Gordon**, 110 East 23rd Street, New York.

Are you looking for an opportunity to get ahead? Do you want a chance to prove that you can make good? **ACCEPT THE OFFERS OF SOME OF THE RELIABLE CONCERNS LISTED HERE.** They offer to start you in the most interesting business in the world—the business of making money.



**Write Now!**



Read every offer carefully. Then write to those which appeal to you. A two-cent stamp will start you along the road to big success. **NOW IS THE TIME!** Make every day your pay day! For advertising rates, address **Combined Magazines Co.**, Straus Bldg., N. Y. C.

**THIS IS YOUR CHANCE TO WIN**

**Agents—\$250 month.** Raincoats. All Colors. Your choice \$2.65. Part time \$2 hour. Complete line 60 patterns, silks, suedes; tweeds, Leather-Lyke. Outfit sent free postpaid. Write **Comer Mfg. Co.**, Dept. 9-U, Dayton, Ohio.

**New! Sell Semi-Made Dresses** "almost make themselves." Also dress goods, trimmings. We show you how. Write **Princess Silk Mills**, 244-M Fifth Ave., New York.

**Tailoring Salesmen: Sell Simpson's** new \$23.50 pure virgin-wool Union made-to-measure suits and overcoats; commissions in advance; exclusive territory; big outfit, 175 samples FREE. **J. B. Simpson**, 843 Adams, Dept. 1503, Chicago.

**Man of good appearance, personality.** Special sales work; resident at least 3 years. Position pays about \$35 week to start. **Gordon Harvey**, Box L, Chicago.

**Earn Money at Home, Oil Paint.** New Method, Easily Mastered. Oil Paint Outfit Given. Write free book. **Pictorial Art Studios, Inc.**, 2926 Broadway, Dept. 3-C, Chicago.

**AGENTS—District Managers.** \$8.88 for Men's Utility Suits, resists sparks, snags, water. No Competition. **FREE Kit.** 888 Company, Dept. GC-20, Fort Wayne, Indiana.

**Sell from actual sample garments.** Finest lingerie, shirts, collars, underwear, etc. Million-dollar factory furnishes complete equipment worth \$53.00. Make \$47 to \$115 weekly. Commissions advanced daily. Write **Tellson Mills, Inc.**, Suite G-10, 1107 Broadway, N. Y.

**Winner for YOU!** Sell DeLuxe box 21 engraved Xmas cards with envelopes for \$1.00. Send 50c for sample. Particulars free. **Ufert**, 331 Sixth Avenue, New York.

**Sell "HOOK-FAST"**—an amazing men's belt that never slips! \$15 daily easy! Personal initials. **Platt-Croyd** buckles and emblems. Get Free Belt offer. **National Crafts**, Dept. G-14, 41 John St., New York.

**Sell Shirts!** I furnish free samples. Ties included. Personal initials. Liberal 25% commission. Write today. **Rosecliff Shirts**, Dept. G-16, 1237 Broadway, New York.

**\$10.00 Daily!** Spare time! Sell all-wool guaranteed made-to-measure suits, overcoats only \$23.50. Complete outfit furnished FREE. Write **Jay Rose Co.**, 415 S. Wells, Chicago.

**\$100 week selling better-quality, all-wool, made-to-measure suits and overcoats** at \$23.50. Highest commissions. Extra bonus for producers. Large swatch samples FREE. **W. Z. GIBSON, Inc.**, 500 Throop Street, Dept. U-692, Chicago.

**A Business of Your Own Making Sparkling Glass Name and Number plates, checkerboards, signs.** Big book and sample free. **E. Palmer**, 550, Wooster, Ohio.

**My Agents make \$90 a week** wearing and showing my beautiful New Raincoat. Give away hats to each customer. Write today for plan. **Robert King**, 230 So. Wells, Dept. GA-7, Chicago.

**Tailoring Salesmen sell all wool, made-to-measure Suits, Overcoats, \$24.50, one price.** Established line. Successful over 30 yrs. **Great Western Tailoring Co.**, Dept. 202, Chicago.

**Agents—Catholic; Pleasing Proposition** that Pays Hustlers \$50 per Week and Up. No Competition. **New Article, United Religious Goods Co.**, 215 United Bldg.; Covington, Ky.

**Agents—250% Profit! Povar Varnish.** Duco, lacquer polish, sells fast, best season now. Young and older men find Povar real breadwinner. Beautiful package attracts everyone. **Povar**, Dept. K, Flak Building, New York.

**Attention.—Sell trousers to every mechanic, garage man, farmer.** Three pairs \$5.50, commission \$1.00. Toughest work pants made. **FREE Outfit.** Write **TODAY.** Longwear Trousers, Dept. L, 489 Broome St., New York.

**If I Show You An All Virgin Wool Suit** tailored-to-order, valued at \$35.00, that you can sell for \$22.50, make \$4.00 yourself, give you absolutely Free, complete selling outfit, will you give my proposition a trial? **C. M. King**, 2238 S. La Salle, Chicago.

**Agents—90c, an hour earned** advertising and distributing samples to consumers. Write quick for territory and particulars. **American Products Co.**, 2077 Monmouth, Cincinnati, O.

## LEARN AT HOME

**Learn at Home. Big Opportunities.** Movie Photographers, Portrait, Commercial or News Photographers or start own business. Write for catalog. **New York Institute of Photography**, Dept. 141, 10 W. 33rd St., N. Y.



## PAINT SHOW CARDS

and SIGNS. LEARN AT HOME IN SPARE TIME. EARN \$75 WEEKLY. PREPARE NOW. FORTY LESSON COURSE. \$5 DOWN. \$5 MONTHLY. CIRCULAR FREE. **Universal School of Lettering**, WATERBURY, CONN.

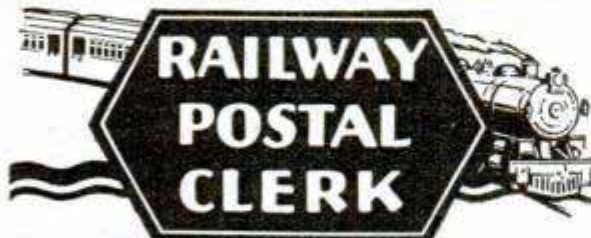

## RAILWAY POSTAL CLERK

**\$1900 to \$2700 a year**

Long vacations with pay. Work easy. Travel on fast trains with all expenses paid, including hotel. No worries about the future.

### MY FREE BOOK TELLS HOW

you can get a job as Railway Postal Clerk, Post Office Clerk, City Mail Carrier, R. F. D. Mail Carrier, Postmaster, Forest Ranger, Internal Revenue and numerous other fine paying Government positions. If you are a citizen, between 18 and 65 years, you can get a Government Civil Service Position. I'll show you how. Get the facts in my 48-page booklet. It is absolutely free. Write today.

**PATTERSON SCHOOL, A. R. Patterson, Civil Service Expert,** 87 Wisner Building, Rochester, N. Y.

**FREE To Men Fearing Old Age**



Do you really know the truth about that often misunderstood subject of rejuvenation? Do you realize that there is now a sane, successful way frequently to relieve the pain and discomfort of a set of conditions so common to men of older years—disturbed sleep, aches in feet, legs and back, loss of pep, etc.? Prostate gland disorder is often the cause of such disorders. Too often it is blamed on bladder trouble. If you have this gland trouble or any of the symptoms mentioned you will want to learn about this amazing new drugless treatment, already tested by more than 40,000 men. Full details and interesting facts about "old age" are contained in an interestingly illustrated free book, "Why Many Men Are Old at 40." Send for your copy now. No obligation. Simply address **The Electro Thermal Company**, 2107 Morris Ave., Steubenville, Ohio. Western address: Dept. 21G, 303 Van Nuys Bldg., Los Angeles, Calif.



# Men Wanted in Radio



**Positions Open Now  
in fastest growing industry  
\$250 to \$850 a Month**

You are needed at once in the big pay end of radio—the Sales Division—to sell new A C sets, electric phonographs and combinations. 10,000 dealers want *specially trained men* to help handle the one billion dollars to be spent this year by public. You get 10% cut of part of this

rich melon—and you get in on ground floor of fastest growing industry.

I train you by mail in your spare time. Many earn while learning. No past experience needed. You can sell 5 out of 9 by my Proven Demonstration Methods. Nothing else like it. My plan endorsed by leaders in the industry—Brunswick, Victor, Sonora and others.

My graduates now earning \$250 to \$850 a month. Bowen writes: "I was a drug store clerk making \$125 a month before taking your training. I made \$10,000 last year selling radios and phonographs." Nubling is making \$100 a week. Trambitas made \$5,000 last year. Hunter made \$900 in December. Leve earns \$500 a month. Many have become Assistant and General Sales Managers.

One of these big-pay positions is ready for YOU now. I have requests for my graduates from dealers in 30 states. Fascinating work. Your time is your own. Write today for FREE copy of "Rich Returns from Radio and Phonograph Salesmanship" and details of positions open.

**C. H. MANSFIELD, President**

1031 So. Broadway, Dept. 73, Los Angeles, Cal.

## LEARN TO FLY Commercial Aviation Needs Men

We teach by practical instruction and guarantee to make each student master of his ship. All instruction on U. S. Gov't Licensed Aircraft by Gov't Licensed Transport Pilots. The cost is low considering the practical experience of daily flying, combined with ground work and theoretical instruction. Write us at once for further information. DO IT NOW!

**VON HOFFMANN AIRCRAFT CO.**

Distributors for Ryan Monoplanes, same as "The Spirit of St. Louis," also Eaglerock Biplanes.

108 Lambert—St. Louis Flying Field, ANGLUM, MO.

# Electricity!

Learn in Los Angeles

Be an electrical specialist. Gain quick success in this most fascinating and profitable field. Learn at National in the center of tremendous electrical projects costing more than \$100,000,000.00—unlimited opportunities now.

Practical, intensive training by National's job-experience method in 6 to 9 months. All technical essentials included. School endorsed by leaders in electrical industry. You learn all branches of electricity; radio. Million dollar institution; all modern equipment and training facilities.

Life scholarship. No age limit. Free employment service. Over 17,000 successful graduates. 23rd year. Big illustrated 84-page catalog sent FREE. Write today.



**NATIONAL ELECTRICAL SCHOOL**

Dept. 521 4006 Figueroa St., Los Angeles, Calif.

Send me the big, FREE National Electrical Book that explains everything.

Name.....  
Address.....  
City..... State.....

**Free Book**

JESSE G. VINCENT, Vice-president of the Packard Motor Car Company, writes: "I take pleasure in recommending the International Correspondence Schools.

"I took up an I.C.S. course in Mechanical Engineering when I was working at the bench as a tool-maker and am glad to state that it enabled me to obtain the education that was absolutely necessary that I might be in a position to take advantage of opportunities for advancement as they presented themselves."

In addition to Jesse G. Vincent, many other leading figures in the automobile industry got their first real start toward success through this great "University of the Night."

Walter P. Chrysler, President of the Chrysler Corporation, is a former I.C.S. student. So is E. V. Rickenbacker, Sales Director for the La Salle car. So is Hiram Walker, Chief Engineer of the Chandler Motor Car Co.

The best way for you to prepare for success in the automobile field is to study with the same school that helped so many other men to win success.

**Mail the Coupon for Free Booklet**

INTERNATIONAL CORRESPONDENCE SCHOOLS

"The Universal University"

Box 5544-F, Scranton, Penna.

Without cost or obligation, please send me a copy of your booklet, "Who Wins and Why," and full particulars about the subject before which I have marked an X:

- |  |  |
|--|--|
| <input type="checkbox"/> Complete Automobile Course    | <input type="checkbox"/> Gas Engine Operating                            |
| <input type="checkbox"/> Automobile Electric Equipment | <input type="checkbox"/> Complete Gas Engine Course                      |
| <input type="checkbox"/> Electrical Engineering        | <input type="checkbox"/> Architect                                       |
| <input type="checkbox"/> Electric Lighting             | <input type="checkbox"/> Architects' Blueprints                          |
| <input type="checkbox"/> Mechanical Engineer           | <input type="checkbox"/> Contractor and Builder                          |
| <input type="checkbox"/> Mechanical Draftsman          | <input type="checkbox"/> Architectural Draftsman                         |
| <input type="checkbox"/> Machine Shop Practice         | <input type="checkbox"/> Concrete Builder                                |
| <input type="checkbox"/> Railroad Positions            | <input type="checkbox"/> Structural Engineer                             |
| <input type="checkbox"/> Civil Engineer                | <input type="checkbox"/> Chemistry <input type="checkbox"/> Pharmacy     |
| <input type="checkbox"/> Surveying and Mapping         | <input type="checkbox"/> Airplane Engines                                |
| <input type="checkbox"/> Metallurgy and Mining         | <input type="checkbox"/> Agriculture <input type="checkbox"/> Navigation |
| <input type="checkbox"/> Steam Engineering             | <input type="checkbox"/> Radio <input type="checkbox"/> Mathematics      |

### BUSINESS TRAINING COURSES

- |  |   |
|--|---|
| <input type="checkbox"/> Industrial Management                   | <input type="checkbox"/> Advertising                  |
| <input type="checkbox"/> Personnel Management                    | <input type="checkbox"/> Business Correspondence      |
| <input type="checkbox"/> Traffic Management                      | <input type="checkbox"/> Show Card and Sign Lettering |
| <input type="checkbox"/> Accounting and C.P.A. Coaching          | <input type="checkbox"/> Stenography and Typing       |
| <input type="checkbox"/> Cost Accounting                         | <input type="checkbox"/> English                      |
| <input type="checkbox"/> Bookkeeping                             | <input type="checkbox"/> Civil Service                |
| <input type="checkbox"/> Secretarial Work                        | <input type="checkbox"/> Railway Mail Clerk           |
| <input type="checkbox"/> Spanish <input type="checkbox"/> French | <input type="checkbox"/> Common School Subjects       |
| <input type="checkbox"/> Salesmanship                            | <input type="checkbox"/> High School Subjects         |
|  | <input type="checkbox"/> Illustrating                 |

Name.....  
Street.....  
Address.....

City..... State.....

Occupation.....

If you reside in Canada, send this coupon to the International Correspondence Schools Canadian, Limited, Montreal



# Pains

Vanish Almost  
Instantly

with  
**Violet Ray**

Scientific, Painless Treatment  
Used by Doctors,  
Hospitals, Sanitariums  
—Now Offered to  
Every Home



Thousands of men and women suffering from rheumatism, paralysis, neuritis, bronchitis, skin diseases, headaches, constipation, sprains, prostate trouble, goitre and many other ailments, even hay fever and asthma, have found quick relief, new health and vitality with this marvelous scientific invention. Try it.

## Violetta

**10 Days  
FREE  
Trial**

For Health—Beauty—Vigor

Every home should have one. Saves hours, days, months of suffering. No medicine. Painless, pleasant treatment. Violet Rays penetrate to every nerve affected. Also generates pure oxygen—wonderful for pulmonary troubles. Simple, safe—anyone can use VIOLETTA. Don't suffer pain and poor health when you can now try VIOLETTA 10 days FREE.

**This Book Free** Tells all about violet rays—how this remarkable discovery of Nikola Tesla, the electrical wizard, now brings this mysterious curative power to all. Contains many astounding testimonials from our thousands of satisfied users. Send for all the facts and our liberal trial offer.

**VI-REX CO., Dept. 731**  
2304 Warren Avenue, Chicago

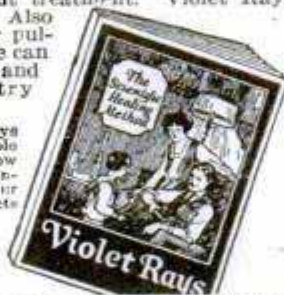

VI-REX COMPANY  
2304 Warren Ave., Dept. 731, Chicago.

Please send me your free book on Violet Rays and details of your 10-day free trial offer.

Name .....

Address .....

City ..... State .....

Illment .....



# Learn AVIATION

Money — fame — adventure! They all await you in Aviation. Experts who can fly—who can design, build and repair airplanes and motors, are in big demand everywhere. You can make from \$75.00 to \$500.00 a week after thorough training. You may be internationally famous in a year!

### Prepare for Big Pay Jobs

We give you complete and thorough flying and ground instructions on modern equipment such as Travel Air and other new-production ships, and on Whirlwind, Caminez and other new engines. You'll be taught Air Navigation, Meteorology, Aerodynamics, Airplane Construction and Maintenance, Motor Overhaul, Airport Management—and you'll learn to fly by flying with expert transport pilots. You'll find yourself in a hotbed of aviation activity. You'll see all the latest planes zooming and roaring, coming and going at our field. Parks is not a correspondence school.



212-D Mo.  
Theatre Bldg.

ST. LOUIS, MO.

**FREE**  
This  
Inspiring Book!

Send at once for "Skyward Ho!" the free aviation book that gives facts about opportunities—shows how you can get into this great industry that is making fortunes for many almost overnight. Special offer for this money saves you half the cost—if you write at once.



# DRAFTING

**BOOKS SENT FREE!**

### For Beginners

Written so you can understand every word, by 18 famous Engineers and Architects. Deluxe, flexible binding. 1750 pages, 1050 blue prints, charts and diagrams. Prepares you for a good Drafting job in mechanical or architectural lines. Sent for 15 days' free use, if you mail coupon immediately.

Only fifteen minutes a day with these WONDER BOOKS will prepare you for a good Drafting job in less than a year! Mechanical and Architectural Drafting from simple straight lines to important, complex plans, a step at a time! Built especially for beginners, for men with only grammar schooling. Drafting room practice plus engineering made easy and clear!

### Big Field—Big Demand—Big Pay!

Competent Draftsmen are urgently needed right now in all building and manufacturing lines at \$50 to \$100 a week. That's just the beginning—for draftsmen have the best chance for advancement! Pleasant, fascinating work, easy to learn and do. Learn quick with these books—send coupon for a set FREE, and see for yourself!

**A year's Consulting Membership in the American Technical Society now given free to all readers of this famous Cyclo-pedia of Drafting. Many say that's worth more than cost of books.**

American Technical Society  
Dept. DB-19, 58th & Drexel Ave., Chicago



## Modern American Homes FREE!

American Technical Society  
Dept. DB-19, 58th & Drexel Ave., Chicago

Send for 15 days' free use 4-volume set of DRAFTING. In return for mailing this coupon promptly send absolutely FREE "Modern American Homes," 112 plates, exteriors, interiors and plans. I will pay the few cents delivery charges. If I wish I may return books in 15 days and owe you nothing. But if I prefer to keep them I will send \$1.80 after 15 days, then \$2.00 a month until \$14.80 (special reduced price) is paid.

Name .....

Address .....

Employed by .....

Address .....



# CASH IN ON RADIO Now



ACT AS A  
RADIO  
DOCTOR



BUILD SETS FOR  
YOUR NEIGHBORS



HELP YOUR  
DEALER

## EARN

## \$75<sup>00</sup> a Week

Follow the Example of Thousands  
Join the Radio Association  
Learn Radio

### Take Advantage of Radio's Big-Pay Opportunities

THE RADIO ASSOCIATION OF AMERICA will help you make money in Radio, full or part time, by training you to be a "radio doctor," to build sets, "tailored" to your neighborhood needs, that you can sell for less than the "ready-made" sets offered by your local dealer, or to become a Radio Service Man for a radio dealer. Hundreds earn \$3 an hour spare-time serving as "radio doctors."

#### Earned \$500 in Spare Hours

Member Lyle Follick, Mich., reports \$500 earnings so far in spare-time. Member Werner Eichler, N. Y., earns \$50 weekly spare-time. Member F. J. Buckley, Mo., earns as much spare-time as he gets from his employer.

If interested in Radio, join the Association. You will receive a comprehensive and practical training in Radio that will not only enable you to earn money in spare hours but to fit yourself for Radio's big-pay opportunities. Scores of our members are now connected with big radio organizations in different capacities. Membership in the Association has increased the salaries of innumerable men.

Member W. E. Thon, Chicago, was a clerk in a hardware store. The training we gave him enabled him to secure the managership of a Radio Department at a 220% increased salary.

"I attribute my success entirely to the Radio Association," he writes. "Your method of instruction is wonderful."

#### We Will Start You in Business

Our cooperative plan will start you in business without capital. "In 1922 I was a clerk," writes Member K. O. Benzing, Ia., "when I enrolled. Since then I have built hundreds of sets—from 1-tube Regenerative to Superheterodynes.

"I am now operating my own store and my income is 400% greater than when I joined the Association. My entire success is due to the splendid help you have given me."

Membership gives you the benefit of proven money-making plans, the privilege of buying radio parts at wholesale, the cooperation of our Employment Department, the backing, advice of the Association in carrying out your plans. Investigate all it can do for you!

#### ACT NOW—for No-Cost Membership

The success of the Association during 1927 was so tremendous that we can offer a limited number of memberships that need not cost you a cent. Write today for details and our book, "Your Opportunity in the Radio Industry," that will open your eyes. Let us hear from you at once.

RADIO ASSOCIATION OF AMERICA  
Dept. PM-7, 4513 Ravenswood Avenue,  
Chicago, Ill.

Gentlemen:

Please send details of your Special Memberships and copy of your book, "Your Opportunity in the Radio Industry."

Name.....

Address.....

City..... State.....



*Airport Seaborne*

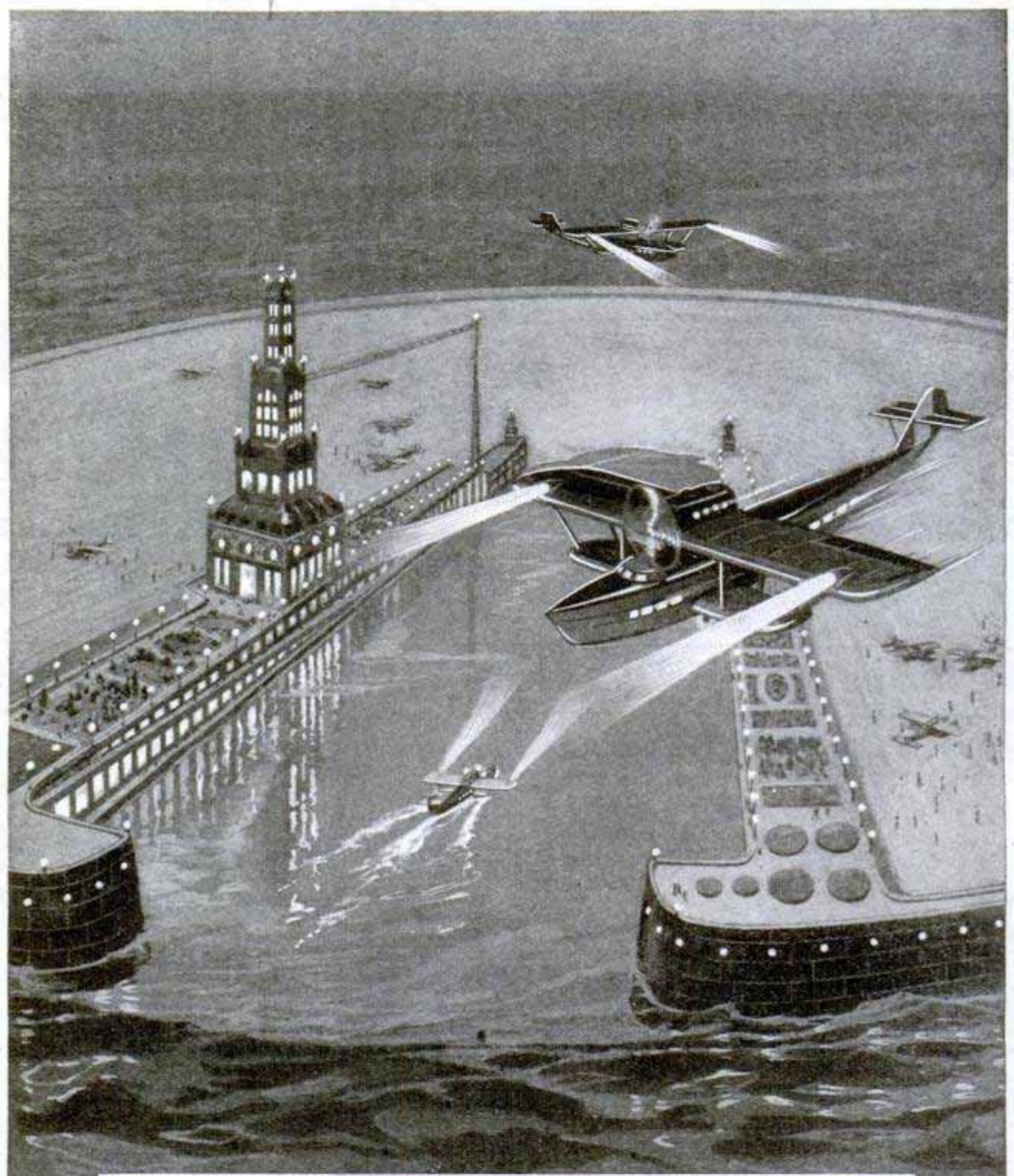

Landing Fields on the Sea, a Possibility of the Future; Artificial Islands in the Oceans, along the Routes of Inter-Continental Airplanes; They Would Provide Fueling and Repair Facilities for the Aircraft and Accommodations for Passengers. This Sketch Was Prepared from Data Gathered by French Aeronautical Engineers, and the Plan Has an Interesting Counterpart in a Scheme Already under Way, to Construct a Number of Large Open-Decked Boats, Somewhat like Airplane Carriers, to Patrol the Flying Routes, Provide Emergency Landing Space for Planes and to Help Keep Them on Their Course



# Popular Mechanics Magazine

REGISTERED IN U. S. PATENT OFFICE

WRITTEN SO YOU CAN UNDERSTAND IT

Vol. 50

JULY, 1928

No. 1

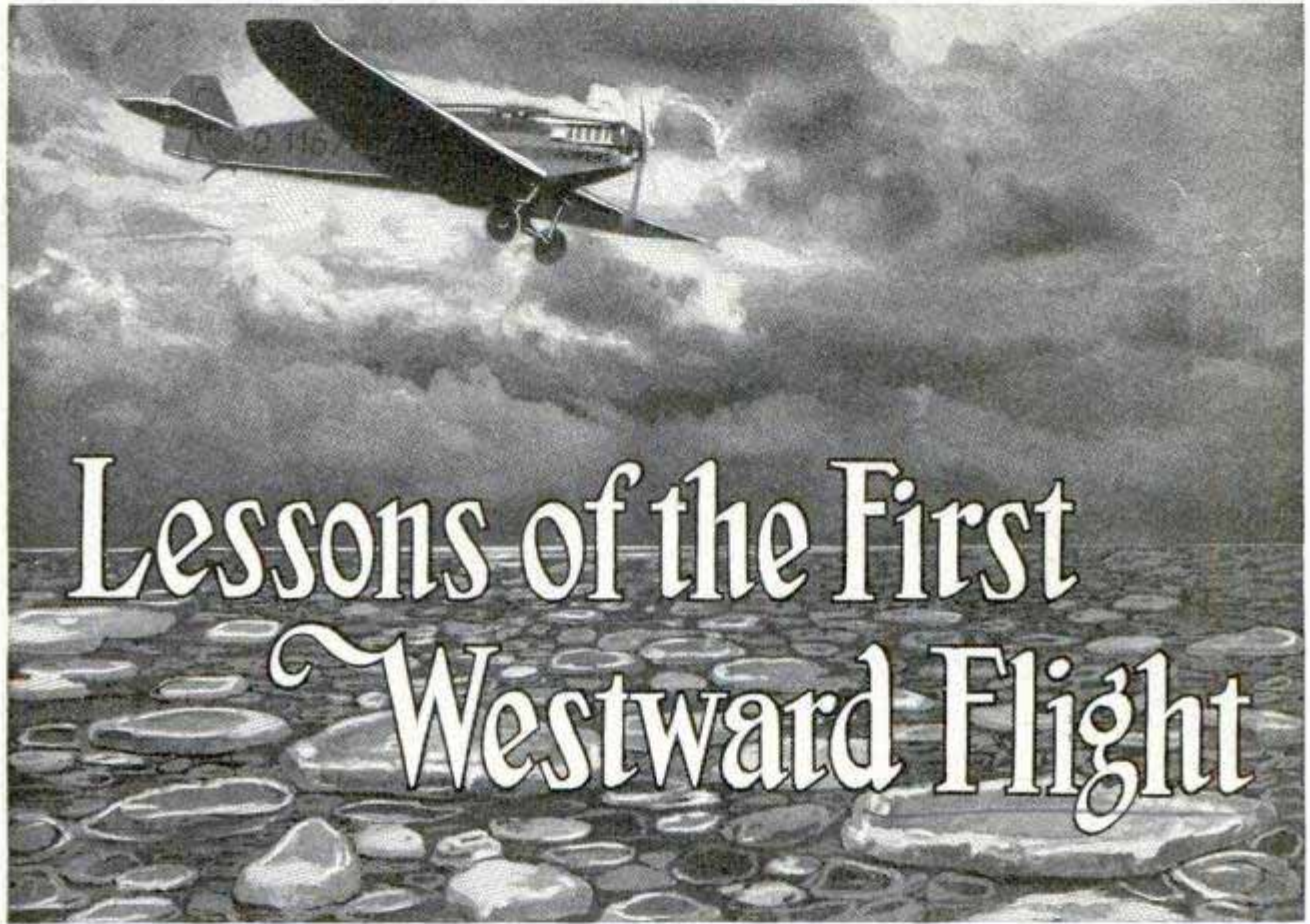

The Junkers Plane "Bremen," First to Cross the North Atlantic from East to West, Succeeding Where Nungesser, Coli, and a Number of Other Brave Airmen and Women Failed

By CAPT. HERMAN KOEHL

Chief Pilot of the "Bremen" on Its History-Making Flight

**B**EHIND the great acclaim which greeted the "Bremen" flight, there was one thought always uppermost in my mind. And that was—what did our flight mean for transatlantic flying in the future?

I hope that our flight will contribute in a large measure to the success of transatlantic flying and that those who endeavor to cross by air in the future will profit by our experience and findings.

As I took turns as pilot and navigator of the "Bremen" on its voyage from Baldonnell, Ireland, to Greenly island, on the North American continent, I made constant observations, some on paper, others in my mind. The best way in which I

can explain the various phases and problems which confronted us is to take you step by step on the journey, encountering the difficulties as they arose.

The weather, of course, is the most important thing at the start. On the morning of April 12, we learned that a high pressure was forming over the greater part of the ocean. The winds of the preceding days were fast diminishing, but we knew that the atmospheric conditions were going to be our chief enemies.

The most dangerous region, we figured, was the low-pressure area between Greenland and Canada. Flyers in the future must be prepared to cope with the situa-



702  
2

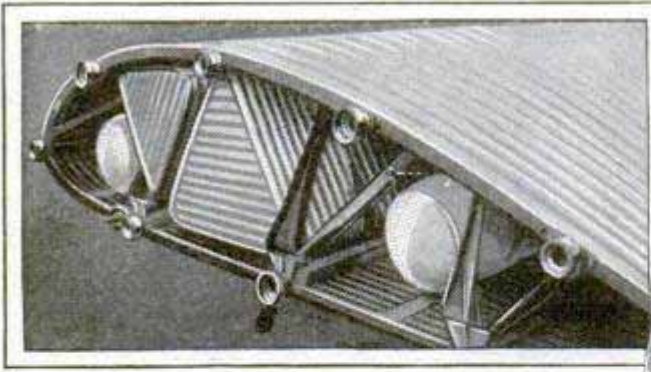

Section of the "Bremen's" Wing, Showing Gas Tanks and Bags to Keep Plane Afloat in Case of a Descent at Sea

tion prevailing there.

At the time of our hop-off, there was a fresh south wind. That was suitable for the start in the most favorable direction. Of course, every little detail in the weather had to be reckoned with and we had to worry about the motor—would it carry us through?

Well, at 5:00 a. m. we climbed into the "Bremen," after Baron von Huenefeld and Major Fitzmaurice had made a last and thorough examination of the ship. Strong hands seized the propeller and swung it around, and on the third revolution it started to whirl, not to stop until the "Bremen" reached another world.

As I sat at the controls, I felt that the motor was in good running order. The propeller was making the required 1,375 revolutions per minute. I shut off the gas and, on my fingers, counted and checked the levers that had to be tried. I found the gasoline worked all right, and in a little while I knew we would be headed for the North American continent, fame or death.

At 7:05 we were passing over the mountains and approaching the ocean. I was making notes of everything, the wind, the consumption of gasoline from the different tanks, and observing how the "Bremen" was taking the air. Soon we

were flying from thirty-five to fifty feet over a calm ocean. We were going at an average speed of 105 miles per hour.

Now the smoke bombs which we brought along were to come into use for the first time. By throwing over the side two of them, we discovered that we were riding with a southeast wind that was traveling at ten miles an hour. So we rose to 14,000 feet to take full advantage of the favorable easterly current.

Another hazard we had to face was the clouds. I managed to cross their margins always, but even as we skirted along, the air from them was icy-cold. Woe to the pilot who dares to penetrate into the thick of those clouds, especially in the



Here Is the Wing Tip of "Bremen's" Steel Propeller, Bent in Landing on the Ice of Greenly Island

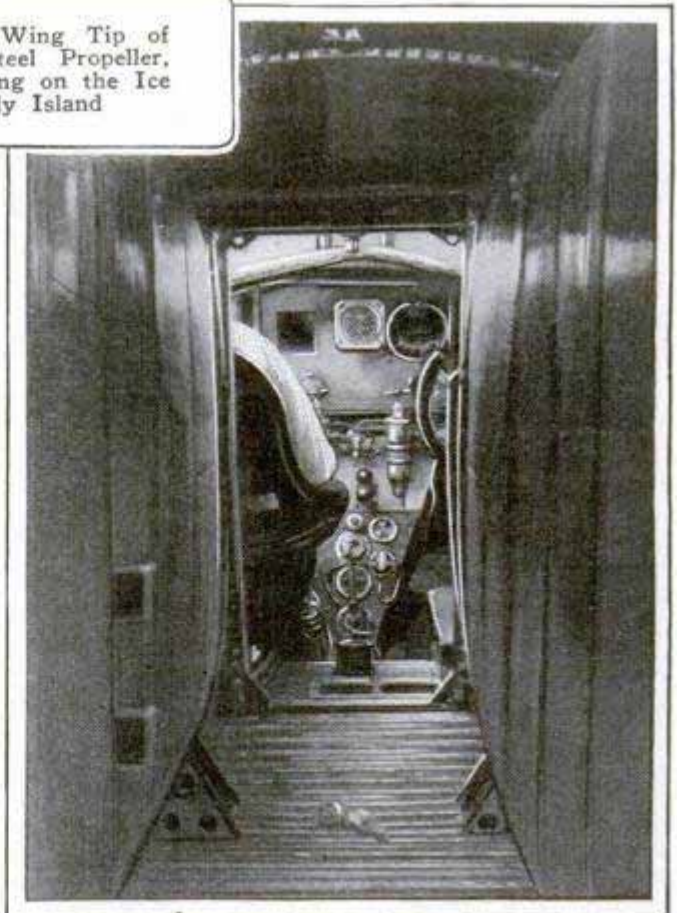

Looking Forward past the Huge Gasoline Tanks Built into the Cabin Walls; the Two Pilots Rode Side by Side at Dual Controls





The "Three Musketeers" of the North Atlantic, Baron Gunther von Huenefeld, Major James Fitzmaurice, and Captain Herman Koehl, Three War-Time Enemies Now United

darkness. I kept constant watch over the atmospheric dials. I noticed that the wind had increased and changed the course fifteen degrees further north.

From 5:30 to 9:35, we were flying on gas coming from two right cabin tanks. Then we turned on the four wing tanks. It was smooth flying through the day. At 7:20 that night, I noticed that the gas in the gauge sank. Trouble was lurking somewhere. The control wheel had stopped functioning. It was a time for quick and efficient action. The cabin tanks were turned on. The necessary gas was pumped into the tank by two hand pumps, and three minutes later it was running fine.

I figured to fly fourteen hours on the amount of gas which remained. While this hope was surging within me, I gazed off, at the suggestion of my companions, and, lo, we noticed a white line on the western horizon. There were dark shadows. It looked as if we three were riding on to a certain death.

All of this I mention as a part of the history of our flight. I hope it will be a guidance to airmen of the future who will try to navigate these same passes of the sky. The dark line on the horizon was one of threatening stretches of clouds from north to south. This was now the

most perilous region, I think, in the east-to-west flight. It was here that we would have to combat the low-pressure enemy.

I wondered, as we approached that dark line, would the "Bremen" make the grade? Would it stand the test? It was going to be a moonless night where we had hoped for a clear sky beyond that dark curtain. There was no turning back now. We were about 300 miles from Newfoundland.

### GREATER SPEED IS NEED

By BARON von HUENEFELD

THE western flight over the Atlantic has shown that an airplane can conquer the winds and that we have learned lessons that will be of great value in the future.

I believe that passenger service will not be made use of so much at first as the mail transport. However, if we are in possession of motors which will enable us to cover 180 miles or more an hour, the dangers caused by changing weather will be lessened and the passenger service will gain favor in the public's eye.

I have no doubt whatsoever but that such motors will be constructed in a short time, and we can confidently expect successful developments in this direction in the next few years.

*Baron v. Huenefeld*



702  
4

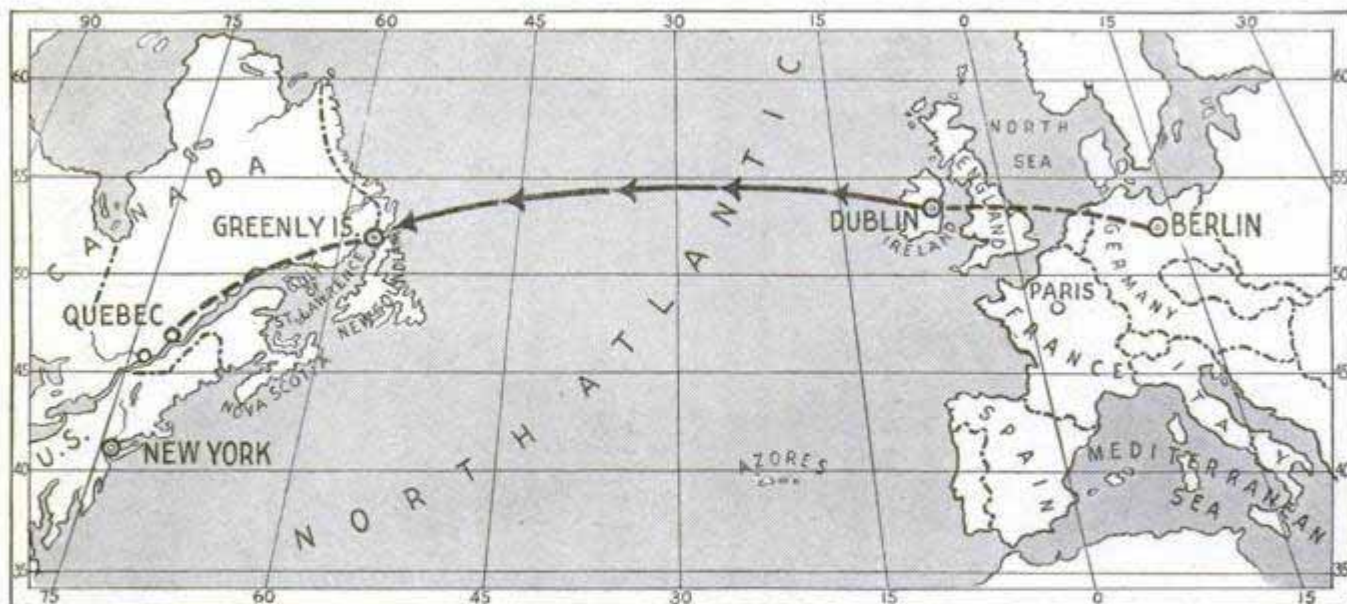

From Berlin to Lake St. Agnes with Two Stops, in Ireland and at Greenly Island, This Is the Route the "Bremen" Flyers Took; at Greenly, They Were Far to the North of the Newfoundland Course

At this point, the fight which is the flyers' greatest enemy in transatlantic flying began—it was the battle against the elements. We rose 4,750 feet over those sinister clouds. And away we sped to the west. But we ran into another avalanche of clouds in this higher region. Our only salvation now lay in sinking into the fog beneath us.

So we came down and felt our way above the surface of the water. It was our first fog, but we managed to pull through it. The fogs, I think, will never be much cause for worry. It is the clouds and the storms which are to be feared.

When we sank away from the second bank of clouds, we came down to within seventy-five feet of the water. We were

so close that the spray of the waves beat through the half-closed window. The "Bremen" shook in all its joints. The wings were bending and the steering wheel received blow after blow of unusual violence. It was man's duel with the mighty powers of nature.

Now, the thought comes to my mind that only the most capable of pilots should ever be engaged in this hazardous transatlantic flying. I can foresee the day when there will be special schools of aviation which will specialize in training pilots for ocean flights. And I can see where existing aviation schools will, if they haven't covered the ground already, include this study in their courses.

The compass, of course, played a great part in our voyage. Navigation consists solely in watching the compass. When we approached that doomful, dark lining on the horizon, I found we were still high enough to keep my direction between the dark clouds and the high waves. But when the waves began beating up against us and the plane began tossing, the compass was reeling and staggering.

It was with great difficulty that I was able to tell in what direction we were going. To make matters worse, the light which revealed the compass dial was put out of commission. I had to use a pocket light to read it. It was at a time when we were flying through a fog. The best I could do now was to fly straight ahead.

At this point I began to appreciate the great value of radio. We did not take

### LOOKING TO THE FUTURE

By MAJOR FITZMAURICE

AS a representative of the Irish Free State Flying Corps, one of the world's youngest flying services, I welcomed the opportunity to come to America as co-pilot of the "Bremen" not only for the honor of helping fly the first plane across the North Atlantic from east to west, but because of the impetus our successful flight will give aviation in my native land.

The location of Ireland as the nearest point in the Old World on the great-circle course to the New World will make it the crossroads of Atlantic aerial navigation in the future.



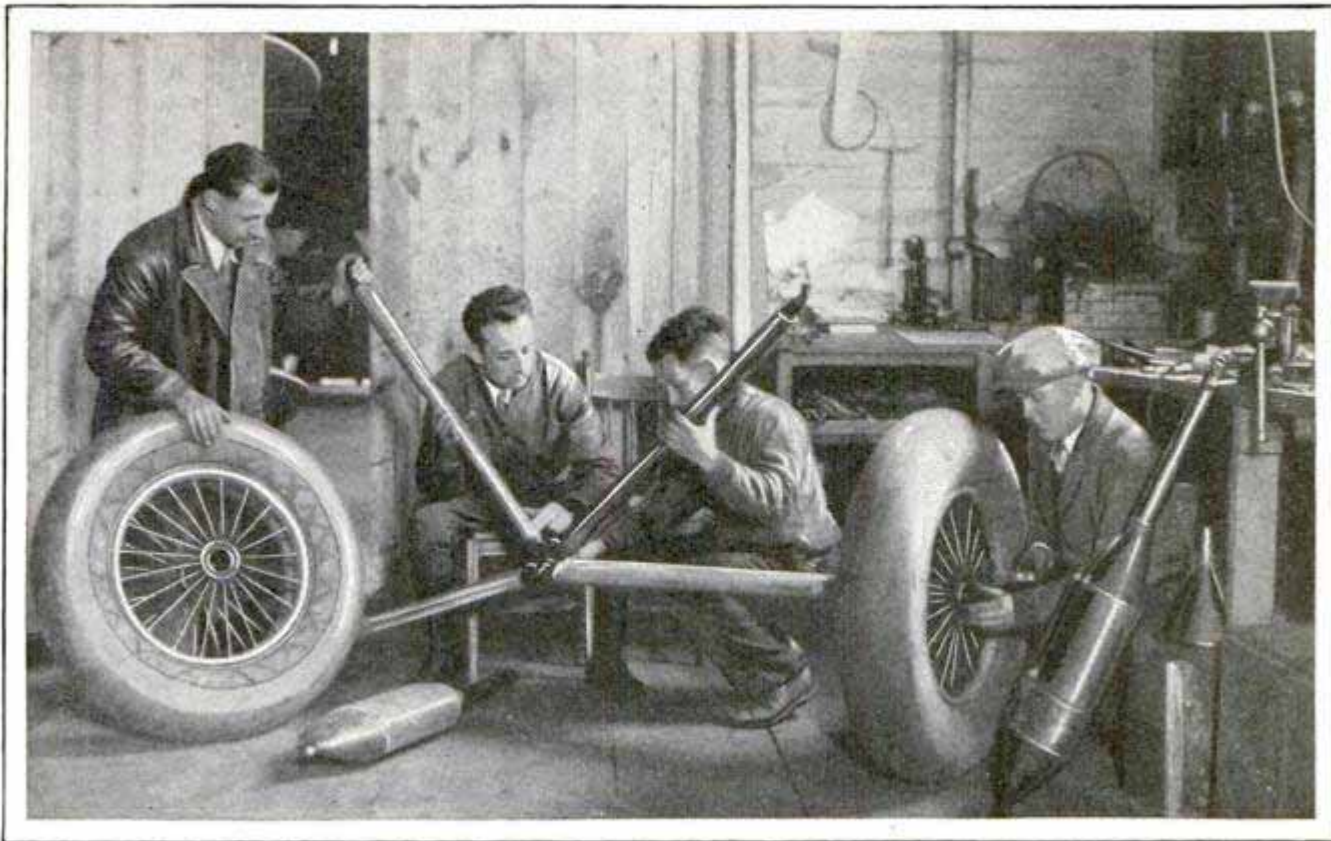

Assembling a New Landing Gear for the "Bremen" from Spare Parts in the Junkers' Hangar on Long Island; Fred Melchior, Second from Left, Later Left to Recover the Transatlantic Plane

wireless equipment with us. Now that we were in peril, with the compass failing, the only instrument to save us from destruction would have been the radio.

Although we realized that the radio would have been a vital aid at this juncture, we knew that before we started out, but we decided that the apparatus would have been so heavy that it would not have been worth the risk. But now I can say with certainty that the radio will figure prominently in future flying over the ocean.

When the compass trouble developed, I was piloting through a fog. Gradually we were flying better and better. One gets used to the fog and can soon learn all there is to know about flying in it.

Aside from the compass, if I were to mark the next vital instrument on the "Bremen," I would say it was the altitude meter. To keep a steady altitude is not an easy matter by any means. I came to know this when I turned the wheel over to Major Fitzmaurice and I took the post as navigator.

Then, I sought the Pole star. I found it easily. But when I compared it with the compass I found that it had gone mad. The compass pointed in quite another direction. We had gone too far north. But we couldn't positively verify this. We

maneuvered a southwest course by the Pole star.

Major Fitzmaurice threw over some light bombs. You see, we were prepared for every contingency. Our only mistake was that we omitted the radio.

With the light bombs glaring, we discerned forests and snow below. Soon we were dodging mountain tops. A little while later I looked at the altitude meter and found that we had descended to only thirty-five feet to glide along these mountain tops. We knew we had reached the North American continent. Our joy was unbounded.

The great lessons from the "Bremen" flight center around the combat of the atmospheric conditions with a rugged plane and proper instruments. That the day is not so very far off when many others will be following our trail from east to west over the Atlantic there is no doubt in my mind. The "Bremen" flight taught me that.

(Signed)

(Koehl)



Civil. U. S. Woodbury, New. Bureau.

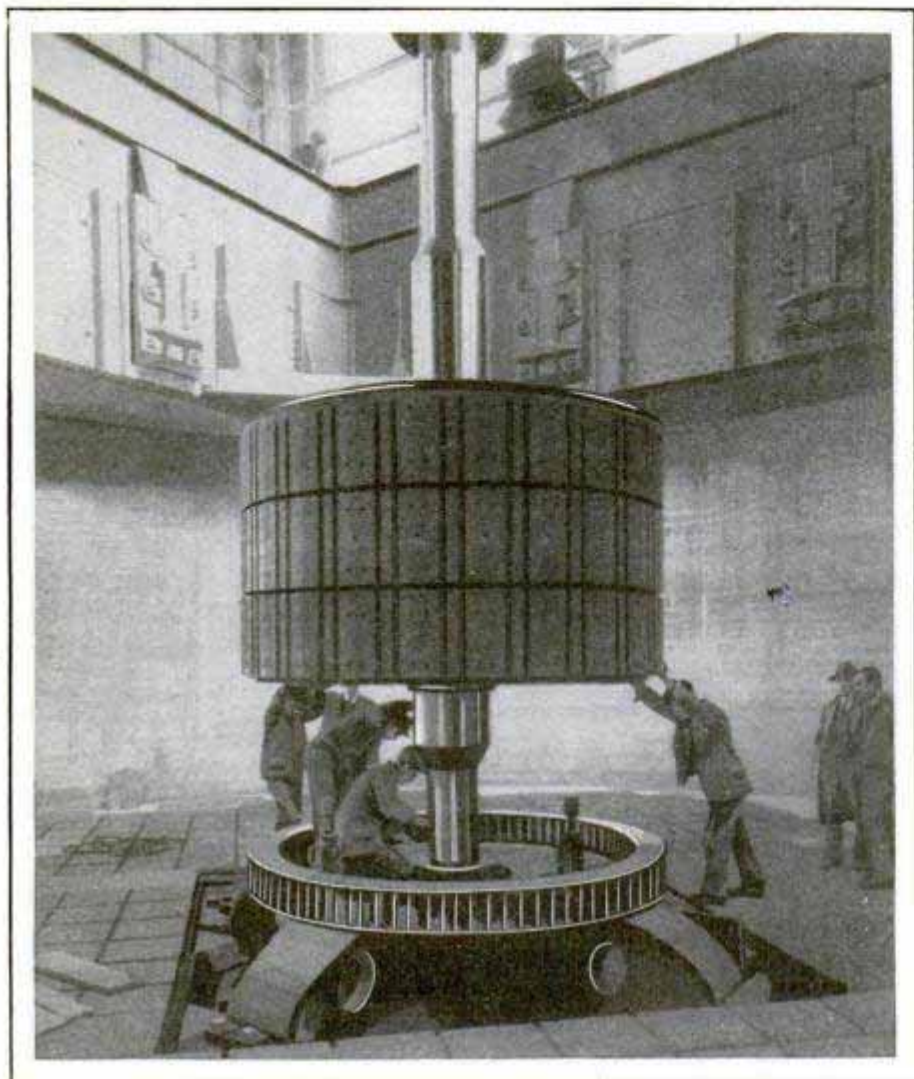

Courtesy General-Electric Co.

Inside the Rotor-Testing Pit Where the Big Units Are Whirled at High Speeds to Discover Any Hidden Weakness

### ROTORS TESTED IN DEEP PIT TO PREVENT ACCIDENTS

Double speed tests on the rotors of big turbine generators, some of them weighing as much as 500 tons, are conducted in a deep pit at an eastern plant so that, in case of failure of the wheel, no one would be injured by the flying pieces. The pit is a circular chamber, thirty feet in depth and surrounded by two concentric walls of heavily reinforced concrete, between which there is a cushion of sand. Over the top, is placed a cover, eight feet thick, of concrete and steel plate, and around the rim are two ring girders, each two and one-half feet deep. The pit is housed in a large brick and steel building in a field a quarter of a mile from the nearest factory building. Such precautions are necessary, according to J. D. Harnden, in charge of the testing operations, for when the rotors are running at high speed,

the centrifugal force is extreme. For instance, one going at twice its normal speed, produces centrifugal force approximately four times the usual value. The velocity of the rim of a forty-foot rotor, at double its normal speed would be about five miles a minute. The tests are of importance, for they show whether or not the rotors will stand the strain, should they be allowed to run away after installation in the power houses. An observation building stands 300 feet from the pit and is connected to it by electric cables that enable the engineers to control the speed of the rotors at all times. Means are also provided for taking pictures of the vibrations set up, and the tester "listens in" with a microphone to determine if the piece is behaving properly. The motors that whirl the rotors

range from 1,000 to 3,000 horsepower, and at the bottom of the pit is a large vertical roller bearing capable of sustaining the weight of the largest rotor to be built.

### PECAN-NUT CRACKER PREVENTS BREAKING THE MEATS

546

A pound of pecans can be cracked in about two and one-half minutes, it is claimed, with a special cracker a southern inventor has devised. The nut is held in a small socket and force applied with a lever that splits the shell the long way, helping to remove the contents in an unbroken condition. There is no danger of injuring the fingers and shells are not thrown about the room.

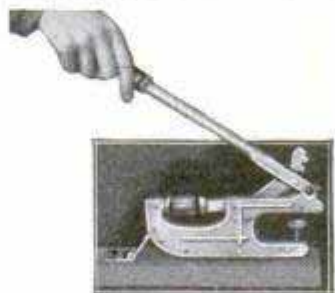

Miller Specialty Co.

Mr. J. Lloyd



"SKYROCKET" AUTO IS PROPELLED BY GUNPOWDER

no. 11 Sagunt

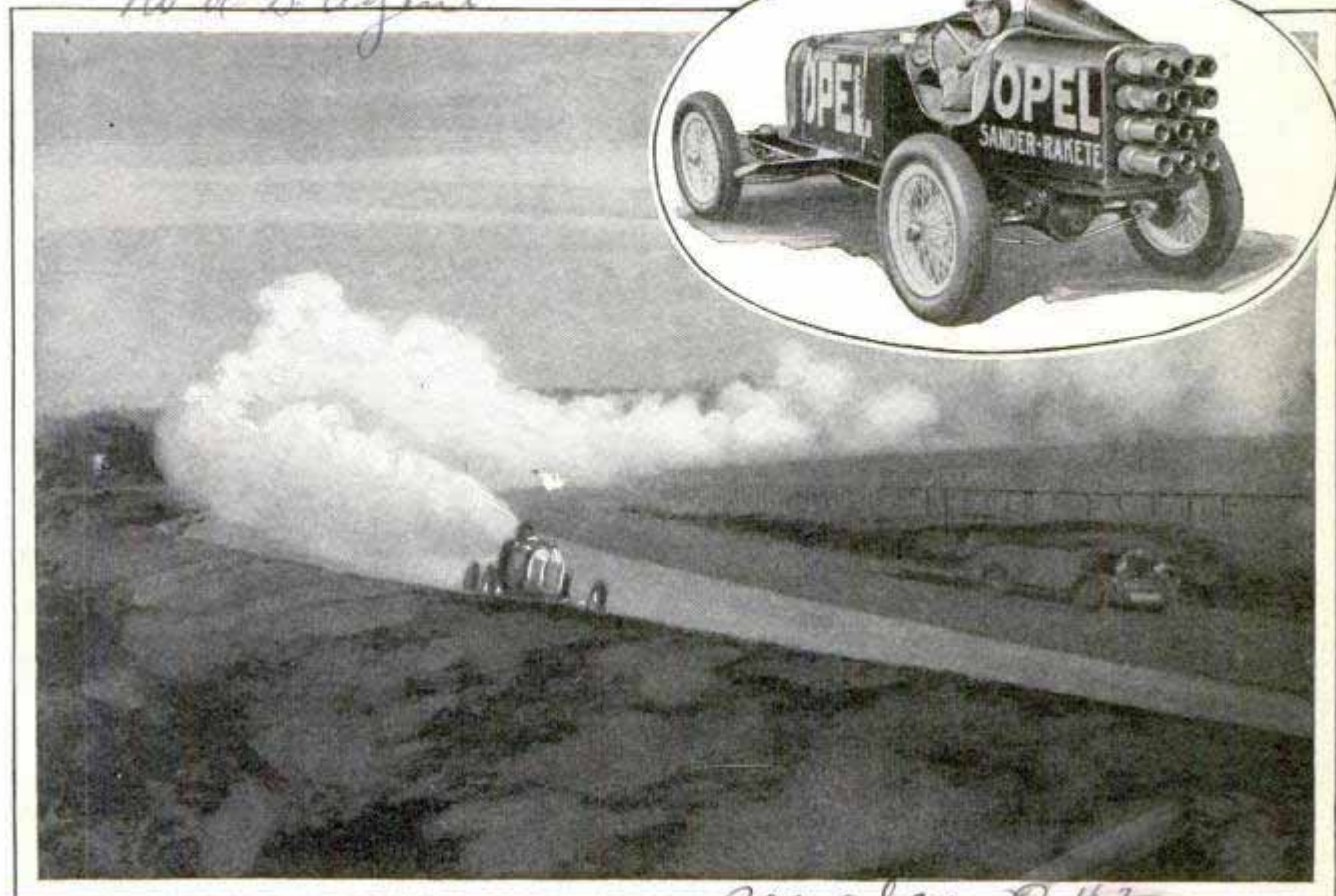

Close View of the Rocket Automobile and Glimpse of It in Action; Speed of More Than Sixty Miles an Hour Was Developed within Eight Seconds in the Trial Test

see also p. 42

Automobiles propelled like sky rockets may be the next development in transportation. In a recent test in Germany, a car operated on this principle developed a speed of over sixty-two miles an hour in eight seconds. The usual motor is replaced by chambers in which charges of powder are exploded. The force is communicated directly to the axles. It is believed that this principle may be adapted to airplane motors.

numerous experiments, as it has been shown that it has the highest visibility in snowy regions. The tests were made by observing samples of the shade against a white background at various heights.

SPECIAL PAINTS FOR AIRPLANES TO PROMOTE SAFETY

To provide greater visibility and, therefore, increased safety for aircraft, a special series of colored paints has been developed. For polar flying, a scarlet vermilion shade has been devised after

AUTOMATIC FISHLINE REEL AIDS IN BAIT CASTING

3888

A fishing reel that automatically retrieves the line after a cast, has been introduced. This is accomplished by a spring which is wound as the plug on the line travels through the air. Sufficient tension is produced to wind the reel back again. Casts of forty to sixty feet may be made after a little practice, and there is a lever control to release the spring and to stop it so as to prevent backlash.

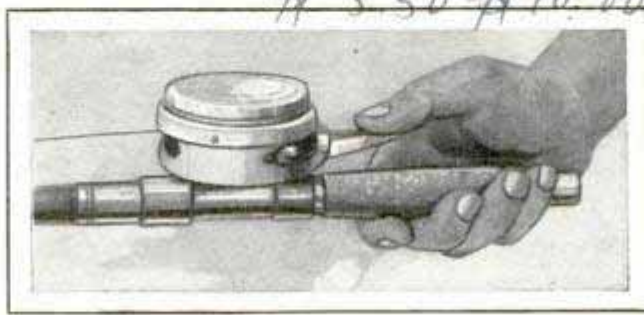

Reel Which Automatically Winds Up the Line After Cast Has Been Made

6. I. du Pont de Nemours & Co. Wilmington, Del.

E. I. du Pont de Nemours & Co.

Martin Automatic, Fishing



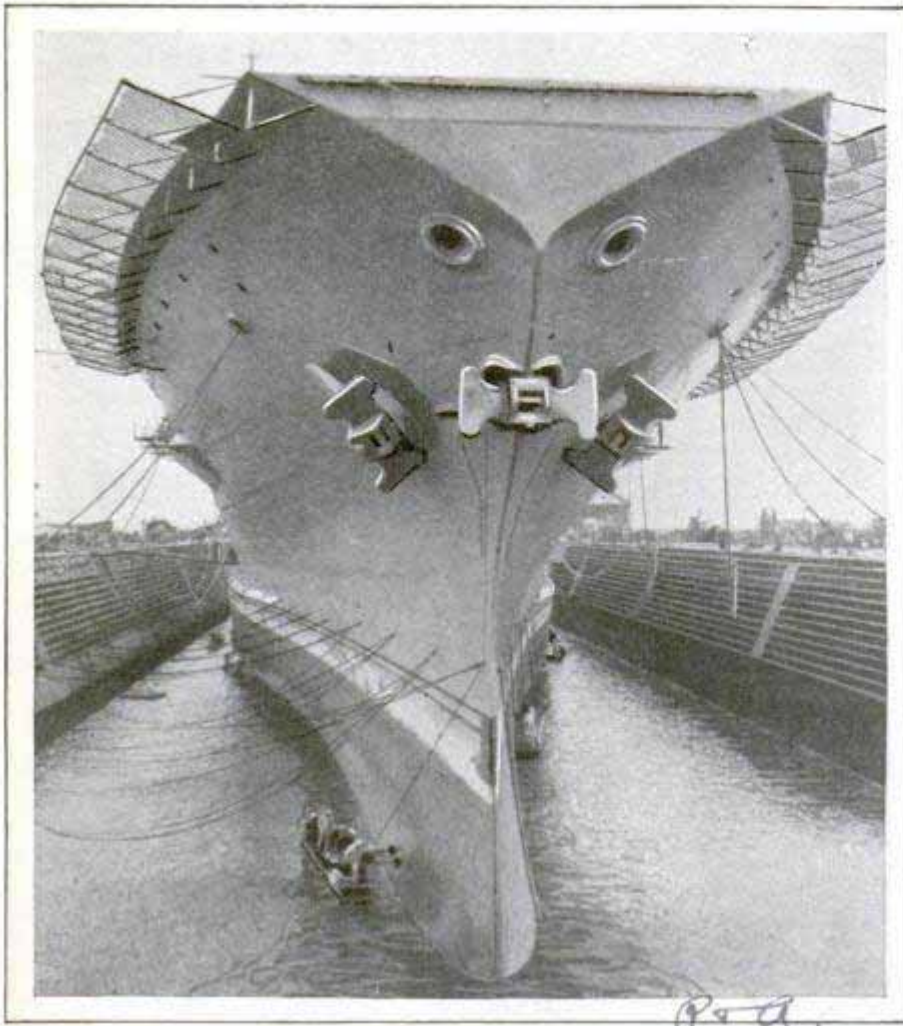

Prow of the "Lexington," Huge Airplane Carrier of the U. S. Navy, in Dock at San Francisco Preparatory to Trials

**AIRPLANE CARRIER GIVEN BATH BEFORE OFFICIAL TRIALS**

Visitors at the dock in San Francisco had a good look at the "fighting face" of one of the most recent additions to the navy, when the "Lexington," giant airplane carrier, was washed and prepared for its official trials off the California coast. The tests were to determine the speed and other factors of the huge unit, while planes were to practice landing and taking off from the broad deck. The navy has devised special braking equipment for the aircraft so that they can be halted quickly after alighting on the deck.

**"MAGIC LOG" FOUND IN JUNGLE AT RISK OF LIFE**

After risking his life in the steaming jungles of western Panama, G. Proctor Cooper, war veteran and forester, has found two "magic logs" of cacique wood, a rare variety, to which marvelous cura-

tive powers are attributed by the Panama Indians. Until Cooper's find, made for the Field Museum of Natural History, Yale university, the New York Botanical Gardens and the United Fruit company, under whose auspices he was traveling, only a small fragment of the wood, about the size of a man's finger, was known outside of Panama. It is ruby and black in color and, in some lights, is suffused with a golden sheen. It is found, not in the live tree, but in rotting chunks and logs in the jungle, being the almost imperishable heart of a fallen trunk that the ants and worms have picked clean of bark and sapwood. Before he found the precious wood, Cooper traveled through treacherous swamps, infested

with fever, crossed rivers that carried the mules yards below the landings, and endured many other hardships. One of the logs will be exhibited at the Field museum and the other at Yale.

**SILVER GUITAR AMPLIFIES TONE THROUGH DIAPHRAGMS**

Three specially constructed diaphragms within the body of a silver guitar, are said to greatly amplify the tones of the instrument and emphasize their beauty.



Silver Guitar with Diaphragms Which Are Said to Amplify and Otherwise Improve the Tones

The silver is proof against rust and not so susceptible to changing weather conditions as wood.

*National String Instrument Co.*

*Chicago Musical Instrument Co. 311 S. Wabash Ave. Chicago*

*3662*

*\$125.00 - \$145.00 - \$165.00*



1519 Connecticut Ave

# QUARTZ LIGHT TUBES HELP SIMPLIFY TELEVISION

Rods of fused quartz, through which light will flow, even around bends, like water through a hose, are used by C. Francis Jenkins, the Washington inventor, in the newest system of television, demonstrated recently through the radio transmission of a movie film from his laboratory to his home. The quartz rods made it possible to replace the large disk, which had been the most bulky part of previous television receivers, with a small drum barely seven inches in diameter. Quartz has the peculiar property of passing light through itself without losing any through radiation along the sides. In the Jenkins machine a series of neon-light units are mounted in a globe in the center of the revolving drum, and from them the

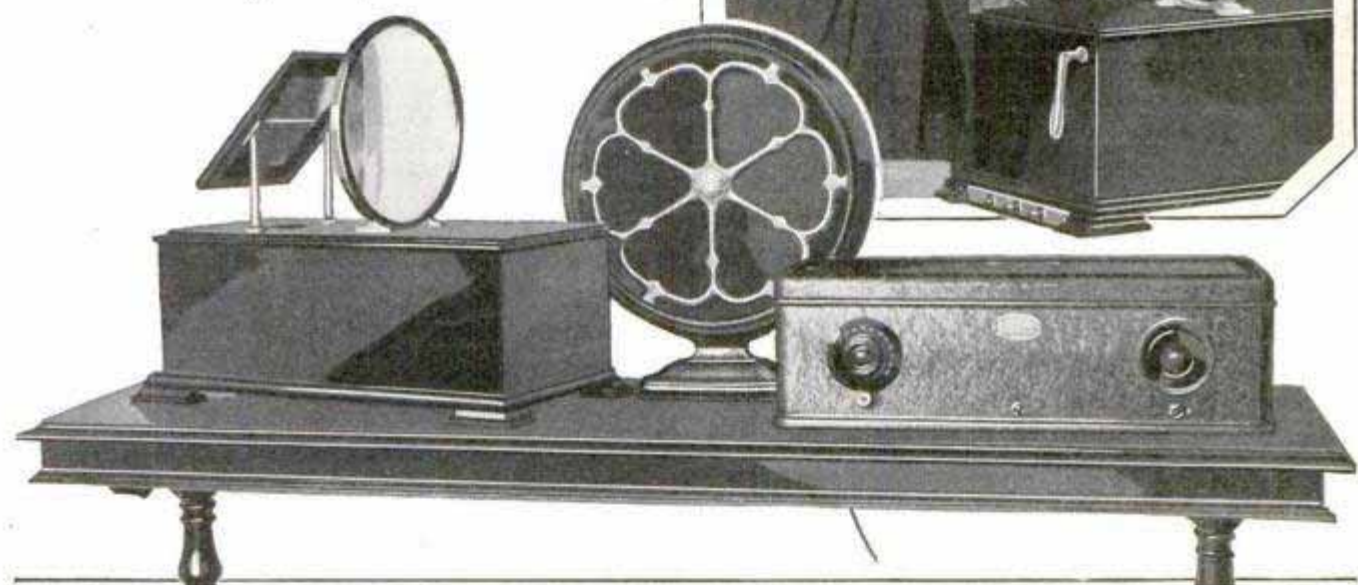

Francis Jenkins with His Scanning Drum, Filled with Quartz Rods as Light Conductors, and, Below, the Receiver, Loud Speaker and Picture Apparatus, Showing the Receiving Lens and Mirror

little quartz rods lead out to the edge, terminating in a series of small holes arranged in a helical row. The drum spins at 3,600 revolutions per minute, a commutator making contact with the neon lights as the signals are received from the transmitting station. The points of light, carried through the quartz rods, are passed upward through a hole in the top of the receiver cabinet, which is a standard size table-type radio-receiver box. Above the outlet hole is a mirror, set at an angle of forty-five degrees, to deflect the vertical light beams into a horizontal direction, thus forming a vertical picture. In front of the mirror, a large oval reading glass magnifies the small image on the mirror,

so that the eye sees a relatively large picture. As in all television receivers, the motor of the drum must run in unison with the motor of the corresponding disk at the sending station.

## STAINS KEPT FROM LINOLEUM WITH AUTO FINISH DOPE

A preparation, whose base is the same as that of modern auto finish, is now being used to protect linoleum from fruit stains, ink spots and other blemishes. It fills the pores of the material, preventing the absorption of fluids, and produces a surface finish which both reduces wear and makes the linoleum easier to clean.

England - Nobel Chemical  
Furnishes, Ltd.

E. J. du Pont de Nemours



**OSTRICH HUNTERS IN AUTO CATCH BIRDS ALIVE**

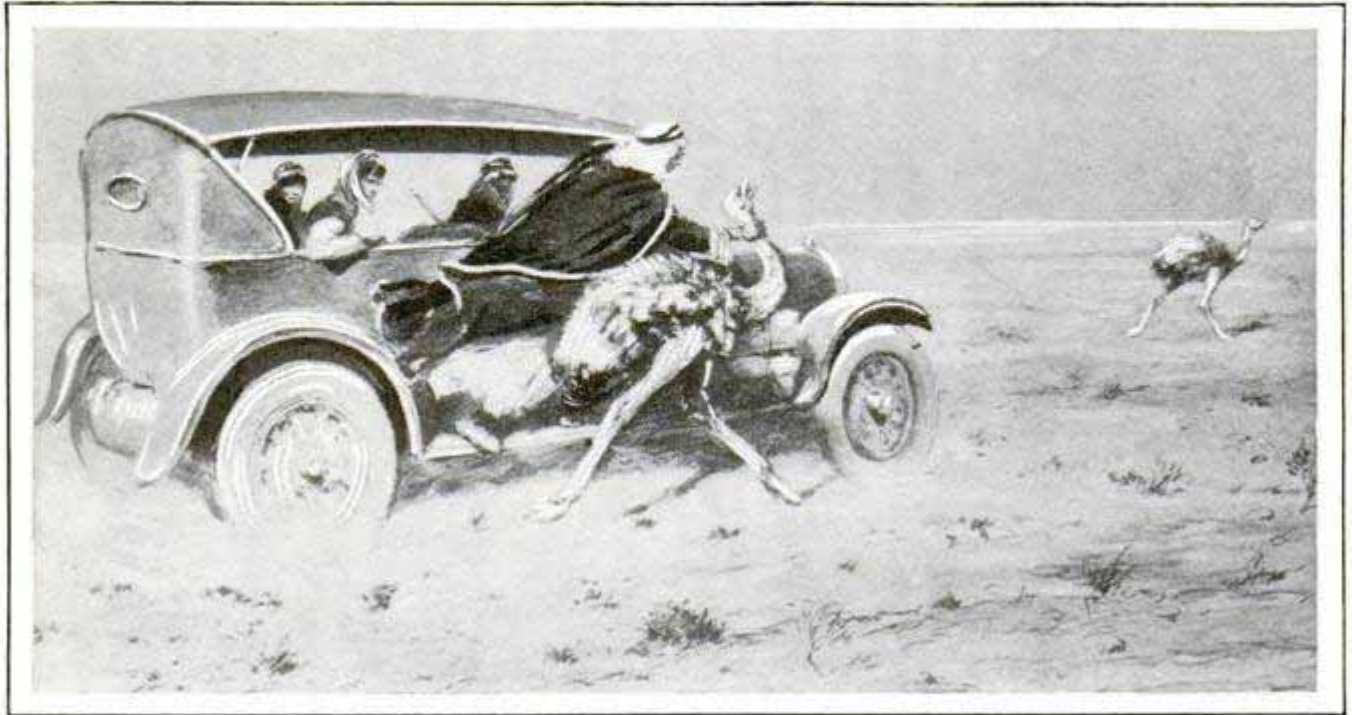

© The Illustrated London News  
 Artist's Drawing of the Ostrich Hunt from an Automobile; as the Car Overtook the Birds, They Were Grasped about the Neck and Pulled Aboard, Too Exhausted to Struggle

Two ostriches were captured alive in an Arabian desert by a party of hunters who pursued and overtook them in an automobile after shooting four others. At first, the birds outdistanced the cars, but they soon tired and as the auto approached alongside, a hunter stepped on the running board, grasped the first ostrich about the neck and pulled it into the car. Its companion was caught in the same manner. The birds were too exhausted to struggle.

center mark are small figures of animals. These fall back when struck by the bullet, but bob up again when the smaller target in the center is hit. The unit weighs but three and one-half pounds.

**"BLIND SPOT" IN ARCTIC SHRUNK TO SIZE OF TEXAS**

The unknown area in the Arctic has dwindled to a region about the size of Texas, according to the National Geographic society. In his last flight, Capt. Wilkins surveyed most of the Arctic ocean between the "Norge's" path in 1926 and the outpost islands between Greenland and Hudson bay. The chief "blind spot" still remaining is along the Siberian coast, a stretch of some 900 miles 400 miles wide. The Wilkins-Eielson hop over the pole in twenty hours, gives encouragement to the hopes for short air routes across the pole. London and Tokyo will benefit chiefly by such a short cut. By the Mediterranean, Suez canal and Indian ocean, the distance is 13,033 miles. By the trans-Siberian railroad, 7,500 miles. The air-line distance by way of North

**ANIMAL TARGET FITS ON FENCE AND IMPROVES SKILL**

Many of the thrills afforded in a shooting gallery are offered by an automatic animal target for .22-caliber rifle practice in the home or yard. On each side of the



Small Shooting Gallery for Rifle Practice; the Figures Fall When Struck but Reappear if Center Target Is Hit

Crosman Arms Co.

Geographic

Illustrated London News  
 April 7, 1918  
 616  
 C.567

492

slods

\$0.75



Cape, Norway, and Nova Zembla is 6,300 miles. Airplanes would thus effect a saving of 1,200 miles and during the spring and summer daylight reigns at the pole, an additional factor to encourage flights.

661  
**ODD SOURCES OF COLORS**

Real carmine is prepared only from the bodies of a certain species of small insects and Prussian blue is made from horses' hoofs and other animal matter, by fusing with potassium carbonate. Turkey red comes from a small plant that grows in Hindustan; raw sienna and raw umber are obtained from natural earths in Sienna and Umbria, Italy. India ink is manufactured from camphor, and the Chinese are the most expert in making it, according to reports.

(clipping)  
**SUMMER HAT WITH EYESHADE ELIMINATES SUN GLARE** 575

The front part of the brim of a summer sport hat for women is a transparent eye-



Sun-Visor Sports Hat Shields the Eyes and Face and Has Adjustable Band to Make It Fit

shade, to shut off the glare of the sun. The hat is light in weight and has a band with buckles with which it can be adjusted to fit any head.



© Henry Miller  
Turning Crank of the Curious Hammer-Drum That Is Used Instead of a Church Bell in Some European Villages

**BIG DRUM BOX SERVES AS BELL IN CALL TO CHURCH**

In some European villages, a curious drum arrangement is employed as a substitute for a bell in announcing church services. It is modeled after the same plan as the "noise makers," the whirling hand devices, seen in this country at football games and other occasions. As a crank is turned, a series of hammers strike against the top of the drum which is shaped as a large box. The sound is amplified in the chamber and as the drum is usually placed on the roof, the clatter can be heard for a considerable distance. A young boy is usually employed to operate the crank.

**RUBBER LINING IN FURS HELPS DRIVE AWAY MOTHS** 607

By substituting a lining of rubber and wool for the natural skin of furs, an English expert is said to have found a way to protect the articles from moths. The insects are attracted only by the skin, it is said, and when they cannot find it, they do not molest the rest of the fur. Important details of the process are being kept secret, but the method involves freezing the fur, shaving it from the skin and then, while the ends protrude, pouring coatings of liquid rubber to form a new skin. The wool is added for warmth.

Superior Hat Co,  
2301 Madison, i

and George H. Holden, 11111  
Highfield Drive, Eng.



Power Bldg. Minneapolis Minn.

587

Price - \$15.00 C.O.D.

West Coast - 300 Third Ave. Venice, Calif.

Combination Outdoor Gymnasium for Children Has Several Exercising Units for Ready Use and Four or Five Youngsters May Play at the Same Time



**OUTDOOR GYM FOR CHILDREN SIX UNITS IN ONE**

Swing, teeter-totter, turning bar, trapeze, turning rings and parallel bars are combined in a single compact gymnasium unit for children. It is intended for outdoor use but may be installed inside, and four or five youngsters can play upon it at once. The different parts are made ready for use in a few seconds and the whole outfit occupies but little space. The apparatus weighs about seventy pounds and is four feet wide and seven feet high.

**GUARD HOUSES FROM TORNADO WITH VENTS IN SIDES**

618. Making holes in the side of a house to reduce the likelihood of damage from tornadoes is the plan proposed by L. V. Teesdale, of the U. S. forest products labora-

tory, and he has an interesting reason. Property damage caused by tornadoes is due principally to two causes, the explosive effect and flying debris. By the explosive effect, walls are blown outward, due to the sudden change in air pressure, a quick lowering on the outside with consequent inner strain that causes the building to collapse outward. By arranging vents that would open automatically in case of a tornado, this internal strain would be relieved and the structure spared from possible damage, it is believed. Special windows, panels or doors could be arranged so that they would fly open, it is suggested, and skylights might be installed in the same manner, on the principle of "panic" doors in theaters. Buildings already erected could be equipped with vents fashioned in this way.

**HANDHOLE IN AUTO SIDE WINDOW FOR SIGNALS**

30 2 Arm signals can be made from the closed automobile, without lowering the window, through a hinged door over an opening. The installation can be made in a few moments and is not difficult. The aperture also affords an effective means of ventilating the interior of the car.

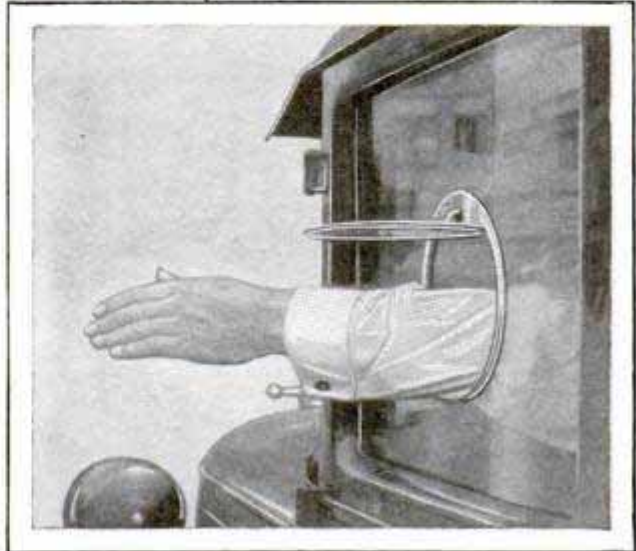

Hinged Section in Auto Door for Making Arm Signals; Opening Also Is Aid to Ventilation

made in; Vis Harry W. Cooper Co., 2344 S Michigan



19 Blvd. de Capucines  
Paris, France

**POPULAR MECHANICS**

**SEEK GLORIES OF OLD ROME  
IN CIRCUS RUINS** 659

Work has been started in Rome on clearing the site of the Circus Maximus, once capable of seating 350,000 persons, and said to be the place where the conflagration of the city in Nero's time was started. Engineers believe that ten years will be required to finish the task, which was begun April 21, Rome's birthday and the Italian Labor day. While many art treasures and fragments already have been taken from the area, it is hoped that even greater trophies will be found in the excavations. According to legend, the big fire that Nero witnessed was started by applying torches under wooden steps which led to superstructures of marble and wooden beams with extensive hangings. The blazing amphitheater, in turn, served as a gigantic torch to ignite houses on the heights near by. The site, until now, has been an eyesore.

**AIR-FED MINNOW-BUCKET KEEPS  
BAIT ALIVE SEVERAL DAYS**



Fresh bait is assured the fisherman by a minnow bucket now on the market and supplied with air to keep the minnows alive for a considerable time. This is attained simply by an air chamber at the bottom and a pump on the side, which needs to be worked only once a day or so, to make air bubble through the water.

**X-RAY SEARCH FOR TREE ILLS  
TO HELP SAVE FORESTS** 652

Ailments of trees are now being studied with the aid of the X-rays. Trunks which apparently are sound, may be decayed inside, X-ray photographs disclose. This manner of examination does not damage the tree and is more certain than some other methods; experts declare. The rays distinguish clearly between sound wood and decayed and also reveal other details.

Experimenter - Thomas  
Vernaloy, City Forester



Outer Pocket for Swimmers, and a Close View Un-attached; It Is Handy for Cigaretts, Etc.

**WATERPROOF PACK FOR BATHER  
KEEPS VALUABLES DRY**

For the convenience of swimmers, a small pocket, attached to the bathing-suit belt, keeps cigarets, matches and valuables dry. It also prevents loss and holds the articles where they may be reached with the greatest convenience.

**HOSE NOZZLE THAT HOLDS SOAP  
SIMPLIFIES WASHING AUTO** 612

Rubbing and the use of rags are eliminated in washing the automobile with the aid of a special nozzle. It has a chamber for soap inside. When this is filled and the nozzle attached to the hose, water is applied in the usual way until the soap is all dissolved. Then the car is rinsed with clear water and allowed to dry. By this method scratching of the finish is avoided and a considerable saving in time is attained.



B + J Mfg Co.  
4326 Elston Ave.

Also non-airfed  
 Air - Fed Mfg Co.  
 Wilsey, Cadman  
 and Dean B.

B + J Mfg Co.  
Brooklyn, N.Y.  
13

slipcase  
75 cents



HOW ANIMAL ILLS ARE BEING CURED BY

Failing Eyesight in Your Pet Dog No Longer Need Go Uncorrected, For He Can Be Fitted with a Pair of the Spectacles Made Famous in the Movies and Will Be the Envy of All the Dogs on His Street; Below, When a Young Lion Gets Sick He Is Very Sick Indeed and Readily Submits to Nursing; Giving Medicine to Some Animals Is a Difficult Job, but with the Meat Eaters, the Pill or Capsule Can Always Be Concealed in an Incision in the Day's Beef, in Hope That the Unsuspecting Patient Will Swallow the Dose

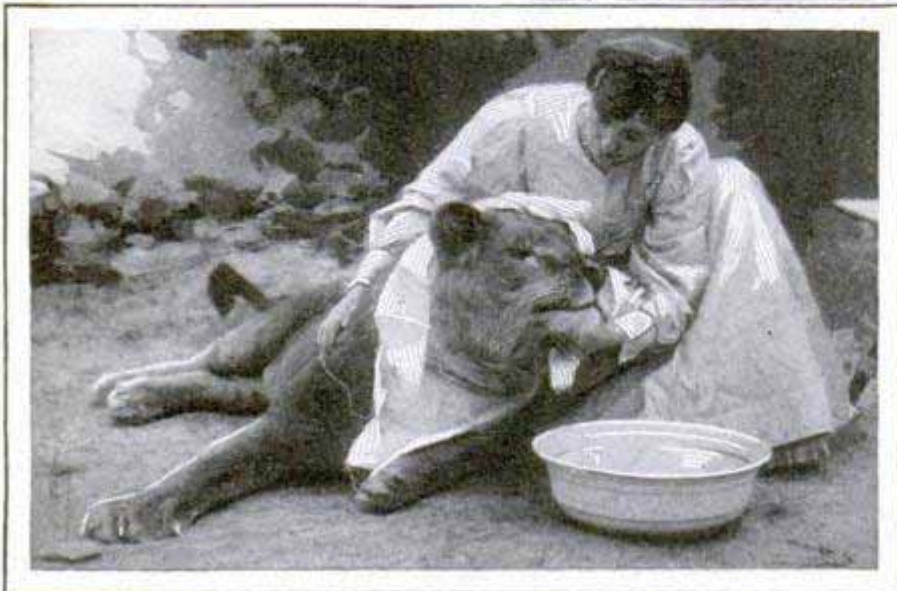
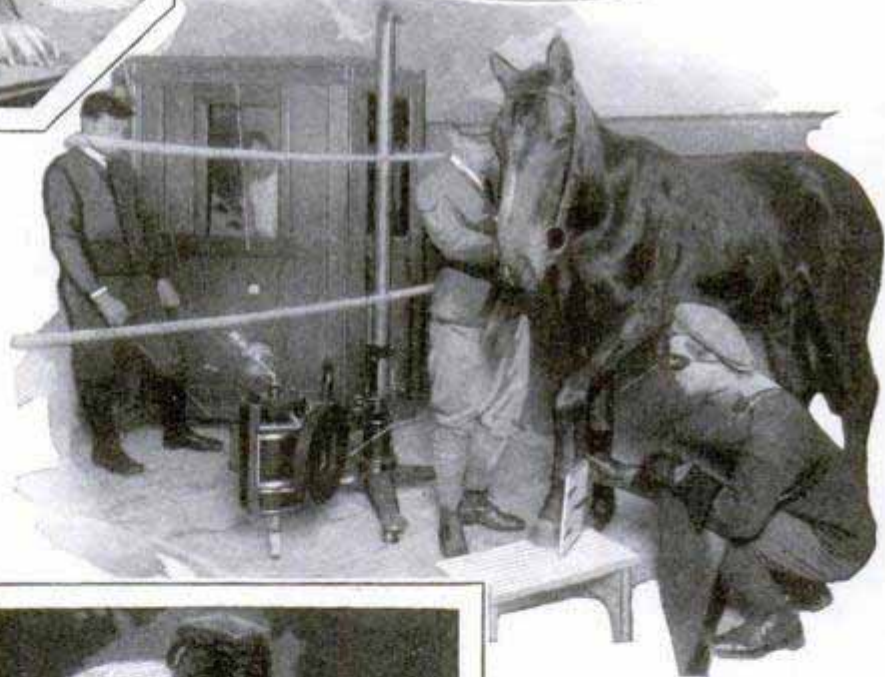

A Brown Bear in the Hagenbeck Zoo, at Stellingen, Germany, Goes In for a Course of Electrical Treatment, Top, and a Valuable Horse Gets His Forefoot X-Rayed to Reveal the Source of a Hidden Trouble That Has Been Making Him Limp; Most Animals Are Docile When in the Doctor's Hands, Seemingly Understanding That an Effort Is Being Made to Relieve Their Distress; Doctoring Animal and Human Patients Does Not Differ Much, Except That the Former Get Wholesale Doses Corresponding to Their Size, Which Makes the Elephant's Pill the Grandfather of All Nostrums



LATEST APPLICATIONS OF MEDICAL SCIENCE



This Fox Terrier Lost His Forefoot in a Street-Car Accident, but in the Hands of a Skillful Veterinary His Wounds Are Not Only Healed, but He Is Fitted with an Artificial Leg; Animals and Birds Quickly Learn to Adapt Themselves to Artificial Limbs and, after a Few Trials, Are Able to Get Around with Almost the Ease and Grace of One Completely Equipped as Nature Made Him



A Convalescent Dog Lies in the Nurse's Lap While Taking an Artificial Sun Bath in the Hospital at Cologne, Germany; Treating Valuable Show Animals and Beloved Pets Is a Lucrative Business in Most Any of the Larger Cities



In Vienna, the Society for the Prevention of Cruelty to Animals Operates a Fleet of Autos Equipped with Cage Bodies; They Not Only Gather Up Stray Dogs and Cats from the Streets and Seek to Find Them Good Homes, but Likewise Remove the Ailing Pets to the Hospital for Treatment; at the Right an Elephant Is Being Treated for a Chill, Almost as Serious to Him as a Sore Throat to a Giraffe





603  
**MODEL TOWN FOR RABBITS**  
**NEW PARK ATTRACTION**

Rabbits in Chicago's Lincoln park were housed in attractive model cottages this season. The small houses are painted in handsome colors and are protected with tin in spots where the rabbits are likely



One of the Streets in Lincoln Park's Rabbit Village; the Model Houses Are Partly Lined with Tin to Protect Them from Being Gnawed and Are Warmly Built to Shield the Pets in the Cold Season

to gnaw. The village includes seven houses and a "district school," arranged along small streets, the entire assembly being surrounded by a high wire fence. An old-fashioned mill for lettuce and carrots is to be erected later.

658  
**EIGHTEEN-TON STEEL DOORS**  
**GUARD BANK OF ENGLAND**

Concrete walls, eight feet thick, steel doors weighing eighteen tons each, electric locks and an intricate system of sensitive alarms are among the protective barriers about the vaults of the new Bank of England, being completed in London. The main vault is fifty feet below the surface, a room twenty yards square and so constructed that experts declare it could not be entered by exploding ten tons of dynamite or the use of the most efficient oxyacetylene apparatus. A glove or a pocketbook dropped in an unlikely spot, would instantly sound a half dozen electric alarm bells and along the winding stairs and passages leading to the vault

are other sensitive points where the least pressure will sound an alarm. It is estimated that it would take 100 cracksmen a year to get into the main vault and then their work would just be begun, for they would be confronted by a double door of two-inch bars of the most resistant steel known, and beyond it are two other big doors, each weighing eighteen tons, secured by special locks. In addition to all these safeguards, the entrance to the treasure chambers is constantly watched by relays of detectives.

3/8  
**FISHLINE IS CASED IN RUBBER**  
**FOR BETTER CASTING**



Longer casts and elimination of most of the backlash are features claimed for a braided-silk fishing line incased and impregnated with rubber. It is said to uncoil or reel up much more smoothly and lies lightly on the water, being suitable for fly or bait casting.

Cont Francis Slicie  
 17 Blvd. de Capucines.

Newton Line Co  
 Homer N.Y.



433  
*Sole Agent. A. E. Spedding + Bros. 211 State Street, Chicago*

**AIR USE SPREADS IN ALASKA** 643

Alaska may be considered still somewhat on the frontier, but that it is not far behind the rest of the world in the most modern form of transportation, is evidenced by recent reports of an airship company there. Its planes have flown 300,000 miles, carrying 1,000 passengers and 30,000 pounds of freight and baggage, all without loss or injury. Considering that the territory over which the planes are operated is rugged and wild, that temperatures of fifty degrees below zero are encountered and that there is constant danger of severe storms, the performance is regarded as unusually creditable.



Retrieving Golf Ball with the Extension Net, the Handle of Which Collapses for Carrying in the Bag

**GOLF-BALL RETRIEVER SAVES LOSS AND PLAYERS' TIME**

When the golf ball drops into the water hazard, it is easily recovered with the aid of a collapsible retriever now on the market. This is simply an extension metal handle with a small net on the end. When not in use, it telescopes into such length that it can be carried without difficulty in the caddy bag. It is fashioned as one piece, adds but little to the weight of the equipment and is always in readiness for instant service.

**TIME BOMB TO SHOOT OIL WELL REDUCES HAZARD** 454

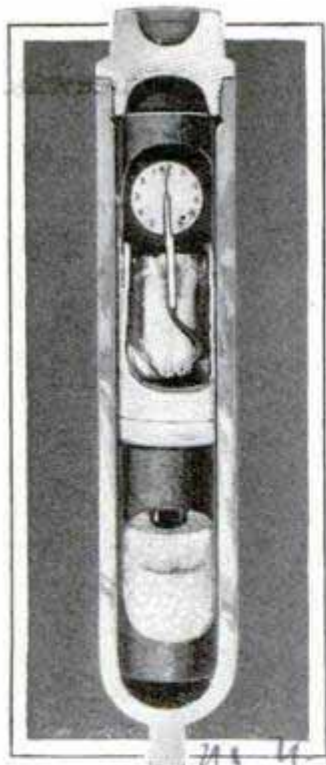

Likelihood of a premature explosion is reduced in shooting oil wells by using a time bomb a western engineer has devised. It is set off by means of an alarm-clock mechanism at any interval desired, from one to eleven hours. This gives the operators ample time to pull out the casing before the shot goes off. The bomb itself is of cast iron, eighteen inches long, and contains

slightly more than a pound of dynamite which explodes the shot previously lowered into the well.

**FOLDING AUTO LUGGAGE TRUNK HOLDS BIG LOAD** 3807

Barrels, cans and other bulky objects may be carried on the rear of the automobile when a folding trunk is opened up. It provides several additional square feet of space and has a capacity of 400 pounds. When closed, it becomes a neat trunk with room for the spare tire on the back. A canvas cover is provided to protect the carrier and its load from mud, dust and rain when it has to be kept open.

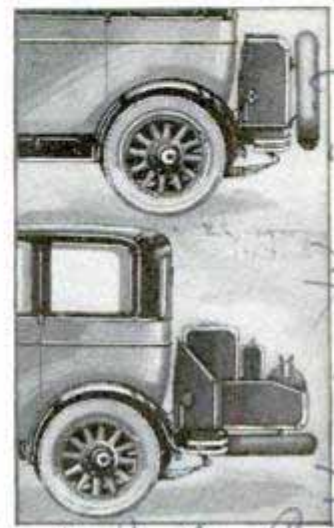

Out of every 100 persons about 96 are color-blind.

*Ball Retriever C. Raleigh Chicago*

*Chicago. Toy & Distribution Corp. 2017 Michigan*

*Kari Keen Mfg. Co. 509 Plymouth St. Chicago*

*Bleeker*

*Kari Keen Mfg. Co.*



237



# Avigation

flew to Hawaii. For the navy, Comm. John Rodgers also became expert in avigation, and now the science is taught in the advanced flying courses of both the army and the navy.

In flying over land, the airplane pilot picks up landmark after landmark and thus finds his course by constantly comparing the terrain below him to the explanatory charts he carries with him in the cockpit. Occasional fog or storm may drive him down or obscure his vision for short periods. At night he flies by means of beacons mounted at convenient locations. Avigation concerns him very little.

Over the sea, however, he finds no marks which could be set down on a chart, and he must actually navigate his craft precisely as do mariners on the surface of the sea beneath him. Furthermore, his observations must be taken more frequently and often his celestial observations must be taken in the full sweep of the slip stream, and his sextant and other instruments may be almost torn from his grasp. His horizons may be clouded, and at all times he is subject to countless and capricious wind eddies and currents.

In addition, the avigator must work in a very confined space; he has no commodious and capacious chart room in which to develop the mathematics of his work as has the sea-level navigator—and yet, under the compulsion of almost con-

Lieut. Arthur Gavin, Winner of the 1927 Schiff Trophy, "Shooting the Sun" with an Aircraft Sextant

By G. K. SPENCER

*331-34 th St  
La Brea Calif.*

**A**VIGATION, the science of navigating in the air, as a result of recent long-distance flights over water, has been brought dramatically to public attention, and already a number of schools devoted exclusively to the teaching of aerial navigation have been established.

Realizing that the time must come when air and seaplane pilots would be operating over portions of the earth on which they could observe no familiar landmarks, the army and navy first began the study and teaching of avigation to small classes of senior pilots. Of these classes, two of the earlier graduates were Lieut. Lester Maitland and Albert Hagenberger, who



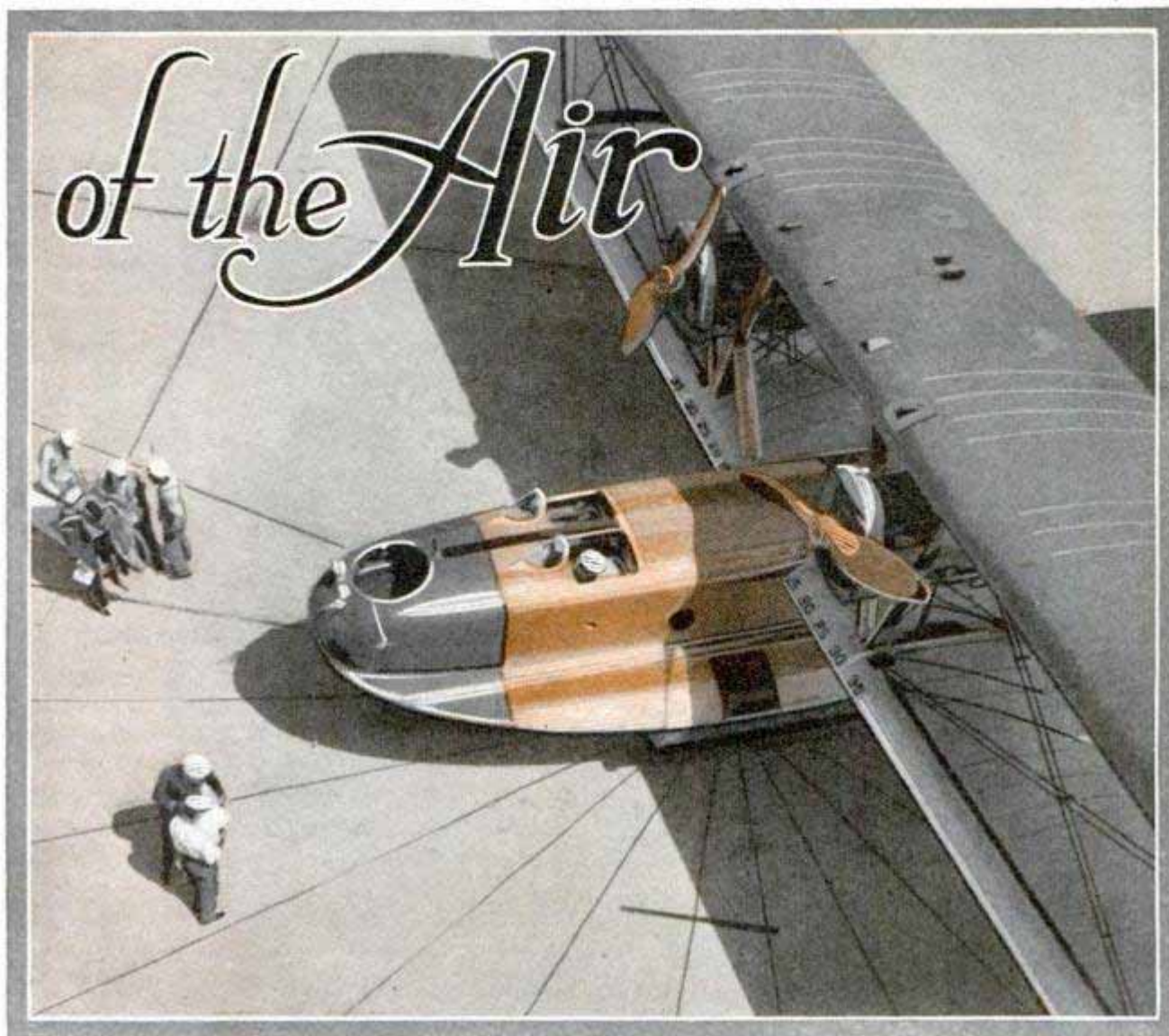

Swinging Ship to Correct the Compass of a Huge Twin-Motored Flying Boat; Note the Compass Points Laid Out in Radiating Lines on the Concrete Base to Guide the Correctors

stant avigation from the moment he leaves land until he again reaches it, he arrives at his objective. How does he do it?

First, the avigator employs practically all the instruments of the navigator, with the addition of the earth-inductor compass and methods for computing drift, that is, the movement laterally of a plane off its course due to air currents. These must all be compensated for in the avigation of the craft. Owing to the varying magnetic values of an airplane due to static charges of electricity gathering from the air on metal braces and connecting rods, magnetic compasses in aircraft are given to erratic behavior and, consequently, wide variations.

Avigation in each individual case must begin long before a flight is made. The avigator prepares himself with all the available charts, and plots his course. He

then ascertains, by a study of known meteorological data, the proper time to begin his flight, and if he is obliged to fly regardless of weather, he studies the meteorological data to discover just how he may avoid unfavorable conditions.

Once in the air, however, he begins to employ his navigating instruments. Before the flight, his compasses have been "swung." That is, the plane has been set on the ground, whether it be land or seaplane, and moved around a pivot in a circle, while the compass is carefully checked to see how it reads at each point of the compass. A chart is made of its reading on each point. Due to the metal in the motor, and other parts of the plane, the compass varies its readings in certain directions because of magnetic distortion. After this chart is made, and the plane is in flight, if the avigator sees his compass



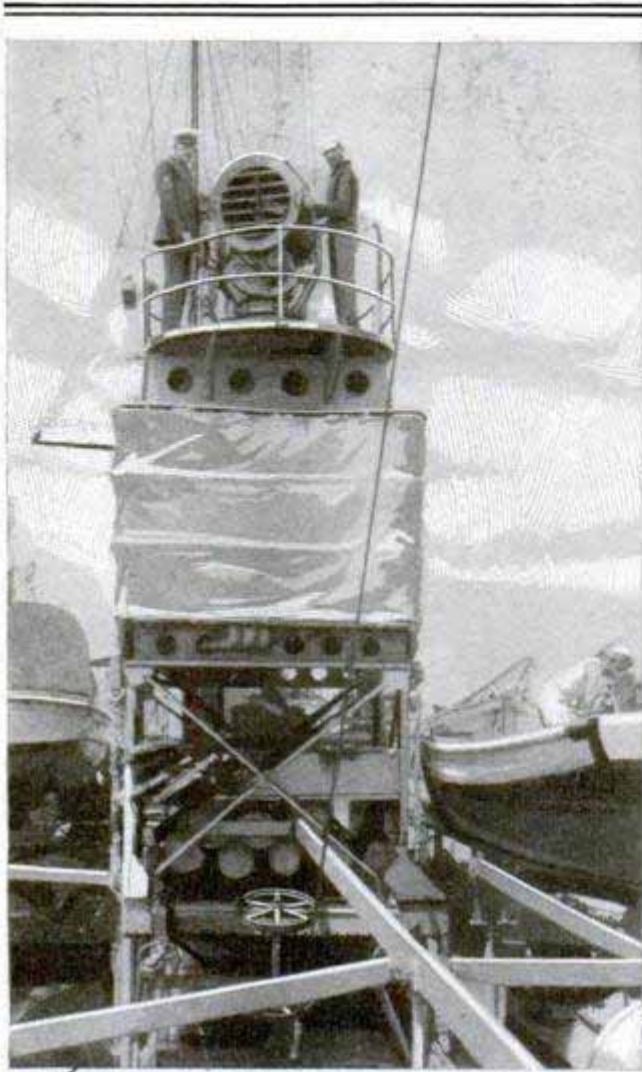

reading due north, and his chart says that on this reading the instrument is two points off, he knows that he is really not heading due north but that much off. This is the purpose of swinging ship, whether it be a plane or a seagoing vessel. They swing ship in order to get a characteristic history of the activity of their compasses. Every time a new metal addition is made to a ship, and every time she takes on metal cargo to any great extent, she must be swung anew, for the metal affects the compass readings and these must be charted for the benefit of the avigator or navigator.

Everyone knows the principle of the electric generator. A coil of wire is swung at right angles to powerfully charged electromagnets, and a current is thus induced in the coil. This current flows forth and is made to serve a useful purpose. If the powerful magnetic poles of the generator are kept charged, and if the central swinging coils are not moved, they tend to take up a position parallel to the lines of force from the magnets, in a position in which no current is induced. It is only when

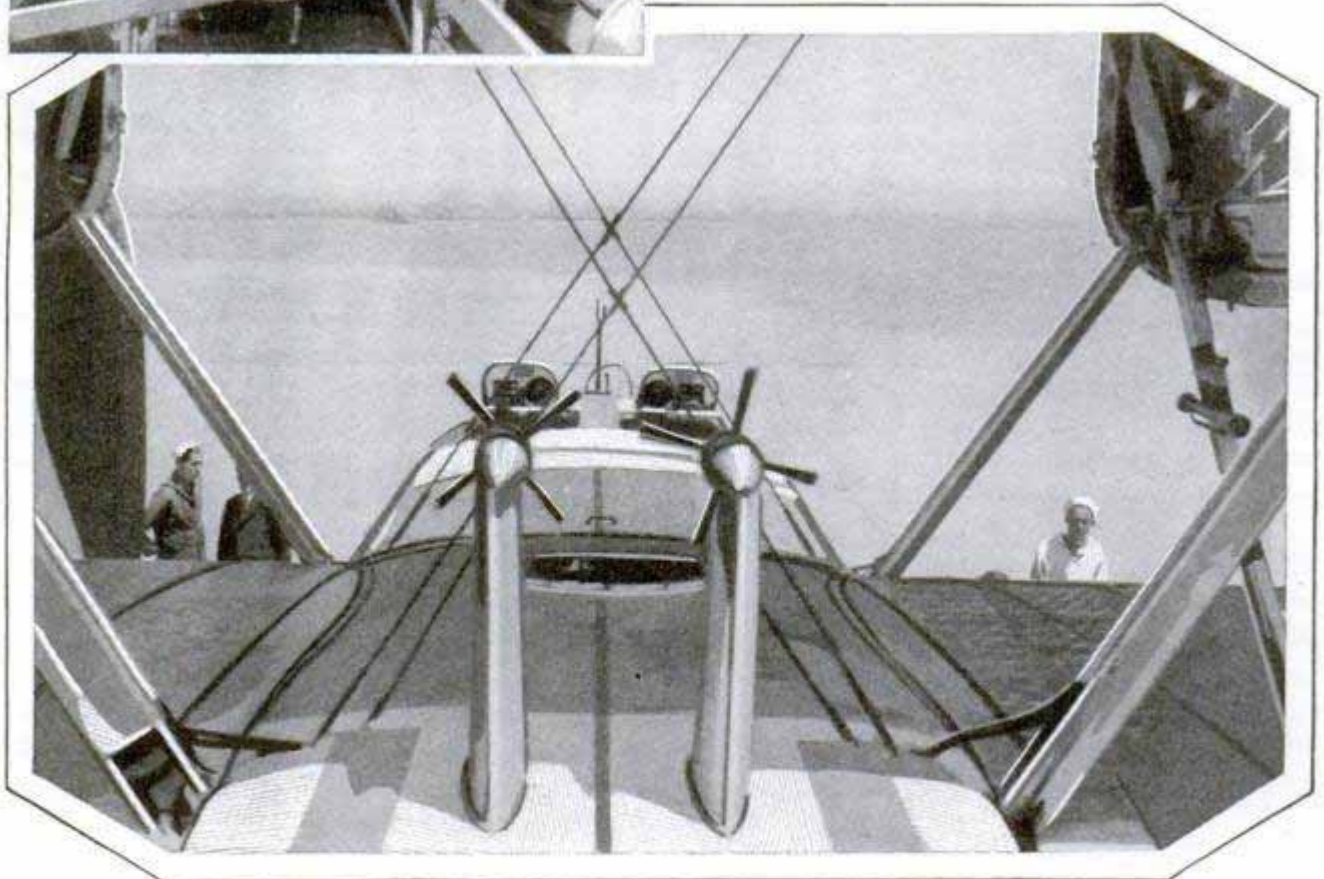

Aircraft Beacon on a Destroyer, Top, and View Looking Forward on a Navy Plane; the Two Propellers Drive the Radio Generators; Pilot's and Avigator's Seats Are in the Ship's Nose



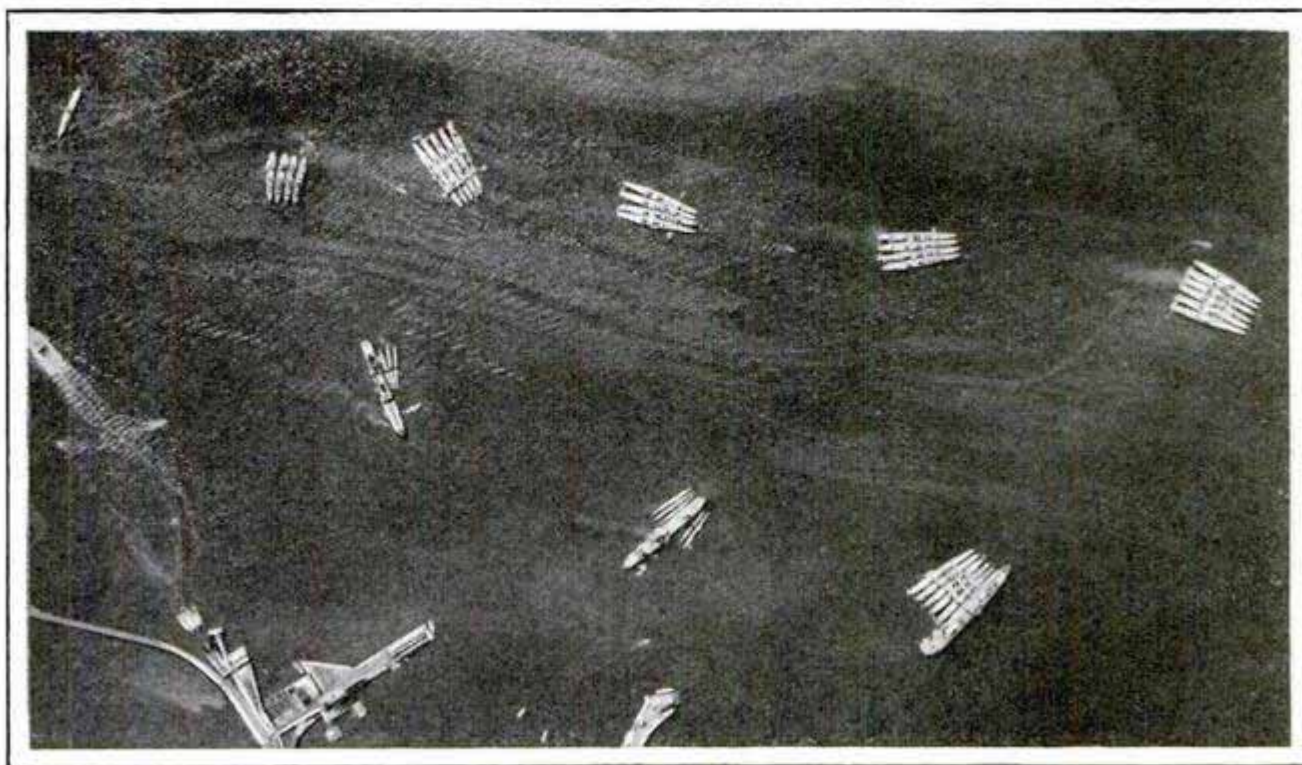

This Is the Way Squadrons of Destroyers, Submarines and Submarine Mother Ships Look When Photographed from 20,000 Feet; There Are Two Mother Ships with Subs in the Center

they are forcibly and mechanically moved about in the lines of force that they develop a current of electricity in themselves.

This principle is made to serve a useful navigational purpose in aviation. The earth is a great electromagnet, with lines of force moving from the south pole to the north pole, along the lines of longitude. Therefore, if a coil of wire, with a central magnetic core, is delicately balanced on a pivot, and charged with electricity from a battery, it will tend to get into a parallel position with the lines of force of the earth. By placing this device in the form of an instrument in an aircraft, and adjusting it so that the indicator must retain a certain position in relation to the course to be followed in flying to some far-distant overseas objective, it is possible to follow a true course straight to the destination, by merely keeping the needle or indicator on the spot desired by constantly heading the plane in such a direction that the indicator will continue to read the course on which it is set. Naturally, the course is also corrected from time to time for drift, the earth's curvature and for magnetic errors in the compass itself, which were found when the plane was swung just before setting out on the long flight.

Avigation by compass, either of the

magnetic or the earth-inductor type, is known as dead reckoning. There are, however, two other forms of avigation, and these, with the addition of compass navigation, must all be used together. By a combination of fortunate circumstances, it may be possible to reach a far objective by dead reckoning alone. The element of chance has much to do with that kind of navigation. In fact, chance is an element in any navigation or avigation, but it is reduced to a very minor factor when to dead-reckoning avigation is added astronomical navigation and radio navigation. The former treats of the stars and the latter of the radio beam or direction finder.

For use in aircraft, a sextant has been developed which can be held while the operator stands in the slip stream. This is the stream of air thrown back by the propeller and it makes difficult any attempt to hold the ordinary sextant. Inasmuch as it is often necessary to take frequent and long sextant observations in order to decide the position of the plane as to latitude and longitude, when the horizon is obscured, the sextant used in avigation possesses long grips and can be held firmly in a violent gale. In a long flight, there will generally be from two to three earth-inductor compasses and from two to four magnetic compasses, including a master



238



Destroyer Radio Operator Sending Out a "Sea Beam" to Aircraft; the Instrument in Front of Him Is the Standard Navy Radio Phone

compass mounted in a non-magnetic tripod in the compartment of the avigator.

Because of the fact that various metal parts of the plane may become magnetized in flight from the action of air and moisture, a pelorus is carried to check on the compasses. This instrument is designed merely to give the bearing of the plane from any object. When the sun can be seen, it is only necessary to take a pelorus bearing to get the plane's true heading.

To obtain the drift of an aircraft, or the rapidity with which stray wind currents are driving it off its course, it is necessary in the day time to use smoke bombs and

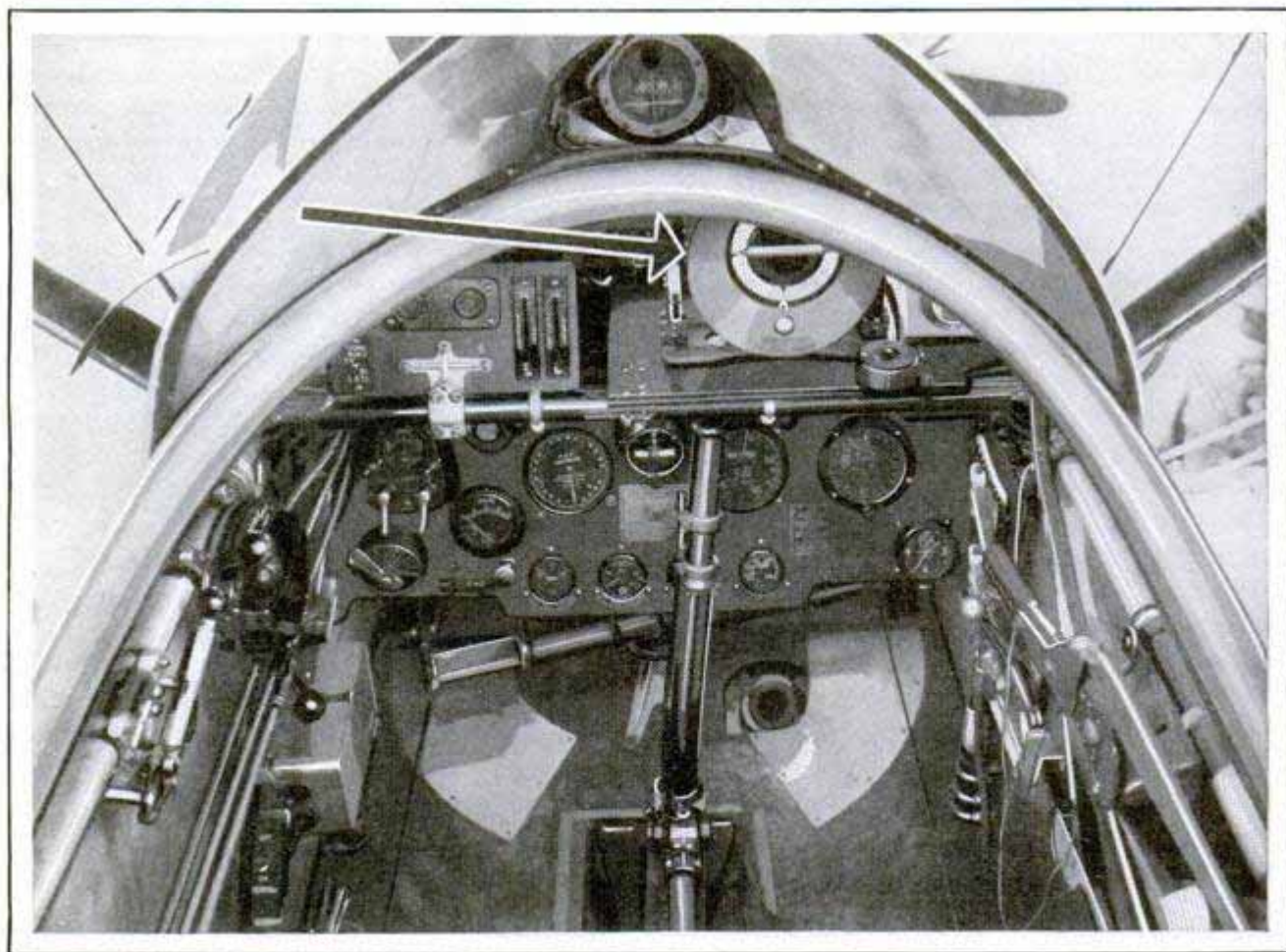

Cockpit of a Douglas Transport Plane; the Arrow Points to a German Bank-and-Turn Indicator Loaned the U. S. Government in Exchange for Avigation Information from This Country



at night bombs which give off light. After passing these bombs as they float on the surface of the sea, the avigator takes a bearing on them from the plane, and thus estimates his drift. Of course, he also reckons his total drift every time he can obtain a "fix" with his sextant, placing him exactly over some part of the earth's surface.

With the radio loop, operated from the point of destination, the avigator holds his plane always pointed toward the direction from which the radio signals come. In the path of such a beam, or "beacon," as it is more properly called, the plane may be kept headed in the proper and desired direction to safely complete its flight, but the method is not as yet as perfect as it might be, and thus all the three major forms of avigation must be used to keep on the safe side.

Though not strictly avigational equipment, the air-speed meter and bank-and-turn indicator in the pilot's cockpit of modern aircraft are of great value in fixing the position of a plane from the avigator's point of view.

If, having obtained the celestial bearings he desires, the avigator finds himself flying over a sea and under an interminable cloud layer, he may plot his position fairly accurately by obtaining his rate of drift by the smoke-bomb method, computing his air speed and the approximate velocity of the wind against him, and taking his course into consideration. A clever avigator will make only a slight error under such a contingency, and this error may be almost entirely the fault of the compass.

**TEAR GAS TRAPS MURDERERS IN JUNGLE VALLEY**

Tear-gas bombs were effectively used in catching a number of natives of the Solomon islands who had murdered white officials. The refugees were cornered in a small valley and quickly surrendered.



Where Part of the Town Used to Be; Hotel in San Pedro, Calif., Stranded on Old Street Level

**HOTEL LEFT STRANDED ON HILL SHOWS CITY'S CHANGE**

For several years, engineers have been engaged in removing hills to make the streets more level in San Pedro, Calif. The vast amount of earth that has been dug away can be visualized from the accompanying illustration of a hotel which stands on the old level.

**MOTOR BABY CARRIAGE SAVES NURSE-MAID WALKING**

Pushed by a motorcycle that has a speed of only a mile and one-half an hour, a baby carriage introduced in England allows the attendant to ride. It is large enough for two infants and is especially serviceable on grades.

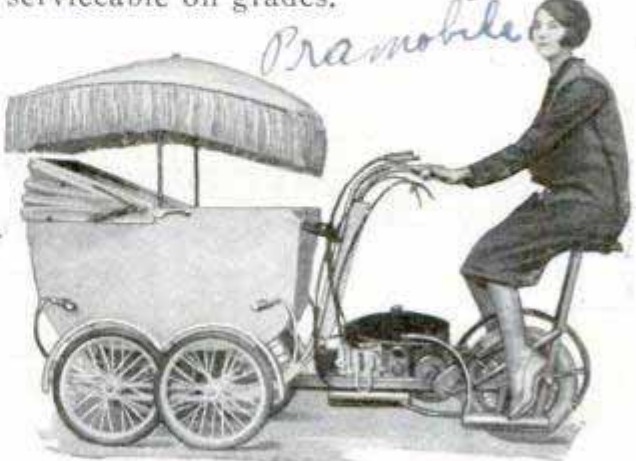

Now the Nurse Maid Also Enjoys a Ride; the Motorized Baby Carriage in Use

*Emb. O. White, 19 Waringah Road, Norman, Sydney, Australia*

*Am. Charles A. Posserman, 614 S Central Ave, Colandale, Calif.*

*Pacific*

*Stinkley's, Ltd.*

*England.*

358

437





"Walking Wheel" for Testing Dogs' Manner of Following Trail; It Was Run on Cable to Eliminate a Human Attendant

### WALKING WHEEL TESTS DOGS IN FOLLOWING TRAIL

That dogs do not depend wholly upon the sense of smell in following a trail has been demonstrated in Germany by means of a curious "walking wheel" that produced imitation footsteps from models of shoes. The wheel was rolled along the ground, imprinting realistic tracks. In several tests, the dogs demonstrated their ability to follow these artificial footsteps.

### SYNTHETIC WEATHER DECIDES QUALITY OF PAINTS

In a relatively few days, men at the bureau of standards determine the quality of paint samples by subjecting them to artificial weather tests. The experiments quickly achieve what would require weeks or years to do under natural conditions. A carbon arc produces the effect of the sun's

rays, and water spray and ozonized air duplicate the action of rains and time. According to the investigators, the results of these accelerated tests are strikingly like the effects produced under actual exposure. Instead of trusting to a visual inspection of the breakdown in the paints, means have been developed for measuring the extent of failure by other methods.

### ICE MACHINE FOR TOURISTS RUN BY AUTO

Automobile touring can now be enjoyed in greater luxury through the introduction of a refrigeration unit on the trailer. The compressor is run by means of a gear and belt drive from the trailer axle. When a sufficiently low temperature is reached, the gear is thrown into neutral. The unit will hold its cold for twenty-four to forty-eight hours, insuring refrigeration for two days while camping. When a longer stop is made, the machine is driven by attaching an extension shaft with proper pulley to one rear wheel of the automobile and using a belt to the trailer.

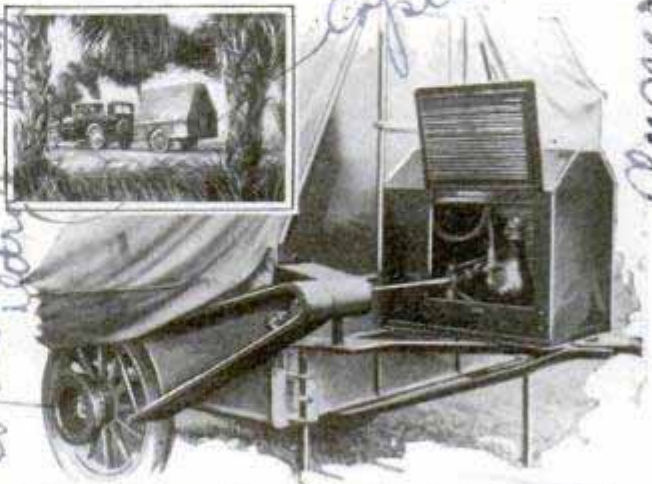

Trailer and Car on Journey, and Method of Connecting Ice Machine to the Axle

*P. H. Walker*  
*U.S. Adm. 5/4/23/28*

*Burlon*  
*Evchamg Products Co. 630 44-100*

*411*  
*W. G. Maxwell, 745*  
*manlius, Ill.*  
*owner - Mr. and Mrs. Capeland*

*installed by B. I.*



368

**LENGTH OF PLANTS' WORKDAY SPEEDS THEIR GROWTH**

By subjecting them to batteries of powerful electric lights from five to twenty-four hours at a time, various kinds of plants have been grown at an unusually rapid rate at an eastern experimental institute, and interesting facts have been learned concerning their behavior under these artificial conditions. It was found, for instance, that the tomato would not stand twenty-four-hour continuous illumination, but red clover grew well, lettuce and radishes flowered on day lengths greater than twelve hours and buckwheat on all day lengths from five to twenty-four. The percentage composition of starches and sugars manufactured by the plants increased with day lengths usually up to a nineteen-hour working day. In a few plants, it increased up to a twenty-four-hour day.

**KEYLESS TUMBLER DOOR LOCK HELPS PREVENT THEFT**



Designed on the principle of a bank-vault lock, a combination unit for the house, garage or other door has been introduced. It has no key, is said to be pick-proof and is simple to operate. Although it may be set to any one of many combinations, there are but three numbers to remember and the lock may be opened in four seconds or less. An additional feature is that it may be easily manipulated in the dark, as the audible "stops" of the mechanism enable the operator to turn it properly and a notch permits finding the neutral starting position without difficulty.

*Hudley Lock Corp.*  
*26 1/2 Franklin*

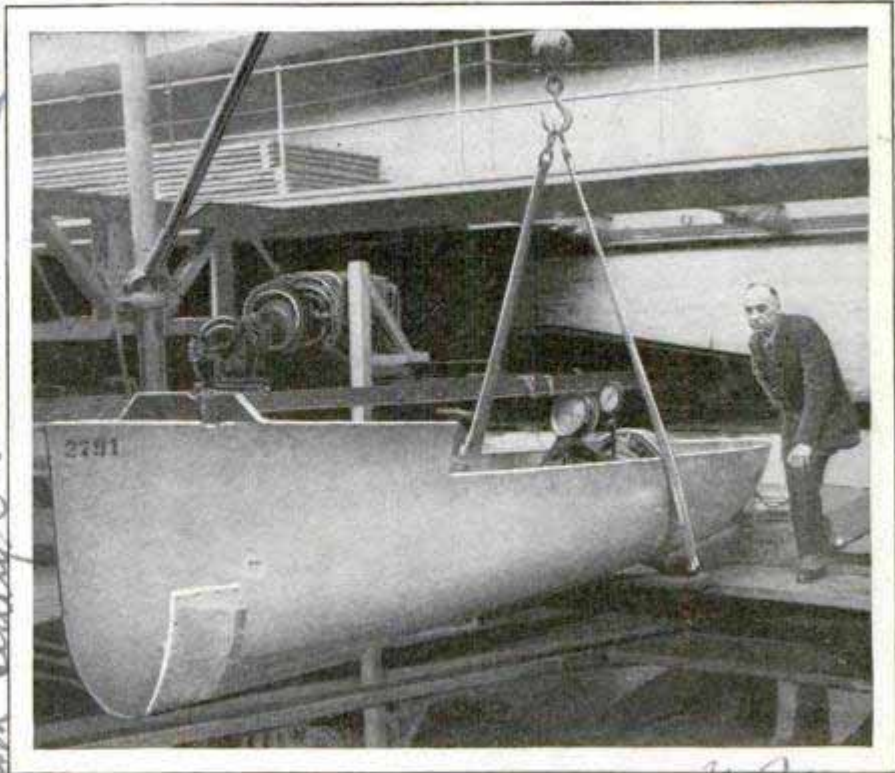

Model of Fast Steamer That Is Expected to Make Trips across the Atlantic in Four Days

**MODEL OF FOUR-DAY LINER TESTED IN TANK**

Voyages across the Atlantic in four days are expected in fast steamers now being planned by an eastern company. Each ship will be able to carry 800 first-class passengers and will have a speed of thirty-three knots or about thirty-eight miles an hour. A model of one of the steamers was tested recently at the Washington navy yard.

**SCRUB BRUSH OF STEEL WOOL SIMPLIFIES CLEANING PANS**

Long strands of steel wool have been fashioned into a brush for scouring pots and pans. Since the points of the wires are applied to the surface to be cleaned, a more effective performance is assured than when the wool is employed flat, as in the ordinary sponge arrangement. As the strands become worn, they may be pulled out from the holder until they are entirely used up.



*Whiskette Mfg. Co. Phila*  
*3240 N. 13th St.*

*Described by Mr. John M. ...*  
*Wrote before natural ...*  
*From Daily Science ...*  
*Spring 1900 ...*  
*Cylinder \$5.00 ...*

*Trans Oceanic Corp.*



526

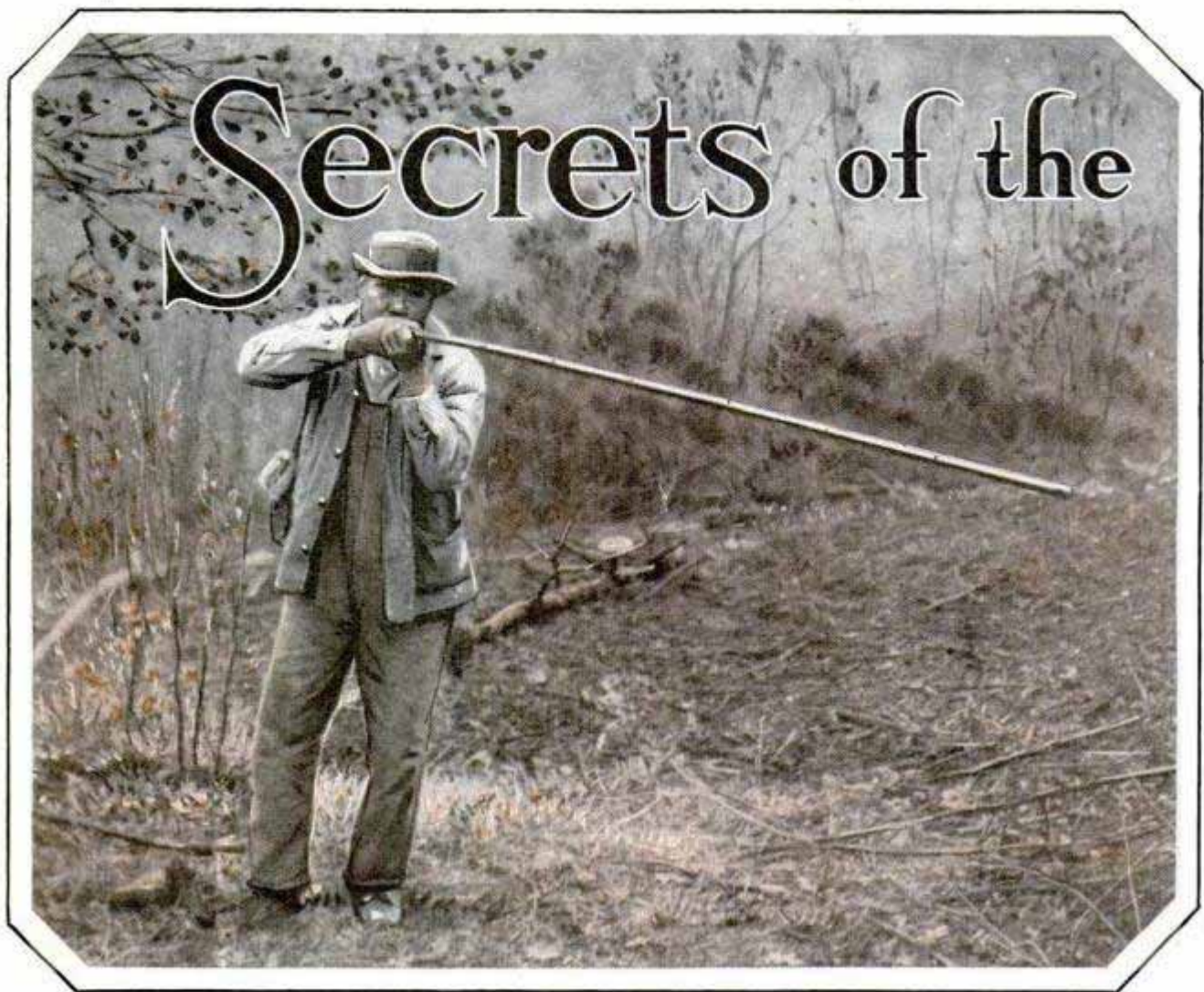

# Secrets of the

A Cherokee Indian of the North Carolina Smokies Shooting an Arrow from a Ten-Foot Blowgun; the Older Indians of the Proposed National Park Cling to the Ancient Weapon

By BOB BECKER *of Association of Commerce, W. S. La Salle, Chicago*

**I**N the Great Smoky mountains of North Carolina persists a remnant of primitive Indian culture which better than anything else shows what advances have been made in the mechanics of firearms. This throwback to savagery is the Cherokee Indian blowgun, a curious and little understood weapon which had its origin (in the western hemisphere) in the Indian tribes of South America.

The blowgun is just what its name implies. As made by the Cherokees of the Great Smokies, it is a long hollow tube of bamboo cane, usually nine to ten feet in length and bored out and polished so that the tube will offer little friction to an arrow. Through this weapon the Cherokees blow slender missiles ranging in length from eighteen to twenty-four inches. They are feathered with thistle-down. No tips are fitted to these arrows.

The Cherokees simply whittle them down to a sharp point, and they are ready for use. The average layman, viewing this strange outfit whose efficiency depends on a healthy pair of lungs, cannot believe that small mammals and birds can be shot by the blowgun, and at first thought, it does seem strange that kills can be made by anything so fragile and apparently so devoid of shocking power. But the fact remains that the Cherokees have been using this blowgun over a period of several centuries as a weapon of the chase, and many a rabbit, squirrel, dove, grouse or other small game has gone into their cooking pots via the blowgun route, even though the mechanics of blowing an arrow with enough force to kill still is something of a mystery.

The Cherokee blowgun is in a perfect setting, as far as the wilderness and the



# Great Smokies

primitive are concerned, for the eastern band of Cherokees who use this weapon live in one of the least known, least traveled and possibly least appreciated areas of the United States. The motion-picture director assigned to film the story of the Cherokees would call the atmosphere perfect, the locations superb and the scenery almost incomparable because these eastern Indians live on the North Carolina side of the Great Smoky mountains, an exquisitely beautiful range which Uncle Sam is going to take over as a national park. The last stand of the eastern wilderness, a natural wonderland with seven peaks higher than Mt. Washington in Vermont, a hundred square miles of virgin timber, numerous picturesque streams, rivers and waterfalls and scenery comparable with that in our national parks of the west—the Great Smoky national park will have, as an additional feature, the presence of 2,800 Cherokees and their curious blowguns. A bit of the old in a rare setting of the primitive.

Bryson City, N. C., is the natural gateway to the Indian reservation where you find Cherokees who own and use such guns. This little town of 1,200 people is fourteen miles from Indianland. Trailing the blowgun, we first visited the store at Cherokee in the reservation, a central meeting place of the Indians from which news and messages can be sent by the grapevine route to members of the tribe living back in the mountains. Here we met Jack Gloyne, the white storekeeper, who put us in touch with various Indians owning blowguns and who secured a guide and interpreter for us, as many of the old Cherokees do not speak English.

At Cherokee, you are in the beginnings of the Great Smokies. The only roads are those which wind and twist through the valleys. Above you are the hill and mountain crests, round-topped and forested. Log cabins of the Cherokees perch high up the mountainsides, some hidden away



An Indian of the Great Smoky Mountains with His Bamboo-Cane Gun, through Which He Blows Arrows Feathered with Thistledown, to Kill Small Game



in "hollers" (valleys), so that you need a guide to find them; others quite lost in the timber far from the auto highway or well-beaten paths. Occasionally the valleys are broad enough to give the Cherokees a flat piece of land for their cornfields. But horizontal fields are not the general rule. The blowgunners will clear a steep mountainside and on the slope they will plant their corn in long, looping horizontal rows, much like the Aymara Indians of Peru till the mountainsides overlooking Lake Titicaca. Agriculture is not

easy down there in the Great Smokies. We had to walk a number of up and down miles (mostly up) to get our first glimpse of a blowgun. With Jim West, our guide and interpreter, we started north from Birdtown—a small Indian settlement on the reservation—following an ever-ascending trail past small cornfields, cabins whose shy occupants gave us no chance for conversation, across small clear brooks and then straight up through the forest to the home of Samson Welch, a sixty-year-old Cherokee who is a famous

blowgun shooter. Samson was building a corncrib on the mountainside. Although poor in worldly wealth, many a white man would give thousands for this Indian's view of valleys, forested slopes and mountain ranges, as we could look from Welch's lofty perch for miles across the Smoky country. Welch brought out his old blowgun and two arrows to show us how the weapon worked and to demonstrate his skill. The gun was so old that the yellow tint of cut bamboo cane had turned to a rich brown or mahogany color. On a former hunt, the gun had

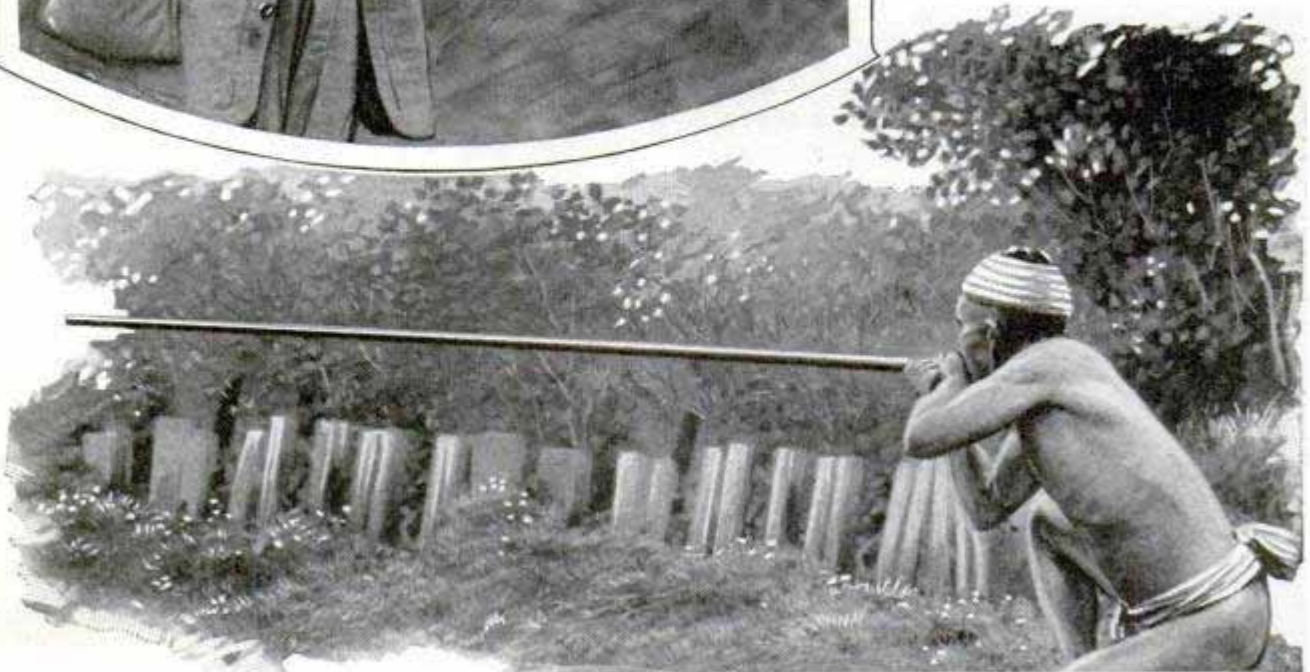

Half the World Apart, but Using the Same Technique; Above Is a Cherokee of the Carolina Mountains and Below a South Sea Islander, Both Using the Same Hold to Aim Their Blowguns



been cracked, so the Indian had wrapped it with stout twine. Notwithstanding this fracture, the gun shot perfectly, as was then demonstrated.

We set up as target a piece of paper, five by two inches, and asked the Indian to shoot at it. For the moment we almost forgot our curiosity in the speed or accuracy of an arrow, because our attention was taken by the position assumed by the Indian in shooting. You would imagine that the right hand should grasp the gun at the breech while the left hand stretched out to take hold of the gun much like a rifle shooter holds his rifle by the forearm. But no! Welch pressed both hands close to his mouth, took a deep breath and—plup!—the small arrow feathered with thistledown shot from the blowgun and struck the target in the center. He was standing forty feet from that piece of paper. By way of proving that the first shot was no fluke, he slipped the second arrow into the breech of the gun (slightly



larger in diameter than the muzzle), drew another deep breath and then blew sharply through the gun. Plup!—quicker than the eye could follow, the second arrow whizzed through the air and struck the paper target within an inch and a half of the first.

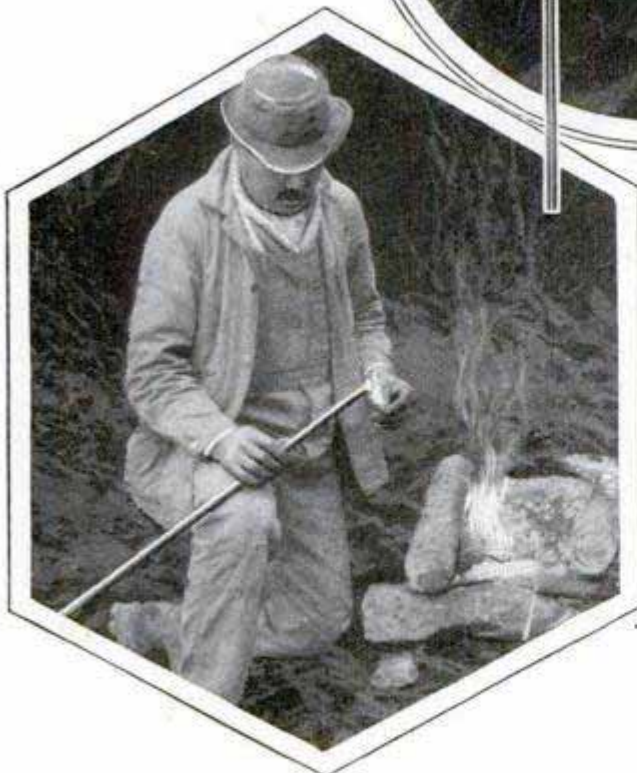

Making a Blowgun Dart; First the Thistledown Is Bound in Place, Then the Loose Ends of Fiber Are Burned Away; Center, the Finished Product

The Cherokee then explained, through the interpreter, one or two of the tricks of this curious weapon: First, a smooth bore, and, because this smoothness is desirable, an old gun which has seen considerable use and has been kept clean is almost preferable to a new one. Second, feathering of thistledown thick enough to completely fill the bore of the gun, so that you cannot blow around the arrow. Third, a dry barrel and a dry arrow, for the blowgun of the Cherokees is pretty much of a fair-weather gun. Fourth, a quick blow through the tube; in other words, exhaling a deep breath quickly and with all your lung power gets force and distance. As Welch explained, the ordinary killing distance of the blowgun is around forty, fifty or sixty feet. He told us that just once in his life had he



bagged a turkey with his gun. As a rule his game is squirrels, rabbits and partridges.

Inasmuch as Indian arrows are usually finished with feathers, the Cherokee blowgun arrows, feathered with thistledown, represent a unique departure in the manufacture of Indian hunting equipment. To make an arrow, the Cherokee proceeds as follows: Removing the outer covering of the pod of the thistle, the silky material is held in one hand while, with the other, he plucks out the seeds. Then, after manipulating the packet of down so that it can be wrapped around the shaft of an arrow, he fastens the down to the shaft by means of stout thread, wrapping the latter round and round the base of the down. The first installment tied on, another chunk is laid on the shaft just above it, and so on up the shaft, until five or six inches of this fluffy, silky feathering is on the arrow. A twist of the arrow to shake out the loose thistledown, and the dart is ready.

Although the art of making blowguns and the old-time skill of the Cherokees in using this primitive weapon have been on

the decline during the past few years until there is grave danger that blowgunnery may soon be a lost art in the Great Smokies there is hope for the perpetuation of this accomplishment in the proposed Great Smoky mountain national park. It is believed that, with the establishment of this magnificent eastern playground, plus the presence of thousands of summer visitors to the Great Smokies, the Cherokees will be stimulated into a wider use of the blowgun. The weapon is bound to interest anyone who sees it, and once the Cherokees are shown how the sport of blowgun shooting may be promoted with benefit to their purses, it is more than likely that they will take up the manufacture of this weapon, recover their lost proficiency with it and stage not one but several blowgun tournaments each year, which should attract many visitors.

The Great Smoky range is a notable spot with its many high, forested peaks, some of which haven't even a horseback trail to their wilderness isolation. This imposing range forms the framework for the new national park, half in east Tennessee and half in western North Carolina,

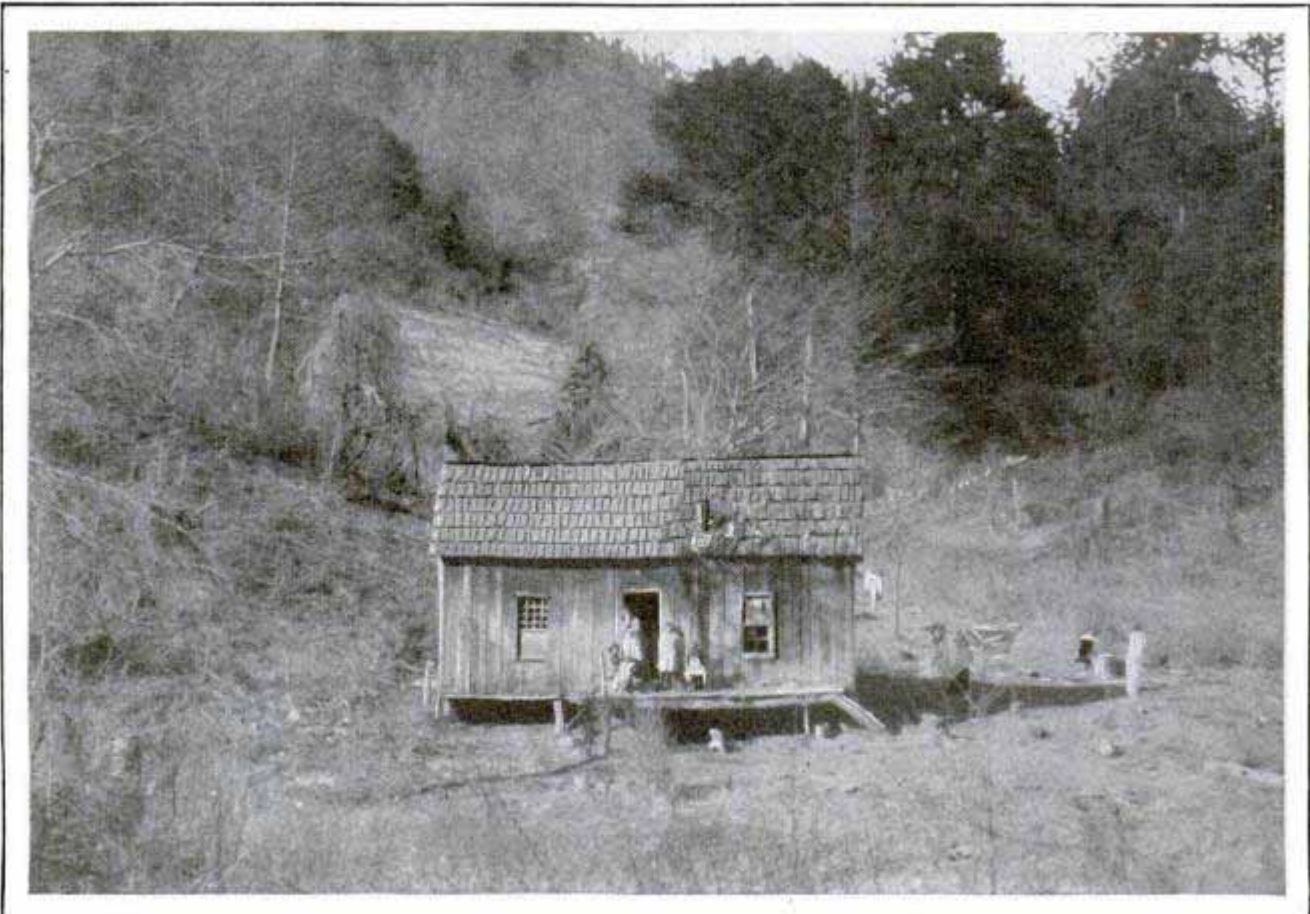

Typical Mountain Cabin in the Great Smoky District, Where a Vast Area of Virgin Wilderness and Magnificent Scenery Is Being Planned as an Eastern National Park



632. *Samuel*  
*mfg Co, 1504 S*  
*31 Akard St*  
*Dallas*  
*Texas.*

and that the park will be established is practically a certainty, since the Laura Spelman Rockefeller foundation has given \$5,000,000 toward the project. This sum, with the millions which Tennessee and North Carolina are furnishing, will enable the backers of the project to go ahead. And Uncle Sam is not only willing, but eager, to see this eastern wilderness, rich in natural beauty and in history, conserved and at the same time made available as a playhouse for the American people in a section lacking in this respect.

A park containing 428,000 acres of virgin forest, covering a saw-tooth, winding range of mile-high mountains over which a smoky blue haze seems to linger always—this is what the park will be at first. Later, it is planned to increase its size to 704,000 acres. Picture in this great forested area, the ancient home and hunting grounds of the Cherokees and still the home of those interesting whites known as the mountain highlanders, 137 species of trees and 174 species of shrubs; imagine, if you can, the turbulent trout streams, cascades and waterfalls which add their charm to the mountain valleys; picture that dreamy blue haze over peaks and bridle paths that climb through age-old forests; assemble these features—and you can visualize the charm of the Great Smoky range which is going to be the heart of the proposed national park.

**ANIMALS' EYES TELL THE TIME ON NOVELTY CLOCK**

Eyes serve as dials in novel animal-shaped clocks now on the market. The pupils rotate, that of the left eye showing the hours and the one on the right, the minutes. The clocks are hand-carved from natural woods. Marks are used to designate the numerals and the changing expression creates great amusement.



Electric Ice Shaver, for Preparing Drinks and Refreshments at Booths

**AUTOMATIC ICE SHAVER CUTS COST OF DRINKS**

For preparing various kinds of drinks and other refreshments, an electrically operated ice shaver has been introduced. It reduces waste, saves the time of one man and requires practically no attention once it is set in operation, as the block of ice is held firmly against the shaving blades until it is used up. Current is furnished from a lighting socket.

**STEEL THAT WON'T WEAR OUT TO IMPROVE AUTOS**

A new nitrated steel, which is comparatively impervious to wear, is expected to prolong greatly the life of automobiles and other machines. Chrome and nickel steel, compared with the new product, are said to be like putty. According to one test, an automobile cylinder of cast steel showed wear of forty per cent after the car had been driven 18,630 miles, while a cylinder of nitrated steel had worn but two per cent. It is believed that use of the metal will result in the elimination of cylinder linings and saving in oil.

*each hand \$17.00*  
*both hands \$20.00*

*announced by Prof*  
*Smillet, Director Central*  
*Academy of Science, Urbana*

*Stein & Alboogen mfg. J. Oswald*  
*Chicago*



*owned by Malcolm Winter Haven Fla.*



© Dahlgren

The Outboard-Motor Boat, Built with Stepped Bottom on the Hydroglider Principle, Just as It Left the "Springboard" for Its Thirty-Five-Foot Leap

### BOAT LEAPS THIRTY-FIVE FEET IN MOTOR TEST

The power of outboard motors was strikingly demonstrated at a recent exhibition in Winter Haven, Fla. With a running start, a small boat was sped to an elevated platform from which it hurtled through the air for a distance of thirty-five feet. The craft was piloted by an eighteen-year-old boy.

the wings. This acts as a fatal guide, tending to steer the plane toward the ground or sea, in spite of the efforts made to counteract its effect. Before the "Bremen" left, extensive experiments were staged to test the efficiency of the oil.

### RADIO AMPLIFIER FOR PHONE LATEST AID TO THE DEAF

Quickly attached to an ordinary telephone receiver, an amplifying unit permits persons with defective hearing to enjoy conversation with much less difficulty. The device is simply a special input transformer with standard radio tubes and batteries.

### PARAFFIN ON AIRPLANE WINGS PREVENTS ICE FORMATION

Paraffin oil spread on the wings of the "Bremen" played a large part in the recent air victory over the Atlantic, according to flying experts. The substance prevented the formation of ice, the pilot's most dreaded enemy next to fog, as the plane passed through storms. Besides adding dangerous weight to the flying craft, the ice has a tendency to form a protruding, curving edge on the rim of

One set of dry cells and a twenty-two and one-half volt B-battery are said to last approximately one year. In connection with the amplifier, a loud-speaker horn may be used where privacy is not desired. This allows persons with normal hearing free use of both hands while answering the telephone, as it is not necessary to hold a receiver to the ear.



Radio Comes to the Aid of the Deaf in Telephoning; the Amplifying Unit in Use

*to be verified in Chicago, 159 N. W. Taylor, 159 N. W. Taylor, 159 N. W. Taylor*

*632*

*491*

*\$45.00 for a set*

*Acrophone*

*Christian Science Monitor*

*4/21/21*

*The Barton Co.*

*512 210, 22nd Place*



Chief Spectroscopic Laboratory  
Bureau of Standards  
POPULAR MECHANICS  
WASHINGTON D.C.

RARE METAL IS FOUND  
IN SUN

637

Hafnium, an element discovered in Denmark is present in the sun, according to special photographs made of that body. This is determined by examining the light produced by the substance under an apparatus that splits light rays into their constituent colors, or spectrum. Hafnium produces in this a characteristic pattern of bands whereby it can be identified in examining the light from the sun. Although the substance is believed to be more plentiful in the earth's crust than lead or tin, it, so far, has been obtained only in small quantities.



Printing Campaign Photographs of Al Smith

TARGET FLAGS SCORE  
AUTOMATICALLY

402

In addition to showing the score of the shots, an automatic target, being tested by the French army, tells if the bullet strikes above or below or to one side of the bull's-eye. This is accomplished by small flags that spring out from the side of the target. They are actuated by the bullet striking against steel rings back of the mark itself. These rings are so connected to levers that they cause the proper flags to appear at the border of the target.



Side View of Target and Flags Exposed

RAPID PHOTO PRINTER HELPS  
POLITICAL CAMPAIGN

Large-sized photographs are printed quickly and evenly in a special reel apparatus devised for turning out pictures in great numbers. The paper is handled as a continuous sheet, like a roll of film, saving the manipulation of small sections. After the reel has dried, the photos are cut and pressed.

RED DOT ON AUTOMOBILE TIRES  
GUIDES IN BALANCING

Many persons have been mystified by the presence of a small red spot on the side of balloon tires. The mark looks as though a drop of paint had been splashed on the rubber by mistake, but there is nothing careless about it. In fact it has been placed to show exactly where the valve should be fixed in order to maintain balance in the tire. This is done to prevent "shimmying," the weight of the valve being sufficient to throw the tire out of balance if it is wrongly located. The mark is made on the lighter side of the casing.

From H. St. Clary. 4/12/28

La Scene de Vie P. 261

M. Anton Vanger  
Norwegian

Photo Products  
The Art of Photo Products  
New York  
1776  
roadway

Chicago Tribune 3  
4/22/28



508

605

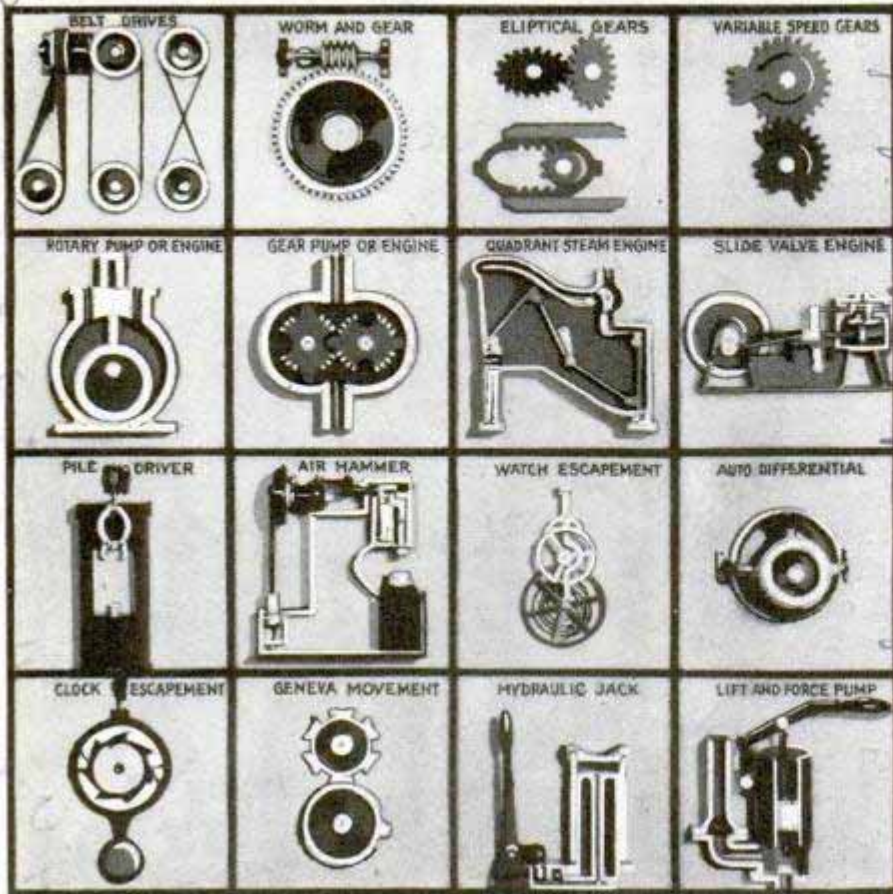

One of the Exhibits in the Mechanical Museum; a Display of Models Showing How Various Machines Actually Work

### HIDDEN RIVERS ARE EXPLAINED BY NATURE OF SOIL

Underground rivers are explained in three ways, according to geologists who have studied these oddities of nature. Some are caused by water seeping through porous limestone rock and running under the surface, to collect and reappear again. Others originate in sandy and gravel districts where the stream sinks through the loose upper strata. The third cause is found in volcanic areas where sections of lava have been submerged and then become porous on cooling. This spongy material allows the water to trickle through the upper layers and flow along natural fissures until it may emerge again as large springs or streams. Such underground rivers are common in Idaho, Oregon and California. Their course is sometimes traced by putting dyes into the water.

*Julian S. Sears, U.S. Geological Survey*  
*Chas. P. Berkey, Prof. of Geology and Mineralogy, Columbia University, New York*

### MARVELS OF MECHANICAL AGE EXPLAINED IN MODEL SHOW

Do you know how the starter starts the car? Exactly how an automobile engine operates? How a steam engine uses the same steam three times? These, and many other interesting questions concerning the working of mechanical units of everyday life are answered in an entertaining exhibit of models, which has just been prepared. The collection is a group of easily understood pieces, accurate in every respect, but minus the complicated features that often perplex the layman. Included in the exhibit are models illustrating the action of different types of gears, the fundamental mechanical principles, clock movements of various sorts, automobile parts, steam engines, and many other articles. The collection will be taken around the country for exhibit in many places.

### DRIVER CONTROLS REAR SHADE 622. TO STOP GLARE

So that the automobile driver can raise and lower the rear curtain himself to keep out the glare of headlights, a simple cord control has been introduced. It can be installed in any closed car in a few moments, is durable and certain in operation.

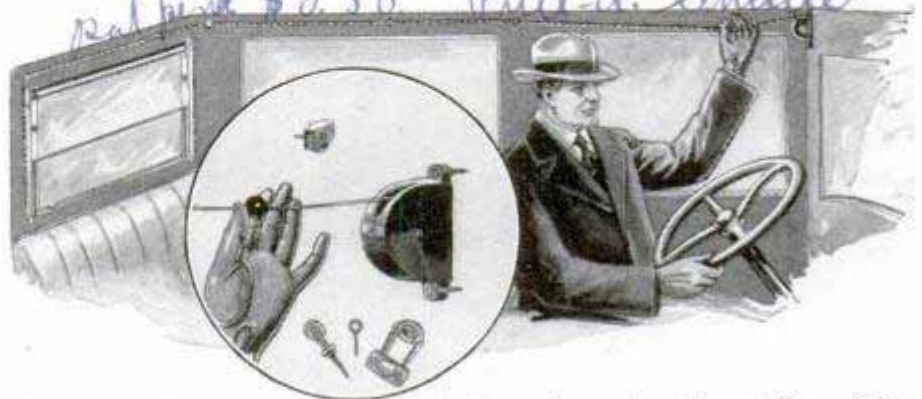

Drawing to Show the Shade Cord in Operation, and a Closer View of the Pulley Attached at Front of Car

*Ren Mfg Co., Lyceum Bldg, Worcester, Mass*



3 21 Welcome to Monterey  
 Button Co, Haydenville, Mass  
**DIVING for SEA FOOD**



Abalone Diver with His Net Basket, Ready to Descend to the Sea Bottom; Most of the Divers Are Japanese; They Pry the Mollusks Loose from the Rocks with an Iron Bar

By H. H. DUNN

2722, Prince St  
 Berkeley, Calif

**V**ARIED and valuable are the harvests of the sea, some of them a bit weird, such as the cuttlefish, sting rays and sea cucumbers, of which thousands of tons are gathered every year for sale in oriental markets. But diving for shellfish for food supply is one of the most unusual, and is carried on in only one place in the world—Monterey bay, on the coast of California.

In the south seas, and off the shore of Lower California, men in rubber suits, lead-soled shoes and real iron hats, descend hundreds of feet for pearls, throwing away the oyster in which they are found.

At Monterey, similarly equipped divers walk the bed of the ocean, 125 to 150 feet below the surface, prying shells, the size of dinner plates, from the rocks, to sell the abalone "steaks" contained therein for forty to sixty cents a pound, and the pink, green, black and gray shells for \$4,000 to \$5,000 a ton.

From these shells come blister pearls, where the single-shelled mollusk has

sought to protect itself from an intruding worm or bit of gravel. These blisters are of small value, and are sold with the run of shell, but now and again a real pearl, usually pink and of fine luster, is found in the flesh of the abalone. These have sold as high as \$1,000 each, and as low as \$5. So important is the abalone, for food and shell, that the state fish and game commission is experimenting with the planting of the mollusks in suitable places along the rock-bound coasts of central and northern California.

Nearly 3,000,000 pounds of abalone steaks and several thousand tons of shell were taken from Monterey bay in 1927, without visible diminution of the supply, so when I stepped to the deck of a fifty-foot motorboat for a day with the abalones, I moved into as well established an industry as that of the cod fishers of New England. Directed by Americans, the majority of the abalone fishermen are Japanese, including the divers. A sixty-horsepower oil engine drove the motor-

Abalone jewelry  
 H. H. Wessendorf Co. Angeles  
 734 S. San Pedro St. Calif



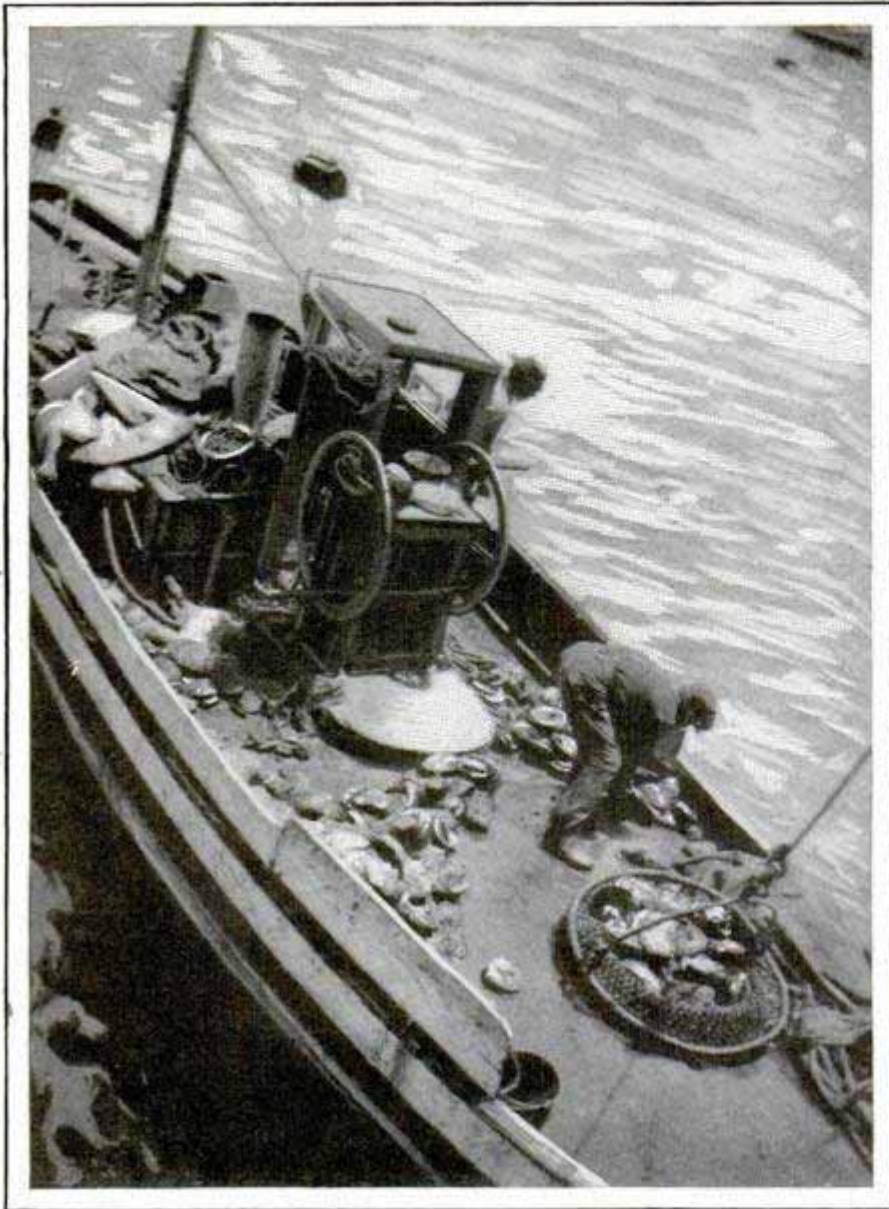

Two Men Watch the Air and Life Lines, While the Diver Is Below, and Pull Up His Filled Basket

boat and, towed behind, were two twenty-five-foot skiffs, each with a small gasoline engine, with emergency oars lashed to the gunwales and a stationary air pump set amidships.

Imato and Gono, divers, lounged aft on the mothership, while, in the wheelhouse, the five members of the crew and the captain were finishing breakfast. Out to sea the captain turned "Anna's" nose, the diving skiffs being dropped more than 100 feet behind on the towline. In a little more than four hours we were a mile off a group of rocky peaks rising like jagged lumps of coal from the sea.

The motorboat stopped, dropped anchor, and pulled the skiffs alongside. Imato and Gono slipped each into a skiff and began putting on the diving suit, first

the eighty-pound rubber combined trousers and shirt, then the shoes, weighing twenty pounds each, and the belt, with 150 pounds of lead hooked to it, like a bandolier full of cartridge clips. Each of these ten-pound weights could be unhooked and thrown away, in case a shark or an octopus became too attentive and immediate rise to the surface would be necessary. Last of all, the two assistants in each skiff fastened on the helmet, all metal and weighing seventy pounds.

The air hose was tested, and the rope running with it carefully hooked into a shoulder plate, so that no strain would come on the small rubber tube at the point where it entered the helmet. The great glass eyes were wiped off, the signal and haul-away lines run out to eliminate kinks, and the air pump started to test the supply which must be the diver's only link with life for four to five hours. To do this,

the small gasoline engine was disconnected from the propeller of the diving boat and hooked up to the air pump.

In the middle of his belt, well back on one side, each diver carried a brass scabbard, packed with grease, into which was thrust a knife with a blade fourteen inches long, two-edged and sharper than the proverbial razor. Thus equipped—and carrying a basket and steel prying bar—Imato descended slowly. A man stationed himself at the steadily running air pump, watching the reserve tank which maintains a steady pressure of sixty pounds, so that, should the pump break down, enough air would be on hand to last the underwater worker until he could be pulled to the surface.

Another man held the signal cord in





Removing the "Steaks" from the Abalone Shells; an Active Diver Will Bring Up a Ton or More of Meat a Day, and the Product Sells at Forty to Sixty Cents a Pound Wholesale

one hand and the haul-away line in the other, while the inch-thick rope, by which the diver would be lifted from the twenty fathoms of water beneath us, lay across a chock in the gunwale, where both men could reach it instantly. A line of bubbles showed the course of the abalone hunter. In a very few minutes, two jerks on the signal cord set a third helper to hauling away on the basket line. In it came, packed with two dozen abalones, none less than eight inches in diameter.

Below, the abalone diver has his troubles. He must pass through forests of kelp, whose "trunks," firmly grown to the rocks, often are more than 100 feet long, tough as leather, resilient as rubber, and seemingly eager to wrap themselves around any moving thing that touches them. This, of course, is all in the diver's imagination, but a man, once entangled in kelp, is in a difficult and dangerous position, from which he has to cut himself free, all the time keeping careful guard that he does not foul his air line, and that, by his active movements, he does not attract the attention of some huge octopus or wandering shark.

Abalones prefer the grassy sides of rock and gravel slopes near the kelp beds, and

often the largest are found in the very midst of the kelp forests, which cover thousands of acres of sea bottom off the California coast. The abalone feeds through six or more holes in the rim of the shell, just above the lip. Having clamped itself to a rock by its huge foot, which covers all the open side of the shell, the mollusk pulls water through these holes, ejecting it the same way and taking out whatever suitable food supply may be carried therein.

Since the shells of all the abalones of commercial size and age are completely covered with barnacles, small plants and sea anemones, the diver must know what he is looking for, and be able to see it amid surrounding rocks covered with exactly similar growth. In the dull light under the water, this is particularly difficult, but the capable abalone diver has no difficulty in earning \$25 or more a day of five hours. Since the open season covers nearly ten months of the year, he is permanently employed, and receives, as annual wages, probably more than any other follower of the deep-sea diving business.

Once he finds an abalone, the diver, with one quick motion, thrusts his pry bar under the thick edge of the shell. If the



shellfish senses the approach of an enemy, and clamps its shell firmly to the rock, the diver might just as well pass on to the next abalone, because this one will not release its grip for several hours. The gripping power of an eight-inch abalone has been estimated at 300 to 500 pounds. One strong man, with both hands caught, provided he could save his fingers, would have difficulty in lifting an adult abalone from its rock without the aid of a bar. With one hand, he has no chance.

Rough water is another serious condition confronting the diver. One would believe that the sea at a depth of 125 to 150 feet would be quiet, but under certain conditions the tides and currents set sand and mud in motion to such an extent that the diver cannot see the bottom, far less pick out grass-grown shells among other ocean-bed vegetation. In such cases, the diver calls for a lift and is hauled to the surface, whereupon the diving boat is moved to another location, often a matter of many miles, since the abalone is never found on sandy bottom, but only on rock and gravel beds.

When the abalones are taken to shore, as we took ours after the two boats had accumulated a little more than four tons, the meat is removed from the shells, averaging about nine pounds of steaks to the dozen mollusks. The shells are then spread out to dry, whence they go to make jewelry, for which there is a large demand; blister pearls being cut out and made into pendants, watch fobs, tie pins and brooches, while the less brilliantly colored parts of the shells are converted into knife and manicure-instrument handles, souvenir spoons, ladles and paper knives. The occasional pearls found go to enrich both finder and cannery owner, since the price usually is divided between the two.

After the meat has been removed from the shell and the foot and other inedible parts are cut away, the remainder is thoroughly washed in fresh water and passed to a long table, where men with sharp knives dexterously separate the white meat, or steak, from the dark. The latter is canned, or dried, largely for shipment to the orient. The white meat is then sliced to proper thickness by a ma-



Abalone Diving Is Done from Small Boats, Towed to the Edge of the Fishing Grounds by a Motor Craft; the Fishing Crew Then Rows In among the Rocks to Drop the Divers



1499.

chine. Thereafter it is sent to the pounders. These are men equipped with wooden mallets, with which they pound each steak on a hardwood block until the flesh is soft and tender. It is then packed in ten-pound boxes for shipment to the sea-food restaurants, where demand is considerably greater than supply.

### FIT SHIPS WITH TWO RUDDERS TO STEER BACKWARD 614

Big boats for service across the English Channel are now being fitted with a rudder at the bow as well as one at the stern, so that they can be more easily steered out of harbors. The craft are often too large to turn around in the harbor and it is difficult to maneuver them backward. With the bow rudder, however, the task is much easier. When going to sea, the main helm is put amidships, and the ship is steered from the after bridge, employing the rudder at the bow. When out of the harbor, the engines are stopped, the captain and officers go to the main bridge and operation becomes normal. To prevent confusion and reduce the danger of collisions, ships navigating backward are required to carry two black balls on a mainmast yard, as a signal that their usual starboard and port sides are reversed.



How Man Learned to Use Wings; a Successful Flight Was Made Recently with Lilienthal's Glider

### FRANCE HONORS EARLY AVIATOR WITH MUSEUM MODEL

One of the original gliders made by Otto Lilienthal, famous German pioneer in aviation, is to be duplicated in a model ordered by the French government for exhibit in the national air museum at Meudon. That Lilienthal was a skilled designer of wings is proved by the fact that

one of the first gliders he made was successfully flown just recently. It weighs forty-four pounds and can be folded up. The daring German kept his balance in the air by shifting his weight. One day, a sudden gust upset the experimenter and he was killed, but his findings contributed much to the later success of motor aircraft.

### VISIBLE PULSE RECORD TAKEN WITH ELECTRICITY 362.

A visible record of the action of the pulse for any desired period, is obtained without discomfort to the subject or tedium to the observer with an electrical instrument developed in Germany. Levers attached to the patient's wrist move with the pulse beats, causing an electric circuit to be opened and closed, thereby intermittently actuating the recording apparatus which inscribes the curve on a roll of paper.



Recording Pulse Beats on Paper, for a Longer and More Accurate Study of the Heart

Electricitäts-Gesellschaft 'Eantis'  
Berlin 24. Hermannstr. 100.



3842



Testing Special Fire-Escape Ladder, Which Is Held to the Wall to Prevent Swaying

### WALL-GRIPPING FIRE LADDER PREVENTS SWAYING

Greater security is offered in using a fire-escape ladder introduced in England for permanent installation on homes and factories. Its rungs are held firmly to the wall by means of metal projections which keep it from swaying. It is less conspicuous than other forms of fire escapes.

### SPRINGS ON TILTING AUTO SEAT ADD TO COMFORT

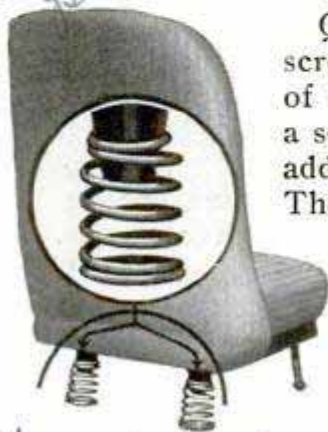

Quickly slipped on or screwed to the bottom of the automobile seat, a set of durable springs adds to riding comfort. They rest on the bottom of the car to take up bumps and vibrations, and can be fitted to almost any type or make of car.

Universal Spring Co.  
Elwood, Ind.

### BROWN EYES WITHSTAND GLARE BETTER THAN BLUE

606

In a few generations, almost all persons will have brown eyes, a London specialist predicts. He bases his theory on the fact that brown eyes are better adapted to strong lights than blue, and that nature will therefore produce a brown-colored iris in the eyes of people who habitually face the strong illumination of artificial lights. Natives of the tropics have dark eyes, he points out, to shield them from the glare of the sun, while inhabitants of northern latitudes have gray or blue eyes, better suited to the less intense natural light in those regions. The eye was not intended for the uses which civilization demands of it, the doctor holds, and, consequently, a natural change to fit the conditions will occur, or individuals will have to wear goggles with colored lenses.

Harvard City Star 4/19/28

### SCRATCHER CLEANS FILTER BED TO PURIFY WATER

496

Time and labor are saved in cleaning filter beds that purge the water in an eastern city, by using a special tractor. At its front are a series of rotating heads with sharp teeth that penetrate the filter sand. These heads turn in opposite direc-



Tractor Water-Filter Cleaner, Showing the Long Teeth That Stir Up the Sand

tions as the tractor moves slowly along. The sand, thus stirred up, is further cleansed by drawing off the scum and other impurities in somewhat the same manner as a vacuum cleaner sucks up dust. Only two men are needed to operate one of the tractors. The machine cleans a swath eighty inches wide at a speed of fifteen feet a minute.

2504 hand  
\$2.00 - \$3.00 for 4



580

# PORTABLE SEARCHLIGHT HELPS AIRPLANES LAND

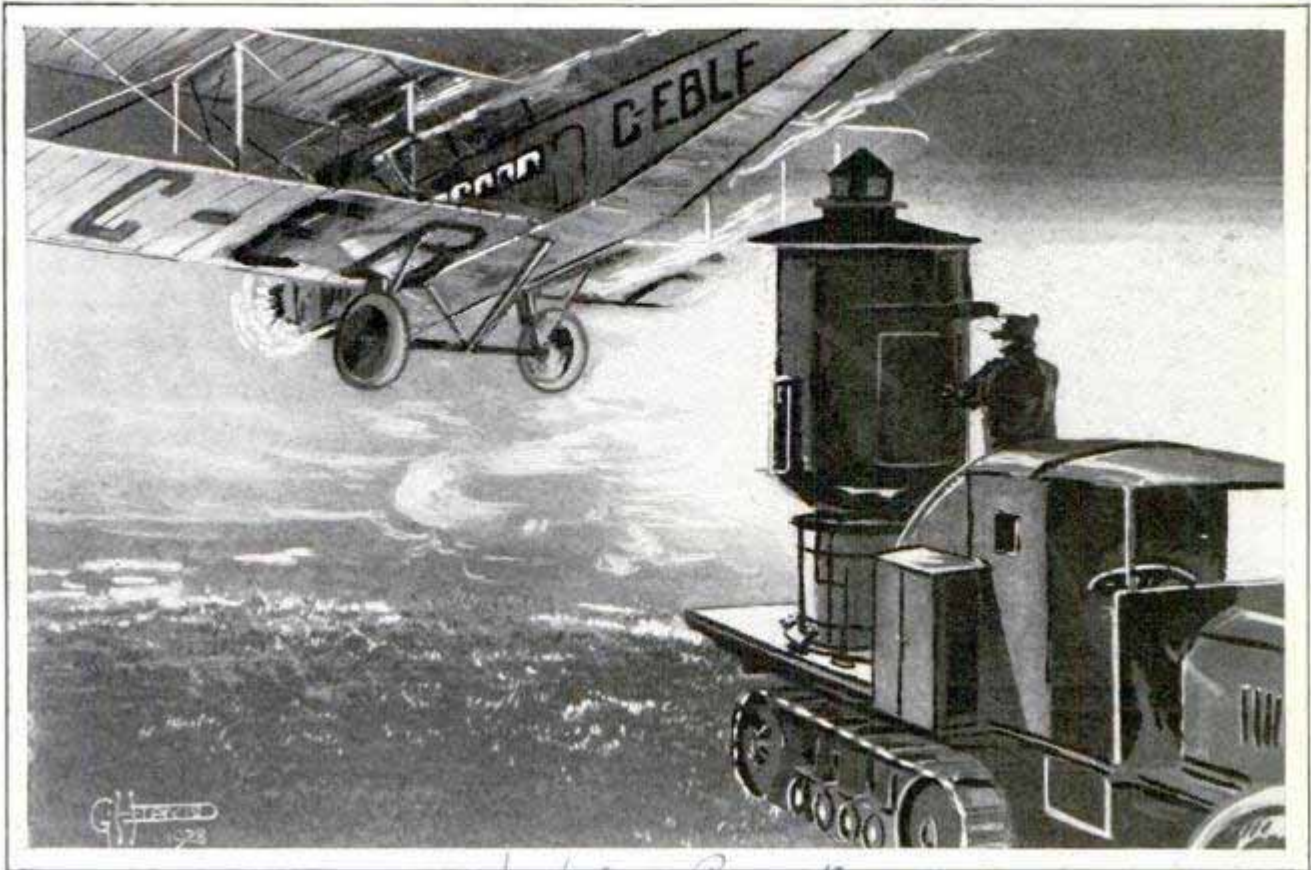

Courtesy The Illustrated London News

3/3/28 0529

Portable Landing Beacon, Mounted on an Endless-Tread Tractor, Used at Croydon Field, London, to Enable Planes to Land at Night; the Beam Is Pointed into the Wind

A million-candlepower beam of light, moved at will about the field on a truck, enables trans-Channel air liners to land safely at Croydon field, the London airport. The motor truck is driven across the field when a plane approaches and takes up its position at the down-wind end of the runway. When the beam flashes on, the pilot circles around behind the searchlight, and then glides in, coming down with the light behind him and the broad illuminated path stretching, clearly defined, ahead.

ance of greater space between them and enables the eye and the camera to follow them correctly. On buggy wheels, four sets of two spokes each were painted out, using different shades.

## FRUIT-JAR TOP AS MOUSETRAP IS ALWAYS SET

462

By substituting a special trap lid for the ordinary top, a glass fruit jar may be used effectively for catching several mice. A swing door in the lid falls back, so that the

## PUZZLE OF WHEELS IN MOVIES SOLVED BY PAINTING

610

In moving pictures of a buggy, wagon or similar vehicle in motion, the wheels sometimes appear to turn backward instead of forward or to be stationary. This is due to the fact that the movement of the spokes is too slow to be synchronized with the rapid, separate exposures on the film. The difficulty has been corrected by the simple expedient of painting out groups of spokes. This gives the appear-

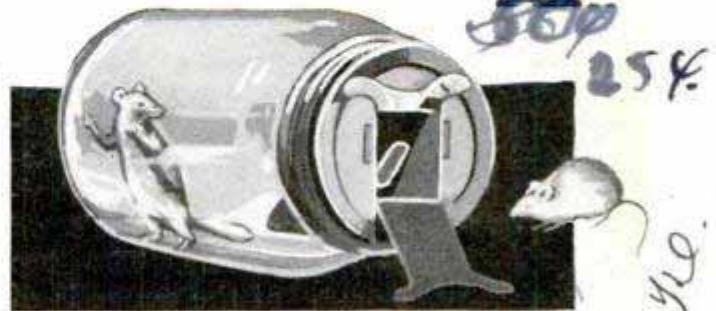

Fruit Jar Converted into Mousetrap by Attaching Special Top; the Trap Is Always Set

mouse cannot escape, but is in position to catch another. The device is sanitary.

John Nicholas, head

Metro Goldwyn Mayer Sanitrap Mfg. Co.  
 137 1/4 2nd St. N.Y.C.  
 6/3/27



Ventura Blvd

Russelheim, Bavaria

Germany

381 Reseda Calif



Both Sides of the Newspaper Column Are Cut at Once with This Timesaving Unit

### CUTTER FOR NEWS CLIPPINGS SUBSTITUTE FOR SHEARS

For cutting out newspaper clippings, a double-bladed instrument, somewhat like a pair of calipers, has been introduced as a substitute for shears. It may be set to different widths, there are no parts to get out of order, and an evenly trimmed clipping is obtained.

### METER SHOWS TIRE PRESSURE WHILE INFLATING

Inflate-Meter



Attached to the air hose where it can easily be read, a meter shows the pressure in the tire and also in the supply tank. This saves using separate gauges, insures greater accuracy and eliminates loss of meters. The top of the gauge is of unbreakable glass, and a hook provides a convenient rest for the hose when it is not in use.

### AUTO RUN LIKE A ROCKET DEVELOPS HIGH SPEED

396

A speed of sixty miles an hour was attained eight seconds after the start, with an automobile propelled on the rocket principle, using the recoil from explosives, according to reports of the tests in Bavaria. Powder was employed as the fuel. Small charges of it were fed into a chamber fitted at one end with a series of plates which allow the gases to escape slowly. The recoil impulse from the entire chamber was applied as power directly to the axles. Engineers see a further practical application of this method of propulsion to a rocket that might be shot from Europe to America carrying mail. Already, rockets have been sent to a height of six miles with a speed of several hundred miles an hour and tests with larger ones, that are expected to ascend sixty miles with apparatus for recording temperature and air conditions, are planned. It is also believed that the rocket idea could be utilized in a motor for airplanes. The engines could be made lighter and flights would not be affected by atmospheric conditions as they are at present.

Kant Hall Mfg Co.

### TRANSOM ADJUSTED TO CHAIN 1932 AND THEN LOCKED

Opening the transom to just the angle desired has been simplified by the chain adjuster shown here. A pull on a handle brings the frame down, and locks it in position when the chain is released. The attachment is easily fitted to most transoms.

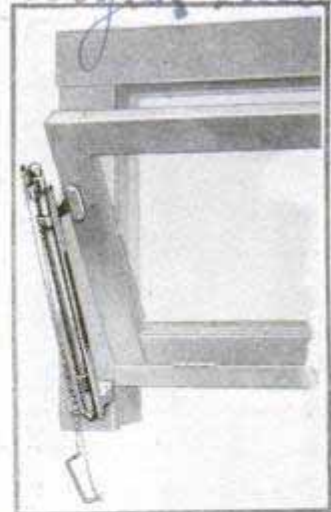

The Popular Mechanics Bureau of Information offers its free service to all readers of this magazine. Names and addresses of manufacturers and dealers in articles described, and any other details in our possession, will be promptly furnished by addressing the Bureau.

Illinois - Walter - d Bowles, 31 S. Douglas St., Springfield, Ill.

Specialty Manufacturers Inc.

Post 158



# ICE from an OIL WELL

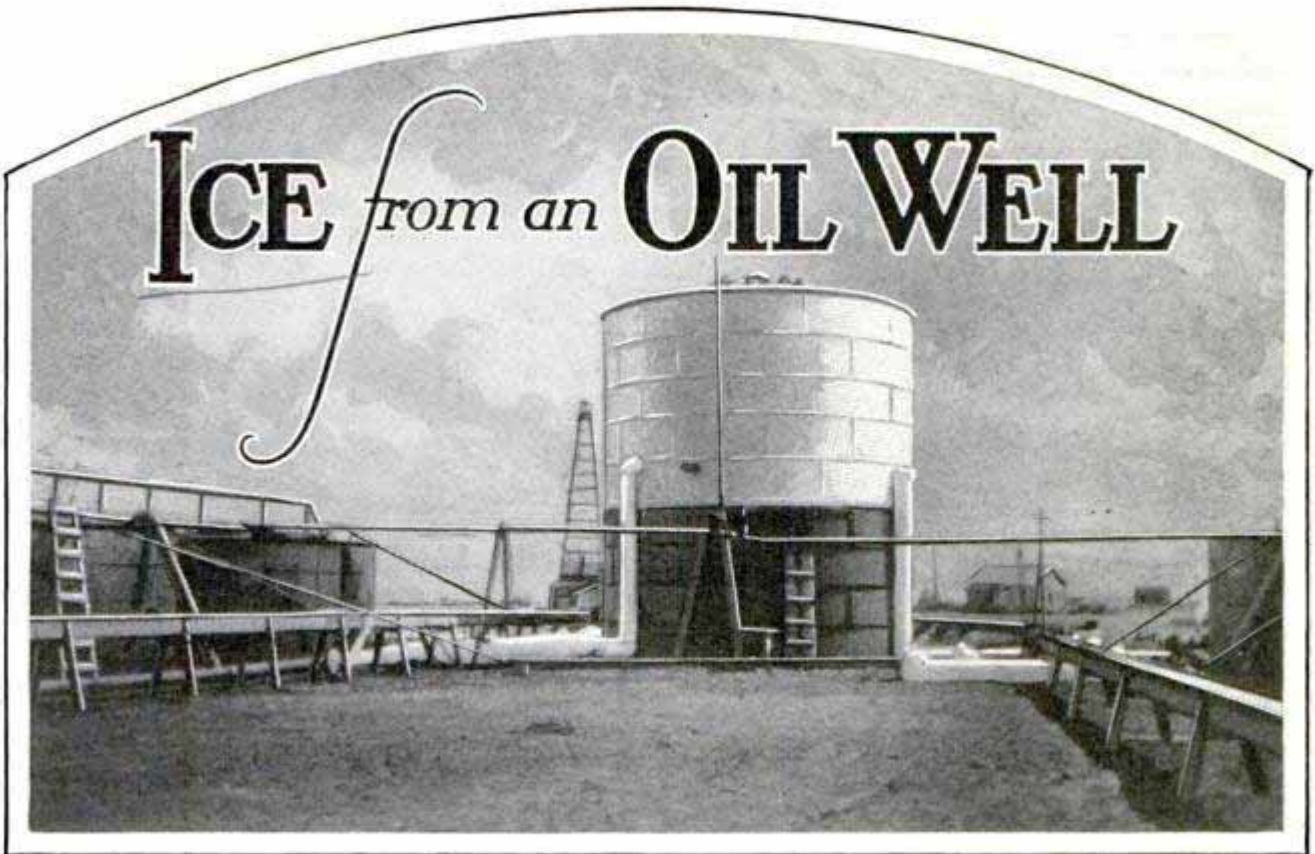

Storage Tank and Pipe Lines Coated with Frost at Freak Well Whose Output Has Such a Low Temperature That It Freezes the Water Out of the Air When Brought to Surface

**C**OMMERCIAL ice from an oil well? In northern Colorado there is one whose output is like nothing encountered by drillers anywhere else in the world. This freak well is the discovery hole on the North McCallum dome, a Jackson county structure being developed by the Continental Oil company, of Denver. On the charts the producer is labeled "Sherman No. 1." In the vicinity it is better known as the "Ice Cream" well.

From its deep bore pours a frozen mixture of gas and oil that reaches the surface at a temperature of 126 degrees Fahrenheit below zero. By a wide margin, the oil holds the record as the coldest that ever came out of the ground.

The well is unusual in several other respects. Its derrick floor is 8,240 feet above sea level. From this elevation the bore goes down 5,130 feet, giving the well the distinction of being the deepest oil producer in Colorado. Another unusual feature is that the oil is straw-colored and so clear that a person looking down into a filled 500-barrel tank may count the rivets on its wall.

This producer is located in a region not particularly inviting to the seeker for oil. Winter temperatures range to 25 below

zero and water lines have to be buried seven feet to get below the freezing zone. Snow often blocks the highways and, in midwinter, the district is likely to be shut off for periods of several weeks, excepting for the train that is supposed to make three trips weekly from Laramie, and quite often manages to fight through the deep drifts.

When the well was brought in, the frozen gas-oil mixture shot high above the derrick and descended in an icy cascade. Soon the derrick was heavily coated by the stuff and the ground near by was covered with frosty heaps.

A week passed before the drillers were able to install high-pressure fittings and put the flow under control. This delay made it possible for residents of the vicinity and visitors from Denver to come to gaze upon the geyser that spouted from nearly a mile below the surface. They speculated with interest upon the strange performance, but arrived at no explanation why the gushing stream should try to imitate a snowstorm.

It was noted that the light-yellowish oil gave the heaps on the ground a creamy tinge. This suggested to some visiting spectators the ice-cream nickname for the





well. Several weeks later, an analysis of the gas in the mixture had been completed. It showed eighty per cent of carbon dioxide, and the presence of a small percentage of helium has caused government chemists to make further tests. The efficiency of carbon dioxide as a fire extinguisher forms the basis of one of its commercial applications.

With the well under control, the producers faced the problem of making use of their peculiar product. It was necessary to evolve an economical process for thawing out the mixture and separating the gas from the oil. There were no precedents. Oil drillers had struck carbon-dioxide gas on a few previous occasions, but never before had it been encountered in combination with oil.

W. H. Price, of Casper, Wyo., finally worked out the successful separation process now in use. The mixture runs from the well head into a 1,500-barrel tank, the leader pipes entering the tank eight feet above the bottom. Into the lower part of this tank other pipes convey live steam under pressure. The ends of the

oil and steam lines turn after entering the tank, causing a swirling motion that aids the thawing process.

The shutting in of the well, even though it stopped the spouting forth of that "snow" from 5,000 feet underground, did not reduce Sherman No. 1 to the appearance of an average gusher. The icy coating on the derrick and the frozen heaps on the ground melted away, but there still remain visible evidences of the "Ice Cream" well's individuality.

No visitor to the site fails to note the jacket of ice that incases the fittings at the well head and covers all pipes leading therefrom and the whole upper part of the near-by separator tank. The ice is as ever-present as in a refrigeration plant.

Now, a way is being sought to find a profitable use for the carbon dioxide. The quantity of wasted gas is estimated at 30,000,000 cubic feet daily, far more than sufficient to supply all the soda fountains and other users of carbon dioxide in the United States.

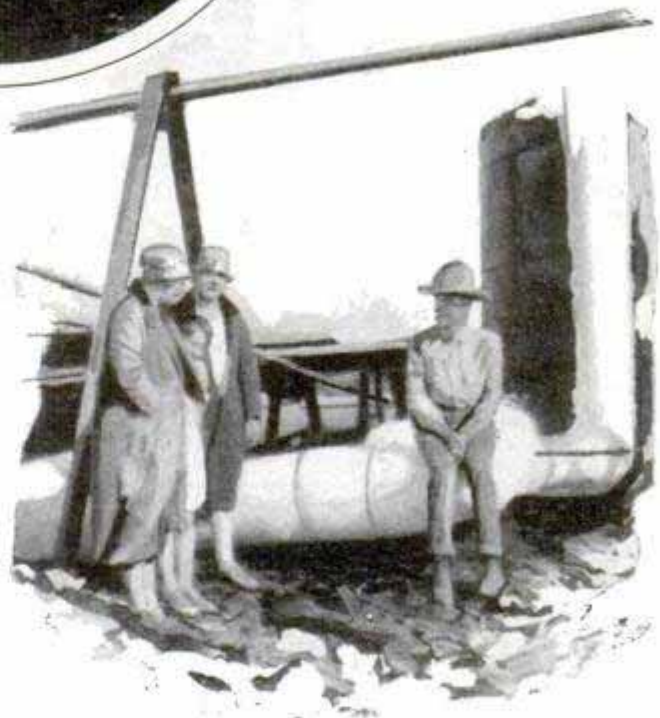

The Freak Well, Frozen Valves, and a Cool Seat for One of the Workmen While Resting



**SHIPS KEEP CATS TO CURB RAT MENACE** 625

Almost all the larger Atlantic liners now carry a regular force of cats to wage constant warfare against rats and so protect the cargo and reduce the likelihood of spreading disease. The number of cats kept on a ship varies from ten to twenty, depending upon the size of the vessel. The animals are housed in various parts of the steamer and appear on the rationing or feeding books, the same as sailors and passengers. The best cats are allowed anywhere except the run of the first-class cabins, but the slower animals are confined to the hold or steerage. At the end of the voyage, they are given a short holiday and are often seen on deck, basking leisurely in the sun.

**GRIP FOR DRUMS TO PREVENT ACCIDENTS** 760

Metal drums, containing heavy materials and weighing as much as 850 pounds each, are sometimes difficult to handle but the task has been simplified with a special lever-grip pole. To a hickory shaft, five feet long, an adjustable hook has been attached to afford a grip on the projecting rim at the head of the drum. A heel engages one of the annular flanges on the side of the container. With this tool, one man can tip up and handle a heavy drum with little difficulty and with much less danger of incurring an accident.

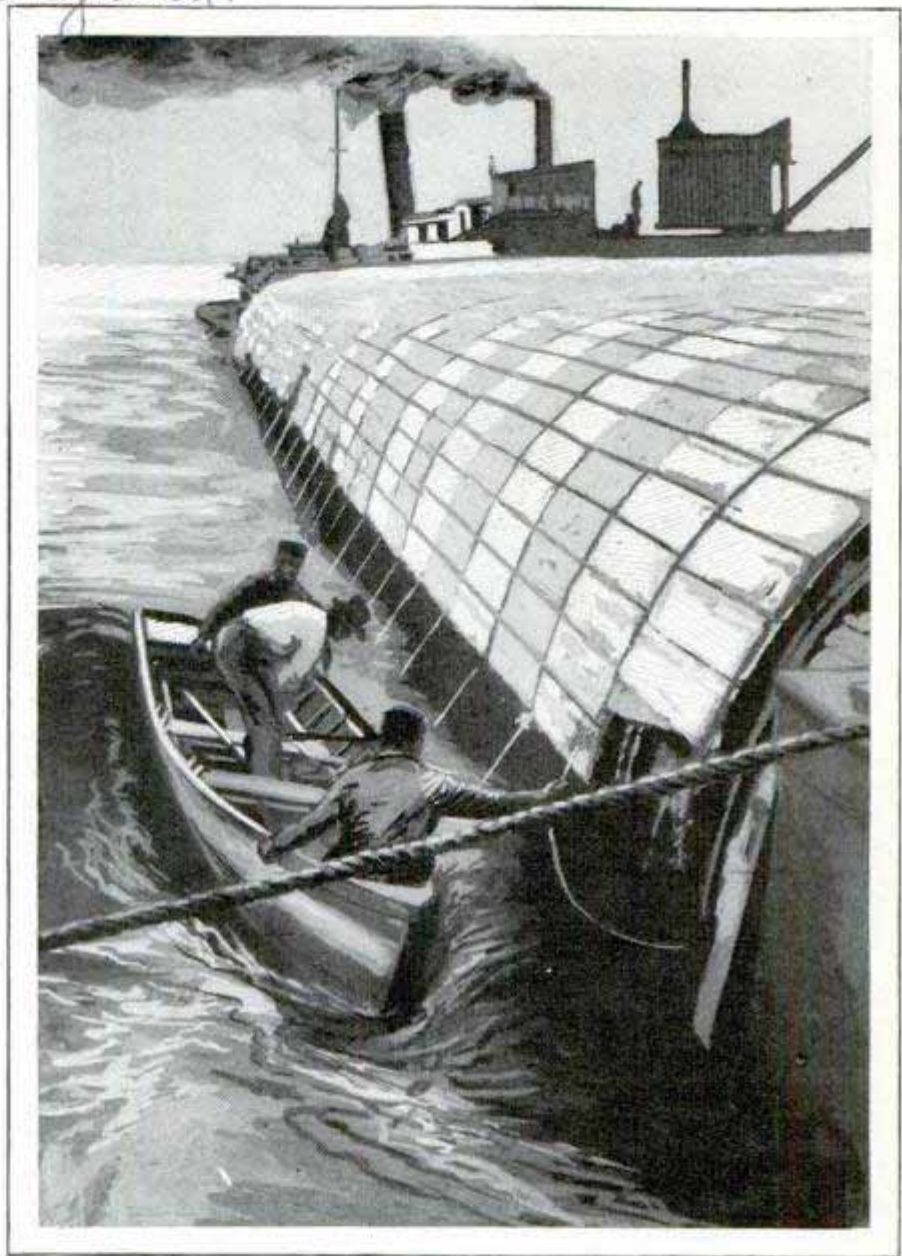

Courtesy Engineering News-Record  
 Shielding a Levee with a Concrete Mattress; a Large Section of Cement Blocks on Flexible Reinforcing

**LAY CONCRETE MATS IN RIVER TO CURB FLOODS** 470

By strengthening the banks and levees of the Mississippi river with concrete mattresses, large sections of slabs connected by wire reinforcement, engineers hope to prevent breaks and consequent floods. The mats are made on special barges from which they are launched and sunk until a protective floor is laid from 200 to 300 feet out into the stream. Sinking crews can place an average of 70,000 square feet a day, or about a mile of river a month. The cost is approximately \$225,000 a mile, somewhat cheaper than willow mats. By this means, river control can be achieved in a reasonable time, engineers believe.

*Dr. Seth S. Sigbee,  
 841 S. Tancred St.*

*Engineering News  
 Record 3.18.28*



46  
247

168 Marlborough St.  
Boston, Mass

WHERE HUMAN BEINGS SERVE AS BURDEN CARRIERS

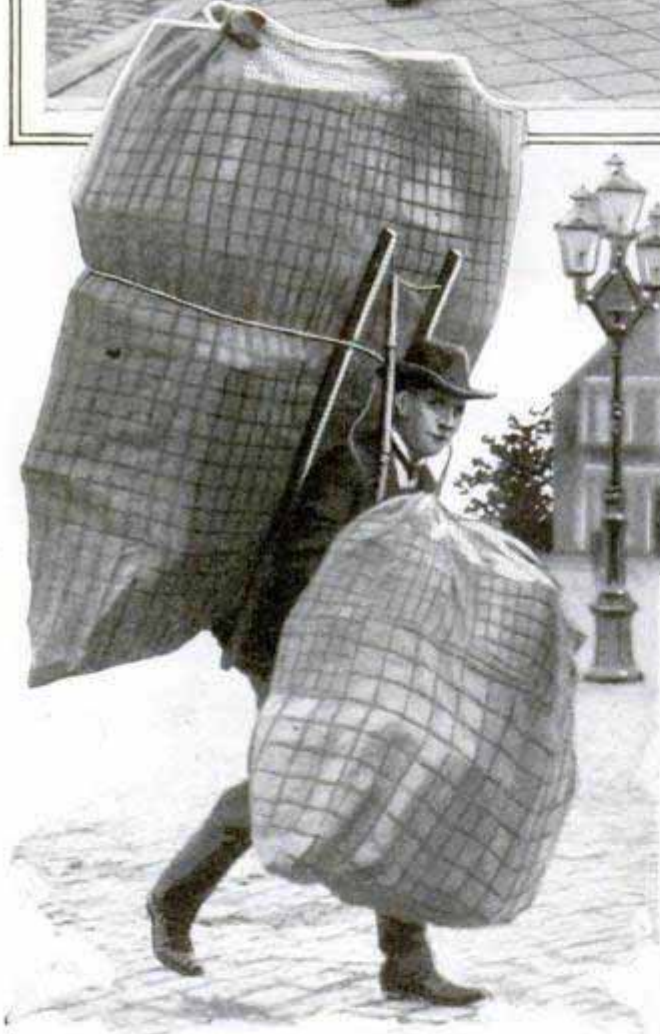

In Lichtenfels, Upper Franconia, the Center of the Basket-Weaving Industry in Germany, Workers Carry Their Products under Canvas Covers to Hide the Patterns from Competitors; Upper Left, a Human "Van" with a Load of Flower Baskets



The Load Is Light but Bulky and Requires Expert Packing to Prevent Damage to the Goods; the Man Above Is Delivering an Order to a Wholesaler and, at Right, Old Woman Peddling Her Wares to Country Customers; Nearly Everyone in Lichtenfels Knows How to Make Baskets



430 Wabash Ave  
Chicago 90

G. H. Withington  
Los Angeles, Calif

**BASS VIOL MADE OF ALUMINUM WARP-PROOF**

608

Aluminum is used instead of wood for the body of a bass viol now on the market. The instrument has a deep, rich tone, will not warp or crack, weighs only about one pound more than the wooden instrument and can be handled with less difficulty, as there is practically no danger of breakage. The bridge is of wood and the sound post inside of magnesium. Extensive experimental work was necessary to achieve the proper grade of metal and construction to insure an instrument of satisfactory tone and one that would be more easily kept in tune even under adverse circumstances. A viol of dependable pitch is considered highly important for orchestra work and, for that reason, the aluminum one is expected to overcome many of the difficulties encountered with wooden instruments, especially on tours, when a wide variety of climatic conditions may be met. Metal clarinets and flutes have been introduced with marked success and experiments have been made with metal cellos. Research in this direction is continued.

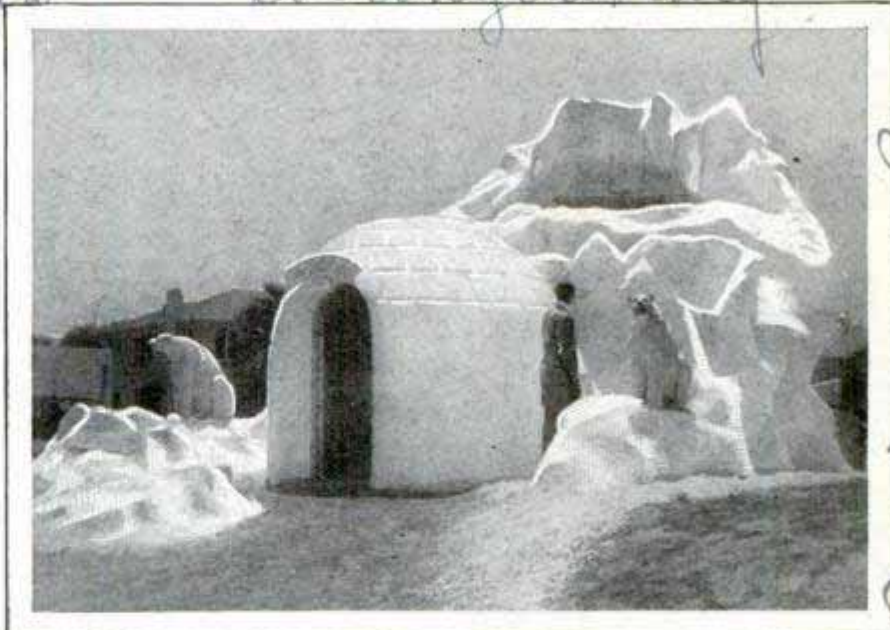

Suggesting Coolness Outside as Well as In; the Ice-Cream Parlor Constructed as an Igloo

**ICE-CREAM STAND LIKE IGLOO HELPS DRAW CROWDS**

To call attention to the kind of merchandise he handles, a Los Angeles refreshment dealer has fashioned his stand to resemble an igloo. Its white, sparkling exterior and the polar-bear figures at the entrance are visible at considerable distance, attracting attention of passers-by.

**PACK ICE AROUND FRUIT TREES TO FOIL FROSTBITE**

By placing ice around the trunks of fruit trees, an Oklahoma grower prevented loss from late frosts. The ice chilled the ground and the roots, keeping the sap from rising and delaying the budding until after the hazard of frost. The experiment, so far, has been tried on a small scale only, but it is believed the plan is suitable for more extensive application where ice is abundant. A trench is dug around the tree, filled with ice and then soil is spread on top to keep the ice from melting too rapidly.

**SPRAY OUTFIT RUN BY AUTO SAVES EXTRA PUMP**

455

With little trouble, the automobile may be converted into a handy spraying outfit for treating trees, calcimining, roof painting and many other tasks where special apparatus is usually employed. The tank for the liquid is carried on the running board and air pressure is obtained from the engine.

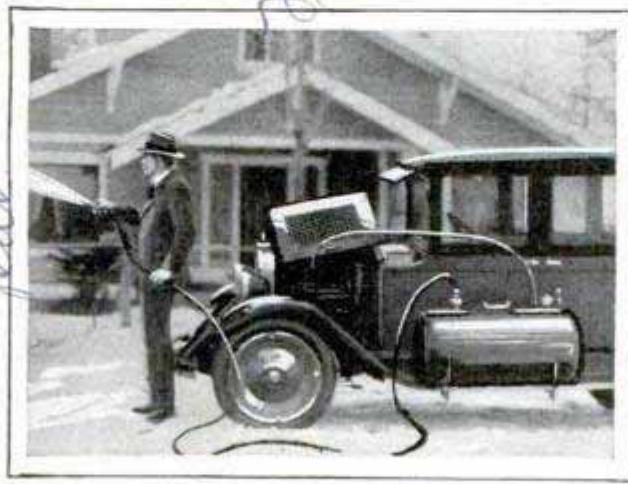

Spray Tank on Auto Running Board and Connected to the Motor to Obtain Pressure

also - Cooper Square, New York  
252 Tremont St. Boston, Mass

Mrs. Prandy, James B. and B. H. Nelson

Collican 120 N. Broadway  
Los Angeles, Calif

Emb. John

Mr. J. B. Pass  
Abilene State Hospital

Sim Diet Spray  
G. Alton Wms  
H. H. McGary Chief Engineer,  
Public Service Co



# RINGS OF TREES TO SOLVE WEATHER MYSTERIES

Events in the Life History of a Giant Sequoia as Charted on Annual Rings of a Cross Section

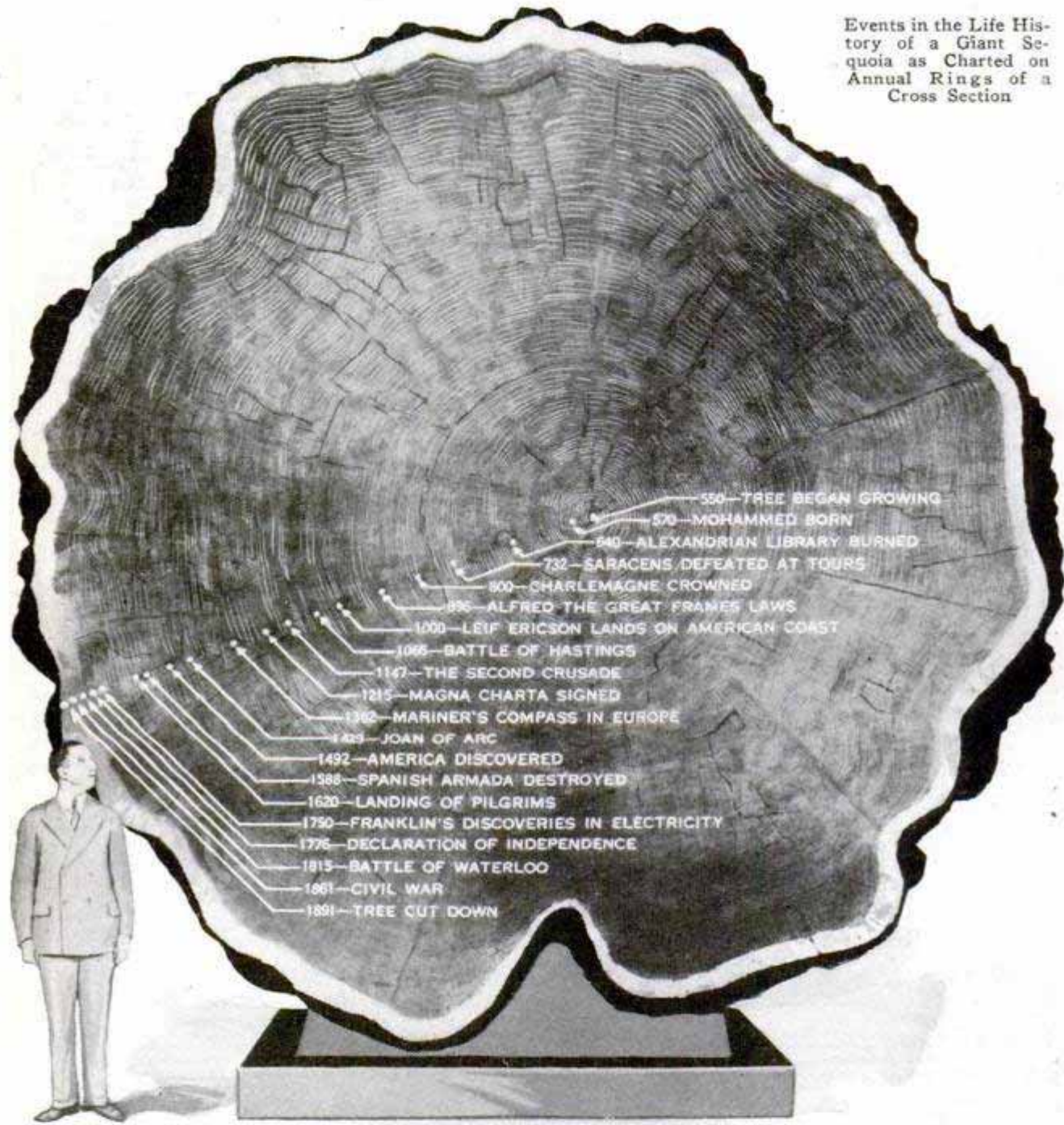

Light on the weather changes of the past is gained from a study of the rings of trees and furnishes a basis for forecasting the fluctuations of the future, according to experts who have spent considerable time in reading the "language of the trees," as revealed in the annual rings. Dr. Andrew E. Douglass, of the University of Arizona, discovered that there was a striking correlation between the rings of a large number of trees he studied and the actual weather conditions as shown by government reports, and his

research has been amplified by that of Dr. Ellsworth Huntington, of Yale, and Dr. Ernst Antevs, of the University of Stockholm, on the sequoias of California. Dr. Huntington and his assistants measured the rings in the stumps of 451 trees, the dates of whose cuttings were known. Nearly 100 of them were 1,000 years old, three had lived more than 3,000 years and the rings of the oldest registered 3,210 years. Trees of this kind, Dr. Huntington declares, were sturdy saplings in the days of the Trojan war and did not reach



*W. W. ... Co., 2275 S. ...  
536 Lumber St., Chicago.*

old age until they had lived for seventeen or eighteen centuries. From these measurements, the investigator was able to construct a fairly reliable climatic curve back to a time before the days of Christ. While this record applies only to California, he found that the main fluctuations agree with those of a curve of climatic changes in western Asia, which he prepared on the basis of ruins, lakes and other evidence. Some of the larger changes in the ring record appear to correspond with the sunspot cycles.

**PICTURE CHART RESTS THE EYES AFTER LONG STRAIN**

*548*

Setting-up exercises for the eyes are recommended by authorities in many cases, to relieve the organs of the strain of continued use at intense study or other duty. There are various forms of these exercises, but one that has been indorsed is to glance at a chart of pictures of pleasing colors and of different shapes. This gives the eye a chance to relax from the strain of constant focusing, giving refreshment and putting new muscles into play. When the eyes become very tired, simply closing them for a few seconds and relaxing the body at the same time will also bring great relief.

*by Dr. Paul W. Isoldenburg, Warwick, Mass.*

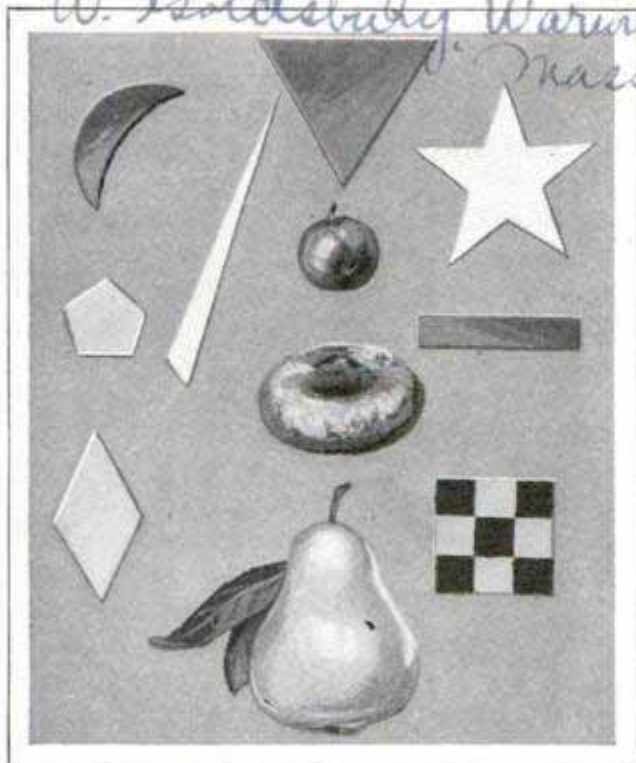

After Long Use, Glancing at This Chart of Colored Objects Rests the Eyes



*536*

Showing How Pads Keep Glass and Paper from Slipping; They Require No Adhesive

**SLIPLESS PADS KEEP GLASS TABLE TOPS IN PLACE**

Small pads of felt, treated on either side with a composition covering, have been put on the market to eliminate metal corners and other means of keeping glass desk and table tops from slipping. The pads also hold the glass free from the wood, preventing sweating and sticking to the varnish. Four pads, half an inch in diameter, placed under the corners of a glass, make it almost impossible to move it sideways, though it may be lifted upward for cleaning without difficulty. The pads also can be placed under telephones, inkwells, ash trays and other objects, or used under the feet of a typewriter. Placed under a writing machine, the full pressure of both hands is not sufficient to move the typewriter. The gripping power of the pads is so great that, if a sheet of paper is held between two of them, it will be torn rather than pulled free. The material is also produced in inch-wide reels, coated on one side only. The uncoated side can be shellacked to the edges of a desk, to support a glass covering the entire top, and has the advantage of making the space beneath the glass dust-proof.

(Synthetic sausage skins are being made of cellulose.)

*American Chemical Society*

*W. W. ... Co., Chicago  
4311 Quaker, Chicago*



440

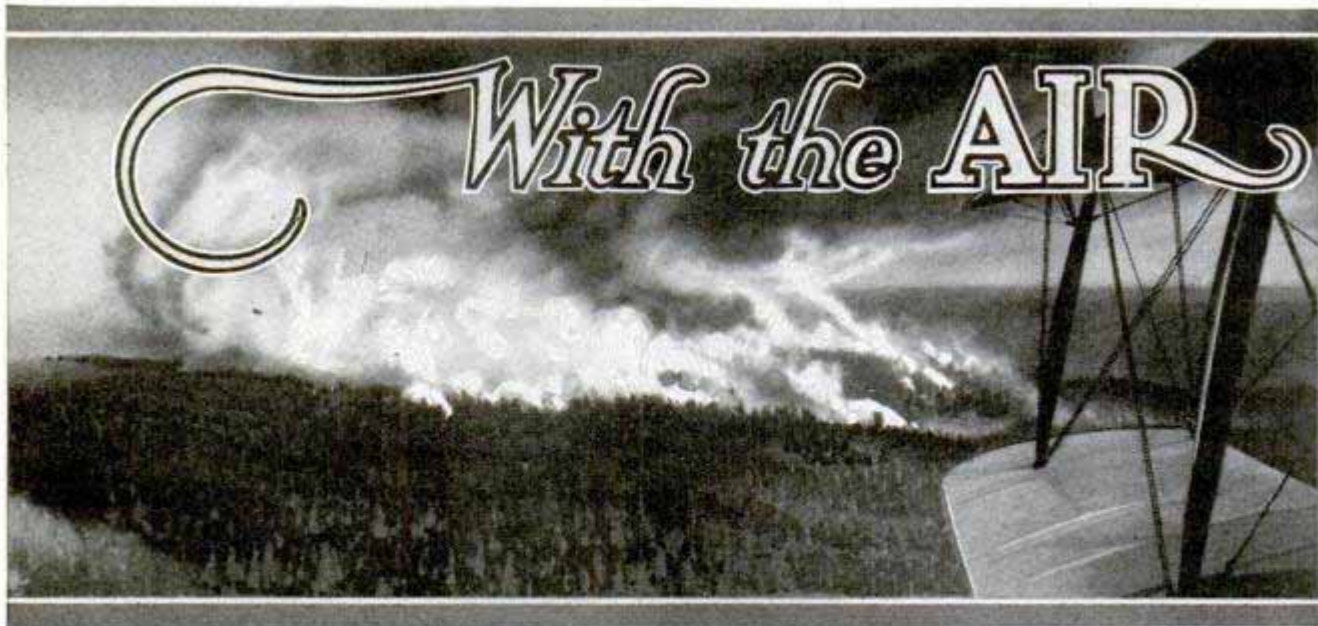

How a Forest Fire Looks from an Airplane; the Observer Can Quickly Estimate Its Extent, Direction and Progress and, So, Aid in Curbing It More Intelligently

Courtesy U. S. Forest Service

By JAMES NEVIN MILLER

*Washington, D.C. 2112 es JNM*

**F**LYING low over a blazing forest fire, an air-patrol pilot heard a terrific noise above the whirring of his Liberty motor. His oil pipe had burst! Tragedy loomed, for the intense heat seemed to spell a burning plane at any moment. But the pilot kept his head. With something of luck and more of pluck, he made for an old lake bed some miles away. And after deft maneuvers of the plane a landing was successfully made.

Small numerically is Uncle Sam's air patrol. Something like eight planes, an equal number of pilots and thirteen mechanics took part in its maneuvers last summer. Small, too, were the number of flying hours as compared with those of the previous year. Only 247 flights were made, comprising a total of 547 flying hours, and all in all, only thirty-five fires were sighted via the plane method.

Figures aren't supposed to lie. Yet they do in the case of the air patrol. Despite the fact that today its planes are used mainly for emergency purposes and that the patrol is still, after some ten years of employment, in an experimental stage, the importance of the airplane as an adjunct to the ground method of combating forest fires is firmly established. Never a year goes by without at least two or three new uses of the plane in this connection being discovered.

Aircraft play much the same sort of

role in fighting the red enemy of our forests as they do in ordinary military maneuvers. They are used to gain a rapid bird's-eye view of great conflagrations and to direct the attack accordingly—an extremely important consideration, notably in the case of mountainous districts where reconnaissance of sizable fires is slow and arduous when attempted from the ground.

During the past season, fire-control operations in the national forests in California, Oregon, Washington, northern Idaho and western Montana were directed from five bases: at Mather Field and Griffith Park, Calif.; at Eugene, Oreg., and at Seattle and Spokane, Wash. Spread about in this valuable timberland are some 1,000 rangers, whose job is to direct all fire-fighting maneuvers. Key men are so placed that, whenever a fire occurs, they may be counted on to be at the scene of conflagration in an amazingly short time. Practically every mountain peak has its lookout, whose iron-clad duty is to remain at his post, day in and day out, forever watching for fires. Sighting one by its telltale path of smoke, he phones the nearest ranger, who thereupon starts directing operations among his highly trained squad, consisting of assistant ranger, fireman, truck driver, and, in the case of a tremendous blaze, a score or so emergency men hired from the nearest towns.



# PATROL

With such a system, small wonder that Uncle Sam can boast that his "iron men of the forests" are able to stop at least fifty per cent of all forest fires before they exceed a quarter of an acre, and halt eighty-nine per cent before they consume ten acres. Never very far away from the scene of ground fire fighting is the airplane patrol, ready at all times for immediate action. Ordinarily the pilot is of tried caliber—a reserve officer of the army air corps. His plane, in the past, has been the old-style but fairly trustworthy de Haviland, borrowed from the army. This year, however, new planes of latest model and greater cruising power will be assigned to the patrol.

Out in the Columbia national forest in southwest Washington, no less than 100 good-sized fires were blazing away on successive days last summer. Immediate and concerted action was necessary. Whereupon the fire-patrol leader in the district, a Mr. Brundage, jumped into a plane at Vancouver, some seventy or eighty miles away, and in three hours was able to make a complete survey of an immense stretch of land, running into hundreds of acres. With no doubt in his mind as to the approximate extent and seriousness of the fires, he had the situation under control in short order.

For years a besetting problem of the ranger has been to devise schemes destined to combat the peculiar and devastating electrical storms of the northwest. It has been estimated that they cause something like forty per cent of all forest blazes. Back in 1926, no less than 150 fires are believed to have started on July 6 by a

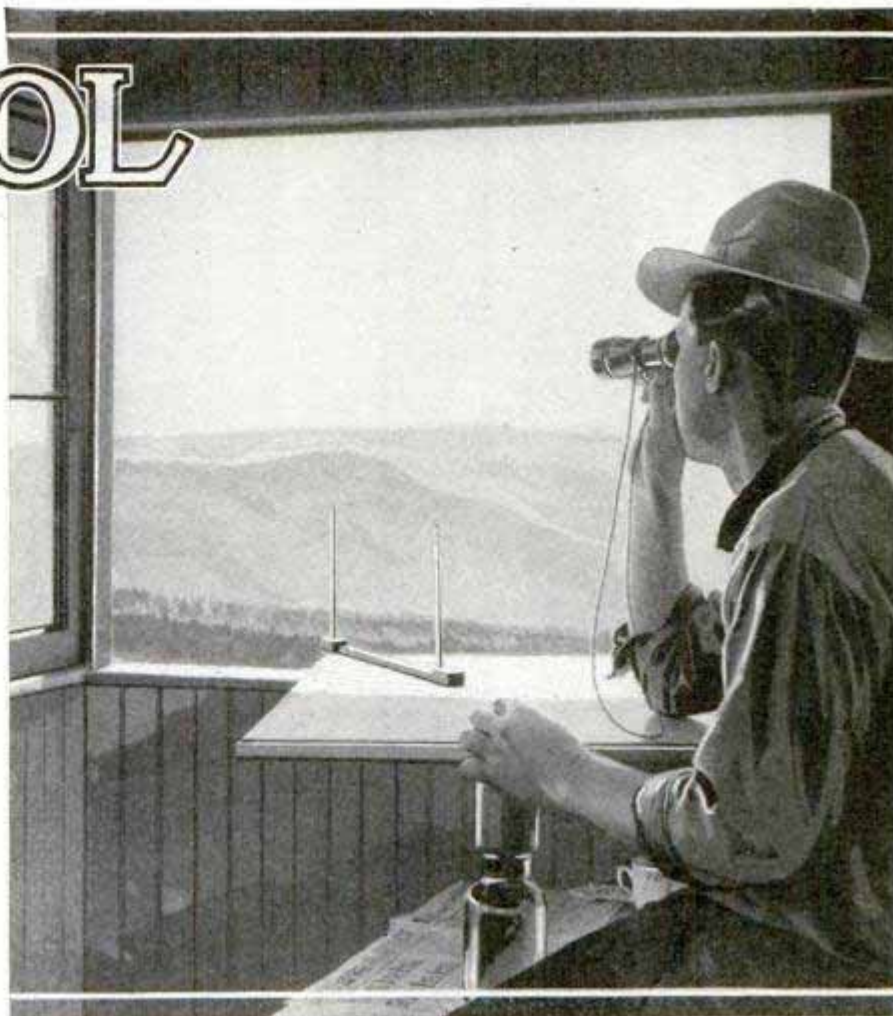

Fire Lookout at Marties Peak Station, Tahoe National Forest, California; His Main Duty Is to Watch for Smoke

single storm, and six days later, seventy-two fires arose from one tempest. Lightning has a habit of starting fires in inaccessible spots, notably in the remote canyons and potholes of the mountainous regions, which are impossible to view accurately from the ground or even from the high-mountain lookout points. Oftentimes it is several hours, frequently a day or more, after such a monster storm, before a lookout may gain the line-up of the resulting fires. The airplane, on the other hand, gives an immediate observation weapon whose accuracy rarely fails. Down into the most remote corners, the machine can dive and drop messages to ground workers, offering direct instructions as to fire locations. Usually the messages are placed in canvas bags, weighted with sand. Or, if the observer happens to be in strange territory, he need only look for the triangular ground signs, which show locations of key men.

Speed in surrounding a fire with a control line is as vital as speed in reaching



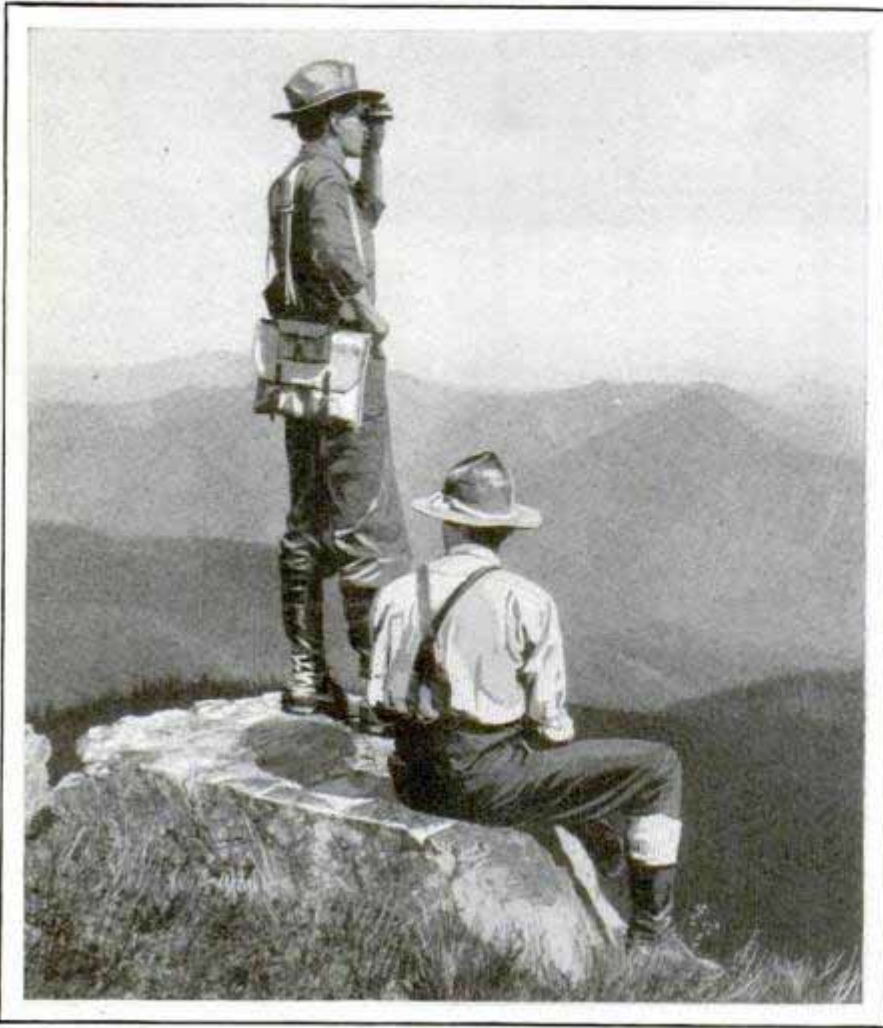

Rangers on Fire-Patrol Duty in the Cabinet National Forest, Montana, Where Nature Has Provided Her Own Observation Towers

it. A control line is simply a cleared way, of varying width, through the timber, undergrowth and fallen logs, with a narrow trench to mineral soil. The line is widened by setting backfires which spread from the trench toward the main blaze, thus increasing the chance to hold it. In heavily timbered regions it often requires from fifty to 100 men to construct a mile of such a fire barrier in a day; and when weather conditions are adverse, or incorrect tactics have been used, the control line so laboriously constructed may easily be lost. Here again the airplane has proved its efficiency.

An interesting by-product of aerial-patrol operations in the past few years has been its moral effect on incendiaries, careless campers and reckless forest users. Back in 1918—the first year flights were made—it was noticed that a severe outbreak of incendiarism stopped short upon the starting of the air patrol. Later it was learned that plane observers were able to see the offenders long before those

on the ground could locate the plane's position.

A new use for planes in fire control, which has developed during the past two years, is the transporting of fire-fighting tools and supplies and dropping them, where needed, upon the actual fire lines. From time to time inventors and commercial interests have advocated the placement of chemicals from the air as an effective means of combating forest fires. Not long ago the idea was tested out carefully at Mather Field, Calif. Pilots Potter and L. W. Hess carried on a series of experiments involving attempts to extinguish small fires by dropping chemicals upon them from airplanes. Flying low, Hess threw down several gallons of liquids. Two bottles hit within eight feet of their goal,

the liquids spattering over it liberally. But the fire burned merrily on. Fairly conclusively the tests showed the feasibility of approaching pretty close to small fires via the plane method, and, what is perhaps more important still, that present-day extinguishers are hardly powerful enough to smother fires in the open.

A well-known corporation now claims to have developed a new type of fire-fighting equipment which shoots out carbonic-acid gas in such form as to create extremely low temperatures which condense atmospheric moisture and simultaneously exude so much gas that the flames are thereby smothered. Under a 900-pound pressure, the gas is put into small tanks weighing about forty pounds and suitable for handling by the average man. Larger tanks, holding about four charges, are announced to be used as supply units.

It is claimed for the idea that it enables a man to get unusually close to a blazing pile of slash. Foresters point out, however, that it would not extinguish fires as



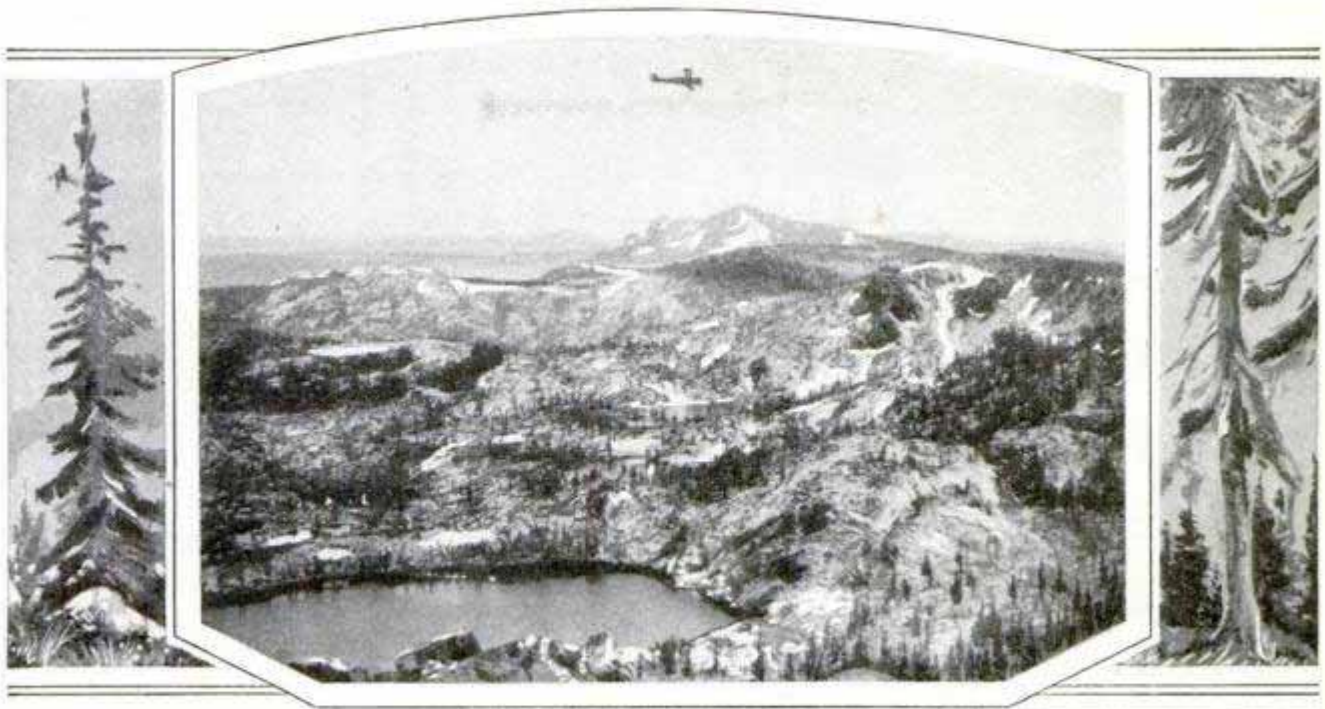

A Bit of the Cleveland National Forest in California with Airplane Patrol on Duty, and, at Right, a Serious Fire in the Suislaw National Forest, Oregon; the Air Patrolmen, Though Few in Number, Co-Operate Effectively with the Rangers on the Ground; Half of the Fires That Occur Usually Gain Little Headway

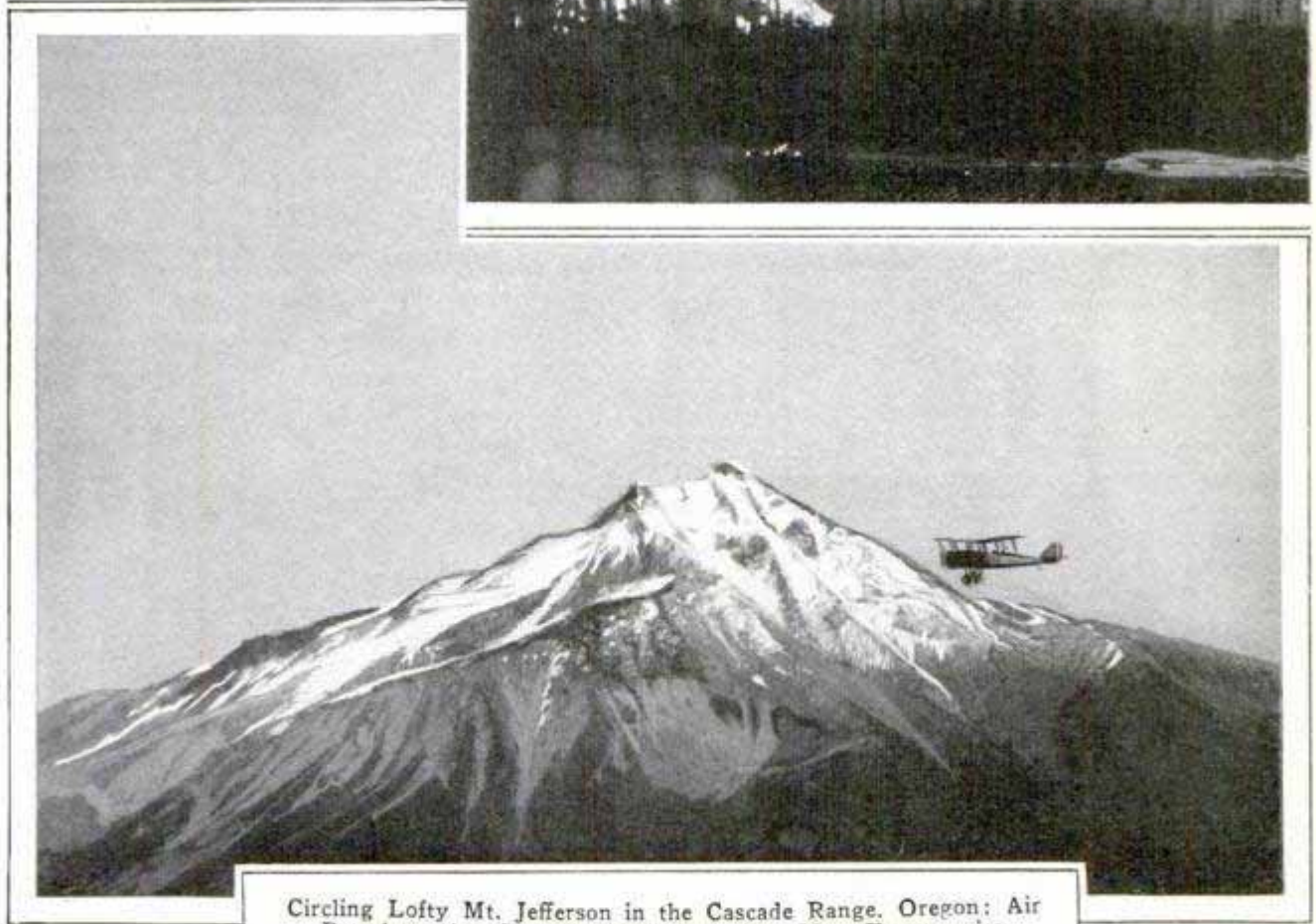

Circling Lofty Mt. Jefferson in the Cascade Range, Oregon: Air Patrolmen Are Capable Flyers Trained to Meet Emergencies





It Has Been Estimated That Lightning Causes About Forty Per Cent of All Forest Fires; Here Is a Remarkable Photograph of a Flash Striking in the Mount Baker National Forest

Ranger on Duty in Cabinet National Forest, Montana, a Sturdy Guardian of Our Valuable Timber Resources; the Introduction of the Airplane-Patrol System Has Made His Work Easier and Safer, but with the Increase in the Number of Campers, There Is Still Much for Him to Do



Above, a DeHaviland Plane on a Patrol Trip in Southern California, and, at Left, One of the Peculiar Ground Signals That Help the Pilot Get His Bearings; Flying over Rough and Wooded Areas, Where Landing Spaces Are Few and Far Between, It Is Essential That the Aerial Patrolman Keep Constant Watch of His Location



efficiently as does water, because the gas tends to evaporate and combine with the air to such an extent that its effectiveness would be lost. Moreover, in handling the gas it is necessary for the operator to be exceedingly careful. The material comes out at so low a temperature that there is imminent danger from freezing.

Some time in 1923, a London paper carried an article to the effect that M. Turpin, inventor of melinite, had laid before the French ministers of war and agriculture a comprehensive plan for fighting forest fires from airplanes. He proposed that the center of the conflagration should be attacked with various chemicals or combinations of them.

Soon the U. S. forestry service was besieged with queries on the subject from well-meaning persons. Why could not the United States devise such a plan, they wanted to know. Very much to the point was the forest-service reply:

"Theoretically, it ought to be possible to suppress a forest fire by using one of the liquid combinations which form a heavier-than-air gas that would exclude the oxygen and stop the fire. The trouble with this is that, in addition to the prohibitive weight of the necessary volume of chemical extinguisher, the gas itself will float away if there is the slightest slope in the ground.

"The center of the conflagration is the least of our concern. The critical point of every forest fire is its outer margins. No effort is ever made to extinguish forests already ablaze. Every energy is directed toward preventing its further advance either by direct attack on its margins, where this is practicable, or by clearing all combustible material from a narrow path of the fire and holding it within limits until it dies down for lack of fuel to continue. An attack on the center would appear to be utterly futile unless you have sufficient means and materials to overwhelm the conflagration completely."



A Few of the Jeweled Objects Discovered in the Tomb of the Sumerian Queen, Shub-Ad

**JEWELS FIFTY CENTURIES OLD FOUND IN QUEEN'S TOMB**

Rings of gold and silver, inlaid golden rosettes and small animal figures of the precious metal were among articles found in the tomb of the Sumerian queen Shub-Ad, unearthed recently by members of the joint expedition of the museum of Philadelphia and the British museum. The jewelry is over 5,000 years old, and adds to the interest of the discoveries in recent expeditions to Ur of the Chaldees.

**LIGHT FOR KEYS AND COPY SAVES TYPISTS' EYES**

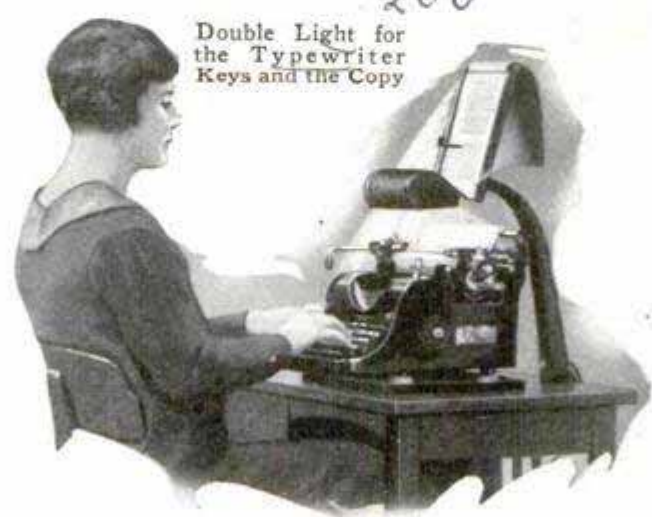

Double Light for the Typewriter Keys and the Copy

Both the typewriter keys and the copy are illuminated from a light combined with a convenient holder that may be attached to the desk with little trouble. The rays are directed in such a way as to reduce glare and eyestrain to a minimum.

*Algemeine Elektrizität*  
*Apresellchaft m. b. H.*

*International*

*Leonard C. Woolley, Director*

*in Ur of Chaldees*  
*Dr. Albert Neuburger*  
*Winterfeldstr. 2, Berlin W. 30*  
*neue*  
*hermann*



Close View of the Glass Jewels, and a Sign, Made of Them



Courtesy General Electric Co.

**SIGNS SET IN FLASHING JEWELS  
 AID ADVERTISING**

Use of sparkling glass jewels, like those introduced at the Panama-Pacific exposition and at other displays, has now been made in advertising. Signs, lettered with the glittering gems, and kept in constant motion by an electrical agitator, have made their appearance. One of the first was made of 400 of the jewels set on a gold background and brilliantly illuminated at night by colored flashlights. During the day, the gems reflect the light that strikes them so that they can be seen at a considerable distance.

**FORD'S JUNK PILE IS GRAVE  
 OF MANY SHIPS**

Henry Ford owns one of the world's largest junk piles as the climax of his excursion into ship breaking, following his purchase of 199 war-time ships from the government. The junk pile is a mile and a quarter long, thirty feet high and seventy-five feet wide, and represents the odds and ends left over after the Ford experts had finished salvaging everything usable. Their salvage work was so complete that, when they finished, they de-

clared, paraphrasing the Chicago packer's boast, that nothing had been lost but the noise made by the workmen. The huge junk pile will be fed into the blast furnaces and remelted to be turned out again as chassis members, engine blocks and other parts of cars, trucks and tractors. When Ford bought the ships from the government for \$1,706,000, steel was selling for \$10.50 a ton, and it cost him \$13 a ton for his steel scrap by the time the vessels had been reduced to 200,000 tons of scrap and 16,000 tons of plate. To offset the \$937,000 loss on the steel deal, however, he salvaged in one item alone—the 199 power plants of the

ships—material valued at approximately \$6,000,000. The boilers and engines were put to work in Ford factories all over the world. In addition to the profit of nearly five million made on the engines, thousands of other items were reclaimed, including electrical equipment, refrigerators, windows, doors, lavatories, bathrooms, deckhouses—which are used as watchmen's shanties—radio sets, cables, tanks, bunks, mirrors, pipe and fittings, valves, gauges, scales, hardware, stoves, furniture, pumps and many other things.

**POCKET SUNDIAL AND COMPASS  
 LATEST AID FOR HIKERS**

102  
 A sundial of practical value is offered hikers and campers in a pocket unit that can be used with little trouble and may be adjusted for any section of the country. The indicator of the dial folds flat when not in use so that the article may easily be carried. The compass is safely housed under a glass top.

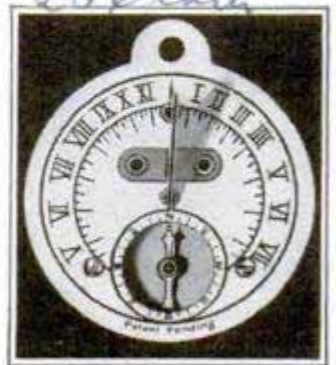

...Coul. Wash. Inc. Wash.  
 Detroit & re. Pireas

George W. Moore,  
 44 H. Armsworth



**MINIATURE FLYING FIELD BUILT FOR TOY PLANES**

Los Angeles boys, interested in aviation, have been furnished a special landing field for their model planes. It is under the direction of the city playground

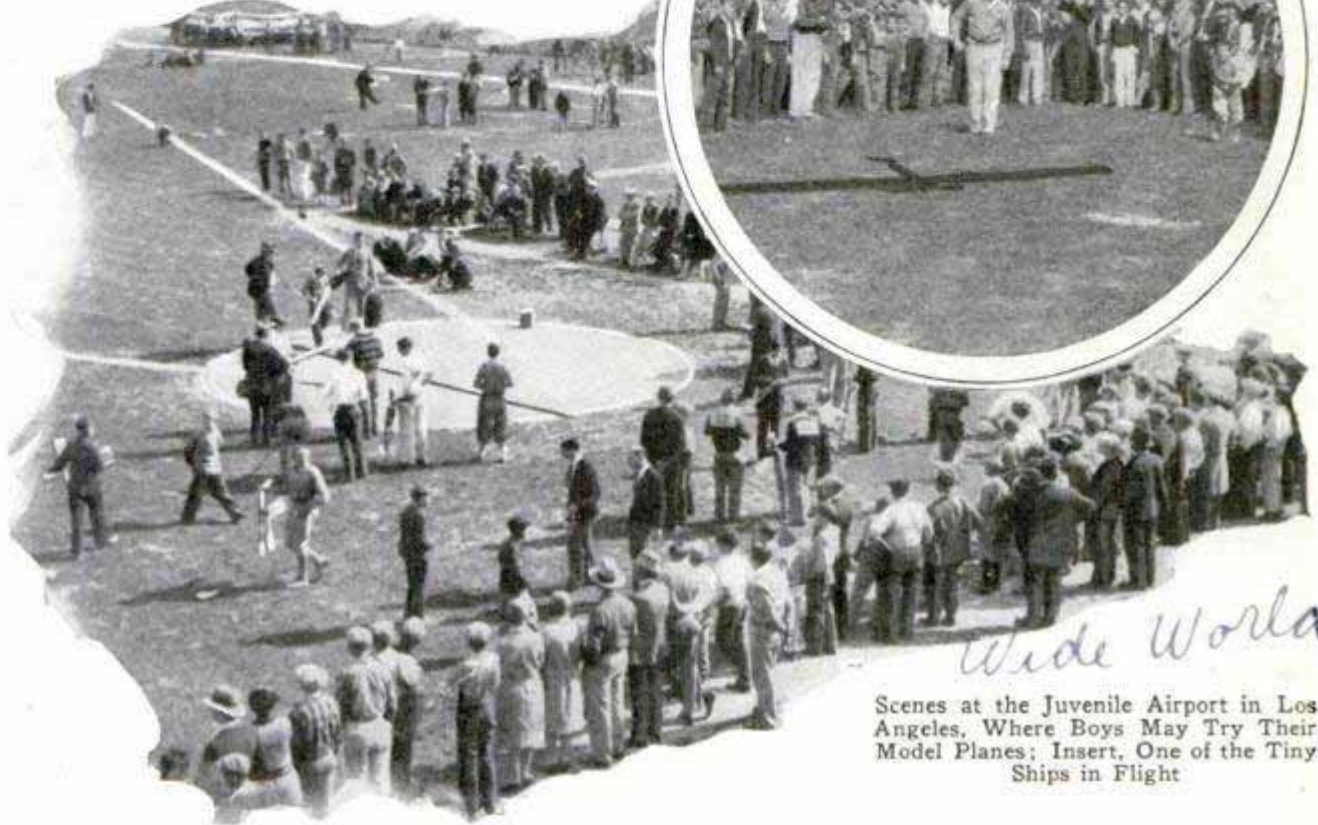

*Wide World*

Scenes at the Juvenile Airport in Los Angeles, Where Boys May Try Their Model Planes; Insert, One of the Tiny Ships in Flight

commission and is laid out in close imitation of a real field with runways and loading areas. On the grounds is a machine and carpentry shop where miniature ships

may be constructed, and regular classes are held to help the youngster build them. Contests are held to demonstrate the efficiency of the tiny planes.

**ELECTRIC LIGHT GROWS WHEAT IN THIRTEEN WEEKS**

*480*

Wheat that reached maturity in thirteen weeks has been produced at the University of California under electric lights and with jars of water containing the proper food for the development of the grain. Under ordinary field conditions, wheat requires about five months to mature. The quality of the laboratory variety is said to be superior to that produced in the usual way. The lights were turned on for sixteen

hours each day, and lengthening the time of exposure as the plants developed, increased the growth at an astounding rate.

**PRESS FOR GOLF CLUBS KEEPS SHAFTS FROM BENDING**

*205*

Golf-club shafts are likely to become bent and warped, especially after being stored in damp places. To prevent this trouble, a special press has been devised. It holds six or more clubs, and each shaft fits into a specially designed groove. Straps prevent bending.

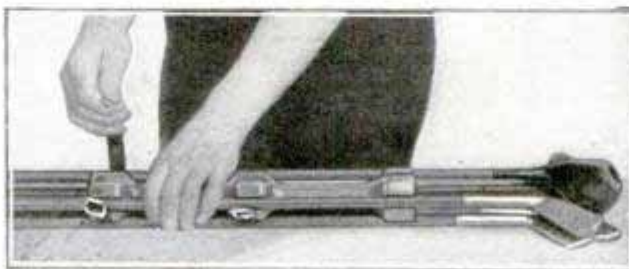

Golf-Club Press That Holds Six Sticks and Keeps the Shafts from Warping

*U.S. of P. Mail Nutrition*

*Experiments made by Prof. H. W. Henshaw, U.S. Department of Agriculture*

*A.S. Spalding & Co. Chicago 211 S. State*



Mr. Name O'Neale, 1020 ...  
Washington, D.C.

Geophysical Methods of Prospecting  
10 cents C. & G. 5: 420

# New Magic in Treasure



Seeking Metals with a Divining Rod, from a Centuries-Old Woodcut; the Rod Is Still Believed In by Many

turns the ore body into a giant battery, continually releasing electric currents, flowing from the top to the bottom. A couple of iron rods stuck into the ground a few feet apart and connected to a sensitive galvanometer will detect the currents and locate the ore.

Another way of finding metal deposits is to use the radio—a direction-finding system comparable with that used in locating ships at sea. The ship sends out signals, which are received

on a vertical loop coil on shore, the signals reaching maximum intensity when the loop is pointed directly toward the transmitting vessel.

Ore bodies cannot send out signals, but they can be made to radiate secondary electromagnetic waves after being excited by waves sent out from a radio transmitter. A second coil picks up the waves from the ore and indicates its direction. After the bearing is plotted on a chart of the region, the receiver is moved, and another bearing taken. With two or more bearings, the intersecting lines determine the position.

A radio treasure hunter is being used in Panama with success to locate the buried gold and silver hidden by the Spaniards when Sir Henry Morgan looted the isthmus. An American officer has a treasure-hunting concession from the Panama government, and already has unearthed a large number of rare and valuable deposits.

One of the most unusual treasure hunters in practical use is the seismograph and artificial earthquake, used to locate new oil deposits. The seismograph is the same instrument employed to detect and record

THE United States bureau of mines is about to issue a book on magic. It will tell how to find buried treasure by the latest methods, all of them improvements on the divining rod of immemorial antiquity.

Instead of the forked twig of hazel, willow, peach, or some other tree—the familiar “doodle bug” or “water witch” used by diviners for centuries—the modern treasure hunter utilizes a radio set, a galvanometer, a seismograph, or similar scientific discoveries.

The new magic of buried-treasure hunting is entirely different, and it already is being put to practical use on a considerable scale. It finds new ore bodies, locates underground lakes of petroleum, and is even applied to locating of treasure buried by men.

Some of the treasure finders are by-products of the war, others an outgrowth of the development of radio. One of the simplest is a method of locating deposits of silver sulphide far into the earth. Water, seeping down after a rain, oxidizes such deposits to some extent, the top layers more than the lower ones, and the result is an electrochemical action which

Probably Lieut. Willigins  
who does not give up  
I have order issued  
against him



# Hunting



Making an Artificial Earthquake with Explosives, So That the Underground Waves May Be Measured to Indicate the Presence of Ore and Other Shock-Resisting Substances Far Below

earthquakes, and it is used in the same way. The only difference is that a few sticks of dynamite are exploded to furnish the shock. Vibrations travel at one rate through air, at another through water, still another for earth, a fourth speed for rock near the surface, a fifth for deep-lying rock, and at other speeds for various materials which may be found within the earth. The dynamite is exploded by remote electrical control from the seismograph station, and the elapsed time until the shock is received by the instrument is recorded and compared with the known distance it had to travel.

Its success in locating oil hinges on the fact that salt domes and oil are found in many localities together. Where there is a salt dome there is apt to be oil. In free air, the sound waves travel 1,100 feet a second, through rock near the earth's surface 6,000 feet, and still faster farther underground. But in salt domes the speed may reach 16,000 feet a second, so the shock that arrives too soon to have trav-

eled through earth and rock all the way, probably passed through a salt dome on its journey.

The dipping needle, another of the treasure hunters, resembles in its action the hazel-twig divining rod, except that there is no question of its workings, and of the scientific explanation for them. The needle is simply a compass magnet suspended by a thread on a horizontal pivot so that it can move in a vertical plane. In an instrument fitted in this manner, the needle inclines at various angles at different places on the earth's surface, save that, theoretically, it will remain horizontal at the equator, provided there are no other factors to influence it. The presence of a mass of magnetic metal such as iron ore, or even a buried metal pipe, will change the angle, however. Carried across country, any change in its inclination indicates the presence of some attracting body underground.

Even the plumb bob—a lead weight on a string used by builders to check vertical



objects—can be used to locate ore. Theoretically the plumb bob, responding to the force of gravity only, should point directly toward the center of the earth at all times. But a near-by mountain may have enough attraction to deflect it, and a great mass of high density underground will influence it in the same manner.

A variation of the plumb-bob method, which is much more useful as an ore locator, employs an ingenious balance to measure variations in the attraction of gravity. Two small weights of gold or platinum are mounted on a light horizontal beam, which is supported in the middle by a fine wire. One of the weights

is fastened to the end of the beam, and the other hung a few inches below the opposite end.

When the device is brought in the neighborhood of a large ore deposit, the latter will act on the two weights with different force, causing the beam to twist. The extent of the twist is measured, and observations are made in other positions until the location of the attracting body is fixed and charted.

Buried treasure, whether planted by nature or by man, has always exercised a peculiar fascination upon the mind. The triumph of going out and digging up something no one knew was hidden often is equal to the actual gain. That explains the popularity of the divining rod through the centuries. Commonly supposed to have descended from the casting sticks used by the Romans in taking auguries of forthcoming events, the "doodle bug" made its appearance in its present-day form—a forked twig—as early as the fifteenth century, almost simultaneously with Columbus' discovery of America. Basil Valentine, an alchemist of the late fifteenth century, mentions it being used in the Hartz mountains of Germany by ore prospectors. In Queen Elizabeth's time it was taken to England by Cornish tin miners and employed to locate tin deposits. After the tin mines played out, it still continued in use for finding water, and it has its devotees to the present day, despite the frequent declaration of science that there is no more chance of finding



An Up-to-Date Water Hunter in England, Armed with His "Water Witch," Usually a Forked Hazel Twig Which Is Supposed to Dip When It Approaches Water; at Right, Diagram Showing How the Ore-Finding Balance Works When Suspended in the Vicinity of an Underground Ore Body; Seismographs, Radio Detectors and Other Scientific Instruments Are Being Used with Success, but Science Has Failed to Find Any Proof That the Water Finder Really Works

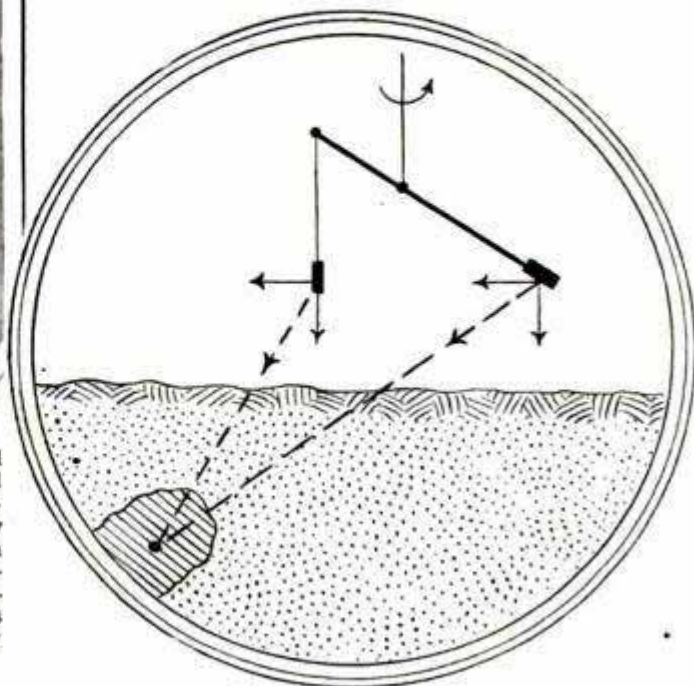



water with a divining rod than there is without it.

One reason why it has survived all scientific attempts to ridicule it, is the unexplainable fact that "water witchers" frequently have a record of far more successes than failures. Prof. W. S. Barrett, F. R. S., who devoted several years to a study of diviners in England admitted that fact, and decided that "motor-automatism" on the part of the holder caused the rod to twist without conscious volition on his part. What produces the involuntary twitching, though, remains a secret. It has been suggested that some people's ears may be peculiarly susceptible to sounds from running water underground; that the diviner's mind becomes a blank so that the faintest impression of the object searched for produces an automatic



A Woodcut of 1700 A. D. Ridiculing the Divining-Rod Devotee, Who Is Shown with a Tray Full of Instruments in One Hand, While, with the Other, He Twists the Nose of All-Seeing Wisdom, Represented with Three Eyes; Retribution Awaits Him Above, Indicated by a Whip and a Plague of Locusts; at Left, Diagram Showing How Rain Turns a Sulphide-Ore Body into a Giant Electric Battery, to Be Detected by the Galvanometer and Pair of Electrodes Shown at A

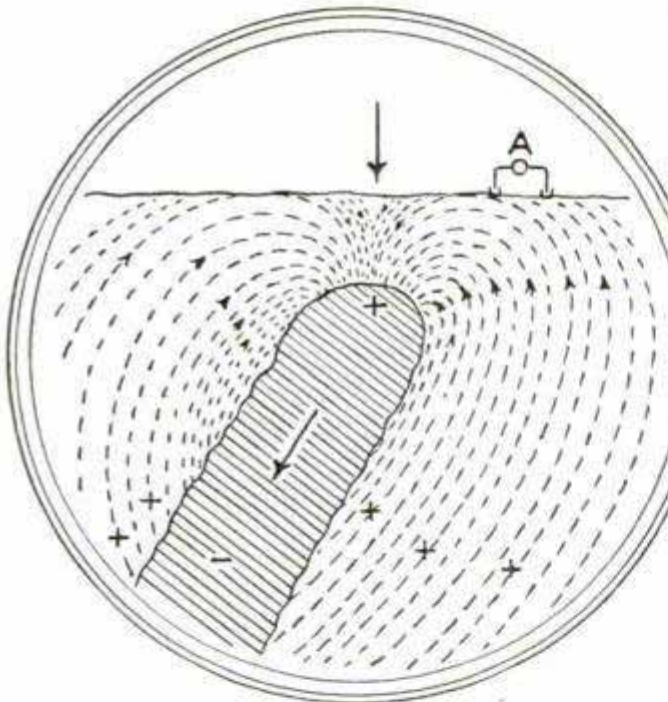

motion of the indicator, and similar reasons. Like the homing instinct of birds and dogs, the diviner's ability, scientists have decided, lies beneath the level of any conscious perception.

None of the diviners have a logical explanation for their success, nor can they explain their failures, which usually are fairly frequent. Accurate observations made in England by several scientists, showed, however, that the percentage of successes over failures exceeded what might be fairly attributed to chance.

In the Middle Ages such miraculous powers were credited to expert water di-

viners that they turned their hand to everything from searching for buried treasure to hunting witches and heretics for the church. Their abuses in the latter field became so great that in 1701 the Inquisition forbade the employment of the divining rod for purposes of justice.

ONE-WAY WINDOWS 49

Designed especially for household use, a window introduced by an English inventor permits a person inside to look out but presents an opaque surface to one attempting to look in.

Class. J. Vaurie  
1 Madison Ave. 10  
From "Laird" Murron Stephanie Angus. Bste. France - Stranger.



## KNOCKDOWN MODEL OF YACHT EASILY ASSEMBLED



Various Sections of the Model Yacht, and a Complete Assembly; Parts Are Connected in a Short Time

In a few hours, any boy who can handle simple tools, may assemble the parts of a knockdown model yacht now on the market and enjoy the pleasure of a small boat that sails. Besides saving time in construction, the knockdown outfit can be shipped with less danger of breakage.

## STEEL BUILDING SAFEST SPOT WHEN LIGHTNING STRIKES

The chance of the average person being struck by lightning while in his home is one in several million, declares R. N. Spurck, an engineer of the General Electric company, who has made a number of experiments with man-made flashes of high voltage. Make the chances as many million as you desire to calm your fears, he says, for the probability is so remote that a few million make no difference. Bolts can hardly touch you if you are in a

steel building, and almost every dwelling with plumbing or electric wiring is safe. The house may catch fire but lightning is not likely to hurt the occupants. The top of a hill, with no trees about, is the most perilous position as regards lightning, but the ordinary home surrounded by dwellings of approximately equal height is likely to be struck only about once in 1,000 or 2,000 years. During an electrical storm, keep away from walls in which pipes or wiring are concealed. Do not stand between two metal objects, such as a heating radiator and the plumbing pipes. Under the bed is one safe spot, but there are many other places in the home equally safe. The air-vent pipe that goes through the roof functions as a lightning rod in the usual home-plumbing system. Mr. Spurck explains the apparent mystery of lightning tearing off the sole of a shoe by the fact that when a bolt encounters the moisture, almost always present on the inside, steam is formed and the sole may be blown off. A perspiring laborer has a better chance for his life than a white-collared clerk in case lightning strikes him, for the moisture may carry the bolt off the laborer's body. When lightning strikes a crowd and kills several persons, the common belief is that the bolt was more violent than one which kills but one person. The reverse is true. Weaker bolts, thwarted by the resistance of a body, branch off and may kill other persons, but the more powerful flash shoots on downward into the ground.

## TIGER FACE ON MOTOR FRONT FEATURES HUNTING CAR

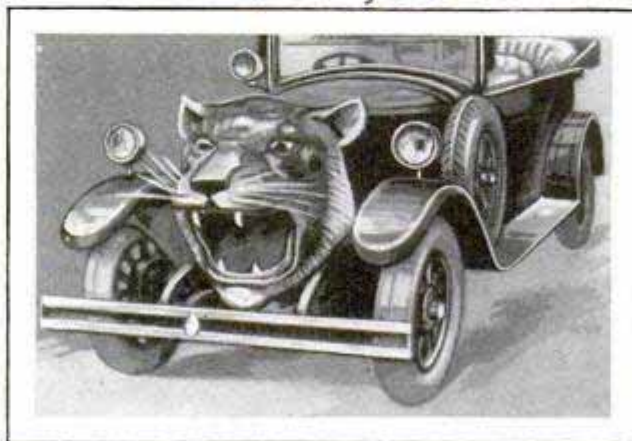

Tiger-Front Automobile for Hunting in India; the Figure's Eyes Are Flashing Green Lights

On the radiator front of an automobile, made in Berlin for hunting in India, is the replica of a tiger's head. The eyes are flashing green lights and the teeth are of steel. Besides being an attractive ornament, the head will probably aid in running the car through the jungle growths.



**DIRECT STEAMING  
 OF ENGINE ENDS  
 SMOKE EVIL**

By piping steam from a central plant to locomotives in the roundhouses, thus making it unnecessary to keep separate fires under all the boilers, several railroads have reduced the smoke evil in their localities and are effecting savings in time and fuel. When the engine comes in, its fire is dumped, connection is made with the steam supply through a flexible piping from the main conduit, and the steam is introduced into the boiler through a special valve at the bottom, in somewhat the same way that air is pumped into automobile tires. The steam and hot water of incoming engines are utilized for locomotives going out. The engine is not fired again until it has been run out of the roundhouse. Tests of the system have given satisfaction in plants at Gouldsboro and New Orleans, La., Fort Worth, Tex., and at Chicago.

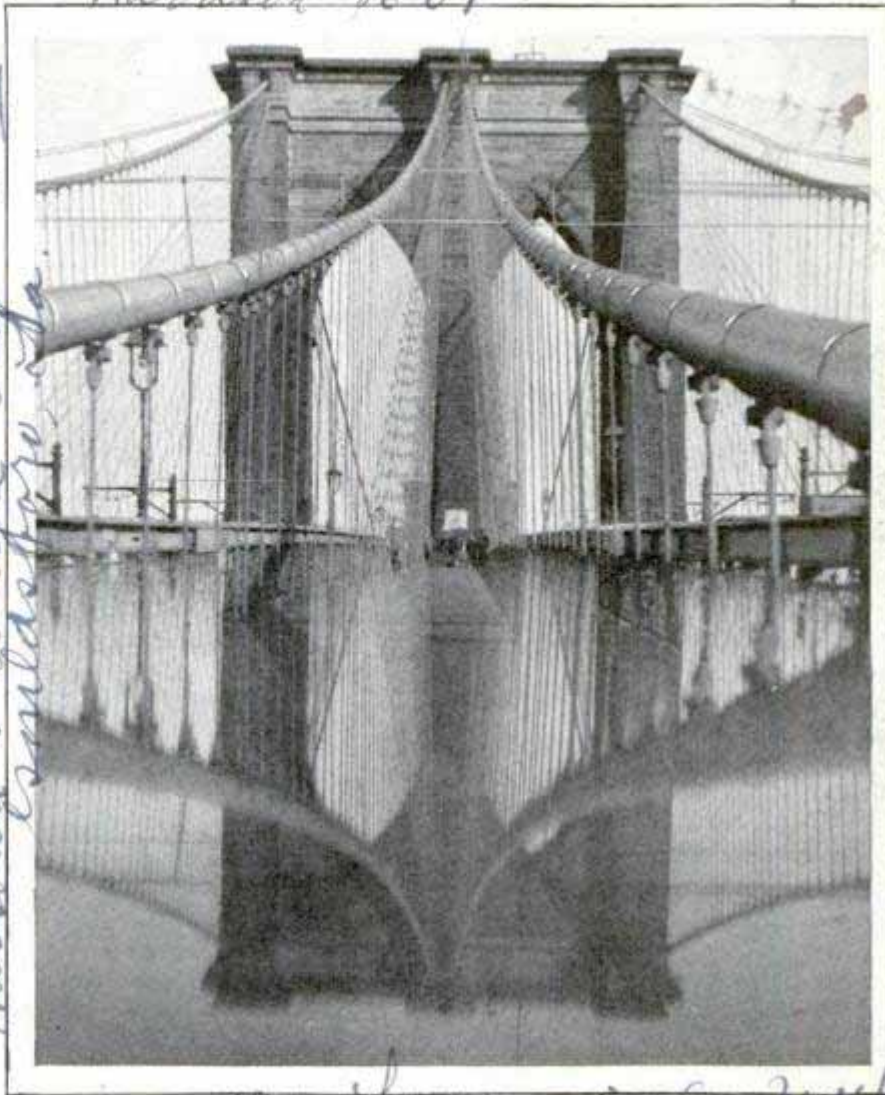

© Herbert Photos  
 Mirror Photograph of Brooklyn Bridge, a "Rainy Day" Effect Produced with the Aid of Reflector Attachment on the Camera

**"MIRROR" EFFECT IN PHOTOS  
 OBTAINED ON DRY DAYS**

Photographs, emphasizing the mirror effect which is so pronounced on rainy days, can be taken in dry weather with the aid of a special attachment an eastern man has devised. It permits taking the approximate equivalent of a double exposure, but no distortion is noticeable.

**A CURE FOR SEASICKNESS**

University of Chicago professors report successful treatment of seasickness by administering three to five grains of sodium nitrate every two hours. The chemical has a reducing effect on the blood pressure, thus diminishing the strain on the vestibule of the ear, which is thought to be the seat of the trouble. Of sixteen persons tested, eight were cured in two hours.

**HOLDER FOR STAIR CARPETS  
 SAVES CLEANING TIME**

To keep stair carpets in place, a swing holder has been introduced. It fits tightly against the covering, but, to release the carpet, it is simply pushed back, saving the removal of tacks or nails. Furnished in an ornamental pattern the holder does not detract from the appearance of the stairs and is claimed not to work loose easily.

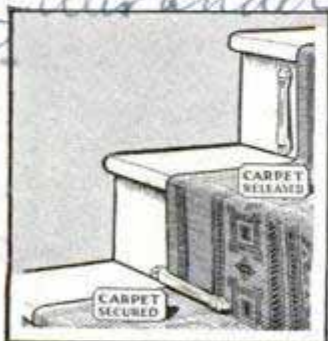

appearance of the stairs and is claimed not to work loose easily.

Chicago N.W. (R) Alton Pacific Ry.  
 Halstead's Chicago, Ill. in Ft. Worth, Texas  
 Chicago N.W. (R) Alton Pacific Ry.  
 Halstead's Chicago, Ill. in Ft. Worth, Texas  
 Chicago N.W. (R) Alton Pacific Ry.  
 Halstead's Chicago, Ill. in Ft. Worth, Texas

messrs. Halstead's Chicago, Ill. in Ft. Worth, Texas

staff camera man,  
 name not given.  
 recent attachment

480 Lexington Ave New York  
 Grand Central Palace

3935

R. Newton + Co. 41  
 Mountain St.

Medical faculty.

Dr. Frank and Dr. Hayden  
 Dr. Hayden  
 Dr. Hayden



45 Westbourne Terrace,  
Brookline, Mass

Holder with Hose  
in Two Positions



Price \$2.75

### GARDEN-HOSE HOLDER SAVES STEPS AND GETTING WET

Service of a special sprinkler can be obtained from the ordinary garden-hose nozzle with an adjustable holder now on the market. It directs the spray at any angle desired, and can be regulated without shutting off the water or approaching too close to the nozzle to get wet when it is running. A sharp spike anchors it firmly in the lawn when one position is desired for some time.

### COPPER ANAEMIA PREVENTIVE RAT TESTS SHOW

Copper is an essential factor in keeping the blood red and the body vigorous. University of Wisconsin chemists have declared. Their tests show that it has an important effect on anæmia in rats, a disease similar to anæmia in children who have been fed exclusively on milk. A shortage of iron has been credited with being responsible for the disorder, and, although iron compounds are still limiting factors, their influence, according to the

Wisconsin investigators, depends upon the presence or absence of copper. The daily feeding of iron in various forms to rats afflicted with anæmia did not check the trouble. But when a supply of iron was obtained by feeding dried liver, or the ash of dried liver, corn or lettuce, an improvement was noticed. The chemists observed a pale, bluish color in the ash of the substances prepared, the typical hue produced when copper compounds are burned. This led them to add copper sulphate as a supplement to an iron compound in the whole-milk diet. Striking cures were the result. The role of copper in plant and animal tissue is not clearly understood, but it is believed to act as an agent that causes the beneficial functions of other chemicals. Experiments with copper in the diets of human anæmia patients are planned at leading hospitals.

### HAND-SIZE AUTO-BRAKE TESTER. 471 SIMPLE AS A WRENCH

One man can perform an accurate examination of the automobile brakes with the aid of a hand-sized tester that is said to be as efficient as the larger and more complicated units, and yet does not take up valuable garage space. The amount of tension is registered by an arrow at the side when the tester is depressed against the wheels, so that brakes can be equalized exactly and with little trouble. With each unit, a locking-type pedal depressor is furnished.

Brake Tester, and View in Use

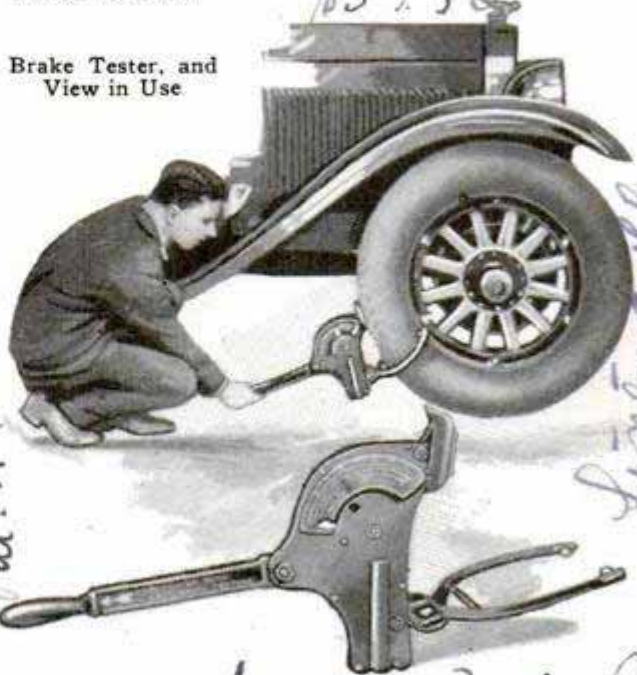

Cal. Aug. 2, 1929

Daily Science News Bulletin  
Vol. 3, 67, 2  
17/28

Cal. H. 26, 4970

Lincoln

Dr. B. Hall  
Madison

Norwalk Auto Parts Co.  
Norwalk Ohio



## WHERE SPEED OF SHIPS IS TESTED WITH MODELS

The speed of American ships, their fitness, their seaworthiness and their beauty of line are studied in a picturesque pool at the nation's capital. Not many people see this basin of water. It

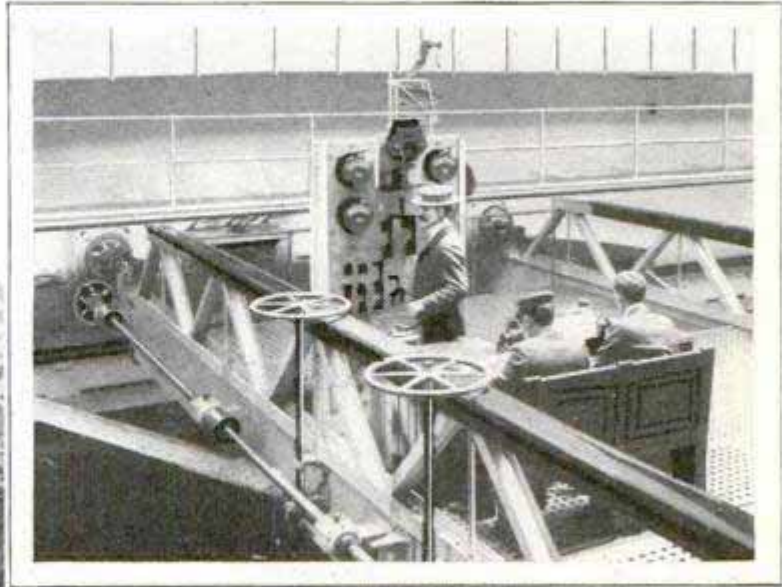

View of the Model-Ship Testing Pool and the Suspended Carriage Where the Measuring Instruments Are Located, and the Observers Stand during the Test

is not on the list for tourists, yet it is one of the most interesting sights in Washington. The experimental model basin is located in the navy yard. It is housed in a long, low building, covering an enormous pool of water, 470 feet in length, some forty-two feet wide and fourteen feet deep, containing more than 1,000,000 gallons of water. The models tested are all twenty feet long and made of California redwood. From a seat on the giant carriage above, the behavior of the craft is watched. Just how fast the liner will go, how much fuel it will consume, how much it will cost to operate, is all discovered and checked by the tests administered to the miniature. The basin gives the solution and the answer to the work of the ship's designers. It proves absolutely if he is right or wrong in speed construction of the hull and as to behavior under storm conditions. For here, by means of giant fans and other devices, storms can be simulated. Chiefly, it is the speed of the model that is watched. It generally takes

two weeks to properly test a ship's model. In that time, its every movement in the water is closely reported, graphed and charted for later study and recording. The forty-ton carriage that spans the basin is used for measuring instruments, for observation and for the towing of the models. It is operated by four electric motors under easy and instant control. The resistance offered to the hull of the little craft is recorded, and the speed indicated.

### FLYING BECOMING SAFER 591

According to statistics compiled by a life-insurance company, aviation accidents, in proportion to the mileage flown throughout the United States, are diminishing. In 1926, there were 160 fatal accidents in air operations, including those that happened to pilots, mechanics and others. Full reports for 1927 have not yet been compiled, but it is believed that the total will be less, although the mileage was far greater.

*Dr. Frederick L. Hoffman*  
*Prudential*



3) 29



Target Practice at Dummy Figure of Man behind Barrier Which Represents the Bars of a Bank Cashier's Cage

### TARGET DRILL FOR BANK CLERKS — HELPS CURB ROBBERS

Los Angeles police have been instructing various bank clerks of the city in target practice so that they may be better able to cope with robbers in case of necessity. A target, shaped like a man, is used, and to duplicate, as nearly as possible, actual conditions in a bank, the shooting is done behind a shelter which is composed of a partition with a window and a set of bars to represent those around the tellers' cages.

### MAN-MADE LIGHTNING SETS NEW RECORD WITH FLASH

Artificial-lightning flashes of 3,600,000 volts each, the highest ever obtained with laboratory apparatus, were made in an experimental plant of the General Electric company recently, in connection with work being

done to further protect life and property from lightning. These huge sparks, each with voltage about seventeen times greater than that carried by the highest-voltage transmission line in this country, lasted only about one-ten-millionth of a second, and electricity for them was stored in artificial clouds just as it is accumulated in real thunder clouds in the sky. Waves of lightning, the tests showed, travel along a metal wire just as water waves travel on the ocean. As waves splash up to a double height when they strike a wall, so the lightning waves "splashed" up to double voltage when they struck the end of a line.

From direct voltages of 3,000,000, voltages of more than 5,000,000 were observed by reflection from the open end of a line during the experiments. Lightning is one of the greatest foes of electrical apparatus, and much already has been done in the company's laboratory to produce outfits that will be proof against accidental flashes.

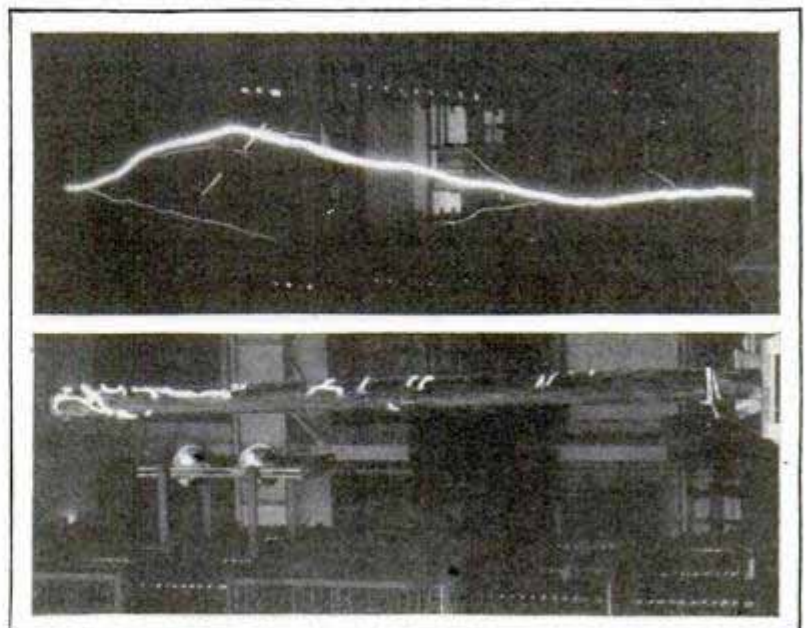

One of the Giant Man-Made Lightning Flashes and Part of the Apparatus; Electricity Was Stored in Artificial Clouds

Courtesy General Electric Co.

P. Utzfeld, Mainz  
Germany



4639 Montgomery Ave. 3317

Bethesda, Md.

# With UNCLE SAM'S DEVIL DOGS



Soldiers of the Sea on Guard at the Mouth of the Ozama River in Santo Domingo; a Scow and a Tent Become Headquarters for the Marine Guards of the Patrol Boats

DOWN the streets of Paris island, S. C., swings a regiment, led by a brass band. The bandmaster twirls his gold-plated baton, tosses it into the air, and the band blares into life with one of the most stirring marching songs ever written:

"From the halls of Montezuma  
To the shores of Tripoli..."

Another regiment of "leathernecks" has completed its twelve weeks of intensive training and is off somewhere back of beyond to tell some restless people that fire-arms are dangerous things to play with, and they must be good. For, wherever in the world local governments fail and the lives and property of foreigners are threatened, sooner or later a squad, or a company or a regiment of United States marines will happen along to restore peace.

There are a thousand officers and 18,000 men serving in the "Soldiers of the Sea"—and seventy-five per cent of them are on foreign duty. Marines are guarding international trains, patrolling rivers and protecting legations and foreign settlements in China. A leatherneck army is

chasing bandits through the hills of Nicaragua. In Haiti they are the guardians of the peace. There are detachments in the Philippines, Guam, on the Panama canal, at Guantanamo, Cuba, and in the Hawaiian and Virgin islands.

When mail bandits got active at home, the government called for the marines and installed armed guards on the trains. In fact, it has become so customary to shout for the marines whenever trouble threatens that senators have even suggested using them to deal with local disorders, and a marine general, Smedley Butler, got a leave of absence to reorganize the Philadelphia police.

Starting primarily as a seagoing police force—and therein lies the age-old enmity of sailor for sea soldier—the marines also were used as sharpshooters to repel boarders in the hand-to-hand fights of sailing-ship days, and as landing forces to take and hold enemy towns.

They still retain their naval connections as a separate corps under the navy department, but most of their fighting now is



3519 68

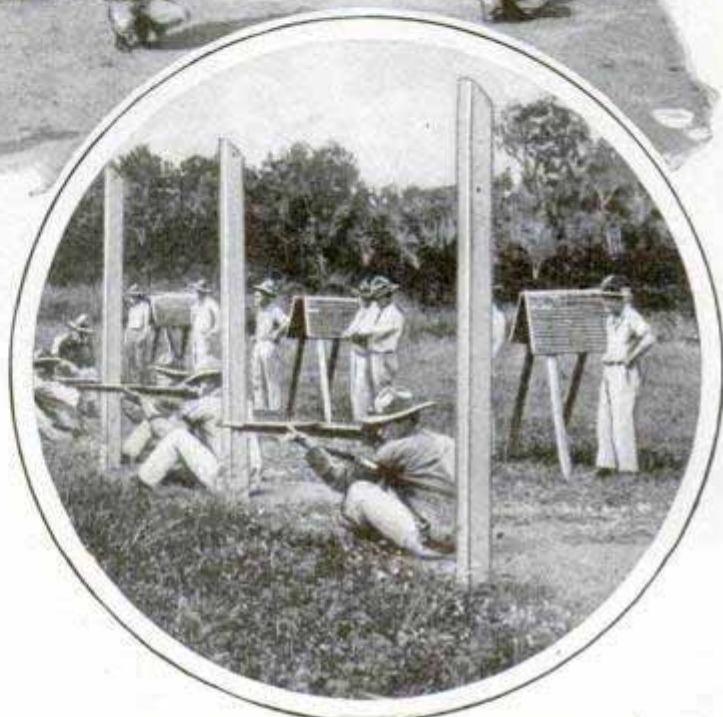
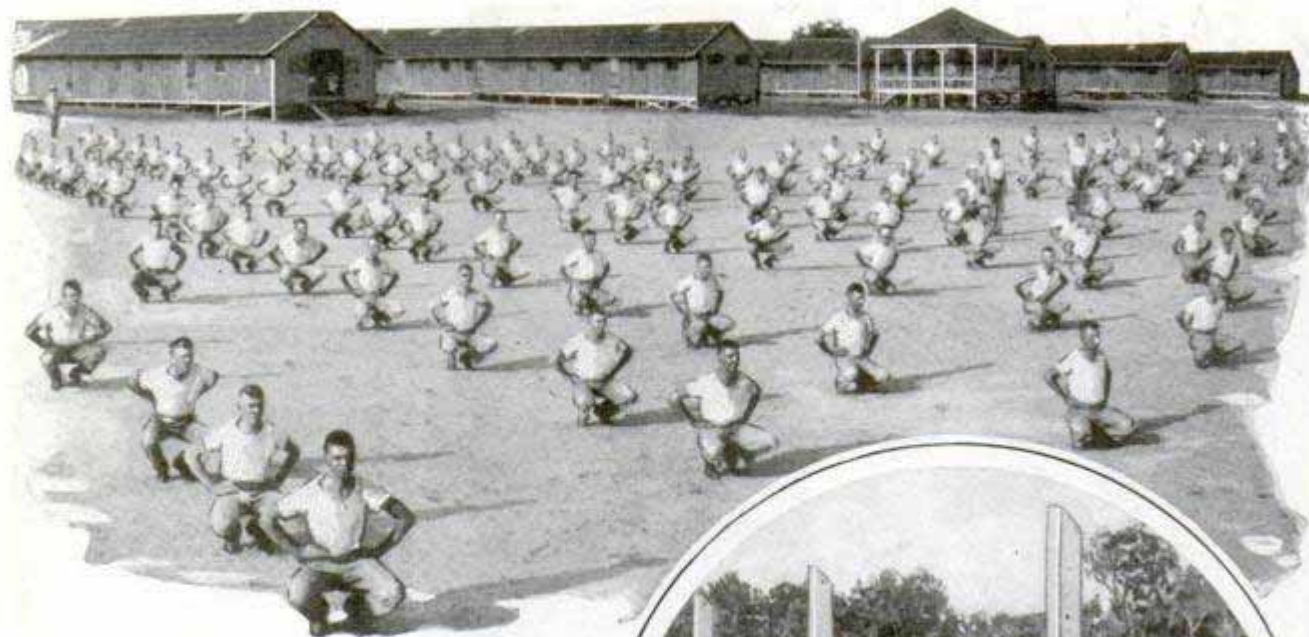

Recruits Doing Their Daily Dozen at Paris Island, S. C., and Marines on the Rifle Range at Guantanamo Bay, Cuba

done on land, for the days of hand-to-hand sea fights have passed.

Within the corps, though they form an army and a navy of their own, capable of handling river and harbor patrols afloat, or of fighting on land or in the air, they are infantry, artillery, machine gunners, tank corps, sappers, scouts, cavalry and air force, all rolled into one.

In time of war, if the navy doesn't need them, the president is empowered to transfer the leathernecks to the army, and it was under army leadership that they invaded the halls of Montezuma at the taking of Chapultepec during the Mexican war; fought at Vera Cruz with Gen. Funston, and served in the second division when they stopped the German advance in the wheat-fields along the Marne and earned the name of "Devil Dogs" in grudging admiration from the same Germans who had named England's kilted Scotsmen the "Ladies from Hell."

Only one out of every eight or nine who applies to join the marines gets past the initial examination and is sent either to Paris island, on the Atlantic, or San Diego, on the Pacific. Out of these two schools, at the end of twelve weeks' training, come leathernecks, and before the hard-boiled drill sergeants have finished the three months' drill, the recruit has fairly earned the title.

The Pacific fleet gets its marine replacements from the depot at San Diego, and the Atlantic fleet draws either from

the school in South Carolina or the big marine base at Quantico, Va., which is the real headquarters of the corps. In times of emergency, entire regiments are shifted around the world. Drafts from the east and west coasts were rushed to China a year or so ago, and far-flung marine stations contributed to the division mobilized in Nicaragua.

The fight with Sandino's bandit army in the Nicaraguan mountains has been the most extensive small war in recent years, not because of the size of the enemy force, but because of the difficult country over which the troops have to move. Mountainous and sparsely settled, without roads or navigable streams, with impenetrable jungle lining the few poor trails, it has been ideally adapted to the guerilla tactics of the bandits, and is the worst place in the world for operations with organized forces.





Marines as Artillerymen Man the Coast-Defense Guns at Guantanamo, and as Soldiers, Right, Guard the Nicaragua Mail

The marine air force, however, introduced a new note in Central American warfare. Swooping over the bandit lairs, the marine flyers sprayed the surprised rebels with machine-gun fire and scattered them with deadly little bombs. The only way to tell the difference between presumably peaceful natives and the armed bandits was to wait until the latter opened fire, but once they attempted to attack the planes, the retribution

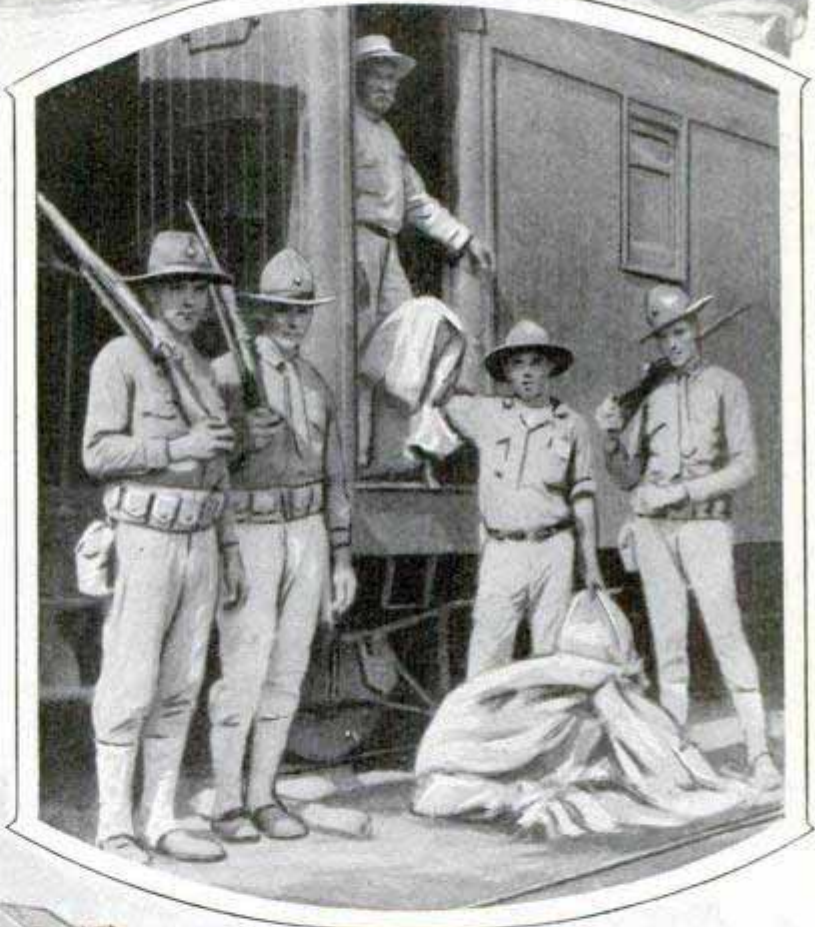

Marine Patrol Sets Out for a Tour through the Unpacified Districts in the Island of Haiti



35/19  
70



Marine Pack Train, in Haiti, and, Left, with the Camera, Lieut. Schilt, Hero of the Evacuation by Air of Wounded Comrades in Nicaragua



followed so swiftly and effectively that the Sandino forces soon discovered their only safety lay in not firing on flyers at all. Lieut. Christian Schilt, a marine flyer, has been recommended for the congressional Medal of Honor for flying through bandit fire again and again, landing his ship

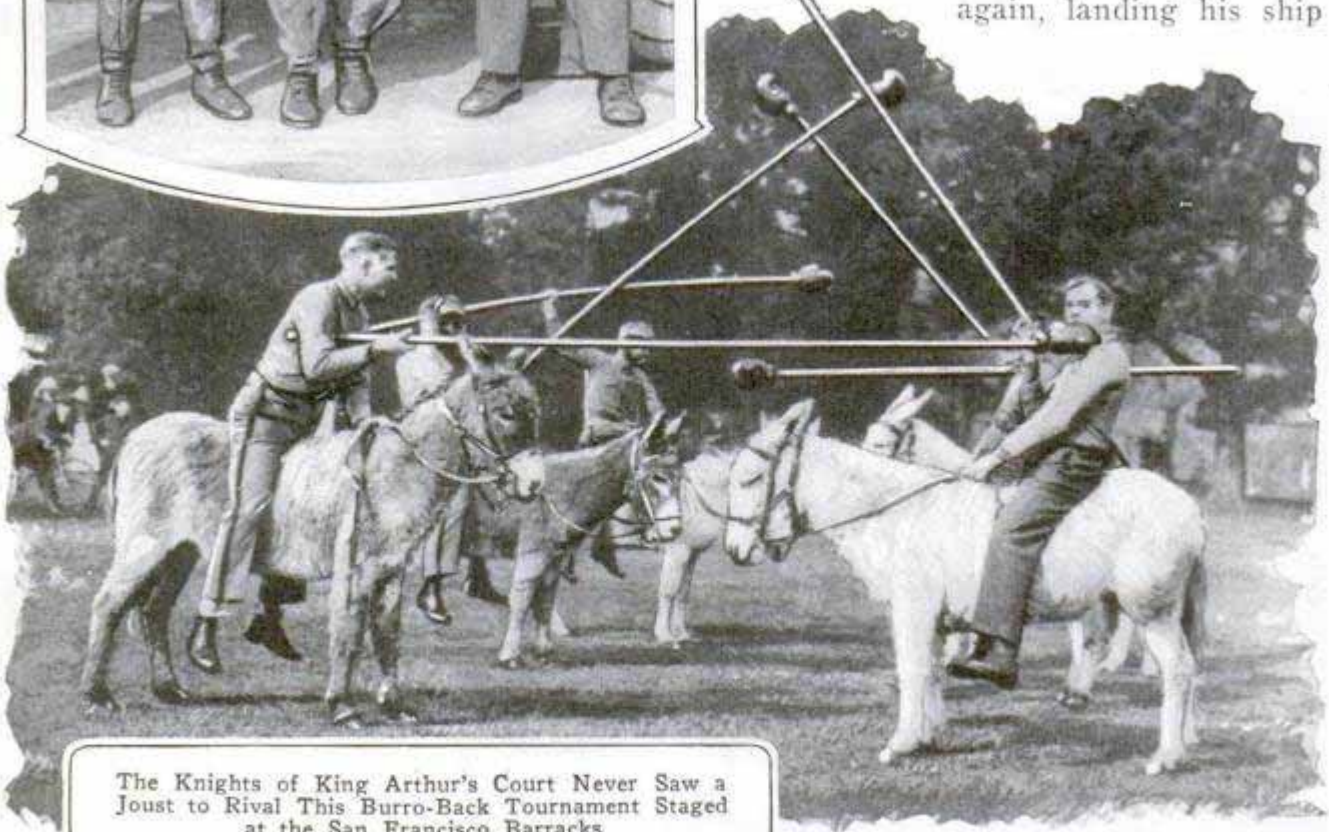

The Knights of King Arthur's Court Never Saw a Joust to Rival This Burro-Back Tournament Staged at the San Francisco Barracks



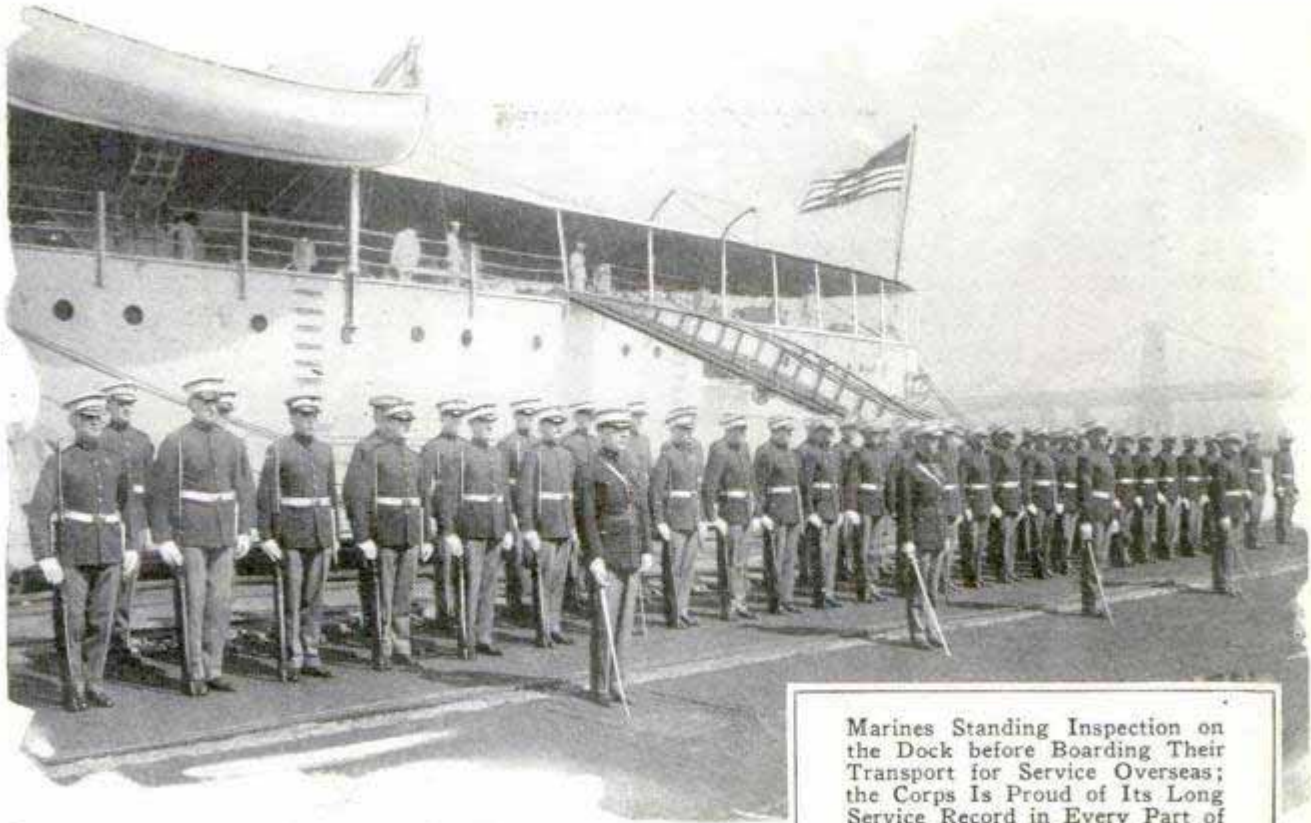

Marines Standing Inspection on the Dock before Boarding Their Transport for Service Overseas; the Corps Is Proud of Its Long Service Record in Every Part of the World

in a narrow rutted street of a tiny hill village and ferrying out five loads of wounded marines after one battle.

In their journeys over the globe, the devil dogs have been forced to adapt themselves to every sort of primitive condition, and Nicaragua was no exception. The only suitable draft animals to transport supplies to the regiments chasing the bandits were oxen, hitched to unwieldy wooden-wheeled carts. Marine ox trains were organized, mules were brought in to transport light mountain guns, and with the very latest thing in fighting planes humming overhead to guard the trails, the leathernecks have moved steadily up country.

Pacifying a country is one task, but before it is safe to leave, there must be some assurance of future order; so, simultaneously with the move on the rebel strongholds, the marines set to work to organize and train a Nicaraguan national guard to take their place when they left. Marines were detached and loaned to the Nicaraguan government, which commissioned them in the guard. Corporals became sergeants, sergeants were commis-

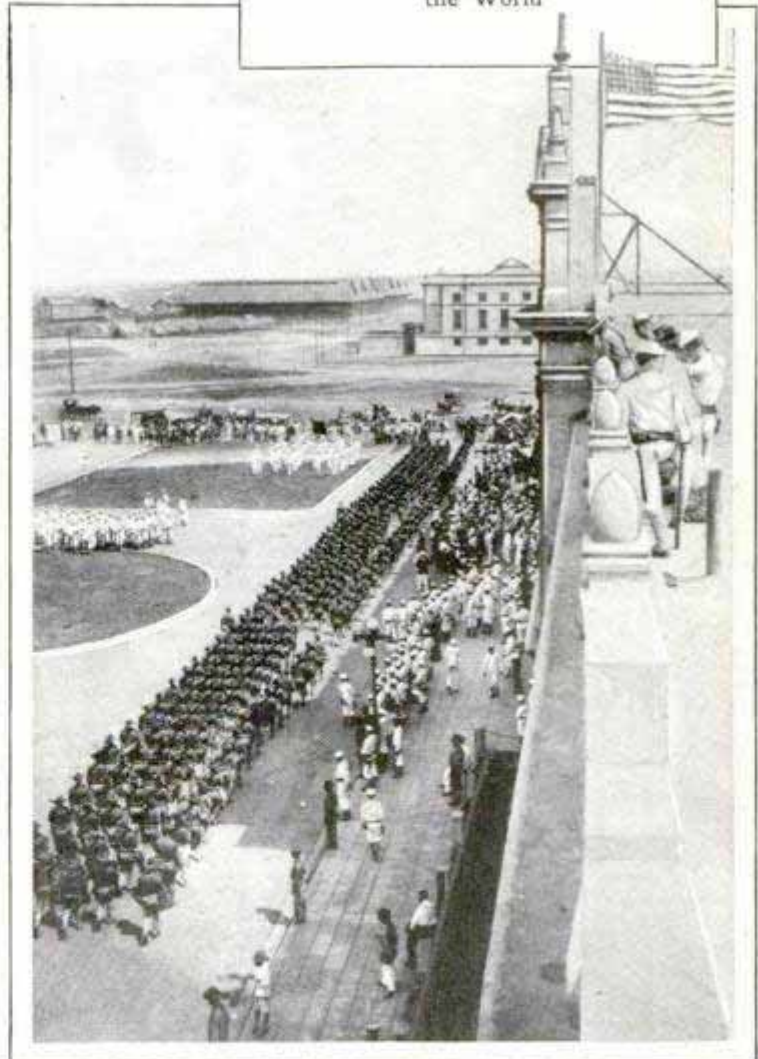

Marines Marching Past as the Stars and Stripes Is Hoisted over Vera Cruz, Mexico, Following Its Occupation; the Expedition in 1914 Was the Marines' Second Venture in Mexico



sioned as lieutenants and captains, lieutenants as majors, captains as colonels, and so on. As fast as the native troops were trained, they were sandwiched in among the marine companies for active service. Training the natives was a difficult problem, because they have never had any conception of a military force without political affiliations. Native armies always belonged to the ruling politician or took the side of the politician who was trying to oust the temporary ruler. Several of the native recruits had to be discharged because they talked politics in public, but eventually the bulk of the new troops began to get the idea of a national army unconnected with any faction.

For the marines themselves training never stops. They are encouraged to pursue correspondence courses, which are fur-

nished by the government. The schooling—subjects being optional with the students—covers stenography, automobile mechanics, carpentry, plumbing, farming, poultry raising, radio and similar courses which will fit the men for profitable work when they retire from the service.

The corps has six bands, including the famous marine-corps band stationed at Washington, and operates musical schools at Paris island, San Diego and Quantico, from which 150 trained musicians are graduated each year. Schools for cooks and bakers, operated by the corps, turn out 500 experienced bakers each year for service in the corps. Athletics gets its share of attention, with rowing, swimming, baseball and football as major interests, and boxing, wrestling, polo and other games for those who prefer them.

The formation of the seagoing infantry goes back to Colonial times. One battalion of leather-necks fought with Washington at Princeton and Trenton. John Paul Jones, Barry and Biddle all had marine detachments to aid in their sea victories. Marines fought the pirates of Tripoli and the Barbary states, and they have met West Indian freebooters, South sea cannibals, West African slave raiders, American Indians, and have even served in Abyssinia, as guard for a legation sent to negotiate a treaty with old King Menelik.

Although they are connected with the navy department, their officers

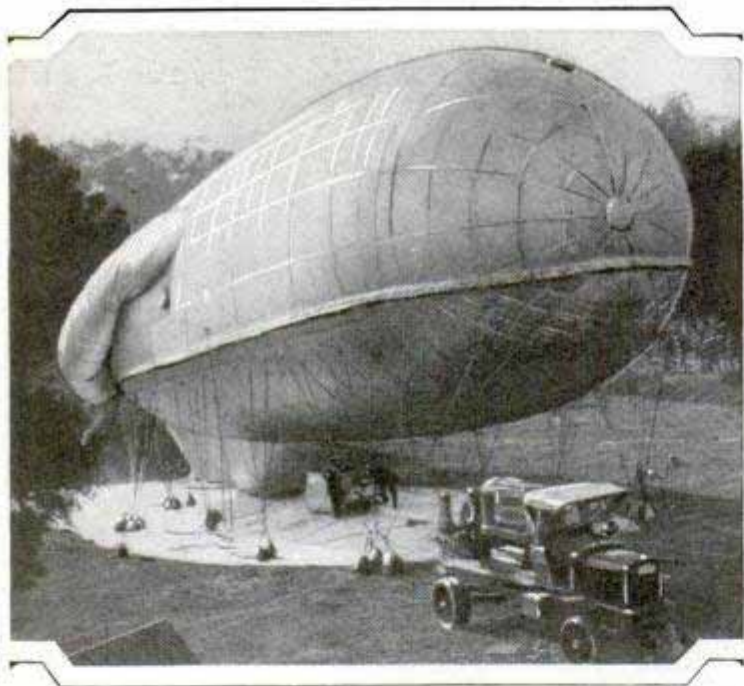

Marine-Corps Sausage Balloon Used in Maneuvers on the Historic Battlefield at Gettysburg, and Gunners in the Field with a Pair of Long-Range Anti-Aircraft Guns



50 Church St  
New York

POPULAR MECHANICS

have army titles, the commanding officer being a major general, a post now filled by Maj. Gen. John A. Lejeune. Officers for the corps come partly from the ranks, and partly from the naval academy at Annapolis. Students there who elect to enter the corps are given special training in their final year, and are then commissioned as second lieutenants, U. S. M. C., instead of as ensigns, U. S. N.

SHIP'S SPEED AND DISTANCE SHOWN ON LOG

The speed of a ship and the distance it travels are automatically registered on a special meter which has recently been introduced. An important part of the apparatus is a rod which extends through the bottom of the vessel and into water not affected by the ship's motion. Pressure created by the velocity of the vessel is transmitted through tubes connected to the rod and is translated into terms of speed on a special instrument calibrated to record the number of knots. An electrical apparatus, operated in conjunction with the speed meter, shows the distance traveled. The readings on both the speed and distance indicators are duplicated on dials set at convenient points in the ship.

BOTTLE OPENER ON KEY TOP ALWAYS AT HAND



Keys with tops notched to form a convenient bottle opener have been placed on the market. Blanks of this pattern are available so that smiths may fashion a key of any desired form from them.

ODORS TO CURB COLDS

An eastern physician employs four small bottles of pungent substances to aid in treating colds in the head. The sufferer is asked to sniff each in turn until he can distinguish one of the odors. The practice is said to stimulate the affected membranes and afford relief in some cases.

280  
Martin Supply Co. 73  
351 Fourth Ave  
New York



Brush Head Turned, to Show Ease of Up-and-Down Movement for Thorough Tooth Cleaning

TOOTHBRUSH HEAD ON PIVOT GIVES BETTER CLEANING

With an adjustable toothbrush, now on the market, the teeth may be scrubbed with an up-and-down movement as well as across, thereby reducing the likelihood of decay and making the cleaning task somewhat easier. With a simple twist, the head of the brush may be set at any angle desired.

HOLE CUTTER FOR ELECTRICIAN SAVES TIME AND WORK

For cutting conduit holes in cabinets, gutters, switches and the like, a simple tool is now available. It fits handily in the kit and operates on sheet metal, fiber, bakelite and other materials. The cutter itself is made of high-speed tool steel and the shank fits a standard brace.

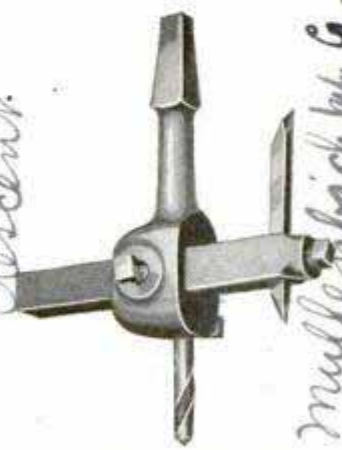

Chicago-5311 Kenmore Ave

Independent Lock & Brass  
72 West 14th St  
Chicago

Mr. Paul W. Goldsbury  
Warwick Mass

Mullenbach Co.  
1116 E. 14th St  
Los Angeles, Calif.  
Present Shop 1016



607

Science of Ervick (Bully) 368-C  
Washington 4/19/21  
50-100 - \$3.00, 100-5.00, \$2.85.  
500-5,000 - \$2.75



Ironing Board Attached to the Springs of the Disappearing Bed; One Space-Saving Position

### IRONING BOARD ON BED SPRINGS SAVES SPACE AND FURNITURE

Designed especially for hotels and apartment buildings in which disappearing beds are installed, a folding ironing board may be fastened to the bed spring or to any convenient door or wall. It is held up out of place by a spring catch which is released by pressure of the finger when the board is wanted. The arrangement keeps the guest from spoiling other furniture in the hotel room, saves space and involves but little work of installation, as the board is fastened with screws.

### HUNT SUGAR CANE BY AIRPLANE TO INCREASE U. S. YIELD

Over the lands of the head-hunters in New Guinea, an airplane expedition will soar this summer in search of varieties of sugar cane that may be grown to advantage in the United States. In a few hours, they will be able to cover a territory that would require months to explore on foot. The venture is partly inspired by the success of other kinds of sugar cane, imported

here, which have yielded far more than the domestic varieties, and also brings to light a romantic incident of the disastrous floods in Louisiana, in 1927. Until two years ago, the sugar-cane industry there had been suffering severely from inroads of plant diseases. A tested variety, imported from Java, had thriven in spite of insect and other pests, however, for, though it contracted the disease, it was not harmed by it. The floods threatened to destroy a large plantation of this cane. Would the planters below consent to the cutting of the levees so that it might be saved? They did, but the sacrifice was rewarded for the imported variety is producing far greater yields than the old, disease-ridden kinds. The airplane expedition will search for other canes that may be cultivated here with even better results.

### BANK VAULT OPENS FROM INSIDE TO FOIL ROBBERS

Easily installed in the bank vault, a special handle arrangement releases the locks from the inside, so that anyone trapped within may quickly escape. This would frustrate a robber's plan to shut a bank attache in the vault until the time locks operated, as the prisoner could open the doors before or after that time. In operating the handle, knowledge of the vault's combination is not necessary.



Interior View of Vault, Showing Handle That Unlocks Door from Inside

Developed and installed  
Anker Lock Alarm Co.

234 S. Seventh Ave  
La Grange, Ill.



427

Uthai Vincent Wilcox Washington  
Norman C. McLeod, 2720 Maryland  
Ave.  
Baltimore  
Md.

# Fire Fighting Underground

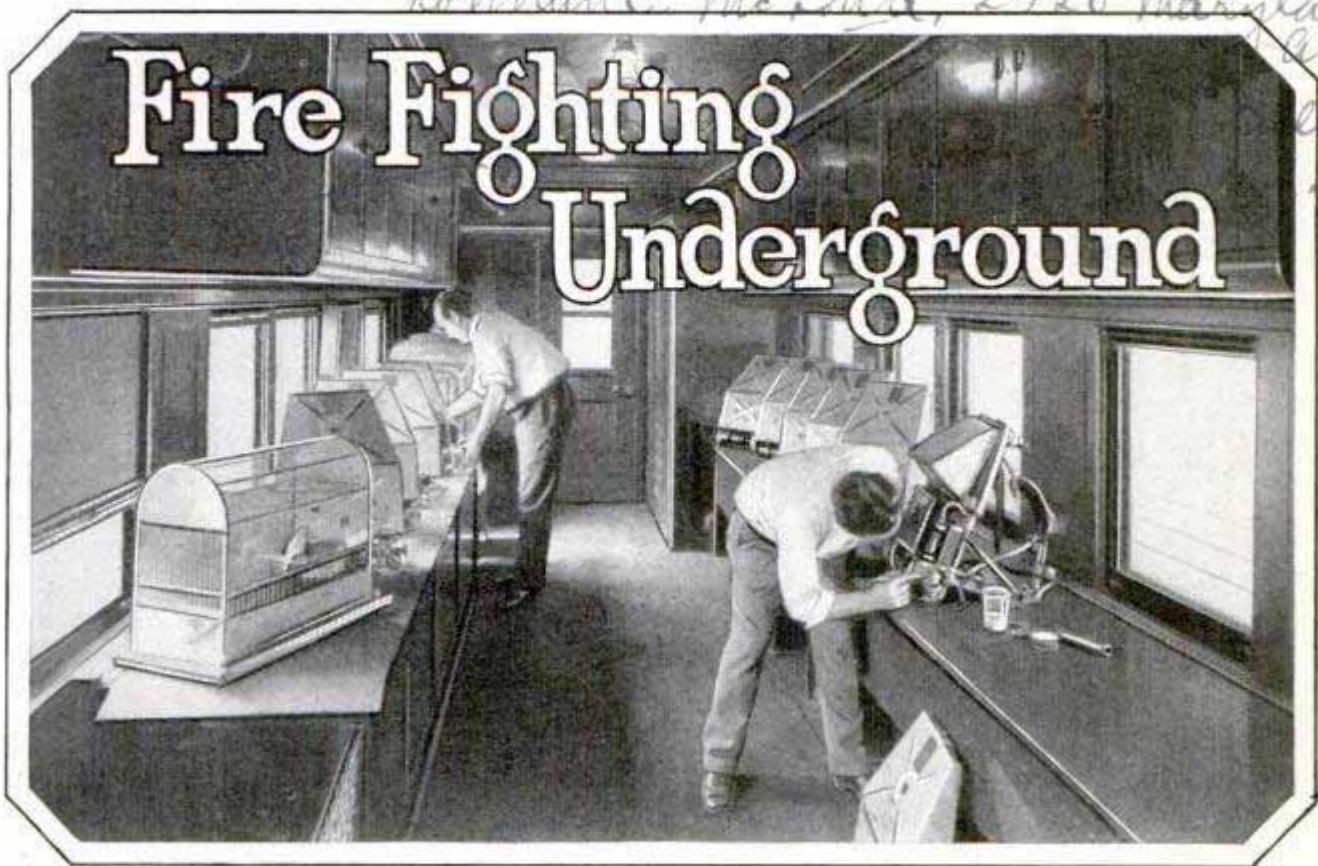

Canaries to Test Mine Air, Left Foreground, and Two Mine-Rescue Workers, in the New Bureau of Mines Car, Inspecting the Oxygen-Breathing Apparatus Used Underground

**S**PEEDING a thousand miles through the night, clipping eleven hours from the best railroad time for the journey on a trip unique in the annals of international humanitarian work, a mine-rescue car from the United States recently crossed into Canada to put out a fire in the biggest gold-producing mine in North America and recover the bodies of thirty-nine victims of the disaster.

The dispatch of equipment and men outside of the country was without parallel, but the job was all in the day's work for the crew. Car No. 3, the latest and finest of the ten at the disposal of the bureau of mines, was at Jenners, Pa., a mining village seventy-five miles south of Pittsburgh, when the appeal for help was received. It was in charge of Russell G. Thornburg, foreman miner, who had just been transferred after a long period of rescue work in the Alaskan mines, and to reach Canada the car would have to pass through Pittsburgh, where the experimental station of the bureau of mines is located, and where additional expert fire fighters and equipment could be obtained.

It was nearly midnight when the order reached the car, reposing on a rusty siding of a meandering branch-line railroad.

An engine was obtained and hastily fired up, the car jolted down the mountain spur to another branch-line junction a dozen miles away, and down that line in time to be hooked onto a main-line passenger train at 4:00 a. m. Reaching Pittsburgh at dawn, the car picked up four more fire fighters and began loading extra apparatus.

Fifteen sets of oxygen helmets and tanks, the absence of which had kept the Canadians out of the burning mine, were taken, as well as twelve gas masks built to bar any form of poison gas. The Canadians have gas masks, but they are useless when thick smoke and poisonous fumes have driven out all air, for then there is no oxygen to breathe. Two dozen carbon-monoxide self-rescuers, a little device to be worn at the belt and used to filter out poisons temporarily in an emergency, an assortment of electric and flame safety lamps, ten cylinders of oxygen, poison-gas detectors, and four canaries were among the equipment. The canaries were all veterans of many mine fires in which, by drooping or falling over unconscious, they had warned the crew of poison gas before it had become dangerous to the men. There were also several sets of gas-analysis apparatus which enable the bearer,

Bolinger said mine  
75  
Crest





Filling Flasks with Oxygen on Mine-Rescue Car; Each Steel Bottle Lasts Two Hours, Then Another Must Be Connected to the Mask



With the Apparatus Above, It Is Possible, by Analyzing a Sample of Air, to Tell Whether Fire Is Raging Underground, or Poison Gas Is Present in Dangerous Amounts



A Rescue Crew Adjusting Oxygen Masks and Tanks before Entering a Burning Mine; the Masks Render Them Immune to Every Form of Gas and Smoke for Two Hours

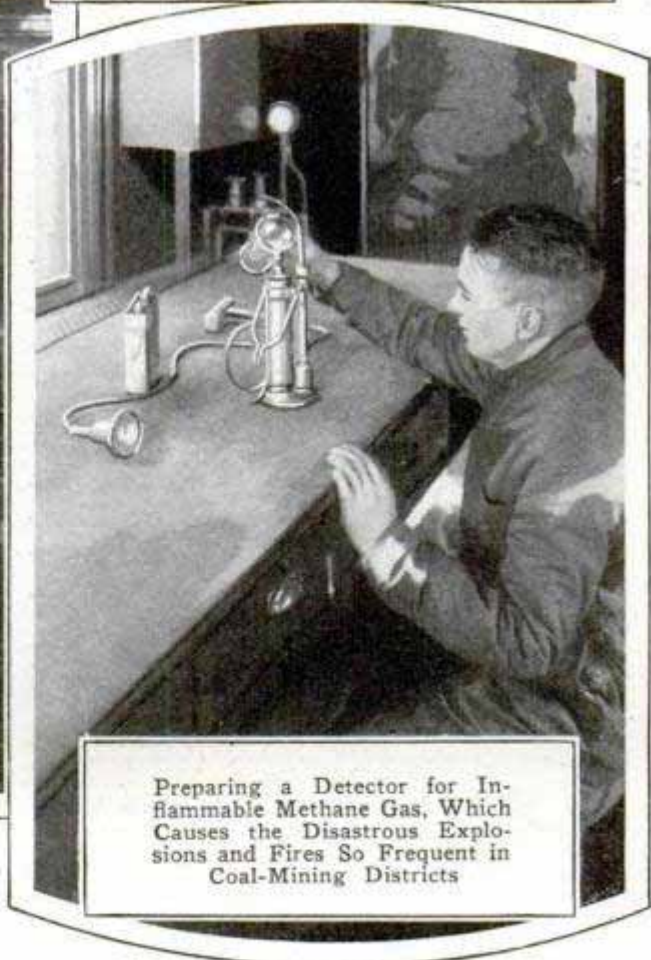

Preparing a Detector for Inflammable Methane Gas, Which Causes the Disastrous Explosions and Fires So Frequent in Coal-Mining Districts



through examination of an air sample from any part of a mine, to determine whether there is fire or dangerous gas in the immediate vicinity.

With that load, and fire experts gathered from Washington, Pittsburgh, and from a mine fire on which they were working at Wilkes-Barre, the car started northward. Between Pittsburgh and Buffalo, pulled by a special engine, it clipped two hours off the passenger-train record. The Canadian national lines took over the car at the border, rushed it to Toronto and, after a brief stop, on for the last 485-mile dash into upper Ontario, over a winding frontier road, with snakelike curves through the endless forests, where snow lay four feet deep. The engineer on the last division was nearly frozen when the train reached Timmins shortly after daylight.

As the car came to a halt on the mine siding, the difference between fighting an above-ground and an underground fire became apparent. There was no speeding of apparatus to

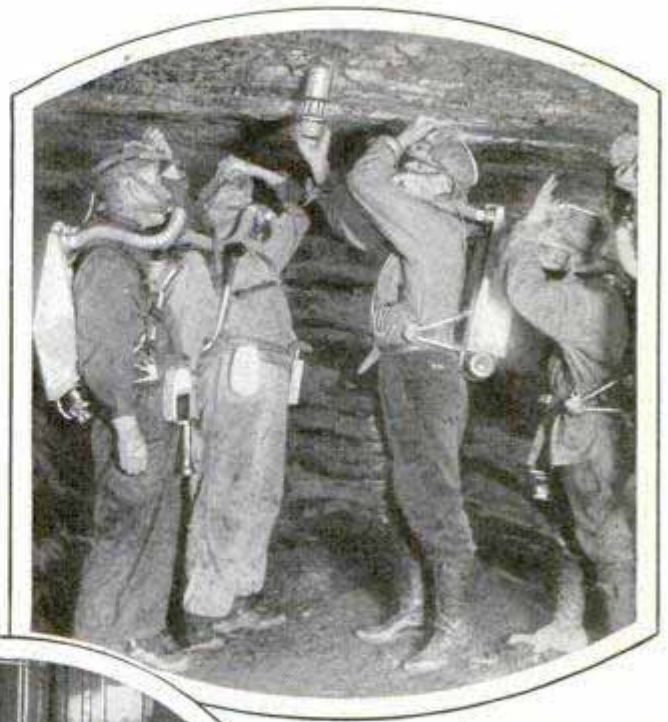

Using a Safety Lamp to Detect Dangerous Gases Clinging to Roof of a Coal Mine, and the Crew, at Left, Studying the Map before Going Underground

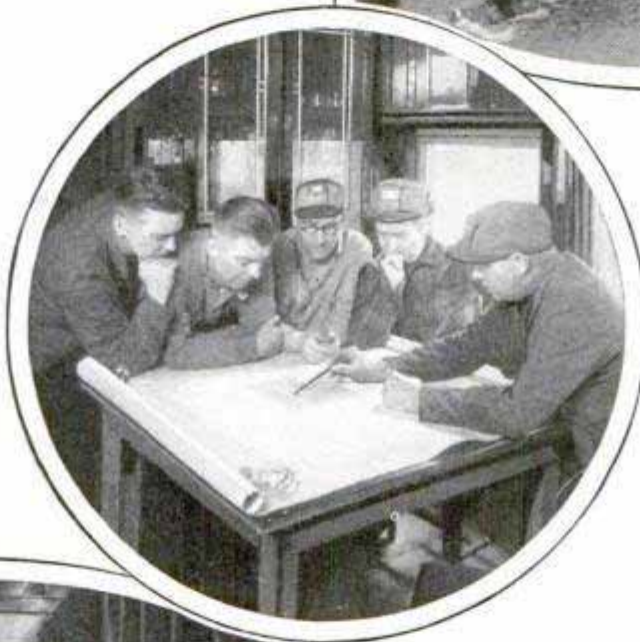

the scene, nor did the rescue crew hurriedly don their oxygen masks and dash to the mine cage. Instead, they called for maps of the 100 miles of tunnels in the great Hollinger mine and a report on conditions and what had

been done since the fire started. When they reached the reeking smoke-filled levels, only one course was possible; the mine must first be cleared of smoke so they could see ahead. The objective was the area of smoldering fire, where tunnel timbering was ablaze, but a bare 300 feet from the known fire center was a powder-filled magazine, which the flames might attack before the men could prevent it.

At 11:30, the firemen reached the magazine and found both its attendants dead. Screens were erected to isolate the magazine and force pure air ahead to drive the fire back. Hours were spent covering the last 300 feet, but at 5:20 in the afternoon the fire center was reached, and an order went back to bring up the hose. At 6:45, the rescue crew turned on the water.

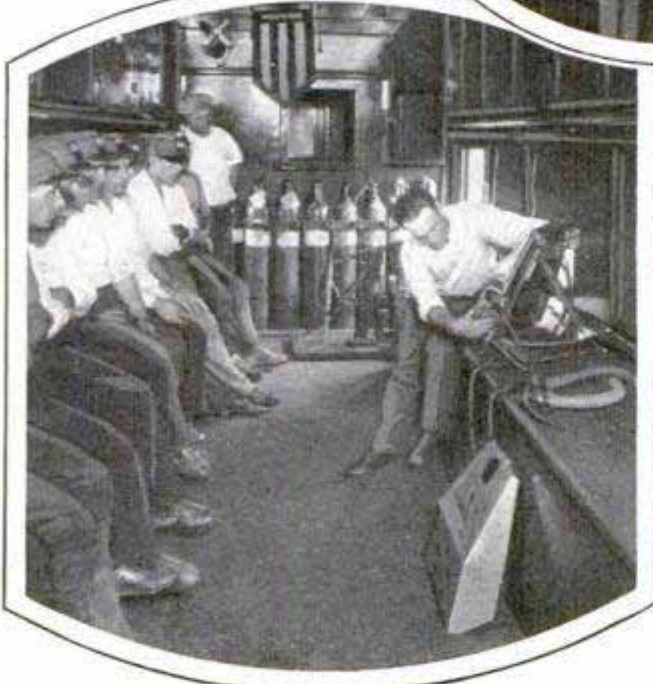

Forty Thousand Miners Were Trained Last Year, as These Are Being Taught, How to Safeguard Their Lives When a Mine Fire Occurs



*Com. W. A. ... 331-34 ... Oakland, Calif.*

50 <sup>9</sup> LIGHTED AIRPLANE TARGETS AID NIGHT SHOOTING

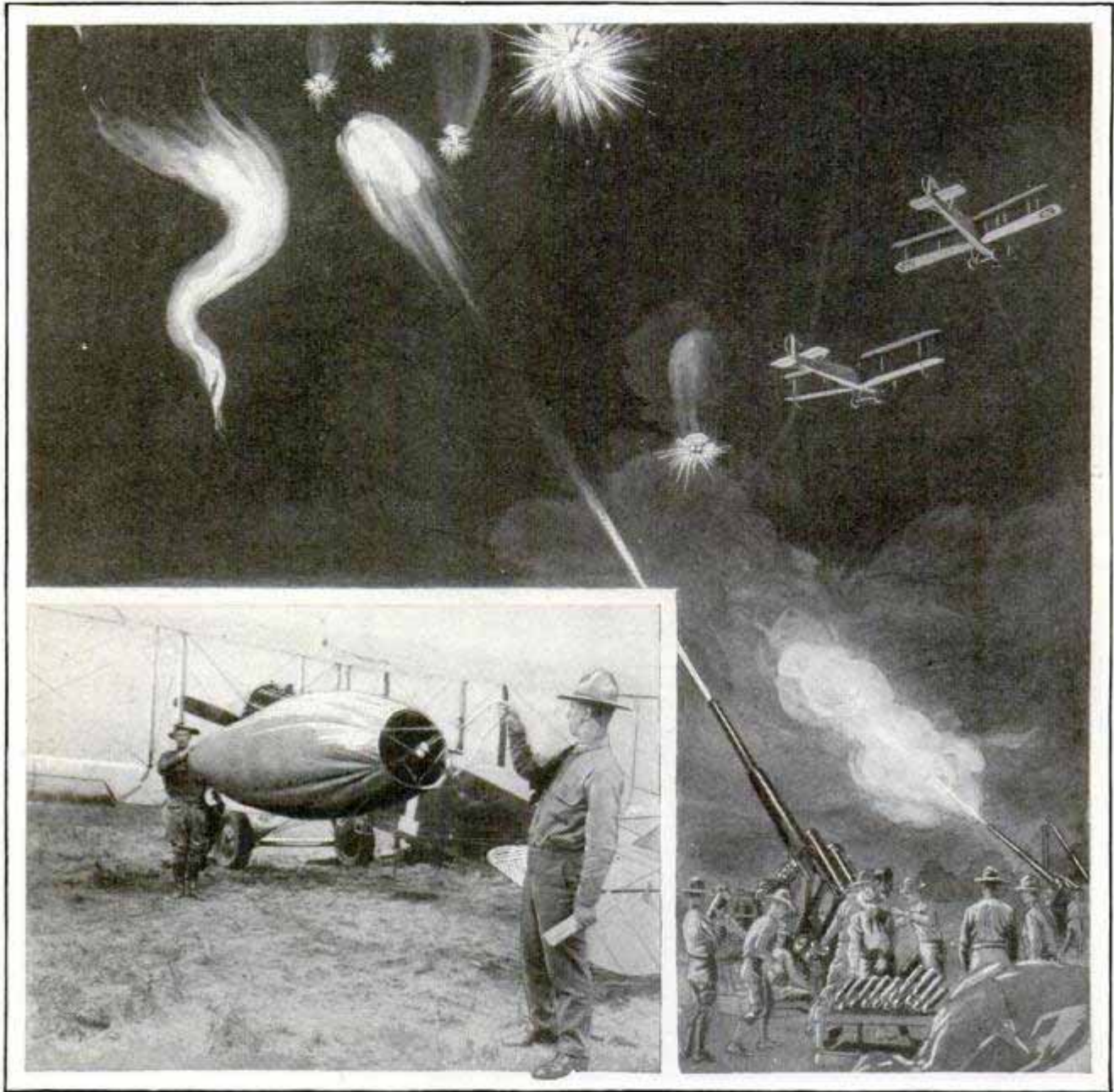

One of the Sleeve-Shaped Targets with the Light in Front, and Drawing Illustrating How Night Gunnery Practice with the Flying Marks Might Appear

Sleeve-shaped targets, towed by airplanes and having small flashlights mounted on the frame, are being used by the navy for gun practice at night. They are towed a safe distance behind the plane and, at an altitude of several hundred feet, closely resemble a real plane as it would appear if flying "dark" at a much greater height. The lights are placed on the front of the target so that the gunners can fire directly at them as they would have to do under actual fighting conditions and, in an attack of a plane on a ship, the flying craft always comes straight at or over the vessel. The reason for night practice is

that the use of strong searchlights in locating hostile planes is not always possible in warfare. On the other hand, if the lights are used, they sometimes suddenly blind the enemy pilots so that gunners on the vessels will have a chance to hit their craft before the bombs are dropped.

**SOUND WAVES SET OFF ALARM TO FRIGHTEN BURGLARS**

Efficient protection of banks and vaults against burglars is provided by an alarm so sensitive that it is set off by waves caused by talking, striking or tampering

*S. B. McChintock Co., Inc.  
139 ...*



with the protected area in any manner that produces a noise. The operating mechanism is electrical and is concealed in a cabinet together with the clock that governs the setting and release of the system, while the other important part of the installation—a small case on which the sound vibrations strike and relay their action to a loud gong on the exterior—may be placed on a ceiling, wall or other convenient location. It is inconspicuous and, of course, cannot be disconnected from the alarm circuit, while the system is operative, without sounding the signal. A special feature of the apparatus is that it is automatically reset. Should one alarm be given, it adjusts itself for another after the bell has rung for a certain time. Tests with the alarm showed that it was set off by the sound of voices in the vault, by cutting through the walls, and by the noise of explosives or the backfire of an oxyacetylene torch.

**DISPENSER FOR SHAVING CREAM PROMOTES SANITATION** 362



Shaving cream is applied directly to the brush from a special dispenser now on the market, eliminating the unsanitary mug, and effecting a saving of the cream. The unit is stationary, so there is no difficulty in finding the tube. One container holds enough cream for more than 500 shaves, and it is easily refilled.

Chicago, L. A. Coate, Austin, California

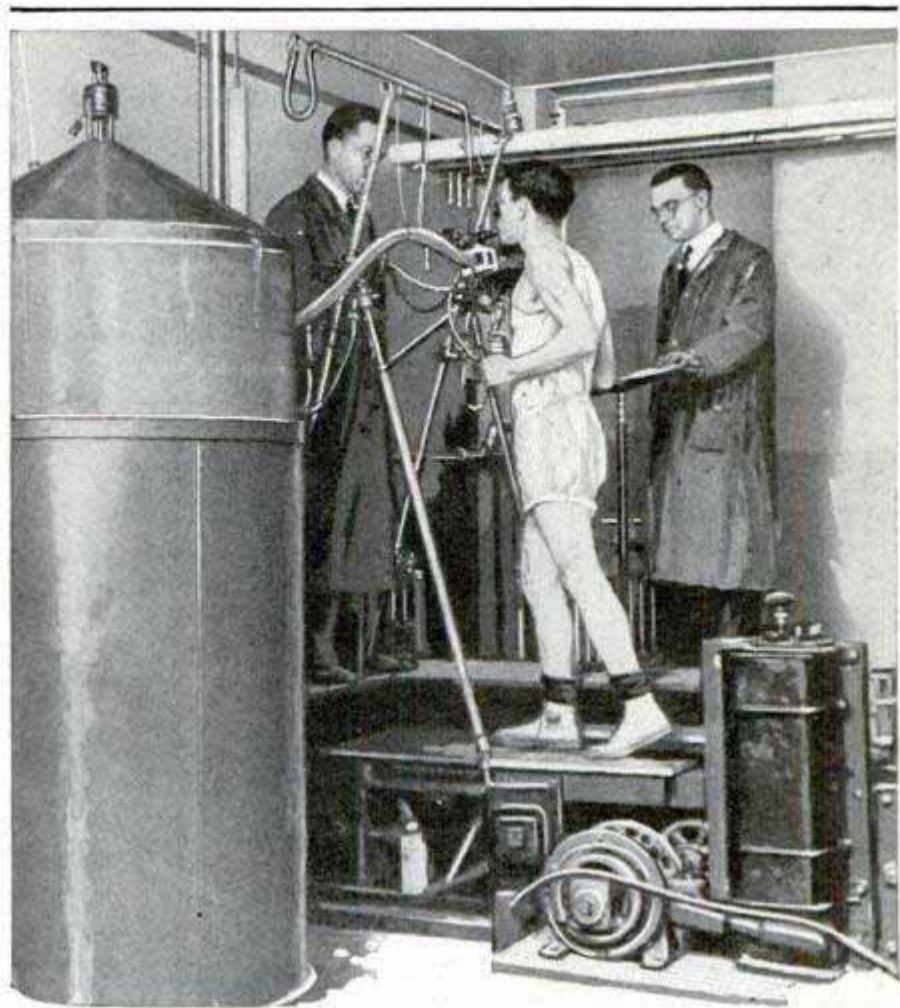

Treadmill Practice for a Runner While Experts Make Measurements and Tests to Show the Degree of Fatigue after Performance

**TREADMILL TEST FOR ATHLETES AIDS STUDY OF FATIGUE**

Interesting findings concerning the relation of physical exertion and fatigue have been made at Harvard University by examining athletes while they are performing various tasks. One of the experiments consists in placing a subject on a treadmill and having him wear a special mask while he exercises on the mill. Carbon dioxide, given off in breathing, is collected and measured, to estimate the accumulation of poisons as a result of the exercise. The treadmill can be adjusted to demand different degrees of exertion. By correlating the effort expended with the length of time the test lasts and the amount of oxygen consumed, an analysis of the subject's performance may be more accurately made than would be possible in an actual race.

Gold is said to be the most widely distributed metal, next to iron.

Chicago, L. A. Coate, Austin, California

Chicago, L. A. Coate, Austin, California

Chicago, L. A. Coate, Austin, California

Chicago, L. A. Coate, Austin, California



# LATEST NAVY AMPHIBIAN CARRIES GUNS AND BOMBS

Successful tests are reported to have been made with the navy's latest "warship of the skies," a huge, two-motored bombing plane that can alight on land or

the plane was carrying a useful load of 3,000 pounds and behaved satisfactorily in every maneuver. The ship is a duplicate of the ill-fated "Dawn." It

Side View of the Giant Amphibian Sikorsky Plane for Bombing Service

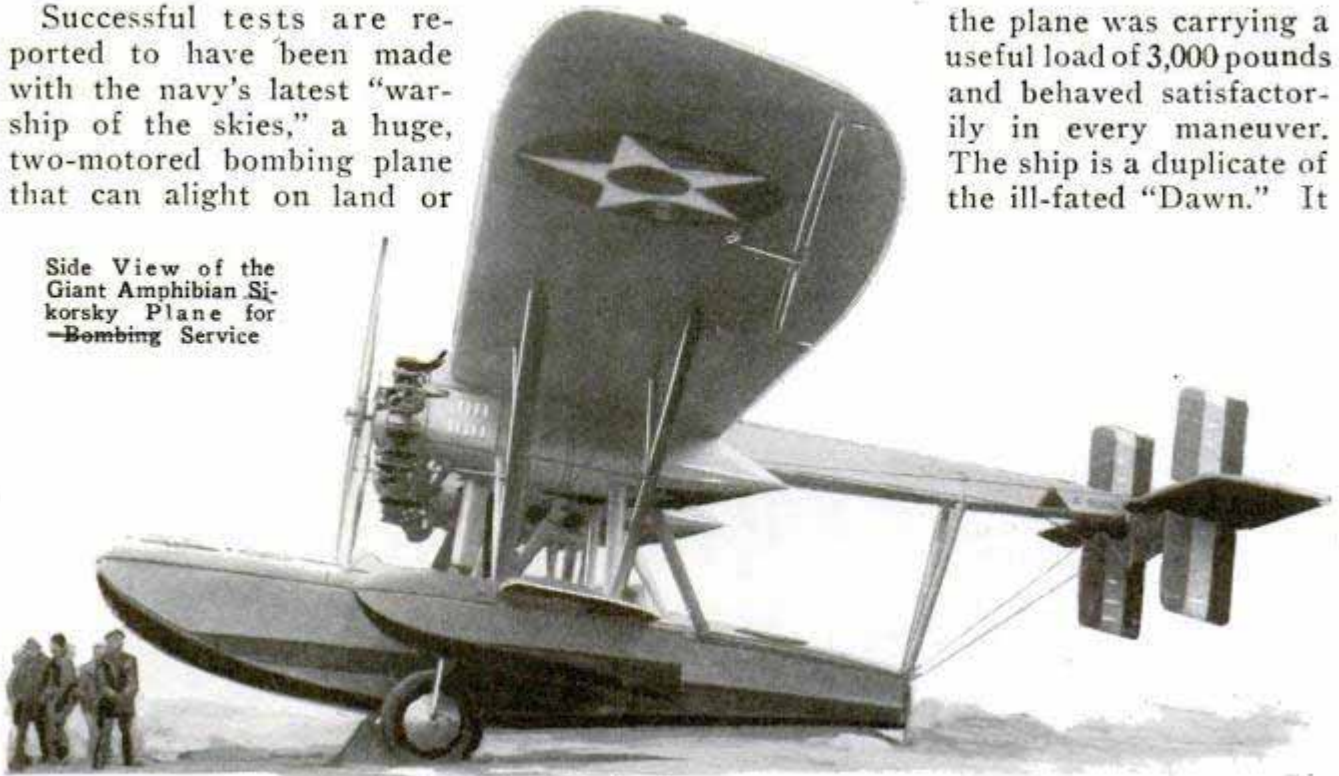

water. Besides bombs, it carries three machine guns. On one of the test flights,

has four cockpits, one for two passengers and the others for machine guns and crew.

## GUIDE TEACHES GOLF PUTTING TO IMPROVE GAME

player of faults that he may have acquired in previous putting practice.

To aid in acquiring skill in putting, a special holder for the club has been devised by a well-known golf player. It is attached to the stick handle by a clamp and has projecting arms that fit against the legs. The club is allowed to swing as a pendulum and in the correct manner to accomplish a successful putt. By using this guide for a few trial strokes and then putting without it, the beginner makes rapid progress in learning the correct form. The attachment fits in the golf bag, is put on or taken off in a few seconds, and is said to be especially helpful in curing the young

## ROOTS AS MINERS

Roots of vegetables and other plants are among nature's most efficient miners, investigation by Prof. John E. Weaver and Dr. William E. Bruner, of the University of Nebraska, has disclosed. By excavating a deep trench alongside the various plants studied, and carefully following the development of the roots, they traced the operations of radishes, beans, melons and other products. A four-year-old rhubarb plant was found to occupy a cylindrical space of soil equivalent to eight feet



Putting Guide in Use, and Close View, Showing Connection with Grip

*Ansbert Hemeth  
1307 W. ...*

*Clairly ...  
no. 067-10, 4:5/28*



Warner Mfg. Co., 5 & 7 E. Seventh St. 81  
510. Minneapolis, Minn.

in diameter and eight feet deep, while some of the longer roots reached eleven feet, and a ten-year-old horseradish plant had roots fourteen feet deep.

**SEEK TO IMPROVE PARACHUTES WITH SILK SUBSTITUTES**

Search for a satisfactory substitute for silk in making parachutes is under way at Washington. The United States needs 5,000 of these articles in peace time, and would require 30,000 to 40,000 in the event of war. Most of the raw material for them is imported. Silk is light, strong and durable and has the valuable quality of "bounce," that is, it springs out of the wrappings and, so, quickly assumes a position where it will open. Other materials tested have many of the desirable features of silk but lack this springiness. Cotton yarn has been treated and woven with a degree of success, and experiments have been made with the cellulose substitute for silk, but this substance has too great a tendency to absorb moisture. So far, the best results have been attained with long-staple cotton of a special grade. Recently, American research workers discovered a way to weave the silk so that the parachutes would have even greater bounce than was possible with the imported fabric.

**TRUCK WITH REVOLVING SIGNS LATEST ADVERTISING AID**

Revolving drums on the sides of an automobile truck that appeared in Tampa,



Moving Billboards on Auto Truck; the Posters Revolve as Vehicle Proceeds and Are Lighted at Night

Fla., recently, carried forty different signs, advertising various products. The posters turn as the auto is run and, at night, the legends are brilliantly lighted with electricity from the truck's circuit.

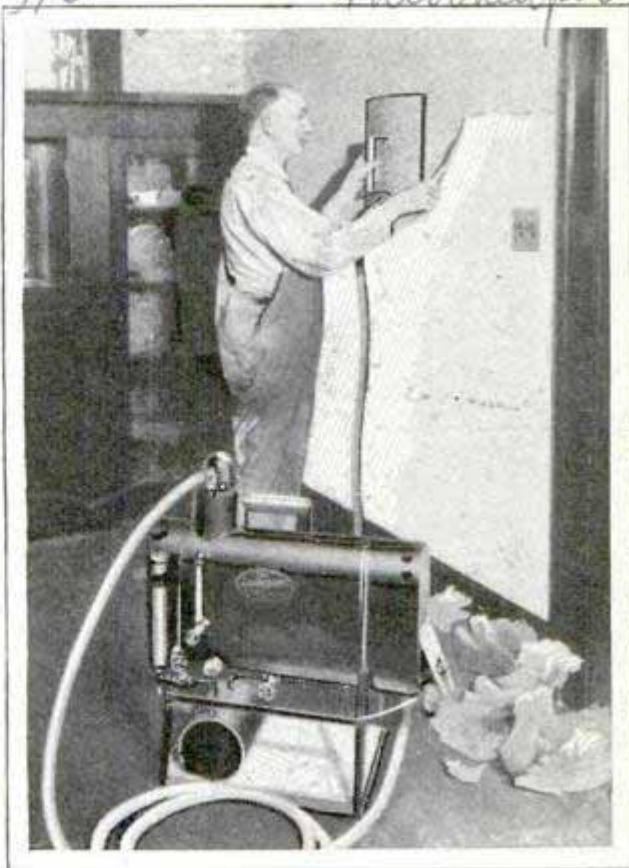

Removing Old Wall Paper with the Portable Steaming Outfit, Which Also Cleans the Wall

**STEAM WALL-PAPER REMOVER ALSO CLEANS SURFACE**

Old wall paper is easily and quickly removed with a portable steaming outfit now on the market. The vapor is applied through a hose and a wide concentrating plate which is held against the wall. The steam is generated in a lightweight boiler which one man can easily carry and is cheap and simple to operate. Steaming the paper for a few seconds softens it so that a scraper can be run underneath it and the paper loosened from the wall without damage to the plaster or other material below.

**LIGHTS DIMMED TO TELL TIME IN SOUTH AFRICAN TOWN**

Residents of Bloemfontein, South Africa, never have to guess when it is eight o'clock in the evening, for at that time the street lights are dimmed for a few seconds. This is done from the power-control station on reception of a telephone signal from an observatory. The plan has proved of great service, as the dimming occurs when most persons are at home so they can regulate their clocks.

Turned left, no address

American Wall Paper Co., Lincoln Ave Chicago. 76 E. 7 St. Haled and 4664

Michigan Bloemfontein, S. A.

J. H. Bloodgood, 3210

Cent. M. K. Jessup, 90 Tamart Huesen



2044

# IT WAS *the* GARDEN



By J. EARLE MILLER

ARE the Americas—the New World of the map makers—really the Old World in which man originated, and from which civilization spread?

Four widely scattered discoveries of prehistoric remains in recent months have strengthened the belief that, if man did not actually originate in the western hemisphere and spread from here over the world, he at least arrived in the Americas in a very primitive state back in glacial times, thousands of years earlier than any previous evidence had indicated.

At Vero, Fla., human bones and weapons and utensils have been found in the same stratum of soil with the bones of the extinct mammoth. At Colorado, Mitchell county, Tex., and near Folsom, N. Mex., arrow heads, better made than those in use by the Indians when the first white men arrived, have been dug up both within and under the bones of a type of bison that has long been extinct. Another find, near Frederick, Okla., produced arrow heads and five "metates" used for grinding flour, from beneath the remains of mammoths and a camel. Dr. Harold J. Cook, honorary curator of paleontology of the Colorado Museum of Natural History, who examined the Fred-



Carved Stone Heads of the Serpent God Ku-Kul-Can at Chichen-Itza, Yucatan, and Corn Goddess of the Aztecs

erick discoveries before they were removed from the ground, declared there was no question that the samples of human handiwork were contemporaneous with the extinct animal species among which they were found.

The four discoveries, taken together,



# of EDEN *in* AMERICA?

have revived interest in the search for further facts about the early history and civilization of the Mayas of Central America and the Incas of South America. Dr. Gregory Mason, leader of the Mason-Blodgett expedition now working in Central America, is a firm believer, as are the others who have excavated among the Mayan ruins, that the ancient civilization of the New World is as old or older than that of Egypt, and in many ways superior.

The ancient Egyptians' knowledge of mathematics and astronomy has long been one of the wonders of the world, but the work of the last few years in Central America has proved that the ancient Mayas were better astronomers and better mathematicians. In fact, they invented zero, which made possible our modern system of decimal counting.

Even within the time of recorded history, as preserved in the few books that survived the Spanish conquest and dated only from 176 A. D., the Maya astronomers were far ahead of their contemporary Romans. All calendar systems are based on the exact calculation of the length of the year, and, since the year consists of 365.2422 days or 29.53 lunar periods, neither the revolutions of the earth in relation to the sun, nor the revolutions of the moon in relation to the earth can be divided exactly. The old Julian calendar, which was in use in southern Europe until 1582, and in Russia until within the last few years, made the year twelve minutes too long, and at the time Russia changed to the modern Gregorian calendar the accumulated error amounted to two weeks.

But 2,000 years before that the Mayas had calculated the length of the year to

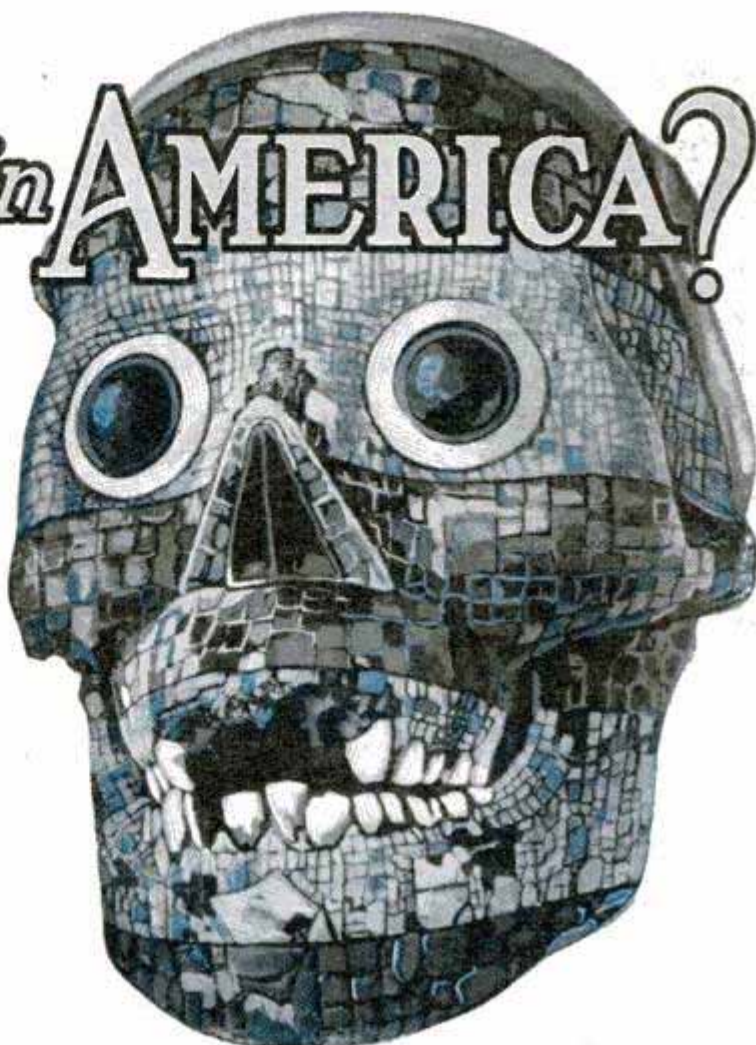

Mask Made of a Human Skull Inlaid with Turquoises, a Fine Example of Mayan Work in Precious Stones

within an error of one day in 2,148 years. Our present calendar is not much better, for it has an error of a day in 3,323 years. The Mayas, with similar accuracy, had calculated the lunar period to within one day in 300 years.

The Maya astronomers didn't stop there, however, for they determined with great accuracy the periods of the revolution of Venus, probably of Mars, and possibly of Jupiter, Saturn and Mercury. The Venus calendar was frequently employed, and they were aware that eight solar years almost exactly equal five Venus years, and sixty-five Venus years 104 solar years. The solar, lunar and Venus calendars were often combined so that incredibly long periods of time could be accurately calculated. Calculations up to 34,156 years have been found on some of the carved calendar rocks which they erected long before their historical records in book form began.

It was here that their invention of zero played a big part. The symbol is so com-



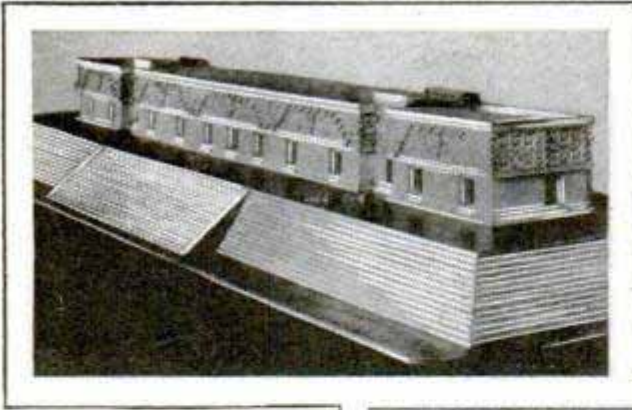

Model Showing the Reconstructed House of the Governors at Chichen-Itza, Above, and, at Right, an Altar Piece from a Temple at Palenque, Yucatan

mon to us that most people fail to realize its unusual character—a symbol for nothing. Yet, without such a symbol, rapid mathematical calculations would be impossible, for it is the zero which makes place-value numeration possible and distinguishes, for example, 170 from 1,700 or 17,000. While the Mayas had been using the symbol for ages, it was not until between the sixth and seventh centuries that zero was invented in India, from where it spread to Europe several centuries later. The Mayas had anticipated the Hindu inventor by a thousand years.

Without the familiar zero, instead of nine numbers to learn, the mathematician would have to have a separate name for each number as high as his calculations were to go.

The Mayas and the Aztecs had a similar and very involved calendar by which, by means of systematic changes of names and numbers, they could distinguish any day within a calendar round of fifty-two years—the unit in which they kept their records. The Aztecs could not go any farther than this, and couldn't distinguish between two days of the same name in

different calendar cycles. But the Maya mathematicians created what they called the "long count," in which they reckoned, as we do today, the elapsed time from an initial point, the system by which we measure from the presumed date of the birth of Christ. In the long count they measured by kins, or days, uinals of twenty days, tuns, or years of 360 days, katuns of twenty years, and baktuns, or

cycles of 400 years. They also used a great cycle, but there is some doubt whether it was 5,200 or 8,000 years.

Aside from their intellectual achievements, they produced pyramids as big and bigger than those in Egypt, even though not so well built; their carving of stone is equal to the best of the Old World, and as workers in gold and precious metals and in painting, they were the

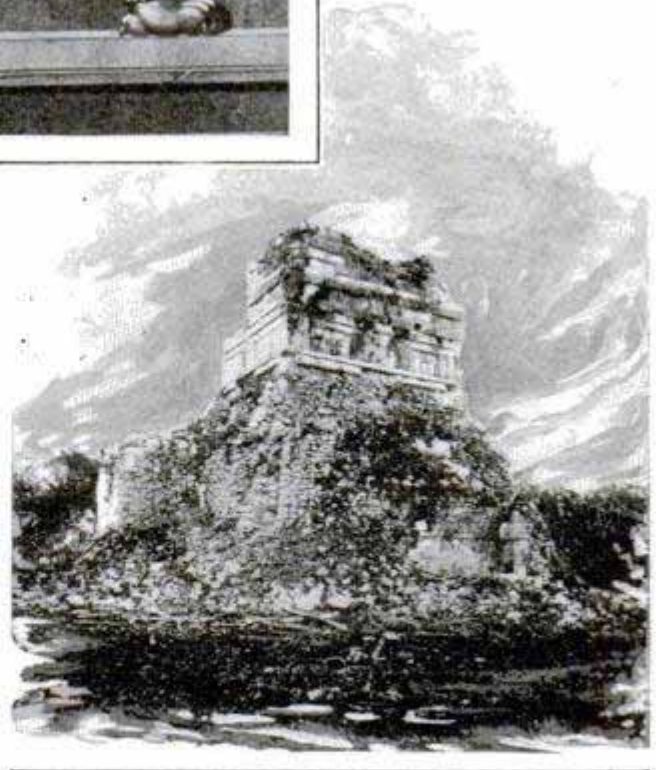

Ruins of the Temple of the Tigers, So Named Because of the Many Carved Beasts in Its Decorations, as They Appeared Before Repairs Were Made



244

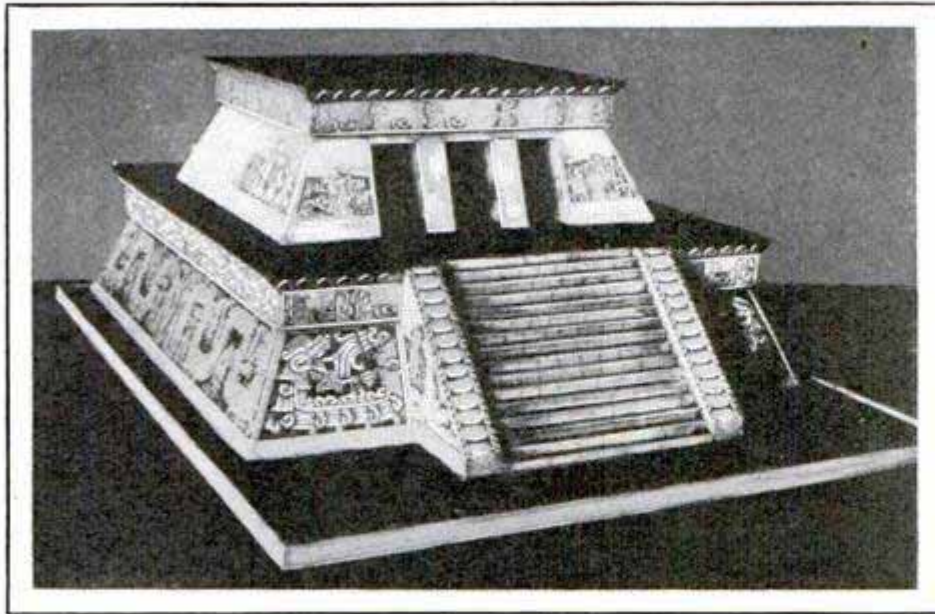

Aztec Goddess of the Harvests, Above; Aztec Civilization Reached a High Level, but Had Already Begun to Decline Before the Spaniards Came

Above Is a Model from the National Museum Showing the Reconstruction of One of the Temples of Chichen-Itza; the Mayas Built Massive Flat-Topped Pyramids and on Them Erected Squat, One or Two-Storied Temples of Perfectly Fitted Stone Blocks; Because They Never Learned to Build an Arch, They Were Limited in Height

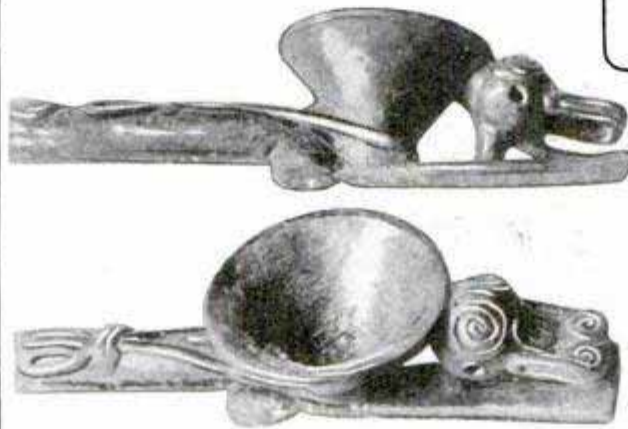

Carved Pipe Found in the Temple of the Warriors, Which Has Been Excavated and Repaired by the Carnegie Institution Expedition, at Chichen-Itza, Yucatan; the Bird's Head Supporting the Bowl Is a Symbolic Emblem Connected with the Religious Rites of the Mayas; Chichen-Itza Became Famous When Its Sacrificial Pool Yielded Hundreds of Skeletons of Victims

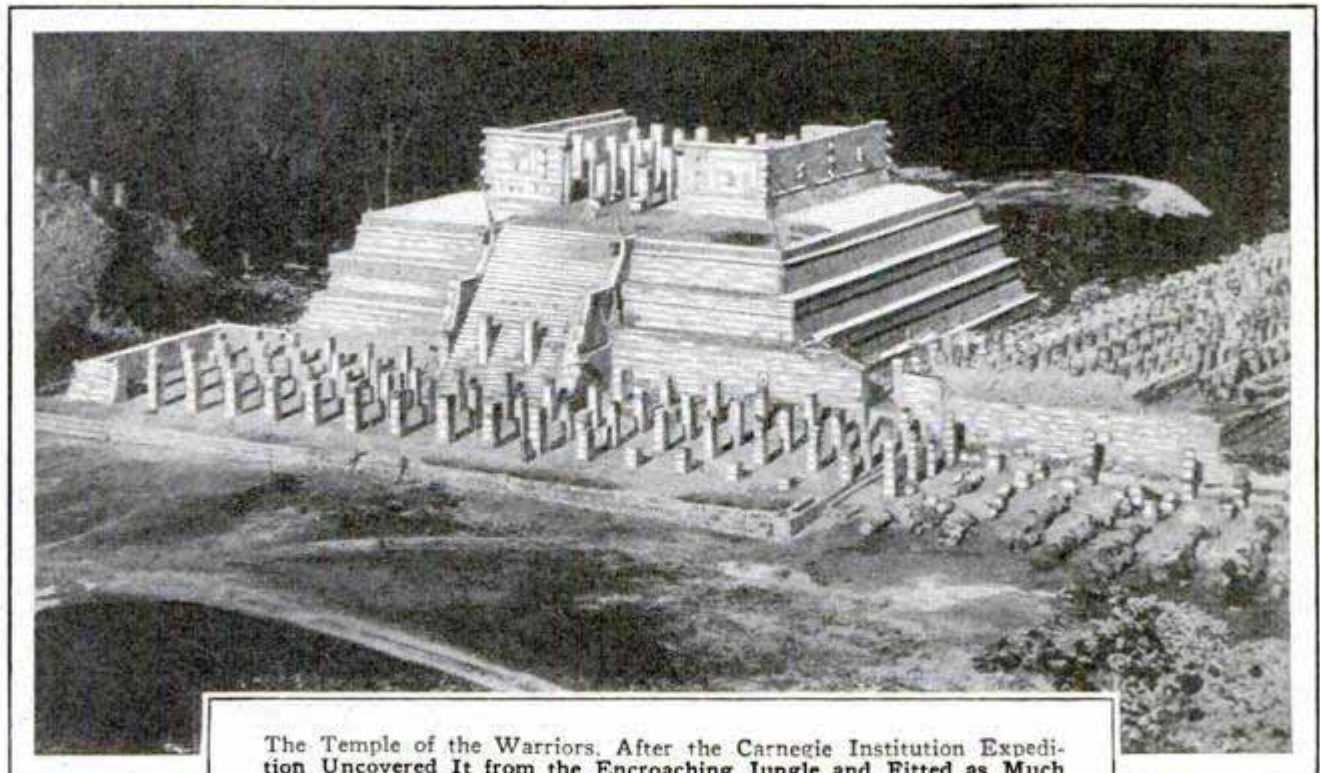

The Temple of the Warriors. After the Carnegie Institution Expedition Uncovered It from the Encroaching Jungle and Fitted as Much as Possible Together; in Front and at Right Are Portions of the Forest of Columns Which Once Supported the Roof of a Court



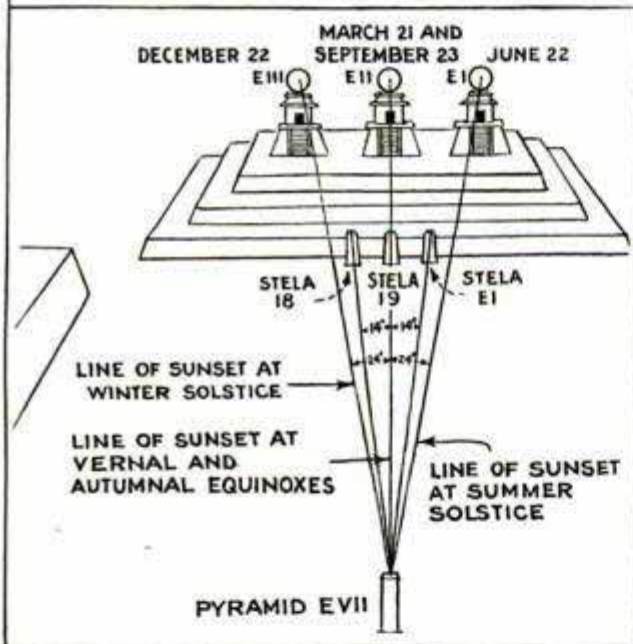
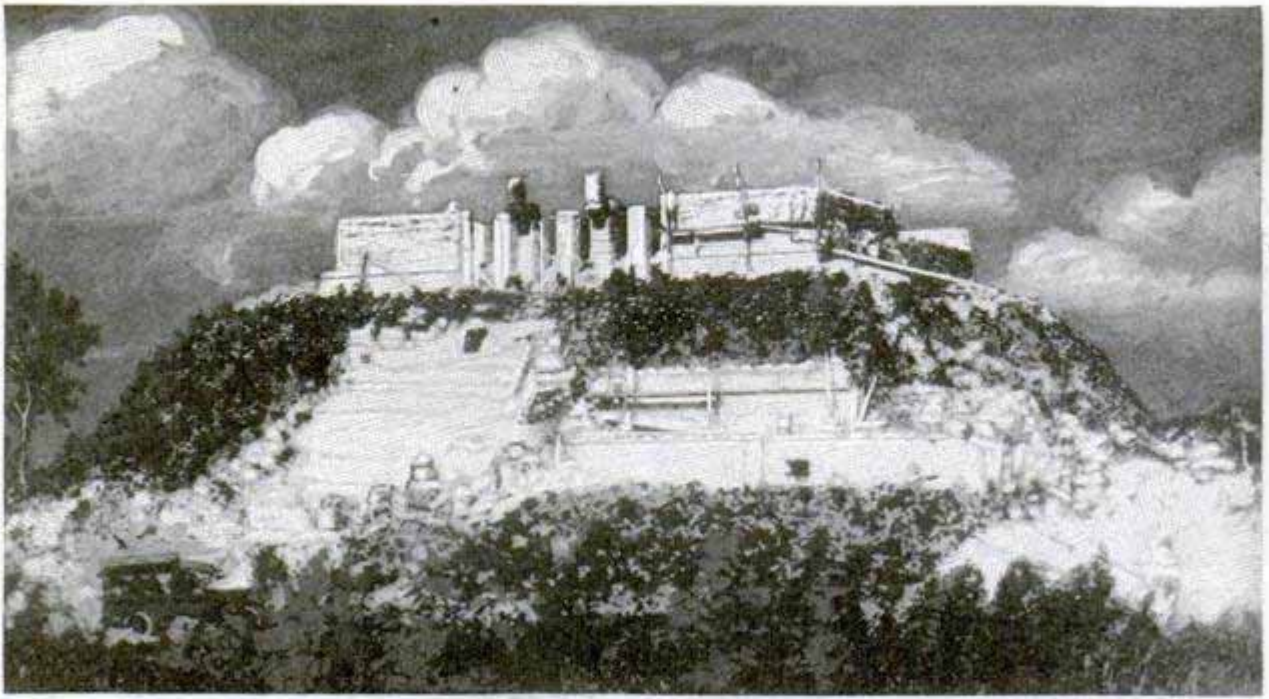

Diagram Showing How the Mayan Astronomers Determined the Dates of Solstices and Equinoxes, and, Above, Ruins of a Mayan Temple

equals, and in some cases may be classed as the superiors, of the Egyptians.

While their buildings, in the main, were erected of small stones, the skill with which they faced and fitted these together without mortar equaled that of the best craftsmen of Egypt, Greece and Rome. Most of the temples and palaces were located on flat-topped pyramids, the latter being built of stone facing filled in with rubble and dirt. Their failure to build solid-stone pyramids from huge blocks, after the Egyptian manner, was not due to inability to handle the big blocks, for they

did use them when the occasion warranted. Instead, they were much more modern than the Egyptians, for they saved the vast expense and labor of solid-stone construction with good results, even if the structures were not so lasting.

Their one big drawback architecturally, was their failure of discovering the principles of the arch. Without an arch, they were limited in the height to which they could build, and structures of more than one or two stories are quite rare. A four-story tower at Palenque, in southern Mexico, is a notable exception.

The old empire of the Mayas, centering in Guatemala, and abandoned, for some unknown reason, about 600 A. D., was notable more for its sculpture and other decorations than for its architecture. When the new empire arose in Yucatan to flourish from 980 to 1450—a half century before the Spanish arrived—the conditions were reversed, and architecture triumphed over sculpture, though the latter remained good.

The history of the new empire is rather well known from several Mayan books, called the Books of Chilam-Balam, which were secretly circulated after the Spanish ecclesiastics had destroyed most of the records of the Mayan priests. To the student of the early history of man in America, however, they are not so interesting as the carved record rocks of the





Stone Head from a Mural Decoration on a Yucatan Temple: Many of the Mayan and Aztec Carvings Are Striking Works of Art, Despite the Ravages of Time

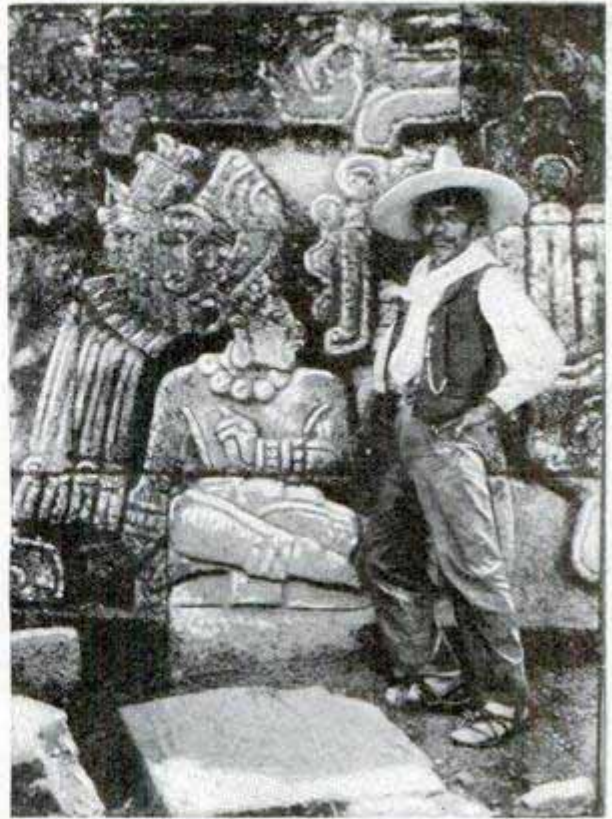

A Maya of the Present Day Standing beside the Carving of a High Chieftain of His Ancestors; the Enormous Head-dress of the Ancient King Is Typical of His Rank, as Shown in Many Temple Decorations



An Ancient Aztec Painting Showing the Sun God Quelling the Darkness of Night, While Two Worshipers Stand with Bowed Heads; It Was the Aztecs Who Introduced the Feathered-Serpent Cult



An Elaborately Sculptured Mayan Jar, Found in Guatemala by One of the Expeditions of the Museum of the American Indian, of New York; Symbolical Figures in Deep Relief and Constant Repetition of the Feathered-Serpent Motif Indicate the Vessel Probably Was Used in Some of the Temple Rites Introduced to the Mayas by the Conquering Aztecs



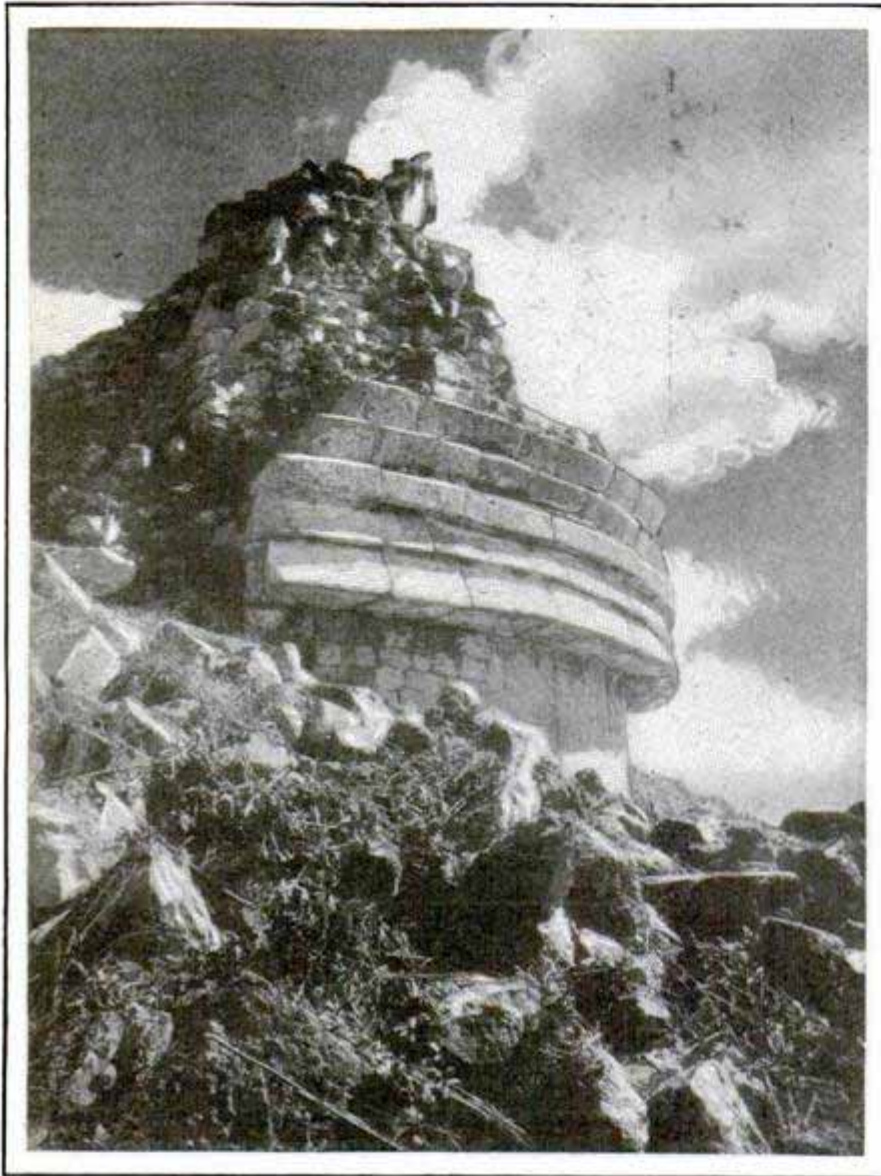

Ruins of the Mayan Astronomical Observatory at Chichen-Itza Before the Carnegie Expedition Began the Work of Rebuilding

older empire. In the jungle ruins in Guatemala these record books of the Mayan astronomers still stand, for they were carved from stone. Every five years, a date stone was erected as a sort of permanent calendar. At least seventeen cities were flourishing in Guatemala and the surrounding region when the old empire reached the height of its development, about the year 520. At that time the civilization in Central America was the equal of any in the world, and far above that of our Teutonic ancestors in Europe.

Why the Mayas should suddenly desert their cities, which were splendid towns that had flourished, in some cases, for several hundred years, remains an unsolved mystery, but the answer probably lies in climatic changes, which made it impossible to raise enough food.

What happened in the next three centuries is another mystery, but, for some reason, the Mayas appear to have built no permanent homes, nor attempted to carry on their culture, until it was finally revived in Yucatan in the latter part of the tenth century.

Colonel Lindbergh's recent flights over Central America started a tourist rush that way, and it is probable that within a few years as many Americans will be going to Yucatan and Guatemala to see the enormous ruined cities, as have flocked to the Valley of the Kings in Egypt in the past.

### COIN-IN-SLOT GOLF TESTS SKILL OF PLAYERS

Some of the thrills of a real game of golf are afforded by a coin-in-the-slot unit which features a small course with opportunities for drives and putts. The coin releases the mechanism, and the

player manipulates two levers, one controlling the tee and the other the dummy golfer, a small figure of a man with a club that swings in realistic fashion when one of the levers is operated. If the ball goes into one of the openings of the "drive" targets, a "putting hole" opens into which the ball is to be driven with the fewest possible strokes. Score is kept with a special device used as part of the game. Considerable skill is required in manipulating the two levers and in "keeping the eye on the ball."



*Chester Pollard  
Amusement Co. Inc. New York*





Crayon-Dye Design as It Appears after Transfer from Paper to the Fabric, and Applying the Pattern with Aid of Hot Iron: Blotting Paper Is Placed on Both Sides of the Cloth to Prevent Damage

CRAYONS OF INDELIBLE DYES SIMPLIFY DECORATING

Dyeing fabrics and other materials without the use of liquids is now possible through the introduction of a special kind of crayon dye. The design or picture is traced with the crayons in the colors desired upon paper and then transferred to the cloth with a hot iron. Blotting paper is placed on both sides of the fabric. If wanted, designs already drawn upon transfer paper, may be obtained. The crayon dyes are furnished in a wide variety of shades, will not damage the cloth and are easier to use. Since the pattern is first applied to the paper, there is less danger of spoiling the fabric.

ANTS TUNNEL SIXTY-FIVE FEET TO REACH WATER SUPPLY

A riddle that has puzzled scientists for years was solved by a farmer in South Africa recently, while he was digging a well. The mystery was how ants kept their nests moist through three years of drouth. Examination showed that the hills were always liberally supplied with heated vapor and it was supposed that the

insects had some way of producing the moisture themselves. This theory was abandoned, however, when the well diggers found a miniature shaft, little more than two inches in diameter, running from an ants' nest to a water reservoir sixty-five feet below the surface. An endless chain of white ants was observed day and night, descending the shaft, taking on a supply of water and going back.

RETARDER ON OUTBOARD MOTOR SLOWS SPEED FOR TROLLING

Easily attached near the propeller, a plate has been introduced for a popular make of outboard motor so that the speed of the boat can be reduced to permit trolling. It is operated on a spring hinge so that it rises as the speed of the motor is increased, and makes it possible for the fisherman

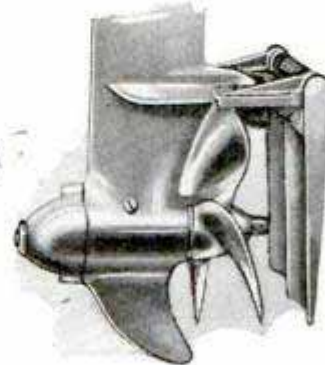

to obtain a satisfying rate of speed going to and from the fishing grounds.

Carl H. ...  
Colombiere ...

...  
... d. l.

W. H. Daguerre known.

517



409  
90

7-10-23 rd St  
New York

Bulletin No 367  
4/7/28

# POPULAR MECHANICS



Cards for Golf Game; on Front Faces Are Instructions for the Next Deck to Be Played From

## NEW GOLF GAME USES CARDS INSTEAD OF BALLS

Indoor golf played with cards instead of clubs, balls and nets, is the latest for the devotee. The game is played with a special deck of ninety cards, divided into four suits, designed for nine holes of either match or medal play. The four parts of the deck, printed in different colors, form a driving deck, approach deck, hazard deck and putting deck. As each card is played, it is turned face down, and on the back are found instructions for the next play. Two of the decks contain twenty-four cards, one twenty-eight and one fourteen, the numbers, in connection with the instructions on the back, being calculated so that, regardless of how the plays work out, there will always be enough cards to finish nine holes of play. The four decks are shuffled separately and laid down in a row. The first player takes a card from the driving deck, turning it over to find his next play on the back. The second

does the same, and the one who is the greatest distance from the hole has the next play, as in ordinary golf. The lowest possible score for eighteen holes is forty-eight, but par for the game is fixed at seventy.

## WHALES OF ANTARCTIC BRING THOUSANDS APIECE

565

Under modern methods of extracting the valuable products, whales caught in the antarctic will bring as high as \$10,000 apiece. The humpbacks, found off the coast of California, sometimes realize \$2,500 each, while the white whale of the northern Atlantic is prized for its hide, which is shipped to Scotland for the manufacture of shoestrings. Floating factories that convert the whales into material for the soap companies, bone charcoal for the sugar-refining industry, dried meat and chicken feed, simplify the task of turning the catch into profit. Members of the United States biological survey have

asked for information about the logs of old whaling vessels, as these records are considered valuable data concerning the migrations of the big sea mammals. Parasites found on the whales may also give a clue to the animals' wanderings. For instance, one species of known southern origin has been discovered on whales in northern waters.

## HOSE WASHER IS OVAL-SHAPED TO PREVENT LOSS



By cutting them in an oval shape instead of round, rubber washers for the garden hose are not likely to fall off. They fit more tightly than the usual kind and hence

reduce the time and bother involved in frequent displacements.

Always  
Hol-Lite Hose Washer  
C. Ross Central Co.



at medical supply association  
England

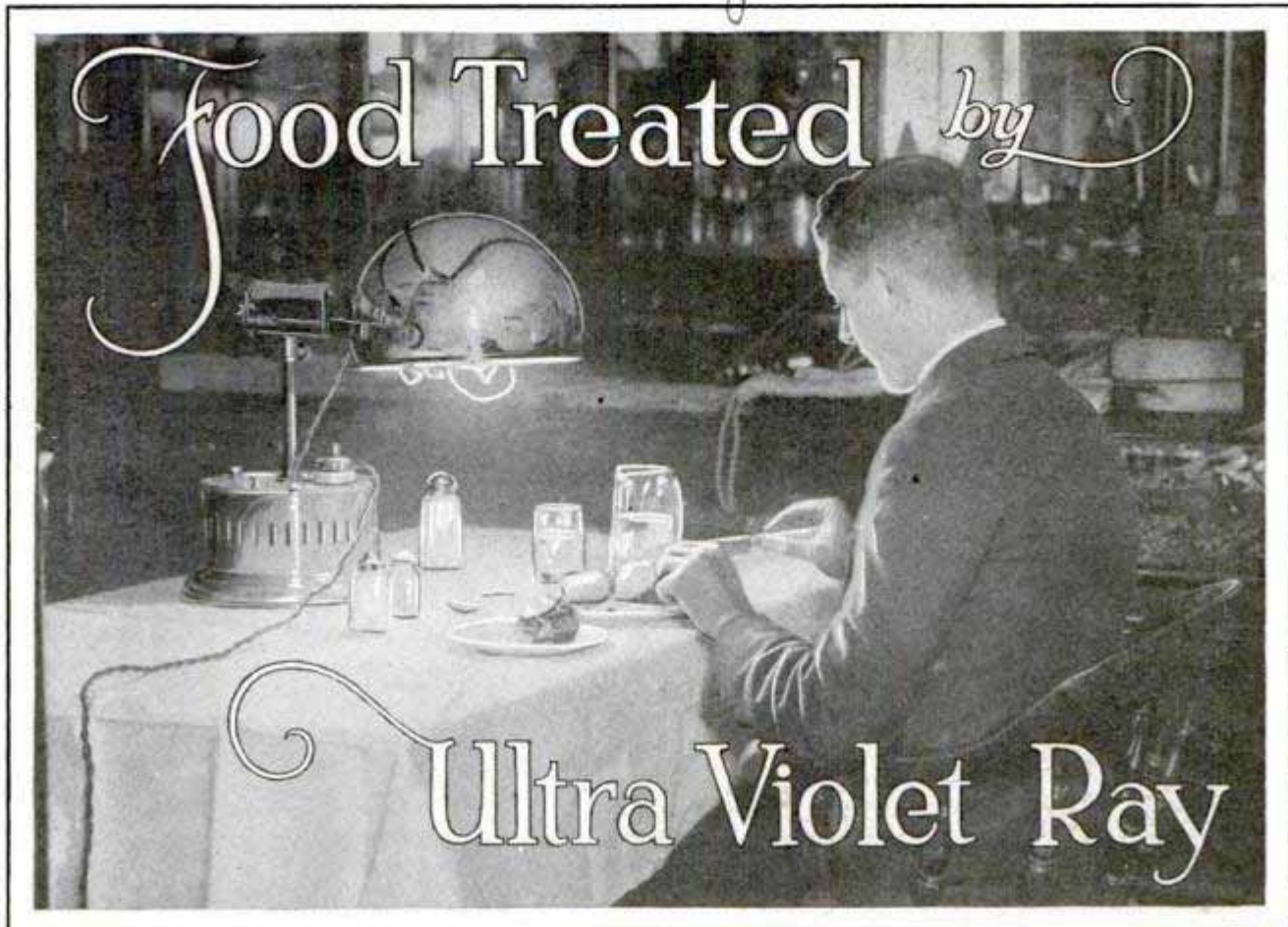

By CRAG DALE

World War

AT the University of Wisconsin there is a young man, named Harry Steenbock, who has calmly turned down upward of a million dollars for his patent of an apparatus that will transfer life-sustaining ultraviolet rays into virtually all food. He refused the fortune and then gave his patent to the university because he didn't want money to interfere with his ambition, which is to keep on plugging away at the mystery of light—what it, or lack of it, does to people and animals.

But the trustees of the university, quick to see the commercial value of the discovery, already have started the golden flow of dollars into a chemical research fund through licensing the use of the basic patent to several large food manufacturers. One company alone pays \$50,000 annually for its license, and now is carrying on elaborate experiments to determine how these health-giving, bone-building rays can best be transferred to the great troughs of oats that pass slowly under the lamps. Other manufacturers are experimenting with the making of an apparatus that can be used in the home, on

the table, like a toaster, or on the farm to give greater vitality to pigs and chickens.

Prof. Steenbock's accomplishment is, in more or less technical words, the capture of a chemical food element known as vitamine D, and its induction by use of ultraviolet-ray lamps into almost all ordinary foods: wheat, oats, corn, flour, cabbages, spinach, butter, milk, eggs, oleomargarine, hominy, lettuce, potatoes, rice—any food, except sugar and salt. Vitamine D is, as chemists recently have discovered, that property in food which enables the human or animal system to absorb and hold the proper amount of calcium from foods which will eliminate all possibility of rickets in growing children, and, at the same time, stimulate growth to the maximum that the heredity of a child, or animal, will permit. Next to sunlight, it is found most abundantly in cod-liver oil.

"It is in the sun that the great life forces are contained," explained Prof. Steenbock, in telling about his discovery. "Chemistry, I believe, has its base, or origin, in the sun's rays. Until very recently, scientists have thought that it was the

muffets. Quaker Oats Co.  
L. S. J. ...



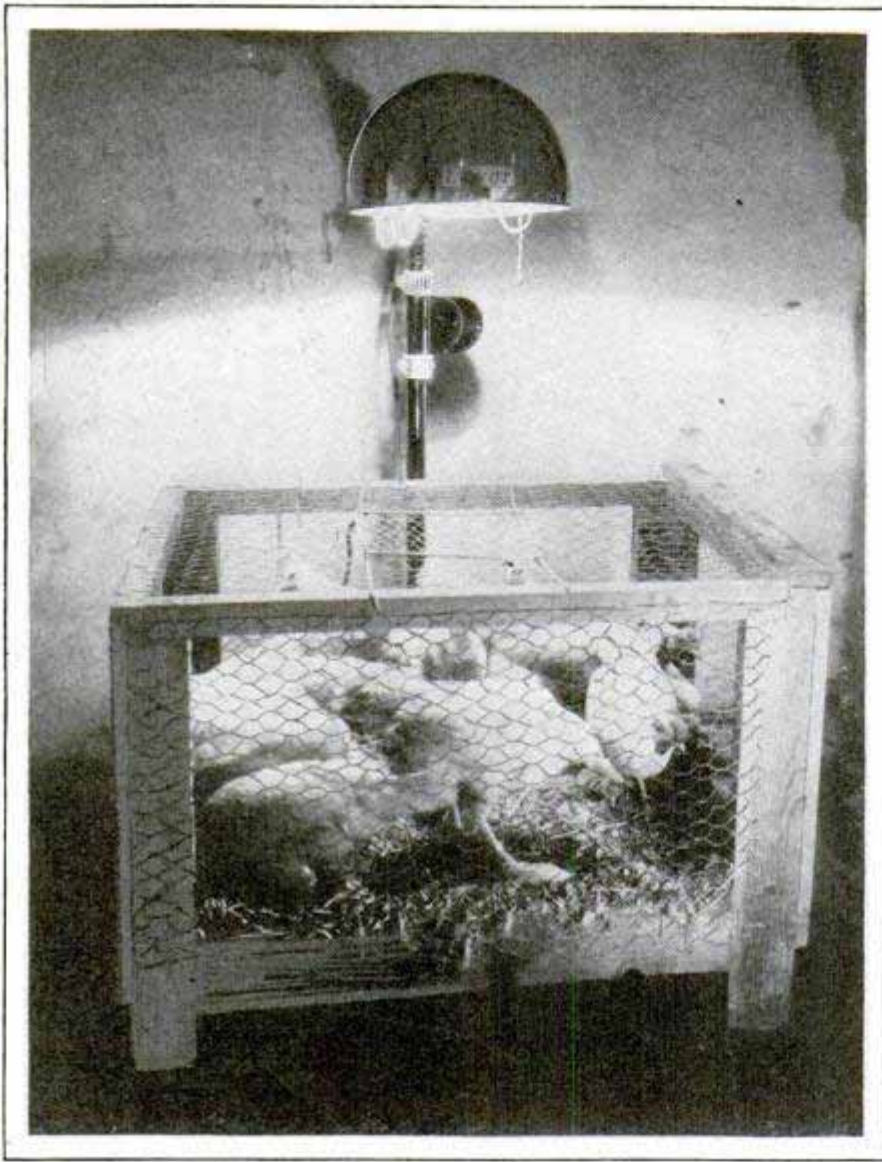

Group of Hens Whose Egg Production in Winter Was Doubled as a Result of Ten Minutes' Exposure Daily

heat rather than the light of the sun that accomplished growth. Exhaustive study of the codfish was one of the things that disproved the theory of heat. We found that ultraviolet rays penetrate water with comparative ease. The chemistry of the codfish is such as will absorb and store away a relatively large amount of vitamine D which the fish gets from sunlight."

But even when it was determined that light rays were the curative factor in rickets, it still was thought that the only possible way in which they could be used beneficially was through direct application of the rays to the subject. After a year of experiments, Prof. Steenbock became convinced that there must be some indirect method of irradiation with ultraviolet rays. And then he hit upon the test that made him famous.

With a quartz mercury lamp the young

professor treated a half dozen rats, daily for several weeks. Then he killed them. He had another pen of rats which he had been feeding in such a way that they all were sorely afflicted with rickets. From the dead rats, Steenbock took the livers and fed them to the rats that were dying from rickets—and within ten days every one of these rats had been completely cured.

Now, Steenbock had the proof that it was not only the ultraviolet ray itself that had a chemical effect upon the tissues of the body, but that it could be transferred through food even when the ray was not from the sun itself. That knowledge led to other and varied experiments—arduous, involved in a mass of detail and taking more than a year to accomplish. But from them all Prof. Steenbock evolved the positive method of irradiating all cereals and

all natural fats with the ultraviolet rays.

"How ultraviolet rays can act in connection with the ability of the body to assimilate calcium, we do not know as yet," explained Prof. Steenbock. "We do know that, under certain conditions, humans cannot assimilate calcium, much less store any of it in body tissue in the absence of these radiations.

"The substance in the body upon which ultraviolet rays act in order to irradiate the body is called cholesterol, and it is found very extensively in nerve tissue and in the skin. Light—either sunlight or artificial ultraviolet rays—activates that substance with antirachitic vitamine D.

"As a matter of fact, there is relatively little of the ultraviolet ray of the proper wavelength that reaches the surface of the earth. It may be that other rays, as yet unknown, counteract the ultraviolet spec-





Harry Steenbock Giving a Demonstration to Poultry Raisers and School-Teachers of How to Virtually Eliminate the Usual Losses in Raising Young Chicks

trum to a great extent. Ordinary window glass completely baffles ultraviolet rays."

Prof. Steenbock took occasion to shatter a hitherto unchallenged belief:

"Milk has no active vitamine D, neither has butter fat," he declared. "That is not due to the lack of compounds that can be irradiated, but rather to lack of radiation itself. We have carried on extensive experiments with cows in an effort to determine what effect irradiation has upon them, and we have found that they do not respond in any degree either to direct radiation or to cod-liver oil. That is rather remarkable and, as yet, we do not know why."

Prof. Steenbock sums up his work in food irradiation, saying: "The future use of irradiated foods in the treatment of rickets, and in the diet of growing children, is unquestionable, and rickets is only one of the number of forms of disturbed calcium relations. It has even been shown definitely that excessive lack of calcium reserve in mothers' milk can be prevented by radiant energy. Certain forms of tuberculosis yield readily to irradiation, and

we are getting favorable results in the treatment of some cases of anemia."

During the progress of Steenbock's experiments, he and some of his associates at the university discovered that baby chickens are extremely sensitive to rickets. They also knew that only about thirty per cent of all winter eggs hatch under incubation. Combining these two facts, it occurred to the scientists that one reason why the hatching rate of these eggs was so low, was that the baby chick in the egg had rickets so acutely that it could not peck its way out of the shell.

Feeling sure that irradiation would solve that difficulty and result in more hens laying more hatchable eggs—which, in turn, would result in lower winter prices for eggs—Steenbock began irradiating a group of hens, keeping an equal number, from the same flock and of the same breed, away from artificial irradiation. The first result was that, during February, the irradiated hens laid 173 eggs. The non-irradiated hens laid sixty-eight eggs during the same period, and there were twelve hens in each group.



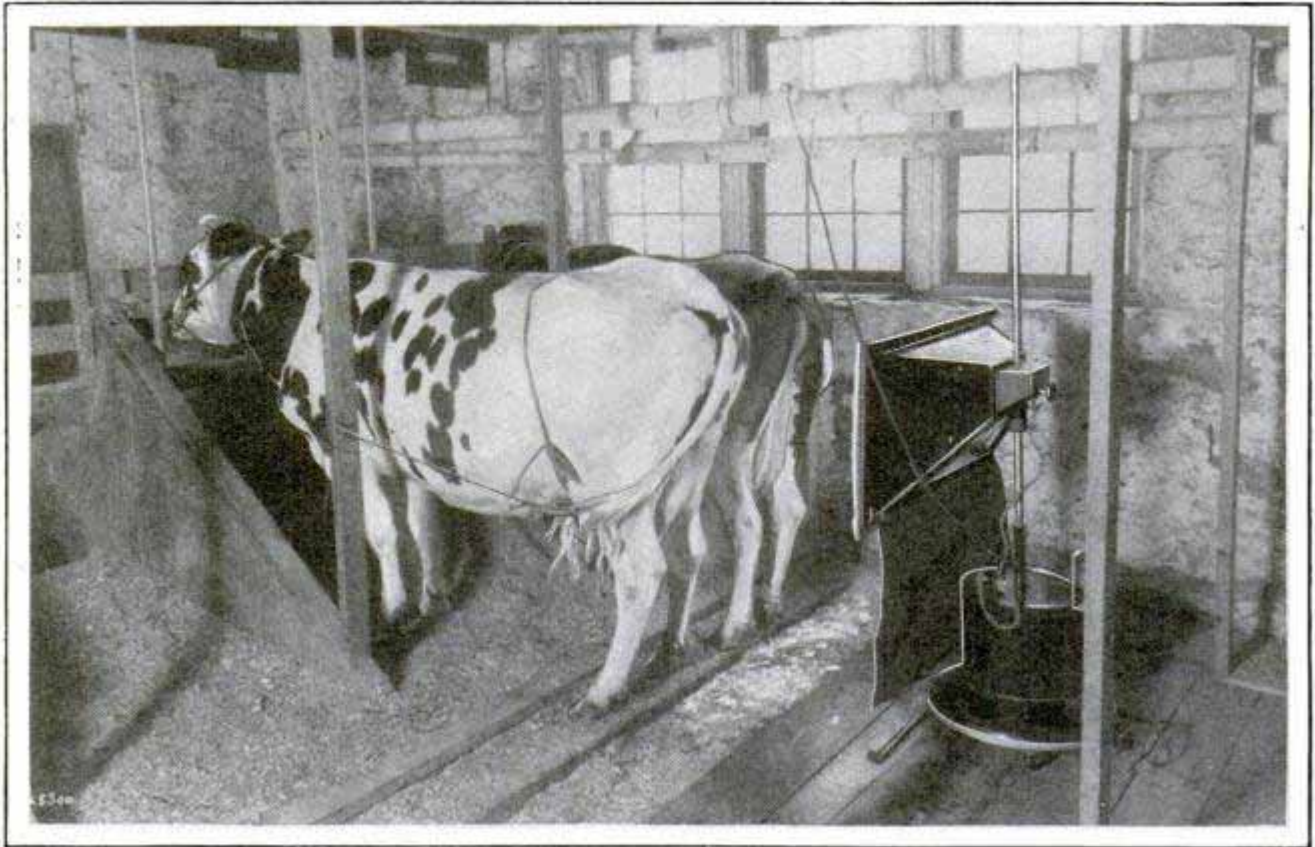

Science Struck a Snag When It Attempted to Increase the Vitamine D in Cows and Improve the Nutritive Value of Milk through Irradiation, for the Cows Were Not Affected by the Light

The eggs from the irradiated hens were incubated and 168 of them hatched out healthy chicks. Only twenty-two eggs from the non-irradiated group of hens were

hatched. In March, the same experiment was continued with the same hens, showing an even higher percentage of eggs and chicks for the irradiated group.

**SIMPLE SOIL-TESTING OUTFIT TO IMPROVE LAWNS**

In a few seconds' time, and with but little trouble, you can make a chemical test of the soil of your lawn or garden to determine if it contains the necessary materials to aid the growth of grass and plants. A pinch of the soil is placed upon a small paper, which is folded in the shape of a trough. Then it is moistened with a chemical squeezed from a tube. The liquid thoroughly mixes with the soil and changes color, according to the nature of the sample. By letting the surplus chemical drain off and drop upon a test chart, showing different colors and giving an anal-

ysis according to that color, proof is obtained whether the ground is acid, neutral or contains too much alkali. The chart also tells how much limestone to add for general crops.

**FUSED-QUARTZ THERMOMETER REGISTERS HIGH HEAT**

Temperatures of more than 1,800 degrees Fahrenheit are registered on a thermometer of fused quartz, employing gallium instead of mercury. The reason for these substitutes is that glass melts at a far lower temperature than those which the meter records and mercury would boil and explode the instrument.



Dropping Testing Liquid on Sample of Soil; It Is Then Drained Off and Compared to Color Chart

*The Albert Dickinson Co.  
2750 W. 35th St. Lf.*

*Was analyzed in General Research Laboratory  
General Testing Co.  
Sylvester Boyer  
15 Fortisque Terrace*



**MYSTERY MINERAL CURBS FIRE AND PREVENTS RUST.**

A whole mountain of a mysterious mineral substance near Libby, Mont., is being utilized for a number of practical purposes. At first believed to be worthless, it has been treated to make efficient insulation against fire, water and sound and is also adaptable to the manufacture of cement products, paint, plaster, roofing and many other materials. When heat is applied to it, the mineral expands to many times its original thickness and assumes a beautiful golden color. In this form, it is insoluble, vermin-proof and is lighter than cork. Analysis has shown that it is composed of silica, aluminum oxide, magnesium and small amounts of calcium oxide, sodium and potassium oxide. It is being successfully used as lining for ovens and for safes to keep out moisture.

discovered by  
 a chemist  
 at Libby, Mont.  
 in 1912  
 and  
 developed  
 by  
 the  
 U.S. Army  
 for  
 use  
 in  
 the  
 war



Mask-Equipped Bicycle Brigade of a Russian Army Unit during Practice Maneuvers and Gas Drill

**SOLDIERS ON WHEELS TO FIGHT IN GAS MASKS**

Bicycles play practically no part in the operations of the American army, but a cycle corps of gas fighters is an interesting branch of the Russian military organization. In recent maneuvers the cycle brigade took an active part. The chemical phase of warfare has been studied extensively in Russia.

**SIPHON PIERCES BOTTLE CAP TO KEEP CONTENTS FRESH**



Carbonated beverages of all kinds are kept fresh when using a special siphon now on the market, as the unit is attached without removing the bottle top. It pierces the cap so that the content remains fully charged until the last drop. To obtain the beverage, the bottle is turned upside down and the plunger of the siphon pressed.

age, the bottle is turned upside down and the plunger of the siphon pressed.

Edison has been granted more than 1,150 patents.

**BELL ALARM ON DOORKNOB WARNS OF BURGLARS**

Easily attached to doors or windows, an alarm bell furnishes a signal to warn of the presence of intruders. It is connected so as to ring as soon as the knob is turned or the window raised. It has no keys or batteries and will last indefinitely. The noise helps frighten marauders away, as well as warning persons inside.

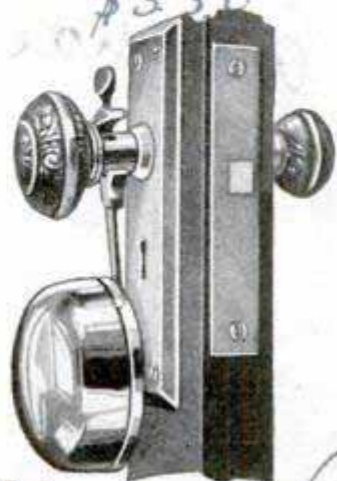

Vaughan's Novelty  
 1000 Carroll

Keystone Utilities Co.  
 313 135



*Springfield Street Obj. Co  
Springfield Mass*



At Work on Model of the Moon in Plaster of Paris; a Dentists' Drill Was One of the Tools Used

### CARVE MODEL MOON IN PLASTER WITH DENTAL DRILL

Among the instruments an amateur astronomer in Los Angeles has used in making a relief model of the moon is a dentists' drill. It is helpful in carving out the small craters and other irregularities on the surface of the model which is fashioned of plaster of paris. Photographs supplied by Mount Wilson observatory and data obtained through two high-powered telescopes of his own have been used by the astronomer in preparing the model.

### CASING OF SHOCK ABSORBER IS MOISTURE-PROOF

A shock absorber which eliminates the freezing troubles of the hydraulic type and the possibility of spring and reel breaks in the usual friction type, is being marketed by a Michigan factory. The strap in the new absorber does not enter the friction casing, but is attached to it on the outside. Within the casing, two segments of a split ring are expanded when a



*Autohide*

downward force is exerted on the strap, and their friction against the casing controls the movement and eases the rebound. The casing is water-tight.

### BUSLIKE STREET CAR MAKES LESS NOISE

Marked reduction in noise, greater speed and comfort, and other important improvements are said to have been realized in a street car modeled after a motor bus. Upholstered seats, a wider aisle and more attractive appearance inside and out, are features of note, while the car is

lower, with a single step for entrance and exit. Bearings are of the roller type and the gears run in an oil-tight case in a bath of oil. There is an expanding inside brake for each wheel. Thorough tests are said to have been satisfactory.

### AUTOMATIC HAND FIRE FIGHTER WILL NOT DAMAGE GOODS

Effective protection against fire is afforded in a hand extinguisher which is similar to the larger chemical units carried by fire departments, does not damage clothing or furnishings and is always ready for instant service. It is set into operation simply by striking a plunger on the bottom against the floor or other surface. This penetrates a capsule inside, releasing an acid that combines with a chemical to force a powerful stream of liquid from the nozzle. The materials are said not to deteriorate with age, the extinguisher is quickly refilled after use and, being light and compact, is easily handled in an emergency.



*150  
\$5.00*

*Chicago*

*The Anker-Holth Mfg Co  
Portland, Ore.  
The Anker-Holth Mfg Co  
Los Angeles, Calif*

*The National Portland Cement Co  
6539 Melba Ave*



**AUTOS STOPPED AT CROSSING BY TOUCH OF BUTTON**

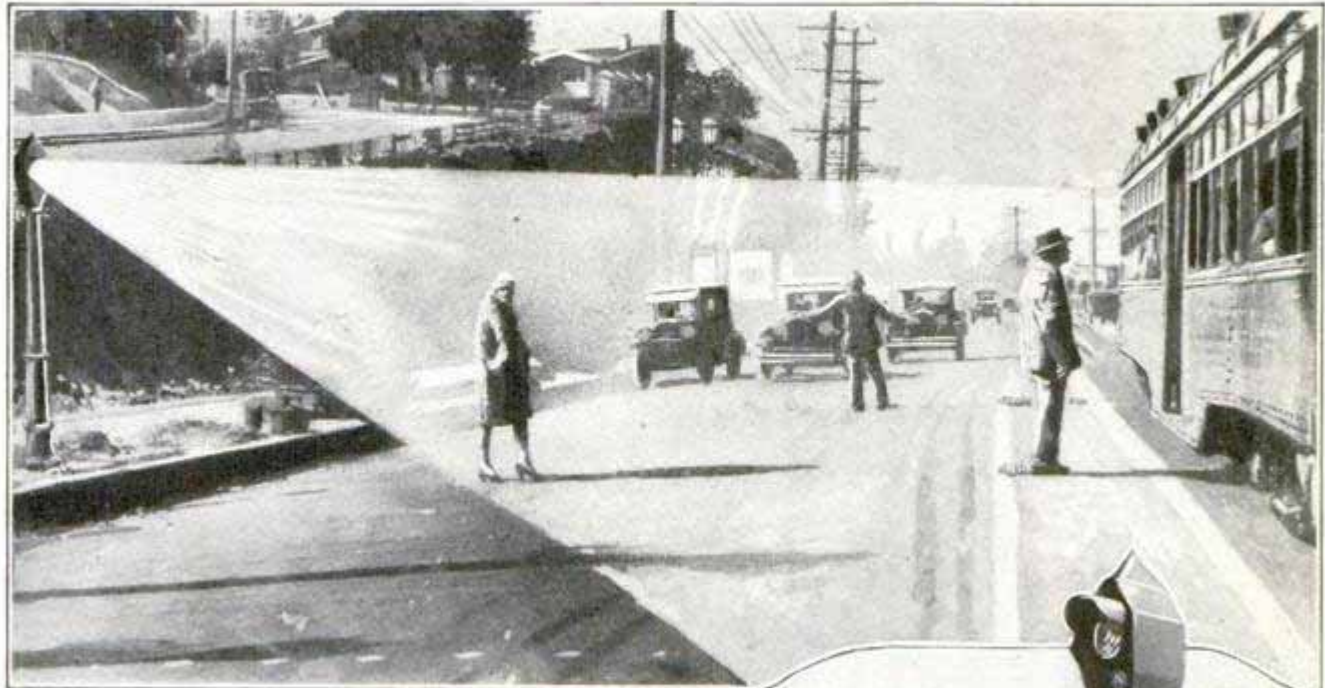

Pedestrians' Light Shining to Guide Street Car and a Close View of the Signal with Button at Side

Of special service on outlying street-car routes is a combination floodlight and a red signal for the pedestrian. When he wants to stop a car, he presses a button on the side of the lamp-post. This causes a red light to flash and, at the same time, a brilliant floodlight illuminates the street to the track so that he can cross to the car in safety. The red light also warns automobiles to come to a halt.

**TIME RAZES ANCIENT TOWER IN FEW MINUTES** 564



After standing for nearly 1,130 years, the wonderful tower of Charlemagne, in Tours, France, crumpled and fell into ruins within a few minutes recently. This is said to be the most abrupt disintegration of such a structure on record. Twenty-four hours before the fall, cracks showed on its face. The mayor ordered persons dwelling near by to vacate their premises, but no great fear was at first entertained that the tower would collapse. However, when the cracks became wider, the watchers realized that the end of the stone pile, which had been visited by thousands of tourists, was near. Almost the entire population of 70,000 gathered to see the strange passing of the historic landmark. The fire department played

searchlights upon it. A few moments after eight o'clock in the evening, the massive pile trembled, swayed and then sank into a pile of broken stone that littered the street for a distance of 200 feet. No one was injured in the crash. The tower was the last standing part of the famed Abbey of Saint Martin which was completed in the year 800. Two hundred monks at that time lived in its dormitories.

*Mr. Francis Luchie of the Canadian Commission 1700 W. 1st Ave*



371  
3,033 Calvert St.  
Baltimore Md.



# The MYSTERY

of bird habits, but is solving economic problems as well. The United States biological survey has found the basis for game-bird regulation by studying the habits of the migrating flocks through the seasons. It is trying to solve the problem of ending the depredations of the red-winged blackbird in southern rice fields by finding the best season and the best place to fight the marauders, for they have proved immune to attack with poison bait during the rice season, when they are in the south, and so must be fought at some other place and season.

The National Geographic Society and the Carnegie Museum have dispatched a joint expedition to Venezuela to study the winter life of birds which nest in the United States in the summer. Many birds travel thousands of miles with the change of the seasons in search of suitable weather. The ducks and geese which flock to the Gulf of Mexico shores in winter do their nesting in summer from the northern United States to the Arctic ocean. A year or so ago an unusually bad winter in the far north drove the white snowy owls southward in thousands, and every taxidermist in New England was kept busy for weeks preparing the rare specimens bagged by hunters, for these owls are rarely seen in that district.

Two hundred years ago a great gray heron was captured in Germany, which wore upon one of its legs several metal bracelets. An inscription on one of the rings, after being translated, revealed that the heron had been captured in Turkey several years before, and that it had been marked and released. This is the first recorded experiment in bird banding, an activity which is now teaching us many secrets of bird life. Today, ornithologists, government workers, and amateurs are trapping birds in all parts of the United States, and in other countries, too, and placing tiny aluminum bands upon their legs. Then they are released and records kept of their goings and comings.

The capture of the Turkish heron did not stir much curiosity or interest, and

F. C. Lincoln, in Charge of Government Bird Banding, Attaching a Tag to a Mallard Duck

**T**HOUSANDS of lapwings, small European birds of the plover family, appeared out of the sky on the coast of Newfoundland recently, and dropped to the ground, many so exhausted that they died.

Hitherto almost unknown on this side of the Atlantic, the entire flock had spanned the Atlantic, from east to west, something man at that time had failed to do. Occasionally lapwings, caught by rare easterly gales, have been blown to Ireland, but this flock was forced across the Atlantic, unable to fight its way back to European shores. The normal flying speed of this bird is about forty miles an hour, and with a tail wind behind, the flock may have averaged seventy miles an hour for the crossing.

The migration of birds over the world is a fascinating study, investigation of which is not only adding to the knowledge



# of BIRD MIGRATION

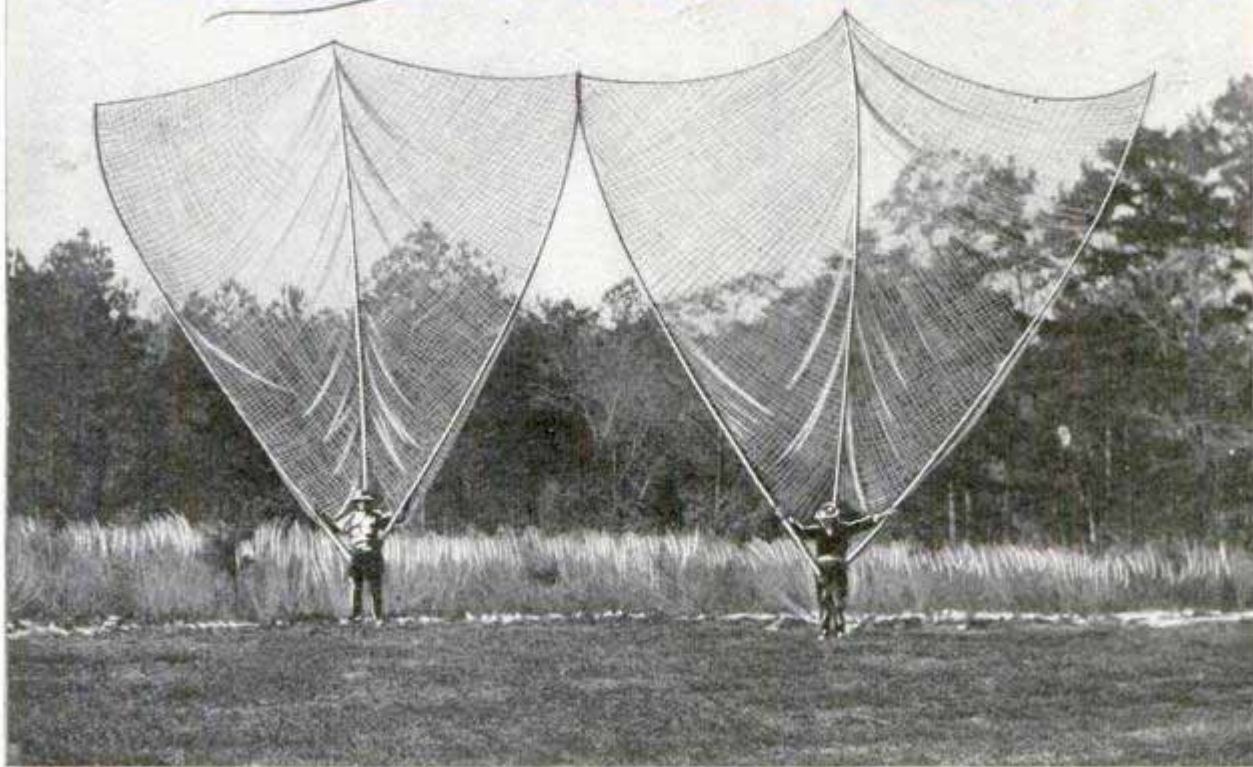

Pair of Clap Nets Developed to Catch Quail; the Two Outside Poles Are Swept Forward and Together like Wings, to Catch the Birds in Mid-Air as They Are Scared from Their Nests

it was not until a hundred years later that bird banding was attempted again. Bruggmann, a Dutch naturalist, began to puzzle about the long-legged, long-billed storks that made Holland their summer home, and which are supposed to have something to do with the birth rate. These storks had a habit of going away for the winter, and returning again in the spring.

"Do the same storks return to the same village or windmill each year?" he wondered. So he captured several of the lanky birds and fastened metal rings upon their legs. He then set them free and began a long period of waiting, to see if any of the marked birds would return after the winter was over. He never saw one of the birds again, and concluded that they choose a different home each summer. His conclusion was not strictly well-founded, because the bands may have been torn off by the birds during their southern journey.

Nearly another century passed before Christian Mortensen, a Dane, banded several species of birds in an effort to learn something of their habits. He was more

successful than his Dutch neighbor, because several of his birds were captured later, still wearing their bands. This success inspired other bird students, and bird banding as a method of studying the inhabitants of the air spread to other European countries. The World War put a temporary end to the work.

Bird banding in the United States really started in 1909, when Dr. Leon J. Cole, of New York, founded the American Bird-Banding association. Early methods of marking birds were crude and unsatisfactory. One of the principal drawbacks, and a rather unpleasant one, was the necessity of killing the birds in order to recapture them after they had been marked.

It remained for S. Prentiss Baldwin, of Cleveland, a business man turned ornithologist, to do away with putting birds to death in order to learn their secrets: He devised a series of traps in which the birds could be caught repeatedly, without injury. These traps take several forms, from the ordinary sparrow traps, consisting of a shallow wooden frame covered with wire or cord mesh and operated by



39 100

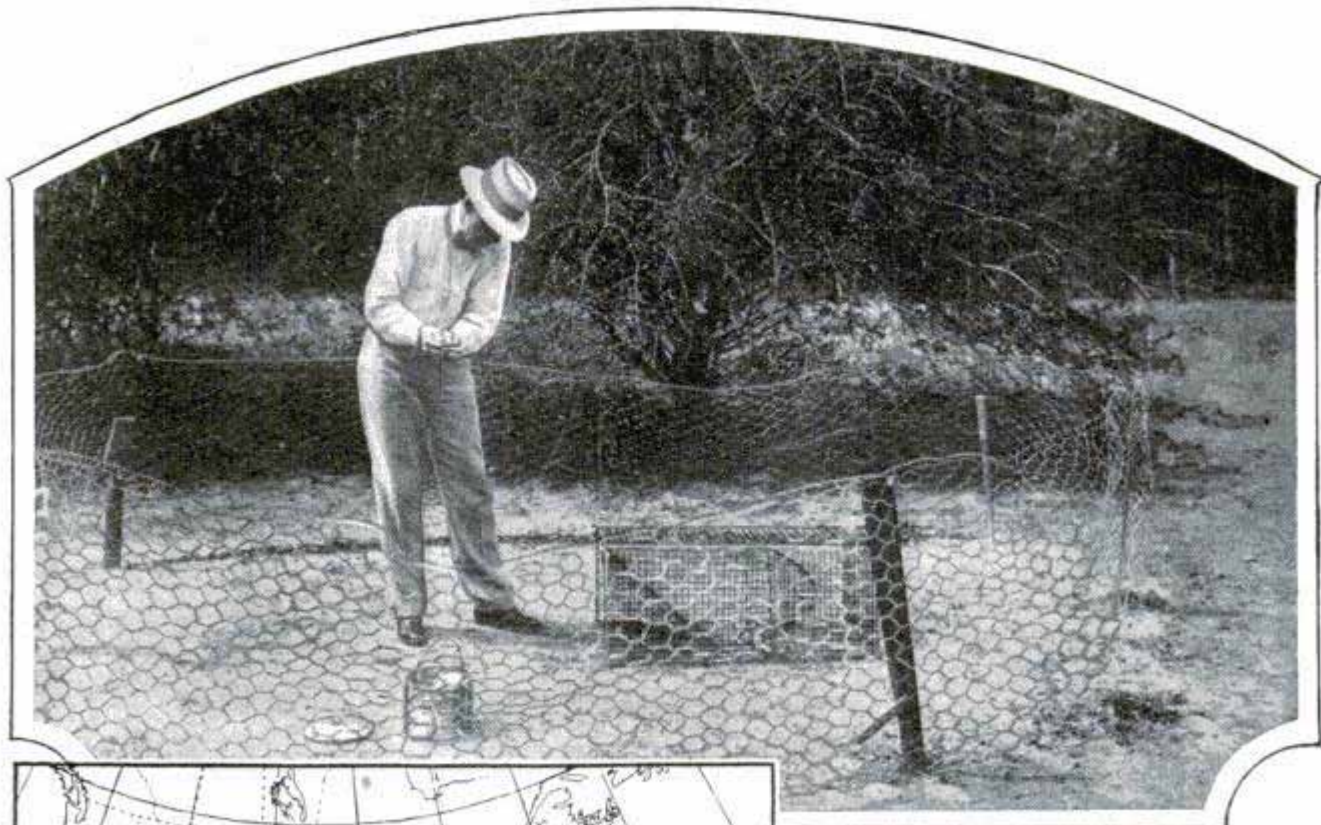

Bird Trap, Protected by Wire Fence, to Keep Dogs and Cats from Annoying the Feathered Captives

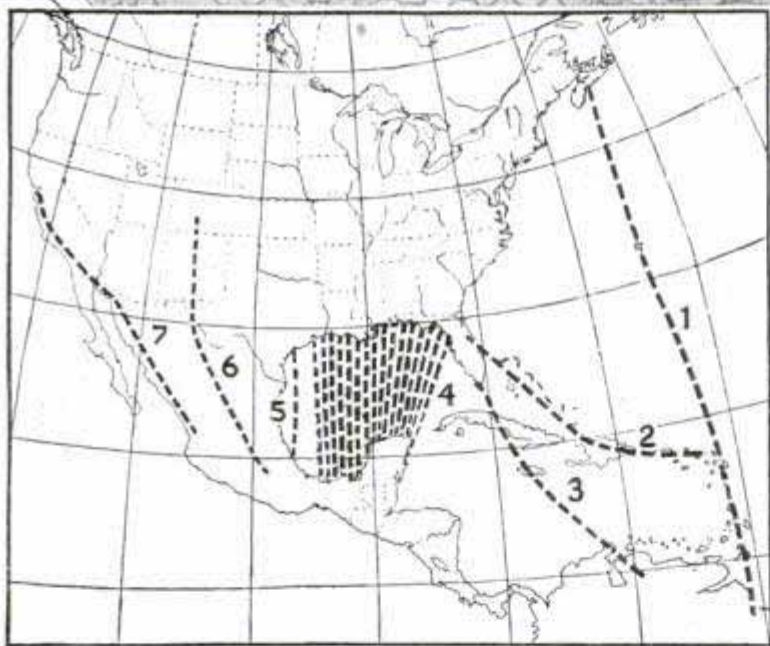

Bird-Migration Routes; Most of Them Use Route Four, Though It Necessitates a Flight of 500 to 700 Miles across the Gulf

a jerk of a string, to large house traps, big enough to hold several men. The system of trapping, as perfected by Baldwin, was adopted by other bird banders, and is largely responsible for the entering of the United States government into the field. The activity is now under the control of the biological survey, and permits to operate bird traps and banding stations must be obtained from this bureau.

About fifteen years ago, Baldwin purchased a farm near Cleveland. Time and again, the beauty of the scene was marred by the cry of some wild bird in trouble. Perhaps a cat had caught one of the little

robins just learning to fly; or a red squirrel was robbing a song sparrow's nest; or English sparrows were trying to break up the home of a family of wrens.

Baldwin set out to rid his farm of these enemies. He set out sparrow traps, and the English sparrow population in the vicinity rapidly dropped to a low figure. The work proved interesting, and he soon became an enthusiastic student of bird life. Banding attracted his attention and he now spends much of his time at it.

Fifteen years ago there were perhaps a few hundred birds on Baldwin's farm. Today, on the five acres where he maintains his banding station, the bird population is denser than at any other place in the United States. There are thousands of them—wrens, robins, bluebirds, song sparrows, chipping sparrows and many others. This proves at least one thing: Bird banding is not cruel, and does not frighten the birds in any way, as many people have been led to believe.

In fact, a banding station becomes a sort of seasonal home for the birds. There birds of a feather, and birds of



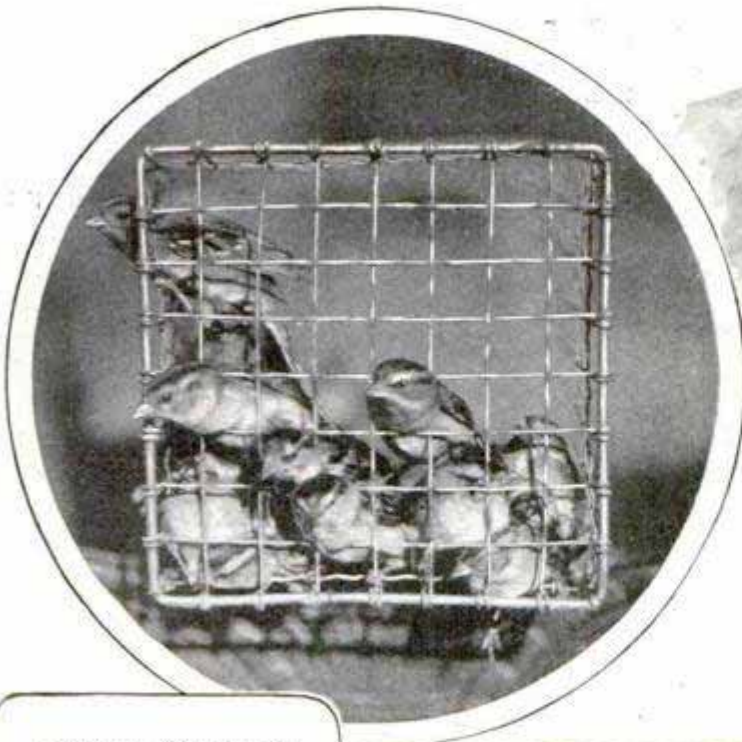

Chipping Sparrows in a Trap Cage, Above; They Are Often Confused with the Obnoxious English Sparrow, Largely Because, like Their Relation, They Prefer to Live Close to People



It Looks a Bit Rough, but This Is the Best Method of Handling Live Wild Birds, as They Are Not Injured, and Seldom Struggle; the Bird, Which Has Been Caught in a Trap, Is the Familiar Mourning Dove Whose Cry Is Popularly Supposed to Herald an Approaching Rain-storm; in Fact, It Is Sometimes Called the Rain Dove

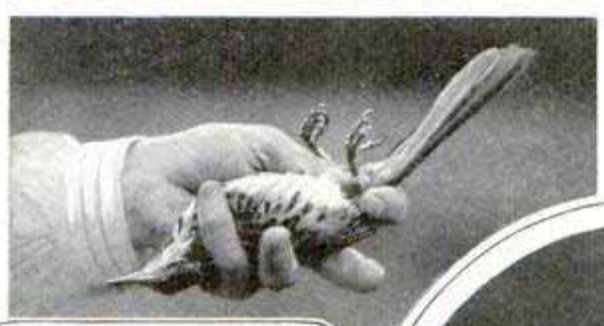

With the Little Finger Held Snugly over the Neck, the Bird Will Not Struggle While the Band Is Being Attached to Its Leg



When First Banded a Bird Is Held in This Manner, While Its Color and Species Are Being Determined; Note Its Grasp on the Little Finger



The Proper Method of Holding a Red-Bellied Woodpecker; the Little Finger Serves as a Perch; Its Beak Is Very Strong and It Is Well to Be on Your Guard When Handling This Bird



After Examination, the Brown Thrasher Is Permitted to Lie in the Palm; Frequently It Rests like This for Several Minutes before Flying Away after Its Release



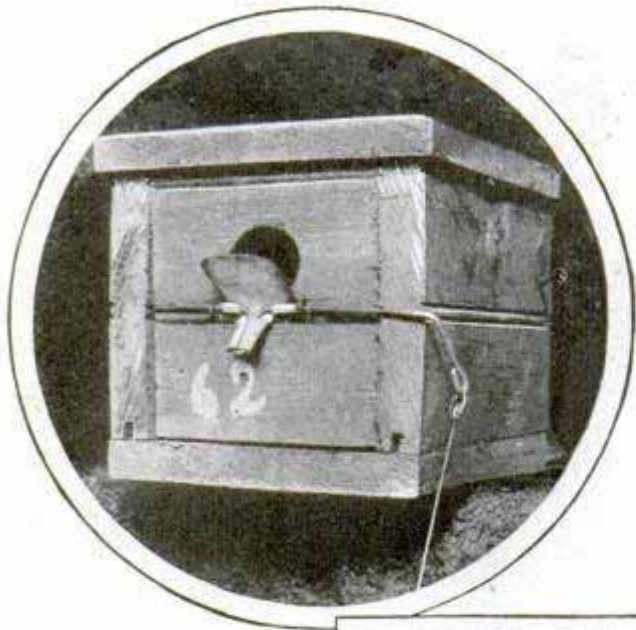

widely separated natures meet on a common ground where they find food, water, shelter and protection from their natural enemies. Some of the little fellows become so fond of the place that they spend a large portion of their time in the traps, obtaining food.

"But the birds must be terribly frightened by being caught in traps and then held in the hands for examination," many of the visitors to Baldwin's farm exclaim.

Bird banders have found that the birds are not in the least scared, and that many of them seem to like the experience. Of course, there are some kinds, such as the cardinal, which create quite a disturbance when caught, but their objections are only temporary. They always return.

"It is the experience of every bird bander that most of the birds taken from traps continuously operated are 'repeats,' or birds which have been in before," Baldwin explains. "My records show many cases of birds that form the trap habit, and are caught four or five times a day.

"Probably few of us experience a real

fright—the fear of immediate death or terrible injury—more than two or three times in a lifetime; and we never forget it. But every wild bird lives in a daily danger and fright for its life. A hawk sails overhead; a cat passes near by; a dog comes quickly around the corner, or a snake or rat lurks under a bush, and the bird must move quickly to a place of safety. If a bird took seriously every escape from danger its nerves would not last a month.

"So, if you catch a bird in a trap or in your hand, and it struggles desperately to escape, release it at once. It probably will fly to a near-by bush and proceed to smooth its feathers or to sing mockingly, all fear gone. Then you can catch it again."

Single-family homes are used by Baldwin in studying wrens. These houses are equipped with trapdoors so that the birds can

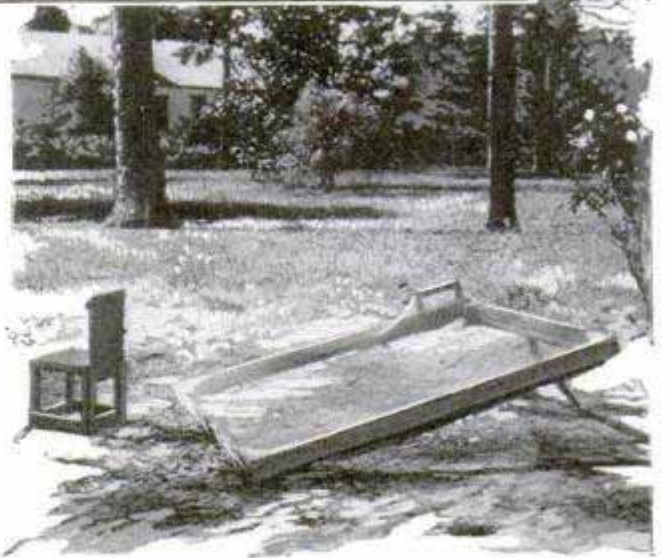
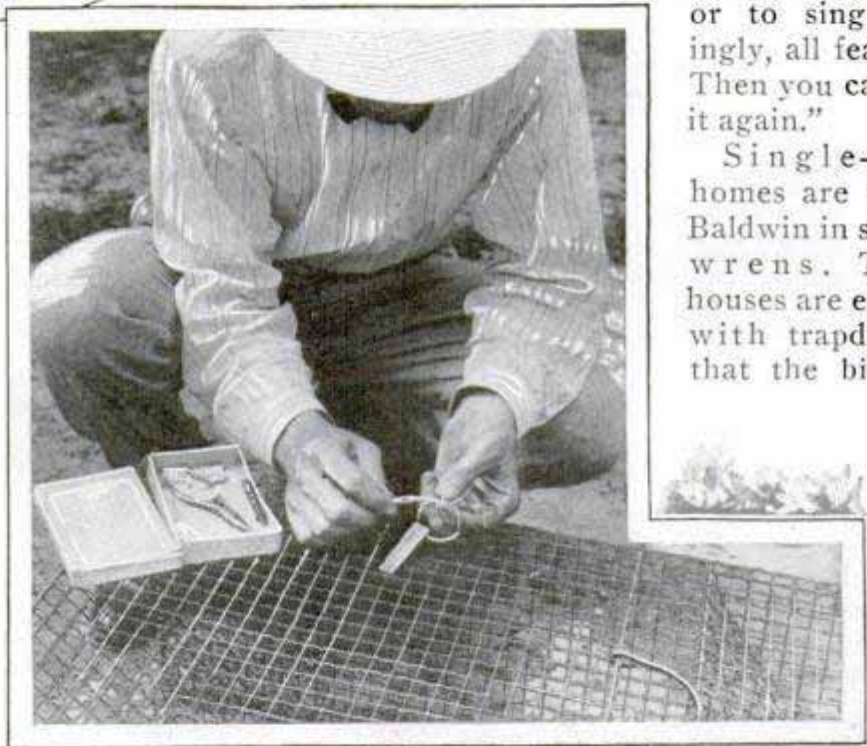

Nest with Perch Trap, a Bird Bander and His Tools, and a Drop Trap, with Gathering Box at the Left



be captured for study. A jerk on a string operates the trap. In writing the family history of a generation of wrens, Baldwin begins with the time the parent birds arrive from their winter home in Central America. After the nest is completed, the mother bird lays her eggs. Baldwin numbers each egg and assigns it a place in a record book. The eggs are weighed each day during the incubation period to determine the change caused by evaporation of moisture in them. When the sprawling, ugly baby wren picks its way into the world there is a number waiting for it—the same as that on the egg from which the bird came. The mark is placed on the wren's beak until it is old enough to wear an aluminum bracelet. The baby birds, like the eggs, are examined daily for weight and other variations.

Before the little wren becomes old



T. E. Musselman and S. Prentiss Baldwin, Examining Chipping Sparrows with Diseased Feet, Result of a Mysterious Malady

enough to fly or to fear the men who visit it daily, it is banded, the band being fastened to its leg by means of small pliers. The band bears a serial number, and a notice to the finder to report it to the biological survey.

The young wren, now nearly full-grown, launches itself into the world after a few trial spins. Perhaps it will be found next in some other state, or even in its Central American winter home. Often a bird will return year after year to its birthplace, while some of its brothers and sisters never return.

"Wrens become so accustomed to being handled, measured and photographed from day to day that they learn to expect it," Baldwin said.

"We have attempted to extend the intimate studies of wrens to other species, but have not had much success. Robins were tried, but they are such suspicious, nervous birds that they are scared away if their nest is bothered in the least."

Electricity has been called to the aid of the bird student. Baldwin has devised an apparatus for recording the time when mamma Wren leaves the nest, how long she stays away, when she returns, and when she changes position on the eggs.

The why, where, how far, and when of bird migration is one of nature's greatest mysteries. It is not yet known where the tiny warbler, the size of a man's thumb, gets its energy to fly without stop the 2,400 miles from Nova Scotia, over the

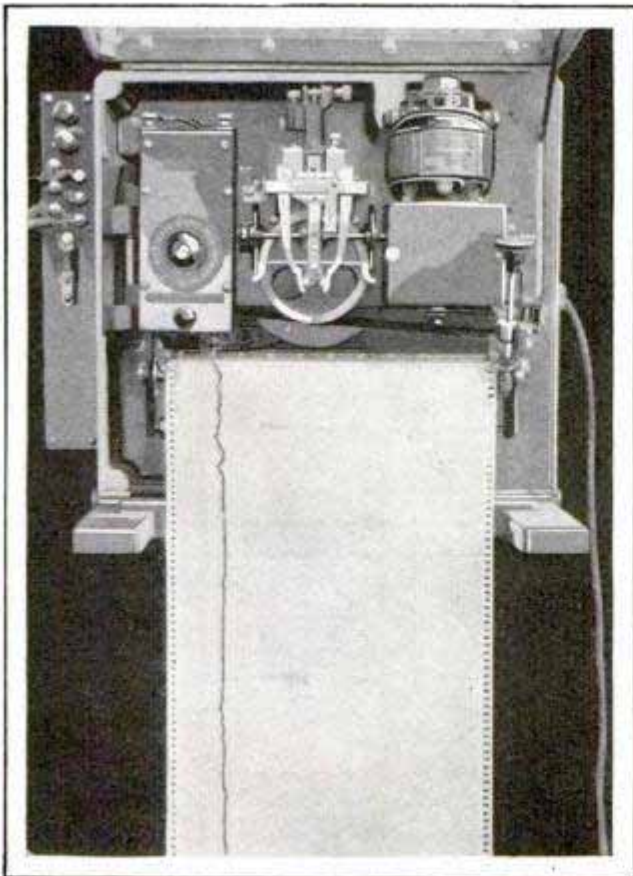

An Electric Recorder for the Mother Bird; Placed in the Nest It Registers Every Absence



379  
104

Pragerstrasse, Berlin W. 50  
Germany

Atlantic, to the Lesser Antilles or South America, a non-stop record that man may not equal for many years, at least as far as efficiency is concerned. Or why does the arctic tern fly 11,000 miles from its home near the south pole to a nesting place in the arctic regions, and back again each year? What determines the routes taken by the robins, cardinals, bluebirds and other of our better-known birds in their annual pilgrimage to the southlands?

Birds are among our most valuable natural assets. Their menu includes all kinds of bugs, worms, mosquitoes and other insects which destroy our food and other materials. If birds were to disappear suddenly from the earth, it would be only a matter of a short time until insects would be well on their way to becoming the only inhabitants of the globe.

Bird banding, then, is to be classed as a valuable service in the community and nation. The biological survey is trying to interest more persons in the work, so that more complete results may be obtained. Anyone over eighteen years old can trap and band birds, providing he obtains a permit and instructions from the survey. In some states it is necessary to have a permit from the state government also.

So, the next time you capture a bird, dead or alive, which is wearing a numbered band, notify the biological survey of the fact, giving the number on the

band, the kind of bird, the place captured, and other details. You will be helping a worthy cause in doing this.

**DOUBLE-MOTORED SNOWPLOW  
CLEARS SWISS ROADS**

289 Equipped with two fifty-horsepower motors, an efficient snowplow has been introduced in Switzerland to clear the roads. One of the engines drives the rig itself while the other operates the snow-throwing blades that hurl the drifts far to either side. Last winter, more than nine miles of the road from St. Moritz to Maloja were cleared of snow thirteen feet deep in about four hours.

*Sherman maker*

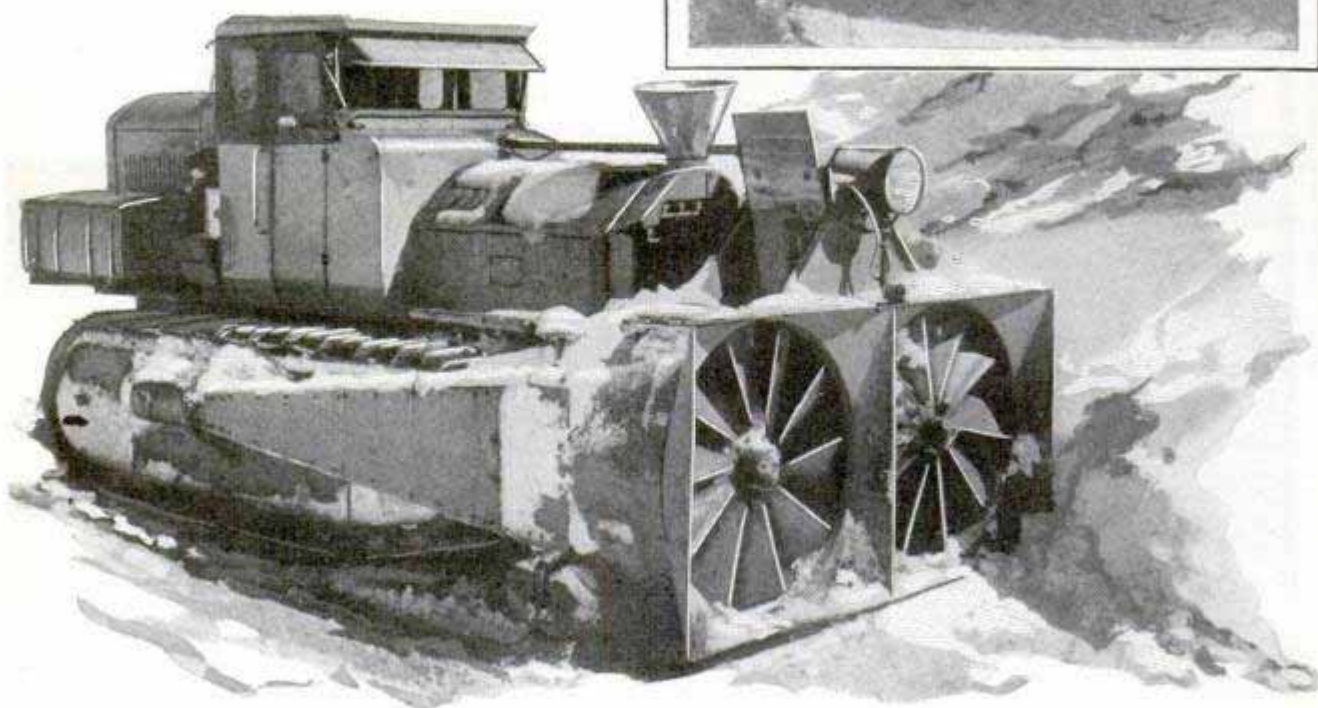
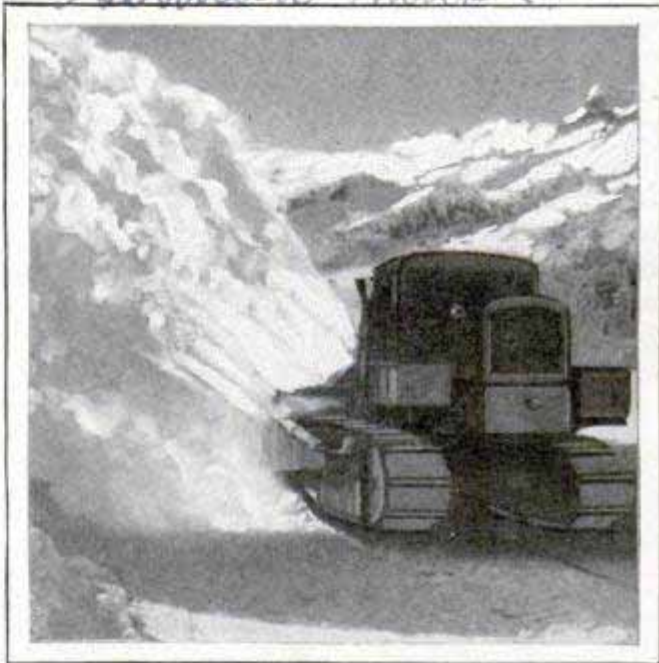

Huge Road-Clearing Rig to Combat Snowdrifts in the Alps; It Has Two Fifty-Horsepower Motors and Can Be Operated in Difficult Places with Endless-Tread Drive

*Mr. Hannomag, Hanover.  
Ludwig Hermann*



4/12/28

Wilson National Press  
105  
Bldg., Washington D.C.

### TELEPHONES' LIFE IS TESTED WITH PHONOGRAPH

"Joe took father's shoe bench out. She was waiting at my lawn." These sentences are repeated over and over again from phonograph records into telephone transmitters, while engineers measure the effect of the sounds in one of the testing laboratories of the Bell Telephone company. The words have been chosen because they represent simple combinations of speech that contribute most appreciably to loudness. The sentences are like the well-known statement, "the quick young fox jumps over the lazy brown dog," a test sentence for typists, containing all the letters of the alphabet. Engineers declare that 5,400 calls of two minutes each constitute an average year of service for an ordinary desk-telephone transmitter, a performance which is completed in about fifteen days in the laboratory test. According to the way the instrument stands the trial, estimates are made as to its approximate rate of aging under actual service conditions.

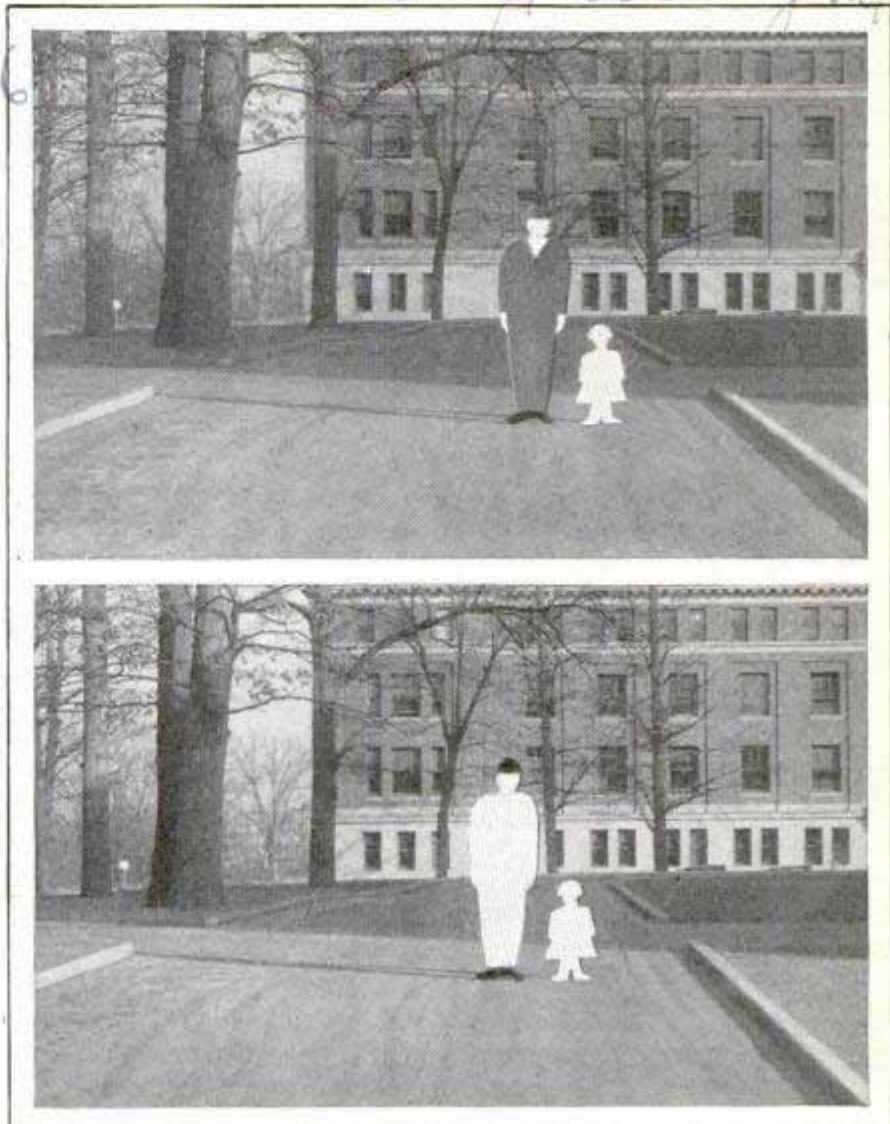

Dummies Used in Headlight Tests at Bureau of Standards; Note How Light Clothing Shows Up Adult Figure

### LIGHT-COLORED CLOTHES HELP PROMOTE AUTO SAFETY

By the use of dummies of adults and children, scientists at the bureau of standards have performed a number of tests that show some of the hazards of night automobile driving and the difficulties of providing adequate lighting. One of the striking results of the experiments proved the importance of light-colored clothing at night as an additional protection to the pedestrian. When the dummy of the man was dressed in white it was seen twice as easily as when clothed in dark garb and appeared to be considerably larger. This was due to a familiar optical illusion. Light-colored automobiles were likewise much more clearly visible at night than those painted in dark hues. The tests showed that light clothing at night is a protection from automobiles.

### AN IRON BOOKKEEPER

For banking establishments, a device has been introduced that opens the mail, counts and sorts coins and coupons and enters the results in a book, performing many of the functions of a human clerk. One person can operate it, and it is said to strike a balance in four hours where four days have been required with ordinary methods.



Mr. Albert de Bary

35



Projector Which Throws Illuminated Pictures on the Clouds

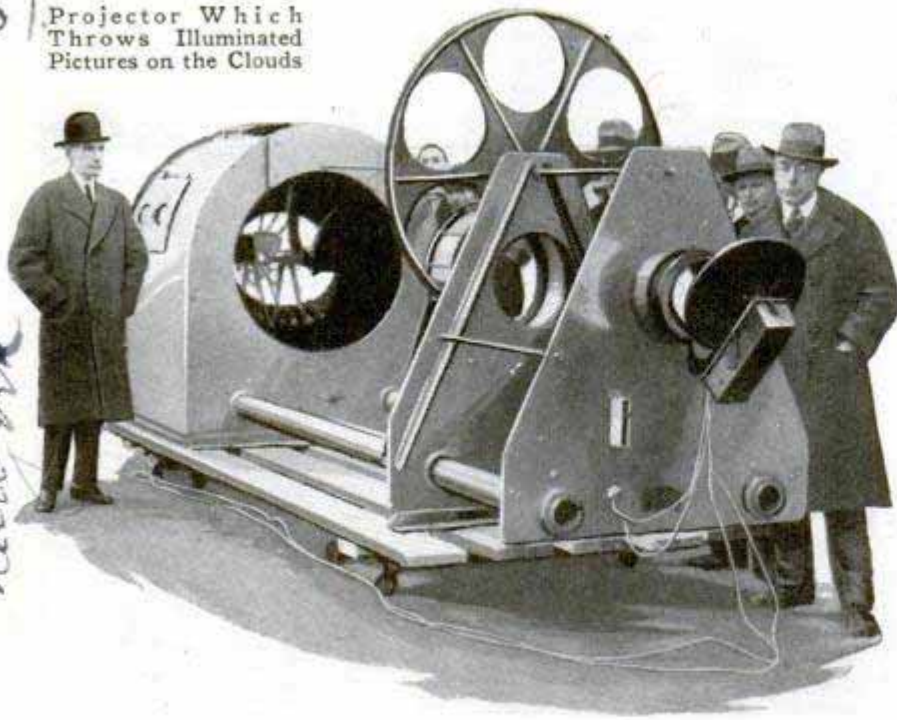

was revealed in one of the chariots. Around it were found the skeletons of a man and four animals, supposed to have been the driver and his team. The animal skeletons have been identified as an early species of horse. Evidence that the master and the animals were victims of a sacrifice to ancient gods was found, or the man may have been a prisoner of war or killed by his own comrades in arms. Between two of the horse skeletons was discovered a shaft, terminating in a metal boss and supporting

### PICTURES THROWN ONTO CLOUDS FOR ADVERTISING

Six different pictures are projected upon the clouds in less than five minutes with an improved machine recently introduced for night-time advertising. At a distance of about 500 yards, each picture is 170 yards wide and remains in view for forty-five seconds. Then a circular holder turns automatically and a new one is exposed. The process is repeated as long as the projector is left in operation.

### CHARIOTS FIFTY CENTURIES OLD FOUND IN MESOPOTAMIA

One almost complete four-wheeled chariot and another in a more fragmentary state have been dug up on the site of the ancient city of Kish by members of the Field Museum-Oxford University joint expedition to Mesopotamia. They are about 5,000 years old, scholars estimate, and are believed to be the oldest wheeled vehicles ever excavated. An apparent tragedy

ing the rings through which the reins had passed. This gives new light on the manner in which the chariots were rigged by the Sumerians. As the pieces were taken out, they were sprayed with oak varnish to aid in preservation, and the parts were carefully packed in plaster of paris and layers of paper, to insure safety for them during shipment.

### PERMANENT JACKS FOR AUTO SIMPLIFY REPAIRS

3996

Permanently attached to the car springs, jacks for each wheel of the automobile are quickly let down for service and raise the car by means of a long wrench which is folded into small space for carrying. The jacks are constructed to stabilize the auto-

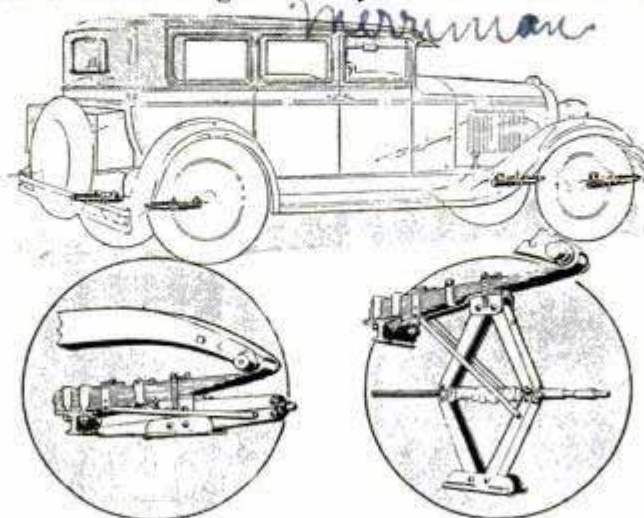

View of the Car with Jacks Attached, and Drawings Showing the Unit Folded and Extended

mobile, are said to work as well in driving on a hill or sloping road as on the level, and contribute to the comfort of riding. The principal feature is that they eliminate the unpleasant task of setting the jack in place and are convenient for lifting the auto off the floor when stored.

*U. S. 485 2nd Ave New York*

*572*

*Merriam*

*Central 2652 Dept of business 11/17/30*

*Sta. Gas Sales Co. 12th & Monroe Chicago*



SHIP THAT SWALLOWS TRAINS IS USED AS FERRY

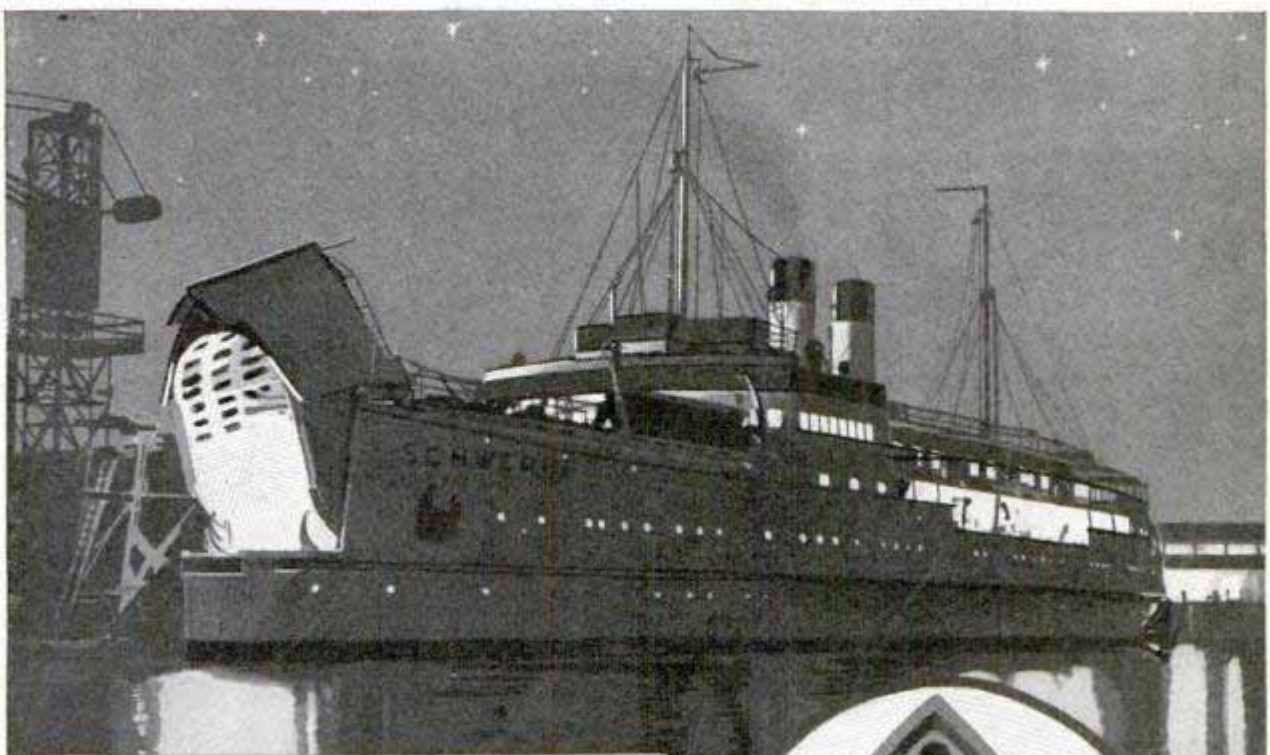

Like Some Fire-Breathing Dragon Out of an Ancient Fairytale, the New German Car Ferry "Schwerin," Above, Opens Its Mighty Jaws by Lifting Its Bow and Swallows a Train of Twenty Passenger and Forty Freight Cars for the Through Service across the Baltic Sea, Which Links Berlin and Copenhagen Via the Port of Warnemuende; Closed, the Jaws Can Turn the Waves or Crush Ice

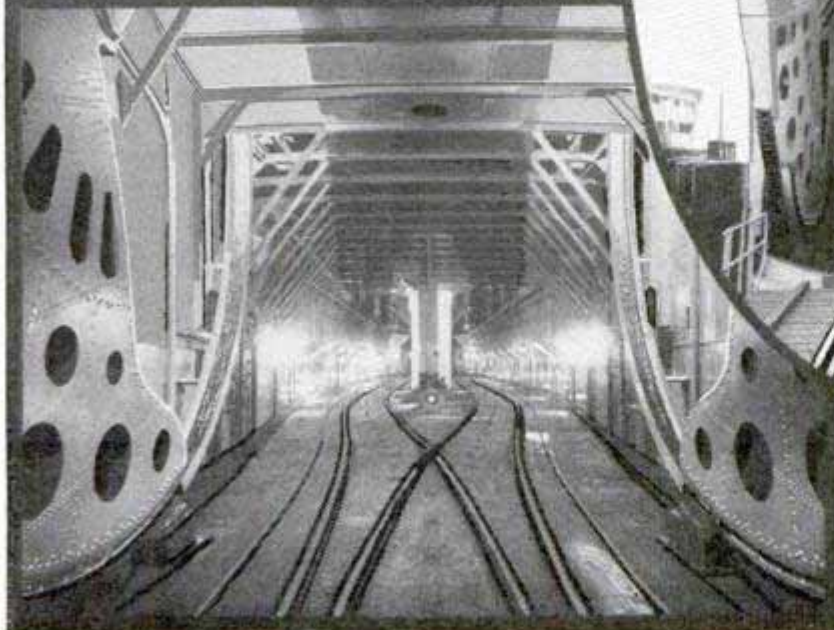
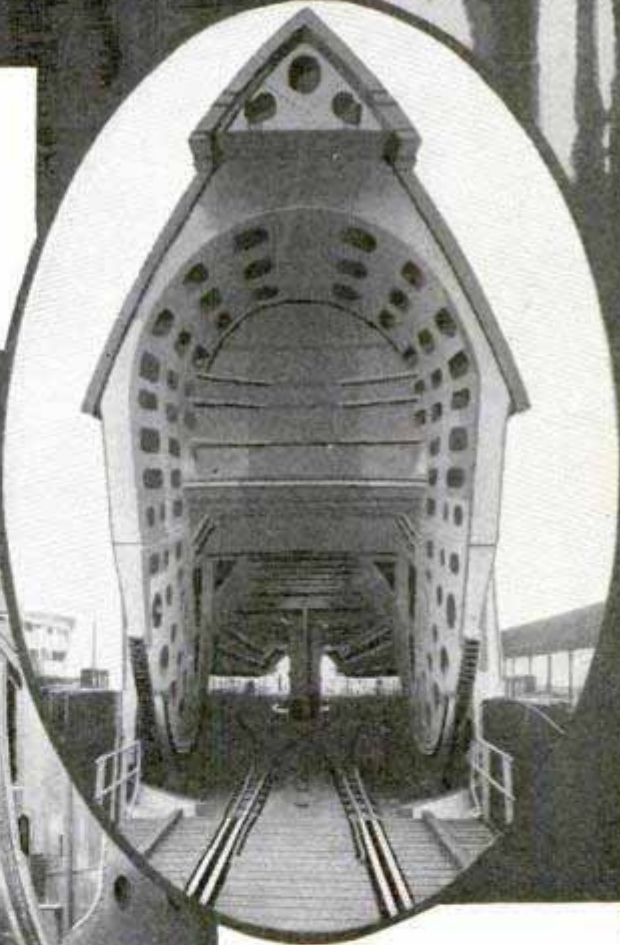

Tall as a House, the Open Bow, Above, and, at Left, a View of the Tracks Inside; the Ship's Funnels Rise in the Center

*Herbert*



"SHOOTING" THRILLING FIRE RESCUES IN MOVIES



Above, How Building Looked in the Film; Below, the Model Where Small Fire Was Built



The Real Building. Above, and, Below, the Position of the Model, the Camera and the Structure Itself during the Filming of the Scene

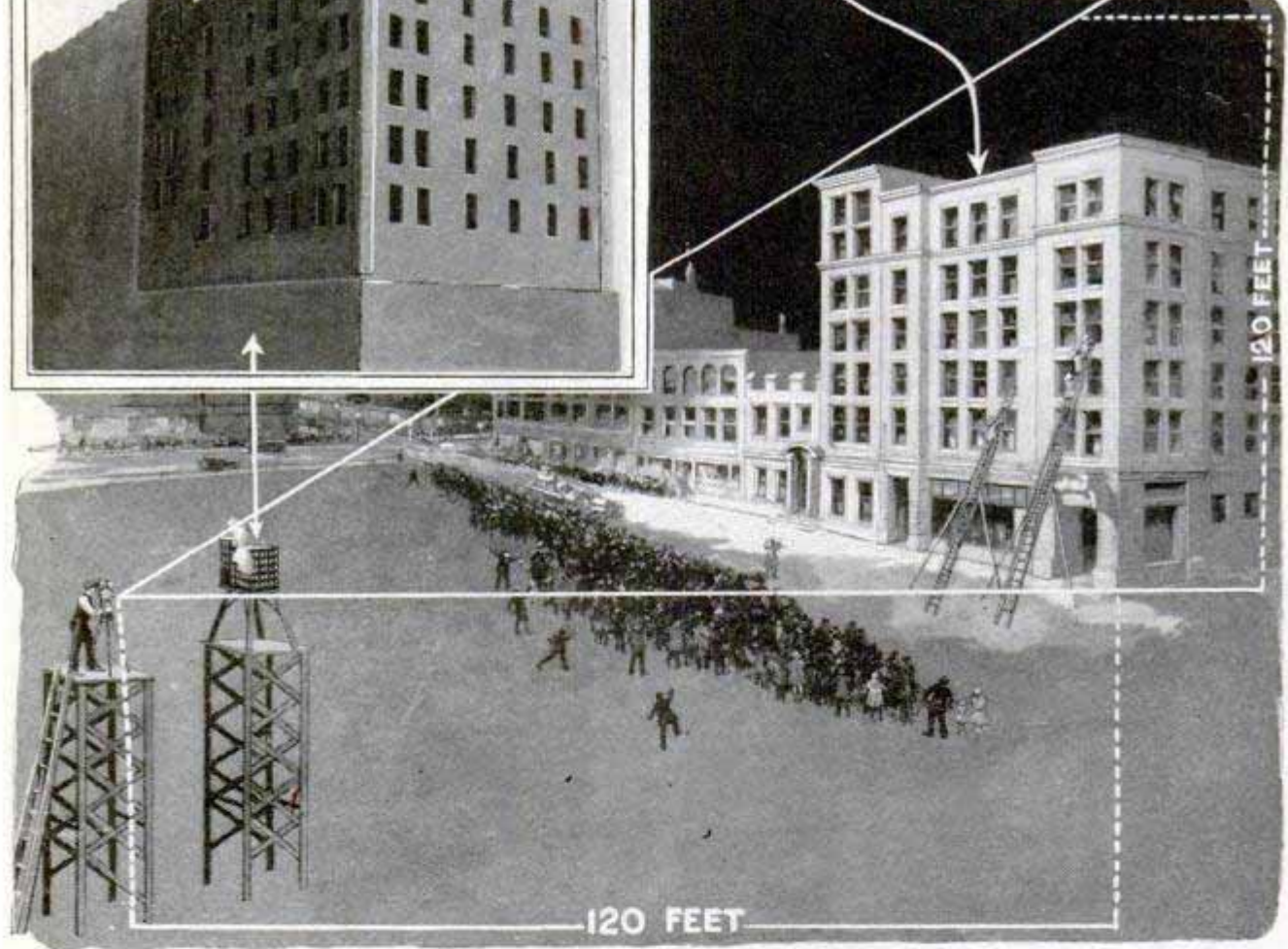
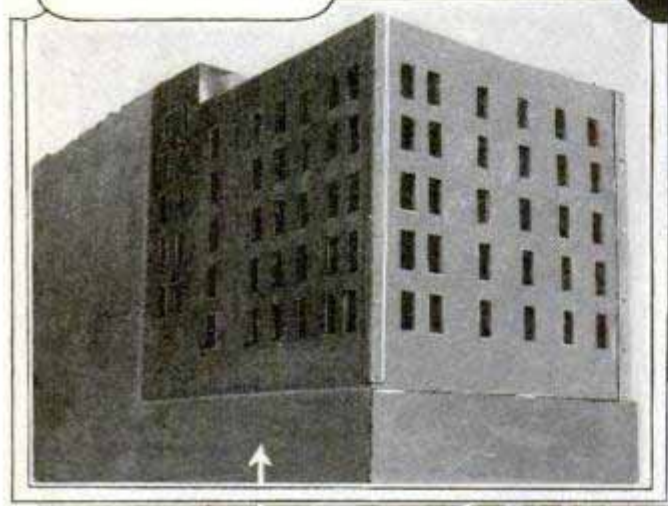

Firemen made daring rescues from upper stories, streams of water played against the walls, and billows of smoke apparently rolled among the licking flames. So it looked in the motion picture, at least, while spectators enjoyed the thrills of a night's battle with the fire demon. But

dawn came and the building that had figured in the conflagration was absolutely untouched. Not so much as a soot mark marred its gleaming walls. There had been no fire though the movie showed real smoke and real flames. The effect was produced by a simple stunt in double-



*at low Surfacings  
Machine Co. 508 S  
St. Clair St  
Toledo,  
Ohio.*

exposure photography. The scene had been taken at night, and at the correct distance in front of the camera, a carefully modeled miniature of the real building had been placed in such a way that the film was "shot" directly through it. Oil-soaked rags were set ablaze behind the model, which was painted a dull black so that it would not be seen in the picture, and the real building was brilliantly illuminated on the exterior. The fire and smoke seemed to come from the real structure where the firemen were performing their rescues in absolute safety, save for the slight hazard of a few drops from the hose lines.

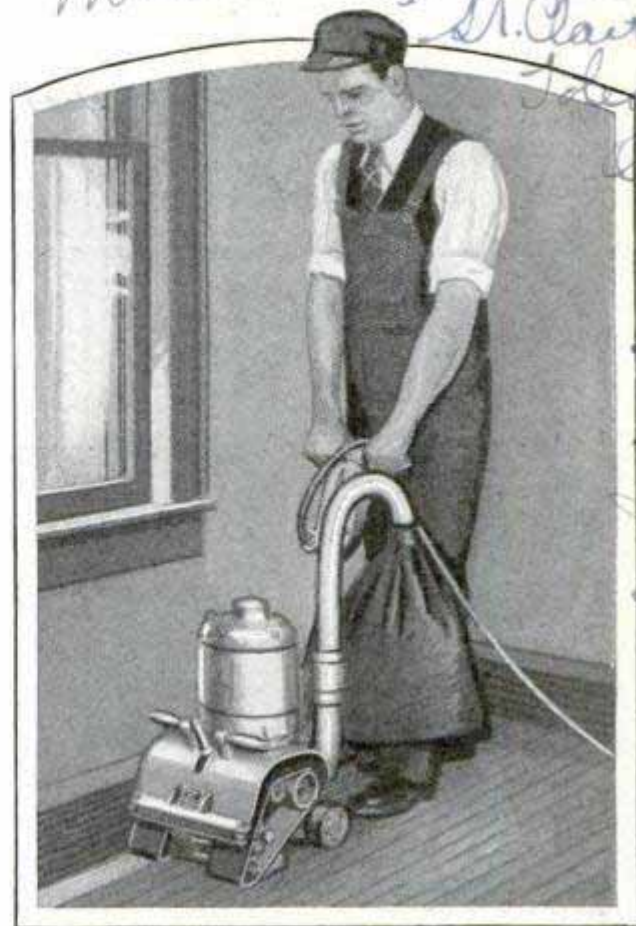

Sanding the Floor Close to the Baseboard Is Easy with This Motor-Driven Unit

**FLOOR SURFACER SANDS EDGES SAVING HAND LABOR**

Edges, corners, narrow closets and other places are easily reached with a motor-driven floor surfacer which eliminates hand scraping. The work is done by abrasive belts that run over flexible shoes. They are so adjusted that the machine can be operated flush with the walls and in places inaccessible to the ordinary sander. Dust is collected by a vacuum fan. The apparatus has rubber-tired wheels, weighs less than 100 pounds and, since the butt ends of a floor can always be surfaced with the grain, it insures a better-looking job.

*Chicago - 218 Lincoln*

**FOLDING MAPS FOR AUTOISTS EASY TO HANDLE**

Road maps, folded by a patented process so that they are never opened to a size larger than the pocket cover which contains them, have been perfected by a Minneapolis map publisher. The Minnesota map is already on the market and the others are to follow as fast as the plates can be prepared. The folding method enables the user to turn pages right, left, up or down and follow from section to section without ever opening the map; in fact, it is so pasted in the folder that it cannot get out of fold. A complete map of the state is printed in a fold of the cover, laid off and numbered in corresponding sections, so that the driver who uses it can see the state as a whole. An index on the map locates all towns and villages. An automatic machine has been developed to take the flat sheets and covers and cut, fold and paste them. The folding process is applicable to all kinds of maps, charts, prints and other material where folding is necessary for carrying or filing.

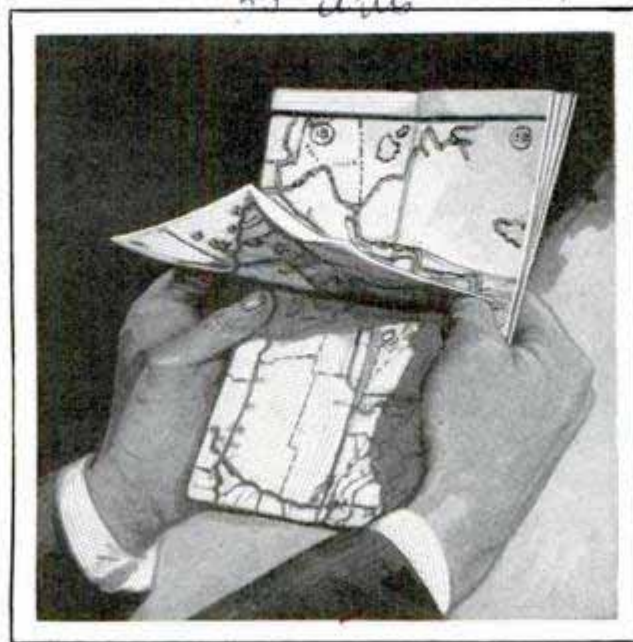

Map Folded and Pasted So All Parts Are Accessible; It Never Opens Larger Than Its Cover

*(make - roll - 30 - 50 - 60 - 70 - 80 - 90 - 100 - 110 - 120 - 130 - 140 - 150 - 160 - 170 - 180 - 190 - 200 - 210 - 220 - 230 - 240 - 250 - 260 - 270 - 280 - 290 - 300 - 310 - 320 - 330 - 340 - 350 - 360 - 370 - 380 - 390 - 400 - 410 - 420 - 430 - 440 - 450 - 460 - 470 - 480 - 490 - 500 - 510 - 520 - 530 - 540 - 550 - 560 - 570 - 580 - 590 - 600 - 610 - 620 - 630 - 640 - 650 - 660 - 670 - 680 - 690 - 700 - 710 - 720 - 730 - 740 - 750 - 760 - 770 - 780 - 790 - 800 - 810 - 820 - 830 - 840 - 850 - 860 - 870 - 880 - 890 - 900 - 910 - 920 - 930 - 940 - 950 - 960 - 970 - 980 - 990 - 1000)*

*click - 43 - 44 - 45 - 46 - 47 - 48 - 49 - 50 - 51 - 52 - 53 - 54 - 55 - 56 - 57 - 58 - 59 - 60 - 61 - 62 - 63 - 64 - 65 - 66 - 67 - 68 - 69 - 70 - 71 - 72 - 73 - 74 - 75 - 76 - 77 - 78 - 79 - 80 - 81 - 82 - 83 - 84 - 85 - 86 - 87 - 88 - 89 - 90 - 91 - 92 - 93 - 94 - 95 - 96 - 97 - 98 - 99 - 100*



# New Ways to Avoid



For Serving Meals in Bed, This Tray with Folding Legs Is Convenient; It May Also Be Used as a Reading Rack



It Clamps to the Floor-Lamp Standard; a Handy Ash Receiver

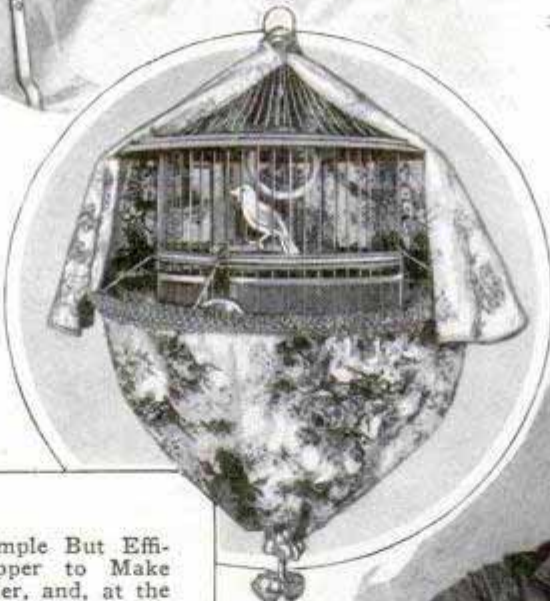

Left, a Simple But Efficient Chopper to Make Meat Tender, and, at the Right, an Attractive Cover for the Birdcage to Catch Seeds and Feathers



It Transforms Milk Bottle into a Pitcher; a Special Pouring Cap



Silver Balls as Substitutes for Ice; They Contain Frozen Liquid to Chill Drinks and Foods





# Home Drudgery



Rubber and Bristle Scrubber for Cleaning Pans

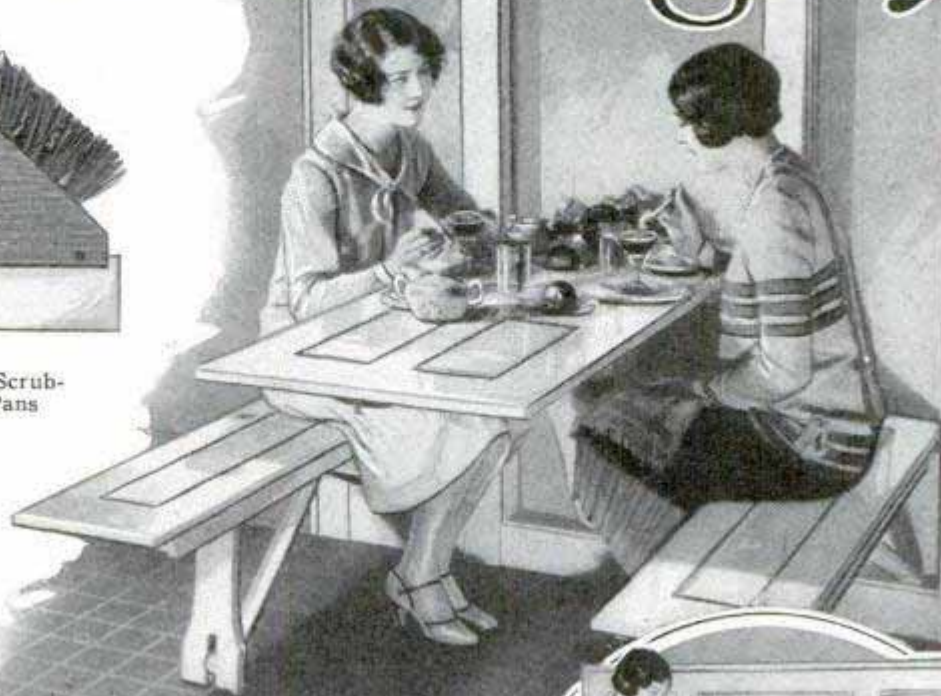

Added Convenience in Built-In Furniture; This Folding Dining Set Includes an Ironing Board as Is Seen Underneath at Right



Fc  
Tr  
Chi.  
  
F.  
F.  
  
Mi.  
Lo.  
  
Pit  
Chi.



Holes in the Milk Can Are Sealed, after Pouring, by This Easily Attached Spring Stopper



Liquid Floor Wax Is Evenly Distributed from Cylinder on Top of the Felt Pad

Not Readily Broken and Easy to Use; a Pitcher, the Handle of Which Is "Built-In"



*mansh. Esford  
Circus, London, W. & Eng.*

*V.C. J. Lalonde, Supt. of Fire Alarm  
Systems, Ottawa, Canada*

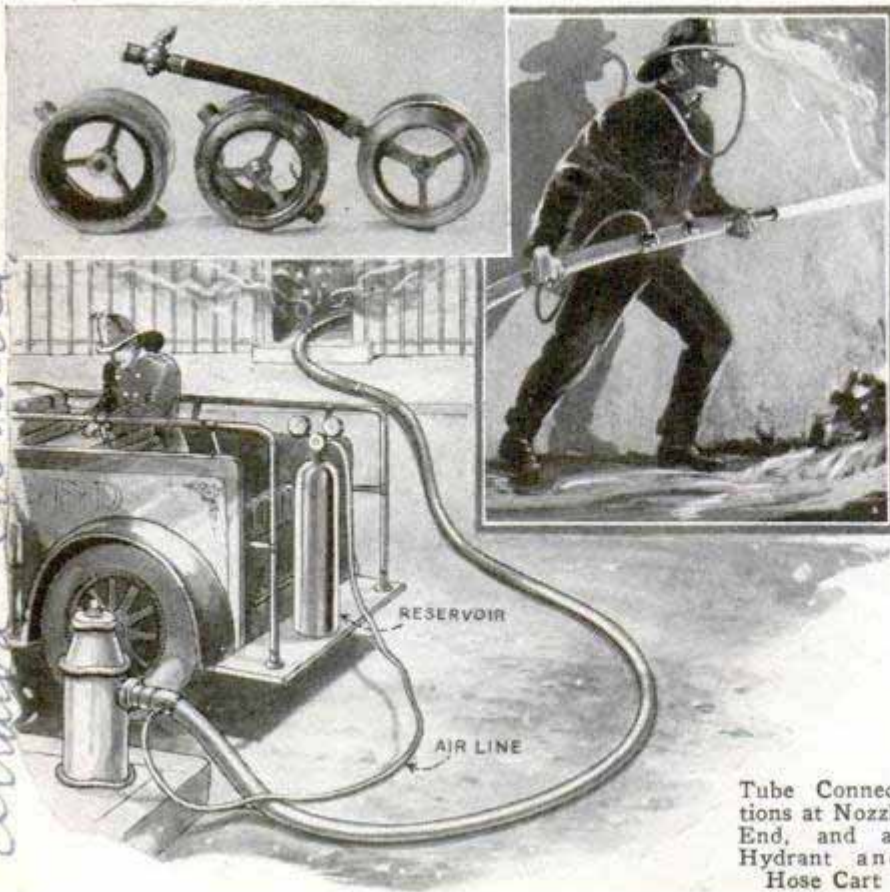

### OXYGEN TUBE IN FIRE HOSE TO HELP SAVE LIVES

By means of a special coupler attachment, a supply of oxygen or air can be sent to the fireman's mask from the hose line, in an arrangement a Canadian expert has devised. The small tube, carrying the refreshing gas, is inside the water conduit and is protected from damage in this way. The simple turn of a valve admits the flow to the mask, and connections are made at the source with a special container on the fire wagon. In a recent test, a fireman remained in a smoke-filled building for half an hour under conditions that would have rendered him unconscious

without the mask and gas supply. He reported that he felt no harmful effects after the test, and that the oxygen, passing through the inner tube, had been pleasantly cooled by the water.

### FILM NIGHTMARES GET ZEST FROM DISTORTAGRAPH

An invention that turns a simple movie into a nightmare of distortion has been perfected by an Englishman, H. G. Ponting, who was Capt. Scott's photographer on his ill-fated trip to the south pole. People, animals or inanimate objects are changed into grotesque caricatures by successively distorting various portions. The process makes it possible to rephotograph an ordinary still picture and make it live on the film as it flows from one grotesquerie into another. An ordinary postcard photo of a race horse was shown by the inventor to an audience in London. As retaken for a movie, it became successively a short-legged dachshund-like animal, a long-legged giraffe type, a combination horse and mule, and other shapes. A picture of a cow became equally fearsome. The machine, called a "distortagraph," uses a combination of lenses to produce entirely new optical effects. Pictures of Lloyd George, Charley Chaplin and Mayor William Hale Thompson were

successively distorting various portions. The process makes it possible to rephotograph an ordinary still picture and make it live on the film as it flows from one grotesquerie into another. An ordinary postcard photo of a race horse was shown by the inventor to an audience in London. As retaken for a movie, it became successively a short-legged dachshund-like animal, a long-legged giraffe type, a combination horse and mule, and other shapes. A picture of a cow became equally fearsome. The machine, called a "distortagraph," uses a combination of lenses to produce entirely new optical effects. Pictures of Lloyd George, Charley Chaplin and Mayor William Hale Thompson were

Tube Connections at Nozzle End, and at Hydrant and Hose Cart

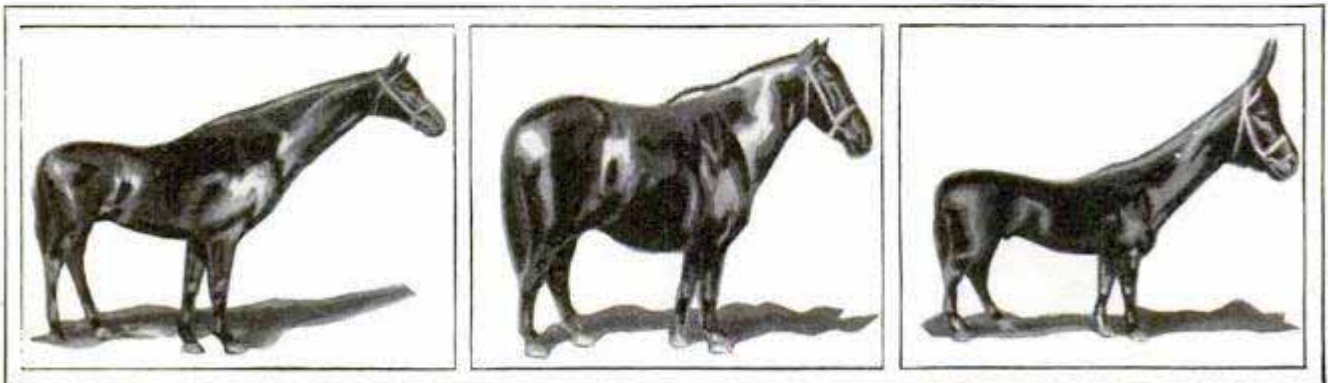

Three Pictures of a Famous Race Horse After They Have Been Run through the "Distortagraph," the Newest Agency for Making Funny Movies Still Funnier

*London Express 2/20/25*



227. Cleopatra  
Massage Co.  
Baltimore, Md.

turned into weird monstrosities, which, like a cartoonist's caricature, still preserved enough of the original's features to be recognizable. The invention is expected to revolutionize the making of fairy-story films, animal pictures, and comedies in which film faking plays a part.

Face Steamer in Use; Switch Controls Temperature, and Breathing Tube Insures Comfort



PORTABLE VAPOR FACE-BATH  
LATEST BEAUTY AID

Eliminating the use of hot towels, lights and other apparatus, a portable steamer to give the face a vapor bath has been introduced for home or beauty-parlor use. It gives the skin and scalp a thorough steaming, the temperature being controlled by a regulating switch; is simple to operate and saves time. The subject is exposed to no discomfort, as a supply of fresh air is obtained through a tube.

ELEPHANTS SERVE  
AS TRACTORS ON  
AFRICAN FARMS

Plowing fields with elephants has proved only about one-fourteenth as costly as with tractors in the Belgian Congo. An elephant can be kept for about twenty-five cents a day; a well-trained animal will plow more than an acre a day and is also useful for pulling stumps, piling timber and for many other heavy tasks.

Elephants were imported from India to work in the Congo when the depredations of the tsetse fly proved so injurious to horses and cattle. The Indian animals did not long survive the African climate, but their trainers taught the Congo natives some of the secrets of capturing and teaching young wild elephants.

KINDLING CUBES FOR CAMPERS  
SIMPLIFY STARTING FIRES

Making a fire is often a difficult task when camping, and to simplify the process, a small cube of easily ignited material has been introduced for use with the match. It has a hole in it, the match is stuck through, lighted, and the cube catches fire, forming a small blaze that will more readily ignite sticks or other materials.

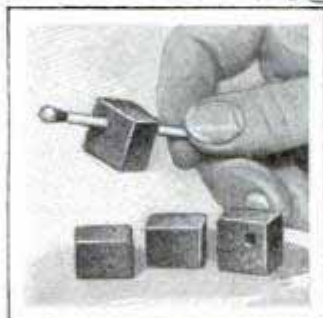

SUGAR OBTAINED FROM CORN  
USED IN MANY FOODS

Besides its cane and beets, the United States has an important source of sugar in its corn fields, although this product has not yet been produced in any great quantities, due to the intricate processes involved in its manufacture. It has proved useful in medicine, especially for feeding infants and invalids, and serves an important purpose in the food industry.

Warms at Bop. Use  
Kings district  
Kale

American Manufacturing Products Co. 4124 2nd St. N.W. Wash. D.C.  
Corn Products Refining Co. 17 Battery Place

A. L. White Co. Camp Co.  
Box 388 - Dan...

New York Times 3/8/28



3615  
114

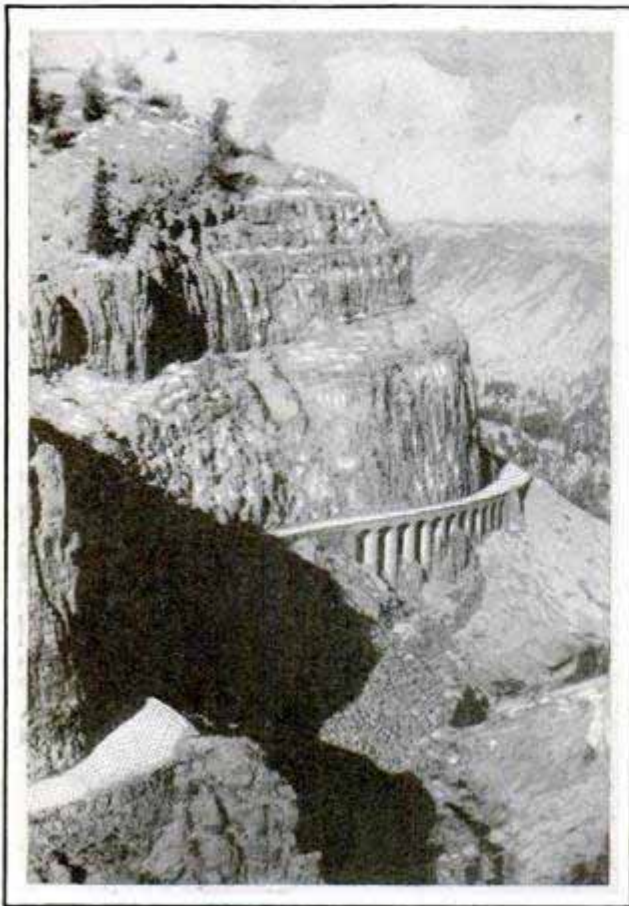

Where an Auto Road Stands on "Stilts"; Section of Highway in Golden Gate Canyon, Yellowstone Park

### AUTO ROAD ON CANYON WALL MARVEL OF ENGINEERING

One of the most picturesque improvements in the Yellowstone park is the automobile road recently completed along Golden Gate canyon. Part of the way, it cuts into the steep mountain sides and is carried by arch supports. The highway is of concrete.

### TALL BUILDINGS GUARD OTHERS FROM LIGHTNING

Tall buildings and rods mounted on high towers, protect neighboring structures from lightning if the latter are not so high as to extend out of the cone of protection, according to the findings of F. W. Peek, Jr., of the General Electric company. This protected area extends around the base of the high building for a distance of between two and four times its height, the experiments show. The tests were made with artificial lightning at pressures of 3,500,000 volts on small model buildings, but confirmation of the laboratory findings has been obtained from a study of real

electric storms. Last summer, for instance, during a shower in New York city, the New York World building was struck by lightning. It is within the 1,100-foot circle about the base of the Woolworth tower, but its dome extends about 100 feet outside of the cone of protection. Had the World building been 200 feet closer to the Woolworth building, it would not have been struck, Mr. Peek believes. Practical application of the results of some of the lightning experiments has been made in safeguarding oil-storage tanks. Tall rods, placed outside the big reservoirs, provide overlapping cones of protection and so reduce the danger of fires.

### WINDOWS WASHED FROM INSIDE WITH SPRING SWAB

Cleaning the outside of the window is simplified with a collapsing unit operated from the inside so that the use of ladders is unnecessary. The outfit is worked somewhat like a pantograph, the motion of an extension handle inside being reproduced with the cleaning pad, attached to a similar bracket, outside. There is a handle grip to keep the washer steady and the window needs to be raised but a few inches. The scrubbing member is pointed so that it will reach up under the portion covered by the upper winflow.

Pantograph Window Cleaner in Operation from Inside

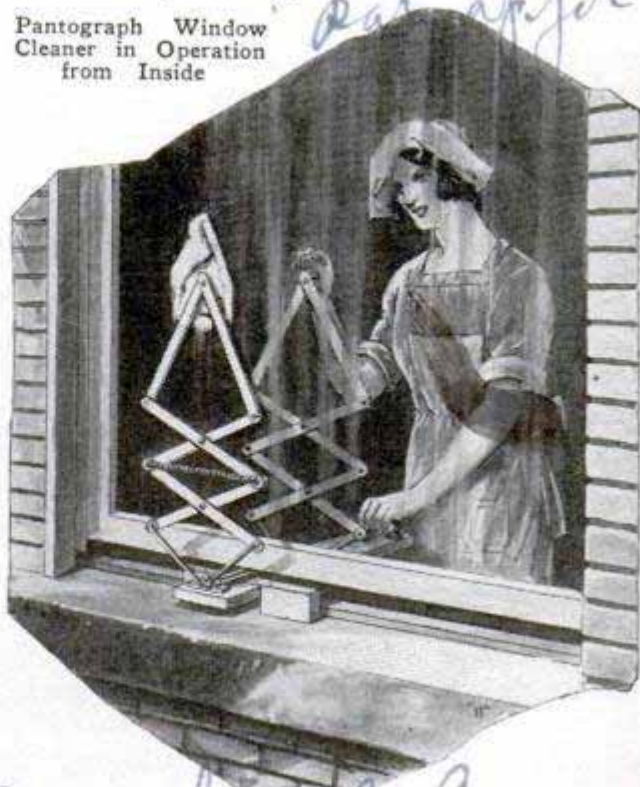

Mark Coley Co.  
2818 W. Lake.

Stationery of D. G. ...  
561



70  
Carnegie Library 201  
Carnegie St.  
Marion, Ind.  
Ohio.

# Easy Tricks

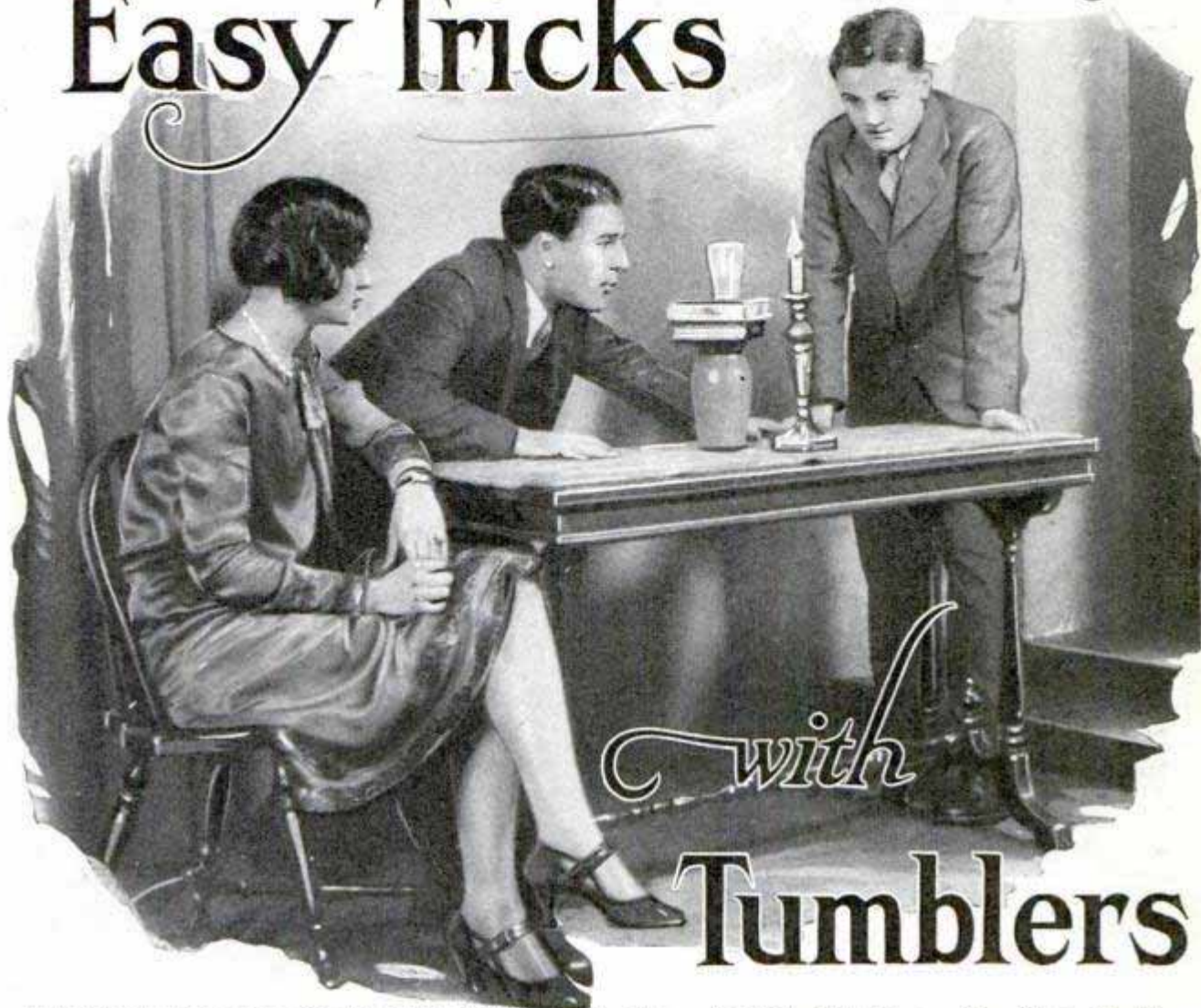

with  
**Tumblers**

It Is Easy to Blow Out a Candle Sheltered behind a Tumbler, and It Would Be Just as Easy If the Tumbler Was Several Times Larger, For the Air Simply Sneaks around It

**B**EING with tumblers, which are of glass, these little tricks should be very easy to see through.

The performer takes a tumbler. He gets dramatic. "Ladies and gentlemen," he draws, with the smile of the wizard on his face, "I have just discovered that I have a wonderful magical power which enables me to blow through solid objects. Look!"

He arranges a lighted candle and a glass as shown above and then blows directly against the glass. "Allez!" And the candle flame on the opposite side of the glass is whiffed away! But, really, there is nothing wonderful about it, for the single air current made by blowing on the glass merely splits and sneaks around the tumbler and joins forces again on the other side to put out the candle.

Imagine anyone asking you to support a heavy tumbler on a single sheet of paper

which rests on the edges of two other tumblers! "But, Amos, he did it! He folded the paper up in them there little accordion pleats, as shown, and, well—that was all there was to it!"

For the next effect the performer exhibits a tumbler, a strip of paper and a coin. He delicately balances the coin on the edge of the tumbler, with the slip of paper underneath it. The problem is to take the paper completely away without dislodging the coin.

Without previous knowledge of the law of inertia governing this effect, the average spectator will either take the paper by the extreme end and jerk it away, or he will attempt to move it cautiously on the basis of "gently does it." Neither way works. But if you hold the extreme end of the paper in one hand and strike the center portion smartly with the other, as shown, you will be surprised to find how



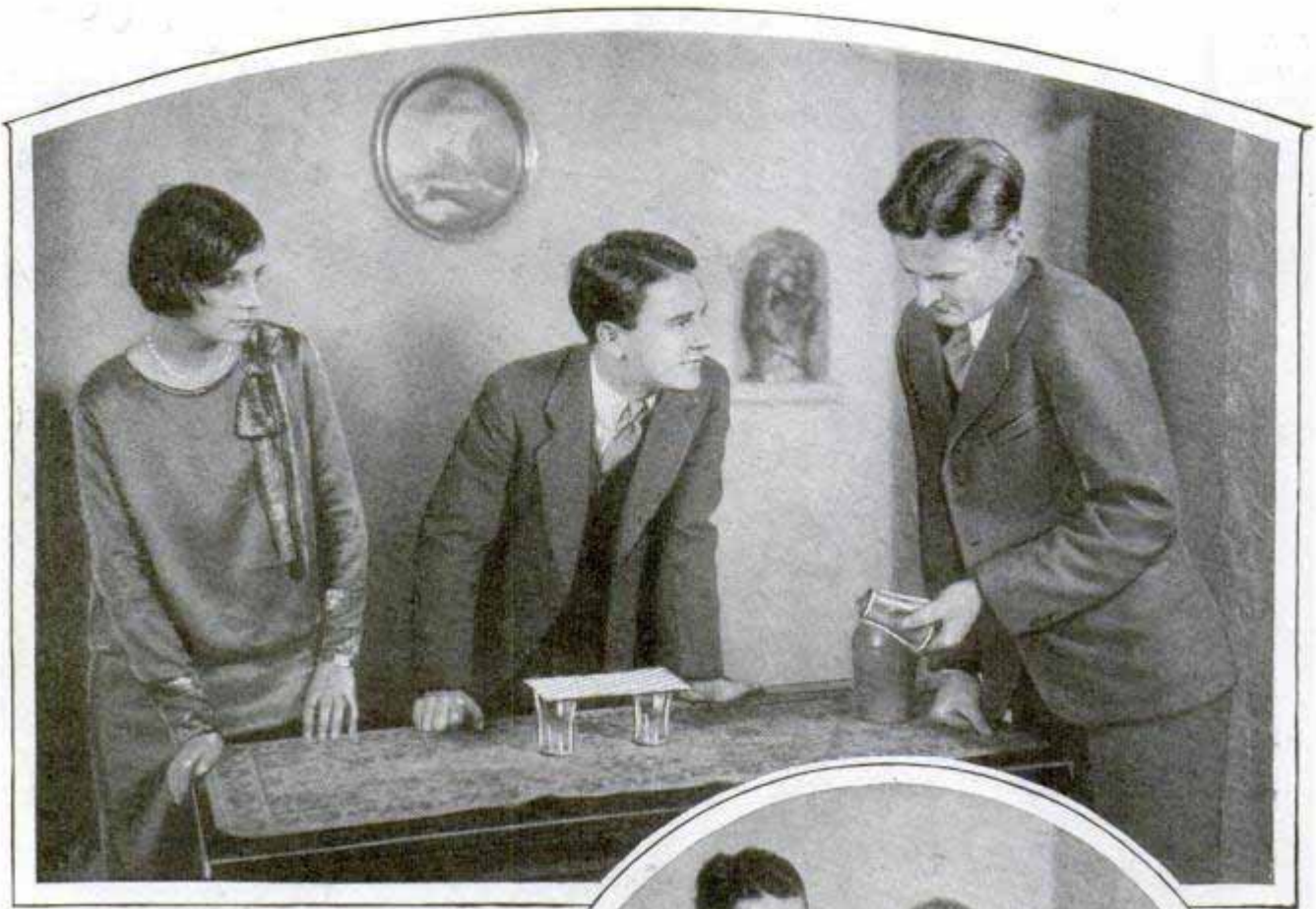

easily the paper comes away and how motionless the coin remains balanced on the edge of the glass.

The levitation of a lady has nothing on this one! The problem is to raise a tumbler by merely pressing the hand, face down, on the mouth of it. Mr. Match does the trick. Light him. Drop him into the tumbler. Place your hand, face down, over the mouth of the tumbler. And there you are! The match heats the air inside the glass, causing it to expand. When you place your hand over the glass the match goes out, the air cools and contracts, creating a partial vacuum, and the outer air pressure holds the glass tight against your hand.

Try this one on your dining table! The performer takes a glass half full of water

A Sheet of Ordinary Paper Will Support a Water Glass, Provided It Is Properly Folded in Accordion Pleats

and puts a plate over its mouth. The glass is then inverted and the plate placed on the table. And now, here's the catch: Can you drink the glass of water, using one hand only?

Well, just like everything else, it's easy if you know how. It's a good "daily dozen." Bend over, resting the top of your head on the upturned bottom of the glass. Now, if you will press the tumbler



tightly against your head by lifting up on the plate, you can raise the glass and balance it on your forehead. From there it is a simple matter to remove the plate and then drink the water. All with one hand! It's a pretty wet trick if you miss!

The next swindle, up to a certain point, is identical with a little ceremony you've done several times before. You place an expensive cut-glass tumbler on the edge of the table. You eye it deliberately. You knock it off the table.



There Is a Trick in Withdrawing the Paper Strip from Beneath the Balanced Coin, without Disturbing the Latter

But—it doesn't break! That's the trick. To perform this effect you must set the tumbler at the extreme edge of the table, mouth up. Then push it off gently by pressing with your right forefinger lightly against the lower part of the glass. If you have done this carefully, the tumbler will make a half revolution in its downward flight, and alight squarely on its rim. A smash from a fall like this is virtually impossible, even with the most delicate glass-work. It's not a certainty, however. Better try it with a pillow on the floor for the first few times.

The average tumbler will quite placidly submit to being made to stand on its base,

but when the magician makes an ordinary tumbler stand on one edge of its base—well, that's why we call him a magician. Let's see how he does this clever bit of jugglery. You'll need a match. This match is previously slipped under the table cover. With a little manipulation, you can rest the tumbler at an angle against this concealed match, and make it stand on edge in a manner strangely mystifying.

The trick of making the tumbler stick to the palm by creating a partial vacuum inside has an interesting relation, done, however, with a milk bottle instead of a glass. The stunt is to put a hard-boiled egg into a milk bottle without breaking the egg. First boil your egg and remove the shell. Now try fitting it into the mouth of a milk bottle, and see how far it comes from passing the bottle neck. But, if you

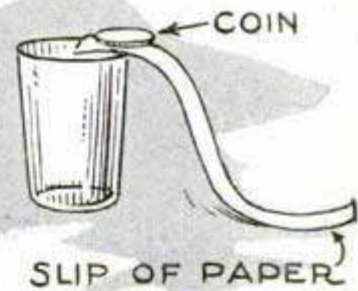





All It Takes to Make a Tumbler Stick to Your Hand in Any Position Is a Bit of Hot Air, Provided by a Lighted Match Before You Start the Trick; the Hot Air Cools, and a Partial Vacuum Does the Rest

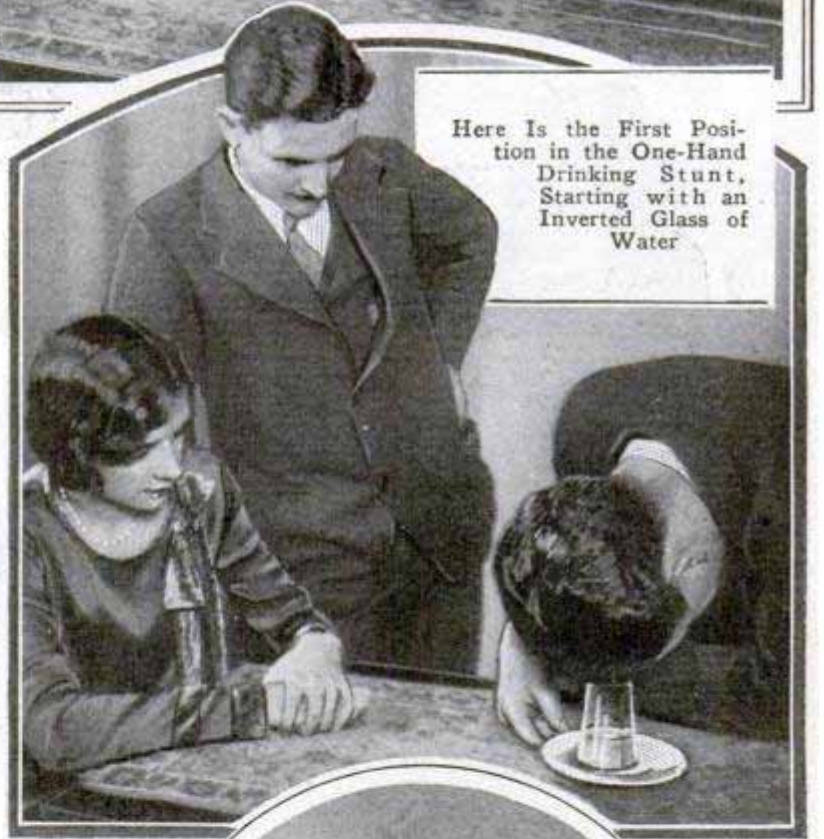

Here Is the First Position in the One-Hand Drinking Stunt, Starting with an Inverted Glass of Water



In the Second Position, Shown Above, the Tumbler Has Been Raised and Is Balanced on the Forehead, Pressure on the Plate Holding It in Place and Keeping the Water Inside during the Maneuver; the Next Step, at the Right, Is to Keep the Glass Balanced While You Remove and Discard the Plate; Then You Are Ready to Drink the Water





drop a lighted match into the bottle first, to heat and expand the air, and then place the egg in the bottle neck, you will see it slowly contract and draw itself out longer until it slides with a plop into the bottle, resuming its natural shape and showing not a single break.

Want to get the egg out again? That's easy. Lift the bottle to the lips, blow as hard as you can, building up a nice bit of compressed air, then, still keeping the mouth of the bottle sealed tight with the lips, tilt the head back until the egg slips down and seals the neck.

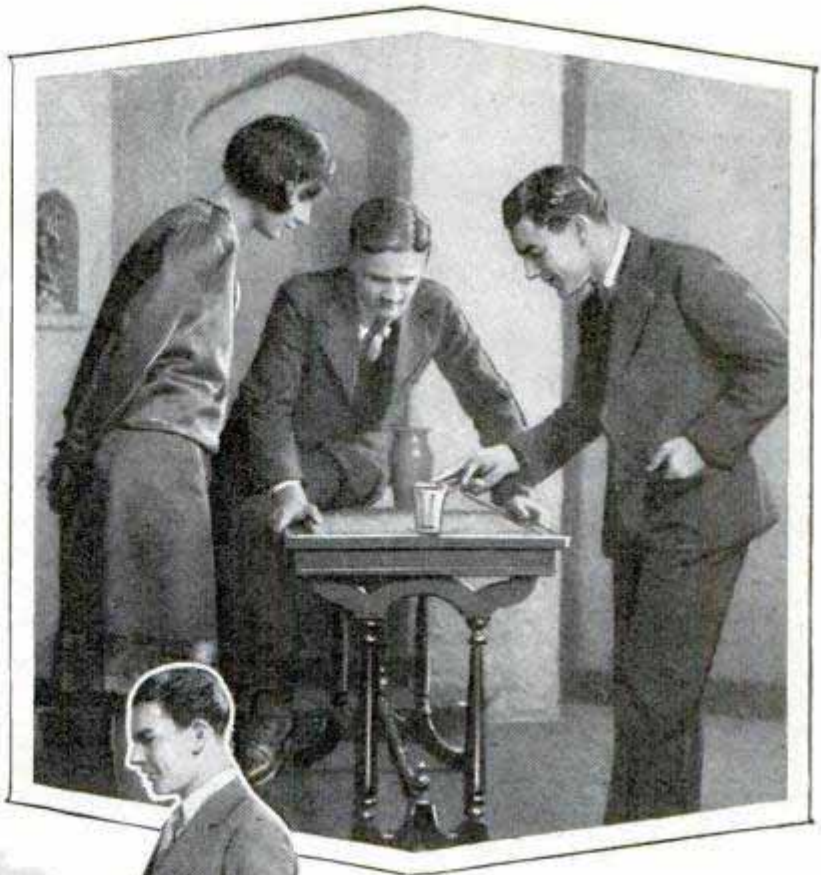

Can You Knock an Expensive Cut-Glass Tumbler off the Table and onto the Floor without Breaking It? It Is Best to Practice with a Cheaper Glass Until You Acquire the Knack

Then you can set the bottle down on the table and watch the egg come out.

The lighted match exposes how the trick is done, but it is possible to perform it without any visible aid, and then you have something really mystifying. All you need is a hot place where the bottle can be set for a few moments to warm the inside air. You can have your bottle waiting on a radiator in winter, or you may have a small electric hot plate con-

sealed somewhere under the table. Get the bottle good and warm, then put it on the table, drop the peeled egg into the mouth, casually announce that shortly you will have the egg descend into the milk bottle, without damage to either, and proceed with another trick, keeping an eye on the egg. It may take the bottle several minutes to return to room temperature, but as it cools and the air inside contracts, the egg will start down. At the moment you see it begin to move, you can proceed to do the egg trick.

Tumblers are very useful things for the magician, mostly because they are transparent, and the audience therefore think they can see everything. Ever watch a magician lay a pack of cards on top a tumbler, completely covering the mouth, then borrow a half dollar, make it vanish, and have it appear in the glass? Know how to do it? One of the simplest ways is to palm a half dollar, exhibit your deck of cards, fanning them out, then, holding the coin against the back of the deck and showing the face, place the



deck, face up, on the glass, the coin being caught between glass rim and deck. Drape a handkerchief over the cards to conceal where the coin comes from.

Now borrow the half dollar; hold it in the right hand, then, apparently, transfer it to the left, and use the presumably empty right hand to pick up a wand or pencil. Wave the left hand, which apparently holds the coin, over the glass, and at the same time tap the end of the deck, opposite to the one covering the coin, with the wand. That tilts the deck up and the half falls into the glass with a loud clink. Under cover of removing the handkerchief and deck and extracting the half, the borrowed coin can be pocketed and your own returned to the lender.

Did you ever see a deck of cards placed in a tumbler, and then have a chosen card rise right up out of the deck at the magician's command?

Here's how it is done. The deck presented the audience, is one of the prepared "forcing" decks sold by magic stores, and arranged so the user can force certain cards on the customers. After these cards are chosen and returned to the deck, the magician lays it down on his table while arranging the tumbler, and then picks up another deck, already prepared for the trick. A black silk thread has been knotted

through a hole in one card of this deck, and this card is placed three or four cards down from the front of the pack. The thread leads up over the top of the cards, and is then drawn back across the top of the deck. Holding it in that position, the chosen cards, which correspond to those later to be forced on the audience, are inserted at intervals, each one, as it is pushed down into the deck, pushing ahead of it the thread, so that each of the cards rests in a loop of the string.

After all the cards are in place, the thread is cut to leave an end a couple of feet long, and a bent pin is attached to the end. When the deck is placed in the tumbler, the pin is hooked into the performer's clothing. To make a card appear from the deck all he has to do is move his body slightly away from the pack, when the card nearest him will rise. After it reaches the top and falls out, the next comes up, and so on until all have appeared.



Balancing a Tumbler on One Edge Looks Difficult, but a Bit of Forethought in Planting a Match beneath the Table Cover Before the Guests Arrive Makes It an Easy Trick to Do



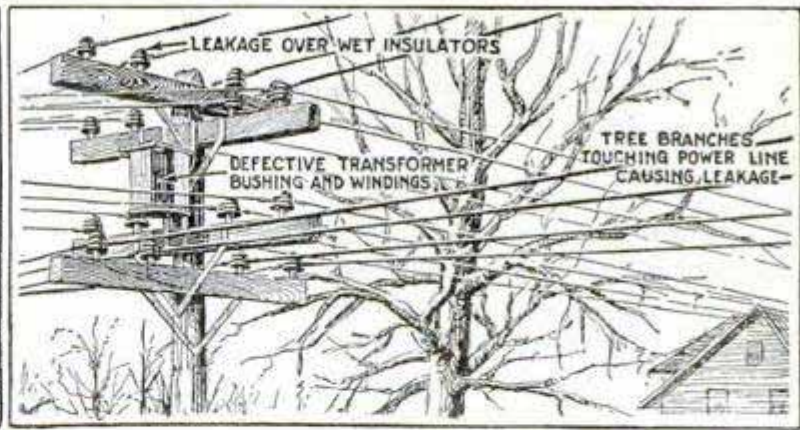
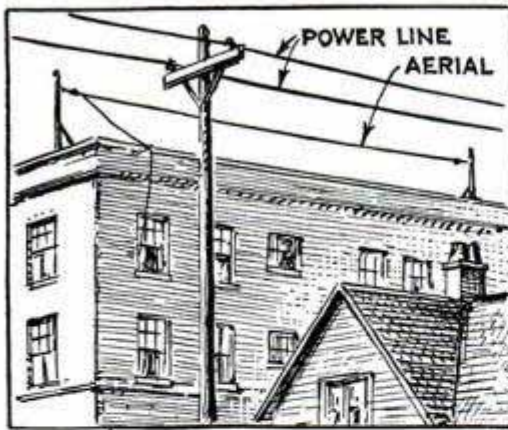

## Drums, Hums and Crackles

By E. R. HAAN

**D**RUMS, hums and crackles are quite familiar to radio listeners, in fact, many set owners have never heard a good clear radio program because of such interference. These conditions are often accepted as a necessary evil, but it is quite possible, in many cases, to remedy these troubles.

If drumming noises, hums and crackles, intermittent or continuous, persist, and you are sure the fault does not lie in the set, batteries or eliminators, you will probably find its source in a near-by power line or some electrically operated device. One of the simplest tests by which you can assure yourself that the trouble is not in the radio installation is to remove the aerial lead from the binding post on the set. If the noise stops, it is reasonably safe to release the set from suspicion. On the other hand, if the interference is continuous or sustained over long periods of time, this indicates at once that the trouble is not caused by atmospheric conditions, since interference of this class comes in crackles and crashes of varying intensity.

In this article we are dealing with sustained, monotonous hums, drumming noises and crackling sounds of similar nature, known as "man-made static." The

National Electric Light association has classified such interferences under the following heads: power circuits, industrial applications and household appliances. Under the first head are grouped lines, insulators, lightning arresters, transformers, generators and motors. The second group lists arc-light circuits, telephone and telegraph lines, pole changers and converters, street cars and sign flashers. Under household appliances, we find electric pads, violet-ray machines, flatirons, doorbells, light switches and small motors.

Heading this article are two sketches showing the most common form of interference, that at the left representing an aerial parallel to a power line. This might, in many cases, be the most convenient way to install the aerial, but it is also an ideal method of picking up interference. To correct troubles of this type, merely run the aerial at right angles to the power line. The sketch at the right shows three

forms of interference, rather exaggerated as concentrated in such a limited area, but nevertheless entirely possible. Defective insulators, or insulators coated with ice or sleet, provide a path for an arcing discharge; transformers may have a distinct core hum, and most of us have seen the



Tightening Switch-Box Connections; Condensers Are Shown Connected above the Box



display of fireworks resulting from tree branches rubbing against high-tension lines in wet weather. The only remedy for such troubles is to call the power company.

Obviously, loop receivers are not subject to these troubles as much as those of the outdoor-aerial type; yet, if the loop receiver is placed close to electric-lighting wires or to extension cords on lamps, some trouble may be experienced. Shielding the whole receiver or the coils only will often eliminate much of the line pick-up in the home. Two heavy-duty fixed condensers of either 2 or 4-mfd. capacity may be placed in series across the supply line and a lead to the ground taken from the center connection, between the condensers. This will do away with much of the extraneous noise carried by the line. The remedy just described may be applied at the switch box, or, if stationary or semi-stationary motors are in use in the building for any purpose, such as operating blowers for oil burners, lathes, washing machines, etc., the condensers may be connected in series and shunted across the 110-volt terminals of the motor. Bad contacts in fuse or switch boxes may cause a sputtering or crackling sound often difficult to locate. The remedy is to tighten all contact screws, and see that the blades

of switches make good contact with their clips. The same applies to light sockets. Bad contacts in thermostatic controls, or in the mechanism of electrically operated household appliances, often cause trouble that can be remedied by simple repairs. The heating pad is a common offender, and in this case the best thing to do is buy a new one. This is the case also with defective electric irons. When they have reached the stage where their complaint is heard in the loud speaker it is an indication that they have outlived their usefulness. If automatic telephones are in use, a clicking sound is often heard in the speaker of the receiver when the calling dial on the telephone is rotated, and similar noises are heard when doorbells are operated or lights turned on or off. These noises, of course, are temporary, and do not cause much annoyance.

Interference from farm-lighting plants is a common complaint in rural localities. These plants are equipped with a magneto that sounds very much like an amateur experimenting with a spark-coil transmitter, as far as the radio receiver is concerned. The remedy consists in shielding the high-tension lead from the magneto to the spark plug by slipping a length of flexible metal tubing over it.

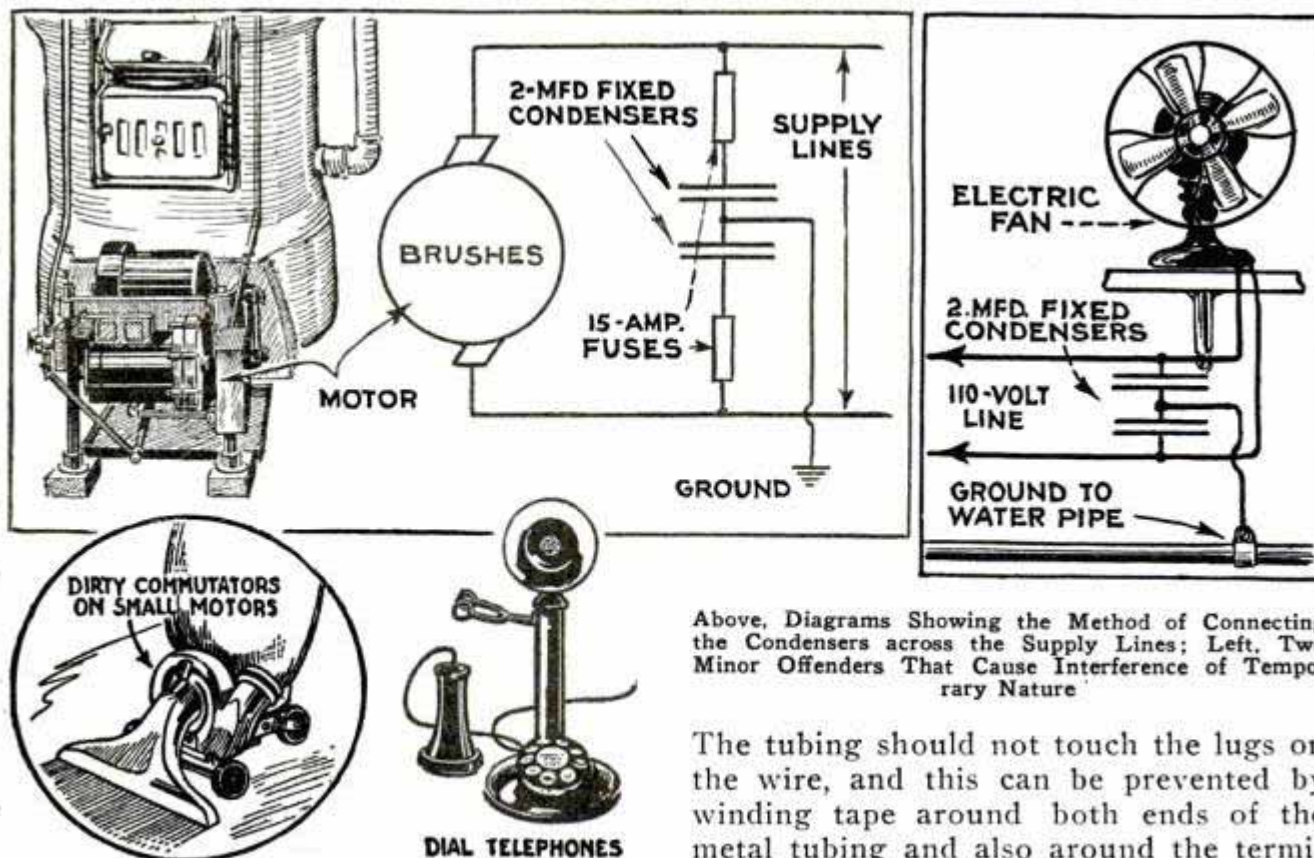

Above, Diagrams Showing the Method of Connecting the Condensers across the Supply Lines; Left, Two Minor Offenders That Cause Interference of Temporary Nature

The tubing should not touch the lugs on the wire, and this can be prevented by winding tape around both ends of the metal tubing and also around the termi-



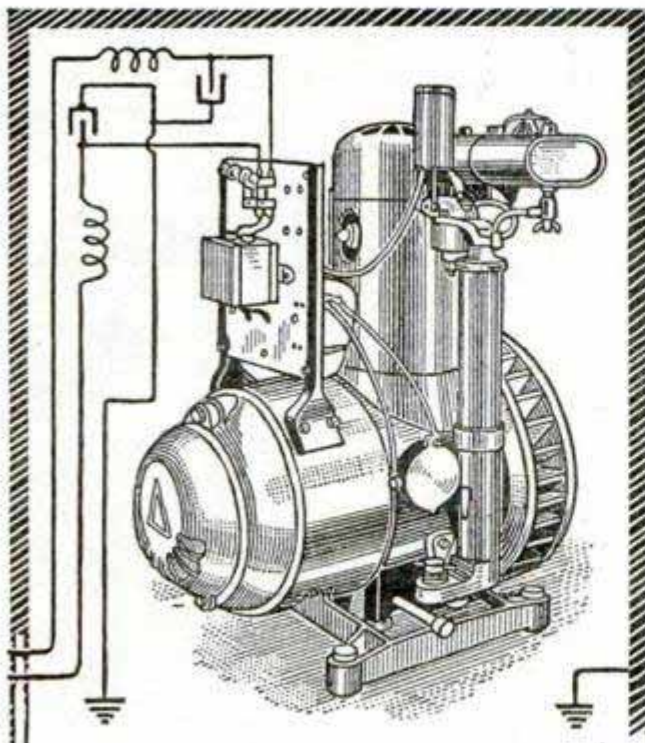

POINT OF INTERFERENCE

LOOP OF RECEIVER

LOOP OF RECEIVER

KNOWN ANGLES

KNOWN DISTANCE

HIGHWAY OR STREET

Left, Above, Completely Shielded Farm-Lighting Plant, Showing Method of Using Condensers and Coils; Below, Diagram for Locating Trouble by Means of a Portable Loop Set; Right, Tracing Interference to Noisy Motor Generator

nals. An insulated wire is then soldered to the metal tubing and connected to a water pipe or to a metal rod driven into the ground.

As an alternative, the entire plant may be shielded (see page 122). The method of using heavy-duty fixed condensers previously described to prevent interference caused by sparking commutator brushes may also be applied as shown in the same illustration. Condensers from discarded Ford coils can be used for this purpose, and it is a good idea to insert fuses between the output lines of the generator and the condensers, to prevent a short circuit in case one or both of the condensers break down. A further precaution is to provide inductance coils in the line. These coils are wound on a tube, 2 in. in diameter and 3 in. long, and con-

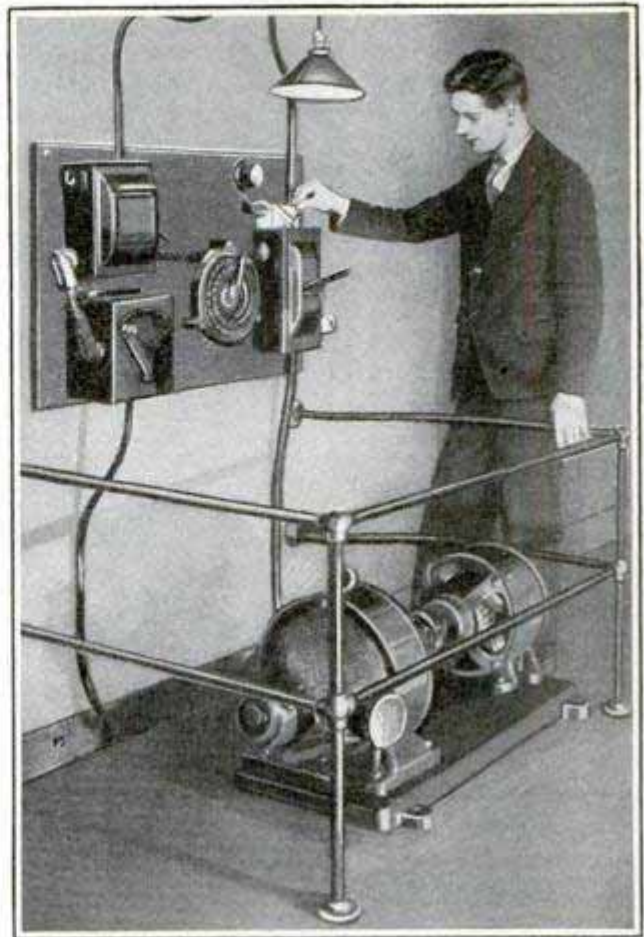

sist of about 150 turns of the same kind and size of wire as that used for the output lines of the generator.

To locate interference caused by electrical devices about the home, operate the set and tune in the interference at a loud volume, then turn off the various appliances one by one until the offender is located. Neighborhood troubles may be located by means of a portable loop receiver. It is carried to points in the vicinity of the suspected source, and the loop rotated, at each stop, until it points in the direction at which the noise is heard at its loudest. By making a complete circle and plotting the lines determined by the loop, it is usually an easy matter to locate the source of the trouble. If the point of interference is quite a distance away, the location of the point of trouble may be quickly approximated by the method shown in the diagram at the lower left on this page. The intersection of the dotted lines represents the place from which the interference is radiated; it is then an easy matter to determine the distances from the observation points to the source of trouble by comparing them with the line of which the length is known.



Laboratories 285 N. 6th St.

Brooklyn N.Y.

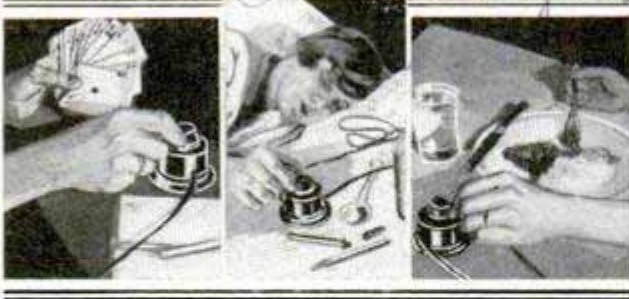

Control for Remote Operation Reduces Volume of Receiver to Suit the Occasion

Handy Tone and Volume Control

The table-type volume control shown in the photos provides a variable resistance in the form of an accessory rather than a part. The unit consists of a micrometric variable resistance with a range of from 0 to 500,000 ohms, mounted in a metal stand and provided with standard cord-tips and a connection block. Several useful applications are illustrated in the photos, and on any occasion when it is desirable to reduce the volume of the set the outfit will save many steps. It may be employed as a volume control also for electric phonographs, or used in connection with a.c. tube harness. The current-handling capacity is sufficient to assure long operating life.

Radio Speaker in Colonial-Type Tilting Table



A modern cone speaker built to resemble a colonial tilt-top table has recently made its appearance on the market. The table top is an efficient baffle board said to greatly enhance the tonal effect. The unit is designed to exclude moisture, keeping the speaker efficient in any climate.

New Tube Has Five Elements

A new tube recently introduced in France has five elements, a filament, three grids and one plate, six connections being necessary for operation. Four of these are on the base in the usual position, the other two being on the side of the insulated base itself. A tube of this type is, of course, usable in many varied and complicated circuits. A favorite circuit is one where the triple-grid tube acts simultaneously as first detector, oscillator and r.f. amplifier with regeneration. A three-tap loop and condenser are used to control regeneration, as in many circuits now common in this country, except that the single tube does the work of several.

Low-Loss Midget Condenser

The low-loss midget condenser shown in the illustration is now available for use where a minimum of power loss is demanded. In the new instrument bakelite replaces metal wherever possible. It is specially designed for neutralizing and balancing, to compensate for coil and condenser variation. There are two sizes: one 7-plate type with a capacity range from 3.5 to 25 mmf., and one 13-plate, ranging from 4.8 to 50 mmf.



Hum Caused by Glow Tube

In properly designed B-eliminators the glow tube is a useful device and has a definite place, but if applied to some of the existing eliminators, it often causes a hum. The increased current drain saturates the limited choke coils and this is what causes a troublesome hum in an otherwise quiet eliminator. Hence, the glow tube should be used only in eliminators known to have ample chokes for the extra current drain, which often reaches 15 to 30 milliamperes.

Clarnatak

Crosley Radio Corp. 115 State Street Cincinnati

Victor Electric & Mfg Co. 223 Broad St. New York



# Facts and Fads for Radio Fans

1733 R

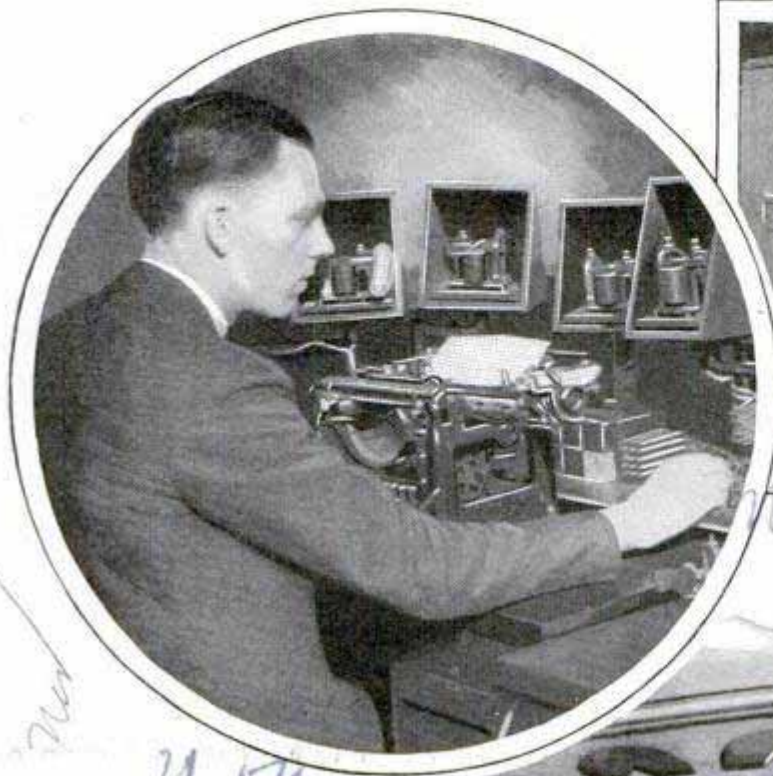

Portable Transmitter, Designed for Signal-Corps Communication with Aircraft. Is Suitable for Either Telegraph or Voice

1160758 R  
811- R

Above, Edward C. Hartman, Whose Duties Are Similar to a Train Dispatcher's, Is Radio Dispatcher for the New Chicago Studio of the National Broadcasting Company, Operating over the Blue Network; the Telegraph Equipment Shown Is a Temporary Installation

2154



1809 R

164

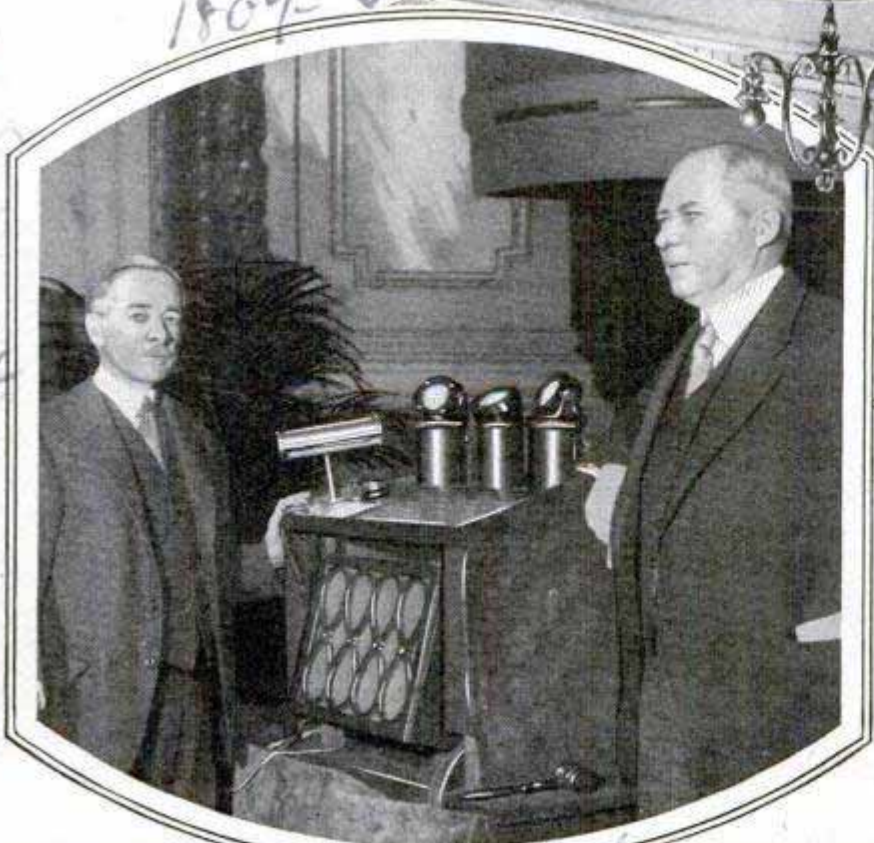

Above, One of the Largest Loud Speakers in the World Is Built into the Ceiling of a Residence at Oak Park, Ill., the Artistic Electric-Lighting Fixture Adding to the Decorative Effect; Left, Dr. F. B. Jewett and Gen. John F. Carty, of the American Institute of Electrical Engineers, at the New York Meeting, Addressing, via Radiophone, a Joint Session of English Engineers Held in London; Although Separated by the Atlantic, Both Bodies Heard the Speakers Clearly as well as the Applause of the Audiences

Wide World Photos # 548560



1555-06  
126

\$32.00

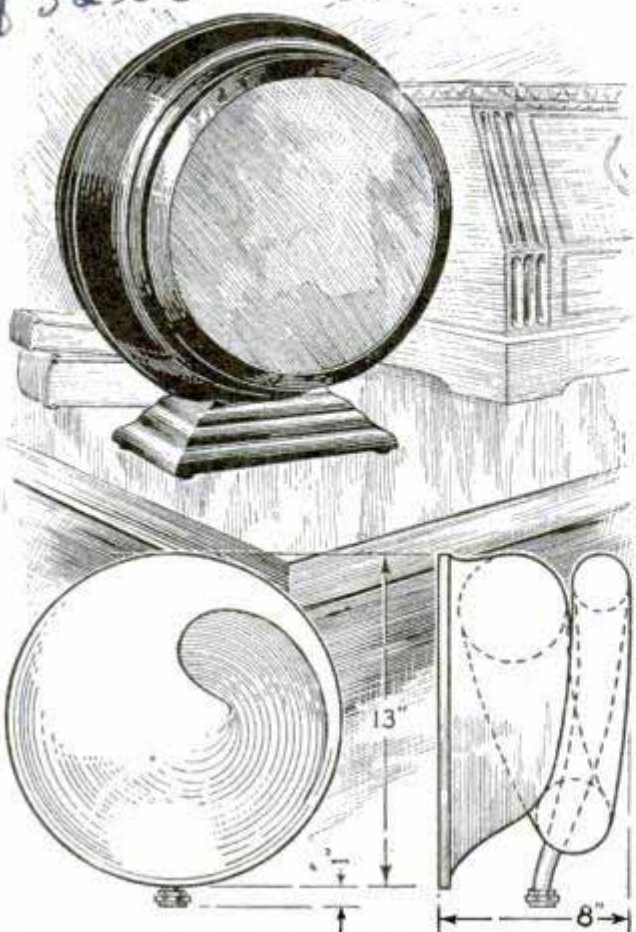

New Drum Speaker of Compact Design; Below, Diagrams Showing the Construction of Tone Chamber

### Compact Exponential-Type Speaker

The drum-type exponential speaker shown in the illustration is very compact for a unit with a long tone chamber. Built to meet the need for a quality reproducer, it does not incorporate a cone or conventional horn, but has a tone chamber which is coiled in small-shell fashion and is said to assure a high quality of reproduction. The drum is attractively finished in bronze.

### Correct Grid Bias Saves Batteries

A grid bias properly used in the r.f. stages of a radio receiver will result in a saving of B-battery current as well as increase the sensitivity and selectivity of the set. When the CX-301A or similar tubes are used in the r.f. stages and a B-battery voltage of 90 volts is applied to the plates, a C-biasing battery of 4½ volts should be used. If the set builder wishes to avoid the use of a C-battery for this purpose, a convenient method, and one which does not introduce coupling between the stages, is to obtain the grid bias from the 1-volt

drop in the filament circuit. A fixed resistance of 4 ohms may be added in the negative filament lead to each r.f. amplifier tube, and the grid-return lead from the tube may then be connected with the negative lead from the A-battery. When the rated current of .25 amp. is flowing through the tube, a negative grid voltage of 1 volt will be obtained by the use of this resistor.

### Homemade Filament-Control Units from Old Rheostats

Fixed filament resistors for radio tubes may be made from old rheostats by removing the resistance wire and using various lengths for different types of tubes. For a.f. tubes, where filament current is not critical, these homemade units work as well as the more expensive types. Unwind the resistance wire from an old 6-ohm rheostat and rewind it on a strip of the insulating material, cut to the size required. For the standard 201-A or 301-A tubes a resistance of about 4 ohms is required, and about two-thirds of the original winding will be needed. Holes are then drilled in the ends of the insulating strip and Fahnestock clips used for terminals, or the end of the strip may be placed under the filament terminal of the socket and the nut screwed down on the wire; a soldering lug may then be used for the other terminal.

### New Aerial Easily Installed

The coiled-wire aerial shown in the sketch can be erected easily and quickly on either a gable or flat roof. It takes little room and is ideal for congested districts where roof space is at a premium. The cap, terminals, coils, guy wires, roof bracket and all necessary parts are supplied by the manufacturer. Compact aerials of this type are less sensitive to static and other interferences, and work well with all circuits.

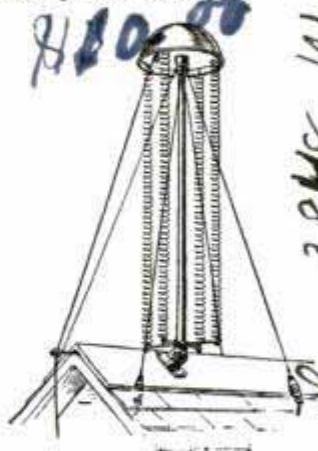

1958  
Lee, 3848 W. Pine St. Louis, Mo.  
G.H.

Radio July 6, 1958



# BUILDING AN EDISON- TYPE B-BATTERY

By L. B. Robbins



FOR an inexpensive storage B-battery the Edison type has several advantages: First, a 100 or 140-volt unit is smaller and lighter than the ordinary storage battery; second, there is no destructive acid to spill, and third, the nickel-steel elements are non-sulphating and last indefinitely. Batteries of this type hold a charge, when idle, for long periods, making recharging unnecessary if the battery is not being used. The elements are sold by many concerns, and the test tubes can be bought in quantities from chemists' supply houses at a very small price. The total cost of material for building a 100-volt unit is about \$5, and for a 140-volt block about \$7. For the former you need 78 flint-glass test tubes, 6 in. long and  $\frac{3}{4}$  in. in diameter; 78 rubber separators, preferably with perforations to allow quick circulation of the electrolyte, and 78 pairs of elements. The positive element (the round one) is  $4\frac{1}{2}$

in. long, and the negative (flat) element 3 in. The connector is of soft steel, about 4 in. long. Two pounds potassium hydroxide, 1 oz. good mineral oil, such as liquid paraffin, and 5 lb. distilled water are also required.

For the case and fittings, cut  $\frac{1}{2}$ -in. white pine to the sizes indicated in the diagrams on pages 128 and 129. To complete the material, obtain four Fahnstock clips, or suitable binding posts, some rubber-covered

hookup wire, a small piece of thin copper sheet, solder suitable for steel, 8 small copper tacks or rivets, 12 ft. of No. 12 brass wire, and enough sheet rubber or felt to cover the bottom of the case.

The inside measurements of the latter should be  $11\frac{1}{8}$  by  $5\frac{1}{8}$  in. by 3 in. deep; countersink the nail heads and apply a coat of shellac or waterproof paint for a finish. Measure down  $\frac{1}{2}$  in. around the sides and ends and, with a No. 12 drill, bore 12 holes in each side and five

Left to Right, Test Tube; Unformed Pair of Elements; Elements Bent to Shape for Inserting, and Perforated Rubber Separator

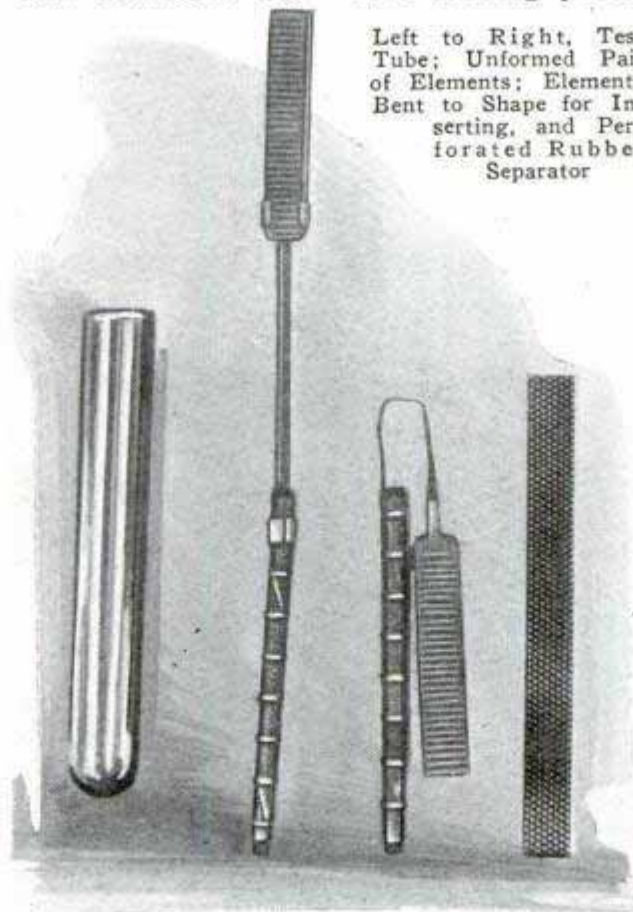



in each end, spacing them  $\frac{13}{16}$  in. apart. Cut the brass wire into suitable lengths and pass through the holes to form 78 square cells for the test tubes. Previous to fitting the wires, the rubber or felt pad is laid in the bottom of the case. Fasten the four clips to the front of the case as shown in the photos and insert the test tubes in their cells.

Distilled water is now poured into an earthenware or glass bowl, and the 2 lb. of potassium hydroxide stirred in until dissolved. The solution will become quite warm at this stage and should be allowed to cool thoroughly before proceeding fur-

from the positive plate to the top about  $\frac{1}{4}$  in. Two of the connectors are sawed in half so as to leave two single positive and two single negative elements. A perforated rubber separator is placed in each test tube, after which the elements are inserted. Starting from the lower left-hand corner, put a single negative element in front of the separator. (See page 129.) Place the positive plate of a double element on the other side of the rubber separator, with the connector straddled over to the next cell, into which the negative element is inserted. Continue this operation in the direction indicated by the arrows until 39 cells have been filled; a single, positive element is placed in the last section of the 39th cell. Start the 40th cell with a single negative element and continue in the same manner until the 78th cell is filled with the last single positive element.

The ends of the steel connectors on each single element may be

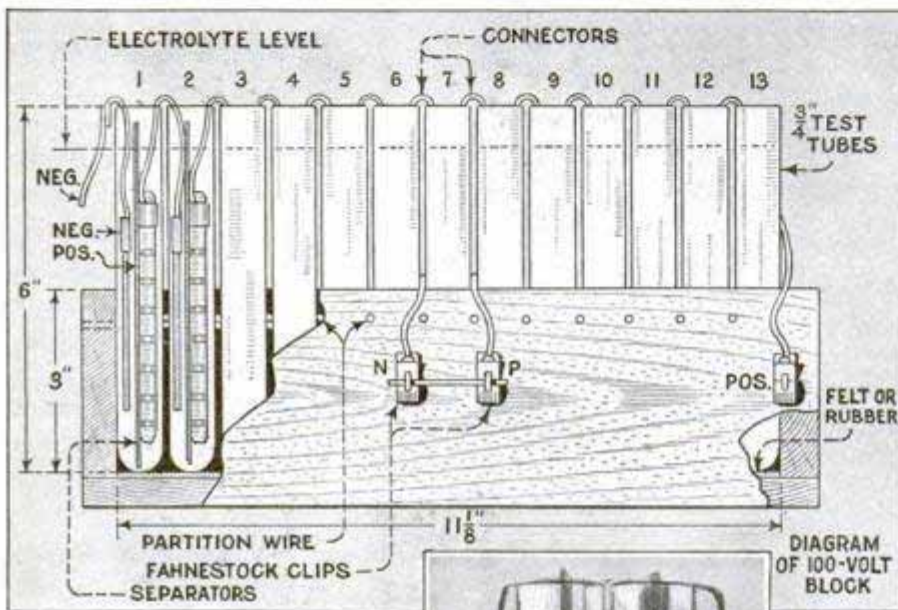

ther. It is tested with an absolutely clean hydrometer (not one that has been used for testing an acid battery). If the reading is higher than 1250, add distilled water, if lower, add more of the chemical. Leave the solution to settle and then filter or decant it to remove the scum.

Preparation of the elements for placing in the test tubes is now in order. Bend the connectors over a strip of wood so that the horizontal portion will be about  $\frac{3}{4}$  in. long, and the length of the part

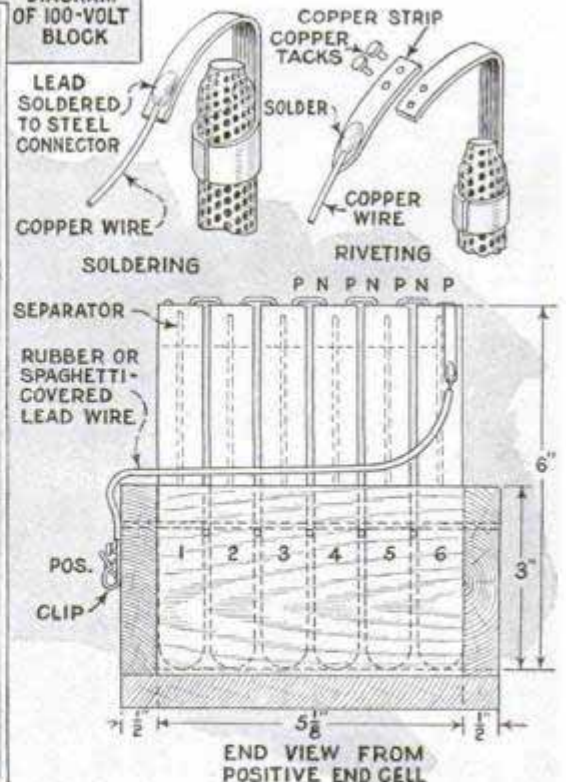
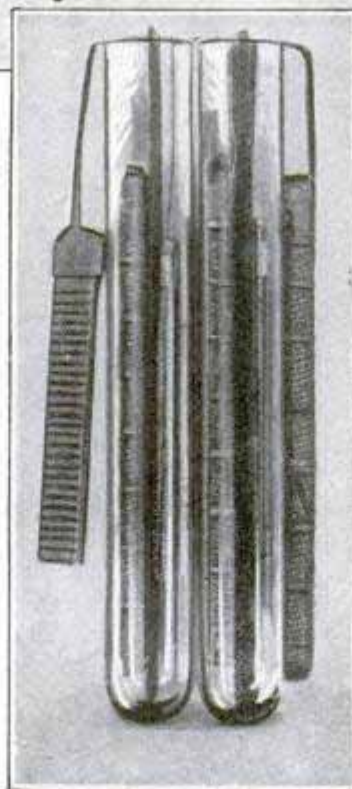

Upper Left, Sectional Diagram of the 100-Volt Block, Showing the Cell Arrangement; Bottom, Left, Two Completed Cells with Positive and Negative Elements and Separators between Them; Right, Sectional View from Positive End Cell; Above, Methods of Connecting Lead Wire to Elements

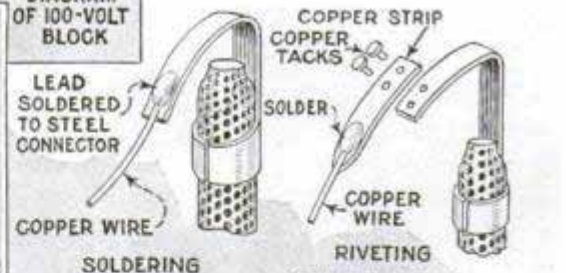



either riveted to a narrow strip of copper and the lead wire soldered to the end of the copper strip or the copper lead wire may be soldered directly to the steel connector with special steel solder as illustrated. The riveting method is the better, but, if used, do

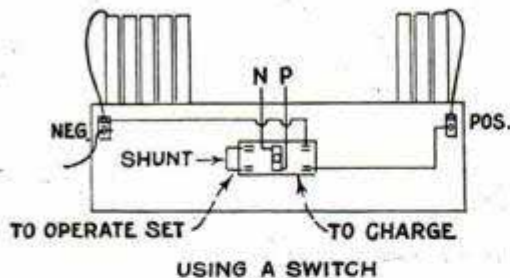
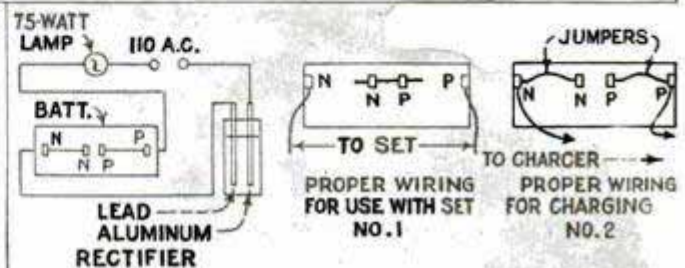
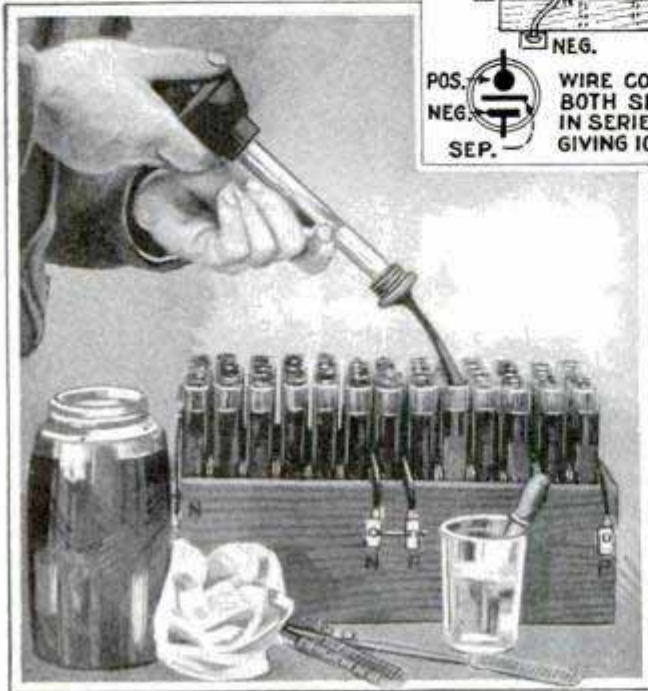
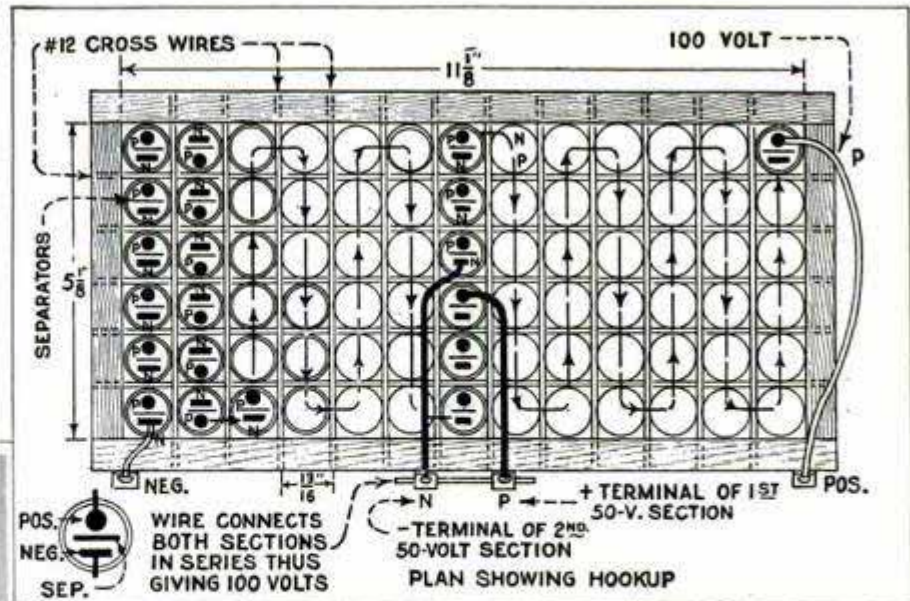

Upper Right, Top View Showing Cell Arrangement and Hookup; Below, Wiring Diagrams for Charging; Left, Filling the Cells with Electrolyte; Bottom, Using a D.P.D.T. Switch for Quick Charging Connections

not bend the copper strip over inside the cell so that it comes in contact with the solution. Keep it entirely outside the cell. The copper-wire leads from positive and negative elements are taken to the clips on the side of the case, as shown, the two clips on the left being negative and the two on the right positive. Keep all wiring well separated in order to avoid short circuits.

Now assemble the battery, and if there

is any play between the cells take it up by inserting cardboard strips between them. Fill each cell with solution to within 1 in. of the top; the plates will soak up some of the liquid so it will probably be necessary to repeat this procedure once. Next, with a clean medicine dropper, place about six drops of the mineral oil on top of the solution in each cell, and the battery is ready for charging. The oil prevents evaporation of the electrolyte and creeping of the salt on the connectors.

Any type of trickle charger can be used to charge the battery, although the method indicated on this page employs a homemade electrolytic rectifier. This consists of a glass jar (1-pt.) with a wooden cover, a lead electrode, 5/8 in. wide and at least 1/8 in. thick, and an aluminum strip, 1/4 in. wide and 1/8 in. thick. The length of the strips depends on the height of the jar and is not important, but both should be of chemically pure metal. Sandpaper the strips and boil them in a solution of caustic soda to remove all traces of grease, and do not handle the part exposed to the solution before inserting it in the jar.



Turn over  $\frac{1}{2}$  in. of the top of each strip, drill the ends for binding posts, and mount them on the underside of the cover by means of binding posts inserted through the top. The depth of the liquid and the



The Completed B-Battery Ready for Use

spacing of the electrodes determine the amperage the rectifier will deliver. One-fourth-inch separation and immersion in the solution to a depth of about  $3\frac{1}{2}$  in. are about right in order to obtain the required  $\frac{1}{4}$ -amp. charging rate. Note that the lead electrode is connected to the negative side of the battery. The electrolyte used in the rectifier is made of common borax and distilled water, adding borax until the water will not take up any more. Let the solution settle and pour off the clear liquid. After filling the jar to the correct height, add about  $\frac{1}{4}$  in. of heavy mineral oil to prevent evaporation. Use either a 60 or 75-watt lamp; the socket for this and a shallow box for holding the rectifier may be mounted on a baseboard.

A low rate of charge is necessary for batteries of the Edison B-type. If 110-volt d.c. current is available, no rectifier is needed and connecting a 50-watt lamp in series with the battery will suffice. When charging, the short jumper wire between the middle N and P-clips is removed and others fitted to connect the two negative and two positive clips as shown. The charging wires are then connected to the positive and negative outside terminals. This arrangement charges the two 50-volt sections in parallel. When this is done, remove the outside jumpers and put the central one back, placing the 78 cells in series. A tap must be connected for the detector supply at either the 22 or 45-volt cell. This may be done with a small spring clip, which should be removed when the battery is charged.

Other B-voltages may be obtained in the same manner. Each cell gives approximately 1.3 volts, and to find the 45-volt tap you count the cells, from the negative end, until the number of cells counted (in this case 35) multiplied by 1.3 gives the voltage desired. For charging the battery from a 32-volt d.c. system the battery will require slightly different wiring. Instead of dividing the battery into two 50-volt sections it must be cut into four 25-volt sections, and, of course, the rectifier is omitted. Continue the charge for 12 hours, for d.c. current, and 15 hours for a.c. current. Overcharging will not injure this battery, even if it is left on charge for two or three days.

When building batteries of higher voltages, do not make any unit much larger than  $67\frac{1}{2}$  volts as they must be charged in parallel. For example, a 140-volt battery may be built up of two, but a 200-volt type should be divided into four 50-volt sections, arranged for charging in parallel as described.

Change the solution about once a year if in constant use, and keep the level up in both the battery and rectifier by adding distilled water as required. As the specific gravity of the electrolyte remains unchanged whether the battery is charged or discharged, hydrometer readings are useless. Hence, a B-battery voltmeter of the type designed with a resistance of 1,000 ohms per volt is necessary for testing the charge. Be sure to turn off the charging current when taking the reading. The battery will show full voltage after about two hours, but the charge should always be continued for the full allotted time.

A large blueprint of the layout and wiring diagrams, as well as additional data on the rectifier unit and methods of adapting standard 2-amp. chargers for use with the battery, if preferred, may be obtained from Popular Mechanics radio department, 200 E. Ontario st., Chicago, for 25 cents to cover cost and mailing. Specify blueprint No. 134.

Popular Mechanics' radio department offers its information service free to all readers of our magazine. We will be glad to help you with your problems, and will promptly answer all inquiries.



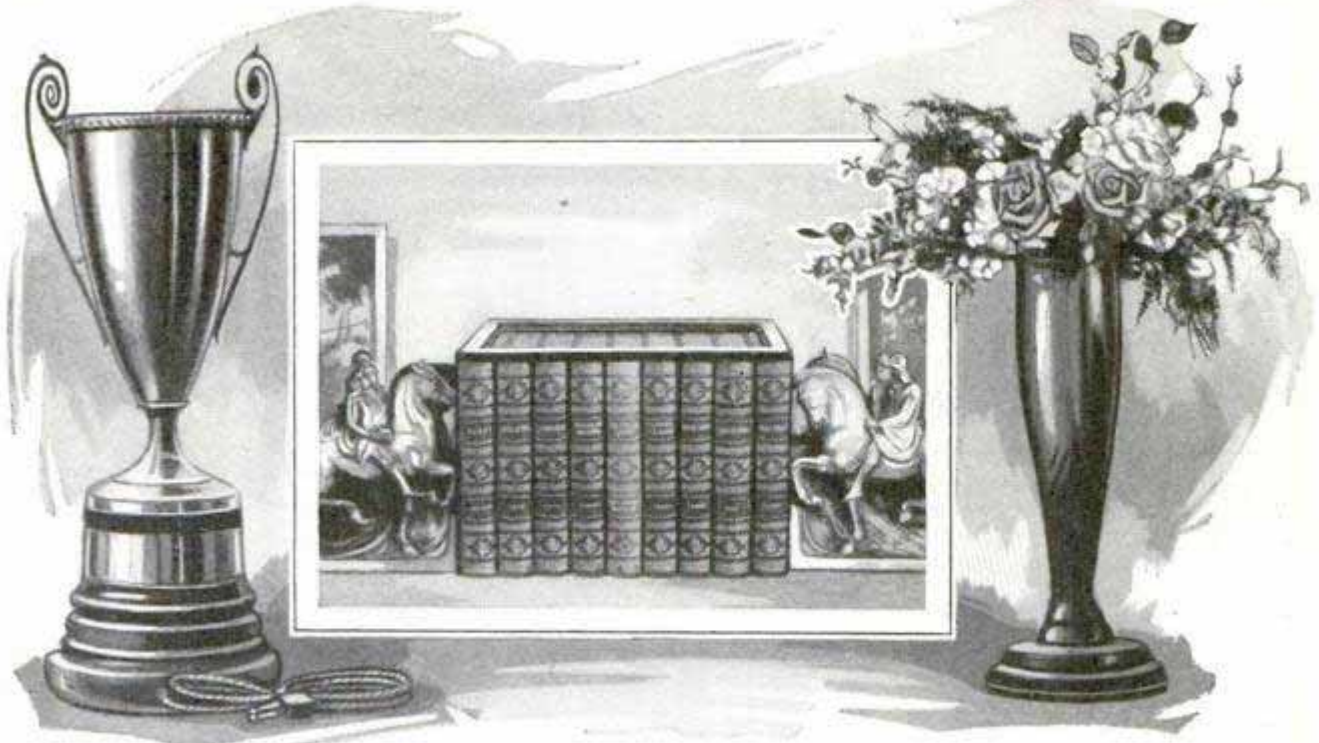

The Trophy Cup, Row of Books and Flower Vase Shown Above Conceal an Efficient Loud Speaker in Each Unit and Will Give an Artistic Touch to the Radio Installation

**Artistically Designed Loud Speakers**

This attractive group of loud speakers is the result of an effort to make the speaker harmonize with the furnishings of the home. Speakers, concealed in table lamps, or walls or bookcases, have been described and illustrated from time to time, but this group goes a step further and combines the speaker with an artistic decoration suitable for any home. The trophy cup at the left is wrought in sterling silver, either chased or embossed, stands 24 in. high, and is equipped with a powerful speaker unit and 25 ft. of extension cord. The type at the center has a serpentine tonal chamber concealed within a cabinet designed to represent a row of books, bound in cloth, gold and morocco. The bronze book ends may be moved to provide space for real books between them. The vase at the right is made of black walnut, 24 artificial flowers and ferns being supplied with this unit, which stands 20 in. high.

**Detector-Tube Kinks**

The plate voltage for most tubes now in use as detectors is 45 volts, but this does not mean that 45 volts is specifically required for the plate. It may work well

with 90 volts and usually does work better at some other voltage, such as 50, 40, 22½ or even as low as 17 volts. Detector B-voltage is not critical in modern tubes, but seems to vary in that one particular fixed voltage will give better results than another with individual tubes. If the detector tube used is of the 300-A or 200-A type, one should never exceed the rated voltage of that type. It is far safer and better to try lower voltages.

*submarine*  
**Compact Short-Wave Adapter**

*1507-R*

A compact unit for adapting any receiver for reception of messages on wavelengths between 30 and 75 meters, is now available. The unit shown requires no additional tubes or batteries and no changes are necessary in the set wiring. A short aerial and ground are connected to the instrument and a cable with plug connects it to the set. It operates as a wave changer with superheterodynes and as a detector unit with other receivers.



*W. J. King Co.  
Washington, D.C.*



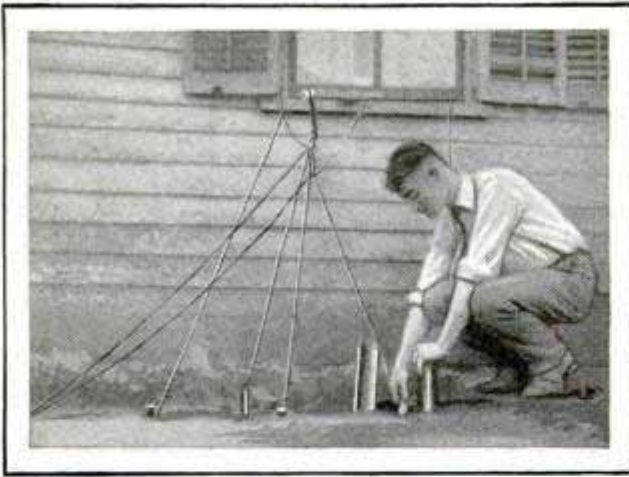

Ground System Used by Pierce, Showing the Simple but Effective Arrangement

### Extra Grounds Bring DX-Record

A good ground connection is important for DX-reception and the use of several extra grounds in a well-wetted soil adds greatly to the possible range of the standard receiver. An interesting demonstration of this fact was brought to my attention when Walter R. Pierce, Jr., of Saundertown, R. I., showed proof of extreme distance reception on his two-tube set. The photo indicates the simple method of installing the extra grounds. The wires were fastened to pipes and rods driven into the soil 1 or 2 ft. apart, and a leaking auto radiator was buried to the cap at one end of the row. This was filled with water frequently to insure a good electrical contact with the damp earth.—Armstrong Perry, Westport, Conn.

### Causes of Hum in A. C. Sets

A common and troublesome cause of hum in sets employing a.c. tubes is due to coupling in the parts of the circuit that are common to both r.f. and detector circuits. If the instruments in the set are properly located and the wiring carefully planned, most of this hum can be eliminated. Cabled leads and the introduction of loops where crowded parts complicate wiring also help to avoid coupling effects. The use of the grid condenser and leak arrangement for the detector, while highly efficient and sensitive, often makes the area surrounding the detector portion very critical and unstable. Shielding this part, or changing the detector to the grid-bias method may also remedy the trouble. If these changes do not eliminate

the coupling that causes the hum, a simple and very effective method is to insert a .1-meg. fixed resistor in the grid-return lead between the F-terminal of the r.f. transformer secondary of the detector circuit and the resistor which provides the grid bias for the r.f. and detector circuits. A .1 mfd. by-pass condenser should then be connected between the F-terminal of the transformer mentioned and the cathode terminal of the detector tube.

### Auto Generator for Radio Batteries

A discarded auto generator and a small gas engine can be adapted for charging radio batteries. A 1-in. rubber belt on the engine flywheel, and an oil cup of the visible-feed type mounted to lubricate the generator bearing complete the assembly. Small gas engines of the portable 3-hp. variety are quite common around the modern farm of today, and the average garage junk heap will furnish a generator that can be used. The original drivewheel on the generator was toothed to mesh with the timing gears of the auto; therefore, it was necessary to have a blacksmith shrink a steel band on it to form a smooth surface for the belt. To check the charging rate, an ammeter of the inexpensive dashboard type may be mounted on the generator; the brushes are then set so that, at the normal speed of the engine, the output will be 10 amp. for the storage battery, or less, according to the type of

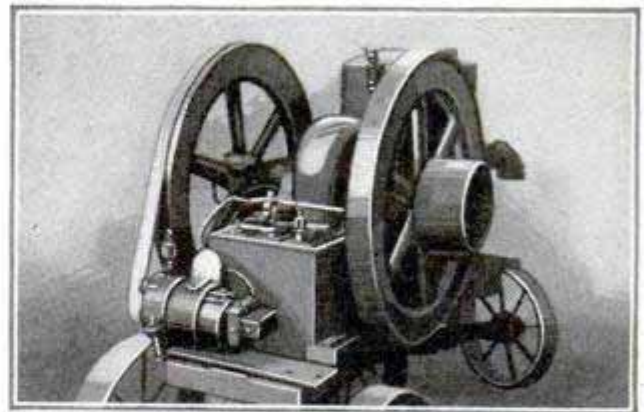

Auto Generator for Charging Batteries, Showing the Method of Belting It to a Small Gas Engine

battery. This device provides a handy means of charging both auto and radio batteries for those who are remote from electric lines and battery-service stations. The outfit, except engine, cost \$2.50



**Radio Set in Loud Speaker**

A four-tube radio set built inside a loud speaker is a novelty on the market. The whole set, with the exception of the batteries, is contained in a drumlike casing and weighs slightly less than ten pounds when fully equipped. One side of the drum is the instru-

means of an adjusting screw at the bottom the cone can be swung outward to give access to parts of the set. The dimensions of the unit are 9 in. from cone tip to control knob, by 17 in. in over-all height. All instruments are mounted on the front panel which is held in place with five screws. The circuit used is of the reflex type, and the volume and range are

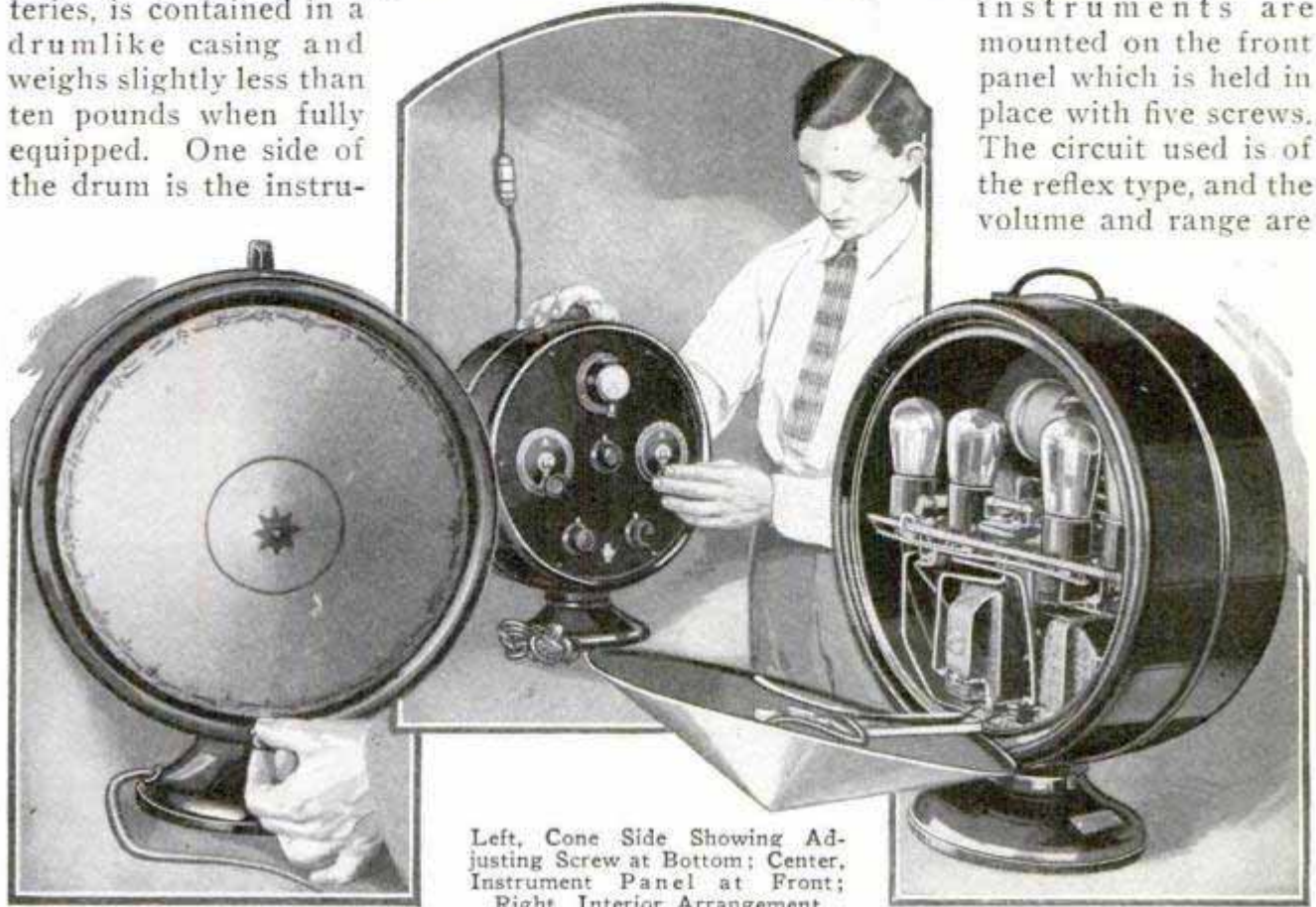

Left, Cone Side Showing Adjusting Screw at Bottom; Center, Instrument Panel at Front; Right, Interior Arrangement

ment panel on which are mounted two tuning dials, switch, rheostat, regeneration control and a small clock. The opposite side consists of a free-edge loud-speaker cone, 12 in. in diameter, the latter unit being mounted on an aluminum arm. By

said to be excellent. The drum rests on a base and may be rotated after the set is tuned to the station desired so that the cone faces the operator. The ground and aerial connections used with this receiver are the ordinary ones,

**Handy Tool for Set Builder**

A surgeons' artery clamp makes an excellent tool for wiring a radio set; these clamps resemble a pair of slender-nose pliers with handles similar to those on shears. The handles may be locked together so that a piece of work is held tightly between, the jaws leaving the hands free for soldering. Clamps of this type may be obtained from physicians or hos-

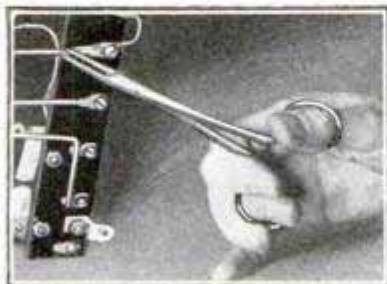

pitals, as they are discarded frequently because corrosion renders them unfit for surgical purposes.

**Testing Amplifier Tubes**

The common practice of using alternating current for heating the filaments of amplifier tubes has provided a new market for a.c. meters. These meters are necessary to determine the volume of current flowing through the filament or the voltage applied to the terminals. Meters designed for direct current and steady voltage cannot be used for this purpose. If a d.c. voltmeter is placed across an a.c. line the needle will not deflect.





THESE valuable kinks have been written especially for Popular Mechanics Magazine by prominent radio experts. They represent not merely ideas, but practical advice from the best technicians in the profession on methods that will help make your set more efficient in operation, more convenient to handle or easier to build.

### Iron-Core R. F. Transformers

Contrary to general belief, r.f. transformers that have distinct advantages may be built with iron cores. The writer has found a special type of these particularly useful in the second stage of r.f. amplification of a standard five-tube receiver, the other inductances being of the conventional air-core type. An iron-core r.f. transformer should have an equal number of turns on the primary and secondary. I prefer to wind the coils on the outside of a bakelite tube base, the glass bulb being broken out of the base or removed with heat. No. 30 d.c.c. wire is used for both coils,

which are wound one on top of the other, the ends being brought down through the prongs of the tube and soldered in place

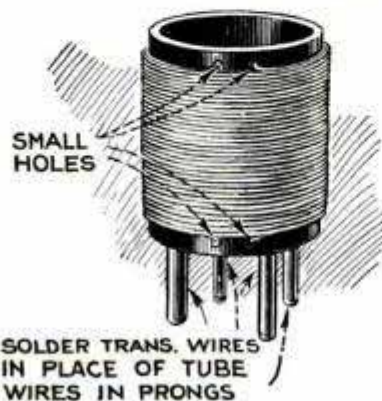

so that the transformer unit may be plugged into a standard socket. After building the coil and connecting it to the rest of the radio circuit, pack small steel laminations, such as may be taken from a broken-down transformer core, inside the tube base and operate the radio set. You will find the amount of iron used determines the tendency of the set to oscillate: the more iron, the less oscillation. Also, contrary to experience with air-core transformers, the set tends to oscillate more on the long wavelengths. Such a transformer, in fact, is deliberately designed to be efficient on long waves and comparatively non-oscillatory on the short waves.—L. J. Lesh, consulting engineer, Chicago, Ill.

### Using Two or More Speakers

There is an increasing tendency among radio listeners to use two or more loud speakers. There are certain rules for connecting the speakers to obtain the best results. When two or more speakers are placed directly in the plate circuit of the usual output stage, it is best to connect



them in parallel. If they are connected in series, the resulting drop in the combined windings will reduce the plate voltage below that necessary for efficient operation. Conditions are completely changed, however, when a choke filter output is used. With this arrangement, a high resistance in the speaker circuit is of comparatively small importance, as the direct circuit flows through the choke instead of the speaker windings. These chokes are usually designed to have a low d.c. resistance combined with a high impedance at radio frequencies. When an output filter of this type is used, it is advisable to place the speakers in series.—J. B. Bayley, chief engineer, Station WAAT, Irvington, N. J.

### Protecting Tube Filaments

Small fuses for protecting the tube filaments are sometimes difficult to obtain, and the larger types are too clumsy to use in a radio receiver. These fuses can be made from an old gridleak tube, however. The resistance element is removed from the gridleak by taking off the metal caps and pulling out the corks inserted in the ends. This element is discarded but all other parts used. The fuse links are made of tin or lead foil, cut in strips about  $\frac{1}{16}$  in. wide; one end of the foil is pulled

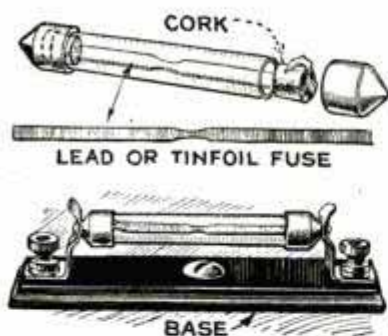

through the cork and the link is then slipped through the glass tube and the other cork. The foil should protrude about  $\frac{1}{4}$  in. beyond the cork ends, where it is turned up so as to make contact with the metal caps. These are now replaced and the unit is clipped into the gridleak mount. Several of these fuses may be made up at one time for emergencies. Before inserting a new fuse, the cause of the blowout should be investigated and the trouble corrected. These fuses will protect the tubes from damage in case B-battery leads are accidentally touched to the filament line from the A-battery.—H. R. Wallin, radio operator, S. S. "Hahira."

### Vibrator Charger Changed to Tungar

Battery chargers of the vibrator type may be changed over to tungar operation at slight cost. Remove the transformer

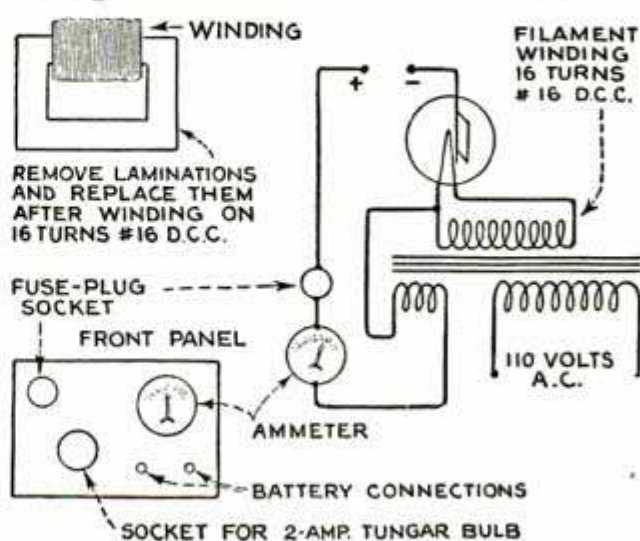

Diagram of Connections for Changing a Vibrator Charger into the Tungar Type

from the vibrator charger and note the 110-volt and low-voltage windings. Next remove the laminations from one end of the core, wind two layers of friction tape on the leg opposite the original windings, and over the tape, 16 turns of No. 16 d.c.c. wire. This winding is for the filament of the tungar bulb; be sure to leave enough wire at each end of the coil for connections. Tape this winding carefully and replace the end of the core. Set the transformer in its original position, and remove the vibrator and its connections from the panel, but leaving the fuse-plug socket with its connections, together with the ammeter, on it. At a convenient place, fasten an ordinary porcelain socket for the tungar bulb, and make the connections as shown. For these use heavy insulated wire and mark the polarity of the battery connections.—C. E. Paulson, operator, Station KFHL, Oskaloosa, Iowa.

### Cleaning the Soldering Iron

Electric soldering irons, when used with rosin-core solder, become coated with a deposit, making clean joints difficult. To clean the iron, I use a jelly glass filled with sand which is moistened with a sal-ammoniac solution. Plunging the iron into this mixture quickly cleans and tins it.—C. A. Benedict, engineer, Goodell-Pratt Co., Greenfield, Mass.



**Pipe Lengths for Aerial Masts**

The writer recently encountered a problem in supplying an aerial mast for an apartment house having a peculiar sloped-roof construction, and finally hit on the idea illustrated in the sketch, applications of which will meet various emergencies of this nature. Plumbers' fittings

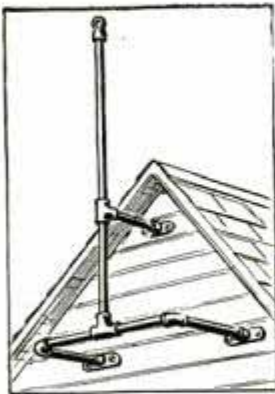

Construction Details Showing Various Arrangements Suitable for Any Type of Roof

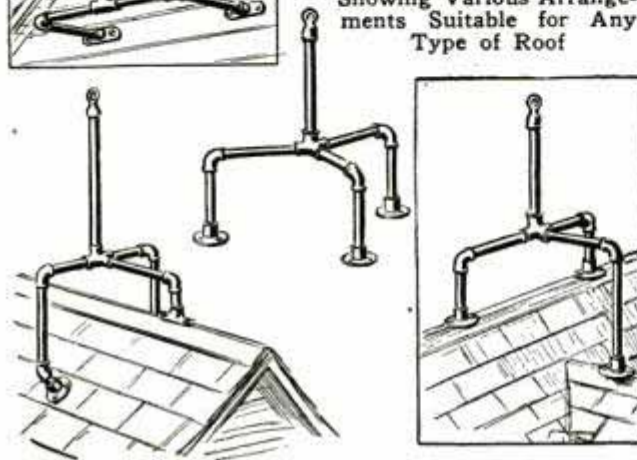

and suitable pipe lengths are easily obtained from your local supply dealer, who will cut the threads and supply the necessary deck mounts. The sketches show the construction so clearly and it is so simple that further comment is unnecessary.—E. Stuart Capron, consulting engineer, Buffalo, N. Y.

**Worth-While Hints on Wiring**

Builders will be well repaid for the time spent in securely soldering the spring contacts in tube sockets to the locking screws. This also applies to the lugs and screws of terminals usually mounted on bakelite strips; a good mechanical and electrical connection makes for efficiency. It is no longer considered good practice to run wires in spaghetti except to prevent short circuits or contact with baseboards, losses frequently having been traced to superfluous use of spaghetti. Many electric soldering irons have a copper element much too small for good work; in attempting to make a soldered connection with an iron of this type, the parts to be joined absorb the heat so fast that the

copper is cooled to a point where it will not flow the solder. A joint made with half-heated solder not only breaks off quickly but constitutes a high-resistance connection that will invariably produce poor results.—Arthur H. Jackson, chief technician, Gosilco Radio Products Co., Huntington Park, Calif.

**Look Out for Bad Tubes**

Many radio users believe that if a tube is burning it is also working, but this is not always so; it may light and still be worthless. One of the quickest ways of restoring a dead set to life is to insert a good tube successively in each socket, thus quickly locating the bad tube. In a superheterodyne, one faulty tube may require more than the rated filament voltage to make it function, and by increasing the voltage to satisfy this one tube, the others are overloaded. This will result in erratic operation and greatly shorten the life of the tubes. Tubes of the 199-type are the chief offenders in causing trouble of this nature.—E. L. Watkins, engineer, Trego Radio Mfg. Co., Kansas City, Mo.

**New Socket of Universal Type**

The socket shown herewith has been designed for mounting either on metal or bakelite. It is small, makes a neat appearance and takes up less room on the baseboard than the usual type. A three-point wiping spring contact, the full length of the tube prong, insures a good tight electrical connection. The top of the socket

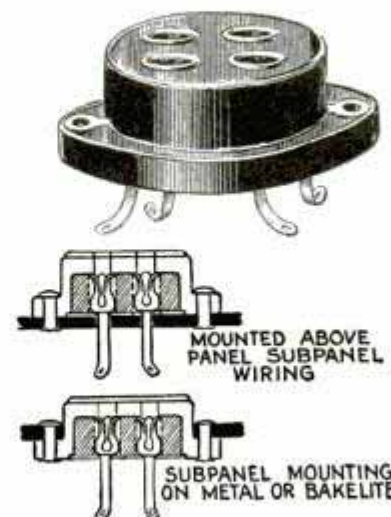

is exactly the same as the standard tube base. The upper diagram shows the method of mounting the socket above the panel for subpanel wiring. Six small holes or one large and two small ones are

drilled in the panel. The lower diagram shows the subpanel-mounting method.

*Handwritten note:* H. H. ... Co., 47 ...





## How to Make Jewel Trees

By H. C. McKAY

2101 Myra Court, Brooklyn, N.Y.

ONE of the most recent and most popular of table ornaments is the jewel tree. The first models introduced were of blown glass and very fragile; then came trees with solid stems and pressed-glass leaves and blossoms, and now the true "jewel tree," with its stems of jewels made in the weeping-willow effect has

For the tree illustrated the following materials are needed: 25 ft. No. 18 bare copper wire; 12 ft. pearl (or other) beads; 1 black-glass base; 1 transparent-glass flower holder; 1 ball heavy crochet thread; 1 jar shellac; 1 tube ballotini; 1 short string gold beads; 1 spool No. 28 d.s.c. copper wire; 1 tube celluloid cement.

Cut 11 or 12 lengths of the No. 18 wire about 2 ft. long. Bind them temporarily with the fine wire, once near the end of the bundle, once about 3 in. from the end, and once about 8 in. from the end. Put this bundle of wire in the flower holder and wedge it temporarily in place. Now bend the wires in curves resembling the drooping branches of the weeping willow. This is shown in Fig. 1. To make the tree hold its shape at this stage, it will be necessary to add temporary wire bonds where two or more branches follow the same stem

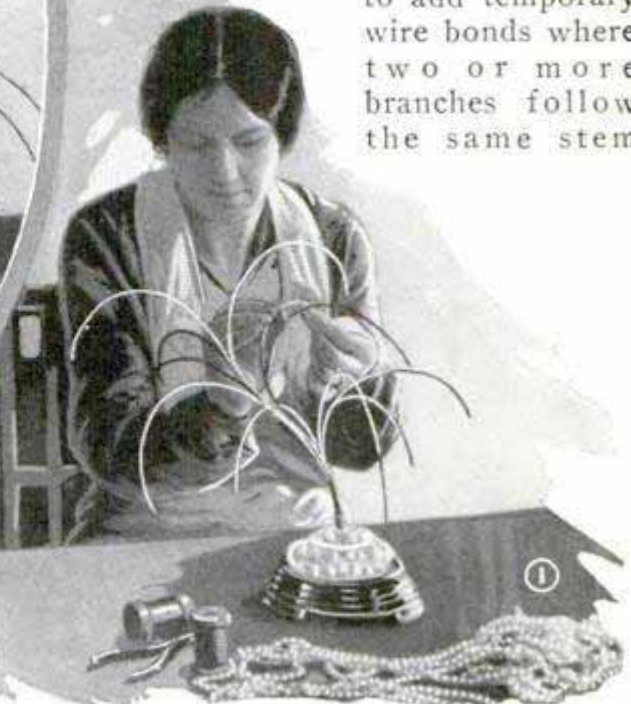

found even greater favor than the first two forms. The jewel tree is one of the most easily made of all modern art ornaments.

*Chicago - 62 E Randolph*



above the first branch. When the tree has been shaped satisfactorily, wrap the bottom of the bundle with No. 18 wire to shape the base to the opening in the flower holder. Make this a loose fit, as a cord wrapping goes on top of the wire.

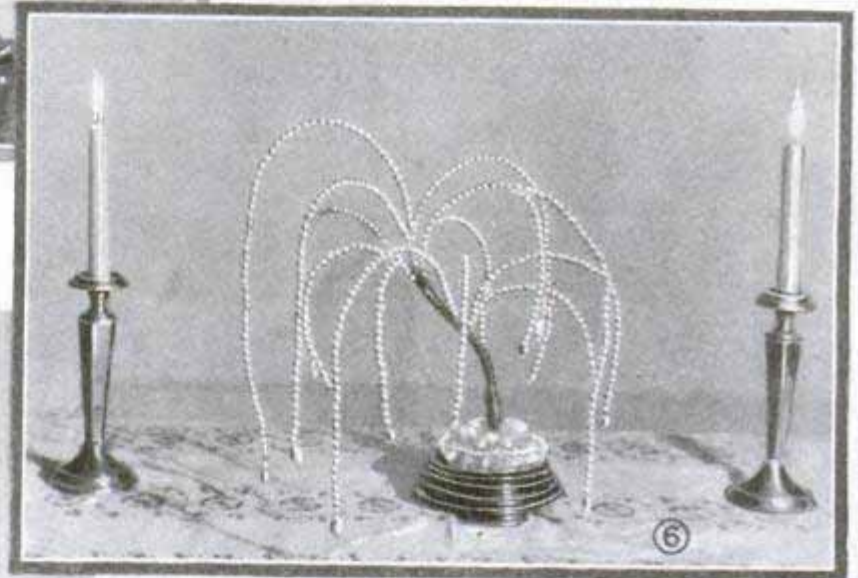

The next step is applying the crochet-thread wrapping to the stem. This is neither a long nor difficult task if started from the bottom. Wrap the base to fit the holder; then wrap the stem, keeping the turns of cord touching. As a branch is passed, the thread is passed over it instead

of under, so that the entire length of the main stem can be wrapped, leaving the branches free at the proper places. This will be understood better when actually doing the work. A good job of wrapping is almost impossible to do if the start is made at the top. Fig. 2 shows this process.

When the tree is wrapped, the pearls are unstrung and pushed onto the wire branches, one at a time. The cheap paraffin-filled pearls will retain their places. Each pearl is pushed firmly home before the next is applied. Fig. 3 shows this step. In this stringing, a space long enough for two beads is left at each branch tip.

After the branches are strung, the trunk is coated. It and all branches, up to and including the base of the first pearl, are covered heavily with white shellac. Be-



fore this sets, the trunk is sprinkled with the tiny glass beads (ballotini) made for coating lamp shades. These may be silver, gold, green or variegated. Figs. 4 and 5 show the coating and beading respectively.



Now set in its holder and attach the "droops." For this purpose pearls are strung upon the fine wire. A large gold bead forms the "anchor" through which the wire is twisted. Then a colored bead is strung, next small gold beads and finally pearls until the desired length is attained. About 3 in. of wire should be left exposed.

The protruding end of a branch is now nicked with cutting pliers and coated heavily with celluloid cement. The end pearls of the droop are pushed up along this wire. Then the fine wire is pulled up until no space shows, and the end is cut off short. The celluloid cement soon dries hard and holds the droop firmly. Fig. 7 shows a droop being attached. This completes the tree. Its appearance is improved by taking care to balance the branches in the first step. This does not mean symmetry, however. The branches are curved until they look right and then

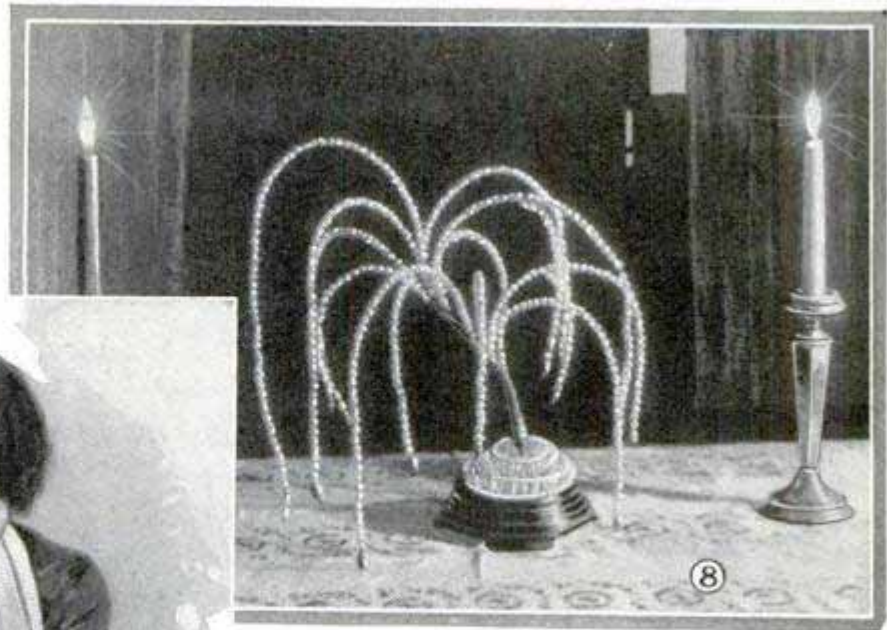

any surplus length is cut off. The black-glass subbase also adds greatly to the artistic effect. Fig. 6 shows the tree under illumination by candle and daylight, and Fig. 8 by candle light alone.

The bill for the tree amounted to \$1.15, all materials being purchased in a local ten-cent store. An almost exactly similar tree, but less finely finished, is now on sale for \$49.50 in a large New York department store.

#### Holder for Linotype Ejector Blades

Where the earlier designs of linotypes are in use, it is necessary to stock a variety of widths of ejector blades to accommodate the different lengths of slugs being cast. These blades are usually hung on nails, placed in a drawer or on a near-by shelf. The drawing shows a simple, inexpensive and convenient holder for them. It consists of a block of hardwood of suitable size and thickness, grooved lengthwise with a

saw, to receive the blades. A cross groove is cut at the rear end and in it is inserted a strip of wood furniture, against which the blades are

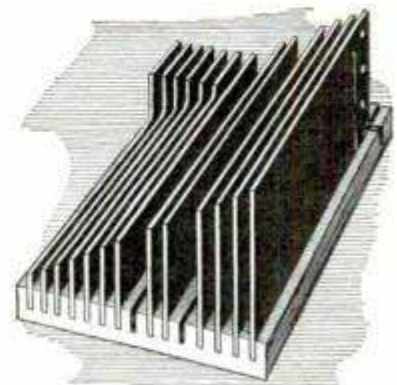

pushed to keep them in alinement. The holder is attached to a near-by shelf.



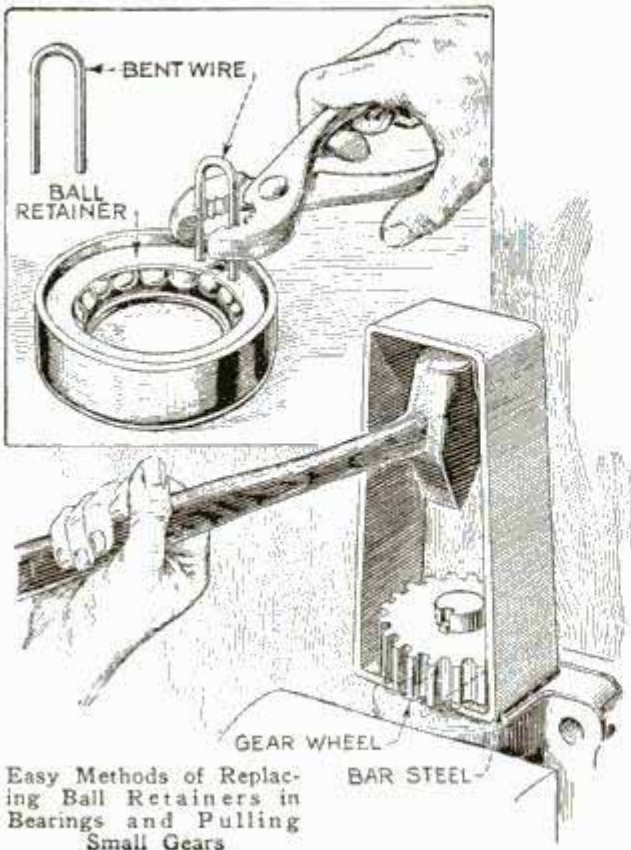

Easy Methods of Replacing Ball Retainers in Bearings and Pulling Small Gears

### Replacing Ball Retainers and Pulling Tight Gears

Difficulty is often experienced when replacing ball retainers in bearings. Prying the retainer into place is an awkward procedure, and is likely to bend the retaining ring. A quick, practical method of doing the work is shown in the drawing. Take a length of wire, bend it to a U-shape, so that the ends will readily fit into the holes in the retainer. Then, with a pair of pliers, grip the wire as indicated and force the ends of the retainer together so that it can be slipped in place. When a gear puller is not available, a simple serviceable tool can be improvised, which is very effective on small gears that are almost inaccessible. It consists of a piece of bar steel, long enough to be bent to the shape shown and allow the swinging of a hammer inside.

### How to Prevent Sweat Marks on Felt Hats

The life of the average felt hat is often reduced at least one-half by the sweat mark, which appears on the band and around the edges. New bands will, of course, prolong its usefulness, but by putting into practice the following suggestion, the sweat mark, as well as the cost of the bands, will be eliminated. Cut a strip of waxed paper slightly larger than the hat band and fit this inside of the band. This will prevent perspiration from soaking through the band and hat. Sometimes a doubled strip of waxed paper will not affect the fit of the hat. Ordinary paper will not do, as it absorbs moisture readily.—Henry A. Courtney, Atlanta, Ga.

### Wave Cradle for Ship Models

When one has a ship model completed, it may be provided with a realistic cradle of the kind shown in the drawing. It is made from five pieces of wood, one serving as the base and the others as wave profiles, which are arranged parallel to each other and nailed to the base. Make the base of fairly heavy wood and about as long as the model. Cut out four pieces of thinner wood, the same length as the base and of sufficient width to permit waves to be drawn upon them. Adjacent pieces should be arranged so that the crests of one are between the crests of the other. Saw them out to shape with a jig or coping saw, or whittle them out with

a knife. Paint the wave pieces and set them away to dry. When dry, they are fastened to the base as indicated, two on each side of the ship's keel. The two central ones form the support for the ship and the others are set about 1 in. farther from the keel. When the model is set on such a cradle, it should be located on a stand or shelf just below the level of

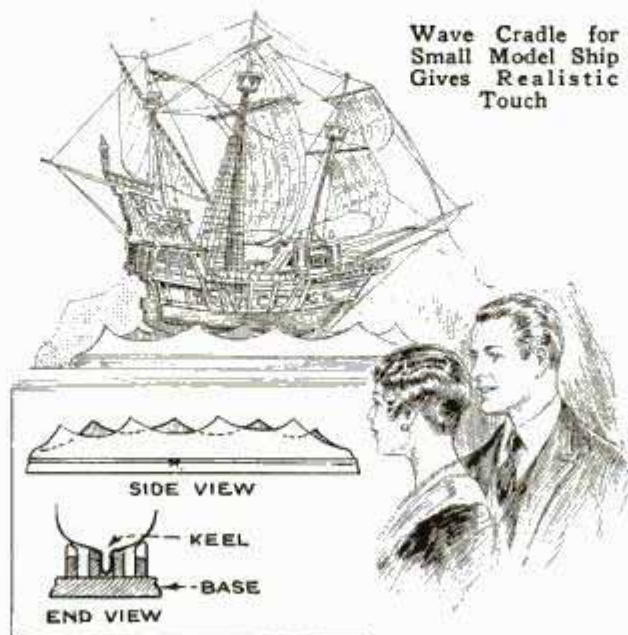



the eye, and it will then appear as if riding a heavy sea when viewed from either side.—L. B. Robbins, Harwich, Mass.

### Repairing Locks

In taking some kinds of locks apart, it is necessary to file off all the riveted metal, but this procedure leaves one handicapped when it comes to reassembling. Many times the riveted portion is a little extension of one side of the lock case itself. An easy way out of this difficulty is to take a small drill and countersink the rivet hole, even if this is square, as is often the case on auto-door locks. After assembling, rivet the metal down into the countersink, and the lock will be held together securely.—Sherwood J. Gee, Salt Lake City, Utah.

### Sturdy Support for the Garden Hose Nozzle

When a lawn sprinkler is not available, you can readily improvise one, as shown in the illustration. It consists merely of a wooden support on which the nozzle end of a garden hose is mounted, a couple



of nails or screw hooks being used to hold the hose in position securely. The base and vertical piece are made of 2-in. wood, while the pivoted leg is a strip of 1-in. wood.

The latter can be swung out to serve as a leg holding the base in an inclined position. This enables the user to get at the support and move it about without getting wet.—Chas. F. Goldthwait, Waterbury, Conn

### Wheeled Truck for the Home

Besides being useful for moving flour barrels in the storeroom or pantry, the wheeled truck shown in the drawing has been found convenient when heavy boxes, chests and pieces of furniture have to be

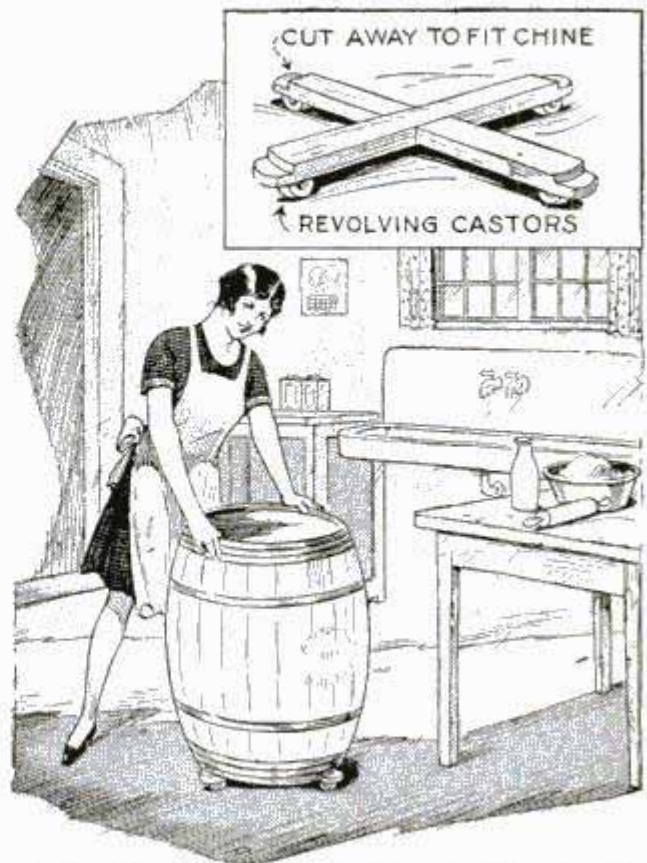

Simple Wheeled Truck for the Home Is of Considerable Utility for Moving Heavy Articles About

moved during house-cleaning time. The construction of the truck is clearly indicated in the detail. It consists of two crosspieces, equipped with revolving castors, the ends of the crosspieces being cut away to fit the chine of the barrel, if the truck is used for this purpose.—E. L. MacFarlane, Frederickton, N. B., Can.

### Light Reflector Made of Tinfoil

In many cases where electric lamps are provided on walls over tables or workbenches, a reflector is desired. The common type of tin reflectors used on drop cords cannot be attached to wall lights to throw the light down. A good reflector can, however, be provided by getting a sheet of tinfoil and fitting it around the lamp as shown. Two-thirds of the lamp is covered in this way, and the light is reflected where it is needed.—Irvin L. Oakes, Pleasant Hill, Ohio.

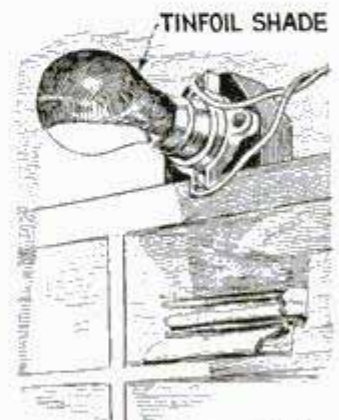



### Spray Gun for Fertilizer

Many small crops are greatly benefited by an occasional feeding of liquid fertilizer.

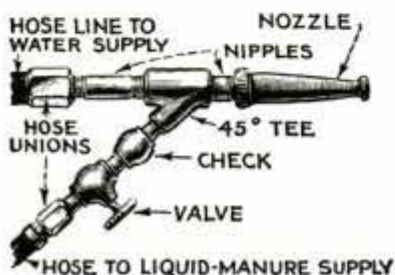

This is usually kept in diluted form in large barrels and spread by means of small garden sprays or even with an old broom. The home gardener can make a spraying outfit to use with the garden hose, at regular water pressure, as shown in the cut.

This will distribute the fertilizer thoroughly with a minimum of labor and is well worth the making. Assemble an ejector of pipe fittings about as shown. The fittings should be of such size that they can be coupled to a  $\frac{3}{4}$ -in. hose union. The tee must be a  $45^\circ$  fitting with the side opening pointed toward the hose. Screw the hose nozzle ahead of the tee on a close nipple as shown. Below the side opening of the tee is a check valve that keeps the water pressure from driving the liquid down but allows it to rise, and a valve to control the flow. The length of hose on the end dips into the fertilizer receptacle. Fasten the regular hose line to the water cock and place the bottom hose in the fertilizer. Then turn on the water pressure and adjust the nozzle. The stream, passing by the tee, will draw up some of the fertilizer and eject it in the form of a spray. This flow of fertilizer is regulated by the valve.

### New Dowels in Chairs

Two or three times while gluing up loose chairs, I had to replace broken dowels. When drilling out the old ones, I always used a  $\frac{3}{8}$ -in. drill for a  $\frac{3}{8}$ -in. dowel, but found that it was almost impossible to get the drill centered exactly

and bore the hole at the same angle as the old dowel. I stopped at a cabinet shop and noticed that a workman was replacing an old dowel by using a  $\frac{5}{16}$ -in. drill for a  $\frac{3}{8}$ -in. dowel. He said that he always used a drill just a trifle smaller than the dowel to be removed. With a small scratch awl, he then chipped away the outer shell of the old dowel, which left the original hole ready for the new one. —Frederick J. Pease, Wauwatosa, Wis.

### Effective Cleaner for Fabrics

A large New England industrial plant, which operates its own laundry, has discovered that an emulsion made of soap flakes and benzol will remove many spots from clothing that are hard to efface by other means. The mixture is thoroughly shaken up in a bottle until it is emulsified into a thick creamlike fluid. It is then applied to the spot with a sponge or cloth and rubbed in lightly, after which the spot is washed out with soap and water. This treatment leaves no ring and is a solvent for troublesome paint spots and other foreign substances.

### Removing Old Wick from Oil Stove

Kerosene-burning stoves with cylindrical burners are in use in many homes



in rural districts and small towns. Often considerable trouble is experienced in removing burned-out wicks. This task can be facilitated by using a simple tool made from an old hacksaw blade. The end of the blade is

ground down on an emery wheel to the shape shown. In use, the sharp point is inserted between the wall and the wick, as shown, allowing the latter to be caught and pulled out easily.—W. C. Wilhite, Hornsby, Ill.



### How to Hold Flowerpots on Shelves

People who live in upper flats often keep a row of flowerpots on the outside window sill or on a board fastened to the sill. Every time the window is opened there is danger of accidentally knocking a pot off the board, which means a pot and plant destroyed, to say nothing of the danger to persons who might be below the window. This hazard was minimized by one woman who drove a number of screws into the shelf, letting the heads project about 1 in. The pots were then placed so that the screws entered the drain holes in the bottom. So set, the pots cannot readily be pushed or knocked off the board.—J. E. Noble, Toronto, Can.

### Water Wings Made from Rubber Balls

Anyone desiring support in the water, when learning to swim, will appreciate the improvised water wings shown in the drawing. They can be made in the following way: Tie the ends of a length of wide tape, which will fit around the chest and pass under the arm pits, to the ends of some ordinary adhesive tape, or electricians' friction tape. Pass the tape around the circumference of two large rubber balls. The tape can be more securely fastened to the balls by using several short crosspieces over the long piece, as indicated, to prevent it from slipping or pulling off.—L. B. Robbins, Harwich, Mass.

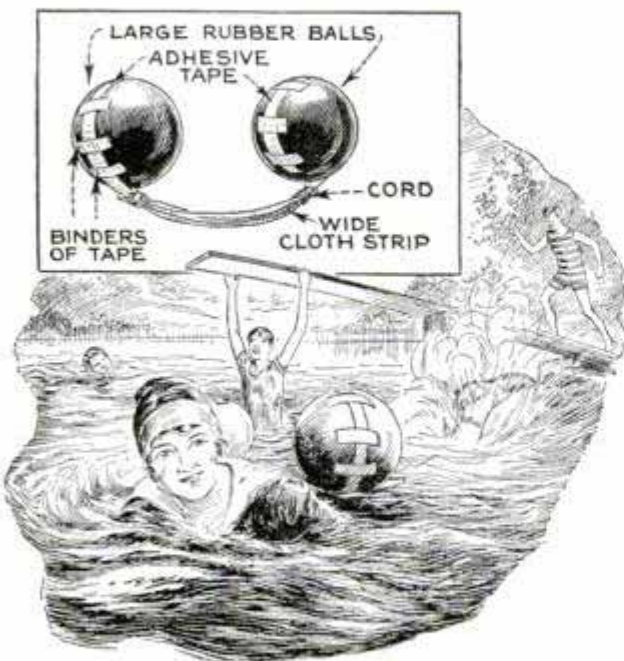

Water Wings Improvised from Large Rubber Balls Have Considerable Buoyancy



Collapsible Drawing Table Is Attached to a Closet Door in Home or Apartment

### Drawing Table Attached to Door

In apartments and homes where space is limited, a collapsible drawing table, attached to a closet door, will be found convenient. It consists of a few boards, hinges and an electric-light fixture, arranged as indicated. The whole assembly is attached to the door by means of two large wood screws. When not in use, the prop under the table is let down and the table is dropped to a vertical position so that the door can be closed. Just above the table a small shelf is provided for pens, pencils, erasers and ink. The underside of the table is fitted with a strip of wood, in which a number of holes are drilled to receive the end of the prop. This permits the user to set the board at any convenient angle. The T-square can be hung on a small nail driven into the supporting board on the door. The light fixture will, of course, have to be equipped with a lamp-cord long enough to extend to the nearest socket of the house-lighting supply.—L. E. Wilcox, Minneapolis, Minn.

ⒸA bone collar button makes a good substitute for a plug in repairing a puncture in a single-tube bicycle tire.



Using Pails to Reduce Speed of Boat Driven by Outboard Motor

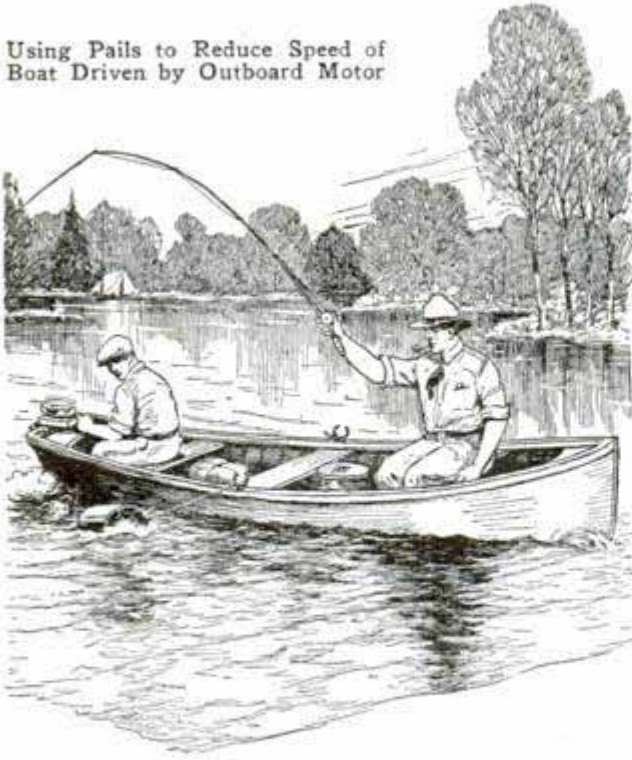

### Checking Boat Speed for Trolling

Some outboard motors, attached to a light rowboat, cannot easily be throttled down sufficiently to permit the slow, deep trolling necessary to get the "big fellows." A simple method of checking the speed of the boat is to drag a pail on each side, as shown in the illustration. The motor can then be set to any desired speed.

### Improving Gas-Stove Oven

In many gas-stove ovens it is almost impossible to burn both the upper and lower flames at the same time, since not enough air is fed for proper combustion of the gas. Anyone handy with tools can easily overcome this trouble with a little careful work. Cut a hole, about 2 by 5 in. in size, in the side of the oven, as far back and as low as possible. Then cut

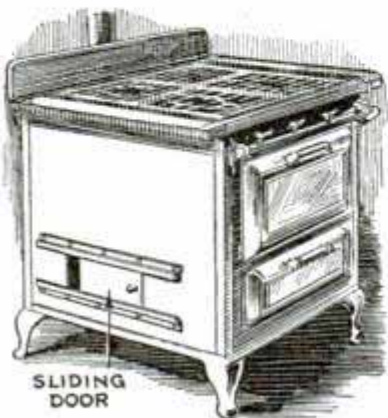

and bend two lengths of light galvanized iron to form slides and rivet them to the oven side, above and below the opening, as shown in the illustration.

Another piece of galvanized iron is cut to form a sliding door that will cover the opening completely, and slipped into the slides. A wooden knob is fitted to form a handle, and a stop arranged at the "blind" end of the door, to complete the job. When both flames are used in the oven, they should be watched and if it is observed that one of them seems to "wander round," indicating lack of air, the sliding door should be opened and adjusted until the trouble is corrected.—George L. Michel, Jersey City, N. J.

### Homemade Beading Tool

Sometimes it is desirable to cut a bead on the edge of a board or a pair of rabbeted doors, and on similar work. This is not a hard matter where one has a beading plane at hand, but can also be done very neatly with the aid of the improvised tool shown in the drawing. Take a little block of wood and run a rather large flat-head screw into it, allowing the head of the screw to project from the side of the block the same distance as the width of the finished bead. Before driving in the screw, take a file and cut away one edge or corner of the slot on the outer edge of the

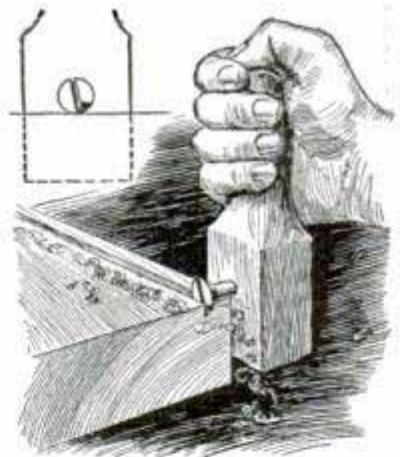

screw head and turn the screw so that the long corner will cut into the wood that is to be beaded. Run the screw-head cutter back and forth like a marking gauge; this will cause the screw head to cut down into the wood until stopped by the body of the screw. Then round up the outside edge of the work with a block plane and finish with a piece of sandpaper. Folding the sandpaper will cause it to go down into the bead better. The finished result will be a bead that cannot be told from one cut with a regular plane. The same method may be used for cutting a bead on the edge of curved work. When working on the inside sweep, the block into



which the screw is driven must be rounded off to fit the curve. The outside edge can be worked off better with a spokeshave than with a block plane.—F. R. Rodgers, New Palestine, Ind.

### How to Make a Bicycle Coaster

Have you an old bicycle rusting away in the cellar? If so, why not make some use of it by converting it into a scooter or coaster for the boy, or, better still, let him do the work himself? The procedure is simple: Remove the wheels, handlebar, seat and driving gear so that nothing is left but the framework itself, and attach a pair of small baby-carriage, or similar, wheels to the rear and front forks with suitable bolts and nuts. The wheels must be small so that the frame will almost touch the ground. Drive a round hardwood stick through the hole formerly holding the crank bracket. This forms the necessary support for the feet. Another stick of wood, with a crosspiece, is driven into the handlebar hole to serve as the handgrip, and a similar piece, with a broader crosspiece, into the saddle hole, for a backrest.—Horace E. Goodwin, St. John, Can.

### Cure for Rattling of Brake Rods

Rattling brake rods are more or less annoying and the rattle is somewhat difficult to cure. However, by stretching an ordinary screen-door spring across both rods, near the rear end of the car, as shown, the trouble is readily overcome. The ends of the spring are securely attached to the brake rods, the tension required depending on the looseness of the rods. The installation of a spring in this way does not hinder the operation of the brake.—M. N. Stanley, Brookline, Mass.

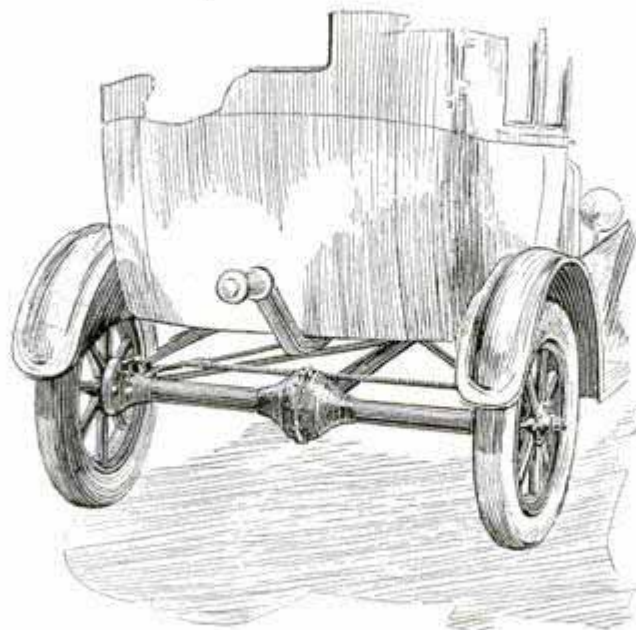

Installation of Coil Spring on Auto Brake Rods Prevents Rattling

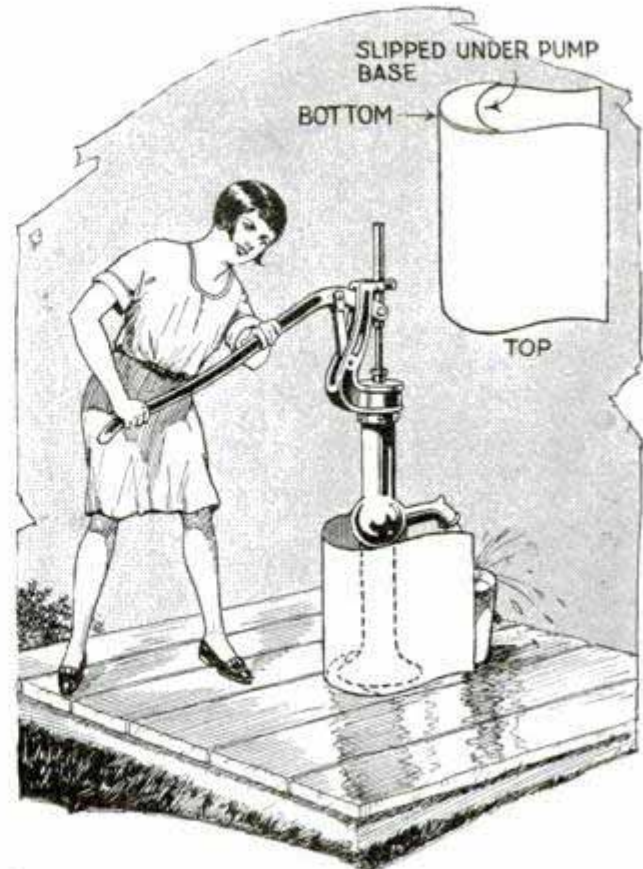

Splash Guard Consisting of a Large Tin Can, Cut Open and Fitted around the Pump Base

### Guard for Pump Prevents Splashing

Anyone who has used an outdoor pump has been splashed on more than one occasion, especially during windy weather. In order to prevent such trouble, a simple sheet-metal guard may be provided. That shown herewith was made from a discarded carbide can, although any other can of similar size can be used. Open the can along the seam with a pair of tin shears, trimming the sharp corners. Cut out a portion of the bottom of the can, leaving a crescent-shaped piece to be slipped under the pump base, the lagscrews being temporarily loosened for this purpose. After the bottom of the guard is slipped in place, the screws are again tightened and the guard will be held securely.



Secret Compartment  
for Valuables Built in-  
to Kitchen Cupboard



### Secret Compartment for Valuables

A secret compartment with nothing to betray its presence may be built into any small, deep cupboard in the house, preferably in the kitchen. Merely add a new partition or back of tongue-and-grooved stock, a few inches in front of the old one, somewhat like the false bottom of a trunk. Before toe-nailing the pieces to the ceiling and floor lining of the cupboard, glue together or nail to a connecting strip on the back side, three or more pieces for a door, which will slide up through a slot in the ceiling of the cupboard. Clean the joints or grooves adjoining this sliding section, and apply paraffin to make the door move easily. Conceal the toe-nailing of the solid part of the partition to the floor and ceiling by neat strips of quarter-round set in front. One or two nail holes on the back wall of the cupboard, which will not attract any attention, furnish the "key" to the secret compartment. Insert a nail in one of these holes to serve as a lever for lifting the sliding door. Anyone can make such a compartment.—A. May Holaday, San Jose, Calif.

☞ To prevent water colors from crawling, add a few drops of ammonia or lime water, or a solution of sal soda.

### Anti-Rattlers for Auto Hoods

After hood clamps of an auto have lost some to their tension through constant use, they become loose. New springs can be installed, but this is a rather difficult job, and, in the end, the hood becomes just as rattly as before. One method of preventing this trouble is to cut out anti-rattlers from solid squares of rubber. Slots are cut in the squares so that they can be slipped on the lower edge of the hood near the clamps. Thus the hood will be raised slightly and the clamps will take a firmer hold.—Glen F. Stillwell, Collinsville, Ill.

### "Shadow-Sketching" a Fine Pastime

Few people can hold a nicely sharpened pencil over a clean sheet of paper without automatically writing, scribbling or drawing. Here is an amusement that anyone can follow in order to draw weird and grotesque figures of which a few examples are given in the illustration. The term "shadow-sketching" describes this pastime quite accurately, drawings being made simply by tracing the outline of a shadow cast by a crumpled piece of paper on a clean sheet. The figure drawn in this way resembles some object and can usually be made to represent a head, the missing details of which may be filled in later according to one's fancy. It is claimed that some cartoonists resort to this practice when they desire a distinctive type of face.



Distinctive Heads and Faces Can Be Drawn by Merely Tracing Shadows



*lacquers*  
*135* *Wabash Chicago 10.47 the*  
*Wabash* *new York*

# STENCIL DECORATING WITH LACQUERS

By Hobart N. Durham



**S**TENCILING, while mechanical and so simple in its essentials that anyone can master it, nevertheless presents an opportunity for the exercise of one's artistic taste to beautify many of the plainer types of objects found in the home. Above all, the process is flexible, readily adapting itself to the decoration of any material in as simple or as ornate a manner as desired. With a view to showing the basic process and some of its more practical applications, this article describes well-tried methods, which can be readily carried out in the home at a very small outlay, leaving to the reader the choice of combining the essentials and adapting them to his own taste or using them as set forth.

For stenciling of the type to be described, one need purchase only a small quantity of spraying and brushing lacquers of various colors; stencils, which may be bought or easily made, and a sprayer of a type similar to those commonly employed with insecticides. In the commercial adaptation of these processes, air brushes are used, but their price, as a rule, is too high for the amateur who has only a limited amount of the work to do. The sprayer should have a comparatively small reservoir and a well-made pump, as shown in Fig. 4. This size will make a better spray and waste less of the lacquer in cleaning. Such a sprayer can usually be bought for about 25 cents. As to the lacquers, any of the quick-drying nitrocellulose lacquers will be suitable and small cans of several colors should be on hand. For priming the surface of the material, if of wood, a can of priming lacquer will be found very useful. It is applied before the sprayed coatings.

The stencils can be bought quite cheaply

and decorators' stencils will answer very well. If you wish to use your own designs, the stencils may easily be cut at home from either oiled paper or thin celluloid. The designs most suitable for stenciling are massive and should present but little detail, as this complicates the cutting and generally lessens the effect of the completed work. The various illustrations in this article show simple designs which can be artistically arranged, and represent a type best suited to reproduction by the stenciling process.

To cut the stencils from paper or celluloid, one may use either a sharp knife or a safety-razor blade to sever from the sheet those parts which are to be removed. The designs should first be drawn on the sheet. If you are a poor free-hand artist, use celluloid, place the sheet over a design and trace it. In cutting, care should be taken to avoid joining the two ends of a curved line, for if this happens, that portion included within the line will be left without support and will drop out. To avoid this, small "ties" should be left, as shown in Fig. 1, running from the outside of the design, to support the central portion of the stencil. It will also be well to leave these ties in case the design has unstenciled parts jutting into the areas to be stenciled.

Old photographic film, particularly the

*Lacquer - Washes*  
*White Lead 1900*  
*Chicago*



larger sizes, will be found a good substitute for new celluloid, the emulsion being first removed by soaking the film in hot water. After this cleaning, there still remains a thin coating of gelatin, which will readily take ink, so that the design can easily be drawn on it. One advantage of thin celluloid over paper, is that it need not be cut completely through. It is sufficient to scratch the surface deeply and then bend the celluloid sharply at the scratched line, when it will crack along the line just as if the cut had been made completely through the sheet.

If the ties are accidentally omitted or cut by mistake, a small narrow piece of celluloid or paper, cemented across the gaps, will serve equally well. The cementing can be done with some of the clear lacquer.

For complicated work, which would necessitate an extraordinary number of ties, it is better to use a different type of stencil, which may be made in the following manner: A piece of rather coarse organdie, or other open-mesh fabric, is stretched taut in an embroidery frame of a size considerably larger than the design to be stenciled, and the parts which correspond to the unpainted parts of the design are stopped out with a rather thick solution of glue or gelatin. This may be done with a brush, being careful to apply it only to those parts which are not to allow the color to pass. The glue should be sufficiently thick to fill the meshes, as any pinholes left in the coating will cause undesirable spots of color in the finished work. By holding the stencils to the light after they have been coated and dried, these pinholes may be detected. If any are found, they can be filled in with drops of glue. When the glue has dried, the stencils are ready for use in the same manner as the paper or celluloid stencils, except that, after use, they must be cleaned of the lacquer, which otherwise would remain in the unglued part of the fabric and make the stencil un-

fit for duplications of the same design.

Having the stencils, the object to be decorated should be given a coat of primer, or undercoat, followed with a coat of lacquer of the color desired for the article as a whole. Thus, if it is desired to produce a gray table with designs of blue, the table should first be given a coating of primer, then a coating of gray lacquer, after which the stencil should be placed on the surface and the blue lacquer applied through the openings in it.

The attaching of the stencil to the surface may be done by means of pins, weights around the edge (if the stencil is to be used in a horizontal position) or in some other way. One very convenient method of fastening stencils is to punch

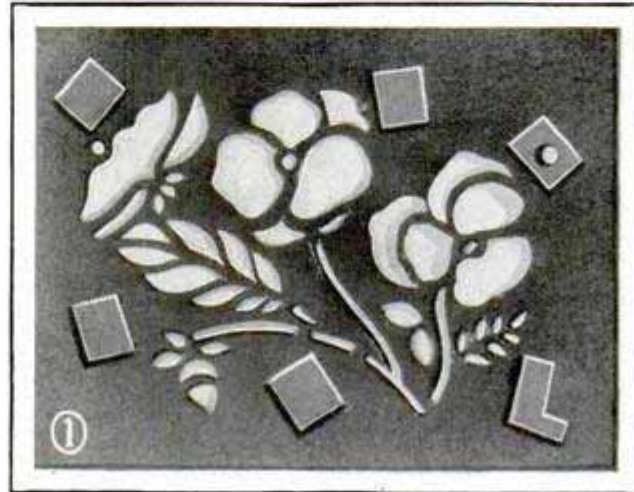

small holes, about  $\frac{1}{4}$  in. in diameter, around the edges, as well as in the large interior parts, and stick small squares of adhesive tape over these holes on the upper side of the stencil. After a stencil has been applied to the object in the proper position, it may be fastened firmly by pressing the tape through the holes into contact with the surface of the object. This in no way interferes with the work, and the stencil can be removed readily without marring the finished surface. Enough of these holes and adhesive patches should be provided to insure that all parts of the stencil will lie flat against the work. Should it happen, on removing the stencil, that any of the adhesive remains, it can be wiped off with a cloth moistened with a small amount of lacquer thinner, or carbona.

Of course, the design should be appropriate to the object to be decorated, and equally important, its position should be carefully determined so it will be symmetrical and occupy the proper space, as in Fig. 2. Wrongly placed, a design will mar the general appearance as much as it will enhance it if properly placed.

With the stencil firmly secured to the work, the sprayer should be filled with



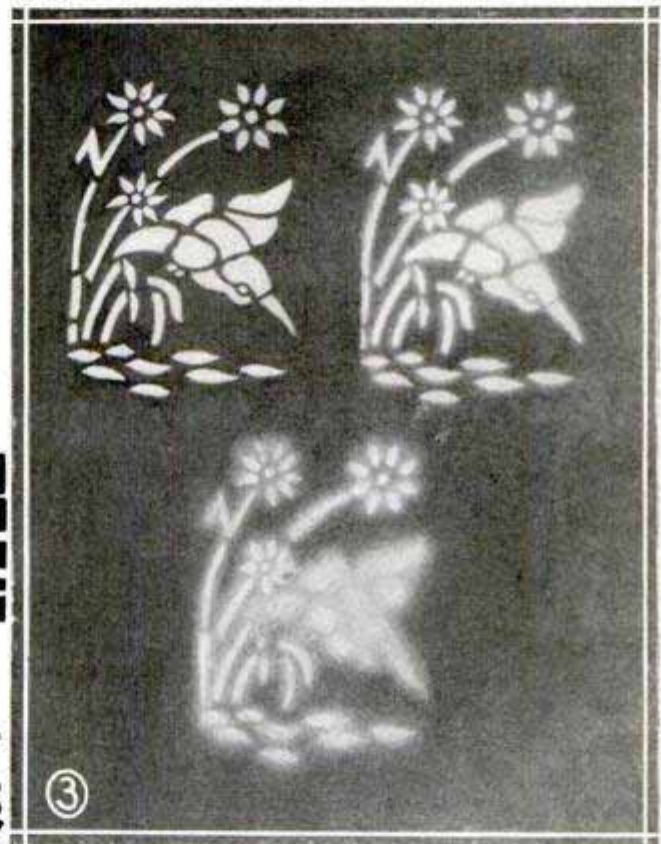
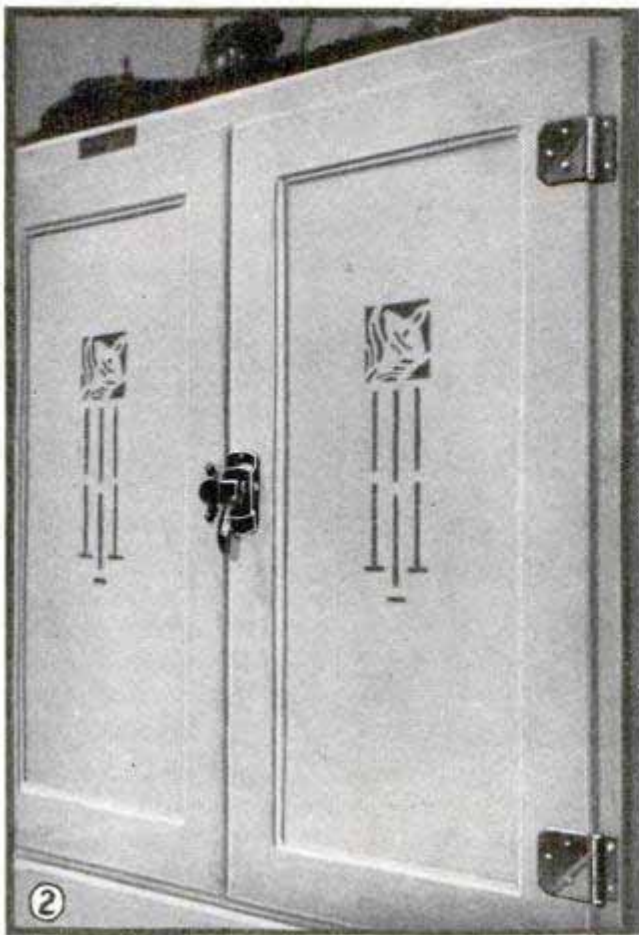

lacquer and pumped a few times to insure a ready, even flow from the nozzle. It is better to have the work in a vertical or tilted position, as in this way the sprayer can be pointed directly at the open parts of the stencil without spoiling the result by any lacquer which might collect on and drip from the nozzle. If the sprayer is held so as to direct the spray perpendicularly to the surface, as shown in Fig. 4, and then moved about while spraying, an even coating will be easily obtained, while, if held at an angle, the spray will diminish in intensity as the distance from the nozzle becomes greater, resulting in an uneven coating. Advantage can easily be

taken of this usually undesirable feature, and by intentionally spraying at an angle, the color may be shaded from full strength to a faint suggestion, producing highly decorative effects.

Beautiful blended color effects may be obtained by directing the spray at an angle to produce the greatest intensity at one side of the design and then repeating the process with a different, but harmonious, color from the opposite side. Both colors should be sprayed before the stencil is removed and, if carefully done, the colors will merge into each other in the central portions of the design, enhancing the appearance greatly.



After the spraying has been completed, the stencil is removed. Unless the lacquer has dried thoroughly, this should be done without sliding the stencil over the surface, to avoid smudging the surface and spoiling the work. In any case, the best practice is to form the habit of lifting the stencil at one corner and pulling it up and away from the surface of the object.

If the stencil has not been held tightly against the surface, it will probably be noticed that the design will have a fuzzy or blurred edge extending slightly beyond the parts which were intended to be colored during the stenciling. The farther the stencil is spaced from the surface, the greater will be this softened edge and the more indistinct the design. If the stencil is spaced only a slight distance from the work, however, this may be put to good advantage in producing soft, pleasing designs of indistinct outline. The effects of various spacings are shown in Fig. 3. The most distinct of these designs was produced by having the stencil in close contact with the surface to be decorated, while the most diffuse was made with the stencil separated from it about  $\frac{3}{8}$  in. The design at the upper right shows the proper spacing, about  $\frac{1}{8}$  in., which gives a desirable degree of diffusion.

Where comparatively small stencils are used, some means should be provided to keep the parts of the work outside the area of the stencil from receiving any of the mist which always envelops the spray. This may be effected by cutting a hole, slightly smaller than the stencil, in a sheet of wrapping or newspaper and placing this over the object before the stencil is attached. The stencil is then fastened over the hole and the sheet forms a mask that protects the finished parts of the work. (See Fig. 4.)

In addition to the stencils already mentioned, ferns and other leaves can often be used with good results for certain types

of work. They are either held flat against the surface to be stenciled or merely laid on it. In the latter case certain parts will be close to and other parts slightly away from the surface, and this will produce a

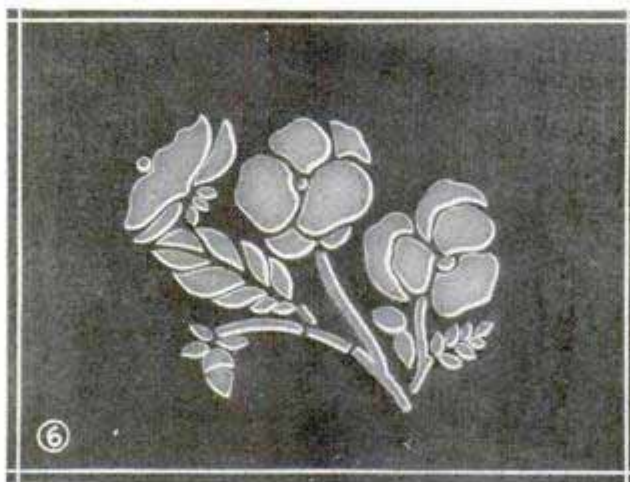

combination of sharp and blended designs whose irregularity will be unusual but pleasing. Stenciled designs of this type as well as some of the other larger designs, may be improved by spraying a touch of appropriate color in the centers of the bold parts of the design,

slightly relieving the expanse of the single color. Some designs can be more conveniently reproduced by using a stencil made of several small parts, which are applied to the surface to serve as masks, as for example, where a stripe or line border is desired. In these cases, the surface is first sprayed with the color desired for the border. The entire surface need not be covered and the spray may well be limited to an area slightly greater than that which is to form the border. Over this area is then pasted a narrow strip of paper of exactly the same width as the stripe or border to be produced and the remainder of the surface is sprayed with the desired color of lacquer. When the second coat has fully dried, the paper strip is removed from the surface, revealing the even stripe, of the same color as the underlying first coating of lacquer. This process avoids cutting a long slit in a stencil, which could not be as readily secured to the surface, and, when used for designs other than stripes, eliminates much of the work.

Silhouettes may also be used as masks by lightly attaching them to the surface to be decorated and spraying the color on them and around the design. If desired, the color may be shaded off around the silhouette by directing the spray principally at the mask and allowing only the edge of the spray to fall on the background surrounding the mask. Either silhouette or reversed effects may be ob-



tained in this manner, depending on whether the surface is dark or light relative to the color of the lacquer. Such designs may be effectively used for decorating lamp shades, spraying the lacquer on a sheet of parchment either before or after it has been made into a shade. A cut-out silhouette design of this type, with the lacquer sprayed around the design, is shown in Fig. 5. Only one coating of lacquer should be used in this case, in order to leave the light portions of the parchment transparent.

A type of work which lends itself very readily to some objects is done by using a

piece of lace as a stencil. The lace preferably should be rather coarse and need not be new. First, it should be given a thorough coating of lacquer to render it stiffer and less absorbent, and, when dry, it may be tightly held to the work by pinning or sewing. When the lace stencil is applied, the color is sprayed to strike the surface perpendicularly and thus avoid creeping under the threads of the lace.

A relief effect can be produced by stencils used for other designs with a slight change in manipulation. After the design has been finished by spraying, the stencil is removed and replaced in a posi-

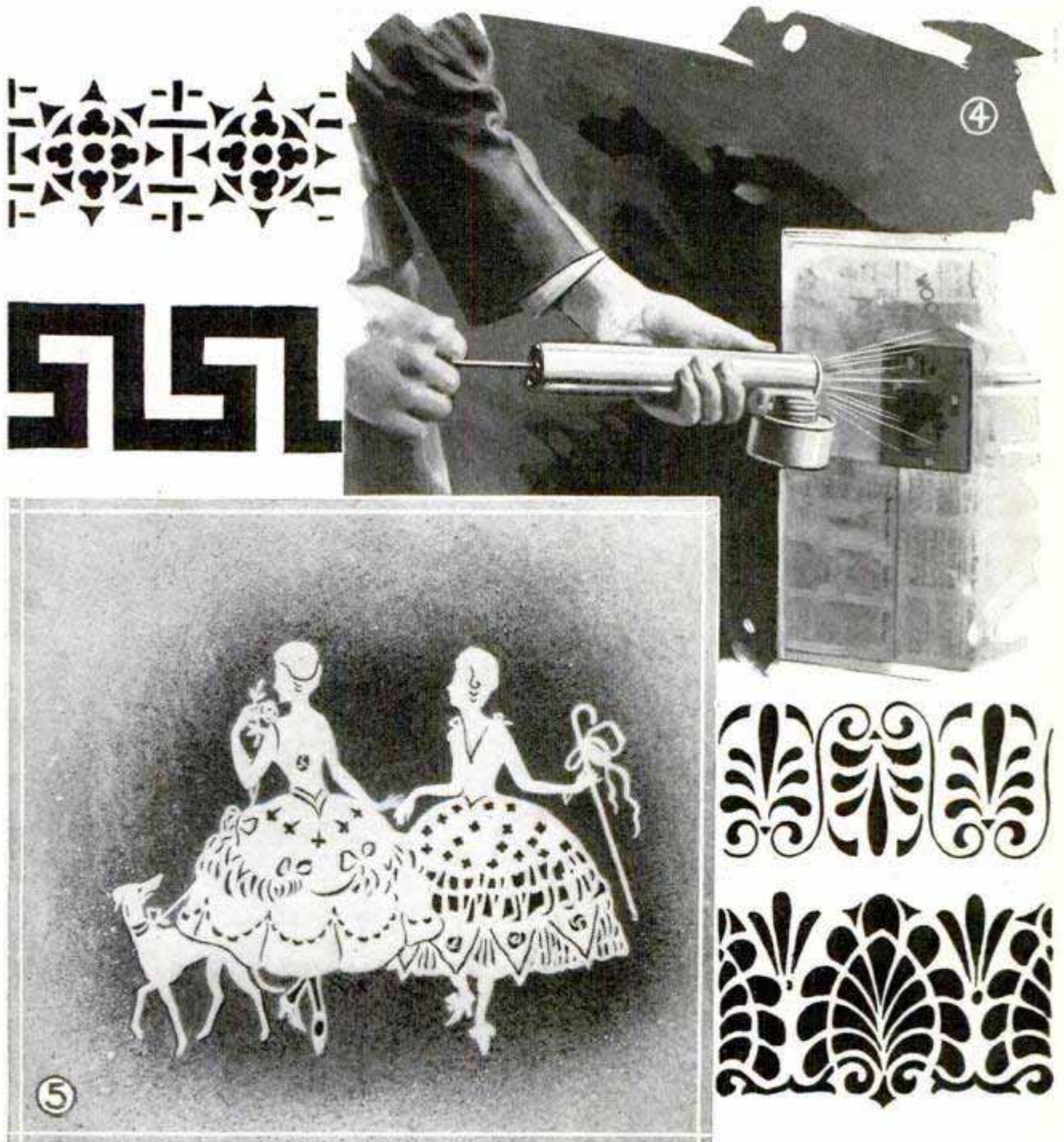



tion slightly shifted, in a single direction only. With the stencil thus displaced, a very light spray, or, better, a spray slightly different in color, is directed on the parts not previously colored by the first stencil-

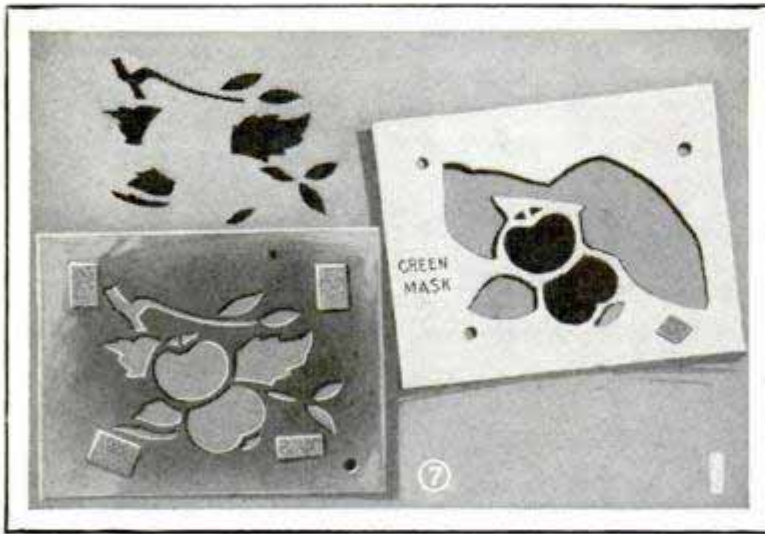

ing operation. Too much lacquer should not be sprayed in this second step, if the color is used, and the best effects are produced by spraying only a light cloud of color in these unstenciled parts. If too much lacquer is sprayed, the effect will be totally lost and the design will appear as though the stencil had been incorrectly cut. This is avoided by using lacquer of a different color. Properly done, the stenciled design will appear as if in relief, casting a shadow to one side, as may be seen in Fig. 6.

Stenciling in more than a single color presents a few complications in the cutting of the stencils, but with simple designs the cutting does not involve extraordinarily difficult work. One of the easiest ways is to cut the stencil as if the design were to be done in one color, that is, so all the parts of the design will appear on a single stencil, and then cover certain parts with small pieces of paper. Attach this stencil to the object, stencil the first color, remove the paper and cover the remaining openings with paper so that the uncolored parts alone will receive the color on the second spraying. An example is shown in Fig. 7. In this, the leaf and stem portions, which are to be stenciled in green, are covered with a paper mask, while the red is applied through the fruit parts. When dry, the stem and leaf portions are uncovered and sprayed with green. In doing multicolor work, it will

be found convenient to leave the stencil on the work while the paper masks are changed, as in this manner the question of register will be avoided. If it is necessary to remove the stencil from the surface of the object, or if more than a single stencil is being used, some marks should be made on the surface to insure that the following stencils will be properly placed with respect to the parts which have already been sprayed. One way of doing this is to mark lightly on the object the outline of the opposite corners of the first stencil.

Instead of pasting small pieces of paper over the openings in the stencil, it may be better for the particular design to use masking sheets over the stencil, each masking sheet being so made as to block out the proper portions of the stencil. To make these masks, lay the stencil successively on top of several sheets of rather heavy paper, cut to the same size as the stencil, and trace the design on each of these sheets by passing a pencil around the edges of all the openings in the stencil. The parts of the design to be in a particular color, say, red, are then removed from a single sheet; the parts for another color are removed from a second sheet, and so on. This need not be done as accurately as the stencil cutting, the only requirement being that the removed parts should be at least as large as the stencil openings, but not so large as to cover a portion of the stencil intended to pass another color. In use, the stencil is first attached to the object and one of the masking sheets is laid over and in register with the stencil, blocking for all but the color to be sprayed. After spraying the first color, the surface should appear as in the upper-left part of Fig. 7. Then the second mask may be put in place and sprayed with the proper color, the process being repeated until the entire design has been stenciled in the several colors. If the colors of a multicolored design are to be placed close together, it may require a separate stencil for each. These should be made on sheets of the same size, to insure that they will properly register, and the portions for each color may be cut after tracing the design



on each of the sheets in exactly the same position.

All of the stenciling processes may be used equally well on furniture and other woodwork or even on draperies and walls. The latter have generally been decorated by stenciling with brushed paint, but by spraying paint or lacquer in the manner described, many unusual effects are obtained that can be produced as well by no other method.

After using the spray gun, or when a different-colored lacquer is to be applied, it should be thoroughly cleaned by draining the reservoir, pumping until all the lacquer has been removed that can be sprayed out and then washing the can with a small quantity of lacquer thinner, some of which should be sprayed to clean the nozzle. If the sprayer is to be left unused for only a short time, the cleaning may be avoided by dropping into the pipe leading to the reservoir a small-headed nail, to keep the lacquer from drying and clogging the nozzle. In using the sprayer with lacquers, there is only one precaution which need be observed: work in a well-ventilated place away from open flames. The solvents employed for the lacquers are inflammable and have an objectionable odor which will sometimes, and with some people, cause a slight headache. Otherwise, there are no dangerous or disagreeable effects.

### Key Deflates Toothpaste Tubes

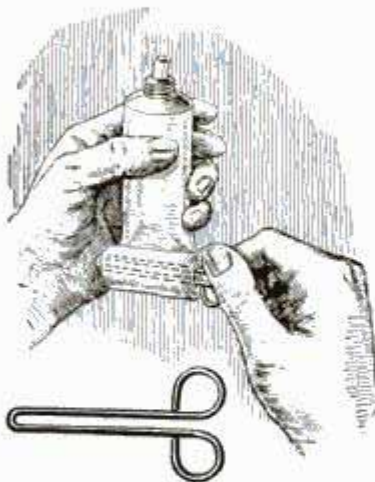

When using toothpaste, ointment or other material put up in tubes, it is difficult to force out the contents completely by squeezing the tube with the fingers. The simple wire clip shown in the drawing, which can be made in a few moments, will be found handy for this purpose. After a tube has been emptied, it is unrolled, and the clip removed for reuse.—G. M. Beerbower, Tarrytown, N. Y.

### Rubber Splash Guard for the Washboard

One housewife, inconvenienced in the use of a washboard by water splashing



Splash Guard for the Wash-tub Made from an Old Inner Tube

on her clothes and on the floor, remedied the trouble by providing a guard on the board, as shown in the drawing. It was made from a section of discarded inner tube and was tacked onto the edge of the board so that it deflects all the water back into the tub. As the guard is made of pliable rubber, it has no rough edges and there will be no possibility of garments being torn nor risk of injury to one's hands.

### Kinks for Using Plaster of Paris

A plaster-of-paris mixture will remain soft longer if it is added to the water instead of stirring the water into the plaster. The mixing is easier, too. If it is found desirable to keep the mixture soft for a very long period, add ten per cent vinegar to the water before the plaster is put in. To make the plaster hard when finished, add five per cent table salt to the water when mixing. Asbestos powder, about fifteen per cent by volume, will increase the toughness of the plaster and make it durable and hard, so that it will neither flake nor crack.—Frederick L. Minter, Milwaukee, Wis.





A Lawn Roller Made from a Sewer Tile Filled with Concrete and a Mounting of Pipe

### Easily Made Concrete Lawn Roller

To keep the lawn in good condition, it is necessary to have a lawn roller. One can readily be made of concrete, as shown in the accompanying illustration. Get a drain tile, 2 ft. in diameter. If it has a bell or flared end, cut this off with a cold chisel and hammer. Set the tile on a wooden platform, so that the concrete can be poured in. Before pouring the concrete, a length of pipe should be placed in the center of the tile to serve as an axle, the centering being done by making a cross to fit over the open end of the tile, and cleats nailed to the ends of the crosspieces to hold them in place securely. A hole drilled equidistantly from four points on the side of the tile, where the crosspieces fit

over it, will be in the exact center. A hole is also drilled in the wooden platform to receive the lower end of the pipe, which also must be centered accurately. With the pipe in place, pour in the concrete. After it has been allowed to set for a few days, the ends of the pipe axle are cut to the most suitable length and threaded for caps. The mounting for the roller is made of pipe and fittings, all of which as well as the construction are clearly indicated.—A. J. R. Curtis, Chicago, Ill.

### Improved Corn Planter Works Quickly and Saves Stooping

A corn planter that eliminates much hoeing and stooping can be made by anyone in a short time. Wire a 3-ft. length of iron pipe to a broom handle, 4 ft. long, and cut the bottom end of the latter to a point. Insert the spout of a tin funnel in the upper end of the pipe and fasten it so that it will not fall out. Walk along the row and, at the proper intervals, force the point end of the handle into the earth and drop three or four kernels of corn through the funnel into the hole. Then scrape some earth over them with the foot.—L. B. Robbins, Harwich, Mass.

### Homemade Tire Spreader

To make inspection of the inside of tires, the homemade spreader shown in the drawing will be found of considerable utility. It consists of two strap-iron hooks, cut and bent to the shape indicated and attached to wooden arms, which are hinged together, as shown. When the arms are brought together and locked in that position by a wire loop, the walls of the tire will be held apart, enabling the work-

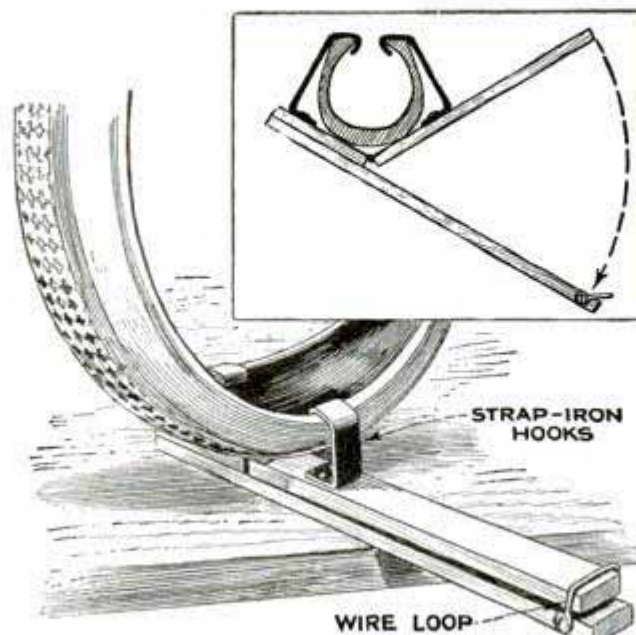

Simple Tire Spreader for the Small Garage Proves Entirely Satisfactory

man to examine the inside.—Lowell R. Butcher.—Des Moines, Iowa.



# Make This "Tim Turner" Windmill

By L. R. BROWNE

**T**HE novel "Tim Turner" windmill shown in the illustration consists of the following parts: 1 piece of  $\frac{5}{8}$ -in. wood, 4 by 10 in.; 1 piece of 1-in. hardwood, 1 by 12 in.; 1 piece of  $\frac{1}{8}$ -in. hardwood, 4 by 12 in.; 1 piece of  $\frac{3}{16}$ -in. brass or iron rod, 20 in. long; two alarm-clock gears; one brass bushing,  $1\frac{1}{4}$  in. long and having an inside diameter of  $\frac{3}{8}$  in.; one  $\frac{3}{8}$ -in. bolt, 4 in. long; two  $\frac{3}{16}$ -in. washers, and two cotter pins.

The 4 by 10-in. piece is used as a base. The two uprights that support the shafts are made of oak or other hardwood, and are fastened to the base with two long wood screws, driven up through the base. Drill two  $\frac{3}{16}$ -in. holes through each upright, the upper hole about 1 in. from the top and the position of the lower hole being determined by the size of the gears used. These holes are to hold the shafts and must therefore be in alinement. The propeller is made of strong straight-grained wood, 1 in. square and 12 in. long. Start

to form each blade as near the center of the piece as possible, leaving a square portion uncut at the point where the shaft enters it. The vane is attached by cutting a notch,  $\frac{1}{8}$  in. wide and 2 in. deep, in the center of the rear part of the base, as shown. The vane must fit in the notch snugly; it is glued in place and then nailed.

By laying out  $\frac{1}{2}$ -in. squares on a piece of paper, as shown in Fig. 2, a pattern for the man can be easily made. Cut the figure out of  $\frac{1}{8}$ -in. hardwood with a coping saw. The arm and leg pivots are made of small nails, bent over at each end after placing. Leave the joints rather loose and free, to allow easy motion. To make the sharp right-angle bends, in the  $\frac{3}{16}$ -in. shaft, which form the crank, file notches in the rod about halfway through, and bend toward the notches. Two of these

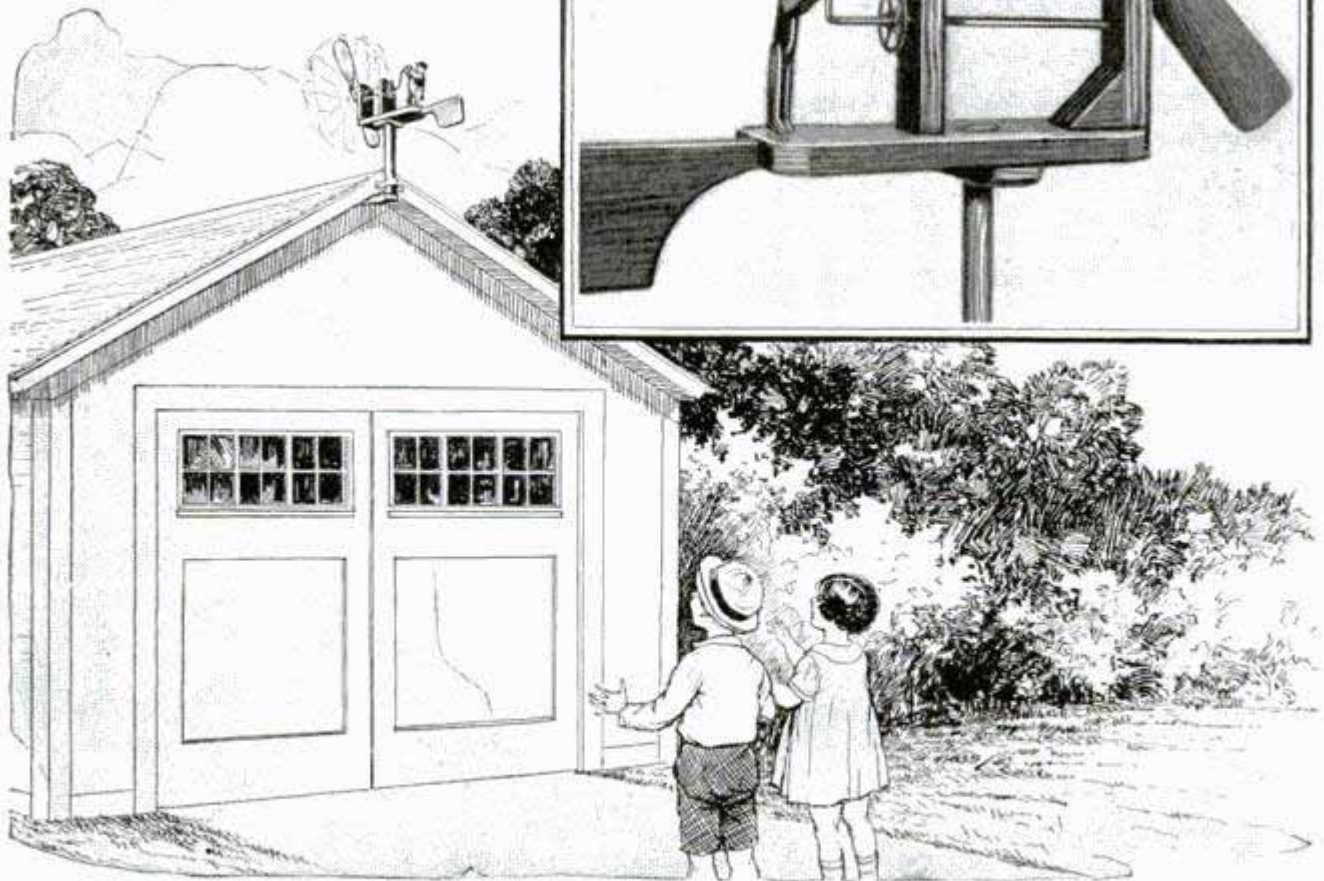

When the Propeller of This Unusual Windmill Is Driven by the Wind, the Wooden Figure Appears to Be Cranking the Propeller by Hand



bends,  $\frac{3}{4}$  in. apart, will give a good throw to the crank. Fig. 3 shows the shaft notched and partly bent.

An old alarm clock will furnish a suitable pinion and gear for the mill, a pair having about 6 to 1 ratio being most satisfactory. Drill holes through both gears to fit the shafts, and tin the shafts well with solder at the point where each gear is to be attached, building up the solder so that the gears make a snug fit. Set a gear

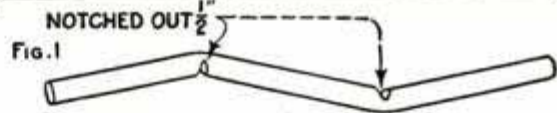
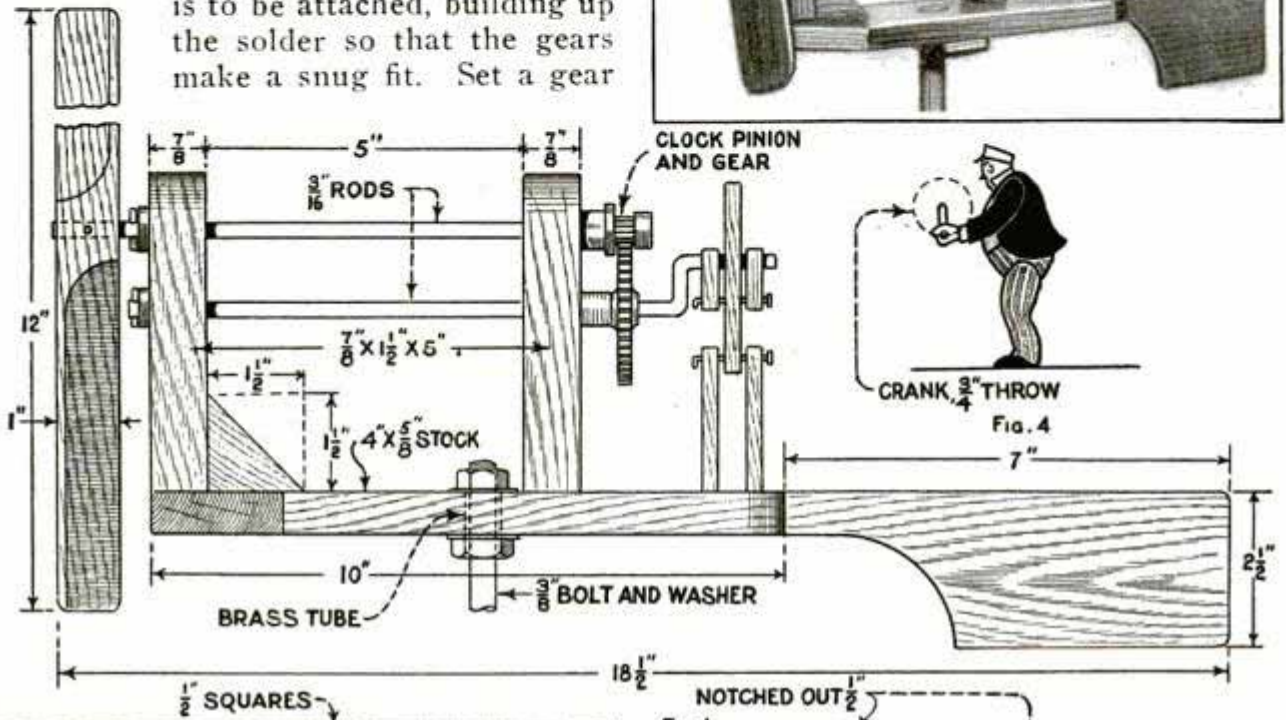
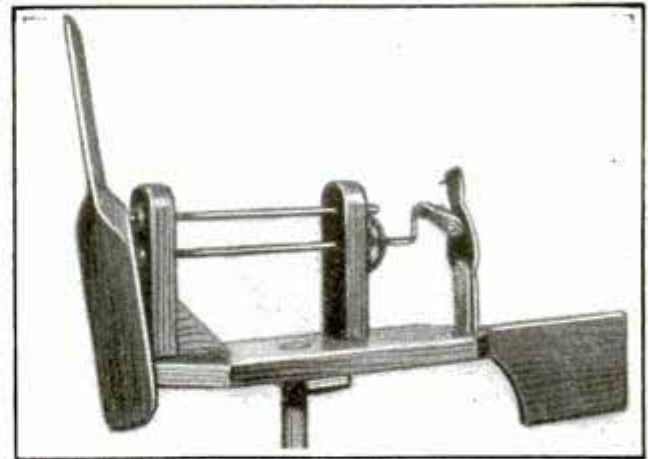

METHOD OF BENDING CRANK  
Fig. 3

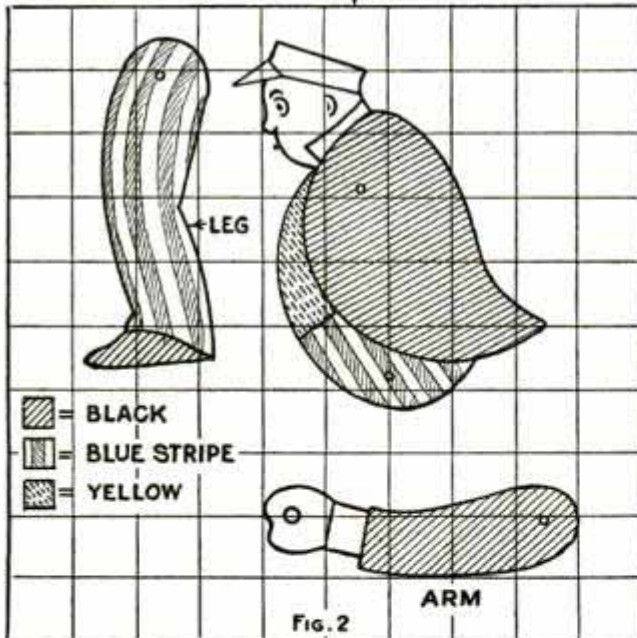

Fig. 1, Assembly View of the "Tim Turner" Windmill; Fig. 2, Template of the Parts for Making It; Fig. 3, How to Form the Crank

in position and heat the shaft until the solder begins to flow. When the solder is cold, the gears will be firmly held in place. A shoulder of solder and a number of small washers, slipped on the shaft, form the thrust bearings of the gear and the propeller end of the shaft, respectively, as shown in Fig. 1.

The propeller is fastened to the shaft by drilling a small hole through both and pinning them together with a finishing nail. In centering the base for the pivot, allow a slight extra weight at the front to compensate for the pressure of the wind. A  $\frac{5}{8}$ -in. block is used on the bottom of the base at the pivot point to give a firmer bearing. Make the brass bushing a tight fit in the base and run the 4-in. bolt through this and into the end of a 2 by 2-in. upright, which is fastened to the roof of the garage or house. Do not use glue in any part of the construction as moisture will soon destroy it. Paint all the parts in contrasting colors, suggestions concerning hues being given in Fig. 2. Either lacquer or one of the new quick-drying enamels is suitable for finishing, as these come in bright, glossy colors.



### Protection against Clogged Gutters

Thousands of home owners who have shade trees around the house are troubled each year by leaves falling into the rain gutters. The first rain washes them into the downspouts, clogging these so that water cannot pass as it should. Later on, in the winter, ice collects in the pipes, the rusting process begins and the ice may even crack the pipes, which means renewal. Save yourself this trouble by getting a wire guard of the kind used for electric lamps. Put one in the top of each pipe to serve as a strainer, which will prevent the leaves from going down. It will be necessary to remove accumulations of leaves and small branches above the strainers occasionally or at least twice a year, in the spring and fall.—L. A. Heinle, Toledo, Ohio.

### Removing Stubborn Headlight Rims

Headlight rims on autos are often rather difficult to remove when it is necessary to replace a burned-out lamp, dust off the reflector or do some other work on the light. The task is especially difficult if the surface of the rims is highly polished. However, by merely wrapping a strip of friction tape around the edge, as shown in

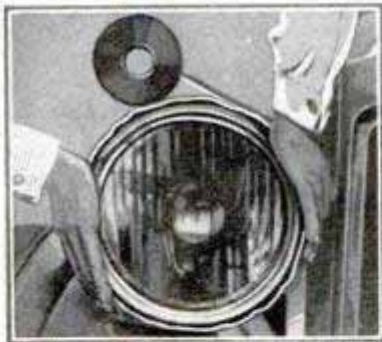

the photo, enough friction will be provided to permit one to loosen the rim without much trouble. Gasoline can be used to wipe off all traces of the adhesive after the tape has served its purpose and has been removed.—W. J. Douglass, Missouri Valley, Iowa.

### Carrying Outboard Motor on Automobile

A convenient method of carrying an outboard motor on an automobile is shown in the drawing. A U-shaped piece of sheet metal is fitted over the front or rear door on the left side of the car and the motor is clamped to this in the same way that it is clamped to the stern board

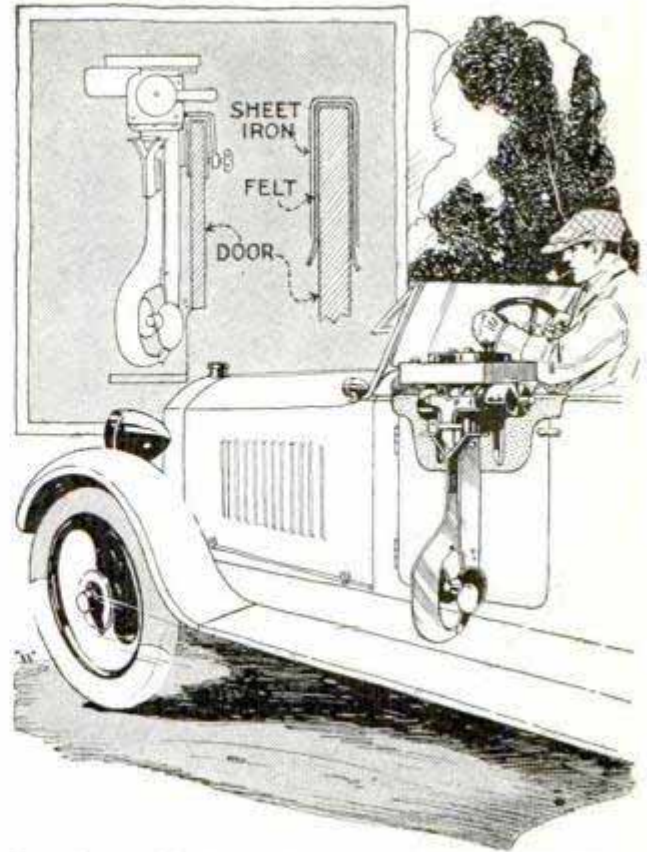

Carrying an Outboard Motor on the Door of a Touring Car without the Risk of Hurting Either

of a boat. A piece of soft material, such as felt, outing flannel or the like, is first placed over the door to protect the finish and door upholstery. The sheet metal piece should be a little longer than the width of the door so as to overlap the door frame. This is advisable, if not necessary, in order to remove some of the weight from the door and prevent it from opening accidentally.

### Holder for the Flashlight

If it is necessary to use a flashlight while working alone, difficulty is often experienced in focusing the light on the work, while both hands are engaged. A good support for the flashlight can readily be made from two clothespins, wedged together as shown in the photo. The height of the support can be varied by pressing the tops or feet of the clothespins together to change the distance between them.





### Carrying Case for Gasoline Lanterns

A gasoline lantern is a valuable addition to a motor camper's equipment, but many

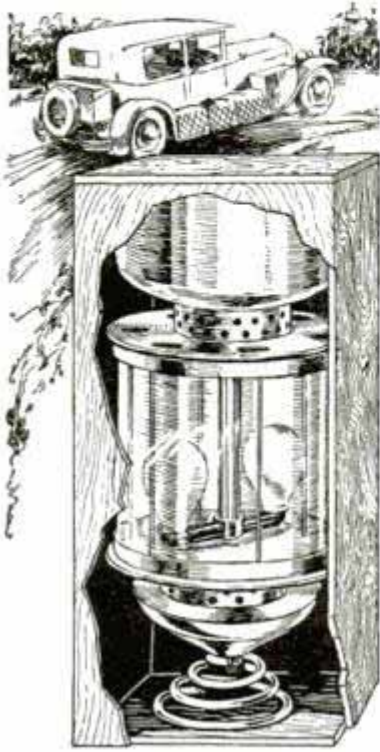

tourists object to its use because of the frequent breakage of mantles, due to the vibration of the car. The risk of breakage can be eliminated if a coil spring is provided under the dome nut of the lantern as shown, and the lantern is carried in an inverted position in a suitable con-

tainer. The spring should be made of No. 22 or 24-gauge piano wire. The carton in which the lantern was originally packed will serve as a temporary container until a suitable carrying case can be made. The most important thing is to fit the spring and always carry the lantern upside down.

### Proper Care of the Saxophone

The saxophone is a finely machined instrument that seldom gets out of order if properly handled, but, like every other piece of mechanical apparatus, needs occasional adjustment. The most frequent trouble is leakage around the pads. This is caused by the condensation of moisture from the breath on the pads and the neglect of wiping it off when the instrument is put away. Moisture also condenses on the inside of the metal body and settles at the bottom of the bow bend. This is later blown out of the tone holes and sprayed onto the pads, which, being made of the finest kid skin backed by wool felt, gradually harden and crack from it. Be careful to wipe out the instrument thoroughly with a soft cloth when finished playing. This can be done best by tying one end of a string to the cloth and the

other to a cloth-covered sinker. Drop the latter through the bell of the horn and let it come out of the small end when the gooseneck is removed. The cloth can be pulled through without difficulty. Two or three such wipings will thoroughly dry the inside of the horn. Wipe off the pads and remove the mouthpiece from the gooseneck. Clean the gooseneck by pulling the cloth through it. Also clean the mouthpiece in the same way after the reed has been removed. Carefully pat the moisture from the reed with a dry cloth, reset it and put on the cover. In all cases, when the horn is wiped and dried, put it into its case. Twice a season, the pins and long rods that act as bearings for the various pads should be oiled with a drop of the best quality light machine oil, which will not gum. Be sure to keep the oil away from the pads as it will ruin them. If oil is accidentally spilled on them wipe it off at once and then apply talcum powder. This powder is good for a sticking valve pad also. When tuning up in cold weather, warm the saxophone a few minutes before attempting to play it, otherwise the pitch will be flat.

### Cabinet Hides Electric Meter

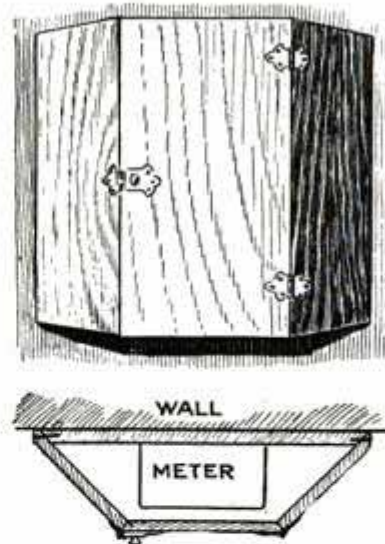

While building my home, I had intended to put the electric meter in an out-of-the-way closet, but found that this was against the rules of the electric company. As there was no basement, the

meter was installed in the kitchen. Here, however, it presented a very objectionable appearance, which I improved by building a cabinet around it, finishing the inclosure to harmonize with the rest of the woodwork.—John T. Neufeld, Chicago.

☞ Sew straps to the mattresses so that they can be handled more easily.



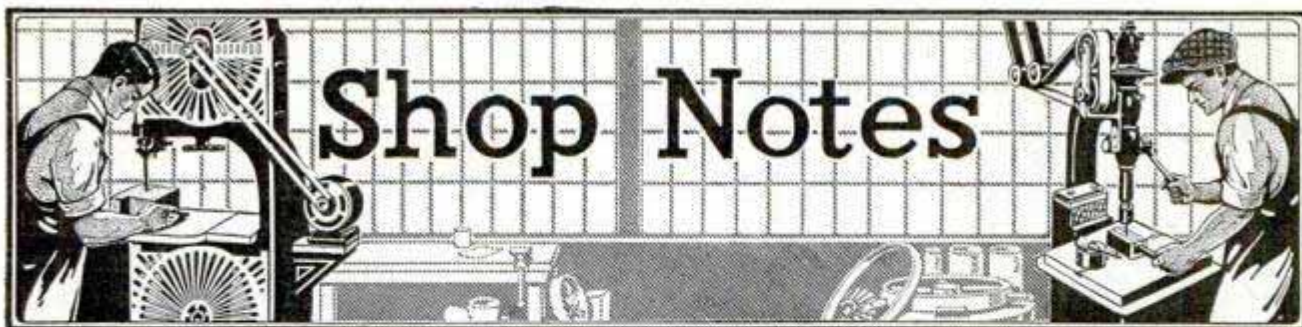

All Shop Notes published in 1927, in book form—Fifty Cents—from our Book Department

## Handy and Compact Home Workshop

By F. L. COAKLEY

ORDINARILY the basement is the best place, if not the only one, to locate the home workshop, but space is often rather limited and it cannot be entirely devoted to this use. Other household duties are also performed there, and it is quite necessary to arrange the shop as compactly and orderly as possible.

meal, beginning with a few hand tools. Not being satisfied with these, I installed a small lathe, then a grinder and a drill press. By this time the equipment was pretty well scattered all over the basement, as my workbench was not large enough to accommodate everything. There were shavings here, chips there, dirt and oil spots everywhere. A storm of protest came, as this condition interfered with the washing.

Now, however, there are no more com-

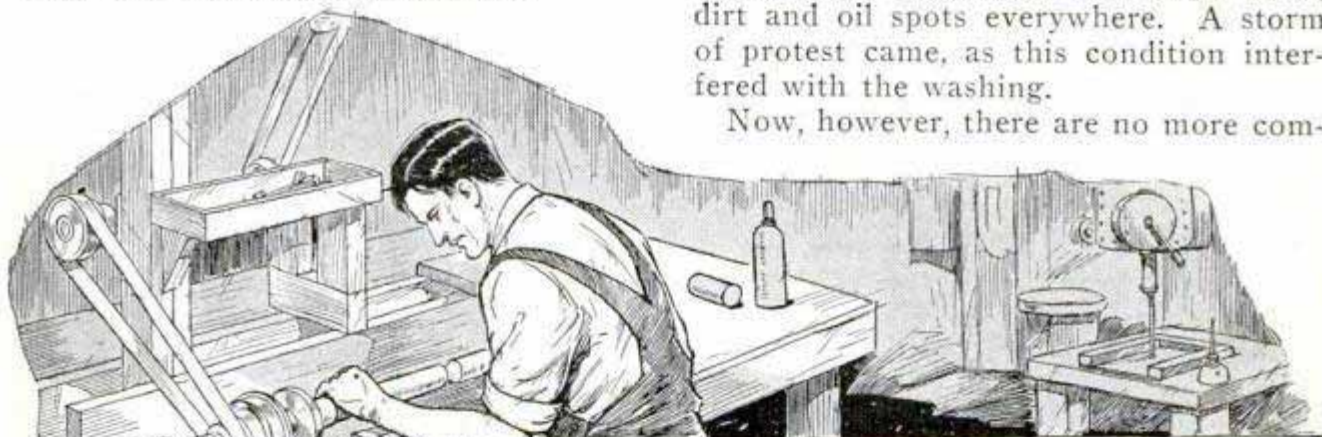

Installation of the Home Workshop on a Sturdy Double Bench, Which Is Bolted Together to Permit Dismantling and Moving; the Plan View Shows the Arrangement of the Machines, Motors and Shafts

When I first considered the installation of a home workshop, I purchased the necessary equipment piece-

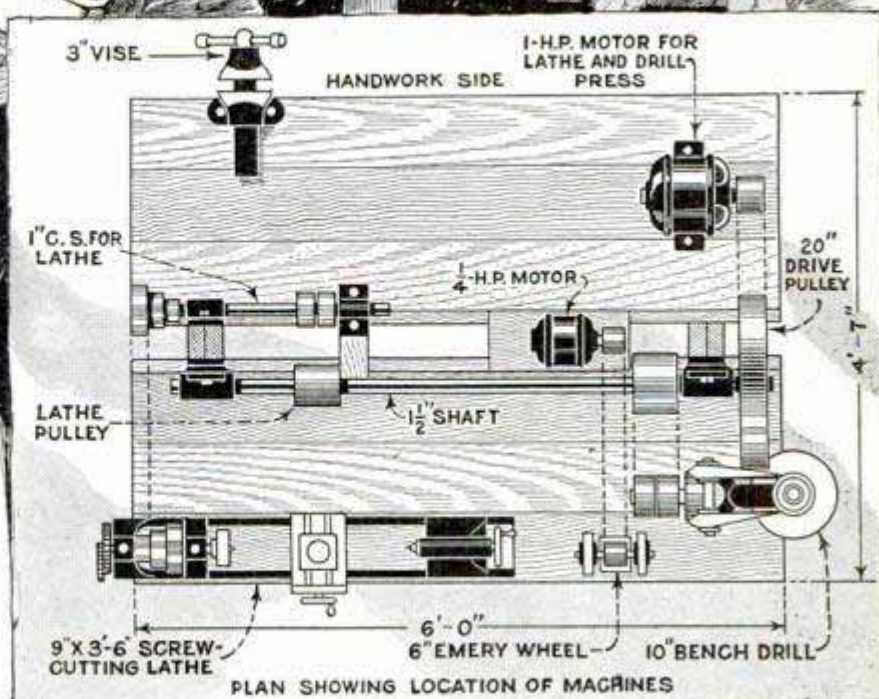



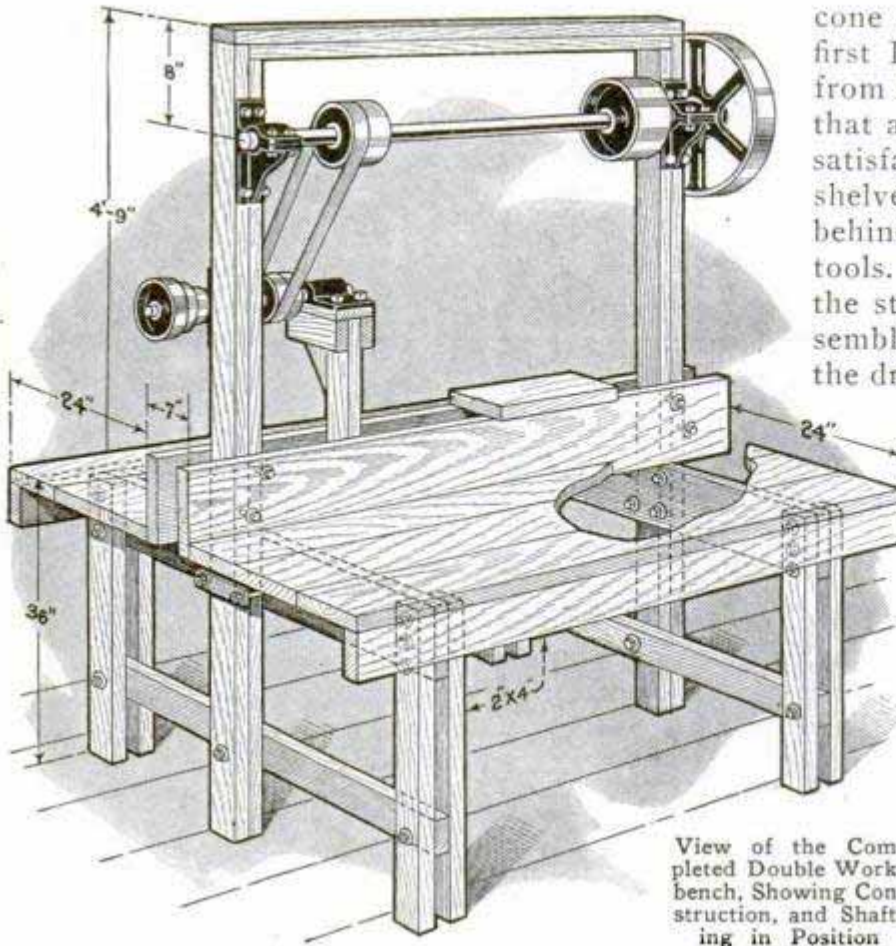

View of the Completed Double Workbench, Showing Construction, and Shafting in Position

plaints, for the basement is clean and tidy, and my workshop is confined to the double bench shown in the drawings. This is located in one corner, and if necessary, I can build a partition around it and provide a padlocked door.

The frames of the bench are of 2 by 4-in. stock, the upper rails being 1½ by 8 in. The top and back ledges are also made of 1½ by 8-in. boards, and the framework is bolted throughout. The center frame that supports the line and countershafts is made up from doubled two-by-fours, and in the manner shown clearly in the illustration. No further dimensions are necessary, as the length, width and height of the bench may have to be varied to suit individual conditions.

A 9-in. screw-cutting lathe, grinder and a 10-in. drill press are mounted on one side, while all the hand tools, including a 3-in. vise, are kept on the other side. A 1-hp. electric motor is used to run the lathe and drill press, while one of ¼ hp. drives the grinder. The former is located on the left-hand side of the bench, and is belted to a 1½-in. shaft, which is held by suitable hangers. This is in turn belted to the countershaft, which carries the

cone pulley for the lathe. At first I drove the grinder directly from the countershaft, but found that a separate motor gave more satisfactory results. Two small shelves are conveniently located behind the lathe to hold the lathe tools. All the dimensions, size of the stock, and the method of assembly are clearly indicated in the drawings. Bolts were used to hold the parts together, so that tightening could be done when necessary, and so that the bench could be dismantled and moved, if desired.

Several friends predicted that the bench would prove weak, and would soon loosen up, but after three years of use, it is still perfectly solid, and the machines operate with a minimum of vibration, although the bench is neither fastened to the floor nor to the wall, and stands away from all other support.

### Burr Remover for Matrices

An operation occasionally necessary in linotype maintenance is the removal of burrs on the ears of matrices, caused by their repeated striking on the front plate, or on the entrance of the matrix into the assembly stick. This is a detail that requires exceptional care on the part of the

operator, as inexperience in the use of a file may damage the type face. The drawing shows a simple and effective

way of doing this work without risk of injury to the working faces of the matrix. Along one edge of a piece of furniture, a metal block being preferable, a narrow slot is cut to receive a thin fine file, having a safety edge. The slot should be just deep enough to allow the file to project a distance equal to about one

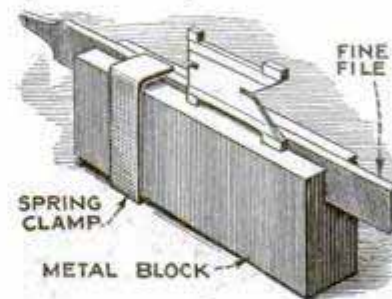



point less than the width of the ear or lug on the matrix. A small spring clamp, made of brass, is used to hold the file in the slot. This accessory has proved both speedy and accurate.

### Getting Telegraph Line over Flooded River

A telegraph engineer, engaged in restoring telegraph service over a large flooded river, which had washed out the only bridge in the vicinity, found that the main river had changed its course. The torrent could not be crossed by boat nor by the most daring rider on horse and the use of harpoon guns and rockets was impossible. The difficulty was overcome by means of the device shown in the drawing. It consists of three boards, about 8 in. wide and 3 ft. long, nailed together as indicated and provided with a metal strip to serve as a weight, which holds the device upright when it floats. A short crosspiece of 1-in. wood is securely fastened about 10 in. from one end, and a light but strong line is attached as indicated. The current propelled this device across the river, the light rope was tied to a heavier rope and this to the telegraph wire.—O. Johnson, Pahaitua, New Zealand.

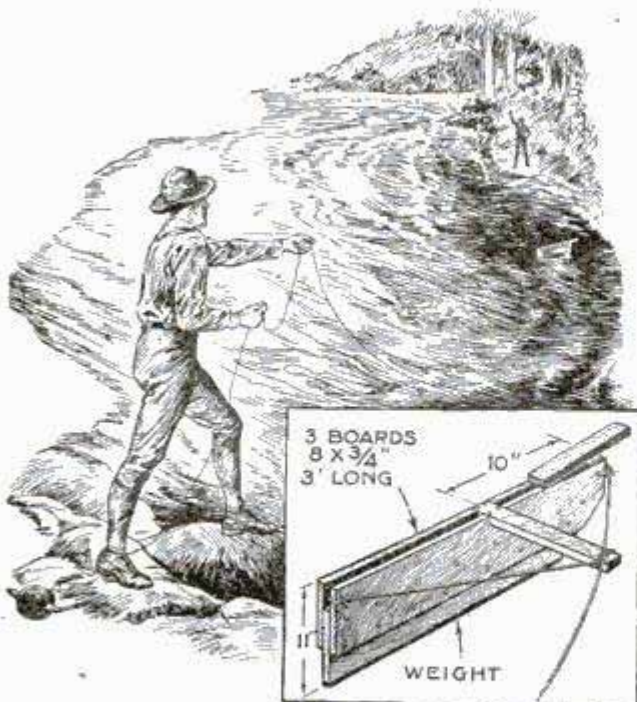

Device Which Proved of Great Help to Get a Telegraph Line across a Flooded River

Tape Holder on a Belt Rack in Stock Room Facilitates the Measurement of Belting

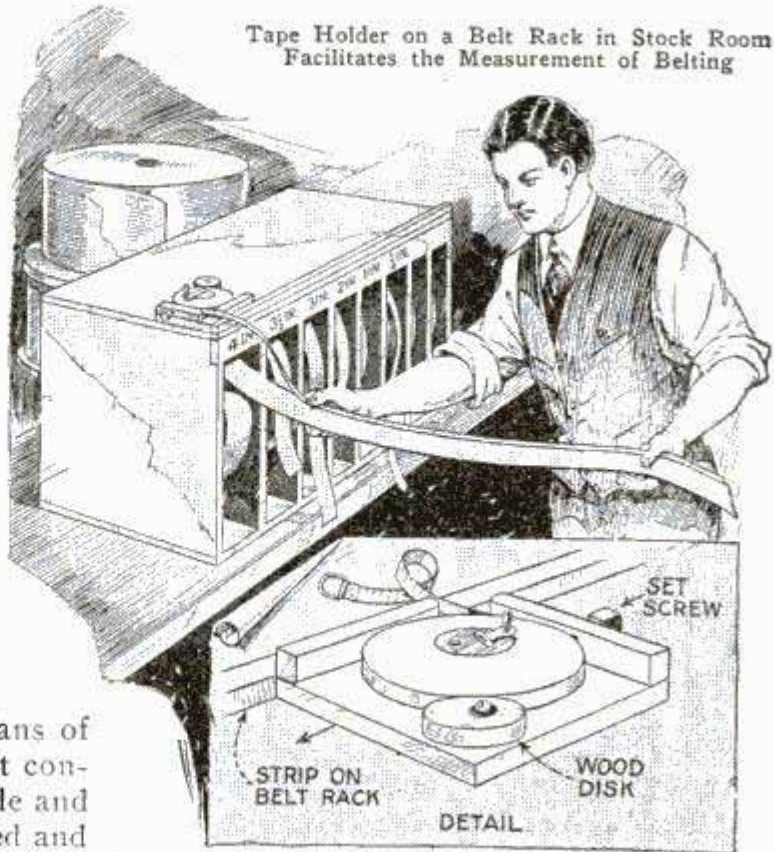

### Tape-Line Holder for the Stock Room Saves Time and Material

The holder shown in the drawing will save many broken tape lines in the stock or supply room when used to measure belting, etc. It consists of a square wood base, with two strips nailed at right angles and a space left between them at one corner for the line to run through, and a wood disk, such as a barrel bung, fastened to the base with a wood screw. The screw is placed off center so that, when the disk is turned, it will clamp the tape securely. The holder can be moved along the top of the rack to the belt to be measured, a wood strip being nailed on the top edge of the rack to prevent the holder from pulling off when the measuring is being done.—D. S. Jenkins, Xenia, Ohio.

### Cutting and Bending Sheet Iron

We had considerable cutting and bending to do on a piece of sheet iron. Instead of marking the iron, we made an ink drawing on paper, which was much easier to do than marking off the design on the iron. The drawing was glued to the iron, and drilling, cutting and bending were then accomplished without any trouble.—W. L. Miles, Providence, R. I.



# Trucks for Unloading Autos

By L. M. JORDAN

**T**HE task of unloading automobile bodies and chassis from railway cars with ordinary trucks is quite hard. To make it easier, a Ford dealer built the two special trucks shown in the accompanying drawing and photos. They were constructed of iron pipe and fittings, securely joined by welding.

The right-hand photo shows a truck which is used for unloading bodies. The wheels and axle of an ordinary loading truck are used. Two lengths of 1½-in. pipe, bent to a V-shape, are bolted to the axle and serve as braces for the frame, to which they are welded. The latter, of 1½-in. pipe, consists of two sidepieces, which extend to serve as handles and are welded to the braces, three crosspieces and two short pipe nipples welded to the top of the sidepieces near the handgrip end. In use, the car body is lifted at one end until the truck can be run under it and the front of the body passes

over the two nipples on the handles. These prevent the body from slipping on the truck when the handles are pulled down.

The other photo shows the truck made for unloading chassis. Another set of loading-truck wheels with axle is used. A V-shaped or triangular frame is attached to the axle and the ends are welded to a single 2½-in. pipe, serving as a tongue. A 20-in. length of the same stock is welded to the underside of the tongue near the handle end, to serve as a rest when the truck is set down. A smaller V-shaped frame, of the same-size pipe, is welded, vertically to the axle, to the rear end of the main frame. A piece of 3-in. pipe, 8 in. long, is welded on top of the smaller frame and to the tongue. A 3½-in. sleeve union, drilled to receive two short pieces of ½-in. iron rod, which are welded in the holes and extend horizontally on opposite sides, is slipped over the 3-in. piece and left loose. The outer ends

Inconvenience Caused by the Use of Ordinary Trucks for Unloading Auto Bodies and Chassis from Railway Cars Can Be Overcome by Providing Two Specially Made Trucks of the Kind Shown in the Photos

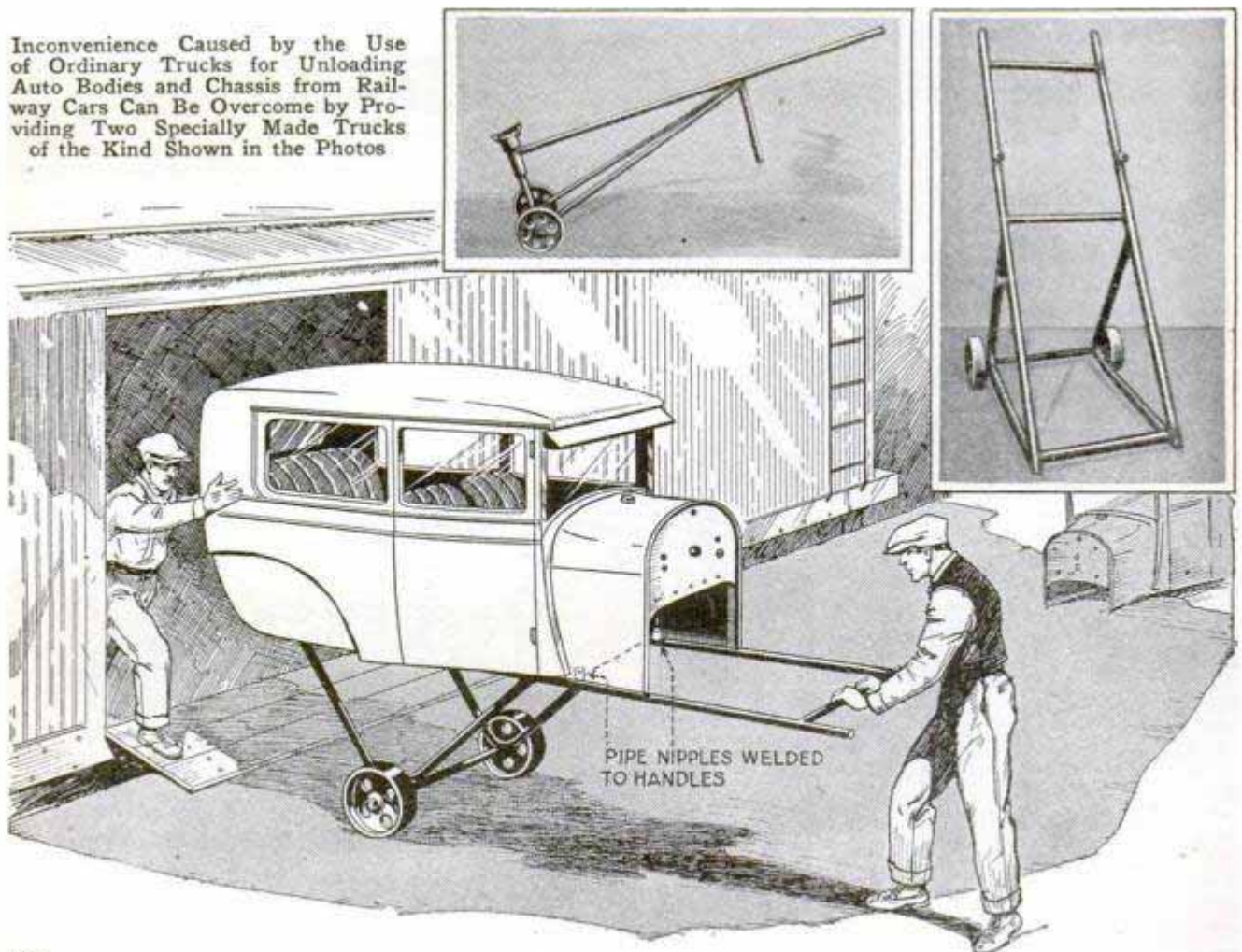



of the rods are bent upward, as shown. When loading, the rear end of a chassis is raised until the truck can be run under it to a point where the oil-drain plug in the underside of the flywheel or clutch housing can be let down into the sleeve, while the housing rests on the bent rods. This holds the chassis securely. The handle or tongue is then brought down, balancing the chassis on the truck so that it can be readily wheeled about. The drive-shaft housing rests between a fork of bolts near the handgrip.

### Torch Illuminates Writing Pad

Night clerks in railroad yards or manufacturing plants, or anyone who has to do writing at night out of doors, will appreciate a light on the writing-pad holder, as shown in the drawing. It is made up of a 3-cell flashlight battery, an auto dash lamp with switch incorporated, two small angle brackets, a spring clip and a few lengths of wire. Attach the battery to the top of the writing-pad holder. In order to make room for it, the writing-pad clip may have to be moved down. Screw the angle brackets to the board so that they make contact with the positive and negative ends of the battery. Also attach the spring clip so that the battery will not easily be dislodged. The dash lamp is fastened on next, the method of doing this depending on the particular construction of the lamp used. Connect the wires to the lamp and to the brackets. A good electrical connection to the latter can be made by inserting a soldering lug over the end of one of the screws holding the bracket and then driving the nut down tightly.—William C. Thomas, Chicago, Ill.

White woodwork can be kept fresh by rubbing it with a moistened cloth dipped in whiting; the surface should then be washed with clear water and dried.

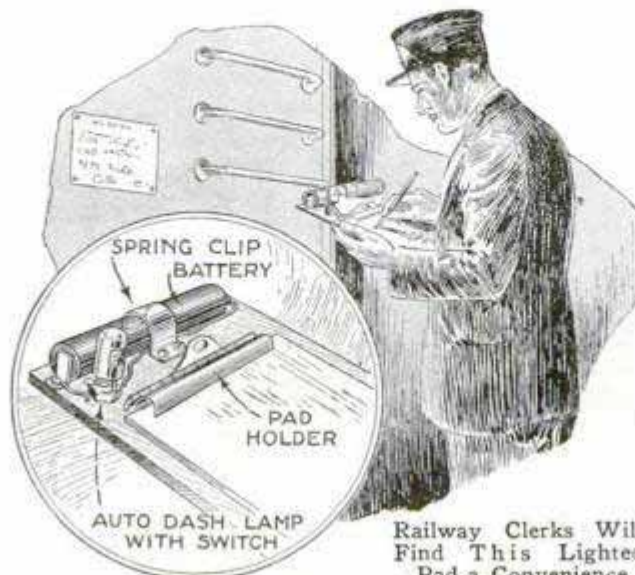

High Folding Ladder for the Tree Trimmer Is Attached to an Auto Trailer

### Help for the Tree Trimmer

For years Mr. Corliss, of Alhambra, Calif., has worked at trimming trees, and has experienced difficulty in finding a secure platform of adjustable height, which was at the same time portable. He devised an auto trailer fitted with an extension ladder, as shown, and this was found satisfactory. It folds to a height of 10 ft., can be extended to about 25 ft., and is secure so that the worker can mount it with perfect safety. It is also provided with wheels and fitted with a connecting tongue by which it can be towed. The ladder support is lifted off the ground when the trailer is being towed.—John Edwin Hoag, Los Angeles, Calif.

Railway Clerks Will Find This Lighted Pad a Convenience



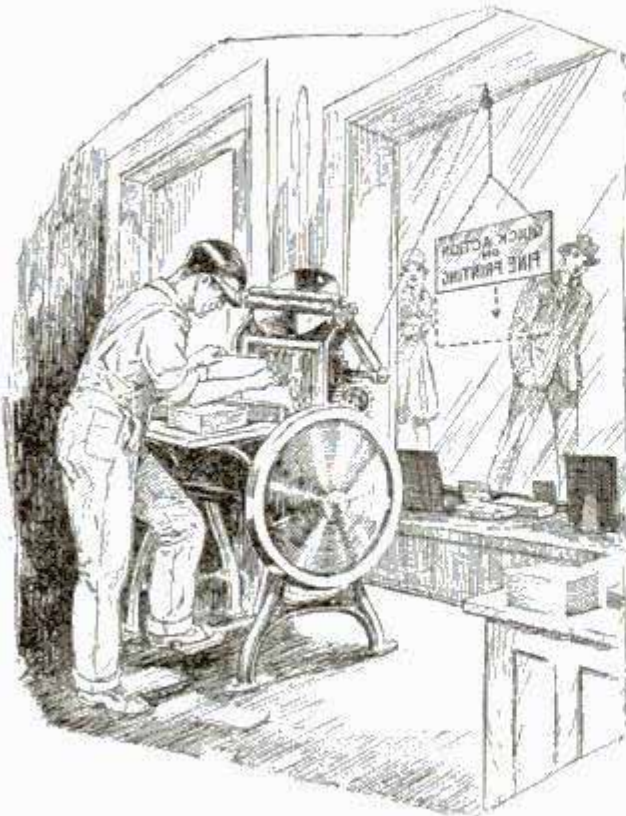

This Motion Sign Is Actuated by the Printing Press and Attracts Considerable Attention

### Motion Sign Advertises Printer

Motion usually increases the effectiveness of advertisements. The sign shown in the drawing was arranged by a printer in the following manner: One of the Gordon presses was located near the front window. A pulley was driven into the top of the window frame near the glass and a length of stout cord run over it, one end of the cord being attached to the roller frame of the press, and the other to the sign. When the press is in operation, the sign moves up and down. If the press is not situated near the window, a longer cord can be run over two or more pulleys to reach the press.

### Draining Oil from Wooden Barrels

In some places where heavy fuel and lubricating oil is delivered in the ordinary 40 to 50-gal. wooden barrels, the bung is taken out and the oil removed by allowing it to run out. Then the bung is replaced and the barrel placed in a tank of hot water for about an hour. This treatment heats and thins the oil so that it drains out completely when the bunghole is again opened. Unless wooden barrels containing heavy oil are subjected to such treatment, from 3 qt. to 2 gal. of oil will

be left in each. This is no exaggeration, as I have taken barrels which had been set out as completely empty, placed them in a hot-water bath, as described above, and then drained more than a gallon of oil from some of them. The treatment is particularly useful during winter when the oil is congealed. Storing the barrels in a hot and dry place will help to make the oil more fluid but will soon destroy empty barrels. The hot-water treatment will not injure them in the least.—James E. Noble, Hollyburn, Can.

### Closing Small Leaks in Pipe Fittings

To close a pinhole in a cast or malleable-iron pipe fitting, take ordinary tin or lead foil, fold it to form several thicknesses and place it over the hole. With a small hammer drive the foil into the hole. This will usually stop the leak permanently, whether the pipe carries air, gas, hot or cold water or other liquids. But the method is not effective for leaks in steam pipes. Sometimes a pinhole in a malleable-iron fitting on a steam line can be closed by hammering the metal over the hole, but this cannot be done, of course, in the case of cast-iron fittings.

### Tool for Driving Fence Posts Single-Handed

Usually it takes two men to set steel fence posts, one man to hold the post

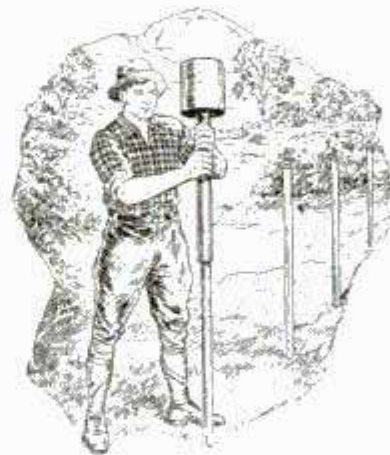

while the other is driving it into the ground with a sledge. The work can, however, be done single-handed by using the home-made tool shown in the drawing. It consists of a

length of pipe, large enough to be slipped over the fence post, and a weight securely attached to the top end. The weight can be made by setting one end of the pipe in a pail and pouring concrete around it.—John B. Smoller, Atlantic, Iowa.



# Build Your Own Garage

by R. O. BUCK and  
H. W. MICHELSON

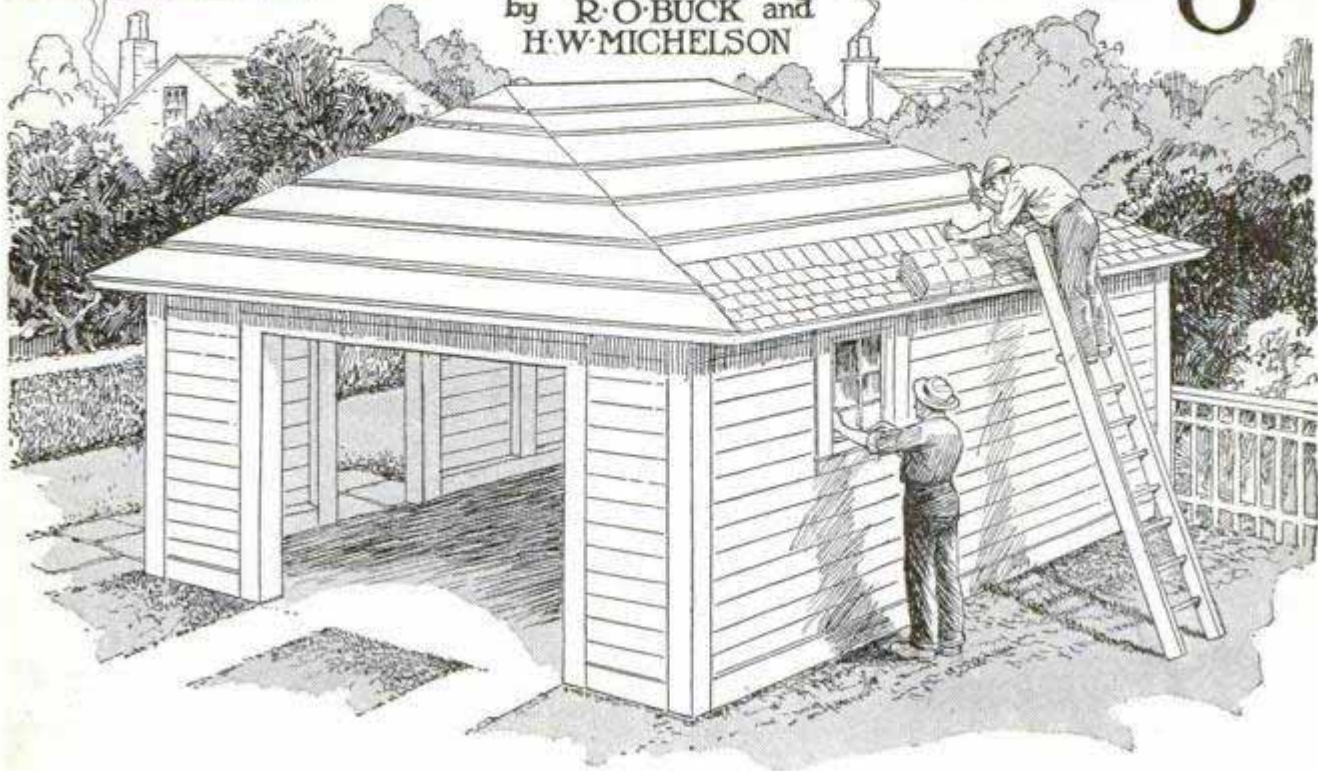

## PART I

A GREAT many men who are handy with tools and build little conveniences into their homes hesitate about tackling so large a project as a garage, because they fear it will be beyond their ability. With this in mind, it should be stated at the outset that one of the writers constructed the garage illustrated herewith during a two weeks' vacation, altogether unaided, and derived considerable pleasure from it, not to mention the profit.

There were two considerations which led me to build my own garage; first, because I wanted the pleasure of building it, but principally because I had more time than money. My experience was so altogether satisfactory that I think it is worth passing on to you.

My garage is a well-built and

roomy structure, large enough to house any make of car and with sufficient space on the sides for a workbench, shelves, etc. The floor is of concrete, pitched so that water will run off through a drain at the center. The garage faces the front, making it necessary to build tracks of cement to the street. This part of the work I did not attempt, but had a contractor put them in after the garage was completed, at a cost of \$140. For an additional \$60 he

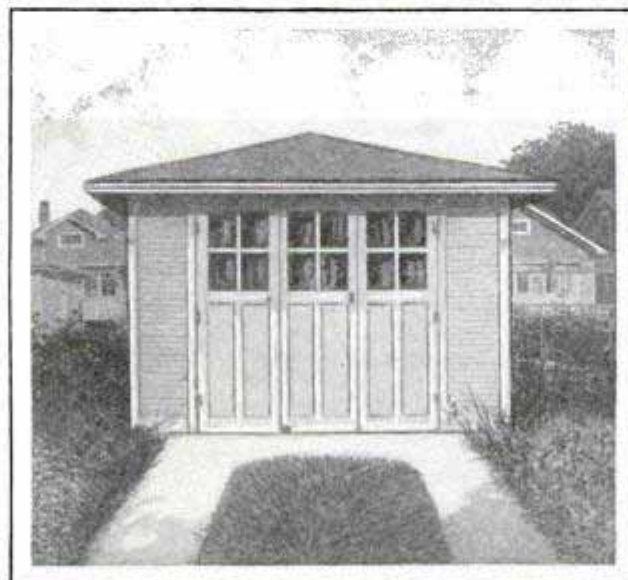

would have put in my cement pad also and I would have been saved some rather hard labor. However, I did this work myself at a fraction of the cost. If you have a good alley that stays dry and is passable the year around, you can save the expense of the tracks; mine is low and inclined to be bottomless at some



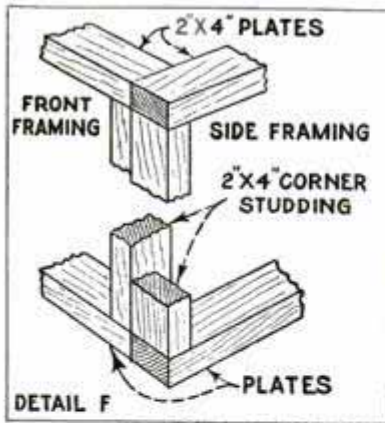

seasons of the year. In locating the garage, I made use of some valuable tips from my neighbor, who had always

about 6 in. of surface soil between the wall trenches for the floor. Around the outside of the trench, I placed wood forms, as shown in the sketch. In order to fasten the structure securely to the cement pad, a set of bolts were used as shown in both Figs. 1 and 2. I cut the 2 by 4-in. wood sills to exact length, drilled holes as shown, and placed 1/2-in. bolts in them, with the heads down and

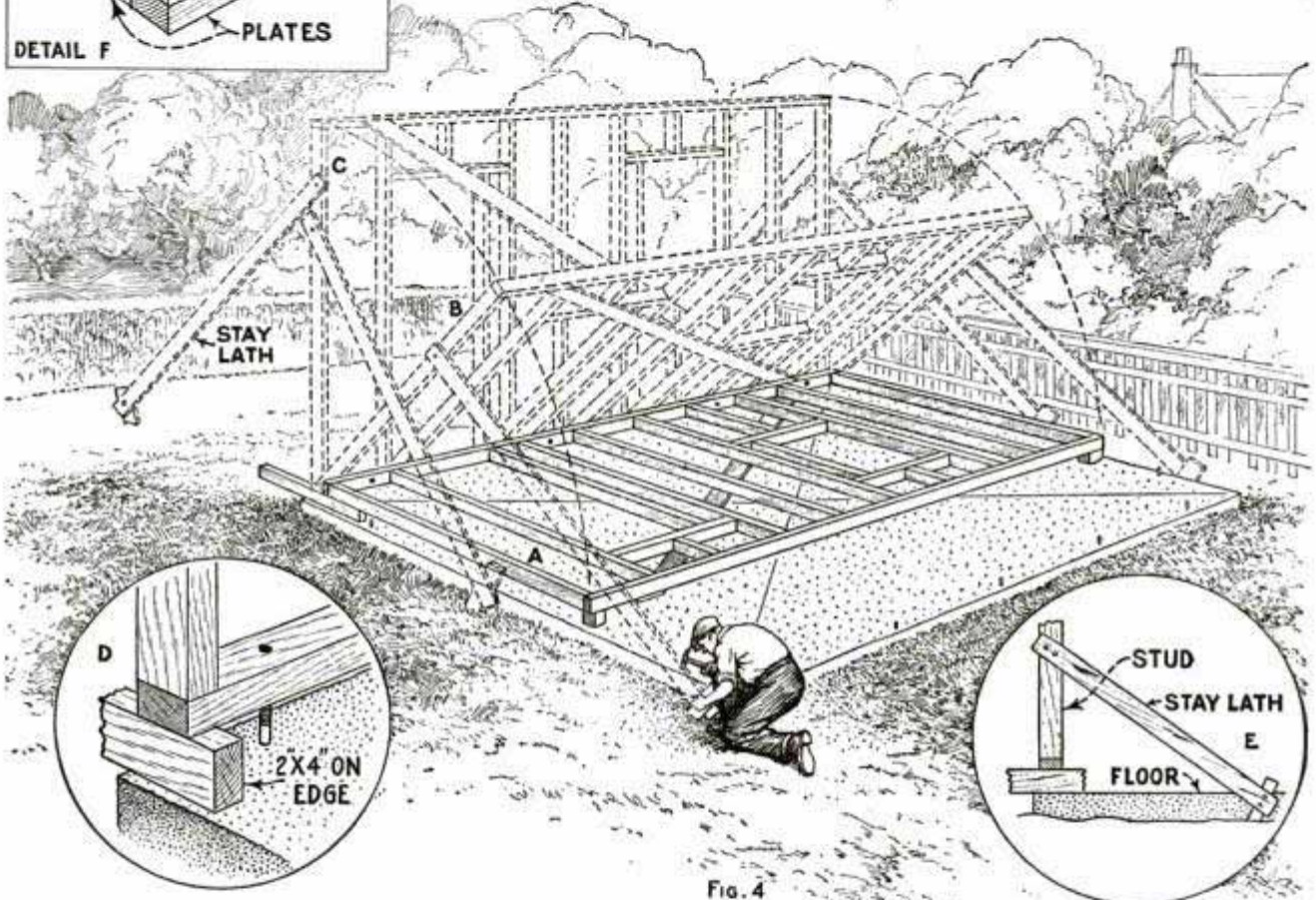
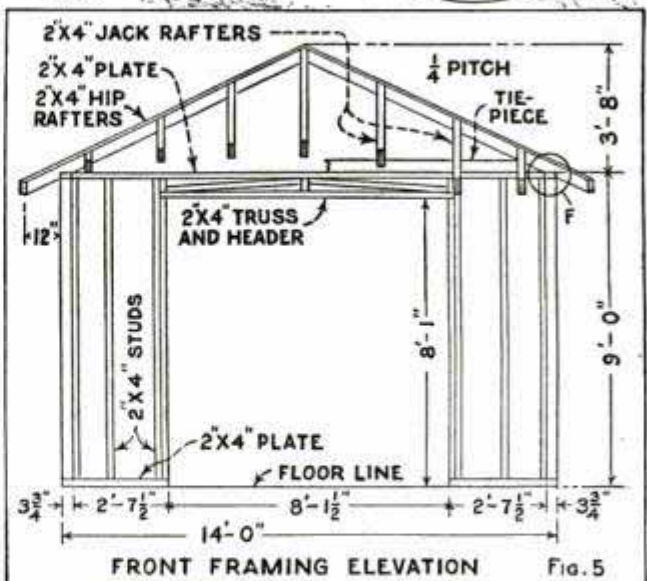

Fig. 4

encountered considerable difficulty in backing his car from the garage to the street without running off the tracks, because he had to round a curve and back up a grade as well. I placed my garage directly in line and nearly level with the street for this reason.

It took me two days to lay the cement pad which served as both wall and floor. Incidentally, this proved to be the hardest part of the whole job from the standpoint of physical labor.

The floor of the garage was laid 2 in. above grade so that surface water would not come in under the door in the spring or during rainy weather. A section through the floor and wall is shown in Fig. 1. I dug a trench, 18 in. deep, all around the outer edge of the plot I had staked off for the pad and also removed



the nuts turned on. The sills were then put in position across the forms and fastened with light strips of wood for brac-



ing. The purpose of all this, of course, was to space the bolts in the concrete to coincide with the holes in the sills. Do not fail to mark these pieces both as to side and end so that you can replace them later.

To square up the sides and ends, I took

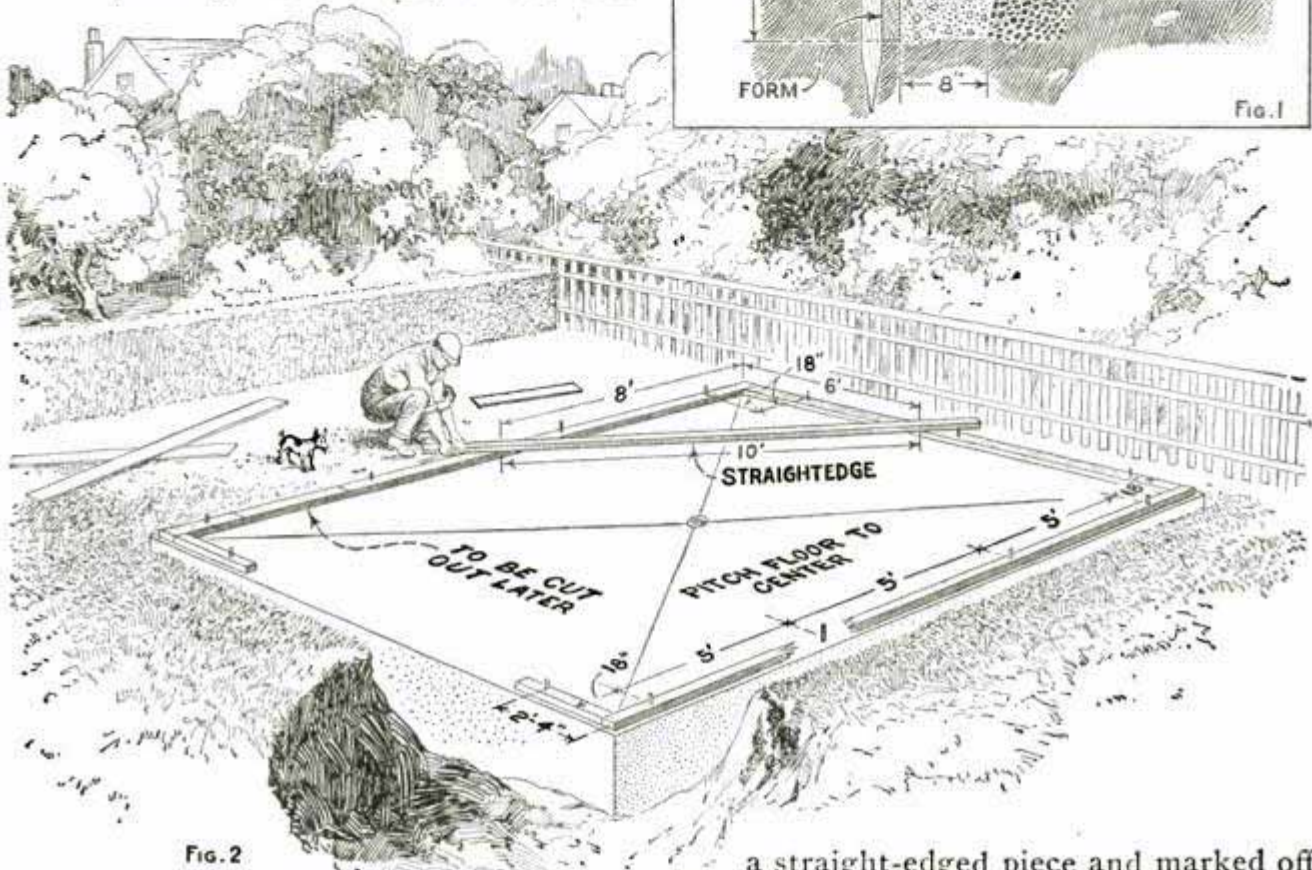
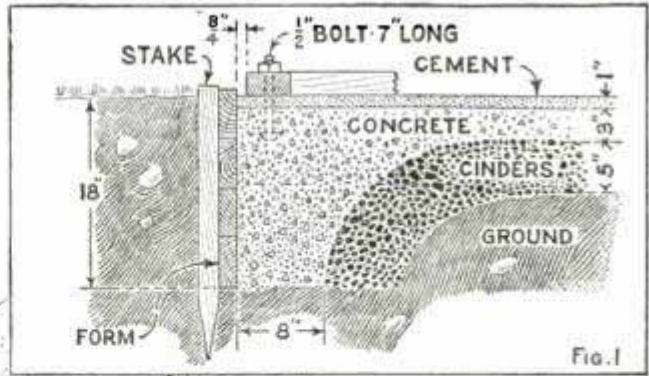

Fig. 2

a straight-edged piece and marked off exactly 10 ft. on it, after which I measured 6 ft. along the end form and 8 ft. along the side form, as shown on Fig. 2. With the straightedge on these two points, the distance between them diagonally should be 10 ft. when the corner is square. Check the adjacent corner also.

The cement pad was made up of a layer of cinders, well tamped and about 5 in. thick, 3 in. of concrete, and 1 in. of cement. Cinders are often omitted on work of this type, but are specified in all first-class jobs and the result, I believe, is better. The wall, of course, was concrete all the way with the exception of the 1 in. of cement at the top. The concrete was mixed in the proportion of 1 part cement, 3 parts sharp sand and 5 parts gravel. For the finishing coat I used 1 part cement to 2 of sand.

It is important that the cement be well mixed with the sand and gravel

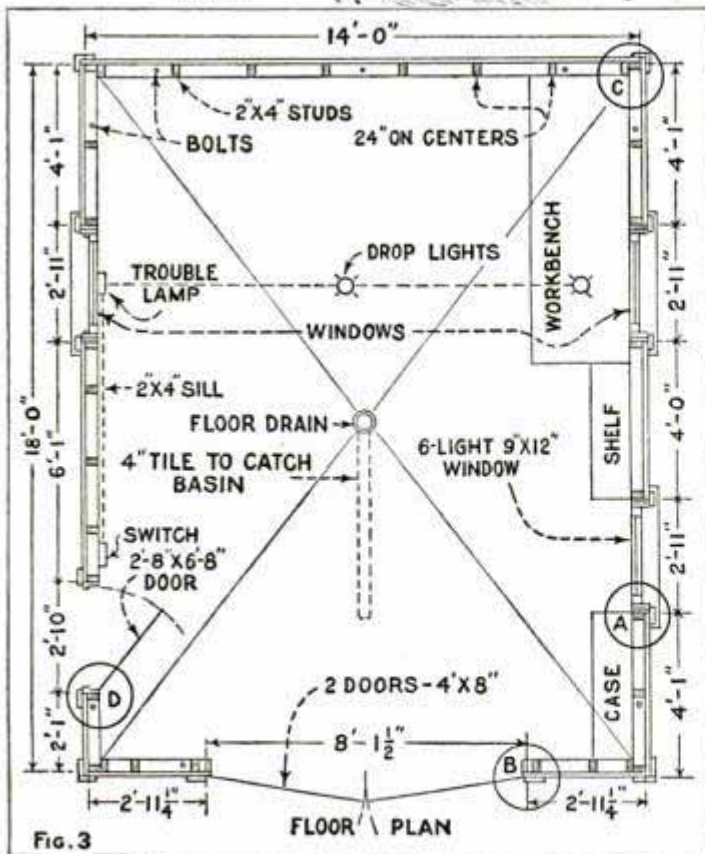

Fig. 3



before adding the water and again after this is done. I mixed the cement in a steel wheelbarrow, which made it much easier on my back and saved an extra handling, as I could wheel the mixture to the part of the floor I was making and simply dump the load. The mixing, of course, I did alongside the pile of sand and gravel.

The drainage of the floor, as mentioned previously, was planned toward the center. I ran a 4-in. tile line from the center of the floor to the catch basin, with a fall of 1 ft. in 25, as the distance was not very great. If the soil is very sandy where you are building your garage, you may be able to use a seepage tank for drainage purposes. This consists of an old oil barrel, well drilled with large holes and buried 1 or 2 ft. under the center of the floor. The concrete over the top of the barrel should be reinforced with some old iron rod or pipe to strengthen the concrete after the barrel rots. The seepage tank will take a reasonable amount of water at a time and is much easier to build and less expensive than the tile. Another way, of course, is to slope the floor toward the large doors so that the water will run out under them.

The concrete was allowed to set several hours before the finishing coat was applied. A plank was laid from one sill to the other to kneel on while finishing the center of the floor with a cement trowel, after it had been scraped to proper slope with a long straight-edged board in the usual way.

After allowing the floor to dry three days, I took out the forms, planned my framing procedure and started this part of the job. One of the greatest problems I had was how I was going to handle the job of framing alone, as none of my neighbors were home during the day. I found, however, that I could cut most of the material in advance and began with the plates, corner studs, etc. The sills were all cut and ready, as they were used to space the bolts in the concrete.

I had the framing material all laid out on the ground when it occurred to me that, by framing the corners as shown in detail F, Fig. 4, I could assemble each wall complete on the floor, then raise it into place and nail all together when done. Starting with a side wall, I securely spiked

the members of the wall together. The spacing of the studs, headers, etc., is shown on the floor plan and also on the side and end elevations, Figs. 3, 5 and 6, respectively.

It is advisable to check all measurements very carefully before cutting any of the material, as I found to my sorrow when I cut the material for both sides the same, neglecting to take into consideration that, while one side has a window and a door, the other side has two windows. The framing should also be squared carefully by using the 6, 8 and 10-ft. rule described previously.

After the side walls are all framed they should be held square with temporary diagonal braces, as shown in Fig. 4. These braces should be nailed on the inside of the frames so that they will not interfere with siding, and may be left on until the garage is finished. Fig. 4 shows one side assembled and ready to be raised. There were two problems to be solved in connection with this operation. First, the sill had to be raised above the level of the anchor bolts, yet in line with them so that the holes would coincide with the bolts and the frame could be dropped into position. It was also necessary to swing the frame to a vertical position. Of course, if you have some one to help you, this does not present such a problem, but I had to do it alone and I found it rather heavier and more unwieldy than I could manage conveniently.

The first part I accomplished by placing short pieces of 2 by 4-in. stuff, on edge, under the sill to raise it above the bolts, as shown at D, Fig. 4. To raise the assembled framing sections, I nailed stay lath on each end, as shown at E, Fig. 3, so that I could raise one end a few inches, brace it, then walk to the other end and treat it similarly. By repeating this operation, raising each end a few inches at a time, I was able to get the whole thing in position without much effort. As soon as it was vertical, I nailed stay lath from the other side as well, which held it into position until the blocks could be removed and the sill dropped over the bolts. After testing the wall with a level to be sure it was plumb, I secured the stay lath with additional nails, placed the washers and nuts on the bolts and tightened them.



The assembly and raising of the other side was accomplished in the same manner. The back framing being very simple and light, was swung into place easily.

The front framing elevation, Fig. 5, gives full dimensions for making a truss over the doorway so that it will not be necessary to put heavy timbers across the door span, as is the usual practice. Good tight joints are very important in the truss, however, as its strength depends on the bracing of the various members.

Care must be taken before nailing the corner studs into place that the structure is square and plumb. Detail F shows the method of

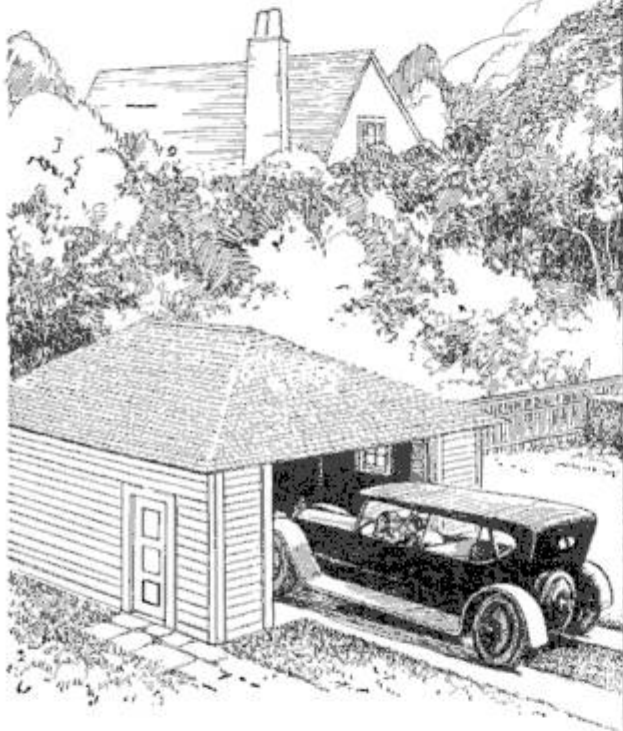

fastening the corners together. The three tie-pieces may be nailed into place at this stage, as shown on the roof-framing plan, Fig. 7. Their purpose, of course, is to keep the side walls from spreading when the roof, and the snow load the roof will carry, are placed on them. They will also be found convenient to support planks for staging, while you are nailing the rafters in place. It is convenient, though not absolutely necessary, to have a scaffold on the outside of the structure also. This should be built at this stage if it is to be of greatest use.

The type of roof I selected, the hip roof, is not the easiest type to frame, but is so much more attractive than the gable roof, that I felt it was worth the extra work. The material required for a hip or gable

roof of the same size, is about the same, the difference being in the labor involved.

A roof-framing plan, together with a side and front-framing elevation, show

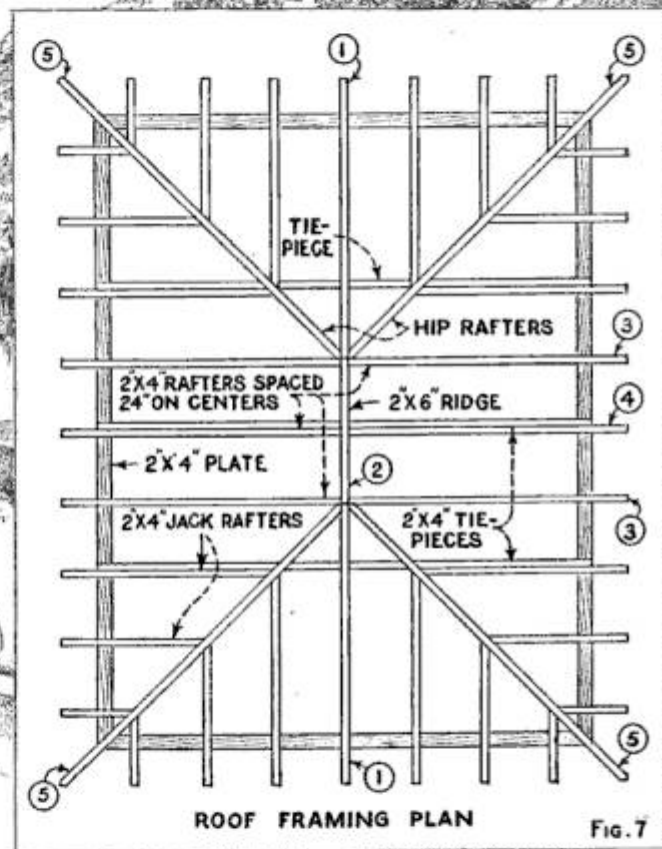

the exact size and position of the various members. A skeleton view of the entire building will be given in the second article, so that there will be no doubt about the arrangement of the various rafters.

My first step in framing the roof was to space off, and mark on the plates, the center lines of all of the rafters along the four sides of the structure. All of the rafters were spaced 24 in. from the center of one rafter to the center of the next. I started the spacing from the center of the plates, working each way toward the ends so that



any irregularity in the spacing would come at the corners where it would be less noticeable.

The various members of the roof are numbered, in Fig. 7, in the order in which I found it expedient to set them up. I started with the two end

of the rafters is as follows: A roof 14 ft. wide has a run of 7 ft. and a rise of 3 ft. 6 in., if the roof is quarter pitch, as in this case. This is equivalent to saying that it has a rise of 6 in. to every foot of run. If you place a square on your rafter so that the 6 and 12-in. marks are on an edge as shown in Fig. 9 (Part II), and repeat seven times, the length and cuts of the rafter will be determined. To this, however, must be added the width of the plate and the length of the overhang.

Of course you could figure the length of the rafters arithmetically also by getting the length of the hypotenuse of a triangle whose legs are 7 ft. and 3 ft. 6 in. That is, get

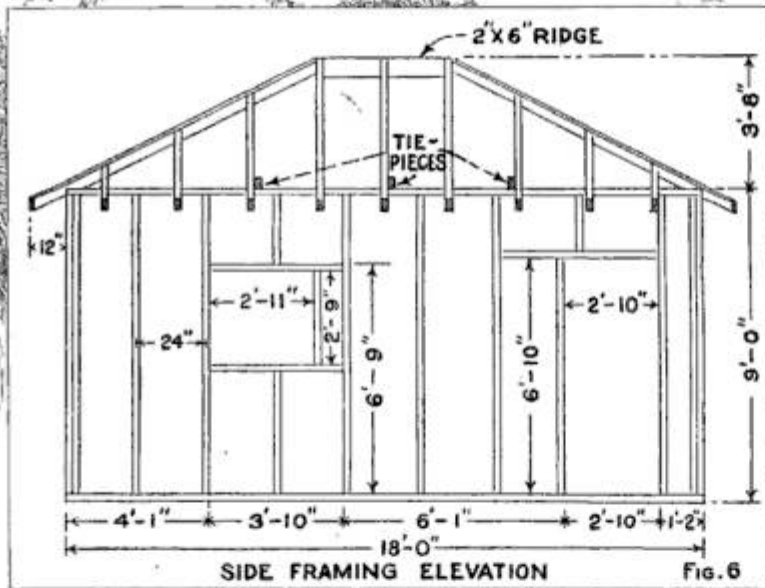

center rafters and ridge which I put together temporarily with cleats, then raised and fastened with stay lath. They must be perfectly plumb, of course, as they are to be used as a guide to measure others.

It is rather difficult for an amateur to cut all of the roof members in advance; however, if all of the rafters are cut "on the ground" and put into place, they will serve as a framework to which the hip and jack rafters can be fitted readily in the order suggested. Rafters 1, 3 and 4 are all the same length. Also the slope of the sides and ends of the roof are the same.

The method of determining the length

the square root of the sum of the squares of these two sides. (Get out the old school book and dig up the method for extracting the square root!) The slant of the cut can be obtained with the square as in the first method.

After all the rafters have been spiked into place, the roof framing is complete. It took me all of one day to do this part of the job, but I encountered no special

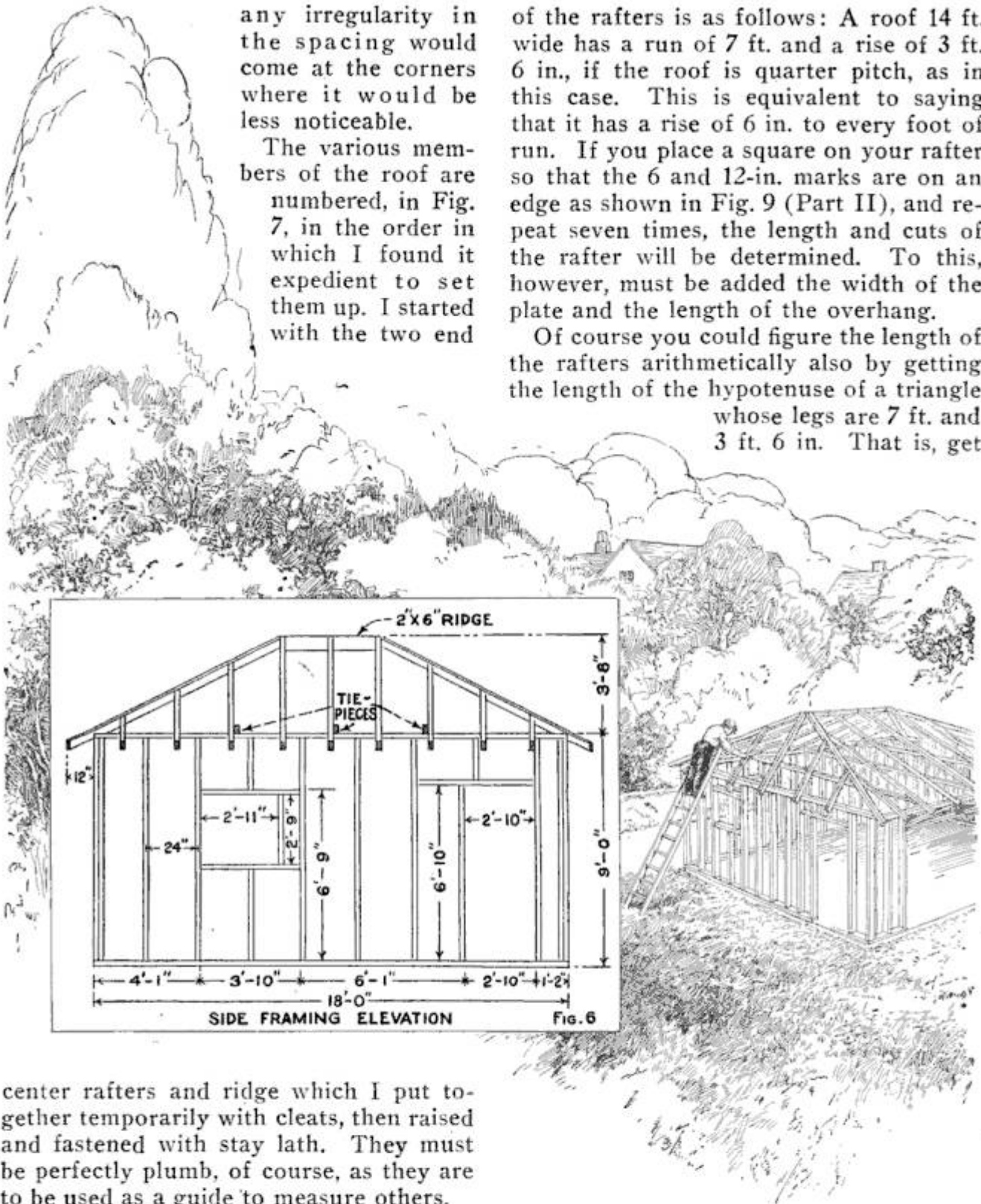



difficulties and do not believe that you will have any trouble with this part of the job.

(To Be Continued Next Month)

### Preventing Tractor from Rising

To prevent his tractor from rising unexpectedly at the front end while disking, a Mississippi farmer fastened one end of a strong chain to the front axle and the other end to the disk harrow. This helped greatly in holding the front end down, as it could not rise until the chain was slackened. When arranged in this way, the tractor is held down by the weight of the implement it is pulling as long as the chain remains taut.—Bunyan Kennedy, McCool, Mississippi.

### Permanent Stop Sign on Railroad Tracks

Sometimes the blue flag on railroad sidings, rip tracks or yards is forgotten, or is not placed at the proper location. This can be corrected by using a permanent sign, as shown in the drawing. It is made of sheet steel, a hinged joint being provided so that the sign can be dropped on the ground between the tracks when desired. It should be flat enough so that workmen will not trip on it accidentally. As such a sign is in view at all times and therefore is a constant reminder, it will not be forgotten easily.

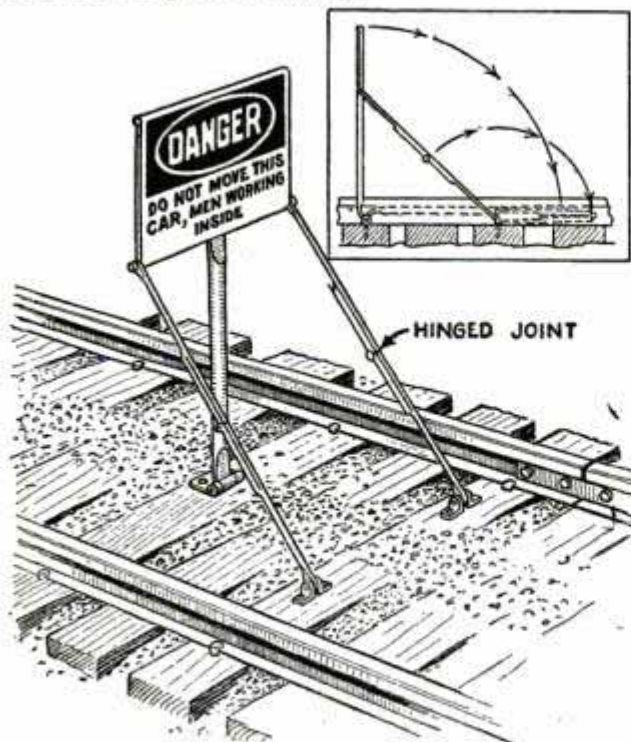

Collapsible Stop Sign on Railroad Sidings Is Always Ready for Use

The Manipulation of a Heavy Electric Rock Drill May Be Made Easy by Means of a Simply Arranged Counterweight as Indicated or in Some Other Convenient Manner

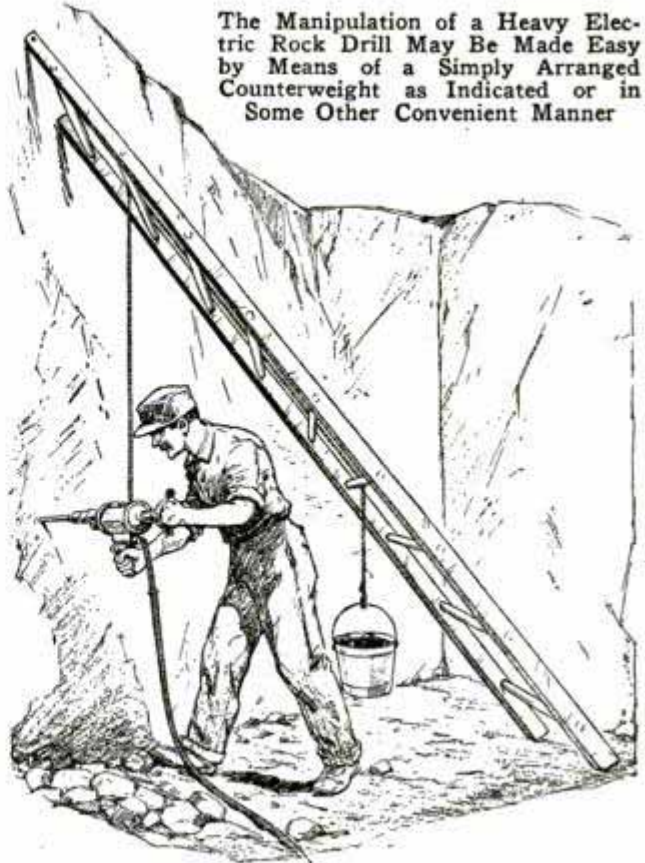

### Counterweight for Electric Rock Drill

When preparing a site for a power house, considerable rock drilling was necessary. To make the work easier, the heavy electric drills were counterbalanced, as shown in the drawing, with the result that much labor and time were saved. A ladder was set in the position indicated and a length of sash rope, one end of which was tied to the drill and the other end to a pail, was slipped over a few rungs of the ladder. Enough sand was put into the pail to balance the drill. The same method can, of course, be applied equally well to other heavy tools and machines, which must be lifted by the operator while using them.—I. R. Hicks, Centralia, Mo.

### How to Clean White Tile

Tile walls in bathrooms are usually washed with soap and water when they become dirty, but it has been found that, so treated, they soon show a series of tiny cracks which in time become larger. The water causes the trouble, not the soap. To prevent cracking, rub the wall with a soft cloth soaked in turpentine. Kerosene may also be used for this purpose.—L. H. Georger, Buffalo, N. Y.



### Making Brake Bands Round

An important but often neglected part of relining auto brake bands is to true



Cast-Iron Rings Used as Forms on Which Auto Brake Bands Can Be Hammered True

the bands so that they are perfectly round before putting them back on the drums. We had considerable trouble in this respect, so we had a number of cast-iron rings made at a local foundry, to accommodate all the regular sizes of brakes. The rings were chucked in a lathe and those intended for rounding internal expanding bands were bored out, while those intended to be used for the contracting type of band were turned to the same diameter as the drums. The method of using the rings is plainly shown in the photos. The contracting band, after being relined, is placed around a ring of the right size, drawn tight and gone over lightly with a hammer until it is properly shaped. For the expanding type, the relined band is slipped down inside the right-size ring, expanded and then hammered to shape.—Avery E. Granville, LaGrange, Ill.

### Cleaning Nozzle of Blowtorch

The nozzle of a gasoline blowtorch often becomes clogged with dirt. As the opening is too small to permit the insertion of a wire to clean it, and the nozzle is at the back end of the burner opening, it cannot be reached for blowing the dirt out. A good method of cleaning is to remove the needle valve and the pack nut, and pour out enough gasoline to eliminate the pressure. Then get a short piece of copper

tubing that will enter the burner end and fit squarely against the end of the nozzle. The dirt in the opening can then be removed by compressed air or by blowing through the tube. As the needle has been taken out, the dirt will be forced back through the opening and out of the torch.—E. T. Gunderson, Jr., Humboldt, Iowa.

### Valve-Grinding Kink

When grinding valves, the compound used works away from the grinding surfaces and more has to be supplied, especially if the valve is badly pitted. This is necessary, because the compound will not flow back when the pressure forcing it from between the grinding surfaces is removed. A good mixture to use for this purpose consists of ordinary grease and abrasive compound. First heat the head of the valve with a torch, until you can barely stand to touch it with the hand. When the mixture is applied, it will melt and run together when the valve is lifted. This keeps the abrasive on the grinding surface.

### Cable Stand for Linemen

Cable reels are heavy and hard to raise without special equipment. The task can be made much easier by the use of an

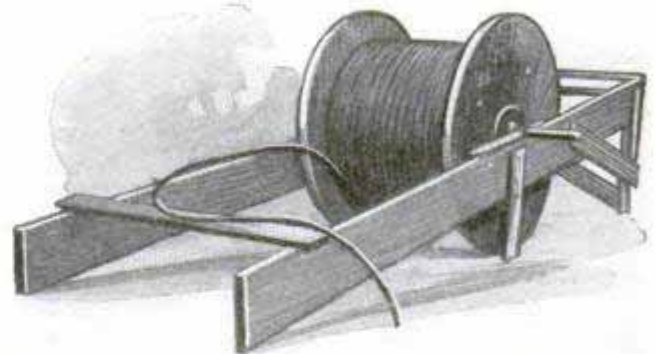

Wooden Frame Serves as an Emergency Cable Stand for the Lineman

emergency stand as shown in the photo. It consists of a 2 by 12-in. frame, set in the position indicated. After putting a length of heavy pipe through the core, the reel can be rolled high enough on the frame to clear the ground. A block of wood should be nailed on to hold the pipe in place.—Carlton Groat, Portland, Oreg.



### Casting Box for Printers

Printers often receive paper matrices for making stereotypes. Those not possessing a regular casting box have to send the work to some other printer. A practical box can be improvised without any trouble. Take a chase, lay the matrix, face up, in the center, and place four brass rules around the matrix, and lock it up in the usual manner. See that the corners of the rules butt against each other so that the melted metal will not leak through when poured. Melt some lino-type metal and pour it over the matrix to the top of the brass rules. Then let it cool until hard, which can be determined by touching it with a screwdriver. When cool, the stereotype is unlocked and trimmed to the required size. To make the stereo type-high, place a 36-pt. slug against the trimmer knife on the saw and bring the gauge against it, which will give an accurate measurement for height. If no saw trimmer is available, use a piece of coarse emery cloth or sandpaper on a flat block of wood.—Samuel Rubin, Holyoke, Mass.

### Old Boiler Flues Used as Fence Posts

In a western irrigation district old worn boiler flues were used as posts when building several miles of hog fence. The flues were cut to equal lengths and were set about 8 ft. apart. The top and bottom wires were stapled to 2 by 6-in. boards, which were fastened to the flues by means of threaded U-bolts and nuts, as shown.—Ivan E. Houk, Denver, Colo.

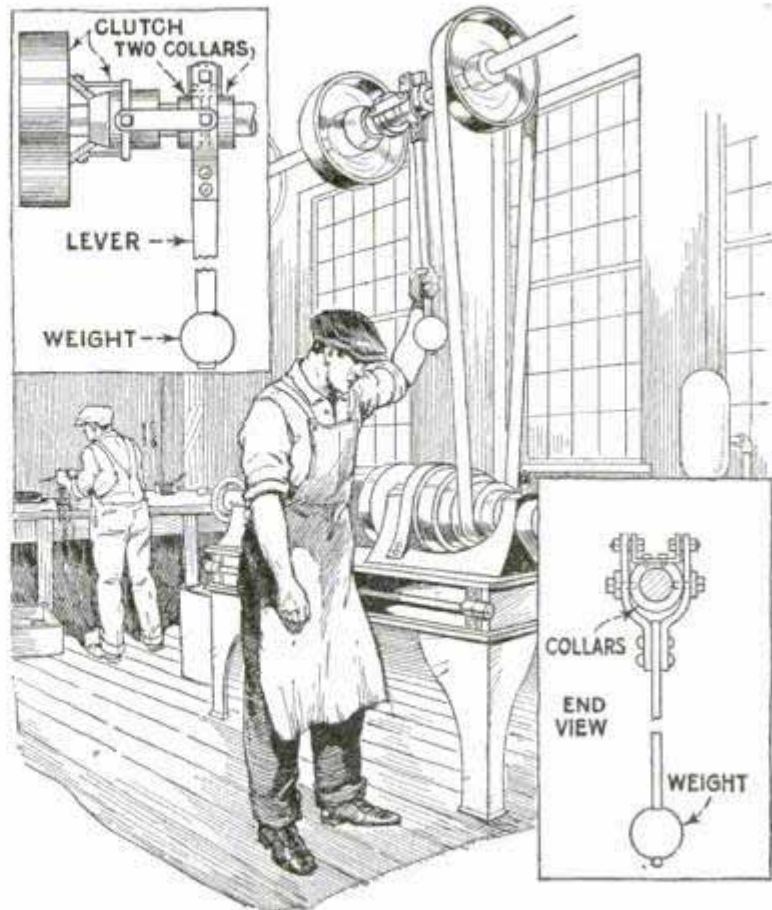
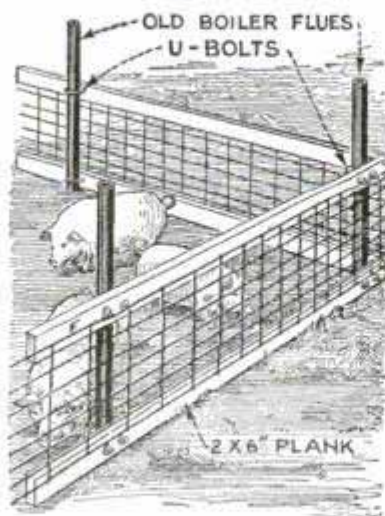

Belt and Pulley Shifters Installed Directly on the Lineshaft without Extra Support

### Belt Shifter Installed on Lineshaft

Some time ago I installed a hundred automatic machines. This was not such a difficult task but each row had to be driven individually with a clutch arrangement. Just how to arrange the shifters was a problem, as there was no ceiling, wall or any solid support near the lineshaft. However, the novel type of shifter illustrated, installed directly on and supported entirely by the lineshaft, was found a satisfactory solution. While the exact dimensions depend, of course, on the size of the shaft, etc., the drawing shows the construction of the shifter. In this case three standard  $1\frac{15}{16}$ -in. collars were used. One was flattened for the handle or pivot bracket and was made a running fit between the two others, which were securely set on the shaft.—F. W. Schrader, Woodstock, Can.

☐ A large spring cotter may be converted into a serviceable pair of tweezers by grinding the open end to a point; before grinding, wrap the cotter with a string, near the eye, to close the open end.



### Paint-Removing Fitting for Blowtorch

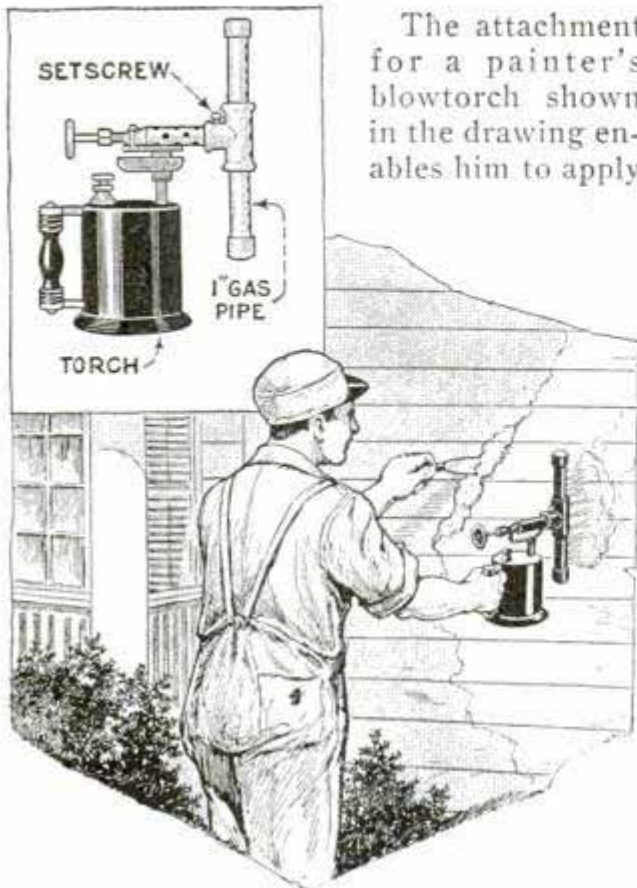

The attachment for a painter's blowtorch shown in the drawing enables him to apply

Pipe Attachment on the Painter's Blowtorch Applies the Flame Uniformly

the flame more uniformly over the painted surface, previous to scraping, and this feature is of special advantage on windy days. It is made of 1-in. pipe and fittings, drilled with  $\frac{1}{4}$ -in. holes, to permit the escape of the flame, and provided with a setscrew so that it can be securely attached to the nozzle of the torch.—G. E. Hendrickson, Argyle, Wis.

### A Simple Magnetic Chuck

A machinist friend of mine recently had occasion to put into shape some of the plates of a meat grinder. General machine shops are often called upon to resurface these, so that the little device used by him for holding them on a lathe faceplate will be of interest. It consists of an old U-shaped magnet, the kind that is used in magnetos, and is fitted with a block of soft wood between its sides, the wood being fastened with a couple of screws. Through the center of the block a hole is drilled, large enough to take the tip of the plate. A small screw was driven into the block to engage the plate

and afford a positive drive, and the device was ready for use. In order to prevent the magnet from losing its strength, an iron bar is kept across the two ends.—E. P. Shockey, Bowling Green, Ohio.

### Keep Your Watch Clean

Some years ago, I met a man who said that he could wear his watch several years without having it cleaned. He turned his watch pocket inside out, and showed his trick. He had provided a buttonhole in the bottom of the pocket, which allowed the dirt to sift through, and the watch was always in a clean pocket. Many workmen cannot help getting dirt and sand in their pockets, and if they let it remain there, the watch will get dirty and cease running very soon.—A. L. Neuenchwander, Miami, Fla.

### Focusing Cloth for Windy Days

Photographers who engage in outdoor photography are frequently inconvenienced by the difficulty of keeping the focusing cloth in place, especially on a windy day. The cloth is also likely to be blown away when left on the camera. To avoid such annoyances, one photographer sewed a length of small chain to the hem of the cloth. This weighted the cloth sufficiently to hold it in place.



Small Chain Sewed to the Edge of a Focusing Cloth Makes It Easier to Handle



## Gluing Ivories on Piano Keys

By F. R. RODGERS

**A**LTHOUGH usually a troublesome job, re-gluing of the ivory tops on piano keys, when they have come off for some reason or other, can be done effectively by the following method: First, the front of the keyboard should be removed. It may be necessary also to take out the screws holding the pivots, which should be done so the complete keys can be lifted from the action. When several of the ivories have come off, or are loosened, care should be taken to keep the right ivory for its particular key, for in some cases they will not interchange. Scrape all the old glue from both key and ivory with a knife.

When one simply tries to lay a block on top of the ivory and clamp with a thumbscrew in order to glue the ivory in place, it will almost invariably slip, causing part of the ivory to extend outside of the key while exposing the raw wood on the other side. To avoid this, make special blocks as follows: Rip a piece of board and plane square to the exact width of the key; the thickness is immaterial. Saw off blocks just as long as the wide part of the key, since it is usually the wide part that comes off. Cut off some pieces of thin wood as long as the blocks, and fasten, with brads or small-head nails, one on each side of the block. These side-pieces will form a groove into which the key will fit. The same result can be obtained by plowing a groove the width of the key in a suitable length of wood and then cutting it into pieces as long as the keys, although the first method is easier and just as good.

Use hot glue and warm the blocks,

which will prevent the glue from chilling and setting too quickly. Spread an even coat of glue on the key, lay the ivory on it and cover with a strip of thin paper, allowing the paper to come over the sides of the key; then push the block down over the

sides of the key and clamp, with just enough pressure to hold firmly. The ivory cannot slip sideways, and it is an easy matter to hold it forward, as the pressure is applied with the clamp. The paper keeps the glue that will be squeezed out of the joint from sticking the block fast. When dry, most of the paper can be torn off, and the remainder will yield to a little sponging with warm water. Scrape off what little glue is left on the edges of the key and re-

place it in the piano. The result will prove very satisfactory.

A word as to the glue may not be amiss. No doubt any glue will do, but the old-fashioned hot glue is best and the white kind is better than the dark, since with the white glue there is no danger of discoloring the ivory. Cook it in a regular double gluepot and do not have it too thick, as all the surplus glue must be squeezed from the joint. The glue should flow freely when hot, with about the same body as varnish. The white glue usually will not set as quickly as the general run of dark glue, although having the clamping blocks good and hot will prevent the glue from setting before the ivory can be properly fastened in them. If hot glue seems too troublesome to use, or no gluepot is available, select any good prepared glue that is rather light in color, and warm it by placing in a pan of hot water.

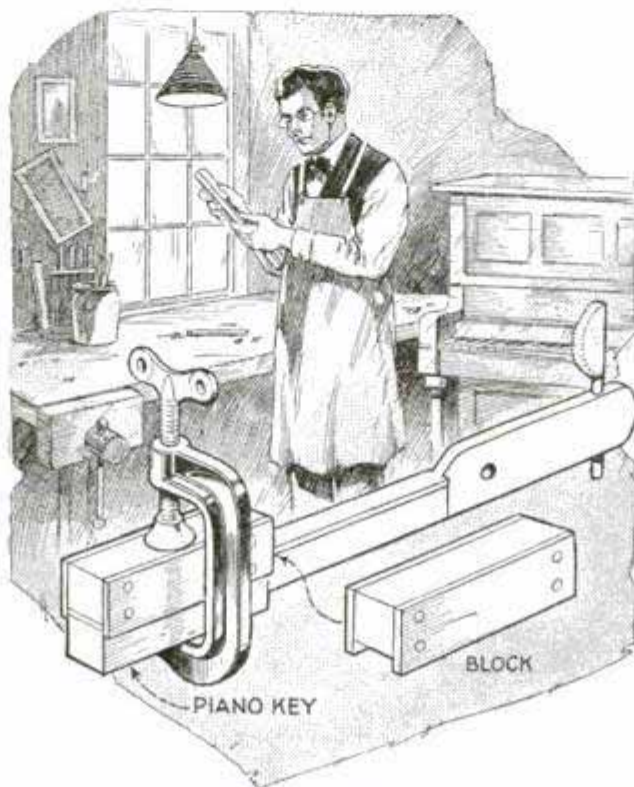

A Simple Jig for Re-Gluing Piano Ivories That Will Insure a Good Job



## Is This Your Home?



Copyright, the Architects' Small House Service Bureau

Plan No. 4A39

**Q**UESTIONS regarding home building addressed to this magazine will be answered by The Architects' Small House Service Bureau of the United States, Inc., controlled by the American Institute of Architects and indorsed by the United States department of commerce. Blueprints, specification forms, and material lists for the house shown here may be obtained from The Architects' Small House Service Bureau for a small fee. If further information is desired, literature describing the plan service and publications of The Architects' Small House Service Bureau will be sent you upon request. A booklet entitled "50 Ways to Lower Home Building Costs," illustrated by ten Bureau homes actually lived in and showing how as much as \$1,000 can be saved on a home, may be obtained for 20c.

**E**SSENTIALLY this is a four-room house with an entrance porch, and, if desired, a porch off the garden. There is no basement nor attic. In other words, all you see here is useful house. But the parts have been proportioned so that the appearance is fine. Anyone seeing this house set among trees and in a garden, even of the most simple sort, will be struck with its pleasantness and the good taste and trimness of its lines.

As to the plan, there is a living room with a big fireplace, with a metal hood that acts as a reflector to throw the heat from the fire back into the room.

Then there are two bedrooms. They are of medium size, but large enough to take the furniture. The kitchen is modern and fully equipped. The sink and the laundry tray form one unit. A cover goes over the tray when not in use, forming to all practical purposes, a standard drainboard. One fixture is made to serve the purposes of two. The house heater goes behind the chimney stack under an arch of masonry.

Each bedroom has a corner location with two windows and cross ventilation, so they possess all that any bedroom can really afford.

As to the construction, there is no ceiling to this house. The roof does double duty, just as other parts of the building do. Up at the top there is a dormer. In summertime this house will be cool. The dormer will let out the heated air. Closed in winter with the heavy insulation of the roof, all the heat will be trapped in. This method of using the roof for a ceiling not only effects a saving in the cost of construction but adds appreciably to interesting appearances. Besides, it gives the rooms themselves more cubic content. They are more airy, less stuffy.

The floor is of concrete laid over the ground and finished with linoleum. In order that the ground may be well drained and no dampness come through the floor, there is a course ten inches thick of loose rock with gravel above, and the concrete is laid over the gravel.



# No other Push Drill like a "YANKEE"



Eight "Yankee" Drill Points, 1/16" to 11/64", in handle of Push Drill. Each drill point individually tested by "Yankee" experts.

No "Yankee" Tool ever was made to compete on price. Nobody ever saved anything by buying a cheap tool.

"Yankee" Tools are made for good workmen. Both mechanic and amateur. Good workmen cannot afford to waste time and labor.

They will tell you to save money—by buying a "Yankee" Automatic Push Drill. . . Save on every job—in convenience, speed, labor, accuracy.

The "Yankee" Push Drill, like the "Yankee" Spiral Ratchet Screw-driver, is standard the world over.

Designed right . . . made and finished right . . . balanced right . . . for the work it has to do. So little pressure of your hand needed with a "Yankee" that you hardly realize the point is biting swiftly into the wood!

Ask your hardware dealer for the genuine "Yankee" Automatic Push Drill. Look for the name on the tool.



WRITE us for "Yankee" Tool Book, free. Action pictures of these ingenious tools in use. Spiral and Ratchet Screw-drivers. Ratchet Hand, Breast and Chain Drills. Automatic Bench Drills. Ratchet Braces. Ratchet Tap Wrenches. Removable-base Vises. Etc.

NORTH BROS. MFG. Co., Philadelphia, U. S. A.

# "YANKEE" TOOLS

*Make Better Mechanics*

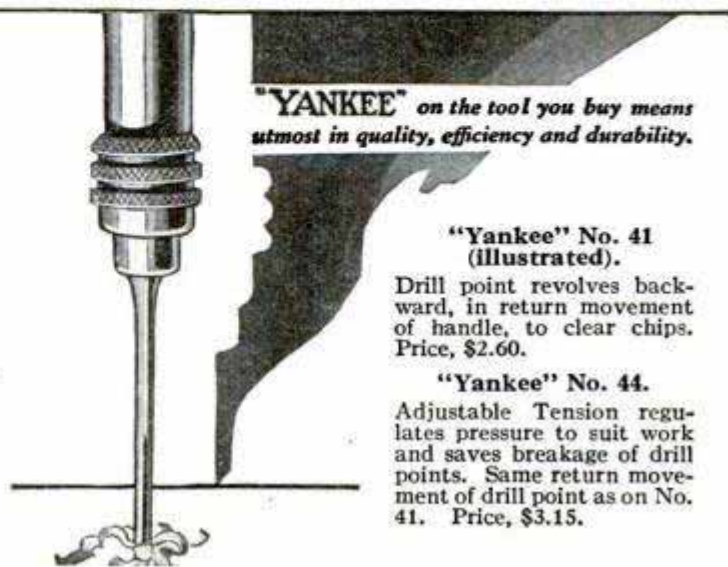

"YANKEE" on the tool you buy means utmost in quality, efficiency and durability.

### "Yankee" No. 41 (illustrated).

Drill point revolves backward, in return movement of handle, to clear chips. Price, \$2.60.

### "Yankee" No. 44.

Adjustable Tension regulates pressure to suit work and saves breakage of drill points. Same return movement of drill point as on No. 41. Price, \$3.15.



*This is the Clayton & Lambert No. 70 fire-pot with tinner's hood. Produces a working flame in ninety seconds. Flame controlled as easily as a lamp. The burner orifice cannot be enlarged by tightening the needle valve. No chance of ruining the fire-pot that way—that's an exclusive C & L feature. Will heat a pair of soldering coppers and melt a pot of metal at the same time.*

Ready for use  
*in a minute  
 and a half!*  
 —and that's  
 only part of  
 the story



YOU'RE going to get a real kick out of it—the first time you light up one of these new Clayton & Lambert fire-pots. No hanging around waiting for it to warm up—ready for business in a minute and a half in any weather. Cold and wind make no difference. Clayton & Lambert took care of that in designing these new fire-pots.

And after you get that hot, blue flame you can control it as easily as a lamp. Turn it up or down, just where you want it. *There's* a chance to save a lot of fuel.

You can use it on inside jobs without annoying anybody—it's noiseless, odorless and smokeless. If you have to haul it around a lot, you'll appreciate its lighter weight before the day's over. And the rougher the work the more you'll be

thankful for that husky red rim around the base which protects the tank from denting and leaking.

Most hardware and supply stores sell these Clayton & Lambert fire-pots. If they don't have them in stock they can get them for you quickly. And you'll certainly be well repaid for being particular and asking for them by name. For the performance of Clayton & Lambert products has made this company the largest producer of fire-pots and blow-torches in the world, giving you quality articles at the savings permitted by quantity production.

# CLAYTON & LAMBERT

MANUFACTURING CO.

DETROIT, MICHIGAN





Less than a  
teaspoonful  
to the gallon  
*but what a difference ETHYL makes!*

**E**THYL is the name of the "anti-knock" compound developed by General Motors Research Laboratories to make motor gasoline more efficient.

Leading oil companies mix it with their gasoline at their refineries to form *Ethyl Gasoline* — the standard high compression fuel.

There is less than a teaspoonful of ETHYL fluid in a gallon of Ethyl Gasoline — but what a difference it makes!

In cars of ordinary compression, ETHYL eliminates that "knock" and power loss as carbon forms — and turns the higher compression created by the carbon deposits into extra power. As for the new high compression cars, ETHYL made them possible!

Ethyl Gasoline is now available throughout the United States and Canada at pumps bearing the ETHYL emblem. Ride with ETHYL today.

**ETHYL GASOLINE CORPORATION**

25 Broadway, New York City  
56 Church St., Toronto, Ont., Can.

**ETHYL  
GASOLINE**

*Knocks out that "knock"*

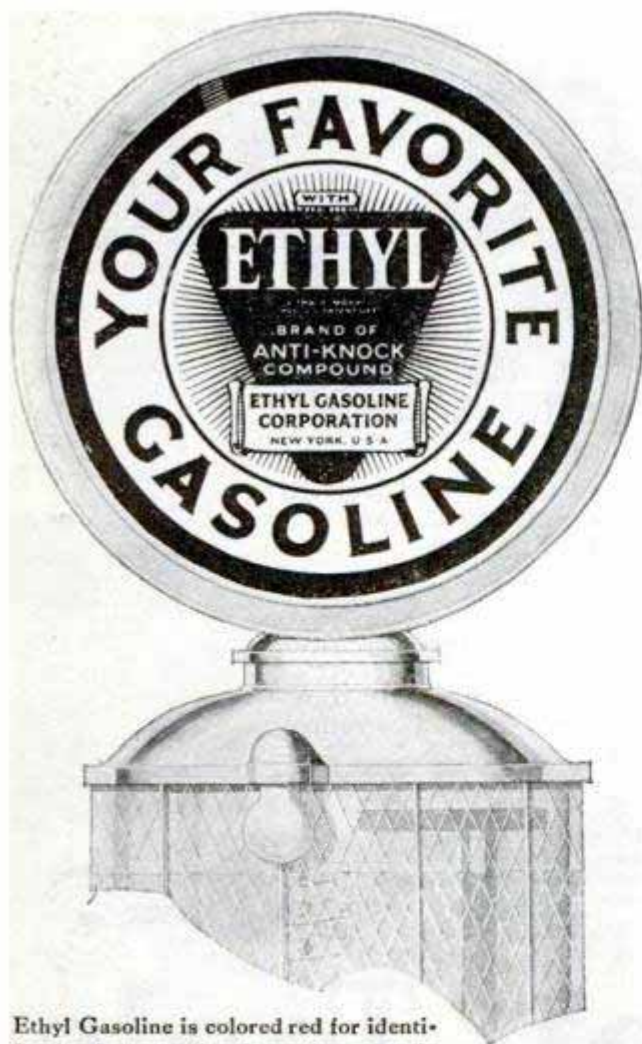

Ethyl Gasoline is colored red for identification but not all red gasolines contain ETHYL, whose active ingredient is tetraethyl lead. It takes more than dye to make an "anti-knock" (high compression) fuel.



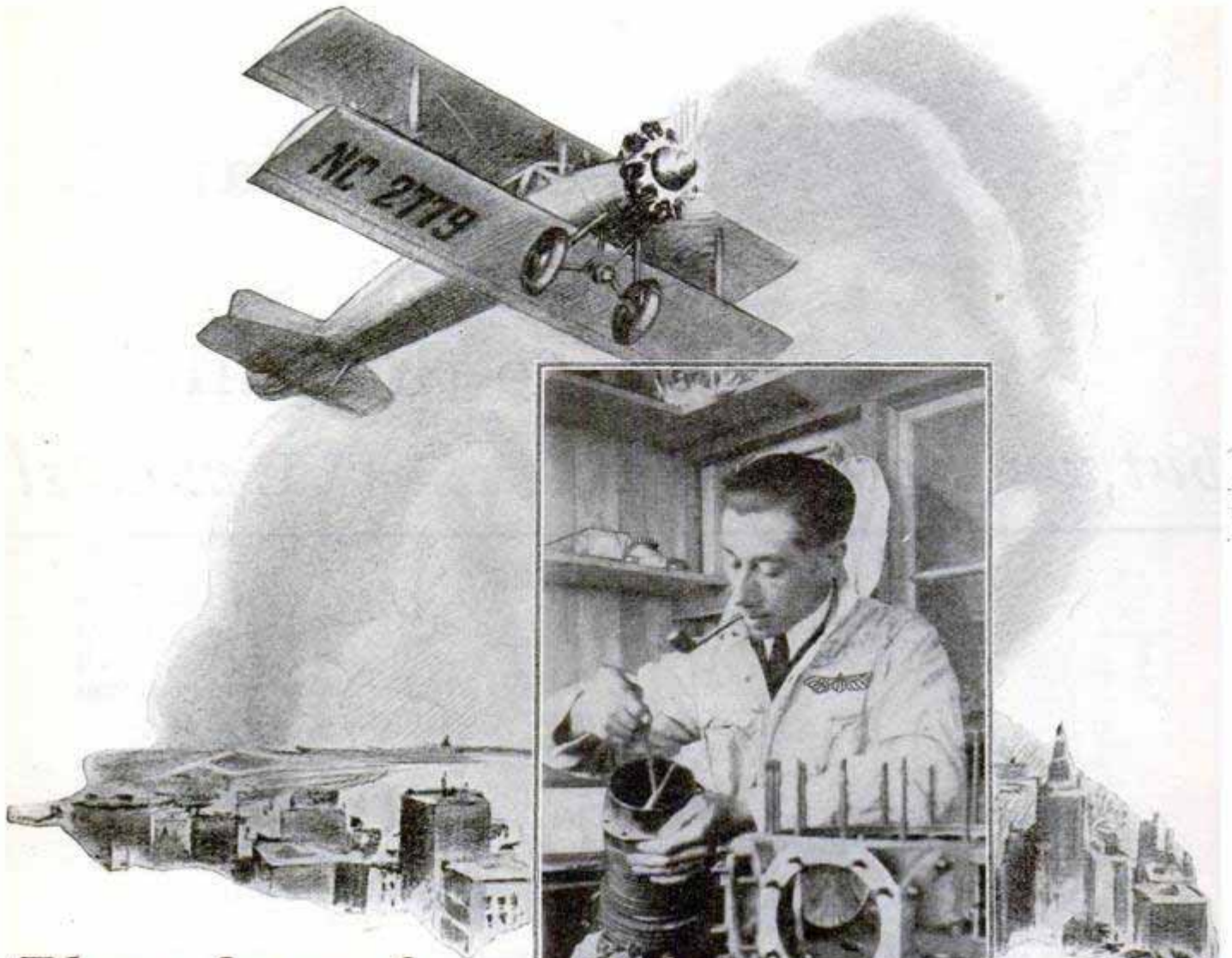

## They depend on Starrett accuracy

A mail plane drones westward from Chicago. A huge express freight plane lands gracefully at Dallas. An air liner takes off at Boston.

Thousands of miles a day they fly safely and surely with the finest motor equipment the world has ever known — requiring extreme precision of workmanship in manufacture and maintenance.

In the shops of these leading Air Transport operators, where the Whirlwinds, Wasps and other motors are groomed for additional hundreds of



hours of flying, you will find Starrett Tools. Aviation mechanics have learned to put their faith in Starrett accuracy.

Whatever your use of tools you need Starrett accuracy and dependability. Ask your tool dealer for Starrett's. Write us for your copy of the new Starrett Catalog No. 24 "AP" illustrating more than 2500 Starrett Tools.

### THE L. S. STARRETT CO.

World's Greatest Toolmakers  
Manufacturers of Hacksaws Unexcelled  
Steel Tapes—Standard for Accuracy  
ATHOL, MASS., U.S.A.



# Use Starrett Tools



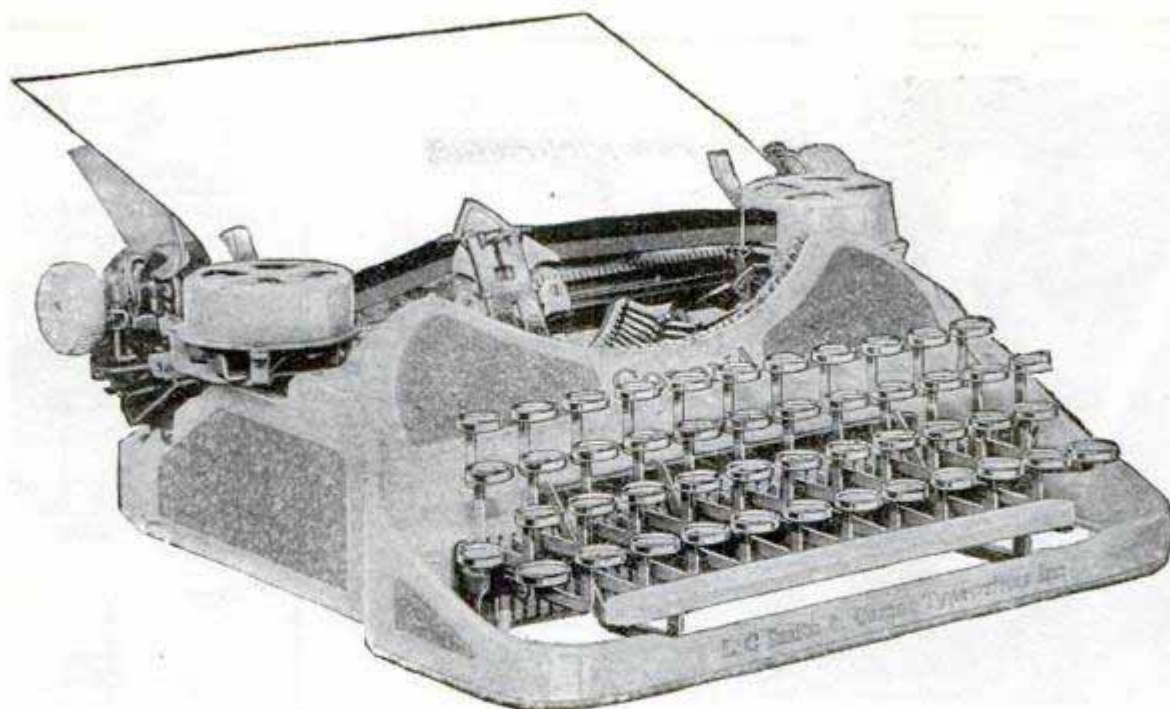

## The most modern "Personal Writing Machine"

**M**ORE than a million Coronas preceded this latest and most up-to-date machine. More than twenty years' experience have helped to make it the compact, convenient, portable typewriter it is today.

That is why you should have no hesitation in choosing Corona as your own Personal Writing Machine.

Corona is light, yet strength has not been sacrificed. Its tough aluminum frame has stood unbelievable abuse without breaking.

Corona is compact, graceful in design without sacrificing completeness. The keyboard is standard, the type-bar action is like that of a big machine. The ribbon is full twelve yards long, self-reversing. There is a real variable line

spacer, back spacer, margin release—every convenience modern skill can apply to a portable typewriter.

### Buy on easy terms

Get your Corona now. You need it—everyone does. Pay for it in convenient monthly installments. You'll never miss the money, and you'll never want to get along without Corona, once you have found out how useful it is. Go to any Corona store, or mail the coupon.

Our local representative will gladly leave a Corona at your home for you to examine at your leisure—and without obligation. Sold on convenient terms.



MAIL THIS COUPON

L C Smith & Corona Typewriters Inc  
712 E. Washington Street, Syracuse, N. Y.

Please send me your latest folder illustrating the  
new Duco finished Coronas in actual colors.

Name.....

Address.....



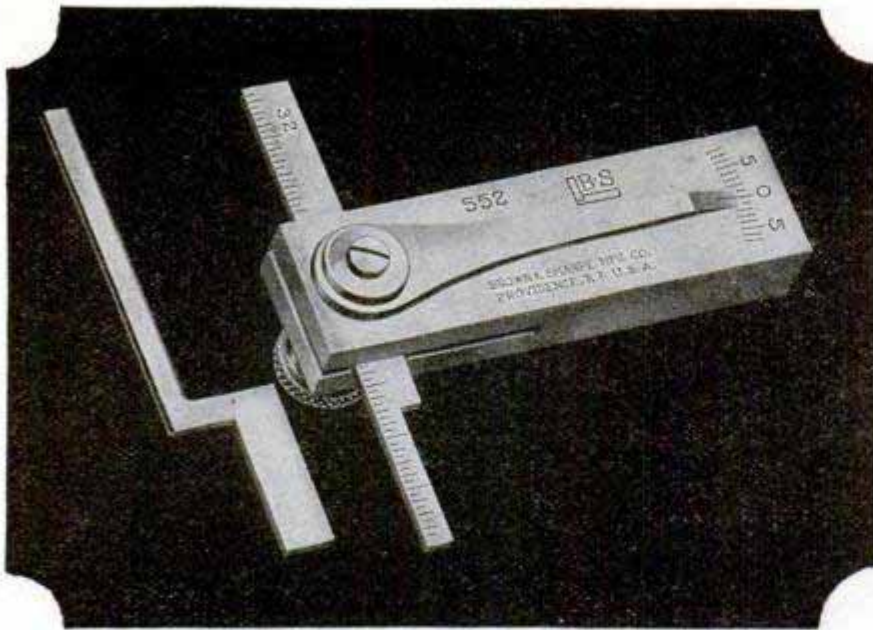

Die Makers' Square No. 552 is a typical Brown & Sharpe Tool made to do the specialized work of the die maker and pattern maker.

## The Professional Tools of the Skilled Mechanic

The specialized knowledge of the trained mechanic is applied practically with precision tools. Especially is this true in the case of fine measurements. Fractions of a degree, split thousandths of an inch—unimportant trifles to the layman—are of vital importance to the trained mechanic.

Brown & Sharpe Tools, because they permit such micro-measurements and because many of them are designed for specialized work, aid in translating the mechanic's skill into tangible results.

Get a free copy of Catalog No. 30, listing over 5,000 items—at your dealer's or direct from us. Dept. P. M., Brown & Sharpe Mfg. Co., Providence, R. I., U.S.A.

# BROWN & SHARPE TOOLS



\* MICROMETER CALIPER  
No. 11 RS



\* VEST POCKET SPEED  
INDICATOR  
No. 746



\* DIAL TEST INDICATOR  
No. 733



\* TWIST DRILL AND  
STEEL WIRE GAUGE  
No. 705



\* RULE DEPTH GAUGE  
No. 615



\* AUTOMATIC CENTER  
PUNCH  
No. 771

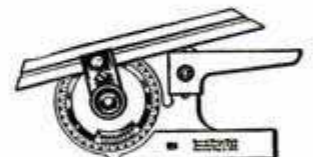

\* UNIVERSAL  
BEVEL PROTRACTOR  
No. 496

\* A description of this tool  
appears in Catalog No. 30.



"WORLD'S STANDARD OF ACCURACY"



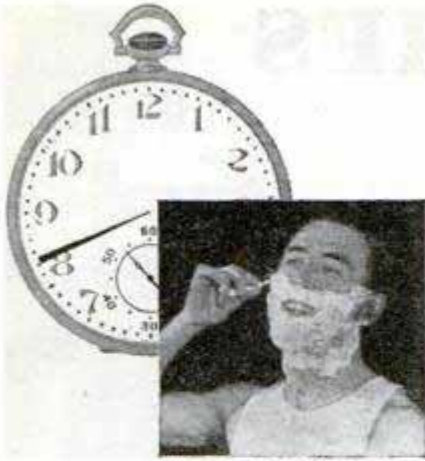

**HALF A MINUTE.** Whatever the reason for the morning rush, rely on the swift, even sureness of your Gillette Blade for the smoothest shave per second in the world.



**ONE MINUTE.** Just sixty seconds of lathering. A different lathering time means a different job for your Gillette Blade—but always the same smooth comfort.

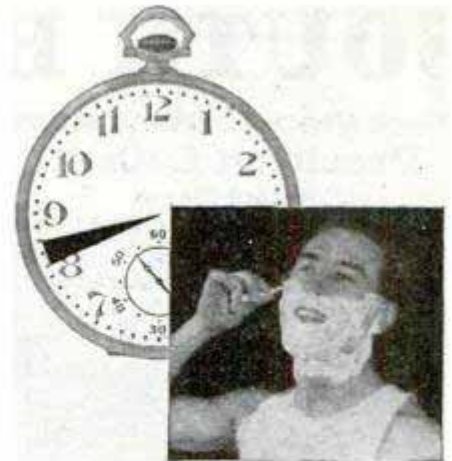

**TWO MINUTES.** A bit longer to prepare your beard. Lathering time may vary but the one constant thing about your daily shave is your even-tempered Gillette Blade.

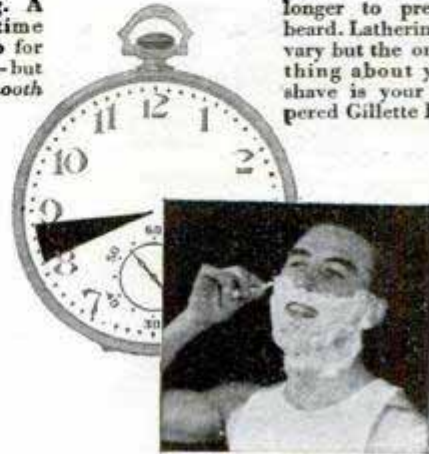

**THREE MINUTES.** Ideal for thorough softening of your beard. It may seem a bit luxurious to spend so much time lathering up, but you'll be repaid by the fullest measure of comfort that your Gillette Blade can give you.

## You fast shavers— here's the smoothest, surest shave per second in the world!

**T**IME affects the comfort of your shave, of course. Lots of men have to "race" it. Slow shaving is a luxury, which we can't always afford.

But the smooth, kind, thorough job that the Gillette Blade does on its easy path is something you can't afford to pass up—for it's the smoothest shave *per second* in the world.

Gillette hones and strops every blade on instruments so fine that variation of one ten-thousandth of an inch sends out a tell-tale signal. Gillette "coaxes" perfect shaves into every blade as no human hands could possibly hone and strop it. And nearly half of Gillette's people are special inspectors, paid double when they find a single blade that won't do a superb job of shaving.

It has cost twelve million dollars in the last ten years alone to keep this blade doing its job so uniformly and so *well* that eight out of ten men prefer it.

Gillette keeps faces smooth and comfortable; men of sixty look twenty years younger; young men are starting right, and staying young. No man ever gave the Gillette Blade the identical task two days in succession. Shaving conditions may change, but the blade meets every man's conditions.

GILLETTE SAFETY RAZOR CO., BOSTON, U. S. A.

# Gillette



To be sure of a smooth, comfortable shave under any conditions, slip a fresh Gillette Blade in your razor.



# SOUTH BEND LATHES

**Back Geared Screw Cutting  
Precision Lathes**  
For Tool Room  
Manufacturing—Machine Shop  
Repair Shop  
Service Station—Laboratory  
Engineering Shop

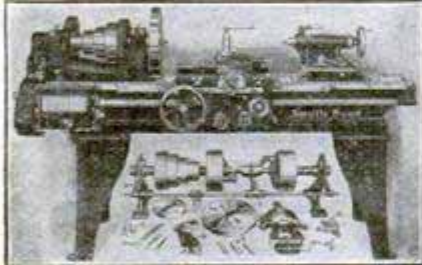

16" x 8' Quick Change Gear Lathe, Straight Bed..... **\$570**

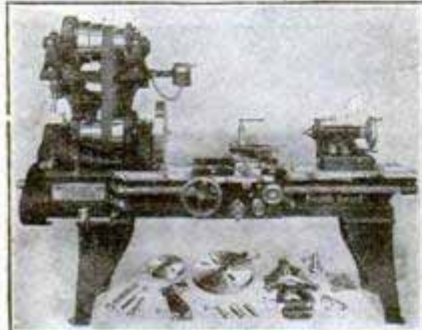

18" x 8' Quick Change Gear Motor Driven Lathe..... **\$908**



9" x 2 1/2' Junior Back Geared Screw Cutting Bench Lathe. **\$150**

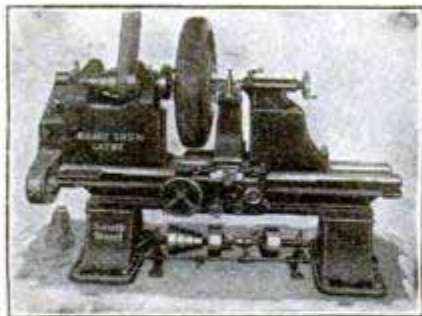

**Brake Drum Lathe**  
Handles all Brake Drum work without removing tire or rim, up to 33" diameter..... **\$425**

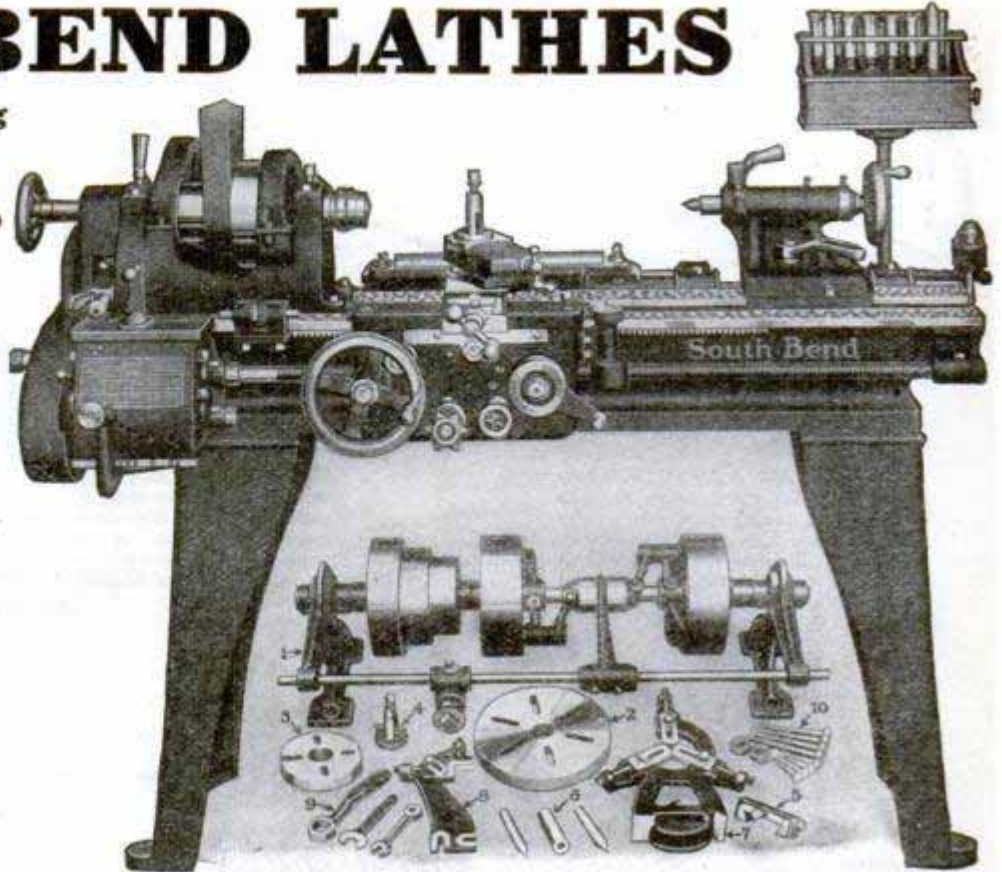

11" x 4' New Model Precision Tool Room Lathe with Counter-shaft and Regular Equipment..... **\$335**

## Other Popular Selling Sizes

The Prices of Popular Selling Sizes with Countershaft and Equipment

Size of Lathe	Shipping Weight	Standard Change Gear	Quick Change Gear
9" x 3'	490 lbs.	<b>\$235.</b>	<b>\$270.</b>
11" x 4'	725 lbs.	<b>\$300.</b>	<b>\$335.</b>
13" x 5'	1110 lbs.	<b>\$352.</b>	<b>\$402.</b>
15" x 6'	1550 lbs.	<b>\$430.</b>	<b>\$490.</b>
16" x 6'	1875 lbs.	<b>\$480.</b>	<b>\$540.</b>

## Easy Payment Plan—10 Months to Pay

Small down payment, balance in 10 equal monthly payments, or you can purchase through your nearest machinery dealer.

**FREE—Write for No. 89A Catalog and New Booklets** describing 210 sizes and types of NEW MODEL South Bend Lathes. Check off in the squares below, indicating the lathes in which you are interested.

- 9" Junior Booklet
- 11" Lathe Booklet
- 13" Lathe Booklet
- 16" Lathe Booklet
- 18" Lathe Booklet
- New General Catalog No. 89A
- "How to Run a Lathe," Price 25c
- Auto Mechanics Service Book, 25c
- Brake Drum Lathe Circular

## SOUTH BEND LATHE WORKS

Main Office & Works, 639 E. Madison St., South Bend, Ind., U. S. A.  
New York City Salesroom, 183 Centre Street

Carried in Stock by Machinery Supply Dealers in Principal Cities Throughout the World

ATLANTA, GA.—Fulton Supply Co., 70 Nelson St.  
BALTIMORE, MD.—Carey Mach. & Supply Co., 119 E. Lombard St.  
BIRMINGHAM, ALA.—Moore-Handley Hdwe Co., 21st & Ave. "A"  
BOSTON, MASS.—Joseph Beal & Co., 465-71 Atlantic Ave.  
CHICAGO, ILL.—Scott Bausbach Mach. Co., 189 S. Clinton St.  
CINCINNATI, OHIO—The E. A. Kinsey Co., 835 Fourth St., W.  
CLEVELAND, OHIO—Clark Machinery Co., 1235-45 St. Clair Ave.  
DALLAS, TEX.—Huey & Philip Hardware Co., 1029 Elm St.  
DENVER, COL.—Hendrie & Bolthoff Supply Co., 1621 17th St.  
DETROIT, MICH.—Lee Machinery Co., 3171 Bellevue Ave.  
HOUSTON, TEX.—Wessendorf, Nelms & Co., 317 Preston Av.  
KANSAS CITY, MO.—H. J. Brunner Mach. Sup. Co., 1512 Grand Av.  
LOS ANGELES, CALIF.—Eccles & Davies Mach. Co., 320 San Pedro St.  
MILWAUKEE, WISC.—Western Iron Stores Co., 145 W. Water St.

NEW ORLEANS, LA.—Oliver H. VanHorn Co. Inc., 522-534 Camp St.  
NEW YORK CITY, N.Y.—J. E. Beggs Co., 183 Centre Street  
OMAHA, NEB.—Interstate Mach. & Supply Co., 1006-10 Douglas St.  
PHILADELPHIA, PENN.—Delta Equipment Co., 148 N. Third St.  
PITTSBURGH, PENN.—Somers, Fittler & Todd Co., 329 Water St.  
PORTLAND, ORE.—The Portland Machinery Co., 62-4-6 First St.  
PROVIDENCE, R.I.—The E. A. Eddy Mach. Co., Eddy & Clifford Sts.  
ST. LOUIS, MO.—Blackman-Hill & Co., Inc., 1513 N. Broadway St.  
ST. PAUL, MINN.—Robinson-Cary & Sands Co., 4th & Wacouts Sts.  
SAN FRANCISCO, CALIF.—C. F. Bulotti Mach. Co., 829 Folsom St.  
SEATTLE, WASH.—Perine Machinery Co., Inc., 209 First Ave., S.  
TOLEDO, OHIO—The Kirkby Mach. & Supply Co., 20-22 St. Clair St.  
MONTREAL, QUE.—Can. Fairbanks-Morse Co., 84 St. Antoine St.  
TORONTO, ONT.—A. R. Williams Machinery Co., 66 Front St., W.



# Read what expert users say about the new Stanley Electric Drills

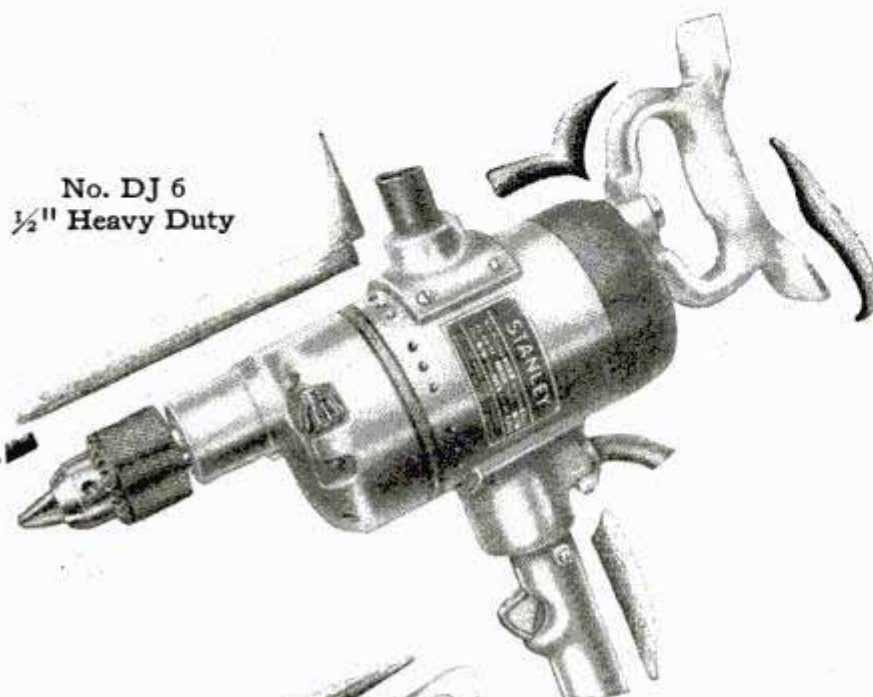

No. DJ 6  
1/2" Heavy Duty

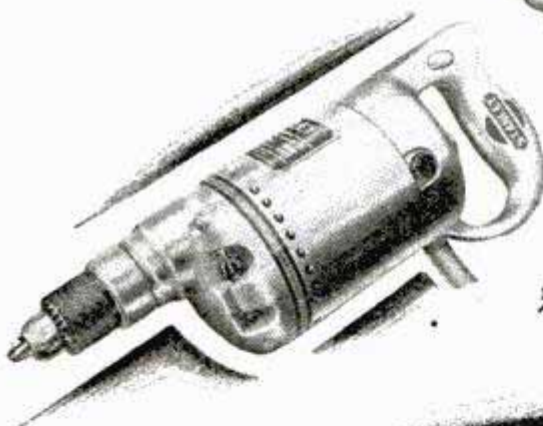

No. DB 14  
1/4" Heavy Duty

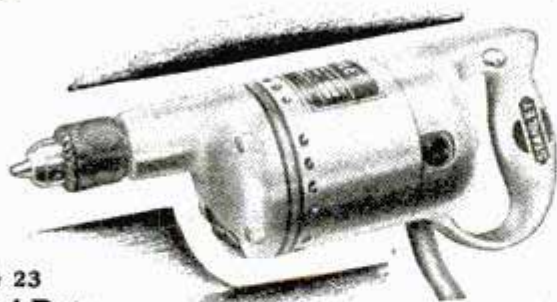

No. DG 23  
1/4" Standard Duty

Performance speaks for itself.

Consequently we have asked expert carpenters and mechanics to try out these new Stanley Electric Drills and give us their opinions. Here are a few of the many gratifying comments we received:

"I used it almost continually all day and it didn't heat up at all."

"I never saw a stronger motor. It is almost impossible to stall it."

"The easiest drill to operate that I ever saw."

"The men in our shop always pick the Stanley Drill."

"We have never had anything that would touch it for power and performance."

You too, no matter what kind of work you are doing, will like these new Stanley Electric Drills once you have tried them.

Most dealers will have them and will be glad to let you test their efficiency on either wood or steel. We feel confident that you will render the same verdict as the men whose comments are noted above.

Send the coupon for Catalog Sd59 which contains full information as to size, weights, and capacities.

# STANLEY TOOLS

The choice of most carpenters

The Stanley Rule & Level Plant  
New Britain, Conn.

Please send me Catalog Sd59 describing the new Stanley Electric Drills.

Name \_\_\_\_\_

City \_\_\_\_\_

State \_\_\_\_\_



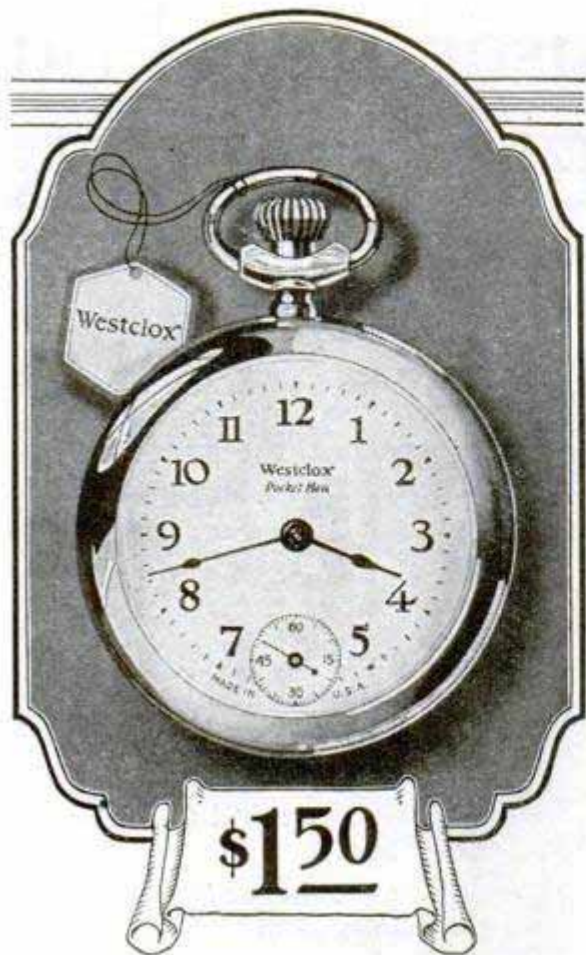

## New Model Pocket Ben

The Westclox watch!

**F**OR sturdiness, for reliability, day in and day out, you can't beat the new model Pocket Ben—and it's mighty good looking, too! Millions depend on it. So can you. Sold everywhere for \$1.50.

*Built by the makers of Big Ben and other Westclox*

WESTERN CLOCK COMPANY  
La Salle, Illinois



### New Westclox Auto Clock

Attractive, convenient, reliable. Fits any car. Quickly attached on dash or above wind-shield



SPEED — LUXURY — LOW COST

## The Quad Super Elto

### 4 Cylinder Outboard Motor

**F**INEST runabout performance is now yours at a fraction of usual costs! The Quad, sensational 4-cylinder portable outboard motor drives big, comfortable boats 25 miles an hour. Instant starting, utterly vibrationless, absolutely dependable. Drives racing craft at 35 miles and better. Send for book on Super Elto motors, also complete directory of outboard boats and builders.

ELTO OUTBOARD MOTOR COMPANY  
Ole Evinrude, President  
Mason Street Dept. AA, Milwaukee

**FREE!**  
**30 DAY TRIAL!**

Radio's most amazing bargains, direct from big, reliable maker (8th successful year). All Electric or Battery sets. Consoles or table cabinets. Don't buy unless 30 days trial proves Miraco unobtainable at 2 to 4 times the price for selectivity, distance, volume and rich, Cathedral tone. Turn 1 dial for all stations. Completely assembled, fully guaranteed sets!

**Free literature, users' testimony and BIG SPECIAL OFFER**

**MIDWEST RADIO CORPORATION**  
Pioneer Builders of Sets  
407-D Miraco Bldg., Cincinnati, O.

**Powerful 6-7 or 8 Tube Guaranteed RADIO**

**RETAIL \$36.75 to \$69.75**

**BIG DISCOUNTS to User Agents**

### The International Motor Saw

does every sawing job from straight cutting to intricate scroll and design work; crosscuts, rips, miters, bevels, inside and outside jig sawing and scroll cutting. One saw instead of several.

Write for full description. Dept. S, The International Stamping Co., 400 N. Leavitt St., Chicago, Ill.

### 38,000 CANDLEPOWER — NO GLARE!

Wonderful New Invention Solves Headlight Problem

Trippe Reflector just discovered by Chicago man solves the auto headlamp problem. This wonderful device gives a terrific light of 38,000 candlepower absolutely without glare. Slips right into headlamp over old reflector, easily installed. Comes complete for both headlamps and sells for only a few dollars. Agents wanted everywhere. Wire or write TODAY!

**AGENTS — You Want This Proposition — Write Today!**

**AERIAL ELECTRIC CO.**  
338 W. Ohio St.  
Chicago, Ill.





# COOL TRIPS on HOT DAYS!

SLIP away from the hot, smoky city—for an hour, a day or a week—on a Harley-Davidson Twin. Shady lanes, the beach, or breeze-swept country roads are only a few minutes away. Know the truly great pleasures that only the motorcycle can give you. It's so handy on work days, so thrilling on play days — so economical and dependable always.

You can easily afford the Twin's low first cost and its 2¢ per mile operating cost! Sold as low as \$310 f. o. b. factory. Ask your dealer about his convenient Pay-As-You-Ride Plan.

*Send the coupon for our latest catalog.*

**HARLEY-DAVIDSON MOTOR COMPANY**  
DEPARTMENT P MILWAUKEE, WIS.

## HARLEY-DAVIDSON Motorcycles



**The Single**  
1¢ per mile pays all operating expenses of the Single — the famous "80 miles per gallon" solo mount that has won world-wide endorsement. Costs only \$235 f. o. b. Milwaukee.

HARLEY-DAVIDSON MOTOR COMPANY  
Dept. P, Milwaukee, Wis.

Interested in:  Twin  Single. Send catalog and full details.

Name.....

Address.....



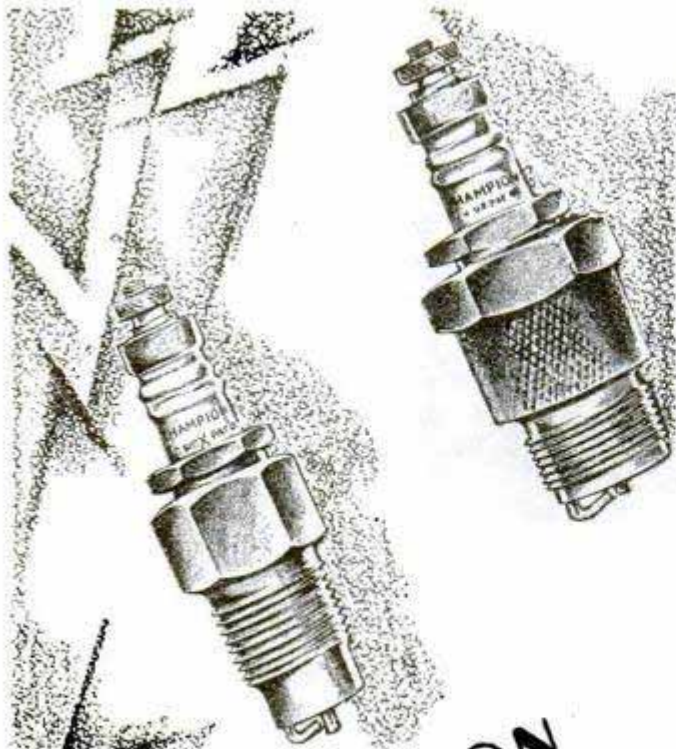

**CHAMPION**  
has always  
pioneered

**F**OR more than 16 years Champion has led in spark plug development and that is why today it is accepted as the better spark plug and outsells throughout the world two to one.

Today, more than ever before, Champion leadership stands unchallenged.

For Champion is of two-piece, compression tight construction, with a new solid copper gasket seal.

Its insulator is of sillimanite, a rare mineral of which Champion controls the only known source of supply. This insulator is specially heat treated to withstand the greater compression and higher temperatures of the modern engine. It is practically unbreakable and greatly resists carbon formation.

A fixed spark-gap under all driving conditions is assured by the special analysis electrodes, which greatly resist pitting and burning.

For these reasons you can buy dependable Champions with every assurance of better engine operation and greater car satisfaction, as do two-thirds of motorists the world over.

**CHAMPION**  
**Spark Plugs**

TOLEDO O

*Taylor* **STORMOGUIDE JR.**  
**\$10**

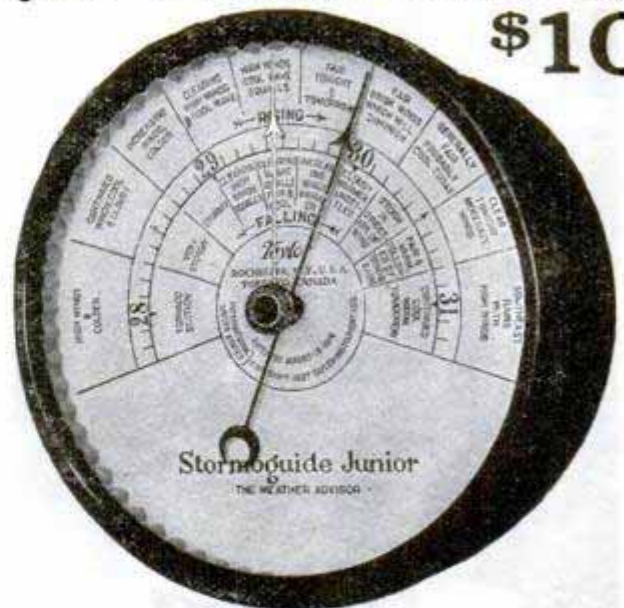

**F**IT your plans to the weather. Pick out the good days—go suitably prepared on the stormy ones.

The Stormoguide Jr. has a simple chart, which gives weather forecasts on its dial. "Clear tonight, fair with fresh winds tonight and tomorrow; storm brewing in direction of wind." Indicating probabilities for 12 to 24 hours in advance. No puzzling words of ordinary barometer, fair, change, stormy. *Enables you to plan your activities with the weather.*

*Description*—STORMOGUIDE JR., 4½-inch white dial, mahogany finish, bakelite case, glass crystal, good grade aneroid movement, supporting legs; adjustable for altitudes 0 to 2500 feet.

PRICE.....\$10.00

At Your Dealers or Send Direct

*Taylor Instrument Companies*

ROCHESTER, N. Y., U. S. A.

Canadian Plant, Tycos Building, Toronto

Manufacturing Distributors in Great Britain, Short and Mason, Ltd., London

**Ingersoll**  
WATCHES & ALARM CLOCKS

**FREE RADIO BOOK!**

40 pages chock-full of vital information for radio set builders. 14 new Aero circuits—receivers, transmitters, radiophones, short wave—fully described. Complete construction data, schematics, photos, etc. Exactly the book you've wanted. Write for FREE copy TODAY. Address

AERO PRODUCTS, Inc., Dept. 107, 1772 Wilson Ave., Chicago, Ill.

**\$75 to \$125 Weekly**

**5 Down** Charging Batteries Starts You

Let me show you how to make big money right from the start. I've prepared a FREE book explaining all details. First week's profit pays for all equipment. You can get all the battery charging business in your community with my Service Station Charger—it's years ahead

of ordinary chargers—handles 50% to 70% more batteries. I explain everything—start you in a business of your own and put you on the way to big money. Write for FREE Book.

C. F. HOLMES, Chief Engineer, Dept. PM  
Independent Electric Works, 5116 Ravenswood Ave., Chicago

**FREE BOOK—Just Out**





# There are *savings* in both of them!

This *free* book will put money in your bank account

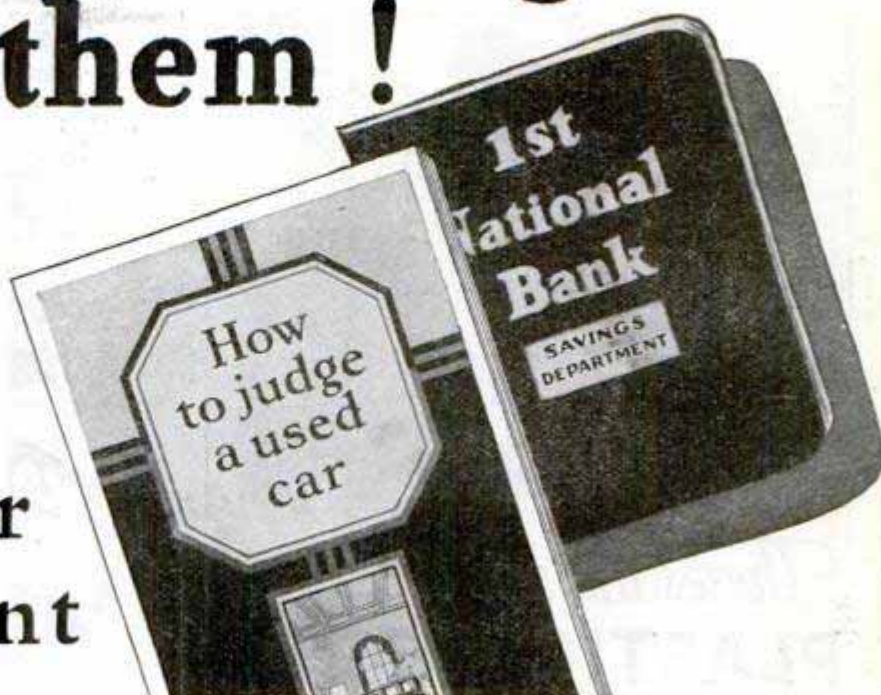

"The money I saved on my used car by an hour spent with your free book, 'How to Judge a Used Car,' has added more than a hundred dollars to my bank balance!" writes one motorist.

"How to Judge a Used Car" tells what code prices on used cars mean—what the speedometer should tell—how to judge a car's actual condition—how to avoid "orphans"—how to set a fair price on a used car bought of a friend, etc. Compiled by experts who have spent years in buying and selling used cars, it contains information never before made public.

And it costs only a 2c stamp!

This free book explains also the famous Studebaker Pledge—what it means to your safety and satisfaction—how it assures you of prices marked in plain figures,

permitting 5 full days tryout and a 30-day Guarantee on Certified Studebakers.

More than 137,000 motorists have profited by the information contained in "How to Judge a Used Car." Send for your copy TODAY!

## Pledge to the Public on Used Car Sales

- 1 Every used car is conspicuously marked with its price in plain figures, and that price, just as the price of our new cars, is rigidly maintained.
- 2 All Studebaker automobiles which are sold as CERTIFIED CARS have been properly reconditioned, and carry a 30-day guarantee for replacement of defective parts and free service on adjustments.
- 3 Every purchaser of a used car may drive it for five days, and then, if not satisfied for any reason, turn it back and apply the money paid as a credit on the purchase of any other car in stock—new or used. (It is assumed that the car has not been damaged in the meantime.)

© 1927 The Studebaker Corporation of America

Where this Pledge is displayed by Studebaker dealers, you can buy a used car safely.

THE STUDEBAKER CORP. OF AMERICA

Dept. G-72 South Bend, Ind.

Please send me my copy of your valuable free booklet, "How to Judge a Used Car."

Name.....

Street.....

City..... State.....

# STUDEBAKER

**The Great Independent**





## There's the can of PLASTIC WOOD

(Reg. U. S. Pat. Off.)

It's just about the handiest thing in the home workshop—for it handles like putty and hardens into wood.

Its uses are countless. For example—sealing joints and corners in a wooden frame; building up gouged or chipped or splintered wood; filling cracks or knot holes; forming a wooden filling to take nails or screws in holes bored in metal; covering countersunk screws or bolts; moulding to particular needs.

When hard it can be worked like any natural wood—sandpapered and chiseled, planed and sawed, turned in a lathe. It will not crack or splinter, takes nails and screws firmly, and will not disintegrate or crumble in any weather conditions. It is waterproof, greaseproof and weatherproof, and the perfect filling under paint, lacquer, or varnish.

### Around the House

There are innumerable uses for Plastic Wood—filling floor, baseboard and door cracks, mouse holes and pipe holes; holding loose handles, repairing broken toys. Extensively used for model boat working, and on big boats, too.

**Handles  
Like  
Putty**



**Hardens  
Into  
Wood**

At Hardware and Paint Stores

1 lb. can \$1.00.

1/4 lb. can 35 cts.

ADDISON-LESLIE COMPANY, MFRS.  
402 Bolivar Street Canton, Mass.

# Improves-

tone fidelity, clarity, sensitivity - by automatically keeping tube filament voltage constant, despite "A" battery variations.

# AMPERITE

The "SELF-ADJUSTING" Rheostat



eliminates hand rheostats. Simplifies wiring, tuning, panel design. Particularly essential with Battery Eliminators. Accept only Amperite. \$1.10 mounted (U.S.A.)

**FREE**—"Amperite Book" of latest circuits and construction data. Write Dept. PM-7

**RADIALL CO.**  
50 Franklin St., New York



This 132 Page Radio Catalog and Encyclopedia

## FREE

Containing 75 radio hook-ups, 500 illustrations, 1000 articles. Wholesale Prices

Build your own with Rasco parts. The lowest prices in the country.

**Radio Specialty Company**

98E Park Place

NEW YORK, N.Y.

## SOLDERALL

METAL IN PASTE FORM



The only convenient metal solder

Every Electrical Connection needs Solderall for perfect reception

25¢

The SOLDERALL CO., NEWARK, N.J.

### 6-TUBE RADIO COMPLETE

\$34.75 to \$66.66

Licensed R. C. A. Circuits. Shielded. One Dial

Write for catalog. Big discounts to agents

Consumers Radio Co., Dept. 167, 4721 Lincoln Ave., Chicago

## KEEP YOUR LAWN MOWER SHARP



with a BERGHMAN LAWN MOWER SHARPENER— \$1.95

You can easily and quickly use a BERGHMAN and get wonderful results. It is adjustable and lasts forever. Just a few strokes on each blade and your mower cuts like new. **KEEP YOUR LAWN MOWER IN SHAPE THIS SUMMER** by sending today for this handy sharpener.

G. BERGHMAN COMPANY  
5737 W. Chicago Ave. Chicago



**Motorize**  
Your work shop!

**Free Trial!**

**SPEEDWAY SHOP** Big, new metal and woodworking shop. Attaches to lamp socket. \$10 Down—Easy Payments. This Speedway Shop is high grade, for regular work. A money-maker. Get full particulars. Write today. Electro-Magnetic Tool Company, Department 213, 1830 South 52nd Ave., Cicero, Illinois (Adjoining Chicago).



# WORKACE Electric WOODWORKER

Complete Outfit Including Planer, Saw, Lathe and Electric Motor and Many Useful Attachments

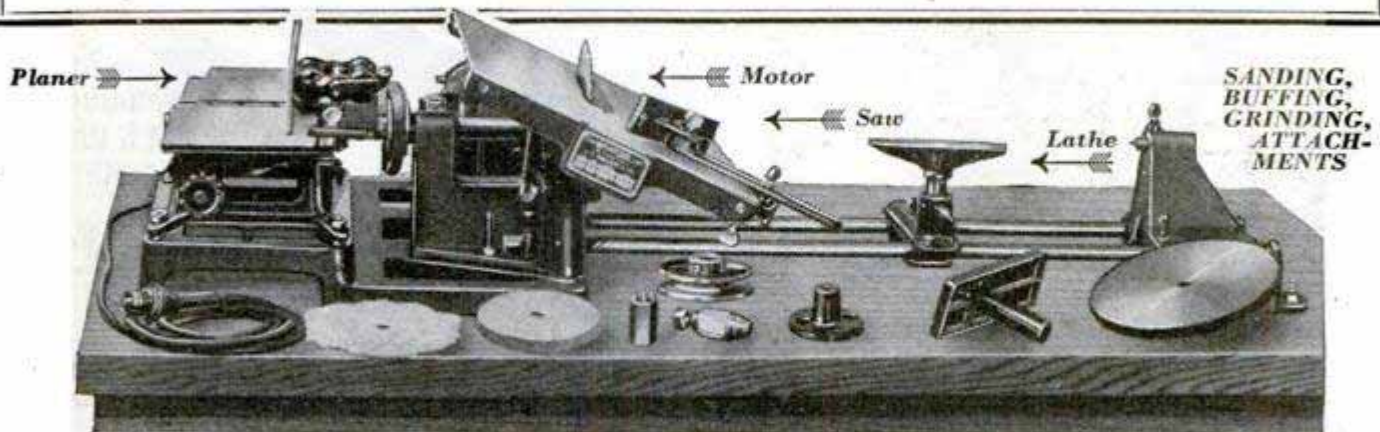

## FAST — ACCURATE — COMPLETE

### Every kind of woodworking operation

This is a COMPLETE All-Electric Shop. It costs a lot less than most other outfits—and for every dollar you pay, you're getting THE BIGGEST VALUE—you can't beat it, anywhere! You can prove every word of this by actually using the Workace Woodworker at home or in business. You'll find it fast and

accurate—you can perform every kind of woodworking operation, make furniture or other useful and decorative things for your own home or for profit. Planing, sawing, turning, drilling, grinding, sanding or buffing—it is all the same to the Workace Woodworker. You can save time on every operation, do the work better and cleaner, too!

Amazing low price . . . . . includes everything

That's because all the modern up-to-date manufacturing facilities of the J. D. Wallace Company, suppliers of standard woodworking equipment for industrial and commercial uses, are utilized to produce the Workace Woodworker. Materials and workmanship are 100% and the designing of the Workace is strictly professional. Woodworking plants, pattern shops, carpenter and cabinet shops all over the world use Wallace equipment. It's the kind of machinery you want—you can't afford to own any other.

### Become an expert woodworker

There is no end to the number of useful and decorative things you can make with the Workace. Tables, chairs, footstools, screens, lamps, lattices, fences, cabinets, doll houses, bookcases, chests—you'll soon become an expert. Woodworking is the greatest hobby a man can have—hundreds turn it to profit too.

The Workace Woodworker has power, strength and capacity to handle quickly and economically any job you'll ever want to do . . . mitering, tapering, rabbeting, beveling,

**\$89**

#### Includes all this:

- 4' Planer
- 8" Circular Saw
- 6' x 36" Lathe
- 8" Disc Sander
- 6" Buffing Wheel
- 5" Emery Grinder
- 1/4" Drill Chuck
- 1/4" H. P. G. E. Motor, 110 Volt, A. C., 60 cycle
- Endless V Belt, two 4' and one 2 1/4' V Belt Pulleys, Cast Iron Sub Base and 10 ft. Cable with separable Plug.

slotting, turning, crosscutting, ripping—anything. Every unit works from the motor. The parts are sturdy and well-fashioned. The regular Wallace UNQUALIFIED GUARANTEE assures replacement of defective parts for one year.

## EASY TERMS

Get the outfit right away  
**SEND TODAY**

The terms are all in your favor. In fact, this whole advertisement, the merchandise offered and the easy method of purchasing is new and revolutionary.

A small down payment brings the complete Workace All-Electric Woodworker ready to set up and use right away. The monthly payments are so small you'll scarcely miss them. Many pay for their Workace Shop out of profits from the work it does. So can you.

Get it—use it—you'll find the Workace Electric Woodworker the best investment you ever made. Send this coupon now—today—and we'll see that you get full details and a complete description right away!

**Wallace**  
PORTABLE MACHINES

The Planer and Circular Saw are each complete units and may be purchased separately at the corresponding low price of \$25.00 each.

J. D. Wallace & Co.,  
Adams St. and California Ave.,  
Chicago, Illinois.

That Workace Electric Woodworker sure looks good to me. I want to know ALL about it, including your easy terms, right away.

Name . . . . .

Address . . . . .

City . . . . . State . . . . .



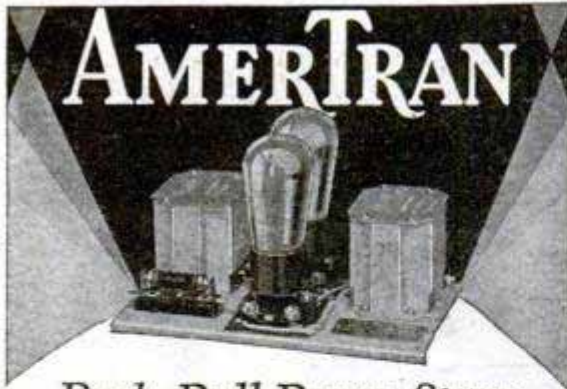

## AMERTRAN Push-Pull Power Stage for Dynamic Speakers

For best results, every dynamic type speaker should be preceded by a push-pull amplifier. This is particularly true because they reproduce frequencies as low as 30 cycles and the attendant hum from raw AC on the filaments of power tubes is greatly pronounced unless filtered out by a push-pull amplifier.

The AmerTran completely wired push-pull power stage has been specially designed for dynamic speakers. Consists of type 151 input and output transformers (200 for working out of 210 type tubes or 362 for 171 type tubes). Completely wired with sockets and resistances. Also available for cone type speakers and for both 210 and 171 tubes.

Licensed under Patents owned or controlled by R. C. A. and may be bought with tubes

Price complete (without tubes) \$36.00.  
(slightly higher west of Rocky Mountains)

Write us for look-up of this remarkable instrument.

**AMERICAN TRANSFORMER COMPANY**

Transformer Builders for more than 28 Years  
152 Emmet Street, Newark, N. J.

## MOVIES AT HOME



Many models of genuine MOVIE MACHINES, some as low as \$3.75, all using standard size big theatre films. Our stock of films is the most complete and lowest in price—with an exchange service. Films of leading stars and religious subjects are available. **DON'T DELAY. WRITE FOR FREE INTERESTING CATALOGUE NOW!**

**PARAMOUNT MFG. CO.**

Dept. 1371-B

BOSTON, MASS.



Here's the  
"Dope" on How to  
Improve Your Radio

"The Gateway to Better Radio"—just that—36 pages and cover—88 illustrations and over 20,000 words of practical, concise, readily understood text—prepared by Austin C. Lescarboua and our engineering staff. Usable. Unselfish. Unbiased. Just the plain and workable radio truth, no matter where you stand in radio.

Ask your radio dealer for a copy, or send 25 cents in stamps or coin direct to us.



MEMBER  
**RMA** American Mechanical Labs. Inc.  
Specialists in Variable Resistors  
285 No. 6th St., Brooklyn, N. Y.

**CLAROSTAT**  
Reg. U. S. Pat. Off.

# Yes

—hand sanding is made 5 times faster with the

## TAKE-ABOUT Sander

The only hand belt surfacing machine. Now making money for thousands of carpenters, builders and woodworkers. Quick, easy belt change. Sands floor edges right up to the baseboards. Finish unequalled by any machine, due to belt principle. Plug in light socket, let the belt work—you merely guide it. Pays for itself.

Write for further details  
**The Porter-Cable Machine Co.**  
1704 - 10 N. Salina St., SYRACUSE, N. Y.

## FREE BULLETIN



Ask Us About Big Profits  
in Crescent Woodworking Machines

This 6" Bench Jointer illustrated is one of the Crescent line that can be mounted on a work bench and operated from a light socket.

Write for literature on our complete line. No obligation to you.

**The Crescent Machine Co.**

93 Columbia St., Leetonia, Ohio

## DO YOU

WANT a new business profession of your own, with all the trade you can attend to? Then become a foot correctionist, and in a few weeks earn big income in service fees,—not medical nor chiropody—easy terms for home training, no further capital needed, no goods to buy, no agency. Address

**Stephenson Laboratory, 1 Back Bay, Boston, Mass.**

## Better than a Brush



### 46 handy home uses

Ideal for applying brushing Duco, or any brushing lacquer to your car, furniture, screens, etc. Less work, less time; richer finishes. Anyone can do it. Change tanks—and oil springs, spray plants, etc.

Automatic continuous spray action; equal to outfits at three times its price.

### LACQUER-WELL SPRAYER

Challenger Model, complete as shown.....\$3.45  
Same less pump, ready to connect with any tire pump..... 2.25  
Master Model, larger throughout..... 4.50  
Same less pump, ready to connect with any tire pump.... 2.75  
Spray Gun Model..... 2.50  
Extra tanks with screw tops 25c each



Send check or money order—we pay postage anywhere in U. S. or Canada.

**The Lacquer-Well Spray Co., Dept. R, 2012 E. 105th St., Cleveland, O.**



**PIN A DOLLAR BILL TO THIS**

and get this genuine leather 5-window-pass case. Holds Railroad Passes, Auto License, Lodge Cards, etc. Masonic or Shrine Emblem stamped on in gold free. Your name or other stamping 35c extra per line. Cash must accompany order.



We carry **EVERYTHING MASONIC**

Send for free catalogue No. 10 P. M. of Books, Monitors, Jewelry; No. 11 P. M. of Lodge Supplies.

*We Have Been in Business 67 Years!*

**REDDING MASONIC SUPPLY CO.**  
200 Fifth Ave., Desk P. M. NEW YORK



**\$60 a week**

Make \$60 a week and be your own boss simply taking orders for my amazing new, fast-selling All-Weather Coat. World's biggest value—only \$3.98. At my bargain price every man, woman, child a red-hot prospect. Everyone buys! Stone cleared \$605 in 30 days.

**Amazing New Raincoat**  
Never before such a value! This new coat is so attractive you'd expect it to cost twice its price. Finely tailored of high-quality, guaranteed rubberized fabric. Popular style. Six striking, vivid colors. Windproof, dustproof and waterproof. **ONLY \$3.98**

**No Experience Needed**  
No capital required. I tell you what to do—I furnish everything absolutely FREE. Sample coat for demonstration at no cost. Spare time or full time. If \$60 a week sounds good to you, write at once for details of my amazing new money-making plan. No cost or obligation. Don't delay, write today.  
**C. E. COMER, Comer Mfg. Co.**  
Dept. SW-5133 Dayton, Ohio

**THIS COAT ONLY \$3.98**

**BUILD YOUR OWN CLOCK WITH OUR HELP**



Turn idle hours into welcome dollars building clocks, very profitable spare time work. We furnish plans, instructions, works, dials and all materials at low prices.

**BANJO CLOCKS, MANTEL CLOCKS WORKS AS LOW AS \$1.65**  
**GRANDFATHER CLOCKS WITH CHIMES**

Ask for our attractive **FREE** Blueprint plan and catalog.  
**AMERICAN CHIME CLOCK COMPANY, Dept. G**  
1691 Ruffner Street PHILADELPHIA, PA.

**THIS WONDERFUL INVENTION**



converts any ordinary cook stove into a gas stove. **OXO-GAS** is made from kerosene and air. Cheaper, cleaner and more efficient than coal.

*Responsible distributors wanted*

**GLORIA LIGHT CO., 111-7 No. May St., CHICAGO, ILL.**

**No CANVASSING**

**\$10 A DAY**  
in Spare Time

**WE** are in immediate need of several men and women in every state to act as our District Sales Managers, full or spare time. No house-to-house canvassing. A dignified, respectable, good paying position open to honest, reliable men and women. Write for details. No obligation.  
**BADGER SPECIALTY MFG. CO.**  
19 S. Third St., Ft. Atkinson, Wis.

The Old Reliable Credit Jewelers

**LOFTIS BROS. & CO.**

Dept. 8-894  
108 N. State St.  
Chicago Ill.

**DIAMONDS AS LOW AS \$100 A WEEK**  
Genuine Diamonds Guaranteed **CASH OR CREDIT**

**Beautiful Diamonds—Special Values!**

First quality Diamonds at a great saving! Dazzling gems of fine blue white color—all special importations—exquisitely set in mountings of solid 18-k white gold. Buy direct from Loftis, the importer, and save what others pay to middlemen. Order now—direct from this ad!



No. 877  
\$50  
\$1.25 a wk.



No. 878  
\$100  
\$2.50 a wk.



No. 879  
\$160  
\$3.75 a wk.



No. 864  
\$87.50  
\$1 a wk.

Satisfaction guaranteed, or money back. Goods sent for your free examination on request. **Credit Terms:** Pay one-tenth down; balance weekly, semi-monthly, or monthly at your convenience. All goods delivered on first payment.

**Diamond Catalog Free!**

Big 132-page book, illustrating our Diamonds, Watches, Jewelry, Silverware, and gift articles for all occasions, sent absolutely free. Write today.



**Rectangular Wrist Watch No. 868**  
Solid 14-k white gold, 16 Jewels, Gold filled bracelet to match, \$15. \$3.50 down, \$3.50 a month.



No. 830  
\$75  
\$1.75 a wk.



No. 887  
\$100  
\$2.50 a wk.

**Cushion Nickel, 6 Jewels—high Strap Watch grade Leather strap. Special \$8.50**

**"To Be Successful, Look Successful—Wear a Genuine Diamond"**



No. 860  
\$75  
\$1.75 a week



**Only \$85 \$2.25 a week**

**No. 860 HANDSOME RING FOR MEN—An unusual value. Solid 18-k White Gold set with a Brilliant Blue White Diamond.**

**No. 884 STUNNING DINER RING, priced especially low. Solid 18-k White Gold set with 3 dazzling Blue White Diamonds.**

**RAILROAD WATCHES GUARANTEED TO PASS INSPECTION**

**HAMILTON NO. 992, 21 Jewels. Adjusted to 5 Positions. Gold filled 25-Year Quality Case \$55**

**ELGIN'S LATEST RAYMOND, 21 Jewels, 8 adjustments. Runs 40 hours one winding. Gold filled 20-Year Quality Case \$55**

**ILLINOIS "BUNN SPECIAL," 21 Jewels, Adjusted to 6 Positions. Gold filled 25-Year Quality Case. 60 hours, 1 winding. \$50**

**HOWARD RAILROAD WATCH, 21 Jewels, \$80 Adjustments. 25-Year Quality Gold filled Case. Railroad Watches sold on our regular credit terms.**

**17 JEWEL ELGIN No. 14. Thin Metal White gold filled, 20 year quality case; 12 size; silver dial; assorted \$23.50 \$2.85 Down and \$2.85 a Month.**



**BEAUTIFUL WEDDING RINGS SPECIAL LOW PRICES**



**No. 824—The "Elite" solid 18-k white gold \$7.50**  
Set with 8 Diamonds, \$22.50; 6 Diamonds, \$32.50; 7 Diamonds, \$42.50; 9 Diamonds, \$52.50; 12 Diamonds, \$67.50

**Send for Free Catalog!**



# 3 to 35 M.P.H.

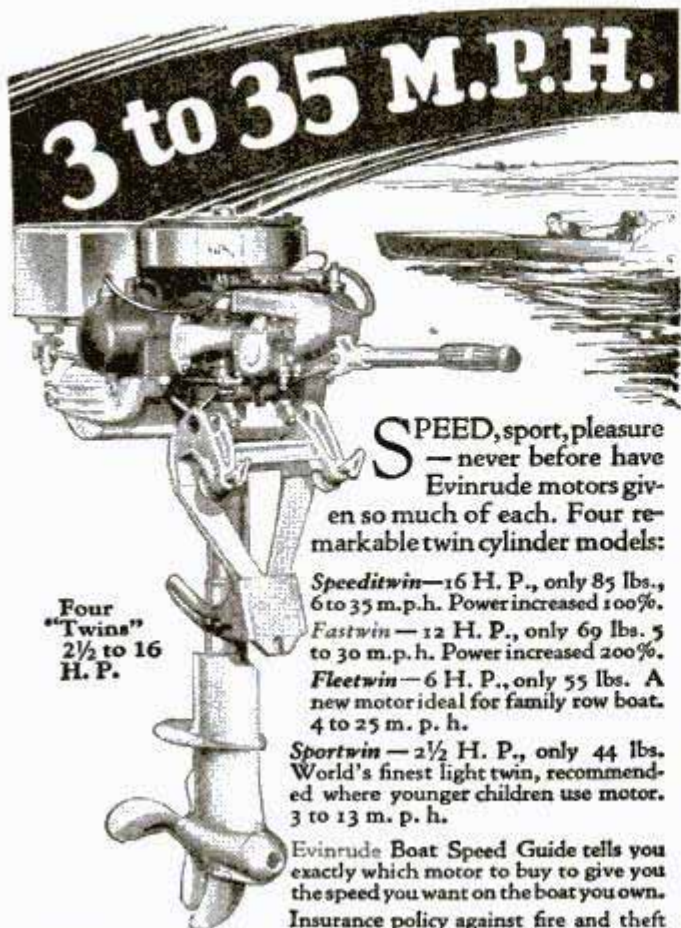

**S**PEED, sport, pleasure — never before have Evinrude motors given so much of each. Four remarkable twin cylinder models:

**Speeditwin**—16 H. P., only 85 lbs., 6 to 35 m.p.h. Power increased 100%.

**Fastwin**—12 H. P., only 69 lbs. 5 to 30 m.p.h. Power increased 200%.

**Fleetwin**—6 H. P., only 55 lbs. A new motor ideal for family row boat. 4 to 25 m. p. h.

**Sportwin**—2½ H. P., only 44 lbs. World's finest light twin, recommended where younger children use motor. 3 to 13 m. p. h.

Evinrude Boat Speed Guide tells you exactly which motor to buy to give you the speed you want on the boat you own.

Insurance policy against fire and theft from \$1.10 to \$2.10, depending on your model.

Time payments—as small down payment as \$31.10 puts an Evinrude on your boat.

Write for 1928 Evinrude Year Book  
**EVINRUDE MOTOR CO.**  
 2418 27th Street Milwaukee, Wis.

from \$1.10 to \$2.10, depending on your model.  
 Time payments—as small down payment as \$31.10 puts an Evinrude on your boat.  
 Write for 1928 Evinrude Year Book  
**EVINRUDE MOTOR CO.**  
 2418 27th Street Milwaukee, Wis.

# EVINRUDE

## NEW VEST POCKET ADDING MACHINE

Guaranteed 5 yrs.



**BABY CALCULATOR**  
 CHICAGO, U.S.A.  
 PATENT APPLIED FOR

**ADDS, SUBTRACTS, MULTIPLIES, DIVIDES**

Costs only \$2.50 each yet does work of \$300 machine. Not a Toy but a real adding machine that everyone should carry. Made of steel and indestructible. Million dollar capacity. Fits in pocket. Weighs 8 ounces. Will not make mistakes. So simple child can operate. Instructions furnished. Be modern in dealing with figures—order your machine today.

**Free Trial**  
**SEND NO MONEY—**

Just name and address. We will ship Calculator immediately. On delivery pay postman \$2.50 (Plus few cents Postage). (If outside U. S. send cash.) 10c additional in Leatherette Case. If not satisfied after 10 day trial you get your money back. **THOUSANDS OF SATISFIED USERS.**

This is the lowest priced practical calculator made. "Why pay more for inferior imitations?" Order from this ad.

**\$2.50**  
 Total Cost

----- Mail Coupon Today -----

**BABY CALCULATOR SALES COMPANY**  
 Dept. 31, P. O. Box 1118, CHICAGO, ILL., U. S. A.

I am enclosing \$2.50—send adding machine prepaid.  
 Send Adding Machine C. O. D. \$2.50 plus postage. (10c additional in Leatherette Case)

Name.....  
 Address.....  
 City..... State.....

**AGENTS** Write for big commission and territory proposition.

# Thompson BEATS the World on BOATS

**THOMPSON BOATS**

## CATALOG FREE!



**OUTBOARD MOTOR BOATS**—A complete line of strictly up-to-date racing models, good for over 30 miles an hour. Also some entirely new models for general pleasure use with a speed of 20 to 26 miles an hour. Built strong and durable and absolutely safe.

**Rowboats \$44.00 and up**—  
 The most complete line ever offered, at real money-saving prices.

**Canoes \$48.00 and up**—  
 Some all wood, others canvas covered. Light, swift, safe, strong and durable. Choice of many distinctive color combinations.

**Motor Boats**—  
 With or without Engine. For Lakes, Rivers, Shallow water and weeds.

**CATALOG FREE — SAVE MONEY — ORDER BY MAIL**  
 Please state the kind of boat you are interested in (30)

→ TWO LARGE FACTORIES ←

**THOMPSON BROS. BOAT MFG. CO.**  
 213 Ann St. (Write to) 113 Elm St.  
**PESHIGO WISCONSIN (Either Place) CORTLAND NEW YORK**

## Sport Bodies for Fords AT FACTORY PRICES!



This Model in Grey Prime **\$39.50**

Write for Booklet A-2 Showing Other Models

**SPORT FACTORIES, AURORA, ILL.**

### CAN YOU SELL GAS at 5c PER GAL.?

If so write me quick. My Distributors make as high as \$3,000.00 per month. Let me show you how.

**SEND FOR FREE TRIAL**

Proof of astounding success and my \$15.00 a day Guarantee to Distributors.

**Frank Andrews, Dept. 805-K.B., 154 E. Erie St., Chicago, Ill.**



## LE PAGE'S GLUE

ATTRACTIVE FURNITURE YOU CAN MAKE YOURSELF

Send 10c for LePage's Home Work Shop Book containing complete directions for making 20 different projects. LePage's Craft League, (383) Essex Ave., Gloucester, Mass.

## AUTOMATIC CONCERTINA (SMALL SIZE ACCORDION)

**PLAYED WITH INTERCHANGEABLE ROLLS**

Without any faint idea of music or notes, without study or practice, you can play perfect like an artist any songs, dances, fox trots, one steps, operas, marches, etc. Nobody can see the mechanical arrangement, everybody must think you are an artist. Wonderful tone, playing complete with all bass and accompaniments. Music is wanted and welcomed everywhere. Biggest assortment of Rolls, latest hits. Three models, for Home, Concerts, Paid Entertainers. \$30.00, \$45.00 and \$60.00 and free music rolls. Descriptive circular No. C. mailed free.

**TREASURE SALES COMPANY 1690 Boston Road NEW YORK, N. Y.**





**Oh Boys!**  **Great Fun with Model AIRPLANES**

Actual Photo

**The "SPIRIT of ST. LOUIS" MODEL READY TO FLY—\$5.00**

Made to scale—22' high lift wings, metal propeller, powerful two bearing motor, shock absorber landing gear. Shipped ready to fly—guaranteed. Exceptional value—extra strong construction. Learn about aviation with these actual flying models.

Also Fokker—Fairchild and Seaplane models. Specify model when ordering. Cost only \$5.00 postpaid in U. S. A.

Send ten cents (3 for 25c) for Racing Glider and complete catalog showing these real models of famous airplanes. Agents and dealers—write for discounts.

**THE CLINTON TOY COMPANY**  
DEPT. No. 2A NORTH HAVEN, CONN.

**Photos ENLARGED**

Size 16x20 inches  
Same price for full figure or bust, groups, landscapes, or pet animals, etc., enlargements of any part of group picture. Safe return of your own original photo guaranteed.

**98c**

**SEND NO MONEY** Just mail photo or snapshot (any size) and within a week you will receive your beautiful life-like enlargement size 16x20 in. guaranteed fadeless. Pay postman 98c plus postage or send \$1.00 with order and we pay postage.

**SPECIAL FREE OFFER** With each enlargement we will send FREE a hand-tinted miniature reproduction of photo sent. Take advantage now of this amazing offer—send your photo today.

**UNITED PORTRAIT COMPANY**  
1652 Ogden Ave. Dept. 366 Chicago, Ill.



**Take 10 Shaves — FREE**

Accept a generous test sample of this amazing shaving cream to prove that the remarkable claims men make for it are true



**GENTLEMEN:**

Advertising claims may sound much alike. And meritorious products that suit one may fail to please another. Hence we feel, in common fairness, that the way to introduce our new shaving cream is by offering a free test at our risk.

Thus, if it suits you—as it does the majority of those who try it—you will then buy it. Whereas, should it not, you will be out nothing.

If this reasoning appeals to you, detach the coupon now. Send it before you forget. We promise 10 delightful shaves which we believe will win you—as it has thousands—to this new delight.

**These 5 exclusive features**

1. Multiplies itself in lather 250 times.
2. Softens the beard in one minute.
3. Maintains its creamy fullness for 10 minutes on the face.
4. Strong bubbles hold the hairs erect for cutting.
5. Fine after-effects due to palm and olive oil content.

**Now make the trial, please**

No doubt your present shaving preparation suits you, yet there may be a better way. We've tried to find one for you, and will thank you to give it a test. Just send the coupon now, before you forget.

THE PALMOLIVE-PEET COMPANY, CHICAGO, ILL.

**10 SHAVES FREE and a can of Palmolive After Shaving Talc**

Simply insert your name and address and mail to Dept. B-1510, Palmolive, 3702 Iron St., Chicago, Ill.

Residents of Wisconsin should address Palmolive, Milwaukee, Wis.

.....  
.....  
(Please print your name and address)

**Makes Old Ford a Tractor**

Now you can convert that old Ford car into a useful farm tractor without altering any Ford parts. We furnish the traction wheels, drive gears and auxiliary axle and mountings, ready to clamp on to the Ford frame. Pulls 16" plow.



Write for Free Particulars.  
Shaw Mfg. Co., Dept. 4507, Galesburg, Kan.

**DON'T WASH YOUR AUTO**

DRY CLEAN IT and all highly polished surfaces with



**THE WUNDA WIPER**

A chemically treated cloth. Removes road dirt and dust Without Scratching. Just as good for furniture.

PRICE DELIVERED 75 Cents  
**HOWARD DUSTLESS-DUSTER CO.**

Agents Wanted

Makers of Jiffy Window Cloths  
497 C Street BOSTON, MASS.

**Beautiful HOUSES \$900 and BUNGALOWS**

CAN BE BUILT FOR AND UP

This and many others in my new book, Building Plans for Modern Homes, will save you hundreds of dollars. One of the most complete and comprehensive books of plans ever published by any architect. New edition just off the press. Nearly 600 floor plans and photographs of Colonial houses, bungalows, etc., costing from \$200 up; gives sizes and cost to build. Sent postpaid for \$3.00.



**FREDE RICK H. GOWING**  
ARCHITECT  
101 Tremont St., BOSTON, MASS.

**PRINT Your Own**

Cards, Stationery, Circulars, Labels, paper, tags, menus, book etc. Save money and time, cut cost in half. Pays for itself in a short time. Sold direct from factory only. **Print for Others, Big Profits.** Complete Outfits, \$8.85 up. Job Presses \$11 up, Rotary \$149. All easy, rules sent. Write catalog presses, type, paper, cards, ink etc.

**EXCELSIOR**  
THE KELSEY CO., U-37, Meriden, Conn.





## JOHNSON HAS GIVEN WINGS TO WATER TRAVEL



**S**KIMMING close to the water in a Johnson powered boat gives a sensation of swiftness far beyond actual speeds. Not until you have sat at the throttle of a Johnson and felt this *winged speed*, tinged with daring, can you know what boating really is.

5 models of Johnsons — including family, fishing and racing types; \$115 to \$275. Sold on free trial and payment plan. All prices F. O. B. Waukegan, Ill.

## JOHNSON MOTOR COMPANY

2463 Pershing Rd., Waukegan, Ill.

Export Division: 75 West St., New York City

IN CANADA

Canadian Johnson Motor Company, Ltd., Peterborough, Ontario. Distributors: Peterborough Canoe Co., Peterborough, Ont., Hoffars, Ltd., Vancouver, B. C.

# Johnson

## Outboard Motors

WORLD'S LARGEST MANUFACTURER OF OUTBOARD MOTORS

## Shoot the Best Gun

The NEW BENJAMIN is the finest air rifle ever made. Unlike all others. Has amazing accuracy—shoots hard and far. It's the original American genuine AIR operated rifle. One to six pump strokes compress air to any desired degree of power. Same force as in air drills and air hammers except you control the shooting force. Never loses force—no springs or levers to get out of order. Makes crack shots quickly, inexpensively. Gives years of delightful recreation with utmost safety. At your dealer's, or sent postpaid for \$5.00.

### Shoot 5 Days FREE

We give you five days, ammunition supplied, to test the NEW BENJAMIN. If in this time you don't believe it to be the finest air rifle you've ever seen or used, and if you don't believe it is the one and only air rifle for you, return it, postpaid, and your money will be refunded at once.

## The NEW BENJAMIN AIR RIFLE

America's Original Air Rifle

**\$5** at your dealer's or sent postpaid direct from factory on FREE Trial as above if dealer does not handle it—write for our wonderful offer.

### Get This Book and Details FREE

BENJAMIN AIR RIFLE & MFG. CO.  
845 N. Broadway, St. Louis, Mo.

Please send your amazing offer and free copy of "The Shooter's Art," telling how to become a crack shot, how to hold, aim, and handle guns and guide others in use of guns.

Name \_\_\_\_\_

Address \_\_\_\_\_

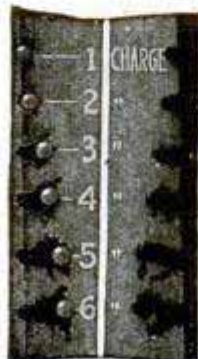

## MAKE YOUR FORD Into The "LARK"

\$5.00 Red-i-Kut life size patterns Class—Snap



38-inch Easy Riding Seat

Famous sure-fit RED-I-KUT life-size patterns and picture instructions show how you can easily convert your Ford into this Fast, Saucy, Sport-Car as thousands have done with easily obtained materials. No need to lay up the car. Rear seat folds, making 4-passenger car. Send 10c coin for actual body, photo and new manual of other distinctive sport body patterns from \$5.00 up—"RNO" Steel "Swing-Lo" Irons, Tops and Windshields. ORDER RIGHT NOW

KUEMPEL COMPANY, 98 Kuempel Bldg., GUTTENBERG, IOWA

## ROW BOATS

From factory direct to you

Prices: \$2400 and up

Write for catalog L-1

SPORT FACTORIES



AURORA, ILLINOIS



## Silk Hose 5c a Pair

An astonishing new discovery called Duro-Silk now allows any woman to make any silk stocking "Run Proof," wear twice as long and never fade. Duro-Silk gives any woman who uses it a pair of silk hose for 5c. In a recent test, a chiffon silk hose, treated with Duro-Silk, was drawn over finger nails 5,573 times without a break or run. The originators want agents who can make from \$75 to \$200 per week, and will send sample to introduce. Write

CURTAN MFG. CO., Dept. 805-K, D., 154 E. Erie St., CHICAGO



## RAISE BELGIAN HARES

NEW ZEALAND REDS—Chinchillas—Flemish Giants  
MAKE BIG MONEY—We supply stock and pay you following prices for all you raise: Belgian Hares \$2 each—New Zealand \$3 each—Chinchillas \$4 each—Flemish Giants \$5 each. 32-page illustrated book, catalog and contract, also copy of Fur Farming magazine, tells how to raise skunk, mink, fox, etc., for big profits, all for 10c. Address

OUTDOOR ENTERPRISE CO., Box 25, Holmes Park, Mo.





McCleary Sanitarium at Excelsior Springs, Mo.—  
the largest institution in the world devoted to the  
treatment of piles and other rectal troubles.  
(Only curable cases are accepted.)

## Pay Nothing If Not Cured

That's our offer to Pile and Rectal sufferers everywhere. Let us prove to you, at our own risk that surgery is not necessary in the treatment of piles—that the McCleary Mild, Serum-Like treatment heals surely, quickly and safely. Thousands upon thousands have already learned this to their everlasting joy and gratitude. Let us send you the proof free.

**Free Book** Send name and address today for a copy of Dr. McCleary's new book, copyrighted, fully illustrated and printed in colors. We gladly send it postpaid, in plain wrapper, Free for the asking. Write today.

**The McCleary Sanitarium**  
654 Eims Blvd., Excelsior Springs, Mo.

## AGENTS 500% PROFIT GENUINE GOLD LEAF LETTERS

**S** guaranteed to never tarnish. Anyone can put them on stores and office windows. Enormous demand, large profits. Paul Clark says: Smallest day \$28.70. R. L. Reel made \$920 in two months. Write today for free sample and liberal offer to general agents.  
**METALLIC LETTER CO., 433-B N. Clark St., CHICAGO**

## I Offer You \$8.00 a Day ~and a

Write quick for new proposition. We offer \$8.00 a day and a new Chevrolet Coach for demonstrating and taking orders for Comer Suits. Spare time. No experience required. Sample outfit free. Write now.



**COMER MFG. CO., Dept. SW-5132, Dayton, Ohio**

Cal. 30-40 Six Shot



**KRAG CARBINE**

Price  
**\$9.75**

All the qualities of a high price rifle. In fine used condition, all working parts guaranteed for one year. Send today for our Free 50-page illustrated catalog of money saving values; Guns, Ammunition, Cutlery, Sports and Gov't goods. Terms Cash. No C. O. D.

**W. Stokes Kirk, 1627-P. M. North 10th St., Philadelphia, Pa.**

## Catch Fish!

Eels, Mink, Muskrats with our new folding galvanized **STEEL WIRE TRAP**. Write for our **FREE TRAP OFFER** and Bargain Catalog. \$1 Box of our famous Fish Bait FREE to introduce our traps.  
**WALTON SUPPLY CO., 3502 JUNIATA AVE., ST. LOUIS, MO.**

## OLD TOWN CANOES

are unsurpassed in durability. Light in weight and easy to handle. Low in price too. New catalog shows all models, also fast seaworthy boats for outboard motors. For free copy address,  
**OLD TOWN CANOE CO., 1867 Middle St., Old Town, Maine**

# WURLITZER

REG. U.S. PAT. OFF.

**"Bill Carola"  
Landaus  
Seranaders**



Couldn't Play a  
Note—Now Makes

**\$100  
a week**

"When I sent for your catalog, I didn't know a note of music. A few months after I bought my Wurlitzer instrument, I had taken my place in a professional orchestra. Now I am making \$100 a week, three times what I made as clerk. I wish everybody knew how easy it is—anyone who can whistle a tune can learn to play a musical instrument."

—Bill Carola

## Free Trial Easy Payments

You may now have any Wurlitzer instrument for a simple free trial in your own home. Examine the instrument, note the fine workmanship, the full, rich tone value and especially how easy it is to play. No obligation to buy—no expense for the trial. We make this liberal offer because we want you to try for yourself a genuine Wurlitzer instrument, the result of 200 year's experience in musical instrument building.

Easy payments are arranged to suit your convenience. This is your opportunity to try a famous Wurlitzer instrument in your own home. Send for

## Free Book

Illustrates and describes every known musical instrument—more than 3000 articles, many of them shown in full colors. All genuine Wurlitzer instruments—buy direct from Wurlitzer and save money. Special offers on complete outfits.

We also give you our Free Trial, Easy Payment Plan. No obligation.

## Send Coupon Today!

**The Rudolph Wurlitzer Co., Dept. B177**

117 E. 4th St., Cincinnati

Send me your Free Book on musical instruments. Also your Free Trial, Easy Payment Plan. No obligation.

Name .....

Address .....

City ..... State .....

Instrument .....

Copyright, 1928, The Rudolph Wurlitzer Co.



# TURNER

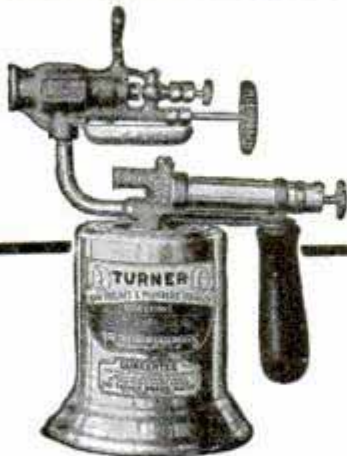

MASTER LINE

## Blotorches are safe!

And now you can have safety as well as efficiency in a blotorch. That's why the TURNER No. 45 leads the field—*bar none*. Patented Automatic Safety Valve gives positive protection against excess or bursting pressure—explosion is impossible. Makes the TURNER 100% safe.

### Special Construction Features

The Turner No. 45 Blotorch embodies every modern improvement. An adjusting tube provides correct amount of air for any gravity fuel. Patented Baffle and Heater Plug perfectly gasify present day gasoline or kerosene; no changing of parts necessary; 400 degrees more heat perfectly controlled. Grooved Pistol Grip Handle fits any hand comfortably.

*TURNER Blotorches are fearlessly guaranteed. Examine them at your nearest dealer's—or write us for details and prices. You can't afford to overlook the safety protection which they assure.*

**THE TURNER BRASSWORKS**  
Sycamore, Ill. U.S.A.

# PARKS

WOODWORKING MACHINES

Cabinet Shop  
Special No. 10

**\$290**

With Motor

You ought to have this handy Parks in your shop. Compact, complete machine designed like a big production outfit at  $\frac{1}{2}$  the cost. Fits in a corner of your basement. Does any kind of cabinet and joinery work. *Write for circular.*



**The Parks Woodworking Machine Co.**

1500-40 Knowlton St.

Cincinnati, Ohio

Canadian Factory: 208 Notre Dame East, Montreal

## \$25 To \$50 Make \$25 to \$50 per day and be Your Own Boss! Per Day Drilling Wells!

Cash in on demand for good wells in every community! Any man with mechanical turn of mind can easily operate one of our drills, make big money, be independent, work the year 'round! A few hundred dollars starts you in this big paying business—pay balance out of earnings! Write for FREE CATALOG describing ARMSTRONG ALL STEEL WELL DRILLS—gasoline traction or non-traction models.

Write now—today—Armstrong Mfg. Co., 810 Chestnut St., Waterloo, Iowa.



Lathes \$6.00 to \$75.00. Largest line of small lathes in America. Send six cents for 32 page catalog of lathes, drill presses, bench saws, jig saws, band saws, etc.

**SYIPHER MANUFACTURING COMPANY**  
Dept. D Toledo, Ohio

**\$10<sup>00</sup>**

**DOWN**  
Brings  
this Lathe  
to You

## MEN WANTED

to become floor surfacing contractors—Pay averages \$30.00 per day—no lay offs—your own boss—work the year round—demand ever increasing—New "American" machines do the finest work and are easiest to handle. Complete information sent free without obligation. Write today.

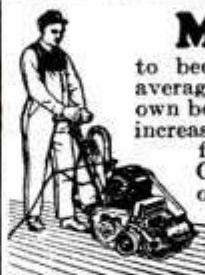

**AMERICAN FLOOR SURFACING  
MACHINE COMPANY**

523 S. St. Clair Street Toledo, Ohio

## BURN YOUR NAME ON TOOLS

### WITH THE ARKOGRAF

**PROTECT YOUR TOOLS FROM THEFT**  
Write with electricity any name or design on the hardest and finest tools and instruments, or any metal, like writing on paper with pen or pencil. **Complete Outfit \$3.50—Prepaid Anywhere** Interesting illustrated circular free. Write today. Agents wanted.  
ARKOGRAF PEN CO., 1171 E. Stark St., Portland, Oregon

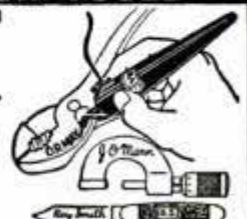

GOODSELL-PRATT COMPANY *Toolsmiths* GREENFIELD, MASS. U.S.A.

**GOODSELL-PRATT**  
1500 GOOD TOOLS



# SIMONDS

## SAWS FILES KNIVES STEEL

for Portable Rigs  
THE SIMONDS  
"60"

AVAILABLE ON  
WODACK  
ALTA  
SKILSAW  
CROWE  
KWICKSAW  
PORTO  
SPEEDWAY  
ESKAY  
WALLACE

**S**IMONDS Saws have so much greater wearability—so much longer life—so much more value—that the country's leading manufacturers of electric hand saws and portable rigs, now supply

Simonds Saws in order to insure the performance of their products. When ordering your next "electric" or portable rig, specify Simonds "60" for economy.

SIMONDS SAW AND STEEL COMPANY

"The Saw Makers"

Fitchburg, Mass.

Established 1832

BRANCH OFFICES AND SERVICE SHOPS IN PRINCIPAL CITIES



No better, neater cases made than the **GERSTNER TOOL CASES** for Machinists and Toolmakers. You will take pride in one. Send a postal for free catalog.

*Gerstner & Sons*

455 Columbia St., Dayton, Ohio

**ONE HANDLE TAKES THE PLACE OF MANY**  
WITH THIS NEW FLEXIBLE HANDLE SOCKET SET

1/4" square connection. Six sockets 7-10", 14", 9-10", 8-3", 11-10", 13" hex openings. Chrome Vanadium steel. Speedy. Guaranteed. Money back if 10 days' trial doesn't satisfy. \$3.65, prepaid, cash with order; \$3.90, C. O. D. Handle only, \$1.75 cash, \$1.90. G.O.D. Agts. Wm. D. Tool Service Sales Co., Box 4605, Sellwood Sta., Portland, Oregon



Illustration clearly shows flexibility of handle.



"H&A," the Better Wood Lathe

WRITE FOR PRICES ON SAW TABLES HAND SAWS SWING SAWS JOINTERS SCROLL SAWS

MOUNTED on heavy structural steel bed—vibrationless, accurate, perfectly balanced—a wonderfully fine tool at modest cost. Made with 3, 4 or 5-foot bed; complete home shop accessories furnished. Write for details.

HESTON & ANDERSON, 607 Western Ave., Fairfield, Ia.

## WITTE Engines

Buy Direct from Factory—Low Cash or Term Prices—Save \$15 to \$200. New Features—includes WITTE all-fuel carburetor and Automatic Throttling Governor. Engine runs on low grade fuels, or Gasoline—Smooth as electric motor. Easy Starting. FREE Catalog—2 to 30 HP.

Witte Engine Works 174B Oakland Ave., Kansas City, Mo. 174B Liberty St., Pittsburgh, Pa.

# TOOLS that Do Wonderful Things!

WONDERFUL results have been accomplished with Cornwell Tools. . . . They do things that no other tools will do. . . . You will be amazed at the demonstration tests, suggested under the various tools described in booklet, for proving their astounding toughness. . . . We will replace any tool that does not stand these tests or give you your money back.

**CORNWELL QUALITY TOOLS**

Made from Special Formula Steel

The steel used in Cornwell Tools is Swedish Charcoal Process Molybdenum Steel produced under our famous Cornwell Formula. . . . They are forged, heat treated, hardened and tempered in oil. All tools made by hand. . . . NOT drop forged and case hardened.

Money Back if Not Satisfied

You take no risk in buying Cornwell Quality Tools—if you ever saw tools as good as these, return your order and get your money back.



The Cornwell Quality Tools Co., Dept. Z, Mogadore, Ohio. (Formerly at Cuyahoga Falls, Ohio.)

Send me new illustrated catalog with prices on full line of Cornwell Hand-Made Tools.

Where Employed  
Name.....  
Address.....  
City..... State.....



# DEVITT 8" COMBINATION SAW

## 8,000 IN USE!

**A  
SHOPFUL  
OF TOOLS  
WITHIN ARMS  
REACH!**

SAW TABLE RAISED  
SHOWING EMERY  
WHEEL, SAW  
GUARD AND  
DRILL AT-  
TACHMENT



PLANER AT-  
TACHMENT  
ON SAW TABLE

SHOWING  
SANDING  
DISC  
ATTACHED



TABLE  
TILTED FOR  
BEVELING

DADO HEAD  
ATTACHED  
FOR  
GROOVING

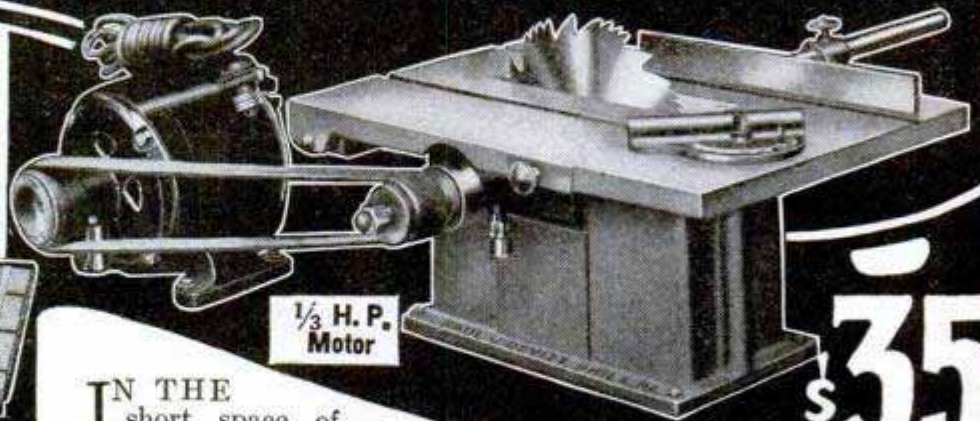

$\frac{1}{3}$  H. P.  
Motor

**\$35**

F.O.B. PHILA

**I**n the short space of four years, the Devitt 8-Inch Combination Saw has become a practical necessity in thousands of shops, factories and households everywhere. Many imitators have sprung up, but Devitt leads them all. Think of the convenience and economy of this handy little machine that will rip, cross cut, bevel, miter, groove, mortise, tenon, drill, rabbet, grind, buff and polish. Attachments are easily and quickly adjusted. The saw and motor, when set up for work, occupy very little room. Saw is equipped with  $\frac{1}{3}$  H.P. 60 cycle, 1750 R. P. M. 110-volt A. C. Motor which can be attached to ordinary light socket, and provide power for other purposes when wanted. A cut up to  $2\frac{1}{4}$ " can be made without planing. Comes complete with following attachments—12"x16" table, 8" Combination Saw, iron pulley for saw table, 10" ripping fence, adjustable cut off miter gauge, motor-specifications as above,  $1\frac{1}{4}$ " endless leather belt, wood pulley, 8 ft. cord and plug, 6" buffing wheel,  $\frac{3}{8}$ " 3 jaw drill chuck, 5" emery wheel, 6" sander, saw guard, and 2" dado insert. \$35.00 F. O. B. Phila. Height  $7\frac{1}{2}$ ", shipping weight, 100 lbs.

(Only \$12 extra for Planer Attachment to fit on table top. Can smooth pieces up to 2 inches wide. Price, F. O. B. Phila.)

Send today for our attractively illustrated 4-page circular

## PAUL J. DEVITT

Dept. I 1102 SOUTH 2ND ST. PHILA., PA.

## RADIO PANELS

**BAKELITE—HARD RUBBER**

Cut, drilled and engraved to order. Send rough sketch for estimate. Our complete Catalog on Panels, Tubes and Rods—all of genuine Bakelite or Hard Rubber. Mailed on Request.

**STARRETT MFG. CO.** 524 S. Green St. Chicago, Ill.

## SOFT WATER

—Without a Cistern

If you have hard running water in your home, you can have all the fresh Soft Water you want. No pumps—no waiting for rain—no dirty roof washings.

**Champion Fresh Water Softener**

softens hard water as fast as you draw it from the faucet. Water always clear, clean, fresh, odorless, and softer than rain water. Comes complete ready to connect to water pipes without plumber's help in any home—old or new. Saves work, soap, clothes.

**Easy Terms—\$5 Down**

and a year to pay balance of our low factory price, or only \$78 cash with order on 30 days' trial. Write for free circular today.

Champion Water Softener Co. 189 W. Madison Street Dept. K. CHICAGO, ILL.

## AGENTS AND SIGN MEN

Now Making \$50.00 to \$100.00 and Up Per Week Selling Our GOLD LEAF SIGN LETTERS

**R**

For store and office windows, board signs, trucks and glass signs. We also make to order script signs and business emblems singly or by the thousands. A permanent business. No capital or experience required. Big demand in every city. Samples and Literature Free.

CONSOLIDATED SIGN LETTER CO. 71-X W. Van Buren CHICAGO, ILL.



*We start you  
in business*

*and help you succeed*

New plan. No experience or capital needed. We furnish everything. Spare or full time. You can easily make

**\$50-\$100 weekly** — Write at once

Madison Shirt Mfrs. 564 Broadway, New York





**I Earned \$2200 IN FOUR MONTHS**

**THIS** is Richard A. Oldham. He earned \$2200.00 in four months with a Haywood Tire Repairing outfit. For 20 years he was telegraph operator on the Illinois Central Railway. He is now 58 years old. He answered my advertisement—quit his job—bought a plant and opened a business. He just wrote me: "I have made more in eight months than  $2\frac{1}{2}$  years as operator." There are now 500 stations where tire repairing is neglected.

**I Must Have 500 Men To Fill These Positions**

I have a Big interesting Book to send you. It tells all about tires—gives inside figures and profit. Send for it! What Oldham and others are doing You can do. \$4500 to \$7500 per year is conservative. Open shop. You can get business all around you. Put out a Haywood Sign and business will come to you. Now get started. Send for the Big Book and start making money.

J. A. Schreiber, Pres.

**HAYWOOD TIRE EQUIPMENT CO.**  
2330-K Ogden Ave., CHICAGO, ILL., U. S. A.  
Cable Address Fanbro



**HB PAINT SPRAY DOES THE WORK OF FIVE MEN**

**QUICK, EASY PROFITS!**

Practically no investment. Small space required. Steady demand and BIG PROFITS refinishing autos, furniture—painting houses and barns with HB quick spray method. One man does the work of five with brushes. Pays for itself on easy monthly payments. 30 DAYS' TRIAL. Write today for details.

**HOBART BROS. CO.**  
Box M781, Troy, Ohio

**EASY TERMS. 30 DAYS TRIAL. QUICKLY PAYS FOR ITSELF.**

**LARGE 48 PAGE \$1.00 BOOK Free**

**STANDARDIZED Circular Service**

Mail Dealers!—Sell Books, Formulas, Novelties, Bargains! Our Ready Made Circular Service Saves You Money. Large Profits! Thirty Attractive Propositions. Popular Sellers. Large Catalog "Sell by Mail" Free!

**B. A. ELFCO**  
519 So. Dearborn St. Chicago, Illinois

**Part-Time Men Get This Suit FREE**

**Make \$45 a Week and up**

Cash profits paid in advance

No question about it, any man can easily earn \$45 a week and up, just showing our wonderful outfit and taking orders for our high-grade tailoring. Never before such low prices and beautiful styles.

**Your Own Clothes FREE**

To introduce our unbeatable values, classy styles and perfect tailoring, we make this introductory free suit offer—something different, better, bigger, more liberal than any offer ever made.

**Handsome Carrying Case Outfit**

of large real cloth samples—everything furnished FREE.

Write today for free suit and big money-making offer.

**SPENCER MEAD CO., Wholesale Tailors, Dept. U816, Chicago**



# Heats Home for 25c a Week!

"I can run my Bulldog furnace steady for fourteen days in normal weather conditions on the actual cost of fifty cents." So writes F. R. Redetzke, of Cleveland, North Dakota. He adds: "Hard to believe is it? That's what some of my neighbors thought until I showed them! We have an unlimited amount of grain screenings in this country. That's the fuel I am using."

That's what the Bulldog does with about the lowest grade fuel you can think of! Here's what it does with coal: "With the Bulldog Furnace I used 3 tons of hard coal last winter to heat our 8 room house."  
—Lester F. Coons, Ellenville, N. Y.



If you are even thinking of a pipeless furnace, or any furnace, write for our free catalog. The Bulldog is one furnace you MUST investigate. Comes completely erected. Fits any height of basement and you install it yourself.

# No Money Down

Small Monthly Payments

The Bulldog is sent for free inspection. Then, if satisfied, you make only small monthly payments at our amazingly low price. Factory connections in both East and West. We ship from nearest point. Don't consider buying any furnace until you find out about the Bulldog. Write at once for our special offer and our free catalog together with the wonderful record of Bulldog success. Mail this coupon today.

**Bulldog Furnace Co.**  
Babson Bros. Sole Distributors  
19th and California Ave., Dept. B-135 Chicago

Without obligating me in any way please send me your free catalog and special offer on the Bulldog Pipeless Furnace.  
(Print Name and Address plainly)  
Have you a basement? Yes  No

Name.....  
Address.....



# \$351<sup>00</sup> CLEARED ~ IN ONE DAY

So writes W. H. Adams of Ohio. Letter from California man reports \$11275 sales in three months; New Jersey \$4000 profits in two months; Pa. \$3000 profits in four months. Ira Shook \$365 sales in one day. Bram bought one outfit April 5 and 7 more by August. Iwata bought one outfit and 10 more within a year.



J. R. Bert says "only thing I ever bought that equaled advertisement." John Culp says: "Everything going lovely. Crispette wrappers all over



town. It's a good old world after all." Kellog, \$700 ahead end of 2d week. Wholesale or retail. Big profits either way. No town too small. Business is pleasant, fascinating and dignified. You manufacture a food product.

## WE START YOU IN BUSINESS

Furnish secret formulas, raw material and equipment. Little capital required; no experience needed.

## Build a Business of Your Own

No limit to the sale of Crispettes. Everybody likes them. It's a delicious food confection. Write for facts about a business that will make you independent. Start now, in your own town.

## PROFITS \$1000 MONTH EASILY POSSIBLE

Send postal for illustrated book of facts. It contains enthusiastic letters from others—shows their places of business, tells how and when to start, and all information needed. Free. Write now!

**LONG-EAKINS COMPANY**

728 High Street

Springfield, Ohio

You too can play a

## MANDOLIN

IT'S so easy to bring sweet music from the Gibson you learn to play quickly, just like Peggy Eames, little heroine of "Our Gang" comedies. At home, in camp, on the beach, wherever music is wanted, you can take your Gibson. It makes you the life of the party. Gibsons are today's most popular stringed instruments, on the air and records.

**EASY PAYMENT Plan.** Send coupon for details. Mention instrument: Mandolin, Guitar, Banjo, Ukulele.



*Gibson*

Gibson, Inc., 703 Parsons St., Kalamazoo, Mich. Please send literature and details of payment plan on

.....(Instrument)  
Name.....  
St. or R. F. D.....  
City..... State.....

## 6 TUBE SUPERPHONIC RADIO—\$16.95 FREE—6 tubes, tested and matched.

An amazing value that can't be beat! Latest 6 tube tuned radio frequency circuit. Metal chassis, shielded. Extremely selective. Long distance reception. Send for complete descriptive circular. Value \$60.00, our price \$16.95. Write today.

**RADIO EQUIPMENT CO., DEPT. 10-G, 549 S. WELLS ST., CHICAGO, ILL.**



## WADE AMATEUR MECHANICS, REPAIR SHOPS, INVENTORS, STUDENTS

**BENCH LATHE**  
A real machine tool for the home work bench—capacity 4" dia. x 12" length. For Metal—Wood—Composition Materials. Turning—Facing—Boring—Drilling—Winding—Thread Cutting. Accurate—Strong—Quiet—Compact. Slide-rest has travel entire length of bed. Leadcrew inside bed. No. 1 Lathe, plain headstock, \$28.00. No. 2 Lathe, back-gear headstock, \$38.00. Extra for lathes with 18 inches between centers, \$7.00. Complete line of accessories at equally low prices. Write for free catalog.

**THE GEROLD CO. Dept. P-44 120 Liberty St. New York**

# EDWARDS METAL ROOFING



## BIGGEST VALUE · LOWEST COST

Buy your metal roofing, shingles, Spanish tile, sidings, etc., DIRECT from the world's largest manufacturer of sheet metal building materials, at BIG SAVINGS. Thousands of satisfied users.

We own our own rolling mills. Enormous output insures lowest production costs. Factory-to-consumer plan makes prices rock bottom. You get the benefit. Many varieties. Edwards metal roofs last longer, look better. Resist rust, fire and lightning. Roofing, shingles, etc., of COPPER BEARING STEEL at special prices. This steel stands the acid test. Outlasts the building to which applied.

## Ready Made Garages and Buildings

Low in cost. Easily erected. Permanent. Good-looking. All types and sizes to suit your purse and purpose. Now's the time for action. Write for Roofing and Material Book No. 150 and for Garage Book.

— FREE — **EDWARDS MFG. CO.**  
SAMPLES BOOKS ESTIMATES  
700-750 Butler St., Cincinnati, Ohio

# BLANK AUTOMATIC

22 CAL. SIX SHOT  
With 100 Blank Cartridges FREE  
No Permit or License Required



You need no permit or license to own this newly invented high power, but absolutely safe and harmless automatic. Positively not a toy. Built like a real automatic, same in construction, appearance, finish, weight and every other detail—except that it fires blank cartridges only. Handy for self-defense. Tightens traps, screws away doors; handy in the house—a real home protector—without the danger of keeping dangerous firearms at home. Play a practical joke on your friends. Ideal at festivals, fairs, picnics, outings, camping, hikes, outdoor sports, etc., etc. Blue steel, case hardened frame, a duplicate of internationally famous German automatic. Makes powerful loud report. Has six shot magazine that can be reloaded instantly. Uses standard blank cartridges. Checkered grip. Box of 100 cartridges free with each automatic. Convenient pocket size. Send no money. Pay on delivery \$4.99 and express charge.

**JENKINS CORP, 621 Broadway, New York, Dept. 23J7**

## PLUMBING-HEATING

**YOU SAVE HALF**  
Send for BIG FREE BOOK of Guaranteed Plumbing and Heating. Everything cut-to-fit. 50 yrs. in business. Thousands of customers. "You saved me \$400.00," says Mr. Edw. Borkosky of N. J. Write today.  
**HARDIN-LAVIN CO., 107-17 C Parshing Rd., CHICAGO**

## \$3 commission - MEN'S SUITS

**\$888** Any one can earn \$2,000 extra money yearly in view of low price. Up to date styles, workmanship. Variety of beautiful patterns.  
**FREE SALES KIT 888Co., Dept. G-7, Fort Wayne, Ind.**





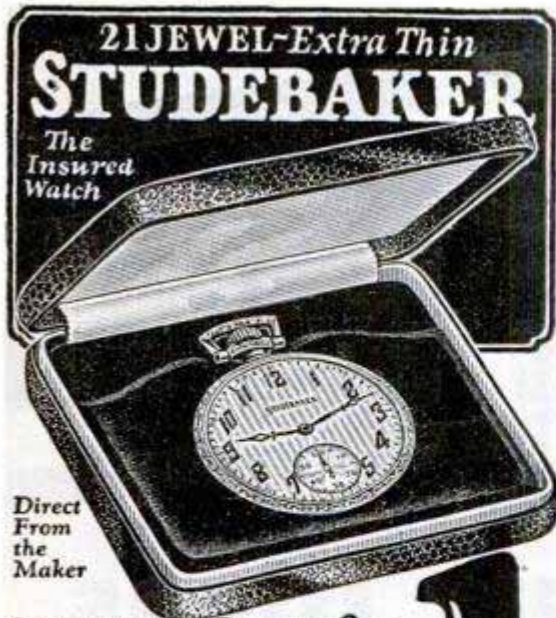

Just \$1.00. The balance in easy monthly payments. You get this famous Studebaker 21-Jewel Watch direct from factory at a saving of thirty to fifty percent. Your choice of 80 new Art Beauty cases and dials. Latest designs in white gold, yellow gold and green gold effects, 8 adjustments, including heat, cold, isochronism and five positions. Insured for a lifetime. Ladies' Bracelet Watches, Men's Strap Watches, Diamonds and Jewelry, too. All sold on easy monthly payments. Your credit is good! Write today for free book of Advance Watch Styles or Jewelry Catalog.

**Watch Chain FREE!** For a limited time we are offering a beautiful Watch Chain free. This special offer will be sent to everyone who writes at once. Don't delay! Get this free chain offer today—while it lasts.

**STUDEBAKER WATCH COMPANY**  
 Directed by the Studebaker Family—known for three-quarters of a century of fair dealing  
**Dept. R997 South Bend, Indiana**  
 Canadian Address: Windsor, Ont.

Sent for \$1

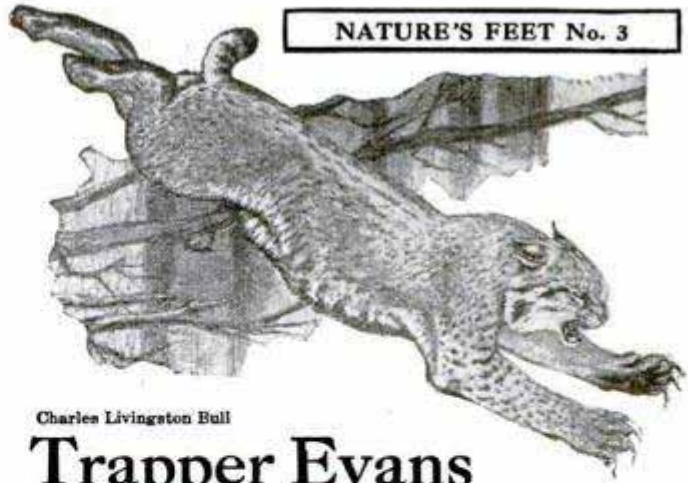

NATURE'S FEET No. 3

Charles Livingston Bull

## Trapper Evans tells how the wildcat keeps in training—

“THE wildcat could not move quickly enough to catch his quarry were it not for the fact that he keeps himself physically fit by a form of setting-up exercises.

“As you follow a cat's trail in the snow, suddenly you will see where he has made a tremendous leap, carrying him high into the air and about 10 feet. Upon coming down once again he takes his usual gait. By keeping his feet and leg muscles constantly exercised and using them, he is in perfect condition for the time when he needs every ounce of strength and energy.”

*Trapper Evans*

**K**EDS special models for boys give your feet much of the sure grip and spring of the wildcat's paws. In them your feet grip surely. And the special Feltex innersole keeps your feet comfortable.

Write for our free booklet containing all kinds of information on games, sports, camping, vacation suggestions and other interesting subjects. Dept. 2370 1790 Broadway, New York City.

### United States Rubber Company

#### An Offer of the Actual Footprints of the Wildcat

By special arrangement with Trapper Evans the makers of Keds are now able to offer you the actual tracks of many American wild animals. Each one is an original, identical footprint—hardened in clay-like material, mounted on felt. Write to Trapper Evans Care of Keds Outdoor Dept. 2370 1790 Broadway, New York City, enclosing 35c and obtain a track of the wildcat sent postpaid in U. S. and Canada.

A complete list with prices of the wild animal tracks made by Trapper Evans will be mailed free on application.

The "Royal Tread" In white or brown

They are not Keds unless the name Keds is on the shoe



Copyright 1928 by United States Rubber Company

**\$1500 WITHOUT MOTOR** **SCHROETERS** No. 15 Motor Driven SCROLL SAW for Home or Small Shop

The saw is mounted on a neat wood base and has a 7 1/2-inch nickel plated tilting table which is essential for inlay work. The work which can be accomplished is marvelous. Has a range of work from the finest inlay up to 7/8-inch white pine. A practical machine for sawing Radio panels such as bakelite, sheet brass, hard rubber, bone, fibre, etc. Has 16-inch swing. Weight only 21 pounds without motor. We supply a catalog of 200 miniature scroll saw designs with each machine.

Add \$500 when boring attachment is wanted

For More Information Write for Our Scroll Saw and Tool Catalog  
**SCHROETER BROS. HARDWARE CO.**  
 810 Washington Ave., ST. LOUIS, MO.

## MOTORCYCLES

Price \$10 and up purchased through our Co-Operative Plan for as low as \$1.00 down and \$1.00 per week  
**Indians Harley-Davidsons Ace Henderson and Cleavelands**  
 Send ten cents for Bulletin A.  
 Motorcycles shipped to all parts of the world  
**WALKER-INDIAN CO., 78 Brookline Ave., BOSTON**

## Start to Play Very First Day

Be the life of the party. Xylorimbists make \$5 to \$25 a night. No knowledge of music required. Wonderful for home. Free, easy lessons; five days' trial; a year to pay.  
**Send Coupon for BIG FREE BOOK!**

**YOU CAN PLAY THE XYLORIMBA**

J. C. Deagan, Inc., Dept. B-145 1770 Berceau Ave., Chicago  
 Send me, without obligation, full details of Free Trial offer and easy-payment plan on the Deagan Xylorimba.

Name \_\_\_\_\_  
 Address \_\_\_\_\_



# PATENT

## Protect Your Ideas

### Take the First Step Today

If you have a useful, practical, novel idea for any new article or for an improvement on an old one, you should communicate with a competent Registered Patent Attorney AT ONCE. Every year thousands of applications for patents are filed in the U. S. Patent Office. Frequently two or more applications are made for the same or substantially the same idea (even though the inventors may live in different sections of the country and be entirely unknown to one another). In such a case, the burden of proof rests upon the last application filed. Delays of even a few days in filing the application sometimes mean the loss of a patent. So lose no time. Get in touch with me at once by mailing the coupon on the opposite page.

### Prompt, Careful, Efficient Service

This large, experienced organization devotes its entire time and attention to patent and trade mark cases. Our offices are directly across the street from the U. S. Patent Office. We understand the technicalities of patent law. We know the rules and requirements of the Patent Office. We can proceed in the quickest, safest and best ways in preparing an application for a patent covering your idea. Our success has been built on the strength of careful, efficient, satisfactory service to inventors and trademark owners located in every state in the Union.

### NO CHARGE for Information On How to Proceed

The booklet shown here contains valuable information relating to patent procedure that every inventor should have. And with it I will also send you my "Record of Invention" form on which you can sketch your idea and establish its date before a witness. Such evidence may later prove valuable to you. Simply mail the coupon and I will send you the booklet, and the "Record of Invention" form, together with detailed information on how to proceed and the costs involved. Do this NOW. No need to lose a minute's time. The coupon will bring you complete information entirely without charge or obligation.



My Patent Law Offices  
Just Across  
Street From  
U.S. Pat. Office



Above is a view of my drafting and specification offices where a large staff of experienced experts are in my constant employ. All drawings and specifications are prepared under my personal supervision.

# NEWS

*Inventors*

*Write for these* **Free Books**

**Strict Secrecy Preserved**

All communications, sketches, drawings, etc., are held in strictest confidence in strong, steel, fireproof files, which are accessible only to authorized members of my staff. Feel free to write me fully and frankly. Your case will have my personal attention. It is probable that I can help you. Highest references. But **FIRST**—clip the coupon and get my free book. Do **THAT** right now.

**Clarence A. O'Brien**

*Registered Patent Attorney*

Member of Bar of: Supreme Court of the United States; Court of Appeals, District of Columbia; Supreme Court, District of Columbia; United States Court of Claims. Practice confined exclusively to Patents, Trade marks and Copyrights

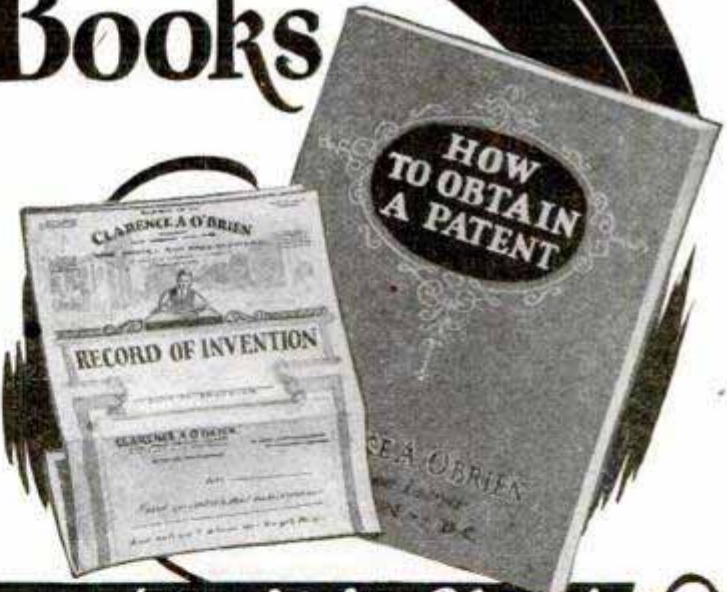

**Clip this Coupon and Mail it Now!**

**CLARENCE A. O'BRIEN, Registered Patent Attorney**

709 Security Savings and Commercial Bank Bldg., Washington, D. C.

Please send me your free book, "How to Obtain a Patent," and your "Record of Invention" form without any cost or obligation on my part.

Name.....  
(Important: Write or Print name clearly.)

Address.....



# PATENTS

TRADE-MARKS · DESIGNS  
FOREIGN PATENTS

**MUNN & CO.**  
PATENT ATTORNEYS

*Associated since 1846 with the Scientific American*

SCIENTIFIC AMERICAN BUILDING  
24 W. 40th St., New York City

SCIENTIFIC AMERICAN BUILDING  
Washington, D. C.

TOWER BUILDING  
Chicago, Ill.

VAN NUYS BUILDING  
Los Angeles, Cal.

HOBART BUILDING  
San Francisco, Cal.



Books and Information on Patents and Trade-Marks by Request.  
Associates in All Foreign Countries.

## 1000 NEEDED INVENTIONS!

Here is the most remarkable book ever offered to inventors. One Thousand needed inventions listed and described. Arranged as follows: General Problems; Automotive; Mechanical; Electrical; Chemical; Radio; Marine. Separate chapter on the Ten Most Needed Inventions. This book may give you one idea that will win you a fortune. Nothing else like it has ever been published. Compiled at enormous expense. Edited by Raymond Francis Yates, formerly Managing Editor of a leading scientific magazine. Over 100 pages, durably bound. Price \$1.25.

### SEND NO MONEY

Cut out this advertisement and send it to us with your name and address, plainly written, and your copy of this remarkable book will be sent immediately. Pay the postman only \$1.25, plus postage, on arrival. Money back, after 10 days' examination, if desired. Limited edition. Write NOW. (Outside U. S. \$1.45, cash with order.)

**BUREAU OF INVENTIVE SCIENCE**  
Dept. 37 Rochester, New York



## PATENTS

Send us sketch or model for advice and exact cost of patent. Our book "How to Obtain a Patent" sent free. It tells how to apply for Patents, Trade Marks, Foreign Patents, Copyrights, etc.; gives information on Patent Procedure; tells what every inventor should know. Thousands of inventors, who are our clients, are our reference.

**CHANDLEE & CHANDLEE, 25 Years' Experience**  
410 Seventh St. Washington, D. C.

## PATENTS

Trade Marks, Copyrights, Patent Litigation Handbook with illustrations, 100 mechanical movements. Sent free on request.

**ALBERT E. DIETERICH**  
formerly member examining corps U. S. Patent Office  
**PATENT LAWYER and SOLICITOR**

621-A, Ouray Bldg.  
27 Years' Experience Washington, D. C.

# PATENTS

Booklet Free Highest References  
Promptness Assured Best Results

Send drawing or model for preliminary examination of Patent Office records.

## ALL BUSINESS GIVEN PROMPT AND PROPER ATTENTION

Listed Patent Lawyer in the latest editions of the Rand-McNally Directory of Bankers and Attorneys, of Chicago, Ill.; The Baggott & Ryall Directory of Attorneys, New York City; The Lawyers Guaranteed Directory, Detroit, Michigan; The Lawyers and Bankers Quarterly, published by the Legal Directory Publishing Company of St. Louis, Mo.; the American Lawyers Annual, Cleveland, Ohio.

**WATSON E. COLEMAN,**  
REGISTERED PATENT LAWYER

Victor Building, 724 Ninth Street, N. W.  
**WASHINGTON, D. C.**



# PATENTS

## To the Man with an Idea

PATENTS Procured. Trade Marks Registered. —A comprehensive, experienced, prompt service for the protection and development of your ideas. Preliminary advice gladly furnished without charge. Booklet of information and form for disclosing idea free on request.

**IRVING L. McCATHRAN, Patent Lawyer,**  
Formerly with and successor to RICHARD B. OWEN  
200 Owen Bldg., Washington, D. C.  
41-E Park Row, New York City

### TRADE-MARKS REGISTERED

## BLUE BOOK ON PATENTS AND PRIORITY RECORD BLANK GRATIS.

**MONROE E. MILLER, PATENT LAWYER**  
411-2 Ouray Building, WASHINGTON, D. C.  
ELECTRICAL AND MECHANICAL EXPERT

## INVENTORS

who derive largest profits know and heed certain simple but vital facts before applying for Patents. Our book Patent-Sense gives those facts; sent free. Write **LACEY & LACEY, 646 F St., Washington, D. C. Established 1869.**

**EDGAR M. KITCHIN**  
**Attorney & Counsellor at Law**  
Patent and Trade Mark Specialist 805 G St. N. W., Washington, D. C.

## GRAY HAIR NO DYE!

— NEW unusual discovery. For men and women. Quickly restores original youthful color. Youthray is not a dye. Applied to scalp. Excellent tonic and Hair Restorer. Ends falling hair and dandruff. Stainless. No one will know you use it. Results guaranteed. Get booklet and free trial offer today.  
**RAY LABORATORIES, 648 N. Michigan Ave., Dept. 67B, CHICAGO, ILL.**

## How to Straighten Bow and Knock-kneed Legs!

Improve your personal appearance by using the new patent "Lim-Straitner," Model 18. Corrects bow legs and knock-kneed legs safely, quickly and permanently at home. No costly operation or discomfort. Is worn at night. Easy to adjust; its result will save you soon from further humiliation and will improve your personal appearance 100 per cent. Write today for copyrighted Physiological and Anatomical book and experience of others without obligation. Enclose a dime for postage.  
**M. TRILETY, Specialist Dept. 1642L BINGHAMTON, N. Y.**

## Buy a BULOVA WATCH —the Modern Way

**WHAT YOU DO—**  
SEND A DOLLAR with Name and Address, and brief note telling us something about yourself.  
Simply state: (1) how long at address, (2) age, (3) married or single, (4) name and address of employer, (5) nature of work, (6) how long in employ.  
All information held strictly confidential—no direct inquiries to employer.

**WHAT WE DO—**  
Upon arrival of your order, we will open a 10 month Charge Account and send selection for approval and 15 DAY TRIAL. If satisfied, pay \$2.75 monthly; otherwise return and dollar will be refunded.

You pay the Nationally Advertised Cash Price—  
**No More \$28.50**  
\$1 with order, \$2.75 a month



14K green or white gold filled case; guaranteed 15-Jewel Bulova Movement; radium numerals and hands; genuine leather strap.

Flexible transparent cap, which protects the movement.

## L.W.SWEET Inc

To Any Adult interested in the purchase of Diamonds, Watches or Jewelry we will send without obligations our beautiful booklet illustrated in colors.

DEPT. 68-M  
**1660 Broadway**  
NEW YORK

# PATENTS

## Don't Lose Your Rights To Patent Protection

Before disclosing your invention to anyone send for blank form "EVIDENCE OF CONCEPTION" to be signed and witnessed. As registered patent attorneys we represent hundreds of inventors all over the United States and Canada in the advancement of inventions. The form "Evidence of Conception," sample, instructions relating to obtaining of patents and schedule of fees sent upon request.

**LANCASTER & ALLWINE**  
480 Ouray Bldg. WASHINGTON, D. C.  
Originators of forms "Evidence of Conception."

# INVENTORS PROTECT YOUR IDEAS

Send for our Guide Book, **HOW TO GET A PATENT**, and Evidence of Invention Blank, sent Free on request. Tells our terms, methods, etc. Send model or sketch and description of your invention for **INSTRUCTIONS**. No charge for the above information.

**RANDOLPH & CO.**  
301 Victor Bldg., WASHINGTON, D. C.

NAME \_\_\_\_\_  
STREET \_\_\_\_\_  
CITY \_\_\_\_\_ STATE \_\_\_\_\_



**Jar It! Drop It!**  
It GOES just the Same



It's a Gothic  
**JARPROOF**  
WATCH

"Gothic Jarproof" performance is neither luck nor miracle! The secret of its unusual dependability is in the special, patented construction of the movement. Guaranteed to withstand accidental knocks, shocks and jars. No other watch in the world like it.

**A FULL YEAR TO PAY**

Send \$1.00 with order and your watch comes to you postage prepaid—No C.O.D. to pay on arrival.

Send Only \$1

**10 DAYS FREE TRIAL**  
After examination and free trial, pay balance in 12 equal monthly payments. No interest—No extras. All transactions strictly confidential. Satisfaction guaranteed or your money back.



**B. T. 1—Engraved rectangular case, green or white gold filled; 15 Jewel "Gothic Jarproof" movement; radium dial and hands. Guaranteed accurate; dependable—**  
**\$28.50**  
\$2.30 a mo

**FREE CATALOG**  
Latest catalog of genuine diamonds, standard watches, fine jewelry and silverware. Write now for copy. Complete issue of Ladies' and Gen's "Gothic Jarproof" Watches.

**ROYAL DIAMOND & WATCH CO.**

ADDRESS DEPT. 11-G 170 BROADWAY, N.Y.

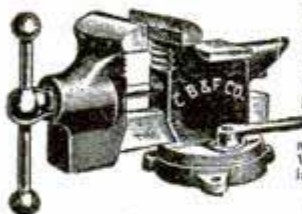

**Champion Swivel Bench Vise**  
Only \$2.25 \$2.25 A Bargain  
Just the Vise for the Home Workshop. Draw Bar, Handle and Screw made of Steel. Jaws high-grade steel, knurled and ground. Machine Cut Thread on Screw. All steel parts highly polished. Body and Base are Ducted. No. 30 Radio, Garage and Home Workshop Vise. Width of Jaw 3 inches, opens 3 inches, weight 13 lbs. Shipped in Carton.

Now Is Time to Buy—Order Today

**Champion Blower & Forge Co., Dept. "V" Lancaster, Pa.**

**SENSATIONAL \$3 Typewriter Offer**

**3**  
AFTER 10 DAY FREE TRIAL

DON'T SEND US A CENT—we'll ship you a genuine L. C. Smith for a 10-Day Free Trial. Put it to any test in your home or office—no one will urge you to buy. Compare it with any machine made. Then, if you decide to keep it, we'll make you the **LOWEST PRICE EVER OFFERED** and give you **EASY MONTHLY PAYMENTS** so small you'll never miss them.

**The ONLY Ball-Bearing Typewriter**



Because of its ball-bearing construction, the L. C. Smith is the *easiest running and longest wearing* typewriter made. ALL THE 1928 ATTACHMENTS.

**Guaranteed for 5 Years HIGHEST QUALITY** re-noved. Don't buy any typewriter until you have tried an L. C. Smith. For the sake of your future satisfaction, accept our **FREE TRIAL OFFER.**

**\$3 Worth Extras FREE**

By acting now, you get Tools, Waterproof Cover, valuable Home Study Course in Touch Typewriter Free. Play safe. Use the ball-bearing L. C. Smith 10 days before deciding on any machine. Write TODAY for details of our Special Offer and manual of typewriter information.

**Smith Typewriter Sales Corp.**  
117-360 East Grand Avenue, Chicago

**MOTORCYCLES**

**WE WILL TRUST YOU**  
Pay As Low As \$2.00 per Week  
Hendersons, Harley-Davidsons, Indians  
Slightly used and rebuilt. Hundreds to select from.  
Send 10c for list today.

**MYEROW BROS. CO., 15 Berkeley St., Boston, Mass., U. S. A.**

**SQUAB BOOK FREE**

Breed squabs and make money. Sold by millions at higher prices than chickens. Write at once for free 40-page book beautifully printed in colors telling how to do it. You will be surprised.  
**PLYMOUTH ROCK SQUAB CO.**  
634 H Street Melrose Highlands, Mass.

**FOY'S BIG BOOK, in Colors**

A complete guide to successful Poultry and Squab Raising. Low prices on CHICKS, Breeding Stock and PIGEONS.  
Write Today! FREE!  
**FRANK FOY, Box 18, Clinton, Iowa**

**HOLLAND PRINTS**

Wonderful new way of binding kodak pictures. Keep a photographic record. Sample Holland print from your negative for 10c.  
**FRANK SCOBIE, 43-H, SLEEPY EYE, MINN.**

**Make Up Your Own Workshop!**

With Boice-Crane portable bench machines you can make up your own workshop in any combination you want and all operated from one double shaft motor. Why cramp your ambitions with poorly constructed tools when you can make real things with Boice-Crane bench machines and build them the way you want to build them? Boice-Crane bench machines are powerful, sturdy, he-man tools, quality-built and just as easy to own as makeshifts. Three or four Boice-Crane machines can be operated from Boice's double-shaft motor connected to any light socket. We show two here:



**Universal Hand Saw.** Elevates for crooving. Cuts 2 1/2 in. stock. Insert takes 6 x 1 in. dado head, cope heads and 8 in. sand disc. Select any Boice machine you want together with double shaft motor and later add machines as you want them without adding cost for power units.

**Universal Jig Saw.** Table 8 in. dia. tilts 45 deg. both ways. Saw-to-frame 10 in. Uses blades 1-8 to 3-8 in. wide.

Make the things you want to make, the way you want to make them with equipment that you want to make them with! Send 10c for new catalog "B" describing the complete line of Boice-Crane circular saws, jig saws, band saws, mortisers, jointers, lathes, etc. Thousands in use the world over.

**W. B. & J. E. BOICE Dept. PM. 7-D Toledo, Ohio**





# Ground Out Static

with **SUB-AERIAL**



Let Ground Waves Bring You Amazing Distance, Crystal Clear Tone Quality, and Greater Volume and Selectivity without Distortion.

Sub-Aerial has brought a new epoch in Radio. No need longer to bother with troublesome, overhead Aerials. Why risk breaking your neck to put up roof aerials only to have the first storm blow them down? Forget your Aerial Troubles. Why not use the whole earth as a static and noise filter with Sub-Aerial?

**Costs No More Than an Overhead or Loop Aerial** and less than many. Hook your set on to the newly discovered Ground Waves that bring practically static free reception. Don't stand for the squawks and tin pan reception you get from Air Waves when you can step right out and leave that stuff.

If you don't believe us, try it yourself. If you do not find we're right—absolutely right—you don't pay us a cent for the test.

**TRY IT FREE** We know so well the surprising results you'll get that we'll let you put in a Sub-Aerial entirely at Our Risk. Don't take down your overhead Aerial. Pick a summer night when static and noise interference on your old Aerial are "Just Terrible." If Sub-Aerial doesn't Sell Itself to You Right Then On Performance—you needn't pay us a cent. Send for "all the Dope on Sub-Aerial." You'll be surprised. Do it NOW.

## UNDERGROUND AERIAL SYSTEMS

St. Clair Building, Dept. 8-K  
Cor. St. Clair & Erie Sts., Chicago, Ill.

Can Be Installed in a Few Minutes

**MAIL THE COUPON**

Underground Aerial Systems, Dept. 8-K,  
St. Clair Bldg., cor. St. Clair & Erie Sts.,  
Chicago, Ill.

Send me complete information on Sub-Aerial, Proof and Free Trial Offer. No obligation.  
Name.....  
Address.....  
City.....  
State.....

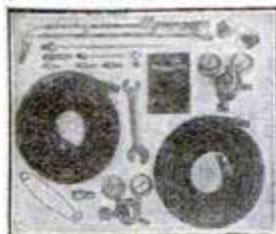

## Start a Welding & Battery Shop

- Lead Burning Outfits.....\$18.00 up
- Welding Outfits.....25.00 up
- Soldering Outfits.....8.00
- Lead Burning Torches.....6.00
- Welding Torches.....10.50 up
- Cutting Torches.....30.00 up
- Regulators and Gauges.....9.50 up
- Paint Sprayers.....14.00

Welding Supplies  
Superior Oxy-Acetylene Machine Co.  
P. O. Box 285 Hamilton, Ohio

# LYNCH

**A. C. Hum-Killer Complete with Mount, \$1.00**

Arthur H. Lynch, Inc., 1775 Broadway, N. Y. C.

## A SHIP MODEL FOR \$4 98



Build an exact replica of the historic Santa Maria or the Mayflower with your own hands. We will furnish the parts cut to fit and ready to assemble complete for only \$4.98 plus a few cents for postage. No tools needed except a small hammer. Parts for model of Constitution may be purchased for \$6.98. Write for our illustrated catalog.

**MINIATURE SHIP MODELS**  
Dept. P-9, 3818-20-22-24 Baring St., PHILADELPHIA, PA.

## The SILVER ACE MODEL AIRPLANE

Flies 800 Feet

(Wing Spread 30 in. Weight 3-3/4 oz.)

Thousands of scale model enthusiasts in every State of the Union and in many foreign countries know that the SILVER ACE is the best to buy and the simplest to build—Convertible Monoplane, Biplane, Seaplane.

Have you seen the wonderful new SILVER ACE Dummy Whirlwind Motor and the SILVER ACE Pontoons? Ask your local store to show you the latest SILVER ACE. Ready to Fly or Partly Assembled.

Our new Content Kit costs only \$5.00  
Catalog 10 cents

**AERO MODEL CO., 329 Plymouth Court, CHICAGO**

## ENJOY the THRILL of ELECTRIFIED RADIO at SMALL COST

only  
\$6 85  
complete

**FREE TRIAL**

Banish forever all the annoyance and expense of buying new "B" Batteries with a TOWNSEND "B" POWER UNIT. Hooked up in a few moments—and you have permanent power from your light socket.



that time on. Use same tubes now in your set. No changes needed. You'll be amazed at the way Townsends improve your reception and add to distance getting. More than 50,000 now in use. Send coupon today for full information and free trial offer.

## Townsend Laboratories, Chicago

-----COUPON-----

TOWNSEND LABORATORIES,  
713 Townsend St., Dept. 15, Chicago, Ill.

Please send me full information on the Townsend "B" Power and Free Trial Offer.

Name.....  
Address.....



# PATENTS TRADE MARKS COPYRIGHTS

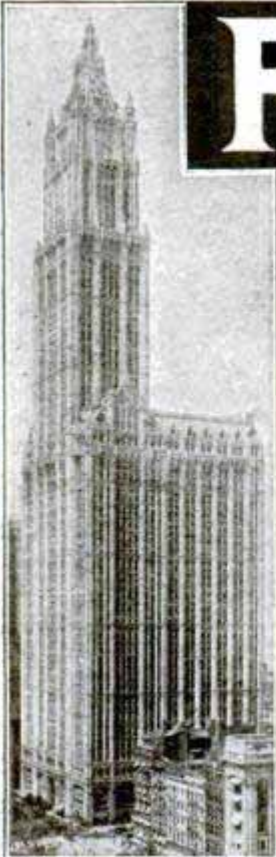

Our New York Office  
Suite 1007 Woolworth Bldg.



Our Philadelphia Office  
Suite 518-519 Liberty Bldg.



Our Washington Office, Victor Bldg.



**Have You An Idea?**

**Our Offer:** FOR THE PROTECTION  
OF YOUR INVENTION

## YOUR FIRST STEP

The inventor should write for our blank  
form

### "RECORD of INVENTION"

This should be signed and witnessed and  
returned to us together with model or  
sketch and description of the invention for

### INSPECTION AND ADVICE

*No Charge for the Above Information*

### Our Five Books Mailed Free to Inventors

*Our Illustrated Guide BOOK*

### How to Obtain a Patent

Contains full instructions regarding U. S. Patents.  
Our Methods, Terms, and 100 Mechanical Move-  
ments illustrated and described.

### Our Trade Mark Book

Shows value and necessity of Trade Mark Protec-  
tion. Information regarding *Trade Marks and un-  
fair competition in trade.*

### Our Foreign Book

We have Direct Agencies in Foreign Countries, and se-  
cure Foreign Patents in shortest time and lowest cost.

### Progress of Invention

Description of World's Most Pressing Prob-  
lems by Leading Scientists and Inventors.

*We Regard a Satisfied Client* as our best advertise-  
ment, and furnish anyone, upon request, lists of clients  
in any state for whom we have secured patents.

*Highest References—Prompt Service  
—Reasonable Terms*

## VICTOR J. EVANS & CO.

**PATENT ATTORNEYS**

Main Offices: 789 9th St., N. W., Washington, D. C.

*Opposite U. S. Patent Office*



# DELAYS ARE DANGEROUS IN PATENT MATTERS

## IMPORTANT! To Avoid Delay!

YOU SHOULD HAVE YOUR CASE MADE SPECIAL IN OUR OFFICE to save correspondence, secure protection and early filing date in the Patent Office. To secure **special preparation** of your case send \$25.00 on account with model or sketch and description of invention.



MAIN OFFICE, VICTOR J. EVANS & CO.—VICTOR BUILDING, WASHINGTON, D. C.

*Our Lawyers Practice in all U. S. Courts and defend Clients in Suits involving Patents, Trademarks and Copyrights*

All Communications and Data Strictly Confidential. Interference and Infringement Suits Prosecuted

OUR ORGANIZATION OFFERS **PERSONAL SERVICE** By Experienced Patent Lawyers, Solicitors and Draftsmen

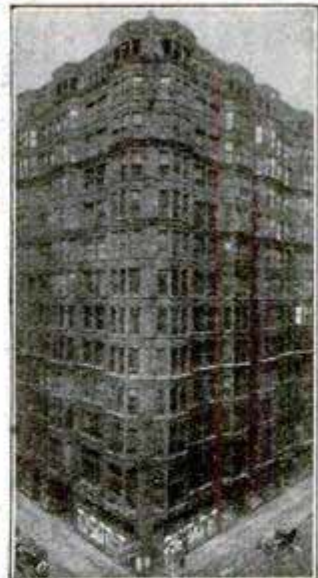

Our Chicago Office Suite 1114 Tacoma Building



Our Pittsburgh Office Suite 514 Empire Building



Our San Francisco Office Suite 1010 Hobart Building

**FREE  
COUPON**

**VICTOR J. EVANS & CO.  
PATENT ATTORNEYS**

NEW YORK OFFICES  
1007 Woolworth Bldg.

CHICAGO OFFICES  
1114 Tacoma Bldg.

PHILADELPHIA OFFICES  
518-519 Liberty Bldg.

PITTSBURGH OFFICES  
514 Empire Bldg.

SAN FRANCISCO OFFICES  
1010 Hobart Bldg.

MAIN OFFICES: 789-9th Street, N. W., WASHINGTON, D. C.

Gentlemen: Please send me *Free of Charge* your books as described on preceding page.

Name .....

Address .....



# 18 Tools In One S&B SAW Money Back Guarantee

## 8" Combination S&B SAW 12" Band Saw

The only machine that you can tilt the table to 45° without removing insert. Big advantage on pattern work.

Sent to You on 15 days approval

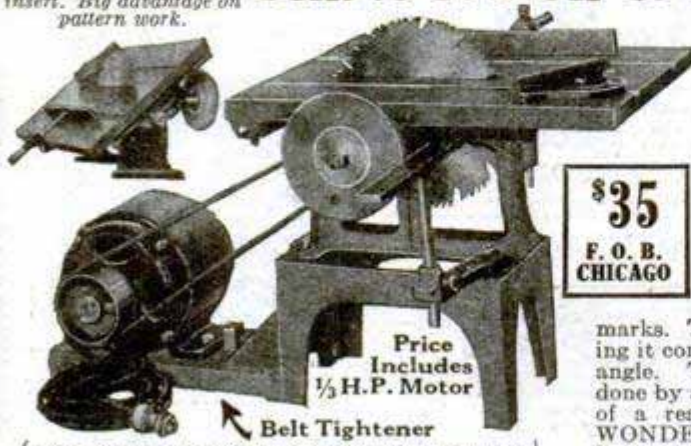

**\$35**  
F. O. B. CHICAGO

Price Includes 1/2 H.P. Motor

Belt Tightener

1/2 H. P. Motor-40°-100% overload Double Shaft Extension

### 18 Tools in One—Greatest Machine You Ever Saw

THE S&B 8-in. COMBINATION SAW (18 tools in one) is the ideal machine for the shop, factory or the home; will rip, cross cut, bevel, miter, mortise, groove, drill, tenon, grind, rabbet, buff and polish. Motor is mounted on a base that is a part of the machine proper. Run from any light socket, also provides power for other purposes when the saw is not in use. Complete with attachments and price includes 1-3 H. P. Motor, 60-cycle, 110-Volt A. C. Price \$35.00 F. O. B. Chicago. Shipping Weight 100 lbs.

(Planer attachment to fit on table top will smooth pieces up to 2 in. wide, \$10 extra.)

**SCOTT-BANSBACH MACHINERY CO.**  
130 So. Clinton St., Dept. 77, CHICAGO, ILL.

**12" Band Saw**  
Positively a sensation and at this LOW PRICE you can NOW do the 1001 things you wanted quick and easy. This 12" BAND SAW has a tilting table, with Mitre and sturdily built. Ideal for the shop or home.

### S&B Scroll Saw

Here is the outfit of practical usefulness. Will cut wood and light metal true to marks. Table top tilts to 45 degrees, making it convenient and easy to cut at proper angle. Thousands of jobs can NOW be done by any man or boy with the accuracy of a real mechanic. This S&B WONDER SCROLL SAW is free from vibration.

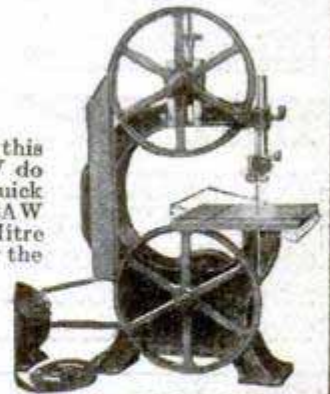

\$35.00 F.O.B. Chicago without Motor

### Scroll Saw



Delights Every Boy

\$15.00

F. O. B. CHICAGO  
1/2 H. P. A. C. Motor \$12 extra

Write for Complete Illustrated Folder—Dealers Wanted.

**\$25 a Day Selling**  
**NEW SAFE Cigar Lighter**  
Automatic for Autos

Now selling thru Specialty Salesmen. Offers you a Permanent Business in the gigantic Auto Accessory Industry. The fastest seller ever out for hard-hitting Specialty Salesmen. Don't waste time. Send \$2.50 for sample and special offer for exclusive agency franchise—NOW!  
SELF LIGHTER CO., 5950 2nd Blvd., Dept. B-135 Detroit, Mich.

**LIGHTING FIXTURES**  
Ready to hang

Direct from the manufacturer. Completely wired, including glassware. Send for new catalogue No. 29. Just Reduced Prices. Special Proposition to Dealers.

**Erie Fixture Supply Company, Inc.**  
Station A  
ERIE, PA.

**DIE-CASTING MACHINES**  
R. BYRD, 318 REED, ERIE, PA.

**SAVE 1/2**

on plumbing, heating, hardware, paint, roofing and millwork supplies. Large quantity buying enables us to offer Grade "A" merchandise at great savings. Send today for free catalogue—over 120 pages of enormous bargains.

**STANLEY PLUMBING SUPPLY CO., Inc.**  
400 N. 12th St. Philadelphia, Pa.

## Out of Work! Got a Foley Filer!

### Now Making Good Money!

Here's how A. Stolz, 132-08 Hillside Ave., Richmond, N. Y., got into a good paying business of his own: "I lost my job on account of a strike. I took my last money and bought a Foley Saw Filer and now I am making a comfortable living. Am doing a lot of work for carpenters."

### FOLEY Automatic SAW FILER

You can make big money and be your own boss if you get a Foley. It files all kinds of saws automatically. Does better and faster work than hand filers. You get \$.50 to \$.75 for running each saw through the Foley. \$1.25 to \$1.75 for retooling. Practically no competition. Carpenters, contractors, factories, schools, and every home has steady year round business for you. A respected, skilled business! Write for free information about how to start a money-making saw filing business.

**Foley Saw Tool Co., Inc., 229 Foley Bldg., 9 Main St. N. E., Minneapolis, Minn.**





# LUMINOUS PAINT

**Make Your Watches, Clocks, Etc., Visible by Night**

The very latest discovery in the scientific world. Hitherto, practically unobtainable except at an exorbitant price, we have at last succeeded in producing this remarkable LUMINOUS PAINT, which, applied to the surface of any article, emits rays of white light, rendering it perfectly visible in the dark. **THE DARKER THE NIGHT, THE MORE BRILLIANT IT SHINES.** Quite simple to use. Anvise—you can do it. A little applied to the dial of your watch or clock will enable you to tell the time by night. You can coat the push buttons or switch plates of your electric lights, match boxes, and innumerable other articles; make your own Luminous Crucifixes, Luminous Rosaries, etc. Small bottle, price 25c. Larger sizes, 50c and \$1 postpaid. **JOHNSON SMITH & CO., Dept. 825 RACINE, WIS.**



## CIGARETTE MAKER

Roll your own and save money. Better and quicker; saves more than half. Use your favorite brand of tobacco. Neat, useful, handy. Pocket size, weighs 1/2 oz. Made entirely of metal, nickel plated. 25c, 3 for 65c postpaid anywhere.



## GOOD LUCK RING

Very striking, quaint and uncommon. Silver finish; skull and crossbones design, two brilliant, flashing gems sparkle out of the eyes. Said to bring good luck. Only 25c postpaid.



## Exploding Cigarettes

JUST LIKE ORDINARY CIGARETTES. BUT SUCH REAL STARTLERS! The box contains ten genuine cigarettes of excellent quality. They appear so real, but when each cigarette is about one-third smoked, the victim gets a very great surprise as it goes off with a loud BANG! A great mirth provoker yet entirely harmless. Price 25c box.

## NOVELTY BADGES



Kissing Permit 10c. Garter Inspector 10c. Two very novel metal badges, nickel plated, that you can wear, giving you fun out of all proportion to their trifling cost. 10c, each badge, 3 for 25c, or 75c per doz. postpaid anywhere.

## MIDGET BIBLE

**GREAT CURIOSITY** Smallest Bible in the World. Size of a postage stamp. 200 Pages. Said to bring good luck to the owner. A genuine work of art. Must be seen to be appreciated. Make good money selling them to friends, church acquaintances, etc. PRICE 15c. 3 for 40c, 12 for \$1.35, 100 for \$3.50. Also obtainable in Leather Binding, with gold edges. Price 50c each, 3 for \$1.25, \$4.50 per doz. Magnifying Glass for use with Midget Bible, 15c.

## STAGE MONEY

With a bunch of these bills, it is easy for each person of limited means to appear prosperous by flashing a roll of these bills at the proper time and peeling off a genuine bill or two from the outside of the roll, the effect created will be found to be all that can be desired. Prices, postpaid: 40 Bills 20c, 120 for 50c, or \$3.50 thousand postpaid.



## Comical Motto Rings

Lots of harmless fun and amusement wearing these rings. Made in platinum finish (to resemble platinum), with wording on enameloid, as illustrated. Price, only 25c Postpaid. **JOHNSON SMITH & CO.**

# JOHNSON SMITH & CO.

Dept. 825

RACINE, WIS.

A De Luxe Edition of our new 1928 CATALOG mailed on receipt of 25c. Handsome binding. Bigger and better than ever. Only book of its kind in existence. Nearly 600 pages of all the latest tricks in magic, the newest novelties, puzzles, games, sporting goods, rubber stamps, unusual and interesting books, curiosities in seeds and plants, etc., unobtainable elsewhere. Remit by Stamps, Coin, Money Order, Check, etc. Unused U. S., Canadian and Foreign Stamps also accepted.

# BLANK CARTRIDGE PISTOL

Protection against Burglars, Tramps, & Dogs



Well made and effective, modelled on latest type of Revolver; appearance alone is enough to scare a burglar. When loaded it may be as effective as a real revolver without danger to life. It takes standard 22 Cal. Blank Cartridge—obtainable everywhere. Special cash with order offer: 1 Superior quality Blank Cartridge Pistol, 100 Blank Cartridges, and our new 550 page De Luxe Catalog of latest novelties; all for ONLY \$1.50. Shipped by Express only. Cannot go by parcel post. Extra Blank Cartridges 50c per 100. Special Holster (Cowboy Type) for pistol 50c. No C. O. D. shipments.

Special Offer  
1 Blank Cartridge Pistol  
100 Blank Cartridges  
1 640-page Novelty Catalog  
**ONLY \$1.50**

The Lot Shipped by Express Only Cash With Order Only

## THROW YOUR VOICE

Into a trunk, under the bed or anywhere. Lots of fun fooling the teacher, policeman or friends.



## THE VENTRIL

a little instrument, fits in the mouth out of sight, used with above for Bird Calls, etc. Anyone can use it.

Never Fails. A 16 page course on ventriloquism, the Ventrilo, ALL FOR 10 CENTS

## MAGICIAN'S BOX OF TRICKS

Apparatus and Directions for a Number of Mysterious Tricks, Enough for an Entire Evening's \$100 Entertainment... Anyone Can Do Them



It is great fun mystifying your friends. Get this Conjuror's Cabinet, and you will be the cleverest fellow in your district. It contains the apparatus for ten first-class tricks, including THE MAGIC BALL AND VASE TRICK (a wooden ball placed inside, and upon replacing the lid has disappeared and is found in someone else's pocket); THE HINING TRICK CARDS (can be made to change completely no less than five times); DISAPPEARING COIN BOX (a coin, placed in the wooden box, vanishes entirely or changes into a coin of another denomination); THE GLASS GONNET TRICK (a coin is dropped into a glass of water and when the water is poured out the coin has vanished and is found somewhere else); THE RIBBON FACTORY FROM THE MOUTH TRICK (a seemingly endless supply of colored paper ribbons comes out of your mouth); the DISAPPEARING HANDKERCHIEF (a handkerchief held in the hand mysteriously vanishes); the WIZARD'S RING COIN TRICK; the ENCHANTED BOTTLE (see one but yourself is able to make it lay down); the GREAT HAT AND DICE TRICK (a large die is placed on top of a hat, disappears, and is found underneath yet no one has touched the hat), and last, but not least, the GREAT FIANTOM CARD TRICK, or two from five leaves nothing. Full instructions are sent for performing each trick. In addition to the above, a number of other tests and illusions are fully explained for which you can easily make or procure the necessary apparatus. Price complete \$1.00 postpaid.

## U. S. BABY TANK

It goes with real Yankee Pep—by its own power  
Most remarkable toy ever invented. By drawing the Tank backward, either with the hand or over the floor or table and then placing it down, it will crawl along, overcoming all obstacles, in the same lifelike manner as the larger Tank that proved so deadly in the great war. What makes it go is somewhat of a mystery, for there is no mechanism to wind up as is usually understood with mechanical toys, yet this tank will keep plodding along ten times longer than the ordinary run for toys. It will perform dozens of the most wonderful stunts; it will go backward or forward at will; 2 1/4 inches long. Price only 25c pre-paid. **JOHNSON SMITH & CO.**

## Look 35c Look Instrument.

Greatest thing yet. Nine separate articles in one. Everybody delighted with it. Odd, curious and interesting. Lots of pleasure as well as very useful. It is a double Microscope for examining the wonders of nature. It is also an Opera Glass, a Stereoscope, a Burning Lens, a Reading Glass, a Telescope, a Compass, a pocket Mirror, and a Laryngoscope—for examining eye, ear, nose and throat. It is worth all the cost to locate even one painful cinder in the eye. Folds flat and fits the pocket. Something great—you need one. Don't miss it. Sent by mail. Only 35c or 3 for \$1.00 **JOHNSON SMITH & CO., DEPT. 825, RACINE, WIS.**



Dept. 825 RACINE, WIS.



# At last..the perfect way to press neckties!

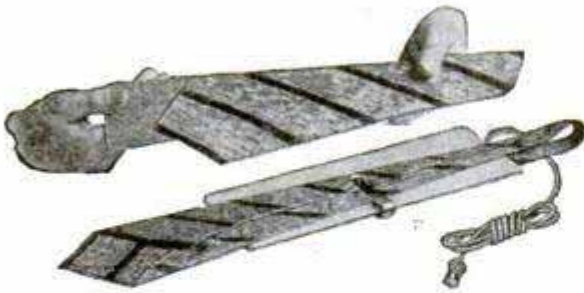

TyWiz in 5 minutes will make them look like new... TyWiz, the electric necktie press. Uses heat! pressure! moisture! The first time a necktie press for home use has had all three. Removes wrinkles from the lining as well as presses the face...yet prevents you pressing the seams and lining through! An amazing performer that keeps your neckties always looking like new. Sent postpaid for only \$1.00. Money back if not satisfied.

**\$100** **TyWiz**  
Complete **The ELECTRIC Necktie Press**

HARE MFG. CO.,  
600 So. Delaware Ave., Philadelphia, Pa.  
I enclose \$1.00. Please send me a TyWiz postpaid, with your money-back guarantee.  
Name.....  
Street.....  
City and State.....

## BIG PROFITS IN "RED HOT" BUSINESS

New, sanitary, electric, complete Red Hot kitchen soon to be announced. Get advance details. Very small investment starts you on the road to independence. Write at once to—

**FOOD DISPLAY MACHINE CORP., Dept. B-135**  
500-510 N. Dearborn Street Chicago

# Diamonds Here at 60% of Market Price

Free Bulletin lists diamonds as low as \$60 per carat, also Gems of Finest Quality at higher per carat charges, but proportionately Low Bargain Prices. This 3/4 less 1-10 carat correctly cut diamond, a snappy blazing solitaire at \$68.50. This 75 year oldest largest Diamond Examining Firm in all the world lends money on diamonds. Thousands of unpaid loans and other bargains. Many from big cash deals direct with European Diamond Cutters. Must sell NOW.

## WHY PAY FULL PRICES

Costs Nothing to See

Any Diamond sent for absolutely free examination at our risk. No obligation. No cost to you. Latest Listings—Unpaid Loans. Sent Free. Describes Diamond Bargains in Detail, gives cash loan values guaranteed. Explains unlimited exchange privilege. Write today for your copy of Diamond Bargain List. Use blank below, clip ad and mail.

Name.....  
Address.....

Try out and mail today to— Jos. De Roy & Sons, 1970 De Roy Building Pittsburgh, Pa. Only Opposite Post Office



**\$68.50**  
3/4-1/16 Carat Correctly Cut



# Only a Buescher

## Gives You All These Features

**Clyde Doerr**  
the famous saxophonist, and other great professionals choose Buescher Saxophones because of more perfect recording.

**Easy to Play**  
**Easy to Pay**  
**6 Days' Trial**

**Patented Snap-on Pads**—the greatest improvement for beauty of tone—easy to replace—no more cementing. Found only on the Buescher.

**Patented Automatic Octave Key**—always positive.

**Perfect scale accuracy**—every tone always full, clear and true.

**Hands never moved** from one playing position.

**Convenient key arrangement**, simplifies fingering of rapid passages.

## FREE BOOK

Illustrates all the various models, and contains pictures of many famous professionals, also first lesson chart. Send your name for copy, or ask for circular on any other instrument in which you are interested.

**BUESCHER BAND INSTRUMENT CO.**

2551 BUESCHER BLOCK, ELKHART, IND.

**OTTAWA LOG SAW**  
**ONLY \$39**  
GREATEST OFFER EVER MADE  
PUTS THIS OTTAWA TO WORK FOR YOU

**Make Money!** Wood is valuable. Saw 15 to 20 cords a day. Does more work than 10 men. Ottawa easily operated by man or boy. Falls trees—saws limbs. Use 4-hp. engine for other work. **30 DAYS TRIAL.** Write to day for FREE book and greatest log saw offer ever made. Shipped from factory or nearest of 10 branch houses.  
**OTTAWA Mfg. Co.** 1741 W Wood St. OTTAWA, KANSAS  
Room 1741 W Magee Bldg., PITTSBURGH, PA.

**MAKE A MOTORCYCLE**  
**OUT OF YOUR BICYCLE** with a STEFFEY MOTOR ATTACHMENT. RELIABLE—ECONOMICAL—EFFICIENT. Easy to attach. Fits any wheel. Send 10 cents for circulars.  
**STEFFEY MFG. CO., Dept. P, 3924 Fairmount Ave., Phila., Pa.**

**SHOW All Wool Tailoring**  
**\$23.50**  
**LARGE SIZE SAMPLES DO IT MEN!**  
\$12 a day. \$75 a week. Cash daily IN ADVANCE. Liberal Bonus. 2000 men doing it. Hustlers make more selling our famous all-wool \$23.50 and \$33.50 tailored-to-measure union made clothes. Greatest values ever offered. **Customer satisfaction brings 90% repeat orders.** We train the inexperienced. Tailoring's most attractive outfit—over 100 extra large cloth samples—furnished FREE to reliable men willing to work for success. **Write Today.**  
**Make \$12 A DAY Full or Part Time**  
**PIONEER TAILORING COMPANY**  
Congress and Throop  
Dept. U-1116 CHICAGO



**"Where'd you get the new car, Bob?"**  
**"Say, Mac, you may not believe me**  
**but I got it out of this can of**  
**RENUZIT!"**

**Sounds Like a Miracle**

It IS a Miracle—a scientific Miracle that is astounding the motor world! If YOU had seen Bob's car before he found out about Renuzit, and could see it NOW—you'd hardly believe your eyes! It's as snappy looking as on the day he bought it. Yes, without doubt—RENUZIT is proving one of the great sensations of the motor age.

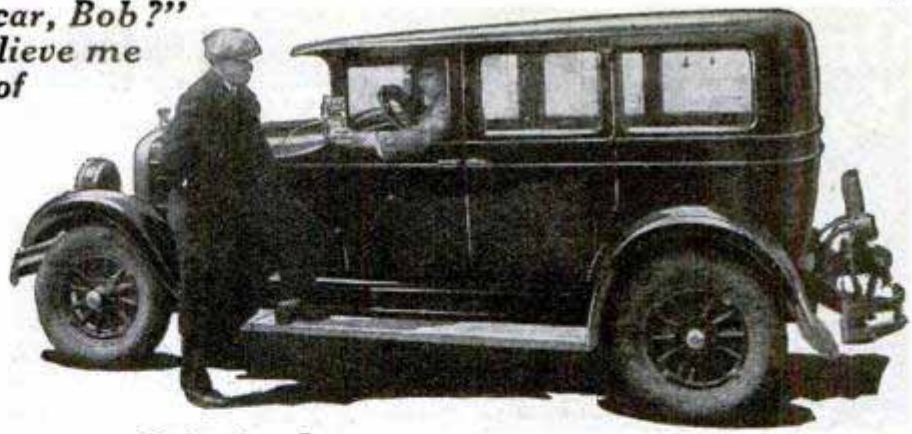

**Miraculous Fluid Renews Original Finish of Any Car in 30 Minutes!**

- Not a Polish**
- Not a Paint**
- Not a Cleaner**
- Not a Wax**

You just flow RENUZIT onto any automobile with a piece of cheese cloth and immediately the ORIGINAL color and lustre of that car is like new again. It's not a polish, cleaner, wax or Paint—but a marvelous chemical discovery that restores the original color and glowing lustre of any painted, enameled or lacquered surface. No tiresome polishing or rubbing. Harmless—Lasting—Sure.

**Car Stays Like New!**

RENUZIT not only restores instantly the original smart sheen to any faded, dull or worn surface—but **KEEPS IT THAT WAY.** Simple to apply as "A B C"—Dries almost immediately. No trouble—No Bothers—No Mess, not even a brush is needed.

**Test RENUZIT Free**

You have the privilege of trying RENUZIT yourself right now without risk or obligation. Prove to yourself what miracles it accomplishes. See your own car being transformed to a thing of glistening beauty! Send coupon TODAY for full details and Free Test Order.

**CURTAN MFG. CO.**

154 E. Erie St., Dept. 805-K.R., Chicago, Ill.

**RENUZIT**

**AGENTS—\$200 a Week Easy**

So like a Miracle is this wonderful fluid that agents all over the country are making almost unbelievable profits. Full or spare time—RENUZIT sells like the wind. Car Owners simply can't resist it! One glance at what it does—and they are more than eager to try it. And our proposition is so GOOD that no one could help making money with it. Live wires should make \$200 and up a week without any trouble. If you are the man with selling sense we are looking for—you will realize at once what a big opportunity you have as a RENUZIT representative. Here's the coupon. Use it for big results.

**CURTAN MFG. CO.,**  
 154 E. Erie St., Dept. 805-K.R., Chicago, Ill.

Rush full details of RENUZIT, with Free Trial Offer. No obligation.

Name.....  
 Address.....  
 City..... State.....

**WINDMILL-RAINBOW-FLASHER**

**SPINNING AUTO LIGHT**—Spins with the wind. Red, White and Blue trick light. Most beautiful light in the world. Everybody wants One. Auto, motorcycle, airplane, canoe. Put on any auto in few minutes. Radiator, mudguards, side or top. Just patented. Be first. Pay when you receive the flasher \$1.50 plus postage. Money back Guarantee. Send today.



**GO LIGHT CO., 78 Milford Ave., Newark, N. J.**

**"Interlox"**

Speeds up all measuring. Slides in and out—no fudging. Direct-reading for instant inside measurements, as well as outside. Any length, 2 to 8 ft. 20c lineal ft. If not at dealers, sent postpaid.

**MASTER SLIDE RULE**



**MASTER RULE MFG. CO., 813 E. 136th Street, NEW YORK**

Dealers and Agents: Write for attractive proposition.

**34 in. Waco Craftsman's Lathe**

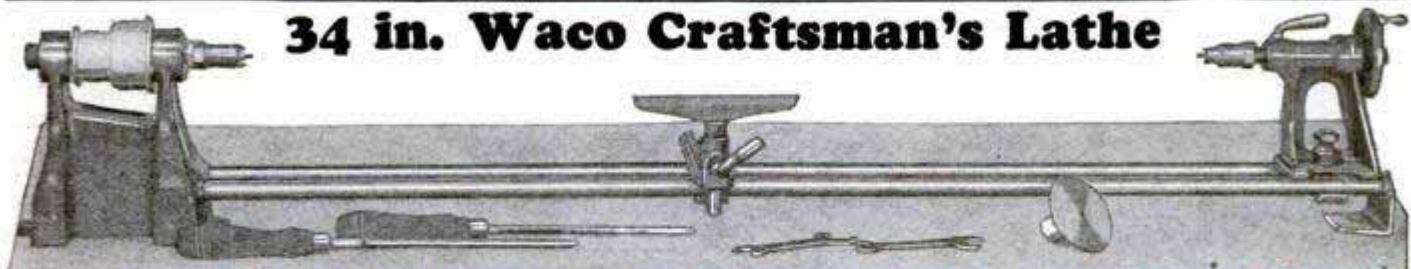

**START YOUR SHOP NOW — ONLY \$30.00**

Use any kind of power—any motor, 1/4 H.P. or greater and in this offer you get the **BEST LATHE EVER MADE AT TWICE ITS COST.** Complete with NEW two-step cone pulley Belt Drive Ballbearing Headstock—screw tightening tailstock, 45 in. rail lathe bed, wood center, dead center, face plate, turning tools and wrenches—complete with WACO guarantee of complete satisfaction. **ASK ANY OWNER.**

**SAME TOOLS — SAME QUALITY AS OUR FAMOUS *Red Jacket* EQUIPMENT**



- WACO Power Bench Saw Complete with 6 inch blade. .... \$24.00
- New Two-Step Cone Pulley, Belt Drive Ballbearing Headstock. . \$15.00
- WACO Buffer set—scratch, emery rag, with attachments, set. . \$5.00

**WRITE FOR OUR LITERATURE—IT'S FREE—IT'S INTERESTING**

**The New Waco Headstock**

allows the use of any motor you now own—enables you to start a Home Work Shop at small cost. Be sure to get our new IDEA CATALOG—send the coupon now.

**Waco Tool Works, Inc.**  
 542 No. Parkside Ave.  
 Chicago, Ill.

**This Coupon Brings All the New "Shop Dope"**  
 No obligation—Simply fill in and mail

Waco Tool Works, Inc., Dept. 107,  
 542 N. Parkside—Chicago.

Please send me your free Idea Catalog.

Name.....  
 Address.....  
 City.....



**One Year To Pay**

**No Red Tape 10 Days Trial**

**No. 40 - \$62**  
**\$5 Deposit - \$1.25 Week**

This exquisite diamond ring is considered extremely handsome. The best quality, full cut, genuine blue-white diamond full of fiery brilliance and sparkling colors, is set in this popular 18kt. solid white gold mounting. It makes a wonderful engagement ring or friendship ring. Your friends will think you paid \$100.00 for it. Everyone will admire it. The gift case is free. Write for illustrated Catalog.

**18 KARAT**

**SEND** With your order to show good faith. **ONLY \$1** When postman delivers ring, pay C. O. D. \$4, balance of deposit. Take 10 days for trial. If you keep it, pay only \$1.25 a week for one year. **Don't bother writing a letter:** Just pin this ad with a dollar to a piece of paper with your name and address on it.

**PRICE CUT TO \$62.00 - WORTH \$100.00**

You can now buy this gorgeous ring at the wholesale price. Compare it with similar rings at \$100. We guarantee it to stand any test or comparison. Greatest bargain offered by any Diamond Importer. We allow 8% annual increase in exchange for a larger diamond ring.

**Write for** It brings our large **Catalog** right into your home. Tells how to buy diamonds like an expert. Gives information that other jewelers dare not tell. State if white or colored.

**AGENTS WANTED - EARN \$200 WEEK. WRITE FOR DETAILS**

**STERLING DIAMOND & WATCH CO. INC.**  
 DIAMOND IMPORTERS - \$1,000,000 STOCK - ESTABLISHED 1879  
 1540 BROADWAY DEPT. 2494 NEW YORK

**Money Back GUARANTEE**

We are an old established firm of diamond importers. You take no risk. If you are not satisfied that the ring is the biggest bargain you ever got, return it within 10 days and we will refund every cent you paid. All credit dealings kept strictly confidential. You get the best of service. No needless delay.

**A CARAT**

Our catalog gives complete information about weights and grades of blue-white diamonds. Starting at remarkably low price of \$197.00 a carat, and giving you one whole year to pay.

**\$93 a Week - Sure**  
 in this Amazing New Business  
**-PUFFLES**



Here's your chance to get into an amazing new business — one with no competition, selling something that appeals to men, women and children. Puffles operators are reporting earnings anywhere from \$75 to \$125 a week.

**Sensation at the CHICAGO FOOD SHOW**

Puffles—crispy, crunchy, vari-colored, deliciously flavored—made in exactly 5 seconds—amazed the crowds at the Chicago Food Show. Amazing crowds everywhere shown. A Puffles stand acts like a magnet and you reap big profits.

**Sell Like Lightning Special Free Starting Offer**

The mystery of the Puffles machine draws the crowd. Placed in any window, in candy stores, drug stores, at beaches, parks, fairs, carnivals—anywhere—it attracts instant attention. And you make \$4 profit on each dollar's worth of raw flakes.

For a short time we are giving 50 lbs. of raw flakes with each outfit — enough to start you in business for nothing and pay you a profit as well. Write at once for full details.

**PUFFLES, Inc.**  
 Dept. 50B, 3027 S. Wabash, Chicago

**USE ENGINITE FOR YOUR MOTOR COOLING SYSTEM**

**The Wonder Fluid**



Applied through radiator. Gives pleasure to motorists. Prevents overheating. Removes rust, scale and corrosion scientifically. SAVES GAS AND OIL. ADDS PEP AND LIFE TO MOTOR. Non-injurious, non-inflammable. It is a preservative. Four treatments in one can, price \$1.00 (West of Rockies 25 cents extra). Sent C. O. D. Postage prepaid. Guaranteed or money refunded. Reg. at U. S. patent office. Dealers write for proposition.

**Manufactured by**  
**INDUSTRIAL REFINING COMPANY**  
 120 West 42nd Street NEW YORK CITY

**AGENTS**

Make big earnings, taking orders for made-to-individual measure suits at less than ready-to-wear prices. Giant Chicago wholesale house makes world's greatest values at \$23.50 and \$29.50. Your profit \$4 and \$5 per sale in advance—we deliver and collect. No experience needed, work full or part time.

**FREE OUTFIT** Send no deposit. Write for details of our unique money-making plan. Nothing like it ever before offered. Act at once.

**GENERAL TAILORING CO., DEPT. 7A, 529 South Franklin St., Chicago**

**MYERS ELECTRIC IRON CORD HOLDER**

A wonderful invention. Keeps cord out of way while ironing. Grips the ironing board. Tested and approved by Good Housekeeping Institute.

**AGENTS WANTED**  
 Sample 50 cents postpaid.  
**C. A. MYERS CO.**  
 6339 Woodlawn Ave., CHICAGO, ILL., U. S. A.



**NOW! You Can Do Your Own NICKEL-PLATING**

For Plating Nickel, Brass, Copper, Silver, Gold, etc.

**See the Nickel Flow**



**Make \$150 to \$500 a Week**

**New Scientific Invention Enables Anyone To Nickel-Plate Anywhere with Aladdin Portable Outfit**

This marvelous Invention enables anyone to NICKEL-PLATE anything—anywhere; in the Home, Garage, Office, Store or Shop—in fact, you can do all the NICKEL-PLATING on any automobile with the ALADDIN ELECTRO PORTABLE OUTFIT in a very short time—without removing any of the parts. This interests every auto owner (and others) because you can SEE THE NICKEL FLOW NOW take the Plater to the job instead of taking the job to the Plater. This offers wonderful ECONOMY to users and BIG MONEY-MAKING possibilities to AGENTS. Be the first in your locality. WRITE FOR FREE BOOKLET.

**Introductory Offer \$6.50 Plus Postage**

**P. J. F. BATENBURG Dept. 33 RACINE, WISCONSIN**

**AGENTS WANTED EVERYWHERE**



# NEW SNIPS

These snips incorporate many new features in design and construction. They will cut the toughest metal cleanly and easily, and they hold their keen cutting edges.

Crescent Snips are entirely drop-forged of special analysis steel with blades hardened all the way through. Let your hardware dealer show you their many new features. Sold with an unconditional guarantee. Crescent Tool Catalog on request.

**CRESCENT TOOL CO.**

210 Harrison St., Jamestown, N. Y.

**\$1.00**  
10 inch

8 Sizes  
7 to 14 inches  
Proportionally  
priced.



**CRESCENT and Smith & Hemenway TOOLS**

## Your Coat and Vest Can Be Matched with New Trousers

Get full wear out of that good coat and vest by buying **New Trousers to Match**

You save the cost of a new suit. Each pair tailored to your measure. Over 80,000 patterns to choose from. Mail vest or sample of your suit and we will submit sample of cloth for approval.

Enclose return postage if vest is sent.

We employ no agents.  
**ACME PANTS MATCHERS**  
Dept. BT-14, 20 W. Jackson, Chicago-76

**\$3.99** Lifetime Precision **Men's Watch** Strap

Worn by practical men everywhere. Guaranteed shock proof and weather proof. Perfect time keeper. Radium dial. Fine imported full jeweled movement. Rich silver finish. Genuine leather strap. Sold elsewhere for \$10.00. Fully guaranteed to give you complete and entire satisfaction. **SEND NO MONEY:** Pay to your postman only \$3.99 plus the postage on delivery.

**JENKINS CORPORATION**  
621 Broadway, New York, Dept. 23F7

## Sell Real Oriental Perfumes

**WANTED:** 1000 more men and women to retail genuine perfumes, toilet waters, cosmetics, which have taken the country by storm. 31 charming articles. Rare Hindu formulas—indescribable tropical essences of matchless fragrance and unsurpassed quality. Tremendous appeal everywhere builds quick, permanent business. **100% profit for you.** No experience needed—we show you how and supply sample case absolutely **FREE.** Make big money. Full or spare time. Write **Romola Parfumeries, Inc., Dept. 105 Armour Station, Chicago**

## AIRPLANE

12-inch scale model of Lindbergh's Spirit of St. Louis. Scientifically designed and very realistic. Only scale model priced under five dollars that will rise from ground by own power. Flies 30 ft. or more and stays



In air 8 to 10 seconds. Easily built in 2 or 3 hours. No tools needed. Construction set, with all parts and full directions, postpaid in U.S., only 50c. (no stamps). Satisfaction or money back. Send today.  
**Mann & Benton, Chillicothe, O.**



# Over 15,000 Satisfied Users

# SPRAYIT

*Electrically*



**\$34.50**  
complete

Electric Sprayit is shipped complete ready to use—no accessories to buy—universal motor operates from either direct or alternating current. A small investment for great results.

• • Just Plug into any Electric Light Socket • •

—that's all there is to it. You don't have to invest in an expensive compressor and storage tank in order to have all the advantages of spray painting. The Electric Sprayit equips you with a practical, easily portable spray painting device.

Every manufacturer, shop man, contractor, plumber, building manager, etc., will find hundreds of uses for this handy labor-saving device, uses which will almost immediately repay the small investment.

### Sprays any Finish

The Electric Sprayit sprays any finish, stain, or liquid preparation of proper consistency, including lacquers, enamels, bronzes, calcimine, whitewash, disinfectants, and even dry powders. Electric Sprayit is a proved product of merit now serving many thousands of enthusiastic users.

*You can't afford to be without it. Order your Electric Sprayit today.*

**The Electric Sprayit Co. Inc.**  
320 Colfax Ave. E., South Bend, Indiana



**THE ELECTRIC SPRAYIT COMPANY, Inc.,**  
320 Colfax Ave. E., South Bend, Ind.

- Send me an Electric Sprayit at \$34.50, f.o.b. South Bend.
- Send me full information and guarantee on Electric Sprayit.

Name.....

Address.....



## "Mocar" Model Airplanes THAT FLY

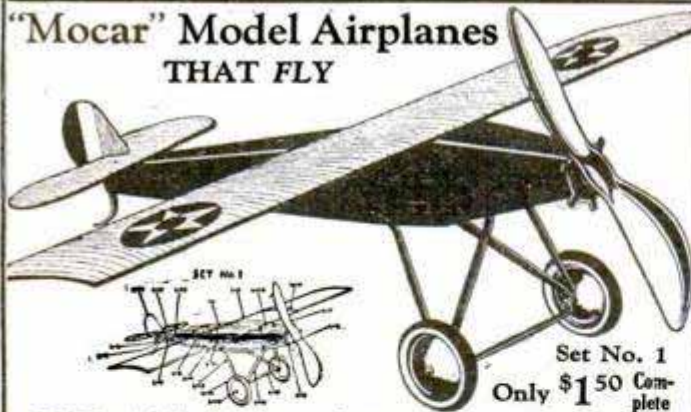

Set No. 1  
Only \$1.50 Complete

**BOYS**—at last, here is a real aluminum model airplane that really flies. And at a small price. The "Mocar" monoplane—Set No. 1—is a copy of the famous Spirit of St. Louis. Wing spread 18 inches, fuselage 12 inches, powerful motor, ball bearing propeller, rubber tired disc wheels. Weight complete only about 2 3/4 oz. This is a practical, simple, real model plane that gives you a whole lot of fun for the moderate cost. The all metal construction makes a sturdy plane that will stand a lot of abuse. The outfit is mounted on cardboard with all parts plainly marked, and full instruction for assembly. Pliers only tool necessary. Complete with rivets, bolts, nuts, wheels, wing and fuselage covering material, only \$1.50 post-paid anywhere in U. S. A. (3 for \$4.00). Great fun, learn how to make and fly airplanes. Order now.

### THE MOUNT CARMEL MFG. CO.

Dept. M MOUNT CARMEL, CONN.  
Jobbers, dealers and schools write for net prices.

The illustration below shows set mounted complete ready for assembly. Small cut above shows all metal skeleton ready for covering and the large illustration, actual cut of finished plane.

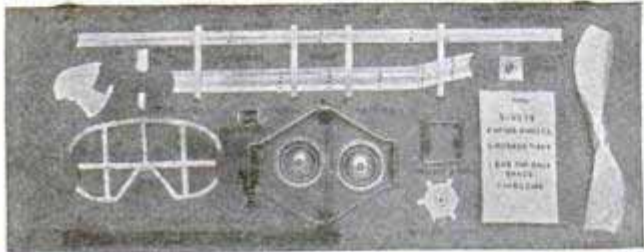

## NEW WAY LACQUER SPRAY



### Smoother and Swifter Than Brushing

For the easy and practical application of lacquer paints. A smooth, durable, glossy finish assured. Paint and refinish automobiles, furniture, screens, radiators, machinery, etc. Well designed and built, adjustable atomizing head affords a continuous spray. Useful for spraying oils, insecticides, etc.

Type "C-P"—as shown—complete with 1 1/2-in. heavy duty pump, 8 ft. tubing, shut-off valve—New Way dual top for use on either metal or glass containers. Glass furnished as standard—\$4.45.

Type "C-P"—less foot pump. For your pump or air supply—\$3.25.

Type "A"—Attached hand pump. Dual top. Easy clean glass container assures visibility. The sturdiest and finest hand spray—\$1.95.

Type "C" De Luxe. Complete with large auxiliary pressure tank and moisture trap. A professional outfit for shops. Heavy duty 1 1/2-in. pump, pressure gauge on tank, shut-off valve, 10 ft. hose, New Way dual top and glass container—\$7.95.

Type "C"—tank, pump and gauge only—\$4.75.

Extra Glass or Metal Tanks with Air Tight Tops for Keeping Lacquers and Liquids Handy for Use... 25c

Send 10 cents postage for 3000-word booklet: "How To Do Lacquer."

### NEW WAY SPRAY GUN COMPANY

Dept. Q-7 5511 Euclid Ave. Cleveland, Ohio  
Headquarters for Lacquer Spraying Equipment.

## JUST OUT Spors No. 9 Combination Pen and Pencil

AGENT'S SAMPLE 66c Sells for \$1.35. Make 8 different colors.

Guaranteed 2 years. Money back if not pleased.

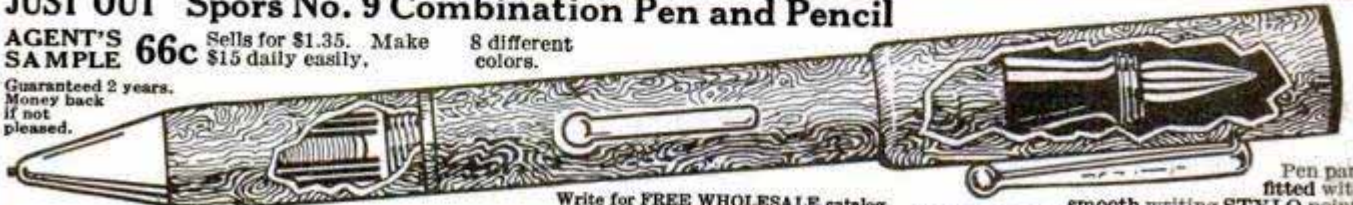

Write for FREE WHOLESALE catalog.

F. SPORS & CO., 528 MAIN STREET, LESUEUR CENTER, MINNESOTA

Pen part fitted with smooth writing STYLO point.

## Cut the Family Barber Bills



### Belle City Home Electric Hair Clipper

Anyone can trim or bob hair, shorten bangs, clip neck or underarms in a shape almost impossible with hand clippers or shears. Operates on direct and alternating current. Will not clog or cut the skin, and cuts as cleanly as a razor. Thousands in use. Rigidly guaranteed.

Fits Any Light Socket

### TEN DAYS' FREE TRIAL

If your hardware or electrical dealer can't supply you, write for interesting booklet, or order from this ad. Send no money—pay postman \$8.75. Return it in ten days if not satisfactory. State whether 110, 220 or 32 volt current is used.

Dealers and Representatives Wanted

Belle City Appliance Co., 1022 12th St., Racine, Wis.

## Make your radio an electric A. C. Set!

No harnesses, adapters or changes in wiring. Not even new tubes are necessary. The Kuprox AC Power Pack makes any receiver using ordinary tubes an electric AC set. Your dealer has several models from \$26.50 up. Write for booklet. The Kodak Radio Corp., 517 E. Pearl Street, Cincinnati, Ohio.

## AGENTS

### Sell Genuine Diamonds on Cash or Credit

Everyone is always thinking of buying real jewelry for themselves or as a gift for some dear one. Show them our plan of CASH OR CREDIT. Show them how they can have a beautiful genuine diamond ring, high grade watch, standard-make silverware or any solid gold jewelry they desire, CASH OR CREDIT with 12 months to pay. You will find customers everywhere ready to order Sterling merchandise.

We put you in the diamond and jewelry business for yourself without a single cent investment. We have a line that beats anything seen yet is lower in price! Guaranteed.

No matter what you are selling you have the opportunity to make extra profits with this new remarkable line.

The genuine diamond and jewelry business is not seasonal. Every day people have occasion to buy for an anniversary, wedding, birthday, etc. Show our nationally advertised line and get these sales that mean big profits for you.

### SEND FOR FREE OUTFIT

Write for complete free outfit which contains illustrated catalog in colors, order blanks and full instructions. We send by return mail everything to start you earning without delay—no investment—write today—NOW. STERLING DIAMOND & WATCH CO., Inc. 1540 Broadway, Dept. A-165, New York, N.Y.



OVER \$85 Weekly! Easy!



# Swear Off Tobacco

## Tobacco Habit Banished Let Us Help You

### Quick Results

Trying to quit the tobacco habit unaided is often a losing fight against heavy odds, and may mean a serious shock to your nervous system. So don't try it! Make the tobacco habit quit you. It will quit you if you will just take **Tobacco Redeemer** according to directions.

It doesn't make a particle of difference whether you've been a user of tobacco for a single month or 50 years, or how much you use, or in what form you use it. Whether you smoke cigars, cigarettes, pipe, chew plug or fine cut or use snuff—**Tobacco Redeemer** will positively remove all craving for tobacco in any form in a few days. Your tobacco craving will usually begin to decrease after the very first dose—there's no long waiting for results.

**Tobacco Redeemer** contains no habit-forming drugs of any kind and is marvelously quick, scientific and thoroughly reliable.

### Not a Substitute

**Tobacco Redeemer** is in no sense a substitute for tobacco, but is a radical, efficient treatment. After finishing the treatment you have absolutely no desire to use tobacco again or to continue the use of the remedy. It helps to quiet the nerves, and will make you feel better in every way. If you really want to quit the tobacco habit—get rid of it so completely that when you see others using it, it will not awaken the slightest desire in you—you should at once begin a course of **Tobacco Redeemer** treatment for the habit.

### Results Absolutely Guaranteed

A single trial will convince the most skeptical. Our legal, binding, money-back guarantee goes with each full treatment. If **Tobacco Redeemer** fails to banish the tobacco habit when taken according to the plain and easy directions, your money will be cheerfully refunded upon demand.

### Let Us Send You Convincing Proof

If you are a slave of the tobacco habit and want to find a sure, quick way of quitting "for keeps" you owe it to yourself and to your family to mail the coupon below or send your name and address on a postal and receive our free booklet on the deadly effect of tobacco on the human system, and positive proof that **Tobacco Redeemer** will quickly free you from the habit.

**Newell Pharmacal Company**  
Dept. 300, Clayton Station, St. Louis, Mo.

### Free Book Coupon

**NEWELL PHARMACAL CO.;**  
Dept. 300, Clayton Station, St. Louis, Mo.

Please send, without obligating me in any way, your free booklet regarding the tobacco habit and proof that **Tobacco Redeemer** will positively free me from the tobacco habit or my money will be refunded.

Name.....

Street and No.....

Town..... State.....



Tobacco Tells on  
Nervous System



Tobacco Ruins  
Digestion

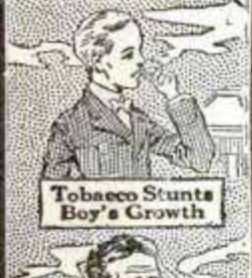

Tobacco Stunts  
Boy's Growth

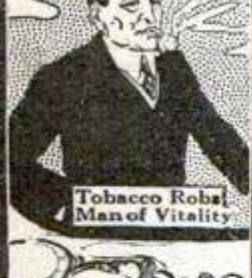

Tobacco Robs  
Man of Vitality



Tobacco Steals  
from You the  
Pleasures, Com-  
forts, Luxuries  
of Life





# REFINISH YOUR CAR

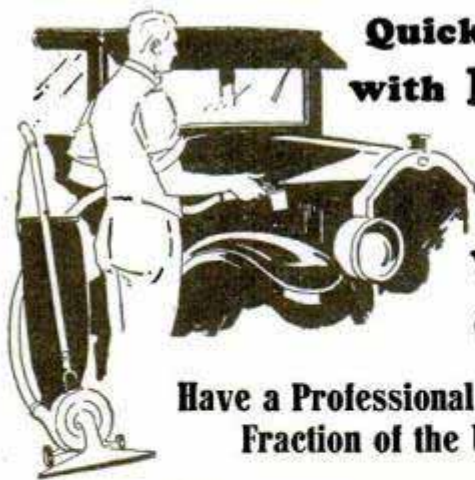

**Quicker, Easier  
with POWER  
From  
Your  
Vacuum  
Cleaner**

**Have a Professional Job at a Small  
Fraction of the Usual Cost**

No excuse for driving a shabby car when the job of refinishing it has been quickened, simplified and made ridiculously inexpensive through the invention of the Royal Spray Attachment.

Attaches right to your vacuum cleaner—utilizes its ready, economical electric power. Merely disconnect the bag, attach the hose and slip the Royal Spray Attachment into place. Thumb button gives you automatic control. Many other uses—such as lacquering furniture, spraying disinfectants, insecticides, etc.—make the Royal Spray Attachment invaluable around the house, garage and workshop. Price is remarkably low—only \$4.95.



Simply fill out coupon and send it with check or money order TODAY.

**ROYAL Spray Attachment** Agents Wanted Everywhere **MAIL THIS NOW!**

The P. A. Geler Company 544 E. 105th St. Cleveland, Ohio  
 ( ) Enclosed is \$4.95 for Royal Spray Attachment, postpaid.  
 Name.....  
 Street.....  
 Town.....  
 State.....



## Flying Cloud Model

Miniature model finishes 20" long. Complete in details. Set consists of Hull Block, 30-1/8" S. P. Blocks, Steering wheel, Anchor, Bell, Capstan, Bits, Flag, Spar materials, Rigging, Brass wire, Pins, etc., also all materials for Deck Houses and rails. Complete set with instructions, \$10.00 plus postage for 5 lbs. Hull shaped and sanded, \$1.00 extra. Figure head 50c. Supply catalog, 10c coin.

ROY HANCOCK, 323 Douglas Ave., Portsmouth, Va.

## NEW AUTOMATIC WINDOW WASHER



*Washes-Cleans-Dries-Polishes  
in ONE Quick Operation.*

Amazing new invention completely revolutionizes window washing. Carries its own water supply! It eliminates all the drudgery and unpleasantness.

Five times as fast as old methods! No pail. No brush. No sponge. No chamols. Your hands never touch water with the NEW AUTOMATIC. Can be used with or without pole. Every housewife, auto-owner, storekeeper and factory owner a live prospect. Sensational demonstration. Sells at sight. Big repeat business. Year 'round seller.

**MAKE \$90 TO \$150 A WEEK!**

Agents coin tremendous profits. Going like wild-fire. Sells for only \$1.95. Liberal profits for agents. \$10 to \$25 a day easy; \$200 to \$300 a week possible.

**WRITE FOR OUR FREE SAMPLE OFFER**

You risk nothing. Don't delay. Write for money making proposition today.

**NATIONAL INDUSTRIES, Wrigley Bldg., Dept. 24, CHICAGO**

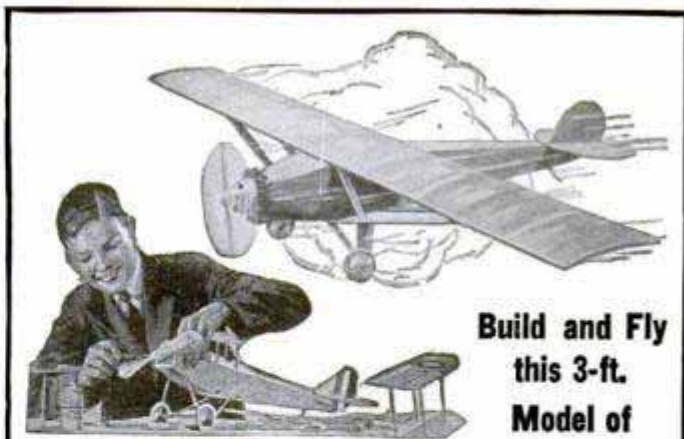

**Build and Fly  
this 3-ft.  
Model of**

## LINDBERGH'S

*"SPIRIT OF ST. LOUIS"*

Plans for Model Airplanes 25c per set  
 New York-Paris Plane, FOKKER North Pole Plane, CURTISS JN4D-2 Biplane, DeHAVILLAND Biplane, N. C. 4 Naval Seaplane, Bleriot, Taube or Newport Monoplanes, Cecil Peel Racer.

This IDEAL New York-Paris Monoplane is a perfect copy, 3-ft. size, of the machine in which Lindbergh crossed the Atlantic Ocean. Any bright boy can build this model: The IDEAL Construction Outfit contains everything needed: all parts, fittings, materials and supplies, including careful instructions, plans and diagrams. The model is wonderful; has many features of the original and is guaranteed to fly.

Complete Construction Outfit. . . . **\$7.50**  
 (West of Denver, Colo., and in Canada, price is \$8.00)

Ask your dealer or order direct.

**New 64-Page Book of Model Airplanes**  
 Teaches the principles of flying; contains plans and directions for building gliders and racers, and full information about scale Models of real planes; also most complete catalog of materials for model builders. Sent 5c postpaid for. . . .

**IDEAL AEROPLANE & SUPPLY CO., Inc.**  
 26 West 19th Street New York City



**My Agents  
Make** *\$90. a Week!* **RAINCOATS  
Given Too!**

Make a tremendous income just wearing beautiful raincoat and showing your friends. Give away hats to each customer! A sensational sales plan! No wonder ambitious men and women everywhere make big quick earnings. Write for big selling outfit free. Start earning at once! You don't need experience. I show you exactly what to do to earn big money every day with this wonderful line of raincoats, slickers and topcoats. Write!  
**Elliott Bradley, 230 S. Wells St., Dept. FL-7, Chicago, Ill.**

**SAMPLE CASE FREE**

**\$10 to \$35**  
 Made Daily (54)

**9 EASY WAYS TO START**

Well-known line of household products—fast sellers—steady repeaters—big profit makers. We supply premiums, samples and advertising. Chance of a lifetime. Write for New 9 Way Plan.

**McNess Co., Desk L, Freeport, Ill.**



# The Up-to-Date Home Craftsman Shop

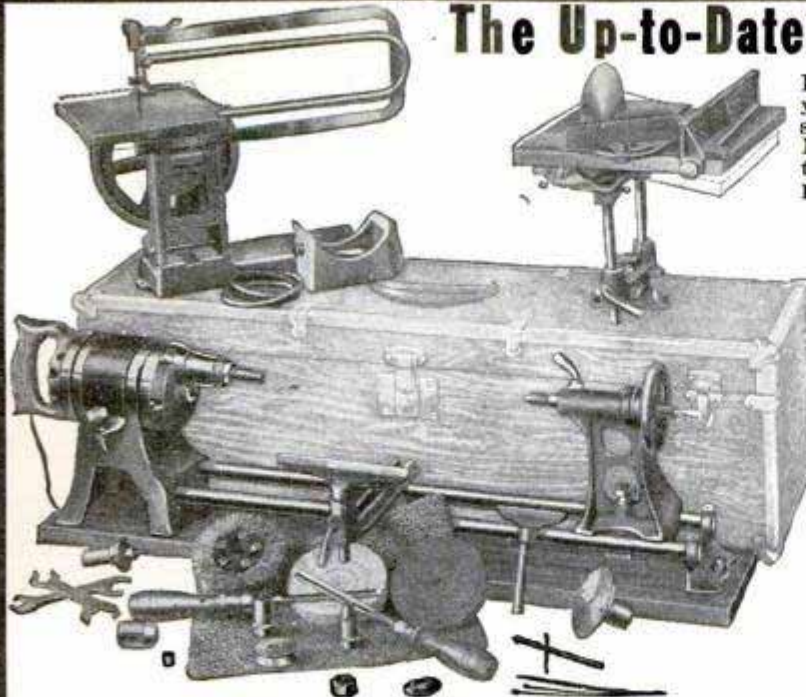

Plug in on any light socket and go to work. Make your old work bench a modern Up-to-Date workshop. Convenient, portable and simple to operate. Now! You can build, or repair furniture, cabinets, toys, boats, novelties and hundreds of other wood projects. Send for Free literature today.

**ONLY \$10 DOWN**

**GUARANTEE**

If upon receipt of the Up-to-Date Home Craftsman Shop you are not satisfied, without question every cent refunded and return express charges paid.

## NEW 12" BAND SAW

Newly developed, of the latest design in Band Saw equipments, this 12 inch Band Saw is guaranteed vibrationless, and accurate in every detail. It is supplied with a tilting table, miter and side gauge.



**\$35.00**

F. O. B. CHICAGO

May be purchased on time payment basis at \$39.00, \$10.00 down and \$10.00 per month. With this plan anyone can own a real Band Saw.

**SENT ON TRIAL**

Use our shop for 10 days at our expense. If not satisfied — return — express charges collect.

**Mail This**

for full particulars to  
**Up-to-Date Machine Works**  
2915 S. Wabash Ave., Chicago, Ill.  
MANAGER, Dept. 14. Without any obligation, please send me all particulars about your shop, 10-day free trial, free blue prints, free craftcourse, also \$10 down payment offer.

NAME.....  
ADDRESS.....

## Home Mechanics Easy With This Equipment

The Shop Complete consists of a Super-power Motor, an accurate Lathe (10" x 34"), a 6" circular saw which features the bevel, miter, side and depth gauges, a Tilting Table, Jig Saw, and all accessories for buffing, grinding, cleaning and all portable or stationary drilling and sawing.

**Blueprints and Craftcourse Free to Users.** Under supervision of Master Craftsman Eugene Maurey, blueprints and craftcourse giving complete information on home handicraft and details for making hundreds of pieces of woodwork. This service **Free** to Up-to-Date Home Craftsman Shop users. **Your own terms on purchase \$10.00 down.** Liberal discount for cash.

**Our Literature Gives All Details**

## MYSTERIOUS

NEW AUTO  
GLARE SHIELD

IN  
REAR-VIEW  
MIRROR  
POSITION

IN  
GLARE SHIELD  
POSITION

Becomes Rear-View  
Mirror By Day  
**AGENTS \$100 A WEEK**

Is easy when you show motorists this amazing device! New kind of mirror glass, semi-transparent at night, filters headlight glare, makes night driving safe! Becomes perfect rear-view mirror in daylight! Swings instantly to either position—always ready—never in the way. A handsome, permanent accessory. Sells on astonishing 10-second demonstration. Balance made \$40 in a day. New 2-way selling plan, with bonus and extra commissions. Write quick for details and sample offer.

LEE-SEE CO. Dept. 87 Kewaunee, Wisconsin

## Real Sport This Summer



With the New  
**CROSMAN  
PNEUMATIC .22**

TAKE along this noiseless, economical .22 on your picnics—it provides fun for everybody. Just the thing to have around the camp and on the motor trip. There's nothing like the new CROSMAN PNEUMATIC RIFLE—more accurate, up to 100 feet, than a .22 powder gun. It never needs cleaning, uses no powder, has no odor, smoke or noise. Cheap ammunition (5 shots for a penny). Ask your dealer to show you this wonder rifle or write us for the FREE "Target and Game Shooting" booklet on America's highest powered pneumatic rifle.

**CROSMAN ARMS CO.**

441 St. Paul Street

Rochester, N. Y.



**FREE TRIAL**  
on  
**any Conn**

SELECT any instrument for band or orchestra; we will permit you to try a Conn in your own home free, without obligation. Conn easy-to-play features enable you to play tunes from the start. With all their exclusive features, Conn cost no more.

Send Coupon Now for free literature and details of trial offer.



Sousa uses and endorses Conn instruments

C. G. Conn, Ltd. **CONN** Mail This  
731 Conn Bldg. BAND INSTRUMENTS This  
Elkhart, Ind. WORLD'S LARGEST MANUFACTURERS Coupon

Please send literature and details of free trial offer on  
(Instrument).....  
Name.....  
St. or R. F. D.....  
City.....  
State, County.....



# CHROME



## The Watch Dog of Power

CHROME, a preservative, guards power when your Burgess Battery is not in use. Thus extra life and service are added. The valuable properties of Chrome in lengthening battery life were long known to scientists, but it remained for Burgess engineers to discover the secret of utilizing Chrome in battery construction. This patented feature, combined with others of equal importance, make Burgess Batteries more dependable and more economical for radio, ignition and flashlight.

**BURGESS BATTERY COMPANY**

General Sales Offices: CHICAGO

In Canada: Niagara Falls and Winnipeg

## BURGESS "SUPER B" BATTERIES



## An antidote for gloom

WITH a good flashlight in your hand you have the better of any dark situation. Touch the switch on your Eveready and a stream of daylight leaps to your defense. A perfect helper, too, when there's a tidy mechanical job to do, and do *right*.

The flashlight habit is one of those things you can't overdo. Work *with* an Eveready and it will work *for* you. And don't forget the power-plant—the battery. Keep your flashlights perfect in performance with those marvels of endurance, Eveready Batteries. They're simply *made* of LIGHT. They're jammed, crammed full of it. They last and *last* and LAST! You'll be paid in service and dependability if you always get genuine Eveready Batteries.

### NEW MODEL WRIST WATCH Amazing Value—Satisfaction Guaranteed



Non-breakable crystal; radium dial. Tells time in the dark. Genuine Pie-Skin Leather strap. Made in United States by old established million dollar watch factory. Perfect timekeeper. Remarkable value at this price—unexcelled anywhere. SEND NO MONEY. Pay Postman on delivery \$2.99 plus postage. AMERICAN WATCH CO. 536 Broadway, New York

### GIANT TELESCOPE ONLY \$1.85



Over 3 ft. long; in 5 sections; brass bound; powerful lenses. See distant objects. Loads of fun! Carrying Case FREE. Send No Money Postpaid only \$1.85 or C.O.D. plus postage. Satisfaction guaranteed or money back. Ferry & Co., Dept. 1778, Chicago

### BIG MONEY MADE!

Our Salesmen-Agents make big money by "cash-ing in" on the unusual demand for Dickinson Tires which our National Advertising has created. Easy Sales! Write Today! We start you Free. Dept. 59. HYDRO-UNITED TIRE CORPORATION, POTTSTOWN, PA. CHICAGO, ILL.

### EASY \$100 a Week

## FUGO FIRE EXTINGUISHER

Unusual opening for live agents in every locality. Make \$5000 or more a year—*easily*. Fugo—the instantaneous automatic fire extinguisher—is needed and wanted in every home, store, theatre, garage, shop, school, automobile, etc. Cheapest fire protection available today. Within reach of all.

**1 Qt. Size \$5.00    2 Qt. Size \$7.50**

*Recharged in a jiffy*

Amazing 30-second demonstration clinches sale—each one sold sells others. Territory going fast. Write at once for wonderful proposition that will make you big money.

**THE NATIONAL FORMETAL CO.**  
6535 Metta Ave., N. E.                      Cleveland, Ohio



# Make Furniture At Home



—either for your own pleasure or to sell. It is easy when you have the instructions supplied in Popular Mechanics Home Furniture Making Library. This library consists of the following cloth-bound, profusely illustrated books of which many thousand have been sold to satisfied customers everywhere:

1. Mission Furniture—Part 1
2. Mission Furniture—Part 2
3. Mission Furniture—Part 3

These three practical, money-saving books contain full directions and drawings for the making of all sorts of furniture, including tables, chairs, stools, davenport, electric table lamps, and many other useful and beautiful articles of furniture. Crystal clear instructions in 3 handy books; 360 pages—186 illustrations. Just follow directions and you'll be amazed at your good results. Use the furniture in your own home or sell it. One man writes he

sold over \$1,000 worth of furniture made from these books. You can do the same.

**Send No Money!** Just write a postal asking that Popular Mechanics Home Furniture Making Library be sent you C. O. D. When the postman delivers the books, simply hand him \$2.98 plus the few cents postage. Money refunded if not delighted.

**POPULAR MECHANICS PRESS**

Popular Mechanics Bldg., Room 708, Chicago, Ill.

## Mechanical Toys

Ship Models, Colonial Bric-a-Brac, Leather and Celluloid articles and hundreds of other useful things are described in our new book, *Make It Yourself*. 460 Pages. Illustrated. Price \$3 Postpaid.

**POPULAR MECHANICS PRESS, 200 E. Ontario St., Chicago**

**BREAKFAST NOOK** and 26 other splendid articles of Built-In Furniture in our new book on this subject. 198 pages. Illustrated. Price \$2.50 Postpaid.

**POPULAR MECHANICS PRESS, 200 E. Ontario St., Chicago**

## MODERN AIRCRAFT

By V. W. Page, just published, is a most complete and informative treatise on every phase of modern aeronautical science and aviation.

Written in simple language for the practical man by an experienced instructor, this book covers types of craft, construction, principles of operation and commercial applications. How any plane flies and is controlled. Parts, their functions and how repaired. Latest engines, instruments and accessories. Deals with all types of planes, engines, etc., used in recent epoch making flights.

A special chapter on aerial navigation. The equipment of airports, airways and landing fields is considered. Dictionary of terms prepared with the help of Army and Navy authorities and civilian airplane constructors.

The completeness of the book may be judged by its 855 pages and 400 illustrations.

**Price \$5<sup>00</sup>**

Will be sent C. O. D. in U. S. Pay postman price and postage.

**Popular Mechanics Press**

**Room P-7**

**200 E. Ontario St. CHICAGO**



# Ring UP \$150 to \$300

## MONTHLY PROFIT

### With an HB 8-Hour Battery Charger

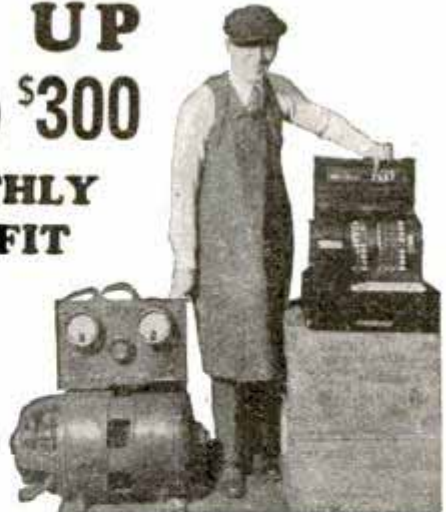

Mechanics, garages, battery shops and filling stations are all adding tremendous profits this season with this new 8-Hour Battery Charging Business. Practically no expense or investment required. No special experience necessary. 8-Hour Service gives you a big advantage over other shops; saves 30% to 50% on electric bills over rectifiers. Find how easily you can have these profits by checking No. 1 below

## Only \$16 Monthly Easily Paid by Increased Profits

### FREE AIR SERVICE



For only \$12 Monthly for a few months you can have the advantage of Automatic Air Service bringing customers to your door. Beltless, Silent, Ball Bearing. Lowest prices for such quality equipment. Get full details without obligation by checking No. 2 below.

### HB TEST BENCH

Best paying equipment for automotive electrical work. Tests starting, lighting, ignition systems. Brings you business from other shops. Priced \$100 to \$150 below similar quality outfits. Write today for full information without obligation. Check No. 3 below.



### PAINT SPRAY



Does the work of five men with brushes. Paints cars, furniture, houses, barns, garages. You can do better, quicker work at lower prices, yet make far more money than old time painters. No experience necessary. Investigate—Check No. 4 below.

## HOBART BROTHERS

Successful manufacturers ~ since 1893 ~

**BOX M78**

**TROY, OHIO**

### Tear off Coupon and Mail Today

HOBART BROTHERS CO.  
Box M78, Troy, Ohio.

Send me complete information on the items I've checked with your 30 day trial offer, easy payment terms, and information on how HB equipment will increase my earnings.

1.  One Day Battery Service Profits
2.  Better Automatic Air Compressor
3.  Electrical Test Bench Opportunities
4.  Portable Paint Spray Business

Name.....

Address.....





## Make the Harmonica YOUR "Musical Pal"

MILLIONS of boys and girls have found the harmonica a most delightful "pal"—and have discovered that it greatly increases their popularity among their friends.

It is so easy to play this instrument that in a short time anyone can render correctly not only the beloved melodies of school and camp, but also the latest songs fresh from Broadway.

Unless you can play the harmonica, you are just not "keeping up with the times." *Today is the day to get started!* In a short time you will play as well as the next "fellow."

Send now for the free instruction book offered below. You will be amazed at the ease with which you can master the simple fundamentals and the quickness with which you will be ready to play favorite selections.

If you have already acquired the "knack" of playing, carry your accomplishment further by learning to perform on the famous "Chromonica"—the only harmonica which includes the half-tones. \* \* \* \*

ASK your teacher, club leader or Scoutmaster to help you start a harmonica band. Tell them to write us for our special brochure, giving full directions for this work.

*This is sent only to adults in authority.*



Grand Prize Awarded  
HOHNER HARMONICAS  
At Sesqui-Centennial  
Exposition, 1926

FREE INSTRUCTION book, fully illustrated. Use the coupon to ask for it.



M. HOHNER, Inc.  
114 E. 16th St., Dept. 508-G, New York  
Please send FREE Instruction Book

Name.....  
Address.....

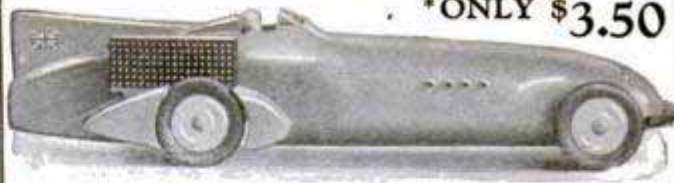

\*ONLY \$3.50

## Here Comes the Big "BLUE BIRD"!

AN exact 19-inch copy of Capt. Campbell's famous 207 miles an hour speedster. Kingsbury has exclusive permission to make it. Built all of steel. Enameled a handsome blue. Powerful clock spring motor. Equipped with rubber bumper to prevent marring or scratching walls or furniture. Ask your toy dealer to show you this wonderful speed toy. See the curious "rudder" tail-piece; the external radiator; the side exhaust pipes; the real Dunlop Tires. If your dealer hasn't it, order direct from us. Your money back if you are not highly pleased!

KINGSBURY MFG. CO  
83-G Myrtle St. Keene, N. H.  
Complete Toy Catalog Free on Request

\*In Canada or West of Miss. \$3.85

## KINGSBURY MOTOR DRIVEN TOYS

SEND 10c for novel eraser—a Kingsbury disc wheel with tire of eraser rubber. Set of four, 35c.



DON'T BE A SLAVE

Be independent and make big profits with the—

### NEW IMPROVED BEISSER KEY MACHINE

You can start a business of your own, no experience necessary. The only key machine that cuts ALL kinds of keys. No hand-filing. Make first keys by number without taking locks apart. Locksmith instructions furnished free. Good Proposition for Agents. Write Today.

### BEISSER KEY MACHINE COMPANY

407 Fort St. East Detroit, Mich., U. S. A.

## Safety Grass Cutter

Newest Invention—Eliminates the old fashioned "Always Dull" Sickle—No more Expense and Bother for sharpening and grinding. The Safety Grass Cutter is always sharp—Uses your old Razor Blades—Cuts grass 100% faster. Handle is adjustable to any convenient cutting angle. Blades can be instantly replaced. Absolutely safe to leave around the house—folds up like a jack knife, hiding the exposed cutting edge. Guaranteed never to get out of order. SEND NO MONEY. Pay postman \$1.00 plus postage on delivery.

Use Your Old Razor Blades

ELBA PRODUCTS MFG. CO.  
Dept. 2 P. M., 726 Atlantic Ave.,  
BROOKLYN, N. Y.



Makes Grass Cutting a Pleasure

ONLY \$1.00



# A NEW HOUSE WIRING MANUAL

**PRACTICAL — PLAINLY WRITTEN**

BY J. G. WOLBER AND O. K. ROSE  
Cass Technical H. S., Detroit, Mich.

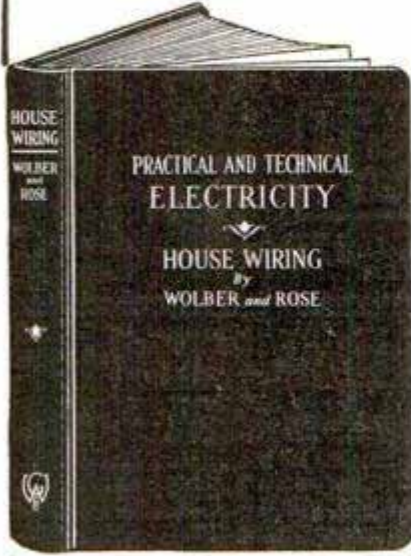

This book is the result of the author's fifteen years of industrial experience and of teaching. The material accumulated during this period of time has been worked over and over until in the author's opinion it was ready for publication.

320 Pages  
662 Illustrations  
Size 7 1/4 x 5 1/4 inches  
Flexible Binding  
Price \$2.50 Postpaid  
Will be sent C. O. D. anywhere in U. S. or possessions.

**POPULAR MECHANICS PRESS**  
Room P-1  
200 E. Ontario St., Chicago

# A PRACTICAL COURSE IN MECHANICAL DRAWING

By WM. F. WILLARD

An ideal book for home study. Each exercise is clinched in the mind of the student by practical application to every day practice. 160 Pages. 157 Drawings. Cloth. Price \$1.00 Postpaid

**POPULAR MECHANICS PRESS** 200 E. Ontario St. CHICAGO

# A POPULAR AVIATION GUIDE at a Popular Price

Prepared to meet the demand for a simplified book on Aviation suitable for young people, beginners, and all persons desiring general information.

Everybody's Aviation Guide by V. W. Page, just published. 256 pages, 140 Illustrations, tells all about flying in simple, easily understood language.



Aviation terms, operating principles, elementary rules, forms of air craft, functions of parts, types of power plants, machines, control systems and methods of flying. Learn now and prepare for the future. Price \$2

Will be sent C. O. D. in U. S. Pay postman price and postage.

**POPULAR MECHANICS PRESS**  
Room P7, 200 E. Ontario St., Chicago

# NEED A BETTER GRIP ON MATHEMATICS?

SEND for a copy of "Mathematics for the Practical Man," only \$1.50. By common sense methods it removes the mystery and difficulties so that algebra and even calculus are made simple.

Assuming your knowledge is limited to arithmetic you quickly and easily gain a working knowledge of Algebra, Geometry, Trigonometry and Calculus. Simply pay postman price of book plus the postage when he hands you the package.

**Popular Mechanics Press**  
Room P1  
200 E. Ontario Street, Chicago



**Pretty Soft**  
\$6000 to \$10,000 a year  
and  
**His Own BOSS!**

**YOU CAN DO IT!** No school—no tuition. Half an hour shows you how. One week's practice makes you an expert. Sounds too good to be true, but is.

Here are the facts.

There's a big demand for the work Clarke FlorKraftsmen are doing! The demand for fine smooth floors grows greater every day. Millions are spent every year sanding old and new floors—in homes—in office buildings. \$25.00 to \$75.00 per day can be yours.

And here's the point. No one can do this work so easily—so beautifully—as the Clarke FlorKraftsmen. Your ambition to succeed, to have the things you want, the extra savings—the extra luxuries, can all be yours. There's no mystery—no magic about it. The facts we will send you show the way.

It's a sure big pay proposition. Many who saw our announcement a month or two ago are now making from two to five times their previous earnings. Costs nothing to get the facts. Be sure to send the coupon NOW.



## CLARKE SANDING MACHINE CO.

Dept. T-7  
3831 Cortland Street  
CHICAGO, ILL.

Originators and for 11 years Manufacturers of Portable Sanding Machines.



answers all calls

**CLARKE SANDING MACHINE CO.,**  
Dept. T-7, 3831 Cortland St., Chicago, Ill.  
Gentlemen: Please send me the facts about **CLARKE FLORKRAFTSMANSHIP.** No obligation to me.

Name.....

Address.....

City..... State.....





Paint by Air  
NOW!

## New-Quick-Easy Way-No Brush

NOW you can own a SPRAY GUN! This wonderful KB SPRAY GUN makes painting a pleasure. Applies Lacquers, Varnishes, Paints, etc., leaving a smooth glass-like finish. Ideal for Automobile painting, Furniture, Wicker-ware, Screens, and any odd job around the house.

MAKE \$50 TO \$100 A WEEK

On account of the unusual demand for this wonderful KB HAND OPERATED SPRAY GUN it opens big money-making possibilities in every locality. Thousands of homes are anxious to get it. Be the first in your locality!

Just order C. O. D. and pay special agent's price of \$9.75, plus transportation on arrival, or if you prefer, remit with order. Either way—satisfaction guaranteed or money back.

Write for Free Folder

**KOCH BROS. MFG. CO., 1515 Lawrence Ave., Dept. 22, CHICAGO**



The  
Ideal  
Home  
Paint-  
ing  
Outfit

Agents  
Wanted

Special Offer  
Complete Outfit Only  
**\$9.75**

Weights only  
7 lbs.

# AMAZING CAP OUTFIT Free!



Just out! Absolutely new! Write or wire today for amazing new Taylor Cap Outfit. S. W. Allen of California made \$40.80 in one day, just showing beautiful styles and rich RAINPROOF fabrics. Charles Horstman walked off with 53 orders in 8 hours. Scores of men making big money this new easy way.

## \$20 a Day Easy!

YOU can also make more money than ever by showing wonderful Taylor Caps. Guaranteed rainproof, an exclusive feature which sells the caps with lightning speed. You pour water on Taylor Cap and it rolls off without moistening fabric. Wear cap in rain or snow and it remains perfectly dry. Amazing three-minute demonstration convinces every man. You keep big commission in advance on every order. Every cap made-to-measure and carefully tailored throughout. Delighted customers tell friends.

### Send Name and Address

New styles and fabrics most beautiful of season. Complete equipment now ready. Write today. Let us send you this big money-making opportunity FREE—without obligation.

TAYLOR CAP MANUFACTURERS  
Dept. 22-G Cincinnati, Ohio

## MODEL AIRPLANES

25c to \$10 Complete  
**CONSTRUCTION SETS**

Raw materials; blueprints; everything needed to make your own models.

GLIDERS, TRACTORS, RACERS, CABIN MONOPLANES

Write for Illustrated Folder "P"

BROADFIELD TOY CO., Hempstead, N.Y. Est. 1919  
Dealers' inquiries invited

## Simplified Radio Blueprints

Blueprints for the most popular sets described in Popular Mechanics Magazine can be obtained for a charge just sufficient to cover the cost of production and mailing. The sets for which blueprints are available are:

Three-Tube, Loud Speaker, Loop Set.....	Dec. 1926 — 25c
Three-Tube, 15 to 550 Meter Set.....	Nov. 1926 — 25c
Four-Tube, Loop Set, for Car or Home.....	Aug. 1926 — 25c
Six-Tube, Portable, Loop Set.....	June 1926 — 25c
Electrolytic B-Eliminator.....	Feb. 1927 — 25c
Non-Radiating Unit.....	May 1926 — 25c
Simple Tube Tester and Chart.....	July 1926 — 25c
New Perfect-Tone Six.....	Mar. 1927 — 25c
Two-Tube Loud Speaker Set.....	Oct. 1927 — 25c
Economy Nine Superheterodyne; Sixty dollars builds this Super, Complete drilling templates and blueprint diagrams.....	Nov. 1927 — 50c
Loop Set for Cabinet Speaker.....	Dec. 1927 — 25c
Aero-Dyne Six Receiver.....	Jan. 1928 — 25c
Homemade A-Battery and Charger.....	Jan. 1928 — 25c
B-Eliminator for Direct Current.....	Feb. 1928 — 25c
Screen-Grid Special.....	Feb. 1928 — 50c
Fifteen Dollar B-Eliminator.....	Mar. 1928 — 25c
Short-Wave Converter.....	Mar. 1928 — 25c
All-Electric Five.....	April 1928 — 25c
Three-Tube All-Wave Set.....	May 1928 — 25c
Push-Pull Power Amplifier and Power Supply Unit.....	June 1928 — 25c

Address the RADIO DEPT.

Popular Mechanics Magazine, 200 E. Ontario St., Chicago  
Back numbers of the magazines describing the construction of the sets can be obtained from our Circulation Department, price 25 cents each.

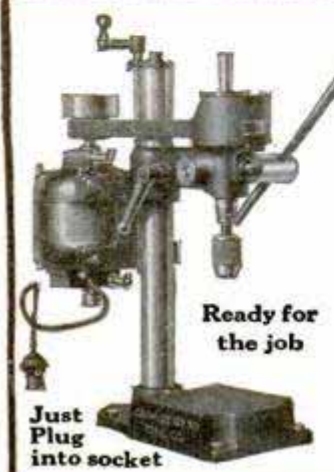

Ready for  
the job

Just Plug into socket

## C-O UTILITY DRILL - NOW!

The Makers of the famous C-O Garage Tools and Equipment, known the world over, offer you a Utility-Drill complete, ready for the job, for ONLY \$34.00.

Not an attachment nor a makeshift, but a real drilling machine designed by master engineers.

Here's real drill value — just read these specifications: Vertical

Also furnished in other voltages and cycles. Prices on request. Order today or if you need more information write for circular.

cal type motor, 110 volt, 60 cycle, single phase, AC, with cord and switch; belt drive; 3-jaw chuck; 11x6" bench space; 23" high; weight 62 pounds.

Bores holes up to 3/8"; works in 9" circle; 2 1/2" up and down spindle run; 7 1/2" range on column; 1100 to 2200 spindle speed.

Ideal for garages, repair and service plants, factories, all mechanics and farm and home craftsmen.

ONLY  
\$34.00  
COMPLETE  
WITH  
MOTOR

FULLY GUARANTEED

CANEDY-OTTO MFG. CO., Dept. PM. Chicago Heights, Ill.



# Make Your Own Summer Furniture

BLUE PRINTS

\$1

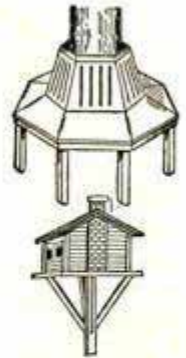
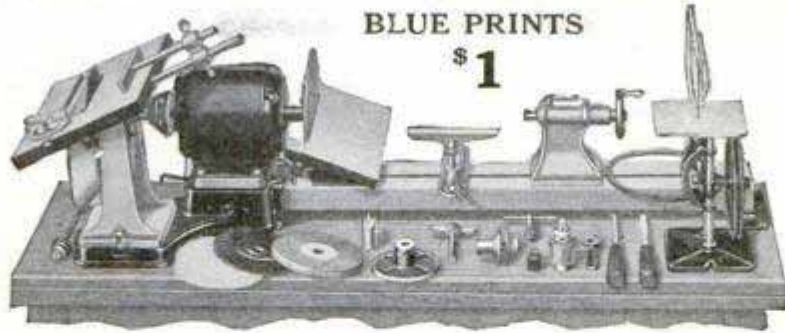

Complete set of 10 Blue Prints, \$1.00

## With a Delta Handy-Shop

The only Shop made with the following, man-size improvements: Powerful 2-shaft motor—handles two or three jobs at once. Heavy U-shaped steel lathe bed—cannot spring or chatter. Improved circular saw with tilting table—no interference in cutting boards. Improved sanding disc with tilting table, operated without detaching saw. Advanced scroll saw with tilting table. Automatically-oiled bronze bearings. Non-slipping V-Belt. Ball bearing tailstock. Heavy veneered wood base. Finest materials throughout. Hundreds in use. Owners amazed at its superiority over ordinary shops.

### 10 Days' Trial

with no obligation to keep it. Ship back, at our expense, if not satisfied. It will save its own cost twice over in making beautiful summer furniture alone. Send coupon today.

Delta Specialty Co.  
(Dept. MP 728)

858-3rd St., Milwaukee, Wis.

Please send me items checked as follows:

- Complete details of the Delta Handy-Shop including Trial Offer and 5 Easy Payment Plans.
- Find \$1.00 enclosed for 10 blue prints of Summer Furniture.

Name.....

Address.....



## LINDYTYPE AIRPLANE



NEW 13-ft. Cross-Atlantic Silver Sea Gull model "Lindytype" Spirit of St. Louis MONOPLANE. Special Introductory Price \$1.00. Rises from ground and flies 75 ft. or more by own power. Entire model finished in BRILLIANT SILVER LUSTRE. Scientifically designed to the last detail. Even the "Lone Eagle" himself is at the controls! Very educational! Decidedly realistic! Sensational performer! Thrilling fun!

as it soars away through the air, banking, turning, soaring before gliding to earth. Easy construction set, all difficult parts formed, put together in evening without tools, complete materials including six inch propeller, adjustable wings, full directions, post-paid U. S. \$1.00. Canada \$1.20. Satisfaction guaranteed or return outfit in five days and receive money back. Order yours NOW!

MODEL AIRCRAFT CO., Box J, CHILLICOTHE, OHIO

**Guaranteed to fly-or-Money Back**

## New Automatic-Electric HAMBURGER MACHINE

ROLLS DIMES INTO YOUR CASH REGISTER!

Start one "Dandy Boy" Hamburger Stand now. Build up a chain of ten or more within a year. Fortunes are being made in this fascinating business.

"Dandy Boy" Automatic Hamburger Machine operates in the front window—stops the crowds and does the selling for you—automatically forms perfectly shaped uniform sized meat patties—drops them on to a revolving griddle—cooks them thoroughly—evenly—hands never touch the meat. Sanitary. Appetizing. Made of solid aluminum.



7c PROFIT ON A 10c HAMBURGER

Thousands of Hamburger stands sell from 200 to 600 hamburgers a day. We help you select locations and tell you step by step how to get into this profitable business. Write for interesting details.

OPERATES IN A WINDOW

SANITARY MFG. CO.  
8513 Plymouth Court, Chicago, Ill.

## GETTING QUALITY IN RADIO RECEPTION

SM

"The Secret of Quality" tells you simply and concisely how to get the most out of your amplifier—how to get quality. This 96 page booklet is yours for the asking—it's free. Write for your copy.

SILVER-MARSHALL, INC., 840 W. Jackson Blvd., Chicago, U.S.A.

## NEW \$1 ITEM BRINGS EASY PROFITS

Sells on sight everywhere. Perfo-Syphon, the gas-tight syphon top for Ginger Ale and all "fizz" drinks. Agents wanted. Make \$15 a day. Write for details or send \$1 for sample.

Vaughan Novelty Mfg. Co., Dept. B-135, 3215 Carroll Ave., Chicago

Books on all subjects are sold by Popular Mechanics Press, 200 E. Ontario St., Chicago, Ill.

## MODEL SAIL BOAT



At last! A real model sail boat that is different from the type found in stores. Think of the joy of putting this 30-inch model together and taking her out to the lake and watch her go. Our special construction set contains all the necessary materials of the finest grades. All parts cut close to shape. Just put together, a little trimming here and there, and the job is done. Special diagrams and full instructions. Everything but the paint. Price of set complete \$4.95 plus postage for 5 lbs. Put a dollar bill in an envelope and we will ship balance C. O. D. Our large illustrated catalog fully describing the above and containing reproductions of photos of various scale models with prices for sets, hulls, blocks, deadeyes, cupstans, anchors, steering wheels, etc., for Flying Cloud, Constitution, Mayflower, Spanish Galleon and others sent postpaid upon receipt of 10 cents.

MODEL SHIP SUPPLY CO., Dept. J, Mineola, N. Y.

## C-A DEVICES WILL SOLVE YOUR BEARING PROBLEMS!



The new C-A ADJUSTER BOLTS for connecting rod bearings keep your bearings always in perfect tension automatically. Installed in less time than fitting one bearing the old way and need no further attention. Made for most all makes of cars. MONEY BACK IF YOU AREN'T PERFECTLY SATISFIED. Specify make and model of car. Sent direct to you. Complete set for Fords, Chevrolets, etc. only \$275

This automatic C-A crankshaft bearing permanently and automatically eliminates end-play in Ford and Chevrolet motors. Installed easily in a few minutes. Just remove crank-case cover—no need to "pull" the motor. Now priced extremely low. Install a C-A Automatic Bearing and dismiss your end-play worries. Direct by mail to you complete for \$275



NOTE THE AUTOMATIC WEDGE ADJUSTMENT

ADJUSTABLE BEARING COMPANY, Inc.

405 Virginia Avenue, INDIANAPOLIS, INDIANA

PAT'D

NORMAL

EXPANDED



## Every Handy Man needs SMOOTH-ON NO. 1



for stopping leaks in steam, water or gas pipes, mending cracks, or leaks in furnaces and boilers, radiators, tanks, sinks, pots and pails, making loose handles tight, tightening loose screws hooks, locks, door knobs, etc., stopping leaks in automobile engine water jackets, in radiator, hose connections, gas tank and gas, oil and exhaust lines, making a fume-proof joint between exhaust pipe and tonneau heater, keeping grease cups, hub caps and nuts from loosening and falling off, etc. Hardens like iron and stays everlastingly tight.

## To Make Wet Cellars Dry Use Smooth-On No. 7

the one practical waterproofing that you can apply yourself, easily, from the inside, to wet or dry surface and with every assurance of thorough water-tightness, even in the wettest seasons. Effective in wet boiler pits, at cracks and porous spots and also excellent for patching and waterproofing any concrete, brick or stone surface to keep water out or in.



Write for  
**FREE BOOK**



# Do it with SMOOTH-ON

SMOOTH-ON MFG. CO., Dept. 37,  
574 Communipaw Ave., Jersey City, N. J.

Please send the free Smooth-On Repair Book.

Name.....

Address.....  
7-28

## It's Amazing How Easy You Can Now Paint With This Outfit



Only  
**\$15.00**

Until now the home owner had to be content with the old-style slow hand brush, with its unsightly laps and brush marks and uneven coverage. Now you can spray lacquers, paints, varnishes, enamels, shellacs and bronzes and make the work easier, look better and finished much faster. Now you can brighten up the home with your choice color schemes. This outfit has been tested and approved for home use and is the latest product of the world's largest manufacturer of airbrush equipment.

### PAINT YOUR OWN AUTO

This Unit Consists of

One Paasche J. D. 1/2 Pint Sprayer, Hand Pump, Tank with Gauge, Fittings and 8 foot Hose.

Also Large Power

Outfits for Commercial Use

Write for **FREE FOLDER**



Paasche Airbrush Co.

J. A. PAASCHE, President

1950 Diversey Pkwy., Chicago, Ill.



### The Quick Way to Music



**KING** Band Instruments offer you the quickest, easiest way to learn music—to play brilliantly. They are *unqualifiedly guaranteed in writing* to be perfect in design, materials, mechanism and workmanship. That's why they'll help you to learn faster and play better.

When a great musician like Edwin Franko Goldman says that King Instruments greatly improved the tone and intonation of his famous band, that's proof that a King will insure your musical success.

Start now! Tell us the instrument you want. We'll ship it to you to try—**FREE**. The price will be no more than you'd pay for a less perfect instrument. Deferred payments will make payment easy.

Why handicap yourself? You can afford to own a King—the instrument of *guaranteed superiority*. Mail the coupon Today for our Handy Reference Catalog and other interesting booklets.





The H. N. White Co.  
5211-02 Superior Ave., Cleveland, O.

Please send me free copy of "The White Way" Magazine and your Handy Reference Catalog. (Check, below, instrument preferred.)

Name..... Age.....  
Address.....  
City..... State.....

Saxophone  Trumpet  Trombone  Alto  
 French Horn  Baritone  Bass  Bugle



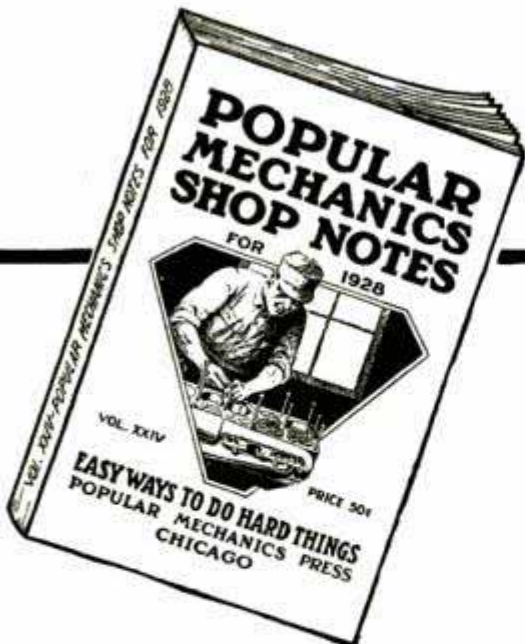

# SHOP NOTES

500 **FOR** 400  
Articles **1928** Pictures

This announcement will be welcomed by thousands because they have learned that each yearly issue of Shop Notes contains dozens of short cuts that save time and money. Every article is written by some man who has tried the idea and found it worth money. The variety of subjects covered is one reason why so many buy Shop Notes each year. In many ways the 1928 issue surpasses previous numbers. The following brief list will give you an idea of the variety of subjects covered.

### SOME OF THE SUBJECTS

- |                        |                          |                         |
|------------------------|--------------------------|-------------------------|
| Artificial Ice Making  | Battery Charging         | Killing Moths in Furni- |
| Sheet Metal Working    | Building-In a Sewing     | ture                    |
| Painting Kinks         | Machine                  | Flagstone Walks         |
| Carpentry              | Cleaning Rifles          | Hints for the Builder   |
| Automobile Repairing   | Bee Keepers' Kit         | Ship Plaque Making      |
| Machine Shop Work      | Culvert Work             | Refinishing Soft-Wood   |
| Farm Mechanics         | Automobile Repairing     | Floors                  |
| Tool Repairing         | Portable Sewing Machine  | Making a Pirate Chest   |
| Lock Repairing         | Hot-Flame Blowpipe       | Homemade Apple Wiper    |
| Key Making             | Automatic Fire           | Setting Window Glass    |
| Concrete Work          | Extinguisher             | Etching Brass and Cop-  |
| Cutting Your Coal Bill | Lawn Mower Repairing     | per                     |
| 75%                    | Beautifying Your Home    | Making a Sewing Cab-    |
| Poultry Appliances,    | Portable Air Compressor  | inet                    |
| Plumbing Kinks         | Gasoline Pump Extension  | Glue and Its Use        |
| Electrical Kinks       | Log Cabin Construction   | Proper Hot-Water Heat-  |
| Power-Line Pole        | Folding Bed for Roadster | er Installation         |
| Straightening          | Cutting Glass            |                         |

## 6,000 Ideas on All Shop Work

There are now 16 volumes of Shop Notes available. And this unrivaled library of shop helps may be had for a special price of \$6.25. If you do not have the back numbers of Shop Notes, you should purchase the entire library. The following are now available: 1908, 1912, 1913, 1914, 1916, 1917, 1919, 1920, 1921, 1922, 1923, 1924, 1925, 1926, 1927, 1928

### Amateur's Guide **PROFESSIONAL'S** **HANDBOOK**

Both amateurs and professionals find Shop Notes of wonderful value. The articles are so clearly written and so thoroughly illustrated that even a boy can follow them. Teachers of Manual Training should have the complete library.

## SEND NO MONEY

Don't send a penny. Just fill in the coupon with your name and complete address, indicate whether you want the whole library or the special offer of 1928 Shop Notes and Lathe Handbook for 98 cents. When the books are delivered to you, pay the postage and deposit price of books with postman.

### SPECIAL OFFER COUPON

POPULAR MECHANICS PRESS,  
200 E. Ontario St., Room P1, Chicago, Ill.

Send me, as per your special offer the following books. I will pay postage and the price of books when they arrive. My money will be refunded if I am not satisfied. (Check what you want.)

- 1928 S. N. and Drilling and Thread Cutting, 98¢  Complete Shop Notes Library (16 vols.) \$6.25

Name.....

Street and No.....

City..... State.....

# Accidents will happen!

**BE PREPARED**  
No One Is Safe From Harm

Our New Policy Costs but \$10 a year and pays \$25 weekly Benefit for stated Accidents or Sicknesses.

**\$10,000 Principal Sum**  
**\$10,000 Loss of Hands Feet or Eyesight**  
**NO MEDICAL EXAMINATION.** Men and Women 16 to 70 Accepted. No Dues or Assessments.

Are You Protected?

**\$10 BILL** } **PAYS FOR A WHOLE YEAR'S PROTECTION**  
Both { **ACCIDENT and HEALTH**

**NO MEDICAL EXAMINATION**  
Men and Women 16 to 70 Accepted. No Dues or Assessments  
**\$10,000 PRINCIPAL SUM. \$10,000 Loss of Hands, Feet or Eyesight**  
**SEND NO MONEY. FREE DETAILS**

-----MAIL COUPON NOW-----

**NORTH AMERICAN ACCIDENT INSURANCE CO.**  
133 Bonnell Bldg., Newark, N. J.

Gentlemen: At no cost to me send me details of the NEW \$10.00 Premier \$10,000 Policy.

Name.....  
Address.....  
City..... State.....

### AGENTS WANTED FOR LOCAL TERRITORY



**The Biggest Profit-Maker at Any Park!**  
For every dollar invested in sugar you can get out \$25 in cash if you own one of our

### CANDY FLOSS MACHINES

Five models of new machines, and many good used machines at sometimes less than half price. We also manufacture and sell other carnival, fair goods and concessions. We buy used floss machines.  
**AUTOMATIC FISHPOND CO. 268 Langden St. TOLEDO, OHIO**

The man who studies gets ahead. Popular Mechanics Press will advise you what books to read to advance in your trade. 200 East Ontario Street, Chicago, Illinois.

## NEW 1928 EDITION MODERN GASOLINE AUTOMOBILE

The type matter has been entirely reset for the thorough revision of this authoritative book by V. W. Page. With 1000 new illustrations this strictly modern work shows every recent improvement in automobiles and their component parts. This most complete and practical treatise describes every part of all types from light cars to heavy-duty trucks and road tractors.

The first book to devote many of its 1150 pages to a complete, illustrated description of the

### NEW MODEL A FORD

Design, construction, operation and maintenance are the broad divisions of the text matter.

All latest developments are dealt with in minute detail.

Size, 6x9 in. Fabrikoid Binding  
Price \$5

Will be sent C. O. D. in U. S. Pay postman price and postage.

### Popular Mechanics Press

Room P 7

200 E. Ontario St.

Chicago

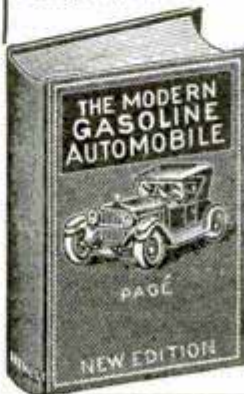

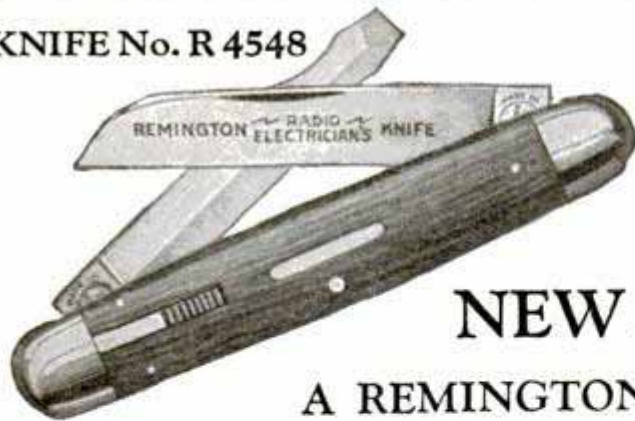

KNIFE No. R 4548

**NEW!**

A REMINGTON  
KNIFE FOR ELECTRICIANS  
AND RADIO FANS . . .

**T**HIS new Remington knife is just what electricians and radio tinkers have been waiting for. Can't be beat for scraping insulation from wires, making connections, tightening up, doing odd jobs. Has one 3-inch sheep-foot blade, and a 2½-inch screw-driver. The blade is forged from high carbon steel, razor sharp, and holds its edge a long time. One side of the screw-driver is ground to a cutting edge. Safety catch prevents screw-driver from closing when in use. Nickel silver bolsters, brass linings.

Ask your dealer to show you the Remington Radio Electrician's Knife. Note its hard, handsome, cocobolo handle. Test its razor-sharp blade. Note the screw-driver... see how strong it is. Knife No. R 4548 is a wonderful value for \$2.00. If your dealer hasn't it in stock, send us his name and the price. The knife will be forwarded at once, postpaid.

REMINGTON ARMS COMPANY, Inc.

*Originators of Kleanbore Ammunition*

25 Broadway New York City

# Remington

KNIVES THAT BITE

© 1928 R. A. Co.

R 4548

## Do You Enjoy Making Things?

If so, you should have a copy of this new book just published by Popular Mechanics entitled

### Make It Yourself

The home mechanic, whether young or old, amateur or professional, will take pride and delight in making many of the things described therein.

Both father and son will find fascination and an association of interest in making useful and ornamental articles for mother to admire upon their completion.

### 900 Articles All Different



There are attractive ship models, a great variety of toys that operate themselves by means of an ingenious application of mechanical principles, novel amusement devices for indoors and outdoors, for both water and land, unique designs in furniture for children, scores of useful appliances for the home, things of beauty and utility for lawn and garden, etc.

Special articles instruct the amateur mechanic in the care and use of tools, special tools for special purposes, how to read and use plans, how to solder, the making of a handy work bench, cuts, joints and methods in woodworking, automobile repairing, installing radio equipment, house wiring, fixture hanging, working in glass, leather, metal, celluloid, lathe work, utilizing parts of old machines to make equipment that would be expensive to buy, etc.

480 Pages—823 Illustrations.

Size 7x10x1½ in. Cloth Binding

Price \$3.00

Mailed Postpaid upon receipt of price anywhere in the world. If you reside in U. S., Hawaii, Porto Rico, Alaska or Mexico, we will send the book by mail C. O. D. if you prefer.

POPULAR MECHANICS PRESS (ROOM P-202)  
200 East Ontario St. Chicago, Ill.

## BUILT-IN FURNITURE

Adds Beauty and Convenience  
to Your Home



With the plans and directions given in this new book by Edwin M. Love any handy man will be able to build the various pieces of popular space-saving furniture.

These useful and ornamental cabinets are easily added to an old house and many are designed to be built into odd nooks and recesses.

The construction is very simple as the walls offer support and no structural alteration of either floors or walls is necessary.

Stock sizes of material are specified in each instance. The home owner will be able to alter designs if necessary to suit available space.

That practically every adaptation of built-in furniture is covered by this book is shown by the following list of contents.

General Details of Construction—Portable Buffet—Recess Buffet—Corner China Closets—Clothes Closet Linen Cabinet—Furnishing a Clothes Closet—Bathroom Cabinet—Linen Closet—Mantel Shelves—Bookcases—Writing Desk—Seats—Indirect Lighting Fixtures—Sewing Cabinet—Corner Kitchen Cupboards—Breakfast Nook—Bathtubs—Laundry Porch Furnishings—Dining Table—Dressing Table—Radio Set—Phonograph—Safe—Shaving Cabinet—Cupboard and Drainboard Cabinet—Clothes Chute—Wood Box—Work Bench and Tool Cabinet—Mortise and Tenon and Dado Joints—Wood Dowels—Bending Small Moldings—Driving Nails and Screws—Care of Tools.

198 pages. Size 7x10 In. Fully illustrated. Price \$2.50 postpaid.

Popular Mechanics Press

Room P-102

200 E. Ontario St.

Chicago, Ill.



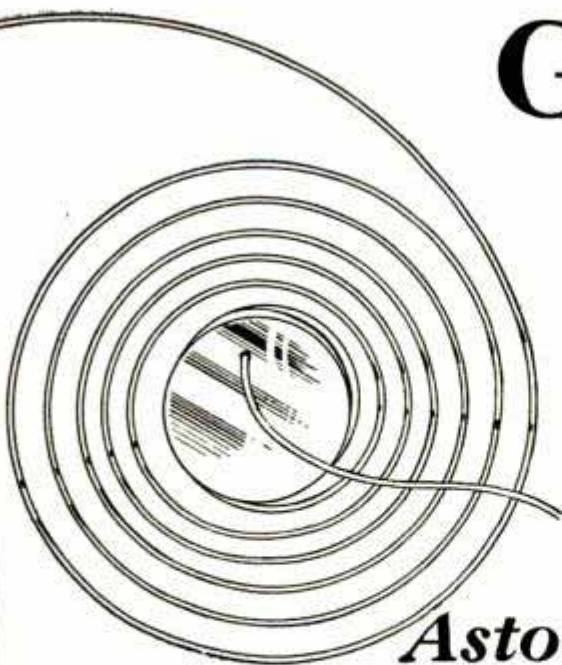

# Get Winter Reception in Summer

in

# Summer

with

*Astounding Successful*

# Ground Antenna

Clearer Ground Wave Reception Allows Greater Distance

Hundreds of satisfied users of the sensational Ground Antenna—Aer-O-Liminator—are wondering how they ever got along without it. All over the country radio owners are finding marvelous satisfaction in freedom from static and noise interference. This revolutionary improvement of reception comes from hooking your receiver to Ground Wave Reception. Radio engineers tell you that the broadcast wave through the ground is in most cases almost static-free and with rare exception carries no noise interference.

## Natural Tone—Better Selectivity

The rapidly increasing army of Aer-O-Liminator owners also enjoy and appreciate the natural human tone and clarity of this Ground Wave Reception. If you haven't tried it you can't imagine the difference!

Another advantage users have found with Aer-O-Liminator is the surprising DX they get. Distant stations formerly drowned out by static or noise interference of air waves now come in clear as a bell. Selectivity is improved because, with pure, clear Ground Wave Reception, you can pick up and log signals that before were lost in the jumble of shrieks and howls so common in DX reception through air waves.

You shouldn't deprive yourself of the new thrill of pure, clear ground wave reception a day longer than necessary. We let you prove it for yourself.

## FREE TRIAL

Make This Thrilling Test at Our Risk!

Install an Aer-O-Liminator (Ground Antenna). Leave your old overhead aerial up. Try out on a night when static is bad. If you do not get a wonderful improvement in freedom from static, greater selectivity and clear, sweet tone without interfering noises, if you can't get good reception on stations that are drowned out by static on your roof aerial, you need not pay us a red cent for this test! Send coupon at once for scientific explanation of Aer-O-Liminator (Ground Antenna), proof of performance and our conclusive iron-bound guarantee and remarkable Free Trial Offer—Mail Coupon TODAY!

# Aer-O-Liminator (Ground Antenna)

*Passed by the National Board of Fire Underwriters Meets requirements of the National Electrical Code Endorsed by Foremost Engineers and Dealers*

**Curtan Mfg. Company**  
Dept. 805-KA  
154 E. Erie St., Chicago, Ill.

## Rush This Important Coupon

Curtan Mfg. Company,  
154 E. Erie St., Dept. 805-KA, Chicago, Ill.

Please send me at once complete description of Aer-O-Liminator, with details of guarantee, Scientific Proof, and Free Trial Offer.

Name.....

Address.....

City.....

State.....



### Easy to Install

Just dig a small hole about 6 inches in diameter and drop Aer-O-Liminator into it.



## Read Proof!

"I have tested and thoroughly approve the Aer-O-Liminator. I find it increases selectivity and volume without distortion, practically eliminates static, gives good, clear tones, both on local and distant stations.

"I would recommend the use of Aer-O-Liminator to every radio owner to get the best reception from his set."  
John E. Christensen,  
(Radio Engineer).

"There's no such thing as static trouble since I got my Aer-O-Liminator. I get stations I never got before—so loud and clear I would almost swear they were in the next room."

R. Curtis,  
ILL.



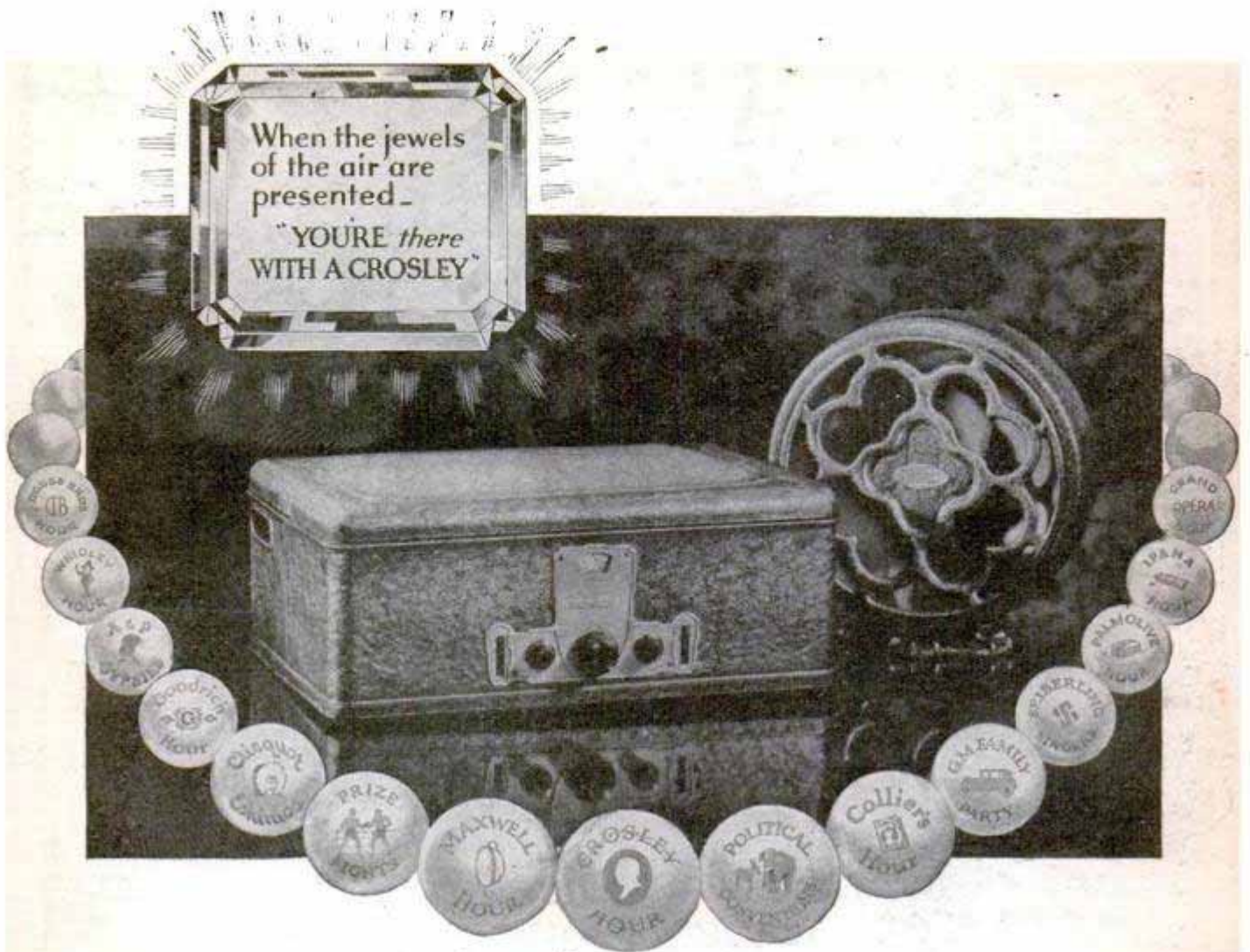

## The New CROSLLEY JEWELBOX

Take advantage of the most amazing offer ever made in all Radio History!

Try this remarkable new Crosley Radio with Crosley new type D Musicone without cost or obligation. Just phone a Crosley dealer—tell him you want to test the new Crosley Jewelbox.

Home is really the place to buy radio!

Home is where you can decide leisurely and surely. Crosley dealers are authorized to home demonstrate this new radio. Antenna unnecessary for such demonstrations—30 feet of wire on the floor of the room will do nicely.

Put the Jewelbox to any test!

Compare it with your old set. Try it with any other! Learn what radio reception can be. Note how easy it will be to break through any surrounding wall of local stations—to bring in distant programs quickly, clearly and in full volume. Be sure you test the Jewelbox with the Crosley new type D Musicone that you may fully realize, if you own an old set or have not heard a Crosley, how far radio has progressed.

Remember—you do this all in your own home—at no cost and no obligation to you!

**\$95**  
WITHOUT TUBES

Try it in your home  
—that's the only way  
to buy a Radio!

Every Crosley Dealer  
is now authorized to  
give you this FREE  
trial!

**THE CROSLLEY  
RADIO CORPORATION**

Powel Crosley, Jr., Pres., Cincinnati, Ohio

Licensed only for Radio Amateur, Experimental and Broadcast Reception.  
Montana, Wyoming, Colorado, New Mexico and West prices slightly higher.



The Musicone finished to match  
the Jewelbox, \$15

The new Crosley Jewelbox is self-contained to operate from light socket.

All in one beautiful case. Add tubes and it's ready to operate! It is powerful. Supplying 180 volts to power output tube it gives full undistorted volume. Other sets supplying 110 to 135 volts result in poor quality, distortion and less volume.

The Acuminators, an exclusive Crosley feature, enable you to tune sharply on distant stations increasing signal strength and volume to a surprising degree.

The new Crosley Jewelbox is up-to-date.

The dial is illuminated—a modern necessary feature. The set is completely shielded as all high grade radios should be. The rich brown finish high-lighted with gold makes it an ornament to grace the finest room. The beauty of the Jewelbox will charm you.

The price of the new Jewelbox is a triumph of manufacturing genius!

Crosley engineers designed this new Crosley Jewelbox under explicit instructions to make first a perfect radio. If the production of their final design had been limited to a few hundred, only wealthy persons could have afforded them. But with efficient Crosley production methods, facilities to manufacture parts in million quantities and a faith in the enormous demand such values would create, this splendid radio receiver is priced at \$95.

Write Dept. 15 for literature.



Easy now to

# DOMINATE STATIC

Get Clear, Loud Distance  
Any Time of Year!

Summer, Fall, Winter or Spring—lightning storm, summer heat, or blizzard—it makes little difference; distant stations come in loud and clear, and unspoiled by static when taken out of the ground with a Rogers Underground Antenna. In all truth, this amazing new device is one of today's greatest forward steps in the perfection of Radio. It *actually* and positively enables you to *dominate* Static.

## The Perfected Invention of DR. J. HARRIS ROGERS

Dr. Rogers is known the world over for his sensational work of both private and governmental nature, in the transmission and reception of ground waves. The Rogers Underground Antenna has been perfected for home use and is manufactured and sold under Dr. Rogers' patents.

### Read the Amazing Facts

When static is present in the air, its strength is invariably greater than the strength of the desired radio signal. Hence, in the air, your reception is dominated by the noise level. In the ground, as Dr. Rogers proved, and as you can prove, there is a lesser amount of static. And when there *is* static in the ground, it is never equal in strength to the strength of the desired radio signal. Therefore, when you use the Rogers Underground Antenna you actually reverse the static-signal ratio; you actually dominate static; you positively bring the distant stations in so loud and so clear that what little static there might be in the ground is barely heard, if at all. You'll be amazed when you compare reception obtained with a Rogers Underground Antenna to the reception you have been accustomed to.

### Try It on Your Set

It costs you nothing to test the Rogers Underground Antenna excepting the five minutes time it takes to install it. Just five minutes of your time—that's all you'll be out, if you're not more than pleased. We don't ask you to pay a cent for the Rogers Underground Antenna if you don't find, after exhaustive test on your own set, that this great radio improvement is all we claim for it and all Dr. Rogers proved it to be when he obtained his patents. Send the coupon now. Let us send you ALL the startling facts and full particulars of the FREE comparative test we want you to make. Clip the coupon. Send it today.

# FREE

THE UNDERGROUND ANTENNA CO.  
4207-R Cottage Grove Avenue, Chicago, Illinois

### Trial Offer Coupon

The Underground Antenna Co.,  
4207-R Cottage Grove Ave., Chicago, Ill.

Send me all the facts on the Rogers Underground Antenna. Also full particulars of FREE Test Offer and GUARANTEE.

Name.....

Address.....

Town..... State.....

Here is an opportunity for you to be the first in your neighborhood to banish static and have almost perfect radio reception. Mail this Coupon *right now*.

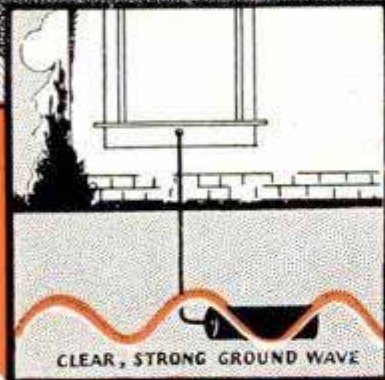
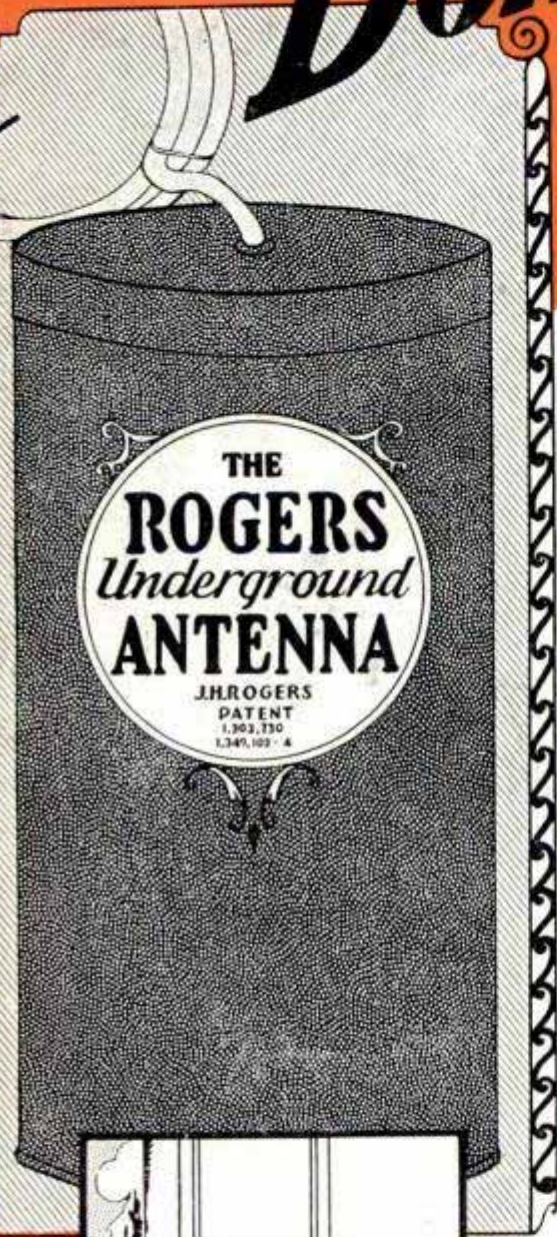

# The ROGERS Underground ANTENNA



H A V E A C A M E L



It's the favorite.

WHEN smoking is recognized as a pleasure, Camel has the call.