

POPULAR MECHANICS

MAGAZINE

WRITTEN SO YOU CAN UNDERSTAND IT

REG. TRADE MARK, GREAT BRITAIN No. 410436

REG. U.S. PAT. OFF.

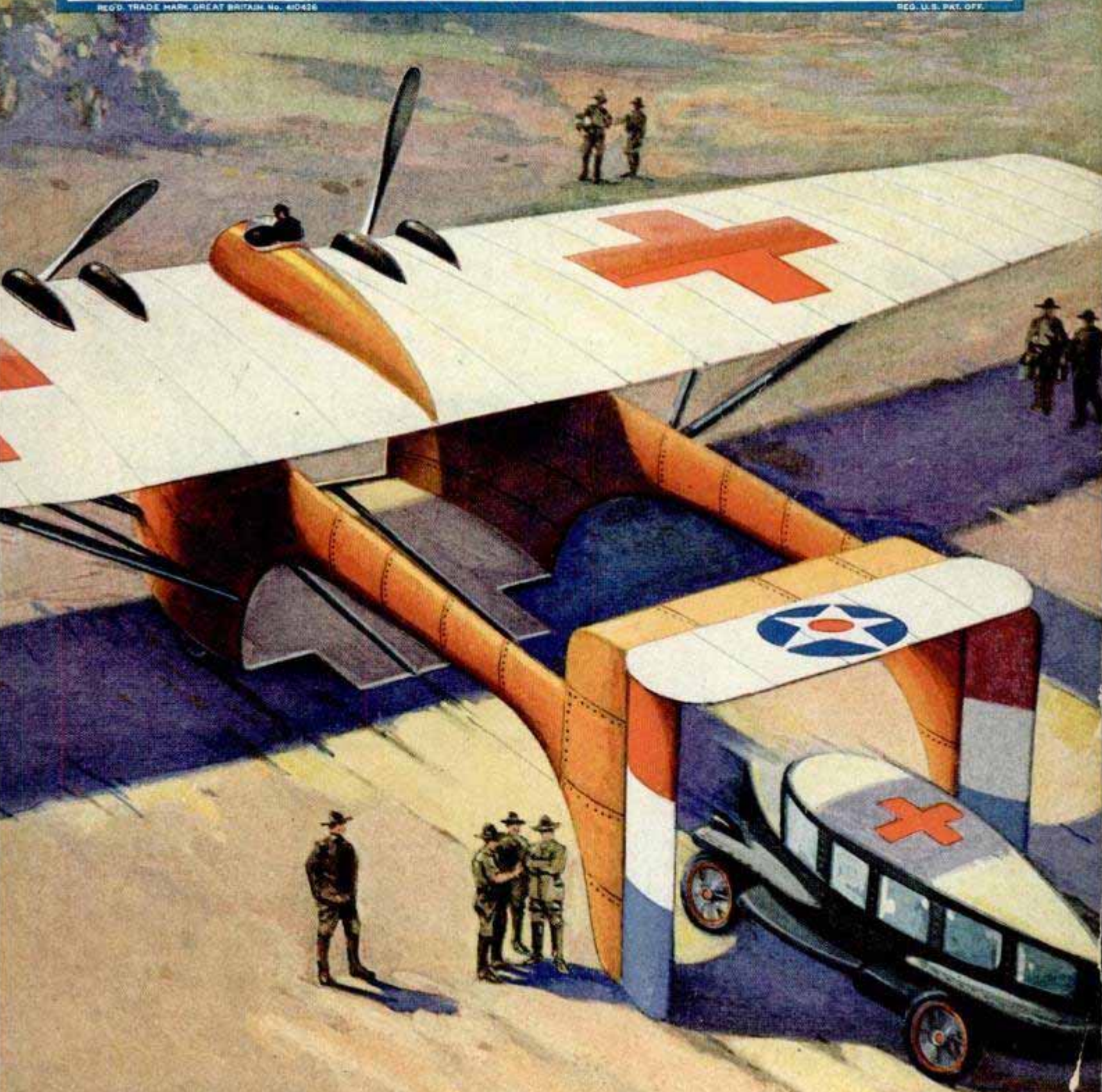

SEE PAGE 384

ATKINS

SILVER STEEL SAWS



Cut
Six
Times
More
Metal

Mr. Happy
Man Says ~

“Get
Them at

Your Hardware Store”

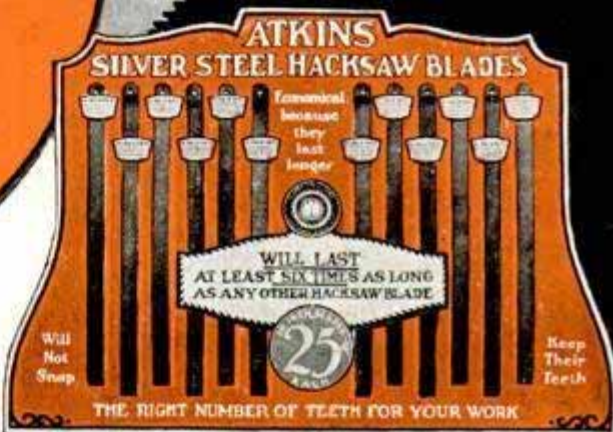

If your dealer cannot supply you, tell us what kind of metal you are cutting, enclosing 25c, and we will send you a sample “SILVER STEEL” blade.

No matter what kind of metal you want to cut, you can do the work faster, easier and better, if you use ATKINS “Silver Steel” Hand Hack Saw Blades.

These wonderful new blades will cut *twice* as fast, and last at least *six* times as long as any other hack saw blade you ever used. Think what a big saving of time, work and money this means to you, on every metal cutting job.

YOUR Hardware Store can show you these new Hack Saw Blades, displayed as shown above. Look for the ATKINS name on every blade you buy, and accept no substitute. We will gladly send folders on “Silver Steel” Hack Saw Blades for hand or power use.



E. C. ATKINS & CO., Est. 1857, 426 So. Ills. St., Indianapolis, Ind.

Leading Manufacturers of Highest Grade Saws for Every Use; Saw Tools, Saw Specialties, Plastering Trowels, Machine Knives, Grinding Wheels and Files.

NOW IS THE TIME TO BUY

**Over 50 years satisfactory service
-DIRECT TO CONSUMER-**

Pay Later on Easy Payments

"New Low" Wholesale Prices on "New Easy" Method PLUMBING and HEATING SYSTEMS AND SUPPLIES

MILLION DOLLAR Bonded Guarantee PROTECTS YOU

The Hardin-Lavin Company founded over 50 years ago has from the beginning specialized in Highest Grade Plumbing and Heating TO THE CONSUMER DIRECT AT WHOLESALE. Our latest catalog (just off the press) is brim full of BIGGER BARGAINS than ever before. Send for your copy TODAY. Our vast buying power and centrally located plant and complete shipping facilities give you the advantage of ROCK BOTTOM PRICES on HIGHEST QUALITY GOODS. Every Plumbing Outfit or Heating Plant you buy from us is backed by our Bonded Guarantee, our Million Dollar Plant and our reputation of over 50 years' ECONOMY service to experienced buyers. The famous Hardin-Lavin New Easy Method of self-installing means TIME and MONEY SAVED.



Royal Bathroom Outfit



Pipeless Heating Plant

CUT-TO-FIT Hot Water Plant

In our latest catalog you will find everything in latest designs of Plumbing Fixtures and Heating Supplies:— Built-In-Tubs, Pedestal Lavatories, Deep Apron Sinks, Laundry Tubs, Hot Water, Steam and Vapor Heating Plants, Pipeless and Warm Air Heating Plants, Supplies, etc. Hardin-Lavin New Easy Method of self-installing enables you to put in your own Plumbing or Heating. No experience needed, we show you how: clear diagrams and instructions guide you accurately. All materials come to you factory-fitted ready for easy assembly. There is no guess work—when the job is finished an expert will approve it.

HOT WATER HEATING PLANT CUT-TO-FIT GUARANTEED

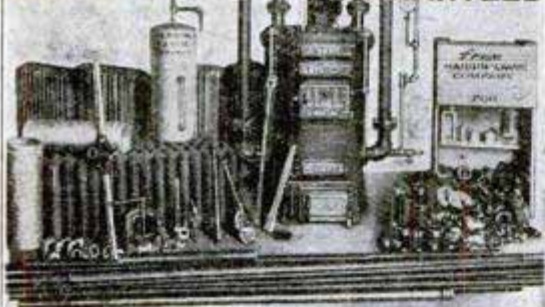

Complete Hot Water Heating Plant ready for shipment with set of installing tools, diagrams, and New Easy Method of self-installing instructions.

FREE Estimate Mail Your Plan or Rough Sketch



Send for Your FREE Copy Today



FULL OF BIG BARGAINS!



Water Supply System

you accurately. All materials come to you factory-fitted ready for easy assembly. There is no guess work—when the job is finished an expert will approve it.

Special! DEFERRED PAYMENTS

In addition to quality goods at wholesale prices, new easy installing method, free plans, and all the other Hardin-Lavin advantages, we have now arranged so that you can BUY ON EASY TERMS. Nowhere else can you find so unusual and complete a combination of merchandise, service and accommodation. Added to all this—without charge—is the co-operation of our corps of Engineering Experts.

Read What Others Say!

Saved \$300

I am more than pleased with my heating plant. I saved about \$300 comparing with local quotations. A. L. Langley, Gary, Ind.

As Represented

The plumbing fixtures arrived in first rate shape. We are very much pleased. Exactly as represented. F. C. Phillipson, Battle Creek, Mich.

Well Pleased

Received our furnace and it is operating with perfect satisfaction. We are well pleased. Mrs. W. MacCasland, Waterbury, Conn.

Finest Ever Seen

The heating plant I purchased from you is a peach, the real thing. I am a satisfied customer. Dr. J. C. Branch, White Cloud, Mich.

Visit Our Plant

When in Chicago we will be pleased to show you thru our Big Modern Plant whether you buy or not. We want you to know us.

Thousands of customers testify to the fact that we have saved them money, time, expense and dissatisfaction. You take no risk when you buy a Heating Plant or Plumbing Outfit from us because our engineering staff has okayed everything before it leaves our plant. **ASK FOR FREE ESTIMATE.** Let this trained group of Plumbing and Heating Engineers help you. Write them freely for advice and information. Ask for estimate without obligation. Send a rough sketch of the arrangement of your rooms if possible and they will design an outfit exactly for your home that will meet all of your individual needs. Thousands of home owners, contractors, farmers, mechanics and nationally known institutions have profited from these made-to-order Hardin-Lavin designs. This help from our engineering staff is free and backed by 50 years of knowing how. They will show you many trade secrets, kinks and wrinkles that will surprise you with big savings of money, time and labor. **WRITE TODAY.**

You can buy on Easy Terms

Highest Quality HARDIN-LAVIN CO. Lowest Prices
107-17 W. PERSHING ROAD, EST. 1876 CHICAGO, ILLINOIS

\$244.00 PROFIT *One day!*

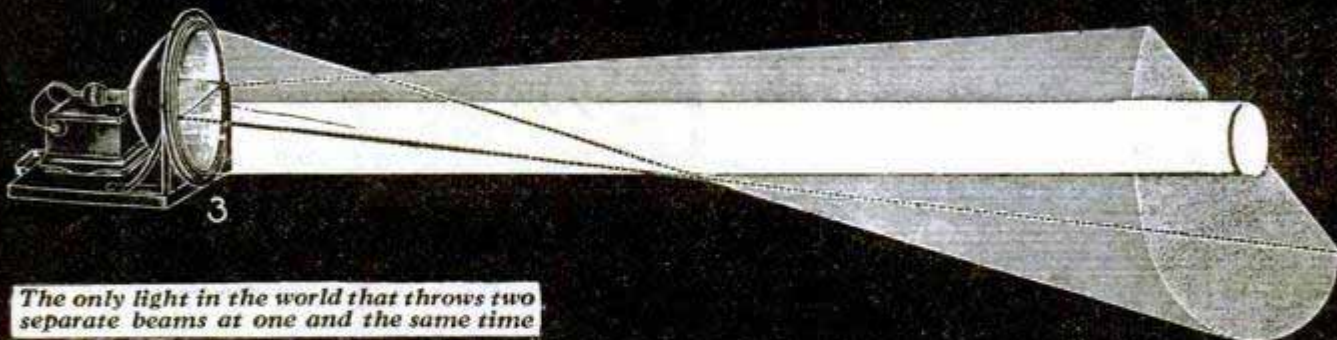

The only light in the world that throws two separate beams at one and the same time

That's what R. W. Helmer made—\$244.00 Profit in One Day—without experience,—just showing most amazing light you ever saw—38,000 Candle Power without Glare

FITS inside regular reflector—easy to install reflector—Wonderful Patented Device—100% more light—no glare. Pocket big money waiting for you now—whirlwind seller makes astounding demonstration, low cost, agents cleaning up.

300% Profit

Big repeater, sells on sight. Enthusiastic customers multiply your sales. Over 300 sets sold in one town of 2,000 people.

Prominent Users

The Governor of Minnesota, the Governor of Colorado, the Mayor of Milwaukee, the General Manager of Milwaukee Motor Club and the Vice-President of Carolina Motor Club are all users of Trippe Offset Reflectors.

Orders Pouring In From All Over the World

Our first advertising appeared in March and we are already shipping TRIPPE OFFSET REFLECTORS to England, South Africa, Australia, New Zealand, Egypt, Cuba, Mexico, and Canada. Many other countries are sending in for information regarding this—the greatest automobile headlight of all time.

Salesmen Enthusiastic

"I have just sold the Anderson-Howard Headlight Service Co. 500 sets TRIPPE OFFSET REFLECTORS, with an additional contract of 300 sets per month, beginning November 1st."—Frank B. Finch, Kansas.

"Have just sold Claude P. Madden 100 sets TRIPPE OFFSET REFLECTORS. Mr. Madden is the best known man in this county, having been mayor of this city two times and is a live wire."—C. S. Helm, Illinois.

"Cramer & Kirkwood, my local agents for this city, took over my entire first shipment of 100 sets TRIPPE OFFSET REFLECTORS. Please rush another 100 sets."—C. R. Bevil, Arkansas.

"Any man who could not sell TRIPPE OFFSET REFLECTORS, could not give food to a starving crowd."—J. G. Oblander.

"Friday night I had headlights inspected by State Inspectors. They said it was the greatest light they had ever put on the screen."—A. P. Wilbur, New York.

"J. E. Dudd, of Washington, wires order for 200 sets and says, 'Here goes for big business, and I feel that I am doing the public a favor in giving them the right kind of light.'"

Ideal Advertising Co., of Wisconsin, writes, "Am enclosing check for 100 sets TRIPPE OFFSET REFLECTORS. We plan on putting out at least ten salesmen."

Powell, of Canada, wires in an order for 200 sets and says, "We have set a quota of 2,000 sets during the next two months and WE CAN DO IT."

Jackson Bros. & Jones, of Cobridge, England, says, "We are pleased to inform you that TRIPPE OFFSET REFLECTORS are just what you claim them to be in every detail."

Wonderful Demonstration

"I set up the demonstrator on my back roof tonight and the whole neighborhood opened the windows and wanted to know what the h— was going on. I agreed with them that the light is simply terrific, yet the glare is removed when attached the correct way to the cars."—W. H. Lamb, Maine.

24,000,000 Prospects Want This Light

Thousands killed in 1927 by weak lights—or glare. Country-wide movement for long, low, level, powerful beam that protects driver without blinding other fellow. Only Trippe Offset Auto Reflectors do this perfectly. Trippe light floods roads and side ditches. No glare to bewilder other drivers. Makes spotlights unnecessary.

Eliminates Glare Without Dimming or Tilting

Motorists are sick and tired of clumsy headlights, fragile dimmers, flimsy tilters and makeshift reflectors. These obsolete devices fail because they're not accurately designed. The Trippe Offset is scientifically correct—let us prove it.

38,000 Candle Power

Certified to in Report No. 42306 of The Electrical Testing Laboratory of New York City, the official testing laboratory of the Society of Automobile Engineers. The report says that TRIPPE OFFSET REFLECTORS meet every requirement of the S. A. E.

Managers

Here is your opportunity to get exclusive territory and make \$1,000.00 and more monthly. Get crews started everywhere. Sell to agents. Clean up big this year and next. This is a real permanent offer.

Exclusive Territory

If you write NOW—tomorrow may be too late. It does not cost one cent to see this remarkable device. At our own risk, we will send you FREE SAMPLE. Test it in every way. It does all we say. Anyone can sell Trippe Offset Reflectors and make big money.

Free Sample Offer—Write Now

Don't hesitate to investigate this big money-making plan immediately. Only the coupon, a postal or letter is needed. You are losing money every day you wait! At least get this proposition in front of you and study it carefully before deciding. One of the greatest money-making schemes ever put before specialty salesmen.

No matter what your experience in selling has been—no matter what you are now selling or what you are making you cannot afford not to get the facts.

Write **WHILE YOU ARE THINKING OF IT.**

MAIL NOW

AERIAL ELECTRIC CO.,
311 W. Ohio St., Chicago.

Without any obligation, please send FREE SAMPLE offer and Trippe Offset Reflector OPPORTUNITY OFFER for
 Salesmen. Distributors.

Name.....

Address.....

City..... State.....

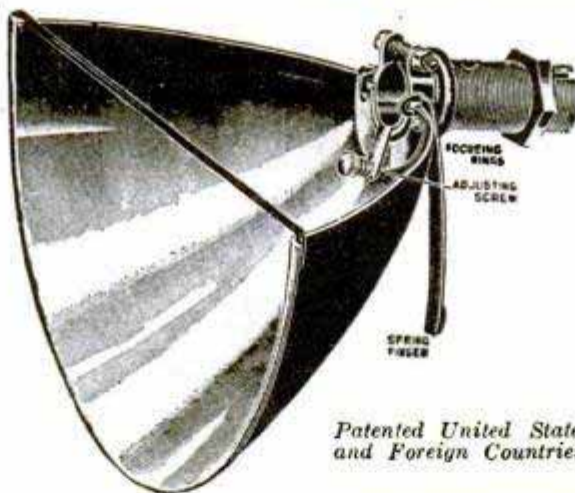

Patented United States and Foreign Countries.

Popular Mechanics Magazine

200 E. Ontario Street, Chicago, U. S. A.

H. H. WINDSOR, Founder

H. H. WINDSOR, Jr., Editor and Publisher

London: Hachette & Cie.,
17 King William Street, Charing Cross, W. C. 2

Paris: Hachette & Cie.,
111 Rue Reaumur

Melbourne: Gordon & Gotch
509-513 Little Collins St.

IED MONTHLY

SUBSCRIPTION:

SINGLE COPY, 25 CENTS

In United States and its possessions, also Canada, Cuba, and Mexico, per year, postpaid - \$2.50

To all other countries in the Postal Union 3.00

All subscriptions are discontinued at expiration. Please examine the date printed on your wrapper.

Entered as Second Class Matter Sept. 15, 1903, at the Post Office at Chicago, Illinois

Entered as Second Class Matter at the Post Office Department, Canada, March 3rd, 1879.

Published monthly by POPULAR MECHANICS CO.

Copyright, 1928, by Popular Mechanics Co.

Copyright in Australia. Copyright in France

Vol. 49

Contents for March, 1928

No. 3

Special Features

Risks Men Face in Submarines	353
Mystery of Port of Missing Planes Solved?	360
Babe Ruth's Homerun Secrets	371
The Modern Alchemists	378
The Latest in Furniture	387
Two Pounds Less Than an Elephant	402
True Stories of the Man Hunters	418
On the Trail of Hidden Treasures	434
The Nation's Greatest Ships	443
Right This Way Gentlemen	451
The World's Deepest Mine	467
You Can Build This B-Eliminator for Fifteen Dollars	473

Advertising	
artistic displays made from paint and tin	449
moving sign at rear of auto	377
Airplanes	
flying hospital plane carries loaded auto	384
giant air liners equipped with diners	356
high-speed midget	439
Airship—monster German for transatlantic flight	428
Amusement Park—joy riders drive own cars on twister	397
Apples—for display have stenciled designs	439
Architecture	
church in form of big tower	377
latest style in German theater	459
transforming unsightly hills into home sites	398
Army, Japanese—drilled to use latest weapons	410
Astronomy	
study aided by adjustable chart of stars	466
three billion stars pictured with large telescope	428
Automobiles	
foot power replaces motor in tiny Paris car	471
home and store on wheels aids candy dealer	368
home on wheels is armored	469
Automobiles—Accessories	
back rest saves driver's clothing	366
dial indicates car performance	395
gasoline meter helps save fuel	472
grease extractor prolongs car's life	374
mirror in door visor aids parking	464
sand boxes increase safety	359
shock absorber keeps wheels on ground	448
Automobiles—Equipment and Supplies	
accelerator run by knee	440
folding top increases comfort	457
Automobiles—Fuel—testing exhaust gas helps save	409
Automobiles—Repairing—rollers to iron out fenders	416
Automobiles—Tires	
pinch tells pressure without touching valve	401
rubber bulb in valve tester shows if air leaks	383
Automobile Truck—that piles wood saves hand labor	450

Aviation	
drydock for flying boats	375
fuel gas for motors to make flying safer	433
sound of plane lights lamps on landing field	412
Bed—for invalids folds into chair	375
Boats and Boating	
fish tail on boat promises greater speed	408
rubber, for motorcycle is army aid	401
water sleds with balloon tubes insure safety	429
Bottle, Nursing—holder for, prevents breakage	396
Bottle Filler—saves time and prevents spilling	471
Bridge—bascule, is engineering feat	461
Cable—automatic oiler prolongs life of	461
Camera—in handbag	439
Candle—wooden has reservoir that supplies oil to wick	417
Cathedral—symbolic carvings for national	394
Cattle—milk shed towed to cows to keep herd in open	432
Checkers—"four-in-row" game	401
Corks—expanding, fit different size bottles	414
Crime—invisible eye is latest terror to crooks	458
Delivery, Milk—motor unit for wagons cuts cost	365
Diving—portable suit carries its own air supply	422
Draftsmen's Supplies—adjustable drawing board	448
Electric Iron—three-heat, helps save current	386
Electric Lights	
moving letters tell latest news	470
shield for plugs prevents frayed wires	397
Electric Power—half million volt insulator	466
Explosions—danger of, curbed by mineral-dust sprayer	425
Filter, Water—self-cleaning for the home	386
Fire Extinguisher—control button saves liquid	366
Fire Fighting—battling three year peat fire in snowshoes	417
Furnace	
dustless ash pit helps save coal	409
fitted with fan affords better heat and ventilation	416
vacuum cleaner for, saves coal and dirt	358
Gasoline Nozzle—has valve to prevent dripping	423
Goats—hunting wild from airplane	433
Gold Mining—the world's deepest mine	467

Carrier Catalog [Continued on Page 4] *Carrier Catalog like Tower 377*

meta Wagon

[Contents—Continued]

*recreant
code 399
wiring 490*

*Paul Lummus 392 Copes Cleaning Suits & ready iron
working machine
auto*

Golf
clock to keep scores 464
mountain as tee permits long drive 364
Grand Opera—voice tester shows singer's suitability for stage 399
History—early, recalled by floodlight on old landmark 422
Homesteads—the race for free land 413
Horse Racing—stalls for starting horses insures better 368
Household Devices 462
House Plan 528
Insects
on crops killed by cold-steam process 431
preserved in metal 366
Inventions—new, from England's patent show 430
Life Saving
pistol shoots line to wrecked ship 386
suit has pockets for food and water 459
Lightning—rubber conductors guard dynamite 417
Logs—as uniforms in novel parade 457
Magnetism—increases vitality and stimulates plant and animal life 432
Map Making—Starting point on Kansas farm 368
Mat, Rubber—helps prevent housewife's fatigue 412
Mending—socks with vulcanizing 369
Mirages, Palace of—produces strange illusions 385
Moving Pictures—color attachment rests eyes 461
Musical Instruments—big horn like a harmonica 400
Muskrats—save fish in northern hatchery 471
Niagara Falls—engineers seeking way to save 465
Oils—blending calculator eliminates guesswork 448
Opera Glasses—fold flat to fit vest pocket 447
Oxen—supplant engines for switching cars 415
Pen, Electric—to burn designs is aid in decorating 441
Playground—on store roof aids women shoppers 369
Flow
with revolving shares thoroughly stirs soil 423
with rotary pulverizer saves farm work 416
Pop Corn—electric popper operates at table 470
Radio
experimenter's telegraph key 483
steel mast easily erected 488
Radio—Aerials—picture frame antenna 482
Radio—Applications
amplifier helps deaf in learning speech 383
doctor answers door in bed 459
faces produce different sounds 439
Radio—Batteries
adding distilled water 483
charging switch for wet B 488
filling storage B 487
non-corrosive connection 476
safety clips 480
Radio—Broadcasting—of opera helped by mixing panel 366
Radio—Condensers
designed for mounting on socket 487
ground-rotor type eliminate body capacity 481
midget easy to make 476
sliding, has many advantages 485
Radio—Construction—drill made from auto horn motor 484
Radio—Eliminator—resistors with mounting to prevent sag 487
Radio—Installation
gas pipe a poor ground 485
of speaker jacks on subpanel 488
wiring set without solder 481
Radio—Loud Speakers
combined with light fixture 481
using leads as aerial 482
Radio—Pictorial 486
Radio—Receiver
adapter makes short-wave set of standard 477
bringing old audio amplifier up to date 483
drum dials feature new nine-in-line 485
Radio—Transformers—plug into standard sockets 481
Radio—Tubes—one does work of three 487
Radium—sentries guard mine in Africa 399
Railroads
high-speed steam car has hidden boiler 425
Hudson bay road will end at Churchill 450
model, aid instruction of trainmen 464
trains as political posters spread Russian ideas 450
travel in Australia aided with uniform gauge 396
Reduction—eating most food in morning aids 456
"Rogues" Gallery—for students simplifies college files 393
Rose Tournament—living picture-puzzle map features 359
Safety Devices and Measures
chorus of sirens on engines to reduce accidents 365
men risk lives in bank vault to test oxygen unit 358
Sawdust—has many uses 459
School, Dairy—canvas "cows" aid in milking lessons 399
Screwdriver—holds screw while starting it 396
Ships—blisters on dreadnaughts to absorb shocks 395

Signs—double-glass prismatic show letters clearly 465
Slot Machine—distributes cigarets and matches 415
Smallpox—red walls urged for patients 416
Smokers' Accessories—rubber bulb breaks-in pipe 48
Soda Dispenser—coin-in-slot, serves drinks quickly 44
Spark Plugs—pressure test shows up defects 32
Statue—three-ton hoisted on dome 393
Stretcher—equipped with springs for moving invalids 42
Sun—heats water for home 41
Telephone Poles—tripods for, resist frost action 42
Telephone
carrier, restores flood-broken service 4
on infant's crib reduces mother's worry 44
Telescope—vest pocket set helps hunter and hiker 47
Tennis—"silent partner" helps develop skill 40
Theater
darkness created by light 432
stage effects with luminous paint 392
Traffic
congestion relieved by auto road through building 411
guided by lamps controlled by auto horn 386
Trees, Cedar—road runs through huge ancient stump 472
Tribal Ceremonies—long-nosed mask features initiations 431
Umbrella—with kinked stick helps shelter two 425
Vacuum Cleaner—sands and waxes floor 364
Volcano—queer island seen as continent in the making 441
Warfare—France builds "tank of the air" for night bombing raids 426
Wheelbarrow—easy-to-empty, needs no blocking 415
Wigs—ancient art of making adds to opera lure 376

in painting 449
AMATEUR MECHANICS

Artist's Supplies—homemade academy board 508
Automobiles—Accessories—heater for Ford sedan 502
Automobiles—Repairing—improved long-handled jack 493
Clothesline—to prevent blowing against trees 502
Fireplace—how to remedy smoking 504
Fish and Fishing—automatic indicator for set lines on the ice 508
Heater, Gas—electrifying 503
Household Devices—utility cart for housewives 489
Ice—harvesting with old auto 504
Mandolin—finger grip on pick 506
Photograph—novel albums 505
Photography—photographing objects through magnifying glass 506
Saddle—safe stirrups 493
Ship Model—Flying Cloud 494
Thermos Bottle—made easy to hold 505
Toys—simple merry-go-round 507

soft mcleaner 390
SHOP NOTES

Automobiles—Repairing—removing roller bearings on Fords 513
Automobiles—Tires—how to care for balloon 520
Bucket—non-overflow 527
Burglar Alarm—for shop window 522
Circles—scribing with a rule 519
Dividers—stretching the point 512
Drilling—improved depth gauge 522
Electric Coil—reversing coil points aids spark 511
Filling Station—novel seat for 526
Furnace—an automatic boiler man 509
Garage Equipment—tongs for removing auto motor 519
Gasoline—guard for tank filling pipe 523
Goggles—electric fan helps sell 521
Loading and Unloading—chute for parcels 523
Logs—metal cone facilitates hauling 512
Lubrication—grease nipples for large grease cups 526
Oil—crankcase, can be burned in stove 526
Paints and Painting
color holders for decorators 527
scaffold for 527
Piano—dolly facilitates moving 524
Pipe Fitting—tin foil for packing glands 518
Rims, Tire—make handy foundry flask 511
Safety Devices and Measures—striped suits protect highway workmen 514
Screwdriver—attachment holds screws securely 524
Tin Cans—devices made from 515
Tools, Parting—automatic chamfering attachment 525
Vise
keyhole-saw 519
two used for press work 513
Wagon—noiseless, easy riding 525
Wheel—repair for broken spoke tenon 519
Wheelbarrow—fender for 514
Wrench, Chuck—improved 511

DRAKE'S PRACTICAL MECHANICAL BOOKS

THEY WILL RAISE YOUR PAY—

ORDER ON 5-DAY TRIAL

The books listed below will perfect you in your chosen trade—pave the way to the big positions. Written in non-technical language—easy to read and understand. Every book covers its subject completely. An entire course of instruction condensed into one volume. Your choice sent postpaid—your benefit 5 days—money refunded in full if not entirely satisfactory. Order direct from this page.

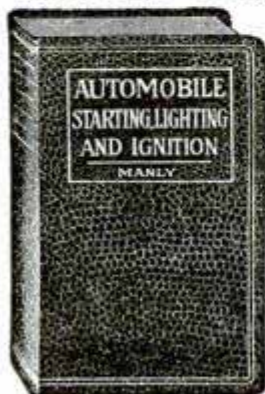

Automobile Books

- Automobile Starting, Lighting and Ignition, by Manly... 700 pp. \$3.00
- Brookes' Automobile Handbook... \$2.00
- Ford Motor Car, Truck and Tractor, by Manly... Cloth \$1.50
- Automobile Battery, Care and Repair, by Manly... Leatherette \$2.00
- Motorcycle Handbook, by Manly... \$1.50



Shop Practice Books

- Practical Heating Systems, Trouble Jobs and Ventilation... \$4.00
- Sheet Metal Workers' Manual... \$2.00
- Oxy-Acetylene Welding and Cutting... Cloth \$1.25
- Slide Rule and Logarithmic Tables... \$2.00
- Handbook for Millwrights... Cloth \$2.00
- Machine Shop Practice... Cloth \$2.00
- Mechanical Drawing and Machine Design... Cloth \$2.00

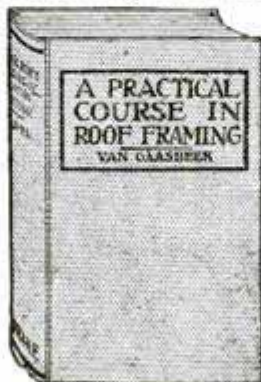

Carpentry Books

- Cloth Binding
- Modern Carpentry, 2 vols... \$3.00
 - The Steel Square, 2 vols... \$3.00
 - Modern Estimator... \$1.50
 - Timber Framing... \$2.00
 - Builders' Architectural Drawing... \$2.00
 - Concretes... \$1.50
 - Practical Bungalows... \$1.00
 - Roof Framing, by Van Gaasbeek... \$1.50

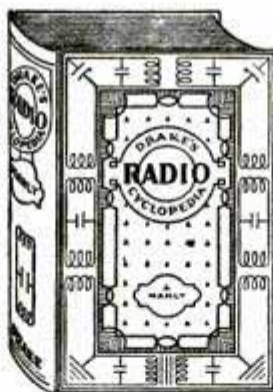

Drake's Radio Cyclopaedia

By H. P. Manly

870 Pages, 985 Illustrations, 1700 Subjects, arranged alphabetically. For Service and Repair Men, Dealers, Salesmen, Experimenters and Designers. Bound in Art Buckram. Price... \$6.00



Painting and Decorating

- Furniture, Furniture Finishing, Decoration and Patching... \$5.00
- Ross Crane Book of Home Furnishing and Decoration... Cloth \$3.00
- House Painting Methods with the Brush and Spray Gun, by Vanderwalker... Cloth \$2.00
- Interior Wall Decoration, by Vanderwalker... Leatherette \$4.00
- The Mixing of Colors and Paints, by Vanderwalker... Cloth \$2.00
- Studio Handbook—Letter and Design... \$3.00
- A Show at Suo'... Cloth \$4.00
- Sign Painting, by... on... Cloth \$4.00
- Strong's Book of Design... Leatherette \$4.00
- Modern Painters' Cyclo... Cloth \$2.00
- Automobile Painting... Cloth \$1.50
- New Hardwood Finishing... Cloth \$1.50
- Wood Finishing, Plain and Decorative... Cloth \$2.00
- Owen's Paint Guide... Cloth \$1.00

Steam Engineering

- Swingle's Handbook for Steam Engineers and Electricians... Leatherette \$4.00
- Examination Questions and Answers for Marine and Stationary Engineers... Leatherette \$2.00
- Steam Boilers... Leatherette \$2.00
- Swingle's Catechism of Steam, Gas and Electrical Engineering... Leatherette \$1.50

Modern Languages

- By Prof. P. S. Allen, U. of Chicago
- French without a Teacher... Cloth \$1.25
 - Spanish without a Teacher... Cloth \$1.25
 - German without a Teacher... Cloth \$1.25
 - Everyday French... \$1.25
 - Everyday Spanish... \$1.25

ORDER DIRECT FROM THIS PAGE — ON OUR MONEY-BACK PLAN

The books listed above are only a few of the many in our catalogue, which you will receive promptly after filling out and mailing us the attached coupon. For quick action order direct from this page—cross name of each book wanted and send in with price quoted. We prepay postage and send the books on our money-back plan.

FREDERICK J. DRAKE & CO.

Publishers

1008 Michigan Ave. CHICAGO

Drake Books Are For Sale at All Book Stores

FREDERICK J. DRAKE & CO.
1008 Michigan Avenue
Chicago, Ill.

GENTLEMEN:—Please send me free, postage paid, your illustrated catalogue which lists and describes 200 Practical Mechanical Books for Home Study.

My name

and my

This one



EUYD-T7X-P71G

Mail Coupon For Free Catalogue
Your Guide to Home Study



To the man whose ship never quite comes in

"WHEN my ship comes in," you say—but your smile cannot hide the worry gnawing at your heart—

A fine sea-going vessel you had thought that ship of yours when you launched it on the business ocean—

Yet the days and months and years slip by—and though others see their ships ride triumphantly to harbor, still you scan the horizon anxiously for a ship that never quite makes port.

No one's *fault*, perhaps—but what a misfortune that so many business ships should founder on a hidden reef or a treacherous shoal, when the channels to Success are plainly charted *and a chart for every channel is available to every thinking man!*

How the Right "Chart" Increased

E. T. Orcutt's Income 500%

Certainly *my* ship-of-fortune seems far off its course, said E. T. Orcutt, in effect, when as railroad clerk at \$20 a week he enrolled with LaSalle for home-study training in Traffic Management.

Before he had completed the training, however, came an opportunity with Hitchings & Co., Elizabeth, N. J., one of the largest manufacturers of greenhouses in the world.

Training had set his "ship" on the right course.

Later, as sales manager, he kept on training with LaSalle—in Business Management.

Since taking his first course, his salary has increased more than 500 per cent.

Recently he has organized his own company, capitalized at \$100,000, of which he is president.

How G. W. Clason Placed His "Ship" on the Right Course

No bands were playing when G. W. Clason launched his "ship" on the business ocean.

Clason had left school at 14, and at 19 his job was to take care of the horses in the barn of a laundry.

"Never mind," said G. W. Clason, "I'll make *my* opportunity right where I am!"

So he learned the laundry business, and at 28 was operating his own plant. When fire wiped his business out, he started again. Unable to finance properly—*through lack of business understanding*, as he testifies—he sold out and became superintendent of the Ideal Laundry Company, Spokane.

Right then he made up his mind to remedy his lack—and enrolled with LaSalle for training in Business Management.

Today, at 47, he is vice-president and a director of this successful company, and commands an income several times as large as when he started with LaSalle five years ago.

"I give all credit to my LaSalle training," writes Mr. Clason. "It has proved by far the most profitable investment I ever made."

No More Drifting!

Send for These Free Books—Today

Are you letting your ship-of-fortune drift where it will—or are you charting its course to the Harbor of Success?

There's a route that will take it straight to its destination. LaSalle can help you find it.

Without cost or obligation, the coupon will bring you a special 64-page booklet fully describing the opportunities in the business field that most appeals to you, and showing you how you can fit yourself to grasp them.

As you value your future—fill in, clip and mail the coupon NOW!

— — — Find Yourself Through LaSalle! — — —

LaSalle Extension University

The World's Largest Business Training Institution

Dept. 364-R Chicago

I would welcome an outline of the LaSalle plan, together with a copy of "Ten Years' Promotion in One," all without obligation.

- Business Management
- Modern Salesmanship
- Higher Accountancy
- Traffic Management
- Railway Station Management
- Law: Degree of LL. B.
- Commercial Law
- Industrial Management
- Modern Business Correspondence
- Credit and Collection Correspondence
- Telegraphy

- Banking and Finance
- Modern Foremanship
- Personnel Management
- Expert Bookkeeping
- Business English
- Commercial Spanish
- Effective Speaking
- C. P. A. Coaching
- Stenotypy—Stenography



Name.....

Present Position.....

Address.....

ELECTRICITY

Complete Study Course and Pocket Library \$10



SHIPPED FREE

A set of **HAWKINS GUIDES** is a true friend to the electrical worker. It tells you how to do any job the right way—without guessing or taking chances.

Hawkins Guides put all the facts about modern electrical engineering at your finger tips. Therefore your chances for advancement in the electrical field are unlimited.

HAWKINS GUIDES DOUBLE YOUR VALUE



Electricity is king! It is the ruling force of today—transportation, communication, light, heat, power—indeed every modern activity is dependent on electricity. Industry is crying for electrical men that know their jobs!

Hawkins Guides teach you all you need to know about electricity in easy, step-by-step lessons. Daily spare time reading of the Guides will greatly increase your value to yourself and your employer in a few weeks. Hundreds of our friends have written us and told us this!

READERS OF HAWKINS GUIDES KNOW HOW



"You can't stump him on an electrical job." "He certainly knows his business." "Certainly have to hand it to him for knowing how."—These are the things employers say about our friends who are readers of Hawkins Guides. No matter what question or problem comes up the Ready Reference Index enables you to give an expert answer at once.

HAWKINS STARTS YOU WHERE OTHERS LEFT OFF

Why should you work at low wages when easy reading of **HAWKINS GUIDES** will give you the money-making knowledge of the expert? Easy daily reading of the Guides will teach you in a few months what it has taken the expert a lifetime to learn!

With **HAWKINS GUIDES** in hand you have a running start to success in the electrical field. You will actually begin where others left off!

NOW!

This coupon is your golden opportunity. Tear it out—send it now!

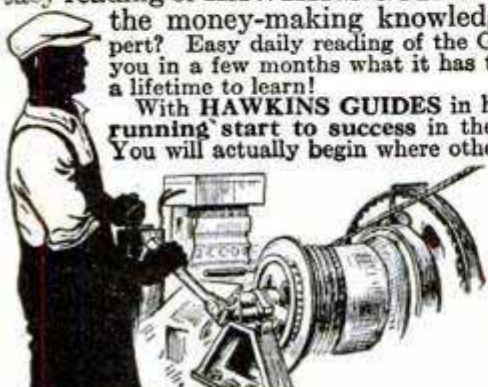

FOR EXAMINATION!

REAL ELECTRICAL EDUCATORS

"Hawkins Guides at \$10 is the best investment I have ever made. Am able to take up almost any electrical job and have never gone to an electrical school."—B. Roessler, Oenaville, Texas.

AS EASY AS A. B. C.

"Everything in Hawkins Guides is very plain and anybody can read and understand them as easy as A. B. C."—J. Knight, Tobyhanna, Pa.

OTHER ENTHUSIASTIC READERS SAY

"Worth ten times their price." "Helped me to two raises in four months." "Better than a school of instruction." "Studied them when I was laid up and got further ahead than if I had been on the job."

Hawkins Guides Explain These Points So You Can Easily Understand:—

Magnetism—Induction—Experiments—Dynamos—Electric Machinery—Motors—Armatures—Armature Windings—Installing of Dynamos—Electrical Instrument Testing—Practical Management of Dynamos and Motors—Distribution Systems—Wiring—Wiring Diagrams—Sign Flashers—Storage Batteries—Principles of Alternating Currents and Alternators—Alternating Current Motors—Transformers—Converters—Rectifiers—Alternating Current Systems—Circuit Breakers—Measuring Instruments—Switch Boards—Wiring—Power Stations—Installing—Telephone—Telegraph—Wireless—Bells—Lighting—Railways. Also many Modern Practical Applications of Electricity and Ready Reference Index.

Hawkins Guides—10 POCKET SIZE NUMBERS

Each number easy to carry around and read in spare time. Big type and clear diagrams. Easy to study and learn. Durable, flexible binding—gold edges. 3,500 pages—4,700 illustrations. Shipped free for examination. Pay only \$1 a month if satisfied. Price of set, complete, \$10.



EXAMINE GUIDES FREE! \$

Let the Guides themselves demonstrate their practical value to you—as a study course, reference work and complete electrical library. You are the judge. Simply send this coupon. No obligation unless you are entirely satisfied. Tear out on dotted line—fill in—mail it NOW!

\$1 PER MO.

FREE EXAMINATION COUPON

Theo. Audel & Co., 65 W. 23rd St., New York City

Please send me (postpaid) for my approval **Hawkins Electrical Guides**, 10 numbers (price \$1 each). If satisfactory I will mail you \$1 in 7 days and further mail \$1 monthly until purchase price of \$10 is paid.

Name.....

Address.....

Occupation.....

Employed by..... 3T30

New Easy Way to

LEARN AUTOS

EARN UP TO \$100 a WEEK

Say goodbye to low pay. Get into the Auto Business, where big pay—extra money—raises come quick! A brilliant future awaits you in the World's Biggest Business. If you're earning a cent less than \$60 a week, clip that coupon. Learn how \$50—\$75—even \$100 a week is possible for you now! Find out about this training which boosted Yancy of Perla, Ark., from \$30 a week up to \$90!

OPEN YOUR OWN AUTO SHOP

My Free Book tells how men make extra money while training, and then go into business with no further Capital. It's the Training that counts, and it is complete training that I give you.

Common Schooling ALL YOU NEED

Men between 15 and 60, with very little education, are becoming Garage Owners, Superintendents, Foremen. Whether you have had years of Auto Experience, or never touched a car before, send for this Free Book Now. I'll show you the quick way to get in line for real success in the Auto Business.

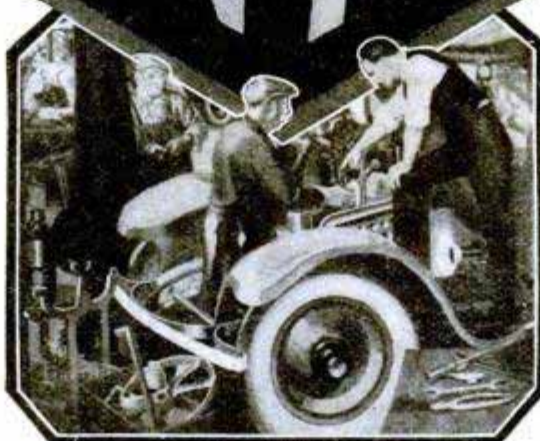

4 TESTING OUTFITS

REPAIR Included

I train you the new, easy and practical "Job-Way." I give you actual Auto Jobs to do, and I give you the Tools and Equipment Free of extra cost too!

Outfits include a complete set of Tools, Self opening Tool Bag, Portable Electrical Test Bench, Electrical Experimental Outfit, and 365 Auto Wiring Diagrams.

AT HOME!

Send coupon for Free Auto Book. See how I train you right at home, in every branch of Auto work—Learn how I prepare you, quickly and easily, for the Big Jobs, paying up to \$100 a week and more. "Job-Way" Training includes all Mechanical and Electrical work—Starting, Lighting, Ignition—also Welding, Brazing, Vulcanizing—everything you need to get in line for a big pay Job as an Electrical and Mechanical Auto Expert.

I'll Help You Get a Good JOB

My Employment Department will help you get a good Job whenever you want one. You don't have to wait until you have graduated to use this service. No sir, as soon as you have shown that you know enough about Autos to hold the Job I'll give you this help whenever you ask for it! What is more, you can use it as long as you live!

Get All the Facts!

Send for my new Free Book now! See what "Job-Way" has done for hundreds. See what it can do for you. Learn all about my legal money-back agreement—and the many added features. Clip coupon now!

B. W. COOKE Directing Engineer
Dept. 316

Chicago Motor Training Corp.,
1916 Sunnyside Ave., CHICAGO

MAIL THIS COUPON

FREE! B. W. Cooke, Directing Engineer, Chicago Motor Training Corporation, Dept. 316, 1916 Sunnyside Ave., Chicago, Ill.

Send me your Book, "Auto Facts." Free of charge. Also full particulars of your 4 working outfits offer and of "JOB-WAY" Training. This obligates me in no way whatever.

Name.....

Address.....

Town.....State.....

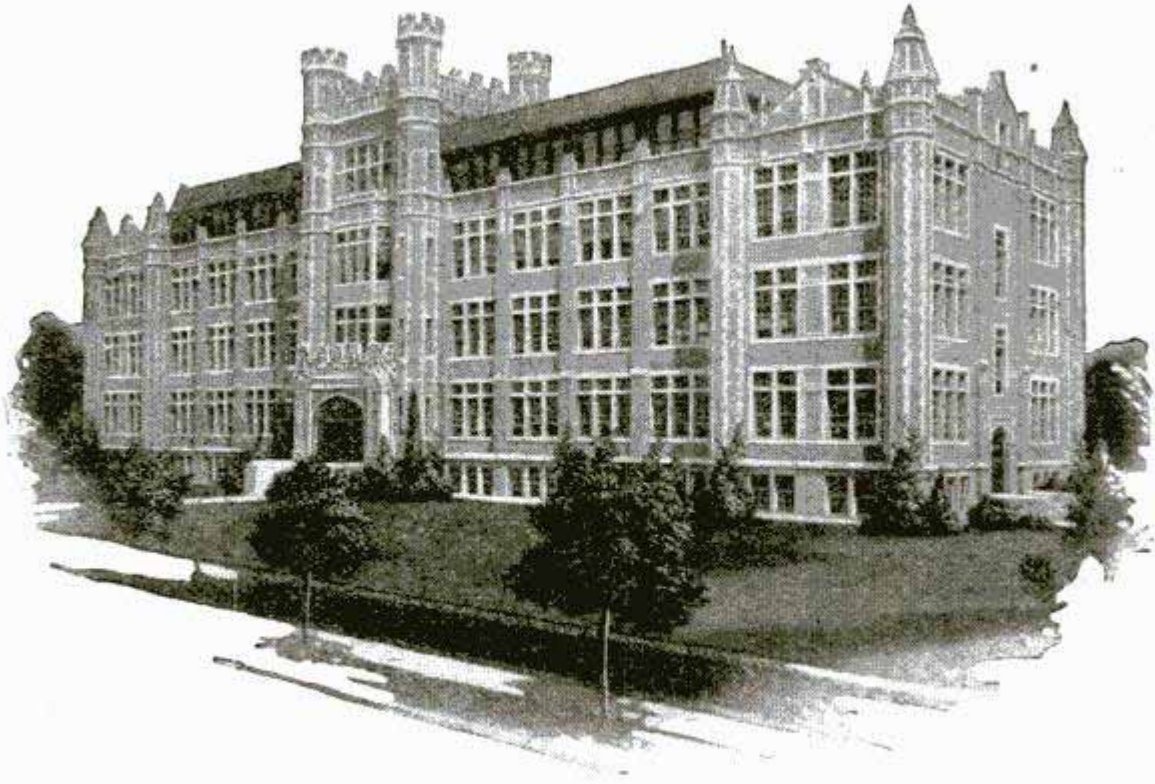

Go to High School at Home

YOU can secure a high school education right at home by studying the splendid new courses recently prepared by the International Correspondence Schools.

These courses are equivalent to the courses given in resident high schools. They have been specially arranged for men and women who wish to meet college entrance examinations, to qualify for a business position, or to make up the education they missed when forced to leave school too soon.

The College Preparatory Course, the High School Commercial Course and the High School English Course include English, algebra, ancient, medieval, modern and U. S. History, physiology, literature, geography, Latin, bookkeeping, drawing, geometry, shorthand, physics, chemistry, salesmanship, advertising, civics, trigonometry, economics, American business law, corporation finance, money and banking, business and trade economics, etc. A diploma is given at graduation.

The lessons are easy to understand and you will make rapid progress because you will be *in a class by yourself* and you will study under the guidance of instructors who are sincerely interested in helping you to get ahead and achieve the bigger things in life.

Just mark and mail the coupon and we will gladly send you interesting free booklets

describing the High School Courses of the International Correspondence Schools or any other subject in which you are interested.

INTERNATIONAL CORRESPONDENCE SCHOOLS

"The Universal University"

Box 5512-F, Scranton, Penna.

Without cost or obligation, please send me a copy of your booklet, "Who Wins and Why," and full particulars about the subject before which I have marked X in the list below:

- College Preparatory Course
- High School Commercial Course
- High School English Course
- High School Vocational Course
- High School Agricultural Course

BUSINESS TRAINING COURSES

- Industrial Management
- Personnel Management
- Traffic Management
- Accounting and C. P. A. Coaching
- Cost Accounting
- Bookkeeping
- Secretarial Work
- Spanish French
- Salesmanship

- Advertising
- Business Correspondence
- Show Card and Sign Lettering
- Stenography and Typing
- English
- Civil Service
- Railway Mail Clerk
- Common School Subjects
- High School Subjects
- Illustrating Cartooning

TECHNICAL AND INDUSTRIAL COURSES

- Electrical Engineering
- Electric Lighting
- Mechanical Engineer
- Mechanical Draftsman
- Machine Shop Practice
- Railroad Positions
- Gas Engine Operating
- Civil Engineer
- Surveying and Mapping
- Metallurgy and Mining
- Steam Engineering

- Architect
- Architects' Blueprints
- Contractor and Builder
- Architectural Draftsman
- Concrete Builder
- Structural Engineer
- Chemistry Pharmacy
- Automobile Work
- Airplane Engines
- Agriculture Navigation
- Mathematics Radio

Name.....

Street Address.....

City..... State.....

Occupation.....

Persons residing in Canada should send this coupon to the International Correspondence Schools Canadian, Limited, Montreal, Canada



**Adventure...
Thrills...
Big Money!**

The Game for Daring Young Men

GET away from the dull, prosaic grind of humdrum work—the narrow restrictions of petty, uninteresting jobs! Break into one of the most fascinating, most thrilling occupations since time began—Aviation—the virile, exciting, romantic game for men of sporting blood!

Many of the big men of the coming generation will be men with the foresight to get into Aviation now—while opportunities abound. They can see that the Golden Age of Aviation has just begun—that the future is almost too stupendous to be imagined.

What other occupation offers you more amazing opportunities? Thrills such as you never had before—the praise and plaudits of the multitude—and a chance to get in on the ground floor where rewards may be unlimited.

Aviation is growing so swiftly that one can hardly keep track of all the astonishing new developments. The skies are dotted with daring young men—from every country come stories of new feats—new victories—new heroes! Everything is set for one of the greatest booms in history. Big fortunes came out of the automobile industry and out of motion pictures. Big fortunes will also come out of Aviation! The development of Aviation as an industry is bringing with it a call for trained men. Those who qualify quickly should find themselves on the road to undreamed of money—success—popularity—and prominence!

that are essential to your success. And, the study of Aviation by our method is almost as fascinating as the actual work itself. Every Lesson is chock-full of interest—and so absorbing that you actually forget you are studying. But best of all are the ultimate rewards you are fitting yourself to gain!

- PICK YOUR JOB!**
- Flying
 - Airplane Instructor
 - Airplane Engineer
 - Airplane Repairman
 - Airplane Assembler
 - Airplane Mechanician
 - Airplane Inspector
 - Airplane Builder
 - Airplane Salesman
 - Exhibition Manager
 - Airplane Contractor
 - Airplane Motor Expert
 - Airplane Designer

Send for FREE Book

Send the coupon for our new, free booklet—*Opportunities in the Airplane Industry*. It is vitally interesting, reads like a romance and tells you things about this astonishing profession you probably never even dreamed of. You owe it to yourself at least to read it. We offer you a free copy now, no obligation. Mail the coupon for yours, today.



American School of Aviation
Dept. 1353
3601 Michigan Ave.
CHICAGO, ILLINOIS

Easy to Become an Aviation Expert!

Get into this thrilling business at once while the field is new and uncrowded. Now—by a unique new plan—you can quickly secure the preliminary training necessary to get a start in the Aviation Industry, either flying or ground work, at home during your spare time. Experts will teach you the secrets—give you the inside facts

Without any obligation please send me FREE booklet *Opportunities in the Airplane Industry*. Also information about your Course in Practical Aviation.

Name.....Age.....

Address.....

City.....State.....



500,000 VOLTS

"Artificial lightning" being developed in Coyne School. Spark of 500,000 volts is shown jumping 30 inches. This gigantic Tesla Coil is the same as that used by Steinmetz, absolutely harmless, because of high frequency.

Learn Electricity on Electrical Machinery in 12 Weeks!

By **ACTUAL WORK**—in the **Great Shops of Coyne**



ANYONE who can see and understand the English language can learn electricity in 90 days. I teach you with as complete an outlay of electrical apparatus as was ever assembled in any institution—30-foot control board—transmitting stations—skeleton houses, huge motors—dynamos—sub-stations—automobiles—

switchboards. In one department we generate enough electricity to supply a small city!

Learn by Doing—No Classes

Enter anytime. Experts teach you on electrical machinery. They guide you every step of the way with individual attention. You do the actual work on real full-size machinery in full operation. Take motors for instance. Instead of learning from books and charts—you actually build motors. You can't help but know all about them. Anyone can learn this fascinating way.

No Experience Necessary

That's how my methods teach men electricity in 12 wonderful weeks. You don't need experience—Coyne training starts from the very beginning. You don't need advanced education—you learn by doing. Age is no handicap—Coyne students range from 16 to 40.

Not a Correspondence School

COYNE Electrical SCHOOL

H. C. Lewis, President Dept. 38-72
500 So. Paulina St., Chicago

Triple Your Earning Power

I don't need to tell you about the opportunities in electricity. They are too many and too amazing to mention. Ordinary jobs run \$50—\$60 and up a week. And Coyne training leads to the biggest positions. Many Coyne men are making up to \$500 a month. Demand for Coyne men often exceeds the supply. Our employment bureau gives you lifetime service after graduation.

Earn While You Learn

We help many students to secure part-time jobs to earn a good part of living expenses while studying.

All Details Sent Free

This school is 28 years old—Coyne training is tested—proven beyond all doubt—endorsed by electrical industry. You can find out everything absolutely free. Simply mail the coupon and let me send you the big, free Coyne book of 150 photographs—facts—jobs—salaries—opportunities. See what Coyne training can do for you in just 90 days! This does not obligate you. So act at once. Just mail the coupon.

Get This FREE Book

Mr. H. C. Lewis, Pres.
COYNE ELECTRICAL SCHOOL,
Dept. 38-72
500 S. Paulina St., Chicago, Ill.

Dear Mr. Lewis: Without obligation send me your big free catalog and all details of Free Employment Service, Radio, Aeroplane and Automotive Electrical Courses, and how many "earn while learning." I understand I will not be bothered by any salesman.

Name.....

Address.....

Town..... State.....

BE AN AUTO PAINTER



**Learn
at
Home**

\$60 to \$90 a Week for YOU!

Get into the big-pay end of the **BIGGEST BUSINESS ON EARTH**—where competition is practically unknown—where you can hold down a Big-Pay Job or, better still, where you can have a business of your own paying up to \$10,000 a year or more. If you are looking for a real short-cut to success, here is your big chance!

No Special Ability Needed

Regardless of your age, experience or education—no matter what you are doing now, you can learn to be an Auto Painter in a few short months. That's my promise to you!

My training costs you only a few pennies a day. After you have completed my quick, easy, pleasant training, if you are not completely satisfied, just say so and every penny of your money will be refunded.

Your Own Business!

Wouldn't you like to have a business all your own and work when and as long as you please? Wouldn't you like to pocket all the profits from your efforts? Well, you can. Come into Auto Painting. Right now there are not enough skilled Auto Painters to take care of the demand. Any city or town in America can support a good Auto Paint Shop—or another one! We teach you the business end—how to get customers and how to keep them—how to equip your shop and how to make big profits. We even help you to get the equipment you need to open your own shop. That's why you require so little capital to start your own business.



**One Shop Talk
One Work Sheet
One Reading Course**
To Prove
That You Can Learn

**I'LL SEND YOU
FREE**

Just to show you how easy, fascinating and interesting my training is, I am making this special offer:—I will send you, without cost or obligation, 1 Shop Talk, 1 Work Sheet and 1 Reading Assignment.

Test Yourself FREE!

Send for these free lessons and learn for yourself how easy it is for you to get into this big-pay end of the automobile industry.

Learn in Spare Time

You don't have to give up your present work. All you need is just spare moments. No long, tedious, text-book reading. All easy, pleasant practice work.

13 Big Outfits

My Shop-Type Method gives you actual experience in every one of the 20 important operations used in modern auto painting. My training covers all of these subjects—priming, surfacing, burning off, striping, monogramming, ducoing, varnishing—everything. You don't need a car to work on. I give you 13 big, complete outfits without extra charge. I furnish wood and metal panels for you to practice on. You do the painting and finishing and then send me specimens as called for. This way I can watch your work and progress. It's just as though I was standing next to you in the shop. Mail coupon now for my big illustrated booklet and for the FREE Shop Talk, Work Sheet and Reading Assignment. If you are looking for a real opportunity, mail coupon today.

G. KING FRANKLIN, Supt.,

AMERICAN AUTO PAINTING SCHOOL
Dept. 1201 425 South Ashland Ave.,
CHICAGO, ILL.

GET THE PROOF

G. King Franklin, Supt.,
American Auto Painting School,
Dept. 1201, 425 So. Ashland Ave., Chicago, Ill.

Please send me, without cost or obligation, your big illustrated book, and the FREE shop talk, work sheet and Reading assignment.

Name

Address

FREE

AUTO

5 AUTO BOOKS SENT FREE!

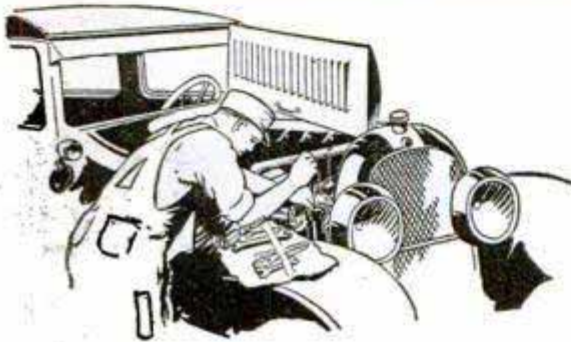

Mail the coupon and we'll send you a set of these remarkable auto books, just off the press. Whether you are mechanic or helper, expert or student, auto owner or driver, if you're interested in autos, by all means take advantage of this opportunity to see the latest and most complete work on autos we have ever published. Built by eighteen of America's greatest automotive engineers. Simple enough for men with little schooling to understand, yet in daily use by hundreds of engineers, service-station superintendents and foremen as an authoritative REFERENCE Cyclopedic. This new edition includes straight-eights, 4-wheel brakes of all types and other features of the 1928 models.

Put the JIFFY INDEX

to work for you!

Can You FIX IT?

Can you take out "play" in differential? Can you kill the "Shimmy" in steering? Can you reset TIMING? Can you put your finger on engine trouble without guessing or tinkering? Can you pull the starter off and fix it? Can you adjust and repair transmission, engine, rear axle, bearing?

These Books Tell How!

They bring the answer to any auto problem instantly. And they show the best, quick, professional way to do EVERY repair and replacement job you will ever need. Auto owners say the cost is saved over and over again by showing how to make adjustments and emergency repairs on the road.

5 Big De Luxe Volumes just off the press!

2400 pages, over 2000 illustrations, wiring diagrams, equipment charts, etc. De Luxe edition with gold-stamped flexible binding. Sent FREE for 15 days' use. If not wanted return express collect. If kept, send only \$2 after 15 days, then \$3 a month until special advertising price, \$24.80, is paid.

A Year's Consulting Membership FREE!

Privilege of consulting engineers of million-dollar American Technical Society on any automotive problem for one year without charge, if you mail coupon immediately.

American Technical Society



Dept. A-319, Drexel Ave. & 58th St.,

CHICAGO, ILL.

The billion-dollar auto industry offers rich prizes to men with gumption enough to really learn all branches of automotive mechanics. A better job, bigger pay—a chance to go into business and get a share of the huge profits, are waiting for any man who even half tries to improve his ability to deliver service. And here's the shortest, easiest way: No tedious studying, no memorizing, no lessons or examinations. Just LOOK UP the fact you seek. You'll find the answer to any auto problem literally at your finger-tips, in the famous JIFFY INDEX. No need to "carry it in your head," at all.



"Was garage hand—now have Shop of my own," writes W. Sidle of Toboso, O.

J. H. Geise of Detroit says: "I received \$50 worth of information out of them the first 5 days."

"I got a raise," says P. Ervin of Yarmouth, N. S., shortly after getting his books.

And D. S. Reld of Siluria, Ala., was offered \$4000 for invention worked out with these Auto Books.

Don't Send a Penny!

AMERICAN TECHNICAL SOCIETY,
Dept. A-319, Drexel Ave. and 58th St., Chicago, Ill.

I would like to see the new 5-volume edition of your AUTO BOOKS, but without obligating me to buy them. I will pay the few cents delivery charges only, but if I choose to, I will return them express collect and owe you nothing. If after 15 days' use I prefer to keep them, I will send you \$2 and pay the balance at the rate of only \$3 a month, until \$24.80 is paid. Please include free membership.

Name.....

Address.....

Employed by.....

Address.....

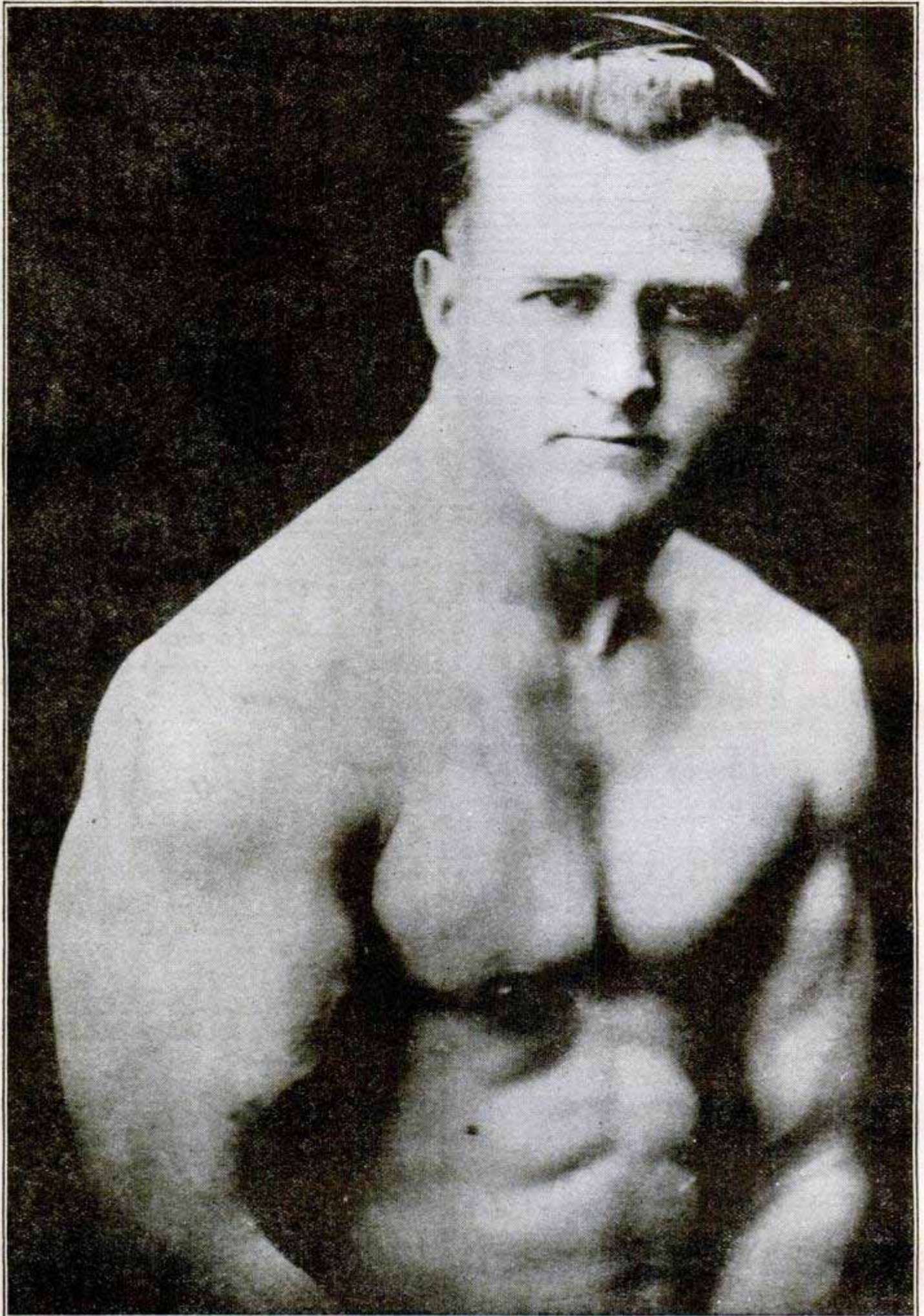

EARLE E. LIEDERMAN, *The Muscle Builder*

Author of "Science of Wrestling," "Muscle Building," "Secrets of Strength," "Here's Health," "Endurance," etc.

How Strong Are You?

Can You Do These Things?

Lift 200 lbs. or more overhead with one arm; bend and break a horseshoe; tear two decks of playing cards; bend spikes; chin yourself with one hand.

CAN you do any of them? I can and many of my pupils can. It is remarkable the things a man really can do if he will make up his mind to be strong. It is natural for the human body to be strong. It is unnatural to be weak. I have taken men who were ridiculed because of their frail make-up and developed them into the strongest men of their locality.

I Want You for 90 Days

These are the days that call for speed. It once took four weeks to cross the ocean—now it takes less than one. In olden days it took years to develop a strong, healthy body. I can completely transform you in 90 days. Yes, make a complete change in your entire physical make-up. In 30 days I guarantee to increase your biceps one full inch. I also guarantee to increase your chest two inches. But I don't quit there. I don't stop till you're a finished athlete—a real strong man. I will broaden your shoulders, deepen your chest, strengthen your neck. I will give you the arms and legs of a Hercules. I will put an armor plate of muscle over your entire body. But with it come the strong, powerful lungs which enrich the blood, putting new life into your entire being. You will be bubbling over with strength, pep and vitality.

A Doctor Who Takes His Own Medicine

Many say that any form of exercise is good, but this is not true. I have seen men working in the factories and mills who literally killed themselves with exercise. They ruined their hearts or other vital organs, ruptured themselves or killed off what little vitality they possessed.

I was a frail weakling myself in search of health and strength. I spent years in study and research, analyzing my own defects to find what I needed. After many tests and experiments, I discovered a secret of progressive exercising. I increased my own arms over six and a half inches, my neck three inches and other parts of my body in proportion. I decided to become a public benefactor and impart this knowledge to others. Physicians and the highest authorities on physical culture have tested my system and pronounced it to be the surest means of acquiring perfect manhood. Do you crave a strong, well-proportioned body and the abundance of health that goes with it? Are you true to yourself? If so, spend a pleasant half hour in learning how to attain it. The knowledge is yours for the asking.

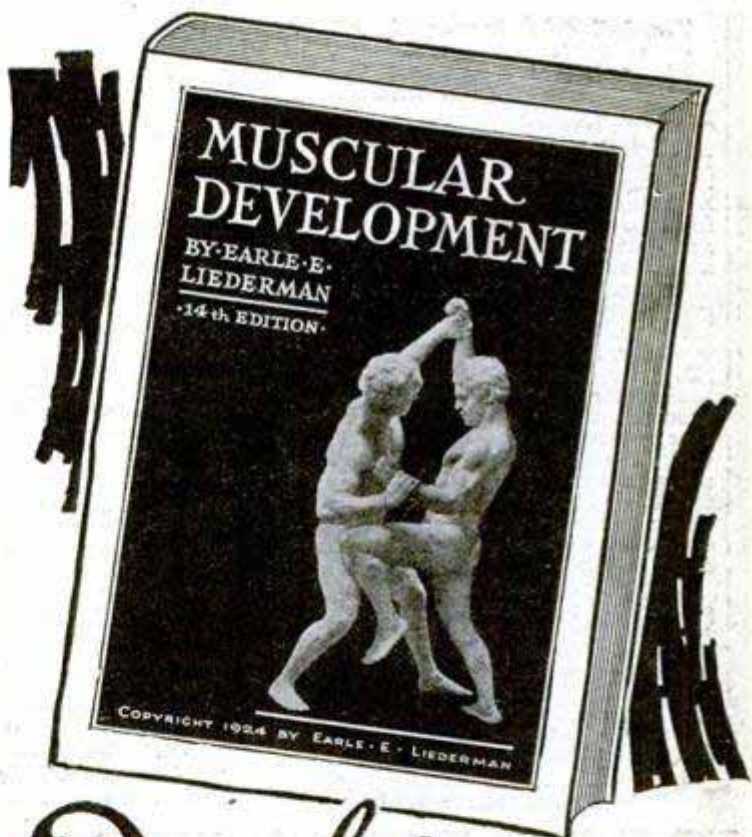

Send For My New
64 Page Book

"Muscular Development"

IT'S FREE

It contains forty-eight full-page photographs of myself and some of the many prize-winning pupils I have trained. Some of these came to me as pitiful weaklings, imploring me to help them. Look them over now and you will marvel at their present physiques. This book will prove an impetus and a real inspiration to you. It will thrill you through and through. This will not obligate you at all, but, for the sake of your future health and happiness, do not put it off. Send today—right now, before you turn this page.

EARLE E. LIEDERMAN

Dept. 2003, 305 Broadway, New York City

DON'T
SEND ONE
PENNY

—
YOUR
NAME AND
ADDRESS
ON A
POSTAL
WILL DO

EARLE E. LIEDERMAN

Dept. 2003, 305 Broadway, New York City

Dear Sir: Please send me, without any obligation on my part whatever, a copy of your latest book, "Muscular Development." (Please write or print plainly.)

Name.....

Street.....

City..... State.....



WILLIAM CLAYTON
McCarrie Graduate
 And His Own Dental Laboratory

From \$30 a Week Bookkeeper to \$150 A Week as Owner of Dental Laboratory

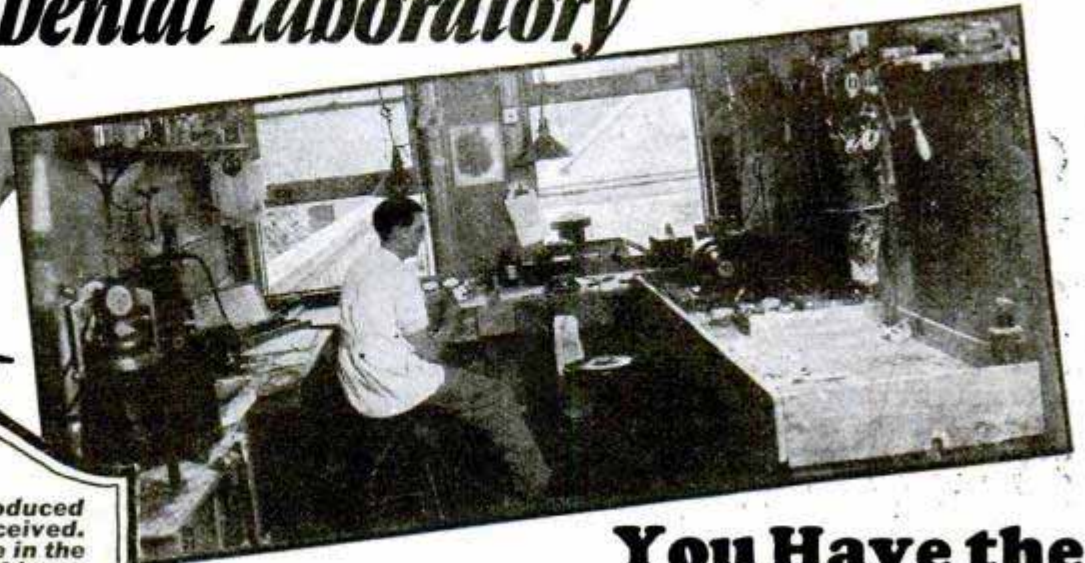

The following is reproduced from a letter we received. The original is on file in the McCarrie School in Chicago

Dear Mr. McCarrie:

I was bookkeeping up until January, 1924, at \$1500 per year, and while having lunch one noon, I picked up a "Popular Mechanics" and ran across your ad, which fascinated me very much. Although making a good living at the time, I was not entirely satisfied, so I wrote for your literature.

Upon receipt of the above, and having read it very thoroughly, I could not help but admit I was quite enthused. Two weeks later I arrived at your school. Completing the course in August, I returned home where I received a position in a laboratory. After a few months experience, I got connected with Dr. L. with whom I stayed two years, resigning my position to open a laboratory of my own, October 15, 1926. I have ten dentists on my list which net me about \$150.00 of business per week, with business increasing rapidly.

Thanking you hardly expresses my appreciation of your most thorough course. Your promises were more than fulfilled, and in closing I want to state that there is a large field open for your graduates. I remain,

A Successful McCarrie Graduate.
 (Signed)
 William H. Clayton.

You Have the Same Opportunity—Learn Mechanical Dentistry

Follow in Clayton's footsteps! Read his inspiring letter telling how he jumped from \$30.00 a week to \$150.00 a week! Many McCarrie graduates are doing the same! Larson writes, "Our laboratory has averaged about \$800.00 a month profit since first of year—not bad for two of your boys who have been in business for only a year." Ostrander says, "I earned as high as \$45 profit in a single day." Another McCarrie man sends us this message: "No trick for me to make \$20.00 a day." Our free book tells many more amazing success stories like this—write for it today!

Day or Night Schools—All Personal Instruction—No Books—No Classes—Work Your Way Thru School—We Help You To Spare Time Job

Enter this fascinating profession—assure yourself steady employment the year round—work that is highly congenial and dignified! Associate with a fine class of people! Earn a splendid income! We have hundreds of testimonial letters on file from enthusiastic McCarrie men who have made good.

Will you accept this big opportunity? The dental profession needs you. It has grown so fast that the demand for mechanical dentists far exceeds the supply. Here is specialized training of the finest sort! No mechanical skill necessary—no special educational requirements—and a quick, sure reward!

SEND FOR INTERESTING BOOK

Read absorbing facts about mechanical Dentistry—the laboratory bench work that the dentist turns over to the laboratory worker, the making of plates, crowns, bridges, etc.—why 64,000 dentists need laboratory work—how we train you in a few months, day or night, for this uncrowded, moneymaking field!

McCarrie Schools are located in Chicago, Detroit, Cleveland, Philadelphia and Boston.

MAIL COUPON TODAY

No obligation—no cost! Mail coupon today and get your free copy of this handsomely illustrated, interesting book—complete details of our special offer—low rates—easy terms. Send coupon today!

McCARRIE SCHOOL OF MECHANICAL DENTISTRY
 Dept. 157 1338 S. Michigan Ave. CHICAGO, ILL.



FREE BOOK

McCarrie School of Mechanical Dentistry,
 1338 S. Michigan Ave.,
 Dept. 157 Chicago, Ill.

Without obligation, please send me your free Book with complete information about how I may become a Mechanical Dentist, how you will help me open a Laboratory, how you will help me find a job while I take my training, etc.

Work Your Way Thru School. We Help You Get Spare Time Job.

Name.....

St. No. or R. F. D.....

City.....State.....

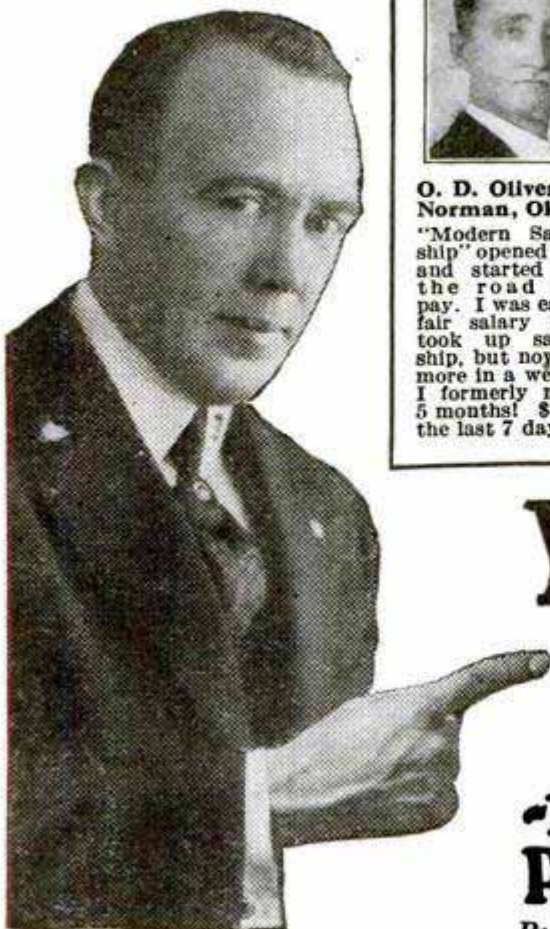

J. E. GREENSLADE,
President



O. D. Oliver,
Norman, Okla.
"Modern Salesmanship" opened my eyes and started me on the road to big pay. I was earning a fair salary when I took up salesmanship, but now I earn more in a week than I formerly made in 5 months! \$1,000 in the last 7 days!"



C. W. Birmingham,
Dayton, O.
"A few years ago I was working in a shop for \$15 a week. Immediately upon completion of my course I was offered a position through N.S.T.A. My earnings were from \$5,000 to \$6,500 per year. Today I am earning \$7,500 per year."



F. B. Englehardt,
Chattanooga, Tenn.
"It is a privilege to tell of the many good things I have received through the N.S.T.A. Without this training I would still be working for the other fellow. This year I will make \$7,500. Some increase!"



Frank Walsh,
Springfield, Mass.
"I was clearing around \$1,000 a year when I was enrolled with N.S.T.A. I have increased my income to \$7,286. I now own my home, drive a nice car, and have a summer camp. My grateful thanks to N.S.T.A."

You're Fooling Yourself

if You Think These Big Pay Records Are Due to LUCK!

But don't take my word for it! When I tell you that you can quickly increase your earning power, I'LL PROVE IT! FREE! I'll show you hundreds of men like yourself who have done it. And I'll show you how you can do it, too.

I'LL come directly to the point. First you'll say, "I could never do it. These men were lucky." But remember, the men whose pictures are shown above are only four out of thousands, and if you think it's luck that has suddenly raised thousands of men into the big pay class you're fooling yourself!

Easy to Increase Pay

But let's get down to your own case. You want more money. You want the good things in life, a comfortable home of your own where you can entertain, a snappy car, membership in a good club, good clothes, advantages for your loved ones, travel and a place of importance in your community. All this can be yours. And I'll prove it to you, Free.

First of all get this one thing right; such achievement is not luck—it's KNOWING HOW! And KNOWING HOW in a field in which your opportunities and rewards are ten times greater than in other work. In short, I'll prove that I can make you a Master Salesman—and you know the incomes good salesmen make.

Every one of the four men shown above was sure that he could never SELL! They thought Salesmen were "born" and not "made"!

When I said, "Enter the Selling Field where chances in your favor are ten to one," they said it couldn't be done. But I proved to them that this Association could take any man of average intelligence—regardless of his lack of selling experience—and in a short time make a MASTER SALESMAN of him—make him capable of earning anywhere from \$5,000 to \$10,000 a year. And that's what I'm willing to prove to you, FREE.

Simple as A.B.C.

You may think my promise remarkable. Yet there is nothing remarkable about it. Salesmanship is governed by rules and laws. There are certain ways of saying and doing things, certain ways of approaching a prospect to get his undivided attention, certain ways to overcome objections, batter down prejudice and outwit competition.

Just as you learned the alphabet, so you can learn salesmanship. And through the NATIONAL DEMONSTRATION METHOD—an exclusive feature of the N.S.T.A. System of

Salesmanship Training—you gain the equivalent of actual experience while studying.

The N.S.T.A. System of Salesmanship Training and Employment Service will enable you to quickly step into the ranks of successful salesmen—will give you a big advantage over those who lack this training. It will enable you to jump from small pay to a real man's income.

Remarkable Book Sent Free

With my compliments I want to send you a most remarkable book, "Modern Salesmanship."

It will show you how you can easily become a Master Salesman—a big money-maker—how the N.S.T.A. System of Salesmanship Training will give you the advantage over men who have had years of selling experience. How our FREE Employment Service will help you select and secure a good selling position when you are qualified and ready. And it will give you success stories of former routine workers who are now earning amazing salaries as salesmen. Mail the attached coupon at once and you will have made the first long stride toward success.



Dept. C-100

N. S. T. A. BUILDING

CHICAGO, ILLINOIS

National Salesmen's Training Association,
N. S. T. A. Building, Dept. C-100, Chicago, Ill.
Send me free your book, "Modern Salesmanship," and proof that I can become a MASTER SALESMAN.

Name.....
Address.....
City.....State.....
Age.....Occupation.....

Not Only the MOST UP-TO-DATE -- But the most READABLE and DEPENDABLE of all Encyclopaedias!

Clearness and simplicity of language, even in the treatment of the most technical subjects, makes Nelson's the most sensible, intelligent, and by far the most interesting of all the encyclopaedias.

Graphic Pictures in Great Pro- fusion Clarify and Intensify the Text Impression following the modern tendency to reach the mind quickly through the eye.

No man is a specialist in every art and science. Therefore when he looks up a subject in Nelson's, its distinct clearness of treatment leaves with him a clearer understanding of the subject than he can ever hope to get from ordinary reference works. Nelson's is graphic.

It Safeguards You Against Error. How can the engineer work with out-of-date methods, or the man in any profession construct his plans without a knowledge of the newest principles? Every subject on which man would be informed is changing constantly. Nine times out of ten, the information you want is on a subject of current importance. Only Nelson's loose-leaf system can keep you up-to-date. You do not use a City Directory that is two years old. Why use reference works far more dangerously obsolete?



Nelson's is the Recognized American Encyclopaedia. It is used in the Library of Congress, U. S. Senate, U. S. Supreme Court, and in Libraries, Universities and Schools in every State in the Union.

Three great editorial staffs are constantly at work under the direction of John H. Finley, LL. D., Editor in chief, former Commissioner of Education, and President of the University of the State of New York; and Associate Editors Sir Robert Falconer, Litt. D., LL. D., President of the University of Toronto, Canada; and Sir Henry John Newbolt, LL. D., Litt. D., Edinburgh, Scotland.

NELSON'S

The importance of the loose-leaf feature of Nelson's Encyclopaedia is best illustrated by the fact that about 2,000 changes are made each year.

Think what this means to you—an Encyclopaedia to last a lifetime—and ALWAYS Up-to-date. Every Encyclopaedia except Nelson's is out of date within six months after it is published. The set you buy today will be as up-to-date ten, fifteen, or twenty years from now as the day you buy it.

THOMAS NELSON & SONS, 381 Fourth Ave., N. Y. Originators of the Loose-Leaf Reference System PUBLISHERS FOR 130 YEARS

Please mail me FREE your portfolio of sample pages and full information how, by the budget easy payment plan I can own Nelson's Perpetual Loose-Leaf Encyclopaedia, with Free Membership in Nelson's Research Library Service Bureau for Special Information, and Nelson's Reader's Guide Free. P. M. March

Name..... State.....
Address..... by Thomas Nelson & Sons
City..... (Adv. Copyright, 1928, by Thomas Nelson & Sons)

Send This Coupon for the Interesting FREE Booklet
The coupon above will bring you a beautiful book of sample pages including illustrations and maps in full colors. Use it Today!

Nelson's Is a Complete Working Reference Library
of World Knowledge that is always up-to-date. Profusely illustrated. New information is constantly substituted for obsolete matter. A complete detailed Atlas of the World. Latest population statistics. Biographies of prominent men and women, past and present. Index Volume containing over 200,000 references. A liberal education through Nelson's Reader's Guide Service, consisting of 33 full study college courses, subjects from Aviation to Zoology. And FREE Research Library Service.

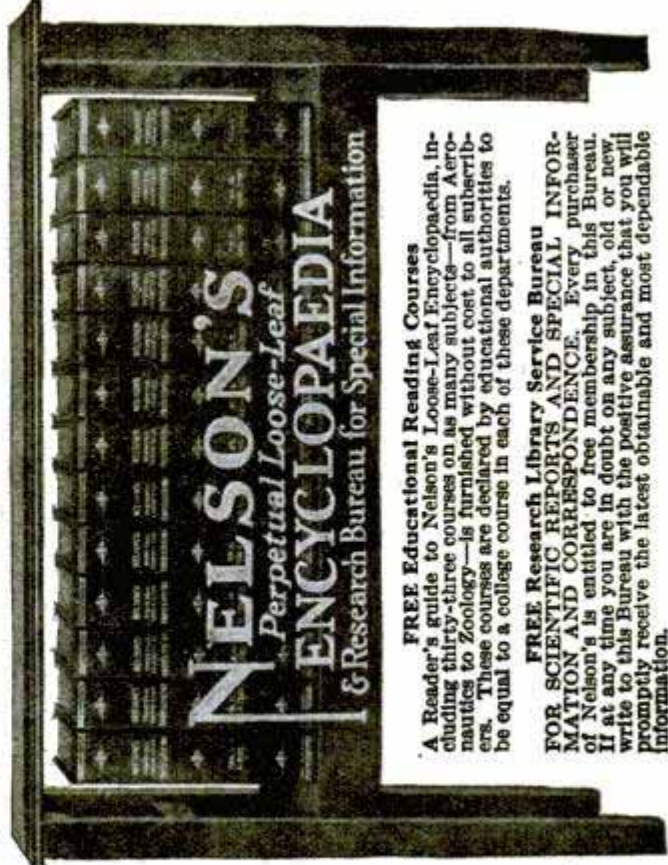

FREE Educational Reading Courses
A Reader's guide to Nelson's Loose-Leaf Encyclopaedia, including thirty-three courses on as many subjects—from Aeronautics to Zoology—is furnished without cost to all subscribers. These courses are declared by educational authorities to be equal to a college course in each of these departments.
FREE Research Library Service Bureau
FOR SCIENTIFIC REPORTS AND SPECIAL INFORMATION AND CORRESPONDENCE. Every purchaser of Nelson's is entitled to free membership in this Bureau. If at any time you are in doubt on any subject, old or new, write to this Bureau with the positive assurance that you will promptly receive the latest obtainable and most dependable information.

I Will Train You at Home to Fill a Big-Pay Radio Job

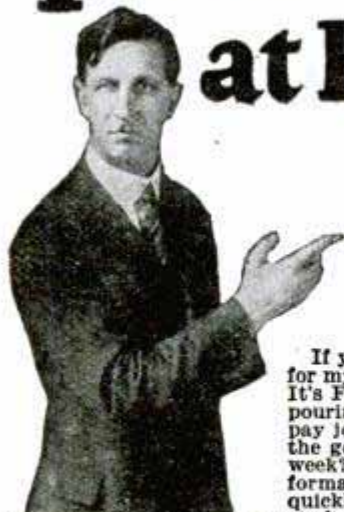

If you are earning a penny less than \$50 a week, send for my book of information on the opportunities in Radio. It's FREE. Clip the coupon NOW. A flood of gold is pouring into this new business, creating hundreds of big pay jobs. Why go along at \$25, \$30 or \$45 a week when the good jobs in Radio pay \$50, \$75 and up to \$250 a week? My book "Rich Rewards in Radio" gives full information on these big jobs and explains how you can quickly learn Radio through my easy, practical home-study training.



Here's the PROOF



Made \$185 in 3 Weeks' Spare Time
I have met with continued success. For instance, recently I realized a profit of \$185 in three weeks

for spare time work. I charge \$1.50 an hour. I have been making good money almost from the time I enrolled. The N. R. I. has put me on the solid road to success. Peter J. Durn, 901 N. Monroe St., Baltimore, Md.

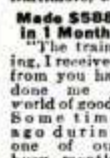

Made \$588 in 1 Month
The training I received from you has done me a world of good. Some time ago during one of our busy months I made \$588. I am servicing all makes of Radio receiving sets. My boss is highly pleased with my work since I have been able to handle our entire output of sets here alone. Herbert Reese, 2215 South "E" Street, Elwood, Indiana.



Earns Price of Course in One Week Spare Time
I have been so busy with Radio work that I have not had time to study. The other week, in spare time, I earned enough to pay for my course. I have more work than I can do. Recently I made enough money in one month spare time to pay for a \$375 beautiful console all-electric Radio. When I enrolled I did not know the difference between a rheostat and a coil. Now I am making all kinds of money. Earle Cummings, 18 Webster Street, Haverhill Mass.

Salaries of \$50 to \$250 a Week Not Unusual

Get into this live-wire profession of quick success. Radio needs trained men. The amazing growth of the Radio business has astounded the world. In a few short years three hundred thousand jobs have been created. And the biggest growth of Radio is still to come. That's why salaries of \$50 to \$250 a week are not unusual. Radio simply hasn't got nearly the number of thoroughly trained men it needs. Study Radio and after only a short time land yourself a REAL job with a REAL future.

You Can Learn Quickly and Easily in Spare Time

Hundreds of N. R. I. trained men are today making big money—holding down big jobs—in the Radio field. Men just like you—their only advantage is training. You, too, can learn Radio just as they did by our new practical methods. Our tested, clear training makes it easy for you to learn. You can stay home, hold your job, and learn quickly in your spare time. Lack of education or experience are no drawbacks. You can read and write. That's enough.

Many Earn \$15, \$20, \$30 Weekly On the Side While Learning

My Radio course is the famous course "that pays for itself." I teach you to begin making money almost the day you enroll. My new practical method makes this possible. I give you SIX BIG OUTFITS of Radio parts with my course. You are taught to build practically every type of receiving set known. M. E. Sullivan, 412 73rd Street, Brooklyn, N. Y., writes, "I made \$720 while studying." Earle Cummings, 18 Webster Street, Haverhill, Mass.: "I made \$375 in one month." G. W. Page, 1807 21st Ave., Nashville, Tenn.: "I picked up \$935 in my spare time while studying."

Your Money Back If Not Satisfied

I'll give you just the training you need to get into the Radio business. My course fits you for all lines—manufacturing, selling, servicing sets, in business for yourself, operating on board ship or in a broadcasting station—and many others. I back up my training with a signed agreement to refund every penny of your money if, after completion you are not satisfied with the course I give you.

Act NOW—64-page Book is FREE

Send for this big book of Radio information. It won't cost you a penny. It has put hundreds of fellows on the road to bigger pay and success. Get it. Investigate. See what Radio has to offer you, and how my Employment Department helps you get into Radio after you graduate. Clip or tear out the coupon and mail it RIGHT NOW.

J. E. SMITH, President,
Dept. 3H,
National Radio
Institute
Washington, D. C.



You can build 100 circuits with the six big outfits of Radio parts I give you

3 of the 100 you can build

Find out quick about this practical way to big pay

Mail This FREE COUPON Today

J. E. Smith, President,
Dept. 3H, National Radio Institute,
Washington, D. C.
Dear Mr. Smith: Kindly send me your big book "Rich Rewards in Radio," giving information on the big-money opportunities in Radio and your practical method of teaching with six big outfits. I understand this book is free, and that this places me under no obligation whatever.

Name.....Age.....
Address.....
City.....State.....

Employment Service to all Graduates
Originators of Radio Home Study Training

Quickly Learn to Play Hawaiian Guitar

Play Like This Native

Bring the romantic, enchanting, entrancing and melodious strains of the great instrument of the Hawaiian Islands into your soul. Become popular and successful. This **short cut method** of home instruction enables you to quickly master Hawaiian Guitar so you will **play as well as Native Hawaiians.**

Our staff of Hawaiian instructors have perfected a method of teaching, so **simple**, that without musical knowledge, you quickly learn to play real music from notes. **Simple as learning your ABC's** and it will not be long before you will play latest Broadway hits.

Only four simple motions to learn. You will then play any music, whether it be popular, dance or classical. Almost from first lesson, you play love songs like Aloha Oe.

To help you get started, we furnish without extra charge when you enroll as a student, a beautiful, full tone, genuine \$18.00 Hawaiian Guitar. Only 1,000 free instruments given away; if you want to get in on this offer, write for particulars at once—you must act quickly.



New Invention—
Kno-All-Chart
QUICKLY TEACHES
YOU HOW TO PLAY
 The newest invention of our Hawaiian instructor, which is exclusively used by us and which we call the "Kno-All-Chart."

quickly teaches you how to play and read notes. So simple is this device that anyone can understand it and begin to play immediately.

Picture Method Easy

We do not depend upon our printed instructions alone for your success as a student, but we also supply you with many pictures of our professors' playing. This enables you to imitate the pictures. **Isn't this easy?**



Phonograph Records Given

As an additional guide, we also furnish you with phonograph records of our Hawaiian instructor's own playing of the piece you are learning. This practically brings our professors from our studio to your own home and enables you to listen to their playing just as if they were actually in front of you.

Genuine \$18.00 Hawaiian Guitar Given

Enroll as a student, and secure a beautiful, full tone, genuine \$18.00 Hawaiian Guitar.

We also furnish every bit of equipment so it is never necessary for you to spend an extra penny. When you graduate, you get a **beautifully engraved diploma** and after graduation, we also give you **six months' free service** and consultation. Send for free particulars now.

GIVEN \$18 Hawaiian Guitar when you enroll!

JAZZ

Your Way to Popularity and Success

No forming class to wait for. Start at once and join band wagon of success and popularity. Do it through Hawaiian Guitar.

Send for free First Lesson and Book. So positive are we you will become one of our students, that if you write at once, we will send you free, our first lesson which will enable you to see just what you can expect when you enroll. You will also receive our big book of full particulars. Write for your copy and free lesson today.

Write at Hawaiian Studio No. 52038 once of New York Academy of Music 100 Fifth Ave., New York, N. Y.

HAWAIIAN STUDIO No. 52038 of New York Academy of Music 100 Fifth Avenue, New York, N. Y.

Please rush your book, "How to Learn Hawaiian Guitar," and my first free lesson. Also reserve a Hawaiian Guitar for me without extra charge. This obligates me in no way whatever.

Name.....
 Address.....
 City..... State.....

THE CHICAGO DAILY NEWS School and College Bureau

Offers You Its Specialized Services in Choosing a School

Last year the School and College Bureau of The Chicago Daily News saved many busy parents and questioning boys and girls both time and worry by sending them prompt, reliable information about just the kind of school they wanted—personal requirements as to location and tuition charges being considered in each individual case.

Again this year many young people will be perplexed by the problem of finding the right school. Why not let us help you?

The Chicago Daily News maintains this service absolutely free of charge to you. No need to hurriedly select a school on mere hearsay when expert advice can be obtained by telephoning Dearborn 1111, writing or calling for a personal interview at

THE CHICAGO DAILY NEWS

School and College Bureau

Dept. K, 15 N. Wells St., Chicago, Illinois

LEARN A TRADE

Be Independent



EASY TO LEARN
 Watchmaking, Watch and Clock Repairing, Engraving and Jewelry Work
 EARN UP TO
\$100 a Week

Big Demand For Trained Men

Great shortage of watchmakers, watch and clock repair men! Grasp this amazing opportunity. Steady employment in any section of the country. Uncrowded money-making field. We help you get big-pay job. Or you can own your own repair shop—easy to start—we show you how—fine income right from the beginning. NOW is the time to start—employers are writing us for trained men. Greatest opportunity of your life!

WE TEACH YOU QUICKLY

Takes but a few months to learn. Day or night school, no books, all personal instruction. Our profit-sharing plan helps you earn tuition. Work your way through school. We help you get part-time job.

FREE BOOK Write today for interesting book on watchmaking. It shows you the tremendous growth of the watch and clockmaking industry, the need for expert watchmakers and the wonderful money making prospects for men who are trained by our competent instructors. **Write Today, SEND COUPON BELOW. NO OBLIGATION.**

NATIONAL SCHOOL OF WATCHMAKING
 1340 South Michigan Avenue, Dept. 36, Chicago, Ill.

NATIONAL SCHOOL OF WATCHMAKING
 1340 South Michigan Avenue, Dept. 36, Chicago, Ill.
 Send me FREE BOOK on watchmaking, watch and clock repairing, engraving and jewelry work.

NAME.....
 ADDRESS.....



They Jeered at Me - But I Made Them Applaud Me Three Weeks Later!

I HAD never been called on to speak before. But the chairman had said: "Oh, it's easy, you won't have a bit of trouble. Just talk naturally." The minute I was on my feet I began to realize that speaking was a lot more difficult than I had expected. Everyone appeared to be bored and hostile. Suddenly I noticed two of the members whispering and laughing. For an instant I almost lost control of myself and wanted to slink out of that room like a whipped cur. But I pulled myself together and made a fresh attempt to get started when someone in the audience said, "Louder and funnier!" Everyone laughed. I stammered a few words and sat down!

And that was the way it always was—I was always trying to impress others with my ability—in business, in social life, in club work—and always failing miserably. Why couldn't I talk easily and fluently like other men talked? Often I saw men who were not half so thorough nor so hard working promoted to positions where they made a brilliant showing—not through hard work, but through their ability to talk cleverly and convinc-

ingly—to give the appearance of being efficient and skillful.

In 20 Minutes a Day

And then suddenly I discovered a new easy method which made me a forceful speaker almost over night. I learned how to dominate one man or an audience of

thousands. At the next meeting, just three weeks later, I got up and made the same speech I had tried to make before—but presented so forcefully, so convincingly that when I had finished they actually applauded me!

Soon I had won salary increases, promotion, popularity, power. Today I always have a ready flow of speech at my command. I am able to rise to any occasion, to meet any emergency with just the right words. And I accomplished all this

by developing the natural power of speech possessed by everyone, but cultivated by so few—by simply spending 20 minutes a day in the privacy of my own home, on this most fascinating subject.

There is no magic, no trick, no mystery about becoming a powerful and convinc-

ing talker. You, too, can conquer timidity, stage fright, self-consciousness and bashfulness. Today business demands for the big, important high-salaried jobs, men who can dominate others—men who can make others do as they wish.

Send for This Amazing Book

This new method of training is fully described in a very informative free booklet called, *How to Work Wonders with Words*. You are told how to bring out and develop your priceless natural gift—which will win for you advancement in position and salary, popularity, social standing, power and real success. Absolutely free. Mail this coupon.

Now
Sent
Free



NORTH AMERICAN INSTITUTE
3601 Michigan Ave., Dept. 1353, Chicago, Ill.

North American Institute,
3601 Michigan Ave., Dept. 1353,
Chicago, Ill.

Please send me FREE and without obligation
my copy of your inspiring booklet, *How to Work
Wonders with Words*, and full information regard-
ing your course in Effective Speaking.

Name.....

Address.....

City..... State.....

There's Quicker, Bigger MONEY for YOU in POULTRY RAISING!



Wherever You Live—
Whatever You Do Now—
\$1000 to \$5000 a Year
Can Be Yours!



YOU Can Do What They Have Done

"Your Course on Poultry Raising is the most practical and complete in the country. You have opened up a pleasant and profitable way for me to gain an independent living."—S. Anderson, Bartington, B.I.
"I have a back-yard flock that has improved fully 100% since I have been following your methods. I am of the opinion that a poultryman cannot be successful without taking your Course."—David Tocarelli, Chicago, Ill.

Spare Time or Full Time YOU Can Cash-In BIG

Instead of knocking at your door, Opportunity is waiting for you in your back yard! Hundreds, thousands of my students have turned to Poultry Raising for PART TIME EXTRA MONEY or FULL TIME BIG PAY. Many start off in just a small way—with a back-yard or vacant-lot flock. Only a few hens—but my profit-producing methods make them pay. Whether you live in a city, town or on the farm—and no matter what kind of work you're doing now—I will show you how to start and how to keep going successfully. *Mistily successful!* The Poultry Market is growing by leaps and bounds. Eggs and poultry meat are commanding real prices, high prices—prices that mean a handsome margin of profit on every egg or bird you can produce. There's not a doubt or question about it—YOU CAN CASH-IN BIG. Why wait—why lose? I'll PROVE that I can put YOU among the big money makers—QUICK.

My Proved Methods Assure Success Right from START

All the "mystery," all the "secrets," all the guesswork are taken out of Poultry Raising by my sure, tested, proved successful methods. I will teach them all to you. Nothing is left out, nothing for you to have to figure yourself. I make it easy for you. It's fascinating, healthful, pleasant, profitable. You'll be your own boss. I'll show you how to make \$1.00 to \$3.00 for every hour of your spare time. What's more, I'll show you the way to a salary of \$5,000 a year AND UP! Start as small as you want; my methods will get the maximum profits out of your flock and make it grow automatically, into a sure source of steady, big income for YOU.

FREE BOOK Shows Way to BIG PROFITS

My big new FREE Book, "How to Raise Poultry for Profit," will amaze you! It brings evidence a-plenty—absolute proof—of what I have done for thousands of others. My forty years experience as Commercial Poultryman and former Senior Poultryman in the U. S. Dept. of Agriculture is yours for real Success and Independence. The Poultry Business credits you—and you need the profits that the poultry business brings. You need my book. Get in line for QUICKER, BIGGER MONEY. Do it this minute—don't delay a day. Get this coupon into the very next mail!



48 Pages
of Money-
making FACTS

Get this FREE Book NOW!

Harry M. Lamon, Pres.,
NATIONAL POULTRY INSTITUTE
Dept. 411-F, Washington, D. C.

Dear Mr. Lamon: Send me FREE Book, "How to Raise Poultry for Profit." I want to know more about MY opportunity to make \$1,000 to \$5,000 a year, spare time or full time.

Name.....

Address.....



JOIN THE RADIO ASSOCIATION

Your Neighbors Will Pay You \$75⁰⁰ a week for Your Spare Time

You can easily sell them your spare hours for \$3 each by serving as "radio doctor," building them sets, selling them supplies at less than retail. A membership in the Association shows you how to cash in on Radio now and trains you for the \$3,000 to \$10,000 openings awaiting qualified men. The Association starts you in business if you wish. Investigate all it has done for others, all it can do for you. A MEMBERSHIP NEED NOT COST YOU A CENT.

Earned \$500 in Spare Hours

Our members are making big money with Radio. Werner Eichler, N. Y., earns \$50 a week—Lyle Follick, Mich., has earned \$500—F. J. Buckley, Mo.—makes as much as he receives from employer—all in spare time. Our members are starting radio stores, getting better positions, increasing their salaries, earning money spare time.

ACT NOW—for No-Cost Membership

Send post card for details of Special Membership Plan that need not—should not—cost you a cent, and our book, "Your Opportunity in the Radio Industry." It will show you how you can cash in on Radio now—and later.

Radio Association of America
4513 Ravenswood Ave., Dept. PM-3, Chicago, Ill.

Anyone CAN LEARN

No talent or experience necessary. Fascinating work. Pays big money. Complete instruction book tells about: Alphabets, Colors, How to Mix Paints, Show Cards, Window Board and Wall Signs, Ready made letters, Gilding, Tricks of the Trade, also gives 100 Alphabets and Designs. Book bound in flexible imt. leather-gold edges, and four hall bearing Show Card Pens. Sent postpaid \$3.00, C.O.D. 10c ex. Gellivie Pub. Co., 57 Rose St. Dept 20, N.Y. City

**EARN MONEY IMMEDIATELY—
WE FURNISH EQUIPMENT TO START!!**

LEARN WATCH REPAIRING

Be a watchmaker—you can learn this profitable trade by correspondence in a few weeks in your own home by the DeSelms Chart System. After you complete the course you will know a watch from A to Z. You will know just what the matter is and how to repair one. When you graduate you will be a practical watchmaker and repairer and competent to fill any position. Positions for our graduates. Ask for our Free Book. It explains our system and terms.

THE DeSELMS WATCH SCHOOL
LOGANSPORT, INDIANA



IF YOU STAMMER

Write for my free book "Millard's Advanced Natural Corrective Course" and a free copy of my speech magazine. 10,000 cases successfully treated. Est. 24 years. Largest school for stammerers in world. Millard Inst. of Normal Speech, 2317 Millard Bldg., Milwaukee, Wis.

LEARN PIANO TUNING AT HOME

Send for FREE copy of the 30th ANNIVERSARY EDITION of our book, "Winning Independence". Read how students master tuning with our TUNE-A-PHONE, and WHY our graduates head the profession in all parts of the world. With Bryant's patented devices, tools, charts and lessons, one learns quickly and easily. Low tuition; easy terms. Diploma granted. MONEY-BACK if not satisfied. \$10.00 to \$25.00 a day, exceptional opportunities and an ideal profession awaits you.

BRYANT SCHOOL OF TUNING, 31 Bryant Bldg., Augusta, Michigan.



BUILDERS TRADE GUIDES

AUDELS CARPENTERS AND BUILDERS GUIDES—4 VOLS. \$6



Inside information for Carpenters, Builders, Joiners, Building Mechanics—all Woodworkers. **1600 pages; 3700 diagrams; flexible; pocket size.** Short-cut instructions, new methods, ideas, solutions, plans, systems—money saving suggestions. An easy progressive course for the apprentice. A practical daily helper and Quick Reference for the master worker. A Helping Hand to Easier and Better Work and Better Pay. To get this aid for yourself, simply fill in and mail the FREE COUPON below.

INSIDE TRADE INFORMATION ON:
 How to use steel square; How to file and set saws; How to build furniture; How to use mitre box; How to use chalk line; How to use rules; How to make joints; Carpenters' arithmetic; Mensuration problems; Estimating strength of timbers; How to set girders and sills; How to frame houses and roofs; How to estimate costs; How to build houses, barns, garages, bungalows, etc.; How to read and draw plans; Drawing up specifications; How to excavate; How to use settings 12, 13 and 17 on the steel square; How to build hoists and scaffolds—skylights; How to build stairs; How to put on interior trim; How to hang doors; How to lath—lay floors; How to paint.



AUDELS PLUMBERS AND STEAMFITTERS GUIDES—4 VOLS. \$6



A new set—just out! A practical, illustrated, Reference Library and Study-Course for Master Plumbers, Journeymen and Apprentice Steamfitters, Gas Fitters and Helpers, Sheet Metal Workers, Draughtsmen, Master Builders, Engineers and all Building Trade Students. **1670 pages; 3642 diagrams; flexible; pocket size.** Guides explain all the principles, advances and short cuts of the Plumbing and Heating trade. Contains instructions on how to figure and estimate jobs. Use FREE COUPON below to examine, without obligation, this valuable work.

INSIDE TRADE INFORMATION ON:
 Soldering, tinning. Joint wiping, bending, beating. Pipe—iron—steel, threading. Mathematics, tables, physics. Materials—iron, steel, copper, brass, lead, tin, antimony. Sheet metal—galvanized—plate. Sanitation, syphonage, tanks. Drainage, sewage, purification. Fixtures—bath—kitchen. Pipe fittings, soil pipe, tools. Laying out work. Roughing. Screwed fittings, flanges, joints. Pipe bending, examples. Elbows. Heating, ventilation, refrigeration. Water supply, mains, wells, tanks. Gas-fittings. Underwriters. Sheet metal work, problems, methods, brazing, heating, lead burning. Welding, various welds, methods. Blacksmithing, forges, tools.



AUDELS MASONS AND BUILDERS GUIDES—4 VOLS. \$6



A new, complete, illustrated trade reference library, for Bricklayers, Cement Workers, Plasterers, Tile Setters and Stone Masons, including a practical outline of Steel Construction. **1100 pages; 2067 diagrams; flexible; pocket size.** A practical Trade Assistant explaining modern methods of masonry construction. Easy to understand and apply. A reliable and authentic reference work and study-course for Master Journeyman and Young Mechanic. Use FREE COUPON below and find out for yourself, without obligation, whether this set will benefit you.

INSIDE TRADE INFORMATION ON:
 Bricklaying, tools, materials; Brick designs, patterns, bonds; Setting frames and foundations; Mortars, scaffolds, estimating; Mortars and mortar mixing; Tile setting, mosaic, hollow tile; Straight edge test, troweling; How to figure brick work; Safe loads, piers, chimneys; Boiler settings, anchors, fire stops; Laborables; Concrete, forms; How to figure concrete work; Stucco—on old and new buildings; Plastering—wood lath—metal; Plasterers agreement; Plastering on various surfaces; Stonemasonry; Cutting, finishing, estimating stone; Derricks, rigging; Steel construction; Fire proof; How to read blue prints.

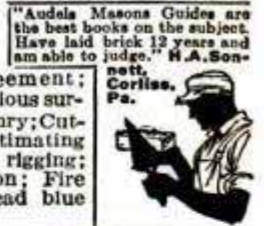

PRACTICAL ELECTRICITY — 1 VOL. \$4

Audels Handy Book of Practical Electricity is a simplified Ready Reference and Study Course in one pocket size, leather bound volume—for Engineers, Professional Electricians and Students. **1040 pages; 2600 diagrams; flexible red leather bound.** A reliable authority and handy helper for every electrical worker. Contains important and valuable wiring diagrams, calculations, machine sketches, helps on maintenance and repair. Use this FREE COUPON today and find out, without obligation, how this handy book will help you in your daily work.

Complete in one handy, red leather bound volume



1040 Pages
2600 Diagrams

INSIDE TRADE INFORMATION ON:

Electro-Therapeutics, X-Rays, Shocks, Welding, Brazing, Radio Hook-ups, Motion Pictures, Telephone, Telegraph, Cranes, Bells, Elevators, Pumps, Tools, Ship Drive, Railways, Vehicles, Automobile Electric Systems, Ignition, Generation, Lighting, Plant Management, Power Plans, Armature Winding, Repairing, A. C. Motors and Apparatus, D. C. Motors and Apparatus, Alternator Construction, Dynamos, Wiring Diagrams, Sign Flashers, Cable Splicing, Power Wiring, Outside Wiring, Switches, Lighting, Rectifiers, Converters, Transformers, Fuses, Circuit Breakers, Rheostats, Electro Plating, Electrolysis, Storage Batteries, Magnetism, Electrical Energy, Conductors, Insulators, Static, Dynamic, Radio Electricity, Applications, Ready Reference and Index Covering the entire field of Modern Electricity.

Learn More and You Will Earn More!

Know your job and you'll never be without one. The skilled man is always in demand. Knowledge is power. Learn your trade thoroughly by easy reading. This coupon is your opportunity for advancement and better pay. You risk nothing in sending for Audels Guides for free examination. Send it NOW!

FREE EXAMINATION COUPON

THEO. AUDEL & CO.,
 65 W. 23 ST., NEW YORK CITY
 Please mail me for free examination the books marked (x) below. If I find them satisfactory, I agree to mail \$1 in 7 days, on each set ordered, and to further mail \$1 monthly on each set until I have paid the purchase price.

- 4 CARPENTERS GUIDES \$6 4 PLUMBERS GUIDES \$6
 4 MASONS GUIDES \$6 1 ELECTRICIANS HANDY BOOK \$4

NAME

ADDRESS

OCCUPATION

EMPLOYED BY..... 3T30

Learn to Write

GOOD hand-writing has been truly called the "Bread and butter of a business education." It should be the determination of everybody to learn to write at least a good business hand. Good writing is the very foundation of business success.

Easy to Learn By my system you can become a good penman at home, in your own room during spare time. Don't be content with the notion that good penmen "are born" such. Because one's ancestors may have been noted for poor penmanship, is no excuse for him to remain an illegible scribbler. My system is original, unique, and highly successful—the result of 25 years' experience.

Your Spare Time Just your spare moments—that's all I ask. If you follow my instructions you will soon be able to write a beautiful hand that will be a source of pride to yourself and envy to your friends. Notice the improvement shown in Mr. Campbell's writing below.

Leland M. Campbell

"I am astonished at the improvement I've made by means of The Tamblin System in so short time."
LELAND M. CAMPBELL,
Campbelltown, Ohio.

Leland M. Campbell

Mr. Campbell wrote his upper signature July 20, and the lower one November 10—a little less than 4 months apart. Hundreds and hundreds of others in all parts of the world are doing as well with my system.

I have had unbounded success in making poor writers good ones and good writers better penmen than they thought possible.

NOW TO
Become
a
Good Penman

**FREE BOOK
WRITE FOR IT
TODAY**

**32
PAGES
HIGHLY
ILLUSTRATED.**

Penmanship is particularly adapted to correspondence instruction, and I absolutely guarantee satisfactory improvement. Distance no barrier. Ladies taught just as successfully as men.



Don't wait, don't delay, begin now to prepare for that position where good penmanship will be required. Send today for my Free Book, "How to Become a Good Penman," which contains copies and beautiful specimens and tells how others have become good penmen by means of the Tamblin System. Your name will be beautifully written on a card with white ink if you enclose stamp.

F. W. TAMBLIN,
418 Ridge Building
Kansas City, Mo., U. S. A.

FREE BOOK COUPON

F. W. TAMBLIN, 418 Ridge Bldg., Kansas City, Mo., U. S. A.
I am interested in improving my penmanship. Please send me free your Book "How to Become a Good Penman."

Name.....

Address.....

Sign and mail this today, before you forget it.

Don't Envy The Plumber BE ONE!

\$11.00-\$16.00 PER DAY and work EVERY day, is the Plumber's wage.

Every skilled workman will tell you that Plumbers have the best of it. WINTER and SUMMER the Plumber is busy at top wages. No skilled Plumber is ever out of a job—compare his opportunities with any trade, plus the opportunities of having your own shop.

We teach you Plumbing with TOOLS (not books) under Licensed Master PLUMBERS in one of the finest equipped schools in America. We make you a Plumber, every branch is taught thoroughly—Lead Work—Blue Print for plan reading—all other tricks.

LEARN IN 8 to 12 WEEKS without previous experience.

If you are making less than \$60.00 a week you owe it to yourself to investigate. Get FREE catalog that tells in pictures and words how we teach this trade. Special rates now.

UNIVERSAL PLUMBING SCHOOL
2030 Troost Ave. KANSAS CITY, MO.

BE AN ARTIST

WE CAN TEACH YOU DRAWING in your own home during your spare time. Twenty-five years of successful teaching proves our ability. Artists receive large salaries. Write Today for Art Year Book

SCHOOL OF APPLIED ART
ROOM NO. 2 BATTLE CREEK MICH.



LEARN WATCH REPAIRING



You can learn by our modern and original system of instruction every part of the Watch Repairing Trade at home as good or better than at a shop. You can earn money while learning and secure a well paying position or start in business after completing our course of instruction. Good watch repairers are always in demand and earn from \$50 to \$75 per week. For particulars apply to the Wisconsin School of Watch Repairing 166 Mason St., MILWAUKEE, WIS.



1,000 Hotel Positions Open!

HOTELS, restaurants, clubs, apartments, hospitals, institutions, schools and colleges everywhere need trained men and women. Over 70,000 high-class positions paying \$2,500 to \$10,000 a year open annually in the hotels of the United States. Nearly one and three-quarter billions of dollars' worth of NEW HOTELS, CLUBS AND INSTITUTIONS being built this year will need over 200,000 trained men and women. Hotels start you at salaries up to \$3,500 a year, with living usually included. At any time there are over 1,000 hotel positions open.

Previous Experience Unnecessary

You can have one of these fascinating, big-pay positions. Thru our Simplified Study Plan we give you the valuable knowledge that it has taken some of the most successful hotel men years to obtain. Age is no obstacle—young and old alike have equal chance for success. Past experience absolutely unnecessary. A common school-education is all you need.

We train you in your spare time and put you in touch with big opportunities. All of your training under the personal supervision of Clifford Lewis, Managing Consultant for over 225 hotels thruout the United States. Our students employed by leading hotels everywhere.

Send coupon today for Free Book, "Your Big Opportunity," showing how we can train you for one of these splendid positions and explaining our Money-Back Agreement.

FREE BOOK COUPON

LEWIS HOTEL TRAINING SCHOOLS,
Room AS-385, Washington, D. C.

Send me without obligation the Free Book "Your Big Opportunity."

Name.....

Address.....

City..... State.....

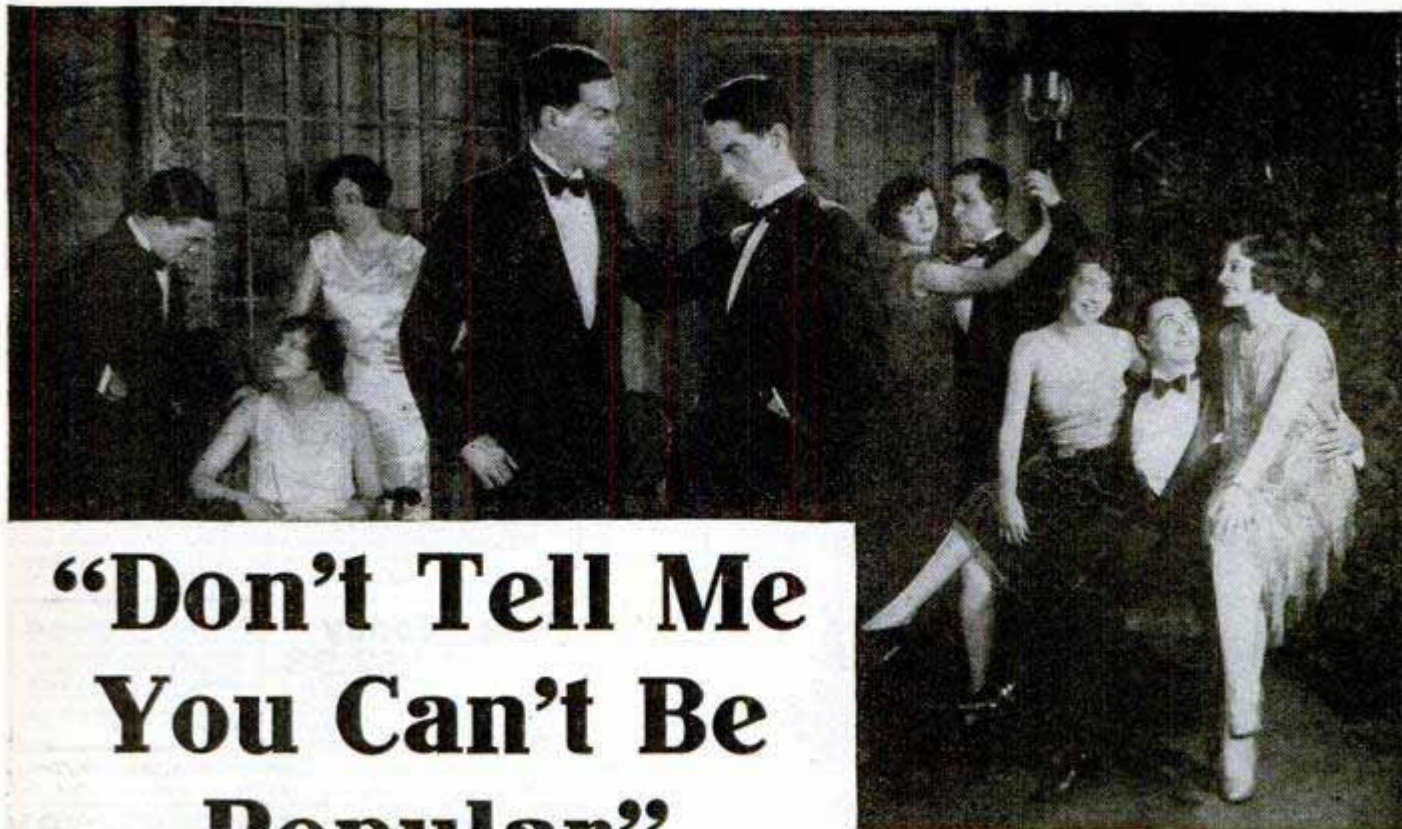

“Don’t Tell Me You Can’t Be Popular”

“I, too, felt the agony of lonely evenings, dreary hours, bitter disappointments. Yet the real secret of popularity was right ‘under my nose’ all the time. Here’s how I found it!”

JACK COADY grabbed me by the shoulder. “Of all people—where have you been keeping yourself? Don’t be a modest violet. Come out of that corner and meet the friends.” He smiled.

But I hesitated. Jack hadn’t seen me for months. He didn’t understand *why* I was alone. And I felt ashamed to tell him.

Finally, however, I could stand it no longer. I was blue—I simply had to confide in someone.

“The trouble is,” I began, “that I haven’t the gift of ‘mixing’—like you. I suppose a man has to be a natural born ‘mixer’ to make friends these days!” And I sulked.

“Well,” interrupted Jack, “I’ll give you a secret that *does* bring friends, if you’ll listen a minute. Only *don’t tell me you can’t be popular!*”

Jack’s Story

“You say I’m a good ‘mixer,’” began Jack. “All right—granted! But here’s where you make your mistake. I wasn’t *born* that way—any more so than you yourself.

“Thirty days ago I was feeling pretty discouraged. My life was just one dull evening after another. Sitting at home reading is okay for

awhile, but I wanted life—people—fun—good times! And why not?”

“So when I saw an ad in a magazine with the heading ‘Why Miss Half the Fun of Life?’ I became interested immediately. And—since there was no obligation—the very next morning I mailed the coupon to Arthur Murray, America’s foremost dancing instructor. I asked for his booklet, ‘A Short Cut to Popularity,’ and his five free lessons in dancing.

“A 32-page booklet and the five free lessons arrived promptly. The booklet explained how the ability to dance well gives poise and self-confidence—how it helps to overcome timidity and awkwardness—how it enlarges one’s circle of friends.

“The lessons I followed carefully—practising before a mirror. Honestly, it was remarkable how easily I learned even the hardest steps.

“Now, of course, dancing seems natural to me. I’m welcome everywhere. I get more real pleasure out of life than I ever thought possible. And, Bill, if you really want to be popular, here’s an easy way to do it—as I did!”

Learn to Dance at Home

This story is typical and it shows you just the chance you’ve been looking for—a chance to become an accomplished dancer right in your own home at a small cost.

No matter how poorly you dance now—no matter if you’ve never been on a dance floor in your life—Arthur Murray’s new method makes you a finished dancer in ten days, or you don’t have to pay a penny for the lessons.

Just think! In ten days’ time you’ll be able to do the French Tango, the Fox Trot, the Waltz and all the smart new steps.

This method of learning dancing is so simple and easy to understand that you can do any of the latest steps in one evening, right in your own room, without music or partner. And in ten days’ time you will be ready to take your place as the best dancer in your set!

Five Lessons FREE

To prove that he can make you a finished dancer in ten days’ time, Arthur Murray is willing to send you five lessons from his remarkable course absolutely free! Just send the coupon (with 10c to cover cost of printing and mailing) and these valuable lessons will be forwarded at once. Also a free copy of his new booklet, “The Short Cut to Popularity.”

Don’t wait—you owe it to yourself to clip and mail this coupon NOW. Arthur Murray, Studio 793, 7 E. 43rd Street, New York City.

Arthur Murray, Studio 793,
7 East 43rd Street, New York City.

To prove that I can learn to dance at home in ten days you may send the FIVE FREE LESSONS. I enclose 10c (stamps or coin) to pay for postage, printing, etc. You are to include free “The Short Cut to Popularity.”

Name.....

Address.....

City.....State.....

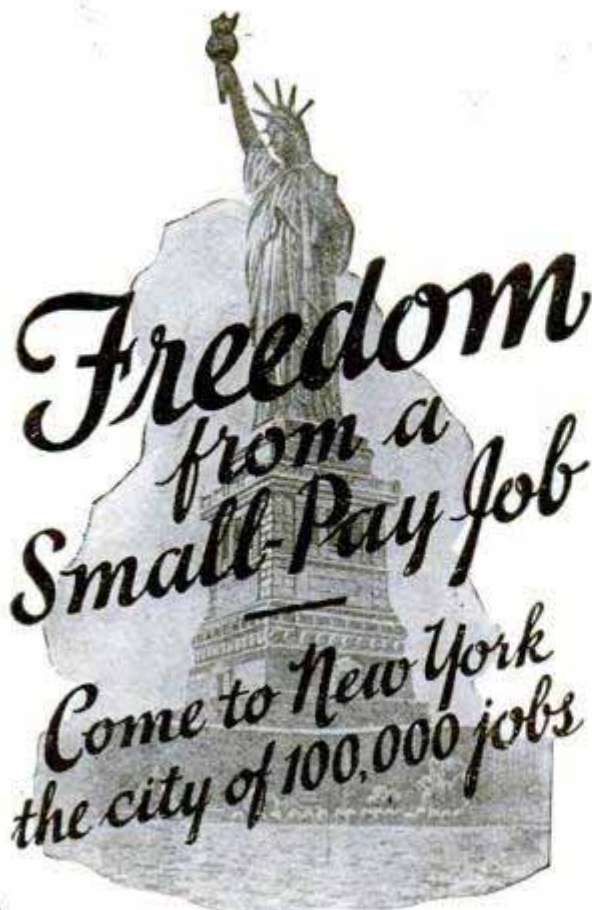

ANY MAN who can read and write and use a pair of pliers can become an electrical expert and free himself forever from the long hours and drudgery of a small pay job.

And you can learn the BIG PAY profession of electricity right in New York City—the heart of the electrical world—the city of 100,000 jobs. At the same time you are learning the BIG PAY profession you can be enjoying the sights and wonders of New York, the modern Bagdad.

Be An Electrical Expert

Graduates of the NEW YORK ELECTRICAL SCHOOL are in demand by all the big electrical companies. Or, if you prefer the independence of a business of your own, there are thousands of opportunities for efficient, dependable men to become electrical contractors. When you are your own boss the money you can make is limited only by your own energy and ability.

Personal Instruction

The NEW YORK ELECTRICAL SCHOOL is not a correspondence school. You learn by doing—by personal instruction on full size standard electrical equipment under the personal supervision of trained instructors.

At N. Y. E. S. you train your hands and mind at the same time. You learn the theories of electricity—and then you are shown how to put the theories into actual practice by solving the problems with your own hands.

The man who has learned electricity by actually doing electrical work under intelligent personal instructors can go to any part of the world and be sure of a good living. There are N. Y. E. S. graduates in all the countries of the world.

Write today for the 48-page booklet giving full information about the N. Y. E. S. Course and showing pictures of the equipment available for your personal use in our two seven-story buildings. Mail coupon now! The New York Electrical School, 44 W. 17th Street, New York.

The New York Electrical School
44 W. 17th Street, New York

Please send me FREE your 48-page booklet. It is understood that this request puts me under no obligation.

Name

Address

\$2500 DRAWING COURSE for \$298



Haven't you often wished that you could draw cartoons, illustrate some idea, sketch some pretty face, etc.? You can do all of these things. One of America's most famous Cartoonists and Illustrators has developed a great, simple system for success in all branches of Commercial Art. This system has revolutionized the entire theory of drawing. It means that drawing can be as easy for you as writing—much simpler than learning shorthand, bookkeeping or typewriting. We are now placing this original system for learning Drawing, Art and Cartooning, consisting of 34 lessons with over 500 illustrations, within reach of every one. If you will devote a few hours each week to the Course WE ABSOLUTELY GUARANTEE that you will learn to draw and draw well before you have half finished the Course. If we fail to make this claim good, we will refund every cent paid us. By eliminating a large office force for answering correspondence, expensive catalogs, etc., we are enabled to make a price of \$2.98, the cheapest price ever known for a high-grade, home study course. Many have sent us letters similar to that of Rob't P. Davis of Detroit, who wrote: "I can't see how you ask so little. It is more than I expected." Learn to draw. It is a big asset, no matter what field you are in.

Send No Money

Just order the course and \$2.98 on arrival pay postman plus a few cents postage, payment in full for the entire Course and Drawing Outfit. If not entirely satisfied, return within five days and we will Refund Money. Address:

If you order the course at once, we will include a drawing outfit, consisting of artist's pencils, pens, paper, erasers, thumb tacks, etc., enabling you to go to work without any additional cost.

LEDERER SCHOOL of DRAWING, Dept. 6848-W, Chattanooga, Tenn. Orders from outside the U. S. A. are payable \$3.28 cash with order.

LEARN MECHANICAL DENTISTRY



making crowns, plates, bridges, etc. for dentists. Unusual demand now and always will be—a human necessity. Steady, dignified Professional Trade. Three to six months training. Easily learned by actual practice. R. R. Fare to nearest school included. Part time positions to help pay expenses while training. Ask for Catalog No. 2.

BODEE DENTAL INSTITUTE
Philadelphia 1305 North Broad Street
Brooklyn 85 Court Street



DRAFTING

BOOKS SENT FREE!

For Beginners 4 Big Volumes

Written so you can understand every word, by 18 famous Engineers and Architects. DeLuxe. Flexible binding. 1750 pages, 1050 blue prints, charts and diagrams. Prepares you for a good Drafting job in mechanical or architectural lines. Sent for 15 days' free use, if you mail coupon immediately.

Only fifteen minutes a day with these WONDER BOOKS will prepare you for a good Drafting job in less than a year! Mechanical and Architectural Drafting from simple straight lines to important, complex plans, a step at a time! Built especially for beginners, for men with only grammar schooling. Drafting room practice plus engineering made easy and clear!

Big Field—Big Demand—Big Pay!

Competent Draftsmen are urgently needed right now in all building and manufacturing lines at \$50 to \$100 a week. That's just the beginning—for draftsmen have the best chances for advancement! Pleasant, fascinating work, easy to learn and do. Learn quick with these books—send coupon for a set FREE, and see for yourself!

A year's Consulting Membership in the American Technical Society now given free to all readers of this famous Cyclopaedia of Drafting. Many say that's worth more than cost of books.

American Technical Society
Dept. D-319, 58th & Drexel Ave., Chicago



Modern American Homes FREE!

American Technical Society
Dept. D-319, 58th & Drexel Ave., Chicago

Send for 15 days' free use 4-volume set of DRAFTING. In return for mailing this coupon promptly send absolutely FREE "Modern American Homes," 112 plates, exteriors, interiors and plans. I will pay the few cents delivery charges. If I wish I may return books in 15 days and owe you nothing. But if I prefer to keep them I will send \$1.50 after 15 days, then \$2.00 a month until \$14.50 (special reduced price) is paid.

Name

Address

Employed by

Address

"Don't make a monkey of yourself"

cried Bob as

I sat down at the piano

I was spending my vacation with Bob when I met his cousin, Helen. It was love at first sight with me. But unfortunately she didn't seem to feel the same way about it.

"You've got nothing to worry about," Bob insisted when I told him my tale of woe. "Just leave it to me. All you need is a little publicity . . ."

The very next day he announced that he'd just had a long talk with Helen.

"Boy! What I didn't tell her about you!" he exclaimed. "Believe me, I boosted your stock sky high!"

"What did you tell her?"

"Well, she's crazy about music. So I conveniently forgot that you can't play a note, and told her you are an *accomplished pianist!*"

"But Bob . . ."

"Not another word! I've got you sitting pretty, now. If you're asked to play—just say that you've sprained your wrist."

That very night we were all invited to the Carew's party. On the way over, I sensed a big difference in Helen—a difference that made my heart beat fast with a new hope.

* * * *

I Am Asked to Play the Piano

A little later in the evening we were all gathered around the piano, listening to the rather indifferent performance of one of the guests.

"I've heard so much about your talent!" cried Helen. "Won't you play something for us?"

"Yes!" "Yes!" "Please!" came from all sides.

With a smile I bowed low . . . and replied that *it would be a pleasure!*

Bob's grin changed to amazement. Calmly ignoring his frantic signals I walked over to the piano. Quick as a flash he followed me.

"For the love of Pete get away from that piano," he whispered excitedly, "don't make a monkey of yourself. If Helen ever hears you play she'll think everything else I told her is bunk, too!"

Turning to the guests, Bob announced, "Perhaps we should wait until some other time. His wrist was slightly sprained in tennis this afternoon, and . . ."

"Oh, that's nothing!" I broke in, and without any further hesitation, I began the first notes of Irving Berlin's famous "Russian Lullaby"! The tantalizing, irresistible strains seemed to throw a spell over the guests. I forgot Bob's astonishment—forgot the glow of ad-



"Why didn't you tell me you knew how to play? When did you learn?"

"You never asked whether I knew how to play," I countered.

"Of course not! Last summer you didn't know one note from another—how was I to guess you'd blossomed into an accomplished pianist overnight?"

"Not overnight, exactly!" I smiled. "Although it almost seemed that way! Remember that Free Demonstration Lesson in music I sent for last summer? Well, when it came and I saw how easy it was to learn without a teacher I sent for the complete course. It's great! Why, almost before I knew it, I was playing simple tunes! I can play *anything* now . . ."

"So you really are an 'accomplished' pianist! The joke's on me, all right!"

"Oh, I wouldn't say 'accomplished,'" I laughed. "But enough of a pianist to get a lot more fun out of life than I used to!"

The above story is typical. You, too, can learn to play your favorite instrument by this remarkable "at home" method. You don't have to know the slightest thing about music. First you are *told* what to do—then a picture *shows* you how to do it—then you do it yourself and *hear* it. No private teacher could make it any clearer.

You learn at home in your spare time. You study when you please—and as much or as little as you please. There are no tiresome scales—no laborious exercises. You play simple, familiar melodies *by note* right from the start.

Free Book and Demonstration Lesson

Our wonderful illustrated free book and our free demonstration lesson explain all about this remarkable method.

If you really want to learn to play take this opportunity to make your dreams come true. Now! Sign the coupon and send it before it's too late. Instruments supplied when needed, cash or credit. U. S. School of Music, 73 Brunswick Bldg., New York City.

U. S. SCHOOL OF MUSIC
73 Brunswick Bldg., New York City.

Please send me your free book, "Music Lessons in Your Own Home," with introduction by Dr. Frank Crane, Demonstration Lesson and particulars of your offer. I am interested in the following course:

.....
Have you above instrument?

Name

Address

City

PICK YOUR INSTRUMENT

Piano	Violin
Organ	Clarinet
Ukulele	Flute
Cornet	Saxophone
Trombone	Harp
Piccolo	Mandolin
Guitar	Cello
Hawaiian Steel Guitar	
Sight Singing	
Piano Accordion	
Voice and Speech Culture	
Harmony and Composition	
Drums and Traps	
Automatic Finger Control	
Banjo (Plectrum, 5-String or Tenor)	

miration in Helen's eyes. On and on I played—losing myself in my music—until thunderous applause shook the room.

That brought me to myself with a start. For the rest of the evening I was the lion of the party.

Bob could hardly restrain his curiosity until we were safely home.

1768

IMPORTANT

160th Anniversary

ENCYCLOPAEDIA at a NEW

Congratulations!

From all over America, telegrams of appreciation are pouring in every day. Here are a few of them:

*From Charles Evans Hughes,
Former Secretary of State:*

I heartily congratulate you on the Anniversary of the founding of the Britannica, an event of high significance in the systematic diffusion of knowledge.

*From Andrew W. Mellon,
Secretary of the Treasury,
Washington, D. C.:*

Accept my congratulations on the 160th anniversary of the founding of the Encyclopaedia Britannica. It has performed a service of inestimable value in making available such a comprehensive body of knowledge.

*From Sir Robert Borden,
Ex-Premier of Canada:*

Upon the 160th anniversary of the founding of the Encyclopaedia Britannica, accept my best wishes for a fitting and inspiring celebration. It is indeed an event of marked significance in the cause of education and culture.

*From Dr. S. Parkes Cadman,
Brooklyn, N. Y.:*

Encyclopaedia Britannica has contributed in manifold and permanent ways to the culture of all English-speaking nations. I congratulate you upon its perennial youth and vigor. It reaches its one hundred and sixtieth anniversary with a wider range of information than ever before during its long and illustrious career.

*From Charles M. Schwab,
New York:*

Let me add my congratulations to those which you are no doubt receiving from many others on the one hundred and sixtieth anniversary of the founding of the Encyclopaedia Britannica and wish you continuing success in the development and expansion of this important work.

YOU can now realize your lifelong wish to own the Encyclopaedia Britannica—the *genuine* Britannica, recognized the world over as the greatest library of knowledge in the world! For this great work is now available at a **NEW LOW PRICE**, and upon **Easy Terms of Payment** that *anyone* can afford. To those who have put off ordering a set, this 160th **ANNIVERSARY SALE** offers an opportunity to save many dollars on the very latest Britannica.

An Epoch-Making Event

The Britannica's 160th Anniversary is an event of tremendous importance from the standpoint of culture and education. And, in order to make this great event mean something tangible to the general public, the publishers of the Britannica have arranged for a special printing of the latest 13th Edition, to be sold at a price so low that *no one* need now be without this indispensable work.

Complete and Authentic

The Encyclopaedia Britannica now, as always, stands head and shoulders above every other work of reference ever published.

That is why one of the publications of the American Library Association calls it "the most famous encyclopaedia in English."

That is why more sets of the Britannica have been sold than of all other encyclopaedias combined.

An Incomparable Value

All other works of reference are pygmies beside it. With its 50,000,000 words, the Britannica contains at least *twice as much reading matter* as the next largest work of reference. Yet **YOU** can actually buy the Britannica at a *lower price*.

More famous Americans have written for the Britannica than for any other American work of reference; and every other civilized country in the world is also represented in the Britannica by the writings of more authorities of that country than you will find in any similar publication in any language.

SEND for FREE Booklet NOW—

ANNOUNCEMENT

1928

SALE of the BRITANNICA LOW Price!

A Wonderful Work That Cannot Be Imitated

The Encyclopaedia Britannica was founded in 1768. Since then numerous editions have appeared, until today the latest, the 13th Edition, stands in a class of its own, unequaled and unrivaled.

The Britannica is not the work of hack compilers, but of the world's greatest authorities—more than 2,500 of them—chosen from all countries for their first-hand

knowledge of the subjects upon which they have been invited to write.

A Marvelous Index Volume

The Encyclopaedia Britannica is the *only* work of reference that has an entire volume devoted to an *Index*—an index which cost more than \$150,000 to produce. This remarkable Index volume, with its 600,000 references, gives you complete command of all the rich resources of this comprehensive work.

While This Offer Lasts Here Is What You Get

The complete 13th Edition of the Encyclopaedia Britannica, comprising the 28 volumes of the latest standard edition, 3 supplementary volumes and an enlarged Index—32 volumes in all!

You get it in the large-page, large-type NEW FORM (32 volumes bound as 16) containing 33,000 pages; 50,000,000 words; 15,000 illustrations, including 550 full page plates (many in color) and 640 maps, on which more than 150,000 separate places are indexed and shown.

And you get all this at a **NELOW PRICE**—an actual saving of many dollars—*If you Act QUICKLY!*

Prove It To Yourself

You have probably always wanted the Britannica, but you have never *needed* it half so much as you do today. To prepare yourself to meet the challenge of tomorrow—to plan and organize your life—to help your children find their life interests—you *must* have the **FACTS** which *only* the Britannica can give you. It is the *one* work you and your family cannot afford to do without. You owe it to yourself to get full particulars of this great work; also details of this great 160th Anniversary Sale Price, which brings this indispensable work within reach of *every* home.

New Illustrated **FREE** Booklet

Write for it now—**TODAY**. Avoid delay. Tear out and fill in the coupon below. It will bring you full particulars of this epoch-making sale, together with handsome illustrated Booklet which tells all about the latest Britannica, and explains the Easy Terms of Payment. Tear out this Coupon **NOW**—before you turn this page. And drop it in your nearest mail box before the last collection tonight.

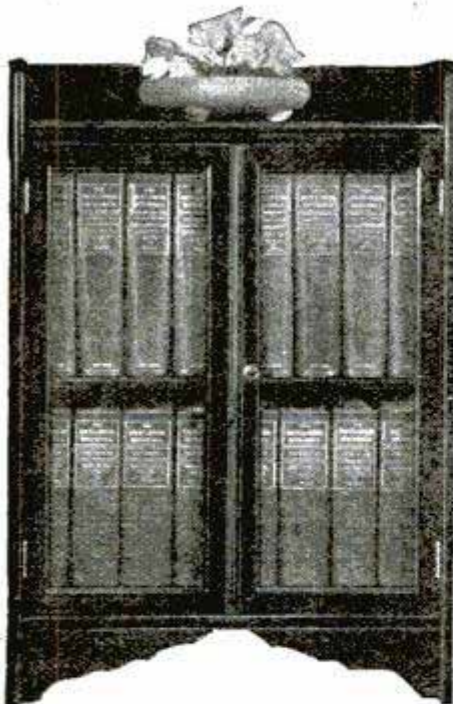

Mail Coupon TODAY

The ENCYCLOPAEDIA BRITANNICA, Inc.
342 Madison Avenue, New York City PMS-B1

Please send me, without obligation on my part, your FREE Booklet; also particulars of your New Low Price Offer and full details of your Easy Payment Plan.

Name

Address

City State



High School Course in Two Years!

You Want to Earn Big Money!

And you will not be satisfied unless you earn steady promotion. But are you prepared for the job ahead of you? Do you measure up to the standard that insures success? For a more responsible position a fairly good education is necessary. To write a sensible business letter, to prepare estimates, to figure cost and to compute interest, you must have a certain amount of preparation. All this you must be able to do before you will earn promotion. Many business houses hire no men whose general knowledge is not equal to a high school course. Why? Because big business refuses to burden itself with men who are barred from promotion by the lack of elementary education.

Can You Qualify for a Better Position

We have a plan whereby you can. We can give you a complete but simplified high school course in two years, giving you all the essentials that form the foundation of practical business. It will prepare you to hold your own where competition is keen and exacting. Do not doubt your ability, but make up your mind to it and you will soon have the requirements that will bring you success and big money. YOU CAN DO IT.

Let us show you how to get on the road to success. It will not cost you a single working hour. Write today. It costs you nothing but a stamp.

American School

Dept. H-374, Drexel Ave. and 58th St., Chicago

American School

Dept. H-374, Drexel Ave. and 58th St., Chicago

Send me full information on the subject checked and how you will help me win success.

- | | |
|-----------------------------|---------------------------|
|Architect |Business Law |
|Building Contractor |Lawyer |
|Automobile Engineer |Machine Shop Practice |
|Automobile Repairman |Mechanical Engineer |
|Civil Engineer |Shop Superintendent |
|Structural Engineer |Employment Manager |
|Business Manager |Steam Engineer |
|Cert. Public Accountant |Foremanship |
|Accountant and Auditor |Sanitary Engineer |
|Bookkeeper |Surveyor (& Mapping) |
|Draftsman and Designer |Telephone Engineer |
|Electrical Engineer |Telegraph Engineer |
|Electric Light & Power |High School Graduate |
|General Education |Wireless Radio |
|Vocational Guidance |Undecided |

Name.....

Address

ELECTRICITY

M A D E E A S Y

REAL WORK with REAL TOOLS on REAL EQUIPMENT
COLEMAN SYSTEM never fails when student means business

All Electrical Subjects Taught
 Armature Winding; Electric Welding; House Wiring; Electric Refrigeration; Farm Lighting; A. C. and D. C. Motors and Generators; Power and Light Switchboards, Dynamos and Transformers; Radio; Storage Batteries; Automotive Electricity.

All Electrical Trades need Skilled Men—Electrical Skill is in Demand at \$200.00 to \$600.00 a Month.

FREE—Automobile Training—FREE.
 Real Cars to Work On—and No Extra Charge

LET COLEMAN TELL YOU HOW—WRITE FOR FREE BOOK
COLEMAN ELECTRICAL SCHOOL
 1628-M Main Street KANSAS CITY, MO.

Learn to Mount Birds



Learn at home by mail, to mount birds, animals, game heads; tan furs, make rugs and robes. Complete lessons. Easily and quickly learned by men, boys and women.

FREE Write today for Free Taxidermy Book. Tells all about it. Every Sportsman, Hunter, Trapper and Nature lover should know this wonderful fascinating art. Save your trophies. Big profits. Success guaranteed. Our school is 20 years old—100,000 graduates. Investigate today. Write for Free Book.

Northwestern School of Taxidermy 3373 Elwood Bldg., Omaha, Neb.

Learn to PAINT SIGNS and SHOW CARDS

We quickly teach you by mail, or at school, in spare time. Enormous demand. Big future. Interesting work. Oldest and foremost school.

EARN \$50 TO \$200 WEEKLY

John Vanson, N. Y., gets \$25 for single show card. Crawford, B. C., writes: "Earned \$300 while taking course." Don't delay. Send today for complete information, samples and guarantee.



DETROIT SCHOOL OF LETTERING
 150 Stimson Ave. Est. 1899 DETROIT, MICH.

TELEGRAPHY

(Morse and Wireless) and RAILWAY ACCOUNTING taught thoroughly. Big salaries; great opportunities. Oldest, largest school. Endorsed by Telegraph, Railway, Radio, and Government officials. Expenses low—opportunities to earn large portion. Catalog free. **DODGE INSTITUTE, Jones St., Valparaiso, Ind.**



12 FEMALE WHY NOT spend Spring, Summer and Fall gathering butterflies, insects? I buy hundreds of kinds for collections. Some worth \$1 to \$7 each. Simple outdoor work with my instructions, pictures, price-list. Send 10 cents (not stamps) for my illustrated Prospectus before sending butterflies.

MR. SINCLAIR, DEALER IN INSECTS,
 Dept. 6, Box 1424, San Diego, Calif.

HYPNOTISM

Learn the secrets of Hypnotism—that strange subtle power which enables you to make others love you; overcome bashfulness; strengthen your memory, mind and will power; realize your ambitions; develop a strong magnetic personality and gain control over others. These magic secrets explained in 25 easy lessons. Complete Course, \$1.00. Satisfaction Guaranteed. Bargain Book Catalog FREE.

FRANKLIN PUB. CO., 800 No. Clark St. Dept. 9422 CHICAGO

YMCA TRADE SCHOOL

Learn Auto Mechanical, Auto Electrical, Battery, Machine, Electrical, Radio Mechanic, Tiling, Bricklaying, Plastering, Plumbing, Welding, Drawing, Estimating, Show Card, Sign Painting, Window Dressing, Fine and Commercial Art.

Write for Catalog 50.
BROOKLYN ENGINEERING INSTITUTE
 (Operated by Bedford Br. Y. M. C. A.)
 1125 Bedford Ave., Brooklyn, New York City.

These Real Blue Prints and Two Books Sent FREE

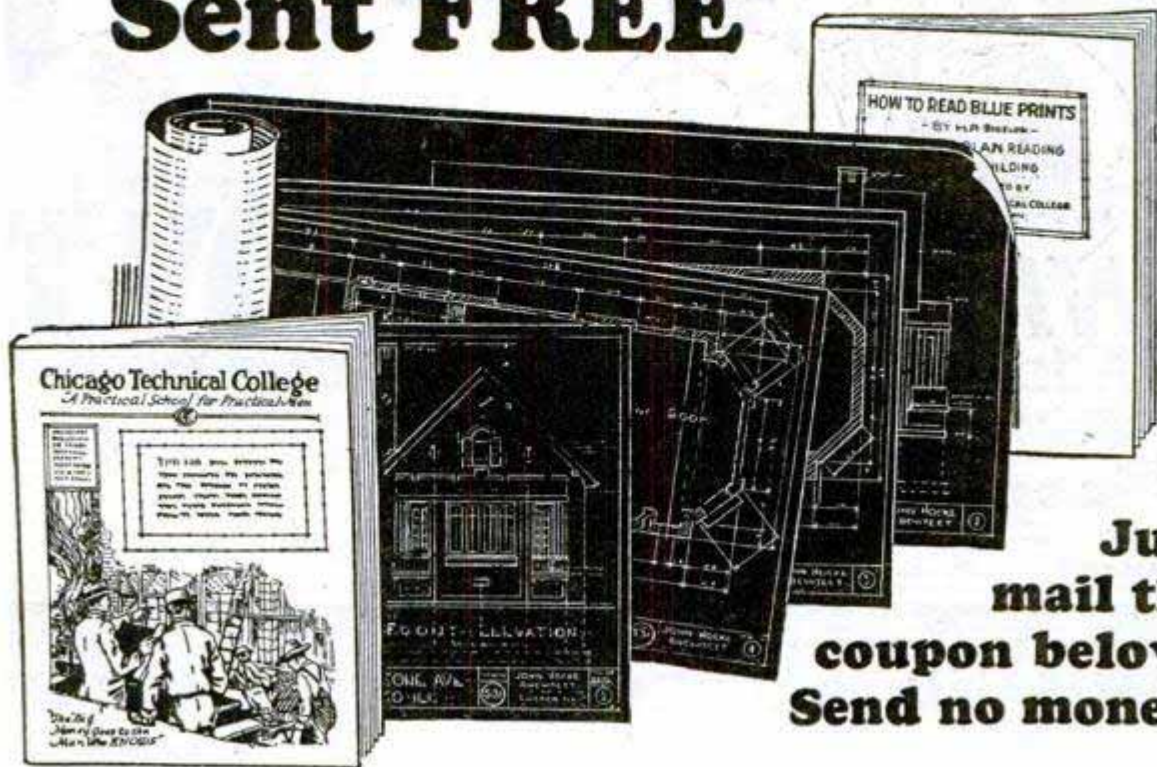

**Just
mail the
coupon below!
Send no money!**

Every builder can get these real blue print plans and our book "How to Read Blue Prints" without sending us a penny. Just send the coupon. Lots of valuable and interesting information—all free. Yes, and we'll send along another book on building; it tells why "the big money goes to the man who *knows*." It explains the practical Chicago Tech. easy method of home-training for men in the building trades. Learn how to get the jobs that pay most money or how to get into your own business as a building contractor.

Plan Reading—Estimating—Superintending, etc.

Train at Home to MAKE MORE MONEY No Schooling Necessary

Learn how to read plans, lay out work and run jobs. Your spare time is enough. Wherever you may be—whatever your job—we can help you quickly to fill a higher place and have a bigger income. Age does not matter. Previous school

training is not needed. This is a practical course for practical men, prepared by practical instructors who have been through every branch of the building game themselves. You owe it to yourself to find out how to make more money.

To Builders Living in or Near Chicago

Visit our Day or Evening School for builders and see with your own eyes the work we do. 1000 builders attend each year. You can get the same training *at home*. Same lessons—same blue prints—same practical instructors—same successful results.

Get the Facts Find out how little time it takes to make more money—much more money—in building. Write today. The coupon brings all *Free*.

**Chicago Technical
SCHOOL for BUILDERS**

Dept. C-141, 118 East 26th St., Chicago, Ill.

Mail the Coupon—NOW

**Chicago Technical
SCHOOL for BUILDERS**

Dept. C-141, 118 East 26th St., Chicago, Ill.

Please send me without obligation, Free and Postpaid, your two Books and Blue Prints for Builders. It is understood that no salesman will call on me.

{Please Write or Print Name Plainly}

Name.....

Address.....

City..... State.....

Age..... Occupation.....

POSITIONS



R.R. MAIL
\$150-\$225



MAIL CARRIER
\$141-\$175



SPECIAL AGENT \$200-\$375



GENERAL CLERK \$95-\$150

WITH THE U.S. GOVT.

MEN-WOMEN-18-55-EARN \$35-\$75 WEEKLY

Ozment's Instruction Bureau, Dept. 234
Mr. Ozment, Director, St. Louis, Mo.
 Send me FREE, particulars about positions marked "X"; locations, salaries, "How to Qualify," opportunities, etc.
 Name.....
 Address.....
 (Write plainly and mail immediately)

ACT NOW!
 Mark with "X" Position or Positions Wanted

- | | |
|--|--|
| <ul style="list-style-type: none"> Railway Mail Clerk P. O. Clerk Prohibition Agent File Clerk Matron General Clerk Chauffeur-Carrier Skilled Laborer Watchman Postmaster RFD Carrier | <ul style="list-style-type: none"> Meat Inspector Special Agent [Investigator] Stenographer-Typist Immigrant Inspector City Mail Carrier U. S. Border Patrol Typist Seamstress Steno-Secretary Auditor |
|--|--|

COMMAND A LARGE, STEADY INCOME!

The Technical man always wins. Technically trained men are in constant demand. Become independent by using your spare time at home to master any of the crafts listed opposite. The St. Louis Technical Institute is one of the most thorough institutions for Technical home study to-day. Our methods and lesson material are so plainly and clearly defined that you will be astonished at your rapid progress. Check the subject in which you are interested and we will send you complete information. Special drafting courses arranged.

ST. LOUIS TECHNICAL INSTITUTE



EST. 1910

HOME STUDY

- ... Drafting } .. Architectural .. Machine
- } .. Electrical .. Structural Steel
- ... Heating & Ventilating Engineering
- ... Plumbing & Sanitary Engineering
- ... Sheet Metal Designing & Drafting
- ... Boiler Maker Laying Out & Inspection
- ... Steel Ship Laying Off & Plan Reading
- ... Contracting & Estimating
- ... Mathematics & Slide Rule Reading

4545 CLAYTON AVE., ST. LOUIS, MO.

Stop Making Mistakes in English

Wonderful new way to improve your English. No rules to learn. No hard study. Grammar, spelling, punctuation, and expression, taught in 15 minutes a day—at home. Self-correcting feature makes it fascinating as a game. Write today for Free Book "How to Speak and Write Masterly English." Address



SHERWIN CODY SCHOOL OF ENGLISH
 53 Searle Building Rochester, N. Y.

MUSIC LESSONS IN YOUR HOME

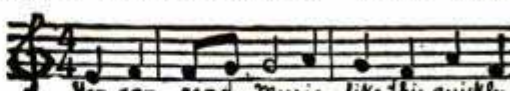

You can read music like this quickly

Write today for our **FREE** booklet. It tells how to learn to play Piano, Organ, Violin, Mandolin, Guitar, Banjo, etc. Beginners or advanced players. Your only expense about 2c per day for music and postage used. **American School of Music, 51 Manhattan Bldg., Chicago**

CHEMISTRY—Learn at home



THE Chemical Industry now ranks fourth among the industries of the United States and it offers a splendid opportunity for ambitious men.

One of the best ways to prepare for a good position in this fascinating field is through the home-study courses in Chemistry offered by the International School of Chemistry.

These courses are complete and practical because they were prepared by some of the best-known chemists in this country, including ALLEN ROGERS, B.S., M.S., Ph.D.

- Head of Department of Industrial Chemistry, Pratt Institute;
- L. M. TOLMAN, Ph.D.—Formerly Chief Chemist, Wilson & Co. Now Vice-president, United Chemical and Organic Products Co.; BRADLEY STODGTON, B.S.
- Head of the Department of Metallurgy, Lehigh University, and OWEN L. SHINN, Ph.D.—Professor of Applied Chemistry, University of Pennsylvania.

INTERNATIONAL SCHOOL OF CHEMISTRY

Division of the International Correspondence Schools
 Dept. 5517-F, Scranton, Penna.

Without cost or obligation, please send me full details of your home-study course in **CHEMISTRY**

Name.....

Address.....

Get Into Flying

1000 Ambitious Men Wanted



BE A KING OF THE AIR

The Thrill of a Lifetime Awaits You

When you get my big new FREE BOOK, "OUT OF THE AIR COMES OPPORTUNITY." Every young man with red blood in his veins will write for this today. What Lindbergh has done is written across the sky. He is the world hero because he knows planes, how to fix them, how to fly them and has a wonderful personality. Read this book. It tells what awaits you in Aviation. Thorough knowledge is necessary for success. This book tells how YOU can get the same practical training that has made others famous. And it tells you everything you want to know about the practical dollar earning side of aviation as well as the romantic.

Opportunities in FLYING

- Aviation Mechanics—\$50-\$125 Week
- Riggers—\$50-\$75 Week
- Flyers—\$125-\$225 Week
- Taxi Service—\$100-\$300 Week
- Aerial Photo Pilot—\$200-\$250 Week
- Special Messenger Service—\$125-\$200 Week
- Aerial Advertising—\$225-\$500 Week
- Crop Dusting—\$125-\$200 Week
- Crop Survey—\$125-\$225 Week

Learn Flying and Mechanics at the Great Sweeney School

We have taught hundreds of students. Many are now doing commercial work at large salaries. New air rates, mail and passenger, creating big demand for men.

YOU can select either the pilot course or ground mechanics course or combine the two courses. All the flying with dual controls and later solos to qualify you. All the ground work in motors, ignition, wings and construction taught by Experts, and five men are needed on the ground for one man in the air. The cost of tuition is extremely low and living conditions are pleasant and economical. Many men just out of the army come here to take up this work. Student body very high class. No previous experience required. We use tools, not books.

150 Acre Flying Field—Hangar and Club House—Instructors—Thorough Construction Course—U. S. Gov't Inspected.

LEARN TO FLY BY FLYING
Sweeney
 SCHOOL OF AVIATION
 4706 SWEENEY BLDG, KANSAS CITY, MO.

Learn Aviation from the ground up by practical experience. Sweeney students are trained by DOING. Thorough ground school work, under skilled instructors in the construction and repair of planes, recovering wings, tuning motor, etc., learning everything about the mechanical work by actual practice. This fits you as an aviation mechanic. You can build your own plane and do anything required in aviation mechanics and construction and repairing when you have finished this work. You are thoroughly taught motors, etc., and work with thousands of dollars' worth of new material, including all types of engines. Aviation is now playing in commercial activities. Progress is rapid. More men are needed every day. You can qualify as a mechanic, or an engineer, or repair man, or bulder, or asa pilot!

SEND NAME TODAY for Free Book, full details of this aviation mechanical course and photographs of planes and equipment actually used; also full information as to the commercial end of flying and opportunities for young men.

SEND THIS NOW

EMORY J. SWEENEY, President
 4706 Sweeney Bldg., KANSAS CITY, MO.

Please send me Free Book about your Aviation Course.

Name..... Age.....

Address.....

Town..... State.....



Win A Prize by Copying this Picture

HAVE YOU a liking for drawing? Then copy this picture and send us your drawing before March 20th—you may win one of the sixty-five prizes.

1st Prize.....\$100.00 4th Prize.....\$15.00
 2nd Prize..... 50.00 5th Prize..... 10.00
 3rd Prize..... 25.00 6th to 15th Prizes 5.00 each

To the Next 50 Best Drawings a Beautiful Fountain Pen

FREE DRAWING TEST. In addition to these prizes, everyone submitting a drawing in this contest may have his art ability tested free. When your Contest Drawing is received, we will mail you our Vocational Art Test. Fill this in, return it, and our staff of Art Instructors will send you a frank personal estimate of your drawing ability. This is free and places you under no obligation whatever.

The purpose of this contest is to discover talent and show you how to develop it. Artistic talent is a peculiar thing—many have it but because of modesty lose their opportunity for success and a larger income. Others believe they have ability but do not, and waste years of effort before they realize the truth.

Artists were never in greater demand than today. Prices for illustrations and commercial art work have greatly increased in the last ten years. Many Federal School graduates who started by answering just such an advertisement as this are now earning \$3,000.00 to \$6,000.00 and more yearly.

Find out if you, too, possess the talent to fit yourself for this highly paid, enjoyable work. Begin your drawing now.

Rules of Contest

1. Contest is open to amateurs over 17 years of age only. Professional artists and Federal School students or graduates are not eligible. Judges of the Contest will be the Faculty of the Federal School of Illustrating. Draw only the girl—no lettering.
2. Send one drawing only, making it exactly 5 inches high on paper about 7 inches square.
3. Use only pencil or pen and ink.
4. No drawing will be returned.
5. Write your name, address, age and occupation on back of drawing.
6. Drawings must reach Minneapolis by Noon, March 20th, 1928. Prizes will be awarded for drawings best in proportion and neatness, as your ability to copy accurately indicates your capacity to observe—the first requisite of an artist. All contestants will be notified of the prize winners. Make your drawing now.

Federal School of Illustrating

3138 Federal School Building, Minneapolis, Minn.

**Success in 1 month
for Leshner!**

"Before starting your course, I did not know a thing about the Tenor Banjo but within one month after I received the first lesson, I was playing with a very good dance orchestra. The course was so easy to understand that my progress was very rapid."—L. V. Leshner, Braddock, N. Dak.



R. J. Smith, 522 N. Mich. Ave., Big Rapids, Mich., makes \$22 extra a week for three evenings play with a dance orchestra.

**\$85 a week
for McCarty!**

"Before taking up your course, I was making \$18 weekly as a clerk and knew nothing about music, but I made my first 'paid' performance in less than eight weeks after starting. Today I owe my salary of \$85 a week as a professional Tenor Banjoist to your excellent training."—Kenneth McCarty, Parkview Hotel, South Haven, Mich.



James J. Delnero, 1467 Westfield St., Springfield, Mass., makes \$32 extra a week for playing with a dance orchestra.

**Over \$278 in Spare
Time for McGriff!**

"When I ordered your Tenor Banjo course I had never had my hands on a Banjo. I now have a \$278 Banjo bought with extra money made by playing. Now also play weekly at the picture show and for dances at our country club, too."—J. P. McGriff, Hawkinsville, Ga.



The Book that started Leshner, McGriff and McCarty is Now

PROBABLY you've never really considered the proposition I have to offer you. Probably like thousands of others whom I have helped find themselves, you have thought of the Tenor Banjo as just a pastime—just a remarkable, melodious instrument for those who have "talent." . . . But then think of **earning \$15, \$20 or \$25 a week EXTRA SPARE-TIME MONEY** for two, three or four nights' fun! Look at the men pictured above. None of them had ever touched a string—ever read a single note.

Ready for YOU!

**I'll train you right at home to
play the Tenor Banjo in 1
to 3 short months**

If you can whistle a tune, read a printed page, understand a picture and hear a phonograph record—then **YOU CAN DO** what Leshner, McGriff and McCarty have done! Many of my students get off their first tune within half an hour after they receive the big Tenor Banjo you see pictured here. It isn't hard or tedious; instead the Play-Way is interesting all the way through. It's like learning a game. **Not one thing stands between you and popularity, good times, scores of new friends—and big EXTRA PAY.**

**Big
Outfit
Comes
with
Very First
Lesson**

**LOOK! My Course even
includes Phono-
graph Records**

Everything you see here—and MORE—comes to you as a part of the Play-Way course. The outfit includes this full professional size Tenor Banjo; Phonograph Records demonstrating every selection in the course; Banjo Pick, Tuner, Extra Strings—copyrighted Gain-Time Chart to help you quickly learn notes. Everything you need to learn—everything you need AFTER you learn. Mail the coupon TODAY.

**A. F. Bloch, President
New York Academy
of Music,
Studio 1038,
100 Fifth Avenue,
New York City**



"The Play-Way to Popularity and Big Pay"—that's the **FREE** book I want you to have. It will **open YOUR eyes**—just as it did for Leshner, McGriff and McCarty. Whatever you've thought about your opportunities, your advantages, your future as a Tenor Banjoist before—you'll want to think again the minute you lift the cover of this remarkable **FREE** book. It has been the stepping stone, the start, for hundreds who today are enjoying more fun, popularity and prosperity than they ever dreamed could be possible. It costs nothing. It may count for much. **Don't pass this page until the coupon's ready to mail.**

Get Your FREE Copy Quick

**A. F. BLOCH, President,
New York Academy of Music,
Studio 1038, 100 Fifth Ave., New York City.**

I'd like to know more about The Play-Way and about my opportunities as a Tenor Banjoist. I'm ready NOW for my copy of your **FREE** book.

Name.....

Address.....

A raise of \$50 a month for just two evenings a week!

Decorate these Giftwares and Make Money



Earn money at home, this fascinating new way, in spare time

We Show You How

THIS is the most delightful work you could imagine; you will enjoy every minute you devote to it. Many people do it solely for the artistic pleasure they get in creating beautiful things. But it also pays surprisingly well, for there is an enormous demand for giftwares. Many of our members make \$10 to \$25 a week, and have built up profitable businesses from small beginnings. Think of decorating a Hanging Shelf, for example, requiring only 3 hours work, and realizing a profit of \$10.50. What other work could be so interesting, and pay so well?

No Special Ability Needed

The national association of homeworkers known as Fireside Industries now has openings for new members. This is your opportunity. Find out how you can secure a membership. The work is easily learned, and easy to do.

You have only to follow the simple directions given by Gabriel Andre Petit, the Art Director, and you can easily learn the latest methods of decorating wooden toys, parchment lamp shades, painted furniture, book-ends, greeting cards, batik and other objects of art.

You are furnished a complete outfit of materials, worth \$10.00 without extra cost. You can start making money almost at once.

Money-Back Offer

What thousands of others are doing in Fireside Industries, you also can do. So sure are we of your success in this fascinating work that we refund your money in full if, after completing your instructions, you are not entirely pleased. You take no risk whatever.

Beautiful Book FREE

The beautiful Book of Fireside Industries, illustrated in color, explains all about this new way to earn money at home. It will be sent you, absolutely FREE and without obligation. Just mail the coupon, or write, enclosing 2c stamp for postage. But do this at once, while openings for new members are being offered.

FIRESIDE INDUSTRIES
Dept. 66-C, Adrian, Mich.

Fireside Industries, Dept. 66-C,
Adrian, Michigan.

Please send me, Free, the book on Fireside Industries, which explains how I may earn money at home. I enclose 2c stamp.

Name

Address

City State

(Write in pencil—ink will blot)

I POSITIVELY GUARANTEE that you can produce wonderful, sweet music in three days and quickly play popular and classical selections.



Complete Outfit Sent on Trial

PLAY A SAW

No notes to read. No dreary practice. Just three short, simple lessons revealing every secret of my 12 years' success as a professional saw musician. Amaze your friends with this sensation of radio, vaudeville, orchestra and lodge entertainment. Send 10c for phonograph record of two beautiful Musical Saw solos which also entitles you to complete information about my special introductory offer of Saw, Bow, Hammer, and Resin, FREE with Course of Instruction.

MUSSEHL & WESTPHAL
814 West Water St. Fort Atkinson, Wis.

Learn Watchwork, Jewelrywork and Engraving

A fine trade commanding a good salary, and your services always in demand. Address **Horological**, Dept. P, Bradley Institute, PEORIA, ILLINOIS, for our latest catalog.

HIGH SCHOOL EDUCATION at HOME - Only \$15⁸⁵

Fascinating question and answer method. Used in High Schools. Every subject covered. Easy terms. Certificate awarded. Write for free folder. High School Home Study Bureau, Inc., (Dept. 253) 31 Union Square, New York City



Every Boy His Own Toymaker

Make your own boats, kites, airplanes, traps, sleds, stilts, diving boards, bird houses, etc. 64 pages illustrated, 10c. Amateur electrician's book, 64 pages illustrated, 10c. 200 kinds iron, wood and wire puzzles catalog with pictures of all and one of our best 25c ones for a dime, postpaid. Western Puzzle Works, Saint Paul, Minnesota



10 Days' Free Examination

Get into the electric wiring field—big demand—big money!

THE whole wiring field covered. Kinks; helps; short cuts; practical, on-the-job electrical data, written particularly to help wiremen, trouble shooters, maintenance men, armature winders, electrical contractors and students.

American Electricians' Library
6 volumes, 2000 pages, illustrated, \$17.50 payable \$1.50 in ten days and \$2.00 a month

The books tell you all you must know about conduit wiring, armature winding, wiring for lighting circuits and switches, wiring for machinery, circuit troubles, circuit testing, or electrical machinery erection. Through a study of this great set you can push yourself into a big-pay job for life.

See it FREE—Send no money—ACT

FREE EXAMINATION COUPON

McGraw-Hill Book Co., Inc.
370 Seventh Avenue, New York

Send me the American Electricians' Library for 10 days' free examination. If satisfactory, I will send you \$1.50 in 10 days and \$2 monthly until the full price, \$17.50, is paid. If not wanted, I will return the books at your expense.

Name

Address

City and State

Position

Company P. M. 3-28

Learn Electricity *in a few weeks*

Earn \$50 to \$125 Weekly

In my wonderful new FREE book, I tell you all about electricity and how YOU can learn it—easily, thoroughly, and surely, in just a FEW SHORT WEEKS. I teach you by the simple, practical, personal instruction method—right in my big electrical school shops fitted with all kinds of electrical equipment — dynamos, motors, engines, bell-buzzer systems, telephone and telegraph systems, all kinds of batteries, power sub-station and many other devices.



Get Real Shop Experience

No books or printed lessons to study—no dry lectures to listen to. No half-way methods. Here you roll up your sleeves and get right into the HEART of electricity by WORKING WITH IT. I teach you every phase of electricity from A to Z—both alternating and direct current. My course covers house-wiring, power-wiring and installation, sub-station work, armature winding, motor and general repairing, telephony, telegraphy. I give you a COMPLETE course in electrical training.

Learning electricity isn't a matter of years at McSweeney Schools—just a few short weeks, that's all. With my simple, practical, easy-to-understand methods of training, anyone can quickly learn electricity. You are told, then shown, then required to DO the actual work of a trained electrician. With McSweeney methods you smash right through the mysteries of electricity in no time at all. You will enjoy your training here, because you actually WORK WITH ELECTRICITY.

Get My Remarkable Offer

Mail the coupon. It will bring you my amazing big new book on electricity FREE—it will bring you my remarkable low tuition offer, which includes R. R. Fare and board. Investigate! Opportunity is calling you. Mail the coupon—get all the facts. The low cost of learning electricity the McSweeney way will surprise you. Mail the coupon now before you turn the page.

J. H. McSWEENEY, Pres.

McSWEENEY
ELECTRICAL SCHOOLS

Dept. 51-CG, CINCINNATI, OHIO, CLEVELAND, OHIO



J. H. McSweeney, Pres.,
McSweeney Electrical Schools, Dept. 51-CG,
Cincinnati, O., Cleveland, O. (Mail to nearest school)

Dear "Mac": I am interested. Please send me your big new electrical book FREE, also details of your remarkable offer which includes R. R. fare and board.

Name.....

Address.....

Town.....State.....

TRAVEL—for 'UNCLE SAM'

**RAILWAY POSTAL CLERKS
MAIL CARRIERS—POSTOFFICE CLERKS
\$1700 to \$3300 a Year for Life**

No "lay-offs" because of strikes, poor business, etc.—sure pay—rapid advancement. City and country residents stand same chance. Common sense education sufficient—no political influence.

STEADY WORK

Cut coupon and mail it before turning the page.



MEN—BOYS 18 to 45

Use Coupon Before You Lose It



COUPON

FRANKLIN INSTITUTE, Dept. A-175, Rochester, N. Y. Rush to me, entirely free of charge, (1) A full description of the position checked below; (2) 32-page book, with list of positions obtainable; (3) Particulars telling how to get the position checked.

- Railway Postal Clerk (\$1900 to \$2700)
- General Clerk (\$1140 to \$1860)
- Postoffice Clerk (\$1700 to \$2300)
- Prohibition Agent (\$1800 to \$3000)
- City Mail Carrier (\$1700 to \$2100)
- Rural Mail Carrier (\$2100 to \$3300)

Name.....

Address.....

DRAFTING—Learn at home



F. E. King was "a poorly paid clerk" when he enrolled for the home-study Drafting Course of the International School of Drafting. Through study and perseverance he became Chief Draftsman of the U. S. Steel Furniture Co. He is now earning more in a day than he used to earn in a week.

A. J. Hutchins became Chief Draftsman for the American Strawboard Company and increased his salary 300%—also as a result of our training.

There is no doubt that Drafting offers a real opportunity to ambitious men and it will pay you to investigate it.

INTERNATIONAL SCHOOL OF DRAFTING

Division of the International Correspondence Schools
Box 5518-F, Scranton, Penna.

Without cost or obligation, please send me full details of your home-study course in DRAFTING

Mail Coupon for Free Booklet

Name.....

Address.....

LEARN fundamentals of DRAFTING IN 4 MONTHS

CHICAGO TECHNICAL COLLEGE

If you are earning less than \$50.00 a week, send the coupon below. It brings you all the facts about Drafting's big money field—and tells how Chicago Tech. makes it possible for you to get started in this dignified, interesting, profession easily and quickly. Jobs are waiting for trained, wide awake serious-minded men—jobs that pay \$60 to \$150 a week to experts.

"Send us more draftsmen" is the call that comes to us from engineering, electrical and architectural firms, railroads and the country's great billion dollar building industry. Answer this call—prepare yourself—be ready when opportunity knocks. A Chicago Tech. fascinating short course gives you what you need to get started in this profitable field. 4 months of intensive, interesting training, then out on the job getting practical experience, and you'll be surprised how soon you will be one of the big pay men.

25th Year



FREE—84-Page Book

This book tells you all you want to know about this 25 year old school. There's so much that is interesting about this old established resident school, you will want to get all the facts. Facts about the organization, men behind it, and our well known courses in Engineering, Electricity, Architecture and Building. And just what this school can do for you—and your future. Get this book—it's interesting and helpful. Just mail the coupon. It doesn't cost you a penny.

In 4 Months at Chicago Tech.

The 4 months you spend in Chicago will be happy months. For it is the center—the hub of all engineering progress. 16 weeks of fascinating study and you're ready to begin Drafting. On your way, too, to big money. Specially trained—all set to make the big step of your life into a field abundant with opportunity. Into a field that pays big money for training and experience. You need only a common schooling. Practical instructors. Part time work available. Free employment service. Living accommodations arranged for. Day or evening classes. Athletics. Many student activities. Enter any time.

You will never realize what Drafting and Chicago Tech. can mean to you until you have all the facts before you. Begin—make the first step to future prosperity and happiness now. Send no money. Just fill in and mail coupon today.

USE THIS COUPON

CHICAGO TECHNICAL COLLEGE
Dept. C-401, 118 E. 26th St., Chicago, Ill.

Please send me, without obligation, free and postpaid, your 84-page Blue Book and facts about how to get started in Drafting in 4 months.

Name.....
Address.....
Town or City.....
Age..... State.....

CLIP and MAIL COUPON-NOW



\$1900 to \$2700 a year



Long vacations with pay. Work easy. Travel on fast trains with all expenses paid, including hotel. No worries about the future.

MY FREE BOOK TELLS HOW
Get my big free book about the Civil Service which tells all about the Railway Postal Service, and other positions, and how I can help you. Write today.

PATTERSON SCHOOL
Arthur R. Patterson, Civil Service Expert
83 Wisner Bldg. Rochester, N. Y.

Become a PHOTOGRAPHER

Attractive money making opportunities in **Portrait, Commercial and News Photography**, or Get Into **Motion Picture Photography**. **Camera Men Earn \$50 to \$250 a Week**. Fascinating Work; in big demand. You can learn at Home or in our N. Y. Studios.



FREE BOOK Tells How—
How to prepare for High Salaried position.
How to start your own business.
How to make money in spare time.
Write for this big illustrated Book and Job Chart today—**FREE**.

N. Y. INSTITUTE OF PHOTOGRAPHY, Dept. 49
10 West 33rd St., New York, N. Y. Estab. 1910

GIVEN TO YOU \$20 Musical Instrument



Yes, we will give you without extra cost a \$20.00 quality **Violin, Tenor Banjo, Hawaiian Guitar, Banjo, Banjo-Guitar, Cornet, Guitar, Mandolin or Banjo-Mandolin**. Learn to play by note. We teach men, women, boys and girls by mail. Amazing new, simplified method. A few cents a day pays for Lessons. Instrument and first lesson sent on **FREE TRIAL**. Over 500,000 successful pupils. Write today.
CHICAGO CORRESPONDENCE SCHOOL OF MUSIC, INC.
1632 North Halsted Street, Dept. 600, Chicago, Illinois.



FLY

Assemble this plane yourself and learn by practical experience to construct and operate aircraft. This plane won the Aircraft Performance Trophy in competition with planes of 90 to 200 H.P. Use your motorcycle motor or the IRWIN 20 H.P. engine. Parts furnished very reasonable to assemble the Meteorplane, the World's first small plane. Send \$3.50 for complete set of Blue Prints and parts price list of this latest Model M-T-2.

IRWIN AIRCRAFT CO.
SACRAMENTO, CAL.

STAMMERING



easily, permanently corrected. Win happiness and success. Ask for full information and special phonograph record. Send dime for postage. Learn how easy it is.
153 Stimson, The LEWIS INSTITUTE, Detroit

Book on Law Free



Write today for this new book. It tells you how a law training will shorten your road to success. It also carries a vital and inspiring message to every ambitious man. Find out about the opportunities that await the law trained man. Find out how you can learn law right in your own home. No obligations. The book is absolutely **FREE**.
Write Today—now—while low tuition fee is in force.

American Correspondence School of Law
3601 Michigan Ave. Dept. 1353 Chicago, Ill.

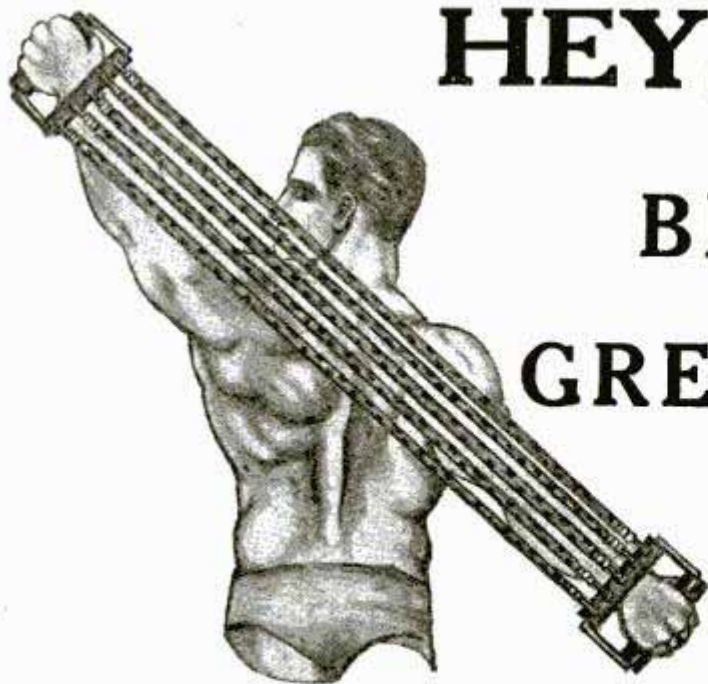

HEY, FELLOWS!

HERE'S

BIG MUSCLES

AND

GREAT STRENGTH

FREE

**THIS STRONG 5-CABLE EXERCISER
AND
A COMPLETE COURSE OF INSTRUCTIONS
WILL BE GIVEN YOU FREE**

with a one year's subscription to "Strength Magazine" at its regular price of \$2.50. No raise in the subscription price has been made on account of this gigantic offer.

The exerciser and course is entirely free to those who subscribe to "Strength." The exerciser consists of 5 strong, elastic cables, black, japanned grips; strongly made cable-end holders and nicked cable-couplings. It's an exerciser you will be proud to display.

The course, which is expertly laid out, tells you how to use this great exerciser for the best results. This course is also illustrated, giving you a clear idea of the exercises.

ABOUT "STRENGTH MAGAZINE"

"Strength" is he-man's magazine. It contains, each month, articles on how to gain health, strength and muscular development. It is loaded with pictures of men who have developed magnificently muscled bodies and prodigious strength.

There are included articles for the ladies who are interested in improving their health, vigor and figures. Live sports stories are also part of this great magazine. "Strength" is by no means dry—it is alive and full of pep. You'll be interested from the first word on.

WHAT THEY'RE SAYING ABOUT THIS PHENOMENAL OFFER

Among sportsmen, athletes, strongmen, etc., this offer is the topic of the day. The opportunity of getting free of charge a physical training apparatus and course, that will develop the muscles and strength and promote health, has never been heard of before. While this offer is comparatively new we are already receiving many commendable letters. Get in on this offer—hundreds are beating you to it every week.

\$2.50 COVERS ALL MAILING CHARGES

Each month for the next twelve will be delivered to your door by your mailman.

No charge is made for these mailings. The exerciser and course will also be mailed to you free of postage charges.

MAIL THIS COUPON NOW

Everybody in the physical training world is talking about this offer. Why? Because it is the most startling of its kind. You can develop that body of yours from the weakling to the real, strong he-man type, and the course and exerciser that does the job so thoroughly for you, costs you nothing. Give that ample thought—consider what it means to you.



A SUBSCRIPTION TO
"STRENGTH"
WILL ENTITLE YOU
FREE
TO THE BIG
MUSCLE
GETTER
ABOVE

MILO PUBLISHING CO., 2747 N. Palethorpe St., Phila., Pa., P.M.-328.

Gentlemen:
Please find enclosed \$2.50 for which send me immediately a 5-cable exerciser and course free and enter my name on your mailing list for a year's subscription to **STRENGTH**.

Name

Address

City

State

Canadian orders \$2.75
—Foreign, \$3.25.

GENUINE CORONA

Limited Offer



\$200
DOWN
BALANCE
EASY
TERMS

HERE'S your chance to secure that Corona you've wanted —on the easiest terms ever offered —at **ONE-THIRD OFF** regular price! Complete in every detail; two color ribbon, back spacer, beautifully re-newed, **NEW MACHINE GUARANTEE**. Recognized the world over as the finest, strongest, sturdiest portable built. Only a limited number of these splendid machines available. To get one, you must act now!

Yours For 10 Days FREE
Send No Money

Experience the joy this personal writing portable typewriter can give you! Use it 10 days free! See how easy it is to run and the splendidly typed letters it turns out. Ideal for the office desk, home, travelling. Small, compact, light, convenient. Don't send out letters, reports, bills in poor handwriting when you can have this Corona at such a low price or on such easy terms.

Carrying Case Included
—If You Act Now

Leatheroid carrying case, oiler, instructions free on this offer. Send no money—just the coupon. Without delay or red tape we will send you the Corona. Try it 10 days. If you decide to keep it, send us only \$2—then \$3 a month until our special price of \$36.25 is paid (cash price, \$33.10). Now is the time to buy. This offer may never be repeated. Mail coupon now.

\$16 SAVED
by using this coupon

SMITH TYPEWRITER SALES CORP.
843-360 E. Grand Ave., Chicago.

Ship me the Corona, F. O. B. Chicago. On arrival I'll deposit \$2 with express agent. If I keep machine, I'll send you \$3 a month until the \$34.25 balance of \$36.25 price is paid; the title to remain with you until then. I am to have 10 days to try the typewriter. If I decide not to keep it, I will repack and return to express agent, who will return my \$2. You are to give your standard guarantee.

Name.....
Address.....
Employed by.....

Telegraphy

PAYS WELL

—and you can thoroughly master it at home, quickly, in spare time, while holding present position. Training includes Morse, Automatic and Wireless. Complete sending and receiving outfits furnished. No instruments to buy. Our Sendograph enables you to receive and send in Morse and Continental codes at home without any outside assistance. Send for our Free Book, "Opportunities in Railway and Commercial Telegraphy." Tells about this attractive, well-paid vocation—how our easy home-study course qualifies for jobs with railways, stock exchange and brokerage houses, newspapers, press bureaus, etc.—how telegraphy has proved the first stepping-stone to executive positions for thousands of ambitious men and women. Write for this interesting book and complete free literature today. Address Dept. 364-Y



LaSalle Extension University
Chicago, Ill.

ACCOUNTING



The uncrowded, highly paid profession of Accountancy offers marvelous opportunities to ambitious men and women. Send for our 80-page book, "How to Learn Accounting," and the first easy lesson. Both will be sent free.

INTERNATIONAL ACCOUNTANTS SOCIETY, Inc.

A Division of the
Alexander Hamilton Institute

Dept. 24, 3411 South Michigan Ave., Chicago, Ill.

START
to
PLAY
Very
First
Day!



YOU CAN PLAY THE XYLOIMBA

Extra Money—Hosts of Friends—Loads of Fun Within Your Reach



Fame and Money Broadcasting



Center of Attraction at Gatherings



Big Money at Dances

HAPPY DAYS are in store for you if you will only act on this suggestion! Cheery evenings playing catchy music alone or with sweetheart, wife or sister; proud moments as center of interest at gatherings; nights of joy making \$5 to \$25 for work that is "play."

The Deagan Xylorimba is your Opportunity! Wonderful for home, in demand at dances and entertainments, yet easiest of all instruments to play. No teacher necessary—you actually play simple melodies the very first day even if you cannot read a note of music right now! **Earns \$60 a Week**—Ralph Smith, Chicago, says: "Played 20 minutes at wedding. Received \$20." L. E. Hallmann, Reading, Pa., writes: "Made \$300 in 5 weeks, spare time. Had never played instrument before."

SEND FOR BIG FREE BOOK! Our new book tells all about the delightful lessons, furnished with each instrument; the five-day trial that removes risk; the wonderful Deagan, easy-payment plan. No obligation—simply fill in and mail the coupon.

J. C. Deagan, Inc., Dept. A1453, 1770 Berneau Ave., Chicago Send me, without obligation, full details of Free Trial offer and easy-payment plan on the Deagan Xylorimba.

Name.....
Address.....

I'll Pay Your Railroad Fare to Chicago Without Extra Cost

UP TO \$15,000 a year for **GREER GRADUATES**

ELECTRICITY, AUTOS, AVIATION now pay hundreds of trained men up to \$200 A WEEK. Here are THE 3 WORLD'S GREATEST BUSINESSES. BILLIONS—not millions, but BILLIONS of dollars are spent in them every year. CHOOSE ONE OF THESE THREE, HERE and NOW.

GREER trained men are NEEDED. I HAVE MADE hundreds of \$10,000 A YEAR MEN. 90,000 in the last 26 years have come to GREER. THOUSANDS MORE in the future will likely come here. BE ONE OF THEM. Send coupon to me for openings.

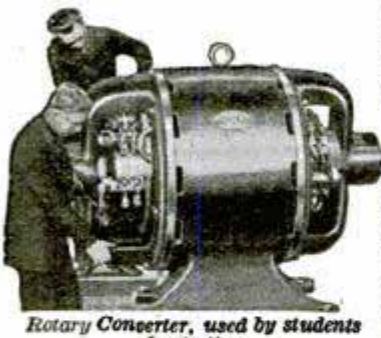

Rotary Converter, used by students for testing

Amazing Opportunities for you in one of World's 3 Biggest Businesses

MEN WANTED

I will help you get a position while learning also after graduation. Never before such unusual opportunities. GET MY FREE BOOK NOW. LEARN ABOUT THE BIG PAY. ELECTRICITY. AUTOS. AVIATION—lead WORLD'S BUSINESS. That's why GREER College selected these Fields and ONLY THESE.



Learn to Boss the Job

ELECTRICITY

AUTOS

Learn in Only 3 Months in GREAT GREER SHOPS ON LARGE LIVE EQUIPMENT

Mine is NOT A CORRESPONDENCE COURSE. You can start any day or any evening. It is PRACTICAL, EASY, QUICK, FASCINATING training. You learn on Great, running, live Equipment in tremendous GREER SHOPS. AUTO Business is BIGGEST BUSINESS in the world. ELECTRICITY is FASTEST GROWING, and yet in its Infancy. AVIATION, most fascinating, alluring business today, is already a Billion Dollar Industry.

Choose one of these 3 wonderful professions today. Trained men are needed by scores, for positions up to \$200 a week and up. Find out now, about my great Shops training.

full of HARD THEORY—NO HEADACHES in GREER PRACTICAL SHOPS TRAINING. You learn to DO BY DOING. You learn to Fly by Flying.

You Get Real Help to BIG JOBS !

TWELVE PEOPLE are in my Big EMPLOYMENT DEPARTMENT getting jobs for Greer men. You get their help AS OFTEN AS YOU NEED IT, both BEFORE and AFTER Graduation.

Get My FREE BOOK NOW

Don't let money hold you back. Get my Free Book. Find out NOW how I PAY YOUR FARE HERE, let YOU ATTEND EITHER DAYS or EVENINGS and help you find DAY or EVENING WORK to PAY YOUR EXPENSES while learning. Then when ready we help you find the real BIG PAY JOB. LEARN how I get you ready so Employers WANT YOU, and GLADLY pay you what you are worth.

Quickest, Easiest of Ways to Become Expert

I'LL PAY YOUR FARE HERE FREE of extra cost, then help you to a JOB WHILE LEARNING. Then I not only FIT YOU to get BIG PAY JOB, but I'll help YOU HOLD IT. Young and Old, Educated and Uneducated, Inexperienced and Experienced have found GREER SHOPS training EASY, FASCINATING and VALUABLE. Coupon below brings details.

Not Correspondence Course

Here at GREER SHOPS you learn on BIG, ACTUAL FULL SIZE Machinery, like you will work on out on the Big Pay Job. You get close personal supervision. NO Guess work—NO books

Erwin Greer

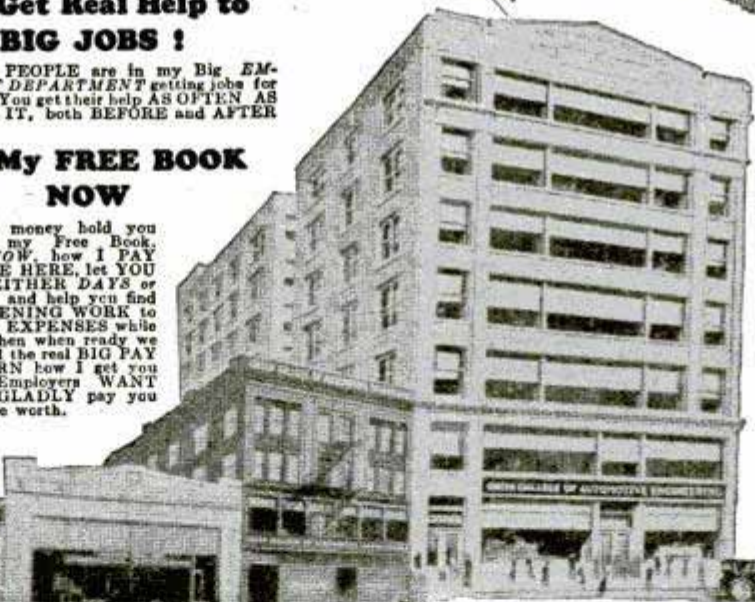

90,000 Students

26 Years Tremendous Success

Above is the important history of GREER COLLEGE. Note the steady 26-years growth, thru genuine SERVICE, from the tiny Shops on the left to the tremendous Building on the right, filled with GREAT TRAINING Equipment. These

moves to always greater quarters mean GROWTH—PROGRESS and SERVICE. What is it you like—ELECTRICITY—AUTOS—or fascinating AVIATION? GREER will train you in EITHER, as YOU SHOULD BE TRAINED.

GREER COLLEGE

Electricity—Autos—Aviation

Dept. 301
2024 So. Wabash Ave.
CHICAGO, ILL.

Get My Big Offer Now!

Would an offer of \$100 a week be OPPORTUNITY or DISAPPOINTMENT for you? If you could HOLD the JOB it would truly be OPPORTUNITY. If you can't hold the \$100 a week job, PREPARE. Be ready. Don't invite disappointment. Learn about GREER SHOPS. Right now if you act quick, I can make you a most unusual short time offer. Clip coupon NOW and find out. Address me personally

ERWIN GREER, President

SCISSORS FOR FREE BOOK

ERWIN GREER, President
Dept. 301
2024 So. Wabash Avenue,
Chicago, Illinois

Send Free Book indicated below and details of Special offer, without obligation to me.

Autos Electricity Aviation

Name.....

Address.....

Get a Grip of STEEL



Send Only 25c for My
Double Strength

Krusher Grip

Increase the size and strength of your arm overnight. A strong grip is the barometer of your personality. With each *KRUSHER GRIP* I will give

FREE

a beautiful illustrated booklet filled with handsome pictures. It tells you how you can possess a manly figure packed with energy and power. How to put inches on your chest, neck, arms, and legs and get a body as shapely as Sandow.

The finest built athletes in the world posed for this booklet which I am offering for a limited time only.

Fill in the coupon and mail with your remittance and get your copy *NOW* while the offer is good.

Don't wait. You can't beat this offer. Good only for thirty days. Let's go.

The Jowett Institute of Physical Culture

597 Fifth Avenue

New York City

The Jowett Institute of Physical Culture

597 Fifth Avenue, New York City

Sir:

Enclosed is 25 cents for your double strength Krusher Grip with which I am to receive your illustrated booklet FREE.

Name _____

Address _____

ELECTRICITY

Practical-Technical TRAINING

Great demand for electrical workers. Prepare NOW for big paying job. Learn quickly by actual work on modern electrical equipment. A. C. and D. C. Motors and Generators; Armature Winding; Power and Light Switchboards; Batteries; Radio; Electric Refrigeration; Electric Elevators; Farm Lighting; Power Plant Operation.

12 WEEKS' INTENSIVE COURSES open to you NOW. Expert instructors teach you how and why. 26th year. Students assisted to positions. Part-time work secured. One and Two-Year courses in Electrical Engineering open in September. Degrees and diplomas. Send for free catalog.

FINLAY ENGINEERING COLLEGE
303 Finlay Bldg. Kansas City, Mo.

LAW

THIS BOOK

FREE!

Study at Home

Become a lawyer.

Legally trained men win high positions and big success in business and public life. Greater opportunities now than ever before.

Earn \$5,000 to \$10,000 Annually!

We guide you step by step. Degree of LL.B. LaSalle law graduates practicing in every state. We furnish all text material, including 14-volume Law Library. Low cost. Easy terms. Valuable, interesting 96-page book free. Send for it NOW.

LaSalle Extension University, Dept. 364-L Chicago



BE AN AIRPLANE BUILDER, PILOT, MECHANIC

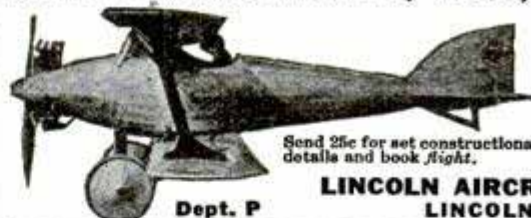

Send 25c for set constructional details and book *Flight*.

Dept. P

LINCOLN AIRCRAFT CO.
LINCOLN, NEBRASKA

Blue Prints and material now ready for builders of the world's famous Lincoln Sport Plane.



Be a drummer!

Trap Drumming made easy in a short time. Our free instruction course furnished with genuine Ludwig Trap-Drum Outfit. Develop your natural sense of rhythm. Go to your nearest dealer or write for full details.

LUDWIG & LUDWIG, 1611 North Lincoln Street, Chicago



"BECOME A LIGHTNING TRICK CARTOONIST"

Send \$1.00 for Laugh Producing Program of 23 Trick Drawings with Instructions. Catalog of Chalk Talk Supplies Free. BALDA ART SERVICE, Dept. 1, Oshkosh, Wis.

EASY NOW TO TRAIN FOR ONLY

GOV'T. JOB\$

9

WHY PAY MORE?

Get on "Uncle Sam's" Pay Roll. Make \$115 to \$250 month to start. Promotions. Vacations with pay. Traveling or local. Men and women, 18-55, trained at home in three weeks. Particulars free. Write, Oxment Instruction Bureau, 248, St. Louis, Mo., immediately.

I Pay **\$60.00** a week for "Leg-work"

For PROFITS
"bigger
than pay
checks
"mail
the
coupon

— because Fairbanks Clothes Sell Themselves!

I mean just that—I am prepared to put into your hands so remarkable a line of men's clothes, that merely **SHOWING** it to a dozen prospects each day, means \$60 to \$100 a week in commissions! I will prove this claim by the records of **HUNDREDS** of Fairbanks representatives. And I will give you a chance to test out this wonder line, without cost or risk, so you can see for yourself that it takes only **LEG-WORK** to make real money with it—that high-pressure salesmanship isn't needed at all.

I'll Set You Up in a Business of Your Own!

If there is no Fairbanks representative in your locality, **GET IN TOUCH WITH ME AT ONCE.** If you can assure me that you are a hustler and mean business, if you can furnish a character reference or two, I will back you with all the resources of this million dollar company and set you up in business of your own. We furnish everything you need, all the capital—all you put in is your time. But I will equip you to meet and beat the competition of retail dealers and merchant tailors—to **under-sell yet over-deliver** every clothing proposition in the field.

Actually \$35 Clothes with a \$23.75 Price-Tag!

I wish you could spend a day going through our mammoth tailoring shops in Chicago—then you would realize that we are putting \$35 to \$40 quality into our garments. Yes, sir!—\$35 to \$40 all-wool fabrics, \$35 to \$40 workmanship. But because of our enormous purchasing power and economies in production, **AND BY SELLING DIRECT TO THE WEARER,** we have smashed the price to only \$23.75! **ACTUALLY LESS THAN ORDINARY READY-MADES COST.** Yet there's a big cash commission for you on each sale!

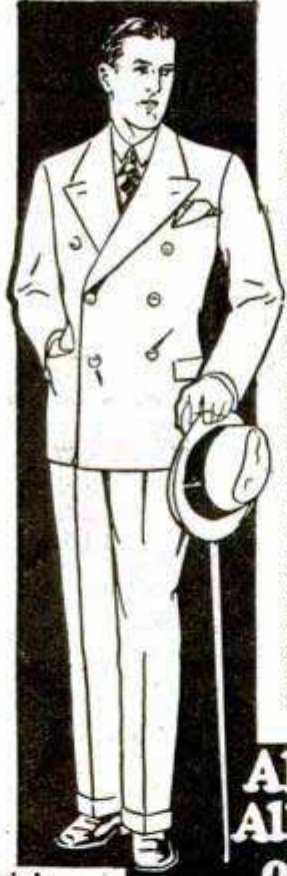

What You Don't Know — We Teach You!

Without one penny of cost, a course in **TAILORING SALESMANSHIP** given to every Fairbanks representative. Valuable selling outfit supplied free—makes its own sales wherever "demonstrated." Wonderful advertising helps furnished, to supply fresh "leads" from time to time. You see we aim to have you make big money and stay with us season after season. We'll show you how to build a **REPEATING** business, which you can call **YOUR VERY OWN.** A business as valuable as if you had invested thousands of dollars for "stock" and fixtures and advertising. Many Fairbanks representatives are earning \$5,000 to \$10,000 a year. These men have no secret system. They simply work. And the line is good enough to bring **DOUBLE** the commissions in return. *While we of course prefer full-time experienced salesmen, we have had such success in developing money-making representatives from clerks, mechanics and agents in other lines, that we are willing to start you on a part-time basis and teach you the business. Coupon and letter will have our immediate attention.*

All Wool
All
one
price
\$23.75
Tailored to
Measure

Free Course in Tailoring Salesmanship Given to All Our Men

FAIRBANKS TAILORING CO. ESTABLISHED 41 YEARS AGO
Dept. 332, Wabansia at Oakley Blvd., CHICAGO, ILL.

FAIRBANKS TAILORING CO.
DEPT. 332, Wabansia at Oakley Blvd., Chicago.

Your proposition looks good and I'd like to get the Fairbanks line on full-time part-time basis. I attach letter stating my entire selling and business experience. I mean business and if you have a line that **SELLS ON SIGHT,** I'll supply the necessary "LEG-WORK."

Name.....
Address.....
Age..... Married?.....



Business demands **SPEED!**
Aviation Service supplies it!

Prepare NOW for This Season's Big Chance
Be trained by a company actually in Air Transport Service

More than 10,000 new planes are being built at this time—with only 3500 licensed pilots available today. Thousands of pilots are needed to fly them—and 17 or 18 ground positions must be filled for every plane! What does this mean for YOU?

But to be licensed, you must pass government tests in Aerodynamics, Aerial Navigation, Airplane Ship Mechanics, Aircraft Motor Mechanics, etc. Simply learning to fly is not enough.

You can get the necessary complete training in the shortest possible safe time from the largest responsible company in Chicago actually engaged in air transport service, with hangar and shops on Chicago's million dollar airport and a school using the latest commercial equipment—the only one in Chicago with Ryan-Whirlwind, Laird-Commercial, and Swallow planes in its fleet.

A. S. T. renders contract commercial transport service to and from all points radiating from Chicago. You train only with U. S. licensed planes, pilots, mechanics, and instructors. Famous aces teach you to fly.

Full or spare time training, day or night classes, or home study. Five-year free employment service. Earn while you learn.

Be ready for this season's big chance for you. Write us about yourself. Our Mr. Theodore Walliser will discuss your qualifications with you personally.

Ask for "The Airway", a book of facts everyone interested in Aviation should have; enclose 10c, coin or stamps.

Send



10c

Address Department PM 3

AVIATION SERVICE AND TRANSPORT INC.
203 N. WABASH AVE., CHICAGO, U.S.A.

Aviation needs salesmen NOW. Write us!



\$100 to \$500 A Week Is Earned
By Cartoonists

Today
DO YOU LIKE TO DRAW?
Billy Hon's Famous Cartoon
Book Will Teach You

A short road to success for the beginner, as well as the advanced art student. A simple, complete course in cartooning, consisting of 30 lessons and over 300 drawings, by a successful newspaper cartoonist.

Sent postpaid for One Dollar.

WASLEY PUBLISHING CO., 210-A West 14th St., Los Angeles, Cal.

Learn Watchwork, Jewelrywork
and Engraving A fine trade commanding

a good salary, and your services always in demand. Address **Horological**, Dept. P, Bradley Institute, PEORIA, ILLINOIS, for our latest catalog.

BE AN OIL EXPERT!

Trained men needed! Geologists, Drillers, Refiners (Chemists and Still Men), Oil Salesmen, earn 2 to 10 times more than in other fields. Write today! **FREE** Booklet! Petroleum Engineering University, Dept. 223, Fort Wayne, Ind.

How Far Did 'LINDY' Fly?
FROM NEW YORK TO PARIS

Solve this Puzzle

The letters on the wing of this plane show the number of miles Lindbergh flew from New York to Paris. The letters in the alphabet are numbered—A is 1, B is 2, etc. Put down the number represented by each letter (C F A I) in the order they appear and you will have the number of miles Lindbergh flew from New York to Paris. Can you work it out? Send your answer today—no obligation or cost to you now, later, or ever. Be wise



AND WIN BUICK or

\$1800 Cash
I am going to give this beautiful new 1928 four door Buick Sedan, also a 1928 Nash Sedan also a 1928 Essex Sedan, also a 1928 Chevrolet Sedan—four cars and a large list of additional costly prizes—over \$5000.00. Cars will be delivered free to winners by nearest auto dealers. I have already given over fifty new automobiles to advertise our business and now YOU can get this new Buick Sedan or cash if you wish. You can win it. It costs nothing to try. First prize winner can have Buick or cash value of car (\$1295.00) and

\$505.00 EXTRA For Promptness!

Be prompt—just figure out what number each letter on the wing of the plane represents. Put them down in order shown. Mail me your answer with your name and address. That's all. Send no money. No obligation. All who answer can share in cash and prizes. In case of tie duplicate prizes given. Everybody rewarded. Hurry! \$505.00 cash extra for promptness.

T. W. Kelly, Mgr., Dept. 552

500 No. Dearborn St., Chicago, Ill.

4 Cars Given



How This Amazing Invention Actually "Talks For You"

KNIVES...SCISSORS...
TOOLS...
SHARPENED FREE!



and Why It Pays Men \$4 to \$14 The First Hour

At last! A PROVED 10-second seller! Put over by a sensational free demonstration! A unique discovery that sharpens knives, scissors, tools, perfectly in a surprising new way. No steel wheels or coarse abrasives. No knack or skill required. Sharpens BOTH SIDES of edge at same time! Fully patented—No competition—Exclusive territories. Read here how you can test it FREE—Then act quick.

YES, men, in a few words, here is the "how" and "why" of an absolutely new invention—a truly amazing device needed everywhere! Startling, yet so simple that it astonishes everyone, man or woman! For this patented wonder-worker does what was never before thought possible. Enables anyone to put a smooth, keen edge on knives, scissors, tools, etc. automatically! Does it in a few seconds at a mere twist of the wrist! No hard steel wheels that shave a knife edge and wear it away in a hurry. Made of special composition carundum that gives the finest cutting edge steel can take. No wonder it pays inexperienced salesmen, as well as old-timers, real money from the very first hour! No wonder so many report steady profits of \$60 to \$160 a week, and the happiest selling of their lives.

Millions of Prospects Wait

Wherever you go, in homes, stores, offices, everywhere this magical device is needed, yes often actually waited for. And why not? You know yourself that there isn't one woman in a hundred who can do a real satisfactory job of sharpening a carving or paring knife in any of the old-style ways. She is usually afraid to tackle her good knives for fear she'll nick up the edges and ruin them. And then she's always scared of cutting herself. And what woman even attempts to sharpen scissors—no matter how dull they are—she has to put up with them till the sharpener man comes round and right there it costs her a good little sum.

Men in stores and shops, butchers, mechanics, garage men, plumbers, shoemakers, every man who uses knives or tools needs this new kind of sharpener. They all see at a glance how much easier to use and how much more efficient it is. That's why Speedo salesmen often make \$4 to \$14 in a single hour practically without saying one word to their prospects.

Mail Coupon for Free Test Offer

So don't spend any more time on small profit propositions where you have to create desire. You can't afford to when this new "self-seller" pays plain ordinary men like J. Williamson, Wis., \$5 his first hour; Gray, Md., says, "Worked less than 5 hours yesterday and made over \$20." Orhoff, Va., reports clear profits of \$522 his first month. Speedo is a real article, sells for real money, pays real profits on every sale. We furnish everything. You make your own profit test FREE. So send at once for details of exclusive territory. Don't risk one penny. Simply get all the facts—TODAY.

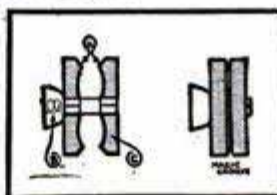

"Magic-Groove" Principle—Patented

See how this "Magic-Groove" method upsets all old-style ways of sharpening. Twin wheels (A) sharpen both sides of blade at same time. Spring action (B) keeps wheels in alignment. To sharpen, blade is simply rested in "Magic-Groove" and drawn back and forth. No need to tilt blade. Impossible to sharpen wrong. (C) Guide for sharpening scissors, too. Absolutely assures correct bevel. Good Housekeeping Inst., Modern Priscilla, and other experts recommend Speedo.



SHARPENS AUTOMATICALLY
The sharpening action with Speedo is absolutely automatic. Knives, tools, etc., are sharpened to the keenest edge in a few seconds. Nothing else even remotely like it. Mail coupon for free test.



**Central States
Mfg. Co.**
Dept. C-701
4500 Mary Ave.,
ST. LOUIS, MO.

Central States Mfg. Co., Dept. C-701,
4500 Mary Ave., St. Louis, Mo.
Please send free test offer and full details.

Name.....
Address.....
Town..... State.....



SHOW CARD LETTERING

Learn at Home

HERE is the very course you need if you want to get a good paying position as a Show Card Letterer or Sign Letterer, or have a business of your own. This course is complete and practical and especially arranged to meet the needs of the student who studies at home. It was written by E. L. Koller, Principal of the School of Art of the International Correspondence Schools, member of the American Federation of Arts, and The National Society of Craftsmen.

Mr. Koller has had twenty years' teaching experience, and his success in helping other men and women is an indication of what he can do for you.

H. L. Wood, a clerk, made more than \$700 "on the side" before he had completed his course and also won \$125 in prizes. Harry William Lord writes that he has more than doubled his salary as a result of studying this I. C. S. course in spare time. William Whitman, a former wagon builder, now has a sign painting business of his own and is earning nearly three times as much as he did before enrolling with the International Correspondence Schools.

There is no doubt that Show Card Lettering and Sign Lettering offer a real opportunity to ambitious men and women. Just mark and mail the coupon and we'll gladly send you a booklet telling all about the I. C. S. course in Show Card Lettering, or any other subject in which you are interested.

INTERNATIONAL CORRESPONDENCE SCHOOLS
 "The Universal University"
 Box 5513-F, Scranton, Penna.

Please send me one of your booklets containing information about the position or subject before which I am marking an X:

- SHOW CARD LETTERING
- ILLUSTRATING
- Office Management
 - Accounting and C.P.A. Coaching
 - Cost Accounting
 - Bookkeeping
 - Secretarial Work
 - Salesmanship
 - Advertising
- TECHNICAL AND INDUSTRIAL COURSES.
- Electrical Engineering
 - Electric Lighting
 - Mechanical Engineer
 - Mechanical Draftsman
 - Machine Shop Practice
 - Railroad Positions
 - Gas Engine Operating
 - Civil Engineer
 - Surveying and Mapping
- CARTOONING
- Commercial Correspondence
 - Stenography and Typing
 - English
 - Civil Service
 - Railway Mail Clerk
 - Common School Subjects
 - High School Subjects
- Steam Engineering
 - Architect
 - Architects' Blueprints
 - Contractor and Builder
 - Architectural Draftsman
 - Structural Engineer
 - Chemistry Pharmacy
 - Automobiles Radio
 - Mathematics

Name.....

Street Address.....

City..... State.....

Canadians may send this coupon to International Correspondence Schools Canadian, Limited, Montreal, Canada



McCleary Sanitarium at Excelsior Springs, Mo.—
 the largest institution in the world devoted to the
 treatment of piles and other rectal troubles.
 (Only curable cases are accepted.)

Pay Nothing If Not Cured

That's our offer to Pile and Rectal sufferers everywhere. Let us prove to you, at our own risk that surgery is not necessary in the treatment of piles—that the McCleary Mild, Serum-Like treatment heals surely, quickly and safely. Thousands upon thousands have already learned this to their everlasting joy and gratitude. Let us send you the proof free.

Free Book Send name and address today for a copy of Dr. McCleary's new book, copyrighted, fully illustrated and printed in colors. We gladly send it postpaid, in plain wrapper, Free for the asking. Write today.

The McCleary Sanitarium
 654 Elms Blvd., Excelsior Springs, Mo.

DON'T WEAR A TRUSS

BE COMFORTABLE—

Wear the Brooks Appliance, the modern scientific invention which gives rupture sufferers immediate relief. It has no obnoxious springs or pads. Automatic Air Cushions bind and draw together the broken parts. Nossalvesor plasters. Durable. Cheap. Sent on trial to prove its worth. Beware of imitations. Never sold in stores nor by agents. Every appliance made to special order and sent direct from Marshall. Full information and booklet sent free in plain, sealed envelope.



BROOKS APPLIANCE CO., 107A State St., MARSHALL, MICH.

FACE ERUPTIONS

such as pimples, boils, carbuncles, rose nose and black heads often result from conditions that are more than skin deep, indicating the need for general treatment instead of mere salves and lotions. KLEERSKIN, a safe and pleasant internal remedy, gets at the source of these disorders and clears the skin until it is smooth, soft and healthy. KLEERSKIN is from the prescription of a well known physician. Experience and clinical records prove it will do all we claim. Full information mailed upon request. Write today to Medco Medical Co., 503 Ridge Bldg., Kansas City, Mo.



**Beautify
your NOSE**

to shapely proportions—
while you sleep!



ANITA NOSE ADJUSTER
 is SAFE, painless, comfortable. Speedy, permanent results guaranteed. Doctors praise it. No metal to harm you. Small cost.

Gold Medal Won 1923

Write for FREE BOOKLET



ANITA CO.,

312 ANITA Bldg., NEWARK, N. J.

Eight Years Ago this Man Piloted the First Plane Across the Atlantic

Today he devotes his entire time to training Men like *You* for Aviation

EIGHT years ago the name Walter Hinton was blazoned in the headlines from country end to country end. He was pilot of the famous NC-4 flight, the very first airplane to fly completely across the Atlantic. A few years later, he again leaped into the limelight, for piloting the first plane from North to South America. The year following, he was the talk of millions once more, because of his great flight to the wilds of the upper Amazon.

But a brilliant career as an aviator is not all that so admirably qualifies him for his present work—that of training men at home for a future in the greatest industry of the age. During the war, Hinton was ordered by the U. S. Navy to teach others to fly—he is one of those fortunate individuals who knows how to impart to others the valuable, practical knowledge he has acquired. Hinton, formerly one of the world's outstanding flyers, is now one of Aviation's greatest instructors.

Train Quickly at Home

Through a course that covers Aviation from A to Z—the cream of his broad experience and careful study—Hinton trains you *right at home* in the fundamentals of Aviation. How planes are designed and constructed; how they're assembled and aligned; what makes them fly; all about their motors, ignition systems, carburetion, instruments, theory of flight, navigation and countless other important facts that only a man with Hinton's experience can give you.



Hinton and The Prince of Wales

The Prince of Wales congratulating Hinton on his history-making flight across the Atlantic in the NC-4.

Hinton Stakes HIS Future on YOUR Future

Today Hinton is staking his entire future upon the futures of his students. *His* success henceforth will be measured in terms of *their* success. He himself is on the job every day carefully supervising each detail of the work of this great Institute. He himself takes personal charge of all instruction. He gives his students not only the fundamentals, which are absolutely necessary for success, but he helps them select their place in Aviation.

The Future in Aviation

1928 will be Aviation's biggest year. Planes will be produced by the thousands. Lines carrying passengers, mail, parcel post, express and even freight will grow as never before. There will be an ever-increasing demand for trained workers of every description—men who can build planes, operate them, sell them, and service them. Already the men who have the knowledge that Hinton's course gives are picking off *real* jobs. And during the months just ahead, the chances for *big, quick SUCCESS* will be even greater.

get his FREE BOOK

Find out **QUICK** how to get into the world's fastest growing industry—and to get ahead with Hinton's backing. Send today for his free book. In it he tell you how the industry is growing—the tremendous strides already made—about his plan for putting his years of well known experience right into your hands ready to use and turn into cash. He tells you what he is doing for others—and exactly *how* and *why* his training can open up a wonderful future for **YOU**. Get the book—the facts. Rush the coupon today.



Lieut. Walter Hinton

Hinton's knowledge has been proved by the acid test of **RESULTS**. On many flights, he had to do all his own repair work, under the most adverse conditions. On other occasions he has flown over uncharted country where a forced landing would have meant disaster. There is no phase of the industry he has not studied—there is almost nothing in connection with Aviation that he does not know from first hand experience. If you want to get into Aviation and get ahead fast—either as a pilot or in one of the many well-paid ground positions—where could you pick a better man to train you than Hinton?



Get Facts Quick

Walter Hinton, Pres., 1-C
Aviation Institute of U. S. A.,
1115 Connecticut Ave.,
Washington, D. C.

Dear Lieut. Hinton: Send me your **FREE** Book telling how you can train me in Aviation *right at home*, for a well-paid job on the ground or in the air.

Name..... Age.....

Street.....

City..... State.....



Aviation Institute of U. S. A.

Walter Hinton, Pres.

1115 Connecticut Ave., Washington, D. C.

PAIN and DISEASE

Quickly Conquered by

VIOLET RAY



Let us tell you how thousands of men and women suffering from rheumatism, neuritis, paralysis, nervousness, skin diseases, headaches, constipation, sprains, prostate trouble, goitre and many other ailments, even hay fever and asthma, have found quick relief—new health and vitality with this marvelous, scientific invention. Pains vanish almost instantly.

Violetta

Ten Days FREE Trial

Endorsed and used by hospitals, sanitariums and physicians. Every home can now have one. Saves hours, days, months of suffering. No medicine. Painless, pleasant treatment. Only the violet ray can penetrate to every nerve affected. Simple, safe, painless—anyone can use VIOLETTA. Why suffer pain and poor health when you can try VIOLETTA 10 days FREE.

This Book FREE

Tells all about violet rays—how this marvelous discovery by Nikola Tesla, the electrical wizard, now brings this mysterious curative power to all. Contains many astounding testimonials from our thousands of satisfied users. Send for the facts and our liberal trial offer today. Mail the coupon now.



VI-REX CO., Dept. 331
2304 Warren Avenue, Chicago

VI-REX CO., 2304 Warren Ave., Dept. 331 Chicago
Please send me your free book on Violet Rays and details of your 10 days' free trial offer.

Name.....
Address.....
City..... State.....
Ailment.....

QUIT TOBACCO



No man or woman can escape the harmful effects of tobacco. Don't try to banish unaided the hold tobacco has upon you. Join the thousands of inveterate tobacco users that have found it easy to quit with the aid of the Keeley Treatment.

KEELEY TREATMENT STOPS Tobacco Habit

Quickly banishes all craving for tobacco. Write today for Free Book telling how to quickly free yourself from the tobacco habit and our Money Back Guarantee.

THE KEELEY INSTITUTE
Dept. A907 Dwight, Illinois

NO JOKE TO BE DEAF

—EVERY DEAF PERSON KNOWS THAT



I make myself hear, after being deaf for 25 years, with these Artificial Ear Drums. I wear them day and night. They stop head noises and ringing ears. They are perfectly comfortable. No one sees them. Write me and I will tell you a true story, how I got deaf and how I make you hear. Address



GEO. P. WAY, Artificial Ear Drum Co. (Inc.)
80 Hoffman Bldg., 2539 Woodward, Detroit, Mich.



BOW LEGS and KNOCK-KNEES UNSIGHTLY

Those afflicted with BOW LEGS should wear the "PERFECT LEG FORMS" and overcome this deformity. Trousers hang perfectly straight. Made of the highest grade Aluminum. Sanitary, Light and Durable. Easy to put on or off. Send for booklet showing photos of men with and without the "PERFECT LEG FORMS."

PERFECT SALES CO.
140 N. Mayfield Ave. Dept. S Chicago, Ill.

DO YOU

WANT a new business profession of your own, with all the trade you can attend to? Then become a foot correctionist, and in a few weeks earn big income in service fees,—not medical nor chiropody—easy terms for home training, no further capital needed, no goods to buy, no agency. Address

Stephenson Laboratory, 1 Back Bay, Boston, Mass.

Save Your Feet

When all else fails, end your suffering with the Heefner Arch Support



No Metal Fully patented. It re-adjusts the entire foot. Write for free book and statements from doctors and users.

Heefner Arch Support Co. 661 M. E. Taylor Bldg. Louisville, Ky.



BUCHSTEIN'S FIBRE LIMB

Is soothing to your stump—strong, cool, neat, light. Easy payments. Braces for all deformities. D. BUCHSTEIN CO. 610 3rd Ave., So. MINNEAPOLIS, MINN.

Send for Catalog Today

Skin Troubles

Cleared up—often in 24 hours. To prove you can be rid of Pimples, Blackheads, Acne Eruptions on the face or body, Barbers' Itch, Eczema, Enlarged Pores, Oily or Shiny Skin, simply send me your name and address today—no cost—no obligation. CLEAR-TONE tried and tested in over 100,000 cases—used like toilet water—is simply magical in prompt results. You can repay the favor by telling your friends; if not, the loss is mine. WRITE TODAY. E. S. GIVENS, 428 Chemical Bldg., Kansas City, Mo.

1928 1929 1930 1931 1932 1933 1934 1935 1936 1937



Will You Be Clerk or Manager Ten Years from Now?

SURELY, this could never happen to *me*," you say—"that I should be sitting at the same desk—be doing the same work, *for ten straight years!*"

But wait a minute—

Exactly the same thing is happening to thousands upon thousands of men thruout the country. It has probably happened to men right in the company you now are working for. *And—unless you deliberately fit yourself for a better job—there is a very good chance that it will happen to you!*

Unthinkable? That's what R. M. Whitney, of Rochester, N. Y., said to himself. Yet lack of training kept him slaving away at low wages for more than twenty years . . .

Trebled His Salary in Three Years

—For more than twenty years, till finally, at the age of 47, and still receiving only thirty dollars a week, R. M. Whitney resolved to be a bookkeeper no longer. He enrolled with LaSalle for training in Higher Accountancy, and completed the course. Almost immediately came the offer of a bigger job.

Less than three years later, the Davenport Machine Tool Company—the very company he had worked for as a clerk—invited him to come back. He returned as Auditor, at a salary-increase of better than 300 per cent.

Today, he is Treasurer of this great company; and in a letter to LaSalle, after commenting on the opportunities LaSalle affords to men in their forties or early fifties, he adds, "And for the young man, who is just getting a foothold in the business world, LaSalle Extension University training is the most profitable investment he could make."

Says Good-bye to Clerkship— Now Heads Successful Firm

We have told you about a man who *waited*—at a cost to himself of probably not less than \$100,000. Now consider the experience of a younger man—G. Roy Eshelman, of Decatur, Illinois—

Eshelman was occupying a subordinate position in the purchasing department of a manufacturing concern—salary \$16 a week. Visualizing the opportunities for skilled accountants, he enrolled with LaSalle for training in Higher Accountancy.

"Thru this training," writes Mr. Eshelman, "I became interested in the Auditing Department and often remained after working hours watching the Auditor at his work. Observing my interest, he soon placed me in his department at a 50% increase in pay, and as I progressed with my LaSalle work, I was shortly rewarded with an additional 40% increase.

"My studies rapidly equipped me to strike out for myself, and at present I have an extensive practice as a Public Accountant, employing four accountants. It is sufficient to say that my present income is *many, many times greater than when I enrolled.*"

Send For These Two Books and Start Toward Real Success

Need you hear more before you investigate the opportunities in Accountancy? Shall we tell you about Pentland—or Gray—or McDuffie—all of them commanding incomes better than \$10,000 a year and all of them still in their thirties?

Or will you face the problem of your future NOW—and send to LaSalle and get further facts and particulars?

Without cost or obligation, the coupon will bring you two books—one a 64-page book entitled, "Accountancy, the Profession that Pays;" the other, "Ten Years' Promotion in One."

How about those next ten years—will you wait, or will you START TODAY to realize the opportunities that lie ahead of you thru sound and practical home-study business training?

Measure your grit and ambition by what you do with this coupon—NOW.

— — — Find Yourself Thru LaSalle — — —

LaSalle Extension University

The World's Largest Business Training Institution

Dept. 364-HR

Chicago

Opportunities in Accountancy—Check below and we will send you copy of "Accountancy, the Profession that Pays," also copy of "Ten Years' Promotion in One," all without obligation.

Higher Accountancy:

Leading to position as Auditor, Comptroller, Certified Public Accountant, Cost Accountant, etc.

Other LaSalle Opportunities: If more interested in one of the other fields of business indicated below, check here:

- Business Management
- Modern Salesmanship
- Traffic Management
- Railway Station Management.
- Law: Degree of LL.B.
- Commercial Law
- Industrial Management
- Business Correspondence

- Banking and Finance
- Modern Foremanship
- Personnel Management
- Expert Bookkeeping
- C. P. A. Coaching
- Business English
- Commercial Spanish
- Effective Speaking
- Stenotypy



Name

Present Position

Address

O. C.
MILLER

Director
Extension
Work
American
School



The American School

A million Dollar *No-Profit* Educational Institution, now offers men a *double* service—training for a specific job, then help in finding the job. For one small price, on terms of only \$6.00 a month, you are now assured of definite benefits, both in position and salary. Write for complete information—*today!*

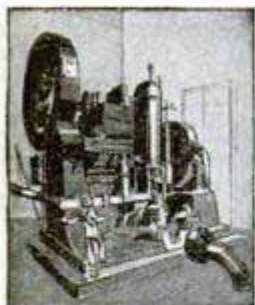

No machine can be built until the Draftsman first builds it ON PAPER. My training prepares you for this work.



Never has the world seen anything like the building boom of today. This has created enormous demand for real Draftsmen.

5 BIG-PAY Branches

The big money in Drafting goes to men who specialize in Machine Design, or Electrical Drafting, or Architectural Drafting, or Structural, or Automotive. It is not enough merely to know *general* Drafting practice. You must know how to calculate and design and plan original work. You need many Engineering subjects to fill the kind of a Drafting position that pays \$60 to \$125 a week. The American School now includes *this specialized training* in its *Drafting course*.

Costly Drafting Outfit Given!

Fine, imported instruments like these help you learn Drafting quickly and easily. These standard quality, full size instruments, board, table, triangles, T square, ink, protractor, etc., given to every student without extra cost.

O. C. Miller, Director Extension Work

The American School

3 Drafting

to prove you can

We have invented a new, simplified way to teach Drafting—the first real improvement in Drafting home instruction in history. We want you to see a few of these new Job-lessons, try them, test your own ability to master them—without one penny of cost or obligation. For instance, you will see how we get away from the “copying” methods used in the past, so you develop into a DRAFTSMAN, instead of a “tracer.” See for yourself the ingenious new method which compels you to think, to solve problems, to do actual Drafting-room jobs from the very first lesson!

A New, Rapid, Simplified Training

Copying drafting lessons prepares you to be only a “tracer.” This new “Job-Method” gives you actual drafting-room jobs in a new one-step-at-a-time way. With pictures which you can understand almost without reading the “lessons.” And that is why the American School-trained Draftsmen can qualify for a good job at big pay when they graduate.

Win Success Thru Drafting

Drafting is easy, fascinating work. Short hours. Big pay. And the Draftsman is always in line for promotion to executive positions. This training is *complete*. It includes high school subjects (if you need them) and all the Engineering and Mathematics Drafting experts require.



FREE Job Service!

The American School now offers its students and graduates, without cost, the services of an efficient employment department keeping in constant touch with employers of Draftsmen all over the U. S. We have placed hundreds of men in good, big-pay Drafting positions. We've made this training so complete, so practical, so easy to master, that our students are bound to **make good**. And so, because the demand for real Draftsmen continues to exceed the supply and because this training actually prepares men for good Drafting positions we back it with a Free Employment Service.

Dept. D-374
Drexel Avenue and
58th St., CHICAGO

Lessons *Actually* FREE

Learn at home in spare time!

Draftsmen Wanted!

\$60 to \$125 a Week!

yourself. Plan your future in Drafting. Even if you have only common schooling, even if you know nothing of Drafting, we guarantee to make you a real Draftsman or to refund your money! Special surprise offer right now to the first 500 men who answer this ad—reduced price, easy terms. Coupon brings complete information.

70,000 fine jobs advertised last year. Get ready to fill one. Get out of the rut. Make something of



Electricity needs Draftsmen who know Electrical principles as well as general Drafting practice. I give you this training.



The demand for Draftsmen experienced in concrete and structural steel work is enormous. Many big-pay positions open.



Every great Auto factory employs Draftsmen who specialize in Automotive work—men who design bodies, plan engines, etc.

I Will Make This Contract With You



American School
—the Million Dollar
Educational Institution



WHEN you enroll for our home-training in Drafting, we agree to give you:

1. Complete Drafting training, by the new Practice-Method.
2. Professional Drafting Outfit, as illustrated.
3. We will help you get a good Drafting position at a substantial increase in pay,

4. or we'll refund every cent of your money.

O. C. Miller
Director Extension Work

Coupon

Brings 3 Lessons FREE!

Get them. Test your own ability to learn Drafting and get ready for a fine job and big pay.

Coupon also brings surprise offer, and complete information about your opportunities for success in Drafting. *Mail It Today!*

Read These Letters!

City of Chicago
Department of Buildings
Gentlemen: The same day I received my diploma I got word that I was one of the two candidates who had successfully passed the examination for Deputy Commissioner of Buildings of the City of Chicago, a position paying \$3600 per year.

There were eight applicants examined besides myself, all men well known to the architectural and engineering profession. Seven of these failed to obtain a passing grade of 70%. My grade was 84.69. Inasmuch as I failed to pass this same examination three years before, my present success is mainly due to the knowledge gained through your School.

Yours very truly,
ROBERT KNIGHT

Got His Draftsman's Job

"I wanted to let you know how I came out in getting that job at the Brownell Co., Dayton, Ohio. I was to start and have a trial at Drawing, and I am still in the Drawing room. The engineer seems to like the work I make, and also the other draftsmen. I thank the school very much for getting me in at this place, because your letter of recommendation helped me a whole lot to get the job."

BERNARD WEBER,
730 St. Nicholas Ave., Dayton, O.

Liberty High School
Bethlehem, Pa.

Dear Sirs:—This is to thank the American School for all that you have done for me since I signed up for the Drafting and Design Course.

In the eight years since then, I have gradually climbed from the position of tracer to that of Head of the Department of Machine Drawing and Design in our magnificent new \$2,000,000 High School here, at many times the salary which I received at that time.

The officials of the Pennsylvania State Department, and Dr. Wm. C. Ash of the University of Pennsylvania, all claim that our Course in Drafting and Design is the best now being taught in this state. Every drafting graduate that we have turned out has proved successful, and one is now Chief Draftsman in a local steel concern. Yours sincerely,
J. S. LEAR

Has Charge of Large Jobs

"Even before I had finished my course, I was put in charge of large construction jobs in different cities. I have been doing that ever since, and the jobs are getting larger all the time. I owe my success to the American School because of the knowledge I gained in mathematics and calculations."

ELMER L. LAMB,
1306 Smith St., Peoria, Ill.

3 Drafting Lessons *Actually* FREE

O. C. MILLER, Director Extension Work
AMERICAN SCHOOL

Dept. D-374, Drexel Ave. and 58th St., Chicago.

Rush 3 Free Drafting Lessons, Job and Raise Offer, complete information, money-back guarantee, etc., to prove I can become a real Draftsman at home in spare time.

Name.....

Street No.....

City..... State.....

You can play the HAWAIIAN GUITAR just like the Hawaiians!

Play all the latest hits just as the Hawaiians do. Be the most popular member of your set, a happy crowd always around you, everybody enjoying and admiring your playing. Get in on all the good times. Entertain your friends—or play professionally. We will help you.



Native Hawaiian expert directs you

You get expert instruction, directed by a world-famous player and teacher, Prof. Walter Kolomoku. He quickly reveals to you the secrets of this fascinating instrument.

Complete Conservatory Course

You get 52 complete printed lessons. Nothing is omitted. Pictures explain every move. And no matter how

little you know about music when you begin, no matter if you have never touched a musical instrument, you can positively learn to play by our plain, easy picture method. You are sure to learn! What we can do for others we can do for you. 51,000 successful students. This record assures your success.

Learn at home in spare time

Study in spare time—in absolute privacy—when you like—as long as you like. Even if you don't know one note from another, our method is so simple you begin a piece your first lesson. In half an hour you can play it!

Only 4 motions to learn

Then you can play any music—popular songs, classical, old-time melodies, native Hawaiian airs—or real jazz—separately or with accompaniment. You'll never be lonesome after you learn to play on this beautiful Hawaiian Guitar.

GIVEN when you enroll— \$15 to \$18 Hawaiian Guitar

With Genuine Seal Grain Fabrikoid Cover and Complete Playing Outfit

Reliable retailers ask \$15 to \$18 for a similar instrument and outfit without the fine Fabrikoid Case, which alone is valued at \$3.50. Yet you receive this sweet-toned splendidly built Hawaiian Guitar, case and entire playing outfit, including picks, steel playing bar, tuning pipe, etc., without one penny of expense, as soon as you enroll.

Pay as you play

We make it easy for you. Start any time with a small first payment—then pay while learning. It comes to only a few cents per lesson. And bear in mind: Your only investment is the cost of the course—we furnish everything else.

FREE Our new illustrated book, "The Romance and Enchantment of Hawaii—Its Music and Its People." A book you will want to keep. You won't lay it down until you have read it from cover to cover. Send for your copy today.

OTHER COURSES: Tenor Banjo, Violin, Tiple, Tenor Guitar, Ukulele, Banjo Ukulele—well-known instructors.

FIRST HAWAIIAN CONSERVATORY OF MUSIC, Inc.

9th Floor Woolworth Bldg., Dept. 548, New York, N. Y.
Approved as a Correspondence School Under the Laws of the State of New York.

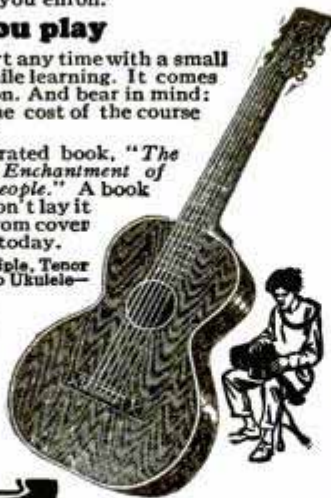

Send This Coupon for Liberal Offer!

FIRST HAWAIIAN CONSERVATORY OF MUSIC, Inc.
9th Fl., Woolworth Bldg., Dept. 548, New York, N. Y.

Please send full information about your 52-lesson Hawaiian Guitar Course. I am not obligated to enroll unless I want to.

Name _____

Address _____

City _____ State _____

Learn to Dance

This New Easy Way

You can learn all the modern dances—Charleston, Black Bottom, Valencia, Canter, French Tango, St. Louis Hop, Latest Waltzes, Fox Trots, etc., at home easily and quickly. New chart method makes dancing as simple as A-B-C. No music or partner required. Learn anywhere, anytime. Win new popularity. Be in demand at parties. Same course of lessons would cost \$20 if taken privately.



Send No Money

Just send your name and address. We'll ship the complete course—323 pages, 49 illustrations—without one cent in advance. When package arrives, hand postman only \$1.98, plus delivery charges, and this wonderful course is yours. Try for 5 days. Money back if not delighted. Send your name NOW. Bargain Book Catalog, 4c.

FRANKLIN PUBLISHING COMPANY
800 No. Clark St. Dept. 9412 CHICAGO

Learn to PAINT SIGNS and SHOW CARDS

We quickly teach you by mail, or at school, in spare time. Enormous demand. Big future. Interesting work. Oldest and foremost school.

EARN \$50 TO \$200 WEEKLY

John Vaasos, N. Y., gets \$25 for single show card. Crawford, B. C., writes: "Earned \$200 while taking course." Don't delay. Send today for complete information, samples and guarantee.

DETROIT SCHOOL OF LETTERING
154 Stimson Ave. Est. 1899/ DETROIT, MICH.

"STAMMERING

Its Cause and Cure"

You can be quickly cured if you stammer. Send 10 cents, coin or stamps, for 288 page cloth bound book on Stammering and Stuttering. It tells how I cured myself after Stammering and Stuttering for 20 years. BENJAMIN N. BOGUE
11103 Bogue Building, 1147 N. Ill. St. Indianapolis

Big Money for You as an Automobile Mechanic

These four practical books, written by five well known teachers of automobile practice, will teach you right in your own home during your leisure time just what you need to know about automobile troubles and repair. They will teach you automobile construction, maintenance and repair as practiced by experts and will help you to earn an expert's pay.

Practical Automobile Library: Four Books—\$1.50 in 10 days and \$2 monthly for 6 months—only \$13.50 in all!

Hundreds of question-answering diagrams—hundreds of clearly-marked illustrations—make the books plain and readily understandable. All the explanations and descriptions are clear, simple, direct. Every chapter is packed with definite, step-by-step, how-to-do-it information. Here is your opportunity to enter a big-pay field.

FREE TRIAL

Send No Money
Mail the Coupon



FREE EXAMINATION COUPON

McGraw-Hill Book Co., 370 Seventh Ave., New York

Send me for 10 days' free examination the New Practical Automobile Library. If satisfactory, I will send you \$1.50 in 10 days and \$2.00 monthly until the special price of \$13.50 is paid. If not wanted, I will return the books at your expense.

Signed _____

Address _____

City and State _____

Position _____

Employer _____ P. M.—3-28

Strongfort—Man Builder tells you how to be powerful



STRONGFORT
Builder of Men

YOU—like every other man worthy the name of "man"—have a burning desire to be strong—to be dynamic—to be vigorous—to be capable of defense—to be an outstanding figure—admired and respected by men and women. You know the penalty of weakness. You know that the skinny fellow with hollow chest and sallow face—like the flabby fellow with too much stomach and too little wind—is a ridiculous object, laughed at and despised—undesirable in company, unsought as a companion.

You don't have to be one of this kind. *You can be a real 100 per cent. man.* You can be just such a man as any one of the splendid fellows I have instructed. The world holds no parallel for the work I have accomplished in upbuilding weak men. And what I have done for others I can do for you through **STRONGFORTISM**—my world famed Course of health and strength building.

STRONGFORTISM

Will Do Wonders for You

I have made powerful men out of mere weaklings and many have become nationally famous. You may not seek tremendous strength. You may not want to become a professional strong man. But you do want good health and manly strength—*every man wants that!* You want energy and vitality. You want a clear, unflinching eye and a steady nerve. You want courage, "sand" and pep! And you can get all these by following in the paths in which I have directed thousands—*you can be a real man.* Above all, you can rid yourself of disheartening weaknesses and blighting ailments such as constipation, indigestion, rheumatism, high blood pressure, nervousness, lassitude, insomnia, catarrh, chronic colds, etc., if you are so afflicted.

Vibrant Life Awaits You

Many young men write me the most pathetic letters about their sorry plight and their hopeless state of mind. What I reveal to them, what I do for them, transforms their lives, makes them happy, joyous souls, with an entirely new outlook on life. My methods give to them speedily a bodily feeling so new, so different, so vigorous that they are like men reborn—vibrant with life, bubbling with energy, eager for contact with others, full of ambition and pep. Results are truly marvelous. Thousands testify to this fact. They tell a story of rejuvenation, restoration and rebuilding of the human body that is beyond dispute.

My Scientific Methods Are Beyond Physical Culture

Do not confuse the *Science of STRONGFORTISM* with gymnastic or ordinary physical culture courses. I am not merely a muscle developer. I am far more than that, for I have devised a system that restores sick, ailing, hopeless men to the Glory of Powerful Manhood—to the Summit of Health, Strength, Happiness and Success—without the use of dope and drugs, lifting and stretching-machines, unnatural deep breathing, starvation diets, nerve-racking routines or other foolish fads and fancies. What I have done for thousands of others I can do for you.

SEND FOR MY Free Book

The experience and research of a lifetime are contained in my wonderfully instructive book, "*Promotion and Conservation of Health, Strength and Mental Energy.*" It will tell you frankly how you can make yourself over into a vigorous specimen of vital manhood. It will teach you how to fit yourself to be a credit to your social and business associates. Just mark the subjects on the free consultation coupon on which you want special confidential information and send to me. It's a manbuilder and a lifesaver. Send for my **FREE BOOK**—Right Now. **TO-DAY!**

Send This **FREE** Consultation Coupon ABSOLUTELY CONFIDENTIAL

Mr. Lionel Strongfort, Strongfort Institute, Dept. 439, Newark, N. J.—Please send me absolutely free my copy of your book, "**PROMOTION AND CONSERVATION OF HEALTH, STRENGTH AND MENTAL ENERGY.**" I have marked (X) before subjects in which I am interested.

.. Catarrh	.. Constipation	.. Weak Heart
.. Colds	.. Overweight	.. Great Strength
.. Asthma	.. Weak Back	.. Lung Troubles
.. Headache	.. Weak Eyes	.. Round Shoulders
.. Rupture	.. Rheumatism	.. Stomach Disorders
.. Thinness	.. Nervousness	.. Increased Height
.. Pimples	.. Short Breath	.. Muscular Development

Other Ailments.....

Name.....

Age..... Occupation.....

Street.....

City..... State.....

STRONGFORT INSTITUTE

LIONEL STRONGFORT, DIRECTOR, L.

Physical and Health Specialist

DEPT. 439

NEWARK, NEW JERSEY, U. S. A.



“I’m going to raise his salary”

“I’ve had my eye on him for some time and I know he can handle bigger work.

“He studies those I. C. S. textbooks every chance he gets, and I want to tell you it has made him a valuable man for this business.

“I’m going to raise his salary and give him that new job we were talking about. I wish we had more men like him.”

How do you stand when your employer checks up his men for promotion? Does he pass you by as just a routine worker, or does he think of you as a man who is ambitious to get ahead? Won't you be far more likely to get the promotion if he knows you are studying at home and are really preparing yourself to handle bigger work?

Think it over. Then act. It takes only a moment to mark and mail the coupon and find what the International Correspondence Schools can do for you, yet that one simple little step may be the means of changing your whole life.

Mail the Coupon for Free Booklet

INTERNATIONAL CORRESPONDENCE SCHOOLS

“The Universal University”
Box 5515-F, Scranton, Penna.

Without cost or obligation, please send me a copy of your booklet, “Who Wins and Why,” and full particulars about the subject before which I have marked X in the list below:

BUSINESS TRAINING COURSES

- | | |
|--|---|
| <input type="checkbox"/> Industrial Management | <input type="checkbox"/> Advertising |
| <input type="checkbox"/> Personnel Management | <input type="checkbox"/> Business Correspondence |
| <input type="checkbox"/> Traffic Management | <input type="checkbox"/> Show Card and Sign Lettering |
| <input type="checkbox"/> Accounting and C. P. A. | <input type="checkbox"/> Stenography and Typing |
| Coaching | <input type="checkbox"/> English |
| <input type="checkbox"/> Cost Accounting | <input type="checkbox"/> Civil Service |
| <input type="checkbox"/> Bookkeeping | <input type="checkbox"/> Railway Mail Clerk |
| <input type="checkbox"/> Secretarial Work | <input type="checkbox"/> Common School Subjects |
| <input type="checkbox"/> Spanish <input type="checkbox"/> French | <input type="checkbox"/> High School Subjects |
| <input type="checkbox"/> Salesmanship | <input type="checkbox"/> Illustrating <input type="checkbox"/> Cartooning |

TECHNICAL AND INDUSTRIAL COURSES

- | | |
|---|--|
| <input type="checkbox"/> Electrical Engineering | <input type="checkbox"/> Architect |
| <input type="checkbox"/> Electric Lighting | <input type="checkbox"/> Architects' Blueprints |
| <input type="checkbox"/> Mechanical Engineer | <input type="checkbox"/> Contractor and Builder |
| <input type="checkbox"/> Mechanical Draftsman | <input type="checkbox"/> Architectural Draftsman |
| <input type="checkbox"/> Machine Shop Practice | <input type="checkbox"/> Concrete Builder |
| <input type="checkbox"/> Railroad Positions | <input type="checkbox"/> Structural Engineer |
| <input type="checkbox"/> Gas Engine Operating | <input type="checkbox"/> Chemistry <input type="checkbox"/> Pharmacy |
| <input type="checkbox"/> Civil Engineer | <input type="checkbox"/> Automobile Work |
| <input type="checkbox"/> Surveying and Mapping | <input type="checkbox"/> Airplane Engines |
| <input type="checkbox"/> Metallurgy and Mining | <input type="checkbox"/> Agriculture <input type="checkbox"/> Navigation |
| <input type="checkbox"/> Steam Engineering | <input type="checkbox"/> Mathematics <input type="checkbox"/> Radio |

Name.....

Street Address.....

City..... State.....

Occupation.....

Persons residing in Canada should send this coupon to the International Correspondence Schools Canadian, Limited, Montreal, Canada

Electric Refrigeration



New Giant Industry Needs Trained Men

Trained men are needed for installing, servicing and selling electric refrigerators. Positions pay \$2,500 to \$10,000 a year! Big opportunity for ambitious men who know the principles of Refrigeration to fill high paid positions.

You Can Study Refrigeration at Home

Our complete Home Study Course in Electric Refrigeration prepares you in your spare time. Easily learned. Common school education is enough. Previous experience unnecessary.

Write for Free Illustrated Booklet

Get in on the ground floor of this magic, booming industry. Our free illustrated booklet tells you all about the opportunities and how to become a trained Refrigeration Expert. Write today.



UTILITIES ENGINEERING INSTITUTE

Dept. 13, 3120 N. Clark St., CHICAGO, ILL.



Wonderful, new device, guides your hand; correct your writing in few days. Big improvement in three hours. No failures. Complete outline FREE. Perfect Penmanship Inst. D-34, St. Louis, Mo.



Play “JAZZ” on the Saxophone

Become a musician so quickly as to astound everyone. Learn by playing real music—instead of tiresome “exercises.” You'll soon become the most popular person in your “set.”

New Easy Method

is a revelation. Nothing else like it for thoroughness and rapidity. So simple that young and old find it easy to play with amazing skill. No “trick music”—but actual notes, learned quickly right in your own home.

FREE BOOK and Demonstration Lesson

offer this wonderful musical opportunity. Send for them today before copies are exhausted. You'll be astounded, thrilled, fascinated, at this easy, rapid way to become a veritable master of your favorite instrument. Instruments supplied when needed, cash or credit.

LEARN TO PLAY ANY INSTRUMENT

- | | |
|-----------------------------------|--|
| <input type="checkbox"/> Piano | <input type="checkbox"/> Mandolin |
| <input type="checkbox"/> Organ | <input type="checkbox"/> Drums and Traps |
| <input type="checkbox"/> Violin | <input type="checkbox"/> Harmony and Composition |
| <input type="checkbox"/> Clarinet | <input type="checkbox"/> Sight Singing |
| <input type="checkbox"/> Flute | <input type="checkbox"/> Ukulele |
| <input type="checkbox"/> Harp | <input type="checkbox"/> Piccolo |
| <input type="checkbox"/> Cornet | <input type="checkbox"/> Trombone |
| <input type="checkbox"/> Cello | <input type="checkbox"/> Saxophone |
| <input type="checkbox"/> Guitar | <input type="checkbox"/> Voice and Speech Culture |
| | <input type="checkbox"/> Automatic Finger Control |
| | <input type="checkbox"/> Piano Accordion |
| | <input type="checkbox"/> Banjo (Plectrum, 5-String or Tenor) |

U. S. SCHOOL OF MUSIC, 73-A Brunswick Bldg., New York City
Send me your amazing free book, “Music Lessons in Your Own Home,” with introduction by Dr. Frank Crane, also DEMONSTRATION LESSON. This does not put me under any obligation. (Please Write Plainly.)

NAME.....

ADDRESS.....

INSTRUMENT..... Have you this inst.?



Free

**1 Regular
25c Vial**

(of which more
than 1,000,000
have been sold)

So positive are we that you will find Merke Derma Vials of wonderful help in ending dandruff and falling hair that we offer you **PROOF** without obligation. Simply mail coupon for one regular 25c Vial **ABSOLUTELY FREE**

**Hermetically
Sealed**



DANDRUFF? FALLING HAIR?

New Kind of Liquid in Vials

Kills Germs that Cause Them!

NOW thousands can say good-bye to worrisome hair troubles—to dandruff, thin, falling hair, approaching baldness. For modern science has developed a remarkable remedy—a new kind of liquid, *hermetically sealed in glass vials*, that is positively guaranteed to end dandruff and stop falling hair—or costs nothing.

This new treatment is the result of countless experiments by the famous Allied Merke Institutes, Inc., Fifth Avenue, New York. These experiments prove that most cases of hair trouble are caused by tiny parasitical germs.

By burrowing their way down into the scalp, these germs which are unseen by the naked eye, finally infect the hair roots, causing them to become dormant—inactive. Result? With the roots no longer able to supply their vital nourishment, dandruff soon forms, and the hair becomes dry, brittle and falls out.

Ordinary tonics and dandruff remedies fail to bring results because these merely treat the *surface* of the scalp, and have little or no effect on the harmful bacteria embedded below the surface.

But this new treatment, called Merke Derma Vials, is a highly concentrated liquid which actually penetrates *beneath* the surface to the roots themselves. It **KILLS** the infecting bacteria, carries off the unhealthy scaly substances which cause dandruff and falling hair, and at the same time, acts to

promote a healthy circulation which supplies the dormant hair roots with the vital, hair-growing nourishment they need.

Extensive laboratory tests by one of the world's foremost research laboratories concluded with a report from which we quote: "The results indicate that the tonic *killed* the test organism (bacteria) *in less than three minutes*. The results also indicate that the tonic is capable of penetrating and preventing the growth of the test organism (bacteria)."

FREE—One Regular 25-Cent Vial

Now—at our expense—you can prove how quickly the Merke Derma Vial Treatment ends dandruff and stops falling hair. Simply read the Free Offer explained in the panel above. Mail coupon TODAY for your Free Vial. Allied Merke Institutes, Inc., Dept. D-163, 512 Fifth Avenue, N. Y. C.

**Allied Merke Institutes, Inc., Dept. D-163,
512 Fifth Avenue, New York City.**

Please send me, without obligation, one of the regular 25c Merke Derma Vials absolutely **FREE**, and tell me how to use it.

Name.....

Address.....

City..... State.....

“Every 3,000 Miles This Amazing Little Me a New Tire

40.8 Miles Per Gallon

Mr. M. E. Miller, Kansas City, writes: “You people claim a saving of 25 to 50% of Gasoline. I have subjected the Vaporizer to a severe and thorough test. After installing one on a Chevrolet, I found I was obtaining 40.8 miles to a gallon whereas formerly I had been getting only 19.5. That is not a saving of 25 to 50% but 124%, so you see that the actual test surpasses your claim.”

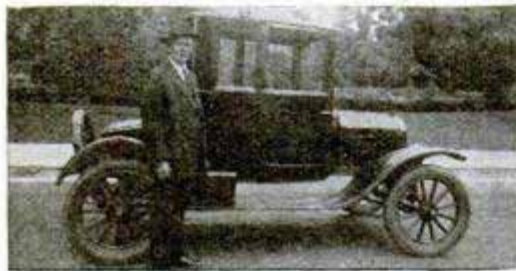

Makes Old Car Run Like New

“I drove to Michigan on a 230-mile vacation trip with my Dodge touring car. I averaged 28 miles a gallon of gas where before I could get only 15 miles a gallon. The Stransky also removed all carbon from my engine and though an old car it runs like new. I'm glad to recommend it.”—Oliver French.



Saved Half the Price of a New Car

H. H. Cummings, Ford Owner, has saved 1905 gallons of gasoline on 50,000 miles! “I have used one on my 1922 Ford which I have driven over 50,000 miles. I am getting 30 miles a gallon where before I got only 12 to 14 miles a gallon.”



Almost Doubled Gas Mileage

L. M. Skorupski made 26 miles a gallon on a Reo Six, which formerly made only 14 miles a gallon. His sister, Lillian Skorupski, drives a Dodge and writes: “I made 41 miles on one gallon of gasoline with the Stransky Vaporizer.”

\$4 an Hour for Salesmen Agents, and Spare Time Workers

Men are making wonderful earnings showing the Stransky Vaporizer to car owners in spare time and full time. Sells fast under our guarantee. Foster made \$357 in two weeks. G. F. Fuller earned \$114 in 5 days. Eberlein sold 23 Vaporizers in 35 minutes! J. W. Cronk actually earned \$51 in an hour. You should be able to earn at least \$3 every hour you put in. We offer demonstrators one Vaporizer FREE, under our unusual offer. Get full details. Simply mail coupon at once.

Device Buys ... FREE"

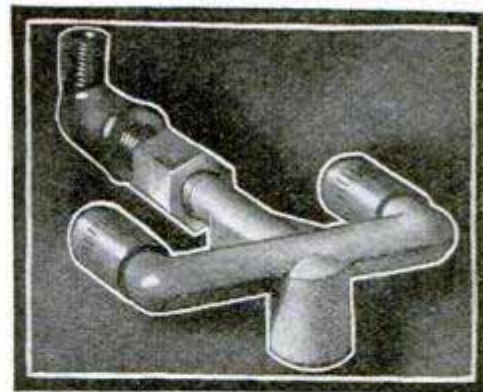

Fits Any Car in 5 Minutes

Anyone can install this device in 5 minutes. Simply loosen one connection to the intake manifold with a wrench. You can do the rest with your fingers!



"The money I save on gasoline more than keeps me in new tires. Figure it out . . . I was getting 13 miles per gallon on my Nash. With gas at 18c plus 2c tax it cost me \$46 to drive 3,000 miles. Now I'm getting better than 26 miles per gallon. It takes just half the gas and I save \$23 to \$25 every 3,000 miles—more than the price of a new tire."

No matter what make of car you drive, the Stransky Vaporizer is unconditionally guaranteed to give you 50 per cent to 100 per cent more miles per gallon or it costs you nothing. As a matter of fact, it is not uncommon for the Stransky Vaporizer to more than double gasoline mileage!

Note These Records

Forty and eight-tenths miles per gallon from a Chevrolet, reported by F. S. Carroll. Forty miles on one gallon in a Ford reported by J. T. Jackson, Michigan. Forty miles per gallon in a Dodge from Brownsville, Tex., to Tampico, Mex., reported by T. L. Brown.

Two Million Owners

Records like these are reported in every mail for every make and model car * * * from 72 different countries * * * the world over.

More than two million Stransky Vaporizers have been installed.

Easily Installed

No bigger than a dollar coin—no more expensive than a good wrench—no more trouble to attach than a fan belt! Attaches to the intake manifold of any car in five minutes. Anyone can do it.

Less Gas—More Power

The Vaporizer supercharges your gasoline after it leaves the carburetor. Completely vaporizes the gasoline. Under this ideal condition you get more compression out of less gasoline and a more complete explosion. Both power, pickup and speed are noticeably increased. Starting is not interfered with as the Vaporizer automatically shuts itself off when the motor is idle.

Make This Test

Test the Stransky Vaporizer on your car—and expect results that will amaze you! Double your mileage—get flashing pickup and power—forget carbon trouble, sluggish motor and fouled spark plugs from over-rich mixture—and save enough on your gasoline to more than keep you in tires. These results are guaranteed or the test costs you nothing.

Mail the coupon below for full details, guarantee, and amazing trial offer, which is even more remarkable than we can tell you here. There is no obligation whatever.

J. A. STRANSKY MFG. CO.

**C-10 Stransky Block
Pukwana, So. Dakota**

J. A. Stransky Mfg. Co., C-10 Stransky Block,
Pukwana, So. Dakota.

Without obligation send me full details of your free trial offer.

Name.....

Address.....

City..... State.....

() Check here for Distributor's Sample Offer and the selling plan.



**Stop
That
Pain!**

**With Violet Ray Vibration
Ozone Medical Electricity**

*The Four Greatest Curative Powers
Generated by This*

Great New Invention!



Elco Health Generators at last are ready for you! If you want more health—greater power to enjoy the pleasures and delights about you, or if more beauty is your desire—write! Ask for the book on these inventions which has just been prepared. It will be sent to you without cost. It tells you how Elco Health Generators aid you in leaving the lethargy and hopelessness of bad health and weakness behind forever. Re-vitalize yourself. Bring back energy. Be wholly alive. Write today!

Here's What Elco Users Say—

"Wouldn't take \$1000 for my Elco."
"Has done me more good in 2 weeks than doctors did in three years."



"Cured my Rheumatism." "My Eczema gone." "Cured my stomach trouble." "Cured my weakness." "Now I sleep soundly all night." "Thanks to Elco my strength and vigor are back." "No more pain." "Colds never bother me now." "Chronic Constipation banished."
These great new inventions generate Violet Ray, Vibration, Electricity and Ozone—combined or separate. They operate on the electric light in your home or on their own motive power at less than 50 cents per year. Elco Health Generators are positively the only instruments which can give you in one outfit Electricity, Violet Ray—Vibration and Ozone—the four greatest curative agents. Send the coupon below. Get the Free Book NOW!

Free Trial

**MAIL COUPON
for FREE BOOK**

Do not put this paper down without sending the coupon. Don't go on as you are with pains and with almost no life and energy. You owe it to yourself to be a better man or woman. You were put here to enjoy life—not just to drag through it. So do not rest another day until you have put your name on the coupon here. That will bring the whole story of these great new inventions. Do it today—now.

**Health
Power
Beauty**

Lindstrom & Company
30 West Lake St. Dept. 13-53 Chicago
Please send me your free book, "Health—Power—Beauty" and full information of your 10-day Free Trial Offer.

Name.....
Address.....

**BE A RAILWAY
TRAFFIC INSPECTOR**



**EARN UP TO
\$250 per month
SALARY**

**PLUS
EXPENSES**

During the last nine years 99.4% of our graduates have been offered positions as Traffic Inspectors at definite salaries, plus expenses, a few days after completing their studies. Traffic Inspectors start at \$120 or more per month and rise rapidly to \$175, \$200 or \$250 per month. As a Railway Traffic Inspector you are practically your own boss—see new faces and places every minute, report only to high officials and are rapidly advanced. It's healthful, outdoor work with regular hours.

**Positions Open —
Waiting for You**

Here's one of hundreds of letters from our students:

Dear Sir:

After completing a course in Traffic Inspection through your school I was immediately put to work on an assignment. I have been engaged in this work ever since and am collecting approximately \$180 per month at present.

*** To anyone desiring an outdoor life with work that is interesting I recommend a course in Traffic Inspection through the Standard Business Training Institute.

(Signed) T. S. Adams.

**Send for FREE
Booklet**

Learn about this great, uncrowded profession, and our refund and employment agreement today. Our free booklet tells all about Traffic Inspection—how we have been able to assist our graduates to positions at definite salaries—why they are so soon promoted to positions paying up to \$250 per month—and what we can do for you.

**STANDARD BUSINESS TRAINING INSTITUTE
Division 2 Buffalo, New York**

LAW Free Book

Write today for FREE 128-page book, "THE LAW-TRAINED MAN," which shows how to learn law in spare time through the Blackstone home-study course prepared by 80 prominent legal authorities, including law school deans, lawyers, and U. S. Supreme Court justices. Combination text and case method of instruction used. All material necessary (furnished with the course, including elaborate 25-volume law library, which is delivered immediately upon enrollment. Many successful attorneys among our graduates. LL. B. degree conferred. Moderate tuition, low monthly terms. Money-Back Agreement.

Write for free book today

**BLACKSTONE INSTITUTE, 4753 Grand Boulevard
De. t. 53 Chicago**



PIANO JAZZ

By Note or Ear. With or without music. Short Course. Adult beginners taught by mail. No teacher required. Self-Instruction Course for Advanced Pianists. Learn 259 styles of Bass, 684 Syncopated Effects, Blue Harmony, Oriental, Chime, Movie and Café Jazz, Trick Endings, Clever Breaks, Space Fillers, Sax Siura, Triple Bass, Wicked Harmony, Blue Obligato, and 247 other Subjects, including Ear Playing. 133 pages of REAL Jazz, 25,000 words. A Postal brings our FREE Special Offer.
Waterman Piano School, 1826 W. Adams St. Los Angeles, Cal.



BART SUPPLIES

Special 48 p. catalog "S"—Show Card and Sign Writer's supplies. Also catalog "A"—Art Supplies. Save Money—write—
BART SUPPLIES, 506 Eustis Bldg., MINNEAPOLIS, MINN.

**Learn
Photography
at HOME**

Make money taking pictures. Prepare quickly during spare time. Also earn while you learn. No experience necessary. New easy method. Nothing else like it. Send at once for free book, OPPORTUNITIES IN MODERN PHOTOGRAPHY and full particulars.
**AMERICAN SCHOOL OF PHOTOGRAPHY
Dept. 1353 3601 Michigan Ave. Chicago, U. S. A.**



RAILWAY POSTAL CLERKS

\$158 Month First Year

Raise to Maximum of \$225 Month

Many other U. S. Government Jobs Open to Men and Boys 18 up

**Post Office Clerks
Rural Mail Carriers**

**City Mail Carriers
Clerks in Customs and Internal Revenue Service**

These are steady positions. Strikes, poor business conditions, lockouts or politics do not affect them. U. S. Government employees get their pay for full twelve months every year. There is no such thing as "HARD TIMES" in the U. S. Government Service.

ALLOWANCE FOR HOTEL EXPENSES

Railway Postal Clerks now get \$1900 the first year regular, being paid on the first and fifteenth of each month. \$79.16 each pay day. Their pay is increased \$100 and \$150 a year. The maximum is \$2700 a year. \$112.50 each pay day. They get extra allowance for hotel expenses when away from home.

PAID VACATIONS

Railway Postal Clerks, like all Government employees, are given a yearly vacation of 15 working days (about 18 days). When on runs they usually work 3 days and have 3 days off duty or in the same proportion. During this off duty and vacation, their pay continues just as though they were working. When they grow old, they are retired with a pension. As Railway Postal Clerks are continually traveling, they have an excellent chance to see the country.



City Mail Carriers—Post Office Clerks

Clerks and Carriers get \$1700 the first year regular and automatically increase \$100 a year to \$2100 with further special increase to \$2300. They also have 15 days' vacation. City residence is unnecessary.

What Will You Earn 5 Years from Now?

Compare these conditions with your present or your prospective condition, perhaps changing positions frequently, kicking around from post to pillar, no chance in sight for PERMANENT employment; frequently out of a position and the year's average salary very low. **DO YOU EARN \$1900 EVERY YEAR? HAVE YOU ANY ASSURANCE THAT A FEW YEARS FROM NOW YOU WILL GET \$2700 OR MORE A YEAR, EVERY YEAR?**



Get Free List of Positions

Fill out the coupon. Tear it off and mail it today—now, at once. **DO IT NOW**—This investment of two cents for a postage stamp may result in you getting a U. S. Government Job.

FRANKLIN INSTITUTE, Dept. A-173, ROCHESTER, N. Y.

(Not connected with U. S. Government)

Rush to me entirely free of charge 32 page book with (1) a full description of the position checked below; (2) a list of U. S. Government jobs now obtainable; (3) tell me how to get the position checked.

- Railway Postal Clerk.. (\$1900-\$2700)
- Post Office Clerk..... (\$1700-\$2300)
- City Mail Carrier..... (\$1700-\$2100)
- Rural Mail Carrier..... (\$2100-\$3300)
- Clerk in Government Offices.... (\$1140-\$1860)
- Prohibition Investigator..... (\$1800-\$3000)

Name.....

Address.....

Use This Coupon Before You Mislays It—Write or Print Plainly.

MAIL COUPON TODAY

LEARN CARTOONING

by the Famous Landon Picture Chart Method



This method of teaching has become nationally famous because it develops originality and has opened the door to success for hundreds of beginners who liked to sketch and copy. A long list of well known cartoonists, now earning from \$75 to \$200 and more per week, credit their start to this instruction. Individual ability is also developed by specialized training for many different fields of cartooning under the personal direction of C. N. Landon, former Art Director of America's largest newspaper syndicate. Home study instruction only—enrollment limited to number who can be trained thoroughly. Easy payment plan offered.

Address C. N. Landon, Director, THE LANDON SCHOOL, 738 National Building, Cleveland, Ohio

Make This Interesting TEST

Whether you think you have talent or not send for a sample Picture Chart to test your ability. With this Chart I will send facts about cartooning which show the possibilities for YOU; and endorsements of scores of former students of this school who are now successful cartoonists, including BLOSSER who draws "Freckles and his Friends," BYRNES creator of "Reg'lar Fellers," BRANNER who draws "Winnie Winkle," FUNG who draws "Gus and Gussie," ETHEL HAYS creator of "Goat Getters," EDWINA who draws "Cap'n Stubbs," and many others. Write today—and state your age.

Electrical Engineering

Course for men of ambition and limited time. Over 5000 men trained. Condensed course in Theoretical and Practical Electrical Engineering including the closely related subjects of Mathematics and Mechanical Drawing.

Students construct motors, install wiring, test electrical machinery. Course designed to be completed in one college year. Prepare for your profession in the most interesting city in the world. Est. 1893. Catalog on request.



Bliss Electrical School

133 Takoma Ave., Washington, D. C.

YOU CAN OIL PAINT

Amazing new method teaches men or women to earn after first lesson. OIL PAINT photos—portraits, landscapes or art subjects. Earn \$18 to \$50 and more a week. OIL PAINT OUTPUT GIVEN. Send now for free illustrated book. PICTORIAL ART STUDIOS Inc. Dept. MP, 2926 Broadway, Chicago, Ill.

LEARN WATCHMAKING

and become independent. We help you secure a position. Easy to learn. Send for FREE CATALOG. ST. LOUIS WATCHMAKING SCHOOL, Dept. 5, ST. LOUIS, MO.

ALWAYS Ask For DENISON'S—52 Years of Hits
Comedy-Dramas, Vaudeville Acts, Farces, Musical PLAYS, Monologs, Dialogs, Comedies, Revues, Entertainments, Musical Readings, Comedy Songs, Chalk Talk Books, Minstrels, Blackface Skits, Make-up Goods. Catalog FREE. T. S. DENISON & CO., 623 S. Wabash, Dept. 9 CHICAGO

PATENTS

Booklet Free Highest References
Promptness Assured Best Results

Send drawing or model for preliminary examination of Patent Office records.

ALL BUSINESS GIVEN PROMPT AND PROPER ATTENTION

Listed Patent Lawyer in the latest editions of the Rand-McNally Directory of Bankers and Attorneys, of Chicago, Ill.; The Baggott & Ryall Directory of Attorneys, New York City; The Lawyers Guaranteed Directory, Detroit, Michigan; The Lawyers and Bankers Quarterly, published by the Legal Directory Publishing Company of St. Louis, Mo.; the American Lawyers Annual, Cleveland, Ohio.

WATSON E. COLEMAN,
REGISTERED PATENT LAWYER

Victor Building, 724 Ninth Street, N. W.
WASHINGTON, D. C.

MECHANICAL ENGINEERING

Learn at home



Mail the Coupon for Free Booklet

MECHANICAL Engineering embraces the design, construction and operation of machines and machine tools. It is a profession which offers almost unlimited opportunities to men who combine mechanical ability with technical training.

One of the best ways to train yourself to secure a position as a Mechanical Engineer is through the home-study courses of the International School of Engineering.

These courses are complete, up-to-date and especially arranged to meet the needs of the student who studies at home. They are particularly helpful and practical because they are written by well-known mechanical engineers.

INTERNATIONAL SCHOOL OF ENGINEERING

Division of the International Correspondence Schools Dept. 5516-F, Scranton, Penna.

Without cost or obligation, please send me full details of your home-study course in MECHANICAL ENGINEERING

Name.....

Address.....

FREE

Get two wonderful books by mailing coupon below.

You get these Genuine High Quality, Imported Drawing Instruments, 14 Other Tools and a Drafting Table—all included in my Home Training Course.

These Two Books—
Mail Coupon!

Yes, Absolutely
FREE



2 Books FREE



Just Send the Coupon Below!

Jobs for Draftsmen in Great Industries—Learn At Home

Automobiles—Electricity—Motor Busses—Aviation—Building Construction.

There are jobs for Draftsmen in all of these industries and in hundreds of others.

Aviation is expanding to enormous proportions.

Electricity is getting bigger every day.

Motor Bus building is becoming a leading world industry.

Building of stores, homes, factories and office buildings is going on all the time.

No structure can be erected without plans drawn by a draftsman. No machinery can be built without plans drawn by a draftsman.

I train you at home, in Drafting. Keep the job you have now while learning drafting.

I will train you in drafting right where you are in your spare time. I have trained men

who are making from \$3,500.00 to \$9,000.00 a year. There is a big future for draftsmen because you plan and supervise the work of others, or you go into business for yourself. Get started now toward a better position, paying a good, straight salary, the year around. Comfortable surroundings. Inside work.

Earn As You Learn

I tell you how to start earning extra money a few weeks after beginning my training.

Employment Service

After training you I help you to get a job without charging you a cent for this service. Employers of Draftsmen come to me for men because they know that Dobe Trained Men make good as they have learned drafting by actually doing the work themselves, in a practical way. Employers know they are not taking chances on men trained by me.

Money-Back Agreement

I train you at home under a positive Money-Back Agreement. If my training does not satisfy you after you have finished, you get every penny back.

Age or Lack of Education, No Drawback

Previous experience is not necessary. You do not need to be a college man or high school graduate.

Help As Long As You Need It

As my student you can write to me any time you want to and as often as you like and I will give you help on any subject pertaining to draftsmanship. I will advise you about jobs, extra work, fees and how to make extra money.

If You Earn Less Than \$70.00 a Week Ask for My 2 FREE Books



Mail this coupon, at once. Get "My Pay Raising Plan" and "Successful Draftsmanship". Both of them point the way to Success. You owe it to yourself to find out what a big opportunity there is in practically all industries, for Draftsmen. These two books are Free. They come to you post paid. Mail the Coupon for them TODAY.

ENGINEER DOBE
1951 Lawrence Ave., Div. 13-53 Chicago

"I'll train you at home"—
Engineer Dobe

FREE BOOK COUPON

ENGINEER DOBE

1951 Lawrence Ave., Div. 13-53 Chicago

Send me free of all cost your book, "Successful Draftsmanship", also plan to earn money while learning and proof of big money paying positions. Also your new book "My Pay-Raising Plan."

Name.....Age.....

Address.....

Post Office.....State.....

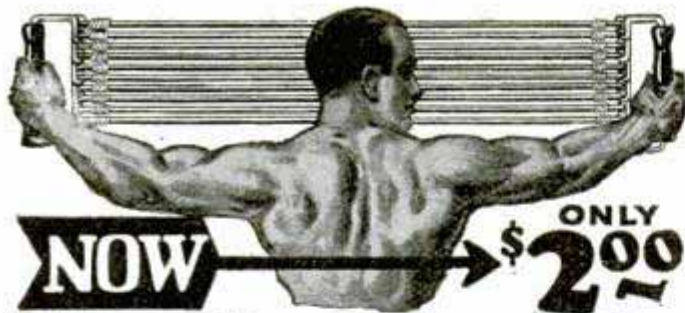

NOW → **ONLY \$2.00**
Giant Chest Expander

and

Progressive Exerciser

Be a muscular marvel. Have the muscles of a superman. Become strong for your health's sake or to astound your friends with extraordinary feats which only men of giant strength can do. In a few short weeks you will easily do stunts which now seem difficult—then real

**Send No Money
 Use This
 Money
 Saving
 Coupon**

muscles and strength will be yours—and yours to keep. If you want exercise to just keep in good shape you can reduce the strength of the Progressive Exerciser by eliminating as many cables as you wish. If you want great resistance so as to build up big solid muscles then use the full strength.

How the Giant Chest Expander and Progressive Exerciser is Made

The Giant Chest Expander and Progressive Exerciser is made with new live, springy rubber so as to give it long wearing and great resisting qualities. Do not pay more for an exerciser that has forty or less rubber strands to each cable. Get the best and most durable. The Giant Progressive Exerciser has 50 strands of the finest rubber procurable to each cable.

Free Instructions

We do not think it enough to send you an exerciser worth double what we ask, so for a limited time, we will also include instructions absolutely free. These instructions are interesting and simple to follow—they show you the short cut to health and strength. Order today before this wonderful offer is withdrawn.

Your Guarantee

The Giant Chest Expander is sold with a guarantee that you will say it is the finest you ever saw or your money back.

5 Cables or double 10 Cables for strength for

\$2 The double strength exerciser has resistance of over 200 lbs. **\$4**

How to Order—Send No Money

Sign your name and address to coupon below and get your Giant Exerciser at the present low introductory price by return mail. The price is made low because we want everyone to enjoy muscles and strength at the lowest possible cost. Don't pay more—order from us—get the most for your money. Use coupon now.

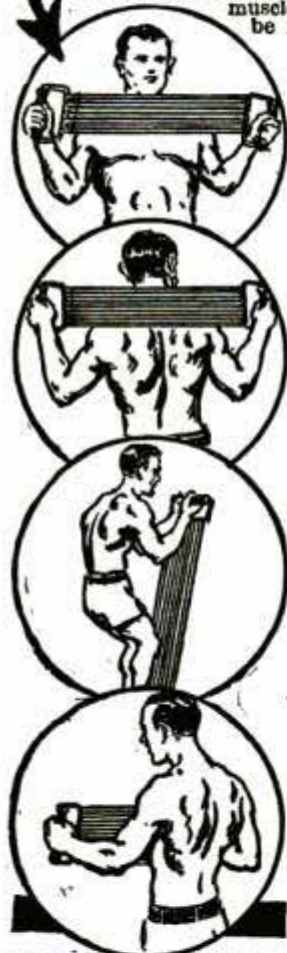

PROGRESSIVE EXERCISER CO.,
 4003 Langdon Bldg.,
 Broadway and Duane Street, New York

Please send Your 10 cable Progressive.
 Your 5 cable Exerciser.

Check the Exerciser you want, and it will be sent you by return mail. Pay postman introductory price, plus few cents postage on arrival. It is understood that if you are not entirely satisfied with your exerciser you may return it within 5 days and get your money back.

Name.....

Street.....

City..... State.....

If you live outside the United States, send cash with order.

Learn Music



Free—Send for This Amazing Book

It will tell you how you can quickly and easily learn to play your favorite instrument, right in your own home and in your spare time. Music will make you popular, welcomed everywhere, and offer many big-money opportunities.

Easy as A-B-C

You need know nothing about music to begin. We give you personal, individual instruction right from the start and guarantee your satisfaction. You will be surprised and delighted that music can be made so easy and fascinating.

Courses in Piano, Violin, Voice, Trumpet, Mandolin, Organ, Banjo, Tenor Banjo, Spanish Guitar, Hawaiian Guitar. Surprisingly low cost; easy terms.

Send for This Beautiful New Book Today

It will tell you all about this great School—now in its 25th successful year—and the wonderful National Academy Method that has meant success to over 200,000 enthusiastic students. Send for it right now, while you think of it. It is FREE.

NATIONAL ACADEMY OF MUSIC
 Dept. 69 702 East 41st Street, Chicago

PREPARE FOR AN

ART CAREER

—thru the only art school operated as a department of a large art organization, who have actually produced over a quarter million drawings for leading advertisers. Where else can you get so wide an experience? Home study instruction. Write for illustrated book telling of our successful students.

MEYER BOTH COMPANY
 Michigan Ave. at 20th St. Dept. 16 Chicago, Ill.

LAW STUDY AT HOME
 Become a lawyer. Legally trained men win high positions and big success in business and public life. Be independent. Greater opportunities now than ever before. Big corporations are headed by men with legal training. Earn **\$5,000 to \$10,000 Annually**. We guide you step by step. You can train at home during spare time. Degree of LL.B. conferred. LaSalle students found among practicing attorneys of every state. We furnish all text material, including fourteen-volume Law Library. Low cost, easy terms. Get our valuable 108-page "Law Guide" and "Evidence" books FREE. Send for them NOW. **LaSalle Extension University, Dept 364-L, Chicago**
 The World's Largest Business Training Institution

MINSTRELS Musical Comedies and Revues, with full instructions for staging. You can stage your own show with our books. Full line of plays, stage songs, crossfire monologues, afterpieces, vaudeville acts and make-up. **CATALOGUE FREE.**
T. S. DENISON & CO., 623 So. Wabash, Dept. 19, Chicago

Learn Advertising at HOME
 Send your name and address for free booklet giving interesting information and vital facts about Advertising. Find out how we prepare you at home, in your spare time, for the opportunities open in this fascinating business. Practical work. No text books. Old established school. Successful graduates everywhere. Just the plan you have always wanted. Write today. No obligation.
PAGE-DAVIS SCHOOL OF ADVERTISING
 Dept. 1353, 3601 Michigan Ave. Chicago, U. S. A.

HOME O WAVE

ASTONISHING DISCOVERY!

Relieves Disease - Wins Health

Heretofore available only through the expensive treatments of trained medical specialists, the sure relief of the soothing, unfelt electro-magnetic wave is now available to you in your home. Thanks to HOMEOWAVE—you can relieve disease—win health!



HOMEOWAVE, by its magnetic action on the tissues and billions of cells of the body, restores the ailing to happy, wholesome health. You don't feel the treatment but you quickly know the unfailing benefits it is guaranteed to bring. You can have HOMEOWAVE in your own home on our no-risk offer.

Rest Yourself to a Full, Virile and Healthy, Happy Life

As you would recline on your bed for a rest, simply plug in HOMEOWAVE to your nearest light socket and you feel immediate relief in your first fifteen-minute treatment.

If you are bothered—periodically or constantly—with any of the diseases or ailments listed on this page, or their symptoms, HOMEOWAVE will prove a God-send to you. If you are never really well or actually sick—if you feel you are only half a man or woman, you need HOMEOWAVE. If you are one of the thousands upon thousands who have tried everything to release yourself from the bondage of sickness and disease without results, you now are offered the proved way to a full life—a virile, healthy, happy life.

Helps Nature Soothe Away Your Ailments

Nature's own method of keeping one healthy and well does not always function properly. The body is composed of billions of cells, constantly being destroyed and renewed, the worn out cells being carried by the blood stream to the organs of elimination. When the human system becomes clogged, toxins form and illness starts. As every true musical tone has its certain vibrations so does the well body have its proper undulations. A musical discord, like the bodily discord of sickness and disease, is faulty in its vibrations. HOMEOWAVE, by the application of electro-magnetic vibrations puts the body in tune, destroys the poisonous toxins, increases oxidation, clears and cleans the vital blood stream so it may be able to function normally and give you your dearest possessions—your health and your life.

HOMEOWAVE will prove to be the ever vigilant watchman that will not only relieve you from the suffering of almost every ailment to which humans are subjected, but it will keep you the whole man or whole woman of glorious health.

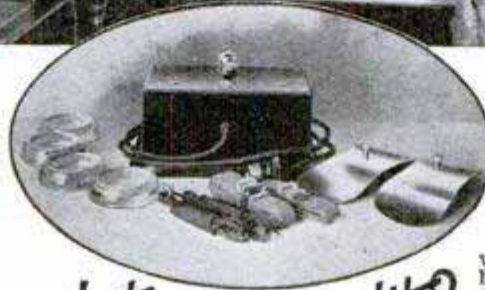

What would you give for Perfect Health?

Anything you have in the world, you will say. At far less than the average family's yearly medical bills, HOMEOWAVE is available to you. It will make you well and keep you well.

If you are harassed with any of the following ailments, or those related to them, HOMEOWAVE is your ray of hope.

Acidosis	Hysteria
Acne	Indigestion
Anemia	Influenza
Arthritis	Insomnia
Asthma	Jaundice
Biliousness	Lumbago
Blood Pressure (high or low)	Neuralgia
Colds	Neuritis
Catarrh	Pleurisy
Constipation	Poor Circulation
Dyspepsia	Rheumatism
Eczema	Tonsillitis
Gastritis	Toxemia
Hay Fever	Ulcers
	Vertigo

It will cost you nothing to know the sure, even quick, relief that HOMEOWAVE will give you. Simply sign and mail the coupon for positive proof of its almost magic benefits.

Mail the Coupon for GUARANTEED Health Insurance

HOMEOWAVE is the discovery and invention of an electrical engineer whose life has been consecrated to the study and application of the healing benefits of electro-magnetic vibrations on the human body. Practically every conceivable disease or sickness has been relieved by the principles embodied in HOMEOWAVE. It is no experiment. Leading practitioners of the medical sciences have given it the most severe tests in their critical clinics.

Naturally, HOMEOWAVE is unconditionally guaranteed. Use the coupon below for a ten-day, no-risk, no-obligation trial. If you do not get positive, definite relief from its use, the trial has cost you nothing. In a vast number of cases, HOMEOWAVE results come instantaneously. No one but yourself alone will be the judge. If a healthy, wholesome body is your cherished hope—if the happiness of your life and your family are dear to you, you will mail the coupon below TODAY.

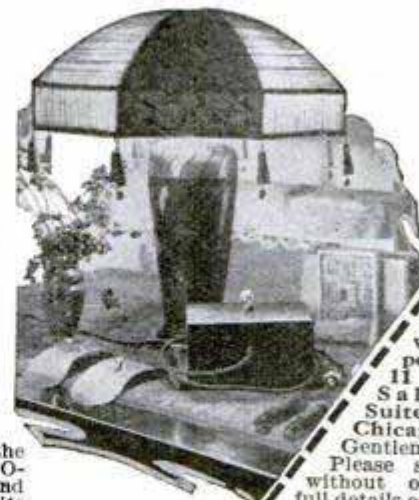

Home-wave Corporation,
11 S. La Salle St.,
Suite 901,
Chicago, Ill.

Gentlemen:

Please send me, without obligation, full details of HOMEOWAVE and your guaranteed, no-risk, 10-day trial offer.

Name.....

Address.....

City.....

State.....

HOMEOWAVE CORPORATION

11 South LaSalle St., Suite 901, Chicago, Illinois

Get a Job Like These!



\$20 a Day for Schreck
 "Use my name as a reference and depend on me as a booster. The biggest thing I ever did was answer your advertisement. I am averaging better than \$500 a month from my own business now. I used to make \$18 a week."
 A. Schreck,
 Phoenix, Arizona.



Makes \$700 in 24 Days in Radio
 "Thanks to your interesting Course I made over \$700 in 24 days in Radio. Of course, this is a little above the average but I run from \$10 to \$40 clear profit every day, so you can see what your training has done for me."
 Fred G. McNabb,
 848 Spring St., Atlanta, Ga.

\$3500 a Year for Beckett
 "When I began with you I was just a common laborer, going from one job to another, working for anything I could get, and that wasn't much. Now my salary is \$3,600 a year and the Company furnishes me with an automobile."
 C. O. BECKETT,
 108 Maple Heights,
 New Lexington, Ohio



\$70 to \$80 a Week for Jacquot
 "Now I am specializing in Auto Electricity and battery work and make from \$70 to \$80 a week and I am just getting started. I don't believe there is another school in the world like yours. Your lessons are a real joy to study."
 Robert Jacquot,
 2005 W. Colorado Ave.,
 Colorado Springs, Col.



Learn to EARN \$3000 to \$5000 a Year

ELECTRICITY
 ~The Big Pay Field~
NEEDS YOU NOW

I Will Train You at Home - Spare time Only Needed

Send Coupon Now

It's your own fault if you don't earn more. Send the coupon and I'll *prove* it to you. Blame yourself if you stick to your small pay job when I have made it so easy for you to learn to earn \$3,000 to \$5,000 a year in Electricity. One billion dollars a year is being spent in electrical work. *Electrical Experts* are badly needed. Just send the coupon. Thousands of men are needed—trained as I train them. They can practically name their own salaries. Everything is ready but the men. Will you answer the call of this big-pay field? Get ready now for the big job I will help you get. The biggest money of your life is waiting for you. Send the coupon.

5 Outfits—Tools and Apparatus Included —No Extra Charge

In addition to giving my students employment service and consultation service, I give them also 5 complete working outfits without extra charge. These include tools, measuring instruments, material and a real electrical motor—among the finest outfits ever put together. You do practical work right from the start. After the first few lessons it enables you to make extra money every week doing odd electrical jobs in your spare time. Some students make as high as \$25 to \$35 a week in spare-time work while learning.

L. L. Cooke, Chief Instruction Engineer
L. L. COOKE
SCHOOL OF ELECTRICITY
 2150 Lawrence Ave., Dept. 13, Chicago

You Can Do It Too!

Let me show you that I can train you just like I trained the four men whose pictures you see here. Just like I have trained thousands of other men—ordinary every-day sort of fellows—lifting them up from starvation wages and starting them on the road to jobs that pay \$60.00 to \$100.00 a week. With my easily learned, spare-time course, I can fit you for one of the biggest jobs in electricity. Send the coupon and I'll tell you how.

Quick and Easy to Learn

Don't have any doubt about your being able to do what these other men have done. McNabb and Schreck and these other fellows didn't have a thing on you when they started. You can easily duplicate their success. Age, lack of experience or limited education do not bar you. Start just as you are and I will guarantee to train you at home with a signed money back agreement. If you are not 100 per cent satisfied with my course it won't cost you a cent. Mail coupon to me today.

Big Electrical Book—FREE

The coupon below will bring you my big free electrical book—over 100 interesting pictures. The real dope about your opportunities in electricity—positive proof that you, too, can learn to earn \$3,000 to \$5,000 a year. Send it now. Send it while the desire for a better job and more money is upon you.



L. L. COOKE,
 Chief Instruction Engineer
 Dept. 13

2150 Lawrence Ave., Chicago

Without obligating me in any way send me your Free Book and particulars of your Electrical Outfit Offers, Employment Service and proof that you can fit me for a big-pay electrical job.

Name.....

Address.....

Occupation.....

The Cooke Trained Man is.. The Big Pay Man ~Always

Classified Advertisements

WORLD'S BEST WANT AD MEDIUM

Advertisements in this section, 30 cents per word, each insertion, minimum 10 words, payable in advance. To be inserted under proper classification in April issue, copy should be in our office February 18th

ADVERTISING AGENCIES

GO into the mail order business! We'll guide you. Free literature and advertising copy service. 30 years' experience behind advice. Try your proposition on this powerful pulling list. 10 leading Sunday papers—Circulation 2,800,000. 4 lines (24 words) only \$16.44. Tribune, Chicago, \$1.40; Star, Indianapolis, \$1.20; Register, Des Moines, \$1.60; Courier Journal, Louisville, \$1.20; Times Picayune, New Orleans, \$0.88; Star, Kansas City, \$1.68; Enquirer, Cincinnati, \$1.44; Press, Pittsburg, \$1.44; Commercial Appeal, Memphis, \$1.20; Journal, Milwaukee, \$1.40. Don't pay more than publishers' rates. Write for our free book. 56 pages of advertising information containing colored U. S. Map. All leading papers, magazines and rates. Proof of insertion guaranteed. Frank W. Lenhoff Advertising Agency, 600 North Michigan Blvd., Chicago. (Established 1897.) Chicago's most Progressive Advertising Agency.

A TEN Dollar Ad may put your proposition over. \$10 pays for a 4 line 24 word classified ad one Sunday in 4 of the largest newspapers. Reach over 6 million readers. Minneapolis Tribune, Buffalo Courier, Detroit Free Press, Kansas City Star, Pittsburgh Press, Indianapolis Star, Atlanta Journal, Cincinnati Enquirer. Free catalogue showing other lists of newspapers and magazines sent on request. Ankrum Advertising Agency, 22 West Jackson Blvd., Chicago. Largest classified advertising agency in the world.

PUT Your proposition before several million readers weekly with newspaper classified ads. 66 page catalog free showing many bargain lists. Rates. Circulation on over 1,000 newspapers and magazines. 17 years' experience. Brinckerhoff, Inc., 37 W. VanBuren, Chicago.

ADVERTISE in 24 Big Sunday Newspapers, 24 words \$15.00. Excellent for securing Agents, Salesmen, and Business Opportunities. Catalog listing 1,000 leading Dailies, Weeklies, Mail Order Magazines, Everything. Free. Wade Advertising, Baltimore Bldg., Chicago.

LOWEST Rates. New Catalog. Owl Agency, Times Bldg., New York.

INCH Display in 50 monthlies, \$2.00; three, \$4.00. Cope Agency, 233P, Campaign, Ill.

FREE—New 1928 Advertisers Rate Guide. 36 pages. Includes everything. Lowest rates. E. H. Brown Advertising Agency, 140 S. Dearborn, Chicago.

ADVERTISE 50 Magazines 5c word, \$4.00 inch; three 10c word, \$8.00 inch. King Advertising, Box 6723, Wilmington, Del.

INCH Display 50 Monthlies Thrice \$8.00. Admeyer, 4112M Hartford, St. Louis, Mo.

FOR ADVERTISERS

ADVERTISER—24 Words, 10 metropolitan Sunday papers, \$10.00. One Inch Ad, 52 magazines, \$5.00. Get our Free booklet listing many advertising, printing and mailing list bargains. Waring Advertising Company, Dundee, Mich.

40 WORDS Insert 50 magazines \$2.00. Empire Agency, Shawano, Wisconsin.

50 WORDS Or less, 4 times \$1; inch display 4 times \$2. Popular Service Magazine, 3414 E. 27th, Kansas City, Mo.

I WRITE letters, folders, booklets, complete followup for manufacturers, mail-order dealers. Long experience. Write for details. L. Taylor, 201 S. Day, Rockford, Ill.

ADVERTISE in 275 country newspapers, 24 words, \$10. Keator, Hartford Bldg., Chicago.

LETTER SPECIALISTS

LETTERS, sales literature written. Long experience. Reasonable. L. Bartells, 504 52nd St., Milwaukee.

POWERFUL Sales Letters—Literature prepared; long, successful experience; rates reasonable. Free counsel. Outline proposition. Finkel Advertising, 15p Fairview, Jersey City, N. J.

SALES PROMOTION

\$50 TO \$50,000 Daily Sales Developed During 28 years for clients by our direct mail plans, copy, campaigns. One product, 1923, an idea; this year \$100,000 orders booked. Fifty year old concern desired 50 national representatives in 1925; we produced 40 in three months. 700 dealers in 10 months at \$3 each, for another. Ten years Sales Promotion Manager Larkin Co. Submit sales problems for Free diagnosis. James C. Johnson, 118A Woodbridge Ave., Buffalo.

AUTOMOBILE SUPPLIES

OWN A Battery Shop. Select one of the improved transformer-type Scioto Battery Chargers. You'll make money with it. Four sizes. Wholesale only. Send for prices. Adams-Barr, Columbus, Ohio.

ELECTRIC Tube Vulcanizer—operates from the lamp socket of your car; complete with twelve patches for \$1.50. R. Kirschmer, 8348 S. Carpenter St., Chicago, Ill.

SAVE Money on Auto and truck repairs. Gears, axles, bearings, motor and transmission parts at 50 to 75% off factory list prices. Satisfactory parts guaranteed. Prompt service. Price lists free. Century Parts Co., 1725 S. 18th St., St. Louis, Mo.

YOU Are Wanted to Resilver Mirrors at Home. Immense profits plating autoparts, tableware, etc. Write for information. Sprinkle, Plater, 77, Marion, Ind.

SIMPLIFIED Liquid-gas carbon remover for cars with windshield cleaner, vacuum tube or priming cup. Works to perfection and you don't have to dirty your hands. Agents Wanted. E. V. M. Laboratories, 10101 Nelson Ave., Cleveland, Ohio.

SLIP-Over tops make perfect Winter enclosures for your roadster or touring car. Patents Pending. Agents, Owners, write Slip-Over Top Co., Norwood, O.

RADIATORS at wholesale prices. All standard makes. Satisfaction guaranteed. Send for prices, stating make and model. Independent Radiator Co., 1119 S. Wabash Ave., Chicago.

TIRE-VALVE-TESTER CO., Elgin, Ill. Sample 35c. Particulars Free.

AUTO Tourists—Here are 133 practical plans for making touring easier, less expensive and more enjoyable. With these we supply a Touring Atlas of the U. S. showing road maps of every state. All this information for the small price of 98 cents plus the postage. Pay postman when he delivers the package. Popular Mechanics Press, Room 908, 200 E. Ontario St., Chicago, Ill.

AUTOMOBILES

PATENTS. Time counts in applying for patents. Don't risk delay in protecting your ideas. Send sketch or model for instruction or write for free book "How to Obtain a Patent" and "Record of Invention" form. No charge for information on how to proceed. Communications strictly confidential. Prompt, careful, efficient service. Clarence A. O'Brien, Registered Patent Attorney, Security Bank Building (directly across street from Patent Office), Washington, D. C. See pages 138 and 139.

AUTO SERVICE EQUIPMENT

BUILD Business with the best of air service. Bring car owners to your door—no matter what branch of automotive service. Costs less to operate than others. Easy, pay-for-itself terms. Free trial. Write D. C. Jenkins, Box M385, Troy, Ohio.

BIG Profits in automotive electrical service with use of low priced testing equipment. Small down payment brings it—pays for itself with handsome income besides. Write for details, no obligation. E. C. Galbreath, Box M384, Troy, Ohio.

JUNK Tires converted into saleable Mds. with our Hoxie. \$200 starts you. Vulcanizing Tires pays 100%. Have Shop Outfits near you \$50 up. Portable Electric Paint Spraying Outfits complete, only 50 lbs. \$61 delivered. Equipment Exchange, 108 East 11th, Los Angeles, Calif.

BIG Opportunity in 8 hour battery charging. Let me tell you how you can install equipment with practically no investment. Earn \$150 to \$300 monthly from it. Bargains in used outfits. Write today. L. C. Helmick, Box M383, Troy, Ohio.

GOOD Chance to get Balloon and High Pressure Tire Retreading outfit. Will sell at great sacrifice. Richardson, 16 Sever, Charlestown, Mass.

FOR FORD OWNERS

UNDERSLUNG With "RKO" Swing Lo Irons. See "Red-i-Kut" ad page 124.

MOTORCYCLES, BICYCLES AND SUPPLIES

MOTOR Cycles Cheaper than Bicycles. \$25 to \$50. Ready to Ride. Tires, \$2.50; Frames, \$3; Forks, \$3; Tanks, \$5; Wheels, \$4; Chains, \$2; Handle Bars, \$5; Engines, \$15; Auto Tires, \$3; Airplane Engines, \$15. Send 30c in Stamps for Catalogues. Price Cutter Deninger, Rochester, N. Y.

MONEY Saving Motorcycle Bargains—Large stock of Used Harley-Davidson—\$70 and up. Send for Free bargain bulletin—Genuine Harley-Davidson Parts and Accessories. Knuth's Harley-Davidson Agency, 2525 Fond du Lac Ave., Milwaukee, Wis.

NEW and used Motor Cycle Parts. Tower Cycle Co., 3904 Kingsland Ave., Pine Lawn, Mo.

BARGAINS in used motorcycle parts for all makes. No Catalog. J. B. Dahl, 3601 Archer Ave., Chicago, Ill.

AVIATION

LEARN to Fly; \$100.00 including Solo. We guarantee to solo you regardless of the number of flying hours required. Our instructors are ex-army aviators and air-mail pilots with wide experience. Our training equipment is the best obtainable. Our course requires about two weeks, depending on the individual. No bond required, no charge for breakage. Eight years without an accident. 76 students graduated in 1925. Commercial aviation is a rapid growing industry. Don't delay! Enroll now in one of the oldest and best known flying schools in America. Write for booklet. Robertson Aircraft Corporation, operators of the United States Air Mail, St. Louis-Chicago, Lambert-St. Louis Airport, Anglum, Mo.

AIRPLANES, Motors and Aircraft supplies; 28 hp. 2 cyl. Lawrence motors \$125; 130 hp. Clerget 9 cyl. rotary motors \$150. Leather breeches \$12.00; sheeplined leather coat \$23.50; wool lined \$18.00. Beaverized sheep leather helmet \$6.00; sheeplined leather helmet \$4.50. Non-shatterable, wide-vision goggles \$4.00, or oval \$2.50. Gold wings with vertical propeller for coat lapel \$1.00. "The Airplane Speaks" book teaching how to fly \$3.00. "Modern Aircraft" book \$5.00. Logan Aircraft, 716 W. Superior, Cleveland.

COMPLETE Flying course. We guarantee to teach you to fly safely and steadily regardless number hours needed. Course includes practical flying instruction, theoretical principles, mechanical knowledge of airplanes and motors. All instruction on modern aircraft by licensed Transport Pilots of long experience. Write for Free booklet. Von Hoffmann Aircraft Co., Distributors for Ryan Monoplanes and Eaglerock Biplanes, 203 Lambert-Saint Louis Flying Field, Anglum, Missouri.

GET Into flying now—learn at America's finest aviation school in Chicago—the center of air activity—on the finest field in the middle west—where the air mail lands. We give you complete instruction in our big downtown factory—you actually work on motors and ships. You fly at our airport in brand new ships with licensed instructors. No limit to your flying time. Write for our big free book "How to Fly." Free to you for the asking. Chicago Aviation Company, 735 N. Clark St., Chicago, Ill.

AVIATION—Complete shop and flying instructions. Modern factory. Day and evening courses, \$100.00 up. American Beauty Aircraft Co., 2850 No. Cicero, Chicago.

WALLACE C-2 two passenger cabin monoplane will be ready for demonstration about March 1st. Many novel features, folding wings, hydraulic landing gear, Elgin instrument board, dual control, adjustable stabilizer, beautifully upholstered cabin, etc. Price \$2,250 without engine and propeller. \$3,800 with 80-h.p. antani ready to fly. May be powered with Curtiss or OX-5 or Ryan-Siemens, Caninec and others. Wallace Aircraft Co., 4710 Irving Pk. Blvd., Chicago.

HEATH Propellers won at the National Air Races again! They represent the most efficient method of aerial drive. Each propeller individually designed for the particular work to be done, as laid out by America's oldest aeronautical engineers. Propeller Catalog 4c. Heath Airplane Company, Chicago, Ill.

SCALE Model Airplanes ready to fly—all types. Send dime for Flying Glider and catalogue. The Clinton Toy Co., Box 141, North Haven, Conn.

To introduce our aviation books we are distributing as prizes an airplane and a \$250 course in flying among first 5,000 purchasers. Write for particulars. Pearson Aviation Company, Coalwood, W. Va.

BE An Airport Designer and Administrative Expert. Golden opportunity in interesting profession. Millions being spent now! Wonderful complete course \$3.00. Dept. A, 154 W. Slauson Ave., Los Angeles.

NEW Nine-cylinder Gnome aeroplane engine \$85. Avro airplane complete \$475. Albert Latshaw, Clarion, Mich.

FLY! With motorcycle engine. Booklet with drawings tells how to design and build Sport Monoplane. Price \$1.00. T. A. Hodgdon, 324 Bay St., Springfield, Mass.

85 M. P. H. Aerodrive Sled-Blueprints. Only 50c. Other sled and boat prints 50c each. Sled, boats, airplane propellers. Ostergaard Aircraft, 4305 North Narragansett, Chicago.

SIMPLEX Air Model Co., Auburn, Mass. Send for Free Booklet.

AERIAL Navigation and Meteorology. A small practical volume containing just the information needed for pilots' examinations. \$2.50 postpaid. Mail order to Captain Lewis A. Yancey, 425 West End Ave., New York City.

BE An Aviator (Air Navigator). Write American Aviators Society, 154 W. Slauson Ave., Los Angeles.

HOW To own your plane and get your course free. Write for full information. Also see page 86 in this issue. Heath Airplane Co., Chicago.

EAGLE ROCK—Government certified, three place commercial ship. Largest production and demand in world. Sold on time payments if desired. \$2,475. Denver. Write or wire Alexander Aircraft Company, Denver, Colo.

FLYERS, Students—A short but complete course in designing, building and operation of aeroplanes. Postpaid 25c. James Aircraft, 1029 Walnut Street, Allentown, Pa.

"AVIATORS" Wanted. Pilots and mechanics. We prepare you in short time. Special rates for winter classes. Send for free booklet, "The Why's, Where's, How's of Learning Aviation." Atkinson Aviation Company, Dept. D, Gary, Ind.

THE American School of Aviation announces a new correspondence course in Mechanics of Aviation. A thorough training in Practical Aeronautics. American School of Aviation, Dept. 1871, 3601 Michigan Ave., Chicago, Ill.

"MODERN FLIGHT," by Chief Pilot Clevenger. Ten years' flying experience form the basis for this simple, complete book of instruction on the operation of an airplane. Send One Dollar to Alexander Aircraft Company, Denver, Colo.

20x4 BALL-BEARING airplane wheels, tires and tubes. Just right for Sport Plane or small automobile. Number limited. Order to-day. Lincoln Aircraft Company, Lincoln, Nebr.

PATENTS. Time counts in applying for patents. Don't risk delay in protecting your ideas. Send sketch or model for instruction or write for free book "How to Obtain a Patent" and "Record of Invention" form. No charge for information on how to proceed. Communications strictly confidential. Prompt, careful, efficient service. Clarence A. O'Brien, Registered Patent Attorney, Security Bank Building (directly across street from Patent Office), Washington, D. C. See pages 138 and 139.

BIGGEST, Best Catalog Model Airplanes. Parts Supplies; 5c postpaid. Ideal Company, 165½ Spring Street, New York.

BOOKS AND PERIODICALS

1927, **THIRD** edition revised. "Radio Theory and Operating," by Mary Texanna Loomis, President Loomis Radio College; member Institute Radio Engineers. 886 pages, 700 illustrations. Used in all Government and private radio schools, many colleges and high schools. Comprehensive, up to date, the standard on radio. Price, \$3.50, postage paid. At your book store, or order direct from Loomis Publishing Company, Dept. M, 405 Ninth, Washington, D. C.

"THE Personal Liberty Course"—A clever combination of mirth, information and instruction for quickly overcoming fear, bashfulness and physical complexes in men. No drugs, no gymnastics. Full particulars free, sealed. Harry J. Gardener, P. O. Box 607, Station C, Los Angeles, Calif.

HYPNOTISM Easily learned. Lessons guaranteed. Postpaid, \$1.10. Smith Pub. Co., Dept. 3, Springfield, Mass.

BOOKS. 6th and 7th Book of Moses, 50c; Albertus Magnus, 50c; Pow-Wow, 50c; Silent Friend, \$1.00; Book of Luck, 25c. The F. & R. Co., 87 Fourth Ave., Dept. 30, New York.

FAMOUS Dyke's Automobile Encyclopedia—Just out, 15th edition. Fully revised to include all latest facts regarding newest developments. Information on repairing and adjusting every part of all motor cars. How to find trouble and fix it. 1,250 Pages, 4,200 Illus. Price, cloth, \$6. Flexible Morocco \$7.50. Will be sent C. O. D. anywhere in U. S. Pay postman price and postage when he delivers book. Popular Mechanics Press, Room 922, 200 E. Ontario St., Chicago.

CURIOUS Books, Unique Novelties, Stunning Pictures, Samples, 10 cents Prepaid. Linds, 214 W. 34th Street, New York.

THOUGHTS Beautiful, a stimulating mental medicine. Send 25c for copy to Pesselman Publications, Dept. A, 1487 St. Marks Ave., Brooklyn, N. Y.

LEARN to draw; Commercial art and cartooning; complete course of self-instruction; 125 illustrations \$2.00. 15 imported art postals, \$1.00. Sample and lists, 10c. Girard Novelty Co., (P.M.) Pawtucket, R. I.

BOOK Manuscripts wanted; published on cooperative plan, Circular free. Meador Publishing Co., 27 Beach, Boston, Mass.

INDUSTRIAL Alcohol. Wright's book. Full directions for making, fully illustrated. \$2.50. Spou & Chamberlain, 120 P.M. Liberty Street, New York, N. Y.

FREE, Wonderful 624-page Dictionary. Box 29C, Station L, New York.

HERE it is—the new revised edition of Rathbun's book Aeroplane Construction and Operation containing all the information about the latest models of planes including the ships flown by Lindbergh and Byrd. Also the latest engines such as the Wright Whirlwind, etc. Authentic data furnished by the manufacturers. Complete and right up to the minute. Price \$2.50, postpaid. Will be sent C. O. D. anywhere in the U. S. or possessions. Popular Mechanics Press, Room 922, 200 E. Ontario St., Chicago, Ill.

PICTURES AND POSTCARDS

FREE Book. What men know about women. Read the Startling and Daring Truths. 10 snappy pocket cards, and copy of America's greatest Magazine. All for 25c. White Mule, Beaver Dam, Wis.

25 VIEWS New York, colored full-size post cards. Send 25 cents stamps. Zmora, 321 Avenue "A," New York City.

BEAUTIFUL Cards of Alaska and California scenery. \$1.00 dozen. Hemenway, 4105 Georgia St., San Diego, Calif.

FREE—True-Blue Listings. Hundreds exchange postcards, stamps. Ericson (10), Elroy, Wis.

FREE—Send address for beautiful 5x16 art print. C. C. Dry, Box 337, Canton, Ohio.

ART Pictures—300 All Different. Particulars 10c. Howard Sales Co., Dept. 15, 1188 Folsem St., San Francisco, Cal.

MAGIC TRICKS, BOOKS AND JOKER NOVELTIES

AMAZE and Mystify! New 1928 "Fun-Magic-Mystery," profusely illustrated; explains many tricks. Also catalogs 750 Tricks—Illusions—Jokes—Puzzles—Boots—Imported Novelties at Reduced Prices. Postpaid 10c. Lyle Douglas, Station A-5, Dallas, Texas.

EIGHT Magical secrets explained, including escapes from safes, trunks, vaults, handcuffs—50c. Information free. William King, Corvallis, Ore.

AGENTS—Sell to Stores World's Greatest Novelties, just out; whirlwind selling sensation; the Bootleggers' Map of America and Pocket Radio Moving Pictures in comics; self-addressed, stamped envelopes for samples. Miller's, 430 E. Tuscarawas St., Canton, Ohio.

MAGIC—Tricks, Books and Supplies. For Amateurs as well as the great professionals. Anyone can learn through our instructions. Feature Acts in Mind-Reading, Spiritualism, Rope Ties, etc. Large Illustrated Professional Catalog, 20c. Chicago Magic Co., 140 So. Dearborn St., Dept. B, Chicago, Ill.

FREE with \$25 order die box. Send 20c for our large catalogue of tricks, wigs, sensational escapes. Oaks Magical Co., Dept. 548, Oshkosh, Wis.

ELECTRIC Fun! Seventy stunts, 110 volts, \$1. TaCutting, Campbell, Calif.

SEVEN Magical Delusions and Catalogs—25c. Gilmagico, Morgan Park, Ill.

THE Flapper. A snappy joke novelty with a real shock 10c. Bowman Novelty Co., Racine, Wis.

TRICKS, Jokes and Novelties. Big Illustrated Catalogue and \$1.00 Trick 20c. American Specialty Co., Swampscott, Mass.

FREE—Our puzzle, trick, game, joke, Novelty Catalog. Wright & Son, 601-G Indiana Ave., Peoria, Ill.

CARD Tricks. Coin tricks, Hypnotism, Ventriloquism. Instructive books, 10c each. Geo. Fenner, 2401 Jefferson, Louisville, Ky.

FIFTEEN Tricks You Can Do 10c; Catalogue Free. Chesters Magic, 403 North State, Chicago.

ILLUSION And Trick Catalog 20c. Lynn's, 105 Beach, Jersey City, N. J.

TRICK, Joke, Puzzle Catalogues, 15c. No Stamps. Lafayette Novelty Co., 855 Lafayette Parkway, Chicago, Ill.

COMPLETE book on Magic. 563 pages; 318 illustrations. Hundreds of tricks. The standard book for years. Make money giving magic entertainments. Send No Money. Just ask for Prof. Hoffman's "Modern Magic." Pay postman postal charges and \$2.00. Popular Mechanics Press, Room 908, 200 E. Ontario St., Chicago, Ill.

GAMES, ENTERTAINMENTS AND PLAYS

LEARN Ventriloquism By Mail—Small cost, 2c stamp brings particulars. Geo. W. Smith, 125 North Jefferson, Room S-243, Peoria, Ill.

Puzzles: Leader and catalogue 10c. (Puzzles wanted.) Puzzles, Fairview, Mass.

PLAYS, Musical comedies and revues, minstrel music, blackface skits, vaudeville acts, monologs, dialog, recitations, entertainments, musical readings, stage handbooks, make-up goods. Big catalog free. T. S. Denison & Co., 623 So. Wabash, Dept. 11, Chicago.

FIRE Tricks, Mysteries you can do. Instructive. Entertaining. Amusing. Only 50c postpaid. Box 251, Hoboken, N. J.

NOVELTIES, CURIOS, ETC.

SEA Curiosities, 39 all different \$1.00. Ray Oviatt, Sarasota, Fla.

STAMP COLLECTING

STAMP Collectors, Send Five Cents for Package Stampo Chewing Gum. A five-cent stamp coupon with every package, 20 coupons good for \$1.00 catalog value in stamps selected from general approvals of leading Atlanta dealer. Send \$1.00 for twenty-five packages (retail value \$1.25 and coupons \$1.25). Additional premiums to first 100 purchasers. Send \$5.00 and get valuable agency and 130 packages of Stampo Gum (retail value \$8.50 and \$6.50 coupons). Agents wanted in every town, stamp club and school. Sample Stampo Gum free if you give us names of general collectors. Get your friends to Chew Stampo and save you the coupons. Tell the world about it and do it now. Dept. P, Pettet Bros. Stampo Products, 962 S. Boulevard, Atlanta, Ga.

THE Big Four! New set 6 Greece (beautiful scenes, Corinth canal); new set 3 Turkey (blacksmith and dog); 5 Costa Rica (gov't adv. bag coffee); 4 Iraq (ferrying animals in native boat), regular price 50c. Special to approval applicants 10c. Dennie, 7763 Logan, Detroit, Mich.

ALL For \$1.00. Here is a Complete Collectors' Outfit, to help you start your stamp collection the right way. The Imperial Outfit contains the Imperial Album. Spaces for 4,000 stamps, 100 pages, illustrated throughout. This is the genuine Imperial Album Bound in the blue cover. 300 Guaranteed stamps from many of the principal stamp issuing countries of the world, all different. 1,000 high grade stamp hinges. 1 Millimetre scale and perforation gauge. 1 Guide to Stamp Collecting, an illustrated handbook for the young collector covering every phase of the hobby. All for \$1.00. And we will send free with it our 80-page price list of packets, sets, approvals, albums, catalogues and accessories. Scott Stamp and Coin Co., 1 West 47th Street, New York, N. Y.

500 DIFFERENT Stamps for 25c! Big Collection 500 Different Stamps from Bosnia-Herzegovina, Crete, Epirus, Hong Kong, Iceland, Kenya and Uganda, Liberia, Malta, Nyassa, North Borneo, Orange River Colony, Siam, Wallis and Futana, and other "hard" countries. Catalogue value \$10.00. Price only 25c to Approval Applicants! Special Bargains, 1,000 different 79c; 15 triangle stamps 49c; 100 Africa 45c; 100 Asia 50c; 100 Balkan States 35c; 100 British Colonies 25c; 100 French Colonies 30c; 100 Portuguese Colonies 50c. All 8 packets for \$3.00! Illustrated Lists Free. Loma Stamp Co., 3926 32nd Street, San Diego, Calif.

MYSTIC'S "Queer Country" Packet! Contains scarce stamps from the following strange lands: San Marino, Antioquia, Congo, Cyprus, Fiji Islands, Gwalior Hyderabad, Iceland, Jhind, Kenya, Uganda, Lebanon, Monaco, North Borneo, Nyassa, St. Thomas Prince, Port Guinea, Siam, Sierra Leone, Tanganyika, Trinidad Tobago, Uban-gi, Upper Volta, Wallis Futuna, Zanzibar. Get this wonderful packet of "freak countries" and make your friends envious! Price only 10c to approval applicants! Write today. Mystic Stamp Company (Dept. 8), Camden, New York.

\$1.00 FREE. Black U. S. Postage. Given Away with each order. Pioneer Stamp Album with 500 illustrations. 150 different stamps from 40 countries, Syria, Lebanon, Hejaz, Liberia, New French Colonies, British, Portuguese Colonies, South Africa, Australia, 500 hinges, 36 page illustrated catalogue. All for 15c. Big Commission to Agents for the Best approval sheets of stamps ever offered. Write for sample outfit. Hussman Stamp Co., Dept. M, 620 Olive St., St. Louis, Mo.

ANCHERS \$\$\$ Outfit—only 12c! Fine triangle stamp; set German stamps with (pre-war) value forty million dollars (interesting!); perforation gauge, mm scale; small album; airmail set; scarce stamp from smallest republic on earth; newspaper set; packet good stamps from Travancore, Malay, Dutch Indies, etc. Entire outfit for 12c to approval applicants! (Nice pocket stock book, value 25c, with every order!) Anchor Stamp Co., 148½ Clerk St., Jersey City, N. J.

WONDERFUL collection 205 different stamps from Gwalior, Haute-Volta, Kouang-Teheou, St. Thomas, South Africa (Springbok), and other "hard" countries; fine triangle stamp; package hinges; millimetre scale, ruler; copy largest stamp in the world (China "Wild Goose," cat. 40c!); big illustrated lists. Total Value \$4.50. All for 10c! Also approvals. Indian Stamp Co., 103 Howard St., Bangor, Maine.

A SNAP—300 Different Foreign and 60 different U. S. Stamps, including \$1 and \$2 revenues, all for only 25c. Free, with each order, our pamphlet which tells "How to Make a Stamp Collection Properly," together with our price lists of albums, supplies and hundreds of bargains in sets, packets, etc. Queen City Stamp & Coin Co., Room 36, 604 Race Street, Cincinnati, Ohio.

200 DIFF. Stamps Free to those sending 10c for 3 mos. trial subscription to America's most popular stamp magazine. Echo, 226 Times Sq. Station, New York.

300 DIFFERENT, 20c; 600, 50c; 1,100, \$1.00. Fred Onken, 630 79th Street, Brooklyn.

FREE—Sample Copy of Stamp Collector's Magazine. World's Best Stamp Paper, 15 John St., New York.

100 FOREIGN Mixture 25c. Napp, 413 Oak Grove, Beloit, Wis.

UNITED STATES And Canadian 32-Page Price list just out, free. Stanley Gibbons, Inc., 35 Ann St., New York City.

BIRDS And beasts: 25 different, 20c; 100 different, \$1.00. French Colonials: 50 different, 10c; 200 different, \$1.00; 400 different, \$3.00. Beautifully illustrated forty page price list free. A. A. Nickles, 213 Seaton, Washington, D. C.

1000 VARIETIES And 1000 Hinges \$1; good stamps on approval. References absolutely necessary. Premiums. A. Frisch, 83-47 Victor Place, Elmhurst, L. I., N. Y.

SELECT Packet—10c. Ed. Barker, 1963 East 9th Street, Brooklyn, N. Y.

25 DIFFERENT Luxemburg with approvals, 12c. Iowa Stamp Co., Cedar Rapids, Iowa.

100 FOREIGN Stamps 3 Cents. Lufbery, Route 3, North Branford, Conn.

FREE—True-Blue Listings. Hundreds exchange stamps, postcards. Ericson (11), Elroy, Wis.

FREE, Big surprise packet with approvals. Bill Barton, Rome, N. Y.

U. S. BANK Mixture, airmails, commemoratives, high values, \$2.69 per pound postpaid. Bill Barton, Rome, N. Y.

CRETE: 8 varieties 15c postpaid. Lists free. Allion, Angola, Ind.

50 DIFFERENT Guatemala stamps \$1.00. 1000 different foreign stamps 75c. 500 used and unused foreign stamps 25c. Arcy, Box 483, Muskogee, Okla.

INVENTORY—Big Packet 10c. Approvals. References. Golden Rule Stamp Co., Box 1248, Chicago.

1,000 MIXED Stamps 10c. Special Enterprises, Sunnithill, Ohio.

HEADHUNTER, Sphinx, tiger, elephants packet of 105 varieties, nickel, plus postage. Universal Shop, 91 Geiston Avenue, Brooklyn, N. Y.

1000 ALL Different stamps, catalog value \$25.00, for only 69c, to approval applicants only; or 500 cataloguing \$10.00 for 19c. Free Price Lists. Rotnem Stamp Co., 809 Northwestern Building, Minneapolis, Minn.

1,000 ALL Different stamps \$1.00. New price list of all United States stamps free. Voorhees, 7 South Dearborn St., Chicago.

FREE 25 Portuguese Colonial Stamps to approval applicants. 2c Stamp. Light-brown's, Osborne Rd., Southsea, England.

STAMPS—Rare triangle Free, with 50 different foreign stamps, illustrated album; stamp hinges; perforation gauge; big illustrated catalog—send 10c for complete outfit. W. Betts, Box 6, Clearfield, Penna.

BEST One-Cent approvals in America. F. P. Hand, 1117 So. 60th St., Philadelphia, Pa.

EXTRAORDINARY Opportunity. Forty-eight different stamps, including magnificent Costa Rica alone cataloguing sixty cents, Niger Coast, Gaboon, and large bargain list of packets and sets. Only Ten cents. Shaw Stamp Co., Bear River, Nova Scotia, Canada.

101 DIFFERENT Free with 50% Approvals, 2c postage. Noemus Stamp Co., 312 East 23rd St., New York.

SPECIAL—25 Different Airmail, 10c; 25 Different French Colonies, 10c. Free! package Hinges 50% Approvals. Webster Stamp Co., Box 11, Tremont Sta., New York.

SURPRISE Packet—Borneo, Australia, Malay, U. S. Commemoratives, Etc., and Illustrated Lists for 6c. Moseley, 4521 Parkview, St. Louis, Mo.

LINDBERGH 2 and 5 cent stamp issued by Panama Government, \$1.00 each. S. Patchett, Cristobal, Canal Zone.

BIG Packet foreign stamps to approval applicants, 4c postage. F. Rudolph, Box 92, Newton, Kansas.

UNITED STATES—26 different, 5c, to buyers from 50% or 60% discount sheets. State size of collection. Leduc, Redlion, Penna.

87 DIFFERENT Countries!! Cyprus, Dahomey, Indore, Jhind, Somali, etc. Marvelous packet 87 different stamps from 87 different countries; many scarce. Twelve cents, but only with Approvals. Lists free. Reimers, 6 Flatiron, Fort Worth, Texas.

FREE—5 Newfoundlands, postage 2c, to approval applicants. Prall, Somerville, N. J.

%c APPROVALS—5,000 Borneo, Sudan, etc. References. Philatelic Exchange, Huntington, W. Va.

BARGAIN—15 British Colonies 15c. Grant, 6317 18th Ave., Brooklyn.

ELBE Loose Leaf Albums, Stock Books and Approval Cards. All sizes. Patented features. Write for catalog. Elbe, 215 Green Street, New York City.

FREE 50 British Colonials, if approvals requested. Postage 4c. Berkeley Stamp Co., South Berkeley, Calif.

20 DUTCH Indies 12c; 10 Newfoundland, 6c; 23 Epirus, 30c; 25 Luxemburg, 15c; 10 Costa Rica, 8c; 16 Armenia, 12c; 25 Egypt, 20c; 25 Japan, 8c. Frederick Jackson, Dos Rios, Calif.

MAGNIFICAROUS Packet foreign stamps, beauties from distant lands. (Many richly colored, unusual designs), free for 2c. Gray Stamp Company, Toronto, Can.

50 DIFFERENT United States 5c to approval applicants, 25 Guatemala 20c; 100 British Colonies 25c. P. M. Glendale Stamp Co., 1312 Linden, Glendale, Calif.

500 DIFFERENT, 29c; 1,000 Different, 69c; 50 Different French Colonies, 9c. Stamp Shop, 15 Pershing Ave., Elizabeth, New Jersey.

15 DIFFERENT Foreign, 2c. C. D. Williams, Oteen, N. C.

1,000 VARIETIES For 69c! Approvals. Kenmore Stamp Co., 703 Kenmore Place, Brooklyn, N. Y.

1000 NICELY mixed stamps, 25c postfree; 1000 hinges 10c; 2000 17c. Approvals. Price lists. Sunshine Stamp Co., 549 East Maryland St., St. Paul, Minn.

FREE, Five mint Philippines to approval applicants. Postage 2c. Eastern Stamp Co., Odenton, Md.

NETHERLANDS RED CROSS No. 468-72 only 26c and Commemorative set free to approval applicants. G. W. Deering, Fairmount, Marlborough, Mass.

FREE—Surprise packet to approval applicants. D. D. Hovey, Jr., 17384 Beaverland, Detroit, Mich.

300—300—300 ALL Different stamps (\$6.00 catalogue); 300 hinges; 5 approval sheets; duplicate stamp album; perforation gauge; millimeter scale and ruler, to approval applicants for only 20c. Edgewood Stamp Company, Milford, Conn.

10 WONDERFUL Triangles 22c. 50 French Colonies 12c. Elwood D. Weber, 1377 Park, Plainfield, N. J.

BOOKLET Telling why and what stamps become valuable and other interesting information; also 10 scarce postage stamps of excellent value, all for 35c. T. Bot-tome, 2934 Shriver, Indianapolis, Ind.

CHAD. 5 Var. Free for name four collectors and 2c stamp. Kolar Co., Dallas, Texas.

SWEDEN Packet, Attractive Stamp 5c to Approval Applicants. Harvey Teeple, Decatur, Ind.

500 DIFF Stamps and one Stamp Cat. \$1.00 for 30c. With our approvals. Pelham Stamp Club, 1844 Paulding Ave., Bronx, N. Y.

FREE, 12 Diff. British Colonies for a request for my popular approvals of large showy picture stamps, at 50% Disc. Postage 2c. Chas. Bushnell, 4728 Princeton Ave., Tacony, Phila., Pa.

UNITED STATES—Fifty different, no current issues, 10c, to approval applicants. Big lists free. Fenway Stamp Co., 161 Massachusetts Ave., Boston, Mass.

BEAUTIFUL Picture Stamps Sent Free. Paul Cornish, Schenectady, N. Y.

110 NEW Europe All Different, a wonderful collection cataloguing several dollars, free to collectors requesting our Net Approvals. Postage 2 cents. Badger Stamp Co., Milwaukee, Wis.

DANZIG Stamps Free—Interesting packet from Danzig with big catalogs free for 2c. Midland Stamp Company, Toronto, Can.

STAMPS, 100, all different, 3c to approval applicants. Glenn R. Knight, Box 3, Sausalito, Calif.

FINEST One Cent Approvals in the United States. Stanton, Niantic, Conn.

MOST Sensational values; over 140 diff. Algeria, Airplanes, Azerbaijan, Barbadoes, Cameroun, Babon, Guyane, Irish set, large French Colony packet, largest stamp, 40 year old U. S., gauge, etc., for 10c to approval applicants. List free. 100 diff. U. S. 30c—1,000 hinges 9c—50 Bavaria 9c. Hawkeye Stamp Co., Cedar Rapids, 39, Iowa.

109 DIFFERENT, Arabia, Azerbaijan, Zanzibar, etc., 10c to approval applicants. Floyd Marsh, 524 Hamilton Ave., Indianapolis, Ind.

UNITED STATES Stamps sent on approval against references. Mark Hanna, New Kensington, Pa.

AIRMAIL Stamps—4 Syria, 55c net; 5 Morocco, 90c. Marney's, 400 Broadway, East St. Louis, Ill.

FREE, 12 Diff. large, showy picture stamps for a request for my popular approvals. Premiums with every purchase. A. Bauer, Palmyra, N. J.

FREE! 101 Diff. Mexico, etc.! Supreme, 2335-9 S. Turner, Chicago.

FREE! 115 Different stamps to approval applicants, 2c postage. Paige Stamp Co., Oak Park, Ill.

STAMPS on approval 1/4c up. Free Premium. Herbert Kelgwin, Middletown, N. Y.

100 FOREIGN postage stamps, 4c; approvals 50% off, references, write for our big bargain lists of packets and sets. Palmer Stamp Co., 8221 Linwood Ave., Detroit, Mich.

24 VARIETIES Cuban stamps, 10 cents. List of 6,000 low-priced stamps free. Address Chambers Stamp Co., 111P, Nassau St., New York City, N. Y.

110 DIFFERENT Stamps, many unused, high values, free to collectors requesting our Net Approvals. Postage 2 cents. Christensen, Milwaukee, Wis.

ONLY 5c! 10 Airmail stamps, including scarce Esthonia triangle; Greece Red Cross set; packet fifty different stamps—all unused from Guyane, Ubangi, etc. All for 5c! Approvals and free lists with each order. Curhan Stamp Company, Gloucester, Mass.

STAMPS, 100 all different. Postage 2c. Lists free. P. M. Quaker Stamp Co., Toledo, Ohio.

1000 MIXED Foreign Stamps 25c. Phil Lundsted, Cape Cottage, Maine.

200 DIFFERENT stamps 10c; 1,000 Hinges 10c. R. H. Carlton, 380 W. So. Temple, Salt Lake, Utah.

FREE Hungary Charity No. 565 to 567 and a surprise packet given to those requesting for my 1, 2, and 3c approvals, and also my 50% discount. Chas. W. Schmidt, P. O. Box 4832, Frankford Station, Philadelphia, Pa.

COVERCO Packet, 250 varieties unused and used stamps 15 cents. Covert Stamp, 39 State, Rochester, N. Y.

STAMPS sent on approval at 70% discount. Reference required. Emory Renoll, Hanover, Pa.

PENNY Approvals that Satisfy. Neil Gronberg, Box 5441, Philadelphia, Pa.

105 CHINA, etc. 2c. Album (500 illustrations) 3c. Bullard, Sta. A, Boston.

200 DIFFERENT Stamps, Zanzibar; Album, 12c. Liberty, 3974 Arsenal, St. Louis, Mo.

STAMPS, 100 varieties, Africa, Brazil, Peru, Cuba, Mexico, etc., 10c; 25 different U. S. 25c; 1,000 mixed, 40c; 1,000 hinges, 15c. List free. C. Stegman, 5941 Cote Brillante, St. Louis, Mo.

TIP-TOP Premium of 50 different, stunning stamps, pocket stamp book, perforation gauge, mm. scale, ruler, good stamp from Kenya & Unganda (cannibal land). Gold Coast Persia, all for 10c to applicants for Tip-Top approvals. Tip-Top Stamp Co., Colorado Springs, Colorado.

FREE—100 stamps to approval applicants. Sending 4c postage. Hedgdon, 1, Stevens Rd., Needham, Mass.

100 DIFFERENT U. S. stamps 40c; no cut squares. Approvals all countries; send reference to M. L. Cook, 527 West 46th Street, Chicago, Ill.

FREE! Loose Leaf Postage Stamp Album at rate of 8 pages each month given with subscription to monthly Journal. Send 2c stamp for prospectus. United Stamp Co., Marquette Bldg., Chicago, Ill.

REVENUES—Telegraphs—Every country. Pretty—Intriguing—Cheap. Mint \$5.00 revenue free to applicants with references. Vanderhoof, 1114 Logan, Denver, Colo.

FREE—200 different stamps to new customers. Auburn Stamp Co., Syracuse, N. Y.

RARE COINS

11 DIFFERENT Coins 25c. 25 different 50c. Oddehon, Box 681, Kansas City, Mo.

ANCIENT Coin about 2000 years old, 2 Crisp Notes, 2 foreign Coins and Catalog 20c. G. Best, Cedar Rapids, Iowa.

40 OLD Coins, all different, \$1.00. 100 different coins, \$3.00. 200 different coins, \$5.00. Monroe Half-Dollar, Unc., \$1.00. Vermont Half-Dollar, Unc., \$1.00. Mexico Two-Peso Gold, \$1.35. Claud Denney, Box 315, Dallas, Texas.

100 WAR Coins, \$1.00. 10 Civil War cents, 50c. 10 Confederate bills, 50c. 10 Foreign bills, 30c. Trade Dollar, \$1.25. 5 Roman Coins, 50c. 10 Arrowheads, 60c. Sesqui-Centennial Half Dollar, \$1.60. Roosevelt medal, 15c. Nagy, 8 P. South 18th, Philadelphia.

COMMEMORATIVE Half Dollars, Uncirculated Lincoln, Pilgrim, Maine, Grant, Oregon and Vermont, \$1.20 each. Monroe, Stone Mountain and Lexington 90c each. 1926 Philadelphia \$1.50. Postage Extra, Ambrose J. Brown, Marblehead, Mass.

CALIFORNIA Gold Quarter 27c; Half 52c; 1838 cent or 1853 5c, 20c; Jackson cent 25c. A. Wylie, Wheaton, Ill.

SPECIAL—1787 Connecticut cent 25c. Durso, 25 Mulberry, N. Y. City.

NICKEL, 3c, 2c and Red Cent 25c. California Gold 1/4, 26c; 1/2, 52c. 4 Bills Confederate, 2 Wild Cat Bills, 20c. Al. E. Bonsall, Richmond, Ind.

OLD Coins, Large Spring Selling Catalogue of coins for sale free. Catalogue quoting prices paid for coins, ten cents. William Hesslein, 101A Tremont Street, Boston, Mass.

\$2 TO \$500 Each Paid for hundreds of old and odd coins. Keep all old money, it may be very valuable. Send 10 cents for illustrated coin value book, 4x6. Get posted. Guaranteed prices. We buy and sell. Clarke Coin Office, LeRoy, N. Y.

OLD Money Wanted. Will pay fifty dollars for nickel of 1913 with Liberty head (no Buffalo). We pay cash premiums for all rare coins. Send 4c for large coin folder. May mean much profit to you. Numismatic Co., Dept. H, Fort Worth, Tex.

UNITED STATES and Foreign Money; Military Decorations Catalogue and Greek coin 10c. Alexis Mengelle, Colorado Springs, Colo.

GET Profit and Pleasure in collecting Old Coins. Send 10c for Large Illustrated Coin Catalogue. You'll be delighted with it. Send for it right now. B. Max Mehl, Numismatist, Mehl Bldg., Dept. P, Fort Worth, Texas. Largest Rare Coin Firm in the U. S.

4 DIFFERENT Coins and List 10c. Anthony F. Torchea, Box 111, Utica, N. Y.

UNITED STATES, Large cent, two-cent bronze, three-cent nickel and Bargain List, 25c. Fifteen dates large cents, \$1.00. George Coffin, Greenwood Mountain, Me.

HUNDREDS Porcelain, War, Etc. Coins. Bills. Catalogue, two War Coins, 10c. Wacker-Dickman Minster, Ohio.

CALIFORNIA Gold—Quarter Size, 27c; 1/2 size, 53c; 3c Piece and Catalogue, 10c. Norman Schultz, Box 746, Salt Lake, Utah.

FOR BOYS

"THE Boy Electrician," pocket size, 75 illustrations, 30c. J. Tillbergh, Proctor, Vt.

BOYS, Girls. Earn Money. Easy Work. R. Bendert, 3683 Helen, Detroit, Mich.

CAMERAS AND PHOTO SUPPLIES

PHOTOGRAPHIC Equipment and accessories of every description are listed and illustrated in our 228-page catalog. It will pay you to secure a copy which is issued free, as our prices are low. We also deal in used goods which are sold under the same guarantee as new goods. Ask for our Bargain Book. Central Camera Co., Dept. E127, 112 S. Wabash Ave., Chicago, Ill.

\$50.00 FOR Photographs—This price paid for photographs if they meet our requirements. Perhaps one of your pictures will bring this amount. For particulars, address Reikrafta, Dept. 11, Denver, Colorado.

ROLL Developed 5c. Prints 3c each. Trial 5x7 enlargement beautifully mounted 25c. Young Photo Service, 405 Bertha St., Albany, N. Y.

SELL your photographs. Booklet lists hundred best magazines. 25c silver. Snyder Publishing Company, Guilford, Conn.

FILMS Developed. Special Trial Offer. Any Size Kodak film developed 5c, prints 3c each. Trial 6x10 Enlargement in handsome folder 40c. Overnight Service. Roanoke Photo Finishing Co., 209 Bell Ave., Roanoke, Va.

GERMAN Cameras, Lenses, Bartro, 6436 La Riba Way, Los Angeles, Calif.

KODAKERS—Bargain Trial Offer. Roll developed and six prints, one hand-tinted, 25c. 8x10 Enlargement 30c. Falls Foto Finishers, Dept. A, Glens Falls, N. Y.

TRANSFER Photographs to metal, china, etc. Patented process. Makes beautiful miniatures. A real art. Lots of fun and profit. Anyone can do it. Outfit supplied to members only. Write about membership. Kyograph Photo System, 21-c W. 17th St., New York.

BIG Money Saved on Photographic Lenses and Apparatus—goods exchanged; repairing done. Ralph J. Golsen, 1128 Argyle St., Chicago, Dept. P.

HAVE You a Camera? Write for Free sample of our big magazine, showing how to make better pictures and earn money. American Photography, 116 Camera House, Boston, 17, Mass.

EARN big money with your camera in your spare time, using Hallorsam Home Portrait Lamp. Write for booklet "Home Portrait Photography" and catalog—both free. The Hallorsam Company, 4747 N. Western Ave., Chicago.

MAKE money in photography. Learn quickly at home. Spare or full time. New Plan. Nothing like it. Experience unnecessary. American School of Photography, Dept. 3431, 3601 Michigan Avenue, Chicago.

MOTION PICTURES

NEW \$150 double spring movie camera, \$37.50; 80 foot spring motor camera. Zeiss's lens, \$80; negative film, 2 1/2c foot; 16 millimeter spring operated camera, \$50; 15 millimeter negative film, \$5 postpaid; 100 foot complete 16 millimeter comedy or western, \$4.50. Camera and projectors bought and exchanged. New twin arc movie lamps, \$40; 3 1/4 x 5 1/2 kodak, \$9. Ray, 296 5th Ave., New York.

\$1,250.00 FOR a Photoplay Story by an unknown writer and sold through our Sales Dept. We revise, copyright and market. Located in the heart of Motion Picture Industry, we know the demand. Established 1917. Send Manuscript for free criticism. Booklet on request. Universal Scenario Company, 206 Western and Santa Monica Bldg., Hollywood, Calif.

WANTED To Buy—Second-Hand Power's, Simplex and Motograph Machines. Also extra mechanisms and stands. Must be bargains. P. O. Box 202, Birmingham, Ala.

NEW Film 1c foot. Searles, 130 Fisk St., Providence, R. I.

FILMS For toy machines. Big Clearance Sale. Bargains. Alton Films, 205 Brush Creek, Kansas City, Mo.

MEN To learn motion picture operating. A big money profession—\$2,000 to \$4,000. Movie Operators School, 61 Sproat St., Detroit, Mich.

FILMS 200 feet full of action \$1.00. J. Brink, 54 Melrose St., Boston, Mass.

THE latest edition of Bass Bargaingram is ready for you. Send stamp. Think! A professional Standard Motion Picture camera outfit as low as \$45.00. Others \$55.00 and \$75.00. Buy from Headquarters. Big Free Catalog. Latest book on "Talking Movies" \$1.50. Bass Camera Company, 177 West Madison St., Chicago.

NEW and Rebuilt Projectors for Theaters, Schools, Churches, Traveling Shows. Supplies and Complete Theater Equipments. Bargain Prices. Free Catalog. Monarch Theatre Supply Co., Memphis, Tenn.

FILMS and Machines, dirt cheap. Stamp for lists, Box No. 5836, Westport Station, Kansas City, Mo.

MOVIE Films, 1,000 ft. reels, \$2.50 each; shipped anywhere on receipt of remittance. Particulars on request. Independent Films, 177 Golden Gate Ave., San Francisco, Calif.

FILMS \$2.50 Reel. Cameras \$35.00-\$65.00. Stewart Marshall, Rome, Ga.

BE A Movie Exhibitor—Big Opportunity—Only Moderate Capital Required—Complete Equipment at Remarkably Low Prices. Write. Atlas Moving Picture Co., 624 South Michigan Ave., Chicago, Ill.

SCENERY TO RENT

WORLD'S Most Beautiful Settings for operas, plays, minstrels. Amelia Grain, Philadelphia.

EDUCATIONAL AND INSTRUCTION

U. S. GOVERNMENT wants men. \$1,700-\$1,900 and up at start. Railway Mail clerk examination coming. Let our expert (former Government examiner) prepare you for this and also Rural Carrier, Post Office, Customs, Internal Revenue, and other branches. Write today for free booklet. Dept. 8, Patterson School, Rochester, N. Y.

RAILWAY Postal Clerks, \$158.00 to \$225.00. Steady work. Common education sufficient. 25 men, 18 up, coached free. Write immediately. Franklin Institute, Dept. A-3, Rochester, N. Y.

STORY Ideas Wanted for photoplays, magazines. Big demand. Accepted any form for revision, development and submission to markets. Established 1917. Send manuscripts for free criticism. Booklet mailed on request. Universal Scenario Company, 406 Western and Santa Monica Bldg., Hollywood, Calif.

MEN wanting railway mail clerk and other Govt. positions, qualify now. Particulars free. Write Mokane Institute, M-21, Denver, Colo.

USED Educational matter bought, sold, exchanged; bargain catalogue free. Handling, 799 Broadway, New York.

INVESTIGATING And Tracing. Work home or travel. Experience unnecessary. Write, George Wagner, 2188 Broadway, New York.

CHIROPODY: Study this interesting and profitable profession by mail. Write for particulars, Dr. Michon, 430 S. DuFrocq, Baton Rouge, La.

WORK For "Uncle Sam." Life Jobs. Steady work. \$95.00-\$275.00 month. Men-boys, 18-50. Thousands 1928 appointments. Common education with our coaching. Experience unnecessary. List positions and full particulars—Free. Write today sure. Franklin Institute, Dept. A-14, Rochester, N. Y.

FIREMEN, Brakemen, Baggage men (white or colored), sleeping car, train porters (colored), \$150-\$250 monthly. Experience unnecessary. \$10 Railway Bureau, East St. Louis, Ill.

BOYS—Men, 16 Up. Become Auto Mechanics. Particulars free. Franklin Institute, Dept. A-400, Rochester, N. Y.

WEALTH, Health, happiness in psychology. Private lessons, G. Anderson, Box 1244, Phoenix, Ariz.

STUDY A Scientific Profession. Sanitation—Bacteriology—Microbiology. Extension—Residential courses. Diplomas—Degrees granted. Urinalysis outfit and prospectus free. Int. College of Microbiology, 722 Calumet Ave., Hammond, Ind.

\$175-\$270 MONTH—Government positions. Experience unnecessary. Expert instructions. Booklet free. Standard Institute, 4554-M Broadway, Chicago.

LEARN To be an Heraldic Artist. Make enlarged pictures of crests and coats of arms for wealthy people. Personal tuition by studio doing this work. Very profitable work easily learned by our method. Heraldic Studios, Rapp Bldg., Winnetka, Ill.

\$400 TO \$700 monthly selling Real Estate my way. We qualify you for a Real Estate Expert or refund your money. Write for Free booklet without obligation. National Real Estate Institute, Dept. 600, Fort Smith, Ark.

ENGINEER Teaches Arithmetic, Algebra, Geometry, Trigonometry, Drafting, Surveying, Aviation. Mondell, 1440 Broadway, New York.

ONE-HAND Chinning, bending and driving spikes with the hands, easy with my instructions, sleights and tricks. Complete one dollar. Jack, Box 585, Milwaukee, Wis.

PHOTOGRAPHERS Earn \$100 week, up. Learn at home. Quick, Short New System. Write for Free Booklet, "Simplified Photography." Ajax Studio & Laboratories, 5PM Columbus Circle, New York.

LEARN Bookkeeping and shorthand at home. Personal instruction by mail in all commercial courses. Pacific Institute, 405 Kress Bldg., Long Beach, Calif.

TRACE Missing People. Excellent paying work. Open to all. Write National Headquarters, 169 East 83rd Street, New York.

DON'T prepare for any Civil Service Examination without seeing our catalogue. Free. Columbian Correspondence College, Washington, D. C.

USED educational matter sold on purchase has's. Also rented and exchanged. Money-back guarantee. Catalog free. (Books, etc. bought.) Lee Mountain, Pigeah, Ala.

SILVERING Mirrors, French Plate. Easily learned; immense profits. Plans free. Wear Mirror Works, Excelsior Springs, Mo.

DOUBLE Entry Bookkeeping mastered in 60 hours with 8 keys; guaranteed; diploma. International Bookkeeping Institute, Dept. 8, Springfield, Mo.

WANT U. S. Government Position; commence \$100 to \$250 month? Men—women, 18-55, trained at home in three weeks. Write, Ozment Instruction Bureau, 101, St. Louis, Mo.

STEAMSHIP Positions—Europe, Orient. Good pay. Experience unnecessary. Men and Women write for free particulars. Box 122-A, Mount Vernon, N. Y.

DECORATIVE Work. Directions for decorating with pressed leaves, antique painting, preserving plants, bouquets of colored grass, tree cone decoration, fungi decoration, decalcomania, crystallized grasses, Grecian painting copper impressions of leaves, skeleton leaves, leather work, modeling in clay, moss work, paper flowers, pearl work, ornamenting with shells, etching shells, transparencies. All this and much more in "Youman's Household Guide." Send no money. Just order on postal. Pay postman \$2 and postal charges. Popular Mechanics Press, Room 908, 200 E. Ontario St., Chicago, Ill.

RADIO OUTFITS AND SUPPLIES

SET Builders: We furnish jobs. No fee. Register now on our list of professional set-builders. Inquiries from your locality will be referred to you. We are headquarters for parts for Hammarlund-Roberts, Silver Shielded Six, Karas Equamatic, Bremer-Tully, Power Six, Harkness Counterfonic and other popular circuits. Register at once. Give references and experience. Allen-Rogers-Madison, Inc., Dept. E, 35 West 31st Street, New York, N. Y.

300 MILE pocket radio, \$2.00. No tubes nor batteries required. Useful and practical. Loud-speaker volume. Order direct today. Spencer Laboratories, 116 Atlas, Akron, Ohio.

A MICROPHONE Button has many uses and will make your crystal set operate loud speaker. Sent prepaid with instructions 85c. Ellis Radio Laboratories, 1213 West Third St., Jamestown, N. Y.

FIVE Tube sets \$25.00 Guaranteed. In massive walnut cabinets. Also 5 tube chassis \$12.00. Vesta 201 tubes \$8.00 Guaranteed. 30 Henry chokes \$1.00. 2 microfarad condenser blocks \$6.00. Send money order. Chas. Hoodwin Co., 4210 Lincoln Ave., Chicago, Ill. Dealers in bankrupt stocks.

WRITE About our efficient power devices. Kimley Electric Co., 441 E. Ferry St., Buffalo, N. Y.

ARE You making money in radio? If not, send for booklet. Co-Operative Radio Doctors, Dept. M, 131 Essex St., Salem, Mass.

GUARANTEED "B" battery eliminators reduced to \$5.00. "A" eliminators. Six-tube single dial light socket sets under \$10.00. Write for "Unusual" catalogue. F. A. Meek, Rockbridge, Ill.

5-TUBE Radio \$9.95. Over 9,000 Bargains. Oman, 166 Concord, St. Paul, Minn.

STANDARD Radio and Phonograph merchandise on cost plus plan. Big saving. Crosley Bandbox \$39.50. Speakers, motors, electric pickups, horns. Federal Supply Co., Kokomo, Ind.

NEW farm Radio \$2.95 postpaid. Needs no tubes, batteries or electrical current. Over 300,000 homes have them. Picture and folder sent free. Crystal Radio Company, Wichita, Kans.

LARKIN'S Radio chart helps you get best and clearest reception. Prepared by expert, prevents trouble, conquers difficulties, gives inside tips on betterments. Improved results 50% to 500%. Larkin, 453 27th Ave., Milwaukee, Wis.

TRADE AND TECHNICAL SCHOOLS

WANT a Foreman's Job? You haven't a chance unless you can read Blue Prints. You may be a good mechanic but if you can't read Blue Prints you won't succeed. I train you quickly. Write me your trade. Carroll Rumsey, 264 Drexel Bldg., Philadelphia.

TELEGRAPHY—Both Morse and Wireless—taught thoroughly and quickly. Tremendous demand. Big salaries. Wonderful opportunities. Expenses low; chance to earn part. School established fifty years. Catalog free. Dodge's Institute, Fern St., Valparaiso, Ind.

WE Train you for commercial radio operating and junior engineering, placing our graduates in positions paying \$150 to \$300 monthly from start. Rapid advancement. Write for catalog of course including extension course. Loomis Radio College, Dept. 5-E, Washington, D. C.

LEARN Radio and Telegraphy. Pleasant steady work. Operators earning big money. Always in demand. No experience necessary. Write Chief Operator, Illinois Telegraph, 1608 W. Madison, Chicago.

PRACTICAL Radio is unusually successfully taught by the McKay Instrument Co. Students study at home, understand Radio and earn big money. Railway Exchange Bldg., Portland, Oregon.

BUSINESS OPPORTUNITIES

EARN liberal second income, not interfering with your present work. Build substantial paying business in comparatively short time making world's biggest selling specialties. Investment small. Profits great! Have others selling your goods. My free, valuable, enlightening literature explaining all, how its possible, without machinery for you to manufacture Loidae, Instant Automobile Refinish; Acmolite, guaranteed radiator anti-freeze; Re-Nu-Shu, factory refinish for old stained shoes; Klerzit, assures clear windshield vision; Alulte, wonderful all-metals polish; catalog of popular priced, Apex guaranteed formulas for 500 necessities. 30 years' experience turning beginners into successful manufacturers. Highest references. Miller, Chemist, 1706-G Jetton, Tampa, Fla.

WE Offer few high-grade men, financially responsible, exceptionally good opportunity to engage in business on their own account, selling neediest and best specialties of their kind. Articles sell all classes of high-grade business men, physicians, surgeons, homes, clubs, etc. Applicant must have fair education, reasonably fluent talker and financially able to invest around \$1,500 for merchandise, maintain office and manage salesmen. Sellstrom Mfg. Co., 342 North Ogden Avenue, Chicago.

READ The Mail Order News—America's Pioneer Mail Trade Journal. Quarter Century Old. Approximately 600 pages yearly of valuable information for beginners and established mail-order houses. Analyzes mail-order business, its opportunities. Practical mail-order ideas, legitimate money-making schemes, instructive articles. Tells how to start, what to sell. Published monthly. Subscription \$3.00 yearly. Send 25c for sample copy. None free. Mail Order News, 360 Bristol Bldg., New York.

START A Crispette shop. Delightful confections. Everybody likes them. Make a lot of money. Adams reports \$364 profits in two days. We start you. Write, Long Eakins, 1962 High St., Springfield, Ohio. (Samples 10c.)

START Beauty Shop, Home, Store, Anywhere. We furnish everything. Details and Plans Free. Liebig's, Beaver Dam, Wis.

WHY Work for others? Employ agents yourself. Make your own products. Toilet Articles, Household Specialties, etc. 500% profit. Valuable booklet free. National Scientific Laboratories, 1984W Broad, Richmond, Va.

KING System Mail-Order Business—sample details free. King Company, Box 6722, Wilmington, Del.

EARN Big money daily. Formulas and details 2c. H. C. Buchholz, Norwood, Ohio.

OPERATE Chewing gum machines. Large profits. Small capital. Particulars Free. Robbins Company, 28 Dodworth Street, Brooklyn, N. Y.

\$1.95 BUYS Minutely-detailed instructions—\$42 started me, netted \$410 monthly; sold later for \$6,000.00; certified accountant's report verifies facts. Northwest origination. No scheme, selling nothing; all details for business \$1.95. Ravetti, Box 688, Tacoma, Wash.

UNLIMITED Opportunities and mail order information 10c. Advance Company, Stillwater, N. Y.

MAKE 25 Quick selling specialties. Entire Plan \$1.00. Easy Mfg. Co., East Dedham, Mass.

BE My partner, selling Auto Seat Covers, ten dollars a day and more. I teach you and furnish material at cost. The Seat Cover Shop, 2419 W. 9th, Los Angeles.

SELL A Necessity at Half Store Price, still make 100%. Small article, nationally advertised, popular as cigarettes. Repeats regularly. Establish route stores, appoint agents. Twenty page booklet 10c. Velvet Product Co., Sta. J-18, Orlando, Fla.

WONDERFUL Opportunity; sell your own products. Famous formulas; get free list. Jordan, 443 "S" St. N. W., Washington, D. C.

FREE Printing with successful formulas. Samples, particulars. Voltine Agency, Roswell, New Mex.

AGENTS Wanted for a new electrical appliance. One of the greatest conveniences offered a man for years. Non-competitive, non-seasonable. Tremendous market. A proposition with a real future for men who want to sell something they believe in. Address Room 513, 600 So. Delaware Ave., Philadelphia.

YOUR Name in Directory, 10c, brings big mails from everywhere. Catalogs, samples, magazines, money-making propositions. Sureka Supplies, 624 Barnett, Kansas City, Kans.

COMPOSITION Floor Making earns industrious men \$12 and more daily if used as trade. Or make business of it with profits up to \$10,000 yearly. Openings everywhere. Semi-Tile, Dept. C, Hollis, N. Y.

RECEIVE Mail from everywhere. Mail-order Agency, Homework propositions, 20c. Larson Bros., P-3410 North Ave., Chicago.

BUSINESS Profession of your own and earn big income in service fees. See Stephenson Laboratories, display ad, page 48.

\$6,000 YEARLY On a vacant lot! Impossible? Not at all. If interested in really making money as "your own boss" at home, get in touch with Geo. L. Brockman, 708 Ridge St., Laporte, Ind.

OPPORTUNITY Knocks once. Here is your chance. Twenty money-making propositions \$1.00. Panco, Box 62, Stock Yards Station, Cincinnati, Ohio.

FREE! Aluminum Scroll Saw for making toys, novelties—on receipt \$1.00 for patterns, instructions. Lever operated Saw and Table \$3.00. Wm. Bogren, 2264 Hermany Avenue, New York.

ATTENTION! Establish for yourself new system real estate, brokerage and insurance agency; office at home; earn \$5,000 year. Stamp free booklet. Hayes Realty Association, Cincinnati, Ohio.

MAIL Order Drug Store. Let us supply your drug store wants. Special, Genuine Gillette Razor and Blade, 27c stamps. Mequon Drug Store, Thiensville, Wis.

SELL By Mail. Marvelous opportunity. Write immediately. Ernest N. White & Co., 1200 S. 1st Ave., Maywood, Ill.

BATTERIES: How to make and repair. Plate formula and complete instructions for making and repairing. \$1.00. Information Bureau, 94 Bonham St., Paris, Texas.

MAKE \$20 Per 100 stamping names on Keytags. Business for all or part time. Travel or home. Sample and instructions 25c. W. M. Ruth Co., Wheelersburg, Ohio.

MAIL Dealers' Wholesale Directory, where to buy thousands of articles, 10c. Lester-Marie Co., 2901 Seminary Ave., Chicago, Ill.

MIRRORS Resilvered at Home. Costs less 5 cents per square foot; you charge 75 cents. Immense profits plating like new; brassy, worn-off autoparts, reflectors, tableware, stoves, etc. Outfits furnished. Details free. Write Sprinkle, Plater, 127 Marion, Ind.

100 WAYS Of making money home, without canvassing. 25c. Joseph Pierce, Mission, San Jose, Calif.

MECHANICS. Painters, carpenters, start furniture refinishing, painting, handyman shop on nearly nothing; winning plan brings customers quickly. John Braceland, 1439 So. Ninth, Philadelphia, Pa.

PERPETUAL Royalty Interest. 640 Acres, entire section, for \$10. Warranty deed covering all minerals, including oil, gas and geotash, famous West Texas mineral region. May make you independent. Write for free information. Southern Investment Corporation, 301 Kress Building, Houston, Texas.

DELAWARE Incorporator. Charters; Fees Small; forms. Chas. G. Guyer, 901 Market St., Wilmington, Del.

ARTIFICIAL marble sanitary flooring instructions, covering wood or cement flooring 1/2 inch thick, fireproof, waterproof, all colors, low cost. Ornamental casting, concrete, plaster, papier-mache decorations, garden furniture, statuary, flexible molds. 18 years instructing the public; particulars and illustrations free. Chris. Mahler, Huntington, N. Y.

CHEMICAL Expert will furnish Formulas and Trade Secrets. All lines. Lists Free. W. L. Cummings, Ph. D., 228 Gordon Ave., Syracuse, N. Y.

SELL by Mail! Books, novelties, bargains! Large profits! Particulars Free! B-Efco, 525 South Dearborn, Chicago.

BIG Bunch Mail. Year 15c. Catalogues, Magazines. Kentucky Agency, Covington, Kentucky.

MONEY in Dry Cleaning; we furnish instructions and machinery; experience unnecessary. Potterf Manufacturing & Supply Co., 4723 Delmar Ave., St. Louis, Mo., U. S.

MAKE Big Profits with a Fur Farm in your backyard. Chinchilla Rabbits, Muskrat, Mink. Write for facts. 252 Conrad's Ranch, Denver, Colo.

PATENTS. Time counts in applying for patents. Don't risk delay in protecting your ideas. Send sketch or model for instruction or write for free book "How to Obtain a Patent" and "Record of Invention" form. No charge for information on how to proceed. Communications strictly confidential. Prompt, careful, efficient service. Clarence A. O'Brien, Registered Patent Attorney, Security Bank Building (directly across street from Patent Office), Washington, D. C. See pages 138 and 139.

WE Start You in Business, furnishing everything; men and women, \$30.00 to \$100.00 weekly operating our "New System Specialty Candy Factories" anywhere. Opportunity lifetime; booklet free. W. Lillyer Ragsdale, Drawer 4, East Orange, N. J.

CHARTERS: Delaware; best, cheapest; free forms. Colonial Charter Co., Wilmington, Del.

SUCCEED With Your Own Products. Make them yourself. Formulas, Processes, Trade-Secrets. All lines. Catalog, circulars free. B. Thaxly Co., Washington, D. C.

SIGNS and Showcards easily painted with Letter Patterns. Large variety of Styles and Sizes. Samples for stamp. John Rahn, a2120 Neva Ave., Chicago.

MAIL-ORDER Business is your opportunity. Breniser's famous handbooks, for fifteen years have shown beginners practically how to get into this fascinating and profitable business. Continually revised, always up to date. Set of ten, \$5. One book and descriptive catalog 25c. None free. Breniser Publisher, 1697 P. Sanson, Philadelphia.

"SCHEMER." Alliance, Ohio, 36 p. monthly, prints Schemes, Tips, Formulas. Subscriber reports \$25,000 from three; another \$10,000 from one. Try it! Year, \$1.00; 3 months, 30c.

A BUSINESS of Your Own Making— Sparkling Glass Name and Number plates. Checkboards, Signs. Big book and sample free. E. Palmer, 540, Wooster, Ohio.

UNPATENTED Ideas Can Be Sold. I tell you how and help you make the sale. Free particulars (Copyrighted). Write W. T. Greene, 810 Jenifer Building, Washington, D. C.

CLASSIFIED list 50 German manufacturers \$1.00. Alexander, 4725 Sheridan, Chicago.

I MADE \$30 a Week Home. French Breadmaking. 15 years' experience; Free Booklet tells. Ashbrook 67, Marengo, Ohio.

BUILD your own business selling Annie Blain Flavors. New Repeat System. Geo. S. Parker, New Brunswick, N. J.

MEN wanting Mail Order work, send reply envelope. Coe, 129 East 59th St., New York.

LEARN the collection business. Good income, quick results. Interesting booklet, "Skillful Collecting" free. National Collectors Assn., Long St., Newark, Ohio.

SELL By Mail. Wonderful opportunity. Particulars free. Mason, 3902 Broadway, Room 5, Chicago.

TELEGRAPHY

TELEGRAPHY—Both Morse and Wireless—taught thoroughly and quickly. Tremendous demand. Big salaries. Wonderful opportunities. Expenses low; chance to earn part. School established fifty years. Catalog free. Dodge's Institute, H St., Valparaiso, Ind.

CHEMISTRY

SUBSCRIBE To The New Popular Chemistry! A monthly chemical magazine containing the latest chemical news, experiments, formulas, recent advancements in medicine, and other interesting features. Three trial copies 30 cents. One year, \$1.00. Book catalog free to yearly subscribers. Popular Chemistry, Dept. MP, Swedesboro, N. J.

YOUR chemical problem solved and working formula or process furnished for \$5.00. Write me. W. Stedman Richard, Industrial Chemist, Box 2402, Boston, Mass.

EXPERIMENTERS' Laboratory apparatus. Chemicals. List 5c. Chemical Apparatus Co., 4402 West End, Chicago.

CHEMICAL Analysis. Formulae, Technical Information. Robert Henderson, Laboratory, Madison, Maine.

CHEMICALS And apparatus. Price list 5c. George Ott, 1218 Chestnut, Reading, Penna.

FORMULAS AND TRADE SECRETS

GUARANTEED Formulas for world's largest selling specialties. Play safe, get my valuable lists, special formulas. Catalog describing Apex formulas, all lines. "Exclusive but not expensive" 30 years supplying particular people, with unequalled service. Miller, Chemist, 1706-H Tampa, Fla.

500 FORMULAS and Big Catalog 20c Ideal Book Shop, Park Ridge, Ill.

WHY Work for others? Employ agents yourself. Make your own products. Toilet Articles, Household Specialties, etc. 500% profit. Valuable booklet free. National Scientific Laboratories, 1984W Broad, Richmond, Va.

REMEDY For pimples. Formula 50c postpaid. No stamps. Chester, Box 404, Oyster Bay, N. Y.

3,000 VALUABLE Formulas Prepaid \$1.00. National Sales Service, 3937 Marburg, Cincinnati, Ohio.

ANY desired formula \$1.00; guaranteed. Central Labs., 233P, Champaign, Ill.

SUPERIOR Storage battery formula and complete manufacturing information for starting and lighting batteries. A real business opportunity. Particulars free. Moline Laboratories, Moline, Ill.

AUTOMOBILE Polish; application lasts six months. No rubbing. Formula \$2.00. Donalee, 109 N. Pearl, Joplin, Mo.

ANALYSIS And Chemical Consultation. Manufacturing ideas made practical. New money-making formulas with valuable starting advice. Charges moderate. Write. Associated Chemists, Indianapolis, Ind.

SUCCEED With Your Own Products. Make them yourself. Formulas, Processes, Trade-Secrets. All lines. Catalog, circulars free. B. Thaxly Co., Washington, D. C.

AGENTS WANTED

PRIVATE Brand Toilet Articles. Household Specialties, Perfumes, Soaps, Extracts, etc. We pack these goods for you under your private label. With your name on the goods you get all the repeat business. Don't sell for others but build up a profitable business for yourself. Highest quality merchandise. Extremely low prices. Quick shipments on both large and small orders. Write immediately for lowest wholesale prices and complete information regarding our amazing offer. Address Supply Department, National Scientific Laboratories, 194W Broad, Richmond, Va.

AGENTS—I'll pay your bills, give you steady income for rest of your life. If you will take care of my business in your locality, full or spare time. You be my partner, make \$15 a day, ride in Chrysler sedan, I furnish. Distribute teas, coffees, spices, extracts, things people eat. I furnish everything; world's finest super sales outfit containing 30 full sized packages; low prices; big repeat business; \$25,000 guarantee on quality. I go 50-50 with you. Get my amazing offer. C. W. VanDeMark, Dept. 102-C, 117 Duane St., Cincinnati, Ohio.

AMAZING New Prepared Cake Flour offers \$15 sure profits daily! "Jiffykake" makes delicious cakes quickly—easily—without muss. Contains eggs, milk, flavor, shortening, etc. Just add water and bake. No failures. Perfect results always. Housewives simply wild over it. Tremendous profits being made with "Jiffykake" and our 350 other fast-selling Household Necessities. Write for Special Introductory Offer. American Products Co., 1723 Monmouth, Cincinnati, O.

\$8.50 To \$20.00 daily pay. Introducing New Insured Hosiery for men, women, children. 57 styles, 40 colors. Must wear or replaced free. Repeat orders sure. Nyland made \$595 one month. Edwards, \$460.00. Mrs. Bone, \$445.25. Why not you? Even spare time work should pay you \$5 per hour. We deliver and collect. You simply write orders. No experience or capital needed. We furnish samples. No matter what you are doing now, write for our offer. Maccoshee Company, Park 2563, Cincinnati, Ohio.

NOCK-O New kind of aluminum cleaner brings profit. A real money maker. \$50.00 a week spare time. Nock-O works quicker and better, endorsed by the largest manufacturer of aluminum in America. Combines a cleaner and a polish, removes all stains and discolorations. We will mail postpaid to agents, a full sized container upon receipt of \$25, together with selling plans. Nock Chemical Laboratory, 8th and Sarah Sts., Dept. C. S. S., Pittsburgh, Pa.

AGENTS, \$180 Month. Bonus besides. Introduce finest line guaranteed hosiery. 126 styles, colors. For men, women, children. Finest pure thread Japanese Silk. All fancy combinations of silk and lisle. Novelty and Sport numbers, full fashioned, chiffon, wool, etc. Must wear 6 months or new hose free. New sales plan. Credit given. Auto furnished. Spare time factory. Write for samples. Wilkmit Hosiery Co., Dept. 4231, Greenfield, Ohio.

OUR Sewing Kits offer more for the money than any other article on the market. Contents: Eight spools of thread, assorted colors to match stockings, lingerie, and apparel worn by women, assortment of needles, thimble, needle threader, premium coupon. Assembled in an attractive, decorated box. Retail 25c, profit 150%; sample 25c. Other fast selling side lines, Lee Brothers, 128E East 23rd St., New York.

COMMON Sense selects the new B. & G. Line to make the dollar. Three staple lines—Undergarments, Rubber Specialties and Sanitary Goods combined to make money making a simple problem. Write B. & G. Mfg. Company, Dept. 329, Pittsburgh, Pa.

MAKE \$3,000 to \$6,000 year with famous Harley Line—groceries, extracts, medicines, toilet preparations, etc. Men have made up to \$1,124 one month. \$8.00 to \$15.00 day easy. Thousands making \$3.00 per part time. Write for amazing offer that puts you in business for your self, without investment. Samples furnished. Harley Company, Desk C-2014, Dayton, Ohio.

\$10 DAILY. New, highly practical, useful 50c article for every home and office. Sells on sight. Hydrawilk Corp., Roselle, N. J.

MAKE \$90 Weekly! Demonstrate new Self-Wringing Mop and Dust Mop. \$5.00 outfit loaned you free, including two actual mops. No money required. Women buy eagerly. Your pay daily. We deliver. Get \$5.00 outfit quick. Delphos Mop Co., 1013-A Washington, Delphos, Ohio.

EXPENSIVE Dresses. (Slightly Handled Samples.) Sacrificed Cheap. Peddlers, Storekeepers, Etc., Write Hirschlar's, 249 West 34th, New York.

MAKE \$25.00 daily selling colored Raincoats and Slickers, Red, Blue, Green, Etc., \$2.95—Hat Free. Commissions daily. Outfit free. Elliott Bradley, 230 So. Wells, Dept. AB-3, Chicago.

WIDESPREAD Demand for our new Food Drink and new Flavorings (Black Walnut, Peach, Dixie Bouquet, etc.). Many other fine products. More salesmen needed. Blair Laboratories, Lynchburg, Va.

QUICK 25c Seller. Something new! Patented garment clasp of many uses, for men, women and children. Send 10c coin and 2c stamp for samples on direction cards. H. Bain, 743 Myrtle Ave., Brooklyn, N. Y.

MODERN Trade. Profits immediately. Experience unnecessary. Cut out signs, window displays. Omana Studio, 715 Baltimore Building, Chicago.

SIGN Men and Agents. Attention: new line, genuine gold foil letters. Samples free. Illinois Gold Leaf Letter Co., 123 South Jefferson Street, Chicago, Ill.

AGENTS—Engraved name plates, signs, numbers, etc., easily sold, profits large. Brett Bros., Roxbury Crossing, Boston, Mass.

UNIVERSAL Auto Signal makes left turn safe. Saves opening doors or windows. Installed in a jiffy without screws or bolts. Retail \$1.98. Distributors wanted. Universal Auto Signal Co., Box 579, Minneapolis, Minn.

BIGGEST Seller to Merchants, Banks, manufacturers. Full or part time—Majik Mirror. Most unique advertising specialty on the market. Good pocket mirror. Held to light, shows merchant's ad in beautiful colors. Big commission. Dollar for samples. Refunded on request or first order. Standard, 215 West 48th Street, New York.

NEW Invention—400% profit. Liquid quick mend for Fabrics and Hosiery. Stops runs. Every woman buys. Hundred other fast sellers. J. E. Johnson Co., Dept. 463, 6129 Wentworth Ave., Chicago.

"HOW to Secure Agents," a specially prepared booklet, tells of one of the most inexpensive methods in which to secure good live producing agents. It is free; write for your copy today! M. L. Rund, Mgr. Classified Advertising, Popular Mechanics Magazine, 200 E. Ontario St., Chicago, Ill.

MAKE \$12 a day from start and liberal bonus selling Pioneer all-wool tailored-to-order suits and overcoats at \$23.50 and up. Commission paid in advance. Striking leather brief case and 100 large cloth samples furnished. We train the inexperienced. Write now Pioneer Tailoring Co., Congress and Throop Sts., Dept. Q-1117, Chicago.

EARN \$15 a Day and Get Your Own Suit Free, taking orders for our fine made-to-measure tailoring. We show you how. Write today for new style outfit, all wool samples, etc., Furnished Free. Progress Tailoring Company, Dept. Q-217, Chicago.

\$15 A DAY Sure. Sell guaranteed solid leather shoes. Unequaled low prices. 85 styles; men's, women's, children's. Free outfit offers complete line shoes, raincoats, leather coats, puttees. Consolidated Shoe System, Dept. 315, Eau Claire, Wis.

STOP! This is your opportunity. Rajah Diamond discovered. Startling and amazing rival of real diamonds. \$100.00 weekly for agents. Rajah Diamond, F20, Salisbury, N. C.

AGENTS! Men and Women make big money—taking orders for our beautiful Dress Goods, Silks, Wash Fabrics, Handkerchiefs, Hosiery, Fancy Goods. 1,000 Samples furnished. The National Importing Co., Dept. C-100, 573 Broadway, New York.

AGENTS Become a regular established McConnon dealer; buy on credit; sell for cash or credit. 228 absolute household necessities; all repeaters. Enjoy a sure income 52 weeks per year, year after year. City or country trade. Capital, experience unnecessary. McConnon & Co., Dept. S56, Winona, Minn.

FLAVORING Extracts—Bottle Yourself! Concentrated—add water! Free labels, whirlwind sellers! 500% profit! Money-making opportunity. Write Thomas Manufacturing Company, Indianapolis, Ind.

LEATHERETTES, Jackets, Slickers, Raincoats. Lowest prices. Largest commissions. Bonus. Outfit free. Sample on trial. Hamilton Raincoats, 4111UT Gladys, Chicago.

BIG Pay Every Day! Complete guaranteed line direct to wearer—Dress Shirts, Work Shirts, Overalls, Coveralls, Work Pants, Sweaters, Underwear, Playsuits. \$10-\$15 daily; experience unnecessary. Big Outfit Free! Nimrod Co., Dept. S, 4922-28 Lincoln Ave., Chicago.

PLAID Slickers and Hat \$2.98; also new Aerotex and Hidellike coats. Outfit Free. American Waterproof, 724P Roosevelt, Chicago.

\$100.00 WEEKLY! Two Suits or Suit and Topcoat, \$33.50. Wool materials—Made to measure. Commission \$6.00-\$8.00. Outfit Free. Garfield Tailors, H1557 Milwaukee, Chicago.

WELLS Cleared \$620.00 in one month with "Business Guide" and free legal service. Write for free outfit. Prof. Nichols, Dept. 4, Naperville, Ill.

WRITE Today for Free Samples finest line Raincoats, Topcoats, Slickers and Novelties. Something different. \$10-\$25 daily easy! Worthmore, H223 W. Jackson, Chicago.

MIRRORS Resilvered at Home. Costs Less 5 cents per square foot; you charge 75 cents. Immense profits plating auto-parts, reflectors, tableware, stoves, Refinishing metalware, etc. Outfits furnished. Details Free. Write Sprinkle, Plater, 128, Marion, Ind.

GENUINE Gold Leaf Letters anyone can put on store windows. Guaranteed to never tarnish. Large Profits. Enormous Demand. Free Samples. Write today. Metallic Letter Co., 438-D North Clark, Chicago.

SUCCEED With Your Own Products. Make them yourself. Formulas, Processes, Trade-Secrets. All lines. Catalog, circulars free. B. Thaxly Co., Washington, D. C.

WHY Work for others? Employ agents yourself. Make your own products. Toilet Articles, Household Specialties, etc. 500% profit. Valuable booklet free. National Scientific Laboratories, 1984W Broad, Richmond, Va.

OH Hello! Why didn't I see this before. Christy's Iron Rust and Stain Remover sells like blazes. Write for free sample. Christy, Inc., 5067 B'way, Newark, New York.

SEMI-AUTOMATIC Nut Cracker. Cracks shell of any nut without smashing kernel. Prepaid \$7.50. Clark Nut Buster, Harrisburg, Pa.

AGENTS—Best seller; Jem Rubber Repair for tires and tubes; supersedes vulcanization at a saving of over 800 per cent.; put it on cold, it vulcanizes itself in two minutes, and is guaranteed to last the life of the tire or tube; sells to every auto owner and accessory dealer. For particulars how to make big money and free sample, address Amazon Rubber Co., Philadelphia, Pa., Dept. 505.

SELL Beautiful "Style Tailored" shirts and neckties direct to wearer at factory prices! Many beginners earn \$50 first week in spare time. \$100 weekly full time easy. Selling outfit Free. Howard Shirts, 1219 VanBuren, Section 11, Chicago.

WOMEN—\$2 An hour spare time; 100% commission; new idea sanitary necessity; sells on sight; every woman buys; new feature never before used; designed by physician; revolutionizes old uncomfortable methods; pay every day; no deliveries, no collections; no experience or capital required. Write Mary P. Coleman, Meriden, Conn.

NO Peddling. Start own business. Home, office. Big profits. Free particulars. Elite, 38 Elizabeth St., New York.

EASY To sell. 140% Profit. Every housewife will buy a Jiffy Huller on sight. Shells peas and over-ripe green beans in a jiffy. Saves ½ to 1 hour time preparing peas and beans for a meal. Send \$1.00 today for Sample and Selling Plans. Strawberry stemmer and pineapple eye-remover free. Money back guarantee. Home Pea and Bean Hulling Machine Co., Marietta, Ohio.

AGENTS—Something new! Quikedge Sharpener. Sharpens any knife or shears in less than minute. Guaranteed. No competition. Make \$60 week. Territory given. Write quick. Quikedge Sharpener Co., Dept. 48, Canton, Ohio.

DISTRIBUTORS, Agents, Salesmen—\$60 a week. Biggest line guaranteed cutlery ever offered. Knives, Razors, etc. Extra commission. Territory given. Write quick for particulars. Novelty Cutlery Co., Desk 1231, Canton, Ohio.

AGENTS—Big Seller—\$20 Daily Easy selling Taylor Caps—made-to-measure—every man buys—some want 2 or 3 caps. Outfit free and Cap free to agents. Write quick for fast money-making proposition. Taylor Cap Manufacturers, Dept. F-5, Cincinnati, Ohio.

WE Start You Without a Dollar. Soaps, Extracts, Perfumes, Toilet Goods, Experience Unnecessary. Carnation Co., 2480, St. Louis, Mo.

100 MORE active men to introduce "Chieftain" Guaranteed Tailored Shirts, 3 for \$4.95. Latest novelties, colors, styles. Dickman, Illinois, in 3 weeks made \$589; Sinton, Texas, in 12 days, \$219.60. Bend, Iowa, in 16 days, \$334.80. Why not you? No experience or capital needed. We deliver and collect. Full working outfit Free. Cincinnati Shirt Company, Shop 1583, Cincinnati, Ohio.

AGENTS—Electric Flashing Plugs, greatest whirlwind dollar sellers. Cost 34c. Customers buy dozens, \$10.00 nationally advertised Dishwashing machine costs agents \$3.75. Hustlers reaping harvest. Write quickly for illustrated literature of these and other money-makers. United Service, 500 Fifth Ave., New York.

1928 DIRECTORY tells where to buy ½ million articles wholesale. 84 pages. Agents wanted. Free Particulars. Pruitt System, Brookfield, Ill.

WE Trust Agents!—Starter Stock and Re-orders on Credit—no bond signers. Finest line 200 guaranteed Extracts. Pure Foods. Toiletries. Big Profits. Write for details. Perkins Products, E-3, Hastings, Nebr.

AGENTS—Make \$3.00 an Hour Taking Orders for our 40 fascinating kitchen specialties. No competition. Write quick. General Products Co., Dept. C 207, Newark, N. J.

AGENTS, \$240 Month. Dri-Klean-It makes any car look like new. Removes mud, grease, tar, road oil all in one operation. No soap or water used. Cleans any car for 10c. Exclusive territory. Make \$5,000 year. Write for free sample. American Accessories Co., Desk 2231, Cincinnati, Ohio.

SELL Radio—30-Day Free trial. Electric or battery sets. 3-year guarantee. Users report unusual results as to tone, selectivity and distance. Exclusive territory and Free radio to producers. West-gale Electric Co., F1751 Belmont, Chicago.

EXTRA Money—Thousands of positions are open to men and women who will devote a few hours a day to selling hundreds of lines of novelties and everyday necessities. Send 10c in stamps for booklet, "How to Start As a Direct Salesman," published by largest direct selling magazine in the world. Send for it today. Opportunity Magazine, Dept. PM-3, 750 North Michigan Ave., Chicago.

\$10 DAILY. Make real profits selling Duplex Sifters. Sift many times as desired without removing flour. Store or home. Retail \$1. Sample 60c postpaid. Uneek, 4520 Lexington, Chicago.

WE Pay \$160 Monthly Salary and Expenses to canvass farmers introducing our guaranteed poultry and stock powders. Bigler Co., M25, Springfield, Ill.

BRING Home the bacon! Selling Christy's Polishing Cloth. Polishes all metals in a jiffy. Easy to demonstrate. Everybody buys. Unusually handsome profit. Write for free sample. Christy, Inc., 5767 B'way, Newark, New York.

AGENTS: Newest sensation—Rhinestone Initial Fountain Pens. Everybody wants one. No competition. \$8.00-\$15.00 daily in advance. Chaton Novelty Co., 602 Blue Island, Chicago.

IF I Send You a Suit made in latest style from finest goods, will you wear it and show it to your friends as a sample of my sensational values? Could you use \$3.00 an hour for a little spare time? If so, write at once for my wonderful new proposition. Address Sales Manager, 133 South Peoria, Dept. 43, Chicago.

HERE It Is—newly invented auto necessity that goes big with New Ford; particulars free. Suburban Box 10, Mt. Washington, Ohio.

GARAGE Men—Use Aloy-Num Pistons, all sizes, all motors, wonderful improvement. Power—Speed—Wear; light weight. Be our Agent. Better results. Big profits. E. N. Egge, Mfg., 7704 S. Main St., Los Angeles, Calif.

WHY Work for others? Employ agents yourself. Make your own products. Toilet Articles, Household Specialties, etc. 500% profit. Valuable booklet free. National Scientific Laboratories, 1984W Broad, Richmond, Va.

MAKE \$50 to \$75 a Week. Everyone needs shoes. Sell Mason's all-leather shoes, amazingly low prices. 85 styles—men's, women's, children's. No experience needed. Big outfit free. Mason Shoe Mfg. Co., Dept. 223, Chippewa Falls, Wis.

HIGHEST Commission \$4.50, selling Globe quality, union-made clothes, direct to wearer. Exclusive territories now open. Outfits free. Dependable, 172R, Crosby, New York.

AGENTS, Portraits, photo-pillow tops, frames, sheet pictures, medallion photo-jewelry, guaranteed hose laundry tablets, food products, toilet requisites, luminous crucifixes. Catalog 50 specialties free. 30 days' credit. Jas. C. Bailey, Dept. C-3, Chicago.

JUST Out—New Patented Apron. No strings or straps—\$20.00 a day every day; over 100% profit; commissions daily. Write for free offer. Sta-Put Co., Dept. 203, St. Louis, Mo.

AGENTS—Make two dollars hourly. Sell new kind of Sharpener. Sharpens all knives, tools, quickly. Demonstrating sample free. Premier Mfg. Company, Dept. 65, Detroit, Mich.

\$50,000. PICTURE Man Friedman made canvassing. Beginners can make \$100.00 weekly with my sales talk. Experienced men make more. Free book. "Profits in Portraits" explains. Sample Free. Picture Man Friedman, Dept. S-E, 541 W. Lake, Chicago.

AGENTS Send for free sample "Fretnot." Washes clothes snow white without rubbing. \$5.00 daily and more easily made. Credit given. Empire, 1549 N. Wells, Dept. 101, Chicago.

INSTANT Weld Welds Rubber Instantly. Stock's Profit One Day \$72.25. Enormous demand. Exclusive territory. Free sample. Tourists Pride Manufacturing Co., Desk G, Minneapolis, Minn.

AGENTS And Mail Dealers cleaning up with Lanowa Combination. 200% profit. Everything furnished. Write quick for sample. Fraser Products, 212-J Westport, Kansas City, Mo.

CALIFORNIA Perfumed beads selling like hot cakes. Agents coining money. Big profits. Catalog Free. Mission Factory P, 2328 W. Pico, Los Angeles, Calif.

AGENTS: Ride in new auto. Show samples and collect \$17.50 cash daily in advance. Bonus besides. Finest new line hosiery. 129 styles and colors. Guaranteed 7 months. Priced to sell fast and repeat. Permanent business. Big profits. Steady income. Spare time satisfactory. No experience needed. Start on credit. Write quick for samples. Betterknit Textile Co., Silk 2031, Greenfield, Ohio.

OUR Agents earn from \$50 to \$200 weekly selling genuine Diamonds, Watches, Jewelry through beautifully illustrated catalog. Cash or Credit. Unusually liberal proposition. Free outfit by return mail. No investment! Any hustler can do it easily. Write Sterling Diamond & Watch Company, Nationally Known Jewelers, Est. 1879, 1540 Broadway, Dept. A108, New York.

AMAZING New discovery! Dissolves dirt like magic. Washes clothes without rubbing. Cleans everything! Harmless to most delicate skin or finest fabric. Big profits! Exclusive territory. Write free sample and proposition now. Two other fast sellers. American Mfg. Co., 1260 California St., San Francisco.

BE Boss—Make and sell 13 new Auto Specialties; fine guaranteed Formulas. Price \$1, cash with order. Refunded if dissatisfied. Central Laboratories, Box 233P, Champaign, Ill.

MEN Wanted; Make \$15.00 Daily, selling Latest Men's fancy rayon Hosiery and Neckwear; imperfections. Send \$5.00 for 5 dozen assorted samples. Lewis Hosiery Co., 12 N. 3rd, Philadelphia, Pa.

YOU Can make 100 to 200 dollars per week selling our Super-Radio. Information mailed free. Metropolitan Watch & Jewelry Co., 620 South Dearborn, Chicago.

AGENTS: Large profits selling our eighteen money-making specialties, including patented All-In-One combined cigarette and match case. Holds package cigarettes and box safety matches. Beautiful, compact, flexible container. Write today for complete information. All-In-One, Dept. A-3, 2810 Portland Avenue, Minneapolis, Minn.

SELL Imported novelties by mail. Sample, instructions, etc., 25c. Bryant Specialties, Brookfield, Ill.

SIGN Agents: Our letters never tarnish; samples free. Monroe Sign Corporation, New Haven, Conn.

AGENTS Opportunity Seekers. Why not make \$10,000 a year? Write right now. Empire Company, Shawano, Wisconsin.

CASH Paid for Butterflies, Insects. See Sinclair Display Advertisement on page 30.

\$40.00 SUITS For \$23.50! All one price, union-made of finest quality Virgin Wool. You don't have to know anything about selling clothing. We guarantee your success if you are honest and willing to work. Write at once. William C. Bartlett, Inc., 850 Adams, Dept. 770, Chicago.

MEN—Women, \$1.80 an hour. No less. Large Mfg. Co., established 30 years. Starting new medallion dept. Amazing new sales plan. First 22 agents average \$1.80 an hour steady. Only 1 agent wanted in locality. Your Own Photo Free as sample. Art Medallion Co., Dept. 71, Corner Campbell and Jackson, Chicago, Ill.

SELL Supreme No-Cement tube and tire patches. 310% profit. Particulars. Write Supreme, 135 Winder, Detroit, Mich.

BIG Profits selling fire cubes. Indispensable for wood, coal consumers. New invention. Samples 10 cents. Lellep, Box 388, San Francisco.

PICTURED Sign Cards, 400% Profit. Sample free. Brenneman, Lima, Ohio.

AGENTS:—Big commissions and bonuses taking orders for our big line of fashionable Dress Fabrics, Handkerchiefs, quality Hosiery, fancy Scarfs, Linens, etc. 1,000 Samples furnished. The National Importing Co., Dept. C-100A, 573 Broadway, New York, N. Y.

MAKE Big money selling tires, all or part time; handsome profit, sell your friends, buy your own tires and save the middle man's profit; guaranteed 15,000 miles. Write at once for territory and full details. Acme Supply Company, Lafayette, Ind.

AGENTS: Big season on. No competition. \$10.00-\$15.00 daily. Rhinestone Initial Buckles, etc., sell on sight. No investment. Chaton Co., 606 Blue Island, Chicago.

OUR Luminous Crucifix shines in the Dark. Every one amazed at the wonderful effect. Easily demonstrated—easily sold. W. G. Hannan Co., 2543 So. State St., Chicago.

ONCE In a blue moon comes a chance like this. Pick up \$5.40 for a few minutes work. Then, if you like, become regular representative making \$10.00 to \$15.00 daily. Big established company. Big line. Big business. Write quick. Pitkin Laboratories, 156 Pitkin Bldg., Newark, N. Y.

\$90 WEEKLY easy as my successful agent! Sell fascinating line of household necessities! Quick buyers. No investment. Free particulars. Handi-Help Co., Dept. C-80, Chicago, Ill.

AGENTS—Sell two Suits! \$19.99! Commission \$5 advanced! Anyone can sell at this phenomenal price! Free Kit! Gold Medal Tailors, Dept. CG-7, Fort Wayne, Ind.

ATTRACTIVE Lodge emblems for autos. Embossed, engraved, never tarnish. 100% profit. Bello Mfg., 96 Friendship, Providence.

SHIRT Selling opportunity. 4 genuine English broadcloth shirts for \$5.00. Large variety of colors. Liberal commission. Experience unnecessary. We manufacture made to measure shirts also. Menzies Shirt Co., 479 E. Tremont Ave., New York.

FREE: Large wholesale Specialty catalog, showing latest best sellers from many parts of the world. Spors Co., Lesueur Center, Minn.

MAGIC Polishing cloth—Great Seller. Big Profit. Free Sample. Get this proposition. Newton & Co., 50 Main St., Newark, New York.

\$1,000.00 REWARD if this is not the greatest money-making house to house proposition ever known. N. R. G. tablets wash clothes in 10 minutes without rubbing. Free Samples. N. R. G. Co., H233 W. Superior, Chicago.

SHOW Us the housekeeper who likes to clean stair corners. Earn big money installing Ideal Corner Dust Shields. Write today. Ideal Stairway Equipment Co., Canton, Ohio.

\$75 WEEKLY. Man or woman wanted with ambition and industry, to distribute Rawleigh's Household Products to steady users. Fine openings near you. We train and help you so you can make up to \$100 a week or more. No experience necessary. Pleasant, profitable, dignified work. Write today. W. T. Rawleigh Co., Dept. 53PPM, Freeport, Ill.

GOLD-LEAF Sign Letters; copyrighted Manufacturing Instructions; profits 1,000%. Johnston Co., Quincy, Ill.

JIFFEX—Pays all profit! Invest \$1.00, make \$20.00. Enclose \$1.00 bill, receive charges prepaid Jiffex for 10 gallons (80 pints) earning you \$20. Jiffex Amazing Glass Cleaner, cleans, polishes windows, windshields, showcases without water, soap or chamois. Wonderful demonstrator. Everybody buys on sight! Receive also many other agent's profitable paying propositions. Satisfaction guaranteed. Miller, Chemist, 1706-F Jetton, Tampa, Fla.

MAN in each town to plate auto parts, reflectors, bathroom fixtures, refinish beds, mirrors, chandeliers; by new method. No capital or experience required. Simple plan of manufacturing at home starts you in big money-making business. Outfit furnished. Free particulars and proofs. Gun Metal Co., Ave. H, Decatur, Ill.

AGENTS: Stamping names on pocket-key protectors. Sample check with your name and address, 25c. Stamping outfits. Emblem checks, check-fobs, name plates. Hart Mfg. Co., Desk 2, 303 Degraw St., Brooklyn, N. Y.

AGENTS—Here's a New One. "Bestever Powdered Hand Soap." Sells like wildfire. Marvelous Discovery. Removes grease, paint, ink, oil, in fact anything from hands. Cannot harm skin. 150% Profit. Great Repeater. Agents simply coining money. "Free Samples Get the Business." Write immediately. Bestever Products Co., 4315W Irving Park, Chicago.

PATENTS. Time counts in applying for patents. Don't risk delay in protecting your ideas. Send sketch or model for instruction or write for free book "How to Obtain a Patent" and "Record of Invention" form. No charge for information on how to proceed. Communications strictly confidential. Prompt, careful, efficient service. Clarence A. O'Brien, Registered Patent Attorney, Security Bank Building (directly across street from Patent Office), Washington, D. C. See pages 128 and 139.

NEW: Just invented; Comb fastens anywhere. Send 10c for a 25c value. Never Lose Comb Mfg. Co., Lesueur Center, Minn.

WHY Not sell us your spare time? \$2.00 an hour, \$19.70 daily easy full time. Introduce 12 months Guaranteed Hosiery—47 styles, 39 colors for men, women, children, including latest "Silk to the Top" Ladies' Hose and Men's Fancies. No capital or experience needed—We furnish samples. Silk hose for your own use Free. New Plan, Milton Mathews, Park 5863, Cincinnati, Ohio.

AGENTS: Liberal commissions and bonuses selling high quality hosiery, handkerchiefs, scarfs, men's ties, curtains, bedspreads, linens. Also a big line of dress goods, silks, etc. 1,000 samples furnished. Write quickly. The National Importing Co., 573 Broadway, Dept. C-100B, New York, N. Y.

WE Have the finest needle case, self-threading needles, needle threaders. \$50.00 to \$200.00 weekly. Samples 25c, particulars free. Empire, 1549 N. Wells, Dept. 201, Chicago.

WHY Work for others? Employ agents yourself. Make your own products. Toilet Articles, Household Specialties, etc. 500% profit. Valuable booklet free. National Scientific Laboratories, 1984W Broad, Richmond, Va.

A BUSINESS of Your Own—Making Sparkling Glass Name and Number Plates, Checkerboards, Signs, Big Book and Sample Free. E. Palmer, 512, Wooster, Ohio.

32 SECONDS complete tire change by Detmer, Ohio, with Morey Quick Action Rim Tool. Sold, singly, 49 three days, cleared \$100. Anderson, Mont., sold 1400 in 14 weeks. Get details for good territory. Harvest time Now. M. Morey Rim Tool, Buffalo, N. Y.

AGENTS—Clever Invention! Inkspoon makes every pen a fountain pen. Fast office seller; big profit, demand increasing everywhere. Exclusive territory offered. Sample free. H. Marul Company, Tribune Bldg., New York, N. Y.

GET Our Free Sample Case—Toilet articles, perfumes and specialties. Wonderfully profitable. La Derma Co., Dept. A, St. Louis, Mo.

AGENTS make \$100 week furnishing Cigar Lighters to merchants on free advertising plan. Particulars sent free, write at once. Drake Mfg. Co., Dept. M, Milwaukee, Wis.

FREE Sample, "Rain Shield Wiper." Retail \$1.00—Cost (25 cents). Sold Clear and Rainy Days. No Cloth—No Paste—No Attachment. (1) Rub keeps windshield clear 48 hours. Experience Unnecessary. NuLife Corporation, Hartford, Conn.

\$60-\$200 A WEEK. Genuine Gold Letters for store windows. Easily applied. Free samples. Liberal offer to general agents. Metallic Letter Co., 438-B North Clark, Chicago.

ONE of the biggest mails on earth. Sent to any address for 10c. Louisiana Distributing Service, Dept. PM, Harmon, La.

COLLECT and Keep \$6.00 commission each sale. 2 suits or suit and topcoat \$27.95. Unusual qualities. Satisfaction guaranteed. Latest patterns. Extra Large outfit free. Deal Direct. LaSalle Gold Seal Clothes, 527 Broadway, Dept. 29, New York City.

SEND 25 cents for a one dollar Cigar Lighter, and learn how to make \$10 a day. Particulars free. Rapid Mfg. Co., 799-T Broadway, New York City.

BIG Money and Fast Sales. Every owner buys Gold Initials for his auto. You charge \$1.50; make \$1.35. Ten orders a day easy. Write for particulars and free samples. American Monogram Co., Dept. 40, East Orange, N. J.

MONOGRAM Automobiles, \$1.35 Profit ten minutes' work; every owner wants them; millions without; particulars free. Motorists Accessories Co., Mansfield, Ohio.

GOLD Leaf window letters and script signs. No experience; 500% profit. Samples free. Consolidated, 69-II West VanBuren, Chicago.

LAMB'SWOOL Polishing Mittens, Brushes. Newhall, 358 Broad, Lynn, Mass.

AUTOMOBILE Specialties. Guaranteed formulas for all latest money makers. Lowest prices. Write for free lists. Murphy, Chemist, Tujunga, Calif.

BIG profits distributing 5c candy specialties to dealers. Fast sellers. Exclusive territory. Universal Sales Company, 631-B Wilson Ave., Brooklyn, N. Y.

REPLATE brassy worn-off Automobile Parts, Reflectors, Bath Room Fixtures, Worn Spoons, Forks, etc., with pure silver. Looks like new. Use U-Kan-Plate Polish. Positively no mercury. \$1.00 half pints. Post Paid. Satisfaction Guaranteed. Agents wanted. Dept. A, U-Kan-Plate Co., Philadelphia.

REMNANT Store, Bethel, Ohio. Greatest Dry Goods Bargains on Earth. Agents and Dealers.

\$50.00 WEEKLY easy. Applying Gold Initials on Automobiles. No experience needed. \$1.45 profit every \$1.50 job. Free samples. "Balco Monograms," X1043 Washington, Boston, Mass.

WANT Distributing Agent for Handslick, powdered hand soap; removes anything from hands; everybody a customer; sample free. Solar Products Co., J-2142 S. Troy, Chicago.

WE Pay \$48 a Week, furnish auto and expenses to introduce our Soap and Washing Powder. Buss-Beach Co., Dept. A42, Chippewa Falls, Wis.

AGENTS—Sell stores 5c candy Specialties, Lorraine Products, Albany, N. Y.

\$16 A DAY Easy—I start you in auto accessory business; no investment; no experience necessary. Landin, 4206 Montrose Ave., Chicago.

GET This. \$1.00 auto necessity. 100% Profit. Repeats like gasoline. Guaranteed. Taylor Products-Mfg. Co., Columbus, Ohio.

WE sell the improved Roco circulating pump, also Strainer Check Valve. Agents wanted. C. A. Smith Co., 100 Central St., Milford, Mass.

AGENTS—Mosco Corn and Callous Remover will build you a steady repeat business. Send today for pocket-size trial outfit. The Moss Co., 396 Searle Bldg., Rochester, N. Y.

AGENTS—Sell Wonderful Pocket Adding Machine. \$7.50 retail, \$2.50 to you. Typewriter Supply, 102 Hersch Bldg., Pittsburgh, Pa.

PREPARED Shoe-Shining Mit. Just Invented. (No Polish Required.) Treated Felt Side Cleans, Polishes. Prepared Side Preserves, Waterproofs. Retail (25c)—Costs (8c). Customers Advertisement if desired. (Sample 15c.) NuLife Shine, Hartford, Conn.

AGENTS Wanted to sell Men's Hats direct from factory. Write for catalog. Model Hat Mfg. Co., Dept M-14, East Orange, N. J.

AGENTS—\$75 week, up. Sell our new complete line Cigar lighters. Big winner, fast sellers. Full or part time. Write today. Sample 25c. Elbee Trading Co., 799A Broadway, New York.

NO difference what you're selling, you can increase your sales 500% by giving our \$1000 policies as free premiums. Costs you nothing. Name your line and write. United States General Underwriter, B501, Willow Hill, Ill.

SEND name, address on postcard. Free introductory copy Modern Salesology Magazine; 1000 money-making opportunities offered by big reliable firms; no obligation. Salesology Magazine, Desk B-38, 500 No. Dearborn, Chicago.

SELL men's neckwear; wonderful proposition. Astor, 318-M Broadway, New York.

WE pay \$50 a week and expenses and give Ford Auto to men to introduce poultry and stock compounds. Imperial Co., D23, Parsons, Kan.

AGENTS—We start you in business and help you succeed. No capital or experience needed. Spare or full time. You can earn \$50-\$100 weekly. Write Madison Company, 566 Broadway, New York.

AGENTS—Make a dollar an hour. Sell Mendets, a patent patch for instantly mending leaks in all utensils. Sample package free. Collette Mfg. Co., Dept. 404, Amsterdam, N. Y.

POLMET—The Wonderful Polishing Cloth that cleans all metals without liquid, paste or powder. Approved by "Good Housekeeping" and "Modern Priscilla"—sells fast at 25c. Sample free. Gale & Co., Inc., 15 Edinboro St., Boston.

WHY Work for others? Employ agents yourself. Make your own products. Toilet Articles, Household Specialties, etc. 500% profit. Valuable booklet free. National Scientific Laboratories, 1984W Broad, Richmond, Va.

ARVEO Polishing Cloths offer big profits to salesmen. Sample and particulars free. Arveo Industries, Box F 147, Grosse Ile, Mich.

NO Dull Times Selling Food. People must eat. Federal distributors make big money; \$3,000 yearly and up. No capital or experience needed; guaranteed sales; unsold goods may be returned. We furnish you with sample case, license and Free Samples for customers—Sure repeat orders. Exclusive territory. Ask now! Federal Pure Food Co., A2307 Archer, Chicago.

AUTO owner tire agent wanted each locality to use and take orders for hand made Mellinger cord and balloon tires; guarantee bond 15,000 miles; shipped prepaid on approval; get your tires free; no capital or experience required; make \$100 to \$300 weekly. Write for wholesale prices and sample kit. Address Mellinger Tire Co., Dept. 400, Kansas City, Mo., or Dept. 400, Philadelphia, Pa., or Dept. 400, Oakland, Calif.

REAL Whirlwind Seller—Nopolout Custom Shirt. Every man buys them. Patented—no competition. Liberal commission. Free selling kit. Make \$15 up daily taking orders direct from consumer at manufacturer's prices. District or local agents. Write Nopolout Shirt Co., Dept. Y, Hazleton, Pa.

PHOTO Medallion Men and Women, the largest line of Photo Novelties in the world. Lowest prices, quickest service. Send for catalogue showing over 200 money makers. Photo medallions, photo medallion clocks, photo mirrors, photo fountain pens, photo powder compacts, photo jewelry and photo buttons. Gibson Photo Jewelry Co., 608-614 Gravesend Ave., Brooklyn, N. Y.

AGENTS make \$10.00 Daily selling Non-Splash Water Filters on sight. Best canvasser's article on market. Investigate. Write for particulars, Desk 14, Seed Filter Company, 73 Franklin Street, New York.

FIBRE Brooms—detachable handles, fine finish. Good profits, repeat sales. The Fibre Broom People, 147-C New Jersey Ave., Brooklyn, N. Y.

AGENTS: 500% profit. "Happy Home Make Shampoo" builds your own big business. Martin of Indiana made \$75.00 in one day. Missouri man made \$750.00 one month. Exclusive territory. Geo. A. Schmidt & Co., Dept. P, 236 W. North Ave., Chicago.

SOMETHING New. Every motorist a buyer of our electro-magnetic-emergency Wonderlamp; takes only one minute to demonstrate and make a sale; no experience necessary; \$5.00 an hour easily made; full time or evenings. Write for sample. Wonderlamp Co., 926 Fisk Bldg., Dept. 10-A, New York.

AGENTS Making Big Money Selling Fibre Brooms, Push Brooms, Dust Mops, Auto Mitten Dusters. Catalog and Samples Free. National Fibre Broom Co., St. Louis, Mo.

WRITE Atlas Sign Works for free working equipment. Beautiful window sign letters. Penny each! Any size. Wonderful offer to general agents, K1032 E. 55th St., Chicago.

\$8.75 AN hour; that's exactly what Ride Air men make every hour they work. No selling experience necessary. Write for full particulars and free sample today. C. F. Hamilton, Dept. C, 530 West 27th St., Los Angeles, Calif.

HIGH-GRADE SALESMEN WANTED

WHY Waste time with fly-by-night propositions when you can have steady employment, liberal commissions selling legitimate line of merchandise? Only responsible persons with clean record considered. Sellstrom Mfg. Company, 358 North Ogden Ave., Chicago.

EASY To sell groceries, paints and auto oils from samples to consumers. Steady profitable work, no capital or experience necessary. Commission advanced. Liberal credit. Loverin & Browne, Wholesale Grocers, B 1500 So. State, Chicago.

BIG Pay every day! Complete guaranteed line direct to wearer—Dress Shirts, Work Shirts, Overalls, Coveralls, Work Pants, Sweaters, Underwear, Playsuits, \$10-\$15 daily; experience unnecessary. Big Outfit Free! Nimrod Co., Dept. 65, 4922-28 Lincoln Ave., Chicago.

FASTEST Selling necessity known. Instant Inserting Instrument Inserts Tire Plugs "Instantly." Large Profits. Enormous Demand. Exclusive Territory. Write Today. Tourists Pride Manufacturing Co., Desk W, Minneapolis, Minn.

SELL Tailoring. Greatest complete line sent free. Prices \$25 to \$43, including \$4.50 to \$8.50 profit in advance. Few restricted territories still open. Write Manager, 831 Adams, Dept. M23, Chicago.

SALESMEN Wanted to sell guaranteed hand-forged tools to garage trade. Hyink Tool & Forge Co., Inc., Grafton, Wis.

DISTRICT Managers with established office and sales organization wanted. We have made and sold more than 17 million shirts since 1863. This is the best proposition of its kind in the country. Only recently we have allowed our product to be sold direct from factory to wearer. Quality, workmanship and price put this line in a class that defies all competition. Write at once for particulars. **Bostonian Mfg. Co., 72 Summer St., Boston, Mass. Established 1863.**

"STERLING" Rotary Shackle Padlock. Sells readily to hardware dealers everywhere. We pay liberal cash commission, and make laid-down prices. Pocket samples and order book furnished. Write us stating territory covered. **Sterling Lock Co., Minneapolis, Minn.**

SALESMEN—Become Independent. Own your business; experience unnecessary, selling our \$7,500 Accidental Death; \$50 Accident; \$25 Sick Weekly Benefits—\$10.00 yearly. Other amounts proportionate. Guaranteed steady income from renewals. \$250,000 deposited Insurance Department, Universal Policy, Dept. A, 40 Clinton Street, Newark, N. J.

MAKE \$25.00 daily selling colored Raincoats and Slickers, Red, Blue, Green, Etc., \$2.95—Hat free. Commissions daily. Outfit free. **Elliott Bradley, 230 So. Wells, Dept. AB-3-S, Chicago.**

ALL-YEAR-ROUND Profitable business selling wonderful new water softener and cleaner. Removes grease, oil, ink and dirt quickly. Every home and business place a live prospect. 100% profit. Big repeat orders. Exclusive territory. Write for free sample. **Seacoast Laboratories, Sea Bright, N. J.**

\$25.00 TO \$50.00 Weekly. Part or Full Time selling advertising Pencils. Splendid side-line. **Abbott Pencil Co., 150 W. Larned St., Detroit, Mich.**

SELLING Automotive Electrical Tools makes good money. Men somewhat familiar with garage work and tool men, here's your chance. Write now. **Barker Specialty Co., Girard, Pa.**

MEN—Sell dependable shrubbery, fruit trees, etc. Steady demand. Complete co-operation. Commissions paid weekly. We deliver and collect. Write **Perry Nurseries, Dept. R-3, Rochester, N. Y.**

BIG Season Just Ahead. Advertising pencils most popular every day—every business prospect. Our line repeats. Big commissions. Established in 1902. **North American Pencil Works, 126 So. Clinton, Dept. 55-J, Chicago.**

WONDERFUL Invention Seals Fifty Envelopes minute. Sells on sight at \$3.50. Exclusive territory. **Kendall Sealer Co., E20, East Jaffrey, N. H.**

WHY Work for others? Employ agents yourself. Make your own products. Toilet Articles, Household Specialties, etc. 500% profit. Valuable booklet free. **National Scientific Laboratories, 1984 W. Broad, Richmond, Va.**

A PAYING Position open to representatives of character. Take orders shoes-hosiery direct to wearer. Good income. Permanent. Write now for free book "Getting Ahead." **Tanners Shoe Mfg. Co., 353 So. C St., Boston, Mass.**

EARN \$20 a day. Establish income for life selling for \$1 a year, \$1,500 accident policy. Write **W. C. Stone, 11 So. LaSalle, Chicago.**

AMERICA'S Greatest Tailoring Line Free. 130 large Swatch Samples—All Wool—Tailored-to-Order—Union Made—sensational low price. Get outfit at once. Address **Dent, 378, Goodwear, 844 Adams, Chicago.**

\$18 TO \$25 daily. Biggest selling line of 2-piece suits \$9.95 and \$12.50; 3-piece wool suit, \$17.95 (regular \$28.00 value). All-wool overcoats, \$18.50. Splendid raincoats, slickers and boys' suits. Biggest commissions. Free outfits. "Jim" Foster, Inc., Dept. 23, 2250 S. Spaulding Ave., Chicago, Ill.

COLLECT and Keep \$6.00 commission each sale. 2 suits or suit and topcoat \$27.95. Unusual qualities. Satisfaction guaranteed. Latest patterns. Extra Large, outfit free. Deal Direct. **LaSalle Gold Seal Clothes, 527 Broadway, Dept. 30, New York City.**

TO Market 3A garage door holders, simple automatic action, quickly installed, instantly attracts garage owners, builders, dealers. Write for exclusive territory proposition. **Knowlson-Stevenson Co., 1118 Packard, Ann Arbor, Mich.**

NEW Punchboards, wholesale. **Interstate Supply Co., Box 700, Minneapolis, Minn.**

\$30 A Week Extra! for your spare time, taking orders for Fairbanks All-wool tailored to measure clothes, absolutely the \$35 kind at only \$23.75. Big commissions. Outfit free. What you don't know we teach you. Tell us all about yourself. **Fairbanks Tailoring Company, Dept. C332, Walsania at Oakley, Chicago, Ill.**

TOOL Salesmen—Sell to auto mechanics, guaranteed line of 120 Oldforge tools—wrenches, pliers, chisels, screw drivers, punches, tool boxes. Exclusive territory. Give complete information about yourself, first letter. **Quality Tools Corporation, New Wilmington, Pa.**

PUNCHBOARD Salesmen—making small towns. One sale a day nets you \$105 weekly. Full commission on repeats. **K&S Sales Co., 4395 Ravenswood Ave., Chicago.**

SALESMEN Make \$10 a Day selling our Business Record and Income Tax Report Book. Indispensable for merchants. Complete record of the year's business. Sell one to every merchant. 100% profit on every sale. Fine side line. Protected territory. No investment necessary for samples. **Pershing & Company, Dept. F, South Bend, Ind.**

DISTRICT Salesman—All wool, Union Made suits, overcoats, \$23.50. Liberal advance commission, bonus. Write for large Free outfit. **Harvey Bros., Dept. 570, Chicago.**

RADIATOR Overflow and water-level indicator for automobiles. Salesmen and Agents wanted. 50% commission. **The Rad-O-Flo Co., Dept. P, 406 S. Main St., Los Angeles, Calif.**

100% PROFITS Selling cigar lighters; guaranteed ten years. \$1.00 for samples. **Raney Bryant, M. F. F., Quantico, Va.**

TRAVELING Salesmen Calling on Retail Stores wanted by large manufacturer of fast-selling specialties entirely different from the average. Year-round sales, main or sideline. Big commission paid immediately on original and repeat business. Opportunity for well paid and permanent connection with old-established firm. If not making \$150 weekly, write today. **Union Specialty Works, Dept. 222, Boonville, N. Y.**

40% COMMISSION selling printed business stationery at knock-out prices. Part or full time. Free outfit. **L Process Service, Minneapolis, Minn.**

COLLECTS Money from the Dead-Beats. Retail—\$5.00. Cost—\$1.00. Profit \$4.00. "New Method." Every Storekeeper, Doctor buys quickly. Wonderful Money Getter. **Federal Association, Hartford, Conn.**

WERE You Ever Offered a Grocery Store? Our proposition is letter. Let us tell you how you can handle groceries, auto oil, tires and paint. No rent, no investment in goods. Big pay. Write. Just say, "Show me." **Hitecock Hill Co., Wholesale Grocers, 38 Kinzie, Dept. 50, Chicago.**

GOLD Leaf window letters and script signs. No experience; 500% profit. Samples free. **Consolidated, 69-V West Van Buren, Chicago.**

SEND name, address on postcard. Free introductory copy Modern Saleslogy Magazine; 1000 money-making opportunities offered by big reliable firms; no obligation. **Saleslogy Magazine, Desk B-39, 500 No. Dearborn, Chicago.**

NO high-pressure salesmanship necessary selling Luminare, our Magic Electric Window and Outdoor Salesman. Demand established. Color, light, motion gets 'em. Greatest quick-change letter system and snappy two-color posters land orders on demonstration. Hustlers collecting \$100 weekly, easy. Protected territory. **Display Products Co., A407-9 East 31st St., Kansas City, Mo.**

PUNCHBOARD Salesmen. 2 hours daily. \$100 every week. New line. Lowest prices. Full commission on repeat business. Catalog free. **Puritan Novelty Co., 1409 Jackson, Chicago.**

ANTIFREEZE prevents radiators freezing. Dricleen, the combined auto cleaner, polisher. Radiator, internal cleaner. Hand scap. Write for free shipment long-profit auto specialties. **Mickman Co., St. Paul, Minn.**

ANY Salesmen Can Sell Them! Merchants everywhere use punchboards. Someone sells them, why not you? Collect big commissions daily. Newest, largest, elaborate catalog sent upon request. **Lincoln Sales Co., 9 So. Clinton, Chicago, Dept. D.**

\$60-\$200 A WEEK. Genuine Gold Letters for store windows. Easily applied. Free samples. Liberal offer to general agents. **Metallic Letter Co., 438-A North Clark, Chicago.**

WALKER Made \$165.00 First Day selling Collection System to Doctors and Merchants. Retail \$6.50. Collects \$65.00. Costs \$1.50. **Adjustment Bureau, Mobile, Ala.**

SALESMEN—Four \$15.00 sales to merchants net you \$40.00 daily. **Sayers Systems, 2813 Sheffield, Chicago, Ill.**

HELP WANTED

HOW To start as a salesman. A remarkable little illustrated booklet which gives you the very information you have always wanted. Shows you how to start immediately. Thousands of positions open to men and women for whole or part time. Send 10c in stamps for it today. **Opportunity Publishing Co., Dept. P.M.-C, 750 N. Michigan Ave., Chicago.**

QUICK Employment—best job—most money. Executives, foremen, engineers, skilled mechanics—everybody—everywhere—send for folder telling how to get the job you want—how to sell your experience and ability at the highest price. Address, **Box 479, South Norwalk, Conn.**

AGENTS—Just Out! \$8.88 for Men's Suits! Anyone can sell. Commission \$: in advance. Free sales kit. **888 Company, Dept. CC-7, Fort Wayne, Ind.**

MAKE \$25.00 daily selling colored Raincoats and Slickers, Red, Blue, Green, Etc., \$2.95—Hat Free. Commissions daily. Outfit free. **Elliott Bradley, 230 So. Wells, Dept. AB-3-M, Chicago.**

YOU Are Wanted To Resilver Mirrors at Home. Immense profits plating auto parts, Tableware, etc. Write for information. **Sprinkle, Plater, 287, Marion, Ind.**

MR. BRUSH Salesmen—Old Established New York brush manufacturers require services of men in all territories to sell their extensive line of Sanitary Twisted in Wire Brushes. We pay larger commission than any other Brush house in the country. Write immediately for our proposition. **Wire Grip Sanitary Brush Corporation, 41-51 East 11th St., New York City.**

CASH Paid for Butterflies, Insects. See Sinclair Display Advertisement on page 30.

BECOME A Landscape Architect. Uncrowded profession; wonderful opportunity for money-making. Easily mastered by mail. Earn while you learn. Est. 1916. Write for details. **American Landscape School, 56, Newark, N. Y.**

WE Start You in Business, furnishing everything; men and women, \$35.00 to \$100.00 weekly operating our "New System Specialty Candy Factories." Few dollars start you home or small room anywhere. Booklet free. **W. Hillyer Ragsdale, Drawer 350, East Orange, N. J.**

SEND name, address on postcard. Free introductory copy Modern Saleslogy Magazine; 1000 money-making opportunities offered by big reliable firms; no obligation. **Saleslogy Magazine, Desk B-40, 500 No. Dearborn, Chicago.**

OBTAIN Employment! 70 Jobs offered one person! Get positions you want, quickly, anywhere. Complete information 50 Cents. Money promptly returned if wanted. **Better Yourself! New Idea Service, Box 39-A, Station K, New York.**

FOREIGN Work—Young men interested in working in romantic South America write at once for information. **South American Service Bureau, 14,600 Alma, Detroit, Mich.**

MAILING LISTS

99% GUARANTEED Mailing Lists. Accurate. Reliable. Guaranteed. The kind that produces business; compiled for every possible business or individual. Lists of every kind of any business or individuals compiled for your individual needs any where. Catalog and information on request. **National List, 847 Broad, Newark, N. J.**

1,000 RURAL Women Buyers' names, \$1.00. **Shearsgreen, PM1427 North Penn, Minneapolis, Minn.**

1,250 WOMEN'S Names, \$1.25. Neatly Typewritten. **Cosmopolitan News Bureau, Box 111, De Leon, Texas.**

1,000 MAIL Buyers; guaranteed new, correct; cash remitters; \$2.00. **Novelcraft Company, Box 25-C, Newport, Minn.**

1,000 NAMES of Men \$1.00, Guaranteed. Mostly Small Town and Rural. **Crescent Mailing Service, Room 110, 527 Crescent, Covington, Ky.**

NAMES—Mail Order Buyers, Agents, Opportunity Seekers, others. Thousand, \$4.00. Price list free. **De Muth Company, Englewood, N. J.**

TYPING SERVICE

EXPERT Typing; duplicate manuscripts 50c 1,000 words. 335 Rockwall, Texas.

TYPEWRITERS AND SUPPLIES

TYPEWRITERS, Motorcycles, Radios, \$5.00-\$35.00. Knights, 1512 Locust, St. Louis, Mo.

TYPEWRITERS—Underwoods \$21, Oliviers \$7, Remingtons \$18, Portables \$14, Smith Premiers \$3. Guaranteed. Write quick. Dee Typewriter Exchange, Ada, Okla.

TYPEWRITERS—Factory Rebuilt Royals, Remingtons, Underwoods, New Royal, Remington and Corona Portables. New "Excellograph" Rotary Stencil Duplicator \$37.50. Terms. Catalog Free. Pittsburgh Typewriter Supply, 945-339 Fifth Ave., Pittsburgh, Pa.

TYPEWRITERS, all standard makes, \$10 up. Fully guaranteed. Free trial. Write for complete illustrated lists. Northwestern Typewriter Exchange, 121 N. Francisco Ave., Chicago.

TYPEWRITERS! All makes — lowest prices, big catalog free. Young Typewriter Co., 654 W. Randolph St., Dept. 5103, Chicago.

PRINTING, ENGRAVING AND MULTIGRAPHING

PERSONAL Letterheads and cards. Samples submitted; low prices. Frushour, 605 East Fairview, South Bend, Ind.

\$4.00 DELIVERED—500 Monogram Letterheads, 7½x8½, 250 Envelopes. Cash. Label Catalog. Eastern Label Co., C. Clintonville, Conn.

CIRCULARS, Folders, stationery. Lowest prices. Samples. Specialty Shop, Box 1051, Fargo, N. D.

SPECIALS—\$2.95 Delivered: 500 letterheads and 250 envelopes or 1,000 letterheads, envelopes, statements, billheads, cards, tags. Cash. Catalogue Free. National Printing, Goshen, Ind.

"NEARGRAVURE"—"Neargravuremboso" Processes—Special—100 each Letterheads—Envelopes, Neargravure, \$3.25; 250, \$4.75—Type Embossed \$4.75; \$7.00. Postpaid. Samples (stamp appreciated). Solidays, Knox, Ind.

200 BOND Letterheads, 8½x11, and 150 envelopes \$2.00. 200 Bond Letterheads, 6x7, and 100 envelopes \$1.00. 250 business or social cards \$1.00. 225 Statements \$1.00. Printed. Dept. E, Hoosier Print Shop, Portland, Ind.

BETTER Value—2000 handset letterheads, fine white watermarked heavy bond, \$7.50 postpaid. Envelopes same price. American Writers' Press, Wayne, Penna.

5,000 ENAMEL Envelope Folders, \$13.75; 5½x8½ Circulars, \$10.00; Ad. Slips, \$5.00. Samples. Good's Printery, Harrisonburg, Va.

HAMMERMILL Bond Letterheads 8½x11, \$3.95 M. Envelopes, Business Cards, Statements, Billheads, Noteheads, Half-size Letterheads, \$2.95 M. Prinrite, 316 Cicott, Logansport, Ind.

MIDWINTER—Special "Lineo" super-quality printing at half. Letterheads and envelopes, \$2.50 thousand; 500, \$1.50. 5-color circulars, \$1.00 thousand, etc. Samplefolio, also samples our self-selling specialties free. The Backlund Co., 672 S. 5th, Minneapolis.

250 LETTERHEADS, envelopes, billheads or cards \$1.25 each. Francis, 12 Bella Vista, Cincinnati, Ohio.

1,000—6½ WHITE envelopes printed, \$2.35; 5,000—\$8.85. Letterheads, 1,000—\$2.95. Spors Printery, Lesueur Center, Minn.

QUALITY Business Printing. Samples. Robert Neater, R. 11, York, Pa.

250 BOND Letterheads, 250 Bond Envelopes. Printed and Mailed, \$3.00. Samples Free. Sunco, Mohawk, N. Y.

1,000 ENVELOPES, letterheads, cards, \$2.90. Circulars, Folders, Catalogs. Thiacomas Co., Martinsburg, W. Va.

200 LETTERHEADS And 100 Envelopes, \$1.00, postpaid. Oberman Company, Box 1268, Chicago.

500 BUSINESS Cards 98c. Other Printing Reasonable. Samples Free. Hanzer's, 1039 S. Cleveland, Philadelphia, Pa.

IMITATION Typewritten Letters mimeographed: 500—\$3.00; 1,000—\$4.00; printed heads, 20-lb. bond, prepaid; samples, price-list, red stamp. Letter Service, 620 Woodland, Kansas City, Mo.

MULTIGRAPHED Letters \$1.75 Thousand. Samples. Profit, Box 1071B, Knoxville, Tenn.

MULTIGRAPHING business correspondence, two dollars thousand. Hammerrill letterheads, four dollars. Miscellaneous printing. Mayera Corporation, Monmouth, Ill.

CIRCULARS, 5,000—5½x8½—\$11. 3½x6—4-page folders \$14. All printing lowest prices. Samples. Garrison Press, Harrisonburg, Va.

DISTINCTIVE—Artistic Business Stationery that Creates Confidence. 1,000 Letterheads or Envelopes \$3.00. Samples. Moulton Printing Company, 1410-P East 8th, Kansas City, Mo.

WE print Stationery, Booklets, Catalogs, Circulars. Samples. Commercial Press, Batavia, Ohio.

250 BOND Letterheads, Envelopes, Billheads, Cards, \$1.35 each. Economic Press, Leonia, N. J.

QUALITY Printing! Reasonable Prices! Send for Free Standardized samples and prices. Folders, Circulars, Catalogs our specialty. Earnest Fantus, 525 South Dearborn, Chicago.

1,000 ENVELOPES \$2.95. Letterheads, circulars, folders, circular letters. We write advertising copy. Free samples. Able Printing Shop, 416 So. Dearborn, Chicago.

5,000 LETTERHEADS, \$10.00, 20 lb. bond. Publications, catalogs big savings. Anville Printing Company, Anville, Pa.

SPECIAL Offer—150 Bond Letterheads, 8½x11, and 150 envelopes printed to order \$1.50. J. Ferreira, 249 Eugenia St., New Bedford, Mass.

PRINTING—All kinds. Superior work, prices low. Battlefield Press, Gettysburg, Pa. Free battlefield souvenir.

100 BOND Letterheads and 100 envelopes printed, 98c. Kalata Printing Company, Ironwood, Mich.

PRINTING, OUTFITS AND SUPPLIES

PRINT Your Own Stationery, cards, bookplate, Christmas cards, circulars, book, pamphlets, etc.; complete outfits, \$8.85; larger, \$11, \$29 rotary \$149. Print for others. Easy and interesting rules sent. Write for catalogue presses, type, paper, etc. Kelsey Company, K-11, Meriden, Conn.

PRE-USED Printing Presses, Type supplies. List for 2c stamp. Popular Bargains, Richland, Pa.

PRINTING Outfits—Presses, type supplies, type novelties. Send stamp for catalogue. Model Press, York, Penna.

DUPLICATORS AND DEVICES

STENCIL Duplicator — \$2.00 — Larger \$3.00, \$3.50, \$4.00. Returnable. Samples. Circular. Primos Specialty Co., Primos, Pa.

YOU can make 50 to 100 copies of a letter, notice, etc., at a cost of three cents on a Heyer Quality Duplicator. Write for free trial offer. The Heyer Duplicator Co., 909 Jackson Blvd., Chicago, Ill.

RUBBER STAMPS

RUBBER Stamps—Name and address 25c, 3 line 35c, including pad 55c. Newman & Son, Auburn, Nebr.

ILLINOIS Rubber Stamp Works, manufacturers. Send for circular. 2913 No. Rockwell St., Chicago.

ADDING MACHINES

NEW \$3.50 Automatic Adding Machine. Adds, subtracts, multiplies, absolutely accurate. Capacity \$999,999.99. Fully guaranteed. 75,000 pleased users. Makes adding easy, positive, quick. Eliminates mistakes. Saves time. Postpaid \$3.50. Bassett Co., 1458-J, Hollywood Ave., Chicago.

FOR THE HOME

SAFETY Door Hook. Absolute protection. Front or rear door can be ajar or closed, but locked on inside against intrusion. When ordering, state if door is flush with frame, opens inward or outward; if molding on inside frame projects beyond door, state how much. Polished bronze or nickel finish, by mail \$4.00. Dixie Sales Company, 627 Witherspoon Building, Philadelphia, Pa.

BEAUTIFY Your home with Built-In Furniture. New book from Popular Mechanics Press describes the making of every variety of this popular space-saving furniture in such a way that any handy man finds it easy to do. Complete description furnished on request. Price \$3 postpaid. Will be sent C. O. D. in U. S. or possessions. Popular Mechanics Press—Room 922—206 E. Ontario St., Chicago.

CEDAR chests only \$11.65—"Red-i-Kut" complete with rich copper trim—you assemble and save half—send for pictures. Kuempel Furniture Company, Guttenberg, Iowa.

ARIZONA Table Delicacies. Orange, Grapefruit Marmalades; Apricot, Fig Preserves; Loganberry, Blackberry Jams; Mesquite Honey. Watermelon Pickle. Box of six 4½ ounce Tumblers assorted \$2.50 Delivered. Try one. Triple L Company, Box 935A, Chandler, Ariz.

GRANDFATHER'S Clock Works. \$5.00. Build your own case; Instructions free; make good profits selling your friends. Clock works with chimes for old or new cases. Write for full particulars. Clock Co., Ruffner St., Philadelphia.

FOR SMOKERS

SEND 10c, silver or stamps, for sample package 20 finest quality cigarettes. Large tin special smoking tobacco sent for 10c. Direct-to-Smoker. French Tobacco Company, Dept. 49, Statesville, N. C.

BOATS AND LAUNCHES

HUBBELL Marine Coolers convert Ford engines into marine motors. Booklet free. Ford speedboat, easily built, large blueprint and directions one dollar. C. C. Hubbell, Perry Ave., Norwalk, Conn.

BUILD Your Own Boat using our Knock-Down ready cut materials. 55 models, outboard motor speedsters, runabouts, cruisers, sail, or row. Send 25c for catalog. Brooks Boat Co., Inc., Rust Ave., Saginaw West Side, Mich.

DIAMOND WATCHES AND JEWELRY

GENUINE Diamonds cheap. Blue-white, approximately ¼ carat, \$35.00. 17 Jewel Waltham or Illinois watch, \$17.00. 21 Jewel Hamilton or Illinois Railroad watch, \$30.00. W. H. Cline, 66 W. Philadelphia, Detroit, Mich.

FTERY, Diamond-like Solitaire, Platinum Finish, on Sterling—only \$2.00—sent C. O. D. Enclose finger size. Write for style sheet and agents' plan. Leadra Co., 143 Congress Ave., Providence, R. I.

WATCH REPAIRING

GUARANTEED Watch Repairing—All makes. Address Jos. Kuss, 7942 Paxton Ave., Chicago, Ill.

LET Me Rebuild Your Watch. Highest credentials from best jewelers, including certificate of proficiency from Horological Institute of America. Twenty years' experience. Joseph A. Plotkin, Certified Watchmaker, 147 West 42nd St., New York City.

ALL makes of Watches repaired by experts. Write International Watch Service, Box 5P, Fordham Station, New York.

ANTIQUES, WAR RELICS AND INDIAN GOODS

FOR Dens. Relics and medals from Europe's Battlefields. Illustrated catalogue, 25c. International, 885 Flatbush Ave., Brooklyn, N. Y.

SEND 5c for fine new list Indian relics, antique firearms. F. E. Ellis, Webster Groves, Mo.

PHONOGRAPHS AND RECORDS

BRUNSWICK Portable Phonograph Plays all standard records. 10 inches square, 2½ inches thick. Weight 10 lbs. Metal case, compact and reliable. Shipped prepaid on receipt of \$10. Maurice Levy, Lyceum Bldg., Pittsburgh, Pa.

BUILD Your own phonograph. Catalog and instructions to build new type horn mailed for 10c. American Phonograph Co., 4116 West 24th Place, Chicago.

MAKE Your Old Phonograph New! Buy Starphonic Reproducer, \$2.49. Money refunded if not satisfied. Pleasing Sound Phonograph Company, 204 East 113th Street, New York.

MUSIC AND MUSICAL INSTRUMENTS

BE A popular musician. Learn without a teacher to play your favorite instrument in spare time at home in few short months. Easy as A-B-C method. Half million delighted students. Send today for Free Book and Demonstration Lesson, also details of low-cost offer. U. S. School of Music, CI Brunswick Bldg., New York, N. Y.

"BANJOS" Should interest all musicians on account of the popularity of the Banjo, as it easily increases a Player's income. Illus. Catalog of 48 pages free. The Bacon Banjo Co., Inc., Groton, Conn., U. S. A.

JAZZ Made easy! All instruments. Winn School, 44 West 34th St., New York.

ATTRACTIVE Music to your words. Dr. Wooler, Composer, Buffalo, N. Y.

SONG Poem Writers, address Hibbeler, DI, 2104 N. Keystone Ave., Chicago.

REAL Composer of music will co-operate with lyric writers of worth. Mail in your poems now. Publication by reliable firm guaranteed on accepted work. Isabel Mayer, Box 92, Medford, Mass.

PIANO Jazz; Teaches Ear Playing, Negro Harmony, Player Effects, Chimes, Blues, Sweet Harmony, Radio Playing, Interesting Information Free. Write "Piano Bill," 207M Ossington, Toronto, Canada.

DON'T Listen all the while. Let me show you how to play the piano for yourself and friends. Extracts from lessons Free. The L. D. D. Music Course, Dept. A, Falls Village, Conn.

WRITE Songs. Big money and reputation. Write for information. J. Gordon Pub. Co., 201 N. Hoyne Ave., Chicago.

SONG-POEM Writers: Address Monarch, 236 W. 55th, Dept. 104, New York.

SONG Poem Writers, Write Sequoia Songwriters' Service, Sherman Branch, Los Angeles, Calif.

MUSICAL Merchandise, instruments, plating, repairing. Guaranteed work. Sternberg's, 59 E. Adams St., Chicago, Ill.

I BUY, Sell, Publish Songs. Chester Escher, 12 Vroom St., Jersey City, N. J.

SONG-WRITERS: Write Song Service Studio, Shubert-Rialto Bldg., St. Louis.

VIOLINS, Deep, Mellow, Soulful — on credit. Easy terms for wonderful instrument. Get details today. Gustav F. Henning, 512 University Building, Seattle, Wash.

FREE—"Song Writers Guide," Beaver, 622 Goodell, Green Bay, Wis.

I WANT Song Poems. Casper Nathan, 3544 N. Racine, Chicago.

"**MUSIC** Composed" to words. Bauer Bros. (formerly of Sousa's Band), Oshkosh, Wis.

PATENT ATTORNEYS

PATENTS. Time counts in applying for patents. Don't delay in protecting your ideas. Send sketch or model for instruction or write for free book "How to Obtain a Patent" and "Record of Invention" form. No charge for information on how to proceed. Communications strictly confidential. Prompt, careful, efficient service. Clarence A. O'Brien, Registered Patent Attorney, Security Bank Building (directly across street from Patent Office), Washington, D. C. See pages 138 and 139.

PATENTS—Write for Instructions. Carl Miller, Registered Patent Attorney (former Patent Office examiner), 211-A McGill Building, Washington, D. C.

PATENTS, Trade-marks, Copyrights. Reliable services by an experienced practitioner devoting personal attention to each case. Inquiries invited. References furnished. B. P. Fishburne, Patent Lawyer, 525-A McGill Bldg., Washington, D. C.

RICHARD E. BABCOCK, Patent Lawyer, Washington Loan & Trust Bldg., Washington, D. C. Booklet.

ESTABLISHED 1861. Milo D. Stevens Company. Free Booklet. Patents, Trade-Marks, Copyrights, Offices, Monadnock Block, Chicago; Barrister Building, Washington, D. C.

INVENTORS—Write for our Guide Book, "How to Get Your Patent," and Evidence of Invention Blank. Send model or sketch of your invention for our prompt examination and instructions free. Randolph & Co., Dept. 430, Washington, D. C.

PATENTS—Write for our free book, "How to Obtain a Patent" and Record of Invention Blank. Send model or sketch of inventions for inspection and instructions free. Terms reasonable. See advertisements on pages 140 and 141. Victor J. Evans & Co., 934 Ninth, Washington, D. C.

DON'T Waste Money patenting worthless inventions. Get our unbiased opinion on patentability and commercial prospects. We don't obtain patents, therefore have no inducement to report favorably unless conditions warrant. Write Patent Research Bureau, Jenifer Building, Washington, D. C.

LACEY'S Patent Sense. Valuable book free. See ad page 143.

PATENTS, Trade-Marks, Copyrights. Prompt personal service. Fifteen years experience. Reasonable rates. References. Send model or sketch for actual search and copies of closest patents. John Patten Duffe, Registered Patent Attorney, Victor Building, Washington, D. C.

PATENTS Procured, prompt service. Personal, careful and efficient service. Highest references. Moderate fees. Send sketch or model for actual search and advice. George P. Kimmel, Master of Patent Law, 54-C Legal Bldg., Washington, D. C.

\$30 GETS "Patent Pending" privilege for simple design. Sterling Buck, 629 F, Washington, D. C.

SELL Your invention before patenting. Write for free particulars. W. T. Greene, 801 Jenifer Bldg., Washington, D. C.

PATENTS Procured; Trade Marks Registered—A Comprehensive, experienced, prompt service for the protection and development of your ideas. Preliminary advice gladly furnished without charge. Booklet of information and form for disclosing idea free on request. Irving L. McCathvan, 200 Owen Bldg., Washington, D. C., or 41-R Park Row, New York.

PERCY S. WEBSTER, 203 Saving and Loan Building, Stockton, California. Long established organization. Patent booklet free.

LANCASTER and Allwine, 221 Ouray Bldg., Washington, D. C. "Originators of the Form Evidence of Conception." Before disclosing your invention to anyone send for blank form to be signed and witnessed. Form and patent information bulletin free.

MONROE E. MILLER, Ouray Bldg., Washington, D. C., Patent Lawyer; Mechanical, Electrical Expert. Booklet and Priority Record blank gratis.

PATENTS obtained under Cooperative Payment Plan. Write for particulars. W. E. Beck, Registered Patent Lawyer, 951 Jenifer Bldg., Washington, D. C.

PATENTS—Free advice. Confidential, prompt personal service of Registered Patent Attorney, former Patent Office Examiner. Booklet. Albert Jacobs, 727 Barrister Bldg., Washington, D. C.

PATENTS, Trade-Marks, Designs. This firm has 27 years' experience and gives expert personal service at reasonable rates. We properly protect your invention. Write for free information and exact cost of procuring patent before proceeding. John B. Thomas & Co., 902 F St., N. W., Washington, D. C.

INVENTORS: Send sketch or model for advice and exact cost of patent. Ask for our Free book: "How to Obtain a Patent." Tells what every inventor should know. Established twenty-eight years. Highest references. Prompt service. Reasonable charges. Chandler & Chandler, 414 Seventh, Washington, D. C.

UNPATENTED Ideas Can Be Sold. I tell you how and help you make the sale. Free particulars (Copyrighted). Write W. T. Greene, 806 Jenifer Building, Washington, D. C.

"**INVENTOR'S** Guide" sent free; contains valuable information. Frank Ledermann, Registered Attorney-Engineer, Woolworth Building, 1712, New York.

INVENTORS having ideas to patent: Write for Booklet explaining Co-operative Plan for handling your applications. Tells how to sell and safeguard your inventions at lowest cost. Ralph Burch, Patent Lawyer, Jenifer Bldg., Washington, D. C.

ADVICE Free! Patents procured—Reasonable—efficient service. 25 years' experience. Chester W. Brown, Registered Patent Attorney, 510 Van Buren Street, Chicago.

PATENTS. Booklet free. Highest references. Best results. Promptness assured. Send model or drawing for preliminary examination. Watson E. Coleman, Patent Lawyer, 724 Ninth St., Washington, D. C.

PATENTS: Much valuable information in our illustrated book on patents and trade-marks sent free with sketch sheet. Send your invention for inspection and opinion. Write today. Bryant & Lowry, 311-A Victor Bldg., Washington, D. C.

PATENTS, Trademarks, Copyrights. Twenty years experience. Validity and infringement investigations specialized. M. E. Jones, 509 Seventh, Washington, D. C.

FOR INVENTORS

PATENTS Procured; Trade Marks Registered—A Comprehensive, experienced, prompt service for the protection and development of your ideas. Preliminary advice gladly furnished without charge. Booklet of information and form for disclosing idea free on request. Irving L. McCathvan, 200 Owen Bldg., Washington, D. C., or 41-R Park Row, New York.

PATENTS. If you have an invention which you wish to patent you can write fully and freely to Munn & Co., for advice in regard to the best way of obtaining protection. Please send sketches, or a model of your invention and a description of the device, explaining its operation. All communications are strictly confidential. Our Hand-Book on Patents is sent free on request. This explains our methods, terms, etc., in regard to Patents, Trade Marks, Foreign Patents, etc. "Scientific American" contains Patent Office Notes, Decisions of interest to inventors and particulars of recently patented inventions. Munn & Company, Solicitors of Patents, 1523 Scientific American Building, 24 W. 40th St., New York City; 524 Scientific American Bldg., Washington, D. C.; 1313 Tower Bldg., Chicago, Ill.; 666 Hobart Bldg., San Francisco, Calif.; 521 Van Nuys Bldg., Los Angeles, Calif.

PATENTS—Write to B. P. Fishburne (a South Carolinian), Registered Patent Lawyer, 525-E McGill Bldg., Washington, D. C.

INVENTIONS Developed—Your crude ideas developed into practical form for your patent application. Model not necessary. Send rough sketch and description for estimate of cost and advice. 27 years' experience. Albert E. Dietrich, Engineer and Registered Patent Attorney, 621½ Ouray Building, Washington, D. C.

INVENTORS Universal Educator—contains 900 mechanical movements; 50 perpetual motions. Tells how to obtain and sell patents. Suggests new ideas. Explains how to select your attorney and avoid patent sharks. Price (revised edition) \$1.00 postpaid. Albert E. Dietrich, 621-Ouray Bldg., Washington, D. C.

I AM in touch with hundreds of moneyed men and manufacturers who wish to buy good inventions. Write Hartley, 38 Court St., Bangor, Maine.

INVENTIONS—Have you conceived one? There is a long, winding road to travel before your vision of rewards can be realized. Send for the new book, "Inventions and Patents, Their Development and Promotion," by an eminent authority. It is designed to guide the inventor on his way and help him avoid pitfalls. Will be sent C.O.D. Pay postman \$2.50 plus postage when he hands you the package. Popular Mechanics Press, Room 922—200 E. Ontario St., Chicago.

PATENT Application Blanks—25 cents. Get a Patent. Protect the Idea. Everything for the Inventor. American Inventors Directory & Inventors Institute, Benning Road, Washington, D. C. Alfred E. Glascock, Director.

FREE: Information regarding Selling Before Patenting. Sterling Buck, 692 F, Washington, D. C.

INVENTORS—Have 1,000 Business Opportunity Seekers, Manufacturers, Investors, Patent Buyers. What have you? W. W. Miles, 3768 Second Boulevard, Detroit, Mich.

PATENTS. Time counts in applying for patents. Don't risk delay in protecting your ideas. Send sketch or model for instruction or write for free book "How to Obtain a Patent" and "Record of Invention" form. No charge for information on how to proceed. Communications strictly confidential. Prompt, careful, efficient service. Clarence A. O'Brien, Registered Patent Attorney, Security Bank Building (directly across street from Patent Office), Washington, D. C. See pages 138 and 139.

INVENTORS—Write for our free book, "How to Obtain a Patent" and Record of Invention Blank. Send model or sketch of inventions for inspection and instructions free. Terms reasonable. See advertisements on pages 140 and 141. Victor J. Evans & Co., 157 Ninth, Washington, D. C.

PATENTS obtained under Cooperative Payment Plan. Write for particulars. W. E. Beck, Registered Patent Lawyer, 950 Jenifer Bldg., Washington, D. C.

LACEY'S Patent Sense. Valuable book free. See ad page 143.

INVENTORS—Cash in on your invention now! Don't delay the sale any longer! Send for a free copy of our specially prepared booklet, "Turn Your Patent Into Money," today! It contains helpful information for all inventors. M. L. Rund, Mgr. Classified Advertising, Popular Mechanics Magazine, 200 E. Ontario St., Chicago, Ill.

SELL Your invention before patenting. Write for free particulars. W. T. Greene, 802 Jenifer Bldg., Washington, D. C.

UNPATENTED Ideas Can Be Sold. I tell you how and help you make the sale. Free particulars (Copyrighted). Write W. T. Greene, 807 Jenifer Building, Washington, D. C.

GET your own patents. Legal blanks, complete instructions \$1. Cutting Sons, Campbell, Calif.

WE Buy patents, everyday household articles or conveniences. Write Cash Stim Ser., Napoleon, Ohio.

PATENTS FOR SALE

SALE Or Royalty—Gearless Variable Power Transmission, with variable eccentric or torque converter; gradual increase from zero to maximum. No gears to shift. No clutch to slip. Revolutionary. R. Edw. Schley, Beaver Dam, Wis.

WE Commercialize Inventions. Communicate with us if you have patent to sell or wish to buy one. North American Finance and Development Corp., Ouray Building, Opposite Patent Office, Washington, D. C.

CASH Or Royalty paid for patents on Dyeing Machinery, small Electrical Appliances or Wood Novelties. C. C. B., 1603 Cowart St., Chattanooga, Tenn.

OUTRIGHT Or royalty—Patent 1,562,553—occupant-propelled vehicle for children and adults; useful for any motive purposes. Price reasonable. Write Peter Hansen, 317 E. 5th St., New York City.

PATENT For sale, reasonable, on non-refillable bottle, No. 1,272,376. Ray Burns, 317 Oswego St., Syracuse, N. Y.

CANADIAN Patent for Sale—Flange Pin Retaining Clip for Piano Actions. Big profits. Best offer takes it. Harry C. Buser, Newburgh, N. Y.

A MACHINE To clean all kinds of window shades. Patent just allowed. \$5,000.00 outright. Box 1, 6947 S. Peoria St., Chicago.

YOUR Idle patent can be turned into ready cash, quickly! One inventor sold his patent at a cost of only \$3.50. Send today for a free copy of our booklet, "Turn Your Patent Into Money." M. L. Rund, Mgr., Classified Advertising, Popular Mechanics Magazine, 200 E. Ontario St., Chicago, Ill.

COLLAPSIBLE Tire Rim patent. Off in three seconds; on in five. Rolls-Royce uses collapsible rim. Others soon will. Possibilities unlimited. Curtis, 1835 Fletcher, Chicago.

PATENT And Trade Mark, Ventilator. Best and Cheapest on Earth. H. F. Neumeyer, Macungie, Pa.

CANADIAN PATENT—Children's Street Wagon. Turns around as pulled. Stops turning when desired. Chas. E. Morris, 1230 N. 29th St., Philadelphia, Pa.

PATENT On improved weather strip for sale. Valuable to manufacturer. John Zivert, 1267 Columbus Ave., Roxbury, Mass.

PATENT For Sale—Inside and outside caliper and divider, three tools in one and then some. U. G. Sweeney, Mount Bullion, Calif.

OUTRIGHT, New household appliance. Automatic Safety Window Washer. Simply raise sash to clean any type or size. Light metal mfrs. write Inventor Elmer E. Shipley, 117 Kentucky Ave., Washington, D. C.

AMERICAN And Canadian Patent on Stump-puller for sale. Will consider royalty. For particulars address Matt Brlas, 3908 Melville Ave., Ind. Harbor, Ind.

OUTRIGHT Or royalty, patented metal cigarette case; very handy; manufactured cheap. William Heap, Manitowoc, Wis.

OUTRIGHT—Patented clasp for envelopes. P. O. Box 4236, Germantown, Philadelphia, Pa.

AUTOMATIC Device to operate Garage or warehouse doors, absolute success. Erole Oliver, 329 Queen Street, Ottawa, Ont.

OUTRIGHT Or Royalty; Patent Pending. Demountable extension rims for Auto wheels for travel through mud. James Nelson, 3 Island St., Monroe, Mich.

FOR Sale—Adjustable Garden Rake. Pending, outright or royalty. William Mul-len, Duff Bldg., New Bedford, Mass.

WE commercialize Inventions. Communicate with us if you have a patent to sell or wish to buy one. American Finance and Development Corp., Ouray Building, Opposite Patent Office, Washington, D. C.

FOR MECHANICS

SET eight spiral expansion reamers \$10.95. Catalog. W. Barnitz, 203 Briggs, Harrisburg, Penna.

FOREMAN, Machine Shop, interested in increasing production on boring mill, lathe or automatic, send \$2.00 and we will forward prepaid a 1/2" square super high speed tool bit that will really cut—and we don't mean maybe. The Fred. A. Snow Company, Dept. P, 1942 W. Kinzie St., Chicago, Ill.

THE Midget Slide Rule instantly solves any mathematical problem. Price \$1.50. Catalogue free. Gilson Rule Co., Stuart, Fla.

SURVEYING INSTRUMENTS

LARGEST stock of new and used surveying instruments in the country direct from factory. Satisfaction guaranteed or money refunded. Also Farm Levels, Wissler, 619 N. Broadway, St. Louis, Mo.

MODELS AND MODEL SUPPLIES

PATENTS. Time counts in applying for patents. Don't risk delay in protecting your ideas. Send sketch or model for instruction or write for free book "How to Obtain a Patent" and "Record of Invention" form. No charge for information on how to proceed. Communications strictly confidential. Prompt, careful, efficient service. Clarence A. O'Brien, Registered Patent Attorney, Security Bank Building (directly across street from Patent Office), Washington, D. C. See pages 138 and 139.

MODEL Steam Engines, Boilers and Model Pipe line fittings. Model Making Supplies. Send 20c for this year's illustrated catalogue and hand book. Bathe Mfg. Co., Dept. D, 5214 Woodland Ave., Philadelphia.

NEW Illustrated catalog. Everything for Ship Models. Dime. Reduced prices on fittings, construction sets. Complete line of Books for Yachtsman's Library, boat-building, modelmaking, blueprints. Both catalogs, .25 coin. Roy Hancock, 323 Douglas Ave., Portsmouth, Va.

DEAD EYES. Hand-turned orangewood, 3/16" or 1/4", 60c dozen; New Idea Plastic design mold, 75c for large tube; New Idea antique compound, 60c per tube; postpaid in U. S. Hatfield & Son, 1762 N. Vermont Ave., Hollywood, Calif.

COMPLETE Steam plant; 1/2"x3/4" engine, boiler, blowlamp, set of boat fittings \$27.00. Send stamp for circular. Model Machine Shop, 212 Price St., Rahway, New Jersey.

SPECIAL Machine builders, tool and die makers, inventor's models production work of all kinds. Dept. L, Quality Hardware & Machine Co., Ravenswood and Thorndale Avenues, Chicago, Ill.

SHIP Model Books with Plans—Clipper Ship or Constitution, \$2.50; Large Clipper or Whaler, \$4.00. Ship Model Builder's Assistant, \$5.00; Rigging Ships, 1600-1720, \$5.00. Pictures, Plans, Supplies, List 5c. Ancient Argosy Antique Shop, 3968 Drexel Blvd., Chicago.

LET Our experience be your guide. Models that are models; tools and equipment for economic manfg. Patterns of all types; manufacturing in all branches. Satisfaction guaranteed. United Machinery Company, Cincinnati, U. S. A.

FIGURE-HEADS, Stern ornaments and scale ship models. Leo A. Siemann, Rockwood, Mich.

MODELS, Experimental Work, Light Manufacturing, and Stamping. Frostholm Bros., Syracuse, N. Y.

WE make working models for inventors and do experimental work and carry a complete stock of brass gears and model supplies. Send for catalogue. The Pierce Model Works, Tinley Park, Ill.

MODEL and Experimental Work at lowest cost. Wagar Model & Machine Works, 115 So. Clinton Street, Chicago.

SHIP model plans, supplies, books, fittings. Interesting catalog of Sea Things, 6c. Sea Arts Guild, 730-M, Winnebago St., Milwaukee, Wis.

THE Modelmaker, a magazine for all interested in making working models, boats, etc. Sample 10c. Modelmaker, 122 Liberty St., New York.

SHIP Models, complete materials and blueprints for building Chinese junk, Venetian sailboat, Viking galley, Nile galley, Bonnie Jean or Mediterranean galley. 60c each, postpaid; 6 for \$3.00. Casson-Craft, Dept. B, Framingham Center, Mass.

MODELS, Tools, Dies and General manufacturing. Logan Machine Co., 652 W. Lake, Chicago, Ill.

SHIP Model Fittings: Send Dime for booklet. A. J. Fisher, 1002 Etowah Ave., Royal Oak, Mich.

WOODS for Models, Scroll Work and inlaying. George Wild, 510 East 11th St., New York.

MANUFACTURING

THIRTY Years designing and building Special Machinery, assisting inventors to perfect their ideas and building their Models. We operate an up-to-date machine shop and model works. We do anything mechanical. Our experience and organization of expert mechanics give results at the lowest cost. See us or write R. G. Clyne Engineering Co., 3500 Easton Ave., St. Louis, Mo.

COMPLETE Manufacturing. Dies and stampings and Special Machinery. Our Engineering department will design and perfect your article; our tool room will tool it for production. Our shop will make any quantity you may need. Models made if necessary. Barth Stamping & Machine Company, 3816 West 34th St., Cleveland, Ohio.

MANUFACTURING Models, Dies, Stampings, Brass Work, one or thousands. Circular Free. Baum's Metal Specialties, Kansas City, Mo.

WE Manufacture Tools, Dies, Jigs, Fixtures, Production Parts, and Experimental Work. Co-operative Engineering Co., 32 South St. Clair St., Dayton, Ohio.

MACHINE Parts, or small machine to make in small lots on contract. Buzzell Co., 200 Congress St., Boston.

WIRE goods made to order. Cooley Mfg. Co., 530 N. Western Ave., Chicago.

SPECIAL Machinery or parts, dies, tools, metal specialties, models, special gears, stock gears and model supplies. Send for Catalogue. The Pierce Model Works, Tinley Park, Ill.

MACHINERY, TOOLS AND SUPPLIES

NO. 60 Hand Cylinder Grinder, \$375.00; Marvel Cylinder Boring Machine, \$115.00; 16x9' Chard Engine lathe, latest type, \$325.00; No. 41 Becker Milling Machine, \$165.00; No. 1 Cincinnati Milling Machine, with dividing heads, \$285.00. Terms if desired. Send for catalog. Cincinnati Machinery & Supply Co., 27 West Second St., Cincinnati, Ohio.

HERE is your opportunity to obtain a real good buy on electric grinders and buffers, which are, full 1/4 HP, 110 volt, 60 cycle, single phase, AC, enclosed dust-proof motor with cord and plug, emery wheel on one side and buffer on the other, at a low price of \$16.75 each. General Distributing Co., Duluth, Minn.

START business of your own, small investment required, doing nickel, copper and silver plating. This work in big demand. Information free. Electro Platers Supply Co., 547 Considine Ave., Cincinnati, Ohio.

OTHERS have successfully sold their machinery through our columns—so can you. Ask me for proof. M. L. Rund, Manager, Classified Advertising, Popular Mechanics Magazine, Chicago.

FOR Sale—Jewelers' lathe with compound rest. B. Nortwed, Mitchell, S. D.

ENGINES, MOTORS AND DYNAMOS

BARGAINS — Motors, Machinery, Wash. Machine Motors \$5.55, 1/2 HP, \$17.50, Electric Drills \$14.75, Elec. Grinders \$7.45, Farm Plant Motors \$3.45, Generators \$15.95, Elec. Vacuum Cleaners \$8.95. 100 other bargains. Send for Bargain Bulletin No. 630. Acme Tool Co., 627 Washington St., Chicago.

ALTERNATING Current, new single phase motors in original factory packages, 1/4 H.P., complete with cord, plug and pulley \$10.75. Same motor with buffing and grinding wheels \$14.25. Larger sizes at special prices. Send for free list. Hyre Electric Co., 615 MW So. Dearborn St., Chicago.

GOVERNORS For all auto engines where used for power plants. Send for circulars. A. C-S Governor Co., Springville, N. Y., or 215 W. Manchester, Los Angeles. Also 54 Carliston St., St. Catharines, Ontario.

BRAND new 6-volt, Bosch motors or starters at \$5.75 each, cash with order. Also 1 KW, 32-volt, new Westinghouse lighting generators \$48.00. General Distributing Co., Security Storage Building, Duluth, Minn.

MAKE your own—half and one horsepower electric motors. A. C. Induction motor model shows winding connections plain sight. Quick easy way. Gaines Bros., Box 481, Gainesville, Texas.

FOR Sale: 1/8 H. P. Motors—60 Cycle—110 Volt—A. C. Current—speed 1800 R. P. M.—Slightly used—first-class condition. \$1.00 each. Cash with order. Also some motors not in running condition, ideal for electrical students, \$1.50 each. The Maytag Chicago Co., 337 W. Madison St., Chicago, Ill.

WRITE for bargain catalogs on electric motors, generators, electric drills, etc. Do not buy, consult us first. General Distributing Co., Security Bldg., Duluth, Minn.

NEW 1/4 horse 110-volt alternating motors \$5.50 each. Also other bargains all sizes direct and alternating. Write for prices stating size and kind of current. Queen City Electric Co., 1736 Grand Ave., Chicago.

BLACKSMITHS

BE a Master Mechanic Blacksmith and Expert Tool Maker and Dresser with colored tempering charts. Price \$1.00. Valuable samples free. W. M. Toy, Sidney, Ohio.

BENDING MACHINES

THE Famous Hossfeld "Wrenchless" Universal Iron Bender is the last word in bending machines. Bends metal, cold or hot, into most any conceivable shape, including Eye Bolts and Automobile Spring Eyes. Bends up to 1" bars or 1 1/2" pipe cold. Thousands in use by all classes of trade, from the smallest shops to the largest railway systems. Write for circular and prices. Hossfeld Mfg. Co., Winona, Minn.

FOR SALE—MISCELLANEOUS

ADDRESSOGRAPHS. Letter Folders, Multigraphs, Envelope Sealers, Duplicators, less than half price. Guaranteed. Pruitt Co., 117 No. Market, Chicago.

SHOP Notes for 1928. Get your copy now. Only a limited edition. Contains all the articles published in the Shop Notes department of Popular Mechanics Magazine during 1927. Send no money. Just write a postal and we'll send 1928 Shop Notes and any one of the other following numbers, 1908, 1912, 1913, 1914, 1916, 1917, 1919, 1920, 1921, 1922, 1923, 1924, 1925, 926, 927. Pay the postman 98 cents and the postage when he hands you the two books. Popular Mechanics Press, Room 922, 200 E. Ontario St., Chicago, Ill.

WANTED—MISCELLANEOUS

MAIL us your discarded Jewelry, Gold, Crowns and Bridges, Watches, Diamonds, Silver, Platinum and old False Teeth. Money promptly mailed. Goods returned if offer refused. United States Smelting Works (The Old Reliable), Dept. 71, Chicago.

CASH For your discarded jewelry, diamonds, old gold. Old watches repaired or exchanged for new. Petersen's Jewelry, 2010 Division, Grand Rapids, Mich.

WANTED—Stories, Poems, etc. Big money for worthy creations. Andrew Duzynsky, 2024 West 18th Street, Chicago, Ill.

FARMS AND FARM LANDS

THE Great Northern Railway serves an agricultural empire in Minnesota, North Dakota, South Dakota, Montana, Idaho, Washington and Oregon. Low round trip rates. Send for free books describing the opportunities offered home-seekers. Improved farms for rent. E. C. Leedy, Dept. 257, Great Northern, St. Paul, Minn.

\$5.00 DOWN, \$3.00 monthly, buys 2 1/2 acres No. Michigan Fruit or Poultry Farm. Camp Site or Summer Home. \$100.00. Burt Lake, Cheboygan County. Finest hunting, fishing, boating, swimming. Good auto roads. Get free booklet and map. O. Hermann, 3106 Indiana Ave., Chicago.

ATTENTION! Get acquainted, cash for your property, farm, hotel or retail store, no matter where located; confidential service. Hayes Business Agency, Cincinnati, Ohio.

80 ACRES, Arkansas; unimproved; fruit and vegetables. Price \$600.00. Easy terms. Q. A. Morgan, Sedalia, Mo.

STROUT'S Spring Farm Catalog, just out; hundreds bargains, like 25 acres black loam, on stream near concrete highway and village; nice 5-room house and buildings, only \$1,100, including horse, 4 cows, poultry, tools, crops; part cash. Write today, copy free. Strout Agency, 255 Fourth Ave., New York City.

CHOICE Cabin Sites, Mantrap Lake, Itasca Park Region, Minnesota. Terms. Write Guy E. Chinn, 1531 Searle, Des Moines, Iowa.

SELL your property quickly for cash, no matter where located. Don't pay big commission. Particulars free. Real Estate Salesmen Co., Desk B, Lincoln, Nebr.

QUICK Action! Get cash for your property; have buyers waiting; all locations—free particulars. Empire Realty Service, 1175 Broadway, New York.

OZARKS—10 acres near White River and proposed power dam, \$100, \$5 monthly. Alvin Zimmerman, 1802 N. 5th, Kansas City, Kans.

10 ACS. With new 3 r. house, for fruits or poultry; nr. Town on Lake Mich. Price \$900. Pay \$15 per mo. J. H. Hill, 19 S. LaSalle St., Chicago.

MONEY made in Mich. potatoes. \$10 down now and easy terms buys land near markets, lakes, streams. Write today. Swigart & Co., P-1276, 1st Nat'l Bank Bldg., Chicago.

SEEDS, PLANTS, TREES, ETC.

FIGS. Beautiful interesting plants for tub, yard or greenhouse, north or south. Luscious fruit first season. Plant postpaid 50c, three \$1. Pecan and fruit catalog free. Fitzgerald's Nursery, Stephenville, Texas.

GROW Kudzu—a Legume—the world's greatest hay, forage and pasture plant. Every farm animal thrives on it. One planting lasts a lifetime. Write for Kudzu facts and free sample. The Kudzu Farms, Inc., Barnesville, Ga.

GINSENG Seed, stratified, for sale. W. N. Long, Florence, Ky.

YAGERIM Alfalfa—yields 50 tons acre—drought proof—seed sufficient plant half acre, \$1, money order. A. Black, Nurseryman, Three Mile, Hokitika, New Zealand.

ROOTS AND HERBS

HERB Doctor Book—10 cents. 250 receipts for making herb medicine. Hazzard Company, Box 1, Vanderveer Park, Brooklyn, N. Y.

OVER 1000 Varieties Medicinal Herbs and Roots. Tested and proved. Dime brings valuable recipe book and complete information. Shawnee, 145 West 112th Street, Chicago.

HONEY

FANCY White Clover Honey, 5-pound Pail, \$1.00; 10, \$1.75. Pay when received. Agents Wanted. Wisconsin Honey Producers, Sheldon, Wis.

MUSKRATS

MAKE Money From Muskrat Fur—Raise Muskrats in dry land pens or hutches. Get the facts. 652, Conrad's Ranch, Denver, Colo.

DOGS AND PETS

AT Stud—Little Sheik, champion coonhound of North America. Write, I. B. Baker, Norwich, Ohio.

BEAUTIFUL Samoyedes and Scottish Terriers. Reasonable. Loganbrae Kennels, Rutland, Vt.

PEAFOWL, Pheasants, Bantams, Pigeons, Rabbits, Birds. Free Circular. John Hass, Bettendorf, Iowa.

PURE-BRED Police, Collies, Eng. Shepherds, Fox Terriers. Barnes Farm, Fairfield, Nebr.

ST. BERNARDS, Champion bred pups, registered prizewinning stock. Scientifically raised to develop size, beauty, intelligence. Reasonably priced. Photos 10c. Brockington, 181-P McKenna Avenue, Montreal.

RAISE Guinea pigs; easy to raise; little space required; very profitable. Particulars and booklet how to raise free. Cavies Distributing Co., 3102 C. C. Station, Kansas City, Mo.

FOR Sale. Minks, squirrels, raccoons, foxes, ferrets, muskrats, ginseng, rabbits, skunks, wolf pups, opossums. B. Tippman, Caledonia, Minn.

PIGEONS, all varieties. John Smith, 1407 Ford Ave., Alpena, Mich.

FLYING Squirrels—Rare, handsome, hardy pets. Mated pair, express paid, safe delivery guaranteed. \$5.00. Wildwoods Fur Farm, Woodville, Texas.

RABBITS

MAKE big profits with Chinchilla Rabbits. Real Money-makers. Write for facts. 852 Conrad's Ranch, Denver, Colo.

PERSONAL

STUDENTS, Memory Developed \$2.00. Cartoon lessons \$1.00. Pop-Goo, Box 471, New York.

SEMENISM Reconciles Religion and Science, piercing materialistic haziness and religious uncertainty with arrows of Truth. Self-addressed envelope brings free sample. P. O. Box 52, Pontiac, Mich.

FREE. Fly-lock, pocket knife, 14K gold point Fountain Pen, or smallest long-range focusing Flashlight. Box 29, Station L, New York.

DREAM Dictionary and "How to Tell Fortunes With Cards"—all for 10c. G. Elsea, Bowling Green, Ohio.

TOBACCO or Snuff Habit Cured or no pay. \$1.50 if cured. Remedy sent on trial. Superba Co., N3, Baltimore, Md.

MAGIC Incense, personality perfume, occult books, catalog 10c. Hindu Publishers, Garrick Building, Chicago.

ANSWERS to mathematical problems of office, store, shop, bank, farm, or factory. Explains and simplifies every principle of arithmetic, mechanics and mensuration. Send No Money. Just ask for Ropp's Calculator. Pay postman \$1.00 and postage. Popular Mechanics Press, 200 E. Ontario St., Room 922, Chicago, Ill.

HEALTH

IF You want to rid yourself of a cold, or excess fat, or gain weight and vitality, and do it the safest and cheapest way possible, state your trouble and send 35c to: Nature Health Bureau, Wood Bldg., Glenside, Pa.

MISCELLANEOUS

VALUABLE Prize, with your name stamped in gold letters, free; and unlimited earning capacity, if you distribute our samples of Monogrammed Stationery, Mechanical Design, 1477 E. 92nd St., Cleveland, Ohio.

MIRRORS Besilvered at Home. Costs Less 5 cents per square foot; you charge 75 cents. Immense profits plating autographs, reflectors, tableware, stoves, refinishing metalware, etc. Outfits furnished. Details Free. Write Sprinkle, Plater, 288, Marion, Ind.

KEY Plug—Makes ordinary door lock pick-proof. Prepaid, \$1.00. Guaranteed. E. Johnson, 116 1/2 E. 78th St., Los Angeles, Calif.

YOU can emboss your stationery as needed. Perfect work guaranteed. Simple—inexpensive. Miller Sales Company, Dept. E, Lexington, Ky.

PRINT 250 Signs or pictures an hour without press, type or machinery. Sample and particulars 10c. Straco, 1013, Springfield, Ohio.

TATTOOING supplies direct from manufacturer. Catalogue. "Waters," 965 Putnam, Detroit.

FAMOUS Bailey Handbook—The book that prepares you to pass the examination for any grade of license for Stationary, Marine and Diesel Engineers, Firemen and Boiler Inspector in any state of the Union or any province of Canada. Flexible cover. Handy Pocket Size. Pay Postman \$2.00 plus postage when he hands you the package. Popular Mechanics Press, Room 922, 200 E. Ontario St., Chicago, Ill.

HOMEOPATHIC and Biochemic preparations sent postpaid to all parts of the world. Manual and booklets free. Halsey Bros. Co., 645 St. Clair St., Chicago, Ill. Established 1855.

WEEDS—Cut them with cutter bar on Shaw Garden Tractor. Also plows, cultivates and runs belt machinery. Low prices. Immediate delivery. Shaw Manufacturing Company, Department C, Galesburg, Kans.

CUTS anybody can make. Simple, cheap process. \$1. Specimens, particulars. 2c stamp. M. Day, Windfall, Ind.

AMATEUR Cartoonists: Make money in spare time with new cartoon selling plan. Write Smith's Service, PM1194, Wenatchee, Wash.

CASH Paid for Butterflies, Insects. See Sinclair Display Advertisement on page 30.

MEXICAN Made pistol holsters, cartridge belts, lariats, horse hair articles; rattlesnake belts; list free. Tex-Mex Leather Co., 309 Esperson Bldg., Houston, Texas.

TELL an army of 3,000,000 live readers all about your offer! If you have anything to sell, buy or exchange, or if you have any reasonable proposition, tell our readers all about it—they'll respond quickly. Our booklet "How to Create More Business" contains some very interesting, helpful facts. Write today for your copy—it's free. M. L. Rund, Manager Classified Advertising, Popular Mechanics Magazine, 200 E. Ontario St., Chicago, Ill.

He Clipped This Coupon



CHARLES F. WORTHEN

American Business Builders, Inc.,
 Authorized Capital \$500,000
 Dept. 4-AA, 18 East 18 St., New York.

Send me—without cost or obligation—your free illustrated book, "How to Become a Real Estate Specialist."

Name: *Charles F. Worthen*

Address: *242 Third St.
 Fall River Mass.*



And Made \$8,500 in 17 Weeks!

C. F. Worthen deserves success.

When he read my ad in the *American Magazine*, he was wise enough to answer it.

He clipped the coupon. He got my free book. He enrolled for my course. He followed my instructions. Now he is out of the rut of routine work and poor pay. Now he has a splendid business of his own. Now he is making more money than he ever thought possible.

If you want to do what Worthen did, send for this remarkable book of business opportunity. Learn the secret of his success. Use my money-making system. Begin at home. In your spare time. No capital—no experience—no special ability needed. Start now. Free book tells how.

Success Without Capital, Experience or Education

C. F. Worthen is not the only one I have put on the high road to real estate success.

Hundreds of ambitious men and women—young and old—have followed my instructions and are now reaping rich rewards—in business for themselves—independent—prosperous—happy.

Mrs. Evalynn Balster, a widowed Chicago school-teacher, with three children to support, made \$5,500 her first deal, using my amazingly successful real estate sales system.

"Bill" Dakin, of Buffalo, N. Y., worked



Own a new business of your own. Be a Real Estate Specialist. Begin now in your spare time. My new book, giving full information and positive proof of amazing success, mailed free.

in a steel mill before he got his copy of this free book. Now he is a successful Real Estate Specialist. Owns his own business. Has a new automobile. Making more money than he ever dreamed he could.

E. G. Baum, III and discouraged, past 50, lost his job as a bookkeeper. Sent for my free book. Made \$8,000 his first year in real estate.

H. D. Van Houten, Passaic, N. J., formerly a grocery clerk, got my free book, followed my advice, and did a gross business of over \$100,000 his first year in real estate.

But I have no more room here to tell you about the many remarkable stories of amazing business success that are coming to me from readers of my free book. So, send for a copy of it today. Don't be skeptical. Don't say "It's too good to be true." Don't cheat yourself. It costs nothing to learn the truth. So mail the coupon now!

My Book Costs You Nothing

If you had to pay \$10 for this book, and take a whole day off to read it, it would pay you to do so. But you don't have to do that. You get the book for nothing if you mail the coupon promptly. And you can read it in thirty minutes. And I guarantee that you will find it the most fascinating book of business opportunity and business success you ever read.

Get this book at once. Learn what it has done for others. Learn what it can do for you in the way of business success—**independence—big earnings—cash profits.**

Others who have sent for this book have revolutionized their business lives—climbed out of the rut of obscurity—built substantial businesses of their own—made more money in a week or a month than they formerly made in a whole year of hard work.

Perhaps this book will do as much for you.

It costs you nothing to find out! Address me personally, President, AMERICAN BUSINESS BUILDERS, INC., Dept. 44-3, 18 East 18 St., New York.

\$1,000 Reward

I will pay one thousand dollars in gold to anyone furnishing proof of the existence of any course in business training which has helped as MANY men and women make as MUCH money in as SHORT a time as my system for becoming a real estate specialist.



Mail This for Free Book!

President, American Business Builders, Inc.
 (Authorized Capital, \$500,000.00)
 Dept. 44-3, 18 East 18 St., New York.

Please send me—without cost or obligation—a copy of your book which shows me how to get into real estate, without capital or experience, and make more money than I ever made before.

Name.....
 Please Print or Write Plainly

Address.....
 (Get this Free Book! Blame Yourself if You Don't!)

Here Is Where to Find What You Want

REALIZING the difficulty one frequently encounters in locating information that may be sorely needed in pursuit of a line of work or study, we have adopted a plan that we believe will be of real service to our readers. To a greater extent than ever before knowledge pertaining to practically every kind of human endeavor is made available through the medium of books. Each month, therefore, we will give descriptions of new and outstanding books that we think will be of the greatest interest. However, if the subject you are interested in is not covered, write us about it and we will try to find a book that will be helpful to you.

New and Outstanding Books

Built-In Furniture

Published January, 1928 by Popular Mechanics Press. Complete plans and directions that will enable any handy man to add to the beauty and convenience of his home by building in buffets, china closets, clothes closets, mantel shelves, bookcases, seats, breakfast nooks, radio sets, writing desks, kitchen cupboards, clothes chutes, etc. 198 Pages. Fully illustrated. Cloth. Price \$2.50.

Make It Yourself

An unusually attractive book for those who take pride and delight in making things. Just published by Popular Mechanics Press. An almost unlimited variety of things to make among its 900 different articles—ship models, mechanical toys, novel amusement devices, furniture, useful appliances, things of beauty and utility. 480 Pages. 823 Illustrations. Cloth. Price \$3.00.

Shop Notes for 1928

Just out. The annual edition of Shop Notes needs but little introduction to readers of Popular Mechanics. It consists of a reprint of all the Shop Notes articles that have appeared in the magazine during the year past in book form and indexed for quick reference. Price 50c per volume. A set of these books covering several years makes a valuable library of shop helps. Reduced price for set of 16 volumes—\$6.25.

Popular Mechanics Boat Book

New, revised edition, just published. Nowhere else at the low price of 50 cents will you find such a fund of valuable information on building and handling a large variety of craft. The new edition covers rowboats, canoes, outboard motors, portable folding boats, motor boats, scows, house and sail boats, punts, trailers, boat houses, catamarans and speed boats. In addition, painting and calking hulls, laying up for winter, etc.

Inventions and Patents, Their Development and Promotion

A new book prepared by Milton Wright, member of the New York Bar, to guide the inventor on the road he must travel before his vision of rewards can become a reality. One of the most valuable features of this book is the pointing out of pitfalls to be avoided. 225 Pages. Cloth. Price \$2.50.

Modern Aircraft

By MAJOR V. W. PAGE, Air Corps, U. S. R. Just published. This new book covers every phase of aeronautical science. Describes and illustrates the Ryan plane made famous by Lindbergh, Wright-Bellanca flown by Chamberlin, Fokker plane used by Byrd in Polar and Trans-Oceanic flights, Wright motor and special navigating instruments fully described. 855 Pages. Size 6x9. Over 500 Illustrations. Cloth. Price \$5.00.

Aeroplane Construction, Operation and Maintenance

By J. B. RATHBUN. New, revised edition. A comprehensive manual of instruction for students, aviators and mechanics. For home study or flying schools. Covers fully the latest types of planes, motors and instruments such as those used in the flights of Lindbergh, Chamberlin, Byrd, Maitland and Hegenberger, etc., 380 Pages. Fully illustrated. Cloth. Price \$2.50.

Dyke's Automobile Encyclopedia

Newly revised 15th edition. Changing times in the automotive world necessitate frequent and thorough revision of this standard work. The modern automobile man cannot "get by" with old fashioned methods. Dyke's is a dependable source of up-to-date information. 1271 Pages. 4300 Illustrations. Cloth. Price \$6.00. Flexible Binding, Price \$7.50.

Carburetor Supplement

The author of Dyke's Automobile Encyclopedia has just completed a book containing everything about carburetors. Detailed instructions for adjusting, cleaning, repairing and replacements on every well-known make of carburetor for all automobiles. Over 240 Illustrations. Cloth. Price \$2.00.

House Wiring

A new practical handbook by J. G. Wolber and O. K. Rose, two instructors who have been for fifteen years compiling material for this book. A working manual for student and electrician that goes into the practical aspects of house wiring in simplified form. 320 Pages. Over 650 Illustrations. Flexible Binding. Price \$2.50.

Any of the above books sent postpaid upon receipt of price. If in the U. S. and you prefer to have books sent C. O. D. we will do so, charging in addition to the price, a small fee to defray the extra expense involved for the service.

Ship Model Making, Vol. 3

Just Out. How to make a model of the U. S. Frigate Constitution (Old Ironsides). In two parts, the first eliminating all unessential details making the work easy and quick for the novice; the second giving all details required for an exhaustively exact, scale model for the experienced craftsman. Cloth. Price \$2.50.

Coping Saw Work

By E. F. WORST. An attractive new book on an intensely interesting kind of light wood-work. Covers the making of toys, jointed and movable, toy-furniture, barns, houses, sheds, etc., bird houses, kites and many small articles useful about the home. Very simple equipment is all that is needed. Profusely illustrated. Large 9 1/2 x 12 1/4. Cloth. Price \$2.40.

Interior Wall Decoration

By F. N. VANDERWALKER. So many new methods of finishing walls have come into vogue that a new book was needed. This excellent treatise gives practical working methods of producing all plain and decorative finishes including all the very latest practice. 451 Pages. 125 Illustrations. Flexible Binding. Price \$4.00.

Wood Finishing, Plain and Decorative

By F. N. VANDERWALKER. A new book of methods, materials and tools for natural, stained, varnished, waxed, oiled, enameled and painted finishes. Antiqued, stippled, streaked and rough glazed finishes together with stain making formulas. 360 Pages. Fully illustrated. Cloth. Price \$2.00.

House Painting Methods With the Brush and Spray Gun

By F. N. VANDERWALKER. The scope of this new book has been confined to methods, materials and tools essential to the painting of exterior surfaces of wood, metal, brick and cement. A full knowledge of details is given so that the work may be done in an expert manner. The methods in use today are the ones given consideration. 386 Pages. 141 Illustrations. Cloth. Price \$2.00.

Furniture Finishing, Decorations and Patching

By PATTOU AND VAUGHN. This complete book, the first in its field, is arranged in five parts: 1. Period Furniture and Modern Styles. 2. Furniture Finishing. 3. Furniture Decoration. 4. Furniture Patching. 5. Special Finishes. 543 Pages. 335 Illustrations. Flexible Binding. Price \$6.00.

Practical Book of Home Repairs

By CHELSEA FRASER. Every home-owner will find here a mine of suggestion. It describes and illustrates how many simple repairs can be made—not only saving the delay and expense of a visit from the carpenter, plumber or locksmith, but with downright satisfaction to oneself. 390 Pages. 250 Illustrations. Cloth. Price \$2.50.

Mathematics for the Practical Man

By GEO. HOWE. Many need a better grip on mathematics. Are you one? This book will help you. By common sense methods it removes the mystery so that algebra and even calculus are made comparatively simple. Even though your knowledge is limited to arithmetic you gain a working knowledge of higher mathematics. Book includes answers to problems. Cloth Binding. Price \$1.50.

Diesel Engines, Marine, Locomotive, Stationary

By D. L. JONES, U. S. Navy. To-day the man who understands the workings, care and operation of the Diesel engine is in demand. The author of this new book has avoided thermo-dynamics, theory and design in order to give the practical man what he needs to know about the actual operation, care and repair. 565 Pages. 341 Illustrations. Cloth. Price \$6.00.

Radio Books

Several excellent new books on this subject, special descriptions of which will be sent on request.

Never
Worry
About
a JOB

MAKE MONEY of Work You Like!

Clip
coupon
for FREE
Auto Book

Cash
in Bank
\$5000 Home
2 Cars!

Learn Auto
Business by
SWEENEY
System of
Practical
Experience

SURE TRADES PAY
\$50 A WEEK
and Up
Big Demand
for Men

MY SPECIAL OFFER

If you are mechanically inclined—if you are willing to work and make a little sacrifice for a few weeks you can ABSOLUTELY PROMISE YOURSELF to make your dream come true. You don't need experience; you don't need education. I train you in REAL SHOPS—with tools, not books. Here's a million dollar investment to back my GUARANTEE. Over sixty thousand men in all parts of the country will tell you what I say is true. Over 20,000 of my men are in business for themselves.

HERE'S a letter that shows what you can do. \$10,000 CASH says it is true and genuine. Why, man—I can show you 500 or a thousand letters just as good. YOU may not have to go broke to pay for your training. But even if you do, what's the odds? See how well it paid Hawkins to go broke.

Dear E. J.:—

All I can say is I was broke when I left Kansas City—had only 25 cents over my ticket to Meridian; came here—went to work in the Dodge Service Station. Then in N. East Service Station—then opened up a service place of my own. Now moved in a larger place— $\frac{1}{4}$ block square. Keeping six mechanics busy. Just built a nice home for over \$5000. Own my own car, and wife has hers—sedan. Own no one, have good stock on hand and money in the bank. I can honestly say—it was Sweeney's wonderful training that did it. Before I went to Sweeney's I worked in a dry goods store as clerk—drawing one of top salaries, \$22.50 a week. Now the expenses of my three kids in boarding school are more than the \$22.50 a week I used to make.

I am still with you in the air at night—using an eight-tube set, Western Electric amplifier.

A. J. Hawkins, Meridian, Miss.

FREE CATALOG AND SPECIAL OFFER

Get my big FREE 64-page catalog. It shows hundreds of actual photographs of men at work in my magnificent new school. Tells all about wages, profits, opportunities in auto business. Explains step by step how you learn. Interesting letters from graduates telling how they made good. Shows how men come from all over the world to this big school. Makes you want to join the crowd. Tells everything you want to know. I will gladly send you a copy beautifully illustrated. I'll tell you how to get into business for yourself. No colored students accepted.

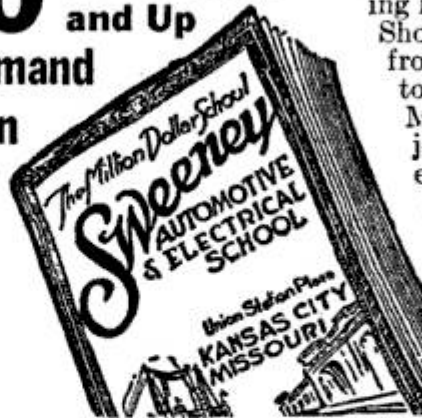

EMORY J. SWEENEY, President
4731 Sweeney Building, Kansas City, Mo.

Send me free, without any obligation, your catalog and Special Offer!

LEARN A TRADE—
Sweeney
AUTOMOTIVE & ELECTRICAL SCHOOL
4731 SWKENY BLDG. KANSAS CITY, MO.

NAME.....

P. O.....

STATE..... AGE.....



\$1,000 Reward

For the Capture of This Man

CONVICT 6138, escaped from the State Penitentiary; Name, Charles Condray; age 37; Height, 5 feet 8 inches; Weight, 141 pounds; Hair, light brown; Eyes, gray.

Easy enough to identify him from his photograph and this description, you may say — but, Condray took the name of "Brown," dyed his hair, darkened his skin, grew a mustache, put on weight and walked with a stoop.

Yet he was captured and identified so positively that he knew the game was up and returned to the penitentiary without extradition. How was it accomplished? Easy enough for the Finger Print Expert. They are the specialists, the leaders, the cream of detectives. Every day's paper tells their wonderful exploits in solving mysterious crimes and convicting dangerous criminals.

More Trained Men Needed

The demand for trained men by governments, states, cities, detective agencies, corporations, and private bureaus is becoming greater every day. Here is a real opportunity for YOU. Can you imagine a more fascinating line of work than this? Often life and death depend on finger print evidence—and big rewards go to the expert. Many experts earn regularly from \$3,000 to \$10,000 per year.

Learn At Home in Spare Time

And now you can learn the secrets of this science at home in your spare time. Any man with common school education and average ability can become a Finger Print Expert in surprisingly short time.

FREE Secret Service Reports

Mail the coupon right now and we will send you free, the confidential reports Operator No. 38 made to his chief and tell you of the wonderful opportunity awaiting the man like yourself, who is ambitious to get ahead in the world. We will also send you the illustrated free book on Finger Prints which explains this wonderful training in detail. Don't wait until this offer has expired. Mail the coupon now. You may never see this announcement again! You assume no obligation. You have everything to gain and nothing to lose. Write at once. Address

University of Applied Science

Dept. 13-53 1920 Sunnyside Avenue, Chicago

UNIVERSITY OF APPLIED SCIENCE

Dept. 13-53, 1920 Sunnyside Avenue, Chicago, Ill.

Gentlemen:—Without any obligation whatever, send me your new, fully illustrated, FREE book on Finger Prints and the Free Reports of Operator No. 38.

Name.....

Address.....

Age.....



Win a
NASH
Sedan

or
\$1400⁰⁰
in cash

Someone who answers this ad will receive a fully equipped De Luxe Model Nash Sedan, or full value in cash if preferred (\$1,085.00). In addition to this Nash Sedan we give away, a latest model Chevrolet Coach or its cash value (\$595.00), a Brunswick Panatrophe Phonograph, a Six Tube Single Dial Freshman Radio, a Corona Portable Typewriter — many other valuable prizes and Hundreds of Dollars in Cash.

Solve This Puzzle

The numbers in the squares to the right spell two words. The alphabet is numbered. A is 1, B is 2, C is 3, etc. Can you make out what the two words are? When you do this, send me your answer right away. It may mean winning the Nash Sedan or \$1,400.00 in cash.

\$315.00 Cash For Promptness

In addition to the two automobiles, the many other valuable prizes and Hundreds of Dollars in Cash, we are also offering a Special Prize of \$315.00 in Cash for Promptness. First prize winner will receive \$1,400.00 in cash, or the Nash Sedan and \$315.00 in cash. In case of ties duplicate prizes will be awarded each one tying. Get busy right away. Solve the puzzle and send me your answer together with your name and address written plainly. **EVERYBODY REWARDED.** Address

M. L. BOEING, Dept. 1773
323 So. Peoria St., Chicago, Ill.

14
1
19
8
19
5
4
1
14

A GREAT BOOK FREE WITH THIS LIBRARY!

For a short time only we will give every subscriber to the New Library of Machine Shop Practice a copy of French's Engineering Drawing—the greatest book on mechanical drawing ever written. This book makes drawing as plain as day and prepares you to handle any drawing job you will ever have to do. It comes to you with the Library of

Machine Shop Practice

9 volumes—3065 pages—3608 illustrations
(A combined home-study course and reference library)
The Machine Shop Library was written for practical men. It gives you the best methods for every kind of machine shop work. It explains machine tools and their operation, drawing and design, tool work, gears and grinding, jigs and fixtures, automatic screw machines and their tools and all of the mathematics you will ever need. Plainly written, completely illustrated—the best kind of help to the machine-shop man who wants to advance himself.

Free
**T
R
I
A
L**

No money down—
only 7c
a day



FREE EXAMINATION COUPON

McGraw-Hill Book Co., Inc., 370 Seventh Ave., New York
Send me for 10 days' free examination the Library of Machine Shop Practice. If satisfactory, I will send \$2.50 in 10 days and \$2 monthly until the special price of \$22.50 is paid. If not wanted, I will return the books at your expense. On receipt of my first payment I am to receive, free of charge, a copy of French's Engineering Drawing.

Signed.....

Address.....

City and State.....

Position.....

Employer..... P.M. 3-28



And Earned \$4930 In 6 Month's



Employment For 500 Men!

I show you an easy way to make an extra income. Just in your spare moments. Simply mail coupon for my exclusive demonstration method.

Lowel Folden made \$35.00 in one day. V. D. Love made \$15.00 an hour. A woman, Mrs. Alfred Larson, made \$1500 extra money within six months. H. C. Bower writes—"They take it out of your hands." You don't need to be a salesman—Face-A-Lite sells itself. Mail coupon for proof that you can make \$10.00 to \$20.00 a day easy.

Do you need extra money? Here is a wonderful opportunity. Here's what Charles Hickey earned in six months' spare time work. A new Chevrolet, fountain pen, Gladstone bag, Elgin watch, Crosley Radio—and \$4,930.00! He made it by showing car owners an amazing new kind of protection against blinding headlights! Agents and car owners can test a sample at my risk. Simply mail coupon below.

Glaring Lights Can't Blind You When You Look Through a Face-a-Lite

LET the headlights blaze in your eyes on the darkest, narrowest road. With a Face-a-lite shading your vision, you can drive right on without slackening speed, without the slightest bit of danger. Glaring headlights cause thousands of accidents each year. A Face-a-lite on your car is better than paying an insurance and costs only a fraction of the premium. Although out only a short time, already over a hundred thousand car owners now use Face-a-lite. Joe Lasker, Anoka, Minn., writes that a Face-a-lite saved him from a serious collision with another car, stalled on the road ahead without lights.

Fits Any Car

Face-a-lite fits any car, open or closed. You can install it yourself in a jiffy. Simply set Face-a-lite so you can look under the hood of the screen. The tiny pin points break up the shaft of light. Face-a-lite throws a shade over your

eyes so you can steer safely around a hair-pin turn. You can see every inch of the road ahead without blocking your vision, or cocking your head to one side.

FREE SAMPLE OFFER

Simply mail coupon below and learn how you can test a Face-a-lite on your own car without obligations to buy. Chas. Hickey wrote for this no-risk sample offer. It started him on the road to success. W. M. Willy, Pres., Face-A-Lite Mfg. Co., Dept. C-79, Mitchell, S. D.



Mail Today!

W. M. Willy, Pres.,
Face-A-Lite Mfg. Co.,
Dept. C-79, Mitchell, S. D.

Yes, without obligating me, send me full description of Face-A-Lite. Also tell me all about your free sample offer and big, money-making proposition.

Name.....
Address.....
City..... State.....



Gain Quick Success and Bigger Pay by Training National's Famous Job-Experience Way Good Jobs Open Now! California Alone Has \$100,000,000 Electrical Development Program

ELECTRICITY . . . the magic wand of Nature. It lights your house, runs your auto, tunes in your radio, warms your hands, chills your food and generates power for gigantic American industries.

Gets Job, Promotion and Increase in Pay

"Since leaving National I have made rapid progress in the electrical trade. I am employed at the International Electric and Supply Co. where you so kindly sent me upon graduation. My employer has promoted me since working here and increased my pay, stating that my services have proved satisfactory." (Signed) Phillip Rudell, Los Angeles, Calif.

And . . . Electricity is generating opportunity, too, FOR YOU, and thousands of men.

17,000 SUCCESSFUL GRADUATES

Right now good jobs are open everywhere for men with real, practical electrical training. You can qualify for these jobs with National training. National's famous training method gives you the experience and job practice that enable you to make good. You can definitely count on success. Over 17,000 successful graduates have proved this for you.

MILLION-DOLLAR TRAINING INSTITUTION

You learn all branches of electricity, including radio, at National. All technical essentials included. All modern equipment and training facilities. Life Scholarship. Low tuition. Free employment service. School endorsed by leaders in electrical industry. Get all the facts in big, illustrated 84-page electrical book. No city like Los Angeles: no school like National. Write today.

NATIONAL ELECTRICAL SCHOOL



Los Angeles, Calif.

Dept. 517 4006 Figueroa St., Los Angeles, California

Please send me your Free, illustrated National Electrical Book describing opportunities in the electrical industry and illustrating National training methods.

Name _____ Age _____

Address _____

City _____ State _____



You can get a pro-motion like this

"Due to the training I received from your course, I have been promoted from the shop to the drafting room. I have completed only 11 lessons but have been able to satisfactorily draw up all the jobs I have been given." (Name on request.)

Ornamental Iron Draftsmen

Get Big Pay! Beginners as high as \$60.00 a week — experienced men up to \$500 a month in executive positions. Learn while on your present job. We'll help you get a position as soon as you qualify. Write for free book telling all about the opportunities in this line.

American Institute of Ornamental Iron and Bronze
3059 Hennepin Ave. Minneapolis, Minnesota

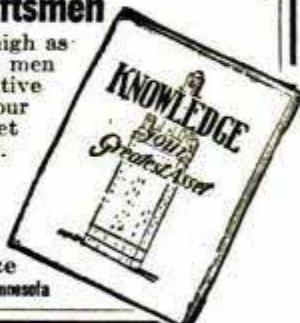

Do You Like to Draw?

If you spend any time amusing yourself at drawing, write for full details about **CARTOONIST EVANS' SIMPLE-EASY-TO-LEARN COURSE IN CARTOONING.** We do not claim to make students rich in a week—but we do claim to teach them how to draw cartoons that sell. Send 6 cents in stamps for portfolio and full details.

The W. L. Evans School of Cartooning
821 Leader Building, Cleveland, Ohio
"The School that has the Reputation."

Learn Watchwork, Jewelrywork and Engraving

A fine trade commanding a good salary, and your services always in demand. Address: **Horological**, Dept. P, Bradley Institute, PEORIA, ILLINOIS, for our latest catalog.

Complete Muscle-Building OUTFIT

Was \$30.00 Now Only \$7.98



You Get All This

Amazing Bargain

- 15 Cable Progressive Exerciser, worth \$ 8.00
- Patented Progressive Handles, 1000 pounds resistance, worth 2.00
- High Tension Hand Grips with 1,000 pounds resistance, worth 1.00
- Patented Progressive Headgear, progressive, adjustable, worth 3.00
- 12 Weeks' Home Instruction Course, worth 15.00
- The Michael McFadden Encyclopedia, worth 1.00

Total Value... \$30.00
You Pay Only... \$ 7.98

Any of the above can be purchased separately at the prices shown.

Rush coupon and save \$22 on this world-famous McFadden Outfit—a complete home gymnasium. Includes EVERYTHING for developing GIANT MUSCLES, health, strength. Big, powerful 15-cable Progressive Exerciser, Hand Grips, Headgear, Instructions, etc. All yours for only \$7.98. Greatest BARGAIN in history. Send coupon or write.

Michael McFadden, Dept. M-124
103 East 13th St., New York, N. Y.

I enclose \$7.98. Send me Complete Outfit as listed. My money back if I want it.

Name _____
Address _____
TOWN _____ State _____



All the Keen Razor Blades You Can Use... For 1/4 Cent Apiece

IMAGINE the joy of having a never-ending supply of super-keen razor blades always on hand, ready to use at a moment's notice! No more bother about remembering to buy new ones! No more "raking" and scraping with dull ones! . . . And all at an average cost of *less than a quarter cent apiece!* Think of it!

Today over *one million* American men are enjoying shaving comfort and economy that almost challenges the belief of those who haven't tried it! . . . For KRISS-KROSS is absolutely unique. The way this amazing invention re-edges razor blades and multiplies their sharpness has set new standards in the cutlery world. The smoothest blade you ever encountered in all your previous shaving experience is just a *sample* of what KRISS-KROSS can give you day after day—and month after month!

UNIQUE INVENTION

KRISS-KROSS is more than a stropper—for it makes

AGENTS!



KRISS-KROSS offers excellent money to reliable men who are willing to act as our local representatives in their home territories—full or spare-time. Many of our men are earning \$100—\$150 a week and more. Even spare-time agents often make \$5—\$12 a day just showing KRISS-KROSS to friends, fellow employees, etc. As example, R. S. Hopkins of Michigan made \$20 his very first day . . . we give you a very generous proposition and start you out with everything you need. Write for details of proposition, agent commissions and free razor offer. No obligation. Just fill in your name below and mail it today to Rhodes Mfg. Co., Dept. C-372, 1418 Pendleton Ave., St. Louis, Mo.

Name.....
 Address.....
 City..... State.....

blades last and *last*—and **LAST!** Many cases are on record where a single blade has stayed 100% keen for over 365 days of daily use! And thousands of men who formerly used a blade 4 or 5 days at best, now write us that 30 to 50 shaves are the very *least* they get since using KRISS-KROSS! Just figure the saving!

KRISS-KROSS sharpens any kind of razor blade on the market (except Durham). Uses the master-barber's secret diagonal stroke. Automatic pressure. Stropps heavy at the start—light at the finish. Takes only 11 seconds. Automatic jig notifies you when your blade is ready with the *keenest cutting-edge that steel can take!*

SPECIAL OFFER NOW

KRISS-KROSS is never sold in stores but is demonstrated by authorized representatives in each locality. If there is no representative near you, mail the coupon below for interesting, illustrated explanation of KRISS-KROSS, together with our generous introductory offer now in force. Also get details on special 3-way razor being given free . . . No obligation, so why not mail the coupon now!

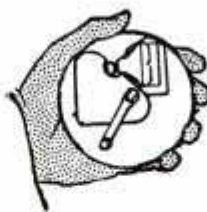

RHODES MFG. CO.

Dept. C-372, 1418 Pendleton Ave., St. Louis, Mo.

SEND THIS COUPON TODAY

GET FREE RAZOR OFFER

Rhodes Mfg. Co., Dept. C-372, 1418 Pendleton Ave., St. Louis, Mo. Without obligation, please send me illustrated booklet and special offer on KRISS-KROSS Stropper. Also give me details of patented, 3-way razor you are giving **FREE.**



Name.....

Address.....

City..... State.....

(Combination coupon and agent panel at left.)



I Will Teach You the Secrets of HYPNOTISM

- or no cost

I'll show you in a few hours how to use the strange, mysterious power of hypnotism to influence the thoughts of others, control their desires, and make you the master of every situation, or the 5-Days' Trial is FREE!

There is nothing uncanny, weird or malign about the amazing power of hypnotism! Everyone has concealed in their make-up the germs of this mysterious power. All you need to do is to train it properly. Then, when this mighty power is released, you can overcome all obstacles, make people obey your commands, gain popularity, success, big money.

Sway Others at Will

When you have this marvelous power at your command, you can work wonders. You can make others love you; develop a magnetic personality; banish fear and worry; improve your memory; overcome bad habits; realize your ambitions; increase your salary. If you have an average active and intelligent mind, you can easily learn the secrets of Hypnotism.

All is now revealed in a wonderful book, "Practical Lessons in Hypnotism," by L. W. deLaurence, a world famous hypnotist. In simple, easy-to-understand language, deLaurence explains the theory and practice of Hypnotism—how to master this power, how to select your subjects, how to hypnotize your subject, how to hypnotize by telephone, mesmerism vs. hypnotism, magnetic healing, various methods of hypnotizing, how to wake up the subject, and scores of other secrets. Prepared especially for self-instruction.

Try 5 Days Free Send No Money

So confident are we that his great book will teach you the amazing science of Hypnotism, that we will send you a copy without one cent in advance. Simply clip and mail the coupon. When the package arrives, pay the postman only \$2.75, plus the delivery charges. Test the powers of hypnotism for 5 days. Then if you are not delighted, return the book and your money will be refunded immediately. Mail the coupon now.

Mysteries of Hypnotism Revealed

- How to Hypnotize at a glance.
- How to make others obey you.
- How to overcome bad habits.
- How to gain confidence.
- How to wake a subject.
- How physicians use hypnotism.
- How to cure bad habits.
- How to induce hypnosis.
- Duration of Hypnotic Sleep.
- Susceptible subjects.
- Methods of Fascination.
- How to give an entertainment.



Franklin Publishing Company,
800 N. Clark St., Dept. 9424, Chicago, Ill.

Please send me your amazing course, "Practical Lessons in Hypnotism" by L. W. deLaurence. When the book arrives, I'll pay the postman only \$2.75, plus delivery charges. If I'm not satisfied after 5 days' trial, I may return the book and you are to refund my money.

NAME.....

STREET AND NO.....

CITY AND STATE.....

If you live outside of U. S. send cash with order.
Bargain Book Catalogue included FREE.

Learn To Fly

Low Rates

Let E. B. Heath, one of the country's oldest flyers and winner Nat'l Air Races 1927, teach you how to build and fly airplanes. Only practical instruction in a real aircraft factory. No books—no papers to study. Our reasonable rates and convenient payment plan will enable you to get started now.

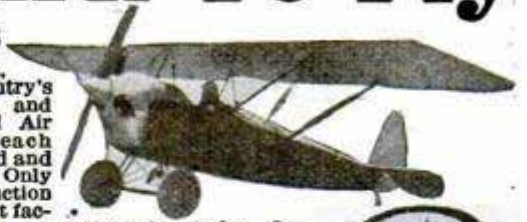

Employment Guaranteed to students in need of additional funds. We will help you earn while you learn. Overtime work in our factory guaranteed to students taking the day courses.

Special Agency Offer whereby students may represent Heath built planes.

Write for Catalog today. Complete information regarding our courses and employment offer free. Send today. No obligation.

HEATH SCHOOL of AVIATION, Dept. 3 73, 2855 Broadway, Chicago, Ill.



FREE CATALOGUE

Virzi Violins

New and Old Italian Violins

Just Arrived from Italy

503 Fifth Ave. E. J. & J. VIRZI NEW YORK

Make Decorative Metal Articles

Pictures and instructions for making: book ends, desk sets, jewelry, desk clocks, drawer pulls, hinges, bookmarks, stationery rack, candlestick, letter holder, whisk broom holder, and many similar articles. Send no money. Just write a postal for "Metal Work and Etching", our 88-page book. Pay postage and 98c to postman.

Popular Mechanics Press, Room 710, 200 E. Ontario St., Chicago, Ill.

Prepares you
to do the
work!

Raises Your
Pay!

Change Your "Luck"

Men who have reached about the maximum pay in office or shop, who seek better-paid, more interesting work, are invited to investigate our combination employment and training service. Tell us on the coupon below the kind of a job you'd LIKE, and we'll make you a NO-RISK proposition to prepare you for it—to help you GET it, to raise your pay—all without cost, if we fail.

You Win "10 to 1"

The cost of this guaranteed training and employment service is only \$6 a month. Over 30,000 men have been accepted for this opportunity in the past 3 years. We'll be glad to tell you how you can qualify, upon receipt of your name and choice of occupation.

American School
Drexel Ave. & 58th St.
Dept. G374, Chicago

New Kind of Employment Service!

Which JOB do you want?

American School, Dept. G374, Drexel Ave. & 58th, Chicago

I would like to get position marked X below. Tell me please, without cost or obligation, how I can get it.

- | | |
|--|---|
| <input type="checkbox"/> Architect | <input type="checkbox"/> C. P. A. and Auditor |
| <input type="checkbox"/> Building Contractor | <input type="checkbox"/> Draftsman and Designer |
| <input type="checkbox"/> Automobile Engineer | <input type="checkbox"/> Electrical Engineer |
| <input type="checkbox"/> Civil Engineer | <input type="checkbox"/> Mach. Shop Practice |
| <input type="checkbox"/> Structural Engineer | <input type="checkbox"/> Mechanical Engineer |
| <input type="checkbox"/> Business Manager | <input type="checkbox"/> High School |

Name.....

Address.....



COMMERCIAL AVIATION NEEDS MEN

The next generation will fly as naturally as this one drives automobiles. Aviation is the fastest growing industry in the world today—offering unlimited opportunities as a commercial pursuit and unsurpassed enjoyment if flying for pleasure alone. The beginner now will be the master of aviation a few years hence—there is honor and prosperity ahead for those who start now and grow with the industry.

WE TEACH YOU BY PRACTICAL INSTRUCTION

Experienced Instructors Under U. S. Gov't Supervision

Realizing that the highest type of equipment and ablest and most experienced instructors are necessary, our course is taught under the direction of licensed transport pilots of long experience and gives practical knowledge of airplanes, motors, etc. Our equipment is new and of modern design, inspected daily. Every ship is licensed and instructors and all equipment, under U. S. Government Inspection.

We guarantee sufficient hours in the air to make each student master of his ship: pilot it safely and steadily. That we know our instruction is thorough is proven by the fact that each student, before finishing the course, must land and take off without assistance or direction, in a modern ship costing us thousands of dollars.

THOROUGH INSTRUCTION AT LOW COST

We teach you by actual flying; no long course is therefore necessary. The cost is low considering the practical experience of daily flying, combined with ground work and theoretical class room instruction, all of which the course includes. Let us tell you more about our complete course and our binding guarantee. Fill out the coupon and mail it to us at once—you assume no obligation. **DO IT NOW!**

VON HOFFMANN AIRCRAFT CO.

Distributors for Ryan Monoplanes, same as "The Spirit of St. Louis" which flew to Paris and Mexico, also Eagle Rock Biplanes.

103 Lambert—Saint Louis Flying Field, Anglum, Missouri

HOW TO OWN YOUR PLANE—GET OUR COURSE FREE

If after becoming a graduate of our school, you desire to purchase a plane, we will allow the cost of your course to apply on the purchase price of the plane. Under this plan, you secure a complete course of instruction without cost to you.

VON HOFFMANN AIRCRAFT CO.,
103 Lambert—Saint Louis Flying Field,
Anglum, Missouri.

Send me full information on your complete Aviation Course and binding guarantee, I assume no obligation.

Name.....
Address.....
Town.....State.....



3 YEARS — \$1.00

THE NATIONAL POULTRY JOURNAL is the one practical Poultry Magazine edited by practical poultrymen. Full of priceless, seasonal information. Now offered you for three years for only \$1.00. 64-page Poultry Book FREE to each new subscriber. Send your \$1 TODAY!

THE NATIONAL POULTRY JOURNAL

Dept. 30 Washington, D. C.

LEARN WATCHMAKING AND ENGRAVING



BY OUR PROFIT-SHARING PLAN OUR GRADUATES SUCCEED

One of our Iowa students started in a very small way—now doing over \$30,000 a year. Another in Wisconsin, over \$10,000 the first year. Day or night classes. Call or write for FREE BOOK.

Chicago School of Watchmaking, Dept. 3801, 549 W. Randolph St., CHICAGO

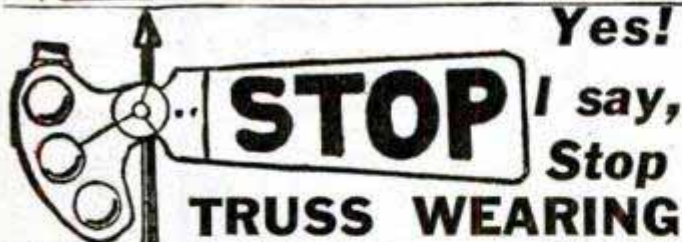

Yes!

STOP

I say, Stop

TRUSS WEARING

FREE — Trial Plapao — FREE

NO MORE RUPTURE—So says Mr. M. R. Newton, Hornell, N. Y., and Mr. Wm. Bartsch, Farmingdale, S. Dak., and many others who will gladly tell all sufferers how they cured their own ruptures of long standing, and also how their friends achieved the same satisfactory results, by the use of a scientific mechanico-chemico system designed for the treatment of the real cause of the trouble, in the privacy of

the home—a system intended to restore the affected muscles to normalcy and not simply to confine the viscera. Make up your mind to close the Hernial opening by the use of **STUART'S ADHESIF PLAPAO-PADS**, so the



Rupture Can't Come Down

Name.....
Address.....

Plapao Co., 503 Stuart Bldg., St. Louis, Mo.
Return mail will bring Free Trial "Plapao"

Rupture Curable Prove It at My Expense

Write your name and address above and receive **FREE TEST PLAPAO** and my 48 page Book on rupture. No charge for them—no obligation—**NOW OR EVER**. For your good—act today. **STUART'S ADHESIF PLAPAO-PADS** are entirely different from the truss—being mechanico-chemico "applicators"—made self-adhesive purposely to keep the muscle-tonic "PLAPAO" continuously applied to the affected parts, and to minimize **painful friction and dangerous slipping**. No straps, buckles or springs attached. Soft as velvet—easy to apply—inexpensive. For almost a quarter of a century satisfied thousands report success. Stacks of SWORN statements bear incontrovertible testimony. No delay from work. Process of recovery natural, so no subsequent use for a truss. Awarded Gold Medal, Rome, Grand Prix, Paris, and Honorable Mention at Panama-Pacific Exposition, San Francisco.



Awarded Gold Medal

From "Puny" to PANTHER-MAN

My FREE Book

tells how you can get a body like I gave the lad at the right. Why delay? The book only costs you a postage stamp and there are no strings to that! Put the coupon in the mail RIGHT NOW. Or send me your name and address on a post-card.



LOOK at these two pictures! LOOK at them!! Then go peek in your mirror and see which one of them is more like you. Never mind blushing! Don't waste time being ashamed! There's no need of staying that way! The chap in the picture got next to himself and wrote to me!

In thirty days I built that man from the sparrow-armed boy in the first picture. I loaded him with muscles. I can do as much—maybe more—for you! If you want a real body! mail the coupon before you go to bed TONIGHT!

TITUS Dept. M-124
105 East 13th St., New York City

TITUS, Dept. M-124,
105 E. 13th Street, New York City.

Dear Sir:—Mail my copy of your big new illustrated book, Better Built Bodies, absolutely FREE and without obligation.



BEFORE

This lad looked pretty hopeless when he came to me. His arms looked like sparrow wings with the feathers removed. His ribs stood out and his bones tried to poke through his skin all over his body. His chest was hollow, his neck scrawny. He had sluggish blood circulation and jumpy nerves. He couldn't sleep. Then he took my course!



30 DAYS AFTER

What a man! In thirty days I built the fellow you see above. I loaded his bones with muscles! I gave him a body that laughs at hardships and illness. He says: "No other apparatus and instruction can touch yours! When the human body will hold another muscle—Titus will put it there!"

Name.....

Address.....

City.....State.....

WIN \$3500.00!

To advertise our product we are going to give over \$6700.00 in prizes. Have already given away thousands of dollars. Virginia Umbarger won \$1445.00. Effie Swearingen, \$1500.00. Louis Siltberg \$2000.00, and others. Addresses on request. You can win \$3500.00.

Can You Find the Twins?

No, it's not as easy as it looks because two, and only two, of the hats on the girls pictured to the right are exactly alike. Find them—mark them—send your answer today. 350 big costly prizes will be given and duplicate prizes will be paid in case of ties to those tying. Costs you nothing, now, later, or ever. All who answer can share in cash prizes. Everybody rewarded. Send answer—learn how to get this prize.

\$1000.00 Extra for Promptness
—or \$500.00 and a New Model Ford Sedan. Send no money, just find twin hats, mark them, answer today.

G.A. Culver, Advertising Mgr., Room 480
500 N. Dearborn St., Chicago

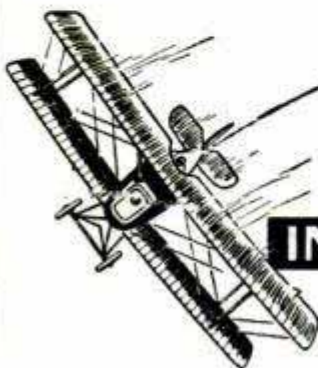

Learn to Fly

1928 calls for 5,000 trained pilots. Start now. Enroll in the largest and oldest flying school in United States.

INSTRUCTION BY AIR MAIL PILOTS

Write for our free catalog. Everyone interested in flying should have it. Tells you everything about entering America's fastest growing industry.

Robertson Flying Services, Inc.

Affiliated with
ROBERTSON AIRCRAFT CORPORATION
(Operators St. Louis-Chicago U. S. Air Mail Route)
LAMBERT ST. LOUIS FLYING FIELD - ANGLOM, ST. LOUIS CO., MO.

Name.....

Address.....

Age.....



Let Me Start You in the Garage Business!

or Train You for a Big Job at \$50 to \$125 a Week

Hundreds of live-wire, money-making, successful garage men all over the country owe their success to McSweeney training. Hundreds of others are successful foremen, mechanics and service men at top salaries. I'm ready to train you and start you on the road to success. After taking my eight weeks practical shop training you will know autos and tractors inside out. You will be all set to start a repair business of your own or accept one of the big pay jobs just begging for skillfully trained men.

MONEY BACK GUARANTEE

If, after completing my training, you are not satisfied, if you are not qualified to accept a big-pay job, your tuition will be refunded. Don't miss this remarkable opportunity. Save money by enrolling at once—and also get my special electrical course FREE. The sooner you start, the sooner you will be ready to earn big pay or go into business for yourself. Mail coupon to nearest school NOW!



WRITE QUICK for my big special Fall and Winter tuition offer which includes **R. R. FARE and BOARD PAID** While Learning

Accept this amazing offer and you have nothing further to worry about. No extras to buy. After 8 weeks of my skillful training you'll be ready to step out and get a real job with big pay—and I'll help you get one of the very best jobs in the country. If you're just an average man and can read and write, I'll guarantee you can learn by my simple, easy, practical method. Furthermore, I'll refund your tuition if you're not satisfied with what I have done for you.

J. H. McSWEENEY, Pres.,

MC SWEENEY

AUTO, TRACTOR and ELECTRICAL SCHOOLS

Dept. 11-CV, CINCINNATI, OHIO; CLEVELAND, OHIO



J. H. McSweeney, Pres.,
McSweeney Auto, Tractor and Electrical Schools,
Dept. 11-CV, Cincinnati, O., Cleveland, O.
Without cost or obligation, send me your big FREE book on Autos; also, full details of your big offer including R. R. Fare and Board Paid.

Name.....
Street.....
Town..... State.....



BOYS

SHOOT STRAIGHT for MONEY and PRIZES

It's easy! Thousands of boys are making their own spending money every week; all of them started like you—without any experience. We supplied everything and showed them how to make money the very first week. You can do the same. Join the Crowell Junior Salesmen. It only takes a few minutes of your spare time and you will be repaid with money and prizes. Fill in the coupon now and I'll send you all information and a big catalogue of prizes. Don't delay! Don't hesitate! Take the first step on the happy road of money and prizes.

Mr. Jim Thayer, Dept. 49,
The Crowell Publishing Co., Springfield, Ohio.
Dear Mr. Thayer: I would like to hit the bull's-eye and make money and win prizes.
My Name.....
Address.....
Town..... State.....

Get this USABLE

993
YEARLY MODELS
1920 thru 1928
ALL MAKES

BIG New BOOK of AUTO WIRING DIAGRAMS

1928 Ford also included!

Wiring Shown Where it Actually IS on the Cars!

Now!—a practical Wiring Diagram Book for only \$5! Nothing like it under \$15! 365 Diagrams, cover 993 models, autos, trucks, busses, starting, lighting, ignition, 1928 included. You don't have to be Electrical expert to use these. Wiring shown as if drawn on chassis. Not schematic. Every diagram uniform. Book bound. Flexible DuPont Fabricoid cover. Substantial paper. Size: 8 1/2 "x11".

Clip coupon. Order your copy now!

Price You Only \$5.00

MAIL THIS COUPON—SEND NO MONEY!

B. W. COOKE CO. PUBLISHERS
1916 Sunnyside Ave., Chicago, Ill.
Dept. 36—Gentlemen: Send me a "Job-Way" Auto Wiring Diagram Book. I will pay the Postman only \$5. If I do not like it I will return it in 5 days and you will refund my money.

5 DAY FREE TRIAL

Name.....
Address.....
Town..... State.....

PAINT IT YOURSELF

Save Money BOOKS ON 5 DAYS TRIAL

1. Modern Automobile Painting
The only book on Auto Painting written in the last ten years. Explains the newest methods of modern automobile finishing; including paint, enamel, and lacquer; with pointers for car and truck owners, refinishers, garage men, repair shops, as well as auto painters. By Marvin J. Pearce, B. S., a Consulting Engineer on Finishing Materials and Methods. Profusely illustrated. Price..... \$3.00

BOOKS FOR PAINTERS, CARPENTERS AND PAPER-HANGERS

2. THE EXPERT HOUSE PAINTER. Instruction for doing every description of painting..... \$3.00

3. THE EXPERT PAINT MIXER. The preparation of paints, interior and exterior..... 1.25

4. THE PAINTING TRADE HAND-BOOK. Technical terms, estimating, shop and office management, etc..... 1.50

5. THE HOUSEHOLD PAINTER. Full decorations for painting, decorating, papering, etc..... 1.25

6. THE EXPERT PAPERHANGER. (Second edition). How to decorate with wall paper, woven fabrics, etc..... 2.50

7. PLASTER AND PLASTERING. Materials, methods and tools for plastering and stucco work..... 1.25

MODERN AUTOMOBILE PAINTING

MARVIN JAMES PEARCE

David McKay Co., Dept. P-23, 604 S. Washington Sq., Philadelphia, Pa.

Enclosed find \$..... in cash or money order, for which send me books whose numbers are checked here, 1 2 3 4 5 6 7
It is understood that I am to have five days to read the books. If not satisfied I will return them for full refund.

Name.....
Address.....
 Check here if you want FREE CATALOG only.

LEARN AVIATION

Our Home Study Course qualifies you to enter Aviation the quick way. A thorough training from motors to navigation, more than 50 subjects. An 8 weeks course for \$18, or on installments, \$3.50 down and \$3 weekly—total \$24.50.

DIPLOMA GIVEN—ENROLL TODAY OR WRITE Dept. M

LeBourget Aviation Institute
591 Summit Ave., Jersey City, N. J.

LEARN TO WHISTLE

BOYS—be the envy of your crowd
I'll teach you in 24 hours to whistle the latest songs and imitate bird calls using your tongue and lips. Easy new method. Amaze your friends—whistle solos at parties, over radio, earn extra money, be popular.
Complete instruction 10c.
FREE with order—Swiss Warbler and an attractive souvenir. You'll like it.

10c

JACK THE WHISTLER, Box 262 Dept. 4X, New Haven, Conn.

MEN NEEDED FOR RAILROADS

Nearest their homes—everywhere—to train for Firemen, Brakemen; beginners \$150-\$250 monthly. Promoted to Conductor or Engineer—\$3,000-\$4,000 yearly—highest wages on railroads. Also clerks.
Railway Educational Association, Dept. D-1, Brooklyn, N. Y.

TEN MAGAZINES for 10¢

10¢ NOW

The smartest, most interesting, entertaining and instructive Magazine in America! 10 weeks for only 10c. Special introductory offer. No magazine like it. Full of important facts, pictures and the best, most popular fiction. For all members of the family. Send name, address and 10c immediately!
THE PATHFINDER, Dept. K-82 Washington, D. C.

I POSITIVELY GUARANTEE

to increase your arms one-half inch in size, chest one full inch, strength 25%, health 100% in one week's time, by following my instructions and using my exerciser 10 minutes mornings and at night. Send \$1 for complete course and exercisers. Satisfaction guaranteed or \$1 refunded.
Prof. J. A. DRYER, Box 1850-P, Chicago, Ill.

SPARE TIME WORK

Wonderful success opportunity. Interesting, healthful outdoor business of your own or spare time or good paying position. No selling or canvassing. Write immediately.
Tree, Box 68, Alfred Station, Detroit, Mich.

FREE!

The rare, valuable secret book which has astounded the world. Reveals the secrets of hypnotism, telepathy, personal magnetism, mesmerism, clairvoyance, mind reading, etc. This book—called the wonder of the 20th Century—worth \$3 but sent Free to you if you order our remarkable course in Practical Hypnotism—teaches you how to control others—make everybody obey your every wish and desire—conquer bad habits, enemies, win success in life and Love, obtain power, wealth, social position. Explains the greatest force in the history of man. The most perfect, complete and easily learned system. Pay only \$2.45 on arrival, including the "Hypnotic Eye," greatest aid to beginners.

EDUCATOR PRESS, FULLER BUILDING, JERSEY CITY, N. J., Dept. H-24

One Little Ounce of Magic Dots Will Hold 25 Ruptures!!

Free!

Amazing new book explains new discoveries on rupture relief. Now sent free to rupture sufferers. Also get free sample of Airtex, the new way to hold rupture without pressing. Not a penny to pay, now or future. Simply tear out coupon below!

NO wonder over 20,000 rupture sufferers have switched to this new way to relieve rupture!

Magic Dot is so light in weight, so small and inconspicuous, that twenty-five of them weigh only one ounce! It would take fully three hundred of them to equal the weight of one truss that consists of steel springs, leg straps and hard cushions!

Think what this invention means to rupture sufferers in convenience alone! Yet convenience is only one of Magic Dot's many benefits in the correction of rupture and the end of constant pain, discomfort and embarrassment!

How it works

If you could always hold your rupture together with your thumb and forefinger, your rupture would probably disappear

in time. That is all the pressure it needs. And that is exactly the way Magic Dot operates. It weighs less than a feather, measures little larger than a quarter. Once fixed in place, it stays in place until you take it off.

But how does it stay always fixed against the rupture despite any movement of the body? The answer is Airtex—the most radical improvement in rupture appliances yet discovered. It is a flesh-soft pad about the size of your palm—filled with myriad air cells that sweep a constant flow of fresh cool air in, through and around the rupture.

You be the judge

You cannot fully appreciate the radical difference and marvelous improvement of Magic Dot until you see it fully described in the book now being sent free to rupture sufferers . . . until you feel the velvet-like softness of Airtex. Read the case histories below. Probably these cases and many others relieved by Magic Dot were worse

than yours. Why suffer needless pain, discomfort and embarrassment? Mail the coupon below now! **New Science Institute, 2146 Clay St., Steubenville, Ohio.**

Mail This NOW

Were These Rupture Cases Worse Than Yours?
 "Am nearly 75 years old so consider the results of my case remarkable. The appliance I purchased from you a year or so ago was beginning to give out, so I thought I should get a new outfit. I took off the old one and my rupture was all gone. Have not worn either the old or new appliance for over a week, have worked every day, and still no sign of rupture." John Terweale, Park Rapids, Minn.
 "My rupture is entirely cured. I believe the cure was complete within sixty days after I put on the appliance. However, I kept wearing it for six months, but now I use nothing of the appliance. I had been ruptured 20 years and my rupture dropped clear down into the scrotum." M. P. Brumbaugh, Juanita, Penna.
 "My rupture was entirely cured in less than 90 days. I have had no trouble from it since. I will be 80 years old in November next. I do not give your truss credit for the full recovery. Think my extreme youth had something to do with the healing." F. B. Hubbard, Centralia, Wash.

2146 Clay St., Steubenville, Ohio.
 free book describing the wonders of
 rupture relief. This request does not
 obligate me.
 Name.....
 Address.....
 City.....
 State.....

New St
 Yes, send me
 the New Science book

Learn Autos

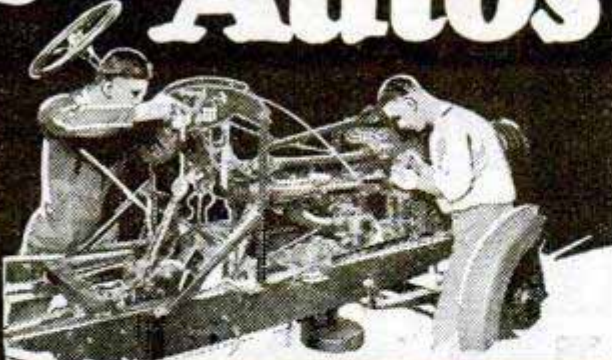

in Los Angeles

Trained Auto Experts Needed Now! Learn an Auto Trade at National in Los Angeles, the Motor Metropolis of the World

AUTOS! Yes! Hundreds of thousands of them right in the city of Los Angeles. Here is the sales-record territory for motor car manufacturers. Here is the year-round busy season for garages, service stations, etc. Here is "opportunity land" for the man who is a trained auto specialist—**AND FOR YOU!** Steady work. Big Pay. Sunshine, amusement and low cost of living.

Now Runs His Own Auto Shop

"I have been operating my shop for three and a half years and have built up a good business and make real profits. Thanks to the training I received at National, my customers always come back a second time. Your school is a real, practical one." (Signed) M. F. Smith, Proprietor H. & H. Garage, Los Angeles.

Practical Training by National's Famous Job-Experience Method

You take no risk. No guess work. **YOU KNOW YOU WILL gain success.** Over 17,000 men have proved the genuine efficiency of National training. Famous job-experience method actually qualifies you for big-pay job. Actual construction and repair work on all types of motors, including Cadillacs, Packards, Chryslers, etc., new and old. Ignition, starting and lighting systems, storage battery repair, machine shop work, etc.

No City Like Los Angeles! No School Like National Men from all parts of America and the world come to National for training. Get the facts. See National through the picture catalog we offer you. Learn of its many advantages. Lifetime scholarship. Free employment service. Up-to-date equipment and training facilities. This million-dollar training institution will back you to get a better job. Mail the coupon now.

NATIONAL

AUTOMOTIVE SCHOOL

Los Angeles, Cal.



Dept. 709 4006 Figueroa St., Los Angeles, California

Send me the big, FREE National Auto Book that explains how I can get a big-pay Auto Job.

Name _____ Age _____

Address _____

City _____ State _____



Reduce This Fleshy Spot

DON'T weaken yourself with starvation diets—don't strain your heart with violent exercises. Here's a wonderful new invention which gives you an instant appearance of slimness and quickly reduces the actual fat—without any danger, discomfort or disagreeable self-denial.

Take Off 2 to 6 Inches With New Self-Massaging Belt

The moment you put on this wonderful, new, self-massaging belt your waist is instantly reduced from 2 to 6 inches—but, better still, you should actually grow thinner day by day. Your stomach disorders, constipation, backaches and shortness of breath generally disappear as the sagging internal organs are put back in normal place. You are filled with a wonderful new energy and will probably look and feel 10 to 15 years younger.

Like Having a Private Masseur

This new, wonderful Well Reducing Belt produces the same results as an expert masseur—only quicker and cheaper. It not only reduces your waistline when you put it on, but is so constructed that every movement you make, every breath you take, imparts a constant, gentle massage to every inch of your abdomen. In a few weeks, inches of fat should actually disappear.

The Well Belt is made of the same kind of scientifically treated rubber that is used by hundreds of professional athletes and jockeys and is highly endorsed for its healthful principles by physicians everywhere. Satisfaction guaranteed or your money instantly refunded without question. The Well Co., 93 Hill St., New Haven, Conn.



THE WEIL COMPANY
93 Hill Street, New Haven, Conn.

Gentlemen: Please send me, without obligation, complete description of the Well Scientific Reducing Belt and also your special 10-day trial offer.

Name.....
Address.....
City..... State.....



BE AN OFFICER in the U. S. Coast Guard \$1700 Up to \$7,500 Yearly

\$780 yearly at the U. S. Academy while training. You rank Ensign to Captain in service. Age requirements 18 to 22. Write Dept. B for information.

COAST GUARD PREPARATORY SCHOOL
4000 Ga. Ave., N. W. Washington, D. C.

Learn MECHANICAL DENTISTRY



In 3 Months Earn Up to \$5000 A Year

WHY spend the best years of your life at uncertain jobs at small pay? You can **EARN WHILE LEARNING** this NEW money-making profession and become independent. Age no barrier, and no previous training required. You **LEARN BY DOING PRACTICAL** work. Day or night sessions. **INDIVIDUAL INSTRUCTION.** Easy terms. Railroad Fare allowed—no extra cost. Address **SECRETARY N. Y. SCHOOL OF MECHANICAL DENTISTRY, 147 West 33 St., NEW YORK.**

SEND FOR FREE BOOK



Write or Mail Coupon
Name.....
Street.....
City..... State.....

He thought he could throw me—



Dear Tom: You know how Ted Brown has always been saying he could throw me with one hand tied behind him, if he wanted to. Well, yesterday, he grabbed hold of me and we had it out. Gee, I wish you'd been there. You know how much bigger Ted is than I. He thought he had me licked dead easy—

but

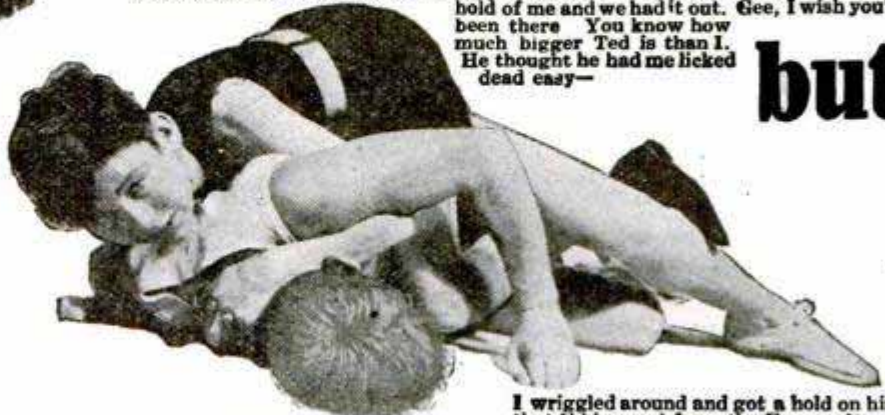

I wriggled around and got a hold on him that I'd learned from the Farmer Burns School of Wrestling. The next second — KERFLOP, and I had Mister Ted Brown on the ground, yelling for me to quit. It's a cinch to handle a fellow half as big again as you are if you know the secret holds. If I were you I'd write to Burns School for their free book about wrestling. So long—FRED.

Learn Wrestling Secrets from Worlds Champions Farmer Burns and Frank Gotch

Learn the marvelous holds, breaks, blocks and tricks that will enable you to handle big, strong men with ease. The renowned FARMER BURNS—"father of scientific wrestling"—and FRANK GOTCH the world's champion, have prepared a series of lessons in which they reveal the inside secrets of training that will make YOU, too, an expert wrestler. All the great secrets of self-defense and jiu-jitsu illustrated by printed word and picture. The lessons teach you how to become a great athlete, and secret knowledge enabling you to throw boys and men larger and stronger than yourself.

Send for FREE Book

Our FREE ILLUSTRATED BOOK tells you all about the advantages in health, vigor and respect that being able to wrestle brings one. It tells you how to learn to become a skilled wrestler in your spare time. Brim full of interesting information about wrestling. Also lots of pictures. INVESTIGATE. Write today for this free book. No obligations. Tear out and mail coupon NOW!



Farmer Burns School
3373 Railway Exchange Bldg., Omaha, Neb.

Please send me at once without obligation your FREE illustrated booklet on Scientific Wrestling, Physical Culture, Self-Defense, and How to Win.

Name.....

Address.....

Age.....

Farmer Burns School 3373 Railway Exchange Bldg. Omaha, Neb.



BIG VALUE FOR 10 CTS.

6 songs, words and music; 25 Pictures Pretty Girls; 40 Ways to Make Money; 1 Joke Book; 1 Book on Love; 1 Magic Book; 1 Book Letter Writing; 1 Dream Book and Fortune Teller; 1 Cook Book; 1 Base Ball Book, gives rules for games; 1 Toy Maker Book; Language of Flowers; 1 Morse Telegraph Alphabet; 12 Chemical Experiments; Magic Age Table; Great North Pole Game; 100 Conundrums; 3 Puzzles; 12 Games; 30 Verses for Autograph Albums. All the above by mail for 10 cents, and 2 cents postage.

ROYAL SALES CO., Desk 961, Norwalk, Conn.



WANT THIS JOB?

\$1700 to \$2300 a Year

MAIL CARRIERS—POSTAL CLERKS

Men 18 up

Steady Work

Paid Vacation

Write immediately for FREE list of positions and full particulars telling how to get a position.

FRANKLIN INSTITUTE

(Not connected with U. S. Government)

Dept. A312

Rochester, N. Y.

DRAW CARTOONS

TURN YOUR TALENT INTO MONEY

Cartoonists earn from \$50 to \$250 per week—some even more. Remarkable Circle System of Drawing teaches you in half the usual-time. Students from all parts of the world are enrolling for this exceptional instruction. Personal criticism service and up-to-the-minute instruction make it easy for National students to attain success.

Send for interesting BOOKLET and SAMPLE LESSON PLATE explaining full details of the Course and what National students are accomplishing. (No salesman will call.)



The National School of Cartooning, 623 Penton Bldg., Cleveland, O.



Amazing New Book Makes Aviation Simple as A-B-C

Are you interested in aviation? Would you like to be a flyer? Do you crave adventure, thrills, popularity, big money? If you do, get into aviation. The opportunities are unlimited! New airports are being built—new airlines are being established—scores of firms are using airplanes for business. This means thousands of jobs—pilots, mechanics, repairmen, instructors, engineers, designers, motor experts, etc. But the trained men will get the big jobs—the big money. Prepare yourself now while the industry is new—while there are more jobs than men.

Become an Expert

You can learn aviation at home in your spare time for a famous flyer, John B. Rathbun, Aeronautical Engineer and Instructor in Aviation, has written a remarkable 380-page book, "Aeroplanes—their Construction, Operation and Maintenance," that explains everything in plain, simple language.

This comprehensive manual of instruction discusses the various types of planes; explains the construction of wings, fuselage, bracing and chassis; shows how to gain balance and stability; figure resistance and power calculations; describes various types of motors, and gives practical lessons in learning to fly. Every step explained with charts, diagrams, or photographs. Most complete work on aviation published. Used as text in flying schools. Gives same instruction, yet costs but a mere fraction.

Write for a Copy Send No Money

No matter whether you are a beginner or a skilled pilot, this marvelous course in aviation will quickly prepare you for a bigger job. Write for a copy. Just send the coupon. When the course arrives, pay the postman only \$2.98, plus delivery charges. Read for 5 days. Then if not satisfactory, return and your money will be refunded. Satisfaction guaranteed. Mail the coupon now to Franklin Publishing Company, 800 N. Clark St., Chicago, Ill.

Learn All About!

- Aeroplane principles
- Aerofoils
- Power calculations
- Propellers
- Aeroplane engines
- First take-off
- Straights, Turning and Balancing
- Flying in the wind
- Proper flight speed
- Gliding, Diving, Spins
- Stunt flying

MAIL THE COUPON NOW

Franklin Publishing Company,
800 N. Clark St., Dept. 9423, Chicago, Ill.

You may send me a copy of your new 380-page book, "Aeroplanes—their Construction, Operation and Maintenance," for my Free Examination. When the book arrives, I'll pay the postman only \$2.98, plus delivery charges. If not satisfactory, I'll return the book within 5 days and you are to refund my money.

NAME.....
STREET & NO.....

CITY & STATE.....
Price outside of U. S. \$3.50 cash with order. Bargain Book Catalog included FREE.



Deafness

Perfect hearing is now being restored in all cases of deafness caused by Catarrhal troubles, Relaxed or Sunken Drums, Thickened Drums, Roaring or Hissing Sounds, Perforated, Wholly or Partially Destroyed Drums, Discharge from the Ears, etc.

Wilson Common-Sense Ear Drums

require no medicine but effectively replace what is lacking or defective in the natural ear drums. They are simple devices, which the wearer easily fits into the ears where they are invisible.

Free Book on Deafness

Soft, safe and comfortable. Write today for 168-page book on deafness giving full particulars and many testimonials. The hearing of thousands of grateful users has been restored by these "little wireless phones for the ears."

WILSON EAR DRUM CO., Incorporated
916 Todd Bldg. LOUISVILLE, KY.



68 BREEDS Valuable New Poultry

Book Free—100 Pages. Fine Pure-bred Northern raised chickens, ducks, geese, turkeys, eggs, baby chicks, incubators & brooders at lowest prices. America's great industry. My 46th year. W. A. Weber, Box 28, Mankato, Minn.

RAISE BELGIAN HARES

NEW ZEALAND REDS—Chinchillas—Flemish Giants
MAKE BIG MONEY—We supply stock and pay you following prices for all you raise: Belgian Hares \$2 each—New Zealand \$3 each—Chinchillas \$4 each—Flemish Giants \$5 each. 32-page illustrated book, catalog and contract, also copy of Fur Farming magazine, tells how to raise skunk, mink, fox, etc., for big profits, all for \$10c. Address

OUTDOOR ENTERPRISE CO., Box 25, Holmes Park, Mo.

FREE Book HOW TO FEED CHICKS

Gives Money Making Secrets of Poultry Raising. Tells how to hatch, care for and feed chicks until fully grown. Gives plan of Poultry and Brooder Houses. Describes Miller's "IDEAL" INCUBATORS with Patented Egg Turning Trays. Oil and Coal Burning BROODERS. Eggs for hatching—Baby Chicks—BARGAIN PRICES. WRITE TODAY! J. W. MILLER CO., Box 12, Rockford, Ill.



SQUAB BOOK FREE

Breed squabs and make money. Sold by millions at higher prices than chickens. Write at once for free 40-page book beautifully printed in colors telling how to do it. You will be surprised.

PLYMOUTH ROCK SQUAB CO.
634 H Street Melrose Highlands, Mass.



PLANS for Poultry Houses

All styles, 160 illustrations; secret of getting winter eggs, and copy of "The Full Egg Basket." Send 25 cents. INLAND POULTRY JOURNAL, Dept. 514 Indianapolis, Ind.

FOY'S BIG BOOK, in Colors

A complete guide to successful Poultry and Squab Raising. Low prices on CHICKS, Breeding stock and PIGEONS.

Write Today! FREE!
FRANK FOY, Box 18, Clinton, Iowa



64 BREEDS Most Profitable chick-

ens, ducks, turkeys and geese. Choice, pure bred northern raised. Fowls, eggs, chicks, incubators at low prices. America's great poultry farm. At it 35 yrs. Valuable 100-page book and catalog free. R. F. Neubert Co., Box 908, Mankato, Minn.

BOW LEGS?

THIS GARTER (Pat'd)
Makes Trousers Hang Straight
If Legs Bend In or Out

Free Booklet—Plain Sealed Envelope
THE T. GARTER CO., Dept. E
South Bend, Ind.



A PERFECT LOOKING NOSE

Can Easily Be Yours
Trados Model No. 25 corrects now ill-shaped noses quickly, painlessly, permanently and comfortably at home (excepting cases caused by improper bone structure). It is a safe and guaranteed patent device of precise adjustment that will actually give you a perfect looking nose. Over 90,000 satisfied users. For years recommended by physicians, 16 years of experience in manufacturing Nose Shapers is at your service. Model 25 Junior for children. Write for testimonials and free booklet, which tells you how to obtain a perfect looking nose.

M. TRILETY, Pioneer Noseshaping Specialist
Dept. 2792 Binghamton, N. Y.



YOURS WITHOUT EXTRA CHARGE 1928 ATLAS

Given to the readers of *Popular Mechanics* who take advantage of this offer now made in connection with **Webster's New International Dictionary**

Universal Question Answerer
To Solve Question Games, Cross Word Puzzles, whatever your question, you will find the answer in the **NEW INTERNATIONAL**. It is used as the authority by puzzle editors.

Words of Recent Interest
rotogravure, Flag Day, vitamin, fourth dimension, skid fin, Fascista, realtor, overhead, soviet, Blue Cross, campfire girl, Devil Dog, broadcast. These are but a few from the thousands of late words—all clearly defined in this great work.



The "Supreme Authority" The Merriam Webster —

A Complete Reference Library in Dictionary Form—with 3,000 pages and type matter equivalent to a 15-Volume Encyclopedia, all in a single volume. India-Paper Edition in Rich, Full Red Leather or Government Test Tan Buckram Binding, also Regular Edition in strong Red Fabrikoid, can now be secured by readers of *Popular Mechanics* on the following remarkably easy terms.

THE ENTIRE WORK (WITH 1928 ATLAS)
DELIVERED FOR \$1.00 with
easy monthly payments thereafter (on approved orders in United States and Canada)
ON SUPERIOR INDIA PAPER

Reduced About ONE - HALF
In Thickness and Weight as compared with the Regular Paper Edition

India-Paper EDITION

Printed on thin, opaque, strong, superior India Paper. It has an excellent printing surface, resulting in remarkably clear impressions of type and illustrations. What a satisfaction to own the new **Merriam Webster** in a form so light and so convenient to use! This edition is only about **one-half** the thickness and weight of the regular edition. Size 12 3/4 in. x 9 3/4 in. x 2 3/4 in. Weight, 8 3/4 lbs.

Regular Paper Edition

Printed on strong book paper of the highest quality. Size 12 3/4 in. x 9 3/4 in. x 5 1/2 in. Weight, 17 lbs. Both editions are printed from the same plates and indexed.

Over 408,000 Vocabulary Terms, and, in addition, 12,000 Biographical Names, nearly 32,000 Geographical Subjects, besides thousands of other References. 3,000 Pages. Over 6,000 illustrations. Constantly improved and kept up to date.



"To have this work in the home is like sending the whole family to college." The only dictionary with the new Divided Page, characterized as "A Stroke of Genius."

The Atlas

Is the 1928 "New Reference Atlas of the World," containing 164 pages. Maps are beautifully printed in colors, including changes brought about by the Great War, New Census figures, Parcel Post Guide, etc., all handsomely bound in red cloth, size 9 3/4 x 12 1/4 inches.

To those who mail this coupon at once!
G. & C. Merriam Co. Home Office **Springfield, Mass.**
Dept. S.
Publishers of Genuine Webster Dictionaries
for Over 82 Years

Please send me free of all obligation or expense complete information including "125 Interesting Questions" with references to their answers, striking "Facsimile Color-Plate" of the new bindings, specimen pages of India and Regular paper with terms of your Atlas offer on Webster's New International Dictionary to *Popular Mechanics* readers. 3-28

Name.....
Address.....

Automobile Mechanics!

You can learn at home the ins and outs of

- 4-wheel brake adjustment
- Rebuilding an engine
- Replacing main bearings and pistons
- Care and repair of starting and lighting systems

- Reboring cylinders
- Timing an 8-cylinder motor

Not expensive *Easy to learn*

Mail coupon for Free Booklet

INTERNATIONAL
SCHOOL
OF AUTOMOBILES

Division of the
International Correspondence Schools
Dept. 5519-F, Scranton, Penna.

Without cost or obligation, please send me full details of your home-study course in **AUTOMOBILE WORK**

Name.....
Address.....

Swear Off Tobacco



Tobacco Tells on Nervous System



Tobacco Ruins Digestion



Tobacco Stunts Boy's Growth



Tobacco Robs Man of Vitality



Tobacco Steals from You the Pleasures, Comforts, Luxuries of Life

Tobacco Habit Banished Let Us Help You

Quick Results

Trying to quit the tobacco habit unaided is often a losing fight against heavy odds, and may mean a serious shock to your nervous system. So don't try it! Make the tobacco habit quit you. It will quit you if you will just take **Tobacco Redeemer** according to directions.

It doesn't make a particle of difference whether you've been a user of tobacco for a single month or 50 years, or how much you use, or in what form you use it. Whether you smoke cigars, cigarettes, pipe, chew plug or fine cut or use snuff—**Tobacco Redeemer** will positively remove all craving for tobacco in any form in a few days. Your tobacco craving will usually begin to decrease after the very first dose—there's no long waiting for results.

Tobacco Redeemer contains no habit-forming drugs of any kind and is marvelously quick, scientific and thoroughly reliable.

Not a Substitute

Tobacco Redeemer is in no sense a substitute for tobacco, but is a radical, efficient treatment. After finishing the treatment you have absolutely no desire to use tobacco again or to continue the use of the remedy. It helps to quiet the nerves, and will make you feel better in every way. If you really want to quit the tobacco habit—get rid of it so completely that when you see others using it, it will not awaken the slightest desire in you—you should at once begin a course of **Tobacco Redeemer** treatment for the habit.

Results Absolutely Guaranteed

A single trial will convince the most skeptical. Our legal, binding, money-back guarantee goes with each full treatment. If **Tobacco Redeemer** fails to banish the tobacco habit when taken according to the plain and easy directions, your money will be cheerfully refunded upon demand.

Let Us Send You Convincing Proof

If you are a slave of the tobacco habit and want to find a sure, quick way of quitting "for keeps" you owe it to yourself and to your family to mail the coupon below or send your name and address on a postal and receive our free booklet on the deadly effect of tobacco on the human system, and positive proof that **Tobacco Redeemer** will quickly free you from the habit.

Newell Pharmacal Company
Dept. 300, Clayton Station, St. Louis, Mo.



Free Book Coupon

NEWELL PHARMACAL CO.,
Dept. 300, Clayton Station, St. Louis, Mo.

Please send, without obligating me in any way, your free booklet regarding the tobacco habit and proof that **Tobacco Redeemer** will positively free me from the tobacco habit or my money will be refunded.

Name.....

Street and No.....

Town..... State.....

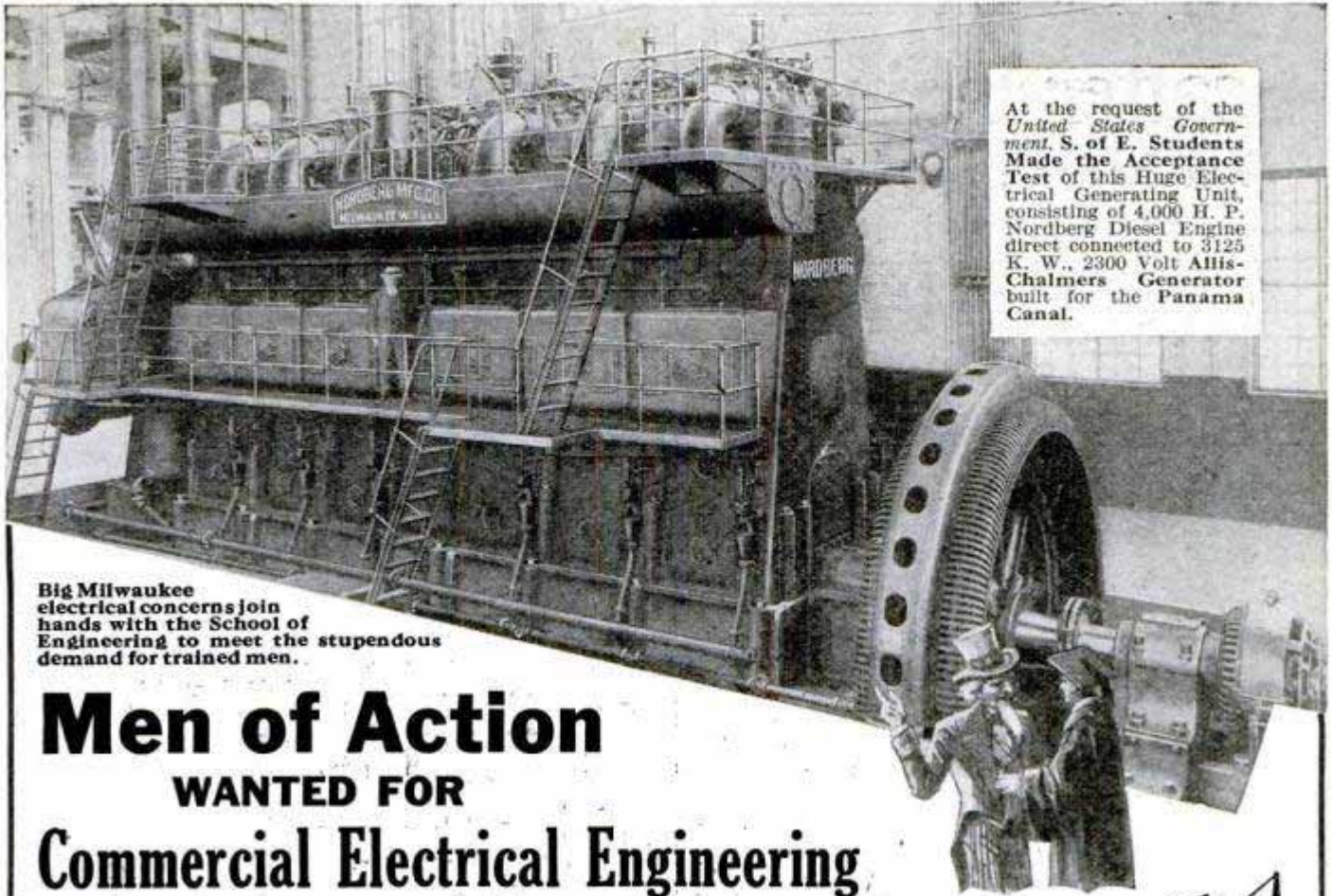

At the request of the United States Government, S. of E. Students Made the Acceptance Test of this Huge Electrical Generating Unit, consisting of 4,000 H. P. Nordberg Diesel Engine direct connected to 3125 K. W., 2300 Volt Allis-Chalmers Generator built for the Panama Canal.

Big Milwaukee electrical concerns join hands with the School of Engineering to meet the stupendous demand for trained men.

Men of Action WANTED FOR Commercial Electrical Engineering

Takes you out of the class of the common laborer of which there is always an over plentiful supply at cheap rates of pay. Makes you a Graduate Electrician, Junior Electrical Engineer, or Commercial Electrical Engineer in 12 short months. Puts you in line for a job where big manufacturers are actually pleading for trained men and glad to pay Big Salaries ranging from \$2,000 to \$10,000 a year. Not a dream—A DEAD SURE FACT! For 23 years we have trained men for the electrical profession and Our Graduates Have Succeeded in All Parts of the World. Our 12 months' intensive training is the boiled down essence of what We Know fits men for big paying positions. It is work you'll love. No Limit to advancement. Practical engineers teach you. They know What to teach and How to teach it, so you can earn money with it. Hundreds of thousands of dollars' worth of actual commercial machinery to work on in this school.

Uncle Sam Asks S. of E. OK!

Think of the opportunity to test plants such as this. The Nordberg Manufacturing Company is only one of many large concerns that is co-operating with School of Engineering students. This type of practical work, while in school, insures your future when you graduate. That's why our men are always in demand and always command big salaries. You can be one of these men if you ACT!

Earn While You Learn

By our special system you may earn part of your way while learning. Our Employment Department will help you secure a position to which you may devote a part of each day, spending the remainder at the school. This plan both solves the students' financial problems and provides splendid experience at the same time. Low tuition fee. Board and room reasonable. Daily Broadcasting WSOE. School Orchestra. Fraternities.

Write for FREE Catalog

Write today for our free, illustrated catalog. Read about this wonderful institution and the great opportunities that lie before you. Find out about our specialized method of training and the details of our "Earn While You Learn" plan.



Radio and Electric Refrigeration

Learn in three months—just 90 days and you can be one of the new group of trained men who will guide and develop the newest and best paying of America's gigantic industries. Radio and Electric Refrigeration are tremendous money makers for the trained man who gets into the game early. Experts are needed for big, responsible, well-paying jobs. We train you quick and help place you in a good position. ACT NOW!

**TERM OPENS
MARCH 26**

School of Engineering of Milwaukee, Dept. PM 328, Milwaukee, Wis.

Without obligating me in any way, please mail free 72-page illustrated book, "Electricity and the One Best Way to Learn It", and particulars regarding the course I have marked with an X.

- | | |
|---|--|
| <input type="checkbox"/> Commercial Elec. Eng. | <input type="checkbox"/> Elec. Refrigeration |
| <input type="checkbox"/> Elec. Eng., B. S. 3 yrs. | <input type="checkbox"/> Radio |
| <input type="checkbox"/> Jr. Elec. Eng. | <input type="checkbox"/> Armature Winding |
| <input type="checkbox"/> Automotive Elec. | <input type="checkbox"/> Light, Heat & Power |
| <input type="checkbox"/> Home Lab. Service | <input type="checkbox"/> Practical Electricity |
| <input type="checkbox"/> I am interested in your Earn While You Learn Plan. | |

Name.....Age.....

Address.....

City.....State.....

Education.....

SCHOOL of ENGINEERING
of Milwaukee
Founded 1905 PM 328 Milwaukee, Wis.

Scatter-brained!
 No wonder he never accomplishes anything worthwhile!



HIS mind is a hodge-podge of half-baked ideas. He thinks of a thousand "schemes" to make money quickly—but does nothing about any of them. Thoughts flash into and out of his brain with the speed of lightning. New ideas rush in pell-mell, crowding out old ones before they have taken form or shape. *He is Scatter-Brained.* He pities himself, excuses himself, sympathizes with himself. And the great tragedy is that he has every quality that leads to success—intelligence, originality, imagination, ambition. His trouble is that he does not know how to use his brain. His mental make-up needs an overhauling. It is a known fact that most of us use only one-tenth of our brain power. The other nine-tenths is dissipated into thousands of fragmentary thoughts, in day dreaming, in wishing. What can be done about it?

Find out by means of Pelmanism; then develop the particular mental faculty that you lack. You can develop it easily; Pelmanism will show you just how; 650,000 Pelmanists, many of whom were held back by your very problem, will tell you that this is true.

Pelmanism is the science of applied psychology, which has swept the world with the force of a religion. It has awakened powers in individuals, all over the world, they did not dream they possessed.

- Among those who advocate Pelmanism are:
- | | |
|---|--|
| T. P. O'Connor, "Father of the House of Commons." | Frank P. Walsh, Former Chairman of National War Labor Board. |
| The late Sir H. Rider Haggard, Famous Novelist. | Jerome K. Jerome, Novelist. |
| General Sir Robert Baden-Powell, Founder of the Boy Scout Movement. | Gen. Sir Frederick Marleat, Director of Military Operations, Imperial General Staff. |
| Judge Ben B. Lindsey, Founder of the Juvenile Court, Denver. | Sir Harry Lauder, Comedian. |
| | Baroness Orczy, Author. |
| | Prince Charles of Sweden. |

—and others, of equal prominence, too numerous to mention here. A remarkable book called "Scientific Mind Training" has been written about Pelmanism. *It can be obtained free.* If you are tired of the stuff that isn't content to remain a slave—if you have taken your last whipping from life—if you have a spark of Independence left in your soul, write for this free book. It tells you what Pelmanism is, what it has done for others, and what it can do for you. Let Pelmanism help you find yourself. Mail the coupon below now—while your resolve to do something about yourself is strong.

THE PELMAN INSTITUTE OF AMERICA
 Approved as a correspondence school under the laws of the state of New York

71 West 45th St. Suite 63 New York City

The Pelman Institute of America, 71 West 45th St., Suite 63, New York City.

I want you to show me what Pelmanism has actually done for over 650,000 people. Please send me your free book "Scientific Mind Training." This places me under no obligation whatever.

Name.....
 Address.....
 City..... State.....

TYPEWRITER PRICES CUT



All Standard Makes your choice of the World's best typewriters—Underwood, Remington, Oliver—full size, late model, completely rebuilt and re-finished brand new. Prices smashed down to half. Act quick.

\$2 and it's yours Free Trial

Just send your name and address and we will mail you our complete **FREE CATALOG** prepaid, fully describing and showing actual photographs of each beautiful machine in full colors. Tells every detail of our direct-to-you small-payment plan. Write now for tremendous saving. No obligation whatever. Still time if you act now.

International Typewriter Exchange
 184 W. Lake St. Department 394 Chicago, Illinois

Outdoor Opportunities

How to raise rabbits, guinea pigs, milch goats, silver foxes, ferrets, white rats, white mice, dogs, cats, pigeons, pheasants, bantams, canaries, bees, frogs, mushrooms, gluing and golden seal for profit. Practical 250-page book with 120 illustrations. Will be sent C. O. D. When postman hands you the package, pay him \$2 plus the postage.

POPULAR MECHANICS PRESS
 Room 506 200 E. Ontario St. CHICAGO

FREE RADIO BOOK!

40 pages chock-full of vital information for radio set builders. 14 new Aero circuits—receivers, transmitters, radiophones, short wave—fully described. Complete construction data, schematics, photos, etc. Exactly the book you've wanted. Write for FREE copy TODAY. Address

AERO PRODUCTS, Inc., Dept. 103, 1772 Wilson Ave., Chicago, Ill.

LEARN RADIO

Good Pay—Advancement —Phenomenal Success in A Life Profession of Fascinating Brain-work.



R. L. DUNGAN Director, R.I.A.

You Can Learn At Home!

Are you going to plod along at a thirty-five dollar a week job when REAL MONEY is waiting for you in radio? After years of experience Radio Institute of America has evolved a new radio course—the most up-to-date of any offered today. All this first-quality equipment for experimental work is furnished FREE WITH THE COURSE—parts for making twelve different radio circuits and the Peerless Signagraph for code instruction.



R. I. A. backed by RCA, G-E and Westinghouse

Moreover, you can STUDY AT HOME. A new booklet describing the course is just off the press. If you want to learn more about the lucrative and fascinating profession of radio send the coupon now for your copy.



RADIO INSTITUTE OF AMERICA
 Dept. L-3 326 Broadway, New York City
 Dear Mr. Dungan:
 Please send me your new catalog.
 Name.....
 Address.....

Don't Pay Me a Cent If I Can't Give You a *Magnetic Personality* -5 Days FREE Proof!



NO matter how lacking you are in qualities of leadership, no matter how colorless, timid, unsuccessful and discouraged you may be, I **GUARANTEE** to so magnetize your personality that your whole life will be completely transformed.

I can give you poise that banishes self-consciousness, charm that makes you irresistibly popular, personal power that will indelibly influence the minds of others and amaze your friends.

I'll make you a fascinating force in social life, a powerful, dynamic, commanding figure in your profession. You'll become more popular, more prosperous, more gloriously successful than you ever dreamed possible!

Let me send you the proof—absolutely free! If within 5 days you do not experience a decided change in your personality, if you do not find yourself making new friends with ease, if you do not discover yourself already on the way to social popularity, business success and personal leadership—just say so. Tell me my principle of personal magnetism can't do every single thing that I said it would do. And you won't owe me one penny!

What Is Personal Magnetism?

What is this marvelous force that raises the sick to glowing, vibrant health, the timid to a new confident personality, the unsuccessful to positions of wealth and astonishing power?

You have it—everyone has it—but *not one person in a thousand knows how to use it!* It is not a fad nor a theory. It is simply you, yourself—your manner—your own marvelous personal force, released and magnified a hundredfold in an amazingly clear-as-crystal, scientific way! More necessary than good looks. More valuable than money. For without it a salesman is handcuffed! Without it a business man is powerless to command! No actor, no teacher, no orator, no statesman can long hold his audience spellbound without this supremely influential magnetic force!



What Is Sex Magnetism?

What is that magnetic, powerful influence that draws one man to one woman—forever, irresistibly? What is that strange never-failing spark that awakens love? What is it, in man or woman, that seems to draw and fascinate—the hypnotic power that no one can resist?

You have it. Everyone has it. **But do you use it?**

Personal magnetism! How easy to release it! How wonderful its results! No long study or inconvenience. Not the slightest self-denial. Just a simple, clear, age-old principle that taps the vast thought and power resources within you, releases the full sweep of your magnetic potentialities and makes you almost a new person from what you were before!

Personal Magnetism is not hypnotism. Hypnotism deadens. Magnetism awakens, inspires, uplifts. Personal Magnetism is not electricity. It is *like* electricity in one way—while you cannot see it, you can observe its startling effects. For the moment you release your Personal Magnetism you feel a new surge of power within you. You lose all fear. You gain complete self-confidence. You become almost overnight the confident, dominant, successful personality you were intended to be—so fascinating that people are drawn to you as irresistibly as steel is drawn to a magnet!

The Facts Are Free

The fundamental principles of Personal Magnetism have been put into an extra large volume under the title of "Instantaneous Personal Magnetism." It is bound in beautiful dark burgundy, with the title gold embossed. Its scope is as broad as life itself. "Fires of Magnetism," "Sex Influence," "The Magnetic Voice," "Physical Magnetism," "The Magnetic Eye," "Oriental Secrets," "Rapid Magnetic Advancement," "The Magnetic Mind," and "Magnetic Healing," are only a few of the subjects covered in this amazing book. A magnificent book that tells you just how to cultivate the magnetic influence of your nature.

You *can* sway and control others. You *can* command success. You *can* influence people to do the things you want them to do. Through this amazing book you gain the key to a magnetic personality in 5 days—or you don't pay one penny! That is my free offer to you.

Send Coupon Today

You must see this wonderful volume—examine it—let it influence indelibly your own personality. You send no money with the coupon—you pay no C. O. D. You get the book first. If you aren't stirred and delighted in the 5-day period, return it and it costs you nothing. Otherwise keep it as your own and remit \$3 in full payment. You are the sole judge. You do not pay unless you are absolutely delighted. And then only \$3.

You simply can't delay! Clip and mail the coupon NOW.

Ralston University Press, Dept. 13-F, Meriden, Conn.

RALSTON UNIVERSITY PRESS
Dept. 13-F, Meriden, Conn.

All right—I'll be the judge. You may send me the volume "Instantaneous Personal Magnetism" for 5 days' FREE EXAMINATION in my home. Within the 5 days I will either remit the special low price of only \$3.00 or return the book without cost or obligation.

Name.....

Address.....

City.....State.....

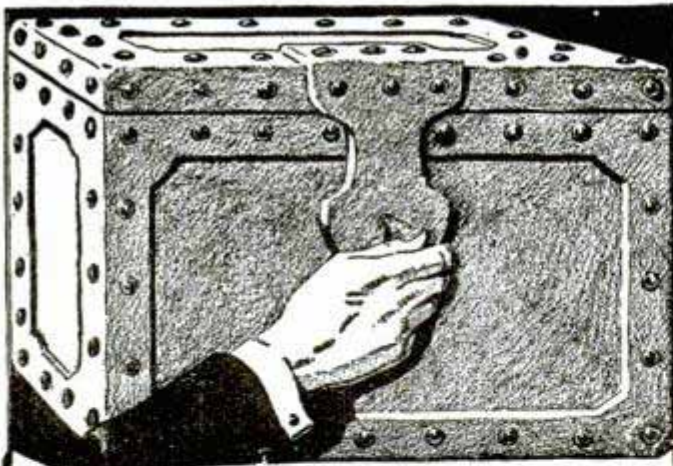

Unlocking for YOU the Age-Old

Secrets of Magic

Baffling secrets of the world's greatest magicians—mysteries never before divulged—supernatural effects of the Orient—massive stage illusions—the most priceless, most treasured Secrets of the Magic Profession now—for the first time—disclosed to YOU in the great Tarbell Course in Magic. Learn to perform like a real magician in a short time—in your spare time—at home. Be the life of every party—the center of every crowd, wherever you go. Business and social success are YOURS when you know magic. And it's EASY with the Tarbell System!

Astonish Your Friends

Study the first lesson and your friends will be amazed at your wonderful Magical powers. You will have that magnetic power that gives you instant popularity in any crowd. Everyone will marvel at your apparently super-natural, psychic power. YOU possess this talent now! Surprisingly easy to bring it out. Send the coupon below now—and find out how easily you can do it.

Earn \$250 to \$1000 a Month

From Impromptu Tricks through Sleight of Hand to Great Stage Illusions—Everything is taught to you so that you can go right out and MAKE BIG MONEY WITH MAGIC. There is a tremendous demand for Magic Entertainment. Clubs, churches, schools, conventions, theaters are on the lookout for Magicians—and they pay \$25 to \$100 for perhaps half an hour's program. Keep your job and make a lot of EXTRA Money on the side. Just master a few easy tricks. Salesmen—business men—professional men—all can use Magic to gain popularity and profits. Easy for YOU to MAKE \$250 to \$1000 a month!

Special Limited Offer! Mail Coupon!

You can now get this great course, endorsed by the world's greatest magicians, at a special low price. But you have to act quickly to get in on this offer. Write now.

**Tarbell System, Incorporated, Studio 13-53
1920 Sunnyside Avenue, Chicago, Ill.**

Please send me your big FREE illustrated and colored booklet giving full information on the Tarbell System of Magic. No obligation on my part whatever.

Name

Address

City and State Age

Learn How to BOX

JIMMY DeFOREST BOXING COURSE

Teaches by mail the Same System he taught Champion JACK DEMPSEY

In 20 weeks, under the System of Jimmy DeForest, WORLD'S GREATEST TRAINER AND MAKER OF CHAMPIONS, you will master the priceless knowledge that made Jack Dempsey his millions, and fortunes for a host of other Jimmy DeForest-trained ring stars. Boys who were once rank amateurs are today earning big money; weaklings have been made strong, courageous; men have learned the art of self-defense. Send today for the now famous book, "THE GOLDEN AGE OF BOXING," greatest book of its kind ever written; full of valuable information, photos of great fighters and pupils who became successes over night. Enclose 10c to cover cost of mailing, etc. WRITE NOW.



JIMMY DeFOREST BOXING COURSE

347 Madison Avenue, Box 128, New York City

WANT WORK AT HOME?

Earn \$20 to \$50 a week retouching photos. Men or women. No selling or canvassing. We teach you at home, furnish working outfit and employment service. Write today. ARTCRAFT STUDIOS, Dept. 50, 3900 Sheridan Road, Chicago.

TELEGRAPH-RADIO

Operators earn \$150 to \$350 month and up. Learn in Chicago or at home. Chance to work while training. We furnish operators to U. S. Govt., Railroads, Com'l Cos., Broadcasting Stations and Ships. CHICAGO TELEGRAPH INSTITUTE, Dept. 1-3-8, 1338 So. Michigan Ave., CHICAGO, ILL.

10c NEW SCIENTIFIC WONDER

3 for 25c "X-RAY" CURIO

BOYS You apparently see thru Clothes, Wood, Stone, any object. See Bones in Flesh. FREE—PKG. RADIO BIG FUN PICTURE FILMS. Takes pictures without camera. "You'll like 'em." 1 pkg. with each 25c order. MARVEL MFG. CO. Dept. 31 NEW HAVEN, CONN.

Learn a FOREIGN LANGUAGE Quickly

The HUGO SYSTEM for home study makes it easy for anyone to learn a foreign language. All unnecessary grammar, rules, etc., eliminated. Eight languages. Get one or more books now.

1. Hugo's Danish Simplified..... \$1.50
2. Hugo's French Simplified..... 1.50
3. Hugo's German Simplified..... 1.50
4. Hugo's Italian Simplified..... 1.50
5. Hugo's Norwegian Simplified.... 1.50
6. Hugo's Russian Simplified..... 1.50
7. Hugo's Spanish Simplified..... 1.50
8. Hugo's Portuguese Simplified.... 1.50

Correct Your Mistakes in ENGLISH

9. How to Avoid Incorrect English will help you. Points out the most common mistakes in grammar, spelling and pronunciation and shows what is correct. A few minutes' pleasant reading of this easy book each evening will develop mastery of English.

SENT ON 5 DAYS' TRIAL Mail Coupon

David McKay Co., Dept. 23, 604 S. Washington Sq., Philadelphia, Pa.

Enclosed find \$..... in cash or money order for which please send me the books whose numbers are checked here. 1 2 3 4 5 6 7 8 9. It is understood that I am to have 5 days to read the books. If not satisfied I will return them for full refund.

Name

Address

() Check here if you want FREE CATALOG only.

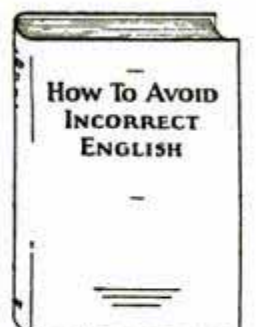

Collect a Week's Wages Every day!

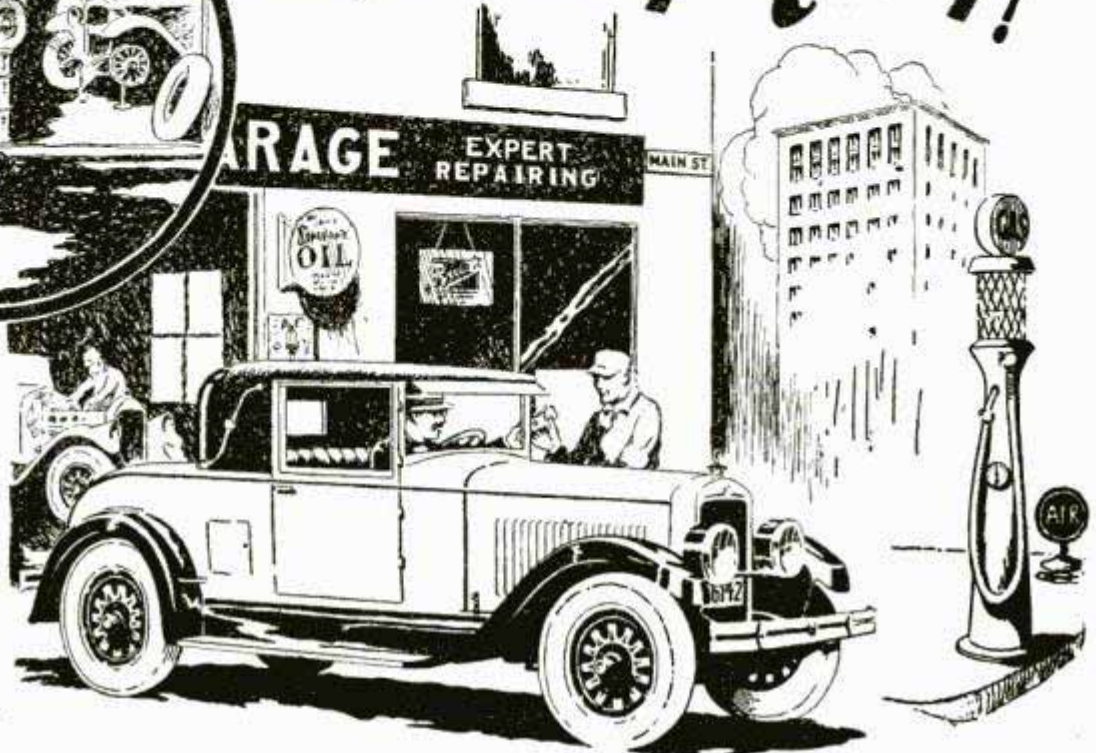
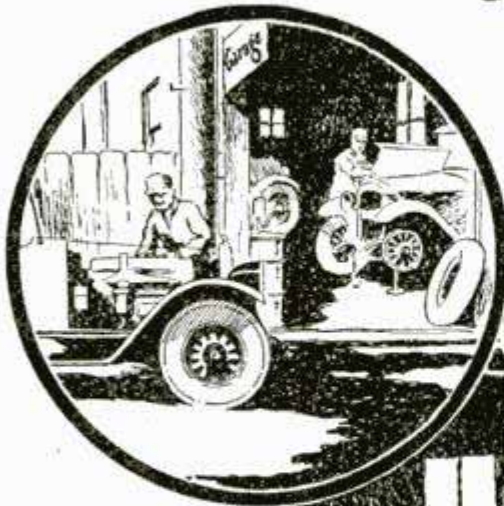

**Start
Small
and
Grow
Big**

A business of your own—based on sound training—makes you the real money. You don't have to start big, but BE AN EXPERT, and you will make big money even in a little shop. Some of our graduates start in alley garages, taking in 2 or 3 cars at a time. Their profits and their reputation soon bring a bigger shop. It's "Michigan State" training that does it. Automobile Repairing is a PROFITABLE business for the qualified man—\$100.00 profit on an overhaul job is not exceptional. 24 million cars now—no end in sight. This means a healthy, growing business and more opportunities every year.

A Business of Your Own

Means you are your own boss—Independent, successful. Money in the bank and a steady income. THOROUGH TRAINING WILL PUT YOU THERE.

TRAINING Indispensable To Success

Come to the "Michigan State" at Detroit. Learn right—get a thorough training in our MASTER COURSE. Six to eight months of practical, intensive training under experts. The modern repairman must know how to completely rebuild cars as well as make ordinary repairs. We teach you how to do it right.

Even garage men need this training. One-fourth of our students are garage men who come here to learn the fine points, so they can advance to better jobs and bigger pay.

Also Shorter Courses. Automobile and Electrical, 12 weeks; Batteries, Tires, Welding and Machine Shop—4, 6 and 8 week courses.

Business Course. Garage Management and training in business fundamentals included with all courses. Taught by one of Detroit's most experienced automobile executives. You need this foundation to build your business on.

Michigan State Automobile School

Established 17 Years
303 Auto Building

A. G. ZELLER, President
DETROIT, MICHIGAN

Big Business Wants Trained Men

We have standing orders from auto manufacturers and dealers to send them men who qualify for advancement as service executives. Good men are always in demand. Men come here daily to take our Master Course, aiming at big jobs—and they get them. Our graduates of a few years ago are now Service Managers, Superintendents, or owners of their own shops—or climbing high in aviation, that great new branch of the motor industry.

AVIATION, Another Coming World Business. As a money-making business, aviation will soon rival the auto industry. Skilled men are needed now. Demand increasing fast. Look to the future. Lay your plans now to be one of the leaders. Send for information on this Course.

LEARN QUICK!

Come to Detroit NOW. Get in this steady, year-round business. It's a big pay business with no strikes, no layoffs. Get thorough training at this world famous school in Detroit, the Auto center. We'll help you to part-time work while learning if you need it. Or write for big illustrated 17th Anniversary Catalog, all about factory endorsed Detroit-training for real success. Write or come now!

Write today—or send the Information Coupon, without obligation. Address, A. G. Zeller, President.

**24,000,000 Cars
NEED SERVICE**

**FREE
CATALOG**



YOU CAN GET THERE QUICK

Michigan State
Automobile School,
303 Auto Bldg.,
Detroit, Michigan

I want to know about Detroit-training to make the most money. Send FREE Catalogs at once.

Name.....

St. & No. R. F. D.....

City..... State.....

Age..... I am interested in:

<input type="checkbox"/> 12 weeks Auto Course	<input type="checkbox"/> Home study course
<input type="checkbox"/> 30 weeks Master Course	<input type="checkbox"/> Aviation
	<input type="checkbox"/> Other branches

CASH IN ON RADIO Now



EARN \$75⁰⁰ a Week

**Follow the Example of Thousands
Join the Radio Association
Learn Radio**

Take Advantage of Radio's Big-Pay Opportunities

THE RADIO ASSOCIATION OF AMERICA will help you make money in Radio, full or part time, by training you to be a "radio doctor," to build sets, "tailored" to your neighborhood needs, that you can sell for less than the "ready-made" sets offered by your local dealer, or to become a Radio Service Man for a radio dealer. Hundreds earn \$3 an hour spare-time serving as "radio doctors."

Earned \$500 in Spare Hours

Member Lyle Follick, Mich., reports \$500 earnings so far in spare-time. Member Werner Eichler, N. Y., earns \$50 weekly spare-time. Member F. J. Buckley, Mo., earns as much spare-time as he gets from his employer.

If interested in Radio, join the Association. You will receive a comprehensive and practical training in Radio that will not only enable you to earn money in spare hours but to fit yourself for Radio's big-pay opportunities. Scores of our members are now connected with big radio organizations in different capacities. Membership in the Association has increased the salaries of innumerable men.

Member W. E. Thon, Chicago, was a clerk in a hardware store. The training we gave him enabled him to secure the managership of a Radio Department at a 220% increased salary.

"I attribute my success entirely to the Radio Association," he writes. "Your method of instruction is wonderful."

We Will Start You in Business

Our cooperative plan will start you in business without capital. "In 1922 I was a clerk," writes Member K. O. Benzing, Ia., "when I enrolled. Since then I have built hundreds of sets—from 1-tube Regenerative to Superheterodynes.

"I am now operating my own store and my income is 400% greater than when I joined the Association. My entire success is due to the splendid help you have given me."

Membership gives you the benefit of proven money-making plans, the privilege of buying radio parts at wholesale, the cooperation of our Employment Department, the backing, advice of the Association in carrying out your plans. Investigate all it can do for you!

ACT NOW — for No-Cost Membership

The success of the Association during 1927 was so tremendous that we can offer a limited number of memberships that need not cost you a cent. Write today for details and our book, "Your Opportunity in the Radio Industry," that will open your eyes. Let us hear from you at once.

RADIO ASSOCIATION OF AMERICA
Dept. PM-3 A, 4513 Ravenswood Avenue,
Chicago, Ill.

Gentlemen:

Please send details of your Special Memberships and copy of your book, "Your Opportunity in the Radio Industry."

Name.....

Address.....

City..... State.....

Radio is better with Battery Power

**Why
pay for waste
space?**

**Buy the
EVEREADY
LAYERBILT**

- it's every inch a battery



This is the Eveready Layerbilt, the unique "B" battery that contains no waste spaces or materials between the cells; the longest lasting of all Evereadys.

IN DRY cell "B" batteries made up of cylindrical cells more than one-third of the space is wasted. That's inevitable. No matter how closely you pack a group of cylinders, there always will be spaces between them. Usually these spaces are filled in with pitch or other substances, to prevent movement of the cells during shipment and breakage of the wires connecting cell to cell.

In the Eveready Layerbilt "B" Battery No. 486 there are no waste spaces between the

cells and no useless materials. Instead of cylindrical cells, this extraordinary battery uses flat cells. It is built in layers and assembled under pressure into a solid block. Electrical connection between cell and cell is automatic, by pressure of the entire side of each cell against its neighbor.

The most surprising thing about this construction is that it actually makes the active materials more efficient. A given weight of them produces more current, and lasts longer, than the same amount when put in the cylindrical cell form. This was the unexpected result of researches into methods of utilizing the hitherto waste spaces. Scientists now know that the flat shape is the most efficient form for the cells in a "B" battery. No wonder the Eveready

Layerbilt is the most convenient and economical of all the Evereadys.

Only Eveready makes the Eveready Layerbilt. Its exclusive, patented construction is Eveready's greatest contribution to radio enjoyment, giving new economy and convenience to battery users. The Eveready Layerbilt, of course, provides Battery Power—silent, reliable, independent, guarantor of the best reception of which your receiver is capable.

NATIONAL CARBON CO., INC.

New York  San Francisco

Unit of
Union Carbide and Carbon Corporation

Tuesday night is Eveready Hour Night
East of the Rockies

9 P. M., Eastern Standard Time
Through WEAJ and associated N. B. C.
stations

On the Pacific Coast
8 P. M., Pacific Standard Time
Through N. B. C. Pacific Coast network

EVEREADY
Radio Batteries
—they last longer

Illustrated to the left is the cylindrical cell type of "B" battery construction. Note the waste space between the cells.



The air is full of things you shouldn't miss

3800

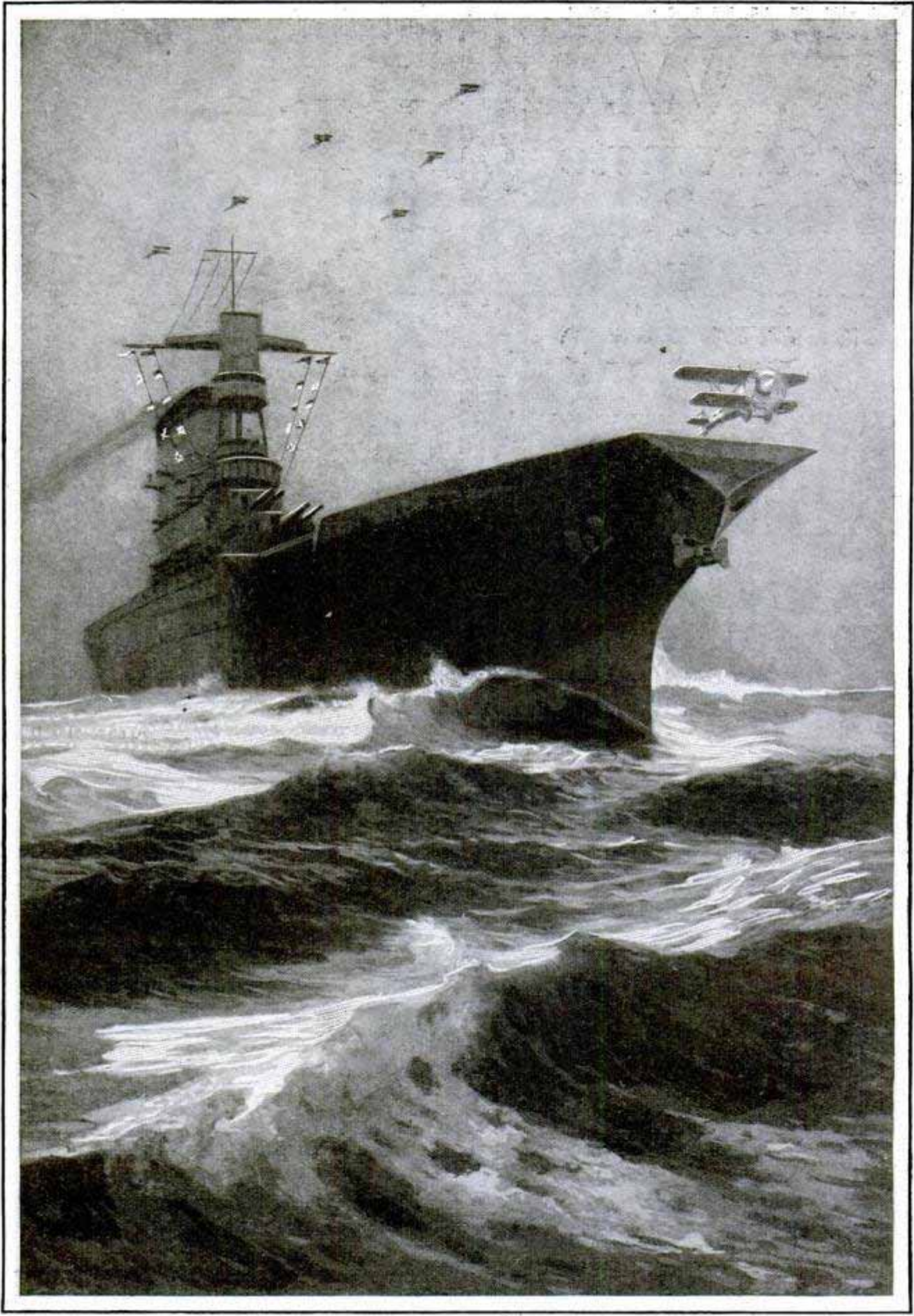

Courtesy General Electric Co.
As the "Saratoga" Will Appear in Actual Service; Artist's Conception of the Huge Carrier at Sea with Plane Taking Off; Only the Turret Guns Suggest a Battleship—See Page 443

Popular Mechanics Magazine

REGISTERED IN U. S. PATENT OFFICE

WRITTEN SO YOU CAN UNDERSTAND IT

Vol. 49

MARCH, 1928

No. 3

3991 Risks Men Face *in* "Subs"

Crew Examining the "Ears" of a Submarine; These Sensitive Units Pick Up and Amplify Incoming Sound Waves to Warn of an Approaching Obstruction

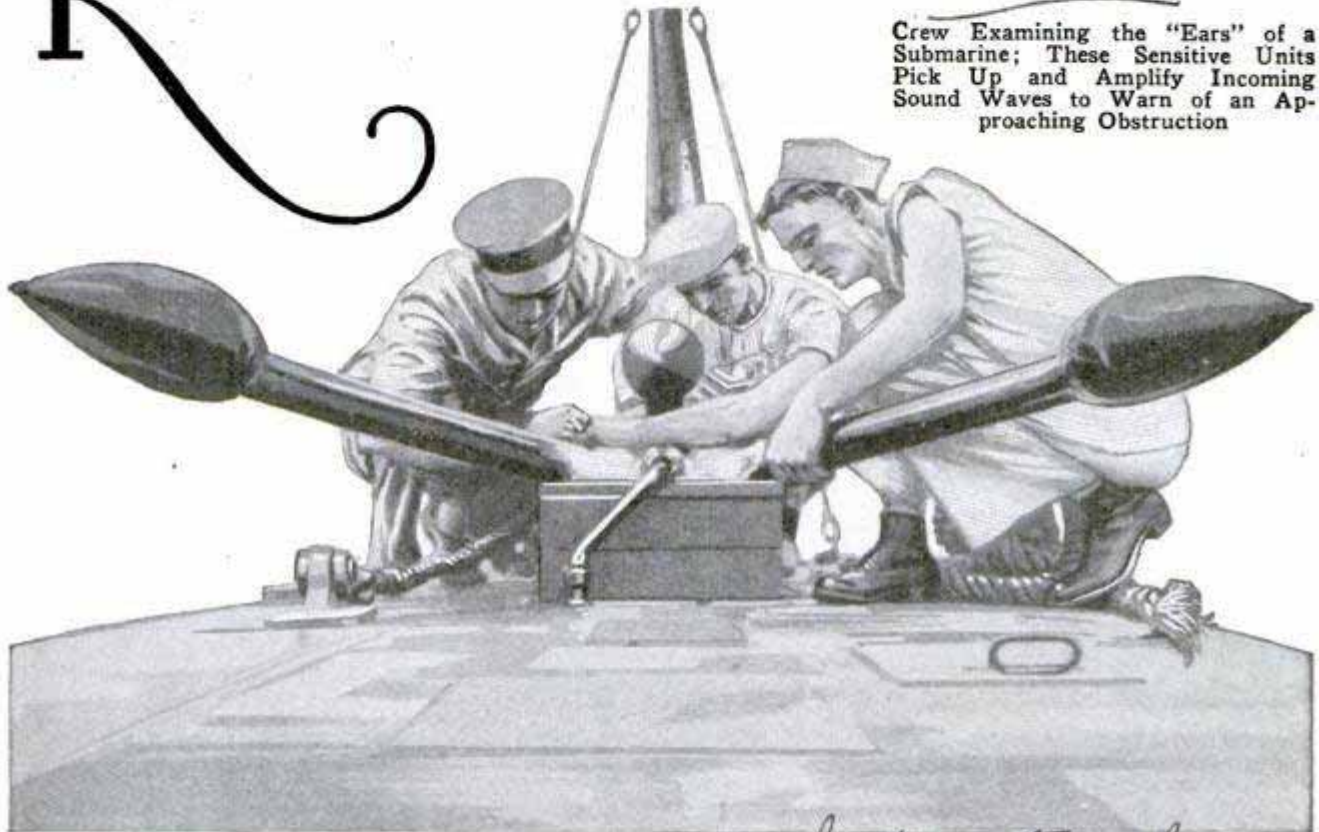

THE terrible loss of life in submarine disasters has brought home to designers the necessity of providing some means of escape for men imprisoned in them.

Many ideas have been suggested, but have been discarded because, if each were installed, the activity of the craft would be so hampered as to render it almost useless.

If the point at which damage might occur were known, it would be easy to invent a means of aid, but such points are almost without limit. For instance, a collision might injure the hull in the vicinity of a lifting eye, thus weakening it, or in the middle, causing it to buckle in raising.

The genius of man has given the undersea boats an uncanny cunning. Almost literally, a submarine can see, feel, hear and talk. It might well be called the

International
masterpiece of the mechanics' art—so much so, in fact, that the greatest element of peril to a submarine lies outside its hull, not within it. That is why the majority of fatal accidents to American undersea boats have been from collision. Three out of five major catastrophes have been of this nature.

"The 'S-4' was equipped with all the latest safety and escape devices," declared Comm. A. G. Dibrell, of the navy, "yet it sank. It is difficult to understand, before the raising of the 'S-4,' how she could have been ignorant of the position of the ship that rammed her. Even without the listening apparatus, it is quite easy to hear the noise of a propeller through the hull itself. Listening devices of the type used on the 'S-4' are extremely accurate and



Composite Photo Diagram to Show How Divers Communicated with Men Imprisoned in the "S-4"; the Hammer Signals Were Answered for Several Hours before Final Silence

sensitive. Why, we even have target practice, submerged, using nothing but the listening device to locate the target.

"It is rather obvious that something went wrong, mechanically, on the 'S-4,' and forced her to the surface despite the greatest efforts of her crew. I have had just that experience myself, but fortunately no surface vessel was near.

"Because of the very nature of accidents to submarines the crews usually perish instantly. But in order to enable any possible survivors of an accident to escape, hatches now are provided in every chamber of a boat with the exception of the battery room. In that one place the presence of even a minute quantity of salt water would generate deadly chlorine gas and kill the entire crew. In the compartment where men were known to have been alive on the 'S-4' there was an escape hatch. But it would have been suicide for any man to have used it at the 100-foot depth to which she sank.

"Those hatches are operated by air pressure. At that depth the water pressure was approximately forty-four pounds to a square inch, so high that it would take a jack capable of lifting ten tons to move one. If a man, operating the escape hatch, were able to stand the necessary air pressure—and it could not have been produced—he would have been shot out of the hatch in the air bubble like a bullet. His rise to the surface would have been so rapid that the instantaneous change in pressure would have killed him."

Lieut. Comm. George Dickson, retired, who designed submarines for the navy, and who was in command of submersibles for eight years, plans to offer a suggestion to the navy department as a result of the "S-4" accident.

"Of course, the 'S-4' should have known that the destroyer which rammed her was close by before she rose," he explained. "The sound of that boat's propeller should have been perfectly audible to all on board. Something went wrong somewhere, but in such an emergency, if the commander of the ship could have notified surface boats that he had to come up, the accident might have been avoided. I think that such a warning might be given by use of a special tank that could be filled with colored water. That tank might be an

integral part of the hull, and could be blown empty by compressed air with such force that it would send up a huge column into the air, just as a whale spouts when coming to the surface. In all likelihood some one on board an approaching surface vessel would see such a signal."

Another suggestion, which has not yet been tried out, calls for the use of a rescue submarine carrying a hollow tube that could be pressed against the side of a disabled craft. After the water had been pumped out, a man might crawl through with a torch and cut a hole in the side that would enable the crew to escape.

Rear Admiral G. H. Rock, assistant chief of the bureau of construction and repair, rejects the idea of life chambers, saying:

"A chamber large enough to hold the crew of a submarine would necessitate an unduly large structure on deck, or else an undue restriction inside the submarine. The deck structure would be objectionable from the point of view of submerged resistance and weight. It would detract too much from the military value of the vessel and there could be no assurance that the opening through which access to such a lifeboat could be had, might not be flooded."

Rear Admiral Rock also frowns upon the use of marker buoys for indicating the position of a sunken submarine, because no such buoy ever has been devised which cannot be accidentally released. Drop keels for the purpose of lightening a sinking vessel have been used but do not meet the navy's approval.

So far as raising sunken submarines is concerned, Admiral Rock believes the pontoon system, aided by derrick hoists, is the only practicable one.

Summing up the efforts and aims of the bureau in preventing accidents, and in rescue work, he says:

"Safety must come through improvements in the internal construction rather than by the provision of additional rescue or external apparatus."

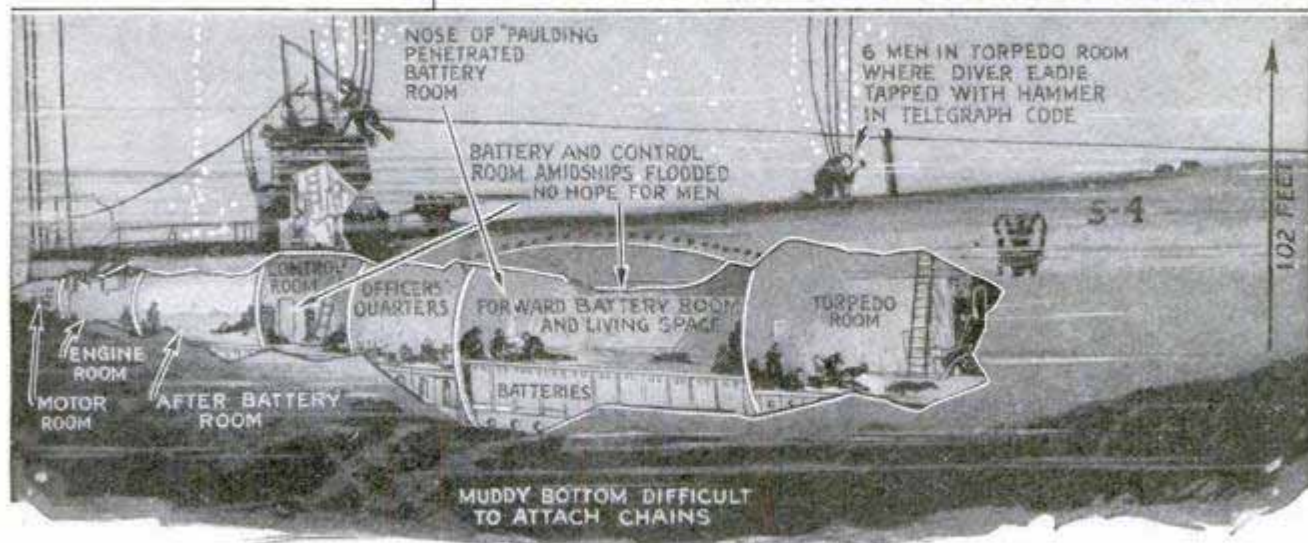
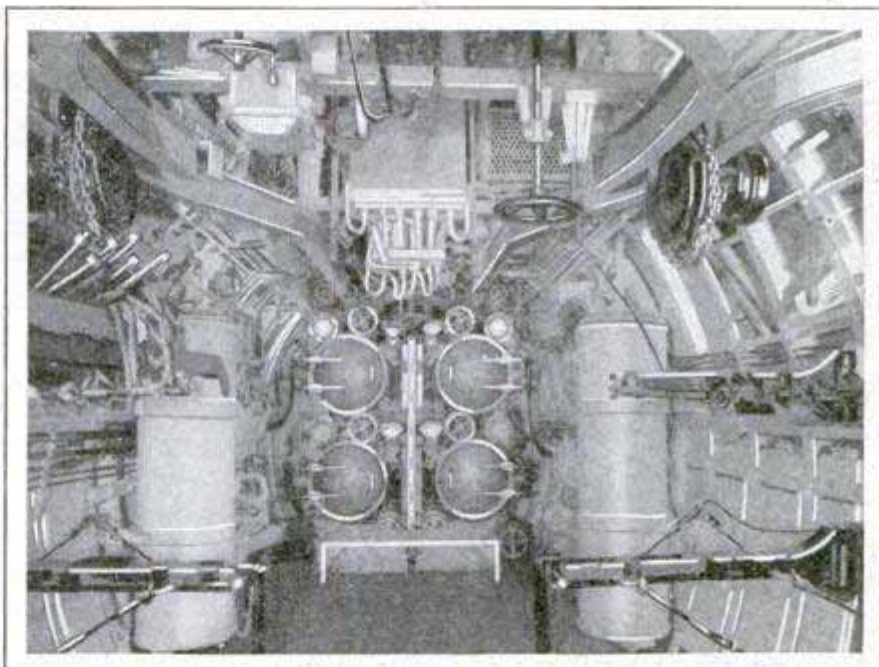

Upper Photo © Henry Miller

Upper Photo, View of After End of Torpedo Room on the "S-4" with Tubes in the Background; Below, Artist's Drawing of the Sub as It Probably Lay on Bottom, and Divers at Work

3863
356

18. Shakespeare Road,
POPULAR MECHANICS

Heron Hill London S. E. 24 Eng.
GIANT LINERS OF THE AIR EQUIPPED WITH DINERS

*airplane
dummy*



*Short Bros. Ltd.
Rochester, England.*



Passengers Who Ride on Air Cushions in New British Liners Can Wear the Seats as Life Preservers; at Left, Food Tray on Back of Seat; Other Views, the Life-Preserver Cushions

New air liners built for the British Imperial airways service from London to India will carry cook-stewards to prepare and serve meals en route. The new planes, giant three-motored flying boats, have all the latest flying conveniences, and are equipped to land on the sea, if necessary. They are to be used on the final stages of the England to India route, crossing Persia and the sea. The flying boats are of all-metal construction with a wing span of ninety-three feet and weigh nine tons loaded. They have seats for fifteen passengers in a roomy cabin and carry a crew of three, including the pilot and a relief pilot, who will take turns at the controls and supervise the navigation, and the cook-steward. Each seat is fitted, on its back, with a folding table tray that can

be raised to serve the passenger in the next seat to the rear. The passengers will ride on air and lean back against air, for both seat cushions are of rubber, inflated. They are so arranged that in case of an emergency landing at sea, the passenger can rise, don his seat cushions and be fully equipped with a life preserver. The flying boats have a speed of 120 miles an hour with their three engines, totaling 1,500 horsepower, and carry enough gasoline to make 760 miles at cruising speed. The London to India airline is the first big link in Great Britain's projected air service to Australia. Because of the enormous distances covered, the weeks consumed in steamer passages, and the fact that much of the route is over land, the service is expected to pay from the start.

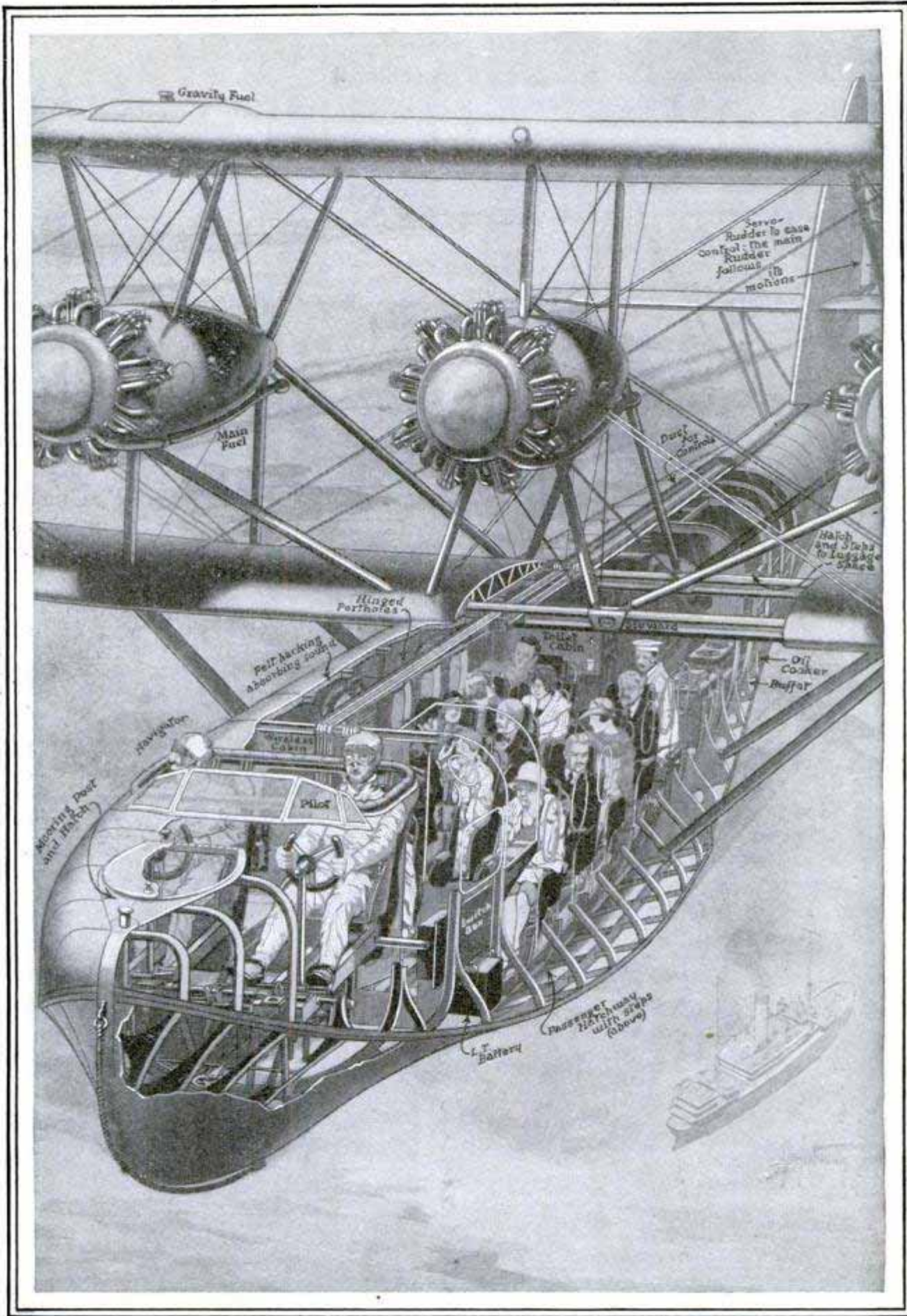

© S. W. Clatworthy

Passenger Accommodations in New Three-Engine Air Liners Built for the London-to-India Service; the Hulls Are Stanchly Built Boats, Capable of Landing and Navigating in Rough Seas; a Steward Is Carried to Serve Meals While in the Air.

The W. D. Sherwin Co.
 Hyde Park
 Boston, Mass.

Rodex
 Vayl as ifer

358

3982

POPULAR MECHANICS

Chicago. 410 N. Michigan

Chicago Jasper Place 3604 N.



Removing Soot from the Furnace by Suction; Applying Vacuum Cleaner Which Eliminates Dust

VACUUM CLEANER FOR FURNACE SAVES COAL AND DIRT

Much of the unpleasant labor and spreading of dirt attendant upon the task of cleaning the furnace has been eliminated by a vacuum outfit which sucks the soot and rust from pipes and flues and deposits them in a bag, just as the home-cleaning vacuum machine does with the dust from the carpets. The unit is designed especially for furnace service and repair men, works from a lighting socket and is easily moved about on wheels. It weighs but seventy-five pounds and has attachments to scour the furnace interior.

MEN RISK LIVES IN BANK VAULT TO TEST OXYGEN UNIT

Staking their lives on the effectiveness of an oxygen-supply apparatus to prevent persons from being suffocated when accidentally imprisoned in vaults, three men recently spent twelve hours in a cramped, air-tight chamber to test the equipment. They emerged, evidently none the worse for their experience, and examination showed that the air within the vault had undergone negligible changes. The men consumed about \$2 worth of oxygen dur-

ing the experiment. The gas was supplied from a cylinder equipped with a regulator to allow the oxygen to be released in varying quantities, depending upon the number of persons in the vault, and a special chemical was applied to the floor to absorb harmful gases given off in breathing.

3889 RARE BIRD'S QUEER "TALKING" PUZZLES SCIENTISTS

A bird, smaller than a canary, with a vocabulary of at least 300 recorded words, with more being added constantly, was exhibited recently before the American Psychological association at Columbia university. The bird, a variety of the African finch, proves, according to Dr. William Morrison Patterson, who has spent two years studying it, that instead of merely singing to pass the time, birds are really talking. Dr. Patterson does not claim that the bird speaks a language, or understands what it is talking about, but merely described the 300 voicelike sounds which the tiny finch has used in the last two years. It has an alphabet of twenty-four phonetic vowels and consonant sounds which it uses to form its bird talk. When talked to, it will answer with words of its own, and not by imitating human sounds, as does the parrot.



African Finch That Has Voice Producing Sounds like Those of Human Speech

new York Herald
 12/7/27

Acetylene Co.
 Unit of Acetylene Co.
 Acetylene Co.
 Unit of Acetylene Co.

new York
 Acetylene Co. 30 242 nd St.

3402. Director, Colgate Psychological Laboratory, Hamilton, N.Y.

Mystery of Port of

By J. EARLE

Government tests write Department of Commerce Aeronautics Branch, Washington, D.C.

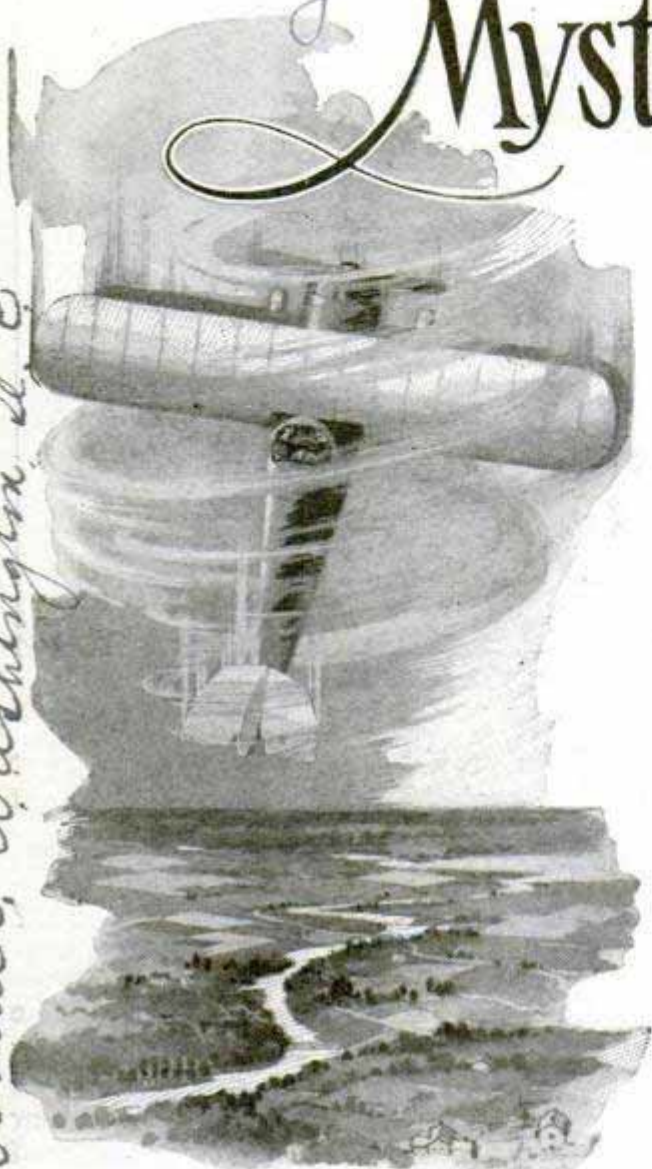

Plunging Out of the Clouds in Helpless Tailspins, Aviators Have Gone to Death Because of Trust in Their Ears

TWO thousand or more aviators have gone to death, including, probably, several of the missing transatlantic and transpacific flyers, because of a mistaken trust in the little semicircular canals of the ear, which furnish, like two spirit levels, the balancing element for the human body.

That is the conclusion of army air-service officials as the result of discoveries by Capt. William Ocker, oldest flying officer of the army air corps, and Surgeon D. A. Myers, army doctor at Crissy field, San Francisco.

They found that, when an aviator flies into fog and clouds and loses all touch with objects on the earth or in the sky, his ear canals not only cease to function properly, but can actually mislead him so

far as to send him crashing down, out of control, in a deadly tailspin.

Flyers have recognized the menace of "blind flying" from the start, and one of the oldest tests for pilots requires them to stand on one foot with their eyes closed, under which circumstance it is difficult to preserve balance. But that a pilot could be misled with his eyes open and with turn and bank indicators on his instrument board to guide him, is a new discovery.

The circumstances surrounding the loss of only one of the ocean flyers of last summer is known. That was the ill-fated "Dallas Spirit," which set out on a rescue mission to search for the missing Dole flight ships. Several hours later, the wireless brought a cryptic message that the plane had gone into a tailspin. Apparently the ship was brought out of the spin safely, for the operator started sending again, only to interrupt with his final SOS, saying they had gone into a spin again.

Captains Ocker and Myers believe the second spin never happened, that it was an imaginary one, and that, in trying to overcome the delusion into which his ear canals had led him, the pilot put the ship into a spin from which it never recovered.

The reason for the delusion is that the ear canals are misled by the eyes. When a plane turns off its course, the compass card immediately begins to swing to indicate the change of direction. As the pilot brings the ship back to the course, the card swings in the opposite direction, but, because of its free movement, continues to swing past the point, leading the pilot, when he can see neither land nor sky, to believe his plane is still turning. Trying to correct that imaginary turn, according to Ocker's discovery, accounts for the ships that have come plunging from the clouds out of control.

Captain Ocker's investigation of the hallucinations of the inner ear go back to 1919, when he tested the first gyroscopic turn indicator, in co-operation with

Missing Planes Solved?

MILLER

Lawrence Sperry, the inventor. He noted that, when a pilot was flying in clear weather, he could spin and spiral at any speed without danger of vertigo. The inner ear and the eyes co-operated to give the flyer both a feeling and a sighting check on his position in relation to the earth. Perfect balance was possible when only a single star could be sighted through the clouds. One object alone was enough to form a relationship for the guidance of the ear. However, as soon as a pilot began to spin or spiral in a fog, vertigo occurred and often pilots spun out of the clouds and crashed without understanding that their vertigo had caused them to deceive themselves.

The answer, he has found, is to keep the eyes fast on the bank and turn indicators and absolutely ignore the messages of the ear canals. Tried out on subjects seated in a flight testing chair, Capt. Ocker demonstrated that a blindfolded person would insist he was spinning right or left when the chair was perfectly still, and that he was in level flight when actually the chair was spinning violently to one side or the other.

Substituting flying instruments, mounted in a box so the subject could see nothing but the dials before him, and telling him to ignore what his senses told him and be guided only by what the instruments showed, Capt. Ocker demonstrated that it was possible to give an absolutely accurate report on every movement. Without exception the ear messages were delusions, wrong every time.

Lieuts. Maitland and Hegenberger, the army pilots who flew the first ship from the mainland to Hawaii, were taught the Ocker's system before they started, and reported on their return that "it carried us through."

Colonel Lindbergh had not been told of the discovery when he designed his "Spirit of St. Louis," but it is interesting that, out of his experience as a night-mail pilot,



Army Flyer Discovers Simple Lesson with This Outfit Will Teach Any Pilot to Fly Safely in Blackest Fog or Deepest Night

he grouped the instruments on his board in such a way that his bank and turn indicators were right together before his eyes. Many people marveled that he should cross the ocean in a "blind" plane, which required a periscope to even see out of, but the answer was that he flew by instruments and disregarded everything else. Being accustomed to flying the night mail in any kind of weather, he had learned to disregard his ears and trust to the instrument board.

Birds, according to Capt. Ocker, are subject to the same failing. After a foggy night at sea, many birds are found dead along the beaches, where they have crashed to earth while apparently believing they were flying safely.

"In fog or blind flying," Capt. Ocker

Captain Ocker's Test Chair, in Which Pilots Are Revolved, with Feet on "Rudder Bar," While Watching Instruments Supported in Front of Their Eyes

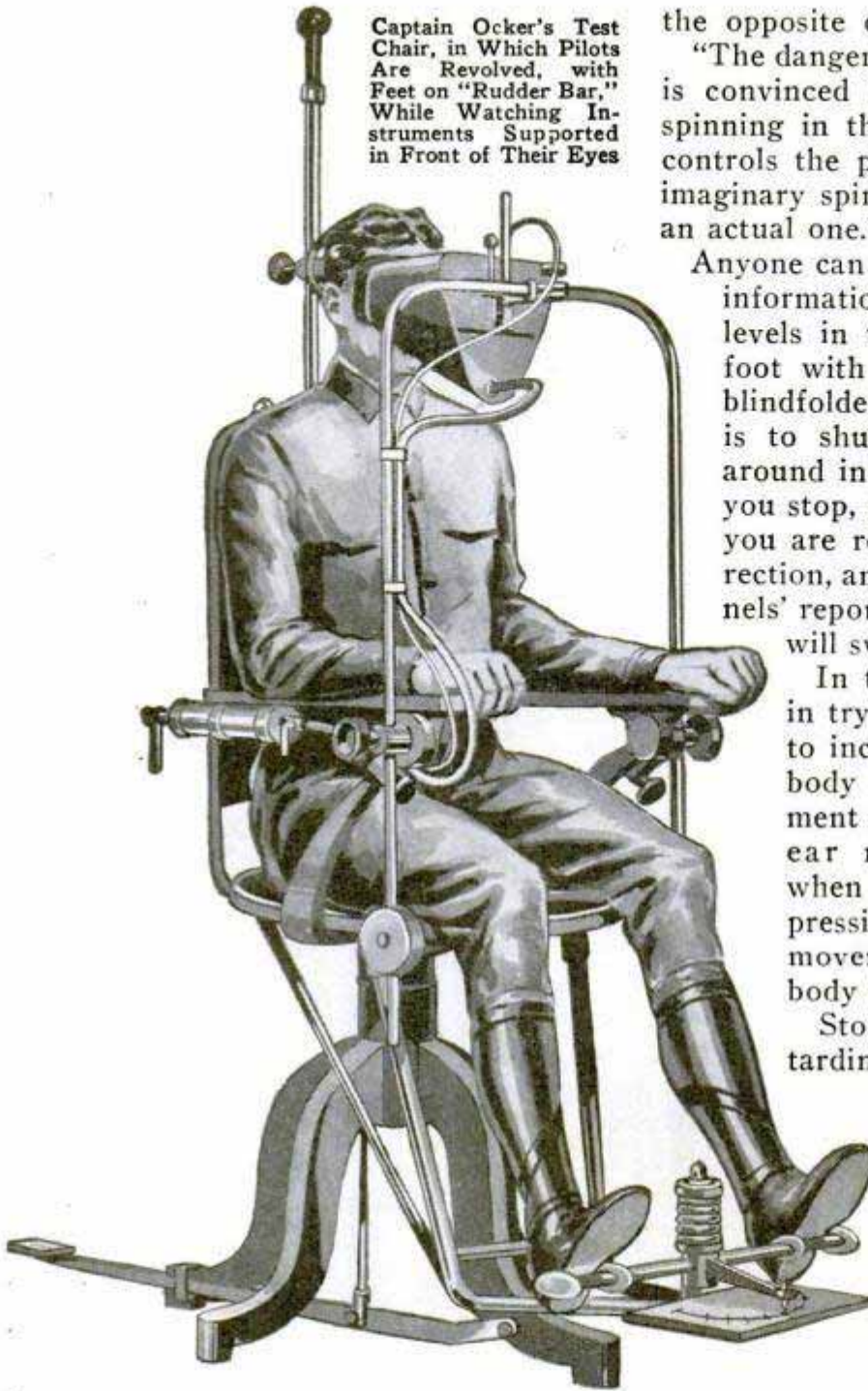

says, "when the 'feel' of the airplane leaves the pilot, there are two distinct hallucinations that all normal pilots are subject to. First, when a plane is turning and then discontinues the turn and flies a straight course, the pilot's senses tell him he is turning in the opposite direction. A glance at the compass apparently confirms this, for the card hasn't come to rest and is swinging in the opposite direction. Secondly, when turning and simultaneously descending—as when spiraling down for a landing—upon straightening out and flying level, the pilot will have the sensation of turning in

the opposite direction and of ascending.

"The dangerous element is that the pilot is convinced by his compass that he is spinning in the opposite direction, so he controls the plane to bring it out of the imaginary spin, and thereby sends it into an actual one."

Anyone can demonstrate the misleading information supplied by the balancing levels in the ears. Standing on one foot with the eyes closed, or while blindfolded, is only one way. Another is to shut the eyes and then turn around in one direction. As soon as you stop, your senses inform you that you are revolving in the opposite direction, and the effect of the ear channels' report is so strong that the body will sway

In the aviation test chair, used in trying out pilots, it is possible to increase the rate at which the body is turning until the movement and the action of the inner-ear mechanism are coincident, when the ears will send the impression to the brain that the movement has ceased and the body is remaining still.

Stopping the movement or retarding the speed at which the chair is turning causes the subject to believe he has begun to turn in the opposite direction. At the same time there is a sensation of falling.

The problem of testing pilots is one that is being constantly studied to improve on old methods

and also to locate the defects that have caused fatal accidents to others. "It takes greater skill," says Dr. Donald A. Laird, director of the Colgate psychological laboratory, "and a more perfect constitution to be a safe air pilot than it does to drive an automobile. Good intentions alone will not make a safe pilot. Early in the war the British found that, out of every hundred of their aviators killed, ninety cases were due to physical and psychological defects. Thorough tests were then started, and, three years later, the proportion was reduced to not more than twenty out of a hundred.

"The defects that hamper a pilot, it should be understood, are not ones that would make him a defective for ground pursuits. They are simply traits and conditions which would be a handicap in piloting an airplane, but might not be a handicap in other important occupations."

Even weight, Dr. Laird points out, can be a handicap in flying, partly because planes are not built, as yet, with room for fat people, and partly because every extra pound carried is just so much more load on the motor and limits the height to which a plane can fly.

"If you have had rheumatism," he adds, "piloting is apt to be hazardous, because rheumatism usually involves organic heart disease, and this is dangerous at high altitudes where the air contains less oxygen."

"Previous attacks of malaria are also considered as disqualifying because of the recurrence of the attacks due to the cold encountered at the higher altitudes. Hay fever used to be considered a disqualification, but now it appears that it may be benefited by flying. Asthma, however, involves a restriction in breathing which makes it unwise for a person so afflicted to ascend into the air as a pilot."

"The best age for flying seems to be from twenty to twenty-eight. A person may learn to fly after twenty-eight, in fact some flyers have learned at such a ripe old age as sixty or more, but the school of aviation medicine believes no pilot can become a really expert flyer if he starts after his twenty-eighth year. One man with a wooden leg is flying a seaplane, but, in general, stiff joints are a bar to handling the controls. Almost perfect eyes are necessary, co-ordinated with ability to judge distance. An error in judgment of a foot may be enough to wreck a plane in landing. Color blindness is also a drawback, particularly in night flying."

Simple Tests of Flying Faculties: 1, You Should Be Able to Hear a Watch Tick Forty Inches Away; 2, Two People, Facing with Eyes a Foot Apart, Should See a Pencil Tip, Brought In from the Side, at the Same Time, Otherwise One's Field of Vision Is Restricted; 3, Depth Perception, Measured at Distance of Twenty Feet, with One Pencil Held Stationary and the Other Moved Back and Forth, Try to Tell When They Are Same Distance from You, an Error of Eight Inches Being Allowed; 4, 5 and 6, Tests for the Inner-Ear Canals; Screw Piano Stool Up Until Feet Are off Floor, Touch Tester's Finger, as in 4, Shut Eyes and Raise

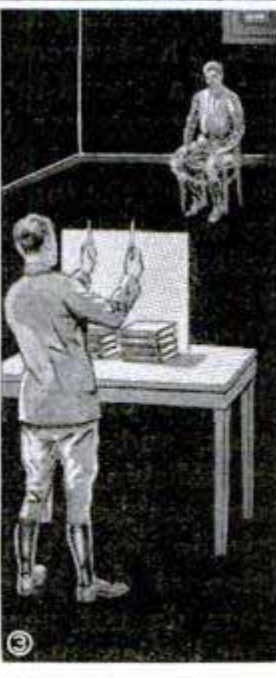

Hand, Then Lower and Try to Touch Fingers Again; Next Revolve Stool Ten Times in Ten Seconds, as in 6, with Eyes Still Closed, and Repeat Touching Experiment; in 7, with Chin on Chest, the Subject Is Revolved Five Times to the Right in Ten Seconds, Then Told to Hold Head Up; if Ears Are Working Properly He Will Fall toward the Right; Repeat This Test in Opposite Direction

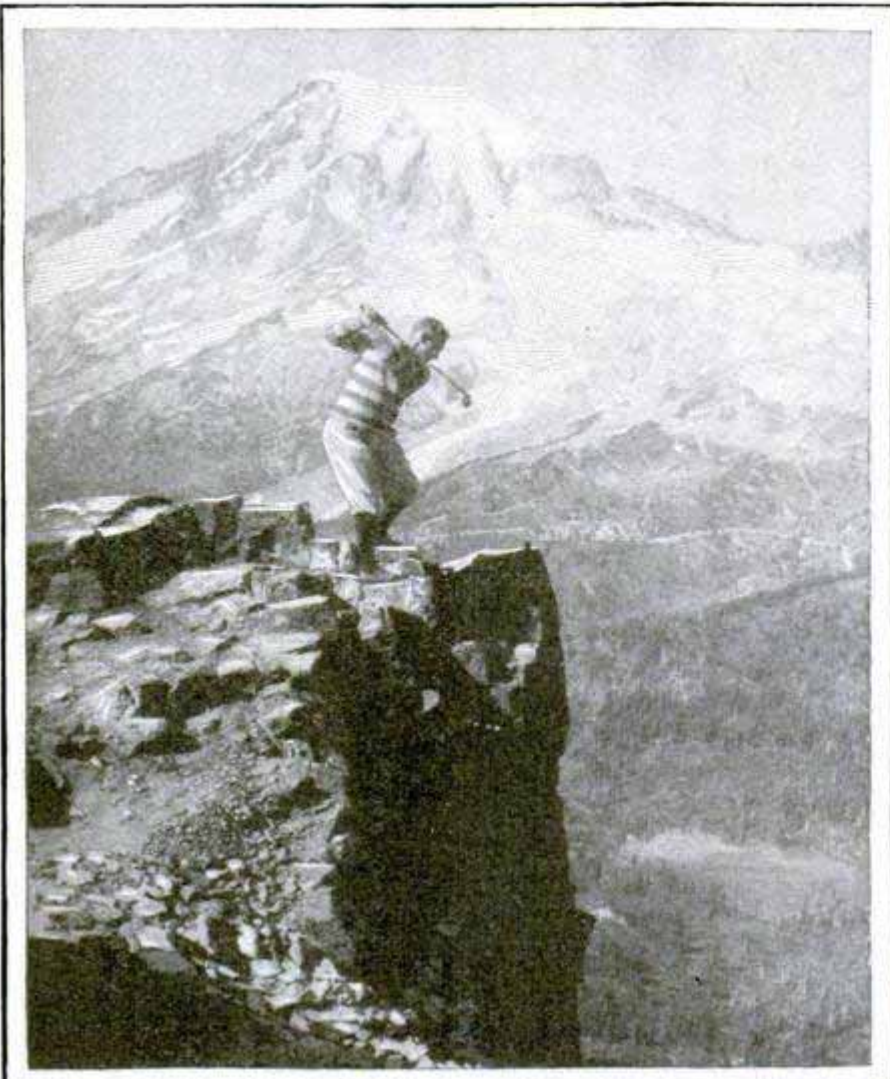

Hazards in Abundance and a Mountain for a Tee; Golfer Making Long Drive from Pinnacle Peak in Rainier National Park

MOUNTAIN USED AS GOLF TEE PERMITS LONG DRIVE

Standing on the tip of Pinnacle peak in the Rainier national park, a golfer recently made a drive of 650 yards from the edge of the cliff. The altitude at that point is over 6,600 feet and it was believed that the thinner air may have helped contribute to the success of the long drive. Wind conditions were also favorable.

GEMS MADE FROM ALUMINUM RIVAL NATURAL STONES

By the magic touch of chemical processes, aluminum is converted into sapphires and other precious stones. To an aluminum powder, a small quantity of oxide of cobalt is added to give it a blue color. The mixture is then put in a furnace and heated to a temperature of more than 2,000 degrees Fahrenheit. As the

material falls upon the glowing points of blow-pipes giving off an oxyhydrogen flame, it forms molten drops of an exquisite blue shade. These are pure sapphires and, when cool, harden into stones of a quality equaling that of the natural gems. Rubies, amethysts, emeralds and topazes are also made from the metal. The foundation of all these is a special kind of glass known as "paste," harder than the ordinary substance used and containing about fifty per cent oxide of lead. Oxide of copper with oxide of chromium is used in preparing imitation emeralds while gold, tin and antimony are employed in the making of rubies.

VACUUM CLEANER SANDS FLOOR ALSO WAXES

Besides being an efficient suction cleaner, a vacuum now on the market is easily converted into a unit for sanding, waxing and polishing hardwood floors. This is accomplished by the attachment of a special tool to the nozzle. A piece of sandpaper is wrapped about it and the pressure of the cleaner is sufficient to smooth off the rough spots on the floor. The dust and scrapings left from this operation are removed by running the vacuum in the usual way, then the polisher may be employed in applying the wax, and, finally, in polishing. The unit requires practically no attention as the bearings do not need to be oiled. As with other implements of its type, the vacuum is run by electric current supplied from a house-lighting socket. Its wheeled base permits easy operation.



Write Paper Advertising Co., 1000 Rockefeller Bldg

3978. ———
Cleveland, Ohio.
540 E 105th
P. A. Miller Co.
maker.

4004
Capt. George H. Holden,
Highfield Veto, Jackson

One of the best Perkins Ave. Cleveland Ohio

Milk Wagon Motorized, Showing Driving Method and How Engine Unit Is Easily Detached

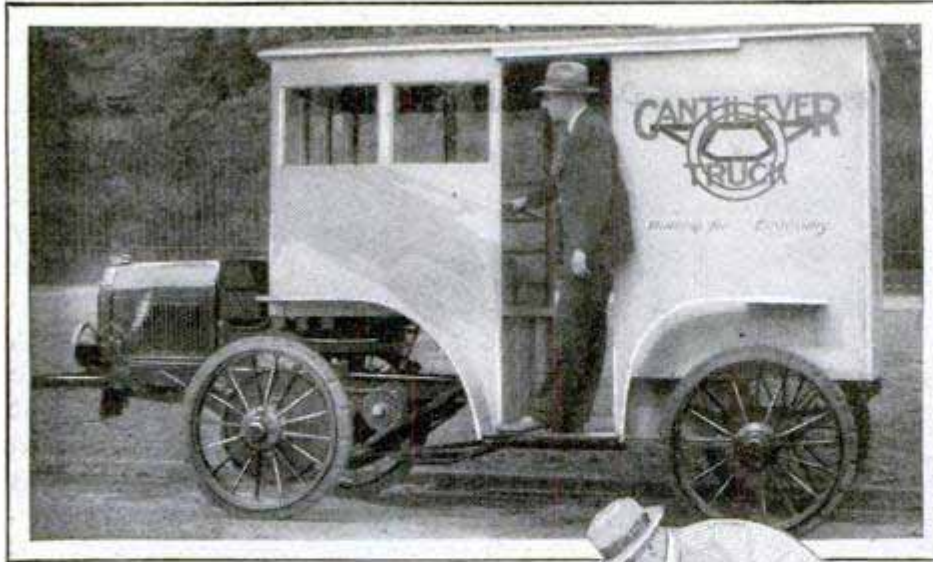

MOTOR UNIT FOR MILK WAGONS TO CUT DELIVERY COSTS

Milk wagons of the drop-center type can be quickly motorized by the attachment of a tractor unit which supplies power at a considerable saving over the horse-drawn vehicle, the manufacturers assert. The outfit is also furnished with a specially built wagon. The principal features of the motor are that the driver operates it standing up, it is pivoted to the wagon both vertically and horizontally and is on a two-wheeled chassis so that it embodies the power plant, driving and steering assemblies all in one unit. This arrangement makes for easy starting, stopping and handling the vehicle in traffic. The motor may be removed from the wagon for repairs and another one quickly attached.

In from five to eight hours of continuous operation, the engine consumes about three gallons of gasoline and the maximum speed is fifteen miles an hour.

CHORUS OF SIRENS ON ENGINES TO REDUCE ACCIDENTS 3701

Four siren whistles, operated as a unit and spreading a penetrating note in as many directions, have been attached to locomotives of a western railroad as an improved warning signal. It is believed that the arrangement will prove especially effective at grade crossings, for the whistles can be heard for three miles, the note is lower, and the fact that the noise is spread in all directions, reduces the likelihood that the signal will be shut off by wind currents or obstructions.

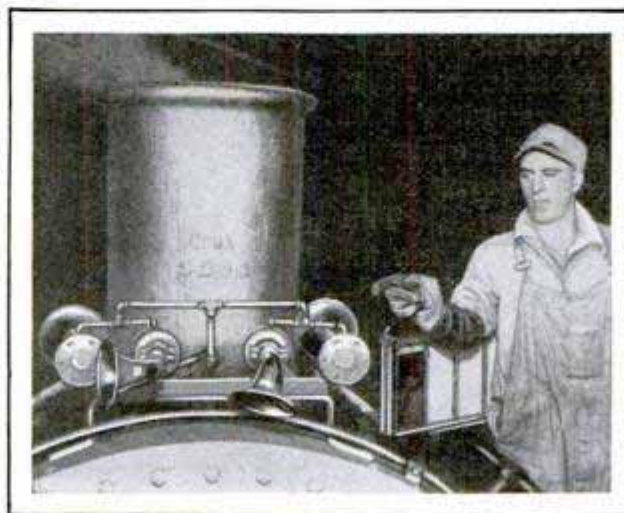

Siren Whistles on Engine Operate as One

I wish complete or a replacement parts what to replace front wheels of wagon.

Engineer George Gray, Southern Pacific Ry.

3643
366

see next page

**OPERA BROADCASTS HELPED
3892 BY MIXING PANEL**

Radio engineers have achieved marked success this year in broadcasting grand opera, one of the most difficult pick-ups in wireless. The improvement is chiefly due to a special mixing panel by which the orchestra music, chorus and solo voices are so blended that a radio listener, miles away, may enjoy the approximate audible equivalent of being in the best seat in the house. The panel was devised to broadcast the Chicago opera. It was designed by Eugene F. Grossman, operating engineer of the National Broadcasting company, who first tested it during the Dempsey-Tunney fight. The panel controls eighteen microphones which are carefully distributed in the orchestra pit, along the footlights and on the stage. During a production, all of them are in the circuit so that it is not necessary to make "cut-ins," and by means of two dials, one for the stage and the other for the orchestra microphones, the operator can successfully balance the output. Besides these controls, there are separate ones for the individual microphones.

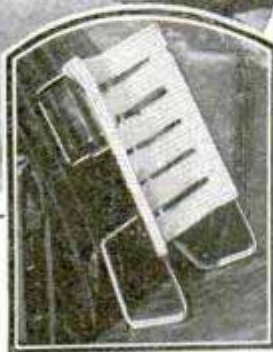

Back Rest in Use and Close View of Its Construction

BACK REST FOR AUTO DRIVERS SAVES WEAR ON CLOTHING

Quickly adjustable to the needs of the user, a back rest for the automobile driver affords an air space between him and the seat cushion for greater comfort, and eliminates practically all friction, so that there is less wear on the clothing. It is easily regulated by means of a simple rod-and-tube arrangement and is of special convenience to persons who need an extension to reach the clutch and brakes.

INSECTS PRESERVED IN METAL BY CHEMICAL PROCESS

Half by accident, a German scientist has discovered a method of preserving insects in copper. The process virtually "petrifies" the specimens and reproduces them in faithful detail. The investigator had undertaken a chemical analysis of some insects and had proceeded to cover them with finely powdered copper oxide. The next step was to heat them in platinum crucibles in an atmosphere of carbon dioxide. At the end of the treatment, the scientist was surprised to find that the outer parts of the insects had been penetrated by the metals so that they were incased in a copper armor on which were reproduced all the delicate markings and other features of the original exterior.

CONTROL BUTTON ON "FIRE GUN" 3887 SAVES LIQUID

Fire-killing liquid in an extinguisher now on the market is not all expended unless the occasion demands it, as there is a control button at the side to shut off



the flow when desired. The remainder may be used again. The unit has no pump, being actuated by pressure created by a gas liberated from a cartridge at the top. To start the extinguisher, a button on the top is struck a sharp blow. This punctures the cartridge,

releasing the gas. A stream can be thrown from twenty-five to thirty-five feet and the extinguisher is easily reloaded.

The Flash Fire Extinguisher Co. 1111 Chestnut St.

Inventory, William Blinn, Montezuma, Ind.

Dr. N. G. Zelensky

Wayton, Ohio.

Chicago Daily News 12/14/27

MANY MIKES USED IN BROADCASTING GRAND OPERA

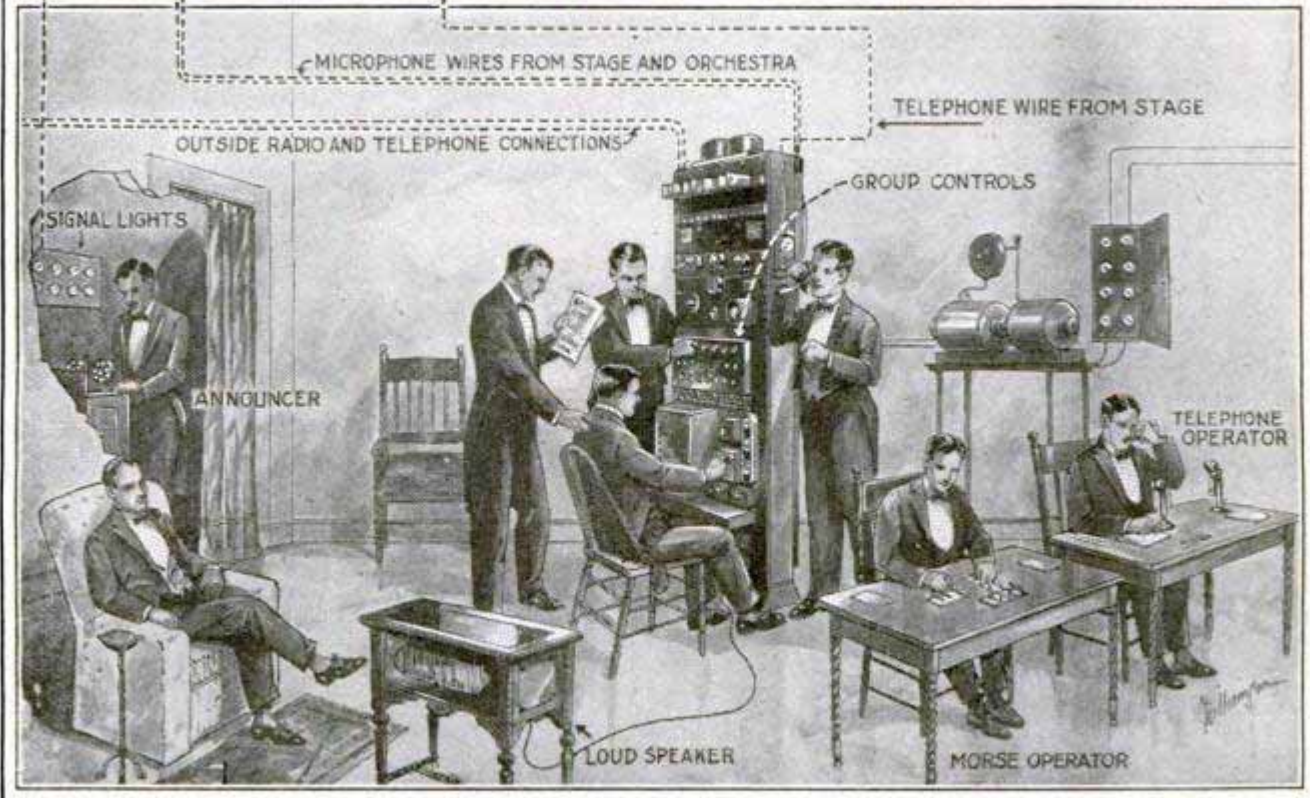
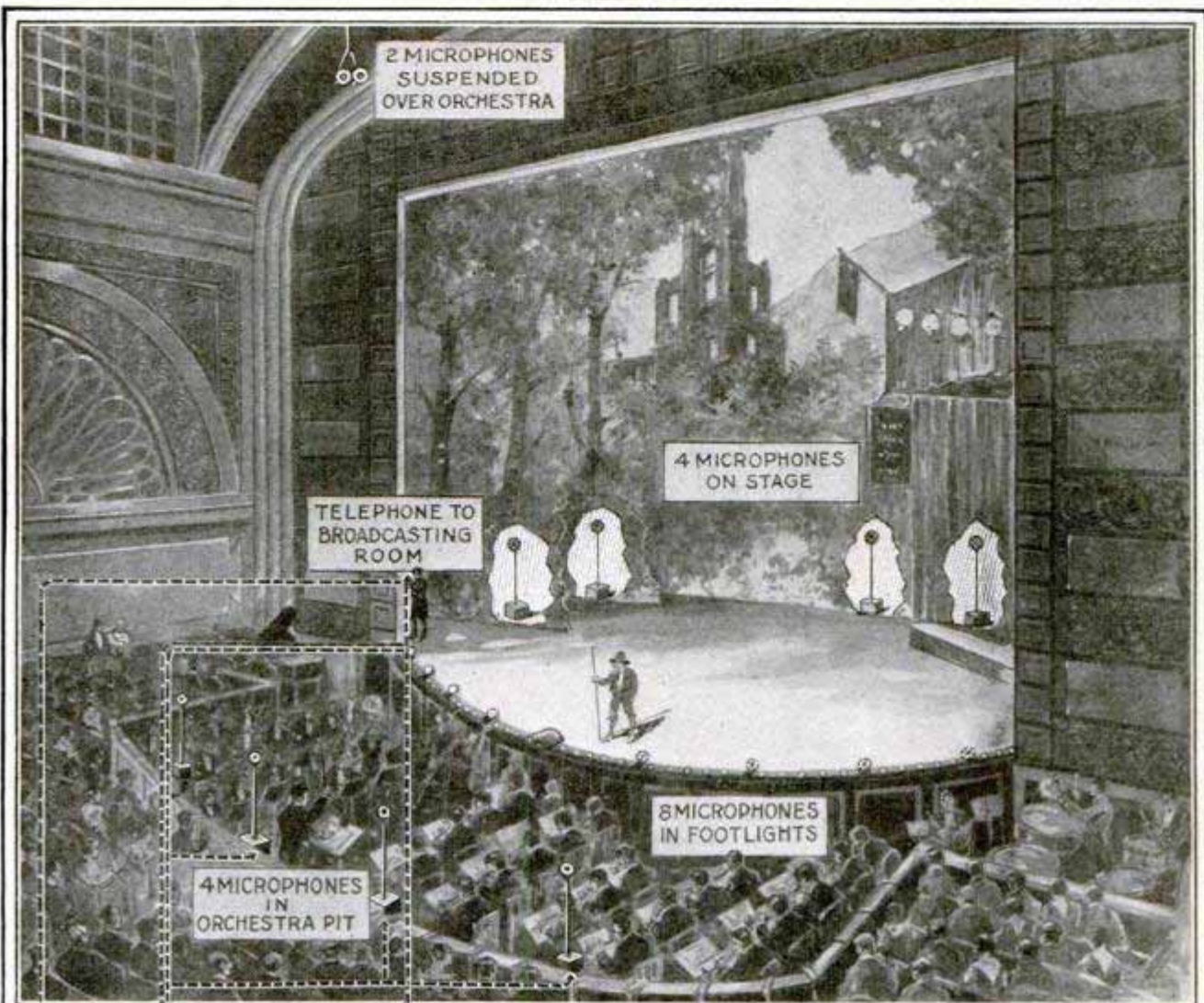

**STALLS FOR STARTING HORSES
INSURE BETTER RACES**

Fewer poor starts in horse races are expected by using stalls at the barrier. They

the fortune they lost as a result of the war. The living quarters include a parlor, bedrooms and kitchen, while in the trailer there is space for an extra bedroom as well as for supplies and provisions. The



To Make the Race Horses Less Restless at the Start; Individual Stalls Are Calculated to Calm Nervous Animals and Insure a Better Get-Away at the Wire

are intended to make restless horses quieter and easier to manage, insure a more even line-up and prevent the actions of one fractious horse from affecting the others as much as often happens with the present method. As installed at Tia Juana, recently, the stalls provided room for sixteen horses with space for three or four more at the outside.

van is quickly converted into an open-air shop when a stop is made. The owner has made successful tours with the outfit, which attracts wide attention.

**STARTING POINT OF U. S. MAPS
ON KANSAS FARM**

From the map makers' and surveyors' viewpoint, the hub of North America is a small marker on Meade's ranch in north central Kansas. It is one of many triangulation stations established by the coast and geodetic survey, but has been designated as the "primary station" after elaborate calculations. The site is marked by a block of concrete with a metal plate, on which is engraved the customary legend of the survey department, but from a scientific standpoint the place is considered worthy of a more elaborate monument in keeping with its importance. A sixth of the world's land surface has been surveyed from this central point as a base, for it happens to be the spot where the two great arcs of triangulation, one extending along the thirty-ninth parallel

**HOME AND STORE ON WHEELS
AIDS CANDY DEALER**

By constructing a combined home and store on an automobile truck, an Austrian nobleman and his family are regaining

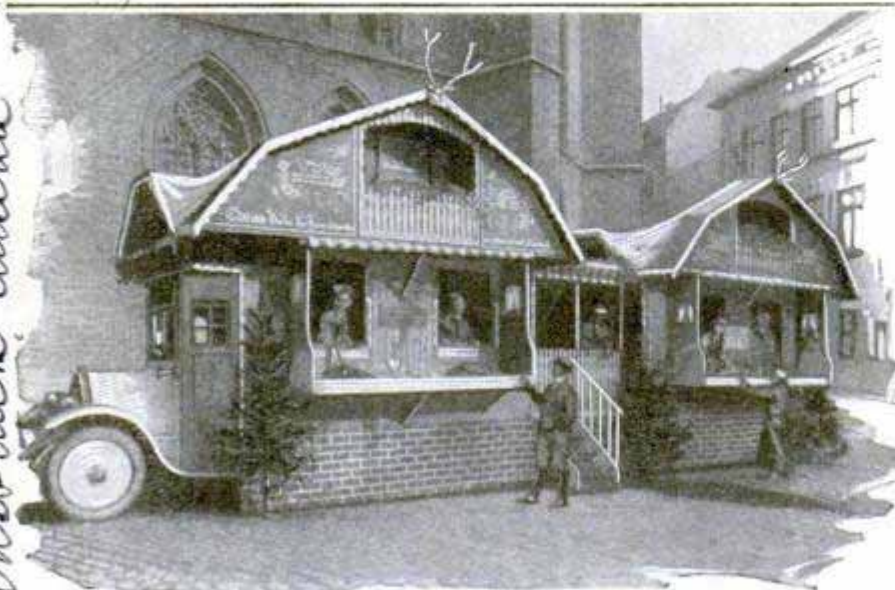

Candy Store and Dwelling on Auto

Kansas City Star
12/4/27

3824

Club's racing plant

Jockey

3681

*Herr Franz von Schlechtleitner
Innsbruck, Austria*

of latitude and the other along the ninety-eighth meridian of longitude, intersect. To establish the point, many years of surveying and a great number of calculations have been made. Canada and Mexico have agreed that this is the central station for surveys and, with its aid, and that of other similar stations, it is now possible to measure the distance between two points to an accuracy such that the error is seldom more than one two-hundred-thousandth part of the total distance.

— 3764 —
MEND SOCKS BY VULCANIZING

Vulcanize your socks instead of darning them is the suggestion of a German inventor who has developed a process of repairing the articles in this way, to save time and labor. An adhesive fabric is placed over the hole, a hot iron applied and the result is said to be a neat and durable mend that can scarcely be detected.



Vulcanizing His Sock; Hole Is Covered with an Adhesive Fabric and Hot Iron Applied to Fix Patch

The material is furnished in a variety of colors and textures.

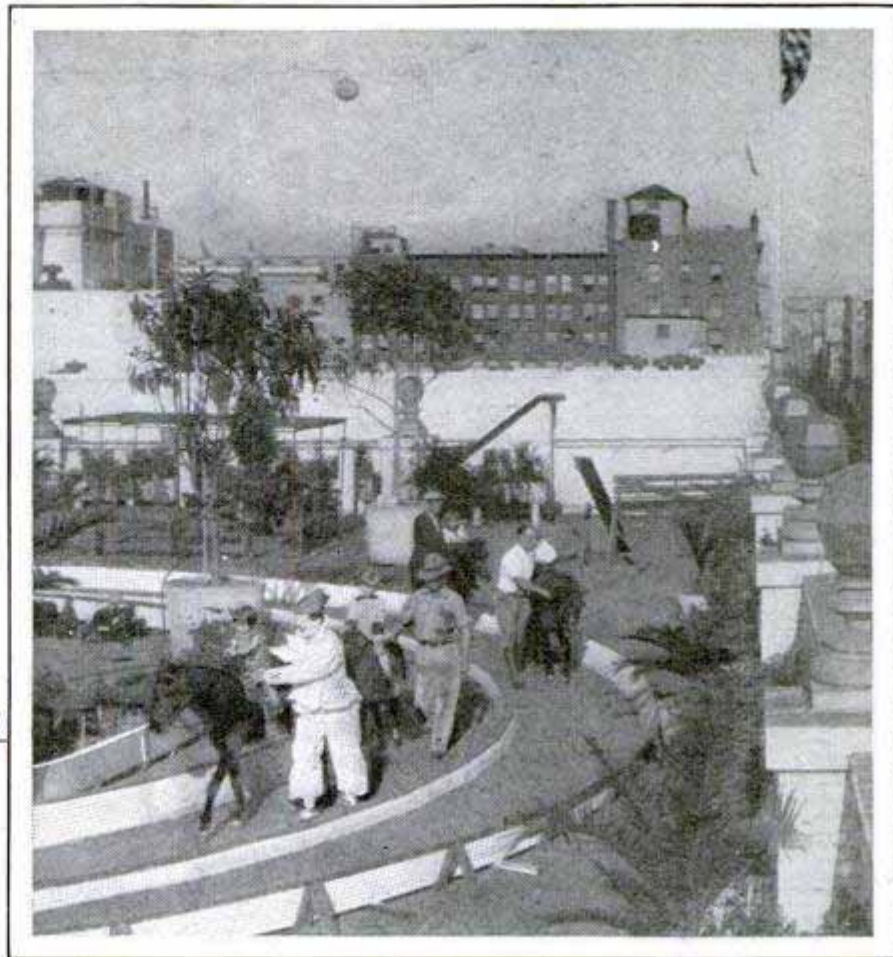

Where Children Play While Their Mothers Shop; Amusement Park on Top of Los Angeles Store Showing Part of Bridle Path

PLAYGROUND ON STORE ROOF AIDS WOMEN SHOPPERS

Swings, teeterboards, and many other amusement devices, are provided for children in a roof-top playground on a department store in Los Angeles. While the mothers are shopping, they can leave their youngsters in charge of attendants on the roof.

TOOTHBRUSH IS USED ON EYES TO CURE DISEASE 3952

By the use of a common toothbrush, with the bristles clipped short, Dr. John McMullen, a United States public-health surgeon, has made progress in the cure of trachoma, a painful eye disease commonly found in parts of the south. The infection first attacks the eyelids, then the eyeball and may eventually cause blindness. The doctor found that, by using a local anæsthetic on the lid, then scrubbing it off with the short-bristled toothbrush, diseased tissue was removed and the sound, though tender, flesh was healed.

Dr. J. McMullen
 Cmd. Emmett Dougherty
 459 National Press

13536

Babe Ruth's

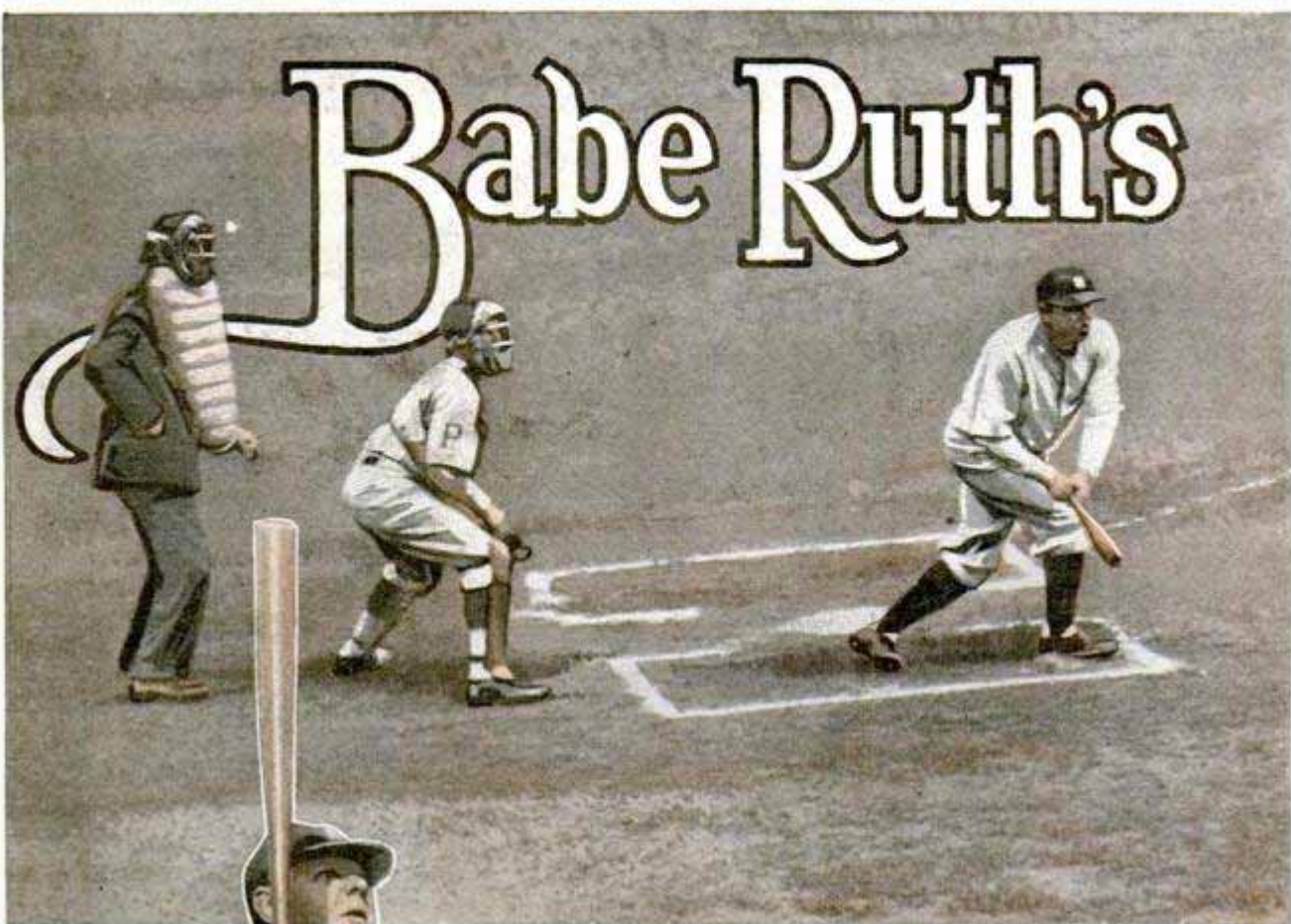

By A. A. ALBELLI *of the News*
25 Park Place. New York

THAT stodgy urchin who used to catch for a school baseball team years ago, now grown to be the greatest figure ever known to the sport, told me the other day that he expects to clout 100 homeruns for the New York Yankees next season.

There is nothing of the braggadocio about Babe Ruth. He is all that baseball-loving America looks for in its idol. The halo which popularity has woven about him has not changed his boyish personality.

"The way I have come to feel," he said, "I can knock out 100 homers any old season from now on." During the 1927 season he reached the record of sixty circuit drives. To this he added two more when the Yankees played the Pittsburgh Pirates in the world's series.

"The only thing that will prevent me from slamming out a century-fold of home runs," continued Babe Ruth, "will be unobliging pitchers. I mean, the boys on the mound are beginning to know what I pick at for good drives.

"They all know I hate a slow curve. It's

With Feet Crossed at the End of a Mighty Swing, the King of Swat Follows a High One with His Eyes

Homerun Secrets

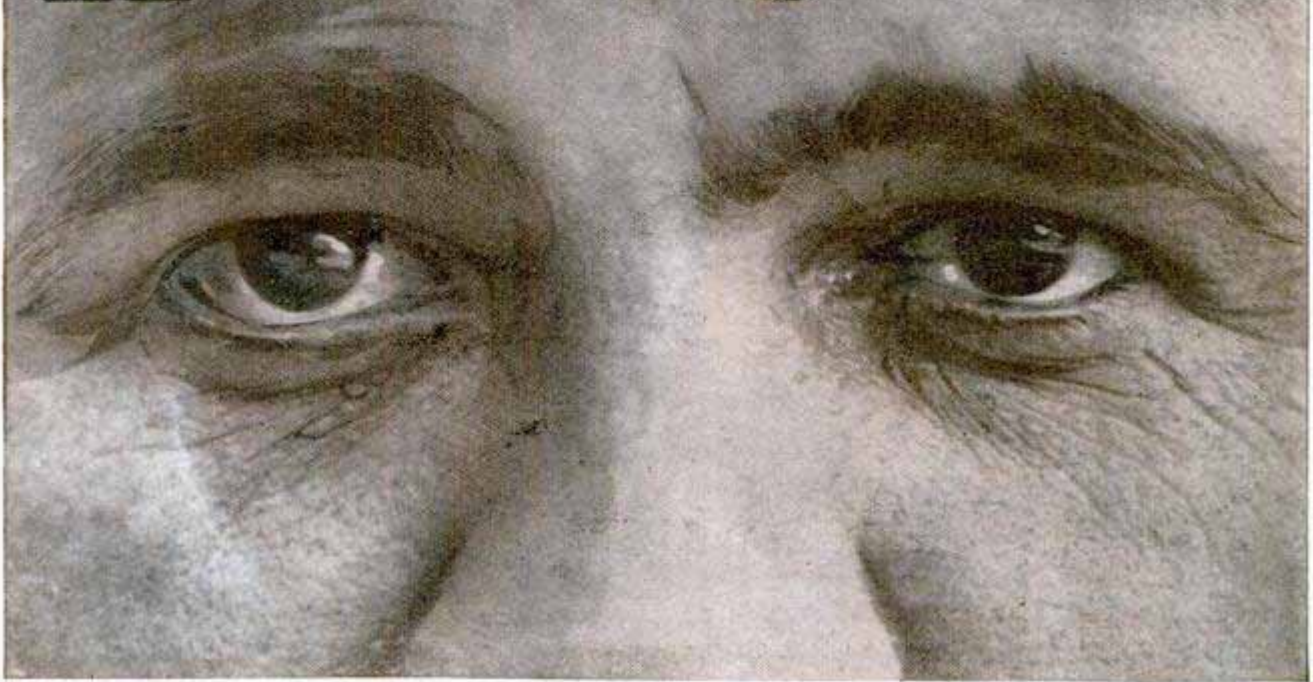

The Highest-Paid Pair of Batting Eyes in the History of Baseball Carried the Babe to a New World's Homerun Record Last Season, Breaking His Own Previous Mark

no secret. What I like best of all is when they steam over fast ones. Those are the ones I nibble at every time.

"Then there's another thing. You know a lot of times a twirler will toss them at me and all around me, but never within line of a good swing. I am not accusing anyone of letting me walk to first intentionally. But you know, I kind of get that feeling."

"How would you explain, shall I say the mechanics, of your homerun swatting?" I asked him.

The big fellow pondered a little while.

"Well, I'll tell you. It's hard to say which element comes first. Co-ordination, that is perfect timing and harmony of action, is a great essential. You have got to develop rhythm and full utility of every muscle.

"My whole body goes with every swing. I swing right from the hips. And those who have seen me take a healthy sock at a ball know what I mean.

"With that co-ordination there is the fact that I assume that strength is behind it."

During the season, Babe Ruth explained, he weighs around 210. He towers over six feet. His shoulders are broad and massive. Yet there is one incongruity. His wrists are very small.

"So, with this might and brawn which I try to keep in the pink of condition, I cannot help but feel that something is bound to happen to the ball when I lean on it. I might tell you I have another trick of keeping the right foot behind the left, not very much. But that helps. I bat left-handed you know.

"Then the eyes play a great part. Oh, yes, the eyes have got to be well educated. I would be lost if I didn't have a sense of judgment which the eyes give me.

"As for trying to control the drive itself, I always aim to slam the ball out on a straight line. Pop flies are a little too dangerous. A lusty drive to the bleachers is sure to do the trick.

"There's a little buddy we must not forget," said Ruth, picking up his bat.

"Look it over," he said, proffering it to me.

It was very heavy, as bats go. It re-

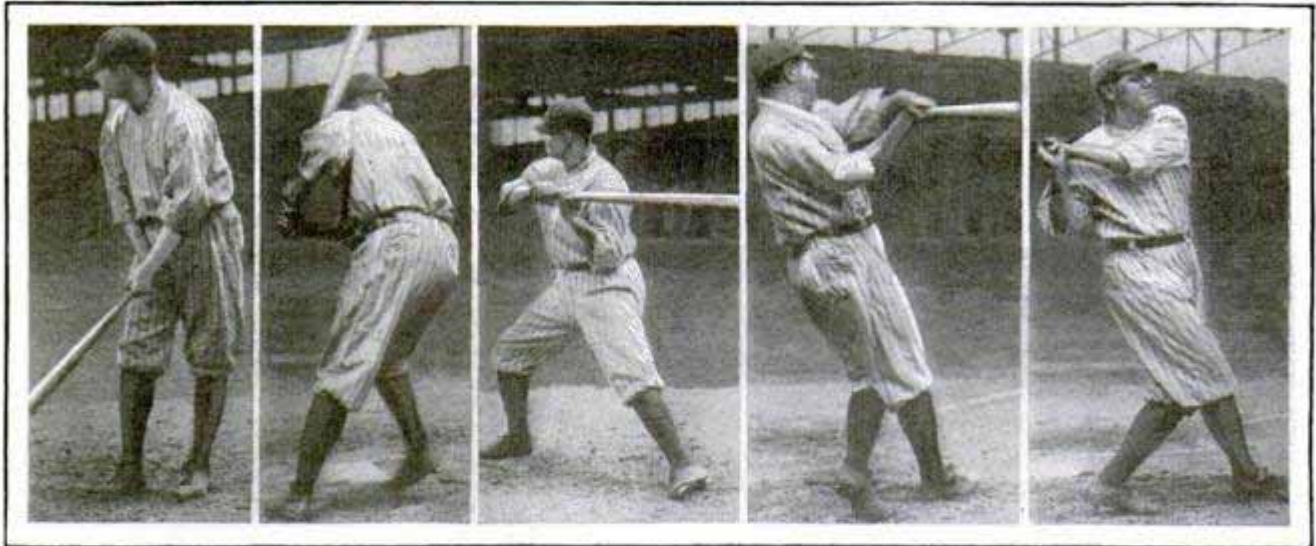

© U. & U.

Knocking Out a Homer, a Series Showing Ruth as He Steps to Bat, Facing the Pitcher, Starting the Swing, in Mid-Swing, and, Finally, Following Through after the Ball

mind ed one of the club of a Neanderthal man.

"It's the heaviest bat in baseball," he said. "It weighs fifty-four ounces.

"Now that we have the hitting of the ball done away with, there remains another very important job and that is circling the bases. I don't care what anyone says, but a batter is lost, no matter in what

part of the field he hits a ball, if he cannot run fast.

"I came to appreciate that fact long ago. I don't do a hundred yards in ten flat. But I'd bet I wouldn't come far from it. Being a speedy runner, then, is another very important factor.

"Of course, when the player is off the baseball diamond, he must not think that

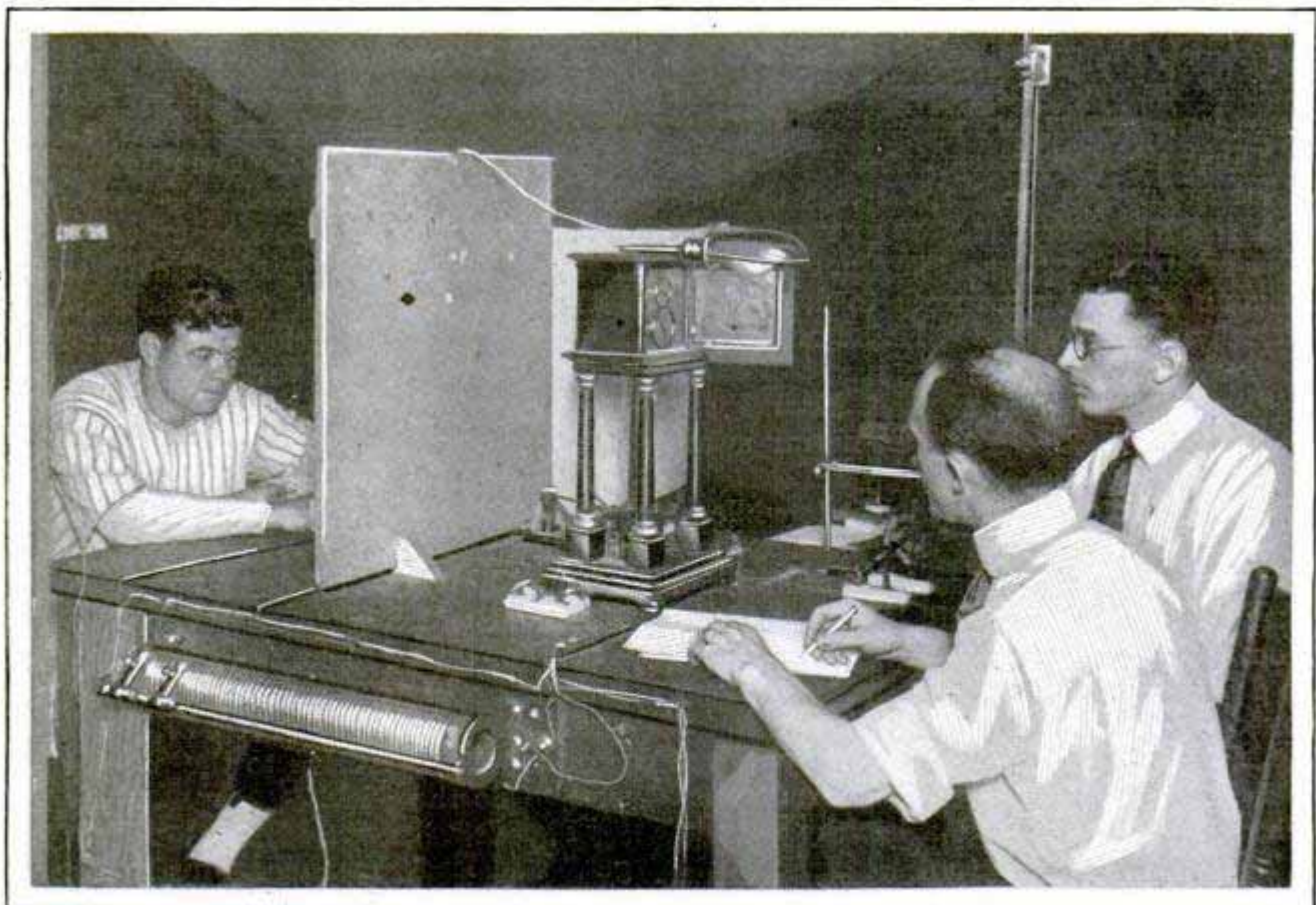

Ruth Being Tested in the Psychological Laboratories at Columbia, Where It Was Found the Co-ordinate Speed of His Eyes, Brain, Nerves and Arm Was Ten Per Cent Faster Than the Average

he can forget his condition. He has got to keep in trim all of the time. He has to follow a strict code. He must do nothing to impair his physical condition."

Babe Ruth, who has hit 416 homeruns in the big leagues since he started with the Boston Red Sox in 1915, has had so glamorous a career that his name means as much to the American boy of today as the names of any three heroes from the pages of history.

"And I am not through yet by any means, as you can judge from what I said about a hundred homers," he said. "I am now thirty-four, and expect to be going strong at forty-four."

Ruth went on to tell the story of his life without any compunction, always clinging to a modest vein.

He was born in Baltimore, Md. His father was a factory hand. They were

poor. At times his mother had to work in a mill to help replenish the family larder.

George Herman Ruth, which is the homerun king's real name, was healthy and husky as a boy. At the age of seven he was sent to St. Mary's industrial school, in Baltimore. It was there that he got his first inkling of baseball. He started off by being the catcher of the team. In 1913 the school team already had a reputation. Babe Ruth was the southpaw pitcher about whom people were beginning to talk and predict things. He was also a good batter.

That winter, Jack Dunn, then manager of the Baltimore eastern-league outfit, saw Ruth. The lad was not yet twenty. Dunn wanted Ruth for his team, but was told that he could not get him without legally adopting him, because he was still a minor, which he did.

The following season Ruth played with Dunn's team and then was sold to the Boston Americans for \$10,000. His salary for that year, 1915, was to be \$4,000. The Red Sox conceived the idea of relegating him to the outfield, so that he might conserve his strength when he came to bat.

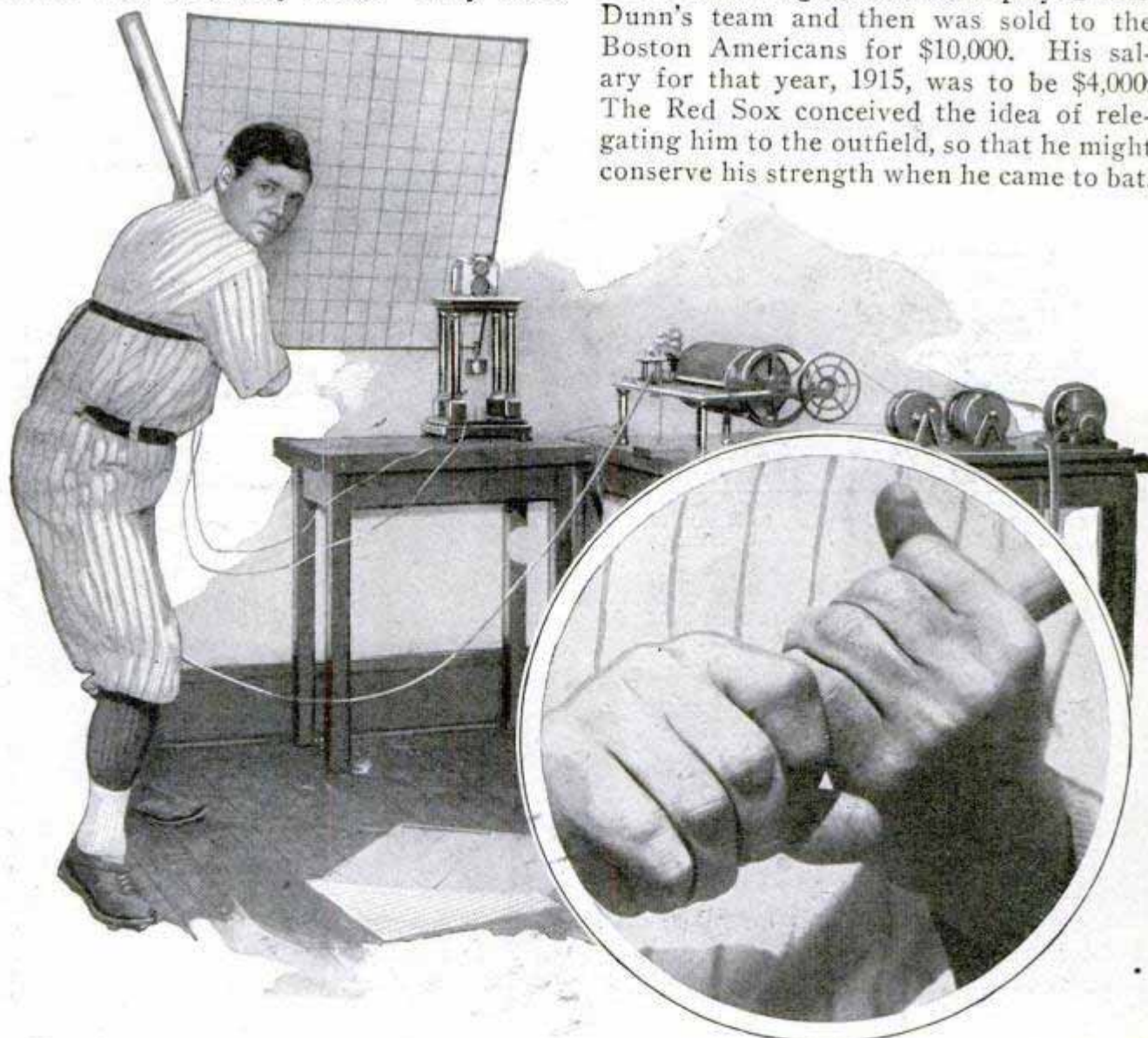

Measuring the Timing of One of Ruth's Mighty Blows and, at the Same Time, the Depth and Evenness of His Breathing; Inset, a Close-Up Showing How He Grips the Bat

He started out as a pitcher with them. In 1919, Babe Ruth won his first real spurs. That year he broke the major-league homerun record with twenty-nine homers. In January, 1920, Harry Frazee sold Ruth to the Yankees for \$150,000. His salary leaped to \$10,000 a year. In the season of that year, Ruth made his debut under the Yankee standard with a total of fifty-four round-the-bases hits. The following year his number mounted to fifty-nine. The year 1922 was the dark age of his career. He promised to come

back and, in 1923, made forty-one homers. He added five the next year. Then came another relapse. In 1925, he fell back to twenty-five homeruns. He made it forty-seven in 1926, and then this last season, he proved his mettle with the sixty.

In 1926, his earnings were \$250,000. Last March, Jake Ruppert, the Yankees' owner, gave Babe Ruth a three-year contract for \$210,000. With the close of 1927, Babe Ruth was hoping to have earned \$200,000 from sidelines, of which he had many.

SPARK-PLUG PRESSURE TEST SHOWS UP DEFECTS



Testing Spark Plugs under Pressure, to Reveal Defects That Might Appear in Actual Operation.

Many spark plugs will spark satisfactorily under normal atmospheric pressure, but fail to function under the sixty or seventy pounds' compression to which they are subjected when installed in a running motor. Those that have this defect are said to be readily detected in a pressure tester. It is a simple outfit, consisting essentially of a cabinet with connections to a lighting socket and to the regular compressed-air line. The spark plug to be tested is screwed into an opening, connected to the electrical circuit and firing accomplished by pressing a button. The air pressure can be regulated by a valve. Motor authorities report that one automobile out of every four is regularly

failing to run at full efficiency owing to imperfect spark plugs, and many of these cannot be detected by the methods usually employed in testing.

SPECIAL NAILS FOR CONCRETE SIMPLIFY BUILDING

With the aid of specially formed steel-wire nails and anchor plates, the task of fixing wooden units or strips directly to concrete surfaces has been greatly simplified. The nails are of a temper that will permit them to be driven into the hard cement without bending, and the plates are adjusted to form a strong support for tile, joists or other members of the construction.

GREASE EXTRACTOR FOR AUTO PROLONGS CAR'S LIFE

Old grease is quickly removed from the auto transmission and differential at the rate of two pounds per minute with a simple extractor now on the market. It is electrically driven and functions by a worm in the nozzle that makes 7,000 revolutions per minute.

It also can be used to fill the cases with new grease. Just as draining the oil before a new supply is introduced gives better lubrication, removing the old before applying fresh, helps prolong the car's life.



Price - \$17.50
J. C. Cleveland

Warren Refining and
Cleveland, Ohio

The Price, Hollister Co, Rockford, Ill.

3669

James Thorbeck

3803 Buckingham 9579

3345 W. Lincoln St. Chicago

\$37.50

\$17.50

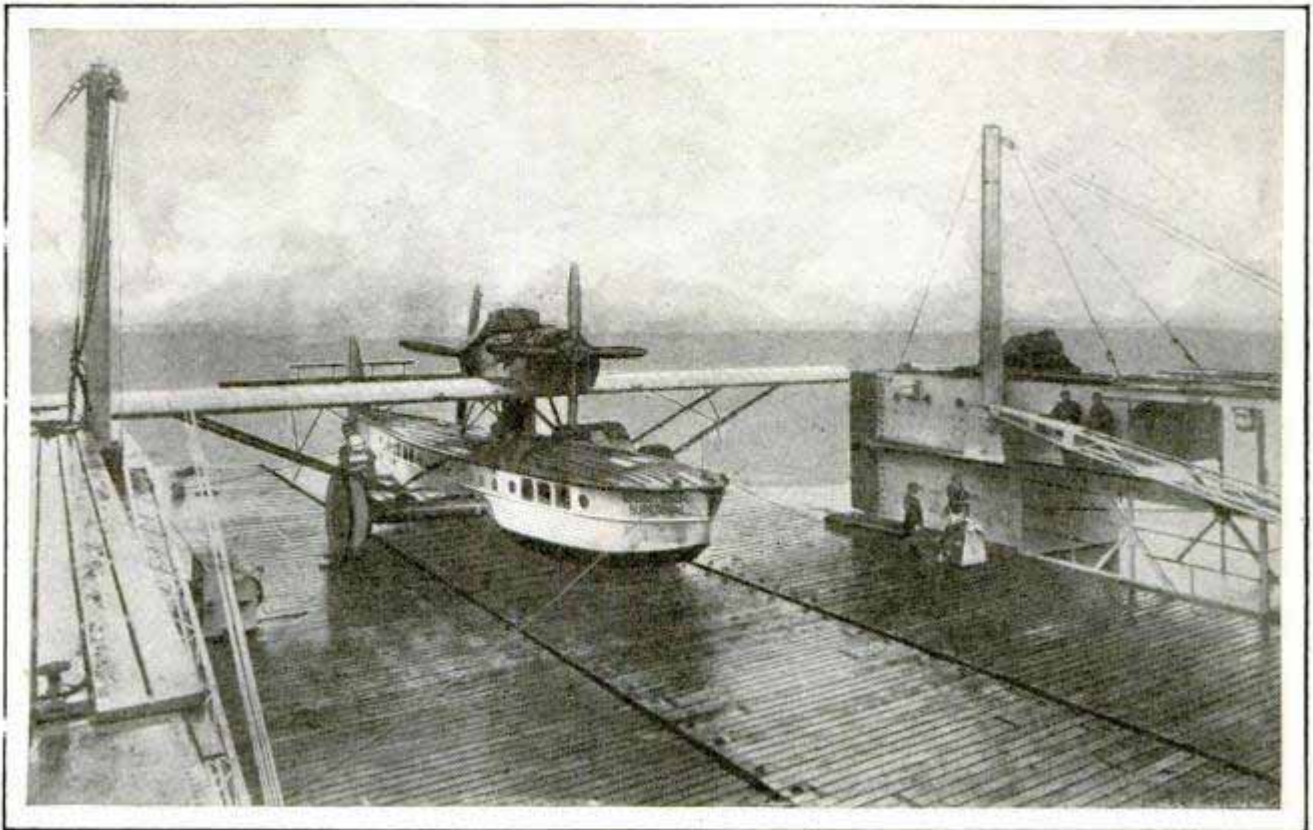

A Floating Drydock for Big Ships of the Air; First Unit of Its Kind in Service in Germany to Facilitate Repair and Other Service; It Weighs 100 Tons

**DRYDOCK FOR FLYING BOATS
LATEST AVIATION AID**

Development of commercial aviation has demanded the installation of various kinds of repair and other equipment and one of the units in this line is a drydock for flying boats. It was recently completed in Germany and has been placed in service to simplify the task of caring for the air-water craft. It weighs 100 tons.

U. S. FARMERS PRODUCE MORE

American farmers produce more per man than growers in any other country, according to Charles J. Brand, who was connected with the department of agriculture for more than twenty years. In 1870, the individual production of grain per acre was 12,000 pounds. In 1925, it had increased to 25,000 pounds. Since 1890, farmers have increased their wheat yields by seventeen per cent, oats by fourteen per cent and potatoes by thirty-nine per cent. In 1880, less than twenty farm acres to each farm worker were used, but the average farmer now cultivates thirty-three acres. There has been a marked increase in the yield of eggs and development of live stock, such as hogs and cattle. Accord-

ing to Mr. Brand, one of the chief problems now before the American farmer is to grow the same quantities at smaller cost per unit of production. Cultivating fewer acres at greater profit is one of the main objectives, he says.

**BED THAT FOLDS INTO CHAIR
HELPS CARE OF INVALIDS**

Arranged so that it can be quickly converted into a chair without removing the occupant, a folding bed, recently introduced abroad, is also equipped with a table, for reading or serving meals. This saves lifting a sick or injured person about and also saves room.



© Henry Miller
To Simplify the Care of Patients; This Bed Folds into a Chair, as Shown, without Removing Occupant

Chicago Evening Post 12/14/27

3920

3297

shown as Lufky chair

Executive secretary and ...erman.

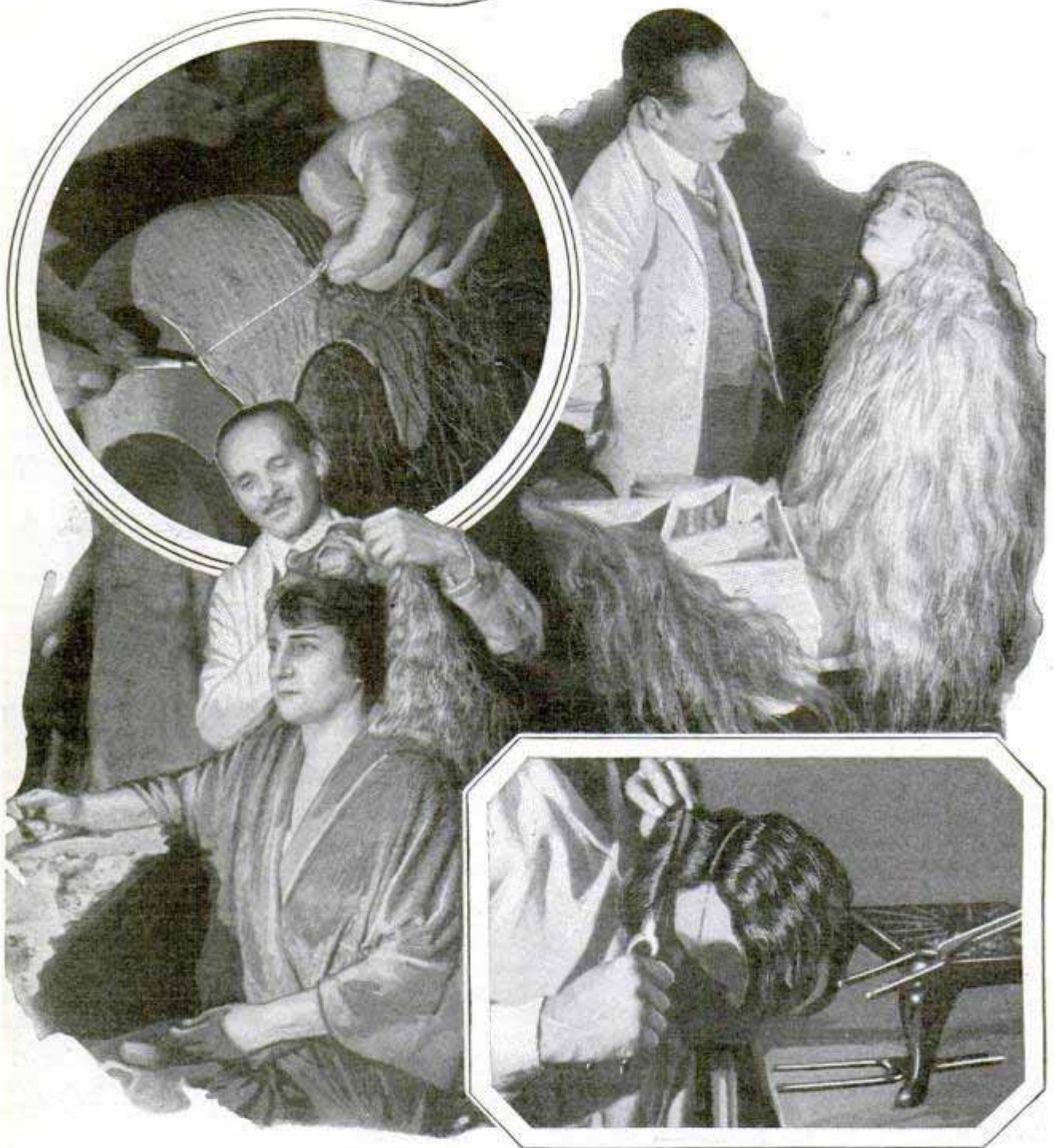
38 46
 ANCIENT ART OF WIG-MAKING ADDS TO OPERA LURE

Wig Foundation on Block; Adolf Senz Inspecting Head Dress Fashioned for Olga Kargau and Fitting Wig on Augusta Lenska; a Detail of the Dressing and Curling when Wig Is Finished

With suitable hair costing from fifty cents to \$50 an ounce, the making and care of wigs for a theatrical organization is an important task. The Chicago Civic Opera company, for instance, kept 150 dozen on hand this season. They are valued at more than \$25,000 and represent practically every style of coiffure devised by the human mind since wigs were first worn many thousands of years ago. A visit to the studio and workshop of Adolf

Senz, the company's wig maker, and one of the few men in the world who thoroughly understands this ancient craft, reveals that a good wig has springs in it, eight of them, to hold it securely in place; that the hairs are intricately woven into a silk-and-mesh foundation with a special needle, instead of being glued on as is sometimes supposed, and that some of the wigs are fashioned of split hair. Chinese hairs, for instance, are often so coarse

3 15 0 537 S Dearborn Chicago 377

that each one can be split into three. Practically no artificial or animal hair is used, as it does not last, will not dress well, and the illusion it makes is not so realistic. Most of the hair is imported, for there is a scarcity of long hair in this country since the bob craze. Careful measurements are made of a character's head, the foundation for the wig is laid out on a block, then the hairs are woven on. The entire process sometimes takes more than a week. Dressing them after they are done and packing and remodeling them call for expert care and handling. Opera and theatrical producers consider the wig one of the most important of all the items of costume, for it changes the wearer's appearance more than any other one article.

MOVING SIGN AT REAR OF AUTO SERVES AS AN AD 3816

Signs in moving letters have proved effective for advertising and other purposes, and now a western motorist has devised a way to adapt the idea to his automobile. By means of a gear-and-ribbon arrangement, the car is made to reel off a legend at the rear which is visible word by word, through a slot in the cabinet that conceals the machinery. The scroll had a capacity of 250 words which could be increased to 600, the inventor declared.

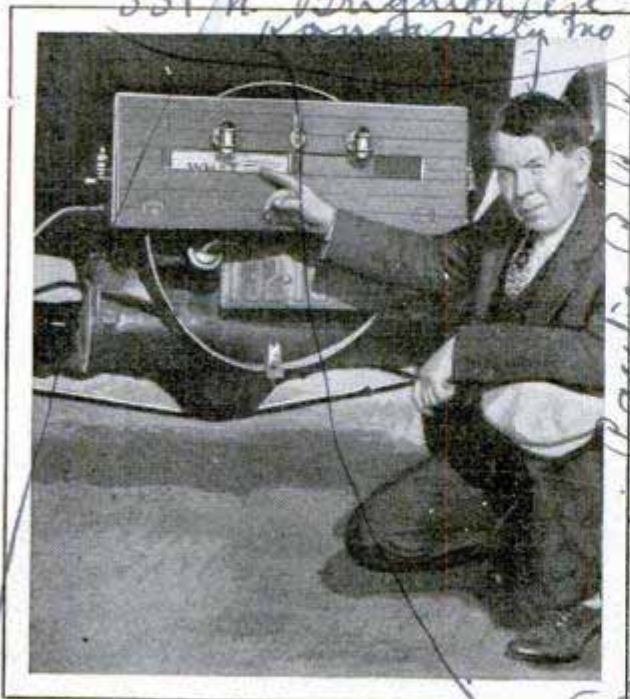

Motion Sign at Rear of Auto; a Reel with Words on It Turns as the Car Proceeds

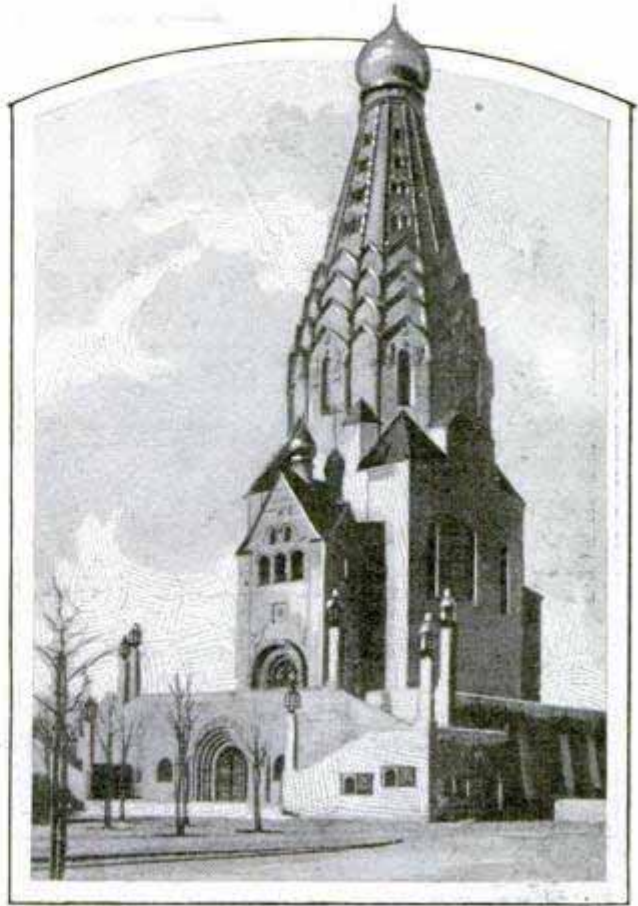

Russian Architecture in a German Church; Memorial Structure in Leipzig with Its Huge Tower

CHURCH IN FORM OF BIG TOWER BUILT IN GERMANY

A striking example of Russian architecture has been introduced in Leipzig, Germany, in a memorial church recently dedicated there. Its main feature is the unique tower that rises from a tapering, broad base. Windows pierce the sides of the tower and a dome surmounts it.

FIND NEW LAKE AND VOLCANO IN ALASKAN WILDS 3936

Aerial surveyors, after further mapping of Alaska, report the discovery of a lake, a river and an active volcano in a district that previously appeared as a blank space on the maps because no one knew what was in it. More than 2,000 square miles of territory were surveyed from the air in the Alaskan range and adjacent country. The stream is the river Chatkatchana, which rises from a lake and has an average speed of fifteen miles an hour. The peaks in the region are extremely steep and rugged and from the highest, Mount Spurr, a plume of steam, rising a thousand feet in the air, could be seen.

U.S. Geological Survey

331 N. Brighton Ave
Kansas City Mo
Western Pacific & W. Kansas City Mo

Louis V. Mallory

3921

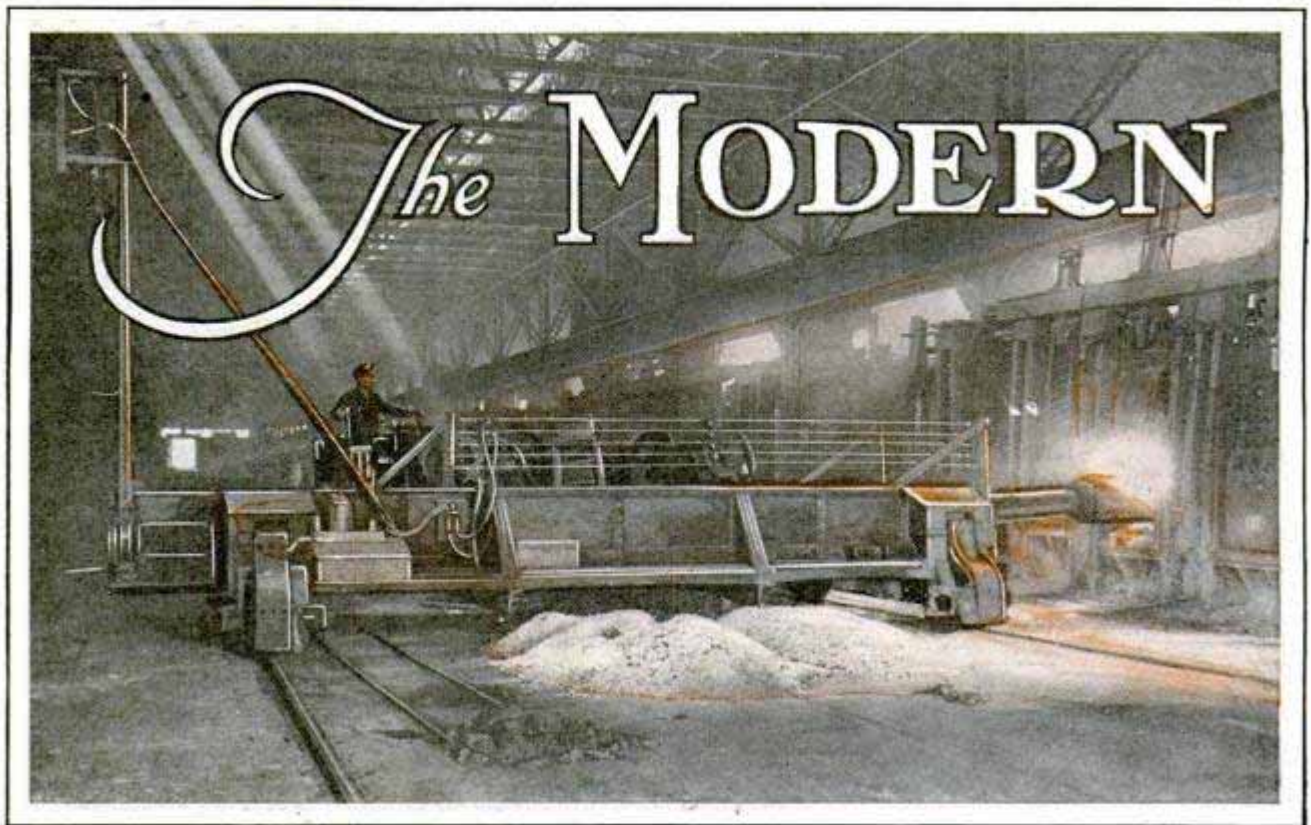

Charging Machine in a Steel Mill; with a Giant Finger, as Clever as an Elephant's Trunk, It Picks Up Iron Boxes of Raw Material and Dumps Them into the Blazing Pits

A GERMAN scientist recently succeeded in producing transparent steel—in sheets so thin they are colorless, the eye can see through them, and even the camera is fooled.

American steel men are producing heat-treated bars so enormously strong that great suspension bridges can be built of chains of them linked together, instead of the usual process of using thousands of steel wires laboriously "spun" back and forth across the river until great cables are built up.

With those two extremes of steel, and all the wonders of new alloys that lie between them, the modern metallurgist out-rides the alchemist who labored unsuccessfully to turn baser metals into gold.

Despite all their queer ideas and amusing methods, the secretive alchemists of old did one good thing for the world, for they founded the science of chemistry, and, worshiping fire as a magical force, perfected the first smelting furnaces, retorts, crucibles, flasks and curiously designed glassware of a modern laboratory.

In his crude brick furnace with hand-operated bellows—the witches' caldron that cost more than one alchemist his life—the chemist of the Middle Ages could

generate a heat of about 1,700 degrees centigrade, so lack of efficiency in the apparatus used was to blame for many of his failures.

What he couldn't do, the modern metal worker, with an electric furnace producing temperatures up to 5,000 degrees, can accomplish with ease. Basically, the modern alchemist's equipment is only a refinement of the methods of the Middle Ages, but the refinement has gone so far that the modern metal chemist can tell just what a steel cable needs to hold up a giant bridge, how the piston rod of an airplane should be made to withstand thousands of impacts per minute, what the springs of a railroad car must endure when traveling at a mile-a-minute speed, or how thick the insulation on an electrical cable must be to carry enormous voltages.

The transparent steel of Dr. Karl Muller, recently exhibited in Berlin, and the massive heat-treated eyebars of the new Carquinez bridge in California and the Florianopolis bridge in Brazil, both are products of modern alchemy. Two years ago Dr. Muller succeeded in producing transparent gold and nickel, and he has now adapted his process for practically every other metal.

ALCHEMISTS

To be transparent the steel sheets are produced so thin that it is impossible to measure their thickness by the most delicate instruments. The only way to determine it is to measure the amount of liquid they displace when immersed. Such sheets are only a few millionths of a millimeter thick, are colorless and transparent, and even the weak alpha rays pass through them without loss of intensity. The current of air from an electric fan, directed across one of the sheets will agitate it into ripples like those on the surface of a pond, yet the steel undergoes no structural changes, and, despite its thinness, can be produced without tears or flaws.

Some idea of how thin metal must be to be transparent can be had by comparison to the ordinary gold leaf used by sign painters. The gold is beaten so thin that it can be handled only with a camel's-hair brush, which first is rubbed through the painter's hair each time a sheet is to be lifted, yet the gold remains opaque.



Pouring Castings from a Huge Ladle of Molten Iron in a German Foundry; the Big Pots Are Lined with Thick Walls of Fire Clay to Protect Them from the Intense Heat

3921

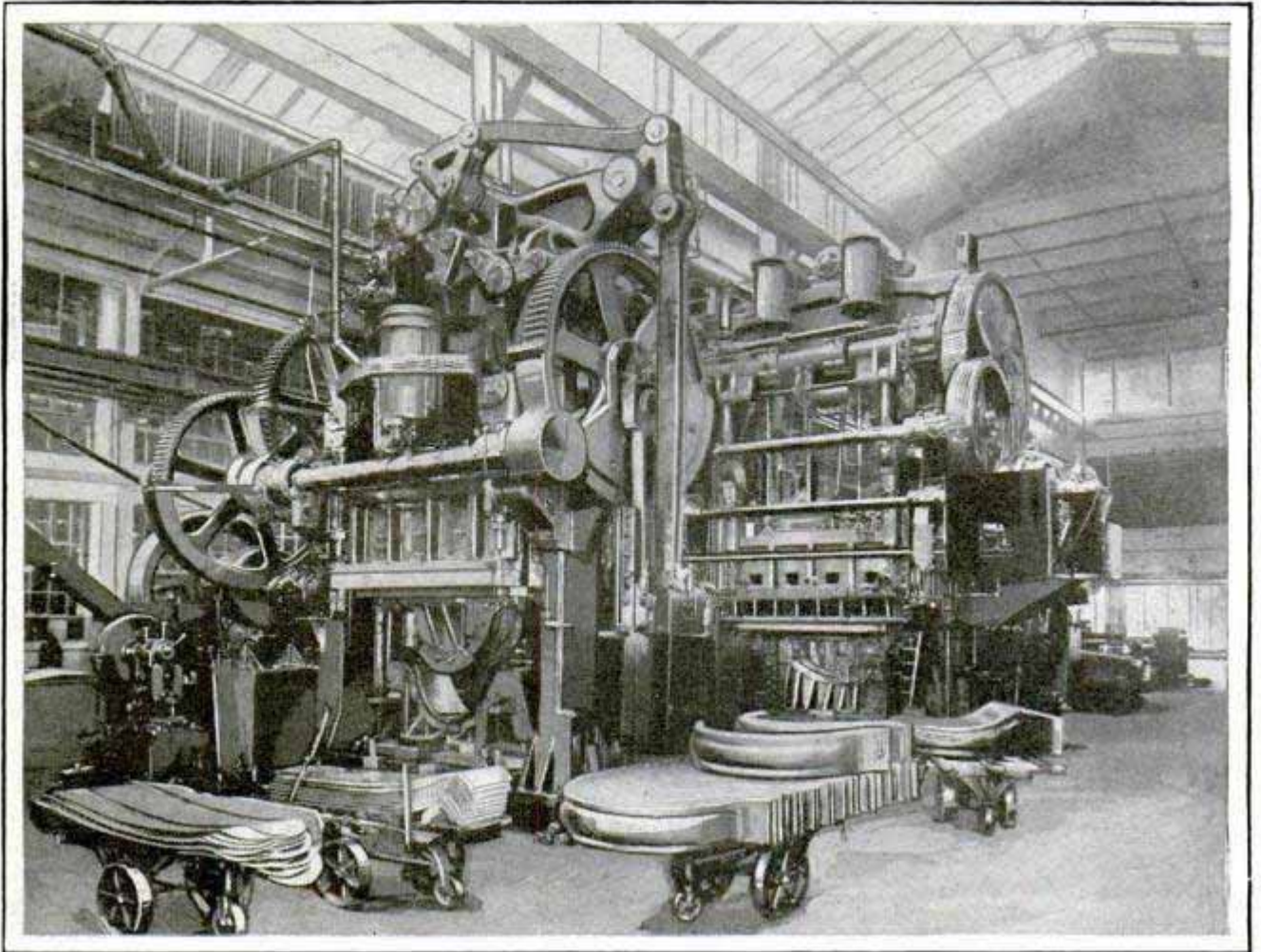

Fender Press in a Detroit Automobile Factory, Which Takes Flat Sheets of Steel and Presses Them into the Intricate Shapes of Full-Crowned Auto Mudguards

The properties of the transparent steel indicate it may find a wide field of usefulness. It transmits light, electric currents, cathode, Rontgen and radioactive rays, it can be magnetized, and it has a minimum of weight and is a very poor heat conductor.

Already successful experiments have been made in applying it to diaphragms in telephones, microphones, medical instruments and apparatus for talking movies. It has the advantage of reproducing tones without distortion because its mass is so infinitesimal. Ordinary speech reproducers are limited in range because of distortion due to the thickness and weight of the metal diaphragm, whereas the transparent steel will not only reproduce all audible tones faithfully, but records vibrations both above and below the range of the ear. Because of its electromagnetic light sensitivity it may be useful in radio and telephone picture transmission, while in the study of steel structure under the microscope the fact that it preserves its

character unchanged will make it particularly useful. The German dye industry is experimenting with the production of hitherto impossible emulsions, using the steel sheets to reproduce tones of an inaudible wave frequency, giving an audible check on the chemical process.

The other laboratory products of steel, particularly the alloys with other metals, are finding constantly increasing use. Modern automobiles are made up of dozens of different kinds of steel, each selected for its special properties in some particular application.

Bridge engineers have been particularly active in the search for new materials, including what the steel men call "strong steels." White and Hazard introduced them first in 1816 when they used steel wire for the first time in bridge building, and wire reached its greatest height of development in the new Philadelphia-Camden bridge. The Hudson river bridge, which will surpass the former in size, probably will be of wire construction, too,

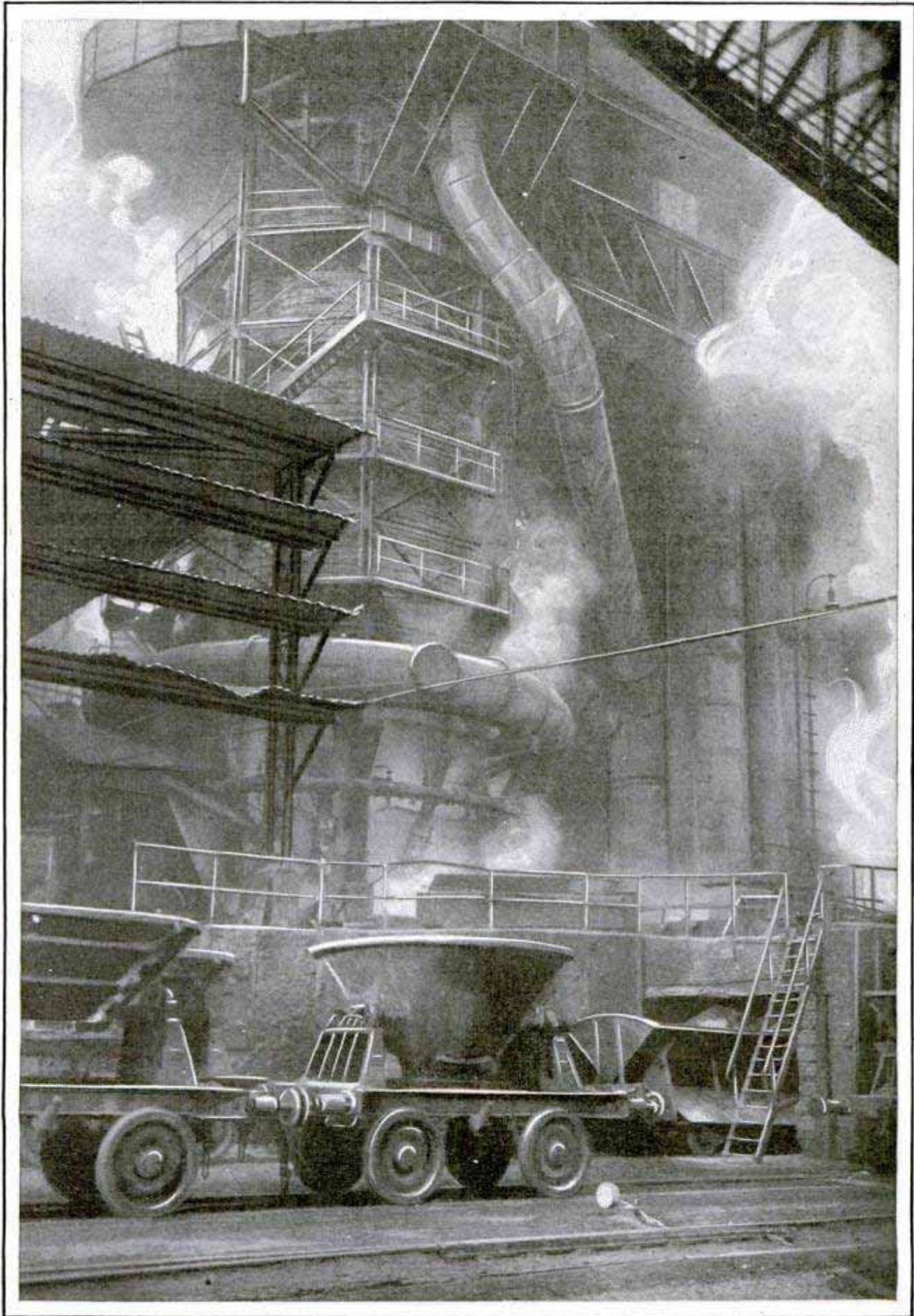

Scene in a German Blast Furnace; the Enormous Pile in the Background Melts Down the Raw Ore and Extracts the Iron, While the Trains of Ladle Cars Carry It Away

3921

though the bids were taken for both wire and heat-treated eye-bars.

Bridges built of modern steel cable will endure for centuries, according to H. C. Boynton, metallurgist of John A. Roebling's Sons Co., which built the Brooklyn bridge. Samples of wire taken from that structure, and from others built since, show exactly the same chemical and other properties as newly drawn wire. Barring some unforeseen catastrophe and failure of proper care, there is no reason, he told a recent steel meeting in New York, why the bridges shouldn't last for many hundreds of years.

Whether bridges built of heat-treated bars will last as long, is doubtful, according to some civil engineers, but their use in the new 2,690-foot bridge connecting Florianopolis, capital of the state of Santa Catharina, Brazil, with the mainland, will provide an interesting test. The Brazilian state capital is located on an island, and has never had any direct connection with the rest of the state. With the new bridge across the strait to the mainland, and the

completion of 100 miles of railroad to link up with an interior road between Rio de Janeiro and Montevideo, the state capital is expecting considerable growth.

The bridge is a novel example of construction not only because of its size, but because the two towers, each 230 feet high, which support the ends of the main suspension span, itself 1,113 feet nine inches long, are so built that they rock on their base, instead of being heavily reinforced and fixed, as are the masonry and steel towers of the larger American bridges. The steel bars which form the suspension, in place of the more commonly used wire cables, are treated until they stand a load of 75,000 pounds to the square inch.

All of the 4,400 tons of steel used was made in the United States and was shipped by steamer 6,000 miles, to the northern end of the island on which Florianopolis is located. Because of the shallowness of the strait, through which only small coasting vessels can pass, it was necessary to transship the material to lighters for the final journey down to the material yard.

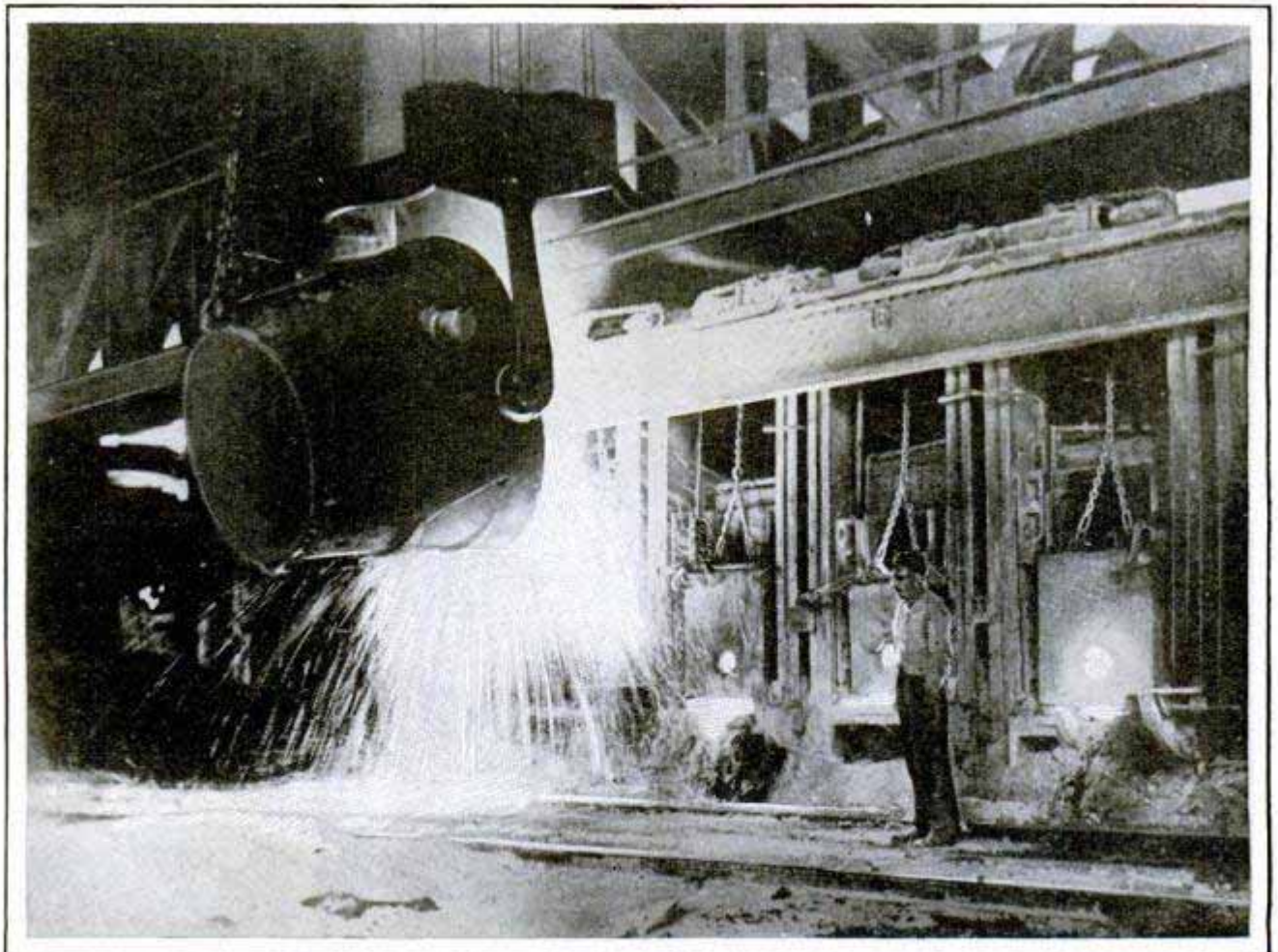

Charging an Open-Hearth Furnace with a Ladle of Molten Iron; the Open-Hearth Method Is Widely Used in Making Steel from the Iron Extracted in the Blast Furnace

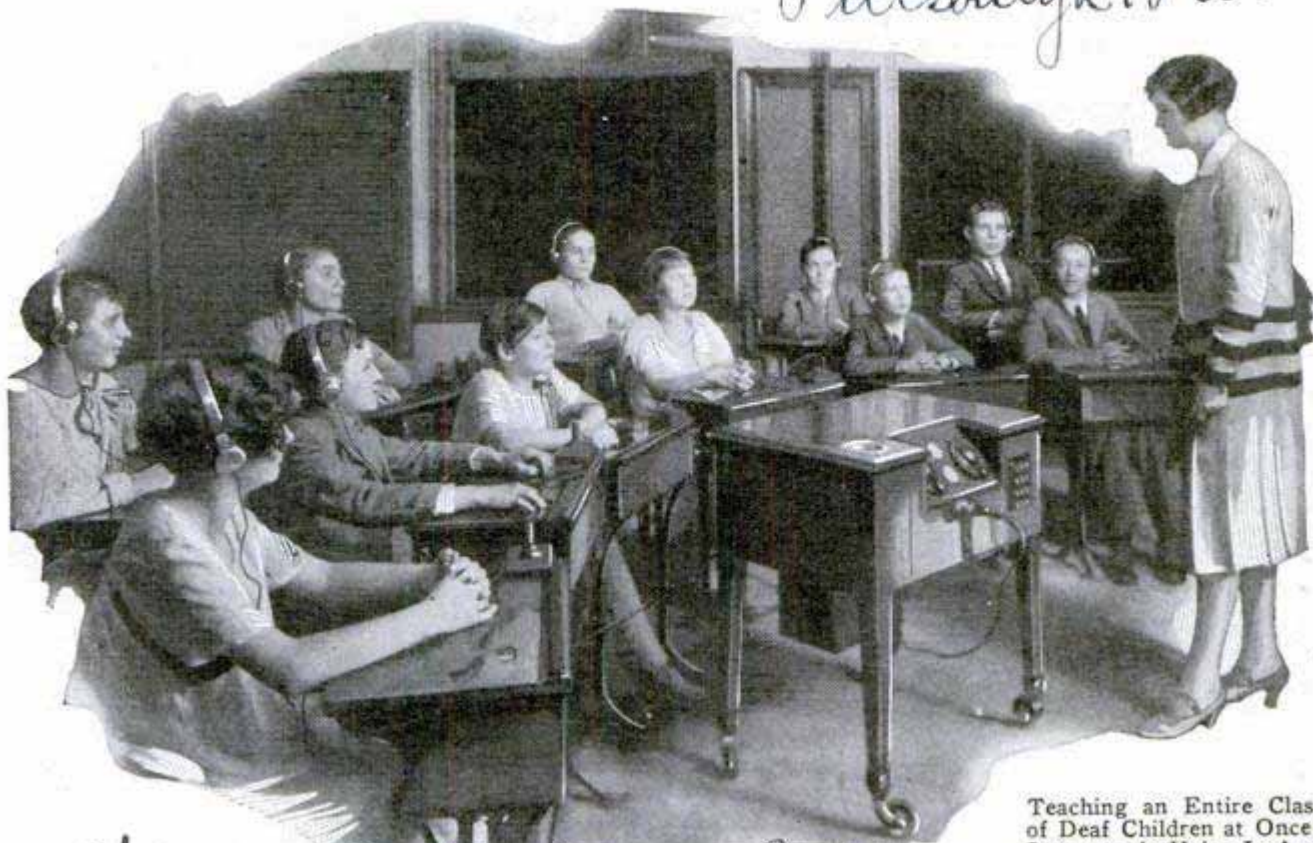

Teaching an Entire Class of Deaf Children at Once: Instructor's Voice Is Amplified and Relayed through Headphones

Chicago - H. J. Wetmer, Pres
 Darwell Furnace Co, 3935 South Park Ave.

RADIO AMPLIFIER HELPS DEAF IN LEARNING SPEECH

Deaf children who still retain fifteen per cent or more of their hearing, are taught in large groups with the aid of an improved apparatus which operates on radio principles. It picks up sounds through an ultrasensitive microphone in the top of a cabinet, amplifies them, and transmits them to headsets which are plugged into a socket at each pupil's desk. At each seat is also a dial control by which the volume of the incoming sounds can be regulated. With this installation, classes numbering up to fifty may be taught simultaneously, the pupils can hear their own voices and the instructor does not have to stand in front of the microphone, as it is so sensitive it picks up sounds from any part of the room.

EIGHT YEARS OF WORK IN LIFE IS MAN'S AVERAGE 4 000

According to recent calculations, the average man works less than eight years of his life. This estimate is based on the assumption that the usual working time is eight hours a day and that the average

man is at least sixteen years old before he starts serious work. The general active period is thirty years, so the person who labors eight out of each twenty-four hours for thirty years, has done ten years of work in his lifetime. This includes Sundays and half holidays. -Deducting those and six months' allowance for illness, leaves about seven and a half years of actual work for the average life.

RUBBER BULB IN VALVE TESTER SHOWS IF AIR LEAKS

Leaky automobile valves are quickly detected with a simple tester now on the market. It consists chiefly of a steel collar, or socket, in which is affixed a strong rubber bulb in the shape of a half ball. By a slight squeeze on the bulb, after the



valve is in place, the user can tell if the valve leaks, as the ball will yield when the air escapes or remain firm if the valve is properly seated.

*E. A. Myers & Sons
 3400 Forbes St.
 Pittsburgh, Pa.
 C. J.
 Mr.
 American Hammered Piston
 Co, 2100
 Chicago, Baltimore, Md.*

*Ans. Miss Is. L. Smith
 730*

Elysee, Paris France

399² 384

POPULAR MECHANICS

P. 529, Member 1929

FLYING HOSPITAL PLANE CARRIES LOADED AUTO

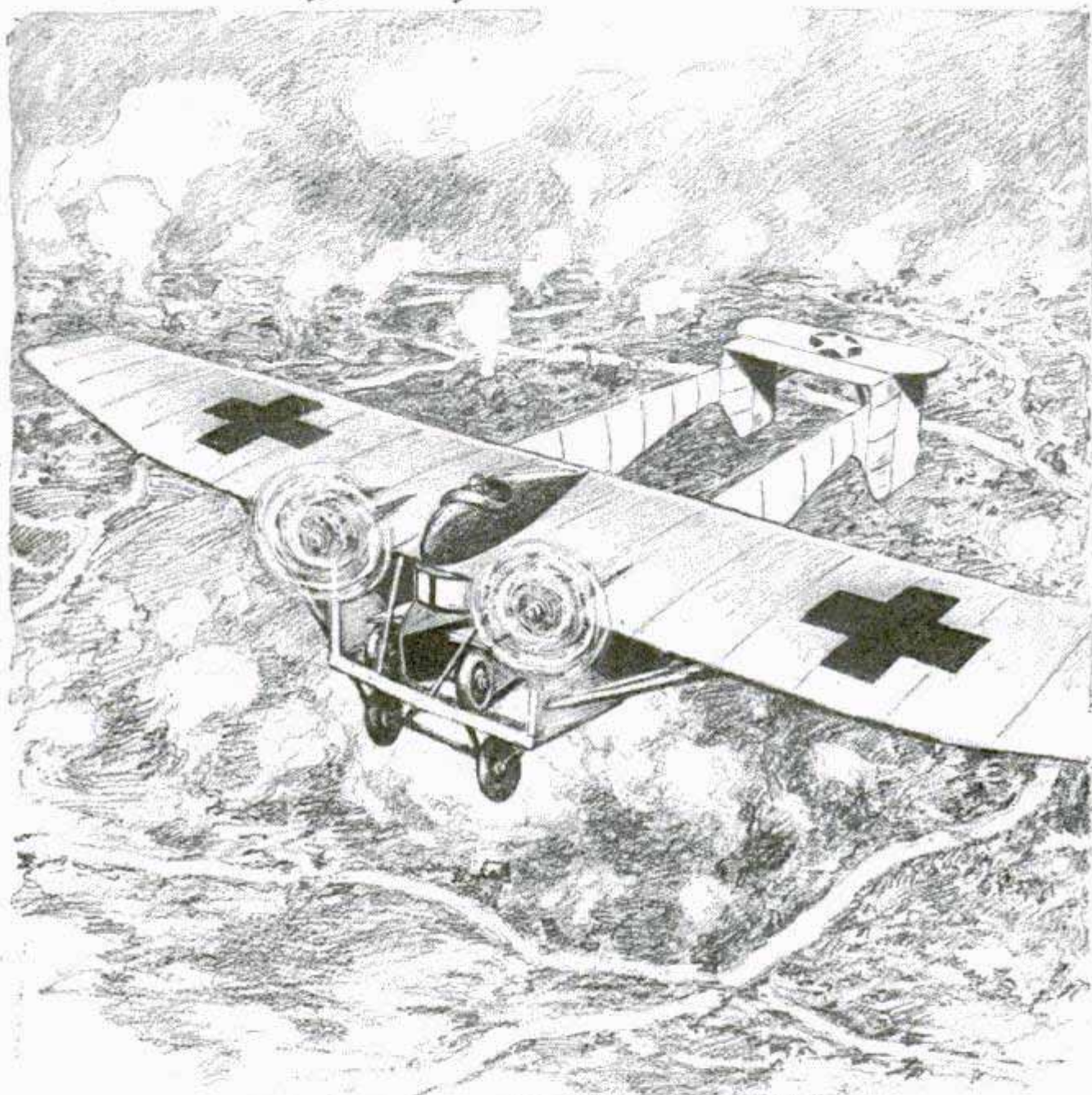

Motor Ambulance Installed in Plane for Emergency Trip through the Air; Note the Plane's Two Bodies

A flying ambulance, which is an ordinary motor car when on the ground, but can take a place in a plane and become the body of the ship when it takes the air, has been designed by M. P. Delcourt, of the Eiffel laboratories, at Saint Cyr, the French West Point. The airplane part of the machine is a big monoplane, with the usual thick wing, on top of which is a small streamlined car containing the pilot's seat and controls. Instead of the usual fuselage, it has two bodies, each leading back from a motor gondola. The bodies are

joined beneath the wing to form a floor on which the ambulance is anchored while in flight, and are joined again at the tail to form a stabilizer above the two rudders. The ambulance is driven onto the floor and fastened in place. It has a streamlined body to reduce air resistance.

Those wishing further information on anything described in the editorial pages can obtain it by addressing Bureau of Information, Popular Mechanics Magazine, Chicago.

PALACE OF MIRAGES PRODUCES STRANGE ILLUSIONS

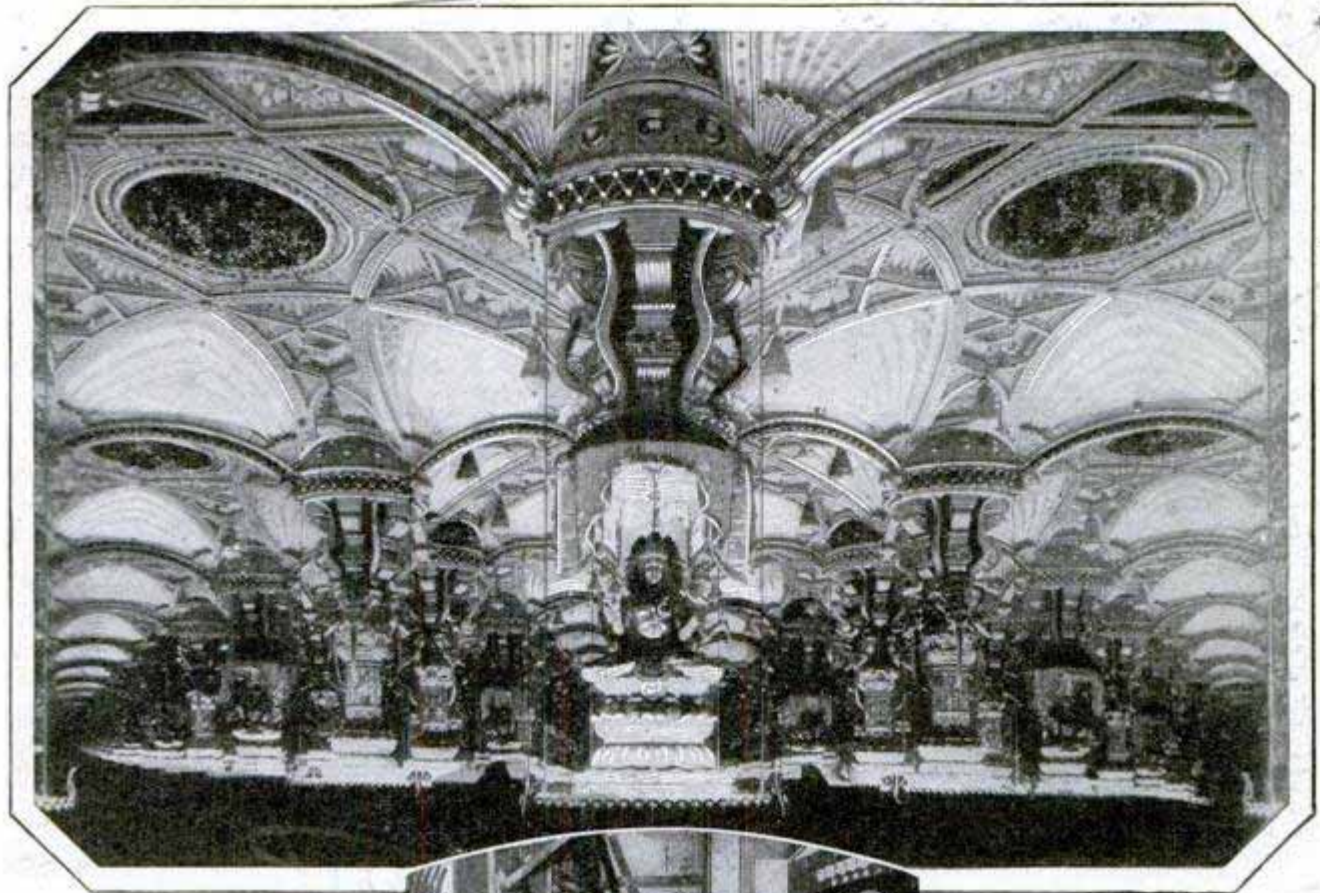

The Palace of Mirages, installed in the Grevin museum, Paris, is a veritable chateau of the Thousand and One Nights. The audience is seated in a hexagonal room, with partitions consisting of a series of mirrors framed by different motifs, columns and pedestals. These are covered by a cupola poised on projecting arches. Following the laws of optics, the illusion produced with the spectators is that of a multitude of identical rooms, placed side by side, radiating in all directions. In the center of the illusion one sees the real hall with looking glasses and six halls, twelve, eighteen, twenty-four, etc., up to the limit of perception. If it is lighted, either with the aid of visible electric lights or projections, the multiplication of mirrors will repeat a motif in all directions. At each angle of the room are installed six rotating



Inside the Wonderland of Magic Reflections, and, Control Apparatus by Which the Illusions Are Changed

drums, on each of which panels of glass, parallel two by two, form three concave angles of 120 degrees. One third of a turn of the drums completely changes the aspect of the room and its perspectives. Successively, the spectator finds himself placed in a Hindu temple, in an Arab palace or in the midst of a boundless forest plunged in darkness. The electric lighting permits no less than

forty-five varied effects, giving place to a multitude of combinations. These effects are obtained by means of 2,500 different colored lights.

Popular Mechanics Magazine does not publish the name of the maker or seller of any device described in its pages, but this information is kept on file and may be obtained, free, by addressing our Bureau of Information.

Handwritten notes:
 Rocket Apparatus
 Ltd., 22 Leadchall St. London E.C. 4
 14 Mansion House Chambers
 U.S.A. 14 Mansion House Chambers
 N. 212 W. 66 St. Wash. D.C.
 Chicago, Ill.
 2239 W. 21st St. Chicago
 Stone Water Filter Co.
 Schermuly Pistol Apparatus Co.
 14 Mansion House Chambers
 23 Leadchall St. London E.C. 4
 88
 35
 3985
 830
 \$8.50 C. 21
 3909
 U.S.A. - R. Sweeney
 See our Products Co. 199 Lafayette New York City
 by Police Dept.

Handwritten: Loustom Court Apts. Baltimore, Md



Shooting Life Line from the Pistol; the Flap Protects User's Hands from Powder Flash

LIFE-SAVING PISTOL SHOOTS LINE TO WRECKED SHIP

Pistols are generally associated with killing, but one recently introduced is intended to save lives by throwing lines to victims of shipwrecks or other disasters. To protect the user against the flash of the charge, a flap is suspended beneath the barrel. The pistol will hurl a slender cord for some distance and this can be used to pull a heavier rope aboard.

WATER FILTER FOR THE HOME IS SELF-CLEANING

Solid materials are removed from the drinking water by forcing it through a simple little filter which can be quickly attached and requires practically no attention.

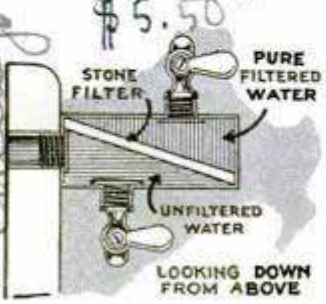

The filtering medium is a special kind of stone manufactured from white sand. The main water supply is forced through one side of the filter and withdrawn, for washing or other purposes, at full pressure and without being filtered. But that which is intended for

drinking is taken from the other side of the stone, which is placed diagonally in the case. The solids removed are nearly all washed out with the full stream of incoming water so that the stone seldom has to be cleaned. The filter is easily connected by shutting off the water, removing the cold-water supply faucet, screwing the filter in place of it and then connecting the two outlet faucets to the filter.

AUTO HORN CONTROLS LAMPS TO GUIDE TRAFFIC

Traffic lights controlled by the sound of the automobile horn have been under tests in Baltimore, Md. A highly amplified microphone along the roadside, is made sensitive to vibration in such a manner as to change a green light to red. The lamps remain in this position for a few seconds and then automatically change back to the original signal. Under the present system, the lights are especially suited to guarding cross roads where fast-moving vehicles are common.

THREE-HEAT ELECTRIC IRON HELPS SAVE CURRENT

Buttons on the side for giving three different degrees of heat and a composition handle that fits the hand and stays cool are the chief features of an electric iron which effects a saving of current. Absence of a back plug saves time and trouble. The cord connection is flexible and swivels to both the movements of the iron and of the operator, while a heavy armor protects the covering from damage. Current is turned on or off by the buttons.



CORNCOB INCENSE

By soaking dry corncobs in fragrant oils, such as that of sandalwood, cinnamon or cloves, and then grinding them to powder, an effective incense has been prepared. White smoke and ashes are produced, and the substance is said to be superior to various other kinds.

The Latest in Furniture



Modern Design in Living-Room Equipment; the Screen Is Black and Silver, Upholstery of Davenport Is Blue, and Pillows Are of Calfskin

A REVOLUTION in furniture design to correspond with the changes in modern home and apartment architecture promises America a new furniture vogue as sweeping as the general desire for mission styles in the late nineties and first decade of the present century.

The new designs, sometimes called "venturus," take various forms, some embodying the skyscraper motif so distinctly American, but always combine simplicity in treatment, straight lines, and, often, the slender grace of Chippendale or Heppelwhite, in marked contrast to the massive heaviness of mission furniture.

Height and slimness are the most usual characteristics—the skyscraper's lines applied to furniture—or the fashionable slenderness of modern dress design. Chairs have taller backs, wall pieces, particularly occasional tables, bookcases and the revived editions of the mid-Victorian what-not, all emphasize height, at the expense of width.

The reason for the change in furniture styles, however, lies in the changing Amer-

ican home—small apartments and small bungalows. Where overstuffed pieces, heavy mission furniture and similar styles cramp the small room in appearance, if not in fact, the new venturus art is designed to give an air of spaciousness and make low ceilings seem higher.

With apartments and houses growing smaller, with more built-in or disappearing furniture and other conveniences, it required a radical departure in design to meet the new limitations on interior decorating. The two or three-room with kitchenette idea, developed for small city apartments, is being applied in three and four-room bungalows. Many home builders, as well as apartment-house designers, have reached the conclusion that some of the things an older generation regarded as indispensable, are really unnecessary in this day and age.

Take dining rooms as an example. The idea of building a house without a dining room would have been unthinkable even a decade ago, but dining rooms can be, and are being, eliminated today. In their place

Wanamaker's, New York.



Above, Stand of Hollow Metal Tubing and, at Right, Electric Candle in Brass



At the Right, a Marble-Topped Table Distinguished by Its Metal Base in Artistic and Sturdy Design

it is possible to drop the dishes into the electric dishwasher and get away in time to see the first show at the nearest movie palace, go on to a bridge club afterward, or out in the country for an automobile ride.

A generation ago the housewife who had no servants didn't have time for matinees, teas and automobile rides because she had a dining room and an enormous kitchen to look after.

The new houses have small kitchens, too, and they are more scientifically planned. The latest thing in apartment-house kitchens is long and narrow—about as wide as an ordinary hall, and three or four times as long as its width. It is laid out like a Detroit automobile plant, for quantity production with the minimum of labor. Starting at the back-porch door there

the one-time butler's pantry becomes a breakfast nook, fitted with Pullman seats and table, which fold out of the way when not in use. The space that a dining room would take is partly added to the living room, making it as large as possible, and for more formal occasions, when company comes, a gate-legged table in the living room takes the place of a dining table. Smaller families, lack of servants, movies, bridge, the automobile, the prevalence of tea rooms and good restaurants, even in small towns, new ideas about health, the reducing craze, smaller meals, refrigerator cars that bring fruit and salad material the year around—all of these and many more factors have had a hand in the decline of the old-fashioned family dinner, a stately affair of many courses followed by a gorged nap.

If the family dines al fresco in a breakfast nook, off sandwiches, a salad and fruit,



are storage compartments (with outside filling doors for the delivery boys to de-

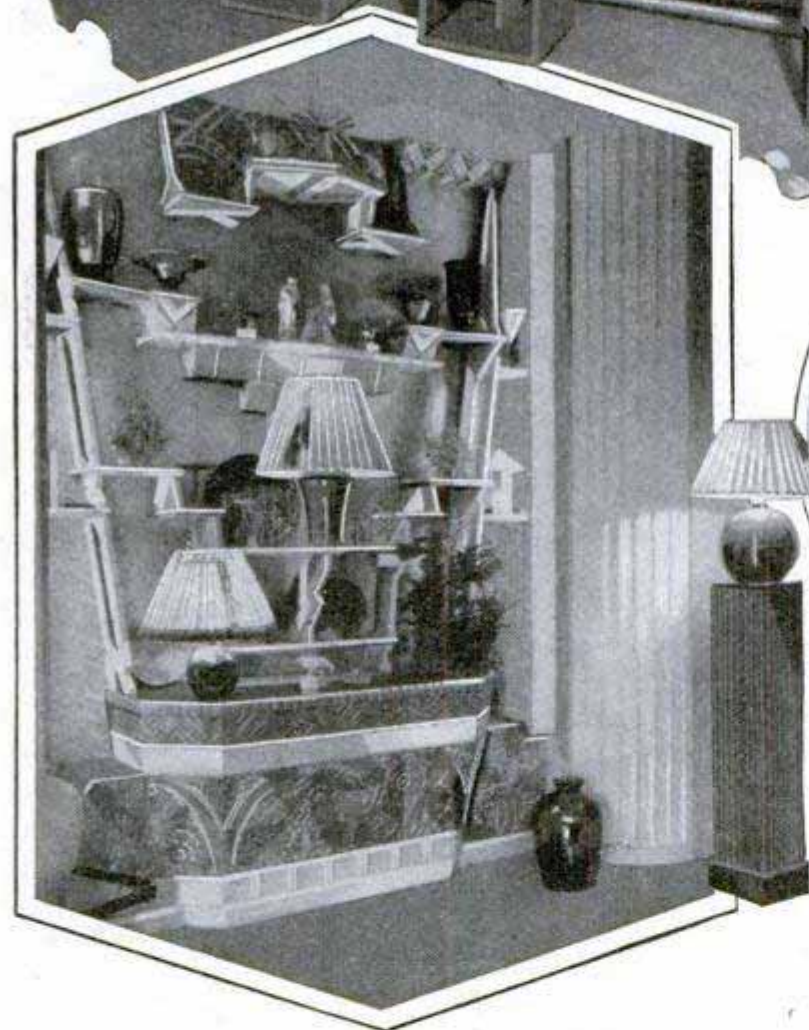
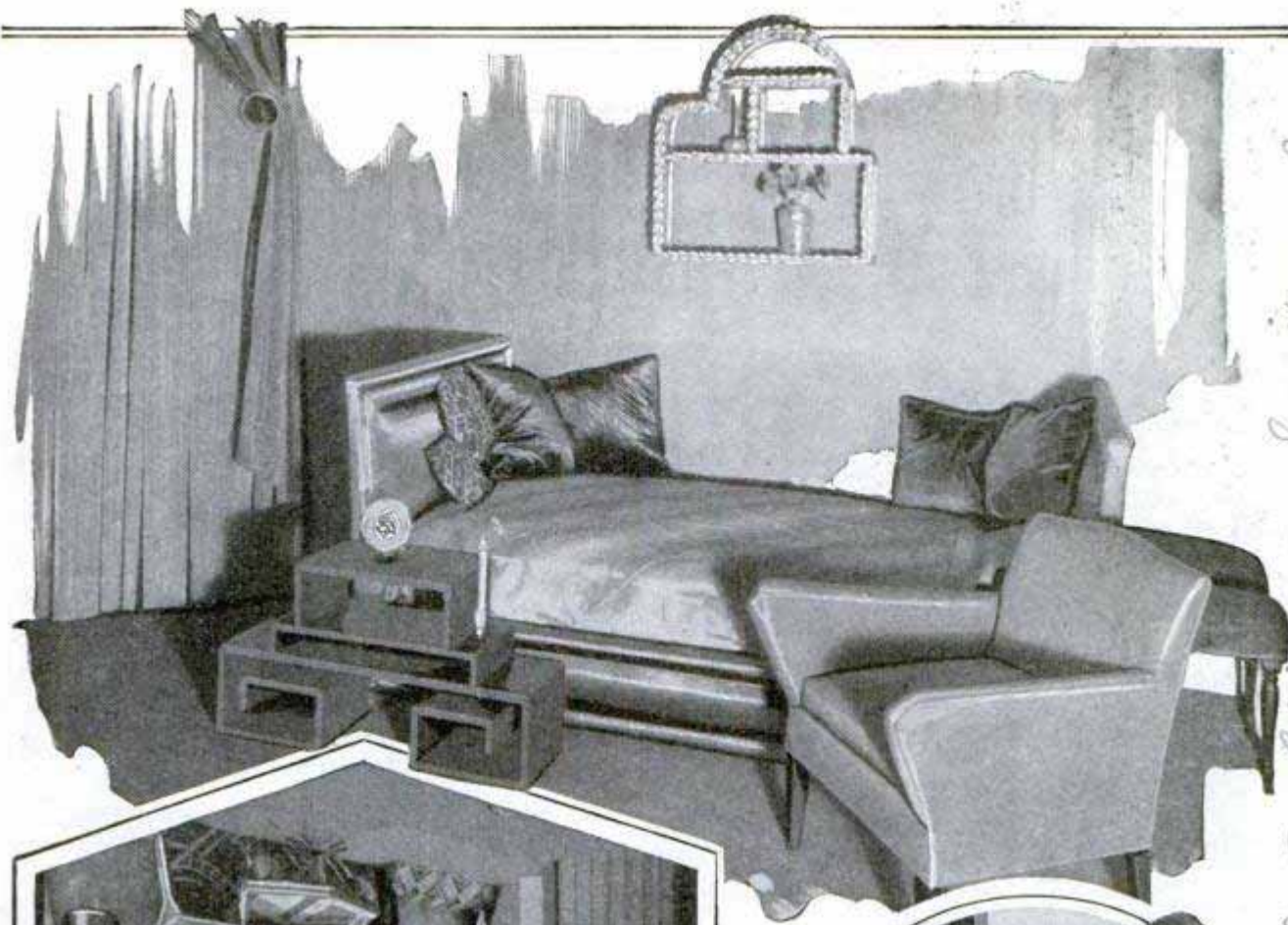

At the Left, the Whatnot of Today, a Roomy Cabinet in Geometric Patterns That Form an Effective Background for a Wide Variety of Objects; Above, Bedroom Furniture in the Latest Style, the Odd "Curled" Stand Being a Conspicuous Feature; Inset Shows One of the Latest Types of Kitchen Sinks with Convenient Spray Hose for Washing the Dishes; It Eliminates the Need of a Dishpan and Saves Drying by Hand

posit their packages without the necessity of a member of the family staying home to receive them) and an ice box, also with an outside door, if ice is used instead of artificial refrigeration. Next, on the same side of the long and narrow room, comes

a series of storage compartments, usually assembled from the units of white-enamelled metal kitchen furniture, and then a work table for preliminary cooking operations. Next to it is the stove, so that after the preliminary assembly job—to

*Edy - D. A. Evinger Sanitary Mfg. Co.
 180 Locust St., Columbus, Ohio.
 Chicago - 77 W. Washington St.*

use a factory phrase—has been completed by placing the food in the proper pots and pans, they can be placed on the fire without taking an additional step. Beyond the stove is the final assembly table, adjoining the door into the dining alcove or breakfast nook.

the aisle, and then the skill-ets and cooking pots, just across from the stove and work table



Utility Table Co., Nashua, N.H.
no. 1001

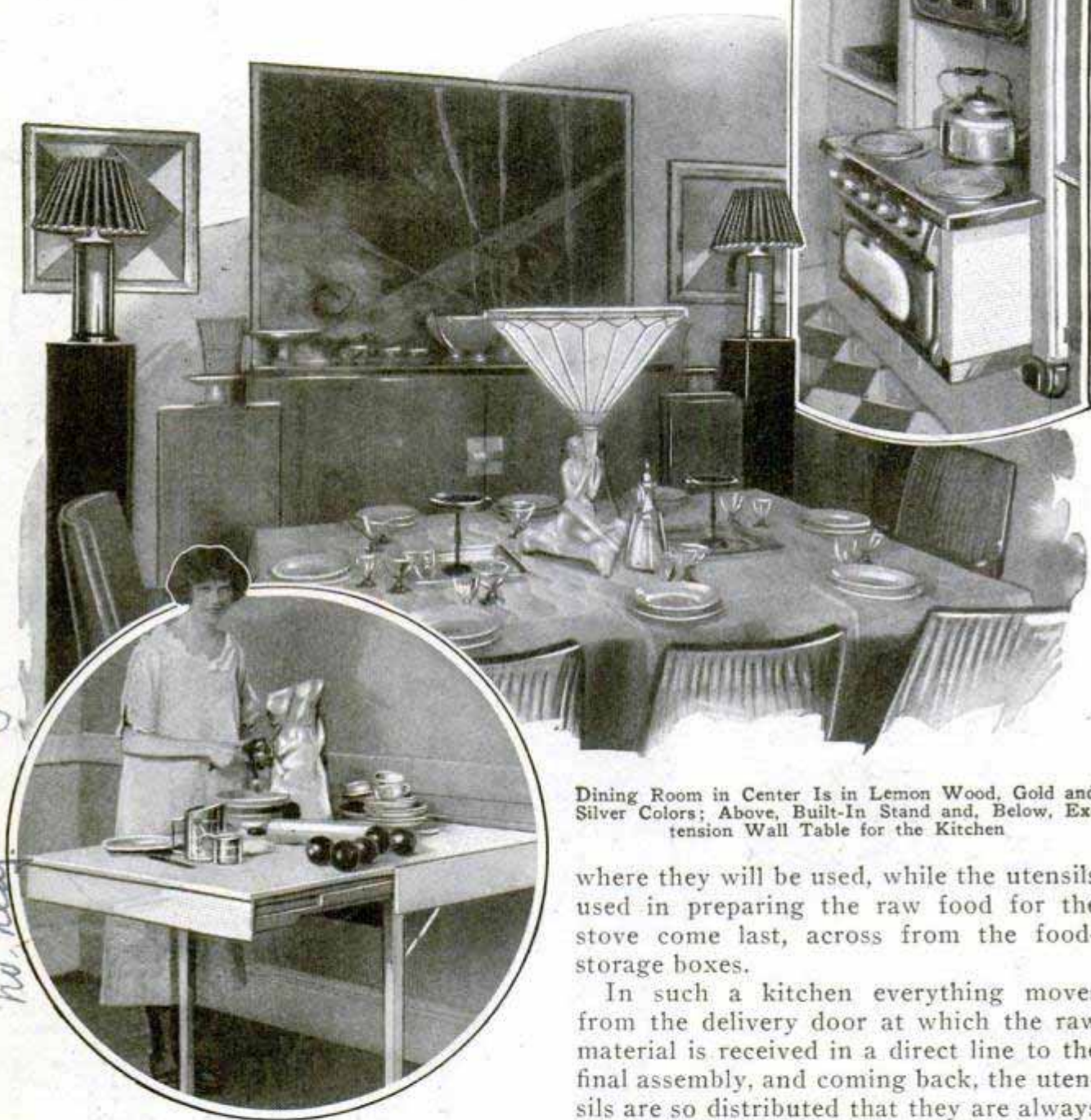

Dining Room in Center Is in Lemon Wood, Gold and Silver Colors; Above, Built-In Stand and, Below, Extension Wall Table for the Kitchen

where they will be used, while the utensils used in preparing the raw food for the stove come last, across from the food-storage boxes.

In such a kitchen everything moves from the delivery door at which the raw material is received in a direct line to the final assembly, and coming back, the utensils are so distributed that they are always within reach at the stage where they will be wanted again.

The new small homes likewise are eliminating the guest room, or at least one guest room, if more than one is needed. Instead of the expense of the extra room a small dressing space is provided, into which a folding bed, mounted on rubber-tired wheels, can be pushed out of sight. When the unexpected guest arrives, the

Coming back, on the opposite side of the room, first is a receiving table for the returning dishes, next the sink, which in the latest apartments has a built-in electric dishwasher, then a drying table, above which wall cabinets take care of the silver and glassware. Next are storage compartments for, first, the dishes which are needed at the final assembly table, across

bed can be rolled out into the living room, and the space it occupied becomes a dressing room, filled with a dresser, mirror and rows of hooks.

Even the bathroom is coming in for attention. For one thing, the bathtub is being eliminated more and more often because it takes up too much room and requires too much time and attention to keep it white and spotless. A shower bath occupies much less space, is far cheaper to install (for it can be surrounded with an ordinary plaster wall coated with waterproof paint) and it takes the minimum of care and attention. The shower bath is also a timesaver, for it eliminates waiting for the tub to fill and empty, and everything in the latest homes is being designed to save time.

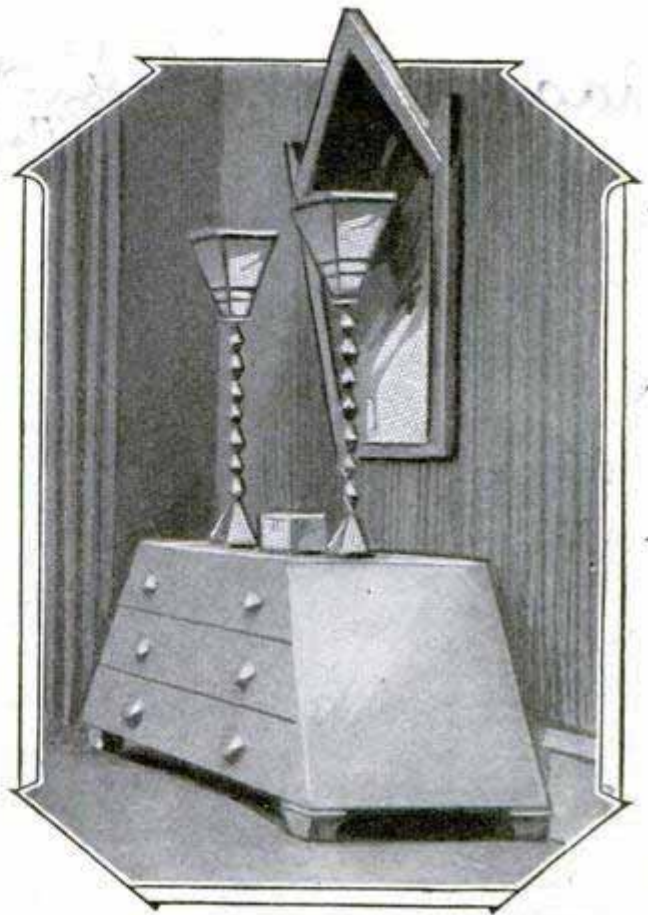

Large Drawers and Unique Lights Distinguish This Dresser for the Modern Bedroom

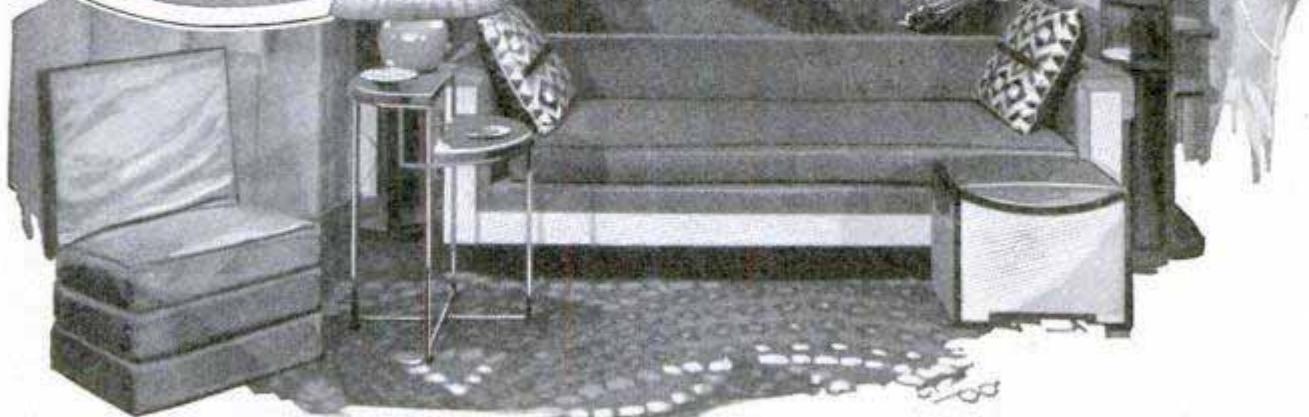

Bright Color Touches and Simplicity of Line Feature This Living-Room Set with Its Metal Table; Above, Convenient Toilet Cabinet and Stand

LUMINOUS PAINT PRODUCES NOVEL STAGE EFFECTS

Radium Chemical Co. Philadelphia Pa.



Decorating Objects with the Luminous Paint, and a Stage Setting as It Appears in the Glow of the Phosphorescent Covering

Among all phosphorescent substances, sulphate of zinc possesses an especially curious property. Upon being exposed to the sun or an electric arc, it absorbs the ultraviolet rays, and if then placed in a dark room it reveals a greenish-yellow light comparable to the nocturnal

sparkling of a glowworm. It can serve either for lighting purposes or as an ideal screen for the ultraviolet rays. Curious effects, and artistic and theatrical decorations are produced in this way. The sulphate of zinc, sold in the form of powder, is mixed with thirty to forty per cent of Canada balsam, liquid gum, white celluloid dissolved in acetate of amyl, or uncolored varnish. A paste is formed which is easily applied to the objects intended for display, whether made of cloth, metal, paper, cardboard or wood. Fans, masks and paintings also are treated with this phosphorescent application. After having designed and painted the objects in the ordinary manner, the decorator touches certain spots with the paste. Perfumers utilize sulphate of zinc, incorporat-

ing it in rice powder and other similar products. These luminous paints communicate to the skin a sparkle more vivid than nature in the semi-darkness of a theater box or a somber drawing room.

H C I O

HONOR INVENTOR OF AUTO

Austrians have honored the name of Siegfried Marcus, credited with the invention of the modern automobile, by erecting a statue to his memory in Vienna. It is of unique design, showing an athletic youth cleaving his way through space, while a cast of the inventor's head is on a front panel. Marcus introduced an automobile as early as 1864, and, in 1875, he devised one that had many of the advantages of the car of today.

Christian Science Monitor 12/22/27

Eschsch Corporation 200 Canal St Newark, N.J. United States Radium Corp. 1535 Canal St New York

Lock Straver P. Augerties N.Y. Pittsburgh Pa.

SUNSPOTS AND WEATHER 400 2.

Predicting weather conditions on the basis of spots on the sun is a process surrounded with mystery to the layman and has inspired all sorts of foolish questions, according to Father Jerome S. Ricard, of the University of Santa Clara, world-renowned astronomer, but he holds that the method is essentially sound and points to his accurate forecasts as proof of the validity of his calculations. He explains that the occurrence of spots on the sun creates certain displacements in the ether which can be measured and their direction ascertained. These changes are carried to the atmosphere of the earth, resulting in disturbances. By noting the effects of rotations of sunspots, he is able to foretell their future effects on the earth. A comparison is found in the relation between motor and airplane. The propeller does not drag the plane through the air but, in whirling, creates a vacuum in front. The rush of air behind pushes the plane forward.

ROGUES GALLERY FOR STUDENTS SIMPLIFIES COLLEGE FILES 3390

Drake university officials adopted the "rogues' gallery" method this season in making up office files of its students. Each was photographed with a card, bearing his or her name. The photos are filed with other student data for permanent reference.

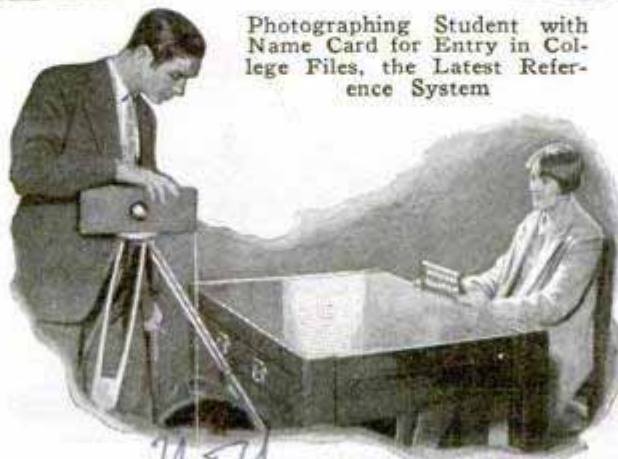

Photographing Student with Name Card for Entry in College Files, the Latest Reference System

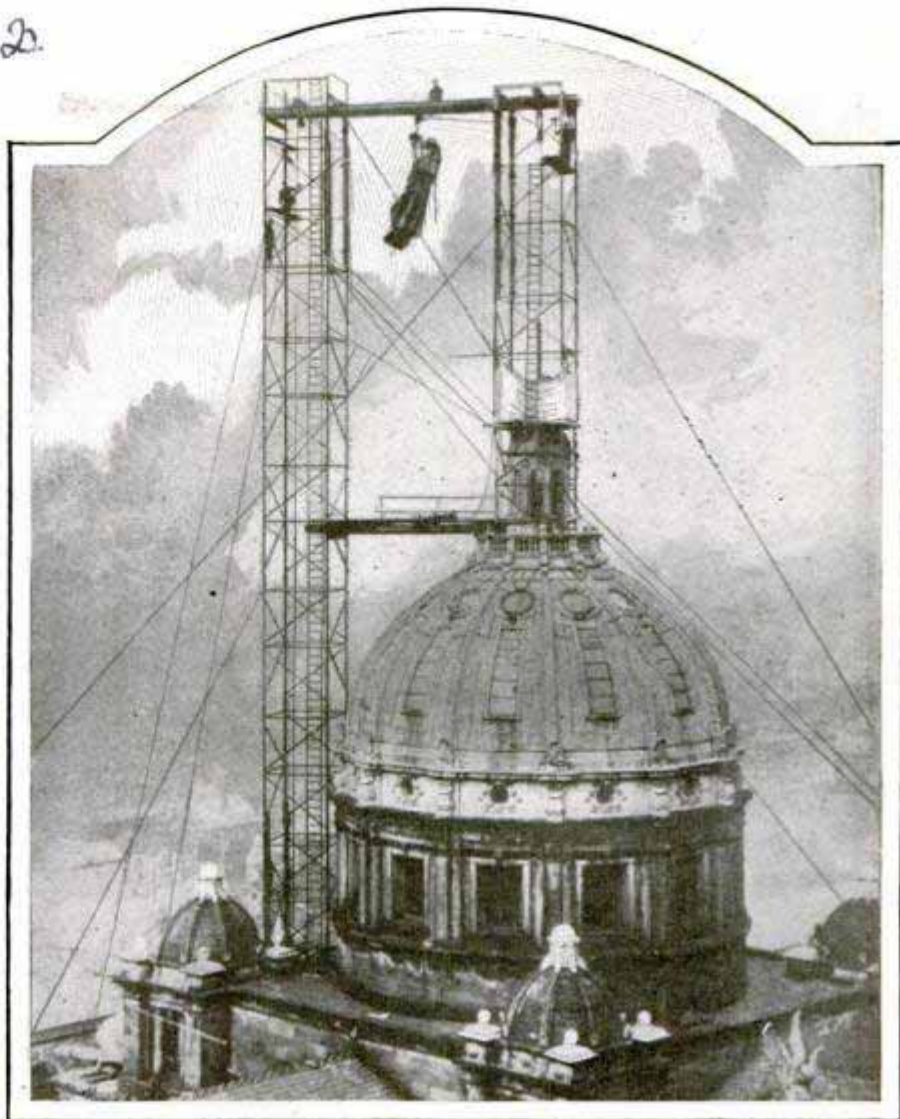

Huge Statue of Washington Being Erected on Courthouse Dome; Pulling the Figure Across Preparatory to Lowering

THREE-TON STATUE-HOISTED ON DOME

Engineers solved a difficult problem in hoisting recently, when they lifted a three-ton statue of Washington to the top of the dome of the Washington county courthouse, Pennsylvania. A special tower was built and connected to a smaller one on top of the peak of the dome. The figure was elevated on the main scaffold, hauled across the "runway" connecting the two and then lowered to its position on the smaller tower. In all, it was raised 175 feet.

SYMBOLIC CARVINGS FOR NATIONAL CATHEDRAL

*Capt Emmet Sloughbury 752
National Press Bldg
Washington D.C.*



St. Dunstan
Tweaks the
Devil's Nose.

Anger Beating
against Stone
from Which He
Is Modeled

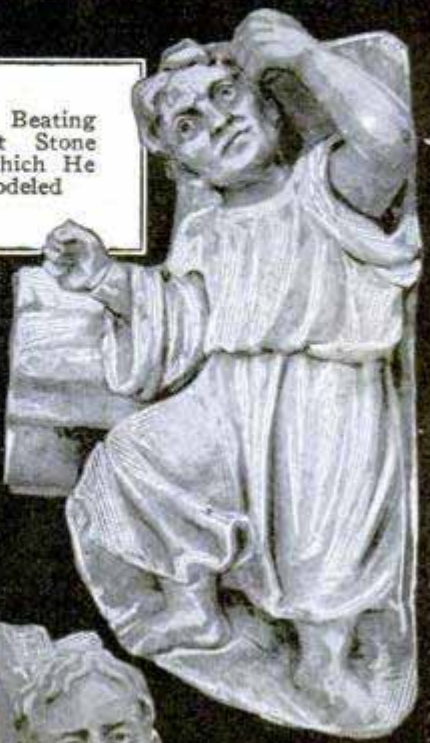

Envy, Thread-
bare, Ogles the
Overcoat of a
Wealthy Citizen



Gluttony, with
Bottle Clutched
in Fist, Gnaws
a Ham Bone



Pride Caught in the Midst of His
Tumble, One of the Washington Ca-
thedral Carvings



The Lion of Judah, Symbolic of Spir-
itual Strength, Is Another of the
Thousand Odd Vaulting Bosses

Chicago

GRAPHITE FOR PISTON IN RING

3977
Escrapoil

Self-lubricating piston rings have recently been introduced in the form of a unit with a groove that carries a supply of a graphite mixture. This is said to greatly increase the life of the piston ring. The graphite material is a specially prepared compound to yield the best results under all conditions and to remain in the groove indefinitely.

AUTO DIAL TELLS BRAKE POWER

3930

For the motorist who desires to know more exactly how his car is performing with respect to maximum net pull, pulling power at thirty miles an hour, frictional losses and other important details, a simple meter has been devised. It is set in the dash or on the steering post, has no outside connections and registers the results on a dial. After proper adjustment, it will enable the driver to measure the grade, either up or down, over which he is passing. It can be used to test the brakes, an acceleration test indicates a possible faulty carburetor adjustment that may be corrected, and other revealing tests can be made. One of the most important is the maximum net-pull test. The pull comes just before a change to second gear is necessary and occurs in most cars between the speeds of from twelve to twenty-five miles an hour. This forms a rating basis on which to compare the performance of other cars.



San Francisco
San, 240-1st St.

Battleship "Utah" in Drydock Where Blisters Were Welded to the Hull to Protect the Vessel from Torpedoes

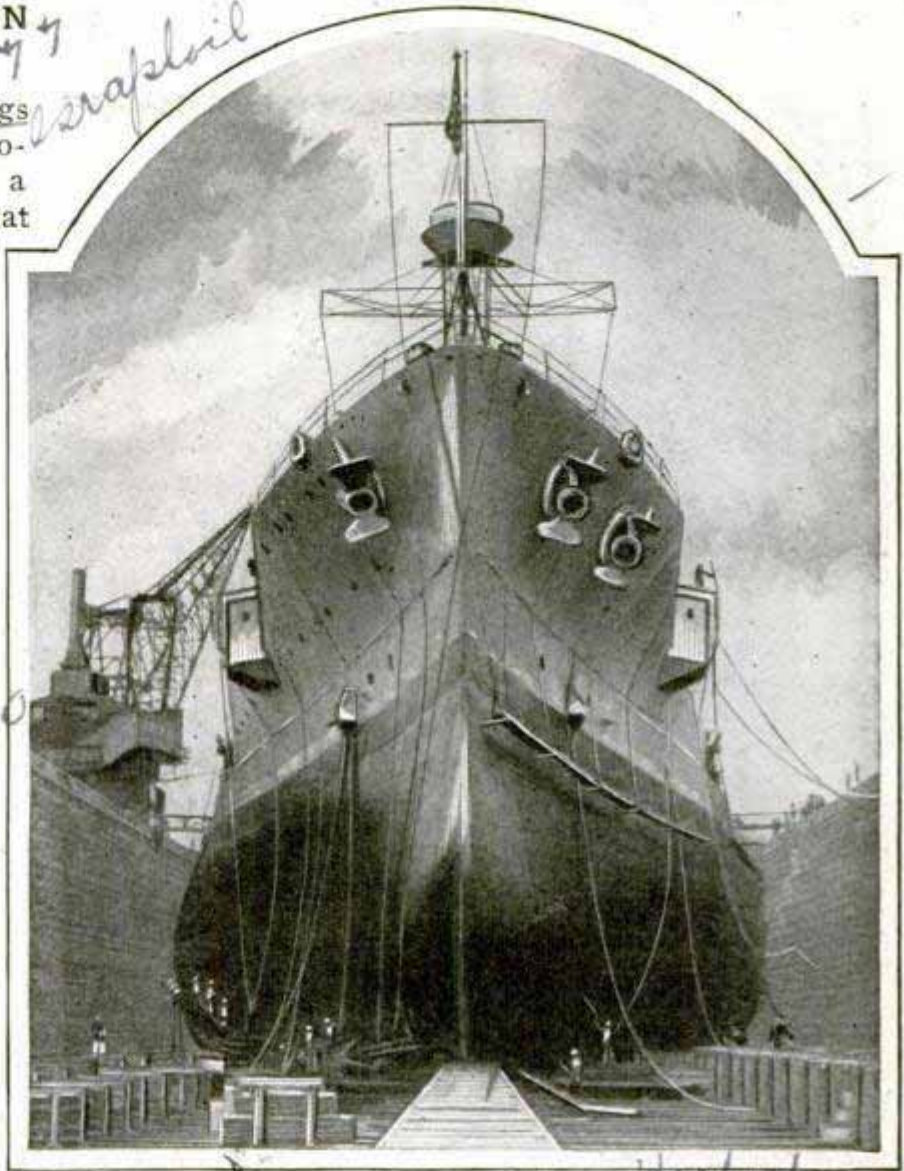

WELD BLISTERS ON BATTLESHIP TO ABSORB SHOCKS

To reduce the force of mine and other explosions against the sides of the ships, the sister dreadnaughts "Florida" and "Utah" are being equipped with shock absorbers or "blisters." These are welded to the hulls as additional armor protection against torpedoes.

AN INSECT ZOO 3944

Insects, lizards and many kinds of reptiles are on exhibition under conditions closely resembling their natural habitats in the Jardin des Plantes, Paris. Miniature forests, inclosed in glass, afford natural living surroundings and spectators may see them at work. The "zoo" is a fulfillment of the wish of Jean Henri Fabre.

Venus is about the size of the earth.

great sales well, C.C. Cheswell, 43 South St. Jointer, Can. of Melrose Highlands, Mass. Boston, Mass.

Charlestown Navy Yard, Boston, Mass.

Mrs. Tapley & Co., Chicago Daily News 12/14/27
T. F. Tottin, Northampton

3879

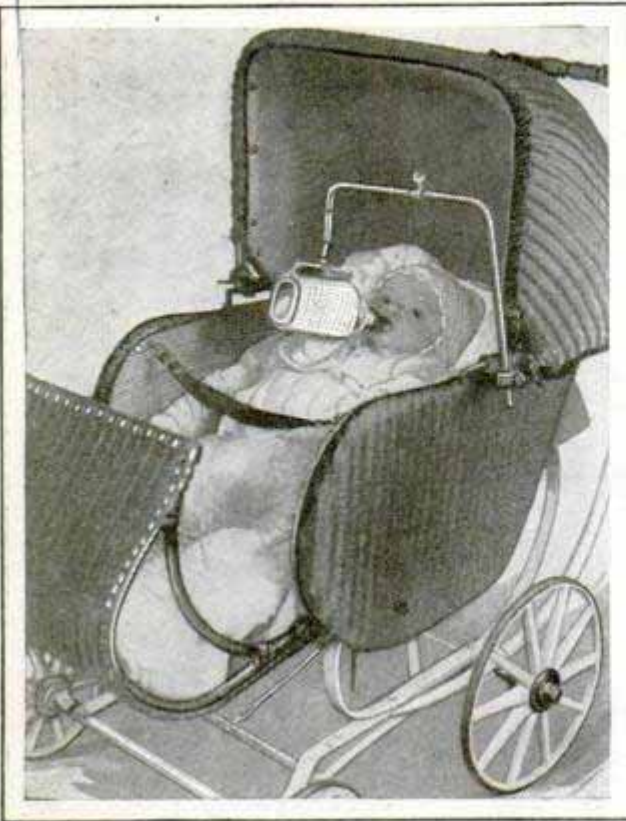

Nursing-Bottle Holder Attached to the Carriage in Convenient Position; It May Also Hold Toys

HOLDER FOR NURSING BOTTLE PREVENTS BREAKAGE

To keep the nursing bottle in position, a convenient holder that may be attached to the crib, high chair or baby carriage has been introduced. It prevents the infant from dropping the bottle, makes it unnecessary to prop up the coverlets to hold it in place, and the child can readjust the bottle without assistance, should it slip away a slight distance. When the bottle is removed, the holder may also be used to support toys and playthings.

AID RAIL TRAVEL IN AUSTRALIA WITH UNIFORM GAUGE

To reach Perth from Sydney, Australia, a passenger by rail must change trains six times and travel on the systems of five states. Part of this difficulty has been due to the fact that the route includes railroads of three different gauges, but this feature will be eliminated when the proposed uniform-gauge, the standard four feet eight and one-half-inch width, is built across the continent. Part of the road has been completed and, last November, the first trains were run over the new line from Sydney to Broken Hill. A

bridge over the river Darling is one of the important units of the road. It is of the bascule type and has a highway for vehicles as well as space for the trains. It had to be constructed to allow for the sudden rise of the river after floods. In dry seasons, the stream will scarcely float a child's boat, but it becomes a torrent after heavy rains. The line shortens the distance between Sydney and Broken Hill by 709 miles and effects a corresponding saving in time, as, formerly, passengers had to change trains four times. It is expected that completion of the entire standard-gauge road will greatly increase the prosperity of the country as a whole.

SCREWDRIVER HOLDS SCREW WHILE STARTING IT

A screwdriver which holds the screw while starting it, but which can be used, if desired, in the ordinary way, is the invention of a Chicago man. A sleeve fitting over the driver operates a pair of jaws that catch the screw after its slot has been placed on the tip of the driver. When not in use the sleeve can be drawn back, bringing the jaws behind the point of the driver, and permitting its use as a normal tool. Either round or flat-head screws of either wood or machine type, are held, and the drivers, in various sizes, take everything from small jewelers' screws up to the largest sizes.

Mr. Peter Collier machine, 124 N. Curtis, Chicago



Screwdriver That Holds the Screw, and Inset, a Close-up of the Jaws Which Do the Work

Chicago-Whitman, Per...
124 N. Curtis, Chicago

3960
Cub. J. A. Robinson, Notary
7 Cooper St., Strathfield

Peter Collier machine
Co., 5229 Blake St.
124 N. Curtis St.

Coney Island, New York City

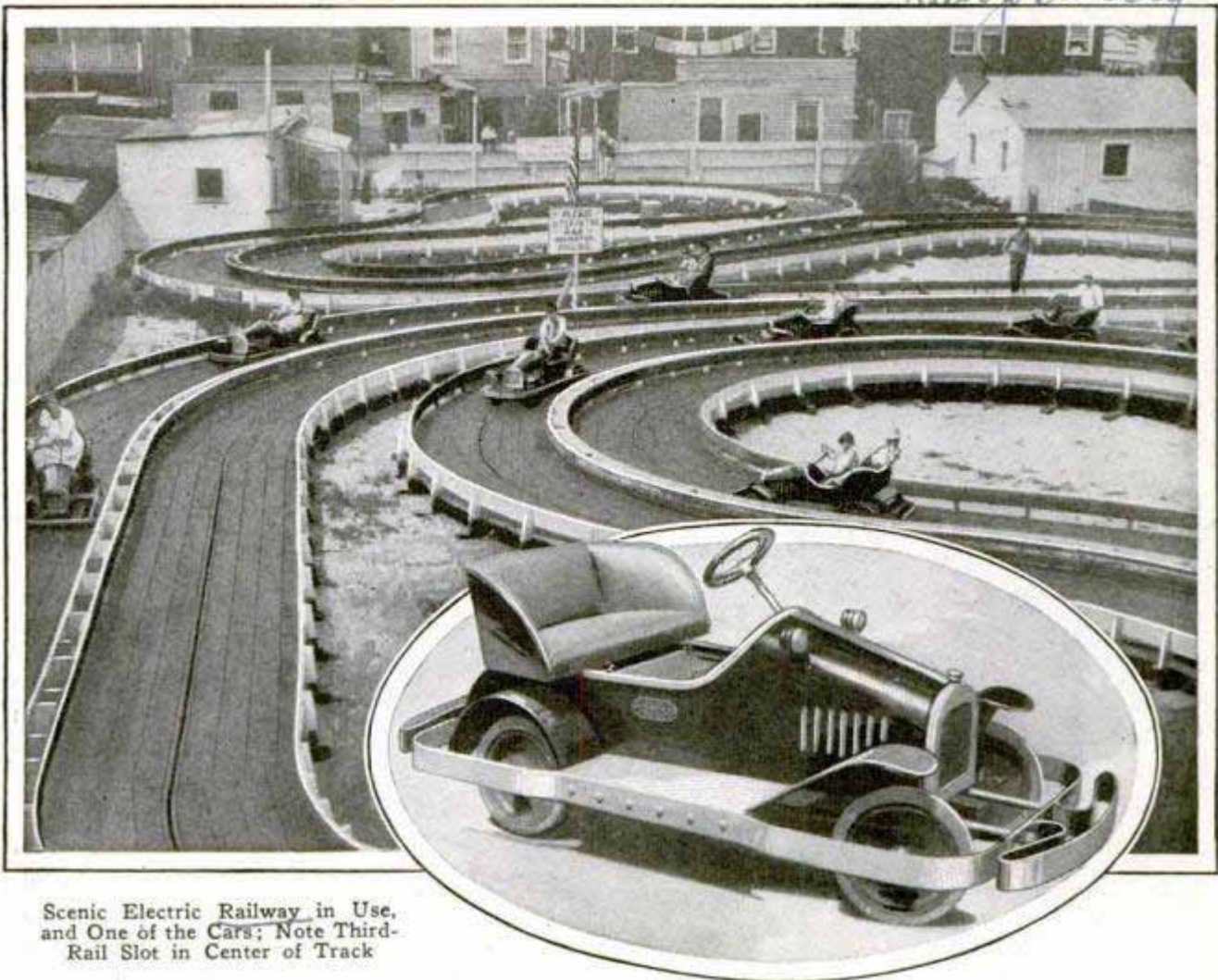

Scenic Electric Railway in Use, and One of the Cars; Note Third-Rail Slot in Center of Track

JOY RIDERS DRIVE OWN CARS ON PARK TWISTER

Thrills of riding on a twisting electric railway at Coney Island are increased because patrons have the pleasure of driving their own cars. The system is of the third-rail variety. In this case, the current conductor is in a center slot where it is safely out of the way. Contact is made through a sliding "dog" connected to the underside of the car. Each unit has a starter operated by the foot. Pressing the switch starts the car and releasing, stops it. The course is nearly 1,000 feet long and has a number of sharp turns.

3979

THRILLS IN TABLE FIREWORKS

Fireworks which can be set off on the dinner table is the latest party surprise imported from Germany. An explosive cap in the base, touched off by lighting a fuse, projects the contents of the pieces into the air. Most of the pieces range from two to four inches high, and to discharge them

M. Wagner

it is only necessary to place them on a plate and touch a match to the fuse. One, decorated in red, white and blue, throws a number of small American flags into the air. Others discharge paper dolls, small animal favors, flowers, confetti, and even a complete deck of cards.

SHIELD FOR ELECTRIC PLUGS PREVENTS FRAYED WIRES

Successive pulling and inserting of the plug on the extension electric cord is likely to fray the wires in time and so lead to possible short circuits or fires. This danger is said to have been eliminated by a clamp which is quickly attached to the plug and has convenient

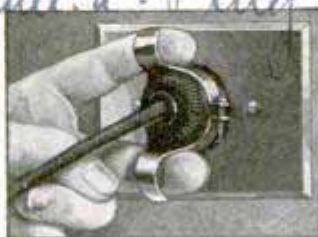

finger brackets to simplify the task of removing the plug. The pull is exerted on the clamp and not on the wire, saving the latter from unnecessary wear.

3760

Chicago J. S. Jacobson Co. 740 W

Levi Mfg. Co. 997 main St., Winchester, Mass.

36 75
398

Chas. ...
205 Union League Bldg
POPULAR MECHANICS
Chas.

TRANSFORMING UNSIGHTLY HILLS INTO HOME SITES



Los Angeles and Other Southern California Cities Are Developing a Distinctive Type of Hillside Architecture That Resembles the Charming Effects of Old-World Towns; Above Is a Typical Terraced Hillside Home, with the Automobile Road Entering above the House Top; at the Right, Garages at the Foot of the Hill and an Elevator Built in an Ornamental Tower to Lift Residents to the House Level

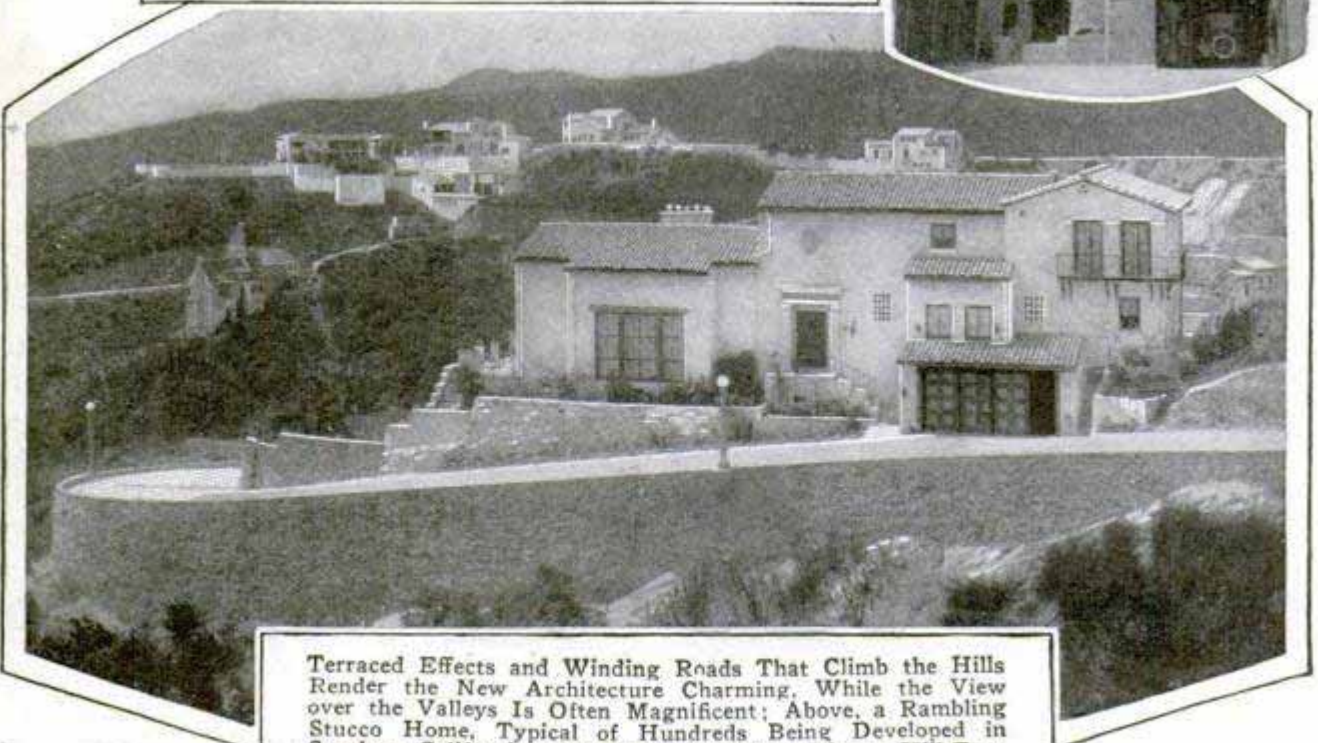

Terraced Effects and Winding Roads That Climb the Hills Render the New Architecture Charming, While the View over the Valleys is Often Magnificent; Above, a Rambling Stucco Home, Typical of Hundreds Being Developed in Southern California, with Others Visible on Distant Hill Tops

SENTRIES GUARD RADIUM MINE IN AFRICA

3960
 Few plots of ground are more carefully watched than an area in Central Africa where Belgian interests own a large tract of radium-bearing rock. Armed sentries are on guard every day and night of the year, lines of tangled barbed wire, similar to those used in the war, surround the district and, except those employed, few persons are ever allowed to handle the precious materials being mined. Every piece of radium rock is carefully checked up as it leaves in sealed trucks to be shipped to the extraction works. Only a few museums have been given specimens from the deposits.

3834
VOICE TESTER SHOWS IF SINGER IS SUITED FOR THE STAGE

Under the misguided impression that they may become concert or opera singers, many persons with excellent voices are spending large sums of money and valuable time in cultivating their talents in that direction, although their efforts are almost sure to fail. The reason is that, though their voices have splendid quality, they lack sufficient volume, range and other essentials necessary for the stage. To reveal the true nature of the voice and prevent a singer choosing a career to which he is essentially unsuited, a Hungarian vocalist has devised a voice tester. It is said to register and indicate the tones with respect to volume and range especially, and the results are held as a fair index of the singer's vocal equipment, whether it would justify training for the operatic platform or not.

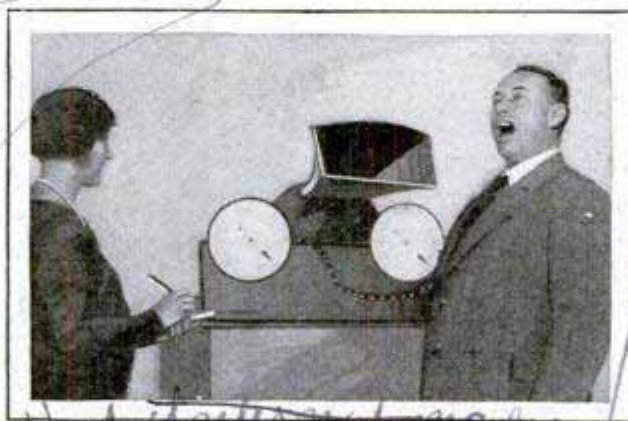

Registering His Voice on Tester Which Is Intended to Show Singer's Possible Fitness for Stage

Joseph Liskey



Learning the Fine Arts of Milking at the Canvas Udders; One of the Lessons at English Dairy School

DAIRY SCHOOL'S CANVAS "COWS" AID IN MILKING LESSONS

Men and boys in England who seek positions on farms in Canada, are often given special training before they go, so that they will be able to start their work without the handicap of inexperience. In one preparatory "school" for prospective dairymen, milking instruction is given with the aid of canvas udders. The lessons teach the correct hand positions and other details essential to a successful milker.

3937
SEEDLESS TOMATOES

A variety of seedless tomato has been produced, after five years of experimenting, by a Kansas man. One of the vines is thirty-seven feet long and the largest tomato it yielded weighed just an ounce less than four pounds. The grower declares that he is not satisfied with his product, as he wants to cultivate one that is sweeter and smoother. He said that he had once grown a seedless watermelon, but that the short season in which the crop can be produced forbade a development of it at a profit.

H. S. Klasse in Newton, Kans

Cont Eric Bergenthal Box 1691
 Johannesburg S. A.

*M. K. ...
114 E 16th St
New York*

38



Harmonica Horn with Its Reed-Chamber Mouthpiece; It Produces the Tones of a Double-Bass Tuba

BIG HORN LIKE A HARMONICA IS EASILY PLAYED

Said to be more easily played than a double-bass horn, but serving much the same purpose as that instrument in an orchestra, a large-size harmonica unit has been introduced. Its music is produced by two series of reeds, set in chambers like those of the ordinary harmonica. The horn serves as an amplifier for the tones, and the instrument is played by blowing instead of alternately blowing and drawing in the breath, as is the case with a mouth organ.

CARRIER TELEPHONE RESTORES FLOOD-BROKEN WIRES

Faced with the worst disaster in its history when New England was recently swept by floods, the telephone company broke all records in restoring service by installing carrier-current phones on some of its principal lines. These phones are a form of wired wireless, in which the conversation impulses are converted into radio waves and dispatched along the existing telephone wires. They supplement

the capacity of the wires, providing additional talking channels without the expense of stringing extra wires, but, more important still, they will jump breaks in the wires, follow them when they have been torn down by storms, and even pass through when the pole lines have been submerged by flood. The New England Telephone company had ordered ten carrier-current outfits, to be delivered next summer, but when the flood came a California company heeded an SOS from New England, waived delivery on equipment which had been built for it, and allowed it to be sent to the flood district. The deal was arranged by long-distance telephone at noon on Nov. 11, drawings were shipped by air mail from Chicago that night, and the machinery started the same day by express, the first lot reaching Boston on the fourteenth.

RUBBER BULB BREAKS-IN PIPE AND HELPS CLEAN IT

Breaking-in a new pipe is usually an unpleasant process, but most of the difficulties are said to have been removed with the aid of a small rubber bulb and tube arrangement, which accomplishes in a few moments what a smoker generally would not attempt to do in less than a day or so. The tube is attached to the stem, the tobacco lighted and the bulb pressed at rapid intervals, the bellows and suction action drawing the smoke out rapidly and giving the pipe the equivalent of actual use. After consuming an ounce of tobacco in this way, the pipe is usually

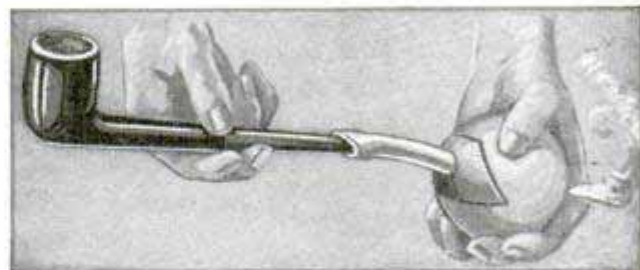

Pipe-Breaker Bulb in Action; Fumes Are Sucked Out to Rear of Ball and Help Clean the Pipe

ready for the smoker. To clean the pipe, the cake is thoroughly scraped out, a filling put in and smoked rapidly with the bulb. The heat generated usually leaves the bowl sweet and dry. Many pipe experts agree that neither bowl nor stem should be washed or any liquids applied.

38 91

*Carl J. N. Hollingsworth
168 1/2 St. ...*

*Albert Breitung
Sherman Hotel*



Blowing Up the Rubber Boat to Give the Motorcycle a Ride; the Collapsible Floats Have Been Found Increasingly Useful in the French Army, Where Special Development of the Motorcycle Is under Way

**RUBBER BOAT FOR MOTORCYCLE—
LATEST ARMY AID**

Motorcycles have become increasingly useful for army service and are now made all the more effective by the introduction of rubber boats on which they can be floated across streams and other bodies of water. The boats are somewhat similar to those used for life-saving purposes and can be quickly inflated.

3804

**"FOUR-IN-ROW" CHECKER GAME
TESTS PLAYERS' WITS**

Checker players are reviving a game that was popular fifty years or so ago, an interesting adaptation of "tick tack too," the familiar paper or blackboard game. The object of the game is to place four men in a row, vertically, diagonally or horizontally.

	1	2	3	4
5	6	7	8	
	9	10	11	12
13	14	15	16	
	17	18	19	20
21	22	23	24	
	25	26	27	28
29	30	31	32	

horizontally. The colored squares of the board are used, each player placing a man alternately. By careful blocking, an opponent can prevent his rival from doing this, even

Cmt. Richard Canning
215-9 11 St

though he has the advantage of the first move. The board is used in the chess position with a white square at the lower right-hand corner.

3770

**PINCH TELLS TIRE PRESSURE
WITHOUT TOUCHING VALVE**

By pinching a balloon tire, the motorist can tell with fair accuracy if it needs inflating, and now *Aut. Pressometer* the pinching process has been adapted to a pressure gauge which gives a reliable report of the tire's contents without removing the

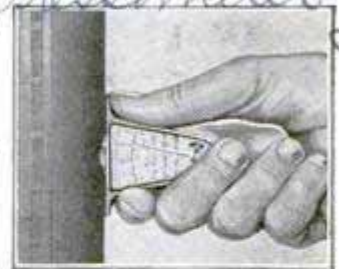

valve cap. The instrument is pressed against the wall of the tire at the side. In doing so, an extension plug which works against a stiff spring in the tester, depresses the tire more or less, according to the air pressure within, and the degree to which the tire opposes this depression is registered on a dial, giving the equivalent of the air pressure in pounds. The device slips into a small holder that can be carried in the pocket and five tires can be tested in about half a minute.

J.W. Gindre & Co. Ltd.
37 Pomeroy St New

Victoria Gardens, Ladbroke Road, London, W.11, Eng.
Hill Gate

Two Pounds



YOU'VE all seen it: The 200-pound man trying mightily, but all in vain, to lift the 110-pound lady from the floor.

You've all heard it: The disgruntled remark of the 200-pound man as he left the stage, neck bulging and forehead beaded: "Whew! Just . . . two pounds . . . less than an elephant!"

And the little lady smiles, receives her \$300 per week, and enjoys the awed plaudits of the public. And the public is entertained and mystified. And backstage, a group of cynical stagehands eye each other knowingly and whisper "applesauce" after the act is all over.

The first acts of this type, notably that of Miss Lulu Hurst, the "Georgia Wonder," were, on the whole, quite legitimate, the various effects being based almost exclusively on the pivot-and-fulcrum theorem of physics. But the majority of weight-lifting acts today are largely faked, and

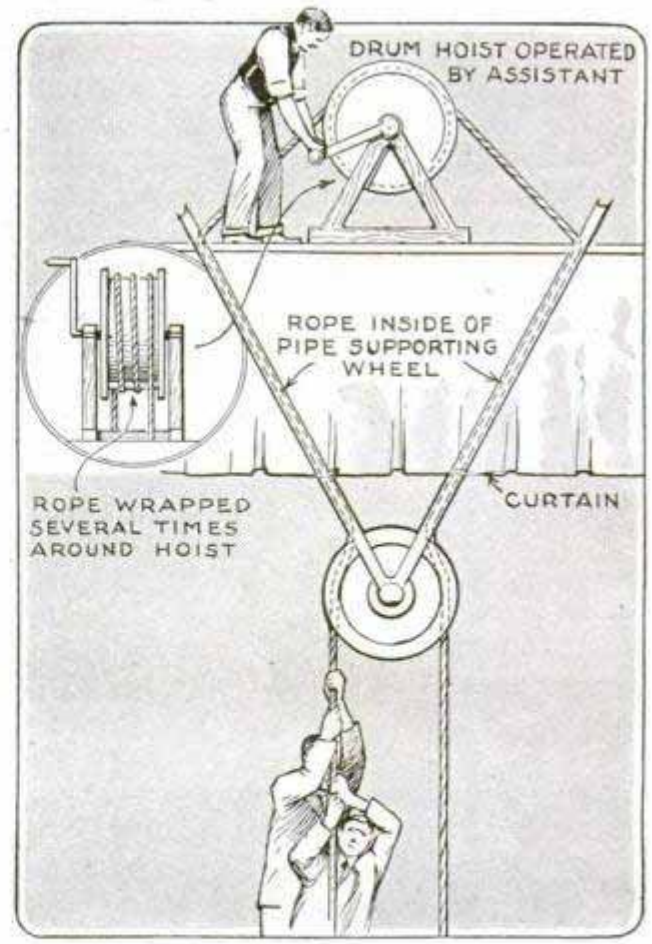

One Small Miss Can Lift a Flock of Weighty Men into the Air, When the Rope of Her Trapeze Swing Is Rigged as Shown in the Diagram; a Stage Hand Does the Real Work

Less Than an Elephant

what was once a scientific demonstration, even to stagehands, has now come to be labeled as "a lotta applesauce."

One of the best examples of this pseudo-weight-lifting is the "Swing Lift." In this effect, recently rather popular, the only visible equipment is a fifty-foot length of rope, which runs from the floor of the stage, up through a large wooden wheel suspended from the flies, and then back to the floor again. One end of the rope is looped together to form a swinging seat; the other end hangs free.

The performer, after giving a short demonstration of body lifts and similar experiments, seats herself in the swing. Her stage manager then invites several husky men to come up on the stage. They come—muscular well-built men, aggregating a total weight of at least 700 pounds. They are requested to take the free end of the rope and pull.

"All together now!"

Up goes the 110-pound lady into the air. Easy! And then the 110-pound lady begins to take on weight. You see her body tense as she applies her "uncanny magnetic force." You see the wheel begin to revolve slowly. You see the five men clutch wildly at the rope. The wheel turns faster. And the young lady is down on the stage, while the five-man ballast is left suspended in mid-air. Seven hundred pounds of baffled manhood leaves the stage. One of them usually grunts:

"Whew! Just...two...pounds...less than an elephant!"

* The explanation of this effect is quite

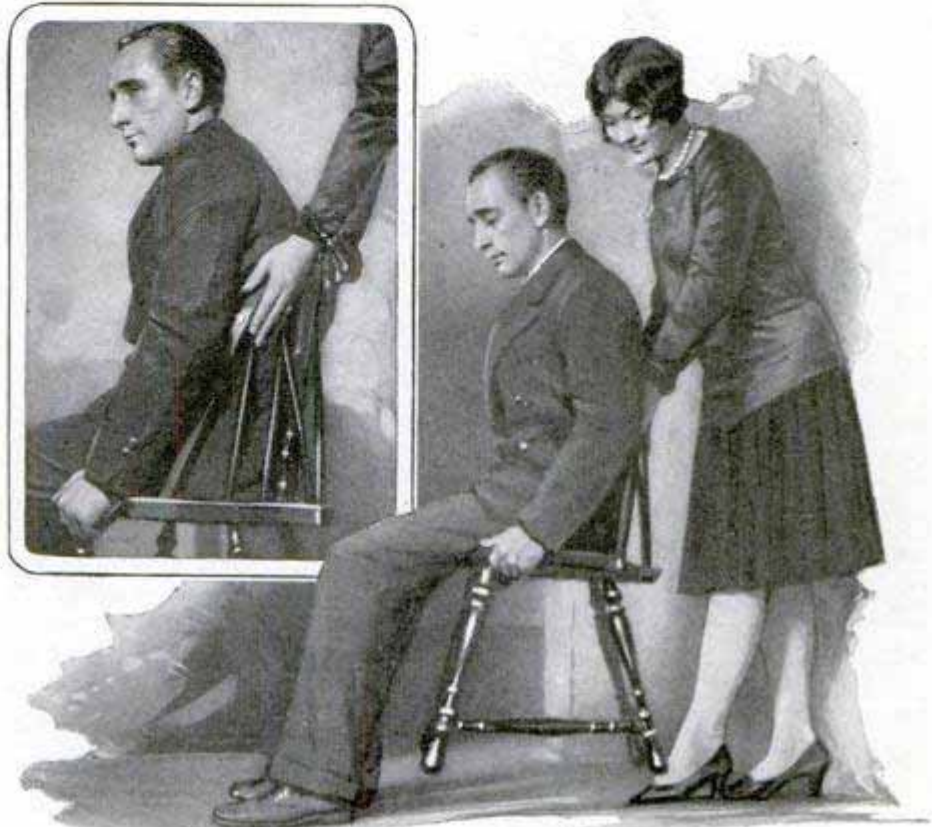

It Looks Hard, But If the Sitter Is Rigid, a Twenty-Pound Push on the Chair Back Apparently Lifts Him

simple, as the sketch will show. The rope, instead of running up around the wheel and back to the floor, as is generally supposed, really runs up to the wheel, then up one of the pipes which support the wheel, around a drum hoist concealed in the flies, back down another of the pipes, onto the wheel again, and down to the committee of men on the stage.

An assistant operates the hoist. Without his hand on the lever, the rope plays back and forth quite freely. On the signal from the stage manager, however, he rests a "magical" hand on the hoist, gives the crank a few turns, and—presto!—down goes the 110-pound lady; up comes the 700 pounds of bewildered masculinity. Then the rope is allowed to go completely through the wheel and fall in a pile on the stage floor—mute evidence that the whole effect was absolutely "on the square."

The illusion just described is usually the feature of a modern weight-lifting act. As a preliminary, the performer invariably



presents a few carefully selected experiments of a similar nature in order to subtly mold the minds of her audience into a receptive state for her concluding effect.

Most of these preliminary experiments require considerable practice for their successful demonstration, but there are many striking effects in this field which can be easily duplicated by anyone. One of the best of these is the "Chair Lift."

Try to imagine the effect for yourself. Suppose you were the girl shown in the picture. Do you think that you could lift the chair on which the man is seated, completely free of the floor, without any great physical exertion on your part? It doesn't seem altogether feasible, does it? Yet the trick can be done, as shown in an accompanying picture, with a minimum amount of physical strength.

Let me explain: The person seated in the chair must be instructed in three very essential requirements, as follows:

1. He must keep his feet firmly on the floor.

2. He must grip the chair seat firmly.
3. He must hold his body, arms and legs absolutely rigid.

That's all there is to it! If you will rest your hands on the back of the chair and press straight forward, not attempting to lift the chair at all, you will find that a push of about twenty pounds will elevate the chair several inches.

Considering still simpler, but none the less effective and mystifying tricks of this nature, we come to the "Finger Snap." In this experiment you ask the biggest man in your audience to place his two fists together, one on top of the other, as shown in the picture. He is somewhat surprised when you knock his fists apart by simply snapping your two

index fingers against his hands. And, paradoxical as it may seem, the tighter the strong man holds, the easier his fists will fly apart.

Try this one: Place your two forefingers together in front of your body, as demonstrated by the girl



The Five-Finger Lift, Top, and, Bottom. How to Defeat a Lifter Who Could Easily Raise the Weight by the Method Shown in the Center



The Whole Crowd Can't Force Your Body against the Wall When You Stand as the Girl Does Above

in the accompanying illustration. You will find that you can successfully resist the efforts of the strongest man to pull them apart. The only conditions imposed on the "puller" is that he stand squarely in front of you, and that he pull steadily in a lateral direction. Your job is to press your fingers together as tightly as possible.

A parallel to the preceding effect is found in the "Hand on Head Lift," which also is illustrated. With her hand pressed firmly down on her head in the manner shown, the girl subject can easily resist the effort of any single person to raise her hand from her head.

An effect which demonstrates the power latent in a single finger is known as the "Five-Finger Lift." In this effect, four men, using a combined lifting power of five fingers, easily lift a 130-pound woman several inches from the floor. All that is necessary is that they place their fingers at the points indicated in the picture and lift in unison. Up she goes!

A test made famous by Annie Abbott, known as the "Press to the Wall," can be successfully duplicated by any athletic young woman. In this test the subject



Clenched Wrists Can't Be Held Together When Extended Forefingers Are Snapped against Them, as Shown in the Pictures Above

3649
406



young lady defying the efforts of the man to raise her from the floor. The position is the whole thing. Notice that the hand on the wrist and the hand on the jugular-vein region of the neck force the lifter to assume a semi-crouched position, at arm's length from the subject. In such a position his lifting strength is practically nil, since the position which he must assume gives him virtually no leverage with which to carry a weight upward.

Another straight lift defies the combined

muscular strength of four men. In this test, the lifters raise the subject by grasping her under the elbows and hands as shown on this page. You will note that, when the lift is allowed, the subject holds her elbows close to her body and tenses her shoulder muscles. To prevent the lift, she allows her elbows to hang loosely, away from her body, while

takes her place as shown in the illustration. By making her arms and body perfectly rigid she can easily resist the combined forces of five or six men trying to press her to the wall. As many as twenty-five or thirty men have been used in this effect for stage presentation; the resisting power of the woman is astounding.



Still coming in for a considerable share of the glory in the average weight-lifting act is the simple "Body Lift." In this lift the performer demonstrates that he (or she) cannot be lifted when he "so wills it" by even the most powerful man. The body lift is a perfectly legitimate piece of science, and although it is not so easy of duplication as the preceding experiments, it is quite possible for practically anyone to develop sufficient technique to defy the efforts of any but the strongest men.

Figures on page 404 illustrate this lift. The center picture shows the position in which the lift can be successfully made. Notice that the lifter can stand close in and erect. The lower figure shows the



It Is Impossible to Lift the Hand from the Girl's Head, Top; Center, Four Men Can't Lift a Girl Whose Arms Are Relaxed, While Two Do It Easily, Below

her shoulder muscles are completely relaxed. Such a posture on her part forces the lifters down into a semi-crouch position where they can exert but little direct pressure upward.

A peculiar stunt, and one which was used during the war as one of the tests given aviators, involves the reflex action of the muscles, although it isn't in any way a "strong man" stunt. The trick is to stand near the wall or some other solid object and press the back of the hand tightly against the wall, holding it there, with all the pressure the arm muscles can exert, for a minute or more. Then allow the arm to drop to the side. Immediately the hand, of

its own volition, will be drawn back toward the wall just as a metal pendulum might be drawn by a powerful electric magnet. The pressure exerted during the minute the hand is in contact with the wall cramps the muscles in that position, so they seek to return to it again.

The principles involved in many of the strong-man stunts on the stage have very practical applications in ordinary life. Take weight lifting, for example. The same method that makes it easy to pick up a person should be applied lifting a heavy weight, a wheelbarrow, for example. The workman who bends over from the waist and picks up the wheelbarrow handles is throwing all the burden on his back muscles, and may strain them seriously. If he bends at the knees,



Try Pulling a Friend's Extended Forefingers Apart After the Tips Have Been Pressed Firmly Together

then lifts the handles as he straightens up, the much more powerful leg muscles do the work and the strain on the arms is down from the shoulders.

"SILENT PARTNER" FOR TENNIS HELPS DEVELOP SKILL 376 2

and
Rene Lacoste, French tennis star, owes some of his cunning with the racket to a contrivance of his own invention, an apparatus that hurls the balls at him from the other side of the net and from various angles so that he can practice difficult shots. The outfit may be operated by an electric motor or by turning a hand crank and is adjusted to develop strokes that would be required only in playing against a skilled opponent.



Loading the Tennis "Gun"; Lacoste Is Seen Supervising the Operation; He Devised the Unit

FISH TAIL ON BOAT PROMISES GREATER SPEED

*Dr. W. Johannes Plum
Cold Springs Harbor NY*



Close View, Showing the Fish-Tail Stern of the Craft, Whale-like Shape of the Boat, and Mrs. William B. Leeds at the Wheel



aboard, setting what was claimed to be a new record for combined speed and weight carrying. The attachment is of duralumin and is raised or lowered by compressed air. On the craft that made the high-speed record, it was about six feet long and four feet wide. By adding this device to boats, engineers see a way to greatly increase speed without amplifying the motor power, and it is believed that it is also suitable for use on torpedo boats and other small naval craft.

Faster motor craft for sport, business and war are promised in the application of an interesting unit to the stern. It is shaped like a fish's tail and serves about the same purpose on a boat as the lateral controls on an airplane. It enables the craft to skim across the water instead of cutting through it. In a recent test, a motorboat so equipped raced across Long Island sound at a speed of more than a mile a minute with twenty-four persons

AMERICAN GOLD SENT ABROAD FIRST TIME SINCE WAR

3870 million dollars in gold coins, packed away in stout kegs in the treasure vault of the "Aquitania," sailed out of New York harbor recently, bound for England. That was the first time since the early

12/9/27

3792

Price \$37.50

days of the war that Great Britain had received gold coins from this side of the Atlantic. For thirteen years the movement had all been from east to west. Gold is shipped whenever the value of the exchange bills of one country rises enough above par to offset the shipping charges, insurance and loss of interest on the money itself while in transit. To ship gold from New York to London at a profit, it is necessary for English bills of exchange to be quoted in New York at two and one-tenth cents above par for the pound, in other words at $\$4.88\frac{3}{4}$ for the English pound, par for which is $\$4.8665$. When the million in gold was shipped recently, the pound was not quite that high, being a half cent below the mark, but the prestige of being the first to ship gold eastward across the sea in thirteen years apparently offset the slight loss. Several million dollars in gold recently was shipped to South America, the two consignments being the first to tap America's great wartime hoard of gold, which reached $\$4,500,000,000$, or about forty per cent of the total supply of the world.

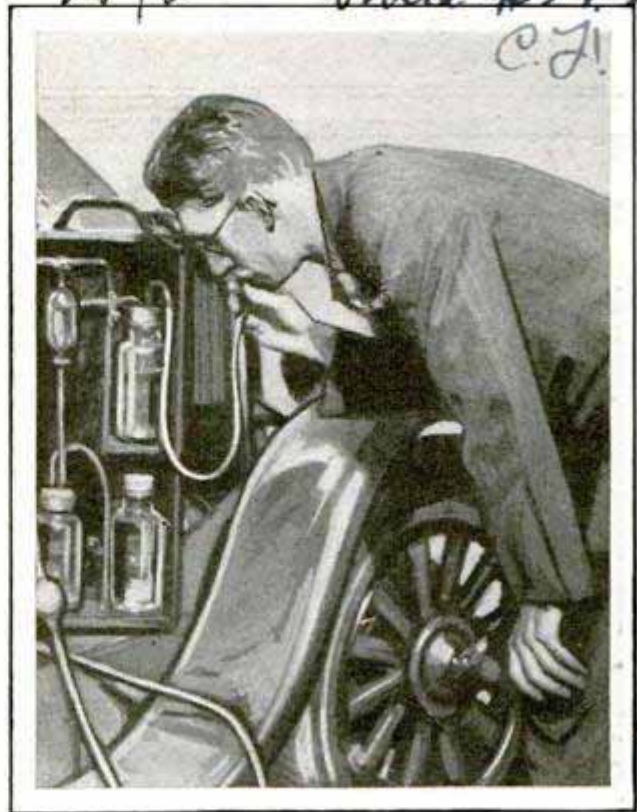

Testing Auto's Exhaust Fumes, to Determine if the Carburetor Has Been Adjusted Properly

TESTING AUTO EXHAUST GAS HELPS SAVE FUEL

As an improvement over the usual method of adjusting the carburetor, a process has been developed that makes use of a simple testing apparatus to examine the exhaust from the motor and so tell accurately if the proper combustion has been effected. It is similar in some respects to the outfit used in making an analysis of flue gases in steam-generating plants. The auto-exhaust tester gives an exact measure of the amount of carbon dioxide in a sample of the gas, so that adjustments of the carburetor can be made until the proper amount is registered. But little skill is necessary in operating the tester.

Interior photographs are being made with the welding arc.

DUSTLESS FURNACE ASH PIT HELPS SAVE COAL 3817

The unpleasant task of removing ashes from the furnace has been simplified by a pit and bucket arrangement, easily installed and designed to save coal and protect the grates. The pit is at the rear of the furnace and holds the bucket which has a handle at the top. Ashes are simply scraped back into the container through a chute and the bucket is lifted out for dumping. By this method, no dust can escape into the furnace room, the draft is improved and there is no danger of dropping live coals on the floor while emptying the ashes. The bucket fits tightly against the sides of the pit.

Batterswick 05 98



Drawing of Ash-Pit Installation, Showing Ease of Disposal of Ashes without Dust

A. B. Meyer, 2664 Burling St.

Rowell Technical Supply Co
 1704-08 Fifth Ave, Pittsburgh, Pa

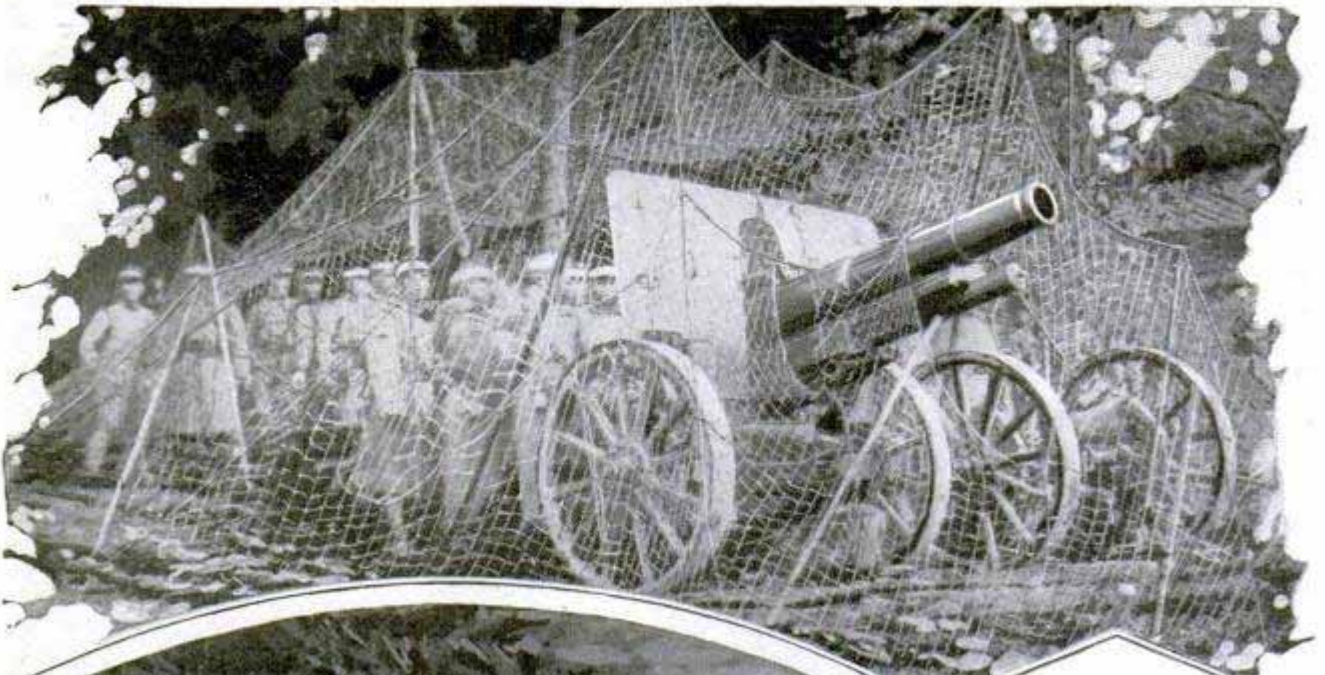
3511
 JAPAN DRILLS ARMY TO USE LATEST WEAPONS

Lessons of the World War, Reflected in the Latest Types of Weapons, Were Taught in the Recent Maneuvers of the Japanese Army, Held in the Shadow of the Sacred Mountain Fujiyama; Above Is a Heavy Field Gun Covered with a Protective Net, on Which Branches Can Be Thrown to Defeat the Eyes of Prowling Airmen; at the Left Is a Light-Machine-Gun Party Advancing into the Open with Wisps of Rice Straw Used for Camouflage; Below, a Group of the Latest-Model Armored Tanks Advancing down a Country Highway

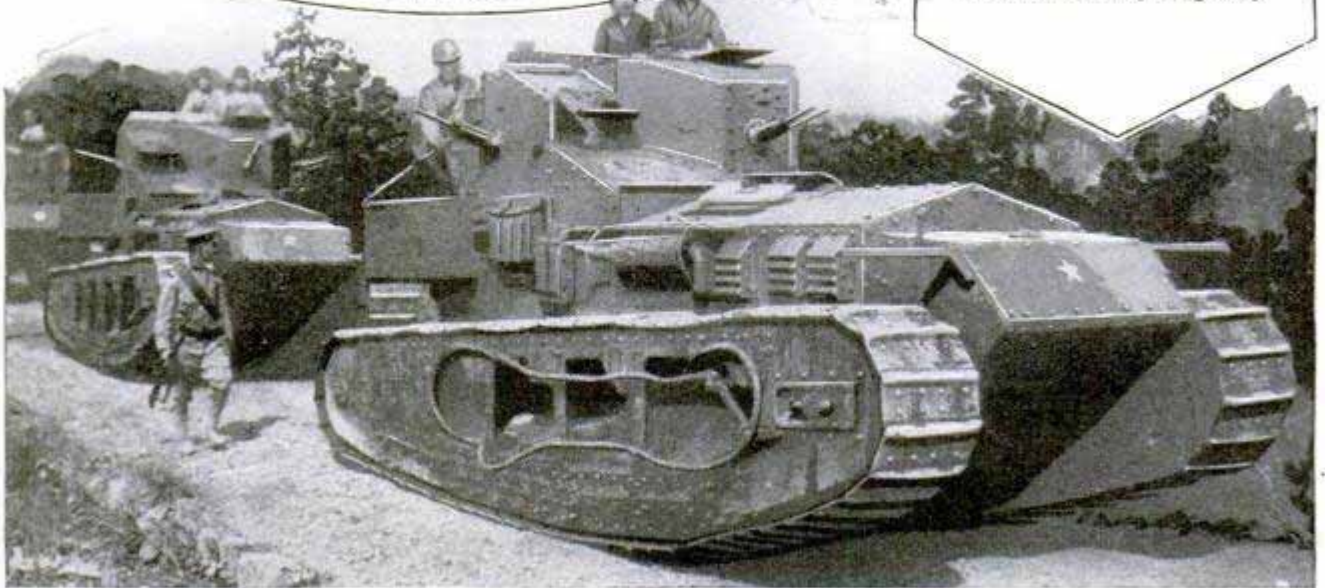

Posh

3865

SUN HEATS WATER FOR HOME

3694

Successful utilization of the sun's rays to heat water for home use, has been accomplished, it is reported, with a simple coil installation a western company has introduced. In sections favored with sunshine most of the year, the system is said to be effective during eight of the twelve months and stores sufficient hot water for night consumption. If desired, a gas-burning heater may be added to the outfit to supplement the sun during times of cold or cloudy weather in winter. A glass-covered, shallow box, containing sheets of copper and coils of pipe that lead to a storage tank, is an essential part of the apparatus. These coils hold a mild solution of alcohol and water, which is kept in circulation by the normal action of heating and cooling, and distributes their heat to warm the water in other pipes within the insulated storage tank. The liquid in the coils is never used, merely serving as the heating medium. The "window box" and pipe coils may be installed in almost any position where exposure to the sun is assured. Some users adapt it to the roof of the house or the garage, as an awning over a back porch or as part of a pergola. At an army balloon school in Arcadia, Calif., it is placed on the ground. After the installation, there is practically no maintenance expense.



Where Autos Will Pass through a Skyscraper; One of the Drives That Leads into the Huge Building as It Appeared under Construction

International

AUTO ROAD THROUGH BUILDING HELPS RELIEVE CONGESTION

Instead of having to go around the structure, autoists will be able to drive through the thirty-two-story Grand Central skyscraper being erected in New York city, for a roadway is laid directly through the center of the building. It is one story above the street level and leads into the recently improved Park avenue. Two viaducts join and pass through the building. Cars pass to the street levels on ramps.

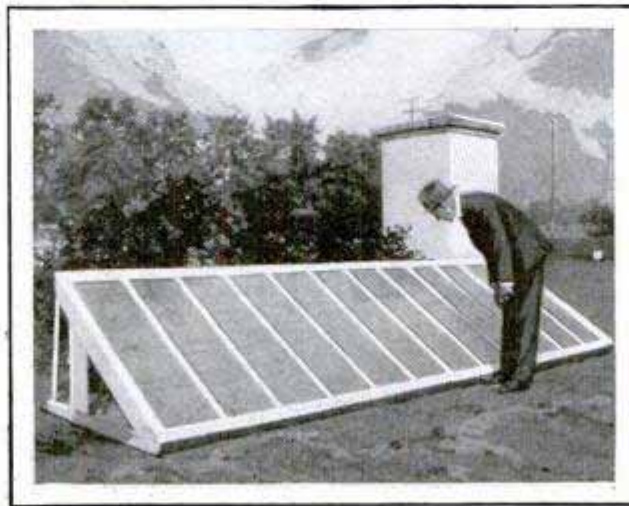

Water-Heating Plant That Utilizes the Sun; the Storage Tank Is Seen in Background at Right

2720 Maryland Baltimore Md

Buffalo N.Y. Sept. 35
594 Main St

FLOODS CAUSE FIRES



It seems a paradox that waters of a flood may prove the direct cause of serious fires, but such was the case after the recent high waters in Vermont. Fires were caused in barns because the hay absorbed water with the result that spontaneous combustion followed. The damp hay passes through a "heating" stage, due to the slow but steady absorption of oxygen which causes oxidation of the entire mass when conditions are suitable. In many cases, owners found it necessary to remove hay from the barns to prevent an outbreak of fire. Spontaneous combustion is one of the most common causes of blazes. It is frequently the result of piling oil or paint-soaked rags where the heat is stored up and increases. Coal is often ignited by heat developed in the pile.

Drawing of the Lenses in Actual Use; Focusing Is Accomplished by Moving the Larger Glass Backward or Forward

C. Far \$2.00.
VEST-POCKET TELESCOPE SET HELPS HUNTER AND HIKER

As a substitute for the ordinary binoculars or field glasses, a pair of lenses that fits in a small case for the vest pocket, has been introduced. To use them, the smaller is held close to the eye and the larger about at arm's length. Focusing is done by moving this larger glass backward or forward. The magnifying power is more than five diameters, adjustment is quickly accomplished, and the bother of a heavier instrument avoided.

3769 SOUND OF PLANE LIGHTS LAMPS ON LANDING FIELD

Practical use of the grid glow tube has been made in an apparatus for lighting the electric lamps of an airport by the whirl of the airplane's motor. With this outfit, a pilot, 1,000 feet or more above the field, may be able to make a safe descent under

BUREAU HANDLES PHONE CALLS FOR ABSENT SUBSCRIBER

At small cost, telephone subscribers in Paris may have the service of a central bureau to handle their calls when they are away from home or office. The exchange is notified when the person leaves, and his line is plugged in at the main office. Calls are received there and are relayed by wire or letter to the subscriber when he notifies the office that he has returned. Messages may also be given to persons who call.



Receiver That Lights Lamps by Sound

difficult conditions, as the lights burst forth without the touch of human hand. A microphone picks up the whirl of the motor. These sound vibrations are transferred in such a way to the sensitive tube that it relays an electric current through switches that turn on the lights. The unit would reduce waste of electricity at airports.

Dr. S. M. Kuntner
Research Dept. Westinghouse

send inquiries to L. H. Learger
490 Broadway Buffalo N.Y.
Contributed by Switzerland 390
Emb. Percy Noel
International Club Geneva

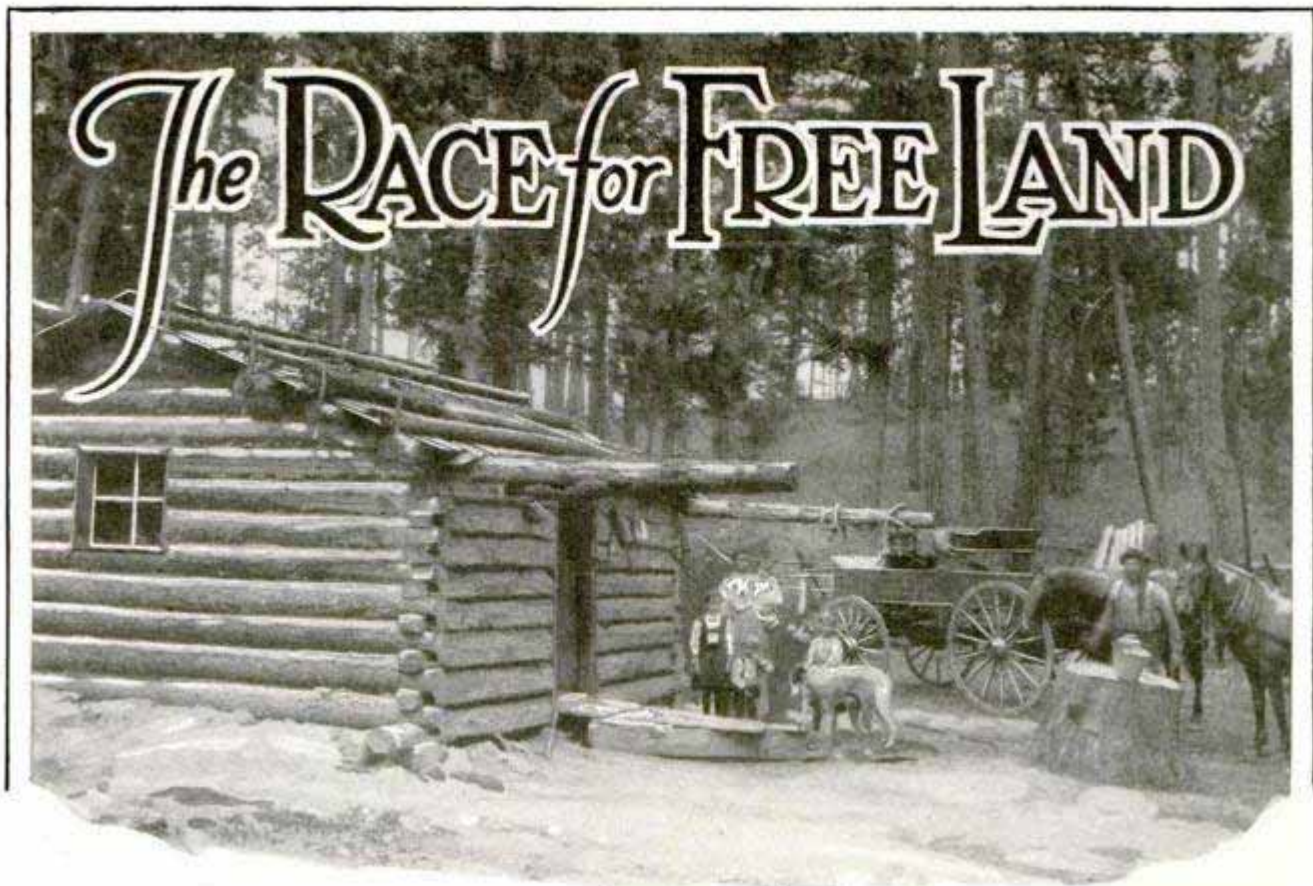

Typical Homestead on the Bitterroot National Forest in Montana; the United States Still Has Many Million Acres of Public Domain Open for Settlement by Pioneers

NEARLY two hundred million acres in the west and almost twice that much in Alaska remain of Uncle Sam's public domain, to be given away some day if settlers can be found who want it. Although thirty-nine years have passed since the greatest land rush in history, when Oklahoma was opened and settled in a single day, the public land-office figures show the government is far from being without open land for new citizens.

The drawback, however, is that the bulk of the land left represents the parts that have been passed over by settlers as undesirable, or claims which were once settled and then abandoned because they would not support the settler.

Some tillable areas can still be found, but most of the 196,056,747 acres, or at least that part of it which has been surveyed and so rendered open to settlement, is suitable for nothing but grazing land. There are still 56,919,013 acres remaining to be surveyed in the United States, while the larger part of the 376,165,760 acres of government land in Alaska has never been surveyed.

Most of the public domain left within
Land.

the states is concentrated in Utah, California, Wyoming, Arizona, New Mexico and Idaho, with occasional small parcels here and there in Kansas, Michigan, Mississippi and Wisconsin.

The gradual elimination of the old free west, when the cattle of the ranch barons roamed a thousand hillsides, will prevent any repetition of the spectacular scenes that marked the settlement of Indian territory, which later became the state of Oklahoma. The government itself barred further land rushes when it substituted the lottery system now used to dispose of desirable new parcels of public land. All the would-be settlers file their names and addresses in sealed envelopes, and on a given day they are drawn by lot, each in turn getting a numbered claim. The lotteries, however, apply only to the opening of entire new tracts following survey. Any of the surveyed and unsettled domain can be taken up at any time, 320 acres of non-irrigable and non-timbered land for dry farming, or 640 acres of grazing land for stock raising.

After the settler has picked the place he wants to live, he settles on the land, and



Chuck Wagon and Camp at the Beef Roundup of the Querna Verda Live-Stock Association on the San Isabel National Forest, Colorado; Grazing Is Permitted on the Forest Lands

must remain there at least seven months out of the year for three years. At least one-eighth of the land must be put into cultivation each year after the second until the time of final proof, and he must have a habitable house on the land at the time he receives his patent.

Under the old law, mineral lands were exempt from settlement and settlers lost their claims if minerals were found prior to the granting of the patent. That often worked a hardship, so, in 1909, the law was amended to permit issuing of patents, but reserving coal deposits to the government, no matter when found. In 1914, another law opened lands containing phosphates, nitrate, potash, oil, gas and asphaltic minerals, with the deposits reserved for the nation. All mineral findings are reserved when grazing-land patents are granted.

BIG INCREASE IN CANARY-BIRD IMPORTS TO U. S

Four times as many canary birds were imported last year as in 1922, according to reports from the department of commerce. Of the 556,417 birds arriving from

foreign countries, 374,895 were canaries. The mounting popularity of the songsters is believed partly due to improvements in their cages. These objects are more ornamental than formerly and, because of their efficient construction, are believed to make the birds feel more at home and so stimulate them to sing.

EXPANDING CORK FOR BOTTLES FITS DIFFERENT SIZES



Suitable to bottles of different sizes, stopper now on the market consists of a turning key that twists a little sliding plunger below against a rubber washer until it fits tightly against the neck of the bottle. Since the washer is soft, there is little danger of breaking the glass and pressure is applied evenly. To remove the cork, the key is simply turned in a reverse

*Abbey Hays Co. Eng.
142
Westminster*

3940
Kansas City Star
12/11/29

Westminster Key Ltd
142 Abbey Hays

12/12/27

merchandising

3860

direction. Some of the stoppers of this kind are fitted with keys that can be removed so that the bottle is securely locked against opening by accident.

OX TEAMS SUPPLANT ENGINES FOR SWITCHING CARS

3919

Oxen, a principal form of motive power centuries ago, are linked with modern industry in Navasota, Tex., where the animals are used to switch cars at a cottonseed mill. It was found that the long delays in waiting for the locomotives to do the task were too expensive, so the oxen were tried as a substitute and proved satisfactory. Six can pull more than 200,000 pounds on the rails. One yoke, recently sold, could handle a box car alone. Large Texas steers with long horns are used and appear to thrive at their labor. They are fed cottonseed meal and become sleek and fat. An experienced driver is required to handle them.

EASY-TO-EMPTY WHEELBARROW NEEDS NO BLOCKING

2618

In emptying many wheelbarrows, the wheel has to be blocked, if on a slight downgrade, or it is difficult to throw the handles up. These obstacles are said to have been overcome in a barrow introduced in France. It is designed especially for heavy loads, the wheel being set far back and the ends arranged so that they strike the ground when lifting, providing a fixed fulcrum.

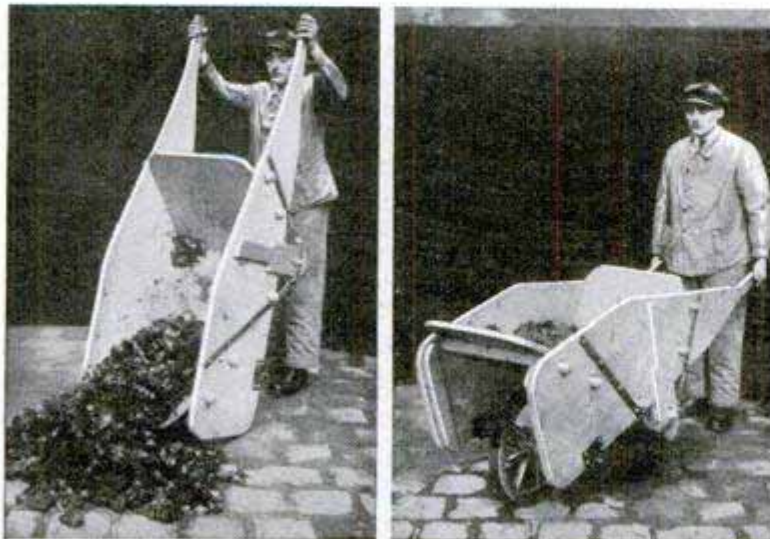

Dumping the Wheelbarrow without Blocking, and Front View, Showing the Wheel Placed Far Back and the Roomy Body

Write H. M. Delano 16 Rue

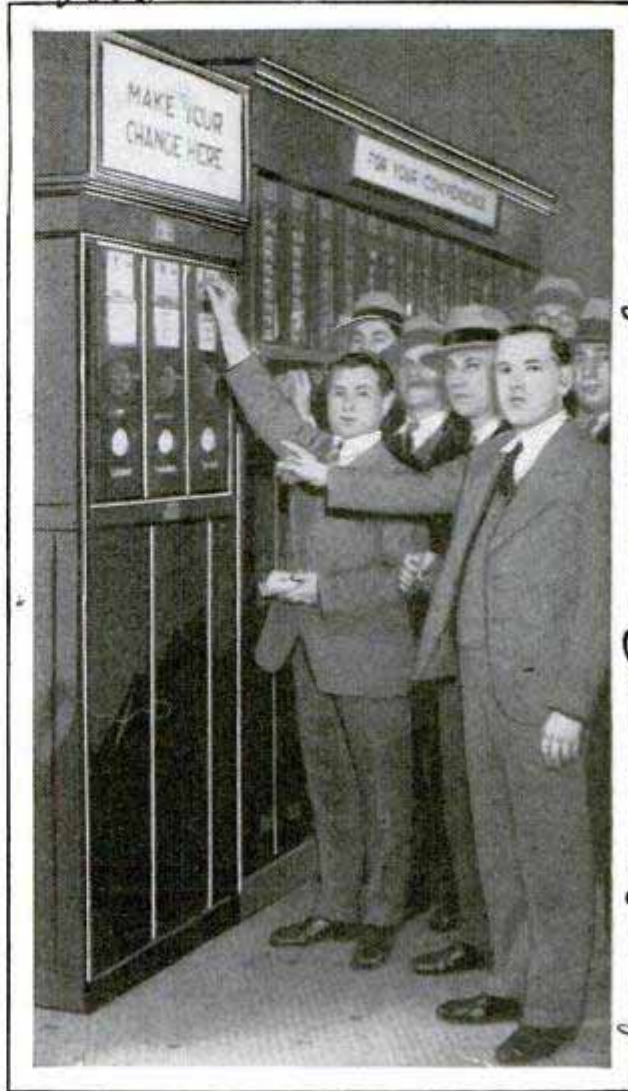

Customers Eager to Try the Cigaret Slot Machine; It Distributes Various Brands and Boxes of Tobacco

SLOT MACHINE FOR CIGARETS DISTRIBUTES MATCHES TOO

Cigaret purchasers may obtain a packet of their favorite brand, a package of matches and a coupon just by dropping a coin in the slot of a rapid dispenser unit introduced in New York city. The outfit saves the clerks' time, takes up but little room in the store and affords display space for the goods.

United Cigar Store 3rd. Broadway
CHINESE IMPORT BROKEN GLASS FOR NOVELTIES 3938

In China, broken glass is valued by manufacturers who work it over into various kinds of novelties. Large quantities are being imported from the United States and almost all kinds of glass are salable, the white-bottle variety being the most desirable.

western cities only

Sanitary Postage Service Corp.
Attn: H. J. Clark
285 Madison Ave. New York

u/30/27

Pulverizer General Implement Co

*William Curtis head Rural
Engineering Dept. at Purdue
Canton Furnace Mfg. Co.
Canton, Ohio*



Pulverizing the Soil as It Is Plowed; Rotary Attachment on Tractor Unit at Purdue University.

ROTARY PULVERIZER ON PLOW SAVES FARM WORK

Attached to the rear of the tractor plow a rotary pulverizer, developed at Purdue university, has proved effective in refining the furrow slices for immediate planting, saving a separate harrowing. The turning blades beat the soil into fine particles, and the operation is said to add but little to the load on the tractor.

BETTER HEAT AND VENTILATION WITH FURNACE FAN

Easily fitted into the cold-air pipe of the hot-air furnace, an electric fan, supplied with current from a lighting socket, gives four complete changes of air to every

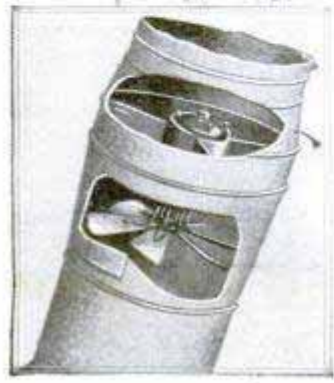

room in the house each hour, thus promoting health and increasing the efficiency of the furnace. When not in operation, the fan folds up, giving full free-air capacity in the pipe for circula-

tion by gravity. As soon as the current is turned on, the blades are opened by centrifugal force.

RED WALLS FOR SMALLPOX 3859 PATIENTS URGED

Painting the walls of a smallpox patient's room red will aid recovery and reduce the chance of disfiguration through pitting, according to Prof. F. Gregoire, of Marquette university, Milwaukee, who has been making a study of the use of color in treating disease. The knowledge that red surroundings were of benefit in treating smallpox has been in existence ever since the time of the Roman empire, he says, but was lost to the modern world until recently. The rays thrown back by red walls ease the skin tension. Black and white, Prof. Gregoire says, are very depressing and should not be used extensively in hospitals because they tend to retard recovery. Tan and reddish colors as well as green tend to stimulate the patient's nervous system and hasten recuperation. Operating rooms, he says, should be painted green as the color relieves the surgeon's eyes and minimizes the chance of errors in operating.

ROLLERS TO IRON OUT FENDERS 3586 REDUCE REPAIR BILLS

Dents in the automobile fenders can be easily smoothed out by an amateur workman in his own garage, it is claimed, by the use of a large and a small roller recently introduced. One is for the rim and edge of the fender and the other, the larger, for the top. Pressure is applied by screwing down the upper wheel of the bracket. The roller

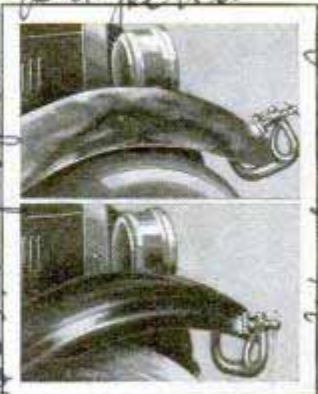

is first run free over the fender, tilted slightly forward until the necessary pressure is obtained, and then passed over the dent with long easy strokes. If the kink or dent is deep and sharp, it is raised with a hammer before the rolling.

*Herman Johnson
1910 Russell Ave*

Chicago - William Jenson, 1460 Byron St.

205 Union League Bldg.
Chicago
Los Angeles, Calif.

BATTLING THREE-YEAR PEAT FIRE IN SNOWSHOES



the burning district has protected its tracks by digging deep trenches parallel to the right of way and filling them with wet sand. Arrangements have been made with an oil company to pipe sea water through its mains and flood the area, if necessary, to prevent the fire from undermining the residential territory near by. If the flooding scheme has to be carried out, it will require the construction of a dam around the entire twelve-acre plot and filling the inclosure with water to a depth of several feet.

Snowshoes, oil-well pipe lines to carry sea water instead of oil, trenches filled with wet sand, and other unusual methods are being enlisted in Los Angeles to extinguish a peat-bog fire that has been burning for three years. The blaze is smoldering within the areas of an exclusive residential district and has threatened the destruction of homes within sight of the city hall. Not long ago, three children became bogged in the area and were seriously burned, one fatally. The fire had spread over twelve acres at that time. City officials have estimated that it will cost at least \$14,000 to extinguish the fire which, in places, is burning between fifteen and thirty feet underground. To make a survey of the district, men at first attempted to walk about on foot, but the danger of sinking into the soft ashes and being burned was too great, so snowshoes were worn to support them. Trenches, ten feet deep, were dug in some parts of the area and pumped full of water. Chemicals have also been used. Drums of a fire-smothering substance are emptied into deep holes, and the resulting fumes have been effective in stopping the blaze. An electric line that runs through

Water Trench Dug to Curb Spread of Fire, a Warning Sign in Danger Area, and Crossing the Burning Tract on Snowshoes

RESERVOIR IN WOODEN CANDLE
378 SUPPLIES OIL TO WICK

Wooden candles have proved desirable substitutes for those of tallow in decorating, as they will not bend or sag under high temperatures, but their practical service has been limited in that they cannot be lighted. This drawback has been overcome in a wooden candle with a small reservoir to hold fuel, which is supplied through a wick. A metal tip prevents burning the wood and keeps the end bright.

Our Bureau of Information will answer all questions regarding articles appearing in this magazine.

W. Adams St.

Cand. L. Ite Mfg Co.
Hotel

Cand. L. Ite Mfg Co.
Benjamin Franklin Hotel, Phila

353 4

TRUE STORIES

Tell Tale Typewriters

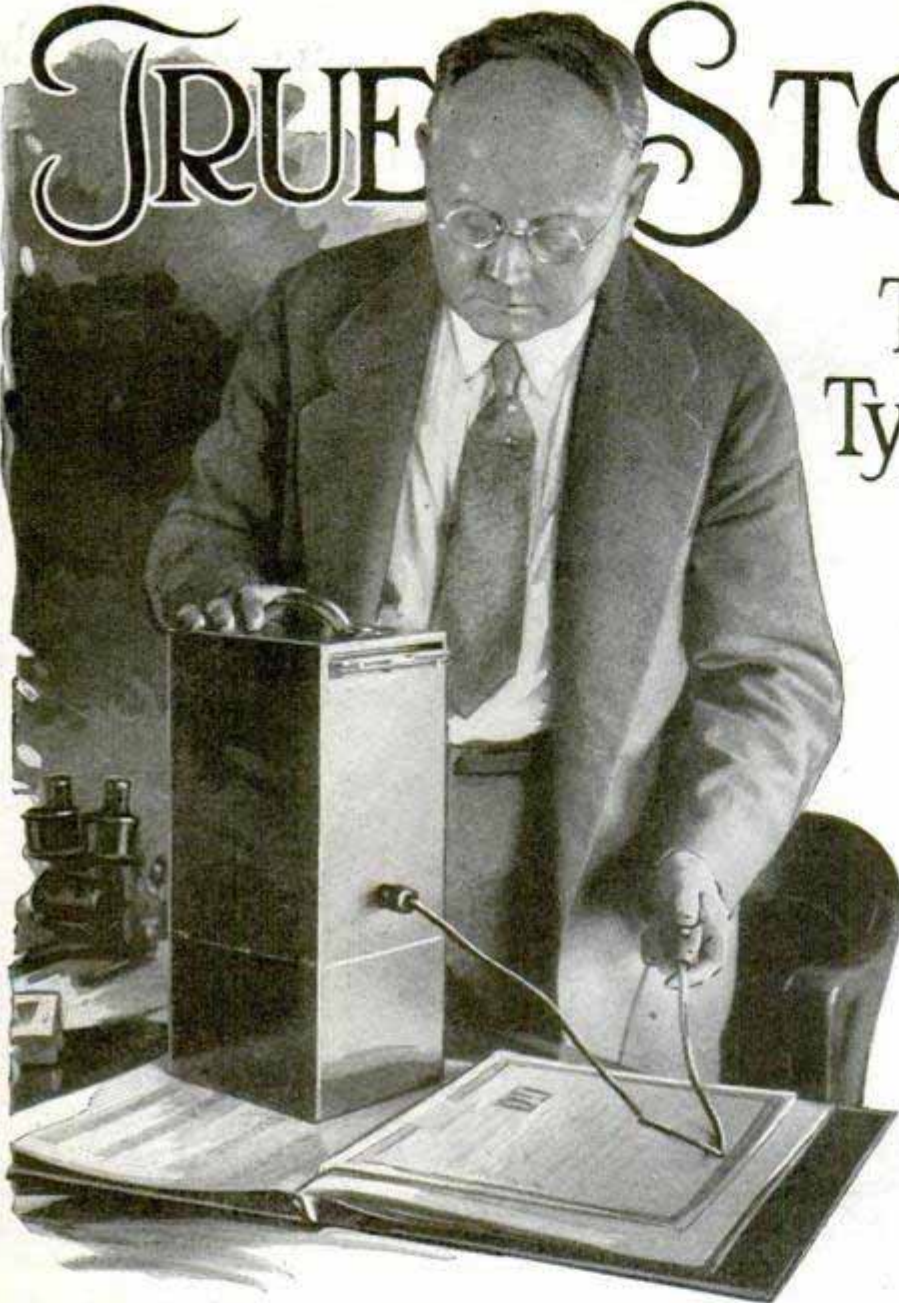

Mr. Wood Using the Special Camera Apparatus to Photograph Portion of a Page When Volume Cannot Be Removed to His Laboratory

By PAUL PADDOCK

examination proved that, although dated 1908, the document had been written on a machine that was not manufactured before 1916. This was established by the style of type. Then, there were five little defects in the typing which tallied perfectly with five defects in the typing done by a machine the defendant had rented a short time before the letter was introduced in court. Finally, the camera showed that a liquid ink eradicator had been used on the page to remove all original contents but the signature, which, with the firm's printed letterhead and the paper itself, was the only genuine thing in the whole document.

WHILE all typewriting may look alike to the ordinary eye, the microscope and camera of the scientific crime detector have revealed that, no two typewriters, even the same make, are alike, and even the peculiarities of the writer are revealed by the cold type when put under the lens.

Not long ago, a letter, dated Dec. 15, 1908, was introduced at a trial in Illinois. It fixed a lawyer's fee at \$2,000 instead of the \$10,000 the court had decreed the defendants should pay, and, naturally, they were anxious to save \$8,000. But the attorneys for the plaintiff detected what appeared to be marks of erasure. Expert

This was a famous exhibit in a case in which the supreme court of Illinois, for the first time in its history, ruled on the question of typewriter forgeries. It is only recently that the courts have fully recognized the significance of evidence of this kind. In older days, the question of the genuineness of a document was left largely to the opinion of someone who professed skill in such matters, but today, ferreting out the forger is one of the most highly developed and exacting phases of criminal investigation.

Step into the office of Jay Fordyce Wood, Chicago, examiner of questioned

*Q. 2010, 134 7/2
La Salle Chicago*

of the MANHUNTERS

documents, and you will see how efficiently modern science is armed to combat the forger. True stories, many of them now matters of court records, far more absorbing than fiction, center about Mr. Wood's microscopes and cameras. Here you will see enlarged photographs of the crooked "m" and the odd "d" of the typewritten ransom letter which helped send two slayers to prison. In this office are interesting solutions of the oft-repeated question, "Is the will genuine?" for Mr. Wood's verdict on signatures and other handwriting has been sought in scores of lawsuits.

"Almost every case brings a new riddle and, consequently, new interest," said Mr. Wood. "and sometimes I feel that, if the people who think they can profit by forging only knew what a broad trail they leave from the instant they touch the paper, they might hesitate a long while before doing so.

"Take the typewriter, for instance. Many persons believe that it will guard their secret securely where the handwriting would expose them at once, but a typewriter is about the worst instrument, from the forger's standpoint, that could be used. Instead of covering up his path, it tricks him at practically every punch of the keys.

"The reasons are simple. For many years, it has been the custom of manufacturers to change the forms of type from time to time. We keep track of these



Fuming Operation in Progress; Fumes Pass from Heated Container through the Tube and Spread over the Page, to Restore Faded Ink So That It Can Be Photographed

changes and know the machine numbers and the approximate dates when the alterations were made; so we have a pretty certain clue that something is wrong if a 1908 letter is written on a 1916 machine.

"Eight makes of typewriters do practically ninety-eight per cent of all the typing in the world, so it is not very hard, usually, to discover which make of machine was employed on a certain piece of work by measuring and comparing the type, as there are telltale peculiarities in the letters of every typewriter. With a camera I can take a photograph of the type, enlarged 2,500 times so that anyone can recognize the clues the machine has left. Instead of protecting the forger, the

typewriter plays tricks that often betray. Now there is another interesting thing about typewriting that not many people realize. It is sometimes possible, from the typing, to identify not only the make and particular machine used but also to identify the operator. No two typists have exactly the same touch, they space



Ink Flowing around Edge of Perforation Showed That Writing Was Made After Paper Was Punched

differently, perhaps, or they make the same mistakes repeatedly. In other words, personality, to a degree, is transmitted through a typewriter just as it is through handwriting.

"Since a typewriter is a mechanical thing, any variation in its normal functions is likely to be very plain. Suppose you type part of a page, release the paper and then reinsert it. Unless you have adjusted the sheet with exacting instruments, it is likely that the rest of your typing will be more or less out of line. Here is a little glass gauge that helps to measure such variations down to the one-thousandth of an inch.

"In every typewriter with the ordinary, or pica, type, there are ten letters to the inch with the exception of one make, which has eleven. Elite type makes twelve letters to the inch. I had a puzzle not many months ago in a specimen of elite typing with eleven characters to the inch instead of twelve. The typing was in a letter which threatened the life of a physician. Finally, I discovered the make of the machine. The manufacturers were able to tell me just where the typewriter had been sent and it was not long before I was confronting the man who had written the letter.

"A common attempt at deception is to use ink eradicators, but they do not re-

move the ink, which is merely bleached so that it cannot be seen by the unaided eye. However skillfully the bleaching has been done, a slight yellowish stain may be left. By letting the light shine through from behind the page and taking a photograph, the stain, because of the action of certain photographic emulsions, appears black in the finished picture, and the tampering is clearly indicated."

Mr. Wood illustrated how scratches on paper stand out as small "hills and valleys" under magnification and proper light. This introduced the question of watermarks, the designs in the body of the paper, and how often they reveal a forgery. The mark is simply a thin place in the page where the fibers have been compressed during manufacture. A dated watermark, or one of special design, introduced at a definite time, is a common clue to paper in a falsified document.

An effective instrument the examiner uses to study questioned documents is the binocular microscope which reveals the surface in three dimensions and makes the slightest alteration or defect clearly visible to the eye. The usual microscope shows objects in only two dimensions. Another tool is the comparison microscope for study of two lines of writing or typing at



Mr. Wood at the Binocular Microscope That "Gets behind the Lines," Revealing a Surface in Three Dimensions Instead of the Usual Two

the same time. With special glass gauges, fine differences in the curves of handwritten or type letters can be distinguished and any malalignment of characters dis-

covered. With color filters, in photographing, difference in the colors of inks may be brought out. It also is easy to restore ink which has been erad-

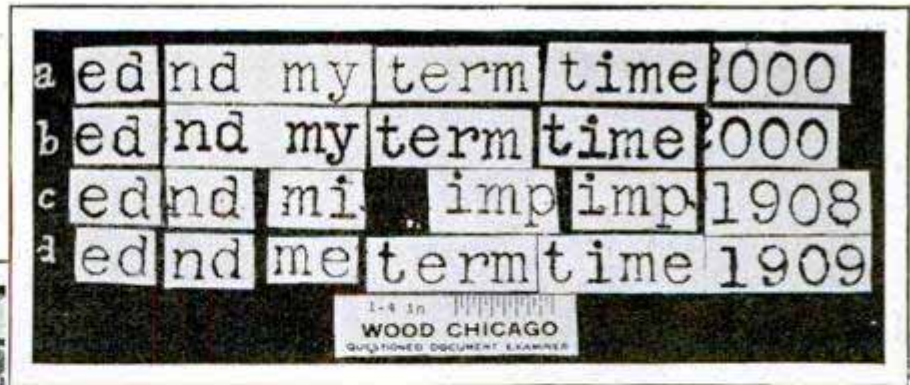

Alterations on an Envelope Cancellation Plainly Revealed by an Enlarged Photograph and Samples of Typing in the Fee Case; Line A Is Reproduced from the Letter Itself; Lines B and C Are from Samples Typed on the Machine Rented by the Defendant, and Line D Is from a Genuine Letter; Note Similarity in the "M's" and "D's" of the First Three Lines as Compared with the Fourth

plied, "and frequently, while you may be sure that the signature or other detail in question is spurious, you cannot present sufficient evidence to justify your opinion and make it valuable as a bit of court testimony or evidence.

"If I find two signatures absolutely identical, I know that one or both of them are forgeries, for you never write your name or any other word exactly the same way every time. Perhaps you

icated, or bleached, to color if the ink contains iron. This is accomplished by fuming. If there was iron in the ink, the fumes of certain chemicals, reacting upon it, cause the writing to reappear so that it can be photographed.

When court records, hotel registers and other documents must be photographed without being moved to a laboratory, he employs a small box camera which is simply placed on top of the page. It contains lights which are connected to a wall socket with an extension cord.

"With all these ways of discovering the forger, how can any fake document escape detection?" Mr. Wood was asked.

"There are some very skillful forgers," he re-

can disguise your handwriting to your own satisfaction but you cannot produce anything other than your own normal handwriting in a free, fluent manner."

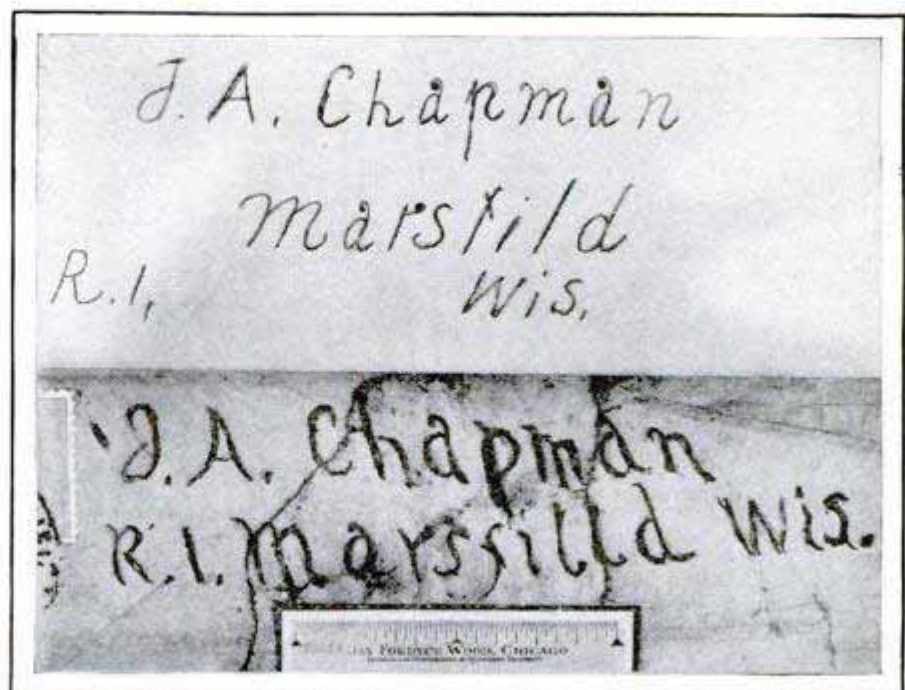

Signatures That Helped Convict a Man of Murder; Lower One Was on Package Containing a Bomb; Compare It with Upper Sample of Writing

29/14 *Kiel Germany*
**PORTABLE DIVING SUIT CARRIES
ITS OWN AIR SUPPLY**



For Diving in Shallow Water; Suit with Air Supply Permits Wearer to Stay Under Ten Minutes

For shallow-water diving where the pressure is not great, a portable outfit, devised in Germany, eliminates the need of air pumps. It is quickly adjusted or removed, is not heavy and is said to permit the wearer to remain submerged for at least ten minutes in safety and comfort.

3808 **LIGHT WAVE TO DISPLACE BAR
AS MEASURING UNIT**

The X-shaped bar of platinum and iridium which has been so carefully guarded for several decades in the vaults of Paris as the world's standard measuring rule, for science and technology, is to be displaced. At a recent meeting of international measuring experts in Paris it was decided to substitute for this standard meter—or International Prototype Meter to give the metal rod its full name—the average length of more than a million and a half waves of light. Technically the new standard meter of the world will be the length of 1,533,164.13 waves of the red ray emitted by atoms of luminous cadmium. When the metric system was established

By Herald Tribune

by France, it was proposed that the meter, as the unit of measurement, should be a definite portion of the circumference of the earth. Actually a mistake was made in the measurements, so the meter never was that small portion of a great circle, and since it was established, science has discovered that the earth not only isn't a round globe, but that it probably changes its shape from time to time, so that no permanent circumference can be assigned to it. The platinum and iridium bar, however, had been accepted by all the bureaus of standards throughout the world as the basic measurement to which all other things were compared. It has many drawbacks, for it was subject to expansion and contraction unless kept at an absolutely even temperature, and was also subject to changes through physical accident. The new standard meter can be reproduced at will and would always be the same.

3293 **FLOODLIGHT ON OLD LANDMARK
RECALLS EARLY HISTORY**

Spotlights are literally turned on one of the early American scenes with the nightly illumination of the house used by Washington for his headquarters at Valley Forge, Pa. The lighting emphasizes the beauty of the old building and attracts the attention of thousands of motorists, many of whom would miss seeing the landmark were it not for the lamps.



Where Washington Had His Headquarters at Valley Forge; House Illuminated by Floodlights

no further information available

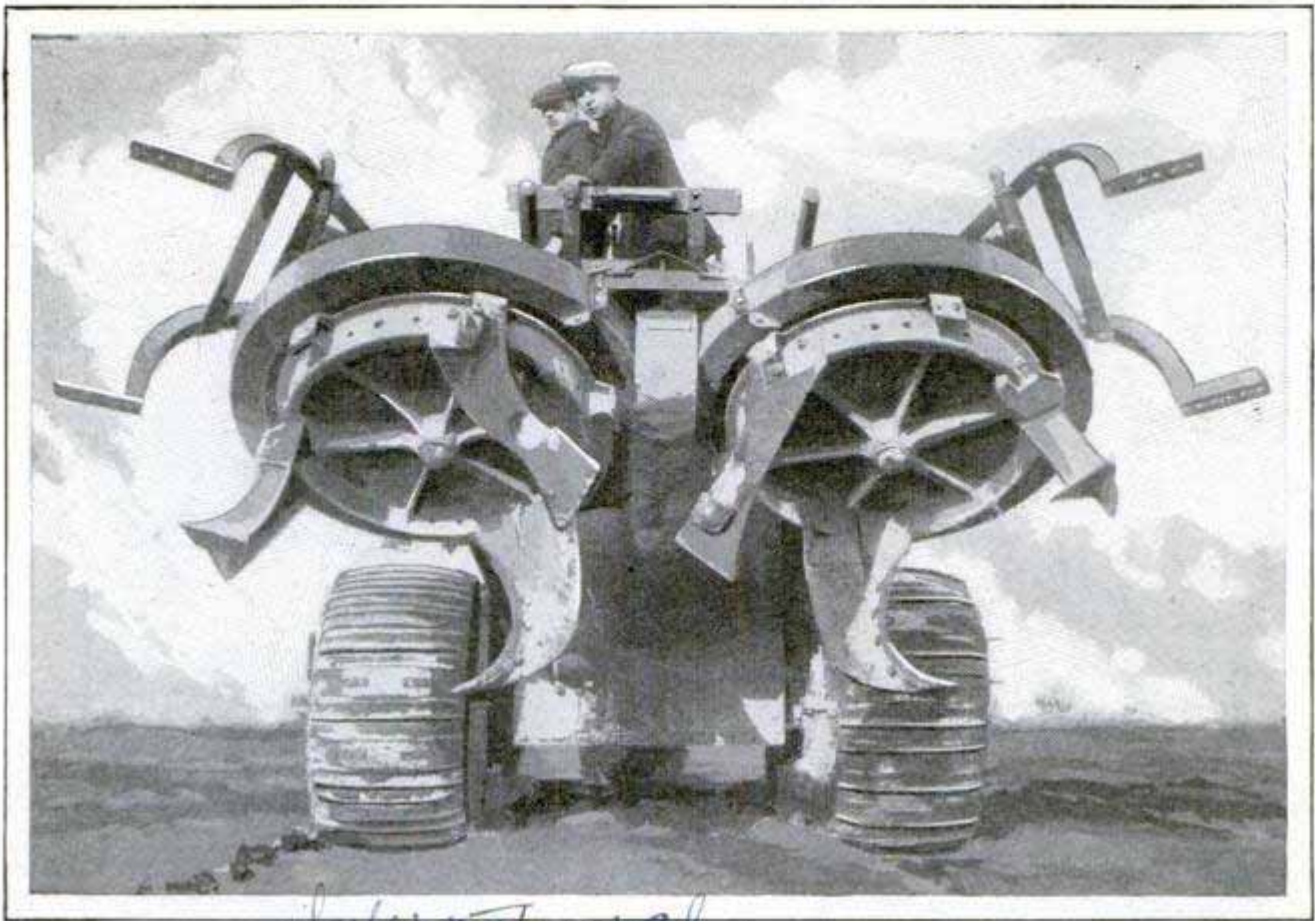

International

Huge Plow Constructed for Work in Large Fields Such as Those of a Sugar Plantation; the Cutters Rotate as the Tractor Proceeds, Thoroughly Stirring and Breaking Up the Soil

PLOW WITH REVOLVING SHARES THOROUGHLY STIRS SOIL

Designed especially for large plantations, a rotating tractor plow has been introduced in London. Instead of the usual form of shares, it has revolving cutters that operate in such a manner that the soil is stirred and is given two breakings in one trip of the outfit.

TALKING MAN MADE OF RUBBER HELPS DRAW CROWDS 3852

Fashioned of rubber and papier-mache, a figure of a man that talks and reproduces realistic facial expressions while doing so, has been devised by Paul P. Moller, chief artist of the department of agriculture. Several weeks were required to construct it and it cost \$1,000. The principal difficulty was in imitating the movements of the face. By arranging two central cords, one on either side of the face, running from the temples in a straight line to the point of the chin, and moving them by the vibrations of an electric motor inside the man, the model was made to produce much

the same expression as that of a human person while talking. The jaw and other movements were synchronized with the speech, which was transmitted through a microphone mouthpiece.

pat. ap
GASOLINE NOZZLE HAS VALVE TO PREVENT DRIPPING 3731

Fitted with a valve that shuts off the flow as soon as the hose is removed, a gasoline nozzle, now

on the market, reduces the likelihood of fires or explosions and prevents waste. The valve is operated by a spring which presses against the top of the tank when the hose is inserted, allowing the valve to open. As soon as the nozzle is



withdrawn, this spring automatically shuts the valve.

The Muller Co, 297 E. Water St. ...

Locomotor

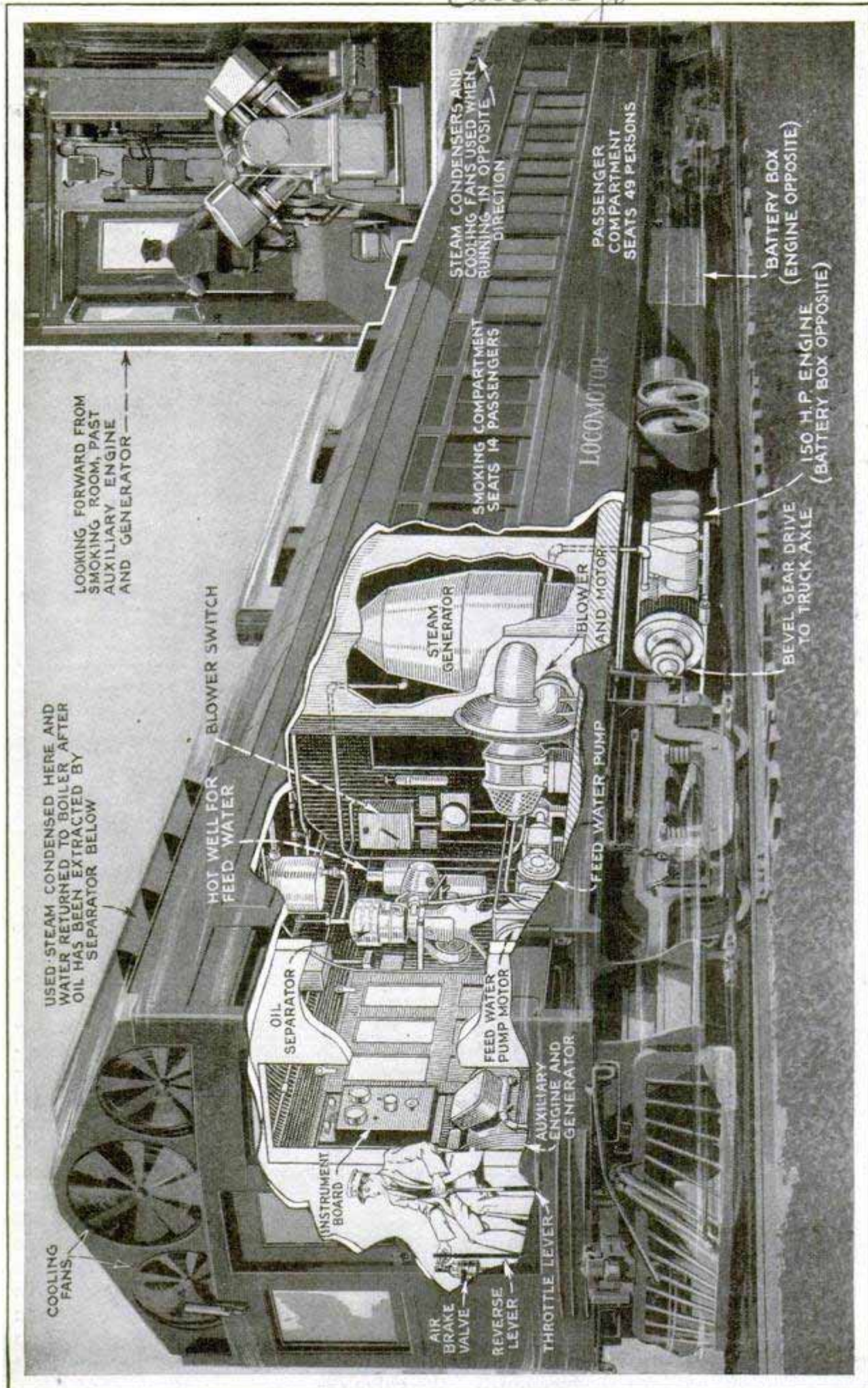

Steam Locomotive and Passenger Car Combined in One, with a Speed of Eighty Miles an Hour; the Power Plant Is Noiseless, Burns Low-Grade Fuel Oil, and, through Two 150-Horsepower Engines, Is Capable of Pulling Several Trailers

HIGH-SPEED STEAM RAIL CAR HAS HIDDEN-BOILER

A self-propelled steam railroad car, literally an enlargement of the steam automobile idea, has been developed to compete with gasoline, Diesel and gasoline-electric cars in handling high-speed passenger traffic. The car, with its steam boiler hidden in the baggage compartment, seats forty-nine passengers in the main compartment and fourteen in the smoking room, and is capable of hauling itself and trailers at a speed of eighty miles an hour. The high-pressure boiler, heated by an oil burner, operates at 600 pounds' pressure, more than twice the usual pressure on the best superheated steam engines. The pressure and temperature are automatically controlled. When the pressure touches 600 pounds, the fire is automatically extinguished, and lighted again when pressure drops to 550 pounds. From the boiler, steam passes, through a storage reservoir, to the two eight-cylinder engines, and then back to condensers located in the roof of the car, and cooled by three blower fans. Condensed, the hot water returns again to the boiler. An ordinary steam engine of similar power, but without a condensing system, would use more than 500 times as much water. As the deposit of solids to form boiler scale is limited to the amount of water originally used, it is estimated that an ordinary steam engine would collect as much scale in one month as the self-propelled car would in forty to fifty years. Although the power plant is located at one end of the car, controls are installed at both ends, so it can be operated in either direction as easily as a double-end street car, eliminating the necessity of turning around.

Whenever you find that you wish to know more about any article in this magazine, write our Bureau of Information.

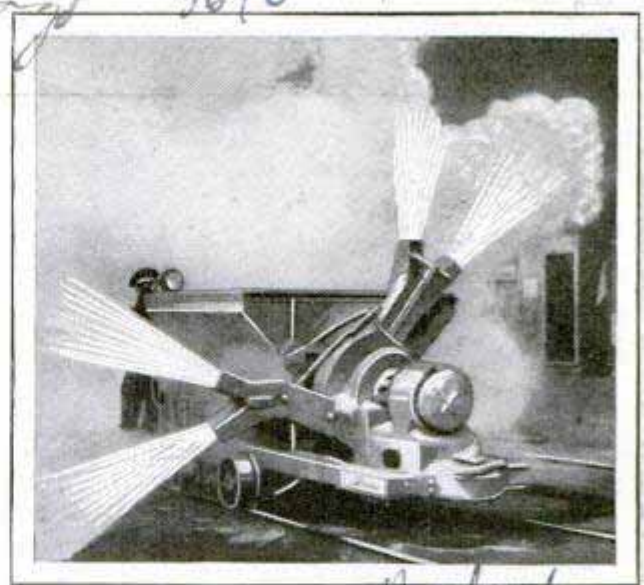

Becker
 Dust-Spraying Outfit in Action; the Particles Help Cleanse the Air of Dangerous Gases

MINERAL-DUST SPRAYER CURBS DANGER OF EXPLOSIONS

Dangerous gases that are likely to explode in tunnels, mine shafts and other confined places, are being counteracted by spraying the interiors with mineral dust. The treatment does not entirely eliminate danger, but, if applied in time, it is said to be effective in about ninety per cent of the cases. The dust eliminates hazardous accumulations of the gas and is spread from a motor-driven blower.

UMBRELLA WITH KINKED STICK HELPS SHELTER TWO



To Make the Umbrella More Effective; the Kink in the Stick Shifts the Canopy Farther to One Side

3597
Corral
 With an ordinary umbrella, it is difficult to shelter more than one person, but an improvement has been introduced by an English inventor in one that has a folding stick. It can be bent over at an angle, if desired, throwing the canopy farther to the side, thus bringing it well over the shoulders of the person walking next to the one holding it. The adjustment is easily made, the "kink" locks securely, and the umbrella can be used with the rod straight, if desired.

Messrs. Selfridge Co. Ltd.

FRANCE BUILDS GIANT "TANK OF THE AIR" FOR



Measuring Eighty Feet from Wing Tip to Tip, This Giant Armored Plane, Literally a Flying Tank, Has Been Completed in France; the Ship Carries One and a Half Tons of Bombs

NIGHT BOMBING RAIDS OVER ENEMY TERRITORY



Instead of the Usual Fuselage, the Crew and Bombs Are Housed in What Is Really a Thickened Section of the Wing; the Craft Weighs Five and a Half Tons and Makes 100 Miles an Hour

3698 SLEEPER IN HUGE ZEPPELIN TO HOLD TWENTY

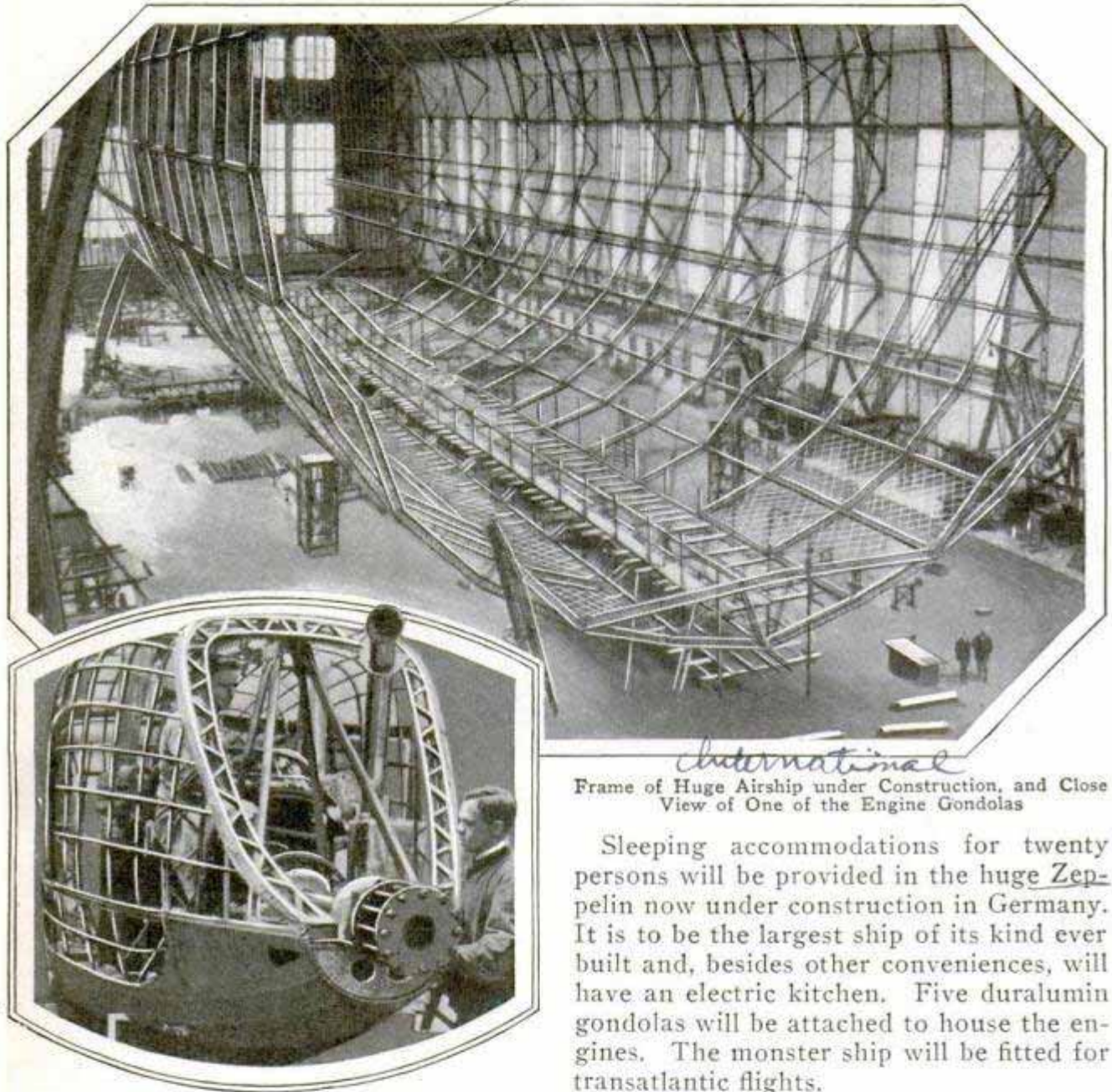

International
 Frame of Huge Airship under Construction, and Close View of One of the Engine Gondolas

Sleeping accommodations for twenty persons will be provided in the huge Zep- pelin now under construction in Germany. It is to be the largest ship of its kind ever built and, besides other conveniences, will have an electric kitchen. Five duralumin gondolas will be attached to house the en- gines. The monster ship will be fitted for transatlantic flights.

PICTURE THREE BILLION STARS WITH BIG TELESCOPES

How man is constantly pushing back the borders of his mental horizon is well illustrated in the activities of the astron- omers who now have instruments whereby they can photograph at least 3,000,000,000 stars. Dr. W. W. Campbell, president of the University of California, recently called attention to the fact that the sharp- est eyes, unaided, can count not more than 7,000 stars in the entire sky, but with mod- ern reflecting telescopes and long-ex- posure photographic plates, the images

of millions of stars can be recorded. Ap- proximately 100,000,000 could be seen if trained observers had the time to sweep the entire sky with the largest telescopes. Astronomers picture our stellar system as a huge space, shaped like a double-con- vex lens. It is so far from one rim to the other that light, traveling at more than 186,000 miles a second, would require from 200,000 to 300,000 years to pass from one edge to the other. The thickness of the system is thought to be about one-fif- teenth of this distance. Our stellar group is believed to be a spiral nebula and, be- yond it, are thousands of other nebulae,

Chicago Evening Post 12/6/29 3875

Research Assn.
231 W. 96th St
New York

3160 not being made
POPULAR MECHANICS #1 30/28.

each containing millions of stars. Some of the objects already recorded on photographic plates are so far away that the light now reaching us from them, probably left its source as long as 100,000,000 years ago.

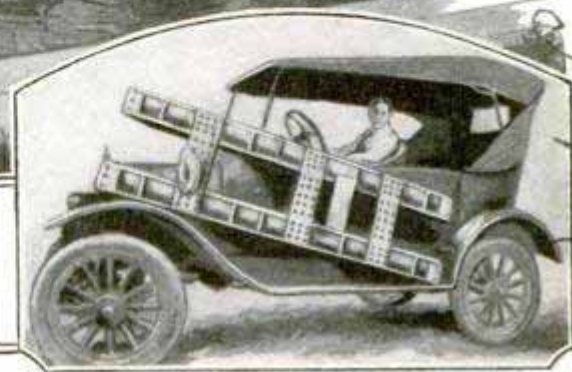
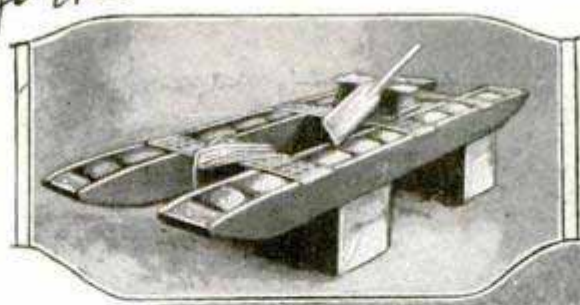

Balloon Tires in Runners of the Water Sled; Craft in Use, and How It Is Transported

A NEW MALADY 38 77

Repeated thrusting of the foot forward to engage the clutch or brakes of the auto, is causing a malady among men known as "chauffeur's foot," according to specialists. It is not found among women, as their high heels have accustomed the muscles and tendons to the forward movements. Inflammation of the heel bone, which causes men to walk somewhat gingerly, is one of the results of the trouble. It would disappear, the doctors say, if chauffeurs wore shoes with higher heels.

2721

SPRING STRETCHER FOR INVALID PREVENTS SHOCKS AND JARS

Transporting sick or injured persons in automobiles or other vehicles can be done with little risk and greater comfort for them in a special stretcher equipped with stabilizing springs. They are adjusted to make the journey as nearly vibrationless as possible, shock absorbers being placed where necessary.

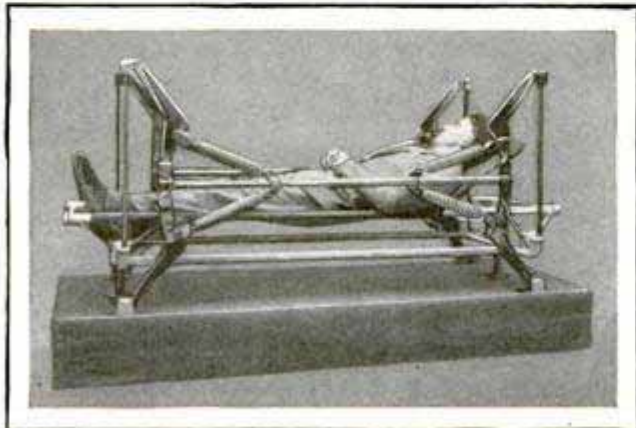

To Shield the Injured Person from Jars during Journey; the Spring Stretcher under Demonstration

maker unknown

WATER SLED OF BALLOON TUBES INSURES BOATING SAFETY

Pontoon-shaped boats, slightly more than seven feet long and two feet wide, have been devised by a Florida man for service and amusement. Balloon tubes in each "runner" insure buoyancy, and, even though the craft should upset, it would not sink. The boats are made for propelling with oars or outboard motors.

TRIPODS FOR TELEGRAPH POLES RESIST FROST ACTION 388

One of the difficulties in building the Hudson Bay railway is that the "heaving" action of the alternately freezing and thawing ground, forces the telegraph poles out of the ground. Putting the posts in concrete foundations does little good, for the frost lifts foundation and all. The problem was solved by erecting tripod supports for the posts. These were placed but a few inches in the ground so that the frost could not obtain a sufficient hold to disturb the legs of the tripod. Bracing with wire struts made a firm base, and the plan has proved so successful that it is proposed to substitute the tripods for ordinary poles along the entire line.

W. Chief Engineer.

Water sled made by C. B. Freeman
 Route 4, Box 291, Coral Gables, Fla.
 C. B. Freeman
 49 W. 76th St New York

354
430

Washing Machine Corp, 235 W. 34th Street New York

POPULAR MECHANICS

Iron "Capitol" Barnett Laundry
NEW INVENTIONS FROM ENGLAND'S PATENT SHOW
Machine Co, Druryton 48



A Midget Washing Machine, with a Glass Front to Display the Work, Above, Was One of the New Things Shown at the Recent Annual Exhibition of Patented Devices in London; at the Right Is Another of the Year's New Things, an Electric Iron with a Heat-Control Switch, Conveniently Placed under User's Thumb



Londoners Have Found a New Use for the Small French-Type Auto Horn; Attached to the Umbrella Handle or Walking Stick, It Furnishes a Convenient Warning Blast for the Pedestrian Who Wants to Stop Traffic While He Crosses

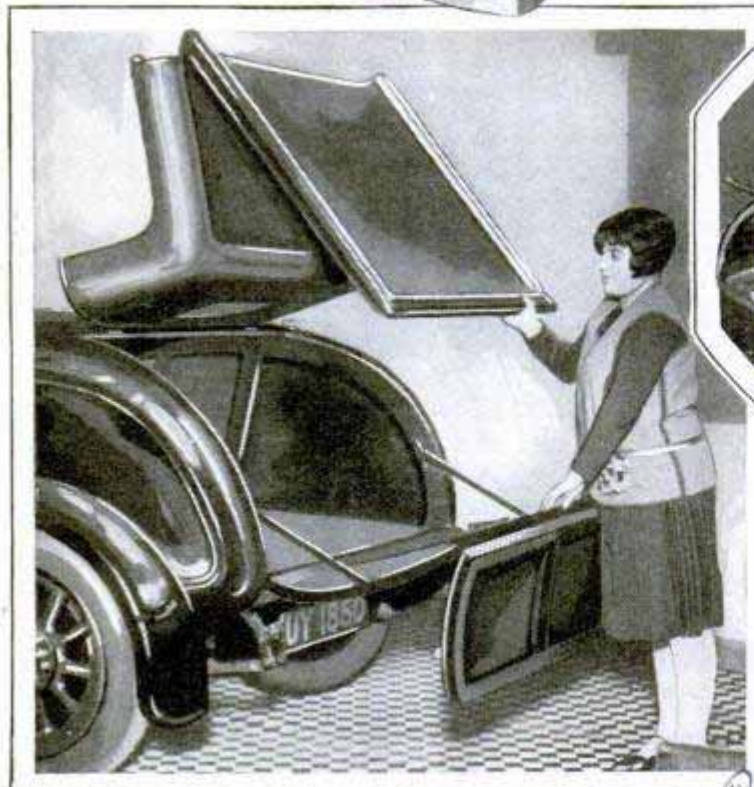

Something Entirely New in Closed Cars with Disappearing Tops Is Being Produced in England; as Shown at the Left, the Collapsible Top Disappears into the Rear Luggage Compartment, an Arrangement That Makes Sturdy and Rigid Construction Possible, Instead of the Usual Folding Canvas Affair; Above Is a New Type of Roller Skate Which Runs on a Single Wheel, Yet Is Claimed to Be Faster and Safer Than the Conventional Kind

P.A.

BEEES MADE BUSIER BY LIGHTS

3713

By directing a beam of light upon the entrance of their hives, an English bee-keeper has stimulated his bees to earlier activity, so that they produce an average of seventeen pounds more honey per colony during the season. He started the experiment in the spring. Light from electric lamps was focused on the hive openings and supplies of food were placed near by, so that the bees could go to work as soon as they flew out.

COLD STEAM KILLS INSECTS ON CROPS

3809

Instead of the usual pressure-spray system of treating plants to kill insects, a cold-steam process has been developed which is said to require smaller quantities of liquid, saves time and reaches all parts of the plant more thoroughly. The poisonous substance is broken up into a fine mist by the introduction of steam from a portable boiler, which burns gasoline, and is distributed at a pressure of eighty to 100 pounds. Water is employed to disintegrate the poison, and the coarseness of the spray can be regulated by means of a valve which governs the amount of steam entering the nozzles. The entire spraying outfit may be mounted on a cart, and as many as eight nozzles can be used at once. The inventor believes the apparatus will effect a saving of thirty to forty per cent in chemicals.

see Sept. 1927-458. Steam spray for clearing out.

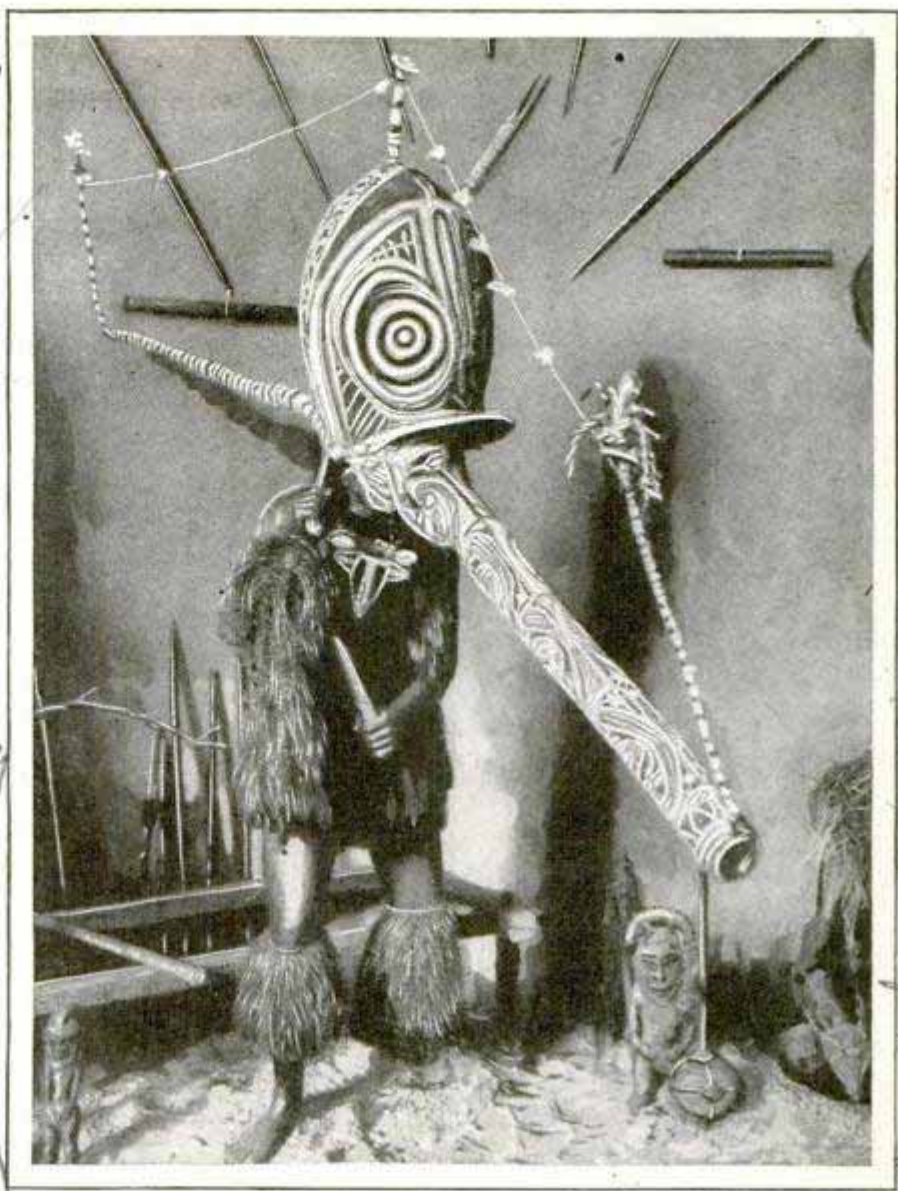

Courtesy The Graphic
Weird Mask Used by Tribe in New Britain during Ceremonies When Boys Are Admitted to Full Membership

LONG-NOSED MASK FEATURES TRIBE'S INITIATIONS

When boys are admitted to full membership in the Baining tribe, inhabitants of New Britain, a ceremonial mask, like the one illustrated here, is worn during the rites. It is considered a rare specimen because of the extremely long nose, only one other of the kind being known to scholars, it is said. This mask was shown at a recent ethnological exhibition in Berlin.



Spraying Field with the "Cold-Steam" Outfit Which Covers Wide Acreage and Does Thorough Work

The Graphic 7/23, 2, 7

Wm. R. Libby, North Carolina State

*Col. Harry Gray, M.P.
England*

3835



Part of the Magnet Apparatus Which Was Used to Stimulate the Growth of Small Animals and Plants

MAGNET AIDS GERM GROWTH AND STIMULATES PLANTS

Interesting effects of magnetism on one-celled animals and on plants have been observed in recent laboratory tests, suggesting the possibility that the treatment may eventually be adapted for the benefit of human life. By periodic applications of magnetism to lowly, single-celled water organisms, Prof. R. A. Muttkowski, of the University of Detroit, found that the vitality of the specimens was greatly increased. This was evidenced by longer life and by greater resistance to poisons. The stimulation apparently caused no harmful after-effects. Radishes and bean sprouts, subjected to the treatment, grew faster and were more quickly revived after withering. The magnetism used was of the same character as that which deflects a compass or picks up nails, but the apparatus employed produced certain oscillations which are thought to have caused the striking effects noted. Physicians have

used the treatment on glands with remarkable results, it is reported. An explanation of the phenomenon is that, in living matter, the motion of the atoms and molecules sometimes lags. The magnetic radiations are thought to re-energize the atoms, restoring their normal momentum.

388 DARKNESS CREATED BY LIGHT IN NEW STAGE EFFECT

Using colored lights in place of a curtain to shut off the stage while scenery is being changed has been introduced in London. The system allows the auditorium lights to remain on, but forms an impenetrable curtain of black before the stage, so the audience cannot see the scene shifters. The inventor made the discovery while experimenting with the effect of colored spotlights on women's gowns. He found that by projecting a certain hue on a blue gown the dress appeared to be black. Substituting a blue ray for the gown, he projected amber and pink rays on the blue light and produced a black screen. In stage use, projectors throw a curtain of blue light across the space usually occupied by the stage curtain, and on that the other rays are projected, to black out the stage.

382 MILK SHEDS TOWED TO COWS TO KEEP HERDS IN OPEN

Believing that his cows will have better health if not confined in barns, an English dairyman keeps them in the open all

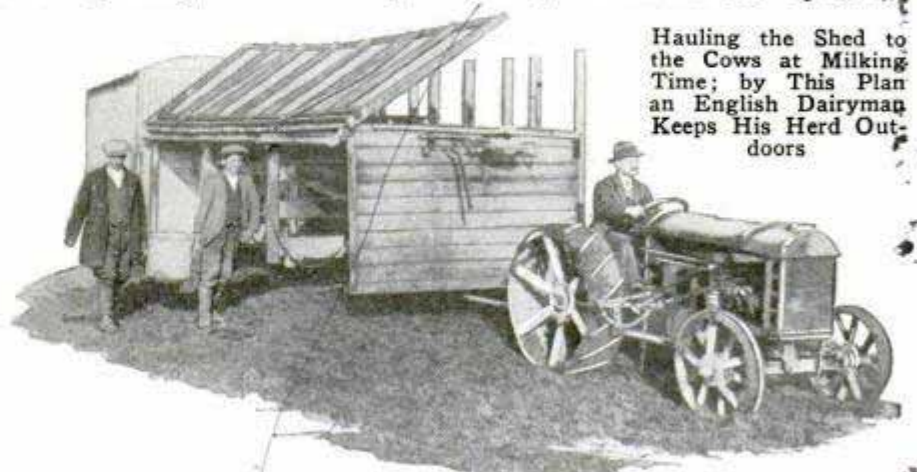

Hauling the Shed to the Cows at Milking Time; by This Plan an English Dairyman Keeps His Herd Outdoors

the time. When the milking hours arrive, sheds are towed to the herd with a tractor instead of bringing the cows in.

*A. J. Hosier,
Wiltshire, Wilts.*

no of sheds & cows & 1913 Sept 11

To Angeles, Calif.
HUNTING WILD GOATS FROM DECK OF FLYING BOAT

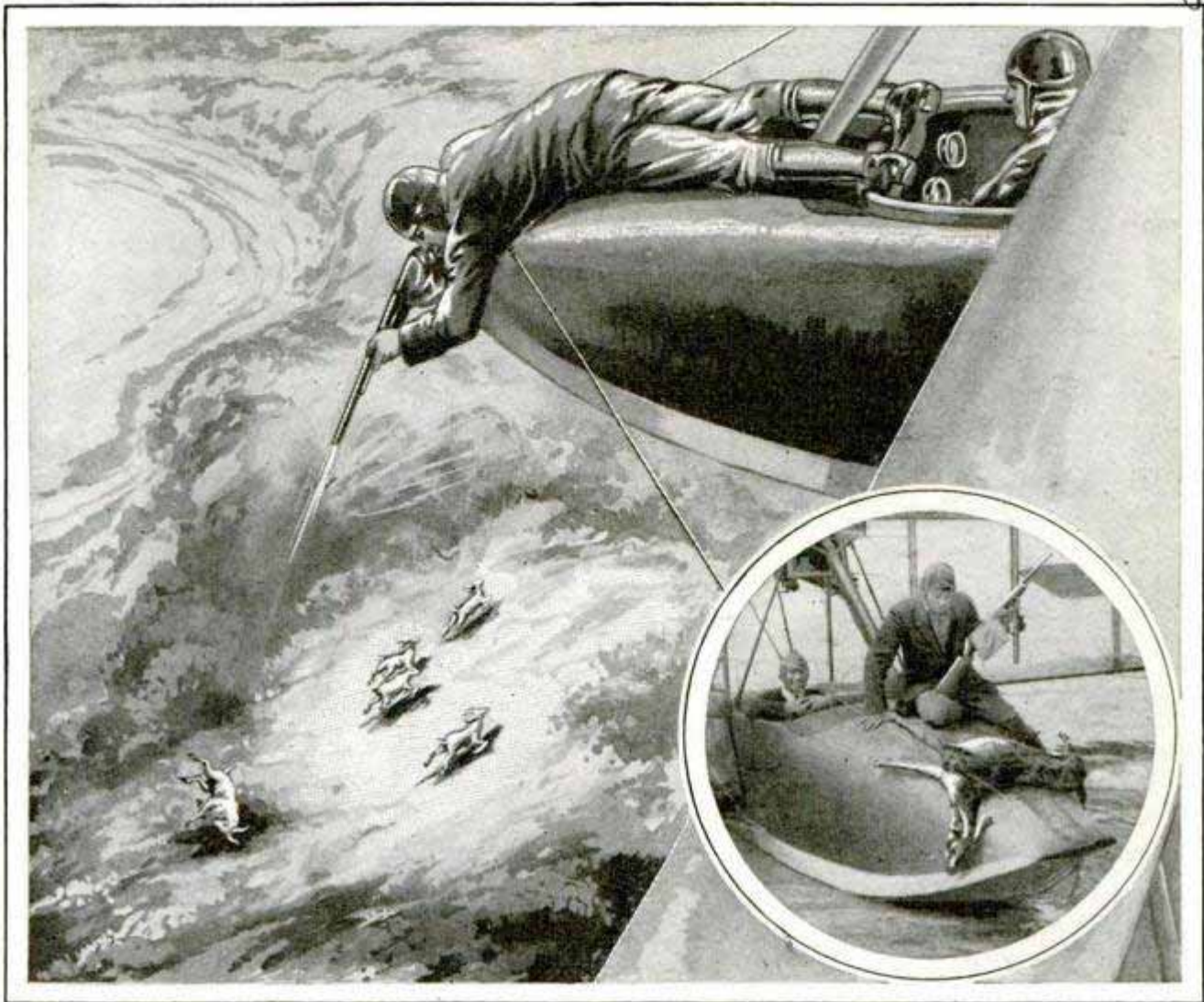

Shooting Wild Goats from an Airplane on Santa Catalina Island; There Is No Bag Limit, but Hunters Must Pay \$2 Each for Every Animal Shot beyond the Free Allowance of One to a Man

After being closed to hunters for nearly twenty years, Santa Catalina island, off the coast of southern California, is now open to sportsmen who desire to hunt wild goats there. It is estimated that the number of these animals on the island is between 20,000 and 30,000. Moreover, under the plan of hunting announced a few days ago, a rich man's sport is placed within reach of the poor man's purse. Each hunter is entitled to one goat. If he wants more, they're \$2 each on a hunting license that's punched like a meal ticket, and there is no bag limit. The wild goats on Santa Catalina island are descendants of domestic Spanish goats liberated there during the sixteenth century by the Cabrillo and Vizcaino expeditions. They were put there to propagate a source of food supply for mariners in distress. Four hundred years of wild life among the lofty

craggs and precipitous canyons of the island has transformed them into an animal that is as difficult to hunt as the bighorn mountain sheep, the chamois, or the ibex. The flesh of these animals, particularly of the younger ones, is comparable to the finest domestic mutton.

**FUEL GAS FOR AIRSHIP MOTORS
 TO MAKE FLYING SAFER**

3872
 Tests with a fuel gas, having nearly the same weight as air, are being conducted in Germany for use in airships. It would do away with liquid fuels, which are a source of danger and a disadvantage in aviation because of the lightening of the ship as they are consumed. Since the gas has about the weight of air, the balance of a dirigible, for instance, would be disturbed very slightly, if at all.

by Zeppelin Works at

3692

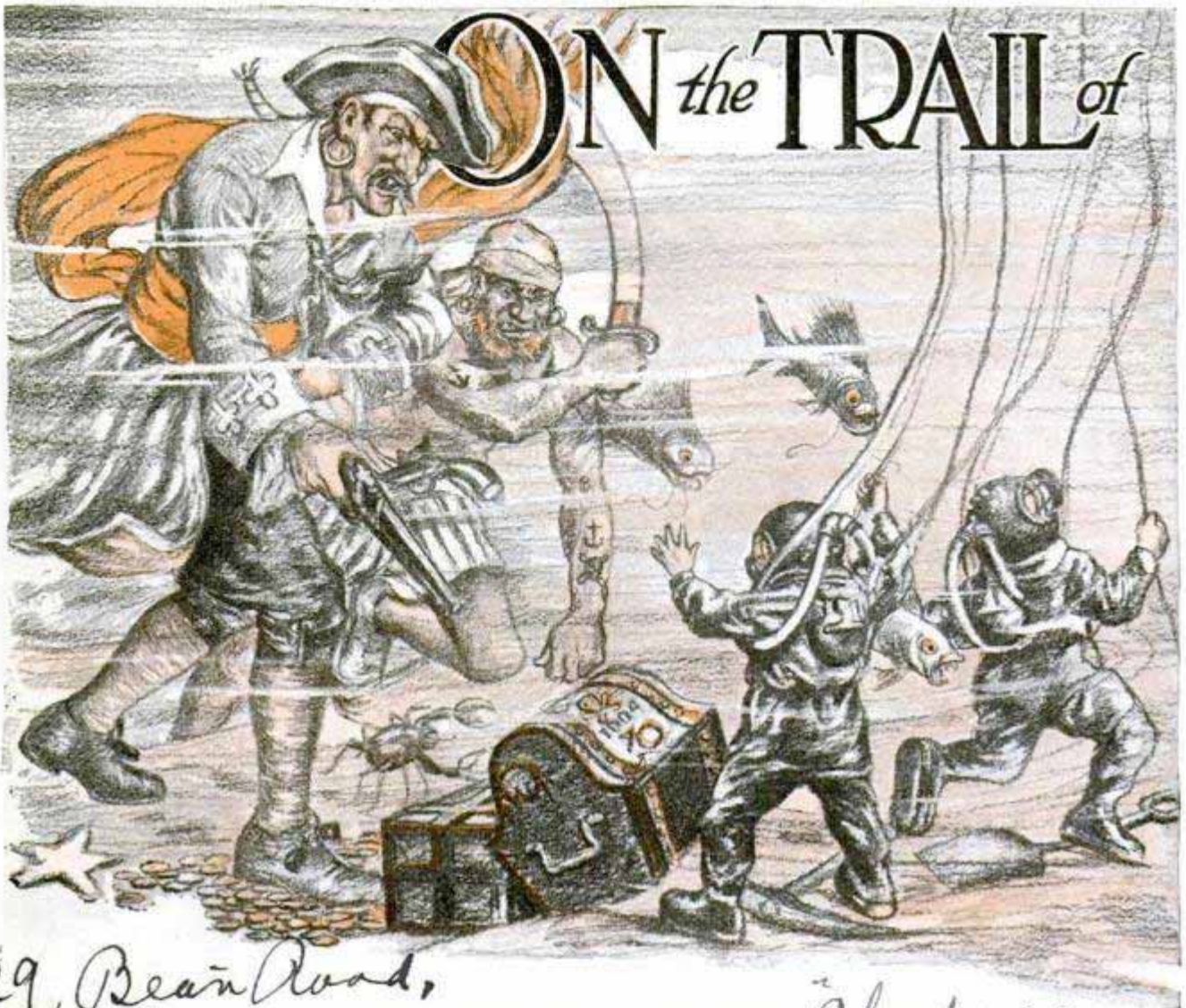

29, Bean Road,
 Barnard Road, Berley Heath, London Eng

By HAROLD T. WILKINS

IN a machine-made age of television and transatlantic planes, the lure of hidden treasure still holds a thrill for everyone. From the far-off day when King Herod, of old Judea, went by night to Jerusalem to explore the tomb of David and Solomon for treasure of gold talents and jewels, and was scared into headlong flight by a blast of flame rushing at him from recesses of the stone vaults, down to our own age, when scientists, collecting for American museums, call in passing at pirate lagoons, human nature has not changed in this respect.

In ports all over the eastern seas, from Singapore and Manila, to Yokohama and Frisco, you will find, today, seafarers who are sure they know of caches of immense treasure ashore on lonely beaches and desolate islands, or sunken bullion wrecks in the waters of the south Pacific, or off China. They have seen old charts with

the imprint of Billy Bones, master of the "Walrus" of Savannah, who sailed the seas under Cap'n Flint, or crude sea-stained maps bearing the "anchor-his-mark" of Israel Hands, who begged his bread in the streets of old Wapping. Sometimes these yarns have a foundation of fact, and the treasure seekers are not always unscrupulous adventurers.

Some of the world's most fascinating stories of land caches of treasure originate in Lower California, Bolivia and Mexico. Back in the Cocopah mountains, in the district of San Diego, Calif., lies an immense treasure waiting to be unearthed by the picks and shovels or radio locators of a modern treasure hunter.

As far back as 1874, an American syndicate, called the Treasure Trove company, started to hunt up this cache. They did not find the gold, but the story is a remarkable one. One day, in 1873, a

HIDDEN TREASURES



Spaniard, named Pedro Pedrillo, tramped into San Diego footsore and broken, but excited. He said he had been two weeks prospecting in the Japa country, on the slopes of the Cocopah range, 300 miles east of San Diego, across the Gila desert. One afternoon in the mountains he came on a crude cross, rudely carved with an inscription in Spanish telling the explorer to dig below.

Pedrillo removed the top soil and found a tin case. Inside was a scroll in faded ink, derived from some kind of berry. Said the long-dead writer:

'To whomsoever may chance to find this writing: I, Captain Jesus Arroa, commander of the brig 'Isabella Catolica,' of 800 tons, and fifteen guns, with a crew of twenty-five men, say that I was wrecked in a great storm off the coast of California, on 29th March, 1682. After we had struck on a reef, we made our way ashore in the ship's cutter. We carried nothing with

us save five cutlasses and an old arquebus, which was all we had saved from our buccaneering. Designing to keep ourselves alive by killing game, we struck inland in a northeasterly direction toward a range of high mountains. Here we met game in plenty, and bears abounded. Our single piece was of much service to us. Eight months we passed on the slopes of the mountains, and in the space of that time, we saw no human beings besides ourselves. Some of our company who had mined gold in the lands about the South seas (that is, Peru) one day saw gleams of sand-gold in the mountains. Much unseasonable rain and wind stormed down the ravines this season, and we at once began to gather and wash the gold from the rocks and the sands, and to store our treasure in hopes of future deliverance, when we desired to carry it to the coast, where peradventure a ship might chance to touch. We stored and hid great quan-

tities of gold dust. Misfortunes then came upon us. A band of painted savages of great stature, with enormous bows in their hands, bore down on our camp in the mountains. All our gold-washing was stopped. They shot a cloud of arrows, killing one of our company and wounding two. We retreated from our camp, but the big warriors followed us for two days, fighting and being resisted by us. I write this, fearing that death may come to all of us tomorrow. Commanding my soul to the Mother of God and all the saints, I will tell where we have hidden our great treasure. I pray that this writing may fall into the hands of a good Christian, whom I solemnly charge to buy, with a portion of the treasure, a golden candlestick for the altar of San Diego, in Seville, to say masses for my soul."

Then followed minute directions how

to locate the cache of buried gold. Pedro Pedrillo, the finder of the document, went to Vallejo to fit out an expedition of twenty men, to invade the Cocopah country. It may be that a landslide obliterated traces of the gold cache, but, anyhow, no report of the success of the expedition has since appeared.

How often is the ghost of luckless Captain Kidd—hanged in chains, in the heyday of piracy when William was on the British throne—dragged out to explain some treasure cache of would-be treasure finders! In May, 1924, for example, some men of Lewiston, Me., were planning a search of the Sheepscott river with the aid of a grappling device invented by a member of the party. The leader of the treasure hunters said that when he was a boy he saw the anchor of a sloop come aboard in the river, with a sea chest

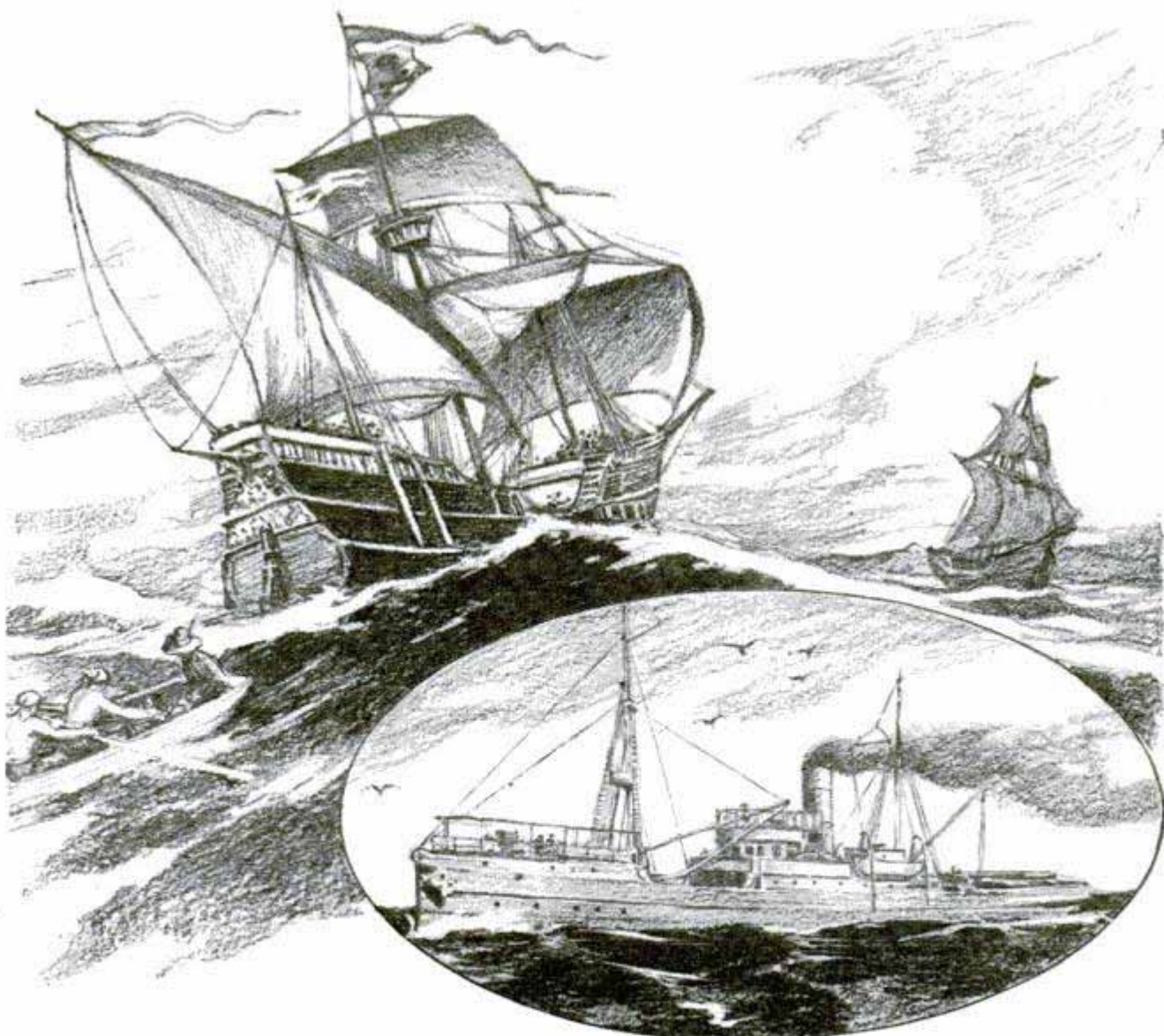

Splendidly Equipped Yachts, Such as That Pictured Below, Are Employed in Search of Treasure Sunk with Vessels of Other Days, but Often to No Avail, for the Sea Guards Well Its Gold

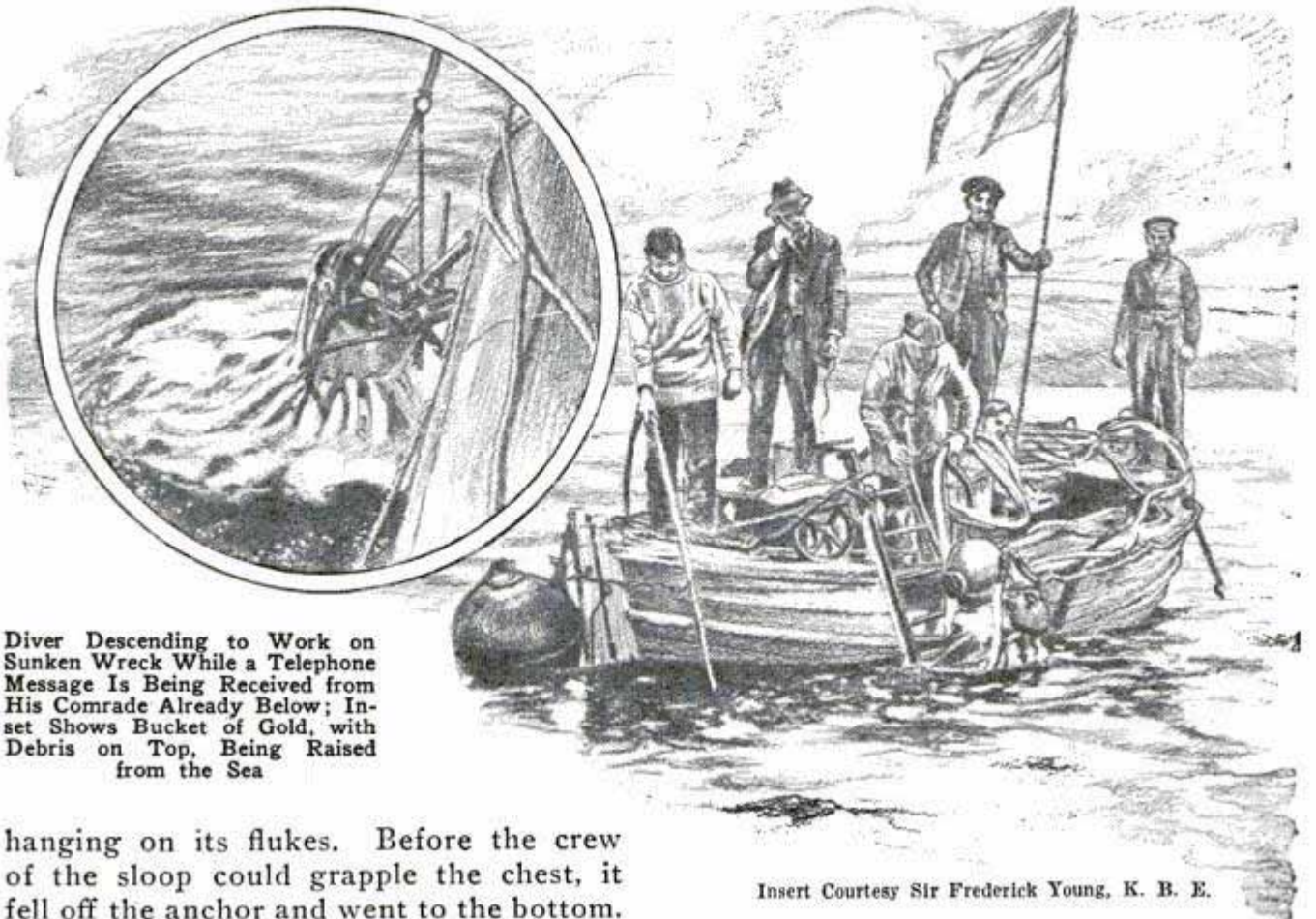

Diver Descending to Work on Sunken Wreck While a Telephone Message Is Being Received from His Comrade Already Below; Inset Shows Bucket of Gold, with Debris on Top, Being Raised from the Sea

Insert Courtesy Sir Frederick Young, K. B. E.

hanging on its flukes. Before the crew of the sloop could grapple the chest, it fell off the anchor and went to the bottom. The party could think of no other possible owner of the chest than the long-dead pirate captain.

Many thousands of dollars of American money have been wasted looking for the buried doubloons and moidores of Captain Kidd, hidden on desolate sea beaches. Did Captain Kidd bury any pieces of eight and gold dust on a lonely island off the American coast, to wait the shovels of modern treasure hunters? Captain Kidd's own story was that he left 20,000 dollars in gold dust and fifty pounds weight of gold from Madagascar, the pirate island, in the custody of a Mr. Gardner of New York. Kidd sent the gaoler of Boston to Lord Bellomont, the governor of old New York and Massachusetts bay, to say that if the governor would let him out of prison he would go to his ship, the "Quedah Merchant," which lay off Hispaniola in the West Indies, and bring off 250,000 or 300,000 dollars, which would otherwise be lost. Bellomont refused to let him out of prison on any pretext. Kidd also said that he had buried gold at Gardiner's island, and at the east end of Nassau island, off the county of Nassau, New York state.

The treasure left in the hand of Gardner

of New York was seized by Governor Bellomont, and when the chest buried in Gardiner's island was dug up, in 1689, it contained no gold, silver or jewels, but silk and fabrics. The great ship left off Hispaniola, and containing piece goods only, was seen in smoke and flames, according to the report of a passing trading vessel. The yarn of Captain Kidd's buried treasure is a pure legend, and would-be treasure hunters will be well advised to forget it.

Every now and again, newspapers tell us that some one is on the trail of the famous "mountain of gold," in far northern Alaska. A number of the richest gold-bearing streams which made the fame of Klondike and Dawson City, are said to have their headquarters in a round mountain, and a few contend that in the heart of this mountain lies the world's greatest treasure. In 1911, prospectors sank a tunnel into this mountain, hoping to find either a huge deposit of gold, or veins streaking through the rocks. They had to give up, owing to the failure of the funds for more engineering equipment.

The American seaboard is ringed round with rich treasure wrecks waiting exploi-

A:Bank

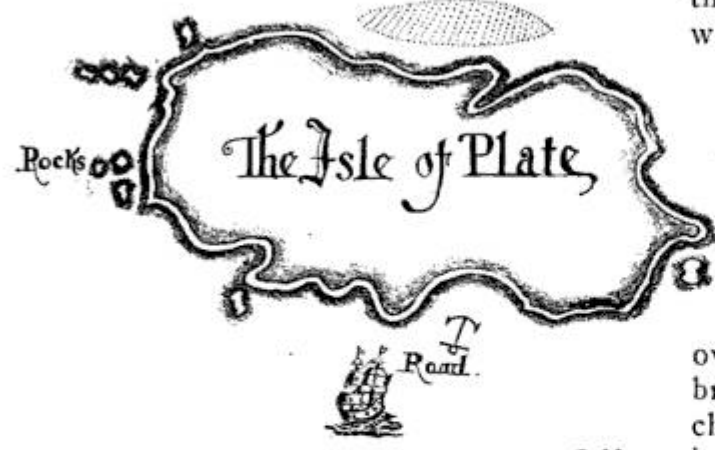

Treasure Island Off Coast of Peru. Named from Golden Plate Sir Francis Drake Is Said to Have Buried There

tation by the modern salvor. There is the British frigate "Hussar," wrecked in the waters of Hell Gate sound, and containing \$4,000,000 in gold, the pay of the British troops engaged in the American Revolutionary war. The steamship "Lexington," sunk off Bridgeport, Conn., has many thousands of dollars and much bullion in her safe and strong rooms. In Delaware bay, lies the "de Braak," with \$5,000,000 in gold and silver coins; off Nantucket lighthouse is the \$2,000,000 bullion wreck of the "Republic"; while in San Francisco bay, is the hulk of the "Rio Janeiro," with a freight of gold, silver, ivory and jade worth \$9,000,000.

A sporting syndicate of New York lawyers and a Wall street broker spent a lot of money, in 1925, trying to raise the treasure of the sunken Ward liner "Merida," rammed in a dense fog and sent to the bottom of nine fathoms of water, off Cape Charles, Virginia, in 1905. It is known that the "Merida," bound from Yucatan to New York, carried a consignment of \$200,000 in silver, and had in her bullion room \$4,000,000 in gold, silver and jewelry, as well as the famous crown jewels of Austria, and the family jewels of ex-President Madero.

Three or four attempts were made to raise the treasure between 1915 and 1925. All failed, because the channel in which the wreck lies silted up, is a battleground of treacherous winds and waves. The 1925 syndicate had the aid of two famous American champion divers, Frank Crilley and J. F. O'Hagan. They found and buoyed the wreck, went down into her twisted cabinways and collapsed bulkheads, and

were blasting their way steadily toward the strong room and the submerged safes, when a storm arose, and made naught the strenuous work of many months and the best brains and latest diving apparatus to be found in America.

Along the highway of the treasure seeker of today, a finger post points ever to Mexico. Many are the gold and jewel hunters, bound to this land of promise, who have ruined their eyesight poring over crabbed charts, and puzzled their brains about stories of long-lost caches of church plate and gold and gems, recorded in rare manuscripts in Britain's and America's libraries and state archives.

A strange tale is told in Tucson City, Ariz., of an Englishman, who, some few years ago, headed a band of miners over the Mexican desert to seek the long-lost treasure of the "Mission Gold." The story runs that when Mexico was first colonized by the Spaniards, a body of monks went to the western part of what is now the state of Sonora. There they founded a mission, in a country inhabited by a fierce tribe of Yaqui Indians. As time passed, an enormous amount of gold drifted out of the possession of the natives into that of the monks. It is said that two tons of gold, worth today, at current prices, around \$1,525,000, were hoarded up by the fathers of the mission. When Maximilian adventured upon his short-lived career as emperor of Mexico, he decreed that all church gold and plate should be confiscated, except such as was in the form of chalices or other ecclesiastical ornaments. So the fathers made haste to convert their gold into cups and crosses. Shortly after, the Yaqui Indians rose in rebellion and drove the priests from their country. Before they went, the treasure was hidden carefully.

On a day in the fall of a recent year, an Englishman met a man in a Tucson saloon who was at death's door and destitute of money or friends. The Englishman befriended him, took the man to his own hotel, and sent for a doctor. For weeks the man was in delirium, and the doctor's heroic efforts barely saved his life. He recovered and told a queer story of a hunt for the gold hidden by the mission priests. Frank Montoya was the sick man's name and, when he was well, he undertook to

no. 1000000000
on maker
International 439

lead seven miners into the Yaqui country. They set out in the following spring, and trailed across miles of burning desert into Mexico. On the 160th day after setting out the miners climbed a high bluff, near which once stood the buildings of Yaqui mission.

As soon as darkness fell, the miners located a huge amount of gold, of which they loaded 200 pounds on each of six burros. On the way back, Indians attacked them. Montoya was shot and killed, and the attackers surrounded every water hole, where the prospectors had cached food and drinking supplies. One of the white men went mad with thirst and had to be shot in order to prevent him from killing the others in his frenzy. Pitched battles with the Indians were fought in which many were shot. The burros, carrying the gold, were either shot down or captured, and all that reached Tucson was three pounds of gold. One man died on arrival, and out of the sixteen men, all told, who at various times have tried to secure the mission gold, fifteen are said to have met untimely ends.

(To Be Continued)

SUN PICTURES ON RIPE APPLES FORM FANCY DISPLAY 3903

By placing wax designs on apples while they are still green and allowing the sun to change the color of the fruit around them, an Austrian grower obtains novel patterns on his apples. The portion covered by the wax remains green, while the

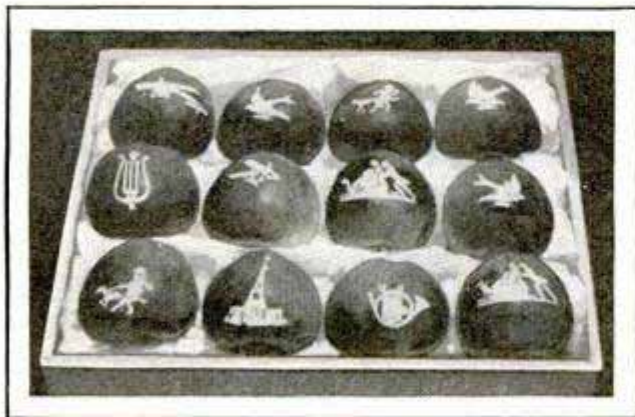

Apples with Designs Made by Applying Stencil Pieces to Surface and Allowing Sun to Color the Rest

rest, tinted by the sun, causes the shielded area to stand out distinctly when the wax coverings are removed.



Handbag Closed, and with Compartment Open to Expose the Camera, Which Is Used in the Usual Way

CAMERA IN SIDE OF HANDBAG SAVES EXTRA CARRYING

For the convenience of the woman tourist, a handbag camera has been introduced. The instrument is concealed in one side of the carrier, which has spaces for the usual articles, but is quickly made ready for photographing simply by raising a flap. The arrangement saves handling two separate articles and the case effectively protects the camera from damage.

FACES REPRODUCED BY RADIO GIVE DIFFERENT SOUNDS 4009

Different faces produce different sounds when sent over the radio by a special process now being developed, but they all have much the same tone as that of the whistle on a peanut stand, according to an eastern engineer. A face with a long nose is said to have a prolonged howl in the middle of its sound reproduction and sunken eyes will yield a noise like that of a muted whistle. A flat face with no deep wrinkles, gives an even note while an irregular one with deep character lines would sound like a tune on a penny whistle, the inventor declares. The tones are produced by converting the light waves into sound waves and then turning them back into light waves so that the picture may be reproduced at the receiving end.

Edgar H. Fisher, associated
with Austin G. Cooley

Vanity Kodak Ensemble
Mirror change pocket
Powder and stage compact
International
Lipstick and Kodak
Eastman Kodak Ensemble

535 2nd Ave
New York



Where Drinks Are Served from Coin-in-Slot Dispensers; Demonstrating the New Equipment in New York Store

COIN-IN-SLOT SODA DISPENSER SERVES QUICK DRINKS

Rapid service, greater cleanliness and reduction in cost are some of the features claimed for an automatic drink dispenser introduced in New York city. The customer slips a nickel in a slot and the desired drink pours forth into a fiber cup.

PHOTOGRAPH SPEED OF BLOOD

Photographs of the human blood stream in circulation are now obtainable with an improved apparatus developed for medical and chemical uses. Radioactive preparations are injected in small quantities into the blood of the patient. These can be detected with the apparatus when they reach different parts of the circulatory system. A record is made on a film as the

material passes a point where a detector is placed, and by suitable amplification impulses, set up by the rays in the substance which was injected, can be built up to such an extent that relays may be operated and a loud speaker made to register the sound. Readings may be made without an incision and by placing one or several chambers on various parts of the patient's body, the time of the arrival of the special substance can be checked at different points.

ACCELERATOR RUN BY KNEE AIDS SAFETY

Added comfort, less danger and economy of fuel are claimed for an automobile accelerator operated by the knee instead of the foot or toe. It is especially convenient on long journeys and has become popular among women. Instead of being attached in the

bottom of the car, this accelerator is actuated by a leather-padded rod that rests against the knee and leg. It can be connected in a few moments, prevents confusion with the brake pedals and does not interfere in any way with the regular operation of the car.

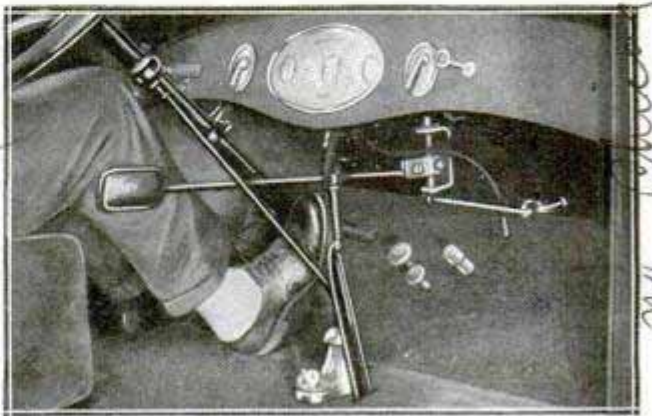

Auto-Accelerator Installation Managed by the Knee; It Adds to Comfort on Long Trips

Having Invented Electric counter & meter, Hans Leeger, Herman
 Schmitt, improved by Dr. C. D. Hewlett, Central Electric
 Schemmady, N.Y.

Dr. Herman Blumgart
at Paradise Memorial

Universal Service
Appliance Corp.

QUEER ISLAND SEEN AS CONTINENT IN THE MAKING

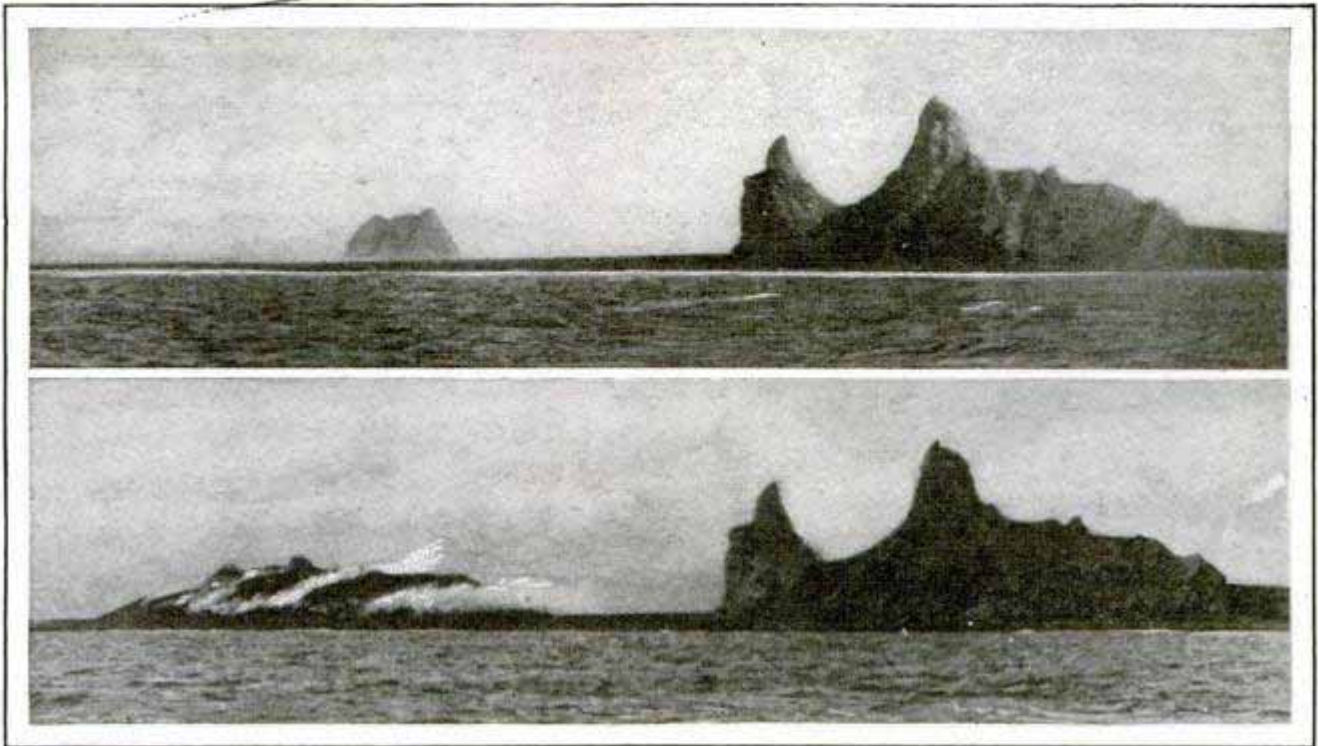

Bogoslof Island, as It Appeared in 1923, Shown by the Upper Photograph, and, in 1927, in Illustration Below; between the Rocks at the Right and Left of Picture Is Tip of Peak "Born" Last Year

Is a new continent being born in the icy waters of Bering sea? This question is again puzzling scientists who are watching with renewed interest the amazing volcanic activities of Bogoslof island—"the island that won't stay put"—a remote uninhabited spot in Bering sea, forty miles from Unalaska, where another volcano has mysteriously thrust upward from the ocean bed. This constitutes the ninth definitely recorded volcanic disturbance since Bogoslof itself came into being 131 years ago amid the terrifying accompaniment of earthquake, fire and steam. The birth of the island, in 1796, was witnessed by a Russian named Kriukof, resident agent of the Russian-American company at Unalaska, who then chanced to be on the nearest part of the adjacent island of Umnak, thirty miles distant. The island continued to grow, and in 1817 its circumference was estimated at two and one-half miles, its height at 350 feet. Since those early days Bogoslof has been the scene of constant amazing disturbances equaled nowhere else in the world. Numerous expeditions have investigated the island and inspected and named the new peaks which arose from time to time, but often the peaks would have mysteriously disappeared before the newly drawn maps

were fairly dry. The latest visit to the strange island was made by the United States coast-guard cutter "Northland." Pictures were taken of the new peak, which showed clouds of steam girdling its crest and issuing from crevices. Bogoslof interests scientists because the new cones are the summit points of a volcano beneath the waves which is 2,000 feet higher than either Vesuvius or Mount Pelee. In other words, they are investigating not only a volcanic island but a great submarine upheaval, 6,000 feet high.

**ELECTRIC PEN TO BURN DESIGNS
LATEST AID IN DECORATING**

Operated by electric current from a house-lighting socket, a stylus pen now on the market is convenient for burning designs or lettering on all kinds of articles. It may also be used for embossing in gold, silver and other colors on fabrics, leather and other materials. Little skill is required as it is employed as an ordinary pen.



Post Electric Co., 78
111

3800

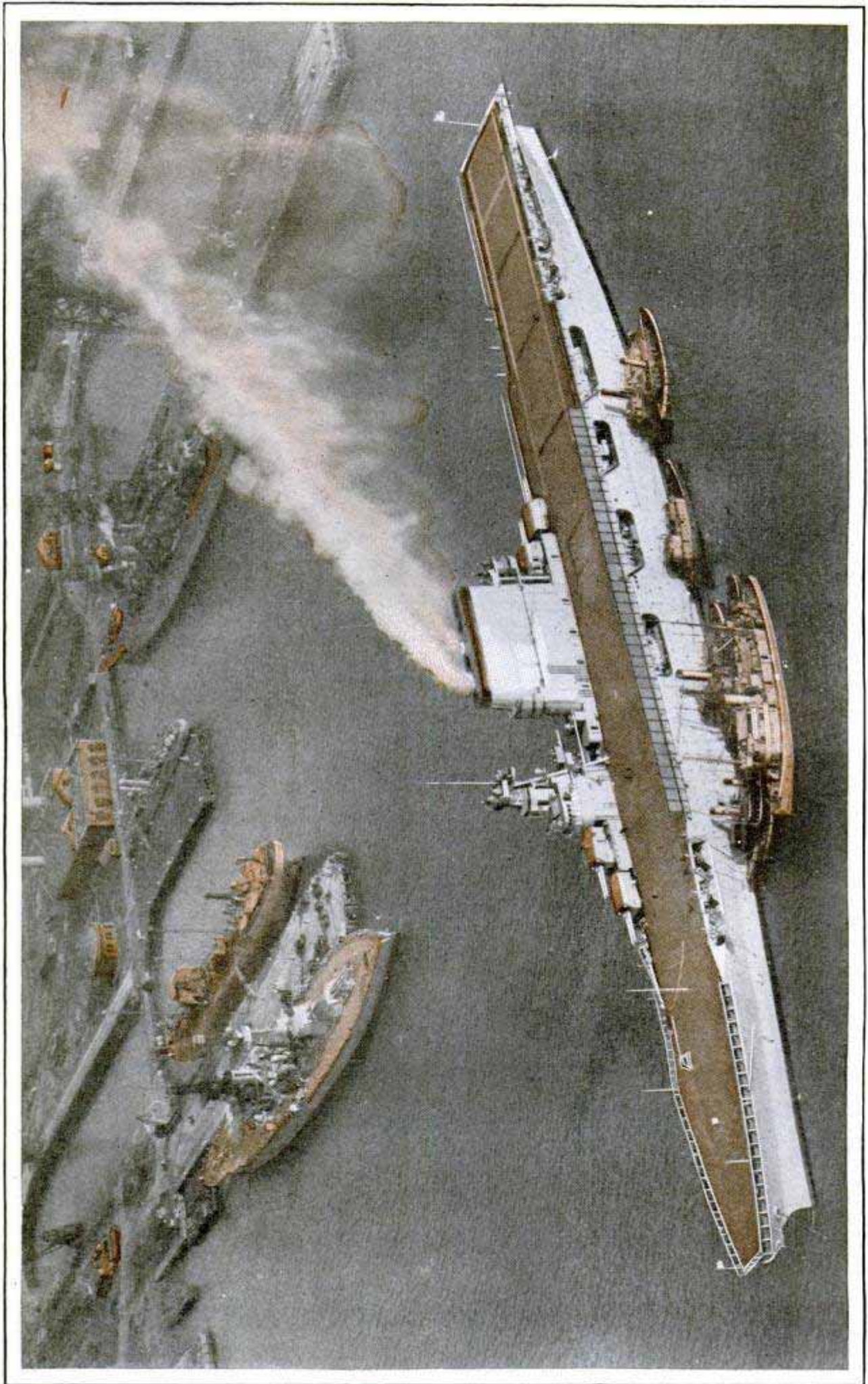

The "Saratoga" Lying at Anchor off Philadelphia Navy Yard, an Aerial View Showing the Enormous Flying-Deck Space; the Battleship with Cage Masts at the Pier in the Upper Left Corner Gives a Contrast in Size, For the Aircraft Carrier Is Almost Half Again as Long

PaA,

The Nation's Greatest Ships

Aero
THE longest and most powerful naval vessels in the world have just been added to the American navy with the completion of the new aircraft carriers "Saratoga" and "Lexington." Built to tear through the seas at thirty-three knots, or about thirty-eight land miles an hour, each can put eighty-eight planes into the air, and at the same time carry on a respectable fight against an enemy on the sea or in the air, for each is armed with eight big eight-inch long-range guns and twelve five-inch anti-aircraft rifles.

Started at the close of the war as battle cruisers, the two ships were changed, after the Washington disarmament conference, into aircraft carriers of the latest type. With their superstructure condensed in tall towers on the starboard side and their smokestacks streamlined into a single unit, they are the weirdest ships in the navy. Bigger than battleships, but as fast as the lean gray destroyers, they are entirely different from anything else afloat. Their great speed requires enormous power, four electric generators, each of 35,200 kilowatts capacity, for each ship. The power of each vessel is sufficient to supply all the electrical needs of a city the size of Boston. Steam turbines, run by sixteen oil-fired boilers, turn the generators, which transmit power to eight enormous electric motors, each of 22,500 horsepower, connected in pairs to four propellers. With 45,000 horsepower driving each propeller, the combined output of 180,000 horsepower makes them the world's fastest big ships.

The navy's entire fleet of six electric-driven battleships now in commission—the "New Mexico," "California," "Tennes-

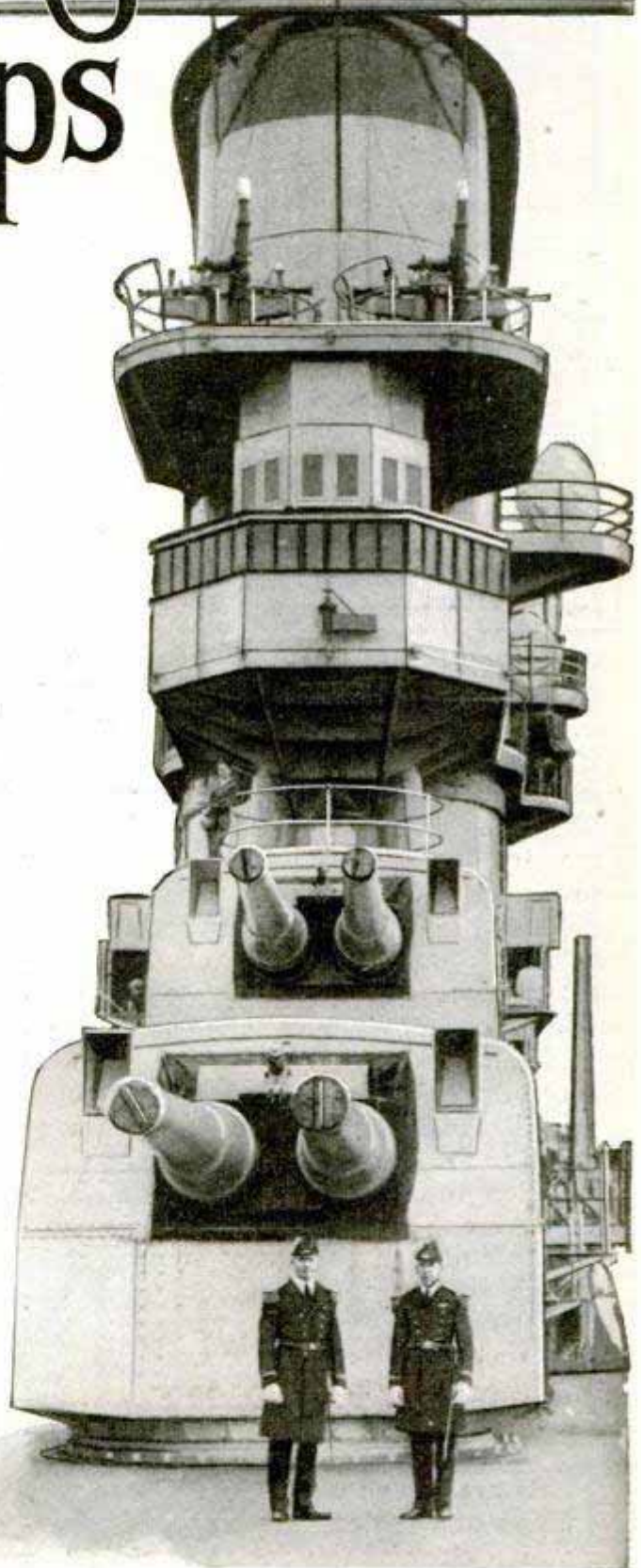

Turrets, Conning Towers and Smokestacks in One Tall Pile; Note Anti-Aircraft Gun, at Right, Pointing Up

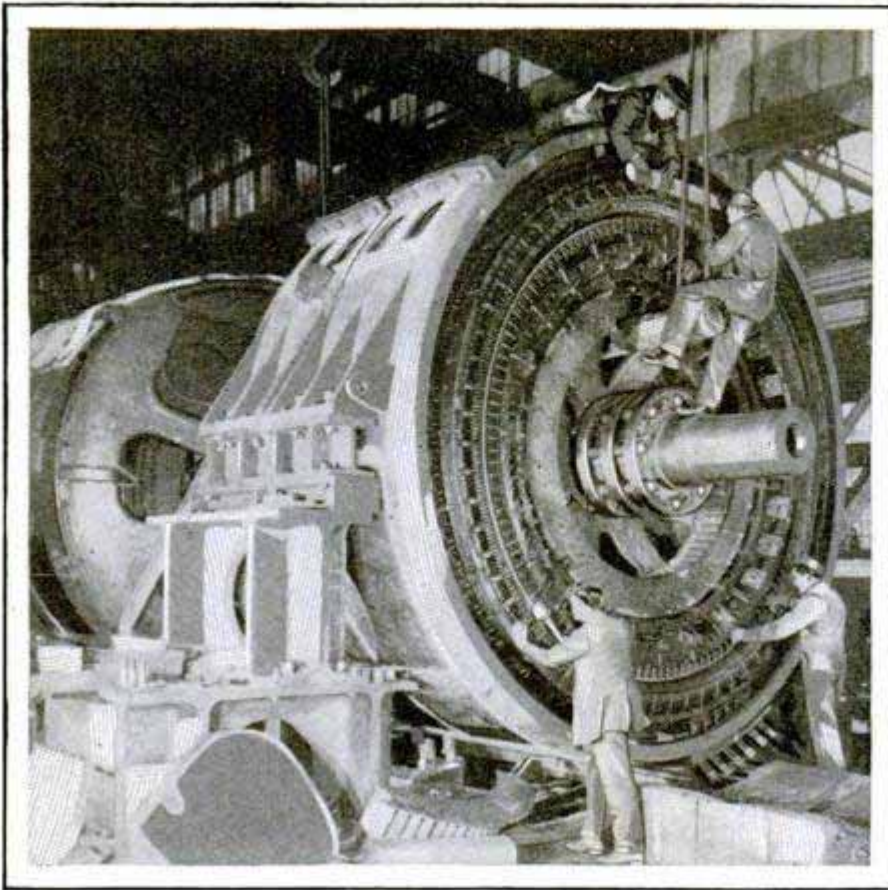

Building the Giant Electric Motors Which Make the Two Aircraft Carriers the Most Powerful Ships Afloat

see," "Maryland," "Colorado" and "West Virginia"—has less power than either of the new ships.

Because of the concentration of all the superstructure, gun turrets and other above-deck equipment at the extreme right-hand side of the ship, the "Lexington" and "Saratoga" are balanced by placing their fuel oil, water and gasoline tanks in the hull on the opposite side. As each tank is emptied, it can be filled with water to keep the ship in trim.

The broad, long landing deck is large enough to drill a regiment on, for the ships have a length of 888 feet and a beam of 105 feet. At either end, the deck flares out over the hull, and also drops somewhat to increase speed when a plane takes off. The deck is equipped with arresting gear to stop a plane on landing within a few feet, instead of allowing it to run along for some distance, as is done on a land field. When the landing deck is in use life nets are rigged along the sides, so that members of the deck force can, if necessary, leap clear of the deck when a plane is landing.

Two levels below the landing deck, the ship has hangars and machine shops for

handling the eighty-eight planes, which include everything from light and fast observation and attack squadrons, to heavy bombers and torpedo planes. Huge freight elevators are built in, to lift the completely assembled planes to the flying deck, the elevators coming to a stop flush with the deck, so they act as part of the flying field when not in use. A new type of catapult, mounted near the bow, can launch seaplanes, while the flying deck is being used by both land planes and amphibians.

Either of the aircraft carriers, according to navy officers, is capable of meeting any existing battle fleet single-handed. With the eight-inch guns

in their turrets, built for unusually long-range work, they can stand off enemy destroyers and cruisers, while their great speed will enable them to maneuver out of range of the heavier battleships. The twelve five-inch anti-aircraft guns are designed to keep the air clear of enemy planes while the carrier's own force is taking the air.

The flying deck is long and wide enough to accommodate the entire complement of set-up planes at one time, and still leave room for ships to take off. Not all of the eighty-eight planes on each carrier will be kept fully assembled at one time, but others can be set up as fast as needed, to replace airplanes shot down or incapacitated by mechanical troubles.

Some idea of the immense size, weight, power and speed of the "Saratoga" and "Lexington" can be gained by comparing them with other naval vessels. The 32,600-ton "Maryland," "Colorado" and "West Virginia," biggest battleships in the navy, are overshadowed by the aircraft carriers, with a displacement of more than 33,000 tons. The difference in size is even more marked, for the battleships, with their enormous weight of heavy armor

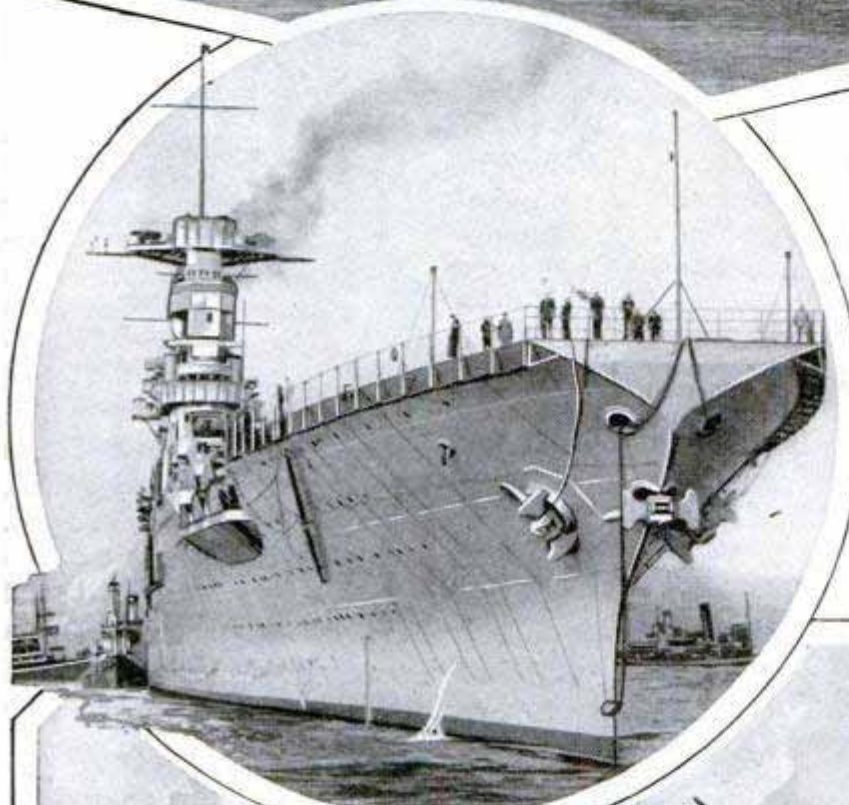
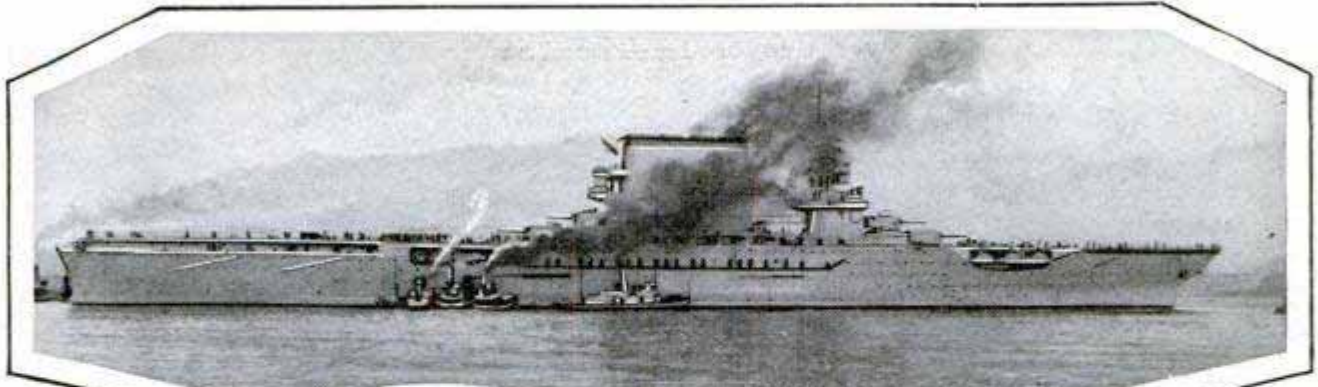

The Weirdest, Most Wonderful Ships Afloat; Three Views of the "Saratoga," Which, with Its Companion Ship, the "Lexington," Are the Navy's Greatest Vessels; the View at the Left Shows the Squared-Off Overhanging Bow, Wide Enough for Planes to Take Off or Land; Below Is a Closeup of the Conning Tower and Turrets and the Enormous Streamlined Structure Which Surrounds the Smokestacks; Note the Searchlight Platforms, Ladders and Walks Built on the Sides of the Stacks, and the Gun Turrets and Control Platforms Facing the Stern, at the Left of the Photograph

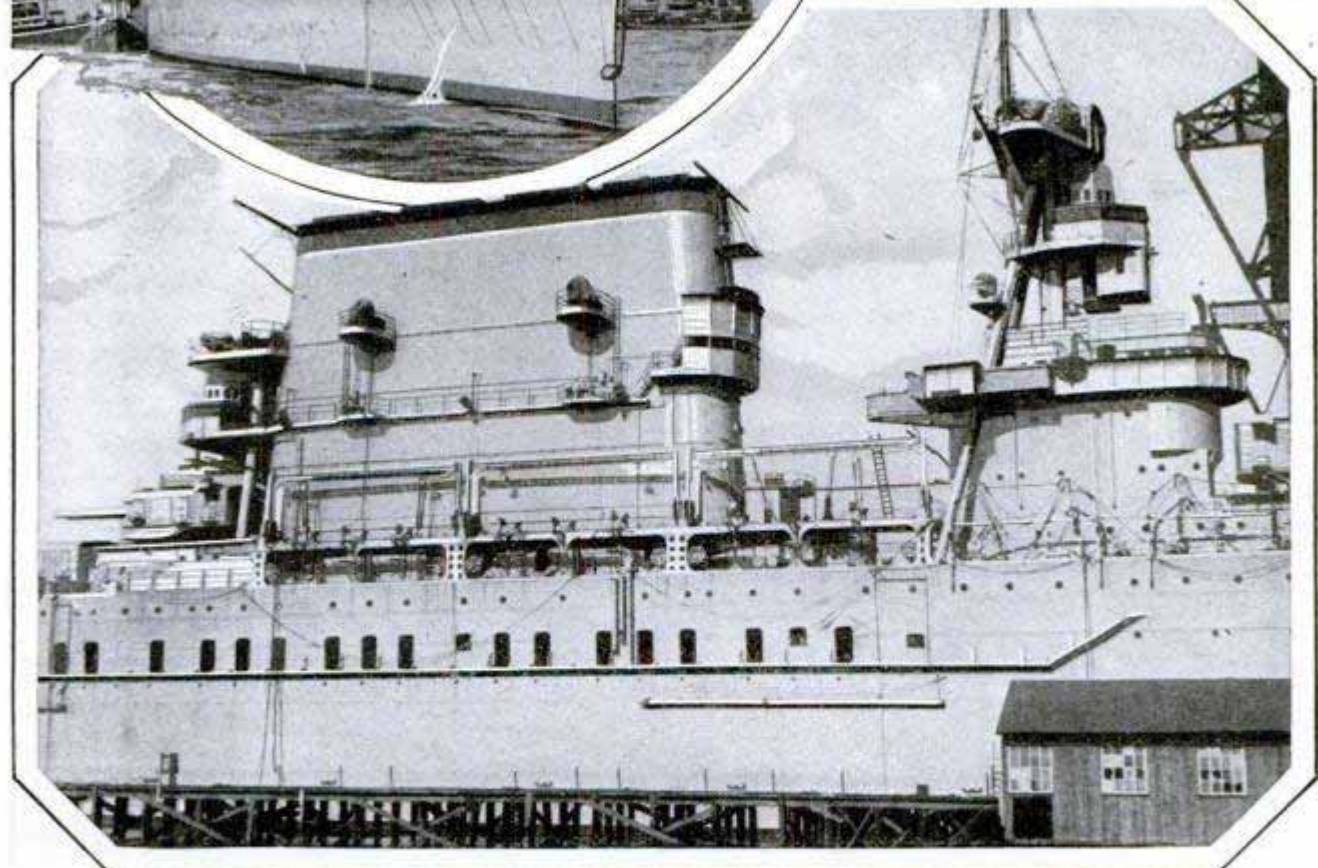

and big guns, are only 624 feet long by ninety-seven feet three and a half inches

beam. The two new ships are each 264 feet longer—more than 40 per cent bigger.

In shaft horsepower either of the new ships, with 180,000 horsepower delivered to her four propellers, is equal to more than five 35,000-horsepower battleships of the "Maryland" class. Their enormous power will drive them practically as fast as the swiftest light cruisers in the fleet, and only two knots slower than the best of the first-line destroyer squadrons, while they can outrun the older torpedo boats.

Complete with her complement of planes, the "Saratoga" cost approximately \$45,000,000 to build.

The shops in the two carriers include not only machine and carpentry departments, but a laboratory for testing engines, fabric, doping and painting shops, a sheet-metal department, plumbing shop and a sewing shop with more than forty sewing machines, to work on wing covers.

The interior of the ships is divided into more than 600 water-tight compartments. Of these 117 are assigned to the supply department, thirty-one for the storage of aviation material, seventy for storage of general stores, and sixteen are utilized for the galley, bakery, butcher shop, general mess-issue room, clothing-issue room and the ship's store, or canteen.

The crew's quarters are on the first deck below the flying field, with the planes stored below them, to give added protec-

tion against bombs dropped from above. The "Saratoga" went into commission with 1,365 enlisted men of naval ratings and 450 aviation mechanics; 104 ship's officers to handle the crew and 115 commissioned aviators.

Besides their usual equipment, each of the carriers has a complete weather-forecasting bureau, in charge of a weather officer and eight assistants. Every type of recording instrument used in land observatories is carried with their records concentrated in the weather bureau on the second deck of the superstructure.

With the addition of the two new ships, the navy now has three aircraft carriers in commission, but is still far under the total tonnage for ships of this type permitted by the Washington treaty, which assigned the American and English navies each 135,000 tons of plane ships. The other carrier, the "Langley," converted from the old navy collier "Jupiter," as an experimental ship, displaces but 12,700 tons, so 56,300 tons can still be added, though no more has been planned, as yet.

When President Coolidge submitted his recent navy plan to congress he included three more aircraft ships, one of which would replace the "Langley," giving them a possible average size of 23,000 tons each, or two big ships and one small one.

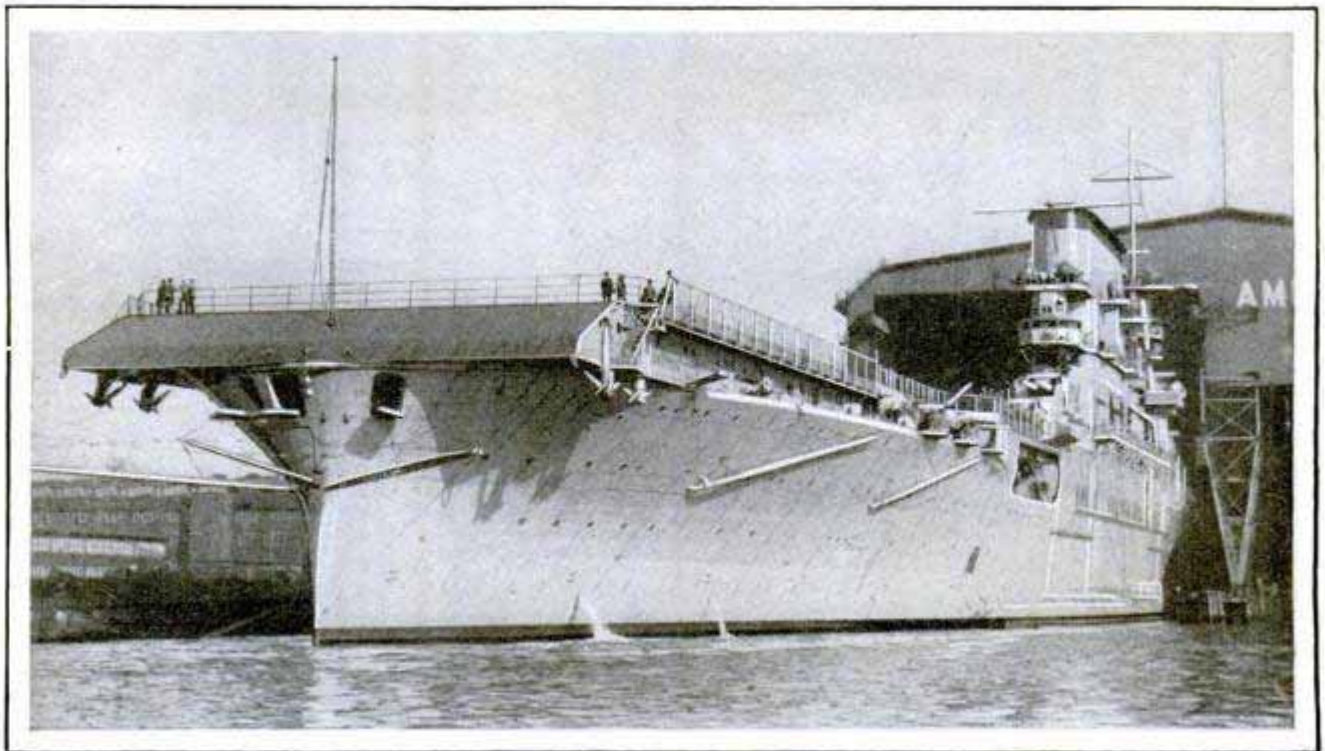

The Stern of the "Saratoga" Is Even More Odd Than the Bow; Four Anchors Hang from the Corners of the Flying Deck; Temporary Railing Is Rigged When the Deck Is Not in Use

American Dynamite Co., Ltd.
Factory at Modderfontein, Transvaal, South Africa

Henry Haberk. 413
Linwood, Ohio
3752
Manufacture of Cycles de France, France.

*Carl Eric Rosenstaple Box 1691 A
 Grand Rapids, Michigan*

**RUBBER LIGHTNING CONDUCTORS
 GUARD DYNAMITE 3958**

In the Transvaal, where more people are killed by lightning than on any other part of the earth's surface; where electricity is so plentiful in the air that hair gives sparks when stroked; where whole mountain ranges consist of solid iron ore on which lightning dances like fireworks, the owners of explosive factories face an extra hazard. Though artificial caves have been hewn in the soil, and ordinary lightning conductors loom in hundreds against the sky which averages one thunderstorm every three days, the engineers who watch the black clouds that so often frown across wild Transvaal hillsides do not feel satisfied. Workmen put on rubber shoes and carry no metal that can produce sparks. As an additional protection, one large plant has been insulated with rubber. The great difficulty arose in giving the gutta-percha the power of "earthing" a current to the ground. Wires made of copper, iron, aluminum and other metals were let into the composition until a sensitive galvanometer showed that the electricity, although it was passing through the rubber conductor, could not leak toward the neighboring stocks of dynamite. This modern protection is flexible, consisting of rubber strips with the afore-said metal reinforcement. It is mounted along the exposed edges of buildings.



Glasses Opened to Expose the Lenses; When Folded, They Can Be Slipped into the Pocket

**OPERA GLASSES FOLD FLAT
 TO FIT VEST POCKET**

H. J. Henri Haberk. 413
 Easily carried in the vest pocket or the handbag, a style of opera glasses now on the market can be folded flat. The lenses are lowered and the case fits over them when the glasses are not in use.

Linwood, Ohio Columbus

A USE FOR OLD NAILS 3939

Almost every land has its dealers in secondhand goods, but in France, where strict economies have been required because of the war's expense, salvage "specialists" are flourishing in large numbers. Among them are men who travel from door to door, mending old china and other articles. Even the coarsest cooking utensils are saved instead of being thrown away, to await the arrival of the expert mender. Numbers of women are adept at weaving new bottoms in cane chairs. Even nails are hammered straight again and old pins made serviceable for further use.

**TELEPHONE ON INFANT'S CRIB
 REDUCES MOTHER'S WORRY**

To simplify the task of caring for the baby, a western inventor has devised a loud-speaker telephone apparatus to be attached to the child's crib. If the infant cries when the parents are in another part of the house, the sound is transmitted from a mouthpiece on the crib to an amplifying receiver in the living room.

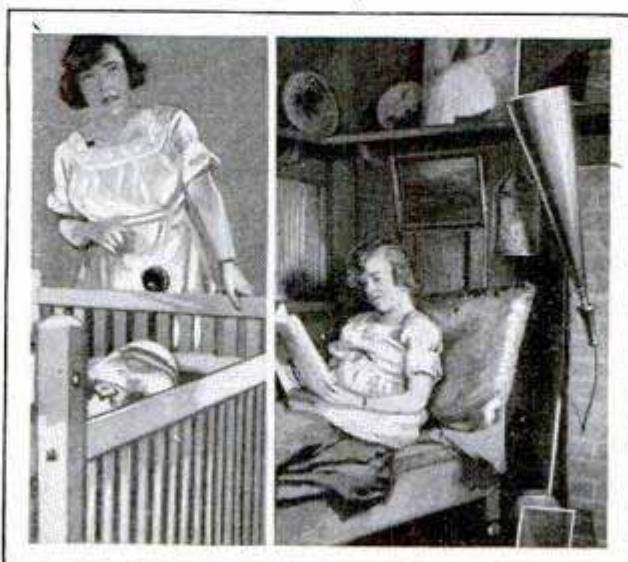

Transmitter on Baby's Crib and the Loud Speaker through Which Baby's Cries Are Heard

and Roy B. Ashbrook, Kansas City

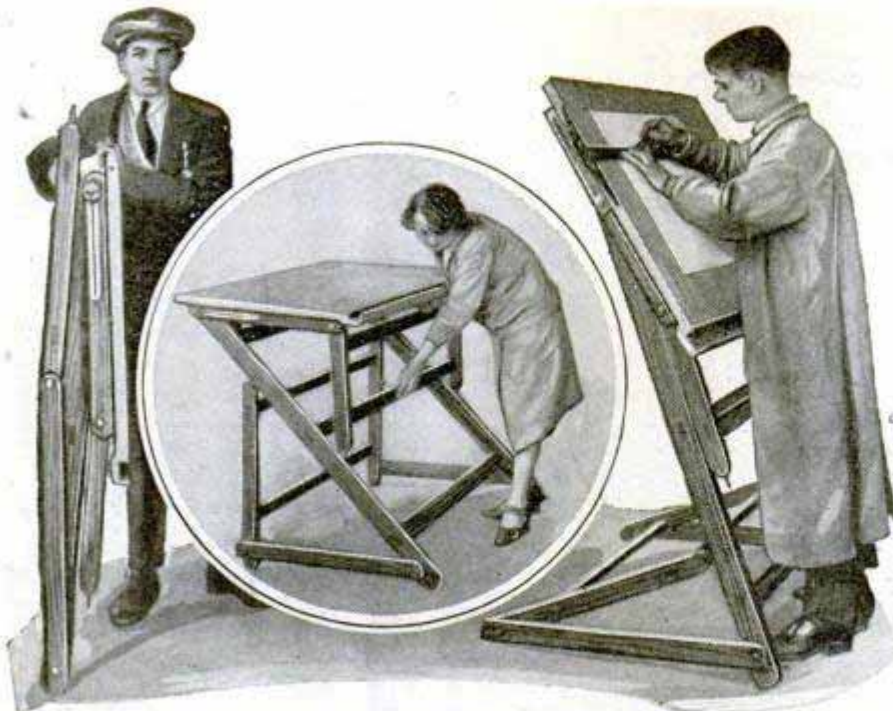

Board Folded, Arranged in Flat Position, and as an Easel; Its Adaptability Suits It Especially to Small Studios

DRAWING BOARD IS ADJUSTED FOR ANY POSITION

For the convenience of draftsmen and artists, a drawing board introduced in France is attached to a collapsible frame which can be adjusted to a horizontal or vertical position with little trouble, and, when not in use, folds flat for storing in small space. In the upright arrangement, the board serves as an easel and allows the artist to work while seated or standing. There are no complicated parts to get out of order, and the outfit is so light in weight that one person can carry it without fatigue.

AUTO SHOCK ABSORBER KEEPS WHEELS ON GROUND



Said to arrest spring vibrations and reactions from road irregularities without interference with the natural flexibility of the springs themselves, an improved shock absorber has recently been placed on the market. It is designed so as to keep the wheels on the ground, thereby providing greater road traction,

easier steering, longer mileage and better braking. It is easily attached to the free shackle end of the spring, and the balancing unit is pointed toward the axle.

CLEANER RESTORES SHEEN OF FUR

3853 By adding a small proportion of paraffin to a preparation generally used for cleaning furs, investigators of the bureau of standards have improved the substance so that it is said to restore the original luster of the furs more thoroughly and is more effective in killing moths and other destructive pests. The treatment is considered an advance over usual dry-cleaning methods, as it does not mat the fur or make leather trimming brittle. The cleaner contains naphtha, to help kill moths, and the paraffin, used in small quantities, appears to restore the fatty content of the fur, often removed by dry-cleaning, and coats the hairs slightly, improving their sheen.

CALCULATOR TO BLEND OILS ELIMINATES GUESSWORK

3569 To blend oils, a simple gauge has been introduced to save the use of a chart or special formulæ and to insure an even grade in the product. It is an easily operated instrument, showing on one side the gravity calculations and, on the other, the viscosity scales. By moving a sliding member to the proper places on the scales, the necessary proportions can easily be determined. The guide is intended especially for those engaged in buying and selling, or experimenting with, oils.

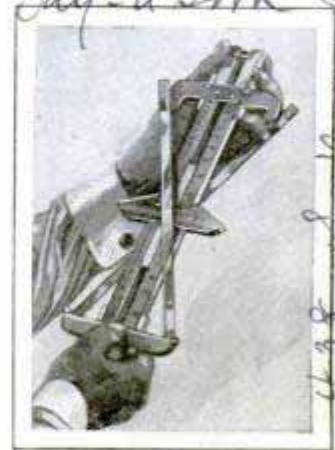

Chicago- 1150 W Jackson Blvd. U.S. agent

Indian Motorcycle Co. C. J. Tagliatone, Mfg. Co.

ARTISTIC DISPLAYS ARE MADE FROM PAINT AND TIN

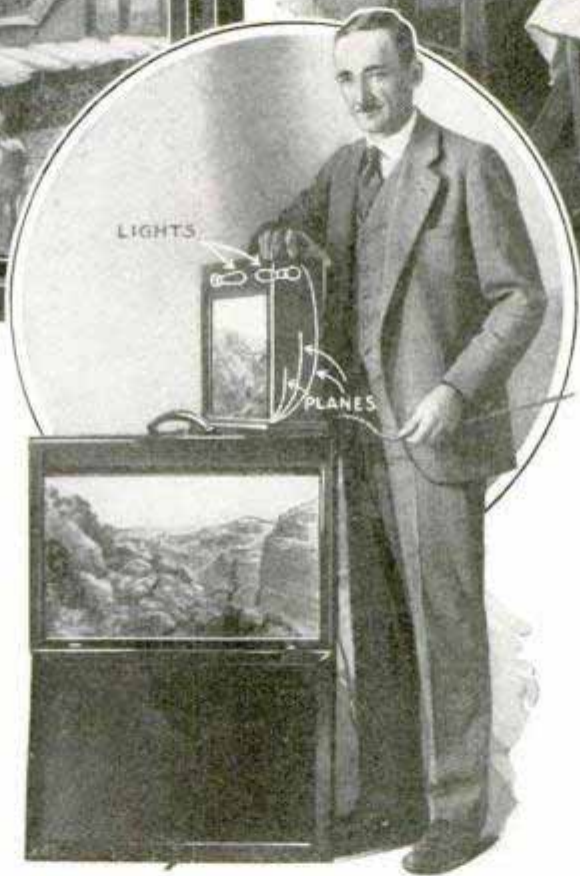
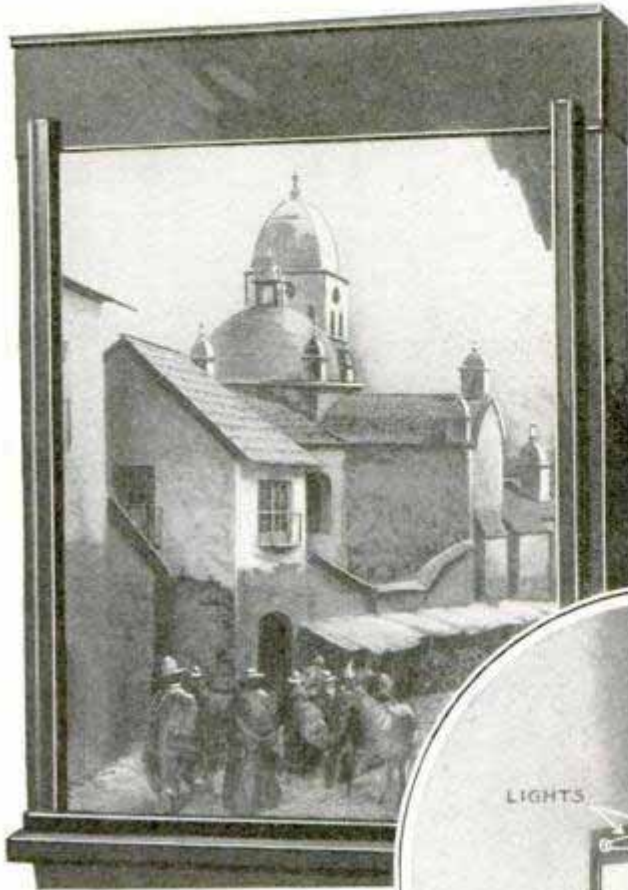

Louis O. Leimert with Samples of His Metal Display Booths and at Work in His Studio; the Cabinets Are Effective for Real-Estate and Similar Exhibitions

An electrically illuminated combination painting and zinc bas-relief, no deeper than the average framed picture but giving the perspective effect of countless miles, has been invented by a western artist for commercial displays. It is designed for the use of real-estate subdivision firms, chambers of commerce, railroads and motion-picture distributing organizations to visually present in a vivid, yet natural manner the attractions of their offerings. The inventor, Louis O. Leimert, uses a series of planes. The first, a piece of zinc, instead of inflammable canvas or wood, is cut out much like the familiar profile piece used in stage settings. This is then curved and, rising from the bottom of the front edge of the metal frame, is soldered in the foreground. The next, also curved and rising higher before being cut out according to the pictorial

requirements, is placed an inch or so back of the first, with succeeding pieces cut and soldered in place in a similar manner. The final flat piece of zinc, curved at top and sides to meet the front edges of the frame and thus mask off the rough edges from the sight of even the most critical observers, is introduced to form the background. Then miniature bridges,

houses, trees, shrubbery, people and animals are carefully cut out by hand from small pieces of the metal and each soldered in place. After this, the metal frame is finished, all the metallic parts of the picture painted in perspective in natural colors, and sockets to hold concealed electric-light bulbs are fastened.

☛ Codfish devour clams, shells and all.

*Diamond Apartments
Palmer Building, Boston*

*Explorers Club,
47 W 76th, New York*

450
2995

not made



Eliminating Laborious Lifting; the Elevated Truck Body Extended to Simplify Task of Stacking Wood

Wide World

AUTO TRUCK THAT PILES WOOD SAVES HAND LABOR

To simplify the task of hauling and stacking cordwood, a Seattle dealer devised an elevating body for his auto truck. It can be raised to a height of more than eleven feet, remaining level during the descent and permitting easy stacking of the load as well as refilling the truck from the top of the pile.

HUDSON BAY ROAD WILL END AT CHURCHILL

388 2

Engineers have chosen Churchill instead of Port Nelson as the Hudson Bay terminus of the railroad that is expected to save wheat growers, and other producers in the central provinces of Canada, large sums in freight charges. Although Churchill is 100 miles to the north, it is about the same distance from Liverpool, and the advantages of the natural harbor there, over the artificial one that would have had to be constructed at Port Nelson, proved a deciding point in favor of the new location. Work was started on the railroad several years ago, was abandoned during and for some time after the World

war, but was started again last summer. It is expected that trains will be running into Churchill by the fall of 1929. The line runs through muskeg which is frozen, even in midsummer, to within a foot or two of the surface. This makes it impossible to do any work with steam shovels. Pick, shovel and wheelbarrow must be used instead. Construction of the road is being done under great difficulties, and the results are doubtful in the minds of many engineers, for they point out that not more than two months of the year are open to navigation through the straits. But believers in the project will rely to some extent on two modern aids in defeating this obstacle, directional radio and airplane scouting to help guide the ships.

TRAINS AS POLITICAL POSTERS SPREAD RUSSIAN IDEAS

3824

Spreading propaganda by means of railway trains "dressed up" as posters, is one of the plans adopted recently in Russia. Banners and other insignia are attached to the engine and the message is spread to every town and city along the way. Some of the poster trains literally travel



All Dressed Up in Propaganda Costume; a Russian Locomotive That Serves as a Traveling Poster

the length and breadth of the land and are seen by thousands of persons.

Right This Way Gentlemen

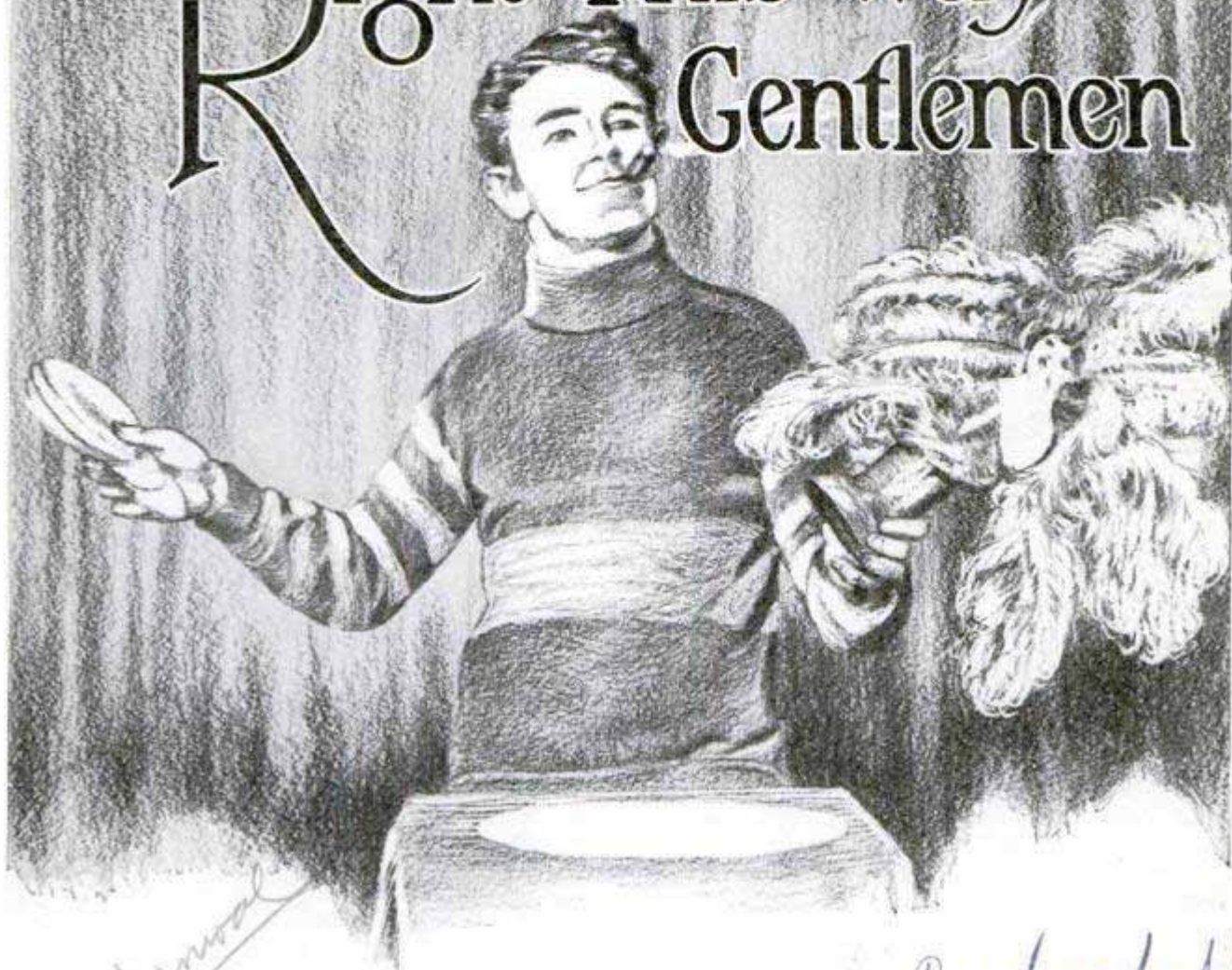

By SAM BROWN

*Carhart St
Marion Ohio*

EVERY spring hundreds of street shows start their migratory tour of the "sticks," bringing with them a host of sure-thing games on which you can try your skill. Many of them, from the innocent-looking "Toss a ring and win a cane" game, to the intricate roulette and paddle wheels, can be "gimmicked" or controlled by the operator.

One of the most ingenious of these games is the "Test your strength" device, wherein a lever, when struck by a hammer, catapults a marker up a steel wire and registers the number of pounds of strength. A blow of 2,000 pounds rings a bell and the strong man is awarded a couple of cigars. The operator controls this game in the majority of cases. At his feet is a lever which only needs a gentle touch and—presto!—the wire is made to hang taut or loose as he desires. And therein lies

the secret. When the wire is tight, a moderate blow will shoot the marker skyward, lighting the colored marking bulbs all the way to the final crash on the bell; but when the wire is loose, the marker encounters considerable friction, and even a Samson smash will fail to register any more than 1,700 or 1,800 pounds.

Perhaps the commonest of all the carnival games is the roulette or paddle wheel. Most of these are run on the square, the operator depending on getting a full board on every spin of the wheel, and then awarding a sixty-nine-cent prize to one of the fourteen people who have paid a dime each for the chance of winning. But most of the manufactured roulette and paddle wheels can be fixed, and the percentage of winnings altered instantly by the operator. There are many ways of controlling these wheels. Us-

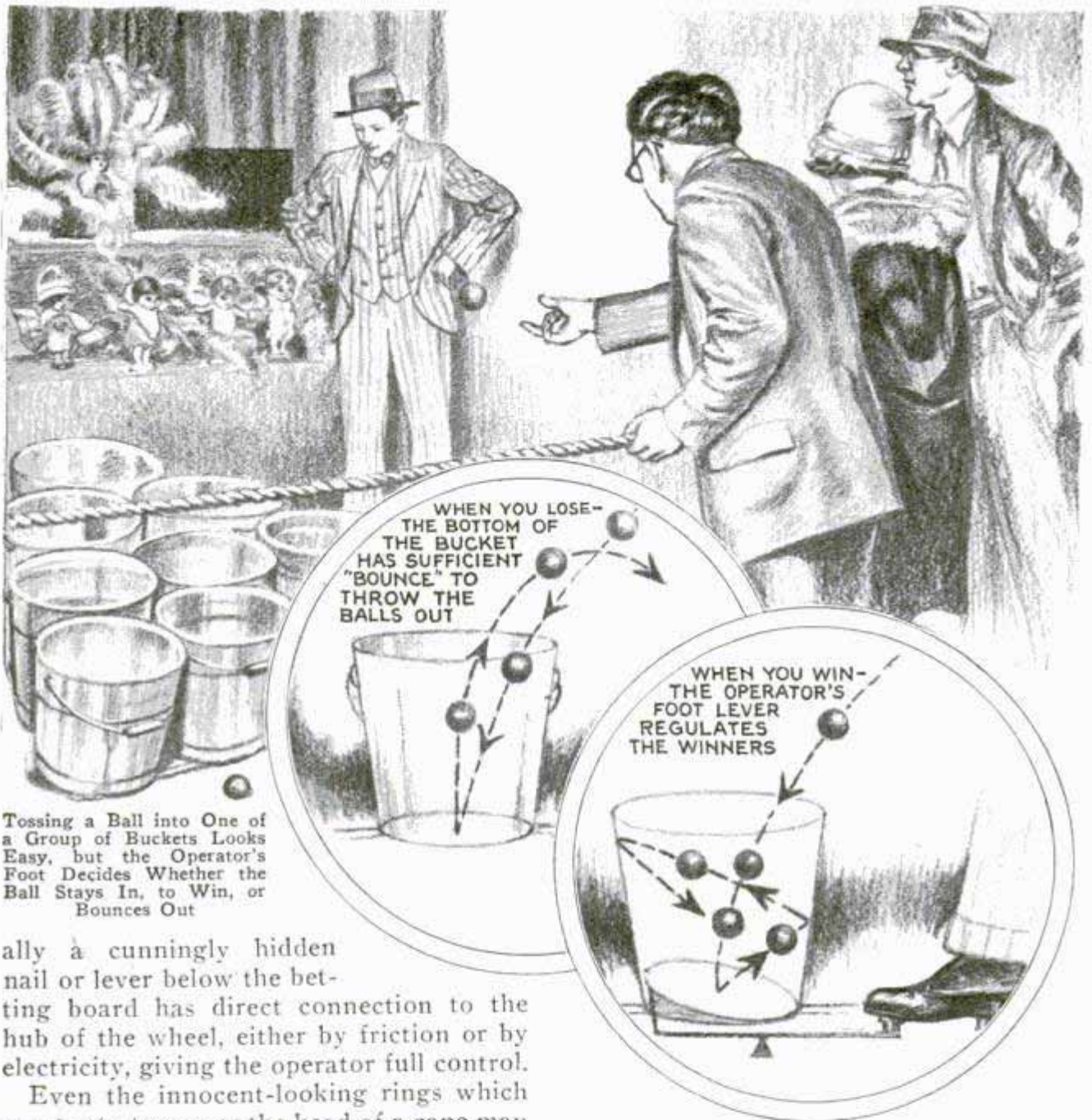

Tossing a Ball into One of a Group of Buckets Looks Easy, but the Operator's Foot Decides Whether the Ball Stays In, to Win, or Bounces Out

ally a cunningly hidden nail or lever below the betting board has direct connection to the hub of the wheel, either by friction or by electricity, giving the operator full control.

Even the innocent-looking rings which you try to toss over the head of a cane may be fixed. This is done by weighting the ring on one side so that it falls on an angle, thereby preventing it from ringing any but the cheaper prizes, while the ten gold-headed canes, with the dollar bills wrapped around their handles, remain the property of the operator.

Another ring game offers prizes mounted on pedestals, the object being to throw a hoop over the pedestal in order to win the prize mounted on it. The "shil" does it with a special set of slightly larger rings which are kept on hand for his appearance, but the rings you play may be a bit elliptic in shape, and since this slight variation from a true circle makes them about one thirty-second of an inch smaller

than the pedestal, you might toss a lifetime without getting anything. If you should look askance at the ring and then at the pedestal, the operator will take the ring, and, pressing it to a more rounded fullness, easily slip it over the stand in question.

Another game which looks absolutely on the square is the pin-and-ball game, consisting of a bowling pin standing on a table, with a suspended ball directly over it. To win in this game, all you need do is to swing the ball forward, miss the pin going, and knock it down coming back. An impossibility! If the ball is suspended squarely over the pin, it is against all laws of gravity for an object its size and weight

to miss the pin going and hit it coming back. When the operator demonstrates, he presses a lever which sets the ball about a quarter of an inch off to one side, and then with a practiced hand, knocks down the pin on the rebound. After his "See how easy it is" demonstration, the ball goes back to its former position and your efforts only go to show that Dame Nature cannot be trifled with—not even for a ten-cent piece!

There are a few games that are always played on the square. One of these is the "Spot it" game. To win you must lay down five small red disks so that they completely cover a larger blue one. The operator shows you how. Your trial, however, usually results in a contribution to the barker's pocketbook. This game is a real game of science—the science of geometry. The sketch shows you the only way the small disks can be placed to completely cover the larger one, and any deviation from this layout, be it only a quarter of an inch, will result in failure. It's not so honest after all! The operator has certain

landmarks on the blue disk, discernible only to himself, without which he, too, would be unable to make the five red disks cover.

The gimmicking even extends to the guileless-appearing ball games. The woeful-looking cats and the pretty white milk bottles that you throw baseballs at are often loaded so that they can withstand a most terrific impact and still remain vertical. The grinning "nigger babies" have been hammered so unmercifully in previous seasons that they present a total solid area of about three square inches, the rest consisting of gaudy

Whether the Wire Is Taut or Slightly Loose, as Determined by a Foot Lever, Decides Winners and Losers

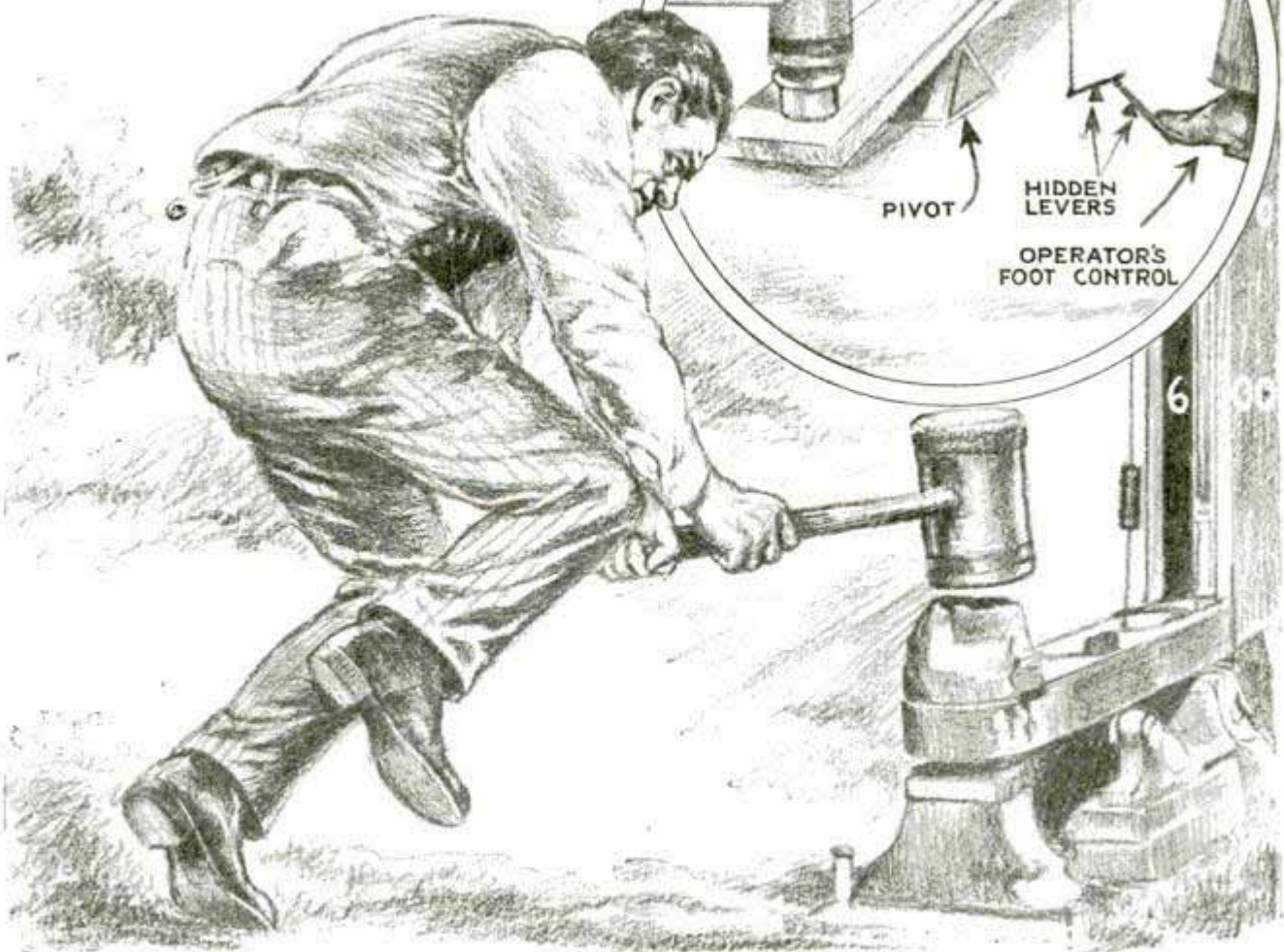

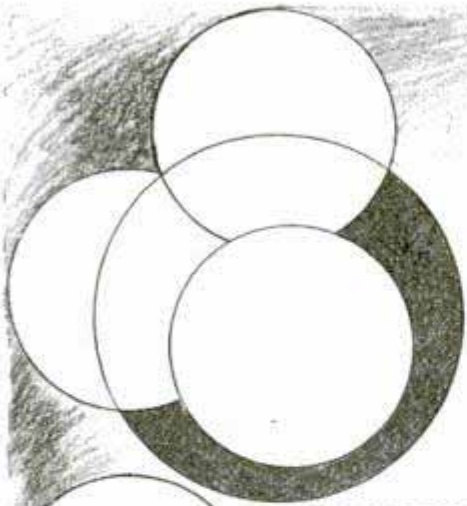

THE PROBLEM OF "SPOT IT" IN WHICH THE LARGE DISK IS TO BE COVERED BY FIVE SMALL ONES. ABOVE, THE WRONG WAY, AND, BELOW, THE SOLUTION

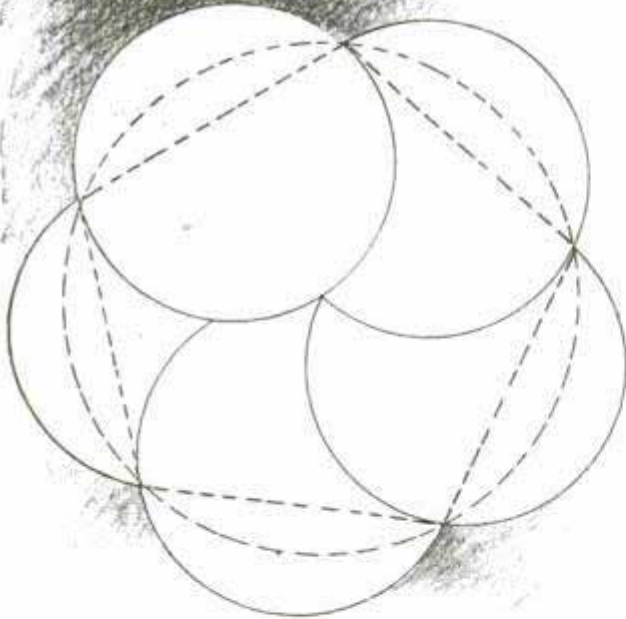
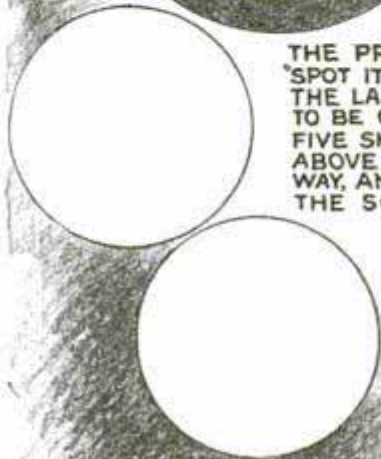

Method of Covering the Entire Surface of One Large Disk with Five Smaller Ones Is Shown at the Left

The buckets are all guaranteed by the manufacturer to reject the ball every time it is thrown in. The only time anybody wins is when the operator thinks that a winner would be good business; then he presses the lever which takes the bounce out of the bottom of the buckets and somebody gets a prize. The winner is complimented on being a very skillful individual. Were you ever one?

There are many variations of the carnival games. The knife pitch, for example. It is basically the same as the cane pitch, in which the player tries to toss the ring over a cane, and fails because the ring is slightly weighted on one side, causing it to fall at an angle that makes it practically impossible to land it over the end of a walking stick.

The shil who runs the knife pitch displays several hundred pocketknives, opened and with their blade tips stuck into his table. It looks like an easy thing to land a ring over one, but all the more valuable knives are so closely placed that the weighted ring is sure to strike on one edge and fall between them, and the chance of putting a two-inch ring over the cheaper ones is slight.

edging through which the ball whizzes without the slightest effect. You cannot throw a ball into the mouth of a grinning face because the operator presses a button which closes the mouth a trifle, making it too small for the ball.

One of the surest of all the sure-thing games is the one with the buckets. To win a prize at any of these bucket games, you must throw so many balls into the buckets in so many tries. Try and do it!

3591

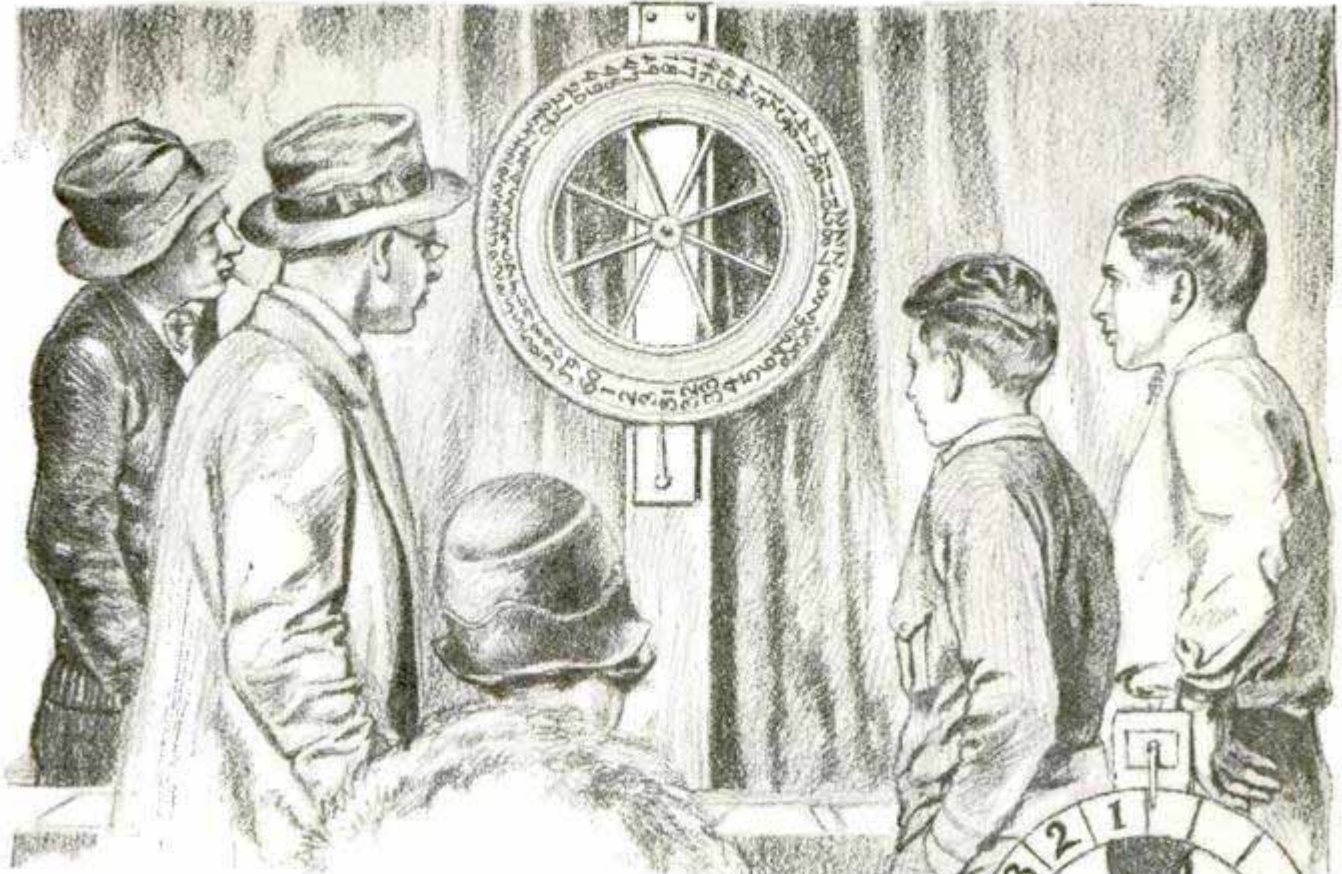

The carnival men talk a language of their own, partly borrowed from the older art of stage magicians. The magician calls the secret, hidden apparatus that enables him to fool the eye a gimmick and the shills have adopted the same term.

Strangely enough they do not mind particularly if the public knows the games are fixed for the house to win. They discovered a long time ago that the older gambling games, three-card monte and the shell racket, which were looked on with disfavor by the law, were very crude.

Profiting by Barnum's dictum that the public likes to be fooled even when it knows it is being misled, the modern shill plays on the carnival spirit that makes visitors willing to spend their dimes with no expectation of winning, and spend them on the chance of getting something they don't want, even if they are permitted to win it.

The crowds surrounding the games in any amusement park consist largely of people who know there is a gimmick in the game, but are willing to spend the money for the amusement derived from the play. A carnival

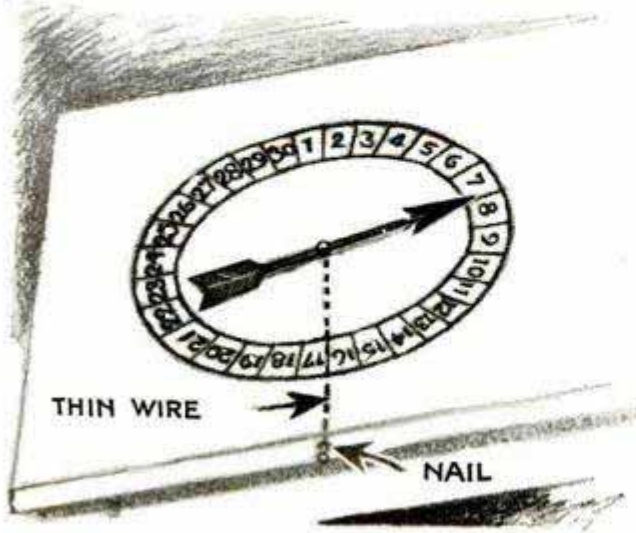

Friction of a Thin Concealed Wire on the Hub of a Spinning Wheel May Be Used to Make Blanks Win

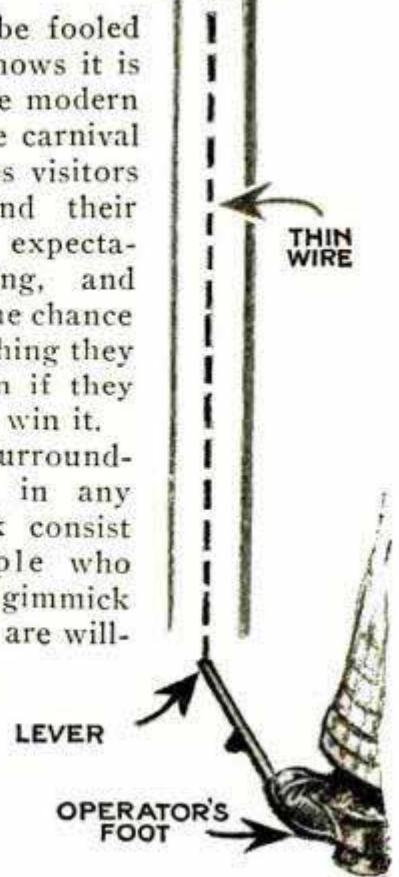

3591

Fredrick Holzgel

man with a "fixed" device is selling a amusement as frankly as the operator of the figure eight, and if, occasionally, he condescends to throw off the gimmick and let a player win a violently painted plaster-of-paris vase, a crepe-paper-dressed doll or some equally eye-start-

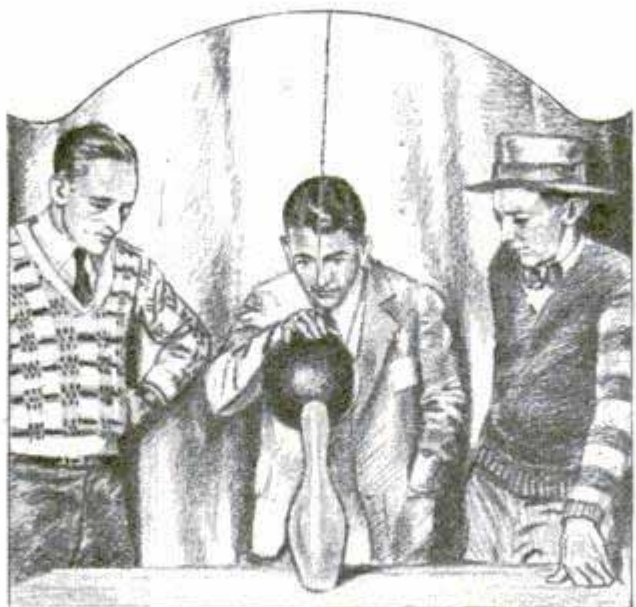

the evening. These are some of the conclusions of a University of Chicago research worker who has been alternately fasting and eating for more than 500 days in an effort to solve some of the mysteries of hunger. At one time, he went forty-one days without eating. He believes



Two of the Games That May Be Fixed; the Suspended Ball Which Must Hit the Pin on the Return Journey, and the Weighted Rings That Always Fall at the Wrong Angle

ling prize, it is merely a favor bestowed, and not something legitimately won.

The fiction that the games are ones of skill and not of chance, and therefore not violations of the anti-gambling code, is maintained but outwardly. The shill knows his customers come to be amused, and that they expect to get their fun out of his conversational sallies and their own futile attempts to beat the game.

EATING MOST FOOD IN MORNING HELPS REDUCE FAT

38 19

Persons desiring to reduce their weight should eat more of their food in the morning, while those who wish to gain in weight will be benefited by heavy meals in

that hunger is caused, not by the contraction of the walls of the empty stomach, but by conditions of the cells in the major food depots, such as the liver, the lymph and the blood. Instead of being a true sensation, in the usual meaning of the word, hunger, he declares, is more of a motor than a sensory phenomenon. That is, it compares with the impulse to breathe. The investigator found that he could not localize the feeling of hunger. Real hunger is usually experienced fifteen hours or so after eating. If the heartiest meal is eaten in the morning, this hunger occurs during sleep and is not noticed, but if the subject has dined heartily at night, he will feel the pangs of hunger late the next morning and so has an appetite for an-

N.W. Eng.
other heavy meal. During his tests, the investigator found that sound sleep was difficult after a few days of fasting.

FOLDING AUTO TOP INCREASES COMFORT 3773

To permit greater enjoyment of the automobile for touring and camping purposes, the tops are being built so that they can be more quickly adjusted for converting the car from a closed to an open vehicle. This has been accomplished in two automobiles introduced in England by a folding and a sliding roof. The arrangement makes it unnecessary to remove side panels or otherwise alter the main top supports. In one, the upper part of the top is simply lifted back and folded away on braces like those of the ordinary folding top, and in the other, the roof is a panel affair with the front or rear part sliding over or under the other, leaving the top open over half of the automobile. The changes are quickly made and greatly add to the pos-



"Wooden Soldiers" on Parade; Members of an Elks Lodge Wearing Spruce-Tree Costumes during a Celebration in Aberdeen, Wash.

TREES ARE WORN AS UNIFORMS IN NOVEL PARADE
Hogman Elks

What appeared to be animated logs were seen on the streets of Aberdeen, Wash., during a recent Elks' celebration, as members of the lodge, wearing spruce tree cores that almost completely covered them, staged a parade. The cores are the remaining portions of the logs after the strips of veneer have been removed. They were provided with inside straps for carrying and holes were cut for the eyes.

TELLTALE CLOCKS IN SUBWAYS REPORT ACCIDENTS 3827

One of the chief difficulties in the operation of an underground railway is that mishaps are likely to be undiscovered by the outside operators for some time and there is often confusion in locating the exact spot where an accident has occurred. To remedy this, a London subway has installed a clock arrangement on which the passage of trains is registered automatically, so that any gap in the service is quickly detected. To supplement this unit, the main control office is being equipped with registers which will show the cause of the accident and where it happened.

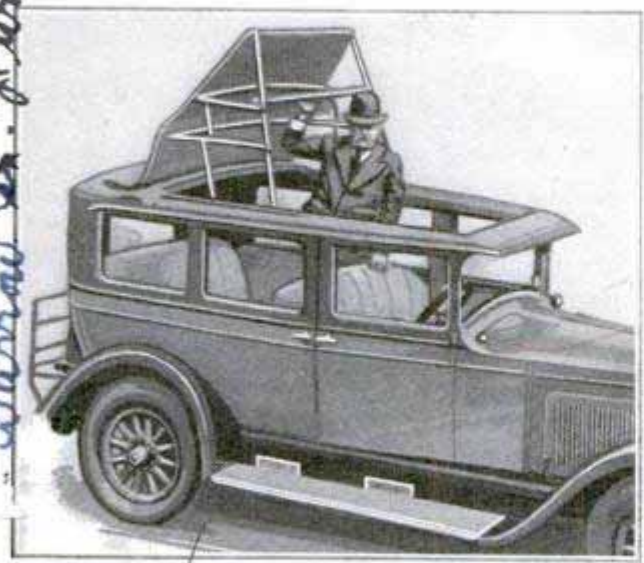

Auto Top Lifted Out and Being Folded Back So That Occupants May Enjoy a Less Obstructed View

sibilities of the car for sleeping purposes or as a room while camping.

127 Abbey Road, London, W. 1. C. C. 11/15/27

Kopalapov-Witlaris Ltd. The Daily Mail 11/15/27

eastern city, with a push-button control that permits the mayor to snap every visitor without the guest knowing he is being photographed. In another installation, the camera is hidden in what appears to be a book.

MANY USES NOW FOR SAWDUST 386

While large quantities of sawdust are burned as waste here, this country imports thousands of tons of the same material from abroad, according to the department of commerce, pointing to the need of further development of salvage. Because of the many uses to which sawdust can now be put, it should be termed "non-utilized" wood instead of waste, according to investigators of the subject. About ten per cent of the average saw log is converted into sawdust during the manufacture of lumber and, recently, large sums have been spent in developing profitable uses for this material.

HIGH-SPEED MIDGET AIRPLANE FOURTEEN FEET WIDE 3702

Although it has only a twenty-horsepower motor, a small airplane built by a western company has developed a speed of 140 miles an hour over a measured course. Its wing span is but fourteen feet. The midget ship was constructed for racing and exhibition purposes only.

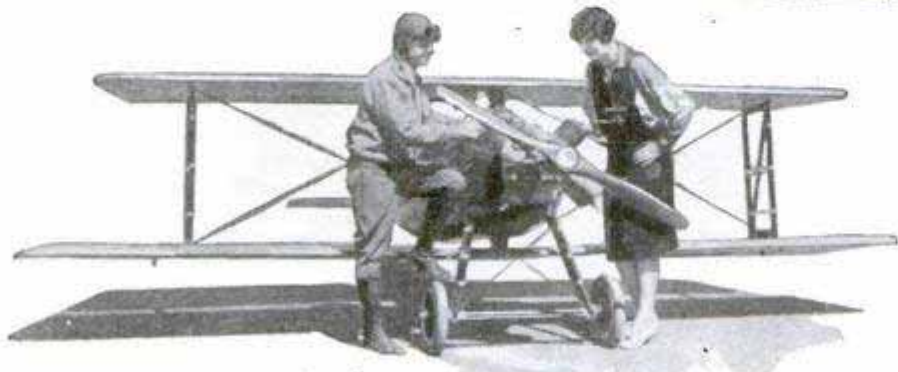

For Racing and Exhibition; the Midget Plane with Fourteen-Foot Wing Spread and Twenty-Horsepower Motor

Chrym Aircraft Co., 126. C. St. Sacramento

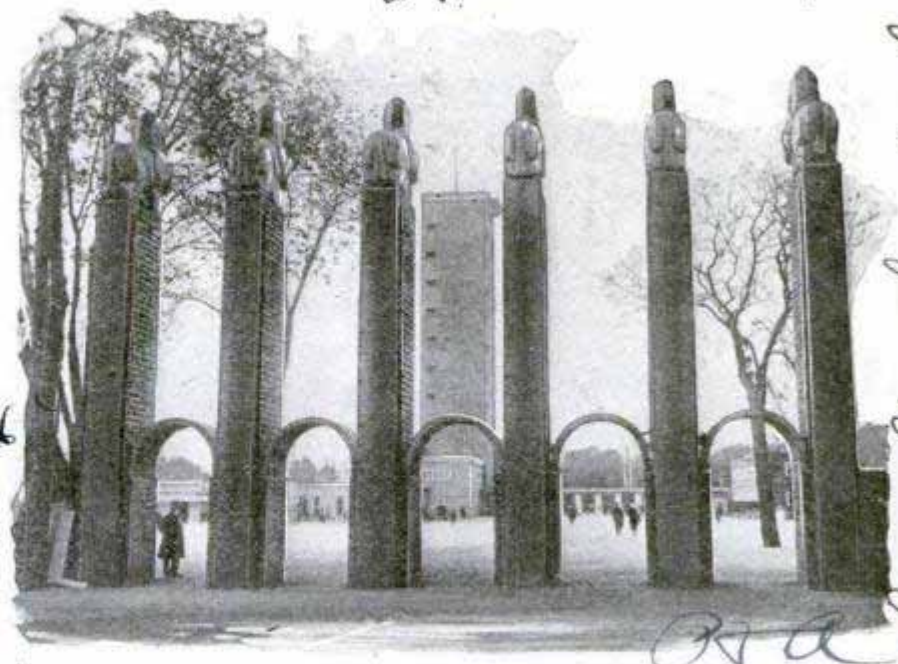

Unusual Gate Posts and Arches at the Entrance to the Theater Grounds at Magdeburg, Germany; the Materials Are Brick and Concrete

LATEST STYLE IN ARCHITECTURE SEEN IN GERMAN THEATER

Tall towers, slender arches, flat roofs and a gate featuring the figures of horses as the chief decoration are among the architectural expressions in a theater at Magdeburg, Germany. Brick and concrete are the principal materials used, and units of the structure are made more distinctive by the fact that a large building lot was available, permitting greater display than is usually practical where theaters must be erected within restricted space.

DOCTOR ANSWERS DOOR IN BED THROUGH LOUD SPEAKER 3865

So that he does not have to get out of bed to answer the doorbell at night, a loud-speaker system has been installed for a London physician. There is a microphone at the door for the caller to use. When this is removed from its hook, a buzzer sounds by the doctor's bed and he can talk with the person outside through a telephone and a loud speaker fitted over the front door.

☐Tortoises live on land and turtles in the water.

Barovox, Ltd. Eng.

54800

Lord Sh. Liverpool, Eng. 50.9

3668

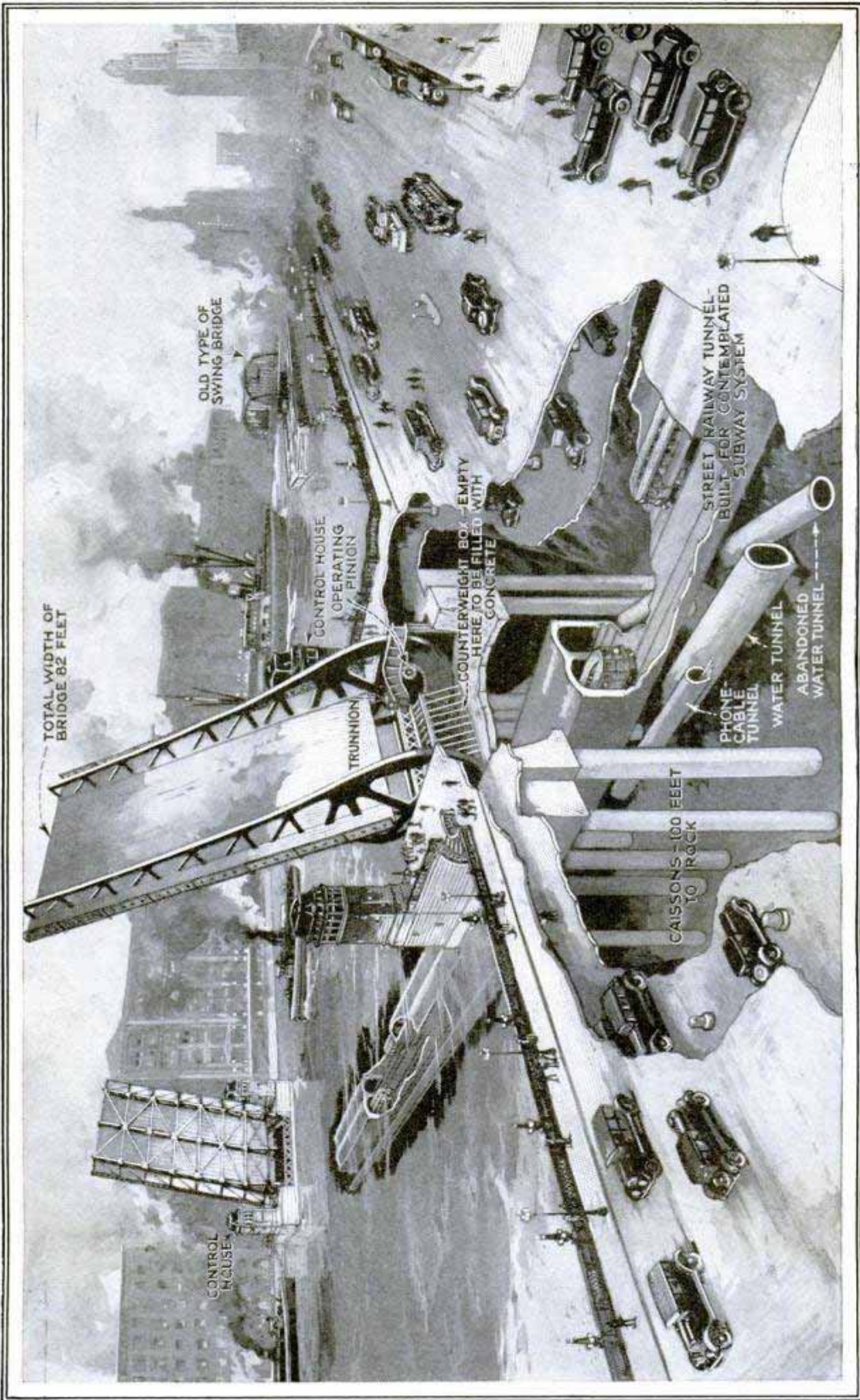

Artist's Drawing of the LaSalle Street Bascule Bridge in Chicago as It Will Appear When Finished; the Street Is Cut Away to Show the Relative Positions of the Bridge Foundations, Subway and Other Details

99112

3621

Marshall Calif

**BRIDGE BUILT LIKE A WATCH
— IS ENGINEERING FEAT**

3668

Building a bridge up in the air, half of it at a time, then tipping the two halves together and making them meet within a fraction of an inch, is the task of Chicago engineers. And they are doing it directly over a subway under the river, where people ride through in street cars. Each leaf of the bridge rests on a 100-ton truss, supported on caissons that reach down to solid rock. Constructed almost as accurately as a watch, exactness to the one-thousandth of a foot is observed in assembling the parts and, although each of the big leaves weighs approximately 1,950 tons with its counterweight, they are so nicely balanced that a gang of men could pull them up by hand. As it is, two 100-horsepower motors are provided for each leaf. They can raise the bridge in three-fourths of a minute. In the finished bridge, the controls will be regulated so that the operator cannot release the center lock that holds the leaves together until the safety gates are down on each side. The bridge will cost approximately \$1,600,000. It will have a roadway fifty-six feet wide with two walks for pedestrian traffic on either side.

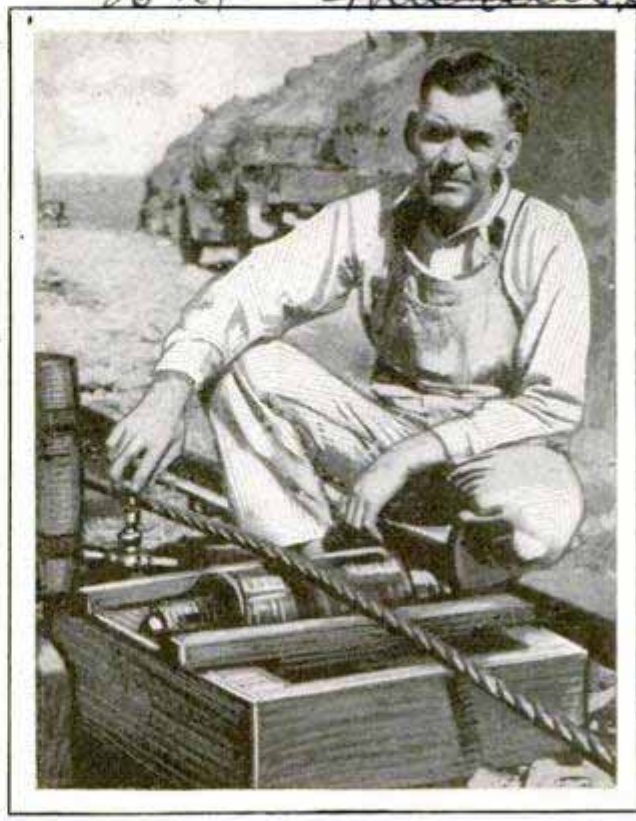

Automatic Oiling Unit to Keep Cables in Good Condition and Prolong Their Life

**OILER PROLONGS CABLE'S LIFE
AUTOMATICALLY**

For steam shovel, drag line, elevator and other rigs, an automatic cable oiler keeps the line in a thoroughly lubricated condition to prolong its service and decrease the likelihood of breakage. It operates equally well in a horizontal, vertical or angular position, according to reports, and consists essentially of a holder for the oil with rollers that permit the cable to slip along easily to receive the proper amount of lubricant. Excess oil is wiped off, and there are rollers to prevent the cable from rubbing on the end of the oil container. Economy of lubricant is another feature that is claimed for the unit.

**COLOR ATTACHMENT ON MOVIE
HELPS REST EYES**

3706

Colored movies in the home are now possible with the aid of a simple attachment. It is merely a box of colored lenses which can be interchanged and combined to form as many as fifteen different hues. The glasses are put in operation and released by pressing buttons on the side of the attachment. It is said that the unit not only adds to the enjoyment of the pictures but helps relieve the strain on the eyes.

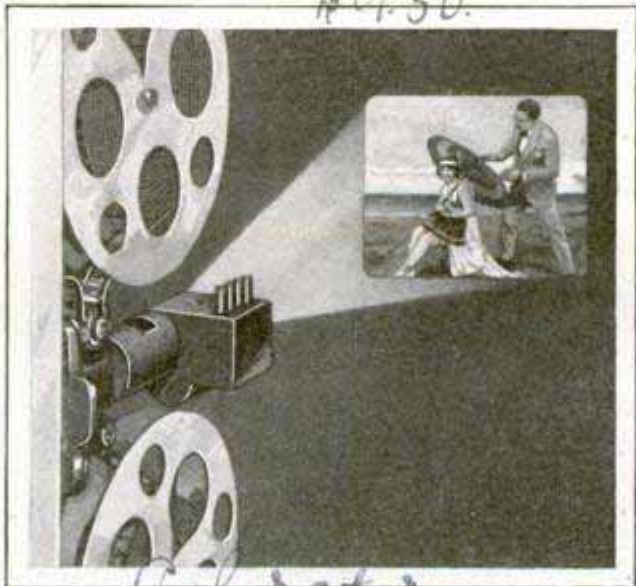

Color Attachment on Home-Size Movie Projector; Note the Buttons for Changing the Effects

Our Bureau of Information will answer all questions regarding articles in this magazine.

For Films, Eastman and other 16 mm

Jamestown, Calif.

*American Cible Products Co.,
Franklin Avenue, Chicago*

3314.

TIME and MONEY

To Recondition Furs, Fine Wire Brush Is Bent to Such an Angle That It Catches Dust and Dead Hairs; Treatment Gives a Gloss and Prolongs Life of Furs



Courtesy Richard E. Thibaut, Inc.
Wallpaper Pictured Above Is Safely Washable as It Is Coated with a Film That Seals the Pores; Suitable for Hotels and Can Be Easily Removed



It Quickly Cleans Dirty Pans; a Steel-Wool Pad on Convenient Handle

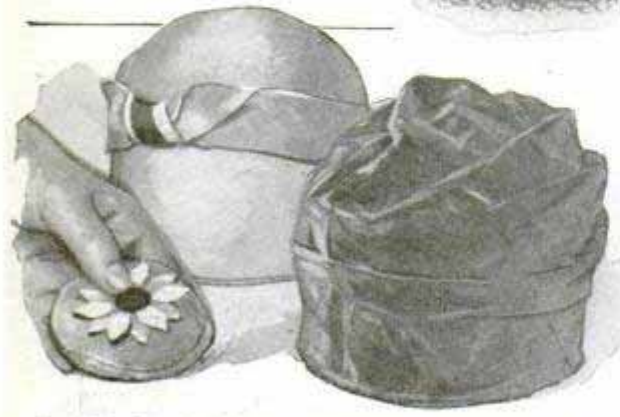

Can Be Carried in the Pocket or Handbag and Folds into a Rosette; a Waterproof Covering for the Hat

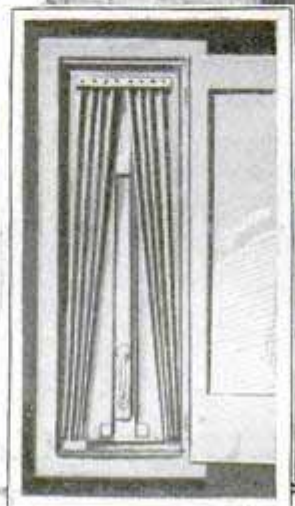

A Clothes Rack in Your Kitchen Wall; This Folding Unit Has Large Capacity and Is Out of Sight When Not in Use

SAVING THINGS for Your Home



Rotary Fruit and Vegetable Press Quickly Removes Skins and Seeds without Soiling Fingers



Sliding Broiler Drawer for the Gas Stove Saves Reaching into Hot Oven and Stooping



Complete Manicure Set in Holder No Larger Than a Pocketknife; It Includes Buffer, Powder, Polish, Nail White, File, Emery Board, and Manicure Stick; Refills Are Easily Obtainable



Push the Back of This Comfortable Chair Down and You Have a Bed. Seventy-Two Inches Long, Big Enough for One Adult

L. M. Railway Co

Speeler & Co
Chapell and RR
Bussell

eliminated with the aid of
a visor over the door
which not only serves as
an efficient shield for the
eyes in all sorts of weather
but also contains a mirror
so that the driver can tell
just how far he is from
the curb. The visor has
curved ends that keep
rain from blowing in, pro-
vides ventilation without
draft and can be installed
in a few moments.

3928

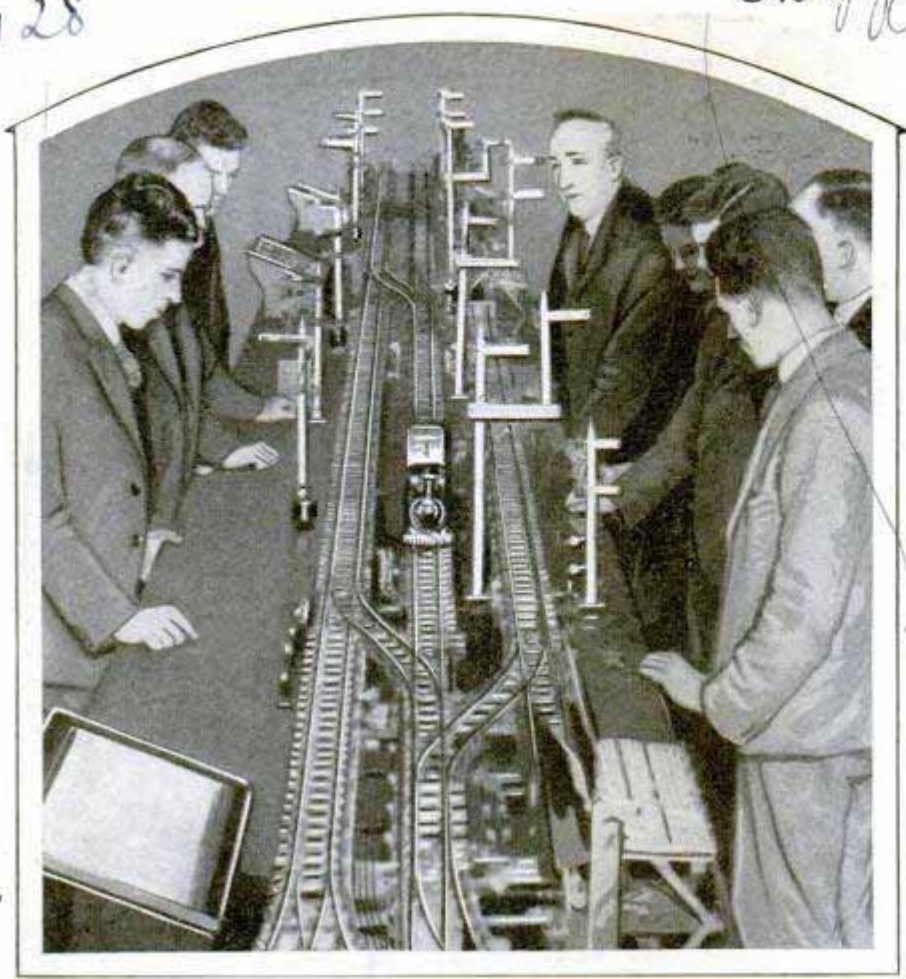

Railroad Class at the Model Operating Board; Tiny Signals Are Worked in Same Manner as Real Ones for Solution of Problems

MODEL RAILWAY FOR TRAINMEN AIDS IN TRAINING

Candidates for positions with a London railway company receive helpful instruction in various duties by using a model railroad. It is built closely after the real lines, with small signal towers, switches and other units that are operated in much the same way as the actual equipment. The outfit is used for demonstrating various details of operating.

MIRROR IN AUTO-DOOR VISOR AIDS IN PARKING

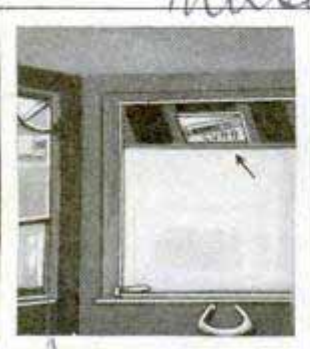

Many auto drivers have experienced difficulty and sometimes embarrassment in being arrested as a result of parking too far from the street curbing. This trouble is

W. M. C. Mason dnc.

eliminated with the aid of a visor over the door which not only serves as an efficient shield for the eyes in all sorts of weather but also contains a mirror so that the driver can tell just how far he is from the curb. The visor has curved ends that keep rain from blowing in, provides ventilation without draft and can be installed in a few moments.

ACID TO CLEAR RUSTY PIPES

Water pipes in a thirty-five-story building in New York were recently cleared of rust by using an acid solution, saving the expense of costly re-piping. The feature of the process was that a substance had been added to the acid to prevent it from corroding the pipe while attacking the rust.

This has been the chief drawback to the use of acid in treating rust-clogged conduits, but the special material eliminated this difficulty.

"CLOCK" TO KEEP GOLF SCORES HELPS PREVENT MISTAKES

Record of the number of strokes for each hole as well as the total for the course is kept on a scoring dial recently introduced for the greater convenience of golfers.



Each hole's requirement is tallied in a separate space around the dial of the instrument and the total is shown in the center. By pulling a release switch, the indicators go back to zero at the end of the game. The scorer is simply constructed and will last indefinitely, it is said.

William B. Mason
Custer
Max Zimmerman
Los Angeles, Calif. 19

Pair. 28 in. or under - \$6.00
over " " \$7.00

ENGINEERS SEEKING WAY TO SAVE NIAGARA FALLS



Miniature Niagara Falls Built to Study Conservation Problem, and Aerial Photo of Horseshoe Falls, Showing Crest Lines of Past Years



Whether Niagara Falls can be stopped from committing suicide through the constant erosion that is gradually eating away the famous Horseshoe falls, may be solved by experiments being made with an actual scale model built in an open field by the Niagara Falls Power company. The model not only shows the present position of the falls, but indicates the old crest of the Horseshoe as it was in 1764 and in 1842. The threatened suicide of the falls is due to the fact that after centuries of constant movement up the stream, during which the crest has moved seven miles, the falls have finally emerged from the narrow gorge and are constantly broadening, providing a wider front over which the water must be spread. Power-company engineers figured that through remedial works above the falls to divert the flow and spread it evenly over the face of the precipice, it would be possible to lessen the

volume of water, and, therefore, decrease the amount of erosion. The model illustrates the effect of weirs placed in the river or the alternate proposal of building a chain of small islands above the Canadian falls to break up the flow.

DOUBLE-GLASS PRISMATIC SIGN SHOWS LETTERS CLEARLY

Especially suited for street signs or warning markers, a double glass is said to reflect the light so that the letters stand out clearly and are visible at considerable distance. The characters are left clear, the top glass being painted. The back panel is of a prismatic nature and is silvered.

Niagara Falls, N.Y.

new Zealand invention American rights for sale N.Y.

Dr. J. W. Walker Thornycroft, with Main Road, Laver N.S.

2720 Maryland Ave
Baltimore, Md

0659

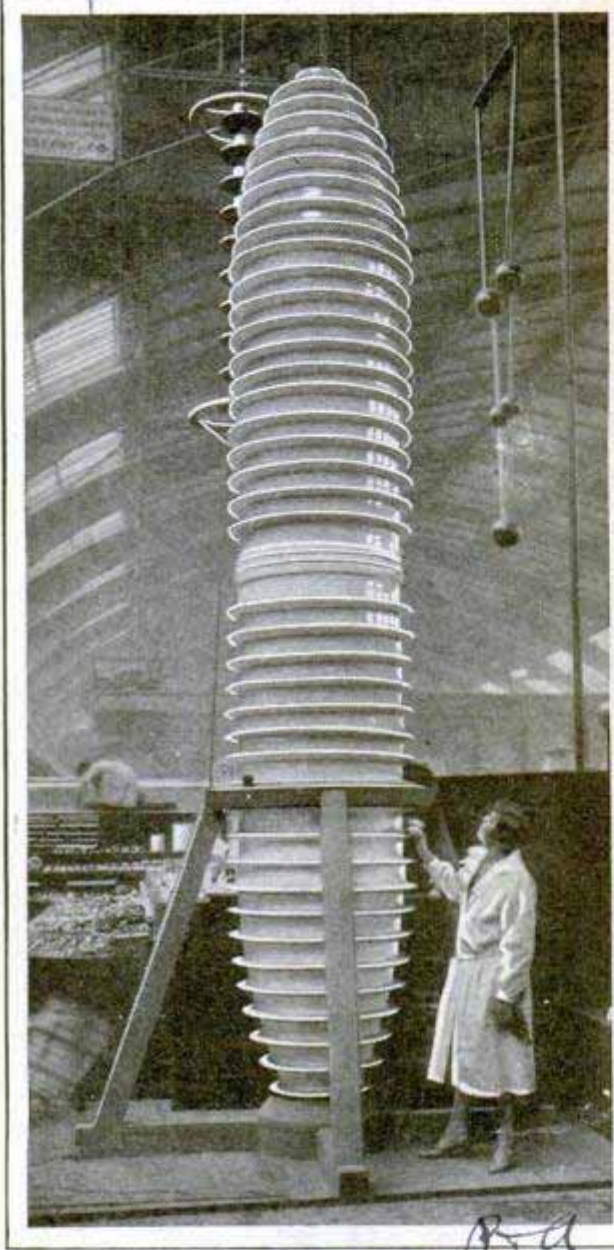

To Keep 500,000 Volts in Check; Huge Insulator Exhibited at Recent Exposition in Germany

HALF-MILLION-VOLT INSULATOR SHOWS ELECTRIC PROGRESS

Berlin
One of the features of an exposition in Germany was a huge insulator adapted to a 500,000-volt power line. The collection emphasized the huge size of various machines required for modern industry and the insulator indicated that the development of electric power has kept pace with other activities.

HUMAN DREDGES IN SUMATRA CHEAPER THAN MACHINERY

3931 Americans are so accustomed to thinking of huge machinery, capable of doing the work of a multitude of men, as being money-saving inventions, that it is hard

to realize that any place exists where human labor is cheaper than mechanical aids. In Sumatra, Dutch East Indies, chiefly noted for its fine tobacco and rubber plantations, labor is so cheap that it can even compete with deep-sea dredges. Harbor improvements recently made at Bencoelen, Island of Sumatra, were carried out by Malay divers, who went to the bottom, gathered up pieces of shale, one at a time, and carried them to the surface, where they were placed on bamboo rafts and propelled by poles out of the harbor. The soft shale was removed to deepen the harbor to enable vessels of twenty-five foot draft to enter. Dynamite cartridges, tied with rags and weighted with stones, were exploded on the bottom, and the swarms of native divers then did the rest of the work. Ordinarily the harbor is frequented by man-eating sharks, but the dynamite killed many and scared the rest away.

3649

ADJUSTABLE CHART OF STARS AIDS STUDY OF ASTRONOMY

A "pocket-size" planetarium has been introduced recently, mainly for the amateur astronomer who likes to pursue his studies with accuracy and convenience, and yet does not have the advantage of elaborate instruments. It is essentially an adjustable chart, showing the positions of the stars, and there are interchangeable disks for the better observation of the fixed and moving bodies.



For the Amateur Astronomer, an Adjustable Chart of the Stars with Interchangeable Disks for Observing Fixed and Moving Bodies in Their True Relation

der Hedern
Nieder Berlin

The WORLD'S DEEPEST MINE

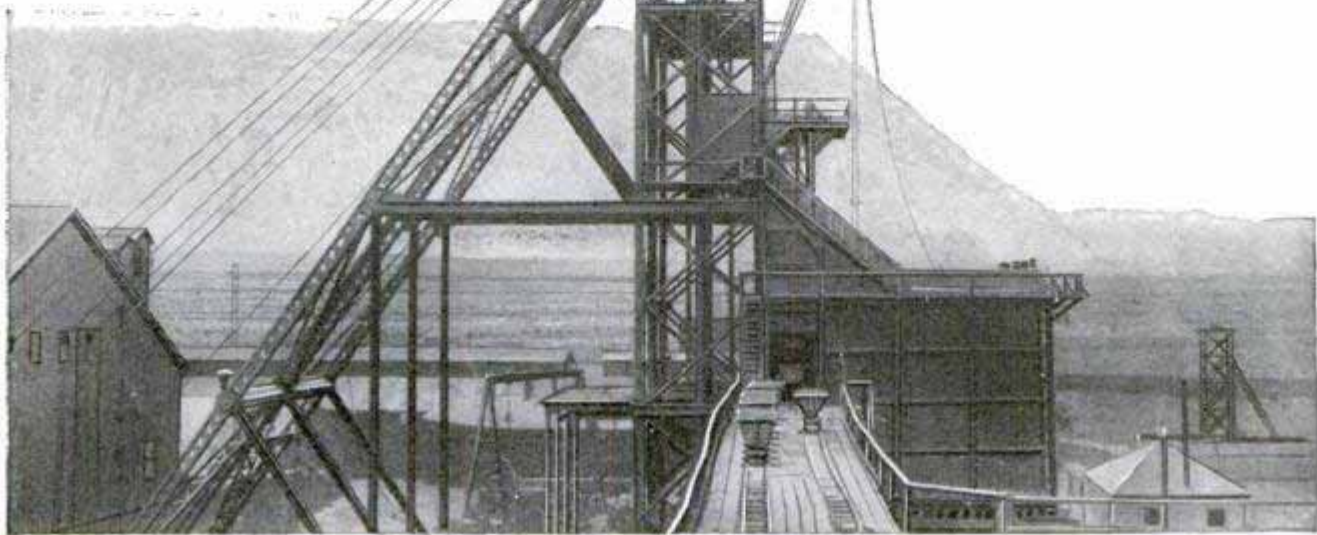

The Hoisting Gear of the World's Deepest Mine; the White Mountain in the Background Is 10,000,000 Tons of Ore from Which 125 Tons of Gold Have Been Extracted

By ^{of my} THOMAS PHELPS

ONE cold morning in July two of us, looking like soldiers in tin helmets and army greatcoats, stepped into a steel box suspended over a hole in the ground by a meager-looking cable, and in eighteen minutes were farther inside the world than any living human being ever had been before, because the Village Deep gold mine at Johannesburg, South Africa, already almost a mile and a half deep and scheduled to reach 8,000 feet below the surface this year, is the world's deepest.

Digging the Village Deep (and getting out the gold en route, about 125 tons so far) cost \$60,000,000 and twenty years of hard work. The top of the mine is simply a lofty headgear, from which hang six cages, or hoists, like baskets on strings. Each has a capacity of five tons. The two man hoists, three-story cages with a capacity of forty men each, run on schedules like trains. Every day they carry 3,000 natives and nearly a tenth as many whites a mile underground and back again.

My guide, a dust inspector, ushered me into one of the hoists and we dropped into darkness, noiselessly save for the rush of air and the faint sing of the cage on the steel guide rails, picking up speed until I began to think we must have missed the bottom altogether.

"Three thousand feet a minute (roughly thirty-five miles an hour) is the fastest the law allows them to run the man hoists," said a voice in my ear. "The rock hoists go 3,800 feet a minute."

Just eighty seconds from the top the cage stopped, with a soft, springy motion that took us up and down three feet or more.

"Good shock absorbers," I observed.

The inspector laughed. "That's the stretch of the steel rope you were looking at up above," he explained.

The door opened upon a busy street and switchyard, all about as dark as a white way at midnight. Natives, clad only in loincloths, were dumping small railroad



Courtesy South African Railway

Half a Mile Underground in a Witwatersrand Gold Mine; the Gold Reef Is More Than Sixty Miles in Length and Extends, in an Inclined Plane, More Than a Mile and a Half Deep

trucks full of ore into bins on either side of the elevators, for haulage to the surface.

"Change cars here," announced the dust inspector. "This is the end of the first line, 4,034 feet underground. We can leave our overcoats here. There will be plenty of heat down below."

He led the way to a cage on rails which ran into a black hole at an angle of forty-one degrees from horizontal. Again we descended. Going straight down from the surface seems natural enough, but sliding down a steep hill on a section of cellar stairway a mile underground in the dark is in a class by itself. Lights gleamed and new, busy subways opened before us, then vanished as we rushed downward. We stopped after a ride of more than half a mile, with the same impressive cable-stretching motion as before. Here was another busy center, amazingly large considering that it is more than a mile underground. Concrete walls, eight feet thick, indicate that the danger of slides or cave-ins is taken seriously.

We changed cars again, for the third and final stage of our journey. We were nearing the end of the line, and had to ride in the "construction train." Every

level we passed was hotter than the last. At the thirty-seventh, 6,869 feet underground, where the guide stopped to test the air, the ventilation engineer told us he was using ten tons of ice a day to cool the air forced into the mine tunnels.

At the end of one drive (blind-alley-tunnel), profusely sweating, naked natives were working a pneumatic drill under the direction of an equally damp white man, stripped to the waist. The din was terrific. The rock the gang was drilling had a temperature of ninety-five degrees. The Village Deep alone has fifty-five miles of underground passageways, while the aggregate of all the shafts and tunnels in the Witwatersrand gold fields would make a subway from New York to San Francisco.

The bottom of the deepest mine in the world is simply the temporary end of the inclined shaft, electrically lighted, twenty feet wide and eight feet high. Sitting there on loose blocks of stone, farther below sea level than the "Lusitania," and looking up at the mile and a half of solid rock between us and the outside of the globe was thrilling, but too hot, and we started for the surface. Half an hour later we were blinking in the sunshine.

*Los Angeles 489 Calif.
rough to 5015 Haldale*

Below Johannesburg, the thermometer goes up one degree for every 219 feet down. At 9,000 feet, vertical depth, engineers estimate the temperature will be 105.8 degrees. At the same rate, six miles down the rock is about as warm as boiling water. Some day, when the sun gets old and the outside of the world cools down to 100 below zero, that difference of 150 degrees between surface temperature and temperature six miles down may save the human race.

Conceivably a high type of civilization might go on for centuries within the earth, after the outside was an unbroken glacier, with oceans of liquid air at the poles. But right now the heat is the great obstacle in the way of further downward progress, reducing the efficiency of the workmen and increasing the ice bill until the gold is barely worth what it costs to get it out.



Life-Saving Suit That Weighs but Twenty-One Pounds and Has Pockets Inside to Hold Food and Water

POCKETS IN LIFE-SAVING SUIT HOLD FOOD AND WATER

Persons are kept afloat for hours, it is said, when wearing a life-saving suit a California man has introduced. It can be donned in two minutes, is constructed of three thicknesses of rubber and rubberized silk and has pockets for food and drinking water. The feet are weighted so that the wearer will be able to keep upright and in the headpiece are a number of valves. These automatically close when the person is submerged, but admit air when his head is above the surface. The entire outfit weighs but twenty-one pounds and is insulated with cork to protect the wearer from the effect of changing weather conditions.

More than 800 kinds of trees are known in the United States.

HOME ON WHEELS IS ARMORED FOR FRONTIER TRAVEL

Portholes of bullet-proof glass and armored sides are features of a three-room apartment a Frenchman has had constructed on a motor chassis for his travels. Apparently, he does not intend to confine his roaming to civilized territory, for the big car is fitted for crossing desert regions as well. A parlor, bedroom, smoking room and a folding kitchenette are included in the apartment with portable radio and other modern conveniences.

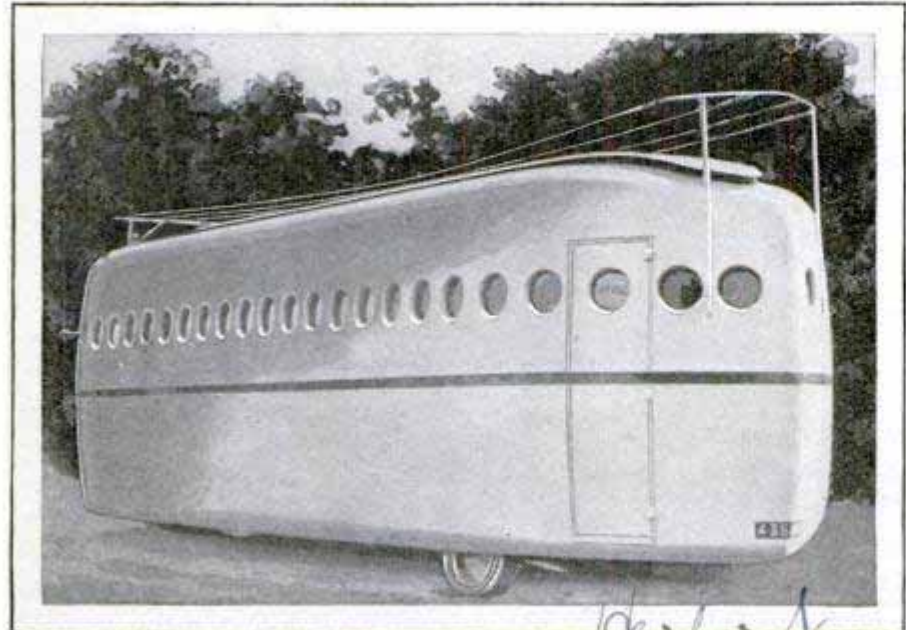

The Traveling Fort for Frontier Explorations; It Contains a Three-Room Apartment and Has Many Modern Conveniences

MOVING LETTERS OF FIRE TELL THE LATEST NEWS

Close View of the Switch Control and Tape; Luminous Bulletin Board on Building, and Detail of Letters

make unknown. suggest taking & traveling letter sign - Liberty Electric Sign Co. 926 Royal St. New Orleans, La.

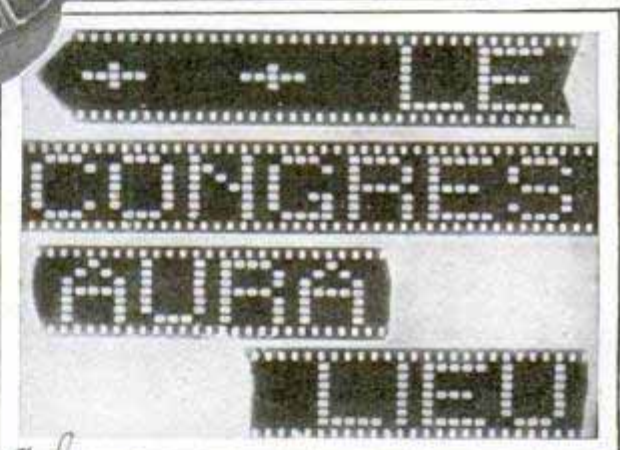
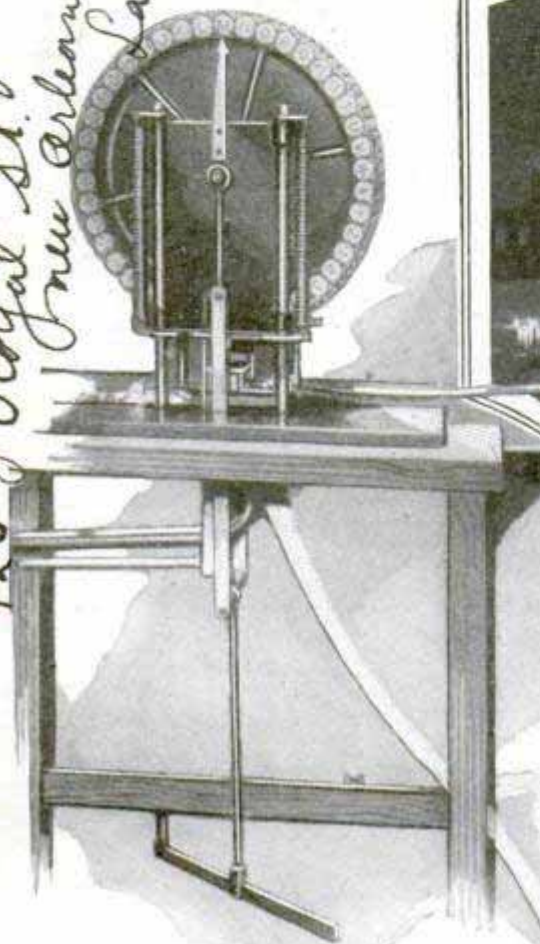

International

News bulletins are written in moving electric letters on signs visible to thousands of promenaders on the Paris streets at one time. The method is similar to that which has been in use for advertising purposes in many large cities, a perforated tape making contacts with electric bulbs that form the proper letters.

The message moves slowly from right to left for easy reading. The events to be chronicled in this fashion are relayed from the newspaper offices, and an operator, sitting in a small cabin near the sign, prepares the perforated tape and places it on a revolving drum. The bulletin board is over fifty feet long and three feet high.

ELECTRIC POP-CORN POPPER OPERATES AT TABLE

3691

It is not necessary to go to the kitchen to pop corn with an electric popper now on the market, for it is quickly connected to any convenient lighting socket and may be used in the living room or at the dining table. The corn is held in a wire basket, which fits upon a base surrounding the heating element. To prevent the kernels



from burning, they are stirred by turning a crank similar to that in a flour sifter. The popping begins in less than three minutes after the current has been turned on, if the corn is in good condition. When the basket is removed, a receptacle for

National Stamping & Electric Works 3212 W. Lake St. Chicago

W. Randolph
471

melting butter may be placed on the heating coils. The popper consumes but little current and, as it may be shut off when not in use, permits further economy. The unit weighs but two pounds and is especially constructed to pop all the corn in the basket.

**MYSTERY SUBSTANCE IN SUN
FOUND TO BE RARE GAS 3800**

What scientists had previously been unable to identify in the sun's corona, has been proved to be argon, by Ira M. Freeman, of the University of Chicago. The substance is a rare gas, constituting about one per cent of the earth's atmosphere and is being used commercially in the manufacture of certain kinds of lights. The discovery is considered remarkable in that the corona of the sun can be observed for only very brief periods during a total eclipse. It has been estimated that during the entire age of science, the total time in which such eclipses have been studied amounts to but one hour.

**FOOT POWER REPLACES MOTOR
IN TINY PARIS CAR 3482**

Run by foot power with the same chain and sprocket arrangement as is provided in a bicycle, a four-wheeled car, like a small automobile, has become popular in Paris. A fair rate of speed can be attained, and the gearing is so adjusted that one man can propel two persons on level ground without extreme effort.

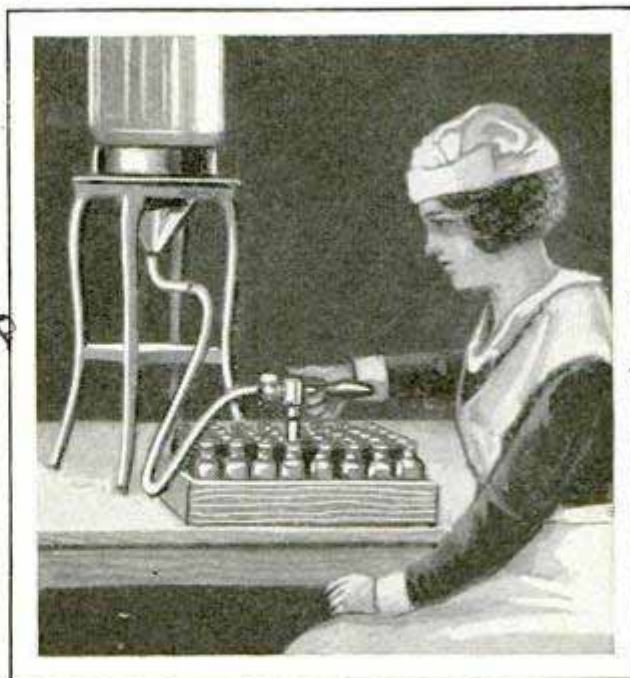

Suitable for Home or Cannery Use; a Bottle Filler with Control Valve to Eliminate Spilling

**BOTTLE FILLER SAVES TIME
AND PREVENTS SPILLING**

Filling small bottles with liquid is accomplished without spilling and at a great saving in time from a glass supply reservoir through a tube controlled by a valve. Pressing the valve with the thumb permits liquid to run into the bottles, and the tube is closed by releasing the pressure.

**MUSKRATS SAVE LIVES OF FISH
IN NORTHERN HATCHERY 3854**

Muskrats are not generally regarded in the role of life-savers, but their beneficial effects on fish in a government hatchery at Gravel lake, N. Dak., close to the Canadian border, have been so great that the animals are being protected from hunters and trappers and are encouraged to build their houses along the shores of the lake. In doing this, they keep the waters from being completely sealed over with ice, with the result that the fish are not likely to smother. Both fish and muskrats are multiplying there.



Lined Up for the Start of a Foot-Power Auto Race; Considerable Speed Can Be Attained on Level Ground Even with Two Persons

*no information on
Whaler. International
U.S. Biological Survey*

*Illinois Bell Co.,
Alton, Ill.*

Director Baldwin Bird
POPULAR MECHANICS
Research Laboratory
near Cleveland
Ohio

**TIME BIRD SPENDS
IN NEST TOLD BY
ELECTRICITY**

With the aid of electrical apparatus, an Ohio man has measured the time a mother wren spends in the nest hatching the eggs, and how much time she takes off. Thirteen minutes is about the average period in the nest without interruption, but the bird is seldom gone more than six minutes at a time during the day. Most of the brooding is done at night and, in the last three days of incubation, the periods of absence are much less frequent. The instrument used to determine the bird's movements is simply a thermo-electrical

unit which registers the temperature of the nest each time the bird goes on or off the eggs. A tiny wire is stretched across the eggs to form a connection with the self-recording instrument.

37 47

**RUBBER MAT FOR HOUSEWIFE
HELPS PREVENT FATIGUE**

Hours of standing on hard floors frequently endanger a housewife's health and greatly contribute to her fatigue. This unpleasant feature of home work is said to be eliminated with a mat of sponge rubber on which to stand. It is especially serviceable while ironing or washing on the cement floor of the basement and may also be used for the knees when mopping or scrubbing floors. When not needed, it may be hung on the wall. As an insulator, it also affords extra protection should there be any hazard in using electrical appliances.



Red-Cedar Stump Shelter House on Auto Highway; It Is Believed to Be at Least 1,250 Years Old, But Is Well Preserved

**ROAD RUNS THROUGH BIG STUMP
OVER TEN CENTURIES OLD**

One of the sights along the Vancouver highway is a giant red-cedar stump which has been cut through and roofed over so that the road is provided with a natural shelter at that point. It is estimated that the stump is at least 1,250 years old.

**GASOLINE METER FOR AUTO
HELPS SAVE FUEL**



To reduce waste and obtain an accurate check on the fuel consumption of the automobile, a gasoline meter, recently introduced, shows, in gallons and tenths of gallons, how much is being used. The record is indicated in legible figures on a dial, and the instrument is mounted in a bracket on the dashboard. It is connected in the fuel line between the supply and the vacuum tank, and is equipped with a dirt and water trap.

34 9 4

Carily connected in the fuel line between supply tank and vacuum tank

*Economy Electric
Devices Co, 37 W*

Krustee Mfg Co

05 35

38 26

You can build this B-Eliminator for Fifteen Dollars by Arthur B. Kennedy

THE B-battery eliminator described in this article, while low in construction cost, is nevertheless a very efficient plate-power supply, delivering to its output terminals 40 milliamp. of pure direct current at 135 volts. It may be used with any type of receiver with the assurance that there will be no hum to mar the loud-speaker output. The simple construction is apparent in the photo, and this new eliminator has a decided advantage over my first model, which appeared in this magazine a year ago, in that there are no difficult electrolytic condenser cells to form. The electrolytic rectifier cells are easy to form, and the low cost of the unit is due to their simple construction.

The four cells are

shown at the rear in the assembly photos, and are contained in a shallow wooden box, the cells being separated by cardboard inserts. Each cell has two electrodes, one made of aluminum and the other of lead. These are fastened to an

insulated jar cover and immersed in a solution of either common borax, sodium bicarbonate or ammonium phosphate. The author prefers a saturated solution of borax, although a solution made of $\frac{1}{4}$ lb. of ammonium phosphate (monobasic) in 1 qt. of distilled water is generally conceded to be the best electrolyte. In either case absolutely pure distilled water must be used. Cells like those shown in the photo may be obtained on the open market and should be of

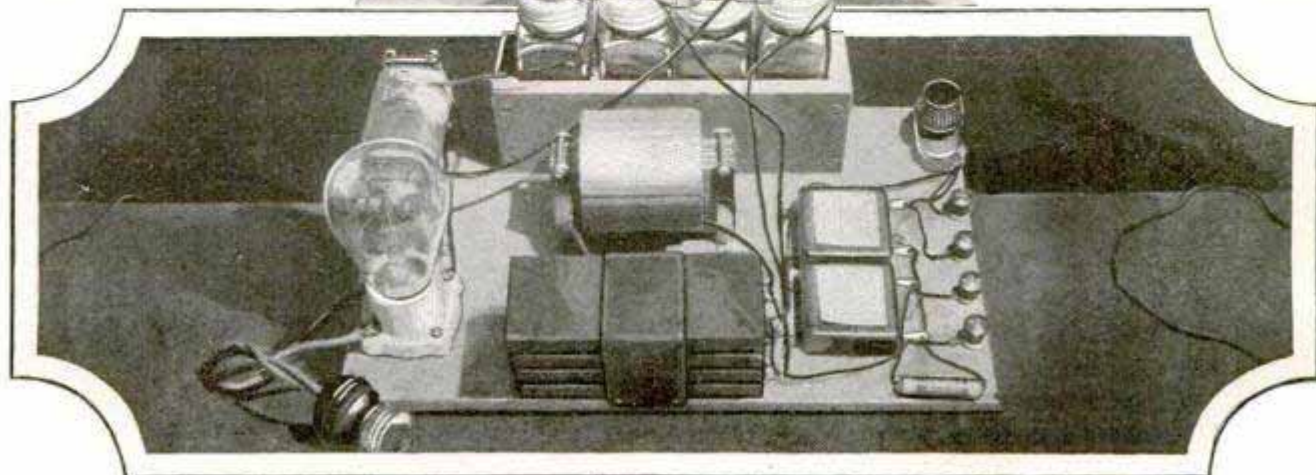
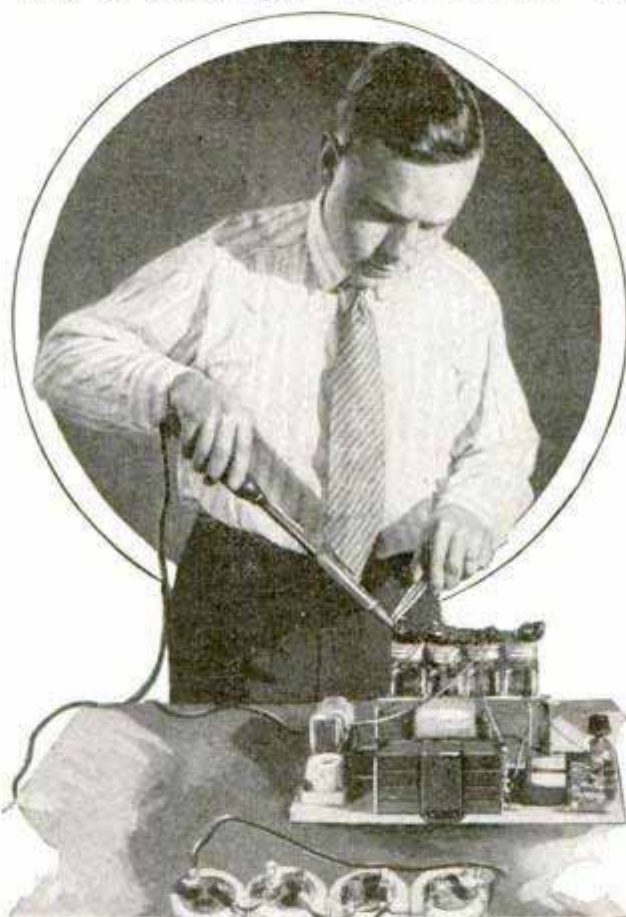

sufficient size to hold 4 fl. oz. of electrolyte. It is an easy matter to make the cells at home; provide four screw-cap pickle bottles of the same size, and, with can opener or bezel cutter, cut a hole, 1 in. in diameter, in each bottle cover. Four disks of hard rubber, thin bakelite, or wood, dipped in paraffin, are cut to the diameter of the bottle necks, and drilled as shown in Fig. 1. Four lengths of 1/8-in. aluminum rod, and the same number of pieces of 1/8-in. hard wire solder are required for the electrodes. Each piece should be 4 in. long, and threaded at one end for 3/4 in., three hexagon brass nuts being provided for each rod. One aluminum and one lead rod are slipped through the insulated disk and fastened in position with a nut above and below the disk, as shown in Fig. 2; the third nut acts as a binding post for connecting the cells. Fahnestock clips can be used instead of the third nuts, if desired.

A tight-fitting rubber tube is slipped over each aluminum rod to within 3/4 in. of its immersed end. The efficiency of the cell depends on this jacket being watertight, and, while rubber tape can be used,

the electrolyte. Mix the electrolyte in a 1-qt. glass jar; 1 pt. of the solution will be required, and it should be stirred with a glass rod. If borax is used, add a tablespoonful at a time until the water will not take up any more of the salt, let the solution stand a few minutes and then decant the clear solution without disturbing the sediment of undissolved salt at the bottom of the jar. The solution must be kept below 100° F., even after several hours of operation, if the cell is to be a good rectifier. To maintain this low temperature we must have a sufficient amount of solution to radiate the heat that is the product of every rectifier; therefore it is necessary to maintain the 4-oz. solution level in each cell at all times.

With a piece of emery cloth or coarse sandpaper, thoroughly clean the exposed section of each aluminum electrode, this cleaning materially aiding the electrode to form. Up to this point the cells will not act as rectifiers, as they must first be formed; this process puts a rectifier layer on the exposed portion of the electrode. This applies also to commercial cells. The forming is accomplished by passing an electric current through the unformed

rectifier jar to decompose the electrolyte, which action in turn attacks the aluminum electrode, building up a coating which has the prop-

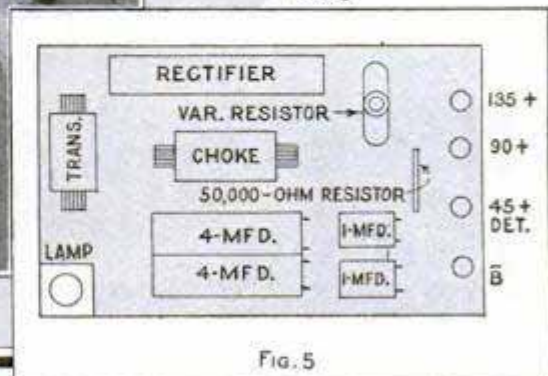
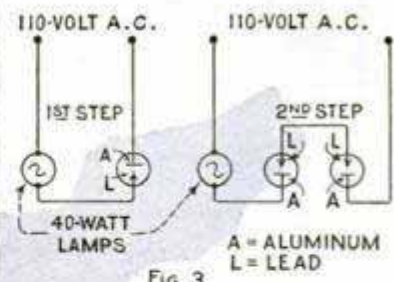
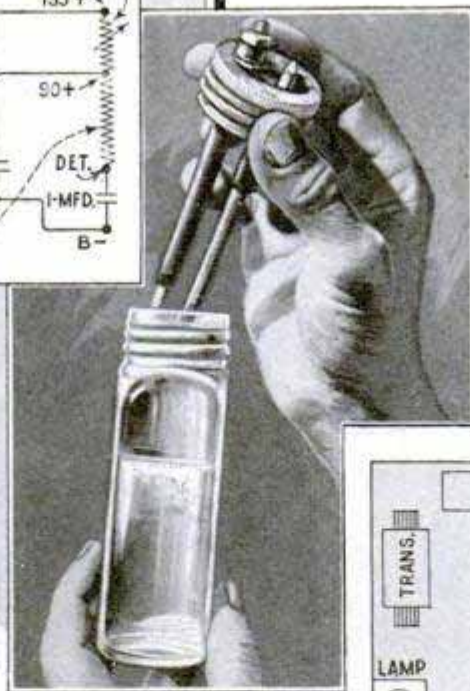
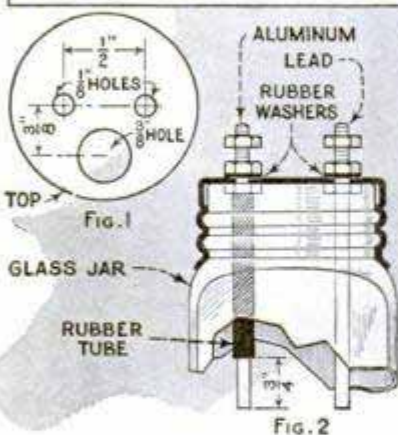
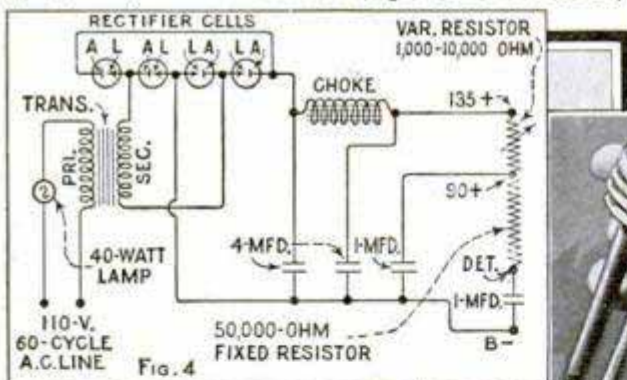

the tight-fitting rubber tube is best. The completed cell now looks very much like the standard commercial article shown in the photo on this page, and is ready for

erty of passing the current in one direction only. This layer allows the current

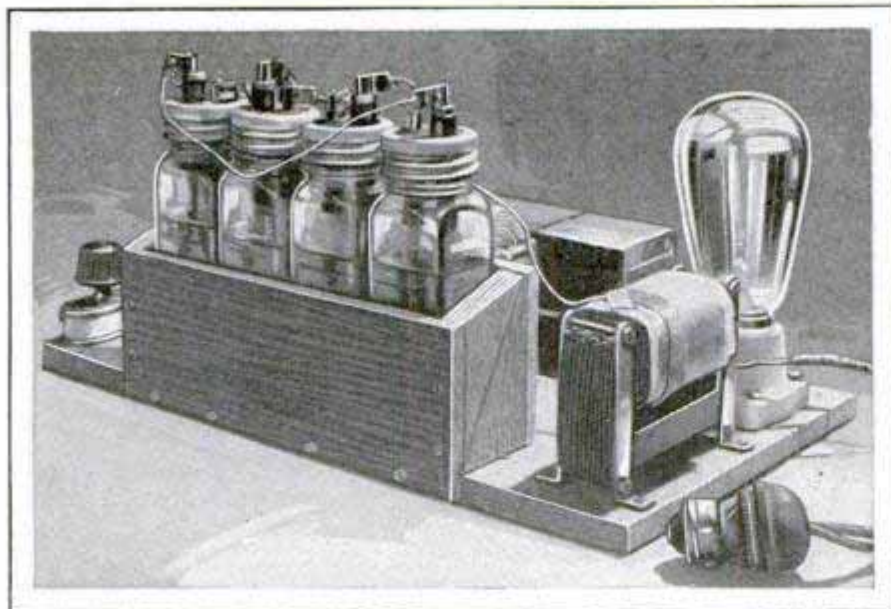

to flow through it from the lead to the aluminum electrode but not in a reverse direction. The forming steps are shown in Fig. 3; for the first step, connect one cell in series with a 40-watt lamp, and permit the 110-volt, 60-cycle alternating house-lighting current to flow through the lamp and cell for five minutes. Repeat this process with each cell, after which they are ready for the second step. Connect two of the cells as shown at the right, Fig. 3, the lead terminals being connected together and one aluminum electrode connected to the 40-watt lamp on one side of the a.c. line, the remaining aluminum electrode being connected to the other side of the line.

Turn on the current; if the lamp lights and goes out immediately, the cells are properly formed; if it does not light at all, they are also properly formed, but if it continues to burn, this signifies that one or both of the cells have not been properly formed. Substitute one of the remaining cells, first in place of one cell then the other; if the lamp still burns, repeat the first step with each of the unformed cells until each pair of rectifier cells extinguishes the lamp instantly. Make sure, in the second step, that the two lead electrodes are connected together and that the current enters and leaves the connected pair of cells through the aluminum electrodes. If the cells refuse to form, the trouble will usually be found in impure water, and the remedy is obvious. To make sure the water used for the electrolyte is thoroughly distilled, a simple

test may be made with a few crystals of nitrate of silver. A sample of the water to be tested is poured into a glass and a few of the crystals added; if the water turns milky, it is unfit for use in the cells.

The wiring diagram is given in Fig. 4, and the instrument layout in Fig. 5. The two 4-mfd. condensers are built up of two 2-mfd. units connected in series and the two 1-mfd. condensers are of the usual heavy-duty type.

While no detailed point-to-point simplified wiring diagram is given here, a large detailed blueprint of this simplified diagram as well as the others, that appear in the article, has been prepared.

The 40-watt lamp in series with the primary of the 160-volt transformer (Fig. 4) is for the purpose of protecting the transformer winding; after the electrolytic rectifier has been left idle for a day or so, it does not begin to rectify immediately, and for a fraction of a second a rather heavy load is therefore placed on the transformer. The lamp limits the current temporarily. The resistors for regulating the output voltages are mounted directly on the baseboard, and the terminals brought

out to standard binding posts or Fahnestock clips, as desired. When not in use, the eliminator must be disconnected from

MATERIAL LIST

- 1 baseboard, ½ by 8 by 13½ in.
- 1 Jefferson transformer No. 359
- 1 Jefferson choke No. 358
- 4 rectifier cells complete
- 1 1,000 to 10,000-ohm variable resistor, Allen-Bradley, Clarostat, Electrad or similar type
- 1 50,000-ohm fixed resistor, Allen-Bradley, Daven, Electrad or similar type
- 4 2-mfd. filter condensers
- 2 1-mfd. filter condensers
- 1 standard screw socket
- 1 outlet plug
- 1 40-watt lamp
- Screws, wires, etc.

the house current. The transformer and choke specified are cased, not open as in the photo. The long insulated wires on the transformer are the priming leads.

The large detailed blueprint can be obtained from Popular Mechanics radio department, 200 E. Ontario st., Chicago, Ill., for 25 cents to cover cost and mailing. Specify blueprint No. 129.

Midget Condenser Easy to Make

Variable condensers of the midget type play an important part in modern sets; they usually appear in the short-wave sets either as a vernier for the antenna-tuning condenser or as a feedback control in various other circuits. The smaller types consist of from three to five plates and

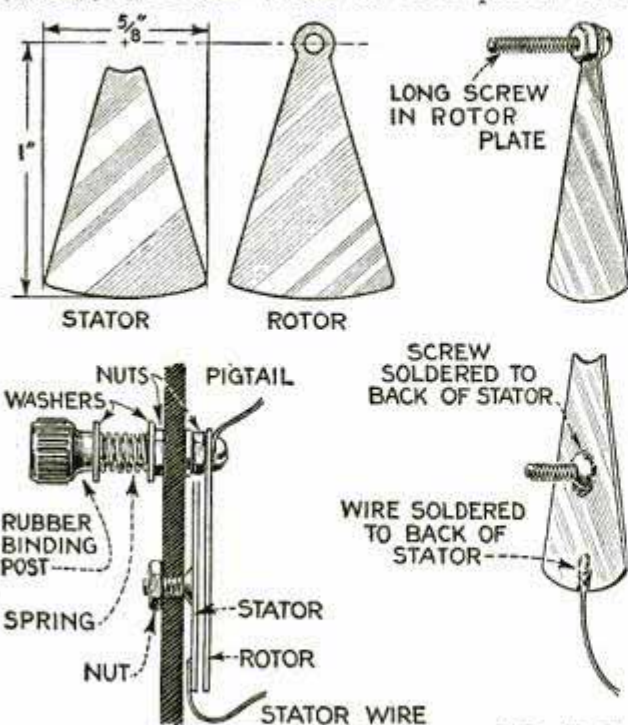

Homemade Midget Variable Condenser of Small Capacity and Details of Its Construction and Assembly

their capacity is often too great for critical adjustment of the antenna circuit in short-wave sets. The writer found the home-made two-plate type shown in the illustration ideal where a very small capacity was required. Cut two plates from No. 20 gauge brass or aluminum sheet to the size and shape shown at upper left. The rotor plate is prepared for mounting with a long brass machine screw, and the plate is held in position by means of a brass nut. Solder a short flat-head screw to the stationary plate in the manner shown, and the unit is ready for mounting. Mount the stationary plate on the panel, lead end down; drill a hole in the panel at such a height that the rotor plate will cover the stator, and place washers or shims behind the nut to separate the rotor and stator plates about 1/16 in. A spiral spring between two washers is then placed over the screw on the front side of the panel, and a rubber binding-post head provides a knob. When using this condenser as a vernier for the tuning condenser, connect the stator lead to the stator plates and the pigtail lead to the rotor plates.—L. B. Robbins, Harwich, Mass.

Non-Corrosive Battery Connection

Corroded spring clips at the battery terminals are a common source of poor radio reception. Many radio owners do not realize how fast this corrosion eats into the wire; it often severs the connection completely. Short lead-wire leads from the battery posts avoid this trouble and are easy to fasten. Short lengths of solid-wire solder, as shown in the sketch, may be used for the purpose, if desired. Slots are sawed in the battery posts, the lead wire inserted and clinched in position by a few light taps with a hammer. Small rubber tubing may be slipped over the lead wires and Fahnestock clip terminals also soldered or clamped at the ends; or binding posts may be used, if desired.

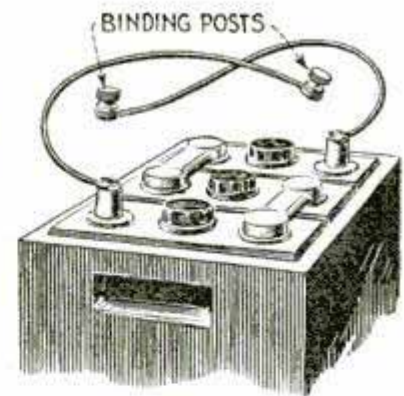

ADAPTER *makes* SHORT-WAVE SET of STANDARD RECEIVER

by Frank L. Brittin

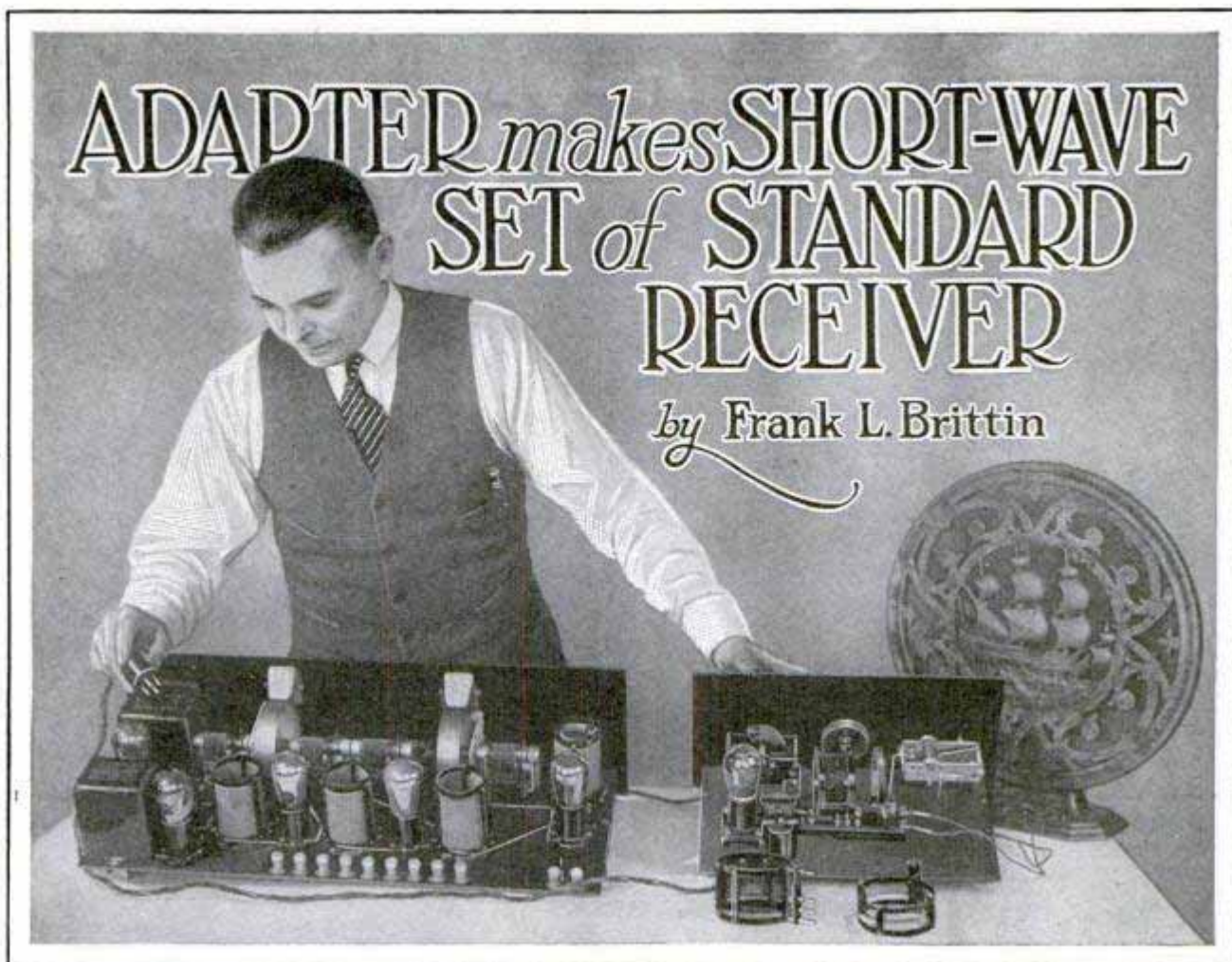

OWNERS of standard broadcast receivers can very easily convert them into the short-wave type with the simple adapter unit described in this article.

This adapter, like any short-wave receiver, is not at all complicated, since it is, in fact, nothing but our old friend the three-circuit tuner. The adapter, fitted with suitable short-wave coils of the plug-in type, is shown in detail on page 478. In use the detector tube is transferred from the receiver to the adapter unit, the filament and plate connections being made by means of an old tube base, plugged into the detector socket in the original set. The adapter unit may be disconnected very quickly, restoring the set to its use as a standard broadcast receiver, as there are no battery connections other than the filament connection provided for in the adapter plug. The complete cost is \$32.41, including the set of short-wave coils and coil-mounting unit.

Short-wave reception is highly satisfactory in localities where static is a year-round trouble maker on standard wavelengths, and in crowded districts the pro-

grams from the large broadcasting stations may often be picked up on the short waves when it is impossible to get them on the standard wavelengths. There are several large stations now broadcasting simultaneously on both the low and high bands, and the short-wave adapter thus becomes a medium through which real selectivity may be attained. For distant reception there is nothing so satisfactory as short-wave broadcasts; we have received several letters from South America, Australia and South Africa reporting reception of American stations on the short waves, and similar reports on foreign-station reception in this country. Loud-speaker amplification is obtained with the same quality as in the original set, as the same audio-amplifier stages are used in both cases.

The layout is very simple, as shown in the upper sketch on page 478, where each instrument is shown in its proper position, ready for wiring. The adapter plug is shown connected to the rear of the sub-panel with three colored leads. The plug is made from the base of an old X-type

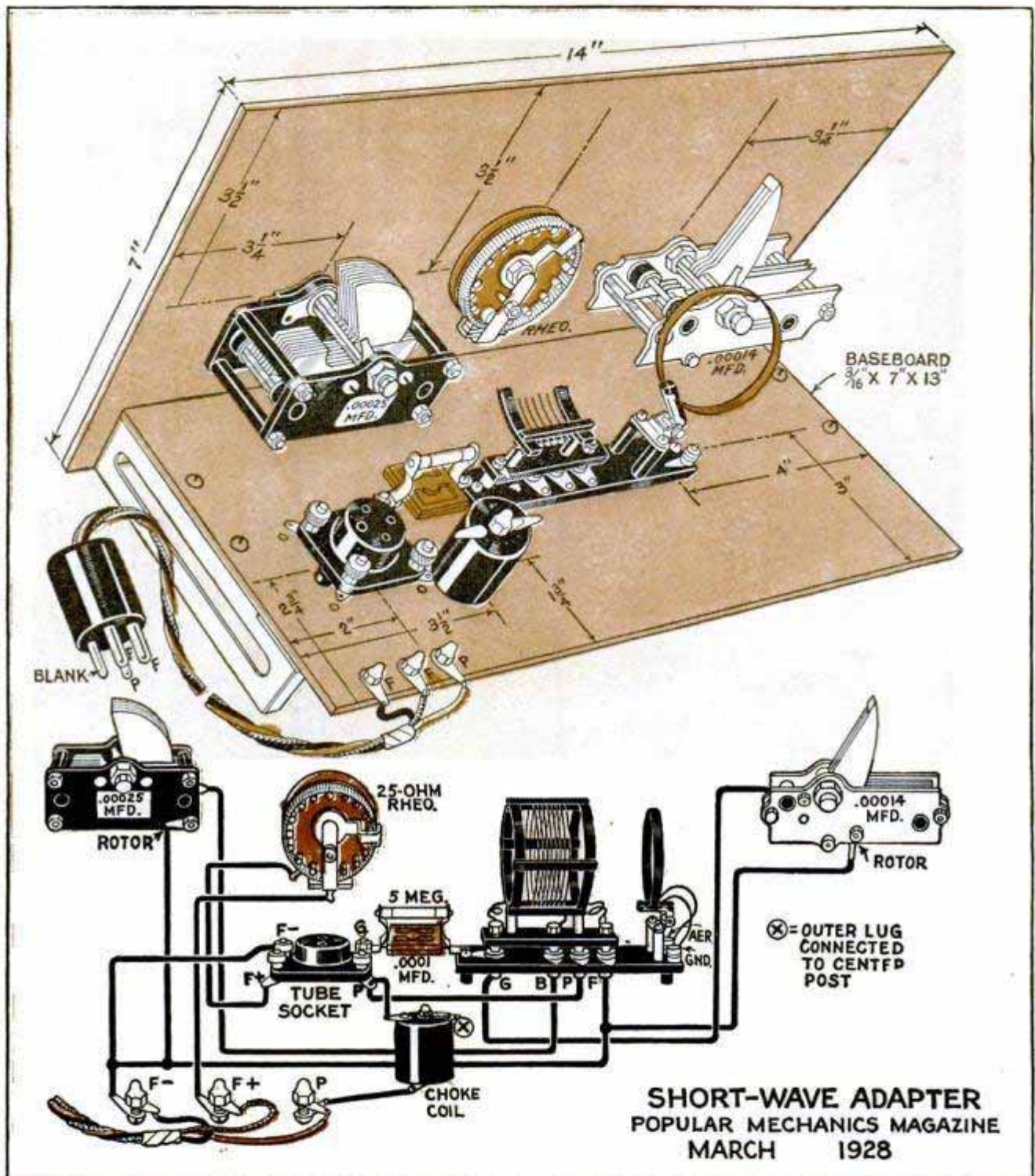

Above, Front and Subpanel Layouts, Showing Instruments in Position; Below, Simplified Wiring Diagram, Showing Original Instrument Layout with Point to Point Connections

tube, the old tube being easily removed from the base by carefully heating the latter over a flame. The internal leads in the base will be found soldered to the prongs; clip these leads, leaving them as long as possible so that the three colored leads can be soldered to them. Looking down into the shell, as shown below the schematic diagram on page 479, the proper prong connections are easily located. Hold the base so that the little pin on the side is up, and you will note that the plate

prong is at the upper right, the grid prong at the upper left is left blank, and the two filament connections are made to the two large prongs below. Sealing wax is then poured in to seal the shell. The colored rubber-covered flexible leads should be 4 ft. long so as to facilitate making quick connections, and the adapter unit may be used either at the side or on top of the usual cabinet or console.

The simplified wiring diagram given below the layout on this page requires little

comment; note, at the point marked X at the choke coil, that three terminals appear at the top, two of which are connected. To make this connection, remove the nut on the center post and place a soldering lug under it, this lug being then soldered to the outer lug at the right; the circuit connections are then made to the remaining lug at the top and the lug at the base of the choke. The machine screw on the base of the choke goes down through the subpanel and the connection is made to a soldering lug under this panel. Be sure the rotor plates of the variable condensers are connected just as shown. The mounting base for the plug-in coils is held in position on the sub-panel by means of two machine screws; note the position of the aerial and ground posts at the right of the coil unit. The aerial and ground leads are removed from the original receiver and connected at these points. To save time, it is more convenient to run a set of separate leads from the main set aerial and ground posts to the adapter and leave them permanently connected. The plug-in coils in the set specified have a range of 15 to 130 meters and are completely interchangeable. The coils are

broadcast bands. The rear-view photos on pages 479 and 480 show the completed unit ready for use; the under-subpanel view on this page shows the subpanel brackets and simple method of wiring. No spaghetti tubing is required, but care should be taken that the wires do not touch at points where they cross. Solder every connection carefully, and make each lead as short as possible.

The tuning is very simple. Connect the adapter plug to the standard set, transferring the detector tube to the adapter unit, and connect the aerial and ground to the base of the coil mounting. Turn on the filament switch of the receiving set

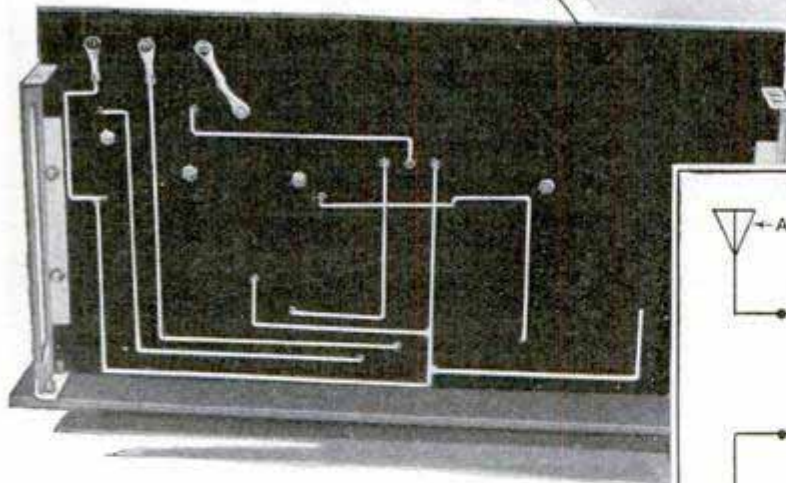
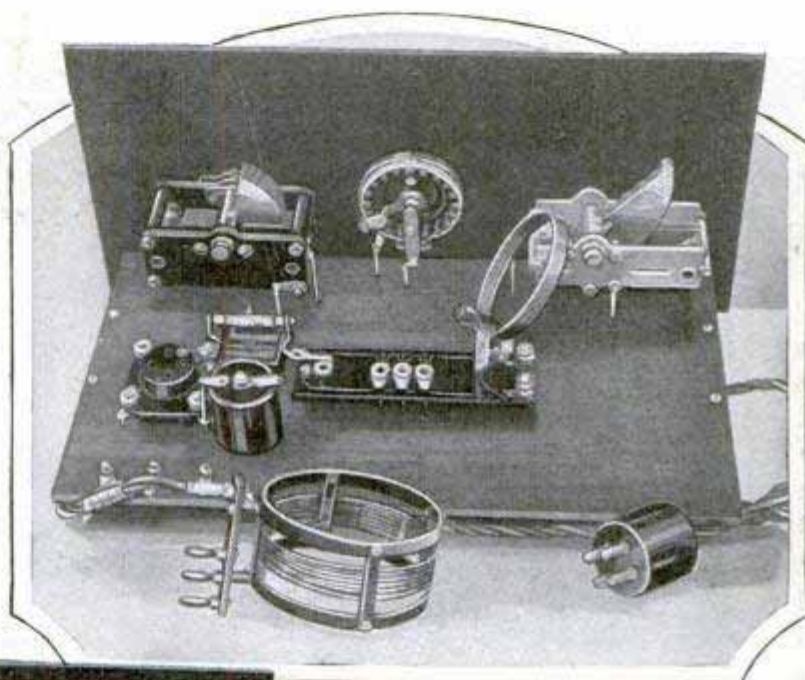

Left, Under-Subpanel View of Completed Unit; Upper Right, Rear View from Above; Below, Schematic Diagram and Sketch of Transfer Plug Connections

the same as those used by the MacMillan and the University of Michigan Greenland expeditions. The mounting base is included with the set of coils. The dials should be of the vernier type for best results, as tuning on the short waves is slightly more critical than on the standard

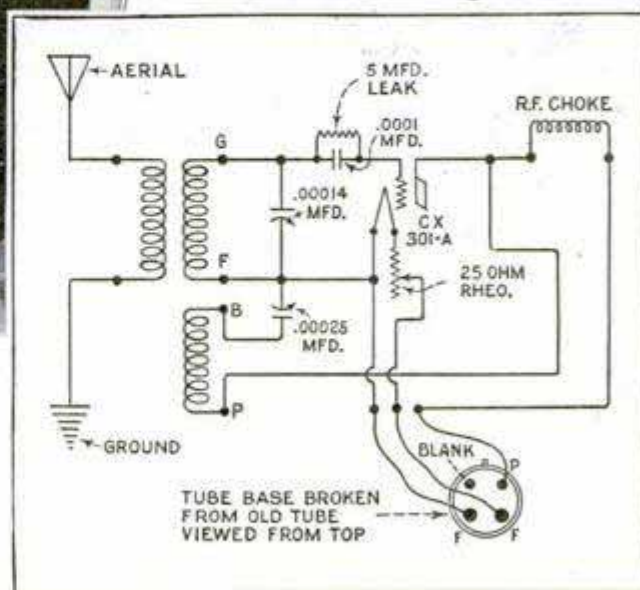

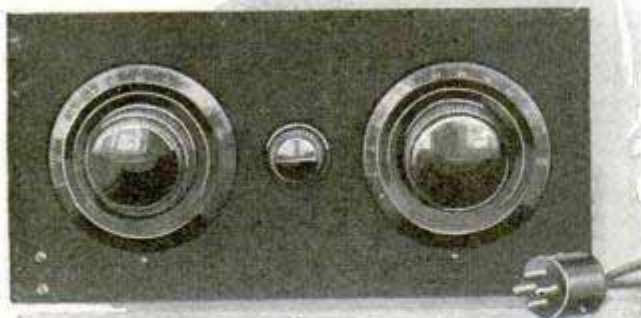

Above, Front Panel; Below, Completed Socket Plug; Right, Plugging in Coil and Transferring Detector Tube

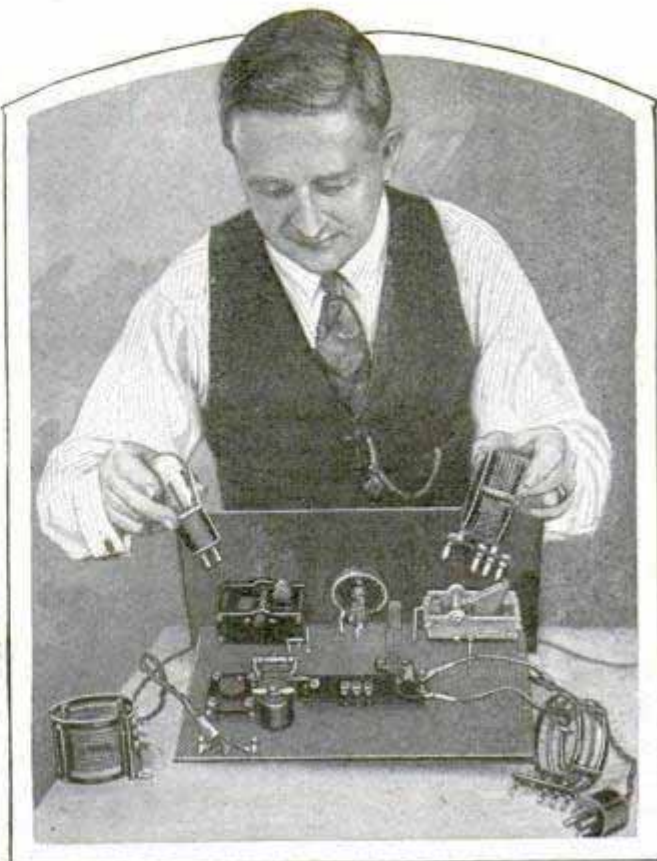

and adjust the detector-tube rheostat of the adapter unit to the point where a slight hissing noise is heard in the speaker. Rotate the vernier dials on the unit until a station is located; volume is then controlled by whatever device is employed on the standard set for adjusting the amplifier output to the speaker. For this particular unit, builders are advised to

MATERIAL LIST

- 1 front panel, $\frac{3}{8}$ by 7 by 14 in.
- 1 subpanel, 3-16 by 7 by 13 in.
- 1 set Aero coils, type LWT-125, complete.
- 1 Amsco variable condenser, .00014 mid.
- 1 Amsco variable condenser, .00025 mid., type 514.
- 1 Aero 60-choke.
- 1 Carter fixed condenser, .0001 mid., with clips.
- 1 Tobe gridleak, 5-meg.
- 1 X-type spring-suspended socket.
- 1 rheostat, 25-ohm, Yaxley, Frost or similar type.
- 2 vernier dials, any good standard make.
- 1 pair Aero, subpanel brackets.
- 1 tube base (may be broken from an old X-type tube).
- 9 6-32 nickelplated brass machine screws, round-head, $\frac{1}{2}$ in. long.
- 4 6-32 brass machine screws, round-head, 1 in. long.
- 3 lengths No. 14 round, tinned-copper busbar wire.
- 15 soldering lugs, long round-hole type.

use the parts specified in the material list. The laboratory tests, of course, were made

with an adapter built up of these parts, and, although other equally good parts may work just as well, unexpected difficulties often arise when substitutions are made. Since short-wave receivers are necessarily designed for low loss, long leads must be avoided, and nothing but high-grade parts should be used.

A large blueprint of the layout and wiring diagrams has been prepared and may be obtained from Popular Mechanics radio department, 200 E. Ontario st., Chicago, for 25 cents to cover cost and mailing. Specify blueprint No. 130.

1312-R Safety Battery Clips

To prevent fire hazard when A-battery leads are short-circuited, a safety clip of the type shown in the drawing has been placed on the market. It consists of a battery clip of the conventional design, to which a fuse-carrying holder is attached, the holder being made to accommodate standard automobile fuses, which can be obtained at any garage or auto-supply shop.



Morris Register &
Council Bluffs.

New Haven Conn
481

Grounded Rotors Eliminate Body Capacity

When buying the parts for a receiver, select variable condensers of the ground-rotor type. This improved type is easily distinguished from the old type by its peculiar construction, the stator plates being insulated from the metal frame and supported by strips of hard-rubber or other good insulating material. The rotor is not insulated, but is grounded to the metal frame or end plates. When the instruments are wired in the circuit it is a simple matter to keep all the rotors at ground potential, resulting in the elimination of troublesome body-capacity effects.

Lumen Radio-light Lighting Fixture Is Also Speaker

A unique combination of radio loud speaker and lighting fixture is shown in the photo; available in several types, it is so designed that any speaker unit may be employed. The combination makes use of two cones, one half the size of the other, each taking a certain proportion of the high and low notes. Both cone diaphragms are suspended on the same pin. The speaker leads are drawn through the lighting fixture, and the latter is securely

anchored so that no vibration is transferred to the speaker. The speaker leads are brought out at the wall plate in the usual manner. Wall plates are now available in a number of different designs,

some providing for aerial and ground connections for the set as well as loud-speaker outlets. The fixtures are made in accordance with prevailing styles for apartment-house and hotel equipment.

Popular Mechanics' radio department offers its information service free to all readers of our magazine. We will be glad to help you with your radio problems, and will promptly answer all inquiries.

C.A. Wolfe, Jr. Rm. 206, 366 Madison Ave

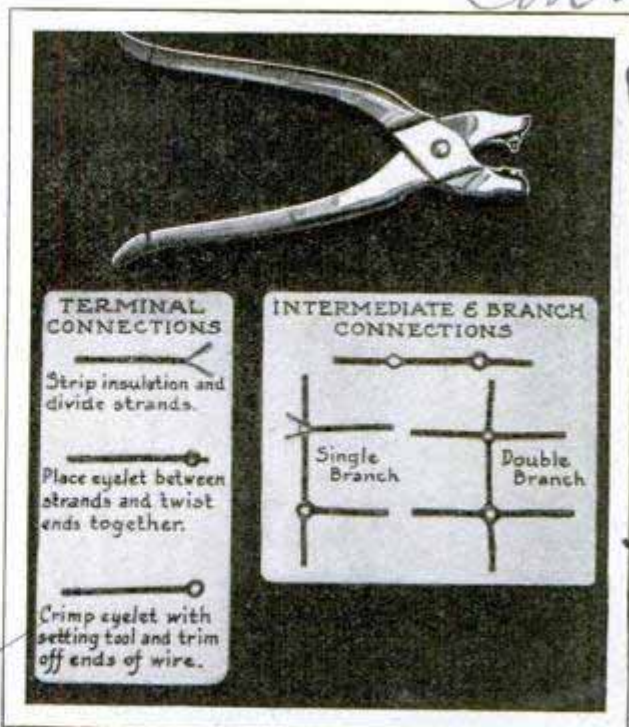

Above, Setting Tool; Below Are Shown Various Steps in Making the Connections

Wiring Set without Solder

At the two recent radio shows, a novel method of wiring a radio set without solder was demonstrated in an efficient and simple manner. The story is practically told in the drawing, and needs little comment; it has some decided advantages for the home-set builder, and the terminal kit is available for less than a good soldering outfit would cost.

1588-R

Transformers Plug into Standard Sockets

Shielded intermediate-frequency transformers and oscillator coils of the plug-in type are now appearing on the market, the types shown in the photo being designed to plug into standard X-type tube sockets. These transformers are put up in matched sets of four, which have been sealed in their aluminum cases. A fifth connection is provided on the case for grounding. Advantages claimed except the plug-in feature, are complete shielding and accuracy in matching.

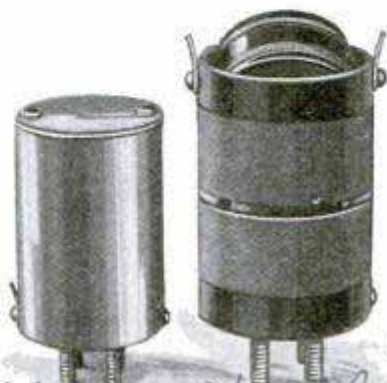

Mississippi Valley Radio Co. 914 Pine

Described several years ago. Letter. 2/21/35



Helpful Hints *from* Radio Experts

THESE valuable kinks have been written especially for Popular Mechanics Magazine by prominent radio experts. They represent not merely ideas, but practical advice from the best technicians in the profession on methods that will help make your set more efficient in operation, more convenient to handle or easier to build.

Using Loud-Speaker Leads as Aerial

Very often loud speakers are utilized in a room 20 or 30 ft. distant from the set,

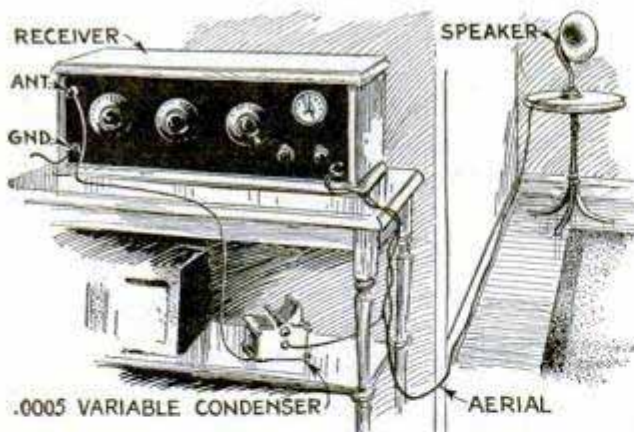

Left, Variable Condenser Showing Connections; Right, Loud Speaker Located in Adjoining Room

and in this case it is quite possible to employ the loud-speaker connecting wire as an aerial. To do this a .0005-mfd. variable condenser is used in the manner shown in the sketch. It is connected between the black lead of the loud speaker and the aerial binding post on the set. To be really efficient, the leads to the loud speaker should be at least 25 ft. long and

2 or 3 in. apart.—Bert E. Smith, engineer, Allen D. Cardwell Mfg. Corp., Brooklyn.

Picture-Frame Antenna

The picture-frame antenna shown in the sketch not only makes a good aerial, but solves the problem for tenants in apartment buildings. Anyone

who has a fairly large picture in a gilded or bronzed frame has a ready-made aerial for instant use; clean a spot on the frame at a point that will not show from the front, and fasten the bared end of a short wire, from the aerial post on the set, to the frame with a small staple.—E. F. Reinhart, engineer, Permway Mfg. Co., St. Charles, Mo.

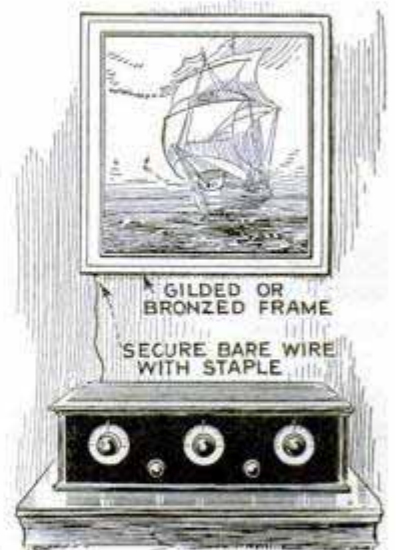

Bringing Old Audio Amplifier Up to Date

As many of the most important improvements recently made on receiving apparatus are in the audio end of the set, this article is for the benefit of the man who has a receiver that was first-class two years ago but now is considered "tinny" or high-pitched. The expense of the alteration is very small as the only additional apparatus necessary is a choke of 30 henrys or more (this choke may be made from the secondary of an old a.f. transformer), two .1-mfd. coupling condensers, two gridleaks and a 2-mfd. condenser. Disconnect the audio transformers, and connect the outside ends of the primaries to the inside ends of the secondaries. Usually these ends are marked P and F; if the coils cannot be seen, try the P and F connections, and, if the signals are weak, make the connections from B to F. The plate of the tube is connected to the two connected ends of the transformer windings and the other end of the primary to the coupling condenser, the other end of the secondary being connected to the positive B-post. This positive B-post will be the detector B, for the first stage, and the

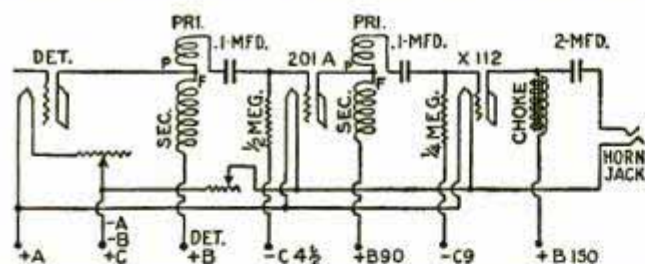

Diagram Showing Completed Audio Changes and Speaker Filter

90-volt B on the second stage. The 30-henry choke coil is connected from the plate of the power tube to the amplifier B-post; this voltage should be 135 to 150 for best results. Note that the 2-mfd. condenser is placed in series with the plate of the power tube and the speaker, to keep the high-voltage d.c. supply out of the speaker windings. With the amplifier wired as shown in the diagram, the volume will be slightly less than that obtained before, but the tone will be greatly improved, bringing in the low notes formerly unheard. If more volume is desired, an additional stage may be used between the detector and first audio, with the grid return to the 4½-volt C-connection. The

gridleaks are installed on single mounts at convenient points and connected as shown in the diagram.—Chas. Middleton, chief engineer, Station WRAF, LaPorte, Indiana.

Experimenters' Telegraph Key

A simple and effective telegraph key may be constructed from an old single-

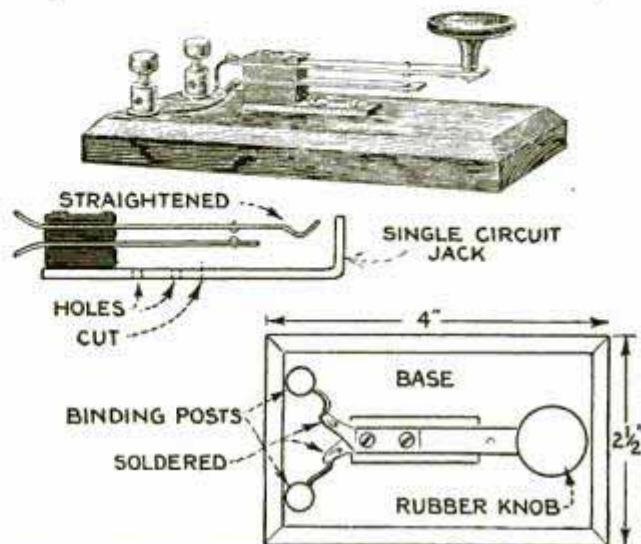

Above, Sketch Showing Completed Key; Below, Construction Details and Top View of Assembly

circuit jack. The base is cut in half, as shown in the sketch, and two small holes are drilled in one of the halves for screws. The upper blade of the jack is straightened out, or can be cut off if desired. A hole is drilled in the upper blade and a telegraph-key knob, or any small rubber knob, fastened at the end of the blade. The base may be of wood, sandpapered and stained if desired; this base is 4 by 2½ by ½ in., two holes being drilled at one end and binding posts inserted. Two wires are then soldered to the ends of the jack blades and connected to the binding posts; these wires may be run underneath the base or on top. The key is now ready for use; the blades are spread apart with the fingers until the correct distance between the silver contacts is obtained.—Herman R. Wallin, radio operator, S. S. "Cornelia," Brooklyn.

Adding Distilled Water to Battery

The storage battery is often placed in a very unhandy position when it is necessary to add distilled water and the usual battery-filling devices do not offer a solution to the problem. I use a quart jar,

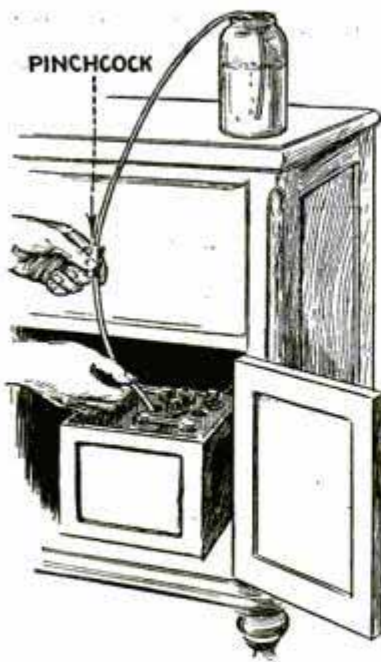

placing it higher than the battery, and regulate the flow of water through a small rubber hose by means of a pinch-cock. The water is siphoned into each cell without spilling, and the hose is handy for use in the garage as well as for the radio battery.—C. R. Yarger, chief engineer, Station KFNF, Shenandoah, Iowa.

radio battery.—C. R. Yarger, chief engineer, Station KFNF, Shenandoah, Iowa.

Radio Drill Made from Auto-Horn Motor

The small electric hand drill shown in the accompanying drawing will be found handy for the radio builder, jeweler or any artisan working in localities not sup-

plied with house-lighting current. This drill operates from a 6 to 8-volt battery. The motor is one obtained from a motor-driven auto horn. It is usually thoroughly shielded by a steel cylinder, and the wire leads come out through holes in the face covering the commutator end of the motor. First make a steel collar that will encircle the motor and can be clamped solidly around it, as shown. Spread the ends of the strap below this bolt to fit over the end of a saw handle. Enlarge one of the bolt holes from the bottom end of the handle; drill similar holes through the ends of the collar, and then fasten it to the handle, in the location indicated, by means of a machine screw and wing-nut. The motor can be swung and clamped at different angles from the handle. Make a switch on the handle that will come under the thumb, by screwing a short piece of spring brass to the wood, with a small knob on the free end. Arrange a second screw under the free end of the spring, as shown in the detail. Enough of the shaft will project from the plain face of the motor to allow the attachment of a small chuck taken from a hand drill. In most cases the shaft back of the chuck is hollow, and can be cut off, drilled and fitted with shims and setscrews so that it can be firmly attached to the motor shaft. The exact particulars of construction are, however, left to the discretion of the builder, as horn motors

Old Auto-Horn Motor Can Be Made into a Handy Drill, Which Is of Considerable Usefulness to Radio Builders, Jewelers and Others

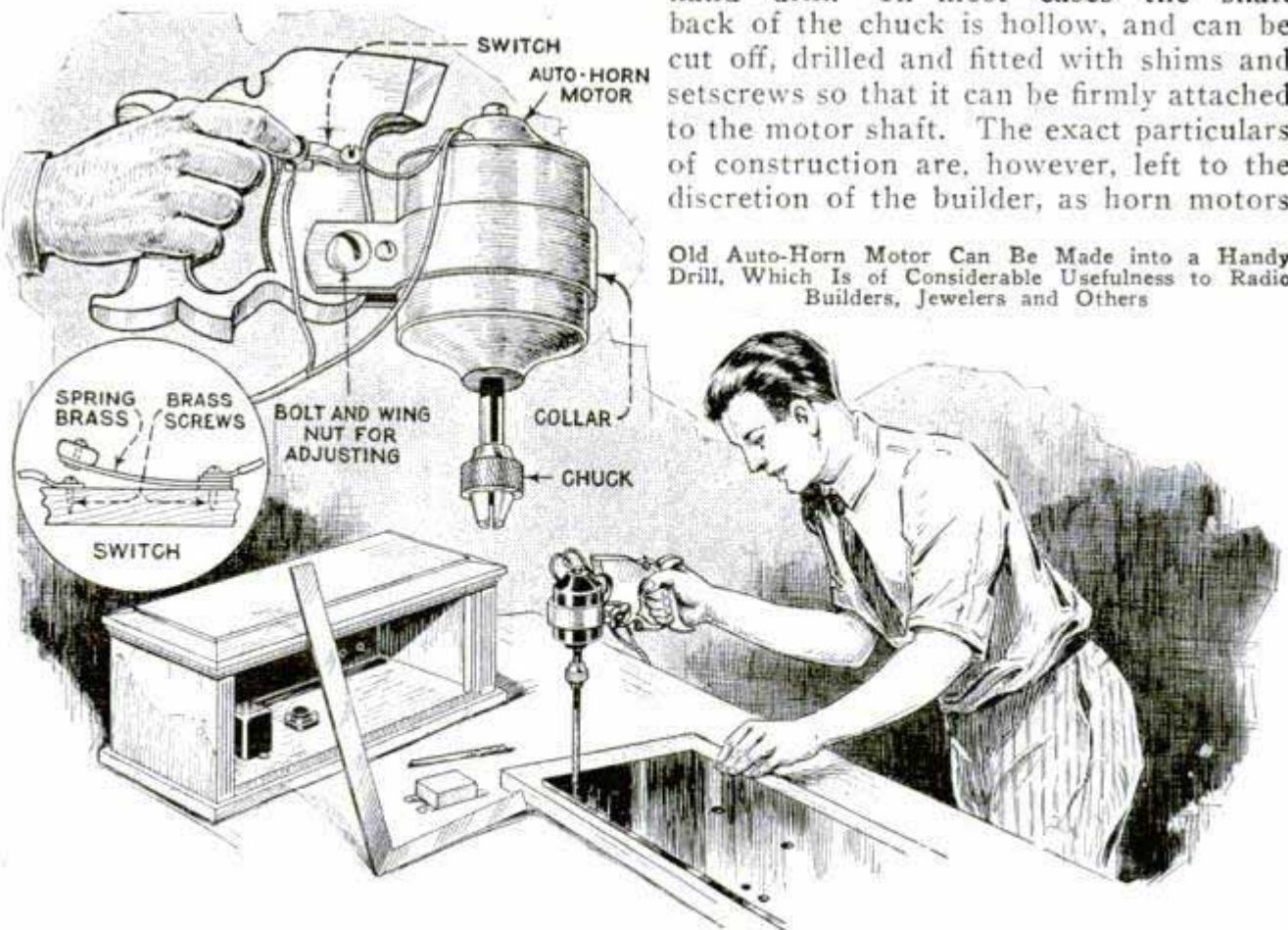

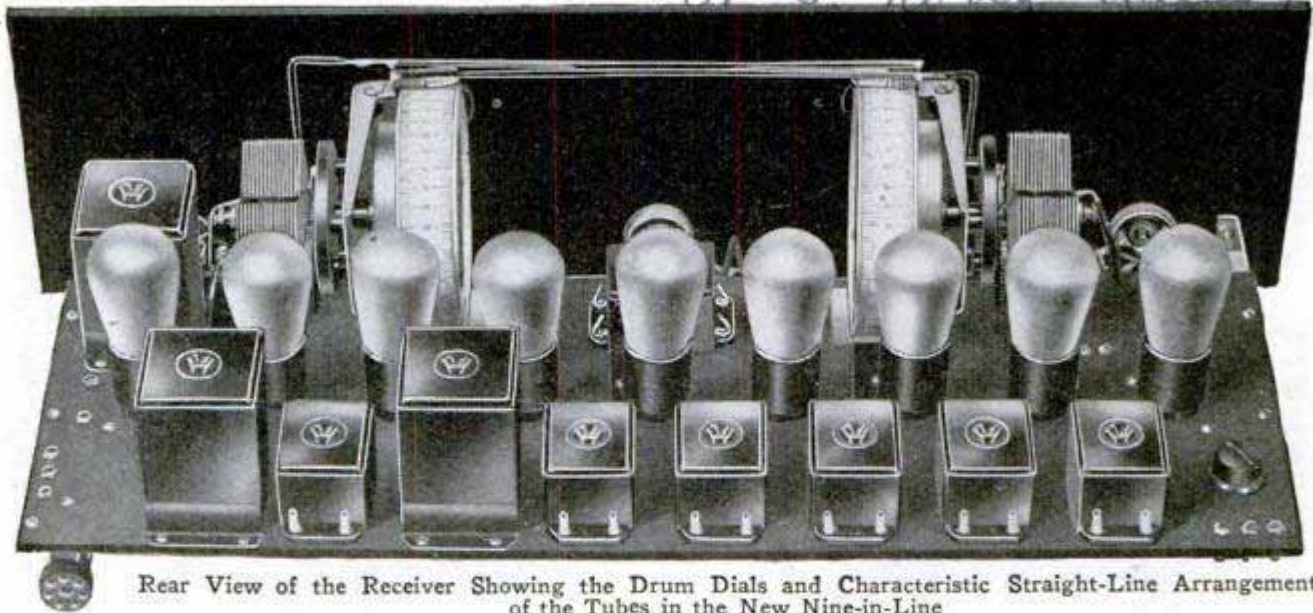

Rear View of the Receiver Showing the Drum Dials and Characteristic Straight-Line Arrangement of the Tubes in the New Nine-in-Line

are not all alike. Extend one of the motor leads to the battery and solder the other to the screw holding the switch. Extend another lead from the screw under the switch to the other battery terminal. By using long flexible leads, the drill can be carried anywhere along the bench or shop. Adjust the angle of the drill as desired, and, holding the handle in a natural position, press down on the switch. The motor will then operate the drill until the switch is released.

Condenser Plates Slide into Engagement

Differing from the usual type of variable condenser, the sliding condenser shown in the photo is said to have many features of advantage. It has a self-cleaning, nickel-silver contact spring, insuring minimum resistance. The main bearing is relieved of all strain, as it is constructed on the same principle as the "floating" automobile axle. The small pinion and shaft are in one piece, and the pinion has helical teeth, engaging with the rack, which insures smooth operation. The slides on which the movable plates are mounted run in accurately milled, parallel grooves. To prevent backlash, a phosphor-bronze spring is used. This keeps the rack in mesh with the pinion and compensates for wear.

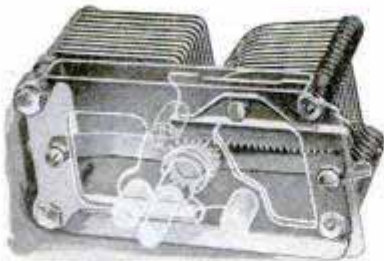

Drum Dials Feature of New Nine-in-Line

The new Nine-in-Line receiver for 1928 has several advantages over previous models; the manufacturer has made several changes in the intermediate transformers, and also greatly improved the a.f. end of the receiver. The addition of an output transformer to keep the high plate current, necessary for the operation of power tubes, from the loud-speaker windings, is a further improvement. New drum dials are an attractive feature of the set, and the low vernier ratio and illuminated scale make close tuning very simple. The rear-view photo of the set shows the arrangement of the drum dials and various other instruments, and the characteristic straight-line arrangement of the tubes. The circuit employed is the usual super-type with several original variations; the wiring diagrams and construction details are supplied by the maker of the parts.

Gas Pipe a Poor Ground

The gas pipe is not only a poor ground but a dangerous connection for any electrical wiring. Lightning in the vicinity of the aerial often induces heavy charges in the aerial and ground system, and sparks sometimes result. Hence, leaking joints in the gas pipe may result in a serious blaze. From the standpoint of a ground for the set it is inefficient, due to the lead-filled joints, which cause a high resistance.—August Jeffers, Philadelphia, Pennsylvania.

Nelson Tool Co, Inc.
781 & 142 nd st

1539 Pa a #1452
 145193
 1487-R Shown at Los Angeles Radio Show
 Pa a 13083
 1433 R
 145193
 1538 R

Facts and Fads for Radio Fans

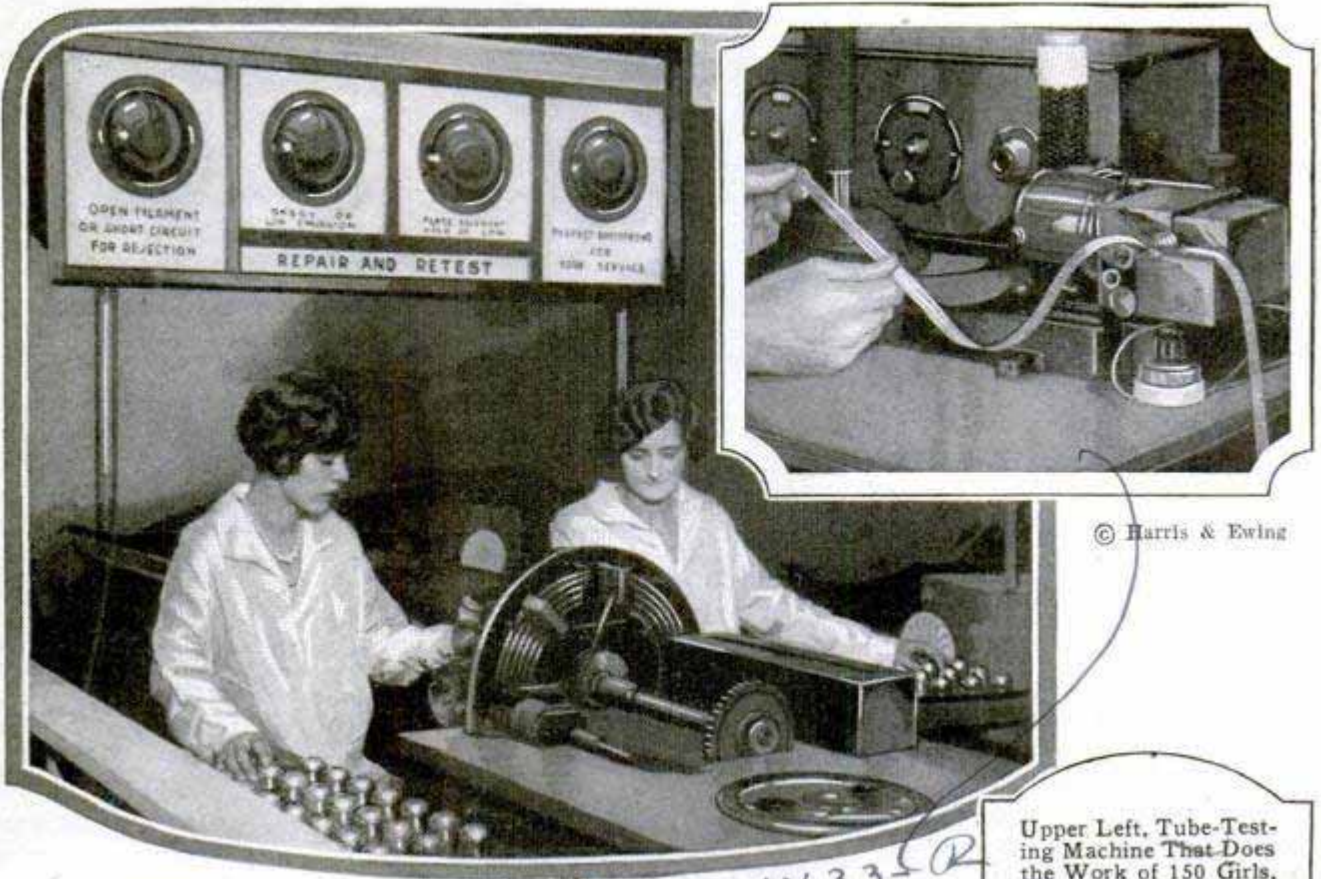

© Harris & Ewing

Upper Left, Tube-Testing Machine That Does the Work of 150 Girls. Automatic Test Indicator Overhead Registering Faulty Tubes Which the Operators Then Discard; Previously Tubes Were Tested One at a Time, a Different Machine Being Required for Each Fault; Right, Radio Equipment Recently Installed in Washington for Broadcasting Weather Forecasts to Aviators

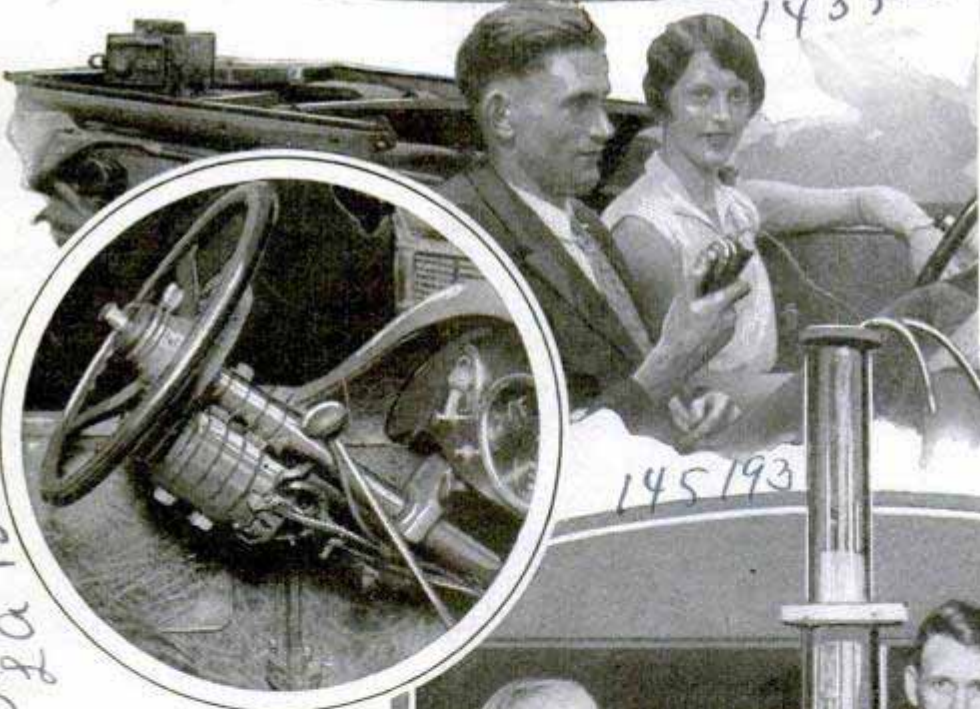

Above, R. L. Mack, Former Naval Radio Operator, Directing a Driverless Car by Means of Radio Control; the Inventor Claims the Control Mechanism is Adaptable to Any Car; Insert, Close-Up of Steering-Column Mechanism in a Second Car, Actuated by Remote Control; at Right, Comparing the New 100-Kilowatt Transmitting Tube with One of the Old Types; These Tubes Were Exhibited at the New York Radio Show



Filling Storage B-Batteries

When adding water to storage B-batteries with a small hydrometer, it is difficult to see when the liquid is high enough in the cell because of the small opening. To save time, add water until it is level with the top of the filler opening, where it can easily be seen, then draw out enough to lower it to the proper level. The withdrawn water is placed in the next cell, and so on for each cell. Since the water is taken out at once and from the top of the cell, it will not be mixed with the electrolyte to any great extent. To equalize any slight amount of the electrolyte that may be carried over, commence at the other end of the battery when water is added the next time.—E. T. Gunderson, Jr., Humboldt, Iowa.

1584 R

Mounting Prevents Resistor Sag

A new line of wire-wound resistors, designed for heavy-duty use in correct voltage regulation for homemade A, B and C-eliminators, is now available. These units are provided with mounting rods and supporting brackets, which prevent sagging of the resistors under heat, and also permit rigid, easy assembly. Designed for use in power packs delivering up to 500 volts,

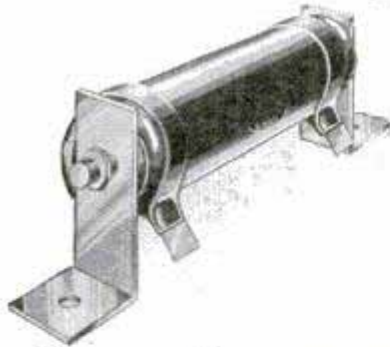

the values range from 500 to 25,000 ohms, with heat dissipation claimed to be in excess of 15 watts. Ruggedly constructed, these

voltage regulators pass, according to their size, from 27 to 150 milliamp., which is ample for all standard units employing the 171 or 210 power tubes.

Carver Radio Corp Newark, N.J.
One Tube Does Work of Three
151 Summit 1202-62
Practically three tubes in one, this addition to the tube field enables the use of a loud speaker with a receiver employing only one tube. Drawing a filament current of only .25 amp. maximum, it may be operated from dry-cell batteries, making it ideal for portable sets. As the fila-

Emerson Radial Co,
25W. 43rd St
New York



BINDING POST CONNECTIONS

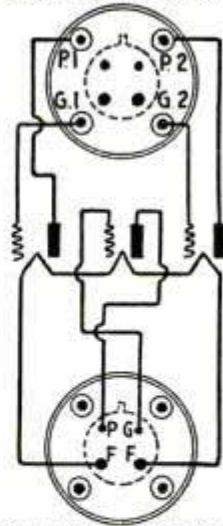

BOTTOM PIN CONNECTIONS

Left, Three-in-One Tube Showing Simple Arrangement of Binding Posts; Right, Diagram of Connections

ment is larger and more rugged than the 199-type of dry-cell tube, it will stand rougher handling and has a much longer life, according to the claim of the manufacturer. The tube has a thoriated filament, and may be reactivated in the usual manner, should it become paralyzed through accidental application of excess voltage. It may also be used on the same rheostat in parallel with any five-volt tube and it fits in any of the standard sockets, so is suitable for any circuit. The diagram shows the usual connections at the tube base and the additional binding-post connections above. Used in a set incorporating one stage of r.f. amplification, detector and two stages of a.f. amplification, the first stage of audio being reflexed on the r.f. stage, the set is capable of giving good distance reception and loud-speaker volume.

Condenser Mounts on Socket

Neutralizing condensers are usually mounted on the subpanel or are held in place with rigid busbar wire, but the type shown in the drawing is designed to be fastened directly on the grid terminal of the socket, which eliminates two soldered connections. It is easily adjusted by means of a small screw and requires less space than most similar instruments.



C.E. + N.S.
Hargraves,
Lab. Prod. Co.

Gunderson - Sternfield
25 N. Dearborn.
Chicago

803-R

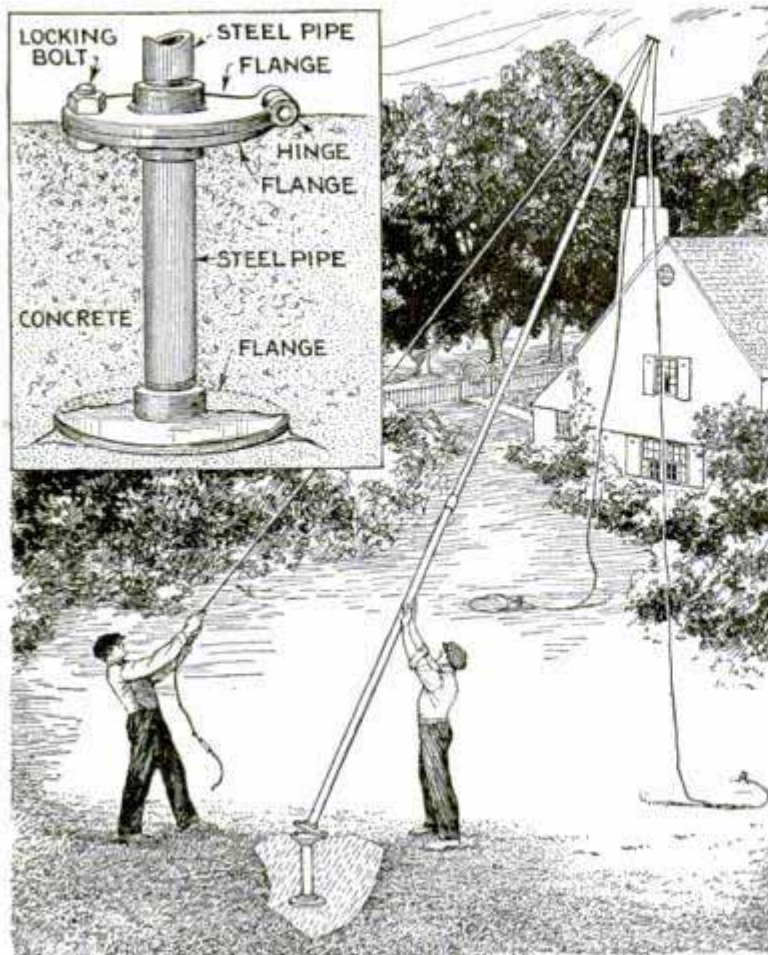

Insert, Base Section Showing Hinged Flanges and Locking Nut; Below, Method of Raising the Mast

Steel Radio Mast Easily Erected

An English manufacturer has recently introduced a strong and neat radio mast that can be erected by any novice. It is made in two sections, the lower part to be imbedded in concrete as shown. The mast proper is hinged to the lower section, and assembled on the ground before erection. For convenience in transport, the mast is built up from three steel tubes, in two 12-ft. sections and a 6-ft. top section. The guy wires are fastened while the mast is still on the ground, and are employed as shown to pull the mast into a vertical position, an easy task due to

the hinged baseplate. The guy wires are then fastened to three steel angles driven into the ground to serve as anchors.

Installing Speaker Jacks on Subpanel

Very few of the modern sets now show speaker jacks on the front panel, the tendency being to do away with a multiplicity of phone and speaker jacks with their complicated wiring. As the speaker plug is seldom withdrawn from the set, the use of two miniature jacks of the cord-tip type, mounted at a convenient point at the rear of the subpanel, answer the same purpose and are hidden from view.

Charging Switch for Wet B-Batteries

An inexpensive switching device for charging wet B-batteries is shown in the accompanying sketch. As it is necessary to charge such batteries in parallel, the normal method of

changing connections is far too slow, and short circuits are likely to occur. The three small porcelain-base d.p. d.t. knife switches are mounted on a piece of hard rubber or bakelite, and batteries and charger connected as shown in the diagram. When the switch is thrown in one direction, the batteries are connected in parallel for charging, and when thrown in the opposite direction they are in series for the receiver.

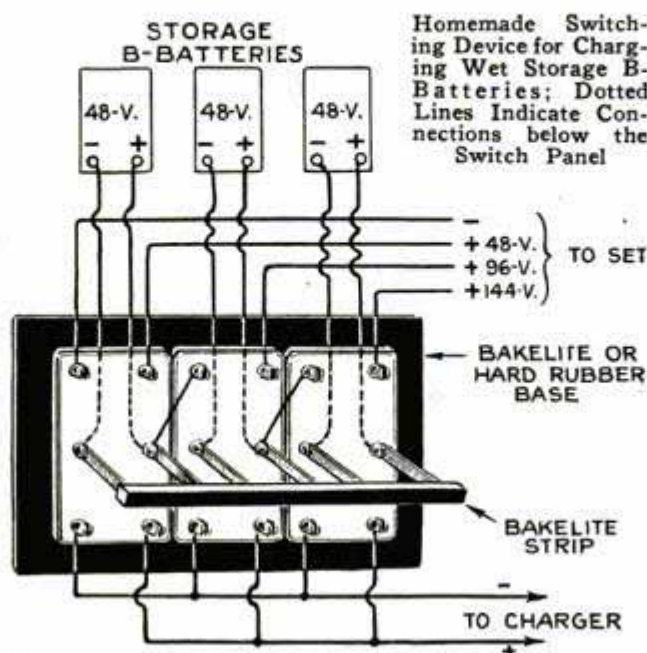

changing connections is far too slow, and short circuits are likely to occur. The three small porcelain-base d.p. d.t. knife switches may be obtained for ten cents each. The fiber strip joining the blades of each switch is removed, and replaced with a narrow bakelite strip, long enough to join the blades of all three switches. The switches are then mounted on a piece of hard rubber or bakelite, and batteries and charger connected as shown in the diagram. When the switch is thrown in one direction, the batteries are connected in parallel for charging, and when thrown in the opposite direction they are in series for the receiver.



Utility Cart for Housewives

By EDWIN M. LOVE

THE utility cart shown in the illustration is a portable cupboard for soaps, cleaning fluids, and necessary cloths, being equipped with a rack for an 8-qt. water bucket and a tray in which the cans and boxes are neatly arranged.

For the long side, cut a piece of 1 by

width will be about 11 in. If the other parts correspond in width, there is no need of being accurate to any set figure. The form of this end is well shown in Figs. 1 and 2. Mark one edge as the face edge, from which to work, and square two fine pencil lines or knife cuts full width across

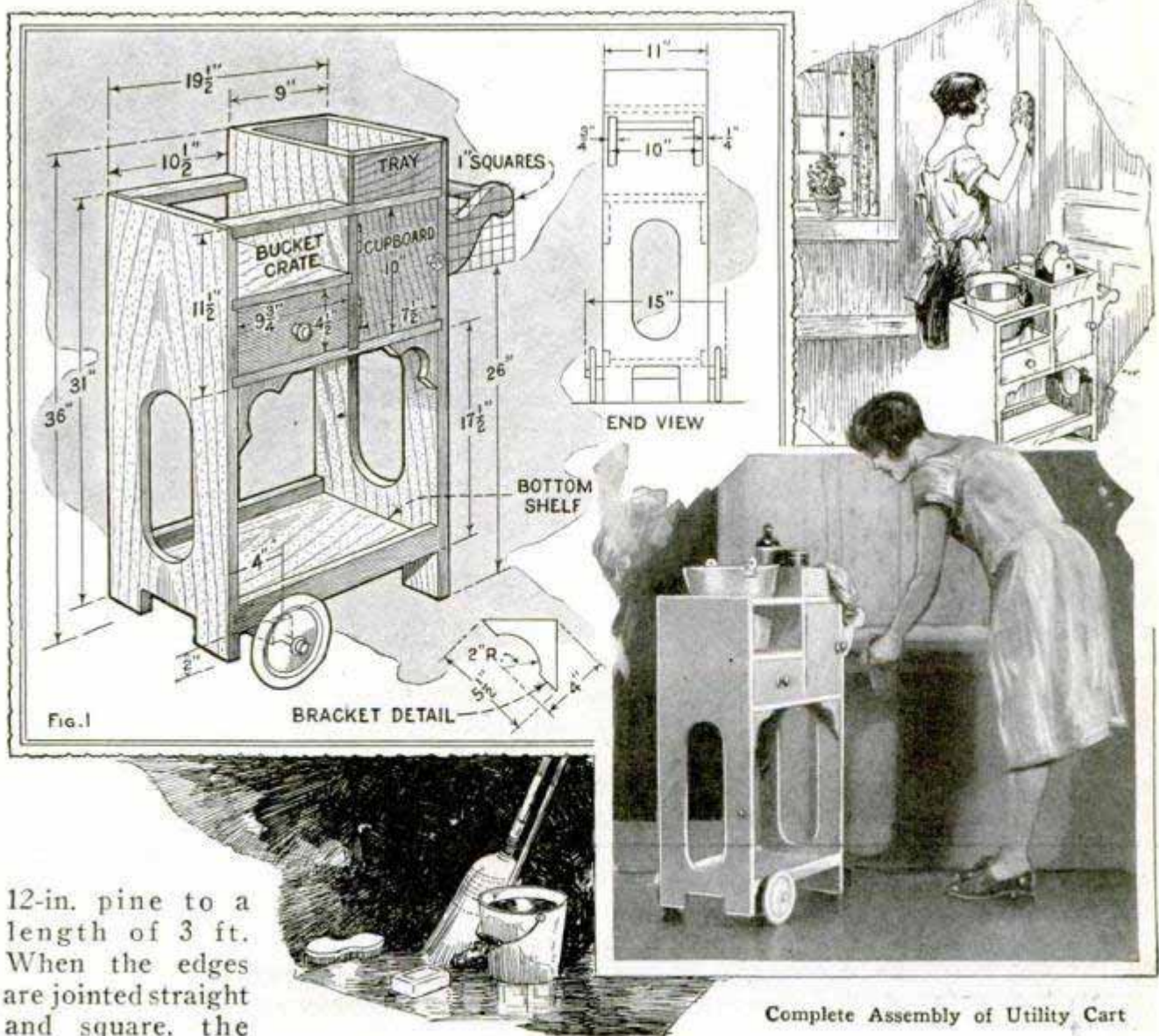

12-in. pine to a length of 3 ft. When the edges are jointed straight and square, the

Complete Assembly of Utility Cart

the unsanded inner face, locating the $\frac{3}{4}$ -in. dado 3 in. below the upper end, as indicated in Fig. 2. Lay out a second dado, 10 in. below the first, and a third 1 ft. $4\frac{3}{4}$ in. below the second. Gauge the three for a depth of $\frac{5}{16}$ in. Crosscut all, working in the waste wood and splitting the lines. If the saw will not follow the line, tack a wooden strip down to guide the blade.

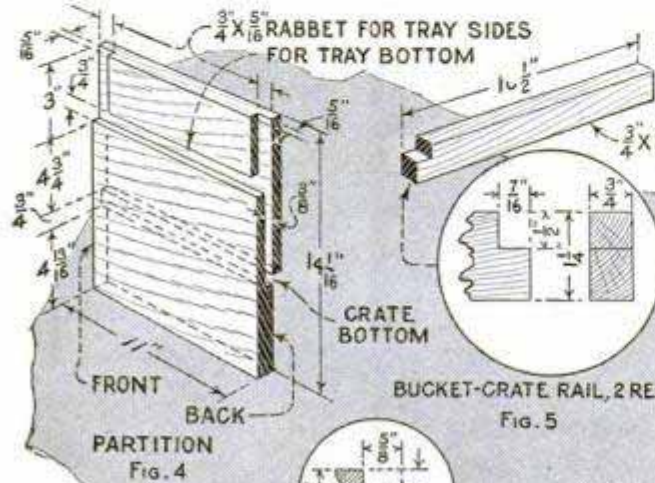

Fig. 4

BUCKET-CRATE RAIL, 2 REQ.
Fig. 5CRATE BOTTOM
Fig. 6TRAY SIDE
2 REQUIRED
Fig. 7BACK
Fig. 8

Fig. 2

SHORT END
Fig. 3

Roughly knock out the waste and trim smooth with a chisel, held flat, or with a router, if one is available. Fig. 3 details the short endpiece. With the long end for a pattern, as in one of the photos, lay out its finished length, as well as the position of the middle and lower dados. In this way inaccuracies will be reduced to a minimum.

The upper dado is $4\frac{1}{2}$ in. above the middle one. Note that in the back edge of each endpiece a rabbet, $\frac{3}{8}$ in. wide and cut to the depth of the dados, is made to house the ends of the three-ply back. Gauge and chisel out the rabbets between

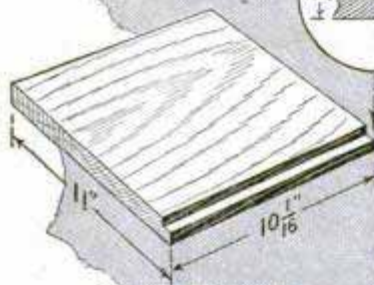
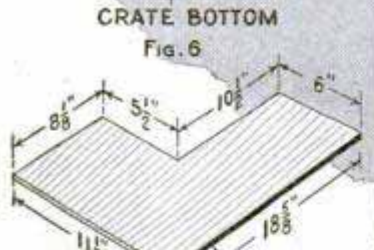
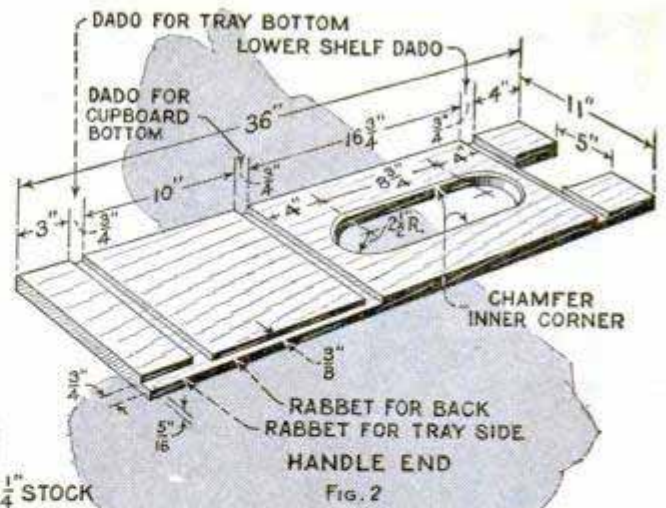
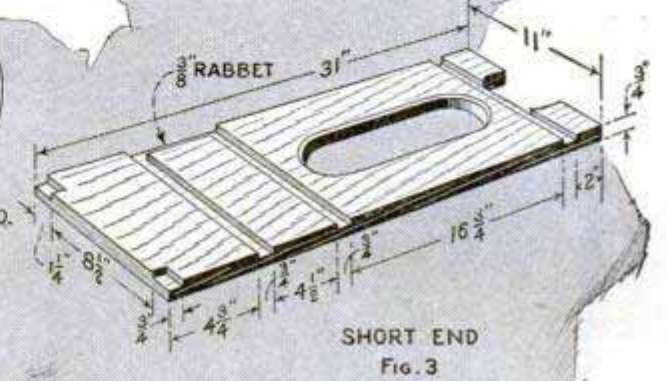
the upper grooves. Likewise, in the long end, cut $\frac{3}{4}$ -in. rabbets to receive the ends of the tray.

The ornamental holes have semicircular ends of $2\frac{1}{2}$ -in. radius, centering on the stock 4 in. from the dados. The feet are laid out by continuing the side lines of the holes, and the rounded corners are made by boring, with a 1-in. bit, from both sides, to avoid splintering. It is immaterial whether they are cut to the bottom of the shelf dado, as in the drawing, or

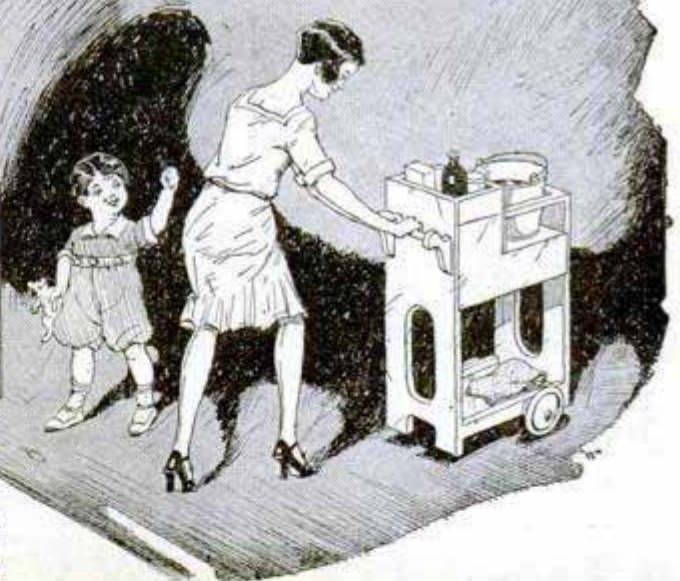

$\frac{1}{2}$ in. below. Cut the top, as well as the curved ends of the holes, with a keyhole saw, and since this tool is likely to splinter the inner face, it may be necessary to make the $\frac{1}{4}$ -in. chamfer indicated in the drawing. Smooth the hole ends with a wood rasp moved in an oblique, rotating motion, as shown in the photo, and lift it on the return stroke. Recesses in the upper corners of the short end, made $\frac{3}{4}$ by $1\frac{1}{4}$ in. and $\frac{5}{16}$ in. deep, carry the bucket-crate rail ends.

The dimensions of the partition are given in Fig. 4. This piece is of 1 by 12-in. stock, cut 1 ft. $2\frac{1}{16}$ in. long. On one side, 3 in. below the upper end, it has a dado, $\frac{5}{16}$ in. deep and $\frac{3}{4}$ in. wide; on the other, a similar dado, $4\frac{1}{16}$ in. above the lower end. Notch the upper $\frac{3}{4}$ in. deep on the front edge, and rip $\frac{3}{8}$ in. off the back edge from the lower end up through the lower dado. Rabbet as shown for the tray ends, as well as for the three-ply back. The bucket-crate bottom, shown in Fig. 6, is 11 by $10\frac{1}{16}$ in. and rabbeted $\frac{5}{16}$ by $\frac{5}{8}$ in. for the back. The tray bottom is $8\frac{1}{8}$ in. long and $10\frac{5}{8}$ in. wide, allowing room for

beted on the back edge, $\frac{5}{16}$ in. deep, to receive the back. The dimensions of the bottom shelf are given in Fig. 10. The nosing, applied after assembly of the cart, is $\frac{3}{4}$ in. by $1\frac{1}{2}$ in., with the ends notched to fit into the end dados and between the cart endpieces.

Before assembling, plane and sand the unsanded sides of the main parts. Try the joints for fit. If too tight, dress the ends of the pieces mating with the dados. Clamp together and secure with six-penny finish nails, driven in at various angles to increase their holding power. Whenever possible, as in the cart ends, conceal the nails by driving them from the undersides of the shelves into the dados. If any edges project, dress them off. Square the frame, holding it so with a diagonal brace tacked across the front.

The tray sides, shown in Fig. 7, are $\frac{3}{4}$ by 3 by $8\frac{1}{8}$ in. in size. Their position in the assembly is shown in Fig. 1. From actual measurement of the cart, make two bucket-crate rails, shown in Fig. 5, notched at the ends to fit into the partition. The other ends fit flush into the notches of the cart end. In direct measurement of the assembly, be sure none of the parts are bowed in or out. The back is made of $\frac{3}{8}$ -in. three-ply stock. (See Fig. 8.) Lay it in place to determine the shape, and bevel the edges a little so that the joint will close

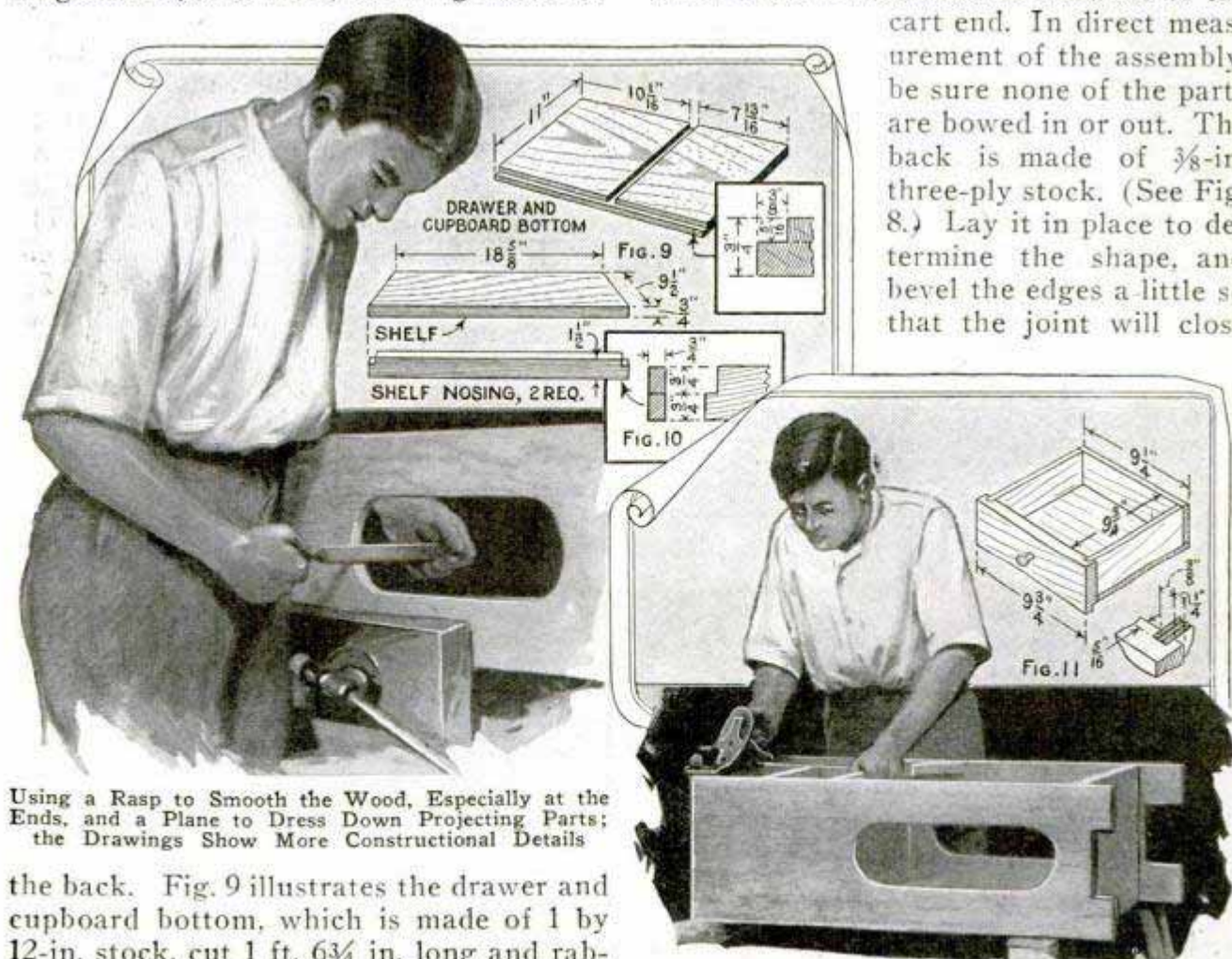

Using a Rasp to Smooth the Wood, Especially at the Ends, and a Plane to Dress Down Projecting Parts; the Drawings Show More Constructional Details

the back. Fig. 9 illustrates the drawer and cupboard bottom, which is made of 1 by 12-in. stock, cut 1 ft. $6\frac{3}{4}$ in. long and rab-

How Dadoes Are Marked from One Endpiece to the Other, and, Below, the Various Parts

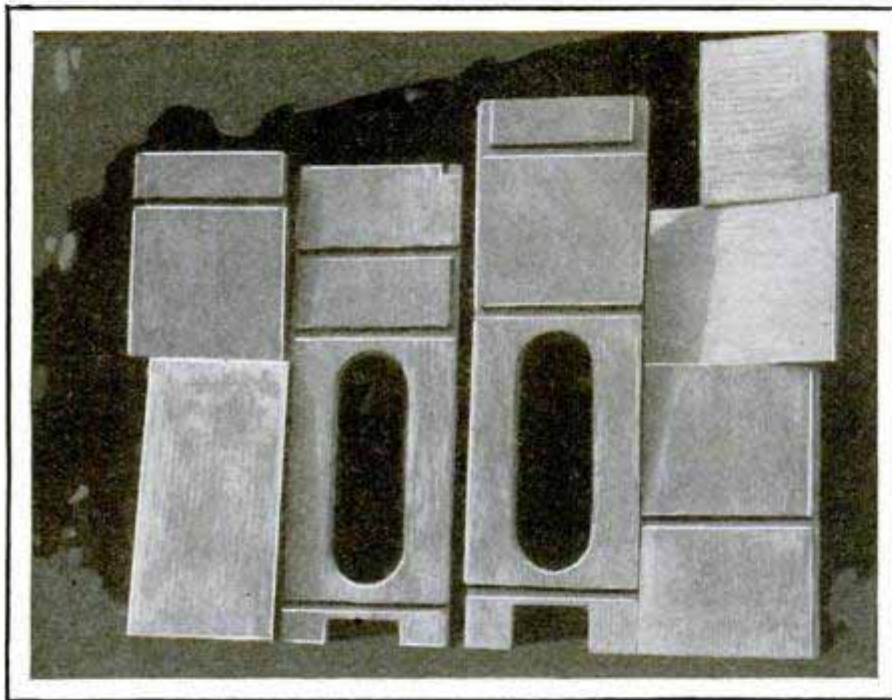

snugly all around. Put the shelf nosings in place, and set the four brackets with a $\frac{1}{4}$ -in. margin. The latter are detailed in Fig. 1. Each is an isosceles triangle with a hypotenuse $5\frac{1}{2}$ in. long, from which is cut out an arc of 2-in. radius, centered 4 in. from the vertex of the right angle. Make a cardboard pattern for the handle brackets by sketching the outline through 1-in. squares, as indicated in Fig. 1. These brackets can be easily shaped by cutting into the outline with a saw and trimming with a chisel and rasp. Cut a handle from a broomstick and bore sockets, $\frac{1}{4}$ in. deep, in the brackets to receive the ends of the handle. Nail the brackets in place with the lower edges 10 in. from the tray top, showing a margin of $\frac{1}{4}$ in. They may be further stiffened by nailing a small tri-

angular hardwood block behind each. Under the bottom shelf mount the wheels, centering 4 in. from the end of the cart, as in Fig. 1, laying the axle in a groove on the underside of a 2 by 2-in. stick, which may be built up from 1-in. scrap.

Fig. 11 gives the dimensions of the drawer. The front is made from a piece cut from an end. The two sides, back and bottom are made of $\frac{3}{8}$ -in. three-ply stock. The sides measure 4 by $9\frac{3}{4}$ in., the back 4 by $9\frac{1}{4}$ in., and the bottom $9\frac{1}{4}$ by $10\frac{1}{8}$ in. Dado the ends into the front, $\frac{5}{16}$ in. deep, and fit the bottom into a $\frac{3}{8}$ by $\frac{3}{8}$ -in. rabbet on the lower edge of the front. Nail $\frac{3}{16}$ by $\frac{3}{4}$ -in. guide strips against the sides of the drawer space, the ends being $\frac{3}{4}$ in. back for stops, and slip the drawer in place to mark the length of the front. Cut the ends, and plane the top until it will enter. The clearance all around should be $\frac{1}{16}$ in., when the front is flush. The door is a piece of well-seasoned 1-in. stock, $7\frac{1}{2}$ by 10 in., hung with two

2 by $1\frac{1}{2}$ -in. loose-pin butts placed $1\frac{1}{4}$ in. from top and bottom. A $\frac{1}{4}$ by 1-in. strip is nailed at the right side of the cupboard $1\frac{3}{16}$ in. from the front, for a stop.

MATERIAL LIST

- 1 piece, 1 by 12 in. by 6 ft., pine, S4S, sanded.
- 1 piece, 1 by 12 in. by 8 ft., pine, S4S, sanded.
- 1 piece, $\frac{3}{8}$ by 20 by 24 in., 3-ply veneer.
- 1 pair 2 by $1\frac{1}{2}$ -in. loose-pin butts.
- 1 elbow catch.
- 2 $1\frac{3}{8}$ -in. glass knobs.
- 1 pair 6-in. disk wheels, with $\frac{3}{4}$ -in. tires.
- 1 axle to fit, 15 in. long, threaded for nut at both ends.
- 1 8-qt. bucket.
- 1 small can of plastic wood.

Fill the nail holes with plastic wood, sandpaper the cart to a smooth surface, and paint as desired.

How to Clean White Kid Gloves

To clean white kid gloves without the use of benzine, gasoline or any other like inflammable substance, proceed as follows: Make a strong solution of any good soap in hot milk and to each pint or so of liquid add the yolk of an egg. Place the gloves on the hands and wash as you would with other materials, running a dry cloth through them after the washing process to force out as much liquid as possible. It has been found that this method has many advantages. The leather will not become stiff, will not stain easily and will have the same appearance as when new, after it has dried.

Improved Long-Handled Jack

A broomstick, used as shown in the accompanying illustration, makes a long-lever auto jack out of an ordinary short-handled one. All that is necessary to do is to drill a hole in the end of the jack handle, fasten a metal strip to the end of the broomstick and bolt the two together. The broom handle should be of such a length that it can readily be stored in the car and, as it is fastened to the jack handle by means of bolts and a thumb-screw, it is quickly detachable to facilitate storing of the equipment.

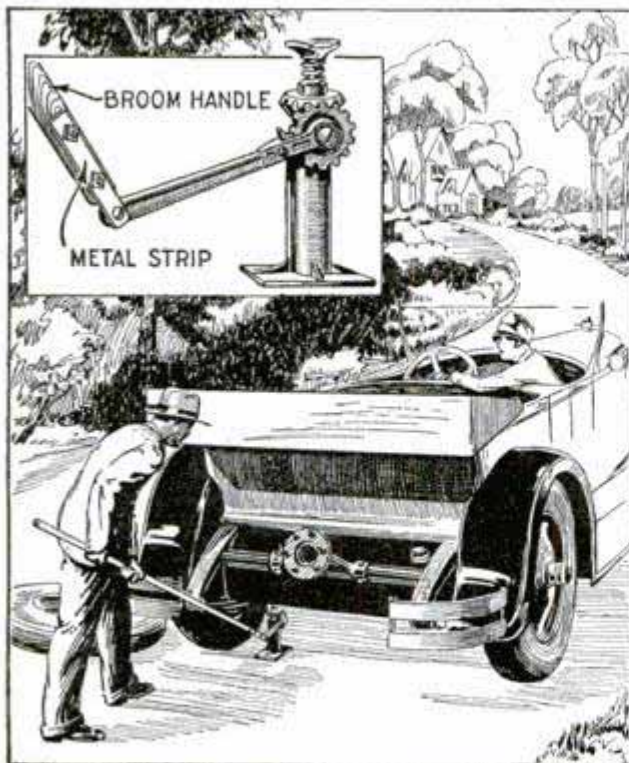

Broomstick Bolted to Jack Handle Gives Motorist Considerable Leverage

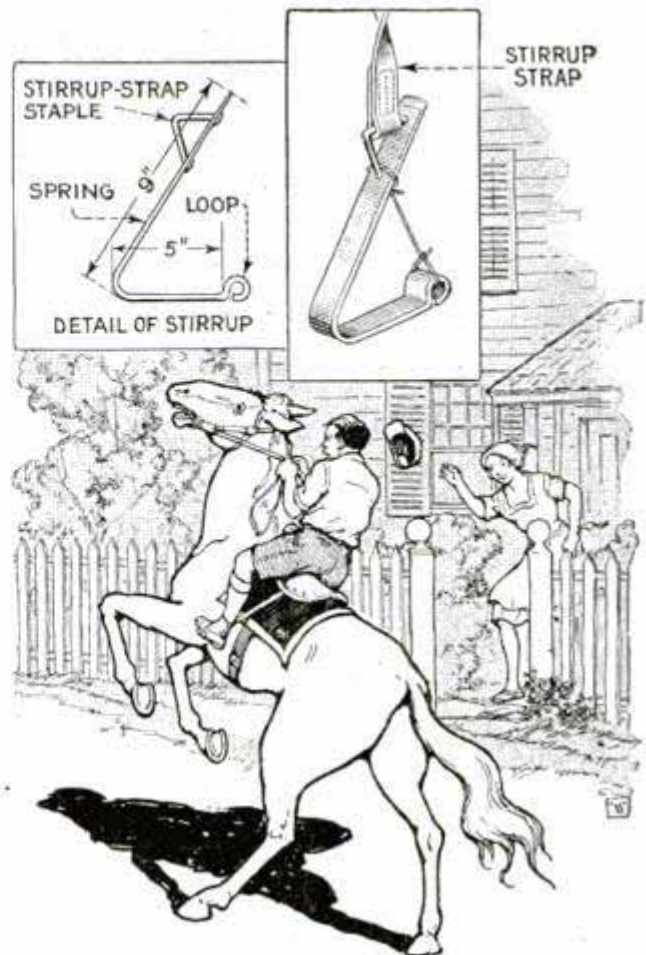

Saddle Stirrup Which Is Especially Made to Insure Safety for Child Riders

Safe Saddle Stirrups

Many kinds of saddle stirrups involve more or less danger for children riders, as the foot is apt to slip through the stirrup and it is then very difficult to release, especially if the horse is moving. Serious accidents have occurred in this way and therefore the safe stirrup shown in the drawing was devised. It is made from an old buggy spring, heated to remove the temper and bent to the shape and size shown. An old shoestring can be tied, as indicated, to keep the foot in the stirrup when the horse is going fast. If the foot should slip through the stirrup and the child should fall, the string will break and release the child. It is, therefore, essential that a string is used which will break in case this should happen.—Luther Strosnider, Onaga, Kans.

☐ When a gilt picture or mirror frame is badly spotted and must be cleaned, brush it with the white of an egg, which is then rubbed off with a soft cloth; this method will not injure the finish.

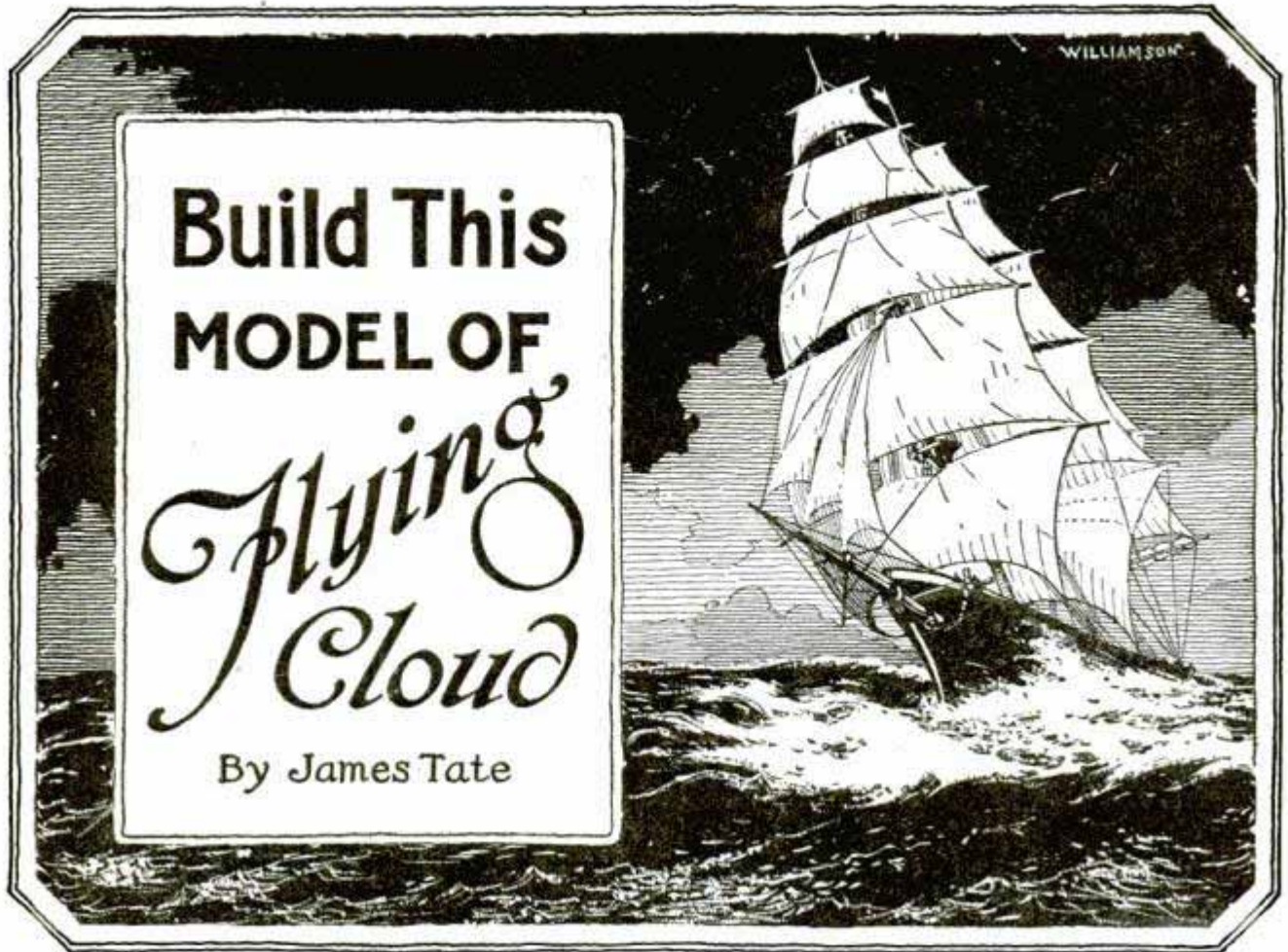

**Build This
MODEL OF**
*Flying
Cloud*
By James Tate

THE names of the various masts and spars of a ship are often confusing to the amateur, although the system is really very simple, once explained. Starting from the bow, the first mast is the foremast, the second the mainmast and the third the mizzen. These names, however, are only applied by the sailor to the lower masts. Each mast consists of two or more separate "sticks." Taking the fore as an example, the lower stick is the foremast; above this, and joined to the lower mast by the crosstrees and cap, is the fore topmast; above this again are the topgallant, royal and skysail masts, in the order named. The last three are usually in one stick, and they

are so in our model. The same system applies to the yards that carry the sails. The lower yard on the foremast is the fore yard; the next above, the topsail yard (the yards being named from the sails), then the topgallant yard, the royal yard

and the skysail yard. Topgallant is usually abbreviated to t'gallant (and pronounced t'garn) and skysail to skys'l.

One of the things that spoils the appearance of the ordinary ship model is that the spars, especially the upper yards, are far too heavy for good proportion. The measurements given for the spars in this model will be

found somewhat difficult to work to in the case of the royal and skys'l yards, and

SHIP-MODEL PRIZES

FEW hobbies enable the amateur to produce such beautiful work with so few tools and such inexpensive material as ship-model building. To encourage such a worth-while and pleasant pastime, Popular Mechanics Magazine offers the following awards for the best models of the "Flying Cloud" made from this series of articles, the first of which appeared in the December, 1927, issue.

- First, \$100 cash and gold medal.
 - Second, \$50 cash and silver medal.
 - Third, \$25 cash and bronze medal.
 - Five awards, \$10 cash and bronze medal.
 - Five awards, \$5 cash and bronze medal.
- Bronze medals also will be awarded for excellence in workmanship.

The contest is open to everyone, regardless of age or sex. The conditions are very simple, and full details will be supplied to every reader addressing the Editor, Amateur Mechanics department, Popular Mechanics Magazine, 200 E. Ontario st., Chicago.

they can be increased in diameter slightly, if the dimensions given are found too delicate. They can be made to these sizes, with patience, and the builder is urged to keep close to the diameters given, so that the appearance of the finished model will be as fine as possible. The lengths, of course, must be adhered to strictly.

When drilling the holes in the deck for the lower masts, drill so that the masts, when set in place, will present the appearance shown at the left in Fig. 79. Do not allow the masts to lean together at the top; they should spread a little. Do not give them too much rake or slant aft. The foremast should rake back about 1° at the skys'l pole, the main a trifle more and the mizzen just a little more. Drill the holes in the deck at least 1 in. deep and preferably two inches.

The lengths and diameters (in inches)

LENGTH OF MASTS, INS.			
	FORE	MAIN	MIZZEN
A	6½	7 ³ / ₃₂	5½
B	1 ⁵ / ₁₆	1 ³ / ₈	1 ¹³ / ₃₂
C	3½	3½	2 ³ / ₈
D	¹⁵ / ₁₆	1	1
E	2 ¹ / ₁₆	2 ³ / ₈	1 ¹³ / ₃₂
F	2	2 ³ / ₈	1 ¹ / ₄
G	1½	1 ¹ / ₈	1 ¹ / ₄
H	⁵ / ₈	¹ / ₁₆	¹ / ₂

DIAMETER OF MASTS, INS.			
	FORE	MAIN	MIZZEN
LOWER	⁵ / ₁₆	³ / ₈	¹ / ₄
TOPMAST	³ / ₁₆ TO ¹ / ₁₆	¹ / ₄ TO ¹⁵ / ₆₄	³ / ₁₆ TO ⁵ / ₃₂
T'GALLANT	¹ / ₆₄ TO ³ / ₃₂	¹ / ₆₄ TO ⁵ / ₃₂	³ / ₃₂ TO ³ / ₆₄
ROYAL	³ / ₆₄ TO ¹ / ₈	³ / ₆₄ TO ¹ / ₈	¹ / ₈ TO ³ / ₃₂
SKYSAIL	³ / ₆₄ TO ³ / ₃₂	¹ / ₆₄ TO ³ / ₃₂	³ / ₆₄ TO ¹ / ₁₆
POLE	⁵ / ₆₄ TO ¹ / ₁₆	³ / ₆₄ TO ¹ / ₁₆	¹ / ₁₆ TO ³ / ₆₄

of all masts are given in Fig. 80, and the key to the lettering will be found at the right of the same drawing. The length

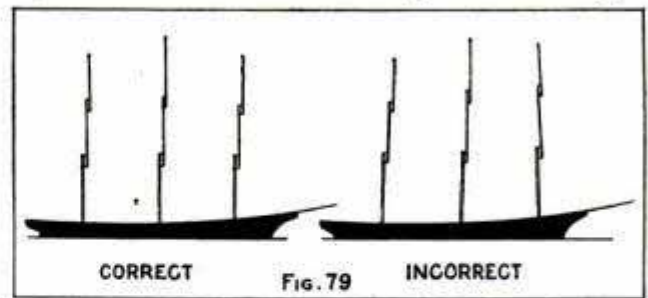

of lower masts (A plus B) is the length above deck, and to this must be added the length that is set into the deck. The length of the topmasts is obtained by adding lengths B, C and D together, plus 1/8 in. for the heel of the mast, and the combined length of the t'gallant, royal and skys'l masts by adding together dimensions D to H inclusive, plus 1/8 in. as for the topmast.

In making the masts, either of two methods may be adopted. They may be made of ordinary round dowel stock, which may be purchased true to size in 3-ft. lengths, or they may be split from

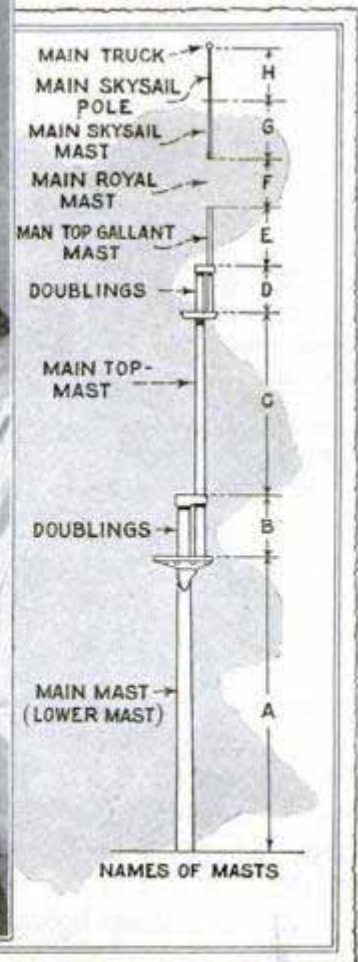
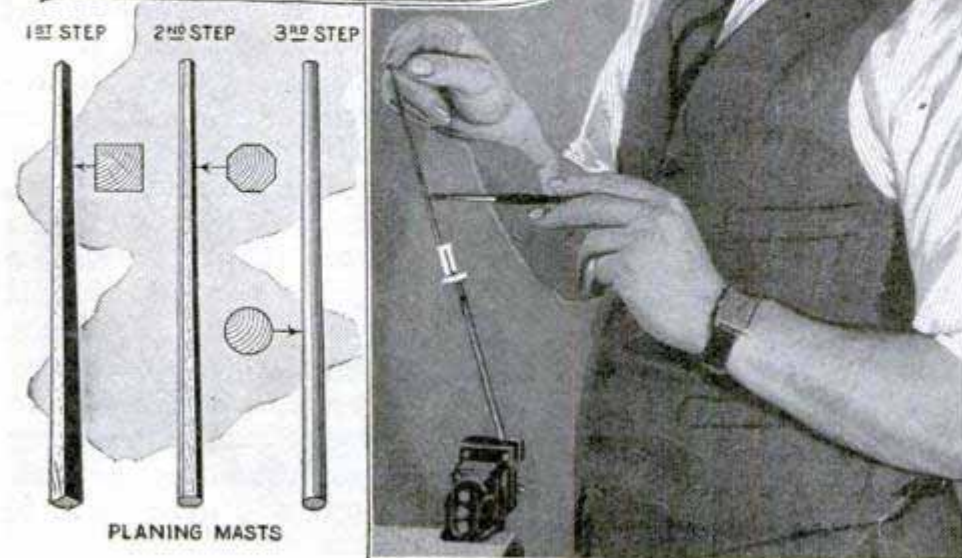

Fig. 80

clear straight-grained spruce or white pine. If dowel stock is used, select the straightest pieces you can obtain. If spruce, do not saw the lengths out of the board, but split them out, so as to insure straight grain. When rounding the spruce masts, plane them up square to size first, then plane off the corners, making them octagonal, and finally round with coarse and fine sandpaper. Where the mast is tapered, plane the taper in while the mast is still square; don't attempt to round and taper it at the same time, or to taper after rounding. The lower masts in this model have no taper, and the upper ones very little taper to each individual mast.

Dimensions B and D in Fig. 80 indicate the "doublings," where the upper mast overlaps the lower. The lower masts being cut to length and fitted to the hull, file the masthead down square for the length of the doublings, B, plus $\frac{3}{16}$ in. for the width of the trestle trees. These are the fore-and-aft timbers that support the crosstrees and the top. On the lower masts they rest on "cheeks" (Fig. 81), and the method of fitting the cheeks is shown in Fig. 81. File down the sides of the mainmast, below the squared head, for a length of $\frac{3}{4}$ in., as shown at A, then glue on two triangular pieces of $\frac{1}{16}$ -in. wood. When the glue has hardened, carve and file the cheeks to the shape shown at C and D. No cheeks are used on the topmasts. Cheeks on foremast are $\frac{5}{8}$ in. long and on mizzen $\frac{1}{2}$ in.

For the trestletrees of the mainmast, cut two slips of $\frac{1}{16}$ -in. hardwood, $\frac{3}{16}$ in. wide and $1\frac{5}{16}$ in. long. Clamp these together in the vise and file four $\frac{1}{16}$ -in. square notches across the pair to take the crosstrees. (See Fig. 82.) The position of the notches is marked from the square masthead. Note that the crosstrees form a square hole forward for the heel of the topmast, and another immediately aft of this for the mainmast head. Cut the notches so that the masts will be a neat fit. Make the crosstrees $1\frac{1}{16}$ in. long, glue in place, making sure that all are square, then file the underside of the crosstrees to a taper, as shown in the rear view of top, and cut the underside of the trestletrees to the shape shown in the side view. Drill small holes with a No. 60 drill in the outer ends of the crosstrees. Cut

the top from $\frac{1}{16}$ -in. wood or celluloid as shown in the plan view, cut the square hole as indicated and glue on top of the crosstree assembly. Drill the No. 60 holes through the top and, on the forward curves of the top, put in four little eyepins on each side, with the eyes underneath. Glue the whole assembly to the masthead, making sure that the top lies parallel to the waterline, regardless of the rake of the mast. The trestletrees and crosstrees for the topmast head are made in exactly the same manner, except that there are only two projecting crosstrees instead of three, and no top platform. The lengths of the lower-mast trestletrees on the fore and mizzen are $1\frac{5}{16}$ in. and $1\frac{1}{16}$ in., respectively, and of the crosstrees, $1\frac{1}{4}$ in. and $1\frac{1}{8}$ in. The trestletrees on fore, main and mizzen topmast heads are $\frac{3}{4}$ in., $\frac{7}{8}$ in. and $\frac{3}{4}$ in., respectively, and the crosstrees $1\frac{5}{16}$ in., $1\frac{1}{16}$ in. and $\frac{7}{8}$ in., in the order named. The heels of the upper masts are supported on the trestletrees by a "fid" which in our model is a pin driven through the heel of the mast, about $\frac{1}{8}$ in. from the lower end, as in Fig. 83.

The upper masts are further bound to the lower by means of the caps. These may be of wood, metal or celluloid. To make a wooden cap, cut a piece of boxwood from an old rule, and file down to $\frac{1}{8}$ in. thick. File a little round tenon (Fig 84) on the square masthead, then drill two holes in the boxwood, located so that the space between the two masts, when the cap is fitted, will be the same as the width of the crosstree between the two. File the cap sides down to the shape shown, making it as narrow as possible. To make a metal cap, cut a piece of thin shim brass, $\frac{1}{8}$ in. wide, set the masts together as in Fig. 85 (or two scrap pieces the same size) and bend the brass around them as shown. Solder the rear lap, then fill in the space between the masts with a drop of solder, remove and dress up square. A spring clothespin will hold the assembly while soldering. There are several bands to go around the masts, and these are made in a similar way, as shown in Fig 87. The futtock bands shown here hold the lower ends of the futtock shrouds coming from the tops, and the eyepins to which the ends of the shrouds are secured should be fastened to the band with a

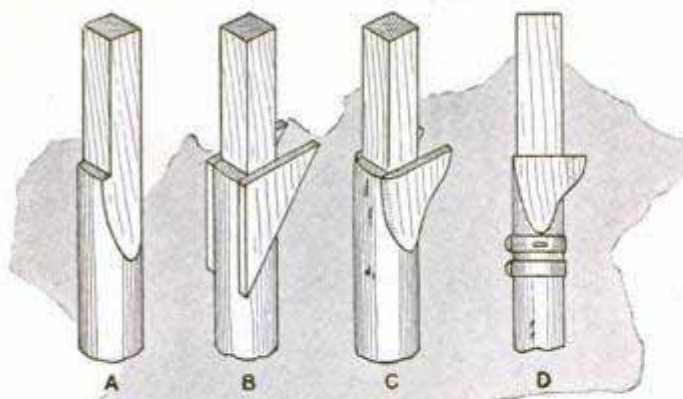

SQUARING LOWER MASTHEADS AND FITTING CHEEKS

Fig. 81

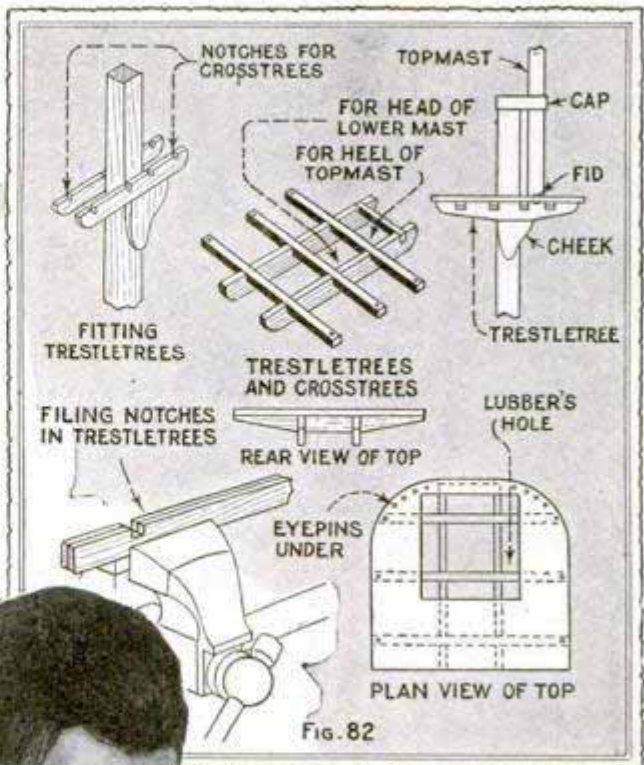
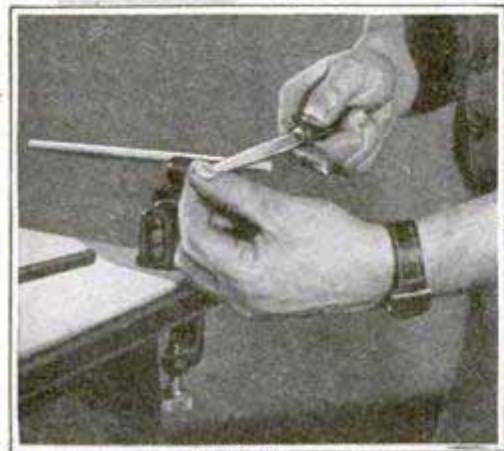

Fig. 82

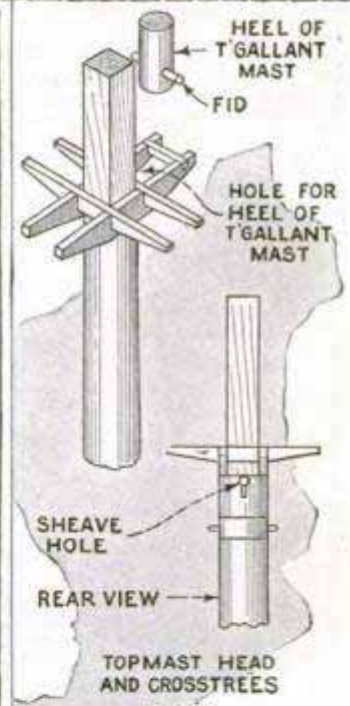

Fig. 83

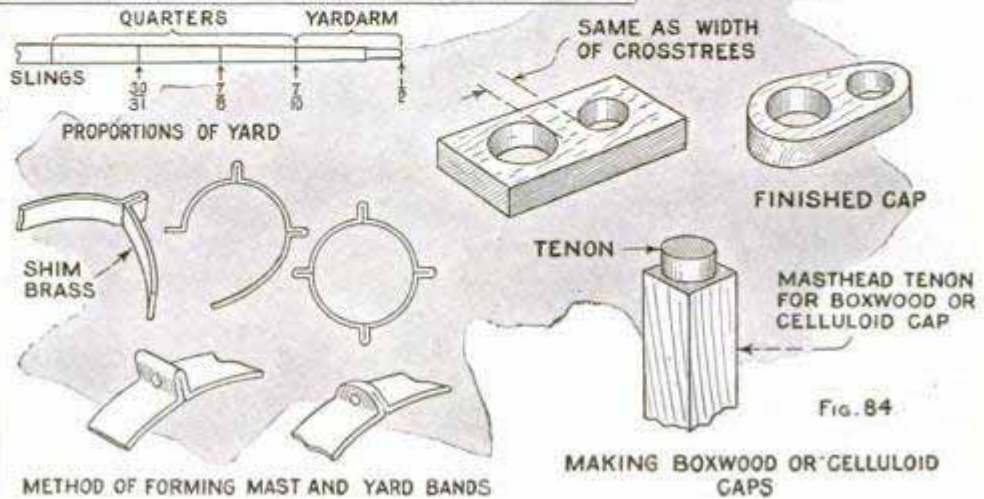
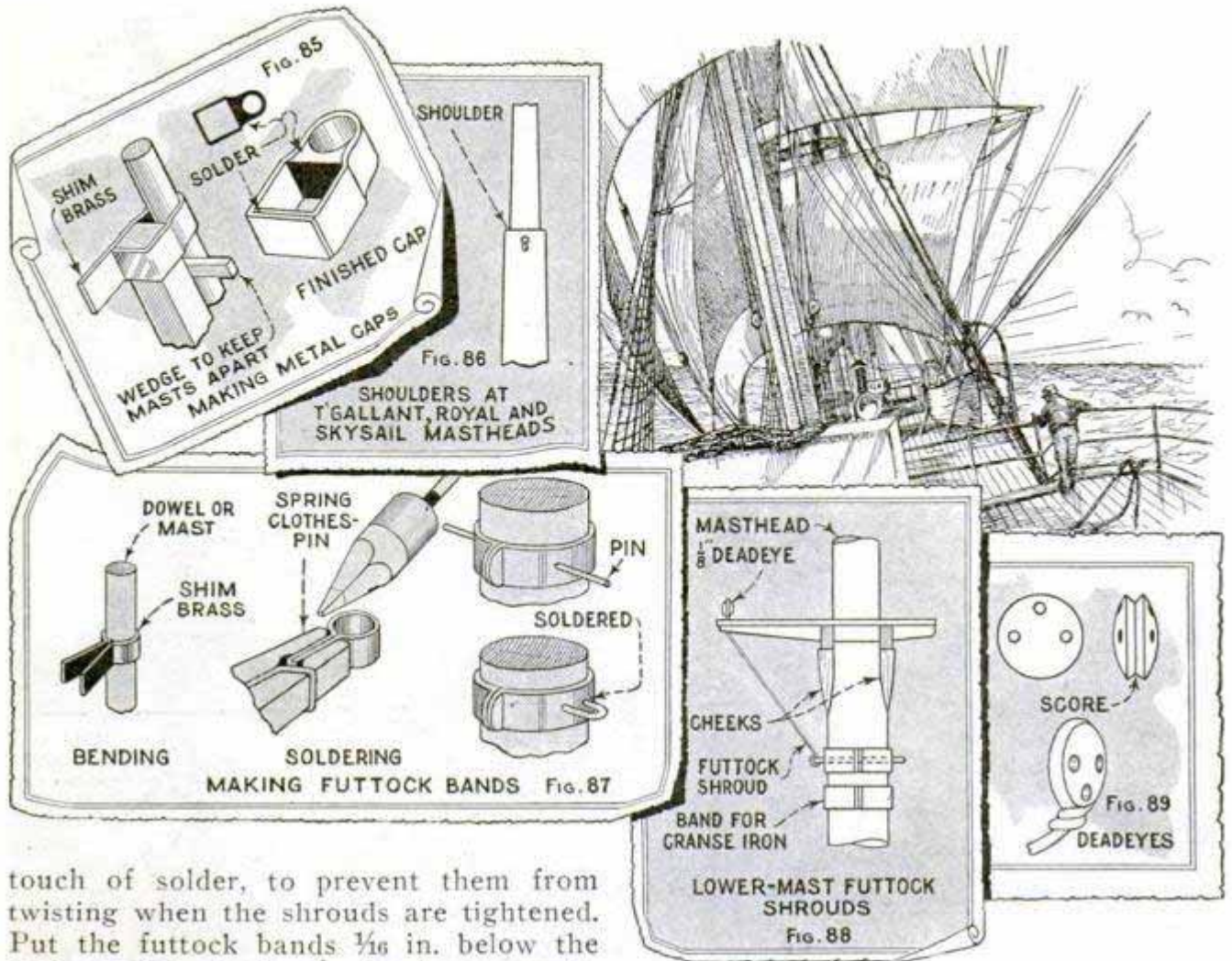

Fig. 84

METHOD OF FORMING MAST AND YARD BANDS

MAKING BOXWOOD OR CELLULOID CAPS



touch of solder, to prevent them from twisting when the shrouds are tightened. Put the futtock bands $\frac{1}{16}$ in. below the ends of the cheeks on the lower masts, and $\frac{3}{8}$ in. below the trestletrees on the topmasts. About $\frac{1}{16}$ in. below the futtock bands, on the lower masts, are the crane-iron bands, made in the same way; the pin of the crane irons, described later, will hold these in place. If the builder wants to put the deadeyes in the tops at this stage he can. Use $\frac{1}{8}$ -in. deadeyes, twist a piece of No. 30 soft-iron wire around the score (Fig. 89), pass through the hole in the top and cross-tree and hook around the eye in the futtock band, Fig. 88.

When tapering the t'gallant, royal and skys'l masts, don't forget to make a decided shoulder at each masthead, as shown in Fig. 86, to carry the gangs of backstays and stays that will be rigged here. Drill a small hole just under each masthead to serve as a sheave hole for the yard hal-yards.

There are two more bands to be placed on the mizzen, the gooseneck and belaying-pin bands, Fig. 90, and these are also of shim brass. The first-named carries the gooseneck of the spanker boom, and forms a bracket for the lower end of

the spencer or trysail mast that runs from the top to the deck just behind the mizzen. This mast is only $\frac{5}{64}$ in. in diameter, and is best made from a straight length of wooden applicator. The upper end is set in a small hole in the top, and the lower in a slight depression in the deck. The belaying pins for the other band can be $\frac{1}{2}$ -in. lengths of common pins, soldered as shown.

The lengths and diameters of the bowsprit and jibboom are shown in Fig. 93, and details of the rigging in Figs. 91, 92 and 93. The bobstay chains should not be heavier than 14 links to the inch, and the martingales 20 links to the inch. The dolphin striker is $\frac{1}{8}$ in. in diameter and $1\frac{3}{4}$ in. long, fitted with a hook at the upper end and with four eyes at the lower, with two hooks on each side, spaced evenly. Put the bowsprit shrouds and the bobstays on first, setting the first up with small rings and a lanyard (Fig. 93) and the bobstays with $\frac{3}{16}$ -in. deadeyes and a black button-thread lanyard. Be sure to arrange the deadeyes with the holes cor-

rectly placed, Fig. 92. The ends of the martingales are set up to the catheads, close to the rail, with single blocks, taking care when fully set up that the dolphin striker hangs vertically.

The yards are made in the same manner as the masts, from dowel stock or spruce, and their dimensions are given in the table, Fig. 99. They do not taper straight from the center to the ends, but the proportions are as in Fig. 84. The yard, on each side, is divided into quarters, and the diam-

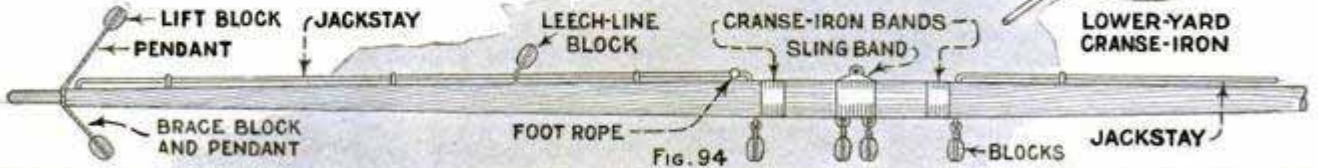
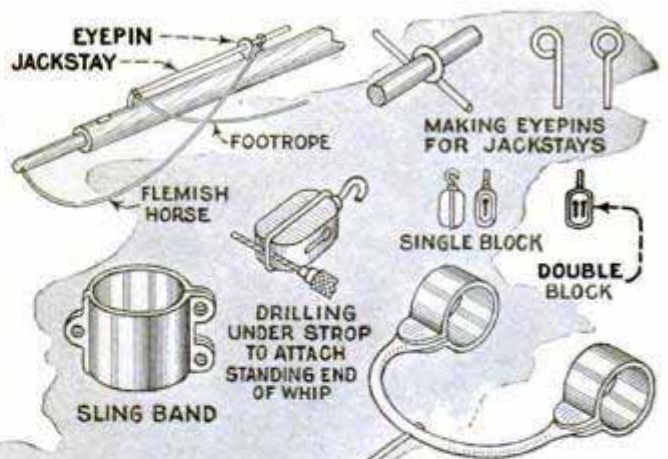
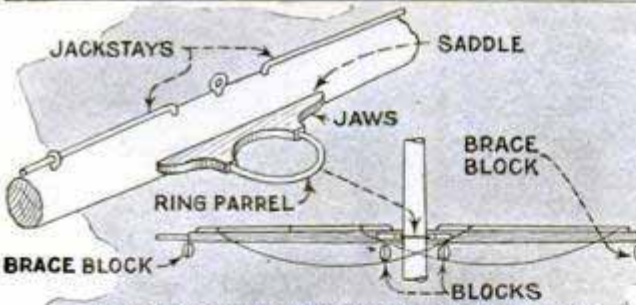
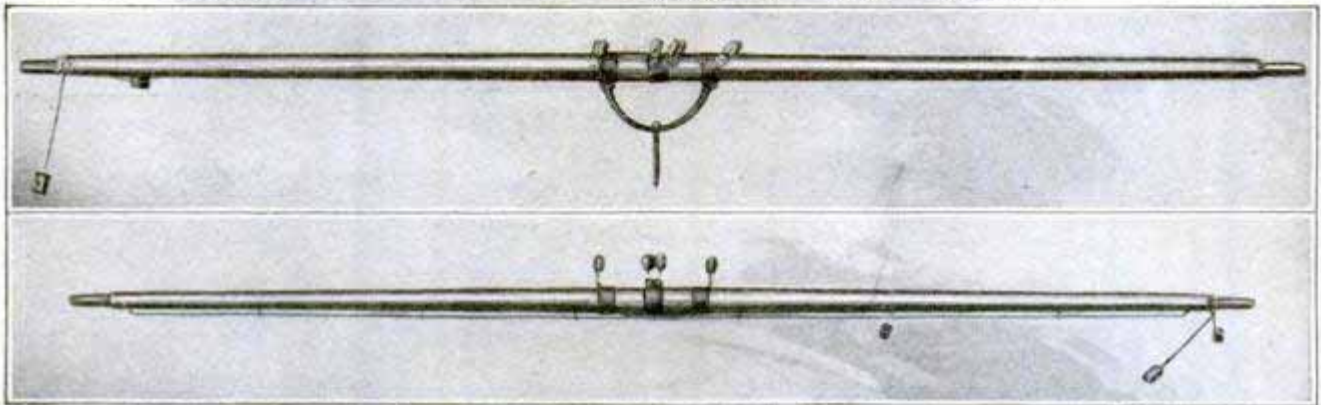

Fig. 94



HOW FOOT ROPES ARE FITTED ON T'GALLANT, ROYAL AND SKYSAIL YARDS
Fig. 96

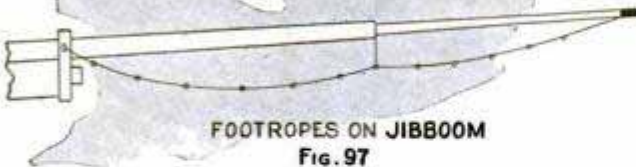
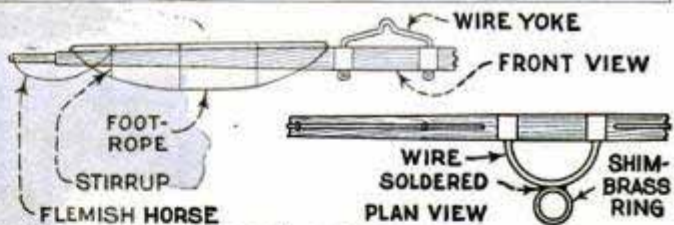

Fig. 97



TOPS'-WARD DETAIL
Fig. 95

eter at the first quarter mark is $\frac{30}{31}$ of what it is at the center or slings, at the second quarter the diameter is $\frac{7}{8}$, at the third $\frac{7}{10}$ and at the end $\frac{1}{2}$ of the sling diameter. Taper one yard according to this rule, and you will be able to taper the others by eye.

The lower yards are held to the masts by crane irons, trusses or cranes, as they are variously called. The crane iron

should not only allow the yard to move vertically up and down, but also to swing horizontally. However, a very good model crane iron is made as shown in Fig. 94, and this will serve our purpose excellently. The bands are made of shim brass, and the iron of $\frac{1}{16}$ -in. brass wire, bent to a half circle and soldered to the bands. A hole is drilled through the center and a stout pin soldered in, then a hole is drilled through the crane-iron band on the mast and into the mast and the crane-iron pin slipped into the hole. By bending the pin slightly, the yard can be set square across the hull, which is the way we will want it. The sling band at the center of the lower yard is bent up in the manner shown in Fig. 84, and finished as

in Fig. 94. The jackstays on top of the yard, to which the sail is fastened, are made for the lower yards of No. 24 iron wire. They must, of course, decrease in size in proportion to the size of the yards, as you go up. When making the eyepins that fasten them to the yard, use a smaller size of wire and form the pins around the jackstay itself.

If the model is afterward to be fitted with sails, the builder will find it convenient to fit all the blocks shown, to avoid later trouble; if not, the only blocks necessary on the lower yards are the lift and brace blocks at the stops on the yardarms. Fit these to the yards with twisted-wire pendants to resemble rope, about $1\frac{3}{4}$ in. long.

The topsail yard fittings are shown in Fig. 95. Jackstays, etc., are fitted in the same way as before. The mast ring or parrel should be soldered up and the yard fitted over the mast before the latter is finally put in place, else it will be necessary to leave the ring open. The crane-iron bands may be narrow strips of black paper, glued round the yard, if soldering is difficult, with the ends of the crane iron driven into small holes drilled into the yard through the center of the paper strips. The yoke for the tops'l tye on top of the

ish horse" is a short footrope on the outer ends of lower and tops'l yards, for the man who had to sit astride the yardarm.

The t'gallant, royal and skys'l yards are fitted to their masts as shown in Fig. 96. Glue a thin strip of wood to the after side of the yard, file it to fit the mast, forming the saddle, then file the jaws to shape. The yard is slung to the mast with a wire ring or parrel. Note how the footropes are fitted so as to form an easy curve. They are aft of the yard, but forward of the mast. Footropes for the jibboom are made of knotted thread, and fitted as in Fig. 97. Little need be said about the spanker boom and gaff, except that the gaff tapers from the throat (inner) end to the outer end, while the greatest diameter of the boom is a little aft of the center. The brail blocks may be omitted on a model not intended to be fitted with sails.

Use $\frac{3}{16}$ -in. blocks for the lower yards, and decrease the size of the blocks and rigging as you go aloft.

Many of the points that may not be clear in this chapter will become perfectly clear when we come to the rigging, and if difficulty is encountered in determining the purpose of any block or other fitting, put the part aside and go on with something else. It will be found convenient, in any event, to have everything above the lower masts so that it can be taken off readily,

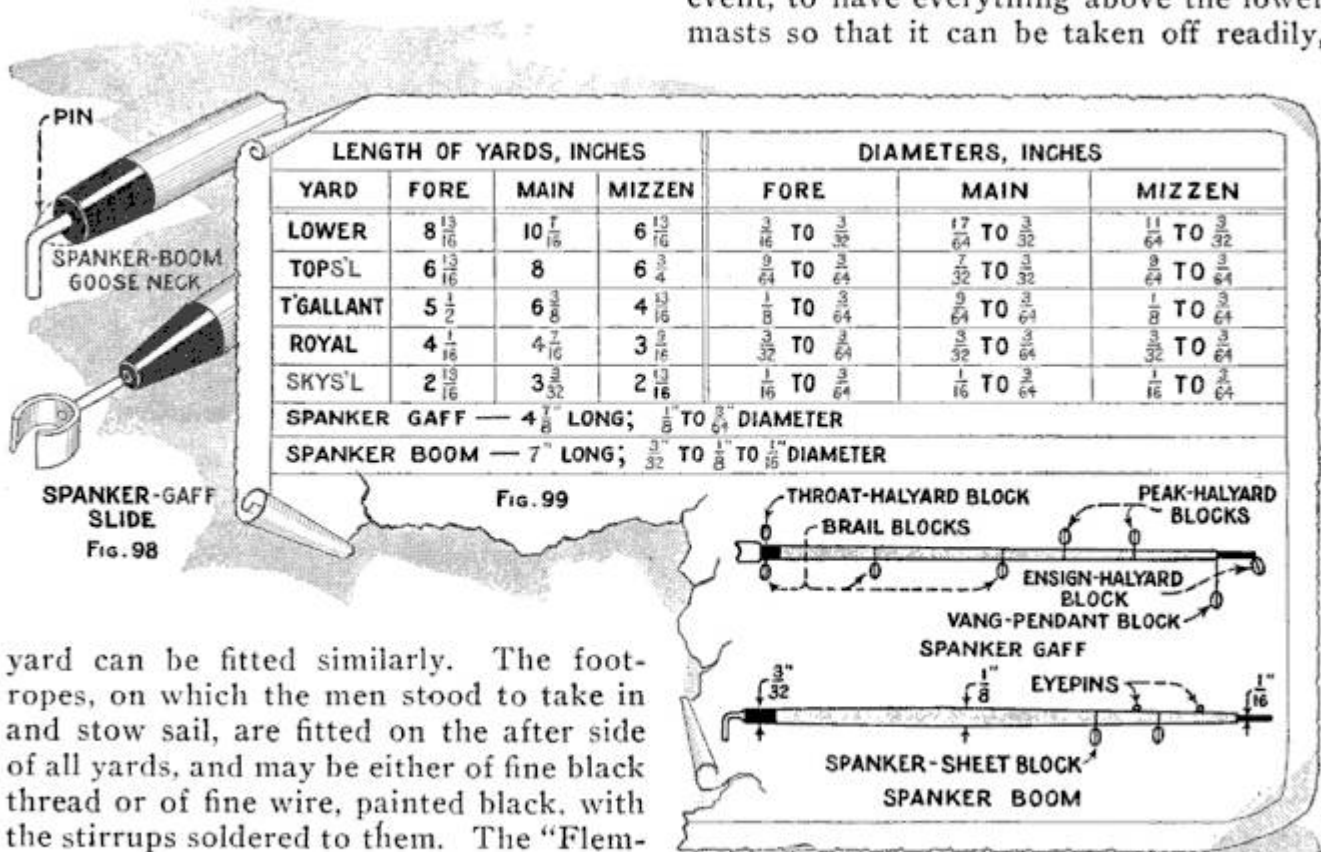

yard can be fitted similarly. The footropes, on which the men stood to take in and stow sail, are fitted on the after side of all yards, and may be either of fine black thread or of fine wire, painted black, with the stirrups soldered to them. The "Flem-

as, if all masts and yards are fitted permanently, they will be found to make the job of fitting the standing rigging much harder.

Paint all lower masts, tops, trestle and crosstrees, doublings and caps flat white. Stain the topmasts, t'gallant, royal and skys'l masts medium oak, outside of the doublings. Stain the spencer mast and the yards in the same way. Paint the ends of the yards outside the stops, and all yard fittings, black, and varnish all stained

and black work. Stain the blocks light oak. The bands on the lower masts are simply made by gluing strips of black passe-partout paper, $\frac{1}{8}$ in. wide, around the masts after painting, although of course, they can be painted on if the worker is skillful enough. Space these bands $\frac{9}{16}$ in. apart. Use the paint thin, but put on enough coats to cover the wood thoroughly.

(To Be Continued)

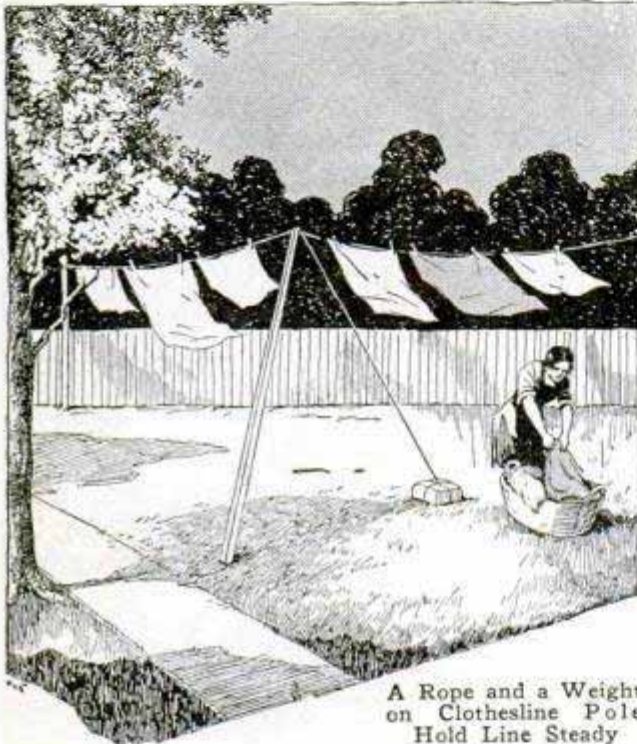

A Rope and a Weight
on Clothesline Pole
Hold Line Steady

Preventing Clothesline from Blowing against Trees

The arrangement illustrated herewith has successfully prevented clothes on the line from blowing against near-by trees or other objects. All that is necessary is to guy the pole with a length of rope having a weight attached at the lower end to be placed on the ground. This will hold the pole, although, on a day when the wind has a tendency to shift, it may be necessary to provide a weight on each side.

Heater for the Ford Sedan

During cold weather it is often desired to have a heater in the car. A good one for the Ford sedan is shown in the drawing and can be made in the following way: A length of ordinary galvanized-iron conductor pipe, about 40 in. long, has

a hole, 3 in. square, cut in it about 2 in. from one end. Slip the conductor over the exhaust pipe in the position indicated, just ahead of the muffler. The hole in the conductor pipe should then be directly under the floorboards behind the front seat. Both ends of the conductor are securely wired to the muffler and exhaust pipe. A short length of square conductor, cut to fit snugly over the hole in the round one, is attached vertically, the upper end projecting through a hole cut in the floorboards. A piece of heavy wire mesh is tacked down on the floorboard over the opening, and the floor mat is cut to correspond. If too much heat comes out, the cut-out section can be slipped back in place over the opening. In use, the air enters the front end of the conductor pipe, is warmed by coming in contact with the hot exhaust pipe, and is conducted into the car. The rear end of the pipe should be closed by butting it against the muffler or by filling it with asbestos paper, for a considerable amount of warm air will otherwise be lost at this joint.

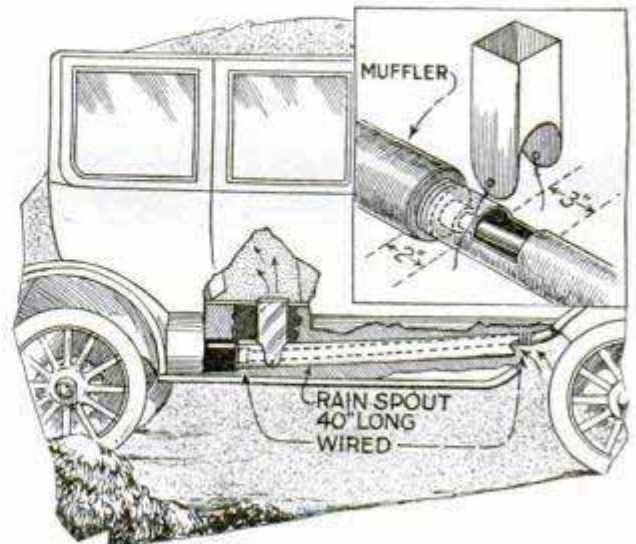

Efficient Homemade Exhaust-Pipe Heater for Ford
Sedan Can Be Made from Conductor Pipe

Gum for False Mustaches

Often the amateur actor is at a loss to find a suitable adhesive for sticking on a false mustache or beard, especially when he has made his own and there is no theatrical-supply store in the vicinity. A gum that is readily soluble is preferred, and the kinds given below can be made from ingredients obtainable at any drug store. The first is made by dissolving 1 oz. of mastic in 2 oz. of ether and 4 oz. of grain alcohol. The second is somewhat more professional and is composed of mastic, 1 oz.; sandarac, 4 oz.; rosin, 12 gr.; ether, 2 oz., and alcohol, 16 gr. Keep these solutions in a tightly corked bottle and apply with a small brush. When using, first clean the skin, dry it and apply the gum to the skin and to the gauze on the back of the false hair; then press the two together, holding them a moment until set. To remove, strip off quickly and wash the skin with alcohol. In emergencies, it will be found that ordinary colodion will serve for the same purpose.—L. B. Robbins, Harwich, Mass.

Electrifying an Old Gas Heater

An old gas heater can easily be made up to date by electrifying it, for the reflector will serve the same purpose, whether gas or electricity is used. To make the change, remove all the gas burners and fixtures from the interior, which usually will leave holes that can be used for wiring. A piece of galvanized sheet metal is cut to fit across the inside of the stove, as indicated, the ends being bent at right angles so that they can be attached to the sides with screws. Through the sheet, two 2½-in. holes are cut for electric-sign receptacles, which are fas-

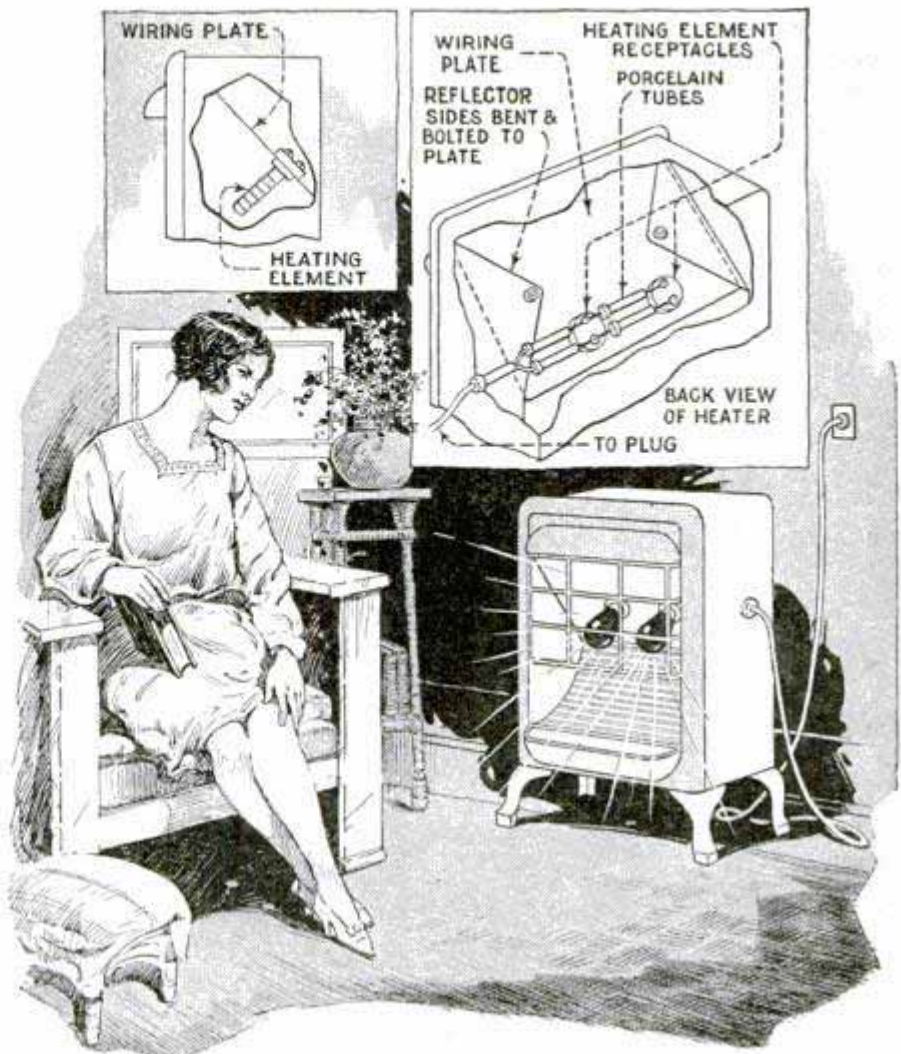

A Simple Way of Transforming a Gas Heater into an Electric Heater at a Slight Cost and Little Work

tened in place securely. After this has been done, the plate is screwed in place, in the manner mentioned above. The detail drawing shows how the receptacles are wired with No. 10 bare copper wire, porcelain tubes being used to protect the wires from heat, and to eliminate short circuits. A heavy-duty two-wire stranded cable of the kind used for flatirons, about 6 ft. long, is connected to the wire and passed through a porcelain tube inserted in the wall of the heater, a plug being provided at the other end for attachment to an electric outlet. Two heating elements of the screw-plug type are obtained from a hardware store and are screwed into the receptacles. Such a heater is easily portable for moving from one room to another, wherever required. The cost of the material is only about \$2.50.—David Baxter, Hutchinson, Kans.

☞ A white spot on furniture varnish may be removed by holding a hot iron over it.



Old Auto Equipped with Spiked Rear Wheels and Provided with Skid Chains on the Front Wheels, Facilitates the Work of Cutting and Hauling Ice

Harvesting Ice with Old Auto

Reuben Currier cuts ice from a pond in Wellesley, Mass. He was particularly anxious to get at the job early this winter, for the first ice was thick and clear. Ordinarily his work requires twenty-five horses and eighty-five men, but both horses and men were scarce this winter so he devised spiked rims for the rear wheels of an old touring car. After that the ice harvest proceeded quickly. First the car was tried with the ice marker and then with the grooving plow, and it was found that a much larger area was covered in this way than with horses. The car was then used for hauling the ice from the far side of the pond to the ice house. It easily towed cakes 100 ft. long, while men laboriously poled cakes only 5 ft. long. The equipment necessary to fit the car for this work was simple. Tires and rims were removed from the rear wheels and in their place,

on each wheel, was applied a demountable rim, fitted with sharpened studs or spikes, which gave excellent traction on the ice. Ordinary skid chains were used on the front wheels, to insure proper steering.

How to Remedy a Smoking Fireplace

Our fireplace smoked whenever a slight wind was blowing, which made it almost impossible to remain in the room. After trying all the usual methods of overcoming the trouble by raising the height of the chimney, installing caps to prevent down draft, etc., the smoking still persisted. However, after careful study of the air and

smoke currents in the chimney, and the action of dampers in the older and successful fireplaces, I decided that an air well would probably remedy the trouble. The arrows in the left-hand detail of the illustration indicate the direction of the air and smoke currents before the

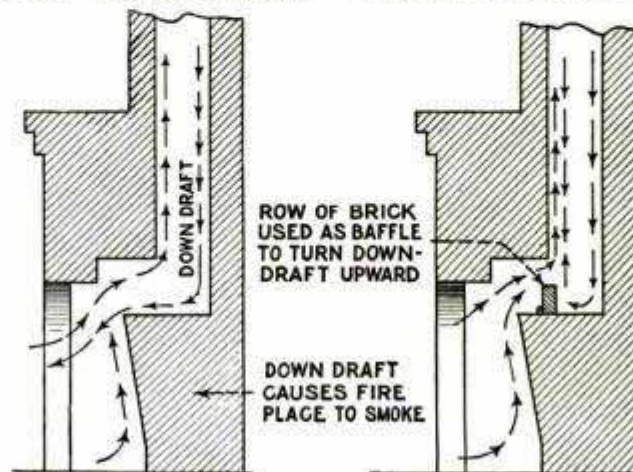

Smoking Fireplaces Can Often Be Remedied by Providing a Shallow Well Made of Bricks

trouble was eliminated, and the right-hand detail shows the path of these currents afterward. All that was necessary was to build up a row of bricks in the position indicated. This baffle provides a shallow well, which turns the down draft upward again, and this draws the smoke up and out of the chimney.—Harold J. Boyd, Orlando, Fla.

Removing Varnish from Antique Furniture

Many amateur craftsmen who have tried to restore valuable pieces of antique furniture, have failed in the attempt because the means of removing the old varnish was not the proper one. The right material to use for this is an equal mixture of alcohol and turpentine. It is poured into a bottle, which is heated by immersing it in hot water. The solution is applied while warm, and it will be found that the old varnish will dissolve at once. The advantage of using this solution is that it can be applied several times to the surface until the latter is free from all old varnish and at the same time it will not destroy the age coloring which is characteristic of antiques.—L. H. Georger, Buffalo, N. Y.

Thermos-Bottle Kink

Thermos bottles are broken usually because they easily slip out of one's hands owing to their smooth casing. Take a piece of an old inner tube, turn it inside out and slip it over the bottle casing. It will then be easy to hold it or to catch it "on the grab," if it does get away.—F. W. Bentley, Jr., Missouri Valley, Iowa.



Novel Photo Album Consisting of a Number of Prints Similar in Shape and Size



Novel Photo Albums

A novel form of small photo album can easily be made by anyone. A paper mask, as shown in the lower detail, is cut from a piece of opaque paper or thin cardboard. The hole cut in the center should fit the negatives to be used. At one side two holes are cut or punched to enable one to bind the complete album. When using the mask, the negatives are laid in the printing frame, and the prints are exposed and developed in the usual way. The finished print will look like that shown in the right-hand detail. The ends of the paper around the outline of the leaves are cut away with scissors, which can readily be done, as the paper outside of the mask will be black. The prints are folded at one side, as indicated by the dotted lines, so that the leaves will fold over. Covers for such an album can be made from any finished cardboard. They are cut the same size and shape as the leaves and the word "Photographs" can be printed or painted in the center by hand. The back cover requires no lettering and is left plain. A colored ribbon is strung through the covers and leaves to bind them together.

☛ A small brass tube forced through the earth into a gopher hole leaves a channel for charging the nest with poison or gas.

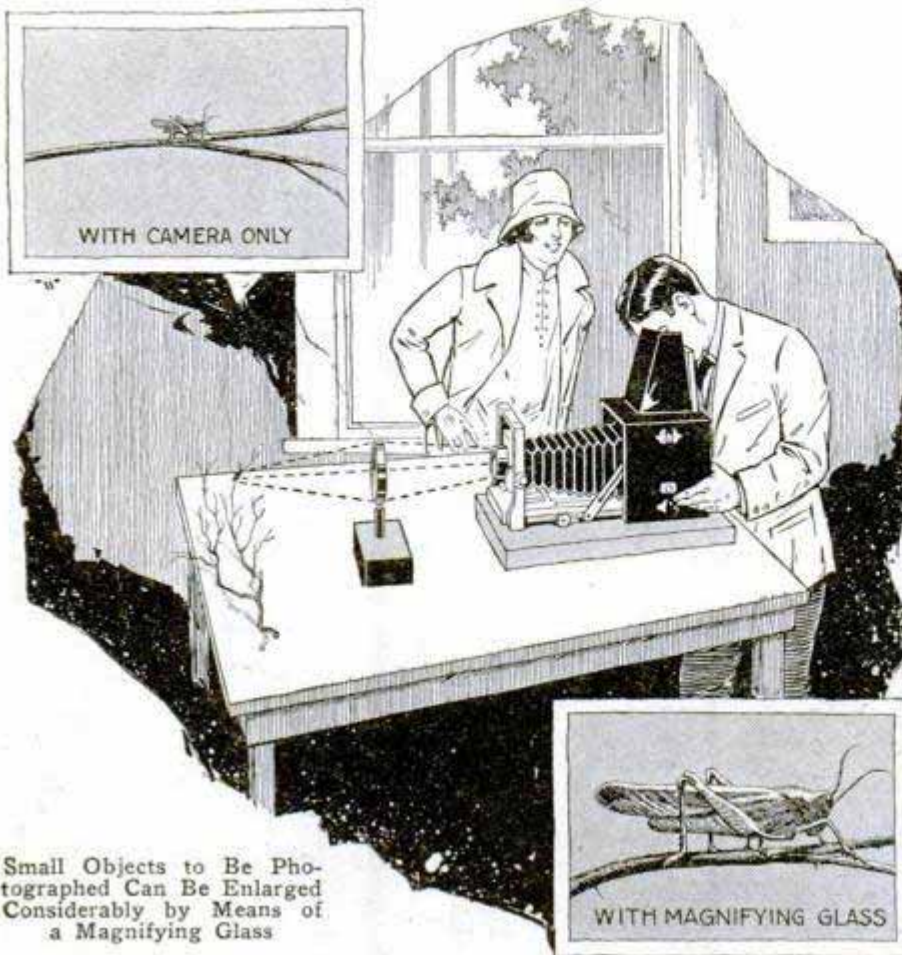

Small Objects to Be Photographed Can Be Enlarged Considerably by Means of a Magnifying Glass

Photographing Objects through Magnifying Glass

Amateur photographers and others sometimes have occasion to make a photo of some small object and secure the largest possible image of it on the negative. Usually photographs of this kind are beyond the limit of their working equipment. Although it is possible to enlarge prints from any good negative, it is desirable to get the largest possible image on the negative. In an effort to accomplish this, I experimented by focusing my camera upon small objects, working through an ordinary magnifying glass. I discovered that the success of the experiment depends on the proper focusing of the magnifying glass with relation to the lens of the camera, and focusing the camera upon the magnified image thus produced. This is quite easy to do with any camera of the reflecting type, one having a ground-glass focusing panel, or by placing a ground glass over the open back of a camera of the "guess-box" focusing type. By magnifying the image through an ordinary 5-in. reading glass, I find that I am able to re-

cord an image in the camera approximately four times the size that the camera will produce ordinarily. To simplify the handling of the reading glass for such work, I made a bracket for it by taking a block of wood and drilling a hole in it to take the handle of the glass. With this arrangement, as indicated, the glass can easily be moved back and forth to obtain the desired focus between the object and the camera.—John Edwin Hoag, Los Angeles, Calif.

Renewing Typewriter Ribbons

Typewriter ribbons can be made to last much longer by reinking them. A popular method is that of using glycerin, but

the disadvantage of this method is that the letters appear splashy and messy. An equally simple, much more effective means, is as follows: Dip a camel's-hair brush into stamping ink and then hold it against the ribbon, while rewinding the latter. The brush should be rotated slowly while doing this in order to spread the ink evenly over the surface of the ribbon.—Thomas Blaine, Evanston, Ill.

Finger Grip on Mandolin Pick

Mandolin picks are usually made of celluloid and the player must pinch them tightly between his fingers to hold them



securely and prevent slipping, which is quite tiresome. A good finger grip can be provided by punching or drilling three small holes in the pick and drawing a length of thread through them, as shown in the accompanying illustration.—Fred Veith, Dansville, N. Y.

A Simple Toy Merry-Go-Round

By DICK HUTCHINSON

NEARLY every child desires toys with motion. Toys having spring or rubber-band mechanisms are, as a rule, rather short-lived, but the hot-air-propelled merry-go-round, shown in the illustration, will last indefinitely, provided, of course, it is well taken care of.

From medium-weight cardboard cut a 5-in. disk and remove the four sectors, as shown in the upper right-hand detail. Then cut four pieces of ordinary writing paper to the shape indicated by the dotted lines of the detail, and bend them over to

form fans, using glue to hold the overlapping edges together. Glue one of the fans to each of the four crossbars, as in the photo at the left. From a piece of $\frac{1}{2}$ -in. soft wood cut out a base with four extended feet. In the center of the base nail a small post, about 2 in. high. This should be rounded and given a high polish on the top end to reduce friction, as it forms the bearing upon which the disk or wheel revolves. Place the latter on top of the post, balancing it carefully. Fasten it by means of a thumbtack, pressed

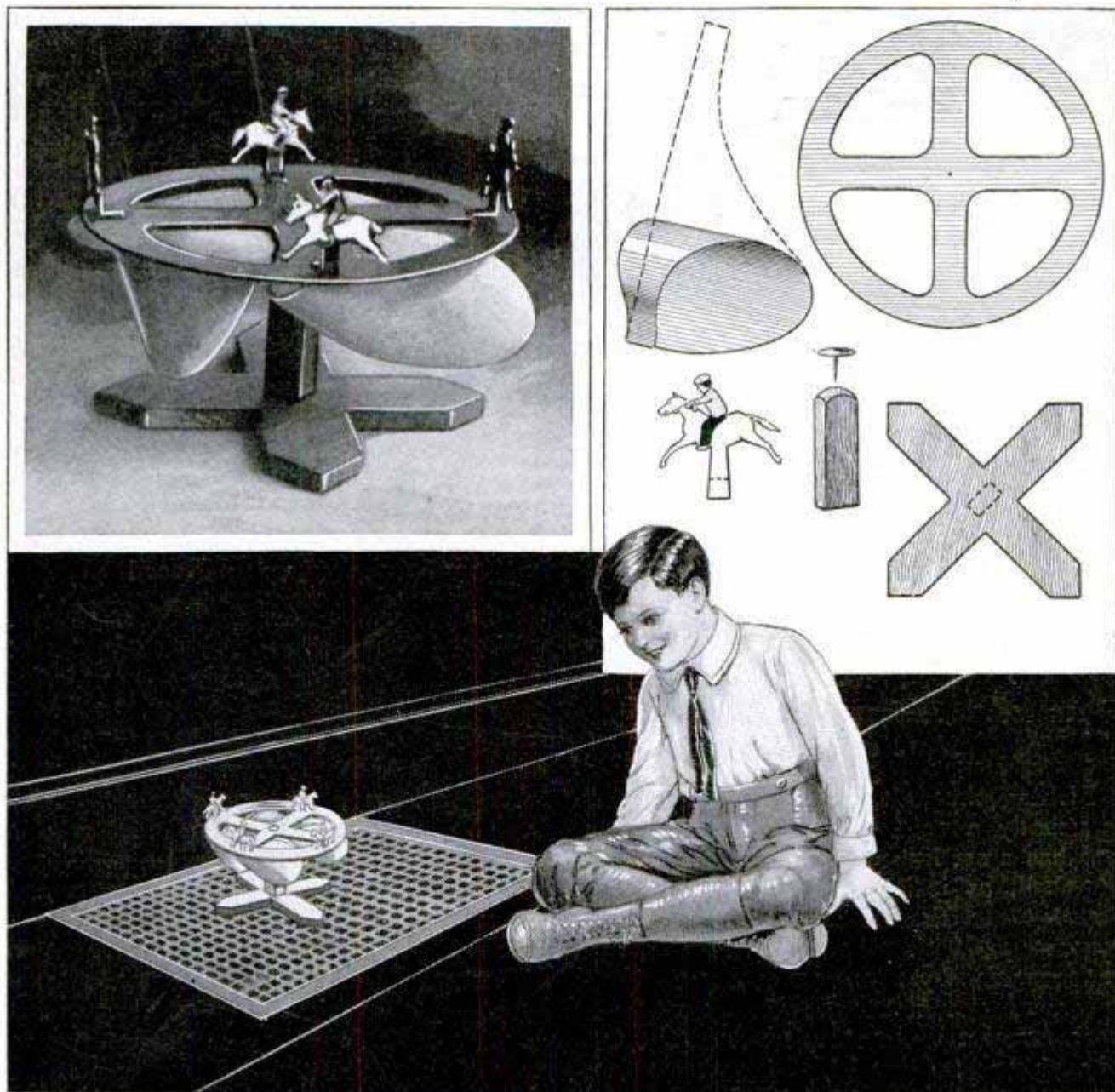

Toy Merry-Go-Round Which Whirls at a High Rate of Speed over a Hot-Air Register, Fans on the Toy Catching the Draft and Propelling It

straight into the center of the post, being careful to allow a little play to permit the platform to rotate easily and enlarging also the hole in the wheel a trifle so that the paper will not bind on the thumbtack.

To complete the toy, cut four mounted horsemen from a piece of medium-weight cardboard, bend the base as indicated by the dotted line of the detail, and glue the base to the wheel so that each figure stands

upright and is headed in the direction that the platform will turn. The horsemen must be all exactly the same size and must be distributed on the wheel to balance it. The same, of course, applies to the location of the fans. To operate the toy it is merely placed over a hot-air register and the draft will cause it to rotate, the rate of speed depending on the amount of draft coming up through the register.

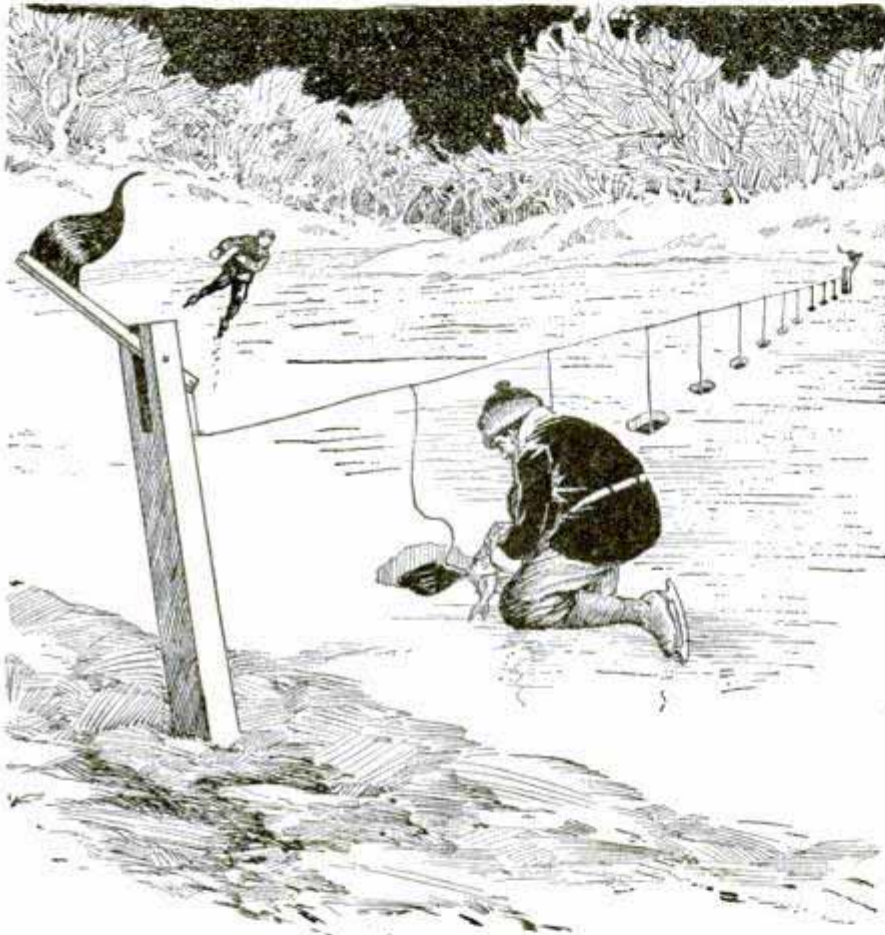

Set Fishing Line on the Ice Has a Number of Leads and Pivoted Flags Which Indicate When Fish Are Caught

Automatic Indicator for Set Fishing Lines on the Ice

Fishing through the ice during winter is usually a cold sport, especially when one has a set line with a number of leads attached, as it is necessary to go from one lead to the other to examine each separately. This objection, however, can be overcome by using an automatic indicator, as shown in the drawing. Two posts are set up, a slot is cut in the top of each, and a short 1 by 2-in. stick with a flag attached, is pivoted in the slot, the set line being attached to the lower end

of the flag sticks. The line is run through a staple or screw eye so that a pull on the line will cause the flag to rise. When no pull is exerted, the flag drops down again. A number of leads, with sinkers and hooks, are provided, the weight of the leads not being sufficient to raise the flags. When a fish is caught there will be a quick jerk and one or both flags will go up. The lead where the fish is caught can then be easily seen. The fisherman can skate around to keep warm and still keep an eye on his lines.

Homemade Academy Board

Art students use quantities of academy board for painting in oils because it is cheaper than canvas. An excellent board, somewhat similar to this, can be made at home for little or nothing. Get some junkboard or equally heavy cardboard, such as is used to hold lace-curtain stock. Pieces of light-weight wallboard will be satisfactory. Size one surface and allow it to dry. Then spread on a coat of thick paint with a pallet. When two pieces are covered, place the painted surfaces together and then pull them apart carefully. This will give the pieces an even but rough-toothed surface, after which they should be laid down flat and allowed to dry.

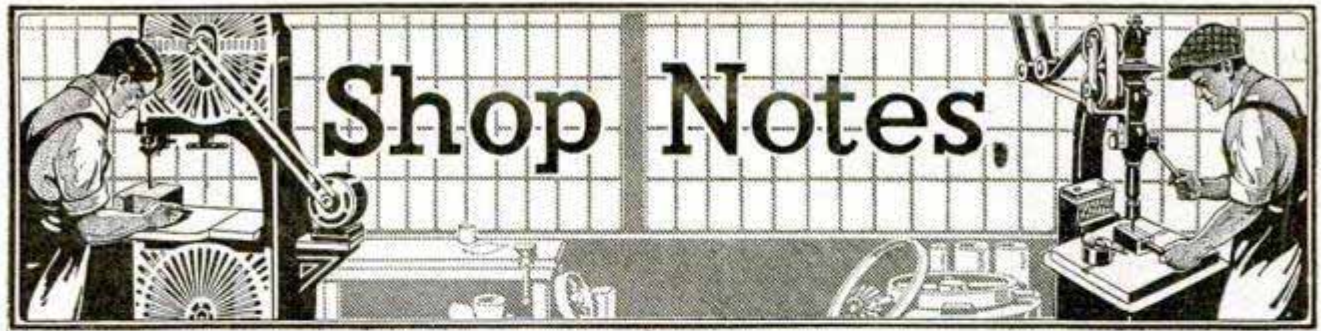

All Shop Notes published in 1927, in book form—Fifty Cents—from our Book Department

An Automatic Boiler Man

Simple Attachment, Operated by Cheap Alarm Clock, Makes Boiler Warm House in Morning

MANY are the homemade devices that have been constructed to open the drafts of the hot-air furnace in the early morning, so that the house will be warm when the occupants get up, but similar devices, designed to do the same job on residence steam boilers fitted with pressure

draft regulators, seem to be few and far between. There is no more difficulty in fitting such an attachment to a steam boiler than to a furnace; the one described in this article took approximately an hour to make and has functioned perfectly for two years. It is a great convenience, in

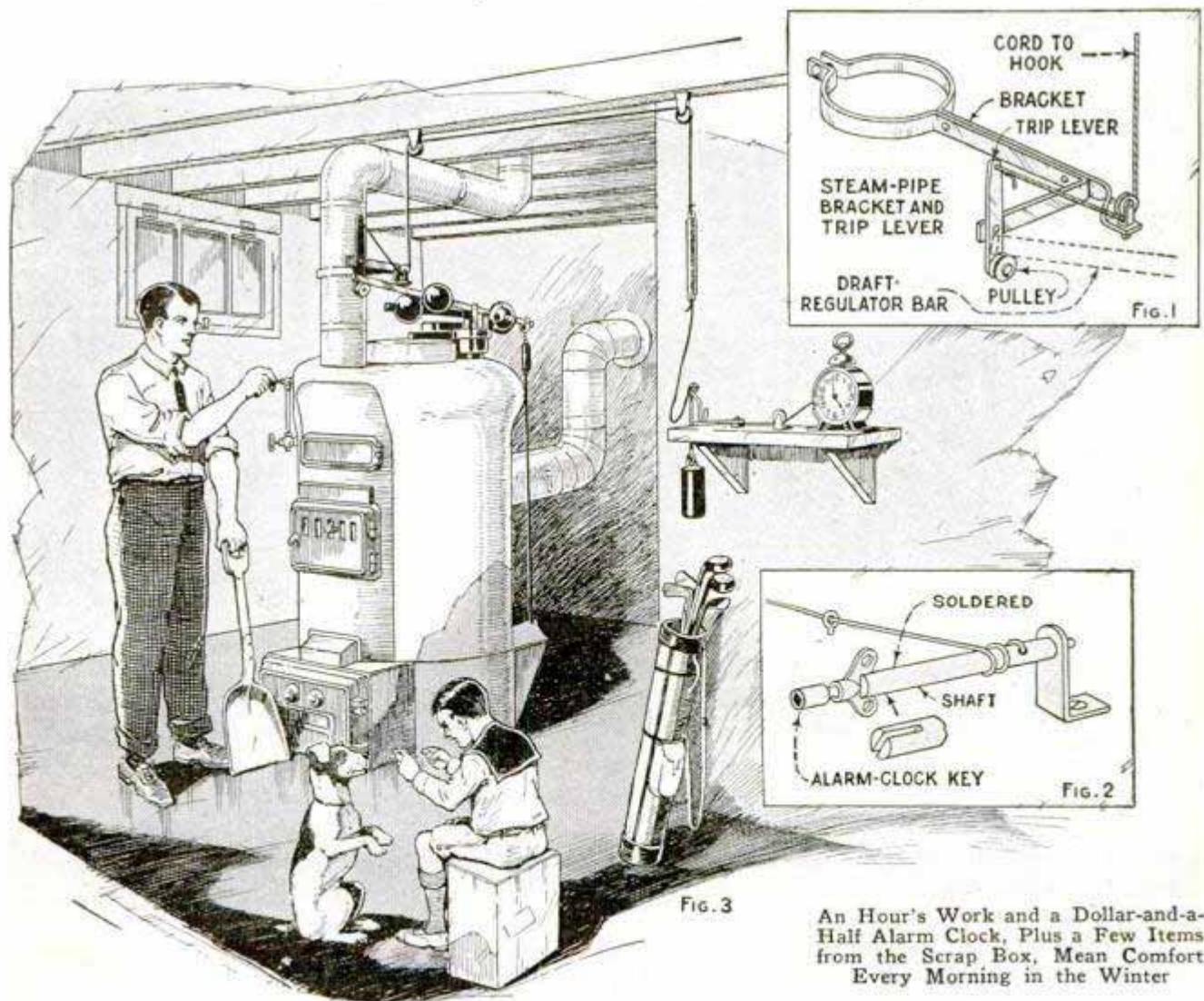

An Hour's Work and a Dollar-and-a-Half Alarm Clock, Plus a Few Items from the Scrap Box, Mean Comfort Every Morning in the Winter

cold weather, to come out of a chilly bedroom and find the rest of the house at 70°, without having to get up at some unearthly hour of the morning to fire up the boiler.

The basis of the attachment is an ordinary alarm clock. This should be a fairly good one; although the one in the original installation cost only \$1.50, still the better the clock the longer service it will give, and it must be of the type in which the key revolves when the alarm rings.

Boilers of the type mentioned have a diaphragm in a casing on top, which expands and contracts under the rise and fall of pressure in the boiler. Operated by the diaphragm is a weighted lever, which opens and closes the ash-pit and check dampers as the pressure varies. The first thing to do is to make the steam-pipe bracket and trip lever shown in Fig. 1. The clamp part of this

bracket is formed to fit the main steam riser from the boiler, and is held firmly to it by means of a couple of stove bolts. The arms of the bracket are extended to within about 1 in. of the regulator lever; here another bolt is inserted in a hole drilled through the bracket arms, and the front arm is then bent parallel to the regulator lever, and cut off an inch or two longer than the latter. On this end the trip lever is mounted. This consists of a strip of flat iron, about 3½ in. long, pivoted on a small bolt at the end of the arm. About 1 in. below the pivot, a small grooved pulley is mounted, and the whole bracket is then so adjusted that the end of the regulator lever will rest on the pulley when the trip is vertical, and will fall clear when the trip lever is pulled backward at the top. A small hole for a stout cord is drilled in the top of the trip lever, then the rear arm of the bracket is twisted and bent as shown in Fig. 1. On this a small pulley is fastened so that the end of the cord from the trip lever can be passed through it; be sure that the regulator lever can move freely past the bracket.

Now to fix up the operating end of the device. Slot the end of a piece of ¼ or ⅝-in. brass rod to fit over the wings of the alarm key, drill a small hole near the other end and solder to the key, Fig 2. Solder two sheet-metal brackets to the clock, as in Fig. 4, so that it can be fastened firmly to a shelf, and mount shelf and clock on the boiler-room wall so that their relation to the boiler is somewhat as shown in Fig. 3. Make and screw to the rear of the shelf a small bracket to act as

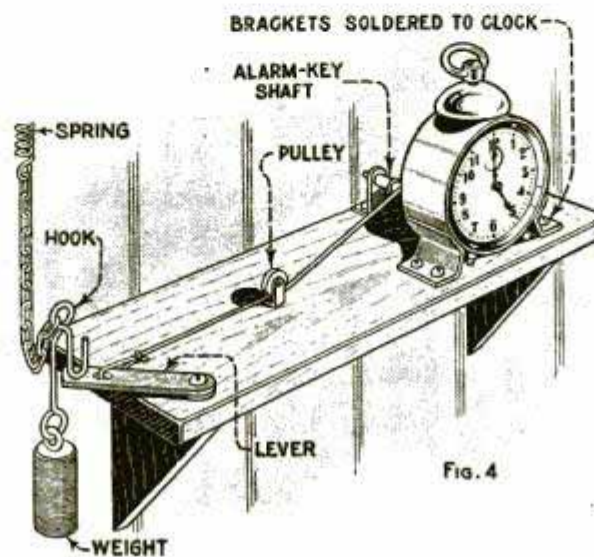

Fig. 4

a bearing for the end of the brass rod. Knot a length of strong fishing line through the hole in the rod, and lead it under a small screw-eye or pulley screwed to the shelf. On the extreme edge of the shelf, pivot the simple lever shown in Fig. 4, and fasten the end of the line to it as indicated. Leave enough line so that, when the alarm is

about half wound, the end of the lever will project about ½ in. over the edge of the shelf. The cord is wound on the alarm-key extension so that, when the alarm goes off, the lever is pulled in toward the clock. Bend a stiff wire hook to the shape shown in Fig. 4, and fasten a weight to it. To the top loop hook a short length of chain and a spring. Directly above the end of the lever, on the ceiling, screw in a pulley, and mount a similar pulley directly over the small-pulley bracket on the boiler. Thread the cord (fishing line) from the end of the trip lever through the small pulley just behind it, then over the two pulleys on the ceiling and fasten the end to the spring at the clock mechanism (See Fig. 3). Set the hook on the shelf lever, adjust the weight on the regulator lever so that it will fall, then pull the trip lever to a vertical position and set the end of the regulator lever on the pulley. Wind the alarm about half, and spring it. The device looks, when in action, like one of Rube Goldberg's cartoons, but it works. The alarm winds up the cord, pulling in the lever on the edge of the shelf, and the

shelf pushes the weight off. The weight pulls the trip lever down, thus allowing the regulator lever to drop and open the drafts. The weight need not be a heavy one, since all it has to do is to pull down the trip lever. Don't try to hook the alarm clock directly to the trip lever; it will work all right, but it imposes rather too much strain on the clock. It is better to use the clock merely to throw off the weight, and let the latter do the work.

Bronzing Cast Iron

The following process will be found effective for imitation bronzing of cast iron: Thoroughly cleanse the iron and rub it smooth. Apply evenly a coat of sweet or olive oil and heat, being careful that the temperature does not rise high enough to burn the oil. Just as the oil is about to decompose, the cast iron will absorb oxygen, and this forms upon the surface a brown-oxide skin, which holds securely, and is so hard that it will admit high polish.

An Improved Chuck Wrench

One end of a small chuck-wrench handle can be drawn out to a spoonlike end and makes a very handy and practical tool. It is an ever-ready implement for "flipping" out cuttings or loosening and lifting out stud shells after they have been drilled and broken down with a round-nose chisel. Shaped as a spoon, the end is much easier on the ball of the thumb when tightening the chuck screw.

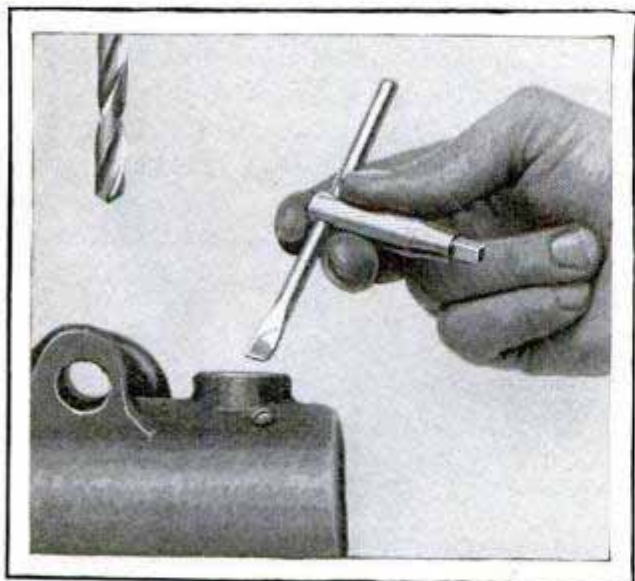

Handle of Lathe Chuck Wrench Ground Down to Spoon Shape Adds to Its Usefulness

Old Truck Tire Rims Can Be Used to Make a Convenient Foundry Flask

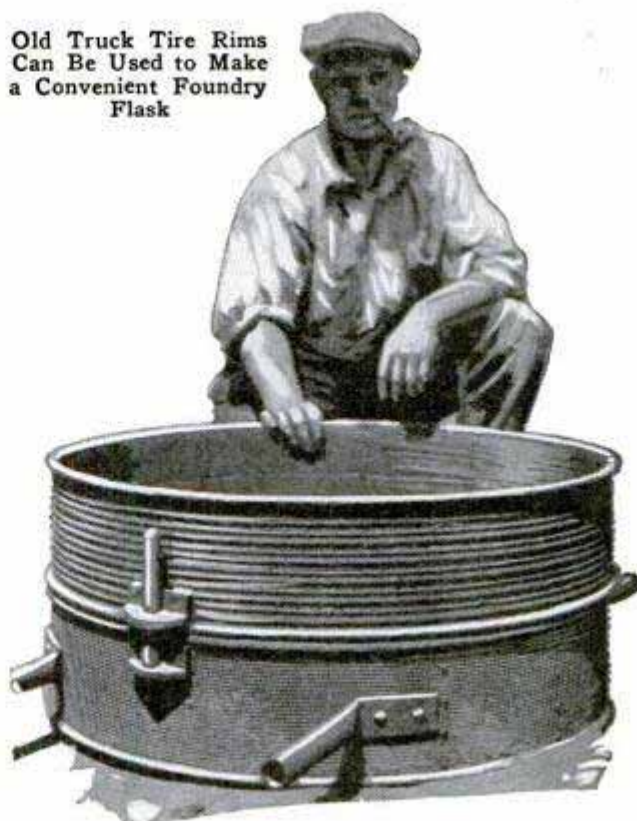

Handy Foundry Flask Made from Tire Rims

By burning the rubber off two old truck tire rims a very handy foundry flask can be made. Use one of the rims for the top, or cope, and the other for the bottom, or drag. A bracket and pin hold the cope and drag together. Pieces of pipe are used for handles.—Carlton Groat, The Dalles, Oreg.

Reversing Coil Points Aids Spark

After considerable use, the platinum points on an electric vibrating coil often become pitted and the spark will suffer in intensity and regularity. A good method of overcoming this trouble, temporarily at least, is to take out the screws holding the points in position over the core of the coil and reverse them. Take care to get the points exactly in line again and the proper distance apart to give the best and fattest spark. This simply reverses the current through the points and as the action differs, one pitting and the other building up a cone, the points will change their surface shape accordingly and tend to become more normal. Of course, when it can be done, they should be removed and filed smooth for best results.—L. B. Robbins, Harwich, Mass.

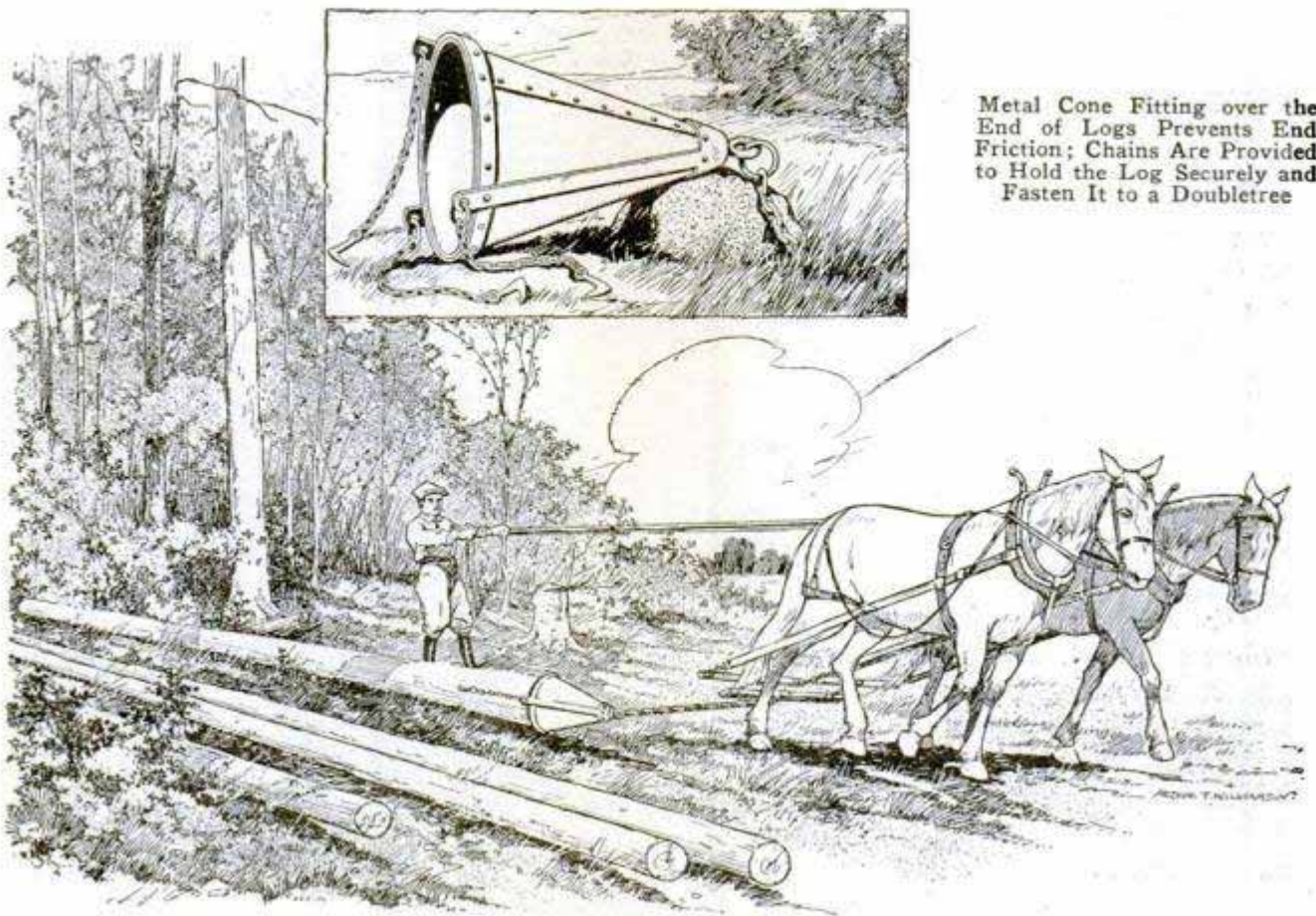

Metal Cone Fitting over the End of Logs Prevents End Friction; Chains Are Provided to Hold the Log Securely and Fasten It to a Doubletree

Metal Cone Facilitates Hauling of Logs

Made of sheet iron or steel, the cone shown in the drawing has been found handy for hauling telephone poles. The cone reduces end friction when the pole is dragged over the ground. The insert clearly shows its construction. Three chains are attached to the flat-iron frame of the cone, dogs being provided on the ends of the chains by means of which these are securely fastened to the log. A ring and chain are attached to the apex of the cone to permit a doubletree to be attached. This simple device carries the front end of the log over all obstructions and saves much time.—G. P. Melrose, Victoria, B. C.

Moisture-Proof Coating on Cellar Walls

In many locations it is impossible to drain off moisture on the outside of cellar walls to insure a dry basement. The next best remedy is to apply a waterproof coating on the wall. Melt 4 oz. of grease with 4 qt. of tar in an old pail or other container. While the grease and tar are being melted, thoroughly mix 2 lb. of pounded glass and 4 lb. of slaked lime, and then add this mixture to the former only in quantities

sufficient to cover a few square feet at a time. Apply the mixture with an old brush to a thickness of approximately $\frac{1}{8}$ in. This coating will waterproof the walls effectively, no matter how much moisture accumulates outside.

Stretching the Point

Lawyers are not the only ones who must often stretch the point. Mechanics frequently have to do it, too. On some repair work, the other day, my dividers were too small. I sharpened a short piece of wire on both ends, bending one of them at right angles.

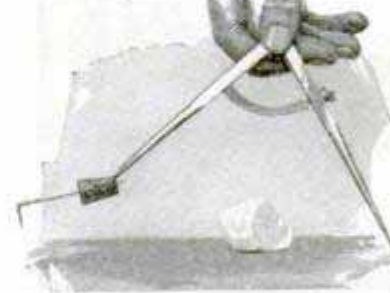

I then forced the straight end through a cork, and stuck it on one point of my dividers, as shown. The extra point

was quite firm and rigid.—Frank W. Bentley, Jr., Missouri Valley, Iowa.

☐ A metal chip from a cutting tool should never be pulled off with the bare hand.

Cheap Glass Stirring Rods

Glass makes the best material for chemical stirring rods, but such rods cost money and are easily broken. Good glass rods that cost nothing can be obtained as follows: Go to a paint shop or hardware store and ask for some narrow strips of glass. These can usually be had and are left-overs from cutting odd sizes of glass. They vary in width from $\frac{1}{2}$ to 2 or 3 in., and also in length. The sharp edges of the glass can be removed by means of a file so that there will not be any danger of cutting the hands.

Removing Roller Bearings on Fords

Quite often it is necessary to remove a roller bearing so that felt washers may be inserted behind them to prevent grease from leaking out on the wheel. A simple tool for pulling out the bearing and the method of using it are shown in the drawing. It consists of an iron rod flattened at one end and bent to the shape shown. The flat end is slipped under the bearing, a length of iron rod is put through the eye and a block of wood is used as a fulcrum under one end of the rod while the other end is pulled, which immediately

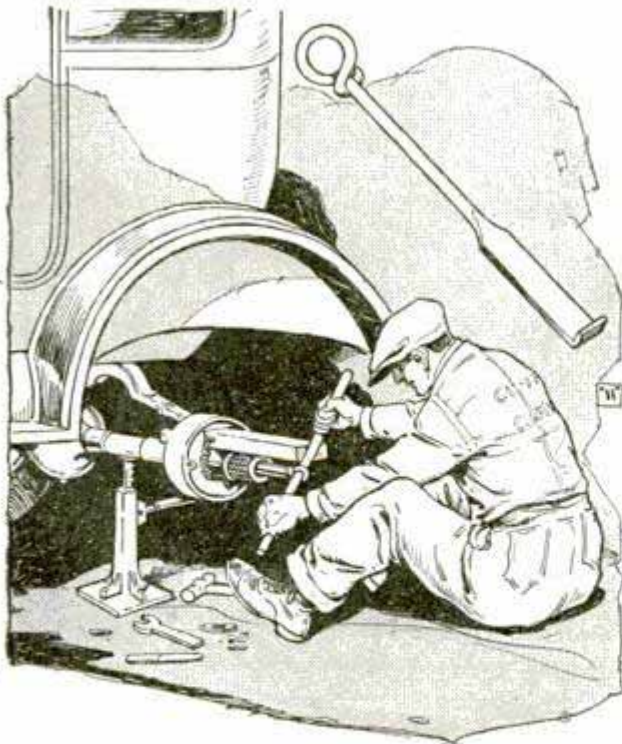

Roller Bearings on Ford Axles Can Readily Be Removed with This Simple Tool

removes the bearing.—C. C. Stuart, Bridgeport, Conn.

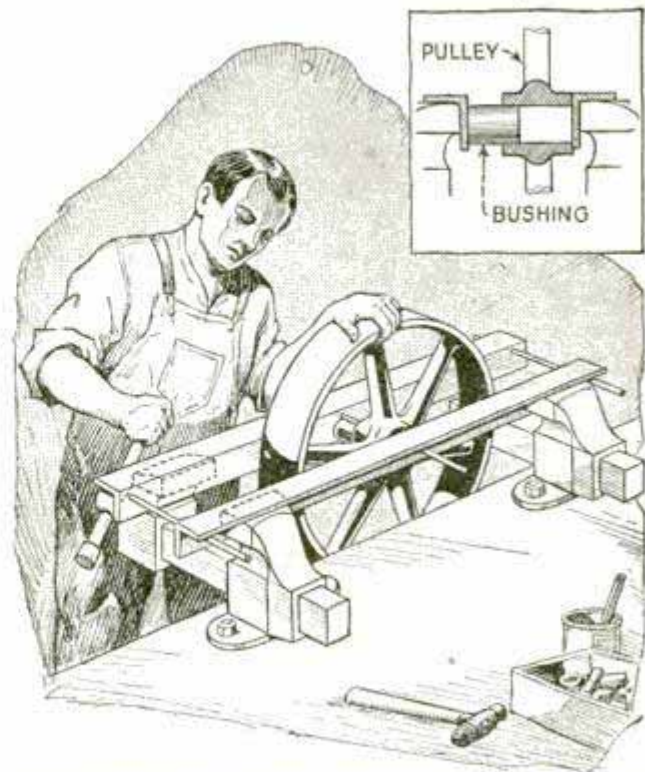

Using Two Vises and an Improved Jig for Pressing Pulleys into Large Wheels

Double-Vise Press

If two vises are set close enough together, they can be used for much press work that could not ordinarily be done in a small shop. Most mechanics have found a vise a handy tool for pressing bushings into pulleys, but this can only be done when the pulley is small enough to allow the bushing to touch the vise jaw. For larger pulleys the two-vise method, shown in the drawing, can be used effectively. A length of angle iron is cut in two, clamped together and drilled in three places to take three rods. The end rods are to hold the angle irons in position when they are laid on the vise jaws and the central rod is to support the pulley while the bushing is being pressed into place. One man can operate this improvised press by opening the vise jaws first, then laying the angle irons on top and dropping the pulley, with the bushing started, between them, and inserting the pin to support it. The vise handles must be operated together.—Harry Moore, Montreal, Can.

Aluminum surfaces may be cleaned with a stiff-bristled brush and a solution of from 5 to 8 parts of water to 1 part of sulphuric acid; then a mixture of fine emery and turpentine should be applied vigorously with the same brush.

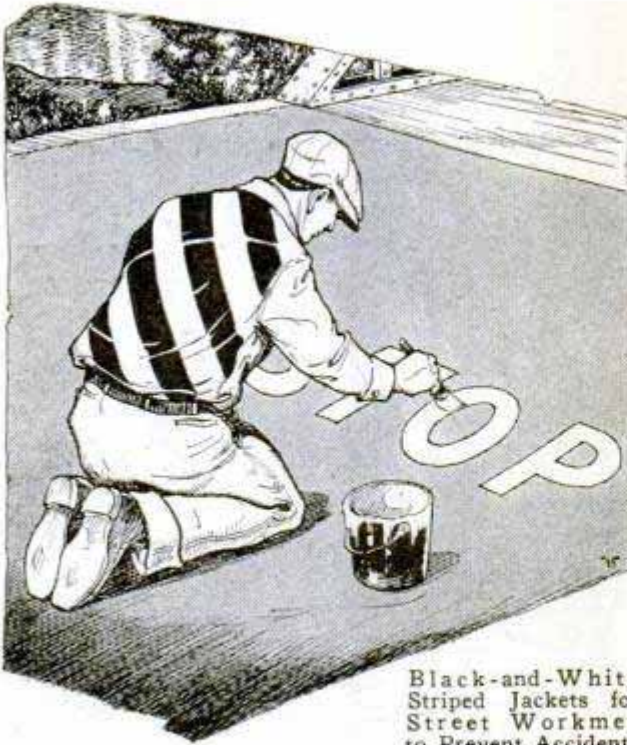

Black-and-White
Striped Jackets for
Street Workmen
to Prevent Accidents

Striped Suits Insure Safety to Workmen

Shirts and jackets having broad black-and-white stripes have proved quite effective in preventing accidents to highway workmen. Clothes thus striped are more conspicuous than plain ones, and autoists, as a rule, immediately identify the wearer as a workman. This precaution is a good, cheap insurance and it is an easy matter to paint the stripes on the cloth. If this method is not desired, separate black and white stripes can be sewed on.—Harry E. Gifford, Medford, Mass.

Save the Drops

Little is known about the proper quantity of lubricating oil to be used in a steam engine. How many drops per minute are right? One drop may not be enough in your engine and ten may be too many. A good test to determine the correct amount of lubricant to use is a "flywheel test." While feeding, say, ten drops of oil per minute to the cylinders, just after a long run and while running at a normal speed, throw off the load from the engine. Then suddenly close the steam valve. The flywheels will cause the engine to continue to run for some time, and that is an important factor. How long does it take the flywheel to stop? By the use of your watch you can determine this to the second. Make a note of the time required

to stop from the instant the steam valve is closed until the engine stops entirely. Do it accurately. The next time try nine drops of oil per minute, but do not allow any other condition to be changed. If the stopping time is the same, you may as well save sixty drops an hour, 600 drops a day, or 180,000 drops a year. Then try eight drops, seven drops, six drops, etc. Finally, use the least number which permits maximum stopping time. Of course, judgment must be used when making this test. Do not choke down the lubricant until the cylinder is likely to be ruined. But as long as the stopping time is at its highest you may feel certain that the cylinder is well lubricated.

Wheelbarrow Fender

A builder noticed that the men pushing the wheelbarrows indoors had trouble in dodging around small pieces of wood that littered the floor. It was almost impossible to keep the floor clean as operations were going on continually and sawed-off blocks of wood were thrown down wherever the workers happened to be. It was thought the best thing that could be done would be to equip the barrows with some simple device to push the obstructions out of the way, and the fender shown in the drawing was found effective for this purpose. It is simply a piece of flat metal, bent to the shape shown, and with both ends drilled to fit over the shaft at each side of



the wheel. When the barrow is needed outside of the building the fender is not used, but is laid back against the body. When it is used indoors, where the floor is level, it is dropped and

effectually pushes aside any obstruction of reasonable size, enabling the worker to go ahead in a straight path.

Tin-Can Mechanics

By L. R. ROBBINS

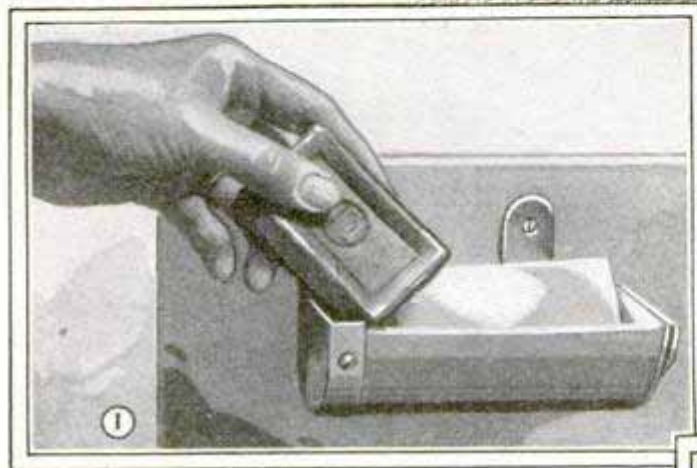

WHEN tin cans are emptied they are usually thrown away. However, a great many useful devices can be made from them, some of which are shown in the accompanying photos and illustrations. Persons living far from centers of trade, and from the cheap-price notion or variety stores, can turn tin cans into real value for the home. All that is necessary is a little patience and the knack of using a few simple tools. The photos show what has been done with tin cans to lighten kitchen labors, and these are only a few of the practical applications, as anyone can devise many more.

The tools necessary for the work are a good pair of small tin snips, a drill or a metal punch, a file, a pair of pliers and a small hammer. Use clean cans and provide a well-lighted bench to work on. It is a good idea to wear a pair of old kid gloves while working, to protect the hands from cuts and to keep them clean. To make the soap dish, shown in Fig. 1, get a can of medium size and one with a cover of the type used on baking-powder cans. Remove the cover and lay it aside. Then, with the snips, cut in a straight line up the side parallel to the seam, and continue the cut to the can bottom. Next cut

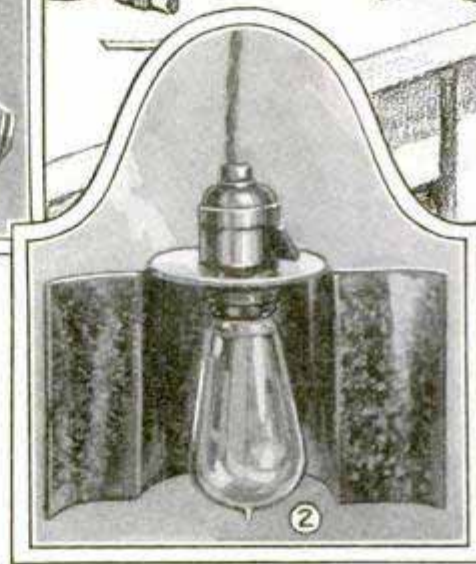

across the bottom along a center line and start up the side at the other end of the cut so that the can will be split about in half along its length. Two tabs are formed in making the last cut up the side. Cut the cover in half and fit the halves to the open ends with a few drops of solder, or by drilling or punching a couple of holes through the can edge and cover to permit riveting. Turn over all uneven edges with the pair of pliers, and hammer down or file off all sharp edges and corners. By giving the completed soap dish a couple of coats of bathtub enamel, or similar waterproof finish, it will make a fine article for the sink and will not rust as long as it is covered with paint or enamel. If placed over the sink, punch two or three holes in the bottom to allow water to drain out. If desired, the holder can be fastened to the wall with screws through the holes in the tabs.

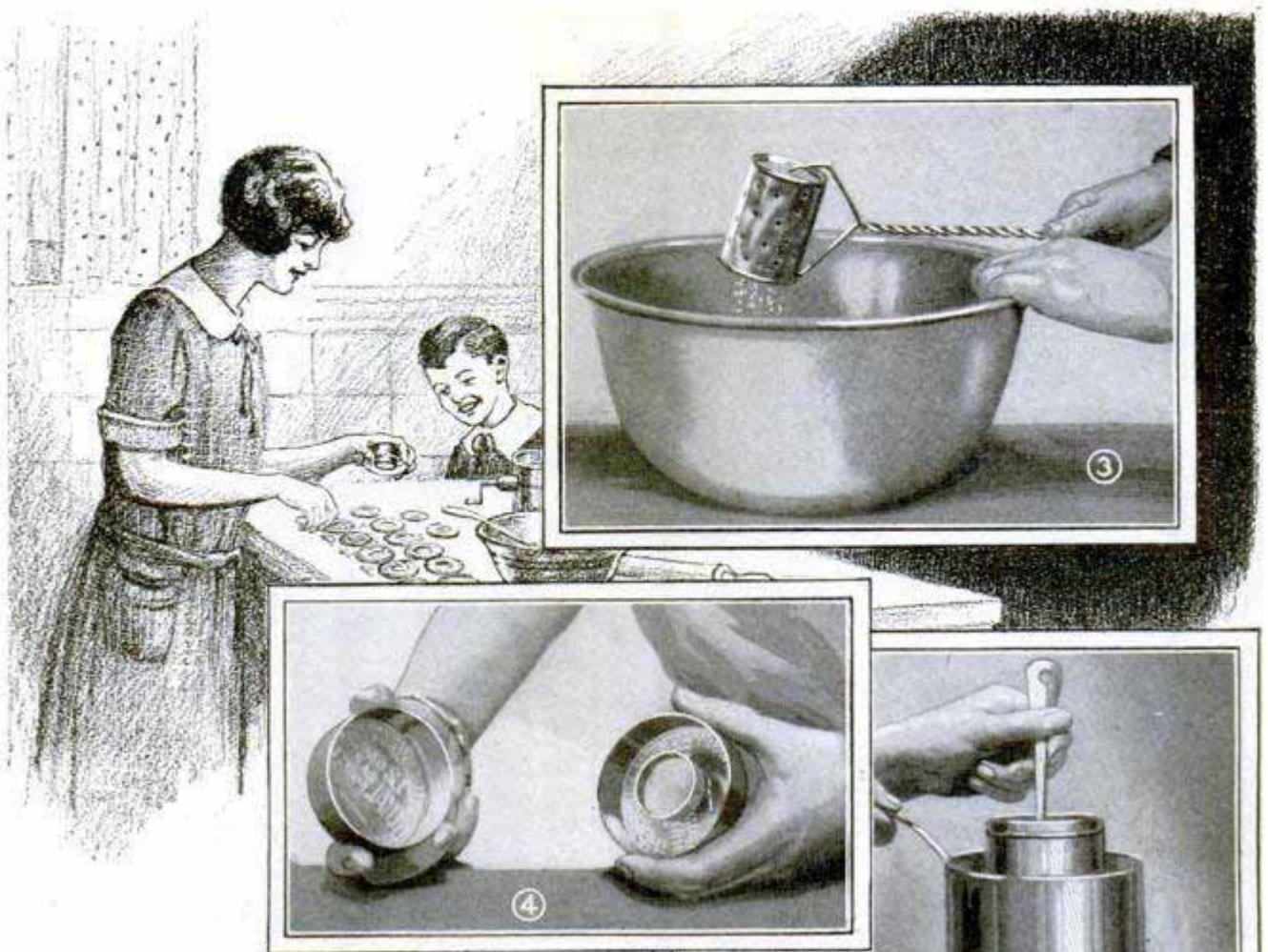

A reflector for a droplight, as shown in Fig. 2, can be made in a very short time. Use a can with a shiny inside. Cans with mottled or enameled linings are not so good for this purpose. Mark a vertical line up the side opposite the seam. Cut along this line with the snips, as straight and evenly as possible, to the end of the can. Cut a round hole through the end just large enough to take the electric-light socket. If the fit is inaccurate, wind the ferrule with a turn or two of tape until the fit is snug. Next cut the sides of the can close to the end until points are reached on each side of the vertical cut about opposite each other. Bend these portions of the side back until they project outward like wings and crease the lines down the side of the can. The result is a semicircular reflector fronted by two wings. The bulb can be screwed into the socket and the light turned on. Such a reflector directs the light down onto the work and in front.

Soap shakers are always necessary in dishwashing, and a good one, shown in Fig. 3, can be made from a small baking-

powder can and a length of galvanized-iron wire. Remove the cover and slip the can over a piece of round wood which will just fit inside. Using a spike, punch a number of holes through the can all around its circumference. Punch a single hole through the center of the bottom and the cover. Twist a handle from wire and arrange it so that the tines must be sprung out before they will engage in the holes in the ends of the can.

Cooky and doughnut cutters, as shown in Fig. 4, are also easy to make from can covers. For the former use a suitably sized cover with an even edge. No handle is needed. To make a doughnut cutter, it is only necessary to solder a small cover to the inside of a larger one, as indicated,

in the center and so that the two cutting edges are even. If you have no soldering outfit, make a hole in the center of each cover and rivet or bolt the two together, using wood, paper or metal washers, if necessary, to hold the edges of the small cover even with those of the larger one.

When it comes to a double boiler for small quantities of material, two tin cans can be used to good advantage, as shown in Fig. 5. It is especially handy for heating glue, chemical mixtures, etc. To make one, get two water-tight cans, one about the size of an apple can and the other about half as large. Cut clear around the apple can with a can opener about halfway up from the bottom, leaving only a narrow section uncut. Then start from the two points where the opener left off and cut a narrow strip to the

edge of the can down toward the inside for the same reason. Fill this can half full of water and then place the smaller can, with the contents to be heated, inside of the larger one. Such an outfit can be made in fifteen minutes or less, and it will be worth making for emergency work.

To make a vegetable slicer, take a long, slender can, such as one in which some brands of round cookies are packed, and peel off the paper or burn off the enamel label. Place the can over a round stick that will fit snugly inside of it. Putting this on a bench, use an old knife blade and a hammer, as shown in Fig. 6, to cut a gash in the tin. Repeat this operation half a dozen times at various points, about 1 in. apart, on the same side of the can. Pry gently under one edge of each cut, to raise the adjacent tin up at a slight an-

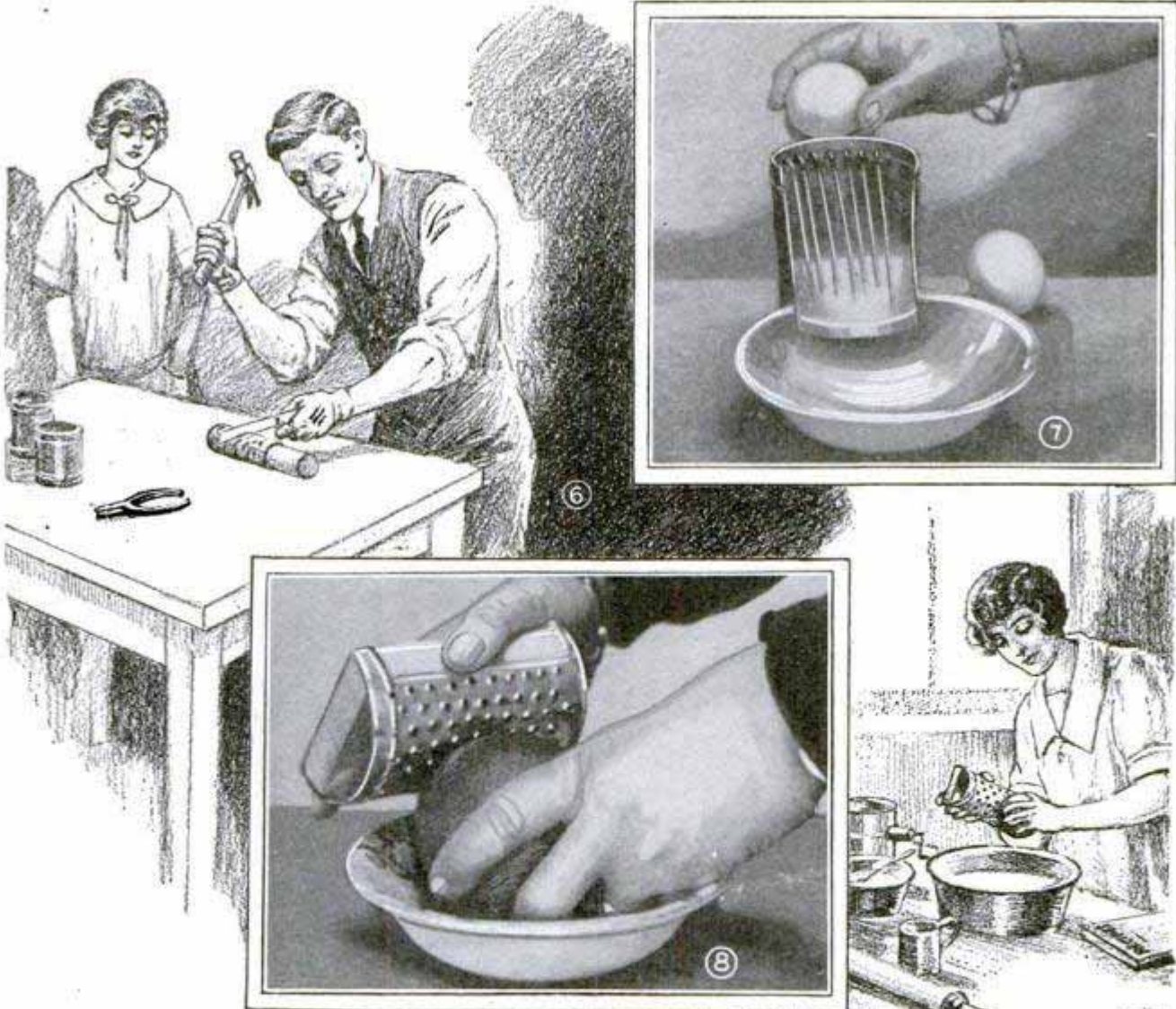

top of the can for the handle. Bend this over as desired and wrap it with tape to prevent cutting the fingers. Turn the

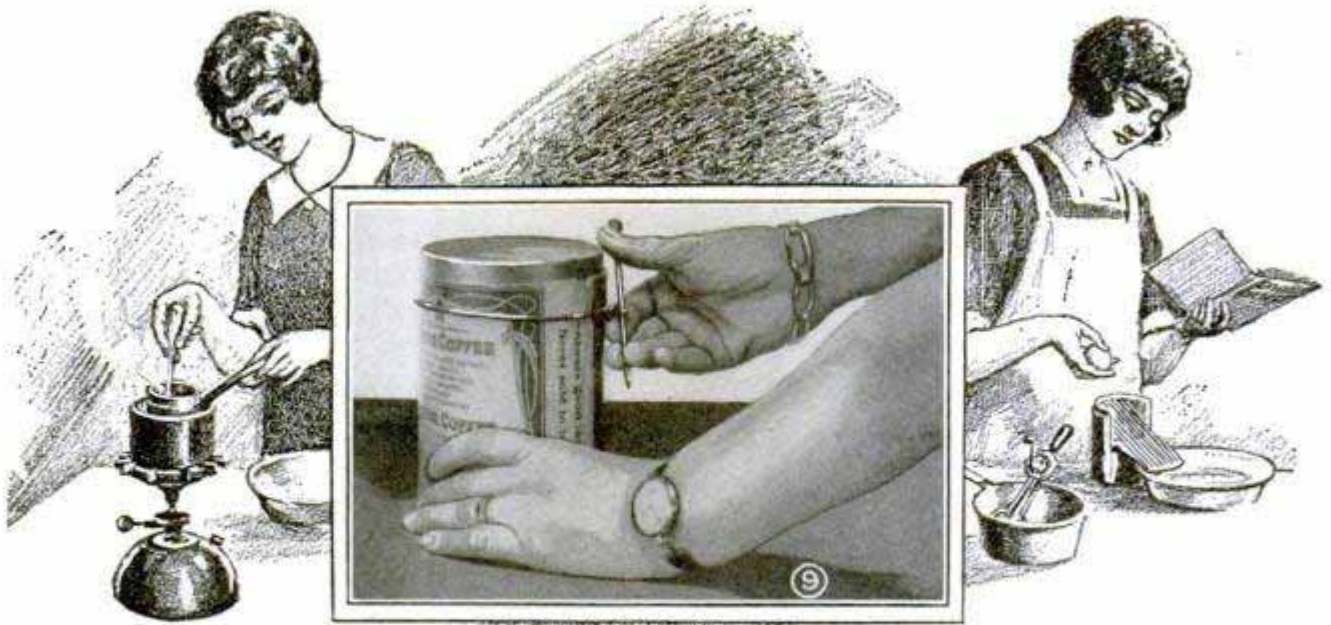

gle to form cutters. To test the implement, pull a raw potato across the cutters, adjusting these until they peel the potato in long thin slices.

Good cake making often calls for an egg separator which is not always handy. One that does the work effectively is shown in Fig. 7. It consists of an empty tin can and a 3-ft. length of wire. The side of the can is cut down for about 3 in. and half the depth of the can. This free piece is flattened slightly by thumb pressure and is then bent out and down at the angle shown. The remaining portion of the top is laid on a block of hardwood and eight holes are punched through the rim just opposite the opened part. Eight 4-in. lengths of the wire are cut and hooked on one end. These are pushed through the holes from the back and allowed to rest on the slanting apron in front. If properly made, the wires will rest parallel and about $\frac{3}{8}$ in. apart. A dish is placed under the apron and an egg is broken and held over the wires. The white runs through to be caught in the bottom of the can, while the yolk runs down the wires into the dish.

A grater, shown in Fig. 8, can be quickly made by splitting a clean can in half lengthwise. Lay it, hollow side up, on a block of wood, and punch holes in it with a large, blunt-pointed spike. This forces a barb on the outside. Turn the edges in and nail it to a piece of wood fitted into the open side. By rubbing it briskly back and forth over the cheese, vegetable or

food to be grated, the job is done just as nicely as can be desired.

Now for a suggestion for opening tight-fitting tin cans: If the cover is driven on so that it cannot be twisted off, make a loose loop of soft wire just under the cover edge around the can, and place a large nail in the loop to twist the wire up tightly. This squeezes the can together, enabling the cover to be pried off without any trouble. The method of doing this is shown in Fig. 9.

Tin Foil for Packing Glands

Packing glands often stick tightly when close to the edge of the stuffing box, and

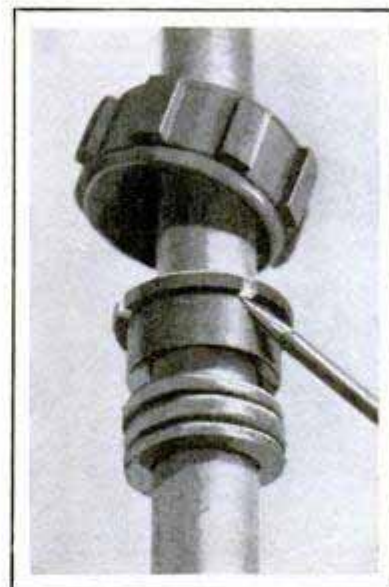

can be removed only by driving them out against the collar. However, owing to hardened oil and presence of scale, forcing the gland from one side often makes it stick more firmly. Several small nicks or grooves cut in

the collar, as shown, when a new gland is applied, make it possible to use a small

spanner to turn it a little before trying to get it out. Several half turns of a gland will invariably loosen it sufficiently to enable starting it easily. This also helps to keep the nut face of the collar true and even.

Keyhole-Saw Vise

Anyone can readily make a keyhole-saw vise for filing, in a short time, as follows: Get a block of wood, about 12 in. long and 2 in. high, and nail it to your bench, then saw a slot, about $\frac{3}{4}$ in. deep, in it. It will be found that the narrow blade of a keyhole saw can be inserted and held securely for filing without difficulty. The blade of the ordinary keyhole saw is just a trifle thicker than the blade of a standard crosscut saw, so that the groove will make a tight fit, preventing the keyhole saw from slipping out when the pressure of the file is on it.

Scribing Circles with a Rule

You can scribe large circles very nicely with nothing but a 2-ft. rule. The wire dowel pin near the middle hinge makes a good pivot, so that it is only necessary to pinch the pencil between the 6-in. sections of the other half, as shown in the photo. This method is much better than a string,



Large Circles Can Be Scribed Accurately by Means of a Rule and a Pencil

for both the pencil and the point are rigid.
—F. W. Bentley, Jr., Missouri Valley, Ia.

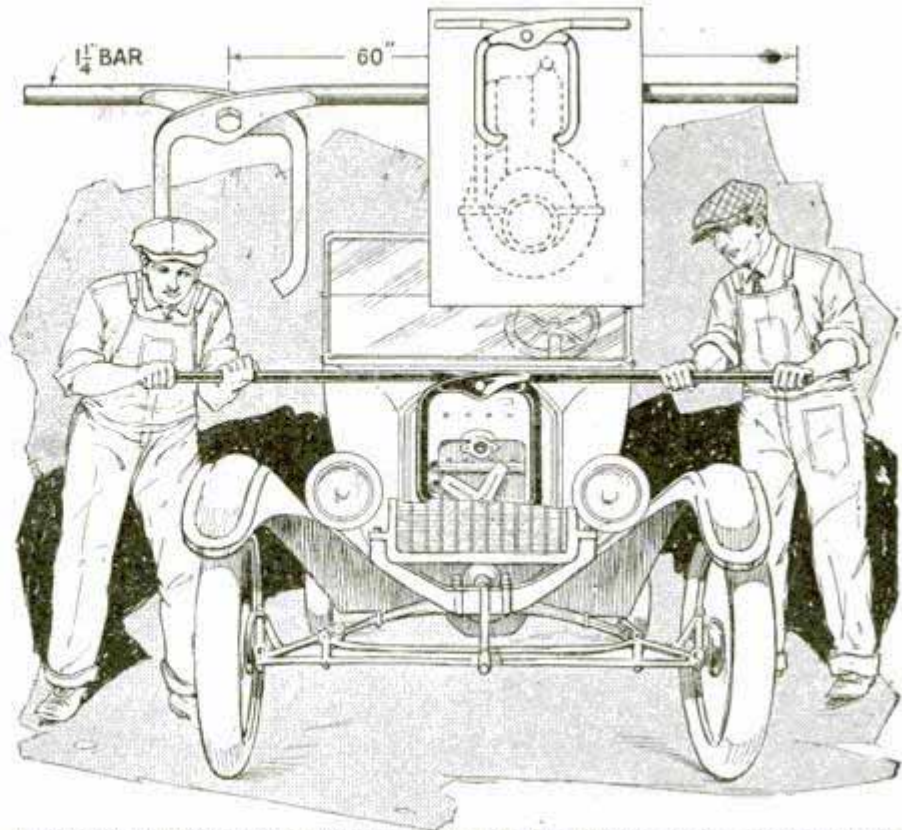

Long Tongs Enable Two Workmen to Lift Automobile Motor from or onto the Chassis without Difficulty

Tongs for Removing Auto Motor

To remove auto motors quickly and with little trouble, one garage uses a pair of tongs with extension handles. The latter are 5 ft. long, to provide considerable leverage and to enable two or four workmen to take hold of them from opposite sides of the car, as shown in the illustration. The tongs are made of $1\frac{1}{4}$ -in. bar stock, bent as indicated and forged flat at the point where they are pivoted together with a loose bolt. With the aid of these tongs the motor can be readily lifted from or returned to the chassis.—G. A. Luers, Washington, D. C.

Repair for Broken Spoke Tenon

It is not necessary to remove a spoke from a wheel because of a broken tenon. A repair can be made as follows: Wrap the end of the spoke evenly, for about 3 in., with fine wire. Drill a small hole in the end of the spoke and drive a 20-penny wire nail through the broken tenon and into the spoke. A coat of paint will make the repair practically invisible. If the spoke is to be repaired without removing the tire, drill a hole through the tire for the nail, countersinking it for the head.

How to Care for Balloon Tires

By G. A. LUERS

THE facility with which balloon tires ride over cobble stones, broken macadam or concrete, and their cushioning effect, which protects the car and gives comfort to the passengers, must necessarily be accounted for either by additional tire expense or by extra care in order to obtain maximum mileage from this type of tire with its relatively thin walls.

The inner tube of a balloon tire has more than double the wall area of the high-pressure type of tube. It is essential that every precaution be taken to protect the tube, as any hole in the wall will deflate it and may then ruin the casing in a short time. A spare balloon tube should be carried in a bag of heavy duck or waterproof canvas. This will prevent chafing from contact with tools. The procedure

of rolling the tube is to deflate it by removing the valve and flattening the tube, with the valve in the center and held up as shown in the upper left-hand detail of the illustration. It is folded into a rectangular bundle, which is held together securely by means of one or more rubber bands, after which it is slipped into the tube bag. Talcum powder or soapstone should be applied liberally before closing the bag.

In case of a flat tire it is essential that the tire be changed immediately, as the thin wall of the casing and the tube will soon be cut and bruised beyond repair. Therefore, do not drive on a flat balloon tire. The use of a cold patch on a balloon tube is not advisable, as the flexibility of the tire will allow it to work

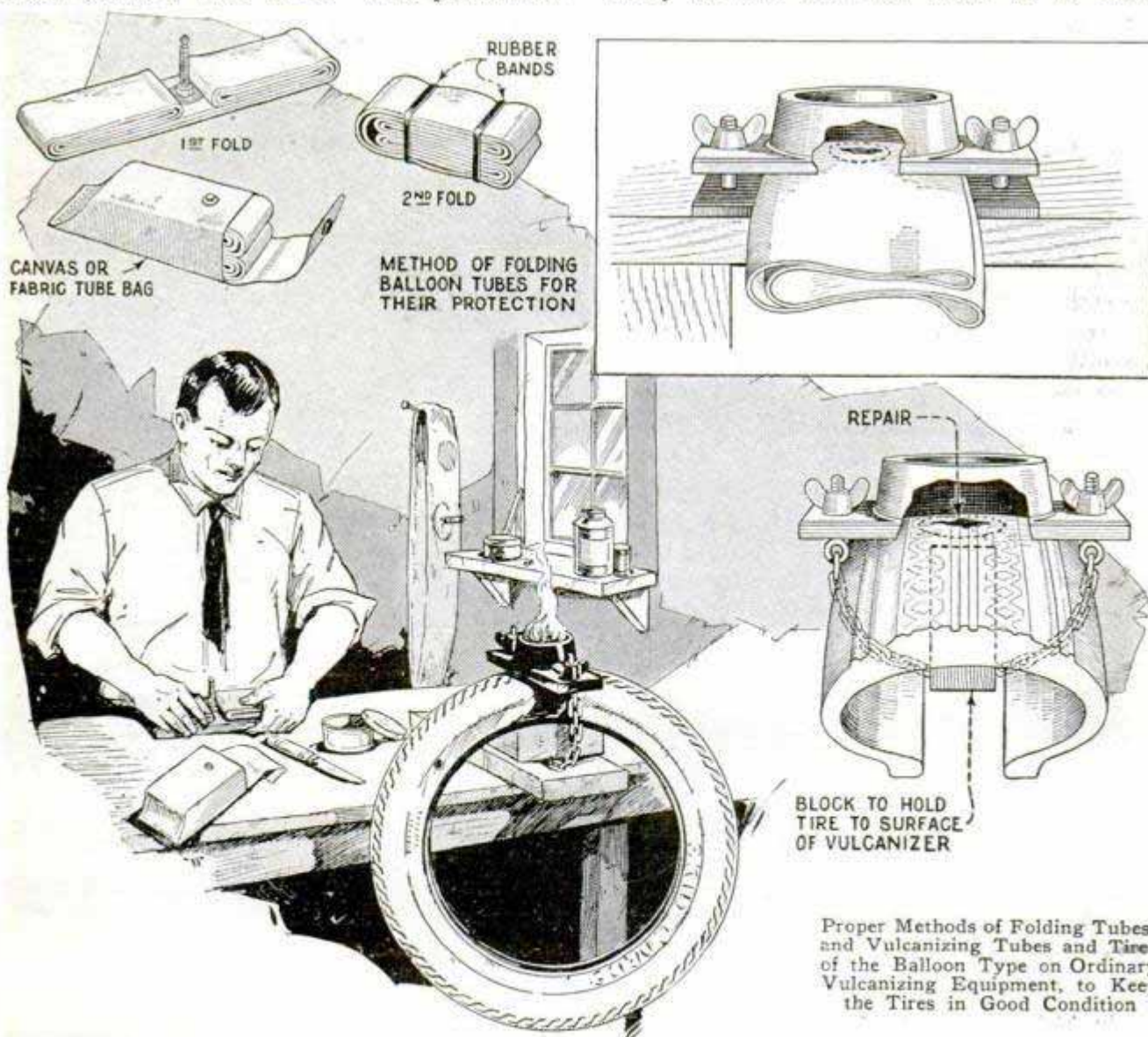

loose, causing the tube to leak slowly, and a soft tube may endanger the casing before the leak is discovered. For this reason leaky tubes should always be vulcanized. It will be found that a balloon tube is too wide to fit into the usual type of vulcanizer. To accommodate the tube to the vulcanizer it is possible to fold it once, making four layers of the wall, and the patch can then be vulcanized in the usual way, as shown in the upper right-hand detail.

Due to the relatively small number of layers of fabric in the casing of balloon tires, it is necessary to protect them against the entrance of water and grit through small cuts. A heavier tire wall, with the reinforcement of numerous layers of fabric, will withstand considerable usage before blowing when the rubber is cut, but a balloon tire has a weak side wall and fractures in the rubber must be repaired immediately to prevent the fabric from weakening. Also, in this case, the usual vulcanizer, possessed by many auto owners, does not readily lend itself for use on balloon tires. However, to use it for this purpose, the casing must be made to fit the curvature of the vulcanizer. This can be done by inserting a small convex block inside of the casing while clamping the vulcanizer over it on the outside. This method will push the patch into contact with the vulcanizer and permit it to be used effectively. Too much emphasis cannot be placed on the necessity of making vulcanized repairs to breaks in balloon tires and tubes.

The pressure for balloon tires varies from 25 to 40 lb., depending on the make of tire used. This information is given the buyer at the time of purchase, and is often printed on a sticker attached to the windshield of a new car. Although high-pressure tires will stand up when inflated 10 or 15 lb. below their required pressure, a drop of 5 lb. is the limit for most balloon tires. To safeguard against the deflation limit, weekly inspection and replenishment of air should be made. An air gauge specially made for balloon tires should be used in order to get accurate readings.

Many chains available for balloon tires are similar to those used on trucks. Obviously, such heavy chains are really unsuitable for passenger cars. When buy-

ing tire chains, the purchaser should assure himself that he is obtaining the chain made especially for balloon tires.

Electric Fan Helps Sell Goggles

In a Los Angeles motorcycle shop, an electric fan on the accessory counter has



Testing Goggles or Driving Glasses in Front of an Electric Fan

been found a valuable adjunct to the sale of goggles and driving glasses. The prospective purchaser when trying to determine whether or not the goggles or driving glasses offer him the protection desired, is asked to step in front of a fan, which is then turned on. With his face in front of the fan, the customer decides whether the goggles fit.

Leather Piston Packing

A service pump in a street-railroad power plant gave considerable trouble by water slipping past the plunger. The engineer could find no remedy until he tried six ordinary leather packing rings, which easily fitted in the water cylinder when dry. These were placed on the piston just as ordinary packing, and the follower plate and nut put in position. Since using this packing the pump will often run eighteen months without attention.

Burglar Alarm for Windows

Recently I installed a burglar-alarm system in a small shop, using radio jacks

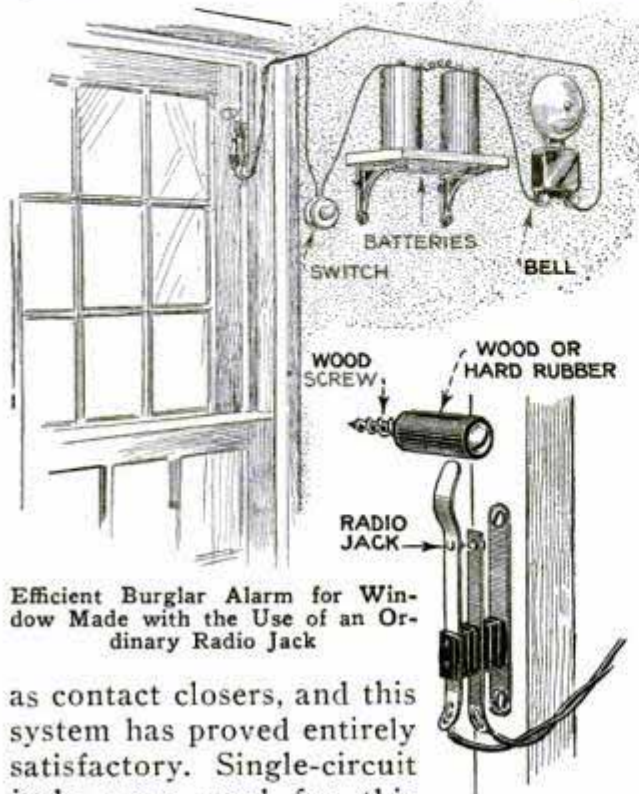

Efficient Burglar Alarm for Window Made with the Use of an Ordinary Radio Jack

as contact closers, and this system has proved entirely satisfactory. Single-circuit jacks were used for this purpose. No change was made in them except to flatten the bent blade slightly, as shown, and to cut off part of the frame, the remaining part being drilled for wood screws with which the jack was securely fastened to the upper sash. A 1-in. length of $\frac{1}{2}$ -in. dowel stock, hard-rubber or bakelite rod, with a hole drilled through the center, was used in conjunction with the jack, being so installed that when the window was opened, the round rod would press the outer blade of the jack against the inner contact, closing a circuit and causing a bell to ring. If the lower sash is not permanently fastened, a jack should also be installed on it as well as on the upper sash. The same type of circuit closer can be used on a door, the round rod projecting from the door and the jack being placed against the wall.—Herman R. Wallin, Brooklyn, N. Y.

Belting Horizontal to Vertical Pulleys

Quarter-turn belts connecting horizontal with vertical shafts often give trouble. The belt on the vertical pulley is attracted by gravity and does not stay up where it belongs. This difficulty can usu-

ally be overcome by employing a vertical pulley having more than ordinary crown. It is not always necessary to use an idler pulley on drives of this sort. If possible, it is best to avoid the use of idlers because they consume power and cause wear. Another thing to bear in mind is to use as light a belt as possible. Where the distance between pulleys is so great that the weight of the belt causes it to leave the vertical pulley regardless of the crown, it is best to use a guide pulley. Some belt men use two guide pulleys, but unless the distance between transmission pulleys is unusually great, only one guide pulley should be used. It should support the side of the belt going onto the pulley, on the vertical shaft. The side of the belt leaving that pulley does not need support. Where distances between pulleys are exceedingly great on quarter-turn drives of this kind, the problem is sometimes solved by shifting the pulley on the vertical shaft up or down, as the case may be, until a position is located which holds the belt centrally at all times.—W. F. Schaphorst, Newark, N. J.

Improvised Depth Gauge

When drilling a number of holes to a certain depth with a wood auger, a depth gauge is necessary. If one is not available, take a block of wood, 1 to $1\frac{1}{2}$ in. square and as long as the distance from the tip of the auger to the chuck. Drill a hole lengthwise through the center of the block and cut off a section equal to the depth of the hole desired. Slip the block over the auger and push it tightly against the chuck. The size of the hole in the block should be the same as the size of the auger so that it fits tightly.



Uneven heat in tempering causes irregular strain and cracks in tools.

Oversize Printers' Rollers

Rollers for presses are cast larger than the bearing rollers at the ends, and as a result the rollers jump when passing onto the type forms. This is especially troublesome with small forms as it not only fills the type with ink but is wearing on the rollers. The usual remedy is to lock up type-high roller bearers in each end of the chase. The bearers will take the ink and smear it on each end of the drawsheet where one is likely to get his fingers into it. A better method is to get one or more strips of felt and fasten them with glue to the roller guides at each end of the press. This raises the rollers so that they pass over even single-line card-job forms smoothly. The felt will wear for months in the ordinary small-town job shop before replacement is necessary.

Guard for Gas-Tank Filling Pipe

Gas-tank filling pipes that extend above the ground at auto-service stations usually come up through well-sodded ground. However, as gasoline is ruinous to grass, if spilled on it, which usually happens when the tank is being filled, one station owner placed an old auto rim around the pipe, and filled the space inside with gravel. The rim was painted to give it a neat appearance. If any gasoline spills, it falls on the gravel, where it evaporates without hurting the sod outside the rim. —Dale R. Van Horn, Lincoln, Nebr.

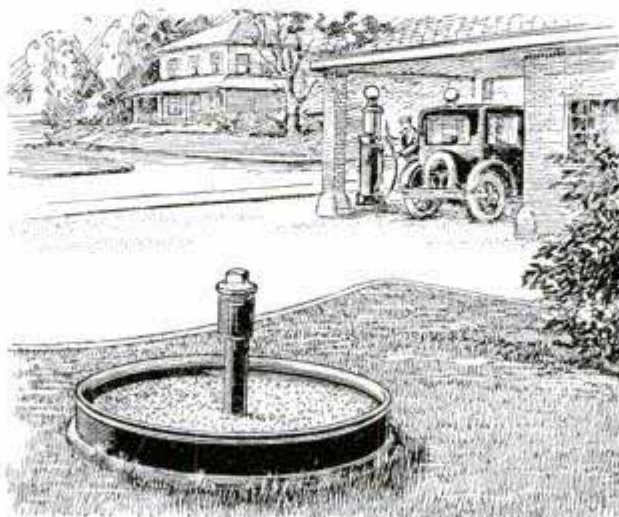

Old Auto Rim and Gravel Filling around Pipe of Gas Tank Protect the Grass

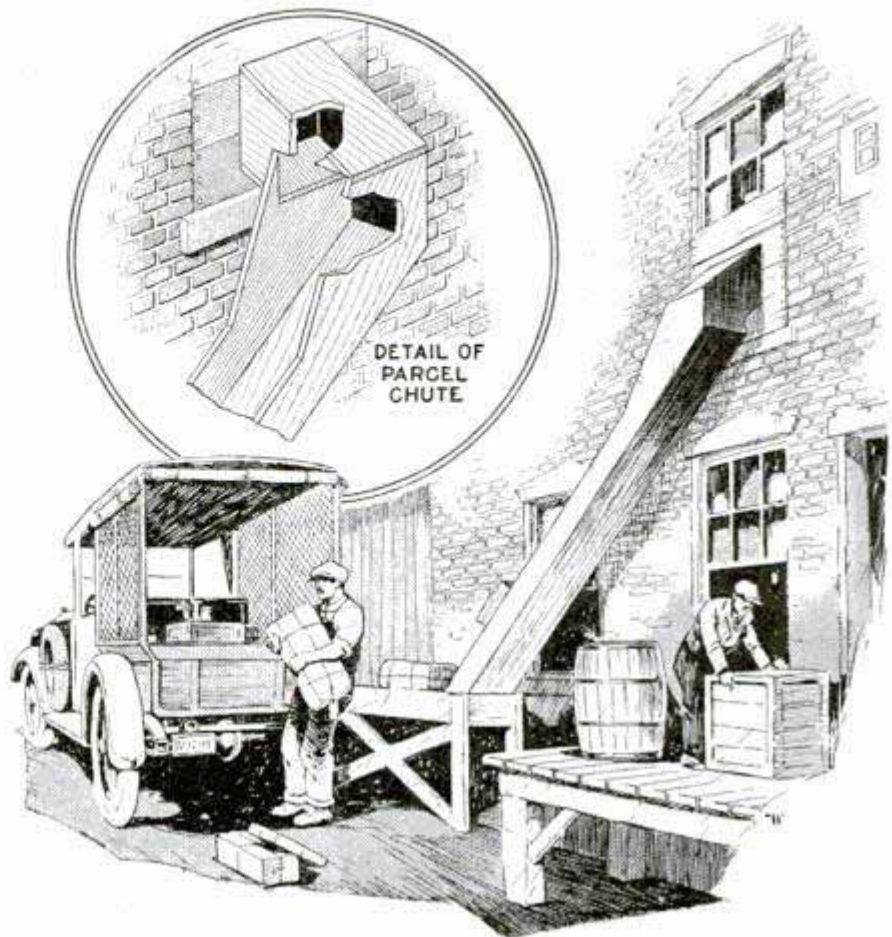

Handy Wooden Chute Conveys Parcels from Second-Floor Shipping Room to a Loading Platform Below

Chute for Parcels

Shipping departments located on the second floor will find this method of handling wrapped parcels of great value to them, inasmuch as it saves labor and floor space. A window, facing the alley or street where loading takes place, is boarded up in the manner shown in the illustration, and an inclined chute, made of 1-in. lumber, is run from the window

to the loading platform or bin into which the parcels slide. Ordinary large furnace piping can be used instead of 1-in. lumber, if care is taken when assembling it. The lower end of each section of pipe is slipped into the upper section of the length below it, so that there will be no edges for the parcels to catch on.

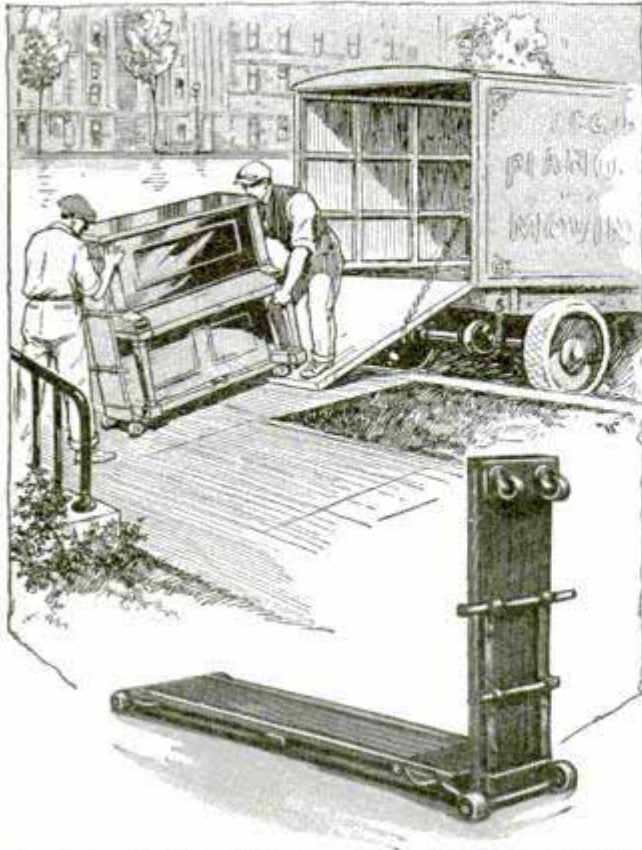

Two-Sided Dolly Which Is Handy for Moving Pianos and Similar Heavy Objects

Dolly Facilitates Piano Moving

Moving pianos and similar articles is hard work at the best, but here is an improved dolly which will make the task much easier. It is really two dollies combined, at right angles to each other. Both parts are equipped with casters, the two on one end being of the bed-post variety. The piano is strapped on the dolly and left there until the destination is reached, making it easy to handle at any time.—Jos. C. Coyle, Denver, Colo.

Repair for Galvanized Tanks

It became necessary for us to have additional tank space but we did not feel justified to purchase a new tank. We found an old tank on the junk pile. The seams had opened and rust had eaten through the bottom at a dozen places. We gave it a thorough washing out and then applied a coating of ordinary street asphalt. For the seams and holes along the sides, we applied the asphalt in the same manner as solder, melting it with a blowtorch just enough so that it would roll out into a strip, wedging this into place and then flowing it with the flame. We spread

a thin layer all over the bottom of the tank, and a thicker layer around the seams at the edges. Then we poured in the water, which caused the asphalt to set almost instantly. We intended this simply for a temporary job, but the tank has not shown a leak after two years of service. The asphalt in the bottom, where it is always covered with water, never softens. In very hot weather, the patches along the sides soften until the asphalt gets pliable like rubber, but it has never run. Recently we cleaned out our good tank and also spread a thin layer of asphalt over the bottom to prevent it from rusting.—Ralph W. McPherson, Wahoo, Nebr.

Screwdriver Attachment Holds Screws Securely

Various methods have been adopted for holding screws securely to a screwdriver, and the one shown in the accompanying drawing has been found particularly useful for holding screws in deep recesses. It also enables one to remove a screw from such a place without any danger of the screw falling down into the machinery or other place where it is not wanted. The screw-holding device can be made by anyone and consists of a length of flat iron, bent to the shape shown, and a small coil spring. The only change made in the screwdriver is that the shoulders are ground on the blade, as indicated in the lower detail. The attachment is applicable to either large or small screwdrivers

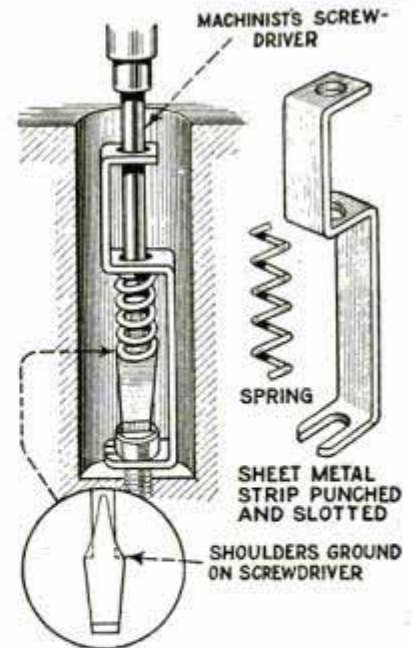

and can be used with wood or with machine screws. It is obvious that the width of the slot or recess in which the tool is used must be such that the screwdriver can be moved sidewise enough to disengage from the screw, after starting this.

Noiseless Wagon

By using both front and rear axles and wheels of a discarded auto, an easy-riding

the slot of a pin driven in the tool. A small pin through both parts completes the assembly. In operation, the diamond-pointed tool enters the slot made by the parting

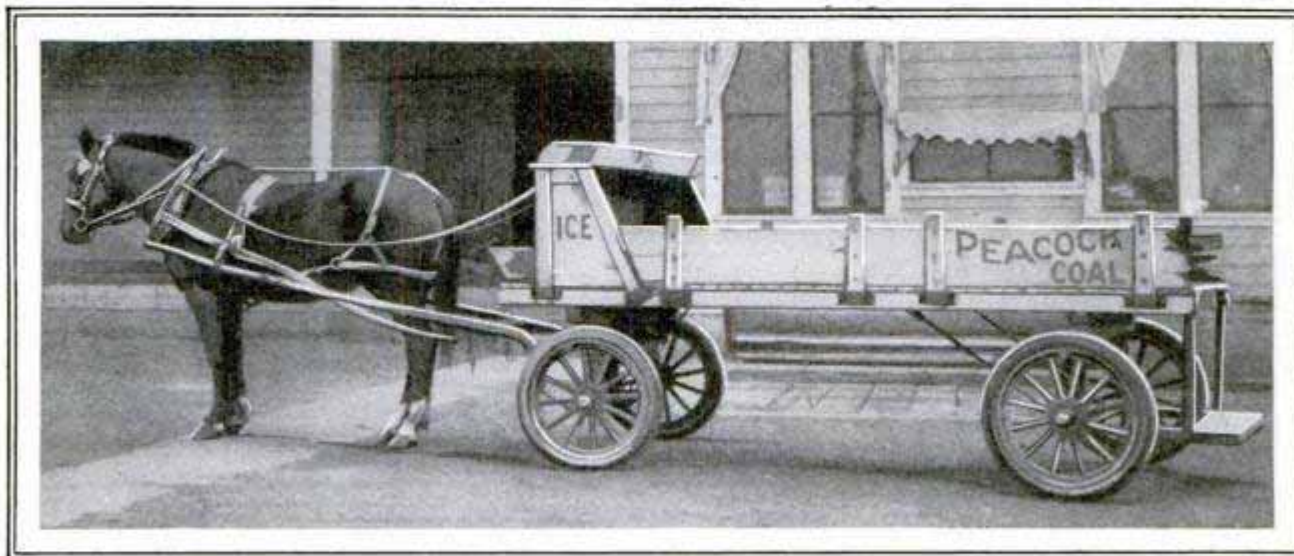

Using Discarded Auto Wheels and Axles on a Wagon Makes It Easy-Riding and Noiseless

and noiseless wagon can be made. Such old auto parts can usually be purchased much cheaper than wagon wheels.—Carlton Groat, Portland, Oreg.

Automatic Chamfering Attachment on Parting Tool

Many lathe and screw-machine operators use a file or a hand tool to break the corners of the slot made by a parting tool. In the absence of a double toolpost, the parting tool can be fitted with a chamfering tool, which can be adjusted to suit the work and will thereafter automatically perform its task without further attention on any brass-rod work. First of all, cut off a piece of round steel for a tool-holder. Drill this through the center to take the tool, tap it for a tightening screw and tap it again for the connecting piece, which is flattened at the other end to fit in

tool and breaks the corners. As the parting tool is fed further in, the round tool holder strikes the work, causing the holder to ride up the work and permitting the parting tool to complete the cutting off. When the parting tool is withdrawn, the attachment drops down ready for the next cut.

Insuring Proper Chimney Draft

Down draft and "choking" in a chimney often occur when the chimney top does not rise higher than the peak of the roof.

This is especially true when the chimney is an outside one and comes up alongside the house. The smoke is cut off and is held up in the chimney. To overcome this difficulty the chimney should be three feet above a horizontal line from the peak of the roof. Often a group of trees stand close to the house, the tops rising above the top of the chimney, and the same trouble may occur.

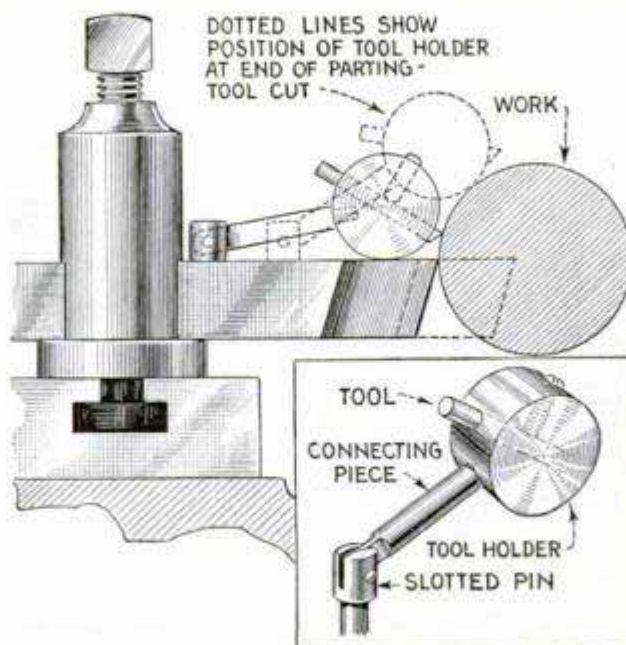

Automatic Chamfering Attachment on the Parting Tool, Useful in Absence of Double Toolpost

Old Crankcase Oil Burned
in Garage Stove Gives Heat
at Small Cost

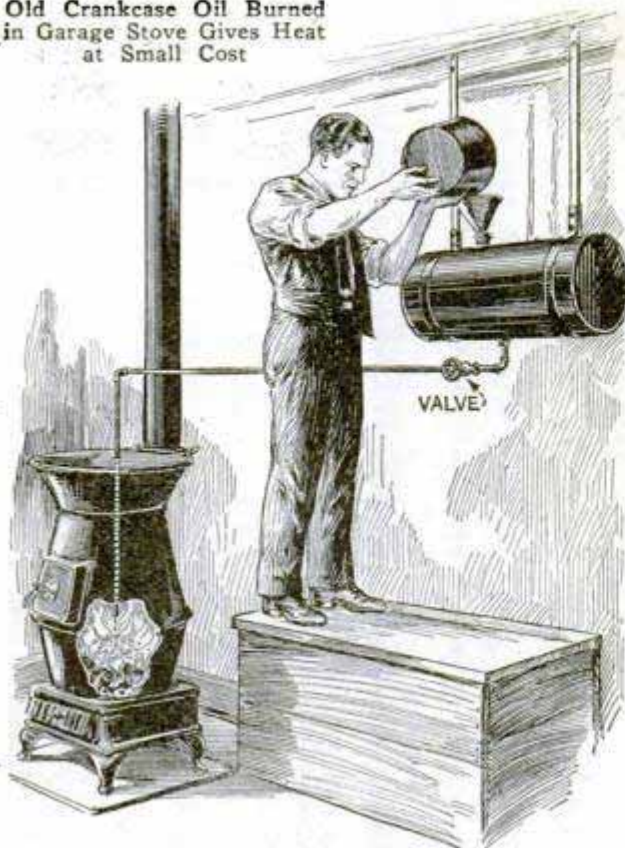

Burning Crankcase Oil in Stove

Most garages have a large quantity of old crankcase and other waste oil. This is usually thrown away, but it can be used as fuel in a common stove or furnace by means of the simple arrangement shown in the drawing. A tank of 5 or 10-gal. capacity should be suspended above the stove, but a safe distance from it. An old auto gasoline tank will serve the purpose well. A $\frac{1}{2}$ -in. pipe is tapped in the bottom of the tank and run to the stove, as indicated. The pipe should project inside of the stove at least 8 in. and a valve is provided in the pipe line to regulate the flow of oil. When all connections have been made, the line and tank must be thoroughly tested for leaks. After the apparatus has been completed, the tank is filled with oil and a fire is built in the stove. The firepot should be well filled with fuel so that the dripping oil will not get into the ash

pan before it is burned. When the fire is burning well, open the oil valve gradually so that the oil will slowly drop into the fire. A small amount of oil will keep the stove burning all day. In order to safeguard the oil tank against fire while filling it, a heavy felt washer should be placed around the pipe just under the tank to absorb any overflow oil, which might follow the line to the stove. A stove burning oil in this way has saved one garage owner about 80 per cent of fuel otherwise required during the season.—S. A. Marshall, Jr., Rome, Ga.

Grease Nipples for Large Grease Cups

When grease nipples for pressure grease guns are being fitted to machines, it is not always desirable to discard the large grease cups, which may be turned frequently with the fingers. A practice in one shop is to fit the cap of the grease cup with a grease nipple, and to fill it with the grease gun. This involves only drilling and tapping for $\frac{1}{8}$ -in. pipe thread. Apart from provision for making half turns or more of the cover between the intervals of grease-gun lubrication, the large supply of grease will feed at any time when the bearing becomes heated enough to make the grease flow.—G. A. Luers, Washington, D. C.

Novel Seat for Filling Stations

Many filling stations have a guardrail along the drive, consisting of a gas pipe run through 4 by 4-in. posts, set in the ground at 6-ft. intervals. If desired, a seat can be made by simply cutting square holes in a 2 by 12-ft. plank, to fit snugly over the posts, and nailing cleats to the underside of the plank on each side of the posts. The seat thus made is rigid, permanent and just the right height for most people to sit on it comfortably.—Dale R. Van Horn, Lincoln, Nebr.



Simple Seat on Filling-Station Guardrail Can Be Made from a Plank

see October 1941 156

Color Holders for Decorators

When doing stenciling and line work on walls and ceilings, it is necessary to have several colors at hand. To have these handy, it is best to arrange a sufficient number of tin cans on a stout cord or small rope, tying it as a belt around the waist. Holes are made in the tops of the cans to admit the cord or rope. This will save a great deal of stooping.

Non-Overflow Bucket

The type of bucket shown in the drawing was constructed to stop continual splashing on the floor of a manufacturing concern. The buckets are used to clean the chips out of drill jigs after each operation. They are filled with a soda solution, and, formerly, when an operator dropped a jig carelessly into the bucket, or dipped one when the bucket was almost full, the contents would overflow on the floor, making it slippery. To prevent this, a hollow handle was provided to take care of the overflow. It was made of 1-in. tubing bent to a semi-circular shape, as shown, and the ends fitted into elbows, which are threaded into short nipples passing through holes in the bucket. The nipples are tightened with locknuts on each side so that the handle works on the threads of the nipples. Ordinarily the bucket is filled to within a couple of inches of the top. If the level of the liquid is raised, it runs into the hollow handle instead of overflowing.

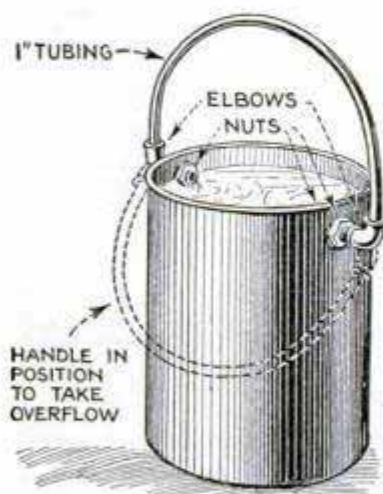

ing. Lifting the handle causes the overflow to run back into the pail.—Harry Moore, Montreal, Can.



Simple Lean-To Scaffold Is Easy to Erect and Takes Little Space in the Workman's Truck

Scaffold for Painting

For working at certain heights on the outside of buildings, as for instance when painting window sashes, the simple scaffold shown in the photo will be found to be of considerable utility. It consists of two supports, each of which has a 3-ft. horizontal member, a forked leg and suitable braces for holding the two members together securely. The end of each support is set against the wall of the building and a plank is laid across them. This scaffold takes little space in the truck and is therefore easy to transport, a feature which is especially appealing to the workman. It is, of course, necessary to set the legs squarely on the ground or the scaffold may collapse when the workman gets on it. The legs should not be set on smooth surfaces where they are likely to slip.—Edward A. Weatherston, Chicago.

Is This Your Home?



Copyright, Architects' Small House Service Bureau



Plan No. 3A7

QUESTIONS regarding home building addressed to this magazine will be answered by The Architects' Small House Service Bureau of the United States, Inc., controlled by the American Institute of Architects and endorsed by the United States department of commerce. Please inclose 10c in stamps or coin. Blueprints, specification forms, and material lists for the house shown here may be obtained from The Architects' Small House Service Bureau for a small fee. If further information is desired, literature describing the plan service and publications of The Architects' Small House Service Bureau will be sent you upon request. A booklet entitled "50 Ways to Lower Home Building Costs," illustrated by ten Bureau homes actually lived in and showing how as much as \$1,000 can be saved on a home, may be obtained for 20c.

IF three rooms meet the needs of your family, why build more? For the young couple just starting their married life, a three-room cottage supplies almost all that is required. For the old folks, going on after children have left home, three rooms provide comfort, conveniences and light responsibilities as to housekeeping.

The popularity of this type of home seems unquestionable, if one may judge from the multitude of these which fringe all our cities. Unfortunately many of the houses thus seen have no architectural character, and yet there is no reason why they cannot be just as attractive as the larger houses. The fundamental principles of good architecture, which are fine appearances, good plan, and sound construction, apply just as well to small houses as to larger ones. In this design the architect has made use of the simple element of wall openings and roof to get balance, and construction is simplicity itself.

The house is of frame construction with an exterior of stucco. It is equipped with casement windows. A hooded porchway

under the main roof leads to the living room. One of the end walls is made a bit more decorative by including an oriole window. There is a trellis at the side of the door, upon which vines may be trained.

The plan could hardly be improved upon. A special feature is the living room. This is entered from the porch, and along one side of it is a large window with four casements. Along the end is the oriole window with built-in cupboards at either side. On the inside wall is the fireplace. At the other end is placed a huge coat closet. At the rear of the house are arranged, in order, kitchen, bathroom and bedroom, with a hallway connecting them all and a linen closet in the hall.

This house might very well be built without a basement and heated by one of the several specially designed heating systems that have been devised for small houses. Even though it is a small house, the rooms are of unusually good size. The closets are deep and commodious. If extra sleeping space is desired, a bed can be installed in the closet off the living room.

You can't loosen a "YANKEE" Handle



This man drove the blade of "Yankee" No. 90 Plain Screw-driver right through a four-inch plank — without splitting the handle.

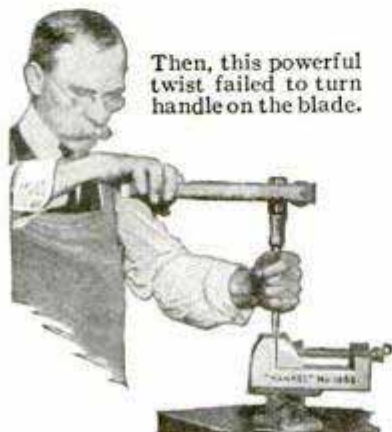

Then, this powerful twist failed to turn handle on the blade.

No job can make the blade of a "Yankee" Plain Screw-driver turn or loosen in the handle. "Yankee" ingenious construction (found in no other screw-driver) makes blade and handle practically a one-piece tool.

"YANKEE" Plain Screw - drivers

No. 90—Standard Style, 15 sizes, 1½ to 30 in. blades. Price (8 in. blade) 75 cents.

No. 95—Cabinet Style, 11 sizes, 2½ to 15½ in. blades. Price (8½ in. blade) 65 cents.

"Yankee" Drivers are made to work with. Handles are shaped to fit the hand and give a firm grip. The blade steel is hardened and tempered exactly right.

Every individual blade is tested twice before leaving factory—another reason why a "Yankee" Driver lasts.

Write for Free "Yankee" Tool Book



Shows how "Yankee" Tools make work easier: Spiral Screw-drivers, Ratchet Bit Braces, Ratchet Breast, Hand, Chain, and Bench Drills, Automatic Push Drills, Ratchet Tap-wrenches, Vises, with removable base, etc.

Dealers Everywhere
Sell "Yankee" Tools

"Yankee" on the tool you buy means the utmost in quality, efficiency and durability.

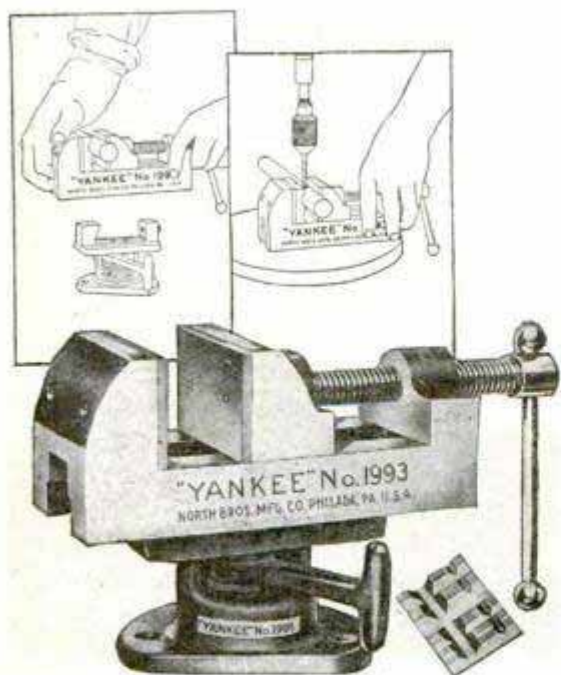

The Handiest Vise in the World

Designed for continuous work—from bench to machine and back again, through all operations. Swivel base. Detaches from its base. Get the size most convenient for your work. No. 1993—jaws open 3½ inches. Price, \$9.90.

NORTH BROS. MFG. CO., Philadelphia, U. S. A.

"YANKEE" TOOLS

Make Better mechanics

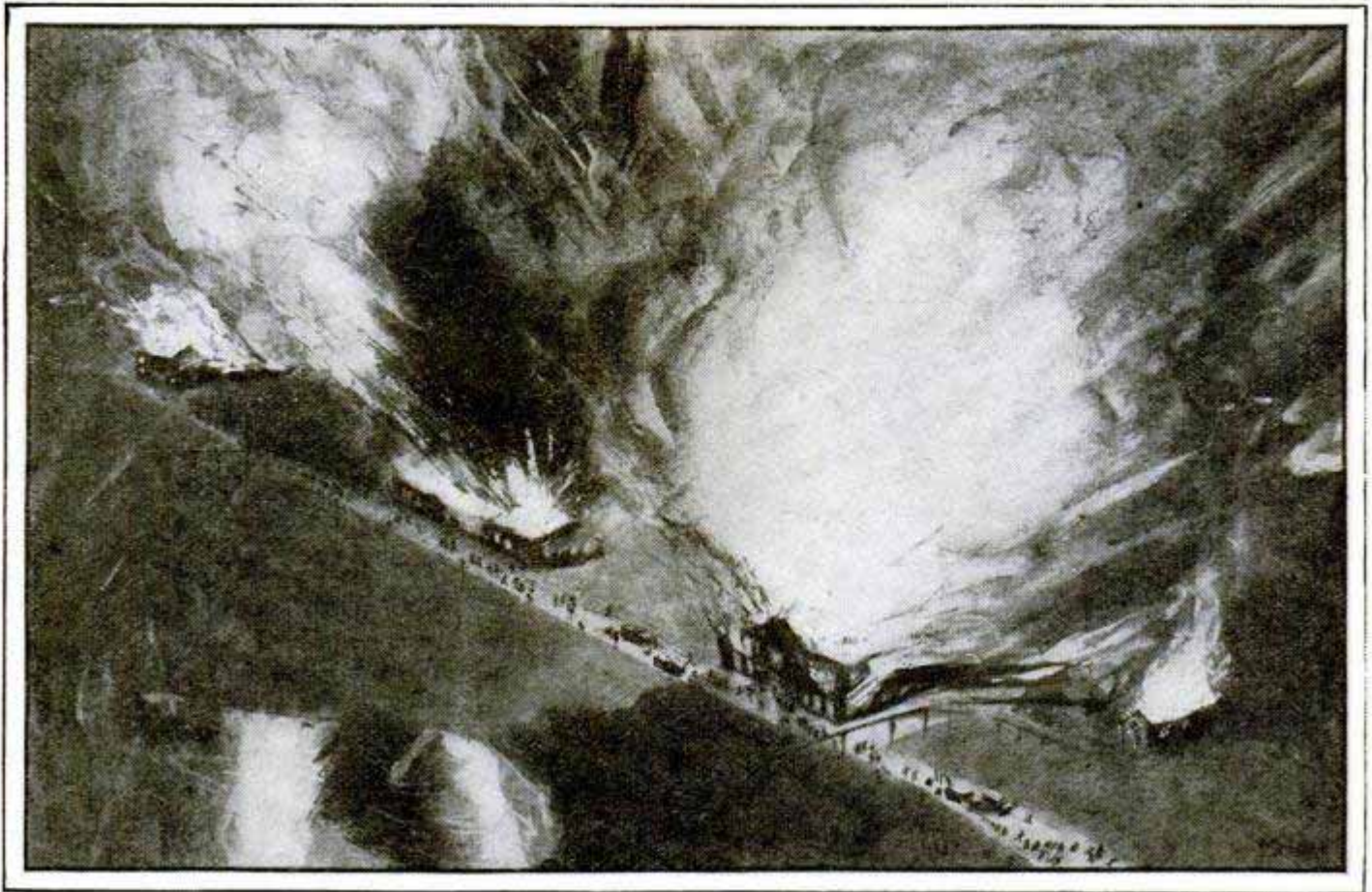

The Spirit of Service

*An Advertisement of the
American Telephone and Telegraph Company*



IN JULY, 1926, lightning struck the Navy Arsenal at Denmark Lake, New Jersey. The explosion demolished the \$80,000,000 plant, rocked the countryside, left thousands homeless and many dead. While the community fled in terror, fresh explosions hurled fragments of shell and debris far and wide.

High upon the roster of those who responded to the call of duty were the telephone workers. Operators in the danger zone stayed at their posts. Those who had left for the day and others on vacation, on their own initiative, hurried back to help handle the unprecedented volume of calls. Linemen and repairmen braved exploding shells to restore the

service. Within a little over an hour emergency telephone service was established, invaluable in caring for the victims and in mobilizing forces to fight the fire which followed.

In spite of repeated warnings of danger still threatening, no telephone worker left the affected area.

Through each of the day's twenty-four hours, the spirit of service is the heritage of the thousands of men and women who have made American telephone service synonymous with dependability. In every emergency, it is this spirit that causes Bell System employees to set aside all thought of personal comfort and safety and, voluntarily, risk their lives to "Get the message through."

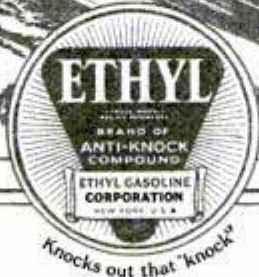
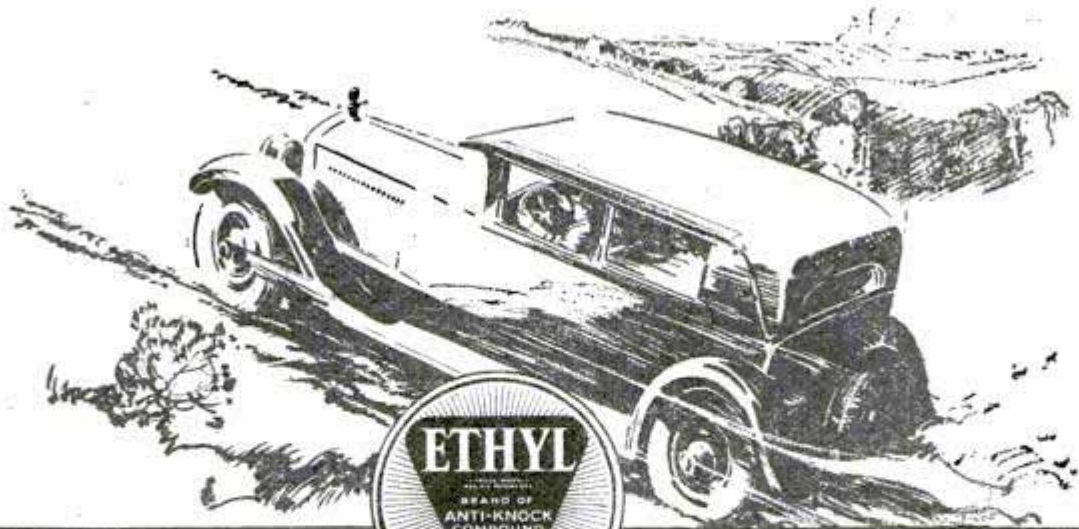

Whatever your driving conditions

—*climate—weather*

—*temperature—altitude*

your car will run best on

ETHYL GASOLINE

There is nothing mysterious about Ethyl Gasoline. It is selected motor gasoline containing "ETHYL" fluid, the compound developed by General Motors Research to take advantage of the higher compression created by carbon or by advanced engine design.

So effective is "ETHYL" fluid—a patented compound containing tetraethyl lead—that less than a teaspoonful to a gallon of gasoline gives you car performance you have never known before.

You get more power on hills and heavy roads, quicker acceleration, reduced gear-shifting and a cooler engine—and *as for high compression engines, Ethyl Gasoline made them possible!*

More than 1,000,000 car owners are now riding with "ETHYL." And its price is merely the price of good gasoline plus the few extra pennies that the "ETHYL" ingredient costs.

ETHYL GASOLINE CORPORATION . 25 Broadway, New York City

ETHYL GASOLINE IS THE YARDSTICK BY WHICH OTHER GASOLINES ARE MEASURED.

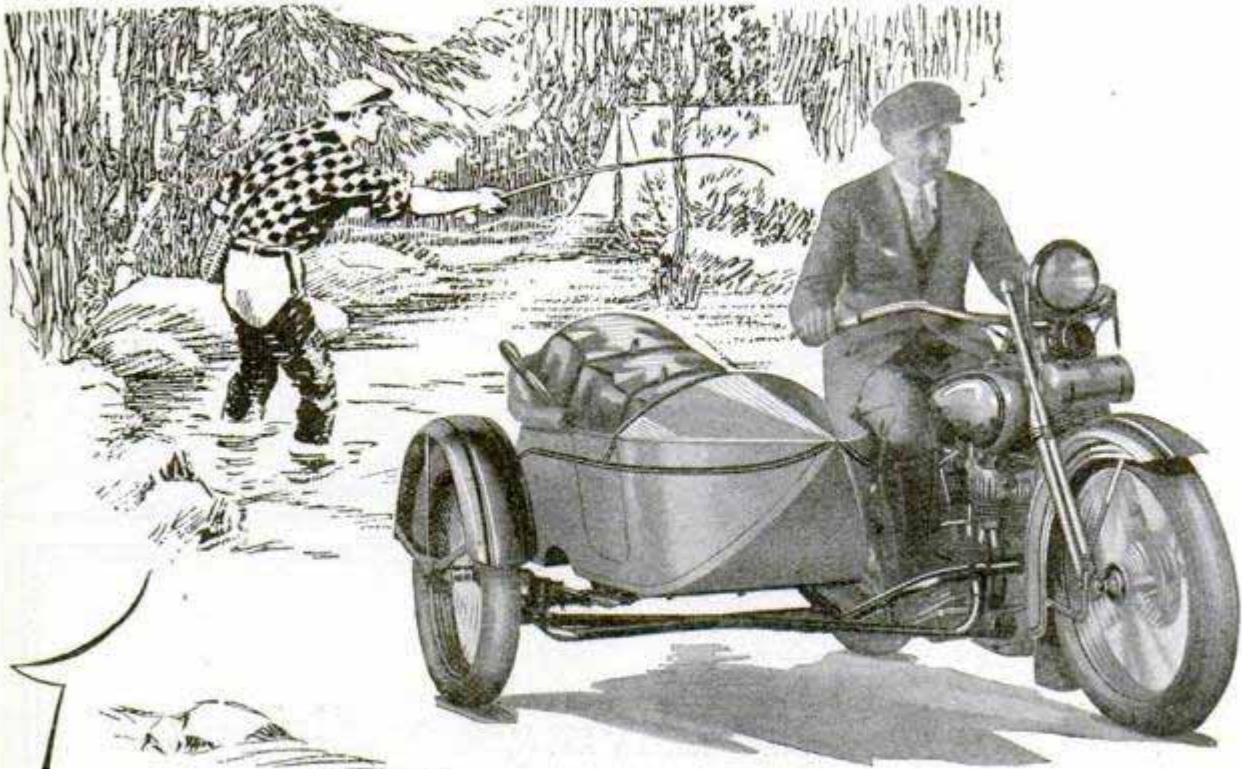

Where the Big Ones Rise!

SOME place, far off the beaten track, there's a shimmering lake or a cold, rushing stream where the "big ones" lurk. You know the place!

Pack up your old kit bag — take a friend along in the chummy sidecar, and be on your way to a holiday crowded with happy, care-free sport.

The Harley-Davidson takes you wherever you want to go — comfortably, swiftly and economically. Upkeep? *2¢ per mile pays for gas — oil — tires and all!* Front and rear brakes, and other great features are built into the new 1928 models.

Prices as low as \$310 f.o.b. factory, and your dealer's convenient Pay-As-You-Ride-Plan make the Harley-Davidson easy to own. You'll enjoy a demonstration. *Send coupon for catalog.*

HARLEY-DAVIDSON MOTOR COMPANY
Department P
Milwaukee, Wis.



The Single — famous Harley-Davidson solo mount that travels 80 miles to the gallon of gas. Priced at \$235 complete, f. o. b. factory.

HARLEY-DAVIDSON MOTOR CO.,
Dept. P., Milwaukee, Wis.

Interested in Twin Single.
Send catalog and complete details.

Name.....

Address.....

Mail the
Coupon!

HARLEY-DAVIDSON

Motorcycles

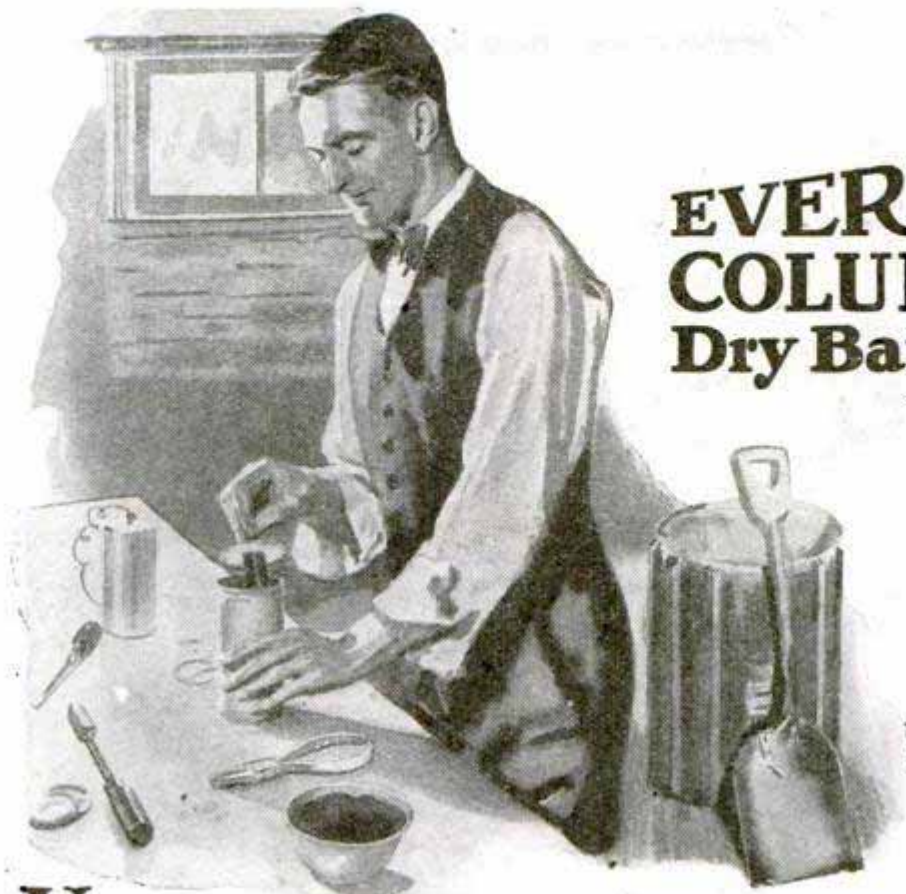

EVEREADY COLUMBIA Dry Batteries

-they last longer

You
needn't experiment with batteries

THE field for building things and experimenting with new ideas is so big it's a waste of time to try out different kinds of dry batteries. If there is anything in the electrical field that's fixed, it's the six-inch dry cell with the Eveready Columbia label. We did

the fixing. Into it we put all our 33 years of battery making, and believe us when we say the Eveready Columbia Dry Battery has no superior.

NATIONAL CARBON CO., INC.
New York  San Francisco

Unit of
Union Carbide and Carbon Corporation

FOR RADIO: Insist on the No. 7111 dry cell, six inches of battery goodness, scientifically designed to give its best results on radio sets using tubes of WD-11 and WX-11, and UV-199 and UX-199 types.



A *reliable* BENCH LATHE at a price you can afford

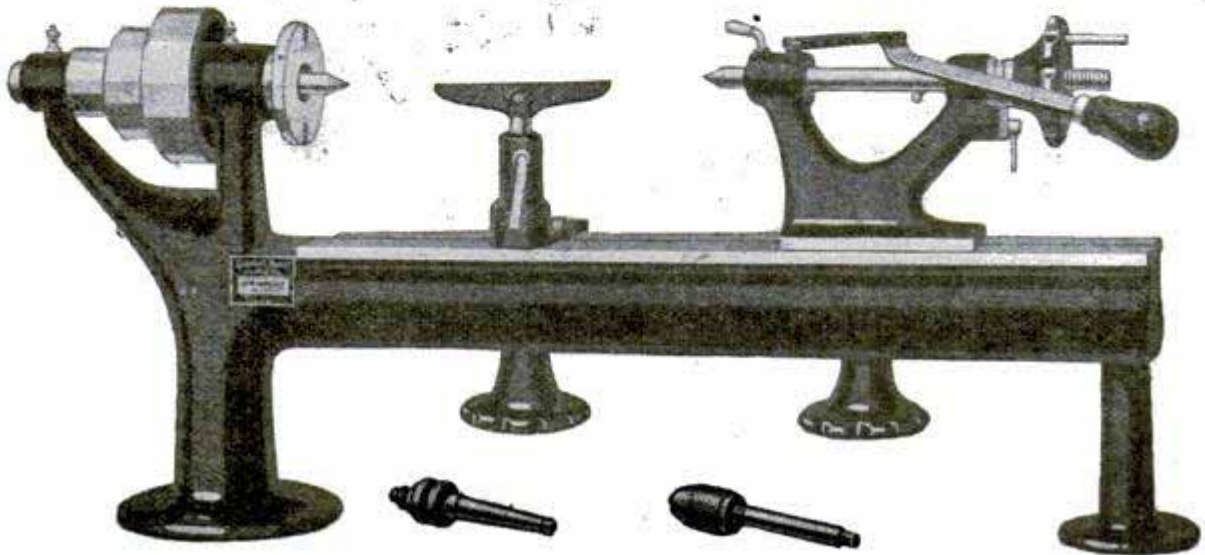

No 125—\$40

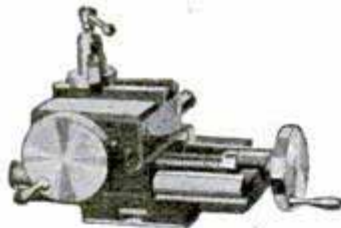

No. 132 Slide Rest
List \$17.50



No. 128 Turret Attachment. List \$50.00



No. 194 Saw Table
(saw not included)
List \$17.50

If you don't require ultra precision, but do want a reasonably accurate lathe, this one will serve your purpose and meet your pocket-book.

This lathe is sturdily built and dependable, and is designed especially for use in trade schools, repair shops and the home workshop.

It has Milled Bed and Tail Stock with Milled Base, both Screw and Lever Feed and 3-Step Cone Pulley. Capacity: 7" swing; 12" between centers. Live Spindle fitted with cone bearing. Measures 25" over all and is 11½" high.

No. 125 . . . List \$40.00.

No. 494 Bench Lathe is similar, but has larger T Rest and longer bed. Capacity 7" swing; 18" between centers. List \$44.00.

Either lathe can be driven by a ¼ H. P. motor.

Ask to see these Lathes and Accessories at your dealer's. Or write us for Lathe Booklet, which will be sent FREE on request.

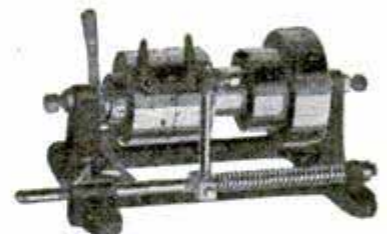

No. 130 Countershaft
List \$12.00

GOODELL-PRATT COMPANY, GREENFIELD, MASS., U. S. A.

MAKERS OF *Toolsmiths*, MR. PUNCH

GOODELL-PRATT

1500 GOOD TOOLS



CORONA in *colors!*

[Channel blue]



Write us today for a free copy of this illustrated folder showing the new Duco finish Coronas in actual colors.



CORONA has caught the colorful spirit of modern times! Scarlet, blue, green, maroon, cream, lavender—there is a Corona for every decorative scheme. (And, of course, the standard black Corona.) When you buy Corona, you know you are getting the utmost value in portable typewriters—the only portable with a twenty-year record of satisfactory performance. More Coronas are in use than all other makes of portables combined. See these new colored Coronas at the nearest Corona store. Convenient payment plan.

L. C. Smith—the Ball-Bearing Office Machine. Its light touch and easy action increase output, eliminate fatigue.



L. C. Smith & Corona Typewriters Inc
Established 1903

Sales offices in principal cities of the world
312 E. Washington Street, Syracuse, N. Y.

Delta Handi-Shop

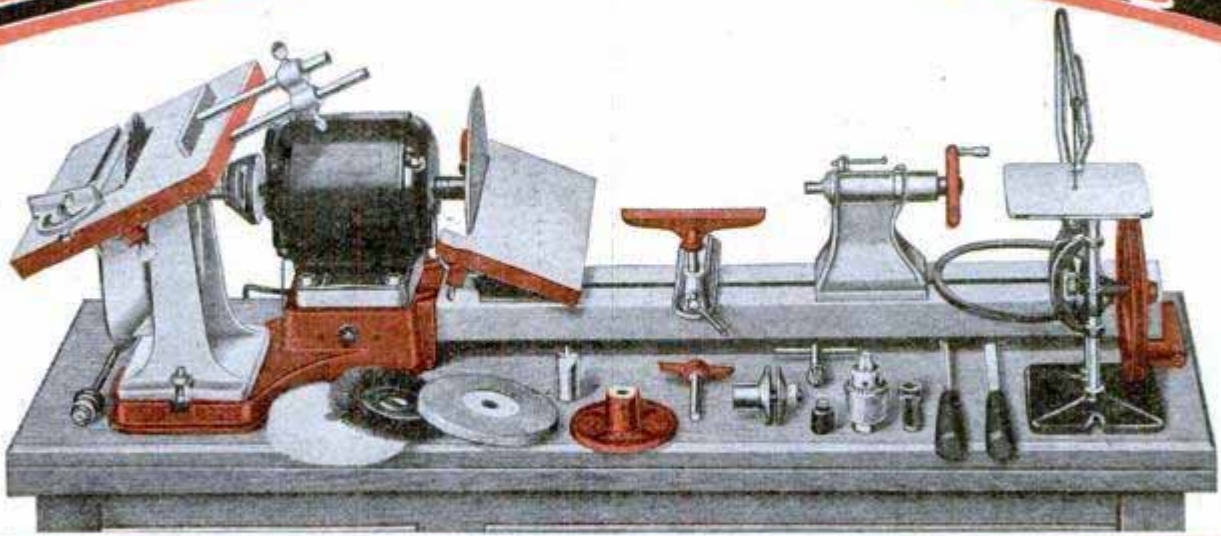

Numerous Tool Combinations are Possible

This remarkable shop does away with the constant changing and breaking-up of set-ups—heretofore one of the greatest drawbacks in the average workshop. The Delta's *big, powerful, fully-enclosed* motor, with its great overload capacity, has *two shafts—so as many as three tools can be ready for work at one time*. Suppose you have cut your work on the Circular Saw—you immediately sand it smoothly to the line without changing or breaking up the set-up. Or, you have a lathe job between centers—a tool needs sharpening—you grind it without breaking up the lathe operation. Combination after combination, possible because of the unusual design of the Delta Handi-

Shop, could be described here if there was room.

Keep in mind that the Delta Handi-Shop is a *big, sturdy, practical* unit for home or commercial use, with so much genuine quality and real machine-value built into it that our customers everywhere do not hesitate to voice their satisfaction. It is really easy to make the many attractive things that every ambitious man wants to make if you do not handicap yourself with inefficient tools.

We earnestly urge you to send for our handsome, big, 2-color folder that completely illustrates and describes the Delta Handi-Shop. That shows you many of the beautiful things you can easily make. How you can earn money in full or spare time. How to develop your ideas and inventions. How to work for profit, recreation and health! That shows you a big true picture, in actual colors, of the Delta Handi-Shop itself. That proves to you, by actual photographs, the exceptionally large range of work possible. That shows you examples of unusual work.

If You Would Gratify Your Longing

to make beautiful things—develop your inventive and creative ability—increase your earnings—better your health through interesting diversion—then do not fail to send the coupon.

Delta Specialty Co. (Dept. MP328)
858 3rd St., Milwaukee, Wis.

Send me your illustrated color folder describing Delta Handi-Shop. Tell me about your Free Trial Offer, Free blue prints and Easy Payment Plan.

Name.....

Street Address.....

City.....State.....



"I'll be there on the dot!"

New Model

Pocket Ben

You can be on time if you have a sturdy, reliable watch.

The new model Pocket Ben is that sort. And he's mighty good-looking, too—a favorite among busy men.

Sold everywhere for \$1.50. With night-and-day dial, \$2.25.

Built by the makers of Big Ben and other Westclox

WESTERN CLOCK COMPANY
La Salle, Illinois



New Auto Clock

Attractive, convenient, reliable. Fits any car. Quickly attached on dash or above wind-shield. Price \$2.50.

Thompson BEATS the World on BOATS

THOMPSON BOATS CATALOG FREE!



OUTBOARD MOTOR BOATS—A complete line of strictly up-to-date racing models, good for over 30 miles an hour. Also some entirely new models for general pleasure use with a speed of 20 to 26 miles an hour. Built strong and durable and absolutely safe.

Rowboats \$44.00 and up

The most complete line ever offered, at real money-saving prices.

Canoes \$48.00 and up

Some all wood, others canvas covered. Light, swift, safe, strong and durable. Choice of many distinctive color combinations.

Motor Boats

With or without Engine. For Lakes, Rivers, Shallow water and weeds.

CATALOG FREE — SAVE MONEY — ORDER BY MAIL

Please state the kind of boat you are interested in (30)

TWO LARGE FACTORIES

THOMPSON BROS. BOAT MFG. CO.

213 Ann St.
PESHTIGO
WISCONSIN

(Write to
Either Place)

113 Elm St.
CORTLAND
NEW YORK

Walsh Garden Tractor

and Power Mower
Plows, Seeds, Cultivates, Mows Lawns & Hay
For Gardeners, Florists, Fruitmen—Walk or Ride
SPECIAL FACTORY PRICE
Single & Twin Engine-Belt Jobs. Catalog Free
Minneapolis, Minn.
WALSH TRACTOR CO. 8328 Talmage Av. S.E.

DIAMONDS

Write for this Beautifully Illustrated CATALOG

Buy From Diamond Importers
Since 1879 we've imported our diamonds—save middleman's profits. Blue white grades only. No risk. Money back if not satisfied. Cash or credit. One year to pay. \$1,000,000 stock.

Write for Catalog Hundreds of bargains in Diamonds. Watches, Jewelry, etc. It brings our large Jewelry Store right into your home. Buy diamonds like an expert. Know grades, qualities and values before buying. Contains information other jewelers dare not tell, such as weights and grades of diamonds.

STERLING DIAMOND & WATCH CO., Inc.
1540 Broadway Dept. 2439 New York

A COMPLETE JOB

Without using other equipment this Junior Wood Worker has all the tools necessary for all types of wood working.

Shipping weight 350 lbs.

The Cost is Reasonable—The Results The Best

Carpenters, Furniture Makers, Repairers, Home Shop Owners and others have all profited by having this Wood Worker at their service.

Sold With or Without Motor

KORNAU MACHINE CO.
Station A,
CINCINNATI, OHIO

Write for details

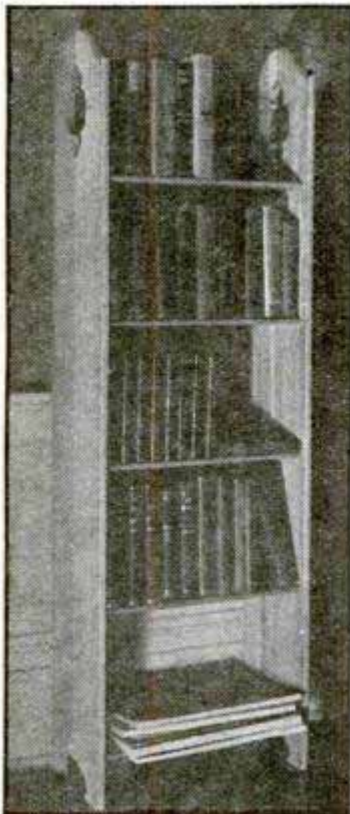

BOOK STAND
See LePage's Book, page 18

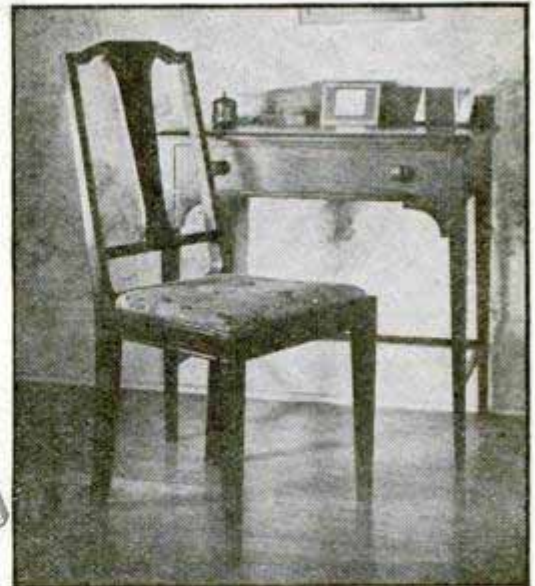
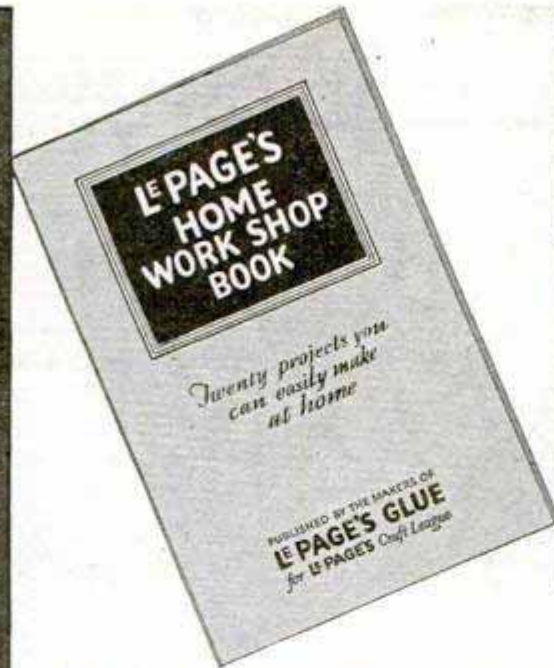

TABLE DESK AND CHAIR
See LePage's Book, pages 15 and 16

Here's LePage's New Home Work Shop Book—Handed to You for a Dime

A book that cost us \$3316.57 to prepare

Contains complete, easy-to-follow directions for making 20 attractive pieces of household furniture

Any man handy with tools can make these handsome, useful articles right at home

EACH piece of furniture was designed for LePage's by an expert—William W. Klenke, Instructor in Woodworking, Central Commercial and Manual Training High School, Newark, N. J. Assurance is given that each article and the directions for making it are perfectly practical.

The directions for each are given in three parts, namely: complete dimension drawing of all the parts, simple printed directions for making given step by step from start to finish, and a photograph of the finished article. Suggestions for suitable woods to use and directions for the best ways to finish each are also given.

The photographs shown on this page show the pleasing results you can obtain for a few evenings' fun (not really work) during the winter. And in addi-

tion to the 4 articles shown here, the book includes the following 16 articles: Occasional Table, Spanish Ship Model, Folding Sewing Screen, Fernery Stand, Tilt Top Table, Piano Bench, Costumer, Priscilla Sewing Box, Cedar Chest, Card or Console Table, Turned Bench, Dressing Glass, End Table with Book Trough, Foot Stool, Back Rest and Hanging Book Shelves. Where else could you get complete directions for making all these things for only 10 cents?

Send 10 cents for this NEW LePage's Home Work Shop Book

OVER 40,000 copies have already been sold. Just write your name and address on the coupon below, tear it out and mail to us today with 10 cents in coin or stamps, and we will at once send you a copy of LePage's New Home Work Shop Book, postage paid. Address LePage's Craft League, 583 Essex Ave., Gloucester, Mass. Tear out coupon now so you won't forget it.



SMOKING CABINET
See LePage's Book, page 13



LE PAGE'S GLUE

**HANDIEST TOOL IN
YOUR WORKSHOP**

LEPAGE'S CRAFT LEAGUE,
583 Essex Ave., Gloucester, Mass.

Gentlemen: Enclosed please find 10 cents (coin or stamps) in payment for LePage's New Home Work Shop Book. Please send a copy of this book to

Name.....

Street.....

City..... State.....



Cracked Walls easily fixed

IT'S SO easy to make cracked walls or ceilings as good as new with Rutland Patching Plaster. You just mix with a little water and fill the crack or hole. Anyone can do it! No muss or bother.

Rutland Patching Plaster makes a perfect patch that's as lasting as the wall itself. It will not crack, crumble, shrink or fall out.

Paint, wall paper and hardware stores sell Rutland Patching Plaster. If your dealer hasn't it, we will mail a package direct and you can pay the postman 30c plus postage. Rutland Fire Clay Co., Dept. V-5, Rutland, Vermont. Also makers of Rutland Roof Coating.

GOVERNORS
FOR GAS OR AUTO ENGINES
CANDEE-SMITH GOVERNOR CO., SPRINGVILLE, N. Y.
ALSO 54 CARLSTON ST., ST. CATHERINES, ONTARIO



Gas Engines-Air Motors-LOW PRICES-HIGH QUALITY

We now handle the famous **SEAMAN** gas engines in both commercial and marine type. Patented features make these engines unexcelled in service, economy and endurance. Supply headquarters for Bearing, Belting, Books, Brass, Electrical Supplies, Engine Plans, Fibre, Gears, Lathes, Machines, Pulleys and Supplies for **Handy Men**. Complete Catalog 25c—Refunded First \$2 Order

AMALGAMATED SALES AND SERVICE CORPORATION
327-M SOUTH LASALLE STREET CHICAGO, ILL.



Buy a BULOVA WATCH —the Modern Way

WHAT YOU DO—
SEND A DOLLAR with Name and Address, and brief note telling us something about yourself.
Simply state: (1) how long at address, (2) age, (3) married or single, (4) name and address of employer, (5) nature of work, (6) how long in employ.
All information held strictly confidential—no direct inquiries to employer.

You pay the Nationally Advertised Cash Price — **No More \$28.50**
\$1 with order, \$2.75 a month

WHAT WE DO—
Upon arrival of your order, we will open a 10 month Charge Account and send selection for approval and 15 DAY TRIAL. If satisfied, pay \$2.75 monthly; otherwise return and dollar will be refunded.



L.W.SWEET Inc

To Any Adult interested in the purchase of Diamonds, Watches or Jewelry we will send without obligation our beautiful booklet illustrated in colors.
DEPT. 68-H
1660 Broadway
NEW YORK

MAKE YOUR FORD Into The "LARK"

\$5.00 Red-i-Kut life size patterns Class-Snap Famous sure-fit RED-I-KUT life-size patterns and picture instructions show how you can easily convert your Ford into this **Fast, Saucy, Sport** Car as thousands have done, with easily obtained materials. No need to lay up the car. Rear seat folds, making 4-passenger car. Send 10c coin for actual body photo and new manual of other distinctive sport body patterns from \$5.50 up—"**RSO**" Steel "Swing-Lo" trims, Tops and Windshields. **ORDER RIGHT NOW.**
KUEMPEL COMPANY, 94 Kuempel Bldg., GUTTENBERG, IOWA

MOTORCYCLES

Price \$10 and up purchased through our Co-Operative Plan for as low as \$1.00 down and \$1.00 per week **Indians Harley-Davidsons Ace Henderson and Clevelands**
Send ten cents for Bulletin A. Motorcycles shipped to all parts of the world
WALKER-INDIAN CO., 78 Brookline Ave., BOSTON

30 Days' Free Trial
New Models now ready for delivery direct from our factory. **Astonishing low prices and terms.** Do not buy until you get them. **RIDER AGENTS WANTED** to ride and exhibit sample. Make big money. Many models \$21.50 up. **Guaranteed \$1.50 each, wheels, tires, lamps, horns, equipment at half usual prices. Send No Money.** Write for our marvelous prices and terms on **RANGER Bicycles.**
Mead CYCLE CO. Dept. F-108 CHICAGO





Laugh at Cold Weather

Get out your car. Use it in any kind of weather, cool or cold, blizzard or sunshine, makes no difference, for a

Marvelous Invention Starts Your Car in 2 Seconds in Any Weather

Yes, this is true. Not a bit of exaggeration. No matter how cold it is, no matter how frosty the motor, you can start your car instantly with this new device, the Impelerator. Works from the Dash. Once installed always ready, no extra attachments, no fussing. Always makes starting easy.

Saves Batteries Saves Gasoline

The Impelerator is an amazing invention designed to put POWER into your motor when needed most. No flooded cylinders. No trouble to start in ANY KIND OF WEATHER if you have an Impelerator attached to your Dash. You will find this amazing device will save many times its cost in taking the strain off the battery, in saving gasoline, to say nothing of eliminating trouble and annoyance.

Amazing Results

Truly startling results have been had whenever the Impelerator has been used. Its simplicity, its effectiveness, make it a pleasure to drive any car in the winter. Four cylinders, six cylinders, eight cylinders. All are alike when equipped with the Impelerator. This marvelous device makes cars start easily in any kind of weather. It puts the vital vapor that spells Power into the heart of your engine and makes it start like a race horse.

Over 200,000 Sold

The Impelerator is a wonderful adaptation of a scientific principle which enables you to start your car instantly in any kind of weather. Over 200,000 have been sold and no owner would sell it at any price if he could not secure another. Letters galore testify to the wonderful value of this amazing device, the cost of which is so little as to be insignificant.

Agents Wanted

Men who like to sell things, men who want to make more money, to be independent of the daily grind of a mere job, men who understand how easy it is to sell a really good thing, write quick for full particulars of the offer which should enable any one to make **Big Money**

Don't wait a day. Don't give someone else the chance to get in ahead of you. Grab good territory while it is open. Write or wire now. We believe there are tremendous possibilities in selling this moderate priced device, the Impelerator, which solves most motorists' winter troubles. Write or wire today.

IMPELERATOR CORPORATION

Dept. 938

25 E. Jackson Blvd.

CHICAGO

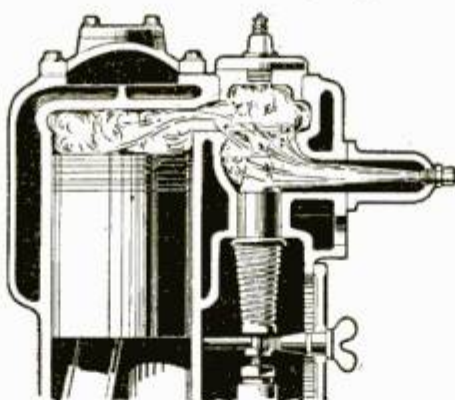

Puts Power Here

Drive All Winter

You can get real fun out of winter driving for you can let your car stand anywhere without worry. When you are ready to go, no matter what the temperature, use your Impelerator to start your engine instantly. The cost is practically nothing. It fits any car and you can install it yourself in a few minutes, or any garage will install it for you. No extra attachments of any kind, just the complete Impelerator which we send to you, designed to make cold motors start instantly.

Sent on Trial

Thousands of cars equipped with the Impelerator are proof positive that no claim is exaggerated, that the Impelerator will do all and more than we claim for it. As Further Proof, we agree to give you your money back if you install the Impelerator and are not more than satisfied with the result. Try it one day, five days, ten days if you like and if you don't find that it's a real pleasure to start on a cold morning, if you don't find that it always works and that it eliminates all starting trouble due to a cold engine, send it back and we will refund to you every penny that you have sent us. Could anything be more fair, could anything be more positive proof of the tremendous value of this automobile device?

Impelerator Corporation, Dept. 938
25 E. Jackson Blvd.,
Chicago, Ill.

You may send me Free information about your trial offer on the Impelerator and tell me how I can have one on my car.

If Interested in Agency Proposition—Check Here

NAME

STREET No.....

CITY

STATE

New! 12" BAND SAW

Made by the Manufacturers of the Famous Up-to-Date Home Craftsman Shop

The Up-to-Date Band-Saw can be operated by direct belt drive from regular Up-to-Date Motor, or any individual motor or gasoline engine or line shaft or any motor connected with any Work Shop. It features a 45 degree tilting table, a riter and side gauge. Constructed completely of semi-steel. The shafts are steel hardened ground, the machine is positively vibrationless. Inspect this machine at our expense. Take advantage of the 10 day free trial, use the order blank below. Send your order today.

Detailed Specifications of the Up-to-Date Band Saw

- Saw Table 8-in. x 10-in.
- Fly Wheels 12-in. Dia.
- Base 17-in. x 3-in.
- Sawing Swing 12-in.
- Sawing Thickness 4 1/2-in.

10-Day FREE Trial



ONLY \$10.00 DOWN

\$39.00 WITHOUT MOTOR Up-to-Date Super-power Motor **\$40.00**

ORDER BLANK

Up-to-Date Machine Wks., Inc., Dept. 20, 2915 S. Wabash Ave., Chicago, Illinois.

Enclosed find check or money order for the commodity marked below.

- \$35.10 full purchase price of 1 Up-to-Date Band-Saw less 10% discount for cash with order.
- \$71.10 cash in full less 10% for 1 Band-Saw and 1 Super Power 1/2 H. P. Motor.
- \$10.00 1st payment on Band-Saw. If I keep it I agree to remit \$10.00 monthly until paid in full.
- \$10.00 1st payment on Band-Saw and Motor.

Above payments returned if not satisfied after 10 days.

SIGNED.....
 ADDRESS.....
 BANK REFERENCE (Given on Time Payments).....

PIN A DOLLAR BILL TO THIS

and get this genuine leather 5-window-pass case. Holds Railroad Passes, Auto License, Lodge Cards, etc. Masonic or Shrine Emblem stamped on in gold free. Your name or other stamping 35c extra per line.



We carry **EVERYTHING MASONIC**

Send for free catalogue No. 10 P. M., of Books, Monitors, Jewelry; No. 11 P. M., of Lodge Supplies.

We Have Been in Business 67 Years!

REDDING & COMPANY

200 Fifth Ave., Desk P. M.

NEW YORK

AGENTS

HERE is a new Household Device that beats a vacuum cleaner and all attachments. It not only sweeps thoroughly and cleans walls and ceilings but also washes and dries windows and scrubs and mops floors. Requires no electricity. Every home a prospect. Only \$2.95. Over half profit. Write your name and address at the edge of this ad and mail to us today for complete selling terms.

HARPER MFG. CO.
 543 Seventh St., Fairfield, Iowa

DEALERS Write for Terms

LACO OIL BURNER

Always Dependable Most Economical

Whichever size LACO you install—whether for small home, mansion, building or apartment—it is always dependable and most economical. Five sizes, each the lowest price on the market. Automatic, clean heat; requires no adjustments; safe as a gas range; as simple as the ordinary kerosene lamp. **GUARANTEED.** Write for prices and details of LACO trouble-free, dependable, economical heat.

LACO GAS BURNER CO.
 704 Cass St.
 Griswold Iowa

SAVE 1/2

We sell everything in plumbing, heating, hardware, paint, roofing and millwork supplies. Due to large-quantity buying, we are able to offer you Grade A merchandise at enormous savings. Satisfied customers in every State. Send for our elaborate catalog—over 95 pages of surprising bargains.

STANLEY PLUMBING SUPPLY CO., Inc.
 400 N. 12th Street, PHILADELPHIA, PA.

KINKADE GARDEN TRACTOR AND POWER LAWNMOWER

A Practical, Proven Power Cultivator for Gardeners, Suburbanites, Truckers, Florists, Nurserymen, Fruit Growers.

AMERICAN FARM MACHINE CO.
 1058—33rd Ave. S. E., Minneapolis, Minn.

Catalog Free

LIGHTING FIXTURES

Ready to hang

Direct from the manufacturer. Completely wired, including glassware. Send for new catalogue No. 29. Just Reduced Prices. Special Proposition to Dealers.

Erie Fixture Supply Company, Inc.
 Station A ERIE, PA.

UP-TO-DATE MACHINE WORKS

ONLY \$10 DOWN



SENT ON TRIAL

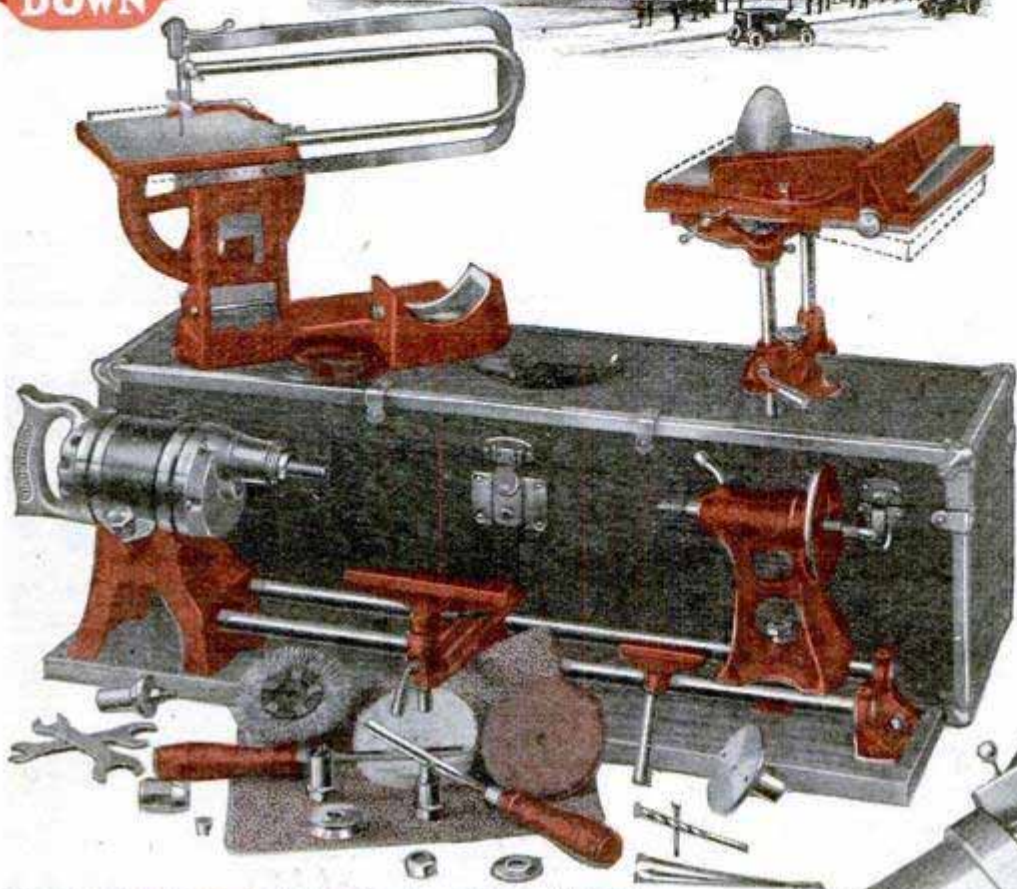

THE FIRM BACK OF THE UP-TO-DATE MACHINE SHOP

For 15 years "Up-to-Date Machine Works" has been a standard of perfection in mechanical production. It has built its business and increased production about the substantial guarantee placed on every one of over 1,000 commodities. "We place an unconditional guarantee as for satisfaction. If upon receipt of your order you find it is not up to standard, without question or delay every cent refunded." Such is the organization which manufactures, distributes and instructs owners of the Up-to-Date Home-Craftsman Shop.

This Outfit a Superior Development Over All Others

The Up-to-Date Home-Craftsman Shop can be used in any home lighting fixture, making of your old fashioned work bench a complete machine shop. Complete it is made up of a Super-Power Motor, a precision lathe (10" x 34"), featuring the bevel, a miter, side and depth gauges, a tilting table, jig-saw, and all accessories for buffing, grinding, cleaning and all portable or stationary drilling and sawing. This equipment will make you an advanced craftsman. Master mechanics have designed and skilled engineers have constructed this equipment which, after inspection, you will agree is the best of its kind. For those who build, invent, create and construct at home, it is unexcelled.

Our Latest Development 12" Band Saw

This, the latest development in band saw equipment, supplied with tilting table, miter and side gauge, complete semi-steel construction; operated with either individual motor or regular Up-to-Date Super-Power Motor. For complete details mail coupon below.



Individual Headstock

Supplied where no electricity is available. This headstock can be operated by gasoline engine, individual motor, or line shaft. Included with our regular Up-to-Date Home-Craftsman Shop upon request. Note circular saw arrangement together with lathe bed.



THE SUPER-POWER MOTOR

This motor, the drive power of our shop equipment, is positively the latest development in electric drill motors. It is guaranteed as for complete satisfaction. It produces 1/2 H.P. operating on 110, 220, or 32 volt currents either A.C. or D.C. and is guaranteed not to burn out or wear out in the ordinary use of home or factory. It drives the lathe, circular saw, jig saw, a 15" band saw, a 4" jointer with amazing power and durability. For further details on this Super-Power Motor and the perfected shop it operates, mail the coupon below TODAY.

Our Educational Department

Under Personal Supervision of Master Craftsman Eugene E. Maurey offers special correspondence crafts course, giving in simple detail full information on home handcraft. Blue print service included in this course FREE to our users.

THE UP-TO-DATE GUARANTEE

After receipt of the Up-to-Date Home-Craftsman Shop if you are not satisfied, without question or delay, every cent refunded and return express charges paid.

Carefully Designed Blue Prints FREE TO SHOP OWNERS

Working blue prints of furniture and other items which are useful about the home and shop. Hundreds free to shop owners.

YOUR own terms on purchase. \$10.00 down—balance arranged to your convenience. Liberal discount for cash.

4' Jointer MODEL A-1928
Accessory to Up-to-Date Shop



10 DAY FREE TRIAL

Use our shop for 10 days at our expense, if not satisfied—Return—express collect.

MAIL THIS For Full Particulars To UP-TO-DATE MACHINE WORKS
2915 South Wabash Ave.,
Chicago, Ill.

MANAGER, Dept. 2:—Without any obligation, please send me full particulars about your shop, 10 day free trial, free blue prints, free crafts course. Also \$10.00 down payment offer.

Name.....
Address.....

NOW! You Can Do Your Own NICKEL-PLATING

Make \$150 to \$500 a Week



Everyone Is Enthusiastic About This Outfit

New Scientific Invention Enables Anyone To Nickel-Plate Anywhere with Aladdin Portable Outfit
 This Marvelous Invention enables anyone to NICKEL-PLATE anything—anywhere; in the Home, Garage, Office, Store or Shop—in fact, you can do all the NICKEL-PLATING on any automobile with the

\$650
 F. O. B. RACINE

ALADDIN ELECTRO PORTABLE OUTFIT in a very short time—without SEE THE NICKEL FLOW removing any of the parts. This interests every auto owner (and others) because you can NOW take the Plater to the job instead of taking the job to the Plater. This offers wonderful ECONOMY to users and BIG MONEY-MAKING possibilities to AGENTS. Be the first in your locality. **WRITE FOR FREE BOOKLET.**

P. J. F. BATENBURG Dept. 26 RACINE, WISCONSIN **-AGENTS- WANTED EVERYWHERE**

AGENTS

This Money-making Invention is paying our Men a Fortune!

Here's your opportunity to make real money! My patented double edge razor blade stropper is sweeping the country with the biggest and easiest sales that have ever been made by agents. It sharpens all edges of the blade without removing the blade. It permits men to enjoy 500 clean satisfactory shaves from a single razor blade. This appeal of economy and practicability gets quick customers and many friends for you. It sharpens with a true diagonal stroke giving the blade the same keen edge the barber gives razors he strops. It retails for only \$2.00 and pays you 100% commission on each and every one you sell. The double edge has been a steady seller from the minute it was put on the market. V. Fisher of Arlington, N. J., sold 12 in 15 minutes—L. Storr, of St. Louis, sold 36 the first day and H. Gardner, of Chicago, sold one gross the first week. This gives you an idea of the big profits you can make.

TESTED SALES PLANS FREE
 Don't send me a single cent. All I ask is that you send me your name and address and receive my literature which shows you the many tested plans that pave the way for a profitable all-year-round business. Write today. There is no obligation. Do it this very minute before you forget and miss out on this big paying proposition.
MORTON SALES CO., Dept. 802, 10-15 46th Ave., Long Island City, New York

I'll Pay You \$40 A DAY!

To Show My Mysterious Cigarette Lighter to Men

Quick, easy profits for you with this amazing invention. Lights cigarettes and cigars in strongest wind. New principle of ignition. Does work of expensive lighters. But sells for only 50c. Guaranteed for 10 years.

Morgan sold 60 in one day. Johnson cleaned up \$63.00 in two days. No experience necessary. Work full or spare time. Send \$3.00 for dozen lighters or 50c for agent's sample. You make 100% clear profit. Satisfaction guaranteed or money back.

MASTERLITE MFG. CO., Desk S-23
 110 E. 23rd Street NEW YORK CITY

MOVIES AT HOME

Many models of genuine MOVIE MACHINES, some as low as \$3.75, all using standard size big theatre films. Our stock of films is the most complete and lowest in price—with an exchange service. Films of leading stars and religious subjects are available. DON'T DELAY. WRITE FOR FREE INTERESTING CATALOGUE NOW!

PARAMOUNT MFG. CO.
 Dept. 1371 BOSTON, MASS.

HB PAINT SPRAY DOES THE WORK OF FIVE MEN

"Paint Spraying Brings Quick, Easy Profits"

HB does the work of five brush painters. One man can do the work of five painters with brushes with an H B Portable Paint Spray. Does automobile painting, furniture refinishing, house painting, inside and out, at prices no one can touch, with big profits for yourself. Pays for itself—Only \$20 monthly. Easy payment terms brings it to you with practically no investment. **Thirty Days' Trial.** Write for valuable bulletins.

Hobart Bros. Co., Box M381, Troy, Ohio

EASY TERMS. 30 DAYS TRIAL QUICKLY PAYS FOR ITSELF.

Take Your Share of Real Fun!

Start now. Play a clarinet, the stellar instrument. A few lessons and you can play your first tune. Ahead lies months—yes, years—of wonderful, delightful fun! You will be sought to play in local bands and orchestras. You'll lead! And, it will be profitable!

The clarinet today is recognized as one of the most popular instruments. When a small down payment, easy terms, will secure this beautiful PAN-AMERICAN clarinet now, why wait until you have lost enthusiasm? You'll enjoy the intimate clarinet-piano concerts at home this month as PAN-AMERICANS are Easy to learn to play.

The PAN-AMERICAN clarinet is moderately priced, with* in your means, yet of superior quality, giving the real clarinet tone. The only moderately priced clarinet Factory Guaranteed. Suitable for all classes of work.

Free Trial Offer
 PAN-AMERICAN, manufacturers of America's Foremost High Grade, Moderately Priced Instruments, urges you (without obligation) to write to us this week, asking for complete details of our free trial offer and easy payment plan.

Write today for illustrated catalogue showing all band instruments

The Pan-American Band Instrument & Case Co. Dept. G-16 ELKHART, IND.

21 JEWEL-Extra Thin STUDEBAKER

The Insured Watch

Sent for Only—

Sold Only Direct from Factory

Save 30% to 50%!



JUST \$1.00 down brings you the famous 21-Jewel Studebaker Watch direct from factory. Balance in easy monthly payments. Buy direct and save 30% to 50%. Your choice of 80 magnificent, new cases and dials. Yellow, green and white gold effects. Exquisite thin models. 12 Size and 16 Size Studebaker Watches have 21 Jewels, 8 Adjustments—Insured for your lifetime!

Ladies' Bracelet Watches, Men's Strap Watches, Diamonds and Jewelry also sold at lowest prices and on easy monthly payments. Send coupon for full details.

**Special Offer
Watch Chain
FREE!**

For a limited time we are offering a magnificent Watch Chain Free. To all who write immediately we will include particulars of this astounding offer. Offer is limited. Send the coupon NOW!

Send Coupon for Free Catalog

The coupon below will bring you a copy of our beautiful new six-color catalog. It contains complete information on watch making. It tells how you can buy a 21-Jewel Studebaker Insured Watch direct from the maker—save big money and pay for it in easy monthly payments.

The Studebaker Watch Company is directed by members of the famous Studebaker family—known for 75 years of honest dealing.

STUDEBAKER WATCH COMPANY

Directed by the Studebaker Family—three-quarters of a century of fair dealing

WATCHES • DIAMONDS • JEWELRY

Dept. J907 • South Bend, Indiana

Canadian Address: Windsor, Ontario

New Jewelry Gift Book Now Ready!

Our new 72-Page Gift Book of America's lowest priced, high-quality Watches, Diamonds and Jewelry is now ready! Send coupon for your copy!

STUDEBAKER WATCH COMPANY

Dept. J907 South Bend, Indiana

Please send me your free catalog of Advance Watch Styles and details of your \$1.00 down offer.

Please send me free catalog of Jewelry and Diamonds.

Name.....

Street or R. F. D.

City..... State.....



Save on Ladies' Bracelet Watches, Strap Watches for Men, Diamonds and Jewelry. Sold on the easiest kind of payments!



4 SHIP MODEL PLANS \$1

Plans and Instructions for VICTORIA, Pirate ship, Clipper ship, HALF MOON—all for \$1. Big Bargain—Send NOW. Interesting catalogue 6c.

SEA ARTS GUILD

730-A Winnebago St., Milwaukee, Wis.

FREE TO BOYS

"THE SHOOTER'S ART" Tells how to hold, aim and handle rifles; helps you guide others in correct knowledge of guns. Gives facts that make crack shots. Contains safety and common sense instruction every parent and boy should have. Helps to make boys leaders. Your copy Free. Write at once.

The NEW BENJAMIN Air Rifle

America's Original Air Rifle **Outshoots All Others**

\$5 at your dealer's or sent postpaid. Write! BENJAMIN Air Rifle & Mfg. Co., 845 N. Broadway, St. Louis, Mo.



Part-Time Men Get This Suit FREE

Make \$45 a Week and up
Cash profits paid in advance
No question about it, any man can easily earn \$45 a week and up, just showing our wonderful outfit and taking orders for our high-grade tailoring. Never before such low prices and beautiful styles.

Your Own Clothes FREE

To introduce our unbeatable values, classy styles and perfect tailoring, we make this introductory free suit offer to those who qualify—something different, better, bigger, more liberal than any offer ever made. Handsome Carrying Case Outfit of large real cloth samples—everything furnished Free. Write today for free suit and big money-making offer.

SPENCER MEAD CO., Wholesale Tailors, Dept. Q-816, Chicago



Big Outfit FREE

\$351⁰⁰ CLEARED IN ONE DAY

So writes W. H. Adams of Ohio. Letter from V. A. Marini of California reports \$11,275 sales in three months. Jacob Gordon of New Jersey "54800 profits in two months." Alexander of Pennsylvania "53000 profits in four months." Ira Shook \$365 sales in one day. Bram bought one outfit April 5 and 7 more by August 28. Iwata, bought one outfit and 10 more within a year. Mrs. Lane of Pennsylvania says "sold 8000 packages in one day." J. R. Bert says "only thing I ever bought that equaled advertisement." John Culp says: "Everything Going Lovely. Crispette wrappers scattered all over town. It's good old world after all." Kellog, \$700 ahead end of second week.



WE START YOU IN BUSINESS

Furnish secret formulas, raw materials, and equipment. Little capital required; no experience needed.

BUILD A BUSINESS OF YOUR OWN

No limit to the sale of Crispettes. Everybody likes them. It's a delicious food confection. Write for facts about a business that will make you independent. Start now in your home town.

Profits \$1000 a Month Easily Possible

Send postal for illustrated book of facts. It contains enthusiastic letters from others—shows their places of business, tells how and when to start, and all information needed. Free. Write now!

LONG-EAKINS COMPANY

328 High Street

Springfield, Ohio

Going to Build Remodel or Repair?

DON'T think of building a new home or repairing an old one without a copy of our free woodwork catalog.

To those who contemplate building or remodeling, this book is a valuable work of reference. In it are found the latest ideas and most advanced styles for everything in millwork. It illustrates and describes windows and sash of all kinds, including porch and storm sash, doors, frames, mouldings, screens, porchwork, stairwork, hardwood flooring, interior finish, cabinet work—in fact, practically everything in manufactured millwork. Every article in the book shows a low money-saving price direct to you.

FREE ESTIMATES

Send us your lumber and millwork bills for a free estimate. Let us quote prices on your material and tell you the exact amount of freight. Then compare our prices with others. This service costs you nothing and places you under no obligation whatever.



CHICAGO MILLWORK SUPPLY CO., 1444 W. 37th St., Chicago, Ill.
PLEASE SEND ME YOUR FREE BOOK

Name _____
Town _____
State _____
Occupation _____ St. No. _____

Book is Free

EDWARDS METAL ROOFS

LAST LONGER · LOOK BETTER

SAVE YOU MONEY



Edwards Metal roofing, shingles, Spanish tile, sidings, ready-made garages and farm buildings, are rust-

proof, fire-proof, lightning-proof. Last three

times as long as ordinary kind.

Quality in every detail. Styles and types for every purpose. Easy

and economical to apply. Lifetime satisfaction.

We are the world's largest manufacturers of sheet metal building materials. We control every operation from the raw metal to the finished product. You can buy from us at manufacturers' prices and save all intermediate profits. Write today for our Free Samples and prices. Ask for Roofing Book No. 150 or for Garage Book.

FREE SAMPLES, The Edwards Mfg. Co.
Books and Estimates 300-350 Butler St., Cincinnati, O.

AGENTS 500% PROFIT GENUINE GOLD LEAF LETTERS

S guaranteed to never tarnish. Anyone can put them on stores and office windows. Enormous demand, large profits. Paul Clark says: Smallest day \$28.70. R. L. Reel made \$920 in two months. Write today for free sample and liberal offer to general agents. METALLIC LETTER CO., 433-B N. Clark St., CHICAGO

COOKS BY BURNING AIR

Does Away With COAL!
Converts any ordinary stove into gas range. Produces clean heat much cheaper and is far more efficient than coal. Burns 96% air and 4% kerosene. Installed in few minutes. Types for all heating purposes. Reliable distributor wanted. GLORIA LIGHT CO., 111-3 N. May St., CHICAGO

AGENTS: \$14 A DAY

Our wonderful new plan will put you in the \$5,000 class. 350 High quality products at low prices. Every one a household necessity. All fast sellers. Big orders in every home. Repeat business. Steady income.

NEW PLAN—BIG PROFITS

We show you new way to build permanent business. Big profits from the start. Work spare time or full time. No capital or experience required. Free outfit. Automobile given. Write now.

American Products Co., 192 American Building, Cincinnati, O.



FREE New Book FACTORY PRICES

Save $\frac{1}{3}$ to $\frac{1}{2}$

New FREE book quotes **Reduced Factory Prices**. Introduces sensational **5-Year Guarantee Bond** on Stoves, Ranges, Furnaces. 200 styles and sizes. Beautiful porcelain enamel ranges and combination gas and coal ranges in soft grey and delft blue.



Mahogany porcelain enamel heating stoves. Cash or easy terms—as low as \$3 down, \$3 monthly. 24 hr. shipments. 30 day free trial.

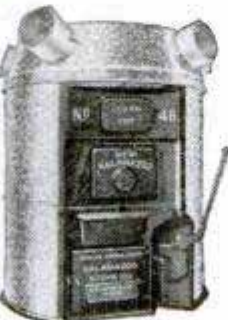

Pipe or Pipe-\$59.95 less Furnaces \$59 up

360 day approval test. Satisfaction guaranteed. 26 years in business, 600,000 customers. Write today for your copy of this FREE book.

KALAMAZOO STOVE CO., Mfrs.

391 Rochester Ave.

KALAMAZOO

MICH.

Ranges \$37.75 up

"A Kalamazoo Direct to You"
Trade Mark Registered

Beautiful HOUSES \$900 and BUNGALOWS

CAN BE BUILT FOR AND UP

This and many others in my new book, Building Plans for Modern Homes, will save you hundreds of dollars. One of the most complete and comprehensive books of plans ever published by any architect. New edition just off the press. Nearly 600 floor plans and photographs of Colonial houses, bungalows, etc., costing from \$200 up; gives sizes and cost to build. Sent postpaid for \$3.00.



FREDERICK H. GOWING ARCHITECT

101 Tremont St., BOSTON, MASS.

I Offer You \$2.50 a Month

and a

Write quick for new proposition. \$250 a month. Raincoats. All Colors. Your choice \$2.65. Part time \$2 hour. Complete line 60 patterns, silks, suedes, tweeds, Leather-Lyke. Outfit sent free postage prepaid. Write **COMER MFG. CO., Dept. W-5123, DAYTON, OHIO**



Developing Star Salesmen is my hobby!

No matter what you are doing now, you can earn **\$100 a week** if you will let me show you how to sell tailored-to-measure all wool quality suits for **\$23.50** and **\$31.50**. Complete selling outfit **absolutely FREE**. Liberal commissions paid in advance—extra bonus money—steady income from repeat orders. All you do is sell—we deliver and collect. A wonderful opportunity for ambitious men. **Write NOW** for choice territory.

W. Z. GIBSON, Inc., 500 Throop St., Dept. Q-516, Chicago



Learn RADIO for BIGGER PAY!



J. E. Smith President

Jobs paying \$50 and all the way up to \$200 a week are waiting for the Radio-trained man. Get into the new, growing Radio profession if you want to earn more money, have bigger opportunities for the future. I will train you at home in your spare time. Previous experience not needed—you learn quickly in a simple, clear and unforgettable way. Grade school education, or even less, is enough to start.

Earn \$15, \$20, \$30 Weekly Right Away "On the Side"

You learn it all by doing. So practical is the training you get that almost from the time you start you can put your new knowledge to use. Little Radio jobs I'll show you how to do in your spare hours can bring you as much as \$15, \$20, \$30 extra cash, weekly, after you get well started. This Radio training of mine is the one that's world-famous as the "Course That Pays for Itself." Many of my students put aside enough extra cash to start their own Radio business on graduation—all earned by this spare-time Radio work done while they are learning.

64-Page Book Sent FREE

Free—a 64-page book that tells you all about the bigger opportunities in Radio—the big money to be earned—how I'll prepare you thoroughly and completely for the Radio profession—how to make spare time cash. Gives all information about the six big outfits of Radio material I send you. You can build 100 Radio circuits with these outfits, yet there's no extra charge. Surprisingly low tuition fee can be paid in small monthly amounts. Get the proof. Radio needs you—learn what it has to offer you. No obligation for the book—it's sent free—just mail the coupon today.

Address: **J. E. SMITH, President**

Dept. 3H
National Radio Institute
Washington, D. C.



J. E. SMITH, President,
National Radio Institute,
Dept. 3H, Washington, D. C.

Dear Mr. Smith: Kindly send me your free 64-page book with all information about learning Radio for bigger pay. I understand this places me under no obligation.

Name.....
Address.....
Town..... State.....
Occupation.....

The Old Reliable Credit Jewelers **LOFTIS BROS. & CO.** EST'D 1852 Dept. L-894 108 N. State St. Chicago Ill.

DIAMONDS CASH OR CREDIT
Genuine Diamonds Guaranteed Bigger Diamond Ring Values!

Newer styles, finer quality, bigger values. We import our Diamonds from Europe—that's why we can sell to you for less. Our rings are solid 18-k white gold, magnificently engraved, and set with gorgeous blue white Diamonds of exceptional beauty. Order now!

No. 871 \$200 \$5 a wk.
 No. 872 \$125 \$3.25 a wk.
 No. 873 \$50 \$1.25 a wk.
 No. 874 \$100 \$2.50 a wk.
 No. 852 \$37.50 \$1.00 a wk.
 No. 847 \$150 \$3.75 a wk.

No. 857 Ladies' Wrist Watch
 Solid 14-k white gold case, 15 Jewels. \$27.50. \$2.75 down 2 month

Satisfaction guaranteed, or money back. Goods sent for your free examination on request. Credit terms: Pay one-tenth down; balance weekly, semi-monthly, or monthly at your convenience. All goods delivered on first payment.

Send for Free Catalog
 Big 132-page book, illustrating our Diamonds, Watches, Jewelry, Silverware, and gift articles for all occasions, sent absolutely free. Write today.
 "To Be Successful, Look Successful!"—own and wear a genuine Diamond!

Men's Diamond Rings
 Two exceptional values in men's Diamond rings. Each ring is solid 18-k white gold, hand carved and engraved, set with a magnificent blue white Diamond. Order yours today!

Wedding Rings
 No. 824—The "Elite" \$750 solid 18-k white gold set with 3 Diamonds, \$22.50; 6 Diamonds, \$32.50; 7 Diamonds, \$42.50; 9 Diamonds, \$52.50; 12 Diamonds, \$67.50. All platinum, \$25. With 3 Diamonds, \$60; 6 Diamonds, \$70; 7 Diamonds, \$80; 8 Diamonds, \$100 circled by Diamonds, \$200

17-Jewel Elgin No. 14 Thin Model
 White gold filled, 20-Year Quality Case; 12 size; silver dial; assorted patterns, \$22.50. \$2.35 down and \$2.35 a month.

Railroad Watches — Guaranteed to Pass Inspection
 HAMILTON No. 992. 21 Jewels. Adjusted to 5 Positions. Gold filled 25-Year Quality Case . . . \$55
 ELGIN'S LATEST RAYMOND. 21 Jewels, 8 adjustments. Runs 40 hours one winding. Gold filled 20-Year Quality Case . . . \$55
 ILLINOIS "BUNN SPECIAL" 21 Jewels. Adjusted to 6 Positions. Gold filled 25-Year Quality Case. 60 hours 1 winding . . . \$50

CREDIT AT CASH PRICES



HOLLAND PRINTS
 Wonderful new way of binding kodak pictures. Keep a photographic record. Sample Holland print from your negative for 10c.
 FRANK SCORIE, 43-H, SLEEPY EYE, MINN.

MOTORCYCLES

WE WILL TRUST YOU
 Pay As Low As \$2.00 per Week
 Hendersons, Harley-Davidsons, Indians
 Slightly used and rebuilt. Hundreds to select from.
 Send 10c for list today.
 MYEROW BROS. CO., 15 Berkeley St., Boston, Mass., U. S. A.

TRIPLE Your PROFITS DOUBLE Your SALES

Send for catalog, just off the press, chock-full of all the latest, best and quickest sellers in useful items for home, men, women and children. Jewelry, Silverware, Cutlery, Leather Goods, Electrical Appliances, Novelties, Gifts, etc.

SAMPLE BARGAIN Offer 4 PIECE FRENCH BRIAR PIPE SET \$12.00 Dozen
 Sample Outfit \$1.25 Plus Postage

Amberlite stems, plush lined box. Retail as high as the \$10.00 price stamped on box.

H. SHAPIRO, Dept. 82D, 81 Bowery, NEW YORK, N. Y.

Big Pay Every Day

Make \$100 a week right from the start writing orders for Hutchins tailored-to-measure trousers, knickers and riding breeches. They sell on sight! Every garment is strictly made to measure—not a stock proposition! We attend to deliveries and collections. Pocket large cash commissions in advance.

FREE OUTFIT! We furnish you new complete outfit and new model Ford car. No red tape—nothing to pay. Earn real money this new easy way. FREE trouser offer. Wear a pair of Hutchins trousers made to your measure. Send postcard today. Hurry!

3.00 HOUR

HUTCHINS PANTS CO.
 Dept. 211 Cincinnati, Ohio

Agents \$12.00 a day
NEW Self-Heating IRON

New invention now makes ironing easy in every home. Ends hot stove drudgery. Cuts ironing time in half. Saves steps. Costs one cent for 3 hours use. No attachments. No cords. No tubes. Gives quick regulated heat. Guaranteed. Sells fast. Mrs. Wagner, Ohio, sold 24 in few hours spare time. Moyer, Pennsylvania, made \$164 in one week. You can do as well. Work all or spare time. No experience needed. No capital. New plan. Simply take orders. We deliver and collect. Commissions paid same day you take orders. Send for exclusive territory and FREE OUTFIT OFFER. Write today.
THE AKRON LAMP CO., 483 Iron St., AKRON, OHIO

Do Your PRINTING

Cards, stationery, circulars, tag, labels, paper. Complete Outfits, \$8.85 up, Job Presses \$11 up, Rotary \$149. Card Cutters, \$3. Save money. Print for others, big profits. All easy rules sent. Write for catalog presses, type, paper, cards, ink etc. **THE KELSEY CO., 6-37, Meriden, Conn.**

STOP Ford & Chevrolet CRANKSHAFT END-PLAY!

C-A ADJUSTABLE BEARING corrects and prevents end-play without removing motor. Eliminates many troubles. Easy to install—simply drop pan. For Ford, \$2.75; for Chevrolets, \$4.25. Ask your dealer or sent prepaid by **ADJUSTABLE BEARING CO., Dept. P, 405 Virginia Ave., Indianapolis, Ind.**

Any Wurlitzer Instrument Try in Your Own Home

See for yourself the superior quality of these famous instruments, the result of 200 years' experience. Every known instrument. No expense for trial. Easy terms if desired.

Send for New Catalog—Free
Rudolph Wurlitzer Co.
 Dept. 1773, Cincinnati

When white water
roars a challenge



WHEN the rapids swirl and leap about you; when the swift current carries you on at express train speed, then you'll be most grateful for the perfect balance of your "Old Town Canoe."

"Old Towns" are patterned after actual Indian models. Famous for their steadiness and durability. Light in weight too. Priced as low as \$67. From dealer or factory.

New catalog gives complete information about all models, including sailing canoes, square-stern canoes, dinghies, etc. Also racing step-planes, baby buzz hydroplanes, etc. Write for free copy today. OLD TOWN CANOE Co., 1862 Middle Street, Old Town, Maine.

"Old Town Canoes"

You-and This New Machine
Can Earn
\$500 a Month

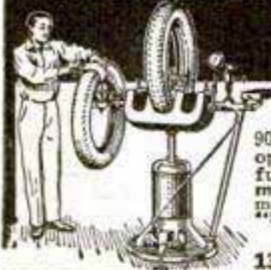

Operate a Tire Repair Shop

90,000,000 Tires in use. America's greatest opportunity for men with small capital. We furnish everything—\$100 and up. **Easy payments.** We train you **FREE** right at home. Start making money at once. Write today for Free Book "Steps to Success."

Haywood Tire Equipment Co.
1334 South Oakley Chicago, Illinois

DENINGER WILL TRUST YOU

SEND 30c IN STAMPS FOR CATALOGUES
BIG MONEY SAVING FOR YOU

Used and rebuilt motorcycles \$25 to \$100,
used bicycles \$9.50, tandems \$20.
All machines fully guaranteed.
New bicycles and motorcycles
at factory prices, save dealers'
profits. Motorcycle and auto-
mobile tires \$3. Complete line
frames, engines, supplies.

DENINGER PRICE CUTTER, ROCHESTER, N. Y.

PAY AS YOU RIDE

Catch Fish!

Eels, Mink, Muskrats with our new folding galvanized **STEEL WIRE TRAP.** Write for our **FREE TRAP OFFER** and Bargain Catalog. **\$1 Box** of our famous Fish Bait **FREE** to introduce our traps. **WALTON SUPPLY CO., 3501 JUNIATA AVE., ST. LOUIS, MO.**

Send for "The Nestler Plan" the book that will bring you big profits!

This book fully explains the amazingly successful Nestler method of servicing and retreading automobile tires. Tells how to start a profitable spare-time or full-time Nestler business of your own. Write to Dept. 33.

NESTLER RUBBER FUSING CO., Inc.
245 West 55th Street, NEW YORK, N. Y.

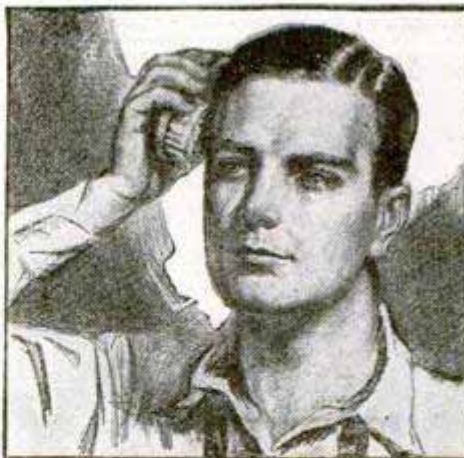

"Takes only a minute—
lasts all day"

Toothbrush — razor — *Stacomb*. All part of getting ready for a successful business day.

Men of affairs rely on *Stacomb* to give just the right set to their hair. To keep it smooth, orderly—*all day long*. To counteract dandruff, too (*Stacomb* supplies needed oils to the hair—whereas water dries out the scalp). Try *Stacomb* yourself—free.

NEW LIQUID
Stacomb

Reg. U. S. Pat. Off.

Standard Laboratories, Inc.
Dept. F-2, 113 W. 18th St., New York

FREE Send me sample of *Stacomb* as checked: New liquid form Cream form

Name

Address

**NEW VEST POCKET
ADDING MACHINE**



ADDS, SUBTRACTS, MULTIPLIES, DIVIDES
Does work of \$300 machine. Guaranteed 5 years. **NOT A TOY.** Made of steel and indestructible. Million dollar capacity. Fits in pocket. Will not make mistakes. So simple child can operate it. Instructions furnished. Everybody should carry one for figuring.

FREE TRIAL \$2.50 Total Cost

SEND NO MONEY—Just name and address. We will ship Calculator immediately. (On delivery pay postman \$2.50 (Plus few cents Postage). (If outside U. S. send cash). 10c additional in Leatherette Case. If not satisfied after 10 day trial you get your money back. **THOUSANDS OF SATISFIED USERS.**

This is lowest priced practical calculator made. "Why pay more for inferior imitations?" Order from this ad.

Guaranteed **Mail Coupon Today**

BABY CALCULATOR SALES COMPANY
Dept. 41, P. O. Box 1118, CHICAGO, ILL., U. S. A.
 I am enclosing \$2.50—send adding machine prepaid.
 Send Adding Machine C. O. D. \$2.50 plus postage. (10c additional in Leatherette Case)

Name

Address

City

State

AGENTS Write for big commission and territory proposition.

RADIO IS BETTER WITH DRY BATTERY POWER



made to run
the *full* race!

ANY horse can make a good start But it takes real stamina to *finish!*

So it is with batteries. *Staying* power is the quality to look for—unfailing power over a long period of service. Millions prefer Burgess Chrome Batteries for just this reason. They hold up They last.

Next time, buy black and white striped Burgess Chrome Batteries. You are certain to get longer and better service for your money.

Chrome—the preserving element used in leather, metals, paints and other materials subject to wear, is also used in Burgess Batteries. It gives them unusual *staying* power. Burgess Chrome Batteries are patented.

Ask Any Radio Engineer

BURGESS BATTERY COMPANY

General Sales Office: CHICAGO

Canadian Factories and Offices: Niagara Falls and Winnipeg



BURGESS
FLASHLIGHT & RADIO
BATTERIES

\$75 to \$125 Weekly

\$5 Down Charging Batteries Starts You



Let me show you how to make big money right from the start. I've prepared a FREE book explaining all details. First week's profit pays for all equipment. You can get all the battery charging business in your community with my Service Station Charger—it's years ahead of ordinary chargers—handles 50% to 70% more batteries. I explain everything—start you in a business of your own and put you on the way to big money. Write for FREE Book.

C. F. HOLMES, Chief Engineer, Dept. PM
Independent Electric Works, 5116 Ravenswood Ave., Chicago



FREE BOOK—Just Out



THIS 100 PAGE
RADIO CATALOG

FREE

Contains "Hook Ups"
75 Radio Illustrations
500 Over 1,000
Articles

Special proposition for
Dealers, Agents,
Set Builders

"Build your own with 'RASCO' Parts",
RADIO SPECIALTY CO., 98 E Park Place, New York, N. Y.

RADIO PANELS
BAKELITE—HARD RUBBER

Cut, drilled and engraved to order. Send rough sketch for estimate. Our complete Catalog on Panels, Tubes and Rods— all of genuine Bakelite or Hard Rubber. Mailed on Request.

STARRETT MFG. CO. 524 S. Green St. Chicago, Ill.

\$3 commission—MEN'S SUITS

\$8.88
FREE SALESKIT

Any one can earn \$2,000 extra money yearly in view of low price. Up to date styles, workmanship. Variety of beautiful patterns. 888 Co., Dept. C-7, Fort Wayne, Ind.



BIG RADIO CATALOG
From the "Big, Friendly Radio House"

NEW 1928 Book offers finest, newest well-known sets; parts, eliminators, accessories at lowest prices. DEALERS—WRITE for this CATALOG!

Western Radio Mfg. Co.

132 West Lake St., Dept. 32, CHICAGO, ILL.

All Metal Chassis Shielded Ready to Wire

6 TUBE SUPERPHONIC

Radio ALL PARTS MOUNTED

Only \$16.95

FREE! 6 TUBES UX 201-A TYPE Tested and Matched

Can be wired in a few minutes

COAST to COAST RECEPTION

An amazing value that can't be beat! Latest 6-tube tuned radio frequency circuit. Extremely selective, marvelous sensitivity. Three stages of radio frequency, detector and two stages of low ratio audio frequency, for improved tone quality. Two-dial control. Straight line frequency condensers. All metal chassis. Shielded. Clear and realistic reception guaranteed. Beautiful black front panel (7"x18"); ornamental design, degree and kilocycle markings in gold. Metal panel and sub-panel. Complete chassis. No extra parts to buy. All parts mounted. Simply connect a few wires. No special tools needed. Kura-Kash indicator knobs. New type UX sockets. All hook-up wire and colored battery cable included. Value \$60.00, our price **\$16.95**.

Tested and Approved

Severe laboratory tests have proved the remarkable efficiency of this set. Owners everywhere are sending us letters praising its wonderful receptive qualities.

NO RADIO KNOWLEDGE NEEDED!

Simple Wiring Directions

Very easy to wire this set with the instructions we furnish. Just connect a few wires. All you have to do is to follow numbers. That is all. Can be wired in a few minutes by anyone. No radio knowledge needed. Make money by wiring these sets in your spare time and selling them to your friends.

SEND NO MONEY

Just write your name and address on a post card and ask us to send you this great outfit together with 6 tubes. We will ship them right away. When they arrive, pay only \$16.95 plus a small delivery charge. (Foreign countries send \$19.50 with order. We pay shipping charges.)

RADIO EQUIPMENT CO., Dept. 10-C, 549 S. Wells St., Chicago, Ill.

Throwing Away Their Washboards!

Women are literally throwing away their washboards on account of a recent discovery used in washing clothes. No rubbing, yet clothes are spotlessly clean. Will not injure fabric. Write to D. O. Kittredge, Tunkhannock, Pa., for FREE sample. **Agents Wanted.**



Just to know that you can be there

No matter how remote from the center of activities, you know you can be there if you have a Cunningham Radio Tube in every socket of your set.

They are truly conquerors of time and space that reproduce with absolute fidelity pure, natural tone undistorted.

Don't use old or inferior tubes—use new tubes throughout.

E. T. Cunningham, Inc.

NEW YORK CHICAGO SAN FRANCISCO

Extraordinary offer in lady's wrist watch

BG1-Solid 14Kt. white gold hand engraved case set with 4 genuine diamonds, 4 sapphires; 15 jewel guaranteed movement \$8.15 a month. \$39.75

Wear Now Pay Later

No red tape. No interest **10 Days FREE Trial** Send only \$1 with order and your choice comes to you parcel-post prepaid on **10 Days Free Trial**. Pay postman only \$1 more on delivery; after free trial, pay balance in 12 equal monthly payments. Money back guarantee.

SEND ONLY

FREE "Royal's Book of Gems" Thousands of special values in genuine diamonds, watches and jewelry illustrated. Free to adults only—write now for your copy.

FULL YEAR TO PAY

BG2—Think of it! 3 genuine first quality blue white diamonds, set in latest hand carved and pierced 18Kt solid white gold lady's mounting; the greatest diamond value ever offered. \$2.31 a month. \$29.75

All transactions strictly confidential **Royal Terms make buying Easy** Order today with absolute confidence

Established 1896

ROYAL DIAMOND & WATCH CO.

ADDRESS DEPT. 10 C 170 BROADWAY N.Y.

DEVITT 8" COMBINATION SAW

8,000 IN USE!

A SHOPFUL OF TOOLS WITHIN ARMS REACH!

SAW TABLE RAISED SHOWING EMERY WHEEL, SAW GUARD AND DRILL ATTACHMENT



PLANER ATTACHMENT ON SAW TABLE

SHOWING SANDING DISC ATTACHED



TABLE TILTED FOR BEVELING

DADO HEAD ATTACHED FOR GROOVING

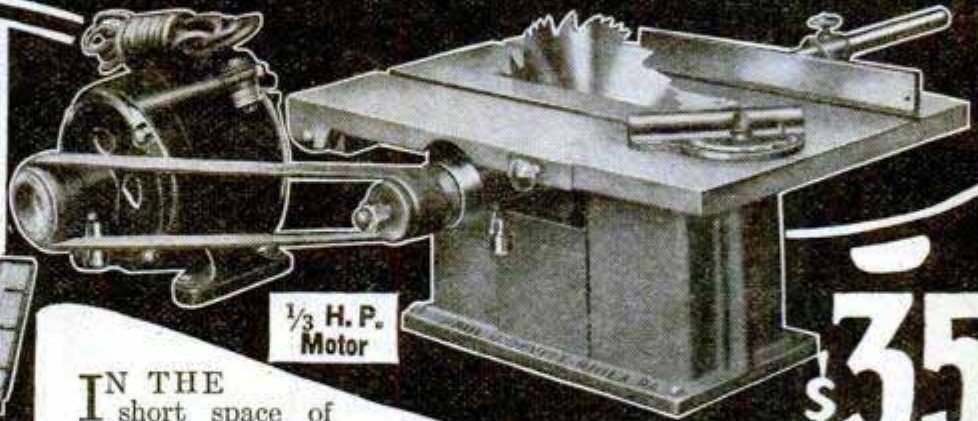

1/3 H.P. Motor

\$35

F.O.B. PHILA

In the short space of four years, the Devitt 8-Inch Combination Saw has become a practical necessity in thousands of shops, factories and households everywhere. Many imitators have sprung up, but Devitt leads them all. Think of the convenience and economy of this handy little machine that will rip, cross-cut, bevel, miter, groove, mortise, tenon, drill, rabbet, grind, buff and polish. Attachments are easily and quickly adjusted. The saw and motor, when set up for work, occupy very little room. Saw is equipped with 1/3 H.P. 60 cycle, 1750 R. P. M. 110-volt A. C. Motor which can be attached to ordinary light socket, and provide power for other purposes when wanted. A cut up to 2 1/4" can be made without planing. Comes complete with following attachments—12"x16" table, 8" Combination Saw, iron pulley for saw table, 10" ripping fence, adjustable cut off miter gauge, motor-specifications as above, 1 1/4" endless leather belt, wood pulley, 8 ft. cord and plug, 6" buffing wheel, 3/8" 3 jaw drill chuck, 5" emery wheel, 6" sander, saw guard, and 2" dado insert. \$35.00 F. O. B. Phila. Height 7 1/2", shipping weight, 100 lbs.

(Only \$12 extra for Planer Attachment to fit on table top. Can smooth pieces up to 2 inches wide. Price, F. O. B. Phila.)

Send today for our attractively illustrated 4-page circular

PAUL J. DEVITT

Dept. E 1102 SOUTH 2ND ST. PHILA., PA.

Makes Old Ford a Tractor

Now you can convert that old Ford car into a useful farm tractor without altering any Ford parts. We furnish the traction wheels, drive gears and auxiliary axle and mountings, ready to clamp on to the Ford frame. Pulls 16" plow.

We supply a Belt Pulley also



Write for Free Particulars. Shaw Mfg. Co., Dept. 4503, Galesburg, Kan.

OTTAWA LOG SAW ONLY \$39



GREATEST OFFER EVER MADE PUTS THIS OTTAWA TO WORK FOR YOU

Make Money! Wood is valuable. Saw 15 to 20 cords a day. Does more work than 10 men. Ottawa easily operated by man or boy. Falls trees—saws limbs. Use 4-hp. engine for other work. 30 DAYS TRIAL. Write today for FREE book and greatest log saw offer ever made. Shipped from factory or nearest of 10 branch houses.

OTTAWA MFG. CO. Room 1741 W Magee Bldg., PITTSBURGH, PA.



TOOL CHESTS of QUALITY

for Machinists and Tool makers are shown in our free catalog. Write for it to-day.

H. Gerstner & Sons

451 Columbia St., DAYTON, OHIO



STEEL BLUE Elite Diamond
IF YOU CAN TELL IT FROM A DIAMOND
SEND IT BACK!

\$389 C.O.D.

1 Carat Elite Diamonds. Matchless for their dazzling rainbow brilliancy. You'll be delighted. Elite Rings surpass all others. Stand acid and other tests. Handsomely Engraved Ring, sterling Guaranteed. Looks like \$250.00. Proud owner offered \$85.00 5 minutes after buying one.

COLLAR AND CUFF LINKS GIVEN

With each ring order, we give free beautiful Combination Set. Set with small Elite Diamonds. **SEND NO MONEY.** Just send name, address and finger size. On arrival pay postman \$3.89 and postage. Satisfaction Guaranteed. Write today. Cash with Canadian or foreign orders.

ELITE JEWELRY HOUSE, Dept. 399, 609 S. Paulina St. CHICAGO ILLINOIS

SIMONDS

SAWS FILES KNIVES STEEL

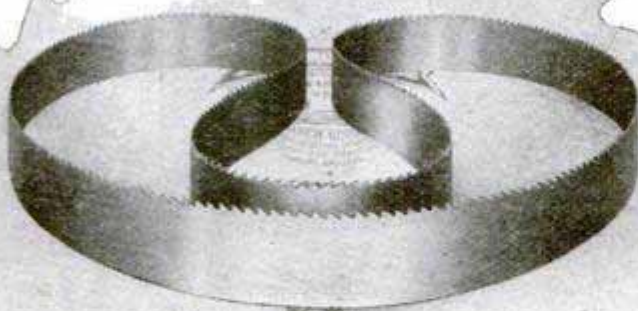

Nickel Steel for Band Saw Toughness

SIMONDS Band Saws are made of a special alloy steel to insure greater toughness, strength, and improved wearing qualities. They will hold their tension longer, stand more feed, and do more work, than other saws that cost just as much. Specify Simonds for economy!

SIMONDS SAW AND STEEL COMPANY

"The Saw Makers"

Fitchburg, Mass.

Established 1832

BRANCH OFFICES AND SERVICE SHOPS IN PRINCIPAL CITIES

BURN YOUR NAME ON TOOLS WITH THE ARKOGRAF

PROTECT YOUR TOOLS FROM THEFT
Write with electricity any name or design on the hardest and finest tools and instruments, or any metal, like writing on paper with pen or pencil. **Complete Outfit \$3.50**—Prepaid Anywhere. Interesting Illustrated circular free. Write today. Agents wanted. **ARKOGRAF PEN CO., 1171 E. Stark St., Portland, Oregon**

ONE HANDLE TAKES THE PLACE OF MANY WITH THIS NEW FLEXIBLE HANDLE SOCKET SET

1/2" square connection. Six sockets, 7-16", 1/2", 9-16", 5-8", 11-16", 3/4" hex openings. Chrome Vanadium steel. Snappy. Guaranteed. Money back if 10 days' trial doesn't satisfy. **\$3.65**, prepaid, cash with order; **\$3.90**, C. O. D. Handle only, \$1.75 cash, \$1.90 C. O. D. Acts. Winst. Tool Service Sales Co., Box 4605, Sellwood Sta., Portland, Oregon

Illustration clearly shows flexibility of handle.

STANDARD GARDEN TRACTOR

Plows Seeds Cultivates Mows Hay and Lawns

A Powerful Tractor for Small Farms Gardeners, Florists, Nurseries, Fruit Growers and Poultrymen **DOES 4 MEN'S WORK**
Walking & Riding Equipment
Free Catalog. Does Belt Work

STANDARD ENGINE COMPANY
3221 Como Ave. Minneapolis, Minn.

Crescent Wood Working Machines

are neat in design, substantially built and are intended for hard, continuous service. Users of wood working machinery who appreciate quality always investigate Crescent machines before placing their orders.

Send today for circulars of Band Saws, Saw Tables, Self Feed Rip Saw, Shapers, Jointers, Variety Wood Worker, Planers, Planer and Matcher, Disk Grinders, Cut Off Table, Swing Saws, Bayers, Hollow Chisel Mortisers, Tenoners, Universal Wood Workers.

93 Columbia St.
The Crescent Machine Co. Leontia, Ohio, U. S. A.

Hand Made TOOLS of Amazing Strength

CORNWELL Quality Tools

Only the finest Swedish Charcoal Process Molybdenum Steel, produced under our famous Cornwell Formula, enters into these hand-made tools. Forged, heat treated, hardened and tempered in oil. **NOT** drop forged and case hardened.

Let Us Demonstrate

Ask for salesman to call and show you many startling demonstrations that no other tools in the world will stand. Or send for free descriptive booklet, order tools, and make these tests at our risk.

Money-Back Guarantee

If you ever saw tools as good as these, return your order and get your money back. This is the strongest guarantee for any tools on the market and shows our complete faith in our product.

The Cornwell Quality Tools Co.
Dept. V. Mogadore, Ohio.
(Formerly at Cuyahoga Falls, Ohio.)
Send me new illustrated catalog with prices on full line of Cornwell Hand-Made Tools.

..... Where employed

Name.....

Address.....

City..... State.....

Mail this Coupon for New Free Book

PATENT

Protect Your Ideas

Take the First Step Today

If you have a useful, practical, novel idea for any new article or for an improvement on an old one, you should communicate with a competent Registered Patent Attorney AT ONCE. Every year thousands of applications for patents are filed in the U. S. Patent Office. Frequently two or more applications are made for the same or substantially the same idea (even though the inventors may live in different sections of the country and be entirely unknown to one another). In such a case, the burden of proof rests upon the last application filed. Delays of even a few days in filing the application sometimes mean the loss of a patent. So lose no time. Get in touch with me at once by mailing the coupon on the opposite page.

Prompt, Careful, Efficient Service

This large, experienced organization devotes its entire time and attention to patent and trade mark cases. Our offices are directly across the street from the U. S. Patent Office. We understand the technicalities of patent law. We know the rules and requirements of the Patent Office. We can proceed in the quickest, safest and best ways in preparing an application for a patent covering your idea. Our success has been built on the strength of careful, efficient, satisfactory service to inventors and trademark owners located in every state in the Union.

NO CHARGE for Information On How to Proceed

The booklet shown here contains valuable information relating to patent procedure that every inventor should have. And with it I will also send you my "Record of Invention" form on which you can sketch your idea and establish its date before a witness. Such evidence may later prove valuable to you. Simply mail the coupon and I will send you the booklet, and the "Record of Invention" form, together with detailed information on how to proceed and the costs involved. Do this NOW. No need to lose a minute's time. The coupon will bring you complete information entirely without charge or obligation.

My Patent Law Offices
Just Across
Street From
U.S. Pat. Office



Above is a view of my drafting and specification offices where a large staff of experienced experts are in my constant employ. All drawings and specifications are prepared under my personal supervision.

NEWS

Inventors Write for these Free Books

Strict Secrecy Preserved

All communications, sketches, drawings, etc., are held in strictest confidence in strong, steel, fireproof files, which are accessible only to authorized members of my staff. Feel free to write me fully and frankly. Your case will have my personal attention. It is probable that I can help you. Highest references. But **FIRST**—clip the coupon and get my free book. Do **THAT** right now.

Clarence A. O'Brien

Registered Patent Attorney

Member of Bar of: Supreme Court of the United States; Court of Appeals, District of Columbia; Supreme Court, District of Columbia; United States Court of Claims. Practice confined exclusively to Patents, Trade marks and Copyrights

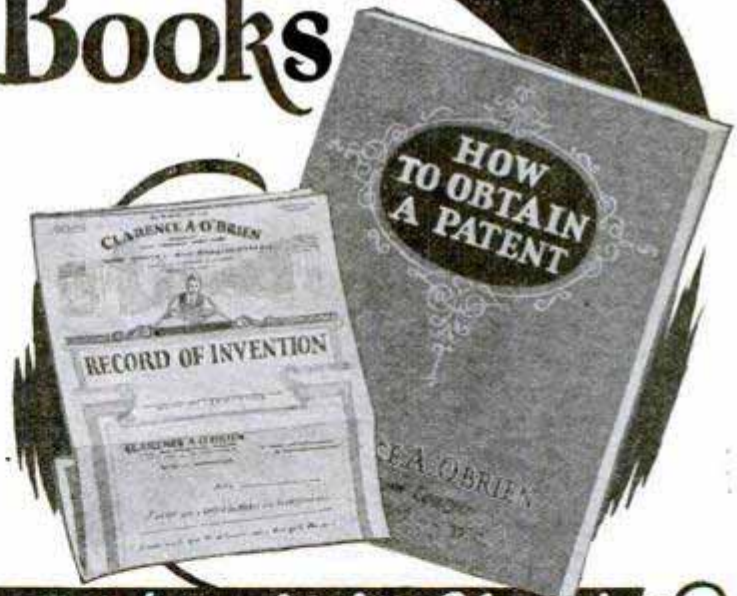

Clip this Coupon and Mail it Now!

CLARENCE A. O'BRIEN, Registered Patent Attorney

705 Security Savings and Commercial Bank Bldg., Washington, D. C.

Please send me your free book, "How to Obtain a Patent," and your "Record of Invention" form without any cost or obligation on my part.

Name.....

(Important: Write or Print name clearly.)

Address.....

PATENTS TRADE-MARKS AND COPYRIGHTS

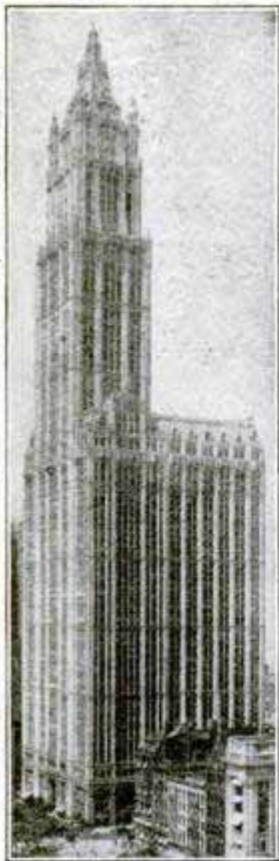

Our New York Office
Suite 1007 Woolworth Bldg.



Our Philadelphia Office
Suite 518-519 Liberty Bldg.



Our Washington Office, Victor Bldg.



Have You An Idea?
Our Offer: FOR THE PROTECTION
OF YOUR INVENTION

YOUR FIRST STEP

Before disclosing an invention the inventor should write for our blank form

"RECORD of INVENTION"

This should be signed and witnessed and returned to us together with model or sketch and description of the invention for

INSPECTION AND INSTRUCTIONS

No Charge for the Above Information

**Our Five Books Mailed
Free to Inventors**

Our Illustrated Guide BOOK

How to Obtain a Patent

Contains full instructions regarding U. S. Patents. Our Methods, Terms, and 100 Mechanical Movements illustrated and described.

Our Trade Mark Book

Shows value and necessity of Trade Mark Protection. Information regarding *Trade Marks and unfair competition in trade.*

Our Foreign Book

We have Direct Agencies in Foreign Countries, and secure Foreign Patents in shortest time and lowest cost.

Progress of Invention

Description of World's Most Pressing Problems by Leading Scientists and Inventors.

We Regard a Satisfied Client as our best advertisement, and furnish anyone, upon request, lists of clients in any state for whom we have secured patents.

**Highest References—Prompt Attention
—Reasonable Terms**

VICTOR J. EVANS & CO.

PATENT ATTORNEYS

Main Offices: 789 9th St., N. W., Washington, D. C.

Opposite U. S. Patent Office

PATENTS TRADE-MARKS AND COPYRIGHTS

IMPORTANT

HAVE YOUR CASE MADE SPECIAL TO AVOID DELAY. YOU SHOULD HAVE YOUR CASE MADE SPECIAL IN OUR OFFICE to save correspondence, secure protection and early filing date in the Patent Office. To secure **special preparation** of your case send \$25.00 on account with model or sketch and description of invention.



MAIN OFFICE, VICTOR J. EVANS & CO.—VICTOR BUILDING, WASHINGTON, D. C.

Our Lawyers Practice in all U. S. Courts and defend Clients in Suits involving Patents, Trademarks and Copyrights

All Communications and Data Strictly Confidential. Interference and Infringement Suits Prosecuted

OUR ORGANIZATION OFFERS **PERSONAL SERVICE** By Experienced Patent Lawyers, Solicitors and Draftsmen

**FREE
COUPON**

**VICTOR J. EVANS & CO.
PATENT ATTORNEYS**

NEW YORK OFFICES
1007 Woolworth Bldg.

CHICAGO OFFICES
1114 Tacoma Bldg.

PHILADELPHIA OFFICES
518-519 Liberty Bldg.

PITTSBURGH OFFICES
514 Empire Bldg.

SAN FRANCISCO OFFICES
1010 Hobart Bldg.

MAIN OFFICES: 789-9th Street, N. W., WASHINGTON, D. C.

Gentlemen: Please send me *Free of Charge* your books as described on preceding page.

Name _____

Address _____

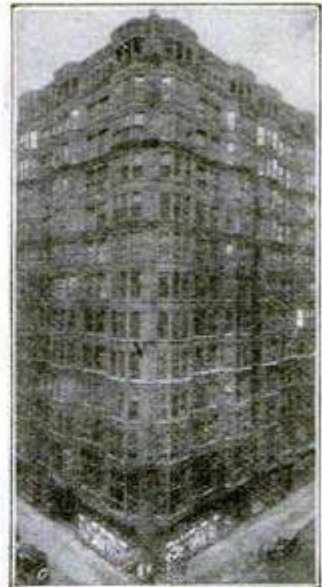

Our Chicago Office
Suite 1114 Tacoma Building



Our Pittsburgh Office
Suite 514 Empire Building



Our San Francisco Office
Suite 1010 Hobart Building

PATENTS

TRADE-MARKS · DESIGNS
FOREIGN PATENTS

MUNN & CO.
PATENT ATTORNEYS

Associated since 1846 with the Scientific American

SCIENTIFIC AMERICAN BUILDING
24 W. 40th St., New York City

SCIENTIFIC AMERICAN BUILDING
Washington, D. C.

TOWER BUILDING
Chicago, Ill.

VAN NUYS BUILDING
Los Angeles, Cal.

HOBART BUILDING
San Francisco, Cal.



Books and Information on Patents and Trade-Marks by Request.
Associates in All Foreign Countries.

PATENTS

Trade Marks, Copyrights, Patent Litigation Handbook with illustrations, 100 mechanical movements. Sent free on request.

ALBERT E. DIETERICH
formerly member examining corps U. S. Patent Office
PATENT LAWYER and SOLICITOR

621-A, Ouray Bldg.
27 Years' Experience Washington, D. C.

New Products Wanted for Manufacture

An engineering firm of long standing has been requested to arrange contacts between holders of patented products and manufacturers seeking additional lines to manufacture.

Only patented products or those which have applied for patents will be considered. Submit sufficient data to enable us to determine whether further negotiations are desirable.

Address Box 306

Popular Mechanics Magazine
200 E. Ontario St. Chicago, Ill.



PATENTS

Send us sketch or model for advice and exact cost of patent. Our book "How to Obtain a Patent" sent free. It tells how to apply for Patents, Trade Marks, Foreign Patents, Copyrights, etc.; gives information on Patent Procedure: tells what every inventor should know. Thousands of Inventors, who are our clients, are our reference.

CHANDLEE & CHANDLEE, 25 Years' Experience
410 Seventh St. Washington, D. C.

PATENTS

Protect your Inventions and Trade-Marks today. Write for illustrated patent book and sketch sheet and terms free.

BRYANT & LOWRY, 311 Victor Bldg., Washington, D. C.

EDGAR M. KITCHIN
Attorney & Counsellor at Law

Patent and Trade Mark Specialist

805 G St. N. W., Washington, D. C.

PATENTS

**Don't Lose Your Rights
To Patent Protection**

Before disclosing your invention to anyone send for blank form "EVIDENCE OF CONCEPTION" to be signed and witnessed. As registered patent attorneys we represent hundreds of inventors all over the United States and Canada in the advancement of inventions. The form "Evidence of Conception," sample, instructions relating to obtaining of patents and schedule of fees sent upon request.

LANCASTER & ALLWINE
480 Ouray Bldg. WASHINGTON, D. C.
Originators of forms "Evidence of Conception."

PATENTS

Booklet Free **Highest References**
Promptness Assured **Best Results**

Send drawing or model for preliminary examination of Patent Office records.

ALL BUSINESS GIVEN PROMPT AND PROPER ATTENTION

Listed Patent Lawyer in the latest editions of the Rand-McNally Directory of Bankers and Attorneys, of Chicago, Ill.; The Baggott & Ryall Directory of Attorneys, New York City; The Lawyers Guaranteed Directory, Detroit, Michigan; The Lawyers and Bankers Quarterly, published by the Legal Directory Publishing Company of St. Louis, Mo.; the American Lawyers Annual, Cleveland, Ohio.

WATSON E. COLEMAN,
REGISTERED PATENT LAWYER

Victor Building, 724 Ninth Street, N. W.
WASHINGTON, D. C.

1000 NEEDED INVENTIONS!

Here is the most remarkable book ever offered to inventors. One Thousand needed inventions listed and described. Arranged as follows: General Problems; Automotive; Mechanical; Electrical; Chemical; Radio; Marine. Separate chapter on the Ten Most Needed Inventions. This book may give you one idea that will win you a fortune. Nothing else like it has ever been published. Compiled at enormous expense. Edited by Raymond Francis Yates, formerly Managing Editor of a leading scientific magazine. Over 100 pages, durably bound.

Send No Money

Cut out this advertisement, and send it to us with your name and address, plainly written, and your copy of this remarkable book will be sent immediately. Pay the postman only \$1.25 plus postage on arrival. Money back, after 10 days' examination, if desired. Limited edition. Write NOW. (Outside U. S. \$1.45 cash with order.)

BUREAU OF INVENTIVE SCIENCE

Dept. 33 Rochester, New York

BLUE BOOK ON PATENTS

AND PRIORITY RECORD BLANK GRATIS.

MONROE E. MILLER, PATENT LAWYER
411-2 Ouray Building, WASHINGTON, D. C.
ELECTRICAL AND MECHANICAL EXPERT

INVENTORS who derive largest profits know and heed certain simple but vital facts before applying for Patents. Our book *Patent-Sense* gives those facts; sent free. Write **LACEY & LACEY, 646 F St., Washington, D. C. Established 1869.**



GEARS ALL KINDS SMALL

The most accurate made and prices reasonable. We carry a complete line of gears in stock for immediate shipment. Can also quote on special gears of all kinds. Send us your inquiries.

WRITE FOR CATALOGUE 10

CHICAGO STOCK GEAR WORKS
105-109 S. Jefferson St., CHICAGO

PATENTS

To the Man with an Idea

I offer a comprehensive, experienced, efficient service for his prompt, legal protection and the development of his proposition.

Send sketch, or model and description, for advice as to cost. Preliminary advice gladly furnished without charge.

My experience and familiarity with various arts frequently enable me to accurately advise clients as to probable patentability before they go to any expense.

Booklet of valuable information and form for properly disclosing your idea free on request. Write today.

IRVING L. McCATHRAN, Patent Lawyer

Formerly with and successor to
Richard B. Owen

200 Owen Bldg., Washington, D. C.
41-E Park Row, New York City

TRADE-MARKS REGISTERED

INVENTORS PROTECT YOUR IDEAS

Send for our Guide Book, **HOW TO GET A PATENT**, and Evidence of Invention Blank, sent Free on request. Tells our terms, methods, etc. Send model or sketch and description of your invention for **INSTRUCTIONS**. No charge for the above information.

RANDOLPH & CO.
301 Victor Bldg., WASHINGTON, D. C.

NAME.....

STREET.....

CITY..... STATE.....

1-3/16 ct. \$118

Ask Why

Diamonds

HERE (Every Quality) 60% of Market Price

Legitimate Offers of a 3/4 Century House

Jos. DeRoy & Sons

See why this 1 less 3/16 ct. faultlessly cut blue-white diamond is just \$118. Try to match at 60% more, this, or other startling cash offers. Examination free, of course. A 3/4 century institution, now of 10 large loan companies rated financially over a million dollars, operating as the world's largest diamond banking house. Loans made over \$35,000,000.00 on Diamonds, Jewels, Watches, in sums of \$5.00 to \$5,000.00.

All Details Free With Latest List

Jos. DeRoy & Sons, 1966 DeRoy Bldg. Opposite Post Office, Pittsburgh, Pa.

Yes, you can send me free, in plain envelope, without obligation on my part, the detailed reasons, for startling diamond offers at a mere fraction of real values, to individuals, dealers, wholesalers alike. Mail this coupon now!

Name.....

Address.....

Low as \$60 a Carat for Diamonds

WANTED

500 worthy MEN and WOMEN

to stop working long hours for poor pay and begin retailing Rawleigh's Good Health Products to your neighbors. Easy to sell monthly \$250-\$500 worth of flavors, spices, food products, toilet preparations, medicines, soaps, veterinary and poultry products. Over 150 different daily necessities used by yourself and your friends. No selling experience needed—we show you just how to succeed. Low prices. Good values. Complete service. For free particulars

Send this coupon!

W.T. RAWLEIGH CO. Dept. 9 PPM Freeport, Ill.

Please tell me how I can make more money

Name.....

Address.....

City.....State.....



Build and Fly this 3-ft. Model of LINDBERGH'S "SPIRIT OF ST. LOUIS"

Plans for Model Airplanes 25c per set

New York-Paris Plane, FOKKER North Pole Plane, CURTISS JN4D-7 Biplane, DEHAVILLAND Biplane, N C-4 Naval Seaplane, Bieriot, Taube or Nieuport Monoplanes, Cecil Pro-11 Racer.

Complete Construction Outfit \$7.50 (West of Denver, Colo., and in Canada, price is \$8.00)

Ask your dealer or order direct.

New 64-Page Book of Model Airplanes

Teaches the principles of flying; contains plans and directions for building gliders and racers, and full information about scale Models of real planes; also most complete catalog of materials for model builders. Sent 5c postpaid for.....

IDEAL AEROPLANE & SUPPLY CO., Inc. 408 West Broadway, New York City

AGENTS AND SIGN MEN

Now Making \$50.00 to \$100.00 and Up Per Week Selling Our GOLD LEAF SIGN LETTERS.

R

For store and office windows, board signs, trucks and glass signs. We also make to order script signs and business emblems singly or by the thousands. A permanent business. No capital or experience required. Big demand in every city. Samples and Literature Free.

CONSOLIDATED SIGN LETTER CO. 69X W. Van Buren CHICAGO, ILL.

INCREASE YOUR PROFITS! FREE AIR WILL DO IT!

Sell more Accessories, Gas, Oil, Tires, Batteries, Repair Jobs, Paint Jobs. You'll sell more of everything if you give a BETTER, MORE DEPENDABLE AIR SERVICE THAN THE OTHER FELLOW.

Only \$12 Monthly—Paid by Added Profits

HB is the lowest priced dependable Ball Bearing, Silent Spiral Inval Drive, Automatic Air Compressor. Try it in your shop for 30 Days at our risk—on absolute Money Back Guarantee.

A letter or card will bring complete details.

HOBERT BROS., Box M382, TROY, OHIO



WHITE FLAME BURNERS

make your old kerosene lamps and lanterns give a brilliant white light better than electricity or gas. Doubles your light. Saves oil. NO MANTLE TO BREAK. Guaranteed Safe and Reliable. DeRights every user. Send now for complete sample postpaid 50 cents, stamps or coin, 3 for \$1.25. Money Back if Not Satisfactory. Live Representatives Wanted. Exclusive Territory.

WHITE FLAME LIGHT CO., 68 Clark Bldg., Grand Rapids, Mich.



AUTOMATIC CONCERTINA (SMALL SIZE ACCORDION)

PLAYED WITH INTERCHANGEABLE ROLLS

Without any faint idea of music or notes, without study or practice, you can play perfect like an artist any songs, dances, fox trots, one steps, operas, marches, etc. Nobody can see the mechanical arrangement, everybody must think you are an artist. Wonderful tone, playing complete with all bass and accompaniments. Music is wanted and welcomed everywhere. Biggest assortment of Rolls, latest hits. Three models, for Home, Concerts, Paid Entertainers. \$30.00, \$45.00 and \$60.00 and free music rolls. Descriptive circular No. C. mailed free.

TREASURE SALES COMPANY 1690 Boston Road NEW YORK, N. Y.



500 MEN WANTED

to sell \$9⁰⁰ Worth of Shirts for \$6²⁵ and

MAKE \$90 A WEEK



How would you like to make \$90 or \$100 every week in your spare or full time? Sell this wonderful line of high grade broadcloth shirts and build up a big income for yourself. BOSTONIAN nationally known shirts sell 3 for \$6.95 (postage paid). Formerly sold to the public through stores at \$3 and \$3.50 each. Amazing new low price brings quick sales. \$1.50 commission for you on every sale. We start you with no investment or experience. Just write for astounding new selling outfit which fits neatly into coat pocket, samples of fine broadcloth and full details of our proposition. Everything free. Start on the money-making road to \$90 a week. Send name and address to



Bostonian Mfg. Company
Makers of Fine Shirts for Over 60 Years
72 Summer Street, Dept. B-28
Boston, Mass.

Photos ENLARGED

Size 16x20 inches
Same price for full figure or bust, groups, landscapes, or pet animals, etc., enlargements of any part of group picture. Safe return of your own original photo guaranteed.

98c

SEND NO MONEY Just mail photo or snapshot (any size) and within a week you will receive your beautiful life-like enlargement size 16x20 in., guaranteed fadeless. Pay postman 98c plus postage or send \$1.00 with order and we pay postage. **SPECIAL** With each enlargement we will send FREE a hand-tinted miniature. **FREE OFFER** reproduction of photo sent. Take advantage now of this amazing offer -- send your photo today, **UNITED PORTRAIT COMPANY**
1652 Ogden Ave. Dept. 363 Chicago, Ill.



Save Your Feet

When all else fails, end your suffering with the

Heefner Arch Support

No Metal

Fully patented. It re-adjusts the entire foot. Write for free book and statements from doctors and users.

Heefner Arch Support Co. 661 M. E. Taylor Bldg. Louisville, Ky.



SAVE 30 TO 80% ON AUTO PARTS
Write us for prices on your requirements. Everything for the car at prices only Warshawsky can offer!
WARSHAWSKY & CO. 1915-35 S. State St. Dept. PM3, Chicago
World's Largest Replacement Parts House

WATKINS Wants Men

Ten Million Dollar concern has openings for those who are ambitious to have steady earnings. For 60 years we have been manufacturing big line of guaranteed household products used in homes everywhere. No limit to what you can make. Freeberg, Calif., clears \$385 a month. Boyle, N. Y., makes \$80 a week. Foelschow, Ill., average earnings for the past ten years \$300 per month. Just write and say you are interested.
Address
"WATKINS" C. S., 10B, Winona, Minn.

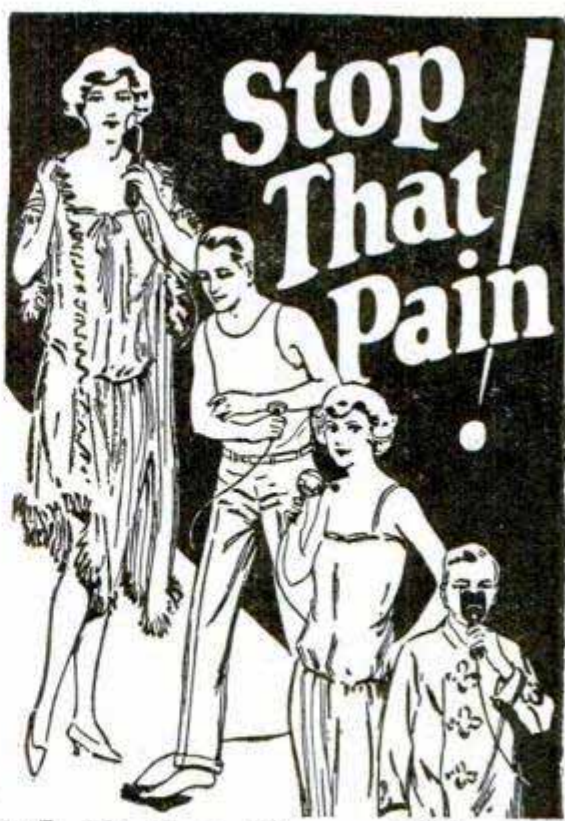

Stop That Pain!

With Violet Ray Vibration
Ozone Medical Electricity

The Four Greatest Curative Powers
Generated by This

Great New Invention!



Elco Health Generators at last are ready for you! If you want more health—greater power to enjoy the pleasures and delights about you, or if more beauty is your desire—write! Ask for the book on these inventions which has just been prepared. It will be sent to you without cost. It tells you how Elco Health Generators aid you in leaving the lethargy and hopelessness of bad health and weakness behind forever. Re-vitalize yourself. Bring back energy. Be wholly alive. Write today!

Here's What Elco Users Say—

"Wouldn't take \$1000 for my Elco."
"Has done me more good in 2 weeks than doctors did in three years."
"Cured my Rheumatism."
"My Eczema gone."
"Cured my stomach trouble."
"Cured my weakness."
"Now I sleep soundly all night."
"Thanks to Elco, my strength and vigor are back."
"No more pain."
"Colds never bother me now."
"Chronic Constipation banished."



These great new inventions generate Violet Ray, Vibration, Electricity and Ozone—combined or separate. They operate on the electric light in your home or on their own motive power at less than 50 cents per year. Elco Health Generators are positively the only instruments which can give you in one outfit Electricity, Violet Ray—Vibration and Ozone—the four greatest curative agents. Send the coupon below. Get the Free Book NOW!

MAIL COUPON for FREE BOOK

Do not put this paper down without sending the coupon. Don't go on as you are with pains and with almost no life and energy. You owe it to yourself to be a better man or woman. You were put here to enjoy life—not just to drag through it. So do not rest another day until you have put your name on the coupon here. That will bring the whole story of these great new inventions. Do it today—now.



..... Lindstrom & Company.....
30 West Lake St. Dept. 93-53 Chicago
Please send me your free book, "Health—Power—Beauty" and full information of your 10-day Free Trial Offer.

Name.....
Address.....



JAPANESE ROSE BUSHES

The Wonder of the World

Japanese Rose Bushes bloom all the year round. Just think of it. Six weeks after planting the seed, the plants will be in full bloom. It may not seem possible, but we positively guarantee it to be so. They will bloom every ten weeks, Summer or Winter, and when three years old the bush will be a mass of roses, bearing from five hundred to a thousand roses on each bush. The flowers are in three shades—white, pink, and crimson. The plants will do well both in and out doors. We guarantee at least three bushes to grow from each packet of seed. Price, 10c packet, 3 pkts. for 25c postpaid.

Chinese Fragrant Tree Fern



Just introduced; noted for its rapid growth. An exceptionally pretty ornamental plant. Foliage is rich dark green. Forms grand pyramidal bushes about 5 feet high. Branches very desirable for decorative purposes, wreaths, etc. Seeds 15c pkt., 3 for 40c.

Weather Plant



NATURE'S WEATHER PROPHECY
By mysterious changes that take place, this remarkable plant accurately forecasts the weather many hours in advance. Will grow anywhere all the year around. An interesting house plant. Bears large, fragrant, pink, butterfly shape flowers. Seeds, 15c packet, 3 for 40c, postpaid

GROUND ALMONDS

Amazingly Prolific—Easily Grown From Seed
The Ground Almond has a flavor that is MOST EXCELLENT, resembling the coconut. The meat is snow white, covered with a shell or skin of brown color. It grows close to the surface and anything from 200 to 300 Almonds may be expected from a single nut. There is no trouble whatever in growing anywhere and in any kind of soil. May be planted any time, and in eight or ten weeks from time of planting you will have an ENORMOUS CROP of the MOST DELICIOUS ALMONDS YOU EVER TASTED. Seeds 15c Pkt.



Perfume Plant

Blooms only at night, giving forth the most delightful scented fragrance for quite a distance. Causes much comment. For house or garden. Also valuable because of rare perfume made from it. SEEDS, 10c pkt., 3 for 25c.

Calabash or Pipe Gourds

A luxuriant and rapid growing climber; thrives anywhere. Produces the ornamental gourds from which the famous African calabash pipes are made. Grow this interesting vine and make your own. Seeds, with instructions, 15c pkt., 3 for 40c.

Mammoth Peanuts

Peanuts can be easily cultivated. Their culture is very simple and exceedingly interesting. Mammoth Peanuts grow to an astonishing size. It is a good producer, very prolific, and the giant nuts have a thick, heavily ribbed protecting shell. The plant is very attractive, the leaves being of odd shape and a handsome green shade, tinted through the center with white. You will derive much pleasure cultivating this interesting species. Seeds 15c pkt., 3 pkts. for 40c.

Musk Plant

A universally admired favorite for house, flower garden or greenhouse. A very fine house plant. Lives for years. Is of the sweet scented variety, giving forth much fragrance. Also valuable on account of the perfume that can be made from it. Seeds 15c pkt., 3 for 40c.



Kudzu Vine

Most rapid growing vine known. Will grow 20 feet in one week. Luxuriant foliage, lovely purple flowers, very fragrant. Nothing to equal it for shade purposes and quick growth. Seeds 15c packet, 3 for 40c.

Japanese Climbing Cucumber

Unusually strong and vigorous growing vine. Attains twice the size of ordinary varieties. Grows readily on fences, poles, trellises, etc. One hill will keep an entire family supplied all summer. Seeds 15c packet, 3 for 40c, postpaid.

GIGANTIC NEW GUINEA BUTTER BEANS

THE NEW EDIBLE VEGETABLE WONDER
Grows to an astonishing size, the Beans measuring from 3 to 6 feet long, and weighing anything from 10 to 15 lbs., and even more. One Bean is sufficient for a family for several meals. Very palatable and rich in nutritious materials. The delicate Buttery Flavor is much appreciated. The Vines are easily grown, very prolific, and a most welcome and valuable adjunct to your garden. Try them; you will find them the most delicious vegetable you have ever tasted. Imported direct. Unobtainable elsewhere. Sample package of Seeds with full directions for cultivating and cooking. 25c, postpaid.

Yard Long Bean

Produces enormous crop of long, slender, round pods, of excellent quality for snap beans. Pods grow from 2 to 5 feet in length. Very tender and fine flavor. The vines are rampant growers; an interesting curiosity. Seeds 15c pkt., 3 for 40c

THE REMARKABLE FIREFLY PLANT



A Vine that Blooms at Night
Fills the Atmosphere with Fragrant Aroma
One of the most rapid growing vines known. Under favorable conditions this vine has been known to grow OVER 25 FEET IN A SINGLE WEEK. In a very short space of time indeed the Vine has climbed to a great height, and is covered with IMMENSE FLOWERS, from 5 to 7 inches in diameter. It is, indeed, a great novelty, for, unlike other plants, the flowers OPEN IN THE EVENING, and remain open until about noon the following day. In dull weather they will remain open all day. It is a most INTERESTING SIGHT to watch the opening and closing of the flowers as the clouds appear and disperse. As the flowers open they give forth the most DELIGHTFUL AROMA and the whole atmosphere around is full of scented fragrance. It is always the object of favorable comment, and much curiosity is aroused by people passing at night time as to the cause of the charming aroma, frequently stopping in an endeavor to satisfy their curiosity. PRICE, 19 CENTS packet, two packets for 35 CENTS, POSTPAID. JOHNSON SMITH & CO

The Great Wonderberry

A luscious berry that may be grown and ripened from seed in any soil or climate in 3 months. The flavor is fine and unsurpassed for eating raw, cooked, canned or preserved in any form. The fruit is blue-black in color, and tastes like a luscious, rich blueberry. One bush will produce an enormous amount of fruit, yielding great masses of rich fruit all Summer and Fall. Packet, 10c, 3 pkts. for 25c, postpaid.

Bush Musk Melon

A vineless Musk Melon, grows in bushes, and thus can be cultivated in the smallest garden. The fruit is of the popular Jonny Lind type, but larger, averaging 5 inches in diameter. The flesh is very deep, edible almost to the rind and is colored light green, flushed with salmon toward the center. The quality is superb, lusciously sweet and juicy. Packet of seeds with full directions for culture, 15 cents, 3 packets for 40 cents, postpaid.

The Great Umbrella Palm

A Graceful House or Conservatory Plant
Easily Grown From Seed Winter or Summer
The Japanese Umbrella Palm is a semi-aquatic plant. It is easily grown from seed either in a bowl of water or in very damp soil. Probably the most usual, as well as the most interesting method, is to cultivate the plant in a bowl or jardiniere filled with water, with two or three inches of good garden soil at the bottom. The seeds soon commence to germinate, and the plant shoots up stems two to three feet high and rapidly assumes a most pretty palm-like appearance, as shown in the engraving. The tops of the stems are surmounted by a whorl of umbrella-shaped leaves, of waxy appearance. We will send a package of this seed, with full instructions for culture, for only 15c or three packets for 40c postpaid.

Butterfly's Own Bush

This plant is a veritable refuge or haven for butterflies, and it attracts all the most beautiful types of butterflies to the neighborhood. Bees, too, are very fond of it. It is a pretty plant bearing perfectly double flowers, ranging from white to rich crimson, deep red and pink, lilac and other delicate shades. Packet 10 cents, 3 for 25 cents postpaid.

FAMOUS MEXICAN FIREFLY PLANT

Beautiful hedge plant, grows 2 to 2 1/2 feet high and resembling a closely clipped evergreen. The globe-shaped or pyramidal bushes are close and compact, and of a pleasing light green color. May be grown singly or in the form of a hedge or background. In early autumn the whole bush becomes carmine or blood red, hence the name of Mexican Fire Plant, or "Burning Bush," as it is sometimes called. Selected Seeds, 10c

CROWN OF THORNS

A very curious clover-like plant, can be cultivated indoors or outdoors, the three red blotches on the leaves representing the wounds of Christ. Has curious thorny seed ball: if loosened at tip the hull is found to consist of a long prickly-edged band wound spirally around the seed cluster, giving the plant its name. Seeds 15c packet, 3 for 40c.

Asparagus Sprengeri

The best plant for hanging baskets. Masses of rich, gleaming foliage droop in a very graceful manner. The foliage when cut for decorative purposes will last for weeks in water. The seed pods are very pretty red berries adding to its beauty. Packet, 25c, 3 pkts. for 65c postpaid

"Wong-Bok" Chinese Cabbage

Novelty from China and should be grown in every garden. Seems to be a cross between Celery and Coss Lettuce. Flavor is more mild than any other cabbage. Can be served on the table and eaten raw or cooked like cabbage, spinach or lettuce or made into salad. Grows very rapidly, easy to cultivate. You can create quite a sensation by cultivating this remarkable novelty. Seeds, 15c packet, 3 pkts. for 40c.

TREE OF HEAVEN

This splendid ornamental tree is a native of China, and is called the Tree of Heaven, on account of its great beauty. Very hardy, thrives in any soil, no matter how poor, and grows from 6 to 10 feet high from seed the first summer. The leaves are from 5 to 6 feet in any length, giving it a grand appearance. Nothing outside the tropics can rival it for lawn decoration. Large panicles of bloom, followed in season by great clusters of colored seed pods, make the tree a continual thing of beauty. Packet, 15c; 3 packets 40c

SURPRISE FLOWER GARDEN

Over Hundred Varieties of Mixed Flower Seeds
MANY RARE AND CURIOUS NOVELTIES
An Abundance of Flowers Assured Throughout the Season
A mixture of easily grown annuals that bloom very soon after sowing the seed; colors vary in their time of blooming. Those who cannot give the constant care necessary for finely arranged flower beds will be delighted with the Surprise Wild Flower Garden. Will prove a continual surprise and pleasure, as new varieties and the old garden favorites flower successively throughout the season. There are over a hundred varieties of seeds. Many of the plants may be taken inside as house plants and will bloom during the winter. Fine for children, also teachers for school gardens. Packet, 15 cents, three packets for 40 cents, postpaid. J. S. & CO.

WHY DON'T YOU GET INTO BUSINESS FOR YOURSELF?

We'll give you a FREE plan and help you get started. Make as high as \$20 a week extra in spare time while you get started. No canvassing. File saws for carpenters, contractors, schools, factories, meat markets, farmers and homes. Have a year around income. You can do it easy with a

Foley Automatic Saw Filer

Let us show you how easy you can get into a good paying business of your own. Write for the FREE plan that will start you. Write today. Address—



Foley Saw Tool Co., Inc.
225 Foley Bldg.
9 Main St. N. E.,
Minneapolis, Minnesota

SALESMEN! \$100 WEEKLY SELL COX HOLDFAST SCREW DRIVERS

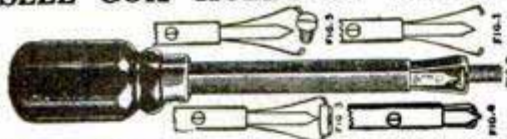

Also made to use in Yankee or Ratchet Handle. Sells on sight to

Garages, Radio Men etc. Self Holding. Self Releasing. Sample & Proposition, 50c. S. J. COX, Dept. F, Franklin, Pa.



\$10⁰⁰
DOWN
Brings this Lathe to You

Lathes \$6.00 to \$75.00. Largest line of small lathes in America. Send six cents for 24 page catalog of lathes, drill presses, bench saws, jig saws, band saws, etc.

SYEPHER MANUFACTURING COMPANY
Dept. D Toledo, Ohio

CLASS PINS 35¢
NEW CATALOG FREE!
DESIGNS SHOWN SILVER PLATE 35¢ EA. \$3.50 DOZ. STERLING SILVER 50¢ EA. \$5.00 DOZ. GOLD PLATE 50¢ EA. \$5.00 DOZ. FOR 2 COLORS ENAMEL. ANY LETTERS AND DATE.
BASTIAN BROS. CO., 828 BASTIAN BLDG. ROCHESTER, N.Y.

MECHANICS-GARAGEMEN Speed up!
AUTOMATIC brake and clutch adjuster. Holds pedals any desired pressure, while making adjustments. Saves one man's time. Also insures brake protection while car washing; set brakes, excludes all grit, grease and water. EXCEL TOOL CO., \$2.85 with post paid.
1157 Columbia St., San Diego, Cal.
NO RATCHETS. NO GEARS.
PUSH PEDAL. That's all.
AGENTS write for this fast seller. EXCLUSIVE TERRITORY.



**No Need to Borrow
Money When You Can Easily Earn
\$150 to \$300 Monthly
With Practically No Investment On Your Part**

Your banker will advise installing HB Equipment because it pays for itself without tying up your working capital, brings you big profits from pleasant work, is simple and easy to operate—and comes to you on

30 Days' Trial

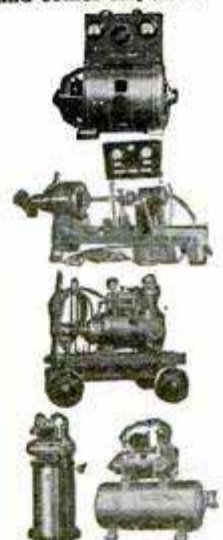

- 1. 8-Hour Battery Service** brings hundreds of new customers. Charges batteries in 1/2 the time and saves 30% to 50% of electric bills over rectifiers. For more information check No. 1 in coupon below.
- 2. Big profits in auto electrical service** with the new **HB Universal Test Bench**. Priced to save you at least \$100 over any similar quality bench on the market. For full details check No. 2 in coupon.
- 3. Spray Painting with new HB Portable Paint Spray** does high class work at 1/5 the cost of old time brush methods. You get five men's income for one man's labor, painting autos, houses, barns, furniture, etc. For information check No. 3 below.
- 4. Business Building Air Service** now available for as low as \$11 monthly for a few months. Brings car owners to your door day and night. Check No. 4 for full details.

You can have the moneymaking advantages of HB Equipment in your shop for as low as

Only \$11 to \$16 Monthly

for a few months—just a small part of the extra profits it will bring you. For full information without obligation, check and mail the coupon below.

HOBART  BROTHERS
Successful manufacturers ~ since 1893 ~

BOX M-38 TROY, OHIO

Tear Off Coupon and Mail Today

HOBART BROTHERS CO.
Box M-38, Troy, Ohio.

Send me complete information on the items I've checked with your 30 day trial offer, easy payment terms, and information on how HB equipment will increase my earnings.

- One Day Battery Service Profits
- Electrical Test Bench Opportunities
- Portable Paint Spray Business
- Better Automatic Air Compressor

NAME.....
ADDRESS.....

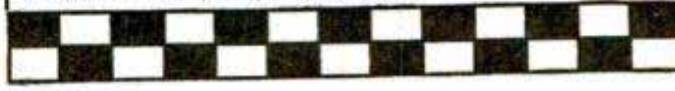

EVERYBODY WANTS! This HANDY TOOL KIT!

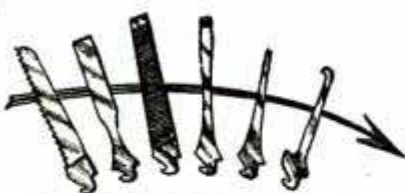

This fine tool kit includes Cross Cut Saw, Wood Chisel, large Screwdriver and File, small Screwdriver, Borer, Cork Puller and Cap Lifter, and strong, sturdy Pocket Knife.

In Leather Case



Here's the first practical small tool kit ever offered for sale. You will find the HANDY Tool Kit invaluable for those odd little jobs in the home, shop, office, camp, garage, boat and on the farm. Each part is a real tool made of the finest steel properly tempered and nickel plated to prevent rust. Kit is only 3 1/4 inches wide and 4 1/4 inches in length. Weight 6 oz. Costs only \$3.00.

Tools fit in knife handle and are easily inserted as illustrated.



SEND NO MONEY

Just fill in coupon below and send it TODAY. We will send you the HANDY Tool Kit parcel post C. O. D. You pay postman \$3.00 when delivered. If you are not satisfied after 10 days that this kit is worth more than you paid for it, just return it and your money will be refunded.

HANDY SALES CO.,

Room A-5, 2 Broadway, New York City.

Please forward TODAY one HANDY Tool Kit postpaid C. O. D. I will pay postman \$3.00. I have privilege of returning kit within ten days if not satisfied.

Name.....

Address.....

A Condenser That Has Made Radio History

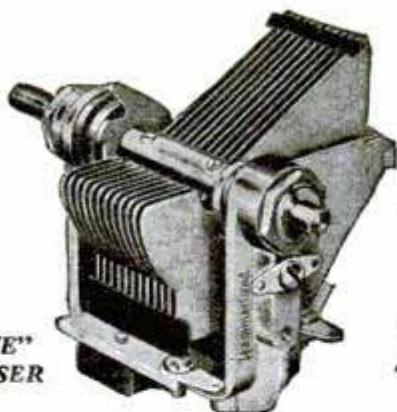

The Famous "MIDLINE" CONDENSER

Your Dealer Sells It

The Hammarlund "Midline" Condenser is officially specified for more than a score of the featured radio circuits of the season.

It is praised and recommended by radio engineers and fans throughout the world.

Write for Folder

HAMMARLUND MANUFACTURING CO.
430 W. 33rd St., New York, N. Y.

For Better Radio
Hammarlund
PRECISION PRODUCTS

Save 1/2

CON-RAD 6

SINGLE DIAL CONTROL

Satisfy yourself!

30 days FREE TRIAL



6 TUBE SETS
Completely assembled
\$34.75 to \$66.66
RETAIL PRICES

Completely Shielded GENUINE LICENSED CIRCUITS
Manufactured under license grants of Radio Corporation of America and Affiliated Companies

The set that is the talk of the Radio trade. Acknowledged as the greatest radio value. A Con-Rad 6-tube completely shielded chassis with single illuminated dial control. Absolutely the latest in radio receivers. Manufacture under license grants, insures highest quality; chassis incorporates all of the features found in most efficient receivers. Complete shielding insures freedom from all foreign noises. Very selective and sensitive. Brings in long distance stations with wonderful tone and volume. Both table and console cabinets come in the newest styles and most beautiful woods.

Prove It Yourself—30 Days Free Trial

A Con-Rad Receiver is ready to pass any test you demand. Try it in your home on our 30 day Free Trial Offer and be satisfied. If you are not, return the receiver to us and your money will be refunded. You must be satisfied!

Demonstration sets sent on FREE TRIAL. Make big money working full or spare time taking orders for Con-Rad Radios.

Write today for complete information. Our catalog gives full details of the Con-Rad Line of 1928 and our liberal 30 day Free Trial offer.

CONSUMERS RADIO CO.

Dept. 162, 4721 Lincoln Ave., Chicago

\$1 DOWN 21 Jewel Burlington

Nothing less than 21 Ruby and Sapphire Jewels a good enough for the Burlington masterpiece.
Quality and Style
Adjusted to the second-temperature-isochronism-positions. 25 year Gold Strata Case, in 100 designs. \$1 down. Balance in small monthly payments. Send for free book.
BURLINGTON WATCH CO. Dept. 13-53
19th St. & Marshall Blvd. Chicago, Illinois

NO MORE FOLDING—IT SLIDES!

THE SPEEDY RULE

Interlox

MASTER SLIDE RULE

A direct-reading inside caliper Fine for outside measurements too. Quick, strong, durable. All lengths, 2 to 8 ft., 20c per lineal ft. If not at dealers, sent postpaid.

Master Rule Mfg. Co. 813 E. 136th St. New York

Dealers and Agents: Write for attractive proposition.

LOCAL MAN WANTED TAILORING

Large wholesale manufacturing tailors want sober, honest, responsible man in your community to take orders for tailored-to-order, all virgin wool suits at \$22.50. Commission \$4.00 in advance and bonus. Part time men welcome. Write today.
CERTIFIED CLOTHING CO., Dept. PM, 2238 S. LaSalle St., Chicago

Agents! PROTECT CHECKS — and Make \$150 Weekly Too!

It took me 17 years to perfect the marvelous "2 in 1" Security Pen! Now it's the most amazing clean-up for agents in the country! Show men and women this sensational fountain pen with its astounding demonstration features and the sales just pile up in front of your eyes! Because the Security Pen, in addition to being a high grade writing pen, is equipped with a practical, handy "CHECK PROTECTOR" device that never fails. The crooks who stole 250 million dollars in one year by raising and forging checks haven't a chance with this marvelous new SECURITY on the market. Get in on this money-making adventure yourself!

MEN WANT THIS HANDY DEVICE

You can call on men and women all day long and you'll find very few who aren't interested in the double-feature Security Pen. Our representatives tell us they close 3 out of every 5 calls and sometimes more. R. W. Storts, of Peoria, Illinois, writes, "The man that can't sell Securities, couldn't sell bread in a famine!" They all like the idea of having a pen ALWAYS handy for regular use, and, at the same time, a device to thwart the thieves who make their living off unprotected checks.

Prices: Only \$5 and \$7

Some people have been paying as much as \$10 for just a plain fountain pen. Security, with its many exclusive and patented features, sells for only \$5 for the medium size and \$7 for the Giant size. Think of it! And your commission is almost 100% on some models.

SECUROGRAPH, \$1.50

Some prospects already have a good fountain pen. In that case, you don't lose the sale. Instead you sell the Securograph—the new vest pocket check-protector without the pen—for \$1.50. Get a sample at special introduction price of only \$1.00 NOW!

A Perfect Writing Instrument HERE



HERE'S A HANDY CHECK PROTECTOR

2 in One!

HOW TO GET STARTED

CHECK-PROTECTOR
Security
FOUNTAIN PEN

SECURITY PEN CORP.

John H. Kritikson, Pres.

316 Fifth St. Mt. Carmel, Ill.

Security Pen Corp.
316 Fifth St., Mt. Carmel, Ill.

I am enclosing \$..... Please send me
 Security Pen (Medium Size) \$5.00
 Security Pen (GIANT Size) \$7.00
 Securograph Check Protector \$1.00
 Fine Medium Coarse Stub-Point.
 Orange Mottled Black-Color.
 Full particulars about agent's proposition.

Name.....
 Street.....
 Town..... State.....

Mail the Coupon Today!

The sooner you get started, the quicker you'll be raking in the BIG PROFITS! Don't wait! In a short time you'll be successful and independent. Send the coupon TODAY and get ready for the money-making surprise of your life.

Your Big Chance—Act Now!

New Improved SPORS Fountain Pen. 60 Day Trial. Money back if not pleased

Agents' Sample **65c** Sells for \$1.25. Writes like a \$7 Pen
 Make \$10 Daily Easily

LADIES' OR MEN'S STYLE
 Comes in Green Molot or Blue Marble
 Guaranteed 2 Years Improved Point



F. SPORS CO.

MAKES \$8.40 IN TEN MINUTES

I sold my dozen pens in about 10 minutes. Will order another dozen soon. TRACY KRENZ, Nebraska.
 Write for FREE Wholesale Specialty Catalog.
 128 MAIN ST. LESUEUR CENTER, MINN.

BE A REAL WOODWORKER

A LATHE AT A PRICE YOU CAN AFFORD

[Complete with 3 cutting Tools]

\$600

THIS LATHE will turn wood up to 1 1/2" in diameter and 5" in length. Within these practical limits you can make on it anything ANY LATHE CAN MAKE. Toys, candle sticks, spindles, or any sort of turnings. And you can own this lathe, complete with 3 tools of high grade steel (skew point, round point and square), and a woodworker's illustrated manual, all for \$6.00.



If this seems too good to be true, look at this lathe at any hardware, sporting goods, or department store, or send 10 cents for complete illustrated full color catalogue, describing not only this lathe but jig saw, \$4.00, drill press, \$4.50, universal 1/35 horsepower motor \$7.50, and dozens of other items.

KNAPP ELECTRIC CORP.
 Dept. 89 Port Chester, N.Y.

Manufacturers of "AMERICAN INDUSTRY IN MINIATURE"
 REG. U.S. PAT. OFF.

Work Shop, complete with motor - - - \$27.50
 Catalogue in full color for 10c in stamps
 Prices Denver West and Canada slightly higher
 FOR SALE BY T. EATON CO.



Make big money from repair work



Practically every householder spends at least \$10.00 to \$50.00 each year and many spend several times that much on simple repairs that can be made *quickly, easily* and *well* with

Smooth-On No. 1

With a can of Smooth-On, you can save this money in your own home — and by doing similar repair work for others, you can make money.

No skill is required to make repairs and the amount of Smooth-On used on any one job seldom costs more than a few cents.

Typical repairs that can be made perfectly with Smooth-On:—Stopping leaks in steam, water, gas, oil or stove pipes, mending cracks, breaks or leaks in furnaces and boilers,

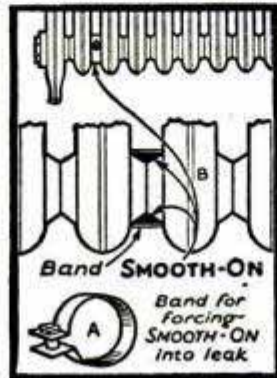

Leak at radiator joint stopped with Smooth-On

radiators, tanks, sinks, pots and pails, making loose handles tight on umbrellas, knives, hammers, brushes, drawers, etc., tightening loose screws, hooks, locks, door knobs, etc.

On the Automobile:—Making bursted water jackets and pumps good as new, stopping leaks in radiator, hose connections, gas tank and gas, oil and exhaust lines, making a fume-proof joint between exhaust pipe and tonneau heater, tightening loose headlight posts, keeping grease cups, hub caps, and nuts from loosening and falling off, etc.

To get perfect results, write to us for and use the Smooth-On Repair Book. Free if you return the coupon.

Get Smooth-On No. 1 in 7 oz., 1-lb. or 5-lb. tins at any hardware store or if necessary direct from us.

SMOOTH-ON MFG. CO.
Dept. 37, 574 Communipaw Ave.
JERSEY CITY, N. J.

Do it with SMOOTH-ON

SMOOTH-ON MFG. CO., Dept. 37,
574 Communipaw Ave., Jersey City, N. J.

Please send the free Smooth-On Repair Book.

Name.....

Address.....

Extra Income

Spare time-Part time-Full time profits

200 to 500% Profit

Cleared \$2700 Invested \$97

H. G. Young of New Jersey invested \$97 in Utility molds and made \$2700 clear profit working in spare time. Mr. Stanley, Chicago, cleared \$2165 in spare time on \$100 investment. One Michigan man sold \$2000 worth to one concern. Hundreds of others are earning big money manufacturing these ornamental concrete products. Send for FREE catalog at once. We show you how.



Write Your Own Pay Check!

In a manufacturing business of your own making brick, block and tile. Unlimited opportunity. Big future. Investigate now. Write for machinery catalog—it's FREE.

CONCRETE EQUIPMENT CO.
570 Ottawa Ave. Holland, Mich.

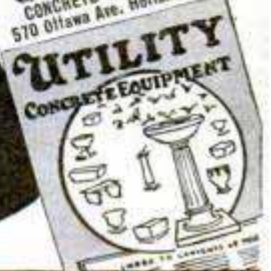

Send for Catalog

The Quick Way to Music

KING Band Instruments offer you the quickest, easiest way to learn music—to play brilliantly.

They are *unqualifiedly guaranteed in writing* to be perfect in design, materials, mechanism and workmanship. That's why they'll help you to learn faster and play better.

When a great musician like Edwin Franko Goldman says that King Instruments greatly improved the tone and intonation of his famous band, that's proof that a King will insure your musical success.

Start now! Tell us the instrument you want. We'll ship it to you to try—FREE. The price will be no more than you'd pay for a less perfect instrument. Deferred payments will make payment easy.

Why handicap yourself? You can afford to own a King—the instrument of *guaranteed superiority*. Mail the coupon Today for our Handy Reference Catalog and other interesting booklets.

KING

BAND INSTRUMENTS



The H. N. White Co.
5211-97 Superior Ave., Cleveland, O.

Please send me free copy of "The White Way" Magazine and your Handy Reference Catalog. (Check, below, instrument preferred.)

Name..... Age.....

Address.....

City..... State.....

- Saxophone Trumpet Trombone Alto
- French Horn Baritone Bass Bugle

ENGINES

A YEAR TO PAY

Only
\$5
Down

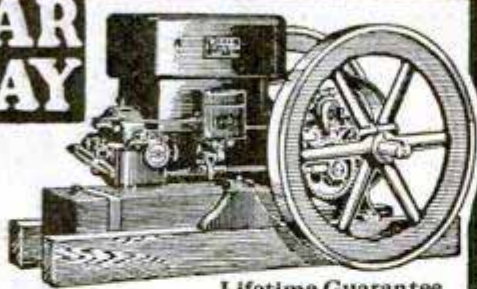

Lifetime Guarantee

You'll get a real surprise when you read Ed. Witte's **Big Free Book** on engines. Nothing like it ever published before.

Amazing Power

Users say it is almost mysterious the way **WITTE Engines** purr under the heaviest loads. "Amazing"—best expresses the marvelous flow of power now made possible by the **50 New Feature Refinements**—but send for the **free Book**. Read for yourself.

EASY TO OWN

Easy Payments? Certainly. You'll never miss the money. **New Low Prices**. Tremendous savings made possible by **Factory to User plan**.

FREE. Send for your copy of Ed. Witte's **Free Book** today.

WITTE ENGINE WORKS

1743 Oakland Ave., KANSAS CITY, MO.
1743 Liberty St., PITTSBURGH, PA.

**KEROSENE GASOLINE
GAS OIL DISTILLATE OR GAS**

Speedway Shop

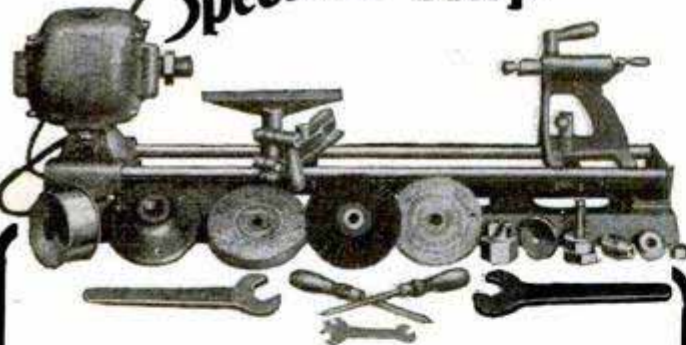

Completely Motorizes Your Work Bench

This is the shop used by carpenters, small manufacturers, machine shops, and craftsmen. Powered by the famous **Speedway motor**. Works from any lamp socket. The **Super Speedway Shop** pictured above contains:

These Seven Heavy Motor-Driven Tools

1—Motor-Driven Lathe on heavy cast iron base; 2—Speedway Bench Drill; 3—Bench Saw with 6 inch blade; rips, cross-cuts, mitres, grooves; 4—Pattern Makers' Jig Saw with 10 inch throat; 5—Motor-driven Grinder with emery wheel; 6—Six inch Scratch Brush; 7—Six inch Buffer and Polishing Wheel; also all necessary parts including chisels, saw blades, etc.

\$10 Down Puts It In Your Home

We give you ten days free trial in your own home. Pay only \$10.00 down, which is refunded if you do not keep the shop. Balance in easy monthly installments while you enjoy it. Speed up your work.

24 Free Working Blue Prints

We give you 24 working blue prints of toys, furniture, etc. We show you how to make money selling the products of your shop.

Write Today for Ten Day Free Trial

Write to the world's only manufacturers of a complete line of Portable Electric Saws, Hammers, Drills and Grinders, for our 10 day Free Trial Offer. **SpeedWay Shop** is a money maker for the small job man. Let us send you full particulars. Just sign your name on the margin.

ELECTRO MAGNETIC TOOL COMPANY
Dept. 2-M 1830 So. 52nd Ave. CICERO, ILL.



Here's
an Amazing New
Business **THAT PAYS UP TO**
\$1,000 A MONTH

MEN, here is a real, red hot money-making opportunity! It's a chance to jump into business for yourself and make more money every week than the average man makes in a month.

Surprising as it may sound, we actually put you in a business, with the first day's profits often running from \$18 to \$55. \$350 to \$600 the first month is not unusual for ambitious men.

Cut in on the Big Money

All you need is the ambition to make real money. We supply you with complete equipment to make and sell that famous new food specialty—**Brown Bobby**—a greaseless doughnut baked by electricity!

It's a crispy, flaky, delicious new kind of doughnut cooked without one drop of oil or grease. Easily digested by everyone. More appetizing than old-style doughnuts ever were. Costs less to make. Sells four times as fast. No baker's skill required. Just add water to our prepared "Mix." You can open a shop; rent cheap floor space in a grocery, delicatessen, lunch-counter, drug store, etc. Or start at home—and make up to \$250 your very first week.

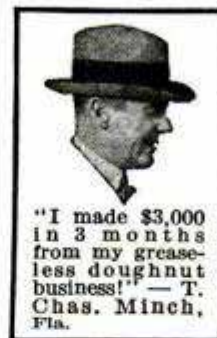

"I made \$3,000 in 3 months from my greaseless doughnut business!" — T. Chas. Minch, Fla.

Start At Once ANYWHERE!

Men and women everywhere are starting in this business daily! YOU cannot afford to delay! Details will gladly be sent without obligations of any sort. Such an amazing money maker may never come your way again. So fill in and send the coupon at once! **TODAY!**

MAIL COUPON NOW!

**Food Display Machine Corp.,
Dept. 13-53, 350 W. Huron St., Chicago, Ill.**

Gentlemen: Please send me the plan by which I can cash in on **Brown Bobby**, the Greaseless doughnut. It is understood that this obligates me in no way whatever.

Name.....

Address.....

City..... State.....

These And Other Gifts Given

WE MAKE IT EASIER TO SELL Here's What We Do To Help You To EACH PERSON You Sell FREE

Both FREE with each bottle of our fragrant perfume at 15c a bottle. Remarkable value—that's why our plan is the easiest ever offered. Try it—you can't lose—use the coupon in opposite corner. **ACT NOW!**

A Purse-Size Packet of the Famous MAD CAP ROUGE and a Silverware Certificate. Good for 6 Silver-plated Teaspoons.

Famous Mad Cap Rouge and Silverware Certificate FREE with each bottle, makes it easy. Send for 20 bottles and easy double plan for getting this outfit. Use Coupon.



Either watch is given for selling our fragrant perfume at 15c a bottle. Famous Mad Cap Rouge and Silverware Certificate FREE with each bottle, makes it easy. Send for 20 bottles and easy double plan. Send no money—just the coupon at bottom. Please write plainly. **BELL PERFUME CO., Dept. P. X. 5, Chicago, Ill.**

Have Your Own Movie Show!

This is the Famous Keystone Moviegraph—best made. Operates on principle of professional models. Shows moving pictures as well as slides. Practice reel of Tom Mix picture furnished. Also 50 slides, bill posters, show tickets, etc. Yours for selling our fragrant perfume at 15c a bottle. Mad Cap Rouge and Silverware Certificate FREE with each bottle, makes it easy. Send for 20 bottles and easy double plan for getting this outfit. Use Coupon. **BELL PERFUME CO., Dept. P. X. 19, Chicago, Ill.**

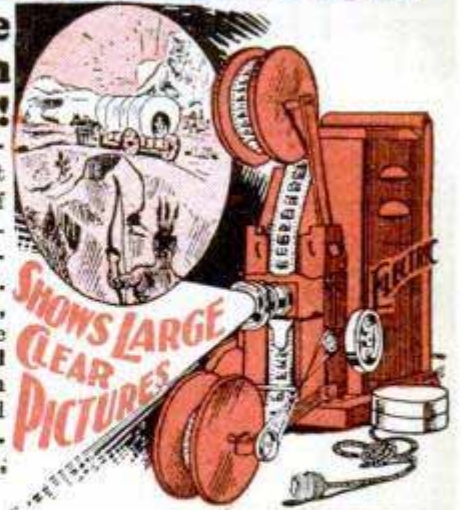

10-YR. GUARANTEED WRIST WATCHES

For Girls, Boys, Ladies or Men

Both watches are beauties. Non-tarnishable, white satin finish cases, richly engraved. Fitted with Genuine Jeweled Movements. Guaranteed for 10 years. Girl's watch is dainty Tonneau shape. Comes with ribbon bracelet and metal clasp. Boy's watch shows time in the dark. Has leather strap and buckle.



THIS WATCH SHOWS THE TIME IN THE DARK

1000 SHOT REPEATER AIR RIFLE BOTH GIVEN FOR SELLING

This famous King Lever Action, powerful Repeater rifle or large size, Genuine Eastman, Roll Film Camera, yours for selling only 20 bottles of our fragrant perfume at 15c each. Famous Mad Cap Rouge and Silverware Certificate FREE with each bottle, makes it easy. Send no money—just the coupon at bottom. **BELL PERFUME CO., Dept. P. X. 18, Chicago, Ill.**



22 Cal. HAMILTON RIFLE SEND NO MONEY

Here is a real comrade for you. A rifle that's a dandy. Has bronze barrel—will not rust nor pit. Has automatic shell ejector, front and rear sights, beautiful walnut finish stock, trigger guard, etc. Shoots 22-Calibre cartridges. Yours for selling our fragrant perfume at 15c a bottle. Famous Mad Cap Rouge and Silverware Certificate FREE with each bottle, makes it easy. Send for 20 bottles and easy double plan. We trust you. Just send the coupon at bottom. **BELL PERFUME CO., Dept. P. X. 34, Chicago, Ill.**

American Flyer 3 Car Electric TRAIN GIVEN



8 Section Track Included
When it comes to Electric Trains none can compare with that made by the American Flyer Mfg. Co. It's in a class by itself. And this is an example of the values we give for selling our perfume.

This train and track given for selling our fragrant perfume at 15c a bottle. Famous Mad Cap Rouge and Silverware Certificate FREE with each bottle, makes it easy. Send for 20 bottles and easy double plan for getting this outfit. We trust you—just send the coupon. Please write plainly. **BELL PERFUME CO., Dept. P. X. 28, Chicago, Ill.**

WE TRUST YOU—JUST MAIL COUPON

Send me Postpaid 20 bottles of your fragrant Perfume also 20 purse packets of MAD CAP ROUGE and SILVERWARE CERTIFICATE FREE. I will pay the Postage at 15c a bottle and give the Rouge and Silverware Certificate FREE with each bottle. Will remit in 30 days and select gift from your catalog, sent with Perfume.

BELL PERFUME CO., Dept. P. X., Chicago, Ill.

Name..... (Please print name plainly)
R. F. D., Box.....
or Street No.....
City.....
State.....



THIS BOOK WAS WRITTEN FOR MEN PAST 40

An amazing book has been written for every man past 40 but regardless of your age you should send for it at once if you have any of the following symptoms—disturbed sleep, aches in legs, feet or back, sciatic or rheumatic pains, constipation, weakness, or pronounced disorders of the prostate gland. The book is FREE.

PERHAPS you are one of the many men who suffer in one or more ways the result of a disordered prostate gland. (Medical science says that about 2 out of 3 men past a certain age have this disorder.) Sometimes, but not always, the victim thinks he is suffering with bladder or kidney trouble. Or perhaps it is loss of vitality, mental depression, various aches and pains, etc. What a blessing to mankind it has been since science has revealed that a host of disorders common to maturing men is really caused by disordered prostate gland.

New Drugless Gland Stimulant

And thousands of men praise a remarkable book, "Why Many Men Are Old at 40" which has taught them a new method of drugless gland stimulation—applied by anyone in the privacy of his own home. Men who have read this book point to it as a means of saving them serious operations. Others as a result of it are living youthfully, even though past the age of 60, 70 and

80. Thousands of men of all ages praise the author for the great benefits it has brought them.

Mail the Coupon

This book is FREE to you if you will ask for it. Merely fill out and mail the coupon below, but write at once before the edition is exhausted. Mail your letter to W. J. KIRK, Pres., 2103 Morris Ave., Steubenville, Ohio. If you live West of the Rockies, mail your inquiry to The Electro Thermal Co., 303 Van Nuys Building, Dept. 21-C, LOS ANGELES, CALIF.

Yours FREE

If You Have These Symptoms

W. J. Kirk, Pres., 2103 Morris Ave., Steubenville, O.
 Please send me at once the FREE booklet you are distributing "Why Many Men Are Old at 40." I understand the book is free and does not obligate me in any way.

Name.....
 Address.....
 City.....State.....

All Separate Machines in Boice's Home Work-Shop!

Here's Boice's new Work-Shop! Three individual machines—not mere attachments—each separate and complete in itself. Always ready at any time to do three different jobs—sawing, jig sawing, and lathe turning. Heavy duty motor gives plenty of power.



and the three books of 125 designs included in Boice's Work-Shop.

Universal Handisaw. Cuts stock 2 1/4". Elevates for grooving. Table 15"x17" tilts 45° for bevelling. Head 6"x1" and also cope heads and 8" sand disc. Jointer attachment fits on right of table. Guides always remain parallel to saw regardless of tilt or elevation of table. No other saw of equal cost has this feature.

New Jig Saw. Vertical stroke 1 1/4". Saw-to-frame 10". Table tilts 45°. Uses blades 3/8" to 5/8". Bronze bearings.

Utility Lathe. Swings 8"x19" C. to C. 3 speeds. For wood or light metal turning.

Send 10c for New 1928 Catalog of 64 pages describing Boice-Crane Work-Shop, band saws, mortisers, circular saws, and books of designs on how to make furniture and toys.

W. B. & J. E. Boice,
 Dept. P.M. 3-D Toledo, Ohio

100 Edwin's Genuine OLD FASHION SMOKERS
 15¢ QUALITY \$5.00
 GUARANTEED



Our Customers call 'em
DIAMONDS IN THE ROUGH

THREE REASONS WHY we can afford to sell these wonderful cigars at this price
FIRST- No Fancy Boxes, Bands or Labels
SECOND- Mass Production
THIRD- No Charge Accounts Losses, etc.

With your first order we will send you

FREE OF CHARGE OUR VARIETY SAMPLE CASE

Containing a selection of 12 of our Biggest selling cigars priced up to 30¢, a 100 just "Get Acquainted"

This Special Offer is limited to one order and holds **GOOD ONLY, UNTIL MAR. 15**
OUR GUARANTEE
 Smoke as many as you like and if you do not receive **AT LEAST DOUBLE VALUE** we will cheerfully refund **YOUR MONEY IN FULL**

We have been established since 1903. In these 25 years we have made many thousands of satisfied customers who buy from us regularly. We refer you to any bank in U.S. or Cuba. Send check or pay postman on arrival

In addition we will include **WITHOUT CHARGE FACTS EVERY SMOKER SHOULD KNOW!**
 Half a century with Tobacco

A most interesting 28 page book, just published by Charles Renard, N.Y. Facts heretofore withheld from the public are now disclosed! The inner workings of the tobacco industry fully explained. A valuable addition to your library, particularly if you are a smoker. It will save you many a dollar on your tobacco purchases. For leather bound copies send \$3.50 direct to pub.

DEPT. P. EDWIN CIGAR CO.
 2338-40 THIRD AVE. NEW YORK

SM
Do You Know the Secret of Quality Reproduction?
 "The Secret of Quality" tells you simply and concisely how to get the most out of your amplifier—how to get quality. This 96 page booklet is yours for the asking—it's free. Write for your copy.
SILVER-MARSHALL, INC., 840 W. Jackson Blvd., Chicago, U.S.A.

NEW AND REBUILT EQUIPMENT
 Everything for "The Movies," Machines, Screens, Chairs, Generators and Supplies, Complete Stationary and Travelling Outfits: Free Catalog. Write Dept. M.
MONARCH THEATRE SUPPLY CO.
 395 SO. SECOND ST., MEMPHIS, TENN.



"Be the Life of the Party"

Play a Tune in 10 Minutes

Anyone can play the Ukulele, Tenor Banjo, Guitar, Banjo Uke or Mandolin with an amazing new invention. **NO** knowledge of music required. *Play tunes from the start by numbers instead of notes, or by notes if you wish. Simple as 1-2-3, "just press the keys and play."*

Astonish your friends by playing latest "hits" and old favorites. **NO** more costly lessons! **NO** weeks of tiresome practice! So simple a child can use it. Over 50,000 delighted users—**young and old, men and women** now playing.

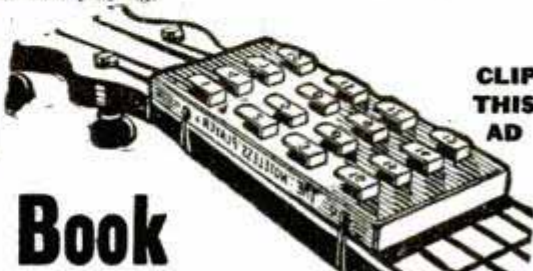

CLIP THIS AD

Free Book

Send for free book telling the *amazing story* of this *marvelous device*. Contains letters from hundreds now playing who could never play before. E-Z Player can be attached to your own instrument in a jiffy. Or we'll send you choice of instruments with Player attached on *easy payment terms*. Satisfaction guaranteed. "No play, no pay!" Have more fun, popularity, money-making chances, more friends—*send today for free book*. No obligation.

FERRY & CO., Manufacturers

1750 N. Robey St. Dept. 9774 Chicago, U.S.A.

Every Woodworking Job By Lamp Socket Power
 All machines portable, electric—sturdy, efficient, reasonably priced. Just check the machines in which you are interested, write your name and address in the margin and return this ad to us for complete information. Dealers in all principal cities.
HESTON & ANDERSON 603 Western Ave. Fairfield, Iowa

Model Ship Builders
 If you have not started your Flying Cloud model our special construction set will enable you to go to it without any delay. We can supply all Flying Cloud builders with the various deck fittings such as capstans, steering wheels, stanchions, bits, chocks, and many other items. Large illustrated catalog showing cuts of photos of various ship models, together with prices for construction sets, tools and all fittings sent postpaid upon receipt of ten cents.
MODEL SHIP SUPPLY CO., Dept. H, Mineola, N.Y.

HAND MADE ITALIAN ACCORDIONS
 Best in the world. 10-year guarantee, lowest prices. **FREE** instruction, ask for **FREE** catalog. **RUATTA, SERENELLI & CO., 1014 Blue Island Ave. Dept. M Chicago, Ill.**

Your Coat and Vest Can Be Matched with New Trousers
 Save the price of a new suit. We match hundreds of coats and vests satisfactorily every day. Each pair tailored to your measure. 80,000 patterns. We submit sample of cloth for your approval. Just mail your vest or a sample of the suit. *We employ no agents.*
ACME PANTS MATCHERS
 Dept. BP-14, 20 W. Jackson, Chicago

A handful of daylight

A GOOD flashlight is worth another pair of eyes. Especially when there's a neat little repair-job to do. It hits the spot with bright, white light. Nothing like it for investigating the "innards" of a radio set, trouble-hunting around a machine, solving mechanical mysteries or just plain tinkering.

And don't forget that to make your flashlight a real getter, load up with Eveready Batteries. They are brimming with life and power and sure-enough LIGHT.

Get the flashlight habit. Work with a handful of daylight. And always use Eveready Batteries—the same make that you find on the best radio sets.

FREE Radio Catalog

To Dealers: New, illustrated 1928 Wholesale Radio Catalog gives lowest prices on accessories, kits, packs, parts and sets. Features master-built single control radio sets for both battery and all electric operation. Full showing of "A" and "B" Eliminators and thousands of other great values. Write on business letter-head for this free book today. HAMILTON-CARR CORPORATION, 711 W. Lake Street, Dept. 394, CHICAGO, ILL.

Ingersoll

WATCHES & ALARM CLOCKS

Do You Control Your Radio Set?

Do you run your radio or does it run you? Doubtless you would welcome positive control of volume, without distortion, to suit the occasion—from dance music for shuffling feet to soft background for dinner conversa-



tion. You would enjoy tone control from sharp, crisp speech, to soft, mellow, soothing music. You would have better results with line-voltage control for that radio power unit or those A-C tubes.

And it's all so simple with Clarostats—micrometric resistance units available in three types and several ranges for every radio purpose!

MEMBER
RMA

Ask your dealer how. Or better still, send for our booklet, "Micrometric Resistance" which tells how to get the best radio results. And when you buy Clarostats, be sure you get the genuine article in distinctive green box and with name stamped on nicked shell.

AMERICAN MECHANICAL LABORATORIES, Inc.
Specialists in Variable Resistors
285 North 6th Street - Brooklyn, N. Y.

VOLUME CONTROL CLAROSTAT

WANTED! MEN with callouses on their hands

Men who like to work—men who like to do things with their own hands—men who get a real satisfaction out of doing a craftsmanlike job—men who can have a real affection for a machine that helps them do these things.

If you're that kind of man—you won't always have to work with your hands.

For you, we have a plan that helps you get somewhere in the world—quicker than you can without our plan. At the start, you can make \$25 a day—doing the work yourself. As you go along, you can have others work for you, and \$75 a day then becomes possible, in a real business of your own.

What is this plan? It's built around a remarkable machine—which sands wood by a new principle, where speed takes the place of weight. It sands floors—800 to 1600 square feet per day in new buildings. It refinishes old floors—300 to 800 square feet a day. It does shop work—interior trim—bench work. It's the powerful, fast-cutting Clarke Vacuum Portable Sander now used by such big companies as Ford Motor Company, Pullman Company, Western Electric—and thousands of wood working shops, builders and floor surfacers. Of course, it isn't necessary that you have callouses on your hands. What it really takes is ambition, and a desire to get ahead. The machine is actually as easy to operate as a vacuum cleaner—it's light-weight—it makes all work pleasant.

You want to advance—make more—have better things?? Then realize on that WILL to succeed. For the good of your own future—investigate at once! The actual facts mean money and advancement to you. Mail the coupon now!



CLARKE SANDING MACHINE CO.

Dept. P-3, 3831 Cortland St., Chicago, Ill.

For 11 years, Originators and Manufacturers of
Portable Sanding Machines.



CLARKE SANDING MACHINE CO.,
Dept. P-3, 3831 Cortland St., Chicago, Ill.

Gentlemen: Please send me the actual facts on CLARKE FLOOR-CRAFTSMANSHIP. No obligation to me.

Name.....
Address.....
City.....
State.....



Speed is
not born . . . but made

FOR most fellows athletic success is a matter of hard work. Skill in games comes only after long practice. Speed, too, has to be developed by training.

But one thing is certain. If you want to develop the speed and fast foot-work you need in sports today, nothing is more important than right shoes.

And coaches and champion athletes in many sports agree that Keds are the shoes that will help you attain this necessary speed.

There are Keds for nearly every sport, indoors and outdoors. Keds soles are tough and springy—they absorb the jars that tire muscles and slow down play. The uppers are light, yet strong to protect your ankles against sudden twists and sprains. And the special Feltex innersole keeps your feet comfortable.

Write for our free booklet containing all kinds of information on games, sports, camping, vacation suggestions and dozens of other interesting subjects. Dept. 1970, 1790 Broadway, New York City.

United States Rubber Company

THE "GLADIATOR"

A sturdy athletic Keds. The special anti-skid sole is stoutly built. Made in both white and brown.

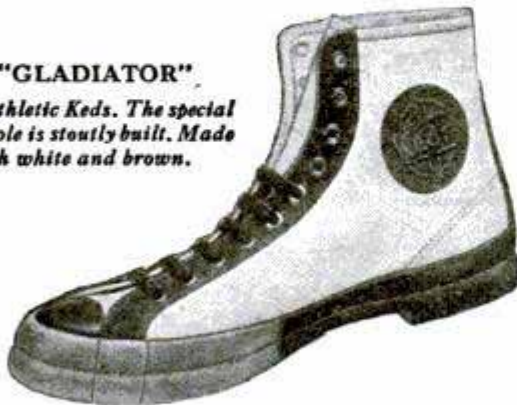

They are not Keds unless the name Keds is on the shoe

Trademark Reg. U. S. Pat. Off.

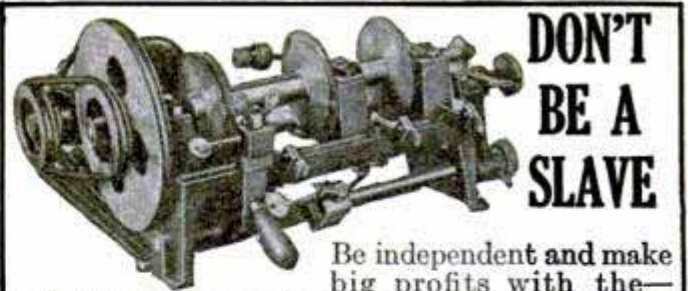

**DON'T
BE A
SLAVE**

Be independent and make big profits with the—
NEW IMPROVED BEISSER KEY MACHINE
You can start a business of your own, no experience necessary. The only key machine that cuts ALL kinds of keys. No hand-filing. Make first keys by number without taking locks apart. Locksmith instructions furnished free. *Write today for Full Particulars.*
BEISSER KEY MACHINE COMPANY
407 Fort St. East Detroit, Mich., U. S. A.

**Boils 50 Gallons
In Less Than Hour**

No Other Compares With This
Improved Oil Burner

Use Ordinary Kerosene or Coal Oil
[Burns Outdoors as Well as Indoors]
THE most remarkable Kerosene Burner ever built. Boils down apple cider, maple syrup, molasses, etc., in half the ordinary time. Ideal burner for dairies, butchers, indispensable on the farm.
PRODUCES TERRIFIC HEAT WITH SILENT BLUE FLAME

**NO NOISE
NO SMELL
NO SMOKE
NO SOOT**
So efficient it produces twice the amount of heat of City gas at half the cost. So simple anyone can install and operate. Double generator assures continuous operation without shut-downs. Nothing to wear out, starts in a jiffy, will last a life time. Every burner guaranteed fully. Write for special introductory price and free catalog of outdoor utility and kitchen stove oil burners.
HOME MFG. CO., Dept. 1713, 18 E. Kinzie St., CHICAGO



**START to PLAY
Very First Day!**

**Pleasant,
Easy
Lessons
Show You
How!**



Extra Money—Hosts of Friends—Loads of Fun Within Your Reach

HAPPY DAYS are in store for you if you will only act on this suggestion! Cheery evenings playing catchy music alone or with sweetheart, wife or sister; proud moments as center of interest at gatherings; nights of joy making \$5 to \$25 for work that is "play."

The Deagan Xylorimba is your opportunity! Wonderful for home, in demand at dances and entertainments, yet easiest of all instruments to play. No teacher necessary—you actually play simple melodies the very first day even if you cannot read a note of music right now!

Earns \$60 a Week—Ralph Smith, Chicago, says: "Played 20 minutes at wedding. Received \$20." L. E. Hallmann, Reading, Pa., writes: "Made \$300 in 5 weeks, spare time. Had never played instrument before."

Send for Big Free Book! Our new book tells all about the delightful lessons furnished with each instrument, the five-day trial that removes risk, the wonderful Deagan easy-payment plan. No obligation—simply fill in and mail the coupon.

J. C. Deagan, Inc., Dept. B1453, 1770 Berteau Avenue, Chicago
Send me, without obligation, full details of Free Trial offer and easy-payment plan of the Deagan Xylorimba.
Name
Address



Sovereign of the Seas, built by Mr. John F. Nichols of New Rochelle, N. Y., from blueprints

In Building Model Ships

... when a filler is needed, when a tool slips, or when special modeling is necessary, use

PLASTIC WOOD

Reg. U. S. Pat. Off.

In the building of the clipper-ship model shown above, Mr. Nichols says: "Plastic Wood aided me in many ways: it was used in filling up the cracks between the seven layers of $\frac{1}{2}$ -inch board used for the hull: it was used in the tops, caps, and crosstrees to make them secure to the mast, and in making the bulwarks fit tightly to the hull. Plastic Wood was also used to fill openings around the masts and bowsprit, and for such minor uses as securing belaying pins, pumps and deck fittings to the deck. Also for moulding the figure head and decorations."

For Home Uses, Too—

For many household repairs—cracks, loose handles, furniture, etc.—it is invaluable. It is waterproof and greaseproof. Send for folder showing such uses.

Handles Like
Putty
1 lb. can \$1.00



Hardens Into
Wood
 $\frac{1}{4}$ lb. can 35 cts.

At Hardware and Paint Stores

ADDISON-LESLIE COMPANY

400 Bolivar Street

CANTON, MASS.

Millions can't be Wrong



Join This Multitude of Happy Shavers—
but Don't Switch Till You Let This 10-day
Test at Our Expense Prove Our Case to
You

GENTLEMEN:

Rarely is a new product received with such acclaim as has greeted Palmolive Shaving Cream.

Literally millions who have tried it have been won from lesser methods. Most of them accepted our invitation to shave ten days "on us" before they made a switch.

That test does the business. That settles all doubt. After ten days of perfect shaves very few ever return to old methods. Won't you, too, give us a chance to prove what we have done for you?

5 Remarkable Features

1. Multiplies itself in lather 250 times.
2. Softens the beard in one minute.
3. Maintains its creamy fullness for 10 minutes on the face.
4. Strong bubbles hold the hairs erect for cutting.
5. Fine after-effects due to palm and olive oil content.

Now Send the Coupon, Please

We take the risk—not you. We undertake to please you... to win you in ten shaves. The coupon is for your convenience. Won't you use it, please?

THE PALMOLIVE-PEET COMPANY, CHICAGO, ILL.

10 SHAVES FREE and a can of Palmolive After Shaving Talc

Simply insert your name and address and mail to Dept. B-1460, Palmolive, 3702 Iron St., Chicago, Ill.

Residents of Wisconsin should address Palmolive, Milwaukee, Wis.

.....
.....
(Please print your name and address)



LUMINOUS PAINT

Make Your Watches, Clocks, Etc., Visible by Night

The very latest discovery in the scientific world, hitherto practically unknown, LUMINOUS PAINT, which, applied to the surface of any article, emits rays of white light, rendering it perfectly visible in the dark. THE DARKER THE NIGHT, THE MORE BRILLIANT IT SHINES. Quite simple to use. Anyone—you can do it. A little applied to the dial of your watch or clock will enable you to tell the time by night. You can coat the push buttons or switch plates of your electric lights, match boxes, and innumerable other articles; make your own Luminous Crossifixes, Luminous Rosaries, etc. Small bottle, price 25c. Larger size, 50c and \$1 postpaid. JOHNSON SMITH & CO. Dept. 819 RACINE, WIS.



CIGARETTE MAKER

Roll your own and save money. Better and quicker; saves more than half. Use your favorite brand of tobacco. Neat, useful, handy. Pocket size, weighs 3/4 oz. Made entirely of metal, nickel plated. 25c, 3 for 65c postpaid anywhere.



GOOD LUCK RING

Very striking, quaint and uncommon. Silver finish; skull and crossbones design, two brilliant, flashing gems sparkle out of the eyes. Said to bring good luck. Only 25c ppd.



Exploding Cigarettes

JUST LIKE ORDINARY CIGARETTES, BUT SUCH REAL STARTLERS! The box contains ten genuine cigarettes of excellent quality. They appear so real, but when each cigarette is about one-third smoked, the victim gets a very great surprise as it goes off with a loud BANG! A great mirth provoker yet entirely harmless. Price 25c box.

NOVELTY BADGES



Kissing Fermis 10c. Carter Inspector 10c. Two very novel metal badges, nickel plated, that you can wear, giving you fun out of all proportion to their trifling cost. 10c, each badge, 3 for 25c, or 75c per doz. postpaid anywhere.

MIDGET BIBLE

GREAT CURIOSITY. Smallest Bible in the World. Size of a postage stamp. 200 Pages. Said to bring good luck to the owner. A genuine work of art. Must be seen to be appreciated. Make good money selling them to friends, church acquaintances, etc. PRICE 15c each, 3 for 40c, 12 for \$1.35, 100 for \$7.50. Also obtainable in Leather Binding, with gold edges. Price 50c each, 3 for \$1.25, \$4.50 per doz. Magnifying Glass for use with Midget Bible. 15c.



STAGE MONEY

With a bunch of these bills, it is easy for each person of limited means to appear prosperous by flashing a roll of these bills at the proper time and peeling off a genuine bill or two from the outside of the roll, the effect created will be found to be all that can be desired. Prices, postpaid: 40 Bills 20c, 120 for 50c, or \$3.50 thousand postpaid.

MAGIC FLUTE

The Magic Flute, or Humanstone, is a unique and novel musical instrument that is played with nose and mouth combined. There is just a little knack in playing it which, when once acquired after a little practice, will enable you to produce very sweet music that somewhat resembles a flute. There is no fingering, and once you have mastered it you can play all kinds of music with facility and ease. When played as an accompaniment to a piano or any other musical instrument, the effect is as charming as it is surprising.



SURPRISE MATCHES

More fun than fighting with your wife. Look just like ordinary matches. Put up in boxes just like regular Safety Matches. As the victim tries to light one he gets quite a surprise. Price 10c per box, 3 boxes for 25c, 12 for 75 cents.



These clever locks cannot be opened unless you know the combination. No key necessary. For your locker, bicycle, tool chest, mail box, thousands of uses. Shackle and tumbler nickel plated. Weighs a trifle over one ounce. Small yet strong. Secret and full instructions with each lock. Price 25c or 3 for 65c postpaid.



Wonderful X-Ray Tube

A wonderful little instrument producing optical illusions both surprising and startling. With it you can see what is apparently the bones of your fingers, the lead in a lead pencil, the interior opening in a pipe stem, and many other similar illusions. A mystery that no one has been able to satisfactorily explain. Price 10c, 3 for 25c, 1 dozen 75c. JOHNSON SMITH & CO.



Every Boy His Own Toy Maker

A great book for boys. It gives plain, practical instructions for making all manner of toys, machines and other articles, amusing and useful. Tells how to make a Steam Engine, a Photographable Camera, a Windmill, Microscope, Electrical Machine, Galvanic Battery, Electric Telegraph, Electrotyping Apparatus, Telephone, Kaleidoscope, Magic Lantern, Aeolian Harp; how to make Bonts of all kinds, Kites, Balloons, Paper Toys, Masks, Card Racks, Wagons, Carts, Toy Houses, Bows and Arrows, Pop Guns, Slings, Fishing Tackle, Rabbit and Bird Traps, etc. 200 illustrations. PRICE 25c POSTPAID.



Serpent's Eggs

Box contains 12 eggs. When lit with a match, each one gradually hatches itself into a snake several feet long, which curls and twists about in a most life-like manner. Price per box, 10c postpaid, 3 for 25c.



BLANK CARTRIDGE PISTOL

Protection against Burglars, Tramps, & Dogs. Special Offer 1 Blank Cartridge Pistol 100 Blank Cartridges 1 550-page Novelty Catalog ONLY \$1.50



Well made and effective, modelled on latest type of Revolver; appearance alone is enough to scare a burglar. When loaded it may be as effective as a real revolver without danger to life. It takes standard .22 Cal. Blank Cartridge—obtainable everywhere. Special cash with order offer: 1 Superior quality Blank Cartridge Pistol, 100 Blank Cartridges, and our new 550 page De Luxe Catalog of latest novelties; all for ONLY \$1.50. Shipped by Express only. Cannot go by parcel post. Extra Blank Cartridges 50c per 100. Special Holster (Cowboy Type) for pistol 50c. No C.O.D. shipments

THROW YOUR VOICE

Into a trunk, under the bed or anywhere. Lots of fun fooling the teacher, policeman or friends.

THE VENTRILLO a little instrument, fits in the mouth out of sight, used with above for Bird Calls, etc. Anyone can use it. Never Fails. A 16 page course on ventriloquism, the Ventrilo, ALL FOR 10 CENTS



It is made in the shape of and looks like a regular Automatic Pistol. No one is likely to stop and ask you whether it is real or not. Thus it is likely to prove itself very handy in an emergency. On pressing the trigger it opens up as shown in the illustration at the right, revealing nine most useful articles—Opera and Field Glass, Telescope, Mirror, Magnifying Glass and Burning Lens, Reading Glass, Sun Dial, Sun Compass, etc. In the handle of the revolver there is a place for various pocket necessities, such as First Aid Articles, Buttons, Pins, etc. The Pistol is of sheet metal, blued finish, that can be carried comfortably in pocket. PRICE \$1.00 postpaid.

Watch Charm Pistol \$1.75

Exact reproduction of a real pistol; actually five REAL BLANK CARTRIDGES of miniature size. Illustration is an actual size. 1 1/4 inches long, with ring at end for attaching to watch chain. Loads like a regular pistol. Pull the trigger and it goes off with a loud bang. Pistol is break open type; illustration shows position for loading. Made entirely of high grade steel, nickel plated, octagon barrel, handomely engraved handles, complete in box with cleaning rod. PRICE \$1.75. Also furnished with pearl handles. \$2.50. BLANK CARTRIDGES, 50c per box of 25. JOHNSON SMITH & CO., Dept 819, RACINE, WIS.



MICROPHONE TRANSMITTER BUTTON



You can easily make a highly sensitive detector-phone by using this Transmitter Button to collect the sound waves. You can build your own outfit without buying expensive equipment. It is simple and inexpensive. You can install an outfit in your home and hear conversations being held all over the house. You can connect up different rooms of a hotel. This outfit was used by secret service operatives during the war. It is being used on the stage. It is ultra-sensitive and is the greatest invention in micro-phones. You can mount the button almost anywhere—card board boxes, stove pipes, stiff calendars, on the wall behind a picture frame, etc. Button is so light and small it cannot be detected. Persons can be overheard without suspecting it. You can listen in on conversations in another room. A deaf person in the audience can hear the speaker. Connected to phonograph, piano or other musical instrument, music can be heard hundreds of feet away. Button may be used to renew telephone transmitters; often makes an old line "talk up" when nothing else will. The ideal microphone for radio use; carries heavy current and is extremely sensitive. Amplifies radio signals. Countless other similar uses will suggest themselves. Experimenters find the button useful for hundreds of experiments along the lines of telephones, amplifiers, loud speakers, etc. Many fascinating stunts may be devised, such as holding the button against the throat or chest to reproduce speech without sound waves. PRICE \$1.00. JOHNSON SMITH & CO., DEPT. 819, RACINE, WIS.

JOHNSON SMITH & CO.

Dept. 819 RACINE, WIS.

A De Luxe Edition of our new 1928 CATALOG mailed on receipt of 25c. Handsome binding. Bigger and better than ever. Only book of its kind in existence. 550 pages of all the latest tricks in magic, the newest novelties, puzzles, games, sporting goods, rubber stamps, unusual and interesting books, curiosities in seeds and plants, etc., unprocurable elsewhere. Remit by Stamps, Coin, Money Order, Check etc. Unused U. S., Canadian and Foreign Stamps also accepted.



THE EXPO WATCH CAMERA



The most wonderful and ingenious Camera made. It is but little larger than a watch, which it closely resembles. You can carry the Expo about in your pocket and take pictures without any one being the wiser.

Less Than 2 Cents

a Picture
The Expo loads in daylight with 10 or 20 Exposure Films, costing 25c and 35c respectively, and thus the pictures taking part of a whole day's outing may be had for a very nominal sum—Little more than one cent a picture.

Easy to Manipulate

It is simplicity itself to operate. Takes pictures through the stem, where the Rapid Fire Lens is located. The photos (5-8x7-8) may be enlarged to any size. Operated as Quick as a Flash. Times and instantaneous shutters; weighs but 3 ounces; nickel plated. Endorsed by amateurs and professionals the world over. Thoroughly practical—printing and developing of films just the same as ordinary cameras—in daily use by the police, newspaper reporters, detectives, and the general public. Important hints have been secured with the Watch Camera by enterprising reporters. Provisions clear, sharp negatives indoors or outdoors equal to any camera on the market, size or price notwithstanding. Sold Under a Positive Guarantee.

Expo Watch Camera \$3.60 FILMS, 10 Exposures 25c, 20 Exposures 35c
Price Post Paid Leather Pocket Carrying Case, 35c



Rubber Chewing Gum



10c Pkge.
3 for 25c P.Pd.

It is just like a regular package of chewing gum and looks so real that it fools everybody. Of course no one suspects it is not genuine until they start to chew it. There's a world of fun in this rubber chewing gum—4 sticks to the package. Price, 10c Pkge.; 3 for 25c; 12 for 75c postpaid.

INVISIBLE INK

The most confidential messages can be written with this ink, for the writing makes no mark. Cannot be seen unless you know the secret. Invaluable for many reasons. Keep your postals and other private memorandums away from prying eyes. Great fun for playing practical jokes.

Only 15c a Bottle; 3 for 40c.



POCKET CIGAR LIGHTERS



Simplex Lighter 20c

You may pay more, but these two Lighters will do the work as well as the most expensive. The "SIMPLEX" (Illustrated on the left) sells for but 20c; lights merely by giving the wheel a turn with the thumb. The "AUTOMATIC" (on right) lights automatically; press the button, the lid flies open and lights wick at same time. Better, safer and cheaper than matches. A light instantly available whenever you want it. Prices: Simplex Lighter 20c; Automatic Lighter \$1.00; extra flints for either 5c each. All postpaid.



Automatic Lighter \$1.00

RESURRECTION PLANT



LIVING FERNLIKE PLANT of a dark green color. Simply place the plant in saucer of water, it will open up and start to grow in 20 minutes. When taken out it will dry up and go to sleep until placed in water again. Fine house plant—summer or winter. 10 cents each or 3 for 25c., 75c per doz., postpaid.

One of the most wonderful plants known. Possesses the strange power of turning in a few minutes from an apparently lifeless, dry herb to a



Great Fire Eater



With the Fire Eater in his possession any person can become a perfect salamander, apparently breathing fire and ejecting thousands of brilliant sparks from his mouth, to the horror and consternation of all beholders. Harmless fun for all times, seasons and places. If you wish to produce a decided sensation in your neighborhood don't fail to procure one. We send the Fire Eater with all the materials, in a handsome box, the cover of which is highly ornamented with illustrations in various colors. Price of all complete only 30 cents, postpaid.

Send remittance (Postage Stamps accepted) for all articles listed on above and previous page to

SQUIRT ROSE

25c



A REAL STARTLER. This is the most popular of all squirt tricks. The flower in your coat looks so fresh and sweet that everyone is tempted to inhale the delightful perfume. Then at the moment to press the bulb. Geewhikkens. Don't they jump? There is a very long rubber tube that easily reaches to the pocket of your coat or trousers, and the bulb is large enough to make a dozen snorts with one loading. PRICE 25c each, or 3 for 65c postpaid

MAGICIAN'S BOX OF TRICKS

Apparatus and Directions for a Number of Mysterious Tricks, Enough for an Entire Evening's Entertainment \$1.00

ANYONE CAN DO THEM

It is great fun mystifying your friends. Get this Conjuror's Cabinet, and you will be the cleverest fellow in your district. It contains the apparatus for ten first-class tricks, including THE MAGIC BALL AND VASE TRICK (a wooden ball is placed inside, and upon replacing the lid has disappeared and is found in someone else's pocket); THE HINDOO TRICK CARDS (can be made to change completely no less than five times); DISAPPEARING COIN BOX (a coin, placed in the wooden box, vanishes entirely or changes into a coin of another denomination); THE GLASS GLOBET TRICK (a coin is dropped into a glass of water and when the water is poured out the coin has vanished and is found somewhere else); THE RIBBON FACTORY FROM THE MOUTH TRICK (a seemingly endless supply of colored paper ribbons comes out of your mouth); THE DISAPPEARING HANDKERCHIEF (a handkerchief held in the hand mysteriously vanishes); THE WIZARD'S RING COIN TRICK; THE ENCHANTED BOTTLE (no one but yourself is able to make it lay down); THE GREAT HAT AND DICE TRICK (a large die is placed on top of a hat, disappears, and is found underneath yet no one has touched the hat), and last, but not least, THE GREAT PHANTOM CARD TRICK, or two from five leaves nothing. Full instructions are sent for performing each trick. In addition to the above, a number of other feats and illusions are fully explained for which you can easily make or procure the necessary apparatus. Price complete \$1.00 postpaid, JOHNSON SMITH & CO.



U. S. BABY TANK

25 Cents

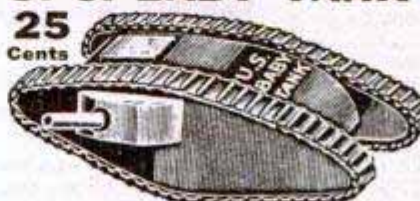

It goes with real Yankee Pep—by its own power

Most remarkable toy ever invented. By drawing the Tank backward, either on the floor or table and then placing it down, it will crawl along, overcoming all obstacles, in the same life-like manner as the larger Tank that proved so deadly in the great war. What makes it go is somewhat of a mystery, for there is no mechanism to wind up as is usually understood with mechanical toys, yet this tank will keep plodding along ten times longer than the ordinary run for toys. It will perform dozens of the most wonderful stunts; it will go backward or forward at will; 2 1/4 inches long. Price only 25c prepaid. JOHNSON SMITH & CO.



BOYS' HAND CUFFS

65c

them over the wrists and you have your pal securely handcuffed. These Handcuffs stand for Law and Order and, in the hands of the boy, inspire him with respect for Civic Virtues. They are entirely nickel-plated all over. Price only 65c pair postpaid.

Female SEX Indicator - Male Sex Indicator



Hold the MAGIC INDICATOR over a man's hand—instantly it moves in a straight line backward and forward. Hold it over a woman's hand and it describes a complete and continuous circle. The same action can be obtained over a letter written by a man or woman, etc. It is fascinating; baffling. We have never been able to figure out how it's done—but we've never seen it fail. Many novel and entertaining feats may be performed with the Sex Indicator. For example, similar results can be obtained with animals, cats, dogs, rabbits, over birds, chickens, canaries, etc. Also used to predetermine the sex of chickens and birds, etc. In fact it is sold as a patented egg tester in Europe. Price 25c, or 3 for 65c, postpaid.

Comic Celluloid Buttons



Wear one and see the effect. 70 different notions, each better than the other. Above 2 for 10c, 12 all different for 45c, or 50 for \$1.50 postpaid.



Comical Motto Rings

Lots of harmless fun and amusement wearing these rings. Made in platinum finish (to resemble platinum), with wording on an enameloid, as illustrated. Price only 25c postpaid.

The "Little Giant" Typewriter

A First Class Writing Machine For \$1.50



A perfect little typewriter for \$1.50. There are thousands of persons who would like to use a typewriter but whose needs and business do not warrant the expense attached to the purchase and use of a fifty or seventy-five dollar machine. To such persons we confidently recommend our Little Giant. It is strongly made, but simple in construction, so that anyone can quickly learn to operate it and write as rapidly as they would with pen and ink. The letters of the alphabet most frequently used are so grouped as to enable one to write rapidly, the numerals 1 to 10, and the punctuation marks being together. With this machine you can send your best girl typewritten love letters, address envelopes, make out bills, and do almost any kind of work not requiring a large, expensive machine. With each typewriter we send a tube of ink and full printed instructions for using the machine. Price complete \$1.50 by mail postpaid to any address in the world.

18 Tools In One S&B SAW *Money Back Guarantee* 8" Combination S.B. SAW 15 Days Approval

The S&B 8-in. Combination Saw (18 tools in one) is the ideal machine for the shop, factory or the home; will rip, cross cut, bevel, miter, mortise, groove, drill, tenon, grind, rabbet, buff and polish. The greatest machine you ever saw; no other machine so complete and efficient as the S&B—actually

\$35

F. O. B. CHICAGO

18 tools in one! You will marvel at the wonderful beveling, grooving, butting, etc. All attachments are adjusted in a few seconds without any difficulty. Very little space is used and the motor is mounted on a base that is a part of the machine proper; this is an exclusive feature! The motor: 1/2 H.P., 60-cycle, 110-volt A.C., run from any light socket also, provides power for other purposes when the saw is not in use. Complete with attachments: 12-in. x 16-in. Table, 8-in. Combination Saw, Iron Pulley for Saw Table, 10-in. Ripping fence, Adjustable Cut-Off Miter Gauge, Motor 1/2 H.P., 3-in. Pulley, 6-in. Buffing Wheel, 5-in. Emery Wheel, 6-in. Sander, 1/4-in. 3-Jaw Drill Chuck, 1 1/4-in. Endless Leather Belt, 8-foot Cord and Plug, and 2-in. Dado Insert. Price \$35.00, F.O.B. Chicago. Shipping weight 100 lbs. (Planer attachment to fit on table top will smooth pieces up to 2 in. wide, \$12.00 extra. Flexible Shaft Grinder attachment, \$35.00 extra.)

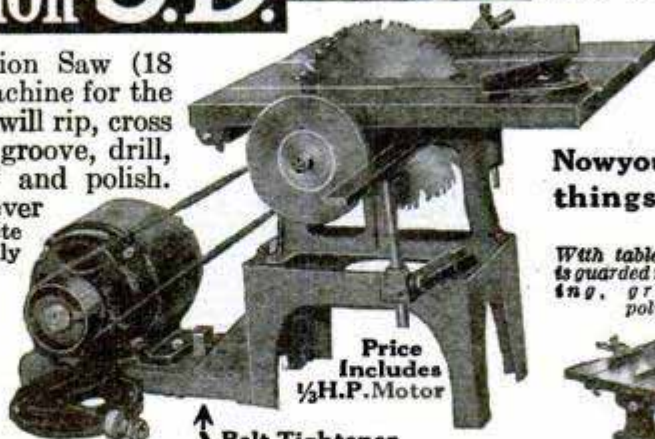

Price Includes 1/2 H.P. Motor

Belt Tightener

1/2 H.P. Motor—40%—100% overload Double Shaft Extension

THE WONDER OUTFIT for any MAN or BOY

Now you can make the things you wanted

With table raised—saw is guarded ready for drilling, grinding or polishing.



Ready for dado or planer head and special molding work—Table is adjustable.

Planer attachment—most practical ever adapted to a saw table.



Flexible shaft grinding attachment—especially good for metal patterns, routing, grinding, die-castings, etc.



The only machine that you can tilt the table to 45° without removing insert. Big advantage on pattern work.



Write for Complete Illustrated Folder

SCOTT-BANSBACH MACHINERY CO.

130 So. Clinton St.

Dept. 65

CHICAGO, ILL.

DO ALL YOUR OWN PAINTING New—Quick—Easy Way—By Air—No Brush

NOW anyone can own and operate a spray outfit and apply lacquers, brushing lacquers, varnishes, enamels, paints, etc. The KB SPRAY GUN makes painting easy; gets into the most intricate places where it would be impossible with a brush. A wonderful smooth-glass-like finish is applied with this New Hand Operated KB SPRAY GUN on Automobiles, Furniture, Wicker Ware, Screens, etc., in fact, on anything in and around the house. Women are delighted with it. Makes painting a pleasure. THROW AWAY THE OLD BRUSH.

MAKE \$100 TO \$250 A WEEK (NO EXPERIENCE NECESSARY)

On account of the unusual demand for this wonderful KB Hand Operated SPRAY GUN it opens big money-making possibilities in every locality, everyone is interested in this marvelous outfit when they see the excellent work it does. A great many homes have been brightened with this amazing outfit and thousands of homes are anxious to get it. Be the first in your locality.

Write for Free Booklet

KOCH BROS. MFG. CO.

1515 Lawrence Ave.

CHICAGO

Special Offer
COMPLETE
OUTFIT
Only \$9⁷⁵



AGENTS WANTED



The "SILVER ACE" FLYING MODEL FLIES 800 FEET

De Luxe Model covered with waterproof silk (Ready to Fly) \$12.50
Standard Model (Ready to Fly) 10.00
Partly Assembled 8.00
Knocked Down 7.00
50 Cents Extra for Packing and Shipping

Weight, less than four ounces—Wing Spread, 30 inches—Demountable motor and wings—Balsa wood sides and ribs—Flexible propeller and landing gear—Celluloid wheels—Shock absorbers—Winding Device for rubber. Complete parts and instructions for assembly in half a day's time

Model Supplies of All Kinds

THE AERO MODEL CO. Dept. P, 421 S. Clark St. CHICAGO

Send for 100 HOME PLANS!

Buy Direct From Mill!

Get our low wholesale prices before you build. We furnish complete lumber cut to plan at mill; architects' plans free with order. Saves you 30% labor cost and 18% lumber waste. Customers say they save \$200 to \$2000. One guaranteed price covers all — no extras. Many put up own homes. We also supply lumber and building material for any job. Write for free estimate — wholesale prices.

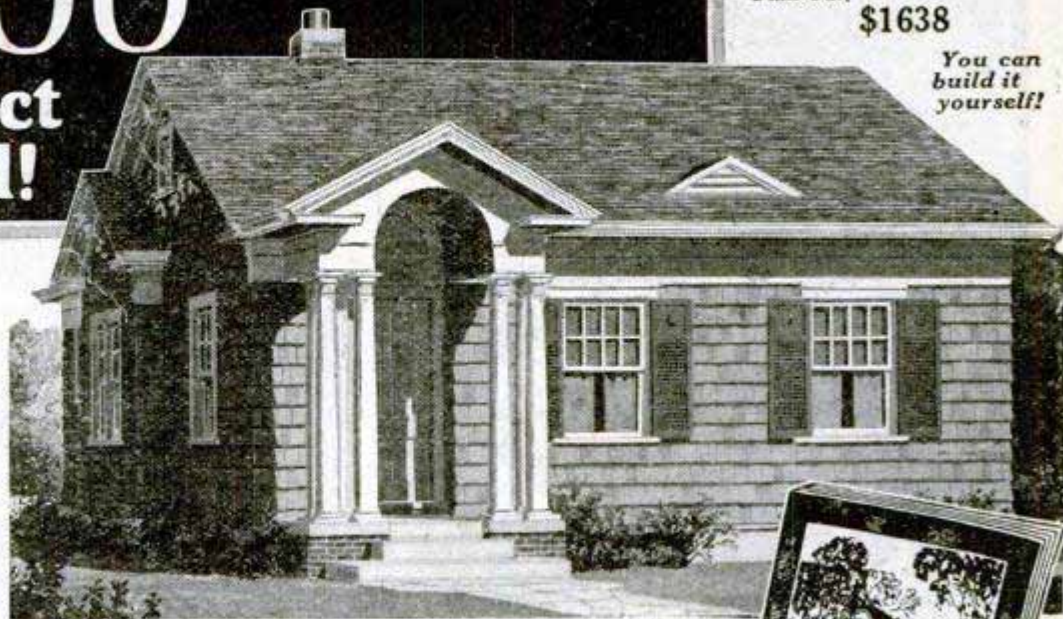

"THE CASCADE"

5 Rooms and Bath. Built-in conveniences. Materials, Plan-Cut.

\$1638

You can build it yourself!

140-Page Book FREE!

shows photos, floor plans, specifications, direct-from-mill prices on 100 PLAN-CUT HOMES. Also ask for books on Garages, Summer Cottages, Barns and Poultry Houses.

Garages and Poultry Houses

20 different sizes and styles. Easy to build Plan-Cut.

No. 459
16 x 20
\$160



Write or Send Coupon



Gordon-Van Tine Company
1089 Case Street, Davenport, Iowa
Satisfaction Guaranteed or Money Back
Please send me Book of 100 Home Plans.

Name.....

Address.....

Gordon-VanTine

(Established 1865)

PLAN-CUT Homes



BE INDEPENDENT START A BATTERY AND WELDING SHOP

GET SUPERIOR'S PRICES BEFORE YOU BUY. WELDING OUTFITS for—Welding—Cutting—Lead Burning—Carbon Burning—Soldering—Brazeing—Radiator work. Outfits \$18.00 to \$69.20.

The Superior Oxy-Acetylene Mach. Co. HAMILTON, OHIO P. O. Box 285

PORTABLE WONDER SAW MODEL 3-A BUILT-IN MOTOR

Not a toy, adaptable for use in schools, laboratories, pattern shops, manufacturing and home use. It rips, cross-cuts, also jig and scroll saw. Automatic splash lubrication. Operates from light socket. Write for further information—**THE MACHINE CRAFT CO. VALPARAISO INDIANA**



\$22.50
to
\$42.50

AGENTS \$7 A DAY SURE AMAZING NEW APRON

NO STRINGS
NO STRAPS

Just Out Not sold in stores. New PATENTED Apron without strings, straps, buttons, or hooks. Women grab it. Attractive cretonne patterns. Secret girdle holds it. Green made \$26.25 in a day. Mrs. Fragg \$16.80 in 2 hours. Big profits. Full or spare time. We deliver and collect. **WRITE TODAY SURE. FREE SELLING OUTFIT OFFER.**
STA-PUT CO., Dept. 203A, 711 N. 11th St., St. Louis, Mo.



Get the facts on this New Speedster!

NEW, sensational B class speed motor. Drives racing hulls 25 miles and over. Thrilling performance—instant starting—absolute dependability. Write for literature. Elto Outboard Motor Co., Ole Evinrude, Pres., Mason St., Dept. AA, Milwaukee.

The Super Elto Speedster

LYNCH

for 25¢

P. M. 3

you can learn how to remodel your set for better radio reception. Send coupon or see your dealer.

Arthur H. Lynch, Inc.
1775 Broadway
New York City

1775 Broadway N. Y. C. Send me a copy of "Resistance the 'Control Valve' of Radio" for enclosed 25c.

Name.....

Street.....

City..... State.....



Get that
Typewriter
You've Needed



ONLY \$3⁰⁰ DOWN

Now's the time to buy that typewriter! By filling out the coupon you'll receive a genuine L. C. Smith at the lowest price and on the easiest terms ever made on this famous typewriter. For 20 years it has been recognized as the fastest running, easiest writing and longest lasting typewriter. The choice of railroads, big corporations like the Standard Oil. The U. S. Government uses over 50,000.

The Machine With A 5-Year Guarantee

Once you try this superb typewriter, you'll want to keep it. Only the L. C. Smith has these vital features: ball bearings at every point of friction, all the writing visible all the time, basket shift, back spacer, 2-color ribbon, and all the latest operating attachments. Beautifully re-newed. **IT IS THE WORLD'S ONLY BALL BEARING TYPEWRITER.**

**SEND NO MONEY!
10-DAY FREE TRIAL**

Fill out—mail the coupon, and we will send you one of these superb machines. Try it in your own home or office for 10 days. Put it to any test. Use it just as if it were your own machine. Compare the work it turns out. If you're not delighted, return it. The L. C. Smith at this price, on these terms, may never be repeated. Act now! Mail coupon today. Save money. \$3 worth of extras and valuable Touch Typewriting Course included if you act at once.

**SMITH TYPEWRITER SALES CO.
113-360 E. Grand Avenue, Chicago, Ill.**

Ship me the L. C. Smith, F. O. B. Chicago. On arrival I'll deposit \$3 with express agent. If I keep machine, I'll send you \$5 a month until the \$68.70 balance of \$69.70 price is paid; the title to remain with you until then. I am to have 10 days to try the typewriter. If I decide not to keep it, I will repack and return to express agent, who will return my \$3. You are to give your standard 5-year guarantee.

Name.....
Address.....
City..... State.....
Employed by.....

\$3.99 **Cifet) me Precision Men's Strap Watch**
Worn by practical men everywhere. Guaranteed shock proof and weather proof. Perfect time keeper. Radium dial. Fine imported full jeweled movement. Rich silver finish. Genuine leather strap. Sold elsewhere for \$10.00. Fully guaranteed to give you complete and entire satisfaction. **SEND NO MONEY:** Pay to your postman only \$3.99 plus the postage on delivery.
JENKINS CORPORATION
621 Broadway, New York, Dept. 23F3

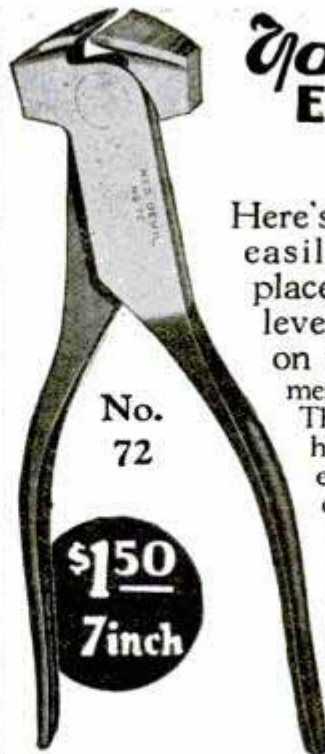

**You need this
END CUTTING
NIPPER**

Here's a nipper that cuts easily in out-of-the-way places. It has tremendous leverage. A slight pressure on the handle delivers tremendous power at the jaws. The shape of the double-hammer head makes the tool extremely efficient for pulling cotter pins, nails, etc. Absolutely guaranteed by your hardware or accessory dealer.

No. 72

**\$150
7inch**

Crescent Tool Co.
210 Harrison St., Jamestown, N.Y.

- Wrenches
- Chisels
- Snips
- Pliers
- Punches
- Hacksaws
- Screw Drivers
- Auger Bits
- Nippers

**CRESCENT
and Smith & Hemenway
TOOLS**

Made and guaranteed by the
Originators of the Crescent Wrench



**The International
Motor Saw**



Modern methods demand better equipment. Here it is. The International Motor Saw does all sawing jobs; cross cuts, rips, bevels, miters, and scroll work.

Write for full description. Dept. S.
The International Stamping Co.,
400 N. Leavitt St., Chicago, Ill.

\$45 Buys This Motor Cycle

It's a Harley-Davidson, 16 H. P. twin chain drive, magneto and clutch. It has power and can get up and go on the open road at a speed which thrills. This is only one of hundreds of bargains in used motor cycles which you can get. Send for Free Catalog. It tells of big bargains and tremendous values in used motor cycles. Repairs quickly done. Motor cycles exchanged. Send us your machine to be overhauled.
Oliver Cycle & Motor Co., 1045 N. Grand Ave., St. Louis, Mo.



FREE 1000 Illustrations ELECTRIC FIXTURE CATALOG!

Write today for your copy. Save 50% direct from Manufacturer. No Middleman's Profit. **OUR SPECIAL: 8 Room Electric Set,** ready to hang, \$24.50—Other bargains.
UNITED LIGHTING FIXTURE CO.
83 Flatbush Ave., Dept. M, Brooklyn, N.Y.



The man who studies gets ahead. Popular Mechanics Press will advise you what books to read to advance in your trade. 200 East Ontario Street, Chicago, Illinois.

WADE AMATEUR MECHANICS, REPAIR SHOPS, INVENTORS, STUDENTS
BENCH LATHE
A real machine tool for the home work bench—capacity 4" dia. x 12" length. For Metal—Wood—Composition Materials. Turning—Facing—Boring—Drilling—Winding—Thread Cutting. Accurate—Strong—Quiet—Compact. Slide-rest has travel entire length of bed. Leadscrew inside bed. No. 1 Lathes, plain headstock, \$28.00. No. 2 Lathes, back-gear headstock, \$58.00. Extra for lathes with 18 inches between centers, \$7.00. Complete list of accessories at equally low prices. Write for free catalog.
THE GEROLD CO. Dept. P-41 120 Liberty St. New York



PLEASANT & PROFITABLE Employment Selling the Famous Dodson Bird Houses



Wren House



Flicker House



Martin House of 48 rooms

We want a bright, active young man or young lady to represent us in each community. All that is required is willingness to work—we teach you the rest.

No Experience Necessary

Dodson Bird Houses, etc., have been advertised extensively for years and are well known among bird lovers and sell quickly. They are scientifically designed and built to attract each little tribe of song birds. Dodson Bird Houses, Shelters, Feeding Stations, Bird Baths, Special Foods, Sparrow Traps, etc.—in fact, our entire line attracts the happy song birds and adds beauty to any home grounds.

Home owners, Golf and Country Clubs, managers of Parks, etc., are your customers. Every one with a yard is a prospective purchaser. You take orders from our beautifully illustrated catalog—no samples to carry. Orders often run into hundreds of dollars. We pay liberal commission to right persons. Give age, three references and selling experience, if any.

Joseph H. Dodson, Inc.
650 Harrison Avenue
KANKAKEE, ILLINOIS



A HINT TO THE MODEL BUILDER!
Your Flying Cloud, or Santa Maria will cost you less money, if you order from our new illustrated catalog. Contains all the hard-to-make materials, figure heads, crosstrees, etc. Dime. 25c (silver) and we'll include complete catalog of Books for a Yachtman's Library.
BUY HANCOCK, 323 Douglas Ave., PORTSMOUTH, VA.

See Miles Away

Big 3 1/2 Ft. Telescope

Lend wings to your eyes! People and objects miles away seem close. Wonder telescope brings new pleasures to home, farm, camp, travel, sport. Study the mysterious Sun spots; see Moon and Stars as never before. See people on the beach, on the mountains, etc.

FREE Yes, absolutely free! A handsome leatherette Carrying case and Shoulder Strap. Also Solar Eye Piece to view the sun—a special feature, found only on expensive instruments.



CLIP THIS AD

5 Sections
8 Power Lenses
Brass bound; measures 12 in. closed; powerful achromatic lenses protected by dust caps.

Thousands Pleased

P. Brush wrote: "Watched submarines three miles off coast." Ed. Foster: "Tall time on clock five miles away." C. Scribner: "See lighthouse 18 miles away." Mrs. Yarbrough: "Could tell color of aeroplane four miles away." S. M. Gearhart: "Can see men working seven miles away."



5 DAY TRIAL



SEND NO MONEY

On delivery of Telescope, free Case, Strap and Eye Piece pay Postman only \$1.85, plus postage (2 complete outfits \$3.50). Satisfaction guaranteed or money refunded. Send today, entertain your friends! Be first to have one.

FERRY & CO., Dept. 1774, Chicago, U. S. A.

\$20.00 to \$40.00! FOR YOU PER DAY!

Get What You Are WORTH!

Most men, accustomed to making three to six dollars a day, hypnotize themselves into believing that a \$20.00 to \$40.00 a day proposition is beyond their ability. It's all the bunk! You don't have to have a fine education, a pull and a lot of business experience to make \$20.00 to \$40.00 a day. All you need is unbeatable desire, determination and the opportunity to get out of this world what others are getting.

Two-Thirds of Success Is Making a Decision

If you actually want to make more money—more than you have ever made in your life—you can do it. Write to us and we'll show you how to do it with the

American Universal Floor Surfacing Machine

No special training nor large capital is necessary. We show you how it's done in a couple of hours. Floor surfacing has grown to be a big, important business. Men become specialists at it and earn big money. It's a clean, healthy, inside job, not dependent on weather conditions. There are no dull seasons—always plenty of work. Every new floor has to be surfaced. Thousands of old marred and scarred floors need re-surfacing. Think what that means! It's your opportunity. The "American Universal" floor surfacing machine is the only one that does re-surfacing that experts endorse 100%. It takes the place of six hand scrapers. Works by electricity. Simple, easy and quick. Write today for full particulars, reports of users making big money and our special five-day free trial plan. Clip and sign the coupon now. Go out and put it in the mail box now. Decide now that you will get into something that will pay you the bigger money that other men are getting.



The American Floor Surfacing Machine Co.

523 South St. Clair St.
Toledo, Ohio

**American Floor Surfacing Machine Co.,
523 South St. Clair St., Toledo, Ohio.**

Please send me at once, full particulars about floor surfacing as a profitable business the "American Universal Way."

Name.....
Address.....
City..... State.....

Outselling because it is the Better Spark Plug

TODAY, more than ever before, Champion merits the world preference which enables it to outsell, two to one.

For, today, Champion is better than ever before with new improvements and new advances in spark plug design, including:

The exclusive Champion sillimanite core which resists the higher compression of the modern engine—a new sillimanite glaze which keeps free from carbon and oily deposits—a new, patented compression-tight gasket seal—and improved special-analysis electrodes assuring a fixed gap.

Champion X—for
Ford Model T

60c

Champion—for all
cars other than
Model T Ford

75c

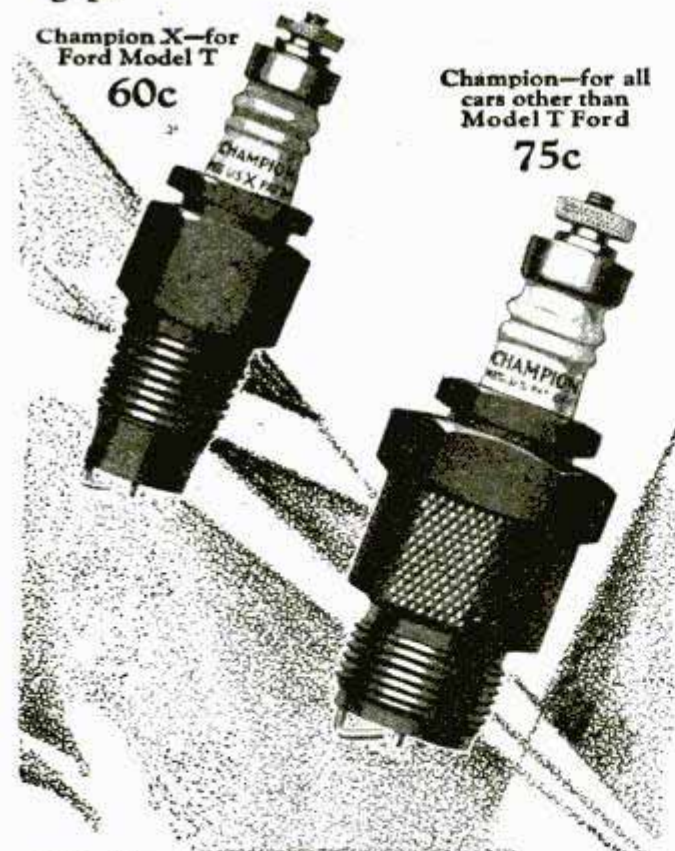

Champion

Spark Plugs

TOLEDO, OHIO

PARKS

WOODWORKING MACHINES

Cabinet Shop
Special No. 10

\$290

With Motor

You ought to have this handy Parks in your shop. Compact, complete machine designed like a big production outfit at $\frac{1}{3}$ the cost. Fits in a corner of your basement. Does any kind of cabinet and joinery work. Write for circular.

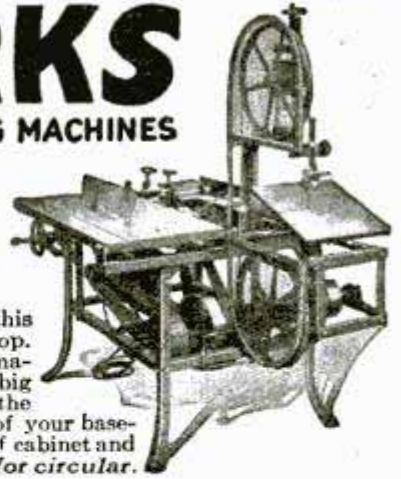

The Parks Woodworking Machine Co.

1500-40 Knowlton St.

Cincinnati, Ohio

Canadian Factory: 208 Notre Dame East, Montreal

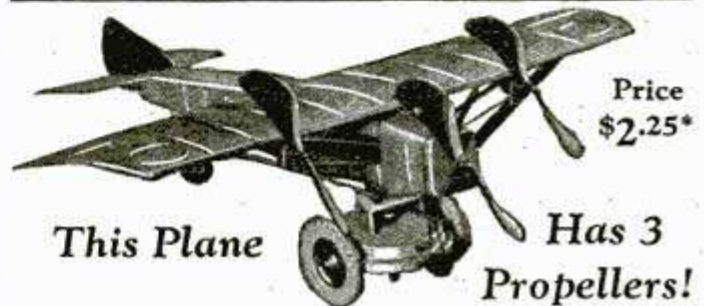

Price
\$2.25*

This Plane

Has 3
Propellers!

LIFE-LIKE model of up-to-date, tri-motor monoplane. All steel—L with handsome silver, gilt and green bronze finish. Bright red wheels, rubber tires. Powerful spring motor sends it swiftly round the floor. Wing spread 15 in. If not on sale at your favorite toy store, send us \$2.25 (*West of Miss. or in Canada, \$2.50) and we'll send you one direct. KINGSBURY MFG. CO., 83-C Myrtle St., Keene, N. H. Complete Catalog Free.

KINGSBURY Motor Driven TOYS

Novel Eraser 10c. Kingsbury Airplane Wheel with tire of Eraser Rubber. Four for 50c.

\$1.00 Will Save Your Speaker



The Craftsman Dollar Speaker Filter is Guaranteed to relieve your speaker of the DC plate current (up to 250 volts). It gives speaker a chance to operate at its best. Attached in a second.

Send Dollar Bill NOW!

Craftsman Radio Products
9 Orchard St. Newark, N. J.



2A
Closed View

BEAUTIFUL RADIO CONSOLE

Model 2A to fit all standard models of Radio Sets up to 9x24 in. panel. Construction of Cabinet: Hinged top, bottom door opens in front. Dimensions of cabinet 42 in. high; 17 $\frac{1}{2}$ x28 in. top; 15 in. deep. Constructed of selected walnut veneer and gum wood. Hand rubbed to a real finish. Price with Horn \$25.00. C.O.D. Factory.

Universal Radio Cabinet Company, Inc.
1756-58 W. Austin Ave., Chicago, Ill.

Cal. 30-40 6 Shot



\$9.75

KRAG CARBINE

All the qualities of a high price rifle. The choice of those who know. Fine used condition, all working parts guaranteed for one year. Send for our Free 50-page catalog of money saving values: Guns, Ammunition, Cutlery, Sports and Gov't goods. Outfitters for 50 years to leading Military and Society Organizations, Theatrical and Wild West Shows. Satisfied customers all over the world. Terms Cash. No C.O.D. W. STOKES KIRK, 1627-P. M. North 10th Street, Philadelphia, Pa.

The Tire which has Revolutionized the whole Tire Industry

Now
Accessible
to Everyone

**LIVE
WIRE
Salesmen
Big Money Here!**

So unusual as to be almost unbelievable. You don't have to be a "world beater" of a Salesman, just a consistent worker, to make \$200 and over a week—*easily*. Others are doing it. Everything *free*. No investment. Exclusive territory now available. Established business ready and waiting, right in your own locality, through our National Advertising.

Get in business for yourself in the Biggest Business in the World. The Automobile ranks First. Tires are the big replacement cost to every auto owner. The Dickinson Cord Tire solves his problem, appeals to his reason and saves his pocketbook. Sales are easy. Re-orders come without effort. Selling the Dickinson Cord Tire establishes you in a *profitable lifetime business*.

The Dickinson Cord Tire is as far ahead of the Tire Industry as the Aeroplane is ahead of the old-time horse and buggy. It is made by the DICKINSON AUTOMATIC TIRE BUILDING MACHINE, of which we are the *exclusive users*. Every tire is made with automatic precision. No misfits. No hand mistakes. Every tire perfect and a racing tire. Tire strength, comfort and endurance are tripled. Satisfaction, Speed and Economy—*guaranteed*.

Proof against "stone bruise" and that old bogey "blow-out," 100% pure live rubber. Embodies correct motor-traction principles never before applied. More miles per gallon of gas. *Guaranteed* for one year against *everything* that can happen to a tire except loss by theft or damage due to wilful abuse.

Every auto owner a prospect. Make a sale of one Dickinson Cord Tire and you make a friend who will add to your profits—by recommendation. Costs user nothing, as savings in fuel consumption range from 10% to 17%. The Strongest, Fastest and Easiest Riding Tire in the World is open to your Exclusive Representation in Your Territory. Write today for complete information—(Dept. 59).

HYDRO-UNITED TIRE CORPORATION

J. G. FEIST, *President*

Pottstown, Pa. Address Nearest Branch Chicago, Ill.

**FREE
This case
\$40 a Day
PROFIT...**

This case makes the sales, sets you up in a lifetime business and makes you independent. Show the quality of a Dickinson Cord Tire and the prospect sells himself. Sales easy. Repeat business comes to you. Preference given to first applicants for Exclusive Territory. No investment. Write now.

Name
Address (59)
Town
State



DICKINSON
The World's Perfect Tire

electrify your set the easy practical Knapp way....

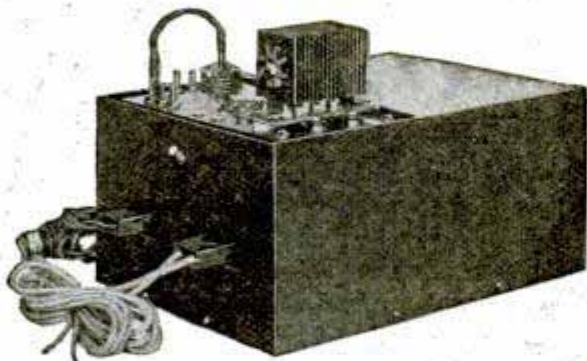

The Kit completely assembled with metal cover in place. Operates on 105-120 volts AC 50 to 60 cycles.

Knapp "A" POWER KIT

No expensive short lived AC Tubes, no troublesome re-wiring, no annoying hum, increase instead of decrease the efficiency of your set, no waiting—the Knapp "A" Power gives you music instantly at the snap of a switch. This absolutely dry "A" Power is not in any way a battery combination—not something to add to your battery—it is the most efficient "A" Battery Eliminator ever designed. It supplies unflinching "A" current to any set using 201-A or 6-volt tubes, regardless of number.

Magic Silence

So silent is the Knapp "A" Power, that you can place a pair of head phones directly across the output and not be able to detect a hum. This is made possible by the efficient Knapp filter system, consisting of 2 oversized chokes and 2 condensers of 1,500 microfarads each. A new discovery makes these amazing capacities possible in the small space of 2x2x8 inches!

Absolutely Dry

There is not a drop of moisture in the absolutely dry unit. The condensers are baked so that not a drop of moisture remains. The unique, fully patented solid, full-wave rectifier is also absolutely dry. No water, no acid, no alkali, no tubes, no electrolytic action. Nothing to get out of order. Nothing that needs attention.

Assembled in Half An Hour

The Knapp "A" Power Kit is so easily assembled, that within half an hour after you receive it, you can have it in operation. The parts seem to fall in place. No drilling and very little soldering. Everything supplied, even to the screws, wire, drilled base-board and metal cover. It is so complete, that even a plug is supplied so that a "B" Eliminator may be operated from the same switch. We have never seen such simple instructions.

Big Profits for Set Builders

Our President, Mr. David W. Knapp, is offering the set builders of America, for a limited time only, a money-saving, profit-making plan which is unique in the annals of radio. Write us today, before it is too late.



Knapp Electric Corporation
321 Fox Island Road Port Chester, N. Y.



Constant Filament Voltage

AMPERITE

alone keeps tube filament voltage constant despite variations in "A" supply. Tube efficiency demands it. Indispensable with battery eliminators. Eliminates hand rheostats. Simplifies wiring. **FREE**—Amperite Book of latest construction data and circuits. Write Dept. P.M.-3

RADIALL CO., 50 Franklin St., New York

AMPERITE

The "SELF-ADJUSTING" Rheostat

MAKE MONEY in RADIO

Over 4000 Men Now Making
Big Money Thru Our Plan

The CUSTOM-BUILT HI-Q SIX is the most remarkable receiver of recent years—designed by 10 of America's leading radio manufacturers—incorporates every modern feature and many new ideas distinctly in advance of its time—acknowledged by experts as supreme in selectivity, sensitivity and tone—now being built and SOLD by over 4000 novices and professionals—actually costs about \$100 less than finest ready-assembled sets—tremendous nationwide demand opens big money making opportunity for many more wide-awake young radio men. Send 25 cents to-day for complete 48-page Construction Manual with graphs, charts, photos and complete proposition showing how we establish you in this fascinating profit-making business on whole or part time. Hammarlund-Roberts, Inc., Dept. X, 1182 Broadway, New York.

HAMMARLUND-ROBERTS CUSTOM-BUILT HI-Q SIX!

FREE!
30 DAY TRIAL.

Radio's most amazing bargains, direct from big, reliable maker (8th successful year). All Electric or Battery sets, Consoles or table cabinets. Don't buy unless 30 days trial proves Miraco unbeatable at 2 to 4 times the price for selectivity, distance, volume and rich, Cathedral tone. Turn 1 dial for all stations. Completely assembled, fully guaranteed metal literature, users' testimony and **BIG SPECIAL OFFER** MIDWEST RADIO CORPORATION Pioneer Builders of Sets 407-D Miraco Bldg., Cincinnati, O.

Powerful 6-7 or 8 Tube Guaranteed RADIO

RETAIL \$36.75 to \$69.75

BIG DISCOUNTS to User Agents

Convert Your Receiver to A. C. with a KARAS A-C-FORMER

Write us today for full details as to how you can change your present set so as to use the new Cunningham, RCA or CeCo A. C. Tubes for lamp socket operation with the NEW Karas A-C-Former Filament Supply, Type 12 and Carter Adapter Cable Harness. Ask us for particulars and complete information.

KARAS ELECTRIC COMPANY, 4028-C N. Rockwell St., Chicago

RADIO At Half Usual Cost

30 Days' Free Trial Now—lowest prices on latest 5, 6 and 7 tube—**ONE DIAL**—Coast to Coast Radio sets. Buy direct—save half and get 30 Days' Trial in your home. Every set guaranteed. **24 Models to Choose From.** Our Free Catalog shows Table styles, Consoles and handsome De luxe Cabinet outfits at cut prices. Over 15,000 satisfied owners. Don't buy any Radio until you write for our **FREE** catalog and 30 Day Trial offer.

WESTGALE ELECTRIC CO.
Dept. 503, 1750 BELMONT AVENUE, CHICAGO

FREE RADIO BOOK

I Want to send you a Santa Fe Special Watch

for your
Examination
21
Jewels
Approval



**Send No
Money**

Watch Sent on 30 Days Free Trial

In addition to our New Low Price, I will send for your approval one of these Standard Watches, guaranteed for a lifetime of satisfactory service, not only by the Santa Fe Watch Company, but by the Great Illinois Watch Factory. They are found in the pockets of men in the service on every railroad in this country. Senators, Congressmen and Governors keep their official appointments by "Santa Fe Special" time. Army officers and Privates carried them all through the Greatest War in history—thousands of these splendid watches are in use all over the World. If you want one on my liberal new **LOW PRICE PLAN**, you had better write for my Free Watch Book today and make your selection without delay. I will send the Watch for you to see **WITHOUT ONE PENNY DOWN**—I will even allow you to wear the Watch 30 days **FREE**—then sell it to you on a binding money-back guarantee.

Why Not Own A 21 Jewel Watch

You will never miss the few cents a day that will make you own one of these watches—**SEND FOR WATCH BOOK**—illustrating in beautiful colors hundreds of designs and combinations in cases in the **POCKET WATCH, MEN'S STRAP WATCH and LADIES' WRIST WATCH**. You can have your name or monogram and any emblem you may desire engraved in the Case to suit your own ideas.

New Case Designs

I want you to see the new models and wonderful case design in the Santa Fe Special, the Santa Fe Mogul, the Santa Fe Strap Watch and the Petite Santa Fe Princess Watch. No matter what your choice of a watch may be there is a Santa Fe Watch to please you. Send coupon for our beautiful **FREE** catalogue showing hundreds of designs and models in watches and newest creations in Diamond Rings and Jewelry.

**WRITE FOR SPECIAL CASH OFFER — GOOD FOR 30 DAYS
SANTA FE WATCH COMPANY**

Mail 36 THOMAS BUILDING TOPEKA, KANSAS
(HOME OF THE GREAT SANTA FE RAILWAY)

Coupon
for Beautiful
FREE Watch
and
Diamond Book

Santa Fe Watch Company,
36 Thomas Building, Topeka, Kansas.
Please send prepaid and without obligation your Watch Book Free, explaining your "No Money Down" Offer on the Santa Fe Special Watch.
Name.....
Address.....
City..... State.....



FREE A limited offer! With every Santa Fe Special, a beautiful gold chain or strand of exquisite pearls. Write today.

SOUTH BEND LATHES

FOR
Tool Room
Manufacturing
Machine Shop
Repair Shop
Service Station
Laboratory
Engineering Shop

Precision
Popular Prices
Practical Attachments
Easy Payment Terms

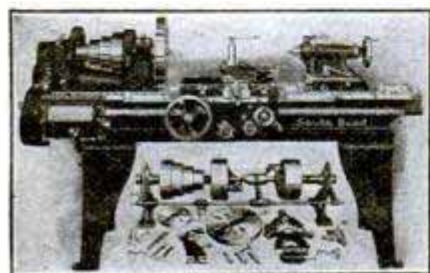

16" x 8' Quick Change Gear \$570
 Lathe, Straight Bed.....
Described fully in Booklet No. 16

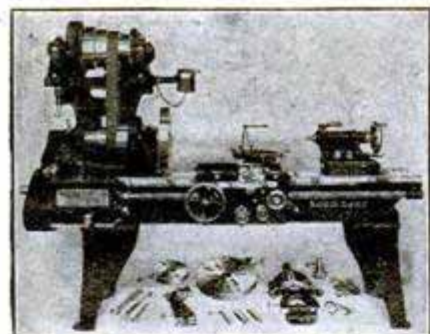

18" x 8' Quick Change Gear \$908
 Motor Driven Lathe.....
Detailed specifications given in Special Booklet No. 18

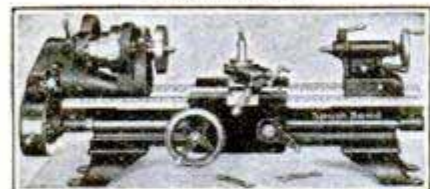

9" x 2 1/2' Junior Back Geared, \$150
 Screw Cutting Bench Lathe...
Shown complete in Booklet 22K

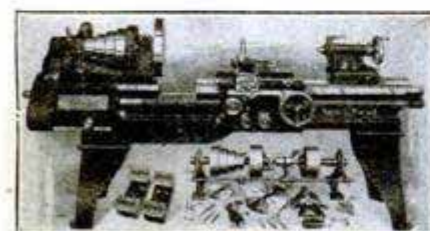

16" x 6' Quick Change Gear \$620
 Gap Bed Lathe.....
Shown complete in Booklet No. 16

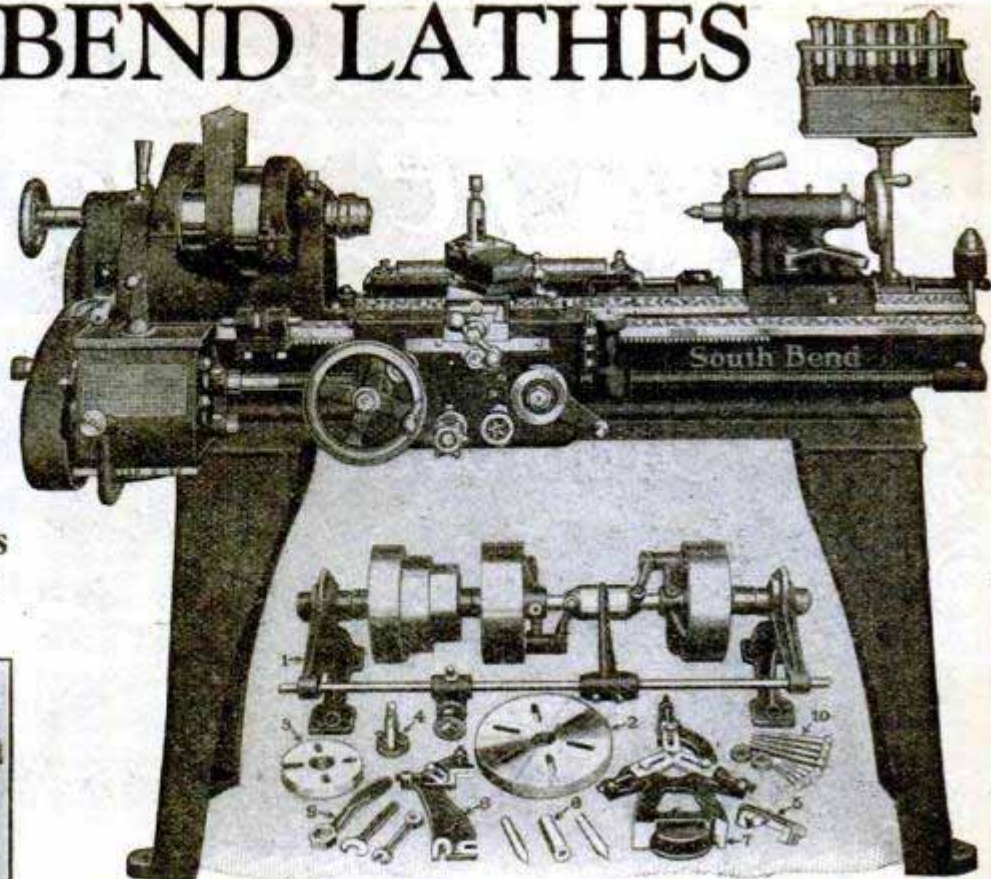

11" x 4' New Model Precision Tool Room Lathe with Countershaft and \$335
 Regular Equipment.....
One of the types illustrated in Special Booklet No. 11

Other Popular Selling Sizes

The Prices of Popular Selling Sizes with Countershaft and Equipment

Size of Lathe	Shipping Weight	Standard Change Gear	Quick Change Gear
9" x 3'	490 lbs.	\$235.	\$270.
11" x 4'	725 lbs.	\$300.	\$335.
13" x 5'	1110 lbs.	\$352.	\$402.
15" x 6'	1550 lbs.	\$430.	\$490.
16" x 6'	1875 lbs.	\$480.	\$540.
16" x 8'	2035 lbs.	\$510.	\$570.
18" x 10'	2840 lbs.	\$685.	\$750.

Easy Payment Plan—10 Months to Pay

Small down payment, balance in 10 equal monthly payments, or you can purchase through your nearest machinery dealer.

FREE—Write for No. 88 Catalog and New Booklets

Six special descriptive booklets listed below illustrate, describe, and price 210 sizes and types of NEW MODEL South Bend Lathes. New General Catalog also illustrates and describes the complete line of New Model Lathes, Attachments, Chucks and Tools. Over 300 illustrations showing work the lathes will do.

Check off in the squares below, indicating the lathes in which you are interested—Tear this sheet out of the book and mail to us. Special booklets and Catalog No. 88 mailed free postpaid on request.

- | | |
|--|---|
| <input type="checkbox"/> 9" Junior Booklet 22K | <input type="checkbox"/> 16" Lathe Booklet |
| <input type="checkbox"/> 9" Lathe Booklet | <input type="checkbox"/> 18" Lathe Booklet |
| <input type="checkbox"/> 11" Lathe Booklet | <input type="checkbox"/> New General Catalog No. 88 |
| <input type="checkbox"/> 13" Lathe Booklet | <input type="checkbox"/> "How to Run a Lathe," price 25c |
| <input type="checkbox"/> 15" Lathe Booklet | <input type="checkbox"/> Auto Mechanics Service Book, 25c |

ESTABLISHED 1906—OVER 38,000 LATHES IN USE

SOUTH BEND LATHE WORKS

Main Office & Works, 635 E. Madison St., South Bend, Ind., U.S.A.
 New York City Salesroom, 183 Centre Street

GOOD TOOLS ARE ESSENTIAL TO GOOD WORK

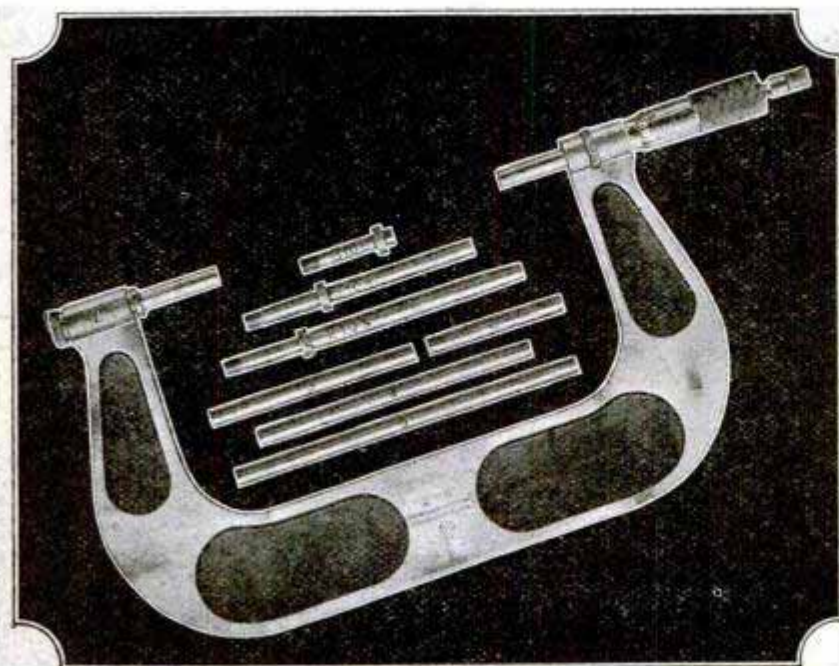

Micrometer Caliper No. 55 has a broad range of measurements, from 2" to 6", by thousandths of an inch. Range of measurements is easily obtained by four anvils, quickly changed and positively held in place by knurled nut.

Trained Hands Demand Fine Tools

Mechanics prefer Brown & Sharpe tools because they know they can rely on their accuracy. These fine tools set a "world's standard of accuracy" and maintain this accuracy under hard usage.

These tools are on the job in thousands of shops where metal is worked, where all types of work depend on their reliability.

The Brown & Sharpe line of small tools includes over 5,000 items for both industrial and home use. Catalog No. 30 describes them in detail. Copy at your hardware dealer's or sent free on request. Department P. M., Brown & Sharpe Mfg. Co., Providence, R. I., U. S. A.

BROWN & SHARPE TOOLS



* MICROMETER CALIPER
Catalog No. 11



* VEST POCKET SPEED
INDICATOR
Catalog No. 746

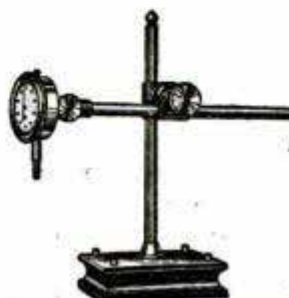

* DIAL TEST INDICATOR
Catalog No. 733



* TWIST DRILL AND
STEEL WIRE GAUGE
Catalog No. 705



* RULE DEPTH GAUGE
Catalog No. 615



* AUTOMATIC CENTER
PUNCH
Catalog No. 771

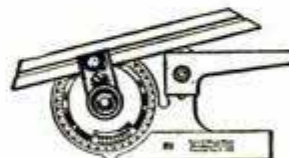

* IMPROVED UNIVERSAL
BEVEL PROTRACTOR
Catalog No. 496

* This tool shown in
Catalog No. 30

BS "WORLD'S STANDARD OF ACCURACY"



He GETS What He Wants

He's the most popular fellow in town; a sheik in the parlor, a ring leader with the boys. Wherever he goes he gets what he wants with his

BUESCHER

True Tone Saxophone

Do you long for social popularity? The admiration of friends? A welcome hand at gay parties? Good times with *those you like best*? Do you want to be *successful*? A favorite with your "boss" and your fellow workers? All these things, *and more*, are yours if you will learn to play this most wonderful of all musical instruments.

YOU Can Do It, Easy

Within a week you can be playing tunes. Three lessons, given on request with each new instrument, explain easy fingering and give you *quick start*. You might even be a wizard like Tom Brown, whose Buescher Saxophone has made him famous and rich.

Six Days' Trial—Easy Terms

Try a Buescher, *any instrument you choose*, in your own home for six days. This is a most liberal offer. If you like it, pay a little each month. *Play as you pay*. Without obligation, mail coupon below for beautiful literature and details of trial plan. *Get Started! NOW.*

BUESCHER BAND INSTRUMENT CO.
Everything in Band and Orchestra Instruments
2306 Buescher Block Elkhart, Indiana

BUESCHER BAND INSTRUMENT CO. 421
2306 Buescher Block, Elkhart, Ind.

Gentlemen:—Without obligating me in any way please send me your free literature. Mention instrument interested in.

Age?..... Name instrument.....

Name.....

Address.....

MAKE YOUR RADIO an ELECTRIC Set with a TOWNSEND "B" Power Unit \$6⁸⁵ at a Cost of Only

Com-
plete

Why pay up to \$450 or more to own an electric set when you can quickly and easily make your own set all electric in this new surprisingly inexpensive way?

Approved by the laboratory tests of Radio News and Popular Radio.



We show you how. Write for full information.

Townsend Laboratories

713 Townsend St.,

Dept. 15,

Chicago, Ill.

FREE Wholesale Radio Catalog

Dealer-Set Builders! Save Money!

Send for this book of bargains. Everything in Radio—all the newest hook-ups. Sets, kits, parts, cabinets, consoles and supplies. If you want the best for the least money, you need this catalog.

SHURE RADIO COMPANY
347 D. West Madison St., CHICAGO, ILL.

1928
WHOLESALE
RADIO
CATALOG



**SPEED
LATHE**
\$10.50

complete as shown. 7" swing, 24" metal bed, 3 speed cone pulley. Longer bed \$1.00 per additional foot.

JEFFERSON MFG. CO., Fairfield, Iowa

AUTO RUNS 40 MILES ON GALLON OF GAS

Automobile engineers who worked for years in an effort to reduce gasoline consumption have found the solution in a marvelous invention that fits all cars. An actual test made by one of the engineers showed 40 miles on a gallon of gas. Thousands of car owners have already installed this new invention. They not only report amazing gas savings but are also surprised to find quicker pick-up, instant starting, smoother running motors and disappearance of carbon. E. Oliver, 999-196 E. Third St., Milwaukee, Wis., for a limited time is offering a free device to those who will help introduce it. He also needs men everywhere to make over \$100 weekly in their own territory taking care of local business. Write him at once for free sample and big money-making offer.—Adv.



"I found it in my Starrett Catalog"

"Here's a combination square that's eight tools in one—a marking gage, rule, try-square, miter, depth gage, height gage, level and plumb—and it's only one of many real useful tools I've found in my Starrett Catalog."

Every man or boy who loves to do good work with good tools—whether it's carpentry, metal working, motor repairing or model building—needs his own copy of the Starrett Catalog No. 24"AP" illustrating and describing over 2500 high grade tools.

Write for your copy today. It's free.

Then ask your tool dealer to show you the Starrett Tools you need.

THE L. S. STARRETT CO.
World's Greatest Toolmakers
Manufacturers of Hacksaws Unexcelled
Steel Tapes—Standard for Accuracy
ATHOL, MASS., U. S. A.

Use Starrett Tools



“Real Money in the Bank”

“Think of it, Nell—\$460! And to think that just a few months ago we couldn't save a cent.

“Remember the night we talked it over and you persuaded me to send in that I. C. S. coupon? It was the best investment we ever made.

“The boss says there will be a still better position open for me soon if I keep on showing the same interest in my work. It certainly does pay to study in spare time.”

Thousands of men now know the joy of happy, prosperous homes because they let the International Correspondence Schools prepare them in spare time for bigger work.

One hour after supper each night, spent with the I. C. S. in the quiet of your home, will prepare you for the position you want in the work you like best.

This is all we ask: Without cost or obligation, put it up to us to prove how we can help you.

Mail the Coupon for Free Booklet

INTERNATIONAL CORRESPONDENCE SCHOOLS

“The Universal University”

Box 5514-F, Scranton, Penna.

Without cost or obligation, please send me a copy of your booklet, “Who Wins and Why,” and full particulars about the subject before which I have marked X in the list below:

BUSINESS TRAINING COURSES

- | | |
|--|---|
| <input type="checkbox"/> Industrial Management | <input type="checkbox"/> Advertising |
| <input type="checkbox"/> Personnel Management | <input type="checkbox"/> Business Correspondence |
| <input type="checkbox"/> Traffic Management | <input type="checkbox"/> Show Card and Sign Lettering |
| <input type="checkbox"/> Accounting and C. P. A. | <input type="checkbox"/> Stenography and Typing |
| Coaching | <input type="checkbox"/> English |
| <input type="checkbox"/> Cost Accounting | <input type="checkbox"/> Civil Service |
| <input type="checkbox"/> Bookkeeping | <input type="checkbox"/> Railway Mail Clerk |
| <input type="checkbox"/> Secretarial Work | <input type="checkbox"/> Common School Subjects |
| <input type="checkbox"/> Spanish <input type="checkbox"/> French | <input type="checkbox"/> High School Subjects |
| <input type="checkbox"/> Salesmanship | <input type="checkbox"/> Illustrating <input type="checkbox"/> Cartooning |

TECHNICAL AND INDUSTRIAL COURSES

- | | |
|---|--|
| <input type="checkbox"/> Electrical Engineering | <input type="checkbox"/> Architect |
| <input type="checkbox"/> Electric Lighting | <input type="checkbox"/> Architects' Blueprints |
| <input type="checkbox"/> Mechanical Engineer | <input type="checkbox"/> Contractor and Builder |
| <input type="checkbox"/> Mechanical Draftsman | <input type="checkbox"/> Architectural Draftsman |
| <input type="checkbox"/> Machine Shop Practice | <input type="checkbox"/> Concrete Builder |
| <input type="checkbox"/> Railroad Positions | <input type="checkbox"/> Structural Engineer |
| <input type="checkbox"/> Gas Engine Operating | <input type="checkbox"/> Chemistry <input type="checkbox"/> Pharmacy |
| <input type="checkbox"/> Civil Engineer | <input type="checkbox"/> Automobile Work |
| <input type="checkbox"/> Surveying and Mapping | <input type="checkbox"/> Airplane Engines |
| <input type="checkbox"/> Metallurgy and Mining | <input type="checkbox"/> Agriculture <input type="checkbox"/> Navigation |
| <input type="checkbox"/> Steam Engineering | <input type="checkbox"/> Mathematics <input type="checkbox"/> Radio |

Name.....

Street Address.....

City..... State.....

Occupation.....

Persons residing in Canada should send this coupon to the International Correspondence Schools Canadian, Limited, Montreal, Canada

Going Camping?
Going Fishing?
Going Anywhere?

ONLY
\$37.50

for this highest grade Auto Camp Trailer



We sell you all parts with the exception of lumber and tires to build this Trailer for \$37.50 F. O. B. here or, use these parts to build any other Trailer to fit your particular need. Parts come completely assembled, also blue prints, showing how to build this Trailer. Highest grade material such as Timkin Roller Bearings, Shock Absorbing Spring Draw Bar, Hitch for car, etc. We also build this Trailer complete and many kinds of special bodies and Trailers.

Write us for circular today

STANDARD TRAILER CO., Cambridge Springs, Pa.



BUILD YOUR OWN CLOCK WITH OUR HELP

Profitable spare time work for the winter. Turn idle hours into welcome dollars by building clocks from our instructions.

We furnish plans, instructions, blue prints, works, dials and all materials at surprising low prices. You make a fine profit building artistic clocks for your friends.

Banjo Clocks, Mantel Clocks, Beautiful Grandfather Clocks with chimes, complete works as low as \$5.00, other styles at all prices.

WRITE FOR OUR CATALOG AND FREE BLUE PRINT PLAN

AMERICAN CHIME CLOCK COMPANY
1670 Ruffner Street, Philadelphia



FUGO FIRE EXTINGUISHER

EASY \$100 a Week

Unusual opening for live agents in every locality. Make \$5000 or more a year—easily. Fugo—the instantaneous automatic fire extinguisher—is needed and wanted in every home, store, theatre, garage, shop, school, automobile, etc. Cheapest fire protection available today. Within reach of all.

1 Qt. Size \$5.00 2 Qt. Size \$7.50

Recharged in a jiffy

Amazing 30-second demonstration clinches sale—each one sold sells others. Territory going fast. Write at once for wonderful proposition that will make you big money.

THE NATIONAL FORMETAL CO.

6535 Metta Ave., N. E. Cleveland, Ohio

\$1

Sharp Razor Blades

with the

GIANT-X GRINDER

Save money—use your old blades over and over again. 4 inch “Fibrasive” Wheel sharpens any make of blade. Reversible blade holder, made to last a lifetime. Worth several dollars. Direct from maker at a big saving. Price to introduce \$1. Money back guarantee. Send \$1. Giant Co., 2010 Washington Boulevard Building, Detroit, Mich.

A SHIP MODEL FOR \$4.98



Build an exact replica of the historic Santa Maria or the Mayflower with your own hands. We will furnish the parts cut to fit and ready to assemble complete for only \$4.98 plus a few cents for postage. No tools needed except a small hammer.

Write for our illustrated catalog.

MINIATURE SHIP MODELS

Dept. O-7, 3818-20-22-24 Baring St., PHILADELPHIA, PA.



OVER 15,000
IN USE

This Man
is making
\$4.00 to \$6.00
an hour
**with the IDEAL
LAWNMOWER
SHARPENER**
-Why don't You?

**Sharpens Lawnmowers
to Razor Edge**

The Ideal Lawnmower Sharpener is a wonderful, but simple, machine that sharpens lawnmowers perfectly, scientifically, without dismantling the mower. Sharpens them as emery dust, files and obsolete methods never could.

**Sharpens Any Mower
in 20 Minutes**

Just pick up any mower, set it in the Ideal, make a few simple adjustments and proceed to sharpen. In 15 to 20 minutes after you pick up the mower it is ready for the lawn, and you have made \$1.50 to \$2.00, depending on the charge you fix.

No Training Required

You don't have to be a mechanic to use the Ideal. Its operation is simple and practically automatic once you start to grind.

**Set Up Ready to Grind
in a Few Minutes**

Shipped practically completely assembled. Uncrate it, place in position, plug into a light socket and it is ready to start earning for you.

**Special Grinding Wheel
Attachment**

For sharpening grass shears, hedge shears, sickles, scythes, axes, etc., etc. Will add many dollars to your income.

**Skate Sharpener Attachment
Included**

Sharpens all makes of skates—including hockey with shoe attached. The "Ideal" earns money all the year round.

Uses Little Power

Operated by 1/4-H.P. Motor attached to light socket or can be run direct from line shaft.

Man, Why Don't You Do That?

You've got the chance—the same chance as W. T. Moore, Twin Falls, Idaho, who made \$1200 net profits in 90 days—the same chance as Walter Wever, Middletown, N. Y., who made \$1000 in 4 months—the same chance as hundreds of others who have reaped rich rewards with this amazingly efficient lawnmower sharpener.

Idaho, who made \$1200 net profits in 90 days—the same chance as Walter Wever, Middletown, N. Y., who made \$1000 in 4 months—the same chance as hundreds of others who have reaped rich rewards with this amazingly efficient lawnmower sharpener.

Our Free Book Tells You How these men and many others have made themselves independent—built substantial permanent BIG PAYING businesses with this Ideal Grinder. Send for this book today—It's Free.

Use Your Spare Time If you work at a trade, put an Ideal in your basement and earn \$4 to \$6 an hour evenings and Saturday afternoons. E. W. McCormick, Saginaw, Mich., writes: "Five years ago I bought an Ideal Sharpener on which I have ground over 5,000 lawnmowers. In the last few weeks I worked at my trade, machinist, full time 9 hours a day. I also ground 97 mowers which netted me \$114.10 clear gain."

Earns \$820 in 55 Days

Zeno Brandon, Middletown, Ohio, writes: "I have made \$820.70 in 55 days with my 'Ideal.' Have made as high as \$38.70 in one day."

\$2100 in One Season

W. F. Kendt, Buffalo, writes: "I sharpened 994 lawnmowers last season and the receipts were nearly \$2100—not bad for a side line."

Hundreds of Dull Mowers in your locality are waiting to be sharpened. Owners are looking for a place to get them sharpened. No town too small. R. S. Newcomer, Vinton, Ia., writes: "People come from miles around and other towns to get their mowers ground." Customers delighted with "Ideal" sharpened mowers. Brag and tell their friends. Your business grows by leaps and bounds.

You Make Money Right Away Geo. E. Kearney, Stillwater, Minn., writes: "We set the machine up 2 weeks ago Friday; since that time have sharpened 102 mowers." That's close to \$200 in Kearney's pocket for 2 weeks' work!

This Is Your Chance, MAN! MAKE US PROVE IT. Our contains proof of what we say. Send today for it.

THE FATE-ROOT-HEATH CO., Dept. G, Plymouth, Ohio



**MAKE EVERY
SPARE HOUR PAY
YOU \$4.00 to \$6.00**

Send for FREE BOOK Today!

Sign and Mail This Today

**THE FATE-ROOT-HEATH CO.,
DEPT. G, PLYMOUTH, OHIO.**

You'll have to prove that I can make money with the "Ideal" Grinder. Send me your FREE BOOK.

Name.....

Address.....



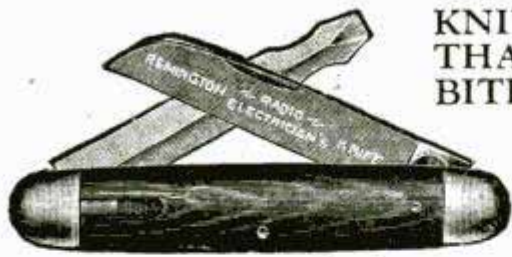

KNIVES
THAT
BITE

NEW! A Remington Knife for Electricians and Radio Fans

This new Remington Knife is just what electricians and radio tinkers have been waiting for. A knife for *real* work, yet light and good-looking. Can't be beat for scraping insulation from wires, making connections, tightening up, doing odd jobs. Has one 3-inch sheep-foot blade, and a 2½-inch screw driver. The blade is forged from high carbon steel, razor sharp, and holds its edge a long time. One side of the screw driver is ground to a cutting edge. Safety catch prevents screw driver from closing when in use. Nickel silver bolsters, brass linings.

Although designed specially for electricians, it will appeal to engineers, mechanics, workmen. A dandy general utility knife, handy around shop, factory or in the house. It's the kind of knife that stands up—that lasts. Hand-honed and tested at factory.

We cannot do justice to this knife in an advertisement. So ask your dealer to show you the Remington Radio Electricians Knife. Note its hard, handsome cocobolo handle. Test its razor-sharp blade. Note the screw driver see how strong it is. You wouldn't sell this knife for ten times what you paid for it if you couldn't get another. Knife No. 4548 is a wonderful value for \$2.00. If your dealer hasn't it in stock, send us his name and the price. The knife will be forwarded at once, post paid. Money returned if you're not satisfied.

REMINGTON ARMS COMPANY, Inc.
Established 1816
25 Broadway New York City

Remington

Arms Ammunition Cutlery
Cash Registers Service Machines

© 1928 R. A. Co.

How do you do your work on WOOD?

—the same as your granddad did OR with a

TAKE- ABOUT Sander

Here is a belt surfacing machine of only 14 pounds that will sand more than five times faster than is possible by hand. It does work that no machine has ever done before. Simple as a plane to use.

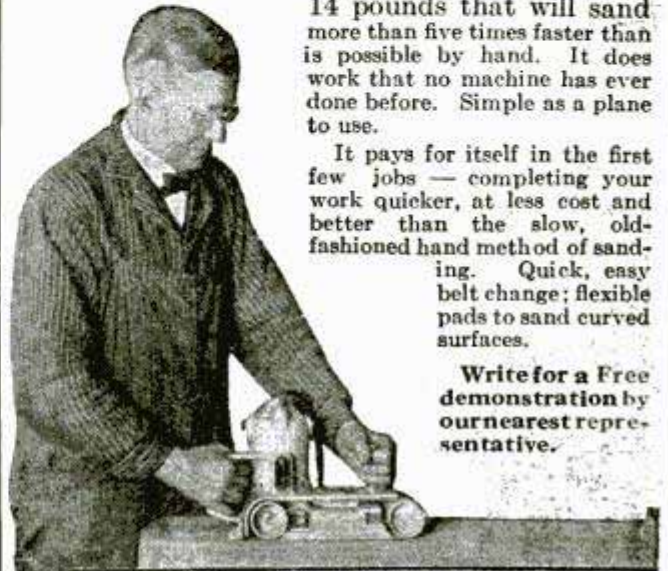

It pays for itself in the first few jobs — completing your work quicker, at less cost and better than the slow, old-fashioned hand method of sanding. Quick, easy belt change; flexible pads to sand curved surfaces.

Write for a Free demonstration by our nearest representative.

MADE ONLY BY THE
PORTER-CABLE MACHINE COMPANY
1704-10 North Salina St. SYRACUSE, N. Y.

TYPEWRITERS!

All Makes—lowest prices
Big Catalog FREE
YOUNG TYPEWRITER CO.
Typewriter Headquarters
654 W. Randolph St., Dept. 1103, Chicago



SOLDER'ALL

METAL IN PASTE FORM



The
only
convenient
metal
solder

Every Electrical
Connection needs
Solderall for perfect reception

25¢

The SOLDER'ALL CO., NEWARK, N.J.

Play in a Band

FOLLOW Sousa's advice and get into a band or orchestra. With a Conn instrument, used and endorsed by Sousa and his artists, you learn to play quickly. Then profit and pleasure open to you. Conn's many exclusive features cost you no more.

FREE Trial; Easy Payments. Write for the free literature, mentioning instrument.

C. G. CONN, Ltd.,
331 Conn Bldg., Elkhart, Indiana



CONN
BAND
INSTRUMENTS

BLANCHE AUTO DEVICES COMPANY Announces—NEW GASCONTROL

Installed
without
Drilling or
Tapping

Doubles the Life of Your Gas!

For All Cars—
Including the New Ford

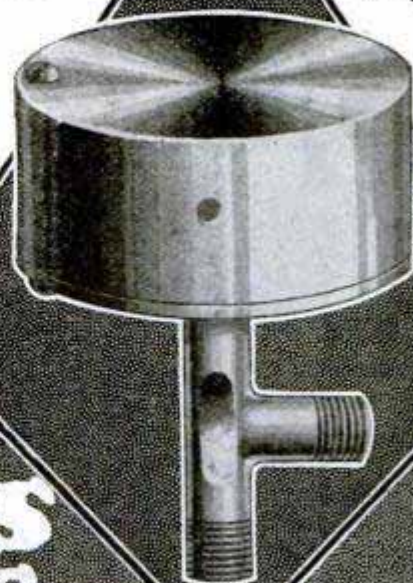

43.8 Miles on 1 Gallon of Gas

with the Blanche Thermostatic Control



Proof of Our
Agents' Success

Below are reproduced a few letters from Blanche agents, showing the big, worthwhile profits our agents have made and are making. You want to get in on this new big opportunity. Act at once.

"Please rush me another hundred Controls by Express C. O. D. I only got in three days this week and that in scattered territory. However, I sold fifty-two."

Very truly yours,
W. H. Loman, Jr.,
South Carolina.

"Please send me eighteen (18) Controls for Fords. Also Plenty of Literature of every form. Business very good and getting better every day."
J. P. Hawley
Michigan.

"I am satisfied with them and would recommend to anybody."
Hiro-A-Ford Co., Tennessee.

GAS CONTROL Completes the Blanche Auto Devices Line for YOU!

Never in automotive history has there been a message of such supreme importance to auto owners and agents. The perfection of GAS CONTROL means that the big reduction on gas cost FOR ALL CARS is at last here! It makes 5c gas possible, not only for Ford Owners, but for ALL OF YOU!

Four Successful Years of Sales

of the Blanche Thermostatic Control for Fords make this announcement of the new GAS CONTROL—completing the Blanche Auto Devices line—doubly important to you. The same consumer satisfaction and demand that has made the Blanche Thermostatic Control a famous success all over the world, together with the same co-operation and progressive sales helps which have made Blanche Agents so successful, mean enormous, multiplied profits in this widened market. We believe that the addition of GAS CONTROL makes the Blanche Auto Devices line the Biggest Money Business for Agents in the automotive field!

Get Free GAS CONTROL Offer

Convince yourself of the astounding results you can get with this amazing, simple little device! GAS CONTROL means a rich harvest for Blanche Agents. Now your field is actually unlimited. Your prospects are legion. The tremendous profits you can make depends only on your ambition—your quick action in getting started. We make this easy for you. Simply mail the coupon NOW!

BLANCHE AUTO DEVICES COMPANY
154 E. ERIE ST. Dept. 805-C CHICAGO ILL.



Where Blanche Auto
Devices Are Made

BLANCHE AUTO DEVICES CO.,
154 E. Erie St., Dept. 805-C, Chicago, Ill.

Gentlemen: Kindly send me at once free GAS CONTROL offer and full details of Blanche Auto Devices Co. Successful Agents proposition. No obligation to me.

Name.....

Address.....

City..... State.....

Mail This Important Coupon Now

The radio leadership of 1928

NOW
\$90

180 volts on the output tube plate!
Gigantic UNDISTORTED volume from the Bandbox!

Power! Power! POWER! A feature of the Crosley AC Bandbox that lifts it head and shoulders above competition!

170 to 185 volts on the plate of the power output tube!

Comparative checkings of competitive radios show interesting figures. Under identical testing conditions the Bandbox shows a full 170 to 185 volts on the plate of the 171 power output tube. Other radios show from 100 to 110 and 130 to 140 volts on the plate of output tube. The 171 power tube should have around 180 volts. This better than 40% superiority in one case and 25% in the other is the difference between today's radio and yesterday's.



MUSICONE \$15
Type D

Crosley Musicones are famous for their value. This new style is no exception. Its low price of \$15 is in keeping with Crosley traditions. It instantly demonstrated its soundness by immediate and enormous sales.

602
Double Unit
AC BANDBOX
Single Unit
704

The Bandboxes are genuine Neutrodyne receivers. Totally and completely shielded, their acute sensitivity and sharp selectivity is amazing.

They have a single illuminated dial.

Contributing much to the success of this 1928 wonder radio is the Mershon Condenser in the power element of the set. Not being paper, the danger of its blowing out is entirely removed so that the desired *heavy voltage* can be used to produce the acoustic and volume results so greatly desired. **IT IS SELF HEALING.** It does not have to be replaced as is the case with paper condensers.

The capacity of smoothing condensers in Crosley power units is 30 mf. Other sets use only a fraction of that condenser capacity. Undersize condensers, transformers, etc., are used in order to build down to a price. Crosley builds up to a standard.

The AC Bandbox is purposely made in two models—the 602 in a double unit—the 704 self contained. This is to provide maximum adaptability in all sorts of surroundings and uses.

The 602 double unit provides console cabinet installation in ALL kinds of consoles.

The 704 is for those who want the entire set in one cabinet. The two sets are identical in elements, design and performance. The physical difference is solely to meet the human differences of taste, necessity and price! The size of the 704 is 17 $\frac{1}{4}$ inches long by 12 $\frac{3}{4}$ inches wide and is 6 $\frac{1}{4}$ inches high.

Battery Type Bandbox \$55

This celebrated model needs no picture for in appearance it is identical to the 602 receiver pictured above. Its amazing performance has won the radio world this season and its value is as outstanding NOW as the day it was first presented!

SELF CONTAINED

\$95



Approved Console Cabinets manufactured by Showers Brothers Co., of Bloomington, Ind., and Wolf Mfg. Industries, Kokomo, Ind., are sold to Crosley dealers by H. T. Roberts Co., 1340 S. Michigan Ave., Chicago, Sales Representatives.

NEUTRODYNE

Crosley is licensed only for Radio Amateur, Experimental and Broadcast Reception.

THE CROSLEY RADIO CORPORATION

Powel Crosley, Jr., Pres.
Cincinnati, Ohio

Montana, Wyoming, Colorado, New Mexico, and West, prices slightly higher. Write Dept. 15 for descriptive literature.

New
401 Dry Cell
Type
BANDBOX
JUNIOR
\$35

A new dry cell receiver with all the features of the Bandbox—selectivity, sensitivity, volume and appearance. For places where AC current or storage battery service is not available or desired.

"You're there with a Crosley"

CROSLEY
RADIO

This Wonder Working Shop

Will Make You a Craftsman

SENT ON TRIAL

Only \$10.00 DOWN

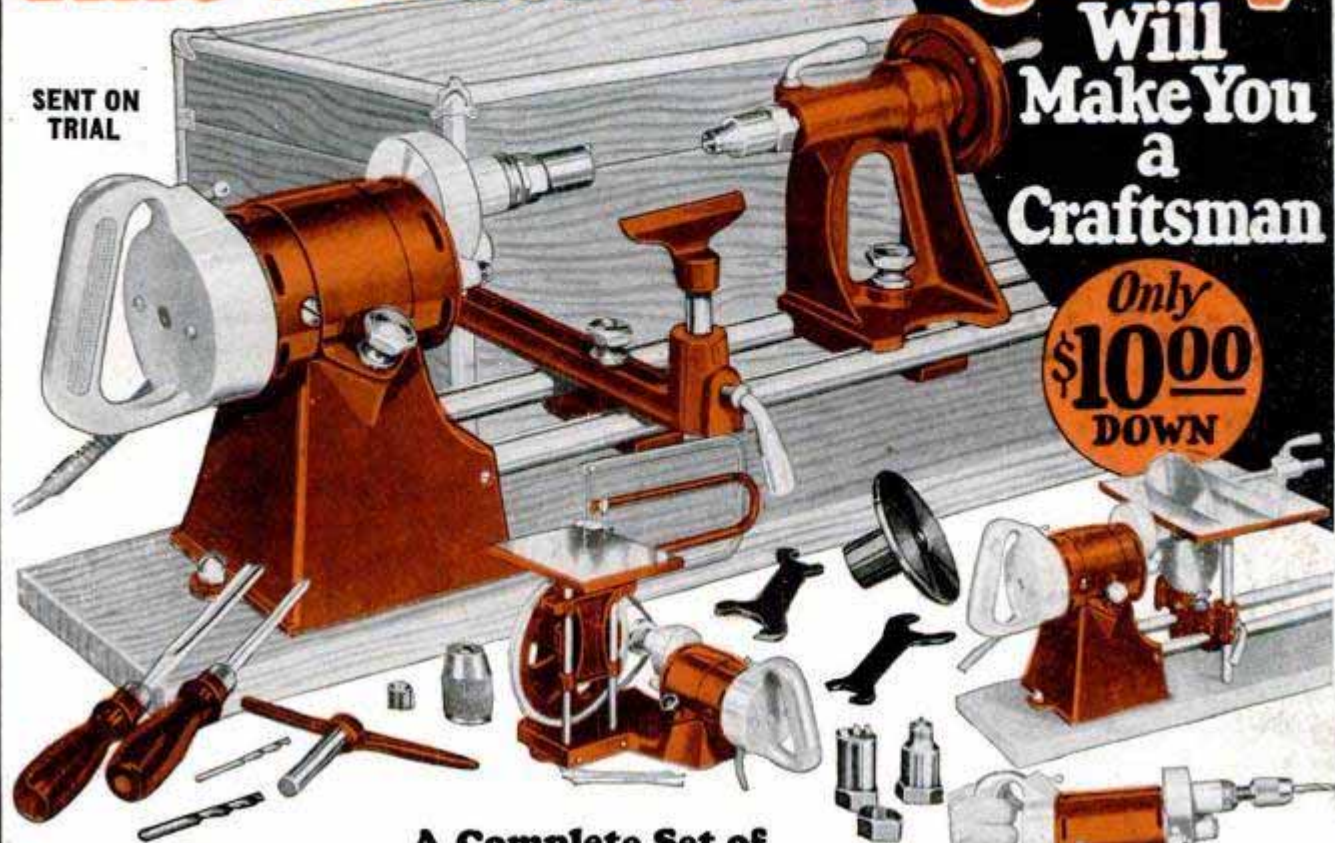

A Complete Set of Craftsman's Home Working Tools

Red Jacket electrically driven tools turn out work like magic. A complete made to order workbench equipment of perfect, efficient and powerful craftsman's tools that are small and compact enough for portable use and so inexpensive that any man or boy may have one.

Red Jacket Waco Craftsman's Lathe

RED JACKET—A chest full of tools designed by a master for the private use of tool lovers and men who want to build, construct, invent and create at home. You will be able to make everything—attractive odd furniture, toys, home and garden improvements, all around manufacturing, repairing.

THE COMPLETE EQUIPMENT consists of a powerful Red Jacket Drill Motor, with direct drive to the Waco precision wood turning lathe (capacity 9 in. x 34 in.); a bench saw, that has depth and side gauges, scroll and jig saw; and all accessories for both portable and stationary power drilling, buffing, grinding and cleaning. Attaches to any light socket and converts your work bench into a complete private tool and machine shop.

Special Crafts Course FREE

SPECIAL CRAFTS COURSE and blueprint service is free to Red Jacket Shop owners—all that there is to know about handicraft methods, raw materials, woods, carving, sawing, turning, designing, carpentering, decorating, is taught by special correspondence.

Buy On Your Own Terms

Only \$10.00 down. Liberal discounts for cash. Easy monthly payment plans. It is no hardship to own a Red Jacket.

10 DAYS' FREE TRIAL

Our literature tells you how to start a job of your own. If you are not pleased return the Shop.

This Headstock furnished where no electricity is available. →

Interesting Literature Free

Send the coupon. You will be surprised with all it contains. Beautiful, Instructive, Fascinating, Interesting. →

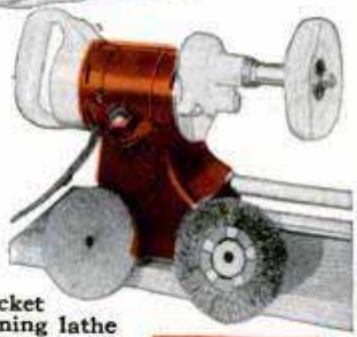

The Waco GUARANTEE
If It Is Not What You Want When You Get It—Send It Back.

- Turning
- Sawing
- Winding
- Spinning
- Grinding
- Buffing
- Polishing
- Cabinet Making
- Scroll Sawing
- Drilling
- Repairing
- Dove-tailing
- Pointing
- Jointing
- Sharpening
- Sanding
- Scratching
- Carving
- Successful Masterpieces

Look out for imitations. There is only one Red Jacket—one Waco—one Wm. L. Aylward, Master-craftsman.

WACO TOOL WORKS, Inc.
542 N. Parkside Ave., Chicago
Manager, Dept. 103. Please send me particulars about 10-day free trial, free blueprints, and \$10 down payment.

Name.....
Address.....

THEY CERTAINLY DO KNOW THEIR
CIGARETTES, THIS YOUNGER CROWD



© 1928, LIGGETT & MYERS TOBACCO CO.



SOMETHING ABOUT FATIMA—
ITS GREATER DELICACY, ITS
MORE SKILLFUL BLENDING
OF FLAVORS — HAS MADE IT,
AS IN OTHER DAYS, A CON-
SPICUOUS FAVORITE WITH
THE YOUNGER SET.

F A T I M A

OUTSTANDING FAVORITE AMONG HIGHER-PRICED CIGARETTES